

LAES

TECHNICAL LIGHTING

TECHNICAL LIGHTING | INDUSTRIAL | OUTDOOR | DECORATIVE

LAES



Quality

At LAES, we have spent more than 60 years developing lighting solutions with a quality standard that is part of our identity. With the transition to LED technology, we have incorporated new processes and control systems that allow us to guarantee more efficient, reliable, and durable products.

We have our own laboratory, where we conduct continuous testing on the performance, lifespan, and light stability of all our lamps and luminaires. These controls enable us to ensure that every product meets the most demanding technical standards before reaching the customer.

Our commitment is clear: to provide high-quality lighting backed by rigorous processes, continuous innovation, and decades of experience that support every LAES product.

A modern office interior with glass partitions and a computer monitor. The word "Qualité" is written vertically in orange on the glass.

Qualité

Chez LAES, nous développons des solutions d'éclairage depuis plus de 60 ans, avec un niveau de qualité qui fait partie intégrante de notre identité. Avec l'évolution vers la technologie LED, nous avons intégré de nouveaux processus et systèmes de contrôle qui nous permettent de garantir des produits plus efficaces, fiables et durables.

Nous disposons de notre propre laboratoire, où nous effectuons des tests continus de performance, de durée de vie et de stabilité lumineuse sur l'ensemble de nos lampes et luminaires. Ces contrôles nous permettent de garantir que chaque produit répond aux exigences techniques les plus strictes avant sa mise sur le marché.

Notre engagement est clair : offrir un éclairage de haute qualité, soutenu par des processus rigoureux, une innovation constante et plus de 60 ans d'expérience qui garantissent chaque produit LAES.



LAES

LIGHTING PROJECTS
PROJETS D'ÉCLAIRAGE



At LAES, we put our experience in the design and development of lighting solutions at your service. With more than 60 years of creating light, we fully understand the needs of each project and deliver reliable, efficient technical solutions.

We offer a wide range of products capable of covering multiple applications, and we also have the ability to develop customized solutions when required. Empathy is part of how we work: we understand your challenges and turn them into real, functional solutions.

Our projects department provides tailored proposals, combining innovation, quality, and technical rigor. An increasing number of clients trust LAES's strength and experience to take their lighting projects to the next level.

Chez LAES, nous mettons à votre disposition notre expérience dans la conception et le développement de solutions d'éclairage. Plus de 60 ans consacrés à la création de lumière nous permettent de comprendre en profondeur les besoins de chaque projet et d'apporter des réponses techniques fiables et efficaces.

Nous disposons d'une large gamme de produits capables de couvrir de multiples applications, et avons également la capacité de développer des solutions spécifiques lorsque le projet l'exige. L'empathie fait partie intégrante de notre manière de travailler : nous comprenons vos défis et les transformons en solutions concrètes et fonctionnelles. Notre département projets propose des solutions sur mesure, alliant innovation, qualité et rigueur technique. De plus en plus de clients font confiance à la solidité et à l'expérience de LAES pour faire passer leurs projets d'éclairage à un niveau supérieur.

VISUAL INDEX | INDEX VISUEL

TECHNICAL LIGHTNING / ÉCLAIRAGE TECHNIQUE

Onix Track 48V
18



Quarz Track 48V
22



Juno Track 48V
26



NEW

Speaker Track 48V
27

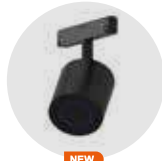

NEW

Cian Spot 48V
28



Orbix Track 48V
30



NEW

Astra Track 48V
31



NEW

Agata 48V
32



Tulipa 48V
33

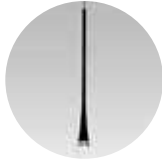

Tallin 48V
34



Track System 48V
36



Polaris AI
42



Polaris
44



Halley
54



Altais
56



Saturn
58



Wallwasher CCT
60



NEW

Hubble
62



Speaker Track
63



NEW

Track System
64



Profiled
72

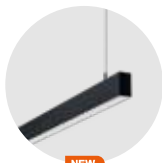

NEW

Tube
98



Circular luminaires
Luminaires circulaires
102

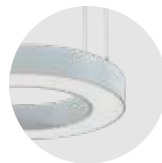

Juno
110



Rigel 118	Mini Spot 122	Nano 124	Kubix 128 NEW	Naos CCT 130	Vega 132
Rings Support de spots 136	Orion 140	Syrius CCT 142	Draco cardan 143	Steplight mini 144	Qatar 147 NEW
Dubai 148	Cairo 150	Kuwait 151	Lumina 152	Lightbox 154	Lightround 155
Neonflex 360 156 NEW	LED Strips Bandeaux LED 158 NEW	Aluminium profile Profilé aluminium 174	LED Panels Dalles LED 182	Downlights 188	Ceiling light Plafonnier 200

INDUSTRIAL LIGHTING / ÉCLAIRAGE INDUSTRIEL

Volga PRO
208



Volga CCT
210



NEW

Hydra
212



Kompact PRO CCT
214

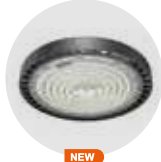

NEW

Kompact
216



OUTDOOR LIGHTING / ÉCLAIRAGE

CTT Projectors
Projecteurs CTT
220



NEW

Slim Projectors
Projecteurs Slim
222



Sensor Projector
Projecteur Sensor
223



Ground
224



Ground LED
224

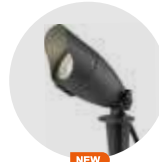

NEW

Garland
Guirlande
226



Dora
230



Olivia
232

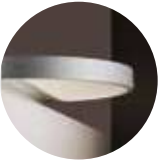

DM3
234



Amos Mini
236



Blitz
238



LID Wall
240



Glam
242



Nora
244

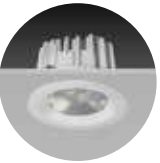

Path HT
245



Lid
246



Geo
247



Neck
248



Pin
249



Lid Wall Stello
250



Match
251



DECORATIVE LIGHTING / ÉCLAIRAGE DÉCORATIF

Tallin
254



Venecia
256



Budapest
257

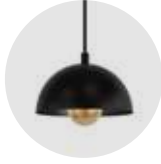

Firenze
258

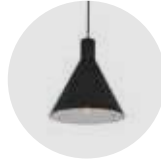

Milan
260



Vilna
261







LED PRODUCT LIFETIME

DURÉE DE VIE DU PRODUIT LED

The individual lifespan of an LED is defined as the number of operating hours until it stops emitting light. When referring to the lifespan of a group of LEDs, two concepts are distinguished:

Average life: reached when 50% of the light sources in the group have ceased to function.

Useful life: considered reached when luminous flux degradation exceeds 30% compared to the initial value, at which point replacement is recommended.

LAES will always indicate in its price list or technical datasheet the useful life of each product, based on tests carried out in our laboratory under the following switching cycle:

Standard LED products: 10 hours on / 1 hour off

BASIC range: 8 hours on / 1 hour off

La durée de vie individuelle d'une LED est définie comme le nombre d'heures de fonctionnement jusqu'à ce qu'elle cesse d'émettre de la lumière. Lorsque l'on parle de la durée de vie d'un ensemble de LED, deux notions sont distinguées :

Durée de vie moyenne : atteinte lorsque 50 % des sources lumineuses du groupe ont cessé de fonctionner.

Durée de vie utile : considérée comme atteinte lorsque la dégradation du flux lumineux dépasse 30 % par rapport à la valeur initiale, moment à partir duquel le remplacement est recommandé.

LAES indiquera toujours dans sa liste de prix ou sa fiche technique la durée de vie utile de chaque produit, sur la base d'essais réalisés dans notre laboratoire selon le cycle de commutation suivant:

Produits LED standards : 10 heures allumé / 1 heure éteint

Gamme BASIC : 8 heures allumé / 1 heure éteint

WARRANTY POLICE

WARRANTY CONDITIONS

The warranty period begins on the date the invoice is issued.
 For the warranty to be valid, the product must be installed and used in accordance with the technical specifications and installation standards established by Lámparas Especiales S.L.
 The specific warranty duration for each product is indicated in Table I, considering a maximum of 4,000 operating hours per year.
 The ambient temperature during use must not exceed the permitted operating range (-10 °C to +40 °C). Lámparas Especiales S.L. shall not be liable for damages resulting from:

- Incorrect installation
- Improper use
- Inappropriate handling
- Short circuits
- Any circumstances unrelated to the normal operation of the product

Lamps must operate in open luminaires, ensuring a minimum clearance of 10 mm around the lamp.

The electrical installation must not present voltage fluctuations exceeding ±10% of the nominal value.

The warranty does not cover failures caused by weather events, storms, or other external factors.

This warranty does not include labour costs associated with the disassembly or installation of the products.

POLITIQUE DE GARANTIE

CONDITIONS DE GARANTIE

La période de garantie commence à la date d'émission de la facture.
 Pour que la garantie soit applicable, le produit doit être installé et utilisé conformément aux spécifications techniques et aux normes d'installation établies par Lámparas Especiales S.L.
 La durée spécifique de la garantie pour chaque produit est indiquée dans le Tableau I, en considérant un maximum de 4 000 heures de fonctionnement par an.
 La température ambiante pendant l'utilisation ne doit pas dépasser la plage de fonctionnement autorisée (-10 °C à +40 °C).
 Lámparas Especiales S.L. ne sera pas responsable des dommages résultant de:

- Installation incorrecte
- Utilisation inappropriée
- Manipulation inadéquate
- Courts-circuits
- Toute circonstance étrangère au fonctionnement normal du produit

Les lampes doivent fonctionner dans des luminaires ouverts, en garantissant un espace minimum de 10 mm autour de la lampe.

L'installation électrique ne doit pas présenter de fluctuations supérieures à ±10 % de la valeur nominale.

La garantie ne couvre pas les défaillances causées par des phénomènes météorologiques, des tempêtes ou d'autres causes externes.

La présente garantie n'inclut pas les coûts de main-d'œuvre liés au démontage ou au montage des produits.

ENERGY LABELLING ÉTIQUETAGE ÉNERGÉTIQUE

The new energy labeling system establishes a revised scale ranging from A to G, replacing the previous range that extended from A++ to E. This reclassification has been in force since 1 September 2021.

All LAES products are registered in the EPREL database. As existing stock is depleted, our product packaging will progressively incorporate the new energy labels in accordance with current regulations.

Le nouveau système d'étiquetage énergétique établit une échelle révisée allant de A à G, remplaçant l'ancienne classification qui s'étendait de A++ à E. Cette reclassification est en vigueur depuis le 1er septembre 2021.

Tous les produits LAES sont enregistrés dans la base de données EPREL. À mesure que les stocks existants s'écoulent, l'emballage de nos produits intégrera progressivement les nouvelles étiquettes énergétiques conformément à la réglementation en vigueur.

Previous system Ancien système

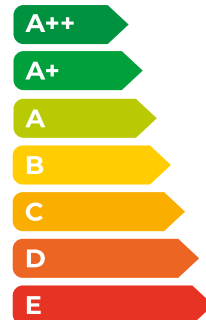

New system Nouveau système

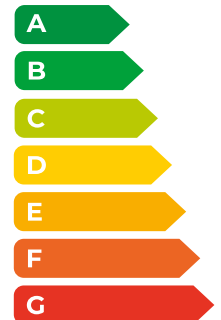

SYMBOLY / SYMBOLOGIE



Volts
Volts



Not dimmable
Non dimmable



Cut-out dimensions
Mesures de coupe



Watts
Watts



Dimmable
Dimmable



Orientation angle
Angle d'orientation



Lumens
Lumens



Ultraviolet-free
Sans ultraviolets



Tilting angle
Angle basculant



Color temperature
Température de couleur



IP rating
Indice de protection



Combined Ingress protection
Indice de protection combiné



Color Rendering index
Indice de rendu chromatique



Impact protection
Indice de protection



Lamp holder included
Douille incluse



Unified Glare Rating
Indice d'éblouissement unifié



Driver included
Driver inclus



Bulb not included
Ampoule non incluse



Diameter
Diamètre



Warranty
Garantie



Adjustable color temperature
Température couleur réglable



Length-Height
Longueur-Hauteur



Indoor use
Utilisation intérieure



Three-phase connection
Connexion triphasé



Socket
Douille



Outdoor use
Utilisation extérieure



RGB Colors
Couleurs RGB



Beam angle
Angle de faisceau



Outdoor / indoor use
Utilisation extérieure / intérieure



RGB Colors + White
Couleurs RGB + Blanc



Article code
Référence



Magnetic levitation
Portage magnétique



Class II
Classe II



Not suitable for domestic use
Ne convient pas à un usage domestique



Cut-out diameter
Diamètre de perçage

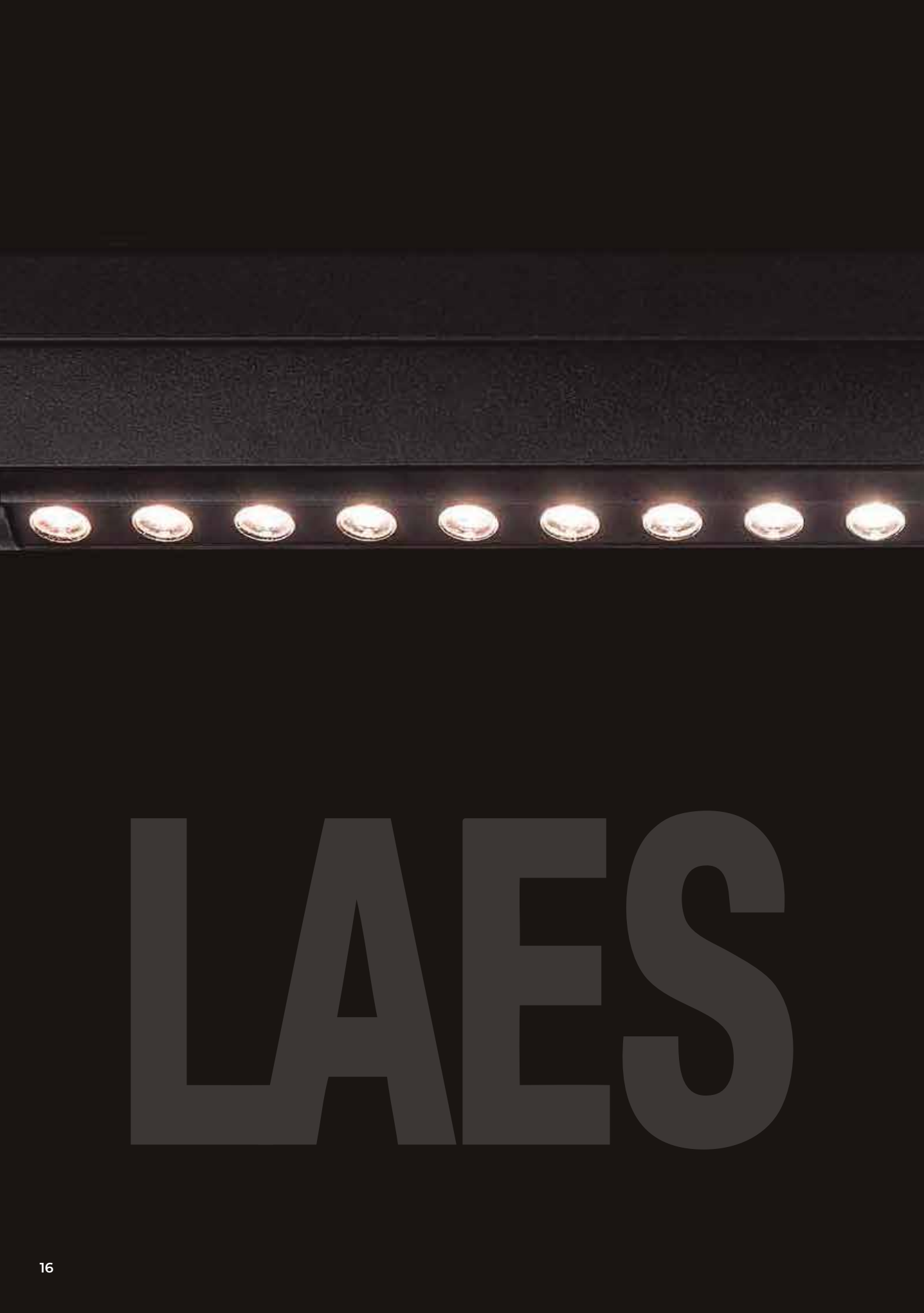

LAES



Track System 48V

Design, precision, and versatility in linear lighting

48V magnetic track systems are designed to meet the aesthetic and functional demands of contemporary projects.

Their low-voltage track installation enables clean, flexible, and easily configurable integration.

Powered by high-performance LED technology, they deliver efficient lighting solutions for general, ambient, or accent use, while maintaining a minimalist and timeless aesthetic.

An ideal solution for residential, commercial, and contract & hospitality projects where

Les systèmes de rail magnétique 48V sont conçus pour répondre aux exigences esthétiques et fonctionnelles des projets contemporains. Leur installation en basse tension permet une intégration propre, flexible et facilement configurable.

Grâce à la technologie LED haute performance, ils offrent des solutions efficaces pour l'éclairage général, d'ambiance ou d'accentuation, tout en conservant une esthétique minimaliste et intemporelle.

Une solution idéale pour les projets résidentiels, commerciaux et hôteliers, où performance et design trouvent un équilibre parfait.

ONIX FIX

Track System 48V



Temperatures | Températures



Finish | Finition



Materials | Matériaux



Light source | Source lumineuse

SMD LED - L80B10

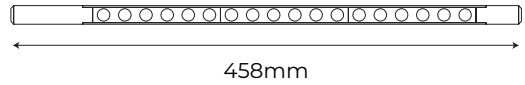

LED lifetime | Durée de vie LED

40.000h



W	Flux	K	A°	Ref.
18	1500Lm	2700K	38°	206012
18	1500Lm	3000K	38°	203622
18	1500Lm	4000K	38°	206029

ONIX OPAL

Track System 48V



Temperatures | Températures



Finish | Finition



Materials | Matériaux

Aluminium



Polycarbonate



Light source | Source lumineuse

SMD LED - L80B10

LED lifetime | Durée de vie LED

40.000h

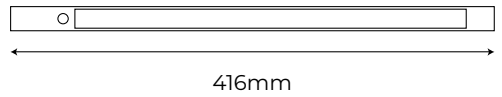

W	Flux	K	A°	Ref.
10	450Lm	2700K	120°	206036
10	450Lm	3000K	120°	201208
10	450Lm	4000K	120°	206043

ONIX INFINITY

Track System 48V

Adjustable | Orientable

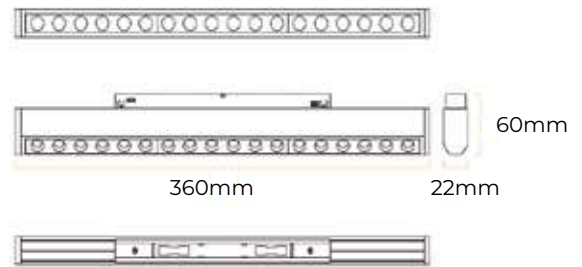

Temperatures | Températures



Light source | Source lumineuse

SMD LED - L80B10

Finish | Finition



LED lifetime | Durée de vie LED

40.000h



Materials | Matériaux

Aluminium



Polycarbonate



Dimmable



To be checked | À vérifier

W	Flux	K	A°	Ref.
18	1500Lm	2700K	38°	206050
18	1500Lm	3000K	38°	201215
18	1500Lm	4000K	38°	202694

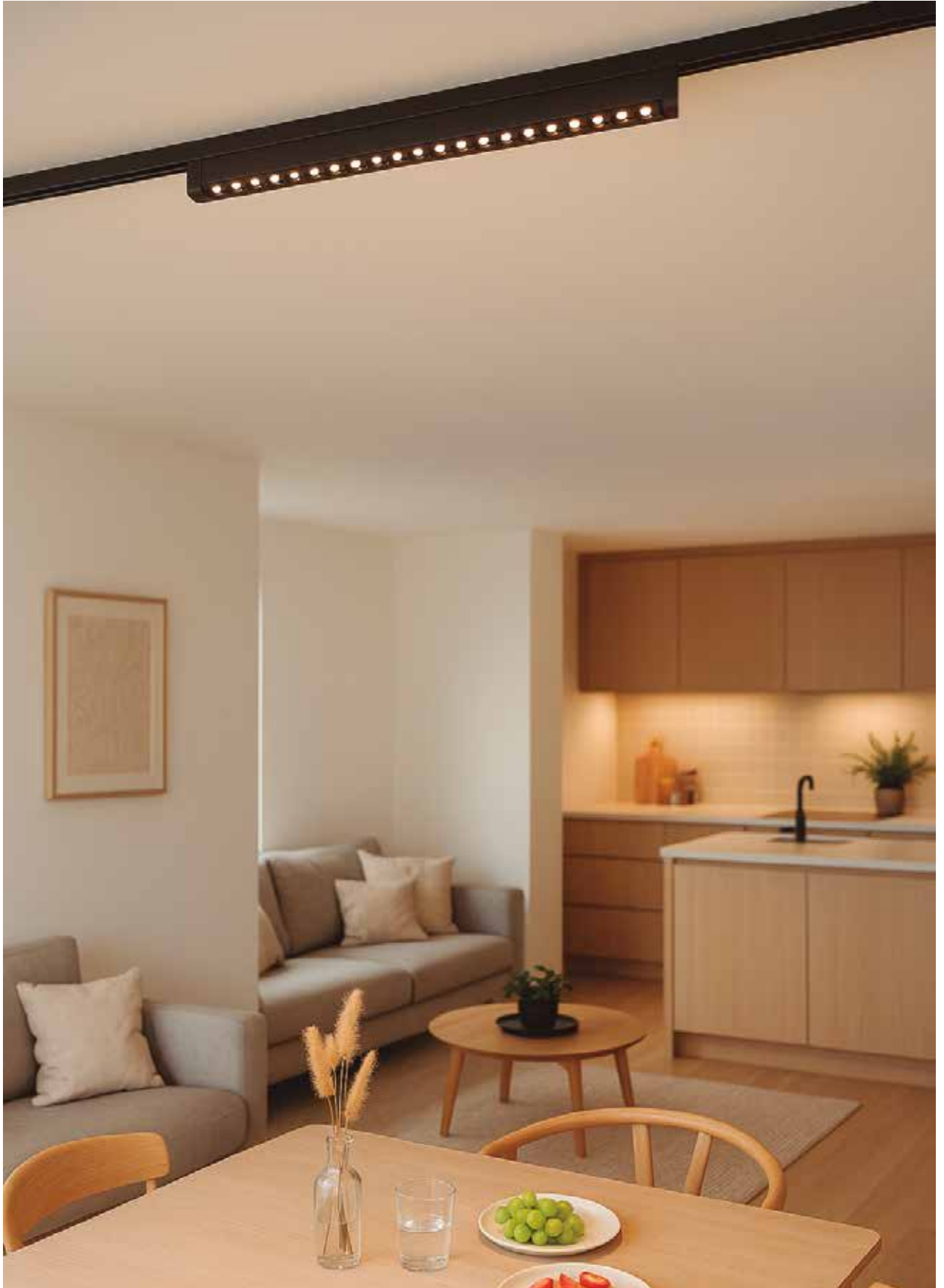

QUARZ ZOOM

Track System 48V



Temperatures | Températures



Finish | Finitions



Materials | Matériaux

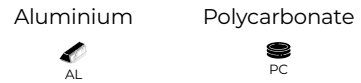

Light source | Source lumineuse

SMD LED - L80B10

LED lifetime | Durée de vie LED

40.000h



Dimmable



To be checked | À vérifier

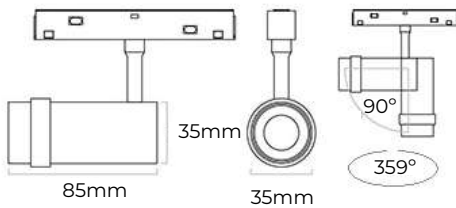

W	Flux	K	A°	○	●
7	580Lm	2700K	15°-45°	206098	206074
7	580Lm	3000K	15°-45°	203820	201222
7	580Lm	4000K	15°-45°	206067	206081

QUARZ 8W

Track System 48V

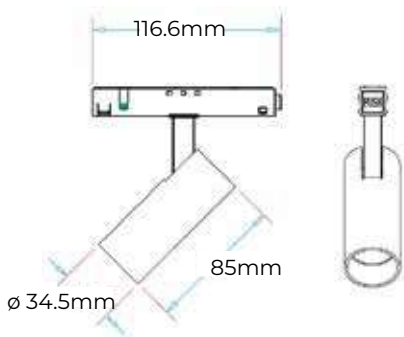

Temperatures | Températures



Finish | Finitions

White | Blanc Black | Noir

Materials | Matériaux

Aluminium



Polycarbonate



Light source | Source lumineuse

SMD LED - L80B10

LED lifetime | Durée de vie LED

40.000h



Dimmable



To be checked | À vérifier

W	Flux	K	A°	○	●
8	650Lm	2700K	36°	208580	208566
8	650Lm	3000K	36°	203141	201239
8	650Lm	4000K	36°	208597	208573

QUARZ 18W

Track System 48V

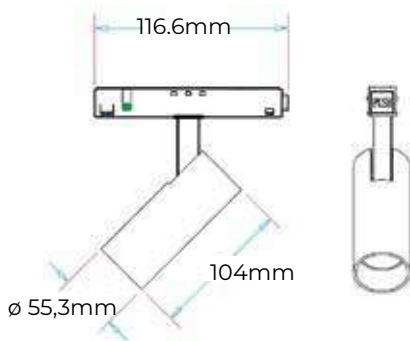

Temperatures | Températures



Finish | Finition



Materials | Matériaux

Aluminium



Polycarbonate



Light source | Source lumineuse

COB LED - L80B10

LED lifetime | Durée de vie LED

40.000h



Dimmable



To be checked | À vérifier

W	Flux	K	A°	Ref.
18	1450Lm	3000K	36°	201253
18	1450Lm	4000K	36°	209587

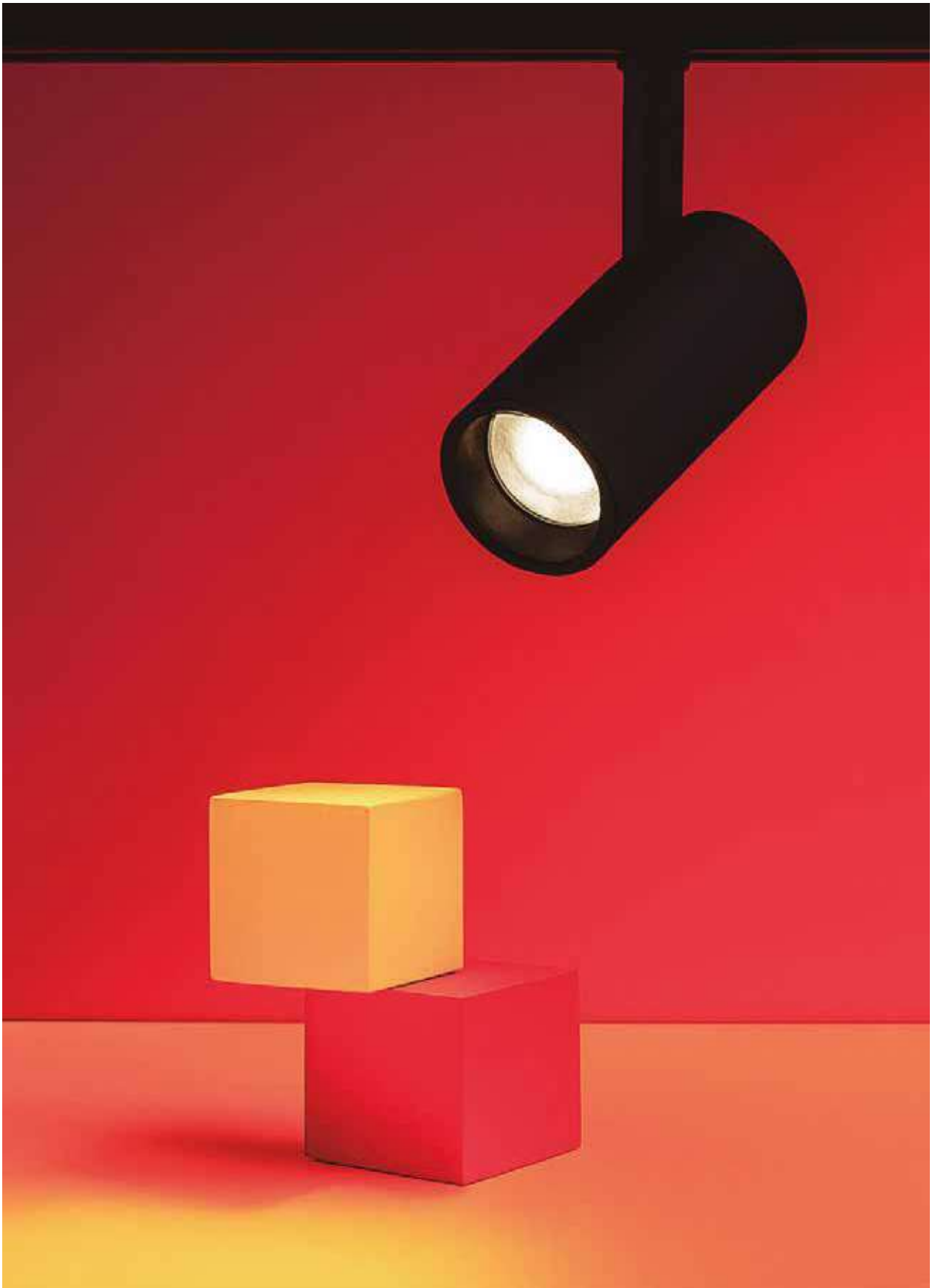

JUNO TRACK

NEW

Track System 48V



Finish | Finitions

- White | Blanc
- Black | Noir

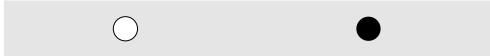

209679

209686

Materials | Matériaux

Aluminium



Max. power | Puissance maximale

7W - LED



Lamp holder | Douille

Lamp | Lampe GU10 - 48V - 35mmø

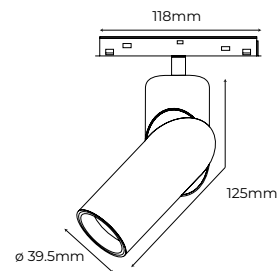

Dichroic | Dichroïque 35mmø

K	Flux	Ref.
2700K	350Lm	210118
3000K	350Lm	210125



SPEAKER

NEW

Track System 48V

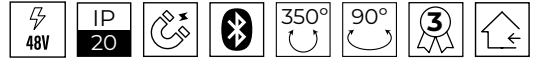

Bluetooth®



Finish | Finition



Black | Noir

Materials | Matériaux

Aluminium



Polycarbonate



Power | Puissance

10W



Bluetooth®

Version 5.4 | >10 m unobstructed

Version 5.4 | >10 m sans obstacles

Signal frequency | Fréquence du signal

12db

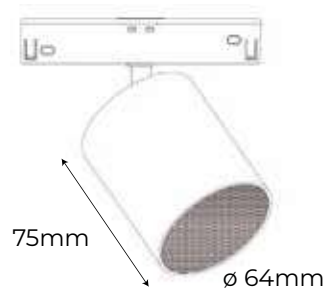

Ref.

210101

CIAN SPOT

Track System 48V



C



SQ

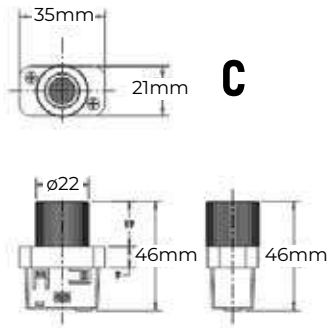

C

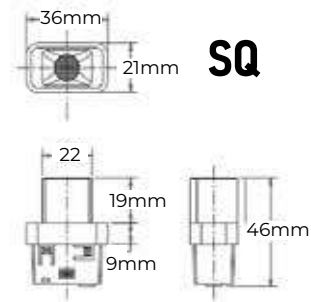

SQ

Temperature | Température



Finish | Finition



Black | Noir

Light source | Source lumineuse

COB LED - L80B10

Materials | Matériaux

Aluminium



Polycarbonate



LED lifetime | Durée de vie LED

40.000h



W	Flux	K	A°	C	SQ
2	160Lm	3000K	38°	201291	201307



ORBIX NEW

Track System 48V

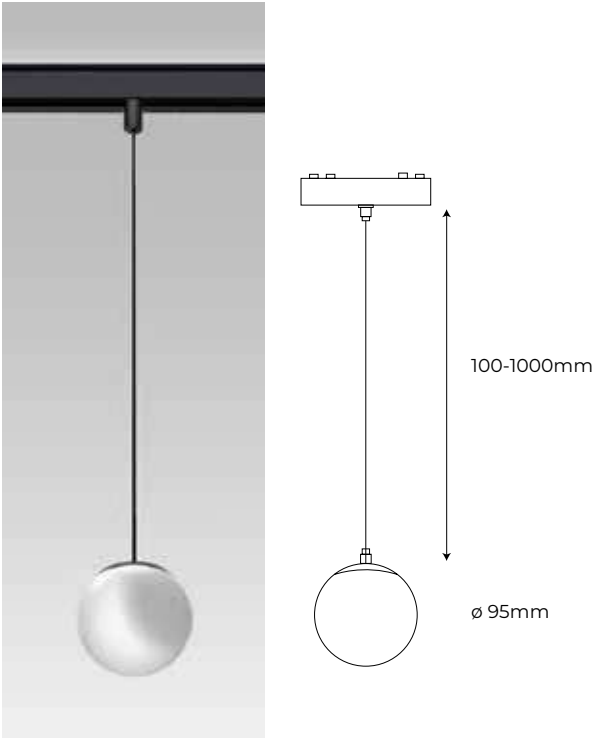
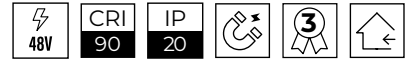

Temperature | Température



Finish | Finition



Black | Noir

Light source | Source lumineuse

SMD LED - L80B10

Materials | Matériaux

Aluminium



Polycarbonate



LED lifetime | Durée de vie LED

40.000h



W	Flux	K	A°	Ref.
6	450Lm	3000K	180°	210088

ASTRA

NEW

Track System 48V

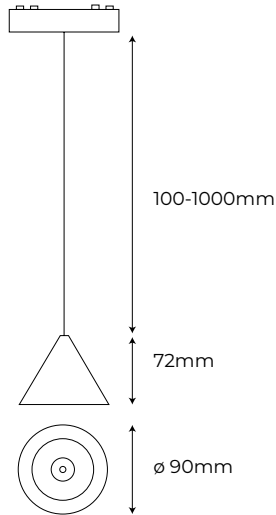
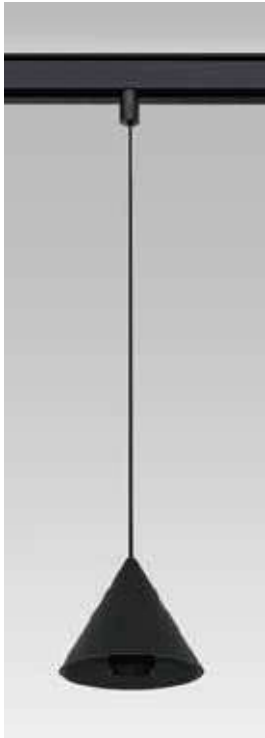

Temperature | Température



Finish | Finition



Black | Noir

Light source | Source lumineuse

SMD LED - L80B10

Materials | Matériaux

Aluminium



Polycarbonate



LED lifetime | Durée de vie LED

40.000h



W	Flux	K	A°	Ref.
6	500Lm	3000K	24°	210071

AGATA

Track System 48V

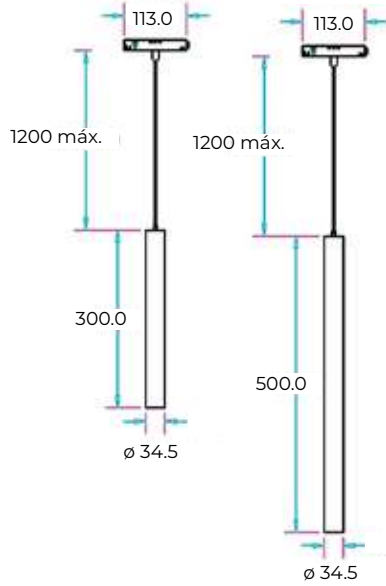

Temperature | Température



Finish | Finition



Black | Noir

Light source | Source lumineuse

COB LED - L80B10

Materials | Matériaux

Aluminium



Polycarbonate



LED lifetime | Durée de vie LED

40.000h



mm	W	Flux	K	A°	Ref.
ø34,5x300	10	800Lm	3000K	38°	201284
ø34,5x500	10	800Lm	3000K	38°	201277

TULIPA

Track System 48V

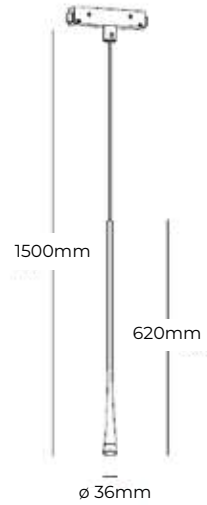

Temperatures | Températures



Finish | Finition



Light source | Source lumineuse

COB LED - L80B10

Materials | Matériaux

Aluminium



Polycarbonate



LED lifetime | Durée de vie LED

40.000h



W	Flux	K	A°	Ref.
6	370Lm	3000K	38°	201598
6	370Lm	4000K	38°	202762

TALLIN ORO^{D50}

Track System 48V

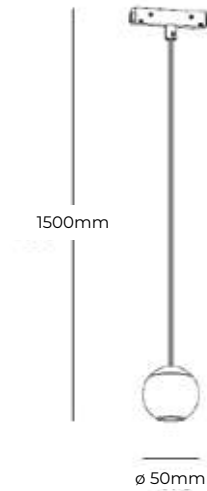
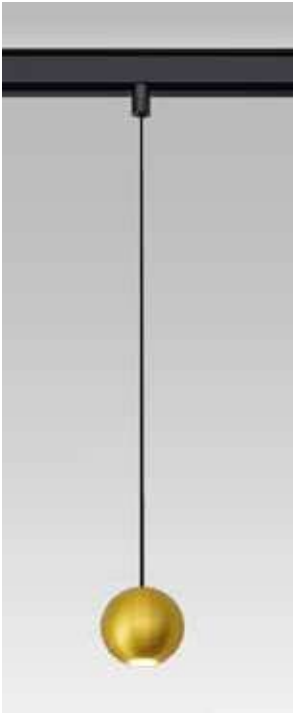

Temperature | Température



Finish | Finition



Golden | Or

Light source | Source lumineuse

COB LED - L80B10

Materials | Matériaux

Aluminium



Polycarbonate



LED lifetime | Durée de vie LED

40.000h



W	Flux	K	A°	Ref.
4,5	220Lm	3000K	38°	201727

TALLIN Black^{D70}

Track System 48V

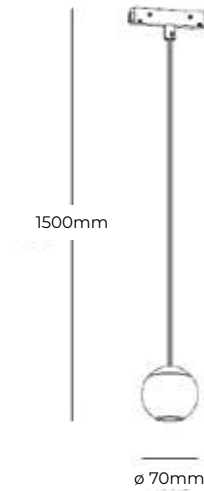
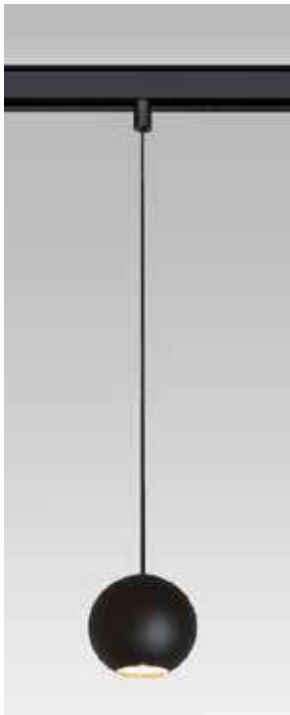

Temperature | Température



Finish | Finition



Black | Noir

Light source | Source lumineuse

COB LED - L80B10

Materials | Matériaux

Aluminium



Polycarbonate



LED lifetime | Durée de vie LED

40.000h



W	Flux	K	A°	Ref.
8,5	410Lm	3000K	38°	201734

SURFACE TRACK RAIL EN SAILLIE

Track System 48V

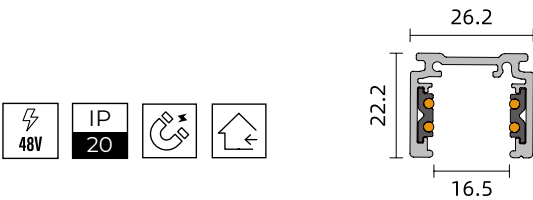

Finish | Finitions

- White | Blanc
- Black | Noir

Materials | Matériaux

- Aluminium
- AL

Rated voltage per circuit
Tension nominale par circuit

48V / 15A

cm	<input type="radio"/>	<input type="radio"/>
100cm	202878	202175
200cm	202885	202182
300cm	202892	202199



ACCESSORIES | ACCESSOIRES



Rail end cap
Embout de fin rail

- 203042
- 202205



"L" Right connector
Connecteur en "L" droit

- 202991
- 202229



"L" Left connector
Connecteur en "L" gauche

- 202984
- 202212



"L" Vertical connector
Connecteur en "L" vertical

- 203028
- 202236



Ceiling Fixing trackrail
Fixation au plafond rail

- 203066
- 202243



Suspension kit 3 meters wire
Kit de suspension câble 3 mètres

- 203073
- 202250

DEEP SURFACE TRACK RAIL EN SAILLIE

Track System 48V

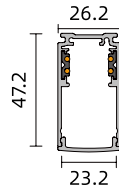
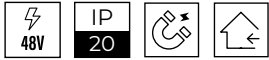

Finish | Finitions

White | Blanc Black | Noir

Materials | Matériaux

Aluminium



Rated voltage per circuit
Tension nominale par circuit

48V / 15A

cm	<input type="radio"/>	<input checked="" type="radio"/>
100cm	207002	202106
200cm	207019	202113
300cm	207026	202120



ACCESSORIES | ACCESSOIRES DEEP



Rail end cap
Embout de fin rail

207033 202137



"L" Right connector
Connecteur en "L" droit

207057 202151



"L" Left connector
Connecteur en "L" gauche

207040 202144



"L" Vertical connector
Connecteur en "L" vertical

207064 202168



Ceiling Fixing trackrail
Fixation au plafond rail

203066 202243



Suspension kit 3 meters wire
Kit de suspension câble 3 mètres

203073 202250

RECESSED TRACK RAIL ENCASTRABLE

Track System 48V

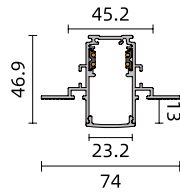
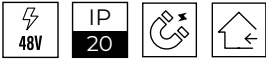

Finish | Finitions

White | Blanc

Black | Noir

Materials | Matériaux

Aluminium



AL

Rated voltage per circuit

Tension nominale par circuit

48V / 15A

cm	<input type="radio"/>	<input checked="" type="radio"/>
100cm	202908	202267
200cm	202915	202274
300cm	202922	202281



ACCESSORIES | ACCESSOIRES



Rail end cap
Embout de fin rail

203059 202298



"L" Right connector
Connecteur en "L" droit

203011 202311



"L" Left connector
Connecteur en "L" gauche

203004 202304



"L" Vertical connector
Connecteur en "L" vertical

203035 202328

DRIVERS

Track System 48V



DALI
IN-TRACK



V	W	○	●
48V	100W	206142	203400
48V	250W	209150	203844

V	W	Ref.
48V	100W	209631
48V	150W	202403
48V	250W	209648

CONNECTORS | CONNECTEURS

Track System 48V



Left-side connection
Connecteur gauche

202939 202335



Right-side connection
Connecteur droite

202946 202342



Linear joint with contact
Jonction linéaire avec contact

202953 202359



External L connector
Connecteur en L extérieur

202960 202366



Flexible connector
Connecteur flexible

202977 202373



Track System 230V

Dual sensor

POLARIS AI NEW

Track System



Easy installation | Installation facile

Smart lighting powered by AI technology
Éclairage intelligent alimenté par la technologie IA

AI automatically adjusts the color according to different objects
 L'IA ajuste automatiquement la couleur en fonction des différents objets

Dual Sensor
 Capteur double

Custom app
 App personnalisée



Customization and data collection
 Personnalisation et collecte de données

Temperature | Température



Light source | Source lumineuse

COB LED - L80B10

Finish | Finitions



LED lifetime | Durée de vie LED

50.000h



Materials | Matériaux

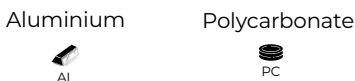

Dimmable

Dimmable



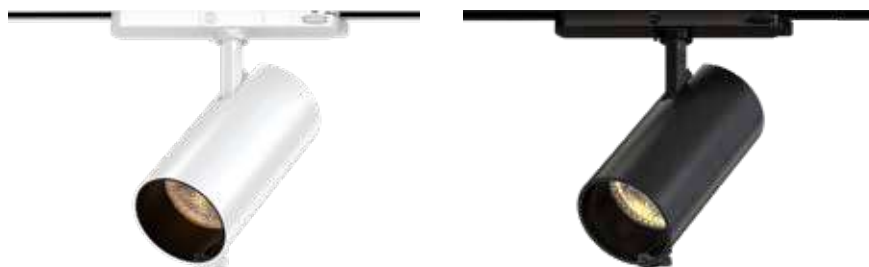

W	Flux	A°	○	●
---	------	----	---	---

30	2300Lm	24°	209297	209303
----	--------	-----	--------	--------

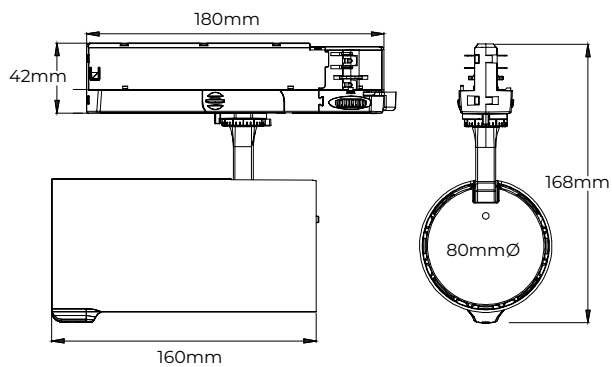

32W

POLARIS ZOOM

Track System



Selectable power via driver
Puissance sélectionnable via le driver

Temperatures | Températures (CTT)



Light source | Source lumineuse

COB LED - L80B10

Finish | Finitions



LED lifetime | Durée de vie LED

50.000h



Materials | Matériaux

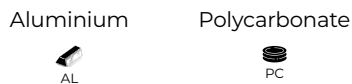

Optional dimming | Dimmable en option



W	Flux	K	A°	●	○
32	3000Lm	2700K-3000K-4000K	20°-60°	210033	210040



20W-30W

POLARIS SHORT

Track System



Temperatures | Températures



Finish | Finitions



Materials | Matériaux

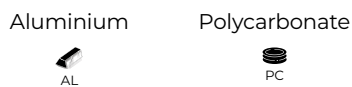

Light source | Source lumineuse

COB LED - L80B10

LED lifetime | Durée de vie LED

50.000h



Optional dimming | Dimmable en option

CASAMBI

DALI



W	Flux	K	A°	○	●
20	1800Lm	2700K	15°	208009	208047
20	1800Lm	3000K	15°	201741	201765
20	1800Lm	4000K	15°	201758	201772
20	1800Lm	2700K	24°	208016	208054
20	1800Lm	3000K	24°	201789	201802
20	1800Lm	4000K	24°	201796	201819
20	1800Lm	2700K	36°	208023	208061
20	1800Lm	3000K	36°	201642	201666
20	1800Lm	4000K	36°	201659	201673
20	1800Lm	2700K	60°	208030	208078
20	1800Lm	3000K	60°	201826	201840
20	1800Lm	4000K	60°	201833	201857
30	2850Lm	2700K	15°	208085	208122
30	2850Lm	3000K	15°	201871	201895
30	2850Lm	4000K	15°	201888	201901
30	2850Lm	2700K	24°	208092	208139
30	2850Lm	3000K	24°	201918	999785
30	2850Lm	4000K	24°	201925	201932
30	2850Lm	2700K	36°	208108	208146
30	2850Lm	3000K	36°	201611	201864
30	2850Lm	4000K	36°	201628	201635
30	2850Lm	2700K	60°	208115	208153
30	2850Lm	3000K	60°	201949	201963
30	2850Lm	4000K	60°	201956	201970

20W

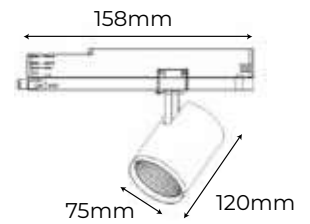

30W

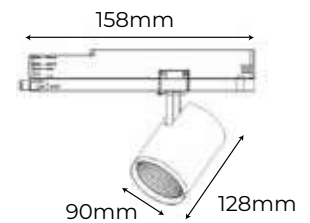

40W

POLARIS SHORT

Track System



Temperatures | Températures



Finish | Finitions



Materials | Matériaux

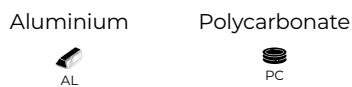

Light source | Source lumineuse

COB LED - L80B10

LED lifetime | Durée de vie LED

50.000h



Optional dimming | Dimmable en option

CASAMBI

DALI



W	Flux	K	A°	○	●
40	3700Lm	2700K	24°	208160	208191
40	3700Lm	3000K	24°	999402	999426
40	3700Lm	4000K	24°	999419	999433
40	3700Lm	2700K	45°	208177	208207
40	3700Lm	3000K	45°	999365	999389
40	3700Lm	4000K	45°	999372	999396
40	3700Lm	2700K	60°	208184	208214
40	3700Lm	3000K	60°	999440	999464
40	3700Lm	4000K	60°	999457	999471

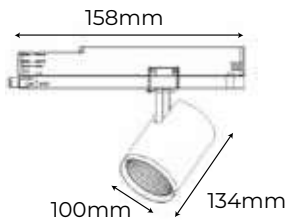

ACCESSORIES | ACCESSOIRES

Asymmetrical glare-free ring | Black
 Anneau anti-éblouissement asymétrique | Noir

Ref. 202687

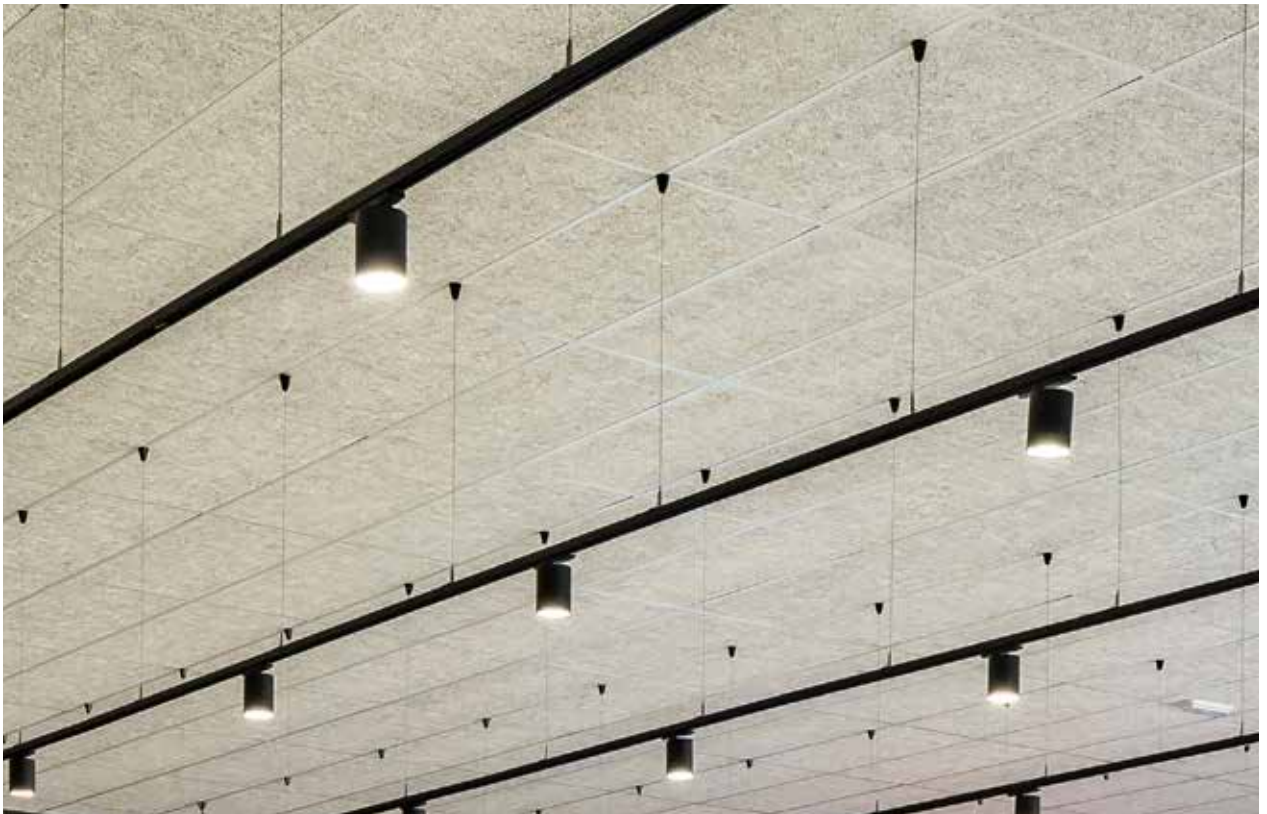

10W

POLARIS

Track System



Temperatures | Températures



Light source | Source lumineuse

COB LED - L80B10

Finish | Finitions



LED lifetime | Durée de vie LED

50.000h



Materials | Matériaux

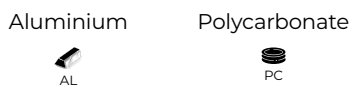

Optional dimming | Dimmable en option



W	Flux	K	A°	○	●
10	750Lm	2700K	15°	202779	207859
10	750Lm	3000K	15°	991925	991987
10	750Lm	4000K	15°	991932	991994
10	750Lm	2700K	24°	207835	207866
10	750Lm	3000K	24°	991949	992007
10	750Lm	4000K	24°	991956	992014
10	750Lm	2700K	45°	207842	207873
10	750Lm	3000K	45°	991963	992021
10	750Lm	4000K	45°	991970	992038

ACCESSORIES | ACCESSOIRES

Anti-glare grille
Grille anti-éblouissement

Ref. 200492



10W

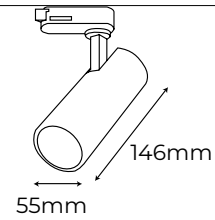

30W

POLARIS

Track System



Temperatures | Températures



Light source | Source lumineuse

COB LED - L80B10

Finish | Finitions



LED lifetime | Durée de vie LED

50.000h



Materials | Matériaux

Aluminium



Polycarbonate



Optional dimming | Dimmable en option

CASAMBI

DALI



W	Flux	K	A°	●
30	2850Lm	2700K	15°	207965
30	2850Lm	3000K	15°	995329
30	2850Lm	4000K	15°	995336
30	2850Lm	2700K	24°	207972
30	2850Lm	3000K	24°	995343
30	2850Lm	4000K	24°	995350
30	2850Lm	2700K	38°	207989
30	2850Lm	3000K	38°	994964
30	2850Lm	4000K	38°	994971
30	2850Lm	2700K	60°	207996
30	2850Lm	3000K	60°	994988
30	2850Lm	4000K	60°	994995

ACCESSORIES | ACCESSOIRES

Anti-glare grille 30W
Grille anti-éblouissement

Ref. 995374



Track-mounted projector base 30W | Black
Base de projecteur pour rail 30W | Noir



Ref. 992908

30W

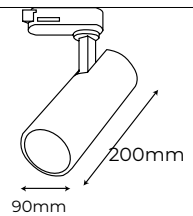

7W - 12W - 20W

HALLEY

Track System



Temperatures | Températures



Light source | Source lumineuse

COB LED - L80B10

Finish | Finitions



LED lifetime | Durée de vie LED

50.000h



Materials | Matériaux

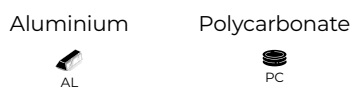

Optional dimming | Dimmable en option

CASAMBI

DALI



W	Flux	K	A°	○	●
7	560Lm	2700K	20°	995084	995107
7	600Lm	3000K	20°	997446	997460
7	600Lm	4000K	20°	995091	995114
7	560Lm	2700K	40°	995008	995022
7	600Lm	3000K	40°	997453	997477
7	600Lm	4000K	40°	995015	995039
12	1050Lm	2700K	15°	995121	995145
12	1100Lm	3000K	15°	997385	997415
12	1100Lm	4000K	15°	995138	995152
12	1050Lm	2700K	24°	995169	995183
12	1100Lm	3000K	24°	997392	997422
12	1100Lm	4000K	24°	995176	995190
12	1050Lm	2700K	38°	995046	995060
12	1100Lm	3000K	38°	997408	997439
12	1100Lm	4000K	38°	995053	995077
20	1700Lm	3000K	15°	201987	202007
20	1700Lm	4000K	15°	201994	202014
20	1700Lm	3000K	24°	202021	202045
20	1700Lm	4000K	24°	202038	202052
20	1700Lm	3000K	36°	201680	201703
20	1700Lm	4000K	36°	201697	201710
20	1700Lm	3000K	60°	202069	202083
20	1700Lm	4000K	60°	202076	202090

7W

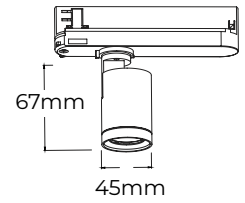

12W

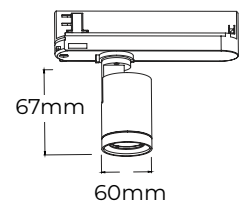

20W

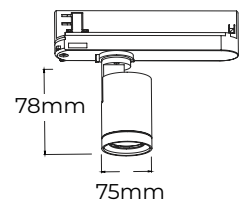

15W - 30W

ALTAÏS

Track System

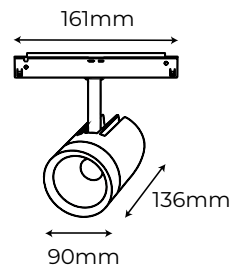

Temperatures | Températures



Light source | Source lumineuse

COB LED - L80B10

Finish | Finitions



LED lifetime | Durée de vie LED

50.000h



Materials | Matériaux

Aluminium



Polycarbonate



Optional dimming | Dimmable en option

CASAMBI

DALI



W	Flux	K	A°	Ref.
15	1200Lm	3000K	38°	992267
30	2900Lm	4000K	24°	992465
30	2800Lm	3000K	38°	992441
30	2900Lm	4000K	38°	992472
30	2800Lm	3000K	60°	992458
30	2900Lm	4000K	60°	992489



20W - 30W

SATURN

Track System



Temperatures | Températures



Light source | Source lumineuse

COB LED - L80B10

Finish | Finitions



LED lifetime | Durée de vie LED

50.000h



Materials | Matériaux

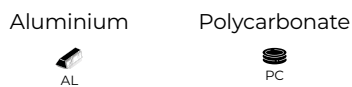

Optional dimming | Dimmable en option



W	Flux	K	A°	○	●
20	1450Lm	3000K	15° > 45°	997965	997989
20	1450Lm	4000K	15° > 45°	997972	997996
30	2800Lm	3000K	15° > 45°	-	998023
30	2900Lm	4000K	15° > 45°	-	998030

20W

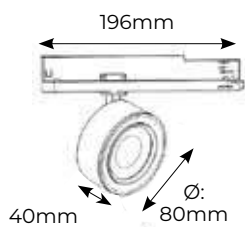

30W

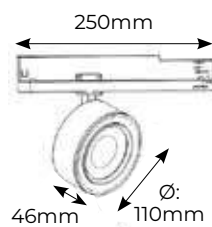



NEW

30W - 40W - 50W

WALLWASHER CCT

Track System

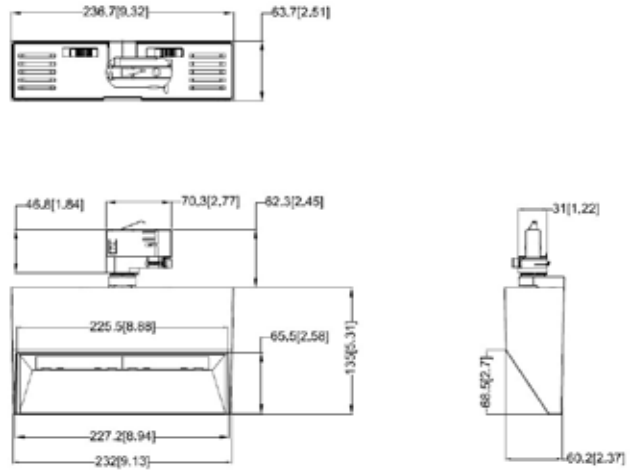

Temperatures | Températures (CCT)



Light source | Source lumineuse

COB LED - L80B10

Finish | Finitions



LED lifetime | Durée de vie LED

50.000h



Materials | Matériaux

Aluminium



Optional dimming | Dimmable en option



W	Flux	K	A°	○	●
30-40-50	5000Lm	3000K-3500K-4000K	60° > 90°	209730	210132

HUBBLE



TRACK SYSTEM

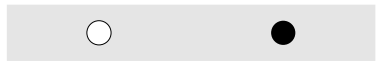

992175 992168

SEMI-RECESSED SEMI-ENCASTRÉ



992717 992724

SURFACE-MOUNTED EN SAILLIE

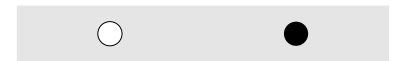

992670 992687

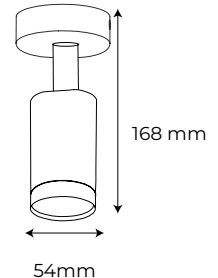
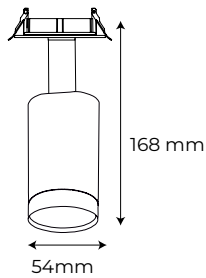
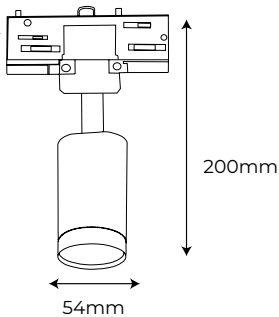

Finish | Finitions

○ White | Blanc ● Black | Noir

Max. power | Puissance maximale

50W
⚡

Materials | Matériaux

Aluminium Polycarbonate
AL PC

Lamp holder | Douille

GU10 Lamp | Lampe GU10
⚡

SPEAKER

Track System



Bluetooth®



Ref.
210095



Finish | Finition

●
Black | Noir

Bluetooth®

Version 5.4 | >10 m unobstructed
Version 5.4 | >10 m sans obstacles

Materials | Matériaux

Aluminium



Polycarbonate



Signal frequency | Fréquence du signal

12db

Power | Puissance

10W
⚡

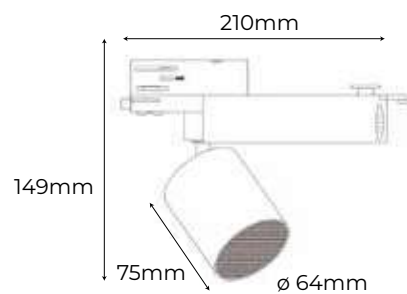

SURFACE-MOUNTED OR SUSPENDED THREE-PHASE TRACK

RAIL TRIPHASÉ EN SAILLIE OU EN SUSPENSION

Track System

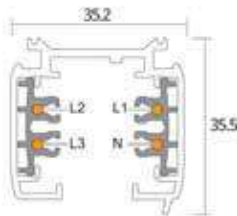

Finish | Finitions

- White | Blanc
- Black | Noir

Materials | Matériaux

Aluminium



Rated voltage per circuit

Tension nominale par circuit

220-240Vac 50/60Hz

cm	○	●
100	200034	200027
200	200058	200041
300	200072	200065

ACCESSORIES | ACCESSOIRES



Right-side connection
Alimentation droite

○ 200119 ● 200102

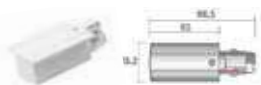

Left-side connection
Alimentation gauche

○ 200096 ● 200089



Linear joint with contact
Jonction linéaire avec contact

○ 200133 ● 200126



Linear joint without contact
Jonction linéaire sans contact

○ 200157 ● 200140



Central connection and
linear joint
Alimentation centrale et
jonction linéaire

○ 200171 ● 200164



"L" Left connector
Connecteur en "L" gauche

○ 200195 ● 200188



"L" Right connector
Connecteur en "L" droit

○ 200218 ● 200201



"T" left external connector
Connecteur en "T" gauche
extérieur

○ 200232 ● 200225



"T" left inner connector
Connecteur en "T"
gauche intérieur

○ 200256 ● 200249



"T" right external
connector
Connecteur en "T" droit
extérieur

○ 200270 ● 200263



"T" right inner connector
Connecteur en "T" droit
intérieur

○ 200294 ● 200287



Flexible connector
Connecteur flexible

○ 200522 ● 200515

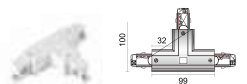

"T" right inner and outer
connector
Connecteur en "T" droit
intérieur et extérieur

○ 203417 ● 203424

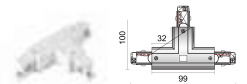

"T" left inner and outer
connector
Connecteur en "T" gauche
intérieur et extérieur

○ 203431 ● 203448



"X" right external connector
Connecteur en "X" droit
extérieur

○ 200317 ● 200300



End cap
Embout de fin

○ 996258 ● 996265



Suspension kit steel tension
cable | 5 m
Kit de suspension câble de
tension en acier pour rail | 5 m

○ 996159 ● 996166



Direct fixation to ceiling
Fixation directe au plafond

○ 996173 ● 996180



Schuko rail adapter
Adaptateur de rail Schuko

○ 998702 ● 998719



Electromechanical rail adapter
Adaptateur électromécanique
pour rail

○ 998689 ● 998696

RECESSED THREE-PHASE TRACK RAIL TRIPHASÉ ENCASTRÉ

Track System

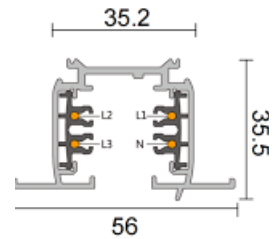

Finish | Finitions

- White | Blanc
- Black | Noir

Materials | Matériaux

Aluminium



Rated voltage per circuit
Tension nominale par circuit

220-240Vac 50/60Hz

cm	○	●
100cm	200331	200324
200cm	200355	200348
300cm	200379	200362

ACCESSORIES | ACCESSOIRES



Middle connection end cap
Embout de finition pour connexion centrale

- 200393
- 200386



L connection end cap
Embout de finition pour connexion en L

- 200416
- 200409



T connection end cap
Embout de finition pour connexion en T

- 200430
- 200423



X connection end cap
Embout de finition pour connexion en X

- 200454
- 200447



Start connection end cap
Embout de départ

- 200478
- 200461

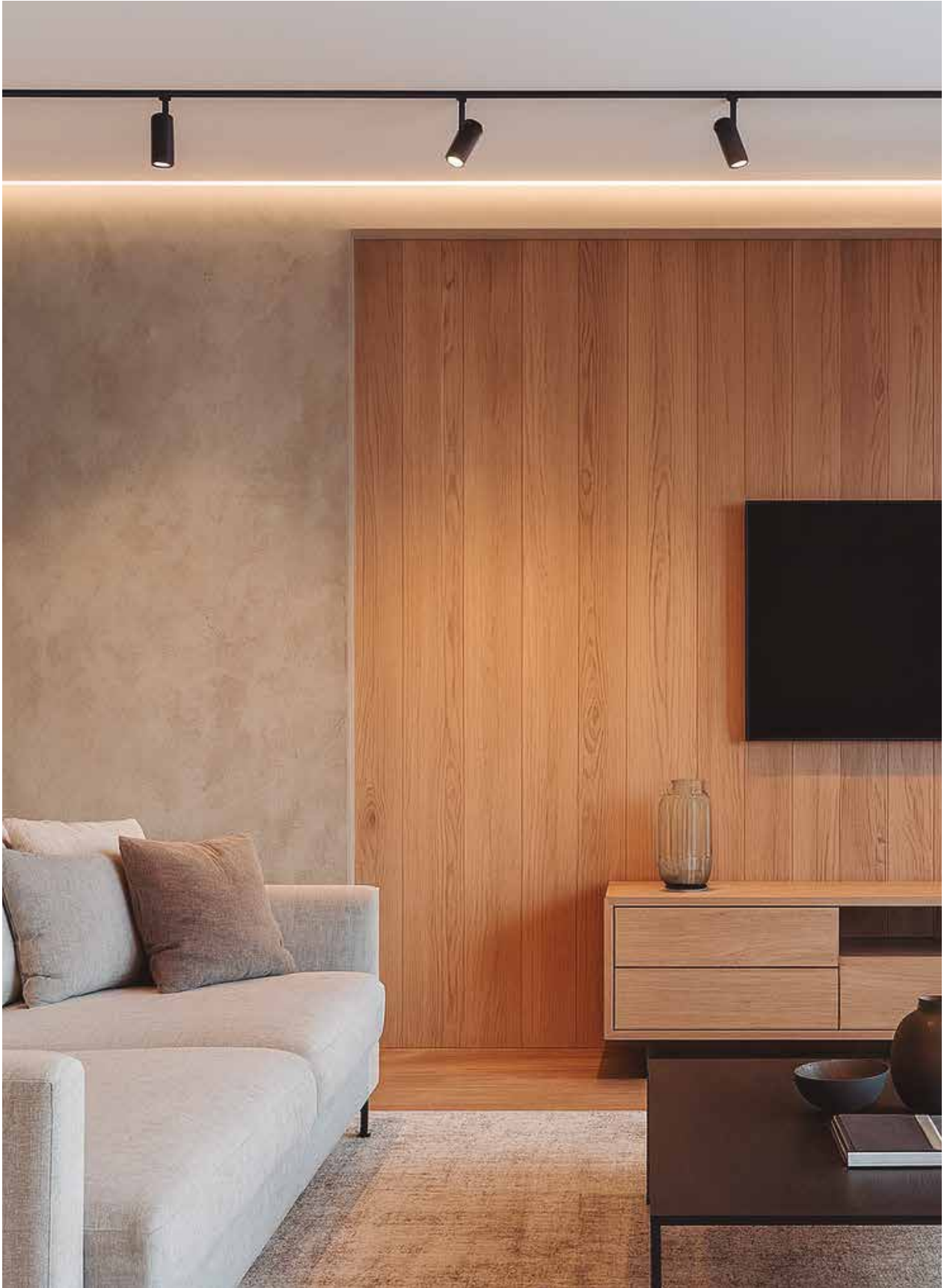



SURFACE-MOUNTED OR SUSPENDED THREE-PHASE TRACK

RAIL TRIPHASÉ EN SAILLIE OU EN SUSPENSION

Track System

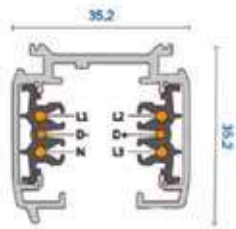

Finish | Finitions

○ White | Blanc

● Black | Noir

Materials | Matériaux

Aluminium



Rated voltage per circuit















Tension nominale par circuit

220-240Vac 50/60Hz

cm	○	●
100cm	995855	995886
200cm	995862	995893
300cm	995879	995909

ACCESSORIES | ACCESSOIRES



 <p>Right-side connection Alimentation droite</p> <p><input type="radio"/> 995930 <input checked="" type="radio"/> 995947</p>	 <p>"T" Right -01 connector Connecteur en "T" droite -01</p> <p><input type="radio"/> 996111 <input checked="" type="radio"/> 996128</p>
 <p>Left-side connection Alimentation gauche</p> <p><input type="radio"/> 995916 <input checked="" type="radio"/> 995923</p>	 <p>"T" Right -02 connector Connecteur en "T" droite -02</p> <p><input type="radio"/> 996135 <input checked="" type="radio"/> 996142</p>
 <p>Rail-to-rail electrical connection Jonction électrique entre rails</p> <p><input type="radio"/> 995954 <input checked="" type="radio"/> 995961</p>	 <p>"T" Left -01 connector Connecteur en "T" gauche -01</p> <p><input type="radio"/> 996074 <input checked="" type="radio"/> 996081</p>
 <p>Central feeder Alimentation centrale</p> <p><input type="radio"/> 995978 <input checked="" type="radio"/> 995985</p>	 <p>"T" Left -02 connector Connecteur en "T" gauche -02</p> <p><input type="radio"/> 996098 <input checked="" type="radio"/> 996104</p>
 <p>Cross connector Connecteur en croix</p> <p><input type="radio"/> 995992 <input checked="" type="radio"/> 996005</p>	 <p>Suspension kit steel tension cable 5 m Kit de suspension câble de tension en acier pour rail 5 m</p> <p><input type="radio"/> 996159 <input checked="" type="radio"/> 996166</p>
 <p>"L" Right connector Connecteur en "L" droite</p> <p><input type="radio"/> 996036 <input checked="" type="radio"/> 996043</p>	 <p>Direct ceiling fixation Fixation directe au plafond</p> <p><input type="radio"/> 996173 <input checked="" type="radio"/> 996180</p>
 <p>"L" Left connector Connecteur en "L" gauche</p> <p><input type="radio"/> 996012 <input checked="" type="radio"/> 996029</p>	 <p>End cap Embout de finition</p> <p><input type="radio"/> 996258 <input checked="" type="radio"/> 996265</p>
 <p>Flexible connector Connecteur flexible</p> <p><input type="radio"/> 996050 <input checked="" type="radio"/> 996067</p>	 <p>Electromechanical rail adapter Adaptateur électromécanique pour rail</p> <p><input type="radio"/> 200010 <input checked="" type="radio"/> 200003</p>

LAES





PROFILED

PROFILED NEW NANO CCT *Infinity*

Direct / Indirect lighting
Éclairage direct / indirect

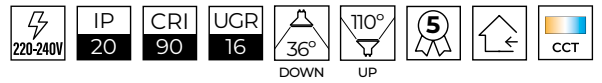

Top view | Vue de dessus



Bottom view | Vue de dessous



Height adjustable | Réglable en hauteur

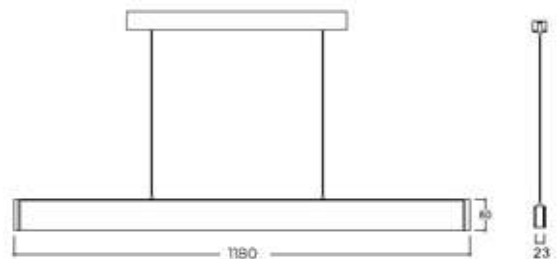

Motion sensor

Light dimmer | Variateur de lumière

Temperatures | Températures (CCT)



Light source | Source lumineuse

OSRAM - L80B10

Finish | Finitions



LED lifetime | Durée de vie LED

50.000h



Materials | Matériaux

Aluminium



Dimming | Variation d'intensité

Built-in sensor dimmer
Variateur avec capteur intégré





W down	W up	Flux down	Flux up	K	mm	Ref.
28	12	1700Lm	600Lm	3000K-4000K-5000K	23x80x1180	210057

PROFILED SLIM Micro

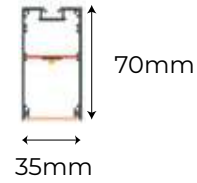
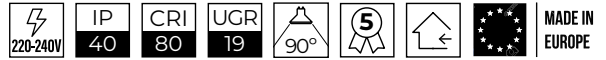

Diffuser | Diffuseur

Microprismatic | Microprismatique

Temperatures | Températures



Light source | Source lumineuse

OSRAM - L80B10

Finish | Finitions



LED lifetime | Durée de vie LED

50.000h



Materials | Matériaux

Aluminium



Optional dimming | Dimmable en option



W	Flux	K	L	○	●	W	Flux	K	L	○	●
11	835Lm	3000K	310	205077	205411	54	4239Lm	3000K	1700	205350	205695
11	835Lm	4000K	310	205084	205428	54	4239Lm	4000K	1700	205367	205701
14	1077Lm	3000K	410	205091	205435	57	4465Lm	3000K	1800	205374	205718
14	1077Lm	4000K	410	205107	205442	57	4465Lm	4000K	1800	205381	205725
17	1327Lm	3000K	505	205114	205459	60	4723Lm	3000K	1900	205398	205732
17	1327Lm	4000K	505	205121	205466	60	4723Lm	4000K	1900	205404	205749
20	1569Lm	3000K	605	205138	205473	63	4973Lm	3000K	2000	206104	206128
20	1569Lm	4000K	605	205145	205480	63	4973Lm	4000K	2000	206111	206135
23	1819Lm	3000K	705	205152	205497	66	5214Lm	3000K	2100	210330	210354
23	1819Lm	4000K	705	205169	205503	66	5214Lm	4000K	2100	210347	210361
26	2069Lm	3000K	805	205176	205510	68	5238Lm	3000K	2200	210378	210392
26	2069Lm	4000K	805	205183	205527	68	5238Lm	4000K	2200	210385	210408
30	2326Lm	3000K	905	205190	205534	78	6089Lm	3000K	2300	210415	210439
30	2326Lm	4000K	905	205206	205541	78	6089Lm	4000K	2300	210422	210446
33	2576Lm	3000K	1000	205213	205558	78	6089Lm	3000K	2400	210453	210477
33	2576Lm	4000K	1000	205220	205565	78	6089Lm	4000K	2400	210460	210484
36	2826Lm	3000K	1100	205237	205572	80	6245Lm	3000K	2500	210491	210514
36	2826Lm	4000K	1100	205244	205589	80	6245Lm	4000K	2500	210507	210521
39	3060Lm	3000K	1200	205251	205596	84	6557Lm	3000K	2600	210538	210552
39	3060Lm	4000K	1200	205268	205602	84	6557Lm	4000K	2600	210545	210569
42	3286Lm	3000K	1300	205275	205619	87	6791Lm	3000K	2700	210576	210590
42	3286Lm	4000K	1300	205282	205626	87	6791Lm	4000K	2700	210583	210606
45	3528Lm	3000K	1400	205299	205633	90	7026Lm	3000K	2800	210613	210637
45	3528Lm	4000K	1400	205305	205640	90	7026Lm	4000K	2800	210620	210644
48	3755Lm	3000K	1500	205312	205657	93	7260Lm	3000K	2900	210651	210675
48	3755Lm	4000K	1500	205329	205664	93	7260Lm	4000K	2900	210668	210682
51	4005Lm	3000K	1600	205336	205671	96	7494Lm	3000K	3000	210699	210712
51	4005Lm	4000K	1600	205343	205688	96	7494Lm	4000K	3000	210705	210729

Other sizes, shapes and colors available upon request
 Autres tailles, formes et couleurs disponibles sur demande

ACCESSORIES | ACCESSOIRES

Ceiling rose + 3 core cable (white)
 Rosace + Câble 3 fils (blanc)

Ref. 208603

Ceiling rose + 3 core cable (black)
 Rosace + Câble 3 fils (noir)

Ref. 208610

Ceiling rose + 5 core cable (white)
 Rosace + Câble 5 fils (blanc)

Ref. 208627

Ceiling rose + 5 core cable (black)
 Rosace + Câble 5 fils (noir)

Ref. 208634

Suspension + steel wire 1.5m
 Suspension + câble acier 1.5m

Ref. 205992

Suspension + steel wire 2.5m
 Suspension + câble acier 2.5m

Ref. 206005

Connector kit union
 Kit connecteur union

Ref. 202410

Mitre cutting
 Coupe ongles

Ref. 202427

Trimless fixing for 35x70 profile
 Fixation trimless pour profilé 35x70

Ref. 208252

Wall mounting profile | White
 Fixation murale pour profilé | Blanc

Ref. 994216

Wall mounting profile | Black
 Fixation murale pour profilé | Noir

Ref. 993745

PROFILED SLIM Opal

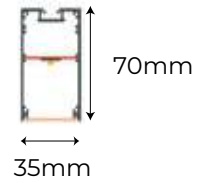

Diffuser | Diffuseur

Opal | Opale

Temperatures | Températures



Light source | Source lumineuse

OSRAM - L80B10

Finish | Finitions



LED lifetime | Durée de vie LED

50.000h



Materials | Matériaux

Aluminium



Optional dimming | Dimmable en option



W	Flux	K	L	○	●	W	Flux	K	L	○	●
11	726Lm	3000K	310	203226	207392	54	3685Lm	3000K	1700	207316	207675
11	726Lm	4000K	310	203233	207408	54	3685Lm	4000K	1700	207323	207682
14	936Lm	3000K	410	203240	207415	57	3881Lm	3000K	1800	207330	207699
14	936Lm	4000K	410	203257	207422	57	3881Lm	4000K	1800	207347	207705
17	1154Lm	3000K	505	207071	207439	60	4105Lm	3000K	1900	207354	207712
17	1154Lm	4000K	505	207088	207446	60	4105Lm	4000K	1900	207361	207729
20	1364Lm	3000K	605	207095	207453	63	4323Lm	3000K	2000	207378	207736
20	1364Lm	4000K	605	207101	207460	63	4323Lm	4000K	2000	207385	207743
23	1581Lm	3000K	705	207118	207477	66	4533Lm	3000K	2100	210736	210750
23	1581Lm	4000K	705	207125	207484	66	4533Lm	4000K	2100	210743	210767
26	1798Lm	3000K	805	207132	207491	68	4553Lm	3000K	2200	210774	210798
26	1798Lm	4000K	805	207149	207507	68	4553Lm	4000K	2200	210781	210804
30	2022Lm	3000K	905	207156	207514	78	5293Lm	3000K	2300	210811	210835
30	2022Lm	4000K	905	207163	207521	78	5293Lm	4000K	2300	210828	210842
33	2239Lm	3000K	1000	207170	207538	78	5293Lm	3000K	2400	210859	210873
33	2239Lm	4000K	1000	207187	207545	78	5293Lm	4000K	2400	210866	210880
36	2456Lm	3000K	1100	207194	207552	80	5429Lm	3000K	2500	210897	210910
36	2456Lm	4000K	1100	207200	207569	80	5429Lm	4000K	2500	210903	210927
39	2660Lm	3000K	1200	207217	207576	84	5700Lm	3000K	2600	210934	210958
39	2660Lm	4000K	1200	207224	207583	84	5700Lm	4000K	2600	210941	210965
42	2857Lm	3000K	1300	207231	207590	87	5904Lm	3000K	2700	210972	210996
42	2857Lm	4000K	1300	207248	207606	87	5904Lm	4000K	2700	210989	211009
45	3067Lm	3000K	1400	207255	207613	90	6107Lm	3000K	2800	211016	211030
45	3067Lm	4000K	1400	207262	207620	90	6107Lm	4000K	2800	211023	211047
48	3264Lm	3000K	1500	207279	207637	93	6311Lm	3000K	2900	211054	211078
48	3264Lm	4000K	1500	207286	207644	93	6311Lm	4000K	2900	211061	211085
51	3481Lm	3000K	1600	207293	207651	96	6514Lm	3000K	3000	211092	211115
51	3481Lm	4000K	1600	207309	207668	96	6514Lm	4000K	3000	211108	211122

Other sizes, shapes and colors available upon request
 Autres tailles, formes et couleurs disponibles sur demande

ACCESSORIES | ACCESSOIRES

Ceiling rose + 3 core cable (white)
 Rosace + Câble 3 fils (blanc)

Ref. 208603

Ceiling rose + 3 core cable (black)
 Rosace + Câble 3 fils (noir)

Ref. 208610

Ceiling rose + 5 core cable (white)
 Rosace + Câble 3 fils (blanc)

Ref. 208627

Ceiling rose + 5 core cable (black)
 Rosace + Câble 3 fils (noir)

Ref. 208634

Suspension + steel wire 1.5m
 Suspension + câble acier 1.5m

Ref. 205992

Suspension + steel wire 2.5m
 Suspension + câble acier 2.5m

Ref. 206005

Connector kit union
 Kit connecteur union

Ref. 202410

Mitre cutting
 Coupe ongles

Ref. 202427

Trimless fixing for 35x70 profile
 Fixation trimless pour profilé 35x70

Ref. 208252

Wall mounting profile | White
 Fixation murale pour profilé | Blanc

Ref. 994216

Wall mounting profile | Black
 Fixation murale pour profilé | Noir

Ref. 993745

PROFILED SLIM *Infinity*

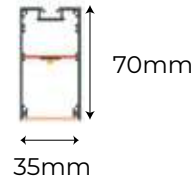

Temperatures | Températures



Light source | Source lumineuse

OSRAM - L80B10

Finish | Finitions



LED lifetime | Durée de vie LED

50.000h



Materials | Matériaux

Aluminium



Optional dimming | Dimmable en option





ACCESSORIES ACCESSOIRES

Ceiling rose + 3 core cable (white)
Rosace + Câble 3 fils (blanc)

Ref. 208603

Ceiling rose + 3 core cable (black)
Rosace + Câble 3 fils (noir)

Ref. 208610

Ceiling rose + 5 core cable (white)
Rosace + Câble 3 fils (blanc)

Ref. 208627

Ceiling rose + 5 core cable (black)
Rosace + Câble 3 fils (noir)

Ref. 208634

Suspension + steel wire 1.5m
Suspension + câble acier 1.5m

Ref. 205992

Suspension + steel wire 2.5m
Suspension + câble acier 2.5m

Ref. 206005

Connector kit union
Kit connecteur union

Ref. 202410

Mitre cutting
Coupe onglet

Ref. 202427

Trimless fixing for 35x70 profile
Fixation trimless pour profilé
35x70

Ref. 208252

Wall mounting profile | White
Fixation murale pour profilé |
Blanc

Ref. 994216

Wall mounting profile | Black
Fixation murale pour profilé |
Noir

Ref. 993745

W	Flux	K	L	○	●
10	1113Lm	3000K	35x70x334	205756	205879
10	1113Lm	4000K	35x70x334	205763	205886
20	2225Lm	3000K	35x70x652	205770	205893
20	2225Lm	4000K	35x70x652	205787	205909
30	3338Lm	3000K	35x70x970	205794	205916
30	3338Lm	4000K	35x70x970	205800	205923
40	4450Lm	3000K	35x70x1288	205817	205930
40	4450Lm	4000K	35x70x1288	205824	205947
50	5563Lm	3000K	35x70x1606	205831	205954
50	5563Lm	4000K	35x70x1606	205848	205961
60	6675Lm	3000K	35x70x1924	205855	205978
60	6675Lm	4000K	35x70x1924	205862	205985
70	7788Lm	3000K	35x70x2242	211139	211153
70	7788Lm	4000K	35x70x2242	211146	211160
80	8900Lm	3000K	35x70x2560	211177	211191
80	8900Lm	4000K	35x70x2560	211184	211207
90	10013Lm	3000K	35x70x2878	211214	211238
90	10013Lm	4000K	35x70x2878	211221	211245

Other sizes, shapes and colors available upon request
Autres tailles, formes et couleurs disponibles sur demande

PROFILED

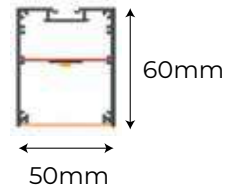

Temperatures | Températures



Light source | Source lumineuse

TRIDONIC TCI - L80B10

Finish | Finitions



LED lifetime | Durée de vie LED

50.000h



Materials | Matériaux

Aluminium



Optional dimming | Dimmable en option

CASAMBI



Diffuser | Diffuseur

Opal or microprismatic
Opale ou microprismatique



ACCESSORIES ACCESSOIRES

Suspension + steel wire 2 m,
Profiled (1 pc.)
Suspension + câble acier 2 m,
profilé (1 pièce)

Ref. 993417

Direct suspension profiled
(1 pc.)
Fixation directe au plafond,
profilé (1 pièce)

Ref. 993424

Ceiling rose + transparent
3-wire cable (black)
Rosace + câble transparent 3
fils (noir)

Ref. 993653

Ceiling rose + transparent
3-wire cable (white)
Rosace + câble transparent 3
fils (blanc)

Ref. 994124

Ceiling rose + transparent
5-wire cable (black)
Rosace + câble transparent 5
fils (noir)

Ref. 998658

Ceiling rose + transparent
5-wire cable (white)
Rosace + câble transparent 5
fils (blanc)

Ref. 998641

Emergency kit 1 h, 30% lumens
Kit de secours 1 h, 30% lumens

Ref. 991901

Union connector kit
Kit de jonction de connecteurs

Ref. 202410

Mitre cutting
Coupe d'onglet

Ref. 202427

Controller kit + profiled
autonomous control
Kit contrôleur + commande
autonome Profiled

Ref. 202458

Profiled controller
Contrôleur Profiled

Ref. 202441

Trimless mounting
Fixation sans cadre

Ref. 205060

W	Flux	K	mm	○	●
8	1200Lm	3000K	50x60x300	993998	993523
8	1200Lm	4000K	50x60x300	994001	993530
8	1200Lm	5000K	50x60x300	994018	993547
16	1850Lm	3000K	50x60x570	994025	993554
16	1850Lm	4000K	50x60x570	994032	993561
16	1850Lm	5000K	50x60x570	994049	993578
32	3600Lm	3000K	50x60x1130	994056	993585
32	3600Lm	4000K	50x60x1130	994063	993592
32	3600Lm	5000K	50x60x1130	994070	993608
40	4600Lm	3000K	50x60x1410	994087	993615
40	4600Lm	4000K	50x60x1410	994094	993622
40	4600Lm	5000K	50x60x1410	994100	993639
48	5500Lm	3000K	50x60x1690	996326	996296
48	5500Lm	4000K	50x60x1690	994469	996302
48	5500Lm	5000K	50x60x1690	996340	996319

Other sizes, shapes and colors available upon request
Autres tailles, formes et couleurs disponibles sur demande

PROFILED TRACK

Track System

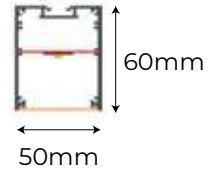
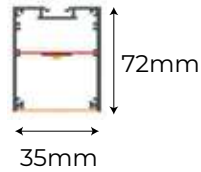

Temperatures | Températures



Light source | Source lumineuse

TRIDONIC TCI - L80B10

Finish | Finitions



LED lifetime | Durée de vie LED

50.000h



Materials | Matériaux

Aluminium



Optional dimming | Dimmable en option

CASAMBI



Diffuser | Diffuseur

Opal or microprismatic
Opale ou microprismatique



W	Flux	K	mm	○	●
16	2800Lm	3000K	35x72x580	203950	203851
16	2800Lm	4000K	35x72x580	203967	203868
24	4200Lm	3000K	35x72x860	203974	203875
24	4200Lm	4000K	35x72x860	203981	203882
32	5600Lm	3000K	35x72x1140	203998	203899
32	5600Lm	4000K	35x72x1140	204001	203905
40	7000Lm	3000K	35x72x1420	204018	203912
40	7000Lm	4000K	35x72x1420	204025	203929
48	8400Lm	3000K	35x72x1700	204032	203936
48	8400Lm	4000K	35x72x1700	204049	203943
<hr/>					
8	1400Lm	3000K	50x60x300	206272	206159
8	1400Lm	4000K	50x60x300	206289	206166
16	2800Lm	3000K	50x60x570	206296	206173
16	2800Lm	4000K	50x60x570	206302	206180
24	4200Lm	3000K	50x60x850	206319	206197
24	4200Lm	4000K	50x60x850	206326	206203
32	5600Lm	3000K	50x60x1130	206333	206210
32	5600Lm	4000K	50x60x1130	206340	206227
40	7000Lm	3000K	50x60x1410	206357	206234
40	7000Lm	4000K	50x60x1410	206364	206241
48	8400Lm	3000K	50x60x1690	206371	206258
48	8400Lm	4000K	50x60x1690	206388	206265

Other sizes, shapes and colors avail able upon request
 Autres tailles, formes et couleurs disponibles sur demande

PROFILED WOOD

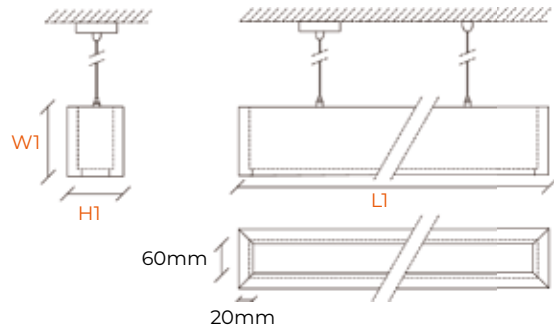

Temperatures | Températures



Light source | Source lumineuse

TRIDONIC TCI - L80B10
Equipped with PCB | Équipé d'un PCB

Finish | Finitions



Walnut | Noyer



Pine | Pin

LED lifetime | Durée de vie LED

50.000h



Materials | Matériaux

Aluminium profiled + solid wood
Profilé en aluminium + bois massif

Optional dimming | Dimmable en option

CASAMBI



Diffuser | Diffuseur

Opal or microprismatic
Opale ou microprismatique



W	Flux	K	W1 x H1 x L1 mm	W	P
30	4300Lm	3000K	100x102x1144	208269	208344
30	4300Lm	4000K	100x102x1144	208276	208351
37	5500Lm	3000K	100x102x1424	208283	208368
37	5500Lm	4000K	100x102x1424	208290	208375

Other sizes, shapes and colors available upon request
 Autres tailles, formes et couleurs disponibles sur demande

ACCESSORIES | ACCESSOIRES

Suspension kit 2,5m profiled (white)
 Kit de suspension 2,5m profiled (blanc)
 Ref. 996623

Suspension kit 2,5m profiled (black)
 Kit de suspension 2,5m profiled (noir)
 Ref. 998726

PROFILED WOOD SLIM

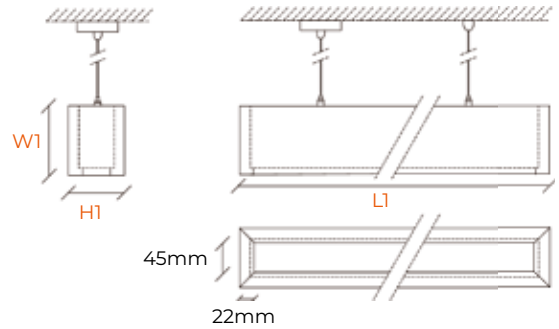

Temperatures | Températures



Finish | Finitions



Walnut | Noyer



Pine | Pin

Materials | Matériaux

Aluminium profiled + solid wood
Profilé en aluminium + bois massif

Diffuser | Diffuseur

Opal or microprismatic
Opale ou microprismatique

Light source | Source lumineuse

TRIDONIC TCI - L80B10
Equipped with PCB | Équipé d'un PCB

LED lifetime | Durée de vie LED

50.000h



Optional dimming | Dimmable en option

CASAMBI





W	Flux	K	W1 x H1 x L1 mm	W	P
30	4300Lm	3000K	85x102x1144	208306	208382
30	4300Lm	4000K	85x102x1144	208313	208399
37	5500Lm	3000K	85x102x1424	208320	208405
37	5500Lm	4000K	85x102x1424	208337	208412

Other sizes, shapes and colors available upon request
 Autres tailles, formes et couleurs disponibles sur demande

ACCESSORIES | ACCESSOIRES

Suspension kit 2,5m profiled (white)
 Kit de suspension 2,5m profiled (blanc)
 Ref. 996623

Suspension kit 2,5m profiled (black)
 Kit de suspension 2,5m profiled (noir)
 Ref. 998726

PROFILED CORK

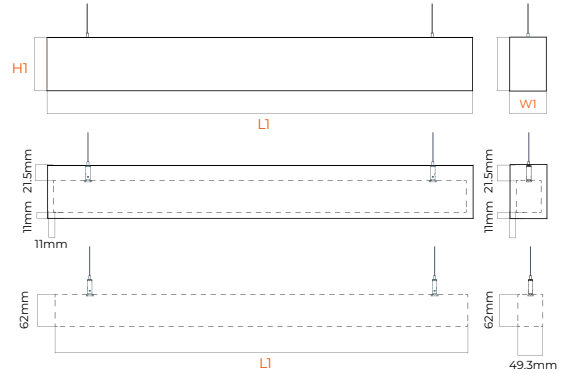
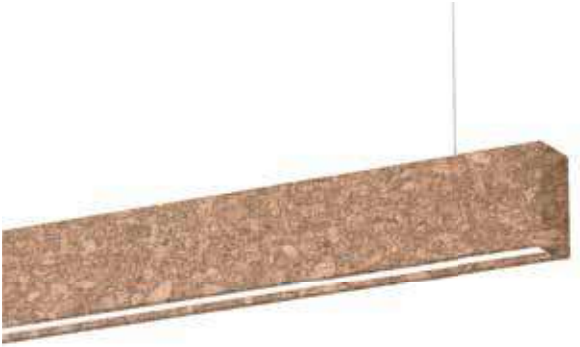

Temperatures | Températures

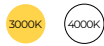

Finish | Finitions



Materials | Matériaux

Aluminium profiled + Cork
 Profilé en aluminium + Liège

Diffuser | Diffuseur

Opal or microprismatic
 Opale ou microprismatique

Light source | Source lumineuse

TRIDONIC TCI - L80B10
 Équipé with PCB | Équipé d'un PCB

LED lifetime | Durée de vie LED

50.000h



Optional dimming | Dimmable en option





W	Flux	K	W1 x H1 x L1 mm	Ref.
18	1850Lm	3000K	75x100x588	208429
18	1850Lm	4000K	75x100x588	208436
35	3700Lm	3000K	75x100x1148	208443
35	3700Lm	4000K	75x100x1148	208450
43	4620Lm	3000K	75x100x1428	208467
43	4620Lm	4000K	75x100x1428	208474
56	6010Lm	3000K	75x100x1848	208481
56	6010Lm	4000K	75x100x1848	208498

*Other sizes, shapes and colors avail able upon request
Autres tailles, formes et couleurs disponibles sur demande*

ACCESSORIES | ACCESSOIRES

Suspension kit 2,5m profiled (white)
Kit de suspension 2,5m profiled (blanc)
Ref. 996623

Suspension kit 2,5m profiled (black)
Kit de suspension 2,5m profiled (noir)
Ref. 998726

PROFILED

DIRECT AND INDIRECT LIGHT
ÉCLAIRAGE DIRECT ET INDIRECT

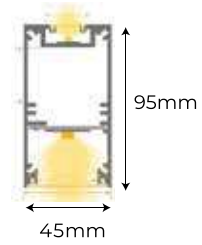

Temperatures | Températures



Light source | Source lumineuse

TRIDONIC TCI - L80B10

Finish | Finitions



LED lifetime | Durée de vie LED

50.000h



Materials | Matériaux

Aluminium



Optional dimming | Dimmable en option

CASAMBI



Diffuser | Diffuseur

Opal or microprismatic
Opale ou microprismatique



W	Flux	K	mm	○	●
16	1800Lm	3000K	45x95x300	994131	993660
16	1800Lm	4000K	45x95x300	994148	993677
32	3600Lm	3000K	45x95x570	994155	993684
32	3600Lm	4000K	45x95x570	994162	993691
64	7300Lm	3000K	45x95x1130	994179	993707
64	7300Lm	4000K	45x95x1130	994186	993714
80	9300Lm	3000K	45x95x1410	994193	993721
80	9300Lm	4000K	45x95x1410	994209	993738

Other sizes, shapes and colors avail able upon request
 Autres tailles, formes et couleurs disponibles sur demande

ACCESSORIES | ACCESSOIRES

Ceiling rose + 3 core cable (white)
 Rosace + Câble 3 fils (blanc)
 Ref. 994124

Ceiling rose + 3 core cable (black)
 Rosace + Câble 3 fils (noir)
 Ref. 993653

Suspension + steel wire 2m Profiled (1pc.)
 Suspension + câble acier 2m Profiled (1 pc.)
 Ref. 993462

Profiled Ceiling wall White (1pc.)
 Accroche au mur Profiled Blanc (1pc.)
 Ref. 994216

Profiled Ceiling wall Black (1pc.)
 Accroche au mur Profiled Noir (1pc.)
 Ref. 993745

Ceiling rose + transparent cable 5 wires (white)
 Rosace + câble transperent - 5 câbles (blanc)
 Ref. 998641

Ceiling rose + transparent cable 5 wires (black)
 Rosace + câble transperent - 5 câbles (noir)
 Ref. 998658

Emergency kit 1h 30% lumens
 Kit de secours 1h 30% lumens
 Ref. 991901

PROFILED

RECESSED
ENCASTRABLE

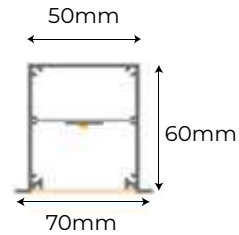

Temperatures | Températures



Light source | Source lumineuse

TRIDONIC TCI - L80B10

Finish | Finitions



LED lifetime | Durée de vie LED

50.000h



Materials | Matériaux

Aluminium



Optional dimming | Dimmable en option

CASAMBI



Diffuser | Diffuseur

Opal or microprismatic
Opale ou microprismatique



W	Flux	K	mm	○	●
8	1200Lm	3000K	70x60x300	994230	993769
8	1200Lm	4000K	70x60x300	994247	993776
8	1200Lm	5000K	70x60x300	994254	993783
16	1850Lm	3000K	70x60x570	994261	993790
16	1850Lm	4000K	70x60x570	994278	993806
16	1850Lm	5000K	70x60x570	994285	993813
32	3600Lm	3000K	70x60x1130	994292	993820
32	3600Lm	4000K	70x60x1130	994308	993837
32	3600Lm	5000K	70x60x1130	994315	993844
40	4600Lm	3000K	70x60x1410	994322	993851
40	4600Lm	4000K	70x60x1410	994339	993868
40	4600Lm	5000K	70x60x1410	994346	993875
48	5500Lm	3000K	70x60x1690	996388	996357
48	5500Lm	4000K	70x60x1690	994476	996364
48	5500Lm	5000K	70x60x1690	996401	996371

Other sizes, shapes and colors avail able upon request
 Autres tailles, formes et couleurs disponibles sur demande

ACCESSORIES | ACCESSOIRES

Recessed mounting profile, 70x60 mm
 Fixation pour profilé encastré, 70x60 mm
 Ref. 993493

Emergency kit, 1h autonomy – 30% luminous flux
 Kit de secours, autonomie 1h – 30 % flux lumineux
 Ref. 991901

MINI PROFILED

RECESSED - External driver

ENCASTRÉ - Driver externe

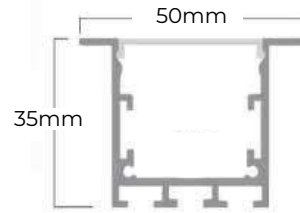

Temperatures | Températures



Light source | Source lumineuse

TRIDONIC TCI - L80B10

Finish | Finitions



LED lifetime | Durée de vie LED

50.000h



Materials | Matériaux

Aluminium



Optional dimming | Dimmable en option

CASAMBI



Diffuser | Diffuseur

Opal or microprismatic
Opale ou microprismatique



W	Flux	K	mm	○	●
16	1850Lm	3000K	35x35x580	994360	993899
16	1850Lm	4000K	35x35x580	994377	993905
16	1850Lm	5000K	35x35x580	994384	993912
32	3600Lm	3000K	35x35x1140	994391	993929
32	3600Lm	4000K	35x35x1140	994407	993936
32	3600Lm	5000K	35x35x1140	994414	993943
40	4600Lm	3000K	35x35x1420	994421	993950
40	4600Lm	4000K	35x35x1420	994438	993967
40	4600Lm	5000K	35x35x1420	994445	993974

Other sizes, shapes and colors available upon request
 Autres tailles, formes et couleurs disponibles sur demande

ACCESSORIES | ACCESSOIRES

Fixing clamps for 35x35 mm profile
 Supports de fixation pour profilé 35x35 mm

Ref. 993516

Emergency kit, 1h – 30% lumen output
 Kit de secours, autonomie 1h – 30 % flux lumineux

Ref. 991901

MINI PROFILED

External driver

Driver externe

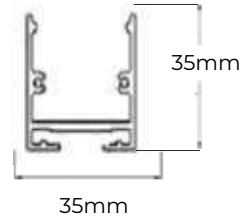

Temperatures | Températures



Light source | Source lumineuse

TRIDONIC TCI - L80B10

Finish | Finitions



LED lifetime | Durée de vie LED

50.000h



Materials | Matériaux

Aluminium



Optional dimming | Dimmable en option

CASAMBI



Diffuser | Diffuseur

Opal or microprismatic
Opale ou microprismatique



W	Flux	K	mm	○	●
16	1850Lm	3000K	35x35x580	994698	994827
16	1850Lm	4000K	35x35x580	994704	994834
16	1850Lm	5000K	35x35x580	994711	994841
32	3600Lm	3000K	35x35x1140	994728	994858
32	3600Lm	4000K	35x35x1140	994735	994865
32	3600Lm	5000K	35x35x1140	994742	994872
40	4600Lm	3000K	35x35x1420	994759	994889
40	4600Lm	4000K	35x35x1420	994766	994896
40	4600Lm	5000K	35x35x1420	994773	994902

Other sizes, shapes and colors avail able upon request
 Autres tailles, formes et couleurs disponibles sur demande

ACCESSORIES | ACCESSOIRES

Ceiling rose XL + 2 m cable (white)
 Rosace XL + câble de suspension 2 m (blanc)

Ref. 996289

Ceiling rose XL + 2 m cable (black)
 Rosace XL + câble de suspension 2 m (noir)

Ref. 996272

Ceiling rose + transparent cable 3 wires (white)
 Rosace + câble transparent, 3 fils (blanc)

Ref. 994124

Ceiling rose + transparent cable 3 wires (black)
 Rosace + câble transparent, 3 fils (noir)

Ref. 993653

Suspension + steel wire 2m (1pc)
 Suspension + câble acier 2m (1pc)

Ref. 994674

Direct mounting clip (1 pc.)
 Fixation directe (1 pc.)

Ref. 994681

Trimless Fixing for 35x35 profiled
 Fixation trimless pour profilé 35x35

Ref. 204322

Emergency kit, 1h – 30% lumen output
 Kit de secours, autonomie 1h – 30 % flux lumineux

Ref. 991901

PROFILED TUBE 60H

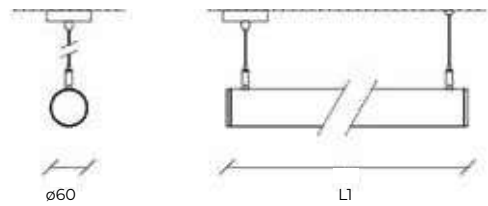
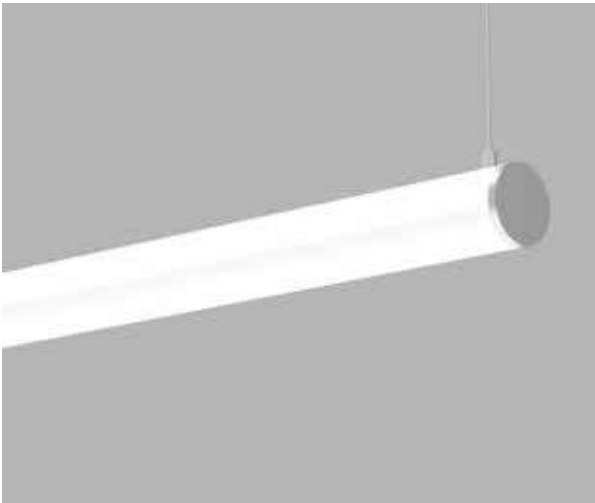

Temperatures | Températures



Materials | Matériaux

Aluminium



Polycarbonate



Optional dimming | Dimmable en option



Light source | Source lumineuse

TRIDONIC TCI - L80B10

LED lifetime | Durée de vie LED

45.000h





W	Flux	K	L1	Ø	Ref.
16	2000Lm	3000K	570mm	60mm	201406
16	2000Lm	4000K	570mm	60mm	201413
32	3900Lm	3000K	1130mm	60mm	201420
32	3900Lm	4000K	1130mm	60mm	201437
40	4850Lm	3000K	1410mm	60mm	201444
40	4850Lm	4000K	1410mm	60mm	201451

ACCESSORIES | ACCESSOIRES

Ceiling rose + transparent cable 3 wires (white)

Rosace + câble transparent, 3 fils (blanc)

Ref. 994124

Ceiling rose XL + transparent cable 3 wires (white)

Rosace XL + câble transparent, 3 fils (blanc)

Ref. 996289

Suspension + steel wire

Suspension + câble acier

Ref. 993417

Metal end cap | White

Embout métallique | Blanc

Ref. 202465

Metal end cap | Black

Embout métallique | Noir

Ref. 211443

Metal end cap | Gray

Embout métallique | Gris

Ref. 211450

Surface-mounted installation

Fixation en montage en saillie

Ref. 993424

PROFILED TUBE 60V

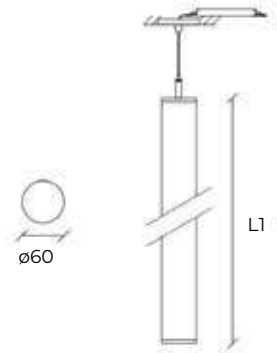

Temperatures | Températures



Materials | Matériaux

Aluminium



Polycarbonate



Optional dimming | Dimmable en option



Light source | Source lumineuse

TRIDONIC TCI - L80B10

LED lifetime | Durée de vie LED

45.000h





W	Flux	K	L1	Ø	Ref.
18	1000Lm	3000K	470mm	60mm	201345
18	1000Lm	4000K	470mm	60mm	201352
38	2100Lm	3000K	970mm	60mm	201369
38	2100Lm	4000K	970mm	60mm	201376
62	3450Lm	3000K	1570mm	60mm	201383
62	3450Lm	4000K	1570mm	60mm	201390

ACCESSORIES | ACCESSOIRES

Suspension Kit 1.2m
 Kit de Suspension 1.2m
 Ref. 201468

Driver protection box
 Boîtier de protection pour driver
 Ref. 201475

PROFILED SLIM PRO

Circular luminaire | Luminaire circulaire



PENDANT | SUSPENDU



SURFACE | EN SAILLIE



TRIMLESS

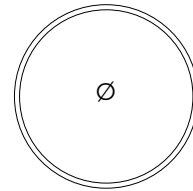
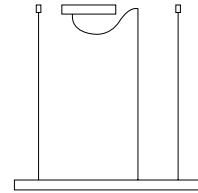
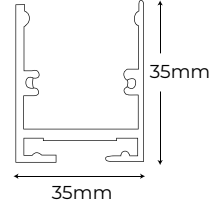

Temperatures | Températures



Light source | Source lumineuse

PCB by OSRAM / TRIDONIC - L80B10

Finish | Finitions



LED lifetime | Durée de vie LED

50.000h



Materials | Matériaux

Aluminium



Optional dimming | Dimmable en option

CASAMBI



Diffuser | Diffuseur

Frosted | Dépoli



W	Flux	K	Ø mm	○	●
48	3695Lm	2700K	600	204063	204056
48	3695Lm	3000K	600	204087	204070
48	3695Lm	4000K	600	204100	204094
76	5850Lm	2700K	900	204124	204117
76	5850Lm	3000K	900	204148	204131
76	5850Lm	4000K	900	204162	204155
100	7700Lm	2700K	1200	204186	204179
100	7700Lm	3000K	1200	204209	204193
100	7700Lm	4000K	1200	204223	204216
120	9240Lm	2700K	1500	208931	208924
120	9240Lm	3000K	1500	208955	208948
120	9240Lm	4000K	1500	208979	208962
140	10780Lm	2700K	1800	208993	208986
140	10780Lm	3000K	1800	209013	209006
140	10780Lm	4000K	1800	209037	209020

ACCESSORIES | ACCESSOIRES

Ceiling rose + 4 white suspension cables
Rosace + 4 câbles de suspension blancs

Ref. 209136

Ceiling rose + 4 black suspension cables
Rosace + 4 câbles de suspension noir

Ref. 209983

Ceiling rose | 4 custom-length white suspension cables
Rosace de plafond | 4 câbles suspension blancs sur mesure

Ref. 209143

Ceiling rose | 4 custom-length black suspension cables
Rosace de plafond | 4 câbles suspension noir sur mesure

Ref. 209990

PROFILED CIRCULAR



PENDANT | SUSPENSION



SURFACE | EN SAILLIE

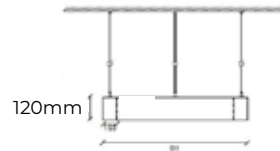

Temperatures | Températures



Materials | Matériaux

Aluminium



Diffuser | Diffuseur

Frosted | Dépoli

Light source | Source lumineuse

PCB by OSRAM / TRIDONIC - L80B10

LED lifetime | Durée de vie LED

50.000h



Optional dimming | Dimmable en option

CASAMBI





W	Flux	K	H mm	Ø mm	Ref.
74	9300Lm	3000K	120	900	997040
74	9300Lm	4000K	120	900	997057
97	12400Lm	3000K	120	1200	997064
97	12400Lm	4000K	120	1200	997071

Other sizes and colors available upon request
 Autres tailles et couleurs disponibles sur demande

ACCESSORIES | ACCESSOIRES

Ceiling rose + white cable
 Rosace + câble suspension blanc
 Ref. 997088

Ceiling rose + tailor-made white cable
 Rosace + câble suspension blanc sur mesure
 Ref. 995848

LUNA

Circular luminaire
Luminaire circulaire



PENDANT | SUSPENSION



SURFACE | EN SAILLIE

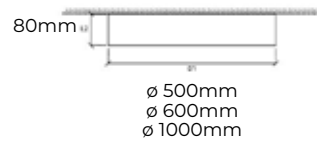

Temperatures | Températures



Materials | Matériaux

Aluminium



Diffuser | Diffuseur

Opal or microprismatic
Opale ou microprismatique

Light source | Source lumineuse

PCB by OSRAM / TRIDONIC - L80B10

LED lifetime | Durée de vie LED

50.000h



Optional dimming | Dimmable en option

CASAMBI





W	Flux	K	H mm	Ø mm	Ref.
40	3000Lm	3000K	80	500	995770
40	3000Lm	4000K	80	500	995787
72	5850Lm	3000K	80	600	995794
72	5850Lm	4000K	80	600	995800
100	14750Lm	3000K	80	1000	995817
100	14750Lm	4000K	80	1000	995824

*Other sizes and colors available upon request
Autres tailles et couleurs disponibles sur demande*

ACCESSORIES | ACCESSOIRES

Ceiling rose + white cable 2.5m
Rosace + câble suspension blanc 2.5m
Ref. 995831

Ceiling rose + tailor-made white cable
Rosace + câble suspension blanc sur mesure
Ref. 999358

LUNA

Recessed

Encastré

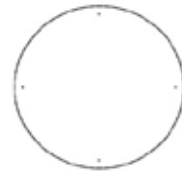
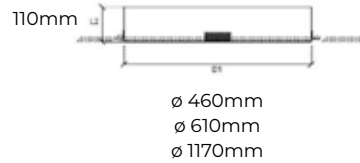

Temperatures | Températures



Light source | Source lumineuse

PCB / TRIDONIC - L80B10

Materials | Matériaux

Aluminium



Polycarbonate



LED lifetime | Durée de vie LED

50.000h



Diffuser | Diffuseur

Opal or microprismatic
Opale ou microprismatique

Optional dimming | Dimmable en option

CASAMBI





W	Flux	K	H mm	Ø mm	Ref.
37	2800Lm	3000K	110	460	999211
37	2800Lm	4000K	110	460	999228
60	6400Lm	3000K	110	610	999235
60	6400Lm	4000K	110	610	999242
134	15500Lm	3000K	110	1170	999259
134	15500Lm	4000K	110	1170	999266

Ceiling mounting kit included. Other sizes, shapes and colors available upon request.

Kit de fixation au plafond inclus. Autres tailles, formes et couleurs disponibles sur demande.



JUNO FLEX NANO

Surface-mounted projector

Projecteur en saillie

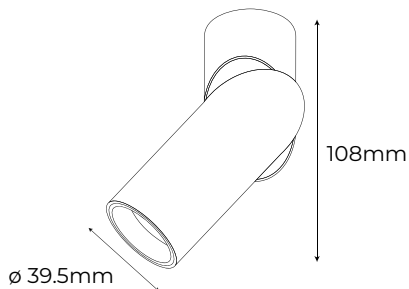

Finish | Finitions

○ White | Blanc ● Black | Noir

Materials | Matériaux

Aluminium



Max. power | Puissance maximale

60W



Lamp holder | Douille

GU10 Lamp | Lampe GU10 - 35mmø



○ 209709 ● 209693

JUNO FLEX

Surface-mounted projector

Projecteur en saillie



Finish | Finitions

○
White | Blanc

●
Black | Noir

Materials | Matériaux

Aluminium



Max. power | Puissance maximale

60W



Lamp holder | Douille

GU10 Lamp | Lampe GU10 - 35mmø

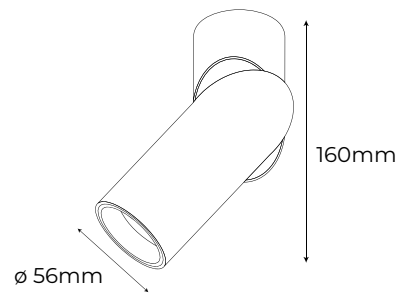

203288

203295

JUNO FLEX TRACK

Track system



Finish | Finitions

○
White | Blanc

●
Black | Noir

Materials | Matériaux

Aluminium



Max. power | Puissance maximale

60W



Lamp holder | Douille

GU10 Lamp | Lampe GU10 - 35mmø

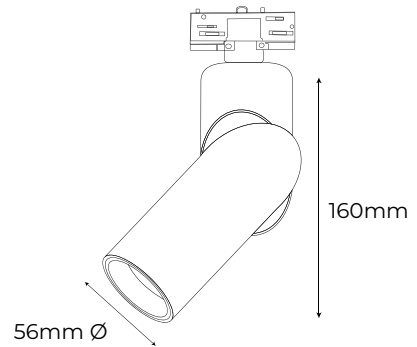

203301



203318

JUNO

Surface-mounted / pendant projector
Projecteur en saillie / suspendu



20° LED Optic on request
Optique de 20° sur demande

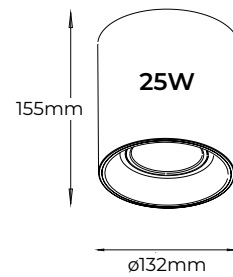
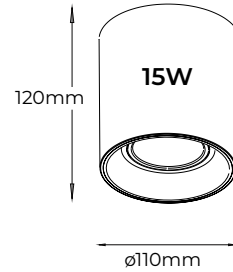

Materials | Matériaux

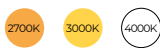

Finish | Finitions



Materials | Matériaux



Light source | Source lumineuse

CITIZEN - L80B10

LED lifetime | Durée de vie LED

35.000h



Optional dimming | Dimmable en option





W	Flux	K	○	●
15	1425Lm	2700K	203097	209266
15	1425Lm	3000K	997514	997576
15	1425Lm	4000K	997545	997606
25	2400Lm	2700K	209617	-
25	2400Lm	3000K	997521	997583
25	2400Lm	4000K	997552	997613

ACCESSORIES | ACCESSOIRES

Suspension kit white 2.5m
Kit de suspension blanc 2.5m

Ref. 977675

Suspension kit black 2.5m
Kit de suspension noir 2.5m

Ref. 997682

JUNO GU10

Surface-mounted projector

Projecteur en saillie

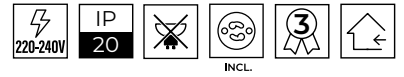

Finish | Finitions

- White | Blanc
- Black | Noir

Materials | Matériaux

Aluminium
AL

Max. power | Puissance maximale

50W
⚡

Lamp holder | Douille

GU10 Lamp | Lampe GU10 - 50mmø

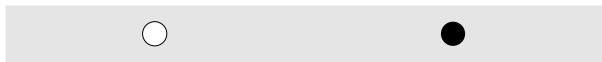
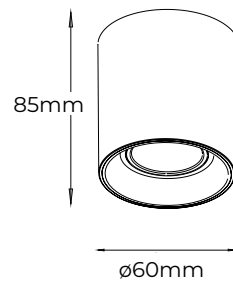

997484

997491

JUNO GU10 Basic

Surface-mounted projector

Projecteur en saillie

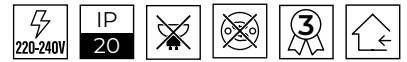

Finish | Finitions

○ White | Blanc ● Black | Noir

Materials | Matériaux

Thermoplastic | Thermoplastique

Max. power | Puissance maximale

50W



Lamp holder | Douille

GU10 Lamp | Lampe GU10 - 50mmø

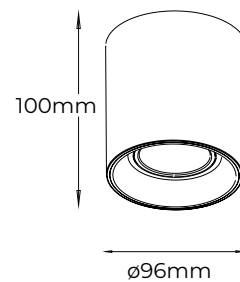

994551



994797

RIGEL GU10

Pendant luminaire
Luminaire suspendu

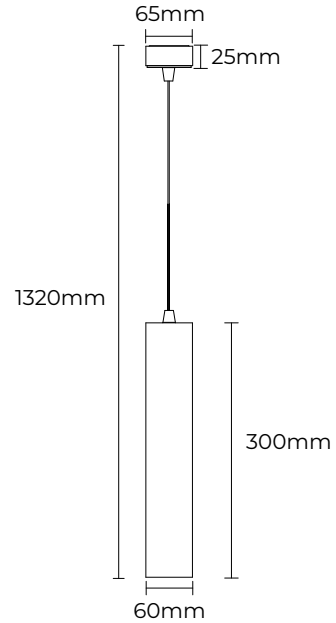

Finish | Finitions

○ White | Blanc ● Black | Noir

Max. power | Puissance maximale

50W
⚡

Materials | Matériaux

Aluminium
AL

Lamp holder | Douille

GU10 Lamp | Lampe GU10 - 50mmø





ACCESSORIES | ACCESSOIRES

Electromechanical rail adapter
Adaptateur électromécanique pour rail
6A - 10Kg - White / Blanc

Ref. 998689

Electromechanical rail adapter
Adaptateur électromécanique pour rail
6A - 10Kg - Black / Noir

Ref. 998696

RIGEL MINI

Pendant luminaire
Luminaire suspendu

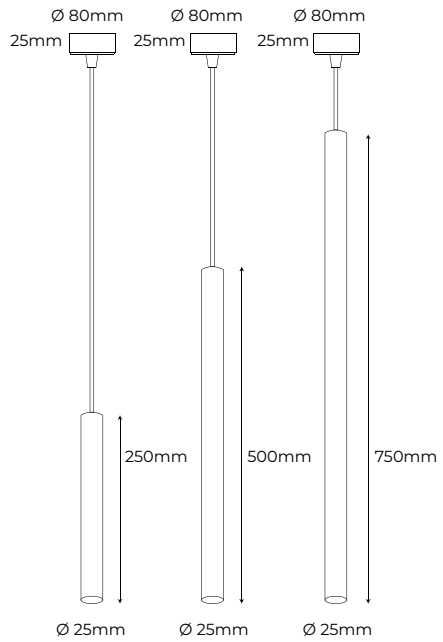

Temperatures | Températures



Other color temperatures available
Autres températures de couleur disponibles

Power – Lumens | Puissance – Lumens

5W - 500Lm

Light source | Source lumineuse

COB LED - L80B10

Finish | Finitions

- White
Blanc
- Black
Noir
- Grey
Gris
- Cooper
Bronze
- Golden
Or

LED lifetime | Durée de vie LED

50.000h



Materials | Matériaux

Aluminium



Dimmable

Not dimmable | Non dimmable





	250mm	500mm	750mm
○ White Blanc	204827	204872	204926
● Black Noir	204810	204865	204919
● Grey Gris	204834	204889	204933
● Cooper Bronze	204841	204896	204940
● Golden Or	204858	204902	204957

MINI SPOT

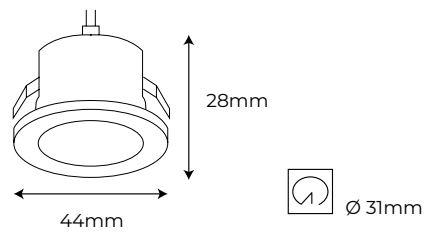

Temperatures | Températures



Finish | Finition



Materials | Matériaux

Thermoplastic | Thermoplastique

Light source | Source lumineuse

LED - L70B20

LED lifetime | Durée de vie LED

20.000h



Dimmable

Not dimmable | Non dimmable





W	Flux	K	A°	Ref.
3	240Lm	2700K	38°	996227
3	240Lm	3000K	38°	996234
3	240Lm	4000K	38°	996241

ACCESSORIES | ACCESSOIRES

Mini-Spot LED decorative ring black
 Collettere à anneau décoratif pour
 mini-spot LED noir

Ref. 997163



Mini-Spot LED decorative ring silver
 Collettere à anneau décoratif pour
 mini-spot LED argent

Ref. 997170



Mini-Spot LED decorative ring gold
 Collettere à anneau décoratif pour
 mini-spot LED or

Ref. 209624



NANO SPOT

Recessed
Encastré

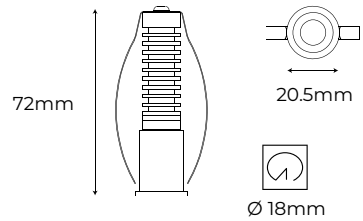

Temperatures | Températures



Finish | Finition



Materials | Matériaux

Aluminium



Light source | Source lumineuse

SAMSUNG LED - L70B50

LED lifetime | Durée de vie LED

30.000h



Dimmable

Not dimmable | Non dimmable





W	Flux	K	A°	Ref.
2	180Lm	2700K	36°	204452
2	180Lm	3000K	36°	204469

ACCESSORY | ACCESSOIRE

Nano recessed ring (Black)
 Colerette nano encastrable (noir)

Ref. 204490

NANO PROJECT

Recessed
Encastré

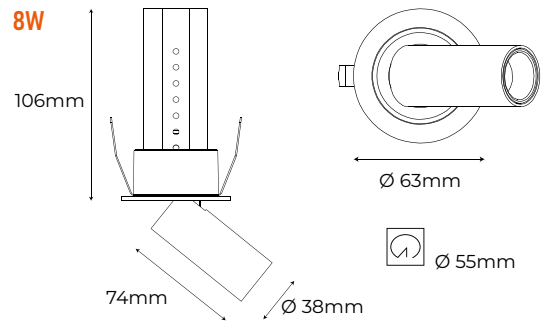
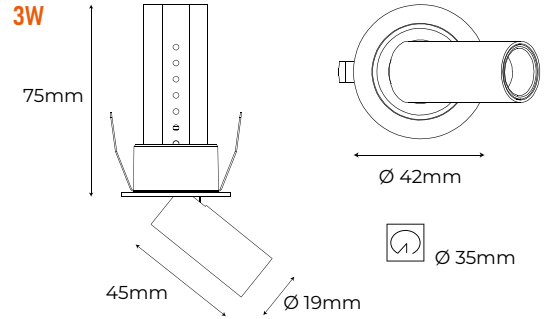
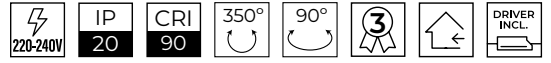

Temperatures | Températures



Light source | Source lumineuse

SAMSUNG LED - L70B50

Finish | Finitions



LED lifetime | Durée de vie LED

30.000h



Materials | Matériaux

Aluminium



Dimmable

Not dimmable | Non dimmable



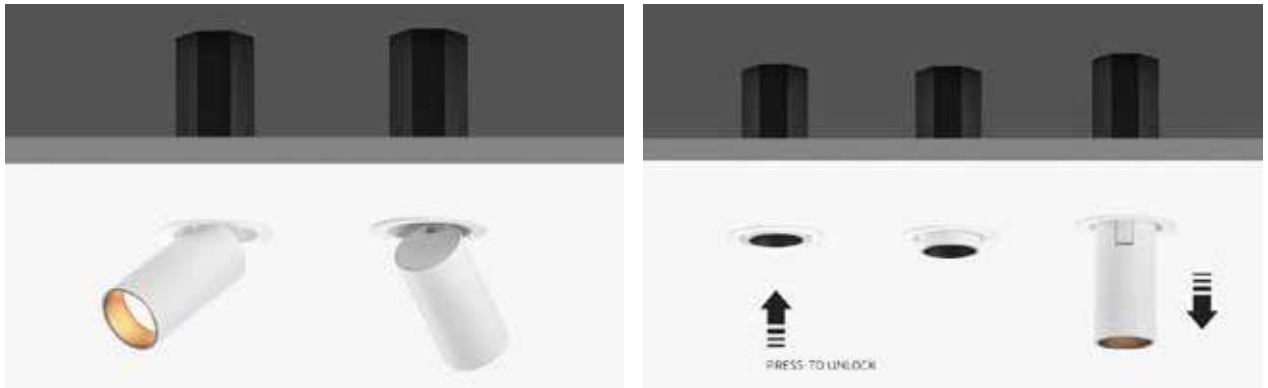

W	Flux	K	A°	○	●
3	180Lm	2700K	15°	204377	209747
3	180Lm	2700K	25°	204384	209754
3	180Lm	2700K	36°	204391	209761
3	180Lm	2700K	60°	204407	209778
3	180Lm	3000K	15°	204414	209785
3	180Lm	3000K	25°	204421	209792
3	180Lm	3000K	36°	204438	209808
3	180Lm	3000K	60°	204445	209815
8	480Lm	2700K	15°	209822	209907
8	480Lm	2700K	25°	209839	209914
8	480Lm	2700K	36°	209846	209921
8	480Lm	2700K	60°	209853	209938
8	480Lm	3000K	15°	209860	209945
8	480Lm	3000K	25°	209877	209952
8	480Lm	3000K	36°	209884	209969
8	480Lm	3000K	60°	209891	209976

KUBIX NEW

Downlight



Temperature | Température



Finish | Finition



Black | Noir

Materials | Matériaux

Aluminium



Light source | Source lumineuse

COB LED - L80B10

LED lifetime | Durée de vie LED

50.000h



Optional dimming | Dimmable en option



KUBIX
4-LED

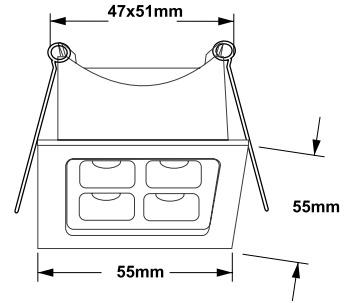

KUBIX LINE
5-LED

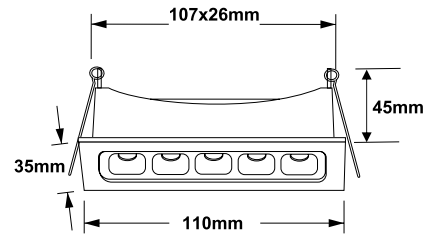

KUBIX BIG
9-LED

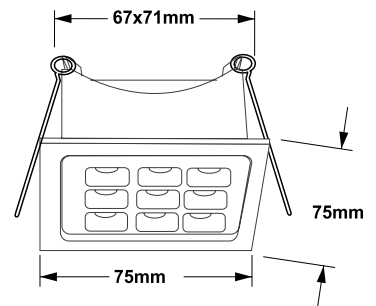

	n° LED	W	Flux	K	A°	Ref.
Kubix	4	7	560Lm	3000K	35°	210200
Kubix Line	5	8	680Lm	3000K	35°	210194
Kubix Big	9	14	1195Lm	3000K	35°	210217

NAOS CCT

Recessed
Encastré

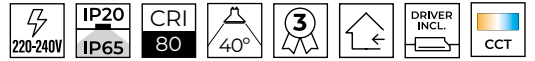

Temperatures | Températures (CCT)



Finish | Finition



Materials | Matériaux



Light source | Source lumineuse

LED COB - L70B50

LED lifetime | Durée de vie LED



Optional dimming | Dimmable en option





MINI

W	Flux	K	A°	Ref.
5	400Lm	2700K - 3000K - 4000K	40°	999853

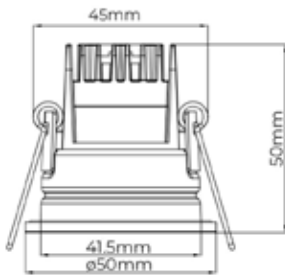

BIG

W	Flux	K	A°	Ref.
10	800Lm	2700K - 3000K - 4000K	40°	999860

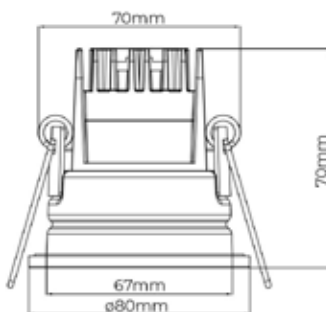

ACCESSORIES | ACCESSOIRES

MINI

White + gold decorative ring
 Colerette décorative Blanche + Dorée
 Ref. 999907



Black decorative ring
 Colerete décorative noire
 Ref. 999891



ACCESSORIES | ACCESSOIRES

BIG

White + gold decorative ring
 Colerette décorative Blanche + Dorée
 Ref. 999884



Black decorative ring
 Colerete décorative noire
 Ref. 999877



VEGA PRO CCT

LED COB Module

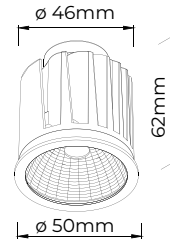

8W

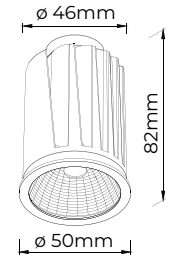

12W

Light source | Source lumineuse

LED COB - L80B10

Temperatures | Températures (CCT)



LED lifetime | Durée de vie LED

50.000h



Materials | Matériaux

Aluminium



Dimmable

Optional dimming | Dimmable en option



W	Flux	K	A°	Ref.
8	765Lm	2700K-3000K-4000K	38°	203202
12	1020Lm	2700K-3000K-4000K	38°	203219

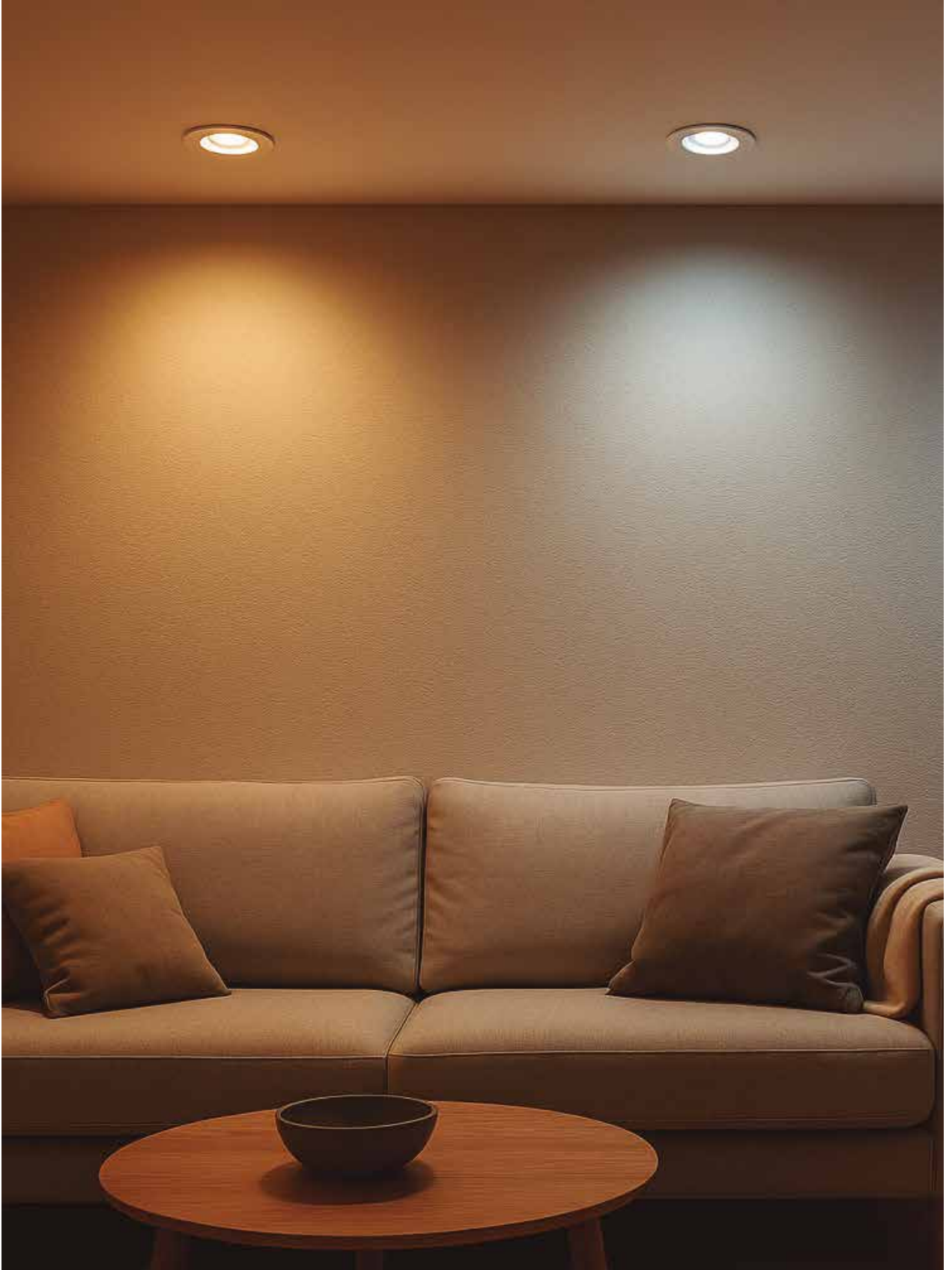

VEGA

LED SMD Module



Temperatures | Températures



Light source | Source lumineuse

SMD LED - L80B10

Finish | Finition



LED lifetime | Durée de vie LED

30.000h



Materials | Matériaux

Aluminium



Dimmable



W	Flux	K	A°	Ref.
8	600Lm	2700K	38°	997934
8	660Lm	4000K	38°	989618

VEGA SLIM

LED SMD Module

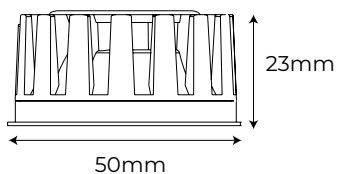

Temperatures | Températures



Light source | Source lumineuse

SMD LED - L70B10

Finish | Finition



LED lifetime | Durée de vie LED

20.000h



Materials | Matériaux

Ceramic | Céramique

Dimmable



W	Flux	K	A°	Ref.
7	500Lm	2700K	38°	996197
7	500Lm	3000K	38°	996203
7	500Lm	4000K	38°	996210

VEGA MODULE / DICHROIC ACCESSOIRES
ACCESSOIRES MODULE VEGA / DICHROÏQUE

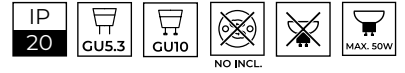

Removable anti-glare spotlight with white ring
 Support de spot anti-éblouissement amovible avec anneau blanc

Materials | Matériaux Aluminium Ref. 206982

Removable anti-glare spotlight with black ring
 Support de spot anti-éblouissement amovible avec anneau noir

Materials | Matériaux Aluminium Ref. 206999

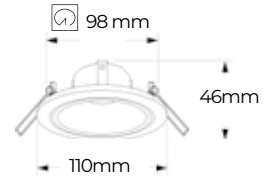
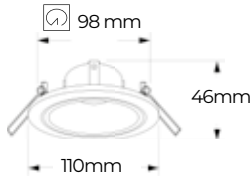

Adjustable round white spotlight holder
 Support de spot rond orientable blanc

Materials | Matériaux Aluminium Ref. 989649

Adjustable square white spotlight holder
 Support de spot carré orientable blanc

Materials | Matériaux Aluminium Ref. 989656

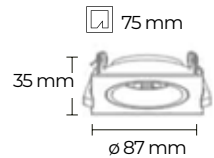
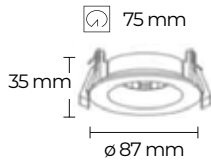

Adjustable black anti-glare round ring
 Anneau rond noir anti-éblouissement réglable

Materials | Matériaux Aluminium Ref. 201185

Adjustable white anti-glare round ring
 Anneau rond blanc anti-éblouissement réglable

Materials | Matériaux Aluminium Ref. 201178

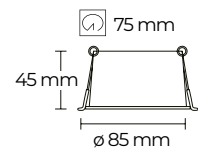
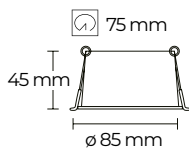

VEGA MODULE / DICHROIC ACCESSOIRES
ACCESSOIRES MODULE VEGA / DICHROÏQUE

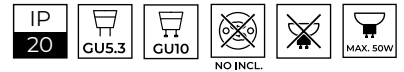

Black anti-glare round ring
 Support de spot basse luminance noir

Materials Thermoplastic **Ref. 994520**
Matériaux Thermoplastique



Black asymmetrical anti-glare round ring
 Support de spot asymétrique basse luminance noir

Materials Thermoplastic **Ref. 994544**
Matériaux Thermoplastique



White anti-glare round ring
 Support de spot basse luminance blanc

Materials Thermoplastic **Ref. 992564**
Matériaux Thermoplastique



White asymmetrical anti-glare round ring
 Support de spot asymétrique basse luminance blanc

Materials Thermoplastic **Ref. 994537**
Matériaux Thermoplastique



White anti-glare square ring
 Support de spot carré basse luminance blanc

Materials Thermoplastic **Ref. 994513**
Matériaux Thermoplastique



White asymmetrical anti-glare square ring
 Support de spot carré asymétrique basse luminance blanc

Materials Thermoplastic **Ref. 994506**
Matériaux Thermoplastique



IP65
VEGA MODULE / DICHROIC ACCESSOIRES
 ACCESSOIRES MODULE VEGA / DICHROÏQUE

IP65 round ring
 Support de Spot IP65

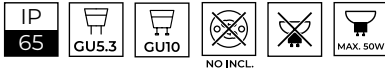

Materials | Matériaux Aluminium

- White | Blanc - 998924
- Black | Noir - 998931



MINI
35mmø - DICHROIC ACCESSOIRES
 35mmø - ACCESSOIRES DICHROÏQUE

Fixed spotlight ring
 Support de spot fixe rond



Materials | Matériaux Aluminium

- White | Blanc - 207750
- Black | Noir - 207804

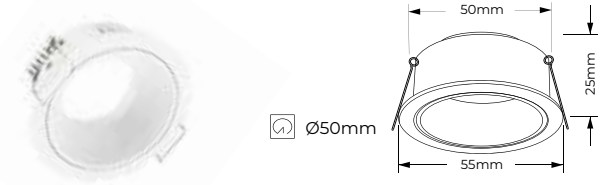

TRIMLESS
VEGA MODULE / DICHROIC ACCESSOIRES
 ACCESSOIRES MODULE VEGA / DICHROÏQUE

Fixed spotlight ring
 Support de spot fixe rond

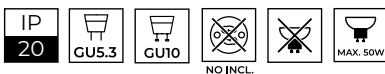

Materials | Matériaux Aluminium

- White | Blanc - 203547
- Black | Noir - 203554

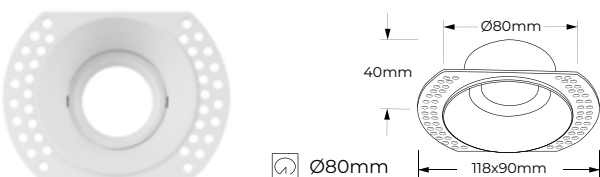

MINI TRIMLESS
35mmø - DICHROIC ACCESSOIRES
 35mmø - ACCESSOIRES DICHROÏQUE

Fixed spotlight ring
 Support de spot fixe rond



Materials | Matériaux Aluminium

- White | Blanc - 207811
- Black | Noir - 207828

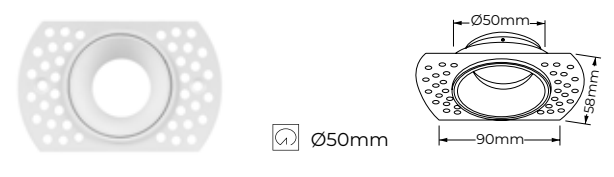

VEGA MODULE / DICHROIC ACCESSOIRES ACCESSOIRES MODULE VEGA / DICHROÏQUE

Fixed spotlight ring
Support de spot fixe rond

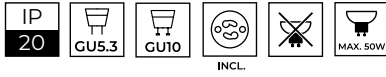

Materials | Matériaux

Aluminium

○ White | Blanc - 901368

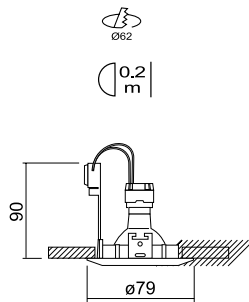

Adjustable round ring
Support de spot rond orientable



Materials | Matériaux

Aluminium

○ White | Blanc - 901382

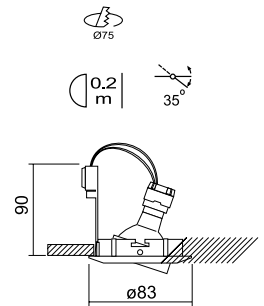

Fixed spotlight ring
Support de spot fixe rond

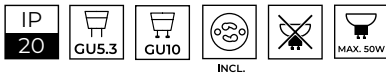

Materials | Matériaux

Aluminium

○ White | Blanc - 901405

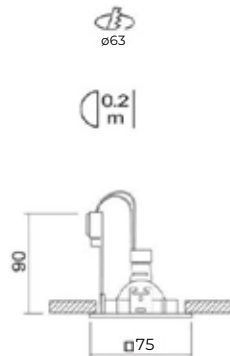

Adjustable square ring
Support de spot carré orientable



Materials | Matériaux

Aluminium

○ White | Blanc - 901429

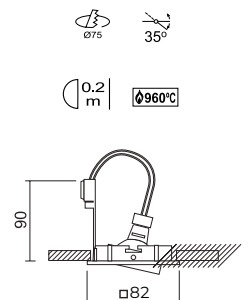

20W - 40W

ORION

Tilting spotlight
Spot basculant

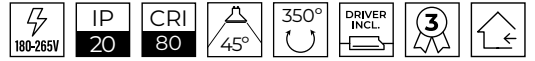

20W

Ø 155mm

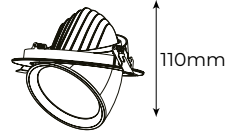

Ø 140mm

40W

Ø 190mm

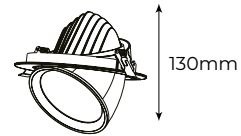

Ø 170mm

Temperatures | Températures



Light source | Source lumineuse

CITIZEN COB LED - L80B10

Finish | Finitions

White | Blanc Black | Noir

LED lifetime | Durée de vie LED

30.000h



Materials | Matériaux

Aluminium



Polycarbonate



Optional dimming | Dimmable en option





W	Flux	K	○	●
20	1600Lm	3000K	988154	999525
20	1800Lm	4000K	988161	999532
40	3200Lm	3000K	988192	999549
40	3400Lm	4000K	988208	999556

SYRIUS CCT

Tilting spotlight
Spot basculant

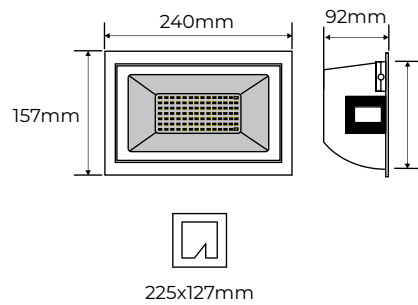

Temperatures | Températures (CCT)



Light source | Source lumineuse

SMD LED - L80B10

Finish | Finition



LED lifetime | Durée de vie LED

30.000h



Materials | Matériaux

Aluminium



Optional dimming | Dimmable en option



W	Flux	K	Ref.
40	3500Lm	3000K - 4000K - 6000K	203370

DRACO CARDAN

Adjustable
Orientable

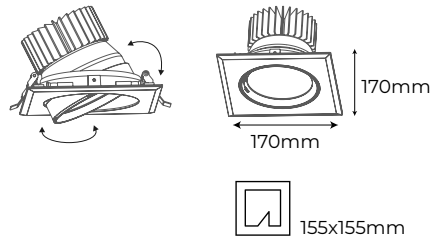
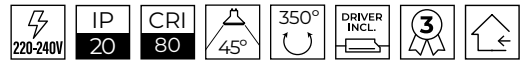

Light source | Source lumineuse

EPISTAR COB LED

Temperatures | Températures



LED lifetime | Durée de vie LED

30.000h



Finish | Finitions

White | Blanc Black | Noir

Optional dimming | Dimmable en option



Materials | Matériaux

Aluminium



Polycarbonate



ACCESSORY | ACCESSOIRE

24° beam angle reflector
Réflecteur à angle de faisceau 24°

Ref. 989069



W	Flux	K	<input type="radio"/>	<input checked="" type="radio"/>
20	1900Lm	3000K	988734	988741
20	2100Lm	4000K	988710	988727

STEPLIGHT MINI

Rectangular
Rectangulaire

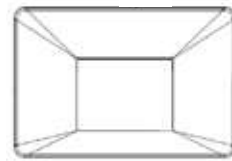
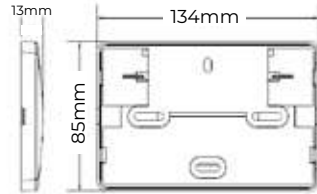

Temperature | Température



Light source | Source lumineuse

SMD LED

Finish | Finitions

White | Blanc

Black | Noir

LED lifetime | Durée de vie LED

25.000h



Materials | Matériaux

Polycarbonate



Dimmable

Not dimmable | Non dimmable



W	Flux	K	<input type="radio"/>	<input checked="" type="radio"/>
3	150Lm	3000K	201574	201581

STEPLIGHT MINI

Round
Rond

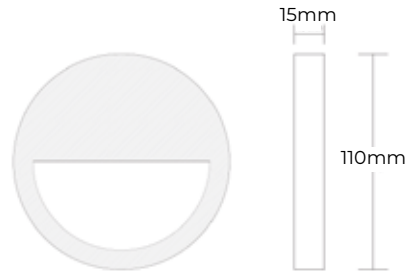

Temperature | Température



Light source | Source lumineuse

SMD LED

Finish | Finitions



White | Blanc



Black | Noir

LED lifetime | Durée de vie LED

25.000h



Materials | Matériaux

Polycarbonate



Dimmable

Not dimmable | Non dimmable



W	Flux	K	○	●
3	200Lm	3000K	201550	201567

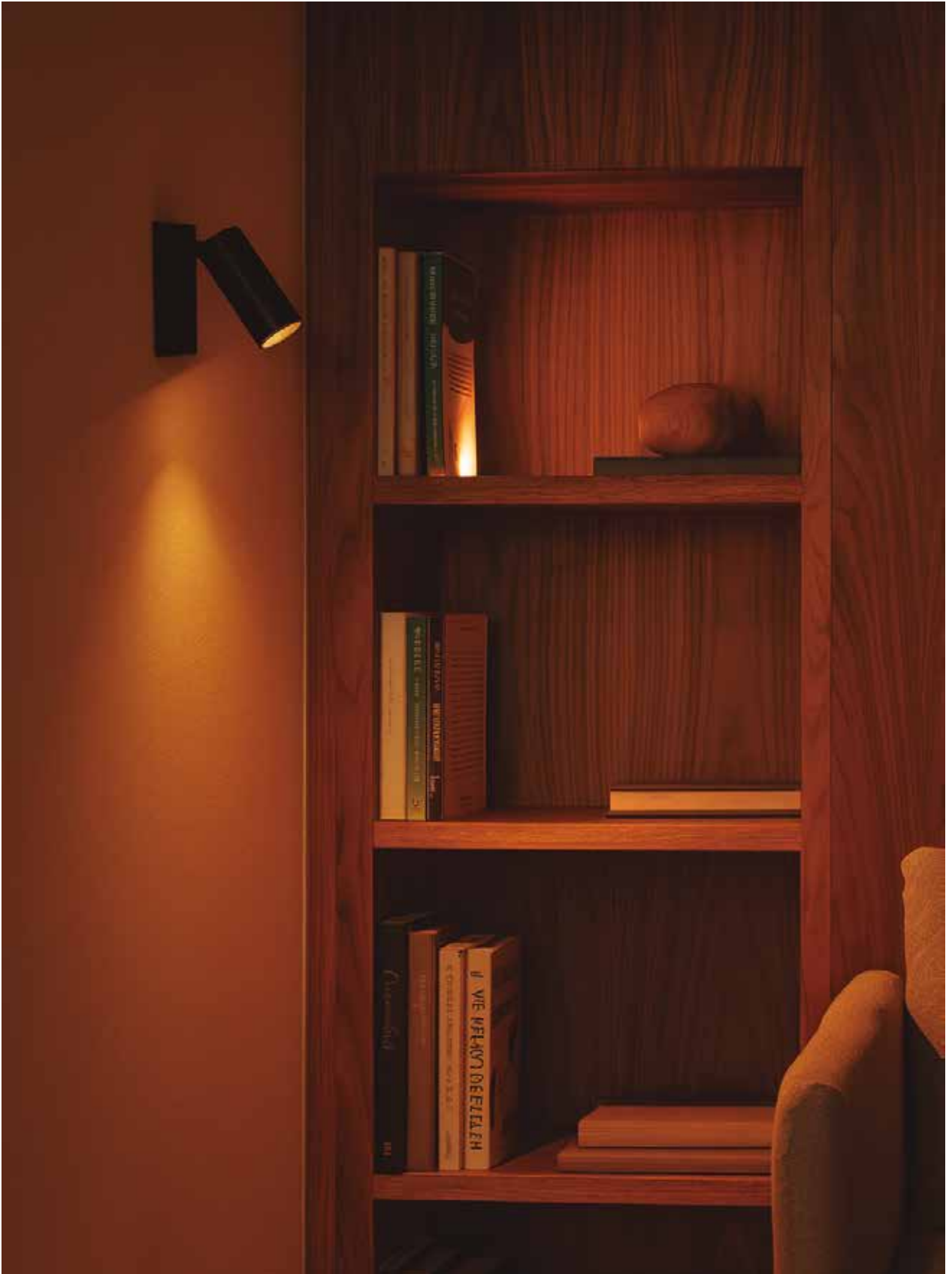

QATAR NEW

Wall-mounted luminaire
Applique murale

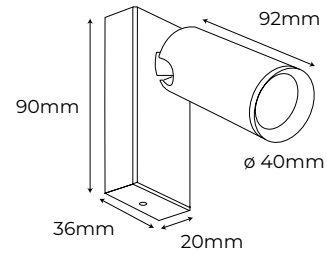

Materials | Matériaux

Aluminium



Lamp holder | Douille

GU10 Lamp | Lampe GU10 - 35mmø



Max. power | Puissance maximale

7W



Colour | Couleur

Ref.

○	White Blanc	210170
●	Black Noir	210163

DUBAI

Wall-mounted luminaire
Applique murale



UNIDIRECTIONAL | UNIDIRECTIONNEL

Materials | Matériaux

Aluminium



Max. power | Puissance maximale

60W



Lamp holder | Douille

GU10 Lamp | Lampe GU10 - 50mmø



Colour Couleur	Ref.
○ White Blanc	204674
● Black Noir	204667
● Silver Argent	204681
● Cooper Bronze	204698
● Golden Or	204704

BIDIRECTIONAL | BIDIRECTIONNEL

Materials | Matériaux

Aluminium



Max. power | Puissance maximale

60W



Lamp holder | Douille

GU10 Lamp | Lampe GU10 - 50mmø



Colour Couleur	Ref.
○ White Blanc	204728
● Black Noir	204711
● Silver Argent	204735
● Cooper Bronze	204742
● Golden Or	204759

DUBAI IP65

Wall-mounted luminaire
Applique murale

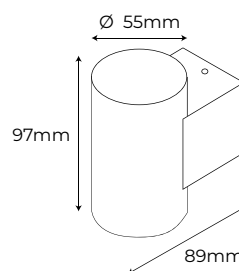

BIDIRECTIONAL | BIDIRECTIONNEL

Materials | Matériaux

Aluminium



Max. power | Puissance maximale

60W



Lamp holder | Douille

GU10 Lamp | Lampe GU10 - 50mmø



	Colour Couleur	Ref.
○	White Blanc	209662
●	Black Noir	209655



CAIRO

Wall-mounted luminaire
Applique murale

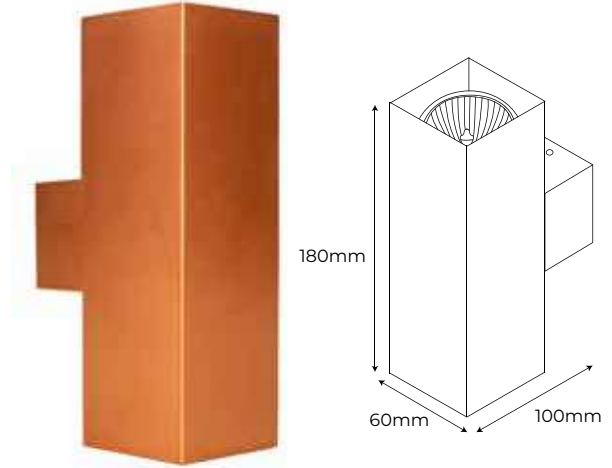
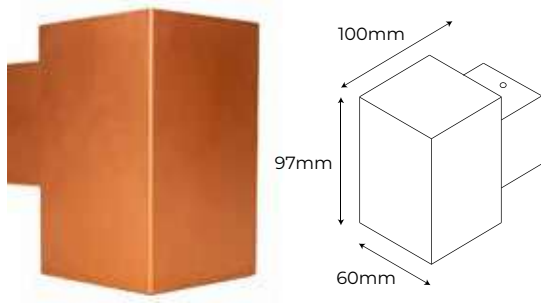

UNIDIRECTIONAL | UNIDIRECTIONNEL

Materials | Matériaux

Aluminium



Max. power | Puissance maximale

60W



Lamp holder | Douille

GU10 Lamp | Lampe GU10 - 50mmø



BIDIRECTIONAL | BIDIRECTIONNEL

Materials | Matériaux

Aluminium



Max. power | Puissance maximale

60W



Lamp holder | Douille

GU10 Lamp | Lampe GU10 - 50mmø



	Colour Couleur	Ref.
○	White Blanc	204520
●	Black Noir	204513
●	Silver Argent	204537
●	Cooper Bronze	204544
●	Golden Or	204551

	Colour Couleur	Ref.
○	White Blanc	204575
●	Black Noir	204568
●	Silver Argent	204582
●	Cooper Bronze	204599
●	Golden Or	204605

KUWAIT

Wall-mounted luminaire
Applique murale

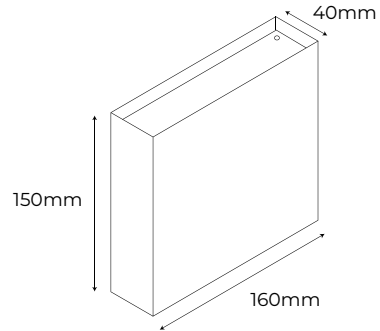

Temperature | Température

3000K

Other color temperatures available
Autres températures de couleur disponibles

Light source | Source lumineuse

SMD LED - L80B10

Materials | Matériaux

Aluminium



LED lifetime | Durée de vie LED

35.000h



Power - Lumens | Puissance - Lumens

3W - 230Lm



Dimmable

Not dimmable | Non dimmable



Finish | Finitions

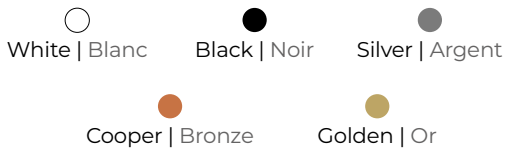

	Colour Couleur	Ref.
○	White Blanc	204629
●	Black Noir	204612
●	Silver Argent	204636
●	Cooper Bronze	204643
●	Golden Or	204650

LUMINA MINI

Wall-mounted luminaire

Applique murale

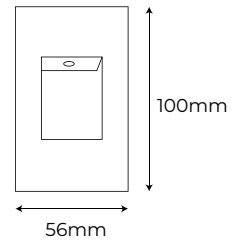

Temperature | Température



Light source | Source lumineuse

LEDSTAR - L80B10

Materials | Matériaux

Aluminium



LED lifetime | Durée de vie LED

50.000h



Power | Puissance - Lumens

1W - 230Lm



Dimmable

Not dimmable | Non dimmable



Finish | Finitions

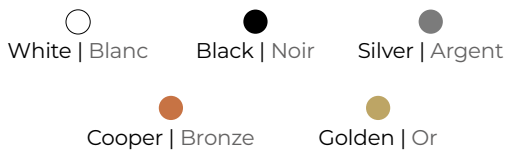

Colour Couleur	Ref.
○ White Blanc	205022
● Black Noir	205015
● Silver Argent	205039
● Cooper Bronze	205046
● Golden Or	205053

LUMINA

Wall-mounted luminaire
Applique murale

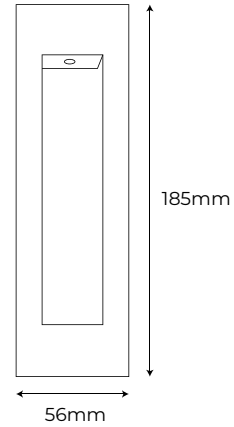

Temperature | Température



Light source | Source lumineuse

LEDSTAR - L80B10

Materials | Matériaux

Aluminium



LED lifetime | Durée de vie LED

50.000h



Power | Puissance - Lumens

1W - 230Lm



Dimmable

Not dimmable | Non dimmable



Finish | Finitions



	Colour Couleur	Ref.
○	White Blanc	204971
●	Black Noir	204964
●	Silver Argent	204988
●	Cooper Bronze	204995
●	Golden Or	205008

LIGHTBOX

Wall-mounted luminaire
 Applique murale

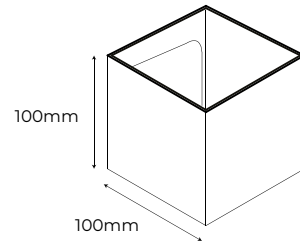

Temperature | Température



Light source | Source lumineuse

COB LED - L80B10

Materials | Matériaux

Aluminium



LED lifetime | Durée de vie LED

50.000h



Finish | Finitions

White | Blanc

Black | Noir

Dimmable

Not dimmable | Non dimmable



W	Flux	K	<input type="radio"/>	<input checked="" type="radio"/>
2 x3W	150Lm	3000K	204339	204346

LIGHTROUND

Wall-mounted luminaire
Applique murale

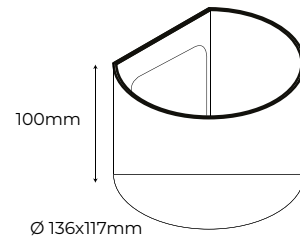

Temperature | Température



Light source | Source lumineuse

COB LED - L80B10

Materials | Matériaux

Aluminium



LED lifetime | Durée de vie LED

50.000h



Finish | Finitions

White | Blanc

Black | Noir

Dimmable

Not dimmable | Non dimmable



W	Flux	K	<input type="radio"/>	<input checked="" type="radio"/>
2 x3W	150Lm	3000K	204353	204360

NEONFLEX 360 NEW

24V LED linear strip

Bandeau LED linéaire 24V



Temperatures | Températures



Dimmable

According to driver | Selon driver

Diameter | Cut-out diameter

Diamètre | Diamètre de découpe

Ø 25mm | Free cut - Coupe libre

LED lifetime | Durée de vie LED

50.000h



Light source | Source lumineuse

SMD LED - 2835 (160LED/m)

W/m	Lm/m	K	V	Ref.
15	975	2700	24V	210019
15	1050	3000	24V	210026



ACCESSORIES | ACCESSOIRES

Ø25 mm clip (1 pc)
Clip Ø25 mm (1 pc)
Ref. 210262

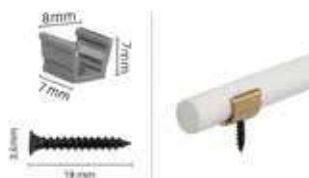

PVC ring (1 pc)
Anneau en PVC (1 pc)
Ref. 210286



Suspension kit (1.5 m cable)
Kit de suspension (câble 1,5 m)
Ref. 210279



Direct ceiling suspension (2 pcs)
Suspension directe au plafond
(2 pcs)
Ref. 210293



End cap kit with direct entry + end cap
Kit bouchon entrée directe + bouchon
de fin
Ref. 211252



Vertical cable suspension kit (1.5 m
cable)
Kit de suspension câble vertical (câble
1,5 m)
Ref. 210309



SMD 120/240 IP20

24V LED strips
Bandeaux LED 24V



Temperatures | Températures



Light source | Source lumineuse

SMD LED

Wide | Largeur

10mm - Rolls of 5 meters | Rouleaux de 5 mètres

LED lifetime | Durée de vie LED

50.000h



Cut | Section

50mm / 33mm

Dimmable

According to driver | Selon driver

LED Type	W/m	Lm/m	K	V	Ref.
SMD 120 LED/m	12	1020	2700	24V	202588
SMD 120 LED/m	12	1020	3000	24V	202595
SMD 120 LED/m	12	1092	4000	24V	202601
SMD 240 LED/m	25	2640	2700	24V	202618
SMD 240 LED/m	25	2750	3000	24V	202625
SMD 240 LED/m	25	3130	4000	24V	202632

SMD 120/240 IP67

24V LED strips
Bandeaux LED 24V



Temperatures | Températures



Light source | Source lumineuse

SMD LED

Wide | Largeur

12mm - Rolls of 5 meters | Rouleaux de 5 mètres

LED lifetime | Durée de vie LED

50.000h



Cut | Section

50mm / 33mm

Dimmable

According to driver | Selon driver

LED Type	W/m	Lm/m	K	V	Ref.
SMD 120 LED/m	9,6	1008	2700	24V	998511
SMD 120 LED/m	9,6	1008	3000	24V	998528
SMD 120 LED/m	9,6	1058	4000	24V	998535
SMD 240 LED/m	15	1800	2700	24V	998542
SMD 240 LED/m	15	1800	3000	24V	998559
SMD 240 LED/m	15	1900	4000	24V	998566

COB IP65

220V LED strips

Bandeaux LED 220V



Temperatures | Températures



Light source | Source lumineuse

COB LED

Wide | Largeur

15mm / 7,5mm - By meters | Par mètres

LED lifetime | Durée de vie LED

50.000h



Cut | Section

100mm

Dimmable

Not dimmable | Non dimmable



W/m	Lm/m	K	V	Ref.
14	868Lm	2700K	220V	203677
14	896Lm	3000K	220V	203684

ACCESSORIES | ACCESSOIRES

End cap with outlets
Embout de fin avec prises

Ref. 204292

Clips and screws
Clips et vis

Ref. 204315

End cap
Embout de fin

Ref. 204308

COB IP20

24V LED strips
Bandeaux LED 24V



Temperatures | Températures



Light source | Source lumineuse

COB LED

Wide | Largeur

10mm - Rollos de 5 metros

LED lifetime | Durée de vie LED

50.000h



Cut | Section

50mm

Dimmable

According to driver | Selon driver

W/m	Lm/m	K	V	Ref.
15	1330Lm	2700K	24V	202489
15	1380Lm	3000K	24V	202496
15	1530Lm	4000K	24V	202649
25	2120Lm	2700K	24V	202502
25	2340Lm	3000K	24V	202519
25	2450Lm	4000K	24V	202656

SMD 240 IP20

24V LED strips
Bandeaux LED 24V



Temperatures | Températures



Light source | Source lumineuse

SMD LED

Wide | Largeur

10mm - Rolls of 5 meters | Rouleaux de 5 mètres

LED lifetime | Durée de vie LED

50.000h



Cut | Section

33mm

Dimmable

According to driver | Selon driver

LED Type	W/m	Lm/m	K	V	Ref.
SMD 240 LED/m	19,2	2074	2700	24V	206487
SMD 240 LED/m	19,2	2112	3000	24V	206494
SMD 240 LED/m	19,2	2227	4000	24V	206500
SMD 240 LED/m	23	2990	2700	24V	206401
SMD 240 LED/m	23	3105	3000	24V	206418
SMD 240 LED/m	23	3220	4000	24V	206425

SMD 128 IP20

24V LED strips
Bandeaux LED 24V



Temperatures | Températures



Light source | Source lumineuse

SMD LED

Wide | Largeur

10mm - Rolls of 5 meters | Rouleaux de 5 mètres

LED lifetime | Durée de vie LED

50.000h



Cut | Section

62mm

Dimmable

According to driver | Selon driver

LED Type	W/m	Lm/m	K	V	Ref.
SMD 128 LED/m	16,8	1814	2700	24V	206609
SMD 128 LED/m	16,8	1848	3000	24V	206616
SMD 128 LED/m	16,8	1949	4000	24V	206623

SMD 128 IP20 / IP54

24V LED strips
Bandeaux LED 24V



Temperatures | Températures



Light source | Source lumineuse

SMD LED

Wide | Largeur

8mm - Rolls of 5 meters | Rouleaux de 5 mètres

LED lifetime | Durée de vie LED

50.000h



Cut | Section

62mm

Dimmable

According to driver | Selon driver

LED Type	W/m	Lm/m	K	V	Ref.
IP20 SMD 128 LED/m	9,6	988	2300	24V	206678
IP20 SMD 128 LED/m	9,6	1037	2700	24V	206685
IP20 SMD 128 LED/m	9,6	1056	3000	24V	206692
IP20 SMD 128 LED/m	9,6	1114	4000	24V	206708
IP54 SMD 128 LED/m	9,6	1037	2700	24V	206739
IP54 SMD 128 LED/m	9,6	1056	3000	24V	206746
IP54 SMD 128 LED/m	9,6	1114	4000	24V	206753

SMD 180 IP67

24V LED strips
Bandeaux LED 24V



Temperatures | Températures



Light source | Source lumineuse

SMD LED

Wide | Largeur

10mm - Rolls of 5 meters | Rouleaux de 5 mètres

LED lifetime | Durée de vie LED

50.000h



Cut | Section

33mm

Dimmable

According to driver | Selon driver

LED Type	W/m	Lm/m	K	V	Ref.
SMD 180 LED/m	14,4	1267	2700	24V	206760
SMD 180 LED/m	14,4	1267	3000	24V	206777
SMD 180 LED/m	14,4	1354	4000	24V	206784

NEW

RGB DIGITAL SPI 60



IP20 / IP67

24V LED strips

Bandeaux LED 24V

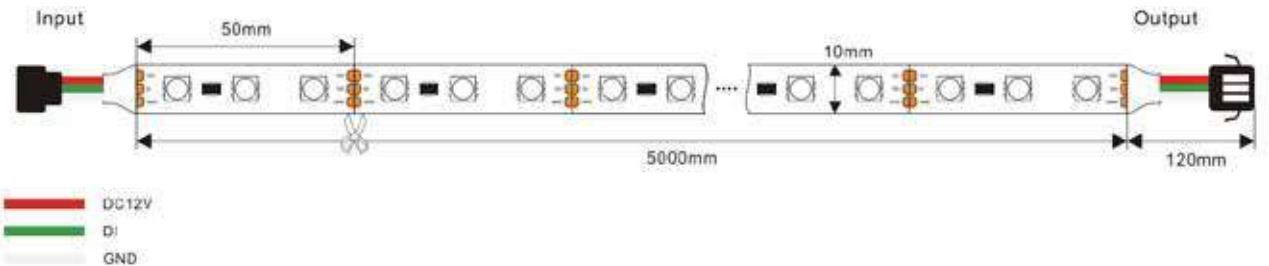

N° Pixel

10 pixel / meter | mètre

Light source | Source lumineuse

SMD LED

Wide | Largeur

10mm - Rollos de 5 / 10 meters | mètres

LED lifetime | Durée de vie LED

50.000h



Cut | Section

100mm

Control | Contrôle

SPI UCS 1903

Other ICs available on request
Autres circuits intégrés sur demande

LED Type	W/m	K	V	Ref.
IP20 SMD 60 LED/m	13	RGB	12V	211528
IP67 SMD 60 LED/m	13	RGB	12V	211535

NEW

RGB DIGITAL SPI 72

IP20 / IP67

24V LED strips

Bandeaux LED 24V

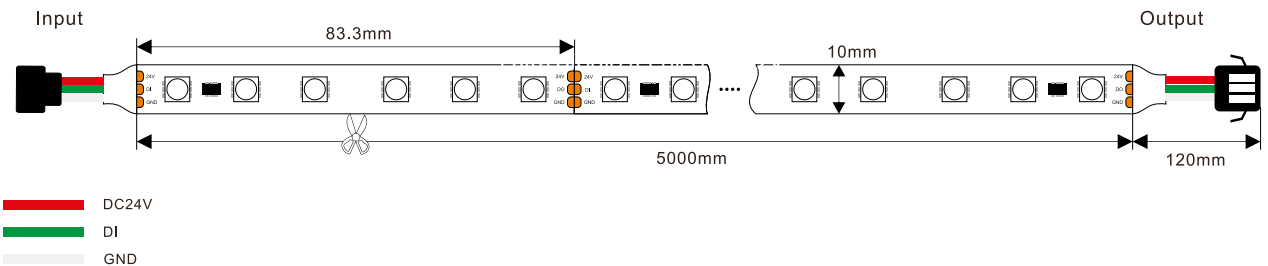

N° Pixel

12 pixel / metro

Light source | Source lumineuse

SMD LED

Wide | Largeur

10mm - Rollos de 5 / 10 meters | mètres

LED lifetime | Durée de vie LED

50.000h



Cut | Section

83.3mm

Control | Contrôle

SPI UCS 1903

Other ICs available on request
Autres circuits intégrés sur demande

LED Type	W/m	K	V	Ref.
IP20 SMD 72 LED/m	15	RGB	24V	211542
IP67 SMD 72 LED/m	15	RGB	24V	211559

NEW

RGB+W DIGITAL SPI 60



IP20 / IP67

24V LED strips

Bandeaux LED 24V

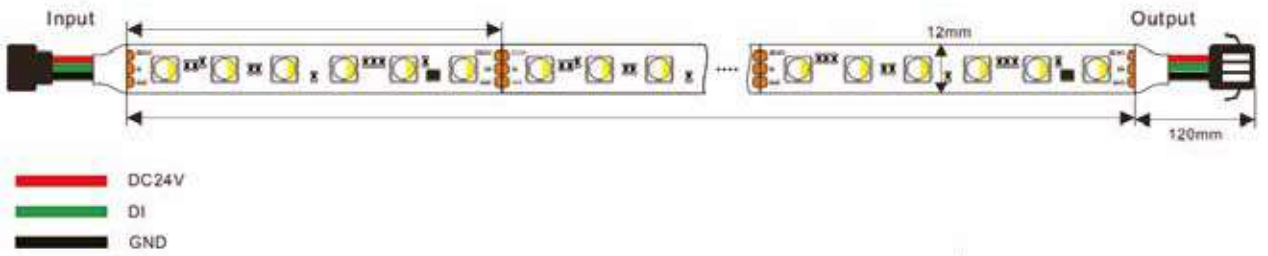

N° Pixel

10 pixel / meter | mètre

Light source | Source lumineuse

SMD LED

Wide | Largeur

12mm - Rollos de 5 / 10 meters | mètres

LED lifetime | Durée de vie LED

50.000h



Cut | Section

100mm

Control | Contrôle

SPI UCS 2904

Other ICs available on request
Autres circuits intégrés sur demande

LED Type	W/m	K	V	Ref.
IP20 SMD 60 LED/m	16	RGB + 2700	24V	211481
IP67 SMD 60 LED/m	16	RGB + 2700	24V	211498

NEW

RGB+W DIGITAL SPI 72



IP20 / IP67

24V LED strips

Bandeaux LED 24V

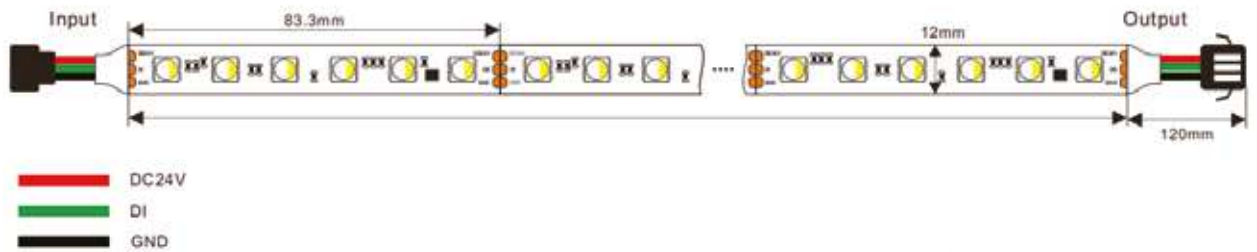
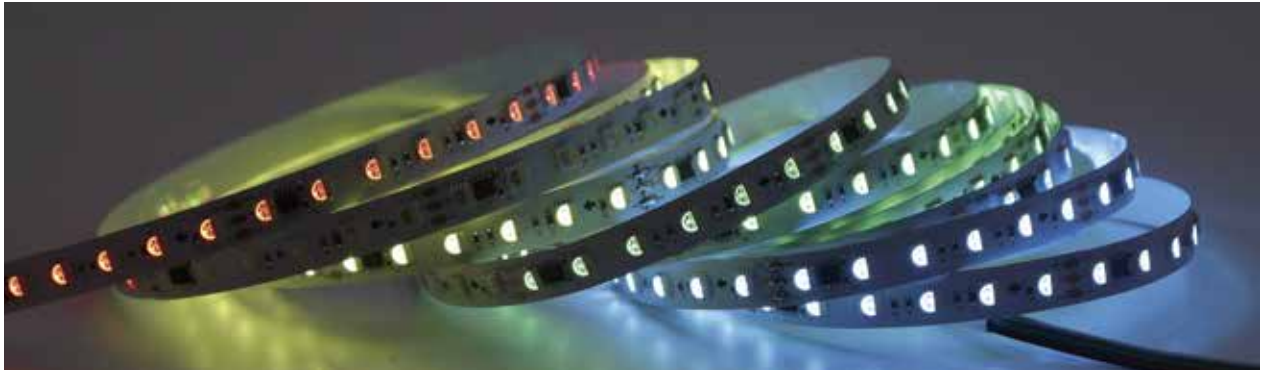

N° Pixel

12 pixel / meter | mètre

Light source | Source lumineuse

SMD LED

Wide | Largeur

12mm - Rollos de 5 meters | mètres

LED lifetime | Durée de vie LED

50.000h



Cut | Section

83.3mm

Control | Contrôle

SPI UCS 2904

*Other ICs available on request
Autres circuits intégrés sur demande*

LED Type	W/m	K	V	Ref.
IP20 SMD 72 LED/m	22	RGB + 2700	24V	211504
IP67 SMD 72 LED/m	22	RGB + 2700	24V	211511

RGB + W 96 IP20

24V LED strips
Bandeaux LED 24V



Temperatures | Températures



Light source | Source lumineuse

SMD LED

Wide | Largeur

12mm - Rolls of 5 meters | Rouleaux de 5 mètres

LED lifetime | Durée de vie LED

50.000h



Cut | Section

65mm

Dimmable

According to driver | Selon driver

LED Type	W/m	Lm/m	K	Ref.
SMD 96 LED/m	23	1120	RGB + 2700K	206821
SMD 96 LED/m	23	1120	RGB + 3000K	206838
SMD 96 LED/m	23	1120	RGB + 4000K	206845

RGB + W120 IP20 / IP65

24V LED strips
Bandeaux LED 24V



Light source | Source lumineuse

SMD LED

LED lifetime | Durée de vie LED

50.000h



Dimmable

According to driver | Selon driver

Wide | Largeur

12mm - Rolls of 5 meters | Rouleaux de 5 mètres

Cut | Section

50mm

LED Type	W/m	Ref.
IP20 SMD 120 LED/m	14,4	998603
IP65 SMD 120 LED/m	14,4	998610

LED DRIVERS DRIVERS LED

IP
20

W	V	Ref.
30	24V	997842
60	24V	999808
120	24V	997866
180	24V	997873

IP
67

W	V	Ref.
20	24V	998399
35	24V	998405
150	24V	998412



DIMMERS VARIATEURS

DALI-DALI Push mini dimmer
Variateur DALI-DALI Push mini

Ref. 998122

24V DALI-DALI Push dimmer
Variateur 24V DALI-DALI Push

Ref. 998382

12-24V 6-channel controller with remote
Contrôleur + télécommande 12-24V 6 canaux

Ref. 202540

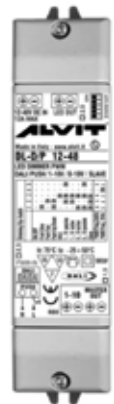

RGB CONTROLLER CONTRÔLEUR

RGB mini controller with remote 12-24V 5A
per channel
Contrôleur RGB mini + télécommande
12-24V 5A par canal

Ref. 202557

RGB mini controller with remote 24V 3A
× 5 channels | 36-72W
Contrôleur RGB mini + télécommande 24V 3A
× 5 canaux | 36-72W

Ref. 203127

RGB controller with remote 24V 6A per channel
Contrôleur RGB + télécommande 24V 6A par canal

Ref. 202564

RGB+W controller with remote 24V 6A per channel
Contrôleur RGB+W + télécommande 24V 6A par canal

Ref. 202571



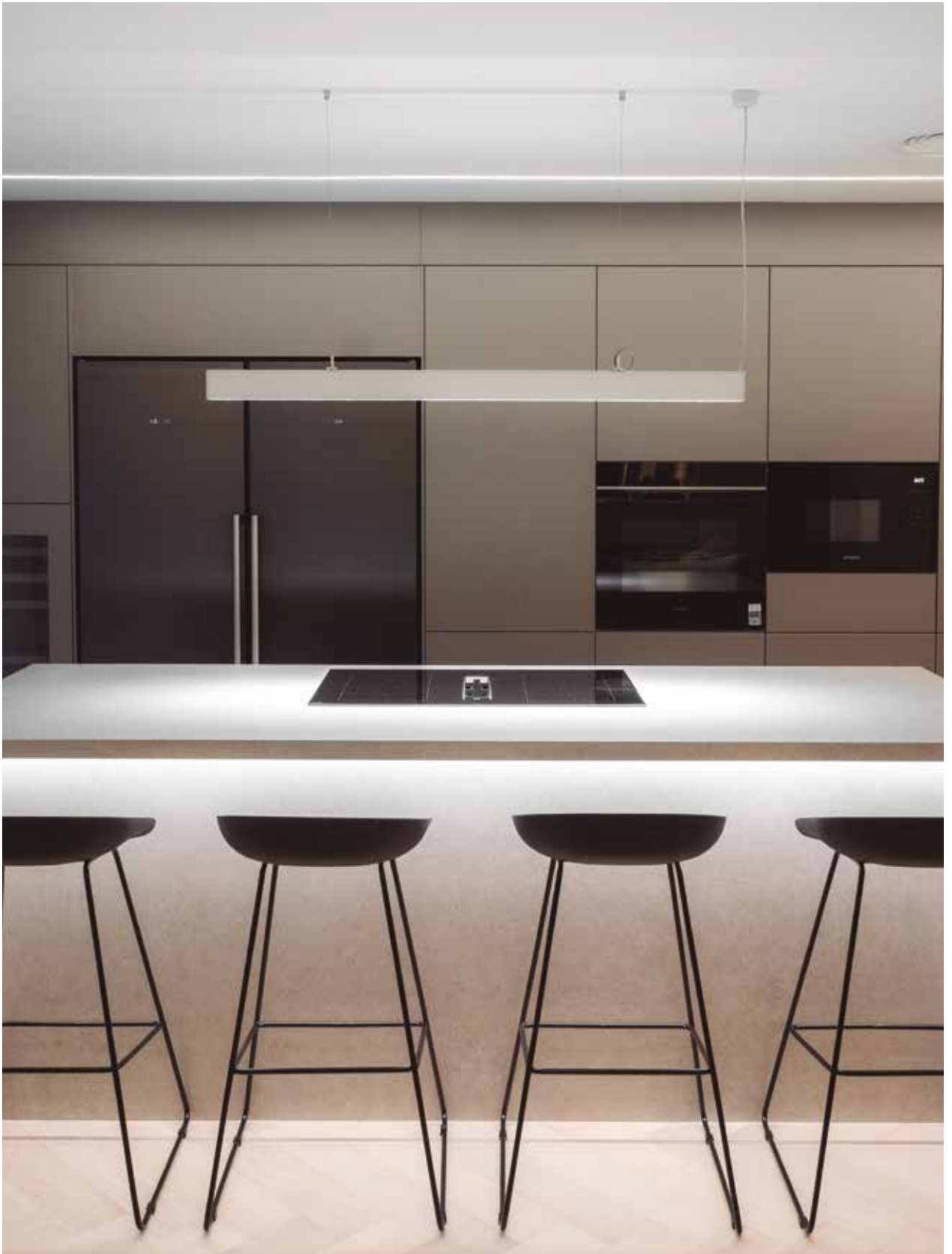

8mm
SURFACE PROFILE
PROFILÉ EN SAILLIE

Aluminium | Diffuser included | Diffuseur inclus

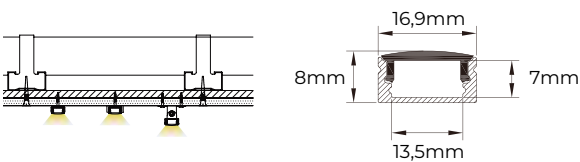
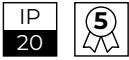

Finish | Finitions

Aluminium **A** White lacquered | Laqué blanc **W** Black | Noir **B**

200850	200867	208870	1m
208771	208788	208511	2m
998191	998207	-	3m

ACCESSORIES | ACCESSOIRES

End cap 8mm | Embout de fin 8mm

- A** Ref. 998290 
- W** Ref. 998757 
- B** Ref. 200966 

Fixing clamps 8mm | Support de montage 8mm

- Ref. 998351 

Custom mounting + LED strip
Montage sur mesure + bandeau LED
Ref. 0006

15mm
SURFACE PROFILE
PROFILÉ EN SAILLIE

Aluminium | Diffuser included | Diffuseur inclus

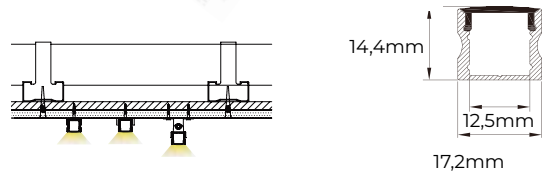

Finish | Finitions

Aluminium **A** White lacquered | Laqué blanc **W** Black | Noir **B**

200898	200904	208894	1m
208818	208825	208535	2m
998238	998245	-	3m

ACCESSORIES | ACCESSOIRES

End cap 15mm | Embout de fin 15mm

- A** Ref. 998306 
- W** Ref. 998337 
- B** Ref. 200973 

Fixing clamps 15mm | Support de montage 15mm

- Ref. 998368 

Custom mounting + LED strip
Montage sur mesure + bandeau LED
Ref. 0006

8mm RECESSED PROFILE PROFILÉ ENCASTRABLE

Aluminium | Diffuser included | Diffuseur inclus

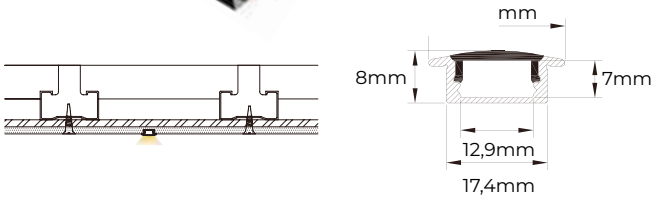
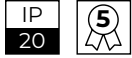

Finish | Finitions

Aluminium **A** White lacquered | Laqué blanc **W** Black | Noir **B**

200874	200881	208887	1m
208795	208801	208528	2m
998214	998221	-	3m

ACCESSORIES | ACCESSOIRES

End cap 8mm | Embout de fin 8mm

- A** Ref. 998733
- W** Ref. 998320
- B** Ref. 208672



Fixing clamps 15mm | Support de montage 8mm

Ref. 998351



Custom mounting + LED strip
Montage sur mesure + bandeau LED
Ref. 0006

15mm RECESSED PROFILE PROFILÉ ENCASTRABLE

Aluminium | Diffuser included | Diffuseur inclus

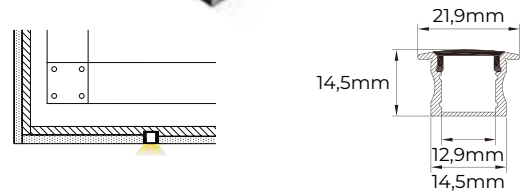

Finish | Finitions

Aluminium **A** White lacquered | Laqué blanc **W** Black | Noir **B**

200911	200928	208900	1m
208832	208849	208542	2m
998252	998269	-	3m

ACCESSORIES | ACCESSOIRES

End cap 8mm | Embout de fin 15mm

- A** Ref. 998740
- W** Ref. 998764
- B** Ref. 208689



Fixing clamps 15mm | Support de montage 15mm

Ref. 997507



Custom mounting + LED strip
Montage sur mesure + bandeau LED
Ref. 0006

19mm
CORNER PROFILE
PROFILÉ EN ANGLE

Aluminium | Diffuser included | Diffuseur inclus

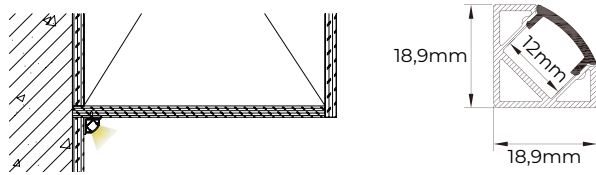
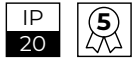

Finish | Finitions

Aluminium **A** White lacquered | Laqué blanc **W** Black | Noir **B**

200935	200942	208917	1m
208856	208863	208559	2m
998276	998283	-	3m

ACCESSORIES | ACCESSOIRES

End cap 19mm | Embout de fin 19mm

- A** Ref. 998313
- W** Ref. 998344
- B** Ref. 201024



Fixing clamps 19mm | Support de montage 19mm

Ref. 998375



Custom mounting + LED strip
 Montage sur mesure + bandeau LED

Ref. 0006





KIT 8mm
SURFACE PROFILE
PROFILÉ EN SAILLIE

Aluminium
2 meters profile, Diffuser, 2 end caps and 2 fixing clamps
Profilé 2 mètres, Diffuseur, 2 embouts de fin, 2 fixations

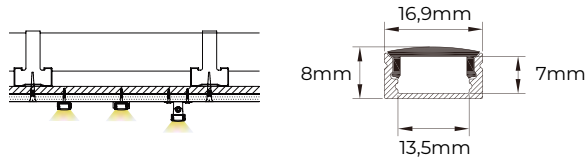
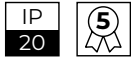

KIT 15mm
SURFACE PROFILE
PROFILÉ EN SAILLIE

Aluminium
2 meters profile, Diffuser, 2 end caps and 2 fixing clamps
Profilé 2 mètres, Diffuseur, 2 embouts de fin, 2 fixations

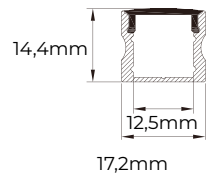

Finish | Finitions

- Aluminium
A
200751
- White lacquered | Laqué blanc
W
200768
- Black | Noir
B
200959

Finish | Finitions

- Aluminium
A
200799
- White lacquered | Laqué blanc
W
200805
- Black | Noir
B
200560



KIT 8mm
RECESSED PROFILE
PROFILÉ ENCASTRABLE

Aluminium
2 meters profile, Diffuser, 2 end caps and 2 fixing clamps
Profilé 2 mètres, Diffuseur, 2 embouts de fin, 2 fixations

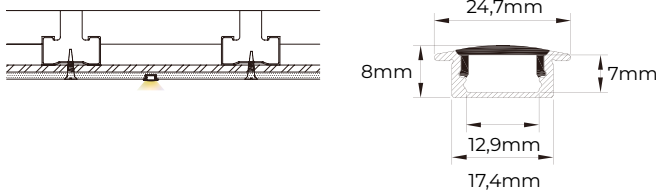
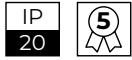

KIT 15mm
RECESSED PROFILE
PROFILÉ ENCASTRABLE

Aluminium
2 meters profile, Diffuser, 2 end caps and 2 fixing clamps
Profilé 2 mètres, Diffuseur, 2 embouts de fin, 2 fixations

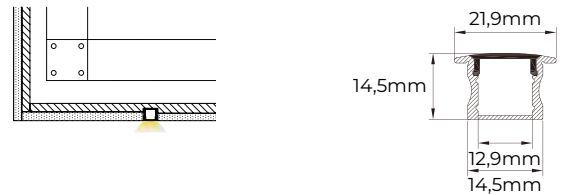

Finish | Finitions

Aluminium White lacquered | Laqué blanc Black | Noir
A W B
 200775 200782 201192

Finish | Finitions

Aluminium White lacquered | Laqué blanc Black | Noir
A W B
 200812 200829 201048



KIT 19mm
CORNER PROFILE
PROFILÉ EN ANGLE

Aluminium
 2 meters profile, Diffuser, 2 end caps and 2 fixing clamps
 Profilé 2 mètres, Diffuseur, 2 embouts de fin, 2 fixations

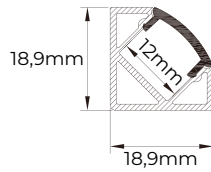
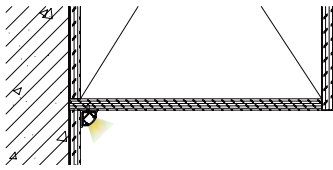
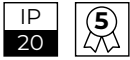

Finish | Finitions

Aluminium	White lacquered Laqué blanc	Black Noir
A	W	B
200836	200843	201017





BACKLIT

LED Panel

Dalle LED

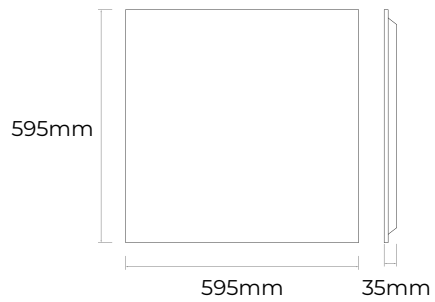

Temperatures | Températures



Finish | Finitions



Materials | Matériaux



Light source | Source lumineuse

PCB - L80B10

LED lifetime | Durée de vie LED

45.000h



Dimmable



Optional | En option



W	Flux	K	Ref.
36	3500Lm	3000K	997699
36	3500Lm	4000K	997705
36	3500Lm	5000K	997712

ACCESSORIES | ACCESSOIRES

Steel wire suspensions (4 pcs.)
 Suspensions par câbles acier (4 pièces)
 Ref. 208245

Surface mounting frame
 Kit de pose en saillie
 Ref. 208238

Spring clip mounting (4 pcs.)
 Kit de fixation par ressorts (4 pièces)
 Ref. 988512

Recessed mounting frame for plasterboard
 Cadre encastrable pour placo (plaque de plâtre)
 Ref. 996807

BACKLIT BASIC

LED Panel
Dalle LED

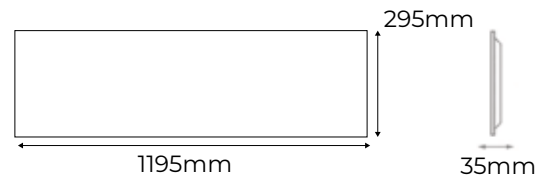
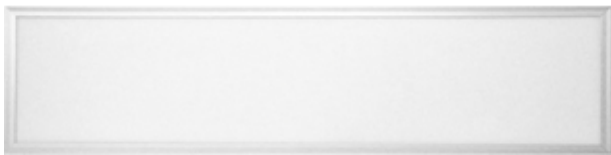
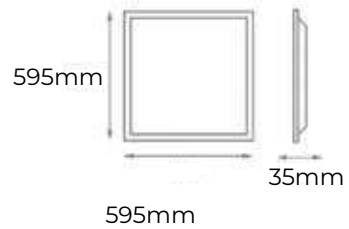

Temperatures | Températures



Light source | Source lumineuse

PCB - L80B10

Finish | Finitions



LED lifetime | Durée de vie LED

20.000h



Materials | Matériaux

Aluminium



Dimmable



Optional | En option



mm	W	Flux	K	Ref.
595x595	36	3240Lm	3000K	999129
595x595	36	3240Lm	4000K	999136
595x595	36	3240Lm	6000K	999143
1195x295	36	3240Lm	3000K	999150
1195x295	36	3240Lm	4000K	999167
1195x295	36	3240Lm	6000K	999174

ACCESSORIES | ACCESSOIRES

Steel wire suspensions (4 pcs.)
Suspensions par câbles acier (4 pièces)

Ref. 991635

Spring clip mounting (4 pcs.)
Kit de fixation par ressorts (4 pièces)

Ref. 988512

595x595 mm surface mounting frame
Kit de pose en saillie 595x595 mm

Ref. 988505

1200x300 mm surface mounting frame
Kit de pose en saillie 1200x300 mm

Ref. 992182

595x595 mm recessed mounting frame for plasterboard
Cadre encastrable pour placo 595x595 mm

Ref. 996807

LAES

DOWN LIGHTS



ANTI GLARE

Recessed downlight
Downlight encastrable



Temperatures | Températures



Finish | Finition



Materials | Matériaux

Aluminium



Thermoplastic | Thermoplastique



Light source | Source lumineuse

LED COB - L70B50

LED lifetime | Durée de vie LED

30.000h



Dimmable



Optional | En option

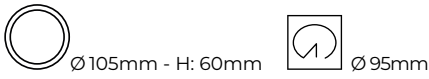

W	Flux	K	Ref.
10	700Lm	3000K	995695
10	700Lm	4000K	995701
10	700Lm	6500K	995718

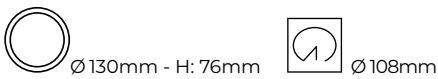

W	Flux	K	Ref.
12	950Lm	3000K	989373
12	950Lm	4000K	989380
12	950Lm	6500K	996333

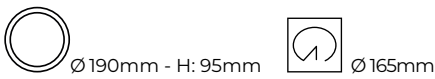

W	Flux	K	Ref.
18	1650Lm	3000K	992755
18	1750Lm	4000K	992762
18	1750Lm	6500K	992779

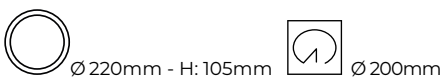

W	Flux	K	Ref.
18	1650Lm	3000K	992786
18	1750Lm	4000K	992793
18	1750Lm	6500K	992809
30	2600Lm	3000K	992816
30	2800Lm	4000K	992823
30	2800Lm	6500K	992830

SPICA CCT

Recessed downlight
Downlight encastrable

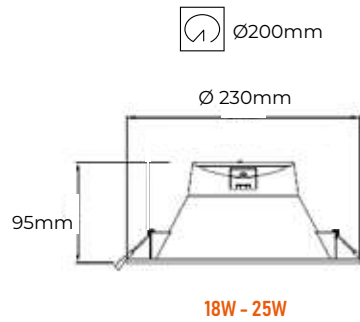
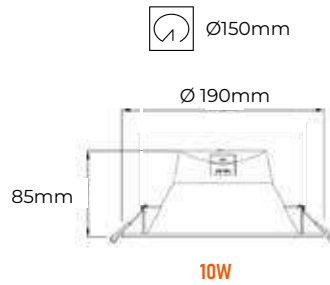

Temperatures | Températures (CCT)



Light source | Source lumineuse

SMD LED - L80B10

Finish | Finition



LED lifetime | Durée de vie LED

12.000h



Materials | Matériaux

Thermoplastic | Thermoplastique



Dimmable

Not dimmable | Non dimmable



W	Flux	K	Ref.
10	860Lm	3000K-4000K-6000K	998962
18	1550Lm	3000K-4000K-6000K	998979
25	2130Lm	3000K-4000K-6000K	998986

12W - 18W

DOWNLIGHT BASIC

Surface
En saillie

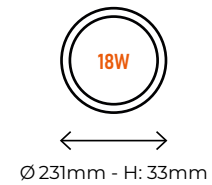
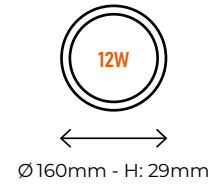

Temperatures | Températures (CCT)



Light source | Source lumineuse

SMD LED - L80B10

Finish | Finition



LED lifetime | Durée de vie LED

12.000h



Materials | Matériaux

Thermoplastic | Thermoplastique



Dimmable

Not dimmable | Non dimmable



W	Flux	K	Ref.
12	900Lm	3000K	990058
12	905Lm	4000K	990065
12	910Lm	6500K	990072
18	1500Lm	3000K	203172
18	1500Lm	4000K	203189
18	1500Lm	6500K	203196

30W

DOWNLIGHT CCT

Semi-recessed
Semi-encastré

COMPLETE FIT 30

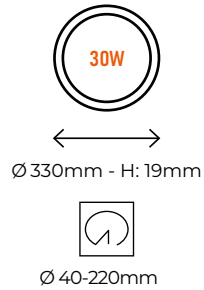

Temperatures | Températures (CCT)



Light source | Source lumineuse

SMD LED - L80B10

Finish | Finition



LED lifetime | Durée de vie LED

20.000h



Materials | Matériaux

Thermoplastic | Thermoplastique



Dimmable

Not dimmable | Non dimmable



W	Flux	K	Ref.
30	2800Lm	3000K-4000K-6000K	992595

9W

DOWNLIGHT COB

Tilting
Basculant

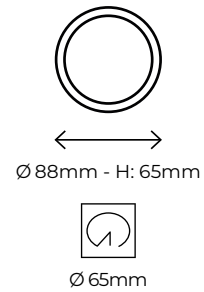

Temperatures | Températures



Light source | Source lumineuse

LED COB - L80B10

Finish | Finition



LED lifetime | Durée de vie LED

30.000h



Materials | Matériaux

Aluminium



Dimmable

Not dimmable | Non dimmable



W	Flux	K	Ref.
9	810Lm	3000K	986938
9	810Lm	4000K	986945

8W

DOWNLIGHT BASIC

Tilting
Basculant

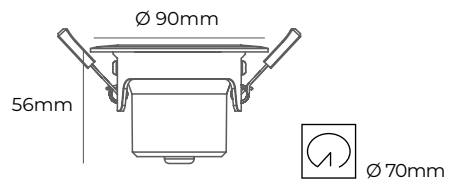

Temperatures | Températures (CCT)



Light source | Source lumineuse

SMD LED - L80B10

Finish | Finitions



LED lifetime | Durée de vie LED

15.000h



Materials | Matériaux

Thermoplastic | Thermoplastique



Dimmable

Not dimmable | Non dimmable



W	Flux	K	○	●
8	600Lm	2700K	995633	995664
8	600Lm	3000K	995640	995671
8	600Lm	4000K	995657	995688

6W

DOWNLIGHT BASIC

Recessed
Encastrable

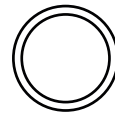

↔
Ø100mm - H: 35mm



Ø75mm

Temperatures | Températures



Light source | Source lumineuse

SMD LED - L80B10

Finish | Finition

○
White | Blanc

LED lifetime | Durée de vie LED

15.000h



Materials | Matériaux

Thermoplastic | Thermoplastique



Dimmable

Not dimmable | Non dimmable



W	Flux	K	Ref.
6	380Lm	4000K	988864
6	400Lm	6000K	988857

12W

DOWNLIGHT BASIC

Recessed
Encastrable

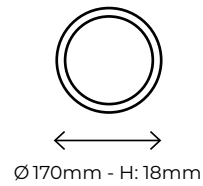

Temperatures | Températures (CCT)



Light source | Source lumineuse

SMD LED - L80B10

Finish | Finitions



LED lifetime | Durée de vie LED

12.000h



Materials | Matériaux

Thermoplastic | Thermoplastique



Dimmable

Not dimmable | Non dimmable



W	Flux	K	○	●
12	900Lm	3000K	202700	989847
12	900Lm	4000K	202717	989854
12	910Lm	6500K	201314	989861

18W

DOWNLIGHT BASIC

Recessed
Encastrable

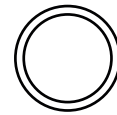

↔
Ø 225mm - H: 19mm



Ø 204mm

Temperatures | Températures (CCT)



Light source | Source lumineuse

SMD LED - L80B10

Finish | Finitions



LED lifetime | Durée de vie LED

12.000h



Materials | Matériaux

Thermoplastic | Thermoplastique



Dimmable

Not dimmable | Non dimmable



W	Flux	K	○	●
18	1400Lm	3000K	202724	989878
18	1400Lm	4000K	999914	989885
18	1470Lm	6500K	999921	989892

24W

DOWNLIGHT BASIC

Recessed
Encastrable

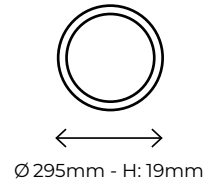

Temperatures | Températures (CCT)



Light source | Source lumineuse

SMD LED - L80B10

Finish | Finitions



LED lifetime | Durée de vie LED

12.000h



Materials | Matériaux

Thermoplastic | Thermoplastique



Dimmable

Not dimmable | Non dimmable



W	Flux	K	○	●
24	1950Lm	3000K	989816	989908
24	1950Lm	4000K	989823	989915
24	2000Lm	6500K	989830	989922

NEW CODES AS THE CURRENT STOCK RUNS OUT | NOUVEAUX CODES APRÈS ÉPUISEMENT DES STOCKS ACTUELS

24	1950Lm	3000K	202731	-
24	1950Lm	4000K	202748	-
24	2000Lm	6000K	202755	-

10W

DOWNLIGHT IP44

Recessed
Encastrable



Easy installation. Suitable for humid zones
Installation facile. Convient aux zones humides

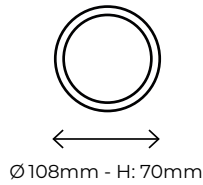

ACCESSORIES | ACCESSOIRES



White ring
Collorette blanche
989052



Chrome ring
Collorette chromé
988772



Chrome stepped ring
Collerette à gradins chromée
988796



White stepped ring
Collerette à gradins blanche
988789



White square ring
Collorette carrée blanche
988802



White tilting ring
Collorette orientable blanche
988819

Temperatures | Températures



Finish | Finition



Materials | Matériaux

Thermoplastic | Thermoplastique



Light source | Source lumineuse

SMD LED - L80B10

LED lifetime | Durée de vie LED

30.000h



Dimmable



W	Flux	K	Ref.
10	800Lm	3000K	988765
10	850Lm	4000K	988758

18W - 24W

CEILING LIGHT CCT PLAFONNIER CCT

Surface | En Saillie

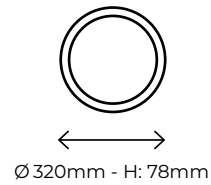

Temperatures | Températures (CCT)



Light source | Source lumineuse

SMD LED - L80B10

Finish | Finition

○
White | Blanc

LED lifetime | Durée de vie LED

50.000h



Materials | Matériaux

Polycarbonate



Dimmable

Not dimmable | Non dimmable



	W	Flux	K	Ref.
	18-24	2400Lm	3000K-4000K-6000K	207767
	18-24	2400Lm	3000K-4000K-6000K	207774
	18-24	2400Lm	3000K-4000K-6000K	207781
	18-24	2400Lm	3000K-4000K-6000K	207798

20W

CEILING LIGHT PLAFONNIER

Surface | En Saillie

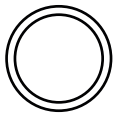

Ø 220mm - H: 72mm

Temperatures | Températures



Finish | Finition



Materials | Matériaux

Polycarbonate



Light source | Source lumineuse

SMD LED - L80B10

LED lifetime | Durée de vie LED

25.000h



Dimmable

Not dimmable | Non dimmable



ACCESSORIES | ACCESSOIRES



Asymmetrical lighting accessory | White
Accessoire éclairage asymétrique | Blanc

997569



Asymmetrical lighting accessory | Black
Accessoire éclairage asymétrique | Noir

997590

W	Flux	K	Ref.
20	1600Lm	3000K	997538
20	1660Lm	4000K	986778
20	1660Lm	6500K	986785

15W

CEILING LIGHT PLAFONNIER

Surface | En Saillie



L: 215mm A: 115mm H: 62mm

Temperatures | Températures



Light source | Source lumineuse

SMD LED - L80B10

Finish | Finitions



LED lifetime | Durée de vie LED

25.000h



Materials | Matériaux

Polycarbonate



Dimmable

Not dimmable | Non dimmable



W	Flux	K	Ref.
15	1200Lm	3000K	998771
15	1200Lm	4000K	998788
15	1200Lm	6000K	998795

30W

CEILING LIGHT PLAFONNIER

Surface | En Saillie

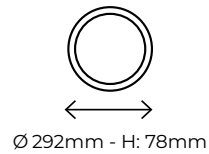

Temperatures | Températures



Light source | Source lumineuse

SMD LED - L80B10

Finish | Finitions



LED lifetime | Durée de vie LED

25.000h



Materials | Matériaux

Polycarbonate



Dimmable

Not dimmable | Non dimmable



W	Flux	K	Ref.
30	2400Lm	4000K	986815
30	2500Lm	6500K	986822

18W

CEILING LIGHT CCT PLAFONNIER CCT

Surface | En Saillie

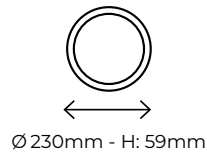

Temperatures | Températures (CCT)



Light source | Source lumineuse

SMD LED - L80B10

Finish | Finitions

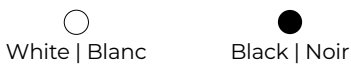

LED lifetime | Durée de vie LED

25.000h



Materials | Matériaux

Polycarbonate



Dimmable

Not dimmable | Non dimmable



W	Flux	K	○	●
18	1600Lm	3000K-4000K-6000K	997880	997910

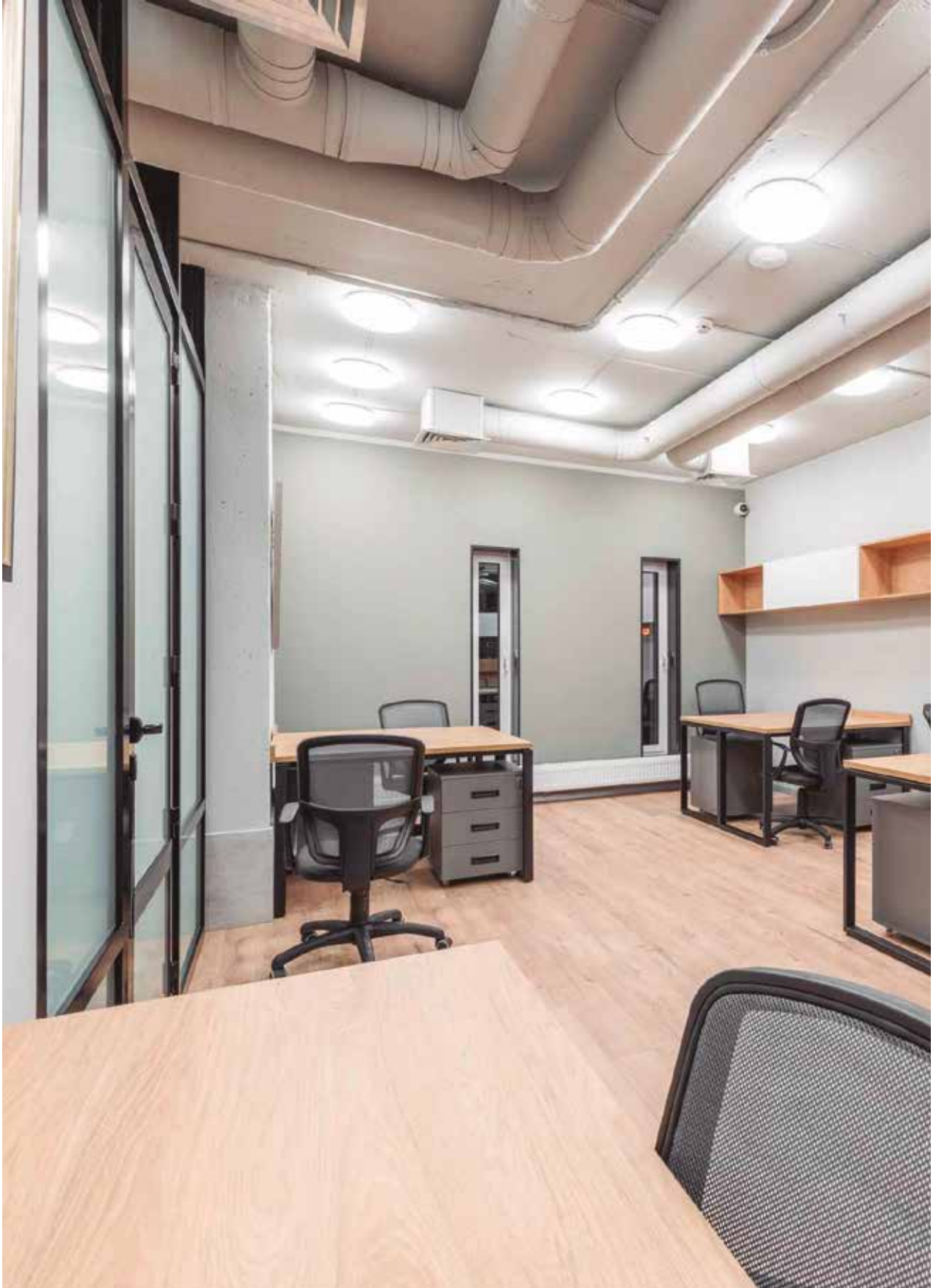

LAES



INDUSTRIAL LIGHTING

ÉCLAIRAGE INDUSTRIEL



VOLGA PRO

LED tri-proof luminaire
Luminaire LED étanche



Dip switch / Cable 5x2.5mm / Fast connection
Sélecteur / Câble 5x2.5 mm / Connexion rapide



Stainless steel clips.
Clips en acier inoxydable

Polycarbonate construction.
Construction en polycarbonate

Temperatures | Températures



Light source | Source lumineuse

SMD LED - L80B10

Finish | Finitions

●
Grey | Gris

LED lifetime | Durée de vie LED

50.000h
🕒

Materials | Matériaux

Polycarbonate
●
PC

Optional dimming | Dimmable en option





Included Accessories
Accessoires inclus

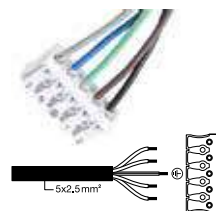
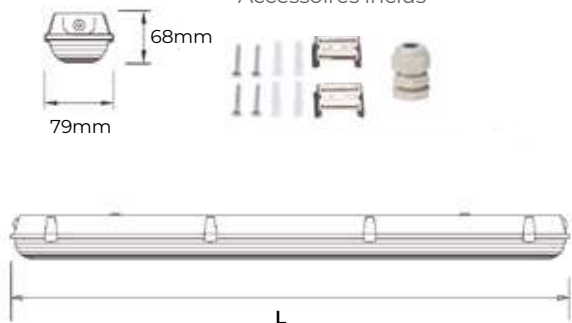

Screwless terminal block. Loop-in/loop-out wiring with 5x2.5 mm cable.
Bornier sans vis. Câblage entrée/sortie en boucle en 5x2,5 mm.

W	Flux	K	L	Ref.
9-12-15-18	1350Lm - 1800Lm - 2250Lm - 2700Lm	4000K	600mm	211344
18-24-30-36	2700Lm - 3600Lm - 4500Lm - 5400Lm	4000K	1200mm	211351
24-32-40-48	3600Lm - 4800Lm - 6000Lm - 7200Lm	4000K	1500mm	211368

ACCESSORIES | ACCESSOIRES

3h emergency kit / quick connection
Kit de secours 3h / connexion rapide

211474

VOLGA sensor
Capteur VOLGA

203264

VOLGA CCT NEW

LED tri-proof luminaire
Luminaire LED étanche



Stainless steel clips
Polycarbonate construction

Clips en acier inoxydable
Construction en polycarbonate



Temperatures | Températures (CTT)



Light source | Source lumineuse

SMD LED - L70B20

Finish | Finitions



LED lifetime | Durée de vie LED

50.000h



Materials | Matériaux

Polycarbonate



Optional dimming | Dimmable en option



W	Flux	K	L	Ref.
9-12-15-18	1350Lm - 1800Lm - 2250Lm - 2700Lm	3000K - 4000K - 5000K	605mm	211375
18-24-30-36	2700Lm - 3600Lm - 4500Lm - 5400Lm	3000K - 4000K - 5000K	1205mm	211382
24-32-40-48	3600Lm - 4800Lm - 6000Lm - 7200Lm	3000K - 4000K - 5000K	1505mm	211399

W	Flux	K	L x W x H (mm)	Ref.	PVR €
48	7500Lm	4000K	1500x79x68	201116	60,00

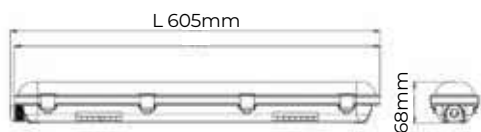

ACCESSORIES | ACCESSOIRES

VOLGA 2W 3h emergency kit
Kit de secours VOLGA 2W 3h

201154



VOLGA sensor
Capteur VOLGA

203264

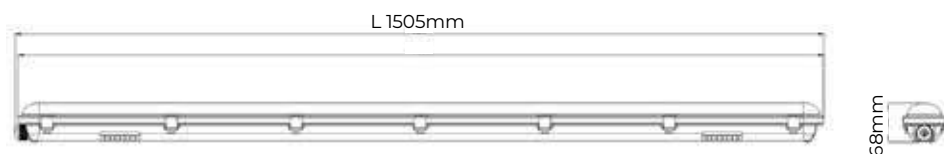
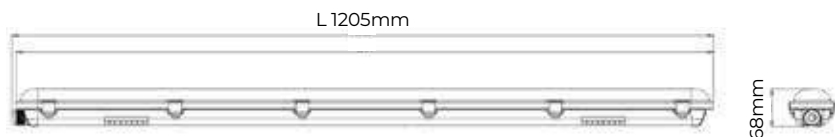

HYDRA

LED tri-proof luminaire
Luminaire LED étanche

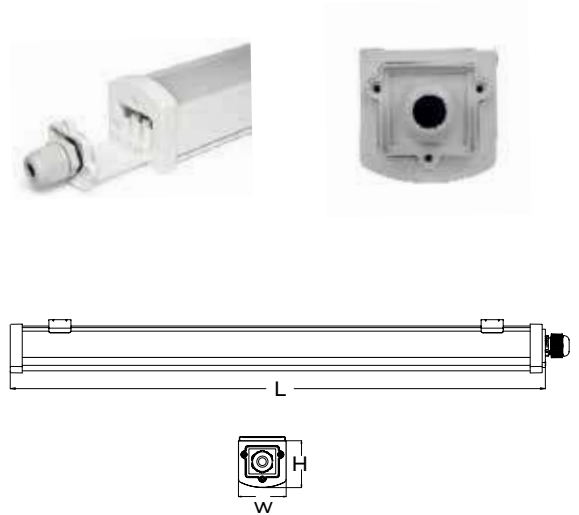
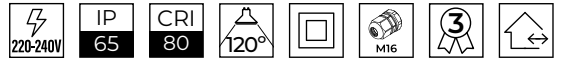

Temperatures | Températures



Light source | Source lumineuse

SMD LED

Finish | Finitions



LED lifetime | Durée de vie LED

30.000h

Materials | Matériaux



Dimmable

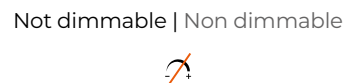

W	Flux	K	L x W x H (mm)	Ref.
18	1800Lm	4000K	600x50x49	992939
18	1850Lm	6000K	600x50x49	992946
36	3600Lm	4000K	1200x50x49	992953
56	5600Lm	4000K	1500x50x49	992977

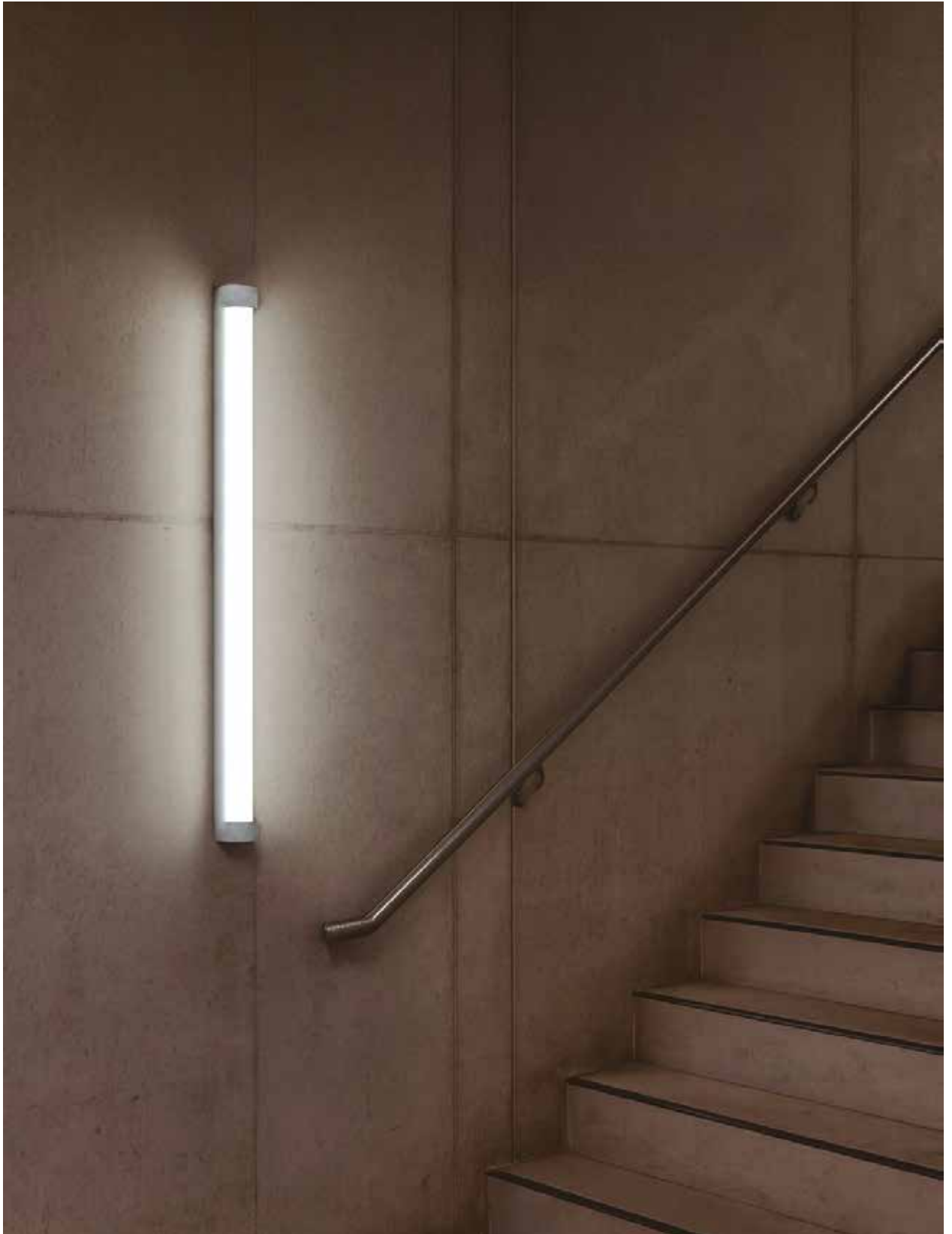

KOMPACT PRO CCT NEW

Industrial luminaire
Luminaire industriel

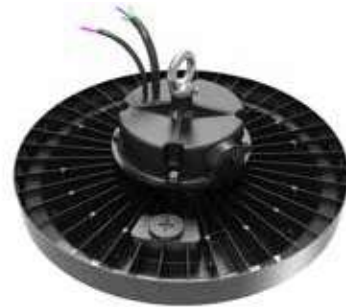
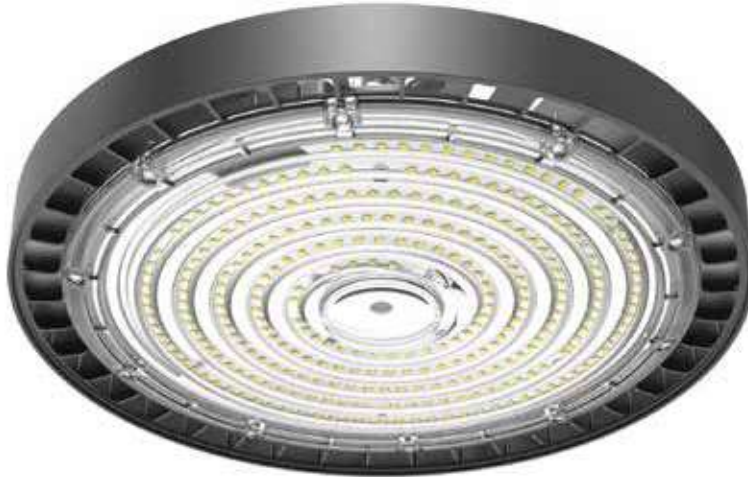

Temperatures | Températures



Light source | Source lumineuse

SMD LED

Finish | Finitions

Black | Noir

LED lifetime | Durée de vie LED

50.000h



Materials | Matériaux

Aluminium



Polycarbonate



Dimmable

1-10V & PMW

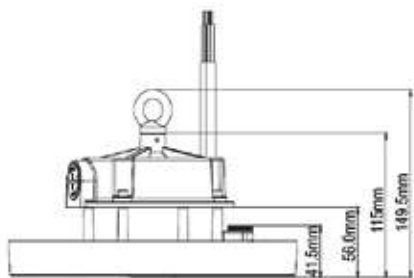
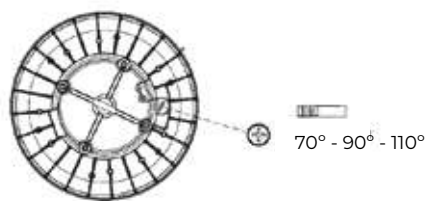
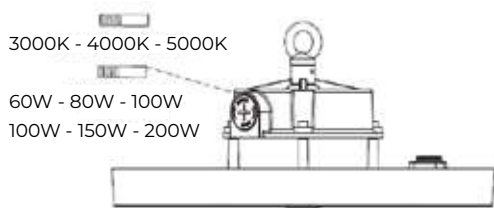

60W - 80W - 100W Ø 230mm

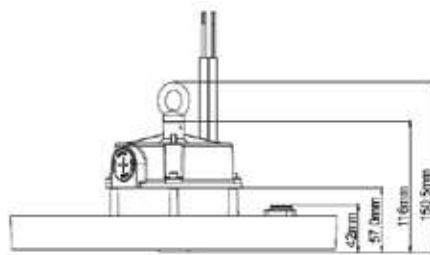

100W - 150W - 200W Ø 310mm

W	Flux	K	A°	Ref.
60 - 80 - 100	10200Lm-13600Lm-17000Lm	3000K - 4000K - 5000K	70° - 90° - 110°	211320
100 - 150 - 200	17000Lm-25500Lm-34000Lm	3000K - 4000K - 5000K	70° - 90° - 110°	211337

KOMPACT

Industrial luminaire
Luminaire industriel



Temperatures | Températures



Light source | Source lumineuse

SMD LED

Finish | Finitions



LED lifetime | Durée de vie LED

50.000h



Materials | Matériaux

Aluminium



Polycarbonate



Dimmable



ACCESSORIES | ACCESSOIRES

Clamp mounting fixture | Fixation par serrage



100W - 230mm - Ref. 997309

150W - 295mm - Ref. 997316

200W - 350m - Ref. 997323

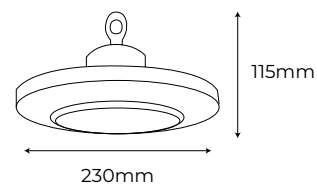

W	Flux	K	A°	Ref.
100	15000Lm	3000K	120°	202847
100	15000Lm	4000K	120°	997194
100	15000Lm	5000K	120°	997255

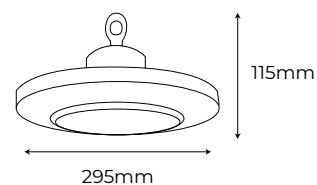

W	Flux	K	A°	Ref.
150	22500Lm	3000K	120°	202854
150	22500Lm	4000K	90°	997200
150	22500Lm	4000K	120°	997217
150	22500Lm	5000K	90°	997262
150	22500Lm	5000K	120°	997279

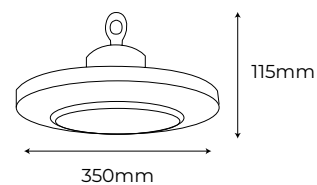

W	Flux	K	A°	Ref.
200	30000Lm	3000K	120°	202861
200	30000Lm	4000K	90°	997224
200	30000Lm	4000K	120°	997231
200	30000Lm	5000K	90°	997286
200	30000Lm	5000K	120°	997293

LAES

**OUTDOOR LIGHTING
ÉCLAIRAGE EXTÉRIEUR**



100W

PROJECTOR NEW

PROJECTEUR

PRO CCT

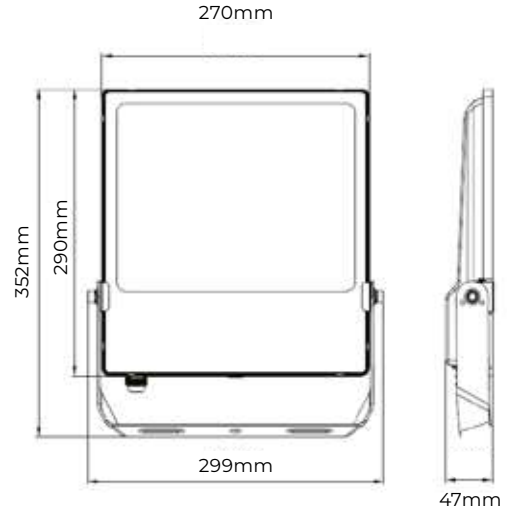

Temperatures | Températures (CTT)



Finish | Finitions



Materials | Matériaux

Aluminum + Glass | Aluminium + Verre

Light source | Source lumineuse

SMD LED - L80B10

LED lifetime | Durée de vie LED

50.000h



Dimmable

Not dimmable | Non dimmable



W	Flux	K	Ref.
50 - 75 - 100	9000Lm - 13500Lm - 18000Lm	3000K - 4000K - 5000K	211306

200W

PROJECTOR NEW

PROJECTEUR

PRO CCT

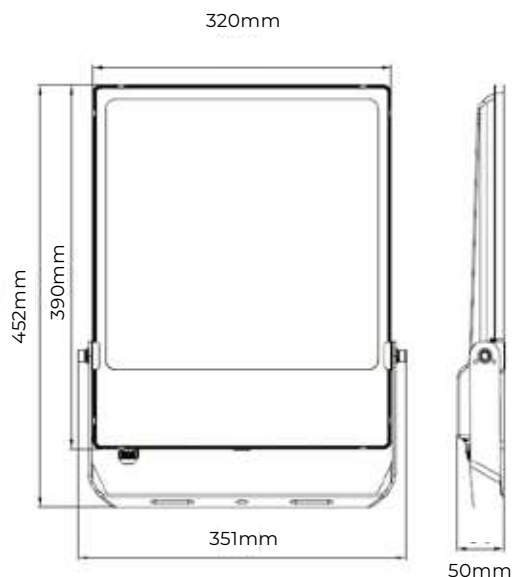

Temperatures | Températures (CTT)



Finish | Finitions



Materials | Matériaux

Aluminum + Glass | Aluminium + Verre

Light source | Source lumineuse

SMD LED - L80B10

LED lifetime | Durée de vie LED

50.000h



Dimmable

Not dimmable | Non dimmable



W	Flux	K	Ref.
100 - 150 - 200	18000Lm - 27000Lm - 36000Lm	3000K - 4000K - 5000K	211313

PROJECTOR PROJECTEUR SLIM

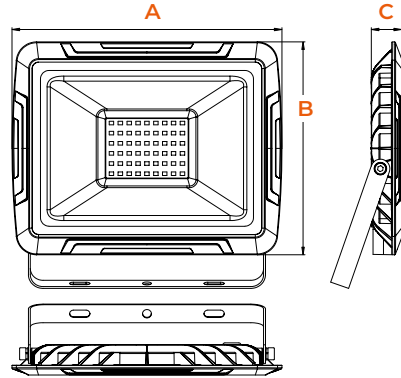

Temperatures | Températures



Light source | Source lumineuse

SMD LED - L80B10

Finish | Finitions



LED lifetime | Durée de vie LED

20.000h



Materials | Matériaux

Aluminum + Glass | Aluminium + Verre

Dimmable

Not dimmable | Non dimmable



W	Flux	K	MEASURES MESURES	Ref.
10	800Lm	4000K	A: 98mm B: 76mm C: 20mm	995466
10	800Lm	6500K	A: 98mm B: 76mm C: 20mm	995473
20	1600Lm	4000K	A: 133mm B: 97mm C: 21.5mm	995480
20	1600Lm	6500K	A: 133mm B: 97mm C: 21.5mm	995497
30	2600Lm	4000K	A: 168mm B: 120mm C: 22.5mm	995503
50	4000Lm	4000K	A: 213mm B: 168mm C: 24mm	995527
50	4000Lm	6500K	A: 213mm B: 168mm C: 24mm	995534

PROJECTOR PROJECTEUR SLIM Sensor

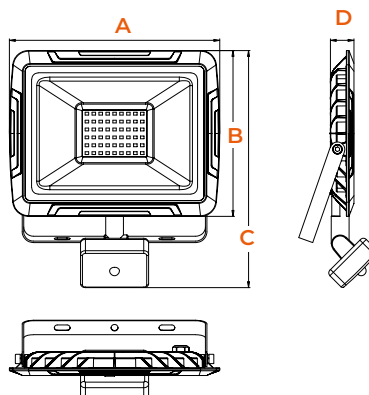

Temperatures | Températures



Light source | Source lumineuse

SMD LED - L80B10

Finish | Finitions



LED lifetime | Durée de vie LED

20.000h



Materials | Matériaux

Aluminum + Glass | Aluminium + Verre

Dimmable

Not dimmable | Non dimmable



W	Flux	K	MEASURES MESURES	Ref.
50	4000Lm	4000K	A: 213mm B: 168mm C: 2400mm D: 24mm	995589
50	4000Lm	6500K	A: 213mm B: 168mm C: 2400mm D: 24mm	995596

GROUND



Materials | Matériaux

Metal | Métal

Max. power | Puissance maximale

35W



Lamp holder | Douille

Bombillas GU10 - 50mmø



Finish | Finitions



Black | Noir

Ref.

995268

GROUND LED



Materials | Matériaux

Metal | Métal

LED lifetime | Durée de vie LED

35.000h



Dimmable

Not dimmable | Non dimmable



Finish | Finitions



Black | Noir



Corten

W

Flux

K



6

420Lm

3000K

995275

211429



GARLAND GUIRLANDE

Indoor - Outdoor | Intérieur - Extérieur



Initial cable 1,5 meters.
Câble de départ 1,5 mètres

Max. power lamp holder: 25W
Max. puissance douille: 25W

Cable diameter: 7mm
Diamètre extérieur câble: 7mm

Possibility of connection between garland up to 60m max.
Possibilité de connexion entre guirlande jusqu'à 60m max.

Compatible with E27 bulb
Compatible avec ampoule E27

Finish | Finitions

●
Black | Noir



Length Longueur	Lamp holder Douille	Ref.
5m	5 pcs.	989007
5m	10 pcs.	991673
10m	10 pcs.	989014
10m	20 pcs.	991659
15m	15 pcs.	989021
15m	30 pcs.	991918
20m	20 pcs.	989038
20m	40 pcs.	991666



LAES *by*
BOLUCE[®]
ILLUMINAZIONE

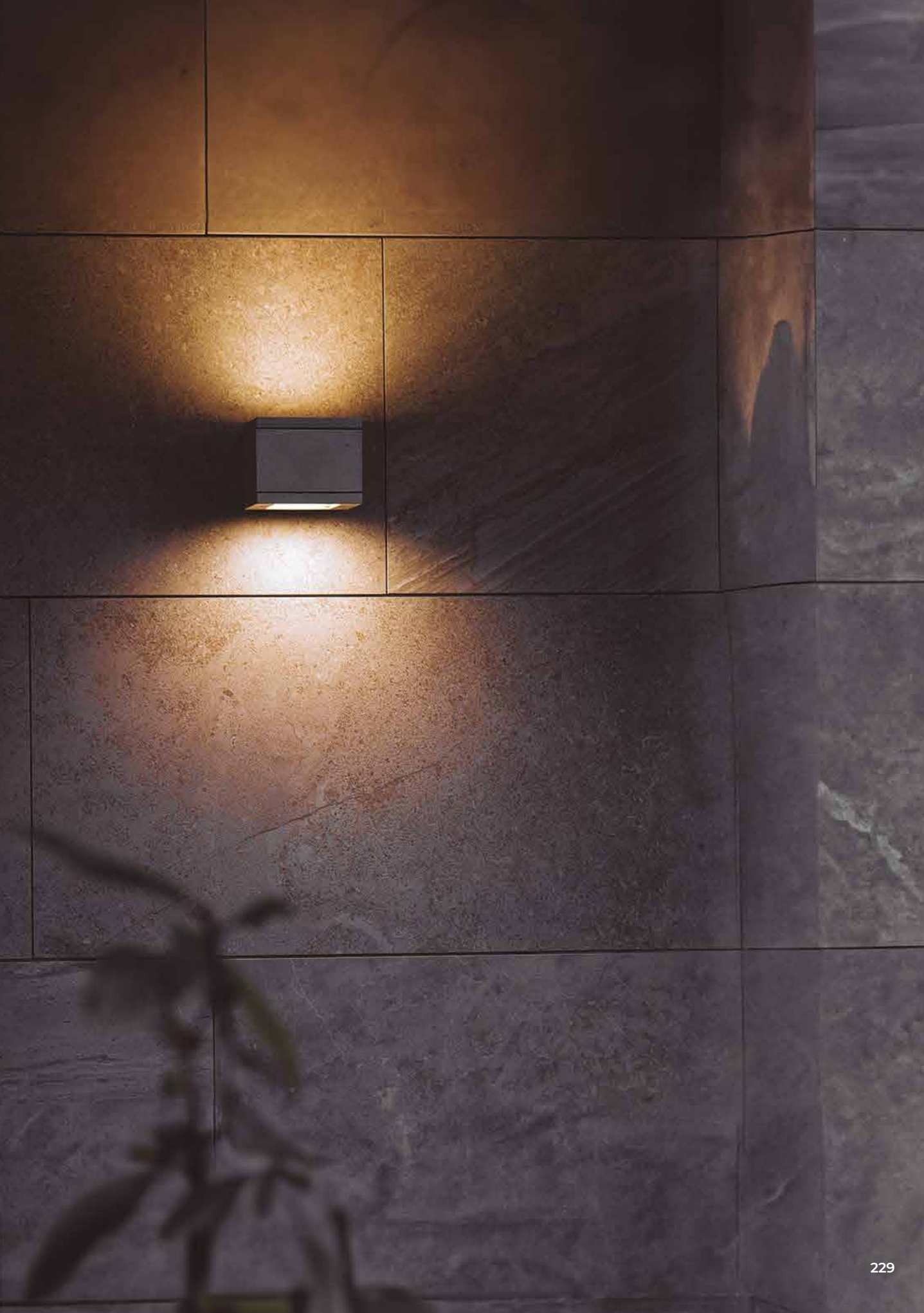

DORA

Unidirectional
Unidirectionnel

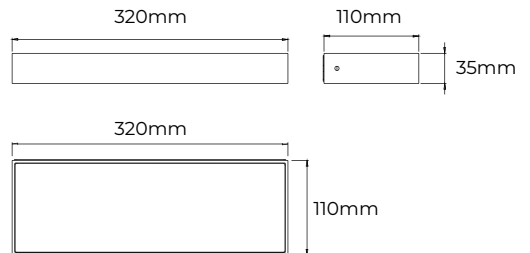
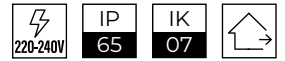

Temperatures | Températures



LED lifetime | Durée de vie LED

35.000h



Materials | Matériaux

Aluminum + Glass | Aluminium + Verre

Dimmable

Not dimmable | Non dimmable



	Colour Couleur	W	Flux	K	Ref.
(S)	Silver Argent	15	2000Lm	3000K	3820.674
(A)	Anthracite Anthracite	15	2000Lm	3000K	3820.679
(W)	White Blanc	15	2100Lm	4000K	3820.662
(S)	Silver Argent	15	2100Lm	4000K	3820.664
(A)	Anthracite Anthracite	15	2100Lm	4000K	3820.669

DORA

Bidirectional
Bidirectionnel

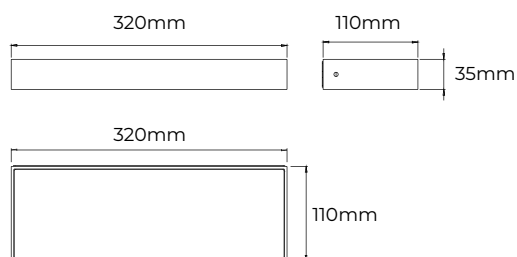

Temperatures | Températures



LED lifetime | Durée de vie LED

35.000h



Materials | Matériaux

Aluminum + Glass | Aluminium + Verre

Dimmable

Not dimmable | Non dimmable



	Colour Couleur	W	Flux	K	Ref.
S	Silver Argent	15	2000Lm	3000K	3822.674
A	Anthracite Anthracite	15	2000Lm	3000K	3822.679
S	Silver Argent	15	2100Lm	4000K	3822.664
A	Anthracite Anthracite	15	2100Lm	4000K	3822.669

OLIVIA

Unidirectional
Unidirectionnel

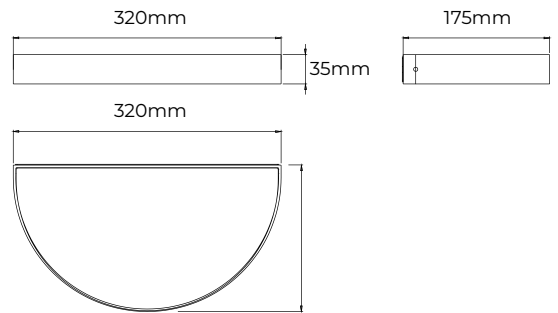
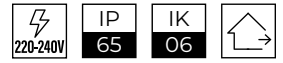

Temperatures | Températures



LED lifetime | Durée de vie LED

35.000h



Materials | Matériaux

Aluminum + Glass | Aluminium + Verre

Dimmable

Not dimmable | Non dimmable



	Colour Couleur	W	Flux	K	Ref.
A	Anthracite Anthracite	15	2000Lm	3000K	3830.679
A	Anthracite Anthracite	15	2100Lm	4000K	3830.669
S	Silver Argent	15	2100Lm	4000K	3830.664

OLIVIA

Bidirectional
Bidirectionnel

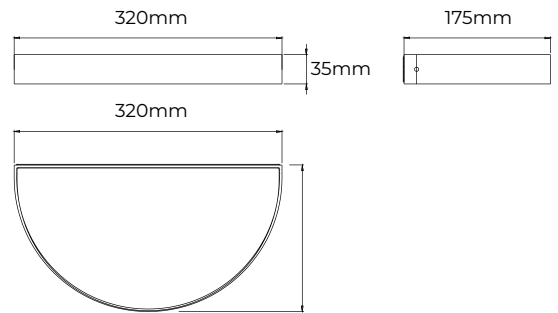

Temperatures | Températures



LED lifetime | Durée de vie LED

35.000h



Materials | Matériaux

Aluminum + Glass | Aluminium + Verre

Dimmable

Not dimmable | Non dimmable



	Colour Couleur	W	Flux	K	Ref.
A	Anthracite Anthracite	15	2000Lm	3000K	3832.679
A	Anthracite Anthracite	15	2100Lm	4000K	3832.669

DM3 70° / 70°

Bidirectional
Bidirectionnel

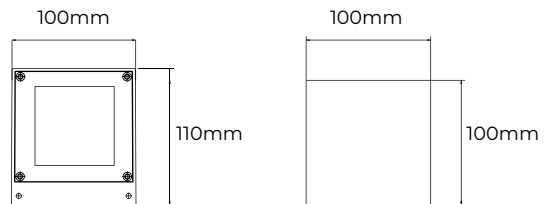

Temperatures | Températures



LED lifetime | Durée de vie LED

35.000h



Materials | Matériaux

Aluminum + Glass | Aluminium + Verre

Dimmable

Not dimmable | Non dimmable



	Colour Couleur	W	Flux	K	Ref.
(W)	White Blanc	2 x 4	2 x 510Lm	3000K	4032.672
(B)	Black Noir	2 x 4	2 x 510Lm	3000K	4032.673
(S)	Silver Argent	2 x 4	2 x 510Lm	3000K	4032.674
(A)	Anthracite Anthracite	2 x 4	2 x 510Lm	3000K	4032.679
(W)	White Blanc	2 x 4	2 x 510Lm	4000K	4032.662
(B)	Black Noir	2 x 4	2 x 510Lm	4000K	4032.663
(S)	Silver Argent	2 x 4	2 x 510Lm	4000K	4032.664
(A)	Anthracite Anthracite	2 x 4	2 x 510Lm	4000K	4032.669

DM3 10° / 70°

Bidirectional
Bidirectionnel

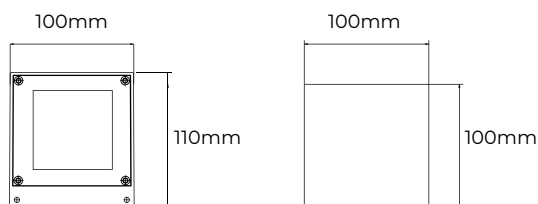
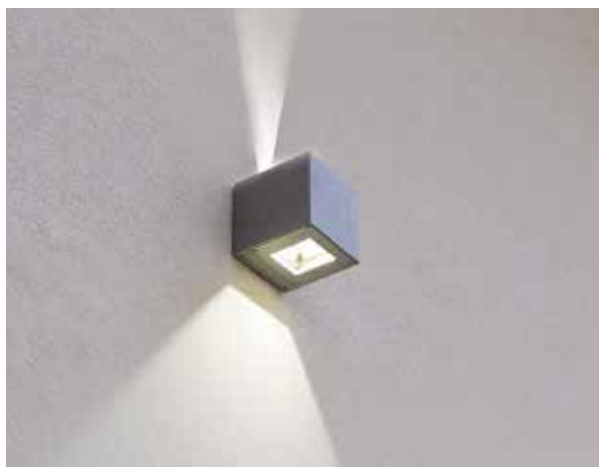

Temperatures | Températures



LED lifetime | Durée de vie LED

35.000h



Materials | Matériaux

Aluminum + Glass | Aluminium + Verre

Dimmable

Not dimmable | Non dimmable



	Colour Couleur	W	Flux	K	Ref.
(W)	White Blanc	2 x 4	2 x 510Lm	3000K	4033.672
(B)	Black Noir	2 x 4	2 x 510Lm	3000K	4033.673
(S)	Silver Argent	2 x 4	2 x 510Lm	3000K	4033.674
(A)	Anthracite Anthracite	2 x 4	2 x 510Lm	3000K	4033.679
(W)	White Blanc	2 x 4	2 x 510Lm	4000K	4033.662
(B)	Black Noir	2 x 4	2 x 510Lm	4000K	4033.663
(S)	Silver Argent	2 x 4	2 x 510Lm	4000K	4033.664
(A)	Anthracite Anthracite	2 x 4	2 x 510Lm	4000K	4033.669

AMOS MINI 70° / 70°

Bidirectional
Bidirectionnel

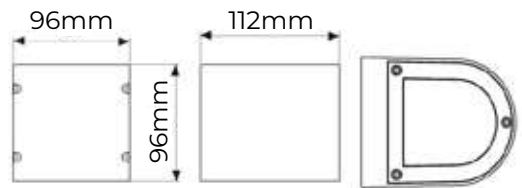

Temperatures | Températures



LED lifetime | Durée de vie LED

35.000h



Materials | Matériaux

Aluminum + Glass | Aluminium + Verre

Dimmable

Not dimmable | Non dimmable



	Colour Couleur	W	Flux	K	Ref.
S	Silver Argent	2 x 4	2 x 510Lm	3000K	8092.674
A	Anthracite Anthracite	2 x 4	2 x 510Lm	3000K	8092.679
S	Silver Argent	2 x 4	2 x 510Lm	4000K	8092.664
A	Anthracite Anthracite	2 x 4	2 x 510Lm	4000K	8092.669

AMOS MINI 10° / 70°

Bidirectional
Bidirectionnel

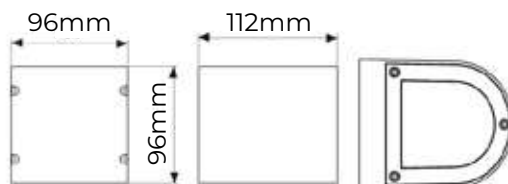

Temperatures | Températures



LED lifetime | Durée de vie LED

35.000h



Materials | Matériaux

Aluminum + Glass | Aluminium + Verre

Dimmable

Not dimmable | Non dimmable



	Colour Couleur	W	Flux	K	Ref.
S	Silver Argent	2 x 4	2 x 510Lm	3000K	8093.674
A	Anthracite Anthracite	2 x 4	2 x 510Lm	3000K	8093.679
S	Silver Argent	2 x 4	2 x 510Lm	4000K	8093.664
A	Anthracite Anthracite	2 x 4	2 x 510Lm	4000K	8093.669

BLITZ 124

Bidirectional
Bidirectionnel

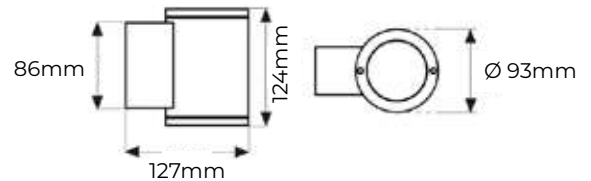

Temperatures | Températures



LED lifetime | Durée de vie LED

35.000h



Materials | Matériaux

Aluminum + Glass | Aluminium + Verre

Dimmable

Not dimmable | Non dimmable



	Colour Couleur	W	Flux	K	Ref.
S	Silver Argent	2 x 4	2 x 500Lm	3000K	9076.674
A	Anthracite Anthracite	2 x 4	2 x 500Lm	3000K	9076.679
S	Silver Argent	2 x 4	2 x 510Lm	4000K	9076.664
A	Anthracite Anthracite	2 x 4	2 x 510Lm	4000K	9076.669

BLITZ 252

Bidirectional
Bidirectionnel

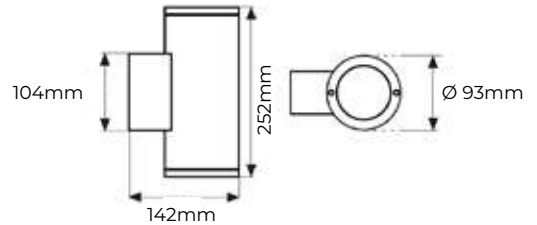

Temperatures | Températures



LED lifetime | Durée de vie LED

35.000h



Materials | Matériaux

Aluminum + Glass | Aluminium + Verre

Dimmable

Not dimmable | Non dimmable



	Colour Couleur	W	Flux	K	Ref.
S	Silver Argent	2 x 4	2 x 500Lm	3000K	9072.674
A	Anthracite Anthracite	2 x 4	2 x 500Lm	3000K	9072.679
S	Silver Argent	2 x 4	2 x 510Lm	4000K	9072.664
A	Anthracite Anthracite	2 x 4	2 x 510Lm	4000K	9072.669

LID WALL

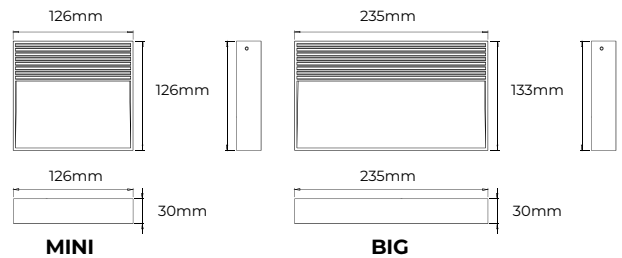
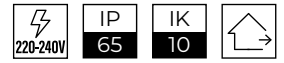

Temperatures | Températures



LED lifetime | Durée de vie LED

35.000h



Materials | Matériaux

Aluminum + Glass | Aluminium + Verre

Dimmable

Not dimmable | Non dimmable



MINI	Colour Couleur	W	Flux	K	Ref.
S	Silver Argent	5	580Lm	4000K	3873.664
A	Anthracite Anthracite	5	580Lm	4000K	3873.669

BIG	Colour Couleur	W	Flux	K	Ref.
S	Silver Argent	13	1410Lm	3000K	3870.674
A	Anthracite Anthracite	13	1510Lm	3000K	3870.679
S	Silver Argent	13	1410Lm	4000K	3870.664
A	Anthracite Anthracite	13	1510Lm	4000K	3870.669



GLAM

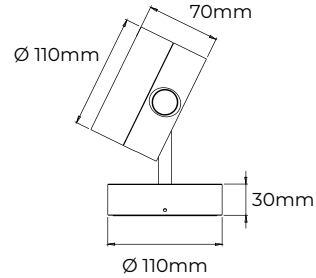

Temperatures | Températures



LED lifetime | Durée de vie LED

35.000h



Materials | Matériaux

Aluminum + Thermoplastic
Aluminium + Thermoplastique

Dimmable

Not dimmable | Non dimmable



	Colour Couleur	W	Flux	K	Ref.
Ⓔ	Black Noir	8.4	1060Lm	3000K	3850.67.383
Ⓔ	Black Noir	8.4	1120Lm	4000K	3850.66.383

ACCESSORIES | ACCESSOIRES

Stainless steel spike
Piquet en acier inoxydable

Ref. PQ50



IP67 connecting device with driver 350 mA / 500 mA / 750 mA with 2 poles, 3 ways for cables Ø 4÷9,5 mm
Système de connexion IP67 avec driver 350 mA / 500 mA / 700 mA à 2 broches, 3 voies par câble Ø 4÷9,5 mm

Ref. CN24

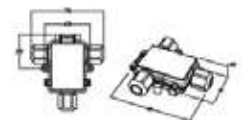

Driver Glam BIG - 700mA (1 to 2 luminaires)
Driver Glam BIG - 700mA (1 à 2 luminaires)

Ref. D50



NORA

Downlight



IP65 driver available on request
Driver IP65 disponible sur demande

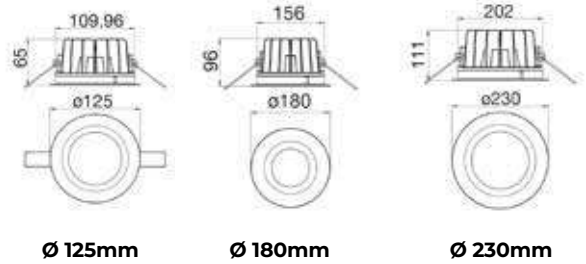

Temperatures | Températures



LED lifetime | Durée de vie LED

35.000h



Materials | Matériaux

Aluminum + Glass | Aluminium + Verre

Optional dimming | Dimmable en option



DALI only IP20 | DALI uniquement IP20

	Colour Couleur	W	Flux	K	A°	Ø mm	Ref.
Ⓜ	White Blanc	11	1560Lm	4000K	38°	125	1210.20.382
Ⓑ	Black Noir	11	1560Lm	4000K	38°	125	1210.20.383
Ⓢ	Silver Argent	11	1560Lm	4000K	38°	125	1210.20.384
Ⓜ	White Blanc	24	3610Lm	3000K	70°	180	1811.172
Ⓑ	Black Noir	24	3610Lm	3000K	70°	180	1811.173
Ⓢ	Silver Argent	24	3610Lm	3000K	70°	180	1811.174
Ⓜ	White Blanc	24	3610Lm	4000K	70°	180	1811.192
Ⓑ	Black Noir	24	3610Lm	4000K	70°	180	1811.193
Ⓢ	Silver Argent	24	3610Lm	4000K	70°	180	1811.194
Ⓜ	White Blanc	37	5190Lm	3000K	90°	230	1812.172
Ⓑ	Black Noir	37	5190Lm	3000K	90°	230	1812.173
Ⓢ	Silver Argent	37	5190Lm	3000K	90°	230	1812.174
Ⓜ	White Blanc	37	5190Lm	4000K	90°	230	1812.192
Ⓑ	Black Noir	37	5190Lm	4000K	90°	230	1812.193
Ⓢ	Silver Argent	37	5190Lm	4000K	90°	230	1812.194

PATH HT

Surface
En saillie

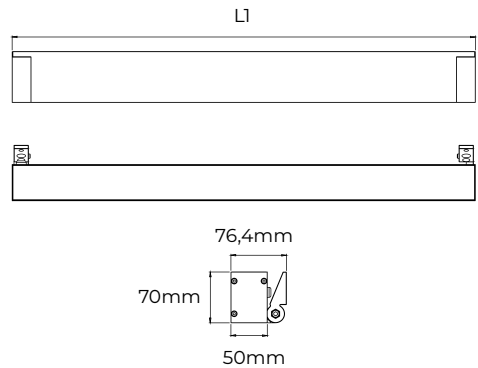
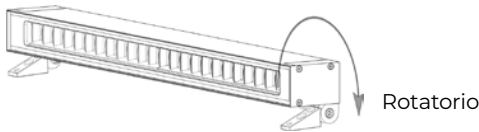
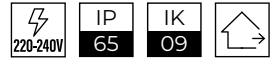

Temperatures | Températures



LED lifetime | Durée de vie LED

35.000h



Materials | Matériaux

Aluminum + Glass | Aluminium + Verre

Optional dimming | Dimmable en option



	Colour Couleur	W	L1	Flux	K	Ref.
S	Silver Argent	16,5	637mm	1800Lm	3000K	3840.67.644
S	Silver Argent	16,5	637mm	2100Lm	4000K	3840.66.644
S	Silver Argent	33	1208mm	3600Lm	3000K	3842.67.644
S	Silver Argent	33	1208mm	4200Lm	4000K	3842.66.644

ACCESSORIES | ACCESSOIRES

Wall mounting kit
Kit mural

Ref. 06.3840

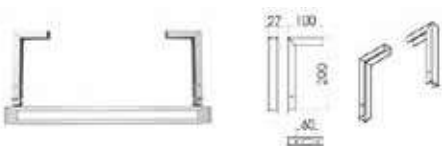

IP68 connecting device H2O STOP with 3 poles
for cables between Ø 7÷13 mm

Dispositif de connexion IP68 H2O STOP avec 3
pôles pour câbles entre Ø 7÷13 mm

Ref. CN22

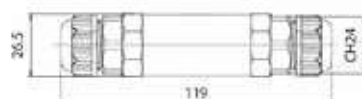

LID

Recessed
Encastrable

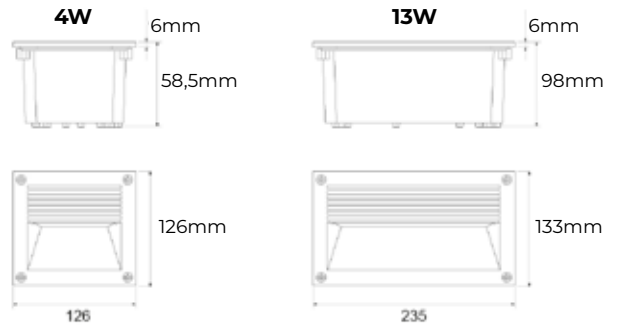

Temperatures | Températures



LED lifetime | Durée de vie LED

35.000h



Materials | Matériaux

Aluminum + Glass | Aluminium + Verre

Optional dimming | Dimmable en option



	Colour Couleur	W	Flux	K	Ref.
B	Black Noir	4	500Lm	3000K	3073.673
S	Silver Argent	4	500Lm	3000K	3073.674
A	Anthracite Anthracite	4	500Lm	3000K	3073.679
B	Black Noir	4	510Lm	4000K	3073.663
S	Silver Argent	4	510Lm	4000K	3073.664
A	Anthracite Anthracite	4	510Lm	4000K	3073.669
S	Silver Argent	13	1790Lm	3000K	3070.564
A	Anthracite Anthracite	13	1790Lm	3000K	3070.569
S	Silver Argent	13	1790Lm	4000K	3070.553
A	Anthracite Anthracite	13	1790Lm	4000K	3070.559

GEO

Recessed
Encastrable



ROUND

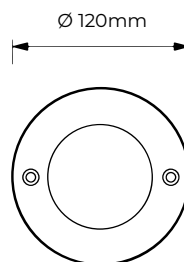

SQUARE

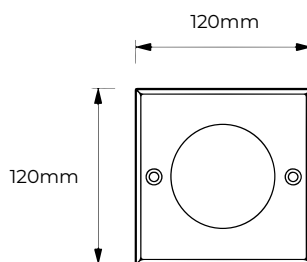

Temperatures | Températures



LED lifetime | Durée de vie LED

35.000h



Materials | Matériaux

Aluminum + Glass | Aluminium + Verre

Optional dimming | Dimmable en option



	Colour Couleur	Shape Forme	W	Flux	K	Ref.
S	Silver Argent	○	4	500Lm	3000K	5081.670
S	Silver Argent	○	4	510Lm	4000K	5081.660
S	Silver Argent	□	4	500Lm	3000K	5082.670
S	Silver Argent	□	4	510Lm	4000K	5082.660



NECK

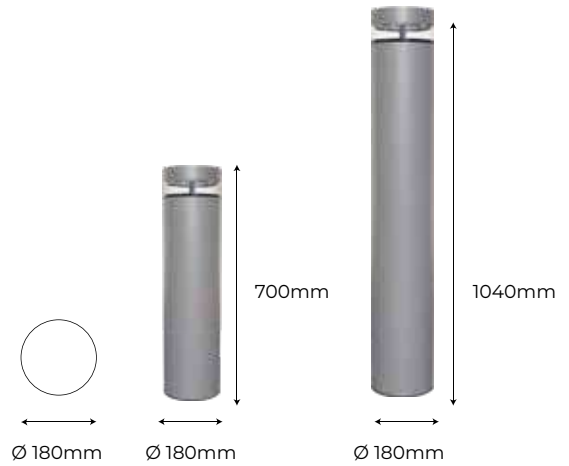

Temperatures | Températures



LED lifetime | Durée de vie LED

35.000h



Materials | Matériaux

Aluminium + Polycarbonate

Dimmable

Not dimmable | Non dimmable



	Colour Couleur	W	Flux	K	L	Ref.
B	Black Noir	25	2880Lm	3000K	700mm	8047.673
S	Silver Argent	25	2880Lm	3000K	700mm	8047.674
A	Anthracite Anthracite	25	2880Lm	3000K	700mm	8047.679
B	Black Noir	25	3020Lm	4000K	700mm	8047.663
S	Silver Argent	25	3020Lm	4000K	700mm	8047.664
A	Anthracite Anthracite	25	3020Lm	4000K	700mm	8047.669
B	Black Noir	25	2880Lm	3000K	1040mm	8049.673
S	Silver Argent	25	2880Lm	3000K	1040mm	8049.674
A	Anthracite Anthracite	25	2880Lm	3000K	1040mm	8049.679
B	Black Noir	25	3020Lm	4000K	1040mm	8049.663
S	Silver Argent	25	3020Lm	4000K	1040mm	8049.664
A	Anthracite Anthracite	25	3020Lm	4000K	1040mm	8049.666

Post flange accessory
Accessoire de fixation pour poteau

Ref. 8049



PIN



Temperatures | Températures



LED lifetime | Durée de vie LED

35.000h



Materials | Matériaux

Aluminium + Polycarbonate

Dimmable

Not dimmable | Non dimmable



	Colour Couleur	W	Flux	K	L	Ref.
B	Black Noir	25	2880Lm	3000K	460mm	5182.673
S	Silver Argent	25	2880Lm	3000K	460mm	5182.674
A	Anthracite Anthracite	25	2880Lm	3000K	460mm	5182.679
B	Black Noir	25	3020Lm	4000K	460mm	5182.663
S	Silver Argent	25	3020Lm	4000K	460mm	5182.664
A	Anthracite Anthracite	25	3020Lm	4000K	460mm	5182.669
B	Black Noir	25	2880Lm	3000K	660mm	5181.673
S	Silver Argent	25	2880Lm	3000K	660mm	5181.674
A	Anthracite Anthracite	25	2880Lm	3000K	660mm	5181.679
B	Black Noir	25	3020Lm	4000K	660mm	5181.663
S	Silver Argent	25	3020Lm	4000K	660mm	5181.664
A	Anthracite Anthracite	25	3020Lm	4000K	660mm	5181.669

Post flange accessory
Accessoire de fixation pour poteau

Ref. TR5180



LID WALL STELLO



Temperatures | Températures



LED lifetime | Durée de vie LED

35.000h



Materials | Matériaux

Aluminum + Glass | Aluminium + Verre

Dimmable

Not dimmable | Non dimmable



	Colour Couleur	W	Flux	K	L	Ref.
(S)	Silver Argent	5	540Lm	3000K	500mm	3876.674
(A)	Anthracite Anthracite	5	540Lm	3000K	500mm	3876.679
(S)	Silver Argent	5	540Lm	3000K	900mm	3878.674
(A)	Anthracite Anthracite	5	540Lm	3000K	900mm	3878.679

MATCH



Temperatures | Températures



LED lifetime | Durée de vie LED

35.000h



Materials | Matériaux

Aluminium + Polycarbonate

Dimmable

Not dimmable | Non dimmable



	Colour Couleur	W	Flux	K	L	Ref.
Ⓑ	Black Noir	11.5	1900Lm	3000K	600mm	4331.673
⒮	Silver Argent	11.5	1900Lm	3000K	600mm	4331.674
Ⓐ	Anthracite Anthracite	11.5	1900Lm	3000K	600mm	4331.679
Ⓑ	Black Noir	11.5	1900Lm	4000K	600mm	4331.663
⒮	Silver Argent	11.5	1900Lm	4000K	600mm	4331.664
Ⓐ	Anthracite Anthracite	11.5	1900Lm	4000K	600mm	4331.669
Ⓑ	Black Noir	11.5	1900Lm	3000K	850mm	4330.673
⒮	Silver Argent	11.5	1900Lm	3000K	850mm	4330.674
Ⓐ	Anthracite Anthracite	11.5	1900Lm	3000K	850mm	4330.679
Ⓑ	Black Noir	11.5	1900Lm	4000K	850mm	4330.663
⒮	Silver Argent	11.5	1900Lm	4000K	850mm	4330.664
Ⓐ	Anthracite Anthracite	11.5	1900Lm	4000K	850mm	4330.669

Post flange accessory
Accessoire de fixation pour poteau

Ref. TR 43



LAES

DECORATIVE LIGHTING
ÉCLAIRAGE DÉCORATIF



TALLIN

Pendant | Suspension



MADE IN EUROPE

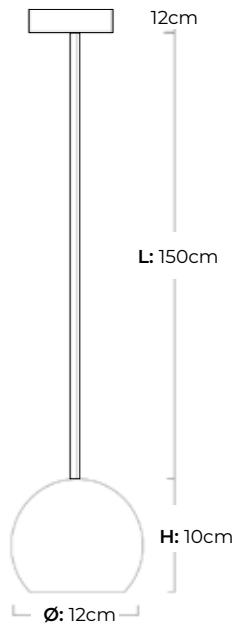

Materials | Matériaux

Steel + textile cable | Acier + câble textile

Max. power | Puissance maximale

⚡ 60W

Lamp holder | Douille



GU10 Lamp | Lampe GU10 - 50mmø

	Color Couleur	Ref.
○	White Blanc	997620
●	Black Noir	997637
●	Golden Or	997644

Out of range product available | *Suspension made on request

Autres modèles disponibles hors catalogue

*Suspension faite sur demande

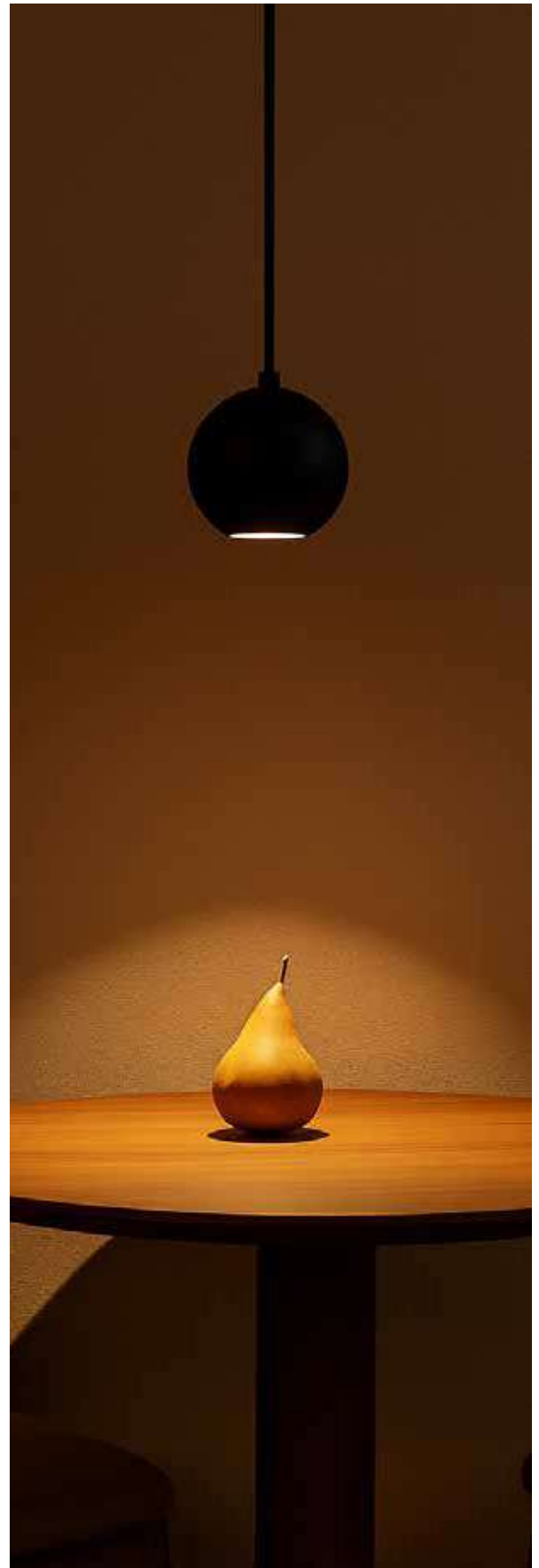

TALLIN

Surface | En Saillie

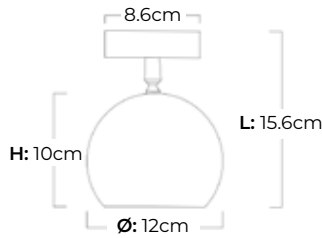
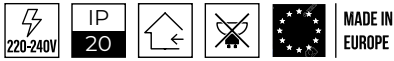

Materials | Matériaux

Steel | Acier

Max. power | Puissance maximale

⚡ 60W

Lamp holder | Douille

🔌 GU10 Lamp | Lampe GU10 - 50mmø

Color | Couleur

Ref.

○	White Blanc	998801
●	Black Noir	998818
●	Golden Or	998825

Out of range product available
Autres modèles disponibles hors catalogue

TALLIN

Wall Light | Applique Murale

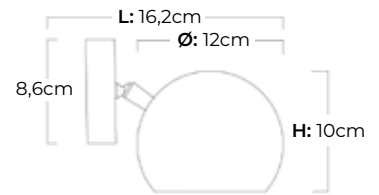
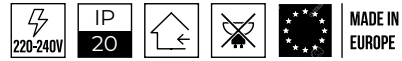

Materials | Matériaux

Steel | Acier

Max. power | Puissance maximale

⚡ 60W

Lamp holder | Douille

🔌 GU10 Lamp | Lampe GU10 - 50mmø

Color | Couleur

Ref.

○	White Blanc	998832
●	Black Noir	998849
●	Golden Or	998856

Out of range product available
Autres modèles disponibles hors catalogue

VENECIA

Pendant | Suspension



MADE IN
EUROPE

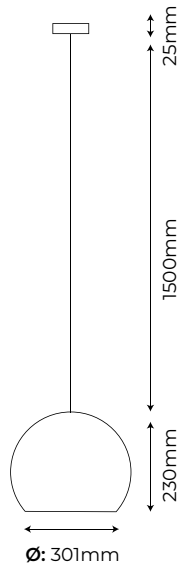

Materials | Matériaux

Aluminium

Max. power | Puissance maximale

⚡ 60W

Lamp holder | Douille

🔌 Lamp | Lampe E27

Color | Couleur

Ref.

○	White Blanc	204773
●	Black Noir	204766
●	Silver Argent	204780
●	Cooper Bronze	204797
●	Golden Or	204803



BUDAPEST

Pendant | Suspension



MADE IN EUROPE

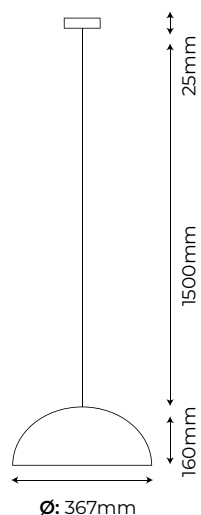

Materials | Matériaux

Aluminium

Max. power | Puissance maximale

⚡ 60W

Lamp holder | Douille

🔌 Lamp | Lampe E27

	Color Couleur	Ref.
○	White Blanc	209181
●	Black Noir	209174
●	Silver Argent	209198
●	Cooper Bronze	209204
●	Golden Or	209211

Out of range product available | *Suspension made on request

Autres modèles disponibles hors catalogue

*Suspension faite sur demande



FIRENZE M

Pendant | Suspension



MADE IN EUROPE

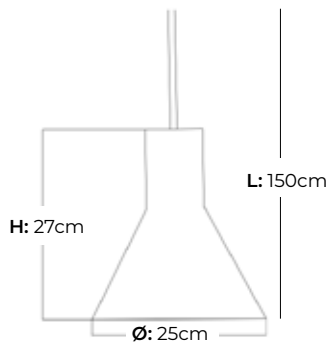

Materials | Matériaux

Aluminium

Max. power | Puissance maximale

⚡ 60W

Lamp holder | Douille

🔌 Lamp | Lampe E27

Color | Couleur

Ref.

○	White Blanc	998863
●	Black Noir	998870
●	Golden Or	998887

Out of range product available | *Suspension made on request

Autres modèles disponibles hors catalogue

*Suspension faite sur demande



FIRENZE S

Pendant | Suspension



MADE IN EUROPE

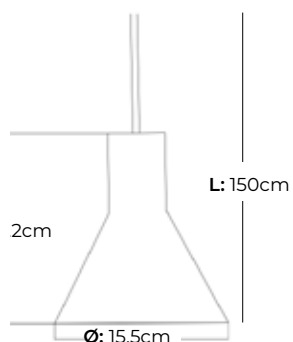

Materials | Matériaux

Aluminium

Max. power | Puissance maximale

⚡ 60W

Lamp holder | Douille

🔌 Lamp | Lampe E27

	Color Couleur	Ref.
○	White Blanc	998894
●	Black Noir	998900
●	Golden Or	998917

Out of range product available | *Suspension made on request

Autres modèles disponibles hors catalogue

*Suspension faite sur demande



MILAN

Pendant | Suspension

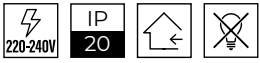

Materials | Matériaux

Aluminium

Max. power | Puissance maximale

⚡ 60W

Lamp holder | Douille

💡 Lamp | Lampe E27

Color | Couleur

Ref.



Black | Noir

987621



VILNA

Aluminium Pendant | Suspension en aluminium



Materials | Matériaux

Aluminium

Max. power | Puissance maximale

⚡ 60W

Lamp holder | Douille

💡 Lamp | Lampe E27

	Color Couleur	Ref.
●	Graphite grey Gris graphite	987690
○	White Blanc	987676
●	Matt aluminum Aluminium mate	987683
●	Matte bronze Bronze mate	987713
●	Copper Cuivre	987706







LAES

Polígon Industrial Cova Solera
Carrer Roma, 20
08191. Rubí. Barcelona. España
Apartado de Correos 199

Tel. +34 93 586 20 28

atencioncliente@laes.com

www.laes.com

