

PRUSA
RESEARCH
by JOSEF PRUSA

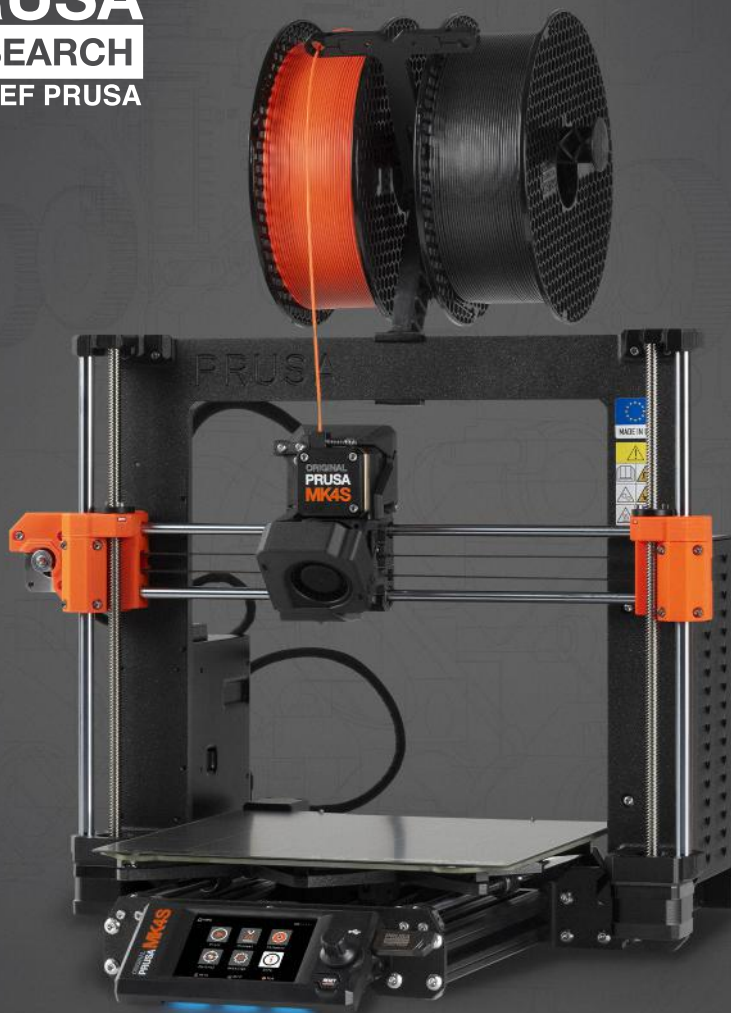

ORIGINAL INSTRUCTIONS



3D PRINTING HANDBOOK

FOR THE ORIGINAL PRUSA MK4S 3D PRINTER

Original Prusa MK4S: Official Instructions

Handbook version 1.01 - September 26th, 2024

If you need to download this handbook in other languages, such as **Deutsch, Français, Italiano, Español, Čeština, and Polski**, visit <https://prusa.io/mk4s> or scan the QR code on the right. This link will also take you to a hub containing the latest downloads (firmware, handbook, drivers, PrusaSlicer) and help articles.



In this handbook, you will learn everything you need to set up your printer, use it, perform routine maintenance, and more. Assembly instructions, along with other useful information, can be found at prusa.io/mk4s.

The handbook primarily references the Original Prusa MK4S, as it is virtually identical to the MK3.9S from the user's perspective. Therefore, the instructions provided are equally applicable to the MK3.9S.

Quick Guide to the First Print

1. Read the Safety Instructions carefully (**page 8**).
2. Place the printer on a flat and stable surface and plug it in. (**page 15**)
3. If you bought the assembled printer, remove the test print from the print sheet (remove the sheet, bend it, remove the print), then place the print sheet back. (**page 17**)
4. Calibrate the printer using the Selftest Wizard. (**page 18**)
5. Insert the USB drive that came with your printer and print your first object. (**page 23**)



Tips, advice or important information that will help you when working with the printer.



This part of the text is very important, please read it carefully! It is directly related to the correct operation of the printer and its safe operation.



This information applies to the Original Prusa MK4S 3D printer assembly kit.

How to contact Prusa Research technical support:

First, check the last sections of this manual that deal with common problems, or go to prusa.io/mk4s (you can also scan the QR code at the top of the page) for a complete list of the most common problems and solutions. If your problem is not listed here, or the solution does not work, please send an email to info@prusa3d.com and/or use our chat at prusa3d.com. Try to describe your problem as accurately as possible and include pictures or videos.

JOSEF PRUSA®, PRUSA RESEARCH®, PRUSA POLYMERS®, PRUSA ORANGE®, ORIGINAL PRUSA®, PRUSA 3D®, and PRUSAMENT™ are registered trademarks of Prusa Development a.s. used by Prusa Research a.s. under license from Prusa Development a.s. | JOSEF PRUSA, ORIGINAL PRUSA, and PRUSAMENT are registered trademarks (or trademark applications) of Prusa Development a.s. and are used by Prusa Research a.s. under license from Prusa Development a.s. in the following countries: Australia, New Zealand, Israel, Mexico, South Korea, Turkey, Ukraine, Russia, Kazakhstan, Switzerland, China, Colombia, Uzbekistan, Philippines and Norway. | All other company names and product names mentioned in this publication are trademarks and registered trademarks of their respective companies.

About the Author

Josef Průša (*23. 2. 1990) became interested in 3D printing when he began studying at the University of Economics in 2009 - it started off as a hobby, a new technology open to modifications and improvements. The hobby quickly became his passion, and Josef became one of the main developers of the international open-source (all works are freely available for any use) RepRap project by Adrian Bowyer. Today, Prusa's design in various versions can be seen all over the world; it is one of the most used printer designs. The goal is to increase public awareness of 3D printing technology.

All of Josef Průša's 3D printers are open-source. In the spirit of the RepRap project, you can use your printer to produce parts for other 3D printers. The Original Prusa product range is constantly being expanded with new models and improvements.

His main goal is to make 3D printing technology more understandable and easier for ordinary users. Josef Průša also holds workshops for the public, participates in professional conferences, and promotes 3D printing. He has lectured at TEDx conferences in Prague and Vienna, at the World Maker Faire in New York, at the Maker Faire in Rome, and at the Open Hardware Summit at MIT. He has also taught the Arduino course at Charles University and was a lecturer at the Academy of Arts, Architecture and Design in Prague.

In his own words, he envisions a not-so-distant future where 3D printers will be available in every household. If anything is needed, you can easily print it out. The boundaries in this field are being pushed every day... We are glad you are part of it!



Table of contents

1. Introduction	10
2. Unpacking and Package Contents	11
2.1. How to Move the Printer	11
2.2. Contents of the Package and Accessories	12
3. Original Prusa MK4S Overview and Glossary	13
3.1. Connecting and Disconnecting the Power Cable	15
3.2. Error Screens	15
4. Your First Print	16
4.1. Basic controls	16
4.2. Preparing Flexible Print Sheets	17
4.3. Selftest (Calibration Wizard)	18
4.4. Running the Selftest	19
4.5. Inserting (Loading) filament	20
4.6. Unloading (Removing) Filament	22
4.7. Starting the First Print	23
4.8. Removing a Printed Object from the Print Sheet	25
4.9. Selftest Troubleshooting	26
4.10. First Print Troubleshooting	26
4.10.1. LoadCell calibration fails	26
4.10.2. First layer peeling off from the bed	26
4.10.3. Nozzle moves too high/low, or extrudes plastic outside the print area	27
4.10.4. The nozzle does not start extruding, even after multiple attempts	27
4.10.5. After a few hours of printing, the nozzle stops extruding filament	28
4.11. Updating the Firmware	29
4.12. Sample Models	30
4.13. Factory Reset	30
5. Advanced User Guide	31
5.1. Prusa Academy Courses	31
5.2. Network Connection	32
5.3. Touch Control	34
5.4. Cancel Object	34
5.5. Stealth Mode	34
5.6. Input Shaper and Pressure Advance	34
5.7. Using Nozzles with Various Diameters	35
5.8. Multi-Material Upgrade 3	36
5.9. Original Prusa Enclosure	36
5.10. Flashing an Unofficial (Unsigned) Firmware:	37
6. Printing Your Own Models	38
6.1. Obtaining Printable Models	39
6.2. Create Your Own Model	40
6.3. What is a G-code File?	40
6.4. PrusaSlicer	41
6.5. PrusaSlicer Interface Explained	42
6.5.1. Initial Setup and General Workflow	43
6.5.2. Using Supports	44
6.5.3. Speed vs Print Quality	45
6.5.4. Infill	46
6.5.5. Brim	46
6.5.6. Printing Objects Larger than the Print Volume	47

6.5.7. Printing Multicolored Objects (without MMU3)	48
6.5.8. Slicing and Exporting	49
7. Material Guide	50
7.1. PLA	50
7.2. PETG	51
7.3. ASA (ABS)	52
7.4. PC (polycarbonate) and PC Blend	53
7.5. PVB	54
7.6. Flexible Materials	55
7.7. PA (Polyamide) / PA11CF	56
8. Regular Maintenance	57
8.1. Flexible Print Sheets	57
8.1.1. Double-Sided TEXTURED Print Sheet	59
8.1.2. Double-Sided SMOOTH Print Sheet	59
8.1.3. Double-Sided SATIN Print Sheet	60
8.1.4. Improving the Adhesion	60
8.2. Keeping the Printer Clean	60
8.3. Bearings	60
8.4. Fans	61
8.5. Extruder Feeding Gear	61
8.6. Electronics	61
8.7. Extruder is Clogged or Jammed	61
8.8. Cleaning the Nozzle	62
8.8.1. The filament does not come out of the nozzle.	62
8.8.2. The filament does not come out of the nozzle or only a small amount comes out	62
8.9. Troubleshooting Faulty Sensor Readings and Removing Errors	62
8.10. Filament Sensor	62
9. FAQ - Frequently Asked Questions and Basic Troubleshooting	63
9.1. Mesh Bed Leveling Fails	63
9.2. Printer Does Not Recognize the Inserted USB Drive	63
9.3. Loose Belts	64
9.4. Homing Failed	64
9.5. Heating Error	64
9.6. Fan Error	64
9.7. Reverting to an Older Firmware	64
9.8. Nozzle Hitting the Sheet / Other Z-axis Issues	64
10. Advanced Hardware Troubleshooting	65
11. Troubleshooting Print Quality Issues	65

Product Information

Name:	Original Prusa MK4S	Original Prusa MK3.9S
Manufacturer:	Prusa Research a.s., Partyzánská 188/7a, Holešovice, 170 00 Praha 7, Česká republika	
Contacts:	Phone: +420 222 263 718, e-mail: info@prusa3d.com	
EEE Category:	3 (IT / Telecommunications Equipment)	
Power Supply:	100-240 VAC, 2.8 A max., 50-60 Hz	
Frequency Bands:	WLAN: 2400,0-2483,5 MHz	
	NFC: 13,553-13,567 MHz	
Maximum Radiated Radio Frequency Performance (WLAN):	< 100 mW e.i.r.p.	
Maximum Magnetic Field Strength (NFC):	< 60 dBuA/m at a distance of 10 m	
WLAN standard:	IEEE 802.11 b/g/n	
Operating Temperature Range:	18 °C - 38 °C	
Maximum Air Humidity:	85%, non-condensing	
Printer Dimensions:	Width: 460 mm	
	Depth (with bed centered): 420 mm	
	Height (without spool and spoolholder): 385 mm	
Build Volume (Width × Depth × Height):	250×210×220 mm	
Installed Nozzle Diameter:	0.4 mm	
Supported Filament Diameter:	1.75 mm	
Weight (With Packaging / Without Packaging):	12.4 kg / 7.6 kg	

The serial number of the Original Prusa MK4S product is printed on the nameplate located on the printer frame and also on the packaging. The serial number of the Original Prusa MK3.9S product is located on the nameplate included in the upgrade kit, which must be attached to the printer frame. The Original Prusa MK4S and Original Prusa MK3.9S are devices intended for use only in indoor environments, where they are protected from external influences.

Operating conditions in accordance with the General Authorization of the Czech Telecommunication Office No. VO-R/10 and No. VO-R/12.

Simplified Declaration of Conformity

The manufacturer, Prusa Research a.s., hereby declares that the products Original Prusa MK4S and Original Prusa MK3.9S are in conformity with Directive 2014/53/EU applicable in the European Union and with Statutory Instruments 2017 No. 1206 applicable in the United Kingdom.

The full texts of the Declaration of Conformity are available at the website: prusa3d.com.

Original Prusa MK4S / Original Prusa MK3.9S Warranty Information

The parts for the Original Prusa MK4S 3D printer are covered by a 24-month warranty for end customers in the EU, and a 12-month warranty for business customers and end customers in the rest of the world. Consumables and parts subject to wear and tear are excluded from this warranty. The warranty period starts on the day the customer receives the goods.

The seller is not liable for any damage caused by improper handling of the purchased product, or damage caused by handling in violation of the information and recommendations given in the official manuals and instructions. The warranty also expires in the event of unskilled interventions and the use of unofficial hardware and software modifications.

Safety Symbols and Their Meanings



Caution: strong magnetic fields. Do not place objects sensitive to magnetic fields on the marked areas, as they could be irreversibly damaged.



Attention: moving mechanical parts. Be careful not to injure your hands when you are in close proximity to equipment with mechanical parts.



Information on function, operation and service can be found in this manual or online at help.prusa3d.com.



Before any servicing, read the instructions and disconnect the product from the power supply.



Take extra care when handling or touching parts marked with this symbol and avoid other hazards listed for specific symbols, such as hot surface hazards - burns may occur.



Warning: hot surface! The marked object may be hot and extra care must be taken when touching it to avoid burns.



Attention: moving parts. Unprotected moving mechanical parts can cause injury, so take extra care.



Do not print directly on this surface!



This product is made up of components that must be disposed of in accordance with the Waste Electrical and Electronic Equipment Directive, so take it to an e-waste collection point.

Safety Instructions and Disclaimer

Non-compliance with the information in this manual or assembly instructions can result in injuries, poor print results, or damage to the 3D printer. Ensure that anyone working with the printer understands and comprehends the contents of this manual. Since we cannot control the conditions in which you assemble the Original Prusa MK4S printer, we do not accept responsibility for any losses, injuries, damages, or expenses arising from or associated with the assembly, handling, storage, use, or disposal of the product. Information in this manual is provided without any express or implied warranty.

Handling the 3D Printer

Exercise caution when handling the 3D printer. It is an electrical device with moving and heated parts.

Placement and Basic Use

- Ensure the printer is placed and operated in a suitable location to avoid potential risks.
- This device is intended for indoor use only. Do not expose it to water or snow. Contact with water and other liquids can damage electronics, cause short circuits, and other types of damage. Always operate the printer in a dry environment.
- Place the printer in a secure, dry location. The surface must be level and stable—ideally, a workbench. Ensure there is at least 30 cm of space around the printer. Obstructions near the printer can affect its operation or cause excessive wear on cable sheaths or the cables themselves. Worn cables can pose a risk (electric shock, fire).
- Ensure that no vents/fans are blocked. The printer has built-in fan speed monitoring, but in some cases (incorrect assembly, component damage, unofficial firmware), the monitoring may not work correctly. Insufficient cooling can lead to overheating and severe printer damage (risk of electronic damage, fire).
- Ensure the printer is placed to prevent tipping or falling. If the printer has suffered physical damage, do not use it—damaged parts can pose a safety risk.
- Power adapters and cords must be placed to avoid tripping, stepping on, or otherwise damaging them. Make sure the cables are not damaged. If they are, stop using the device immediately and replace the cables. Damaged cables are a safety risk - risk of electric shock.
- Do not leave the printer unattended while it is on! The printer is equipped with temperature control and several smart safety features, but misuse or unexpected component failure can pose a fire hazard.
- Never interfere with the print area when the printer is in operation. Also, prevent foreign objects from entering the print area and the area around the printer to avoid collisions.

Electrical Safety

- The printer can only be powered through a standard 230 VAC, 50 Hz or 110 VAC, 60 Hz power outlet. Never use alternative sources, they may cause problems or even damage the printer.
- Do not use the printer if the power cable is damaged—damaged cables can lead to electric shock.
- Never disassemble the printer's power supply as it contains no user-serviceable parts. Always have the printer serviced by a qualified technician. Improper handling of the power supply can lead to printer damage and increased risk of electric shock.
- You can disconnect the device from the electrical grid by pulling out the plug. The electrical outlet must be easily accessible.
- When disconnecting the power cord from the outlet, pull the plug, not the cord. This will reduce the risk of damage to the plug or the power outlet.
- Never, under no circumstances, disconnect electrical parts while the Original Prusa MK4S printer is on — this includes disconnecting the Nextrunder from the motherboard, disconnecting the heated bed, disconnecting the LCD, and others. Always turn off the printer before disconnecting electrical parts.

The printer is equipped with a replaceable fuse located in the fuse holder near the connecting connector of the power source and it protects the entire printer. Before replacing the fuse, switch off the printer and disconnect the power supply by pulling out the power cord from the outlet. Push the fuse holder out using a flat screwdriver, remove the fuse and insert a new one. Push the fuse holder back in place. Always make sure the new fuse has the same value as stated on the label. If the fuse blows repeatedly, contact the tech support.

Mechanical Risk

Moving mechanical parts of the printer can cause injury.

- Never interfere with the internal components of the printer when it is connected to power or in operation—risk of injury from mechanical parts or electric shock.
- Prevent unauthorized persons, including children, from handling the printer, even when it is not printing.

Burn Risk

- Do not touch heated parts of the printer – heatbed, print plate, and parts of the printhead. There is a risk of burns.
- Warning! During printing, parts of the print head and the print bed can heat to very high temperatures! Do not touch them until the print has finished and the printer has cooled down—risk of burns.

Proper Use of Double-Sided Print Sheets

Each type of print sheet requires slightly different maintenance. Improper handling and use can damage the print sheet, heated bed, or other parts of the printer. Print sheets are consumables and subject to wear.



The surface of the textured and satin print sheet must not be cleaned with acetone!

- Please refer to the Flexible Print Sheets chapter for maintenance instructions.
- Use highly concentrated isopropyl alcohol (90% or more) to degrease the sheet surface.
- Do not use products that contain IPA as one of the components (e.g. hand sanitizers) - these products usually contain other additives that may negatively affect the properties of the printing plate.
- Do not wash under running water, as the sheet may corrode.
- Do not remove the PEI film from the plate surface.
- Before printing, clean the print sheet surface with a cloth moistened with isopropyl alcohol.
- Printing sheets are held in place on the heated bed with strong magnets - be careful when placing the sheet on the heatbed to avoid injury.
- Do not move the sheet when it is magnetically attached to the heated bed—friction can damage the heated bed.

Working with Filaments

When handled correctly, working with filaments is simple and safe. Please read the following recommendations.

- Always use the recommended temperatures for the selected material.
- Beware of molten plastic—it can cause burns! If molten plastic hangs from the nozzle, do not remove it by hand—use pliers or another tool.
- Some materials may emit a strong odor when printing - regularly ventilate the room.
- Handle the filament according to the instructions on the following pages of the handbook.
- Always ensure the end of the filament is properly secured—either inserted into the extruder or threaded through the spool hole. If you accidentally release the end of the filament, it can easily tangle and knot.

1. Introduction

Thank you for purchasing the Original Prusa MK4S 3D printer from Prusa Research! Your support allows us to invest in further development of 3D printers and other 3D printing products, such as **PrusaSlicer**, our amazing slicing software. We also have our own in-house line of resins and filaments (Prusament), operate [Printables.com](https://www.printables.com) and partake in many other awesome activities - check it out on our Blog at blog.prusa3d.com!

The MK4S is an upgraded version of our previous model, the Original Prusa MK4. It features several important improvements that make printing faster, easier and even more reliable. The MK4S continues to excel in print quality, delivering objects that are solid, durable, dimensionally accurate, and with a beautiful surface finish. It is the result of the ongoing work of many talented developers and we hope you will enjoy working with it.



2. Unpacking and Package Contents

If you purchased the printer as a fully assembled model, simply remove the top foam inlay from the box. Find a good place for the MK4S. **You need at least 520×520mm of space for the printer to operate.** Keep in mind that the heatbed moves back and forth during printing and **the cables must not hit a wall** when the heatbed is in the rearmost position. Grab the top part of the metal frame and lift the printer from the box - **see the chapter below: How to Move the Printer.**



If you purchased the assembly kit, head on over to help.prusa3d.com to learn how to assemble it!

2.1. How to Move the Printer

If you want to move the Original Prusa MK4S printer, use the recommended method - **grab the top of the printer frame and lift the printer.** Never lift the printer by the cables, filament holders or X-axis.

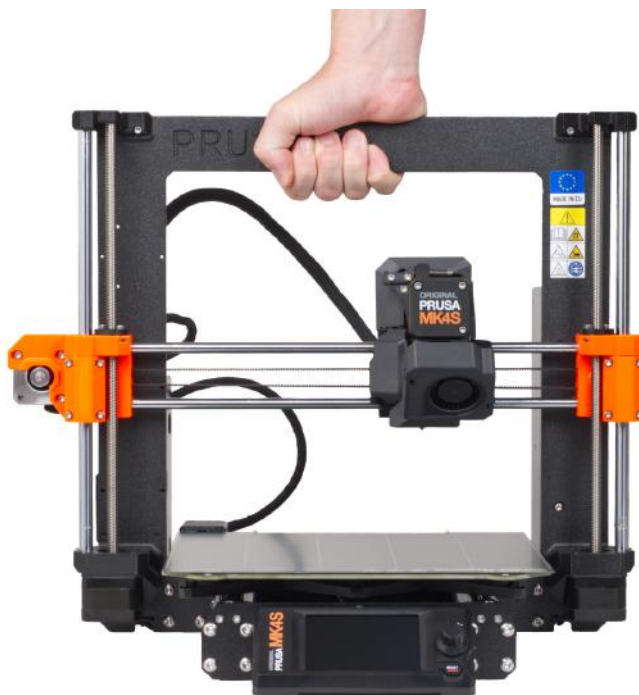

2.2. Contents of the Package and Accessories

Your Original Prusa MK4S printer package includes:

- Documentation
- USB drive with sample prints (G-codes)
- MK4S Toolset
 - Uni-wrench
 - 13-16 wrench
 - Philips screwdriver
 - Nose pliers
 - Allen and torx keys
- Alcohol-saturated wipe (for initial calibration), acupuncture needle
- Double-sided Smooth PEI Print Sheet
- 1kg spool of Prusament (only with an assembled printer)
- Spoolholder
- Spare parts
- Prusa lubricant for bearings
- A pack of Haribo gummy bears

These are the basic tools and accessories necessary for assembly and basic maintenance. **We recommend purchasing a few extra accessories**, such as:

- **Cutting pliers** for cutting the end of filaments or removing supports from printed objects
- **Isopropyl alcohol** (90% or more) for cleaning the print sheet
- **Paper wipes** for cleaning the print sheet
- **Plastic spatula** for removing plastic from the print sheet - you can actually print one!

3. Original Prusa MK4S Overview and Glossary

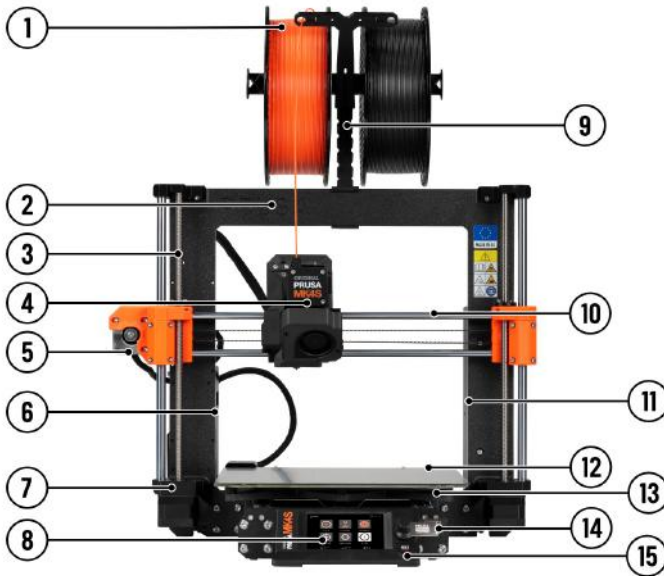

1. **Filament spool** - The Original Prusa MK4S is compatible with 1.75mm filaments.
2. **Frame**
3. **Z-Axis** - vertical, consists of threaded and smooth rods, moves the Nexttruder up and down.
4. **Nexttruder** - Our new next-generation extruder with a planetary gearbox and LoadCell sensor.
5. **X-axis stepper motor** - moves the Nexttruder left and right.
6. **Electronics box** - housing for the xBuddy board. Ethernet and Wi-Fi ports are accessible from the rear.
7. **Z-axis stepper motor** - one of two total. Z-axis motors move the Nexttruder up and down.
8. **LCD** - used for control and configuration of the printer.
9. **Spoolholder**
10. **X-axis** - a general name for the entire horizontal assembly consisting of two smooth rods, an X-axis motor, a belt and plastic parts. The Nexttruder moves along the X-axis from left to right.
11. **Power Supply Unit**
12. **Print sheet** - easy to maintain, held in place with strong magnets embedded in the heatbed.
13. **Heatbed** - proven Prusa MK52 heatbed.
14. **USB port and USB drive** - use the USB drive to print G-Codes (print files) and flash firmware.
15. **Rotary knob** - main control device with the Reset button directly below it.

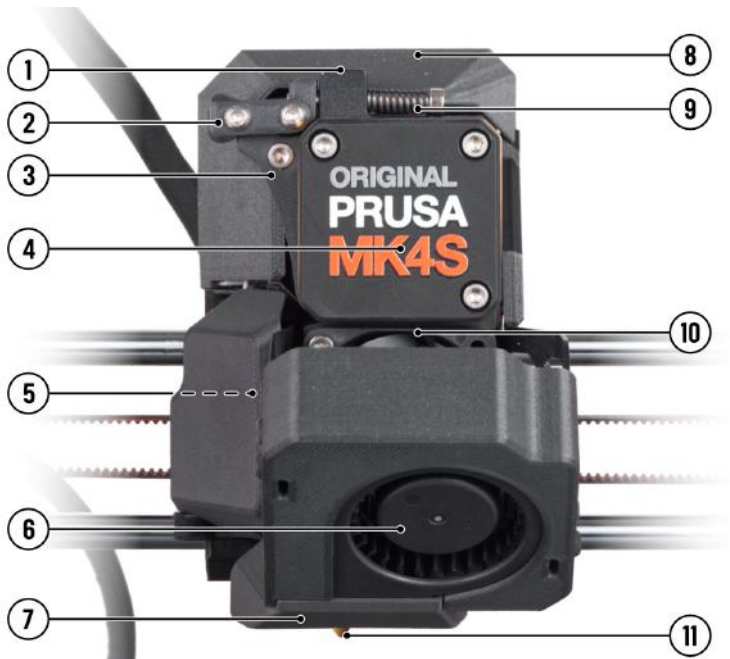

1. **Filament insertion point (from the top)** - the MK4S is compatible with 1.75mm filaments.
2. **Idler lock (swivel)** - flip upwards to unlock the idler door.
3. **Idler** - maintains pressure on the filament strand which is moved further into the extruder by the extruder gear.
4. **Planetary gearbox and extruder motor.**
5. **Thumbscrew cover** - flip the cover open to access the thumbscrews - you can detach the nozzle by unscrewing them.
6. **Print fan** - high-performance turbine for cooling the printed object
7. **Fan shroud** - directs the air from the print fan towards the printed object.
8. **Electronics cover** - covers the break-out board.
9. **Idler screws** - these screws are used to adjust the pressure of the idler.
10. **Heatsink fan** - cools the aluminum heatsink behind it.
11. **Nozzle** - by default, a 0.4mm nozzle is installed.



DO NOT remove the cover of the gearbox unless you have a gearbox alignment tool that comes with the assembly kit. If you have a factory-assembled machine, the gearbox is precisely aligned and calibrated. There is no need to access it. You could misalign the gearbox by removing the cover.

3.1. Connecting and Disconnecting the Power Cable



Always pull the connector, do not pull on the cable itself! Incorrect handling can lead to damage to the connector or cable.

The power supply port is located on the rear side of the printer. Before you plug or unplug the cable, turn the printer off using the physical switch on the power supply unit next to the power supply port. See the picture below to learn how to correctly disconnect the power plug from the power supply.



3.2. Error Screens

If the printer encounters a critical error, **an error screen will be displayed with a description of the error.** The information on the screen is intended to facilitate easy identification, diagnosis and resolution of the error. **Pay special attention to the text on the screen.** Most error messages are supplemented with a QR code - scanning it (e.g. using a camera on a mobile phone) will take you to a relevant online article with instructions on how to proceed.



This is a sample QR error code serving as an example of an error message.

4. Your First Print

To get your printer up and running, please pay attention to the information in the following chapters. We will go through the basics together - you'll be printing in no time!

In this chapter you will learn how to:

- Control the printer
- Prepare the print sheet for the first print
- Perform initial calibration
- Insert filament
- Start the first print
- Remove the print
- Troubleshoot basic issues
- Update the firmware

4.1. Basic controls

You can control your printer using both the **touchscreen and the rotary knob** next to it. Rotate the knob to select items on the screen and press it to confirm your selection. The reset button is located under the rotary knob. Pressing the reset button is the same as quickly turning the printer off and on again. It is useful in cases where it is necessary to immediately stop an action that the printer is currently performing.



4.2. Preparing Flexible Print Sheets



If you have ordered a pre-assembled printer, a print sheet with a test print will already be installed on the printer. The test print must be removed before proceeding to the next step! Remove the print sheet and carefully bend it on both sides. Then turn it by 90° and repeat the bending until the print separates from the print sheet. Then place the sheet back on the printer.

Make sure there is no debris on the heatbed before you install the print sheet. It could either throw off the first layer calibration or possibly even damage your printer. Do not drag the print sheet while it's attached with magnets, you could scratch and damage the heatbed. If you need to readjust the print sheet, always lift it up by grabbing the front two corners, adjust its position and then place it back down.

The Original Prusa MK4S comes standard with a double-sided smooth PEI print sheet. If you have a different type, we recommend that you **carefully study how to properly treat the surface in the Regular Maintenance chapter**.

There are high-temperature magnets embedded into the heatbed that hold the removable flexible print sheets in place. On the back of the heatbed, you will find two pins that fit exactly into the cutout of the print sheet. **Before installing the sheet onto the heatbed, make sure that it is perfectly clean. Never print directly on the heated bed!**

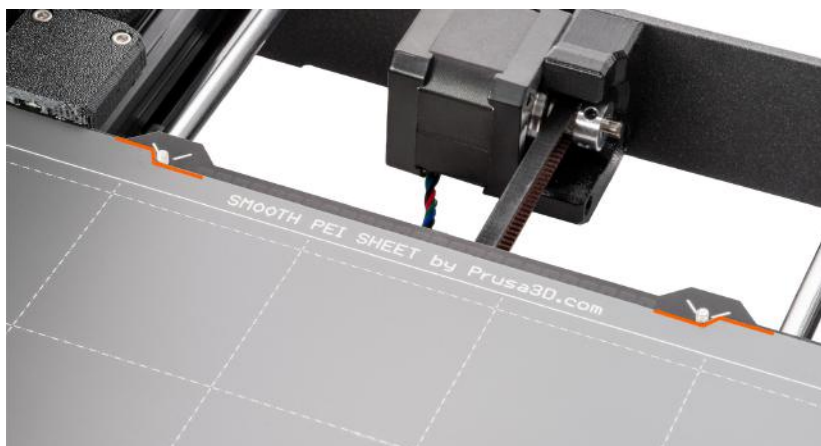

Attach the sheet by first aligning the rear cutout with the locking pins on the back of the heated bed (marked in orange in the picture above). Hold the sheet by the front two corners and slowly lay it down onto the heated bed - **watch your fingers!**

For your first print, it is enough to **wipe the bed using the supplied cleaning wipes** soaked with isopropyl alcohol. You can do it now, but make sure **not to touch** the surface of the sheet afterward.

4.3. Selftest (Calibration Wizard)



The print sheet must be installed onto the printer before the calibration!!!

When you first power on the Original Prusa MK4S, the Selftest (Calibration wizard) will start. **The wizard will walk you through the initial calibration and all necessary tests to start printing.** Completing the entire checklist is mandatory. But don't worry, it's gonna be super easy, barely an inconvenience!

The first thing the wizard will perform is the internet setup configuration. This is completely optional and you may choose to completely skip this step. The printer will be fully functional even in fully offline mode. Follow the simple steps on the screen to connect the printer to the network. More information can be found in the Advanced User Guide.

The Wizard will provide you with text descriptions and illustrations of the individual steps. It is designed to make the process as automated and understandable as possible. For clarity, some actions are further described in the following chapters. You can also start the Selftest manually using the *LCD menu - Control - Run Full Selftest*.



The purpose of the calibration is to check whether your printer is in good shape. If you built the printer as a kit, the Selftest checks for basic assembly issues. If you ordered a pre-assembled printer, the Selftest can help identify issues that could be caused, e.g., by rough handling during shipping. It's a one-time process that doesn't need to be repeated before every print. Rerun it if you encounter issues with your printer (more on that in the advanced sections of this handbook).

4.4. Running the Selftest



During the Printer Selftest, do not manipulate or touch the printer unless the calibration asks you to. If the printer is placed on an unstable surface or if there is another running 3D printer next to it, it may affect the accuracy of the calibration negatively. The printer should be placed on a stable surface.

For the Selftest and the filament sensor calibration, **you will need at least 5 cm (2 in.) of filament.**

The Selftest is a set of **various tests that serve as a diagnostic tool.** With their help, you can detect the most common problems, such as **incorrect wiring of cables.** The progress and results of each test will be displayed on the LCD. If the Selftest detects an error, the testing will be interrupted and the cause of the error will be displayed on the screen.

The following tasks will be performed:

- Test of heatsink fan and print fan
- Test of the X, Y, and Z axis
- Gearbox alignment
- Heater tests
- LoadCell test
- Network connection (optional, explained in the Advanced User Guide)
- Setting up the filament sensor - more info below:

At one point, the Selftest will ask you to **calibrate the filament sensor** by inserting a piece of filament into the slot on the top of the extruder. A minimum of 5 centimeters (2 in.) is required, however, **we suggest simply preparing an entire spool of PLA filament,** so you can start printing once the Selftest finishes.

Continue to the next chapter (Inserting filament) to learn how to properly attach a filament spool and prepare the material.

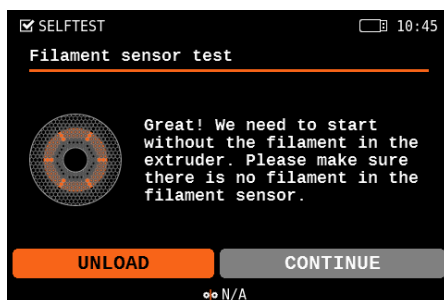
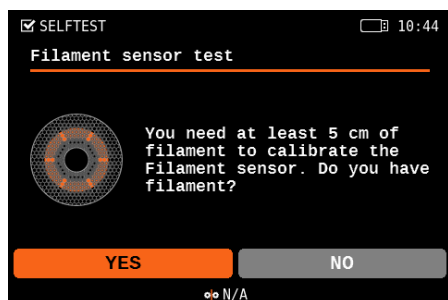

4.5. Inserting (Loading) filament

First, prepare a spool of filament - **we strongly recommend using PLA** because it's easy to work with. Take the spool, make sure the end of the filament is properly secured and place the spool onto the spoolholder on top of the printer's frame.

Carefully unhook the end of the filament strand and make sure not to let go, otherwise, the tension in the strand would cause the filament to quickly tangle up.

1. **Cut the end of the filament into a sharp point.** Push the filament through the hole in the filament guide and insert the plastic strand into the opening at the top of the Nextruder. If the filament sensor is on, the filament will be automatically fed. If the filament sensor is off, proceed to step 2, otherwise skip to step 3.
2. Select *LCD Menu - Filament - Load Filament* and confirm with the button.
3. The Preheat menu will automatically appear. Select the **material of the filament you want to insert** and confirm the selection.
4. Wait until the nozzle reaches the desired temperature.
5. Select Continue to start feeding the filament. Push the filament into the Nextruder lightly until you feel that the extruder gear grabbed the filament and is pulling it in.
6. The feed wheel will then push the filament further into the extruder. Once it heats up fully, it will push out a bit of material from the nozzle. **The printer will ask if the color of the extruded filament is okay.** The message on the screen will say: Yes / Purge More / Retry. Check if there is filament extruded from the nozzle, then select:
 - If the filament is extruded and the color is correct, select YES
 - If the filament is not extruded or is contaminated with another color, select: PURGE MORE (you can repeat this step)
 - If the filament is not extruded and PURGE MORE doesn't help, repeat the loading procedure by choosing RETRY



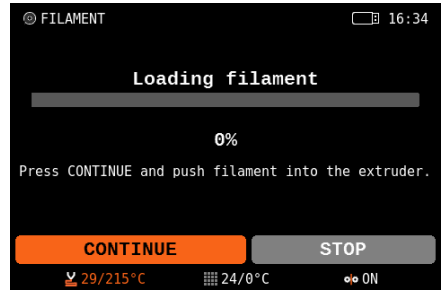
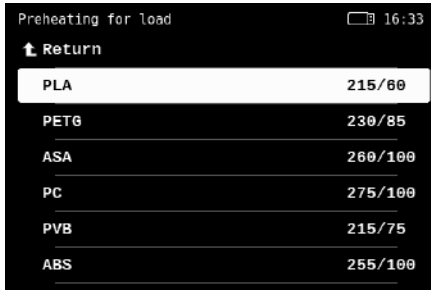

The printer remembers which filament is inserted into it even when you turn it off. The type of filament is displayed in the lower section of the LCD menu.

For the next step (Starting the First Print), leave the filament inserted in the printer. If for any reason you need to change the filament, the procedure is described on the next page.

4.6. Unloading (Removing) Filament

1. Select *LCD Menu - Filament - Unload Filament*
2. The printer will preheat automatically. As soon as it reaches the right temperature, the filament will be unloaded from the extruder in a few seconds.
3. Once the extruder stops unloading the filament, remove it from the extruder by hand. The filament needs to be wound up on the spool and secured carefully so that it does not tangle up.

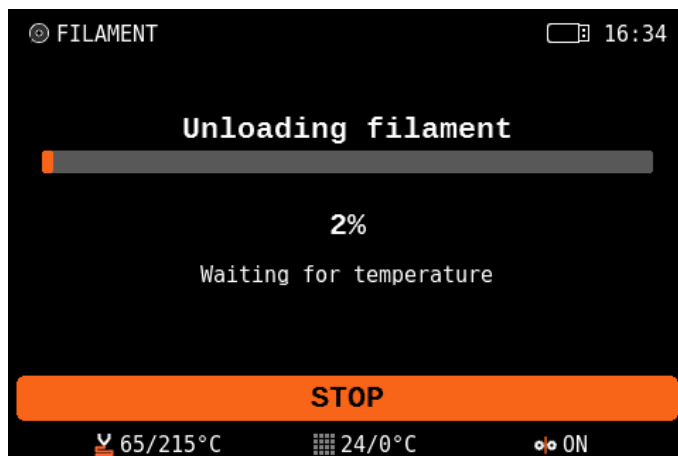

Tangled filament? Let's fix it!

If you accidentally manage to let go of the end of the filament and the strand quickly retracts onto the spool, it's possible that the filament became tangled. This poses a risk during printing - a knot can form on the strand of filament, which will inevitably lead to a failed print. Simply remove the spool from the spoolholder and start unwinding the filament strand from the spool until you find the crossed section. Fix it and wind the filament back onto the spool.

4.7. Starting the First Print

If you haven't done it already, clean the print sheet with the enclosed wipe saturated with isopropyl alcohol or spray a bit of isopropyl alcohol onto the sheet and wipe it clean with a paper towel. Please note that the enclosed wipe has limited use as IPA evaporates quickly.



Then select **one of the test objects from the Print menu** (only appears if a USB drive is inserted). Confirm the selection by pressing the rotary knob.

Watch the printer closely during the first print. We recommend **selecting the Keychain**. It gives you a good quick overview of whether everything is properly set up. The nozzle will first preheat to 170 °C independently of the selected filament - the temperature is lower to prevent the filament from dripping from the nozzle.

Then, the printer performs **Mesh Bed Leveling** - the nozzle will check the distance to the print sheet in several places to **create a virtual height map of the surface**. This allows the printer to lay down a perfect first layer every time. Subsequently, the printing of the object or objects will take place.

Optionally, **if you have more than one color of PLA filament**, you can also select **the Dual-Color Keychain**. It's a great demonstration of multi-colored print using only one extruder. During the print, the machine will ask you to change the filament. Simply **follow the instructions on the screen** to achieve the effect visible in the photo below.

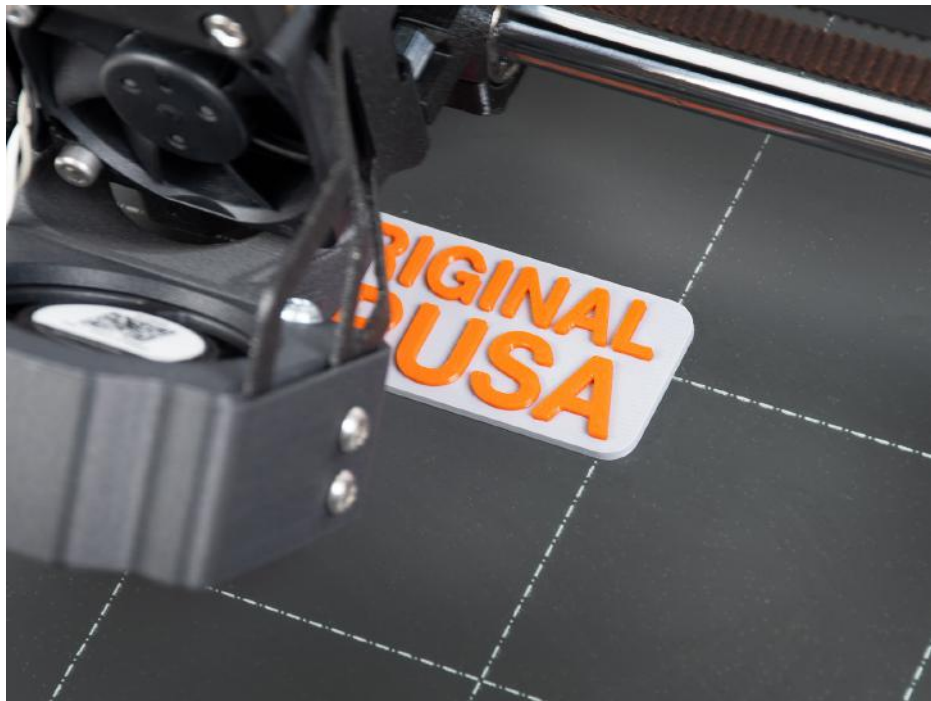

Carefully observe the quality of the first layer. The Original Prusa MK4S is equipped with very accurate LoadCell technology, which measures the distance between the nozzle and the bed with perfect accuracy. However, it may happen that **due to, e.g., traces of grease, the print may not hold well.**



If you find that the plastic is peeling off the bed, **stop the print by selecting the Stop print icon on the screen.** Clean the bed and try again.



If the first print fails repeatedly, go to the **First Print Troubleshooting chapter**, where you will find useful tips and tricks.

4.8. Removing a Printed Object from the Print Sheet

Once the print job is finished, wait until the print sheet cools down. The print plate and heated bed may exceed 100 °C, depending on the settings - contact with unprotected skin can cause burns, so check the heatbed temperature in the footer of the LCD screen!

Depending on the type of material, it may happen that the print will separate from the print sheet automatically by itself after cooling. If not, remove the print plate and carefully bend it on both sides. Then turn it by 90° and repeat the bending. **Be sure to remove all pieces of plastic** - don't forget the priming line next to the print.



! If there are plastic remnants on the plate, do not remove them with your nails, you could get injured. Use a plastic spatula to remove the remaining plastic.

i Try not to touch the print surface with your fingers - fingerprints are greasy and can reduce adhesion.

4.9. Selftest Troubleshooting



If you built the printer using the assembly kit, it's possible you missed a step in the walkthrough or you forgot to connect something. No worries, fixing an issue is actually pretty straightforward. Just follow the instructions on the screen.

The Selftest identifies all common and even less common issues with your printer with great accuracy. The firmware can recognize whether the fans, heating elements, sensors and other components of the printer do not respond as they should and raises an error when it happens.

If you see a heating-related error during the Selftest, make sure that the print sheet is placed on the heated bed as described in the previous chapters.

If you need to check the connection or disassemble any part of the printer, please follow the link on the error screen or simply visit help.prusa3d.com and look for a relevant help article.

4.10. First Print Troubleshooting

The calibration and pre-print setup of the Original Prusa MK4S are fully automated - the filament is automatically inserted, axes checked and the first layer precisely measured. If a printing issue does occur, it usually falls into one of the following scenarios:

4.10.1. LoadCell calibration fails

Solution: This usually happens when you tap the nozzle too briefly or with not enough force. Repeat the calibration and push the nozzle a bit harder.

4.10.2. First layer peeling off from the bed

Solution: The most common cause is grease on the bed or an unsuitable combination of material and print surface (e.g. PLA and textured sheet).

Make sure that the sheet is sufficiently **degreased using isopropyl alcohol** - more information can be found in the **Regular Maintenance chapter**. In the **Materials chapter**, you can find information on how to properly print specific filament types. Water with a bit of dish soap is also an option if you don't have access to IPA - **make sure to clean and dry the sheet thoroughly to prevent rusting**.

4.10.3. Nozzle moves too high/low, or extrudes plastic outside the print area

Solution: Make sure that the print sheet is properly installed and that nothing is blocking the X/Y/Z axes.

If the print sheet is not installed properly (e.g., it's not aligned with the heatbed), it may cause various printing issues. **Make sure that nothing is obstructing the movement of the axes** and that all packaging material and transport fixations have been removed from the printer. Run the Auto Home calibration from the menu to test all three axes.

Another possibility is that the LoadCell sensor is not performing as expected. Make sure the LoadCell sensor cable is properly connected and repeat the LoadCell Test from the Control menu.



If you built the printer using the assembly kit, double-check the parts on the X (horizontal) and Z (vertical) axes and compare them with the official assembly manual. It's possible that you might have overlooked a small detail. Make sure the screws securing the motors are tightened correctly.

4.10.4. The nozzle does not start extruding, even after multiple attempts

Solution: Make sure that the filament can reach the extruder gear inside the Nextruder and that the nozzle is not clogged.

First of all, **load the filament exactly as described in the Loading the Filament chapter**. Once the loading procedure is completed, unlock the idler door on the extruder by lifting the small clamp, then flip the door open and see if the filament strand reached the large extruder gear. If it didn't, it means that something is blocking the movement of the filament. If the filament appears completely loaded (it goes across the extruder gear towards the nozzle), it means the nozzle might be blocked. This won't happen with a new printer, but if you have been using it for a while, it might be a possibility. If you hear the extruder gear clicking during Purging, it may be a sign the nozzle is blocked. Head to the Troubleshooting chapters of this handbook or look for a detailed solution at help.prusa3d.com.

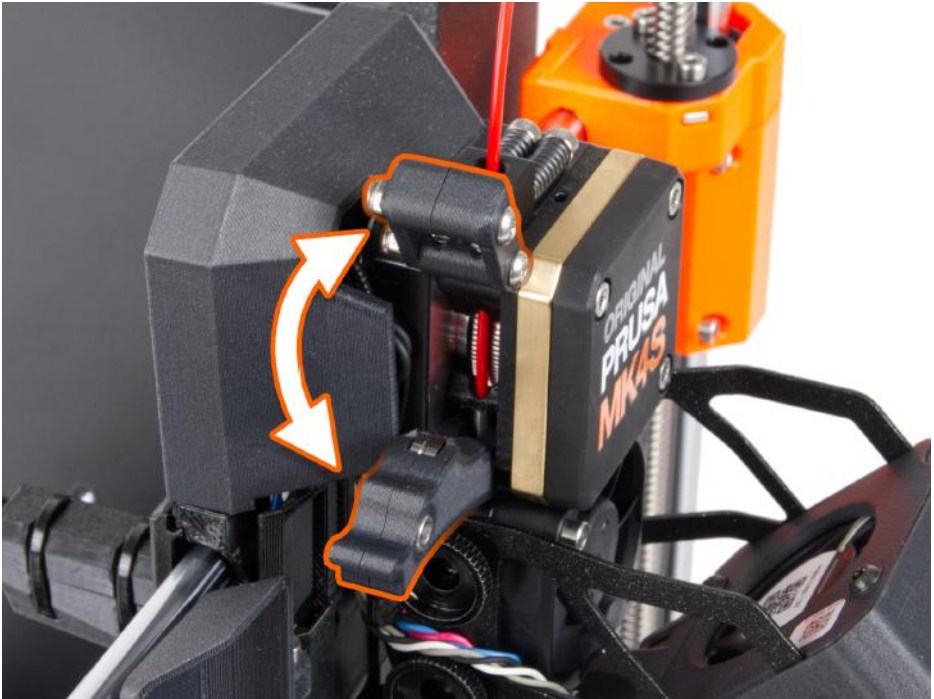

If you built the printer using the assembly kit, it's possible you might have over-tightened the screws on top of the extruder and the idler is so tight, filament won't pass through it. Open the idler on the side of the extruder and double-check that the filament can reach the gear. You can decrease the pressure of the idler by loosening the two screws on top of the Nextruder.

4.10.5. After a few hours of printing, the nozzle stops extruding filament

Solution: First, check if the filament isn't tangled. If it's not the case, unload it, wait for the printer to cool down and then remove the hotend from the extruder (see help.prusa3d.com for exact instructions) and check if the steel filament guide isn't deformed. This might happen when you overtighten the thumbscrews. Another possibility is that the nozzle is clogged or blocked. Check the Troubleshooting section of this handbook or look for detailed instructions at help.prusa3d.com.

4.11. Updating the Firmware

The Original Prusa MK4S is ready to print once assembled and powered on. To make sure you have the most up-to-date version of the firmware with the latest features and settings, we recommend checking prusa3d.com/drivers.

You can perform the firmware update after you complete the initial Selftest.

To check your firmware version, navigate to *LCD Menu - Info - Version info*.

To update your printer's firmware, follow these instructions:

1. Download the correct version of the firmware from prusa3d.com/drivers and unzip the file.
2. Copy the .BBF file to a USB drive formatted with FAT32 - you can use the USB drive that comes with your Original Prusa MK4S printer.
3. Insert the USB drive into the printer.
4. Restart the device using the reset button (located under the rotary knob).
5. The update process should begin automatically. Confirm flashing by selecting FLASH and pressing the knob.
6. Wait until the process is completed.



To force a firmware installation (e.g. if you need to load an older firmware), insert the USB drive containing the desired .BBF file, restart the printer, wait for the logo to show up and press and hold the control button during the system startup until the firmware installation screen appears.

4.12. Sample Models

The USB drive that came with your Original Prusa MK4S 3D printer contains a number of **sample files** (G-codes). We recommend keeping them on the flash drive.

These files have been prepared (sliced) and thoroughly tested by us. **If you encounter issues with print quality at any time, try loading and printing one of the sample files** - especially the Prusa Logo Keychain. These sample files are designed to test the basic functionality of your Original Prusa MK4S.

If your own custom print fails and the sample files are printed correctly, it means there's probably an issue with the way your files are sliced. Try reslicing them again with the default PrusaSlicer settings and check for the basic issues:

- Incorrect printer/nozzle profile (the Original Prusa MK4S is equipped with a 0.4mm nozzle by default)
- Incorrect material settings
- Missing supports
- Incorrectly configured infill
- The model is not in contact with the print sheet

If the sample files are not printed correctly, check the Troubleshooting section, our Knowledge Base at help.prusa3d.com or contact our tech support.

4.13. Factory Reset

If you feel like you changed settings that have negatively affected your 3D printer, you can always revert to factory default values and try again. Factory Reset can be done via *LCD Menu - Settings - System - Factory Reset*. This will reset all the saved values to their default state.

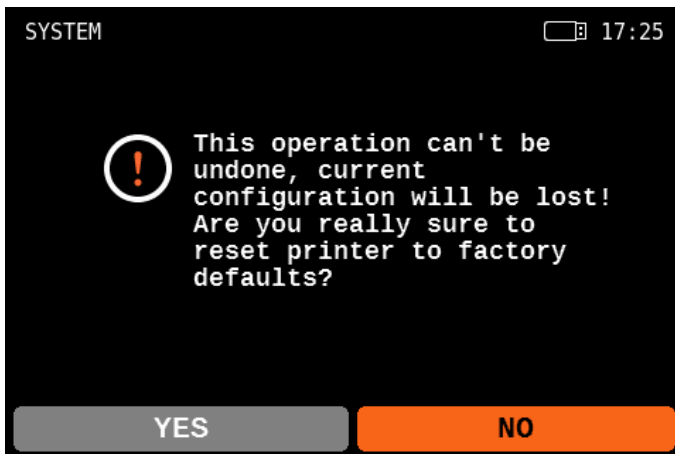

5. Advanced User Guide

This part of the handbook covers everything you need to know once you manage to successfully print your first sample object. Network connection, printing your own models, slicing - all this (and more) is covered on the following pages.

5.1. Prusa Academy Courses

Become an expert in 3D printing! Our Prusa Academy offers **comprehensive online courses on various 3D printing-related topics**. Each course features easy-to-read texts with many pictures and short videos, links for inspiration and further study, quizzes for testing your knowledge, a certificate of completion and more! With our online courses, you can quickly learn how to model your own models and master advanced 3D printing techniques. Visit academy.prusa3d.com to join!

Design Principles for 3D Printed Parts

100% complete

- 1 Getting started
- 2 3D printing limitations
- 3 **Applied design**
 - ✓ 3.1. Vertical holes
 - ✓ 3.2. Sacrificial columns
 - ✓ 3.3. Sacrificial layers
 - ✓ 3.4. Staggered layers
 - ✓ 3.5. Fillets and chamfers
 - ✓ 3.6. Embedding items mid-print
 - ✓ 3.7. Threads
 - ✓ 3.8. Print in place mechanisms
 - 3.9. Compliance and living hinges
 - ✓ 3.10. Splitting model into multiple parts
 - ✓ 3.11. Multiple assembled parts
 - ✓ 3.12. Integrated part strength
 - ✓ 3.13. Quiz: Applied design
- 4 What's next?

Share your feedback

Need help?

Box with a living hinge

The design process is extremely easy, simply extrude a rectangular shape connecting your two objects and extrude it to the desired height.

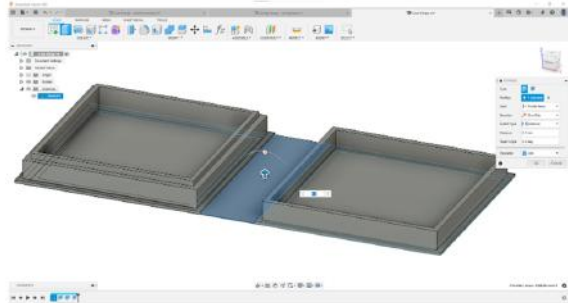

Since the square will connect both the base and the lid, you need to make sure you have enough distance to allow the **hinge to flex without breaking or additional bending stress**. The total height of the **box** once closed, in this case, is 16mm from base to surface:

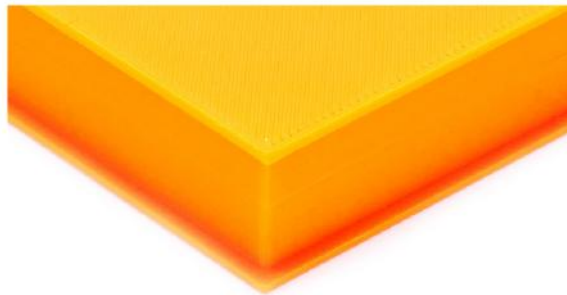

Closed box with a height of 16 mm

5.2. Network Connection

Original Prusa MK4S has an onboard Ethernet (RJ45) interface and a Wi-Fi module for connecting to the network. **Please be aware that some of the network functions may not be fully implemented in the shipped firmware version.** Please check our website prusa3d.com and social media for information on the latest firmware versions.

Original Prusa MK4S can be connected to a local network (LAN/Wi-Fi), which allows you to have an overview of various functions of the printer through the web interface called Prusa Connect. The printer has DHCP enabled by default. If you need to check if the printer was assigned an IP address correctly, you can check it in *LCD Menu - Settings - Network*.

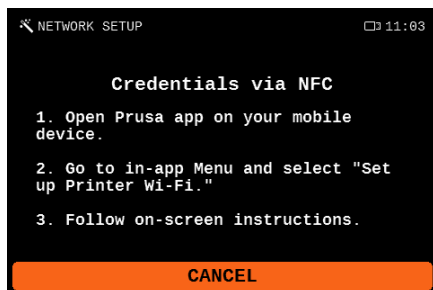

You have four options of how to connect to the wireless network:

Entering credentials using the touchscreen

You can manually enter the Wi-Fi SSID and password via the touchscreen. Due to the limited space on the screen, the touch keyboard has a layout well-known from phones with hardware keyboards. Each button is assigned a certain number of characters. You select each character by pressing the button a certain number of times.

Network scan

Similar to entering all your credentials via the touchscreen, except here you can select the Wi-Fi SSID from the list of detected wireless networks and then use the touchscreen to enter just the password.

NFC & Prusa Connect mobile application

If you have a mobile device with NFC and the Prusa app installed, you can enter your Wi-Fi credentials into the application and share them with the printer by holding your phone up to the NFC sensor.

Setup file with network credentials

To connect the printer to a wireless network, via the **credentials file** please navigate to the *Network* menu and select *Wi-Fi* and look for the *Load credentials from a file* menu option.

1. Start PrusaSlicer 2.8.0 or newer.
2. Insert a USB drive into your computer.
3. In PrusaSlicer, navigate to: *Menu - Configuration - Wi-fi configuration file*.
4. Enter login credentials for your Wi-fi.
5. Select "Write" and save the file to the USB drive.
6. Save the file.
7. Insert the USB drive into your printer and choose Load Credentials from File in the printer's menu.
8. You should be connected to Wi-Fi in a couple of seconds.

Subsequently, on a computer or mobile phone connected to the local network, open a web browser and go to connect.prusa3d.com and log in with your Prusa Account. You will be taken to Connect, our web UI for remote printer management.

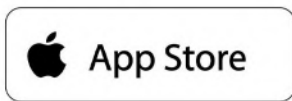

For more information about connecting to Wi-Fi networks and activating Prusa Connect online features, please check our website help.prusa3d.com.

5.3. Touch Control

With the touch option enabled, you can control most items on the screen. You can also swipe up and down through the menus, and swipe left or right (depending on your preference) to go back one step in the menu hierarchy. There are exceptions in which it is necessary to use a knob to control the screen, such as manually setting the target temperature or moving the axes. You can enable touch control in Settings -> User Interface -> Touch.

If you have problems with touch, enable the Touch Sig Workaround option in Settings -> User Interface -> Touch Sig Workaround.

5.4. Cancel Object

When printing multiple objects at once, any of them may become detached from the heatbed or fail to print for other reasons. In this case, you can select "Tune menu -> Cancel Object" to skip printing the selected object. The rest of the objects will continue printing unchanged, saving you a lot of potentially wasted filament.

If you are unsure which object to select (for example, you have individual instances-copies instead of names), you can wait for the nozzle to move to the failed object and then select the Cancel Current Object option. If you have selected an incorrect object to skip, you can use the menu actions to resume printing it.

5.5. Stealth Mode

With Stealth Mode enabled, the firmware limits the acceleration, feedrate, and jerk values, resulting in reduced printer noise. Due to these limits, the overall printing time is slightly increased. You can switch between Normal and Stealth Mode anytime, even during printing. After enabling, Stealth Mode will be activated once several G-code commands in the buffer (printer memory) are processed. You can enable the Stealth Mode option in Settings -> Stealth Mode.

5.6. Input Shaper and Pressure Advance

The Original Prusa MK4S utilizes Input Shaper and Pressure Advance features, allowing it to print faster and with better quality, reducing ringing, overshoots, and issues with inconsistent filament extrusion.

Input Shaper analyzes the printer's movements and applies a filter to the input signals, leading to canceling resonance vibrations and reducing ringing (ghosting). Thanks to faster travel speed and acceleration, it enables faster printing and minimizes stringing.

Pressure Advance aims to improve the quality of printed parts by compensating for the pressure changes in the nozzle during printing.

5.7. Using Nozzles with Various Diameters

The Original Prusa MK4S comes equipped with a **0.4mm nozzle** by default. This nozzle offers a good quality-speed ratio. However, for some projects, a nozzle of a different diameter might be more suitable.

The Original Prusa MK4S uses **special nozzles with a metal filament guide**, making them easy to swap and highly reliable. We offer a wide range of nozzles of various diameters on our e-shop, ranging from 0.25mm to 0.8mm nozzles. You can set the diameter of your nozzle from 0.25mm to 1.0mm in increments of 0.05mm in Menu -> Settings -> Hardware -> Nozzle Diameter.



To give you even more options for your 3D printing projects, we developed a **Nextruder to V6 nozzle adapter**. When you install it, you can easily use any type of V6-compatible nozzles, including high-flow models. More information on alternative nozzles and their installation can be found at prusa3d.com and help.prusa3d.com.

5.8. Multi-Material Upgrade 3

The MK4S is fully compatible with the latest generation of our **Multi-Material Upgrade 3 add-on**, or MMU3 for short. The MMU3 vastly expands your 3D printing possibilities by giving you the option to **print with up to 5 colors at the same time**. However, you can also mix different materials, e.g. standard filaments (PLA) with **water-soluble filaments**.

The MMU3 has been reworked from the ground up, offering a high level of reliability, improved controls and expanded firmware capabilities.

You can learn more about the MMU3 at prusa3d.com!

5.9. Original Prusa Enclosure

The Enclosure is an optional accessory that encloses your 3D printer and provides a stable printing environment with increased temperatures. This makes printing from advanced materials, such as PCCF, Nylon, PP, ASA, and many others, easier as it eliminates drafts and prevents the warping of printed objects. The Enclosure also lowers printer noise and covers every moving part of your printer, increasing its safety.

The Enclosure can be equipped with various optional add-ons, such as the Advanced Filtration System or a mechanical lock, which prevents unauthorized access to your 3D printer - an ideal solution for schools, hackerspaces, and other public places. You can also install an LED Strip to illuminate the print area and a fire suppression system.

The Original Prusa Enclosure is available in our e-shop.

5.10. Flashing an Unofficial (Unsigned) Firmware:

We take security seriously. Before each firmware update, we rigorously test it to ensure that all of its security features are working correctly. **If any of the sensors detect an unexpected reading, the heater will be immediately disconnected to prevent any damage to the printer or its surroundings.** We cannot guarantee the same level of security with unofficial (community) firmware.

Official firmware is signed with a private key and the printer verifies the key before updating.

To flash your own (or unofficial) firmware to the printer, **you must first break the seal on the mainboard** and place a jumper in the correct position. **Doing this voids the electronics warranty.** To break the seal, you must open the electronics box and locate a safety fuse. Then, take a small flathead screwdriver or very thin sharp pliers and break off the thin middle part of the fuse. **Before attempting this procedure, carefully review the photo in this chapter!**

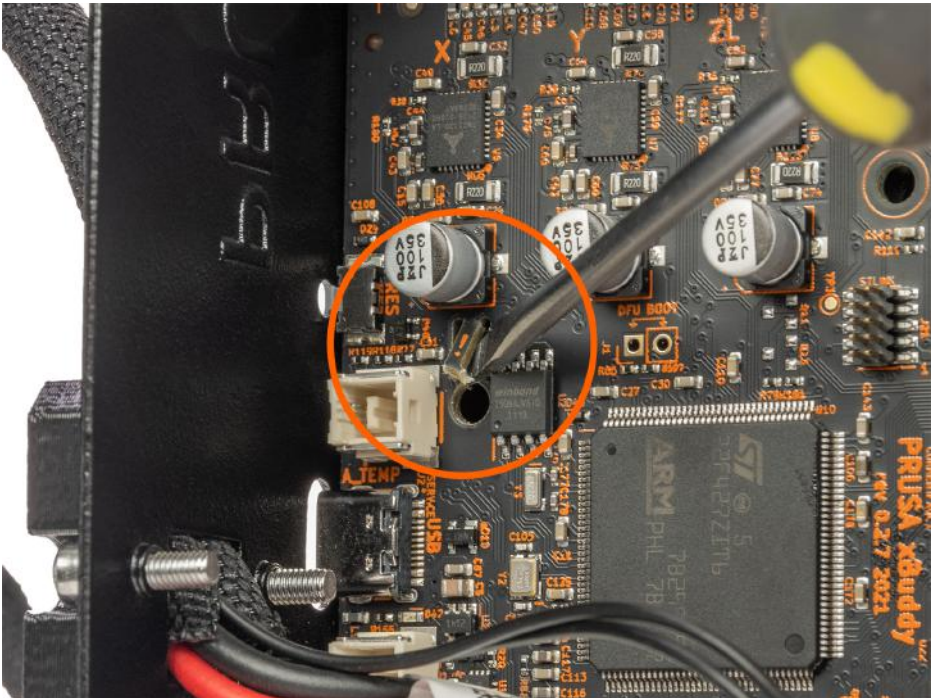

Breaking the seal is **irreversible** and is recommended only for very experienced users.



Breaking the seal on the mainboard of the Prusa MK4S is **IRREVERSIBLE** and leads to the **VOIDING OF THE WARRANTY ON ELECTRONIC PARTS OF THE PRINTER**. If you break the seal, we disclaim any responsibility for any damage to the printer and/or its surroundings (e.g. in case of a fire).

6. Printing Your Own Models

Your Original Prusa MK4S should be now fully calibrated and the first print was a success. And now, you want to print your own model - be it something you already modeled, or something you downloaded from the internet.

Here's a little catch: **it's not possible to print models downloaded from the internet directly.** Before you can print a model, you need to prepare it for the printer - we call this process "slicing". Generally speaking, you need to tell the printer what should be inside the printed object (infill), how detailed the model should be and a couple of other things. Plus, you need to keep in mind several things like the stability or durability of the print.

We'll go through the process with you. We'll introduce our own slicing software PrusaSlicer and tell you the basics about slicing.

To summarize:

- Find a suitable 3D object for printing and download it (usually in .stl or .obj format)
- Import the object into [PrusaSlicer - www.prusaslicer.com](http://www.prusaslicer.com)
- Select the nozzle diameter (default is 0.4mm) and layer height
- Use the built-in tools to scale, move and rotate the object. Find the optimal orientation:
 - Large flat base
 - Minimal overhang angles to reduce the number of supports required for printing
 - If supports are necessary, try to rotate the object so that the supports are not in direct contact with areas that need to have top print quality (e.g., the face of a statue)
- Select the infill type and density
- Slice the object
- Inspect the preview
- Export the G-code and print it

6.1. Obtaining Printable Models

The easiest way to start with 3D printing is to **download models from the internet** - they are usually in .3mf, .stl or .obj formats. Luckily, there are many enthusiasts in the 3D printing world, so **a large number of 3D models are available for free**. You can download anything from a simple die to detailed figures from your favorite games, movies, and series; mechanical parts, RC accessories, various household items, and even massive complex projects.

Get the best models at Printables.com!

One of the best places for free 3D models is [Printables.com](https://www.printables.com), a large online library **full of high-quality 3D models** managed by Prusa Research. Its main goal is to bring together a large community of designers, creators, and 3D printing enthusiasts - regardless of the brand of 3D printer they prefer. There are **regular community contests with 3D printers and filaments as main prizes**, and there is also a rewards system with virtual and physical goods - simply by being an active member, you can collect points and exchange them for a spool of Prusament or other cool stuff.

Thanks to its focus on high-quality, unique, and useful 3D models, you are only a few clicks away from discovering something new and amazing to print. And before you actually download and print something, you can use the advanced built-in 3D model viewer, which works with STL and 3MF files as well as G-codes. Visit [Printables.com](https://www.printables.com) and discover all kinds of activities, contests, events, groups, collections, and more!

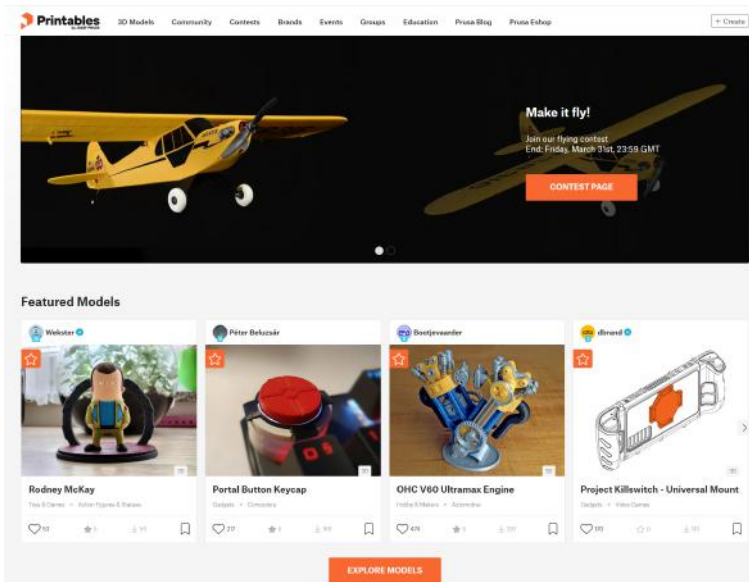

Models are usually available to download either for free under the Creative Commons - Attribution - Non-Commercial License (models cannot be used commercially and must always include the author's name), or for a small fee. We have selected the most interesting websites for you:

- www.printables.com
- www.thingiverse.com
- www.myminifactory.com
- www.gambody.com



Keep in mind that models in .stl, .obj, etc. formats cannot be printed directly. First, these files need to be "sliced" (prepared for printing), which results in a G-code file. This file contains the actual instructions for the printer. You place the G-code on a USB disk and then insert it into the printer. Then you just start printing. You will find out more in chapters What is a G-code file? and PrusaSlicer.

6.2. Create Your Own Model

To create your own 3D model, you need a special program - a 3D editor.

There is a wide range of different programs available, so you can choose the one that best meets your needs. To get started, the best option is Tinkercad (www.tinkercad.com) - an online editor which runs in your browser window, with no installation required. It is free, intuitive and there are a lot of tutorials available online. Tinkercad is mainly focused on the creation of less detailed and larger (mechanical) parts, ideal for FFF/FDM printing. Your MK4S will have no problems printing them.

Another popular tool is Autodesk Fusion 360 (www.autodesk.com/products/fusion-360) for PC, Mac and iPad. On the web, there is a simple guide available along with a lot of detailed video tutorials, making it an ideal choice for both beginners and professionals. Check out our Prusa Academy for some great beginner tutorials at prusa3d.com/category/prusa-academy!

6.3. What is a G-code File?

3D models you have either created or downloaded from the internet need to be converted from their original format (.stl, .obj, .3mf, etc.) into a file containing specific instructions for the printer - the G-code. This is the format that 3D printers can understand. This file contains instructions about the movement of the nozzle, the amount of filament to be extruded, temperature settings, fan speeds and more. There are dozens of different slicers available, each with its own advantages and disadvantages. We suggest using our PrusaSlicer.

6.4. PrusaSlicer

As the name suggests, PrusaSlicer (prusaslicer.com) is our own in-house developed slicer software based on the open-source project Slic3r. **PrusaSlicer is an open-source, feature-rich, frequently updated tool** that contains everything you need to export the perfect print files for (not only) your Original Prusa MK4S. The standout features of PrusaSlicer are:

- Clean and simple UI
- Fine-tuned print and material profiles with automatic updates
- Precise print time/feature analysis
- Customizable supports and modifiers
- Built-in shape gallery
- Variable layer height
- Color painting
- Various print settings

Thanks to the strong community and a dedicated team of developers in Prusa Research, PrusaSlicer is **constantly evolving** with new features and improvements based on community feedback.

From print quality improvements to reducing print time and minimizing filament usage, even small updates can have a significant impact on your 3D printing experience. Best of all, **PrusaSlicer is completely free for everyone** (it even includes profiles for 3rd party printers) and is frequently considered the best slicer on the market by independent reviewers.

PrusaSlicer comes with a G-code Viewer, a lightweight application, which you can use to quickly preview G-codes from all popular slicers. Its behavior is identical to the preview in PrusaSlicer (the same code is used), however, you can load an external G-code file.

We currently parse, and up to some level interpret, G-code from PrusaSlicer, Slic3r, Slic3r PE, CURA, ideaMaker, Simplify3D, Craftware and KISSlicer. PrusaSlicer G-code Viewer is part of the PrusaSlicer installer package. Simply download the latest PrusaSlicer and the standalone G-code Viewer will install together with it automatically.



Download PrusaSlicer now!

The latest stable version is always available at prusaslicer.com. Development alpha/beta versions can be downloaded from github.com/prusa3d/PrusaSlicer - these are unstable builds with the latest features.

6.5. PrusaSlicer Interface Explained

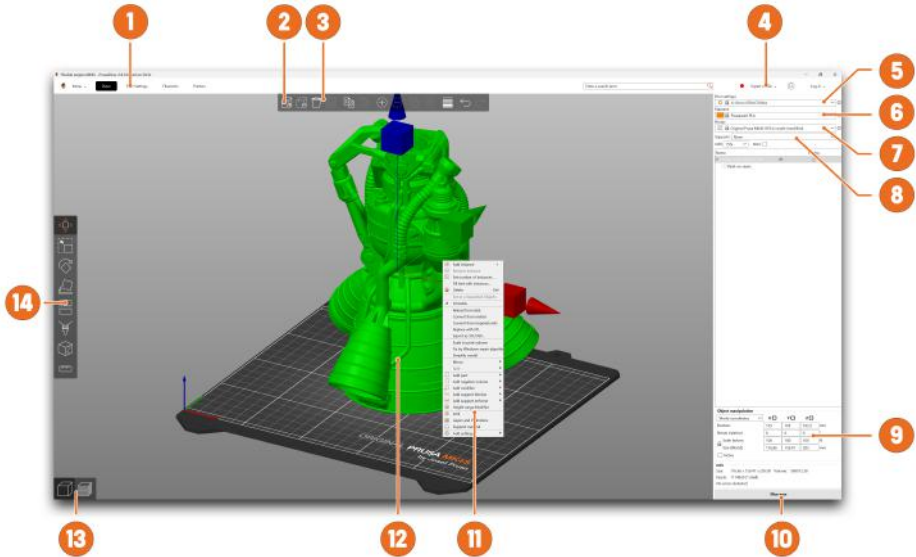

1. Opens detailed Print, Filament and Printer settings
2. The Add button is used to import a 3D model into the scene
3. The Delete and Delete All buttons remove the model(s) from PrusaSlicer
4. Switching between Simple, Advanced and Expert modes
5. Settings for printing speed and quality
6. Material selection
7. Printer selection
8. Quick settings for Infill density, Supports and Brim
9. Information about model size / printing time (after slicing)
10. Slice / Export button
11. Right-click the model to open a context menu
12. Model preview in 3D
13. Switch between 3D editor and Preview mode
14. Move, Scale, Rotate, Cut, Paint-on Supports, Seam Painting tools

6.5.1. Initial Setup and General Workflow

Upon launching PrusaSlicer, select Original Prusa MK4S from the Printer drop-down menu on the right (No. 6 in the PrusaSlicer overview on the previous page). If you don't see the Original Prusa MK4S in the list, **you need to add it either by using Add Printer-Add Presets menu item** (in the same menu), **or by using Configuration - Configuration Wizard** from the top menu bar.

Then select the layer height, infill and the material you intend to use. **If you are not sure about the layer height, stick with 0.15mm profiles as they give generally good results.**

Recommended infill values are between 5-20 % but it heavily depends on the model and how durable it needs to be. More infill means a more durable model, however, it will take longer to print and more material will be consumed. For general use, there is no point in going above 40% infill, unless your project really requires it.

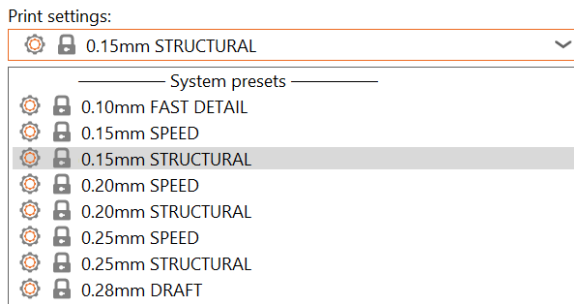

Please note that the default profiles have a tested specific setting for each type of filament. If you choose a different profile, it may affect the print quality negatively.

PrusaSlicer allows you to import objects in STL, OBJ, AMF, STEP and 3MF formats - these are the most common types of 3D files you can find on the internet.

You can either drag them directly into the 3D editor window or use the Add... button from the top bar. **To modify the model, use the tools on the left sidebar, i.e. Move, Scale and Rotate.** If an object is blue, it means it does not fit into the print bed and it needs to be moved or scaled down.

There is no universal way to place the model on the bed, it always depends on the specific shape. However, a general rule is that the bigger the flat surface of the model that touches the bed, the better it will hold - so try to **position the largest flat surface of the model downwards.** You can use the Place on Face (F key) function to do it quickly.

6.5.2. Using Supports



Supports are printed structures resembling scaffolding. They are used for printing complex objects. After printing, they can be easily separated from the output.

You can find a large number of objects that can be printed without supports - just place them in the right orientation on the bed, slice them and you can print. **Not all objects, however, can be printed without supports.**

If you are printing an object with walls that rise at an angle less than 45°, these overhangs will cause issues with print quality. **Also, keep in mind that the printer cannot start printing mid-air.** In such cases, supports are necessary.

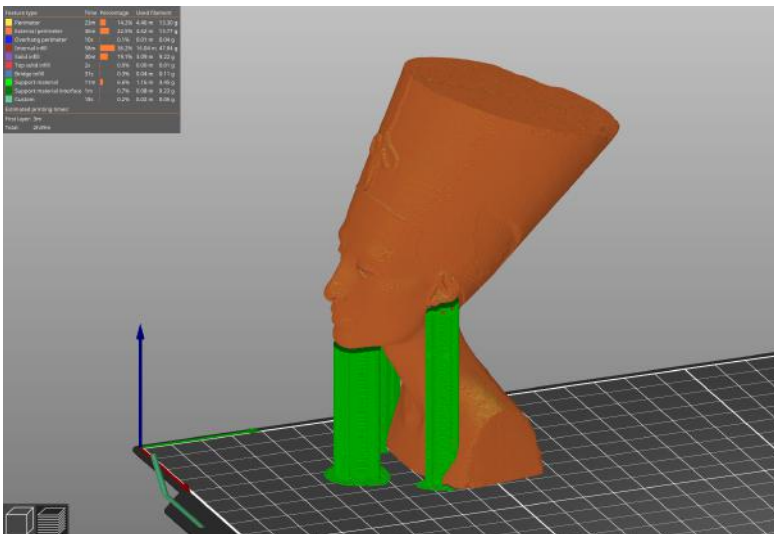

How to tell whether an object needs supports?

The shortest answer is: it comes with experience. With your first prints, stick to the default PrusaSlicer values ("Supports Everywhere"). Once you feel comfortable with printing complex shapes using default support settings, try playing around with the Overhang threshold option in the settings. We have an extensive list of detailed tutorials available at help.prusa3d.com/category/prusaslicer_204 if you need guidance.

You have three options to choose from when selecting support generation:

- **Support on Build Plate Only** - generates supports only in the space between the object and the print bed.
- **For Support Enforcers Only** - generates supports only where enforced by placed modifiers.
- **Everywhere** - generates supports everywhere.

The default support pattern usually works correctly, but **if you need to modify the places where the supports will be generated**, just go to the **Print Settings** tab and select **Support Material**.

- Check the Generate Support Material box.
- The Overhang Threshold allows you to set the minimum angle for printing the support material. Setting the value to zero will enable an automatic calculation. Try generating supports with different angle settings to see which value works best for your object.
- Enforce Supports is an option mainly used for small models or models with a small base to prevent them from being broken or detached from the print bed during the printing process.
- Wherever the supports touch the model, they are usually associated with a lower surface quality. Try to reduce or even avoid the need for supports by rotating or shifting the model accordingly.

6.5.3. Speed vs Print Quality

A small object can be printed in a few minutes but printing bigger models can take a lot of time - sometimes even dozens of hours.

The printing speed is affected by several factors. Primarily, it depends on the layer height. This can be set in PrusaSlicer in the Print Settings drop-down menu in the upper right corner. 0.15mm STRUCTURAL is pre-set, but you can speed up the printing by choosing e.g. 0.20mm SPEED. Models printed like this will have less detail and more visible layers.

If you care more about quality than speed, choose 0.10mm (FAST DETAIL). The appearance of the models will improve, at the cost of a decreased printing speed.

Some profiles may have two variants.

- **Structural** - slower perimeter and infill printing, improves the surface quality and structural integrity
- **Speed** - faster perimeter and infill printing, without too much impact on the surface quality, top speed while keeping good quality and accuracy

The speed can be adjusted during printing, via the *LCD Menu - Tune - Speed*. Then use the knob to adjust the speed up or down. Observe the effect of the speed change on the print quality and choose the settings that suit you best. Remember that **this setting does not affect the acceleration of the printer**, so the printing time will not be shortened proportionally to the speed setting change.

6.5.4. Infill

Another parameter that affects the properties of the printed object is Infill. It affects the printing speed, strength and appearance of the object. Objects printed with the FFF/FDM method usually do not have 100% density. Instead, they contain a certain geometric structure inside. It can take various forms, from simple square grids or hexagons to more complex patterns. The purpose of the infill is to stiffen the object from the inside. Most models are printed with 10-15% infill, but if you need a really solid structure, you can choose a higher density.

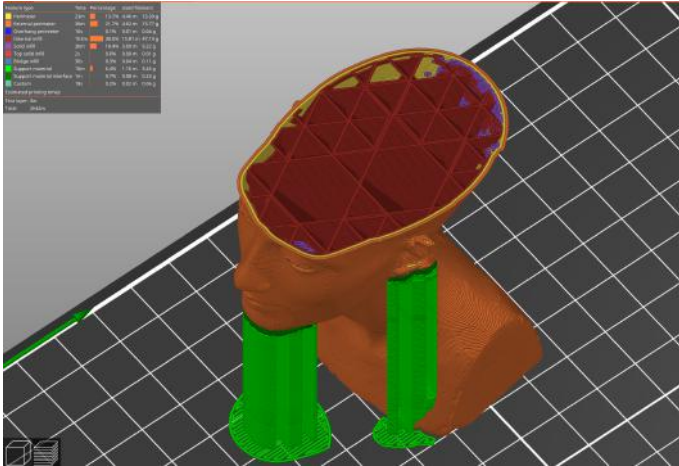

6.5.6. Printing Objects Larger than the Print Volume

The Original Prusa MK4S printer has a print volume of 250 × 210 × 220 mm. If this is not enough for your project, you can use PrusaSlicer's built-in tools to find a solution.

i Don't let the size of the print bed be a limitation – at blog.prusa3d.com you can find tips on how to assemble large models from several smaller parts.

Of course, you can also resize the imported model to fit the bed. The **Scale tool** is there to help you with that. If you want to print an object which is too large in its original size for the print bed, you can **cut it into several smaller parts**. Use the **Cut tool** from the left menu (or press the letter C). Either place the cutting plane manually or set an exact height using the Cut tool dialog. Choose whether you want to keep only the part above the cut, below it, or both.

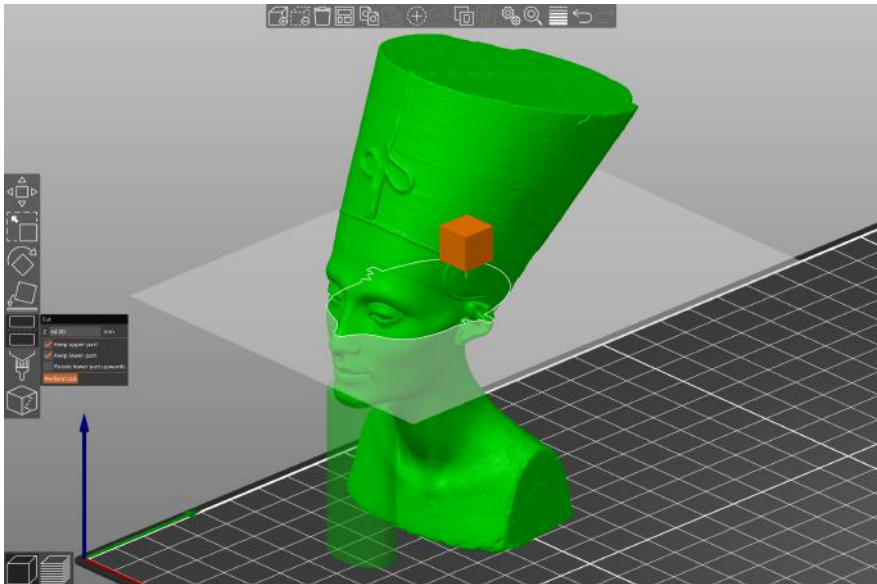

6.5.7. Printing Multicolored Objects (without MMU3)

If you want to have a print with layers in different colors, it can be easily set up directly in PrusaSlicer - follow the instructions below.

1. Switch to the layer view (Preview) using the button in the left bottom corner.
2. Use the slider on the right to select the layer in which you want to change the color.
3. Click on the orange icon with the plus sign.
4. An immediate preview will appear. You can undo the color change by clicking on the gray cross which will appear instead of the orange plus sign.
5. Export the G-code and you can start printing!

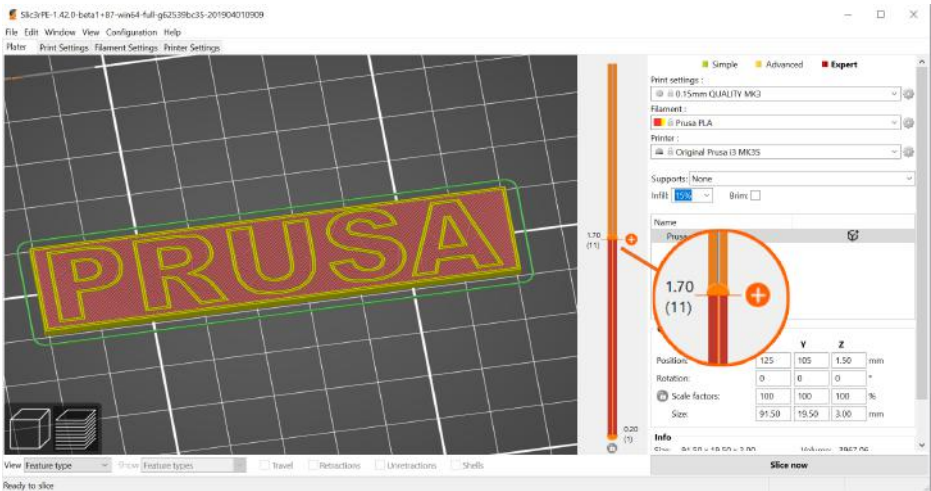

Once the printer reaches the layer, where the color change should happen, **the printer will pause and display a prompt on the screen.** Follow the instructions on the screen to finish the filament change.

6.5.8. Slicing and Exporting

One of the most important phases of the slicing process is the final check of the sliced object in the Preview. Using the slider on the right, you can **review all the print layers** of the object one by one. This will help you **identify problematic spots** - for example, if the bottom of the object doesn't stick well to the bed or if some of the parts are missing supports and are "hanging in the air".

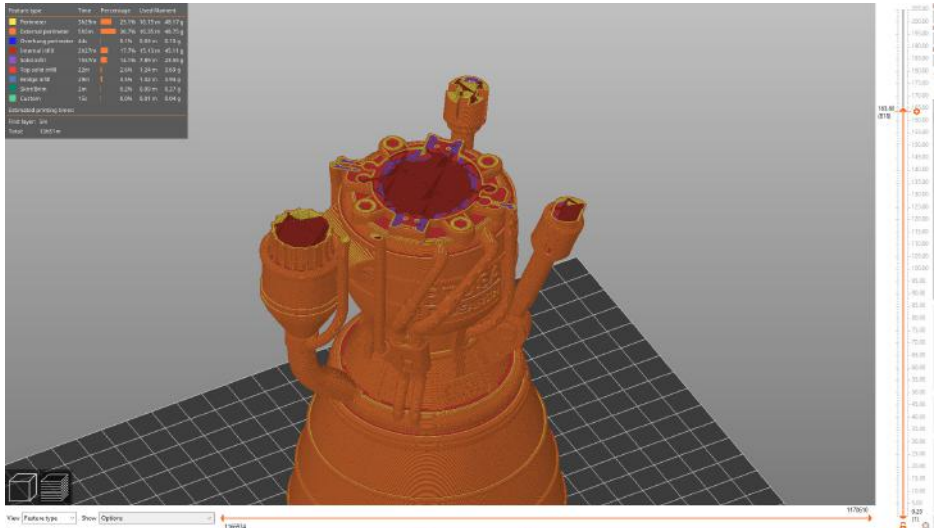

Before you export the model as G-code and upload it to the USB drive, always check it in the Preview first. It's the best way to avoid mistakes during printing.

7. Material Guide

A full table of materials is available online! Due to limited space within this guide, we can only provide a brief overview of popular materials here. Visit help.prusa3d.com/materials to find a **full overview of a wide range of printing materials**. The Original Prusa MK4S 3D printer is compatible with almost all filaments available. Individual materials may differ not only in color but also in mechanical and optical properties, or even in printing difficulty.



Prusament (prusament.com) is our in-house made line of **high-quality filaments**. We were not satisfied with the quality of filaments on the market, so we decided to make our own! **The whole manufacturing process is closely monitored** and every spool is thoroughly tested for string diameter, color consistency, and mechanical properties.

We are the only manufacturer that gives customers the option to **fully inspect the parameters of every filament spool**. Just scan a QR code on the spool to see all details online. We offer a wide range of various materials at prusa3d.com and it keeps growing every day!

7.1. PLA

PLA is the most commonly used material for 3D printing. It prints easily and prints from PLA are very hard. Perfect choice for printing large objects due to low shrinkage (prints don't warp on the bed) and for printing detailed small models.

Advantages

- Easy to print, suitable for beginners
- Easily print small detailed models
- Trouble-free printing of larger objects
- Almost odorless
- Affordable
- Wide range of colors

Disadvantages

- Brittle and inflexible
- Low temperature resistance (50-60 °C)
- Difficult post-processing
- Not suitable for outdoor use (low UV and temperature resistance)

Typical uses: Prototypes, toys, action figures, jewelry and small detailed models in general, architecture models and more!

Tips and tricks: Prints best on a smooth (or satin) print sheet. When post-processing PLA prints, it is best to use wet sanding to achieve better results. If you use sandpaper dry, the heat generated by friction can start to deform the printed object. PLA can only be dissolved in chemicals such as chloroform or heated benzene. For gluing, a good quality superglue is sufficient, certain types of PLA can also be glued with acetone.

- **Nozzle temperature:** 215 °C
- **Heated print bed temperature:** 50-60 °C
- **Print surface:** Make sure the print sheet is clean, as per instructions in the Regular Maintenance chapter.

7.2. PETG

PETG is one of the most popular materials for 3D printing. It is a great choice for parts that will be subject to mechanical stress. Compared to PLA, it has a higher temperature resistance, it is more flexible and less brittle. Thanks to its low thermal expansion, it holds well to the bed and does not warp. Printing with it is almost as easy as with PLA, but unlike PLA it offers much better mechanical properties. Parts of our printers are printed with PETG!

Advantages

- High temperature resistance
- Easy printing
- Low thermal expansion
- Durable and tough
- Easy machining (sanding)
- Printing almost without smell
- Glossy surface
- Good adhesion of layers

Disadvantages

- Not suitable for printing small/highly detailed models
- Nozzle can leave thin filaments (stringing)
- Problematic bridging and overhangs
- Strong adhesion to the bed
- Cannot be smoothed with commonly available solvents, soluble only in dangerous chemicals
- Removal of supports can be difficult

Typical use: Mechanical parts, Holders and cases, Waterproof prints (flower pots).

Tips and tricks: PETG requires a higher heatbed temperature (85 °C). PETG usually has worse results when bridging two points, plus PETG tends to string - this means it's leaving fine plastic strings on the surface of the print (which can be relatively easily removed). Stringing can be reduced by setting appropriate retraction and using lower printing temperatures - we recommend sticking to the values in PrusaSlicer profiles. The print must be well cooled - it has better details and stringing can be prevented to some extent. However, if you want the most durable print, try turning off the print fan. A higher temperature will cause the layers to stick better to each other, resulting in better mechanical resistance. Generally, we recommend printing the first few layers with the fan turned off (for adhesion) and then turning it on at 50% power.

- **Nozzle temperature:** 240 °C
- **Bed temperature:** 70-90 °C
- **Print surface:** A textured print sheet and a satin print sheet do not require any special preparation, just keep them clean and free of grease. If you want to use a smooth PEI print sheet, you should apply a thin layer of glue stick, as PETG may adhere too strongly to the sheet surface, making it difficult to remove prints from the sheet.

7.3. ASA (ABS)

ASA and ABS are very similar materials. In some respects, ASA is better than ABS. ASA is UV-stable compared to ABS and shrinks slightly less during printing. When it comes to post-processing, ABS and ASA can be similar, but the latter is currently more popular, so we will focus mainly on it.

ASA is a strong and versatile material. A higher melting temperature than PLA gives ASA good thermal resistance, so your prints will not show signs of deformation up to temperatures around 100 °C. Unfortunately, compared to PLA, ASA has a very high thermal expansion, which complicates printing, especially larger models. Even with a heated bed set to 100 °C, the print can start to warp and detach from the bed. ASA also produces a noticeable odor during printing.

Best printed in the Original Prusa Enclosure.

Advantages

- High impact and wear resistance (lower than PETG)
- Very good thermal resistance
- Suitable for outdoor use - UV stable
- Soluble in acetone - can be used for gluing
- Possibility of smoothing with acetone vapors
- Detailed prints without stringing (leaving fibers on the print)
- Easy post-processing (e.g. sanding, cutting, etc.)

Disadvantages

- Difficult printing
- Tendency to warp (printing in an enclosed box is recommended)
- Unpleasant smell when printing (contains styrene)

Typical uses:

- Cases and protective covers
- Prototypes
- Spare parts
- Toys and figures
- Parts suitable for exterior use

Tips and tricks: Printing with ASA/ABS is much easier if the printer is placed inside an environment with increased stable temperatures. This significantly reduces both deformation and layer separation. Thanks to acetone, it is easy to join several prints together. Just lightly rub the contact surfaces and press the parts together. In addition, it is possible to smooth the prints with acetone vapors and get a perfectly glossy surface. Be careful when handling acetone!

- **Printing temperature:** 220-275 °C
- **Bed temperature:** 90-110 °C (larger objects require higher temperature)
- **Print surface:** ASA and ABS materials work best with a satin print sheet, which requires no special preparation - just keep it clean and free of grease. However, if you are printing ABS/ASA on a textured/smooth print bed, it is necessary to apply a glue stick.

7.4. PC (polycarbonate) and PC Blend

Polycarbonate (PC) is a technical material boasting excellent strength, tensile strength, and resistance to high temperatures. It is however quite demanding to print, thus making it suitable mainly for advanced users. This of course does not apply to our Prusament PC Blend, which is much easier to print compared to other polycarbonates. Polycarbonate surpasses all of the aforementioned materials in its mechanical, chemical, and thermal resistance.

Best printed in the Original Prusa Enclosure.

Advantages

- High-temperature resistance
- High strength and tension resistance
- Clear polycarbonate is transparent
- Good electrical insulation properties

Disadvantages

- Pure polycarbonate is highly hygroscopic
- High nozzle and bed temperatures
- Strong warping, especially for large models
- Mild smell during printing
- Separating layer application recommended
- High price

Typical uses: Polycarbonate is mostly suitable for technical components, for which we require a higher resistance to mechanical wear and tear and high temperatures.

Tips and tricks: Consider printing in a closed box - to prevent warping of the printed objects; enable the "Brim" feature in PrusaSlicer - set it higher than the default outline, ideally to the whole height of the print; add a "Skirt" in PrusaSlicer around small objects; do not print in low-temperature zones;

- **Nozzle temperature:** 270-275 °C
- **Bed temperature:** 110 °C for the first layer, 115 °C for the following layers
- **Print surface:** Textured print sheet and smooth print sheet with a layer of stick glue offer the best adhesion properties. Although the textured print sheet offers good adhesion properties on its own, we recommend applying a separating layer of glue to prevent wear/damage to the surface.

7.5. PVB

Polyvinyl butyral (PVB) is a material that can be easily smoothed with isopropyl alcohol (IPA). Prints, when properly set up, are clear and transparent, thus making PVB a suitable material for printing vases, lamp shades, and other decorative models. The printing settings are similar to those for PLA, but the mechanical properties of PVB are slightly better.

Advantages

- Similar printing settings to PLA
- Transparent filament
- Suitable for decorative models - vases, lamp shades, etc.
- Chemical smoothing with IPA
- Good toughness
- Good tensile strength (similar to PETG and PLA)
- Less prone to warping (less than PLA)
- Suitable in combination with 0.8mm nozzle

Disadvantages

- Lower adhesion between layers
- Hygroscopic material (absorbs moisture)
- Higher price

Typical uses: PVB finds its best use when printing transparent (translucent) models – e.g. jewelry, vases, lamp shades, etc.

Tips and tricks: PVB has good adhesion to clean smooth or satin print sheet, while textured print sheets have rather poor adhesion. If you want to print translucent prints which you will later smooth with isopropyl alcohol, we recommend using a bigger nozzle (0.8mm) and enabling the "Spiral vase" mode in PrusaSlicer. When printing with multiple perimeters, the individual layers will be clearly visible even after smoothing with isopropyl alcohol.

Store the filament in a dry environment – PVB is a material prone to absorbing moisture, which can negatively affect the quality of the print. Always return the filament to its plastic bag with silica gel, or let it dry for 4 hours at 60 °C before printing with it.

The main advantage of PVB material is that it can be smoothed with isopropyl alcohol (IPA). Models printed from PVB can be smoothed in IPA vapors, by immersing into an IPA bath, or by directly applying IPA on the object surface (by using a sprayer or brush). Detailed instructions can be found on our blog at blog.prusa3d.com.

- **Nozzle temperature:** 215±10 °C
- **Bed temperature:** 75 °C
- **Print surface:** Do not use the standard textured print bed. PVB will better adhere to the clean smooth or satin print bed. Textured print sheets may not have sufficient adhesion properties.

7.6. Flexible Materials

Flexible filaments are typically very strong and elastic materials. In many cases, the classic hard plastic (PLA, PETG) may not be ideal or even completely unsuitable for certain models. Whether you are printing a phone case, a housing for an action camera or even wheels for an RC car, it is better to use a flexible material.

These materials are often expensive and not very common and are not suitable for beginners. Before you start printing with Flex, clean the nozzle from the previous material by inserting PLA into the preheated extruder and pushing out all the previous material. For Original Prusa 3D printers, we recommend using Semiflex or Flexfill 98A, or Filatech FilaFlex40, for which we have tuned profiles in PrusaSlicer.

Advantages

- Flexibility and elasticity
- Minimal shrinkage
- Excellent adhesion of layers
- Great resistance to wear

Disadvantages

- Requires a special procedure for inserting filament
- Very poor bridging and overhangs
- Requires lower print speed
- Higher price
- Absorbs moisture - must be stored in a dry environment

- **Nozzle temperature:** 220 - 260 °C
- **Bed temperature:** 40 - 85 °C. (larger objects require higher temperature)
- **Print surface:** If you are printing on a smooth or satin print sheet, apply a separation layer to it! A glue stick is ideal. Textured sheets with a powder-coated PEI surface do not require a separation layer - the print will hold well and can be easily removed from the sheet after cooling.

7.7. PA (Polyamide) / PA11CF

Polyamide (also known as Nylon) is a versatile material known for its durability and is commonly used for 3D printing special models due to its high difficulty in printing (not applicable to PA11CF) and higher costs. There are several types of polyamide, which differ in properties such as temperature resistance, water absorption and adhesion to different types of surfaces. Prusament PA11CF has great temperature resistance (up to 192 °C), strong resistance to a range of chemicals, and prints easily. Some polyamides, including the PA11CF, are reinforced with carbon fibers to reduce shrinkage, often at the expense of mechanical strength. We recommend the PA11CF for printing extremely stressed parts, such as plastic engine components, etc.

Best printed in the Original Prusa Enclosure.

Advantages

- Great temperature resistance (up to 192 °C)
- Resistance to a range of chemicals
- Hard and resilient in thick layers, flexible in thin layers
- Smooth glossy surface of clean PA
- Excellent layer adhesion
- Suitable insulation material

Disadvantages

- Not suitable for printing small/highly detailed models
- Prone to warping (not applicable to PA11CF)
- Challenging bridging and overhangs
- Strong (or too weak) adhesion to the surface
- Cannot be smoothed with commonly available solvents, dissolvable only in dangerous chemicals
- Difficult to remove supports
- Highly hygroscopic material

Typical use: Mechanical parts, holders and housings, electrical insulation parts, movable parts, and parts requiring high temperature resistance.

Tips and tricks: It is absolutely essential to **keep the filament dry**, otherwise its adhesion and overall printing quality will significantly worsen. Therefore, we recommend drying the filament for at least 4 hours at a maximum temperature of 90 °C before printing. The print from a dried polyamide should have a smooth and glossy surface, while materials reinforced with carbon fibers have a matte surface.

When printing polyamides, **we recommend using an enclosed printer with active filtration** or keeping the printer in a well-ventilated room. Not only are potentially hazardous particles released when printing (all) PA, but the higher ambient temperature also reduces warping and improves layer adhesion. Carbon-reinforced polyamides can be printed without a covered printer, but due to the internal tension caused by the sudden temperature change, the finished prints may have slightly worse mechanical properties.

- **Nozzle temperature:** 240 - 285 °C
- **Bed temperature:** 70 - 115 °C
- **Print sheet surface:** For printing most polyamides we recommend using our special PA Nylon print sheet, which ensures ideal adhesion even when its only cleaned with water. However, the adhesion of some types of polyamide may be too high, leading to damage to the sheet, so we recommend checking the compatibility in our material table (help.prusa3d.com/materials). We do not recommend printing polyamides on a smooth print sheet, and when using a textured or satin sheet a layer of paper glue (glue stick - Kores / PVA gluestick) must be applied.

8. Regular Maintenance

The Original Prusa MK4S was designed from the beginning as a true print "workhorse". Despite its high reliability, it is still a device with mechanical components that require more or less regular maintenance. Follow the instructions below to keep your printer in perfect condition for as long as possible.

8.1. Flexible Print Sheets

To achieve the best adhesion of the print surface, it needs to be kept clean. Choose the right cleaning agent depending on the type of print sheet (see below). Drop a small amount of the agent onto a clean paper towel and wipe the print surface. Best results will be achieved when the print sheet is cold, otherwise, you may burn yourself on the nozzle or heated bed. Also, the alcohol will evaporate before it has a chance to clean anything. Details can be found in the chapter **Your First Print** in this manual.

The effect of various print sheets on the first layer can be seen below. **From left to right: smooth, satin and textured powder-coated print sheet.**



The print surface does not need to be cleaned before every print, just be aware of not touching it with your fingers.

Recommended cleaning agents differ slightly depending on the type of print sheet. Instructions for the use of specific materials (e.g. the need to use a separation layer to avoid damaging the surface) can also be found in the previous chapter.

	Correct usage:	Risks and dangers:
Print sheet with smooth PEI surface	<ul style="list-style-type: none"> • Isopropyl alcohol 90%+ (IPA) is the best option for degreasing. Do not use dermatological hand products which may contain isopropyl alcohol - they contain other additives (ointments, hydrating ingredients). • Warm water with a few drops of dish soap (in case IPA does not remove residues like sugar from the bed) • Acetone - occasionally for thorough cleaning of the print sheet • When printing with Flex material you need to apply glue stick (Kores / PVA gluestick) 	<ul style="list-style-type: none"> • Prints from PETG would stick too strongly to the sheet cleaned with isopropyl alcohol (IPA) and removing it could damage the surface. Materials such as PETG, ASA, ABS, PC, CPE, PP and FLEX should only be printed with a separating layer (glue stick).
Print sheet with a textured powder-coated surface	<ul style="list-style-type: none"> • Isopropyl alcohol 90%+ (IPA) - best for degreasing 	<ul style="list-style-type: none"> • Do not use acetone
Satin print sheet	<ul style="list-style-type: none"> • Suitable for PLA and PETG • 90% isopropyl alcohol (IPA) is the best degreaser • For printing flexible filaments you need a separating layer of glue (Kores) • Broad spectrum of supported materials; including advanced materials such as PC Blend and others 	<ul style="list-style-type: none"> • Never use acetone! • For printing ASA and PC Blend you need to add a brim, outline or shield around the print • Do not use sharp objects to remove the print from the bed!



Consumable materials such as print sheets are not covered by our warranty unless they arrive damaged or incorrectly manufactured. Print sheets are consumables and the warranty only applies to defects that appear immediately after unpacking.



All original print sheets made in Prusa Research are double-sided.

8.1.1. Double-Sided TEXTURED Print Sheet

- Surface resistant to damage and scratches
- The texture on the surface of the sheet is transferred to the bottom side of the printed object
- Simpler Z-axis calibration
- FLEX does not require glue (Kores / PVA gluestick) application to the print bed
- After the print sheet cools down, the print usually detaches itself
- PLA prints with a small contact area may require a brim
- Large PLA prints may warp
- **Never clean with acetone**

The textured powder-coated surface applied directly to metal allows us to create a print sheet that is highly resistant to damage. If a heated nozzle hits it, the metal is able to quickly dissipate heat. **The textured powder coating also gives the bottom surface of the print a unique, interesting texture.** The textured surface is able to mask most scratches and similar types of damage caused by various tools. One can only scratch the highest points of the texture, yet this type of damage will not be visible on the print.



Never clean the textured powder surface with acetone! This will cause micro-cracks in the PEI layer, which will eventually lead to a significant deterioration of the surface quality.

8.1.2. Double-Sided SMOOTH Print Sheet

- Excellent for PLA
- Great adhesion to almost all materials
- Smooth bottom layer of prints
- Even small prints will hold well
- Occasionally clean with acetone

For printing materials such as PETG, ASA, ABS, PC, CPE, PP, Flex and others, it is necessary to apply a glue separation layer. More information can be found in the Materials Guide.



The industrial adhesive used to attach the PEI layer to the print sheet tends to soften at temperatures above 110°C. The adhesive can then move beneath the surface, creating small bumps.



If you notice small bubbles appearing beneath the PEI layer on the flexible print sheet, just flip it over and print on the other side. After a few days or weeks, the bubbles should disappear. The bubbles have no effect on the print quality.

8.1.3. Double-Sided SATIN Print Sheet

- Suitable for PLA and PETG
- Soft texture on the bottom part of the print
- **Only use quality isopropyl alcohol (90+ %) to clean**
- FLEX requires the use of a glue separation layer (Kores / PVA glue stick) on the print sheet
- Wide range of supported materials, including advanced materials such as PC Blend and more
- Easy maintenance and good adhesion
- **Do not use acetone! Acetone will damage the surface of the print sheet!**
- When printing with ASA and PC Blend, a brim or a raft may be required around the print, depending on the model height
- **Do not use sharp metal objects to remove prints from the sheet (e.g. a metal spatula)**

8.1.4. Improving the Adhesion

In certain special cases, such as printing a very tall object that touches the print sheet with a very small area, it may be necessary to **improve the adhesion**. PEI is fortunately a chemically very resistant polymer, so it is possible to **apply various substances to improve adhesion without risking damage to the surface**. This also applies to various materials whose adhesion to PEI would be very weak under normal circumstances. More information can be found on the website help.prusa3d.com/materials.



Before applying anything to the print sheet, consider using the Brim feature in PrusaSlicer to increase the area of the first layer.

8.2. Keeping the Printer Clean

After several hours of printing, various kinds of debris may start to accumulate around the printer parts or under the heatbed - pieces of filament, dust, scraps, broken supports, etc. Always make sure that the parts of the printer are clean. You can use a brush, a small broom or a vacuum to remove debris.

8.3. Bearings

Every couple hundred hours, the smooth rods should be cleaned with a paper towel. Then look for the white tube in the package and apply a little bit of the included lubricant on the smooth rods and move the axis back and forth a couple of times. This cleans the dirt and increases longevity. For a detailed maintenance guide, please head to help.prusa3d.com

If you feel the axis is not running smoothly anymore, bearings can be taken out and greased on the inside (they need to be removed from the axis because the plastic lip will prevent most of the grease from getting inside).

8.4. Fans

The RPM (revolutions per minute) of both fans is constantly measured. This means that the printer will **report an error if the fan suddenly slows down**, for example due to a piece of filament stuck in it. In such a case, check and remove any dirt from the relevant fan. Do not try to bypass the RPM check - this could damage the printer! Both fans should be checked and cleaned after every few hundred hours of printing. Dust can be removed with compressed air in a spray can, small plastic threads can be removed with tweezers. **Do not blow compressed air on the running fan.**

8.5. Extruder Feeding Gear

The feeding gear in the extruder does not need any lubricant. Over time, **a filament powder deposit may form in the grooves**, causing poor extrusion of filament. Remove the debris using compressed air in a spray, small plastic threads can be removed with tweezers. Use the access opening on the side of the extruder. Clean as much as possible, then turn the wheel (LCD Menu - Control - Axis) and continue.



Warning: Never, under any circumstances, open the gearbox itself unless you have the gearbox alignment tool that comes with the MK4S assembly kit. There is no need to open the gearbox cover.

8.6. Electronics

It is a good practice to check and optionally reconnect the electrical connectors on the xBuddy board and electronics board in the Nextruder every 600-800 hours of printing.

8.7. Extruder is Clogged or Jammed

Clogged extruders can cause issues when printing or when loading a new filament. On the top of the extruder, there is a pair of screws directly next to the filament insertion point. You can adjust the idler pressure by loosening or tightening these screws. By unlocking the top clip, you can open the idler and check the filament track for any blockages. **When you open the idler, you can easily clean the feed gear of all filament remnants. We recommend regularly cleaning the gear.**

8.8. Cleaning the Nozzle



Do not touch the nozzle during this procedure - it is hot and there is a risk of burning yourself! To better access the extruder during cleaning, raise the extruder to the top of the Z-axis in the LCD menu - Control - Movement - Z Axis.

8.8.1. The filament does not come out of the nozzle.

If the filament does not pass through the extruder and no plastic is being extruded, check the following:

- Open the idler on the side of the extruder to see if the filament strand reached the extruder gear and continues down into the nozzle
- See if the temperatures are set correctly (215 °C for PLA, 260 °C for ASA, etc.)
- Check if the fan on the side of the extruder is spinning

If the filament strand is not visible (does not reach the extruder wheel), the problem is likely near the filament entry point or the filament sensor. Inspect the path of the filament and see if the filament sensor isn't stuck.

8.8.2. The filament does not come out of the nozzle or only a small amount comes out

The filament does not come out of the nozzle or only a small amount comes out

1. Heat the nozzle to the appropriate temperature for the filament material you are printing with or slightly above. First, feed the filament, then insert an acupuncture needle (included in the package) or thin wire (0.3-0.35 mm) into the nozzle from the bottom to a depth of about 1-2 cm. Use protective gloves in case material suddenly starts to come out of the nozzle.
2. Select the Load Filament option from the LCD menu and check that the nozzle is actually extruding the filament.
3. Again insert the wire or acupuncture needle into the nozzle and repeat the whole procedure several times. If the filament is being extruded correctly, the nozzle is clean.

If the filament still doesn't come out and the nozzle is clogged, you can perform a cold pull method to clean the insides of the nozzle. You can find the Cold Pull wizard in the printer's LCD Menu.

8.9. Troubleshooting Faulty Sensor Readings and Removing Errors

If you encounter problems with the filament sensor, such as incorrect (or random) readings, make sure that everything in the Nextruder is correctly wired and that there is no debris in the filament path inside the extruder. If this doesn't help, please contact our tech support.

8.10. Filament Sensor

The filament sensor is calibrated during the initial Selftest and can be also re-calibrated from the printer's Control menu. If you encounter random readings, unload the filament, turn the printer off and remove debris from the Nextruder - either using tweezers or a can of compressed air.

9. FAQ - Frequently Asked Questions and Basic Troubleshooting

In case of a critical failure, the Original Prusa MK4S may display an error screen with short instructions on how to proceed. This screen contains a link to a detailed article on our Knowledge Base at help.prusa3d.com as well as a QR code that can be scanned by a mobile phone to quickly access the link.

9.1. Mesh Bed Leveling Fails

In case the automatic first layer calibration (Mesh Bed Leveling) fails, the cause is likely to be either the Load cell sensor or a misaligned X/Z axis. Run the Auto Home and Z-axis calibration from the Control menu and see if the issue goes away. Move the Z-Axis all the way upwards until it hits the endstops. You will hear a couple of clicks from the motors. This way, you can ensure the horizontal axis is perfectly level. Make sure the print sheet is correctly placed and re-run the Load cell calibration again. Then start the print again.



If you built the assembly kit and you're seeing errors related to either homing or Mesh Bed Levelling, there might be an issue related to incorrect assembly. Closely inspect all axes. Make sure all screws are tight. You can turn off the printer and move the Nextruder left and right, and the heatbed back and forth to ensure that the movement is smooth.

9.2. Printer Does Not Recognize the Inserted USB Drive

If the printer does not recognize the USB drive, try restarting the printer first. In case the error "Error mounting USB drive" appears, the most probable cause is an incompatible file system (e.g. exFAT). Use a smaller USB drive (4-16GB) formatted with the FAT32 file system. More information on formatting and using USB drives can be found on our Knowledge base at help.prusa3d.com. Once the USB drive is inserted, one of two situations may occur: **Cannot access the Print menu after inserting the USB drive**

1. Restart the printer first
2. Use a USB drive formatted to FAT32 with a single partition
3. Try using a different USB drive

If you have tried multiple USB drives and none of them can be read, there may be a problem with the mainboard. Contact our technical support. **USB drive is recognized but no files are visible in the file browser:**

1. Make sure you are using compatible G-code
2. Make sure the file is correctly written to the drive (in Windows use the "Safely remove" function before ejecting the drive)
3. Try a different USB drive and a different G-code file
4. Try renaming the file to something simpler, e.g. model.gcode

9.3. Loose Belts

Check both belts to make sure they are properly tensioned. Loose belts can cause printing errors or prevent the printer from starting up. The easiest way to check the belt tension is to print a circular object. If the result is not perfectly round, you need to adjust the belt tension. Instructions can be found at help.prusa3d.com.

9.4. Homing Failed

This issue is usually caused by a blockage in one or more axes. Perform the Auto Home calibration from the LCD Menu and observe the movements of the printer. Make sure the cables leading to the extruder are not touching anything (a wall, shelf, etc.). Make sure nothing is applying pressure onto the heatsink or the extruder motor (e.g., too long screws at the back of the Z-carriage) - this doesn't happen on a factory-built MK4S, but if you built the MK4S as a kit, it's possible there's an issue with assembly.

If you have assembled the Original Prusa MK4S using the assembly kit, make sure that the cables running from the electronics to the extruder are not blocked by anything. Carefully inspect the rear side of the extruder and compare it to the assembly manual to make sure that the cable bundle leading from the extruder is not causing incorrect homing.

9.5. Heating Error

If the printer stops and the screen is red with a heating-related error, please check the connections of the heating element and thermistors. Detailed descriptions can be found at help.prusa3d.com.

9.6. Fan Error

If your printer stops and displays a fan-related error message, check both fans on the print head. It is possible that they are not spinning because they got clogged up. If the problem is elsewhere (e.g. cable connection) visit help.prusa3d.com for more information.

9.7. Reverting to an Older Firmware

Sometimes it is necessary to reinstall an older version of firmware. Upload a file containing the older firmware onto a USB drive formatted with the FAT32 system. Insert the drive into the printer, press the restart button and once the Original Prusa MK4S logo appears on the screen, press and hold the knob. This will activate the firmware update screen. Select "Flash" to reinstall the current firmware with the version from the USB drive.

9.8. Nozzle Hitting the Sheet / Other Z-axis Issues



This issue is usually related to the assembly kit - the assembled printers coming from the factory are thoroughly tested before we ship them out.

If you are having issues with first-layer calibration or Mesh Bed Leveling procedure, first make sure everything is properly wired - check the connectors on the electronics board in the Nextruder. Next, perform Auto Home calibration on all axes to make sure that everything is properly aligned - the print sheet is correctly placed, and the X-axis isn't skewed. Run the Load Cell sensor calibration again.

10. Advanced Hardware Troubleshooting

Due to the length of the articles, it is not possible to include detailed troubleshooting guides in this handbook. However, the Original Prusa MK4S will display an error screen with a short recommendation on how to proceed further if it runs into a problem. This screen will also contain a link to a detailed article in our Knowledge Base at help.prusa3d.com. Additionally, there is a **QR code that you can scan with your mobile phone** for quicker access to the link. Troubleshooting guides for component replacements and advanced hardware issues can be found online at help.prusa3d.com.

11. Troubleshooting Print Quality Issues

If prints are not quite up to your expectations or even have major flaws (shifted layers, ghosting, under-extrusion), it is necessary to find the cause of the issue and address it. On our website help.prusa3d.com you will find troubleshooting guides for 3D printing quality issues, including pictures and specific advice for different types of printers (some of which may still be in English only).



Printables

by JOSEF PRUSA

**PRINT AND SHARE!
JOIN OUR COMMUNITY!**

Download 3D models for free
at [printables.com](https://www.printables.com) and participate
in design contests!

**Follow us for tips, guides,
inspiring videos and amazing 3D prints!**

Share your prints with

#printedbyprusa

