

# MOTO

NEO  
TOOLS

GRAPHITE



**FORCE**  
OUT OF THIS  
WORLD



**SIŁA**  
NIE Z TEGO  
ŚWIATA

1000Nm

# SPIS TREŚCI

## CONTENTS

### ЗМІСТ

#### WYPOSAŻENIE WARSZTATU / WORKSHOP EQUIPMENT / ОБЛАДНАННЯ МАЙСТЕРНІ

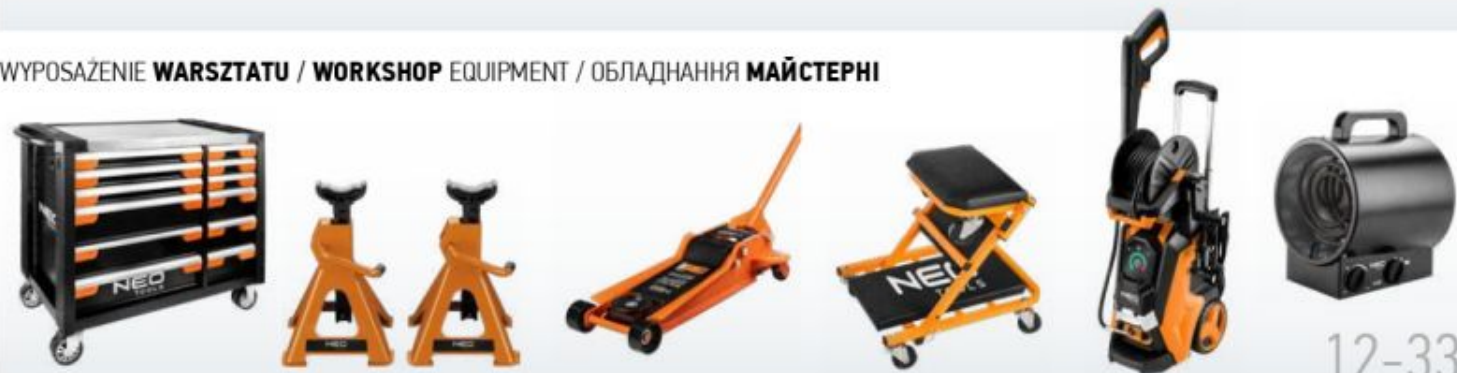

12-33

#### NARZĘDZIA RĘCZNE MECHANICZNE / MECHANICAL HAND TOOLS / МЕХАНІЧНІ РУЧНІ ІНСТРУМЕНТИ



35-103

#### NARZĘDZIA SPECJALISTYCZNE / SPECIALIZED TOOLS / СПЕЦІАЛІЗОВАНІ ІНСТРУМЕНТИ



105-141

#### NARZĘDZIA I AKCESORIA PNEUMATYCZNE / PNEUMATIC TOOLS AND ACCESSORIES / ПНЕВМАТИЧНІ ІНСТРУМЕНТИ ТА АКЦЕСУАРИ



143-156

#### NARZĘDZIA I AKCESORIA MOTOCYKLOWE / MOTORCYCLE TOOLS AND ACCESSORIES / ІНСТРУМЕНТИ ТА АКЦЕСУАРИ ДЛЯ МОТОЦИКЛІВ



158-163

**OŚWIETLENIE / WORKSHOP LIGHTING / ОСВІТЛЕННЯ**



**NORMALIA WARSZTATOWE / WORKSHOP STANDARD ITEMS / СТАНДАРТНІ ПРЕДМЕТИ МАЙСТЕРНІ**



**CHEMIA MOTORYZACYJNA / AUTOMOTIVE CHEMICALS / АВТОМОБІЛЬНА ХІМІЯ**



**BHP / OHS / ОХОРОНА ПРАЦІ**



**ELEKTRONARZĘDZIA I AKCESORIA / POWER TOOLS AND ACCESSORIES / ЕЛЕКТРОІНСТРУМЕНТИ ТА АКЕСУАРИ**



**AKCESORIA I GADŻETY MOTORYZACYJNE / AUTOMOTIVE ACCESSORIES AND GADGETS / АВТОМОБІЛЬНІ АКЕСУАРИ ТА ГАДЖЕТИ**





**NEO**  
TOOLS

### NEO TOOLS to...

Wysokiej klasy narzędzia dla profesjonalistów i wymagających użytkowników

### NEO TOOLS is...

Top class tools for professionals and demanding users

### NEO TOOLS це...

Високоякісні інструменти для професіоналів і вимогливих користувачів



Zapraszamy na kanały marki NEO TOOLS w mediach społecznościowych

Come and browse NEO TOOLS social media channels

Запрошуємо на канали марки NEO TOOLS у соціальних мережах



@NEOTOOLS



@NEOTOOLSOFFICIAL



YouTube  
VIDEO CONTENT

NEOmov



Informacje o nowościach produktowych, wydarzeniach, konkursy, porady oraz video

Information about novelties, events, competitions, tips and videos

Інформація про нові продукти, події, конкурси, поради та відео

VIDEO produktowe, porównania i testy produktów w wielu wersjach językowych

Product related VIDEOS, product comparisons and tests in multiple language versions

ВІДЕО про продукти, порівняння та тести продуктів у різних мовних версіях



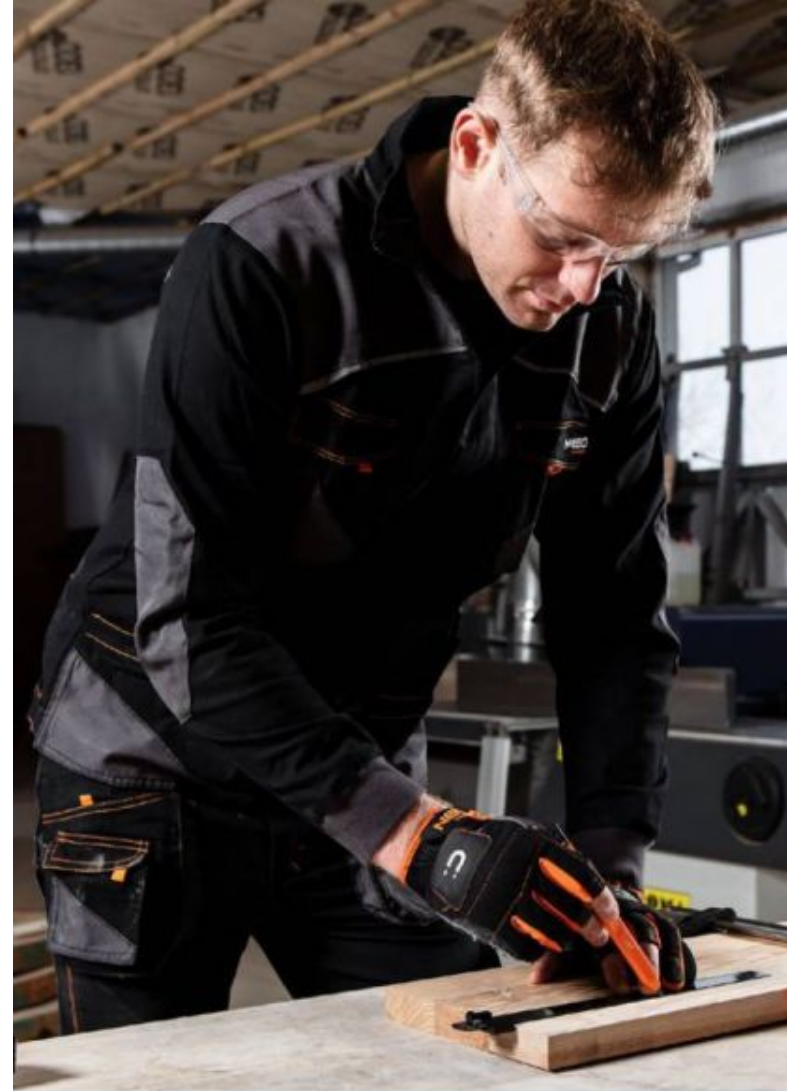

## JAKOŚĆ

Najwyższa jakość materiałów i najnowocześniejsze rozwiązania technologiczne to kluczowe założenia standardów jakości NEO TOOLS. Narzędzia NEO TOOLS to ergonomiczne, precyzyjnie wykonane narzędzia stworzone do pracy w najcięższych warunkach. Produkty NEO TOOLS testowane są zarówno w specjalistycznych laboratoriach jak i w miejscach pracy profesjonalistów.

## QUALITY

High quality of materials and well proven technical solutions are the key foundations of the NEO TOOLS quality standards. High quality and precision of workmanship make the NEO TOOLS tools fit for use in the harshest conditions. NEO TOOLS products are tested in specialised laboratories as well as in professionals' workplaces.

## КАЧЕСТВО

Высокое качество материалов и проверенные технические решения являются ключевыми принципами стандартов качества NEO TOOLS. Благодаря высокому качеству и точности исполнения инструменты NEO TOOLS отлично проявляют себя в сложнейших рабочих условиях. Продукты NEO TOOLS тестируются как в специализированных лабораториях, так и на местах работы профессионалов.

### Laboratorium NEO TOOLS

Narzędzia NEO TOOLS poddawane są specjalistycznym i rygorystycznym testom wytrzymałościowym. Badania jakościowe oparte są o normy europejskie. System zarządzania jakością w Dziale Technicznym posiada certyfikat zgodności z jedną z najważniejszych norm dotyczących kontroli jakości ISO 9001:2015

### NEO TOOLS laboratory

NEO TOOLS undergo specialised and rigorous strength testing. Quality testing is based on European standards. The quality management system of the Technical Department is certified for compliance with one of the most important standards in the quality control field: ISO 9001:2015.

### Лаборатория NEO TOOLS

Инструменты NEO TOOLS подвергаются строгому специализированному тестированию на прочность. Проверка качества выполняется согласно европейским нормам. Система управления качеством в техническом отделе имеет сертификат соответствия одной из важнейших норм, касающихся контроля качества ISO 9001:2015







\*

W procesie produkcji wykorzystywane są starannie wyselekcjonowane materiały, a jakość narzędzi jest stale weryfikowana w trakcie rygorystycznych procedur kontrolnych. Produkty NEO TOOLS spełniają najwyższe kryteria jakościowe, czego znakiem jest 25-letni okres ochrony gwarancyjnej na narzędzia mechaniczne NEO TOOLS.

Manufacturing process uses carefully selected materials, and the tool quality is constantly verified with rigorous control procedures. NEO TOOLS products meet the highest quality criteria, which is confirmed with 25 years warranty for NEO TOOLS mechanical tools.

В процессе производства используются старательно отобранные материалы, а качество инструментов постоянно верифицируется в ходе строгих контрольных процедур. Продукты NEO TOOLS отвечают наивысшим критериям качества, что подтверждает 25-летняя гарантия на механические инструменты NEO TOOLS.



Narzędzia NEO TOOLS cieszą się zaufaniem wymagających użytkowników oraz profesjonalistów, którzy poszukują rozwiązań na najwyższym poziomie. O niezawodności i uznaniu ze strony środowiska biznesowego świadczą liczne wyróżnienia. Najważniejszym z nich jest międzynarodowy certyfikat TÜV, który jest jednym z najbardziej rozpoznawalnych znaków jakości na świecie.

NEO TOOLS earned trust of demanding users and professionals who search for solutions of the highest standards. Reliability and recognition in the business sector are confirmed with numerous prizes and distinctions. The most important of all is the international TÜV certificate, one of the most recognised quality marks in the world.

Инструменты NEO TOOLS пользуются доверием требовательных пользователей и профессионалов, ищущих решений на наивысшем уровне. О надежности и признании со стороны профессионального сообщества свидетельствуют многочисленные знаки отличия. Важнейший из них - международный сертификат TÜV, являющийся одним из наиболее узнаваемых знаков качества в мире.





## TESTOWANIE NARZĘDZI

Narzędzia mechaniczne i warsztatowe marki NEO TOOLS są testowane nie tylko laboratoryjnie, ale przede wszystkim w realnych warunkach pracy. Nasze narzędzia zanim wejdą na rynek używane są w profesjonalnym warsztacie mechanicznym NEO Garage.

Dzięki temu możemy zaoferować Państwu najwyższej jakości produkty przeznaczone do pracy w branży motoryzacyjnej.

## TOOL TESTING

NEO TOOLS brand mechanical and workshop tools are tested not only in the laboratory, but also in real working conditions. Before they enter the market, our tools are used in the professional mechanical workshop NEO Garage.

This allows us to offer you the highest quality products for automotive work.

## ВИПРОБУВАННЯ ІНСТРУМЕНТУ

Механічний та слюсарний інструмент торгової марки NEO TOOLS тестується не тільки в лабораторії, але, перш за все, в реальних робочих умовах. Наші інструменти перед виходом на ринок проходять випробування в професійній механічній майстерні NEO Garage.

Завдяки цьому ми можемо запропонувати Вам продукцію найвищої якості для автомобільних робіт.

# NEO GARAGE

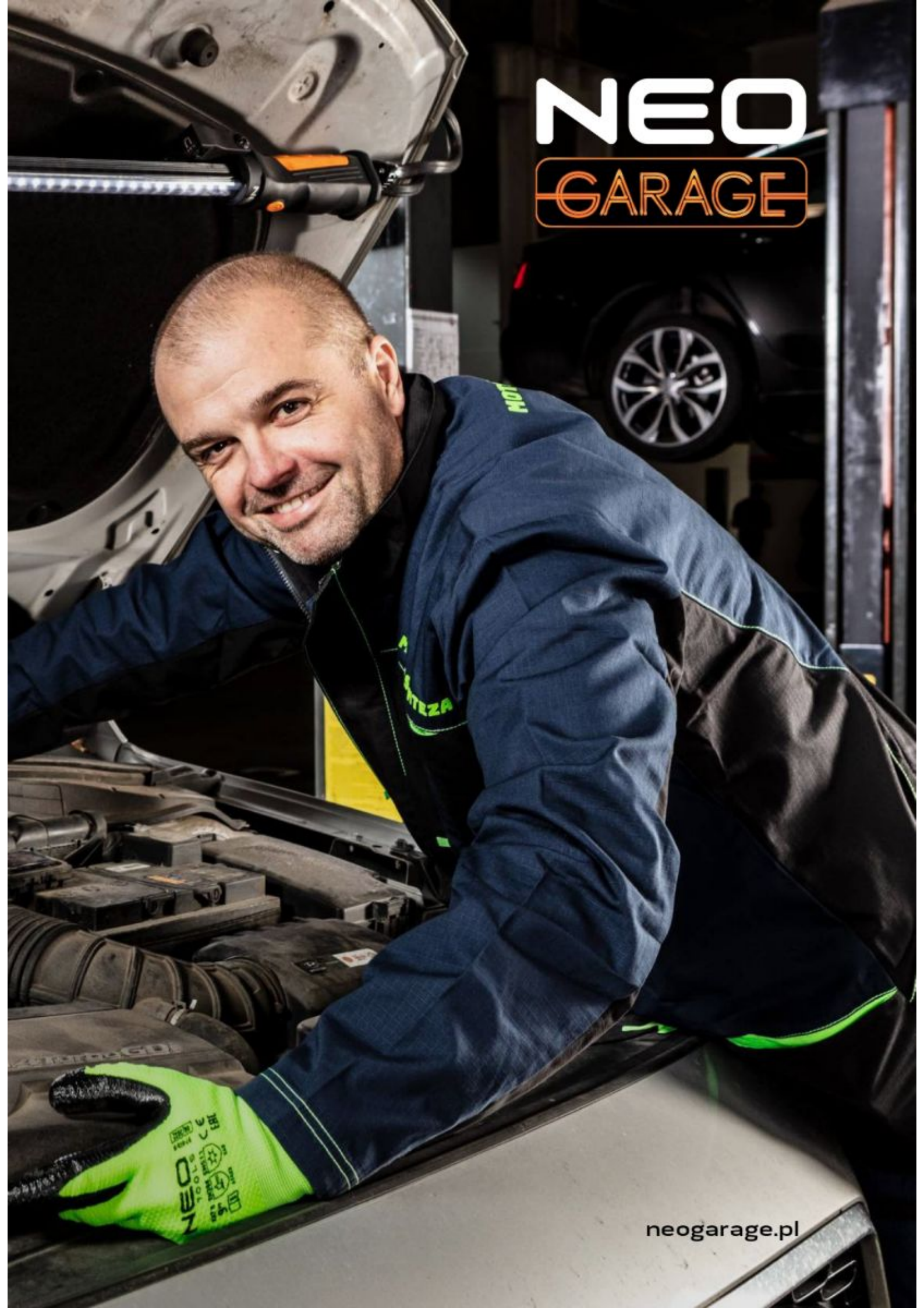

[neogarage.pl](http://neogarage.pl)

# NEO GARAGE

## GARAŻ GARAGE ГАРАЖ

NEO Garage oferuje rozbudowaną i dopasowaną do potrzeb użytkowników ofertę garażowania różnego typu pojazdów

NEO Garage offers an extensive and tailor-made offer for garaging various types of vehicles.

NEO Garage пропонує широку та індивідуальну пропозицію для зберігання різних типів транспортних засобів

neogarage.pl

NEO  
GARAGE

## SALA KONFERENCYJNA CONFERENCE ROOM КОНФЕРЕНЦ-ЗАЛ

Możliwość organizacji spotkań biznesowych w wyjątkowym otoczeniu.

Exceptional environment for business meetings.

Можливість організації ділових зустрічей в унікальній обстановці.

## EVENTY EVENTS ПОДІЇ

Dysponujemy przestrzenią 1000-1500 m<sup>2</sup> do zagospodarowania na potrzeby eventowe

We have 1,000-1500 m<sup>2</sup> of space available for event use.

Маємо простір 1000-1500 м<sup>2</sup> для проведення заходів

## STANOWISKA SAMOBSŁUGOWE SELF SERVICE STATIONS СТАНЦІЇ САМООБСЛУГОВУВАННЯ

Możliwość samodzielnej naprawy i konserwacji pojazdów. Udostępniamy niezbędne narzędzia oraz myjnie i stanowiska do auto-detailingu.

Possibility to repair and maintain vehicles yourself. We provide the necessary tools as well as a car wash and auto-detailing stands.

Можливість самостійно ремонтувати та обслуговувати транспортні засоби. Ми надаємо необхідні інструменти, а також автомийки та стенди для автосервісу.

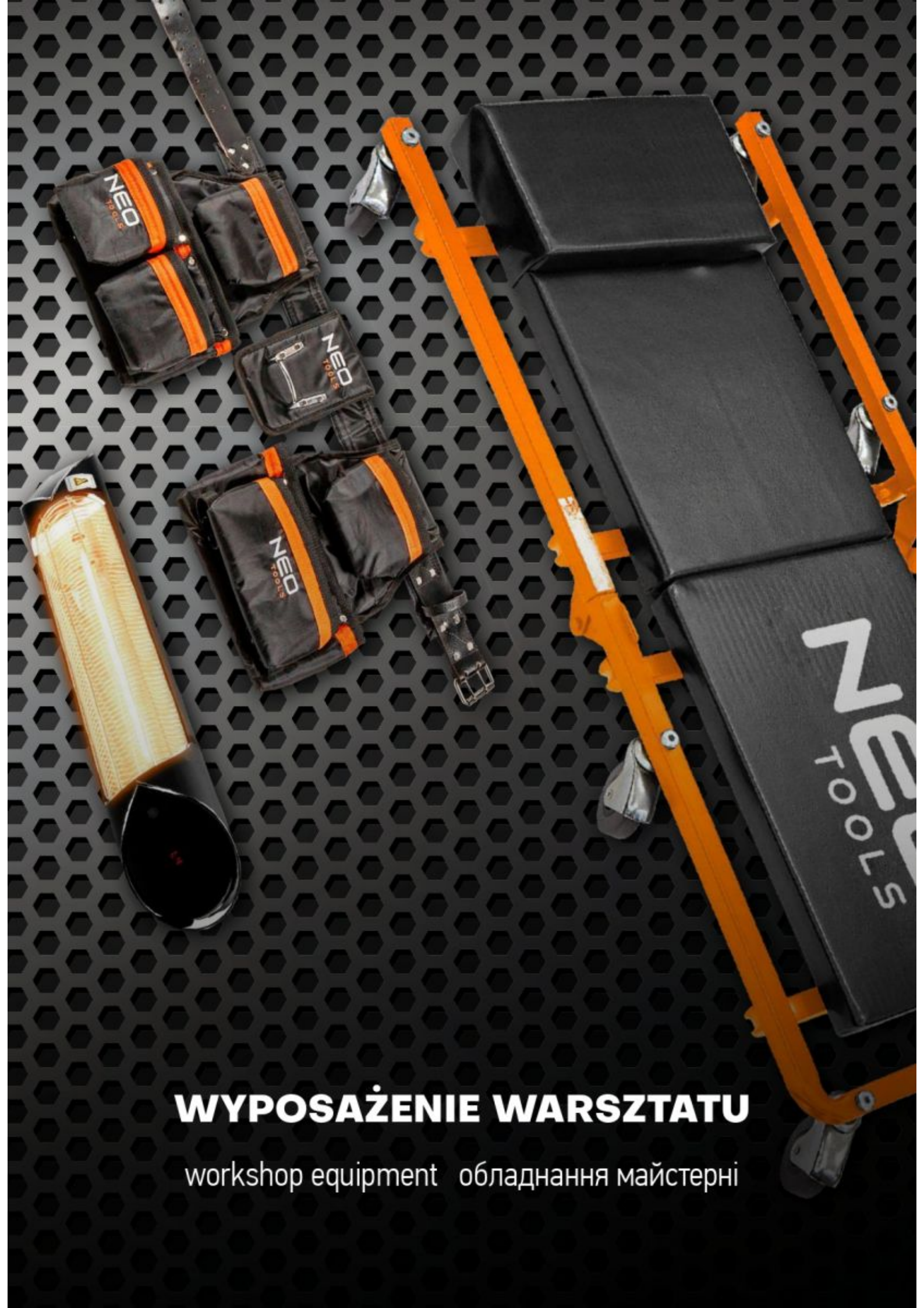

## WYPOSAŻENIE WARSZTATU

workshop equipment    обладнання майстерні

## Szafka narzędziowa

Tool cabinet / Werkzeugschrank / Шкафчик для инструментов / Шафа інструментальна / Műhelykocsi / Dulap pentru scule / Skříňka na nářadí / Skrinka na náradie / Omalica za orodje / Įrankių spintelė / Instrumentu skapis / Тоолстакарр / Шкафче за инструменти / Ormar za alate / Ormanić za alatke / Нτουκαπόκι για εργαλεία / Armario de almacenaje para herramientas / Carrello porta utensili / Estante p. Ferramentas / Rmoire à outils / Gereedschapskast



Ref.	D [mm]	W [mm]	H [mm]	capacity [kg]	☒	EAN
84-214	460	680	825	280	0/1	5907558426373

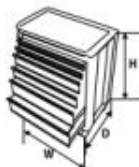

Ref.	D [mm]	W [mm]	H [mm]	capacity [kg]	☒	EAN
84-221	460	680	1030	280	0/1	5907558422238



Ref.	D [mm]	W [mm]	H [mm]	capacity [kg]	☒	EAN
84-225	465	1105	978	600	0/1	5907558422269



Ref.	D [mm]	W [mm]	H [mm]	capacity [kg]	☒	EAN
84-220	460	810	980	300	0/1	5907558418293



Ref.	D [mm]	W [mm]	H [mm]	capacity [kg]	☒	EAN
84-222	460	680	1030	280	0/1	5907558422245

## Wózek warsztatowy

Workshop trolley / Werkstattrollwagen / Тележка для инструмента / Візок інструментальний / Műhely kocsi / Cărucior de atelier / Dřilenský vozík / Dřilenský vozík / Delovniški vozček / Vežmēlis dārbtuvēms / Instrumentu ratiņi / Токојојакџу / Работна количка / Kolica za radionicu / Radionička kolica / Καρότα εργαλείων / Carrito de taller / Carrello portautensili / Carrinho de oficina / Chariot d'atelier / Werkplaatskar



Kompatybilne z wkładkami narzędziowymi NEO  
Compatible with NEO tool inserts  
Совместимость с инструментальными вставками NEO

Ref.	D [mm]	W [mm]	H [mm]	capacity [kg]	☒	EAN
84-229	390	630	810	130	0/1	5907558435610

## Uchwyt na papier

Paper sheet holder / Papierhalter / Держатель для бумаги / Тримач для паперу / Papírtartó / Suport pentru hârtie / Držák na papír / Držák na papír / Držalo za papir / Papiriaus laikiklis / Papīra turētājs / Pabenhoidik / Постава за хартия / Držáč za papír / Držáč za papir / Βάση χαρτίου / Portapapeles / Portacarta / Suporte de papel / Poignée pour papier



1mm  
COLD  
STEEL  
ADAPTER  
INCLUDED

Ref.	☒	EAN
84-271	0/10	5907558481617

## Kosz na śmieci

Dust bin / Papierkorb / Κορμυνα для мусора / Смітник / Szemetkosár / Coș de gunoi / Odpadkový koš / Smetný koš / Koš za smeti / Šukšlijų dėžė / Atkritumu grozis / Prügikorv / Кош за отпадъци / Košarica za smeće / Kanta za smeće / Καλάθι ακουμβίων / Cubo de basura / Cestino della spazzatura / Cavote de lixo / Poubelle



1mm  
COLD  
STEEL

5.5L

250x  
68x  
250mm

Ref.	☒	EAN
84-274	0/4	5907558481624

75kg  
capacity



- 3** shelves
- AL**
- LOCK**
- 4** Swivel wheels
- 2** components handle
- BRAKE**



Ref.	D [mm]	W [mm]	H [mm]	capacity [kg]	☒	EAN
84-404	420	660	835	75	0/1	5907558471625

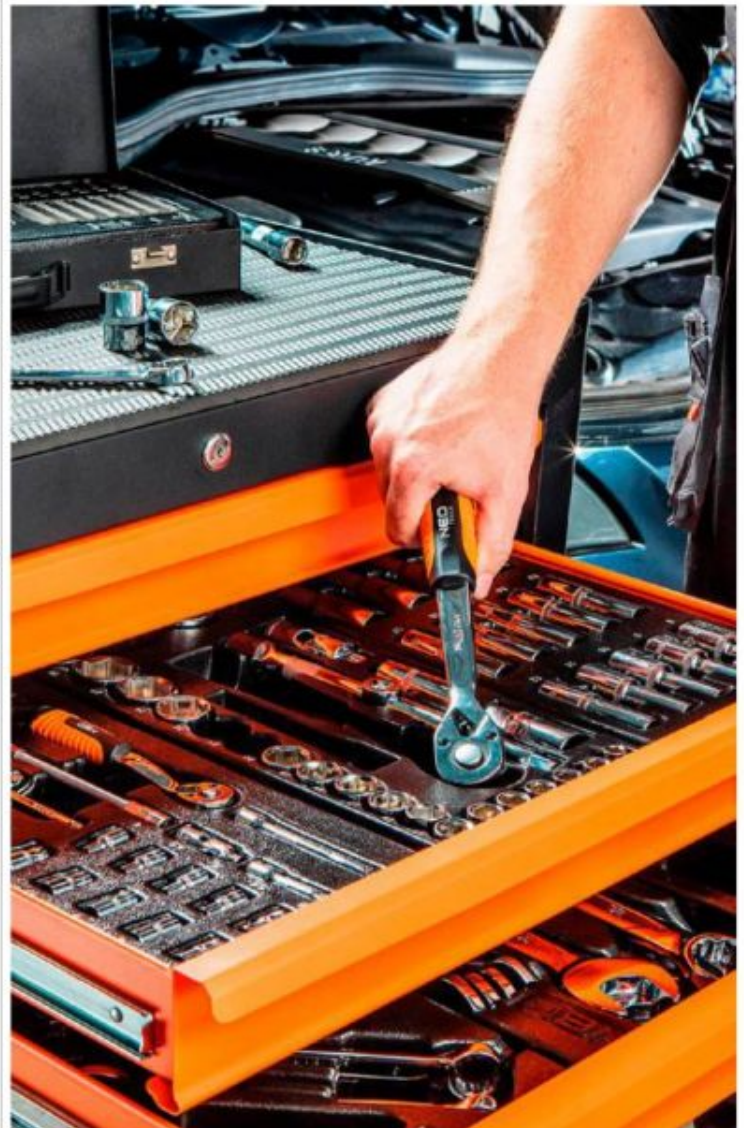

## Haki

Hooks / Hacken / Крюки / Гачи / Horgok / Cărlige / Håky / Skoby / Kijuke / Kablioi / Āji / Haagid / Крю / Kuke / Kuke / Γάντζοι / Ganchos / Ganci / Anzais / Crochets / Haken



x3

40 mm

for 84-500 84-501

Ref.	L [mm]	⊠	EAN
84-096	40	0/65	5907558439267



x5

85 mm

for 84-500 84-501

Ref.	L [mm]	⊠	EAN
84-097	85	0/50	5907558439274



x5

40 mm

for 84-500 84-501

Ref.	L [mm]	⊠	EAN
84-095	40	0/100	5907558439250



for 84-500 84-501

Ref.	⊠	EAN
84-092	8/40	5907558439151

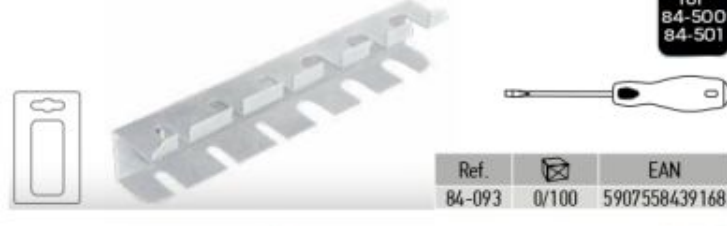

for 84-500 84-501

Ref.	⊠	EAN
84-093	0/100	5907558439168

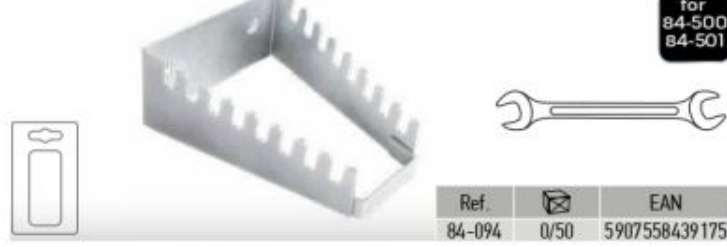

for 84-500 84-501

Ref.	⊠	EAN
84-094	0/50	5907558439175



for 84-500 84-501

Ref.	⊠	EAN
84-098	0/100	5907558442526

## System modułowy I

Modular system / Modulares System / Модульная система / Модульна система / Moduláris rendszer / Sistem modular / Modulární systém / Modulový systém / Modularni sistem / Moduläre sistema / Moduluja sistéma / Moduloarne süsteem / Модулна система / Modularni sustav / Модуларни систем / Αρθρωτά σύστημα / Sistema modular / Sistema modulare / Sistema modular / Système modulaire / Modulair systeem

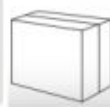

Ref.	L [mm]	W [mm]	H [mm]	⊠	EAN
84-259	745	510	1020	0/1	5907558431674



## System modułowy I

Modular system / Modulares System / Модульная система / Модульна система / Moduláris rendszer / Sistem modular / Modulámi systém / Modulový systém / Modulami sistem / Moduline sistema / Modulu sistema / Modulaame süsteem / Модулна система / Modularni sustav / Модуларни систем / Αρθρωτό σύστημα / Sistema modular / Sistema modulare / Sistema modular / Systéme modulaire / Modulair systeem



Ref.	L[mm]	W[mm]	H[mm]		EAN
84-257	585	385	422	0/1	5907558431650



Ref.	L[mm]	W[mm]	H[mm]		EAN
84-256	585	385	322	0/1	5907558431643



Ref.	L[mm]	W[mm]	H[mm]		EAN
84-266	585	460	765	0/1	5907558433968



Ref.	L[mm]	W[mm]	H[mm]		EAN
84-269	450	260	224	0/1	5907558443592



Ref.	L[mm]	W[mm]	H[mm]		EAN
84-267	576	259	237	0/1	5907558433975



Ref.	L[mm]	W[mm]	H[mm]		EAN
84-255	585	385	190	0/1	5907558431636



Ref.	L[mm]	W[mm]	H[mm]		EAN
84-268	585	385	131	0/1	5907558443585



Ref.	L[mm]	W[mm]	H[mm]		EAN
84-350	448	322	126	0/1	5907558459708



## System modułowy II

Modular system / Modulares System / Модульная система / Модульна система / Moduláris rendszer / Sistem modular / Modulární systém / Modulový systém / Modulami sistem / Moduläre sistema / Modulu sistema / Modulaarte systeem / Модула система / Modulární sustav / Модуларни систем / Αρθρωτό σύστημα / Sistema modular / Sistema modulare / Sistema modular / Système modulaire / Modular system



Ref.	L[mm]	W[mm]	H[mm]	☒	EAN
84-066	530	380	690	1/1	5907558450118



Ref.	L[mm]	W[mm]	H[mm]	☒	EAN
84-062	530	380	690	0/1	5907558450071



Ref.	L[mm]	W[mm]	H[mm]	☒	EAN
84-060	530	310	130	1/1	5907558450057



Ref.	L[mm]	W[mm]	H[mm]	☒	EAN
84-065	257	182	65	1/1	5907558450101



Ref.	L[mm]	W[mm]	H[mm]	☒	EAN
84-061	530	310	225	1/1	5907558450064

## Warsztat mobilny

Mobile workshop / Werkzeugkasten / Мобильная мастерская / Скриня інструментальна / Szerszámkosz / Cutie scule / Náradová skříňka / Basa na náradie / Škatla za orodje / Įrankių dėžė / Instrumentu koferis / Тооrиcтaкacт / Куфap зa инcтpументу / Kutija za alat / Kutija za alat / Εργαλειοθήκη / Caja de herramientas / Carrello porta utensili / Caixa p. ferramentas / Caisse à outils / Gereedschapskist

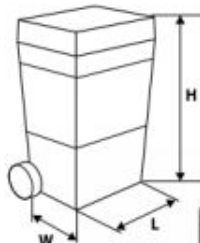

Ref.	L[mm]	W[mm]	H[mm]	☒	EAN
84-115	495	360	710	0/1	5907558421682

## Skrzynka narzędziowa

Tool box / Werkzeugkasten / Ящик для инструмента / Сундук инструментальна / Szerszámháza / Cutie scule / Nářadová skříňka / Baza na náradie / Škatla za orodje / Įrankių dėžė / Instrumentu koferis / Tööriistakast / Нудар за инструменти / Kutija za alat / Kutija za alat / Εργαλειοθήκη / Caja de herramientas / Valigetta elettricista modulare / Caixa p. ferramentas / Caisse à outils / Gereedschapskist



Ref.	L [mm]	W [mm]	H [mm]	☒	EAN
84-102	460	240	255	0/1	5907558409574
84-105	545	280	270	0/1	5907558408683



Ref.	L [mm]	W [mm]	H [mm]	☒	EAN
84-114	495	360	710	0/1	5907558439182



25 years  
WARRANTY



STEEL



Ref.	L [mm]	W [mm]	H [mm]	m [kg]	☒	EAN
84-100	460	220	210	4,3	1/1	5907558409437
84-101	550	220	210	5	1/1	5907558409444

## Organizer

Organizer / Organizer / Организатор / Организатор / Szortimenter / Organizer / Organiser / Organiser plast na spoj. materiál / Škatla za orodje / Systemeris / Siskunkaste / Saituskast / Организатор / Kutija za alat / Kutija za alat / Organizer / Organizador / Organiser / Agenda / Organiseur / Organizer



12 wymiowych pojemników  
12 removable containers  
12 съёмные контейнеры



Antywstrząsowe narożniki  
Anti-shake corners  
Антивибрационные углы



Poliwęglanowa pokrywa  
Polycarbonate cover  
Поликарбонатная крышка



Aluminiowe zapięcie  
Aluminum clasp  
Алюминиевая застежка



Ref.	info	☒	EAN
84-130	40 x 40 x 12 cm	0/1	5907558431216

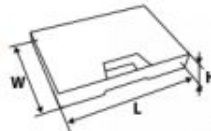

Ref.	L [mm]	W [mm]	H [mm]	☒	EAN
84-118	390	290	65	0/1	5907558439229
84-119	490	390	65	0/1	5907558439236



## Plecak monterski

Tool backpack / Monteurrucksack / Рюкзак монтерский / Рюкзак монтерський / Szerszámos hátizsák / Rucsac pentru mecanic / Batoh na náradí / Plecniak na náradie / Nahrbtník za orodje / Montuotojo jrankij kupriné / Instrumentu mugursoma / Тооristаde seljakott / Монтьорска раница / Rusak za montere / Monterski ranac / Σάκος εργαλείων / Mochila de montador / Zaino porta utensili / Mochila para ferramentas / Sac à dos porte-outils / Monteur rugzak



POLYESTER  
600D



Ref.	☒	EAN
84-304	0/6	5907558425833

## Plecak monterski na kołach

Tool backpack with wheels / Monteurrucksack mit Rädern / Рюкзак монтерский на колесиках / Рюкзак монтерський на роликах / Szerszámos hátizsák / Rucsac pe roți pentru mecanic / Batoh na náradí na kolečkách / Plecniak na náradie na kolieskach / Nahrbtník za orodje na kolesih / Montuotojo jrankij kupriné su ratukais / Instrumentu mugursoma uz ritejiem / Тооristаde seljakott, rotastega / Монтьорска раница на колела / Rusak za montere s kotačima / Monterski ranac sa točkicama / Σάκος εργαλείων με ρόδες / Mochila de montador sobre ruedas / Trolley/zaino in tela / Mochila para ferramentas com rodas / Sac à dos porte-outils à roulettes / Monteur rugzak op wielen



POLYESTER  
600D



Ref.	☒	EAN
84-303	0/2	5907558425826

## Torba monterska na kołach

Tool bag with wheels / Monteurtasche / Монтерская сумка на колесиках / Торба монтерська на роликах / Szerszámtáska / Geantă pe roți pentru mecanic / Taška na náradí na kolečkách / Taška na náradie na kolieskach / Torba za orodje na kolesih / Montuotojo krepšys su ratukais / Instrumentu soma uz ritejiem / Тооristаkott, rotastega / Монтьорска торба на колела / Torba za montere s kotačima / Monterska torba sa točkicama / Ταύτο εργαλείων με ρόδες / Bolsa de montador sobre ruedas / Trolley in tela / Bolsa para ferramentas com rodas / Sac porte-outils à roulettes / Monteurstas op wielen



POLYESTER  
600D



Ref.	☒	EAN
84-302	0/2	5907558425819

## Stolek z torbą monterską

Chair with tool bag / Sitz mit Monteurtasche / Табурет складной с монтерской сумкой / Столик із монтерською торбою / Szerszámtáska szék funkcióval / Scaunul cu geantă pentru mecanic / Skládaci židle s taškou na náradí / Stolik s taškou na náradie / Miza s torbo za orodje / Staliukas su montuotojo krepšiu / Taburete ar instrumentu somu / Тооristаkotiga laud / Табуретка с монтьорска торба / Stolica s torbom za montere / Stolica sa monterskom torbom / Πισσόμνο ακαμμάκι με ταύτο εργαλείων / Silla con bolsa de montador / Seggiolino pieghevole con borsa / Banca con bolsa para ferramentas / Sac à outils avec siège pliant / Kruk met monteurstas



POLYESTER  
600D



Ref.	☒	EAN
84-306	0/10	5907558425796

## Saszetka

Waist bag / Gürteltasche / Поясная сумка / Торба на таску / Űntáska / Borseta / Ledvinka / Ledvinka / Pasna torbica / Deklas / Jostas soma / Vöökott / Πασακια / Pasna torbica / Torbica / Τασατάκι μέσης / Riñonera / Marsupio porta utensili / Bolsa / Sacoche porte-outils à ceinture



Ref.	☒	EAN
84-311	0/70	5907558428377

## Torba monterska

Tool bag / Monteurtasche / Сумка монтерская / Торба інструментальна / Szerszámtáska családok új fém fogantyúval / Geanta scule / Montérska brašna / Taška montérska kožená / Torba za orodje / Monteno krepšys / Instrumentu soma / Toonistakott / Нудар за инструменти / Torba za alat / Torba za alat / Σάκος για εργαλεία / Bolsa para herramientas / Borsa per meccanico / Saco p. montagem / Sac de montageur / Montagetas



Ref.	☒	EAN
84-301	0/2	5907558425802



Ref.	☒	EAN
84-308	0/4	5907558427745



Ref.	☒	EAN
84-300	0/4	5907558417258



Ref.	☒	EAN
84-305	0/6	5907558417265



Ref.	☒	EAN
84-315	0/35	5907558428391



## Pas monterski

Picer belt / Monteurriemen / Пояс монтерски / Pas dla instrumenty / Szerszámövátáska övvel / Bandă adezivă / Montérský pás / Opasok na náradie / Pas za orodje / Monterio diržas / Instrumentu josta / Liimimispressi lint / Колан за инструменти / Pojas za alat / Pojas torbica / Ζώνη μονταρίματος / Cinturón para herramientas reforzado / Cintura porta utensili / Cinto p. montagem / Ceinture de monteur / Montageriem

x12

PVC 1680D 400 g/m<sup>2</sup>



Ref. 84-330  
 0/5  
 EAN 5907558415667

## Uchwyt na młotek

Hammer holder / Aufnahme für Hammer / Зажим для молотка / Τримач для молотка / Kalapács tartó / Suport pentru ciocan / Držák na kladívko / Uprádko kladiva / Vrejte za kladivo / Plaktko rankena / Āmura ietvere / Vasarahaikid / Држачка на чул / Drška za čekić / Hvatač za čekić / Προσάρμογός σφυριού / Sujeción para martillo / Gancio per martello / Manche de martelet / Houder voor hamer

PVC 1680D

400 g/m<sup>2</sup>



Ref. 84-332  
 50/100  
 EAN 5907558415681

## Pas do kabur

Picer belt / Monteurriemen / Пояс монтерски / Pas dla instrumenty / Őv szerszámotáskához / Bandă adezivă / Montérský pás / Opasok na náradie / Pas za orodje / Monterio diržas / Instrumentu josta / Liimimispressi lint / Колан за инструменти / Pojas za alat / Pojas torbica / Ζώνη μονταρίματος / Cinturón para herramientas reforzado / Cintura / Cinto p. montagem / Ceinture de monteur / Montageriem

PVC 1680D 400 g/m<sup>2</sup>



Ref. 84-335  
 50/100  
 EAN 5907558421941

## Materiałowe etui na narzędzia

Textile tool case / Werkzeugkoffer aus Stoff / Τканевые чехлы для инструментов / Тканевы чехлы для инструменти / Textil szerszámotartó / Husă textilă pentru scule / Materiálové pouzdra na náradí / Materiálové pouzdro na náradie / Etui iz blaga za orodje / Medžaginis įrankių dėklas / Auduma apraiki instrumentiem / Kengast tööriistavahlar / Платнен напъф за инструменти / Etui za alat / Υφασμάτινη θήκη εργαλείων / Estuche textil para las herramientas / Valigetta per utensili in tessuto / Estujo téxtil para as ferramentas / Trousse rangement des outils en tissu / Stoffen gereedschapsetu

22 POUCHES



Ref. 09-890  
 0/40  
 EAN 5907558458923

## Kieszon na narzędzia

Tool pocket / Werkzeugtasche / Συμκα для инструментов / Карман для инструменти / Szög és szerszámotartó / Buzunar pentru scule / Kapsa na náradí / Vrecko na náradie / Žep za orodja / Dėklas įrankiams / Instrumentu somira / Τοορίστασκι / Прерадка за инструменти / Futrola za alat / Džep za alat / Τάπητα εργαλείων / Portaherramientas / Marsupio porta utensili / Bolso p. ferramentas / Poche à outils / Gereedschapzak

x4

PVC 1680D

400 g/m<sup>2</sup>



Ref. 84-333  
 0/50  
 EAN 5907558415698

x8

PVC 1680D

400 g/m<sup>2</sup>



Ref. 84-334  
 20/40  
 EAN 5907558415704

## Perforacja narzędziowa

Tool wall / Werkzeuglochung / Панель перфорированная для инструментов / Панель инструментальная / Szerszámfal / Suport perete pentru unelte / Perforace pro uchlucení držáků náradí / Panel na náradie / Stenski regal / Sienele įrankiams / Instrumentu plaukts / Τοορίσταλις / Перфорация на инструменти / Perforirani organizier za alate / Polica za alat / Τάχος για εργαλεία / Tablero organizador para herramientas / Perforazione per attrezzi / Perfuração de ferramentas / Plaques perforées pour outils / Gereedschapswand

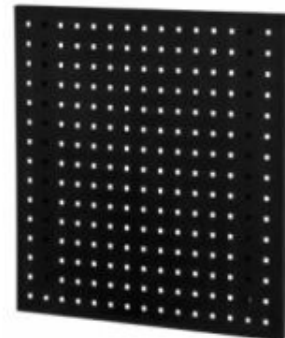

90 cm  
 2 cm

steel thickness 0.8 mm

steel cold SPCC

includes WALL PLUGS

Ref. 84-500  
 H [mm] 600  
 W [mm] 600  
 D [mm] 20  
 0/1  
 EAN 5907558454253

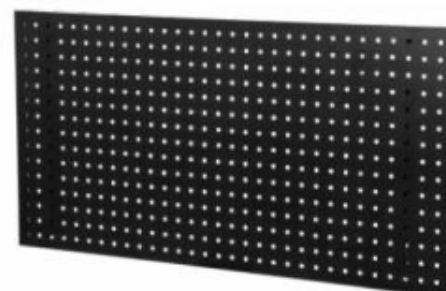

120 cm  
 2 cm

steel thickness 0.8 mm

steel cold SPCC

includes WALL PLUGS

Ref. 84-501  
 H [mm] 600  
 W [mm] 1200  
 D [mm] 20  
 0/1  
 EAN 5907558454260

## Hak na pojemnik

Hooks / Hacken / Υγκύνη / Гаки / Horgok / Cârțige / Háký / Skoby / Kľjuka / Kabliaci / Äki / Haagid / Үкүк / Kuke / Kuke / Γάντζοι / Ganchos / Ganci / Anzöis / Crochets / Haken

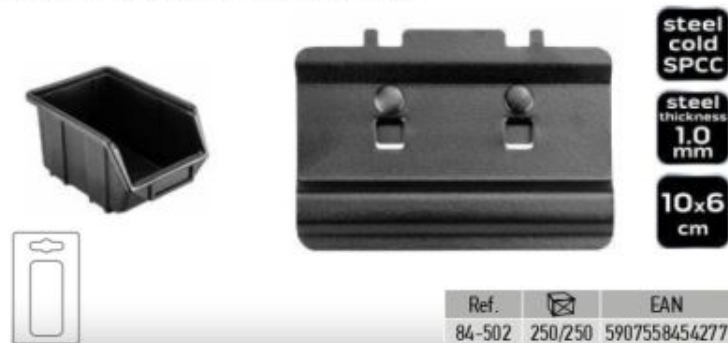

steel  
cold  
SPCC

steel  
thickness  
1.0  
mm

10x6  
cm

Ref.	Box	EAN
84-502	250/250	5907558454277



steel  
cold  
SPCC

steel  
thickness  
1.0  
mm

13x6.5  
cm

Ref.	Box	EAN
84-503	250/250	5907558454284

## Haki

Hooks / Hacken / Υγκύνη / Гаки / Horgok / Cârțige / Háký / Skoby / Kľjuka / Kabliaci / Äki / Haagid / Үкүк / Kuke / Kuke / Γάντζοι / Ganchos / Ganci / Anzöis / Crochets / Haken

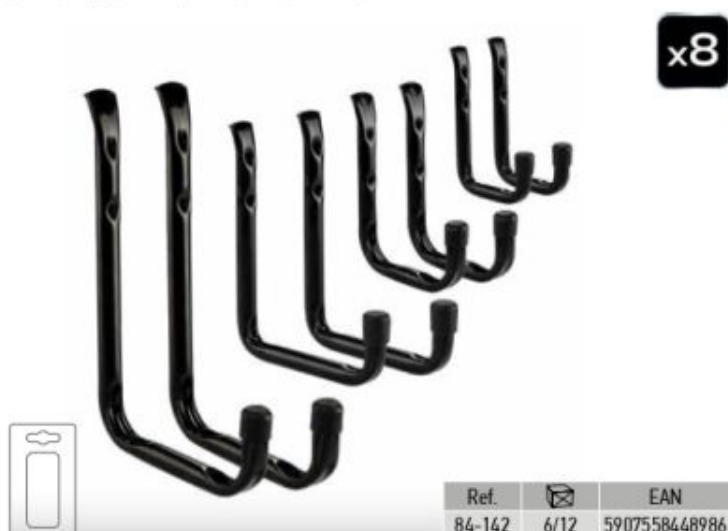

x8

Ref.	Box	EAN
84-142	6/12	5907558448986



SOFT  
padding

x16

Ref.	Box	EAN
84-143	6/12	5907558448993

## Listwy magnetyczne

Magnetic tool holders / Magnetische Werkzeughalter / Держатели магнитных инструментов / Магнитни приклучачи инструменати / Mágneses szerszám tartók / Suporturi de scale magnetice / Magnetické držáky nástrojů / Magnetické držáky nástrojov / Magneta držala za orodje / Magnetični jrankiči laikikliai / Magnētisko instrumentu turētāji / Magnētlīste tūristade hoidjad / Магнитни държачи за инструменти / Magnetski držači alata / Magnetni držači alata / Μαγνητικά εργαλεία στηρίξης / Portaherramientas magnéticas / Portautensili magnetics / Porta-ferramentas magnéticas / Porte-outils magnétiques / Magnetische gereedschapshouders

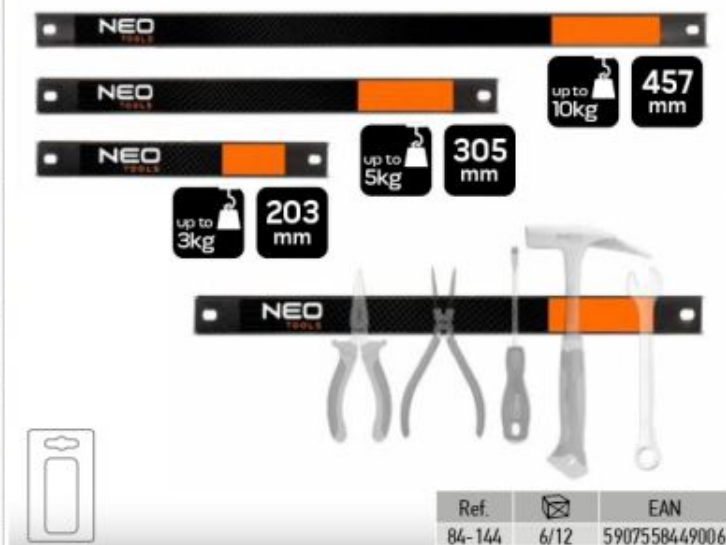

up to  
10kg  
457  
mm

up to  
5kg  
305  
mm

up to  
3kg  
203  
mm

Ref.	Box	EAN
84-144	6/12	5907558449006

## Uchwyty na nasadki

Socket holders / Steckdosenhalter / Держатели розеток / Тримачи розеток / Alzattartók / Suporturi de prize / Držáky zásuvek / Držáky na zásuvky / Držala za vtičnice / Kištukinių lizdų laikikliai / Kontaktligzdų turētāji / Pistikupesade hoidjad / Държачи за гнезда / Držáči utičnica / Држачи утичница / Υποδοχής pričos / Soportes para enchufes / Portaprese / Porta-soquetes / Supports de douilles



ABS 360° x6 1/4" 3/8" 1/2"

Ref.	Box	EAN
08-002	0/20	5907558473964



## Wózek transportowy

Multipurpose trolley / Transportwagen / Тележка грузовая / Вóзак транспортувальний / Molnárkocsi / Cărucior de transport / Převravný vozík / Prepravný vozík / Transportni vozček / Maišelis transportavimui / Ratiqi / Veokäru / Транспортна колица / Transportna kolica / Transportna kolica / Καρότσα μεταφοράς / Carretilla de transporte / Carrello di trasporto / Carrinho de transporte / Chariot de maintenance / Transportwagen



capacity  
**80kg**

600D polyester

Bottom solid insert

depth  
**30cm**

8,85 kg

folded size  
70x55x15 cm

Ref.	☒	EAN
84-405	0/1	5907558485509



max  
**150 kg**

max  
**120 kg**

Ref.	☒	EAN
84-402	0/1	5907558431612



max  
**200 kg**

Ref.	☒	EAN
84-401	0/1	5907558431605



max  
**300 kg**

Ref.	☒	EAN
84-403	0/1	5907558431629

## Platforma transportowa

Transport platform / Транспортная платформа / Platforma de transport / Anyagmozgató kocsi / транспортна платформа / Dopravná plošina / Transportní plošina / Transportplattform / Transportna platforma / Transporto platforma / Transporta platforma / Transportplattform / Транспортна платформа / Transportna platforma / Транспортная платформа / Πλατφόρμα μεταφοράς / Plataforma de transporte / Piattaforma di trasporto / Plataforma de transporte / Plateforme de transport / Transportplattform



Ref.	capacity [kg]	☒	EAN
84-141	200	0/6	5907558448979

## Taśma do bagażu

Luggage strap / Gepäckband / Лента для багажа / Стрічка багажна / Rakományrugzító / Bandă de bagaje / Popruh na zavazadla / Pás na náklady / Trak za prtljagu / Krovinių tvirtinimo juosta / Bagāžas lente / Κορμάνημαδ / Лента за багаж / Traka za prtljagu / Traka za prtljag / Ταινία αποσκευών / Cinta para maleta / Cinghie con cricchetto / Fita p. Bagagem / Bande à bagage / Bagageband



Ref.	KG	L [m]	W [mm]	☒	EAN
84-140	2500 / 5000	5	50	0/10	5907558448962



## Najezd samochodowy

Car ramp / Autorampe / Автомобильная рампа / Автомобільна рампа / Autó gámpa / Rampa auto / Nájezd na auto / Nájezd na auto / Автогámpa / Automobilių gámpa / Auto gámpa / Auto kaldtee / Рáмпa за нoлa / Rampa za auto / Авто рампа / Рáмпa αακoтíηιoυ / Rampa de cache / Rampa per auto / Rampa de carro / Rampe de voiture / Auto onrijplaat

910x  
310x  
170 mm

3000kg

2pcs PP



Ref.	[t]	☒	EAN
10-478	3	1/1	5907558495874

## Podnośnik warsztatowy

Shop crane / Werkstattheber / Внутривцeвoй нрaн / Нрaн гaрaжнoй / Műhelydarú / motorkiemelő zsírűf / Cric de atelier / Dilenský zvědok / Dilenský zdvihák / Dvigalka / Keltuvus dirbtuvėms / Profesionālais pacēlājs / Tōōkojotungraud / Подвизaч / Рaдиoнiчкa дiзaлiцa / Рaдиoнiчкa дiзaлiцa / Γepανός γα γκαράζ / Gato de taller / Gruetta / Elevador de oficina / Vérin d'atelier / Werkplaats hijstestel



Ref.	[t]	H [mm]	☒	EAN
11-720	2	25-2382	0/1	5907558419665

## Podstawki pod samochód

Jack stands / Kiz-Unterlagen / Підставки αακoтíηιoυ / Підстава нiд αακoтíηιoυ / Emelő bak / Suport de ridicare / Podpěra panenka / Podpěra panenka / Podstavki za hidr avlično dvigalka / Automobilinis domkratas / Paliktnis zem auto / Tungraua alused / Стоiна за нoлa / Držaaž za auto dizalicu / Drzac za auto dizalicu / Γρúκoς σταθερός / Soporte para coche / Cavalletti di sollevamento / Suporte para carro / Supports pour voiture / Autosteunen

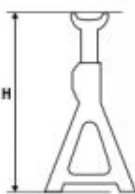

x2



Ref.	[t]	H [mm]	☒	EAN
11-750	3	295 - 415	1/1	5907558418361
11-751	2	278 - 423	1/1	5907558418378

## Wciągarka łańcuchowa

Chain block / Kettenwinde / Лебeдкa цeпнaя / Tαλη λαηιρεοοα / Láncas emelő / Troliu cu lant / Řetězový kladkostroj / Refežovný zdvihák / Veržna dvigalka / Grandininé gervé / Kēdes vinča / Kettvints / Βερικιανα λεβeδνα / Λαηčani podizač / Λαηčana dízalica / Βαρúλκo με αλυσθα / Cabria de cadena / Paranco a catena / Guincho de corrente / Treuil à chaîne / Kettingtakel



Ref.	[t]	L [m]	☒	EAN
11-760	1	3	0/1	5907558418385
11-761	2	3	0/1	5907558418392
11-762	3	3	0/1	5907558418408
11-763	5	3	0/1	5907558418415

## Podnośnik pneumatyczny

Air floor jack / Werkstattheber / Πνευματικeς αiμωκρaт / Нрaн гaрaжнoй / Műhelydarú / Cric de atelier / Dilenský zvědok / Dilenský zdvihák / Dvigalka / Keltuvus dirbtuvėms / Profesionālais pacēlājs / Tōōkojotungraud / Подвизaч / Рaдиoнiчкa дiзaлiцa / Рaдиoнiчкa дiзaлiцa / epανός γα γκαράζ / Gato de taller / Cric da oficina / Elevador de oficina / Vérin d'atelier / Werkplaats hijstestel

3T

MAX 420 mm

145 mm

6-12 bar

16.5 kg



Ref.	[t]	☒	EAN
11-737	3.0	0/1	5907558476125

## Podnośnik przesuwny

Floor jack / Schiebeheber / Домкрат подкатной / Домкрат / Aluminium hidraulikus krokodílemelő / Cric de podea / Přenosný zvedák / Žbvičák hydraulický vozík / Hidraulická dvígačka / Domkratas / Pacēlājs / Tungraud / Крик / Hidraulická auto dizalica / Hidraulická auto dizalica / Γρύλος τράβηκι / Gato hidráulico / Sollevatore a carrello / Elevador de deslize / Cric mobile / Schuifrijshoestel

1.25t AL  



Ref.	[t]		EAN
11-730	1.25	0/1	5907558416930

3T  



Ref.	[t]		EAN
11-732	3.0	0/1	5907558436716

2.5t  



Ref.	[t]		EAN
11-731	2.5	0/1	5907558416947

2.5T  12.5kg



Ref.	[t]		EAN
11-733	2.5	0/1	5907558476132

## Podnośnik słupkowy

Bottle jack / Säulehebergerät / Домкрат гидравлический бутылочный / Домкрат стлупковий / Palackemelő / Cric colo ană / Zvedák pistový / Sôbrakový zdvihák / Dvígalka / Hidraulinis keltuvas / Mastu pacēlājs / Latt-tungraud / Колоноен подемник / Stupna dizalica / Stubasta dizalica / Γρύλος υδραυλικός μπουκαλάς / Gato hidráulico de botella / Sollevatore a bottiglia / Elevador com colunas / Cric bouteille / Pootrijstoesstel



Ref.	[t]	H [mm]		EAN
10-450	2	181 - 345	1/6	5907558470468
10-451	3	195 - 370	1/6	5907558470475
10-452	5	215 - 413	1/4	5907558470482
10-453	8	230 - 456	1/4	5907558470499
10-454	10	230 - 460	1/4	5907558470505
10-455	15	230 - 460	1/2	5907558470512
10-456	20	240 - 452	1/2	5907558470529

## Leżanka warsztatowa

Car creeper / Werkstattfliege / Лежанка рабочая / Візок на роликach для / Роботи під автомобілем / Szerelőágy, összecsukskható / Sezlong de atelier / Dilenská lehátka / Montážne ležadlo / Delavniski ležalnik / Sulankstoma lona, dirbtuvams / Darba guļamkrēsls / Veerevalus / Мониторсько килимче / Radionička ležaljška / Radionički kauč / Ξαλκιάτρα συνεργείου / Camilla de taller / Lettino sottomacchina / Carinho de oficina / Divan d'atelier / Werkplaatsbank

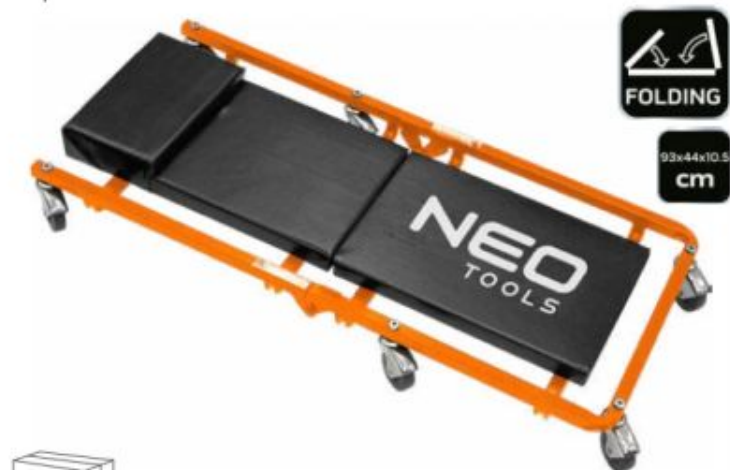

93x44x10.5  
cm



Ref.	m <sub>max</sub> [kg]	☒	EAN
11-600	150	0/1	5907558418347



40x14x10.2  
54.5x40.5x48  
cm



Ref.	m <sub>max</sub> [kg]	☒	EAN
11-601-1	150	1/1	5907558445282

## Stolek warsztatowy na kółkach z półką na narzędzia

Workbench on wheels with tool shelf / Werkbank auf Rädern mit Werkzeugablage / Верстак на колесах с полкой для инструментов / Верстак на колесах з полицєю для інструментів / Kerekes munkapad szérszámú polccal / Bancul de lucru pe roți cu raft pentru scule / Pracovní stůl na kolečkách s policií na nářadí / Pracovni stól na kolieskach s policou na náradie / Delovna miza na kolesih s polico za orodje / Darba stalas ant ratukų su įrankių lentyna / Darba galds uz ritejiem ar instrumentu plauktu / Ratastel töölaud koos tööriistariivliga / Работна маса на колела с рафт за инструменти / Radionički stolac na kotačima s policom za alat / Radionička stolica na točnoimama sa policom za alat / Τραχήλατος πάγκος εργαλείων με ράφι εργαλείων / Banco de trabajo con ruedas y estante para herramientas / Banco da lavoro su ruote con ripiano portautensili / Bancada de trabalho sobre rodas com prateleira para ferramentas / Établí sur roulettes avec étagère à outils / Werkbank op wielen met gereedschapplank



Ref.	☒	EAN
11-604		5907558477269

## Stojak na silnik

Engine stand / Motorhalter / Стенд для ремонта двигателя / Стенд для ремонту двигуна / Motorszereelő állvány / Stativ pentru motor / Stojan na motor / Stojan na motor / Stojalo za motor / Variklio stovas / Deinėja remonta stativs / Mootoristend / Стойка за двигатели / Stalok za motor / Stalok za motor / Βάση επισκευής κινητήρων / Soporte para motor / Cavallo supporto motore / Supporte de motor / Support moteur / Motor onderstel



Ref.	☒	EAN
11-710	0/1	5907558436662

## Składana mata do pracy pod samochodem

Foldable mat for working under the car / Faltbare Matte für Arbeiten unter dem Auto / Σκληρή ματρες για εργασία υπό το αυτοκίνητο / Foldable mat for working under the car / Faltbare Matte für Arbeiten unter dem Auto / Σκληρή ματρες για εργασία υπό το αυτοκίνητο / Összecsukskható szőnyeg az autó alatti munkához / Covoraș pliabil pentru lucru sub mașină / Składací podložka pro práci pod autem / Kladacia podložka na prácu pod autom / Skladacia podložka na prácu pod autom / Sulankstomas kilimėlis darbu po automobiliu / Salokāms pakļāpš darbam zem automašīnas / Kokkupandav matt auto all töötamiseks / Σεγναμεα ματρες για εργασία υπό τα αυτοκίνητα / Sklopiva prostirka za rad ispod automobila / Σκληπιαμα προστιρκα για ραδ ισποδ αυτομοβιλα / Πλισοβιμεο ματρες για εργασία κατω από το αυτοκίνητο / Alfombra plegable para trabajar debajo del coche / Tappetino pieghevole per lavorare sotto l'auto / Tapete dobrável para trabalhar embaixo do carro / Tapis pliable pour travailler sous la voiture / Opvouwbare mat voor werkzaamheden onder de auto



120x  
40x23  
cm

Ref.	☒	EAN
10-599	0/4	5907558473957

## Belka do podnoszenia silnika

Engine beam hoist / Balken zum Anheben des Motors / Βαλκα για ποδύεμα δωιγεατεμ / Βαλκα για ποδύεμα δωιγεατεμ / Motoremelő gerenda / Bară pentru ridicarea motorului / Nosnik pro zvedání motoru / Nosnik na zavesenie motora / Dvigalka za avtomobilski motor / Variklio keltuvos / Sija motora paclšanai / Mootori kástmise tala / Γρεδα za ποδύεμα ηα δωιγεατεμ / Greda za podizanje motora / Greda za podizanje motora / Τραβέρσα ανύψωσης κινητήρων / Viga elevadora para el motor / Trave di sollevamento del motore / Viga elevadora do motor / Barre support moteur / Balk voor het heffen van de motor

CAPACITY  
500  
kg

730-1480  
mm  
WORKING  
RANGE

0-205  
mm  
ADJUSTABLE  
HEIGHT



Ref.	☒	EAN
11-749	0/1	5907558459760

## Podnośnik do skrzyń biegów

Transmission jack / Getriebeheber / Трансмисиональная стойка / Стійка трансмісійна / Sebességváltó emelő / Cric pentru cutia de viteze / Zvedák převodovek / Zdvih prevodovky / Dvigalo za menjalnik / Pavarų dėžės keltuvai / Ätrumkårbas domkrats / Käigukasti tungraud / Трансмиссионен подемник / Podizač mjenjača / Dizalica za menjač brzina / Σαφαναύρακος / Elevador de caja de engranajes / Martinetto per scatole del cambio / Elevador da caixa de velocidades / Jack de transmission



500kg

min  
0,9 m  
max  
1,9 m



Ref.	☒	EAN
11-712	0/1	5907558436679

## Prasa hydrauliczna

Hydraulic press / Hydraulische Presse / Гидравлический пресс / Прес адралічний / Hidraulikus prés / Presă hidraulică / Hydraulický lis / Hydraulický lis / Hidraulična stiskalnica / Hidraulinis presas / Hidrauliskā prese / Hidrauliline press / Хидравлична преса / Hidraulična preša / Hidraulična presa / Υδραυλική πρέσα / Prensa hidráulica / Pressa idraulica / Prensa hidráulica / Presse hydraulique



Ref.	☒	EAN
11-711	1/1	5907558445534



20T

0-905 mm



Ref.	☒	EAN
11-714	0/1	5907558436686



500kg

min  
0,9 m  
max  
1,9 m



Ref.	[mm]	☒	EAN
11-716	1500 x 780 x 830 - 980 mm	0/1	5907558436693

## Stół warsztatowy

Work bench / Werkstattbank / Стол-верстак / Верстак / Állítható munkapad / Tejghea timpläne / Dřilenský stůl / Stół pracowný / Delavníška miza / Darbastalis / Darba galda / Τσόρπικ / Работна маса / Stol radionički / Radni sto / Πάγκος εργασίας / Banco de trabajo / Banco da lavoro / Mesa de oficina / Etablí d'atelier / Werkplaatstafel

1500x  
780x830  
mm



## Mata serwisowa na błotniki, magnetyczna

Car body servis cover, magnetic / Servicematten für Kotflügel, magnetisch / Накладки магнитная на крыло / Накладки магнітні до брызговики / Mágneses sárvédő takaró / Rogozini servisiu pentru aripi, magnetice / Ochranné přehozy na blatníky, magnetické / Servisné rohože pre blatníky, magnetické / Servisne abloge za blatnike, magnetne / Apsauginė magnetinė dangė ant sparno / Mašīnas spārma magnētiskais paklājs instrumentiem / Parilauzde hooldusmatid, magnetilised / Магнитно покрывало за напипци / Servisne mate za blatobrane, magnetske / Servisne podloge za branike, magnetne / Μαγνητική πόδια φρεσού / Alfombras de servicio para guardabarros, magnéticas / Stuoie per manutenzione sui parafranghi, magnetiche / Coberturas magnéticas para para-lamas / Bâches de garde-boue magnétiques / Service matten voor spatlappen



1200x1000 mm



Ref.	📦	EAN
11-718	0/20	5907558436709

1000x630 mm



Ref.	📦	EAN
11-719	0/25	5907558459753

## Pokrowiec ochronny, folia ECO 5w1

Protective cover, ECO foil 5in1 / Schutzhülle, ECO 5in1 / Folie / Защитный чехол, фольга ECO 5in1 / Зашитне покрывалка, фольга ECO 5in1 / Védőburkolat, ECO 5in1 fólia / Husa de protectie, folie ECO 5in1 / Ochranný kryt, fólie ECO 5in1 / Ochranný kryt, fólia ECO 5in1 / Zaščitna prevleka, folija ECO 5in1 / Apsauginis dangtelis, ECO 5in1 folija / Aizsargpārvalks, ECO 5in1 folija / Kaitsekote, ECO 5in1 folium / Защитно покрывало ECO фольга 5in1 / Zaščitna navlaka, ECO 5in1 folija / Защитни поклонаци, ЕЦО 5in1 фольга / Funda protectora, lámina ECO 5 en 1

5in1



Ref.	📦	EAN
10-485	0/1	5907558495270

## Myjka wodna ciśnieniowa

High pressure cleaner / Wasserhochdruckreiniger / Моечная машина / Машина мийна / Magasnyomású mosó / Masina de spalat cu presiune / Vodni tlaková myčka / Tlaková vodná čistička / Visokotlačni čistilec / Aukšto slėgio plovimo įrenginys / Augstspiediena mazgājama ierīce / Survepesur / Vodostrojina pod naliagan / Visokotlačni čistač / Čistač sa visokim pritiskom / Плувня / Limpadora de presión / Idropulitrice / Aparelho de lavar de pressão / Nettoyeur à eau haute pression / Hogedrukreiniger



2000W



230V- 50Hz

OUT: 100 bar  
MAX 150 bar

AUTO STOP system



6L/min  
MAX 7.5L/min

3 YEARS WARRANTY  
10 YEARS PROTECTANT



Ref.	📦 [kg]	📦	EAN
04-705	8,04	1/1	5907558469493

## Agregat prądowórczy

Electric generator / Stromerzeugungsaggregat / Электрогенератор бензиновый / Електрогенератор бензиновий / Áramfejlesztő / Grup electrogen / Elektrický agregát / Prúdový agregát / Električni generator / Generatorius / Benzina elektrogenerator / Voolluotomissee / Электрически агрегат / Agregat za struju / Naponski generator / Γεννήτρια βενζίνης / Grupo electrógeno / Gruppo elettrogeno / Gerador de eletricidade / Groupe électrogène / Elektrische generator

**GRAPHITE** **3 YEARS WARRANTY**

  
2000W /  
max 2200W

  
230V - 50Hz

  
12V   
15 L



Ref.	[kg]	⊠	EAN
58G904	36	1/1	5902062087928

  
2800W /  
max 3000W

  
230V - 50Hz

  
12V   
15 L

**3 YEARS WARRANTY** **10 YEARS OVERLOAD PROTECTION** **AVR** **ENGINE PROTECT** **COPPER WIRE** **OVERLOAD PROTECTION**



Ref.	[kg]	⊠	EAN
04-730	53 kg	1/1	5907558483680

**3 YEARS WARRANTY** **10 YEARS OVERLOAD PROTECTION** **AVR** **ENGINE PROTECT** **COPPER WIRE** **OVERLOAD PROTECTION**

  
6000W /  
max 6500W

  
230V - 50Hz

  
12V   
25 L



Ref.	[kg]	⊠	EAN
04-731	88.3 kg	1/1	5907558483697

  
7000W /  
max 7500W

  
400V - 50Hz

  
12V   
25 L

**3 YEARS WARRANTY** **10 YEARS OVERLOAD PROTECTION** **AVR** **ENGINE PROTECT** **COPPER WIRE** **OVERLOAD PROTECTION**



Ref.	[kg]	⊠	EAN
04-732	91 kg	1/1	5907558495997

## Odkurzacz warsztatowy



Workshop vacuum cleaner / Werkstattstaubsauger / Пылесос промышленный / Пылесос професійний / Műhelyporszívó / Aspirator atelier cu sistem vacuum / Dilerský vysosač / Dielenský vysosač / Industrijski sesalnik / Pramoninis siurblys / Rūpniecības putekļsūcītājs / Tööstuslik tolmuimeja / Промышленна прасосмашина / Radionički usisavač / Industrijski usisavač / Ηλεκτρική σκούπα επαγγελματική / Aspirador / Aspirapolvere da officina / Aspirator de oficina / Aspirateur d'atelier / Werkplaatsstofzuiger

**GRAPHITE**

**ENERGY+ system**

**3 YEARS WARRANTY**

  
18V DC  
230V-50Hz   
180W

  
20 L   
32 mm



Ref.	[kg]	⊠	EAN
58GE124	4.9	0/1	5902062082572

**GRAPHITE**

**ENERGY+ system**

**3 YEARS WARRANTY**

  
18V DC  
230V-50Hz   
150W

  
12 L   
32 mm



Ref.	[kg]	⊠	EAN
58GE133	3.8	0/1	5902062096333

## Odkurzacz przemysłowy

Industrial vacuum cleaner / Industriestaubsauger / Пылесос промышленный / Πυλосος προμωσλοαύ / Ipari porziwó / Aspirator industrial / Průmyslový vysavač / Priemyselny vysavač / Industrijski sesalnik / Pramoninis dulku siurblys / Rūpnieciskais puteklisūcējs / Toostuslik imur / Промышленна прахосмоулача / Industrijski usisavač / Industrijski usisivač / Βιομηχανική ηλεκτρική σκούπα / Aspirador industrial / Aspiratore industriale / Aspirador industrial / Aspiretur industriel / Industriële stofzuiger



**1400W**

**230V- 50Hz**

**30 L**

**32 mm**

**MAX 2000W**

Ref.	[kg]	☒	EAN
04-738	8.3	0/1	5907558483079



**1600W**

**230V- 50Hz**

**35 L**

**32 mm**

**MAX 1800W**

Ref.	[kg]	☒	EAN
04-739	10.4	0/1	5907558483086

## Wentylator

Fan / Fan / вентилатор / вентилатор / ventilator / ventilator / větrák / vetrák / Ventilator / Ventilatorius / Ventilators / Ventilator / Вентилатор / Πλενασ / Ανεμιστήρας / Admirador / Fan / Fan / Ventilateur

**50W** **∅ 40 CM** **3 AIRFLOW SPEEDS** **L R** **COPPER MOTOR**



Ref.	☒	EAN
90-001	0/1	5907558442717

**45W** **∅ 40 CM** **TIMER 0.5 - 7.5 h** **REMOTE CONTROL**

**3 AIRFLOW SPEEDS** **L R** **NORMAL/ SLEEP/ NATURA** **COPPER MOTOR**



Ref.	☒	EAN
90-002	0/1	5907558442724

**100W** **∅ 45 CM** **3 AIRFLOW SPEEDS** **L R**

**HEAVY DUTY** **EXTRA POWER** **COPPER MOTOR**



Ref.	☒	EAN
90-003	0/1	5907558442731





# Promiennik

Infrared heater / Heizkörper / Ραδιатор / Radiator / Radiator / Radiator / Infrarot heater / Infraroudonųjų spindulų šildytuvas / Infrasarkanais šildītājs / Infrapuna küttesead / Инфракрасный обогреватель / Infracrveni grijač / Инфрацрвени грејач / Υέρυθρη θερμάστρα / Calentador de infrarrojos / Riscaldatore a infrarossi / Infrarood verwarming / Chauffage infrarouge



**2kW** carbon infrared heating lamp 10 000h IP55 32m²

Ref.	📦	EAN
90-039	0/4	5907558457902



**2kW** 24m² 6000h low glare amber lamp IP65

Ref.	📦	EAN
90-032	0/4	5907558447439



**1kW** carbon fiber lamp 3m² AUTO OFF 6000h IP44

Ref.	📦	EAN
90-035	0/4	5907558447460



**400/800 W** QUARZ

Ref.	📦	EAN
90-112	0/8	5907558495348



**400/800/1200W** ROTARY BASE CARRYING HANDLE HALOGEN LAMP

Ref.	📦	EAN
90-113	0/1	5907558495355



**600/1200 W** QUARZ WHEELS

Ref.	📦	EAN
90-111	0/1	5907558495331



**400/800/1200W** HALOGEN LAMP ROTARY BASE

Ref.	📦	EAN
90-114	0/1	5907558495362



## Nagrzewnica i wentylator

/ Electric heater and fan / Обогреватель и вентилятор / Fűtés és ventilátor / Нагрівач і вентилятор / Incalziator si ventilator / Heizung und Lüfter / Ohřevič a ventilátor / Ohřevič a ventilátor Elektrišni grelec / Elektrinis šildytuvas / Elektriskais sildītājs / Elektrisks / Електричний нагрівач / Elektrišni grijač / Електрични грејач / Ηλεκτρική θέρμανση / Calentador eléctrico / Stufa elettrica / Elektrische verwarming / Chauffage électrique



2400W

2 in 1



Ref.	P [kW]	[m³/h]	☒	EAN
90-070	2,4	460	0/4	5907558447576

## Termowentylator

Thermoelectric fan / Thermoelektrischer Ventilator / Термоелектричний вентилятор / Термоелектричний вентилятор / Termoelektramos ventilator / Ventilator termoelectric / Termoelektrický ventilator / Termoelektrický ventilator / Termoelektrični ventilator / Termoelektrinis ventilatorius / Termoelektriskais ventilators / Termoelektriline ventilator / Термоелектрически вентилятор / Termoelektrični ventilator / Термоелектричний вентилятор / Термоелектрически вентилятор / Ventilador termoelectrico / Ventilatore termoelectrico / Thermo-elektrische ventilator / Ventilateur thermoelectrique



800/1500 W

FLAME EFFECT

PTC

Ref.	P [kW]	☒	EAN
90-110	0.8/1.5	0/1	5907558495324

## Nagrzewnica olejowa

Oil heater / Ölheizung / Масляный нагреватель / Масляный нагревач / Ölajmelegítő / Incalziator cu ulei / Ohřevič oleje / Ohřevič oleje / Grelnik olja / Alyvas šildytuvas / Eļļas sildītājs / Ökütteseade / Нагрівач на масло / Grijač ulja / Грејач уља / Βερμαντήρας λαδιού / Riscaldatore dell'olio / Olie verwarmmer / Réchauffeur d'huile



20 kW

DIESEL OIL / KEROSENE

550 m³/h

19 l

Ref.	P [kW]	[m³/h]	☒	EAN
90-080	20	550	0/1	5907558457919



DIESEL OIL / KEROSENE

Ref.	P [kW]	[m³/h]	[l]	☒	EAN
90-081	30	750	34	0/1	5907558457926
90-082	50	1100	50	0/1	5907558457933



20 kW

38L

600 m³/h

21,3 kg

DIESEL OIL / KEROSENE

🔥

Ref.	P [kW]	[m³/h]	☒	EAN
90-086	20	600	0/1	5907558495423

## Nagrzewnica gazowa

Gas heater / Gasheizung / Газовый обогреватель / Газовий обігрівач / Gázmelegítő / Incalziator pe gaz / Plynový ohřevič / Plynový ohřevič / Plynski grelec / Dujinski šildytuvas / Gāzes sildītājs / Gaaskütteseade / Газов нагрівач / Plynski grijač / Газни грејач / Βερμαντήρας αερίου / Calentador a gas / Stufa a gas / Gaskachel / Chauffage à gaz



GAS heater

PIEZO

Ref.	P [kW]	[m³/h]	[bar]	☒	EAN
90-083	15	580	0,7	0/1	5907558457940
90-084	30	1000	0,7	0/1	5907558457957
90-085	50	1000	1,5	0/1	5907558457964



## **NARZĘDZIA RĘCZNE MECHANICZNE**

mechanical hand tools    механічні ручні інструменти

## Szafka narzędziowa

Tool cabinet / Werkzeugschrank / Шкафчик для инструментов / Шкаф инструментальный / Műhelykocsi / Dulap pentru scule / Skříňka na nářadí / Skrinka na náradie / Omalica za orodje / Įrankių spintelė / Instrumentu skapis / Тоолгистакар / Шкафче за инструменти / Омар за алате / Ормацич за алатке / Ντουλανάκι για εργαλεία / Armario de almacenaje para herramientas / Carrello porta utensili / Estante p. Ferramentas / Rmoire à outils / Gereedschapskast

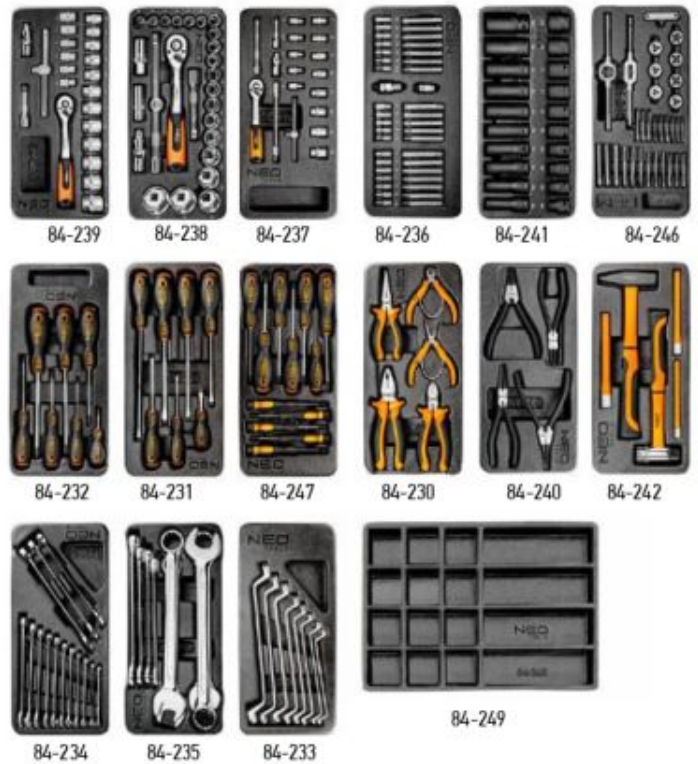

## 229 elements

Ref.	D [mm]	W [mm]	H [mm]	capacity [kg]	☒	EAN
84-225+G	465	1105	978	600	0/1	5907558487503



## 174 elements

Ref.	D [mm]	W [mm]	H [mm]	capacity [kg]	☒	EAN
84-220+G	465	775	978	300	0/1	5907558465020

## Szafka narzędziowa

Tool cabinet / Werkzeugschrank / Шкафчик для инструментов / Шафа інструментальна / Мűhelykocsi / Dulap pentru scule / Skříňka na nářadí / Skrinica na náradie / Ormarica za orodje / Įrankių spintelė / Instrumentu skapis / Тоолнстаккapp / Шкафче за инструменти / Ormar za alate / Ormaric za alatke / Ντουλανάκι για εργαλεία / Armario de almacenaje para herramientas / Carrello porta utensili / Estante p. Ferramentas / Rnoire à outils / Gereedschapskast



**129 elements**



84-236

84-240

84-230

84-242



84-237

84-238

84-235

84-234

84-232

Ref.	D [mm]	W [mm]	H [mm]	capacity [kg]	☒	EAN
84-222-9	460	680	1030	280	0/1	5907558426441



**176 elements**



84-230

84-231

84-232

84-233



84-234

84-236

84-237

84-239

84-238

Ref.	D [mm]	W [mm]	H [mm]	capacity [kg]	☒	EAN
84-222-12	460	680	1030	280	0/1	5907558426427



**149 elements**



84-230

84-231

84-232

84-233



84-234

84-236

84-237

84-239

84-238

Ref.	D [mm]	W [mm]	H [mm]	capacity [kg]	☒	EAN
84-221-9	460	680	1030	280	0/1	5907558426403

## Szafka narzędziowa

Tool cabinet / Werkzeugschrank / Шкафчик для инструментов / Шофа инструментальна / Мűhelykocsi / Dulap pentru scule / Skříňka na nářadí / Skrinka na náradie / Ottarica za orodje / Įrankių spintelė / Instrumentu skapis / Тööriistakapp / Шкафче за инструменти / Ottaric za alate / Ottaric za alatke / Ντουλαπιά για εργαλεία / Armario de almacenaje para herramientas / Carrello porta utensili / Estante p. Ferramentas / Rnoire à outils / Gereedschapskast



84-230



84-234



84-236



84-237



84-238



84-247



117 elements

Ref.	D [mm]	W [mm]	H [mm]	capacity [kg]	☒	EAN
84-214-6	460	680	825	280	0/1	5907558426380

## Szczypce

Pliers set / Zange / Клепци / Пласкозубци, набор / Fogókészlet / Set clește plat / Kleště / Kliešte, súprava / Klešče / Replés / Клепцѝ комплекс / Nářístate komplet / Щипци / Клејѝта / Klesta set / Συλλογή πειστών / Alicates / Pinza / Pinças / Pince / Tangen



x5

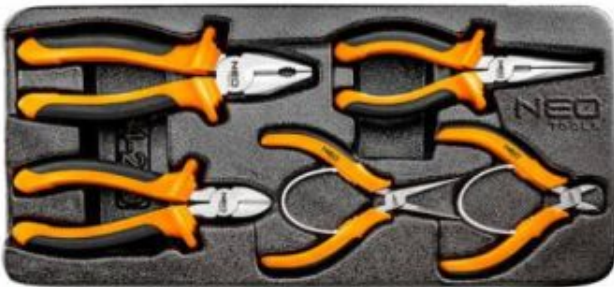

55-60 HRC

DIN 5745

DIN 5746

DIN 5749

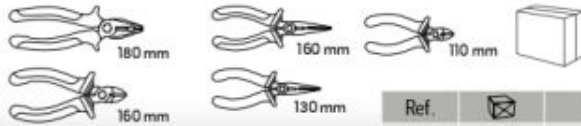

Ref.	☒	EAN
84-230	0/10	5907558424270

## Szczypce do pierścieni osadczych

Circip pliers / Zange für Stellringe / Щипцы для стопорных колец / Щипци для стопорних кілець / Zégergyűrű fogókészlet / set clește cu spirală / Kleště pro stavěcí kroužky / Segerky vonkajšie rovní / Klešče seger / Replés Ziedams / Sprostogredzenu stangas / Vedrunāpīstads / Клепци Зееер / Кружна Клејѝта / Крузна klesta / Αορλεκοταμίλες / Alicates para anillos de asiento / Set di pinze per anelli elastici / Pinças p. Anéis / Pince pour bagues de retenue / Tang voor dopringen

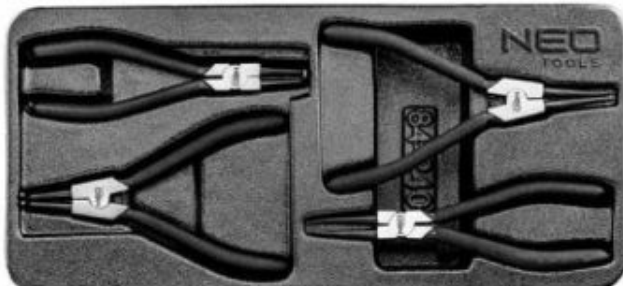

25 years guarantee

TOV certification

CrV steel

x4

180 mm, zewnętrzne, proste / external, stright tip / щипцы для внешних/прямые  
 170 mm, zewnętrzne, wygięte / external, bent tip / щипцы для внешних/загнутые  
 180 mm, wewnętrzne, proste / internal, stright tip / щипцы для внутренних/прямые  
 170 mm, wewnętrzne, wygięte / internal, bent tip / щипцы для внутренних/загнутые

Ref.	☒	EAN
84-240	0/10	5907558424379

## Zestaw narzędzi

Tools set / Werkzeugsatz / Набор инструментов / Набор інструментів / Szerszámkészlet / Set saule de grādinā / Sada nářadí / Súprava náradia / Garnitura orodja / Įrankių komplektas / Instrumentu komplekts / Тööriistakomplekt / Гедорє номинент / Set uređaja / Set alata / Συλλογή εργαλείων / Juego de herramientas / Set utensilii / Kit de ferramentas / Jeu d'outils / Gereedschapsset



10; 13; 16 mm

Ref.	☒	EAN
84-242	0/10	5907558424393

## Pilniki

Files / Feilen / Ханушники / Hanušniki / Reszeltő készlet / Pile / Pilníky / Pilníky / Pile / Dildes / Viles / Vilid / Punu / Turpije / Turpije / Лижє / Sopletes / Set di lime / Limas / Limes / Vlijen



Ref.	☒	EAN
84-244	0/10	5907558424416

## Wkrętaki

Screwdriver set / Schraubendreher / Отвертки / Відкрутки, набір / Fogókészlet / Set şurubelnițe / Šraubovky / Súprava skrutkovačov / Garnitura izvijacačev / Atsuktunai / Skruvin griežu komplekts / Крувкеегајате комплект / Отвертки набор / Odvijaci set / Συλλογή από καταβίβα / Destornilladores / Set gravite piatti / Chaves de fenda / Tournevis / Schroeuvendroaers



3.0 x 75; 5.5 x 100; 5.5 x 200; 6.5 x 38;  
6.5 x 125; 6.5 x 150; 8.0 x 150 mm



PH0 x 75 mm; PH1 x 75 mm; PH1 x 100 mm; PH2 x 38 mm;  
PH2 x 100 mm; PH2 x 150 mm; PH3 x 150 mm



PH00, PH0, PH1 T10, T15, T20, T25  
PZ0, PZ1, PZ2 SL 2mm; SL 3mm

Ref. 84-247  
EAN 5907558424447

## Klucze nasadowe

Drive socket set / Steckschlüssel / Набор сменных головок / Ключи торцевые / Dugókulcskészlet / Trusa tubulare / Nástrčné kľúče / Nástrčné kľúče / Nasadni ključ / Veržerakčio antgaliai / Nomináimo galvu komplekts / Podravnötmeđ / Сменными накрайниками за ключове / Nasadni ključevi / Ključevi natikači / Σετ με καρούβια / Llaves de vaso / Set bussole / Chaves articuladas / Djeft à douilles / Dopsleutels



4; 4.5; 5; 5.5; 6; 7; 8; 9; 10; 11; 12; 13; 14 mm  
50; 100 mm  
148 mm  
155 mm  
1/4"

Ref. 84-237  
EAN 5907558424348



6; 7; 8; 9; 10; 11; 12; 13; 14; 15; 16; 17; 18; 19; 20; 21; 22; 24 mm  
195 mm  
75 mm  
3/8"

Ref. 84-239  
EAN 5907558424362



8; 10; 11; 12; 13; 14; 15; 16; 17; 18;  
19; 20; 21; 22; 24; 27; 30; 32; 34; 36 mm  
16, 21 mm  
125; 250 mm  
255 mm  
1/2M x 3/8F  
1/4"

Ref. 84-238  
EAN 5907558424355



## Nasadki udarowe

Impact sockets / Schlagaufsätze / Насадки ударные / Патрони перфораторни / Gépi dugókulcs készlet / Břítare percutante / Príklerové nástavce / Príklerové nástavce / Udarni nasadni ključ / Kalimo antgaliai / Trecienuzgaf / Lööksotsakud / Ударни наставка / Ударни насадни наставка / Ударне капце / Υποδοχές κρουστικού αντιβλακτικού / Llaves de vaso para atornilladores de impacto / Set bussola a percussione / Bocais de impacto / Douilles de choc / Slagdoppen



10; 12; 13; 14; 16; 17; 19; 21; 22; 24 mm

10; 12; 13; 14; 16; 17; 19; 21; 22; 24 mm

Ref.	☒	EAN
84-241	0/10	5907558424386

## Nasadki sześciokątne długie

Hexagonal sockets / Sechskantaufsätze / Головки сменные шестиугольные / Насадки шестигранные / Dugókulcs hosszú készlet / Capete tubulare hexagonale / Šestihránné nástavce / Šestihránné nástavce / Šestkotni nasadni ključ / Šešakampiai antgaliai / Šešstūra nomaiņamās galvas / Kuuskantpadrunid / Шестугольные наставка / Šesterokutne kapice / Šestougaone nasadke / Καρυδιάς εξήγωνα / Vasos hexagonales / Set bussola / Bocais hexagonais / Douilles à 6 pans / Zeskant doppen

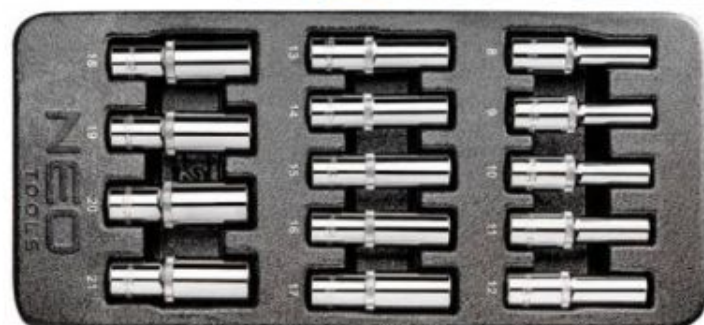

8, 9, 10, 11, 12, 13, 14, 15, 16, 17, 18, 19, 20, 21 mm

Ref.	☒	EAN
84-243	0/10	5907558424409

## Końcówki wkrętakowe

Driver bits / Einsätze für Schraubendreher / Насадки / Наконечники викрѣткови / Birkészlet / Set bit / Šroubovákové nástavce / Skrutkovacie nástavce / Nastavki za izvijače / Atsuktuvo antgaliai / Škrūvgrieža uzgaf / Krivikeerijaotsakud / Нақрѣткѣтѣ за отвѣртка / Nastavci za odvijajač / Nastavci za odvijajač / Καταβιβόμενες / Puntas destornilladoras / Set inserti / Ponteiros chave de fenda / Embouts de tournevis / Schroevendraaiereindstukken



● H4, H5, H6, H7, H8, H10, H12 ● H4, H5, H6, H7, H8, H10, H12  
● M5, M6, M8, M10, M12 ● M5, M6, M8, M10, M12  
★ T20, T25, T30, T40, T45, T50, T55 ★ T20, T25, T30, T40, T45, T50, T55

75 mm 30 mm

Ref.	☒	EAN
84-236	0/10	5907558424331

## Klucze płasko-oczkowe

Ratchet wrench set / Maul-Ringschlüssel / Ключи комбинированные / Ключи рожково-накидні, набір / Csillag-villáskulcs készlet / Set chei cu clichet / Očekarložné ključ / Súprava OP račioných ključov / Күмүш вилчаста-оброңчи / Raktas plokščias - kėlpinis / Kombinėto atslėgu komplekts / Pėrkmutrėnėtmetė komplekt / Ключ зvezdozачечен / Set ključeva / Кључ комбиновани / Συλλογή πολυγώνων καρταναίος / Llaves combinadas (de estrella y a carraca abierta) / Set chiavi combinate / Chaves planas-de luneta / Clefs à fourche polygonales / Moersleutels



6x100; 7x110; 8x120; 9x130; 10x140; 11x150; 12x160; 13x170; 14x180; 15x190; 16x200; 17x210; 18x220; 19x230 mm

Ref.	☒	EAN
84-234	0/10	5907558424317

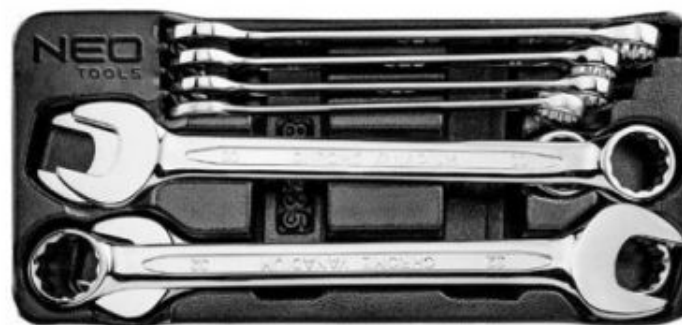

20x240; 21x250; 22x260; 24x280; 27x310; 29x340; 30x340; 32x360 mm

Ref.	☒	EAN
84-235	0/10	5907558424324

## Klucze oczkowe odgięte

Offset ring spanner set / Ringschlüssel gebogen / Ключи накидные коленистые / Ключи накидні колінасті, набір / Csillagkulcs készlet / Set chei inelare de deviație / Očekarložné ključ / Súprava očkových ključov / Garritura obrožnih ključev, upognjenih / Kėlpinis, lenktų raktų komplektas / Kombinėto izliekto atslėgu komplekts / "Ofset" mutrėnėtmetė komplekt / Ключ лѣпа / Кључ окасти / Кључ окасти set / Συλλογή καρταναίων κλειδίων με κεκλιμένη κεφαλή / Llaves de estrella, acodadas / Set chiavi inclinate ad anello / Chaves de luneta curvadas / Clefs polygonales contre-caudées / Gebogen ringsleutels

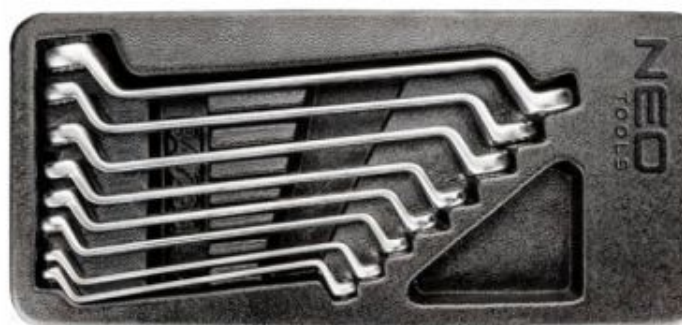

6x7; 8x9; 10x11; 12x13; 14x15; 16x17; 18x19; 20x22 mm

Ref.	☒	EAN
84-233	0/10	5907558424300

## Klucze sześciokątne

Hex keywrench set / Sechskantschlüssel / Ключи шестигранные / Ключи шестигранные / Imbusz kulcs készlet / Set chei hexagonale / Ključ šestihriane / Súprava predĺ. Imbus klúčov s guľkou / Garnitura ključev imbus / Šešakampni raktai / Seškarši atslėgų komplektas / Kuuskant-mutrivõtmete komplekt / Шестыугольні ключоўе / Kľuč imbus set / Kľuč imbus / Εξαγωνικά κλειδιά / Claves allen / Chiavi esagone / Chaves hexagonais / Clefs à 6 pans / Zeskantsleutels



25 years  
GUARANTEED

S2  
steel

x6



DOUBLE  
COMPONENT  
HANDLE

● H4; H5; H6; H7; H8; H10; H12

Ref.	📦	EAN
84-254	1/12	5907558483956

## Klucze Torx

Torx key set / Torx-Schlüsselset / Ключи torx / Набор крестовых шестигранных торцовых ключей «torx» / Torx kulcskészlet / Set chei torx / Ključ Torx / Торцовé ključe / Kľučí torx / Torcioví raktai / Atslėgas torx / Torx-võtmed / Ключоўе torx / Set torx ključeva / Torx ključevi / Set κλειδίων torx / Claves torx / Chiavi torx / Chaves torx / Clefs Torx / Torxleutels



25 years  
GUARANTEED

S2  
steel

x6



DOUBLE  
COMPONENT  
HANDLE

★ T10; T15; T20; T25; T30; T45

Ref.	📦	EAN
84-264	1/12	5907558483963

## Narzynki i gwintowniki

Tap and die set / Schneisen und Gewindebohrer / Плашки и метчики / Позначники и плашки, набор / Menetkészítő készlet / Set scule tăiere filet interior și exterior / Závrtnice a závrtníkov / Súprava závrtníkov / Garnitura vreznikov in nareznikov navoja / Snieggjövés ir sniegkljai / Vrtgnezú komplekt / Kraani ja valuvõrmi komplekt / Метчицу и плашки / Nareznice i ureznicke / Set ureznika i nareznika / Ελικοκρετες και κολλοκίττα / Cojinetes y machos de roscar, juego / Set di filiere a maschi / Cassonetes e roscas / Filières et tarauds / Snijplaat en schroefdraad snijtoestel

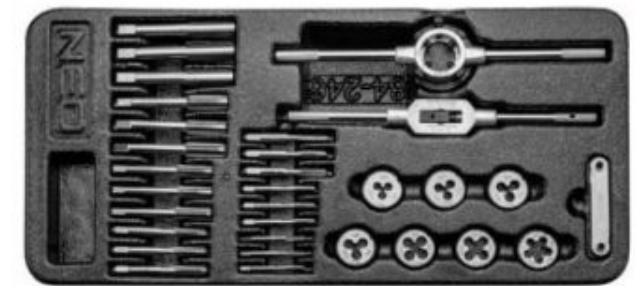

25 years  
GUARANTEED



HSS  
steel

x31

DIN  
352



M3; M4; M5; M6; M8; M10; M12 - 25 x 9 mm

	Ref.	📦	EAN
3xM3; 3xM4; 3xM5; 3xM6; 3xM8; 3xM10; 3xM12	84-246	0/10	5907558424430

## Wkład profilowany

Profiled insert / Profileinsatz / Профилированный вставной элемент / Organiser / Tároló rekeszes tábla / Cartuş profilat / Profilovaná vložka / Profilovaná vložka / Profiliran vložek / Profiluotas įdėklas / Profilēts ieliekamais elements / Profilitud tihend / Профилен элемент / Profilirani umetak / Profilisani umetak / Διατάχτη ένθετο εξάρτημα / Bandeja clasificadora perfilada / Vassoio / Cartucho perfilado / Cylindre profilé / Geprofileerde inzetdeel



25 years  
GUARANTEED

FULL  
DRAWER

550x386 mm

Ref.	📦	EAN
84-249	0/5	5907558424461

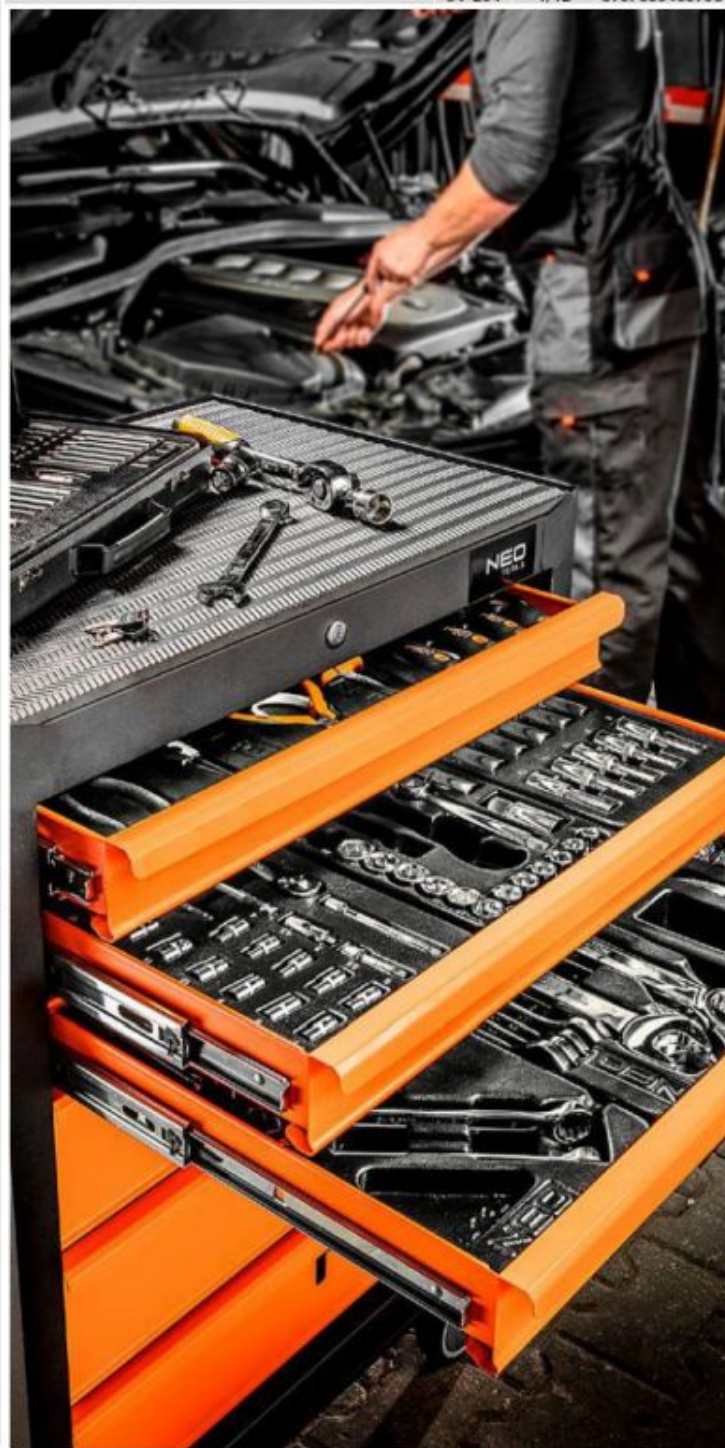

# Klucze nasadowe

Socket wrenches / Steckschlüssel / Набор оменных головок / Ключи торцевой / Dugálucskészlet / Trusa tubulare / Nástrčné kľúče / Nástrčné kľúče / Nasadni ključ / Veržerakšio antgalai / Nomaināmo galvu komplekts / Padrūnvalēd / Сменная насадка для ключа / Nasadni ključevi / Ключи насадки / Set me karabika / Llaves de vaso / Set di bussole SuperLock / Chaves tubulares / Clefs à douilles / Dopsleutels

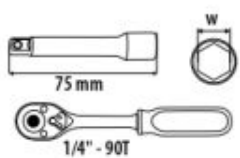

**25 years**  
GUARANTEE



CrV  
steel

x14

1/4"



NEW PATENTED DESIGN



Ref.	W[mm]	⊠	EAN
10-000	4, 4.5, 5, 5.5, 6, 7, 8, 9, 10, 11, 12, 13	5/20	5907558466133

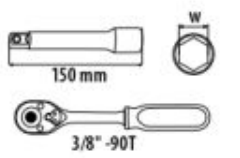

**25 years**  
GUARANTEE



CrV  
steel

x12

3/8"



NEW PATENTED DESIGN



Ref.	W[mm]	⊠	EAN
10-020	8, 10, 12, 13, 14, 16, 17, 19, 21, 22	5/10	5907558466157

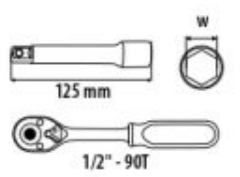

**25 years**  
GUARANTEE



CrV  
steel

x12

1/2"



NEW PATENTED DESIGN



Ref.	W[mm]	⊠	EAN
10-030	8, 10, 12, 13, 14, 16, 17, 19, 21, 22	4/12	5907558466126

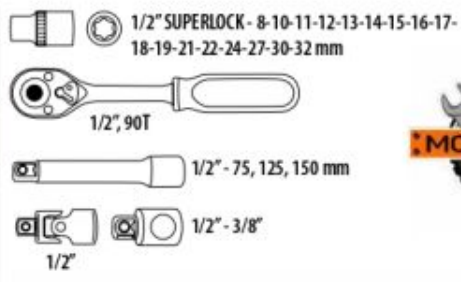

**25 years**  
GUARANTEE



CrV  
steel

1/2"



x23



**23**  
elements

Ref.	⊠	EAN
08-694	1/5	5907558440034

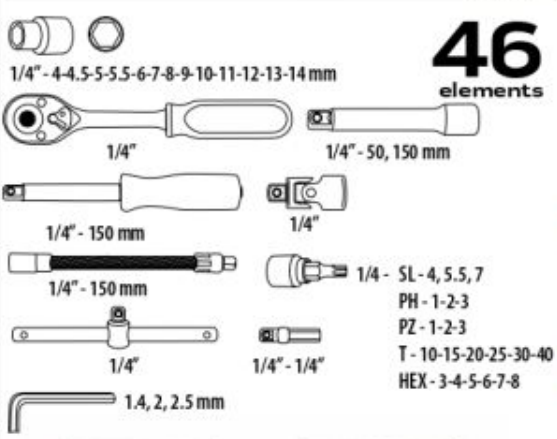

**46**  
elements

**25 years**  
GUARANTEE



CrV  
steel

x46

1/4"

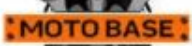

Ref.	⊠	EAN
10-004	1/10	5907558465945

## Klucze nasadowe

Socket wrenches / Steckschlüssel / Набор сменных головок / Ключи торцевой / Dugakulcskészlet / Trusa tubulare / Nástržné kľúče / Nástržné kľúče / Nasadni kľučki / Veržerakčio antgalvici / Nomainimo galvu komplekts / Podravnímed / Сменные наконечники за ключове / Nasadni kľučevni / Kľučevni naitkač / Set pe karubáka / Llaves de vaso / Set di bussole SuperLock / Chaves tubulares / Clefs à douilles / Dopsleutels

  
1/2" - 10-11-12-13-14-15-16-17-18-19-20-  
21-22-23-24-27-30-32 mm

  
1/2" - 72T 1/2"

  
1/2" - 125 mm 1/2" - 16, 21 mm

  
1/2" - 360 mm

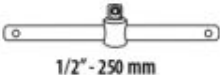
  
1/2" - 250 mm

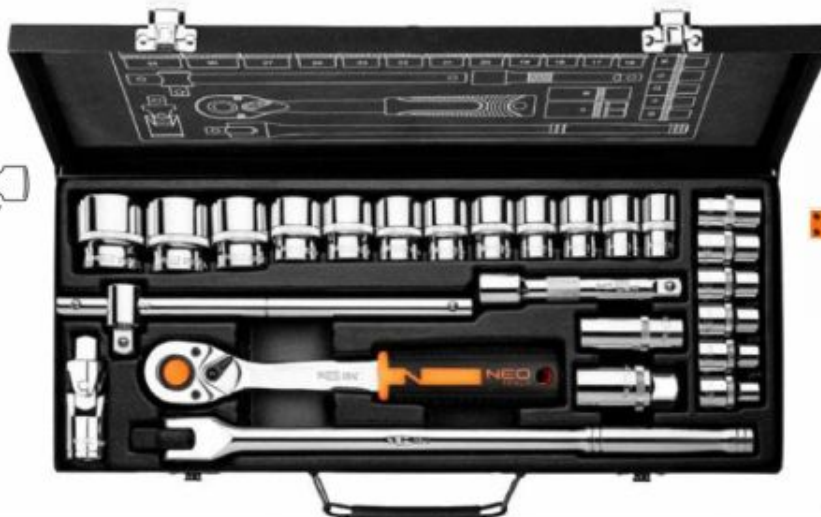

25 years  
GUARANTEE



CrV  
steel

MOTO BASE

x25

1/2"

25  
elements

NEW  
PATENTED  
DESIGN

PRECISE  
4°  
90T

Ref.	☒	EAN
10-036	1/4	5907558466058

  
3/4" - 19-21-22-23-24-26-27-29-  
30-32-35-36-38-41-46-50 mm

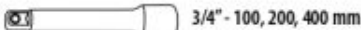
  
3/4" - 100, 200, 400 mm

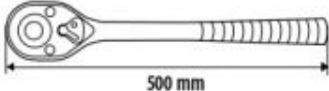
  
500 mm

  
460 mm



25 years  
GUARANTEE



CrV  
steel

MOTO BASE

x21

3/4"

21  
elements

NEW  
PATENTED  
DESIGN

PRECISE  
4°  
90T

Ref.	☒	EAN
08-061	0/1	5907558404173

  
1/4" - 4-4.5-5-5.5-6-7-8-9  
-10-11-12-13-14 mm

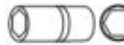
  
1/4" - 4-4.5-5-5.5-6-7-8-9  
-10-11-12-13-14 mm

  
1/4" - E4-E5-E6-E7-E8-E10

  
1/4" 1/4"

  
1/4" - 50; 100; 150 mm

  
1/4"

  
1/4", 140 mm

  
1/4"

1/4" - TX - 8-10-15-20-25-30-40  
PH - 1-2-3  
PZ - 1-2-3  
SL - 4-5-5-7 mm  
HEX - 3-4-5-6-7-8 mm



25 years  
GUARANTEE

CrV  
steel

x63

1/4"

PRECISE  
4°  
90T

NEW  
PATENTED  
DESIGN

PRECISE  
4°  
90T

PRECISE  
4°  
90T

PRECISE  
4°  
90T

PRECISE  
4°  
90T

63  
elements

Ref.	☒	EAN
10-008	5/10	5907558466003

## Klucze nasadowe

Socket wrenches / Steckschlüssel / Набор сменных головок / Ключи торцевой / Dugókulcskészlet / Trusa tubulare / Nástrčné kľúč / Nástrčné kľúč / Nasadni ključ / Veržirakcio anyagjai / Nomainiomo galvu komplekts / Padrunvõtmed / Сменные наконечники за ключове / Nasadni kľučev / Kľučevni natiokači / Set je karbidová / Llaves de vaso / Set di bussolle SuperLock / Chaves tubulares / Ciefs à douilles / Dopsleutels



1/2" - 10-T1-T2-T3-T4-T5-T6-T7-T8-T9-T10-T11-T12-T13-T14-T15-T16-T17-T18-T19-T20-T21-T22-T24-T27-T30-T32 mm



1/2" - 10-T1-T2-T3-T4-T5-T6-T7-T8-T9-T10-T11-T12-T13-T14-T15-T17-T19 mm



1/2" - 16, 21 mm



1/2"



1/2" - 125, 250 mm



1/2"

1/2"



1/2" - 5/16"

5/16" - FD8-FD10-FD12  
PH1-PH2-PH3-PH4  
PZ1-PZ2-PZ3-PZ4  
T20-T25-T30-T40-T45-T50-T55  
H4-H5-H6-H8-H10-H12-H14



25 years GUARANTEE



CrV steel

x58

1/2"

PRECISE 4° 90T

NEW PATENTED DESIGN



58 elements



Ref.	Box	EAN
10-042	1/4	5907558466072



1/2" - 14-15-16-17-18-19-20-22-24-27-30-32 mm

1/4" - 4-4.5-5-5.5-6-7-8-9-10-11-12-13-14 mm



1/2" - 16, 21 mm



1/2" - 90T

1/4" - 90T



1/4" - 150 mm



1/4" - 150 mm



1/2"

1/2"

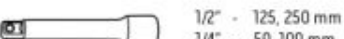

1/2" - 125, 250 mm

1/4" - 50, 100 mm



1/4" - 115 mm



8-10-11-12-13-14-17-19-22 mm



1/2" - 5/16"



1/4" - SL4-SL5, S-SL7  
PH1-PH2  
PZ1-PZ2  
T8-T10-T15-T20-T25-T30  
H3-H4-H5-H6



5/16" - SL8-SL10-SL12  
PH3-PH4  
PZ3-PZ4  
T40-T45-T50-T55  
H8-H10-H12-H14



25 years GUARANTEE



CrV steel

x82

1/4"

PRECISE 4° 90T

NEW PATENTED DESIGN



82 elements



Ref.	Box	EAN
10-058	1/4	5907558465921

## Klucze nasadowe

Socket wrenches / Steckschlüssel / Набор сменных головок / Ключи торцовые / Dugókulcskészlet / Trusa tubulare / Nástrčné kľúče / Nástrčné kľúče / Nasadni ključ / Veržerakčio antgalai / Nomaināmo galvu komplekts / Podravnötmed / Сменные наконечники за ключове / Nasadni ključevi / Ključevi notičači / Set je karpušaka / Llaves de vaso / Set di bussole SuperLock / Chaves tubulares / Clefs à douilles / Dopsleutels



1/2" - 10-11-12-13-14-15-16-17-18-19  
20-21-22-23-24-27 mm

1/4" - 4-5-5.5-6-7-8-10-11-12-13 mm

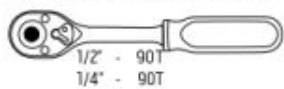

1/2" - 90T  
1/4" - 90T

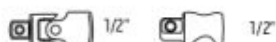

1/2" - 16, 21 mm

1/2" - 125, 250 mm  
1/4" - 100 mm



1/4" - 150 mm

1/4" - 1,5-2-2,5 mm



1/4" - TX8, TX10, TX15, TX20, TX25, TX27,  
TX30, TX40, PH0, PH1, PH2, PH3,  
PZ1, PZ2, PZ3, SL4, SL5.5, SL7, HEX 3,  
4, 5, 6, 8, 10, 1/8", 9/64", 5/32",  
3/16", 7/32", 1/4", 5/16", SPLINE 6, 8



25  
years  
GUARANTEE

TUV  
certified  
CrV  
steel

x73 1/4"

1/2"

MOTO  
BASE

73  
elements

PRECISE  
90T  
NEW  
PATENTED  
DESIGN



Ref.	Box	EAN
10-054	1/4	5907558465938

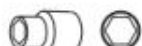

1/2" - 14-15-16-17-18-19-20-22-24-27-30-32 mm

1/4" - 4-4.5-5-5.5-6-7-8-9-10-11-12-13-14 mm

1/2" - 16, 21 mm

1/2" - 90T  
1/4" - 90T

1/4" - 150 mm

1/4" - 150 mm

1/2" - 125, 250 mm  
1/4" - 50, 100 mm

1/4" - 115 mm

8-10-11-12-13-14-17-19-22 mm

1/2" - 5/16"

1/4" - SL4-SL5, S-SL7  
PH1-PH2  
PZ1-PZ2  
T8-T10-T15-T20-T25-T30  
H3-H4-H5-H6

5/16" - SL8-SL10-SL12  
PH3-PH4  
PZ3-PZ4  
T40-T45-T50-T55  
H8-H10-H12-H14



25  
years  
GUARANTEE

TUV  
certified  
CrV  
steel

x82 1/4"

1/2"

MOTO  
BASE

82  
elements

PRECISE  
90T  
NEW  
PATENTED  
DESIGN



Ref.	Box	EAN
10-059	1/4	5907558487695

## Klucze nasadowe

Socket wrenches / Steckschlüssel / Набор сменных головок / Ключи торцевые / Dugkulcskészlet / Trusa tubulare / Nástrčné kľuče / Nástrčné kľuče / Nasadni ključiči / Veržerakčio antgaloai / Nomainiāmo galvu komplekts / Padrunvõetmed / Голівки накрутки для ключов / Nasadni ključev / Ključev natičasti / Set je karbidna / Llaves de vaso / Set di bussola SuperLock / Chaves tubulares / Clefs à douilles / Dopsleutels

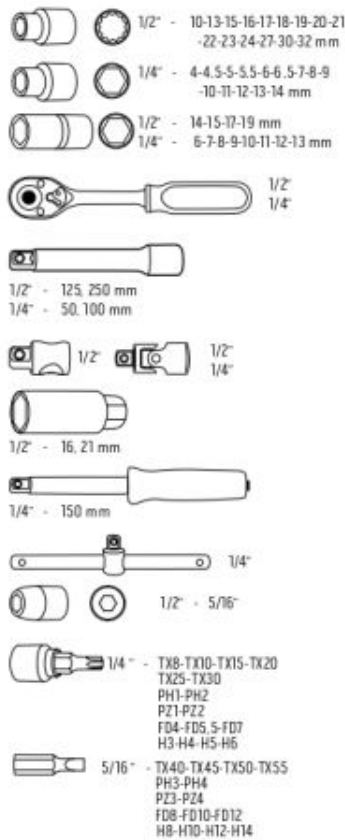

25 years  
GUARANTEE



CrV  
steel

x86 1/4"

PRECISE  
90T 1/2"

NEW  
PATENTED  
DESIGN



86  
elements



Ref.	⊠	EAN
10-060	1/4	5907558465976

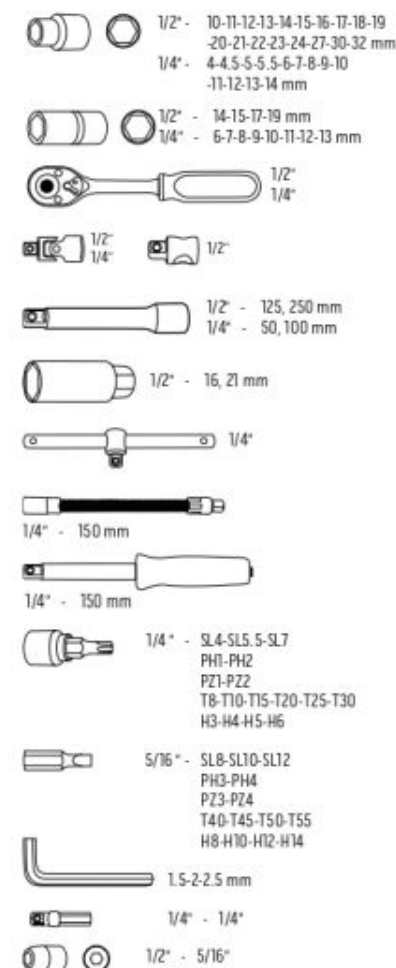

25 years  
GUARANTEE



CrV  
steel

x94 1/4"

1/2"

PRECISE  
90T



94  
elements



Ref.	⊠	EAN
10-062	1/4	5907558465952

## Klucze nasadowe

Socket wrenches / Steckschlüssel / Набор сменных головок / Ключи торцевые / Dugókulcskészlet / Trusa tubulare / Nástržné kľúče / Nástržné kľúče / Nasadni ključji / Veržlerakció antigaljai / Nomaināmo galvu komplekts / Подручній мед / Сменитими накрутниками за ключове / Nasadni ključevni / Ključevni notikači / Set je karubáka / Llaves de vaso / Set di bussole SuperLock / Chaves tubulares / Clefs à douilles / Dopsleutels



1/4" - 4-4.5-5-5.5-6-7-8-9-10-11-12-13-14 mm  
1/2" - 10-11-12-13-14-15-16-17-18-19-20-21-22-24-27 mm



1/2" - 16, 21 mm



1/2" - 72T  
1/4" - 72T



1/4" - 150 mm



1/2" 1/2Mx3/8F  
1/4"



1/2" - 125, 250 mm  
1/4" - 50, 100 mm



1/4"



10-11-12-13-14-15-17-19 mm



SL 5.5x38mm / SL 6.5x100mm  
PH1x38mm / PH2x100mm



1/4"



SL: 3-4-5-6-7-8  
PH: 0-1-2-2-3  
PZ: 0-1-2-2-3  
T: 8-10-15-20-25-27-30-40-45  
TT: 8-10-15-20-25-27-30-40-45  
H: 3-4-5-5.5-6-8



25 mm

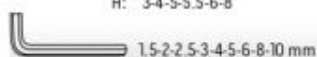

1.5-2-2.5-3-4-5-6-8-10 mm



25 years  
GUARANTEE

CrV  
steel

100  
ELEMENTS

72T

STRONG CASE

ERGO

+

+

+

+

+

+

+

1/4"

1/2"

72T  
1/2"

72T  
1/4"

10-11-12-13-14-15-17-19 mm

x8

x4

1/4"



100  
elements



Ref.	📦	EAN
10-206	1/3	5907558463224



1/4" - 4-4.5-5-5.5-6-7-8-9-10-11-12-13-14 mm  
1/2" - 10-11-12-13-14-15-16-17-18-19-20-21-22-24-27-30-32 mm

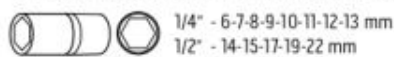

1/4" - 6-7-8-9-10-11-12-13 mm  
1/2" - 14-15-17-19-22 mm

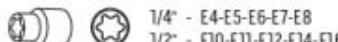

1/4" - E4-E5-E6-E7-E8  
1/2" - E10-E11-E12-E14-E16-E18-E20-E24



1/2" - 16, 21 mm

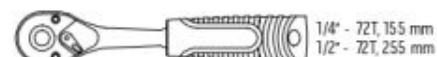

1/4" - 72T, 155 mm  
1/2" - 72T, 255 mm



1/4" - 150 mm



1/2" 1/2Mx3/8F  
1/4"



5/16" - 1/2"



1/2" - 125, 250 mm  
1/4" - 50, 100 mm



1/4", 115 mm

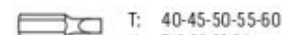

T: 40-45-50-55-60  
H: 7-8-10-12-14  
PH: 3-4  
PZ: 3-4  
SL: 8-10-12



30 mm



1/4" - T: 8-10-15-20-25-27-30  
PH: 1-2  
PZ: 1-2  
SL: 4-5-5-7  
H: 3-4-5-6



1.5-2-2.5 mm



25 years  
GUARANTEE

CrV  
steel

x108

1/2"

1/4"

72T  
1/4"

72T  
1/2"

72

+

+

STRONG CASE

ERGO

+

+

+

+

+

+

+

+

+

+



108  
elements



Ref.	📦	EAN
10-212	1/3	5907558468885



## Klucze nasadowe

Socket wrenches / Steckschlüssel / Набор сменных головок / Ключи торцевые / Dugőkulcskészlet / Trusa tubulare / Nástrčné kľúče / Nástrčné kľúče / Nasadni ključiči / Veržerakzio antgalioi / Normaināmo galvu komplekts / Радгвалітмед / Сменная напратніца за ключоое / Nasadni ključevni / Ključevni natičaji / Σετ με κορυδάκια / Llaves de vaso / Set di bussole SuperLock / Chaves tubulares / Clefs à douilles / Dopsleutels

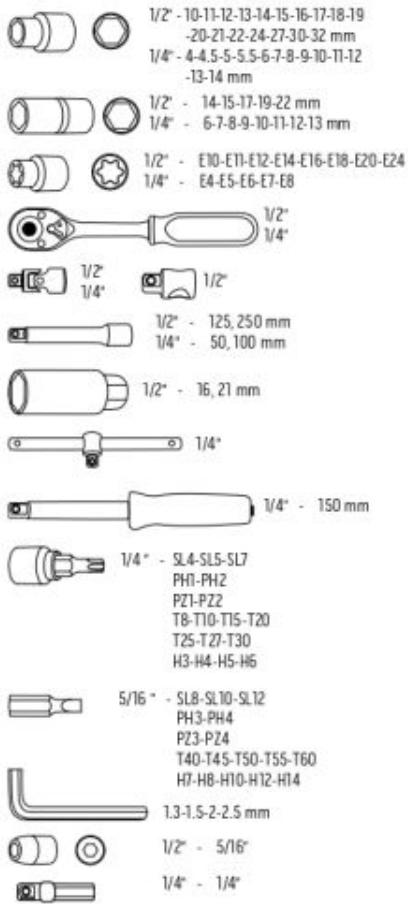

25  
years  
GUARANTEE



CrV  
steel

x110

1/4"

1/2"



PRECISE  
90°



110  
elements



Ref.	☐	EAN
10-066	1/4	5907558465891



# Klucze nasadowe

Socket wrenches / Steckschlüssel / Набор сменных головок / Ключи торцевые / Dugókulcskészlet / Trusa tubulara / Nástrčné kľúče / Nástrčné kľúče / Nasadni ključ / Veržlerakció antgalia / Normainamo galvu komplekts / Padrunvõtmed / Сменные наконечники для ключов / Nasadni ključevi / Ključevi nabikači / Set me karobáka / Llaves de vaso / Set di bussola SuperLock / Chaves tubulares / Clefs à douilles / Dopsleutels



1/4" - 4-4.5-5-5.5-6-7-8-9-10-11-12-13-14 mm  
 3/8" - 10-11-12-13-14-15-16-17-18-19 mm  
 1/2" - 10-11-12-13-14-15-17-19-20-21-22-24-27-30-32 mm



**25**  
years  
GUARANTEE



**216**  
elements



1/4" - 4-5-6-7-8-9-10 mm  
 3/8" - 10-11-12-13-14-15 mm  
 1/2" - 16-17-18-19-22 mm



1/4" - E4-E5-E6-E7-E8  
 3/8" - E10-E11-E12-E14-E16-E18  
 1/2" - E20-E22-E24



3/8" - 18 mm  
 1/2" - 16, 21 mm

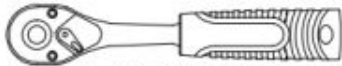

1/4" - 72T 3/8" - 72T 1/2" - 72T

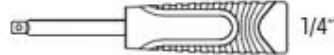

1/4"



1/4"  
3/8"  
1/2"



1/4" - 50, 100 mm  
 3/8" - 150 mm  
 1/2" - 125, 250 mm



1/4" - 115 mm  
 1/2" - 250 mm



1/4" - 1/4"  
 3/8" - 5/16"  
 1/2" - 5/16"



8-10-11-12-13-14-15-16-17-18-19-22 mm



1/4"



1/2" - T: 55-60  
 1/4" - T: 25-27-30-35-40-40-45-50  
 TT: 27-30-35-40-45-50  
 PH: 3-4  
 PZ: 3-4  
 SL: 6-6.5-8  
 H: 5.5-6-6.5-7-8  
 M: 5-6-8-10



1/4"

T: 25-27-30-35-40-45 M: 5-6-8-10  
 TT: 27-30-35-40-45 HH: 3-4-5-6  
 H: 5.5-6-6.5-7-8 S: 1-2  
 PH: 1-2-3 U: 4-6-8  
 PZ: 1-2-3 X: 6-8-10  
 SL: 6-6.5-8 Y: 1-2-3



5/16"

T: 25-27-30-35-40-40-45-50  
 TT: 27-30-35-40-45-50  
 H: 5.5-6-6.5-7-8  
 PH: 3-4  
 PZ: 3-4  
 SL: 6-6.5-8  
 M: 5-6-8-10



1.27-1.5-2-2.5-3-4-5 mm



Ref.	1/2	EAN
10-216	1/2	5907558463255

# Klucze nasadowe

Socket wrenches / Steckschlüssel / Набор сменных головок / Ключи торцови / Dugőkulcskészlet / Trusa tubulare / Nástrčné kľuče / Nástrčné kľuče / Nasadni ključji / Veržierakčio antgaloji / Nomaināmo galvu komplekts / Padrunviedmet / Геметемі напайніцкі за ключоце / Nasadni ključev / Ključevni natičaki / Σετ με καρδιάκια / Llaves de vaso / Set di bussole SuperLock / Chaves tubulares / Clefs à douilles / Dopsleutels



1/2" - 10-11-12-13-14-15-17-19-20-21-22-24-27-30-32 mm  
 3/8" - 10-11-12-13-14-15-16-17-18-19 mm  
 1/4" - 4-4.5-5-5.5-6-7-8-9-10-11-12-13-14 mm



1/2" - 16-17-18-19-22 mm  
 3/8" - 10-11-12-13-14-15 mm  
 1/4" - 4-5-6-7-8-9-10 mm



1/2" - E18-E20-E22-E24  
 3/8" - E8-E10-E12-E14-E16  
 1/4" - E4-E5-E6-E7-E8

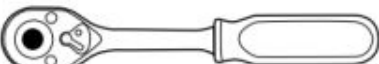

1/2" - 90T; 3/8" - 90T; 1/4" - 90T



1/2" - 125, 250 mm  
 3/8" - 125 mm  
 1/4" - 50, 100 mm



1/2" - 16, 21 mm  
 3/8" - 18 mm



1/2" - 16, 21 mm  
 3/8" - 18 mm  
 1/4" - 50, 100 mm

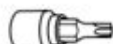

1/2" - T55-T60  
 1/4" - SL4-SL5-SL6-SL7  
 PZ1-PZ2-PZ3, PH1-PH2-PH3  
 T8-T9-T10-T15-T20-T25-T27-T30  
 TT8-TT9-TT10-TT15-TT20-TT25-TT27-TT30  
 H3-H4-H5-H6



1/4" - 115 mm



1/4" - 210 mm



1/4" - 150 mm

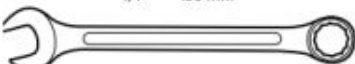

8-9-10-11-12-13-14-15-16-17-18-19 mm



5/16" - T25-T27-T30-T35-T40-T40-T45-T50  
 H5-S-H6-H7-H8, SL6-SL6.5-SL8  
 PH3-PH4, PZ3-PZ4, M5-M6-M8-M10



1/4" - H3, H4, H5, H6, H3, H4, H5, H6  
 PH1, PH2, PZ1, PZ2, T8, T10, T15, T20,  
 T25, TT10, TT15, TT20, TT25, TT40,  
 TT8, TT10, TT20, TT25, M5, M6,  
 M8, SL4, SL5, SL5.5, Tri-WING 1, 2, 3,  
 TORQ 6, 8, 10, S1, S2, SL4, SL6, SL8



1/2" - 5/16"  
 3/8" - 5/16"  
 1/4" - 5/16"



(1,27-1,5-2mm) x 2  
 2,5-3-4-5 mm



Ref.	⊞	EAN
10-076	1/2	5907558465907

# Klucze nasadowe

Socket wrenches / Steckschlüssel / Набор сменных головок / Ключи торцевые / Dugókulcskészlet / Trusa tubulare / Nástržné kľúče / Nástržné kľúče / Nasadni ključji / Veržlerakčio antgaliai / Nomaināmo galvu komplekts / Padrūnūtmed / Сменные наконечники за ключом / Nasadni ključev / Ključevni notikači / Set de carbușoara / Llaves de vaso / Set di bussole SuperLock / Chaves tubulares / Clefs à douilles / Dopsleutels



1/2" - 10-13-15-16-17-18-19-20-21-22-23-24-27-30-32 mm  
7/16", 1/2", 9/16", 5/8", 11/16", 3/4", 13/16", 7/8"  
3/8" - 10-11-12-13-14-15-16-17-18-19 mm  
1/4" - 3.5-4-4.5-5-5.5-6-6.5-7-8-9-10-11-12-13-14 mm  
3/8", 11/32", 5/16", 9/32", 1/4", 5/32", 3/16"



1/2" - 15-16-17-18-19-22 mm  
3/8" - 10-11-12-13-14-15 mm  
1/4" - 4-5-6-7-8-9-10 mm



1/2" - E16-E18-E20-E22-E24  
3/8" - E10-E11-E12-E14  
1/4" - E4-E5-E6-E7-E8



1/2" - 16, 21 mm  
3/8" - 18 mm



3/8" - 14 mm



1/2" - 125, 250 mm  
3/8" - 75, 250 mm  
1/4" - 50, 100 mm



9pcs



1/4" - 110 mm



1/4"



1/4"



1/4"



1/2"  
3/8"  
1/4"

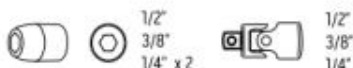

1/2"  
3/8"  
1/4" x 2



1/2"  
3/8"



1/4" 1/4"x1/4"  
1/4"x3/8"

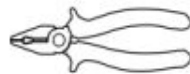

8-9-10-11-12-13-14-15-17-19-22 mm



L=75mm  
8pcs



5/16" L=30mm  
24pcs



L=25mm  
60pcs



**233**  
elements



Ref.	⊞	EAN
10-078	1/2	5907558465914

# Klucze nasadowe

Socket wrenches / Steckschlüssel / Набор сменных головок / Ключи торцевые / Dugalkulcskészlet / Trusa tubulare / Nástrčné kľúče / Nástrčné kľúče / Nasadni ključ / Veržerakzio antgalvai / Nomainiama galvu komplekts / Padriņlīdmeņi / Сменные наконечники за ключом / Nasadni ključevi / Ключеві наконечники / Setje karbidkača / Llaves de vaso / Set di bussole SuperLock / Chaves tubulares / Clefs à douilles / Dopsleutels

-  1/4": 4-4.5-5-5.5-6-7-8-9-10-11-12-13-14 mm  
3/8": 10-11-12-13-14-15-16-17-18-19 mm  
1/2": 10-11-12-13-14-15-17-19-20-21-22-24-27-30-32 mm
-  1/4": 4-5-6-7-8-9-10 mm  
3/8": 10-11-12-13-14-15 mm  
1/2": 16-17-18-19-22 mm
-  1/4": E4-E5-E6-E7-E8  
3/8": E10-E11-E12-E14-E16-E18  
1/2": E20-E22-E24
-  3/8" - 18 mm  
1/2" - 16, 21 mm

-  1/4", 72T  
3/8", 72T  
1/2", 72T

-  1/4": 50, 100 mm  
3/8": 150 mm  
1/2": 125, 250 mm

-  1/4"  
3/8"  
1/2" T55, T60

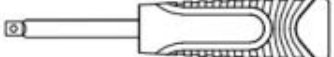
-  1/4", 150 mm

-  1/4", 115 mm  
1/2", 250 mm

-  8-10-11-12-13-14-15-16-17-18-19-22 mm

- 

-  1/4" - 1/4"  
3/8" - 5/16"  
1/2" - 5/16"  
3/8" - 10 mm  
1/2" - 10 mm

-  H: 4-5-6-7-8-10-12  
10x30 mm T: 20-25-30-40-45-50-55  
M: 5-6-8-10-12

-  H: 5.5-6-6.5-7-8  
5/16" x 30 mm M: 5-6-8-10  
T: 25-27-30-35-40-45-50  
TT: 27-30-35-40-45-50  
PH: 3-4  
PZ: 3-4  
SL: 6-6.5-8

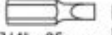
-  H: 5.5-6-6.5-7-8  
1/4" x 25 mm M: 5-6-8-10  
T: 25-27-30-35-40-45  
TT: 27-30-35-40-45  
PH: 1-2-3  
PZ: 1-2-3  
SL: 6-6.5-8  
HH: 3-4-5-6  
S: 1-2  
U: 4-6-8  
X: 6-8-10  
Y: 1-2-3

-  H: 4-5-6-7-8-10-12  
10x75 mm T: 20-25-30-40-45-50-55  
M: 5-6-8-10-12

-  1/4" T: 25-27-30-35-40-40-45-50  
TT: 27-30-35-40-45-50  
PH: 3-4  
PZ: 3-4  
SL: 6-6.5-8  
M: 5-6-8-10  
H: 5.5-6-6.5-7-8

-  1.27-1.5-2-2.5-3-4-5 mm

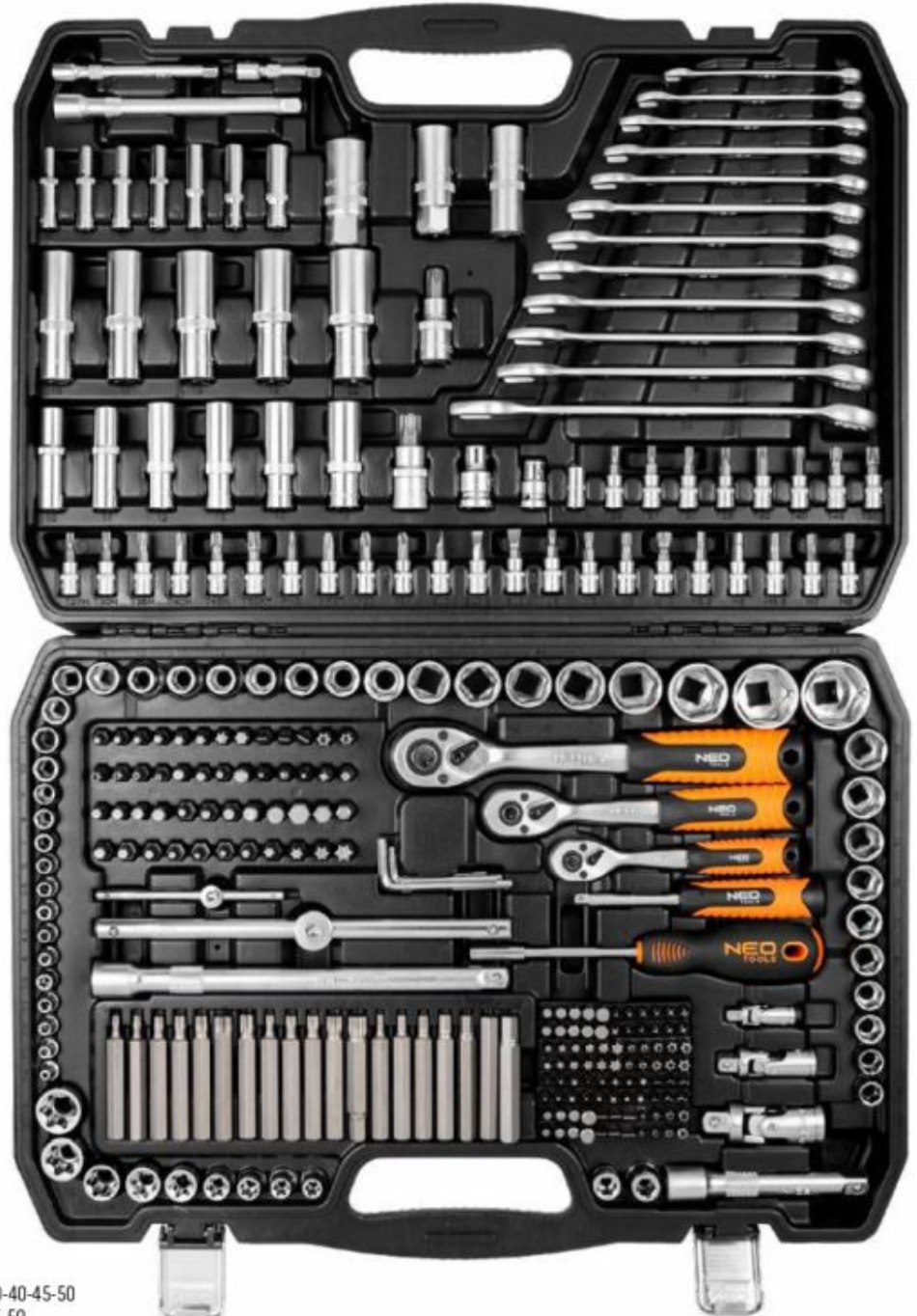

Ref.		EAN
10-218	1/4	5907558468892

## Zestaw narzędzi

Tool and socket set / Werkzeugsatz / Набор инструментов / Инструмент з насадками, набор / Szerszámkészlet / Set scule de grădini / Sada nářadí / Súprava nářadia kombi / Garnitura orodij / Įrankių komplektas / Instrumentu komplekts / Тооrистаде ја подруните комплект / Комплект инструменти / Set alata / Gedora set / Συλλογή εργαλείων / Juego de herramientas / Set di attrezza / Kit de ferramentas / Jeu d'outils / Gereedschapset

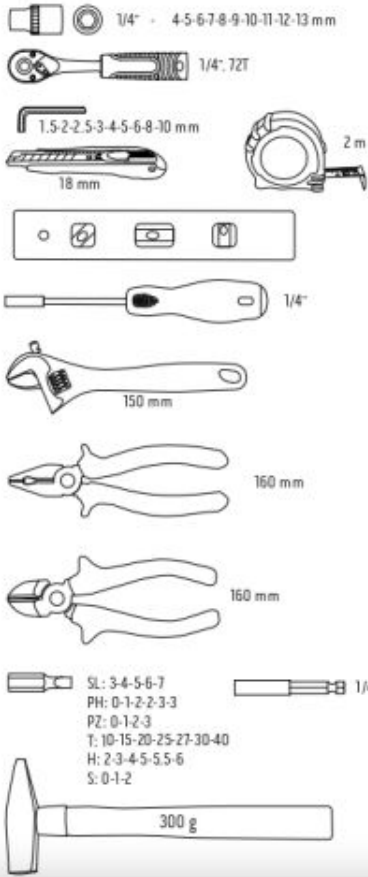

25 years  
GUARANTEE

60  
ELEMENTS

CrV  
steel

72T

STRONG  
CASE

ERGO

1/4"



60  
elements

300g

18mm

1/4"

72T

2m

1/4"

160 mm

160 mm

150 mm

160 mm

160 mm

150 mm

160 mm

160 mm

150 mm

160 mm

160 mm

150 mm

160 mm

160 mm

150 mm



Ref.	⊞	EAN
10-200	1/4	5907558463200

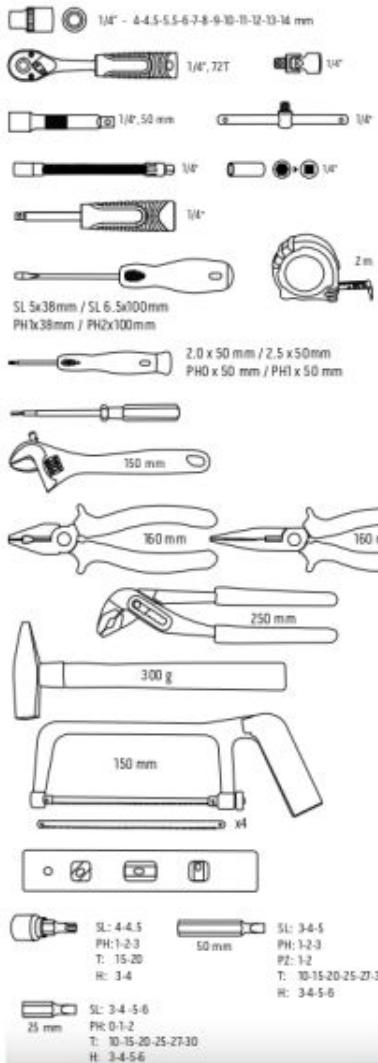

25 years  
GUARANTEE

88  
ELEMENTS

CrV  
steel

72T

STRONG  
CASE

ERGO

1/4"



88  
elements

150 mm

250 mm

160 mm

150 mm

160 mm

300g

150 mm

160 mm

300g

150 mm

160 mm

300g

150 mm

160 mm

300g

150 mm

160 mm

300g

150 mm

160 mm

300g

150 mm

160 mm

300g

150 mm

160 mm

300g

150 mm

160 mm

300g



Ref.	⊞	EAN
10-202	1/3	5907558463217

## Zestaw nasadek

Socket set / Aufsatzset / Набор вставок торцевых / Набор насадок торцевых / Dugókulcs készlet / Set duze / Sada násadek / Súprava nástr. ključov / Gamitura nasadnih ključev / Antgalių rinkinys / Mucija komplekts / Padrunkomplekt / Гедорэ нaмнн. / Set nasadnih ključeva / Gedora set / Συλλογή καρδαικίων / Llaves de vaso / Set di boccole / Kit de bicos / Jeu de douilles / Set van messen

1/4" - 4-5-5.5-6-7-8-9-10-11-12-13 mm  
3/8" - 10-11-12-13-14-15 -16-17-18-19-21-22-24 mm

1/4", 72T  
3/8", 72T

1/4"

1/4"

1/4", 100 mm

3/8", 75 mm

1/4", 50 mm

1/4" 13 mm  
3/8" 19 mm  
1/2" 19 mm

1/4" - 3/8"

1/4"

SL: 4-5-7  
PH: 1-2  
PZ: 1-2  
T: 10-15-20



25 years GUARANTEE

CrV steel

1/4" 3/8"

72T



46 elements



Ref.	☒	EAN
10-019	0/5	5907558495782



## Klucze nasadowe sześciokątne

Socket wrenches / Steckschlüssel / Набор оменных головок / Ключи торцевые / Dugőkulcskészlet / Trusa tubulara / Nástržné kľúče / Nástržné kľúče / Nasadni ključ / Veržeraklo antgalis / Normaināmo galvukomplekts / Padrinvõtmed / Оменети накрайници за ключове / Nasadni ključevi / Ključevi patkovič / Set me narobāka / Llaves de vaso / Set di bussolle SuperLock / Chaves tubulares / Clefs à douilles / Dopsleutels



1/4" - 5, 5.5, 6, 7, 8, 9, 10, 11, 12, 13, 14 mm



1/4" - 4, 5, 6, 7, 8 mm

PH1, PH2, PH3,

PZ1, PZ3, PZ2x2

TT8, TT9, TT10, TT15, TT20, TT25,

TT27, TT30, TT40

H2, H2.5, H3, H4, H5, H6, H7, H8



1/4"



Ref.	☒	EAN
08-603	0/20	5907558409307



5 - 6 - 8 - 9 - 10 - 12 mm



Ref.	☒	EAN
09-570	6/24	5907558450453

## Nasadka sześciokątna

Hexagonal socket / Sechskanteinsatz / Головка оменная шестигранная / Насадка шестигранная / Dugőkulcs / Cheie tubulara hexagonala / Šestihraný nástavec / Šestihraný nástavec / Šestkotni patični nastavek / Šešiokampis antgalis / Sešstūra normaināmo galva / Kuuskantpadrun / Шестозъелна наставка / Šesterokutna kapica / Šestougaona nasadka / Карубіа едгало / Vaso para destornillador hexagonal / Bussola esagonale / Bocal hexagonal / Douille à 6 pans / Zeskant dop

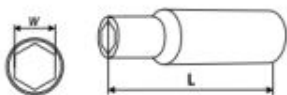

Ref.	W [mm]	L [mm]	☒	EAN
08-487	4	50	25/200	5907558423679
08-488	4.5	50	25/200	5907558423686
08-489	5	50	25/200	5907558423693
08-490	5.5	50	25/200	5907558423709
08-491	6	50	25/200	5907558423716
08-492	7	50	25/200	5907558423723
08-493	8	50	25/200	5907558423730
08-494	9	50	25/200	5907558423747
08-495	10	50	25/200	5907558423754
08-497	12	50	15/150	5907558423778
08-498	13	50	15/150	5907558423785
08-499	14	50	15/150	5907558423792

## Nasadka sześciokątna

Hexagonal socket / Sechskanteinsatz / Головка оменная шестигранная / Насадка шестигранная / Dugőkulcs / Cheie tubulara hexagonala / Šestihraný nástavec / Šestihraný nástavec / Šestkotni patični nastavek / Šešiokampis antgalis / Sešstūra normaināmo galva / Kuuskantpadrun / Шестозъелна наставка / Šesterokutna kapica / Šestougaona nasadka / Карубіа едгало / Vaso para destornillador hexagonal / Bussola esagonale / Bocal hexagonal / Douille à 6 pans / Zeskant dop

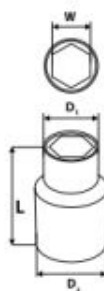

Ref.	W [mm]	L [mm]	D <sub>1</sub> [mm]	D <sub>2</sub> [mm]	☒	EAN
08-220	4	25	7	12	100/500	5907558403787
08-221	4.5	25	7.5	12	100/500	5907558403794
08-222	5	25	8	12	25/200	5907558403800
08-223	5.5	25	8.5	12	25/200	5907558403817
08-224	6	25	9	12	100/200	5907558403824
08-225	7	25	10.5	12	25/200	5907558403831
08-226	8	25	12	12	25/200	5907558403848
08-227	9	25	13	13	50/500	5907558403855
08-228	10	25	14	14	25/200	5907558403862
08-229	11	25	16	16	50/500	5907558403879
08-230	12	25	17	17	15/150	5907558403886
08-231	13	25	18	18	15/150	5907558403893
08-232	14	25	20	20	50/500	5907558403909

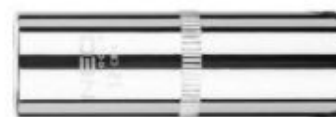
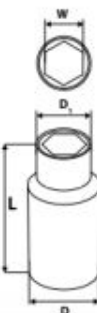

Ref.	W [mm]	L [mm]	D <sub>1</sub> [mm]	D <sub>2</sub> [mm]	☒	EAN
08-235	4	50	7	12	50/500	5907558412055
08-236	4.5	50	7.5	12	50/500	5907558412062
08-237	5	50	8	12	50/500	5907558412079
08-238	5.5	50	8.5	12	50/500	5907558412086
08-239	6	50	9	12	50/500	5907558412093
08-240	7	50	10.5	12	25/200	5907558412109
08-241	8	50	12	12	50/200	5907558412116
08-242	9	50	13	13	50/200	5907558412123
08-243	10	50	14	14	25/200	5907558412130
08-244	11	50	16	16	50/150	5907558412147
08-245	12	50	17	17	50/300	5907558412154
08-246	13	50	18	18	50/150	5907558412161
08-247	14	50	20	20	50/150	5907558412178

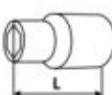

Ref.	W [mm]	L [mm]	☒	EAN
08-442	4	25	25/200	5907558423280
08-443	4.5	25	25/200	5907558423297
08-444	5	25	25/200	5907558423303
08-446	6	25	25/200	5907558423327
08-447	7	25	25/200	5907558423334
08-448	8	25	25/200	5907558423341
08-449	9	25	25/200	5907558423358
08-450	10	25	25/200	5907558423365
08-451	11	25	15/150	5907558423372
08-452	12	25	15/150	5907558423389
08-453	13	25	15/150	5907558423396
08-454	14	25	15/150	5907558423402



## Nasadka sześciokątna

Hexagonal socket / Sechskanteinsatz / Головка сменная шестигранная / Nasadka szesciokątna / Dugókulcs / Cheie tubulara hexagonală / Šestihranjnj nástavec / Šestihranjnj nástavec / Šestkotni natični nastavek / Šešakampis angtalis / Sešstūra patainātā galva / Kuskantrpadrun / Шестъгълна наставка / Šesterokutna kapica / Šestougaona nasadka / Капубіа шітькува / Vaso para destornillador hexagonal / Bussola esagonale / Bocal hexagonal / Douille à 6 pans / Zeskant dop



Ref.	W [mm]	L [mm]	☒	EAN
08-168	8	30	20/200	5907558422757
08-170	10	30	20/200	5907558422764
08-171	11	30	20/200	5907558422771
08-172	12	30	20/200	5907558422788
08-173	13	30	20/200	5907558422795
08-174	14	30	20/200	5907558422801
08-175	15	30	20/200	5907558422818
08-176	16	30	20/200	5907558422825
08-177	17	30	20/200	5907558422832
08-178	18	30	20/200	5907558422849
08-179	19	30	20/200	5907558422856
08-180	20	30	20/200	5907558422863
08-181	21	30	20/200	5907558422870
08-182	22	30	20/200	5907558422887

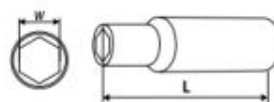

Ref.	W [mm]	L [mm]	☒	EAN
08-184	8	63	20/200	5907558422894
08-185	10	63	20/200	5907558422900
08-186	11	63	20/200	5907558422917
08-187	12	63	20/200	5907558422924
08-188	13	63	20/200	5907558422931
08-189	14	63	20/200	5907558422948
08-190	15	63	20/200	5907558422955
08-191	16	63	20/200	5907558422962
08-192	17	63	20/200	5907558422979
08-193	18	63	20/200	5907558422986
08-194	19	63	20/200	5907558422993
08-195	20	63	20/100	5907558423006
08-196	21	63	20/100	5907558423013
08-197	22	63	20/100	5907558423020

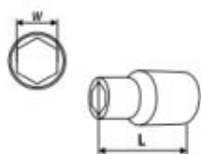

Ref.	W [mm]	L [mm]	☒	EAN
08-408	8	38	20/200	5907558423037
08-409	9	38	20/200	5907558423044
08-410	10	38	20/200	5907558423051
08-411	11	38	20/200	5907558423068
08-412	12	38	20/200	5907558423075
08-413	13	38	20/200	5907558423082
08-414	14	38	20/200	5907558423099
08-415	15	38	20/200	5907558423105
08-416	16	38	20/200	5907558423112
08-417	17	38	20/200	5907558423129
08-418	18	38	20/200	5907558423136
08-419	19	38	20/200	5907558423143
08-421	21	38	20/200	5907558423167
08-422	22	38	20/200	5907558423174
08-423	23	38	20/200	5907558423181
08-424	24	38	20/200	5907558423198
08-425	25	38	10/100	5907558423204
08-426	26	42	10/100	5907558423211
08-427	27	42	10/100	5907558423228
08-429	29	44	10/100	5907558423242
08-430	30	44	10/100	5907558423259
08-431	31	44	10/100	5907558423266
08-432	32	44	10/100	5907558423273

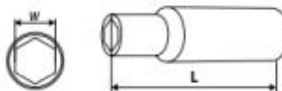

Ref.	W [mm]	L [mm]	☒	EAN
08-458	8	77	20/200	5907558423419
08-459	9	77	20/200	5907558423426
08-460	10	77	20/200	5907558423433
08-461	11	77	20/200	5907558423440
08-462	12	77	20/200	5907558423457
08-463	13	77	20/200	5907558423464
08-464	14	77	20/200	5907558423471
08-465	15	77	20/200	5907558423488
08-466	16	77	20/200	5907558423495
08-467	17	77	20/200	5907558423501
08-468	18	77	20/200	5907558423518
08-469	19	77	20/200	5907558423525
08-470	20	77	20/100	5907558423532
08-471	21	77	20/100	5907558423549
08-472	22	77	20/100	5907558423556
08-473	23	77	20/100	5907558423563
08-474	24	77	20/100	5907558423570
08-475	25	77	10/50	5907558423587
08-476	26	77	10/50	5907558423594
08-477	27	77	10/50	5907558423601
08-478	28	77	10/50	5907558423617
08-479	29	77	10/50	5907558423624
08-480	30	77	10/50	5907558423631
08-482	32	77	10/50	5907558423655
08-486	36	77	4/40	5907558423662



## Nasadka sześciokątna

Hexagonal socket / Sechskanteinsatz / Головка оменная шестигранная / Nasadka szestiuranna / Dugökülés / Cheie tubulara hexagonală / Šestihranjý nástavec / Šestihranjý nástavec / Šestkotni natični nastavek / Šešakampis antgulis / Sešstūra ponaipaiñā galva / Kiuskantpadru / Шестьугольная насадка / Šesterokutna kopica / Šestougaona nasadka / Карубіа сфіркова / Vaso para destornillador hexagonal / Bussola esagonale / Bocal hexagonal / Douille à 6 pans / Zeskant dop

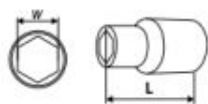

Ref.	W [mm]	L [mm]	☒	EAN
08-008	8	38	20/200	5907558403503
08-009	9	38	20/200	5907558403510
08-010	10	38	20/100	5907558402353
08-011	11	38	20/100	5907558403527
08-012	12	38	20/100	5907558402360
08-013	13	38	20/200	5907558402377
08-014	14	38	20/100	5907558408232
08-015	15	38	20/200	5907558402384
08-016	16	38	20/200	5907558403534
08-017	17	38	20/200	5907558402391
08-018	18	38	20/200	5907558403541
08-019	19	38	20/200	5907558402407
08-020	20	38	10/100	5907558412451
08-021	21	38	20/200	5907558403558
08-022	22	38	20/200	5907558402414
08-023	23	38	10/100	5907558412468
08-024	24	38	20/100	5907558402421
08-025	25	38	10/100	5907558412475
08-026	26	42	10/100	5907558403565
08-027	27	42	10/100	5907558402438
08-028	28	42	10/100	5907558403572
08-029	29	44	10/100	5907558403589
08-030	30	44	10/100	5907558402445
08-032	32	44	10/100	5907558402452
08-036	36	44	10/0	5907558403602

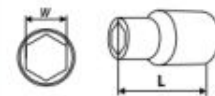

Ref.	W [mm]	L [mm]	☒	EAN
08-300	19	51	10/80	5907558404180
08-301	21	51	10/100	5907558410600
08-302	22	51	10/80	5907558404197
08-304	24	51	10/100	5907558404203
08-306	27	52	10/80	5907558404210
08-307	28	52	10/60	5907558412543
08-308	30	54	10/60	5907558404227
08-309	32	56	10/60	5907558404234
08-316	34	56	10/60	5907558410624
08-319	35	57	10/60	5907558412567
08-311	36	59	10/40	5907558404241
08-312	38	60	10/40	5907558404258
08-313	41	64	10/40	5907558404265
08-314	46	68	10/20	5907558404272
08-315	50	72	10/20	5907558404289
08-340	55	76	10/20	5907558412574
08-341	60	78	10/20	5907558412581



## Nasadka dwunastokątna

Bi-hexagonal socket / Zwölfkanteinsatz / Головка оменная двенадцатигранная / Nasadka dwanaiciuranna / Dugökülés 12 pontos / Cheie tubulara, priză în 12 pute / Dvanašihranjý nástavec / Dvanašihranjý nástavec / Dvanašikotni nasadni ključ / Dvyliakampis antgulis / Dvirašmitstūra ponaipaiñā galva / Kaksteiskantpadru / Дванадцетьугольная насадка / Dvanašterokutna kopica / Dvanašougaona nasadka / Карубіа двьдцекіува / Vaso destornillador de encaje dodecagonal / Bussola Spine / Bocal de doze angulos / Douille à 12 pans / Twaalfkant dop

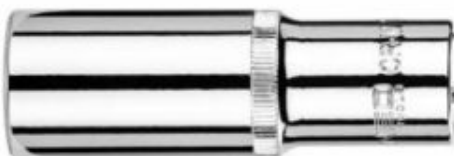
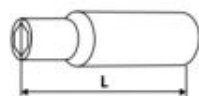

Ref.	W [mm]	L [mm]	☒	EAN
08-039	8	77	12/144	5907558410501
08-040	9	77	20/200	5907558410518
08-041	10	77	20/200	5907558402469
08-052	11	77	20/176	5907558410525
08-042	12	77	20/200	5907558402476
08-043	13	77	20/200	5907558402483
08-053	14	77	20/176	5907558410532
08-044	15	77	20/200	5907558402490
08-054	16	77	12/144	5907558410549
08-045	17	77	20/200	5907558402506
08-055	18	77	20/96	5907558410556
08-046	19	77	20/200	5907558402513
08-056	21	77	6/96	5907558410563
08-047	22	77	6/96	5907558402520
08-058	23	77	6/72	5907558412499
08-048	24	77	6/72	5907558402537
08-049	27	77	10/100	5907558402544
08-050	30	77	10/50	5907558402551
08-051	32	77	6/48	5907558402568

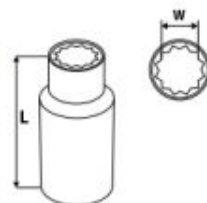

Ref.	W [mm]	L [mm]	☒	EAN
08-070	10	77	8/200	5907558405613
08-086	11	77	12/144	5907558410594
08-071	12	77	20/200	5907558405620
08-072	13	77	12/200	5907558405637
08-073	14	77	20/200	5907558408249
08-074	15	77	12/144	5907558405644
08-075	16	77	20/200	5907558406078
08-076	17	77	20/200	5907558405651
08-077	18	77	6/96	5907558406085
08-078	19	77	6/96	5907558405668
08-080	21	77	6/96	5907558408256
08-081	22	77	6/120	5907558405675
08-082	24	77	6/72	5907558405682
08-083	27	77	6/72	5907558405699
08-084	30	77	10/50	5907558405705
08-085	32	77	6/948	5907558405712



## Nasadka dwunastokątna

Bi-hexagonal socket / Zwölfkanteinsatz / Головка сменная двенадцатигранная / Nasadka dwanaściekątowa / Dugôkulcs 12 pontos / Cheie tubulara, prize in 12 pute / Dvanáctihřanný nástavec / Dvanáctihřanný nástavec / Dvanajstkotni nasadni ključ / Dvyřikakampis antgalis / Divradsmētūra notaiņāmā galva / Kaksteistikantpadrun / Дванадесетозъелна наставка / Dvanaesterokutna kapica / Dvanaestougona nasadka / Καρυδάκι δωδεκάγωνο / Vaso destornillador de encaje dodecagonal / Bussola Spline / Bocał de doze ngulos / Douille  12 pans / Twaalfkant dop

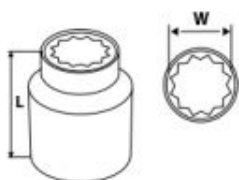

Ref.	W [mm]	L[mm]		EAN
08-320	19	50	10/80	5907558406108
08-333	21	52	10/80	5907558410631
08-321	22	50	10/80	5907558406115
08-322	24	51	10/80	5907558406122
08-323	27	52	10/80	5907558406139
08-324	30	54	10/60	5907558406146
08-325	32	56	10/60	5907558406153
08-335	34	56	10/60	5907558410655
08-326	36	58	10/60	5907558406160
08-327	38	60	10/40	5907558406177
08-328	41	64	10/40	5907558406184
08-329	46	68	10/20	5907558406191
08-331	55	76	10/20	5907558406214
08-332	60	79	10/20	5907558406221



Ref.	W [mm]	L[mm]		EAN
08-580	8	38	10/200	5907558408263
08-581	9	38	10/100	5907558408270
08-582	10	38	20/100	5907558408287
08-583	11	38	10/100	5907558408294
08-584	12	38	10/100	5907558408300
08-585	13	38	10/200	5907558408317
08-586	14	38	10/200	5907558408324
08-587	15	38	10/100	5907558408331
08-588	16	38	10/200	5907558408348
08-589	17	38	10/200	5907558408355
08-590	18	38	10/200	5907558408362
08-591	19	38	10/100	5907558408379
08-592	20	38	10/100	5907558408386
08-593	21	38	10/100	5907558408393
08-594	22	38	10/100	5907558408409
08-595	23	38	10/100	5907558412505
08-596	24	38	10/200	5907558408416
08-597	27	42	10/100	5907558408423
08-598	30	44	10/100	5907558408430
08-599	32	44	10/100	5907558408447



MM	10	12	13	15	17	19	22	24
INCH	3/8	15/32	1/2	19/32		3/4	7/8	15/16
STAR	E12	E16				E24		



Ref.	W [mm]		EAN
08-651	10,12,13,15,17,19,22,24	0/30	5907558406290



MM	10	12	13	15	17	19	22	24
INCH	3/8	15/32	1/2	19/32		3/4	7/8	15/16
STAR	E12	E16				E24		



Ref.	W [mm]	m[kg]		EAN
08-650	10,12,13,15,17,19,22,24	1,1	0/20	5907558406283

## Grzechotka

Ratchet handle / Ratsche / Трещотка / Держак з трещоткою / Rasznikuls / Mner de hurluboare / Řeřtařka / Rařna prepinacia / Rařja / Terkřte / Reversa atslga / Prkratka pide / Трещотка / Rařva za nasadni ključ / Rařva za gedoru / Καρυδάκι / Llave de carraca / Cricchetto / Catraca de furar / Cl  cliquet / Roteł



Ref.	Info	L[mm]		EAN
10-300	1/2"	285	1/10	5907558467338



Ref.	Info	L[mm]		EAN
08-530	1/4"	155	10/50	5907558435689
08-533	3/8"	200	5/25	5907558435696
08-536	1/2"	250	5/20	5907558435702

## Grzechotka

Ratchet handle / Ratsche / Трещотка / Держак з тріщоткою / Racsnikulcs / Miner de hurluitoare / Řehtačka / Račna prepinacia / Raglja / Terkšle / Reversa atslēga / Pirkrotta pide / Трещотка / Račva za nasadni ključ / Račva za gedoru / Κατάνιά / Llave de carroca / Cricchetto / Catraca de furar / Clé à cliquet / Roteel



Ref.	Info	L[mm]	☒	EAN
08-540	1/4"	155	5/50	5907558435719
08-543	3/8"	200	5/25	5907558435726
08-546	1/2"	250	5/20	5907558435733



Ref.	Info	L[mm]	☒	EAN
08-504	1/4"	150	10/50	5907558420708
08-508	3/8"	210	6/48	5907558420715
08-521	1/2"	265	5/25	5907558420722



Ref.	Info	L[mm]	☒	EAN
08-523	1/4"	155	6/72	5907558432190
08-524	3/8"	200	6/48	5907558432206
08-525	1/2"	250	6/36	5907558432213



Ref.	Info	Lmin[mm]	Lmax[mm]	☒	EAN
08-502	1/4"	150	200	10/50	5907558412802
08-515	1/2"	305	445	0/25	5907558408546



Ref.	Info	L[mm]	☒	EAN
08-519	1/2"	285	0/24	5907558410167



Ref.	Info	L[mm]	☒	EAN
08-503	1/4"	145	10/50	5907558412819
08-507	3/8"	195	5/60	5907558412833
08-520	1/2"	255	5/25	5907558412840



Ref.	Info	L[mm]	☒	EAN
08-514	1/4"	150	12/72	5907558406276
08-513	3/8"	200	12/48	5907558406269
08-511	1/2"	250	0/24	5907558402605



Ref.	Info	L[mm]	☒	EAN
08-516	1/2"	255	6/24	5907558409291



Ref.	Info	L[mm]	☒	EAN
08-355	3/4"	500	0/16	5907558404449



Ref.	Info	L[mm]	☒	EAN
08-512	1/4"	105	10/60	5907558403305



Ref.	Info	L[mm]	☒	EAN
08-501	1/4"	105	10/100	5907558412185

## Pokręto

Wheel / Drehknopf / Вороток / Маховик / Hajtőkar / Цупă / Otočnjí knoflík / Ovládacie koliesko / Ragla / Rankena / Grietzwiel / Nupp / Върток / Κοταβίσι / Ručica / Pápolo / Mango / Impugnatura a L / Botão / Tourne-à-gauche / Draaiknop



25 years GUARANTEE



CrV steel

DIN 3122



Ref.	Info	L[mm]	☒	EAN
08-256	1/4"	110	20/200	5907558403961
08-155	3/8"	165	20/100	5907558403770
08-555	1/2"	250	5/25	5907558402650
08-353	3/4"	460	10/10	5907558404425

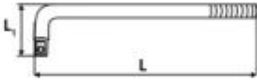

25 years GUARANTEE



CrV steel



Ref.	Info	L[mm]	L <sub>1</sub> [mm]	☒	EAN
08-556	1/2"	250	75	0/40	5907558408607
08-357	3/4"	450	110	0/10	5907558405873

## Przedłużka

Extension bar / Verlängerung / Удлинитель / Подовижувач / Toldószár / Prolongator / Prodłużovák / Predĺženie / Podajšček / Ilgkúlis / Pagarinātājs / Pikenodusvarpas / Удължител / Produziona poluga / Προέκταση / Alargadera / Prolunga / Extensão / Prolongation / Verlengstuk

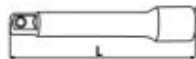

25 years GUARANTEE



CrV steel

DIN 3123



Ref.	L[mm]	Info	☒	EAN
08-251	50	1/4"	20/200	5907558403916
08-252	75	1/4"	20/200	5907558403923
08-253	100	1/4"	25/50	5907558403930
08-254	150	1/4"	25/50	5907558403947
08-151	75	3/8"	20/200	5907558403732
08-152	125	3/8"	20/200	5907558403749
08-153	150	3/8"	20/100	5907558403756
08-552	125	1/2"	10/50	5907558402636
08-554	250	1/2"	10/50	5907558402643
08-350	100	3/4"	10/40	5907558404296
08-351	200	3/4"	10/20	5907558404302
08-352	400	3/4"	0/10	5907558404418



Przedłużka elastyczna  
Flexible extension  
Удлинитель гибкий



Ref.	□	L[mm]	M <sub>max</sub> [Nm]	☒	EAN
08-557	1/4"	140	5	25/100	5907558402667
08-558	1/2"	190	40	10/80	5907558402674



CrV steel

## Rękojeść z przegubem

Flex handle / Handgriff mit Gelenk / Вороток / Ручка з шарніром / Hajtőkar flexibilis / Maner cu articulare / Kloubové vrotadlo / Kľbová rukoväť / Ročaj z zglobov / Rankena su lankstu / Pagarinātājs mucipatslēgai / Liigendiga käepide / Ръкохватка с шарнир / Drška sa zglobom / Drška sa zglobom / Μανέλα ογκοβαίνουσα / Mango con articulación / Impugnatura telescopica / Cabo com Articulação / Poignée articulée / Handvat met spilverbinding



25 years GUARANTEE



CrV steel

1/2"



Ref.	L <sub>min</sub> [mm]	L <sub>max</sub> [mm]	☒	EAN
08-553	470	620	5/20	5907558409598

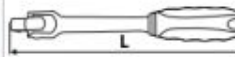

25 years GUARANTEE



CrV steel

1/2"



Ref.	L[mm]	☒	EAN
08-559	250	10/40	5907558403367
08-560	450	10/20	5907558403374

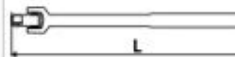

25 years GUARANTEE



CrV steel

3/4"



Ref.	L[mm]	☒	EAN
08-356	510	0/10	5907558404456

## Przegub

Articulated joint / Gelenk / Шарнир / Цвено / Kardáncukló / Articulație / Kloub / Čap / Zglob / Lanktas / Šarnirs / Klamber / Шарнир / Zglob / Zglob / Μεντερές / Articulación / Giunto articolato / Articulação / Articulation / Spilverbinding

25 years GUARANTEE



CrV steel

DIN 3123



Ref.	Info	L[mm]	☒	EAN
08-255	1/4"	35	50/400	5907558403954
08-154	3/8"	50	50/400	5907558403763
08-551	1/2"	65	10/80	5907558402629

## Redukcja / Adapter

Adapter / Reduzierstück / Переходник / Перехідник / Adapter / Adaptor / Redukce / Redukcia / Adapter / Adapteris / Páreja / Адаптор / Adapter / Προσαρμογέας / Adaptador / Adattore / Redução / Réduction / Reductiestuk

25 years GUARANTEE



CrV steel

DIN 3123



Ref.	Info	L[mm]	☒	EAN
08-562	1/4" M x 3/8" F	26	10/100	5907558403329
08-563	3/8" M x 1/2" F	37	10/100	5907558403336
08-565	1/2" M x 3/4" F	50	40/40	5907558403350
08-564	3/4" M x 1/2" F	46	10/100	5907558403343
08-550	1/2" M x 3/8" F	27	25/200	5907558402612

## Końcówka Spline na nasadce

Spline bit / Spline-Endstück / Наконечник „Spline“ / Наконечник „Spline“ / Spline bit / Punct Spline / Nástavec Spline / Nástavec Spline / Nástavec Spline / Antgalis Spline / Užgalis Spline / Splīne-otsak / Накрайник Spline / Nastavak Spline / Nastavak Spline / Μύτη Spline / Punta Spline / Inserto Spline su bussola / Ponteiro Spline / Embout Spline / Splīne eindstuk



Ref.	Info	L[mm]	☒	EAN
08-730	M5	55	12/144	5907558411911
08-731	M6	55	12/144	5907558411928
08-732	M8	55	12/144	5907558411935
08-733	M10	55	12/144	5907558411942
08-734	M12	55	12/160	5907558411959
08-735	M14	55	12/160	5907558411966
08-736	M16	55	12/144	5907558411973



Ref.	Info	L[mm]	☒	EAN
08-740	M5	100	12/96	5907558411980
08-741	M6	100	12/96	5907558411997
08-742	M8	100	12/96	5907558412000
08-743	M10	100	12/96	5907558412017
08-744	M12	100	12/96	5907558412024
08-745	M14	100	12/96	5907558412031
08-746	M16	100	12/96	5907558412048



## Końcówka na nasadce

Bit on socket / Einsatz auf Aufsatz / Головка сменная с насадкой / Наконечник на насадку / Bit / Cap tubulara cu antrenor / Konecowa na nastawce / Konecowa na nastawce / Nastavek za nasadni ključ / Torcinis antgalis su laikikliu / Nomaināmā galva ar uzgali / Otsak padrunī / Накрайник на наставката / Nastavak na kapici / Nastavak za nasadke / Καρβύκι με μύτη / Vaso / Inserto can bussola / Ponteiros no bico / Embouts sur ajutage / Eindstuk op dop



Ref.	Info	L[mm]	☒	EAN
10-316	PH1	37	20/200	5907558471243
10-317	PH2	37	20/200	5907558471250
10-318	PH3	37	20/200	5907558471267
10-319	PZ1	37	20/200	5907558471274
10-320	PZ2	37	20/200	5907558471281
10-321	PZ3	37	20/200	5907558471298



Ref.	Info	L[mm]	☒	EAN
10-334	PH1	87	30/300	5907558471427
10-335	PH2	87	30/300	5907558471434
10-336	PH3	87	30/300	5907558471441
10-337	PZ1	87	30/300	5907558471458
10-338	PZ2	87	30/300	5907558471465
10-339	PZ3	87	30/300	5907558471472

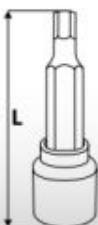

## Końcówki sześciokątne na nasadce

Hexagonal bits on socket / Sechskanteinsätze auf Aufsatz / Головки шестигранные с насадкой / Наконечники шестигранные на насадку / Imbus bit / Trusa capete tubulara cu antrenor / Konecovky šestihranné na nastawce / Šestihranné konecovky na nastawce / Šestkotni nastavki za nasadni ključ / Šešakamprija antgalisi su laikikliu / Nomaināmā galva ar sešstūra uzgaliem / Kuuskkantotsak padrunī / Шестъъгълни накрайници на наставката / Šesterokutni nastavi na kapici / Šestoagoni nastavi za nasadke / Καρβύκια με έξιγώνες / Vasos destornilladores hexagonales / Inserto esagonale can bussola / Ponteiros hexagonais no bico / Embouts à 6 pans sur ajutage / Zeskant eindstukken op dop



Ref.	Info	L[mm]	☒	EAN
10-310	H3	37	20/200	5907558471182
10-311	H4	37	20/200	5907558471199
10-312	H5	37	20/200	5907558471205
10-313	H6	37	20/200	5907558471212
10-314	H7	37	20/200	5907558471229
10-315	H8	37	20/200	5907558471236



Ref.	Info	L[mm]	☒	EAN
10-329	H4	87	30/300	5907558471373
10-330	H5	87	30/300	5907558471380
10-331	H6	87	30/300	5907558471397
10-332	H7	87	30/300	5907558471403
10-333	H8	87	30/300	5907558471410



Ref.	Info	L[mm]	☒	EAN
08-770	H5	55	20/140	5907558409765
08-771	H6	55	12/144	5907558409772
08-772	H7	55	20/160	5907558409789
08-773	H8	55	12/144	5907558409796
08-774	H10	55	20/160	5907558409802
08-775	H12	55	20/160	5907558409819
08-776	H14	55	20/160	5907558409826
08-777	H17	55	20/160	5907558409833
08-778	H19	55	12/96	5907558409840



Ref.	Info	L[mm]	☒	EAN
08-780	H5	100	12/96	5907558409857
08-781	H6	100	20/100	5907558409864
08-782	H7	100	12/96	5907558409871
08-783	H8	100	20/100	5907558409888
08-784	H10	100	20/100	5907558409895



## Końcówki sześciokątne na nasadce

Hexagonal bits on socket / Sechskanteinsätze auf Aufsatz / Головки шестигранные с насадкой / Наконечники шестигранные на насадку / Imbusz bit / Trusa capete tubulare cu antrenor / Końcówki szóstihranne na nástavce / Šestihhranné koncovky na nástavce / Šestkotni nastavki za nasadni kjuč / Šestiokotriai antgaliar su laikikli / Normainämät galva ar sešštira izgajiem / Kuusiokanto tsakud padrunit / Шестоъгелни накрайници на наставката / Šesterokutni nastavci na kapici / Šestougooni nastavci za nasadke / Καρυδιά με μήκος εξάρτησης / Vasos destornilladores hexagonales / Inserto esagonale con bussola / Ponteiros hexagonais no bico / Embouts à 6 pans sur ajutage / Zeskant eindstukken op dop

● H4, H5, H6, H7, H8, H10, H12, H14, H17



Ref.	L[mm]	📦	EAN
08-705	55	0/12	5907558409253

● H4, H5, H6, H7, H8, H10, H12, H14, H17



Ref.	L[mm]	📦	EAN
08-706	100	0/12	5907558409260

## Końcówki Torx na nasadce

Torx bit on socket / Torx-Ersatz auf Aufsatz / Головка сменная с насадкой Torx / Наконечник «Торкс» на насадку / Torx bit / Cap tubulara cu antrenor torx / Końcówka Torx na nástavce / Końcówka Torx na nástavce / Nastavek Torx za nasadni kjuč / Torcinis antgaliar su laikikli / Normainämät galva ar Torx izgaji / Torx-otsak padrunit / Накрайник Torx на наставката / Nastavak Torx na kapici / Nastavak Torx za nasadke / Καρυδιά με μήκη Torx / Vaso torx / Inserto Torx con bussola / Ponteiros Torx no bico / Embouts Torx sur ajutage / Trox eindstuk op dop

25 years GUARANTEE S2 steel CrV steel 1/4"



Ref.	Info	L[mm]	📦	EAN
10-322	T10	37	20/200	5907558471304
10-323	T15	37	20/200	5907558471311
10-324	T20	37	20/200	5907558471328
10-325	T25	37	20/200	5907558471335
10-326	T27	37	20/200	5907558471342
10-327	T30	37	20/200	5907558471359
10-328	T40	37	20/200	5907558471366



25 years GUARANTEE S2 steel CrV steel 1/4"



Ref.	Info	L[mm]	📦	EAN
10-340	T10	87	30/300	5907558471489
10-341	T15	87	30/300	5907558471496
10-342	T20	87	30/300	5907558471502
10-343	T25	87	30/300	5907558471519
10-344	T27	87	30/300	5907558471526
10-345	T30	87	30/300	5907558471533
10-346	T40	87	30/300	5907558471540



25 years GUARANTEE TÜV Rheinland CERTIFIED S2 steel CrV steel 1/2"



Ref.	Info	L[mm]	📦	EAN
08-750	T20	55	12/144	5907558409604
08-751	T25	55	12/144	5907558409611
08-752	T27	55	12/144	5907558409628
08-753	T30	55	12/144	5907558409635
08-754	T40	55	20/160	5907558409642
08-755	T45	55	20/160	5907558409659
08-756	T50	55	12/144	5907558409666
08-757	T55	55	20/160	5907558409673
08-758	T60	55	12/144	5907558417388
08-759	T70	55	12/144	5907558417395



25 years GUARANTEE TÜV Rheinland CERTIFIED S2 steel CrV steel 1/2"



Ref.	Info	L[mm]	📦	EAN
08-760	T20	100	12/96	5907558409680
08-761	T25	100	20/100	5907558409697
08-762	T27	100	20/100	5907558409703
08-763	T30	100	20/100	5907558409710
08-764	T40	100	12/96	5907558409727
08-765	T45	100	20/100	5907558409734
08-766	T50	100	20/100	5907558409741
08-767	T55	100	20/100	5907558409758

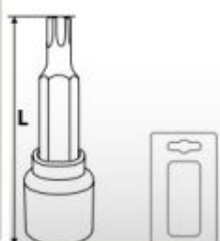

## Końcówki Torx na nasadce

Torx bit on socket / Torx-Einsatz auf Aufsatz / Галванка сменная с насадной Torx / Наконечник «Torx» на насадку / Torx bit / Cap tubulara cu antrenor torx / Концовка Torx на наставку / Концовка Torx на наставку / Nastavek Torx za nasadni ključ / Torcinis antigābis su laikklū / Νοτιαινότῃ γαλβῶν ἢ Torx ἰσχυγῶν / Torx-otsak padrunil / Накрайник Torx на наставката / Nastavok Torx na kapici / Nastavok Torx za nasadke / Καρυδιά με μύτη Torx / Vaso torx / Inserto Torx con bussola / Ponteiros Torx no bico / Embouts Torx sur ojutage / Trax eindstuk op dop

T20, T25, T27, T30, T40, T45, T50, T55, T60

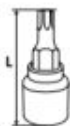

H6, H7, H8, H10, H12  
T25, T30, T40, T45, T50, T60  
M6, M8, M10, M12, M14

T20, T25, T27, T30, T40, T45, T50, T60



H5, H6, H7, H8, H10, H12, H14, H17, H19  
T20, T25, T27, T30, T40, T45, T50, T55, T60, T70  
M5, M6, M8, M10

Ref.	L[mm]	☒	EAN
08-707	55	0/12	5907558409277

T20, T25, T27, T30, T40, T45, T50, T55, T60

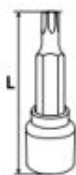

Ref.	L[mm]	☒	EAN
08-708	100	0/12	5907558409284

Ref.	☒	EAN
08-713	0/3	5907558420180

## Końcówki i nasadki torx

Torx bits and socket set / Torx-Aufsätze / Наконечники и галванни таруцеве Torx / Хабір жеп та насадок «torx» / Torx kulcskészlet / Set canule "torx" și juiări / Bity a nástavce Torx / Suprava ključov torx / Garnitura nastavkov z vpenjalom / Antgali Torx ir galvnič rinkinys / Torx atslėgu un muciju komplekts / "Torx" atsikute ja padrunite komplekt / Вложки и накрайници / Set Nasadnih ključeva I biceva / Set biceva I gedora / Συλλογή από μύτες και καρυδιά / Puntas destornilladoras y vasos TORX / Inserti Torx / Ponteiros e Bocais Torx / Embouts et douilles Torx / Torx eindstukken en doppen

E4, E5, E6, E7, E8, E10, E11, E12, E14, E16, E18, E20  
T10, T15, T20, T25, T27, T30, T40, T45, T50, T55, T60  
TT10, TT15, TT20, TT25, TT27, TT30, TT40, TT45, TT50, TT55





Ref.	☒	EAN
08-711	0/12	5907558417111



## Nasadki Torx

Torx sockets / Torx-Aufsätze / Γαλβάνι σμεννίε Torx / Ησαδνι «Torx» / Torx kulus / Tubulara cu capat torx / Nástavce Torx / Nástavce Torx / Nasadni ključ Torx / Torciniai antgaliai / Torx nomaināmas galviņas / Torx-padrinid / Ηαστανι Torx / Karice Torx / Nasadke Torx / Αντιλλακτικές μίτες Torx / Vasos torx / Bussole Torx / Bocais Torx / Douilles Torx / Torx doppen

  E10, E11, E12, E14, E16, E18, E20, E22, E24





Ref.		EAN
08-649	0/15	5907558417074

## Κοιτόκωκι κρέτακωκε

Driver bits / Einsätze für Schraubendreher / Ηασδνι / Ηακωνενηικι σκρηνμοι / Dugókulus bitkészet / Set bit / Šroubovákové nástavce / Skrutkovacie nástavce / Nastavki za izvijače / Atsuktuvo antgaliai / Skrūvgrieža uzgaļi / Kruvikeerajatsakud / Ηακρηνιικι κω σκερηκνι / Nastavci za odvijač / Nastavci za odvijač / Καταβιδόμετες / Puntas destornilladoras / Inserti lunghi e corti / Ponteiros Chave de fenda / Embouts de tournevis / Schraubendreherereinstücken

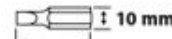

 ± 10 mm  
L 30 mm

 ± 10 mm  
L 75 mm

-  30 mm: T20, T25, T30, T40, T45, T50, T55  
75 mm: T20, T25, T30, T40, T45, T50, T55
-  30 mm: H4, H5, H6, H7, H8, H10, H12  
75 mm: H4, H5, H6, H7, H8, H10, H12
-  30 mm: M5, 6, 8, 10, 12  
75 mm: M5, 6, 8, 10, 12

    
3/8" > 10 mm  
1/2" > 10 mm

   
   
   
 

Ref.		EAN
06-107	0/10	5907558414424

H7, H10, H11, H13, H14, H17, H19, H22, H24  
TS10, TS15, TS20, TS25, TS27, TS30, TS40, TS45, TS50  
T30, T40, T45, T50, T55, T60, T70, T80  
M9, M10, M12, M14, M16  
R7, R8, R9, R10  
H5



Ref.		EAN
08-710	0/3	5907558417104

## Końcówki wkrętakowe

Driver bits / Einsätze für Schraubendreher / Насадки / Наконечники вкрутки / Dugőkulcs bitkészlet / Set bits / Šroubovákové nástavce / Skrutkovacie nástavce / Nastavki za izvijače / Atsuktavo antgaliai / Skruvögrieta uzgāji / Krivikeeraajatsakud / Ηαφραύκιου za αμαεργια / Nastavi za odvijač / Nastavi za odvijač / Κασαβιδάκιτες / Puntas destornilladoras / Inserti lunghi e corti / Ponteiros Chave de fenda / Embouts de tournevis / Schroevendraaiereinstukken



Ref.	Info	L[mm]	☒	EAN
10-970	H5	30	50/200	5907558452884
10-972	H6	30	50/200	5907558452891
10-978	H12	30	50/200	5907558452907
10-980	H5	75	30/120	5907558452914
10-982	H6	75	30/120	5907558452921
10-988	H12	75	30/120	5907558452938



Ref.	Info	L[mm]	☒	EAN
10-920	T30	30	50/200	5907558452785
10-922	T40	30	50/200	5907558452792
10-924	T45	30	50/200	5907558452808
10-926	T50	30	50/200	5907558452815
10-928	T55	30	50/200	5907558452822
10-940	T30	75	30/120	5907558452839
10-942	T40	75	30/120	5907558452846
10-944	T45	75	30/120	5907558452853
10-946	T50	75	30/120	5907558452860
10-948	T55	75	30/120	5907558452877
10-960	T100	75	20/40	5907558452945



Ref.	Info	L[mm]	☒	EAN
10-900	M8	30	50/200	5907558452723
10-902	M10	30	50/200	5907558452730
10-904	M12	30	50/200	5907558452747
10-906	M8	75	30/120	5907558452754
10-908	M10	75	30/120	5907558452761
10-910	M12	75	30/120	5907558452778

## Klucze sześciokątne

Hex key set / Sechskantschlüssel / Ключи шестигранные / Ключ шестигранный / Imbuskulcs készlet / Set chei cu șase laturi / Šestihrani ključ / Šipravní imbus ključov (dlhý) / Garnitura imbus ključev / Šešikampijerakty komplektas / Seškanšu atslēgu komplekts / Kuuskant-mutrivõtmete komplekt / Пумбцы номн / Ključ imbus set / Ključ imbus set / Συλλογή έξιγωνών κλειδών / Llaves Allen / Chiavi esagonali / Chaves hexagonais / Clefs à 6 pans / Zeskantsleutels

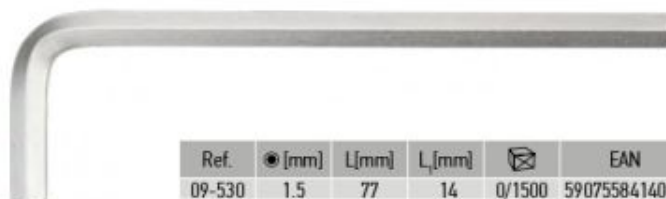

Ref.	●[mm]	L[mm]	L <sub>1</sub> [mm]	☒	EAN
09-530	1.5	77	14	0/1500	5907558414004
09-531	2.0	81	16	0/1500	5907558414011
09-532	2.5	87	18	0/1500	5907558414028
09-533	3.0	94	20	0/1500	5907558414035
09-534	4.0	103	24	0/1000	5907558414042
09-535	4.5	108	26	0/800	5907558414059
09-536	5.0	115	28	0/500	5907558414066
09-537	5.5	122	30	0/500	5907558414073
09-538	6.0	129	32	0/500	5907558414080
09-539	7.0	136	34	0/300	5907558414097
09-540	8.0	147	36	0/200	5907558414103
09-541	9.0	159	38	0/200	5907558414110
09-542	10.0	170	40	0/150	5907558414127
09-543	12.0	190	45	0/80	5907558414134
09-544	13.0	205	48	0/80	5907558414141
09-545	14.0	216	54	0/60	5907558414158
09-546	17.0	245	63	0/40	5907558414165



●[mm]	L[mm]	L <sub>1</sub> [mm]
2.0	85	18
2.5	90	20
3.0	97	23
4.0	106	28
5.0	118	30
6.0	138	36
8.0	159	40
10.0	180	46

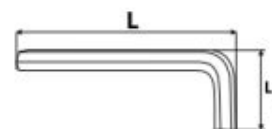

Ref.	☒	EAN
09-523	10/40	5907558414288



●[mm]	L[mm]	L <sub>1</sub> [mm]
1.5	92	15
2.0	100	18
2.5	114	20
3.0	127	22
4.0	143	28
5.0	164	31
6.0	185	37
8.0	205	43
10.0	235	47

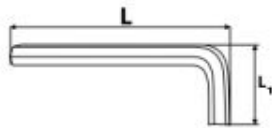

Ref.	☒	EAN
09-525	6/24	5907558414301

## Klucze sześciokątne

Hex key set / Sechskantschlüssel / Ключи шестигранные / Ключи шестигранный / Imbuskulcs készlet / Set chei cu șase laturi / Šestihranný klíč / Súprava imbus klúčov (dlhá) / Garnitura imbus ključev / Šešakampij rakti komplektas / Seškaršu atslėgiu komplektas / Kuuskant-mutrivõtmete komplekt / Лимбкы номн / Ключ имбус set / Ключ имбус set / Συλλογή εξαγωνικών κλειδών / Llaves Allen / Chaves esagonali / Chaves hexagonais / Clefs à 6 pans / Zeskantsleutels

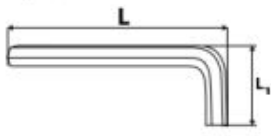

● [mm]	L [mm]	L <sub>1</sub> [mm]
1.5	91	16
2.0	103	19
2.5	115	20
3.0	130	23
4.0	145	29
5.0	166	35
6.0	188	38
8.0	208	43
10.0	230	50



Ref.	📦	EAN
09-512	6/48	5907558403428



● [mm]	L [mm]	L <sub>1</sub> [mm]
1.5	63	15
2.0	75	17
2.5	87	20
3.0	90	23
4.0	100	27
5.0	116	32
6.0	137	37



Ref.	📦	EAN
09-517	10/100	5907558410273

● 1.5 - 2 - 2.5 - 3 - 4 - 5 - 6 - 8 mm



Ref.	📦	EAN
09-571	6/24	5907558450460

## Klucze Torx

Torx key wrench set / Torx-Schlüssel / Ключи Torx / Ключи "Торх" / Torx kulcskészlet / Set chei de tip "torx" / Ключе Torx / Súprava Torx klúčov / Garnitura ključev torx / Rakti TORX / Torx atslėgiu komplektas / "Torx" mutrivõtmete komplekt / Лимбкы номн / Ключ имбус / Ключи Torx / Llaves torx / Set chavi Torx / Chaves torx / Clefs Torx / Torxleutels

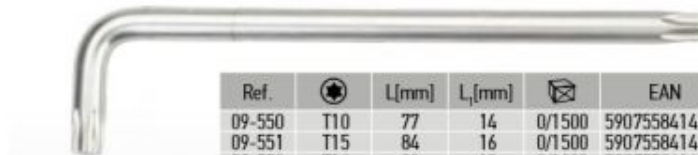
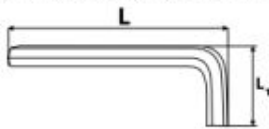

Ref.	●	L [mm]	L <sub>1</sub> [mm]	📦	EAN
09-550	T10	77	14	0/1500	5907558414172
09-551	T15	84	16	0/1500	5907558414189
09-552	T20	92	18	0/1000	5907558414196
09-553	T25	101	20	0/1000	5907558414202
09-554	T27	111	24	0/500	5907558414219
09-555	T30	122	28	0/500	5907558414226
09-556	T40	136	32	0/400	5907558414233
09-557	T45	152	36	0/300	5907558414240
09-558	T50	176	40	0/200	5907558414257
09-559	T55	183	44	0/100	5907558414264



●	L [mm]	L <sub>1</sub> [mm]
TT10	88	20
TT15	93	22
TT20	98	23
TT25	105	24
TT30	119	30
TT40	130	32
TT45	144	37
TT50	160	40

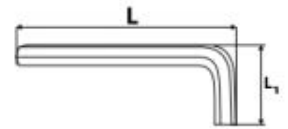

Ref.	📦	EAN
09-524	10/40	5907558414295



●	L [mm]	L <sub>1</sub> [mm]
T10	89	20
T15	105	22
T20	115	23
T25	130	25
T27	146	30
T30	167	35
T40	184	38
T45	204	45
T50	226	50



Ref.	📦	EAN
09-518	6/48	5907558420661



●	L [mm]	L <sub>1</sub> [mm]
T10	89	20
T15	105	22
T20	115	23
T25	130	25
T27	146	30
T30	167	35
T40	184	38
T45	204	45
T50	226	50



Ref.	📦	EAN
09-526	6/24	5907558414318

## Klucze Torx

Torx key wrench set / Torx-Schlüssel / Ключи Torx / Ключи "Torx" / Torx kulcskészlet / Set chei de tip "torx" / Ключи Torx / Súprava Torx klúčov / Garnitura ključev torx / Raktai TORX / Torx atslėgiu komplektas / "Torx" multivirtmetė komplekt / Λωμβύσι κομμάτι / Ключи имбус / Ключи Torx / Llaves torx / Set chiavi Torx / Chaves torx / Clefs Torx / Torxslutels

T9; T10; T15; T20; T25; T27; T30; T40



25 years GUARANTEED



Ref.	☒	EAN
09-573	6/24	5907558450477

## Klucze trzpieniowe z przetyczką

Studwrenches with cotter pin / Schraubenschlüssel mit Splint / Шпильковые ключи со шпильком / Γαϊκόκι κλησι ζι шпильком / Csavarazökulcsok csapszeggel / Chei cu știfturi cu știfturi / Šroubové klíče se závlačkou / Klúče so závlačkou / Ключи за vijake z zatičem / Šakiniai veržiarakčiai su dantytuoju kaiščiu / Atslėgių ar tarpklūvėm / Sprakkeniga multivirtmet / Ключове со шпильки със зъбен колелце / Ключевни и обликo slova L со клинот / Ключевни со Л ключем со илом / Συνδυαστικά κλειδιά με στέλεχος / Llaves de espàrrago con chaveta / Chiani per viti prigioniere con corgiglia / Chaves de fenda com contrapino / Clés à goujon avec goupille fendue / Moersleutels met splijpen

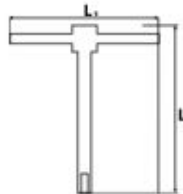

● [mm]	L [mm]	L <sub>1</sub> [mm]
H2	125	65
H2,5	125	65
H3	125	65
H3,5	125	65
H4	177	90
H4,5	177	90
H5	177	90
H6	209	116
H8	248	120
H10	300	143

Ref.	☒	EAN
09-509		5907558477238

## Kluczyk uniwersalny do szafek

Universal control cabinet key / Universalschlüssel für Schränke / Ключ универсальный для шкафов / Ключ универсальный до шаф / Chiave universale per armadietti / Cheie universală pentru dulapuri / Univerzální klíč na rozvodné skříně / Univerzálny klúčik na skriniky / Univerzálni ključ za električne omarice / Elektros spintelių raktas, universalus / Universalis atslėgiu skapiem / Univerzaalne karinõõ / Универсален ключ за шкафчета / Univerzálni ključ za ormare / Univerzálni ključ / Ключиá γενικής χρήσης για ντουλάπα εργασίας / Llave universal para armarios / Chiave universale per armadietti / Chave universal para armários / Clé pour armoires universelle



Ref.	☒	EAN
02-001	50/200	5907558404319



Ref.	☒	EAN
01-402	24/192	5907558449631



Ref.	☒	EAN
02-002	50/200	5907558499780

## Pokrętko

Wheel / Drehknopf / Върток / Маховик / Hajtökar / Clupă / Otočný knoflík / Ovládacie kolesko / Raglja / Rankena / Grietzuvite / Нурп / Върток / Kotočici / Ručica / Pápolo / Mango / Impugnatura a L / Botão / Tourne-à-gauche / Draaiknop



Ref.	☒	EAN
08-257	10/100	5907558466362

## Klucz dynamometryczny

Torque wrench / Drehmomentschlüssel / Ключ динамометрический / Ключ динамометричний / Nyomatékkulcs / Cheie dinamică / Dynamometrický klíč / Dynamometrický ključ / Dinamo metrični ključ / Dinamo metrični raktas / Dinamo metriška atslega / Dinamoetriline vöö / Динамометричен ключ / Dinamo metrični ključ / Obrtni ključ / Δυναμομετρικό κλειδί / Clave dinamométrica / Chiave dinamometrica / Clave dinamométrica / Claf dynamométrique / Dynamometrische steutel

H2, H2.5, H3, H4, H5, H6, H8, H10  
T10, T15, T20, T25, T30  
PH1, PH2, PH3

1/4", H5 x 100 mm

1/4" - 3/8"

1/4", 100 mm

+/- Nm

1/4"

5-25 Nm

L/R

Ref.	Info	⊠	EAN
08-821	0/12		5907558458954

+/- Nm

1/2"

L/R

Ref.	Info	⊠	EAN
08-835	40-220Nm	0/6	5907558458930
08-837	60-330Nm	0/6	5907558458947

25 years GUARANTEE

CrV steel

45

Ref.	Info	⊠	EAN
08-823	3/8", 10 - 60 Nm	1/10	5907558444544
08-824	3/8", 20 - 100 Nm	1/10	5907558444551
08-825	1/2", 40 - 200 Nm	1/10	5907558444568
08-826	1/2", 60 - 350 Nm	1/4	5907558444599

25 years GUARANTEE

CrV steel

45

Ref.	Info	⊠	EAN
08-827	1/2", 20 - 210 Nm	1/10	5907558444575
08-828	1/2", 60 - 350 Nm	1/10	5907558444582

CrV steel

1/4"

45

5-25 Nm

Ref.	Info	⊠	EAN
08-822	5-25Nm	1/20	5907558471168

CrV steel

3/4"

24T

Ref.	Info	⊠	EAN
08-838	160-800Nm	1/2	5907558469745
08-839	20-1000Nm	1/2	5907558469752

1/4" 3/8" 1/2" x3

72 T

L/R

5-25 Nm

20-100 Nm

65-350 Nm

Ref.	Info	⊠	EAN
08-843	5-350Nm	1/4	5907558471168

1/4" 3/8" 1/2" x3

72 T

L/R

5-25 Nm

20-120 Nm

60-330 Nm

Ref.	Info	⊠	EAN
08-845	5-330Nm	1/2	5907558463538

## Kątomierz do dokręcania śrub

Torque angle gauge / Winkelmesser zum schraubenanziehen / Угломер для затяжки болтов / Кутюмер для довинчування гвинтів / Szögmérő csavar meghúzáshoz / Raportor la strângerea șuruburilor / Ühölömër k itahování šroubů / Uhlomer krútiaceho momentu / Kótomter za privijanje vijaka / Углыш узспрудитно катро матуокліс / Leņķmērs skrūvju pievilkšanai / Nurgatõõdik poltide pingutamiseks / Ёломер за дынамометрычнен кюч / Kutomjer za zatezanje vijaka / Uglomer za zavrtanje šrafova / Γωνιόμετρο αίσθησης βιδών / Escuadra para atornillar tornillos / Goniometro per avvitare le viti / Transferidor para aparafusar / Clé de serrage angulaire



1/2"

360°

Ref.	☒	EAN
08-830	1/12	5907558416770

## Klucz płasko-oczkowy

Combination spanner / Maul-Ringschlüssel / Ключ комбинированный / Ключ комбинований, ріжково-напідний / Csillag-villáskulcs / Cheie combinată / Кіюч ошо-плочы / Кіюч OP / Кіюч вічasto-оброші / Raktas plokščas-kilpinis / Kombinētā atslēga / Universaalne mutrivõi / Ключ звездозагачен / Кіюч комбинирани / Кіюч комбиновани / Γερμανοπόλυκλυνο / Llave combinada / Chiave combinata / Chave plano-de luneta / Clé à four che-polygonale / Moersleutel



Ref.	● [mm]	L [mm]	☒	EAN	Ref.	● [mm]	L [mm]	☒	EAN
09-706	6	100	0/200	5907558410914	09-722	22	260	5/50	5907558411072
09-707	7	110	5/200	5907558410921	09-723	23	260	5/30	5907558411089
09-708	8	120	5/200	5907558410938	09-724	24	280	5/50	5907558411096
09-709	9	130	5/200	5907558410945	09-725	25	295	5/40	5907558411102
09-710	10	140	5/200	5907558410952	09-727	27	310	5/50	5907558411126
09-711	11	150	5/200	5907558410969	09-728	28	310	5/40	5907558411133
09-712	12	160	5/200	5907558410976	09-729	29	340	4/40	5907558411140
09-713	13	170	5/200	5907558410983	09-730	30	340	4/30	5907558411157
09-714	14	180	5/100	5907558410990	09-732	32	360	4/40	5907558411164
09-715	15	190	5/100	5907558411003	09-734	34	380	4/20	5907558411171
09-716	16	200	5/100	5907558411010	09-736	36	410	5/10	5907558412611
09-717	17	210	5/100	5907558411027	09-738	38	430	5/20	5907558412628
09-718	18	220	5/100	5907558411034	09-741	41	460	2/10	5907558412635
09-719	19	230	5/100	5907558411041	09-746	46	500	5/10	5907558412642
09-720	20	240	5/100	5907558411058	09-747	50	540	5/10	5907558412659
09-721	21	250	5/100	5907558411065	09-749	60	600	0/2	5907558412673



Ref.	● [mm]	L [mm]	☒	EAN
09-406	6	100	25/400	5907558422375
09-407	7	110	25/400	5907558422382
09-408	8	120	25/400	5907558422399
09-409	9	130	25/400	5907558422405
09-410	10	140	25/400	5907558422412
09-411	11	150	25/300	5907558422429
09-412	12	160	25/300	5907558422436
09-413	13	170	25/300	5907558422443
09-414	14	180	25/200	5907558422450
09-415	15	190	25/200	5907558422467
09-416	16	200	25/150	5907558422474
09-417	17	210	25/150	5907558422481
09-418	18	220	10/120	5907558422498
09-419	19	230	10/120	5907558422504
09-421	21	250	10/100	5907558422528
09-422	22	260	10/100	5907558422535
09-424	24	280	10/80	5907558422559
09-427	27	310	10/40	5907558422580
09-429	29	340	10/40	5907558422603
09-430	30	340	10/40	5907558422610
09-432	32	360	10/40	5907558422627

Ref.	● [mm]	L [mm]	☒	EAN
09-650	6	100	1/25	5907558467482
09-651	7	110	1/25	5907558467499
09-652	8	120	1/25	5907558467505
09-653	9	130	1/25	5907558467512
09-654	10	140	1/25	5907558467529
09-655	11	150	1/25	5907558467536
09-656	12	160	1/25	5907558467543
09-657	13	170	1/25	5907558467550
09-658	14	180	1/25	5907558467567
09-659	15	190	1/25	5907558467574
09-660	16	200	1/25	5907558467581
09-661	17	210	1/25	5907558467598
09-662	18	220	1/10	5907558467604
09-663	19	230	1/10	5907558467611
09-665	21	250	1/10	5907558467628
09-666	22	260	1/10	5907558467635
09-668	24	280	1/10	5907558467642
09-671	27	310	1/10	5907558467659
09-672	29	340	1/10	5907558467666
09-674	30	340	1/10	5907558467673
09-675	32	360	1/10	5907558467680

## Klucz płasko-oczkowy

Combination spanner / Maul-Ringschlüssel / Ключ комбинированный / Ключ комбинований, рижко-накидний / Csillag-villáskulcs / Cheie combinată / Ключ очко-плоский / Ключ ОР / Ключ ви́досто-обро́ти / Raktas plokišios - kilpinis / Kombinētā atslēga / Universaalne mutritviõ / Ключ звездочечен / Ключ комбинирани / Ключ комбиновани / Γερμανοπόλυγωνο / Llave combinada / Cheie combinata / Cheie plana-de luneta / Clef à fourche-polygonale / Moersleutel



Ref.	● [mm]	L [mm]	☒	EAN
09-760	8	90	10/200	5907558410198
09-761	9	93	5/200	5907558410204
09-762	10	96	5/200	5907558410211
09-763	11	98	10/200	5907558410228
09-764	12	102	10/200	5907558410235
09-765	13	109	5/200	5907558410242
09-766	14	113	10/200	5907558410259
09-767	15	118	10/120	5907558410266
09-768	16	123	10/120	5907558412765
09-769	17	129	10/200	5907558412772
09-770	18	131	10/120	5907558412789
09-771	19	134	10/150	5907558412796



Ref.	● [mm]	N	☒	EAN
09-751	6, 8, 10, 12, 13, 14, 17, 19	x8	0/25	5907558411522
09-752	6, 7, 8, 10, 11, 12, 13, 14, 15, 17, 19, 22	x12	0/20	5907558411539
09-753	8, 9, 10, 11, 12, 13, 14, 15, 16, 17, 18, 19, 22, 24, 27, 30, 32	x17	0/6	5907558413106
09-754	6, 7, 8, 9, 10, 11, 12, 13, 14, 15, 16, 17, 18, 19, 20, 21, 22, 23, 24, 25, 26, 27, 28, 29, 30, 32	x26	0/4	5907558413113



Ref.	● [mm]	☒	EAN
09-791	8, 9, 10, 12, 13, 14, 17, 19	0/20	5907558413090

## Klucz płasko-oczkowy z grzechotką

Combination spanner with ratchet / Ringschlüssel mit Ratsche / Ключ комбинированный с трещоткой / Ключ рижко-накидний з тріскою / Csillag-villáskulcs racsnis / Cheie față -metarâ cu cîchet / Ωκροπόλυγωνο / Плоско-очковый ключ с рашгой / Ploščato-obročni ključ z račjo / Raktas plokišios, kilpinis su terkšle / Kombinētā atslēga / Kārīstīga leht-silmsviti / Комбинирана трещоточна / Plošnato-okasti ključ s nastavkom / Plošnato-okasti ključ sa čegrtaljkom / Ключ γερμανοπόλυγωνο με κατάντα / Llaves combinadas (de estrella y a carraça abierta) con carraça / Cheie combinata a cîchet / Cheie plana-de luneta cu catraca de furar / Clef à fourche-polygonale à cliquet / Moersleutel met ratel



Ref.	● [mm]	L [mm]	☒	EAN
09-063	8	140	10/200	5907558424157
09-064	10	160	10/200	5907558416954
09-065	13	180	10/50	5907558416961
09-066	15	190	10/100	5907558416978
09-067	17	213	0/100	5907558416985
09-068	19	235	10/60	5907558416992
09-069	21	237	10/50	5907558424164
09-042	22	252	5/50	5907558424041
09-043	24	274	5/50	5907558424058
09-044	27	332	6/30	5907558424065
09-045	30	349	6/24	5907558424072



Ref.	● [mm]	L [mm]	☒	EAN
09-320	8 mm	20	10/100	5907558444919
09-321	9 mm	21	10/100	5907558444926
09-322	10 mm	22	10/100	5907558444933
09-323	11 mm	22	10/100	5907558444940
09-324	12 mm	23	10/100	5907558444957
09-325	13 mm	26	5/100	5907558444964
09-326	14 mm	27	5/100	5907558444971
09-327	15 mm	27	5/50	5907558444988
09-328	16 mm	28	5/50	5907558444995
09-329	17 mm	30	5/50	5907558445008
09-330	18 mm	31	5/50	5907558445015
09-331	19 mm	32	5/50	5907558445022
09-333	21 mm	38	5/50	5907558445046
09-334	22 mm	38	5/50	5907558445053
09-336	24 mm	42	5/25	5907558445077
09-338	26 mm	45	5/25	5907558445091
09-339	27 mm	45	5/25	5907558445107
09-340	28 mm	49	5/25	5907558445114
09-341	30 mm	49	5/20	5907558445121
09-342	32 mm	52	5/20	5907558445138

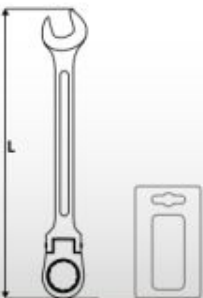

Ref.	● [mm]	L [mm]	☒	EAN
09-051	8	140	10/200	5907558403435
09-052	10	162	10/160	5907558403442
09-055	13	181	10/120	5907558403459
09-057	15	202	10/100	5907558403466
09-059	17	237	10/80	5907558403473
09-061	19	250	10/60	5907558403480
09-062	21	255	10/50	5907558424140
09-053	22	255	5/50	5907558424096
09-054	24	274	5/50	5907558424102
09-056	27	312	5/30	5907558424119
09-058	30	350	6/24	5907558424126
09-060	32	390	8/16	5907558424133

## Klucz płasko-oczkowy z grzechotką

Combination spanner with ratchet / Ringschlüssel mit Ratsche / Ключ комбинированный с трещоткой / Ключ рожково-накидной с трещоточной / Csillag-villáskulcs rosznis / Cheie fixă –inelară cu clichet / Očkolochý klíč ráčnový / Ploché-očkový klíč s račťou / Ploščata-obračni ključ z raglja / Raktas plokščias, klijpinis su terkšle / Kombinētā atslēga / Kōristiga leht-silmusvõti / Комбинирана трещотна / Plošnata-okasti ključ s nastavkom / Plošnata-okasti ključ sa čegrtajkom / Ключи γερμανοαυλήγιο με κατσάνα / Llaves combinadas (de estrella y a carraca abierta) con carraca / Chiave combinata a cinghietto / Chave plana-de luneta z carraca de furar / Clef à fourche-polygonale à cliquet / Moersleutel met ratel



CrV  
steel

x12



Ref.	● [mm]	📦	EAN
09-345	8, 9, 10, 11, 12, 13, 14, 15, 16, 17, 18, 19	1/8	5907558483093

CrV  
steel

72



Ref.	● [mm]	📦	EAN
09-255	8	6/72	5907558495669
09-256	9	6/72	5907558495676
09-257	10	6/72	5907558495683
09-258	11	6/72	5907558495690
09-259	12	6/72	5907558495706
09-260	13	6/72	5907558495713
09-261	14	6/72	5907558495720
09-262	15	6/48	5907558495737
09-263	16	6/48	5907558495744
09-264	17	6/48	5907558495751
09-265	18	6/48	5907558495768
09-266	19	6/48	5907558495775

## Klucze płaskie dwustronne

Flat double sided wrenches / Mutterschlüssel, beidseitig / Ключи с открытым зевом двусторонние / Ключи рожкової двобічної / Villáskulcs készlet / Cheie fixă / Klíče ploché aboustranné / Klíče ploché abostranné / Ploščati abojestranski ključ / Ploščti raktai, dvipusiai / Dvipusēja plakana atslēga / Kahepoolded lehtvõtmel / Ploščni dvojstranski ključevi / Dvostrani plošnatí ključev / Dvočeljusni plošnati ključev / Γερμανικοί κλειδιά δίπλα / Llaves fijas dobles / Chiavi a forchetta doppia / Chaves planas de duas pontas / Clefs à fourches doubles / Vlakke tweezijdige sleutels

25  
years  
GUARANTEE

TUV  
CERTIFIED  
CERTIFIED

CrV  
steel

DIN  
3110



Ref.	● [mm]	L [mm]	📦	EAN
09-806	6x7	120	10/600	5907558411195
09-808	8x9	140	10/200	5907558411201
09-810	10x11	160	10/300	5907558411218
09-812	12x13	170	10/200	5907558411225
09-814	14x15	190	10/100	5907558411232
09-816	16x17	200	10/100	5907558411249
09-817	17x19	220	10/100	5907558411454
09-818	18x19	220	5/100	5907558411256
09-819	19x22	234	10/100	5907558411461
09-820	20x22	230	5/100	5907558411263
09-821	21x23	250	5/100	5907558411270
09-824	24x27	270	5/50	5907558411287
09-825	25x28	285	5/50	5907558411294



25  
years  
GUARANTEE

TUV  
CERTIFIED  
CERTIFIED

CrV  
steel

DIN  
3110



Ref.	● [mm]	N	📦	EAN
09-851	6x7, 8x9, 10x11, 12x13, 14x15, 16x17, 18x19, 20x22	8	0/20	5907558411546
09-852	6x7, 8x9, 10x11, 12x13, 14x15, 16x17, 18x19, 20x22, 21x23, 24x27, 25x28, 30x32	12	0/8	5907558413120



SUPER  
THIN

x8

CS  
steel



Ref.	● [mm]	📦	EAN
09-860	5,5x7, 8x9, 10x12, 11x13, 14x17, 19x21, 22x23, 24x27	0/20	5907558458916



## Klucz oczkowy odgięty

Offset ring spanner / Ringschlüssel, gebogen / Ключ накидной изогнутый / Ключ накидной, вигнутий / Csillagkulcs enyhén hajlított / Cheie inelară-cotită / Ключь оцковий ухнутий / Оцковий ключь обнутый / Оброчни ипрогнени клијуџ / Кіприні рактас, ленктас / Ѕбіекта узтавоас атслѣга / Ківерга отсага сїлтмусвїті / Γληχ ασθεν κληακ ατσηνατ / Fleksibilni okasti ključ / Okasti ključ obnuti / Ключь полїгуло куртї / Llave de estrella acodada / Chiave poligonale doppia / Chave de luneta curvado / Clef polygonale contre-coudée / Gebogen ringsleutel



Ref.	● [mm]	L [mm]	☒	EAN
09-906	6x7	170	5/100	5907558411317
09-908	8x9	180	5/100	5907558411324
09-910	10x11	200	5/100	5907558411331
09-912	12x13	210	5/100	5907558411348
09-914	14x15	230	5/60	5907558411355
09-916	16x17	245	5/100	5907558411362
09-918	18x19	265	5/50	5907558411379
09-920	20x22	290	5/40	5907558411386
09-921	21x23	310	4/40	5907558411393
09-924	24x27	330	4/40	5907558411409
09-930	30x32	370	4/40	5907558411430



Ref.	● [mm]	☒	EAN
09-952	6x7, 8x9, 10x11, 12x13, 14x15, 16x17, 18x19, 20x22, 21x23, 24x27, 25x28, 30x32	0/6	5907558413137

## Klucze oczkowe wygięte

Offset ring spanner / Ringschlüssel, gebogen / Ключ накидной изогнутый / Ключ накидной, вигнутий / Csillagkulcs készlet / Cheie inelară semiluna / Оцковий ключь загнутий / Оцковий ключь ухнутий / Оброчни икривлени клијуџ / Кіприні рактас, ленктас / Ѕбіекта узтавоас атслѣга / Рoolkuu-siltmусvїті / Γληχ ασθεν κληακ ατσηνατ / Okasti savinut ključ / Okasti izvijeni ključ / Ключь полїгуло куртї / Llave de estrella de media luna / Chiavi doppie poligonale a mezza luna / Chaves de luneta curvadas / Clefs polygonales coudées / Uitgebogen ringsleutels



Ref.	● [mm]	☒	EAN
09-176	9x12, 13x15, 14x17, 16x18, 19x22	0/10	5907558404876

## Klucz oczkowy dwustronny z grzechotką, długi

Ring spanner / Ringschlüssel / Ключ накидной / Ключь накидной / Csillagkulcs / Cheie inelară / Оцковий ключь / Оброчни клијуџ / Кіприні рактас / Узтавоас атслѣга / Сїлтмусвїті / Γληχ ασθεν κληακ / Okasti ključ / Πολїгуло κληακ / Llave de estrella / Chave de luneta / Clef polygonale / Ringsleutel



Ref.	● [mm]	L [mm]	☒	EAN
09-360	8 mm	235	10/100	5907558445145
09-361	10 mm	289	10/100	5907558445152
09-362	12 mm	325	10/100	5907558445169
09-363	13 mm	360	5/50	5907558445176
09-364	14 mm	363	5/50	5907558445183
09-365	16 mm	390	5/50	5907558445190
09-366	17 mm	403	5/50	5907558445206
09-367	19 mm	425	5/50	5907558445213
09-368	22 mm	450	5/25	5907558445220



Ref.	● [mm]	☒	EAN
09-370	8, 10, 13, 16, 17, 19	0/8	5907558483109



Ref.	● [mm]	☒	EAN
03-030	5 - 16	5/40	5907558445268
03-031	5 - 27	5/20	5907558445275

## Klucze oczkowe Torx

Offset ring spanner set / Ringschlüssel / Ключи накидные колеччатые / Ключи накидные / Csillagkulcs készlet torx / Set chei inelare de deviație / Ключь оцковь / Сїлтмусвїті / Сїлтмусвїті / Оброчни клијуџ / Кіприні рактас / Комбїнїто зїлекто атслѣга комплекс / Мїтрївїтмете комплекс / Ключь Луна компл. / Ключь окастї / Πολїгуло κληακ / Llaves de estrella / Chiavi combinate Torx / Chaves de luneta / Clefs polygonales / Ringsleutels



Ref.	★ [mm]	☒	EAN
09-980	T6xT8, T10xT12, T14xT18, T20xT24	20/60	5907558412239

## Klucz oczkowy półotwarty

Flare nut wrench / Ringschlüssel halb offen / Ключ разрезной двусторонний / Ключ торцевой наружный двусторонний / Fékssőkulcs / Cheie piulită în formă de can / Otkovij ključ polootevrenij / Ključ otvoreni očkovi / Obračni ključ, odprti / Kļūpis rakts / Bremžu trubiņu atslēga / Vargamutri või / Ключ гаечки / Ключ ексцентричнi / Кључ / Πολύγωνο κλειδί ημίανοκτο / Llave de estrella, abierta / Chiave doppia ad anello aperto / Chave de luneta semi aberta / Clef polygonale demi ouverte / Halbofen ringsleutel

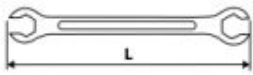

Ref.	● [mm]	L [mm]	☒	EAN
09-141	8x9	130	25/100	5907558404746
09-143	9x11	150	10/200	5907558404753
09-145	10x12	150	10/200	5907558404760
09-147	12x13	170	25/200	5907558404777
09-149	13x14	170	25/100	5907558404784
09-151	15x17	195	25/100	5907558404791

## Klucz trzpieniowy nasadowy

T-socket wrench / Vierkant-Aufsteckschlüssel / Ключ торцевой Т-образный / Ключ шестигранный торцевой насадный / T-kulcs / Cheie fixare forma T / Nástrčkový ključ tytul / T ključ / T ključ, nasadni / T formos rakts / T-veida gala atslēga / T-radruini mutri või / T-образен ключ / T ključ / T ključ / Καταβίβα καρυδάκι τύπου T / Llave de vaso con mango en T / Chiave a T / Chave tubular / Clef mâle à douilles articulée / Imbusdopsleutel



Ref.	● [mm]	L [mm]	☒	EAN
09-302	13	300	25/50	5907558414363



## Klucz fajkowy

L-type wrench / Pfeijenschlüssel / Рожковый ключ / Ключ торцевой угловой / Pipakulcs / Cheie tubulară cotită / Zahnutij ključ / Fajkovij ključ / Угловий кључ / Ружковис rakts / radzaratslēga / Padrunvõid / Ключ луга / imbus ključ / Kosočeljsni zavrtljani ključ / Γερανική κλειδί / Llave de pipa / Chiave a pipa / Chave de cabo curvo / Clef à pipe / Pippsleutel

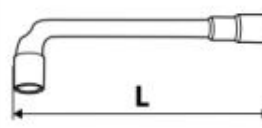

Ref.	● [mm]	L [mm]	☒	EAN
09-203	8	110	10/200	5907558405002
09-205	10	130	10/120	5907558405019
09-208	13	150	10/100	5907558405033
09-212	17	180	10/60	5907558405064
09-214	19	200	10/40	5907558405071



## Wkrętak płaski

Screwdriver slotted / Flachsraubendreher / Отвертка плоская / Відкрутка плоска / Csavarhúzó lapos / şurubeliñâ plată / Šroubovák ploché / Skrutkovač ploché / Ploščati izvijač / Ploščās atsuktavas / Skrūvgnēzis plakans / Lamepa-kruvikeeraja / Отвертка / Odvijajč / Odvijac / Καταβίβα ευκατής / Destornillador plano / Giravite piatto / Chave de fenda plana / Tournevis à fourche / Vlakke schroevendraaier



Ref.	⊖ [mm]	L [mm]	☒	EAN
04-011	3,0	75	12/240	5907558401745
04-012	4,0	100	12/240	5907558401752
04-013	5,5	100	12/120	5907558401769
04-014	5,5	200	12/144	5907558401776
04-001	6,5	38	12/288	5907558411638
04-002	6,5	125	12/144	5907558411645
04-015	6,5	150	12/144	5907558401783
04-016	8,0	200	12/120	5907558401790
04-004	10,0	200	6/96	5907558411669



Ref.	⊖ [mm]	L [mm]	☒	EAN
04-171	3,0	75	12/240	5907558440386
04-172	4,0	100	12/240	5907558440393
04-173	5,5	38	12/240	5907558440409
04-174	5,5	100	12/120	5907558440416
04-175	6,5	150	12/120	5907558440423
04-176	8,0	200	6/60	5907558440430



## Wkrętak krzyżowy PH

Screwdriver Phillips / Kreuzschraubendreher / Отвертка крестовая / Відкрутка хрестовидна / Csavarhúzó philips / şurubeliñâ tip „Phillips” / Šroubovák křížový / Skrutkovač PH / Křížni izvijač / Krížminis atsuktavas Phillips / Skrūvgnēzis krusta PH / Ristpeakruvikeeraja / Отвертка / Odvijajč / Odvijac / Καταβίβα σταυρωτή τύπου philips / Destornillador phillips / Giravite Phillips / Chave de fenda de cruzeta / Tournevis en croix / Knussschroevendraaier



Ref.	⊕	L [mm]	☒	EAN
04-021	PH0	75	12/240	5907558401806
04-006	PH1	75	12/240	5907558411683
04-022	PH1	100	12/240	5907558401813
04-023	PH2	38	12/288	5907558401820
04-024	PH2	100	12/120	5907558401837
04-007	PH2	150	12/180	5907558411713
04-025	PH2	200	12/144	5907558401844
04-026	PH3	150	12/120	5907558401851



Ref.	⊕	L [mm]	☒	EAN
04-177	PH0	75	12/240	5907558440447
04-178	PH1	100	12/120	5907558440454
04-179	PH2	38	12/240	5907558440461
04-180	PH2	100	12/120	5907558440478
04-181	PH3	150	6/60	5907558440485



## Wkrętak krzyżowy PZ

Screwdriver Pozidriv / Kreuzschraubendreher / Отвертка крестовая / Відкрутка крестовидна / Csavarhúzó pozidriv / šurubelníkův tip „Pozidriv“ / Šroubovák křížový / Skrutkovač PZ / Křížní izvijač / Krzyżminis atsuktavas Phillips / Skrivgrueis kresta PZ / Ristpeakruvikeeraja Pozidriv / Отвертка / Odvijač / Odvijac / Καταβίβη τύπου pozidriv / Destornillador phillips / Giravite Pozzi / Chave de fenda de cruzeta / Tournevis en croix / Kriusschroevendraaier



Ref.	+	L [mm]	☒	EAN
04-031	PZ0	75	12/600	5907558401868
04-032	PZ1	100	12/120	5907558401875
04-033	PZ2	38	12/288	5907558401882
04-034	PZ2	100	12/144	5907558401899
04-035	PZ2	200	12/144	5907558401905
04-036	PZ3	150	12/120	5907558401912



Ref.	+	L [mm]	☒	EAN
04-182	PZ0	100	12/240	5907558440492
04-183	PZ1	100	12/120	5907558440508
04-184	PZ2	100	12/120	5907558440515
04-185	PZ3	150	6/60	5907558440522

## Wkrętak Torx

Torx screwdriver / Schraubendreher Torx / Отвертка Torx / Вкрутка «Торкс» / Csavarhúzó torx / Šurubelníkův varf Torx / Šroubovák Torx / Izvijač Torx / Atsuktavas, torcinis / Torx skrūvgrueis / Torx-kruvikeeraja / Отвертка Torx / Odvijač Torx / Odvijac Torx / Καταβίβη Torx / Destornillador con punta torx / Giravite Torx / Chave de fenda Torx / Tournevis Torx / Torx schroevendraaier



Ref.	+	L [mm]	☒	EAN
04-044	T15	100	12/240	5907558401936
04-045	T20	100	12/240	5907558401943
04-046	T25	100	12/144	5907558401950



Ref.	+	L [mm]	☒	EAN
04-186	T10	100	12/120	5907558440539
04-187	T15	100	12/240	5907558440546
04-188	T20	100	12/240	5907558440553
04-189	T25	100	12/144	5907558440560
04-190	T27	100	12/144	5907558440577

## Wkrętak płaski do pobijania

Slotted screwdriver go through / Schraubendreher, flach / Отвертка шлицевая ударная / Відкрутка плоска, ударна / Csavarhúzó üthető lapos / Šurubelníkův impact varf drett / Šroubovák plochý úderový / Sekací plochý skrutkovač / Ploščati izvijač za zabijanje / Smūginis, plokščias atsuktavas / Plakanais skrūvgrueis / Lame loakkruvikeeraja / Отвертка плоска ударна / Plosnati odvijač za nabijanje / Pjosnati odvijač za zabijanje / Καταβίβη κρούσης επίπεδο / Destornillador plano de golpe / Giravite passante piatto / Chave de fenda plano p. malhar / Tournevis à fourche à frapper / Makke slagschroevendraaier



Ref.	⊖ [mm]	L <sub>1</sub> [mm]	☒	EAN
04-019	6,5	125	12/144	5907558403251
04-020	8,0	150	6/96	5907558403268

## Wkrętak krzyżowy do pobijania

Screwdriver go through phillips / Kreuzschraubendreher zum Klappen / Отвертка крестовая усиленная ударная / Відкрутка крестовидна ударна / Csavarhúzó üthető phillips / šurubelníkův cruciulű p.ü spargere / Šroubovák křížový úderový / Skrutkovač úderový PHllips / Ploščati izvijač, udarni / Krzyżminis, smūginis atsuktavas / Skrivgrueis kresta PH sitiena / Ristpeakruvikeeraja / Отвертка / Odvijač / Odvijac / Σταυρωτό καταβίβη τύπου phillips / Destornillador de golpe phillips / Giravite passante Phillips / Chave de fenda de cruzeta p. malhar / Tournevis en croix à frapper / Slagkriusschroevendraaier



Ref.	+	L [mm]	☒	EAN
04-028	PH2	100	12/144	5907558403282

## Wkrętaki do pobijania

Go through screwdrivers / Schraubendreher zum Aufheben / Отвертки ударные / Вкрутки ударні / Csavarhúzókézfzet üthető / Šurubelníka de impact / Šroubováky úderové / Sekacie skrutkovače / Izvijači za zabijanje / Smūginiai suktuvai / Triecienskrūvgrueiš / Löökkruvikeerajad / Ударни отвертки / Odvijači za nabijanje / Odvijače za zabijanje / Καταβίβη κρούσης / Destornilladores de golpe / Set giraviti passante / Chaves de fenda p. malhar / Tournevis à frapper / Slagschroevendraaiers



⊖	Ref.	☒	EAN
5.5x100mm; 6.5x125mm; 8x150mm	04-240	12/24	5907558412857
+	PH1x75; PH2x100		

## Wkrętaki

Screwdriver set / Schraubendreher / Ομοεργία / Βιδώνυμα, набор / Csavarhúzókészlet / Set şurubelne / Sroubováky / Súprava skrutkovačov / Garnitura izvijačev / Atsuktuvai / Skrūvgręziu kompleks / Kruvkeerajate komplekt / Ομοεργία νομν. / Οδύγια / Οδύγια: set / Συλλογή από καταβίδια / Destornilladores / Set graviti / Chaves de fenda / Tournevis / Schroevendraaiers



⊖ 6x125 mm; 5x100 mm; 3x75 mm  
⊕ PH2x125 mm; PH1x100 mm; PH0x75 mm

Ref.	⊠	EAN
04-213	6/24	5907558432220



⊖ 8x150; 6.5x125; 5.5x100; 6.5x38 mm  
⊕ PH2x125; PH1x100; PH0x75; H2x38 mm

Ref.	⊠	EAN
04-207	6/12	5907558422177



⊖ 5.5x75 mm, 6.5x100 mm  
⊕ PH1x75 mm, PH2x100 mm

Ref.	⊠	EAN
04-204	6/36	5907558402254



⊖ 6.5x150; 6.5x125; 5.5x100; 3x75 mm  
⊕ PH2x125; PH1x100; PH0x75 mm

Ref.	⊠	EAN
04-206	6/24	5907558422214



⊖ 4x250mm, 5.5x250mm  
⊕ PH1x250mm, PH2x250mm

Ref.	⊠	EAN
04-214	6/24	5907558435627



⊖ 6.5x150mm; 5.5x100mm; 3x75mm; 5.5x38mm; 6.5x38 mm  
⊕ PH2x150mm; PH1x100mm; PH0x75mm; PH2x38mm

Ref.	⊠	EAN
04-208	6/12	5907558422221

## Wkręćaki

Screwdriver set / Schraubendreher / Отвертки / Βιδωκίτσια, набор / Csavarhúzókészlet / Set şurubeliçe / Śróbownicy / Súprava skrutkovačov / Garnitura izvijačev / Atsuktuvai / Skrūvgriežu komplekts / Krūvķerģaģe komplekts / Отвертки компл. / Οδνιός / Odvijač set / Συλλογή από καταβίδια / Destornilladores / Set giranti / Chaves de fenda / Tournevis / Schroevendraaiers



⊖ 5x250 mm, 4x250 mm  
⊕ PH2x250 mm, PH1x250 mm

Ref. 04-191  
⊞ 6/24  
EAN 5907558442656



⊖ 3.0x75mm, 5.5x100mm, 6.5x150mm  
⊕ PH1x100mm, PH2x150mm

Ref. 04-192  
⊞ 6/24  
EAN 5907558442663



⊖ 5.5x38mm, 5.5x100mm, 6.5x150mm  
⊕ PH1x100mm, PH2x38mm, PH2x150mm

Ref. 04-193  
⊞ 6/24  
EAN 5907558442670



⊖ 2x50mm; 2.4x50mm; 6.5x38mm; 6.5x100mm  
⊕ PH0x50mm; PH1x50mm; PH2x100mm; PH2x38mm

Ref. 04-194  
⊞ 6/24  
EAN 5907558442687

## Wkręćak odwracalny

Reversible screwdriver / Schraubendreher, umwendbar / Отвертка универсальная / Виртука универсальна, з дообними знімними наконечниками / Csavarhúzókészlet / Surubeliçij cunvar dublu, reversibil / Śróbownik oboustranny / Οτάρτσι σκρτκνοαζ / Dvsmerni izvijač / Atsuktuvai su keičiamais antgaliais / Universālais skrūvgriezis / Póratana reaga krūvķerģaģa / Универсальная отвертка / Повратни одвijač / Повратни одвijač / Καταβίδι γενικής χρήσης / Destornillador reversible / Girante reversible / Chave de fenda reversível / Tournevis réversible / Omkeerbare schroevendraaier



⊖ 6x38 mm  
⊕ PH2x38 mm

Ref. 04-201  
⊞ 12/144  
EAN 5907558402230

## Wkręćak z giętkim groszem

Screwdriver with flexible shank with bits / Schraubendreher mit flex. Spitze / Отвертка с гибким стержнем / Βιδωκίτσια з жєлєм на шєрєпє / Csavarhúzó készlet flexibilis nyéllel / şurubeliçe cu corp flexibil cu vîrf / Śróbownik s pruznym hrotem / Skrutkovač Flexi-Bity / Izvijač s pregibno konico / Atsuktuvai su lanksčia šerdimi / Skrūvgriezis ar lokano galu uzgaļiem / Paindava kšepidemeģa krūvķerģaģa / Отвертка с Накройници / Οδνιός / Καταβίδι με εύκαμπτη λαβή και σετ μπιλών / Destornillador con vástago flexible + puntas / Casciavite con la punta flessibile / Chave de fenda com ponta flexível / Tournevis à pointe douce / Schroevendraaier met zachte eindstuk



⊖ 5, 6, 7 mm  
⊕ PH1, PH2, PH3, PZ1, PZ2  
⊕ T15, T20

Ref. 04-212  
⊞ 6/36  
EAN 5907558402261

## Wkrętaki i końcówki wkrętakowe

Screwdrivers and bits / Schraubendreher und Einsätze für Schraubendreher / Отвертки и насадки / Вкрутки и наконечники вкрутки / Csavarhúzó és bitkészlet / Set surubelnya și capete / Šroubováky a šroubovákové nástavce / Skrutkovače a skrutkovačie nástavce / Izvijači in nastavki za izvijače / suktuvai ir antgaliai / Skrūvgręži un to uzgaļi / Krūmveerajad ja krūmveerajotsakud / Отвертки и наконечники за них / Odvijači i nastavi za odvijače / Odvijači i nastavi za odvijače / Καταβίβια και καταβιδώματα / Destornilladores y puntas / Set giraviti e inserti / Chaves de fenda e ponteiros de chave de fenda / Tournevis et embouts de tournevis / Schroevendraaiers en schroevendraaiereinstukken



- ⊖ 8x150; 6.5x125; 5.5x100; 3x75; 2.5x50; 3.0x50 mm
- ⊕ PH2x125; PH1x75; PH00x50; PH0x50 mm
- ⊛ T6x50; T7x50; T8x50 mm

Ref.	⊞	EAN
04-209	5/10	5907558422207



- ⊖ 6.5x125; 5.5x100; 6.5x38; 2.5x50; 2.0x50 mm
- ⊕ PH2x125; PH2x100; PH1x75; PH2x38; PH00x50; PH0x50 mm
- ⊛ T5x50; T6x50; T7x50; T8x50; T9x50; T10x50 mm

Ref.	⊞	EAN
04-211	6/12	5907558422191



- ⊖ 8x150; 6.5x100; 5.5x75; 6.5x38; 2.5x40; 3.0x40 mm
- ⊕ PH3x150; PH2x100; PH1x75; PH2x38; PH00x40; PH0x40 mm
- ⊛ T5x40; T6x40; T7x40; T8x40 mm

Ref.	⊞	EAN
04-210	5/10	5907558422160



- ⊖ 3x75mm, 4x100 mm, 5.5x100mm, 6.5x150mm
- ⊕ PH1x100mm, PH2x150mm

Ref.	⊞	EAN
04-197	6/12	5907558422700

## Wkrętaki precyzyjne

Precision screwdriver set / Präzisions-schraubendreher / Отвертки прецизионные / Відкрутки прецизійні, набір / Műszerész csavarhúzókészlet / set surubelnya jernih mech. / Σύρανατο μικροσκαρτκωαών / Gamitura notančnih izvijačev / Atsuktuvai tiksliams darbams / Skrūvgręžių kompleks / Ταρπισκρυκεραγατε komplekt / Отвертки компл. / Odvijač / Odvijač set / Συλλαγή καταβιδιών ακριβείας / Destornilladores de precisión / Set giraviti di precisione / Chaves de fenda precisas / Tournevis de précision / Fijnschroevendraaiers



- ⊖ 6.5x100mm
- ⊕ PH2x100 mm, PH1x75 mm

Ref.	⊞	EAN
04-196	6/24	5907558422694



- ⊖ 1.5x40 mm, 2.0x40 mm, 2.5x40 mm
- ⊕ PH00x40 mm, PH0x40 mm

Ref.	⊞	EAN
04-225	6/24	5907558402285

## Wkrętak precyzyjny płaski

Slotted precision screwdriver / Feinschraubendreher, flach / Отвертка прецизионная шлицевая / Виртука прецизиона, плоска / Műszerész csavarhúzó / Surubelnjā de precizie, varf drept / Šroubovák precizní plochý / Precizny plochý skrutkovač / Precizni ploščati izvijač / Atsuktuvus plakščias, torcinis / Precizjošais plakanais skrūvgrēzis / Lame peenkrūvikeeraja / Отвертка плоска прецизна / Precizni plosnati odvijač / Precizni plosnati odvijač / Κατασφιδί ακριβείας επίπεδο / Destornillador plano de precisión / Giravite di precisione piatto / Chave de fenda preçisa plana / Tournevis de précision à fourche / Vlakke fijnschroevendraaier



Ref.	Ø [mm]	L [mm]	⊠	EAN
04-112	2,0	50	12/240	5907558435511
04-113	2,5	50	12/240	5907558435528
04-114	3,0	50	12/240	5907558435535

## Wkrętak precyzyjny krzyżowy PH

Cross slotted precision screwdriver / Feinschraubendreher, Kreuz / Отвертка прецизионная крестовидная / Виртука прецизиона, крестообразна / Műszerész csavarhúzó / Surubelnjā de precizie, varf cruce / Šroubovák precizní křížový / Precizny křížový skrutkovač / Křížni precizní izvijač / Atsuktuvus precizinis, kryžminis / Lame ristreakruvikeeraja / Отвертка прецизна крестата / Precizni křížni odvijač / Precizni kukasti odvijač / Σταυροκατασφιδί ακριβείας / Destornillador de precisión phillips / Giravite di precisione Phillips / Chave de fenda preçisa de cruzeta / Tournevis de précision en croix / Fjnkriusschroevendraaier



Ref.	Ø [mm]	L [mm]	⊠	EAN
04-115	2,0	50	12/240	5907558435511
04-116	2,5	50	12/240	5907558435528
04-117	3,0	50	12/240	5907558435535

## Końcówki wkrętakowe precyzyjne z uchwytem

Precision screwdriver bits with holder / Einsätze für Schraubendreher, fein mit Aufnahme / Набор насадок прецизионных с держателем / Насадки виртукова, прецизиона, з рукоятком / Precizios csavarhúzóbetétek tartóval / Set maner si bitii, precizie / Šroubovákové nástavce precizní s držákem / Skrutkovačie nástavce precizne s upevňadlom / Nastavki za precizni izvijač z vpenjalom / Atsuktuvu antgalia, preciziniai su laikikliu / Precizjošus uzgoļu komplekts ar turētāju / Peenkrūvikeerajaotsakud koos käepidemega / Комплект прецизни накрайкили за отвертка с держак / Precizni nastavi čza odvijač s hvatačkom / Nastavci za precizni odvijač s drškom / Σετ με κατασφιδόμελες ακριβείας και προσαρμογέα / Puntas destornilladoras de precisión con mango / Inserti di precisione per avvitare con impugnatura / Ponteiros chave de fenda precisos com suporte / Embouts de tournevis de précision avec manche / Fjnkriusschroevendraaierendstukken met handvat



6.3 x 25 mm

3; 4; 5; 6; 7

4; 5; 6; 6.5

T9; T10; T15; T20; T25; T30

H2.5; H3; H4; H5; H6

PZ1; PZ2; PZ3

Y1; Y2; Y3

U6; U8

2.3

R1

4 x 28 mm

1; 1.5; 2; 2.5; 3; 3.5; 4

1; 1.5; 2; 2.5; 3.5

T3; T4; T5; T6; T7; T8; T9; T10; T15; T20

H0.9; H1.3; H1.5; H2; H2.5; H3; H3.5; H4; H4.5; H5; H6

Y2

U2.6

0.8

2; 2.3

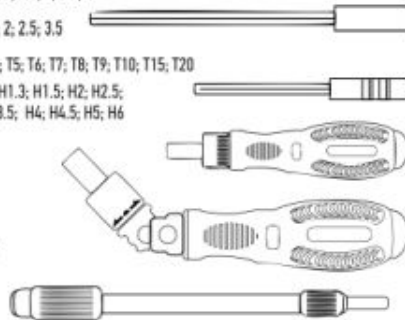

Ref.	⊠	EAN
06-115	0/10	5907558431896



6.3 x 25 mm

3; 4; 5; 6; 7

4; 5; 6; 6.5

T9; T10; T15; T20; T25; T30

H2.5; H3; H4; H5; H6

PZ1; PZ2; PZ3

Y1; Y2; Y3

U6; U8

2.3

R1

4 x 28 mm

1; 1.5; 2; 2.5; 3; 3.5; 4

1; 1.5; 2; 2.5; 3.5

T3; T4; T5; T6; T7; T8; T9; T10; T15; T20

H0.9; H1.3; H1.5; H2; H2.5; H3; H3.5; H4; H4.5; H5; H6

Y2

U2.6

0.8

2; 2.3

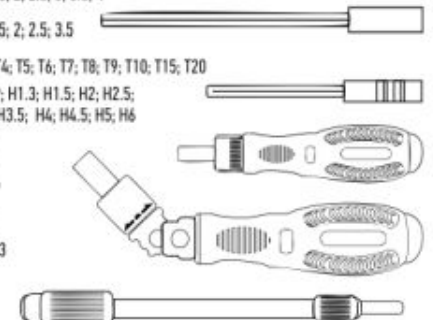

Ref.	⊠	EAN
06-116	0/10	5907558431902

## Końcówki wkrętaskowe precyzyjne z uchwytem

Precision screwdriver bits with holder / Einsätze für Schraubendreher, fein mit Aufnahme / Набор насадок прецизионных с держателем / Насадки викрутковой, прецизион, з рукоятим / Precizios csavarhúzóbetétek tartóval / Set maner si biti, precizie / Šroubovákové nástavce precizní s držadlem / Skrutkovacie nástavce precízne s upevnením / Nastavki za precizni izvijač z vpenjalom / Atsukhno antgaloi, preciznoi su laikikli / Precizjošu uzgoju kompleks ar turētāji / Reenkruvikeerijaotsakud koos käepidemega / Комплект прецизни накрайници за отвертка с держач / Precizni nastavi cza odvijač s hvatačkom / Nastavci za precizni odvijač s drškom / Set me katastróbilites akriféias kai prosoarhóyia / Puntas destornilladoras de precisión con mango / Inserti di precisione per avvitare con impugnatura / Ponteiros chave de fenda precisos com suporte / Embouts de tournevis de précision avec manche / Fijnschroevendraaierendstukken met handvat



CrV steel PRECISION set x53

- 4, 4.5; 5, 5.5; 6, 7 mm
- 2.5; 3; 3.5; 4; 4.5; 5; 5.5 mm
- ⊖ 1; 1.5; 2; 2.5; 3; 3.5; 4 mm
- ⊕ 1; 1.5; 2; 2.5; 3.5
- ⊛ T3, T4, T5, T6, T7, T8, T9, T10, T15, T20
- H0.9; H1.3; H1.5; H2; H2.5; H3; H3.5; H4
- ⊙ Y0.8; Y2
- ▲ 2
- ★ 0.8
- U U2.6
- SIMN 0.8
- ⊗ 1.5

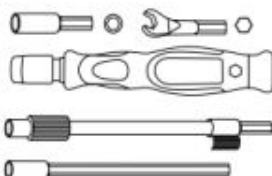

Ref.	⊞	EAN
06-111	20/40	5907558431889



25 years GUARANTEE TOUGHNESS TESTED CrMo steel x17 5/32" 30mm x16



- ⊖ 2.0, 2.5, 3.0 mm
- ⊕ PH00, PH0, PH1, PZ00, PZ0
- ⊛ T6, T7, T8, T9, T10
- H1.5, H2.0, H2.5

Ref.	⊞	EAN
04-228	6/36	5907558410068

## Szko powiększające

Magnifying glass / Lupę / Увеличительное стекло / Збільшувальне скло / Nagyító / Vergrößerungsglas / Lupă / Zväčšujúce sklo / Povečevalno steklo / Didaktinis stiklas / Pateliniošis stikls / Suurendusklaas / Лупа / Povečalo / Lupă / Μεγεθυντικός φακός / Lupa / Lente d'ingrandimento / Lente de aumento / Loupe / Vergrötungsglas /



3xLED light DPT 2.5x 110 mm DPT 4x 20 mm DPT 25x 20 mm x3 AAA

Ref.	⊞	EAN
06-129	10/80	5907558444810

## Soczewki powiększające

Magnifying lenses / Vergrößerungslinsen / Увеличительные линзы / Линзи збільшувальні / Nagyító lencsék / Lentile de mărire / Zvětšovaci čočky / Zväčšujúce čočky / Povečevalne leče / Didaktiniai lęšiai / Pateliniošis lėcas / Suurendusklaasid / Увеличителни лещи / Povečale leče / Povečalo sočiva / Μεγεθυντικοί φακοί / Lentas de aumento / Lenti d'ingrandimento / Lentas de aumento / Lentilles grossissantes / Vergrötende lenzen



2xLED light DPT 1.0x, 1.5x, 2.0x, 2.5x, 3.5x x2 AAA

Ref.	⊞	EAN
06-130	0/40	5907558444827

## Zestaw otwieraków

Opener set / Öffner-Satz / Открывачни набор / Набор інструменту для розпакування / Sztétválasztó készlet / Set deschizătoare / Súprava otváračov / Sada otváračích nástrojů / Set odpiral / Atidarymo komplektas / Atvērēju komplekts / Avaja komplekt / Комплект отварачки / Set otvarača / Отварач сет / Set ανοιχτήρι / Juego de abrir / Leve di separazione / Conjunto abridor / Jeu d'ouvreurs / Opener set



ANTI STATIC x13



Ref.	⊞	EAN
06-127	60/120	5907558444797



## Końcówki wkrętakowe z uchwytem

Screwdriver bits with holder / Einsätze für Schraubendreher mit Aufnahme / Набор насадок с держателем / Наконечники викрутковой, з рукоятком / Csavarhúzó cserélhető feje / Set biti cu suport capat / Šroubovákové nástavce s držadlem / Skrutkovacie nástavce s upínadlom / Nastavki za izvijač z vpenjalom / Atskurtuko antgaliai su laikikliu / Skruvengrežo uzgaļu komplekts ar turētāju / Kruvikeerajooksakud koos käepidemega / Набори насадки за отвёртка с държач / Nastavci za odvijač s hvatačkom / Nastavci za odvijač s drškóm / Set με καταβύθιμα μετ'εξάρτησή / Puntas destornilladoras con mango / Set inserti con supporto / Ponteiros Chave de fenda com Suporte / Erbaouts de tournevis avec manche / Schroevendraaierinstukken met handvat



- ⊖ 3, 4, 4.5, 5.5, 6, 6.5, 7, 8 mm
- ⊕ PH0, PH1, PH2x5, PH3
- ⊕ PZ0, PZ1x2, PZ2x5, PZ3
- ⊕ T8, T10, T15, T20, T25, T27, T30, T40, T45
- ⊕ TT8, TT10, TT15, TT20, TT25, TT27, TT30, TT35, TT40
- H1.5, H2, H2.5, H3, H4, H5, H5.5, H6, H8
- H1/16, H5/64, H3/32, H7/64, H1/8, H9/64, H5/32, H3/16, H7/32, H1/4"
- HT2, HT2.5, HT3, HT4, HT5, HT6
- 5/64, 3/32, 7/64, 1/8, 9/64, 5/32"
- M5, M6, M8
- ⊕ 4, 6, 8, 10 mm
- ⊕ 2, 3, 4 mm
- ⊕ 1, 2, 3 mm
- ⊕ 6, 8, 10 mm
- No0, No1, No2, No3

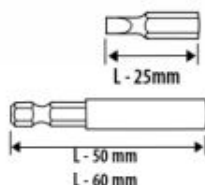

Ref.	📦	EAN
06-104	6/24	5907558406245



- ⊖ 3, 4, 5, 6 mm
- ⊕ PH1x2, PH2x2, PH3x2
- ⊕ PZ1x2, PZ2x2, PZ3x3
- ⊕ T10, T15, T20, T25, T27, T30, T40
- ⊕ TT10, TT15, TT20, TT25, TT27, TT30, TT40
- H2, H2.5, H3, H4, H5, H6

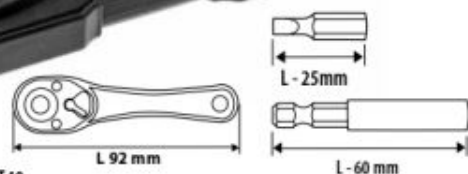

Ref.	📦	EAN
06-105	6/36	5907558402315

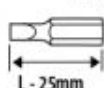
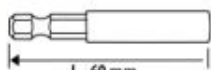

- ⊖ 3, 4, 5, 6 mm
- ⊕ PH1, 2xPH2, PH3
- ⊕ PZ1, 2xPZ2, PZ3
- H3, H4, H5, H6
- ⊕ T10, T15, T20, T25, T27, T30, T40
- ⊕ TT10, TT15, TT20, TT25, TT27, TT30, TT40

Ref.	📦	EAN
06-103	6/24	5907558402346

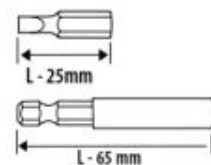

- ⊖ 3, 4, 5, 6 mm
- ⊕ PH1, 2xPH2, PH3
- ⊕ PZ1, 2xPZ2, PZ3
- H3, H4, H5, H6
- ⊕ T10, T15, T20, T25, T27, T30, T40
- ⊕ TT10, TT15, TT20, TT25, TT27, TT30, TT40

Ref.	📦	EAN
06-106	12/48	5907558410143

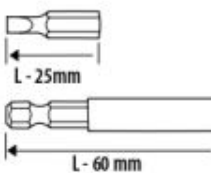

- ⊖ 4, 5, 6 mm
- ⊕ PH1, PH2
- ⊕ T15, T20



Ref.	📦	EAN
06-101	12/120	5907558402339

## Uchwyt do końcówek

Bit holder / Aufnahme für Spitzen / Зажим для наконечников / Тримач до наконечників / Csavarbehajtószer / Dispositiv de prinderea capetelor / Skližidlo na nástavce / Upinadlo na nástavce / Vpenjalo za nastavke / Laikiklis antgaliams / uzgaļu patrons / Otsakuradrun / Держач за накраїнуци / дрška za nastavke / Hvot za nastavke / Προσαρμογέας μπιτών / Mandril de sujeción para puntas / Innesto per inserti con impugnatura / Suporte de ponteiros / Manche pour embouts / Houder voor eindstukken



Ref.	L [mm]	⊗	EAN
06-070	65	10/100	5907558403497

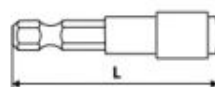

Ref.	L [mm]	⊗	EAN
06-071	60	20/200	5907558405385

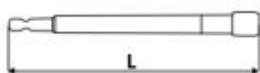

Ref.	L [mm]	⊗	EAN
06-072	150	12/96	5907558410105
06-073	300	12/48	5907558410112

## Końcówki wkrętakowe

Driver bits / Einsätze für Schraubendreher / Насадки / Наконечники оувртымои / Csavarhúzó hegyek / Set biti / Šroubovákové nástavce / Skrutkovacie nástavce / Nastavki za izvijače / Atsuktuvo antgaliai / Skrivgrieža uzgaļi / Krivkveerajatsakud / Накраїнуци за отвёртки / Nastavi za odvijač / Nastavi za odvijač / Καταφιλόδωρες / Puntas destornilladoras / Inserti / Ponteiros de chave de fenda / Embouts de tournevis / Schroeve ndr aviereindstukken

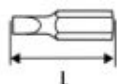

Ref.	⊕	L [mm]	⊗	EAN
06-011	PH2	25	12/120	5907558406351

DIN 3126

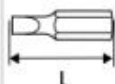

Ref.	⊕	L [mm]	N	⊗	EAN
06-020	PZ2	25	x20	50/150	5907558403015

DIN 3126

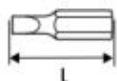

Ref.	⊕	L [mm]	N	⊗	EAN
06-036	PH2	25	x10	50/150	5907558403121
06-037	PH2	50	x5	50/200	5907558403138



Ref.	⊕	⊗	EAN
06-040	PH2	24/192	5907558410099

## Szpikulec

Paint chisel / Spicknadel / Наконечник / Шило / Ár / Tijă ascuțită / Hrot / Šídlo / Igla za pretkanje / Yla / Caurumsitis / Naaskel / Шило / Šijak / Probadáč, šilo / Μίση / Púa / Punteruolo / Ponta / Pointe / Puntbeitel



Ref.	☒	EAN
04-037	12/120	5907558435917

## Haki

Hooks / Hacken / Ξαγκιά / Γαξιά / Horgok / Cârțige / Háký / Skoby / Kijuke / Kabliari / Aki / Haogid / Ньсу / Kuke / Kuke / Γάντζοι / Ganchos / Ganci / Anzóis / Crochets / Haken



Ref.	☒	EAN
04-231	6/72	5907558483901

## Wkrętak udarowy

Impact screwdriver / Schlag-Schraubendreher / Отвертка ударная / Вкрутка ударна / Ütveszavarozó / Surubelniță cu perutor / Šroubovák rázový / Rázový skrutkovač / Udarni izvijač / Smitijinis suktuvos / Τραπέζια skrúvgrizis / Löökkravikeeraja / Ударна отвертка / Odvijač s udarom / Udarni odvijač / Καταβίβει κρούσης / Destornillador de impacto / Cacciavite a percussione / Chave de fenda de impacto / Tournevis à chocs / Slagschroevendraaier



⊖ 5, 6, 8, 10, 12, 14 mm  
⊕ PH1, PH2, PH3



Ref.	m[kg]	☒	EAN
04-250	1,2	0/12	5907558410082

## Wkrętak akumulatorowy

Cordless Screwdriver / Akku-Schraubendreher / Отвертка аккумуляторная / Шрубоверт аккумуляторний / Akkumulátoros csavarozó / Surubelniță cu acumulator / Akumulátorový šroubovák / Akumulátorový skrutkovač / Akumulatorski vijčačnik / Akumulátorinis suktuvos / Akumulatora skrūvgrizis / Akukruvikeeraja / Аккумуляторна отвертка / Akumulatorski odvijač / Akumulatorski odvijač / Επαναφορτιζόμενο καταβίβει / Destornillador a batería / Avvitatore a batteria / Chave de fenda de bateria / Tournevis à batteries / Accu schroevendraaier



Ref.	☒	EAN
04-200	0/16	5907558439380

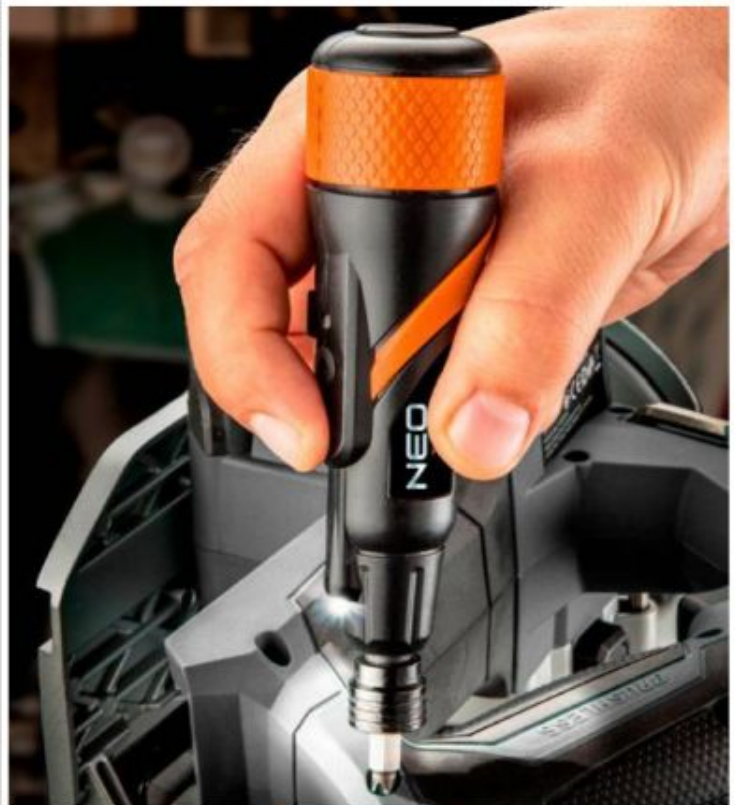

## Wkrętak płaski 1000V

Screwdriver slotted / Flachsraubendreher / Отвертка плоская / Відкрітка плоска / Csavarhúzó / Şurubelniği platı / Šroubovák plochý / Skrutkovač plochý / Ploščati izvijač / Plakšās atsuktuvās / Skrūvgriezis plakans / Лемепа-крувікережа / Отвертка / Одвіяє / Одвіяє / Καταβίβη εγκοπής / Destornillador plano / Giravite piatto 1000V / Chave de fenda plana / Tournevis à fourche / Vlakke schroevendraaier



Ref.	⌀ mm	L [mm]	L <sub>1</sub> [mm]	⊠	EAN
04-051	2,5	150	75	12/600	5907558401998
04-052	3,0	175	100	12/240	5907558402001
04-053	4,0	205	100	12/240	5907558402018
04-054	5,5	230	125	12/144	5907558402025
04-055	6,5	270	150	12/144	5907558402032



Ref.	⌀ mm	L [mm]	L <sub>1</sub> [mm]	⊠	EAN
04-130	0,4	175	75	12/120	5907558433227
04-131	0,6	195	100	12/120	5907558433234
04-132	0,8	198	100	12/120	5907558433241
04-133	1,0	230	125	12/120	5907558433258

## Wkrętak krzyżowy PH 1000V

Screwdriver Phillips / Kreuzschraubendreher / Отвертка крестовая / Відкрітка крестовидна / Csavarhúzó philips / Şurubelniği tip „Phillips” / Šroubovák křížový / Skrutkovač PH / Křížni izvijač / Kryžminis atsuktuvās Phillips / Skrūvgriezis krusta PH / Ristpeakruvikeeraja / Отвертка / Одвіяє / Одвіяє / Καταβίβη σταυρωτή τύπου philips / Destornillador philips / Giravite Phillips / Chave de fenda de cruzeta / Tournevis en croix / Kruisschroevendraaier



Ref.	⊕	L [mm]	L <sub>1</sub> [mm]	⊠	EAN
04-071	PH0	135	60	12/600	5907558402070
04-072	PH1	190	80	12/240	5907558402087
04-073	PH2	215	100	12/144	5907558402094



Ref.	⊕	L [mm]	L <sub>1</sub> [mm]	⊠	EAN
04-137	PH0	160	60	12/120	5907558433296
04-138	PH1	185	80	12/120	5907558433303
04-139	PH2	210	100	12/120	5907558433319
04-140	PH2	285	175	12/120	5907558433326

## Wkrętak krzyżowy PZ 1000V

Screwdriver Pozidriv / Kreuzschraubendreher / Отвертка крестовая / Відкрітка крестовидна / Csavarhúzó pozidriv / Şurubelniği tip „Pozidriv” / Šroubovák křížový / Skrutkovač PZ / Křížni izvijač / Kryžminis atsuktuvās Phillips / Skrūvgriezis krusta PZ / Ristpeakruvikeeraja Pozidriv / Отвертка / Одвіяє / Одвіяє / Καταβίβη τύπου pozidriv / Destornillador philips / Giravite Pozzi 1000V / Chave de fenda de cruzeta / Tournevis en croix / Kruisschroevendraaier



Ref.	⊕	L [mm]	L <sub>1</sub> [mm]	⊠	EAN
04-062	PZ1	190	80	12/240	5907558402056
04-063	PZ2	217	100	12/144	5907558402063



Ref.	⊕	L [mm]	L <sub>1</sub> [mm]	⊠	EAN
04-136	PZ2	210	100	12/120	5907558433289

## Wkrętaki 1000V

Screwdriver set / Schraubendreher / Отвертки / Відкрітки, набір / Csavarhúzókészlet / set şurubelniği / Šroubováky / Súprava skrutkovačov+bity / Komplet izvijačev / Atsuktuvu komplektas / Skrūvgriežu komplekts / Крувікережате комплект / Отвертки комплект / Одвіяє / Одвіяє set / Συλλογή καταβίβων / Destornilladores / Set giraviti 1000V / Chaves de fenda / Tournevis / Schroevendraaiers

- ⊖ 2.5x75 mm, 4x100 mm, 6.5x150 mm
- ⊕ PH1x80 mm, PH2x100 mm



Ref.	⊠	EAN
04-220	6/36	5907558402278

- ⊖ 3x100 mm, 4x100 mm, 5.5x125 mm, 6.5x150 mm, 8x175 mm
- ⊕ PH0x60mm, PH1x80 mm, PH2x100 mm, PH3x150 mm



Ref.	⊠	EAN
04-143	0/12	5907558433357

## Wkrętaki 1000V

Screwdriver set / Schraubendreher / Отвертки / Відкрутки, набір / Csavarhúzókészlet / set şurubelniçe / Šroubováky / Šiprava skrutkovačon-bity / Komplet izvijačev / Atsuktuvų komplektas / Skrivnėžių kompleks / Krivkeerajate komplekt / Отвертки набор / Odvijač / Odvijač set / Συλλογή καταβιδιών / Destornilladores / Set giraviti 1000V / Chaves de fenda / Tournevis / Schraubendreiers



- ⊖ 0.6x100mm, 0.8x100mm, 1.0x100mm, 1.2x100mm, 1.6x175mm
- ⊕ PH0x60 mm, PH1x80 mm, PH2x100 mm, PH3x150 mm



Ref.	📦	EAN
04-142	0/12	5907558433340

## Wkrętak plus-minus 1000V

Screwdriver / Kreuzschraubendreher / Отвертка крестообразная / Відкрутка хрестовидна / Csavarhúzó / şurubelniçe / Šroubovák křížový / Skrutkovač / Кřížní izvijač / Kryžminis atsuktuvus / Skrivnėžis krusta / Ristpeakrivkeeraja / Отвертка / Odvijač / Odvijač / Καταβιδι σταυρωτό τύπου / Destornillador philips / Gravit / Chave de fenda de cruzeta / Tournevis en croix / Kreuzschraubendreier



Ref.	⊖⊕	L[mm]	L <sub>1</sub> [mm]	📦	EAN
04-221	SL/P22	220	100	12/144	5907558432398
04-222	SL/PH2	220	100	12/144	5907558432404

## Konektory

Electric connectors set / Steckverbinder-Set / Коннектори набор / Конектори, набор / Kábelsarukészlet / Conectori set / Konektory šiprava / Konektory / Komplet električnih priključkov / Elektros jungčių rinkinys / Elektrisko savienotāju komplekts / Elektrisistūte komplekt / Комплект электрически соединители / Komplet električnih konektora / Комплект электрических конекторов / Set elektriskih ovljčnikov / Juego de conectores eléctricos / Set di connettori / Conjunto de conectores eléctricos / Jeu de connecteurs électriques / Elektrische connectoren set

x420



x15 6.3 mm 11-10 AWG 4.0-6.0 mm <sup>2</sup>	x15 6.3 mm 11-10 AWG 4.0-6.0 mm <sup>2</sup>	x30 4.8 mm 20-17 AWG 0.5-1.0 mm <sup>2</sup>	x30 4.8 mm 20-17 AWG 0.5-1.0 mm <sup>2</sup>	x50 2.8 mm 20-17 AWG 0.5-1.0 mm <sup>2</sup>	x50 2.8 mm 20-17 AWG 0.5-1.0 mm <sup>2</sup>
x15 M10 20-17 AWG 0.5-1.0 mm <sup>2</sup>	x15 M8 20-17 AWG 0.5-1.0 mm <sup>2</sup>	x20 M5 20-17 AWG 0.5-1.0 mm <sup>2</sup>	x30 4.0 mm 20-17 AWG 0.5-1.0 mm <sup>2</sup>	x15 4.0 mm 20-17 AWG 0.5-1.0 mm <sup>2</sup>	x15 4.0 mm 20-17 AWG 0.5-1.0 mm <sup>2</sup>
x15 M10 15-13 AWG 1.5-2.5 mm <sup>2</sup>	x15 M8 15-13 AWG 1.5-2.5 mm <sup>2</sup>	x20 M5 15-13 AWG 1.5-2.5 mm <sup>2</sup>	x30 4.8 mm 15-13 AWG 1.5-2.5 mm <sup>2</sup>	x30 4.8 mm 15-13 AWG 1.5-2.5 mm <sup>2</sup>	x10 6.3 mm 15-13 AWG 1.5-2.5 mm <sup>2</sup>

Ref.	📦	EAN
01-535	0/36	5907558439366

## Końcówki wkrętakowe z uchwytem 1000V

Screwdriver bits with holder / Einsätze für Schraubendreher mit Aufnahme / Набор насадок с держателем / Наносечени викрутки, з рукоят'ям / Csavarhúzó cserélhető feji / Set biti cu suport carpat / Šroubovákové nástavce s držadlem / Skrutkovacne nastavce s upinadlom / Nastavki za izvijač z vpenjalom / Atsuktuvų antgaliai su laikikliu / Skrivnėžių užgali kompleks ar turėtu / Krivkeerajatsakud koos käepidemega / Накрайники за отвертка с держак / Nastavci za odvijač s hvatačkom / Nastavci za odvijač s držkom / Set με καταβιδιάδες και προσαρτησία / Puntas destornilladoras con mango / Set inserti con supporto / Ponteiros Chave de fenda com Suporte / Embouts de tournevis de précision avec manche / Schraubendreierendstücken met handvat

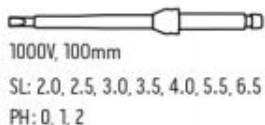

QUICK CHANGE

Ref.	📦	EAN
01-308	0/20	5907558435597

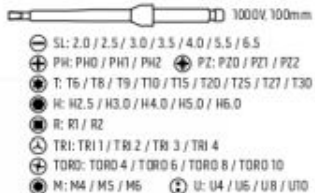

Ref.	📦	EAN
01-309	0/10	5907558435603

## Grzechotka 1000V

Ratchet handle / Ratsche / Трещотка / Держак з трещоткою / Racsnikács / Miner de hurlitoare / Rehtačka / Račva prepínacia / Raglja / Terkšle / Reversa atslēga / Pärkattaja pide / Трещотка / Račva za nasadni ključ / Račva za zadoru / Καρπανά / Llave de carraca / Cricchetto / Catroca de furar / Clé à cliquet / Ratel



Ref.	📦	EAN
01-180	4/28	5907558432817

## Nasadka sześciokątna 1000V

Hexagonal socket / Sechskanteinsatz / Головка сменная шестигранная / Насадка шестигранная / Dugökulcs / Cheie tubulara hexagonală / Šestihraný nástavec / Šestihraný nástavec / Šestikotni patični nastavek / Šešakampis antgalis / Šeštúra potaíniotá galva / Kuuskantradial / Шестыгълна наставка / Šesterokutna kapica / Šestougolna nasadka / Карбоки еѓауило / Vaso para destornillador hexagonal / Bussola esagonale / Vocal hexagonal / Douille à 6 pans / Zeskant dop



Ref.	W[mm]	⊠	EAN	Ref.	W[mm]	⊠	EAN
01-181	10	12/108	5907558432893	01-189	19	12/108	5907558432978
01-182	11	12/108	5907558432909	01-190	21	11/110	5907558432985
01-183	12	12/108	5907558432916	01-191	22	11/110	5907558432992
01-185	14	12/108	5907558432930	01-192	24	11/110	5907558433005
01-186	16	12/108	5907558432947	01-193	27	15/105	5907558433012
01-187	17	12/108	5907558432954	01-194	30	10/90	5907558433029
01-188	18	12/108	5907558432961	01-195	32	10/90	5907558433036

## Klucze sześciokątne 1000V

Hex key / Sechskantschlüssel / Ключи шестигранные / Ключ шестигранный / Imbuskulcs készlet / Set chei cu șase laturi / Šestihraný klíč / Šúprava imbus ključov (dlhé) / Garnitura imbus ključev / Šešakampij raktų komplektas / Šeškanšu atslēgu komplekts / Kuuskant-mutrivõtmete komplekt / Лумбуци компл. / Ключи имбус сет / Ключи имбус сет / Συλλογή εξηλεκτικών κλειδών / Llaves Allen / Chiavi esagonali / Chaves hexagonais / Clefs à 6 pans / Zeskantsleutels



Ref.	● [mm]	⊠	EAN
01-171	3	8/72	5907558432824
01-172	4	8/72	5907558432831
01-175	8	8/48	5907558432862
01-176	10	8/48	5907558432879
01-177	12	6/36	5907558432886

## Klucz płaski jednostronny 1000V

Open single end spanner / Maulschlüssel einseitig / Ключ рожковый одностронный / Ключ рожковый / Villáskulcs / Cheie riułită unilaterală cu avintea deschisă / Plochý klíč jednostranný / Klíč valcový jednostranný / Viličasti ključ / Ploščias vienpusis raktas / Rogačslēga / Uhe avatud otsaga vāti / Ключ гаечен / Ключ вилчастий / Ключ вилчастий / Μονό γαργαλιού κλειδί / Llave fija de una boca / Chiave a forchetta / Chave plana / Clef à fourche simple / Eenzijdig vlakke sleutel



Ref.	● [mm]	⊠	EAN	Ref.	● [mm]	⊠	EAN
01-110	6	9/108	5907558432411	01-119	15	8/72	5907558432503
01-111	7	9/108	5907558432428	01-120	16	8/72	5907558432510
01-112	8	9/108	5907558432435	01-122	18	8/72	5907558432534
01-113	9	9/108	5907558432442	01-124	21	6/54	5907558432558
01-114	10	9/108	5907558432459	01-125	22	6/54	5907558432565
01-115	11	9/108	5907558432466	01-126	24	6/54	5907558432572
01-116	12	9/108	5907558432473	01-127	27	6/36	5907558432589
01-118	14	8/72	5907558432497	01-128	30	6/36	5907558432596
				01-129	32	6/36	5907558432602

## Klucze nasadowe 1000V

Socket wrenches / Steckschlüssel / Набор сменных головок / Ключи торцевые / Dugökulcskészlet / Trusa tubulară / Nástrčné klíče / Nástrčné klíče / Nasadni ključji / Veržlerakcio antgalai / Normantoto galva komplekts / Radialvõtmed / Сменными наконечники за ключове / Nasadni ključev / Ключевы паткачи / Σετ με καρβόκαα / Llaves de vaso / Set di bussola SuperLock / Chaves tubulares / Clefs à douilles / Dopsléutels



19 elements

CrV steel

1000V

x19

1/2"

36

36

36

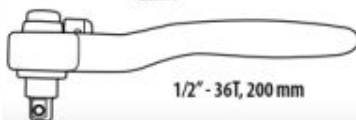
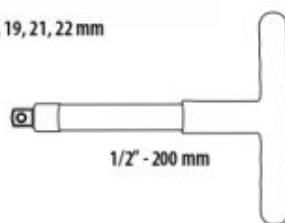
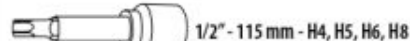
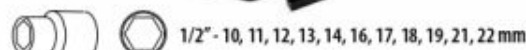

Ref.	⊠	EAN
01-306	0/3	5907558435573



8 elements

CrV steel

1000V

x8

1/2"

36

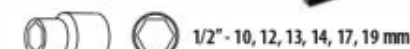

Ref.	⊠	EAN
01-307	0/5	5907558435580

## Skrzynia serwisowa elektryka 52 szt.

Electrician's tool box 52 pcs / Servicekasten für Elektriker 52-teilig / Инструментальный ящик электрика 52 шт. / Инструментальный ящик электрика 52 шт. / Villanyszerelő koffer, 52 db / Căușe scule electrician 52 piese / Elektrikářský servisní box 52 ks / Elektrikářská skříňka s náradím 52 ks / Servisni kovček elektrikařa 52 kos. / Įrankių dėžė elektrikai 52 vnt. / Elektrika instrumentu kaste 52 gab. / Elektriku tööriistakast 52 tk / Ηυφάρυα ινστρυμεντάρια για ηλεκτροτεχνική 52 άρ. / Servisni ormar za električare 52 kom. / Servisna kutija električara 52 kom. / Βαλίτσα εργαλείων ηλεκτρολόγου 52 τμκ / Caja de servicio de eléctrico 52 uds. / Casseta portautensiliu per elettricista 52 pz. / Kit de 52 ferramentas de electricista em caixa / Caisse à outil électricien / Gereedschapskoffer van elektricien 52 st.

160 mm      160 mm      160 mm

180 mm      200 mm

1/2" - 10 / T1 / T2 / T3 / T4 / T6 / T7 / 8 / T9 / T1 / T2 / T4 / T7 mm

1/2" : 115 mm - H4 / H5 / H6 / H8

1/2" - 125 / 250 mm

195 mm

250 V, 3x140mm CE

PH0x60, PH1x80, PH2x100, PH3x150  
2.5x75mm, 3x100mm, 4x100mm, 5.5x125mm, 6.5x150mm

8, 10, 11, 12, 13, 14, 15, 16, 17, 18, 19, 22, 24 mm

210 mm, Ra 30 mm

**25** years GUARANTEED  
**CrV** steel  
**S2** steel  
1000V  
**PP** POLYPROPYLENE  
**EVA**  
DUST WATER  
**IP67** x**52** 1/2" 36

**52** elements

Ref.	☒	EAN
01-311	0/1	5907558439991

## Walizka elektryka

Electrician's suitcase / Elektriker-Koffer / Чемодан электрика / Βαλίτσα ηλεκτρονική / Villanyszerelő koffer / Valiza electricianului / Kufer elektrikaře / Elektrikářský kufrík / Kovček za električare / Logamino elektrika / Elektrika instrumentu koferis / Elektriku kohver / Ηυφάρυα για ηλεκτροτεχνική / Κοψέγ για ηλεκτριčare / Kofer elektrikařa / Βαλίτσα εργαλείων ηλεκτρολόγου / Maletín de eléctrico / Valigetta da eletriciasta / Mala de eletricista / Malette à outils pour électricien / Gereedschapstas elektricien

**S2** steel   **CrV** steel   **CrMo** steel   1000V   **ABS**   **TPR**   1/4"   1/2"   72   x**108**

1/2" - 15-16-17-19-20-21-22-24-27-30-32 mm  
1/4" - 4-4.5-5-5.5-6-7-8-9-10-11-12-13-14 mm

1/2" - E20-E22-E24  
3/8" - E10-E11-E12-E14-E16-E18  
1/4" - E4-E5-E6-E7-E8

1/2" - 72T  
1/4" - 72T

1/2" - 125, 250 mm  
1/4" - 50, 100 mm

1/2" - 16, 21 mm

1/4" - 115 mm

1/4" - 150 mm

1000V  
SL 5.5x125, SL 3x100mm  
PH0x50mm, PH1x80mm  
PH2x100mm

250 V CE

160 mm

1000V 160 mm      0.25-6 mm<sup>2</sup>

1000V 160 mm      0.5-6 mm<sup>2</sup>

190 mm

0.34-6 mm<sup>2</sup>      0.5-16 mm<sup>2</sup>

**108** elements

Ref.	☒	EAN
01-310	0/2	5907558431957

## Zestaw narzędzi izolowanych do aut elektrycznych

Insulated tool kit for electric cars / Isolierter Werkzeugsatz für Elektroautos / Изолированный набор инструментов для электромобилей / Izolovaný nábor nástrojů pro elektromobily / Izolovaná súprava náradia pre elektromobily / Izoliran komplet orodja za električne avtomobile / Izoluotas elektrinių automobilių įrankių rinkinys / Izolēts instrumentu komplekts elektromobilēm / Isolatitud tööriistakomplekt elektrautoide jaoks / Изолиран комплект инструменти за електрически автомобили / Set izoliranih alata za električne automobile / Set izolovaných náradia za elektrické automobily / Set izolovaných εργαλείων για ηλεκτρικά αυτοκίνητα / Kit de herramientas aislada para coches eléctricos / Kit di attrezzi isolati per auto elettriche / Geïsoleerde gereedschapset voor elektrische auto's / Kit d'outils isolés pour les voitures électriques



**CRV steel** **S2 steel** **8Cr14 steel** **51 elements** **1000V** **3/8"**

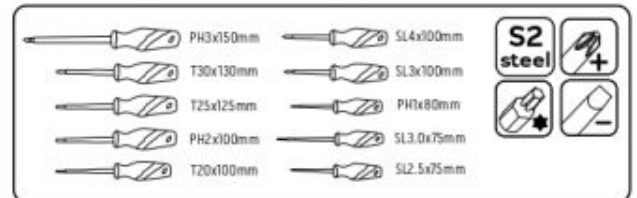
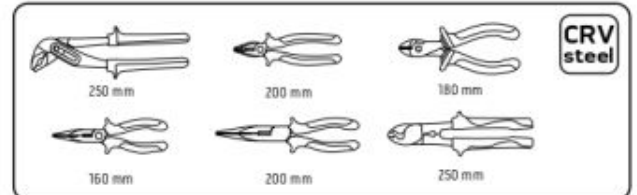
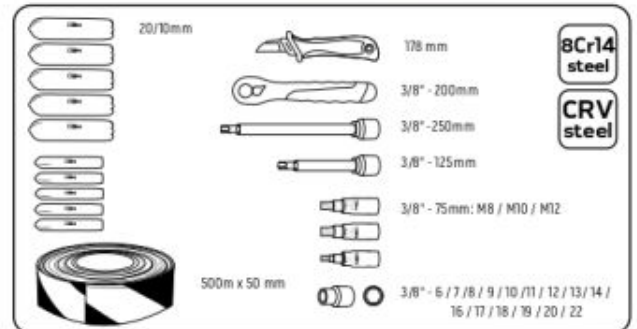

Ref.	☒	EAN
01-312	0/1	5907558493726





## Szczypce uniwersalne

Combination pliers / Kombizange / Πασατουκι / Πασατουκι / Kombináltfogó / cęste universal / Kombinované klešče / Kliešte kombinované / Kombinirane klešče / Universālais replis / Plakanknaibles kombinētās / Universaalnápitsad / Κλειδι κομβιουρακι / Kombinirana klješta / Kombinovana klešta / Πένσα γενικής χρήσης / Alicates universales / Pinza universale / Pinças universais / Pince universelle / Universele tang



Ref.	L[mm]	☒	EAN
01-010	160	6/48	5907558401547
01-011	180	6/48	5907558401554
01-012	200	6/48	5907558401561

## Szczypce wydłużone proste

Combination pliers / Kombizange / Πασατουκι / Πασατουκι / Hosszúcsőrű fogó / cęste universal / Kombinované klešče / Kliešte kombinované / Kombinirane klešče / Universālais replis / Plakanknaibles kombinētās / Universaalnápitsad / Κλειδι κομβιουρακι / Kombinirana klješta / Kombinovana klešta / Πένσα γενικής χρήσης / Alicates universales / Pinza a becco lungo / Pinças retas prolongadas / Pince allongée droite / Lange rechte tang



Ref.	L[mm]	☒	EAN
01-013	160	6/48	5907558401578
01-014	200	6/48	5907558401585



Ref.	L[mm]	☒	EAN
01-250	160	6/60	5907558443646
01-251	180	6/60	5907558443653



Ref.	L[mm]	☒	EAN
01-252	160	6/60	5907558443660
01-253	180	6/60	5907558443677



budowa głowicy oszczędza 40% siły przy standardowym nacisku  
head design saves 40% of force with standard pressure  
конструкция напору экономит 40% усилия при стандартном тиску

Ref.	L[mm]	☒	EAN
01-152	180	6/48	5907558448511
01-153	200	6/48	5907558448528



budowa głowicy oszczędza 40% siły przy standardowym nacisku  
head design saves 40% of force with standard pressure  
конструкция напору экономит 40% усилия при стандартном тиску

Ref.	L[mm]	☒	EAN
01-154	160	6/48	5907558448535
01-155	200	6/48	5907558448542

## Szczypce wydłużone wygięte

Long nose bent pliers / Zange lang, gebogen / Πισοκαυβυζι/υδληννηνη ιαονηνηνη / Щипци удлиженн, изогнуты / Rovidcsőrű fogó / Cęste varf ascuțit indoit / Kliešče predĺžené vyhnuté / Kliešte predĺžené vyhnuté / Koričaste klešče - upognjene / Prailgintos replis, lenktas / Izliektas pagarinātas knaibles / Pikkade kõverate otstega nāpitsad / Клеиди удължени огънати / Izdužena savinuta klješta / Izdužena uvijena klešta / Μυροταιμιο κυρτό / Alicates Teléfono curva / Pinza a becco curvo / Pinças curvadas prolongadas / Pince allongée coudées / Lange gebogen tang



Ref.	L[mm]	☒	EAN
01-015	160	6/48	5907558401592
01-016	200	6/48	5907558401608



Ref.	L[mm]	☒	EAN
01-254	160	6/60	5907558443684
01-255	180	6/60	5907558443691

## Szczypce boczne

Diagonal cutting pliers / Seitenzange / Бокорезы / Βοκορίαι / Oldalcsípó fogó / clește ascuțit diagonal de tăiat sîrmă / Bočni klešče / Цикачки божене / Stranske klešče / Soninés replés / Sänknabbes / Diagonaal-löketangid / Κλεψή Ρεζαίου / Klijesta cvikerice / Klesta poluokruga / Πλαγκοκόπτης / Alicates diagonales / Tranchese laterale / Pinças laterais / Pince latérale / Zjtang



Ref.	L[mm]	☒	EAN
01-017	160	6/48	5907558401615
01-018	180	6/48	5907558401622



Ref.	L[mm]	☒	EAN
01-256	160	6/60	5907558443707
01-257	180	6/60	5907558443714



Ref.	L[mm]	☒	EAN
01-156	160	6/48	5907558448559
01-157	180	6/48	5907558448566



Ref.	L[mm]	☒	EAN
01-158	180	6/48	5907558448573

budowa głowicy oszczędza 40% siły przy standardowym nacisku  
head design saves 40% of force with standard pressure  
конструкция напору экономит 40% усилия при стандартному тиску

budowa głowicy oszczędza 40% siły przy standardowym nacisku  
head design saves 40% of force with standard pressure  
конструкция напору экономит 40% усилия при стандартному тиску

## Szczypce okrągłe

Round nose pliers / Rundzange / Круглозубцы / Κυρλοζυβίαι / Kerekcsőrű fogó / clește rotund / Kulaté klešče / Kliešte s okružlou čelistou / Okrogle klešče / Αρσάλιος replés / Αρσάλιαβλεs / Ürmarmokk-näpitsad / Κλεψή चौकी / Klijesta okrugla / Klesta okrugla / Μισοταϊμίδα με στρογγυλά ράμφη / Alicates redondos / Pinza a becco tondo / Pinças redondas / Pince ronde / Ronde tang



Ref.	L[mm]	☒	EAN
01-020	160	6/48	5907558401646



Ref.	L[mm]	☒	EAN
01-019	160	6/48	5907558401639

## Szczypce precyzyjne płaskie

Precision flat pliers / Präzisionszange flach / Платнозубцы прецизионные / Платнозубци прецизијни плоски / Laposcsőrű fogó / Clește plat / Klešče jetnā mehanika / Klešče ploché mikro / Platske klešče, precízne / Ploščāos replés tikšiemš darbamš / Plakanknabbes / Täppislātemokk-nāpitsad / Клеψή चौकी / Klijesta plosnata / Klesta plosnata / Πλαταϊταιμίδα ακριβείας γενικής χρήσης / Pinza di precisione a becco piatto / Pinças precisas planas / Pince de précision à fourches / Precisie vlakke tang



Ref.	L[mm]	☒	EAN
01-105	130	6/96	5907558401714

## Szczypce precyzyjne czołowe

Precision end cutter pliers / Ślimpräzisionszange / Носовни торцевые прецизионные / Βοκορίαι прецизијни / Hamlokcsőrű fogó / clește frontal / Lklešče čelni jetnā mehanika / Цикачки čelne mikro / Stranske klešče, precízne / Žnyplēs tikšiemš darbamš / Knabbes / Täppisnāpitsad otste löikamšeks / Клеψή ρεζαίου / Klijesta cvikerice / Klesta seice / Επιροδοκόφτης ακριβείας / Alicates frontales de precisión / Tenaglia di precisione / Pinças precisas frontais / Pince de précision frontale / Precisie hoofdtang

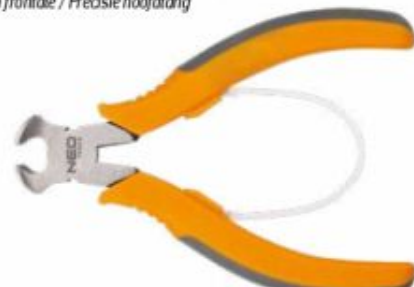

Ref.	L[mm]	☒	EAN
01-101	115	6/96	5907558401677

## Szczypce precyzyjne wydłużone proste

Precise long nose straight pliers / Feinzange, lang, gerade / Плоскогубцы прецизионные удлиненные / Щипци прецизијни, з видоуженими, правими зубима / Hosszúcsőrű fogó / Cieste precizie-varf lung / Kleště precizní prodloužené rovné / Kliešte precízne predĺžené rovné / Precizne ravne podaljšane kleščice / Prailgintos precizines replės, tiesios / Pagarinātas precīzējošas plakanknābles / Pikkade otstega peennäpitsad / Прецизни удължени клещи / Precizna izdužena jednostavna klijesta / Precizna ravna izdužena klešta / Μυτατογίμφο ακριβείας / Alicates puntas redondas larga / Pinza di precisione a becco lungo / Pinças precisas prolongadas retas / Pince de précision allongée droite / Lange rechte precisie tang



Ref.	L[mm]	⊠	EAN
01-102	130	6/96	5907558401684

## Szczypce precyzyjne wydłużone wygięte

Precise long nose bent pliers / Feinzange, lang, gebogen / Плоскогубцы прецизионные удлиненные изогнутые / Щипци прецизијни, з видоуженими, вигнутими зубима / Rövidcsőrű fogó / Cieste precizie-varf indait / Kleště precizní prodloužené vyhnuté / Kliešte precízne predĺžené vyhnuté / Precizne podaljšane upognjene kleščice / Prailgintos precizines replės, išlenkos / Izliektas pagarinātas precīzējošas plakanknābles / Pikkade kõverate otstega peennäpitsad / Прецизни удължени огънати клещи / Precizna izdužena savinuta klijesta / Precizna uvijena izdužena klešta / Μυτατογίμφο ακριβείας κυρτό / Alicates puntas curvas larga / Pinza di precisione a becco curvo / Pinças precisas prolongadas curvadas / Pince de précision allongée courbée / Lange gebogen precisie tang



45°

Ref.	L[mm]	⊠	EAN
01-103	140	6/96	5907558401691

## Szczypce precyzyjne boczne

Precision diagonal pliers / Seitenpräzisionszange / Бокарезы прецизионные / Плоскогубци прецизијни дијагонални / Oldalcsőrű fogó / Cieste diagonal / Kliešte boční jemná mechanika / Cvikáčky bočné mikro / Čelne kleště, precizne / Šoninēs replės tiksliems darbam / Sānknaibles / Diagonāl-tīrpisnāpitsad / Клеци резачки / Klijesta cvikence / Klesta seice / Πλαγκοκόπτης ακριβείας / Alicates diagonales de precisión / Tronchese laterale di precisione / Pinças precisas laterais / Pince de précision latérale / Precisie zijtang



Ref.	L[mm]	⊠	EAN
01-106	110	6/96	5907558401721



Ref.	L[mm]	∅ [mm]	⊠	EAN
01-509	140	0,8 - 2,6	10/50	5907558439281

## Szczypce czołowe

End cutting pliers / Frontzange / Нычачи марочове / Щипци марочови / Homlokcsőrű fogó / Cieste taiere frontala / Kleště čelní / Kliešte čelné / Čelne kleščice / Kandikles / Kniebjamās knābles / Otsnāpitsad / Клеци челни / Čelna klijesta / Čelna klešta / Τακάλια / Alicates de corte frontal / Tenaglia / Pinças frontais / Pince frontale / Hoofdang



Ref.	L[mm]	⊠	EAN
01-021	160	6/48	5907558401653
01-022	200	6/48	5907558401660

## Obcęgi do gwoździ

Carpenters pincers / Beißzange / Клеци дин гвозде / Harapó fogó / cleste dulgher / Sópaci kleště / Cvikáčky čelné / Mizarske kleščice / Župples vinims / Naglu stangas / Puissepa nāpītstangid / Клеци Кепнеден / Stolarska klijesta / Stolarska klesta / Τακάλια Μαραγκού / Tenazas para clavos / Tenaglia da carpiniere / Turqueses p. Pregos / Tenailles à clous / Spijkertang



Ref.	L[mm]	⊠	EAN
01-151	180	6/48	5907558411720
01-150	200	6/48	5907558406054

## Szczypce do pierścieni osadczych

Circle pliers / Zange für Stellringe / Щипцы для стопорных колец / Щипцы для стопорных колец / Zégergűrű fogó / set dește cu spirală / Kleště pro stavěcí kroužky / Segerky vonkajšie rovnie / Klešče seger / Replės žiedams / Sprostgredeņu stangas / Vedrunāpīrsads / Клещи Зеер / Кръзна Кълешта / Кръзна клешта / Ασφαλοποιητής / Alicates para anillos de asiento / Pinza per anelli elastici / Pinças p. Anéis / Pince pour bagues de retenue / Tang voor dopringen



zewnątrznie proste  
external, straight tip  
зовнішній/прости щипці



Ref.	L[mm]	Ra[mm]	☒	EAN
01-085	150	10-25	6/48	5907558440584
01-087	180	19-60	6/48	5907558440607
01-089	230	40-100	6/36	5907558440621



wewnętrznie proste  
internal, straight tip  
внутрішній/прости щипці



Ref.	L[mm]	Ra[mm]	☒	EAN
01-086	150	10-25	6/48	5907558440591
01-088	180	19-60	6/48	5907558440614
01-090	230	40-100	6/36	5907558440638



zewnątrznie wygięte  
external, bent tip  
зовнішній/вигнуті щипці



Ref.	L[mm]	Ra[mm]	☒	EAN
01-091	145	10-25	6/48	5907558440645
01-093	170	19-60	6/48	5907558440669
01-095	220	40-100	6/36	5907558440683



wewnętrznie wygięte  
internal, bent tip  
внутрішній/вигнуті щипці



Ref.	L[mm]	Ra[mm]	☒	EAN
01-092	145	10-25	6/48	5907558440652
01-094	170	19-60	6/48	5907558440676
01-096	220	40-100	6/36	5907558440690



Ref.	L[mm]	Ra[mm]	☒	EAN
01-097	170/180	19-60	4/16	5907558463606

## Szczypce zaciskowe

Locking pliers / Klemmzange / Клещи зажимные / Πλασσοζυγίι obtusioini / Potentfogó / clește fixator / Uprinaci klešte / Klešte fixačné univerzálne / Prijemne klešče / Užspoudimo replės / Fiksatorstangas / Lukustustangid / Клещи Чупак / Stop kleješta / Smrt klesta / Πένιας - fixin / Tenazas grip / Pinza a scatto dritta / Pinças para grampear / Pince de serrage / Krimp tang



Ref.	L[mm]	Ra[mm]	☒	EAN
01-216	250	0-47	6/36	5907558409185



Ref.	L[mm]	Ra[mm]	☒	EAN
01-217	250	0-45	6/36	5907558409192

## Szczypce blacharskie

Axial grip locking pliers / Klemmzange / Клещи зажимные / Плоскозубый обжимник / Patentfogó / Clește fixator / Uprinač kleště / Kliešte fixačné univerzálne / Prijemne klešče / Užspadimo replės / Fiksatorstangos / Lukustangaid / Клещи чирок / Stop kliešta / Smrt klesta / Πένσες - γράφι / Tenazas grip / Pinza griffante / Pinças para grampear / Pince de serrage / Krimplang



**TYPE  
W**  
**195  
mm**

Ref.	info	📦	EAN
11-020	W, max. 25 mm	1/20	5907558445473



**TYPE  
L**  
**195  
mm**

Ref.	info	📦	EAN
11-021	L, max. 57 mm	1/20	5907558445480



**TYPE  
LL**  
**205  
mm**

Ref.	info	📦	EAN
11-022	LL, max. 18 mm	1/20	5907558445497



**TYPE  
JJ**  
**230  
mm**

Ref.	info	📦	EAN
11-024	JJ, max. 40 mm	1/20	5907558445510

## Szczypce uniwersalne 1000V

Combination pliers / Kombizange / Плоскозубцы / Плоскозуби / Kombinált fogó / clește universal / Kombinované kleště / Kliešte kombinované / Kombinirane klešče / Universalios replės / Plakanknaibles kombinētās / Universaalnāpitsad / Клещи комбинирани / Kombinirana kliešta / Kombineeritud klesta / Πένσες γενικής χρήσης / Alicates universales / Pinza universale 1000V / Pinças universais / Pince universelle / Universele tang

**25**  
years  
GUARANTEED

**CrV**  
steel

**1000V**



Ref.	L[mm]	📦	EAN
01-220	160	6/60	5907558433043
01-221	180	6/60	5907558433050
01-222	200	6/60	5907558433067

## Szczypce wydłużone proste 1000V

Long nose pliers / Gerade Zange, verlängert / Плоскозубцы удлиненные прямые / Плоскозуби з видовженими зубцями / Hosszúcsőrű fogó / Clește ascuțit bine / Kliešte predĺžené rovné / Kliešte špicaté rovné / Koričaste klešče / Replės pailgintos, tiesios / Plakanknaibles pagarinātās taisnās / Pikknokk-nāpitsad / Клещи Чокви / Flah Kliešta / Flah klesta / Μυρωταίμφο μακριά πόσηρη / Alicates largos rectos / Pinza a becco lungo 1000V / Pinças retas prolongadas / Pince allongée droite / Lange rechte tang

**25**  
years  
GUARANTEED

**CrV**  
steel

**1000V**



Ref.	L[mm]	📦	EAN
01-223	160	6/60	5907558433074
01-224	180	6/60	5907558433081
01-225	200	6/60	5907558433098

**25**  
years  
GUARANTEED

**CrV**  
steel

**1000V**

**55-60**  
HRC



Ref.	L[mm]	📦	EAN
01-240	160	6/48	5907558433364
01-241	180	6/48	5907558433371

**25**  
years  
GUARANTEED

**CrV**  
steel

**1000V**

**55-60**  
HRC



Ref.	L[mm]	📦	EAN
01-242	160	6/48	5907558433388

## Szczypce wydłużone wygięte 1000V

Long nose bent pliers / Zange lang, gebogen / Плоскогубцы удлиненные изогнутые / Щипци издължени, свиегнати / Hajlított csőrű fogó / Cleave varf ascutit îndoit / Kleště prodloužené vyhnuté / Klešte predĺžené vyhnuté / Koničaste klešče - upognjene / Prailgintas replis, lenktas / Izkriektas pagarinātas knaibles / Pikkade kõverate otsstega näripisad / Клещи удължени огънати / Izdužena savinuta klješta / Izdužena uvijena klešta / Μυσοσταύμδα κούρτο / Alicata Teléfono curvo / Pinza universale 1000V / Pinças curvadas prolongadas / Pince allongée coudées / Lange gebogen tang



Ref.	L[mm]	⊠	EAN
01-227	160	6/60	5907558433111
01-228	180	6/60	5907558433128

## Szczypce do rur 1000V

Water pump pliers / Rohrzange / Клещи трубные / Клещи трубни / Vízpumpa fogó / clește pli pompa de apă / Kleště na trubky / Hosák / Cevne klešče / Replis vamzdraims / Rorstangas / Veepumba tangid / Клеши Гарае / Klješta papige / Klesta papogaj / Γκαζιτανάλια / Tenazas para tubos / Pinza giratubi 1000V / Pinças p. Tubos / Pince pour tubes / Buistang



Ref.	L[mm]	⊠	EAN
01-232	250	6/36	5907558433166

## Szczypce boczne 1000V

Diagonal cutting pliers / Seitenzange / Боковые / Боковиси / Oldalsípő fogó / clește ascutit diagonal de tăiat sîrmă / Bočni klešče / Cvikačky bočné / Stranske klešče / Sorinés replis / Sänknaibles / Diagonaal-löketangid / Клеши Рєзачи / Klješta cvikice / Klesta poluokruga / Πλαγιοκόπτες / Alicates diagonales / Tronchese laterale 1000V / Pinças laterais / Pince latérale / Zijtang



Ref.	L[mm]	⊠ [mm]	⊠	EAN
01-525	160	1.5, 2.5	0/36	5907558404340



Ref.	L[mm]	⊠	EAN
01-226	160	6/60	5907558433104



Ref.	L[mm]	⊠	EAN
01-243	160	6/48	5907558433395



Ref.	L[mm]	⊠	EAN
01-231	180	6/60	5907558433159

## Szczypce do cięcia kabli 1000V

Cable cutter / Kabelabschneider / Кабелорєз / Обрєзачи для кабєлє / Kábelvágó fogó / Cleave pentru tăiat cabluri / Kleště na kabely / Klešte na káble / Nož za rezanje kablov / Kondikles kabeliui / Kabeļu griezējs / Κααβλιόκωι / Резачи за кабєлє / Rezač kablova / Nož za rezanje kablova / Κόψις καλωδίων / Alicata cortacables / Taglia cavo 1000V / Cortador p. Cabos / Coupe-câbles / Knipper voor kabels



Ref.	L[mm]	⊠	EAN
01-244	180	6/48	5907558433401



Ref.	L[mm]	⊠	EAN
01-233	160	6/60	5907558433173

## Szczypce do izolacji 1000V

Wire stripper / Isolierungszange / Бокорезы для зачистки / Бокорізи для зачищення / Kábelcsupaszoló / dește p/ri înlăturarea izolatoarelor / Klešče na izolaci / Klešte odizolovacie / Klešče za snemanje izolacije / Replis izolacijski puimti / Knaibles izolacijski / Kaablitangid / Клеци Заголювачи за монтаж / Klesta za izolaciju / Απογυμνωτής καλωδίων / Alicates pelacables / Pinza spela fiil regolabile 1000V / Pinças p. Isolação / Pince à dénuder / Isolietang



Ref.	L[mm]	Ø [mm²]	⊠	EAN
01-245	160	0.2 - 6.0	6/48	5907558433418



Ref.	L[mm]	Ø [mm²]	⊠	EAN
01-229	160	0.2 - 6.0	6/60	5907558433135

## Zestaw narzędzi 1000V

Tools set / Werkzeugsatz / Набор инструмента / Набор інструментів / Szerszámkészlet / Set scule de grădină / Sada nářadí / Súprava nářadí / Garnitura orodja / Įrankių komplektas / Instrumentu komplekts / Tööriistakomplekt / Гедорє комплекет / Set uređaja / Set alata / Συλλογή εργαλείων / Juego de herramientas / Set attrezi 1000V / Kit de ferramentas / Jeu d'outils / Gereedschapset

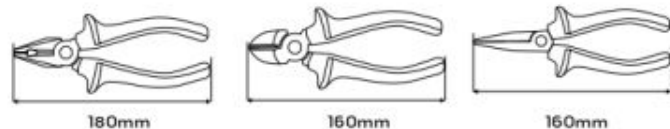

5.5x125mm PH1x80

Ref.	⊠	EAN
01-237	0/8	5907558433210

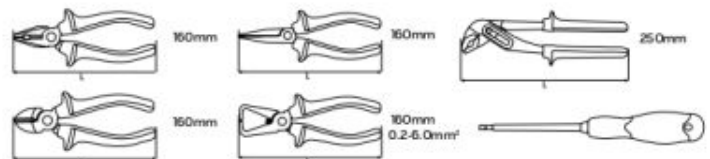

1.0 x 5.5 x 125 mm; 0.8 x 4 x 100 mm; 1.0 x 6.5 x 150 mm  
 PH0 x 3 x 60 mm; PH2 x 6 x 100 mm;  
 PH1 x 4.5 x 80 mm; PH3 x 8 x 150 mm

Ref.	⊠	EAN
01-234	0/6	5907558433180

## Zestaw narzędzi 1000V

Tools set / Werkzeugset / Набор инструментов / Набор инструменнів / Szerszámkészlet / Set scale of grādīnā / Sada nářadí / Súprava náradia / Garnitura orodja / Įrankių komplektas / Instrumentu komplekts / Тööriistakomplekt / Тедорє комплєкт / Set uređaja / Set alata / Συλλογή εργαλείων / Juego de herramientas / Set attrezzi 1000V / Kit de ferramentas / Jeu d'outils / Gereedschapset

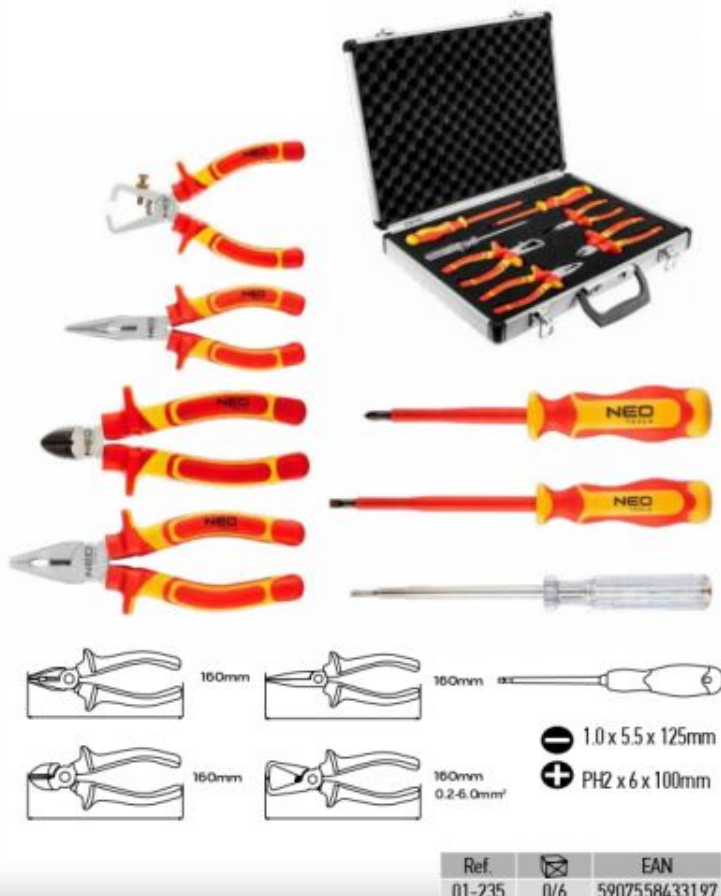

## Nóż monterski 1000V

Fitter's knife / Monteurmesser / Нож монтерский / Нож монтерський / Kábelvágó kés / Cutit pentru cabluri / Nůž montérský / Montérský nůž / Montažni nož / Montuotojo peilis / Montiera nazis / Elektrikunuga / Монтерський ніж / Monterski nož / Monterski nož / Μαχαίρι ηλεκτρολόγου / Cuchillo recto para cables / Coltello per elettricisti / Faca p. montagem / Couteau de monteur / Montagemeser





## Ściągacz izolacji

Wire stripper / Abziehvorrichtung für Isolierung / Съёмник изоляции / Знімач ізоляції / Kábelcsupaszoló / Dispozitiv de scos izolația / Kliešte na stahovanie izolácie / Smetalnik izolacije / Izolacijski priključek / Izolācijas noņēmējs / Isolatsioonitõmmits / Изолупаща скоба / Skidač izolacije / Skidač izolacije / Εργαλείο για αφαίρεση μόνωσης / Alicates pelacables / Spelaflii universale / Ponta de apărta de izolação / Dénudeur d'isolation / Trekker voor isolatie



Ref.	L[mm]	⊠	EAN
01-524	125	15/90	5907558415643

8-28 mm 190 mm



Ref.	L[mm]	⊠	EAN
01-547	190	20/100	5907558421835



Ref.	L[mm]	⊠	EAN
01-400	170	0/40	5907558449617



Ref.	L[mm]	⊠	EAN
01-546	165	20/100	5907558499735



Ref.	L[mm]	⊠	EAN
01-549	180	10/100	5907558421859

## Automatyczny ściągacz izolacji

Automatic wire stripper / Automat. Abziehange / Съёмник изоляции автоматический / Автоматичний стрижач ізоляції / Kábelcsupaszoló automata / Clește automatice p/ă extragerea izolației / Automatski stahovadło izolace / Kliešte odizolovacie automatické / Klešče za snemanje izolacije / Automatinis izoliacijos nuimtuvas / Stangas izolācijas noņēmēšanai automātiskās / Automaatsed kaablitangid / Клеuzzi заоллавачи / Kliešta za izolaciju / Klesta za izolaciju / Αὐτὸματὸς ἀπογυμνωτὴς καλωδίων / Alicates pelacables automáticos / Spelaflii automatica / Aparelho automático de remover isolação / Dénudeuse d'isolation automatique / Automatisch draadstriptang



Ref.	L[mm]	⊠	EAN
01-519	195	10/60	5907558415599



Ref.	L[mm]	⊠	EAN
01-520	170	8/48	5907558415605



Ref.	L[mm]	⊠	EAN
01-500	205	10/60	5907558403190



Ref.	L[mm]	⊠	EAN
01-534	180	10/40	590755843935

## Automatyczny ściągacz izolacji

Automatic wire stripper / Automat Abziehzange / Съёмник изоляции автоматический / Автоматичний стягач ізоляції / Kábelcsupaszoló automata / Clește automatică/plu extragerea izolației / Automatické stahovadlo izolace / Klešte odizolovacie automatické / Klešte za snemanje izolacije / Automatinis izoliacijos nuimtuvas / Stangas izolācijas noņemšanai automātiskās / Autoaatsed kaablitangid / Клецьці за ізоляцію / Klesta za izolaciju / Αὐτόματὸ ἀπομνηκτικὸ καλωδίων / Alicates pelacables automáticos / Spelaflii automatica / Aparelho automático de remover isolação / Dénudeuse d'isolation automatique / Automatisch draadstriptang



## Szczypce do zaciskania końcówek

Crimping pliers / Feinzange, zur Verklammerung der Endungen / Клецьці для обжиму кабельних наконечників / Щипці кабельні зажимні / Kábelcsaru fogó / Clește pentru sertizat/conectori / Klešte na svírání koncovek / Klešte na koncovky / Klešte za stiskanje konic / Replés, antgaliu užspaudimui / Knaibles kabelu uzgali saspišanasai / Otsakinnitusnäpitsad / Клецьці за прутисканне на краіцы на кабелі / Klešta za pritiskanje nastavka / Klešta za pričvrščavanje krajeva / Pêças acrobectâș / Pinzas de presión para puntas / Pinza per terminali / Pinças p. Grampear pontas / Pince universelle de serrage d'embouts / Tang voor eindstukken



## Szczypce do zaciskania końcówek

Crimping pliers / Feinzange, zur Verklebung der Endungen / Клепцы для обжима кабельных наконечников / Щипцы кабельны, затиски / Kábelsaru fogó / Cleste pentru sertizat / conectari / Kleště na svírání koncovek / Klešte na koncovky / Klešte za siskanje konic / Replés, antgaliq užspaudimui / Knaibles kabelu užgoju suspašianai / Otsakinnitusnäpitsad / Клепцы за притискане на краища на кабели / Klešte za pritiskanje nastavka / Klešte za pričvrščanje krajeva / Πένσα ακροδεκτών / Pinzas de presión para puntas / Pinza per terminali / Pinças p. Grampear pontas / Pince universelle de serrage d'embouts / Tang voor eindstukken

0.25-2.5 mm<sup>2</sup>

1.5-6.0 mm<sup>2</sup>

Ref.	L[mm]	⊠	EAN
01-532	140	20/80	5907558432367
01-533	140	20/80	5907558432374

HEX: 8.1 / 6.5 / 5.4 / 2.6 / 1.72 mm

25 years GUARANTEE

240 mm

45 HRC

Ref.	L[mm]	⊠	EAN
01-545	240	10/40	5907558493696

25 years GUARANTEE

100% ALUMINUM CERTIFIED

22-10 AWG

52-57 HRC

Ref.	L[mm]	⊠	EAN
01-503	250	6/36	5907558403213

25 years GUARANTEE

PV PHOTO VOLTAGE

MC4 connector

2.5 / 4 / 6 mm<sup>2</sup>

Pozycjoner w zestawie  
Positioner included  
Позиційник влючений

Ref.	L[mm]	⊠	EAN
01-555	270	10/20	5902062063427

25 years GUARANTEE

RG 6

RG 58

RG 59

RG 62

AWG 16-10 1.5 - 6 mm<sup>2</sup>

AWG 17-10 1 - 6 mm<sup>2</sup>

AWG 17-10 1 - 6 mm<sup>2</sup>

AWG 10-6 6 - 16 mm<sup>2</sup>

AWG 20-10 0.5 - 6 mm<sup>2</sup>

Ref.	L[mm]	⊠	EAN
01-537	220	0/5	5907558439304

200mm

0.1-0.8 mm

two components handle

Ref.	L[mm]	⊠	EAN
01-548	200	10/40	5907558421842

25 years GUARANTEE

EASY SIZE CHANGING

SOFT HANDLE

6-50 mm<sup>2</sup>

Ref.	L[mm]	⊠	EAN
01-530	390	0/10	5907558432343

25 years GUARANTEE

EASY SIZE CHANGING

SOFT HANDLE

10-120 mm<sup>2</sup>

Ref.	L[mm]	⊠	EAN
01-531	610	0/5	5907558432350

## Praska ręczna hydrauliczna do końcówek elektrycznych

Hydraulic hand press for electric bits / Hydraulische Handpresse für Elektrobohrer / Гидравлический ручной пресс для электробит / Прес гидравлический ручной для электрических бит / Hidraulikus kézi sajtó elektramos bitekhez / Presă hidraulică manuală pentru biți electrice / Hydraulický ruční lis pro elektrické bity / Hydraulický ruční lis pre elektrické bity / Hidraulična ročna stiskalica za električne svedre / Hidraulinis rankinis presas elektriniams gražams / Hidrauliška rokas prese elektriskajiem bitiem / Хидравлическая ручная преса за електрически бита / Υδραυλική πρέσα χειρός για ηλεκτρικά εργαλεία / Pressa manuale idraulica per punte elettriche / Prensa manual hidráulica para brocas eléctricas / Presse hydraulique à main pour mèches électriques / Hydraulische handpers voor elektrische bits



Ref.	[mm <sup>2</sup> ]	☒	EAN
01-543	16-300	0/4	5907558485523

## Nożyce do kabli i izolacji

Cable and insulation cutter / Schere für Kabel und Isolierung / Ножницы для кабеля и изолирующей оболочки / Ножницы на кабелю и изолацији / Kábelvágóóóóó / Forfeces taiat/de izolat cabluri / Nůžky na kabely a na izolaci / Nožnice na káble a izolácie / Škarje za kablice i izolaciju / Žirkljes kabelju i izolaciju / Šķēres kabelēm un izolācijai / Kaabli- ja isolatsioonikäärid / Ножницы за кабелю и изолација / Škare za kablove i izolaciju / Makaze za kablove i izolaciju / Ψαλίδι καλωδίων και μόνωσης / Tijeras de electricista / Forbice da elettricista / Tesoura para cabos e isolação / Cisaille à câbles et isolation / Schaar voor kabels en isolatie

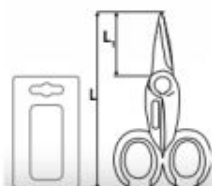

Ref.	L[mm]	L <sub>1</sub> [mm]	☒	EAN
01-511	140	45	12/72	5907558405378

## Obcinak do drutów

Cable wire cutter / Abschneider für Draht / Кабелерез / Обрезающ до тросов / Dróinvágó fogó / Ceste taiat cabluri / Kleště na drát / Kleště cvikacie na káble a oceľové laná / Nož za žice in jeklenice / Kandákljes vrela i plieniniam lynai / Štepljuvai tērauda aukl ugnēzijs / Troad- ja terasjuhtmelõõkur / Резачна за тел използванени въжета / Rezač za žice i čelične sajle / Nož za žicu i čeličnu užad / Κόφτης καλωδίων / Alicate para cortar cable trenzado / Troncatrice per filo / Cortador de arames / Coupe-fils / Knipper voor draad



Ref.	L[mm]	☒	EAN
01-518	210	6/48	5907558413007

## Obcinak do kabli

Cable cutter / Kabelabschneider / Кабелерез / Обрезающ для кабелю / Kábelvágó / Ceste pentru taiat cabluri / Kleště na kabely / Kleště na káble / Nož za rezanje kablov / Kandákljes kabelju / Kabeļu griezējs / Kaabliõõkur / Резачна за кабелю / Rezač kablova / Nož za rezanje kablova / Κόφτης καλωδίων / Alicate cortacables / Cesoie per cavi / Cortador p. Cabos / Coupe-câbles / Knipper voor kabels



Ref.	L[mm]	☒	EAN
01-510	185	12/72	5907558405361



Ref.	L[mm]	max ø [mm <sup>2</sup> ]	☒	EAN
01-513	160	10	6/48	5907558408485
01-514	200	13	6/48	5907558408492
01-515	235	25	6/36	5907558408508



Ref.	L[mm]	☒	EAN
01-401	400	5/10	5907558449624



Ref.	L[mm]	max ø [mm <sup>2</sup> ]	☒	EAN
01-517	440	20	0/12	5907558408515

## Obcinak do drutów i linek stalowych

Cable and steel wire cutter / Abschneider für Draht und Stahlseilen / Κοπτερες / Обрезаюч до дроту і провід / Drótvágó fogó / Ceste taviat cabluri / Kleště na drát a na ocelovú lanku / Klešte cvkvaice na káble a ocelové láná / Nož za žice in jeklenice / Kanakléis vielai ir plieniniam lynui / Stieplu vai tērauda auklu griezējs / Traad- ja terasjuhtmelõõkur / Ρεζακωα za men u stomateni v'azmeta / Rezoč za žice i čelične sajle / Nož za žicu i čeličnu užad / Κόπτης καλωδίων / Alicate para cortar cable trenzado / Troncatrice per cavi e fili in acciaio / Cortador p. Arames e cabos de aço / Usaille à fils et câbles d'acier / Knipper voor draad en staalkabels



Ref.	L[mm]	⊠	EAN
01-512	190	10/60	5907558410891

## Klucz łańcuchowy do rur

Chain pipe wrench / Kettenschlüssel für Rohre / Ключ трубный цепной / Ключ трубный ланцюговий / Csőfogó láncos / Cheie pentru filtrul cu lant / Řetězový hasák na trubky / Ključ reťazový na rúry / Venžni ključ za cevi / Grandininis raktas, vamzdžiams / Κέδες σωρού atsléga / Kett-toruvõti / Верхожен тръбен ключ / Lančani ključ za cijevi / Ključ za cevi lančani / Αλυσακάβουρας σωλήνων / Llave de cadena para tubos / Giratubi a catena / Chave de corrente p. tubos / Clef à chaîne pour tubes / Kettingssleutel voor buizen



Ref.	L [mm]	Ra [mm/°]	⊠	EAN
02-444	300	115/4	0/24	5907558481570

## Szczypce do rur

Water pump pliers / Rohrzange / Клеци трубные / Ключи трубни / Vízpumpa fogó / cleste p/u pompa de apă / Kleště na trubky / Hasák / Cevne klešče / Replēs vamzdžiams / Rorstangas / Veepumba tangid / Клеци Га̀реца / Клешта ра̀риге / Клеста ра̀рагај / Γαφτανάκωα / Tenazas para tubos / Pinza regolabile da idraulico / Pinças p. Tubos / Pince pour tubes / Buistang

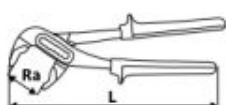

Ref.	L[mm]	Ra[mm]	⊠	EAN
01-202	250	0-36	6/48	5907558434613

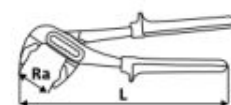

Ref.	L[mm]	Ra[mm]	⊠	EAN
01-200	240	0-31	6/48	5907558434606
01-203	300	0-46	6/24	5907558434620

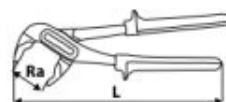

Ref.	L[mm]	Ra[mm]	⊠	EAN
01-204	250	0-42	6/48	5907558412994

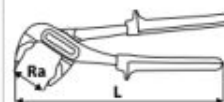

Ref.	L[mm]	Ra[mm]	⊠	EAN
02-435	240	0-52	6/60	5907558464634

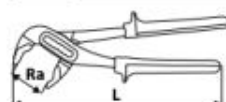

Ref.	L[mm]	Ra[mm]	⊠	EAN
02-412	250	0-38	6/60	5907558463026
02-413	300	0-45	6/48	5907558463033

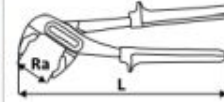

Ref.	L[mm]	Ra[mm]	⊠	EAN
02-401	250	10-45	6/48	5907558462913

## Klucz do rur stillson

Stillson pipe wrench / Rohrschlüssel stillson / Ключ трубный stillson / Ключ трубный «Stillson» / Csőfogó „Stillson” / Cheie reglabila pentru tevi / Kleště trubkové Stillson / Ključ na rury stillson / Ključ za cevi stillson / Raktas vamzdžiams „Stillson” / Cauruļu atslēga / Stillson-toruvõti / Трубен ключ stillson / Ključ za cijev stillson / Ključ za cevi stillson / Σωληνοκράβουρας τύπου Stillson / Llave stillson / Giratubi Stillson / Chave p. Tubos stillson / Clef pour tubes stillson / Sleutel voor stillsonbuizen



25 years GUARANTEE AL



Ref.	L [mm]	Ra ["]	☒	EAN
02-111	450	1 3/4"	0/24	5907558435856

Ref.	L [mm]	Ra [mm/"]	☒ [kg]	☒	EAN
02-415	250	50/1.5	0.62	6/36	5907558463040
02-416	300	70/2.0	0.94	0/24	5907558463057
02-417	350	80/2.0	1.25	0/18	5907558463064
02-418	450	90/2.5	1.79	6/12	5907558463071
02-419	600	100/3.0	2.73	4/8	5907558463088

## Obcinak do rur

Tubing cutter / Rohrschneider / Трубкоп / Трубкоп / Csővágó / Dispozitiv tăiere tevi / Trubkořez / Rezač nirok / Rezalec cevi / Žirklės vamzdžiams / Cauruļgriezējs / Torulökür / Трубкоп / Rezač cijevi / Sekac za cevi / Κόπτης σωληνων / Cortador de tubos / Taglia tubi / Cortador p. tubos / Coupe-tube / Buisknipper



25 years GUARANTEE

Withstand Extreme

max 2.5mm

STEEL

3-22 mm 1/8"-7/8"

CU AL



Ref.	Ra ["]	Ra [mm]	☒	EAN
02-429	1/8-7/8	3-22	50/200	5907558463514



Ref.	Ra [mm]	Ra ["]	☒	EAN
02-040	19-83	3/4-3.1/4	10/30	5907558410006

STEEL

CU AL 3-32 mm 1/4"-1 1/4"



02-042



02-044

STEEL



Ref.	Ra ["]	Ra [mm]	☒	EAN
02-403	1/8-1.1/4	3-32	12/48	5907558462937



Ref.	info	Ra [mm]	Ra ["]	☒	EAN
02-042	-	3-50	1/8-2.0	0/8	5907558414332
02-044	2 x	-	-	24/288	5907558415735

STEEL 12-50 mm 1/2"-2"

CU AL 3-30 mm 1/4"-1 1/4"



Ref.	Ra ["]	Ra [mm]	☒	EAN
02-406	1/2 - 2	12-50	0/10	5907558462968



Ref.	Ra ["]	Ra [mm]	☒	EAN
02-402	1/8-1.1/4	3-32	12/72	5907558462920

## Klucz nastawny

Adjustable wrench / Schraubenschlüssel / Ключ разводной / Ключ разводной заїнової / Csavar kulcs állítható / Cheie reglabilă / Ključ přestavitelný / Nastavitelný klúč / Francoski ključ / Reguliuojamas raktas / Бідратліга / Телітан в'їті / Разводжен заєчен ключ / Podesivi ključ / Francuski ključ / Γαλλικό κλειδί / Llave inglesa / Chave a rullino / Chave regulável / Clé à ouverture réglable / Verstelbare moersleutel



Ref.	Ra [mm]	L [mm]	⊠	EAN
03-017	0-30,5	200	0/36	5907558404326



Ref.	L [mm]	Ra [mm]	⊠	EAN
03-015	150	0-34	6/96	5907558412208
03-014	200	0-38	6/72	5907558404159
03-016	250	0-50	5/30	5907558412215



Ref.	L [mm]	Ra [mm]	⊠	EAN
03-010	150	0-24	6/120	5907558404111
03-011	200	0-28.6	6/60	5907558404128
03-012	250	0-32.8	6/48	5907558404135
03-013	300	0-38	6/24	5907558404142



Ref.	L [mm]	Ra [mm]	⊠	EAN
03-027	150	0-23	6/120	5907558426090
03-028	200	0-28	6/60	5907558426106
03-029	250	0-32	6/48	5907558426113



Ref.	L [mm]	Ra [mm]	⊠	EAN
03-023	155	0-28	6/72	5907558426052
03-024	205	0-32	6/72	5907558426069
03-025	256	0-43	6/36	5907558426076
03-026	306	0-53	6/36	5907558426083



Ref.	L [mm]	Ra [mm]	⊠	EAN
03-019	118	0-28	6/72	5907558426014
03-020	139	0-32	6/72	5907558426021
03-021	156	0-43	6/36	5907558426038
03-022	185	0-53	6/36	5907558426045



## Nóż z ostrzem łamany

Snap-off blade knife / Messer m. gebrochener Klinge / Нож с отламывающимся лезвием / Нож з ламаним лезом / Törhető pengés kés / Cuijt lamă demontabilă / Nůž se zalomeným ostřím / Nožik lámací / Nož / Peilis su nulaužama geležte / Tapašū nazis / Kokkukäivä terävä piirä / Манжетен нож / Skalpel / Skalpel / Κοπίδι «snap Off» / Cúter / Taglierino con lama scorrevole / Faca com lâmina curvada / Couteau à lame cassable / Met met gebroken lemmet



Ref.	W [mm]	⊠	EAN
63-012	25	12/72	5907558443530



Ref.	W [mm]	⊠	EAN
63-050	18	12/72	5907558420760



Ref.	W [mm]	⊠	EAN
63-060	18	12/72	5907558420777



Ref.	W [mm]	⊠	EAN
63-013	9	48/576	5907558484311

## Nóż z ostrzem łamanym

Snap-off blade knife / Messer m. gebrochener Klinge / Нож с отламывающимся лезвием / Нож с ламинированным лезвием / Törhető pengés kés / Csújt láma demontálható / Nůž se zalomeným ostřím / Nožik lamináci / Nož / Peilis su nulaužiamata geležte / Trapešu nazis / Kokkukäina teraga nuga / Макетен нож / Skalpel / Skalpel / Korbī «snap Off» / Cutter / Taglierino con lama scartevole / Couteau à lame cassable / Met met gebroken lemmet



Ref.	W [mm]	📦	EAN
63-021	18	12/48	5907558410457



Ref.	W [mm]	📦	EAN
63-011	18	12/72	5907558410440



Ref.	W [mm]	📦	EAN
63-014	18	40/160	5907558484328

## Nóż z ostrzem trapezowym

Knife with utility blade / Messer mit Trapezklinge / Нож с трапециевидным лезвием / Нож с трапециевидным острием / Trapézpengés összecskukható kés / Cutter cu tăiș trapezoidal / Nůž s trapézovým ostřím / Nůž s trapézovou čepeľou / Nož s trapeznim rezilom / Peilis su trapeicine geležte / Nazis ar trapecevida asmeni / Trapetsleraga nuga / Нож с трапециевидно острие / Nož s trapezostom ostřicom / Nož sa trapezostom ostřicom / Μαχαίρι με τραπεζοειδή ακμή / Cutter con hoja trapezoidal / Taglierino a lama fissa / Faca com Lâmina de trapézio / Couteau à lame trapézoïdale / Trapezium mes



Ref.	📦	EAN
63-700	6/48	5907558483932

## Nóż z ostrzem trapezowym

Knife with utility blade / Messer mit Trapezklinge / Нож с трапециевидным лезвием / Нож с трапециевидным острием / Trapézpengés összecskukható kés / Cutter cu tăiș trapezoidal / Nůž s trapézovým ostřím / Nůž s trapézovou čepeľou / Nož s trapeznim rezilom / Peilis su trapeicine geležte / Nazis ar trapecevida asmeni / Trapetsleraga nuga / Нож с трапециевидно острие / Nož s trapezostom ostřicom / Nož sa trapezostom ostřicom / Μαχαίρι με τραπεζοειδή ακμή / Cutter con hoja trapezoidal / Taglierino a lama fissa / Faca com Lâmina de trapézio / Couteau à lame trapézoïdale / Trapezium mes



Ref.	W [mm]	📦	EAN
63-702	18	0/80	5907558400212



Ref.	📦	EAN
63-705	12/96	5907558472295



Ref.	📦	EAN
63-707	10/80	5907558472356



Ref.	📦	EAN
63-706	12/48	5907558472325



Ref.	📦	EAN
63-704	10/80	5907558472318



## Ostrza łamane

Snap off blades / Klingen, abbrechbar / Лезвия сменяемые отламывающиеся / Леза змінні, що обламуються / Törhető penge / Lame cutter / Odlatovací čepele / Odlatovací čepele / Lamijiva rezila / Laužomi peiliukai / Maināmie nolaužāmie aštri / Υαλοσώτερες / Отламывающиеся остроги / Lamijene oštrice / Lamijene oštrice / Ανασπώμενες λεπίδες / Hojas segmentadas / Ricambio lame scorrevoli / Láminas curvadas / Lames coupées / Gebogen bladen

**x10** TITANIUM blade 0.4mm

3-PHASE CUT 64 HRC TITANIUM COATED

Ref.	W [mm]	⊠	EAN
64-220	9	10/300	5907558400250

**x10** 0.5mm

3-PHASE CUT 64 HRC

Ref.	W [mm]	⊠	EAN
64-010	18	10/300	5907558400229

**x10** BLACK BLADE SK2 steel 25mm

3-PHASE CUT 64 HRC TITANIUM COATED

Ref.	L [mm]	⊠	EAN
64-012	9	10/120	5907558443547
64-013	18	10/120	5907558443554
64-014	25	10/120	5907558443561

**x10** TITANIUM blade 0.5mm

3-PHASE CUT 64 HRC TITANIUM COATED

Ref.	W [mm]	⊠	EAN
64-020	18	10/300	5907558400236

## Ostrza trapezowe

Knife blades / Trapezklingen / Лезвия трапециевидные / Леза ножови / Törhető penge / Csipit lamá / Lichoběžníkové ostří / Ostrie lichoběžníkové / Nadomestna rezila / Keičiamos geležtės / Naža asmeņi / Noaterad / Остроге резерно / Nožiči za skalpel / Nožici za skalpel / Ανταλλακτικές λεπίδες / Hojas trapezoidales / Ricambio lame fisse / Láminas de trapezo / Tranchants trapézoïdaux / Trapezium mesbladen

**x10** BLACK BLADE SK2 steel

Ref.	W [mm]	⊠	EAN
64-015		10/240	5907558443578

**x5** TITANIUM COATED

Ref.	L [mm]	⊠	EAN
64-420	52	10/300	5907558400274

## Ostrza hakowe

Hook blades / Hackenklingen / Лезвия-крючки / Леза ганчови / Törhető penge / Lame secară pentru cutter / Háková čepele / Hákové čepele / Kijukasta rezila / Geležtė / Asmeņi-āķi / Konksterad / Острога за ниву / Kukaste oštrice / Kukasti noževi / Κοιλι τάνητα / Hoja de gancho / Ricambio lame ad uncino / Láminas de anzol / Lames à crochets / Hakbladen

**x5**

Ref.	⊠	EAN
64-610	10/300	5907558400281

**x5** TITANIUM COATED

Ref.	⊠	EAN
64-620	10/300	5907558400298

## Noż uniwersalny

Knife / Universalmesser / Нож универсальный / Нож / Trapezpengés összecuszkodható kés / Csipit / Univerzální nůž / Nož univerzálný / Nož / Universals peilis / Nožis / Nuga / Ножиче / Džepni nožić / Noz / Μαχαίρι γενικής χρήσης / Cuchillo universal / Taglierino a lama fissa / Foca universal / Couteau universel / Universele mes

**x5** SAFETY LOCK METAL BODY

Ref.	⊠	EAN
63-710	6/48	5907558420791

## Nożyczki

Snissors / Schere / Ножницы / Ножичи / Olló / Forfeca / Nůžky / Nožnice / Škarje / Žrklės / Šķeres / Käärid / Ножичи / Škarice / Makaze / Ψαλίδι / Tijeras / forbice da elettricista / Tesoura / Ciseaux / Schaar

**230 mm 6in1** DOUBLE COMPONENT HANDLE NUTCRACKER BOTTLE OPENER BOX OPENER SCRAPER PEELER SCISSORS

Ref.	L [mm]	⊠	EAN
64-001	230	12/72	5907558485462



## **NARZĘDZIA SPECJALISTYCZNE**

specialized tools    спеціалізовані інструменти

## Zestaw kluczy nasadowych do filtra oleju

Car type oil filter wrench set / Steckschlüsselsatz für Ölfilter / Набор торцовых ключей к масляному фильтру / Набор накидных ключей до масляного фильтра / Dugókulcs-készlet olajsűrűhöz / Set de cheitubulare pentru filtru de ulei / Sada miskovitých klíčů na olejové filtry / Sgrana nastavnosvojich ključev na olejovij filter / Set nasadnih ključev za oljni filter / Galvuði ríngkyns tepalo filtra / Eļļas filtra muciņatslēgu komplekts / Āļģitri padrunlõbmete komplekt / Комплект гаечных ключей за масляный фильтр / Garnitura nasadnih ključeva za filter ulja / Garnitura ključeva natikača za filtere za ulje / Σει μοιλοκωνικά κλειδα για φίλτρο λαδιού / Juego de llaves de vaso para filtro de aceite / Completo di chiavi a bussola per il filtro dell'olio / Juego de chaves tubulares para filtro de óleo / Jeu de clés à douille pour filtre à huile / Set van dopseutels voor oliefilter

x30

x16



Ø	Ø mm	N	Car
66/66	66	6	Fiat Punto 1.2; Renault Clio 1.2, Rapid, Twingo
65/14	65	14	Daihatsu; Toyota; Nissan; Fiat; Camry
65/67	65-67	14	Daihatsu; Toyota; Mazda; Mitsubishi
68/14	68	14	Mazda; Ford; Subaru; Toyota
73/14	73	14	Toyota; Lexus
74/15	74	15	Audi; Rover; Chrysler; Lexus; GM
74/76	74-76	15	Ford; Opel; VW; Audi; Mercedes; GM
75/77	75-77	15	VW; Audi; Isuzu; Mercedes; GM; Chrysler
76/12	76	12	Fiat; Mercedes; Renault
76/14	76	14	VW; Porsche; Mercedes; BMW; Audi; Opel; Buick
76/30	76	30	Ford; VW; Renault; Peugeot
76/8	76	8	Fiat; Lancia
78/15	78	15	Nissan; Ford; Toyota
80/15	80	15	Nissan; Honda; Opel; Mazda; Iveco

Ø	Ø mm	N	Car
80/82	80	15	Subaru; Toyota; Honda; Nissan; Iveco; Hyundai; Mazda
86/16	86	16	Volvo
86/18	86	18	VW Golf; Audi A6 TDI; Peugeot; Citroen
90/15	90	15	Honda; Mitsubishi; Isuzu; Mazda
92/10	92	10	Fiat
93/15	93	15	Mazda; Volvo; Mitsubishi; Nissan; Honda
93/36	93	36	Ford; Audi
93/45	93	45	VW; Audi TDI
95/15	95	15	Toyota; Alfa Romeo; Ford
96/18	96	18	Audi A4; A6 TDI; VW Passat TDI; Renault Laguna
100/15	100	15	Isuzu; Mitsubishi; Buick; Hyundai; Iveco; Daewoo; Renault
106/15	106	15	Fiat Ducato
108/15	108	15	Volvo
108/18	108	18	Renault Espace; Laguna; Safrane; Traffic

Ref.	Ra[mm]	⊠	EAN
11-242	66-108	1/2	5907558435955

Ref.	Ra[mm]	⊠	EAN
11-243	65-100	1/10	5907558435962

## Nasadka do filtra oleju

Car type oil filter wrench / Ölfilterkarpen / Съёмник масляного фильтра "чашка" / Знімач масляного фільтра "чашка" / Csésze olajsűrű lehozó / Carō filtru de ulei / Stahovák olejového filtru / Ključ na olejovij filter / Kļuž za oljni filter / Rakts tepalo filtru / Atslēga eļļas filtram / Ölfilteri vöü / Водеща чашка за дрæза / Kļuž za uljni filter / Kļuž za uljani filter / Κλειδί φίλτρου λαδιού / Llave para filtro de aceite / Chiave per il filtro dell'olio / Chave p. filtros de óleo / Clef à filtre d'huile / Sleutel voor oliefilter



3/8"

Ref.	Ø mm	N	⊠	EAN
11-360	76	12	10/60	5907558445299
11-361	65	14	10/60	5907558445305
11-362	67	14	10/60	5907558445312
11-363	73	14	10/60	5907558445329
11-364	76	14	10/60	5907558445336
11-365	74	15	10/60	5907558445343
11-366	78	15	10/60	5907558445350
11-367	80	15	10/60	5907558445367
11-368	90	15	10/60	5907558445374
11-369	95	15	10/60	5907558445381
11-370	108	15	10/60	5907558445398
11-371	86	16	10/60	5907558445404
11-372	86	18	10/60	5907558445411
11-373	96	18	10/60	5907558445428



## Klucz do filtra oleju

Oil filter wrench / Schlüssel für Ölfilter / Съёмник масляных фильтров / Ключ для масляных фильтров / Olajsűrű leszedő / Cheie pentru filtre de ulei / Ključ na olejovij filter / Ključ na olejovij filter / Kļuž za oljni filter / Rakts tepalo filtru / Eļļas filtru atslēga / Ölfiltervöü / Ключ за маслен филтър / Kļuž za filtre za ulje / Kļuž za filter za ulje / Kλειδί αφαίρεσης φίλτρου λαδιού / Llave para filtros de aceite / Chiave per filtro olio / Chave para filtros de óleo / Clef filtre a huile / Filtersleutel



Ref.	Ra[mm]	⊠	EAN
11-237	43-102	1/40	5907558437355



Ref.	Ra[mm]	⊠	EAN
11-239	64-100	1/40	5907558435924

## Klucz do filtra oleju

Oil filter wrench / Schlüssel für Ölfilter / Съёмник масляных фильтров / Ключ для масляных фильтров / Olajsűrő lezedő / Cheie pentru filtre de ulei / Ključ na olejovj filter / Ključ na olejovj filter / Ključ za oljni filter / Raktas tepalo filtrui / Eļļas filtru atslēga / Öljüfiltrvõtö / Ключ за маслен филтър / Ключ за filtre za ulje / Ключ за filter za ulje / Κλειδί αφαίρεσης φίλτρου λαδιού / Chave para filtros de aceite / Chiave per filtro olio / Chave para filtros de óleo / Clé filtre a huile / Filtersleutel



Ref.	Ra[mm]	☒	EAN
11-238	64-120	1/40	5907558437362



Ref.	Ra[mm]	☒	EAN
11-231	73 - 85	6/36	5907558416657



60-115 mm



1/2"

Ref.	Ra[mm]	☒	EAN
11-381	60 - 115	5/20	5907558445459



80-115 mm



Ref.	Ra[mm]	☒	EAN
11-380	80 - 115	1/20	5907558445442

## Klucze do spustu oleju

Oil drainer set / Ölablassschlüssel / Ключи для слива масла / Ключи для зливання оливи / Olajleeresztő kulcs készlet / Cheie pentru dop de scurgere a uleiului / Klucze na vypušteni oleja / Sada klíčů na vypuštění oleja / Vjaki za spuščanje olja / Raktai alyvos išleidimui / Eļļas nolaīšanas atslēgas / Ölkörgi võtmed / Ключоие за източване на масло / Кључеви за испуштање ulja / Кључеви за испуштање ulja / Set αποστράγγισης λαδιού / Llaves para evacuación de aceite / Inserti per tappo olio / Chaves para evacuação de óleo / Clés pour la vidange d'huile / Sleutels voor oliedrainage



60-160 mm



Ref.	Ra[mm]	☒	EAN
11-382	60 - 160	6/24	5907558445466

20°



Ref.	Ra[mm]	☒	EAN
11-240	63.5 - 116	6/36	5907558435931

30°  
60°  
90°



Ref.	Ra[mm]	☒	EAN
11-241	63.5 - 116	5/30	5907558435931



CrV steel

3/8"

x18



Zastosowanie / Application / Применение:

Hex 8 mm: BMW, Ford, GM  
Hex 9 mm: GM  
Hex 10 mm: Ford  
Hex 12 mm: Fiat, Lancia, Peugeot  
Hex 14 mm: Lancia, Mercedes  
Hex 17 mm: Audi, VW, BMW, Austin  
Square 7, 8 mm: Citroen, Peugeot, Renault, Talbot, Volvo  
Square 11 mm: Ford  
Square 13.1 mm: Nissan, Subaru  
Square 3/8": Honda, Mazda, Renault, Saab, Volvo  
Square (5/16"), 10 mm Female, Square: 10 mm: do skrzyń biegów i mechanizmów różnicowych różnych marek aut np. / for gearboxes and differential mechanisms of various makes / для коробки передач и дифференциала автомобилей разных марок: BMW, Ford, Renault, Toyota  
Triangular: 10 mm Renault  
M16 Spline (Tamp-proof): Audi A4 i A6



Ref.	☒	EAN
11-235	0/10	5907558417098

## Końcówka wkrętakowa do korków oleju

Special bit for oil drain plug / Spezial Bit für Ölablassschraube / Бита специальная для сливной пробки / масляного под / Бита для сливной пробки / Bit az olajugókhöz / Bit special pentru dopul de scurgere a uleiului / Specialni bit pro vyrušičení zátky oleje / Specialny bit pre vyrušičaú zátky oleja / Poseben bit za zamašek za izpust olja / Specialus antgalis alyvos išleidimo kamščia / Įrašs bit eļļas iztukšošanas aizbāznei / Spetsiaāle ats āli vāļjalaskekrūvi pīnks / Ключ за маслени тату / Ключ за черове за уље / Кључ за чепове за уље / Кључи за бјугајата ладицу / Llave especial tapón de aceite / Chiave speciale per tappi olio / Chiave especial para óleo / Clé à bouchon d'huile spéciale / Speciale olieplugsleutel



1/4"



Audi / SEAT / Škoda / VW:  
model year 2013 with 1.2 · 1.4 · 1.8 · 2.0 TFSI petrol engines

Audi: A1, A3, A4, A5, Q5

VW: Golf 7

SEAT: Leon, etc. with 1.6 and 2.0 l diesel engines



Ref.	📦	EAN
11-383	20/100	5907558452266

## Zestaw do misek oleju

Oil change tool kit / Ölwechsel-Werkzeugsatz / Набор инструментов для замены масла / Набор инструментов для замены масла / Különleges szerszámkészlet olajcseréhez / Trusă de scule specială pentru schimbul de ulei / Specialni sada nářadí pro výměnu oleje / Specialna sada nářadí na výmenu oleja / Oradje komplet posebnih za menjavo olja / Įrankių rinkinys specialus alyvos keitimui / Įrašs instrumentu komplekts eļļas maiņai / Tööriistakomplekt spetsiaāle õļivahetuseks / Комплект инструментов за смяна на масло / Komplet alata poseban za zamjenu ulja / Комплект апата специални за замену уља / Ебику кит ервајелин уа аллаги ладицу / Kit de herramientas especial para cambio de aceite / Kit attrezzi speciali per cambio olio / Kit de ferramentas especial para troca de óleo / Kit d'outils spécial pour le changement d'huile



5 ELEMENTS

1/4"

3/8"



Audi / SEAT / Škoda / VW:  
model year 2013 with 1.2 · 1.4 · 1.8 · 2.0 TFSI petrol engines

Audi: A1, A3, A4, A5, Q5

VW: Golf 7

SEAT: Leon, etc. with 1.6 and 2.0 l diesel engines



OEM: Connect 31775 Peugeot/Citroen (OEM 9801444780 Plug) and Ford (OEM 18711598 plug) Connect 31776 Ford (OEM 1830727 plug) Connect 31774 BMW (OEM 11137605018 plug) Connect 31771 VAG (OEM 06L 103 801 sump and cam cover plug)

Ref.	📦	EAN
11-384	5/20	5907558452273

## Odciągarka do oleju

Oil suction gun / Ölabszieher / Отсосное устройство для масла / Оливодсмонтувач / Olajleszívó / Tråögator de ulei / Odsávačka oleje (ruční) / Odsávačka na olej / Črpalčka za olje / Alyvos siurblys / Eļļas atvīcējs / Ūlisūstal / Засмошваца маслена помпа / Sisařka za ulje / Pumpra za ispuštavanje ulja / Αναρροητήρας λαδιού / Dispositivo de extracción de aceite / Pistola di aspirazione olio / Máquina de remover óleo / Vidangeur d'huile / Olieafzuiger



METAL

280 mm



Ref.	[ml]	Ø [mm]	L [mm]	📦	EAN
11-510	500	56,4	280	0/20	5907558415346
11-511	1000	62,5	400	0/10	5907558415353

## Mobilna zlewarka do oleju, grawitacyjna

Mobile oil siphon, gravity / Mobilier Ölsiphon, Schwerkraft / Передвижной масляный сифон, гравитационный / Мобильный масляный сифон, гравит / Mobil olajszifon, gravitáció / Sifon mobil de ulei, gravitațional / Мобильный olejový sifon, gravitace / Mobilný olejový sifón, gravitačný / Mobilni sifon za olje, gravitacijski / Mobilus alyvos sifonas, gravitacija / Mobilais eļļas sifons, gravitācija / Mobilne ölsifon, gravitatsioon / Мобилен маслен сифон, гравитачен / Mobilni sifon za ulje, gravitacijski / Мобилни сифон за уље, гравитација / Κινητό σiphón λαδιού, βαρύτητα / Sifón de aceite móvil, gravedad / Sifone olio mobile, gravità / Sifão de óleo móvel, gravidade / Siphon à huile mobile, gravité / Mobeie olie-sifon, zwaartekracht



MAX. OPERATING PRESSURE 0,1 BAR

70L TANK CAPACITY

18 Kg

Ref.	📦	EAN
10-810	0/1	5907558499841

## Mobilna zlewarka-wysysarka do oleju pneumatyczna ze zbiornikiem kontrolnym

Mobile pneumatic oil sink and extractor with a control tank / Mobile pneumatische Ölspüle und -absaugung mit Kontrolltank / Передвижной пневматический маслоприемник и экстрактор с контрольным баком / Мобильный пневматичний масляний приймач і екстрактор з резервуаром управління / Mobil pneumatikus olajtasó és elszívó vezérlőtartállyal / Osmetiv pneumatică mobilă pentru ulei și extractor cu rezervor de control / Mobilni pneumatički olejovj džez a odsavač s kontrolni nářží / Mobilný pneumatičkový olejový džez a odsávač s kontrolnou nářžou / Mobilni pnevmatski zbiralnik in ekstraktor olja s krmilnim rezervoarjem / Mobilni pnevmatine alyvos knauckle ir siurblys su valdymo baku / Mobilā pnevmatiskā eļļas izletne un nosūcējs ar vadības tvertni / Mobilne pnevmatiline õilvalamu ja vāļjatāmbeseade koos juhttraagiga / Мобилен пневматичен маслен приемник и екстрактор с резервоар за управление / Mobilni pneumatski sudoper i ekstraktor ulja s kontrolnim spremnikom / Мобилни пневматични уљни судопер и изваљач са контролним резервоаром / Κινητός pnevmatikός νεραϊκής λαδιού και εβζιλκία με δεβρμενέ ελέγκρου / Fregadero y extractor de aceite neumático móvil con tanque de control / Dissipatore edestrattore d'olio pneumatico mobile con serbatoio di controllo / Dissipador e extrator de óleo pneumático móvel com tanque de controle / Puits et extracteur d'huile pneumatiques mobiles avec réservoir de contrôle / Mobeie pneumatische olie-afzuiging en -afzuiger met controletank



10L CONTROL TANK

MAX. OPERATING PRESSURE 1-3 BAR

70L TANK CAPACITY

6-8 BAR WORKING PRESSURE

25 Kg

Ref.	📦	EAN
10-811	0/1	5907558499858

## Wanna do oleju

Oil drain bucket / Ölwanne / Ванночка для масла / Ванна оливна / Olajkád / Baie de ulei / Vana na olej / Vaňa na olej / Posoda za olje / Vonele teralvi / Vanna eļļai / Ölwanne / Vana za maslo / Posuda za ulje / Kada za ulje / Λεκάνη αποστράγγισης λαδιού / Bandeja para aceite / Contenitore olio / Bandeja para troca de óleo / Bac à huile

7L  
PLASTIC



Ref.	☒	EAN
11-550	0/10	5907558415360

## Miska do zlewania oleju, plynu chłodniczego

Bowl for pouring oil, coolant / Schüssel zum Umfüllen von Öl und Kühlmittel / Чаша для слива масла, охлаждающей жидкости / Чаша для зливання масла, охолоджуючої рідини / Tál olaj, hűtőfolyadék dekantálásához / Bol pentru decantarea uleiului, lichidului de răcire / Nádoba na stáčení oleje, chladicí kapaliny / Miska na dekantáciu oleja, chladiacej kvapaliny / Miska na dekantáciu oleja, chladiacej kvapaliny / Dubuo alvaina, aušinimo skysčiui nupilti / Bļoda eļļas, dzesēšanas šķidrums dekantēšanai / Kausis eļļai, jahutussvedēliku dekanteerimiseks / Нурпа за деанттиране на масло, охладжаша течност / Posuda za pretakanje ulja, rashladne tekućine / Посуда за преливање уља, rashladne течности / Μπολ για μεταγωγή λαδιού, ψυκτικό / Recipiente para decantar aceite, refrigerante / Ciotola per travaso olio, refrigerante / Recipiente para decantar óleo, líquido de arrefecimento / Bol pour décanter l'huile, le liquide de refroidissement / Kom voor het decanteren van olie, koelvloeistof



PE  
16L

Ref.	☒	EAN
10-800	1/6	5907558495799

## Miska do zlewania oleju

Oil drain pan / Ölauffangwanne / Поддон для слива масла / Поддон для зливу масла / Olajleeresztó edény / Tava de scurgere a uleiului / Вырушечá nádoba na olej / Nádoba na vyrušenie oleja / Posoda za izpust olja / Alyvos nutekėjimo indas / Eļļas notekas panna / Öli tühjenduspann / Съд за източване на масло / Posuda za ispuštanje ulja / Посуда за испуштање уља / Ταψή αποστράγγισης λαδιού / Ταψή αποστράγγισης λαδιού / Vaschetta di scarico dell'olio / Bandeja de drenagem de óleo / Bac de vidange d'huile / Olie vangbak

PE  
12L



Ref.	☒	EAN
10-801	1/4	5907558495805

## Nalewak warsztatowy, konewka

Workshop pouter, watering can / Werkstattausgießer, Gießkanne / Навиоана мастерская, лейна / Майстерня наливака, лейна / Műhelyöntő, öntözőkanna / Atelier de turnare, adapatoare / Dilenský nalievač, konev / Dieleński nalievač, kanva / Delavniški točilnik, zalivalka / Dirbtuvių piltuvos, laistytuvas / Darbničas lejējs, lejkanna / Токача валaja, kastekann / Работилница за наливање, лейна / Radionička sipalica, kanta za zalivanje / Радуонична силач, канта за заливање / Χηλιδι σπινθηρίου, πατοστύρι / Vertedor de taller, regadera / Versatore da officina, annaffiatore / Despejador de oficina, regador / Verseur d'atelier, arrosoir / Werkplaatsschenker, gieter

PE



Ref.	V [l]	☒	EAN
10-802	1	1/24	5907558495812
10-803	3	1/20	5907558495829
10-804	5	1/16	5907558495836

## Strzykawka do płynów eksploatacyjnych

Syringe for operating fluids / Spritze für Betriebsflüssigkeiten / Шприц для рабочих жидкостей / Шприц для операційних рідин / Fecskendő működési folyadékokhoz / Seringă pentru fluide de operare / Stříkačka na provozní kapaliny / Striekačka na prevádzkové kvapaliny / Brizga za operativne tekočine / Švirkštas darbiniam skysčiams / Špirce darbišas šķidrumiem / Sústal tövedelőke jaksok / Спринцова за работни течности / Sprica za radne tekućine / Шприц за оперативне течности / Σιρίγγα για υγρά λειτουργίας / Lejiga para fluidos operativos / Siringa per fluidi operativi / Seringa para fluidos operacionais / Seringue pour fluides opératoires / Spuit voor bedrijfsvloeistoffen



PP + PVC  
HOSE 30cm + 30cm

Ref.	V [ml]	☒	EAN
10-805	200	1/25	5907558495843
10-806	500	1/20	5907558495850
10-807	1500	1/10	5907558495867

## Kanister na benzynę

Can for petrol / Benzinbehälter / Канистра для бензина / Канистра для бензину / Üzemanyagkanna, mûanyag / Bidon de benzin / Kanistr na benzin / Kanistra na benzin / Kanister za benzin / Bakas benziniui / Benzina kanna / Bensinikanister / Бидон за бензин / Kanister za benzin / Kanta za benzin / Kánistero benzínis / Bidón para gasolina / Tanica per la benzina / Tanque para gasolina / Jerrycane à essence / Jerrycan voor benzien

HDPE  
PP  
LDPE



Ref.	V [l]	☒	EAN
11-560	10	0/50	5907558436402
11-561	20	0/30	5907558436419

# Lejek

Funnel / Trichter / Воронка / Воронка / Tölcsér, flexibilis, szárúvel / Pálnie / Nálevka / Lievik / Lijak / Piltuvēlis / Piltuve / Lehter / Фунтун / Lijevak / Levak / Xavi / Embudo / Imbuto / Funil / Entornair / Trechter



1,2 L HDPE LDPE

Ref.	Ø, [mm]	Ø <sub>2</sub> [mm]	⊠	EAN
11-555-1	45	160	0/50	5907558474558



Ø125MM DEPTH 250MM HANDLE INCLUDED

Ref.	⊠	EAN
10-808	4/8	5907558499810



FOLDABLE DIMENSIONS: 10.5 X 14.5 CM SILICONE MATERIALS

Ref.	⊠	EAN
10-809	0/50	5907558499827



Ref.	⊠	EAN
11-551	0/72	5907558439977



PP Ø 13 mm Ø 160 mm 90g

Ref.	Ø, [mm]	Ø <sub>2</sub> [mm]	⊠	EAN
11-552	13	160	0/50	5907558435887



PP Ø 160 mm Ø 13 mm 158g height 390 mm

Ref.	Ø, [mm]	Ø <sub>2</sub> [mm]	⊠	EAN
11-553	13	160	0/40	5907558435894

## Smarownica dźwigniowa

Lever-operated grease gun / Schmierspritze mit Hebel / Шприц рычажно-плунжерный / Шприц важільно-плунжерний / Karos zsírzó / Gresor cu prghie / Páková maznice / Páková mazica / Ročna mazalka / Rankinis tepalo presas / Leelotājs ar sviru / Karkgida māģinīssēde / Ръчна малярна / Mazalica ručna / Mazalica na ritnici / Гроабдърочме рожло / Engaradora de palanca / Pistola de lubrificação / Graisseur à levier



400 cm<sup>3</sup> 10000 Psi 8x300 mm

Ref.	⊠	EAN
11-500	0/10	5907558415278



380x125x70mm CAPACITY 500cm<sup>3</sup> WORKING PRESSURE 400bar HOSE TIP 11x300mm EFFICIENCY 1.2cm<sup>3</sup>

Ref.	⊠	EAN
11-501	0/10	5907558426465

## Wężyk do smarownic

Hose for grease gun / Schlauch für Schmiergeräte / Шланг смазочный / Шланг до дозатора оливи / Zsirizó cső / Furtunpentru pistol de gresare/ungere / Hadička pro mazničky / Hadička do maznice / Čev za mazalnike / Žarné tepalník / Cauciulțe elias canărași / Óilipistóliovák / Маршуч за мастьона / Слјезво за mazalice / Crevo za podmazivanje / Ελαστικός σωλήνας λιπανσης / Mangueira para engrasadoras / Tubo in Nylon / Mangueira para lubrificadores / Flexible de graisseur / Slang voor smeerapparaten



Ref.	L [mm]	☒	EAN
11-532	11x300	0/100	5907558415308

length 36mm    ø15cm    M10x1    ø11mm



Ref.	L [mm]	☒	EAN
11-502	11x150	100/200	5907558426472

## Końcówka smarownicy 4 szczękowa

Lubricating nipple 4 jaw / Schmiernippel 4 Backe / Смазочный ниппель 4 щели / Мазтильний ніпель 4 губки / Μεγάλιτμό 4 άλτκαρος / Niplu de lubrifjere 4 făci / Mazací vsuvka 4 čelisti / Mazacia vsuvka 4 čeluste / Mazalna bradavica 4 čeljust / Τεπινο πιπέλις 4 ζανάκουλis / Είλοσανα sprausla 4 spaites / Möärdenippel 4 löulalu / Смазочц нипел 4 челюст / Vrh pištolja za podmazivanje s 4 čeljusti / 4-челусти врх пиштоља за подмазивање / Βηρή λιπανσης 4 απαγώνα / Engrasador 4 mordazas / Nipplo di lubrificazione 4 ganasse / Bocol de lubrificação 4 maxilas / Graisseur 4 mâchoires / Smeernippel 4 kaken



25pcs

Ref.	☒	EAN
11-503	250/500	5907558426489

## Pompa do oleju

Oil pump / Óilpumpa / Масляный насос / Pompa do oliwi / Óilajpumpa / Pompa de ulei / Čerpadlo na olej / Čerpadlo na olej / Čerpačka za olje / Αλυσος pompa / Είλος σίκουλις / Óilpumpa / Маслена помпа / Óljna pumpa / Pompa za ulje / Αντλία λαδιού / Bomba para aceite / Pompa dell'olio / Bomba de óleo / Pompe à huile



TELESCOPIC

capacity 18L/min

for barrels 60/200/220L

800x90x90mm

PVC/NBR



Ref.	☒	EAN
11-565	0/10	5907558426496

## Spryskiwacz ciśnieniowy warsztatowy

Workshop pressure washer / Werkstatt-Hochdruckreiniger / Машина высокого давления для мастерской / Машина високогo тиску для майстерні / Műhelyi magasnyomású mosó / Maşină de spălat cu presiune de atelier / Dílenská tlaková tyčka / Díelenská tlaková utývačka / Tlačni čistník za delavnice / Dirbtuvių slėginis plovimo įrenginys / Darbnicas spriediena mazgātājs / Тоокоја суиверсур / Работилница за миене под налягане / Radionički visokotlačni peraç / Радионична машина за прање под притиском / Пилватиро плевач суверпсиоу / Hidrolimpadora de taller / Idropulitrice da officina / Máquina de lavar a pressão para oficina / Nettoyeur haute pression d'atelier / Werkplaats hogedrukreiniger



1,5L

PP+PE

Ref.	☒	EAN
10-815	0/20	5907558473933

## Zestaw do wymiany płynu hamulcowego i odpowietrzania hamulców

Brake fluid change and brake bleeding kit / Bremsflüssigkeitswechsel und Bremsenentlüftungsset / Замена тормозной жидкости и комплект для продувки тормозов / Комплект для заміни гальмівної рідини та прокачування гальм / Fékfolycadé kcsere és fékölvezető készlet / Kit de schimbare a lichidului de frână și kit de săngerare a frânelor / Sada pro výměnu brzdové kapaliny a odvzdušnění brzd / Súprava na výmenu brzdovej kvapaliny a odvzdušnenie brzd / Komplet za menjavo zavorne tekočine in odzračevanje zavor / Stabdžij skysčio keitimo ir stabdžij nuleidimo rinkinys / Bremžu šķidruma nomainas un bremžu atskurbšanas komplekts / Pidurivedeliku vahetamise ja pidunte tühjendamise komplekt / Комплект за смяна на спирачната течност и обезвъздушаване на спирачките / Komplet za zamjenu kočione tekučine i odzračivanje kočnica / Комплект за замену кошичне течности и за одзрачыванье кошниц / Kit αλλαγή υγρών φρένων LED / Προβαδορ de líquido de frenos LED / Tester líquido freni a LED / Testador de fluido de freio LED / Testeur de liquide de frein et kit de purge des freins / Remvloeistof verversen en remontluchtingsset



0,75L

6-8 bar

1/4"

180L/min

Ref.	☒	EAN
11-268	0/6	5907558404098

## Tester płynu hamulcowego diodowy

LED brake fluid tester / LED-Bremsflüssigkeitstester / Светодиодный тестер тормозной жидкости / Светодиодний тестер гальмівної рідини / LED-es fékfolycadé teszter / Tester de lichid de frana cu LED / LED tester brzdové kapaliny / LED tester brzdovej kvapaliny / LED tester zavorne tekočine / LED stabdžij skysčio testeris / LED bremžu šķidruma testeris / LED pidurivedeliku tester / LED тестер за спирачна течност / LED tester kočione tekučine / ЛЕД тестер кошичне течности / Διακροατής υγρών φρένων LED / Probador de líquido de frenos LED / Tester líquido freni a LED / Testador de fluido de freio LED / Testeur de liquide de frein à LED / LED-remvloeistoftester



Ref.	☒	EAN
11-269	0/100	5907558473926



## Separator

Spreader / Abscheider / Съединик / Сепаратор / Fékmarkahenger visszatámasztó / Separator / Separator / Separator / Separator / Separator / Separator / Сепаратор / Separator / Separator / Διαιρητήρας / Separator / Separatore / Separator / Séparateur / Separator



Ref.	Ra[mm]	📦	EAN
11-125	35-90	5/20	5907558437218



Ref.	Ra[mm]	📦	EAN
11-126	25-60	5/20	5907558437232



Ref.	Ra[mm]	📦	EAN
11-127	25-60	5/20	5907558437232



Ref.	Ra[mm]	📦	EAN
11-128	40-70	1/20	5907558437249

## Zestaw ręcznych separatorów do zacisków hamulcowych

Set of hand separators for brake calipers / Bremskolbenrückstellersatz / Комплект приспособлений для обслуживания тормозных цилиндров / Набор ручных сепараторов для тормозных колодок / Tárcsafék szerelő és visszatámasztó készlet / Set manual de separatori la cleme de frană / Sada na montáž kotoučových brzd / Súprava na montáž kotúčových brzd / Set ročnih ločevalnikov zavornih batov / Slabdiňaj cilindry suspauidimo komplektas / Bremžu cilindru manuālo separatoru komplekts / Piduriklotside separatorite komplekt / Комплект ручних сепараторів за стираними клієми / Set ručnih odvračajoča kočione stezaljke / Pribor ručnih separatora za kočione stezaljke / Set ουλίτηρας κυλίνδρων πέδησης / Juego de separadores manuales para las pinzas de freno / Utensili per il riposizionamento dei pistoncini dei freni / Jogo de separadores manuais para os maxilas de travão / Jeu de séparateurs manuels pour étriers de freins / Set voor handmatige afstanders voor remklemmen



Ref.	📦	EAN
11-123	0/10	5907558419993



Ref.	📦	EAN
11-122	0/5	5907558419986



Ref.	📦	EAN
11-129	1/5	5907558437256

## Separator pneumatyczny z końcówkami

Air brake caliper wing tool / Einstellwerkzeug für pneumatische Bremszylinder / Инструмент регулировки пневматического тормозного цилиндра / Инструмент регулювання пневматичного гальмівного цилиндра / Pneumatikus fékhenger beállító eszköz / Instrument de reglare a cilindrilor de frână pneumatic / Nástroj pro seřízení pneumatického brzdového válce / Nástroj na nastavenie pneumatického brzdového valca / Građe za nastavitve pnevmatičnega zavornega valja / Pneumatinis stabdžų cilindro reguliavimo įrankis / Pneumatisks bremžu cilindra regulēšanas rīks / Pneumatiline pidurisilindri reguleerimise tööriist / Пневматичен инструмент за регулиране на спирачните цилиндър / Alat za podešavanje pneumatskog kočnog cilindra / Alat za podešavanje pneumatskog kočnog cilindra / Εργαλείο ρύθμισης κυλίνδρου πεπιεσμένου αέρα / Herramienta de ajuste del cilindro de freno neumático / Strumento di regolazione del cilindro del freno pneumatico / Ferramenta de ajuste de cilindro de freio pneumático / Outil de réglage du cylindre de frein pneumatique / Luchtremklauwvleugel gereedschap



16  
ELEMENTS

L/R

1/4"

Ref.	☒	EAN
11-132	0/5	5907558445435

## Zestaw do sprawdzania bicia tarcz hamulcowych

Brake disc run out kit / Prüfsatz für Unrundlauf von Bremsscheiben / Набор для проверки тормозных дисков / Набор для перевірки гальмівних дисків / Tárcsafék ütésmérő készlet / Trusă pentru verificarea bății discurilor de frână / Sada pro kontrolu brzdových kotoučů / Súprava na kontrolu brzdových kotúčov / Komplet za preverjanje zavornih diskov / Rinkinis stabdžų diskų patikrinimui / Bremžu disku pārbaudes instrumentu komplekts / Pāduņķetaste kontrollimise komplekt / Комплект за проверка на биенето на спирачните дискове / Set za proveru kočnih ploča / Pribor za proveru kočnih diskova / Σετ ελέγχου διακορπένων / Kit para la comprobación de los discos de freno / Kit per il controllo dell'oscillazione assiale dei dischi freno / Kit de verificação de batimento dos discos de travão / Kit de mesure pour disques de freins / Remschijf opraken kit

±0.01  
mm



Ref.	☒	EAN
11-130	1/10	5907558437263

## Zestaw do montażu szczęk hamulcowych

Tool kit for brake shoe fitting / Bremsbacken-Montagewerkzeugsatz / Инструмент для обслуживания тормозной системы / Набор для монтажу гальмівних колодок / Fékprofaszerező készlet / Set pentru montarea sabotilor de frana / Sada na montáž brzdových čelistí / Súprava na montáž brzdových čelistí / Set za montažo zavornih čeljusti / Stabdžų trinkelų montavimo rinkinys / Bremžu uzliuku turėtojų montavimo komplekts / Pidrūķināde paigaldāmise komplekti / Комплект за монтажване на спирачните челоусты / Set za montažu kočionih čeljusti / Pribor za montažu kočionih čeljusti / Εργαλεία συντήρησης οπισθίων πέδησης / Kit de montaje de mardazas de frenos / Kit per montaggio pinze del freno / Jogo de ferramentas para montagem de maxilas de travão / Jeu d'outils de montage de mâchoire de frein / Set voor montage van remkaken



Ref.	☒	EAN
11-131	1/5	5907558437270

## Ściernice do czyszczenia piast

Wheel hub grinder Schleifmittel zur Reinigung von Naben / Шлифовальні круги для очищення ступиць / Шліфувальні круги для очищення маточин / Kerékagy tisztító dörzstárcsa / Discini pentru curățarea butucilor / Brusne kotouče pro čištění nábojů / Brusne kotúče na čistenie nábojov / Brusi za čiščenje pest / Įrankiai ratų stebulių valymui / Ritepa rumbas širišanos šlėpdiski / Rotaste puhastamise lihketad / Почувствашчи четки за главани / Diskovi za čiščenje glavčine / Brusione ploče za čiščenje čvaršta / Τροχαλ λείανσης για καθαρισμό πλύγινης τροχού / Amoladora para limpiar cubos de ruedas / Dischi abrasivi per la pulizia di mozi / Escovas circulares para limpeza de cubos de rodas / Meules pour nettoyage des moyeux / Wielnaafgrindervoor reiniging



14  
mm

40  
mm

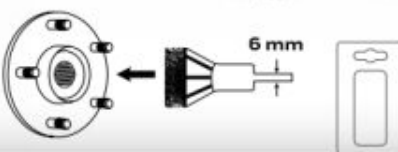

Ref.	☒	EAN
11-135	25/50	5907558437287

ø150  
mm

1/2"



11-136

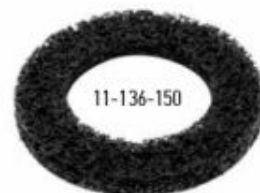

11-136-150

Ref.	☒	EAN
11-136	0/30	5907558411423
11-136-150	0/100	5907558474770

## Klucz do kół

Wheel wrench / Radschlüssel / Ключ для колес / Ключ для монтажу на автомобильных / Kereszt kerékkulcs / Cheie piuliță plu demontarea și montarea roților / Ključ na kola / Ključ na kolesá teleskopický / Ключ за автомобилска кола / Raktas ratams / Ritepi atslēga / Rattavöbi / Ключ за гума / Ключ за kotač / Кључ за точак / Кључи за тракови / Llave extensible para ruedas / Chiave a croce / Chiave para filtro / Clef pour filtre / Wielsleutel

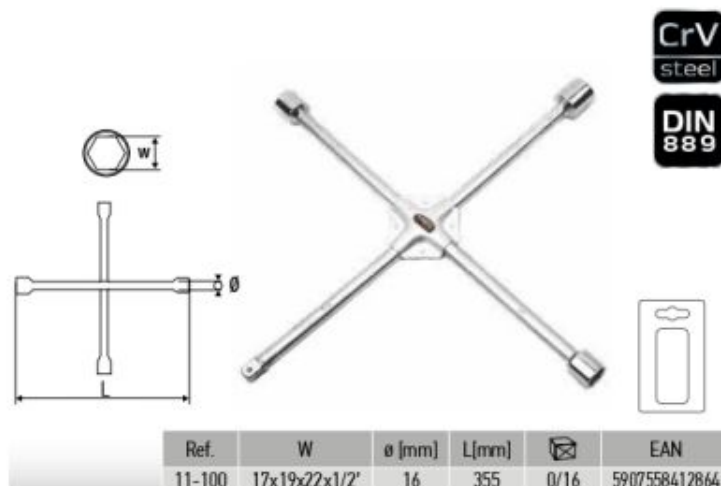

CrV  
steel

DIN  
889

Ref.	W	ø [mm]	L [mm]	⊠	EAN
11-100	17x19x22x1/2"	16	355	0/16	5907558412864

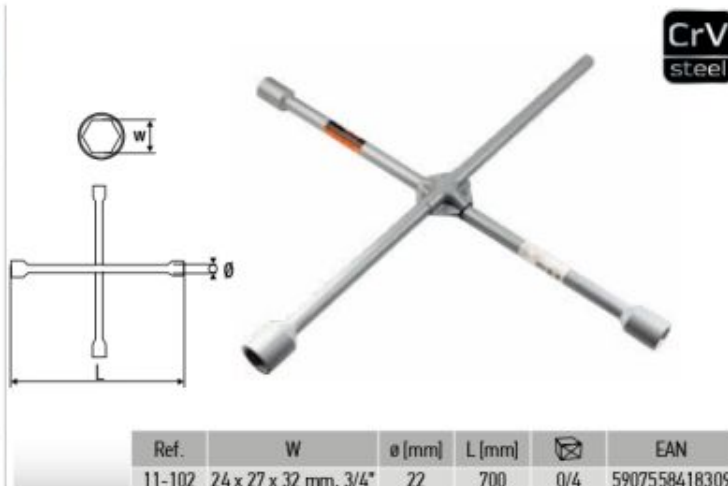

CrV  
steel

Ref.	W	ø [mm]	L [mm]	⊠	EAN
11-102	24 x 27 x 32 mm, 3/4"	22	700	0/4	5907558418309



CrV  
steel

1/2"

Ref.	W	⊠	EAN
11-101	17x19x1/2"	6/12	5907558417135

## Țișka do opon

Wrecking bar / Reifenlöffel / Монтажна автомобильная / Монтажна / Gumibrancs szerelős / Levea pentru pneu / Montážní páka na pneumatiky / Páka na pneumatiky / Žlička za pneumatike / Svrtis padangų montavimo / Lāpstīra riepu montāžai / Rehvitusikas / Щанга за демонтаж на гума / Podázoč za montiranje guma / Kašika za gumu / Κοιτάκια φανοποιίας / Llave cachara para extraer ruedas / Levea per pneumatici / Ferramenta para rodas / Demonte-pneus / Breckijzer

CrV  
steel



Ref.	L [mm]	⊠	EAN
11-111	400	10/20	5907558416619
11-112	500	10/20	5907558416626

## Șciagăce do sprężyn

Spring pullers / Abzieher für Feder / Съёмные приспособления для пружин / Знімачі пружин / Rugóösszehúzó kézi / Ancore de arcuiri / Stahováky pružin / Stáhováky pružin / Izvelekači za vzmeti / Spyruoklių spoustai / Atspėru porėmata iešicė / Vedrutõmmitsad / Слюби за пружини / Skidač za opruge / Stega za oprugu / Εξωκέντρως ελασπίων / Extractor de muelles / Pressori per molle / Ponta de aperto para molas / Extracteurs de ressorts / Trekkers voor veren



Ref.	Ra [mm]	⊠	EAN
11-796	23-280	1/5	5907558436747



70-130  
90-150  
mm



- 70/130 mm, 90/150 mm  
Mercedes
- W123, W124, W126, W140, W202, W210
- W107, W114, W115, W116, W123, W124, W126, W129, W140, W201, W202, W203
- Opel / Vauxhall / Hyundai / Lada / Rover / Saab / Fiat / Ford / Mazda / Toyota / Nissan / Mitsubishi / Peugeot / Volvo / VW

Ref.	Ra [mm]	⊠	EAN
11-798	70-130, 90-150	1/2	5907558436761

## Ściągacze do sprężyn

Spring pullers / Abzieher für Feder / Съёмные приспособления для пружин / Знімачі пружин / Rugóösszehűző kézi / Ancore de arcuri / Stahovák pružin / Stahovák pružin / Izvlačači za vzmeti / Spyrtauklių spaustai / Atspėru nuėmama įerė / Vedrūtīmītsad / Сноба за пружину / Skidači za opruge / Stega za oprugu / Εξυλιέας ελατηρίων / Extractor de muelles / Pressori per molle / Ponta de aperto para molas / Extracteurs de ressorts / Trekkers voor veren

125-212  
88-190  
65-125  
mm



 125/212 mm, 8/160 mm, 65/125 mm.

 BMW: E31 - E67, MINI R50/R52/R53, Fiat, Alfa Romeo, Chrysler, Lancia, Ford, Mazda, Honda, Hyundai, Jaguar, Jeep, Kia, Mercedes C/E, Citroen, Peugeot, Opel, Vauxhall, Saab, Renault, Nissan, Infiniti, Dacia, Mitsubishi, Rover, Subaru, Toyota, Audi, Porsche, Skoda, VW, Volvo

Ref.	☒	EAN
11-797	1/1	5907558436754

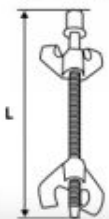

Ref.	L [mm]	☒	EAN
11-807	300	0/10	5907558418453

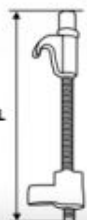

Ref.	L [mm]	☒	EAN
11-808	300	0/10	5907558418460

## Dźwignia do przegubów

Lever for articulated joints / Hebel für Gelenke / Рычаг для шарниров / Вижилъ до шарнири / Gömbfejszerelő villa / Lever de articulation / Podpěra kloubů / Pětko k čarom / Віліце за зглобе / Выцяг швірта / Šarniru svira / Klambrikang / Лост за шарнири / Poluga za zglobove / Poluga za zglobove / Μολός μενισαίδων / Palanca para rótulas / Leva per giunti articolati / Alavanca p. Articulações / Lever pour articulations / Hefboom voor spilverbindingen



Ref.	L [mm]	☒	EAN
11-805	300	0/12	5907558418590
11-806	400	0/12	5907558418606

## Zestaw łomów

Go-through pry bar set / Brechstangen-set / Набор монтажок / Набор лопат / Feszítós készlet / Set de rāngi de oțel / Sada pačidel / Súpřava pačidel / Komplet lomiků / Λαυζήτων ριγκινγς / Λαυζήτου κομπλεκς / Kangide komplekt / Комплет лопат / Set poluga / Garnitura poluga / Set κουτάλες / Juego de palancas / Set di leve da sforzo / Kit de pés-de-cabra / Jeu de pieds-de-biche / Set van breekeijzers



**CrV**  
steel **x4**



Ref.	L [mm]	☒	EAN
11-113	200, 300, 450, 600	0/10	5907558416633

## Ściągacz do przegubów

Ball joint puller / Gelenkabziehvorrichtung / Съёмник шарниров / Пристрій для зняття шарнірів / Gömbcsukló kinyomó / Extractor articulații sferice / Stahovák kloubů / Stahovák na guľaně čaru / Smetalec / Nuēmiklīs šarnīgrams / Nowicjės / Kuullidestõmmitis / Сноба за болтове / Izvlačač / Rodarciger / Κροκιάλαγκο για κοσμάες / Extractor de juntas de rótula / Estrattore di giunti a sfera / Ponta de aperto de articulações / Arrache-articulations / Trekker voor spilverbindingen



Ref.	ø [mm]	☒	EAN
11-801	20	0/20	5907558416527

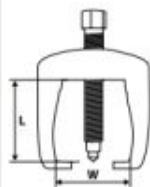

Ref.	L [mm]	W [mm]	☒	EAN
11-803	45	27	0/20	5907558418439
11-804	65	32	0/20	5907558418446



Ref.	ø [mm]	☒	EAN
11-802	19	0/20	5907558418422

## Ściągacz do koła kierownicy

Steering wheel puller / Abzieher für Lenkrad / Съёмное устройство рулевого колеса / Знімач керма / Kormánykerék leszedő készlet / Ancoră de volan / Stahovák volantu / Sťahovák volantu / Izvlekač za volan / Vairo traukiš nuemiklis / Stūres rata noņemata ierīce / Juhtratta tõmmits / Скоба за колелото на волана / Skidač kotača volana / Stega za upravljač / Εξολκείς τρομού / Extractor de volante / Estrattore di volante / Ponta de aperto para volante / Extracteur de volant / Trekker voor stuurwiel



Ref.	📦	EAN
11-816	5/20	5907558419696

## Ściągacz z siłownikiem

Hydraulic puler / Abzieher mit Servoantrieb / Съёмник с гидравликом / Знімач із гидравликом / Lehízó hidraulikus rásegítéssel / Extractor cu dispozitiv de acționare / Hydraulický stahovák / Sťahovák so servomotorom / Hidraulická izvlekač / Hidraulinis nuėmimo įrankis / Novēlcejs ar hidropiedziņu / Servomotoriga tõmmits / Инструмент за демонтаж с цилиндър / Skidač sa cilindrom / Alatka za skidanje sa hidraulikom / Υδραυλικός εξολκείς / Extractor con accionador / Estrattore con cilindro / Extrator com accionador / Extracteur avec vérin / Hydraulische trekker



Ref.	📦	EAN
11-847	1/2	5907558436853

## Ściągacz do piast

Wheel hub puller / Abzieher für Radnaben / Съёмное приспособление для ступиц / Знімач моточин / Kerekagy lehízó készlet / Ancoră de butuc / Stahovák hlavy kola / Sťahovák náboja / Izvlekač za pesta / Stebulni spustai / Rumbu noņemata ierīce / Rattarummu tõmmits / Скоба за шпильку / Skidač za glavčine / Stega za glavčini / Εξολκείς πλήμμης / Extractor de cubos de ruedas / Estrattore a bilanciere / Ponta de aperto / Extracteur de moyeux / Trekker voor naaf



Ref.	📦	EAN
11-811	5/20	5907558418484

## Zestaw ściągaczy do drążków kierowniczych

Steering rods puler set / Abziehvorrichtungssatz für Spurstangen / Набор съёмников шаровых опор и рулевых наконечников / Набор знімачів до кермових тяг / Kormányösszekelő-gömbfejkiújító készlet / Set trågätare bare de comandă / Sada stahováků táhel řízení / Sada sťahovákov táheli riadenia / Set izvlekačev za krmilne drogove / Guolínii atramij ir vairo traukiū nuemimo rinkinys / Stūres uzgaļu un sfērisko balstu novēlceju komplekts / Roolivarda tõmmitsate komplekt / Комплект скобу за изваждане на нормилни цапве / Set skidača za upravljačke šipke / Pribor alatki za skidanje upravljačkog stalka / Σετ εξολκείων αρθρώσεων και κατευθυντήριων ραβδίων / Juego de extractores de barras de dirección / Kit di estrattori per tiranti dello sterzo / Kit de extratores de barras de direção / Kit d'extracteurs de biellette de direction / Trekkers voor stuurstangen



Ref.	📦	EAN
11-799	1/2	5907558436778

## Uniwersalny klucz do drążków kierowniczych

Universal tie rod spanner / Universalschlüssel für Zugstangen / Универсальный гаечный ключ / Универсальный ключ для стяжных шпильок / Universalis nyakkulcskulcs / Cheie universală pentru tije de legătură / Universalni ključ na spojovací tyče / Universalny ključ na tačka / Universalny ključ na tačka / Universālsus verzīdarakšio veržlīaraktis / Universalis atslēga / Universalne sidetangi mutviti / Universalen gaечен ключ за връзна / Universalni ključ za letvu volana / Универсални ключ за управљач / Γενικό κλειδί ραβδίου αινθεσης / Clave universal para tirantes / Chiave universale per tiranti / Chave universal para tirantes / Clé universelle pour tirants / Universele trekstangsleutel



Ref.	📦	EAN
11-875		5907558477191

## Ściągacz dwuramienny i separator

Gear puller set / Abzieher mit zwei schenkeln und ausscheider / Съёмник универсальный с сепаратором / Знімач двооплечевий і сепаратор / Csapágylehízó készlet / Extractor universal cu două brațe și separator / Sada dvouramennyj stahovák a oddělovač / Súprava dvoiramenný sťahovák a separátor / Komplet dvostrukoga separatora s smaloča in ločilnika / Dvišakių nuėmėjų rinkinys su separatorium / Duplecu novēlceja un separatora komplekts / Kahetaruoline tõmmits ja sепаратор / Комплект двураменна стлга със сепаратор / Set dvostraki skidač i separator / Garnitura dvostrako stega i separator / Εξολκείς γενικής χρήσης με διαχωριστή / Juego de extractores de dos brazos y separator / Set separatorare per cambio / Kit sacador de 2 garras e separador / Jeu d'extracteurs a 2 bras et separateur / Tweearmig trekker en separator



Ref.	📦	EAN
11-810	0/4	5907558416572

## Ściągacz trójramienny

Three-arm puller / 3-Arm Abzieher / Съёмник с тремя захватами / Знімач триплечевий / Csarágylehűző, háromkaros / Extractor cu trei brațe / Трёхплечный стahовák / Трёхплечный стahовák / Trokraki snemalec / Csarágylehűző, kétkaros / Extractor cu două brațe / Stahovák dvoarmenný / Dvojramenný stahovák / Dvostruki odvajač / Nušmejas, dvīšakīs / Divplecu novilcējs / Kaheharuline tõmmits / Двухрамenna скоба / Trokraki izvakač / Trokraki alat za skidanje / Εξολκείας με τρεις σιαγόνες / Extractor de tres brazos / Estrattore a tre griffe / Extrator de três braços / Arrache à trois branches / Driearmige trekker



Ref.	L[mm]	☒	EAN
11-868	25	0/50	5907558420128
11-869	50	0/50	5907558420135
11-870	75	0/50	5907558420142

## Ściągacz dwuramienny

2 jaws puller / Abzieher mit zwei schenkeln / Съёмник подшипников 2-х лопчатый / Знімач двоплечевий / Csarágylehűző, kétkaros / Extractor cu două brațe / Stahovák dvoarmenný / Dvojramenný stahovák / Dvostruki odvajač / Nušmejas, dvīšakīs / Divplecu novilcējs / Kaheharuline tõmmits / Двухрамenna скоба / Trokraki stega / Εξολκείας έναρριων πριέων με 2 σιαγόνες / Extractor de dos brazos / Estrattore a due griffe / Sacador de 2 garras / Extrateur a 2 bras / Tweearmige trekker



Ref.	L[mm]	☒	EAN
11-871	25	25/100	5907558420159
11-872	50	25/100	5907558420166
11-873	75	25/50	5907558420173



Ref.	L[mm]	☒	EAN
11-857	150	0/16	5907558416862
11-858	200	0/6	5907558416879
11-859	300	0/2	5907558416886



Ref.	L[mm]	☒	EAN
11-850	75	0/50	5907558416817
11-851	100	0/50	5907558416824
11-852	150	0/50	5907558416831



Ref.	L[mm]	☒	EAN
11-861	100	0/20	5907558416794
11-862	150	0/10	5907558416800



Ref.	L[mm]	☒	EAN
11-865	100	0/16	5907558418514
11-866	110	0/12	5907558418521
11-867	140	0/12	5907558418538

## Ściągacz do łożysk

Gear puller / Lagerabziehvorrichtung / Съёмник подшипников / Пристрій для зняття підшипників / Csapágyelvázó / Extractor elisoidal / Stahovák ložisek / Сталовák dvojitelný / Snemálec / Гуліці п'єдмєткіс / Novlčєjs gultriem / Hammasratta tõmmits / Скоба за лажєру / Izvlačák / Radaräger / Крѡкѡпалаука yа áξωєς πρѡβѡς / Extractor de cojinetes / Estrattore rapporti / Ponta de aperto para rolamentos / Arrache-roulements / Lageronderbank

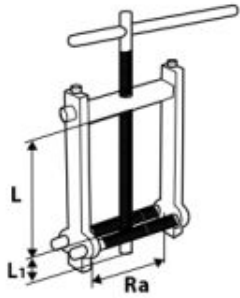

Ref.	L [mm]	L <sub>1</sub> [mm]	Ra [mm]	☒	EAN
11-813	100	20	24 - 55	0/30	5907558418507



Ref.	Ra [mm]	☒	EAN
11-848	35-130	1/2	5907558436860

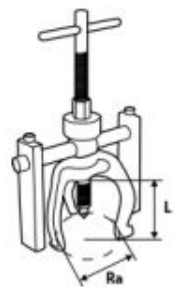

Ref.	L [mm]	Ra [mm]	☒	EAN
11-812	70	18 - 43	0/20	5907558418491

## Zestaw do ściągania i instalowania łożysk

Bearing removal and fitting kit / Radlager-Werkzeug-Satz / Набор для снятия/установки подшипников / Набор для зняття та встановлення вальниць / Csapágyeszerelő szerszámkészlet / Set de dispozitive de scos si de instalat lagare / Sada pro vjěměnu a montáž ložisek / Súprava na demontáž a instaláciu ložísk / Set za snemanje in montažo ležajev / Guolių montavimo komplektas / Gultų novlčiasanas un instališanas komplekts / Laagrite eemaldamise ja paigaldamise komplekt / Комплект за стьєанє и инсталірачє на лажєру / Set za skidanje i instaliranje ležaja / Pribor za skidanje i instaliranje ležišta / Set tonabērtņģģ/āpāriņģģ frģbģvģn / Juego para extraer e instalar rodamientos / Kit estrazione e montaggio cuscinetti / Jogo de ferramentas para remover e instalar rolamentos / Jeu d'arrache-roulement et de monte-roulement / Set voor demontage en installatie van lagers



50-88  
mm

Ref.	Ø [mm]	☒	EAN
11-690	50, 55, 60, 64, 67, 70, 72, 74, 75, 78, 82, 84, 88	1/2	5907558436624



18-65  
mm

Ref.	Ø [mm]	☒	EAN
11-691	18, 19, 20, 21, 22, 23, 24, 25, 26, 27, 28, 29, 30, 31, 32, 33, 34, 35, 36, 37, 38, 39, 40, 41, 42, 43, 44, 45, 46, 47, 48, 49, 50, 51, 52, 53, 54, 55, 56, 57, 58, 59, 60, 61, 62, 63, 64, 65	1/1	5907558436631

## Indukcyjna grzałka do śrub

Induction bolt and screw heater / Induktives Heizgerät für Schrauben / Индукционный нагреватель / Нагревач индукційний / Indukciós hevítő készlet / Incălzător cu inducție pentru șuruburi / Indukční ohřev šroubů / Indukčný ohrievač pre skrútky / Indukcijski grelnik za vijake / Indukcinis šildytuvus varžtams / Indukcijas šildītājs / Induktioo-põldisoojendi / Индукционен нагревател за болтове / Indukcijski grijač za vijake / Indukciaoni grejač za šrafove / Επαγωγικός θερμαντήρας / Calentador de inducción para tornillos / Riscaldatore ed induzione per viti / Aquecedor de indução para parafusos / Pistolet à chaleur inductive pour vis / Inductie dampelaar voor schroeven

700°C 1200W



Ref.	☒	EAN
11-931	0/1	5907558436969

## Zestaw do naprawy gwintów

Thread repairing kit / Gewindereparatursatz / Набор для восстановления резьбы / Набор для відновлення гвинтованих з'єднань / Menetjavító készlet / Set de rectificat fileturi / Sada pro opravi závítů / Súprava na opravi závítů / Set za popravilo navojev / Sriedgimo grankių rinkinys / Skrivju remontkomplekts / Keetereparanduskomplekt / Комплект за ремонт на резьби / Set za popravak navoja / Pribor za popravku šrafova / Σετ αποκατάστασης σπειρωμάτων μβ / Juego de reparación de tornillos / Kit riparazione filetti / Jogo de ferramentas para reparação de roscas / Kit de réparation de taraudages / Schroefdraad herstelset



CrV steel

Ref.	Ø	☒	EAN
11-901	M6	10/40	5907558419870
11-902	M8	10/40	5907558419887
11-903	M10	10/40	5907558419894
11-904	M12	10/40	5907558419900

## Wkłady do naprawy gwintów

Thread repairing kit / Gewindereparatureinsätze / Набор резьбовых вставок / Набор для відновлення гвинтованих з'єднань / Menetjavító betét / Adasuri de rectificat fileturi / Vložky pro opravi závítů / Vložky na opravi závítů / Set za popravilo navojev / Sriedgimo galvūčių rinkinys / Lelikti viřtu remontam / Keetereparandustiiblid / Елементи за ремонт на резьби / Umec za popravak navoja / Umetak za popravku / Σετ εινθετα σπειρωμάτων / Repuestos para reparación de tornillos / Kit riparazione filetti / Cartuxos para reparação de roscas / Inserts de réparation de taraudages / Inzetdelen voor schroefdraad herstel



Ref.	Ø	N	☒	EAN
11-905	M5	20	50/250	5907558419917
11-906	M6	20	50/250	5907558419924
11-907	M8	20	50/250	5907558419931
11-908	M10	20	50/250	5907558419948
11-909	M12	10	50/250	5907558419955

## Narzynki i gwintowniki

Tap and die set / Schneideisen und Gewindebohrer / Плашки и метчики / Плашки и метчики / Плашки и метчики / Menetkészítő készlet / Set scule tăiere filet interior și exterior / Závıtrnice a závıtrníky / Súprava závıtrníkov / Garnitura vreznikov in nareznikov navoja / Sriedgiovės ir sriedgikliai / Viřgrievu komplekts / Krasni ja valuvormi komplekt / Метрици и плашки / Narezniice i urezniice set / Set urezniika i narezniika / Ελικοκόρτες και κολλησιβια / Cojinetes y machos de roscar, juego / Madreviti e maschi / Cassonetes e roscas / Filières et tarauds / Snijplaat en schroefdraad snijtoestel

x110



M2x0,4; M3x0,5; M4x0,7; M5x0,8; M6x0,75; M6x1,0; M7x0,75; M7x1,0; M8x0,75; M8x1,0; M8x1,25; M9x0,75; M9x1,0; M9x1,25; M10x0,75; M10x1,0; M10x1,25; M10x1,5; M11x0,75; M11x1,0; M11x1,25; M11x1,5; M12x0,75; M12x1,0; M12x1,25; M12x1,5; M12x1,75; M14x1,0; M14x1,25; M14x1,5; M14x2,0; M16x1,0; M16x1,5; M16x2,0; M18x1,5;
--



M2x0,4; M3x0,5; M4x0,7; M5x0,8; M6x0,75; M6x1,0; M7x0,75; M7x1,0; M8x0,75; M8x1,0; M8x1,25; M9x0,75; M9x1,0; M9x1,25; M10x0,75; M10x1,0; M10x1,25; M10x1,5; M11x0,75; M11x1,0; M11x1,25; M11x1,5; M12x0,75; M12x1,0; M12x1,25; M12x1,5; M12x1,75; M14x1,0; M14x1,25; M14x1,5; M14x2,0; M16x1,0; M16x1,5; M16x2,0; M18x1,5;
--

Ref.	☒	EAN
11-915	1/3	5907558436907



M3-M12

DIN223  
DIN352

32  
PCS

HSS

Ref.	☒	EAN
12-915	1/10	5907558483291

## Oprapka do narzynek

Handle for die / Schneideisensfassung / Вороток для плашек / Вороток для плашки / Вороток для плашки / Menetkészítő fogtámas / Miner filieră / Objímka závıtrnic / Vratidlo na ořká / Ročaj za narezniice navoja / Sriedgiovės rėmas / Viřgrievu ķermeņi / Valuvormi kėperide / Върток за плашки / Držač narezniica / Okretac narezniika / Χειραβιβη για ελικοκόρτες / Terroja de cojinetes / Impugnatura per filettatrice / Armadura p. Cassonetes / Monture de filière / Kader voor snijplaten

M3-M12 #45 STEEL TWISTING FORCE HIGH STRENGTH



Ref.	☒	EAN
12-909	10/100	5907558483314



## Adapter do gwintowników

Adapter for threading dies / Adapter für Gewindeschneidbacken / Адаптер для резьбоварезных плашек / Переходник для резьбоварезных плашек / Adapter menetes szerszámokhoz / Adaptor pentru matrițe de filetare / Adaptor pro závitníky / Adaptor pre závitníky / Adapter za navojne matrice / Adapteris sriegimo irankiams / Adapteris vītņu vītrotājiem / Adapter keermestusmasinate jaoks / Адаптер за резьбоварезни матрици / Adapter za slavinu / Тан адаптер / Προσαρμογέας για μήτρες σπειρώματος / Adaptador para terrojos de roscar / Adaptatore per filete / Adaptador para matrizes de roscar / Adaptateur pour filières / Adapter voor draadstijfen



Ref.	Info	☒	EAN
12-904	1/4"DR M3-M8		5907558477276
12-905	1/4"DR M5-M12		5907558477283
12-906	3/8"DR M5-M12		5907558477290
12-907	1/2"DR M13-M19		5907558477306

## Pokrętko do gwintowników

Handle for hand tap / Gewindebohrergriff / Вороток для метчиков / Вороток для позначника / Menetűró hajtós / Manivelă burghii manual / Vratidlo k závitníkům / Vratidlo na závitníky / Ročaj za vreznike navoja / Rankena sriegiklams / Vītņgriežatūrētājs / Kasikraani käepide / Въртак за метчик / Držalo / Ureznica / Okretac ureznika / Χειρολαβή για κολλούζο / Manivela para machos de roscar / Impugnatura per filetto / Chave para machos / Τσικμε-à-gauche / Draaïkroep voor draadtap



- T**
- #45 STEEL**
- M3 - M8**
- HIGH STRENGTH**

Ref.	☒	EAN
12-908	25/100	5907558483321

- M3 - M12**
- #45 STEEL**
- TWISTING FORCE**
- HIGH STRENGTH**



Ref.	☒	EAN
12-910	10/100	5907558483307

## Przedłużacz bębnowy

Extension cord / Verlängerungskabel / Удлинительный кабель / Подовожувач / Hosszabbító kábel / Cablu prelungitor / Prodłużovací kabel / Predlžovací kábel / Podaljševalni kabel / Prailginimo kabelis / Pārgarinātājs / Pikkenduskaabel / Удължителен кабел / Produžni kabel / Продужени кабл / Καλώδιο επέκτασης / Cable alargador / Cavo di prolunga / Cabo de extensão / Câble d'extension / Verlengkabel



- CU 100%**
- E/F**
- E**
- thermal fuse**
- IP44**
- ⏚**

Ref.	Info	☒	EAN
90-170	20m, 3x1.5mm <sup>2</sup>	0/2	5907558426526
90-171	30m, 3x1.5mm <sup>2</sup>	0/2	5907558426533
90-172	40m, 3x1.5mm <sup>2</sup>	0/2	5907558426540
90-173	30m, 3x2.5mm <sup>2</sup>	0/2	5907558426557
90-174	40m, 3x2.5mm <sup>2</sup>	0/2	5907558426564
90-175	50m, 3x2.5mm <sup>2</sup>	0/2	5907558426571

## Przedłużacz listwowy

Extension cable / Verlängerungskabel / Удлинительный кабель / Подовожувач / Hosszabbító kábel / Cablu prelungitor / Prodłużovací kabel / Predlžovací kábel / Podaljševalni kabel / Prailginimo kabelis / Pārgarinātājs / Strip extender / Удължителен кабел / Strip produžni kabel / Сланиме продужени кабл / Επέκταση λωρίδας / Cable alargador / Cavo di prolunga / Cabo de extensão / Câble d'extension / Verlengkabel

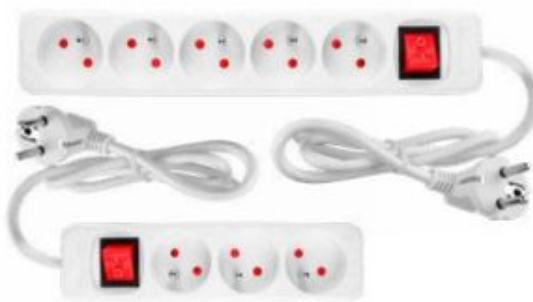

- CU 100%**
- E**
- ON/OFF SWITCH**
- 16A / 230V**
- 3x 1.5mm<sup>2</sup>**
- IP44**
- E/F**
- ⏚**

Ref.	Info	☒	EAN
90-176	1.5m, 3x1.5mm <sup>2</sup> , 3G,	0/40	5907558474923
90-177	1.5m, 3x1.5mm <sup>2</sup> , 5G,	0/40	5907558474930
90-178	3m, 3x1.5mm <sup>2</sup> , 3G,	0/40	5907558474947
90-179	3m, 3x1.5mm <sup>2</sup> , 5G,	0/40	5907558474954
90-180	5m, 3x1.5mm <sup>2</sup> , 3G,	0/30	5907558474961
90-181	5m, 3x1.5mm <sup>2</sup> , 5G,	0/30	5907558474978



- CU 100%**
- E**
- ON/OFF SWITCH**
- 16A / 230V**
- 3x 1.5mm<sup>2</sup>**
- IP44**
- E/F**
- ⏚**

Ref.	Info	☒	EAN
90-182	1.5m, 3x1.5mm <sup>2</sup> , 3G,	0/40	5907558474985
90-183	3m, 3x1.5mm <sup>2</sup> , 3G,	0/40	5907558474992
90-184	1.5m, 3x1.5mm <sup>2</sup> , 4G,	0/40	5907558475005
90-185	3m, 3x1.5mm <sup>2</sup> , 4G,	0/40	5907558475012



## Przewody rozruchowe

Booster cables / Akku-Zusatzleitungen / Стартовые провода / Шнури аварійного пуску акумулятора / Andítókábel róz / Conductors de avanie pentru acumulator / Kabely pro nouzové startování k akumulátoru / Pomocné káble do akumulátora pre núdzový štart / Vžgalni kabli / Avtomobilio izvedimo laidai / Palašanas vadai akumulátoram / Aku avarijuhmed / Αварийни проводници за акумулятора / Rezervni kablovi za akumulator / Hitni kabl za akumulator / Καλώδια έκτακτης ανάγκης για ηλεκτρικό συσσωρευτή / Cables puente para la batería / Cavi di emergenza per la batteria / Cabos de emergência para bateria / Câbles de démarrage pour batterie

2.5m

Cu



Ref.	A max	☒	EAN
11-834	200	0/6	5907558436815
11-836	600	0/5	5907558436822



## Tester akumulatorów

Battery load tester / Battenetester / Тестер батареи / Тестер акумулятора / Akkumulátor tesztelő / Tester de încercare a bateriei / Tester baterii / Tester batterie / Tester akumulatorja / Akumulátoraus batenijos testeris / Akumulatoru bateriju testeris / Aku tester / Тестер на батареюма / Ispitivač baterije / Итисυυααθ battery tester / Ελεγκτής φορτίου μπαταρίας / Comprobador de carga de batería / Tester di carico della batteria / Testador de carga da bateria / Testeur de charge de batterie / Acculaadtester



for  
6/12V  
batteries

100A

VOLTAGE  
ACCURACY  
±0.2V

ANALOG  
METER  
0-16 V DC



Ref.	A max	☒	EAN
11-984	100	1/10	5907558452402



for all  
12V  
batteries

125A

VOLTAGE  
ACCURACY  
±0.2V

DIGITAL  
METER  
0-16 V DC



Ref.	A max	☒	EAN
11-985	125	1/10	5907558452419



for all  
12V  
batteries

Ref.	☒	EAN
11-986	6/36	5907558452419

## Prostownik

Car battery charger / Stromrichter / Выпрямитель / Выпрямляч / Електризаційно / Redresor auto / Усмітновач / Усмертновач / Усметник / Ικτρικός / Akumulatora lādētājs / Alald / Τοκουπρωμεν / Ispravljáč / Ispravljáč / Ανορθωτής / Rectificador / Raddrizzatore carica batterie / Gelijkrichter



Ref.	[A/W]	Ah	☒	EAN
11-891-1	4/70	3-120	1/10	5907558495126
11-892-1	6/100	3-150	1/10	5907558495126
11-893-1	10/160	3-200	1/10	5907558495140



Ref.	☒	EAN
11-890	0/10	5907558463279

## Próbnik elektryczny samochodowy

Car voltage tester / Kfz-Spannungsprüfer V / Индикатор напряжения / Индикатор напруги автомобільний / Jármű fázisceruza / Sonda de luat probe la instalații electrice la automobile / Ζkoušečka napětí autoteletrikářská / Autoskúšačka / Preizkuševalec napetosti za avtomobile / Elektroninis testeris automobiliams / Automašīnas elektrības testēšanas / Auto elektritester / Автомобильный фазометр / Elektronični ispitivač napona / Automobiliški električni tester / Συσκευή έλεγχής τάσης / Prbadador eléctrico para coches / Tester per auto / Testador de tensão para carros / Testeur électrique automobile / Elektrische wagen meetkap



6-24V



Ref.	☒	EAN
11-832	12/240	5907558420418

## Poduszka monterska

Mounting Cushion / Montagekissen / Монтажная подушка / Монтажна подушка / Szerelőpárna / Pernă de montaj / Montážní polštářek / Montážny vankúšik / Montažna blazina / Pagalvė montavimo / Montāžas spilvens / Paigalduspardi / Монтажна възглавница / Montažni jastuk / Монтажни јастук / Μαξιλάρι τοποθέτησης / Cojin de montaje / Cuscino di montaggio / Almofada de montagem / Coussin de montage / Montage kussen



MAX 200 kg  
METAL VALVE  
height 15-60 mm  
150 x 165 mm

Ref.	☒	EAN
50-900	0/100	5907558495249

## Zestaw blokad rozrządu

Timing tool set / Nockenwellen-Arretierwerkzeugsatz / Набор фиксаторов распределения для установки фаз ГРМ / Набор стопорів для розподілювальних валів / Vezérmutengelyblokkoló készlet / Set de blocarea distribuției / Sada blokovači pro opravy rozvodů / Súpina blokad rozvodov / Set blokad gređi / Paskirstymo velenėlių fiksavimo komplektas / Sadales mehānismu fiksatoru komplekts / Jaostas blokeerimise komplekt / Komponent blokiruoci na zasporazpredelenueto / Set alata za blokiranje radlice / Pribor za blokadu razvođenja / Σε συγκράτησης κινηματοφόρων αξόνων / Kit de bloqueo de la correa de distribución / Attrezzi di blocco dell'albero a camme / Conjunto de bloques de engranagem de distribuição / Ensemble de verrouillage de distribution / Set van distributievergrendeling



1.2D TDI PD: ANY, AYZ  
1.4D TDI PD: AMF, ATL, BHC  
1.9D TDI PD: AJM, ANJ, ARL, ASZ, ATD, ATJ, AUY, AVB, AVF, AWX, AXR, BSW, BTB, BVK

Ref.	📦	EAN
11-300	10/40	5907558436051



TDI VAG



TDI VAG



Audi: A1 (10-15), A2 (00-06), A3 (01-13), A4 (Allroad (01-16), A5 (08-15), A6 (11-14), TT (08-14), Q3 (11-15), Q5 (08-15), A6 (10-14)  
Dodge: Caliber (06-11); Ford: Galaxy (02-06);  
Mitsubishi: Grandis (05-10), Lancer (05-10), Outlander (07-10)  
Seat: Alhambra (00-15), Altea/Altea XL (04-15), Cordoba (02-09), Ibiza (02-15), Leon (00-13), Toledo (04-11)  
Skoda: Fabia (00-14), Fabia II (07-15), Octavia (00-10), Octavia II (04-15), Praktik (10-15), Rapid (11-15), Roomster (07-15), Superb (02-08), Superb II (08-15), Yeti (09-14)  
VW: Amarok (10-16), Beetle (02-15), Bora (02-08), Caddy/Maxi (03-15), EOS (06-15), Fox (05-11), Golf (02-15), Golf Plus (05-14), Jetta (05-15), Lupo (02-05), Passat/CC (02-15), Polo (99-14), Scirocco (08-14), Sharan (02-15), Tiguan (07-15), Touran (03-15), Transporter (03-18)



Kody silników / Engine codes / Коды двигателей

1.2D TDI CR: CFWA  
1.4D TDI PD: AMF, BAY, BMS, BNM, BNV, BWB  
1.6D TDI CR: CAYA, CAYB, CAYC, CAYD, CAYE, CLNA  
1.9D TDI PD: AJM, ANJ, ARL, ASZ, ATD, AUY, AVB, AVF, AVQ, AWX, AXB, AXC, AXR, BJB, BKC, BLS, BLT, BMT, BPZ, BRM, BRR, BRS, BRU, BSU, BSV, BSW, BTB, BVK, BXE, BXF, BXJ  
2.0D TDI CR/TDI PD: AZV, BDJ, BDK, BEW, BGW, BHW, BKD, BKP, BKQ, BLB, BMA, BMM, BMN, BMP, BMR, BNA, BPW, BPA, BRC, BRD, BRE, BRF, BRT, BSS, BST, BSX, BUY, BUZ, BVA, BVE, BVF, BVG, BVH, BWC, BWV, CAAB, CAAC, CAAD, CAEE, CAGA, CAGB, CAGC, CAHA, CAHB, CBAA, CBAB, CBAC, CBBA, CBBB, CBDA, CBDB, CBDC, CBEA, CBHA, CBHB, CBDA, CBDC, CCEA, CFCA, CFFA, CFFB, CFFD, CFFE, CFGB, CFCB, CFHA, CFHB, CFHC, CFHD, CFHE, CFHF, CFJA, CGLA, CGLB, CGLC, CGLD, CJAA, CJCA, CJCB, CJCC, CLCA, CLCB, CLJA, CLLA, CNEA, ECD, ECD/BSY, ECD/BYR, ECE/BWD  
DEM:  
Dodge: 98B2, 98B3  
Ford: 310-085/23-059, 303-1054  
Mitsubishi: MB99520A, MB99520B, MB995209  
VAG: T10100, T10050, 3359/T20102, T10115, T10060A/T40098, T20167

Ref.	📦	EAN
11-301	10/40	5907558436068



TDI VAG



Audi: A1, A3, A4 (B8), A5, A6 (C6, C7), TT, Q3, Q5  
VW: Golf V-VI, Passat B6, B7, Polo, Jetta V-VI, Scirocco III, Beetle II, Caddy, Touran, Sharan II, T5  
SKODA: Fabia, Roomster, Practico, Octavia II, Superb II, Yeti  
SEAT: Ibiza, Leon, Exeo, Altea, Alhambra II



Kody silników / Engine codes / Коды двигателей  
1,6 TDI CR (> 2009): CAYB, CAYC  
2,0 TDI CR (> 2007): CAAA, CAAB, CAAC, CBAB, CBBB, CBAA, CFFB, CAGA, CAHA, CAGB, CAHB, CAGC, CCHA, CAVA, CBDA, CBDD, CBAC, CBDC  
OEM: T20102 | U40074 | 3359 | T10050 | T10100 | T10264 | T10265 | T40098 | T10051 | T10052 | T10255

Ref.	📦	EAN
11-302	1/5	5907558436075



TDI VAG



Audi: A4 2.7 TDI (05-09); A4 Quattro 2.0 TDI (05-06); Q7 3.0 TDI (06-09)  
Volkswagen: Touareg 3.0 V6 TDI (08-); Phaeton 3.0 V6 TDI (06-); Diesel 2.7 TDI, 2.0 TDI 3.0 TDI

Kody silników / Engine codes / Коды двигателей  
2.7 TDI V6: BBP, BSG, CAMA, CAMB, CANA, CANC, CAND, CGKA, CGKB  
3.0 TDI V6: ASB, BNN, BKS, BMK, BMZ, BNG, BUG, BUN, CAPA, CARA, CARB, CASA, CASB, CASC, CATA, CDMA, CCWA, CCWB, CDYA, CDYB, CDYC, CEKA  
4.0 TDI V8: ASE  
OEM: T40062 | T40061 | T40049 | 3359 | T40058 | T40060 | 3242

Ref.	📦	EAN
11-303	1/5	5907558436082



VAG



Benzyna / Gasoline / Бензин: 1,2 6V/12V / 1,4 16V / 1,6 16V / 1,6FSI / 1,6FSI  
Diesel: 1,2 TDI / 1,4 TDI / 1,9 TDI / 2,0 TDI / 2,5 V6 TDI / 3,3 V8 TDI / 2,0 TDI (PD oraz CR) / 1,6 TDI CR  
Kody silników / Engine codes / Коды двигателей  
ANY, ASZ, ATD, AMF, ATL, BHC, AXR, AVB, AVX, AWX, AMF, BMS, BNM, BNV, ANJ, ARL, AUY, BTB, BVK, BJB, BKC, AZV, BKD, AXB, AXC, BDJ, BST, AJM, AYZ, BNB, BAY, AXG, AXL, AYC, AVQ, BMP, BRM, BRU, BSU, BXE, BXF, BMM, BDK, AZU, BMN, ATJ, BGW, BHW, ACV, AHY, AJ  
OEM: T10123 | T10120 | 3458 | 3418 | 2065A | 3366 | T10098 | T10121 | 3242 | T10050 | T10100 | T10060A | T10020 | T10008 | T40011 | 3359 | 2064 | 3369 | T10016 | T10264 | T10265

Ref.	📦	EAN
11-304	1/4	5907558436099



VAG



Audi: A3, S3, A5, A6, TT (03-11), SEAT: Ibiza, Leon, Altea, Exeo (04-11)  
SKODA: Fabia II, Octavia II, Roomster, Superb II (04-11)  
VW: Golf, Golf Plus, Jetta, EOS, Scirocco, Tiguan, Touran, Passat (03-11)



Kody silników / Engine codes / Коды двигателей  
2.0FSI: ANWA, AXW, BHD, BLR, BLX, BLY, BMB, BVX, BVY, BVZ  
2.0TSI: AXH, BGG, BHZ, BPG, BPJ, BPY, BUL, BWA, BWE, BWJ, BWT, BYD, BYK, BZC, CDLA, CDLB, CDLC, CDLD, CDMA  
OEM: T10020 | T10252 | T10092 | T10115 | T10060A | 3366 | T40011

Ref.	📦	EAN
11-306	1/10	5907558436112

## Zestaw blokad rozrządu

Timing tool set / Nockenwellen-Arretierwerkzeugsatz / Набор фиксаторов распределительных механизмов фаз ГРМ / Набор стопорів для розподільчих механізмів / Vezérműtengely blokkoló készlet / Set de blocarea distribuției / Sada blokadová pro opravu rozvodu / Súprava blokad rozvodov / Set blokad gredi / Paskirytimo velenių fiksavimo komplektas / Sadales mehānismu fiksatoru komplekts / Jautuse blokeenimise komplekt / Комплeкт блокерів на газорозподелието / Set alata za blokiranje radilice / Pribor za blokadu rozvodnika / Set συγκράτησης κινδικοφόρων αξόνων / Kit de bloqueo de la correa de distribución / Attrezzi di blocco dell'albero a camme / Conjunto de bloqueios de engrenagem de distribuição / Ensemble de verrouillage de distribution / Set van distributievengrendeling



Audi A1 (10-15), A3 (03-13)  
Seat Alhambra (10-15), Altea/Altea XL (08-15), Ibiza/Cordoba (08-12), Leon (07-13), Toledo (07-15)  
Skoda Fabia II (07-15), Octavia II (04-15), Praktik (10-15), Rapid (12-15), Roomster (06-15), Superb II (09-14), Yeti (09-14)  
VW Beetle (11-15), Caddy/Caddy Maxi (10-15), EDS (06-12), Golf (03-12), Golf Plus (03-14), Golf V Estate (07-13), Golf VI Cabriolet (10-15), Jetta (06-14), Passat (05-11), Polo (02-14), Scirocco (08-12), Tiguan (07-12), Touran (03-15)



Kody silników / Engine codes / Коды двигателей:

1.2 TFSI: CBZA, CBZB, CBZC

1.4 FSI: AXU, BNG, BLN

1.4 TFSI: BLG, BMY, BWK, CAVA, CAVB, CAVC, CAVD, CAVE, CAVF, CAXA, CAXC, CDGA, CSMA

1.6 FSI: BAG, BLF, BLP, BTS

OEM VAG: T10170, T10171A, T40011, T10340, T10414

Ref.	📦	EAN
11-305	1/10	5907558436105



Audi A1 - A1 Sportback - A3 - A3 Sportback - A3 CABRIO - S1 - S1 Sportback  
SEAT Alhambra - Altea - Altea XL - Ibiza - Leon - Cordoba - Toledo  
SKODA Octavia II - Praktik - Roomster - Superb II - Yeti - Yeti Outdoor - RAPID - Rapid Spaceback - Superb II  
VW Beetle - Caddy - Caddy Maxi - Eos - Golf Plus - Golf V - Golf V Estate - Golf VI - Golf VI Cabrio - Golf VI Estate - Jetta - Passat - Polo - Scirocco - Sharan - Tiguan - Touran - CC



Kody silników / Engine codes / Коды двигателей:

1.2 FSI/TFSI: CBZA - CBZB - CBZC

1.4 TSI/1.4 / 1.6 FSI: AXU - BAG - BNG - BLF - BLG - BLN - BLP - BMY - BTS - BWK CAXA (03-)

OEM VAG: T10340, T10414, T10171A, T40011, T10170, VAS6079, T10341

Ref.	📦	EAN
11-307	1/5	5907558436129



Audi A3 (2013-)  
Seat Mi (2012-), Leon (2012-), Toledo (2012-)  
Skoda Citigo (2012-), Octavia (2013-), Rapid (2012-)  
VW Up (2012-) and Polo mk5 (2014-), Golf VII (2012-), Jetta (2012-)



1.0 Ecofuel, Ecomotive, Bluemotion, Green Tech

CHYA, CHYB, CPGA

1.2 TFSI: C1ZA, C1ZB

1.4 TFSI: C1BA, C1SA, C1PA

1.4 TGI: CPWA

1.4 TSI MultiFuel CPWA

1.4 Hybrid CRJA

OEM VAG: T10340, T10477, T10476, T10499, T10494, T10487

Ref.	📦	EAN
11-338	0/2	5907558451214



116i E81/82/87/88 (07-12), 118i E81/82/87/88 (06-14), 120i E81/82/87/88 (06-14)  
BMW 3 Series: 316i E90/91/92/93 (07-11), 318i E90/91/92/93 (07-13), 320i E90/91/92/93 (07-14)  
BMW 5 Series: 520i E60/61 (07-10)



Kody silników / Engine codes / Коды двигателей:

N43 B16A/AA, B16AA, B16AA/00, B20A, B20A/AA, B20AA, B20AY, B20K0, B20J0

OEM BMW: 11.8.690 (11.8.691/11.8.692/11.8.693), 11.9.340

(11.9.341/11.9.342), 11.8.710 (11.8.711/11.8.712), 11.3.340, 11.5.120, 11.8.700

Ref.	📦	EAN
11-310	1/5	5907558436136



BMW 1 Series: 118i E81/82/87/88 (04-14), 120i E81/82/87/88 (04-14)  
BMW 3 Series: 316i/hi Compact E46 (01-07), 318i/hi Compact E46 (01-07), 318i E90/91/92/93 (05-12), 320i (E90/91/92/93 (05-14)  
BMW 5 Series: 520i E60/61 (07-10)  
BMW X Series: X1 E84 sDrive 18i (10-12), X1 E84 xDrive 18i (10-12), X3 E83 2.0 (05-10)  
BMW Z Series: Z4 2.0 E85/86 (04-09)



Kody silników / Engine codes / Коды двигателей:

2.0: N42 B18A, N42 B20A, N46 B18, N46 B20, N46 B20B, N46T B20, N46T B20B, N46T B20B2, N46T B20C2, N46T B20C

OEM BMW: 11.9.310 | 11.9.320 | 11.9.302 | 11.9.301 | 11.9.290 | 11.9.302 |

11.9.340 | 11.9.390 | 11.9.350 | 11.9.270 | 11.2.300 | 11.9.190 | 11.9.330

Ref.	📦	EAN
11-313	1/5	5907558436167



BMW 1 Series: 118i E81/82/87/88 (04-14), 120i E81/82/87/88 (04-14)  
BMW 3 Series: 316i/hi Compact E46 (01-07), 318i/hi Compact E46 (01-07), 318i E90/91/92/93 (05-12), 320i (E90/91/92/93 (05-14)  
BMW 5 Series: 520i E60/61 (07-10)  
BMW X Series: X1 E84 sDrive 18i (10-12), X1 E84 xDrive 18i (10-12), X3 E83 2.0 (05-10)  
BMW Z Series: Z4 2.0 E85/86 (04-09)



Kody silników / Engine codes / Коды двигателей:

2.0: N42 B18A, N42 B20A, N46 B18, N46 B20, N46 B20B, N46T B20, N46T B20B, N46T B20B2, N46T B20C2, N46T B20C

OEM BMW: 11.9.301, 11.9.303, 11.9.310, 11.9.320, 11.9.390

Ref.	📦	EAN
11-312	1/5	5907558436150



## Zestaw blokad rozrządu

Timing tool set / Nockenwellen-Arretierwerkzeugsatz / Набор фиксаторов распределения для установки фаз ГРМ / Набор стопорів для розподільчатих валів / Vezérműtengely blokkoló készlet / Set de blocarea distribuției / Sada blokadová pro opravu rozvodu / Súprava blokad rozvodov / Set blokad gređi / Paskirštymo velenėlių fiksavimo komplektas / Sadales mehānismu fiksatoru komplekts / Jautuse blokeerimise komplekt / Комплeкт блокерів на газораспределении / Set alata za blokiranje radilice / Pribor za blokadu razvodjenja / Set συγκράτησης κινδoδοφόρων αξόνων / Kit de bloqueo de la correa de distribución / Attrezzi di blocco dell'albero a camme / Conjunto de bloques de engranagem de distribuição / Ensemble de verrouillage de distribution / Set van distributievevergrendeling



**RENAULT:** Clio, Clio Sport, Twingo, Kangoo, Megane, Scenic, Laguna, Espace, Safrane, Spider, R19, Master, Trafic  
**OPEL:** Arena, Movano  
**VOLVO:** S40, V40  
**Gasoline engine:** 1.2 / 1.4 / 1.6 / 1.7 / 1.8 / 2.0 / 2.2 / 1.4 16V / 1.6 16V / 1.8 16V / 2.0 16V / 2.5 20V  
**Diesel Engine:** 1.9 / 2.5 / 2.8



**Kody silników / Engine codes / Коды двигателей:**  
B16, B18, B20, N7Q, N7U, K4J, K4M, F4P, F4R, D7F, E5F, E7F, E7J, K7M, F1N, F3N, F3P, F2R, F3R, F7P, F7R, J5R, J7R, J5T, F8M, F8Q, G8T, J8S, F9Q, S8U, S9U, S9W  
**OEM:** MOT1348 | MOT1312 | MOT1135-01 | MOT1384 | MOT1337 | MOT1496 | MOT1910-1 | MOT910 | MOT861 | MOT863 | MOT1054 | MOT1318 | MOT1489 | MOT1340 | MOT1386 | MOT1490-1

Ref.	📦	EAN
11-322	1/4	5907558436235



**FIAT** Ducato, MECO Daily 2002-2009  
**CITROEN** Relay, Jumper III 2006-2009  
**PEUGEOT** Boxer III 2006-2009



**Silniki / Engines / Двигатели:**  
2.3 JTD - F1AE0481C, F1AE0481D, F1AE0481N,  
3.0 JTD - F1CE0481D (2004-)  
3.0 HDi - F30DT  
**OEM:** 99360614(-), 0191/2 B, 99360615/2.00.018.200(-), 191/2 A, 99360608/1.860.617.000

Ref.	📦	EAN
11-325	8/32	5907558436266



**Citroen:** C4 Picasso/Grand Picasso (06-10), C5 I (04-08), C8 (05-10), Dispatch/Jumpy (07-11), Xsara 2.0 16v, C5 1.8/2.0 HP, Xsara Picasso 1.8/2.0 16v (02-05)  
**Peugeot:** 406 1.8 16v (00-04), 407 (06-10), 807 2.0 16v (02-05)



**Kody silników / Engine codes / Коды двигателей:**  
1.8 16v: EW7A(6FY)  
2.0 16v: EW10A(RFJ), EW10ABE4(RFH), EW10J4S(RFK)  
**OEM:** 0189S1, 0189S2, 0132AB / 0194A, 0178D, 0194B, 0188M, 0189B, 0188AH, 0189R, 7017TR / 0153U, 0188J2, 0188J2J2, 0178E / 571 TTE

Ref.	📦	EAN
11-321	1/4	5907558436228



**FIAT:** Panda, Idea, Doblo  
**OPEL:** Agila, Corsa, Astra H, Tigra B, Meriva  
**ALFA ROMEO:** 147, 156  
**OPEL:** Astra, Vectra, Signum, Zafira



**Silniki / Engines / Двигатели:**  
1.3 JTD MULTIJET (04-07)  
1.3 CDTi (04-07)  
1.9 / 2.4 JTD, 16V, 20V  
1.9 JTD 16V / 2.4 JTD 20V  
1.9 CDTi (04-06)  
1.7D / 1.9 D FIAT / TD / JTD 2.4

Ref.	📦	EAN
11-323	1/4	5907558436242



**ALFA ROMEO:** MiTo (10-15)  
**FIAT:** 500 (07-15), 500C (07-15), Doblo/Cargo (05-10), Fiorino (09-15), Grande Punto (07-12), Idea (05-12), Linea (07-11), Panda/Panda Classic (09-13), Panda EVO2 (05-12), Punto EVO (09-12), Punto (12-15), Qubo (09-15), Seicento/600 (00-11)  
**FORD:** Ka (09-15)  
**LANCIA:** Musa (05-13), Ypsilon (06-15)



**Kody silników / Engine codes / Коды двигателей:**  
**Fiat:** 1.1 8v; 187A1.000, 1.2/1.2 Dualogic; 169A4.000, 188A4.000 (EVO2 only), 199A4.000, 1.4/1.4 Bi-Fuel LPG/1.4 Natural Power CNG; 199A7.000, 350A1.000  
**Ford:** 1.2 Duratec; 169AA.000(FP4)  
**Lancia:** 1.2 8v; 188A4.000, 1.4/1.4 Bi-Fuel LPG; 350A1.000  
**OEM Ford:** 303-1477 | 303-1478 | 303-1480 | 303-1479  
**OEM Fiat:** 2000004200 | 2190754200 | 2000004300 | 2000004400 | 2190754400 | 2191964400 | 2000004500 | 2190754500 | 2191964500 | 1860987000

Ref.	📦	EAN
11-324	1/5	5907558436259



**FIAT:** Bravo/Brava, Barchetta, Coupe, Doblo Cargo, Idea, Marea/Weekend, Multipla, Siena, Palio/Weekend, Punto, Stilo  
**Silniki benzynowe / Gasoline engine / Бензиновый двигатель:**  
1.2, 1.4, 1.6, 1.8 16V  
**Bravo/Brava, Cargo, Doblo, Ducato, Marea/Weekend, Multipla, Palio/Weekend, Punto, Scudo, Stilo, Ulysse, Ducato, Cromia itd**



**Silniki diesla / Diesel engine / Дизельный двигатель:**  
1.9D, 1.9TD, 1.9 JTD, 2.4TD, 2.4 JTD  
**OEM:** 1860847000 | 1860875000 | 1870697000 | 1860895000 | 1895879000 | 1860898000 | 1860992000 | 1860771000 | 1860161000 | 1860874000 | 1860876000 | 1860845000 | 1860876000 | 1860965000 | 1860901000 | 1860905010 | 1860987000 | 1860985000

Ref.	📦	EAN
11-326	1/4	5907558436273

## Zestaw blokad rozrządu

Timing tool set / Nockenwellen-Arretierwerkzeugsatz / Набор фиксаторов распределителя для установки фаз ГРМ / Набор стопорів для розподільчих валів / Vezérműtengely blokkoló készlet / Set de blocarea distribuției / Sada blokadací pro opravu rozvodu / Súpava blokad rozvodov / Set blokad gređi / Paskirstymo velenėlių fiksavimo komplektas / Sadales mehānismu fiksatoru komplekts / Jaotuse blokeerimise komplekt / Комплект блокировки на газораспределителе / Set alata za blokiranje radilice / Pripor za blokadu razvođenja / Set συγκράτησης κλιβακάρθρων αξόνων / Kit de bloqueo de la correa de distribución / Attrezzi di blocco dell'albero a camme / Conjunto de bloqueios de engrenagem de distribuição / Ensemble de verrouillage de distribution / Set van distributievregrendeling



OPEL:  
Astra, Vectra B/C, Zafira, Signum,  
Frontera  
Silnik benzynowy/Gasoline engine:  
2.2 16V



Kody silników / Engine codes / Коды двигателей:  
ZZSE, ZZZH

Ref.	📦	EAN
11-331	1/5	5907558436297



OPEL:  
AGILA, ASTRA, CORSA, FRONTERA, OMEGA,  
SINTRA, VECTRA, TIGRA, ZAFIRA, (SAAB,  
RENAULT)



Silnik diesla /Diesel engine / Двигельный двигатель:  
1.3CDTi 16V, 1.9CDTi, 2.0 Di, 2.0DT  
OEM: KM-952/09912-38310, KM-953/09919-  
58310, KM-954/09919-08310, KM-955/09919-  
58320, KM-6130

Ref.	📦	EAN
11-330	1/2	5907558436280



FORD:  
Focus, C-Max, Mondeo (2003-2010)

Ref.	📦	EAN
11-335	1/10	5907558436334

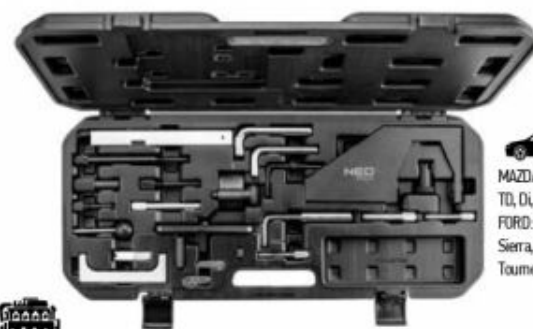

MAZDA: 1.4 1.8 2.0 2.4 2.5 TDCI,  
TD, Di, SCI  
FORD: Fiesta, Courier, Escort, Orion,  
Sierra, Mondeo, Focus, Transit,  
Tourneo, Fusion.



Silniki / Engines / Двигатели:  
Diesel: 1.4 TDCI, 1.8 D/TD, 1.8 Di, 1.8 TDCI, 2.0TD/TDCI, 2.4 Di, 2.5 Di/Turbo/Td  
Benzyna / Gasoline / Бензин: 1.8 Duratec – SCJ  
Kody silników / Engine codes / Коды двигателей:  
C9DC, F9DA/B, C9DA/B, B9DA/B, B9PA, HCPA, FFD, HCPB, P7PA, P9PA, R2PA, R3PA, RWPA, RPK, RPN, RKD, RTJ, ATK, 4EC,  
4ED, 4EA, 4FB, 4FC, 4FD, 4GA, 4GB, 4GC, 4GD, 4GE, 4HB, 4HC  
OEM Mazda: 49 JED1 061

OEM Ford: 21-162 | 21-162B | 303-367 | 303-376 | 23-059 | 310-085 | 21-168 | 303-393 | 23-020 | 23-047 | 23-020 | 21-163 |  
303-620 | 23-019 | 21-210 | 303-507 | 21-251 | 303-698 | 21-262 | 303-734 | 23-029 | 303-1061 | 23-058 | 310-084 | 21-105 |  
21-262 | 303-734 | 21-168 | 303-393 | 21-263 | 303-735  
OEM VAG: 3359 | T10008 | T10050 | 20654

Ref.	📦	EAN
11-333	1/4	5907558436310



Silnik benzynowy / Gasoline engine / Бензиновый двигатель: 1.6 16V  
Kody silników / Engine codes / Коды двигателей: H0DA (2003-2007), H0JA, FNBA, RHBA,  
Silnik diesla / Diesel engine / Двигельный двигатель: 2.0 TDCI  
Kody silników / Engine codes / Коды двигателей: G6DA, G6DB, G6DC (2003-2007)  
OEM Ford: 303-1097 | 303-1054 | 303-1059 | 303-1270 | 303-748 | 303-735 | 303-1277 | 21-259 | 21-263  
OEM Peugeot: 0188X | 0187B | 0189B | 0188M | 0194B | 0132AJ1  
OEM Citroen: 0188X | 0187B | 0189B | 0188M | 0194B | 0132AJ1  
OEM Renault: MOT1430  
OEM Volvo: 9997121 | 9997152 | 9997122



Chrysler Voyager (2001-2008)  
Chrysler Grand Voyager (2001-2008)  
Jeep Cherokee (2001-2008)  
LDV Maxus (2005-2008)



Kody silników / Engine codes / Коды двигателей:  
R2516C, R2516L, R2816K, VM2516L  
OEM: VM1052 | VM9660 | VM8873 |  
VM1080 | VM1068 | VM1089 | VM1053  
Chrysler

Ref.	📦	EAN
11-332	1/10	5907558436303



FORD:  
Galaxy, Mondeo, S-Max, Focus 2010-



Silnik benzynowy / Gasoline engine / Бензиновый двигатель:  
2.0 SCTi EcoBoost/Ti-VCT  
Kody silników / Engine codes / Коды двигателей:  
TNWA / TNWB / TNBA / TPWA / MGOA  
/ X0DA  
OEM: 303-748 | 303-1504 | 303-1565 |  
303-1521

Ref.	📦	EAN
11-336	1/5	5907558436341



## Zestaw blokad rozrządu

Timing tool set / Nockenwellen-Arretierwerkzeugsatz / Набор фиксаторов распределения для установки фаз ГРМ / Набор стопорів для розподільчатих валів / Vezérműtengely blokkoló készlet / Set de blocarea distribuției / Sada blokovací pro organy rozvodů / Súpava blokad rozvodov / Set blokad gredi / Paskiristymo velenių fiksavimo komplektas / Sadales mehānismu fiksatoru komplekts / Jautuse blokeerimise komplekt / Комплект блокировки на газораспределении / Set alata za blokiranje radilice / Pribor za blokadu razvodjenja / Set συγκρατήρας κλιμακωράριων αξόνων / Kit de bloqueo de la correa de distribución / Atrezzo di blocco dell'albero a camme / Conjunto de bloqueios de engrenagem de distribuição / Ensemble de verrouillage de distribution / Set van distributevergrendeling



Ford: Mondeo (00-07), Transit (00-14)  
Citroen: Relay/Jumper III (06-13)  
Fiat: Ducato (06-11) / Ducato (06-11)  
Jaguar: X-Type (03-10)  
Land Rover: Defender Td4 (06-11)  
LDV: Convey (02-06)  
Peugeot: Boxer III (06-12)



Kody silników / Engine codes / Коды двигателей:

2.0D/2.0TD/2.0TDG: A8FA, D3FA, F3FA, D5BA, D6BA, FFA, FMBA, FM8B, HJBA, HJBV, HJBC, HJBE, N7BA, N7BB  
2.2D/2.0TDCi/ECometic: B6, CYFA, CYFB, CYFC, DRFA, DRFB, DRFC, PRFA, PRFB, PGFA, PGFB, QJBA, QJBB (BG), QJBC, QJBD, QJFA, QJFB, SRFA, SRFB, SRFC, SRFD, SRFE, UHFA  
2.2D HDi/JTD:  
P22DTE (4HM), P22DTE (4HU), P22DTE (4HV)  
2.4D/2.0TDCi: D0FA, D2FA, D2FB, D4FA, F4FA, FXFA, H9FA, H9FB, H9FD, J0FA, J0FC, PHFA, PHFC  
2.4D TD/Tdi:  
ZSD 424  
2.4D Td4, 244DT  
OEM: 303-679A/21-238, 303-1151, 303-698/21-251, 303-675/21-234

Ref.	📦	EAN
11-334	1/5	5907558436327



VOLVO:  
Silniki benzynowe/gasoline engine: 4,5,6 cylinder  
S80 (07-), V70 (08-), S80 (06), XC90, V70 (00-08), V70 XC (01-)/XC70 (07), S60, C30, C70 (06-), S40 (04-), V50, S40 (04), V40, 850, C70 Coupe (05), S70, V70 (00), V70 XC (00), 960, S90, V90



Kody silników / Engine codes / Коды двигателей:  
B41XX, B42XX, B52XX, B62XX, B63XX, B85252S

Ref.	📦	EAN
11-337	1/2	5907558436358

## Ściągacz uniwersalny

Universal pulley puller / Universalabzieher / Универсальный съемник / Знімач універсальний / Universalis aqyeltűző / Extractor universal / Univerzální stahovák / Univerzálny stahovák / Univerzalni izvlekač / Universalis nutraukiklis / Universalis novilcejs / Universalne tömmitis / Универсален снабо за демонтаж / Univerzalni skidač / Univerzalna alatka za skidanje / Εξολκείας γενικής χρήσης / Extractor universal / Estrattore universale / Extrator universal / Extracteur de poulie universel / Uniersiele poelietrekker



Ref.	📦	EAN
11-299	1/10	5907558436044

## Nasadki do sondy lambda i wtryskiwaczy

Oxygen sensor and fuel injectors wrench set / Aufsätze für lambda-sonden und einspritzdüsen / Набор насадок для лямбда-зонд и форсунок / Насадки до лямбда-зондів і форсунок / Injektor és lambdaszonda szerelő készlet / Ajutaj pentru sonda lambda și injectoare / Ключи на лямбда сонды и всасывающие форсунок / Nástavce na lambda sondu a vstrekačice / Nasadni ključki za sondu lambda in injektorji / Galvučių rinkinys lambda zondai ir purkštukams / Lambda zondes un sprauslu uzgaļi / Lambda sondi atsakudja pihusid / Накраїниці за лямбда сондою та за інжекторами / Nasadni ključevi za lambda sondu ubrizgivača / Nastave za sondu lambda i brizgalice / Σετ καρβόκων και ακροφύσια για αισθητήρα λямбда και εκχυτήρες / Casquillos para sonda lambda y para inyector / Bussola per sonda lambda e iniettori / Bocais para a sonda lambda e injetores / Douilles pour sondes lambda et injecteurs / Doppen voor lambdasonde en inspuiters



- 78 mm x 17, 19, 27, 28, 30 mm  
- 80 mm x 27 mm  
- 85 mm x 21 mm  
- 90 mm x 22 mm  
- 110 mm x 27 mm

Nasadka sześciokątna 1/2" do sondy lambda / 6 point socket 1/2" for oxygen sensors / Головка 6-гранная 1/2" для лямбда-зонда:

- 80 mm x 20 mm  
Nasadki odjęte do sondy lambda / Offset sockets for oxygen sensors / Головки для лямбда-зонда:

- 31 mm x 22 mm x 3/8"  
- 50 mm x 22 mm x 1/2"

Nasadki dwunastokątne 1/2" do wtryskiwaczy / 12 point sockets 1/2" for diesel injectors / Головки 12-гранные для форсунок:

- 110 mm x 22 mm  
- 150 mm x 22 mm

Ref.	📦	EAN
11-880	0/5	5907558436877



Nasadki dwunastokątne 1/2" do sondy lambda / 12 point sockets 1/2" for oxygen sensors / Головки 12-гранные для лямбда-зонда:

- 78 mm x 22, 28 mm  
- 80 mm x 27 mm

Nasadka sześciokątna 1/2" do sondy lambda / 6 point socket 1/2" for oxygen sensors / Головка 6-гранная 1/2" для лямбда-зонда:

- 90 mm x 29 mm  
Nasadki sześciokątne 3/8" do sondy lambda / 6 point sockets 3/8" for oxygen sensors / Головки 6-гранная 3/8" для лямбда-зонда:

- 74 mm x 27 mm  
- 80 mm x 22 mm  
- 90 mm x 22 mm

Odjęte nasadki do sondy lambda / Offset sockets for oxygen sensors / Головки для лямбда-зонда:

- 31 mm x 22 mm x 3/8"  
- 50 mm x 22 mm x 1/2"

Nasadka dwunastokątna 1/2" do wtryskiwaczy / 12 point socket 1/2" for diesel injectors / Головка 12-гранная 1/2" для форсунок:  
- 108 mm x 22 mm

Ref.	📦	EAN
11-882	0/5	5907558436891

## Klucze nasadowe do sondy lambda

Oxygen sensor socket wrench / Aufsatzschlüssel für lambda-sonde / Торцевые головки для лямбда-зонда / Ключи торцеві до лямбда-зонди / Lambdaszonda szerelő készlet / Chei tubulare pentru sonda lambda / Nástrčné kľuče pro sondy lambda / Nástavcové kľuče na lambda sondu / Nasadni ključki za sondu lambda / Galvutės liambda zondai / Mucipatslēgas lambda zondei / Lambda sondi vāti / Ключови накраїниці за лямбда сондою / Nasadni ključevi za lambda sondu / Ключі патікач за сонде лямбда / Карбόκων για αισθητήρα λямбда / Llave de vaso para sonda lambda / Set di bussola per sonda Lambda / Chaves articuladas para a sonda lambda / Clé à sonde lambda / Dopstetels voor lambdasonde



1/2" x 29 x 90 mm (wycięcie 8 mm)  
1/2" x 27 x 80 mm  
3/8" x 7/8" x 90 mm (wycięcie 20 mm)  
3/8" x 1-1/16" x 74 mm  
3/8" x 7/8" x 80 mm  
1/2" x 22 x 50 mm  
3/8" x 22 x 31 mm

Ref.	📦	EAN
11-881	0/10	5907558436884

## Klucze nasadowe do sondy lambda

Oxygen sensor socket wrench / Aufsatzschlüssel für lambda-sonde / Торцевые головки для лямбда-зонда / Ключи торцевые до лямбда-зонду / Lambdasonda kulcs készlet / Cheitubulare pentru sonda lambda / Nástrčné kľúče pro sondy lambda / Nástavcové kľúče na lambda sondu / Nasadni ključ za sonda lambda / Gavutės lambda zondai / Mucapatslēgas lambda zondei / Lambda sondi vāti / Ключи накрутинци за лямбда сонда / Nasadni ključevci za lambda sondu / Ключі натікає за сонде лямбда / Καρούβια για αισθητήρα λямбда / Llave de vaso para sonda lambda / Set di bussole per sonda Lambda / Chaves articuladas para a sonda lambda / Clé à sonde lambda / Dopsleutels voor lambdasonde

Oskienka w nasadkach pozwalają na montaż bez demontażu przewodów

Nasadki pasują do popularnych aut osobowych poruszających się po europejskich drogach

Open-sided for lambda probe fitting without the removal of cables

The sockets fit popular European cars

Дірочки в голівках дозволяють проводити монтаж без демонтажу проводів

Голівки підійдуть популярним легковим автомобілям на європейських дорогах



Nasadka końcowej sondy lambda (gorącej) / The socket for end lambda probes (hot) / Голівка для кінцевих лямбда-зондів (гаряча) 1/2", 22 mm x 50 mm

Nasadka szczynika podciśnienia i sondy lambda (do sond nisko osadzonych) / The socket for end lambda probes (hot) / Голівка вакуумного датчика і лямбда-зондів (для низько посаджених зондів) 3/8", 22 mm x 30 mm

Nasadka szczynika podciśnienia i sondy lambda / The socket for vacuum sensor and lambda probe / Голівка вакуумного датчика і лямбда-зондів 3/8", 22 mm x 80 mm

Ref.	☒	EAN
11-203	0/20	5907558416763

## Klucz do sondy lambda

Oxygen sensor socket wrench / Schlüssel für lambda-sonde / Ключ для лямбда-зонда / Ключ до лямбда-зонду / Lambdasonda kulcs, rövid / Cheie pentru sonda lambda / Ključ na lambda sondu / Ключ за sonda lambda / Raktas lambda zondai / Lambda zondes atsēģa / Lambda sondi vāti / Ключ за лямбда сонда / Ключ за sonda lambda / Ключ за sonda lambda / Ключи накрутинци за лямбда сонда / Llave para sonda lambda / Set di bussole per sonda Lambda / Chave para a sonda lambda / Clé à sonde lambda / Sleutel voor lambdasonde



Nasadka do długich sond lambda i tam gdzie złącze przewodów nie pozwala na zastosowanie typowej nasadki do sond ze szczeliną

The socket is suitable for long lambda probes and wherever cable connectors do not allow for using typical probe sockets with a gap

Голівка для довгих лямбда-зондів і там, де кабельний роз'єм не дозволяє використовувати типову голівку для лямбда-зондів з зазором

Ref.	W [mm]	☒	EAN
11-204	22	10/100	5907558416749



Nasadka do krótkich sond lambda

The socket is suitable for short lambda probes

Голівка для коротких лямбда-зондів



Ref.	W [mm]	☒	EAN
11-205	22	10/50	5907558416756

## Ściągacze do wtrysków z młotkiem bezwładnościowym

Fuel injector service set / Abzieher für Einspritzungen mit Trägheitshammer / Комплект для снятия дизельных форсунок с обратными молотками / Комплект знімання форсунок зі зворотним молотками / Befescendezőfej kihúzó készlet csúszó kataróccsal / Instalații de decapare pentru injectări cu ciocan inerțial / Sada na vsříkovače s reverzním kladivem / Stahoványi vstrekovalač so zotvaňujúcim kladivom / Izmekacı za injektore z inercijskim kladivom / Dizelinių purkātuku nuņemimo komplekts su atbilstošu plaktiuku / Dizela sprauslu porētnēju komplekts ar inerces āturiu / Kutusepühusti tõmmisad, inertshammiga / Инструмент сноба обратничун за водене на дизели / Skidača za ubrizgivače s inercijskim čekičem / Komplet atlatki za skidanje mlaznica sa inercijskim čekičem / Σε εβρωλητής ακροφυσίων εγχείρηρα ντιζελ με σφραγιστικό ολίσθησης, κεραμής / Extractores para inyección con martillo de inercia / Estratori per iniettori con martello inerziale / Fresas para limpeza de encaixes de injetores / Kit extracteur injection diesel avec marteau coulissant / Injektortrekkers met glihamer

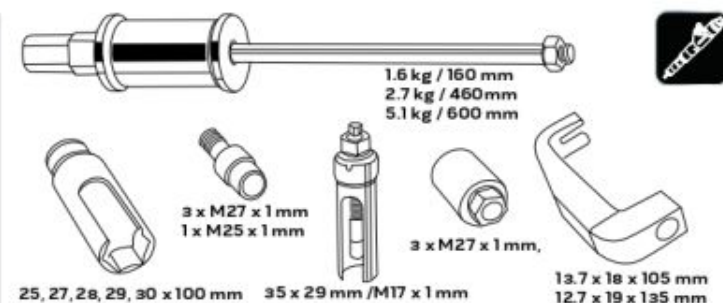
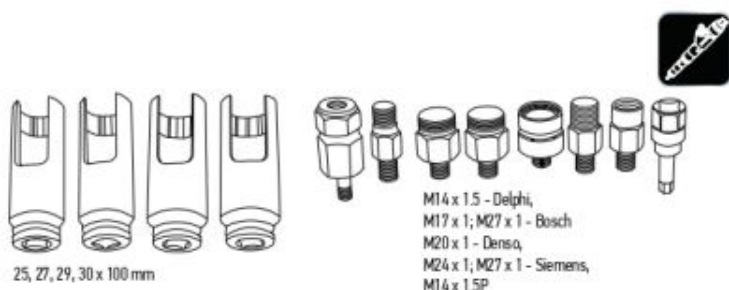

Ref.	☒	EAN
11-883	1/2	5907558435405



Ref.	☒	EAN
11-884	1/1	5907558435412

## Frezy do czyszczenia gniazd wtryskiwaczy

Diesel injector seat cleaning / Fräsen zur Reinigung von Einspritzbuchsen / Набор для чистки посадочных мест дизельных форсунок / Набор для чистки посадочних місць дизельних форсунок / Injektor fűszék maró és tisztító készlet / Freze pentru curățarea prizelor injectoarelor / Frézy na čišťení sedel vsřtkovačů / Frézy na čistenie zásviek vstrekovačov / Orodje za čiščenje ležišč injektorjev / Dyzelinų purkštukų lizdų valymo įrankių rinkinys / Dizela sprauslu ligzdu tīrītāji / Puhustipesade puhastamise frēsid / Фрезы за почищення на лелотна на инжектору / Set za čišćenje priključka ubrizgivača / Pribar za čišćenje utičnica ubrizgivača / Set kabariarou upobokov akropriarou euralipravitičel / Fresas para la limpieza de las tomas de los inyectores / Frese per la pulizia delle sedigli iniettori / Fresas para limpeza de encaixes de injectores / Kit de nettoyage pour sièges d'injecteurs / Freesstukken voor reiniging van injectie nesten



14 x 14 mm, 15 x 19 mm, 15.5 x 15.5 mm, 17 x 17 mm, 17 x 17.5 mm, 17 x 19 mm, 17 x 19.5 mm, 17 x 20 mm, 19 x 21.5 mm

15.5 x 15.5 mm, 17 x 17 mm, 17 x 21 mm, 17.5 x 20.5 mm



CrV steel x4



Freze do gniazd zaworowych diesel. Zawartość: frez 15 mm płaski frez uniwersalny, 17 mm frez płaski dla wtryskiwaczy Delphi/Bosch (BMW/PSA/Renault/Ford), 19 mm Frez płaski dla wtryskiwaczy Bosch (Mercedes CRD), 19 mm Frez kątowy do wtryskiwaczy Fiat/Iveco, Trzpień pilotujący 19 mm HEX

Diesel injector seat cutter set 4 pcs. Edge trimming cutter 15 mm flat, universal, 17 mm flat for Delphi/Bosh injectors (BMW/PSA/RENAULT/FORD), 19 mm flat for Bosh injectors (Mercedes CRD), 19 mm angle edge trimming cutter for FIAT/IVECO, Pilot mandrel 19 mm HEX

Фреза для чистки седел дизельных форсунок. В комплекте: плоская фреза 15 мм - универсальное применение, 17 мм плоская фреза для Delphi/Bosch (BMW/PSA/Renault/Ford), 19 мм плоская фреза для Bosch (Mercedes CRD), 19 мм угловая фреза для Fiat/Iveco, держатель-направляющая 19 мм HEX



Ref.	📦	EAN
11-218	0/20	5907558420401

## Zestaw do centrowania tarcz sprzęgła

Clutch center set / Zentriersatz für Kupplungsscheiben / Универсальный набор для центровки дисков сцепления / Набор универсальный для центрування дисків зчеплення / Kupplungtárcsa központosító készlet / Trusa de centrare a discurilor de ambreiaj / Sada pro centrování spojkových kotoučů / Centrovacia súprava kotúčov spojky / Ključ za centriranje plošč sklopke / Sankabos diskų centravimo rinkinys / Sajūga disku centrēšanas instrumentu universālais komplekts / Sidunketaste tzentreerimise komplekt / Комплект за центровка на съединителу / Set za centriranje ploča spojke / Pribar za centriranje diska kvačila / Set κεντρορίσματος δίσκων συμπλέκτη / Kit de centrado de la placa de embrague / Kit per il centraggio del disco frizione / Kit de centragem de discos de embraçagem / Kit de centrage pour disques d'embrayage

11, 12, 15, 17, 19, 20, 21, 25 mm



Ref.	📦	EAN
11-170	1/10	5907558437348

## Ściągacz do sprzęgieł skrzyń DCT

DCT Clutch Tool / Abzieher für Doppelkupplungsgetriebe / Съемник для сцепления в коробках передач DCT / Знімач до зчеплення у коробках передач DCT / DCT váltó kuplung leszedő szerzők / Strângere pentru ambreiajele DCT / Přípravek na montáž a demontáž spojky k DCT převodovce / Stahovák pre spojky DCT / Orodje za sklopkje DCT / Sankabos diskų nuėtimo įrankis DCT / Ford/Volvo DCT átrumkárba sajuğa porétmés / DCT-kasli sidurite tõõmits / Специализиран инструмент за монтаж/демонтаж на DCT съединители / Alat za sklopanje spojki kovečega DCT / Alatka za izvlačenje kutije kvačila DTC / Εργαλείο εξομπαρίσματος συμπλέκτη στο κούβλο ταχυτήτων / Tirador para embragues DCT / Estrattore frizione per cambio DCT - Ford/Volvo / Extrator de embraçagens das caixas DCT / DCT outil d'embrayage / Kraag voor DCT koppeling



Volvo: C30, C70 (06>), S40 (04>), S60 (11>), S80(07>), S80L, V40 (13>), V40 Cross Country, V50, V60, V70(08>), XC60 Ford: Focus(04>), C-Max, S-Max, Galaxy, Mondeo (07>), Kuga (13>), zatemnik / replacement / замена OEM Volvo 9997435, Ford 308-763

DCT FORD VOLVO



Ref.	📦	EAN
11-171	1/4	5907558437379

## Szczypce do opasek

Clamp pliers / Zange für Kraftstoffleitungen / Щипцы для хомутов / Щипцы для шлангов / Bilincsfogó / Cleste / Kleště na spony / Klešte na hadicové spory / Klešče za vzmetne objemke / Replės žarnelių žiedų užspaudimui / Savicēju knaibles / Koablisidemetre tangid / Щипцы за проводници на горивото / Kļešta za stiskanje / Kļešta za žicu / Λαβίδα σφραγικών στερεώσης / Alicates para bridas / Pinza per morsetti in gomma / Pinças para abraçadeiras / Pince de serrage

Do opasek sprężynujących na przewodach olejowych i wodnych etc.  
Do pracy w miejscach trudnodostępnych  
Długość grzałej części: 630 mm, długość części z rączką: 210 mm  
Zasięg ścisłu: 0 – 45 mm

For spring clips on oil and water hoses  
For difficult to reach places  
Flexible section length: 630 mm, handle section length: 210 mm  
Clamping range: 0 – 45 mm

Для пружинних хомутів паливних, масляних і водних шлангів і т. д.  
Для роботи у важкодоступних місцях  
Довжина гнучкої деталі: 630 мм, довжина деталі з ручкою: 210 мм  
Діапазон затиску: 0 – 45 мм

25  
years  
GUARANTEE



Ref.	W [mm]	☒	EAN
11-221	840	6/36	5907558416602

25  
years  
GUARANTEE



Ref.	☒	EAN
11-222	0/54	5907558418545



Ref.	☒	EAN
11-223	6/48	5907558418552

## Szczypce zaciskowe z tworzywa

Flexible line clamp / Gripzange aus Kunststoff / Набор зажимов с фиксатором / Кліщі для льняних труб / Ónázó fogókészlet műanyag / Cleste de strângere din plastic / Plastové svěrací kleště / Zvieracie plastové klešče / Plastične klešče za prešār cevi / Replės stabdžių šlangėlems užspausi / Plastmasas saspišanas knaibles / Plastist lukustustangid / Стягаючи кліпси от пластмаса / Stezna kļešta od umjetnog materijala / Plastična kļešta / Σετ σφικτήρες με μηχανισμό ασφάλισης / Tenazas abrazaderas de plástico / Pinza occlusione tubo in plastica / Pinças de plástico / Pince de serrage en plastique / Krimptang van kunststof



x3

Ref.	☒	EAN
11-224	0/48	5907558418699



25  
years  
GUARANTEE

x9

Ref.	☒	EAN
11-228	1/5	5907558437386



CrV  
steel

CLIC-R

175  
mm

Ref.	☒	EAN
11-226	6/60	5907558420197

## Zestaw mini szczypiec do pierścieni osadzczych

Mini pliers set for circlips / Mini-Zangenset für Stellringe / Набор щипцов для стопорных колец "mini" / Набор минищипцов до стопорних кільць / Mini pliers set for circlips / Garnitura de mini clesti pentru inele de strangere / Sada precizních kleští na pojistné kroužky / Súprava mini kleští na pojistné kružky / Set mini klešč za objemke / Mini replių komplektas, fiksavimo žiedams / Sprostagredzenu knaibļu komplekts, mini / Lukustusrõngaste minitangide komplekt / Комплект мини щипцов за стопорни пръстени / Set mini seger kļešta za stiskanje / Σετ μικρες λαβίδες για δακτύλια ασφαλείας / Juego de mini alicates para anillos de retención / Kit mini pinze per anelli d'arresto / Pinças para anéis / Jeu de mini-pinces pour colliers de fixation / Set van mini tangen voor dopringen



Ref.	☒	EAN
11-227	24/48	5907558420395

## Zaciskacz do pierścieni

Piston ring compressor / Ringklemme / Оправа поршневых колец / Затискич до кільця / Dugattyűgyűrű szorító szalag / Stränggator de inele / Svērka na kružky / Päs na stáhanovanie prestnych kružkov / Obročni prižetnik / Žedý suspraudėjas / Gredzenū saspriedėjs / Vārusulgur / Стяго за пръстени / Stezaljka za prstenje / Stezoč za prsten / Συμπεραστής δοκτύκων εμβόλου / Compresor para anillos / Morsetto per anelli / Fixador de anéis / Colier de serrage / Ringklem



Ref.	Ra [mm]	📦	EAN
11-250	50 - 125	0/60	5907558418330

## Klucz do demontażu napinaczy z wymiennymi końcówkami

Tensioner pulley / Schlüssel zum Abbau von Spannern mit auswechselbaren Spitzen / Ключ для снятия пружинателі со сменными наконечниками / Ключ для зняття пружинувачів зі змінними наконечниками / Feszítőgörgő kulcs cserélhető fejekkel / Cheia pentru demontarea întinzătoarelor cu capete interschimbabile / Ключ на демонтаж napinací klodky s vyměnitelnými koncovkami / Ключ на odstranovanie napínacích s vymeniteľnými hrotmi / Ключ за odstranitev zategovalnikov z izmenljivimi konicami / Raktas įtempiklį pūtimui, su keičiamais antgaliais / Priekšspriegotāja demontāžas atslēga ar maiņas uzgaļiem / Pngūite eemaldatise vāi, vahetatavate atsakulega / Ключ за демонтажу на обтяжени ролки със сменяеми накрайници / Ключ за демонтажу затежача са измjenjivimi nastavcima / Ключ за demontarea zatezача sa promenljivim krajevima / Ключи одираеиш пружинарнвм ме ανταλλακτικέс μίτες / Llave para quitar los tensores con puntas intercambiables / Chiave per smontaggio dei tenditori con punte intercambiabili / Chave para desmontar tensores com pontas substituíveis / Clé de démontage des détracteurs avec embouts interchangeables / Sleutel voor demontage van spanners met eindstukken

12, 13, 14, 15, 16, 17, 18, 19 mm

E10, E12, E14, E16, E18



Ref.	📦	EAN
11-169	0/10	5907558437331

## Klucz do napinania pasków klinowych

Transmission belt tensioning wrench / Schlüssel zum Spannen von V-Spanngurten / Ключ для затягування клинових ременя / Ключ для затягування клинових пасов / Ékszj feszítő kulcs / Cheia pentru strângerea curelei trapezoidale / Ключ к паринани ременице / Ключ на utáhanovanie klinových remeňov / Ключ за napenjanje klinastega jermena / Pleišniņų diržų užvertimo raktas / Transmisijas siksnas pievilkšanas atslēga / Kiltinātude pīngūtātise vāi / Инструмент за натягане на клинов ремък / Ключ за naprezanje remena / Ключ за zatezavanje klinastih remenova / Ключи тамиаш арпруаеишвм прънтивн / Llave para apretar las correas / Chiave per il tensionamento di cinghie dentate / Chave para tensionar correias / Clé pour tendre des courroies / Spanner voor V-snaar



40-200 mm



Ref.	📦	EAN
11-168	1/6	5907558437324

## Zestaw do alternatora

Combined sockets for alternator / Lichtmaschinen-Schlüsselsatz / Набор для альтернатора / Набор до генератора змінного струму / Készlet generátor szereléshez / Set de alternator / Sada na alternátor / Súprava pre alternátor / Set za alternator / Rinkiny kintamosios srovės generatoriui / Maiņstrāvas ģeneratora instrumentu komplekts / Generatori padrūnrotmete komplekt / Комплект за альтернатора / Garnitura za alternator / Garnitura za alternator / Σε για εναλλακτiρα / Juego para alternador / Kit per montaggio e smontaggio alternatori / Jogo de acessórios para alternador / Kit d'alternateur / Set voor wisselstroomgenerator

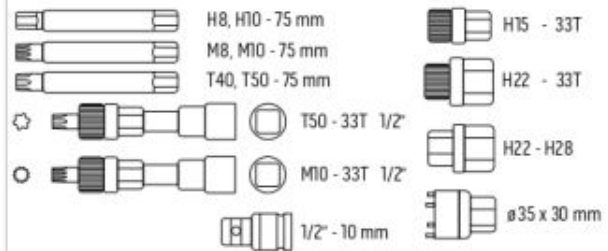

Ref.	📦	EAN
11-167	1/10	5907558437317

## Zestaw do układów ciśnienia/podciśnienia

Tester for vacuum and pressure systems / Satz für Druck-/Vakuumsysteme / Набор для напорних і вакуумних систем / Набор для напорних/вакуумних систем / Vákuum és nyomás tesztelő / Set pentru sisteme de presiune / vid / Tester pro tlakové/podtlakové systémy / Súprava pre tlakové / podtlakové systémy / Set za vakuumske in tlačne sisteme / Rinkiny slėgio / vakuuma sistemoms / Spiediena / vakuuma sistēmu instrumentu komplekts / Rõhu-/vakuumsüsteemide komplekt / Помпа за тестване на вакуум и налягане / Set za sistove tlaka / podtlaka / Pribor za sistem pritiska/vakuuma / Σε για συστήματα νερού αέρος/αποχής υπό πίεση / Probador de sistemas de presión / vacío / Kit per impianti a pressione/in depressione / Kit para sistemas de pressão / subpressão / Testeur de pression / compression / Meter voor druk/onderdruk systemen

-1+3 BAR



Ref.	📦	EAN
11-267	1/10	5907558436013

## Zestaw do diagnostyki systemów Common Rail

Common Rail diagnostic set / Diagnossatz für Common-Rail-Systeme / Набор для диагностики систем Common Rail / Набор для диагностики систем Common Rail / Common rail rendszer diagnosztikai készlet / Trusă pentru diagnosticarea sistemelor Common Rail / Sada pro diagnostiku systémů Common Rail / Sada pre diagnostiku systémov Common Rail / Set za diagnostiku sistemov Common Rail / Diagnostikos rinkinys, skirtas sistemai Common Rail / Common Rail sistemu diagnosticēšanas komplekts / Common Rail sistēmi diagnosticēšanas komplekts / Комплект за диагностика на системи Common Rail / Set za dijagnostiku sustava Common Rail / Pribor za dijagnostiku sistema Common Rail / Διαγνωστικό σετ για συστήματα Common Rail / Set para diagnóstico de sistemas Common Rail / Kit diagnóstico per sistemi Common Rail / Kit de diagnóstico de sistemas Common Rail / Kit de diagnostic pour systèmes Common Rail / Common Rail diagnostische set



BOSCH  
SIEMENS  
DENSO  
DELPHI



Ref.	☒	EAN
11-263	1/5	5907558435979

## Zestaw do testowania systemów wtryskowych

Fuel injection injector pressure test set / Testsatz für Einspritzsysteme / Набор для проверки форсунок впрыска топлива / Набор для проверки форсунок впрыска топлива / Befuelskendiő rendszer tesztelő készlet / Set pentru testarea sistemelor de injecție / Sada pro testování vstřikovačích systémů / Súprava na testovanie vstrekovačích systémov / Set za testiranje injektorskih sistemov / Įpurškimo sistemy testavimo rinkinys / Degvielas iesmidzināšanas sprauslas pārbaudes instrumentu komplekts / Sisesepritseüsteemide testimise komplekt / Komplekt za diagnostika na inžekcionni sistemi / Set za ispitivanje sustava ubrizgivanja / Sistem za testiranje sistema za ubrizgavanje / Σετ ελέγχου ακροφυσίου έγχυσης καυσίμου / Kit para prueba de sistemas de inyección / Kit per il test di sistemi di iniezione / Kit de testagem de sistemas de injeção / Kit d'essai pour systèmes à injection / Brandstofinjectie test set



0-10  
BAR

Ref.	☒	EAN
11-264	1/5	5907558435986

## Miernik ciśnienia sprężania

Compression tester / Verdichtungsdruckmesser / Компрессометр бензиновый / Компрессометр / Kompresszió mérő készlet / Aparat de măsurat compresia / Měřicí přístroj kompresního tlaku / Merač kompresného tlaku / Merlecsipritiska adapter / Kompresijos matuoklis / Kompresijos manometrs / Manometer adaptente komplekt / Компресометр / Mjerač pritiska / Merač pritiska sabijanja / Συμπίεσομετρο βενζίνης / Medidor de aire comprimido / Misuratore della compressione / Medidor de pressão de compressão / Compressiometre compression / Meter van persdruk

70  
BAR x16  
DIESEL



Miernik kompresji do pomiarów ciśnienia sprężania w cylindrach silników wysokoprężnych (diesla)  
Zestaw zawiera różne adaptery pasujące do większości silników aut osobowych i dostawczych  
Maksymalny zakres pomiaru – 70 barów

Pressure gauge for measuring compression pressure in diesel engine cylinders  
The set includes various adapters suited for a majority of passenger and delivery vehicle engines  
The maximum measurement range – 70 bars

Компресометр для вимірювання тиску в дизельних двигунах  
Включає адаптери, які підходять для більшості двигунів легкових і вантажних автомобілів і вантаків

Діапазон вимірювального тиску – до 70 бар

Ref.	☒	EAN
11-262	0/6	5907558416732

21  
BAR



Miernik kompresji do pomiarów ciśnienia sprężania w cylindrach silników spalinalowych benzynowych  
Zestaw zawiera adapter pasujący do większości silników aut osobowych i dostawczych  
Maksymalny zakres pomiaru – 21 barów

Compression pressure gauge for measuring compression pressure in petrol combustion engine cylinders  
The set includes an adapter suited for a majority of passenger and delivery vehicles  
The maximum measurement range is – 21 bars

Компресометр для вимірювання тиску в бензинових двигунах  
Включає адаптер, який підходить для більшості двигунів легкових і вантажних автомобілів  
Діапазон вимірювального тиску – до 21 бар

Ref.	☒	EAN
11-261	0/20	5907558416725



## Szczypce do ściągania przewodów zapłonowych

Spark plug wire boot pliers / Zange zum Abziehen von Zündkabeln / Плоскогубцы для снятия проводов зажигания / Плоскогубци для зняття дротів запалювання / Буйтókábel lehúzó fogó / Clește pentru scoaterea cablurilor de aprindere / Kleště na kabely zapalovacích svíček / Klešte na demontáž zapalovacích vodičov / Klešče za vtiče vzgajalnih svečk / Replij rinkany, užvedimo laidų nušėvinimui / Platknables aizdedzes vadu noņemšanai / Süütehjuhtmete näpitsad / Клещи за кабелу на свещите / Klješta za skidanje žica za paljenje / Klješta za skidanje kablova svećica / Πένσα εξάγωγής μπουζοκαλωδίων / Alicates para quitar los cables de arranque / Pinze per lo scollamento dei cavi d'accensione / Alicates para extração de cabos de ignição / Pincas pour enlever les câbles batterie / Tangen voor bougie leidingen

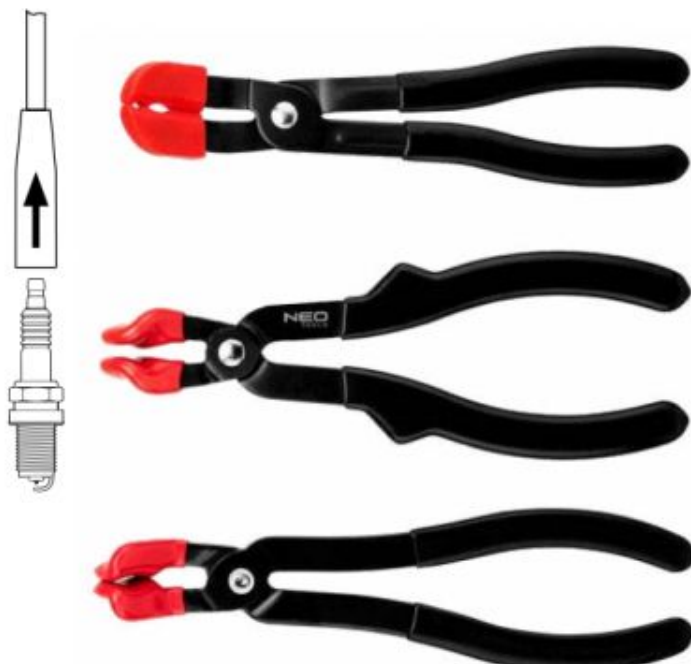

Ref.	☒	EAN
11-165	5/20	5907558437294

## Tester szczelności uszczelki pod głowicą

Head gasket leak tester / Leaktester für Kopfdichtungen / Тестер герметичности прокладок головки блока цилиндров / Тестер герметичности прокладки головки / Fejtömítés szivárgásvizsgáló / Tester de scurgeri garniturii de cap / Tester těsnosti těsnění hlavy / Tester tesnosti tesnenia hlavy / Tester puščanja tesnila glave / Galvutes tarpiklio sandarumo testeris / Galvasblīves noplūdes testeris / Peatite nāi lekke tester / Тестер за теч на уплътнението на главата / Ispitivač curenja brtve glave / Тестер цурења заптивке главе / Ελεγκτής διαρροής φλάντζας κεφαλής / Probador de fugas de juntas de culata / Cerafughe guarnizioni testa / Testador de vazamento da junta do cabeçote / Testeur de fuite de joint de culasse / Koppakking lektester



Ref.	☒	EAN
11-271	0/6	5907558474626

## Szczelinomierz

Feeler gauge / Schiebelehre / Шун / Шун / Hízagmérő készlet / Calabu măsurare grosime / Spårsmär / Listkové mierky / Kontrolni lističi / Ertmij matavimo prietaisas / Spraugsmērs / Mõõlesond / Лубгомер / Kontrolni lističi / Διακωνόμετρο / Calibre de espesores / Calibro a spessori / Medidor de folgas / Jauge d'épaisseur / Voelmaat

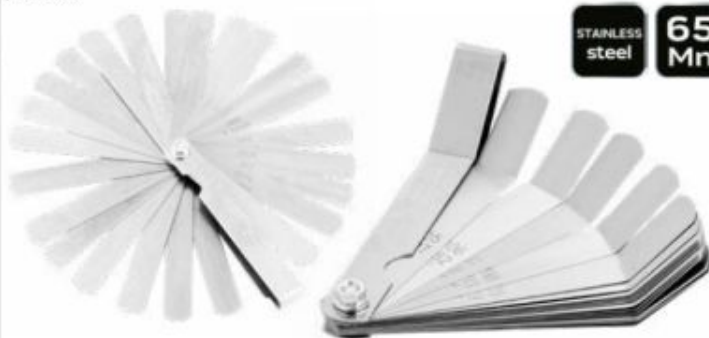

STAINLESS steel  
65 Mn



Ref.	Ra [mm]	N	☒	EAN
11-190	0.04 - 0.63	26	20/120	5907558452433
11-191	0.05 - 1.0	20	20/120	5907558452440
11-192	0.127 - 0.508	16	20/120	5907558452457

## Zestaw do demontażu poduszek powietrznych

Airbag removal tool set / Abbausatz für Luftkissen / Набор для замены подушки безопасности / Набор для замены подушек безпеки / Légzsák kiszereelő készlet / Set pentru scoaterea airbag-urilor / Sada na demontáž airbagů / Súprava na demontáž airbagov / Set za odstranitev zračnih blazin / Oro pogalvni izmontavimo rinkinys / Drošības spilvena noņemšanas instrumentu komplekts / Æihkrøftede eermaldamise komplekt / Комплект за демонтаж на въздушни възглавници / Set za skidanje zračnih jastuka / Pribor za demontiranje vzdušnih jastuka / Σετ αντικατάστασης αερόσακου / Kit de desmontaje de airbags / Kit per lo smontaggio di airbag / Kit de ferramentas de desmontagem de airbags / Kit de démontage des airbags / Set voor demontage van airbags



Ref.	☒	EAN
11-817	1/10	5907558436785

## Ściągacz do ramion wycieraczek

Wiper arm puller / Abzieher für Scheibenwischer / Съемник рычагов стеклоочистителя / Знімач важеля очисників / Ablaktöröl kar lehúzó / Dispozitiv de scos de brate de stergător de parbriz / Stahovák na ramínka stieračů / Stáhnovač na demontáž ramienok stieračov / Snemalec za brisalce / Valytuvų kotų nuėmikis / Stikla tirtāju plecu novīcejs / Kojamehe hoobade tõmmits / Скоба за рамона чистачката / Alat za skidanje brizgaljki / Alat za skidanje ramena brisača / Εξολκός μοχλών υαλοκαθαριστήρα / Extractor de brazos de limpiaparabrisas / estrattore per braccio del tergicristallo / Extrator de limpa-para-brisas / Extracteur de bras d'essuie-glaces / Trekker voor ruitenwisserarmen



Ref.	☒	EAN
11-827	0/120	5907558420067



## Zestaw do demontażu szyb

Car windows disassembling set / Abbausatz für Scheiben / Набор для демонтажа лобовых стекол / Набор для демонтажу вітрового скла / Szélvédő készrelő készlet / Set pentru demontarea geamurilor / Souprava pro demontáž skel / Súprava na demontáž okien / Set za odstranitev stekel / Automobilni stikly išmontavimo rinkinys / Autostiklu demontāžas komplekts / Tuuleklaasi eemaldamise komplekt / Комплект за демонтаж на автомобилна / Set za demontažu stakla / Pribor za demontiranje stakla / Σετ εξαγωγή παραμπρίζ / Kit de desmontaje de ventanillas / Kit per lo smontaggio di cristalli / Kit de ferramentas de desmontagem de vidros / Kit de démontage de vitres



Ref.	📦	EAN
11-819	1/10	5907558436792

## Zestaw nasadek specjalnych

Socket set / Aufsatzset / Набор головок торцевых / Набор насадок торцевых / Törtcsavarkehajtó készlet / Set duze / Sada násadek / Súprava nást. klúčov / Garnitura nasadnih ključev / Αντράχιοι ριγκίνγς / Muciri komplekts / Podrunicomplekt / Гедорэ компл / Šesterokutne kapice / Gedora set / Συλλογή καρδικαίων / Llaves de vaso / Set di boccole / Kit de bicos / Jeu de douilles / Set van doppen

8, 10, 11, 12, 13, 14, 15, 16, 17, 19, 21, 22, 24, 27 mm

2 wybijaki do usuwania śrub z nasadek

2 x punches

2 выдолтки для снятия винтов с головок

Można stosować z kluczami udarowymi

Suitable for impact wrenches

Можно использовать с ударными гайковертами

Wewnętrzna spirala powoduje samoczynne zaciskanie się na uszkodzonej śrubie/nakrętce umożliwiając bezpieczne odłączenie

The innovative spiral profile digs itself into the head of a damaged screw/nut and thereby allows to loosen it securely

Внутренняя спираль вызывает автоматическое зажатие поврежденного болта/гайки, обеспечивая безопасное откручивание

x16 1/2"



Ref.	📦	EAN
11-920	0/10	5907558436914

## Zestaw nasadek specjalnych

Socket set / Aufsatzset / Набор головок торцевых / Набор насадок торцевых / Törtcsavarkehajtó készlet / Set duze / Sada násadek / Súprava nást. klúčov / Garnitura nasadnih ključev / Αντράχιοι ριγκίνγς / Muciri komplekts / Podrunicomplekt / Гедорэ компл / Šesterokutne kapice / Gedora set / Συλλογή καρδικαίων / Llaves de vaso / Set di boccole / Kit de bicos / Jeu de douilles / Set van doppen

9, 10, 11, 12, 13, 14, 15, 16, 17, 19 mm

przełycka 1 szt.

1 x punches

1 x штырь

Wewnętrzna spirala powoduje samoczynne zaciskanie się na uszkodzonej śrubie/nakrętce umożliwiając bezpieczne odłączenie

The innovative spiral profile digs itself into the head of a damaged screw/nut and thereby allows to loosen it securely

Внутренняя спираль вызывает автоматическое зажатие поврежденного болта/гайки, обеспечивая безопасное откручивание

x11 3/8"



Ref.	📦	EAN
11-922	0/20	5907558436938

## Przecinaki do nakrętek

Nut splitters / Meißel für Mutter / Γαϊκονομύ / Разрушач до мутр / Csavaranagyók / Dălți pentru piulițe / Trháč matic / Trhače matic / Lomilci matic / Veržljukiristukai / Ugniežru cirtņi / Meisliid / Cesaхи за гаўку / Rezoč za matic / Sekač navrtanja / Κόφτης παξιμαδιών / Tajadera de tuercas / Spaccadadi / Cortadores de porcas / Burins à écrous / Moerknippers

oszko 9 - 12 mm/klucz 12 mm; oszko 12 - 16 mm/klucz 14 mm; oszko 16 - 22 mm/klucz 19 mm; oszko 22 - 27 mm/klucz 21 mm

9 - 12 mm nut splitter. Spanner drive shaft 12 mm; 12 - 16 mm nut splitter. Spanner drive shaft 14 mm; 16 - 22 mm nut splitter.

Spanner drive shaft 19 mm; 22 - 27 mm nut splitter. Spanner drive shaft 21 mm

размер гайки 9 - 12 мм / ключ 12 мм; размер гайки 12 - 16 мм / ключ 14 мм; размер гайки 16 - 22 мм / ключ 19 мм; размер гайки 22 - 27 мм / ключ 21 мм



Ref.	📦	EAN
11-925	0/10	5907558436945

## Miska magnetyczna, kątowa

Magnetic bowl, angular / Magnetschale, eckig / Магнитная чаша, угловая / Miska magnética, kątowa / Mágneses tál, szögletes / Bol magnetic, unghiuar / Magnetická miska, hranatá / Magnetická miska, hranatá / Magneta posoda, kotna / Magnetinis dubuo, kampinis / Magnētiskā bļoda, kantaina / Magnetauss, nurgeline / Магнитна купа, ъглова / Magneta zdjela, ugolna / Магнетна посуда, угаона / Магнетіка миска, кутова / Cuenco magnético, angular / Ciotola magnetica, angolare / Tigela magnética, angular / Bol magnétique, angulaire / Magnetsche schaal, hoekig



Ref.	☒	EAN
11-617	0/12	5907558499834

## Miska magnetyczna

Magnetic tray / Magnetschüssel / Поддон магнитный / Поддон магнитный / Mágneses tál, rozsdamentes / Tava magnetica / Magnetická miska / Magnetická miska / Magneta posoda / Magnetinis dubenėlis / Magnētiskais trauks / Magnetauss / Магнитен хартер / Magnetska posuda / Magneta činja / Μαγνητικός δίσκος / Plato magnética / Vassoio magnetico / Tacho magnético / Réceptier magnétique / Magnetsche opvangbak



Ref.	L x W [mm]	☒	EAN
11-614	245 x 145	0/24	5907558419702

## Refraktometr

Refraktometer / Refraktometer / Рефрактометр / Рефрактометр / Refraktómetr / Refraktometru / Refraktometr / Refraktometer / Refraktometer / Refraktometras / Refraktometrs / Refraktometer / Рефрактометр / Refraktometer / Refraktometer / Διαθλασιόμετρο / Refrattómetro / Rifrattometro / Refratómetro / Réfractomètre



Ref.	☒	EAN
11-270	0/50	5907558436020

## Chwytnak magnetyczny

Magnetic holder / Magnetgreifer / Магнитный захват / Тримач магнітний / Mágneses csavarkiszédő teleszkópos / Graifár magnetic / Magnetická úchytka / Magnetický zdvihák / Magneta držalo / Magnetinis laikiklis / Magnētiskais satvērējs / Magnetaarats / Магнитен захват / Magnetska hvatajka / Magneti hvatač / Μαγνητική ορπάλη / Agarrador magnético / Supporto magnetico / Caçamba magnética / Preneuzer magnétique / Magnetsch houder



Ref.	☒	EAN
11-610	0/200	5907558418569



Ref.	☒	EAN
11-611	0/100	5907558418576



## Lusterko inspekcyjne

Inspection mirror / Inspektionsspiegel / Зеркало инспекционное / Дзеркальце інспекційне / Vizsgálótükör teleszkópos nyéllel / Oglindă de inspecție / Zrcadlo pro inspekční kontroly / Inšpekčné zrkadlo / Kontrolno ogledalo / Vozdo veidrodelis / Inspekcijas spoguļis / Kontrollspiegel / Контролно огледало / Kontrolno ogledalo / Ogljedalo za inspekciju / Καθρέπτη εξέχου / Espejo de inspección / Specchietto per ispezione / Espelho de inspeção / Mirroir d'inspection / Inspectiespiegel



Ref.	☒	EAN
11-612	0/200	5907558418583

## Nitownica akumulatorowa

Riveter / Nietmaschine / Завиточник / Клепальный инструмент / Popszegecsúzó / Maşină de nituit / Nyitavácso / Kliešte nitovacie oceľové / Pištola za kovčenje / Kniežu stangas / Needitangid / Нитовна / Kliešta za zakovice / Pistolj za pop nitne / Ηλκι / Remachadora / Rivettatrice / Rebitadora / Riveuse / Klinknagelmachine



Ref.	[kg]	☒	EAN
04-617	1,72	0/5	5907558496000

## Nitownica

Riveter / Nietmaschine / Заклепочник / Клепальный инструмент / Popszegesgész / Masina de nituit / Nýtovačka / Kliešte nitovacie oceleové / Pištola za kovičenje / Kriedklis / Kniežu stangos / Needtangid / Hurna-ha / Kliešta za zakovice / Pistolj za pop nitre / Нити / Remachadora / Rivettatrice / Rebitadora / Riveuse / Klinknagelmachine



Steel	Ø 2.4/3.0/3.2/4.0/4.8/5.0 mm	Al	Ø 2.4/3.0/3.2/4.0/4.8/5.0 mm
Cu	Ø 2.4/3.0/3.2/4.0/4.8/5.0 mm	Steel	Ø 2.4/3.0/3.2/4.0 mm

Ref.	Ø [mm]	L [mm]	⊠	EAN
18-101-1	2.4/3.2/4.0/4.8	264	6/24	5907558497304



Steel	Ø 2.4/3.0/3.2/4.0/4.8/5.0 mm	Al	Ø 2.4/3.0/3.2/4.0/4.8/5.0 mm
Cu	Ø 2.4/3.0/3.2/4.0/4.8/5.0 mm	Steel	Ø 2.4/3.0/3.2/4.0/4.8/5.0 mm

Ref.	Ø [mm]	L [mm]	⊠	EAN
18-103-1	2.4/3.2/4.0/4.8	265	6/24	5907558497328



Steel	Ø 2.4/3.0/3.2/4.0/4.8/5.0/6.0/6.4 mm	Al	Ø 2.4/3.0/3.2/4.0/4.8/5.0/6.0/6.4 mm
Cu	Ø 2.4/3.0/3.2/4.0/4.8/5.0/6.0/6.4 mm	Steel	Ø 2.4/3.0/3.2/4.0/4.8/5.0/6.0/6.4 mm

Ref.	Ø [mm]	L [mm]	m [kg]	⊠	EAN
18-106-1	3.2/4.0/4.8/6.0/6.4	480	1.95	0/12	5907558497380



Steel	Ø 2.4/3.0/3.2 mm	Al	Ø 2.4/3.0/3.2/4.0/4.8/5.0 mm
Cu	Ø 2.4/3.0/3.2 mm	Steel	Ø 2.4 mm

Ref.	Ø [mm]	L [mm]	⊠	EAN
18-102-1	2.4/3.2/4.0/4.8	280	6/24	5907558497311



Steel	Ø 2.4/3.0/3.2/4.0/4.8 mm	Al	Ø 2.4/3.0/3.2/4.0/4.8 mm
Cu	Ø 2.4/3.0/3.2/4.0/4.8 mm	Steel	Ø 2.4/3.0/3.2/4.0/4.8 mm

Ref.	Ø [mm]	L [mm]	m [kg]	⊠	EAN
18-107	2.4/3.2/4.0/4.8	275	0.75	6/24	5907558413564

## Lampa lutownicza

Liquid gas blow-lamp / Lötlatze / Лампа паяльная / Газ рідкий для лампи паяльної / Fogasztőkészülék / Lampă sudat cu gaz lichid / Pájová lampa / Pájkováčka plynová / Plinski gorilnik / Litavimo lempa / Lötlatpa / Jootelamp (vedelgaas) / Лампа газова / Plinska lemčica / Gasna lemčica / Κομμένο υγραερίου / Lâmpara de soldar a gas / Lampada per saldare / Lâmpada p. Soldar / Lampe à braser / Soldeerlamp



1.2 kW  
87 g/h  
FOR 190g CARTRIDGE

Ref.	T [°C]	q [g/h]	P [kW]	⊠	EAN
20-021	1350	87	1.2	0/12	5907558455151



PIEZO  
1.2 kW  
87 g/h  
FOR 190g CARTRIDGE

Ref.	info	T [°C]	q [g/h]	P [kW]	⊠	EAN
20-022		1350	87	1.2	0/12	5907558455168
20-045	+ 4 x 20-033	1350	87	1.2	0/12	5907558488265



## Palnik gazowy

Gas burner / Gasbrenner / Горелка газовая / Пальник газовой / Főtűszófeje / Arzator de gaz / Πυρογυήτρικ / Horák / Plynski garňnik / Dujinis degiklis / Gázés degős / Gasapöletti / Нагрівач за горелка / Nastavak za plamenik / Gasna lemilica / Καυστήρας υγραερίου / Soplete / Vescaucio / Moçarica de gás / Chalumeau à gaz / Gasbrander



Ref.	info	T [°C]	P [kW]	☒	EAN
20-025		1300	1.3	10/100	5907558449648
20-041	+ 20-030	1300	1.3	10/100	5907558486773
20-040	+ 2 x 20-030	1300	1.3	10/100	5907558465747



Ref.	T [°C]	P [kW]	☒	EAN
20-026	1350	1.28	10/60	5907558465365

## Nabój z gazem butan

Butane gas cartridge / Butan-Gas-Patrone / Баллон с газом бутан / Балончик (картридж) з газом бутан / Tartály gázlámpához / Cartuş cu gaz butan / Kartuşe s plynem butan / Butánová kartuša / Jeklenka s plinom butan / Butano dujų balionas / Balons ar butāna gāzi / Butaan-gaaspadron / Бутинна с газ бутан / Patrona sa butan plinom / Patrona sa butan gasom / Δοχείο με μείγμα βουτανίου / Cartucho de gas butano / Bombola di gas / Cartucho com gás / Cartouche avec gaz butane / Butaan vervangcartridge



Butan

EN417:  
2012



Ref.	m [g]	☒	EAN
20-030	227	4/28	5907558449655



Butan

EN417:  
2012



Ref.	m [g]	☒	EAN
20-033	190	0/48	5907558468939



Butan

EN417:  
2012



Ref.	m [g]	☒	EAN
20-036	500	0/12	5907558468946

## Mikropalnik

Micror Torch / Mikrobrænnar / Микрогорелка / Минипальник / Fõrrasztõkészülék piezo / Microinjector / Mikrohoiák / Mikro rajkovaõka / Gorilnik / Mikro degikis / Lodlampã mini / Mikroelekklamp / Горелка микро / Mikro Plinska lemilica / Mikro gasna lemilica / Φιλõγραφο / Microsoplete / Micro bruciatore / Mikrotaõarico / Micro-brûleur / Microbrãnder



Ref. 19-905 EAN 5907558465723



Ref. 19-906 EAN 5907558465730

## Lutownica bezprzewodowa

Cordless soldering iron / Kabelloser LõtKolben / Аккумуляторный паяльник / Аккумуляторный паяльник / Akkumulãtoros fõrrasztõrõka / Fier de lipit fãrã fir / Akkumulãtorovã rãjeõka / Bezdrõtovã sprãjkovaõka / Brezõiõni sprãjkalnik / Belaidis lituoklis / Bezvadu lodãturs / Juhtmeta jootekolb / Безжãмен паяльник / Безõрно lemilo / Безжãчно лемпиура / Ααίρηματο κολληõτρα / Soldador inalãmbico / Soldatore a batteria / Ferro de soldar sem fios / Fer à souder sans fil / Draadloze soldeerbout



Ref. 19-250 EAN 5907558491449

## Stacja lutownicza

Soldering station / Lõtstation / Παληνια stãtion / Παληνια stãtion / Fõrrasztõállomãs / Stafie de lipit / Rãjeõci stãnice / Sprãjkovãciã stãnica / Sprãjkalna postaja / Litovimo stotis / Lodõõanas stãcija / Jootejõst / Stãncija za zapõjvãne / Postaja lemilice / Stãnica lemilice / Σαλõθριõ κολληõτρας / Estãcion de soldadura / Stãncione di soldatura / Estãcion de solda / Poste de soudure / Soldeerstation



Ref. 19-200 EAN 5907558468908

## Kolba lutownicza

Soldering tool / LõtKolben / Παληνικ / Παληνια kolba / Fõrrasztõrõka / Fier de lipit / Rãjeõci ruõka / Sprãjkovãciã pera / Sprãjkalnik / Lituoklis / Lodãturs / Jootekolb / Παληνικ / Lemilica / Lemilica / Κολληõτρα / Soldador / Soldatore / Ferro de soldar / Fer à souder / Soldeerbout



Ref. 19-220 EAN 5907558468915

## Koõcõwki do lutownicy

Soldering tips / Lõtspitzen / Наконечники для паяльника / Наконечники до лютувãльника / Fõrrasztõhegyek / Capete pentru cõson de lipit / Наконõкы про рãjeõку / Nãstavec sprãjkovaõky / Kapice za sprãjkalnik / Antgaliai lituokliui / Lodõõanas uzgaõji / Jootekolbi atsakud / Накрãйõници за паяльника / Vrhovi za lemilicu / Nastavec za lemjenje / Mõtes κολληõτραιõ / Voõquillas para soldar / Inserti per soldatore / Ponteiros p. soldador / Embouts de fer à souder / Soldeerindstukken



Ref. 19-225 EAN 5907558468922

## Lutownica transformatorowa

Soldering gun / Trafo-Lötkolben / Παινήκι μετασχηματιστή / Παινήκι πιστολι / Forrasztópisztoly / Cocan de lipit / Pájeci stanice s transformátorem / Pájkovačka elektronická / Spajkalnik / Transformatorinis lituoklis / Lodānurs ar transformatoru / Ιωτεπύστολ / Παινήκι / Πίστολι λειμήλια / Πίστολι λειμήλια / Ηλεκτρικό καλλήτρι με μετασχηματιστή / Pistola para soldar / Pistola per saldatura / Soldador por transformador / Fer à souder redresseur / Transformator soldeerbout

200W 230V 50Hz 3 TEMP SETTINGS A 70-200°C B 201-350°C C 351-500°C LED LIGHT INCLUDES x2 SOLDERING TIPS INCLUDES x2 SOLDERING PASTE



Ref. 19-152 0/10 EAN 5907558472059

## Lutownica do plastiku + zszywki

Plastic welder + staples / Kunststoffschweißgerät + Heftklammern / Σωριδική πλαστικά + σκυβί / Зварювач пластик + скобу / Műanyag hegesztő + kapcsok / Sudor plastic + capse / Svářečka plastů + sponky / Zváračka plastov + sponky / Varilec plastike + sponke / Plastikinis suvirintojas + kabės / Plastmasas metinātājs + skavas / Plastikust keevitaja + klambrid / Пластмассов заваривач + скобу / Varilica za plastiku + spajalice / Пластични заваривач + спажалице / Пластικός συγκολλητής + συνδέσιμες / Soldador de plástico + grapas / Soldatore plastica + graffette / Soldador de plástico + grampas / Soudeuse plastique + agrafes / Kunststof lasapparaat + nietjes



50W 200pcs 50pcs 50pcs 50pcs

Ref. 19-158 0/10 EAN 5907558475272

## Zszywki do plastiku

Staples for plastic / Heftklammern für Kunststoff / Σκυβί για πλαστικά / Набор пластиковых скоб / Түздікарпосок műanyaghoz / Capse pentru plastic / Svorky na plasty / Svorky na plasty / Sponke za plastiko / Plástico spajzačles / Plastmasas skavas / Plastist klambrid / Скобу за пластмаса / Plastične spajlice / Пластичне спажалице / Συρρακτικά για πλαστικό / Grapas para plástico / Punti metallici per plastica / Agrafes para plástico / Agrafes pour plastique / Nietjes voor plastic



150W 230V-50Hz

Ref. 19-151 0/10 EAN 5907558464696



600 pcs for NEO 19-158



Ref. 19-159 25/50 EAN 5907558475289



100W 230V 50Hz LED LIGHT INCLUDES x2 SOLDERING TIPS INCLUDES x2 SOLDERING PASTE

Ref. 19-153 0/6 EAN 5907558472066

## Punktak

Centre punch / Körner / Кернер / Кернер / Pontozó / Punctator / Dűlők / Raznik / Točkalo / Žymeklis / Punktisits / Augumārgisti / Керно / Ručni bušać / Obeleživač / Πόντια αβήρου / Punzón centrador / Punzone / Punção / Pointeau / Doorslag

CrV steel 58-64 HRC AUTO



Ref. 33-090 0/20 EAN 5907558426243



## Wyciskacz do tub

Caulking gun / Auspresser für Tuben / Выжиматель / Толак для выжимания монтажной пены / Kinyomápisztoly / Compresor de tuburi / Αρρίκτασι pistole na tuby / Vytlačač tub / Pistola za tube / Hermetiko pistoletas / izspiedējs / Torutõmmits / Измисочка за туби / isiskivač za tube / Isiskivač za tube / Πιστόλι αδικόνης / Pistola para tubos / Pistola per cartucce / Espresedor para tubos / Pistolet pour tubes / Afichtingspistool



Ref.	L [mm]	☒	EAN
61-001	240	0/24	5907558405842



Ref.	L [mm]	☒	EAN
61-002	240	0/12	5907558405859



Ref.	L [mm]	☒	EAN
61-004	240	0/12	5907558420821

3 tryzienie wyciskające  
3 forcing pins  
3 отжимных штифта



Ref.	V [ml]	L [mm]	☒	EAN
61-005	310	254	0/12	5907558420838
61-006	600	389	0/12	5907558420845

## Mikrometr noniusowy

Vernier micrometer / Feinmessschraube / Верньерный микрометр / Микрометр Верньера / Nullis mikrométer / Micrometru Vernier / Vernierovskij mikrometr / Vernierov mikrometer / Vernierjev mikrometer / Vernier mikrometras / Vernijë mikrometr/s / Vernier mikromeeter / Микрометр Вернье / Vernier mikrometer / Nonius mikrometar / Μικρόμετρο βερνιέρας / Micrómetro vernier / Micrometro a corsoio / Micrómetro Vernier / Micromètre à vernier / Vernier-micrometer



Ref.	Ra [mm]	☒	EAN
75-020	0-25		5907558491548
75-021	25-50		5907558491555
75-022	50-75		5907558491562
75-023	75-100		5907558491579

## Suwmiarka

Caliper / Messschieber / Штангенциркуль / Штангенциркуль / Tolómérő / Suport / Posuvné měřtko / Meradlo posuvné / Pomíčno merilo / Slankmatis / Bidmèrs / Mõõtesirkel / Шублер / Pomíčno mjerilo / Pomíčno merilo / Αναλογικό παχύμετρο / Calibre / Calibro / Calibrador de corrediça / Pied à coulisse / Schuifmaat



Ref.	L [mm]	Ra [mm]	☒	EAN
75-000	234	0-150	10/10	5907558406757



Ref.	L [mm]	Ra [mm]	☒	EAN
75-001	230	0-150	5/25	5907558409468



Ref.	L [mm]	Ra [mm]	☒	EAN
75-011	237	0-150	5/25	5907558408614



## NARZĘDZIA I AKCESORIA PNEUMATYCZNE

pneumatic  
tools and accessories

пневматичні інструменти  
та аксесуари



## Klucz pneumatyczny udarowy

Pneumatic impact wrench / Presluftschlagschlüssel / Ключ пневматический ударный / Ключ пневматичний ударний / Pneumatikus ütvecsavarozó / cheie pneumatică de lovit / Pneumatický nárazový klíč / Pneumatická rázná uťahovačka / Pnevmatiski udarni vijac / Pnevmatinis, smūginis veržiaraktis / Pnevmatiskā sitena pistole / Pnevmatiline löök-mutrivõti / Гайковерт пневматичен / Pnevmatiski Ključ udarni / Pnevmatiski ključ / Συρίδι αέρασ απαστρέφόμενο / Llave de impacto neumática / Chiave pneumatica a percussione / Chave pneumática de impacto / Cléf pneumatique à chocs / Pneumatisch slagstrel



 **1300**  
 **1/2"** **TWIN HAMMER CLUTCH**  
 **7000**  **1/4"**  
 **10mm** **128 l/min**  
 **MAX 6.2 BAR**  **L/R**

Ref. 14-002 1/6 EAN 5907558442533



 **2000**  
 **3/4"** **TWIN HAMMER CLUTCH**  
 **5500**  **3/8"**  
 **10mm** **227 l/min**  
 **MAX 6.2 BAR**  **L/R**

Ref. 14-008 1/4 EAN 5907558442564



 **1300**  
 **1/2"** **JUMBO CLUTCH**  
 **7000**  **1/4"**  
 **10mm** **128 l/min**  
 **MAX 6.2 BAR**  **L/R**

Ref. 14-006 1/6 EAN 5907558442557



 **680**  
 **1/2"** **TWIN HAMMER CLUTCH**  
 **10000**  **1/4"**  
 **10mm** **113 l/min**  
 **MAX 6.2 BAR**  **L/R**

Ref. 14-004 1/6 EAN 5907558442540



 **680**  
 **1/2"**  **7000**  
 **1/4"** **113 l/min**  
 **10mm**  **MAX 6.3 BAR**  
 **L/R**

Ref. 14-500 1/10 EAN 5907558442557



 **320**  
 **1/2"**  **7000**  
 **1/4"** **141 l/min**  
 **10mm**  **MAX 6.3 BAR**  
 **L/R**

Ref. 14-502 1/5 EAN 5907558444841

1/2" -9, 10, 11, 13, 14, 17, 19, 22, 24, 27 mm

## Klucz pneumatyczny uderowy

Pneumatic impact wrench / Pressluftschlagschlüssel / Ключ пневматический ударный / Ключ пневматичний ударний / Pneumatikus ütvecsavarozó / cheie pneumatică de lovit / Pneumatický nárazový klíč / Pneumatiskå råznova utahovačka / Pneumatski udarni vijak / Pneumatinis, smūginis veržiaraktis / Pneumatiskå sitena pistole / Pneumatiline löök-mutrivöi / Γαϊνοέργον пневματιčen / Pneumatski Ključ udarni / Pneumatski ključ / Σπυρί αέρος αναστρέφεινο / Llave de impacto neumática / Chiave pneumatica a percussione / Chiave pneumática de impacto / Clef pneumatique à chocs / Pneumatisch slagsleutel



Ref.	☒	EAN
14-010	1/1	5907558442571

## Klucz kątowy pneumatyczny

Pneumatic angle wrench / Winkelschlüssel pneumatisch / Ключ угловой пневматический / Мурповерт кутсовий пневматичний / Pneumatikus racsnis kulcs / Cheie unghiulară, pneumatică / Uhlavý klíč pneumatický / Pneumatiský uhlavý ključ / Pneumatska raglja / Pneumatinis kampinis rakts / Pneumatiskå lefju atsléga / Pneumatiline nurkvöi / Βελος пневματιčen κλuch / Pneumatski kutni ključ / Pneumatski ugaoni ključ / Κλειδί γωνιακό αέρος / Llave articulada neumática / Chiave pneumatica angolare / Chiave de canto pneumática / Clef d'angle pneumatique / Pneumatisch hoaksleutel



Ref.	☒	EAN
14-012	1/20	5907558442588

## Klucz uderowy kątowy

Angle impact driver / Winkel-Schlag-Schlüssel / Ударный ключ / Ударний кутсовий ключ / Ütvecsavarozó sarokkulcs / Cheie de impact unghiulară / Rázový rohový klíč / Uhlavý ráznový klíč / Kotni udarni ključ / Kampinis smūginis veržiasukis / Lenkveida triecienuzgriežņu atsléga / Nurga-löökivöi / Βελος udarni κλuch / Udarni kutni ključ / Ugaoni udarni ključ / Αεροκλειδί κρούσης / Llave de impacto angular / Chiave a percussione angolare / Chiave de impacto angular / Clé à choc angulaire / Hoakse slagmoersleutel



Ref.	☒	EAN
14-019	0/10	5907558469011

## Szlifierka pneumatyczna kąтова

Pneumatic angle grinder / Pressluftwinkelschleifer / Машина шлифовальная угловая пневматическая / Шліфмашина пневматична наріжня / Pneumatikus csiszoló / Maşină pneumatică de şlefuit sub unghi / Pneumatiskå bruska uhlavá / Brúska pneu. uhlavá / Kotni pneumatski brusilnik / Pneumatinis kampinis šlifjuoklis / Pneumatiskå lefju slíprtaşina / Pneumatiline nurklühvimismasin / Βελουσιούφ пневματιčen / Pneumatska kutna brusilica / Pneumatska brusilica / Γωνιακό τριφείο αέρος / Amoladora pneumática angular / Retificatrice pneumatica angolare / Disco de limar p. cantos pneumático / Meuleuse pneumatique d'angle / Pneumatische versteckschuermachine



Ref.	☒	EAN
14-016	1/20	5907558442601

## Szlifierka oscylacyjna pneumatyczna

Pneumatic finishing sander / Vibrationsschleifer pneumatisch / Колемательный пневматический шлифовальный аппарат / Шліфмашина осциляційна пневматична / Pneumatikus vibrációs csiszoló / Polizor oscilatoriu, pneumatic / Oscilator pneumatică bruska / Pneumatiskå vobročno brúska / Pneumatski vibrajski brusilnik / Vibrocinis, pneumatinis šlifjuoklis / Pneumatiskå oscilācijas slíprtaşina / Pneumatiline taldihvija / Oscilatorren pneumaticen şlef / Pneumatska vibrajska brusilica / Pneumatska oscilatorna brusilica / Παλμικό τριφείο αέρος / Lijadora neumática orbital / Levigatrice a delta pneumatica / Disco de limar reto oscilante pneumática / Meuleuse oscillatoire pneumatique / Pneumatische oscillatie schuurmachine



Ref.	☒	EAN
14-014	1/20	5907558442595



Ref.	☒	EAN
14-018	1/10	5907558442618

## Szlifierka pneumatyczna kątowa

Pneumatic angle grinder / Pressluftwinkelschleifer / Машина шлифовальная угловая пневматическая / Шліфмашина пневматична наріжна / Pneumatikus csiszoló / Máquina pneumática de sfileit sub unghi / Pneumatická bruska úhlová / Brúska pneu. uhlová / Kotni pnevmatski brusilnik / Pneumatinis kampinis šlifjuoklis / Pneumatskå leþja slþpmašina / Pneumaatlīne nurklihvīmismasin / Βελουλαίφ пневматичен / Pneumatska kutna brusilica / Pneumatska brusilica / Γωνιακός φραιός αέρος / Amoladora neumática angular / Retificatrice pneumatice angolare / Disco de limar p. cantos pneumático / Meuleuse pneumatique d'angle / Pneumatische versteckschuermachine



Ref.	☒	EAN
14-508	1/10	5907558444858

## Wiertarka pneumatyczna

Pneumatic drill / Bohrtmaschine pneumatisch / Дрель пневматическая / Дрель пневматичний / Pneumatikus fűrés / Máquina de gaurit pneumática / Pneumatická vrtačka / Pneumatskå vrtalica / Pneumatski vrtalnik / Pneumatinis gręþtuvas / Pneumatska urbjmašina / Pneumaatlīne trell / Пневматична пробивна машина / Pneumatska bušilica / Pneumatska bušilica / Δράπανο αέρος / Taladradora neumática / Τραπανο pneumático / Berbequim pneumática / Erçeuse pneumatique / Pneumatische boormachine



Ref.	☒	EAN
14-026	1/10	5907558442632



Ref.	☒	EAN
14-514	1/10	5907558444865

## Szlifierka mimośrodkowa pneumatyczna

Pneumatic orbital sander / Exzenterschleifer pneumatisch / Машина шлифовальная эксцентриковая пневматическая / Шліфмашина ексцентрикова пневматична / Pneumatikus excenterscsiszoló / Polízor excentric, pneumatic / Pneumatická excentrická bruska / Pneumatická excentrická brúska / Pneumatski ekscentrični brusilnik / Pneumatinis, ekscentrinis šlifjuoklis / Pneumatska ekscentriska slþpmašina / Pneumaatlīne ekscentriklþhvija / Пневматичен ексцентършлайф / Pneumatska ekscentarska brusilica / Pneumatska ekscentrična brusilica / Εκκεντρο τριβείο αέρος / Ljadora neumática excéntrica / Levigatrice rotoorbitale pneumatica / Disco de limar para excéntrico pneumático / Meuleuse excentrique pneumatique / Pneumatische excenter schuermachine



Ref.	☒	EAN
14-013	0/10	59075584469028



Ref.	☒	EAN
14-020	1/12	5907558442625



Ref.	☒	EAN
14-510	1/10	5907558446357

## Pneumatyczny młotek igłowy czółowy

Pneumatic butt-face needle hammer / Pneumatischer Front-Nadelhammer / Пневматический игольчатый чашечный молоток / Γαλβανήν πνευματικήν τρυφερόν μολότοκ / Pneumatikus homlok tűkalapács / Ciocan cu ace pneumatic frontal / Čelní pneumatické jehlové kladivo / Čelové pneumatické ihlicové kladivo / Pneumatisko koničasto kladivo / Pneumatis adatinis plaktukas / Pneumatiskais priekšējais adatu āmurs / Pneumaatlīne ots-nēlhammer / Пневматичен челен иелен чук / Pneumatski iglasti čeoní čekić / Čeoní pneumatski iglasti čekić / Μηροσπινή πνευματική σφύρι βελόνας / Martillo neumático de aguja frontal / Martello pneumatico ad aghi / Martelo de agulha frontal pneumática / Marteau pneumatique à aiguilles frontal / Pneumatische naaldhämmer



Ref.	☒	EAN
14-031	0/10	5907558468977



Ref.	☒	EAN
14-032	1/6	5907558468984

## Młotek udarowy pneumatyczny

Pneumatic impact hammer / Schlaghammer pneumatisch / Молоток ударный пневматический / Περφορατορ πνευματικήν / Pneumatikus vésőkalapács / Ciocan cu percuțe pneumatică / Pneumatické rázové kladívko / Pneumatické přikleponé kladívko / Pneumatisko udarno kladivo / Pneumatis atskélimo plaktukas / Pneumatiskais sitamais āmurs / Pneumaatlīne lookvasar / Пневматичен ударен чук / Pneumatski udarni čekić / Udarní pneumatski čekić / Κρουστική σφύρι αέρα / Martillo neumático de impacto / Martello pneumatico / Martelo de impacto pneumático / Martelet à choc pneumatique / Pneumatische slaghammer

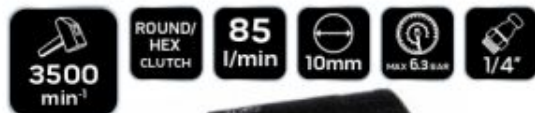

Ref.	☒	EAN
14-028	1/5	5907558442649

## Przecinarka pneumatyczna

Air Cut-Off Tool / Pneumatisches Schneidegerät / Πνευματικός ρεζακ / Пневматичний різальний станок / Pneumatikus vágó / Máquina de cortar pneumática / Pneumatiscká řezačka / Pneumatiscká pila / Pneumatis rezalnik / Pneumatis pjaviklis / Pneumatiskais griezējs / Pneumaatlīne lōikur / Пневматичен фреза / Pneumatski rezaoč / Pneumatska seckalica / Εργαλείο διακοπής αέρα / Cortador neumático / Troncatrice pneumatica / Cortador pneumática / Dispositif de coupe pneumatique / Pneumatische doorslijpmachine



Ref.	☒	EAN
14-017	0/20	5907558468891

## Piła pneumatyczna

Air Body Saw / Luftkörpersäge / Воздушная пила / Пневматична пила для тина / Pneumatikus fűrés / a testhez / Ferőstráru pneumatic pentru caroserie / Pneumatiscká pila / Pneumatiscká pila / Pneumatska žaga / Pneumatis pjičklas / Pneumatskais zāģis / Pneumaatlīne saog / Pneumatska pila / Пневматична метсера / Αεροπίλο / Sierra neumática / Sega pneumática / Serra pneumática / Scie pneumatique / Pneumatische zaag



Ref.	☒	EAN
14-034	0/25	5907558469004

## Dłuta komplet

Chisel set / Beitelset / Набор долот / Зубила на пробивачи / Vésőkészlet / Set dălti / Sada dlát / Súprava dlát / Garnitura dlăt / Kaitu komplekts / Kaitu komplekts / Peitite komplekt / Сетачи и шило / Špica / Sekac / Συλλογή από σμίλες / Juego de formones / Set di scalpelli / Conjunto de Raspadores / Jeu de ciseaux



x5

for 14-028

Ref.	☒	EAN
14-029	4/24	5907558455298

## Sprężyny

Springs / Federn / Пружини / Пружини / Rugó készlet / Arcuri / Pružiny / Pružiny / Vazeti / Sprungokliki rinkiny / Atsperes / Vedrud / Пружини / Opruge / Opruge / Στελατήρια / Espirales / Molle / Molas / Ressorts / Yeren



x2

for 14-028

Ref.	☒	EAN
14-030	4/40	5907558455304

## Zszywacz pneumatyczny

Pneumatic stapler / Pneumatische Heftmaschine / Стелпер пневматический / Стелпер пневматичний / Pneumatikus tűzőgép / Capsator pneumatic / Pneumatiskó sešiváčka / Pneumatiská zošiváčka / Pnevmatiski sprežalj / Pneumatins kablų pistoletas / Pneimatskais skavotājs / Pneumatiline klambripūstol / Пневматичен телбод / Pneumatska klamerica / Pneumatska heftalica / Συρρατμάκι αέρα / Grapadora pneumática / Graffettatrice pneumatica / Máquina de pontear pneumática / Agrafeuse pneumatique / Pneumatische hechtmaschine

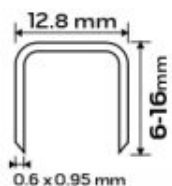

Ref.	☒	EAN
14-572	0/10	590755844889

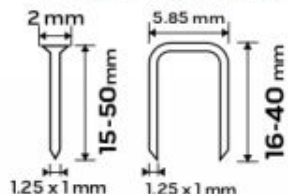

Ref.	☒	EAN
14-570	0/10	5907558444872

## Zszywki

Staples / Klammern / Скобы / Скобу / Τύζοκαρος / Capsator / Sešivací spony / Sponky / Spanke / Kabes / Skavas / Klambri / Терма / Munición za klamericu / Heftalica / Συρρατμάκι / Grapas / Punti metallici / Pontas / Agrafes / Hechters

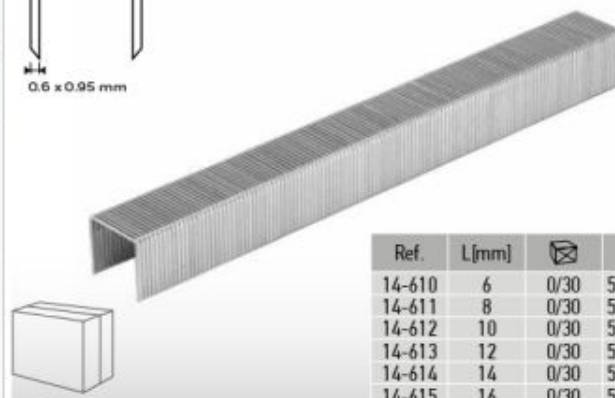

Ref.	L [mm]	☒	EAN
14-610	6	0/30	5907558453720
14-611	8	0/30	5907558453737
14-612	10	0/30	5907558453744
14-613	12	0/30	5907558453751
14-614	14	0/30	5907558453768
14-615	16	0/30	5907558453775

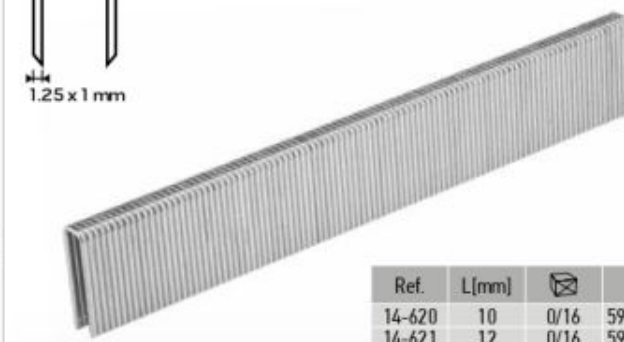

Ref.	L [mm]	☒	EAN
14-620	10	0/16	5907558453782
14-621	12	0/16	5907558453799
14-622	15	0/16	5907558453805
14-623	20	0/12	5907558453812
14-624	22	0/12	5907558453829
14-625	25	0/12	5907558453836
14-626	28	0/12	5907558453843
14-627	30	0/12	5907558453850
14-628	32	0/8	5907558453867
14-629	35	0/8	5907558453874
14-630	38	0/6	5907558453881
14-631	40	0/6	5907558453898



## Gwoździe

Nails / Nägel / Γαοαδι / Црнаи / Тűzőszeg / Cuie / Hřebíky / Klince / Žebly / Virys / Naglas / Noelad / Пупону за мопер / Čavlići za pneumatsku klamericu / Munición za heftalica / Καρπά / Clavos / Chiodi / Pontas / Agrafes / Spijkers

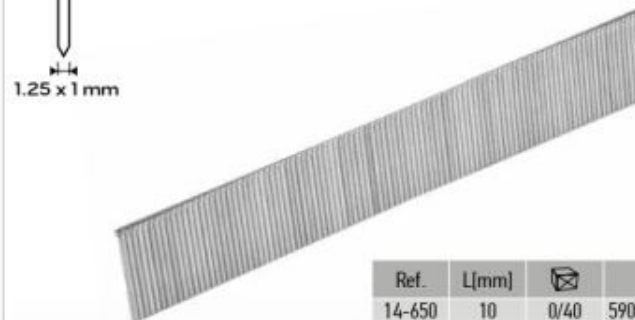

Ref.	L [mm]	☒	EAN
14-650	10	0/40	5907558453904
14-651	15	0/20	5907558453911
14-652	20	0/20	5907558453928
14-653	25	0/20	5907558453935
14-654	30	0/20	5907558453942
14-655	35	0/12	5907558453959
14-656	40	0/12	5907558453966
14-657	45	0/12	5907558453973
14-658	50	0/12	5907558453980



## Nasadka udarowa

Impact socket / Schlagbohrer / Насадка ударная / Патрон перфораторный / Gépi dugókulcs / Brőarő cu percute / Priklepný nástavec / Priklepný nástavec / Udarni nasadni ključ / Antyalis kalímu / Tncienuzgalis / Löökötsak / Ударна наставка / Udarni nasadni nastavak / Udarna karica / Унобошј кривошјкој анталакакој / Llave de vaso para atornilladores de impacto / Bussola esagonale / Bocai de impacto / Douille à choc / Slagboer

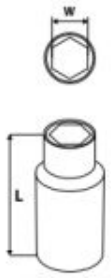

25 years GUARANTEE  
CrMo steel  
1/2"

Ref.	W[mm]	L[mm]	☒	EAN
12-210	10	38	20/200	5907558423808
12-212	12	38	20/200	5907558423822
12-213	13	38	20/200	5907558423839
12-214	14	38	20/200	5907558423846
12-215	15	38	20/200	5907558423853
12-216	16	38	20/200	5907558423860
12-217	17	38	20/200	5907558423877
12-219	19	38	20/200	5907558423884
12-221	21	38	20/200	5907558423891
12-222	22	38	20/200	5907558423907
12-224	24	38	20/200	5907558423914



25 years GUARANTEE  
CrMo steel  
1/2"

Ref.	W[mm]	L[mm]	☒	EAN
12-310	10	78	10/100	5907558423921
12-312	12	78	10/100	5907558423945
12-313	13	78	10/100	5907558423952
12-314	14	78	10/100	5907558423969
12-315	15	78	10/100	5907558423976
12-316	16	78	10/100	5907558423983
12-317	17	78	10/100	5907558423990
12-319	19	78	10/50	5907558424003
12-321	21	78	10/50	5907558424010
12-322	22	78	10/50	5907558424027
12-324	24	78	10/50	5907558424034



1/2" - 10, 12, 13, 14, 16, 17, 19, 21, 22, 24 mm  
CrV steel 1/2" x10



Ref.	☒	EAN
12-101	0/20	5907558414509

1/2" - 10, 11, 12, 13, 14, 16, 17, 19, 21, 22, 24 mm  
CrV steel 1/2" x11



Ref.	☒	EAN
12-102	0/10	5907558414516

1/2" - 10, 12, 13, 14, 15, 17, 19, 21, 22, 24 mm  
CrMo steel 1/2" x10



Ref.	☒	EAN
12-107	0/10	5907558414547

3/4" - 126, 27, 29, 30, 32, 35, 36, 38 mm  
CrMo steel 3/4" x8



Ref.	☒	EAN
12-115	0/6	5907558414523

1" - 27, 30, 32, 35, 36, 38, 41, 42, 50 mm  
CrMo steel 1" x9



Ref.	☒	EAN
12-105	0/2	5907558414530

E10, E11, E12, E14, E16, E18, E20, E22, E24  
CrMo steel 1/2" x9



Ref.	☒	EAN
12-110	0/20	5907558414554

CrMo steel 1/2"



Ref.	☒	☒	EAN
10-258	T30	1/10	5907558469660
10-259	T40	1/10	5907558469677
10-260	T45	1/10	5907558469684
10-261	T50	1/10	5907558469691
10-262	T55	1/10	5907558469707
10-263	T60	1/10	5907558469714
10-264	T70	1/10	5907558469721
10-265	T80	1/10	5907558469738

## Klucze udarowe torx

Impact Torx bit socket set / Torx-Schlagschrauber-Satz / Набор ударных торцевых ключей Torx / Набор ключей ударных «Torx» / Torx gépi kulcsok / Chei cu impact torx / Nástrčné kľúče torx / Rázové kľúče torx / Udamni nasadni kľuč Torx / Smäginiai raktai „TORX“ / Triecienatslēgas torx / Torx-löökivõtmed / Ударни ключове torx / ударни kľučevni torx / Udamni kľučevni torx / Set kroustná mločková kľučba Torx / Claves de impacto torx / Inseti Torx / Jogo de chaves de percussão torx / Clés à choc torx / Torx slagsleutels

★ T25, T27, T30, T40, T45, T50, T55, T60



Ref.	Info	EAN
08-712	0/20	5907558418620

★ T30, T40, T45, T50, T55, T60, T70, T80



Ref.	Info	EAN
10-257	1/10	5907558469653

## Przedłużka udarowa

Impact extension / Wirkungsverlängerung / Ударный удлинитель / Ударний Подовжувач / Toldósár / Prolongator / Prodlužovák / Predĺženie / Podaljšek / Пролікис / Pagarinātājs / Pkendus / Удължител / Produženi roluga / Produzerna roluga / Пролікис / Alargadera / Prolunga / Extensão / Prolongation / Verlengstuk



Ref.	L[mm]	Info	EAN
10-250	50	1/10	5907558469585
10-251	75	1/20	5907558469592
10-252	125	1/10	5907558469608

## Przegub udarowy

Impact joint / Schlaggelenk / Ударный шарнир / Ударний шарнір / Csukló / Articulație de impact / Nárazový kloub / Nárazový čap / Udamni zglob / Lančtas / Samirs / Klamber / Шарнир / Zglob / Zglob / Μετασός / Articulación / Snodo / Articulação / Articulation / Spilverbinding



Ref.	Info	Info	EAN
10-253	1/4"	1/20	5907558469615
10-254	3/8"	1/20	5907558469622
10-255	1/2"	1/10	5907558469639

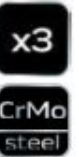

Ref.	Info	EAN
10-256	1/10	5907558469646

## Zestaw do uzdatniania powietrza

Air treatment kit / Luftaufbereitungsset / Набор для очистки воздуха / Комплект до підготовки повітря / Levegőtisztító egység / Garnitură de innoalirea aerului / Sada pro úpravu vzduchu / Súprava na upravenie vzduchu / Komplet za obdelavo zraka / Suslęgto oro apdorojimo įrenginys / Gaisa atīrīšanas komplekts / Ūhupuhastuskomplekt / Комплект за подготвяна на въздуха / Set za pripremu zraka / Pribor za tretiranje vazduh / Set καθαρισμού αέρα / Dispositivo de procesamiento del aire / Filtro, riduttore, lubrificatore / Kit para purificar ar / Jeu pour traitement d'air / Set van mondstukken voor zandblazen



Ref.	Info	EAN
14-734	1/25	5907558452235

## Filtr odwadniacz

Draining filter / Entwässerungsfilter / Φωνιμπ / Φωνιμπ αναρρομη / Víztelenítő szűrő, fémházas / Filtru-dezodorizant / Odvodňovací filtr / Odvodňovací filter / Odvodni filter / Filtras-džiointuvos / Atüdepošanas filtrs / Veefilter / Φωνιμπ za otaodnhovanie / Filter za upijanje vode / Odvodni filter / Φάιλο-διαχωριστής / Filtro de drenaje / Filtro di drenaggio / Filtro / Filtre purgeur / Filter drainage



Ref.	⊠	EAN
14-732	1/50	5907558452228

1/2"

0-9 bar



Ref.	⊠	EAN
14-730	1/25	5907558452211

1/2"

0-9 bar



Ref.	⊠	EAN
14-550	1/125	5907558444896

1/4"



## Zestaw nasadek

Socket set / Aufsatzset / Набор головок торцевых / Набор насадок торцевых / Dugókulcs készlet alufelnihez, vékonyfalú / Set duze / Sada nasadek / Súprowa nástr. ključev / Garnitura nasadnih ključev / Antgalių rinkinys / Mucaru komplekts / Padrunikoplekt / Гедорэ номн / Šester okuine kapice / Gedora set / Συλλογή καρδισκιών / Llaves de vaso / Set di boccole / Kit de bicos / Jeu de douilles / Set van doppen

1/2" - 17, 19, 21 mm



Ref.	⊠	EAN
12-350	0/20	5907558435849

CrMo steel



1/2"

## Przewód ciśnieniowy spiralny

High pressure spiral hose / Spiraldruckleitung / Шланг сжатого воздуха спиральный / Шланг високого тиску / Pneumatikus spiráltömlő / Furtun spiral presiune înaltă / Plakové potrubí spirálové / Vysokotlaká spirálová hadica / Visokotlačna spiralna gibka cev / Spiralinė aukšto slėgio žarna / Spirálveida gaisa caurulvods / Kõrgsurvevoolik (spiraal) / Μαρκυλ za нонпесар / Spiralna crijevo najlonsko / Crevo za visoki pritisak / Σπιροειδής ρύλιος υψηλής πίεσης / Tubo de presión / Tubo a spirale in nylon / Cabo de tensão espiral / Dunite de pression hélicoïdale / Spiraal drukleiding

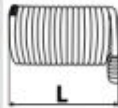

Pu

16 bar max

+35°C  
-10°C

Ref.	L [m]	⊘ [mm]	⊙* [mm]	⊠	EAN
12-070-1	5	6,5	10,0	1/20	5907558474787
12-071-1	10	6,5	10,0	1/10	5907558474794
12-072-1	15	6,5	10,0	1/6	5907558474800
12-074-1	5	8,0	12,0	1/20	5907558474817
12-075-1	10	8,0	12,0	1/10	5907558474824
12-076-1	15	8,0	12,0	1/6	5907558474831

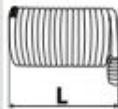

15 m

Pu

16 bar max

Ref.	L [m]	⊘ [mm]	⊙* [mm]	⊠	EAN
14-800-1	15	10,0	15,0	1/6	5907558474848
14-802-1	15	12,0	17,0	1/6	5907558474855



PE

8mm

5mm

16 bar max

Ref.	L [m]	⊘ [mm]	⊙* [mm]	⊠	EAN
14-808-1	5	5,0	8,0	1/20	5907558474886
14-804-1	10	5,0	8,0	1/10	5907558474862
14-806-1	15	5,0	8,0	1/6	5907558474879



## Przewód ciśnieniowy zbrojony

High pressure reinforced hose / Druckleitung verstärkt / Шланг высокого давления армированный / Шланг високого тиску, армований / Pneumatikus tömlő / Furtun armat presiune înaltă / Plakové potrubí vyztužené / Vysokotlaká hadica / Visokotlačna gibka cev / Sustiprinta aukšto slėgio žarna / Augstspiediena gaisa caurulvods / Tugevdatud kõrgsurvevoolik / Μαρκυλ za вис. напесар / crijevo za visoki pritisak / Crevo za visoki pritisak / Ενισχυμένος ρύλιος υψηλής πίεσης / Tubo de presión reforzado / Tubo a pressione rinforzato / Cabo de tensão armado / Dunite de pression armée



PVC

+40°C  
-10°C

Ref.	L [m]	⊘ [mm]	⊙* [mm]	P <sub>max</sub> [bar]	⊠	EAN
12-079	50	8,0	13,0	19	0/1	5907558414936
12-080	50	10,0	15,0	17	0/1	5907558414943
12-081	50	12,0	17,0	13	0/1	5907558414950



## Zwijadło pneumatyczne

Pneumatic reel / Pneumatische Rolle / Пневматическая катушка / Пневматична катушка / Pneumatikus orsó / Bobina pneumática / Pneumatický naviják / Pneumatický navijak / Pnevmatiski kolut / Pneumatine rite / Pneumatiskå spole / Pneumaattiline rull / Пневматична макура / Pneumatiski kolut / Пневматична катушка / Pneumatikó karóú / Carrete pneumática / Bobina pneumática / Carretilha pneumática / Enrouleur pneumatique / Pneumatische haspel



15m

9.5mm

1/4"

20 BAR

hybrid material PVC + RUBBER

Ref. 10-700  
1/1  
EAN 5907558497359



15m

9.5mm

METAL BODY

20 BAR

hybrid material PVC + RUBBER

HEAVY DUTY

1/4"

Ref. 10-701  
1/1  
EAN 5907558497366

## Szybkozłączka

Quick coupler / Schnellkupplungen / Быстрозменная муфта / Муфта швидкозарядна / Pneumatikus gyorscsatlakozó / Conector rapid / Rychlospojka / Rýchlospojka / Hitro spojka / Greitaji jungtis / Ātrsavienotājs / Kārtāhendus / Бърза връзка / Spojnica / Brzo odvajanje / Συζευκτήρας ταχείας απελευθέρωσης / Acoplador rápido / Connettore rapido con presa per tubo / União rápida / Rapport rapide / Snelkoppeling



0-16 BAR

CE

Ref.	⌀ [mm]	⌀ [mm]	⊠	EAN
12-600	4	6	0/36	5907558417685
12-601	6	8	0/27	5907558417692
12-602	8	10	0/27	5907558417708



0-16 BAR

CE

Ref.	⌀ [mm]	⊠	EAN
12-620	7	0/36	5907558417814
12-621	8	0/36	5907558417821
12-622	10	0/36	5907558417838
12-623	12	0/36	5907558417845



0-16 BAR

CE

Ref.	⌀ [mm]	⊠	EAN
12-630	7	0/36	5907558417890
12-631	8	0/36	5907558417906
12-632	10	0/36	5907558417913



0-16 BAR

CE

Ref.	⊠ ["]	⊠	EAN
12-635	1/4	0/36	5907558417920
12-636	3/8	0/36	5907558417937
12-637	1/2	0/36	5907558417944



0-16 BAR

CE

Ref.	⊠ ["]	⊠	EAN
12-645	1/4	0/36	5907558417975
12-646	3/8	0/36	5907558417982



0-16 BAR

CE

Ref.	⊠ ["]	⊠	EAN
12-650	1/4	0/36	5907558417999
12-651	3/8	0/36	5907558418002

## Złącze do węży

Hose connection / Schlauchverbinder / Соединители для шланга / Арматура до шлангу / Pneumatikus tömlőtoldó / Imbinare de furtun / Spojka pro hadici / Spoj na hadicu / Konektor za cev / Jungtis žarna / Šļūtenes savienotāji / Voalüühendused / Соединение за шланга / Spojna za cijev / Spoj za crevo / Συνδεσμοί εύκαμπτου σωλήνα / Junta para mangueira / Connettore per tubo / União p. Mangueira / Raccord pour flexible / Verbindingsstuk voor slang



0-16 BAR

CE

Ref.	⌀ [mm]	⊠	EAN
12-610	6	0/36	5907558417739
12-611	8	0/36	5907558417746
12-612	10	0/36	5907558417753
12-613	12	0/36	5907558417760



0-16 BAR

CE

Ref.	⌀ [mm]	⊠ ["]	⊠	EAN
12-615	6	1/4	0/36	5907558417777
12-616	10	1/4	0/36	5907558417784
12-617	10	1/2	0/36	5907558417791
12-618	12	1/2	0/36	5907558417807

## Końcówka do szybkozłączeni

Quick coupler tip / Endstück für Schnellkupplung / Наконечник быстрого соединения / Насадка для швидко роз'язної муфти / Pneumatikus csatlakozó külsőmenet-gyorsvég / Piesă de conectare rapidă / Κοινωνία για γυχλοσροίη / Nästavec gychlosroja / Nastavek za hitro spojko / Greitaięigs jungties antęalis / Atrsavenojuma uzęalis / Kiriühendusotsak / Накрайник за бърза връзка / nastavak za spojnicu / Kraj za brzo priključivanje / Κεφαλή ταχείας σύνδεσης / Voquilla para acoplador rápido / Connettole rapido con presa per tubo / Poteiro do uniões rápidas / Embout pour raccord rapide / Eindstuk voor snelkoppeling



Ref.	∅ [mm]	∅ [mm]	∅	EAN
12-605	6	8	0/27	5907558417715
12-606	8	10	0/36	5907558417722



Ref.	∅ [mm]	∅	EAN
12-625	7	0/36	5907558417852
12-626	8	0/36	5907558417869
12-627	10	0/36	5907558417876
12-628	12	0/36	5907558417883



Ref.	∅ ["]	∅	EAN
12-640	1/4	0/30	5907558417951
12-641	3/8	0/36	5907558417968



Ref.	∅ ["]	∅	EAN
12-655	1/4	0/36	5907558418019
12-656	3/8	0/36	5907558418026

## Naolejacz

Oiler / Ölgerät / Смазочатель / Оливоразпылвач / Olajozó pneumatikus / Gresor de ulei / Mazací jednotka / Olejovnač / Lubrikator / Терпаліне / Ieșterțias / Öltussende / Смазоч / Naoljivač / Podmazivač / Ψεκαστήρας λαδιού / Lubrificador / Oliatore per utensili pneumatici / Máquina oleadora / Huileur / Smeertestel



Ref.	∅	EAN
14-552	1/200	5907558444902

## Kompresor

Compressor / Kompresor / Компрессор / Kompresor / Kompreszor / Compresor / Kompresor / Kompresor / Kompresor / Kompresorius / Kompresors / Kompresor / Kompresor / Kompresor / Συμπιεστής / Compresor / Compresore / Compresor / Compresseur / Compresor



500W



95 L/min

79dB QUIET OPERATION

Ref.	∅	EAN
12K020	0/1	5907558453676



800W



125 L/min

79dB QUIET OPERATION

Ref.	∅	EAN
12K021	0/1	5907558453683



1150W



180 L/min

79dB QUIET OPERATION



Ref.	∅	EAN
12K022	0/1	5907558453690

## Kompresor olejowy

Compressor - lubricated / Ölkompressor / Компрессор масляный / Компрессор оліїний / Kompressor / Compressor cu ulei / Olejový kompresor / Kompresor / Oljní kompresor / Terälinis kompressorius / Eļļas kompresors / Kompresor (mäntitud) / Компресор / Kompresor / Kompresor / Συμπιεστής υδροαερίματος / Compressor de aceite / Compressore ad olio / Compressor de óleo / Compresseur à huile / Ölje kompressor



100L

1500W

230V ~  
50Hz

280  
L/min

MAX 10 BAR



Ref.	☒	EAN
12K030	0/1	5907558453706



150L

2200W

230V ~  
50Hz

330  
L/min

MAX 10 BAR



Ref.	☒	EAN
12K031	0/1	5907558453713



24L

900W

230V ~  
50Hz

MAX 8 BAR

135  
L/min



Ref.	☒	EAN
12K023	0/1	5907558477313



50L

1050W

230V ~  
50Hz

MAX 8 BAR

169  
L/min



Ref.	☒	EAN
12K024	0/1	5907558477320



40L

1500W

230V ~  
50Hz

MAX  
n<sub>c</sub>=2850

184  
L/min

OFF  
8BAR

MAX  
8BAR

Ta  
+50°C



Ref.	☒	EAN
12K010	0/1	5907558439373



## Pistolet natryskowy

Spray gun / Sprühpistole / Пистолет-распылитель / Фарбопистол / Festékszóró pisztoly / Pistol de duș / Sífkáci pistole / Striekaacia pištoľ / Brizgalna pištola / Purškimo pistoletas / Pistole-smidzinātājs / Pihustuspüstol / Пистолет - распылитель / Pištoľ za prskanje / Pištoľ za prskanje / Πιστόλι ψεκασμού / Pistola de aspersiön / Pistola a spruzzo / Pistola de boriñar / Pistolet à projection / Spuitpistool



## Zestaw lakierniczy

Lacquer set / Lackieret / Набор для лакирования / Комплект до лакофарбувальних робіт / Kompreszor tartozékészlet / Garnitură de lăcuire / Lakovací sada / Súprava na lakovanie / Komplet za lakiranje / Pribor za lakiranje / Set lăcuiri / Juego de herramientas para barnizado / Pistola a spruzzo in kit / Kit p. Verniz / Jeu d'outils de peinture / Lakset



## Pistolet do konserwacji

Maintenance gun / Wartungspistole / Антикоррозийный пистолет со шлангом / Фарбогун / Alküzvédő szórópisztoly tömlővel / Pistol de conservare / Pistole pro údržbu / Konzervačná pištoľ / Pištoľ za nanašanje zaščite / Oro išsiurbimo pistoletas / Konservācijas pistole / Hoolduspistool / Пистолет за конзервација / Pištoľ za održavanje / Pištoľ za konzerviranje / Πιστόλι ψεκασμού για συντήρηση / Pistola de conservación / Pistola per rivestimenti / Pistola p. Conservação / Pistolet d'entretien / Onderhoudspistool



ALU BODY



Ref.	☒	EAN
14-720	1/20	5907558452181

## Pistolet do mycia

Washing gun / Reinigungspistole / Пистолет-распылитель для мытья / Pistolet для мытья / Alküzvédő szórópisztoly / Pistol de spălat / Pistole na myti / Čistiaca pištoľ / Pištoľ za pranje / Plovimo pistoletas / Mazgāšanas pistole / Pesemispistool / Пистолет за миене / Pištoľ za pranje / Pištoľ za pranje / Πιστόλι πλύσης / Pistola de limpiar / Pistola per pulizia / Pistola p. Limpeza / Pistolet de lavage / Waspistool



215 mm 1L 2.5-4 BAR CE



Ref.	☒	EAN
14-706	1/20	5907558452112

## Pistolet do piaskowania

Sandblasting gun / Pistole zum Sandstrahlen / Пескоструйный пистолет с бачком / Пистолет до піскоструменевої обробки / Homokfúvó pisztoly tartályal / Pistol de sablare / Pískovací pistole / Pískovacia pištoľ / Pištoľ za peskanje / Smėliavimo pistoletas / Smilšstrūklošanas pistole / Livapriets / Пистолет за масно / Pištoľ za pješkarjenje / Pištoľ za peskarenje / Πιστόλι αμμοβολής / Pistolas de decapado por arena / Pistola per sabbatura / Pistola p. Areia / Pistolet à sablage / Zandblaaspistool



ALU BODY

1L



Ref.	☒	EAN
14-724	1/10	5907558452204



MAX 8 BAR 0.5-6.8 l/min UMIN 125



Ref.	☒	EAN
14-722	0/40	5907558452198

## Pistolet do pompowania

Inflating gun / Pumpenpistole / Пистолет для подкачки шин / Пистолет до помпвання / Kerékfúvató pisztoly nyomásmérővel / Pistol de pompare / Umflare / Plnicí pistole / Pumpovací pištoľ / Pištoľ za črpanje / Siurbimo pistoletas / Sūkņššanas pistole / Pistolpump / Пистолет за узкопване / Pištoľ za puhanje / Pištoľ za puhanje / Πιστόλι φουσκώματος ελαστικών / Pistola para inflar / Gorfiatore per pneumatici / Pistola p. Bomba / Pistolet de pompage / Pomppistool



ALU BODY

370mm

max 12 BAR

63mm



Ref.	☒	EAN
14-714	1/40	5907558452150



ALU BODY

300mm

max 12 BAR



Ref.	☒	EAN
14-716	1/20	5907558452167

## Pistolet do przedmuchiwania

Blowing gun / Pistole zum Durchblasen / Пистолет для продувания / Пистолет до продування / Pneumatikus lefúvatópisztoly / Pistol de baleioj / Pistole pro profukování / Prefukovací pištol / Izpihovna pištola / Prapūtimo pistoletas / Saurpūšanas pistole / Lābīlputuspūstol / Пистолет за продување / Pištolj za ispuhivanje / Pištolj za produmavanje / Πιστόλι αέρα / Pistola de împiezia a chorro de aire / Pistola aria compressa / Pistola para soprar / Pistolet de soufflage / Aflaaspistool



Ref.	📦	EAN
14-036	10/20	5907558469035

## Pistolet do pompowania

Inflating gun / Pumpenpistole / Пистолет для подкачки шин / Пистолет до помпвання / Kerékfúvató pištoly nyomásmérővel / Pistol de pompare / umflare / Plinici pistole / Pumptovacia pištol / Pištola za črpanje / Siurbimo pistoletas / Sūkņēšanas pistole / Pustolpump / Пистолет за изпомпване / Pištolj za pumpanje / Pištolj za pumpanje / Πιστόλι φουσκώματος ελαστικών / Pistola para inflar / Gonfiatore per pneumatici / Pistola p. Bomba / Pistolet de pompage / Pomppistol



Ref.	📦	EAN
14-718	0/20	5907558452174

## Wężyk do pompowania

Hose for inflating gun / Schlauch zum Pumpen / Шланг к пистолету / Шланг до пистолету / Kerékfúvató támló / Furtun pentru pistol de pompare / Hadička na rutrování / Hadička na rutrovanie / Cev za črpanje / Žarnete pumpavimui / Saurulite sūkņēšanai / Pumtvadovik / Маржуч за напмпване / Сгјево за pumpanje / Crevo za pumpanje / Εύκαμπτος αερίνης πιστολάκι / Manguera para bombeoar / Tubo di gonfiaggio / Manguera p. bombas / Flexible de pompage / Pompslang



Ref.	L [mm]	📦	EAN
14-820	400	0/100	5907558452280



Ref.	L [mm]	📦	EAN
14-708	-	1/100	5907558452129
14-710	83	1/100	5907558452136
14-712	220	1/40	5907558452143

## Ostrza 24T i 32T

24T and 32T blades / 24Z und 32Z Klingen / Οτσάνες 24T u 32T / Леза 24T i 32T / 24T és 32T pengék / Lame de 24T și 32T / Čepele 24T a 32T / Čepele 24T a 32T / 24T in 32T rezilo / 24T ir 32T peiliukai / 24T un 32T asmeņi / 24T ja 32T labad / 24T u 32T oštruetna / 24T i 32T oštrice / Оштрице од 24T u 32T / Λεπίδες 24T και 32T / 24T ja 32T labad / Lame 24T e 32T / Lâminas 24T e 32T / Lames 24T et 32T / 24T en 32T messen

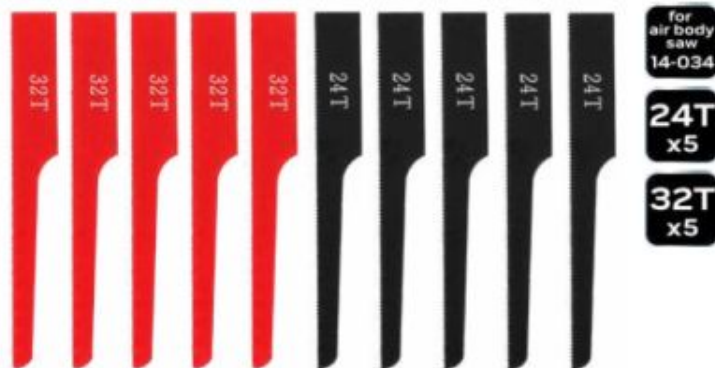

Ref.	📦	EAN
14-034-401	20/200	5907558495898

## Tarcza tnąca

Cutting disc / Trennscheibe / Отрезной диск / Відрізний диск / Vágókorong / Disc de tăiere / Rezací kotouč / Rezací kotouč / Rezalni disk / Рјонито diskas / Gnešanas disks / Lūkēketas / Режущий диск / Disk za rezanje / Диск за сеčenje / Δίσκος κοπής / Disco cortante / Disco da taglio / Disco de corte / Soe circulair / Doorslijpschijf



Ref.	📦	EAN
14-017-400	20/200	5907558495881



## **NARZĘDZIA I AKCESORIA MOTOCYKLOWE**

motorcycle  
tools and accessories

Інструменти та аксесуари  
для мотоциклів

## Pokrowiec oddychający na motocykl / skuter

Breathable motorcycle/scooter cover / Atmungsaktive Motorrad-/Rollerabdeckung / Дышащий чехол для мотоцикла/скутера / Дыхающий чехол для мотоцикла/скутера / Lélegző motorkerékpár/robogó huzat / Acoperire respirabilă pentru motocicletă/scooter / Prodyšný obal na motocykl/skútr / Priedušný obal na motocykel/skúter / Dihajoča prevleka za motorno kolo/skuter / Kvėpuojantis motociklo / motorolerio dangtis / Ερποός μοτοσικλά/σκύτερα πάρσεγς / Дышащэ пакрыццэ за мотоциклет/скаутер / Ανανεώσιμο κάλυμμα μοτοσικλέας/μυριανής / Copri moto/scooter traspirante / Cobertura respirável de motocicleta/scooter / Funda transpirable para moto/scooter / Housse de moto/scooter respirante / Ademende motorfiets-/scooterhoes

220x  
105x  
130 cm

waterproof  
breathable

black  
flat fabric



Ref.	☒	EAN
10-472	0/1	5907558471090

## Pokrowiec na motocykl / skuter

Motorcycle / scooter cover / Motorrad-/Rollerabdeckung / Чехол для мотоцикла/скутера / Чехол для мотоцикла/скутера / Motorkerékpár/robogó védőhuzat / Husó pentru motocicletă/scooter / Potah na motorku/skútr / Poťah na motorku/skúter / Prevleka za motorno kolo/skuter / Motociklo / motorolerio dangtis / Motocikla/skútera pãrsegs / Pokryvasso za motociklet/skúter / Κάλυμμα μοτοσικλέας/σκύτερ / Copertura per moto/scooter / Funda para moto/scooter / Housse de moto/scooter / Cobertura de motocicleta/scooter / Motorfiets-/scooterhoes

246  
x104  
x127cm

190 T  
polyester  
taffeta

waterproof  
resistant  
to UV 150°



Ref.	☒	EAN
10-473	0/1	5907558471106

## Kuweta na narzędzia, silikonowa

Silicone screw cell small / Werkzeugablage, Silikon / Лоток для инструментов, силиконовый / Лоток для инструментов, силиконовый / Szerszámátalca, szilikon / Tavó pentru scule, silicon / Zásobník na nářadí, silikonový / Zásobník na nářadí, silikonový / Pladenj za orodje, silikon / Įrankių dėklas, silikoninis / Instrumentu paliktis, silikona / Таза за инструменти, силикон / Δίσκος εργαλείων, σιλικόνη / Vaschetta per attrezzi, silicone / Bandeja de herramientas, silicona / Plateau à outils, en silicone / Bandeja de ferramentas, silicone / Gereedschapsbakje, silicone /

MADE OF  
STRONG  
TPR  
SILICONE



Ref.	Info [mm]	☒	EAN
10-480	275 x 145 x 25	1/20	5907558471137
10-481	257 x 232 x 25	1/20	5907558471144
10-482	540 x 290 x 35	1/10	5907558471151

## Mata środowiskowa

Environmental mat / Umweltmatte / экологический коврик / экологичний мат / Környezetvédelmi szőnyeg / Covoras de mediu / Environmentální podložka / Environmentálno podložka / Okoljska podloga / Arlinkos kilimėlis / Vides paklājījš / Keskkonna matt / Экологична мат / Ekološki mat / Екологична простирка / περιβαλλοντικό χαλίκι / Aijfombra ambiental / Tappetino ambientale / Tapete ambiental / Tapis environmental / Milieumat

100x  
200CM

POLYESTER  
PVC

5.5kg



Ref.	☒	EAN
10-600	0/4	5907558499865





## Zestaw narzędzi

Tool and socket set / Werkzeugsatz / Набор инструментов / Инструмент з насадками, набор / Szerszámkészlet / Set scule de grădini / Sada nářadí / Súprava nářadia kombi / Gamitura arroj / Įrankių komplektas / Instrumentu komplekts / Тööriistade ja padrante komplekt / Комбинет инструменти / Set alata / Gedor a set / Συλλογή εργαλείων / Juego de herramientas / Set di attrezzi / Kit de ferramentas / Jeu d'outils / Gereedschapsset

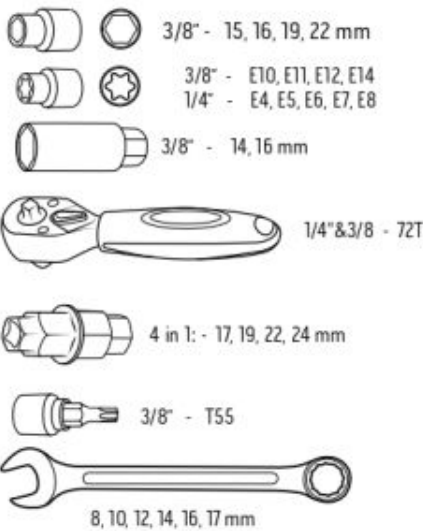

CrV  
steel  
x25  
1/4"  
3/8"

Ref.	📦	EAN
10-500	1/10	5907558466317

## Narzędzie do osi motocyklowych

Motorcycle axle tool / Werkzeug für Motorrad-Achsen / Инструмент для оси мотоцикла / Инструмент для осей мотоцикла / Szerszám motorkerékpár tengelyekhez / Cheie hexagonală ax roata motocicletă / Připravek na osy motocyklů / Nářadí na motocyklové osi / Oradje za osi motocyklov / Motociklo ašijirankis / Motocikla ass riki tris vienā / Mootorratta-teljetoönistad / Инструмент за мотоциклетни оси / Alat za osavine motocykla / Alat za osavine motocykla / Herramienta de eje de motocicleta / Utensile per assi delle moto / Ferramenta para eixos de motocicleta / Outil pour axe de moteur / As Inbus Zeskant voor motorfietsen

6in1



CrV steel	12mm FOR: KTM FRONT AXIS	19mm FOR: YAMAHA
	17mm FOR: BENELLI	22mm FOR: KAWASAKI
	14mm FOR: YAMAHA XT600Z KAWASAKI ZR-4R VERSYS XT600Z	24mm FOR: BMW HONDA SUZUKI

Ref.	📦	EAN
10-501	1/72	5907558466324

4in1



CrV steel	17mm	19mm
	22mm	24mm

Ref.	📦	EAN
10-502	1/72	5907558466331

3in1



carbon steel	19mm
	22mm
	24mm

Ref.	📦	EAN
10-503	1/72	5907558466348

## Wskaźnik zegarowy GMP

GMP dial indicator / GMP-Uhranzeige / Индикатор часов GMP / Годи́ннический индикатор GMP / GMP órás indikátor / Indicator cadran GMP / Účtylkoměr pro nastavení předstihu / Hodinový ukazovateľ GMP / Merka na ura GMP / Laikrodinis viršūnio mirties taško indikatorius / GMP pulksteņa indikators / GMP-numbrināidīk / GMP часоуенное индикатор / Satni indikator GMP / Satni indikator GMP / Indicador de dial GMP / Comparatore GMP / Relógio comparador GMP / Indicateur à cadran GMP / GMP wijzerplaat indicator

CrV  
steel



Ref.	📦	EAN
10-504	1/10	5907558466355



## Zestaw narzędzi do zakuwania i rozkuwania łańcucha

Chain crimping and uncrimping set / Set zum Crimpen und Entcrimpen von Ketten / Набор для обжима и разжима цепи / Набор для обжиму та розжиму ланцюга / Láncfűző és -bontó készlet / Set de sertare și degajare a lanțului / Sada na krimpování a rozplétání řetězů / Súprava na krimpovanie a odkrútkovanie reťaze / Komplet za stiskanje in odpenjanje verige / Grandinių užspaudimo ir atspaudimo rinkinys / Kėdes presėšanos un atpresėšanos kompleks / Tööriistade komplekt keti kokkupressimiseks ja katkestamiseks / Комплект накривача та розкривача ланцюга / Set alata za presovanje i lomljenje lanca / Set alata za presovanje u lomljenje lanca / Set presapaprotos kai ξερπέας αλυσίδας / Juego de engarzado y desengarzado de cadenas / Set di crimpaggio e disincastro per catene / Conjunto de engaste e desengastamento de correntes / Kit de sertissage et de dessertissage de chaîne / Kettingkrimp- en ontkrimpset



INCLUDES PINS SIZES:  
3, 4, 5 mm

FOR CHAIN SIZES:  
520, 525  
530, 532

Ref.	📦	EAN
10-505	1/10	5907558466362

## Zestaw narzędzi do cylinderków hamulcowych

Tool set for brake cylinders / Werkzeugsatz für Bremszylinder / Набор инструментов для тормозных цилиндров / Набор інструментів для гальмівних циліндрів / Szerszámkészlet fékhengerekhez / Set de unelte pentru cilindri de frână / Sada nářadí na brzdové válce / Súprava nástrojov na brzdové valce / Komplet orodja za zavome cilindre / Stabdžių cilindų įrankių rinkinys / Instrumentu komplekts bremžu cilindriem / Tööriistakomplekt pidurisilindrite jaoks / Комплект інструментів за спирачки циліндрів / Set alata za kočione cilindre / Комплект алати за kočione циліндре / Juego de herramientas para cilindros de freno / Set di attrezzi per cilindri dei freni / Conjunto de ferramentas para cilindros de travão / Jeu d'outils pour cylindres de frein / Gereedschapset voor remcilindersicator



12 adapters

Ø 19-30 mm

Ref.	📦	EAN
10-506	1/5	5907558466379

## Narzędzie do rozkuwania łańcucha

Motorcycle chain cutter / Motorrad-Kettenschneider / Мотоциклетна щипка / Розривач ланцюга мотоцикла / Motorkerékár láncvágó / Машина де тїат ланџи де мотоцикле / Motocyklový řetěz řezáč / Refazový rezač na motocykel / Rezalnik verige motomega kolesa / Motociklo grandinės pjoviklis / Motoaikla ķēdes griezējs / Mootorratta kettiliikur / Резец за мотоциклетна верига / Rezač lanca motocikla / Rezač lanca motocykla / Κοπήρας αλυσίδας μοτοαυτοκλήτος / Cortacadenas para motos / Tagliacatena per moto / Corrente de motocicleta cutter / Coupe-chaîne de moto / Kettingnijder voor motorfietsen



FOR CHAIN SIZES:  
415, 420  
423, 428

Ref.	📦	EAN
10-510	1/50	5907558466416



FOR CHAIN SIZES:  
520, 525  
530, 532

Ref.	📦	EAN
10-511	1/30	5907558466423

## Nylonowa szczotka do czyszczenia łańcucha

Chain cleaning nylon brush / Nylon-Bürste für die Reinigung der Kette / Нейлоновая щетка для очистки цепи / Нейлонова щетка для чищення ланцюга / Nylon lánc tisztító kefe / Perie de nylon de curățat lanțuri / Nylonový kartáč na čistení řetězů / Nylonová kefa na čistenie reťaze / Najlonska krtača za čiščenje verige / Nailoninis grandinės valdymo šepetys / Neilona birste ķēdes tīrīšanai / Nailonist ketipuhastushari / Нейлонова четка за почистване на верига / Najlonska četka za čiščenje lanca / Najlonska četka za čiščenje lanca / Βούρτσια καθαρισμού αλυσίδας από νάilon / Cerpillo de nylon para limpiar cadenas / Spazzola in nylon per la pulizia di catene / Escova de nylon para limpeza de correntes / Brosse pour chaîne en nylon / Nylonborstel voor het reinigen van kettingen



Ref.	📦	EAN
10-509	1/100	5907558466409

## Szczypce do wyciągania tłoczków hamulcowych

Brake piston retractors / Zange für das Herausnehmen der Bremskolben / Съемник для тормозных цилиндров / Плоскозубци для зняття гальмівних поршнів / Fékdugattyúk kihúzására szolgáló fogó / Clește pentru extragerea pistoanelor de frână / Kleště na vytažení brzdových pístů / Klešte na vyťahovanie brzdových pístov / Klešče za odstranjevanje zavornih batnic / Stabdžių stūmoklių traukimo žnyplės / Knaibles bremžu virzļu noņemšanai / Pidunkolbide eemaldamise tangid / Клеци за изваждане на спирачки бутана / Klešta za skidanja klipova kočnica / Klešta za skidanje klipova kočnica / Πένσα ανόψματος εμβόλων φρένων / Pinze per l'estrazione dei pistoncini dei freni / Alicata de remoção do pistão do travão / Pinçaux pour retirer les pistons de freins / Remzuiger-demontagetang



CrV steel

16.5mm ~38mm

Ref.	📦	EAN
10-507	1/20	5907558466386

## Zestaw kluczy do szprych motocyklowych

Motorcycle spoke wrench set / Motorrad-Speichenschlüsselsatz / Набор гаечных ключей для мотоциклетных спиц / Набор гаечных ключей для мотоцикла / Motorkerékpár kulökökcskészlet / Set de chei pentru gaze de motocicletă / Sada ključů na motocyklové paprsky / Sada ključů na špiče motocyklov / Garnitura ključev za kolesa z paprati za motorna kolesa / Motociklo veržiarakčij rinkinys / Motociklu spieķu atslēgu komplekts / Mootorratta mutrivõtmete komplekt / Комплект ключев за спици на мотоциклет / Set ključev za žbice motocikla / Комплект ключев за мотоцикле / Σετ κλειδιών ακτινών μοτοσυκλέτας / Juego de llaves de radios de moto / Set di chivani a raggi per moto / Conjunto de chaves de boca de moto / Jeu de clés à rayons pour motos / Motorfiets spaaksleutelset



## Nasadka nakrętki zawieszania - Suzuki

Suzuki suspension nut socket / Aufsatz für Aufhängung-Mutter - Suzuki / Крышка гайки для подвески - Suzuki / Насадка гайки підвіси - Suzuki / Dugókulcs felülegesztés anyához - Suzuki / Capac piulitő suspensie - Suzuki / Nasadka matice odpružení - Suzuki / Nadstavec matice zavesenia - Suzuki / Nastavek za matico vzmetenja - Suzuki / Pakabos veržies dangtelis - Suzuki / Piekares uzgriežņa uzgalis - Suzuki / Vedrustusmutri kork - Suzuki / Копачка на гайката на овчачането - Suzuki / Kapa navrtke ojesa - Suzuki / Profil navrtke trapa - Suzuki / x / Tapa de la tuerca de suspensión - Suzuki / Bussola per dado della sospensione - Suzuki / Tampa da porca de suspensão - Suzuki / Douille de l'écrou de suspension - Suzuki / Kap voor ophangingsmoer - Suzuki



## Zestaw narzędzi do łożysk kół do Harley'a-Davidsona

Harley-Davidson wheel bearing tool kit / Radlager-Werkzeugsatz für Harley-Davidson / Набор колесных подшипников для Harley-Davidson / Набор інструментів для підшипників коліс Harley-Davidson / Keréksaprágy szerszámkészlet Harley-Davidsonhoz / Set de scule pentru rulmenți de roți pentru Harley-Davidson / Sada nástrojů na ložiska kol pro Harley-Davidson / Súprava náradia na ložiská kolies Harley-Davidson / Set orodij za ležaje za kolesa Harley-Davidson / Įrankių rinkinys „Harley-Davidson“ ratų guoliams / Harley-Davidson riteņu gulptu instrumentu komplekts / Harley-Davidsoni rattolaagrite tööriistade komplekt / Комплект інструментів за лагери на колелата за Harley-Davidson / Set alata za ležajevе kotoča za Harley-Davidson / Set alata za ležajevе točkova Harley-Davidson / Σετ εργαλείων ρουλεμάν τροχών για Harley-Davidson / Kit de herramientas para rodamientos de ruedas de Harley-Davidson / Kit di attrezzi per cuscinetti delle ruote per Harley-Davidson / Kit de ferramentas para rolamentos de rodas de Harley-Davidson / Ensemble d'outils pour patiers des roues Harley-Davidson / Gereedschapset voor wiellagers van Harley-Davidson



## Klucz hakowy

Hook wrench / Rohrzange / Ключ трубный / Ключ для крутящих шлицевых гаек / Unverzárts csőfogó / Cheie secera / Hákový kľúč / Hákový kľúč / Kijakasti ključ / Raktas-kablys / Άγκυρα uzgriežņu atslēga / Haakvöti / Ключ за за врътели шлицеве гайки / Kijakasti ključ / Kijakasti ključ / Γαλλικό κλειδί / Llave de gancho / Chiave a gancho / Chave de gancho / Clé à crochet / Haaksleutel



## Ściągacze do kół zamachowych

Flywheel pullers / Schwungradabzieher / Съемники маховика / Знімачі маховика / Húzószerszámok lendkerékhez / Extractoare de volante / Stahováky setvačnická / Sťahovač na zotrvačnický / Orodje za snemanje vztrajnika / Smagračij nuemiklaci / Spararata saviložij / Horarata tömmitääd / Издървачи за маховици / Izvlekač za zotrvačnik / Kalkvlekač zamažaja / Εξοκείας βολών / Extractor de volante de inercia / Estrattori a volano / Extratores de volante / Outils pour enlever la roue d'inertie / Wiegwieltrekkers

Right threads: M14 x P1,5;  
M16 x P1,5; M18 x P1,5;  
M19 x P1,0;  
M20 x P1,0; M22 x P1,0;  
M22 x P1,5; M24 x P1,0;  
M25 x P1,5;  
M26 x P1,0; M26 x P1,5;  
M28 x P1,0; M27 x P1,25;  
M28 x P1,5;  
Left threads - M27 x P1,0



## Blokada kosza sprzęgła

Clutch cage retainer / Kupplungskorbsschloss / Ключ-блокировка корзины сцепления / Фіксація кошика зчеплення / Kupplungskorb-zár / Blocare corz abtreiaij / Ključ na spojkovú koš / Blokada koša spojky / Blokada koša / Sankabos dežės užraktas / Sąjūga grązo slėdžene / Sidurikovi lukk / Заклювање на коша на съединителя / Blokada košarice kvačila / Blokada košarice kvačila / Εργαλείο αποκράτησης καρπίνας συμπλέκτη / Bloqueo de la jaula del embrague / Blocco cestello fizione / Bloqueio do cesto de embraagem / Outil de verrouillage du panier d'embrayage / Koppelingsmandblokkade



## Zestaw narzędzi do montażu i demontażu łożysk główki ramy w motocyklach

Motorbike head frame bearing installation and removal tool kit / Werkzeugsatz für die Montage und Demontage von Motorradkopflagern / Набор инструментов для установки и снятия подшипников головной рамы мотоцикла / Набор инструментов для установки та зняття підшипника головної рами мотоцикла / Motorkerékrár fejcsapágy szerelési és eltávolítási szerszámkészlet / Kit de instrumente de instalare și demontare a rulmenților pentru montarea și demontarea cadrului capului motocicletei / Sada nástrojů pro montáž a demontáž ložisek rámu hlavy motocyklu / Súprava nástrojov na montáž a demontáž ložiska rámu hlavy motocykla / Komplet orodij za namestitve in odstranitev ležaja okvirja glave motomega kolesa / Motoaiklo galvos rėmo guolių montavimo ir nuėmimo įrankių rinkinys / Motoaiklo galvas rāmja gultņu uzstādīšanas un noņemšanas instrumentu komplekts / Tööriistade komplekt mootorrattaste roolipea laagrite paigaldamiseks ja eemaldamiseks / Комплект инструментов за монтаж и демонтаж на лагер на рамата на мотоциклета / Set alata za montažu i skidanje ležajeva glave upravljaoča na motociklima / Set alata za ugradnju i uklanjanje ležajeva glave upravljaoča na motociklima / Kit εργαλείων εγκατάστασης και αφαίρεσης ρουλεμάν πλαίσιο κεφαλής μοτοσικλέας / Kit de herramientas para la instalación y el desmontaje de los rodamientos del cuadro de la moto / Kit di strumenti per l'installazione e la rimozione dei cuscinetti del telaio della moto / Kit de ferramentas de instalação e remoção de apoios de cabeça de motocicleta / Kit d'outils de montage et de démontage des roulements du cadre de la tête de la moto / Motorfiets hoofdframe lager installatie en verwijdering gereedschapset



TYPE  
T  
HANDLE

7  
psc  
adapters

DIAMETER  
SIZES  
32-46  
mm

Ref.	📦	EAN
10-588	1/2	5907558466966

## Wyważarka statyczna do kół motocyklowych

Static motorcycle wheel balancer / Statische Motorrad-Radiuswuchtmaschine / Статическай балансіроўшчыня колес мотоцикла / Балансир статичный для колес мотоцикла / Statikus motorkerékrár kerékígyensúlyozó eszköz / Echilibrator de roți statice pentru motocicletă / Statická vyvažovačka kol motocyklu / Statická vyvažovačka kolies motocykla / Statična izravnalna naprava za kolesa motornih koles / Statinis motociklo ratų balansavimo įtaisas / Statiskais motoaiklo riteņu balansieris / Statiiline tasakaalustaja mootorrattaste jaoks / Статичен балансир за колела на мотоциклета / Statički uređaj za balansiranje kotača motocykla / Статични баланс точков за точкове мотоцикала / Στατική εξισορρόπηση για τροχούς μοτοσικλετών / Equilibrador estático de ruedas de moto / Equilibratore statico della ruota della moto / Rota de motocicleta estática balancer / Équilibreur statique de roue de motocyclette / Statische motorfiets wiel balancer



max  
21"

14-28  
mm  
AXIS

3,9  
kg

Ref.	📦	EAN
10-590	0/1	5907558466980

## Mobilny podnośnik hydrauliczny do quadów i motocykli

Mobile hydraulic jack for quads and motorbikes / Mobilier hydraulischer Wagenheber für Quads und Motorräder / Мобильный гидравлический домкрат для квадроциклов и мотоциклов / Мобильний гидравлічний домкрат для квадроциклів та мотоциклів / Mobil hidraulikus emelő quadokhoz és motorkerékrákokhoz / Cric hidraulic mobil pentru quad-uri și motociclete / Mobilni hidraulički zvedák pro čtyřkolky a motocykly / Mobilný hydraulický zdvihák pre štvorkolky a motocykle / Mobilni hidraulični dvigalo za štirkolesnike in motoma kolesa / Mobilus hidraulinis keltuvos keturračiams ir motociklams / Mobilais hidrauliskais domkrats kvadracikiem un motocikiem / Mobilne hidrauline tungraud nelikutele ja mootorrattastele / Мобилен хидравлически повдигач за четиринолни и мотоциклети / Мобилна хидрауличка дизалица за квадове и мотоцикле / Мобилна хидраулична дизалица за квад и мотоцикле / Μητρώος υδραυλικός γρύλος για quads και μοτοσικλέτες / Gato hidráulico móvil para quads y motos / Martinetto idraulico mobile per quad e moto / Macaco hidráulico móvel para quads e motocicletas / Cric hydraulicque mobile pour quads et motos / Mobeie hydraulische krik voor quads en motoren

up to  
680kg

27  
kg

MAX  
375  
mm  
MIN  
115  
mm  
H



Ref.	📦	EAN
10-596	0/1	5907558467048

## Podnośnik pod motocykle off-road, cross, enduro

Lift for off-road, cross, enduro motorbikes / Hebebühne für Off-Road-, Cross- und Enduro-Motorräder / Подъемник для внедорожных, кроссовых, эндуро мотоциклов / Підйомник для позашляхових, кроссових, ендуро мотоциклів / Emelő terep, cross, enduro motorkerékrákokhoz / Lift pentru motocicletă off-road, cross, enduro / Zvedák pro terénní, crossové a enduro motocykly / Zdvihák pre terénne, crossové a enduro motocykle / Dvigalo za terenska, cross in enduro motoma kolesa / Keltuvos vsureigiams, krosiniams, enduro motociklams / Pacēļis bezceļu, krosa, enduro motocikliem / Tāstuk off-road, cross, enduro mootorrattastele / Подъемник за офроуд, крос и ендуро мотоциклети / Lift za terenske, cross, enduro motocykle / Подъемник за офроуд, крос, ендуро мотоцикле / Ανεκλιτήρας για μοτοσικλέτες εκτός δρόμου, cross, enduro / Elevador para motos off-road, cross, enduro / Sollevatore per moto off-road, cross, enduro / Elevador para motos de todo-o-terreno, cross e enduro / Élévateur pour motos tout-terrain, cross, enduro / Lift voor off-road-, cross- en enduramotoren



up to  
200kg

MAX  
460  
mm  
MIN  
250  
mm  
H

11  
kg

Ref.	📦	EAN
10-598		5907558477214

## Stojak motocyklowy na tylne koło

Rear wheel motorbike stand / Hinterrad-Motorradständer / Подставка для мотоцикла с задним колесом / Подставка для мотоцикла с задним колесом / Hátsó kerék motorkerékpár állvány / Suport pentru motocicletă cu roți spate / Stojan na zadní kolo motocyklu / Stojan na zadné koleso motocykla / Stojalo za zadnje kolo motornega kolesa / Galinio rato motociklo stovas / Aizturīgējā riteņa motocikla statīvs / Tagumise rata mootorratta statiiv / Стойка за мотоциклет със задно колело / Moto stalak za stražnji kotač / Станак за мотоцикл за задњи точак / Βάση μοτοσικλέτας πίσω τροχού / Caballete rueda trasera moto / Cavalletto per moto con ruota posteriore / Suporte de roda traseira para motocicletas / Béquille de moto à roue arrière / Achterwiel motorstandaard



Ref.	📦	EAN
10-604		5907558477221

## Stojak motocyklowy pod przednie koło

Motorcycle front wheel stand / Vorderradständer für Motorräder / Стойка переднего колеса мотоцикла / Подставка для передних колес мотоцикла / Motorkerékpár első kerékállvány / Suport pentru roata din față a motocicletei / Stojan na přední kolo motocyklu / Stojan na predné koleso motocykla / Stojalo za sprednje kolo motornega kolesa / Priekinis motociklo ratų stovas / Motocikla priekšējo riteņa statīvs / Mootorratta esiratta statiiv / Предна стойка за колело на мотоциклет / Stalak za motocikl ispod prednjeg kotača / Станак за мотоцикле испод предњег точака / Στήριγμα μπροσταού τροχού μοτοσικλέτας / Caballete de rueda delantera de moto / Cavalletto anteriore per moto / Suporte da roda dianteira da motocicleta / Béquille de roue avant de motocyclette / Motorfiets voorwielstandaard



up to  
680kg

19"  
7-13cm

Ref.	📦	EAN
10-602	0/1	5907558467109

## Przyrząd do demontażu i montażu kół motocyklowych

Tool for dismantling and mounting motorbike wheels / Werkzeug für die Demontage und Montage von Motorradrädern / Инструмент для демонтажа и монтажа колес мотоцикла / Инструмент для демонтажу и монтажу мотоциклетних колес / Szerszám motorkerékpár kerek le- és felszereléséhez / Urealtă pentru demontarea și montarea roților de motocicletă / Nástroj na demontáž a montáž kol motocyklu / Nástroj na demontáž a montáž kolies motocykla / Orodje za demontažo in montažo koles motornega kolesa / Įrankis motociklo ratams išmontuoti ir sumontuoti / Instruments motociklu riteņu demontāžai un montāžai / Toonist mootorratta rataste lahtivõtmiseks ja kokkupanemiseks / Инструмент за демонтиране и монтиране на колела на мотоциклети / Alat za demontažu i montažu kotača motocikla / Alat za demontažu i montažu točnovala motocikla / Εργαλείο για την αποσυναρμολόγηση και τοποθέτηση τροχών μοτοσικλέτας / Herramienta para desmontar y montar las ruedas de la moto / Attrezzo per smontare e montare le ruote della moto / Ferramenta para desmontagem e montagem de rodas de motos / Outil pour le démontage et le montage des roues de motos / Gereedschap voor het demanteren en monteren van motorfietswielen

12"-20"



Ref.	📦	EAN
10-606	0/1	5907558467147





# OŚWIETLENIE

workshop lighting    освітлення

# Latarka

Torch / Taschenlampe / Фонарик / Лямпарик / Aluminium Zazl-ben zseblampra/vizsgálgólampra / Lanterna / Bateria / Lampa / Svetilka / Žibintuvelis / Lukturis / Pölet / Фенерче / Baterijska / lampa / Lampa / Φακός / Linterna de mano / Torcia / Lanterna / Torche / Zaklamp



**10W**  
**1000 max lm**

**250 m**

**BATTERY Li-ion 3.7V 2200mAh**

**OSRAM P9 LED**

**BATTERY INDICATOR**

**USB charging cable**

**ALUMINIUM BODY**

**4.5h charging**

**1st click:**  
100% min 3 h

**+ 1st click:**  
40% max 7 h

**+ 2nd click:**  
10% max 25 h

**2nd click:**  
**OFF**

**click + hold:**  
**STROBE**

**3W**  
**300 max lm**

**CREE XPE+COB LED**

**ALUMINIUM BODY**

**BATTERY Li-ion 3.7V 2000mAh**

**3h charging**

**POCKET CLIP**

**small size EDC compatible**

**ROTATING**

**USB charging**

**MAGNETIC**

Ref. 99-034 50/100 EAN 5907558451443



**1st click:**  
3% max 60 h

**2nd click:**  
10% max 10 h

**3rd click:**  
40% max 3 h

**4th click: OFF**  
press 2 seconds:  
100% max 45 sec.

**double click:**  
**STROBE**

**30W**  
**3300 max lm**

**BATTERY Li-ion 3.7V 4000mAh**

**OSRAM P9 LED**

**220 m**

**ALUMINIUM BODY**

**USB charging cable**

**6h charging**

**IPX4**

Ref. 99-037 20/40 EAN 5907558451474



**1st click:**  
100% max 5 h

**2nd click:**  
50% max 10 h

**3rd click:**  
SIDE 100% max 5 h

**4th click:**  
SIDE STROBE

**5th click: OFF**

**10W**  
**800 max lm**

**BATTERY Li-ion 3.7V 2000mAh**

**CREE T6+COB LED**

**USB charging cable**

**ALUMINIUM BODY**

**2in1**

**150 m**

**5h charging**

**IP20**

**small size EDC compatible**

Ref. 99-033 0/50 EAN 5907558451436



**1st click:**  
100% min 3 h

**+ 1st click:**  
40% max 7 h

**+ 2nd click:**  
10% max 25 h

**2nd click:**  
**OFF**

**click + hold:**  
**STROBE**

**20W**  
**1500 max lm**

**ALUMINIUM BODY**

**ZOOM**

**250 m**

**x6 AA**

**CREE XHP50.2 LED**

**3h work time**

**IPX4**

Ref. 99-035 20/40 EAN 5907558451450



**1st click:**  
100%

**2nd click:**  
OFF

**3rd click:**  
20%

**4th click:**  
OFF

**5th click:**  
SOS strobe

light press: cycle modes

**20W**  
**1500 max lm**

**ALUMINIUM BODY**

**ZOOM**

**250 m**

**x6 AA**

**CREE XHP50.2 LED**

**3h work time**

**IPX4**

Ref. 99-036 4/24 EAN 5907558451467



**100% 200lm**  
2h

**50% 100lm**  
5h

stroboscope

**3W**  
**max 200lm**

**ZOOM**

**CREE XP-E2**

**waterproof IPX7 30min**

**x3 AAA**

**ALUMINIUM BODY**

Ref. 99-101 12/72 EAN 5907558425482

# Latarka

Torch / Taschenlampe / Φανάριον / Λάμαρακ / Aluminium Zest-ben zseblámpa/vízsgólámpa / Lanterna / Baterka / Lampa / Svetilka / Žbintuvélis / Lukturis / Pöleti / Фенерче / Baterijska / lampa / Lampa / Φακός / Linterna de mano / Torcia / Lanterna / Torche / Zaklamp



<b>10W</b> 500lm	<b>950 m</b>	ANODIZED FINISH
OSRAM LED	BATTERY Li-Ion 3.7V 4000mAh	
4h charging	3h working	
USB C + cable	62.5x200 mm	
	<b>IPX4</b>	

Ref.	📦	EAN
99-070	4/24	5907558464948



<b>10W</b> 500LM	SST20 LED	<b>100 m</b>	WORKING TIME 3h 130...
CHARGING TIME 3h	3.7V 800mAh Li-Ion	cable included	USB C
WORKING TIME 2h 500...	BATTERY INDICATOR	EDC	
	ALUMINUM BODY	<b>IPX4</b>	

Ref.	📦	EAN
99-074	10/40	5907558464986



<b>10W</b> 1500LM	<b>200 m</b>	CHARGING TIME 4h	<b>3.7V</b> 4000mAh Li-Ion	BATTERY INDICATOR	cable included	USB C
SST40 LED	WORKING TIME 2.5h 1500...	WORKING TIME 3h 900...	WORKING TIME 7h 350...	WORKING TIME 9h 200...		
					POCKET CLIP	
					ALUMINUM BODY	
					<b>IPX4</b>	

Ref.	📦	EAN
99-075	10/40	5907558464993



<b>20W</b> 2000lm	<b>180 m</b>	CHN LED	CAPACITY & CHARGING INDICATOR
4h charging	ALUMINUM BODY	USB C + cable	
	BATTERY Li-Ion 3.7V 2200mAh	ANODIZED FINISH	<b>IPX6</b>
			POCKET CLIP

Ref.	📦	EAN
99-067	6/48	5907558464917



1st click:  50%

2nd click:  100%

3rd click:  RED STROBE

<b>4W</b> 400 max lm	COB LED	x3 AA INCLUDED
	POCKET CLIP	

Ref.	📦	EAN
99-045	50/100	5907558452365



<b>3W</b> 200 max lm	ALUMINUM BODY
	COB LED
	x3 AA
	<b>IP20</b>

Ref.	📦	EAN
99-032	0/75	5907558451306



<b>3W</b> 90LM	2in1	4 LIGHT FUNCTIONS	COB LED	LASER	cable included	USB
CHARGING TIME 30min	WORKING TIME 40min	3.7V 120mAh Li-Pol	RED LIGHT MODE	ABS BODY		
					32.5mm x 32mm x 18mm	<b>14g</b>
						<b>IPX4</b>

Ref.	📦	EAN
99-078	10/80	5907558465709



<b>100 lm</b>	OSRAM P9 LED	small size	EDC compatible
	1h worktime	<b>35 m</b>	
x1 AAA NOT INCLUDED	ALUMINUM BODY	ANODIZED FINISH	
HEAD ROTATE on/off	<b>9g</b>	<b>IPX4</b>	

Ref.	📦	EAN
99-068	20/200	5907558464924



# Latarka czółowa

Headlamp / Sírnlampe / Фонарь налобный / Латарак начі́нны / Fejlámpa / Lampă cap / Čelni baterka / Lampo čelová / Čelna svetilka / Žbintuvēlis / Lukturītis uz pieres / Esilatēms / Лампа за главо / Lampo za glavu / Ručna lampo / Φακός κεφαλής / Linterna de frente / Lampadina frontale / Lanterna de testa / Torche frontale / Hoofdzaklamp

**6W**  
600 max lm

**90 m**

**CREE XPG3 LED**

**USB magnetic charging cable**

**small size EDC compatible**

**2h charging**

**BATTERY Li-Ion 3.7V 700mAh**

**IPX4**



1st click:

**40% max 2 h**

press 2 seconds:

**100% max 40 sec.**

2nd click:

**10% max 6 h**

double click:

**STROBE**

3rd click: OFF

Ref.	📦	EAN
99-027	10/80	5907558451252

**10W**  
1000 max lm

**200 m**

**CREE L2 LED**

**USB charging cable**

**BATTERY Li-Ion 3.7V 2000mAh**

**ALUMINUM BODY**

**5h charging**

**IP20**



1st click: **70% max 4 h**

2nd click: **45% max 4 h**

3rd click: **12% max 6 h**

long press: OFF

press fast 2 times:

**100% max 2.5 h**

+ click 1: **STROBE**

+ click 2: **SOS**

long press: OFF

press 2 seconds:

**Red**

+ click 1: **STROBE**

+ click 2: **Blue**

long press: OFF

Ref.	📦	EAN
99-028	0/50	5907558451269

1st click: **100% max 1.5 h**

2nd click:

**50% max 3 h**

3rd click:

**STROBE**

4th click: OFF

**10W**  
800 max lm

**USB charging**

**150 m**

**CREE XML T6 LED**

**ZOOM**

**IP20**

**BATTERY Li-Ion 3.7V 1200mAh**

**4h charging**



Ref.	📦	EAN
99-026	56/112	5907558451245

1st click: **40% max 5 h**

2nd click: **15% max 9 h**

3rd click: **3% max 60 h**

4th click: OFF

press 2 seconds:

**100% max 40 sec.**

double click:

**STROBE**

**20W**  
2000 max lm

**200 m**

**CREE XHP502 LED**

**USB charging cable**

**BATTERY Li-Ion 3.7V 4000mAh**

**ALUMINUM BODY**

**6h charging**

**IPX4**



Ref.	📦	EAN
99-029	10/40	5907558451276

1st click: **100%**

2nd click: **40%**

3rd click: **RED**

4th click: **RED strobe**

long press: **MOTION SENSOR**

**3W**  
180lm

**COB LED**

**MOTION DETECTOR**

**BATTERY Li-Ion 3.7V 500mAh**

**50 g**

**ABS BODY**

**RED LIGHT MODE**

**1.5h charging**

**2.5h working**

**USB**

**CAP HOOK**

**IPX4**

**360°**



Ref.	📦	EAN
99-069	6/48	5907558464931

**3W**  
250LM

**5 LIGHT FUNCTIONS**

**MOTION SENSOR**

**XPE+ COB LED**

**ADJUSTABLE ANGLE**

**3.7V 1200mAh**

**WORKING TIME 4h**

**BATTERY INDICATOR**

**RED LIGHT MODE**

**CAP HOOK**

**CHARGING TIME 2.5h**

**ABS+PC MATERIAL**

**USB**



Ref.	📦	EAN
99-073	25/50	5907558464979

## Latarka czołowa

Headlamp / Stirnlampe / Фонарь налобный / Лямпарик на чільний / Fejlampa / Lampă cap / Čelní baterka / Lampo ĉelová / Čelna svetilka / Žibintuvélis / Lukturītis uz pieres / Eslatern / Лампа за главо / Lampo za glavu / Rucna lampo / Φακός κεφαλής / Linterna de frente / Lampadina frontale / Lanterna de testa / Torche frontale / Hoofdzaklamp



100% 400lm

2h

50% 200lm

5h

stroboscope



5W  
max  
400lm



CREE  
R5

x3  
AAA



Ref.	📦	EAN
99-200	10/40	5907558425505

100% 250lm

3h

50% 125lm

5h

stroboscope



3W  
max  
250lm



CREE  
XPE

x3  
AAA



Ref.	📦	EAN
99-201	0/40	5907558425710

## Lampa na szyję

Neck lamp / Nackenlampe / Нашийная лампа / Нашийний світильник / Nyaklámpa / Lampă pentru gât / Lampo na krk / Lampo na krk / Svetilka za vrat / Kaklo lampo / Kakla lampo / Kaela lampo / Лампа за врата / Svetilka za vrat / Лампа за врат / Φωλακικό λαμπύρι / Lámpara de cuello / Lampada da collo / Lámpada de pescoço / Lampe de cou

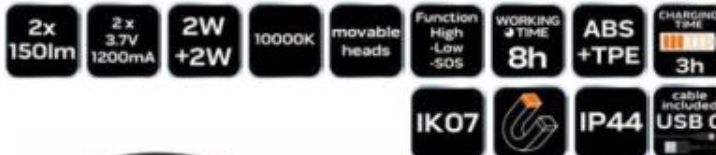

2x 150lm  
2x 3.7V  
1200mA  
2W  
+2W  
10000K  
movable heads  
Function High-Low-SOS  
WORKING TIME 8h  
ABS +TPE  
CHARGING TIME 3h  
IK07  
IP44  
cable included  
USB C

Ref.	📦	EAN
99-112	0/20	5907558475715



Ref.	📦	EAN
99-115	12/120	5907558475913



Ref.	📦	EAN
99-097	0/120	5907558493702

## Lampa 3w1

Lamp 3in1 / Lampe 3in1 / Лампа 3 в 1 / Лампа 3in1 / Lámpa 3in1 / Lampă 3in1 / Lampo 3v1 / Lampo 3v1 / Svetilka 3v1 / Lampo 3in1 / Lampe 3in1 / Lamp 3in1 / Лампа 3в1 / Lampo 3u1 / Лампа 3в1 / Lámpa 3en1 / Lampada 3in1 / Lámpada 3 em 1 / Lampe 3en1 / Lamp 3in1



2200mAh  
Li-ion  
3.7V  
3in1  
150m max range  
max 350lm  
COB LED  
ZOOM  
WORKING TIME 6-8h  
CHARGING TIME 4h  
battery indicator  
quick easy change  
IP44  
cable included  
USB C

Ref.	📦	EAN
99-107	0/20	5907558499674

# Lampa warsztatowa

Workshop lamp / Werkstattlampe / Лампа переносная / Лампа переносна / Stekkiilampi / Lampă atelier / Dienská lampa / Dielenská lampa / Delavniška svetilka / Lampa dirbtuvėms / Pārnesājamā lampa / Тоқоқо лампа / Лампа работна / Radna lampa / Radna lampa / Λάμπα εργαστηρίου / Lámpara de taller / Lampada da officina / Lämpada de oficina / Lampe d'atelier / Werkplaatslamp

1st click: 100% max 1.5 h  
2nd click: 50% max 3 h  
3rd click: 100% max 3 h  
4th click: OFF  
press 2 seconds: RED LIGHT max 3 h  
+ click 1: RED STROBE  
+ click 2: OFF

**3W**  
200 max lm

**COB LED**  
**2in1** LAMP + TORCH

BATTERY Li-ion 3.7V 1200mAh

FOLDING

4h charging

IP20

USB charger + cable

Ref.	ⓦ	EAN
99-041	0/50	5907558452327

**2x350 lm**  
**700 max lm**

**2x 4.5W**  
**4000 K**

**2x BATTERY** Li-ion 3.7V 2200mAh

**SMD LED**

2h work time

2h charging

CHARGER INCLUDED

x6

Ref.	ⓦ	EAN
99-047	0/8	5907558452389

1st click: 100% max 2h  
2nd click: 30% max 7h  
3rd click: OFF

**8W**  
600 max lm

FOLDABLE HOOK

**SMD LED**

BATTERY Li-ion 3.7V 2200mAh

USB 5V/1A CHARGER INCLUDED

ABS

600 lm

4h charging

IMPACT RATING IK08

**10W**  
900 max lm

**SMD LED**

6500 K

25000h work time

IP54

ABS

LEDs x24

363x50x50 mm

IMPACT RATING IK08

CRI Ra≥80

CABLE 5m EU socket

H05RN-F2 x1.0mm²

230V 50Hz

Ref.	ⓦ	EAN
99-043	0/24	5907558452341
99-044	0/16	5907558452358

**5W+1W**  
500 lm

CHARGER INCLUDED

**2in1** lamp torch

DIMMING

**COB LED**

CAPACITY INDICATION

BATTERY Li-ion 3.7V 2600mAh

HOOK

MAGNETIC

3.5h charging

2-2.5h working

ABS BODY

270x90x80 mm

USB C charger + cable

IP20

Ref.	ⓦ	EAN
99-065	0/20	5907558464894

1st click: max 3.5 h  
2nd click: OFF  
3rd click: max 6 h  
4th click: OFF

**300 lm**

**2in1** LAMP + TORCH

**COB LED**

x3 AA INCLUDED

ABS

360°

ADJUSTABLE STAND

Ref.	ⓦ	EAN
99-042	0/24	5907558452334

**10+5 W+W**  
550+150 LM

**2in1** LAMP + TORCH

**COB LED**

CHARGER INCLUDED

cable included USB C

DIMMING

RED LIGHT MODE

360°

CHARGING TIME 3h

WORKING TIME 3h 3.5h LAMP TORCH

3.7V 2000mAh

BATTERY INDICATOR

HOOK

x2

IP20

Ref.	ⓦ	EAN
99-071	10/20	5907558464955

## Lampa warsztatowa

Workshop lamp / Werkstattlampe / Лампа переносна / Лампа переносна / Steklámpa / Lampā atelīer / Dīlenskā lampā / Dielenskā lampā / Delavniška svetilka / Lampa dirbtuvēms / Pārnesjamā lampa / Točkaja lamp / Лампа работна / Radna lampā / Radna lampā / Λάμπα εργαστηρίου / Lámpara de taller / Lampada da officina / Lámpada de oficina / Lampe d'atelier / Werkplaatlamp

**10W**  
**1000 max lm**

**BATTERY** Li-ion 3.7V 4000mAh

**SMD LED**

**3.5h** work time

**4.5h** charging

**CHARGER INCLUDED**

**X4**

1st click:  
**100% max 3.5h**

2nd click:  
**50% max 6h**

press 2 seconds:  
**FLASHING**

FOLDABLE HOOKS with magnets

ADJUSTABLE WORKING DISTANCE 130 - 200 cm

Ref.	📦	EAN
99-048	1/4	5907558452396

**2in1** CHARGER INCLUDED

**COB LED**

**4W+ 1W** LAMP+ TORCH

**max 400lm**

**torch**

**ABS** 3.7V 2200mAh Li-ion

cable included **USB C**

CHARGING TIME 3-3.5h

WORKING TIME 4-4.5h for 50% brightness

**IP20** **IK07** battery indicator

**HOOK**

Ref.	📦	EAN
99-102	0/10	5907558495478

**6W**  
**500lm**

**BATTERY** Li-ion 3.7V 2400mAh

**COB LED**

**HOOK**

**3-4h** charging

**FOLDING CONSTRUCTION**

**ABS BODY** max 4h (50%) working

**400x 65x52 mm** **IP20**

Ref.	📦	EAN
99-066	0/20	5907558464900

## Lampa szperacz

Searchlight / Suchscheinwerfer / Προσχευατορ / Προσχευατορ / Fényezőró / Reflector / Světlomet / Svetlozet / Zářomet / Prožektorius / Prožektors / Prožektor / Προσχευατορ / Reflektor / Ρεφλεκτορ / Προβολέας / Reflector / Proiettore / Holofote / Projecteur / Zoeklicht

**1000lm**

**Li-ion 3.7V 2200mAh**

**RANGE 350m**

**USB C**

**STROBE function**

**6h** charging

**8h** working

**SST40 LED** **ABS**

**IP44** **USB C cable included**

Ref.	📦	EAN
99-114	0/20	5907558475265

**10+3 W W**  
**500+150 LM LM**

**2in1** LAMP+ TORCH

**COB LED**

**POWERGATE**

cable included **USB**

**RED LIGHT MODE**

HEATING THREAD

ADJUSTABLE STANDING BASE

CHARGING TIME 3.5h

WORKING TIME 3h 4h LAMP TORCH

**3.7V** 2000mAh **BATTERY INDICATOR**

**HOOK** **x2** **IP20**

Ref.	📦	EAN
99-072	25/50	5907558464962

## Lampka do kluczy

Key lamp / Schlüssel Lampe / Ключевая лампа / Лампа для ключа / Kulcslámpa / Lampā cu cheie / Ключонá лампа / Ключонá лампа / Ключона светилка / Pagrindinis žibintas / Galvenais lukturis / Võtme lamp / Ключовая лампа / Лампа за ключове / Лампа за ключове / Λάμπα κλειδί / Lámpara de llave / Lampada a chiave / Lámpada de chave / Lampe à clé / Sleutel lamp

**5V** 500mAh **Li-ion**

**4** FUNCTIONS

**COB LED** cable included **USB C**

**500 LM**

**30pcs LED** **58 gr** **6cm x 4,6cm**

CHARGING TIME 15min

WORKING TIME 3h **IPX4**

Ref.	📦	EAN
99-109	0/200	5907558499728

## Naświetlacz

Floodlight / Scheinwerfer / Прожектор / Прожектор / Díszkiválógép / Projector / Světlo / Svetlomet / Reflektor / Prožektorius / Floodlight / Floodlight / Прожектор / Reflektor / Φθοοδυναμικ / Προβολέας / Luz de inundación / Proiettore / Floodlight / Projecteur / Schijnwerper

1st click:



2nd click:



3rd click:



4th click: OFF



10W  
750  
max lm

COB LED

HANDLE/SUPPORT

ABS

IP20

POWER BANK



Zasilane 3xAA lub 2x18650  
Powered by 3xAA or 2x18650  
Работает на 3xAA или 2x18650

Ref. 99-038 0/40 EAN 5907558452297

30W  
3000  
max lm

POWER BANK

CHARGER INCLUDED

SMD LED

BATTERY Li-ion 3.7V 8000mAh

ABS + AL

CAPACITY INDICATION

USB C charger + cable

4.5h charging

ADJUSTABLE SUPPORT

TRANSPORT HANDLE

IP54

210x180x55 mm

1st click:

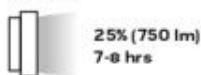

2nd click:

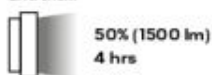

3rd click:



4th click: OFF



Ref. 99-064 0/10 EAN 5907558464887

1st click: Large LED 100% max 2h

2nd click: Small LED 100% max 5h

3rd click: OFF  
press 3 seconds: Both LEDs 100% max 2 min

750  
+250  
max lm

10W +3W

CREE CREE XPG LED

HANDLE/SUPPORT

POWER BANK

BATTERY Li-ion 3.7V 2600mAh

ABS + TPR

USB charger + cable

4.5h charging

IP20



Ref. 99-040 10/20 EAN 5907558452310

## Latarka inspekcyjna + laser + UV

Inspection lamp + laser + UV / Inspektionslampe + Laser + UV / Инспекционная лампа + лазер + УФ / Инспекційна лампа + лазер + УФ / Ellenőrző lámpa + lézer + UV / Lampa de inspecție + laser + UV / Inspekční lampa + laser + UV / Inspektiva lampa + laser + UV / Inspektionslampe + laser + UV / Инспекционная лампа + лазер + UV / Αρβύρας λampa + laseris + UV / Pārbaudes lampa + lasers + UV / Kontrolllampe + laser + UV / Инспекційна лампа + лазер + UV / Inspekcijska lampa + laser + UV / Inspekcijska lampa + laser + UV / Λάμπα επιθεώρησης + λέιζερ + UV / Lámpara de inspección + laser + UV / Lampada di ispezione + laser + UV / Lâmpada de inspecção + laser + UV / Lampe d'inspection + laser + UV / Inspectielamp + laser + UV

450lm  
+  
140lm



4in1

LAMP TORCH

DIMMING

COB LED

LASER

365nm UV

USB C cable included

ALUMINIUM BODY

MAGNETIC POCKET CLIP

CHARGING TIME 3h

WORKING TIME 2.5h

3.7V 800mAh Li-ion

BATTERY INDICATOR

5W + 3W

165mm x 23mm

IP20



Ref. 99-077 50/100 EAN 5907558465013

## Lampa + trójkąt ostrzegawczy

Lamp + warning triangle / Lampe + Warndreieck / Лампа + предупреждающий треугольник / Лампа + попереджувальний трикутник / Lámpa + figyelmeztető háromszög / Lampă + triunghi de avertizare / Lampa + výstražný trojuholník / Lampa + výstražný trojuholník / Svetilka + oprotolní trikotnik / Lampa + israjomasis trikampis / Lampa + brīdinājuma trīsstūris / Lamp + hoiatusnirk / Лампа + предупредителен триъгълник / Lampa + trokut upozorenja / Лампа + трокуа упозореня / Лампа + проєболопнікo тръгълно / Lámpara + triángulo de advertencia / Lampada + triangolo di emergenza / Lâmpada + triângulo de advertência / Lampe + triangle de présignalisation / Lamp + gevarendriehoek

1st click:



10W  
800  
max lm

COB LED

RUBBER POINTS

ADJUSTABLE HANDLE/SUPPORT

X4 AA NOT INCLUDED

NYLON +TPR BODY

220x220x45 mm

2nd click:



3rd click:



4th click: OFF



Ref. 99-076 5/10 EAN 5907558465006

## Lampa do inspekcji lakieru

Paint inspection lamp / Inspektionslampe für Farbe / Лампа для проверки лакокрасочного покрытия / Лампа для перевірки фарби / Festfellenőző lámpa / Lampă de inspectie a vopselei / Kontrolni lampă na nátery / Lampă na kontrolu farby / Svetilka za pregled barve / Dažų tikrinimo lempa / Krāsas pārbaudes lampā / Vārvi kontrol-lamp / Лампа за проверка на боята / Lampă za pregled boje / Лампа за преглед боје / Λαμπίρα επιθεώρησης βαφής / Lampada di ispezione della vernice / Lâmpada de inspecção da pintura / Lámpara de inspección de pintura / Lampe d'inspection de la peinture / Verf inspectielamp



cable included <b>USB C</b>	<b>COB SMD</b>	<b>2in1</b>	<b>max 400lm</b>	<b>4000mAh 3.7V</b>
<b>WORKING TIME max 4h</b>	<b>UV</b>	battery indicator	charging indicator	<b>LIGHT warm natural cold</b>
<b>HOOK</b>	<b>CRI Ra ≥ 90</b>	<b>CHARGING TIME 4,5h</b>	<b>CHARGER INCLUDED</b>	charger <b>5V 2A to 230V AC 50Hz</b>
<b>185x 50x 32mm</b>	<b>245g</b>	<b>IP56</b>		



Ref.	☒	EAN
99-098	0/10	5907558493719

## Lampa 360 stopni

Lamp 360 degrees / 360-Grad-Lampe / Лампа 360 градусов / Лампа на 360 градуса / Lámpa 360 fokos / Lampă de 360 de grade / Lampă 360° / Lampă 360° / Svetilka 360-stopniška / Lampă 360 laipsnių / Lampă 360 grādu / Lamp 360 kroadi / Лампа 360-градусова / Lampă 360 stupnjeva / Лампа 360 степену / Λαμπίρα 360 μορών / Lampada a 360 gradi / Lampadina frontale / Lámpara de 360 grados / Lampe 360 degrés / Lamp 360 graden



<b>2x 4300lm</b>	<b>2x 40W</b>	<b>SMD LED</b>
<b>360°</b>	<b>AC 220-240V 50Hz</b>	<b>5m cable</b>
<b>5000K</b>	<b>HANDLE</b>	<b>MAX WIDTH 94 cm</b>
<b>PC + ABS</b>	<b>IK08</b>	<b>5,8kg</b>
<b>easy transport &amp; storage</b>		<b>IP54</b>



Ref.	☒	EAN
99-099	0/2	5907558495461



## Lampa z czujnikiem ruchu

Lamp with motion sensor / Лампа с датчиком движения / Lampa cu senzor de mişcare / Lámpa mozgásérzékelővel / Лампа з датчиком руху / Svetidlo so snímačom pohybu / Lampa se snímačem pohybu / Lampe mit Bewegungssensor / Svetilka s senzorjem gibanja / Lampa su judesio jutklu / Lampa ar kustības sensoru / Liikumisanduriga lamp / Лампа със сензор за движение / Svetiljka sa senzorom pokreta / Лампа са сензором покрета / Λάμπα με αισθητήρα κίνησης / Lámpara con sensor de movimiento / Lâmpada con sensore de movimento / Lâmpada com sensor de movimento / Lampe avec détecteur de mouvement / Lamp met bewegingsensor



230V 50Hz	SMD LED	MOTION DETECTOR	NO DIMM
60 W <0.5s	30000h work time	CRI Ra≥70	6500 K
-20°< >40°	BEAM ANGLE >100°	CABLE 15cm	ALUMINIUM BODY
PF>0.9	ON/OFF ≥15000	IP65	



Ref.	P [W]	[lm]	☒	EAN
99-094	10	800	0/60	5907558469554
99-049	30	2400	0/20	5907558452464
99-050	50	5000	0/10	5907558452471

## Lampa

Lamp / Lampe / Лампа / Лампа / Lámpa / Lampă / Lampa / Lampa / Svetilka / Lampa / Лампа / Lamp / Лампа / Lampa / Λάμπα / Lámpara / Lâmpada / Lâmpada / Lampe / Lamp /

SMD LED	50W 4500 max lm	230V 50Hz	CABLE 2m EU plug	BEAM ANGLE >120°	6500 K	25000h work time
60 W <1.0s	ON/OFF ≥15000	CRI Ra≥80	PF>0.9	-25°< >45°	NO DIMM	IP65

SMD LED	230V 50Hz	30000h work time	6500 K	ALUMINIUM BODY	IP65	BEAM ANGLE >100°
CRI Ra≥70	60 W <0.5s	ON/OFF ≥15000	CABLE 15cm	NO DIMM	-40°< >50°	PF>0.8



Ref.	P [W]	[lm]	☒	EAN
99-063	50	4500	0/10	5907558452600



Ref.	P [W]	[lm]	☒	EAN
99-093	10	800	0/60	5907558469547
99-051	20	1600	0/40	5907558452488
99-052	30	2400	0/30	5907558452495
99-053	50	4000	0/20	5907558452501
99-054	100	8000	0/10	5907558452518

# Lampa

Lamp / Lampe / Лампа / Лампа / Lámpa / Lampö / Lampa / Lampa / Svetilka / Lampa / Lampa / Lamp / Лампа / Lampa / Lampa / Lámpa / Lámpara / Lampada / Lámpada / Lampe / Lamp

- 100W
- 8500 lm
- 230V
- 50Hz
- SMD LED
- 6500 K
- BEAM ANGLE >110°
- 25° < >45°
- ON/OFF ≥15000
- 25000h work time
- CRI Ra ≥ 80
- max 1.8m
- NO DIMM
- CABLE 3m
- DF > 0.9
- IP65



Ref.	P [W]	[lm]	☒	EAN
99-095	100	8500	0/2	5907558469561

- SMD LED
- H 1.8 m MAX
- 6500 K
- 25000h work time
- 230V 50Hz
- BEAM ANGLE >120°
- 60 < 1.0s
- PF > 0.9
- CRI Ra ≥ 80
- CABLE 3m EU plug
- NO DIMM
- 25° < >45°
- ON/OFF ≥15000
- IP65



Ref.	P [W]	[lm]	☒	EAN
99-059	30	2700	0/4	5907558452563
99-060	50	4500	0/4	5907558452570

- 2x100W
- 16400 lm
- 230V 50Hz
- SMD LED
- 6500 K
- ON/OFF ≥15000
- 25000h work time



- BEAM ANGLE >110°
- 25° < >45°
- CRI Ra ≥ 80
- max 1.8m
- CABLE 3m
- 60 < 1s
- NO DIMM
- DF > 0.9
- ON/OFF switch
- IP65



Ref.	P [W]	[lm]	☒	EAN
99-096	200	8500	0/2	5907558469578

- 230V 50Hz
- SMD LED
- H 1.8 m MAX
- BEAM ANGLE >120°
- 6500 K
- 25000h work time
- 60 < 1.0s
- PF > 0.9
- 25° < >45°
- NO DIMM
- CRI Ra ≥ 80
- CABLE 3m EU plug
- ON/OFF ≥15000
- IP65



Ref.	P [W]	[lm]	☒	EAN
99-061	2x 30	5400	0/4	5907558452587
99-062	2x 50	9000	0/4	5907558452594





## **NORMALIA WARSZTATOWE**

workshop  
standard items

стандартні предмети  
майстерні

## Szczypce do klipsów

Trim clip removal pliers / Trimzange zum Entfernen des Clips / Пинцет для удаления клипсы / Пинцет для удаления клипсы / Vágókaros-eltávolító fogók / Cesti pentru scoaterea detelor / Klešče na odstranění klipů / Kliešte na odstránenie spŕôh / Klešče za odstranjevanje sprank / Sqvarzhi šalinimo replis / Klipi porębianas knaibles / Klambrite eemalāmise tangid / Клеши за премахане на клип / Kliešta za uklanjaje isječka / Клешта за уклањање клипа / Пінсас апаратури клип / Recorte alicates de extracción de clip / Pinza per tagliare clip / Alicates de remoção de cliques de acabamento / Pince pour enlever les clips / Tang voor verwijderen van clip

25  
years  
guarantee

35x35  
mm



Ref.	☒	EAN
11-030	6/36	5907558445527

## Zestaw ściągaczy do tapicerki

Upholstery puller set / Lösehebel-Satz für Polster / Набор съёмников панелей облицовки / Набор знімачів до обивки сапогу / Kárpteszőző készlet / Set de scos piése de tapiterie / Sada pro demontáž čalounění / Súrpana na demontáž žalútenia / Set smotalcev oblazinjenja / Twirtinimo elementu ištraukikly / Tapsėjuma novilcėju / Polstrittmmsate / Комплект шобу за тапіцерыя / Set za skidanje tapicerung / Pribor alata za skidanje tapetarskog materijala / Σετ εξακείας πλακών επένδυσης / Juego de extractores de tapizado / Serie di utensili per interni / Conjunto de extractores para tapiceria / Jeu d'extracteurs de tapisserie / Set van trekkers voor staffering



Ref.	☒	EAN
11-825	6/12	5907558436808

NYLON



Ref.	N	☒	EAN
11-822	x5	6/24	5907558420029
11-823	x6	6/24	5907558420036
11-824	x11	0/10	5907558420043

## Opaska ślimakowa

Hose clamp / Schneckenschelle / Хомут червячный / Хомут завитковий / Tömrlöbilincs / Brätaå cu melc / Šneková sprpa / Sťahovacia páska konová / Objemka na rožža / Sqvarzha / Gütemezsancilçs / Toruklamber / Сшоба с червячна резба / Обжимка са ружжним панојет / Šelna / Обмотачос аргхкћрас оућћна / Bridas / Fascetta a vite / Abraqadeira caracol / Collier de serrage

STAINLESS  
steel

W4



Ref.	Ø [mm]	N	☒	EAN
11-400	8-12 / 9 mm	x3	0/200	5907558420425
11-401	10-16 / 9 mm	x3	0/200	5907558420432
11-402	12-20 / 9 mm	x3	0/200	5907558420449
11-403	16-27 / 9 mm	x3	0/200	5907558420456
11-404	20-32 / 9 mm	x3	0/200	5907558420463

x34



Ref.	☒	EAN
11-981	0/20	5907558435764

## Nity

Rivets / Niete / Закленки / Закленки / Alu popszegecs készlet / Nituri / Njty / Nity / Zakovice / Kriedes / Kriedes / Needtangid / Humoe / Zakovice / Nitna / Пpапaивa / Remaches / Rivetti / Rebites / Rivets / Klinknagels

AL x400



Ref.	Ø [mm]	☒	EAN
11-970	2,4, 3,2, 4,0, 4,8	0/20	5907558437126

## Zestaw spinek samochodowych

Car pins / Auto-Körper-Clipsset / Клипсы крепления обшивки / Набор клипс крепления обшивки / Gépkocsi rögzítő patent készlet / Set de clipuri auto / Sada příchytkek čalounění / Súprava spinek do auta / Set avtomobilskih spinok / Avtomobilinių tvirtinimo elementų rinkinys / Арбушита сáпринáјити комплeктс / Autohvtváde komplet / Комплект автомобильных щипцов / Set sporna za vozila / Komplet spojnice za automobile / Κλιπς ταπετορίας / Kit de remaches de coche / Set di clip per carrozzeria / Luvas de nitilo laranja / Ensemble d'épingles auto / Auto pinnen



x300

OPEL

Ref.	📦	EAN
11-952	0/28	5907558436990

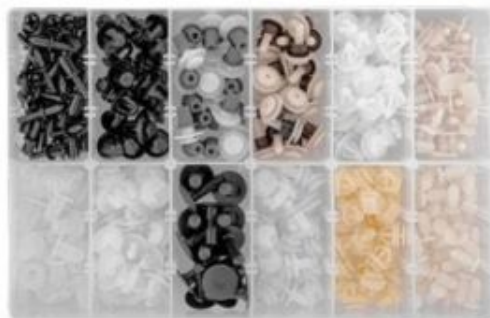

x345

PEUGEOT

Ref.	📦	EAN
11-953	0/28	5907558437003



x408

HONDA

Ref.	📦	EAN
11-956	0/28	5907558437034



x415

MITSUBISHI

Ref.	📦	EAN
11-960	0/28	5907558437072



x290

BMW

Ref.	📦	EAN
11-961	0/28	5907558437089



x360

TOYOTA  
LEXUS

Ref.	📦	EAN
11-950	0/28	5907558436976



x255

VOLKSWAGEN

Ref.	📦	EAN
11-963	0/28	5907558437102

## Pierścienie segera

Seeger rings / Seeger-Ring / Стопорные кольца / Кільця стопорні / Seeger gyűrűk / Inele Seeger / Segerové kružky / Segerove kružky / Seger obroči / Ziedai Segera / Άρξιε un iekšējie sprastgredzeni / Seeger ringid / Ζεεργιου / Uskočnici / Seger prstenovi / Δακτύλιοι συγκράτησης / Anillos seger / Anelli Seeger / Anéis Seeger / Anneaux élastiques / Seeger ringen

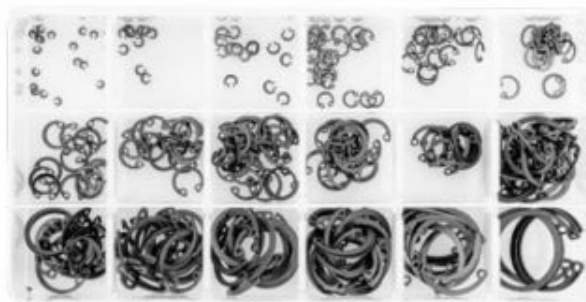

x300

Ref.	📦	EAN
11-975	0/20	5907558437171

## Nakrętki samohamowne

Self-locking nuts / Selbstsichernde Muttern / Самоконтрящиеся гайки / Гайки самоконтрящій / Önzáró anyák / Piulițe cu auto-blocare / Samosvorné matice / Samosvorné matice / Samozaporne matice / Savaimne užsifksuojančios varžės / Pošbremzjošie uzgriežņi / Iseblokeeruvad mutrid / Самозаконтрящү гайки / Samokočne matice / Samokočne matice / Пошмабна аутоарраққуеуа / Tuercas autoblocantes / Dadi autobloccanti / Parcas autotravantes / Écrous freins / Zelfverschuilende moeren

x146

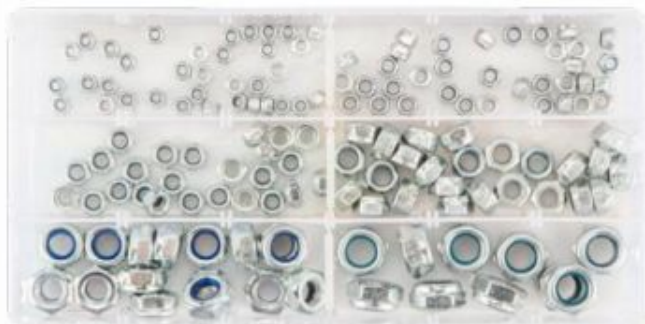

Ref.	Ø [nr]	📦	EAN
11-972	M4 - M12	0/20	5907558437140

## Korki z uszczelkami miedzianymi

Drain plugs and cover pads / Verschlusschrauben mit Kupferdichtungen / Набор медных прокладок и пробок / Набор мідних прокладок і пробок / Menetes dugó és rezalátét készlet / Buzşone cu garnituri din cupru / Zátky s měděným těsněním / Zátky s medenými tesneniami / Čepi za medeninastimi tesnilii / Vanilniakamščajir tarpinės / Väicri ar vara starplikām / Vasktindhétega korkid / Пробки за заточване с медни уплътнения / Затварачи с месингагим бртвами / Komplet čerova sa bakarnim zaprtvama / Σετ χαλκωνυ παραβυσσοτόπων και ταμπών / Tapones con juntas de cobre / Tappi con guarnizioni in rame / Tampões com anéis de cobre / Bouchons avec joints en cuivre / Krukken met messing dichting

x534



Ref.	📦	EAN
11-974	0/10	5907558437164

## Podkładki miedziane

Coper pads / Unterlegscheiben aus Kupfer / Медные шайбы / Шайби мідні / Réz alátétek / Saibe de cupru / Měděné podložky / Medené podložky / Medeninaste podložke / Vaninės tarpinės / Vara starplikas / Vasest seibid / Медну шайбу / Mesingasti podložci / Bakarne podložke / Χαλκινες ροδέλες / Arandelas de cobre / Rondelle in rame / Anéis de cobre / Rondelles en cuivre / Roestvrije onderringen

## Podkładki miedziane

x300

Cu



Ref.	📦	EAN
11-971	0/10	5907558437133

x150



Ref.	📦	EAN
11-979	0/20	5907558435740

## Zestaw smarowniczek

Set of lubricating nipples / Ölerset / Набор маслянок / Набор оливиць / Zsírozszem készlet / Set de căni de ungere / Sada mazničiek / Súpava mazničiek / Komplet mazalnic / Suteripimo dozatorių kompleksas / Eļļas kanniņu komplekts / Māārdēprtside komplekt / Комплект рь-чни маслянокни / Set dozero za mazivo / Komplet maziva / Σετ ελαιοδραμενών / Juego de pistolas engrasadoras / Completo di punti di ingrassaggio / Kit de lubrificadores / Jeu de tubulure de graissage / Set van smeertippels

x110



Ref.	📦	EAN
11-973	0/20	5907558437157

## Sprężyny

Springs / Federn / Пружини / Пружини / Rugó készlet / Arcuri / Pružiny / Pružiny / Vazmeti / Spynuoklių rinkinys / Atsperes / Vedrud / Пружини / Opruge / Opruge / Σετ ελατήρια / Espirales / Molle / Molas / Ressorts / Veren

x200



Ref.	📦	EAN
11-980	0/20	5907558435757

## Koszulki termokurczliwe

Heat shrink sleeves / Wärmeschrumpfende Hüllen / Термоусадочные рукава / Рукави термоусадочни / Zsugorodó készlet / Manşone termocontractabile / Teplozm zmršťitelné rukávy / Teplozm zmršťitelné návleky / Toplotno-skrćne spojke / Termiška susitraukiančios rankovės / Termorucigas uznavas / Termokahanevad sārgid / Термоусаживаемый шпатель / Termo savitļņivi rukavi / Rukavi koji se skupļaju na toploti / Термоусаживаемая муфта / Mangas termoencogibles / Guaine termorestringenti / Mangas termoretráteis / Gaines thermorétractables / Thermokrimp mouwen

x127



Ref.	☒	EAN
11-978	0/20	5907558437201

## Koszulki termokurczliwe "samolutujące"

Heat-shrink solder sleeves / Schrumpfschläuche / Термоусадочные трубки «самолутующиеся» / Термоусадочни тръбици «Самолутајуќа» / Hőre zsugorodó „önforrasztó” cső / Manşone termocontractabile „auto-lipire” / Smeřtovací „pájecí” spojky s címem / Termoizmrlšlovacie buřírky „samospájkovacie” / Termokrćljive tape / Karštje susitraukiantys vamzdeliai / “Pošlodėjejošas” termiškas saraušianšs caurules / “Isepotvad” termokahanevad torud / Термоусаживаемы муфты „самолутующи” / “Samolutujive” termoskupļajušice kořuljice / “Samolentjive” termoskupļajušice kořuljice / Термоусаживаемыя муфта/онна/ Мангас termoencogibles / Guaine termorestringenti / Mangas termoretráteis / Gaines thermorétractables / Thermokrimp mouwen

100 pcs 0.25 - 6.0 mm



Ref.	☒	EAN
11-969	1/200	5907558471069

## Uszczelki (O-ring NBR)

Seals (O-ring NBR) / Dichtungen (O-ring NBR) / Прокладки (O-ring NBR) / Прокладки (O-ring NBR) / Tömítés készlet (o-gyűrű nbr) / Gamturi (O-ring NBR) / Těsnění (O-ring NBR) / Tesnenia (O-ring NBR) / Tesnila (O-ring NBR) / Tarpinės (O-ring NBR) / Blives (O-ring NBR) / Tihendid (O-ring NBR) / Гарнитурa (O-ring NBR) / Birtvila (O-ring NBR) / Zaptivke (O-ring NBR) / Ταμπάκες (O-ring NBR) / Juntas de calafateo (O-ring NBR) / Guarnizioni (O-ring NBR) / Vedantes (O-ring NBR) / Joints (O-ring NBR) / Dichtingen (O-ring NBR)

x225



Ref.	☒	EAN
11-977	0/20	5907558437195

## Uszczelki (O-ring HNBR)

Seals (O-ring HNBR) / Dichtungen (O-ring HNBR) / Прокладки (O-ring HNBR) / Прокладки (O-ring HNBR) / Tömítés készlet (O-gyűrű hnbr) autóklimához / Gamturi (O-ring HNBR) / Těsnění (O-ring HNBR) / Tesnenia (O-ring HNBR) / Tesnila (O-ring HNBR) / Tarpinės (O-ring HNBR) / Blives (O-ring HNBR) / Tihendid (O-ring HNBR) / Гарнитурa (O-ring HNBR) / Birtvila (O-ring HNBR) / Zaptivke (O-ring HNBR) / Ταμπάκες (O-ring HNBR) / Juntas de calafateo (O-ring HNBR) / Guarnizioni (O-ring HNBR) / Vedantes (O-ring HNBR) / Joints (O-ring HNBR) / Dichtingen (O-ring HNBR)

x270



Ref.	☒	EAN
11-976	0/20	5907558437188

## Uszczelki

Seals / Dichtungen / Прокладки / Прокладки / Tömítések / Gamturi / Těsnění / Tesnenia / Tesnila / Tarpinės / Blives / Tihendid / Гарнитурa / Birtvila / Zaptivke / Ταμπάκες / Juntas de calafateo / Guarnizioni / Vedantes / Joints / Dichtingen

x419



Ref.	☒	EAN
11-983	1/20	5907558435788

## Zestaw bezpieczników samochodowych

Car fuse / Set von Auto-Sicherungen / Набор автомобильных предохранителей / Набор запобіжників автомобільних / Gépkocsibiztosíték szett / Set de siguranțe auto / Sada pojistek do auta / Sada automobilových poistiek / Set avtomobilskih varovalk / Automobilių saugiklių rinkinys / Automašīnu drošinātāji / Autokätsmete komplekt / Комплект автомобильни предпазители / Set osigurača za auto / Komplet svečica za avtomobil / Set ασφάλειες αυτοκινήτου / Conjunto de fusibles de coche / Set di fusibili per auto / Kit de fusíveis de automóveis / Ensemble de fusibles auto / Auto bougies

x88



Ref.	☒	EAN
11-993	0/20	5907558435818

## Zestaw bezpieczników samochodowych

Car fuse / Set von Auto-Sicherungen / Набор автомобильных предохранителей / Набор запобіжників автомобільних / Gépkości biztosíték szett / Set de siguranțe auto / Sada pojistek do auta / Sada automobilových pojistiek / Set automobilskih varovalnik / Automobilnių saugiklių rinkinys / Automašinu drošinātāji / Autokātsmete komplekt / Комплект автомобильных предохранителей / Set osigurača za auto / Komplet svečica za avtomobil / Σετ ασφάλειες αυτοκινήτου / Conjunto de fusibles de coche / Set di fusibili per auto / Kit de fusíveis de automóveis / Ensemble de fusibles auto / Auto bougies



## Opaski zaciskowe

Band clips / Klemmschellen / Хомутки стяжные / Хомути стяжні / Kábelkötégek / Cleme conexiune / Hadrivé pásky / Fixačné pásky / PVC vezice / Užspaudėjas / Saviložji / Rihmaklamber / PVC vezice / Κολλήρα σύσφιξης / Fascette per cavi / Cintur p. gramppear / Bride de serrage / Klemmbanden



Ref.	W [mm]	L [mm]	N	📦	EAN
01-620	2.5	80	100	0/500	5907558473391
01-621	2.5	100	100	0/500	5907558473407
01-622	2.5	150	100	0/250	5907558473414
01-623	2.5	200	20	0/625	5907558473421
01-624	2.5	200	100	0/250	5907558473438
01-625	3.6	150	20	0/625	5907558473445
01-626	3.6	150	100	0/125	5907558473452
01-627	3.6	200	20	0/500	5907558473469
01-628	3.6	200	100	0/125	5907558473476
01-629	3.6	300	20	0/250	5907558473483
01-630	3.6	300	100	0/100	5907558473490
01-631	4.8	150	100	0/100	5907558473506
01-632	4.8	200	20	0/250	5907558473513
01-633	4.8	200	100	0/100	5907558473520
01-634	4.8	300	20	0/250	5907558473537
01-635	4.8	300	100	0/60	5907558473544
01-636	4.8	370	50	0/100	5907558473551
01-637	4.8	450	50	0/100	5907558473568
01-638	7.6	200	50	0/100	5907558473575
01-639	7.6	300	50	0/50	5907558473582
01-640	7.6	400	50	0/50	5907558473599
01-641	7.6	500	50	0/50	5907558473605
01-642	9.0	400	50	0/50	5907558473612
01-643	9.0	550	50	0/50	5907558473629
01-644	9.0	650	50	0/50	5907558473636
01-645	12.0	700	50	0/25	5907558473643



Ref.	W [mm]	L [mm]	N	📦	EAN
01-646	2.5	80	100	0/500	5907558473650
01-647	2.5	100	100	0/500	5907558473667
01-648	2.5	150	100	0/250	5907558473674
01-649	2.5	200	20	0/625	5907558473681
01-650	2.5	200	100	0/250	5907558473698
01-651	3.6	150	20	0/625	5907558473704
01-652	3.6	150	100	0/125	5907558473711
01-653	3.6	200	20	0/500	5907558473728
01-654	3.6	200	100	0/125	5907558473735
01-655	3.6	300	20	0/250	5907558473742
01-656	3.6	300	100	0/100	5907558473759
01-657	4.8	150	100	0/100	5907558473766
01-658	4.8	200	20	0/250	5907558473773
01-659	4.8	200	100	0/100	5907558473780
01-660	4.8	300	20	0/250	5907558473797
01-661	4.8	300	100	0/60	5907558473803
01-662	4.8	370	50	0/100	5907558473810
01-663	4.8	450	50	0/100	5907558473827
01-664	7.6	200	50	0/100	5907558473834
01-665	7.6	300	50	0/50	5907558473841
01-666	7.6	400	50	0/50	5907558473858
01-667	7.6	500	50	0/50	5907558473865
01-668	9.0	400	50	0/50	5907558473872
01-669	9.0	550	50	0/50	5907558473889
01-670	9.0	650	50	0/50	5907558473896
01-671	12.0	700	50	0/25	5907558473902

## Opaski zaciskowe

Band clips / Klemmschellen / Хомутки стяжные / Хомутки стяжні / Kábelkötegelő / Cleme conexiune / Hadicové pásky / Fixačné pásky / PVC vezice / Ušpraudėjas / Saviložji / Rihmaklamber / PVC vezice / Καλλάρια ούραφιής / Fascette per cavi / Cintas p. gramppear / Bride de serrage / Klembanden



Ref.	📦	EAN
01-672	0/250	5907558473919

## Taśma naprawcza

Repair tape / Ремонтная лента / Ремонтна стрічка / Javítószalag / Repararea benzii / Páska opravná / Opravná páska



Ref.	W [mm]	L [m]	📦	EAN
56-040	48	20	0/24	5907558446463

## Pistolet do opasek zaciskowych

Cable tie gun / Anzieh pistole / Стяжачоў пистолет / Пистолет для краваток / Meghízó pisztoly / Pistol cu cravată / Krvatová pistole / Krvatová pištoľ / Pištoľ za krovate / Kaklarasıço pistoletas / Kaklasaites pistole / Kabeli sidurnipistol / Пистолет за кабелни връзки / Pištoľ za vezivanje kabela / Пистолъ за vezivanje kablova / Πιστόλι γραβιάτος / Pistola de ator / Pistola per cravatta / Pistola de amarrar / Pistolet à cravate / Spannistool



Ref.	📦	EAN
01-615	0/50	5907558495386

## Taśma izolacyjna

Insulating tape / Isolierband / Лента изолационна / Стрічка ізоляційна / Szigetelőszalag / Banda izolatoare / Izolační páska / Páska izolačná / Izolacijski trak / Izolavimo juosta / Izolācijas lentis / Isoleerteip / Izolir trakis / Ταβιά μόνωσης / Nastro isolante / Fita de isolação / Bande isolante / Isolatband



Ref.	W [mm]	L [m]	kolor	📦	EAN
01-528	15	10		0/500	5907558439335
01-526	15	10		0/500	5907558439311





## CHEMIA MOTORYZACYJNA

automotive chemicals    автомобільна хімія



## Pasta želova do mycia rąk usuwa trudne zabrudzenia

/ Gel paste for cleaning hands of persistent dirt / Gel-Handwaschpaste, entfernt hartnäckigen Schmutz / гелевая паста для мытья рук удаляет сильные загрязнения / гелевая паста для мытья рук удаляет сложные загрязнения / Azselé formájú kézmosó paszta eltávolítja a makacs szennyeződéseket / Pasta-gel pentru spălarea mâinilor îndepărtează murdăria persistentă / Gelová pasta na mytí rukou odstraňuje odolné nečistoty / Gélová pasta na umývanie rúk odstraňuje silné znečistenie / Gel pasta za umivanje rok odstranjuje trdovratne madeže / Gelinė pasta rankoms plauti pašalina sunkiai įveikiamus nešvarumus / Gela pasta roku mazgāšanai noņem stiprus netīrumus / Gelyas kātepesupasta eemaldab ka tugeva määrumise / гел-паста за умывание на руке за отстраняване на силни замърсявания / Pasta u gelu za pranje ruka, uklanja tvrdokorna zaprlanja / Pasta u gelu za uklanjanje tvrdokornih zaprlanja / πάστα ζέλ για το πλύσιμο των χεριών αφαιρεί δύσκολή βρομιά / Pasta gel lavamano para eliminar la suciedad persistente / Una pasta gel lavamani le sporcie difficile da rimuovere / Pasta de gel para lavar mãos que remove a sujeira difícil / Pâte gel pour le lavage des mains ; élimine les saletés tenaces / De gel pasta voor het wassen van de handen die hardnekkig vuil verwijderd



500g

Ref.	Color	⊞	EAN
10-401	Orange	1/0	5907558467154
10-403	Yellow	1/0	5907558467178
10-405	White	1/0	5907558467192



4.0L

Ref.	Color	⊞	EAN
10-402	Orange	1/0	5907558467161
10-404	Yellow	1/0	5907558467185
10-406	White	1/0	5907558467208

## Uniwersalne chusteczki czyszczące do rąk

All-purpose hand wipes / Allzweck-Händereinigungstücher / Универсалные чистящие салфетки для рук / Универсални серветки для очищения рук / Univerzálni käsztítő törölkendők / Servetțele universale pentru curățarea mâinilor / Univerzální ubrousky na čišění rukou / Univerzálnie utierky na čistenie rúk / Univerzálni čistilni i robčki za roke / Universālos ranku valymo servetēles / Universālas roku tīrīšanas salvetes / Univeršālsed kātepuhastusrītkud / Универсални кърпички за почистване на ръце / Univerzalne maramice za pranje ruku / Univerzalne maramice za pranje ruka / Μαντηλάκια καθαρισμού χεριών γενικής χρήσεως / Toollitas lavamano multiso / Fazzoletti universali per pulire le mani / Toalhetes universais para limpar mãos / Lingettes nettoyantes universelles pour les mains / Universele reinigingsdoekjes voor de handen

## Chusteczki ze ścierniwem do mycia rąk oraz czyszczenia powierzchni i narzędzi

Abrasive grit wipes for cleaning hands, surfaces and tools. / Scheuertücher zum Handewaschen und Reinigen von Oberflächen und Werkzeugen / Абразивные салфетки для мытья рук, очистки поверхностей и инструментов. / Абразивни серветки для мытья рук, очищения поверхностей инструментов / Sűrűszeres törölkendők kézmosáshoz, valamint felületek és szerszámok makacs szennyeződésektől való megtisztításához / servetțele abrazive pentru spălarea mâinilor și curățarea suprafețelor și a uneltelor / abrazivni ubrousky na mytí rukou a čišění povrchů a nářadí / Utierky s abrazívnou zložkou na čistenie rúk a čistenie povrchov a nástrojov / čistilni brusilni robčki za čiščenje rok, površin in orodij / Abrazivinės servetėlės rankoms plauti ir paviršiams bei įrankiams valyti / Abrazivas salvetes roku tīrīšanai, kā arī vīstmu un instrumentu tīrīšanai / Abrasivainega rītkud kāte pesmīseks ning pindade ja tīrīstāde puhostamīseks. / Кърпички с абразив за измиване на ръце и почистване на повърхности и инструменти. / maramice sa abrazivom za pranje ruku i čišćenje površina i alata / maramice sa abrazivom za pranje ruka i čišćenje površina i alata. / λευανικά μαντηλάκια για πλύσιμο χεριών και καθαρισμό επιφανειών και εργαλείων / toollitas con abrasivos para lavar las manos y limpiar las superficies y herramientas / fazzoletti con abrasivo per lavare le mani e pulire le superficie e gli strumenti di lavoro / Toalhetes com abrasivo para lavar mãos e limpar superfícies e ferramentas / Lingettes abrasives pour le lavage des mains et le nettoyage de surfaces et d'outils. / schurende doekjes voor het wassen van de handen en het reinigen van oppervlakken en gereedschap



STRENGTH

20x25 cm

100 PCS

Ref.	⊞	EAN
10-407	1/0	5907558467215



STRENGTH

20x21 cm

75 PCS

Ref.	⊞	EAN
10-408	1/0	5907558467222



**BHP**

OHS охорона праці

## Spodnie robocze

Working trousers / Arbeitshose / Брюки рабочие / Штаны рабочие / Munkadzseki / Pantaloni de lucru / Pracovní kalhoty / Montérky / Delovne hlače / Darbinės kelnės / Darba bikses / Τορπιξιδ / Работни панталони / Radne hlače / Radne pantalone / Πανεσλόν εργασιός / Pantalón de trabajo / Pantaloni da lavoro / Calças de trabalho / Pantalon de travail



Ref.	Size	📦	EAN
81-234-XS	XS/46	1/10	5907558470215
81-234-S	S/48	1/10	5907558470222
81-234-M	M/50	1/10	5907558470239
81-234-L	L/52	1/10	5907558470246
81-234-XL	XL/54	1/10	5907558470253
81-234-XXL	XXL/56	1/10	5907558470260
81-234-XXXL	XXXL/58	1/10	5907558470277



Ref.	Size	📦	EAN
81-226-XS	XS/46	12/24	5907558446654
81-226-S	S/48	12/24	5907558446661
81-226-M	M/50	12/24	5907558446678
81-226-L	L/52	12/24	5907558446685
81-226-XL	XL/54	12/24	5907558446692
81-226-XXL	XXL/56	12/24	5907558446708
81-226-XXXL	XXXL/58	12/24	5907558446715

## Spodnie robocze ogrodniczkzi

Working dungarees / Arbeitslatzhose / Πανγυμβιέζον / Ηαπιαγυμβιέζον / Munkaruha - kertész nadrág / Pantaloni de lucru cu pieptar / Pracovní kalhoty s laciem / Pracovní nohavice do záhrady / Delovne hlače / Darbinės kelnės (sodininkams) / Dārzniecās darba bikses / Tööturked / Градинарски работен панталон / Radne hlače na trepete / Pantalone za rad u vrtu / Όλαργα εργασιός με πρόνετες / Pantalón de trabajo tipo mono / Calças de trabalho / Pantalon de travail salopette / Tuinbroek



Ref.	Size	📦	EAN
81-249-XS	XS/46	1/10	5907558470284
81-249-S	S/48	1/10	5907558470291
81-249-M	M/50	1/10	5907558470307
81-249-L	L/52	1/10	5907558470314
81-249-XL	XL/54	1/10	5907558470321
81-249-XXL	XXL/56	1/10	5907558470338
81-249-XXXL	XXXL/58	1/10	5907558470345



Ref.	Size	📦	EAN
81-246-XS	XS/46	0/15	5907558446722
81-246-S	S/48	0/15	5907558446739
81-246-M	M/50	0/15	5907558446746
81-246-L	L/52	0/15	5907558446753
81-246-XL	XL/54	0/15	5907558446760
81-246-XXL	XXL/56	0/15	5907558446777
81-246-XXXL	XXXL/58	0/15	5907558446784



MotiwóK połączenia zbióu roboczú 81-217 w kombinézon (wewnętrzny swak)  
 Could be matched with jacket 81-217 into jumpsuit by zipper on elastic inner panel  
 Можно комбиновать с блузкой рабочей 81-217 в комбинезон (полс на резинке на молнии внутри)

Ref.	Size	📦	EAN
81-227-XS	XS/46	0/24	5907558446937
81-227-S	S/48	0/24	5907558446944
81-227-M	M/50	0/24	5907558446951
81-227-L	L/52	0/24	5907558446968
81-227-XL	XL/54	0/24	5907558446975
81-227-XXL	XXL/56	0/24	5907558446982
81-227-XXXL	XXXL/58	0/24	5907558446999



Ref.	Size	📦	EAN
81-247-XS	XS/46	0/20	5907558447002
81-247-S	S/48	0/20	5907558447019
81-247-M	M/50	0/20	5907558447026
81-247-L	L/52	0/20	5907558447033
81-247-XL	XL/54	0/20	5907558447040
81-247-XXL	XXL/56	0/20	5907558447057
81-247-XXXL	XXXL/58	0/20	5907558447064

## Spodnie robocze

Working trousers / Arbeitshose / Εργασιμὰ ροβὰτιο / Штаньο ροβοτι / Munkadzseki / Pantaloni de lucru / Pracovní kalhoty / Montérky / Delovne hlače / Darbinės kelnės / Darba bikses / Τροϋπίσιδ / Работни панталони / Radne hlače / Radne pantalone / Παντελόνι εργασιός / Pantalón de trabajo / Pantaloni da lavoro / Calças de trabalho / Pantalon de travail



Ref.	Size	☒	EAN
81-231-XS	XS/46	0/20	5907558447071
81-231-S	S/48	0/20	5907558447088
81-231-M	M/50	0/20	5907558447095
81-231-L	L/52	0/20	5907558447101
81-231-XL	XL/54	0/20	5907558447118
81-231-XXL	XXL/56	0/20	5907558447125
81-231-XXXL	XXXL/58	0/20	5907558447132



Ref.	Size	☒	EAN
81-290-XS	XS/46	0/30	5907558497038
81-290-S	S/48	0/30	5907558497045
81-290-M	M/50	0/30	5907558497052
81-290-L	L/52	0/30	5907558497069
81-290-XL	XL/54	0/30	5907558497076
81-290-XXL	XXL/56	0/30	5907558497083
81-290-XXXL	XXXL/58	0/30	5907558497090



Ref.	Size	☒	EAN
81-236-XS	XS/46	0/20	5907558467840
81-236-S	S/48	0/20	5907558467857
81-236-M	M/50	0/20	5907558467864
81-236-L	L/52	0/20	5907558467871
81-236-XL	XL/54	0/20	5907558467888
81-236-XXL	XXL/56	0/20	5907558467895
81-236-XXXL	XXXL/58	0/20	5907558467901



Ref.	Size	☒	EAN
81-228-XS	XS/46	0/20	5907558439427
81-228-S	S/48	0/20	5907558439434
81-228-M	M/50	0/20	5907558439441
81-228-L	L/52	0/20	5907558439458
81-228-XL	XL/54	0/20	5907558439465
81-228-XXL	XXL/56	0/20	5907558439472
81-228-XXXL	XXXL/58	0/20	5907558439489



Ref.	Size	☒	EAN
81-233-XS	XS/46	0/20	5907558467703
81-233-S	S/48	0/20	5907558467710
81-233-M	M/50	0/20	5907558467727
81-233-L	L/52	0/20	5907558467734
81-233-XL	XL/54	0/20	5907558467741
81-233-XXL	XXL/56	0/20	5907558467758
81-233-XXXL	XXXL/58	0/20	5907558467765



Ref.	Size	☒	EAN
81-229-XS	XS/46	0/20	5907558439496
81-229-S	S/48	0/20	5907558439502
81-229-M	M/50	0/20	5907558439519
81-229-L	L/52	0/20	5907558443127
81-229-XL	XL/54	0/20	5907558443134
81-229-XXL	XXL/56	0/20	5907558439540
81-229-XXXL	XXXL/58	0/20	5907558439557

GOOD DESIGN  
2020

## Spodnie robocze

Working trousers / Arbeitshose / Брюки рабочие / Штаны рабочие / Munkdžseki / Pantaloni de lucru / Pracovní kalhoty / Montérky / Delovne hlače / Darbinės kelnės / Darba bikses / Τοσάκις / Работни панталони / Radne hlače / Radne pantalone / Παντελόν εργασιών / Pantalón de trabajo / Pantaloni da lavoro / Calças de trabalho / Pantalón de travail



Ref.	Size	☒	EAN
81-239-XS	XS/46	0/20	5907558451726
81-239-S	S/48	0/20	5907558451733
81-239-M	M/50	0/20	5907558451740
81-239-L	L/52	0/20	5907558451757
81-239-XL	XL/54	0/20	5907558451764
81-239-XXL	XXL/56	0/20	5907558451771
81-239-XXXL	XXXL/58	0/20	5907558451788



Ref.	Size	☒	EAN
81-220-S	S/48	0/10	5907558419085
81-220-M	M/50	0/10	5907558419092
81-220-L	L/52	0/10	5907558419108
81-220-LD	L/54	0/10	5907558419115
81-220-XL	XL/56	0/10	5907558419122
81-220-XXL	XXL/58	0/10	5907558419139



Ref.	Size	☒	EAN
81-230-S	S/48	0/10	5907558419146
81-230-M	M/50	0/10	5907558419153
81-230-L	L/52	0/10	5907558419160
81-230-LD	L/54	0/10	5907558419177
81-230-XL	XL/56	0/10	5907558419184
81-230-XXL	XXL/58	0/10	5907558419191

## Spodnie robocze ogrodniczkzi

Working dungarees / Arbeitslatzhose / Πανυομβινεζον / Ηαρινομβινεζον / Munkaruha - kertész nadrág / Pantaloni de lucru cu pieptar / Pracovní kalhoty s ladem / Pracovné nohavice do záhrady / Delovne hlače / Darbinės kelnės (sodrininkams) / Dārznieces darba bikses / Τοσάκις / Γραδινορασι работни панталон / Radne hlače na trepere / Pantalone za rad u vrtu / Φόρμα εργασιών με πλάτες / Pantalón de trabajo tipo mono / Calças de trabalho / Pantalón de travail salopette / Túnbroek



Ref.	Size	☒	EAN
81-248-XS	XS/46	0/20	5907558451795
81-248-S	S/48	0/20	5907558451801
81-248-M	M/50	0/20	5907558451818
81-248-L	L/52	0/20	5907558451825
81-248-XL	XL/54	0/20	5907558451832
81-248-XXL	XXL/56	0/20	5907558451849
81-248-XXXL	XXXL/58	0/20	5907558451856

## Spodnie robocze na szelkach

Working trousers with suspenders / Arbeitslatzhose / Πανυομβινεζον ροβουσι / Πανομβινεζον ροβουσι / Kantáros munkanadrág / Pantaloni de lucru cu bretele / Montérky na traky / Delovne hlače z parčnicami / Darbinės kelnės su petnešomis / Darba puskombinezons / Traksidēga τοσάκις / Работни панталони с тирантами / Radne farmer hlače / Radne pantalone sa tregerima / Φόρμα εργασιών πρίνα / Pantalón de trabajo con tirantes / Salopette da lavoro / Jardineiras de trabalho / Pantalón de travail sur bretelles



Ref.	Size	☒	EAN
81-240-S	S/48	0/10	5907558419207
81-240-M	M/50	0/10	5907558419214
81-240-L	L/52	0/10	5907558419221
81-240-LD	L/54	0/10	5907558419238
81-240-XL	XL/56	0/10	5907558419245
81-240-XXL	XXL/58	0/10	5907558419252

## Spodnie robocze

Working trousers / Arbeitshose / Брюки рабочие / Штаны рабочие / Munkadzszi / Pantaloni de lucru / Prosonni kalhoty / Montérky / Delovne hlače / Darbinės kelnes / Darba bikses / Тööriksid / Рабочие брюки / Radne hlače / Radne pantalone / Παντελόν εργασιών / Pantalón de trabajo / Pantaloni da lavoro / Calças de trabalho / Pantalon de travail



Ref.	Size	☒	EAN
81-420-S	S/48	0/10	5907558415445
81-420-M	M/50	0/10	5907558415452
81-420-L	L/52	0/10	5907558415469
81-420-LD	L/54	0/10	5907558415476
81-420-XL	XL/56	0/10	5907558415483
81-420-XXL	XXL/58	0/10	5907558415490

## Spodnie robocze na szelkach

Working trousers with suspenders / Arbeitslatzhose / Полюкомбинезон рабочий / Поликомбинезон рабочий / Kantáros munkanadrág / Pantaloni de lucru cu bretele / Montérkové kalhoty / Montérky na tráky / Delovne hlače z naramnicami / Darbinės kelnės su petnešomis / Darba puskombinezons / Traksideda tööriksid / Рабочие брюки с тирежами / Radne farmer hlače / Radne pantalone sa tregenima / Όργανα εργασιών τράντα / Pantalón de trabajo con tirantes / Salopette da lavoro / Jardineiros de trabalho / Pantalon de travail sur bretelles



Ref.	Size	☒	EAN
81-430-S	S/48	0/10	5907558415506
81-430-M	M/50	0/10	5907558415513
81-430-L	L/52	0/10	5907558415520
81-430-LD	L/54	0/10	5907558415537
81-430-XL	XL/56	0/10	5907558415544
81-430-XXL	XXL/58	0/10	5907558415551



Ref.	Size	☒	EAN
81-238-XS	XS/46	0/20	5907558451658
81-238-S	S/48	0/20	5907558451665
81-238-M	M/50	0/20	5907558451672
81-238-L	L/52	0/20	5907558451689
81-238-XL	XL/54	0/20	5907558451696
81-238-XXL	XXL/56	0/20	5907558451702
81-238-XXXL	XXXL/58	0/20	5907558451719



Ref.	Size	☒	EAN
81-451-S	S/48	0/20	5907558486025
81-451-M	M/50	0/20	5907558486018
81-451-L	L/52	0/20	5907558486001
81-451-XL	XL/54	0/20	5907558486032
81-451-XXL	XXL/56	0/20	5907558486049
81-451-XXXL	XXXL/58	0/20	5907558486056



## Krótkie spodnie robocze

Shorts / Kurz hose / Шорты / Κορσέμι Στάνι / Rövidnadrág / Pantaloni Scurți / Kračasy / Krátke Nohavice / Krátke Hlače / Darbiniai Šortai / Šorti / Lühikesed Püksid / Късци Панталони / Krátke Hlače / Krátke Pantalone / Βερμούδες / Pantalones Cortos / Pantaloncini Corti / Calças Curtas / Culotte / Korte Broek



Ref.	Size	☒	EAN
81-565-S	S/48	0/10	5907558428247
81-565-M	M/50	0/10	5907558428254
81-565-L	L/52	0/10	5907558428261
81-565-XL	XL/56	0/10	5907558428278
81-565-XXL	XXL/58	0/10	5907558428285
81-565-XXXL	XXXL/60	0/10	5907558428292



Ref.	Size	☒	EAN
81-277-XS	XS/46	0/30	5907558472387
81-277-S	S/48	0/30	5907558472394
81-277-M	M/50	0/30	5907558472400
81-277-L	L/52	0/30	5907558472417
81-277-XL	XL/54	0/30	5907558472424
81-277-XXL	XXL/56	0/30	5907558472431
81-277-XXXL	XXXL/58	0/30	5907558472448



## Kpl. odzieży roboczej

Set of workwear / Satz Arbeitskleidung / Комбинезон сурдождь / Комбинезон сурдошай / Munkaruha készlet / Set de haine de lucru / Sada pracovních oděvů / Súprava pracovného oblečenia / Komplet delovných obočič / Darbo aprangos komplektas / Darbo apģērbi komplekts / Төрийн хэргийн тооног / Комбинезон рабoтнoг oблeчeннo / Set radne odjeće / Комбинезон рабнe oдeжe / Set рабoчeг oбeяoчeя / Conjunto de ropa de trabajo / Set di abiti da lavoro / Conjunto de roupa de trabalho / Ensemble de vêtements de travail



Ref.	Size	☒	EAN
81-450-S	S/48	0/10	5907558483369
81-450-M	M/50	0/10	5907558483376
81-450-L	L/52	0/10	5907558483383
81-450-XL	XL/54	0/10	5907558483390
81-450-XXL	XXL/56	0/10	5907558483406
81-450-XXXL	XXXL/58	0/10	5907558483413



## Kombinezon roboczy

Working overalls / Arbeitsoverall / Комбинезон рабочий / Комбинезон робочий / Overall / Combinezon de lucru / Pracovní kombinéza / Pracovní kombinéza / Delovni kombinézon / Darbinis kombinezons / Darbo kombinézons / Төйкөмбинезон / Работен комбинезон / Radni kombinézon / Radni kombinézon / Фірма ерачoчeя / Mono de trabajo / Tuta do lavoro / Mascacão de trabalho / Combinação de travail



Ref.	Size	☒	EAN
81-258-XS	XS/46	0/15	5907558451863
81-258-S	S/48	0/15	5907558451870
81-258-M	M/50	0/15	5907558451887
81-258-L	L/52	0/15	5907558451894
81-258-XL	XL/54	0/15	5907558451900
81-258-XXL	XXL/56	0/15	5907558451917
81-258-XXXL	XXXL/58	0/15	5907558451924



## Bluza robocza

Working top / Arbeitsshirt / Блуза робочая / Блyзнa робoчaя / Munkdzseki / Bluza de lucru / Pracovní blůza / Pracovní bunda / Delovna jakna / Darbiniai marškiniai / Darbo krekls / Төйгoжк / Работна блуза / Radna bluza / Radna bluza / Μηλοϊζα еραчoчeя / Sudadera de trabajo / Giacca da lavoro / Blusão de trabalho / Veste de travail



Ref.	Size	☒	EAN
81-214-S	S/48	1/10	5907558470154
81-214-M	M/50	1/10	5907558470161
81-214-L	L/52	1/10	5907558470178
81-214-XL	XL/54	1/10	5907558470185
81-214-XXL	XXL/56	1/10	5907558470192
81-214-XXXL	XXXL/58	1/10	5907558470208



Ref.	Size	☒	EAN
81-216-S	S/48	0/20	5907558446593
81-216-M	M/50	0/20	5907558446609
81-216-L	L/52	0/20	5907558446616
81-216-XL	XL/54	0/20	5907558446623
81-216-XXL	XXL/56	0/20	5907558446630
81-216-XXXL	XXXL/58	0/20	5907558446647



Ref.	Size	☒	EAN
81-250-S	S/48	0/10	5907558419269
81-250-M	M/50	0/10	5907558419276
81-250-L	L/52	0/10	5907558419283
81-250-LD	L/54	0/10	5907558419290
81-250-XL	XL/56	0/10	5907558419306
81-250-XXL	XXL/58	0/10	5907558419313



Ref.	Size	☒	EAN
81-217-XS	XS/46	0/20	5907558446869
81-217-S	S/48	0/20	5907558446876
81-217-M	M/50	0/20	5907558446883
81-217-L	L/52	0/20	5907558446890
81-217-XL	XL/54	0/20	5907558446906
81-217-XXL	XXL/56	0/20	5907558446913
81-217-XXXL	XXXL/58	0/20	5907558446920



Możliwość połączenia ze spodniami roboczymi 81-227 w kombinezon (elastyczny pas z zamkiem w środku)  
Can be matched with jacket 81-227 into a jumpsuit (elastic waistband with a zipper inside)  
Можно комбинировать с брюками рабочими 81-227 в комбинезон (элик на резинке на молнии внутри)

## Bluza robocza

Working top / Arbeitsshirt / Блуза рабочая / Нуртка рабоча / Munkadzseki / Bluza de lucru / Pracovni bluza / Pracovná bunda / Delovna jakna / Darbiniai marškiniai / Darba krekis / Tööjakk / Рабочня блуза / Radna bluza / Radna bluza / Μηκνούχα εργασιών / Sudadera de trabajo / Giacca da lavoro / Blusão de trabalho / Veste de travail



Ref.	Size	☒	EAN
81-218-S	S/48	0/20	5907558451597
81-218-M	M/50	0/20	5907558451603
81-218-L	L/52	0/20	5907558451610
81-218-XL	XL/54	0/20	5907558451627
81-218-XXL	XXL/56	0/20	5907558451634
81-218-XXXL	XXXL/58	0/20	5907558451641



## Bluza polarowa

Polar fleece jacket / Arbeitskittel aus Polarfleece / Блуза из флиса / Μαϊστέρια / Polár munkadzseki / Bluza polar / Fleeceová mikina / Flisová bunda / Јакиџ из флиса / Džempers iš polianinio fliso audinio / Flisō jaka / Flis / Блуза ам флорне / Bluza od polara / Jakna / Μηκνούχα φλις / Chaqueta de polar / Giacca in pile / Carnisola polar / Polo polaire / Fleece trui



Ref.	Size	☒	EAN
81-506-S	S/48	0/13	5907558441482
81-506-M	M/50	0/13	5907558441499
81-506-L	L/52	0/13	5907558441505
81-506-XL	XL/54	0/13	5907558441512
81-506-XXL	XXL/56	0/13	5907558441529
81-506-XXXL	XXXL/58	0/13	5907558441536



Ref.	Size	☒	EAN
81-210-S	S/48	0/10	5907558419023
81-210-M	M/50	0/10	5907558419030
81-210-L	L/52	0/10	5907558419047
81-210-LD	L/54	0/10	5907558419054
81-210-XL	XL/56	0/10	5907558419061
81-210-XXL	XXL/58	0/10	5907558419078



Ref.	Size	☒	EAN
81-507-S	S/48	0/16	5907558498417
81-507-M	M/50	0/16	5907558498400
81-507-L	L/52	0/16	5907558498394
81-507-LD	L/54	0/16	5907558498424
81-507-XL	XL/56	0/16	5907558498431
81-507-XXL	XXL/58	0/16	5907558498448



Ref.	Size	☒	EAN
81-410-S	S/48	0/10	5907558415384
81-410-M	M/50	0/10	5907558415391
81-410-L	L/52	0/10	5907558415407
81-410-LD	L/54	0/10	5907558415414
81-410-XL	XL/56	0/10	5907558415421
81-410-XXL	XXL/58	0/10	5907558415438



Ref.	Size	☒	EAN
81-500-S	S/48	0/20	5907558419498
81-500-M	M/50	0/20	5907558419504
81-500-L	L/52	0/20	5907558419511
81-500-XL	XL/56	0/20	5907558419528
81-500-XXL	XXL/58	0/20	5907558419535





## Bluza polarowa

Polar fleece jacket / Arbeitskittel aus Polarfleece / Ενδυα ια φλιςα / Μαϊστερια / Polár munkadzseki / Bluza polar / Fleeceová mikina / Flísová bunda / Јорџ и флiso / Džemperis iš polarinio fliso audinio / Flísá jaka / Flis / Ενδυαα αα φλια / Bluza od polara / Јакна / Μηλοϋζα φλις / Chaqueta de polar / Giacca in pile / Camisola polar / Polo polaire / Fleece trui



Ref.	Size	☒	EAN
81-501-S	S/48	0/20	5907558429237
81-501-M	M/50	0/20	5907558429244
81-501-L	L/52	0/20	5907558429251
81-501-XL	XL/56	0/20	5907558429268
81-501-XXL	XXL/58	0/20	5907558429275



Ref.	Size	☒	EAN
81-502-S	S/48	1/20	5907558482706
81-502-M	M/50	1/20	5907558482713
81-502-L	L/52	1/20	5907558482720
81-502-XL	XL/54	1/20	5907558482737
81-502-XXL	XXL/56	1/20	5907558482744
81-502-XXXL	XXXL/58	1/20	5907558482751



Ref.	Size	☒	EAN
81-503-S	S/48	1/20	5907558482768
81-503-M	M/50	1/20	5907558482775
81-503-L	L/52	1/20	5907558482782
81-503-XL	XL/54	1/20	5907558482799
81-503-XXL	XXL/56	1/20	5907558482805
81-503-XXXL	XXXL/58	1/20	5907558482812



Ref.	Size	☒	EAN
81-504-S	S/48	1/20	5907558482829
81-504-M	M/50	1/20	5907558482836
81-504-L	L/52	1/20	5907558482843
81-504-XL	XL/54	1/20	5907558482850
81-504-XXL	XXL/56	1/20	5907558482867
81-504-XXXL	XXXL/58	1/20	5907558482874



## Bluza dziana

Knitted sweatshirt / Strickbluse / Τεννηα βλυα / Блyза трикотажная / Kotött blúz / Bluz tricotaј / Pletená mikina / Pletená bunda / Pletena bluza / Džemperis / Trikotázás sporta džemperis / Trikotaažist dressipluus / Τεληφρα αα ραβιαα πρy τεχναα υαααα / Bluza od pletenine / Pletena bluza / Μηλοϋζα ηλεκιαα αημμοαυ / Sudadera de punto / Fejra in tessuto / Blusão em malha / Blouzen tricot / Katoenen trui



Ref.	Size	☒	EAN
81-511-S	S/48	0/20	5907558441420
81-511-M	M/50	0/20	5907558441437
81-511-L	L/52	0/20	5907558441444
81-511-XL	XL/54	0/20	5907558441451
81-511-XXL	XXL/56	0/20	5907558441468
81-511-XXXL	XXXL/58	0/20	5907558441475



Ref.	Size	☒	EAN
81-555-S	S/48	0/10	5907558428063
81-555-M	M/50	0/10	5907558428070
81-555-L	L/52	0/10	5907558428087
81-555-XL	XL/56	0/10	5907558428094
81-555-XXL	XXL/58	0/10	5907558428100
81-555-XXXL	XXL/60	0/10	5907558428117



## Kurtka softshell

Waterproof, windproof jacket, softshell / Wind- und wasserdichte Softshelljacke / Куртка водо- и ветронепроницаемая, softshell / Вирпука з водоішпромацаванай тканіны «softshell» / Softshell munkadzseki / Djaca impermeabila, antivânt, softshell / Vodoodolná, větruvzdorná, softshellová bunda / Vodoodolná, vetruodolná, softshellová bunda / Jakna, odporna na vodu, veter, softshell / Vėjui ir vandeniui atspari striuke („softshell“) / Ūdensnecaurlaidīgavējaka, softshell / Softshell vee- ja tuulekindel jope / Блуза ан налар / Vodootporna, vjetrootporna jakna softshell / Jakna otporna na vodu, veter, sa mekim jezgrom / Αδιάβροχο μπλουζάν για προστασία από τον αέρα / Chaqueta impermeable, antiviento, softshell / Giacca antivento, antipioggia, softshell / Casaca corta vento impermeável softshell / Blouse imperméable pare-brise softshell



Ref.	Size	☒	EAN
81-550-S	S/48	0/10	5907558419542
81-550-M	M/50	0/10	5907558419559
81-550-L	L/52	0/10	5907558419566
81-550-XL	XL/56	0/10	5907558419573
81-550-XXL	XXL/58	0/10	5907558419580



Ref.	Size	☒	EAN
81-551-S	S/48	0/10	5907558427943
81-551-M	M/50	0/10	5907558427950
81-551-L	L/52	0/10	5907558427967
81-551-XL	XL/56	0/10	5907558427974
81-551-XXL	XXL/58	0/10	5907558427981
81-551-XXXL	XXXL/60	0/10	5907558427998

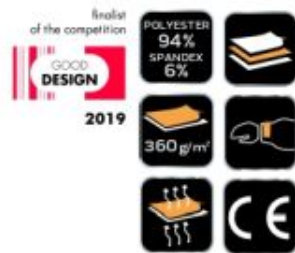

Ref.	Size	☒	EAN
81-558-S	S/48	0/10	5907558434798
81-558-M	M/50	0/10	5907558434804
81-558-L	L/52	0/10	5907558434811
81-558-XL	XL/54	0/10	5907558434828
81-558-XXL	XXL/56	0/10	5907558434835



## Bluza robocza

Working top / Arbeitsshirt / Рабочая толстовка / Куртка рабочая / Munkadzseki / Bluza de lucru / Pracovní blůza / Pracovní bunda / Delovna jakna / Darbiniai marškiniai / Darba kreklis / Тэйякк / Рабочая блуза / Radna bluza / Рабочая блуза / Μελούζα εργασιών / Sudadera de trabajo / Giacca da lavoro / Blusão de trabalho / Veste de travail



Ref.	Size	☒	EAN
81-556-S	S/48	0/10	5907558428124
81-556-M	M/50	0/10	5907558428131
81-556-L	L/52	0/10	5907558428148
81-556-XL	XL/56	0/10	5907558428155
81-556-XXL	XXL/58	0/10	5907558428162
81-556-XXXL	XXXL/60	0/10	5907558428179



## T-shirt

T-shirt / T-Shirt / Футболка сшаньная / Футболка / Póló / T-shirt / Tričko / Tričko / Majica / Apotiniai marškinėliai - T / T-kreklis / T-särk / Тулэарш / T-shirt / Majica kratkih rukava / Κορωμάνη μπλούζα / Camiseta / Maglietta / Camisola / T-shirt / T-shirt



Ref.	Size	☒	EAN
81-609-S	S/48	1/25	5907558470352
81-609-M	M/50	1/25	5907558470369
81-609-L	L/52	1/25	5907558470376
81-609-XL	XL/54	1/25	5907558470383
81-609-XXL	XXL/56	1/25	5907558470390
81-609-XXXL	XXXL/58	1/25	5907558470406



Ref.	Size	☒	EAN
81-640-M	M/50	0/50	5907558483420
81-640-L	L/52	0/50	5907558483437
81-640-XL	XL/54	0/50	5907558483444
81-640-XXL	XXL/56	0/50	5907558483451
81-640-XXXL	XXXL/58	0/50	5907558483468



# T-shirt

T-shirt / T-Shirt / Футболка сменная / Футболка / Póló / T-shirt / Tričko / Trička / Majica / Apertiniai marškinėliai - T/T-kreks / T-särk / Тушърм / T-shirt / Majica kratkih rukava / Κορτομάνιχο μπλουζά / Camiseta / Maglietta / Camisola / T-shirt / T-shirt



COTTON 100%

180g/m<sup>2</sup>





Ref.	Size	☒	EAN
81-642-M	M/50	0/50	5907558483529
81-642-L	L/52	0/50	5907558483536
81-642-XL	XL/54	0/50	5907558483543
81-642-XXL	XXL/56	0/50	5907558483550
81-642-XXXL	XXXL/58	0/50	5907558483567



COTTON 100%

180g/m<sup>2</sup>





Ref.	Size	☒	EAN
81-641-M	M/50	0/50	5907558483475
81-641-L	L/52	0/50	5907558483482
81-641-XL	XL/54	0/50	5907558483499
81-641-XXL	XXL/56	0/50	5907558483505
81-641-XXXL	XXXL/58	0/50	5907558483512



COTTON 100%

180g/m<sup>2</sup>





Ref.	Size	☒	EAN
81-643-M	M/50	0/50	5907558483574
81-643-L	L/52	0/50	5907558483581
81-643-XL	XL/54	0/50	5907558483598
81-643-XXL	XXL/56	0/50	5907558483604
81-643-XXXL	XXXL/58	0/50	5907558483611



COTTON 100%

180g/m<sup>2</sup>





Ref.	Size	☒	EAN
81-610-S	S/48	0/50	5907558432022
81-610-M	M/50	0/50	5907558432039
81-610-L	L/52	0/50	5907558432046
81-610-XL	XL/54	0/50	5907558432053
81-610-XXL	XXL/56	0/50	5907558432060



COTTON 100%

180g/m<sup>2</sup>





Ref.	Size	☒	EAN
81-648-S	S/48	0/50	5907558482942
81-648-M	M/50	0/50	5907558482959
81-648-L	L/52	0/50	5907558482966
81-648-XL	XL/54	0/50	5907558482973
81-648-XXL	XXL/56	0/50	5907558482980
81-648-XXXL	XXXL/58	0/50	5907558482997



COTTON 100%

180g/m<sup>2</sup>





Ref.	Size	☒	EAN
81-647-S	S/48	0/50	5907558483000
81-647-M	M/50	0/50	5907558483017
81-647-L	L/52	0/50	5907558483024
81-647-XL	XL/54	0/50	5907558483031
81-647-XXL	XXL/56	0/50	5907558483048
81-647-XXXL	XXXL/58	0/50	5907558483055



COTTON 100%

180g/m<sup>2</sup>





Ref.	Size	☒	EAN
81-612-S	S/48	0/50	5907558432121
81-612-M	M/50	0/50	5907558432138
81-612-L	L/52	0/50	5907558432145
81-612-XL	XL/54	0/50	5907558432152
81-612-XXL	XXL/56	0/50	5907558432169



COTTON 100%

180g/m<sup>2</sup>





Ref.	Size	☒	EAN
81-649-S	S/48	0/50	5907558482881
81-649-M	M/50	0/50	5907558482898
81-649-L	L/52	0/50	5907558482904
81-649-XL	XL/54	0/50	5907558482911
81-649-XXL	XXL/56	0/50	5907558482928
81-649-XXXL	XXXL/58	0/50	5907558482935

## T-shirt

T-shirt / T-Shirt / Футболка сигнальная / Футболка / Polo / T-shirt / Tričko / Trička / Majica / Aparitina / marškiniai - T / T-krakls / T-särk / Тельняш / T-shirt / Majica kratkih rukava / Κομπομένη μπλούζα / Camiseta / Maglietta / Camisola / T-shirt / T-shirt



Ref.	Size	☒	EAN
81-615-S	S/48	0/50	5907558435344
81-615-M	M/50	0/50	5907558435351
81-615-L	L/52	0/50	5907558435368
81-615-XL	XL/54	0/50	5907558435375
81-615-XXL	XXL/56	0/50	5907558435382



## Koszulka polo

Polo shirt / Polo-Shirt / Футболка-поло / Сорочка-поло / Pólóing / Camisa din tesatura / Tričko polo / Polokošela / Majica z ovratnikom / Marškiniai „Polo“ / Polo krakls / Polosärk / Блузка поло / Polo majica / Polo majica / Κομπομένη μπλούζα polo / Camiseta polo Polo / Camisa polo / Chemise polo / Polo shirt



Ref.	Size	☒	EAN
81-606-S	S/48	0/40	5907558439809
81-606-M	M/50	0/40	5907558439816
81-606-L	L/52	0/40	5907558439823
81-606-XL	XL/54	0/40	5907558439830
81-606-XXL	XXL/56	0/40	5907558439847
81-606-XXXL	XXXL/58	0/40	5907558439854



Ref.	Size	☒	EAN
81-659-S	S/48	0/25	5907558467918
81-659-M	M/50	0/25	5907558467925
81-659-L	L/52	0/25	5907558467932
81-659-XL	XL/54	0/25	5907558467949
81-659-XXL	XXL/56	0/25	5907558467956
81-659-XXXL	XXXL/58	0/25	5907558467963



## Bezrękawnik roboczy

Work body warmer / Arbeitsweste / Жилет рабочий / Безрукава робоча / Mellény jényviszverő / Vesta de lucru / Pracovní vesta / Pracovní vesta / Delovni brezrokavnik / Darbinė liemenė / Darba jaka bez piedurknēm / Төвөст / Работен енек / Radni prsluk / Radnički prsluk / Γιλέκο εργασιών / Chaleco de trabajo / Gilet da lavoro doppio uso / Blusa de trabalho sem mangas / Gilet de travail



Ref.	Size	☒	EAN
81-534-S	S/48	0/10	5907558441789
81-534-M	M/50	0/10	5907558441796
81-534-L	L/52	0/10	5907558441802
81-534-XL	XL/54	0/10	5907558441819
81-534-XXL	XXL/56	0/10	5907558441826
81-534-XXXL	XXXL/58	0/10	5907558441833



Ref.	Size	☒	EAN
81-530-S	S/48	0/20	5907558427011
81-530-M	M/50	0/20	5907558427028
81-530-L	L/52	0/20	5907558427035
81-530-XL	XL/56	0/20	5907558427042
81-530-XXL	XXL/58	0/20	5907558427059



Ref.	Size	☒	EAN
81-532-S	S/48	0/20	5907558427882
81-532-M	M/50	0/20	5907558427899
81-532-L	L/52	0/20	5907558427905
81-532-XL	XL/56	0/20	5907558427912
81-532-XXL	XXL/58	0/20	5907558427929
81-532-XXXL	XXXL/60	0/20	5907558427936



## Koszula flanelowa

Flannel shirt / Flannelhemd / Φανελέσασ ρυθαινα / Сорочка фланелеса / Flaneling / Cămașă de flanelă / Flanelová košile / Flanelová košela / Flanelasta srajca / Flaneliniai marškiniai / Flanelo kreklis / Flanelšärk / Φανελενα ρυσα / Košulja od flanela / Flanelska košulja / Φανελίνο πουκάμισο / Camisa de flanela / Camicia di flanello / Camisa de flanela / Chemise en flanelle



COTTON 100%

CE

Ref.	Size	☒	EAN
81-540-S	S/48	0/36	5907558432244
81-540-M	M/50	0/36	5907558432251
81-540-L	L/52	0/36	5907558432268
81-540-XL	XL/54	0/36	5907558432275
81-540-XXL	XXL/56	0/36	5907558432282



COTTON 100%

CE

Ref.	Size	☒	EAN
81-541-S	S/48	0/36	5907558432299
81-541-M	M/50	0/36	5907558432305
81-541-L	L/52	0/36	5907558432312
81-541-XL	XL/54	0/36	5907558432329
81-541-XXL	XXL/56	0/36	5907558432336



COTTON 100%

170g/m<sup>2</sup>

CE

Ref.	Size	☒	EAN
81-545-S	S/48	1/36	5907558484366
81-545-M	M/50	1/36	5907558484373
81-545-L	L/52	1/36	5907558484380
81-545-XL	XL/56	1/36	5907558484397
81-545-XXL	XXL/58	1/36	5907558484403
81-545-XXXL	XXXL/60	1/36	5907558484410



COTTON 100%

170g/m<sup>2</sup>

CE

Ref.	Size	☒	EAN
81-546-S	S/48	1/36	5907558484427
81-546-M	M/50	1/36	5907558484434
81-546-L	L/52	1/36	5907558484441
81-546-XL	XL/56	1/36	5907558484458
81-546-XXL	XXL/58	1/36	5907558484465
81-546-XXXL	XXXL/60	1/36	5907558484472

## Koszula robocza

Work shirt / Arbeitshemd / Рабочая рубашка / Рубочна сорочка / Munka ing / Cămașă de lucru / Pracovní košile / Pracovní košela / Δελονη μαγίσα / Darbo marškiniai / Darbakreklis / То сарк / Рабочия ρυσα / Radna košulja / Радна мајица / εργασία πουκάμισο / Camisa de trabajo / Camicia da lavoro / Camisa de trabalho / Chemise de travail / Werk shirt



COTTON 100%

140g/m<sup>2</sup>

CE

Ref.	Size	☒	EAN
81-549-S	S/48	0/30	5907558439625
81-549-M	M/50	0/30	5907558439632
81-549-L	L/52	0/30	5907558439649
81-549-XL	XL/54	0/30	5907558439656
81-549-XXL	XXL/56	0/30	5907558439663
81-549-XXXL	XXXL/58	0/30	5907558439670

## Bokserki

Boxers / Boxer / Боксеры / Боксеру / Bokszolók / Boxeri / Boxer / Boxerky / Bokсарice / Boksininkai / Bokseri / Paksijod / Боксерни / Boksojice / Боксеру / Μπόξερ / Boxeadores / Pugli / Puglistas / Boxeurs / Bokser





COTTON 95% ELASTAN 5%

180g/m<sup>2</sup>

x3

Ref.	Size	☒	EAN
81-679-M	M/50	0/50	5907558498769
81-679-L	L/52	0/50	5907558498752
81-679-XL	XL/56	0/50	5907558498776
81-679-XXL	XXL/58	0/50	5907558498783

## Spodnie robocze

Working trousers / Arbeitshosen / Бирки робочие / Штани робочи / Munkaruha nadrág / Pantaloni de lucru / Pracovní kalhoty / Pracovné nohavice / Delovne hlače / Darbinės kelnes / Darba bikses / Τοοπύξιδ / Работни панталони / Radne hlače / Rande pantalone / Παντελόν εργασιών / Pantalón de trabajo / Pantaloni da lavoro / Calças de trabalho / Pantalon de travail / Werkbroek



Ref.	Size	☒	EAN
81-280-S	S/48	0/28	5907558498233
81-280-M	M/50	0/28	5907558498226
81-280-L	L/52	0/28	5907558498219
81-280-XL	XL/54	0/28	5907558498240
81-280-XXL	XXL/56	0/28	5907558498257
81-280-XXXL	XXXL/58	0/28	5907558498264



Ref.	Size	☒	EAN
81-282-S	S/48	0/24	5907558498295
81-282-M	M/50	0/24	5907558498288
81-282-L	L/52	0/24	5907558498271
81-282-XL	XL/54	0/24	5907558498301
81-282-XXL	XXL/56	0/24	5907558498318
81-282-XXXL	XXXL/58	0/24	5907558498325



Ref.	Size	☒	EAN
81-283-S	S/48	0/20	5907558498356
81-283-M	M/50	0/20	5907558498349
81-283-L	L/52	0/20	5907558498332
81-283-XL	XL/54	0/20	5907558498363
81-283-XXL	XXL/56	0/20	5907558498370
81-283-XXXL	XXXL/58	0/20	5907558498387



## Bluza robocza

Working top / Arbeitshirt / Рабочая майка / Хупина робоча / Munkadzseki / Bluza de lucru / Pracovní blůza / Pracovná bunda / Delovna jakna / Darbiniai marškiniai / Darba kreklis / Τοοπύξιδ / Работна блуза / Radna bluza / Rande bluza / Παντελόν εργασιών / Sudadera de trabajo / Giacca da lavoro / Blusão de trabalho / Veste de travail



Ref.	Size	☒	EAN
81-651-S	S/48	0/26	5907558498653
81-651-M	M/50	0/26	5907558498646
81-651-L	L/52	0/26	5907558498639
81-651-XL	XL/54	0/26	5907558498660
81-651-XXL	XXL/56	0/26	5907558498677
81-651-XXXL	XXXL/58	0/26	5907558498684



Ref.	Size	☒	EAN
81-650-S	S/48	0/32	5907558498592
81-650-M	M/50	0/32	5907558498585
81-650-L	L/52	0/32	5907558498578
81-650-XL	XL/54	0/32	5907558498608
81-650-XXL	XXL/56	0/32	5907558498615
81-650-XXXL	XXXL/58	0/32	5907558498622



Ref.	Size	☒	EAN
81-513-S	S/48	0/30	5907558498479
81-513-M	M/50	0/30	5907558498462
81-513-L	L/52	0/30	5907558498455
81-513-XL	XL/54	0/30	5907558498486
81-513-XXL	XXL/56	0/30	5907558498493
81-513-XXXL	XXXL/58	0/30	5907558498509



Ref.	Size	☒	EAN
81-514-S	S/48	0/22	5907558498530
81-514-M	M/50	0/22	5907558498523
81-514-L	L/52	0/22	5907558498516
81-514-XL	XL/54	0/22	5907558498547
81-514-XXL	XXL/56	0/22	5907558498554
81-514-XXXL	XXXL/58	0/22	5907558498561



## Koszulka termoaktywna

Thermal long sleeve / Thermo-Funktionsunterwäsche Hemd langarm / Термоактивная блуза / Футболка з довшим рукавом термоактивна / Thermo alüütlõzet felső / Cămașă termoactivă / Термоактивни триčko / Termo tričko / Termo majica / Termo marškineljai / Termoveļas kreklis / Termoaktivne alussärk / Термоактивна блуза / Termoaktivna majica / Termoaktivna košulja / κοδερμική μπλούζα / Camiseta termoactiva / Maglia termica / Camiseta térmica / Chemise thermoactive / Thermoactive shirt



POLYMER 6.5%  
POLYESTER 93.2%  
ELASTANE 5%



Ref.	Size	☒	EAN
81-660-S/M	S/48 / M/50	0/60	5907558431964
81-660-L/XL	L/52 / XL/54	0/60	5907558431971
81-660-XXL/XXXL	XXL/56 / XXXL/58	0/60	5907558431988



POLYESTER 100%



WARM



Ref.	Size	☒	EAN
81-662-S/M	S/48 / M/50	0/50	5907558448900
81-661-L/XL	L/52 / XL/54	0/50	5907558448917
81-661-XXL/XXXL	XXL/56 / XXXL/58	0/50	5907558431971



COOLMAX 60%  
NYLON 32%  
SPANDEX 8%



Ref.	Size	☒	EAN
81-662-S/M	S/48 / M/50	0/60	5907558463392
81-662-L/XL	L/52 / XL/54	0/60	5907558463408
81-662-XXL/XXXL	XXL/56 / XXXL/58	0/60	5907558463415



ANTIBACTERIAL 60%  
NYLON 32%  
SPANDEX 8%



ODOUR STOP



Ref.	Size	☒	EAN
81-663-S/M	S/48 / M/50	0/60	5907558463422
81-663-L/XL	L/52 / XL/54	0/60	5907558463439
81-663-XXL/XXXL	XXL/56 / XXXL/58	0/60	5907558463446

## Kalesony termoaktywne

Thermal leggings / Thermo-Funktionsunterwäsche Hose / Термоактивные кальсоны / Кальсоны термоактивни / Thermo alüütlõzet alõ / Izmene thermoactive / Термоактивни калоты (spodky) / Termo spodné nohavice / Termo spodnje hlače / Termo kelnès / Termoveļas bikses / Termoaktiivsed pikad alusripid / Термоактивни колін / Термоактивне дуге гаће / Термоактивне pantalone / κοδερμικό κολόν / Mallas termoactivas / Calzamañita térmica / Calças justas térmicas / Caleçon thermoactif / Thermoactive broek



POLYMER 6.5%  
POLYESTER 93.2%  
ELASTANE 5%



Ref.	Size	☒	EAN
81-670-S/M	S/48 / M/50	0/60	5907558431995
81-670-L/XL	L/52 / XL/54	0/60	5907558432008
81-670-XXL/XXXL	XXL/56 / XXXL/58	0/60	5907558432015



POLYESTER 100%



WARM

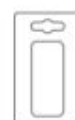

Ref.	Size	☒	EAN
81-671-S/M	S/48 / M/50	0/50	5907558448931
81-671-L/XL	L/52 / XL/54	0/50	5907558448948
81-671-XXL/XXXL	XXL/56 / XXXL/58	0/50	5907558448955



COOLMAX 60%  
NYLON 32%  
SPANDEX 8%



Ref.	Size	☒	EAN
81-672-S/M	S/48 / M/50	0/60	5907558463453
81-672-L/XL	L/52 / XL/54	0/60	5907558463460
81-672-XXL/XXXL	XXL/56 / XXXL/58	0/60	5907558463477



ANTIBACTERIAL 60%  
NYLON 32%  
SPANDEX 8%

WARM

ODOUR STOP



Ref.	Size	☒	EAN
81-673-S/M	S/48 / M/50	0/60	5907558463484
81-673-L/XL	L/52 / XL/54	0/60	5907558463491
81-673-XXL/XXXL	XXL/56 / XXXL/58	0/60	5907558463507

## Czapka z latarką

Cap with flashlight / Mütze mit Sömlampe / Βεΐζβολνα с фонариком / Шапка з латарком / Szapka latarkával / Čičiulă cu lanternă / Čepice s baterkou / Čapka s baterkou / Kapa z lučkou / Kepure su žbintvelüli / Cepure ar lukturii / Lambiga mütts / Шапка с фенерче / Kapa sa svjetiljkom / Kapa s lampom / Kapelo túnuo tǵkezi me fainó / Gorra con linterna / Cappello con torcia elettrica / Gorra com lanterna / Casquette avec torche



81-632

81-630

81-631

**180lm**

**USB charging**

3 light models

**WATER RESISTANT LAMP**

**CE**

Ref.	☒	EAN
81-630	0/100	5907558460179
81-631	0/100	5907558460186
81-632	0/100	5907558460193



**180lm**

**USB charging**

3 light models

**WATER RESISTANT LAMP**

**CE**

Ref.	☒	EAN
81-621	12/120	5907558428308

## Półbuty robocze

Safety shoes / Arbeitshalbschuhe / Полуботинок робочі / Півчеревики робочі / Мункацирџ / Pantofi de lucru / Pracovní obuv / Pracovné poltopánky / Nizki delovni čevlji / Darbo pusbačai / Darbo puszabaki / Töökingad / Роботни обувки ниски (половина) / Radne cipele / Poluduboke radne cipele / Нјмјпота ерџаиас / Botas de seguridad / Scarpa da lavoro / Sapatos de trabalho / Souliers de sécurité / Werkschoenen



**S1 SRC**

COMPOSITE 200J

ANTISLIP

ANTISTATIC

ANTISHOCK

ABRASION RESISTANT

METAL FREE

**CE**

Ref.	Size	Size [cm]	☒	EAN
82-155-39	39	26	0/10	5907558442908
82-155-40	40	26.7	0/10	5907558442915
82-155-41	41	27.3	0/10	5907558442922
82-155-42	42	28	0/10	5907558442939
82-155-43	43	28.7	0/10	5907558442946
82-155-44	44	29.3	0/10	5907558442953
82-155-45	45	30	0/10	5907558442960
82-155-46	46	30.7	0/10	5907558442977
82-155-47	47	31.3	0/10	5907558442984



**S1 SRC**

STEEL 200J

ANTISLIP

ANTISTATIC

ANTISHOCK

ABRASION RESISTANT

**CE**

Ref.	Size	Size [cm]	☒	EAN
82-090	39	26	0/10	5907558426748
82-091	40	26.7	0/10	5907558426755
82-092	41	27.3	0/10	5907558426762
82-093	42	28	0/10	5907558426779
82-094	43	28.7	0/10	5907558426786
82-095	44	29.3	0/10	5907558426793
82-096	45	30	0/10	5907558426809
82-097	46	30.7	0/10	5907558426816
82-098	47	31.3	0/10	5907558426823



**S1P SRA**

STEEL 200J

ANTISLIP

ANTISTATIC

ANTISHOCK

ABRASION RESISTANT

METAL

**CE**

Ref.	Size	Size [cm]	☒	EAN
82-010	39	26	0/10	5907558412604
82-011	40	26.7	0/10	5907558414530
82-012	41	27.3	0/10	5907558414974
82-013	42	28	0/10	5907558414981
82-014	43	28.7	0/10	5907558414998
82-015	44	29.3	0/10	5907558415001
82-016	45	30	0/10	5907558415018
82-017	46	30.7	0/10	5907558415025
82-018	47	31.3	0/10	5907558421002



**S1 SRC**

STEEL 200J

ANTISLIP

ANTISTATIC

ANTISHOCK

ABRASION RESISTANT

**CE**

Ref.	Size	Size [cm]	☒	EAN
82-160-39	39	26	0/10	5907558483970
82-160-40	40	26.7	0/10	5907558483987
82-160-41	41	27.3	0/10	5907558483994
82-160-42	42	28	0/10	5907558484007
82-160-43	43	28.7	0/10	5907558484014
82-160-44	44	29.3	0/10	5907558484021
82-160-45	45	30	0/10	5907558484038
82-160-46	46	30.7	0/10	5907558484045
82-160-47	47	31.3	0/10	5907558484052



## Pólbuty robocze

Safety shoes / Arbeitsschuhe / Полуботинок робочі / Півчеревики робочі / Munkcipő / Pantofo de lucru / Pracovní obuv / Pracovné poltopánky / Nizki delovni čevlji / Darba pusbačiai / Darba pusžabaki / Töökängad / Работни обувни ниски (половинки) / Radne cipele / Poluduboke radne cipele / Ημίμοια εργασία / Botos de seguridad / Scarpa da lavoro / Sapatos de trabalho / Souliers de sécurité / Werkschoenen



Ref.	Size	Size [cm]	☒	EAN
82-100	39	26	0/10	5907558426830
82-101	40	26.7	0/10	5907558426847
82-102	41	27.3	0/10	5907558426854
82-103	42	28	0/10	5907558426861
82-104	43	28.7	0/10	5907558426878
82-105	44	29.3	0/10	5907558426885
82-106	45	30	0/10	5907558426892
82-107	46	30.7	0/10	5907558426908
82-108	47	31.3	0/10	5907558426915



Ref.	Size	Size [cm]	☒	EAN
82-110	39	26	0/10	5907558426922
82-111	40	26.7	0/10	5907558426939
82-112	41	27.3	0/10	5907558426946
82-113	42	28	0/10	5907558426953
82-114	43	28.7	0/10	5907558426960
82-115	44	29.3	0/10	5907558426977
82-116	45	30	0/10	5907558426984
82-117	46	30.7	0/10	5907558426991
82-118	47	31.3	0/10	5907558427004



Ref.	Size	Size [cm]	☒	EAN
82-710	39	26	0/10	5907558430165
82-711	40	26.7	0/10	5907558430172
82-712	41	27.3	0/10	5907558430189
82-713	42	28	0/10	5907558430196
82-714	43	28.7	0/10	5907558430202
82-715	44	29.3	0/10	5907558430219
82-716	45	30	0/10	5907558430226
82-717	46	30.7	0/10	5907558430233
82-718	47	31.3	0/10	5907558430240



Ref.	Size	Size [cm]	☒	EAN
82-700	39	26	0/10	5907558430073
82-701	40	26.7	0/10	5907558430080
82-702	41	27.3	0/10	5907558430097
82-703	42	28	0/10	5907558430103
82-704	43	28.7	0/10	5907558430110
82-705	44	29.3	0/10	5907558430127
82-706	45	30	0/10	5907558430134
82-707	46	30.7	0/10	5907558430141
82-708	47	31.3	0/10	5907558430158



Ref.	Size	Size [cm]	☒	EAN
82-161-39	39	26	0/10	5907558499094
82-161-40	40	26.7	0/10	5907558499100
82-161-41	41	27.3	0/10	5907558499117
82-161-42	42	28	0/10	5907558499124
82-161-43	43	28.7	0/10	5907558499131
82-161-44	44	29.3	0/10	5907558499148
82-161-45	45	30	0/10	5907558499155
82-161-46	46	30.7	0/10	5907558499162
82-161-47	47	31.3	0/10	5907558499179



Ref.	Size	Size [cm]	☒	EAN
82-163-39	39	26	0/10	5907558499278
82-163-40	40	26.7	0/10	5907558499285
82-163-41	41	27.3	0/10	5907558499292
82-163-42	42	28	0/10	5907558499308
82-163-43	43	28.7	0/10	5907558499315
82-163-44	44	29.3	0/10	5907558499322
82-163-45	45	30	0/10	5907558499339
82-163-46	46	30.7	0/10	5907558499346
82-163-47	47	31.3	0/10	5907558499353

## Póľbuty robocze

Safety shoes / Arbeitshaltschuhe / Пољбутички робочие / Пљочеревини робочи / Munkacipő / Pantofi de lucru / Pracovní obuv / Pracovné poltopánky / Nízki delovni čevlji / Darbo pusboćai / Darba puszőbaki / Töökingad / Роботни обуви ниски (пољовини) / Radne cipele / Poluduboke radne cipele / Ημιύψια εργασιός / Botas de seguridad / Scarpa da lavoro / Sapatos de trabalho / Souliers de sécurité / Werkschoenen

02  
SR FO



Ref.	Size	Size [cm]	☒	EAN
82-741-39	39	26	0/10	5907558499186
82-741-40	40	26.7	0/10	5907558499193
82-741-41	41	27.3	0/10	5907558499209
82-741-42	42	28	0/10	5907558499216
82-741-43	43	28.7	0/10	5907558499223
82-741-44	44	29.3	0/10	5907558499230
82-741-45	45	30	0/10	5907558499247
82-741-46	46	30.7	0/10	5907558499254
82-741-47	47	31.3	0/10	5907558499261

S1  
FO



Ref.	Size	Size [cm]	☒	EAN
82-162-39	39	26	0/10	5907558426137
82-162-40	40	26.7	0/10	5907558426120
82-162-41	41	27.3	0/10	5907558426151
82-162-42	42	28	0/10	5907558426168
82-162-43	43	28.7	0/10	5907558426328
82-162-44	44	29.3	0/10	5907558426335
82-162-45	45	30	0/10	5907558426342
82-162-46	46	30.7	0/10	5907558426359
82-162-47	47	31.3	0/10	5907558426366

## Sandaly robocze

Working sandals / Arbeitssandale / Робочие сандалу / Sandale de lucru / Ροβοχι στανδάρτι / Munkaszandál / Pracovní sandály / Pracovné sandále / Delovni sandali / Darbo sandalai / Darba sandales / Töösandadid / Роботни сандалу / Radne sandale / Radne sandale / Σανδάλια εργασιός / Sandalias de trabajo / Sandali da lavoro / Sandálias de proteção / Sandales de travail / Werksandalen

S1P  
SR



Ref.	Size	Size [cm]	☒	EAN
82-089-39	39	26	0/10	5907558426229
82-089-40	40	26.7	0/10	5907558426250
82-089-41	41	27.3	0/10	5907558426267
82-089-42	42	28	0/10	5907558426298
82-089-43	43	28.7	0/10	5907558426281
82-089-44	44	29.3	0/10	5907558426274
82-089-45	45	30	0/10	5907558426304
82-089-46	46	30.7	0/10	5907558426311
82-089-47	47	31.3	0/10	5907558426144

OB  
SRA



Ref.	Size	Size [cm]	☒	EAN
82-720	39	26	0/10	5907558430257
82-721	40	26.7	0/10	5907558430264
82-722	41	27.3	0/10	5907558430271
82-723	42	28	0/10	5907558430288
82-724	43	28.7	0/10	5907558430295
82-725	44	29.3	0/10	5907558430301
82-726	45	30	0/10	5907558430318
82-727	46	30.7	0/10	5907558430325
82-728	47	31.3	0/10	5907558430332

## Trzewiki robocze

Safety boots / Arbeitsschuh / Ботики робочие / Черевини робочи / Munkabakancs / Botas de lucru / Котикова работни обув / Pracovné topánky / Visoki delovni čevlji / Darbo batai / Darba zőbaki / Tőősaap / Роботни обуви аусану / Radne visoke cipele / Radne cipele / Μιατάκια εργασιός / Botas de seguridad altas / Scarpa alta da lavoro / Botas de trabalho / Chaussures de sécurité / Hoge werkschoenen

02  
SR FO

FAST LACE

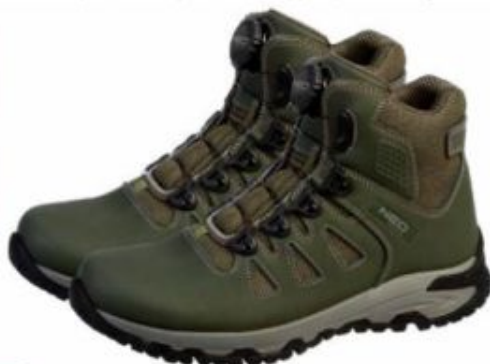

Ref.	Size	Size [cm]	☒	EAN
82-751-39	39	26	0/10	5907558499001
82-751-40	40	26.7	0/10	5907558499018
82-751-41	41	27.3	0/10	5907558499025
82-751-42	42	28	0/10	5907558499032
82-751-43	43	28.7	0/10	5907558499049
82-751-44	44	29.3	0/10	5907558499056
82-751-45	45	30	0/10	5907558499063
82-751-46	46	30.7	0/10	5907558499070
82-751-47	47	31.3	0/10	5907558499087

S3  
SRC



Ref.	Size	Size [cm]	☒	EAN
82-120	39	26	0/10	5907558428698
82-121	40	26.7	0/10	5907558428704
82-122	41	27.3	0/10	5907558428711
82-123	42	28	0/10	5907558428728
82-124	43	28.7	0/10	5907558428735
82-125	44	29.3	0/10	5907558428742
82-126	45	30	0/10	5907558428759
82-127	46	30.7	0/10	5907558428766
82-128	47	31.3	0/10	5907558428773

## Trzewiki robocze

Safety boots / Arbeitsschuhe / Ботинки рабочие / Чревуки работни / Munkabakancs / Bocanci de lucru / Kotniková pracovní obuv / Pracovné topánky / Visoki delovni čevlji / Darbo batai / Darbo zăbaki / Тоісааpad / Работни обувки високи / Radne visoke cipele / Radne cipele / Μητάκια εργασίας / Botas de seguridad altas / Scarpa alta da lavoro / Botas de trabalho / Chaussures de sécurité / Hohe werkschoenen

**S1  
SRC**



Ref.	Size	Size [cm]	☒	EAN
82-165-39	39	26	0/10	5907558484069
82-165-40	40	26.7	0/10	5907558484076
82-165-41	41	27.3	0/10	5907558484083
82-165-42	42	28	0/10	5907558484090
82-165-43	43	28.7	0/10	5907558484106
82-165-44	44	29.3	0/10	5907558484113
82-165-45	45	30	0/10	5907558484120
82-165-46	46	30.7	0/10	5907558484137
82-165-47	47	31.3	0/10	5907558484144

**S3  
SRC**



Ref.	Size	Size [cm]	☒	EAN
82-166-39	39	26	0/10	5907558484151
82-166-40	40	26.7	0/10	5907558484168
82-166-41	41	27.3	0/10	5907558484175
82-166-42	42	28	0/10	5907558484182
82-166-43	43	28.7	0/10	5907558484199
82-166-44	44	29.3	0/10	5907558484205
82-166-45	45	30	0/10	5907558484212
82-166-46	46	30.7	0/10	5907558484229
82-166-47	47	31.3	0/10	5907558484236

**S1P  
SRA**



Ref.	Size	Size [cm]	☒	EAN
82-020	39	26	0/10	5907558415032
82-021	40	26.7	0/10	5907558415049
82-022	41	27.3	0/10	5907558415056
82-023	42	28	0/10	5907558415063
82-024	43	28.7	0/10	5907558415070
82-025	44	29.3	0/10	5907558415087
82-026	45	30	0/10	5907558415094
82-027	46	30.7	0/10	5907558415100
82-028	47	31.3	0/10	5907558421019

## Wkładka do butów

Shoe insert / Einlegesohle / Стельна для обуви / Устінна до чревуки / Talpbetét / Branț de încălzământ / Vložka do obuvi / Vložka do topánok / Vložek za čevlje / Botų vidpadis / Арову иелктрас / Sisetallad / Вложка за обувки / Uložak za cipele / Uložak za obuću / Πλάστ παπουτσιών / Plantilla para zapatos / Soletta per scarpe / Palmilha / Insert de chaussure / Inleggsool



**1  
PAIR**

Ref.	size [mm]	☒	EAN
82-315	36-40	1/200	5907558495492
82-316	41-47	1/200	5907558495508

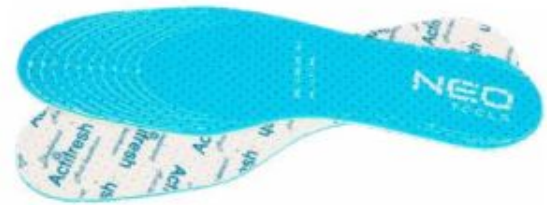

Ref.	size	☒	EAN
82-300	universal	0/300	5907558431438

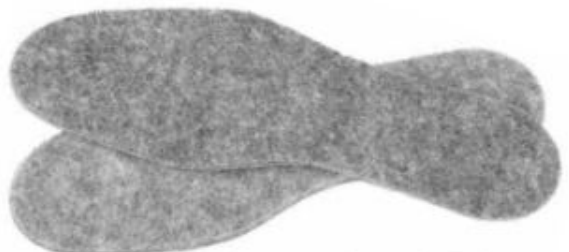

Ref.	Size	☒	EAN
82-325	38-39	0/200	5907558476712
82-326	40-41	0/300	5907558476729
82-327	44-43	0/220	5907558476736
82-328	44-45	0/220	5907558476743
82-329	46-47	0/200	5907558476750



## Wkładka do butów

Shoe insert / Einlegesohle / Стельня для обуви / Устірна до черевяків / Talpatét / Brant de încălțăminte / Vložka do obuvi / Vložka do topánok / Vložek za čevlje / Botų vidpadis / Αρσυνίελίκτρις / Sisetalat / Вложка за обувя / Uložak za cipele / Uložak za obuću / Πλάσι παπουτσιών / Plantilla para zapatos / Soletta per scarpe / Palmilha / Insert de chaussure / Inleggool

ACTIVATED CARBON

SOFT

ODOUR STOP

Ref.	Info	📦	EAN
82-302	1 pcs	0/300	5907558431445
82-303	10 pcs	0/30	5907558431421

WARM

7 mm

SOFT

Ref.	Size	📦	EAN
82-320	38-39	0/200	5907558430578
82-321	40-41	0/200	5907558430585
82-322	42-43	0/200	5907558430592
82-323	44-45	0/200	5907558430608
82-324	46-47	0/200	5907558430615

WARM

SOFT

Ref.	Size	📦	EAN
82-310	38-39	0/200	5907558430523
82-311	40-41	0/200	5907558430530
82-312	42-43	0/200	5907558430547
82-313	44-45	0/200	5907558430554
82-314	46-47	0/200	5907558430561

## Skarpety robocze

Working socks / Arbeitssocke / Рабочие носки / Шкарпетна робоча / Munkazokni / Şosetă de lucru / Pracovní ponožka / Pracovní ponožky / Delovna nogavica / Darbinės kojines / Darba zeķes basic / Toosokid / Рабочен чарпан / Radne čarape / Radna čarapa / Κάλσα εργασίας / Calsetin de trabajo / Calza da lavoro / Meias de trabalho / Chaussette de travail / Werksok

### GRAPHITE

80% COTTON

MADE IN POLAND

Ref.	Size	info	📦	EAN
GD019	39-42	long	50/400	5902062997777
GD020	43-46	long	50/400	5902062997784
GD032	39-42	short	50/600	5902062102669
GD033	43-46	short	50/600	5902062102676

80% COTTON

MADE IN POLAND

Ref.	Size	info	📦	EAN
GD017	39-42	long	50/400	5907558481785
GD018	43-46	long	50/400	5907558481792
GD030	39-42	short	50/600	5907558495294
GD031	43-46	short	50/600	5907558495300

## Skarpety robocze

Working socks / Arbeitssocke / Рабочие носки / Шкарпетна робоча / Munkazokni / Şosetă de lucru / Pracovní ponožka / Pracovní ponožky / Delovna nogavica / Darbinės kojines / Darba zeķes basic / Toosokid / Рабочен чарпан / Radne čarape / Radna čarapa / Κάλσα εργασίας / Calsetin de trabajo / Calza da lavoro / Meias de trabalho / Chaussette de travail / Werksok

COTTON 67%  
POLYESTER 30%  
ELASTAN 3%

SOFT

Ref.	Size	📦	EAN
82-350	39-42	1/60	5907558444605
82-351	43-46	1/60	5907558444612

COTTON 67%  
POLYESTER 30%  
ELASTAN 3%

SOFT

Ref.	Size	📦	EAN
82-355	39-42	1/60	5907558444629
82-356	43-46	1/60	5907558444636

COTTON 67%  
POLYESTER 30%  
ELASTAN 3%

SOFT

Ref.	Size	📦	EAN
82-360	39-42	0/20	5907558444643
82-361	43-46	0/20	5907558444650

COTTON 45%  
COOL.MAX 22%  
POLYESTER 22%  
POLYAMID 6%  
SPAND 6% 4%

ODOUR STOP

SOFT

Ref.	Size	📦	EAN
82-365	39-42	0/20	5907558463576
82-366	43-46	0/20	5907558463583

## Rękawice robocze

Working gloves / Arbeitshandschuhe / Перчатки рабочие / Руквици работчи / Munkakesztyű / Mãos de luva / Pracovni rukavice / Pracovné rukavice / Delovne rokavice / Darbo pirštīnes / Darba cimdi / Тоққандар / Ръкавици работни / Radne rukavice / Radne rukavice / Γάντια εργασιών / Guantes de trabajo / Guanti da lavoro / Luvas de trabalho / Gants de travail / Werkhandschoenen



LATEX COATED  
KAT II  
3143X  
CE



Ref.	Size	☒	EAN
97-640-8	8"	10/100	5907558447811
97-640-9	9"	10/100	5907558447828
97-640-10	10"	10/100	5907558447835



LATEX COATED  
KAT II  
3131X  
CE



Ref.	Size	☒	EAN
97-641-8	8"	10/100	5907558447842
97-641-9	9"	10/100	5907558447859
97-641-10	10"	10/100	5907558447866



LATEX COATED  
KAT II  
3141X  
CE



Ref.	Size	☒	EAN
97-617-8	8"	10/100	5907558448023
97-617-9	9"	10/100	5907558448030
97-617-10	10"	10/100	5907558448047



2x LATEX COATED  
KAT II  
3141X  
CE



Ref.	Size	☒	EAN
97-643-8	8"	10/100	5907558447903
97-643-9	9"	10/100	5907558447910
97-643-10	10"	10/100	5907558447927



NITRILE COATED  
KAT II  
4131X  
CE



Ref.	Size	☒	EAN
97-616-8	8"	10/100	5907558447996
97-616-9	9"	10/100	5907558448009
97-616-10	10"	10/100	5907558448016



NITRILE COATED  
KAT II  
4131X  
CE



Ref.	Size	☒	EAN
97-642-8	8"	10/100	5907558447873
97-642-9	9"	10/100	5907558447880
97-642-10	10"	10/100	5907558447897



NITRILE COATED  
KAT II  
4121X  
CE



Ref.	Size	☒	EAN
97-630-8	8"	10/100	5907558448115
97-630-9	9"	10/100	5907558448122
97-630-10	10"	10/100	5907558448139



NITRILE COATED  
KAT II  
4111X  
CE



Ref.	Size	☒	EAN
97-631-8	8"	10/100	5907558448146
97-631-9	9"	10/100	5907558448153
97-631-10	10"	10/100	5907558448160



anti cut  
PU COATED  
KAT II  
4X43D  
CE



Ref.	Size	☒	EAN
97-609-8	8"	10/100	5907558447934
97-609-9	9"	10/100	5907558447941
97-609-10	10"	10/100	5907558447958



anti cut  
NITRILE COATED  
KAT II  
4X43D  
CE



Ref.	Size	☒	EAN
97-610-8	8"	10/100	5907558447965
97-610-9	9"	10/100	5907558447972
97-610-10	10"	10/100	5907558447989



KAT I  
CE



Ref.	Size	☒	EAN
97-620-8	8"	10/300	5907558448054
97-620-9	9"	10/300	5907558448061
97-620-10	10"	10/300	5907558448078



NITRILE COATED  
KAT II  
4131X  
CE



Ref.	Size	☒	EAN
97-621-8	8"	10/100	5907558448085
97-621-9	9"	10/100	5907558448092
97-621-10	10"	10/100	5907558448108

## Rękawice robocze

Working gloves / Arbeitshandschuhe / Перчатки рабочие / Ръкавици работни / Munkkesztyű / Mănuși de lucru / Pracovní rukavice / Pracovné rukavice / Delovne rokavice / Darbo pirštines / Darba cimdi / Töökindad / Ръкавици работни / Radne rukavice / Radne rukavice / Γάντια εργασις / Guantes de trabajo / Guanti di lavoro / Luvas de trabalho / Gants de travail / Werkhandschoenen



Ref.	Size	⊠	EAN
97-615	10"	12/120	5907558433982



Ref.	Size	⊠	EAN
97-602	10,5"	12/96	5907558406825



Ref.	Size	⊠	EAN
97-611	10"	0/120	5907558421804



Ref.	Size	⊠	EAN
97-603	10"	12/120	5907558409147
97-604	8"	0/12	5907558407655



Ref.	Size	⊠	EAN
97-605	10"	0/96	5907558412901



Ref.	Size	⊠	EAN
97-606	10"	6/96	5907558412918



Ref.	Size	⊠	EAN
97-690-M	M	10/10	5907558484489
97-690-L	L	10/10	5907558484496
97-690-XL	XL	50/10	5907558484502



Ref.	Size	⊠	EAN
97-691-M	M	100/10	5907558484519
97-691-L	L	100/10	5907558484526
97-691-XL	XL	100/10	5907558484533

## Rękawice robocze z magnezem

Working gloves with magnet / Arbeitshandschuhe / Перчатки рабочие с магнитом / Ръкавици работни с магнит / Bőr kesztyű / Mănuși de lucru / Pracovní rukavice / Pracovné rukavice / Delovne rokavice / Darbo pirštines / Darba cimdi / Töökindad / Ръкавици работни с магнит / Radne rukavice / Radne rukavice / Γάντια εργασις / Guantes de trabajo / Guanti di lavoro / Luvas de trabalho / Gants de travail / Werkhandschoenen



Ref.	⊠	EAN
GD013	12/120	5907558462401
GD014	12/120	5907558462418

## Opaska magnetyczna

Magnetic wristband / Магнитный браслет / Магнитний ремінець / Mágneses zsinór / Bandă magnetică / Magnetický páramek / Magnetický páratok / Magnetni trak / Magnetinis apyrankė / Magnētiskā siksnā / Magnētīlnie esinība / Магнитна лента за китка / Magnetska vrpca / Магнетна трака за коштене / Магнитна џиџ / Braccialeto magnetico / Pulsara magnética / Pulseira magnética / Bracelet magnétique / Magnetische polsband



Ref.	⊠	EAN
GD012	10/50	5907558462425

## Półmaska przeciwpylowa

Dust half-mask / Staubschutzmaske / Респиратор противопылевой / Респиратор захисний протипилевої / Pormasz / Mască mică protecție praf / Polomaska protiprašná / Respirátor protiprachový / Zaštitna maska / Puskauki nuo dulky / Aizsargmaska / Tolmuvastane poolmask / Маска противопылевая / Zaštitna maska / Zaštitna maska / Ημίμασκα προστασίας / προστασίας από σκόνη / Máscara para polvo / Semimaschera contro polvere / Máscara contra pó / Demi-masque anti-poussière / Staf half-masker



## Okulary ochronne

Safety goggles / Schutzbrille / Очки защитные / Окуляр противоскользящий / Védőszemüveg / Ochelari de protecție / Ochranné brýle / Ochranné okuliare / Zaštitna očala / Apsauginiai akiniai / Aizsargbrilles / Kaitseprillid / Очуха предпазна / Zaštitne naočale / Zashitne naočari / Γυαλιά προστασίας / Gafas protectoras / Occhiali di sicurezza / Óculos de proteção / Lunettes de protection / Beschermingsbril



## Gogle ochronne

Protective goggles / Augenschutzbrillen / Защитные очки / Окуляр захисні / Védőszemüveg / Ochelari de protecție / Ochranné brýle / Ochranné okuliare / Zaštitna očala / Apsauginiai akiniai / Aizsargbrilles / Kaitseprillid / Защитные очуха / Zaštitne gogle / Zaštitne naočare / Προστατευτικά γυαλιά / Gafas protectoras / Occhiali protettivi / Óculos de proteção / Lunettes google de protection / Veiligheidsbril



## Ostona przeciwdpryskowa

Face protection shield / Splitterschutz / Щиток противоскользящий / Щиток противоскользящий / Arcvédő / Escap protecție față / Clona proti odpryskům / Ochranný štít / Štitník za obraz / Apsauginis skydelis veidui / Pretlauški aizsargmaska / Kaitsevisiir / Предпазен щит / Štitník za lice / Štitník za lice / Μάσκα κεφαλής προστασίας από βροαρίσματα / Máscara protectora facial / Visiera ribaltabile anti scheggia / Proteção / Protecteur anti-éclats / Bescherming tegen tegen slingerende deeltjes



## Pólmaska silikonowa

Silicon mask / Silikon-Halbmaske / Силиконова полмаска / Полмаска силиконова / Szilikon félmaszk / Semimasca cu silicon / Silikonová polomaska / Silikonový respirátor / Silikonaska polmaska / Silikonine puskaüké / Silikona pusmaska / Silikonist respirator / Силиконова полмаска / Silikonaska polomaska / Silikonaska polomaska / Maska jastoi prosoónou apó silikóni / Media máscara de silicona / Maschera di protezione / Semi-máscara em silicone / Demi-masque silicone



Ref.	☒	EAN
97-350	0/60	5907558407730



## Filtr

Filter / Filter / Фильтр / Фильтр / Szűrő / Filtru / Filtr / Filter / Filter / Filtras / Filtrs / Filter / Фильтр / Filtrar / Filteri za prašinu / Φίλτρο / Filtro / Filtro per mascherina / Filtro / Filtre / Filter



Ref.	☒	EAN
97-361	50/200	5907558408058



## Pochłaniacz

Cartridge / Maskenfilter / Фильтрующий патрон А1 / Фильтр / Szűrő / Absorbant / Pohlčovač / Pohlčovač / Absorbent / Filtras / Absorbētājs / Filter / Adsorbent / Adsorbent / Prigušivač / Ανταλλακτικό φίλτρο Α1 / Filtro / Cartuccia / Filtro / Absorbent



Ref.	☒	EAN
97-360	50/200	5907558407747



Ref.	☒	EAN
97-362	50/200	5907558409130



## Czapka z daszkiem

Work cap / Schildmütze / Βεΐσβολνα ραβοονα / Βεΐσβολνα ραβοονα / Láthatósági sapka / Сапка со азарот / Pracovní kšiltovka / Сапка со шилот, ρασοονα / Delovna kapa s šiltom / Кερνε су снарелу / Darbo cepure ar pagu / Nakaga töömüts / Рабоοтна шапка с козурна / Radna kapa / Radnička kapa / Καπέλο εργαοιας τύπου μπάζουα / Gorra de trabajo / Cappella / Boné de trabalho / Casquette de travail à visière



Ref.	☒	EAN
97-590	0/50	5907558415728



## Pasek

Belt / Gürtel / Ремень / Ремень / Öv / Cureau / opasek / Opasok / Pašček / Dirželis irankiams / Josta / Rihm / Копас / Pojas / Каš / Ζώνη / Cinturón / Cintura / Riem



Ref.	L [cm]	☒	EAN
81-900	130	0/160	5907558431148



## Nakolanniki ochrone

Knee protector / Knieschützer / Наколеники защитные / Щитки наколенни заштити / Térdvédő zselés / Genupchierä proteoore / Nakolenky / Chránič kolien / Ščitníky za kolena / Арсауда келамс / Celgalu aizsargi / Рблнекайтсе / Наколеники / Štitky za koljena / Štitky za kolena / Επιγοναδες προστατευτικäs / Rodilleras de protecció / Ginposchiere / Protecção de joelhos / Protège-genoux / Кniebescherming



Ref.	☒	EAN
97-536	6/24	5907558407679



Ref.	☒	EAN
97-535	6/24	5907558419627





## Wkładki piankowe na kolana

Knee foam pads / Knieeinlagen aus Schaumstoff / Вставки-наколенники из пеноматериала / Наколінники поліуретанові / Térdelő betét / Insertii de spuma pentru genunchi / Pěnové vložky kolen / Penové vložky na kolena / Penasti štitniki za kolena / Αρσάρα κελιάς su puty pagalvėlimis / Putuplasta ieliktņi celgaliem / Vahitplastist põlvekaitsmed / Наколенники от пена / Pjenasti štitnik za koljeno / Jastučica od pene za kolena / Προσθαφορέμενες επωνυμίες από αφρώδες υλικό / Rodilleras de espuma / Ginocchiere / Almofada de espuma para joelho / Inserts de protection en mousse pour genoux / Schaumkniebescherming

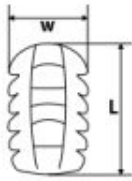

x2



Ref.	W [mm]	L [mm]	Info	EAN
97-530	175	265	0/25	5907558419610

## Wkładki przeciwhałasowe

Earplugs / Ohrstöpsel / Противозвуковые вкладыши / Бераука ("беруши") / Fuldugó pór / Antifoane / zátky do uší / Zátkové chrániče sluchu / Серки за ушеса / Ausų kaištukai / Ausu aizbāžņi / Kōrvatropid / Антифони, поставяни на ушите / Серки за уши / Серони за уши / Οτοσπίδες / Tapones para los oídos / Tappi per le orecchie / Ταμπões de ouvidos / Bouchons d'oreille / Oordopjes



29 dB EN352

Ref.	Info	Info	EAN
97-553	29dB	15/300	5907558481655



32 dB EN352

Ref.	Info	Info	EAN
97-554	29dB	30/600	5907558481662

## Wkładki przeciwhałasowe

Earplugs / Ohrstöpsel / Противозвуковые вкладыши / Бераука ("беруши") / Fuldugó pór / Antifoane / zátky do uší / Zátkové chrániče sluchu / Серки за ушеса / Ausų kaištukai / Ausu aizbāžņi / Kōrvatropid / Антифони, поставяни на ушите / Серки за уши / Серони за уши / Οτοσπίδες / Tapones para los oídos / Tappi per le orecchie / Ταμπões de ouvidos / Bouchons d'oreille / Oordopjes

x10 EN352 CE



Ref.	Size	Info	Info	EAN
97-550	9/11	33dB	25/500	5907558419634

x10 EN352 CE



Ref.	Size	Info	Info	EAN
97-555	5/16	29dB	40/800	5907558419641

x1000 (500 pairs) 38 dB EN352



Ref.	Info	Info	EAN
97-552	38dB	0/20	5907558481648

38 dB x1000 (500 pairs) EN352



Ref.	Info	Info	EAN
97-551	38dB	0/4	5907558481631



## **ELEKTRONARZĘDZIA I AKCESORIA**

power tools  
and accessories

електроінструмент  
та аксесуари

# GRAPHITE

POWER IN YOUR HANDS

3

YEARS  
WARRANTY



Marka **GRAPHITE** zapewnia pełną dostępność części zamiennych oraz materiałów eksploatacyjnych dla urządzeń i elektronarzędzi. Dzięki temu urządzenia mogą być sprawne przez długi czas.

We ensure constant availability of spare parts and consumable materials for devices and power tools. Therefore, the **GRAPHITE** power tools stay operational for years.

Забезпечуємо постійну доступність запчастин та витратних матеріалів для обладнання та електроінструменту. Завдяки цьому електроінструмент **GRAPHITE** залишається справним протягом довгих років.

## GRAPHITE to:

- ▶ szeroki asortyment wysokiej jakości elektronarzędzi i akcesoriów
- ▶ ważny i wiodący element marki stanowi system Energy+
- ▶ elektronarzędzia przeznaczone do intensywnego użytkowania, przy obciążeniach bliskich profesjonalnym
- ▶ produkty z optymalnym zestawem cech: wytrzymałe, ergonomiczne, o mocnych silnikach

## GRAPHITE is:

- ▶ a wide range of high quality power tools and accessories
- ▶ an important and leading element of the brand is the Energy+ System
- ▶ power tools designed for intensive semi-professional use
- ▶ products with optimum set of features: durable, ergonomic, with powerful motors

## GRAPHITE це:

- ▶ широкий асортимент високоякісного електроінструменту та аксесуарів до нього
- ▶ важливим та провідним елементом бренду є система Energy +
- ▶ електроінструмент, призначений для інтенсивного використання при навантаженнях, наближених до професійних
- ▶ продукти з оптимальним набором якостей: міцні, з потужними двигунами та ергономічною конструкцією

ZAPRASZAMY NA KANAŁY MARKI GRAPHITE W MEDIACH SPOŁECZNOŚCIOWYCH

COME AND BROWSE GRAPHITE SOCIAL MEDIA CHANNELS

ЗАПРОШУЄМО НА КАНАЛИ МАРКИ GRAPHITE У СОЦІАЛЬНИХ МЕРЕЖАХ



GRAPHITE

Informacje o nowościach produktowych, porady oraz VIDEO



Information on new products, advice and VIDEOS

Інформація про нові продукти, події, поради та відео



GRAPHITEmov

VIDEO produktowe, porównania i testy produktów w wielu wersjach językowych



Product related VIDEOS, product comparisons and tests in multiple language versions

ВІДЕО про продукцію, порівняння продукції та тести на декількох мовах



QR-code obok produktu to dedykowane dla niego części zamienne

Scan the QR code to purchase spare parts for each GRAPHITE tool

QR-код поряд із продуктом присвячений запасним до нього частинам

graphite.pl

## Wiertarko-wkrętarka akumulatorowa

Cordless drill / Akkuboehrschrauber / Дрель-шуруповерт аккумуляторная / Дрель-шуруповерт аккумуляторный / Akkus ütvefűró / Bormasina-surubelnita cu acumulator / Akumulátorová vrtačka-šroubovák / Akumulátorový vrtací skrutkovač / Akumulatorski vrtalnik-vijačnik / Akumulatoriinis gręžtuvas - sukutvas / Akumulatora urbjmašina-skrūvgrēzis / Akutrell / Аккумуляторен пробивен аутотверпер / Akumulatorska bušilica - izvijač / Akumulatorska bušilica - odvijač / Επαναφορτιζόμενο βραχίονο-κατάρκτη / Taladradora atomilladora a batería / Trapano avvitatore a batteria con percussione / Aparafuradora de batería / Perceuse-visseuse à batterie / Akku-boor-draaimachine

**ENERGY+**  
system  
NEO GRAPHITE



2 - 13 mm



2x 18V 2Ah  
Li-Ion



I: 0-350 min<sup>-1</sup>  
II: 0-1250 min<sup>-1</sup>



1-19  
+ drilling



35 Nm



55 Nm



Ref.	[kg]	⊠	EAN
58G006-SET2	5,02	0/4	5902062503640

**ENERGY+**  
system  
NEO GRAPHITE



2 - 13 mm



18V 2Ah  
Li-Ion



I: 0-500 min<sup>-1</sup>  
II: 0-1700 min<sup>-1</sup>



1-16  
+ drilling



38 Nm



58 Nm



Ref.	[kg]	⊠	EAN
58G020-SET2	5,06	0/4	5902062503688

## Wiertarko-wkrętarka akumulatorowa

Cordless drill / Akkubohrschrauber / Дрель-шуруповерт аккумуляторная / Дрель-шуруповерт аккумуляторный / Akkus ütvefűró / Borvasina-surubelmita cu acumulator / Akumulátoros vrtáčka-šroubovák / Akumulátorový vrtací skrutkovač / Akumulatorski vrtalnik-vijačnik / Akumulatorinis gręžtuvas - sukutvas / Akumulator a urbjmašina-skrūvgręzīs / Akutrell / Аккумуляторный пробивной шуруповерт / Akumulatorska bušilica - izvijač / Akumulatorska bušilica - odvijač / Εναρτηρακιζόμενο βραχάνο-κατσάβλο / Taladradora atornilladora a batería / Trapano avvitatore a batteria con percussione / Aparafuradora de batería / Perceuse-visseuse à batterie / Accu boor-draaimachine

**ENERGY+**  
system

NEO GRAPHITE

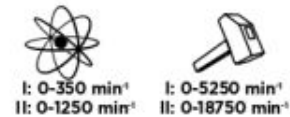

Ref.	[kg]	⊠	EAN
58G010	1,3	0/5	5902062035387

**ENERGY+**  
system

NEO GRAPHITE

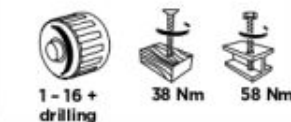

Ref.	[kg]	⊠	EAN
58G019	1,2	0/5	5902062045942

**ENERGY+**  
system

NEO GRAPHITE

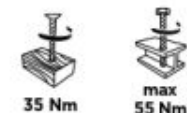
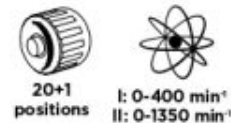

Ref.	[kg]	⊠	EAN
58GE139	1,2	0/5	5902062169297

**ENERGY+**  
system

NEO GRAPHITE

**NEO**  
TOOLS

**3**  
YEARS  
WARRANTY

**10**  
YEARS  
LIFE

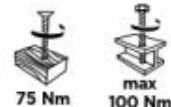

Ref.	[kg]	⊠	EAN
04-616	1,56	1/5	5907558484595

**ENERGY+**  
system

NEO GRAPHITE

**NEO**  
TOOLS

**3**  
YEARS  
WARRANTY

**10**  
YEARS  
LIFE

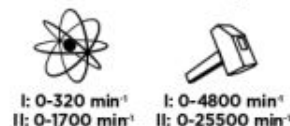
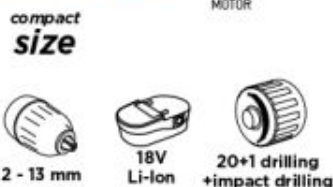

Ref.	[kg]	⊠	EAN
04-619	1,17	0/5	5907558498189

## Wiertarko-wkrętarka sieciowa

Electric screwdriver / Netzschrauber / Дрель-шуруповерт электрическая / Шуруповерт сетевой / Elektromos csavarhúzó / Surubelmita electrica / Elektrická vrtáčka / Elektrický skrutkovač / Električni vijačnik / Elektrinis sukutvas / Tīkla skrūvgręzīs / Elektriline krūvķerēja / Мрежова бормашина / Električna bušilica / Električna bušilica / Ηλεκτρικό βραχάνο-κατσάβλο / Atornillador eléctrico / Avvitatore elettrico / Máquina de par parafusos / Visseuse réseau / Elektrische boormachine

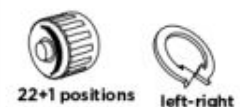
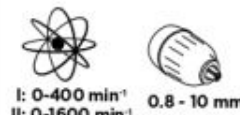
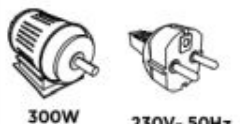

Ref.	[kg]	⊠	EAN
58G793	1,39	1/4	5902062087805

## Zakrętaraka akumulatorowa ENERGY+

Cordless driver / Akku-Schraubmaschine / Гайковерт аккумуляторный / Митроверт аккумуляторный / Akkus ütvecsavarozó / Inčvžar de accumulator / Akumulátorový šroubovák / Akumulátorový šroubovák / Akumulatorski vrtalnik / Akumulatorinis sukutvas / Akumulatora uzvāznis / Keerterpuur / Ударен гайковерт / Akumulatorski zavičaj / Akumulatorski navojni čep / Επιστροφής/βρέμενο καταβιβίς / Dispositivo de cierre a batería / Avvitatore a batteria ad impulsi / Máquina de travar com bateria / Visseuse à batterie / Accu schroefmachine



6.35mm (1/4") 18V Li-Ion

0-2200 min<sup>-1</sup> 180 Nm

Ref.	[kg]	⊠	EAN
58G012	1,2	0/5	5902062035400



6.35mm (1/4") 18V Li-Ion

I. 0-1000 min<sup>-1</sup>  
II. 0-1800 min<sup>-1</sup>  
III. 0-2700 min<sup>-1</sup>  
I. max 80 Nm  
II. max 120 Nm  
III. max 200 Nm

Ref.	[kg]	⊠	EAN
58G024	1,1	0/5	5902062059765



NEO TOOLS



compact size

18V Li-Ion  
BRUSHLESS MOTOR  
6.35mm (1/4")  
max 300 Nm



I. 0-1500 min<sup>-1</sup>  
II. 0-2500 min<sup>-1</sup>  
III. 0-3200 min<sup>-1</sup>  
IV. 0-3600 min<sup>-1</sup>  
I. max 45 Nm  
II. max 120 Nm  
III. max 210 Nm  
IV. max 270 Nm

Ref.	[kg]	⊠	EAN
04-612	0,9	0/5	5907558465600

## Wiertarka udarowa

Impact drill / Bohrhämmer / Дрель ударная / Дрель ударной / Utveřiro / Perforator de lov / Priklepová vrtačka / Priklepová vrtačka / Udarni vrtalnik / Grežtuvas su kalimu / Sibena urbjmašina / Löökdrell / Бормашина ударна / Udarna bušilica / Udarna bušilica / Κρουστικό βράνο / Taladro de impacto / Trapano a percussione / Berbequim de impacto / Perceuse à choc / Slagboormachine



1050W  
230V - 50Hz  
I: 0-1100 min<sup>-1</sup>  
II: 0-3000 min<sup>-1</sup>  
1.5 - 13 mm  
I: 0-17600 min<sup>-1</sup>  
II: 0-48000 min<sup>-1</sup>  
max 16 mm  
max 13 mm  
max 40 mm

Ref.	[kg]	⊠	EAN
58G722	5,4	0/4	5902062024251

## Grzechotka akumulatorowa

Cordless ratchet / Schnurlöse Ratsche / Аккумуляторная трещотка / Аккумуляторная трещотка / Akkus racsni / Clichet fără fir / Akumulátorová ráčna / Akumulátorová ráčna / Akumulatorska vrtavka / Akumulatorinis reketas / Bežvodu tarkšijs / Luhtmeta ratas / Аккумуляторна трещотка / Bežična čerpaljka / Аккумуляторна чергартна / Азирмат қатпана / Carraca inalámbrica / Cricchetto a batteria / Catraca sem fio / Cliquet sans fil / Drooalaze ratel



NEO TOOLS



60 Nm 0-250 min<sup>-1</sup> 3/8"



Ref.	[kg]	⊠	EAN
04-603	0,9	1/20	5907558465525



## Klucz udarowy akumulatorowy ENERGY+

Impact wrench / Schlagschlüssel / Ключ ударный / Митроререт ударный / Útvecsavarozó / Cheie cu percúție / Rázový utahovák / Přilepový klíč / Udarni vijačnik / Atskėjimo plaktukas / Štama atslėga / Löökvõti / Ударен ключ / Udarni ključ / Pneumatski ključ / Κλειδί κρούσης / Llave de impacto / Avvitatore ad impulsi / Chave de impacto / Clef à chocs / Slagsleutel

**ENERGY+**  
system  
NEO GRAPHITE

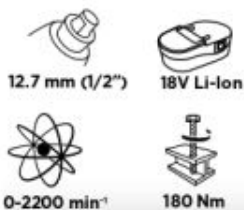

Ref.	[kg]	☒	EAN
58G018	1,8	0/5	5902062045935

**ENERGY+**  
system  
NEO GRAPHITE



Ref.	[kg]	☒	EAN
58G028-1	0,9	1/5	5902062172013

**ENERGY+**  
system  
NEO GRAPHITE

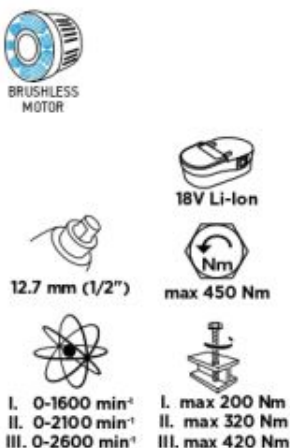

Ref.	[kg]	☒	EAN
58G038	1,25	0/5	5902062089076

**NEO**  
TOOLS

**ENERGY+**  
system  
NEO GRAPHITE

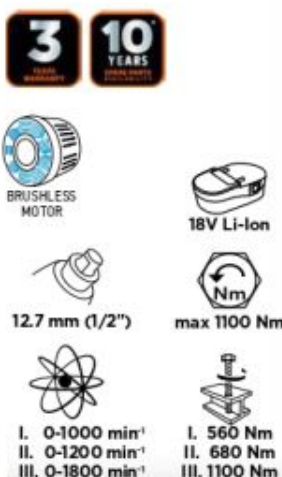

Ref.	[kg]	☒	EAN
04-618	3,01	1/4	590755849573

**ENERGY+**  
system  
NEO GRAPHITE

**NEO**  
TOOLS



Ref.	[kg]	☒	EAN
04-608	1,83	0/5	5907558410761

**ENERGY+**  
system  
NEO GRAPHITE

**NEO**  
TOOLS



Ref.	[kg]	☒	EAN
04-613	1,1	0/5	5907558465617



## Klucz udarowy

Impact wrench / Schlagschlüssel / Ключ ударный / Мутроверт ударный / Ütvecsavarozó / Cheie cu percute / Rázový utahovák / Příklepový klíč / Udarni vijačnik / Sitama atslēga / Celtniecības fēns / Lökövő / Ударен ключ / Udarni ključ / Pneumatski ključ / Ключи кроушис / Clave de impacto / Awiatore ad impulsii / Chave de impacto / Цѣф à choc

**NEO**  
TOOLS

**3**  
YEARS  
WARRANTY

**10**  
YEARS  
EXPERIENCE

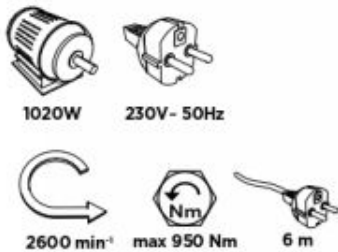

Ref.	[kg]	⊠	EAN
04-720	3,5	1/4	5907558483673

**NEO**  
TOOLS

**3**  
YEARS  
WARRANTY

**10**  
YEARS  
EXPERIENCE

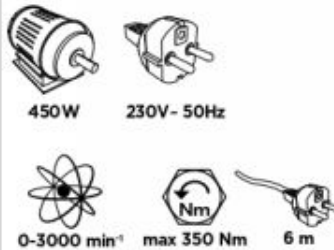

Ref.	[kg]	⊠	EAN
04-719	2,6	0/5	5907558477061

## Szlifierka kątowna akumulatorowa ENERGY+

Cordless angle grinder / Winkelschleifer / Аккумуляторная угловая шлифовальная машина / Шлифмашина кутова (болгарка) / Akkus sarkocsiszóló / Masina de slefuit unghulara / Úhlová bruska / Uhlová bruska / Kotni brusnik / Kampinis šlifuoaklis / Lerka slipmašina / Nurključva / Ђеночнаџ / Kutna brusilica / Ugaona brusilica / Γωνιακό τριβείο / Amotadora angular / Smengliatrice angolare / Disco de limar p. cantos / Meuleuse d'angle / Verstekschuurmachine

**ENERGY+**  
system  
NEO GRAPHITE



Ref.	[kg]	⊠	EAN
58G026	1,7	1/4	5902062059772

**ENERGY+**  
system  
NEO GRAPHITE



Ref.	[kg]	⊠	EAN
58G003	1,5	1/4	5902062035318

**ENERGY+**  
system  
NEO GRAPHITE

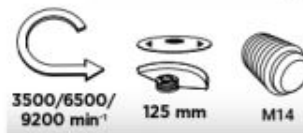

Ref.	[kg]	⊠	EAN
58GE142	1,4	0/6	5902062559166



## Szlifierka kątowa

Angle grinder / Winkelschleifer / Шлифмашина угловая / Шліфмашина кутна / Sarokcsiszoló / Maşină unghulară de şlefuit / Bruska úhlová / Brúška uhlová / Kotri brusnik / Kampinis šlifaviklis / Lejka sljpmasina / Nurkúhviya / Βελοναίφ / Brusilica kutna / Brusilica ugova / Γωνιακός τροχός / Amoladora angular / Smergljotrice angulara / Disco de limar p. cantos / Meuleuse d'angle / Verstekschuurmachine

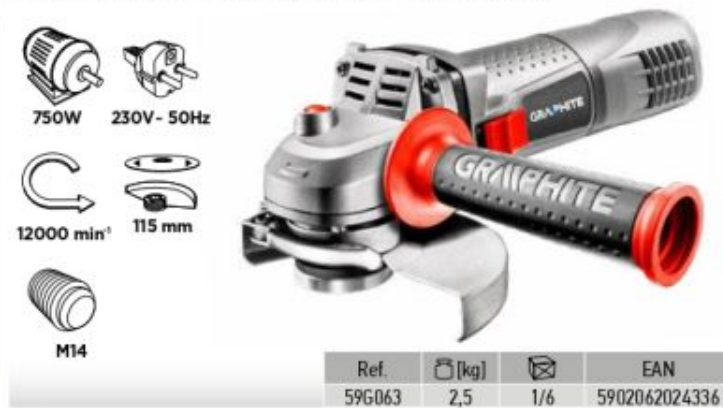

**NEO TOOLS**

**3** YEARS WARRANTY  
**10** YEARS TOOL LIFE



**NEO TOOLS**

**3** YEARS WARRANTY  
**10** YEARS TOOL LIFE



## Urządzenie wielofunkcyjne

Multi-function tool / Mehrfunktionsgerät / Многофункциональный инструмент / Багатофункційний пристрій / Többfunkciós berendezés / Dispozitiv multifuncțional / Multifunkční zařízení / Multifunkčné zariadenie / Večfunkcyjna naprava / Daugifunkcinis įrankis / Daudzfunkcionālā iekārta / Multifunktsionaalne seade / Мультифункціонально устройство / všenatjenski uređaj / Višefunkcionalni uređaj / Εργαλείο πολλαπλών χρήσεων / Dispositivo multifunción / Dispositivo multifunzione / Dispositivo multifuncional / Appareil multifonction / multifunctioneel toestel



## Szlifierka mimośrodowa

Orbital sander / Exzenterschleifmaschine / Эксцентрикoвая шлифовальная машина / Шлифмашина эксцентрикoвая / Excenterscsiszó / Masina de slefuit excentrica / Excentrická bruska / Excentrická bruska / Ekscentrični brusnik / Ekscentrisis šlijvaklis / Ekscentra slijpmašina / Ekscentriklihvija / Шлифмашина эксцентрикoва / Vibrocijska bušilica / Excentrična brusilica / Бюкчро тpибеio / Ljadora excentrica / Levigatrice roto-orbitale / Disco de limar / Meuleuse excentrique / Excenter schuurmachine



300W  
 Ø 125 mm  
 7000-13000 min<sup>-1</sup>  
 1 mm

Ref.	[kg]	⊠	EAN
596348	1,2	1/8	5902062087881

**NEO TOOLS** **3 YEARS WARRANTY** **10 YEARS TOOL LIFE**



350W  
 4000-10000 min<sup>-1</sup>  
 Ø 150 mm  
 5 mm

BRUSHLESS MOTOR

Ref.	[kg]	⊠	EAN
04-721	2,0	0/4	5907558410778

## Polerka

Polisher / Poliermaschine / Полировальная машина / Машина полирувальна / Polirózógép / Masina de lustruit / Leštička / Leštička / Polirka / Poliravimo stakles / Pólēšanas mašina / Poleerija / Машина за полиране / Aparat za poliranje / Polir mašina / Μηχανή αλφάμιτος / Pulidora / Lucidatore / Aparelho polidor / Polisseuse / Polijstmachine

**ENERGY+ system** **NEO TOOLS** **3 YEARS WARRANTY** **10 YEARS TOOL LIFE**



BRUSHLESS MOTOR  
 18V Li-Ion  
 max 150 mm

800-2300 min<sup>-1</sup>  
 M14

Ref.	[kg]	⊠	EAN
04-602	2,8	1/4	5907558465518

**NEO TOOLS** **3 YEARS WARRANTY** **10 YEARS TOOL LIFE**



710W 230V-50Hz  
 max 125 mm  
 2000-4600 min<sup>-1</sup>  
 8 mm 5/16" 6 m

Ref.	[kg]	⊠	EAN
04-700	2,7	1/6	5907558467994

**NEO TOOLS** **3 YEARS WARRANTY** **10 YEARS TOOL LIFE**



230V-50Hz 900W  
 Ø max 150 mm 600-3000 min<sup>-1</sup>  
 M14 6 m

Ref.	[kg]	⊠	EAN
04-701	2,2	0/4	5907558498196



## Opalarka akumulatorowa ENERGY+

Cordless Heat Gun / Schnurlose Heißluftpistole / Аккумуляторная тепловая пушка / Аккумуляторная тепловая пушка / Akku hőlégfúvó / Arma de căldură fără fir / Akumulátorová tepelná pistole / Akumulátorová tepelná pištol / Brezžični toplotni pištol / Akumulátorinis šilumos pistoletas / Bežvada karštuma pistole / Juhtmeta soojuspüstol / Безжичен топлинен пистолет / Безжични топлински pištolj / Безжични топлинни пуштомъ / Πιστόλι θερμότητας χωρίς καλώδιο / Pistola de calor sin cuerda / Pistola termica a batteria / Pistola de calor sem fio / Pistolet à chaleur sans fil

**ENERGY+**  
system

NEO GRAPHITE



18V  
Li-Ion



200 l/min



550°C



Ref.	[kg]	⊠	EAN
58G082	0,6	1/5	5902062503497

## Pistolet klejowy ENERGY+

Glue gun / Leimpistole / Πιστολετ κλεβού / Πιστολετ κλεβού / Ragasztópisztoly / Pistol de lipit / Lepící pistole / Pištol lepiva / Lepilna pištol / Kljiv pistoletas / Limes pistole / Liimpüstol / Πιστολετ за лепило / Pištolj za plastiku / Pistolj za plastiku / Πιστόλι θερμοκόλλησης / Pistola surtidora de pegamento / Pistola incollante / Pistola p. cola / Pistolet à colle / Ljimpistole

**ENERGY+**  
system

NEO GRAPHITE



18V  
Li-Ion



Ø 11 mm



3 min



max 210°C



Ref.	[kg]	⊠	EAN
58G040	0,4	1/5	5907558480078

## Opalarka

Hot air gun / Seingmaschine / Термофен / Фен / Hőlégfúvó / Masina de parit / Opalovací pistole / Opalovacia pištol / Fen / Techninis fenas / Celtniecības fens / Кулерпухур / Πιστολετ за горещ въздух / Puhala vrućeg zraka / Fen / Πιστόλι θερμού αέρα / Descapador por aire caliente / Pistola ad aria calda / Soprador de ar quente / Décapeur thermique / Verfstripper



2000W



230V- 50Hz



I: 300 l/min  
II: 150 l/min  
III: 500 l/min



I: 25°C  
II: 350°C  
III: 550°C



Ref.	[kg]	⊠	EAN
59G522	1,9	0/5	5902062595225



2000W



230V- 50Hz



I: 350 l/min  
II: 350 l/min  
III: 500 l/min



I: 50°C  
II: 50-550°C  
III: 50-550°C



Ref.	[kg]	⊠	EAN
59G526	0,74	1/5	5902062086747

**NEO**  
TOOLS

**3** YEARS WARRANTY  
**10** YEARS TOOL LIFE



2000W



230V- 50Hz



I: 300 l/min  
II: 500 l/min



I: 50°C  
II: 70-600°C



Ref.	[kg]	⊠	EAN
04-710	0,77	1/5	5907558470550



2000W



230V- 50Hz



I: 300 l/min  
II: 500 l/min



I: 350°C  
II: 550°C



Ref.	[kg]	⊠	EAN
59G523	1,0	1/10	5902062086730



### Latarka akumulatorowa ENERGY+

Cordless flashlight / Taschenlampe / Аккумуляторный фонарь / Лямпарик / Akkus lámpa / Lanterna / Bateria / Lampa / Svetilka / Žibintuvėlis / Lukturnis / Pöletti / Фенерче / Batejnjska lampo / Lampa / Φακός / Linterna de mano / Torcia / Lanterna / Torche / Zaklamp



- 18V Li-Ion
- 3W
- 260 m
- 7000 K
- 120°



Ref.	[kg]	☒	EAN
58G007	0,3	1/10	5902062035356

### Przecinarka do metalu

Portable cut-off saw / Metall-Trennmaschine / Пила по металлу / Пилна монтажна / Fémárboló / Aparat portabil de debitat în metal / Rezočka kovu / Rezočka na kov / Rezačnik kovine / Metalu riūklas / Metāla griezējs / Metallisaepink / Сечач за метал / Rezalica za metal / Sekač za metal / Πριόν μετάλλου / Cortador para metal / Troncatrice per metallo / Cortador p. metal / Tronçonneuse à métal / Metaalknipper

- 2600W
- 230V- 50Hz
- Ø 355/24,5 mm
- 3800 min<sup>-1</sup>
- max 120 mm



Ref.	[kg]	☒	EAN
59G873	19	0/1	5902062504890

### Pilarka szablowa akumulatorowa ENERGY+

Sabre saw / Motorstichsäge / Сабельная пила / Пилка шабельна / Szablyafűrész / Ferästräu sabie / Šavlová pila / Chvostová píla / Sabljasta žaga / Tiesinis riūklas / Zobenžāģis / Saabelsaag / Сабелен пилон / Sabljasta píla / Sabljasta testera / Σαβλόραγα / Sierra de vaivén / Sega universale / Serra de sabre / Scie à sabre / Sabelzaag



- 18V Li-Ion
- 0-3000 min<sup>-1</sup>
- 22 mm
- max 60 mm
- max 6 mm



Ref.	[kg]	☒	EAN
58G017	1,8	0/5	5902062035928

### Pilarka szablowa

Sabre saw / Motorstichsäge / Сабельная пила / Пилка шабельна / Mini szablyafűrész / Ferästräu sabie / Šavlová pila / Chvostová píla / Sabljasta žaga / Tiesinis riūklas / Zobenžāģis / Saabelsaag / Сабелен пилон / Sabljasta píla / Sabljasta testera / Σαβλόραγα / Sierra de vaivén / Mini sega a gattuccio / Serra de sabre / Scie à sabre / Sjabelzaag

- 900W
- 230V- 50Hz
- 0-2600 min<sup>-1</sup>
- 20 mm
- max 115 mm
- max 8 mm



Ref.	[kg]	☒	EAN
58G971	3,1	0/6	5902062015716

- 710W
- 230V- 50Hz
- 0-2800 min<sup>-1</sup>
- 20 mm
- max 115 mm
- max 8 mm



Ref.	[kg]	☒	EAN
58G961	2,4	1/6	5902062103093

## Szlfierka stolowa

Bench grinder / Tischnschleifmaschine / Машина шлифовальная настольная / Шліфмашина верстатна / Kőszűrőgép / Masina de slefuit de banc / Stolní bruska / Stolová bruska / Namizni brusilnik / Stationarus galstuvus / Galda sljpašina / Lavakai / Настолнен абрухит / Stolna brusilica / Stona brusilica / Επιτραπέζιο φρέιο / Amoladora de banco / Smerigliatrice da banco / Disco de limar de mesa / Meuleuse d'établi / Tafelschuurmachine

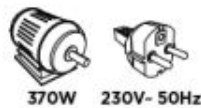

370W 230V- 50Hz



12,7/150 mm



2980 min<sup>-1</sup>



Ref.	Ⓜ [kg]	📦	EAN
59G383	11,1	0/1	5902062593832



## Kompresor akumulatorowy

Inflator with accessories / Akku-Kompressor mit Zubehör / Компрессор аккумуляторный с оснасткой / Компрессор аккумуляторный з принадлежностями / Légkompresszor tartozékokkal / Compresor de cumulator cu accesorii / Akumulátorový kompresor s príslušenstvom / Akumulátorový kompresor s príslušenstvom / Akumulatorski kompresor z opremo / Automobilinis kompresorius su įranga / Akumulatora kompresors ar pie derumiem / Akukompresor koos tarvikutega / Аккумуляторен компресор с оборудване / Akumulatorski kompresor s opremom / Batenjski akumulator s priborom / Συμπιεστής επαναφορτιζόμενος με βοηθητικά εξαρτήματα / Compresor a bateria con accesorios / Compresore a batteria con accessori / Compresor de ar para bateria com acessórios / Compresseur à batterie avec accessoires / Batterijcompressor met accessoires



18V Li-Ion



7 bar



Ref.	Ⓜ [kg]	📦	EAN
58G041	0,8	1/5	5907558480085

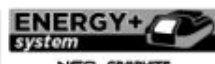

NEO TOOLS

3 YEARS WARRANTY

10 YEARS WARRANTY

BATTERY NOT INCLUDED



18V Li-Ion



max 8 bar



3.8 L



4300 min<sup>-1</sup>



Ref.	Ⓜ [kg]	📦	EAN
04-620	5,68	1/2	5907558495980

## Uchwyt na akumulator Energy+

Energy+ battery holder / Energy+ Batteriehalter / Держатель аккумулятора Energy+ / Тримач аккумулятора Energy+ / Energy+ elemtartó / Support batterie Energy+ / Držák baterie Energy+ / Držak baterije Energy+ / Nosilec baterije Energy+ / Energy+ akumulatoriaus laikiklis / Energy+ akumulatora turētājs / Energy+ akuhoidja / Държач за батерия Energy+ / Energy+ držač baterije / Энерг+ држач батеріє / Στήριγμα μπαταρίας Energy+ / Portarilas Energy+ / Portabatterie Energy+ / Supporte de baterie Energy+ / Support de batterie Energy+ / Energie+ batterijhouder



Ref.	📦	EAN
58G090	0/50	5902062493781

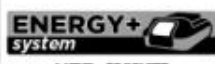

18V Li-Ion



1W

USB out 5V DC 1,5A



Ref.	Ⓜ [kg]	📦	EAN
58G025	0,11	1/50	5907558480092

## Adapter USB - latarka LED ENERGY+

USB adapter - LED flashlight / USB-adapter - LED-taschenlampe / Переходник USB - фонарик LED / Adapter USB — латарк LED / USB adapter - LED lampa / Adapter USB - lanternă LED / USB adaptor - LED svítlna / USB adaptér - LED baterka / Adapter USB - svetilka LED / Jungtis USB - žibintuvelis LED / USB adapters - LED lukuris / USB-adapter - LED-taskulap / USB adapter - LED фенер / Adapter USB - LED svjetiljka / USB adapter - LED lampo / Φαροίσο φαροίσο με USB και φακο LED / Adaptador USB - linterna LED / Adattatore USB - torcia elettrica LED / Adaptateur USB - torche LED / USB adapter - LED zaklamp

## Torba na elektronarzędzia ENERGY+

Power tool bag / Werkzeugtasche / Сумка для электроинструмента / Torba instrumentalna / Gépartó táská / Geanta scule / Brašno na nářadí / Taška na montérská / Torba za orodje / Krepšys įrankiams / Instrumentu soma / Töönistakott / Чанта за инструменти / Torba za alat / Torba za alat / Σάκος για εργαλεία / Bolsa para herramientas / Borsă in telă / Saco p. ferramentas / Sac à outils / Gereedschapstas

**18,5L**  
**Poliester**

18.5 l,  
46x24x45 cm



Ref.	[kg]	☒	EAN
58G092	1.7	0/4	5902062506801

## Akumulator systemu ENERGY+

Battery / Akumulator / Аккумуляторная батарея / Аккумулятор / Akkumulator / Acumulator / Akumulátor / Akumulátor / Akumulator / Akumulátorius / Akumulators / Aku / Аккумулятор / Akumulator / Akumulator / Ηλεκτρικός αισθητήρας / Bateria / Batterie / Batterie / Batterie / Accu

**ENERGY+**  
system

NEO GRAPHITE

**BOOST**  
UP+++



Ref.	[Ah]	☒	EAN
58G001	2.0	0/10	5902062035295
58G004-1	4.0	0/10	5902062107350
58G086	6.0	0/20	5902062501158
58GE152	8.0	0/10	5902062595164

**BOOST**  
UP+++

## Ładowarka do akumulatorów ENERGY+

ENERGY+ battery charger / Akku-Ladegerät / Зарядное устройство системы ENERGY+ / Зарядний пристрій для акумуляторів / Töltő / Incarcator pentru acumulatori / Nabijačka baterij / Nabijačka akumulatora / Polnilnik za akumulatorje / Akumulatorių įkroviklis / Akumulatoru lādētājs / Akulaadija / Зарядно устройство за акумулатори / Punjač za akumulatori / Punjač za akumulator / Φορτιστής / Cargador para baterías / Carica batterie / Carregador de baterias / Chargeur à batteries / Accuoplader

**ENERGY+**  
system

NEO GRAPHITE



Ref.	[A]	☒	EAN
58G002	2.3	0/8	5902062035301
58G085	2x 3	0/10	5902062501141



## Wiertła do metalu

HSS drills / Metallbohrer / Цверла по металлу / Цверла по металлу / Csigaűró / Burghie pentru metale / Vrtáky do kovu / Vrtáky do kovu / Svedri za kovino / Gražtai metalui / Urbis metilam / Metallpuur / Цверла за метал / Svrda za metal / Burgija za metal / Τρυπάνια μετάλλου / Brocas para metal / Punta per metallo / Brocas p. metal / Forêts à métal / Boren voor metaal

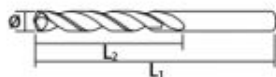
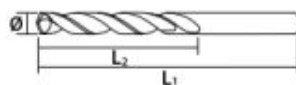

Ref.	Ø [mm]	L1 [mm]	L2 [mm]	⊠	EAN
55H010	2.0	46	24	125/500	5902062997074
55H013	2.5	57	30	125/500	5902062997104
55H014	3.0	61	33	125/500	5902062997111
55H015	3.2	65	36	125/500	5902062997128
55H016	3.5	70	39	125/500	5902062997135
55H017	3.8	75	43	125/500	5902062997142
55H018	4.0	75	43	125/500	5902062997159
55H019	4.2	75	43	120/480	5902062997166
55H020	4.5	80	47	120/480	5902062997173
55H021	4.8	86	52	120/480	5902062997180
55H022	5.0	86	52	120/480	5902062997197
55H024	5.5	93	57	120/480	5902062997210
55H025	6.0	93	57	120/480	5902062997227
55H026	6.5	101	63	120/480	5902062997234
55H027	7.0	101	63	75/300	5902062997241
55H029	8.0	117	75	75/300	5902062997265
55H030	8.5	117	75	75/300	5902062997272
55H031	9.0	125	81	75/300	5902062997289
55H033	10.0	133	87	50/200	5902062997302
55H035	10.5	133	87	50/200	5902062997326
55H036	11.0	142	94	50/200	5902062997333
55H038	12.0	151	101	50/200	5902062997357
55H039	12.5	151	101	45/180	5902062997364
55H040	13.0	151	10	45/180	5902062997371



Ref.	Ø [mm]	L1 [mm]	L2 [mm]	⊠	⊠	EAN
57H010	1.0	34	12	5	20/200	5902062570109
57H012	1.5	40	18	5	20/200	5902062570123
57H014	2.0	49	24	5	20/200	5902062570147
57H015	2.2	53	27	3	20/200	5902062570154
57H016	2.4	57	30	3	20/200	5902062570161
57H018	2.5	57	30	3	20/200	5902062570185
57H020	3.0	61	33	1	20/200	5902062570208
57H022	3.2	65	36	1	20/200	5902062570222
57H023	3.5	70	39	1	20/200	5902062570239
57H024	4.0	75	43	1	20/200	5902062570246
57H026	4.2	75	43	1	20/200	5902062570260
57H028	4.5	80	47	1	20/200	5902062570284
57H030	4.8	86	52	1	20/200	5902062570307
57H032	5.0	86	52	1	20/200	5902062570321
57H034	5.2	86	52	1	20/200	5902062570345
57H036	5.5	93	57	1	20/200	5902062570369
57H038	6.0	93	57	1	20/200	5902062570383
57H040	6.5	101	63	1	20/200	5902062570406
57H042	7.0	109	69	1	20/200	5902062570420
57H044	7.5	109	69	1	20/200	5902062570444
57H046	8.0	117	75	1	20/200	5902062570468
57H048	8.5	117	75	1	20/200	5902062570482
57H050	9.0	125	81	1	20/200	5902062570505
57H052	9.5	125	81	1	20/200	5902062570529
57H054	10.0	133	87	1	20/200	5902062570543
57H055	10.2	133	87	1	20/200	5902062570550
57H056	10.5	133	87	1	20/200	5902062570567
57H058	11.0	142	94	1	20/200	5902062570581
57H062	12.0	151	101	1	20/200	5902062570628
57H064	12.5	151	101	1	20/120	5902062570642
57H066	13.0	151	101	1	20/120	5902062570666
57H014-10	2.0	49	24	10	20/600	5902062221933
57H018-10	2.5	57	30	10	20/400	5902062221957
57H020-10	3.0	61	33	10	20/400	5902062221964
57H022-10	3.2	65	36	10	20/200	5902062221971
57H023-10	3.5	70	39	10	20/200	5902062221988
57H024-10	4.0	75	43	10	20/200	5902062221995
57H026-10	4.2	75	43	10	20/200	5902062222008
57H028-10	4.5	80	47	10	20/200	5902062222015
57H030-10	4.8	86	52	10	10/100	5902062222022
57H032-10	5.0	86	52	10	10/100	5902062222039
57H034-10	5.2	86	52	10	10/100	5902062222046
57H036-10	5.5	93	57	10	10/100	5902062222053
57H038-10	6.0	93	57	10	10/100	5902062222060
57H040-10	6.5	101	63	10	5/50	5902062222077
57H042-10	7.0	109	69	10	5/50	5902062222084
57H046-5	8.0	117	75	5	10/60	5902062222107
57H048-5	8.5	117	75	5	10/60	5902062222114
57H050-5	9.0	125	81	5	10/60	5902062222121
57H054-5	10.0	133	87	5	10/60	5902062222145
57H056-5	10.5	133	87	5	10/60	5902062222152
57H058-5	11.0	142	94	5	10/40	5902062222169
57H062-5	12.0	151	101	5	10/40	5902062222183
57H066-5	13.0	151	101	5	10/40	5902062222206

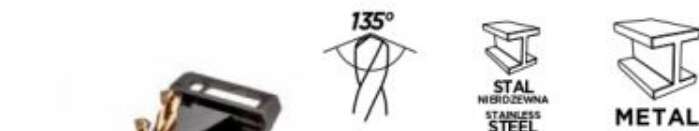

Ref.	Ø [mm]	⊠	⊠	EAN
57H086	4, 5, 6, 8, 10	5	25/100	5902062025364
57H088	1.5, 2, 2.5, 3, 3.2, 3.5, 4, 4.2, 4.8, 5, 5.5, 6, 6.5	13	50/100	5902062570888
57H089	1, 1.5, 2, 2.5, 3, 3.5, 4, 4.5, 5, 5.5, 6, 6.5, 7, 7.5, 8, 8.5, 9, 9.5, 10	19	10/40	5902062570895
57H090	1, 1.5, 2, 2.5, 3, 3.5, 4, 4.5, 5, 5.5, 6, 6.5, 7, 7.5, 8, 8.5, 9, 9.5, 10, 10.5, 11, 11.5, 12, 12.5, 13	25	0/10	5902062570901



## Wiertło bezstopniowe

Stepless Conical Bit / Stufenloser Bohrer / Сверло коническое / Сверло коничне / Fokozatmentes fúró / Burghiu nelărgitor / Kuželový vrták / Kuželový vrták / Stožasti sveder / Konusinis grąžtas / Koniskais urbis / Koonuspuur / Конично сверло / Konusno svrdlo / Glatka burjiga / Трипін з коничною сталею / Broca sin gradus / Punta conica / Broca sem graus / Foret non étagé / Traploze boor



Ref.	ø [mm]	⊠	EAN
57H741	4-32	10/50	5902062577412

## Wiertło stopniowe

Stepped Conical Bit / Stufenbohrer / Сверло ступенчатое / Сверло ступенчате / Lépcsős fúrószár / Burghiu lărgitor conic / Stupňovitý vrták / Stupňovitý vrták / Stopenjski sveder / Pakapinis grąžtas / Pakārpveida urbis / Astmeline puur / Многоствяльное сверло / Stopenasto svrdlo / Konusna - stepenasta burjiga / Трипін діалочна ступів з коничною ділянкою / Broca con gradus / Punta conica / Broca de graus / Foret étagé / Trapboor



Ref.	ø [mm]	⊠	EAN
57H739	4-22	50/100	5902062577399
57H740	4-32	10/50	5902062577405

## Tarcza tnąca

Cutting disc / Schneidescheibe / Диск пильный / Диск різальний / Vágókorong / Disc tăietor / Pilový kotouč / Pílový kotúč / Rezinna plošča / Pjovimo diskas / Žaiga disks / Lökkeketas / Режущий диск / Rezna ploča / Ploče za sečenje / Δίσκος κοπής / Disco de corte / Disco da taglio per metallo / Disco cortante / Disque de coupure / Snijschijven



Ref.	ø1 [mm]	ø2 [mm]	W [mm]	Info	Info	⊠	⊠	EAN
55H570	115	22	1.0	41 A60-T-BF	INOX (Fe+S+Cl<0,1%)	10	7/28	5902062024374
55H572	125	22	1.0	41 A60-T-BF	INOX (Fe+S+Cl<0,1%)	10	7/28	5902062024381



Ref.	ø1 [mm]	ø2 [mm]	W [mm]	Info	⊠	⊠	EAN
55H574	115	22	1.0	41 A60-T-BF	10	7/28	5902062024398
55H576	125	22	1.0	41 A60-T-BF	10	7/28	5902062024404



Ref.	ø1 [mm]	ø2 [mm]	W [mm]	Info	⊠	⊠	EAN
57H700	125	22	1.6	41 A60-T-BF	0/25		5902062577009
57H705	115	22	1.0	41 A60-T-BF	0/25		5902062577054
57H719	230	22	1.9	41 A46-S-BF	25/50		5902062577191



Ref.	ø1 [mm]	ø2 [mm]	W [mm]	Info	⊠	⊠	EAN
08-720	125	22	1.0	41 A60-S-BF	25	0/1	5907558430356
08-722	125	22	1.0	41 A60-S-BF	100	0/1	5907558472363
08-721	230	22	1.9	41 A60-S-BF	25	0/1	5907558430370



Ref.	ø1 [mm]	ø2 [mm]	W [mm]	Info	⊠	⊠	EAN
55H577	115	22	1.0	41 A60-T-BF	10	5/40	5902062107022
55H578	125	22	1.0	41 A60-T-BF	10	5/40	5902062107039



Ref.	ø1 [mm]	ø2 [mm]	W [mm]	Info	⊠	⊠	EAN
55H579	230	22	1.9	A46-S-BF	5	5/20	5902062107046

## Otwornica

Compass saw / Lochsäge / Ножовка / Фреза / Lyukfűrész / Ferüsträu pentru găuri / Dërovka / Dierovacía pila / Luknjarnica / Vienarankis pjūkļas / Rokzäjis / Augusaog / Тесен тpуон / Nareznica / Rušna testera za pravljenje otvora / Πριόν / Sierra de corona / Segà a tazza a doppio metallo / Serra para recorte / Soie à guichet / Gatenknipper

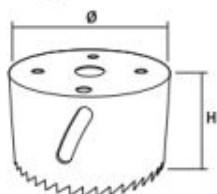

STAL  
NIERDZEWNIA  
STAINLESS  
STEEL



METAL



AL



CU



DREWNO  
WOOD



PLASTIC

Ref.	Ø [mm]	H [mm]	☒	EAN
57H900	16	38	8/96	5902062579003
57H902	19	38	8/96	5902062579027
57H904	20	38	8/96	5902062579041
57H901	21	38	6/72	5902062579010
57H906	22	38	8/96	5902062579065
57H908	25	38	6/72	5902062579089
57H903	27	38	8/96	5902062579034
57H910	29	38	6/72	5902062579102
57H912	32	38	8/96	5902062579126
57H914	35	38	6/24	5902062579140
57H916	38	38	6/72	5902062579164
57H918	40	38	6/24	5902062579188
57H905	44	38	6/72	5902062579058
57H920	46	38	6/24	5902062579201
57H922	51	38	6/72	5902062579225
57H907	54	38	6/24	5902062579072
57H924	57	38	6/72	5902062579249
57H909	60	38	6/24	5902062579096
57H926	64	38	6/72	5902062579263
57H928	67	38	6/24	5902062579287
57H911	70	38	6/72	5902062579119
57H930	73	38	6/72	5902062579300
57H932	83	38	6/72	5902062579324
57H913	86	38	6/24	5902062579133
57H915	92	38	6/24	5902062579157
57H934	95	38	6/24	5902062579348
57H936	105	38	6/24	5902062579362
57H917	114	38	6/24	5902062579171
57H919	140	38	6/24	5902062579195

## Adapter do otwornic

Adapter for hollow annular drill heads / Adapter für Lochsäge / Переходник для коронок / Адаптер переходниці до фрез / Adapter lyukfűrészhez / Adaptor pentru capete gaurite cu coroana / Adapter pro dërovky / Adaptër do dierovacích pil / Adapter za luknjarnice / Jungtis gręzimo karūnai / Adapteris krooņpuiņudei / Адаптер за сарадина / Adapter za nareznice / Adapter za ručne testere / Αντάραρας για πορτοπηλωνα / Adaptador para sierras de corona / Adattatore per sega a tazza / Adaptador do Serras para recorte / Adaptateur de scie à guichet / Adapter voor gatenknippers



STAL  
NIERDZEWNIA  
STAINLESS  
STEEL



METAL



CU



AL



DREWNO  
WOOD



PLASTIC

Ref.	Ø [mm]	Info	☒	EAN
57H938	14-30	adapter	25/50	5902062579386
57H940	>30	adapter	25/50	5902062579409
57H944	6,35	wiertło	25/50	5902062579447

## Wiertła-pily

Saw drills / Bohrer - Säge / Свёрла-пилы / Свёрла-фрезы / Marifűrő készlet / Burghie - ferüsträu / Vrtáky / Pily / Frézovací vrtáky / Svedri-žage / Grązłai - pjūkļai / Urbij-zągi / Puurid-saed / Сападина-тpуону / Svrdla pile / Burgyje-testere / Πριωνάτα тpуωνα / Brocas sierras / Set punta seghettata / Forëts-soies / Boorzagen



HSS  
TiN



DREWNO  
WOOD



SKLEJKA  
CHIPBOARDS

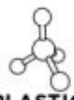

PLASTIC

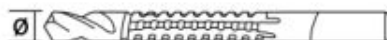

Ref.	Ø [mm]	☒	EAN
57H250	5, 6, 8	12/60	5902062572509

## Fazownik

Beveller / Kegelsenker / Фаска / Фаска / Κύριος έλλειτόρ / Frez de șanfrenare / Dërovka / Vyhľbovacía fréza / Robitnik / Freza grioveliams / Făzes uzgalis / Servoja / Уред за фаску / Gladalo za skošenje / Uredaj za zakašenje / Φρεζομηχανα / Biseľador / Smussatore / Chanfrador / Outil de fraisage / Afschuinapparaat



INOX



STEEL



AL



CU

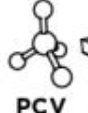

PCV



WOOD



HEX



4-20 mm

Ref.	☒	EAN
56H246	10/100	5902062075499

## Nakrętka szybkoocująca

Quick-action nut / Schnellspannende Mutter / Быстрозахватная гайка / Швидкозахватна гайка / Gyorszáras anya / Puliță cu acțiune rapidă / Rychloúpinací matice / Rychloúpinacia matica / Hitro delujoča matiča / Greito veikimo veržle / Átrás darbibas uzgriezis / Pikamutter / Гаїна с бързо действие / Παχυοή πιελείας βράσης / Brza matica / Навртна са брзим дејством / Tuercà de acciòn ràpida / Dado ad azione rapida / Porca de ação ràpida / Ecrou à action rapide

M14



MIN 1 mm

115-230 mm

Ref.	☒	EAN
56H421	12/120	5902062107015

## Frez z węgla spiekanego

Carbide rotary burr / Hartmetall-Drehgrat / Твердосплавная фреза / Твёрдосплавная фреза / Keresztfogász / Freza din carbura de tungsten / Tvrđakovová rotační fréza / Fréza z tvrdokovu / Rezalnik iz volframovega karbida / Volframo karbido freza / Volframo karbida fréze / Frees / Фреза / Frezer / Glodalo / Фрџа / Broca fresadora / Fresa / Fresa / Fraise / Frees

  
METAL  
DOUBLE CUT  
TOOTH  
**type A**  
(cylindrical)

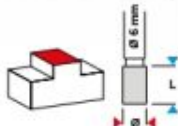

Ref.	$\varnothing$ [mm]	L [mm]	⊠	EAN
55H350	6	16	10/100	5902062508942
55H351	8	20	10/100	5902062508959
55H352	10	25	10/100	5902062508966
55H353	12	25	10/100	5902062508973
55H354	14	25	10/100	5902062508980
55H355	16	25	10/100	5902062508997

  
METAL  
DOUBLE CUT  
TOOTH  
**type B**  
(cylindrical  
with blades  
on top)

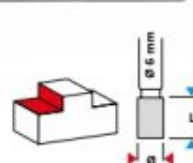

Ref.	$\varnothing$ [mm]	L [mm]	⊠	EAN
55H356	8	20	10/100	5902062509000
55H357	10	25	10/100	5902062509017
55H358	12	25	10/100	5902062509024
55H359	16	25	10/100	5902062509031

  
METAL  
DOUBLE CUT  
TOOTH  
**type C**  
(cylindrical  
rounded)

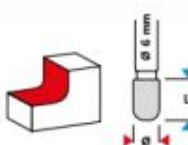

Ref.	$\varnothing$ [mm]	L [mm]	⊠	EAN
55H360	10	20	10/100	5902062509048
55H361	12	25	10/100	5902062509055

  
METAL  
DOUBLE CUT  
TOOTH  
**type D**  
(spherical)

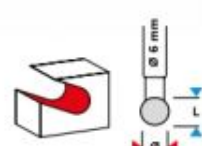

Ref.	$\varnothing$ [mm]	L [mm]	⊠	EAN
55H362	10	12	10/100	5902062509062

  
METAL  
DOUBLE CUT  
TOOTH  
**type E**  
(oval)

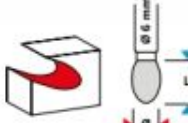

Ref.	$\varnothing$ [mm]	L [mm]	⊠	EAN
55H363	6	10	10/100	5902062509079
55H364	8	13	10/100	5902062509086
55H365	10	16	10/100	5902062509093
55H366	12	20	10/100	5902062509109
55H367	14	22	10/100	5902062509116
55H368	16	25	10/100	5902062509123

  
METAL  
DOUBLE CUT  
TOOTH  
**type F**  
(tree shape  
ball nose)

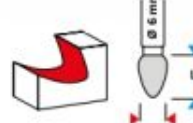

Ref.	$\varnothing$ [mm]	L [mm]	⊠	EAN
55H369	6	18	10/100	5902062509130
55H370	8	18	10/100	5902062509147
55H371	10	20	10/100	5902062509154
55H372	12	25	10/100	5902062509161
55H373	14	25	10/100	5902062509178
55H374	16	25	10/100	5902062509185

  
METAL  
DOUBLE CUT  
TOOTH  
**type G**  
(tree shape  
point)

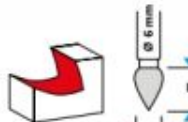

Ref.	$\varnothing$ [mm]	L [mm]	⊠	EAN
55H375	12	25	10/100	5902062509192

  
METAL  
DOUBLE CUT  
TOOTH  
**type H**  
(flame)



Ref.	$\varnothing$ [mm]	L [mm]	⊠	EAN
55H376	12	32	10/100	5902062509208



  
METAL  
DOUBLE CUT  
TOOTH  
**type L**  
(conical)



Ref.	$\varnothing$ [mm]	L [mm]	⊠	EAN
55H377	12	30	10/100	5902062509215

## Tarcza szlifierska z rzepem

Rubber disc / Schleifscheibe mit Klettverschluss / Круг шлифовальный с липучкой / Круг шлифовальный на липучи / Rugalmas csiszoló tárcs / Disc de cauciuc / Leštící kotouč se suchým zřepem / Gumový disk stopkový pevný / Brusilna plošča z velkro papirjem / Guminis šlifavimo diskas / Gumijas pamatine slīpāškat / Kummiketas / Диск гумени / Disk gumeni za brušenje / Δίσκος λείανσης / Disco elástico con velcro / Disco di gomma / Disco p. esmerilha / Meule abrasive à adhésif Velcro / Slijpschijf met velcroband



Ref.	Ø [mm]	☒	EAN
55H928	125	0/50	5902062502803
55H929	150	0/50	5902062502810

## Włóknina ścierna

Abrasive cloth / Schleifstoff / Наждачное волокно / Волокно абразивное / Csiszolófic / Tesáturá abrazív / Brusné rouno / Brusna vlókna / Brusno vlakno / Šljavimo medžaga / Šlīpēšanas audēks / Lihvāud / Абразивна тъкан / Brusna tkanina / Abrasivna tkanina / Υφασμα λείανσης / Tela de lija / Tessuto abrasivo / Tecido abrasivo / Textile abrasif / Papieren zak



Ref.	Ø [mm]	☒	EAN
55H992	125 x 22.2	5/100	5902062503473

## Adapter

Adaptor / Adapter / Αδαντες / Переходник / Közdarab, adaptor / Adaptor / Adaptér / Adaptér / Adapter / Jungtis / Adapteris / Adapter / Αδαντες / Adapter / Adapter / Αντάτορας / Adaptor / Adattore / Adattador / Adapteur / Adapter



Ref.	Ø [mm]	☒	EAN
55H825	125	0/50	5902062502773
55H826	150	0/50	5902062502780



Ref.	Ø [mm]	☒	EAN
55H823	125	0/50	5902062502759



Ref.	☒	EAN
55H320	10/100	5902062509437

## Krażki ścierne

Abrasive discs / Schleifscheibe / Шлифовальные круги / Круги шлифовальні / Csiszolókorongok / Discuri abrazive / Brusné kroužky / Brusne kotūče / Brusne plošče / Šljavimo disketiai / Šlīpēšanas apli / Lihvāngad / Абразивни дискове / Brusni kolūtis / Diskovi za brušenje / Δίσκοι λείανσης / Hoja de lija circular / Dischi abrasivi / Discos abrasivos / Roulette abrasive / Schuurwielen

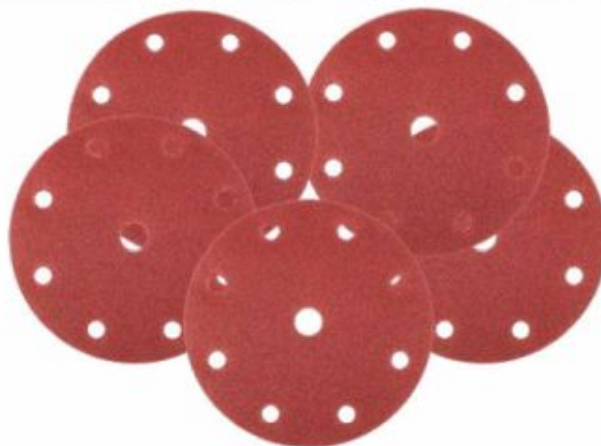

Ref.	Info	Ø [mm]	☒	EAN
08-990	K40	150	0/100	5907558475845
08-991	K60	150	0/100	5907558475852
08-992	K80	150	0/100	5907558475869
08-993	K100	150	0/100	5907558475876
08-994	K120	150	0/100	5907558475883
08-995	K180	150	0/100	5907558475890
08-996	K240	150	0/100	5907558475906

## Krażki ścierne

Abrasive discs / Schleifscheibe / Шлифовальные круги / Круги шлифовальные / Csiszolókorongok / Discuri abrazive / Brusné kroužky / Brusne kotuče / Brusne plošče / Šlifavimo diskeliai / Šlīpēšanas aplī / Lihvröngad / Абразивни дискове / Brusni kolubiči / Diskovi za brušenje / Διακοί λείανσης / Hoja de lija circular / Dischi abrasivi / Discos abrasivos / Roulette abrasive / Schuurwielen



Ref.	Info	Ø [mm]	📦	📧	EAN
55H933	K40	125	5	0/200	5902062502414
55H934	K60	125	5	0/200	5902062502421
55H935	K80	125	5	0/200	5902062502438
55H936	K100	125	5	0/200	5902062502469
55H937	K120	125	5	0/200	5902062502476
55H938	K240	125	5	0/200	5902062502483

Ref.	Info	Ø [mm]	📦	📧	EAN
55H939	K40	125	5	0/200	5902062502490
55H940	K60	125	5	0/200	5902062502506
55H941	K80	125	5	0/200	5902062502513
55H942	K100	125	5	0/200	5902062502520
55H943	K120	125	5	0/200	5902062502537
55H944	K240	125	5	0/200	5902062502544

## Ściernica listkowa

Flap wheel / Blatt-Schleifscheibe / Листовой шлифовальный круг / Круг шлифовальный листовой / Lamellás csiszoló / Disc de rectificat / Brusný kotouč listkový / Brusný lamelový tanier / Brus z lističi / Šlifavimo lapeliai / Lakšņu šlīpēšanas riņķis / Lamell-lihvetas / Лампелен диск / Lepezasta brusna ploča / Kolut za brušenje / Τροχός λείανσης με πτερύγια / Albanico lijador / Spazzola lamellare / Disco abrasivo de folhas / Meule abrasive à lamelles / Schuurblad



Ref.	Info	Ø [mm]	📦	EAN
57H835	K40	115 x 22.2	20/100	5902062503428
57H836	K60	115 x 22.2	20/100	5902062503435
57H837	K80	115 x 22.2	20/100	5902062503442
57H838	K100	115 x 22.2	20/100	5902062503459
57H839	K120	115 x 22.2	20/100	5902062503466
57H840	K36	125 x 22.2	20/100	5902062997012
57H841	K40	125 x 22.2	20/100	5902062997029
57H842	K60	125 x 22.2	20/100	5902062997036
57H843	K80	125 x 22.2	20/100	5902062997043
57H844	K100	125 x 22.2	0/100	5902062997050
57H845	K120	125 x 22.2	20/100	5902062997067

Ref.	Info	Ø [mm]	📦	EAN
55H980	K36	115 x 22.2	20/100	5902062503305
55H981	K40	115 x 22.2	20/100	5902062503312
55H982	K60	115 x 22.2	20/100	5902062503329
55H983	K80	115 x 22.2	20/100	5902062503336
55H984	K100	115 x 22.2	20/100	5902062503343
55H985	K120	115 x 22.2	20/100	5902062503350
55H986	K36	125 x 22.2	20/100	5902062503367
55H987	K40	125 x 22.2	20/100	5902062503374
55H988	K60	125 x 22.2	20/100	5902062503381
55H989	K80	125 x 22.2	20/100	5902062503398
55H990	K100	125 x 22.2	20/100	5902062503404
55H991	K120	125 x 22.2	20/100	5902062503411

## Krażki ścierne fibra

Abrasive fibre discs / Fiberschleifscheiben / Шлифовальные фибровые круги / Круги абразивни фибра / Csiszoló korongok fibra / Discuri abrazive fibre / Brusné kotuče fibr / Vlákniťé brusne kotuče / Brusni diski fibra / Abraziviniai šlifavimo diskai / Šlīpēšanas šķiedradiski / Kiud-abrasivikettad / Абразивни фибр дискове / Fiber brusni diskovi / Brusni fiber disk / Ινώδες διακοί λείανσης / Discos de fibra / Dischi abrasivi in fibra / Discos abrasivos fibra / Disques abrasifs à fibres / Schuurshijven fiber

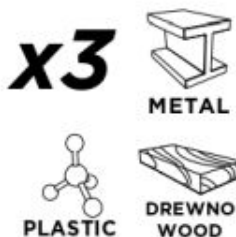

Ref.	Info	Ø [mm]	📦	📧	EAN
55H855	K40	125	3	0/100	5902062810809
55H856	K60	125	3	0/100	5902062810816
55H857	K80	125	3	0/100	5902062810823
55H858	K100	125	3	0/100	5902062810830
55H859	K120	125	3	0/100	5902062810847

Ref.	Ø [mm]	📦	EAN
57H860	125	1/100	5902062502742

## Ściernica trzpieniowa, listkowa

Sanding label cylinder / Blattschleifstift / Круге шлифовальный лепестковый / Круге абразивний лепестковий / Csapas csiszolókorong / Cilindru de șlefuit / Brusnj kotouč listkový s trnem / Brusnj kotič listkový so stopkou / Lamelni brus / Šlifovino padas / Šliflapu disks / Lihvsiinder / Шкурка аетпуно / Lamelni brus sa osovinom / Lamelni brus sa osovinom / Λαστικός κύλινδρος / Abanico lijador / Mola a mandrina, fogli / Roda de esmeril / Meule abrasive à tige, à lamelles / Blad zandsteen

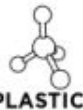

Ref.	Info	W [mm]	☒	EAN
55H754	K40	40x20	1/150	5902062503213
55H755	K60	40x20	1/150	5902062503220
55H756	K80	40x20	1/150	5902062503237
55H757	K40	60x30	1/100	5902062503244
55H758	K60	60x30	1/100	5902062503251
55H759	K80	60x30	1/100	5902062503268
55H760	K40	80x30	1/100	5902062503275
55H761	K60	80x30	1/60	5902062503282
55H762	K80	80x30	1/60	5902062503299

## Szczotka druciana

Wire brush / Drahtbürste / Щетка проволочная / Щетка по металлу / Fozékkefe sodrott / Perie metal / Drátěný kartáč / Keja drátená univerzálna / Želna krtača / Vielinis šepetys / Drašū birste / Traathari / Четка мелена / Četka sa PVC drškom / Četka / Συρμάτινη βούρτσα / Cepillo de alambre / Spazzola a tazza / Escova de arame / Brosse métallique / Draadborstel

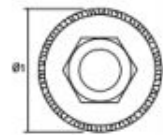

Ref.	Ø1 [mm]	n <sub>v</sub> max [min <sup>-1</sup> ]	☒	EAN
57H581	65	12 500	6/60	5902062575814
57H582	80	12 500	6/60	5902062575821
57H583	100	8 500	6/30	5902062575838

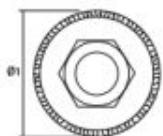

Ref.	Ø1 [mm]	n <sub>v</sub> max [min <sup>-1</sup> ]	☒	EAN
57H585	65	12 500	6/60	5902062575852
57H587	100	8 500	6/18	5902062575876



Ref.	Ø1 [mm]	n <sub>v</sub> max [min <sup>-1</sup> ]	☒	EAN
57H589	100	12 500	6/60	5902062575890
57H591	115	12 500	0/60	5902062575913

## Szczotka druciana

Wire brush / Drahtbürste / Щетка проволочная / Щетка по металлу / Fozékkefe sodrott / Perie metal / Drátěný kartáč / Keja drátená univerzálna / Želna krtača / Vielinis šepetys / Drašū birste / Traathari / Четка мелена / Četka sa PVC drškom / Četka / Συρμάτινη βούρτσα / Cepillo de alambre / Spazzola a tazza / Escova de arame / Brosse métallique / Draadborstel



Ref.	Ø1 [mm]	n <sub>v</sub> max [min <sup>-1</sup> ]	☒	EAN
57H596	115	12 500	6/60	5902062575968
57H598	125	12 500	6/60	5902062575982

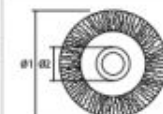

Ref.	Ø1 [mm]	Ø2 [mm]	n <sub>v</sub> max [min <sup>-1</sup> ]	☒	EAN
57H592	125	20	8 500	16, 12 mm	5902062575920

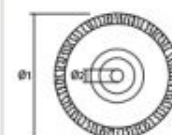

Ref.	Ø1 [mm]	Ø2 [mm]	n <sub>v</sub> max [min <sup>-1</sup> ]	☒	EAN
57H599	50	6,1	4 500	12/120	5902062575999
57H600	75	6,1	4 500	12/120	5902062576002

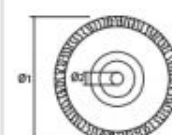

Ref.	Ø1 [mm]	Ø2 [mm]	n <sub>v</sub> max [min <sup>-1</sup> ]	☒	EAN
57H601	50	6,25	4 500	12/120	5902062576019
57H602	75	6,25	4 500	12/120	5902062576026

## Papier ścierny

Sanding paper / Schleifpapier / Бумага наждачная / Папір наждачний / Csiszolópapír / Hírtie smirgthet ce se încheie singură / Brusnj papir / Papier brusny-galka / Brusni papir / Šifavnjo papirius / Smilspapirs / Līvārpaber / Шурна бума / Brusni papir u roli / Brusni papir / Λειαντικό ύφασμα / Lija / Carta abrasiva / Folha de lica / Papier abrasif / Schuurpapier



Ref.	Info	W [mm]	☒	EAN
55H896	K60	280x230	0/500	5902062888198
55H897	K80	280x230	0/500	5902062888204
55H898	K100	280x230	0/500	5902062888211
55H899	K120	280x230	0/500	5902062888228
55H900	K150	280x230	0/1000	5902062888235
55H901	K180	280x230	0/1000	5902062888242
55H902	K220	280x230	0/1000	5902062888259
55H903	K240	280x230	0/1000	5902062888266
55H904	K320	280x230	0/1000	5902062888273
55H905	K600	280x230	0/1000	5902062888280
55H906	K800	280x230	0/1000	5902062888297
55H907	K1000	280x230	0/1000	5902062888303
55H908	K1200	280x230	0/1000	5902062888310
55H909	K1500	280x230	0/1000	5902062888327
55H910	K2000	280x230	0/1000	5902062888334
55H911	K2500	280x230	0/1000	5902062888341



Ref.	Info	W [mm]	☒	EAN
55H884	K36	280x230	0/500	5902062888082
55H885	K40	280x230	0/500	5902062888099
55H886	K60	280x230	0/500	5902062888105
55H887	K80	280x230	0/500	5902062888112
55H888	K100	280x230	0/500	5902062888129
55H889	K120	280x230	0/1000	5902062888136
55H890	K150	280x230	0/1000	5902062888143
55H891	K180	280x230	0/1000	5902062888150
55H892	K200	280x230	0/1000	5902062888167
55H893	K220	280x230	0/1000	5902062888174
55H894	K240	280x230	0/1000	5902062888181

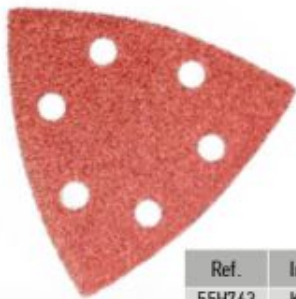

**x5**



Ref.	Info	W [mm]	☒	☒	EAN
55H763	K40	93x93	5	0/200	5902062502827
55H764	K60	93x93	5	0/200	5902062502834
55H765	K80	93x93	5	0/200	5902062502841
55H766	K100	93x93	5	0/200	5902062502858
55H767	K120	93x93	5	0/200	5902062502865
55H768	K240	93x93	5	0/200	5902062502872

## Plótna ściernie

Abrasive cloths / Schleifleinen / Шлифовальные полотна / Полотна наждакові / Csiszolóvászonok / Pânze abrazive / Brusná plátina / Brúsne plátina / Brusna platiná / Šifavnjo papiriai / Slīpēšanas audekls / Lihvrie / Абразивни платна / Brusna platiná / Abrazivna platina / Χαράδι λείανσης / Lijas de tela / Tessutí abrasivi / Teclados abrasivos / Toiles abrasives / Schuurtextielen



Ref.	Info	W [mm]	☒	EAN
55H873	K36	280x230	0/250	5902062810984
55H874	K40	280x230	0/250	5902062810991
55H875	K60	280x230	0/250	5902062888006
55H876	K80	280x230	0/500	5902062888013
55H877	K100	280x230	0/500	5902062888020
55H878	K120	280x230	0/500	5902062888037
55H879	K150	280x230	0/500	5902062888044
55H880	K180	280x230	0/500	5902062888051
55H881	K220	280x230	0/500	5902062888068
55H882	K240	280x230	0/500	5902062888075

## Gąbka ścierna

Abrasive sponge / Scheuerschwamm / Абразивная губка / Губка наждачна / Csiszolászivacs / Burete abraziv / Brusná hauba / Brusna špongia / Brusna gąbka / Abrazivne kempine / Slīpēšanas sūklis / Lihvimīkasin / Абразивна губка / Brusna spužva / Abrazivni sunder / Λειαντικό σπυγγάρι / Esponja abrasiva / Spugna abrasiva / Esponja abrasiva / Esponge abrasive / Schurende spons /



Ref.	Info	W [mm]	☒	EAN
55H912	K60	120 x 95 x 10	0/250	5902062888358
55H913	K100	120 x 95 x 10	0/250	5902062888365
55H914	K180	120 x 95 x 10	0/250	5902062888372



Ref.	Info	W [mm]	☒	EAN
55H915	K60	70 x 25 x 100	0/250	5902062888389
55H916	K80	70 x 25 x 100	0/250	5902062888396
55H917	K100	70 x 25 x 100	0/250	5902062888402
55H918	K120	70 x 25 x 100	0/250	5902062888419
55H919	K150	70 x 25 x 100	0/250	5902062888426
55H920	K180	70 x 25 x 100	0/250	5902062888433
55H921	K240	70 x 25 x 100	0/250	5902062888440



Ref.	Info	W [mm]	☒	EAN
55H925	K80	98 x 25 x 68	0/200	5902062888488
55H926	K120	98 x 25 x 68	0/200	5902062888495
55H927	K180	98 x 25 x 68	0/200	5902062888501



Ref.	Info	W [mm]	☒	EAN
55H922	K80	125 x 25 x 90	0/200	5902062888457
55H923	K120	125 x 25 x 90	0/200	5902062888464
55H924	K180	125 x 25 x 90	0/200	5902062888471

## Brzeczoty bagnetowe

Sabre saw blade / Bajonett-Sägenblatt / Полотно / Полотно пилы с точным зубом / Orvfűrészlap / Panze baioneta / Mečové pilové listy / Mečové pilové listy / Bajonetni žagani listi / Βιμεταλλία πρικλίικια / Asmens zabenžagim / Tåk-sælehed / Сменными лентами за труп / Bajonet listovi pile / Oštrice noža / Πριονόλατες / Hojas de sable / Lama per sega a gattuccio / Láminas / Lames de scie à baionnette / Sabel mesbladen



x2

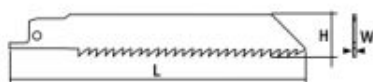

Ref.	L [mm]	H [mm]	W [mm]	TPI / mm	☐	☒	EAN
57H947	250	20	0.9	10 / 2.5	2	0/100	5902062579478
57H948	300	20	0.9	14 / 1.8	2	0/1	5902062579485
57H950	150	20	0.9	10-14 / 2.5-1.8	2	0/150	5902062579508
57H951	150	20	0.9	14 / 1.8	2	0/1	5902062579515
57H952	225	20	0.9	14 / 1.8	2	0/150	5902062579522
57H953	225	20	0.9	18 / 1.4	2	0/100	5902062579539
57H954	225	20	0.9	6 / 4.0	2	0/1	5902062579546

## Brzeczoty do pilarki szablastej

Blade for reciprocating saw / Sägeblatt für Säbelsäge / Пильное полотно для сабельной пилы / Полотно до сабельной пилки / Orvfűrész fürészlap / Pänzä fierăstrău sabie / Pilový list pro šantovou pilu / Cepel šablonej pily / List za sabljasto žago / Πρικλίικια tiesiniat πρικλίικια / Zobenžaga asmenis / Saabelsae tera / Ηοοκοοια za sablen trup / List za sabljastu pilu / Sečivo za kružnu testeru / Πριονόλατα για σαβίλαση / Hoja de sierra para sierra de sable / Lama per sega a gattuccio / Lámina para serra de sabre / Lame de scie sabre / Mes voor sabelzaag

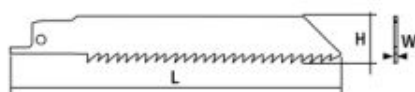

x2

BIM



METAL

Ref.	TPI	L [mm]	H [mm]	W [mm]	☐	EAN
56H040	18	150	19	0.8	25/100	5902062506627

x3 BIM



METAL



Ref.	TPI	L [mm]	H [mm]	W [mm]	☐	EAN
56H048	24/8-14/14	150/150/225	19	0.9	5/20	5902062506702

## Statyw do szlifierek kątowych

Angle grinder support / Gestell für Winkelschleifer / Держатель для угловых шлифовальных / Штатив до шлифовальных машин (бонарок) / Állvány sarokcsiszolóhoz / Stativ pentru polizor unghiular / Stojan na uhlové brusky / Stojan na uhlové brusky / Stojalo za kotni brusilnik / Stovas kampiniam šlifjuokliui / Leřka silpmašinos stativs / Stativ nurklühviale / Stativ za њеловашћ / Stativ za kutne brusilice / Stativ za uęone brusilice / Ορθοστάτης για γωνιακούς λειαντήρες / Soporte para amoladora angular / Supporto per smerigliatrice angolare / Suporte para esmerilhadora de canto / Bâti pour meuleuses d'angle / Steun voor verstekhuurmachines



Ø 115 mm  
Ø 125 mm

Ref.	☐	EAN
56H650	0/4	5902062045652

## Statyw do wiertarki

Drill stand / Gestell für Bohrmaschine / Держатель для дрели / Штатив до дрелю / Fűrőállvány / Stativ pentru masina de gaurit / Stojan na vrtáčku / Stojan na vrtáčku / Stojalo za vrtalnik / Stovas grežtuvai / Urbmašinas stativs / Stativ trellile / Stativ za probna mašina / Stativ za bušilicu / Stativ za bušilicu / Ορθοστάτης δρανάου / Soporte para taladradoras / Supporto per trapano / Suporte de berbequim / Bâti pour perceuse / Steun voor boormachine

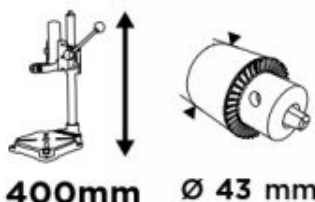

400mm Ø 43 mm

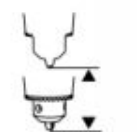

max 60 mm

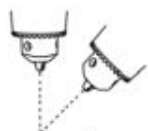

max 90°



Ref.	☐	EAN
56H655	0/6	5902062045676



## Brzeszczot

Bow saw blade / Sägeblatt / Полотно ножовочное / Полотно до ножівки лучинової / Fűrészlap multifunkciós géphez / Lama ferăstrău cu arc / List pile / Plátok náhradný / Rezični list / Gelezié / Arsenis lokzajim / Vibusae leht / Лист за трион бичия / List Pile / List testere / Λεπίδα για τοξοπίλινο / Hoja de sierra de arco / Lama per metallo HSS / Lâmina / Lame de scie



Ref.	W [mm]	☒	EAN
56H006	34	5/150	5902062690067



METAL



Ref.	W [mm]	☒	EAN
56H055	34	10/100	5902062019714
56H056	20	10/100	5902062019721
56H057	10	10/100	5902062019738

BI-METAL  
Co 8%



METAL



Ref.	W [mm]	☒	EAN
56H061	87	10/100	5902062019776

HSS



METAL



Ref.	☒	☒	EAN
56H072	3	10/60	5902062022134



METAL

## Skrobak sztywny

Stiff scraper / Schaber / steif / Скребок жесткий / Скребок жорсткий / Fa kaparó multigéphez / Răzuitor rigid / Tuhý škrabák / Tvrdá špachtla / Togo strigalo / Grandklis tiesus / Stingsr kasiklis / Jäk kaabits / Тєрдє шабєр / Kruta strugalica / Grubi šabler / Σκληρή ξητρα / Rasqueta no elástica / Raschietto rigido per legno / Raspador duro / Racle rigide



Ref.	W [mm]	☒	EAN
56H010	50	5/150	5902062690104

HSS

## Papiery szlifierskie

Sanding paper / Schleifpapier / Бумага наждачная / Папір наждачний / Csiszolópapír multigéphez / Hirtē smirghe ce se încheie singură / Brusnj papir / Papier brusny-rolka / Brusni papir / Šlifavimo papirius / Smišpapiirs / Lijvapaber / Шкурка руло / Brusni papir u roli / Brusni papir / Λεαντικό ύφασμα / Lija / Carta abrasiva / Folha de lixa / Papier abrasif



x5

Ref.	W [mm]	Info	☒	EAN
56H014	83 x 83 x 83	K60 x 2; K80 x 2; K100 x 1	5/100	5902062690142

## Stopa szlifierska

Sanding pad / Schleifteller / Шлифовальная подошва / Шлифовальна поверхня трикутна / Csiszolófej multigéphez / Talpă de șlefuit / Brusná deska / Pracovná patka brusky / Brusna plošča / Šlifavimo padas / Šlīpēšanas pēda / Lihvtald / Шлифовальный щиток / Postolja za brušenje / Πλάκα λείανσης / Placa lijadora / Prostra levigatrice / Complemento da lixa / Plateau de ponçage



Ref.	W [mm]	☒	EAN
56H012	83 x 83 x 83	5/100	5902062690128



Ref.	W [mm]	☒	EAN
56H013	83 x 83 x 83 mm	5/100	5902062007704



## Adapter do urządzenia wielofunkcyjnego

Multi-purpose adapter / Adapter für Multifunktionsgerät / Переходник для многофункционального устройства / Adapter для багатofункціонального пристрою / Adapter universalis berendezéshez / Adaptor pentru dispozitiv multifunctional / Adapter pro multifunkční zařízení / Adapter pre multifunkčné zariadenie / Priključek za večnamensko napravo / Daugiafunkcio įrenginio adapteris / Adapteris daudzfunkcionālai iekārtai / Multifunkcionālais seadme adapter / Adapter za multifunkcionalno ustrojstvo / Adapter za višenamjenski uređaj / Adapter za višefunkcionalne uređaje / Προσαρμογέας πολυεργαλείων / Adaptorador para el dispositivo multifunción / Adattatore per il dispositivo multifunzionale / Adaptador para o dispositivo multifunção / Adapteur pour le dispositif multifonction / Adapter voor multifunctioneel apparaat

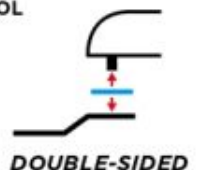

Ref.	☒	EAN
56H420	10/100	5902062071316

## Filc polerski

Polishing felt / Polierfilz / Фетр полировочный / Филц полирувальний / Polírkorong / Píslá sfléifure / Leštici  
 plst / Filcový disk / Filc za poliranje / Veltnis poliravimā / Filas pulēšana / Poleerimsvilt / Диск за полиране /  
 Filc za poliranje / Filc za poliranje / Τούφα γυαλίματος / Fielto para pulir / Feltro per lucidatura / Feltro para poli  
 / Feutre de polissage / Polijstvił

**NEO**  
TOOLS



Ref.	Info	☒	EAN
08-960	Ø 75 mm, 10 mm	1/100	5907558454505
08-961	Ø 125 mm, 10 mm	1/100	5907558454512
08-962	Ø 125 mm, 20 mm	1/100	5907558454529

## Tarcza elastyczna

Backing pad / Flexible Scheibe / Эластичный диск / Диск эластичный / Elasztikus tárcsa / Disc elastic /  
 Elastický kotouč / Elastický kotúč / Elastična plošča / Elastinis diskas / Elastigais disks / Elastne kets /  
 Эластичен диск / Elastična ploča / Elastična ploča / Ελαστικός δίσκος / Disco elástico / Disco elastico / Disco  
 elástico / Disque flexible / Flexibele schijf /

**NEO**  
TOOLS



Ref.	Info	☒	EAN
08-977	Ø 75 mm, max 20150 min⁻¹	1/100	5907558454673
08-968	Ø 125 mm, max 6000 min⁻¹	1/100	5907558454581

## Pad polerski

Foam pad / Polerkissen / Полировальная подушка / Полировальная подушка / Polirgazi betét / Tampon de lustruit / Leštici podložka / Leštica podložka / Blazinica za poliranje / Poliravimo padas / Pulēšanas spilventiņš /  
 Poleerimisradī / Полираца гъба / Срушва за полирање / Подложа за полирање / Σπόγγος στίλβωσης / Almohadilla de pulido / Tamponc per lucidatura / Almofada de polimento / Tampon de polissage / Polijstpad

**NEO**  
TOOLS



Best used  
with NEO  
backing pad  
08-968

Ref.	Info	☒	EAN
08-963	cutting	1/100	5907558454536
08-964	very hard	1/100	5907558454543
08-965	hard	1/100	5907558454550
08-966	medium	1/100	5907558454567
08-967	soft	1/100	5907558454574

**NEO**  
TOOLS



Ref.	Info	☒	EAN
08-978	cutting	1/100	5907558495157
08-979	very hard	1/100	5907558495164
08-980	hard	1/100	5907558495171
08-981	medium	1/100	5907558495188
08-982	soft	1/100	5907558495195

**NEO**  
TOOLS



Ref.	Info	☒	EAN
08-969	cutting	1/100	5907558454598
08-970	very hard	1/100	5907558454604
08-971	hard	1/100	5907558454611
08-972	medium	1/100	5907558454628
08-973	soft	1/100	5907558454635

**NEO**  
TOOLS



Best used  
with NEO  
backing pad  
08-977

Ref.	Info	☒	EAN
08-974	hard	1/100	5907558454642
08-975	medium	1/100	5907558454659
08-976	soft	1/100	5907558454666

## Uchwyt magnetyczny

Magnetic holder / Magnetaufnahme / Держатель магнитный / Патрон магнитный / Toldászár behajt / Support magnetic / Magnetický držák / Magnetické skľučovadlo / Magneto vpenjalo / Magnetinis griebtuvas / Magnētiskais turētājs / Magnetpadrun / Магнитен держак / Magneta hvatačija / Magneta drška / Υποδοχή μαγνητική / Mandril de sujeción magnética / Porta inserti con giunto sferica / Suporte magnético / Manche magnétique / Magnetisch houder

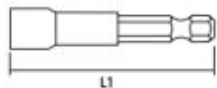

1/4"

Ref.	L [mm]	☒	EAN
56H554	60	50/100	5902062504777

## Adapter

Adaptor / Adapter / Адаптер / Переходник / Közlarab, adapter / Adaptor / Adaptér / Adaptér / Adapter / Jungtis / Adapteris / Adapter / Адаптер / Adapter / Adapter / Ανάρτηρας / Adaptador / Adattatore / Adaptador / Adaptateur / Adapter



Ref.	info	☒	EAN
56H555	1/4" HEX -> 1/4" [0]	50/100	5902062504784
56H556	1/4" HEX -> 1/2" [0]	50/100	5902062504791



IMPACT PROOF

Ref.	L [mm]	☒	EAN
56H557	50	20/40	5902062102416

## Przedłużka

Extension / Erweiterung / Расширение / Rozšíření / Hosszabbítás / Extensie / Prodloužení / Rozšírenie / Podaljšek / Prolongación / Prolongācija / Prolongus / Удължение / Proženje / Продужетак / Еπεκταστή / Extensión / Estensione / Extensão / Extension / Utbreiing



IMPACT PROOF



Ref.	L [mm]	☒	EAN
56H558	150	10/40	5902062102423

## Bity udarowe

Impact bits / Schlag-Bits / Ударные вставки / Бити ударни / Üvecsavarozó bitek / Bit de impact / Úderové bity / Názové bity / Udarani biti / Σμαγινια ανταβια / Trzceniuzagi / Löökmetsid / Ударни битове / Udarani bitovi / Ударни битови / Κρουστικές μύτες / Bits de impacto / Inserti a percussione / Pontas de percussão / Embouts à choc / Schlagbits



x2



IMPACT PROOF

1/4"



Ref.	Info	L [mm]	☒	☒	EAN
56H500	PH1	25	2	50/100	5902062504364
56H501	PH2	25	2	50/100	5902062504371
56H502	PH3	25	2	50/100	5902062504388



x2



IMPACT PROOF

1/4"



Ref.	Info	L [mm]	☒	☒	EAN
56H503	PZ1	25	2	50/100	5902062504395
56H504	PZ2	25	2	50/100	5902062504401
56H505	PZ3	25	2	50/100	5902062504418
56H506	PZ4	25	2	50/100	5902062504425



x2



IMPACT PROOF

1/4"



Ref.	Info	L [mm]	☒	☒	EAN
56H507	HEX4	25	2	50/100	5902062504333
56H508	HEX5	25	2	50/100	5902062504340
56H509	HEX6	25	2	50/100	5902062504357



x2



IMPACT PROOF

1/4"



Ref.	Info	L [mm]	☒	☒	EAN
56H510	SL5.5	25	2	50/100	5902062504432
56H511	SL6.5	25	2	50/100	5902062504449



x2



IMPACT PROOF

1/4"



Ref.	Info	L [mm]	☒	☒	EAN
56H512	TX15	25	2	50/100	5902062504456
56H513	TX20	25	2	50/100	5902062504463
56H514	TX25	25	2	50/100	5902062504470
56H515	TX27	25	2	50/100	5902062504494
56H516	TX30	25	2	50/100	5902062504500
56H517	TX40	25	2	50/100	5902062504517

## Bity udarowe

Impact bits / Schlag-Bits / Ударные вставки / Бити ударни / Ütvecsavarozó bitek / Bit de impact / Üderové bity / Nárazové bity / Udarni biti / Smúgininiai antgaliai / Triecienuzgaļi / Lööknaislid / Υάρηκη βύρνοαε / Udarni bitovi / Udarni bitovi / Κρουστικός μύτης / Bits de impacto / Inserti a percussione / Pontos de percussão / Embouts à choc / Schlagbits



x2

S2

PH

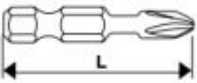

IMPACT PROOF 1\4"

Ref.	Info	L [mm]	📦	📧	EAN
56H518	PH1	50	2	50/100	5902062504524
56H519	PH2	50	2	50/100	5902062504531
56H520	PH3	50	2	50/100	5902062504548



x2

S2

PZ

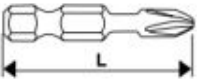

IMPACT PROOF 1\4"

Ref.	Info	L [mm]	📦	📧	EAN
56H521	PZ1	50	2	50/100	5902062504555
56H522	PZ2	50	2	50/100	5902062504562
56H523	PZ3	50	2	50/100	5902062504579



x2

S2

TX

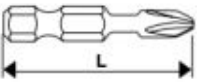

IMPACT PROOF 1\4"

Ref.	Info	L [mm]	📦	📧	EAN
56H524	TX15	50	2	50/100	5902062504586
56H525	TX20	50	2	50/100	5902062504593
56H526	TX25	50	2	50/100	5902062504623
56H527	TX27	50	2	50/100	5902062504647
56H528	TX30	50	2	50/100	5902062504661
56H529	TX40	50	2	50/100	5902062504685



x3

S2

PH

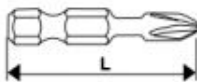

IMPACT PROOF 1\4"

Ref.	Info	L [mm]	📦	📧	EAN
56H543	PH1/PH2/PH3	50	3	50/100	5902062504722

NEO TOOLS



S2 steel  
50 mm x5

Ref.	Info	L [mm]	📦	📧	EAN
09-575	PH1	50	5	12/96	5907558450484
09-576	PH2	50	5	12/96	5907558450491
09-577	PH3	50	5	12/96	5907558450507

NEO TOOLS



S2 steel  
50 mm x5

Ref.	Info	L [mm]	📦	📧	EAN
09-579	PZ2	50	5	12/96	5907558450521
09-580	PZ3	50	5	12/96	5907558450538

NEO TOOLS



S2 steel  
50 mm x5

Ref.	Info	L [mm]	📦	📧	EAN
09-584	TX20	50	5	12/96	5907558450576
09-585	TX25	50	5	12/96	5907558450583
09-587	TX30	50	5	12/96	5907558450606
09-588	TX40	50	5	12/96	5907558450613



x3

S2

PZ

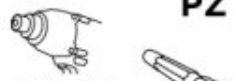
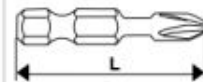

IMPACT PROOF 1\4"

Ref.	Info	L [mm]	📦	📧	EAN
56H542	PZ1/PZ2/PZ3	50	3	50/100	5902062504715

## Bity udarowe

Impact bits / Schlag-Bits / Ударные остовки / Бити ударни / Ütvecsavarozó bitek / Bit de impact / Üderové bity / Nárazové bity / Udarni biti / Smüginini antgaliai / Triecienuzgali / Löökmeislad / Ударни буртове / Udarni bitovi / Udarni bitovi / Κρουστικές μύτες / Bits de impacto / Inserti a percussione / Pontas de percussão / Embouts à choc / Schlagbits

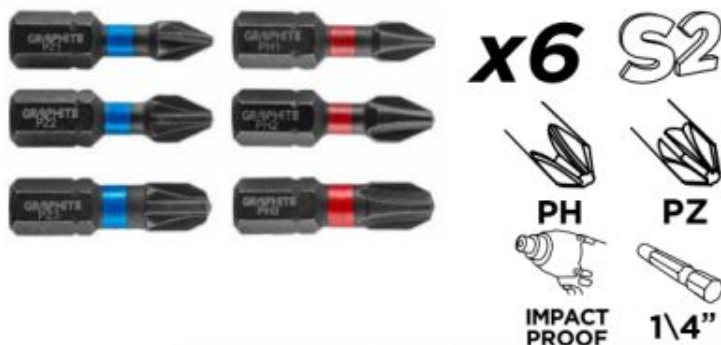

Ref.	Info	L [mm]	📦	📧	EAN
56H540	PH1/PH2/PH3, PZ1/PZ2/PZ3	25	6	50/100	5902062504692



Ref.	Info	L [mm]	📦	📧	EAN
56H541	TX10/TX15/TX20, TX25/TX30/TX40	25	6	50/100	5902062504708



Ref.	Info	L [mm]	📦	📧	EAN
56H544	TX15	25	20	10/100	5902062102362
56H545	TX20	25	20	10/100	5902062102386
56H546	TX25	25	20	10/100	5902062102393
56H547	TX30	25	20	10/100	5902062102409



Ref.	Info	L [mm]	📦	📧	EAN
56H530	PH1	25	20	10/100	5902062504821
56H531	PH2	25	20	10/100	5902062504838
56H532	PH3	25	20	10/100	5902062504845

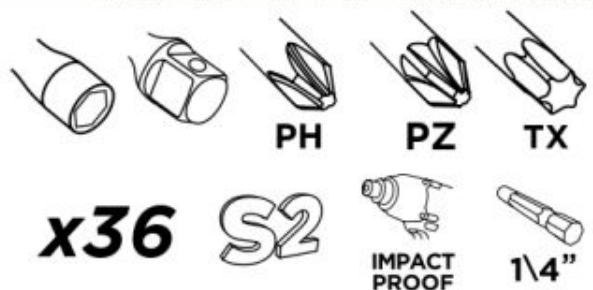

Ref.	Info	L [mm]	📦	📧	EAN
56H533	PZ1	25	20	10/100	5902062504852
56H534	PZ2	25	20	10/100	5902062504869
56H535	PZ3	25	20	10/100	5902062504876
56H536	PZ4	25	20	10/100	5902062504883



Ref.	Info	📦	📧	EAN
56H560	16 x PH1/2/2/2/3, PZ1/2/2/3, TX10/15/20/25/27/30/40 - 25 mm, 14 x PH1/2/2/2/3, PZ1/2/2/2/3, HEX3/4/5/6 - 50 mm, 3 x 6, 8, 10 mm - 48 mm, 1 x 90 mm, 2 x adapter 1/4\", 1/2\" - 50 mm	36	0/10	5902062504807

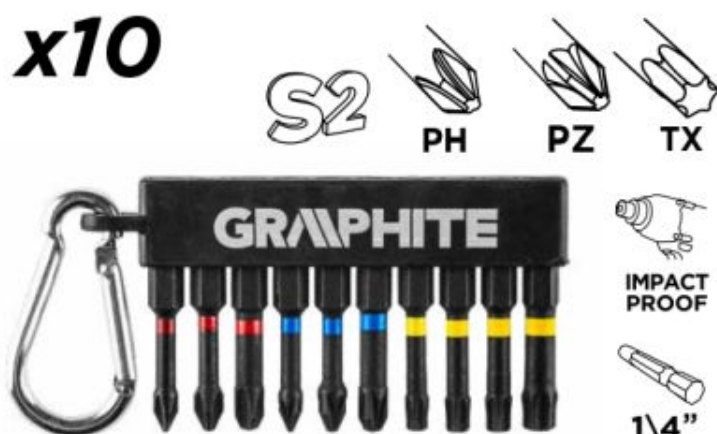

Ref.	Info	L [mm]	📦	📧	EAN
56H562	PH1/PH2/PH3, PZ1/PZ2/PZ3, TX25/TX27/TX30/TX40	50	10	20/80	5902062504814

## Końcówki wkrętakowe

Driver bits / Einsätze für Schraubendreher / Насадки / Наконечники шурупов / Csavarhúzó bit / Set bit / Šroubovákové nástavce / Skrutkovače nástavce / Nastavki za izvijače / Atsuktuvo antgaliai / Skrūvgręžia užgajai / Krivvekerajantsakud / Накрайники за отвертка / Nastavi za odvijač / Nastavci za odvijač / Καταβιβόμενες / Puntas destornilladoras / Punta gravite / Porteiros Chave de fenda / Embouts de tournevis / Schroevendraaierendstukken



- ⊕ PH2x3, PH3
- ⊕ PZ2x3, PZ3
- ⊖ SL4, SL6
- ⊖ H4, H5, H6
- ⊖ T20x2, T25x2, T30x2, T40
- ⊖ TT10, TT15, TT20, TT25, TT27, TT30, TT40
- ⊕ PH2
- ⊕ PZ2



S2



SAFETY FORCE



1/4"

x23

Ref.	📦	📦	EAN
56H612	23	12/48	5902062024473



- ⊕ PH1, PH2, PH3
- ⊕ PZ1, PZ2, PZ3
- ⊖ SL4, SL5.5, SL6.5
- ⊖ H3, H4, H5, H6
- ⊖ TT10, TT15, T20, T25, T30
- 6, 7, 8, 10, 13 mm



S2

1/4"

x26

Ref.	📦	📦	EAN
56H604	26	6/24	5902062024435

## Kątowna nasadka wiertarska

Drill chuck / Bohrfutter / Патрон для дрели / Патрон до дринго / Fúrótokmány / Mandrină de găurit / Skřičadlo pro vrtáky / Slučilo / Vrtalna glava / Griebtuvas gręžtuvai / Urbjmašinas patrona / Drelli padrun / Патрон за бормашина / Stezna glava-bořfuter / Stezna glava-bořfuter / Κεντροσφικτικός βράβανου / Portabrocas / Manubrio di trapano per chiave / Suporte de berbequim / Mandrin de perçage / Boorhouder



KAT 90°  
90° ANGLE



max 3000 min<sup>-1</sup>

Ref.	∅ [mm]	📦	EAN
55H932	0.8 - 10	6/24	5902062000453



- ⊕ PH1, PH2, PH3
- ⊕ PZ1, PZ2, PZ3
- ⊖ SL3, SL4, SL5, SL6
- ⊖ H3, H4, H5, H6, H8
- ⊖ TT10, TT15, T20, T25, T27, T30, T40
- ⊖ TT10, TT15, TT20, TT25, TT27, TT30, TT40



S2

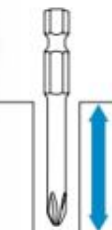

DEEP DRIVE



1/4"

x18

Ref.	📦	📦	EAN
56H606	18	6/24	5902062024442



- ⊕ PH1, PH2x2
- ⊕ PZ1, PZ2x2
- ⊖ H4, H5, H6
- ⊖ TT10, TT15, T20, T25, T30, T40
- 6, 7, 8, 10, 11, 13 mm



S2

1/4"

x24

Ref.	📦	📦	EAN
56H610	24	12/48	5902062024466

## Nasadka uniwersalna

Versatile adapter / Universalersatz / Универсальная насадка / Универсальна насадка / Univerzális tartó / Ataşament universal / Univerzální nástavec / Univerzálnoy nadstavec / Univerzalni nastavek / Universalus antgalis / Univerzāla uzmaņa / Univerzāle otsak / Универсальна приставка / Univerzalni nastavak / Univerzalni nasadni ključ / Μίση γενικής χρήσεως / Llave de vaso universal / Cappuccio universale / Acessório universal / Fixation universelle / Universeel dop

1/4"-3/4"  
7 mm - 19 mm



Ref.	📦	EAN
55H224	1/50	5902062082879



## AKCESORIA I GADŻETY MOTORYZACYJNE

automotive  
accessories and gadgets

автомобільні аксесуари  
та гаджети

## Poduszka opona 3D

3D pillow car tyre / 3D-Reifenkissen / 3D подушка для шин / 3D gumiabrons párna / Perna 3D pentru anvelope / 3D polštář pro pneumatiky / 3D vanüks na pneumatiky / 3D blazina za pneumatike / 3D padangas pagalvė / 3D перу спривенс / 3D възглавница за гуми / Μαξιλάρι ελαστικών 3D / Cojín de neumático 3D / Cuscino per pneumatici 3D / Almofada de pneu 3D / Coussin de pneu 3D / 3D-bandkussen



ø40  
cm

Ref.	☒	EAN
GD023	0/10	5907558484243

## Długopis metalowy 5 w 1

Metal pen 5 in 1 / 5-in-1 Metall-Kugelschreiber / Металлическая шариковая ручка 5 в 1 / Металева ручка 5 в 1 / 5 az 1-ben fém golyóstoll / Píx cu bilă din metal 5 în 1 / Kovové kuličkové pero 5 v 1 / Kovové guľôčkové pero 5 v 1 / Kovinsko pisalo 5 v 1 / Metalinis rašiklis "5-in-1/5-in-1 metalo lodis pildspalva / Метална химикална 5 в 1 / Μεταλλικό στυλό 5 σε 1 / Bolígrafo metálico 5 en 1 / Penna a sfera in metallo 5 in 1 / Esferográfica de metal 5 em 1 / Stylo à bille en métal 5-en-1 / 5-in-1 metalen balpen



Ref.	☒	EAN
GD024	0/100	5907558484250

## Kubek

Mug / Чаша / Muoia / Gipszetőedény / Cană / Kafiúk / Nádoba na sódru PVC / Čaša / Dubuo / Toveris / Tass / Кашок / Pvc posuda / Kadica / Μικρή κούπα / Beker / Bicchiera / Caneca / Bécher



330ml



Ref.	☒	EAN
GD025	6/24	5907558485905
GD026	6/24	5902062093882
GD027	6/24	5907558485912
GD028	6/24	5907558485929



400ml

Ref.	☒	EAN
GD08	0/48	5907558458831

## Poduszka podróżna

Car pillow / Tragetasche / Автомобильная подушка / Автомобильна подушка / Auto párna / Peta pentru maşină / Polštářek do auta / Podložka na prenášanie / Rotovní vložník / Kevonine pagalvė / Cejojntu spřivens / Възглавница за пътуване / Μαξιλάρι ταξιδιού / Cojín para coche para / Neo tools car cushion / Travesseiro de viagem / Oreiller de voyage / Reiskussen



Ref.	☒	EAN
GD016	0/18	5907558472097

## Termos

Vacuum flask / Isolierflasche / Термос / Термос / Termosz / Termos / Termoska / Termoska / Термока / Termosas / Termoss / Termos / Термос / Termos boca / Termos / Θερμός / Termo / Borraccia termica / Garrafa térmica / Thermos / Thermosflles



Ref.	V(ml)	☒	EAN
GD06	600	0/24	5907558454383
GD07	1000	0/24	5907558454390

## GRAPHITE



Ref.	V(ml)	☒	EAN
GD04	800	0/30	5902062025012
GD05	500	0/50	5902062025029



## Szczotka skrobaczka samochodowa do śniegu

Car snow scraper brush / Auto-Schneekratzer-Bürste / Автомобильная щетка для скребка снега / Щетка для чищення снігу для автомобіля / Autó hákarató kefe / Perie de păzuire a zăpezii pentru mașini / Kartáč na škrabání sněhu do auta / Škrabka na sneh do auta / Krtača za strganje snega v avtomobilu / Automobilinis sniego grandiklio šepetys / Automašinos sniego skrapja birste / Auto luntekraaprijahani / Четка за почистване на сняг за кола / Četka za čišćenje snijega za automobil / Автомобилна четка за стругање снега / Βούρτσα ξυπότραςχομώ αυτοκινητού / Cepillo rascador de nieve para coche / Spazzola raschia-neve per auto / Raspador de neve para automóveis / Brosse à neige pour voiture / Auto sneeuwschraper borstel



Ref.	📦	EAN
GD029	1/24	5907558495287

## Zabawki

Toys / Spielsachen / Игрушки / Iapowku / Játékok / Hračky / Hračky / Igrače / Rotaļlietas / Žaislai / Manguasjad / Игрушки / Juguetes / Giocattoli / Brinquedos / Jovets / Speelgoed



Ref.	📦	EAN
GD010	0/8	5907558459906
GD022	0/18	5907558483130

## GRAPHITE



AGE  
3+

2x  
AA

Ref.	📦	EAN
GD021	0/24	5902062998262

## Brelok 6w1

Key ring 6in1 / Schlüsselanhänger 6-in-1 / Кольцо для ключей 6в1 / Брелок для ключа 6в1 / Kulcstartő szerszám 6az1-ben / Breloc 6 în 1 / Пнівсєк на кїучє 6в1 / Privesok na kľuče 6 v 1 / Obesek za kľuče 6 v 1 / Raktų pakabukas 6-in-1 / Atslėgu pėkariš 6-in-1 / Ключодържател 6 в 1 / Μρελόκ 6 σε 1 / Llaveru 6en1 / Portachiavi 6-in-1 / Chaveiro 6-em-1 / Porte-clės 6-en-1 / Sleutelhanger 6-in-1



Ref.	📦	EAN
GD09	250/1000	5907558459876

## Schodek do samochodu 3w1

3-in-1 car stepping tool / Autoeinsteigsstufe 3in1 / Лестница для автомобиля 3 в 1 / Scoadu для автомобиля 3-в-1 / Fellépő gépkocsikhoz 3az1-ben / Treaptă pentru mașină 3 în 1 / Schodek k autu 3v1 / Schodik do auta / Stopnica za vozilo 3v1 / Automobilio laiptelis 3 viename / Pakāpieni trīs vienā automašīnai / Autoaste 3in1 / Бєлєжницє 3в1 / Stupanj za vozilo 3u1 / Stepnica za automobil 3u1 / Σκαλοπάτι αυτοκινητού 3 σε 1 / Escalón de coche 3 en 1 / Scalino per auto 3in1 / Degrau para carro 3 em 1 / Marche de voiture 3 en 1 / 3-in-1 autotrap / 3-in-1 trinn for bil / Fotsteg till bil 3i1 / Porras autoon 3 in 13v1



FITS  
MOST  
CARS

3in1

up to  
230kg

Ref.	📦	EAN
10-477	1/50	5907558471120

## Urządzenie rozruchowe "Jumpstarter"

Boot device "Jumpstarter" / Startgerät "Jumpstarter" / Зарядное устройство "Jumpstarter" / Завантажувальний пристрій "Jumpstarter" / Boot eszköz "Jumpstarter" / Dispozitiv de pornire „Jumpstarter” / Spouštěcí zařízení „Jumpstarter” / Zavádzacie zariadenie „Jumpstarter” / Zagonska naprava "Jumpstarter" / Įkrovos įrenginys „Jumpstarter” / Sākšanās ierīce "Jumpstarter" / Vuutimiseseade "Jumpstarter" / Стартово устройство "Jumpstarter" / Uredāj za pokretanje "Jumpstarter" / Уредбай за покpетанье система "Jumpstarter" / Συσκευή εκκίνησης "Jumpstarter" / Dispositivo de arranque "Jumpstarter" / Dispositivo di avvio "Jumpstarter" / Dispositivo de inicialização "Jumpstarter" / Pénphérique de démarrage "Jumpstarter" / Qpstartapparaat "Jumpstarter"



Ref.	📦	EAN
11-997	1/4	5907558452419

## Wielowarstwowy pokrowiec na samochód

A multi-layer car cover / Mehrschichtige Autoabdeckung / Базатшарооий автомобильний чохол / Многослойный автомобильный чехол / Több rétegű autóvédő / Husz auto multistrat / Viacvrstvový poťah na auto / Večplastna prevleka za avto / Keleji sluoksnij / Automobila pārsegs vairākos slāņos / Pokrywało za kola w niwielko słoj / Κάλυμμα αυτοκινήτου πολλαπλών στρώσεων / Copertura per auto multistrato / Funda de cache multicapa / Housse de voiture en plusieurs couches / Cobertura de automóvel em várias camadas / Autohoes in meerdere lagen



Ref.	📦	EAN
10-474	0/1	5907558471113

## Ostona na szybę

Windshield cover / Windschutzscheibenabdeckung / Вікна кришка / Чехол для лобового стекла / Szélvédőhuzat / Acoperire parbriz / Obal na čelní sklo / Obal na čelné sklo / Zaščita vetrobranskega stekla / Priekinio stiklo apsauga / Vējstikla aizsargs / Прометатор за предно стъкло / Προστατευτικό παρμπρίζ / Copri parabrezza / Funda de parabrisas / Protection de pare-brise / Protector de para-brisas / Voorruitbeschermer



Ref.	Info	📦	EAN
10-470	single insulating layer	1/30	5907558471076
10-471	double insulating layer	1/30	5907558471083

## Narzędzie wielofunkcyjne płatek śniegu 19 w 1

Snowflake multi-tool 19in1 / Multifunktionswerkzeug Schneeflocke 19 in 1 / Мультиинструмент Снежинка 19в1 / Мультифункціяс шэрсзям хіпчехы 19в1-бен / Instrument multifuncțional fulg de zăpadă 19 in 1 / Multifunkční nástroj sněhová vločka 19 v 1 / Multifunkčný nástroj snehová vločka 19 v 1 / Večnamensko orodje snežinka 19 v 1 / Daugiafunkcinis įrankis sniegė 19 in 1 / Daudzfunkcionāls instruments sniegpārslīpa 19 in 1 / Многофункционален инструмент снежинка 19 в 1 / Πολυλειτουργικό εργαλείο χιονοπλάτα 19 σε 1 / Herramienta multifunción copo de nieve 19 en 1 / Strumento multifunzione fiocco di neve 19 in 1 / Flocă de neve de feramenta multifuncțional 19 em 1 / Outil multifonctionnel flocon de neige 19 en 1 / Multifunctioneel gereedschap sneeuwvlok 19 in 1



Ref.	📦	EAN
G0015	0/50	5907558465389



Ref.	📦	EAN
10-475	0/5	5907558473940

## Organizer samochodowy

Car organiser / Auto-Organisator / Автомобильный организатор / Автомобильный органайзер / Auto szervező / Organizator auto / Organizator automobili / Organizator automobilov / Organizator automobilon / Automobilij organizatorius / Auto organizer / Auto korganidaja / Организатор на автомобилу / Organizator za avto / Организатор аутомобила / Οργανωτής αυτοκινήτων / Organizador de coches / Organizatore di auto / Organizador de automóveis / Organisateur de voitures / Auto organizer



Ref.	📦	EAN
10-650		5907558477245



Ref.	📦	EAN
10-651		5907558477252

## Siatka zabezpieczająca do bagażnika

Safety net for the trunk / Sicherheitsnetz für den Kofferraum / Зашитна сетка для багажника / Зашитна сітка для багажника / Biztonsági háló a csomagtaróhoz / Plasa de siguranță pentru portbagaj / Bezpečnostní síť do kufru / Ochranná sieť do kufru / Varnostna mreža za prtljajnik / Apsauginis tinklas bagažinei / Bagažnieka drošības tīkls / Pagasinuimi turvõrk / Предпазна мрежа за багажника / Zaštitna mreža za prtljajnik / Sigurnosna mreža za prtljajnik / Δίκτυ ασφαλείας για το πορτμπάγκτζ / Red de seguridad para el maletero / Rete di sicurezza per il bagagliaio / Rede de segurança para o porta-malas / Filet de sécurité pour le coffre / Veiligheidsnet voor de kofferbak



Ref.	📦	EAN
10-860	0/48	5907558474572

## Narzędzie wielofunkcyjne

Multipurpose tool / Allzweckwerkzeuge / Инструмент универсальный / Инструмент багатofункційний / Multiszerszám / Ureala multifunctionala / Multifunkční nástroj / Viacfunkčné náradie / Večfunkcijsko orodje / Daugifunkciniai įrankiai / Daufunkcionālie instrumenti / Multifunktsionaalne tööriist / Мултифункціонален инструмент / Višenamjenski uređaj / Višefunkcionalne alatke / Πολυερρλείο / Herramienta multiuso / Utensile multiuso / Aparelho multifunções / Outil multifonction / Multifunctioneel gereedschap

LED light ALUMINIUM BODY 10 in 1 +



Ref.	W [mm]	⊠	EAN
01-027	105	6/48	5907558420944

LED light ALUMINIUM BODY 12 in 1 +



Ref.	W [mm]	⊠	EAN
01-026	155	6/36	5907558420937



Ref.	W [mm]	⊠	EAN
01-028	150	6/36	5907558420951

ALUMINIUM BODY 11 in 1 STOP +



Ref	p.	Ref	p.	Ref	p.	Ref	p.	Ref	p.	Ref	p.	Ref	p.
01-010	87	01-192	84	01-534	95	02-044	100	04-073	82	04-705	27		
01-011	87	01-193	84	01-535	83	02-111	100	04-112	77	04-710	218		
01-012	87	01-194	84	01-536	96	02-401	99	04-113	77	04-715	216		
01-013	87	01-195	84	01-537	97	02-402	100	04-114	77	04-716	216		
01-014	87	01-200	99	01-539	96	02-403	100	04-115	77	04-719	215		
01-015	87	01-202	99	01-540	96	02-406	100	04-116	77	04-720	215		
01-016	87	01-203	99	01-542	96	02-412	99	04-117	77	04-721	217		
01-017	88	01-204	99	01-543	98	02-413	99	04-130	82	04-730	28		
01-018	88	01-216	90	01-545	97	02-415	100	04-131	82	04-731	28		
01-019	88	01-217	90	01-546	95	02-416	100	04-132	82	04-732	28		
01-020	88	01-220	91	01-547	95	02-417	100	04-133	82	04-738	29		
01-021	89	01-221	91	01-548	97	02-418	100	04-136	82	04-739	29		
01-022	89	01-222	91	01-549	95	02-419	100	04-137	82	06-011	80		
01-026	241	01-223	91	01-550	94	02-429	100	04-138	82	06-020	80		
01-027	241	01-224	91	01-551	94	02-435	99	04-139	82	06-036	80		
01-028	241	01-225	91	01-552	94	02-444	99	04-140	82	06-037	80		
01-085	90	01-226	92	01-553	94	03-010	101	04-142	83	06-040	80		
01-086	90	01-227	92	01-555	97	03-011	101	04-143	82	06-070	80		
01-087	90	01-228	92	01-615	181	03-012	101	04-171	72	06-071	80		
01-088	90	01-229	93	01-620	180	03-013	101	04-172	72	06-072	80		
01-089	90	01-231	92	01-621	180	03-014	101	04-173	72	06-073	80		
01-090	90	01-232	92	01-622	180	03-015	101	04-174	72	06-101	79		
01-091	90	01-233	92	01-623	180	03-016	101	04-175	72	06-103	79		
01-092	90	01-234	93	01-624	180	03-017	101	04-176	72	06-104	79		
01-093	90	01-235	94	01-625	180	03-019	101	04-177	72	06-105	79		
01-094	90	01-236	94	01-626	180	03-020	101	04-178	72	06-106	79		
01-095	90	01-237	93	01-627	180	03-021	101	04-179	72	06-107	63		
01-096	90	01-240	91	01-628	180	03-022	101	04-180	72	06-111	78		
01-097	90	01-241	91	01-629	180	03-023	101	04-181	72	06-115	77		
01-101	88	01-242	91	01-630	180	03-024	101	04-182	73	06-116	77		
01-102	89	01-243	92	01-631	180	03-025	101	04-183	73	06-127	78		
01-103	89	01-244	92	01-632	180	03-026	101	04-184	73	06-129	78		
01-105	88	01-245	93	01-633	180	03-027	101	04-185	73	06-130	78		
01-106	89	01-250	87	01-634	180	03-028	101	04-186	73	08-002	21		
01-110	84	01-251	87	01-635	180	03-029	101	04-187	73	08-008	56		
01-111	84	01-252	87	01-636	180	03-030	71	04-188	73	08-009	56		
01-112	84	01-253	87	01-637	180	03-031	71	04-189	73	08-010	56		
01-113	84	01-254	87	01-638	180	04-001	72	04-190	73	08-011	56		
01-114	84	01-255	87	01-639	180	04-002	72	04-191	75	08-012	56		
01-115	84	01-256	88	01-640	180	04-004	72	04-192	75	08-013	56		
01-116	84	01-257	88	01-641	180	04-006	72	04-193	75	08-014	56		
01-118	84	01-306	84	01-642	180	04-007	72	04-194	75	08-015	56		
01-119	84	01-307	84	01-643	180	04-011	72	04-196	76	08-016	56		
01-120	84	01-308	83	01-644	180	04-012	72	04-197	76	08-017	56		
01-122	84	01-309	83	01-645	180	04-013	72	04-200	81	08-018	56		
01-124	84	01-310	85	01-646	180	04-014	72	04-201	75	08-019	56		
01-125	84	01-311	85	01-647	180	04-015	72	04-204	74	08-020	56		
01-126	84	01-312	86	01-648	180	04-016	72	04-206	74	08-021	56		
01-127	84	01-400	95	01-649	180	04-019	73	04-207	74	08-022	56		
01-128	84	01-401	98	01-650	180	04-020	73	04-208	74	08-023	56		
01-129	84	01-402	66	01-651	180	04-021	72	04-209	76	08-024	56		
01-150	89	01-500	95	01-652	180	04-022	72	04-210	76	08-025	56		
01-151	89	01-501	96	01-653	180	04-023	72	04-211	76	08-026	56		
01-152	87	01-502	96	01-654	180	04-024	72	04-212	75	08-027	56		
01-153	87	01-503	97	01-655	180	04-025	72	04-213	74	08-028	56		
01-154	87	01-506	96	01-656	180	04-026	72	04-214	74	08-029	56		
01-155	87	01-507	96	01-657	180	04-028	73	04-220	82	08-030	56		
01-156	88	01-509	89	01-658	180	04-031	73	04-221	83	08-032	56		
01-157	88	01-510	98	01-659	180	04-032	73	04-222	83	08-036	56		
01-158	88	01-511	98	01-660	180	04-033	73	04-225	76	08-039	56		
01-171	84	01-512	99	01-661	180	04-034	73	04-228	78	08-040	56		
01-172	84	01-513	98	01-662	180	04-035	73	04-231	81	08-041	56		
01-175	84	01-514	98	01-663	180	04-036	73	04-240	73	08-042	56		
01-176	84	01-515	98	01-664	180	04-037	81	04-250	81	08-043	56		
01-177	84	01-517	98	01-665	180	04-044	73	04-602	217	08-044	56		
01-180	83	01-518	98	01-666	180	04-045	73	04-603	213	08-045	56		
01-181	84	01-519	95	01-667	180	04-046	73	04-608	214	08-046	56		
01-182	84	01-520	95	01-668	180	04-051	82	04-612	213	08-047	56		
01-183	84	01-524	95	01-669	180	04-052	82	04-613	214	08-048	56		
01-185	84	01-525	92	01-670	180	04-053	82	04-616	212	08-049	56		
01-186	84	01-526	181	01-671	180	04-054	82	04-617	136	08-050	56		
01-187	84	01-528	181	01-672	181	04-055	82	04-618	214	08-051	56		
01-188	84	01-530	97	02-001	66	04-062	82	04-619	212	08-052	56		
01-189	84	01-531	97	02-002	66	04-063	82	04-620	220	08-053	56		
01-190	84	01-532	97	02-040	100	04-071	82	04-700	217	08-054	56		
01-191	84	01-533	97	02-042	100	04-072	82	04-701	217	08-055	56		

Ref	p.	Ref	p.	Ref	p.	Ref	p.	Ref	p.	Ref	p.	Ref	p.
08-056	56	08-243	54	08-446	54	08-556	59	08-767	61	09-063	69		
08-058	56	08-244	54	08-447	54	08-557	59	08-770	60	09-064	69		
08-061	42	08-245	54	08-448	54	08-558	59	08-771	60	09-065	69		
08-070	56	08-246	54	08-449	54	08-559	59	08-772	60	09-066	69		
08-071	56	08-247	54	08-450	54	08-560	59	08-773	60	09-067	69		
08-072	56	08-251	59	08-451	54	08-562	59	08-774	60	09-068	69		
08-073	56	08-252	59	08-452	54	08-563	59	08-775	60	09-069	69		
08-074	56	08-253	59	08-453	54	08-564	59	08-776	60	09-141	72		
08-075	56	08-254	59	08-454	54	08-565	59	08-777	60	09-143	72		
08-076	56	08-255	59	08-458	55	08-580	57	08-778	60	09-145	72		
08-077	56	08-256	59	08-459	55	08-581	57	08-780	60	09-147	72		
08-078	56	08-257	66	08-460	55	08-582	57	08-781	60	09-149	72		
08-080	56	08-300	56	08-461	55	08-583	57	08-782	60	09-151	72		
08-081	56	08-301	56	08-462	55	08-584	57	08-783	60	09-176	71		
08-082	56	08-302	56	08-463	55	08-585	57	08-784	60	09-203	72		
08-083	56	08-304	56	08-464	55	08-586	57	08-821	67	09-205	72		
08-084	56	08-306	56	08-465	55	08-587	57	08-822	67	09-208	72		
08-085	56	08-307	56	08-466	55	08-588	57	08-823	67	09-212	72		
08-086	56	08-308	56	08-467	55	08-589	57	08-824	67	09-214	72		
08-090	133	08-309	56	08-468	55	08-590	57	08-825	67	09-255	70		
08-091	133	08-311	56	08-469	55	08-591	57	08-826	67	09-256	70		
08-095	133	08-312	56	08-470	55	08-592	57	08-827	67	09-257	70		
08-151	59	08-313	56	08-471	55	08-593	57	08-828	67	09-258	70		
08-152	59	08-314	56	08-472	55	08-594	57	08-830	68	09-259	70		
08-153	59	08-315	56	08-473	55	08-595	57	08-835	67	09-260	70		
08-154	59	08-316	56	08-474	55	08-596	57	08-837	67	09-261	70		
08-155	59	08-319	56	08-475	55	08-597	57	08-838	67	09-262	70		
08-168	55	08-320	57	08-476	55	08-598	57	08-839	67	09-263	70		
08-170	55	08-321	57	08-477	55	08-599	57	08-843	67	09-264	70		
08-171	55	08-322	57	08-478	55	08-603	54	08-845	67	09-265	70		
08-172	55	08-323	57	08-479	55	08-649	63	08-960	232	09-266	70		
08-173	55	08-324	57	08-480	55	08-650	57	08-961	232	09-302	72		
08-174	55	08-325	57	08-482	55	08-651	57	08-962	232	09-320	69		
08-175	55	08-326	57	08-486	55	08-694	41	08-963	232	09-321	69		
08-176	55	08-327	57	08-487	54	08-705	61	08-964	232	09-322	69		
08-177	55	08-328	57	08-488	54	08-706	61	08-965	232	09-323	69		
08-178	55	08-329	57	08-489	54	08-707	62	08-966	232	09-324	69		
08-179	55	08-331	57	08-490	54	08-708	62	08-967	232	09-325	69		
08-180	55	08-332	57	08-491	54	08-710	63	08-968	232	09-326	69		
08-181	55	08-333	57	08-492	54	08-711	62	08-969	232	09-327	69		
08-182	55	08-335	57	08-493	54	08-712	149	08-970	232	09-328	69		
08-184	55	08-340	56	08-494	54	08-713	62	08-971	232	09-329	69		
08-185	55	08-341	56	08-495	54	08-720	223	08-972	232	09-330	69		
08-186	55	08-350	59	08-497	54	08-721	223	08-973	232	09-331	69		
08-187	55	08-351	59	08-498	54	08-722	223	08-974	232	09-333	69		
08-188	55	08-352	59	08-499	54	08-730	60	08-975	232	09-334	69		
08-189	55	08-353	59	08-501	58	08-731	60	08-976	232	09-336	69		
08-190	55	08-355	58	08-502	58	08-732	60	08-977	232	09-338	69		
08-191	55	08-356	59	08-503	58	08-733	60	08-978	232	09-339	69		
08-192	55	08-357	59	08-504	58	08-734	60	08-979	232	09-340	69		
08-193	55	08-408	55	08-507	58	08-735	60	08-980	232	09-341	69		
08-194	55	08-409	55	08-508	58	08-736	60	08-981	232	09-342	69		
08-195	55	08-410	55	08-511	58	08-740	60	08-982	232	09-345	70		
08-196	55	08-411	55	08-512	58	08-741	60	08-990	226	09-360	71		
08-197	55	08-412	55	08-513	58	08-742	60	08-991	226	09-361	71		
08-220	54	08-413	55	08-514	58	08-743	60	08-992	226	09-362	71		
08-221	54	08-414	55	08-515	58	08-744	60	08-993	226	09-363	71		
08-222	54	08-415	55	08-516	58	08-745	60	08-994	226	09-364	71		
08-223	54	08-416	55	08-519	58	08-746	60	08-995	226	09-365	71		
08-224	54	08-417	55	08-520	58	08-750	61	08-996	226	09-366	71		
08-225	54	08-418	55	08-521	58	08-751	61	09-042	69	09-367	71		
08-226	54	08-419	55	08-523	58	08-752	61	09-043	69	09-368	71		
08-227	54	08-421	55	08-524	58	08-753	61	09-044	69	09-370	71		
08-228	54	08-422	55	08-525	58	08-754	61	09-045	69	09-406	68		
08-229	54	08-423	55	08-530	57	08-755	61	09-051	69	09-407	68		
08-230	54	08-424	55	08-533	57	08-756	61	09-052	69	09-408	68		
08-231	54	08-425	55	08-536	57	08-757	61	09-053	69	09-409	68		
08-232	54	08-426	55	08-540	58	08-758	61	09-054	69	09-410	68		
08-235	54	08-427	55	08-543	58	08-759	61	09-055	69	09-411	68		
08-236	54	08-429	55	08-546	58	08-760	61	09-056	69	09-412	68		
08-237	54	08-430	55	08-550	59	08-761	61	09-057	69	09-413	68		
08-238	54	08-431	55	08-551	59	08-762	61	09-058	69	09-414	68		
08-239	54	08-432	55	08-552	59	08-763	61	09-059	69	09-415	68		
08-240	54	08-442	54	08-553	59	08-764	61	09-060	69	09-416	68		
08-241	54	08-443	54	08-554	59	08-765	61	09-061	69	09-417	68		
08-242	54	08-444	54	08-555	59	08-766	61	09-062	69	09-418	68		

Ref	p.	Ref	p.	Ref	p.	Ref	p.	Ref	p.	Ref	p.
09-419	68	09-706	68	09-930	71	10-344	61	10-802	108	11-223	130
09-421	68	09-707	68	09-952	71	10-345	61	10-803	108	11-224	130
09-422	68	09-708	68	09-980	71	10-346	61	10-804	108	11-226	130
09-424	68	09-709	68	10-000	41	10-401	183	10-805	108	11-227	130
09-427	68	09-710	68	10-004	41	10-402	183	10-806	108	11-228	130
09-429	68	09-711	68	10-008	42	10-403	183	10-807	108	11-231	106
09-430	68	09-712	68	10-019	53	10-404	183	10-808	109	11-235	106
09-432	68	09-713	68	10-020	41	10-405	183	10-809	109	11-237	105
09-509	66	09-714	68	10-030	41	10-406	183	10-810	107	11-238	106
09-512	65	09-715	68	10-036	42	10-407	183	10-811	107	11-239	105
09-517	65	09-716	68	10-042	43	10-408	183	10-815	110	11-240	106
09-518	65	09-717	68	10-054	44	10-450	24	10-860	240	11-241	106
09-523	64	09-718	68	10-058	43	10-451	24	10-900	64	11-242	105
09-524	65	09-719	68	10-059	44	10-452	24	10-902	64	11-243	105
09-525	64	09-720	68	10-060	45	10-453	24	10-904	64	11-250	131
09-526	65	09-721	68	10-062	45	10-454	24	10-906	64	11-261	132
09-530	64	09-722	68	10-066	47	10-455	24	10-908	64	11-262	132
09-531	64	09-723	68	10-076	49	10-456	24	10-910	64	11-263	132
09-532	64	09-724	68	10-078	50	10-470	240	10-920	64	11-264	132
09-533	64	09-725	68	10-200	52	10-471	240	10-922	64	11-265	133
09-534	64	09-727	68	10-202	52	10-472	158	10-924	64	11-266	133
09-535	64	09-728	68	10-206	46	10-473	158	10-926	64	11-267	131
09-536	64	09-729	68	10-212	46	10-474	240	10-928	64	11-268	110
09-537	64	09-730	68	10-216	48	10-475	240	10-940	64	11-269	110
09-538	64	09-732	68	10-218	51	10-477	239	10-942	64	11-270	136
09-539	64	09-734	68	10-250	149	10-478	23	10-944	64	11-271	134
09-540	64	09-736	68	10-251	149	10-480	158	10-946	64	11-299	127
09-541	64	09-738	68	10-252	149	10-481	158	10-948	64	11-300	122
09-542	64	09-741	68	10-253	149	10-482	158	10-960	64	11-301	122
09-543	64	09-746	68	10-254	149	10-485	27	10-970	64	11-302	122
09-544	64	09-747	68	10-255	149	10-500	159	10-972	64	11-303	122
09-545	64	09-749	68	10-256	149	10-501	159	10-978	64	11-304	122
09-546	64	09-751	69	10-257	149	10-502	159	10-980	64	11-305	123
09-550	65	09-752	69	10-258	148	10-503	159	10-982	64	11-306	122
09-551	65	09-753	69	10-259	148	10-504	159	10-988	64	11-307	123
09-552	65	09-754	69	10-260	148	10-505	160	11-020	91	11-310	123
09-553	65	09-760	69	10-261	148	10-506	160	11-021	91	11-311	124
09-554	65	09-761	69	10-262	148	10-507	160	11-022	91	11-312	123
09-555	65	09-762	69	10-263	148	10-508	161	11-024	91	11-313	123
09-556	65	09-763	69	10-264	148	10-509	160	11-030	176	11-314	124
09-557	65	09-764	69	10-265	148	10-510	160	11-100	113	11-315	124
09-558	65	09-765	69	10-300	57	10-511	160	11-101	113	11-316	124
09-559	65	09-766	69	10-310	60	10-569	161	11-102	113	11-317	124
09-570	54	09-767	69	10-311	60	10-570	161	11-111	113	11-320	124
09-571	65	09-768	69	10-312	60	10-571	161	11-112	113	11-321	125
09-573	66	09-769	69	10-313	60	10-572	161	11-113	114	11-322	125
09-575	234	09-770	69	10-314	60	10-573	161	11-122	111	11-323	125
09-576	234	09-771	69	10-315	60	10-574	161	11-123	111	11-324	125
09-577	234	09-791	69	10-316	60	10-575	161	11-125	111	11-325	125
09-579	234	09-806	70	10-317	60	10-576	161	11-126	111	11-326	125
09-580	234	09-808	70	10-318	60	10-577	161	11-127	111	11-330	126
09-584	234	09-810	70	10-319	60	10-578	161	11-128	111	11-331	126
09-585	234	09-812	70	10-320	60	10-579	161	11-129	111	11-332	126
09-587	234	09-814	70	10-321	60	10-580	161	11-130	112	11-333	126
09-588	234	09-816	70	10-322	61	10-581	161	11-131	112	11-334	127
09-650	68	09-817	70	10-323	61	10-582	161	11-132	112	11-335	126
09-651	68	09-818	70	10-324	61	10-583	161	11-135	112	11-336	126
09-652	68	09-819	70	10-325	61	10-584	161	11-136	112	11-337	127
09-653	68	09-820	70	10-326	61	10-585	161	11-136-150	112	11-338	123
09-654	68	09-821	70	10-327	61	10-586	161	11-152	133	11-360	105
09-655	68	09-824	70	10-328	61	10-587	161	11-153	133	11-361	105
09-656	68	09-825	70	10-329	60	10-588	162	11-165	134	11-362	105
09-657	68	09-851	70	10-330	60	10-590	162	11-167	131	11-363	105
09-658	68	09-852	70	10-331	60	10-596	162	11-168	131	11-364	105
09-659	68	09-860	70	10-332	60	10-598	162	11-169	131	11-365	105
09-660	68	09-890	20	10-333	60	10-599	25	11-170	129	11-366	105
09-661	68	09-906	71	10-334	60	10-600	158	11-171	129	11-367	105
09-662	68	09-908	71	10-335	60	10-602	163	11-190	134	11-368	105
09-663	68	09-910	71	10-336	60	10-604	163	11-191	134	11-369	105
09-665	68	09-912	71	10-337	60	10-606	163	11-192	134	11-370	105
09-666	68	09-914	71	10-338	60	10-650	240	11-203	128	11-371	105
09-668	68	09-916	71	10-339	60	10-651	240	11-204	128	11-372	105
09-671	68	09-918	71	10-340	61	10-700	151	11-205	128	11-373	105
09-672	68	09-920	71	10-341	61	10-701	151	11-218	129	11-380	106
09-674	68	09-921	71	10-342	61	10-800	108	11-221	130	11-381	106
09-675	68	09-924	71	10-343	61	10-801	108	11-222	130	11-382	106

Ref	p.	Ref	p.	Ref	p.	Ref	p.	Ref	p.	Ref	p.	Ref	p.
11-383	107	11-832	121	12-071-1	150	12-908	119	14-704	154	55H352	225		
11-384	107	11-834	120	12-072-1	150	12-909	118	14-706	155	55H353	225		
11-400	176	11-836	120	12-074-1	150	12-910	119	14-708	156	55H354	225		
11-401	176	11-847	115	12-075-1	150	12-915	118	14-710	156	55H355	225		
11-402	176	11-848	117	12-076-1	150	12K010	153	14-712	156	55H356	225		
11-403	176	11-850	116	12-079	150	12K020	152	14-714	155	55H357	225		
11-404	176	11-851	116	12-080	150	12K021	152	14-716	155	55H358	225		
11-500	109	11-852	116	12-081	150	12K022	152	14-718	156	55H359	225		
11-501	109	11-857	116	12-101	148	12K023	153	14-720	155	55H360	225		
11-502	110	11-858	116	12-102	148	12K024	153	14-722	155	55H361	225		
11-503	110	11-859	116	12-105	148	12K030	153	14-724	155	55H362	225		
11-510	107	11-861	116	12-107	148	12K031	153	14-730	150	55H363	225		
11-511	107	11-862	116	12-110	148	14-002	143	14-732	150	55H364	225		
11-532	110	11-865	116	12-115	148	14-004	143	14-734	149	55H365	225		
11-550	108	11-866	116	12-210	148	14-006	143	14-800-1	150	55H366	225		
11-551	109	11-867	116	12-212	148	14-008	143	14-802-1	150	55H367	225		
11-552	109	11-868	116	12-213	148	14-010	144	14-804-1	150	55H368	225		
11-553	109	11-869	116	12-214	148	14-012	144	14-806-1	150	55H369	225		
11-555-1	109	11-870	116	12-215	148	14-013	145	14-808-1	150	55H370	225		
11-560	108	11-871	116	12-216	148	14-014	144	14-820	156	55H371	225		
11-561	108	11-872	116	12-217	148	14-016	144	18-101-1	137	55H372	225		
11-565	110	11-873	116	12-219	148	14-017	146	18-102-1	137	55H373	225		
11-600	25	11-875	115	12-221	148	14-017-400	156	18-103-1	137	55H374	225		
11-601-1	25	11-880	127	12-222	148	14-018	144	18-106-1	137	55H375	225		
11-604	25	11-881	127	12-224	148	14-019	144	18-107	137	55H376	225		
11-610	136	11-882	127	12-310	148	14-020	145	19-151	140	55H377	225		
11-611	136	11-883	128	12-312	148	14-026	145	19-152	140	55H570	223		
11-612	136	11-884	128	12-313	148	14-028	146	19-153	140	55H572	223		
11-614	136	11-885	129	12-314	148	14-029	146	19-158	140	55H574	223		
11-617	136	11-890	121	12-315	148	14-030	146	19-159	140	55H576	223		
11-690	117	11-891-1	121	12-316	148	14-031	146	19-200	139	55H577	223		
11-691	117	11-892-1	121	12-317	148	14-032	146	19-220	139	55H578	223		
11-710	25	11-893-1	121	12-319	148	14-034	146	19-225	139	55H579	223		
11-711	26	11-901	118	12-321	148	14-034-401	156	19-250	139	55H754	228		
11-712	26	11-902	118	12-322	148	14-036	156	19-905	139	55H755	228		
11-714	26	11-903	118	12-324	148	14-220	154	19-906	139	55H756	228		
11-716	26	11-904	118	12-350	150	14-500	143	20-021	137	55H757	228		
11-718	27	11-905	118	12-600	151	14-502	143	20-022	137	55H758	228		
11-719	27	11-906	118	12-601	151	14-508	145	20-025	138	55H759	228		
11-720	23	11-907	118	12-602	151	14-510	145	20-026	138	55H760	228		
11-730	24	11-908	118	12-605	152	14-514	145	20-030	138	55H761	228		
11-731	24	11-909	118	12-606	152	14-550	150	20-033	138	55H762	228		
11-732	24	11-915	118	12-610	151	14-552	152	20-036	138	55H763	229		
11-733	24	11-920	135	12-611	151	14-570	147	20-040	138	55H764	229		
11-737	23	11-922	135	12-612	151	14-572	147	20-041	138	55H765	229		
11-749	25	11-925	135	12-613	151	14-610	147	20-045	137	55H766	229		
11-750	23	11-931	118	12-615	151	14-611	147	33-090	140	55H767	229		
11-751	23	11-950	177	12-616	151	14-612	147	50-900	121	55H768	229		
11-760	23	11-952	177	12-617	151	14-613	147	55H010	222	55H823	226		
11-761	23	11-953	177	12-618	151	14-614	147	55H013	222	55H825	226		
11-762	23	11-956	177	12-620	151	14-615	147	55H014	222	55H826	226		
11-763	23	11-960	177	12-621	151	14-620	147	55H015	222	55H855	227		
11-796	113	11-961	177	12-622	151	14-621	147	55H016	222	55H856	227		
11-797	114	11-963	177	12-623	151	14-622	147	55H017	222	55H857	227		
11-798	113	11-969	179	12-625	152	14-623	147	55H018	222	55H858	227		
11-799	115	11-970	176	12-626	152	14-624	147	55H019	222	55H859	227		
11-801	114	11-971	178	12-627	152	14-625	147	55H020	222	55H873	229		
11-802	114	11-972	178	12-628	152	14-626	147	55H021	222	55H874	229		
11-803	114	11-973	178	12-630	151	14-627	147	55H022	222	55H875	229		
11-804	114	11-974	178	12-631	151	14-628	147	55H024	222	55H876	229		
11-805	114	11-975	177	12-632	151	14-629	147	55H025	222	55H877	229		
11-806	114	11-976	179	12-635	151	14-630	147	55H026	222	55H878	229		
11-807	114	11-977	179	12-636	151	14-631	147	55H027	222	55H879	229		
11-808	114	11-978	179	12-637	151	14-650	147	55H029	222	55H880	229		
11-810	115	11-979	178	12-640	152	14-651	147	55H030	222	55H881	229		
11-811	115	11-980	178	12-641	152	14-652	147	55H031	222	55H882	229		
11-812	117	11-981	176	12-645	151	14-653	147	55H033	222	55H884	229		
11-813	117	11-983	179	12-646	151	14-654	147	55H035	222	55H885	229		
11-816	115	11-984	120	12-650	151	14-655	147	55H036	222	55H886	229		
11-817	134	11-985	120	12-651	151	14-656	147	55H038	222	55H887	229		
11-819	135	11-986	120	12-655	152	14-657	147	55H039	222	55H888	229		
11-822	176	11-991	180	12-656	152	14-658	147	55H040	222	55H889	229		
11-823	176	11-992	180	12-904	119	14-699	154	55H224	236	55H890	229		
11-824	176	11-993	179	12-905	119	14-700	154	55H320	226	55H891	229		
11-825	176	11-997	239	12-906	119	14-702	154	55H350	225	55H892	229		
11-827	134	12-070-1	150	12-907	119	14-703	154	55H351	225	55H893	229		

Ref	p.	Ref	p.	Ref	p.	Ref	p.	Ref	p.	Ref	p.
55H894	229	56H421	224	57H026-10	222	57H902	224	59G208	216	81-220-LD	187
55H896	229	56H500	233	57H028	222	57H903	224	59G348	217	81-220-M	187
55H897	229	56H501	233	57H028-10	222	57H904	224	59G383	220	81-220-S	187
55H898	229	56H502	233	57H030	222	57H905	224	59G522	218	81-220-XL	187
55H899	229	56H503	233	57H030-10	222	57H906	224	59G523	218	81-220-XXL	187
55H900	229	56H504	233	57H032	222	57H907	224	59G526	218	81-226-L	185
55H901	229	56H505	233	57H032-10	222	57H908	224	59G873	219	81-226-M	185
55H902	229	56H506	233	57H034	222	57H909	224	61-001	141	81-226-S	185
55H903	229	56H507	233	57H034-10	222	57H910	224	61-002	141	81-226-XL	185
55H904	229	56H508	233	57H036	222	57H911	224	61-004	141	81-226-XS	185
55H905	229	56H509	233	57H036-10	222	57H912	224	61-005	141	81-226-XXL	185
55H906	229	56H510	233	57H038	222	57H913	224	61-006	141	81-226-XXXL	185
55H907	229	56H511	233	57H038-10	222	57H914	224	63-011	102	81-227-L	185
55H908	229	56H512	233	57H040	222	57H915	224	63-012	101	81-227-M	185
55H909	229	56H513	233	57H040-10	222	57H916	224	63-013	101	81-227-S	185
55H910	229	56H514	233	57H042	222	57H917	224	63-014	102	81-227-XL	185
55H911	229	56H515	233	57H042-10	222	57H918	224	63-021	102	81-227-XS	185
55H912	229	56H516	233	57H044	222	57H919	224	63-050	101	81-227-XXL	185
55H913	229	56H517	233	57H046	222	57H920	224	63-060	101	81-227-XXXL	185
55H914	229	56H518	234	57H046-5	222	57H922	224	63-700	102	81-228-L	186
55H915	229	56H519	234	57H048	222	57H924	224	63-702	102	81-228-M	186
55H916	229	56H520	234	57H048-5	222	57H926	224	63-704	102	81-228-S	186
55H917	229	56H521	234	57H050	222	57H928	224	63-705	102	81-228-XL	186
55H918	229	56H522	234	57H050-5	222	57H930	224	63-706	102	81-228-XS	186
55H919	229	56H523	234	57H052	222	57H932	224	63-707	102	81-228-XXL	186
55H920	229	56H524	234	57H054	222	57H934	224	63-710	103	81-228-XXXL	186
55H921	229	56H525	234	57H054-5	222	57H936	224	64-001	103	81-229-L	186
55H922	229	56H526	234	57H055	222	57H938	224	64-010	103	81-229-M	186
55H923	229	56H527	234	57H056	222	57H940	224	64-012	103	81-229-S	186
55H924	229	56H528	234	57H056-5	222	57H944	224	64-013	103	81-229-XL	186
55H925	229	56H529	234	57H058	222	57H947	230	64-014	103	81-229-XS	186
55H926	229	56H530	235	57H058-5	222	57H948	230	64-015	103	81-229-XXL	186
55H927	229	56H531	235	57H062	222	57H950	230	64-020	103	81-229-XXXL	186
55H928	226	56H532	235	57H062-5	222	57H951	230	64-220	103	81-230-L	187
55H929	226	56H533	235	57H064	222	57H952	230	64-420	103	81-230-LD	187
55H932	236	56H534	235	57H066	222	57H953	230	64-610	103	81-230-M	187
55H933	227	56H535	235	57H066-5	222	57H954	230	64-620	103	81-230-S	187
55H934	227	56H536	235	57H086	222	58G001	221	75-000	141	81-230-XL	187
55H935	227	56H540	235	57H088	222	58G002	221	75-001	141	81-230-XXL	187
55H936	227	56H541	235	57H089	222	58G003	215	75-011	141	81-231-L	186
55H937	227	56H542	234	57H090	222	58G004-1	221	75-020	141	81-231-M	186
55H938	227	56H543	234	57H250	224	58G006-SET2	211	75-021	141	81-231-S	186
55H939	227	56H544	235	57H581	228	58G007	219	75-022	141	81-231-XL	186
55H940	227	56H545	235	57H582	228	58G010	212	75-023	141	81-231-XS	186
55H941	227	56H546	235	57H583	228	58G012	213	81-210-L	190	81-231-XXL	186
55H942	227	56H547	235	57H585	228	58G013	216	81-210-LD	190	81-231-XXXL	186
55H943	227	56H554	233	57H587	228	58G017	219	81-210-M	190	81-233-L	186
55H944	227	56H555	233	57H589	228	58G018	214	81-210-S	190	81-233-M	186
55H980	227	56H556	233	57H591	228	58G019	212	81-210-XL	190	81-233-S	186
55H981	227	56H557	233	57H592	228	58G020-SET2	211	81-210-XXL	190	81-233-XL	186
55H982	227	56H558	233	57H596	228	58G024	213	81-214-L	189	81-233-XS	186
55H983	227	56H560	235	57H598	228	58G025	220	81-214-M	189	81-233-XXL	186
55H984	227	56H562	235	57H599	228	58G026	215	81-214-S	189	81-233-XXXL	186
55H985	227	56H604	236	57H600	228	58G028-1	214	81-214-XL	189	81-234-L	185
55H986	227	56H606	236	57H601	228	58G038	214	81-214-XXL	189	81-234-M	185
55H987	227	56H610	236	57H602	228	58G040	218	81-214-XXXL	189	81-234-S	185
55H988	227	56H612	236	57H700	223	58G041	220	81-216-L	189	81-234-XL	185
55H989	227	56H650	230	57H705	223	58G082	218	81-216-M	189	81-234-XS	185
55H990	227	56H655	230	57H719	223	58G085	221	81-216-S	189	81-234-XXL	185
55H991	227	57H010	222	57H739	223	58G086	221	81-216-XL	189	81-234-XXXL	185
55H992	226	57H012	222	57H740	223	58G090	220	81-216-XXL	189	81-236-L	186
56-040	181	57H014	222	57H741	223	58G092	221	81-216-XXXL	189	81-236-M	186
56H006	231	57H014-10	222	57H835	227	58G722	213	81-217-L	189	81-236-S	186
56H010	231	57H015	222	57H836	227	58G793	212	81-217-M	189	81-236-XL	186
56H012	231	57H016	222	57H837	227	58G904	28	81-217-S	189	81-236-XS	186
56H013	231	57H018	222	57H838	227	58G961	219	81-217-XL	189	81-236-XXL	186
56H014	231	57H018-10	222	57H839	227	58G971	219	81-217-XS	189	81-236-XXXL	186
56H040	230	57H020	222	57H840	227	58GE124	28	81-217-XXL	189	81-238-L	188
56H048	230	57H020-10	222	57H841	227	58GE133	28	81-217-XXXL	189	81-238-M	188
56H055	231	57H022	222	57H842	227	58GE139	212	81-218-L	190	81-238-S	188
56H056	231	57H022-10	222	57H843	227	58GE142	215	81-218-M	190	81-238-XL	188
56H057	231	57H023	222	57H844	227	58GE152	221	81-218-S	190	81-238-XS	188
56H061	231	57H023-10	222	57H845	227	59G025	216	81-218-XL	190	81-238-XXL	188
56H072	231	57H024	222	57H860	227	59G063	216	81-218-XXL	190	81-238-XXXL	188
56H246	224	57H024-10	222	57H900	224	59G087	216	81-218-XXXL	190	81-239-L	187
56H420	231	57H026	222	57H901	224	59G175	216	81-220-L	187	81-239-M	187



Ref	p.	Ref	p.	Ref	p.	Ref	p.	Ref	p.	Ref	p.	Ref	p.
81-239-S	187	81-283-XXXL	196	81-507-XL	190	81-555-L	191	81-647-S	193	82-024	201		
81-239-XL	187	81-290-L	186	81-507-XXL	190	81-555-M	191	81-647-XL	193	82-025	201		
81-239-XS	187	81-290-M	186	81-511-L	191	81-555-S	191	81-647-XXL	193	82-026	201		
81-239-XXL	187	81-290-S	186	81-511-M	191	81-555-XL	191	81-647-XXXL	193	82-027	201		
81-239-XXXL	187	81-290-XL	186	81-511-S	191	81-555-XXL	191	81-648-L	193	82-028	201		
81-240-L	187	81-290-XS	186	81-511-XL	191	81-555-XXXL	191	81-648-M	193	82-089-39	200		
81-240-LD	187	81-290-XXL	186	81-511-XXL	191	81-556-L	192	81-648-S	193	82-089-40	200		
81-240-M	187	81-290-XXXL	186	81-511-XXXL	191	81-556-M	192	81-648-XL	193	82-089-41	200		
81-240-S	187	81-410-L	190	81-513-L	196	81-556-S	192	81-648-XXL	193	82-089-42	200		
81-240-XL	187	81-410-LD	190	81-513-M	196	81-556-XL	192	81-648-XXXL	193	82-089-43	200		
81-240-XXL	187	81-410-M	190	81-513-S	196	81-556-XXL	192	81-649-L	193	82-089-44	200		
81-246-L	185	81-410-S	190	81-513-XL	196	81-556-XXXL	192	81-649-M	193	82-089-45	200		
81-246-M	185	81-410-XL	190	81-513-XXL	196	81-558-L	192	81-649-S	193	82-089-46	200		
81-246-S	185	81-410-XXL	190	81-513-XXXL	196	81-558-M	192	81-649-XL	193	82-089-47	200		
81-246-XL	185	81-420-L	188	81-514-L	196	81-558-S	192	81-649-XXL	193	82-090	198		
81-246-XS	185	81-420-LD	188	81-514-M	196	81-558-XL	192	81-649-XXXL	193	82-091	198		
81-246-XXL	185	81-420-M	188	81-514-S	196	81-558-XXL	192	81-650-L	196	82-092	198		
81-246-XXXL	185	81-420-S	188	81-514-XL	196	81-565-L	188	81-650-M	196	82-093	198		
81-247-L	185	81-420-XL	188	81-514-XXL	196	81-565-M	188	81-650-S	196	82-094	198		
81-247-M	185	81-420-XXL	188	81-514-XXXL	196	81-565-S	188	81-650-XL	196	82-095	198		
81-247-S	185	81-430-L	188	81-530-L	194	81-565-XL	188	81-650-XXL	196	82-096	198		
81-247-XL	185	81-430-LD	188	81-530-M	194	81-565-XXL	188	81-650-XXXL	196	82-097	198		
81-247-XS	185	81-430-M	188	81-530-S	194	81-565-XXXL	188	81-651-L	196	82-098	198		
81-247-XXL	185	81-430-S	188	81-530-XL	194	81-606-L	194	81-651-M	196	82-100	199		
81-247-XXXL	185	81-430-XL	188	81-530-XXL	194	81-606-M	194	81-651-S	196	82-101	199		
81-248-L	187	81-430-XXL	188	81-532-L	194	81-606-S	194	81-651-XL	196	82-102	199		
81-248-M	187	81-450-L	189	81-532-M	194	81-606-XL	194	81-651-XXL	196	82-103	199		
81-248-S	187	81-450-M	189	81-532-S	194	81-606-XXL	194	81-651-XXXL	196	82-104	199		
81-248-XL	187	81-450-S	189	81-532-XL	194	81-606-XXXL	194	81-659-L	194	82-105	199		
81-248-XS	187	81-450-XL	189	81-532-XXL	194	81-609-L	192	81-659-M	194	82-106	199		
81-248-XXL	187	81-450-XXL	189	81-532-XXXL	194	81-609-M	192	81-659-S	194	82-107	199		
81-248-XXXL	187	81-450-XXXL	189	81-534-L	194	81-609-S	192	81-659-XL	194	82-108	199		
81-249-L	185	81-451-L	188	81-534-M	194	81-609-XL	192	81-659-XXL	194	82-110	199		
81-249-M	185	81-451-M	188	81-534-S	194	81-609-XXL	192	81-659-XXXL	194	82-111	199		
81-249-S	185	81-451-S	188	81-534-XL	194	81-609-XXXL	192	81-660-L/XL	197	82-112	199		
81-249-XL	185	81-451-XL	188	81-534-XXL	194	81-610-L	193	81-660-S/M	197	82-113	199		
81-249-XS	185	81-451-XXL	188	81-534-XXXL	194	81-610-M	193	81-660-XXL/XXXL	197	82-114	199		
81-249-XXL	185	81-451-XXXL	188	81-540-L	195	81-610-S	193	81-661-L/XL	197	82-115	199		
81-249-XXXL	185	81-500-L	190	81-540-M	195	81-610-XL	193	81-661-S/M	197	82-116	199		
81-250-L	189	81-500-M	190	81-540-S	195	81-610-XXL	193	81-661-XXL/XXXL	197	82-117	199		
81-250-LD	189	81-500-S	190	81-540-XL	195	81-612-L	193	81-662-L/XL	197	82-118	199		
81-250-M	189	81-500-XL	190	81-540-XXL	195	81-612-M	193	81-662-S/M	197	82-120	200		
81-250-S	189	81-500-XXL	190	81-541-L	195	81-612-S	193	81-662-XXL/XXXL	197	82-121	200		
81-250-XL	189	81-501-L	191	81-541-M	195	81-612-XL	193	81-663-L/XL	197	82-122	200		
81-250-XXL	189	81-501-M	191	81-541-S	195	81-612-XXL	193	81-663-S/M	197	82-123	200		
81-258-L	189	81-501-S	191	81-541-XL	195	81-615-L	194	81-663-XXL/XXXL	197	82-124	200		
81-258-M	189	81-501-XXL	191	81-541-XXL	195	81-615-M	194	81-670-L/XL	197	82-125	200		
81-258-S	189	81-501-XXXL	191	81-545-L	195	81-615-S	194	81-670-S/M	197	82-126	200		
81-258-XL	189	81-502-L	191	81-545-M	195	81-615-XL	194	81-670-XXL/XXXL	197	82-127	200		
81-258-XS	189	81-502-M	191	81-545-S	195	81-615-XXL	194	81-671-L/XL	197	82-128	200		
81-258-XXL	189	81-502-S	191	81-545-XL	195	81-621	198	81-671-S/M	197	82-155-39	198		
81-258-XXXL	189	81-502-XL	191	81-545-XXL	195	81-630	198	81-671-XXL/XXXL	197	82-155-40	198		
81-277-L	188	81-502-XXL	191	81-545-XXXL	195	81-631	198	81-672-L/XL	197	82-155-41	198		
81-277-M	188	81-502-XXXL	191	81-546-L	195	81-632	198	81-672-S/M	197	82-155-42	198		
81-277-S	188	81-503-L	191	81-546-M	195	81-640-L	192	81-672-XXL/XXXL	197	82-155-43	198		
81-277-XL	188	81-503-M	191	81-546-S	195	81-640-M	192	81-673-L/XL	197	82-155-44	198		
81-277-XS	188	81-503-S	191	81-546-XL	195	81-640-XL	192	81-673-S/M	197	82-155-45	198		
81-277-XXL	188	81-503-XL	191	81-546-XXL	195	81-640-XXL	192	81-673-XXL/XXXL	197	82-155-46	198		
81-277-XXXL	188	81-503-XXL	191	81-546-XXXL	195	81-640-XXXL	192	81-679-L	195	82-155-47	198		
81-280-L	196	81-503-XXXL	191	81-549-L	195	81-641-L	193	81-679-M	195	82-160-39	198		
81-280-M	196	81-504-L	191	81-549-M	195	81-641-M	193	81-679-XL	195	82-160-40	198		
81-280-S	196	81-504-M	191	81-549-S	195	81-641-XL	193	81-679-XXL	195	82-160-41	198		
81-280-XL	196	81-504-S	191	81-549-XL	195	81-641-XXL	193	81-900	206	82-160-42	198		
81-280-XXL	196	81-504-XL	191	81-549-XXL	195	81-641-XXXL	193	82-010	198	82-160-43	198		
81-280-XXXL	196	81-504-XXL	191	81-549-XXXL	195	81-642-L	193	82-011	198	82-160-44	198		
81-282-L	196	81-504-XXXL	191	81-550-L	192	81-642-M	193	82-012	198	82-160-45	198		
81-282-M	196	81-506-L	190	81-550-M	192	81-642-XL	193	82-013	198	82-160-46	198		
81-282-S	196	81-506-M	190	81-550-S	192	81-642-XXL	193	82-014	198	82-160-47	198		
81-282-XL	196	81-506-S	190	81-550-XL	192	81-642-XXXL	193	82-015	198	82-161-39	199		
81-282-XXL	196	81-506-XL	190	81-550-XXL	192	81-643-L	193	82-016	198	82-161-40	199		
81-282-XXXL	196	81-506-XXL	190	81-551-L	192	81-643-M	193	82-017	198	82-161-41	199		
81-283-L	196	81-506-XXXL	190	81-551-M	192	81-643-XL	193	82-018	198	82-161-42	199		
81-283-M	196	81-507-L	190	81-551-S	192	81-643-XXL	193	82-020	201	82-161-43	199		
81-283-S	196	81-507-LD	190	81-551-XL	192	81-643-XXXL	193	82-021	201	82-161-44	199		
81-283-XL	196	81-507-M	190	81-551-XXL	192	81-647-L	193	82-022	201	82-161-45	199		
81-283-XXL	196	81-507-S	190	81-551-XXXL	192	81-647-M	193	82-023	201	82-161-46	199		

Ref	p.	Ref	p.	Ref	p.	Ref	p.	Ref	p.	Ref	p.
82-161-47	199	82-712	199	84-234	39	90-070	33	97-621-8	203	99-097	168
82-162-39	200	82-713	199	84-235	39	90-080	33	97-621-9	203	99-098	172
82-162-40	200	82-714	199	84-236	39	90-081	33	97-621-10	203	99-099	172
82-162-41	200	82-715	199	84-237	38	90-082	33	97-630-8	203	99-101	165
82-162-42	200	82-716	199	84-238	38	90-083	33	97-630-9	203	99-102	170
82-162-43	200	82-717	199	84-239	38	90-084	33	97-630-10	203	99-107	168
82-162-44	200	82-718	199	84-240	37	90-085	33	97-631-8	203	99-109	170
82-162-45	200	82-720	200	84-241	39	90-086	33	97-631-9	203	99-112	168
82-162-46	200	82-721	200	84-242	37	90-110	33	97-631-10	203	99-114	170
82-162-47	200	82-722	200	84-243	39	90-111	31	97-640-8	203	99-115	168
82-163-39	199	82-723	200	84-244	37	90-112	31	97-640-9	203	99-200	168
82-163-40	199	82-724	200	84-246	40	90-113	31	97-640-10	203	99-201	168
82-163-41	199	82-725	200	84-247	38	90-114	31	97-641-8	203	GD04	238
82-163-42	199	82-726	200	84-249	40	90-170	119	97-641-9	203	GD05	238
82-163-43	199	82-727	200	84-254	40	90-171	119	97-641-10	203	GD06	238
82-163-44	199	82-728	200	84-255	15	90-172	119	97-642-8	203	GD07	238
82-163-45	199	82-741-39	200	84-256	15	90-173	119	97-642-9	203	GD08	238
82-163-46	199	82-741-40	200	84-257	15	90-174	119	97-642-10	203	GD09	239
82-163-47	199	82-741-41	200	84-259	14	90-175	119	97-643-8	203	GD010	239
82-165-39	201	82-741-42	200	84-264	40	90-176	119	97-643-9	203	GD012	204
82-165-40	201	82-741-43	200	84-266	15	90-177	119	97-643-10	203	GD013	204
82-165-41	201	82-741-44	200	84-267	15	90-178	119	97-690-L	204	GD014	204
82-165-42	201	82-741-45	200	84-268	15	90-179	119	97-690-M	204	GD015	240
82-165-43	201	82-741-46	200	84-269	15	90-180	119	97-690-XL	204	GD016	238
82-165-44	201	82-741-47	200	84-271	13	90-181	119	97-691-L	204	GD017	202
82-165-45	201	82-751-39	200	84-274	13	90-182	119	97-691-M	204	GD018	202
82-165-46	201	82-751-40	200	84-300	19	90-183	119	97-691-XL	204	GD019	202
82-165-47	201	82-751-41	200	84-301	19	90-184	119	99-026	167	GD020	202
82-166-39	201	82-751-42	200	84-302	18	90-185	119	99-027	167	GD021	239
82-166-40	201	82-751-43	200	84-303	18	97-300	205	99-028	167	GD022	239
82-166-41	201	82-751-44	200	84-304	18	97-301	205	99-029	167	GD023	238
82-166-42	201	82-751-45	200	84-305	19	97-311	205	99-032	166	GD024	238
82-166-43	201	82-751-46	200	84-306	18	97-321	205	99-033	165	GD025	238
82-166-44	201	82-751-47	200	84-308	19	97-350	206	99-034	165	GD026	238
82-166-45	201	84-060	16	84-311	18	97-360	206	99-035	165	GD027	238
82-166-46	201	84-061	16	84-315	19	97-361	206	99-036	165	GD028	238
82-166-47	201	84-062	16	84-330	20	97-362	206	99-037	165	GD029	239
82-300	201	84-065	16	84-332	20	97-390	205	99-038	171	GD030	202
82-302	202	84-066	16	84-333	20	97-391	205	99-040	171	GD031	202
82-303	202	84-092	14	84-334	20	97-500	205	99-041	169	GD032	202
82-310	202	84-093	14	84-335	20	97-501	205	99-042	169	GD033	202
82-311	202	84-094	14	84-350	15	97-510	205	99-043	169		
82-312	202	84-095	14	84-401	22	97-513	205	99-044	169		
82-313	202	84-096	14	84-402	22	97-514	205	99-045	166		
82-314	202	84-097	14	84-403	22	97-530	207	99-047	169		
82-315	201	84-098	14	84-404	13	97-535	206	99-048	170		
82-316	201	84-100	17	84-405	22	97-536	206	99-049	173		
82-320	202	84-101	17	84-500	20	97-550	207	99-050	173		
82-321	202	84-102	17	84-501	20	97-551	207	99-051	173		
82-322	202	84-105	17	84-502	21	97-552	207	99-052	173		
82-323	202	84-114	17	84-503	21	97-553	207	99-053	173		
82-324	202	84-115	16	90-001	29	97-554	207	99-054	173		
82-325	201	84-118	17	90-002	29	97-555	207	99-059	174		
82-326	201	84-119	17	90-003	29	97-590	206	99-060	174		
82-327	201	84-130	17	90-009	30	97-602	204	99-061	174		
82-328	201	84-140	22	90-010	30	97-603	204	99-062	174		
82-329	201	84-141	22	90-030	30	97-604	204	99-063	173		
82-350	202	84-142	21	90-031	30	97-605	204	99-064	171		
82-351	202	84-143	21	90-032	31	97-606	204	99-065	169		
82-355	202	84-144	21	90-033	32	97-609-8	203	99-066	170		
82-356	202	84-214	12	90-034	30	97-609-9	203	99-067	166		
82-360	202	84-214-6	37	90-035	31	97-609-10	203	99-068	166		
82-361	202	84-220	12	90-036	32	97-610-8	203	99-069	167		
82-365	202	84-220+G	35	90-037	30	97-610-9	203	99-070	166		
82-366	202	84-221	12	90-038	30	97-610-10	203	99-071	169		
82-700	199	84-221-9	36	90-039	31	97-611	204	99-072	170		
82-701	199	84-222	12	90-060	32	97-615	204	99-073	167		
82-702	199	84-222-9	36	90-061	32	97-616-8	203	99-074	166		
82-703	199	84-222-12	36	90-062	32	97-616-9	203	99-075	166		
82-704	199	84-225	12	90-063	32	97-616-10	203	99-076	171		
82-705	199	84-225+G	35	90-064	32	97-617-8	203	99-077	171		
82-706	199	84-229	13	90-065	32	97-617-9	203	99-078	166		
82-707	199	84-230	37	90-066	32	97-617-10	203	99-093	173		
82-708	199	84-231	38	90-067	32	97-620-8	203	99-094	173		
82-710	199	84-232	38	90-068	32	97-620-9	203	99-095	174		
82-711	199	84-233	39	90-069	32	97-620-10	203	99-096	174		





**NEO**  
TOOLS

**GRAPHITE**