

203-235-1200 | 2 COMMERCE BLVD PALM COAST, FL | SS396.COM

SS396.COM

A GROUND UP MOTORS COMPANY

VOL 25A



Camaro

1967-2023
PARTS & ACCESSORIES
CATALOG

2025



OUR MISSION: WE GET IT CAUSE WE'VE BEEN THERE BEFORE.

Whether you shop online or over the phone you can be confident that our team is devoted to keeping your classic American muscle running and looking its best. With over 30 completed Ground Up restorations under our belt, we don't just sell our parts we use them. That's why we stand behind our products as being the best quality detailing and restoration parts.

“
**Helping Restore
Classic American
Muscle Since 1990**
”

CONTACT US

Call Us:

U.S. & Canada: (866) 358-2277

International: (203)-235-1200

Call Center Hours (ET):

Monday-Thursday: 9am-6pm

Friday: 9am-3pm

Saturday: 9am-1pm

Sunday: Closed

Shop Online 24/7 @ ss396.com

GROUND UP
MOTORS

A proud part of the Ground Up
Motors family of brands

WHY SHOP WITH US?

- **HELP WITH THE PROJECT, NOT JUST THE PART.**

We have thousands of parts available in our inventory, ready to ship. Making it easy for us to help you find the perfect fit and get your project moving.

- **EVERYDAY SUPER SAVINGS!**

We're here to help you save with Free Shipping available all year and exclusive kits and bundles to save you time & money.

- **FAST SHIPPING & SATISFACTION GUARANTEE:**

Most orders are packed, shipped, and delivered within 3 days from Miami to New York and as far West as Colorado and Texas. If you are not satisfied with your purchase you can return it for an exchange or refund.



Table of Contents

INTERIOR PARTS & TRIM.....2-45	HEATING & COOLING.....95-100	LIGHTING.....184-190
STEREO & SPEAKERS.....46-48	ENGINE PARTS.....101-120	LOCKS.....191-192
CONVERTIBLE TOP.....49-50	ENGINE COMPARTMENT.....121-129	EMBLEMS.....193-195
TRUNK.....51	HARDWARE.....130-135	STENCILS & STRIPES.....196-198
WHEELS & TIRES.....52-55	EXTERIOR PARTS & TRIM.....136-152	DECALS & PAINT.....199-201
BRAKES.....56-65	SHEETMETAL & RELATED.....153-168	BOOKS & MANUALS.....202
STEERING & SUSPENSION.....66-80	GLASS.....169-172	INDEX.....203-206
TRANSMISSION.....81-90	WEATHERSTRIP.....173-175	ORDER FORMS & POLICIES.....207-208
FUEL & EXHAUST.....91-94	ELECTRICAL.....176-183	



TRUSTED



BRANDS



THROUGH OUT THE CATALOG



Follow Us on Social Media

Let's Get Connected for Our Latest News & Updates



KEEP A LOOK OUT FOR THESE LOGOS THROUGHOUT THE CATALOG.



BUY & SAVE

WITH SS396.COM PRE-BUILT KITS

Find exclusive products found only at ss396.com. Save yourself the trouble of searching for parts and purchase pre-built kits to save time.

Call Us:

U.S. & Canada: (866) 358-2277 · International: (203)-235-1200

Call Center Hours (ET):

Monday-Thursday: 9am-6pm · Friday: 9am-3pm · Saturday: 9am-1pm · Sunday: Closed

Shop Online 24/7 @ ss396.com



Ground Up Motors Junior Interior Kits

These kits feature "out of the box" pre-assembled door panels from PUI. This means that they are ready to install with moldings and window felts where applicable. Seat covers are also crafted by PUI and feature all of the correct grains, materials and colors as original. We finish off these kits with complete PUI headliner and side sail kits which feature OEM grains and colors and a brand new ACC carpet which duplicates OEM style carpets.

JIKIT-68C	1967 Black Coupe	1063.24 kit
JIKIT-67CV	1967 Black Convertible.....	972.99 kit
JIKIT-68C	1968 Black Coupe.....	1211.44 kit
JIKIT-68CV	1968 Black Convertible	1178.19 kit
JIKIT-69C	1969 Black Coupe.....	1211.44 kit
JIKIT-69CV	1969 Black Convertible	1198.14 kit



Super Interior Kits

Our Super Interior Kit is a no brainer! This kit is perfect when most of your interior is wrecked or missing! All of our kits feature "out of the box" PUI door panels and PUI seat covers.

SUKIT-67F	1967 Black Coupe	1447.02 kit
SUKIT-67FV	1967 Black Convertible.....	1411.11 kit
SUKIT-68F	1968 Black Coupe.....	1579.03 kit
SUKIT-68VF	1968 Black Convertible	1606.41 kit
SUKIT-69F	1969 Black Coupe.....	1579.03 kit
SUKIT-69VF	1969 Black Convertible	1626.36 kit



PUI Standard Seat Cover Kits

Replace your front and rear seat covers all in one shot and save with this specially priced PUI seat cover kit! Each kit includes one set of front PUI front bucket seat covers and a set of rear PUI seat covers to get your interior looking showroom fresh.

IUP-671K	1967-68 Coupe	349.58 kit
IUP-671VK	1967-68 Convertible	349.58 kit
IUP-69K	1969 Coupe.....	349.58 kit
IUP-69VK	1969 Convertible	358.13 kit
IUP-70FK	1970 All	652.63 kit
IUP-71FK	1971-73 All	689.68 kit
IUP-74FK	1974-76 All	654.53 kit
IUP-77FK	1977 All.....	666.88 kit
IUP-78FK	1978-79 All	678.28 kit
IUP-80FK	1980-81 Vinyl.....	654.53 kit

Black only. All seat covers ship Oversize.

Pre-Assembled Seats Are A No Fuss Way To Upgrade Your Interior!



IAS-F69S



IAS-F67D

PUI Pre-Assembled Deluxe Seats

If you're thinking about having your deluxe bucket seats re-upholstered or converting from standard to deluxe interior, consider these pre-assembled DLX bucket seat assemblies instead! These assemblies are COMPLETE with frames, tracks and side covers. These assemblies cost much less than buying all of the separate components and paying an interior shop to put it all together. Simply take them out of the box and bolt them in and you're ready to go!

IAS-F67S	1967-68 Standard.....	2699.99 pr.
IAS-F69S	1969 Standard.....	2699.99 pr.
IAS-F67D	1967 Deluxe.....	2699.99 pr.
IAS-F68D	1968 Deluxe.....	2899.99 pr.
IAS-F69D	1969 Deluxe.....	2799.99 pr.
IAS-F68H	1968 Houndstooth	2899.99 pr.
IAS-F69H	1969 Houndstooth	2899.99 pr.

Head rests are not included. Side covers are currently only available in black and can be painted to match. Please state color at time of order. All seats ship in two Oversize 2 boxes. No Volume Discount.

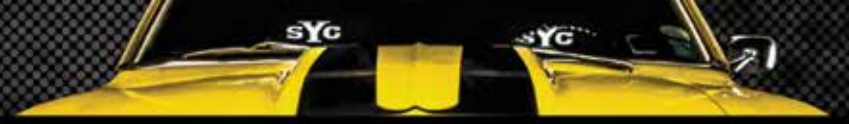

PUI Standard Seat Covers

These PUI seat covers are constructed of the finest quality materials available. These seat covers are perfect for most cars out there whether they are daily drivers or trailer queens.



IUP-671

1967-68 Standard Vinyl

Madrid grain vinyl with dielectrically sealed vertical pleats.



Black	
IUP-671	1967-68 Front Buckets Black.....190.99 pr.
IUP-672	1967-68 Coupe Rear Black176.99 pr.
IUP-672V	1967-68 Convertible Rear Black ..176.99 pr.

Colors

Fill in color code below.

1967-68 Black_10, 1967-68 White_37, 1967 Light Blue_12, 1967 Gold_43, 1967-68 Red_30, 1968 Blue_17, 1968 Ivy Gold_46.

IUP-67FS_U	1967-68 Front Buckets Colors190.99 pr.
IUP-67FS_B	1967-68 Front Bench238.99 pr.
IUP-67FS_C	1967-68 Coupe Rear Colors.....176.99 pr.
IUP-67FS_V	1967-68 Convert Rear Colors176.99 pr.
IUP-67FS_F	1967 Fold Down Rear176.99 pr.
IUP-68FS_F	1968 Fold Down Rear176.99 pr.



IUP-691

1969 Standard Vinyl

Madrid grain vinyl with dielectrically sealed horizontal pleats.



Black	
IUP-691	1969 Front Buckets Black.....190.99 pr.
IUP-692	1969 Coupe Rear Black176.99 pr.
IUP-692V	1969 Convertible Rear Black185.99 pr.

Colors

Fill in color code below.

Black_10, Dark Blue_16, Light Green_23, Dark Metallic Green_24, Red_30, White_37.

IUP-69FS_U	1969 Front Buckets Colors190.99 pr.
IUP-69FS_C	1969 Coupe Rear Colors.....176.99 pr.
IUP-69FS_V	1969 Convertible Rear Colors176.99 pr.
IUP-69FS_F	1969 Fold Down Rear176.99 pr.



IUP-1027

1970 Standard Vinyl

Madrid grain vinyl with Laredo grain vinyl inserts and dielectrically sealed vertical pleats.

Black

IUP-1027	Front Buckets Black.....389.99 pr.
IUP-1032	Rear Black.....296.99 pr.

Colors

Fill in color code below.

Black_10, Bright Blue_14, Dark Metallic Green_24, Saddle_36 & Sandalwood_41.

IUP-70FS_U	1970 Standard Buckets Colors389.99 pr.
IUP-70FS_C	1970 Rear Colors281.99 pr.



IUP-711

1971-73 Standard Vinyl

Madrid grain vinyl with Elk grain vinyl inserts and sewn inserts.

Black

IUP-711	Black Front Buckets.....494.99 pr.
IUP-732	Black Rear230.99 pr.

Colors

Fill in color code below.

1971-73 Black_10, 1971-72 Blue_09, 1971 Jade Green_19, 1971 Sandalwood_41, 1971 Dark Blue_16, 1971, 1973 Dark Saddle_42, 1972-73 Dark Green_25, 1972-73 Covert_29, 1972 White_37, 1972 Tan_47.

IUP-71FS_U	Buckets (Buttons Included)470.99 pr.
IUP-71FS_C	Rear (Buttons Included)230.99 pr.

1974-76 Standard Vinyl

Madrid grain vinyl with Elk grain vinyl inserts and sewn inserts.

Colors

Fill in color code below.

1974-76 Black_10, 1974 Bright Red_32, 1974 Light Saddle_35, 1975-76 White_37, 1975 Sandalwood_41, 1975 Dark Saddle_42, 1976 Firethorn_45 and 1976 Saddle_36.

IUP-74FS_U	Buckets (Buttons Included)461.99 pr.
IUP-74FS_C	Rear226.99 pr.

1977 Standard Vinyl

Sierra grain vinyl with Elk grain vinyl inserts and sewn inserts.

Colors

Fill in color code below.

Black_70, Saddle_36, White_37, Camel_48, & Firethorn_45.

IUP-77FS_U	Buckets (Buttons Included)470.99 pr.
IUP-77FS_C	Rear230.99 pr.

1978-79 Standard Vinyl

Sierra grain vinyl with Elk grain vinyl inserts and sewn inserts with zipper on back. Buttons are included.

Colors

Fill in color code below.

1978-79 Black_70, 1978 White_37, 1978-79 Carmine_38, 1978-79 Camel_48 & 1979 Light Blue_90.

IUP-78FS_U	Front Buckets470.99 pr.
IUP-78FS_C	Rear242.99 pr.

1980-81 Standard Vinyl

Sierra grain vinyl with Elk grain vinyl inserts and sewn inserts with zipper on back and smooth headrest area. Buttons are included.

Colors

Fill in color code below.

Black_70, Navy Blue_18, Light Saddle_35, Carmine_38, Camel_48, Silver_66, Bright Red_77, Oyster_86 & White_37.

IUP-80FS_U	Front Buckets461.99 pr.
IUP-80FS_C	Rear226.99 pr.



IUP-71FSC10U

1971-77 Standard Cloth

Replacement style covers are just like the original standard vinyl seats but feature Madrid grain vinyl sides with full Empress cloth seat facings. The result is a very comfortable seat which still has that original muscle car look!

Colors

Fill in color code below.

Black_10, Light Blue_12, Dark Blue/Navy_18, Dark Red_30, Buckskin_36 & Camel_48.

IUP-71FSC_U	Front Buckets475.99 pr.
IUP-71FSC_C	Rear407.99 pr.



IUP-80FSC10U

1980 Standard Cloth

Sierra grain vinyl with Empress cloth inserts and sewn inserts with vertical pleats and zipper on back.

Colors

Fill in color code below. Black_70, Dark Blue_18 & Camel_48.

IUP-80FSC_U	Front Buckets475.99 pr.
IUP-80FSC_C	Rear319.99 pr.

1981 Standard Cloth

Sierra grain vinyl with Millport cloth inserts and sewn inserts with vertical pleats and zipper on back.

Colors

Fill in color code below. Charcoal_70, Dark Blue_18 & Camel_48.

IUP-81FSC_U	Front Buckets475.99 pr.
IUP-81FSC_C	Rear319.99 pr.



IUP-675

1967 Deluxe Vinyl

Madrid grain vinyl with dielectrically sealed inserts featuring horizontal stitchbar pleats and contrasting accent band border.

IUP-675	Front Buckets	359.99 pr.
IUP-675B	Front Bench w/ Arm Rest	359.99 pr.
IUP-677	Stationary Coupe/Convertible	224.99 pr.
IUP-677F	Fold Down Rear	224.99 pr.

Available in: Black/White, Aqua/Dark Aqua, Bright Blue/White, Red/Black, Off White/Black and Gold/White.



IUP-685

1968 Deluxe Comfortweave

Madrid grain vinyl with dielectrically sealed horizontal pleats.

IUP-685	Front Buckets	438.99 pr.
IUP-685B	Front Bench w/ Arm Rest	438.99 pr.
IUP-686	Coupe Rear	255.99 pr.
IUP-686V	Convertible Rear	268.99 pr.
IUP-686F	Fold Down Rear	255.99 pr.

Available in: Black, Aqua, 68 Blue, Pearl, Red and Ivy Gold.



IUP-068

1968 Deluxe Houndstooth

Madrid grain vinyl with Houndstooth cloth inserts and sewn horizontal pleats.

IUP-068	Front Buckets	499.99 pr.
IUP-168	Coupe Rear	319.99 pr.
IUP-168V	Convertible Rear	319.99 pr.
IUP-168F	Fold Down Rear	319.99 pr.

Available in: Black, White and Pearl.



1968 Deluxe Seat Emblems

Correct with mounting tabs to be folded as original. The retainers allow for the correct recessed look. Does two buckets.

ISE-68DX	1968 Deluxe.....	99.99 kit
----------	------------------	-----------



IUP-695

1969 Deluxe Comfortweave

Madrid grain vinyl with simulated Comfortweave inserts and sewn vertical pleats. Buttons are included.

IUP-695	Front Buckets	427.99 pr.
IUP-696	Coupe Rear	310.99 pr.
IUP-696V	Convertible Rear	326.99 pr.
IUP-696F	Fold Down Rear	310.99 pr.

Available in: Black, Dark Blue, Light Green, Dark Metallic Green, White and Red.



IUP-169

1969 Deluxe Houndstooth

Madrid grain vinyl with Houndstooth cloth inserts and sewn vertical pleats. Buttons are included.

IUP-169	Front Buckets	469.99 pr.
IUP-269	Coupe Rear	279.99 pr.
IUP-269V	Convertible Rear	279.99 pr.
IUP-269F	Fold Down Rear	279.99 pr.

Available in: Black w/ White Houndstooth, Orange w/ Black Houndstooth & White w/ Black Houndstooth.



IUP-701

1970 Deluxe Comfortweave

Madrid grain vinyl with simulated Comfortweave inserts and sewn vertical pleats with horizontal trim strips.

IUP-701	Front Buckets	427.99 pr.
IUP-702	Rear	348.99 pr.

Available in: Black, Bright Blue, Dark Metallic Green, Sandalwood & Saddle.



IUP-70DSC10U

1970 Checkerboard Cloth

Madrid grain vinyl with Checkerboard cloth inserts and double stitched vertical pleats with horizontal trim strips.

IUP-70DSC10U	Front Buckets	519.99 pr.
IUP-70DSC10C	Rear	419.99 pr.



IUP-71DSC10U

1971 Checkerboard Cloth

Madrid grain vinyl with Checkerboard cloth inserts and sewn vertical pleats with horizontal trim strips. Buttons are included.

IUP-71DSC10U	Front Buckets	548.99 pr.
IUP-71DSC10C	Rear	432.99 pr.



IUP-3LTF

1973 LT

Madrid grain vinyl with simulated Comfortweave inserts and sewn vertical pleats. Buttons are included.

IUP-3LTF	Front Buckets	427.99 pr.
IUP-3LTR	Rear	348.99 pr.

Available in: Black and Sandalwood.



PUI Deluxe & Houndstooth Seat Cover Kits

Replace your front and rear seat covers all in one shot and save with this specially priced PUI seat cover kit! Each kit includes one set of front PUI bucket seat covers and a set of rear PUI seat covers to get your interior looking showroom fresh.

IUP-675K	1967 Coupe Deluxe	555.73 kit
IUP-675VK	1967 Convertible Deluxe	555.73 kit
IUP-685K	1968 Coupe Deluxe	660.23 kit
IUP-685VK	1968 Convertible Deluxe	672.58 kit
IUP-068K	1968 Coupe Houndstooth	778.98 kit
IUP-068VK	1968 Convertible Houndstooth	778.98 kit
IUP-695K	1969 Coupe Deluxe	702.03 kit
IUP-695VK	1969 Convertible Deluxe	717.23 kit
IUP-169K	1969 Coupe Houndstooth	712.48 kit
IUP-169VK	1969 Convertible Houndstooth	712.48 kit
IUP-701K	1970 Coupe Deluxe	738.13 kit

Please state color at time of order. All seat covers ship Oversize. No Volume Discount.





IUP-76DSC10U

1976 LT Custom Cloth

Madrid grain vinyl with Empress cloth seat facing and sewn grid with horizontal and vertical lines.

IUP-76DSC10U Front Buckets 470.99 pr.
IUP-76DSC10C Rear 295.99 pr.

Available in: Black and Red.



IUP-77DS70U

1977 LT Custom Vinyl

Sierra grain vinyl with Plisse grain inserts and sewn grid with horizontal and vertical lines.

IUP-77DS70U Front Buckets 470.99 pr.
IUP-77DS70C Rear 295.99 pr.

Available in: Black, Buckskin, White and Light Blue.



IUP-77DSC70U

1977-78 LT Custom Cloth

Sierra grain vinyl with Empress cloth inserts and sewn grid with horizontal and vertical lines.

IUP-77DSC70U Front Buckets 470.99 pr.
IUP-77DSC70C Rear 295.99 pr.

Available in: Black, Buckskin, Carmine, Firethorn, Camel and Light Blue.



IUP-78DS70U

1978 LT Custom Vinyl

Sierra grain vinyl inserts with Rattan grain inserts and sewn grid with horizontal and vertical lines with zipper on back.

IUP-78DS70U Front Buckets 470.99 pr.
IUP-78DS70C Rear 295.99 pr.

Available in: Black, White, Carmine and Camel.



IUP-79DS70U

1979 Berlinetta Custom Vinyl

Sierra grain vinyl with Rattan vinyl inserts and zipper on back.

IUP-79DS70U Front Buckets 470.99 pr.
IUP-79DS70C Rear 295.99 pr.

Available in: Black, Carmine, Camel and Light Blue.



IUP-77DS70U

1979 Berlinetta Custom Cloth

Sierra grain vinyl with Empress cloth inserts and zipper on back.

IUP-79DSC70U Front Buckets 470.99 pr.
IUP-79DSC70C Rear 295.99 pr.

Available in: Black, Carmine, Camel and Light Blue.



IUP-80DS70U

1980-81 Berlinetta Custom Vinyl

Sierra grain vinyl with Derma grain vinyl inserts and zipper on back.

IUP-80DS70U Front Buckets 531.99 pr.
IUP-80DS70C Rear 295.99 pr.

Available in: Black, Navy, Carmine, Camel, Silver, Bright Red and Oyster.

1980-81 Berlinetta Custom Cloth

Sierra grain vinyl with Derma grain vinyl inserts and zipper on back.

IUP-80DSC70U Front Buckets 505.99 pr.
IUP-80DSC70C Rear 295.99 pr.

Available in: Black, Navy, Carmine, Camel, Silver, Bright Red and Oyster.

1982-83 Berlinetta Custom

Colors

Fill in color code below. Light Gray_02, Dark Blue_03

IUP-82DSC_U 1982-83 Berlinetta Front 475.99 pr.
IUP-82DSC_U 1982-83 Berlinetta Rear 400.99 pr.



IUP-82FS38C

1982-85 Standard Vinyl

IUP-82FS38U

Colors

Fill in color code below. Black_70, Dark Blue_18, Camel_48, Red_38

IUP-82FS_U 1982-85 Standard Buckets 319.99 pr.
IUP-82FS_C 1982-85 Standard Rear 319.99 pr.



IUP-82FSC70U

1982-85 Cloth

Colors

Fill in color code below.

Maroon_01, Blue_18, Camel_48, Red_38, Charcoal_70, Gray_02, Black_10
IUP-82FSC_U 1982-85 Cloth Bucket 475.99 pr.
IUP-82FSC_C 1982-85 Cloth Rear 319.99 pr.



IUP-82DSP66U

1982-88 Indy 500 Pace Car

IUP-82DSP66U 1982 Buckets Leather 1199.99 pr.
IUP-82DSP66U 1982 Buckets Vinyl 971.99 pr.

Colors

IUP-84DSC_U 1984-86 Z/28 Deluxe 688.99 pr.
Camel_36, Gray_02, Red_38
IUP-84DSC_C 1984-86 Custom Rear 541.99 pr.
Camel_36, Gray_02, Red_38
IUP-84DSC_CA 1984-86 Rear Split Back 696.99 pr.
Camel_36, Gray_02, Red_38
IUP-88DSC_U 1988-92 Deluxe Cloth 714.99 pr.
Gray_02, Red_38
IUP-88DSC_C 1988-92 Rear Fold Down 541.99 pr.
Gray_02, Red_38

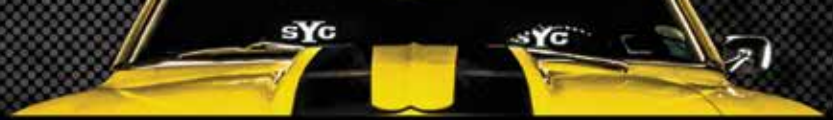

Bucket Seat Backs

OE style reproduction seat backs which will replace your originals. 1967 Camaros originally came with metal seat backs but these will fit as original.

ICI-1021	1967-70 Black.....	74.99 pr.
ICI-1021FSB14	1967-70 Bright Blue.....	186.99 pr.
ICI-1021FSB16	1967-70 Dark Blue.....	186.99 pr.
ICI-1021FSB24	1967-70 Dark Green.....	177.99 pr.
ICI-1021FSB30	1967-70 Red.....	177.99 pr.
ICI-1021FSB37	1967-70 White.....	177.99 pr.
ICI-1021FSB26	1967-70 Orange.....	177.99 pr.
ISB-717	1971-77 Black.....	151.99 pr.
ISB-71714	1971-77 Bright Blue.....	177.99 pr.
ISB-71716	1971-77 Dark Blue.....	177.99 pr.
ISB-71724	1971-77 Dark Green.....	177.99 pr.
ISB-71730	1971-77 Red.....	177.99 pr.
ISB-71742	1971-77 Dark Saddle.....	177.99 pr.
ISB-71737	1971-77 White.....	177.99 pr.
ISB-7881	1978-81 Black.....	99.99 ea.
ISB-7881K	1978-81 Black Set.....	199.98 pr.
ISB-7881-BL	1978-81 Blue.....	99.99 ea.
ISB-7881-RD	1978-81 Red.....	99.99 ea.

No Volume Discount. Ships Oversize.



ICI-1021



ISB-717



ISF-71FU

Seat Foams

Correct density injection molded foam. Each set contains one back and one bottom.

ISF-10	1967-68 Standard.....	84.99 ea.
ISF-10K	1967-68 Standard 2 seats...	169.98 kit
ISF-20	1967 Deluxe.....	79.99 ea.
ISF-20K	1967 Deluxe 2 seats.....	143.98 kit
ISF-40	1968 Deluxe.....	123.99 ea.
ISF-40K	1968 Deluxe 2 seats.....	223.18 kit
ISF-20	1969 Standard.....	79.99 ea.
ISF-20K	1969 Standard 2 seats.....	143.98 kit
ISF-70	1969 Deluxe.....	149.99 ea.
ISF-70K	1969 Deluxe 2 seats.....	299.98 kit
ISF-70FU	1970 Standard/Deluxe.....	215.99 ea.
ISF-71FU	1971-81 Standard.....	174.99 ea.
ISF-71FU	1971-73 Deluxe.....	174.99 ea.
ISF-78FU	1978-81 Deluxe.....	204.99 ea.
ISF-BUN8292FEU	1982-92 Standard.....	204.99 ea.
ISF-BUN8492DU	1984-92 Deluxe.....	204.99 ea.
ISF-BUN823PU-PR	1982 Pace Car.....	414.99 ea.
ISF-BUNREAR	1967-69 Rear.....	69.99 ea.
ISF-70FR	1970-81 Rear.....	326.99 kit
ISF-BUN8292FEFC	1982-92 Rear Solid Back....	326.99 ea.
ISF-BUN8292FECS	1982-92 Rear Split Back....	326.99 ea.

Ships Oversize 2.

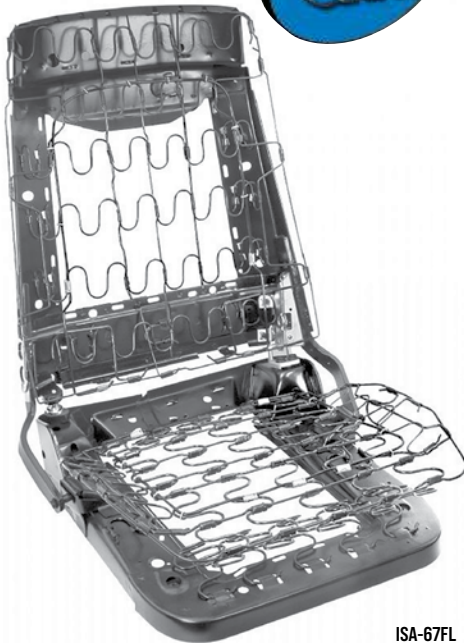

ISA-67FL

Bucket Seat Frame

Complete bucket seat frame with springs installed. Highest quality on the market!

ISA-67FL	1967-68 LH.....	354.99 ea.
ISA-67FR	1967-68 RH.....	354.99 ea.
ISA-67F	1967-68 Set LH/RH.....	899.99 kit
ISA-69FL	1969 LH.....	364.99 ea.
ISA-69FR	1969 RH.....	364.99 ea.
ISA-69F	1969 Set LH/RH.....	999.99 kit

1969 requires headrest hardware, sold separately.

No Volume Discount. Ships Oversize 2.

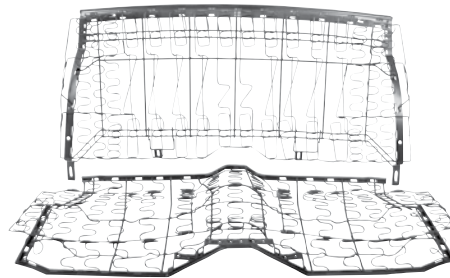

ISF-1052G

Rear Seat Frames

Complete rear seat frame assembly with springs. Excellent for converting from standard interior to deluxe interior.

ISF-1052G	1967-69 Std Coupe, 1968-69 Dlx Coupe.....	669.99 ea.
ISF-1052H	1967-69 Std Convertible, 1967 Dlx Coupe, 1968-69 Dlx Convertible.....	689.99 ea.

No Volume Discount. Ships Oversize 2.

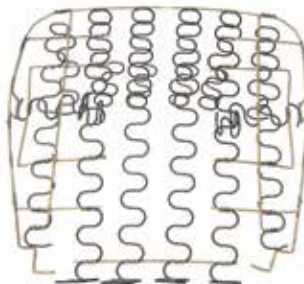

IZ-204

Bucket Seat Springs

Restore the comfort of your buckets with brand new springs!

IZ-201	1967-69 Bottom.....	89.99 ea.
IZ-202	1967-69 Back.....	69.99 ea.
IZ-104	1967-69 Side Support.....	24.99 kit

No Volume Discount. Ships Oversize.



ISC-8X

Rear Fold Down Seat Carpet

Correct 80/20 Rayon/Nylon looped carpet for the optional fold down seat partition.

ISC-8X	1967-68.....	43.95 ea.
ISC-9X	1969.....	43.95 ea.

Available in: Black, Red, Bright Blue, Gold, Turquoise (Aqua), Medium Blue (68 Blue), Ivy Gold, Dark Blue and Dark Green.



Rear Fold Down Seat Partition

Correct divider board

ISP-7X	1967	32.99 ea.
ISP-8X	1968-69	32.99 ea.

Available in: Black, Bright Blue, Red, Light Blue, Dark Blue, Light Blue, Light Green, Dark Green. Ships Oversize 1.



Rear Fold Down Seat Partition Holder

Correct holder which attaches behind the rear seat and holds the bottom of the fold down rear seat partition in place.

IK-410	1967-69	44.99 ea.
--------	---------	-----------



Rear Fold Down Seat Brackets

Correct rear fold down seat brackets which weld or bolt to the floor pan.

IFD-1B	1967-69	59.99 pr.
--------	---------	-----------



Rear Fold Down Seat Latches

OE style reproduction latches for fold down rear seat.

IC-465	1967	14.99 pr.
ICC-69L	1968-69	59.95 ea.



Rear Fold Down Seat Rubber Stoppers

Correct rubber stoppers for fold down rear seat.

ISS-7X	1967	14.99 pr.
ISS-8X	1968-69	11.99 pr.



Seat Cover Installation Kit

Complete set of hog rings and pliers for seat cover installation.

IHG-7	All	16.95 kit
-------	-----	-----------



ISB-735

Bucket Seat Back Retainers

New seat back retainers featuring the correct gauge steel stamping as original. These retainers work with both plastic and metal style seat backs and also allows plastic style panels to be installed on 67 seat frames.

ISB-735	1967-69 All	17.99 pr.
---------	-------------	-----------

Metal style seat backs require 1 retainer per seat, while the 68-69 plastic style seat backs require 2 per seat. Hardware not included.



Side Hinge Covers

OE style reproduction injection molded plastic covers used to cover the brackets between the tops and bottoms of the seats.

ICI-20	1967-70 Buckets	24.99 pr.
ICI-20CLIP	1967-70 Clips	5.99 pr.
IT-39200	1971-81 Buckets	49.99 pr.



ICQ-387

Seat Back Stoppers

Correct rubber coated steel seat stoppers.

ICQ-387	1967-70 Buckets	7.99 pr.
ICQ-67B	1967-70 OE Style Bolt	9.99 pr.



ILH-67FL

Seat Back Latch Hook

Used to secure the seat back in place.

ILH-67FL	1967-69 LH	14.99 ea.
ILH-67FR	1967-69 RH	14.99 ea.



ISL-1052C

Seat Back Latches

Correct seat back latches which mount to the back of the seat and latches to the seat bottom.

ISL-1052D	1968-69 LH	59.99 ea.
ISL-1052C	1968-69 RH	59.99 ea.



ICI-75

Seat Back Chrome Locking Knob

Correct chrome knob used to tilt the seat forward and backward.

ICI-75	1967-70 Buckets	7.99 ea.
--------	-----------------	----------



ICI-315

ICE-4636

Seat Adjustment Knobs

ICI-315	1967-81 Chrome	8.99 ea.
ICE-4636	1967-81 Black	6.99 ea.



IST-1054A



BST-12655

Bucket Seat Tracks and Bolts

Beautiful reproduction seat tracks.

IST-1054A	1967-69 LH 2pc	89.99 ea.
IST-1054	1967-69 RH 2pc	89.99 ea.
IST-7074	1970-74 All LH/RH	164.99 pr.
IST-7581L	1975-81 All LH	219.99 pr.
IST-7581R	1975-81 All RH	219.99 pr.
BST-12655	1967-69 8pc	16.99 kit

*Note: Buckets use all 8 and bench uses 4.



ISE-679

Bucket Seat Track Extenders

These extenders mount to the floor on the drivers side and offset the seat tracks about two inches giving the driver more leg room.

ISE-679	1967-69 Driver Side	109.99 pr.
---------	---------------------	------------

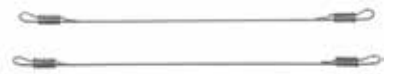

IZ-7581

Seat Release Cables

Reproduction seat release cable front bucket seats release the seat track when the seat track adjustment knob is engaged. Designed for manual style seat tracks only. 1 pair required per vehicle.

IZ-7581	1975-81	42.99 pr.
---------	---------	-----------

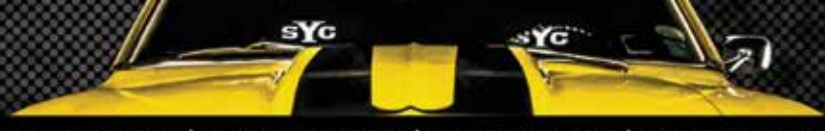

GM Push Button Style



Bowtie Lift Latch Style



GM Plastic Push Button Style



Starburst Push Button Style



Chrome Lift Latch Style

Vintage Style Seat Belts

Now you can have the styling of muscle-era GM seat belts without the high price! Choose from plain chrome lift latch style belts, Starburst push button style belts, Bowtie logo lift latch belts, or GM push button style *Remanufactured belts. Any of these belts will look right at home in your muscle car. Available individually or as a complete 4 piece kit! Hardware is included with all vintage style seat belts. Fill blank with your color choice. Colors are special order and are non-returnable. See ss396.com for color swatches. Not all colors available for all styles.

- SBL-1800-___-74 **Chrome Lift Latch Style**
74" All F/R 34.99 ea.
- SBL-1800-1000-K **Chrome Lift Latch Style (black only)**
4 Piece (2) 74" & (2) 60"125.96 kit
- SBL-1256-___-74 **Starburst Push Button Style**
74" All F/R 29.99 ea.
- SBL-1256-1000-K **Starburst Push Button Style (black only)**
4 Piece (2) 74" & (2) 60" 107.96 kit
- SBL-1205-___-74 **GM Push Button Style***
74" All F/R 54.99 ea.
- SBL-1205-1000-K **GM Push Button Style* (black only)**
4 Piece (2) 74" & (2) 60"197.96 kit
- SBL-305-___-74 **GM Plastic Push Button Style***
74" All F/R75.99 ea.
- SBL-305-1000-K **GM Plastic Push Button* (black only)**
4 Piece (2) 74" & (2) 60"251.96 kit
- SBL-1803-___-74 **Bowtie Lift Latch Style**
74" All F/R 59.99 ea.
- SBL-1803-1000-K **Bowtie Lift Latch Style (black only)**
4 Piece (2) 74" & (2) 60"215.96 kit

- | | | |
|-------------------|----------------------|-----------------------|
| Black = 1000 | Desert Tan = 3009 | Dark Blue = 4004 |
| Flame Red = 2006 | Electric Blue = 4000 | Lime Green = 5004 |
| Red = 2007 | Powder Blue = 4005 | Dark Green = 5006 |
| Red Wine = 2009 | Cobalt Blue = 4006 | Charcoal = 6009 |
| Purple = 2010 | Silver = 6007 | Orange = 7001 |
| Tan = 3000 | Ivory = 8000 | White = 9000 |
| Brown = 3004 | Grey = 6005 | Blue = 4002 |
| Dark Brown = 3005 | Maroon = 2008 | Turquoise = 4009 |
| Med. Beige = 3008 | | Military Green = 5002 |



Shown with GM logo buckles.

1967-73 3 Point Front Seat Belts

Add comfort and safety to your muscle car while still keeping a stock look with Ground Up Motors's 3 point retractable seat belts! These three point belts feature a vintage style lap belt and chest belt so you can have new car safety with old car looks. Each kit includes two seat belts, grade 8 mounting hardware and powdercoated mounting brackets all assembled and ready to bolt in to your Camaro. Instructions are also included. These seat belts mount in the factory locations, meaning there is no drilling required. Seat belts meet FMVSS standards. Fill blank with your color choice.

Front 3 Point Seat Belt Conversion

- SBL-67CA3F- 1967-69 Front w/ Starburst Logo ..431.99 kit
- SBL-67CA3FGM- 1967-69 Front w/ GM Logo*591.99 kit
- SBL-70CA3F- 1970-73 Front w/ Starburst Logo ..431.99 kit

Colors are special order and are non-returnable. See ss396.com for color swatches. Not all colors available for all styles. Ask your sales rep for color availability.

- | | | |
|-------------------|----------------------|-----------------------|
| Black = 1000 | Desert Tan = 3009 | Dark Blue = 4004 |
| Flame Red = 2006 | Electric Blue = 4000 | Lime Green = 5004 |
| Red = 2007 | Powder Blue = 4005 | Dark Green = 5006 |
| Red Wine = 2009 | Cobalt Blue = 4006 | Charcoal = 6009 |
| Purple = 2010 | Silver = 6007 | Orange = 7001 |
| Tan = 3000 | Ivory = 8000 | White = 9000 |
| Brown = 3004 | Grey = 6005 | Blue = 4002 |
| Dark Brown = 3005 | Maroon = 2008 | Turquoise = 4009 |
| Med. Beige = 3008 | | Military Green = 5002 |



Recommended Hardware

- BSB-5-SBL Bolt Fully Threaded 6.99 ea.



IK-320

1967-69 Standard Seat Belts

OE style reproduction lap belts with correct high grade, blow formed ABS housings, web designed belt with correct patterned stitching and correct seat belt retractor/roller assembly.

- IK-319 1967-69 Standard Front 159.99 ea.
- IK-320 1967-69 Standard Rear 129.99 ea.
- IR-173 1967-69 Standard Set 2 Front/Rear 638.95 kit

No Volume Discount.



IK-316

1967 Deluxe Seat Belts

OE style reproduction lap belts with correct retractor, seat belt and buckle assembly with Fisher coach emblem.

- IK-316 1967 Deluxe Front 159.99 ea.
- IK-316R 1967 Deluxe Rear 159.99 ea.
- IR-172 1967 Deluxe Set 2 Front/3 Rear 719.95 kit

No Volume Discount.



IK-315

1968-69 Deluxe Seat Belts

OE style reproduction seat belts with correct retractor, seat belt and buckle assembly with GM emblem.

- IK-315 1968-69 Deluxe Front 159.99 ea.
- IK-315R 1968-69 Deluxe Rear 49.99 ea.
- IR-171 1968-69 Deluxe Set 2 Front/3 Rear 422.95 kit

No Volume Discount.

* Remanufactured. This means the product has been dismantled and reconstructed as necessary. All of its internal and external parts have been cleaned and made rust and corrosion-free. All impaired, defective, or substantially worn parts are restored to sound condition or replaced with new, "rebuilt" or "unimpaired" used parts. All missing parts are replaced with new, rebuilt, or unimpaired used parts.

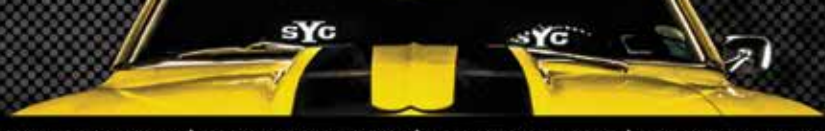

Standard Style GM Logo Seat Belts

OE style remanufactured* seat belt set featuring correct retractor, seat belt and buckle assembly with GM emblem.

Front Sets Lap

SBL-CAM67692007S	1967-69 Red.....	422.99 pr.
SBL-CAM67694002S	1967-69 Blue.....	422.99 pr.
SBL-CAM67695002S	1967-69 Green	422.99 pr.

Front & Rear Sets Lap

SBL-CAM6769FR1000S	1967-69 Black.....	638.95 kit
SBL-CAM6769FR2007S	1967-69 Red.....	535.99 kit
SBL-CAM6769FR4002S	1967-69 Blue.....	535.99 kit
SBL-CAM6769FR5002S	1967-69 Green	535.99 kit.

Front & Rear Sets Lap & Shoulder

SBL-CAM6769KIT1000S	1967-69 Black.....	781.99 kit
SBL-CAM6769KIT2007S	1967-69 Red.....	781.99 kit
SBL-CAM6769KIT4002S	1967-69 Blue.....	781.99 kit
SBL-CAM6769KIT5002S	1967-69 Green	781.99 kit

Front Shoulder Sets

SBL-CAM6769SH2007S	1967-69 Red.....	275.99 pr.
SBL-CAM6769SH4002S	1967-69 Blue.....	275.99 pr.
SBL-CAM6769SH5002S	1967-69 Green	275.99 pr.

No Volume Discount.

Deluxe Style GM Logo Seat Belts

OE style remanufactured* seat belt set featuring correct retractor, seat belt, and buckle assembly with GM emblem.

Front Sets Lap

SBL-CAM67692007P	1967-69 Red	447.99 pr.
SBL-CAM67694002P	1967-69 Blue	447.99 pr.
SBL-CAM67695002P	1967-69 Green	447.99 pr.

Front & Rear Sets Lap

SBL-CAM6769FR1000P	1967-69 Black.....	422.95 kit
SBL-CAM6769FR2007P	1967-69 Red	558.99 kit
SBL-CAM6769FR4002P	1967-69 Blue	558.99 kit
SBL-CAM6769FR5002P	1967-69 Green	558.99 kit

Front & Rear Sets Lap & Shoulder

SBL-CAM6769KIT1000P	1967-69 Black.....	803.99 kit
SBL-CAM6769KIT2007P	1967-69 Red	803.99 kit
SBL-CAM6769KIT4002P	1967-69 Blue	768.99 kit
SBL-CAM6769KIT5002P	1967-69 Green	768.99 kit

Front Shoulder Sets

SBL-CAM6769SH2007P	1967-69 Red	316.99 pr.
SBL-CAM6769SH4002P	1967-69 Blue	316.99 pr.
SBL-CAM6769SH5002P	1967-69 Green	316.99 pr.

No Volume Discount.



Standard Seat Belt Covers

Factory replacement plastic seat belt cover.

IBC-672B	1967-72 Black.....	17.99 ea.
IBC-672R	1967-72 Red.....	17.99 ea.
IBC-672G	1967-72 Green	17.99 ea.
IBC-672BL	1967-72 Blue.....	17.99 ea.



IBR-732

Shoulder Belt Retainers

Correct roof mounted shoulder belt retainers.

IBR-732	1968-70 All	17.99 set
---------	-------------------	-----------



BSB-56

BSB-561

Seat Belt Bolts

Correct shanked style seat belt bolts.

BSB-56	All Front Outer.....	6.99 ea.
BSB-56	1967-68 Front Inner.....	6.99 ea.
BSB-561	1969-72 Front Inner.....	6.99 ea.
BSB-561	All Rear.....	6.99 ea.
BSB-5-SBL	1967-81 No Shoulder *	6.99 ea.

*Threaded all the way



ISB-6789

Seat Belt Retainers

Before seatbelt retractors, these clips held your seatbelt stored along your headliner.

ISB-6789	1970-71.....	48.99 pr.
----------	--------------	-----------



Original Style Retractable Seat Belts

OE style belts feature a correct fit and function like your factory originals. These belts feature the correct front retractors and GM logo like originals. Also available for the first time; correct factory shoulder harness belts. Made in the USA

SBL-6769-1000	1967-69 Front Lap Belts	
	GM Buckle	377.99 set
SBL-6769FR1000	1967-69 Front & Rear	
	Lap Belts GM Buckle.....	539.99 set
SBL-6769KIT1000	1967-69 Front & Rear Lap	
	Belts w/ Shoulder Harness	759.99 set
SBL-6769SH1000	1967-69 Front Shoulder	
	Harnesses.....	253.99 set



ISB-781RD



1974-81 Seat Belt Set

This is a set of factory style seat belts. This four person seat belt set has been assembled with factory three panel webbing with retractors and factory buckles. Perfect for restoring your interior!

ISB-781BK	1974-81 Black	399.95 kit
ISB-781TN	1974-81 Tan	439.99 kit
ISB-781SL	1974-81 Silver	399.95 kit
ISB-781RD	1974-81 Red	399.95 kit
ISB-781BB	1974-81 Bright Blue	399.95 kit
ISB-781MR	1974-81 Maroon	399.95 kit
ISB-781NB	1974-81 Navy Blue	399.95 kit

No Volume Discount.

* Remanufactured. This means the product has been dismantled and reconstructed as necessary. All of its internal and external parts have been cleaned and made rust and corrosion-free. All impaired, defective, or substantially worn parts are restored to sound condition or replaced with new, "rebuilt" or "unimpaired" used parts. All missing parts are replaced with new, rebuilt, or unimpaired used parts.



IN-337

Seat Belt Cover Trim

Correct seat belt trim panels. Black in color. Paint to match.

IN-337	1978-81 w/ T-Tops.....	99.99 pr.
IEG-78F	1978-81 Escutcheon Cover Black	9.99 ea.



IGE-74R

Shoulder Belt Guide Escutcheon

Holds the shoulder belt retainer to the upper portion of the bucket seat back.

IGE-74L	1974-81 LH.....	12.99 ea.
IGE-74R	1974-81 RH.....	12.99 ea.



ILG-73RGRN



ILG-73TGRN

Seat Belt Loop Guides

Choose from either triangle or rectangle style.

Triangle

ILG-73TBLK	1973-81 Black.....	12.99 ea.
ILG-73TBLU	1973-81 Blue.....	12.99 ea.
ILG-73TRED	1973-81 Red.....	12.99 ea.
ILG-73TTAN	1973-81 Tan.....	12.99 ea.
ILG-73TWTE	1973-81 White.....	12.99 ea.
ILG-73TGRN	1973-81 Green.....	12.99 ea.

Rectangle

ILG-73RBLK	1973-81 Black.....	12.99 ea.
ILG-73RBLU	1973-81 Blue.....	12.99 ea.
ILG-73RRED	1973-81 Red.....	12.99 ea.
ILG-73RTAN	1973-81 Tan.....	12.99 ea.
ILG-73RWTE	1973-81 White.....	12.99 ea.
ILG-73RGRN	1973-81 Green.....	12.99 ea.



ILG-8589BLK

1985-89 Seat Belt Loop Guides

Correct seat belt guides for 1985-1989 Camaro. Black. Paint to match.

ILG-8589BLK	All Black.....	44.99 pr.
-------------	----------------	-----------



ISB-67



ISB-69

Seat Belt Holders

New seat belt holders which attach to console.

ISB-67	1967.....	22.99 pr.
ISB-69	1968-69.....	14.99 ea.



SBL-BLADE



INL-15060



INL-15062



INL-15063

Standard Seat Belt Blade & Hardware

This male blade piece is used on the end of the seat belt lap belt to snap into the female receiver for both front and rear belts.

SBL-BLADE	1967-72 Standard.....	14.99 ea.
INL-15060	1967-72 Blade Deluxe.....	14.99 ea.
INL-15059	1967-72 Floor Anchor.....	14.99 ea.
INL-15062	1967-72 Shoulder Anchor.....	14.99 ea.
INL-15063	1967-72 Floor Anchor Cover Lap Belt.....	29.99 pr.



1971-74 Seat Belt Retractor Covers Robbins Style

New reproduction seat belt retractor covers with access doors for Robbins 3200 seat belts. You can check your originals by extending out the seat belt and looking at the tag.

IBR-3200	1971-74.....	49.99 pr.
----------	--------------	-----------



ICI-3CB

Bucket Seat Head Rests

Available as a safety standard for the first time in 1969, our complete headrest assemblies include your choice of a straight or curved bar and feature the correct Madrid grain.

ICI-367	1967 Straight Bar.....	329.99 pr.
ICI-3100	1969 Straight Bar Black.....	329.99 pr.
ICI-3CB	1969 Curved Bar Black.....	329.99 pr.
ICI-3100_	1969 Straight Bar Color.....	329.99 pr.
ICI-3CB_	1969 Curved Bar Color.....	329.99 pr.

Colors Available. No Volume Discount.



ICI-569

Headrest Escutcheon

This is the correct chrome headrest escutcheon. It is attached to the lock bracket and knob assembly which releases or locks the headrest.

ICI-569	1969 Buckets.....	18.99 pr.
ICI-569K	1969-70 Lock Set.....	45.99 pr.



IDA-68FK

IDA-67FK

PUI Standard Pre-Assembled Door Panel Kits

Replace your front and rear door panels all in one shot and save with this specially priced PUI door panel kit! Each kit includes one set of front PUI front door panels and a set of rear PUI door panels to get your interior looking showroom fresh.

IDA-67FK	1967 Standard Coupe.....	391.38 kit
IDA-67FVK	1967 Standard Convertible.....	334.38 kit
IDA-68FK	1968 Standard Coupe.....	539.58 kit
IDA-68FVK	1968 Standard Convertible.....	539.58 kit
IDA-69FK	1969 Standard Coupe.....	539.58 kit
IDA-69FVK	1969 Standard Convertible.....	550.98 kit

Black only. All door panels ship Oversize. No Volume Discount.

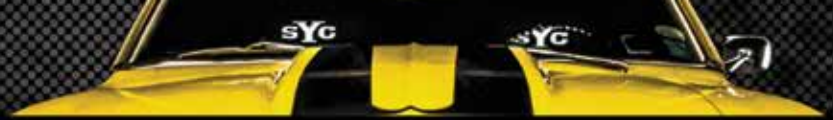

IPA-760

1967 Standard Door Panels - Pre-Assembled

Madrid grain vinyl dielectrically sealed with stitch bar and trim moldings.

Black

IPA-760	All Front	281.99 pr.
IPA-761	Coupe Rear	129.99 pr.
IPA-761V	Convertible Rear*	69.99 pr.

Colors

Fill in color code below. *Black_10, Light Blue_12, Red_30, White_37 & Gold_43*

IPP-67__	All Front	316.99 pr.
IPP-67_C	Coupe Rear	124.99 pr.
IPP-67_V	Convertible Rear*	76.99 pr.

*Convertible rears are not assembled.



IRM-67FF

1967 Upper Door Panel Molding

This upper molding retains the door panels to the door on cars with standard interior. 2 required per car.

IRM-67FF	1967 Front	62.99 ea.
IRM-67FR	1967 Rear	54.99 ea.



IPA-986

1968 Standard Door Panels - Pre-Assembled

Madrid grain vinyl dielectrically sealed with stitch bar with trim moldings, top rails, window felts and door lock ferrules.

IPA-986	All Front	328.99 pr.
IPA-986H	Coupe Rear	238.99 pr.
IPA-986V	Convertible Rear	238.99 pr.
IPP-6810	All Front	417.99 pr.
IPP-6810C	Coupe Rear	285.99 pr.
IPP-6810V	Convertible Rear	288.99 pr.

Available in: *Black (10), 68 Blue (17), Red (30), White (37) & Ivy Gold (46).*



IPA-989

1969 Standard Door Panels - Pre-Assembled

Madrid grain vinyl with dielectrically sealed horizontal design with trim moldings, top rails, window felts and door lock ferrules.

IPA-989	All Front	328.99 pr.
IPA-989H	Coupe Rear	238.99 pr.
IPA-989V	Convertible Rear	250.99 pr.
IPP-6910	All Front	417.99 pr.
IPP-6910C	Coupe Rear	300.99 pr.
IPP-6910V	Convertible Rear	288.99 pr.

Available in: *Black (10), Dark Blue (16), Light Green (23), Dark Metallic Green (24), Red (30) & White (37).*

Deluxe Door Panels 1967-69 Camaro

These new, OE style reproduction deluxe door panels are designed as original and feature the correct grains and materials. The front panels are injection molded and are unassembled. The rears are PUI panels and come pre-assembled with moldings, upper steel rails and window felts. 1967 rear panels are not pre-assembled. *Please state color at time of order. All door panels ship Oversize.*



IDX-701



IDX-801

1967 Deluxe Door Panels

Front door panels are correct Madrid grain vinyl with color keyed carpeting. Rear panels are Madrid grain vinyl with dielectrically sealed horizontal pleats.

IDX-701	Deluxe Front	589.99 pr.
IDX-201	Deluxe Rear Coupe	131.99 pr.
IDX-201V	Deluxe Rear Convertible	138.99 pr.

Rears are not pre-assembled. Front Ship Oversize 2. No Volume Discount. Available in: *Black, Red, Aqua, Gold, Bright Blue and Off White*



7669268



7669267



7742918



7743242

1968-69 Deluxe Door Panels

Front door panels are correct Madrid grain vinyl with color keyed carpeting.

IDX-801	Deluxe Front Black	629.99 pr.
---------	--------------------------	------------

Rear panels are Madrid grain vinyl with top rails, trim moldings and window felts.

IDX-301	Deluxe Rear Coupe	333.99 pr.
IDX-301V	Deluxe Rear Convertible	333.99 pr.

Front Ship Oversize 2. No Volume Discount. Available in: *Black, Red, Aqua, 68 Medium Blue, Pearl, Ivy Gold, Dark Blue, Dark Green, Orange, White and Yellow*



7743242

1967-69 Deluxe Door Panel Moldings

OE style reproduction deluxe door panel moldings produced in stainless material as original.

7669267	1967 Center Molding	74.99 ea.
7669268	1967 Upper Molding	79.99 ea.
7742918	1968-69 Upper RH Molding	74.99 ea.
7742919	1968-69 Upper LH Molding	74.99 ea.
7743242	1968-69 Lower Molding	79.99 ea.



PUI Standard Door Panels for 1970-81 Camaro

These PUI door panels are constructed of the finest quality materials available. These door panels are perfect for most cars out there whether they are daily drivers or trailer queens. Most panels come pre-assembled with moldings and PUI Window felts already installed unless noted. Take them out of the box, hang them on and you're ready to go!

Please state color at time of order. All door panels ship Oversize.



IPA-70S

1970-71 Standard Door Panels

Madrid grain vinyl with dielectrically sealed vertical lines.

IPA-70S	All Front	202.99 pr.
---------	-----------------	------------

Top rails, arm rests and map pockets not included. Available in: *Black, Bright Blue, Dark Metallic Green, Saddle, Sandalwood, Blue, Jade Green and Dark Saddle.*



IPA-72S

1972 Standard Door Panels

Madrid grain vinyl with dielectrically sealed vertical lines.

IPA-72S	All Front	202.99 pr.
---------	-----------------	------------

Top rails, arm rests and map pockets not included. Available in: *Black, Blue, Dark Green, Covert, White and Tan.*



1973-75 Standard Door Panels

Madrid grain vinyl with dielectrically sealed vertical lines.

IPA-73S	All Front	214.99 pr.
---------	-----------------	------------

Top rails, arm rests and map pockets not included. Available in: *Black, Dark Green, Covert, Dark Saddle.*



IPA-76S

1976 Standard Door Panels - Pre-Assembled

Madrid grain vinyl with dielectrically sealed vertical lines with top rail, door lock ferrule and window felts.

IPA-76S All Front427.99 pr.

Arm rests and map pockets not included. Available in: Black, Firethorn, Saddle & White.



IPA-77S

1977 Standard Door Panels - Pre-Assembled

Sierra grain vinyl with dielectrically sealed vertical lines with top rail, door lock ferrule and window felts.

IPA-77S All Front389.99 pr.

Arm rests and map pockets not included. Available in: Black, Saddle, White & Firethorn



IPA-78S

1978-81 Standard Door Panels - Pre-Assembled

Sierra grain with dielectrically sealed vertical stitchbar with trim moldings, top rails, window felts and door lock ferrules.

IPA-78S All Front399.99 pr.

Available in: Black, White, Carmine, Camel, Willow Green, Light Blue, Navy Blue, Light Saddle, Silver, Red & Oyster



IPA-78FDLT70-P

1978-79 Berlinetta Custom Vinyl Door Panels

Sierra grain vinyl and Rattan grain vinyl inserts with dielectrically sealed vertical lines in inserts. The bottoms are carpeted. Trim moldings, top rails, window felts and door lock ferrules are installed.

IPA-78FDLT_P All Front629.99 pr.

Available in: Black (70), White (37), Carmine (38), Camel (48) & Light Blue (90).



IPA-78FDLTC70-P

1978-79 Berlinetta Custom Cloth Door Panels

Sierra grain vinyl and Empress grain cloth inserts with dielectrically sealed vertical lines in inserts. The bottoms are carpeted. Trim moldings, top rails, window felts and door lock ferrules are installed.

IPA-78FDLTC_P All Front629.99 pr.

Available in: Black (70), White (37), Carmine (38), Camel (48) & Light Blue (90).

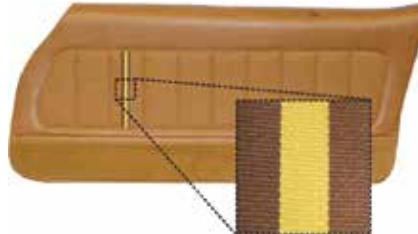

IPA-80FDLT48-P

1980-81 Berlinetta Custom Vinyl Door Panels

Sierra grain vinyl with Derma grain vinyl inserts with dielectrically sealed vertical lines in insert and carpeted bottoms. Features 2 tone accent stripes in insert.

IPA-80FDLT_P All Front673.99 pr.

Available in: Black (70), Navy (18), Carmine (38), Camel (48), Silver (66), Bright Red (77) & Oyster (81).

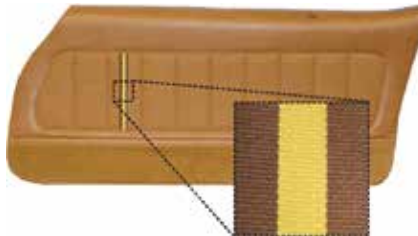

IPA-80FDLTC48-P

1980-81 Custom Cloth Door Panels

Sierra grain vinyl with Empress cloth inserts and sewn vertical lines in inserts and carpeted bottom. Includes top rails, window felts and door lock ferrule. Features 2 tone accent stripes in insert.

IPA-80FDLTC_P All Front673.99 pr.

Available in: Black (70), Navy (18), Carmine (38), Camel (48), Silver (66), Bright Red (77) & Oyster (81).



IPA-82FD02-PB

1982-86 Standard Door Panels

Front door panels are made of the correct grain vinyl designed to match the originals.

IPA-82FD_PB 1982-85 Front.....419.99 pr.

(02) Gray, (70) Charcoal, (18) Dark Blue, (38) Maroon, (48) Camel

IPA-86FD_PB 1986 Front.....483.99 pr.

(02) Gray, (70) Charcoal, (04) Saddle, (38) Maroon



IPA-82DD66-PB

1982 Pace Car Door Panels

IPA-82DD66-PB 1982 Pace Car483.99 pr.



IDP-82FDRAIL-B

1970-92 Upper Door Panel Rail Trim

Made from injection molded plastic, these rails will replace your missing or cracked originals.

IDP-UP 1970-73 All.....119.99 pr.

IDP-82FDRAIL-B 1982-92 All Black Bead199.99 pr.

IDP-82FDRAIL-C 1982-92 All Chrome Bead.....262.99 pr.



IDP-LR

1970-77 Lower Door Panels

Correct reproduction of the 1970-77 standard lower door panels which feature the correct grain as original and include the proper mounting locations for the arm rest pads.

IDP-LL 1970-71 All LH149.99 ea.

IDP-LR 1970-71 All RH149.99 ea.

IDP-LL77 1972-77 All LH149.99 ea.

IDP-LR77 1972-77 All RH149.99 ea.



ISP-71R

ISP-71L

1970-81 Rear Lower Side Panels

OE style reproduction of these often missing interior lower rear side panels. These panels feature the correct grain as original and can be painted to match your interior.

ISP-71L 1970-81 All LH99.99 ea.

ISP-71R 1970-81 All RH99.99 ea.

ISP-71-ID 1970-71 2nd Design LH Black139.99 ea.

ISP-7R-ID 1970-71 2nd Design RH Black139.99 ea.

ISP-71L-R 1970-81 All LH Red.....109.99 ea.

ISP-71R-R 1970-81 All RH Red109.99 ea.

ISP-71L-T 1970-81 All LH Tan109.99 ea.

ISP-71R-T 1970-81 All RH Tan109.99 ea.

ISP-71L-W 1970-81 All LH White109.99 ea.

ISP-71R-W 1970-81 All RH White109.99 ea.



ICI-0842



ICI-4309



ICI-0781



ICI-4303



IE-781



ICI-4304



IE-8008



ICI-4306



ICI-045



ICI-4307



ICI-4302



ICI-4305



ICI-4308

Door Panel Emblems

OE style reproduction emblems for your Camaro.

ICI-0842	1967 Standard.....	25.99 pr.
IE-781	1967 Deluxe.....	24.99 pr.
ICI-0781	1968-69 Standard.....	26.99 pr.
IE-8008	1968-69 Deluxe.....	26.99 pr.
ICI-4302	1974-78 Type LT.....	94.99 pr.
ICI-4305	1974-79 Camaro Red White Blue.....	94.99 pr.
ICI-4303	1974-81 Super Sport SS.....	94.99 pr.
ICI-4304	1974-81 Black Bowtie.....	94.99 pr.
ICI-4306	1977-79 Red Z/28.....	99.99 pr.
ICI-4307	1977-79 Black Z/28.....	99.99 pr.
ICI-045	1978-81 Deluxe.....	57.99 pr.
ICI-4308	1979-81 Berlinetta.....	99.99 pr.
ICI-4309	1979-81 Camaro Orange.....	99.99 pr.

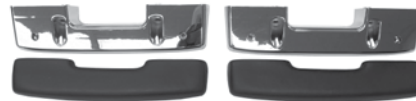

1967 Front Arm Rest Pad & Base Kit

Complete kits with 2 arm rest bases and 2 front arm rest pads.

ARM-KIT1 1967 Black.....80.96 kit



ARM-KIT4

1968-69 Front Arm Rest Pad & Base Kits

Complete kits with 2 arm rest bases and 2 front arm rest pads.

ARM-KIT4	Black.....	76.46 kit
ARM-KITA10	White.....	139.99 kit
ARM-KITA20	Pearl.....	139.99 kit
ARM-KITA30	Red.....	139.99 kit
ARM-KITA40	Parchment.....	139.99 kit
ARM-KITA50	Light Saddle.....	139.99 kit
ARM-KITA60	Dark Saddle.....	139.99 kit
ARM-KITA65	Light Blue.....	139.99 kit
ARM-KITA70	Dark Blue.....	139.99 kit
ARM-KITA75	Bright Blue.....	139.99 kit
ARM-KITA80	Dark Green.....	139.99 kit
ARM-KITA85	Sandalwood.....	139.99 kit

No Volume Discount.



ICI-5101R



ICI-5151

Arm Rest Pads

OE style reproduction arm rest pads.

ICI-5001	1967.....	24.99 ea.
ICI-5101L	1968-69 LH All.....	22.99 ea.
ICI-5101R	1968-69 RH All.....	22.99 ea.
ICI-5151	1970-71 All LH or RH.....	39.99 ea.
ICI-5152	1972-77 w/ 2pc Panel.....	54.99 ea.
ICI-74R	1974-81 RH.....	69.99 ea.
ICI-74L	1974-81 LH.....	99.99 ea.
IXP-03	Attaching Screw.....	0.50 ea.



ICI-5011



ICI-1960R

Arm Rest Bases

OE style reproduction chrome plated and plastic arm rest bases.

ICI-5011	1967.....	19.99 ea.
ICI-1960L	1968-69 LH Black.....	21.99 ea.
ICI-1960R	1968-69 RH Black.....	21.99 ea.
IAM-6872	1968 Molding Inserts.....	36.99 pr.
IPX-997	Attaching Screw.....	0.75 ea.



Arm Rest Bases - Colors

Replacement arm rest bases now available in colors!

ARMBASE-PARCH	Parchment.....	26.99 pr.
ARMBASE-RED	Red.....	26.99 pr.
ARMBASE-BBLUE	Bright Blue.....	26.99 pr.
ARMBASE-DGREEN	Dark Green.....	26.99 pr.
ARMBASE-WHITE	White.....	26.99 pr.
ARMBASE-DBLUE	Dark Blue.....	26.99 pr.



IK-504

Rear Arm Rest Panels

Correct die-stamped steel upper and lower arm rest panels for your deluxe coupe, coupe with fold down rear seat or convertible.

IK-504	1967-69 RH Coupe Dlx.....	89.99 ea.
IK-505	1967-69 LH Coupe Dlx.....	89.99 ea.
IK-506	1967-69 RH Conv.....	89.99 ea.
IK-507	1967-69 LH Conv.....	89.99 ea.

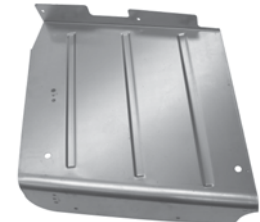

IK-508

Convertible Inner Side Panels

OE style reproduction of the original steel inner side panels which are located directly above the rear arm rest section where the top frame folds down.

IK-508	1967-69 RH.....	89.99 ea.
IK-509	1967-69 LH.....	89.99 ea.



IAT-69R



IAT-68C

Arm Rest Ash Trays

Correct chrome ash tray for rear arm rests.

IAT-69R	1967 Ribbed.....	49.99 ea.
IAT-68C	1968-74 Ribbed.....	32.99 ea.
IAT-70C	1968-74 Smooth.....	33.99 ea.



IRP-67V

Rear Arm Rest Piston Covers

Correct die-stamped vinyl material for covering convertible rear arm rest and piston covers.

- IRP-67V 1967-69 Convertible 98.99 set
- IRP-67VC 1967-69 Deluxe Coupe 81.99 set

Please state color at time of order.



IVH-733

1967 Vent Window Pivot Stud & Handle Kit

Vent window pivot stud and handle kit includes: two faithful reproduction vent window stud assemblies with polished stainless caps, two fiber gaskets, two rubber gaskets, two internal plastic bushing spacers, four special wave washers (two extra). RH and LH vent window chrome die cast handles with roll pins.

- IVH-733 Pivot Stud & Handle Kit 94.99 kit
- IVH-67 Handles Only 54.99 pr.
- IVH-741 Pivot Stud Assembly Only 24.99 kit
- IVH-742 Pivot Stud Nut Chrome 8.99 ea.

Pieces also available separately.



IPQ-82F

1982-92 Window Crank

Reproduction window crank handle for 1982-92 Camaro models. Available in black. Includes mounting clip.

- IPQ-82F ALL 5.99 ea.



IPX-4078B

IPX-4078C

Window Cranks & Hardware

OE style reproduction window cranks in kits or individually! Include 4 cranks, 4 clips and 4 gaskets.

- IPX-4078C 1967-69 Clear Knob Kit 37.32 kit
- IPX-4078B 1967-69 Black Knob Kit 37.32 kit
- IPQ-4080C 1967-69 Clear Knob 8.99 ea.
- IPQ-4080B 1967-69 Black Knob 8.99 ea.
- IPQ-82F 1982-92 All Black 5.99 ea.
- IPX-3850 All Gasket 1.99 ea.
- IPX-39 All Spring 2.19 ea.
- IPX-38K All Clips 4 pc 2.39 kit

No Volume Discount on Kits.



IPX-67GMKIT-BLK

1967-72 Factory Correct Window Cranks

Quality die cast. Correct spline depth and clip engagement. Shorter and with a flatter curvature than later years, with correct thin knob. All 1968 and 1969 rears feature cast number 9715291. 1969 rear and all 1970-72 features cast number 9717838. Clips are included.

- IPX-67GMKIT-BLK 1967 Black Knob 4pc 61.12 ea.
- IPX-67GMKIT-CLR 1967 Clear Knob 4pc 64.52 ea.
- IPX-68GMKIT-BLK 1968 Black Knob 4pc 71.32 ea.
- IPX-68GMKIT-CLR 1968 Clear Knob 4pc 71.32 ea.
- IPX-69GMKIT-BLK 1969 Black Knob 4pc 67.92 ea.
- IPX-69GMKIT-CLR 1969 Clear Knob 4pc 71.32 ea.
- IPQ-67GMB 1967 Black Knob 15.99 ea.
- IPQ-67GMC 1967 Clear Knob 16.99 ea.
- IPQ-68GMB 1968-69 Front, 68 Rear Black Knob 18.99 ea.
- IPQ-68GMC 1968-69 Front, 68 Rear Clear Knob 18.99 ea.
- IPQ-69GMB 1970-72 Front, 69 Rear Black Knob 16.99 ea.
- IPQ-69GMC 1970-72 Front, 69 Rear Clear Knob 18.99 ea.



ICE-4814K



ICE-3520X



Standard Door Handles

Excellent quality reproduction door handles.

- ICE-4814K 1967 23.78 pr.
- ICE-4814 1967 Fits LH & RH 13.99 ea.
- ICE-3520X 1968-69 30.58 pr.
- ICE-3520L 1968-69 LH 17.99 ea.
- ICE-3520R 1968-69 RH 17.99 ea.

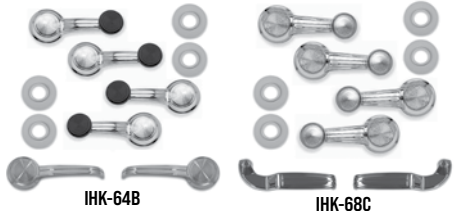

IHK-64B

IHK-68C

Window Crank & Door Handle Kits

This is a set of OE style reproduction window cranks and inside door handles, including (4) cranks, (4) clips and (4) gaskets, (2) handles with clips.

- IHK-64B 1967 Black Knob Kit 61.10 kit
- IHK-64C 1967 Clear Knob Kit 61.10 kit
- IHK-68B 1968-69 Black Knob Kit 67.90 kit
- IHK-68C 1968-69 Clear Knob Kit 67.90 kit



PT-202

PT-203

PT-204

Clayton Machine Works Handles

Easily add a nice custom touch to your interior with these custom handles from Clayton Machine Works! These handles are CNC machined and powdercoated a satin silver. The perimeters and inside truss edges are then re-machined for subtle yet dynamic highlight. A great match to Clayton pedals!

- PT-202 Door Handles 193.99 pr.
- PT-203 Window Cranks 202.99 pr.
- PT-204 Vent Window Cranks 178.99 pr.

No Volume Discount.



Trim Removal Tools

- TRIM-01 Door Panel Removal Tool 9.97 ea.
- TRIM-02 Window Crank/Door Handle Removal... 7.99 ea.
- TRIM-WR Window Roller Removal Tool 18.99 ea.
- TRIM-MAG Mirror & Magnet Kit 2pc 14.95 set
- TRIM-KIT-DLX Trim Removal Tools 3pc 29.99 ea.
- TRIM-CVY1 Clip And Moulding Removal Tool 14.99 ea.

AMK inc PRODUCTS



ISK-70F

Interior Screw Kits

These kits offer the most commonly missing or rusted special style interior screws. All screws are individually bagged and labeled to make replacement painless!

Basic

- ISK-64A 1967 All 22.95 kit
- ISK-68F 1968-69 All 29.95 kit
- ISK-70F 1970-73 All 29.99 kit

OEM Complete Over 300 Pieces

- 67FN-CPS 1967 Coupe, Standard 212.99 set
- 67FN-CPD 1967 Coupe, Deluxe 209.99 set
- 67FN-CVS 1967 Convertible, Standard 183.99 set
- 67FN-CVD 1967 Convertible, Deluxe 187.99 set
- 68FN-CPS 1968 Coupe, Standard 225.99 set
- 68FN-CPD 1968 Coupe, Deluxe 233.99 set
- 68FN-CVS 1968 Convertible, Standard 191.99 set
- 68FN-CVD 1968 Convertible, Deluxe 239.99 set
- 69FN-CPS 1969 Coupe, Standard 279.99 set
- 69FN-CPD 1969 Coupe, Deluxe 258.99 set
- 69FN-CVS 1969 Convertible, Standard 208.99 set
- 69FN-CVD 1969 Convertible, Deluxe 259.99 set
- 70FN 1970-71 All 234.99 set
- 72FN 1972 All 211.99 set
- 73FN 1973-76 All 229.99 set
- 77FN 1977 All 179.99 set
- 78FN 1978 All 208.99 set
- 79FN 1979 All 229.99 set



1975-92 Door Handles ICE-36R
Complete door handle assemblies.

ICE-36L	1975-81 LH.....	9.99 ea.
ICE-36R	1975-81 RH.....	9.99 ea.
IDH-82F	1982-92 Fits LH or RH.....	11.99 ea.



IK-482

1977-81 Door Handle Release Escutcheons
Installed on the panel behind the release handle to provide a finishing touch.

IK-482 1977-81..... 34.99 pr.



IHQ-4656L

IHQ-1463

Deluxe Door Handles

Excellent quality reproduction door handles.

IHQ-4656L	1967 LH.....	23.99 ea.
IHQ-4656R	1967 RH.....	23.99 ea.
IHQ-1463	1968-69.....	36.99 pr.



IG-101

IG-207

Deluxe Door Grab Handles

Replace your cracked or missing original handles with these OE style reproductions. Add new hardware for a totally fresh look.

IG-101	1968-69 Handle.....	31.99 ea.
IG-207	1968-69 Bezels.....	32.99 pr.
IW-405	1968-69 Screw Set 4pc.....	5.99 kit



IPC-1202

Deluxe Door Panel Carpet

Correct 80/20 nylon/rayon blend carpet found on all lower deluxe door panels. Perfect for freshening up your original door panels!

IPC-6701	1967 Black.....	34.95 pr.
IPC-6702	1967 Red.....	34.95 pr.
IPC-6704	1967 Bright Blue.....	34.95 pr.
IPC-6705	1967 Gold.....	34.95 pr.
IPC-6706	1967 Turquoise.....	34.95 pr.
IPC-12	1968-69 Black.....	69.99 pr.
IPC-1202	1968-69 Red.....	69.99 pr.
IPC-1206	1968 Turquoise.....	69.99 pr.
IPC-1208	1968 Medium Blue.....	69.99 pr.
IPC-1209	1968 Ivy Gold.....	69.99 pr.
IPC-1212	1969 Dark Blue.....	69.99 pr.
IPC-1213	1969 Dark Green.....	69.99 pr.



ICE-343

1970-74 Door Handle Assemblies

These correct reproduction inner door handles are OE style to original with escutcheon and mounting bolts. Door handles are available separately.

ICE-343	1970-74 LH w/ Cup.....	46.99 ea.
ICE-342	1970-74 RH w/ Cup.....	46.99 ea.
ICE-70FCL	1970-74 LH w/o Cup.....	19.95 ea.
ICE-70FCR	1970-74 RH w/o Cup.....	19.95 ea.



IDH-1X

IDH-2XL

Deluxe Door Handle Mechanisms

OE style reproduction plated mechanisms.

IDH-1X	1967 Deluxe.....	49.99 pr.
IDH-2XR	1968-69 Deluxe RH.....	42.99 ea.
IDH-2XL	1968-69 Deluxe LH.....	42.99 ea.



IDH-479

IDH-901

Standard Door Handle Mechanisms

OE style reproduction plated mechanisms.

IDH-479	1967 Standard.....	36.99 pr.
IDH-901	1968-69 Standard.....	39.99 pr.



ICI-1708752

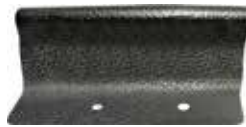

ICI-1708751



IPR-748790

Door Pull Handle Inserts

Fits on the lower door panel. Will fit original or reproduction door panels. Comes in black. Paint as required.

ICI-1708752	1972-77 Insert LH.....	27.99 ea.
ICI-1708751	1972-77 Insert RH.....	27.99 ea.
IPR-748790	1972-77 Bracket All.....	19.99 ea.



JTE-8235

Door Jamb Vents

Choose from replacement style or OEM style with flaps.

JSS-3026	1967-69 Replacement.....	11.99 ea.
JTE-679	1967-69 OEM Style.....	18.99 ea.
JTE-8235	1970-81 All.....	21.99 ea.



IXP-33

IXP-18

Door Panel Plugs & Clips

These are the correct clips and plugs required to install your door panels.

IXP-33	All Clips 12pc.....	9.99 kit
IXP-471	1975-81 All Clips 12pc.....	9.95 kit
IXP-18	All Plug.....	2.19 ea.
IXP-18K	Plug Kit 12pc.....	23.64 kit
IXP-1833K	Plug & ClipKit 24pc.....	32.63 kit
IXP-PLUG-K	Plug Clip & Screw Kit 32pc.....	5.99 kit



IXP-370

Door Panel Molding Clips

Correct clips to attach moldings to the door panel.

IXP-370	1972-77 Small.....	2.99 ea.
<i>6 Required per door.</i>		
IXP-371	1972-77 Large.....	3.99 ea.
<i>4 Required per door.</i>		



IFW-2

Door Panel Washers

Foam washers used under the door panels to seal door handles and window cranks.

IFW-2	1967-81 All.....	6.99 pr.
-------	------------------	----------



Door Panel Water Shields

Correct pre-cut water resistant paper material.

ICK-112

ICK-112	1967 Coupe 4pc	22.99 kit
ICK-112V	1967 Convertible 4pc.....	16.99 kit
ICK-114	1968-69 Coupe 4pc	20.99 kit
ICK-114V	1968-69 Convertible 2pc	17.99 pr.
ICK-X7	1970-81 All 2pc	21.99 kit



1968-69 Inner Door Panel Retainer/Window Guide

Used to support the inner door panels and includes the felt pad used to guide the window when rolling up or down.

7698543	1968-69 Front.....	24.99 ea.
7698542	1968-69 Rear	24.99 ea.

Note: 2 fronts and 2 rears required per car.



1970-81 Inner Door Panel Retainer Plate

Used to support inner door panels. Center/rear includes correct felt padding

IRP-685	1970-78 Forward Plate	19.99 ea.
IRP-760	1970-79 Center/Rear Retainer ..	18.99 ea.



1967-81 Stainless Steel Strikers

Awesome stainless strikers from Eddie Motorsports.

MS277-20M	Door Striker Bolts Machined	61.99 pr.
MS277-20P	Door Striker Bolts Polished	69.99 pr.



Door Lock Knobs & Ferrules

OE style reproduction door lock knobs & ferrules.

ICF-4411	1967 Chrome Knob.....	5.99 ea.
IFF-401	1967 Ferrule	6.99 pr.
ICE-6400	1968-81 Chrome Knob.....	2.99 ea.
IFF-600	1968-81 All Ferrule	5.99 ea.
IFF-700	1970-81 All Ferrule.....	5.99 ea.

IMB-833



Remote Mirror Bezel

This is an OE style reproduction remote side mirror interior bezel.

IMB-833	1968-81 Standard Interior	36.99 ea.
IMB-450	1968-69 Deluxe Interior	36.99 ea.

KVF-RVT



Vent Window Rivet

Correct rivet for vent window.

KVF-RVT	1967	1.95 ea.
---------	------------	----------

IDP-109



Door Panel Screws

Correct size attaching screw for door panels.

IDP-109	All.....	0.50 ea.
---------	----------	----------



4432791

GWS-712

Power Window Switch

Correct OEM style power window switch.

4432790	1967-70 1 Window	57.99 ea.
4432791	1967-70 4 Window	79.99 ea.
GWS-711	1971-81 1 Window.....	34.99 ea.
GWS-712	1971-81 2 Window	59.99 ea.
GWS-1469L	1994-96 LH 2 Window	21.99 ea.
GWS-9496R	1994-96 RH 1 Window	19.99 ea.
GWS-1454L	1997-02 LH 2 Window	16.99 ea.
GWS-9702R	1997-02 RH 1 Window.....	26.99 ea.



IJW-689

Door Jamb Windlace

Correct style windlace in black.

IJW-67	1967	109.99 pr.
IJW-689	1968-69.....	109.99 pr.
IJW-CLIP-F	1967-69 Clips	10.99 pr.



IJW-PERFOOT

Windlace by the Foot

Replacement style snap on vinyl windlace, sold by the foot. Often used to seal interior rear door jamb edges to sill plates and much more. Featuring authentic vinyl grain texture, positive gripping power and rapid application, this flexible snap-on vinyl trim is ideal for classic car applications.

IJW-PERFOOT	All.....	2.10 ea.
-------------	----------	----------

Note: This part is sold by the foot. Ex. Order quantity of 2 to get 2 feet, quantity of 5 to get 5 feet, etc.



IWE-67

Windlace End Caps

Correct molded caps for top edge of rear door panel.

IWE-67	1967	29.99 pr.
--------	------------	-----------



DT-214



DT-236



DT-218

Dashtop Replacement Dash Covers

This molded plastic dash cover simply fits right over the existing dash to cover unsightly cracks! An easier and more economical alternative to complete dash replacement. *Call for Colors.*



DT-214	1967 All Black	209.99 ea.
DT-215	1968 All Black.....	209.99 ea.
DT-236	1969 w/o AC Black.....	209.99 ea.
DT-221	1969 w/ AC Black	209.99 ea.
DT-208	1970-78 w/o AC Black.....	209.99 ea.
DT-218	1970-78 w/ AC Black	209.99 ea.
DT-216	1979-81 All Black	209.99 ea.

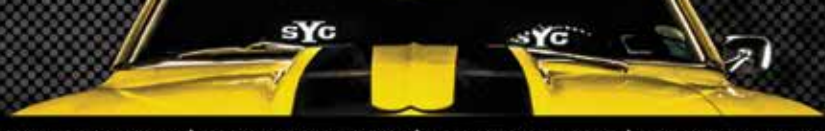

ICI-690E

1969 OEM Style Dash Pad

This is an original equipment quality reproduction padded dash featuring the original correct grain. Constructed of urethane, with a foam over a plastic spine and features a one piece steel reinforcement for a long lasting appearance and quality fit. This dash will fit and function better than any other replacement dash on the market.

ICI-690E	1969 w/o Air Conditioning Black	369.99 ea.
ICI-69A0E	1969 w/ Air Conditioning	369.99 ea.

Dash Pads

1967-69 dashes feature solid fiberglass cores surrounded by vinyl wrapped foam to assure you the best look and fit on the market! All of the factory colors are available and will match your new PUI colored interior exactly. 1970-81 dashes are crafted from urethane materials for an original appearance and fit. You will get the same quality look and feel of an original dash pad without the headaches of sun damage.



ICI-85810

ICI-85810	1967 Black	169.99 ea.
ICI-85810HQ	1967 High Quality Vinyl Wrapped Black	329.99 ea.



ICI-85910

ICI-85910	1968 Black	299.99 ea.
-----------	------------------	------------



ICI-86110AC

ICI-86110	1969 w/o Air Conditioning Black	314.99 ea.
ICI-86110AC	1969 w/ Air Conditioning Black	351.99 ea.
ICI-690E-AC	1969 High Quality Vinyl Wrapped w/ AC Black	369.99 ea.



ICI-801

ICI-801	1970-78 w/o Air Conditioning Black	379.99 ea.
---------	--	------------



ICI-901

ICI-901	1970-78 w/ Air Conditioning Black	379.99 ea.
---------	---	------------



ICI-79

ICI-79	1979-81 All Black	439.99 ea.
--------	-------------------------	------------



ICI-82

ICI-82	1982-92 OE Style Black	529.99 ea.
ICI-8292R	1982-92 Urethane Replacement Style Black	359.99 ea.

Ask your sales rep for color selection. Ships Oversize.



ICI-78K

Dash Clips

Correct dash mounting clips.

ICI-674	1968 Dog Leg Clips	14.99 pr.
ICI-78K	1969 All 6pc	13.99 kit
ICI-311	1970-78 Original Dash 3pc	10.99 kit
ICI-310	1970-78 Repro Dash 6pc	12.99 kit
ICI-312	1979-81 All 3pc	16.99 kit
ICI-K7904	1979-81 Retainer	13.99 ea.



IK-156

1968 Dash Pad Trim Molding

Correct reproduction of the original three piece factory dash molding designed for 1968 Camaros that originally included a dash molding.

IK-156	1968 3pc	169.99 set
--------	----------------	------------

Will not work on reproduction dash pads.



IK-0046

1969-70 Astro Ventilation Emblem

OE style die cast reproduction emblem.

IK-0046	1969-70	14.99 ea.
---------	---------------	-----------



IK-10287314

Dash Center Vent Plate Emblem

Replaces original OE part number 10287314. Red logo script.

IK-10287314	1997-02 All	27.99 ea.
-------------	-------------------	-----------

No volume discount.



IK-10181725

Dash Emblem 25th Anniversary

Features gold and yellow RS logo with red 25th Anniversary model designation.

IK-10181725	1992 RS	25.99 ea.
-------------	---------------	-----------



IK-11DF

IK-544

Defroster Vent

OE style reproduction under dash defroster vent assembly.

IK-11DF	1967-68	159.99 ea.
IVA-69	1969	152.99 ea.
IK-544	1982-92 All Side Vents	22.99 pr.



IK-850

1967-68 Dash Vent Balls

OE style reproduction chrome vent balls with correct accenting.

IK-850 1967-68 Vent Ball 18.99 ea.
Featured on 1967 AC cars & 1968 cars w/ Astro Vents



IK-742



IK-744

1967-68 Dash Vent Bezels

OE style reproduction correct bezels which house the dash vent balls. Available in chrome or black (paint to match).

IK-742 1967-68 Chrome RH 24.99 ea.
 IK-741 1967-68 Chrome LH 24.99 ea.
 IK-744 1967-68 Black RH 20.99 ea.
 IK-743 1967-68 Black LH 20.99 ea.
Featured on 1967 AC cars & 1968 cars w/ Astro Vents



IW-566

1967-68 Dash Vent Bezel Retainers

This part is required to retain the dash vent ball bezel to the dash assembly. Includes screws.

IW-566 1967-68 8.99 ea.
Featured on 1967 AC cars & 1968 cars w/ Astro Vents



IM-23

1967-68 Dash Vent Seals

Correct seals for dash side vents.

IM-23 1967-68 4.99 pr.
Featured on 1967 AC cars & 1968 cars w/ Astro Vents



IW-564BK

1967-68 Dash Vent Knob and Ferrule Set

Correct reproductions available with clear or black acrylic ferrules with black knobs.

IW-564K 1967-68 Clear 18.99 kit
 IW-564BK 1967-68 Black 18.99 kit
Featured on 1967 AC cars & 1968 cars w/ Astro Vents



IK-189

1967-68 Dash Vent Ball Retainer

The vent ball retainer is a necessary part designed to attach the vent duct to the vent bezel assembly.

IK-189 1967-68 18.99 ea.
Featured on 1967 AC cars & 1968 cars w/ Astro Vents



IK-289

Side Vent Shutoff

OE style reproduction shutoff assembly which installs behind the dash air vent bezel.

IK-289 1967-68 RH 64.99 ea.
 IK-290 1967-68 LH 64.99 ea.
Featured on 1967 AC cars & 1968 cars w/ Astro Vents



IC-6

Dash Vent Seal Kit

Reseal your leaky Astro Ventilation System with this complete kit! Includes all of the correct die stamped sponge rubber seals needed.

IC-6 1967-68 22.99 kit
 IC-7 1969 32.99 kit



IK-11AD

1968 Astro Vent Duct

New correct reproduction for non-AC models.

IK-11AD 1968 19.99 ea.
Note: Two required per car.



IVS-528

1968-69 Astro Vent Duct Screws

These screws attach the astro vent duct to the cowl.

IVS-528 1968-69 Screws 9.99 kit



IK-790



IVB-69F

1969 Side Air Vent

Correct injection molded reproduction bezel and vent.

IK-790 1969 Vent 26.99 ea.
 IK-790K Vent Kit Pair 48.58 kit
 IVB-69F 1969 Bezel RH 24.95 ea.



IVC-69F

1969 Air Vent Control

Correct air vent control complete with vent and bezel.

IVC-69FL 1969 LH 99.99 ea.
 IVC-69F 1969 RH 99.99 ea.



IK-668



IK-667

1970-81 Side Air Vents without AC

OE style reproduction injection molded air vents complete with vent bezels and vent deflectors.

IK-667 1970-81 LH w/o AC 89.99 ea.
 IK-668 1970-81 RH w/o AC 89.99 ea.



IK-927

1970-81 Dash Vent Bezel

Injection molded vent bezel which mounts between the inner air duct and the outlet air deflector.

IK-927 1970-81 49.99 ea.

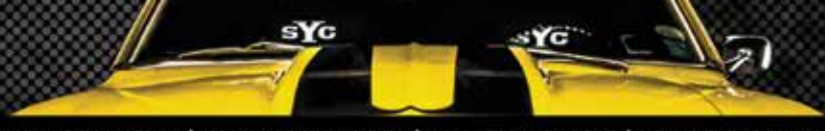

IK-154



IK-269



IK-270



IK-543

Center Air Vents AC

Correct center air conditioning vents.

IK-154	1967-68 Cast 2pc.....	69.99 set
IK-269	1969.....	96.99 ea.
IK-270	1970-78.....	89.99 ea.
IK-543	1979-81.....	46.99 ea.



IK-8407

IK-8408

1970-81 Side Air Vents with AC

OE style reproduction injection molded air vents complete with vent bezels and vent deflectors.

IK-8407	1970-81 LH w/ AC.....	89.99 ea.
IK-8408	1970-81 RH w/ AC.....	94.99 ea.



IK-278

1967-68 Dash Instrument Panel

Injection molded reproduction manufactured to exact factory specifications with correct bright chrome finish around bezel as original.

IK-278	1967-68 All Panel.....	139.99 ea.
IDC-67F	1967-68 Mounting Clips to Dash 2pc.....	7.99 pr.



IK-322

1969 Dash Instrument Panel

Excellent reproduction manufactured from new tooling and features hot stamped chrome lettering surrounding the radio, lighter, wipers and air vent opening with the word Camaro in script as original.

IK-322	1969 All Panel.....	229.95 ea.
IK-3XX	1969 All Panel w/ Clock Opening.....	269.99 ea.
IDC-69F	1969 Mounting Clips to Dash 10pc.....	22.99 kit



ILD-718

1970-81 Lower Dash Instrument Panel

OE style reproduction featuring the correct grain as original.

ILD-712	1970-72 w/o Seatbelt Warning.....	309.99 ea.
ILD-718	1970-81 with Seatbelt Warning.....	269.99 ea.

Note: Requires slight modification to radio holes for 1976-81.



ISC-011

1970-81 Lower Steering Column Panel

This is the lower plastic steering column cover which installs under the steering column and acts as a trim piece to finish off the bottom of the dash.

ISC-011	1970-81 All.....	179.99 ea.
---------	------------------	------------



IGH-020

1970-81 Instrument Cluster Case

OE style reproduction injection molded instrument cluster case.

IGH-020	1970-81 w/ Gauges.....	129.99 ea.
IGH-021	1970-78 w/o Gauges.....	129.99 ea.
IGH-020	1979-81 w/o Gauges.....	129.99 ea.



IK-488



IK-645

1970-78 Dash Instrument Panel

Excellent quality reproductions with correct grains. The 1970-72 panel features chrome trim as original. The 1976-78 woodgrain panel is designed after the one installed in deluxe interiors.

IK-488	1970-72 w/ Trim.....	214.99 ea.
IK-645	1976-78 Woodgrain.....	259.99 ea.

Lettering not included on IK-488. May be installed on all models but requires a 1970-72 wiper switch.



ILA-584



ILA-346

1970-81 Dash Lens Assembly

Injection molded reproduction of the original instrument cluster lens assembly for models with or without gauges.

ILA-584	1970-78 w/o Gauges.....	124.99 ea.
ILA-802	1979-81 w/o Gauges.....	129.99 ea.
ILA-346	1970-78 w/ Gauges.....	149.99 ea.
ILA-370	1979-81 w/ Gauges.....	149.99 ea.



IK-093

1969 Center Dash Bezel

Correct injection molded reproduction dash bezels for center clock or center dash fuel gauge. The lens is included and the hole is pre cut. Lenses are also available separately.

IK-093	1969 Clock.....	36.99 ea.
IK-094	1969 Fuel.....	29.99 ea.
IL-27	1969 Clock Lens Only.....	13.99 ea.
IL-28	1969 Fuel Lens Only.....	13.99 ea.

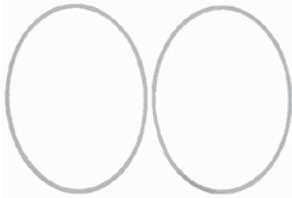

CT-665

1967-68 Instrument Panel Chrome Applique

High tech, ultra thin chrome mylar trim edging for restoring your otherwise nice original dash.

CT-665 1967-6829.99 kit



IL-526



IL-68D



IL-85

Dash Lenses

OE style reproduction of the often scratched or damaged original lenses.

IL-526 1967 All34.99 ea.
 IL-68D 1968 w/o Console Gauge44.99 ea.
 IL-68C 1968 w/ Console Gauge44.99 ea.
 IL-85 1970-78 All84.99 ea.



GPC-68

Printed Circuit Boards

OE style reproduction circuit board.

With Factory Gauges

GPC-67 196759.99 ea.
 GPC-67 1967 w/ Tach 1968 w/o Tach59.99 ea.
 GPC-68 1968 w/ Tach59.99 ea.
 GPC-676 1970-8159.99 ea.
 GPC-801G 1980-81 w/ Gauges & Warning Lights
 All82.99 ea.
 GPC-9092G 1990-92 With Rally Gauges119.99 ea.

With Warning Lights

GPC-67W 1967-6959.99 ea.
 GPC-739W 1970-7959.99 ea.
 GPC-801G 1980-81 w/ Gauges & Warning Lights
 All82.99 ea.



IK-84

1969 Speed/Fuel Lens Assemblies

OE style reproduction lens assemblies to replace your cracked or hazed originals.

IK-84 1969 Fuel74.99 ea.
 IK-24S 1969 Speedometer89.99 ea.



ISP-69F

1969 Instrument Socket Plate

Attaches to the back of the instrument housing above the gauges to provide access to mount the instrument panel lamp sockets.

ISP-69F 1969 All19.99 ea.
Note: Two required per car.



6457934

1967 Dash Fuel Gauge

OE style reproduction fuel gauge with RH turn signal and warning light provisions. For use on all models not equipped with an in dash tach.

6457934 1967249.99 ea.
No Volume Discount.



6431002

1968 Dash Fuel Gauge

OE style reproduction fuel gauge with RH turn signal and warning light provisions. For use on all models not equipped with an in dash tach.

6431002 1968234.99 ea.
No Volume Discount.



6431172

1969 Dash Fuel Gauge

OE style reproduction fuel gauge featuring correct face plate with AC Delco decal. For use on all models not equipped with an in dash tach.

6431172 1969149.99 ea.
No Volume Discount.



6431506

1970-78 Fuel Gauge

OE style reproduction fuel gauge with correct markings for all models with gauges.

6431506 1970-7899.99 ea.
No Volume Discount.



IK-178

1969 Center Dash Fuel Gauge

High quality reproduction of the original center dash fuel gauge which was originally equipped on models with a tachometer and without console gauges.

IK-178 1969159.99 ea.
No Volume Discount.



IQ-464

1969 Center Dash Clock

OE style reproduction center dash clock for models equipped with RPO code U35 clock or U17 special instrumentation. Manufactured with quartz movement for accuracy and cosmetically correct once installed.

IQ-464 1969168.99 ea.
No Volume Discount.



IQ-70

1970-78 In Dash Clock

OE style reproduction in dash clock for models with gauges. Features correct markings and quartz movement for accuracy.

IQ-70 1970-78 249.99 ea.
No Volume Discount.



6473741

1970-78 Amp/Volt Gauge

Reproduction amp/volt gauge featuring correct markings. Calibrated and ready to install.

6473741 1970-75 Amps 140.99 ea.
6474343 1976-78 Volt 104.99 ea.
No Volume Discount.



6489856

1970-78 Temp Gauge

OE style reproduction water temperature gauge with correct markings. Calibrated and ready to install.

6489856 1970-78 120.99 ea.
No Volume Discount.



6480794

1967 Speedometer

OE style reproduction standard 120 mph speedometer. Correctly calibrated and ready to install. Available with or without U15 speed warning indicator.

6480794 1967 289.99 ea.
6480796 1967 w/ Speed Warning 299.99 ea.
No Volume Discount.



6481843

1968 Speedometer

OE style reproduction standard 120 mph speedometer. Correctly calibrated and ready to install. Available with or without U15 speed warning indicator.

6481843 1968 289.99 ea.
6481845 1968 w/ Speed Warning 299.99 ea.
No Volume Discount.



IQ-111

1969 Speedometer

OE style reproduction standard 120 mph or 140 mph COPO speedometer. Correctly calibrated and ready to install. Available with or without U15 speed warning indicator.

6482887 1969 120 239.99 ea.
6482888 1969 120 w/ Spd Wrng 259.99 ea.
IQ-111 1969 140 COPO 219.99 ea.
6492576 1969 140 COPO w/ Spd Wrng... 209.99 ea.
No Volume Discount.



8987263

1970-78 Speedometer

OE style reproduction speedometers with all correct markings.

8987263 1970-78 130 MPH 359.99 ea.
6497236 1970-74 150 MPH 289.99 ea.
No Volume Discount.



6468909

1967 Tachometer

OE style reproduction tachometers to replace your original.

6468909 327 5000 RPM 329.99 ea.
6468910 350, 396/325 5500 RPM 329.99 ea.
6468911 Z/28, 396/375 6000 RPM 329.99 ea.
No Volume Discount.



6468713

1968 Tic-Toc Tachometer

OE style reproduction Tic-Toc tachometers to replace your original.

6468713 327, 350 5500 RPM 369.99 ea.
6468714 396/325-350 5000 RPM 369.99 ea.
6468715 Z/28, 396/375 6000 RPM 369.99 ea.
No Volume Discount.



6469381

1969 Tachometer

OE style reproduction tachometers with correct faceplates and AC Delco decals.

6469381 SS350 5000 RPM 199.99 ea.
6469384 396/375 6000RPM 199.99 ea.
6469384 Z/28 6000 RPM 199.99 ea.
6469382 Early Z/28 5500 RPM 199.99 ea.
6469382 396/325-350 5500 RPM 199.99 ea.
6469383 396/375 6000 RPM 199.99 ea.
No Volume Discount.



5657040

1970-78 Tachometer

OE style reproduction tachometers with correct markings and a lens for the low oil pressure warning light. Correct for all 1970-74 without Z/28 or 396 and all 1975-78 models.

5657040 5000 RPM 279.99 ea.
No Volume Discount.



EHT-335

Dixco Style Hood Tach

These were used on several aftermarket applications for super cars including Yenko and Motion. White, paint to match.

EHT-335 1967-92 User Sets Red Line 218.99 ea.



6454841

ISW-2148

Speed Warning Cables

High quality reproduction of the control cable used with the desirable and highly sought after RPO code U15 (Speed Warning Indicator).

6454841	1967-69 Cable.....	32.99 ea.
ISW-2148	1969 Cable Bracket	24.95 ea.



FHB-115

Speedometer Cable Clip

OE style reproduction of the speedometer cable clip that mounts on the firewall and transmission hump.

FHB-115	1967-69 All	15.99 ea.
---------	-------------------	-----------



IRC-006

Speedometer Cable Retaining Clip

Holds the cable to the back of speedometer.

IRC-006	1969-85 All	8.99 ea.
---------	-------------------	----------



IN-60

Clock Reset Knob

Replacement clock reset knob kit including correct retaining nut. Measures 5/16" long. Includes 2 knobs for early or late cars.

IN-60	1967-81 All	13.99 ea.
-------	-------------------	-----------

No Volume Discount.



ICD-69U

ICD-69L

1969 Center Clock/Fuel Clips

Correct special clips to mount center dash clock or fuel gauge.

ICD-69U	Upper Clips.....	17.95 pr.
ICD-69L	Lower Clips	21.99 pr.



GAC-194KIT

Dash Instrument Socket And Bulb Set

194 bulbs and bulb sockets. If the lights on your dash are dim, flickering, or just plain not working this could be the solution!

GAC-194KIT	1967-2000 Most	7.99 set
------------	----------------------	----------

No volume discount.



GAC-6768

1967-68 High Beam Indicator

Reproduction headlamp hi-beam indicator bulb housing, red lens and ground strap. Mounts on the upper portion of the rear section of the plastic instrument carrier. The ground strap is instrumental in grounding the hi-beam indicator light and gauge cluster assembly. Includes mounting screws. Bulb and wiring are not included.

GAC-6768	All.....	54.99 set
----------	----------	-----------



IDL-686T



IDL-67FB

Indicator Lenses

Replace your missing original indicator lenses with these correct reproductions.

IDL-67FB	1967 Fuel / Brake	15.99 ea.
IDL-680B	1968 Oil / Brake.....	9.95 ea.
IDL-686T	1968 Gen / Temp	9.95 ea.

IDL-69CD



1969 Center Dash Diffuser

Correct diffuser replaces original.

IDL-69CD	1969 Diffuser	9.99 ea.
----------	---------------------	----------



AF-LED194R



AF-LED194



AF-LED194A

Addictive Flow LED Dash Bulbs

A simple direct replacement for your original 194 style dash light bulbs. Excellent to increase brightness and reduce heat and power.

AF-LED194R	Red LED Bulb	7.99 ea.
AF-LED194	194 White LED Bulb	7.99 ea.
AF-LED194A	194 Amber LED Bulb	7.99 ea.



ITT-001

1970-78 Gauge Mounting Plate

Correct mounting plate for fuel gauge and volt gauge.

ITT-001	1970-81	17.99 ea.
---------	---------------	-----------

No Volume Discount.



Dakota Digital RTX Gauge Kits

Designed after stock Camaro clusters, these new packages look like a simple speed/tach combo until the key is turned, revealing four LED bar auxiliary readings for oil pressure, coolant temperature, fuel, and volts. Each pod features a TFT message center for additional info at your fingertips. Available in 1967 or 1968 styles, they fit directly into stock or reproduction gauge bezels (sold separately). The RTX series retains a stock look while incorporating modern features like fully configurable HD TFT displays and a central control box for easy installation. Perfect for a vintage appearance with modern functionality.

RTX-67C-CAM-X	1967	1720.99 kit
RTX-68C-CAM-X	1968	1720.99 kit
RTX-69C-CAM-X	1969	1720.99 kit
RTX-70C-CAM-X	1970-81	1753.99 kit

No Volume Discount.



IZL-DP4000R



IZL-DP4005B

Intellitronix Digital Gauge Kits

State-of-the-art LED Digital Replacement Gauge Panel from Intellitronix. This dash comes with direct fit printed circuit boards, custom fit smoked plexiglass faceplate

IZL-DP4000R	1967-68 Red Illumination	459.99 ea.
IZL-DP4000B	1967-68 Blue Illumination	459.99 ea.
IZL-DP4000G	1967-68 Green Illumination	459.99 ea.
IZL-DP4000T	1967-68 Teal Illumination	459.99 ea.
IZL-DP4000W	1967-68 White Illumination	459.99 ea.
IZL-DP4003R	1982-90 Red Illumination	459.99 ea.
IZL-DP4003B	1982-90 Blue Illumination	459.99 ea.
IZL-DP4003G	1982-90 Green Illumination	459.99 ea.
IZL-DP4003T	1982-90 Teal Illumination	459.99 ea.
IZL-DP4003W	1982-90 White Illumination	459.99 ea.
IZL-DP4005R	1991-92 Red Illumination	459.99 ea.
IZL-DP4005B	1991-92 Blue Illumination	459.99 ea.
IZL-DP4005G	1991-92 Green Illumination	459.99 ea.
IZL-DP4005T	1991-92 Teal Illumination	459.99 ea.
IZL-DP4005W	1991-92 White Illumination	459.99 ea.

No Volume Discount.



HDX-67C-CAM-S

HDX-69C-CAM-K



HDX-70C-CAM-S



Dakota Digital HDX Gauge Kits

Ushering in a new era of muscle machines, Camaros have long been turned into hot rods. Keep the tradition alive and bring yours up to spec with this direct-fit instrument system! It attaches directly to a stock or reproduction bezel (available separately) and supplies you with six analog gauge sweeps and a pair of high visibility TFT message centers. Available with your choice of black or silver alloy gauge-face styling, each HDX system allows the user to select independent illumination colors for the gauge readings and needles, as well as the message centers. Calibration and personal settings are manipulated with the built-in, capacitive-touch buttons or the available Bluetooth App. for Apple and Android devices. Each needle hub is black nickel plated spun-aluminum to match the buttons. All HDX instrument systems feature dead-faced indicators (turn signals, high beam, check engine, cruise control, parking brake, plus two user-definable) and a red, settable warning light for each gauge. With our central control box, installation is greatly simplified with vehicle-harness sourced signals and supplied, solid state sending units connecting cleanly to their respective terminals.

HDX-67C-CAM-S	1967-68 Silver Alloy Face	1616.99 ea.
HDX-67C-CAM-K	1967-68 Black Alloy Face	1616.99 ea.
HDX-69C-CAM-S	1969 Silver Alloy Face	1616.99 ea.
HDX-69C-CAM-K	1969 Black Alloy Face	1616.99 ea.
HDX-70C-CAM-S	1970-78 Silver Alloy Face	1616.99 ea.
HDX-70C-CAM-K	1970-78 Black Alloy Face	1616.99 ea.

No Volume Discount.



VHX-82C-CAM-K-B



VHX-90C-CAM-K-W

1982-92 Dakota Digital VHX System

Fully lit needles, backlit faces, and highly visible LCD message centers are a few of the things that you can see which set the VHX Series apart from yesterday's traditional approach to instrumentation. A few of the features which you don't normally see are the micro-controlled precision stepper motors, solid state sensors for unparalleled accuracy, and user-customizable display feedback.

1982-89 Systems

VHX-82C-CAM-K-B	Black Alloy, Blue Numbers	968.99 kit
VHX-82C-CAM-K-R	Black Alloy, Red Numbers	968.99 kit
VHX-82C-CAM-K-W	Black Alloy, White Numbers	968.99 kit
VHX-82C-CAM-S-B	Silver Alloy, Blue Numbers	968.99 kit
VHX-82C-CAM-S-R	Silver Alloy, Red Numbers	968.99 kit
VHX-82C-CAM-S-W	Silver Alloy, White Numbers	968.99 kit

1990-92 Systems

VHX-90C-CAM-K-B	Black Alloy, Blue Numbers	968.99 kit
VHX-90C-CAM-K-R	Black Alloy, Red Numbers	968.99 kit
VHX-90C-CAM-K-W	Black Alloy, White Numbers	968.99 kit
VHX-90C-CAM-S-B	Silver Alloy, Blue Numbers	968.99 kit
VHX-90C-CAM-S-R	Silver Alloy, Red Numbers	968.99 kit
VHX-90C-CAM-S-W	Silver Alloy, White Numbers	968.99 kit
VHX-90C-CAM-C-B	Carbon Fiber, Blue Numbers	968.99 kit
VHX-90C-CAM-C-R	Carbon Fiber, Red Numbers	968.99 kit

Does not include bezel. No volume discount.

Dakota Digital Instrument Clusters

Dakota Digital Series III instrument systems offer the latest technology and features for your custom vehicle. High brightness vacuum fluorescent displays provide a lifetime of trouble free use while offering increased accuracy and features!



VFD3-67C-CAM-B

1967-68 Camaro Dakota Digital Instrument Cluster VFD3 System

Fits directly into existing bezel. Choose from blue or teal numbers, MPH or KPH and degrees Fahrenheit or Celsius.

VFD3-67C-CAM-B	Blue, MPH, Fahrenheit	779.99 kit
MFD3-67C-CAM-B	Blue, KPH, Celsius	779.99 kit
VFD3-67C-CAM-T	Teal, MPH, Fahrenheit	779.99 kit
MFD3-67C-CAM-T	Teal, KPH, Celsius	779.99 kit

Does not include bezel. No Volume Discount.



VHX-67C-CAM-S-R

1967-68 Camaro Dakota Digital VHX System

The new VHX system will modernize your ride with the latest technology and styling. Attaching directly to the back side of the stock instrument housing, the fitment couldn't be simpler. Fully lit needles, backlit faces and highly visible LCD message centers are a few of the things that you can see which set the VHX Series apart from yesterday's traditional approach to instrumentation.

VHX-67C-CAM-S-R	Silver Alloy, Red Numbers	968.99 kit
VHX-67C-CAM-S-B	Silver Alloy, Blue Numbers	968.99 kit
VHX-67C-CAM-C-R	Carbon Fiber, Red Numbers	968.99 kit
VHX-67C-CAM-C-B	Carbon Fiber, Blue Numbers	968.99 kit

Does not include bezel. No Volume Discount.



VFD3-69C-CAM-B

1969 Camaro Dakota Digital Instrument Cluster VFD3 System

Includes new reproduction bezel. Choose from blue or teal numbers, MPH or KPH and degrees Fahrenheit or Celsius.

VFD3-69C-CAM-B	Blue, MPH, Fahrenheit	999.99 kit
MFD3-69C-CAM-B	Blue, KPH, Celsius	999.99 kit
VFD3-69C-CAM-T	Teal, MPH, Fahrenheit	999.99 kit
MFD3-69C-CAM-T	Teal, KPH, Celsius	999.99 kit

No Volume Discount.



VHX-69C-CAM-C-B

1969 Camaro Dakota Digital VHX System

The VHX system will modernize your ride with the latest technology and styling. Attaching directly to the back side of the stock instrument housing, the fitment couldn't be simpler. Fully lit needles, backlit faces and highly visible LCD message centers are a few of the things that you can see which set the VHX Series apart from yesterday's traditional approach to instrumentation.

- VHX-69C-CAM-S-R Silver Alloy, Red Numbers..... 968.99 kit
- VHX-69C-CAM-S-B Silver Alloy, Blue Numbers..... 968.99 kit
- VHX-69C-CAM-C-R Carbon Fiber, Red Numbers 968.99 kit
- VHX-69C-CAM-C-B Carbon Fiber, Blue Numbers 968.99 kit

Does not include bezel. No Volume Discount.



VFD3-70C-CAM-N-B

1970-81 Camaro Dakota Digital Instrument Cluster VFD3 System

Includes dash housing which fits into bezel. Choose from blue or teal numbers, MPH or KPH and degrees Fahrenheit or Celsius.

- VFD3-70C-CAM-N-B Blue, MPH, Fahrenheit 968.99 kit
- MFD3-70C-CAM-N-B Blue, KPH, Celsius..... 968.99 kit
- VFD3-70C-CAM-N-T Teal, MPH, Fahrenheit..... 968.99 kit
- MFD3-70C-CAM-N-T Teal, KPH, Celsius 968.99 kit

Does not include bezel. No Volume Discount.



VHX-70C-CAM-S-B

1970-81 Camaro Dakota Digital VHX System

The new VHX system will modernize your ride with the latest technology and styling. Attaching directly to the back side of the stock instrument housing, the fitment couldn't be simpler. Fully lit needles, backlit faces and highly visible LCD message centers are a few of the things that you can see which set the VHX Series apart from yesterday's traditional approach to instrumentation.

- VHX-70C-CAM-S-R Silver Alloy, Red Numbers..... 968.99 kit
- VHX-70C-CAM-S-B Silver Alloy, Blue Numbers..... 968.99 kit
- VHX-70C-CAM-C-R Carbon Fiber, Red Numbers 971.99 kit
- VHX-70C-CAM-C-B Carbon Fiber, Blue Numbers 968.99 kit

Does not include bezel. No Volume Discount.

Dakota Digital Instrument systems are normally shipped from the factory with "0" miles on the odometer. If you would like mileage added to the odometer, this can be done at the factory for a charge of \$20. Please contact Ground Up Motors to arrange this service.



ANCAM67



AWCAM67



American Nickel American Tradition Velocity Black



G-Stock All American Vintage



Velocity White Classic White Hot Rod



SG Traditional White

Classic Instruments 1967-68 Camaro Gauges

These gauges include a new reproduction dash bezel. Includes 140 MPH speedo (Velocity Series 160 MPH), 8,000 RPM tachometer (Velocity Series 10,000 RPM), Quad Cluster (Fuel 0-90 ohms, water temp, oil pressure, volts), integrated turn and high beam indicators and illumination for night time driving. Gauges are wired and come with sending units for installation.

- ANCAM67 1967-68 Nickel Series..... 1169.99 kit
- ATCAM67 1967-68 American Series 1488.99 kit
- AWCAM67 1967-68 American Series 1488.99 kit
- GSCAM67 1967-68 G/Stock Series 1310.99 kit
- HRCAM67 1967-68 Hot Rod Series 1310.99 kit
- WHCAM67 1967-68 White Hot Series 1310.99 kit
- CWCAM67 1967-68 Classic White 1310.99 kit
- SGCAM67 1967-68 SG Series..... 1310.99 kit
- TRCAM67 1967-68 Traditional Series..... 1310.99 kit
- VTCAM67 1967-68 Vintage Series 1310.99 kit
- VSCAM67 Velocity Series Black..... 1310.99 kit
- VSWCAM67 Velocity Series White 1310.99 kit
- SN16 Signal Generator 116.99 ea.

Includes new reproduction dash bezel. No Volume Discount.



SN81

SkyDrive GPS Speedometer Sensor

Calibrate your speedometer in less than a minute and you don't even have to leave your driveway! SkyDrive is the worlds most accurate electronic speedometer sending unit. No need for ECU converters or pulse signal generators screwed into your transmission. The new SkyDrive uses GPS satellite signals to operate your electronic speedometer. It updates 10 times per second and with one push of a button it's ready to go!

- SN81V SkyDrive..... 179.99 ea.

Note: Works with all Classic Instruments kits as well as any other manufacturer's electronic speedometer.



FSU1000

Electronic Speedometer Sender

This speedometer sending unit is required for correct operation of your electronic speedometer.

- FSU1000 1967-81..... 90.99 ea.

No Volume Discount. Mechanical gauges do not require this sender.

LS Motor Installation Kit

This kit includes the required sensor adapters for the oil pressure gauge and water temperature gauges. As well as a 10K resistor for the tachometer. The specialized instruction manual, fittings, sensor and electrical component packaged in this kit make the instrument installation on your GM LS based engine simple and straight forward.

- 5284 LS Motor Installation Kit..... 51.99 kit

No Volume Discount.



5289

GPS Speedometer Interface Module

This Auto Meter GPS speedometer interface module can turn any electronic speedometer into a GPS speedometer with just the push of a button. It offers plug and play functionality with any Auto Meter electronic speedometer and simple one-button, 10-second calibration for nearly every other electronic speedometer on the market. It features IP67 construction and is fully sealed against water and dust. It includes a fully sealed and paintable magnetic micro antenna and a lightning-fast 10 Hz sampling rate.

- 5289 GPS Speedo Interface Module 236.95 ea.

PRO SHOP™
Series

Camaro

IK-880

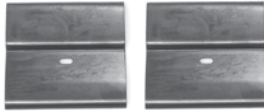

IK-206



IQ-331



IK-8301



IK-524

1969 Dash Grab Handle Kit

Replace your original dash grab handle or upgrade to this option with this complete kit and save! This kit includes trim plate, grab handle, bezels, emblem, mounting plate and hardware.

IK-524KIT 1969 All 139.45 kit

1969 Dash Grab Handle

OE style reproduction dash grab assist handle featuring correct grain.

IK-8301 1969 All 49.99 ea.

1969 Dash Grab Handle Molding

OE style reproduction of the instrument panel molding located above the glove box door area on the dash with mylar trim.

IK-524 1969 All 34.99 ea.

1969 Dash Grab Handle Bezels

Excellent quality triple chrome plated bezels used to mount the dash grab handle to the dash panel.

IQ-331 1969 All 25.99 pr.

1969 Dash Panel Emblem

Original style reproduction dash panel molding emblem which applies directly above the glove box door.

IK-880 1969 All 17.99 ea.

1969 Dash Grab Handle Retainers

Correct backing plates used to secure the dash grab handle.

IK-206 1969 All 25.99 pr.

BUY & SAVE
WITH SS396.COM PRE-BUILT KITS



IK-153KIT

1969 Cherrywood Dash Trim Kit

Give your dash it's original luster back by replacing your faded or worn out original Cherrywood Dash set with this OER reproduction kit. Designed to cover the dash area on 1969 Camaro models with Special Interior Group (Z23) or Custom Interior (Z87) packages. Kit includes the dash plate (dash molding and emblem are attached to this area and holes are provided for installation as shown), glove box door, ash tray section, radio plate and windshield wiper plate.

IK-153KIT 1969 All 319.99 kit
Not eligible for volume discount.



IK-153C

1969 Cherrywood Dash Panel

Authentic reproduction of the original Cherrywood dash plate used to cover up the dash panel, ash tray door and glove box door. This is an excellent replacement for your original plate or makes for a nice upgrade if your Camaro did not originally come with this option.

IK-153C 1969 All 279.99 set



IK-152C

1969 Cherrywood Radio Bezels

OE style reproduction Cherrywood radio bezels which will match your new Cherrywood dash panel.

IK-152C 1969 All 36.99 pr.



IWP-71C

1969 Cherrywood Wiper Plate

OE style reproduction Cherrywood wiper plate which will match your new Cherrywood dash panel.

IWP-71C 1969 All 19.99 ea.



IK-204

Center Dash Panels

Excellent reproduction center dash panels available in either correct black pebblegrain or walnut woodgrain. These will give the ultimate finishing touch to your dash!

IK-202	1967-68 Black w/o AC	79.99 ea.
IK-203	1967-68 Black w/ AC	79.99 ea.
IK-204	1968 Walnut w/o AC	84.99 ea.
IK-205	1968 Walnut w/ AC	84.99 ea.
IK-380B	1967-68 Radio Delete w/o AC ...	82.99 ea.
IK-380C	1967-68 Black Radio Delete	69.99 ea.



IK-524CLIP

Dash Panel Molding Clip

Reproduction of the aluminum clip used to attach the dash panel molding located above the glove box.

IK-524CLIP 1969 All 2.99 ea.
Sold individually, 3 required.



IW-219

Center Dash Panel Retainer

Correct retainer which holds the center dash panel to the dash.

IW-219 1967-68 All 7.99 ea.



IK-SN

Radio Shaft Attaching Nuts

These thin, specially threaded nuts fit nearly all early GM, Delco and Motorola radio shafts.

IK-SN 1967-1978 6.99 pr.



TRIM-HL-F

TRIM-IGN

TRIM-GB

Interior Dash Tools

Handy tools for easily removing and installing dash nuts.

TRIM-HL-F	1967-68 Headlight/Wiper Nut.....	14.99 ea.
TRIM-HL	1969-72 Headlight Nut.....	13.99 ea.
TRIM-IGN	1967-68 Ignition Bezel Nut	11.99 ea.
TRIM-GB	1969-81 Glove Box Nut.....	13.99 ea.



IC-122

1967 Dash Ash Tray

Featuring correct grains and finishes as original.

IC-122 1967 Black Grain..... 54.99 ea.



IC-122K

1967-68 Dash Ash Tray Bracket

OE style reproduction of the original bracket to restore smooth operation of ash tray receiver.

IC-122K 1967-68 All 27.99 ea.



IAT-143A



IAT-144W

1968-69 Dash Ash Tray

Excellent reproduction of the original dash ash tray assembly available in black primer or wood grain.

IC-321 1968 Black 59.99 ea.
 IC-321W 1968 Walnut 69.99 ea.
 IAT-143A 1969 Black 64.99 ea.
 IAT-144W 1969 Cherrywood 69.99 ea.



IC-486

1969 Dash Ash Tray Insert

OE style reproduction insert which fits in the center dash ash tray on your 1969 Camaro.

IC-486 1969 All 26.99 ea.



IC-344

1970-81 Dash Ash Tray

Featuring correct grain as original.

IC-344 1970-81 49.99 ea.



IK-298



ICG-68



IQ-421



ICG-70



ICG-71



ICG-78



ICG-82

Cigarette Lighter Assemblies

Brand new cigarette lighter assemblies with heating elements.

IK-298 1967 All 24.99 ea.
 ICG-68 1968 All 24.99 ea.
 IQ-421 1969 All 24.99 ea.
 ICG-70 1970 All 24.99 ea.
 ICG-71 1971-77 All 24.99 ea.
 ICG-78 1978-81 All 39.99 ea.
 ICG-82 1982-92 All 44.99 ea.



ICH-64K

Cigarette Lighter Housings

Correct 2 piece dash housings for lighter assemblies.

ICH-64K 1967-69 All 29.99 ea.
 ICH-72K 1970-78 All 29.99 ea.



ITS-601

Fiber Optic Ash Tray Socket

Reproduction fiber optic ash tray lamp socket.

ITS-601 1967-81 16.99 ea.



IGD-67F

1967-68 Glove Box Door

OE style reproduction glove box door to replace your dented or rusty original.

IGD-67F 1967-68 Door All 99.99 ea.
 IGD-67-HNG 1967-68 Hinge 26.99 ea.
 IGB-201 1967-68 Screws 3.99 pr.



IGD-905



inside view

1969 Glove Box Door

Excellent reproduction of the original glove box door assembly available in either OE black or Cherrywood.

IGD-659 1969 Black 86.99 ea.
 IGD-905 1969 Cherrywood 89.99 ea.



IGD-446



IGD-615

1970-81 Glove Box Door

OE style reproduction outer glove box door featuring correct grain and logo.

IGD-446 1970-77 92.99 ea.
 IGD-447-I 1972-81 Inner Door 32.99 ea.
 IGD-615 1978-81 99.99 ea.

Lock assembly sold separately.



IGB-023

Glove Box Door Arm Bumper

This bumper installs on the glove box door arm to prevent the glove box door from rattling. Manufactured from rubber as original.

IGB-023 1970-81 6.99 ea.



IGB-169F

Glove Box

Correct, die stamped cardboard reproductions.

IGB-167	1967-68 w/o AC.....	26.99 ea.
IGB-167A	1967-68 w/ AC.....	26.99 ea.
IGB-169F	1969 w/o AC.....	26.99 ea.
IGB-169A	1969 w/ AC.....	26.99 ea.
IGB-170	1970-81 w/o AC.....	26.99 ea.
IGB-170A	1970-81 w/ AC.....	26.99 ea.



IK-0827

1968 Glove Box Emblem

OE style reproduction of the Camaro script logo that attaches to the glove box.

IK-0827	1968.....	17.99 ea.
---------	-----------	-----------



IQ-402

Glove Box Screws

Correct glove box screw kit.

IQ-402	1967-69 All.....	3.95 kit
--------	------------------	----------



18000

Glove Box Lamp Socket, bulb and wire

18000	1967-69 All.....	26.99 kit
-------	------------------	-----------

Complete with socket, bulb and wire or terminal

36134	1970-79 w/ Wire.....	26.99 kit
36136	1980-81 w/ Terminals.....	24.99 kit



ILS-70

Glove Box Lock Striker

Mounts to the dash in the glove box opening to secure the door when it is closed.

ILS-69	1969 All.....	9.99 ea.
ILS-70	1970-81 All.....	11.99 ea.



LGC-6881

Glove Box Lock Casing

This is the assembly that holds your lock cylinder in place and is commonly broken or damaged.

LGC-6881	1969-81.....	11.99 kit
----------	--------------	-----------



IGB-885

Glove Box Support Bracket

Manufactured to factory specifications from correct steel material, this bracket provides structural support for the glove box and secures it to the dash. One required per vehicle.

IGB-885	1970-81 All.....	22.99 ea.
---------	------------------	-----------



IQ-891

1967-68 Glove Box Catch Plate

Correct stamped bright zinc catch plate with two screws for easy installation.

IQ-891	1967-68.....	6.99 ea.
--------	--------------	----------



IK-214



IQ-05

Wiper Knobs

OE style chrome reproduction wiper knobs with correct textures and designs.

IK-214	1967-68 All.....	12.99 ea.
IQ-05	1969-81 All.....	6.99 ea.



IC-079

Wiper Switch Nut

Correct chrome nut used to mount the wiper switch.

IC-079	1967-68 All.....	11.99 ea.
--------	------------------	-----------



DSE121501

DSE Billet Headlight Knob

A great compliment to the DSE billet wiper knob in the Selecta-Speed wiper kit!

DSE121501	1967-69.....	27.99 ea.
-----------	--------------	-----------



IK-268



IK-353



IHL-712



IHL-780



IHL-827



IHL-729



IHL-902

Headlight Knobs

Correct knobs with rods.

IK-268	1967-68 All.....	15.99 ea.
IK-353	1969-70 All.....	19.99 ea.
IHL-712	1971-77 w/ Logo.....	18.99 ea.
IHL-780	1979-80 All.....	31.99 ea.
IHL-827	1982-87 All.....	29.99 ea.
IHL-729	1988-89 All.....	29.99 ea.
IHL-902	1990-92 All.....	29.99 ea.



IC-078



GHR-88



GHR-8292

Headlight Switch Nut

Correct chrome nut used to mount the headlight switch.

IC-078	1967-68 All.....	13.99 ea.
GHR-88	1969-81 All.....	12.99 ea.
GHR-8292	1982-92 All.....	10.99 ea.



IB-590

1967 Dash Knob Bezel Set

Correct 4 piece die cast dash knob bezel set. Includes cigarette lighter bezel, headlight switch bezel, ignition switch bezel, wiper switch bezel and complete sticker set.

- IB-590 1967 All 29.99 set
IDL-347 1967 White Letters Decals Only 6.99 kit



IB-591

1968 Dash Knob Bezel Set

Correct 4 piece dash knob bezel set. Includes lighter bezel, windshield washer bezel, headlight bezel and ignition bezel. Each bezel features correct lettering.

- IB-591 1968 All 18.99 set



NR-492



NR-70



Standard Steering Wheel Kits

Everything you need to replace your original wheel! High quality reproduction steering wheel, center shroud, horn buttons & contacts.

- NR-492 1969 Black 299.99 kit
NR-493 1969 Wood (Grain Insert) 340.96 kit
NR-70 1970 Black 299.99 ea.
NR-3494 1969 Red 329.99 kit
NR-3496 1969 Blue 329.99 kit
NR-3497 1969 Green 329.99 kit

No Volume Discount.



IDK-69C

1969 Dash Knob Kit

Complete dash knob set including lighter assembly, headlight knob, radio knobs and windshield washer knobs.

- IDK-69C 1969 Mono 34.99 set
IDK-69SC 1969 Stereo 34.99 set



IQ-507

Ignition Bezel Nut

OE style reproduction of this special nut.

- IQ-507 1967-68 All 10.99 ea.



IRD-69F

1967-69 Radio Delete Plate

Originally used on specially optioned cars that did not come with a factory radio. Injection molded like original with hot stamped chrome on the edge. This is a show quality piece.

- IRD-67F 1967-68 All Black 99.99 ea.
IRD-69F 1969 All Black 84.99 ea.



IK-712SS

1971-72 SS Steering Wheel

OE style reproduction of this hard to find wheel.

- IK-712SS 1971-72 SS Wheel 379.99 ea.
Will fit most years 1969-81.

KEEP A LOOK OUT FOR THESE LOGOS BELOW THROUGHOUT THE CATALOG FOR BIG SAVINGS AND DISCOUNTS ON KITS!

BUY & SAVE
WITH SS396.COM PRE-BUILT KITS



IRB-678

Radio Face Plate

Correct reproduction of the original radio bezel plate with chrome outer trim and black semi gloss paint.

- IRB-678 1967-68 All 39.99 ea.
IRS-533 1967-68 All Screw Set 4.99 kit



IK-213

IK-245

IRK-712

Radio Knobs

Correct inner and outer radio knobs.

- IK-520 1967-68 Inner (Mono) 8.99 pr.
IK-520S 1967-68 Inner (Stereo) 8.99 pr.
IK-213 1967-68 Outer 23.99 pr.
IK-231 1969-70 Inner (Mono) 11.99 pr.
IK-231S 1969-70 Inner (Stereo) 11.99 pr.
IK-245 1969-70 Outer 19.99 pr.
IRT-712 1971-78 Inner (Mono) 27.99 pr.
IRT-7S 1971-78 Inner (Stereo) 32.99 pr.
IRK-712 1971-78 Outer w/ Logo 27.99 pr.



IK-7Z

1969+ 4 Spoke Steering Wheel-Simulated Rope Wrap

- IK-7Z 1969+ 4 Spoke Wheel 279.99 ea.



IK-704

1971-77 4 Spoke Sport Steering Wheel

Supurb reproduction of the original GM 4-spoke Sport steering wheel designed for many various 1971-1981 GM models with the NK4 steering wheel option. This quality reproduction features a soft black padding original grain material and a 4-spoke design as original.

- IK-704 1971-77 4 Spoke Smooth 289.99 ea.

DER ORIGINAL[®] EQUIPMENT REPRODUCTION

IK-8289



IHC-8289

1982-89 Leather Wrapped Steering Wheel

Reproduction of the original style leather wrapped steering wheel designed for use on 1982-1989 Camaro models. Each steering wheel is produced to factory original specifications with stamped steel center ring and authentic leather grip.

- IK-8289 1982-89 Steering Wheel.....399.99 ea.
- IHC-8289 1982-89 Horn Button 84.99 ea.
- IK-730 1982-89 Horn Contact Wire 15.99 ea.

No Volume Discount.



IWN-KIT



Optional SS Cap



Optional Yenko Cap

Wood Steering Wheel Kits

Add one of these beautiful wood grain steering wheels to your car with one of our kits. Each kit includes steering wheel, hub, contacts, horn cap, cam and hardware.

- IWN-KIT 1967-68 Walnut w/o Tilt406.43 kit
- IWN-7T 1967-68 Walnut w/ Tilt.....406.43 kit
- IWN-KIT-YENKO 1968 Walnut w/o Tilt Yenko Cap446.93 kit
- IWN-7T-YENKO 1968 Walnut w/ Tilt Yenko Cap446.93 kit
- IWN-SSKIT 1967-68 Walnut w/o Tilt w/ SS Cap 446.93 kit
- IWN-SS7T 1967-68 Walnut w/ Tilt w/ SS Cap .446.93 kit
- IRW-KIT 1969 Rosewood w/o Tilt.....420.46 kit
- IRW-9T 1969 Rosewood w/ Tilt.....420.46 kit
- IRW-SSKIT 1969 Rosewood w/o Tilt w/ SS Cap 460.96 kit
- IRW-SS9T 1969 Rosewood w/ Tilt w/ SS Cap .460.96 kit
- IRW-KIT-YENKO 1969 Rosewood w/o Tilt Yenko Cap 460.96 kit
- IRW-9T-YENKO 1969 Rosewood w/ Tilt Yenko Cap .460.96 kit

Can be used on all 1967-81. No Volume Discount.



IXS-69T-H



IXS-SS6970-S



IXS-6970

Comfortgrip Steering Wheel Kits

Add some muscle to your interior with our Comfortgrip steering wheel kits.

Each kit includes steering wheel, hub, contacts, horn cap, cam and hardware. These wheels can be used on all models up to 1981.

- IXS-678-H 1967-68 Black w/ Silver Spokes w/ Holes 274.43 kit
- IXS-6970-H 1969-70 Black w/ Silver Spokes w/ Holes w/o Tilt 283.46 kit
- IXS-69T-H 1969-70 Black w/ Silver Spokes w/ Holes w/ Tilt..... 283.46 kit
- IXS-678-S 1967-68 Black w/ Silver Spokes w/ Slots 269.90 kit
- IXS-6970-S 1969-70 Black w/ Silver Spokes w/ Slots w/o Tilt..... 278.93 kit
- IXS-69T-S 1969-70 Black w/ Silver Spokes w/ Slots w/ Tilt..... 278.93 kit
- IXS-678 1967-68 Black w/ Silver Spokes..... 265.40 kit
- IXS-678-BLK 1967-68 Black w/ Black Spokes 265.93 kit
- IXS-6970-BLK 1969-70 Black w/ Black Spokes w/o Tilt 274.96 kit
- IXS-69T-BLK 1969-70 Black w/ Black Spokes w/ Tilt..... 274.96 kit
- IXS-6970 1969-72 Black w/o Tilt 274.43 kit
- IXS-69T 1969-72 Black w/ Tilt..... 274.43 kit
- IXS-SS678-H 1967-68 Black w/ Silver Spokes w/ Holes SS Cap 314.93 kit
- IXS-SS6970-H 1969-70 Black w/ Silver Spokes w/ Holes w/o Tilt w/ SS Cap 323.96 kit
- IXS-SS69T-H 1969-70 Black w/ Silver Spokes w/ Holes w/ Tilt w/ SS Cap 323.96 kit
- IXS-SS678-S 1967-68 Black w/ Silver Spokes w/ Slots SS Cap..... 310.40 kit
- IXS-SS6970-S 1969-70 Black w/ Silver Spokes w/ Slots w/o Tilt w/ SS Cap 319.43 kit
- IXS-SS69T-S 1969-70 Black w/ Silver Spokes w/ Slots w/ Tilt w/ SS Cap 319.43 kit
- IXS-SS678-BLK 1967-68 Black w/ Silver Spokes w/ SS Cap 306.43 kit
- IXS-SS6970-BLK 1969-70 Black w/ Black Spokes w/o Tilt w/ SS Cap 315.46 kit
- IXS-SS69T-BLK 1969-70 Black w/ Black Spokes w/ Tilt w/ SS Cap 315.46 kit
- IXS-SS6970 1969-70 Black w/o Tilt w/ SS Cap 314.93 kit
- IXS-SS69T 1969-70 Black w/ Tilt w/ SS Cap 314.93 kit
- IXS-69T-YENKO 1969-70 Black w/ Tilt Yenko Cap 314.93 kit
- IXS-6970-YENKO 1969-70 Black w/o Tilt Yenko Cap 314.93 kit
- IXS-6970-BLUE 1969-70 Bright Blue w/o Tilt 283.43 kit
- IXS-69T-BLUE 1969-70 Bright Blue w/ Tilt 283.43 kit
- IXS-6970-RED 1969-70 Red w/o Tilt..... 292.43 kit
- IXS-69T-RED 1969-70 Red w/ Tilt..... 292.43 kit
- IXS-SS6970-BLUE 1969-70 Bright Blue w/o Tilt w/ SS Cap..... 323.93 kit
- IXS-SS69T-BLUE 1969-70 Bright Blue w/ Tilt w/ SS Cap..... 323.93 kit
- IXS-SS6970-RED 1969-70 Red w/o Tilt w/ SS Cap 332.93 kit
- IXS-SS69T-RED 1969-70 Red w/ Tilt w/ SS Cap 332.93 kit

Correct for 1969-70 but can be used on all 1967-81. No Volume Discount.



BUY & SAVE
WITH SS396.COM PRE-BUILT KITS



IK-977



IJ-44

Standard Steering Wheels

GM licensed reproduction standard wheels.

IK-977	1967-68	254.99 ea.
IJ-44	1969	249.99 ea.

Can be used on all 1967-81. No Volume Discount.



IK-436



IK-536

Deluxe Steering Wheels

OE style reproduction deluxe steering wheel featuring correct "spider style" chrome insert. Can be used on all 1967-81.

IK-436	1967 Chrome	309.99 ea.
IK-536	1968 Brushed	319.99 ea.



BUY & SAVE
WITH SS396.COM PRE-BUILT KITS



GT36-5459-1K



GT14-4331-2K

GT Performance Steering Wheel Kits

Our exclusive GT Performance steering wheel kits take away all guess work! Upgrade your worn out original steering wheel with these exclusive GT Performance steering wheel kits! They include everything you'll need to make the swap: steering wheel, hub and horn button.

GT14-4331-1K	1967-68 GT3 Classic Foam Wheel.....	217.99 kit
GT14-4331-2K	1969-81 GT3 Classic Foam Wheel.....	217.99 kit
GT14-5437-1K	1967-68 GT3 Classic Wood Wheel	328.99 kit
GT14-5437-2K	1969-81 GT3 Classic Wood Wheel	328.99 kit
GT36-5431-1K	1967-68 GT3 Retro Foam Wheel Chrome.....	224.99 kit
GT36-5431-2K	1969-81 GT3 Retro Foam Wheel Chrome.....	224.99 kit
GT36-5451-1K	1967-68 GT3 Retro Foam Wheel Stainless	224.99 kit
GT36-5451-2K	1969-81 GT3 Retro Foam Wheel Stainless	324.99 kit
GT36-5457-1K	1967-68 GT3 Retro Light Wood Wheel.....	416.99 kit
GT36-5457-2K	1969-81 GT3 Retro Light Wood Wheel.....	416.99 kit
GT36-5459-1K	1967-68 GT3 Retro Dark Wood Wheel	416.99 kit
GT36-5459-2K	1969-81 GT3 Retro Dark Wood Wheel	416.99 kit



IK-622



IK-623



IM-377



IM-370



IM-370-BLKSPK



IM-379

Sport Steering Wheels

OE style reproduction sport steering wheels to replace your originals or upgrade from standard.

IK-622	1967-68 Walnut	299.99 ea.
IK-623	1969 Rosewood	289.99 ea.
IM-370	1969-70 Black	159.95 ea.
IM-370-BLUE	1969-70 Bright Blue	179.95 ea.
IM-370-RED	1969-70 Red	179.95 ea.
IM-370-BLKSPK	1969-70 Black w/ Black Spokes	169.99 ea.
IM-377	1969-70 Black w/ Silver Spokes w/ Holes	169.99 ea.
IM-379	1969-70 Black w/ Silver Spokes w/ Slots	164.95 ea.

Can be used on all 1967-81.



TOOL-SWPULL

Steering Wheel Puller Kit

TOOL-SWPULL	Steering Wheel Puller 11pc	18.99 ea.
-------------	----------------------------	-----------



IK-062

Steering Wheel Hubs

Correct cast steering wheel mounting hub for all cars with sport wheels.

IK-062	1967-68 All	42.95 ea.
IJ-3520	1969 All	49.99 ea.



IC-583



IW-178E



IW-178B



IC-354



IW-178C



IW-179E



IW-179B



IC-477

1967-68 Horn Cap Assemblies

Correct reproduction horn caps for standard and deluxe wheels. Expertly crafted die cast piece with polished horn caps.

IC-583	1967 Std Chrome	43.99 ea.
IW-178E	1967 RS Chrome	29.99 ea.
IW-178B	1967 SS Chrome	34.99 ea.
IC-354	1968 Std Brushed	43.99 ea.
IW-178C	1968 SS350 Chrome	29.99 ea.
IW-179E	1968 RS Brushed	39.99 ea.
IW-179B	1968 SS Brushed	32.99 ea.
ICC-477	1967-68 Rubber Retainer Ring	6.99 ea.



IC-3380

1967-70 Sport Horn Cap

Excellent reproduction of the original horn cap used on sport wheels and woodgrain wheels.

IC-3380	1967-70 All Sport	54.99 ea.
---------	-------------------	-----------



IHC-71

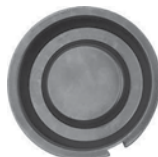

ICR-71



ICE-742



ICE-737



ICE-649



ICE-315

1971-81 NK4 Horn Caps

OE style reproduction caps and accessories for your optional NK4 sport wheel.

IHC-71	1971-81 Horn Cap	19.99 ea.
ICR-71	1971-81 Cap Retainer	10.99 ea.
ICE-742	1971-81 Bowtie Emblem	36.99 ea.
ICE-737	1971-81 Circle Emblem	36.99 ea.
ICE-649	1971-79 Camaro Emblem	36.99 ea.
ICE-315	1973-78 Style LT Emblem	37.99 ea.
ICE-886	All* SS Emblem	36.99 ea.

*Not stock for Camaro, but will fit and function as original.



IWE-6775

IWE-4475

1968 N30 Emblems

OE style reproduction emblems for the 1968 optional N30 deluxe steering wheel.

IWE-6775	1968 SS	26.99 ea.
IWE-4475	1968 SS396	43.99 ea.



IHC-SS

SS Horn Button

Awesome brushed aluminum cap with SS logo for all sport wheels.

IHC-SS	1967-69 w/ Sport	99.99 ea.
--------	------------------	-----------



IHC-YENKO

Yenko Horn Button

Custom brushed aluminum cap with Yenko Logo for all sport wheels.

IHC-YENKO	1967-70 w/ Sport	99.99 ea.
-----------	------------------	-----------



IFK-1



IFK-3



IFK-7888

Hazard Lamp Knob

Brand new chrome flasher knob.

IFK-1	1967-70 Long	13.99 ea.
IFK-3	1967-70 Short	11.99 ea.
IFK-7888	1978-88 4pc Set	10.99 set



NK-126



NK-213



NK-292



IC-588



IC-587

Standard Shroud

Excellent high quality reproduction.

NK-126	1969 Shroud Black	64.99 ea.
NJ-127	1969 Shroud Wood	74.99 ea.
NK-213	1969 Horn Buttons	19.99 pr.
NK-292	1969 Horn Contacts	20.99 pr.
IC-588	1969 SS Emblem	13.99 ea.
IC-587	1969 RS Emblem	14.99 ea.
IC-589	1969 Bowtie	14.99 ea.



IK-8

Horn Contact Kits

Complete kit for repairing horn contacts.

IHC-KIT	1967-68 All Standard	29.99 ea.
IHC-KITX	1967-68 All Deluxe	29.99 kit
IK-7	1967-68 Sport Wheel All	36.99 ea.
IK-579	1969 & Up Sport w/o Tilt	39.99 ea.
IK-8	1969 & Up Sport w/ Tilt	39.99 ea.
ICS-3	1967-69 Sport Spring/Pin	5.99 ea.
ICS-48	1966-69 Cap Mount Sport Wheel	16.99 ea.
IHC-KIT	1970-81 w/ 4 Spoke Wheel	29.99 ea.



ICC-7

Turn Signal Cancel Cam

Correct cam which turns off signal light.

ICC-7	1967-68 All	17.99 ea.
ICC-9	1969 w/o Tilt	18.99 ea.
ICC-93	1969 w/ Tilt	17.99 ea.



TILT-69FA

Original Steering Columns

These steering columns are the real deal! Each original GM unit is professionally rebuilt using OEM parts. We even include the turn signal switch! Limited supply!

TILT-67F	1967-68 Tilt	1489.99 ea.
TILT-69FA	1969 Tilt	899.99 ea.
TILT-69FAOC	1969 Automatic on Column.....	899.99 ea.
INT-69FA	1969 Non-Tilt All	799.99 ea.
TILT-70F	1970-76 w/ Console.....	899.99 ea.
TILT-67F	1970-76 Non-Tilt Floor Shift Automatic.....	1489.99 ea.
TILT-77F	1977-78 w/ Console.....	899.99 ea.
TILT-79F	1979-81 Floor Shift	899.99 ea.

No Volume Discount. Ships Oversize.



ICC-12005



RSC-1072F

Steering Column Cap

Correct cap used to hold the end of column together.

ICC-12005	1969-77	22.99 ea.
-----------	---------------	-----------

Steering Column Clamp Plate

Correct clamps used to hold steering column to firewall.

RSC-1072F	1969	48.99 ea.
-----------	------------	-----------



GIS-1001B

Steering Column Support

Correct bracket which holds the steering column to the bottom of the dash.

GIS-1001B	1967-68	74.99 ea.
GIS-1001E	1969	73.99 ea.



3949736

RCS-1

Steering Column Cover & Shim

Correct injection molded lower covers.

3914799	1967-68 All	36.99 ea.
3949736	1969 All	19.99 ea.
RCS-1	1967 All Shim 2 required.	24.99 ea.



FBK-678

1967-77 Steering Column Lower Bearing Upgrade Kits

You would want to replace this bearing if you are changing the lower steering shaft or replacing the steering coupler that attaches to the gear box, as the lower steering shaft has to be removed to slip the old bearing assembly out and install the new one. You do not need to remove the main steering shaft that this bearing kit goes onto.

FBK-678	1967-68 All w/o Tilt.....	79.99 ea.
FBK-7572	1969-77 All w/ Tilt.....	42.99 kit

No Volume Discount.



FBK-TILT

Steering Column Upper Bearing

New upper steering column bearings. This part commonly fails and is an easy way to make your worn out column like new again.

FBK-TILT	1969-75 w/ Tilt	79.99 ea.
FBK-6977-U	1969-77 w/o Tilt.....	52.99 ea.

Tilt Steering Column Housing Sleeve Floor Shift

Reproduction Camaro tilt steering column housing sleeve. This can be used to replace a column shift sleeve to convert your column to floor shift manual or automatic.



ISC-6981	1969-81 w/ Tilt Floor Shift	149.99 ea.
----------	-----------------------------------	------------

No Volume Discount.



ICG-5008

1969-77 Tilt Ignition Switch Actuator Gear

This is a brand new steering ignition switch actuator gear for tilt columns only. This part commonly fails and is an easy way to make a worn out column like new again.

ICG-5008	1969-77.....	21.99 ea.
----------	--------------	-----------



IT-4470

Tilt Wheel Levers

OE style reproduction tilt wheel release levers.

IT-4470	1967	28.99 ea.
IT-5168	1968-70	15.99 ea.
IT-2951	1971-78	15.99 ea.



IT-3208

Turn Signal Levers

OE style reproduction turn signal levers.

IT-3208	1967 w/o Tilt	24.99 ea.
IT-5165	1967 w/ Tilt	30.99 ea.
IT-5174	1968-70 All	17.99 ea.
IT-5176	1971-81 All	17.99 ea.
IT-25036	1982-83 w/ Wiper & Cruise.....	29.99 ea.



1967-68 Heater Control Assembly

Complete heater control unit pre-assembled and ready to install with faceplate featuring correct lettering.

IHC-67	1967 w/o AC	329.99 ea.
IHC-67A	1967 w/ AC	369.99 ea.
IHC-68	1968 w/o AC	329.99 ea.
IHC-68A	1968 w/ AC	329.99 ea.
IHC-6768K	1967-68 Hardware	13.99 set



IHC-69

1969 Heater Control Assembly

Complete heater control unit pre-assembled and ready to install. Includes faceplate with correct lettering and cables.

IHC-69	1969 w/o AC	319.99 ea.
IHC-69SK	1969 Hardware	16.99 set



IC-425

1977-81 Heater Control Backing Plate

Injection molded heater control backing plate, with included built-in lens retaining clips. Replaces the commonly broken heater control switch mount (for AC or non-AC) easily and reliably.

IC-425	1977-81 All	26.99 ea.
--------	-------------------	-----------



IC-455



IC-410

Heater Control Lenses

Correct letters and backgrounds.

IC-453	1967 w/o AC	20.99 ea.
IC-453A	1967 w/ AC	20.99 ea.
IC-455	1968 w/o AC	20.99 ea.
IC-455A	1968 w/ AC	20.99 ea.
IC-497	1969 w/o AC	18.99 ea.
IC-497A	1969 w/ AC	17.99 ea.
ICR-495	1969 w/o AC White Backing	19.99 ea.
ICR-496	1969 w/ AC White Backing	19.99 ea.
IC-415	1970-72 w/o AC	25.99 ea.
IC-420	1970-72 w/ AC	21.99 ea.
IC-416	1973-79 w/o AC	21.99 ea.
IC-421	1973 w/ AC	21.99 ea.
IC-422	1974-75 w/ AC	24.99 ea.
IC-423	1976-79 w/ AC	24.99 ea.
IC-417	1980-81 w/o AC	24.99 ea.
IC-424	1980-81 w/ AC	21.99 ea.
IC-410	1969-76 Heater Lens Clips 3pc.....	7.99 kit



IJ-660

1967-81 Heater Control Knobs

Chrome heater control knobs.

IJ-660	1967-81 All	4.99 ea.
IJ-426	1967-81 All 4pc	19.96 kit



I-896

1967-68 Heater Lever

Correct reinforced reproduction of this commonly missing defroster and de-ice lever.

I-896	1967-68 All	15.99 ea.
-------	-------------------	-----------



IHC-453CC

Heater Control Cables

Set of three correct heater control cables with inner poly line for smooth operation.

IHC-453CC	1967-68 w/o AC	54.99 set
IHC-497CC	1969 w/o AC	54.99 set
IHC-497ACC	1969 w/ AC	54.99 set



BCR-12658

1967-69 Heater Cable Retainer Set

Correct inner cable retaining clips.

BCR-12658	1967-69 6pc	3.99 kit
-----------	-------------------	----------



I-69FX

1969 Heater Lever Repair Kit

Includes 3 levers, 3 sleeves and 3 knobs to repair your original heater control.

I-69FX	1969 All	49.99 kit
--------	----------------	-----------



IDB-660



IDS-093

1970-78 Defogger

Excellent reproduction defogger switch and bezel which mounts on the right side of the instrument panel as original.

IDS-093	1970-78 Switch	54.99 ea.
IDB-660	1970-78 Bezel	31.99 ea.



IK-48R

IK-48L

Kick Panels

OE style reproduction kick panel assemblies.

IK-48L	1967-68 w/o AC LH	124.99 ea.
IK-48R	1967-68 w/o AC RH	124.99 ea.
IK-8ACL	1967-68 w/ AC LH	115.99 ea.
IK-8ACR	1967-68 w/ AC RH	115.99 ea.
IK-69L	1969 w/o AC LH	74.99 ea.
IK-69R	1969 w/o AC RH	74.99 ea.
IK-9ACL	1969 w/ AC LH	104.99 ea.
IK-9ACR	1969 w/ AC RH	104.99 ea.
IK-7L	1970-81 w/o AC LH	109.99 ea.
IK-7K	1970-81 w/o AC LH/RH	197.98 ea.
IK-7R	1970-81 w/o AC RH	109.99 ea.
IK-7ACL	1970-81 w/ AC LH	115.99 ea.
IK-7ACR	1970-81 w/ AC RH	115.99 ea.
IKJ-9	1967-69 Insulation	9.99 pr.



IRE-1281

Firewall Insulation Pad

Correct die-stamped original material complete with plugs. Rubber plugs also sold separately.

IRE-1281	1967-69 w/o AC	59.99 ea.
IRE-1281A	1967-69 w/ AC	59.99 ea.
IRE-1283	1970-81 w/o AC	59.99 ea.
IRE-1283A	1970-81 w/ AC	59.99 ea.
IRE-PLUG	1967-72 Plug	3.99 ea.



GAC-GRMT

Dimmer Switch Grommet

GAC-GRMT	Carpet Grommet Black	3.99 kit
----------	----------------------------	----------



ICE-4740

IYC-2525

ICE-0296

ICE-3611

Accelerator Pad & Trim

OE style reproduction pads with correct ribbing and stainless trim to finish them off.

ICE-4740	1970-71 Z/28 Pad	25.99 ea.
ICE-0296	1967-81 Pad	6.99 ea.
IYC-2525	1970-71 Z/28 Trim	14.95 ea.
ICE-3611	1967-81 Trim	6.99 ea.

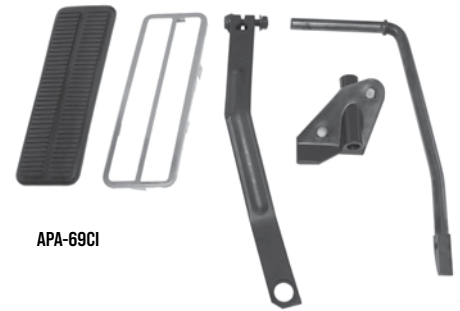

APA-69CI

Accelerator Pedal Linkage Kit

New assemblies complete from the pedal to the arm and includes the pedal trim.

APA-68	1967-69 V8 w/o Cowl Induction	69.99 kit
APA-69CI	1967-69 w/ Cowl Induction	62.99 kit



IST-3



AZC-88



ICE-8078

Accelerator Hardware

Correct hardware for pad and cable.

IST-3	1970-71 Z/28 Stud	4.99 ea.
ICE-8078	1967-81 Spring/Pin	9.99 ea.
AZC-88	Cable Clip	6.99 ea.
AY-12	1968-69 Pedal Rod Support Plastic	21.99 ea.



APA-6CBH



Throttle Linkage To Cable Conversion Kit

Remove the old sticky linkage and upgrade to a smooth operating throttle cable set up. This kit includes the accelerator pedal assembly, accelerator cable, cable bracket and cable retaining clip.

APA-6CBH	1967-69 Holley	145.99 kit
APA-6CBQJ	1967-69 Q-Jet	157.99 kit

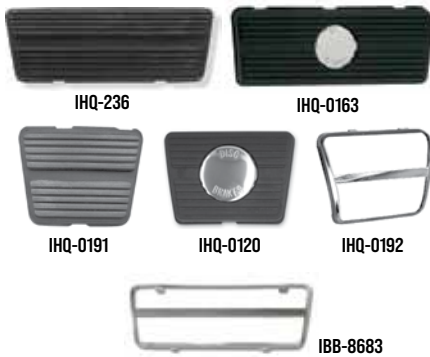

IHQ-236

IHQ-0163



IHQ-0191



IHQ-0120



IHQ-0192



IBB-8683

Brake/Clutch Pads & Trim

OE style reproduction pads with correct ribs and medallions where applicable.

IHQ-236	All Auto Drum 6.5"	5.99 ea.
IHQ-0163	All Auto Disc 6.5"	12.99 ea.
IBB-8683	Auto Brake Trim	8.99 ea.
IHQ-0191	4 Speed Drum Brake	6.39 ea.
IHQ-0120	4 Speed Disc Brake	13.99 ea.
IHQ-0192	4 Speed Trim	6.99 ea.
IHQ-99F	1972-81 Small Clutch	9.95 ea.
IHQ-0125	1972-81 4 Speed w/ Disc Brake	9.95 ea.

Clutch Pads & Trim

IHQ-0191	1967-71 Pad	6.39 ea.
IHQ-99F	1972-81 Pad	9.95 ea.
IHQ-0192	1967-72 Trim	6.99 ea.



IHQ-0229



IHQ-0108

E-Brake Pedal

OE style reproduction emergency brake pedal and stainless trim.

IHQ-0229	1967-68 Pad	3.99 ea.
IHQ-0203	1969-81 Pad	5.99 ea.
IHQ-0108	1967-68 Trim	5.99 ea.
IHQ-0122	1969-81 Trim	5.99 ea.



TA-206-BKM1

Billet Throttle Assembly

This billet throttle assembly by Clayton Machine Works is a killer interior upgrade for your muscle car! This set includes a complete billet throttle assembly with a custom pedal pad featuring unique rubber inserts. Also included are matching pedal covers for your brake pedal (automatic) or brake and clutch pedals (manual). These pads require no drilling and simply clamp over your existing pedals.

Black Anodized

TA-206-BKM1	1967-69 Manual	566.99 kit
TA-206-BKM2	1970-81 Manual	566.99 kit
TA-206-BKA1	1967-69 Auto	479.99 kit
TA-206-BKA2	1970-81 Auto	479.99 kit



3917438

Hurst Shifter

New Hurst Competition Plus shifter complete with Hurst handle and shifter ball.

3914339	1967-68 Muncie	533.99 ea.
3917438	1969 Muncie	575.99 ea.
3916848	1970-72 Muncie	539.99 ea.
3917438	1973-77 Muncie	575.99 ea.
3918794	1974-81 BW T-10	512.99 kit
HURST-3917960	1982 Console/Borg Warner	580.99 ea.

No Volume Discount.



Hurst Installation Kits

3734529

Complete kit with rods, levers, swivels and hardware.

3734529	1967-68 Muncie	315.99 kit
3737437	1969 Muncie	336.99 kit
3737897	1970-72 Muncie	370.99 kit
3738605	1973-74 Muncie	408.99 kit
3738609	1974-81 BW T10	347.99 kit
1957773	1967-81 Mounting Plate Only	45.99 ea.

No Volume Discount.



FW-115



FZ-1420



FW-157

Shifter Balls

OE style reproduction shifter balls.

FZ-1420	Muncie White 5/16"	23.99 ea.
FZ-1424	Hurst White 3/8"	24.99 ea.
FW-115	Chrome 5/16"	24.99 ea.
FW-117	Chrome 3/8"	22.99 ea.
FW-157	Black/Chrome 5/16"	24.99 ea.
FW-159	Black/Chrome 3/8"	23.99 ea.
FW-38HURST	Hurst White 3/8" 4 Speed	55.99 ea.
FZ-14019443	1982-86/91-99 Black	32.99 ea.
FZ-8289M	1982-02 Z28 Leather Black	89.99 ea.



FW-HURST

Hurst T-Handle Shifter Knob

This brushed aluminum T-handle provides a positive feel for accurate gear selection. A favorite in the performance world for years! Includes adapters for most popular shift handles.

FW-HURST	T-Handle	56.99 ea.
HURST-1530010	T-Handle Brushed Alum w/ Button ..	118.99 ea.
HURST-1530011	T-Handle Polished Alum w/ Button ..	122.99 ea.

FACTORY STYLE

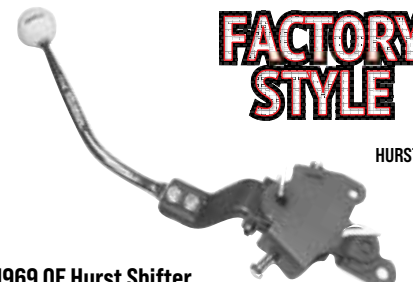

HURST-69

1969 OE Hurst Shifter

OE style reproduction of the highly sought after shifter used on all 1969 Camaro 4 speeds. Features correct style handle exclusive to 1969 Camaros.

HURST-69	1969 All	569.99 ea.
----------	----------------	------------



HURST-69SB
HURST-69BB

1969 OE Hurst Shifter Installation Kits

Correct installation hardware kits for your 1969 Hurst Shifter.

HURST-69SB	1969 SB	179.99 ea.
HURST-69BB	1969 BB	279.99 ea.



NA-578

Reverse Lockout Kit

Complete with 2 rods and swivel mechanism.

NA-578	1969 All	99.99 kit
NA-704	1970-74	149.99 kit



SW280-RCT

1967 Universal Shifter Kit

Universal Camaro shifter that has the look of the factory shifter setup for both the 3 speed TH350/TH400 overdrive 700-R4, 200-4R, 4L60, 4L65 and the 4L80. Complete with neutral safety/back up switch, all rod linkage components and factory-like reverse lock out and detents for each gear. Also includes a universal floor mounting bracket kit.

SW280-RCT	1967 All	499.99 kit
-----------	----------------	------------



FMCK-67S

Manual Transmission Conversion Kit

Planning on swapping from automatic to a 4 speed manual? This kit will take the headache out of the switch by providing you with all of the parts needed to make your conversion simple! This complete kit includes the brake/clutch pedals, Z bar, rods, boots, cross shaft kit, springs, bracket and all hardware!

FMCK-67S	1967-68 SB	241.96 kit
FMCK-67B	1967-68 BB	244.66 kit
FMCK-69S	1969 SB	265.46 kit
FMCK-69B	1969 BB	263.66 kit
FMCK-70S	1970-71 V8	259.07 kit
FMCK-70B	1972-81 V8	264.47 kit

With Headers*

FMCK-67S-HD	1967-68 SB	235.67 kit
FMCK-67B-HD	1967-68 BB	225.78 kit
FMCK-69S-HD	1969 SB	259.17 kit
FMCK-69B-HD	1969 BB	256.47 kit

No Volume Discount. *Includes everything that comes in regular kits except the small spring and extension rod which can not be used with headers.



FCI-99A

IBP-628

Brake Pedal Assembly

OE style reproduction brake pedal assembly for automatic transmission. 6.5" wide.

FCI-99A	1967-72 Auto Pedal 6.5"	49.99 ea.
IBP-628	1967-69 Pedal Pivot Pin	19.99 ea.



FPB-97

FPB-103

Clutch Pedal Bushing & Bumper

Correct nylon bushing used for ease of pedal.

FPB-97	All Bushing	2.99 ea.
FPB-103	All Bumper	7.99 ea.



FCI-1860

Clutch & Brake Pedal Assemblies

Complete reproduction brake/clutch pedals.

FCI-1860	1967-68	89.99 ea.
FCI-1869	1969	109.99 ea.
FCI-1870	1970-71	94.99 ea.
FCI-1872	1972-81	99.99 ea.



IPA-EB

IPA-67FM

Muscle Car Pedal Assembly

This awesome Camaro pedal assembly by Clayton Machine Works is machined from forged aluminum and comes complete with pedal arms, pedals with dimpled rubber pads and all necessary hardware for installation. This means that you'll have that one-off custom look without the one-off price all in a complete easy to install bolt in package.

DBW = Drive by Wire

IPA-67FA	1967 Auto	848.99 kit
IPA-67FAD	1967 Auto DBW	700.99 kit
IPA-67FM	1967 Manual	1124.99 kit
IPA-67FMD	1967 Manual DBW	928.99 kit
IPA-68FA	1968 Auto	848.99 kit
IPA-68FAD	1968 Auto DBW	700.99 kit
IPA-68FM	1968 Manual	1124.99 kit
IPA-68FMD	1968 Manual DBW	928.99 kit
IPA-69FA	1969 Auto	848.99 kit
IPA-69FAD	1969 Auto DBW	700.99 kit
IPA-69FM	1969 Manual	1124.99 kit
IPA-69FMD	1969 Manual DBW	928.99 kit

No Volume Discount.

Muscle Car E-Brake Cover

This e-brake cover is meant to match your Clayton Machine Works pedal assemblies perfectly. It also can be used alone to dress up your interior. Complete with mounting hardware.

IPA-EB	1967-81 All	83.99 ea.
--------	-------------------	-----------

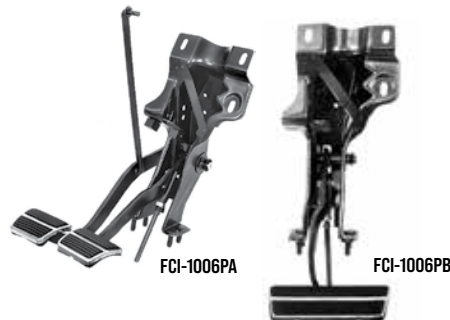

FCI-1006PA

FCI-1006PB

Pedal Assemblies Complete

These complete assemblies come with the support hanger bracket, pedals, pads, pins and bushings. Available in manual and automatic.

FCI-1006PA	1967-68 Manual	284.99 ea.
FCI-1006PB	1967-68 Auto	249.99 ea.
FCI-69FX	1969 4 Speed*	246.93 kit

*Does not include pedal pads or trim.



IBH-8292

1982-92 Parking Brake Handle

Excellent reproduction parking brake handle wrapped in leather.

IBH-8292	1982-92 All w/ Leather	87.99 ea.
----------	------------------------------	-----------



IBA-67



IBA-69

E-Brake Assemblies

OE style reproduction parking brake assemblies complete with correct pad and trim.

IBA-67	1967-68 All	59.99 ea.
IBA-69	1969 All	59.99 ea.
GBL-7RC	Release Rod Clip All	5.99 kit



GBL-852

GBL-852-CC

Brake Light Switches

OE style brake light switches located above the brake pedal.

GBL-852	1967-81 All w/o Cruise Control ...	6.99 ea.
GBL-852-CC	1967-79 All w/ Cruise Control ..	24.99 ea.



IEB-110

IEB-110-CH

E-Brake Knobs

OE style reproduction emergency brake pedal knob with the correct white lettering.

IEB-110	1967-81 Knob Only	6.99 ea.
IEB-110-CH	1967-74 Knob Only Chrome	6.99 ea.



HURST-6371003

Hurst Logo Floor Mats

The embroidered Hurst logo on the front set of mats features the iconic accented Hurst logo. The Elite Series floor mats are also available with the Iconic Gold/Black Hurst logo reminiscent of Hurst Performance cars from back in the day. These mats are cut to an exact OEM cut fit with OEM-style attachment points (when applicable) and non-slip backing.

- HURST-6370000 2010-15 Front/Rear Red Logo 217.99 kit
 - HURST-6371000 2010-15 Front/Rear Gold Logo 158.99 kit
 - HURST-6370003 2016-18 Front Only Red Logo 158.99 kit
 - HURST-6371003 2016-18 Front Only Gold Logo 172.99 kit
- No Volume Discount.*



IBT-GM-BLK

1973-81 OEM Style Rubber Floor Mats

Correct factory style rubber floor mats with ribbing and GM logo. *Will Fit Most 1967-81.

- IBT-GM-BLK 1973-81 Black 89.99 set
- IBT-GM-CAR 1973-81 Carmine 109.99 set
- IBT-GM-TAN 1973-81 Tan 109.99 set
- IBT-GM-GRY 1973-81 Gray 109.99 set
- IBT-GM-BLU 1973-81 Dark Blue 109.99 set
- IBT-GM-LTBLU 1973-81 Light Blue 109.99 set
- IBT-GM-RED 1973-81 Red 109.99 set



IBT-001

Vinyl Floor Mats

GM Restoration vinyl floor mats complete with raised "bowtie" and correct grain. Black only.

- IBT-001 1967-72 4pc 199.99 set



GMF-6769-HC

Firewall Insulators

A Firewall Insulator panel by QuietRide Solutions is your first line of defense to stop engine noise and heat from entering the passenger cabin. This firewall panel is an OEM replacement and is year, make and model specific. It is molded to fit the engine setback and firewall contours and fits like a glove.

- GMF-6769-HC 1967-68 Heater Only 231.99 kit
- GMF-6869-HC 1968-69 Heater Only 231.99 kit
- GMF-6869-AC 1968-69 Factory AC 231.99 kit
- GMF-7081-HC 1970-81 Heater Only 231.99 kit
- GMF-7081-AC 1970-81 Factory AC 231.99 kit



IK-252

Carpet Firewall Guard

Correct plastic injection molded piece which installs below steering column.

- IK-252 1967-69 All 32.99 ea.
- IK-253 1970-81 All 39.99 ea.
- IN-197 1967-81 All Screws 6.99 pr.



ICE-6732K



7644760K

Carpet Sill Plates

Authentic "Body by Fisher" sill plates available as beautiful reproductions.

- 7644760 1967-69 Exact Repro w/ Rivets LH or RH 32.99 ea.
- 7644760K 1967-69 Pair w/ Rivets 62.97 kit
- ICE-6732L 1970-81 LH w/ Riveted Tag 44.99 ea.
- ICE-6732R 1970-81 RH w/ Riveted Tag 44.99 ea.
- ICE-6732K 1970-81 Pair w/ Rivets 84.57 kit
- ISP-KIT Screw Kit 8pc 3.99 kit

Note: 1970-81 are interchangeable. Riveted tag correct for 1970-72. Stick on tag correct for 1973-81.





IC-81

1967 Console Shells

Injection molded, die cast reproduction of the original console shell manufactured to OE factory dimensions with correct etched grain. Includes correct chrome die-cast outer trim.

- IC-85 1967 w/ Gauges..... 529.99 ea.
 IC-81 1967 w/o Gauges..... 499.99 ea.

Ships Oversize. No Volume Discount.



IK-625KIT

1967 Console Gauge Kit

This unique gauge package contains everything you need to replace or add original type console gauges. This complete assembly includes the console gauge bezel, bottom gauge housing, fuel gauge, temperature gauge, amp gauge, oil gauge and clock pre-assembled and ready to install.

Note: If console gauges are being added to non console vehicle, new wiring will be needed.

- IK-625KIT 1967 All 599.99 ea.
 6291987 Battery Amp Gauge 59.99 ea.

No Volume Discount.



IR-7556

1968-69 Automatic Console Kit

Add a factory style console to your Camaro or replace your old one with this complete automatic console kit!

Each kit includes:

- Console Shell
- Shift Plate
- Rear Lamp
- Seat Belt Retainer
- Ash Tray Insert
- Lid
- Forward Plate w/ Emblem or Gauge Package
- Mounting Bracket
- Mounting Hardware
- Reflector
- Shifter Slider w/ Retainer
- Ash Tray Lid w/ Stoppers & Pins
- Lid Hinge
- Lid Spring

- IR-750P 1968 Powerglide 525.41 kit
 IR-750PG 1968 Powerglide w/ Gauges..... 827.82 kit
 IR-750 1968 TH350 or TH400 523.61 kit
 IR-750G 1968 TH350 or TH400 w/ Gauges 826.02 kit
 IR-755P 1969 Powerglide 525.41 kit
 IR-755PG 1969 Powerglide w/ Gauges..... 827.82 kit
 IR-755 1969 TH350 or TH400 523.61 kit
 IR-755G 1969 TH350 or TH400 w/ Gauges 826.02 kit

Ships Oversize. No Volume Discount.



IR-753

1968-69 4 Speed Console Kit

Add a factory style console to your Camaro or replace your old one with this complete 4 speed console kit!

Each kit includes:

- Console Shell
- Tunnel
- Rear Lamp
- Reflector
- Lid
- Lid Spring
- Shifter Plate w/ Emblem
- Ash Tray Lid w/ Stoppers & Pins
- Shift Plate w/ Emblem or Gauge Package
- Mounting Bracket
- Mounting Hardware
- Seat Belt Retainer
- Ash Tray Insert
- Lid Hinge

- IR-753 1968 4 Speed..... 487.64 kit
 IR-753G 1968 4 Speed w/ Gauges 790.05 kit
 IR-756 1969 4 Speed..... 490.35 kit
 IR-756G 1969 4 Speed w/ Gauges 792.76 kit

Ships Oversize. No Volume Discount.



IC-6869

1968-69 Console Shells

Top quality reproduction injection molded console which includes the complete top shell and bottom base sections manufactured in the correct grain and contour.

- IC-6869 1968-69 All 189.99 ea.
 IO-69-YSC 1969 Yenko Hurst Dual Gate..... 136.99 ea.

Ships Oversize. No Volume Discount.



IK-689A

1968-69 Console Gauge Kit

This unique gauge package contains everything you need to replace or add original type console gauges. This complete assembly includes cover, bezels, base, lenses, fuel gauge, temperature gauge, battery gauge and oil gauge pre-assembled and ready to install.

Note: If console gauges are being added to non console vehicle, new wiring will be needed.

- IK-689A 1968-69 All 359.99 ea.
 IQ-253 1968-69 Full Bezel..... 40.99 ea.
 IQ-210 1968-69 Fuel/Oil Bezel 17.99 ea.
 IQ-211 1968-69 Amp/Temp Bezel 18.99 ea.
 IQ-188 1968-69 Gauge Lens 6.99 ea.
 IQ-202 1968-69 Gauge Connectors 19.99 set
 IQ-100 1968-69 Gauge Assy Brackets 8.99 set
 NP-1234Z 1967-69 Oil Line 29.99 ea.
 1596409 1968-69 Low Fuel Sender Only 59.99 ea.
 500274 1967-77 Low Fuel Indicator Module 69.99 ea.

No Volume Discount.

Console & Console Gauge Wiring

If your Camaro did not originally come with a console or came with a console but not gauges, you will need to order one or two of the following harnesses.

Console Gauge Harness

Connects gauges to console harness.

(needed when adding console gauges)

- 32640 1967 A/T Column Shift..... 159.99 ea.
 32635 1967 A/T Console Shift 139.99 ea.
 32630 1967 M/T All 139.99 ea.
 32655 1968 A/T Column Shift 159.99 ea.
 32650 1968 A/T Console Shift 139.99 ea.
 32645 1968 M/T All 139.99 ea.
 32670 1969 A/T Column Shift 159.99 ea.
 32665 1969 A/T Console Shift 139.99 ea.
 32660 1969 M/T All 139.99 ea.

Console Harness

Connects console to dash harness.

(needed when adding a console)

- 10790 1967 A/T 79.99 ea.
 10795 1967 A/T w/ Gauges..... 109.99 ea.
 10800 1967 M/T 26.99 ea.
 10805 1967 M/T w/ Gauges 84.99 ea.
 11945 1968 A/T 72.99 ea.
 11950 1968 A/T w/ Gauges..... 109.99 ea.
 11940 1968 M/T 26.99 ea.
 11955 1968 M/T w/ Gauges 84.99 ea.
 17510 1969 A/T 69.99 ea.
 13085 1969 A/T w/ Gauges..... 107.99 ea.
 17505 1969 M/T 26.99 ea.
 13090 1969 M/T w/ Gauges 84.99 ea.
 17515 1970-73 A/T 59.99 ea.
 17505 1970-73 M/T 26.99 ea.
 15650 1979-81 Auto Shift Indicator 26.99 ea.

A/T = Automatic Transmission M/T = Manual Transmission



IC-798

1970-72 Console Assembly

OE style reproduction console assembly manufactured from all new tooling. Each part is injection molded and assembled allowing easier installation. Includes upper and lower sections, side air vents, ash tray lid, console door assembly and lock assembly.

- IC-798 1970-72 All..... 424.99 ea.

Ships Oversize. No Volume Discount.



IC-930M

1973-81 Console Shell

Complete one piece console assembly for 1973-81 Camaro.

- IC-930M 1973-81 Manual 439.99 ea.
 IC-930A 1973-81 Automatic 439.99 ea.

Ships Oversize. No Volume Discount.

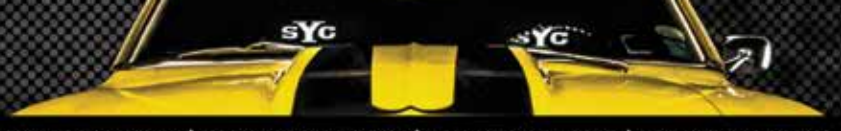

IE-069

1967-69 Console Lid

OE style reproduction metal console lids featuring correct etched grain.

IK-523	1967	98.99 ea.
IE-069	1968-69	39.99 ea.



IK-328

1970-72 Console Lid

OE style reproduction made from new tooling with correct grain. Includes latch and button.

IK-328	1970-72	129.99 ea.
--------	---------------	------------



ICL-554

1973-81 Console Lid

Urethane reproduction of the original padded console lid. Paint to match.

ICL-554	1973-81	59.99 ea.
---------	---------------	-----------



ICL-555

1982-92 Console Lid

OE style reproduction with the correct grain and finish.

ICL-555	1982-92 All Black	153.99 ea.
---------	-------------------------	------------

* Please Call for Colors



ICG-562

1973-81 Console Glove Box Assembly

Correct inner console glove box assembly.

ICG-562	1973-81	44.99 ea.
---------	---------------	-----------



IK-217



IK-866



I-711

1967-69 Console Lid Hardware

OE style reproduction console lid hinge.

IK-866	1967 Hinge	24.99 ea.
IK-217	1968-69 Hinge	22.99 ea.
I-711	1968-69 Arm	13.99 ea.
IK-53	1968-69 Spring	3.99 ea.
BAC-534	1967-72 Lid Bumpers	3.99 pr.



ICD-68F

Heater Console Duct

Installed on all factory console cars. Attaches to heater box to distribute heat evenly in driver and passenger areas. Made of durable fiberglass which looks original.

ICD-68F	1968-69	119.99 ea.
---------	---------------	------------



IE-895



IK-037

1967 Shift Plates

OE style reproduction shift plates with correct semigloss satin black paint with triple chrome plated outer trim.

IK-037	1967 Automatic 2pc	64.99 ea.
IE-895	1967 Manual 1pc	56.99 ea.
ISP-490	Screws 4pc	4.99 kit



IQ-345W



IQ-368

1968 Shift Plates

OE style reproduction shift plates with correct walnut woodgrain with chrome plated outer trim.

IQ-345W	1968 Automatic	59.99 ea.
IQ-368	1968 Manual	84.99 ea.
ISP-490	Screws (4)	4.99 kit



IQ-345R



IQ-370

1969 Shift Plates

OE style reproduction shift plates with correct cherry woodgrain with chrome plated outer trim.

IQ-345R	1969 Automatic	59.99 ea.
IQ-370	1969 Manual	84.99 ea.
ISP-490	Screws (4)	4.99 kit



IC-877



IW-476

1970-72 Shift Plates

OE style reproduction die cast shift plates. 1970-71 manual features shift emblem and 1972 does not as original.

IC-877	1970-72 Automatic	89.99 ea.
IW-476	1970-71 Manual	89.99 ea.
IW-477	1972 Manual	79.99 ea.



ISP-779



ISP-852

1973-81 Shift Plates

OE style reproduction shift plates. 1973-78 features a shift pattern in the dash so the plate has no pattern. 1979-81 features the shift pattern on the shift plate as original.

ISP-779	1973-78 Auto	69.99 ea.
ISP-852	1979-81 Auto	89.99 ea.
ISP-491	Screws 4pc	6.99 kit



ISP-839A



ISP-839M

1983-92 Shift Plates

Correct reproduction shift plates with correct color lettering. Comes complete with slider (auto) or boot (manual 5 speed). 83-89 Models feature white lettering, 90-92 has yellow lettering.

ISP-839A	1983-89 Auto	282.99 ea.
ISP-839M	1983-89 Manual	219.99 ea.
ISP-902A	1990-92 Auto	229.99 ea.
ISP-902M	1990-92 Manual	219.99 ea.



IFP-89W



IFP-89R



IK-614

1968-69 Forward Plates

Excellent quality reproduction woodgrain forward plates and correct emblem.

IFP-89W	1968 Walnut Plate	29.99 ea.
IFP-89R	1969 Cherrywood Plate	29.99 ea.
IK-614	1968-69 Bowtie Emblem	13.99 ea.



IQ-65

4 Speed Emblem

Correct 4 speed console emblems.

IQ-65 1968-69.....14.99 ea.



ISP-F685R

5 & 6 Speed Emblem

5 or 6 speed emblems that look stock!

ISP-F685T 68-69 Tremec 5 Speed 32.99 ea.
 ISP-F685R 68-69 Richmond 5 Speed 60.99 ea.
 ISP-F686T 68-69 Tremec 6 Speed 34.99 ea.
 ISP-F686R 68-69 Richmond 6 Speed 60.99 ea.



ISSFT-HRDW



ISS-6F

Staple Shifter

Complete staple shifter assembly with chrome plated handle, spring loaded lock out trigger and mounting base. Ready to install.

ISS-6F 1968-69 Assembly.....149.99 ea.
 ISH-640 1970-72 Assembly.....169.99 ea.
 ISH-3X 1968-72 Handle Only.....74.99 ea.
 ISSFT-HRDW 1968-72 Repair Kit.....32.99 kit

No Volume Discount.



IK-210



IK-209



IQ-344

Shift Bulb Mounting & Backing Plates

Correct shift plate bulb retainers.

IK-210 1967 Mounting Plate 17.99 ea.
 IK-209 1967 Backing Plate..... 12.99 ea.
 IQ-344 1968-69 Mounting Plate.....14.99 ea.
 IQ-342 1968-69 Shift Lens Backing Plate 11.99 ea.



IQ-343

Console Shift Plate

OE style reproduction shift plate insert featuring flat black paint with raised chrome edges and installation nuts.

IQ-343 1968-69..... 34.99 ea.
 IK-51 1968-72 Shift Plate Seal Kit 16.99 kit



SHIFTKIT-F63

Console Shifter Kit

Complete kit to convert to an automatic console shifter. Kit includes factory style staple shifter, cable, brackets & all correct hardware.

SHIFTKIT-F63 1968-69 TH350229.42 kit
 SHIFTKIT-F64 1968-69 TH400233.92 kit
 SHIFTKIT-F6869-OD 1968-69 700R4/200R4339.25 kit
 SHIFTKIT-F73 1970-72 TH350 247.42 kit
 SHIFTKIT-F74 1970-72 TH400..... 251.92 kit
 SHIFTKIT-F7072-OD 1970-72 700R4/200R4 357.25 kit

No Volume Discount.



SC2244

4 Speed Overdrive Kits

This kit makes it easy to install a modern overdrive automatic in place of your old Powerglide, TH350 or TH400 for improved performance and gas mileage. Each kit includes a new laser cut and hardened detent, indicator plate, hardware and brackets to allow the use of your factory shifter. Works with a TH700, TH200 or 4L60.

SC2244 1968-69..... 196.99 kit
 SC2245 1970-72 196.99 kit
 SC2261 1973-78 168.99 kit
 SC2262 1979-81 168.99 kit



IQ-110P



IQ-110T

Shift Indicator Lenses

Injection molded clear shift indicator lenses.

IQ-109 1967 Powerglide..... 9.99 ea.
 IQ-127 1967 TH350/TH400 8.99 ea.
 S121 1967 700-R4/200-4R 29.99 ea.
 IQ-110P 1968-69 Powerglide 11.99 ea.
 IQ-110T 1968-69 TH350/TH400..... 9.99 ea.
 S150 1968-69 Reverse Pattern 32.99 ea.
 S120 1968-69 700-R4/200-4R 29.99 ea.
 S136 1970-72 700R4/200R4 29.99 ea.



IC-123

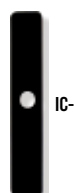

IC-45



IC-124

Shifter Sliders

Correct die stamped plastic shifter sliders.

IC-123 1967 Manual 13.99 ea.
 IC-45 1967 Automatic 7.99 ea.
 IW-340 1967 Slider Retainer 7.99 ea.
 IC-124 1968 Manual 9.99 ea.
 IC-158 1968 Slider Retainer 13.99 ea.



IQ-341

Shifter Tunnel

Correct molded plastic which installs on inside of console.

IQ-341 1969 4 Speed..... 26.99 ea.
 IQ-964 1970-72 4 Speed 34.99 ea.
 IQ-571 1973-81 4 Speed 44.99 ea.



ICE-09



ICE-4526



IK-407



ICE-HURST



ICE-3966



ICE-78UP

Shifter Boots

Brand new injection molded boots.

ICE-09 1967-68 w/o Console..... 32.99 ea.
 ICE-4526 1967-68 w/ Console 17.99 ea.
 IK-8UP 1968 Upper w/ Console 11.99 ea.
 IK-407 1969 4 Speed All 23.99 ea.
 ICE-4526 1969 3 Speed 17.99 ea.
 ICE-3966 1970-81 Lower 24.99 ea.
 ICE-78UP 1970-81 Upper 27.99 ea.
 ICE-HURST Universal 81.99 ea.



ICE-1516



IQ-635



IK-476



IW-764

Shift Boot Retainers

Correct die stamped steel boot retainers.

IQ-635 1967-68 w/o Console 2pc 49.99 ea.
 IK-476 1967-68 w/ Console 19.99 ea.
 ICE-1516 1969 w/o Console Black 13.99 ea.
 ICE-1562 1969 w/ Console Chrome..... 17.99 ea.
 IW-764 1970-81 All 22.99 ea.



IHI-68

Headliner Insulation

Correct factory style insulation to help keep noise and heat from entering car. Cut to fit.

IHI-68 All..... 22.99 ea.



IHT-679F

1967-73 Headliner Retaining Strips

These strips retain the headliner to the roof of the car.

IHT-679F	1967-69 Front 2pc	94.99 pr.
IHT-679R	1967-69 Rear 3pc	109.99 kit
IHT-679CLIP	1967-69 Clip 14pc	36.99 kit
IHT-7081F	1970-73 Front 1pc.....	59.99 ea.
IHT-7081R	1970-73 Rear 1pc	64.99 ea.
IHT-70F	1970-73 Front & Rear 2pc.....	79.95 pr.



Headliners

We offer the highest quality headliners on the market. Period. They duplicate the original colors and grains exactly and come ready to install with correct cardboard covered side sails and extra material for sunvisors. Please include color choice in _.

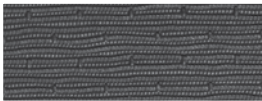

1967 Surry Line Dot



1968-69 Ribbed

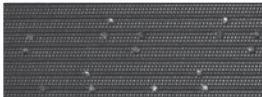

1970-73 Perforated

IRE-426 1967 Black Surry Line Dot..... 133.99 kit
 IRE-426-67FH104 1967 Color Surry Line Dot 133.99 kit

Dark Red_103, Light Blue_104, Bright Blue_106, 67 Gold_118.

IRE-421 1968-96 Black Ribbed 133.99 kit

IRE-421-67FH_ 1968-96 Color Ribbed 133.99 kit
White_101, Dark Red_103, Dark Blue_105, Dark Green_109, Medium Blue_116, Ivy Gold_117.

IRE-425 1970-73 Black Perforated..... 93.99 kit

IRE-425-70FH_ 1970-73 Color Perforated 93.99 kit
White_101, Bright Red_102, Dark Red_103, Dark Blue_105, Bright Blue_106, Dark Saddle_108, Dark Green_109, Sandalwood_111, Buckskin_112.



IBC-12

IBC-591

Headliner Bow Clips

Correct style plastic bow retaining clips.

IBC-12	1967-69 4pc	15.99 set
IBC-20	1967-69 Each.....	6.99 ea.
IBC-591	1970-74 16pc	36.99 set
IBC-7892	1985-92 Clip	4.99 ea.

Headliner Wire Bows

OE style reproduction of these often damaged or missing steel bows.

IHB-400	1967-69 All	86.99 set
IHB-401	1970-73 All.....	64.99 set

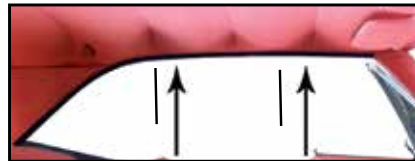

1967-73 Molded Headliner Side Trim

Correct molded urethane headliner side trim.

IHT-58	1967 All.....	59.99 pr.
IHT-68	1968-69 All	59.99 pr.
IHT-703S	1970-73 Side Trim LH/RH All	169.99 set
IHT-7481	1974-81 Side Trim LH/RH w/o T-Tops... 209.99 pr.	



IHT-703K

1970 - 73 Headliner Trim Kit

This is a complete headliner trim kit with front and rear molded trim and the correct metal strips for cars with bow type headliners.

IHT-703K	1970-73 All.....	166.14 kit
----------	------------------	------------



IHT-70F

1967-73 Headliner Retaining Strips

Correct metal strips for cars with bow type headliners.

IHT-679F	1967-69 Front.....	94.99 pr.
IHT-679R	1967-69 Rear	109.99 kit
IHT-679CLIP	1967-69 Clips 12pc.....	36.99 kit
IHT-70F	1970-73 Front & Rear	79.95 pr.
IHT-7081F	1970-73 Front Only	59.99 ea.
IHT-7081R	1970-73 Rear Only.....	64.99 ea.



Coat Hooks

ICH-511

ICH-753

ICH-511	1967-77 Black.....	6.99 ea.
ICH-511K	1967-77 Black Pair*	14.99 kit
ICH-753	1967-77 Chrome.....	6.95 ea.
ICH-753K	1967-77 Chrome Pair*	13.90 kit

**No Volume Discount.*

IRS-426

1967 Coupe Sunvisors

Superior quality sunvisors complete with metal shaft and double stitched vinyl piping in correct surry line dot material. Include color choice in _.

IRS-426	Black.....	124.99 pr.
IRS-426SV7_SC	Color	124.99 pr.

Dark Red_103, Light Blue_104, Bright Blue_106, 67 Gold_118.

IRS-421B

1968 Coupe Sunvisors

Superior quality sunvisors complete with metal shaft and double stitched vinyl piping in correct ribbed material. Include color choice in _.

IRS-421B	Black.....	124.99 pr.
IRS-421B_	Color	125.99 pr.

White_101, Dark Red_116, Medium Blue, Ivy Gold_117.

IRS-421

1969 Coupe Sunvisors

Superior quality sunvisors complete with metal shaft and double stitched vinyl piping in correct ribbed material. Include color choice in _.

IRS-421	Black.....	124.99 pr.
IRS-421SV8_R	Color	124.99 pr.

White_101, 10Dark Red_103, Dark Blue_105, Dark Green_109.

IRS-425

1970 Sunvisors

Superior quality sunvisors complete with metal shaft and double stitched vinyl piping in correct perforated material. Include color choice in _.

IRS-425	Black.....	124.99 pr.
IRS-425-70FV_	Color	124.99 pr.

White_101, Bright Red_102, Dark Red_103, Dark Blue_105, Bright Blue_106, Dark Saddle_108, Dark Green_109, Sandalwood_111, Buckskin_112.

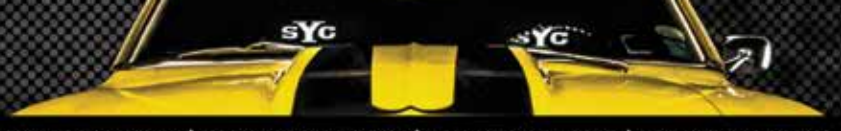

IRS-71F

1971-73 Sunvisors

Superior quality sunvisors complete with metal shaft and double stitched vinyl piping in correct perforated material. Include color choice in _.

IRS-71F Black 124.99 pr.
 IRS-71FV_B Color 124.99 pr.
 White_101, Dark Red_103, Dark Blue_105, Dark Saddle_108, Dark Green_109, Sandalwood_111, Buckskin_112.



IRS-428

1974-76 Sunvisors

Superior quality sunvisors complete with metal shaft and double stitched vinyl piping in correct Madrid material. Include color choice in _.

IRS-428 Black 131.99 pr.
 IRS-428-74FV__ Color 124.99 pr.
 Firethorn_30, Bright Red_32, Light Saddle_35, Saddle_36, White_37, Sandalwood_41, Dark Saddle_42.



IRS-430

1977-81 Sunvisors

Superior quality sunvisors complete with metal shaft and double stitched vinyl piping in correct Sierra material. Include color choice in _.

IRS-430 Black 124.99 pr.
 IRS-430-77FV__ Color 124.99 pr.
 Saddle_36, White_37, Carmine_38, Firethorn_45, Camel_48, Silver_66, Light Blue_90, Met. Red_08, Navy Blue_18, Oyster Z81_81, Oyster_86.



IRS-67VT

1967-69 Convertible Sunvisors

Superior quality sunvisors complete with metal shaft and double stitched vinyl piping in correct Vinyl material for convertible only. Include color choice in _.

IRS-67VT Black 124.99 pr.
 IRS-67SV_V Color 124.99 pr.
 Aqua_902, Light Blue_912, Bright Blue_914, Dark Blue_916, 68 Blue_917, Light Green_923, Dark Met Green_924, Orange_926, Pearl_928, Red_930, White_937, Off White_940, Gold_943, Ivy Gold_946.

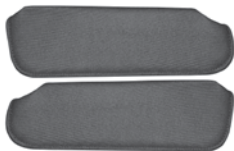

IRS-82FV05

1982-92 Convertible Sunvisors

Sunvisors complete with double stitched cloth piping in correct cloth material for convertible only. Include color choice in _.

IRS-82FV__ 1982-92 124.99 pr.
 IRS-82FV_T 1982-92 w/ T-Top or Convertible.. 124.99 pr.
 Maroon_01, Dark Blue_03, Camel_04, Black_05, Light Gray_06, Red_07, Meimur_08, Doeskin_1711, Charcoal_1769.

IRS-9302FB



1993-02 Sunvisors

Includes one pair of sun visors black mounting brackets and vanity mirror.

IRS-9302FB 1993-02 Black 189.99 pr.
 IRS-9302FT 1993-02 Tan 189.99 pr.
 IRS-9302FDC 1993-02 Dark Charcoal 189.99 pr.



IC-21

Sunvisor Bushing Tip Kit

Correct bushing and tip kit for two visors.

IC-21 1967-69 All 6.99 pr.



IBB-0753

IHQ-332

Sunvisor Supports

OE style reproduction chrome plated supports complete with screws and nylon bushing.

IBB-0753 1967-69 Coupe 24.99 ea.
 IBB-0753K 1967-69 Coupe Pair 44.98 kit
 IHQ-334 1967-69 Convertible Satin 109.99 pr.
 IHQ-332 1967-69 Convertible Chrome ... 109.99 pr.
 IVS-366 1970-81 39.99 ea.
 IBB-7388 1982 Short Pin Chrome 59.99 pr.
 IVS-382 1982-82 w/o T-Tops 48.99 ea.
 IVS-382T 1982-82 w/ T-Tops* 48.99 ea.
 IVS-9302 1993-02 w/o T-Tops 84.99 pr.
 ISS-12545 1967-69 Screws 6 pc 3.99 kit

*Does not include hardware.



K-884

Inner Windshield Trim

Correct upper windshield moldings to finish off your interior.

K-884 1967 All 49.99 ea.
 K-885 1968 All 54.99 ea.
 K-886 1969 All 44.99 ea.
 IHT-590 1970-73 All* 44.95 ea.

*Works with bow style headliner only. Will not work with board style headliner.



K-887

Inner Rear Window Trim

Correct molded plastic rear inner window trim.

K-887 1967-68 All 70.99 kit
 IVK-852 1969 All 79.99 kit
 IHT-592 1970-73 All* 49.99 ea.

*Works with bow style headliner only. Will not work with board style headliner.



IK-483

Rear View Mirrors

OE style reproduction polished stainless steel mirrors with day/night levers.

IM-621 1967 8" Chrome* 39.99 ea.
 IK-483 1967-68 8" Chrome 52.99 ea.
 IM-6788-OE 1967-68 8" Chrome GM Resto ... 54.99 ea.
 IM-6810 1968-69 10" Chrome 54.99 ea.
 IM-7081 1970-82 10" Chrome 69.99 ea.
 IM-419B 1970-86 10" Black 59.99 ea.
 IMB-6812-OE 1967-69 Bushing Insert 4.99 ea.

*This mirror (IM-621) does not have a day/night lever.



GCS-S6065

Billet Rear View Mirror

Show quality polished billet aluminum rear view mirror features ball milled grooves and a day/night lever.

GCS-S6065 All 54.99 ea.

Note: Glues to the windshield glass.



IM-6808-ML

1967-1969 Rear View Mirror w/ Map Light

Custom factory style mirror featuring a built in map light day/night lever. Mounts easily in place of your factory mirror and features correct terminal to plug into your factory fuse block.

IM-6808-ML 8" All 92.99 ea.
 IM-6810-ML 10" All 92.99 ea.
 IM-6812-ML 12" All 109.99 ea.

Rear View Mirror Bracket

Correct bracket for supporting rear view mirror.



IK-23

IK-23 1967 Coupe 42.99 ea.
 IK-19 1967 Convertible 44.99 ea.
 IK-18 1968-69 Coupe 43.99 ea.
 IK-21 1968-69 Convertible 44.99 ea.
 IMP-1Z 1970-81 All 7.99 ea.
 IE-842 1970-86 Adjusting Screw 2.99 ea.



IK-25V



IK-25C

Rear View Mirror Bracket Boot

Correct cover which installs directly over the rear view mirror bracket.

IK-25C 1967 Coupe 31.99 ea.
 IK-25V 1967 Convertible 31.99 ea.
 IBC-68C 1968-69 Coupe 34.99 ea.
 IK-22V 1968-69 Convertible 22.99 ea.

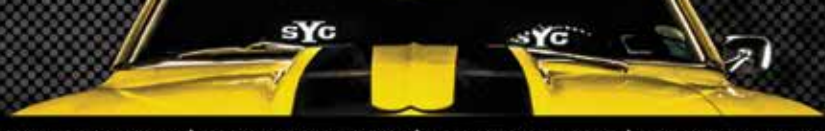

ICE-2777



INQ-0203

Dome Light Lenses

Correct white plastic lenses.

INQ-0203	1967-69 Coupe	7.99 ea.
ICE-2777	1970-81 Coupe	5.99 ea.
ICE-2789	1982-92 Coupe	10.99 ea.



ICE-0351



IHQ-0117

Dome Light Lens Bezel

New plastic molded chrome plated as original.

IHQ-0117	1967-69 Coupe	11.99 ea.
ICE-0351	1970-81 Coupe	12.99 ea.
ICE-0532	1982-92 Coupe	21.99 ea.
IBU-11A	Bulb All	2.99 ea.

IHQ-0117K



Dome Lamp Kit

Complete kit with new plastic molded and chrome plated dome light lens bezel, lens, bulb terminals and harness extension.

IHQ-0117K	1967-69 All	35.99 kit
ICE-0351K	1970-81 All	36.96 kit
ICE-69-MAP	1969-81 Roof Map Light Lens.....	21.99 ea.



Addictive Flow LED Dome Light Bulb

A simple replacement for your dome light bulb. This LED bulb features 3 super bright LEDs in a 211 bulb package.

AF-LED211	211-2 White LED Bulb	6.99 ea.
-----------	----------------------------	----------



IHQ-0117K-LED

ICE-0351K-LED

LED Dome Lamp Kits

Led dome lamp kit w/ a replacement LED dome light bulb.

IHQ-0117K-LED	1967-69 Coupe	46.99 kit
ICE-0351K-LED	1970-81 w/o T-Tops.....	44.99 kit

No volume discount.



Dome Lamp Harness Clips

Correct clips for flat ribbon dual wire.

IDL-CLIP

IDL-CLIP	Most GM Cars	10.99 ea.
----------	--------------------	-----------

I-2194A



1967 Quarter Dome Lamp Kit

Complete quarter dome light kit for 1967 deluxe interior including lenses, bezels, sockets and bulbs for a complete replacement.

I-2194A	1967 w/ Deluxe Interior.....	68.99 kit
---------	------------------------------	-----------

13870



Dome Light Harnesses

Correct dome light harness.

13870	1967-69 All	31.99 ea.
17575	1970-73 All.....	38.99 ea.



BULB-67FI

Interior Bulb Kits

Vehicle specific kits include the following bulbs conveniently bagged & labeled.

1967-68		
BULB-67FI	1967-68	23.99 kit

(6) Instrument Cluster, (2) Turn Signal Indicator, (1) Oil Pressure Indicator, (1) Headlamp Motor Warning, (1) Temp Indicator, (1) Alternator Indicator, (2) Courtesy Light, (1) Radio, (1) Heater / AC Control, (1) High Beam Indicator, (1) Parking Brake Indicator, (1) Console Lamp, (1) Glovebox Compartment, (1) Underhood Lamp, (1) Dome Lamp

1969		
BULB-69FI	1969	24.99 kit

(5) Instrument Cluster, (2) Turn Signal Indicator, (1) Oil Pressure Indicator, (1) Temp Indicator, (1) Clock, (1) Alternator Indicator, (1) Map Light, (2) Courtesy Light, (1) Radio, (1) Heater / AC Control, (1) High Beam Indicator, (1) Parking Brake Indicator, (1) Console Lamp, (1) Glovebox Compartment, (1) Underhood Lamp, (1) Trunk Lamp, (1) Dome Lamp

1970		
BULB-70FI	1970	21.99 kit

(3) Instrument Cluster, (2) Turn Signal Indicator, (1) Oil Pressure Indicator, (1) Temp Indicator, (1) Alternator Indicator, (1) Gearshift Indicator, (1) Radio, (1) Radio w/ Tape Player, (1) Heater / AC Control, (1) High Beam Indicator, (1) Parking Brake Indicator, (1) Windshield Washer Indicator, (1) Console Lamp, (1) Glovebox Lamp, (1) Underhood Lamp, (1) Trunk Lamp, (1) Dome Lamp

1971-72		
BULB-71FI	1971-72.....	24.99 kit

(3) Instrument Cluster, (2) Turn Signal Indicator, (1) Oil Pressure Indicator, (1) Temp Indicator, (1) Map Light, (2) Gearshift Indicator, (1) Radio w/ Tape Player, (1) Heater / AC Control, (1) High Beam Indicator, (1) Windshield Washer Indicator, (1) Console Lamp, (1) Glovebox Compartment, (1) Underhood Lamp, (1) Trunk Lamp, (1) Dome Lamp



IK-901

Pillar Post Moldings

New injection molded moldings in correct factory styles and grains or chrome.

IK-901	1967 Coupe Black	69.99 pr.
IK-902	1967 Coupe Chrome	69.99 pr.
IK-903	1967 Convertible Black.....	69.99 pr.
IK-904	1967 Convertible Chrome	80.99 pr.
IK-601	1968 Coupe.....	129.99 pr.
IK-602	1968 Convertible	129.99 pr.
IK-962	1969 Coupe.....	129.99 pr.
IK-965	1969 Convertible	129.99 pr.

IHS-F70

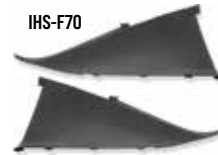

IHS-F75R



IHS-F75L



1970-81 Side Sails

OE style reproduction side sails manufactured in the correct grain.

IHS-F70	1970-74 Black.....	179.99 pr.
IHS-F70R	1970-74 Red.....	189.99 pr.
IHS-F70T	1970-74 Tan	189.99 pr.
IHS-F70W	1970-74 White	189.99 pr.
IHS-F75L	1975-81 LH Black	99.99 ea.
IHS-F75R	1975-81 RH Black	99.99 ea.
IHS-F75LR	1975-81 LH Red	109.99 ea.
IHS-F75RR	1975-81 RH Red.....	109.99 ea.
IHS-F75LT	1975-81 LH Camel	109.99 ea.
IHS-F75RT	1975-81 RH Camel	109.99 ea.
IHS-F75LW	1975-81 LH White.....	109.99 ea.
IHS-F75RW	1975-81 RH White.....	109.99 ea.



IN-107

Fisher T-Top Grommet

Correct injection molded grommet replaces GM number 20066276. Four required per car.

IN-107	1978-81	7.99 ea.
--------	---------------	----------



IN-501K

1978-1981 Fisher T-Top Molding & End Caps

Includes 2 large U-shaped moldings & 4 end caps. These pieces go around and hold up the headliner to finish off the T-Tops. Injection molded as original GM with correct grain. Black only.

IN-501K	Complete Kit 6pc.....	229.99 kit
IN-501	Surrounds Only 2pc	119.99 pr.

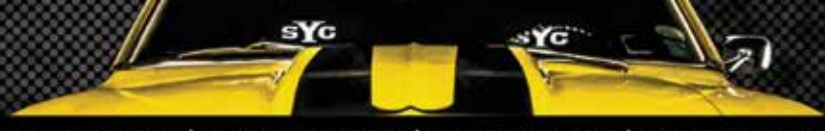

IN-3371

Fisher T-Top Y Moldings

Injection molded as original GM with correct grain.

IN-3371 1978-81 89.99 pr.



IN-664

Fisher T-Top Front Insert Trims

Correct front insert trims constructed of ABS plastic.

IN-664 1978-81 109.99 pr.



IN-519

Fisher T-Top Rear Insert Trims

Correct rear insert trims constructed of ABS plastic.

IN-519 1978-81 109.99 pr.



IN-519R

Fisher T-Top Rail Trim Covers

Correct injection molded rail trim covers in factory colors.

IN-519BL 1978-81 Blue 149.99 pr.
 IN-519T 1978-81 Tan 149.99 pr.
 IN-519R 1978-81 Red 149.99 pr.
 IN-519BK 1978-81 Black 149.99 pr.



ITC-78F

Fisher T-Top Clip

Correct rust resistant stainless steel clip. Mounts to body to allow T-Top to lock into it.

ITC-78F 1978-81 7.99 ea.



ITH-78F

Fisher T-Top Handles

OE style reproduction chrome handles.

ITH-78F 1978-81 59.99 pr.
 ITH-892F 1982-92 Black 42.99 pr.



ISS-82FTT10

1976-02 T-Top Bag

This is a correct reproduction of the T-Top storage bag.

ISS-76FTT10 1976-81 T-Top Bag 139.99 pr.
 ISS-82FTT10 1982-92 T-Top Bag 229.99 ea.
 ISS-93FTT10 1993-02* T-Top Bag 89.99 pr.

* Designed to slip over the glass after the glass is mounted in the rear well area.



ISS-82FTTS05

1982-92 T-Top Sun Shade

These are correct reproductions of the T-Top sun shades

ISS-82FTTS__ 1982-92 T-Top Sun Shade 57.99 pr.
 Maroon_01, Dark Blue_03, Camel_04, Black_05, Gray_06, Red_07, Medium Gray_08, Doeskin_1711, Charcoal_1769.



IER-70F

1970-81 Rear Speaker Enclosure Retainer

Attaches rear speaker enclosure.

IER-70F 1970-81 All 7.99 ea.



GWC-SPK

Speaker/Trunk/Blower Motor Wire Clips

Used to hold the wiring under the dash, power trunk or trunk light wires to hinge, speaker wires to package tray or blower motor wire to vent.

GWC-SPK 1964-77 All 6.99 pr.
 GWC-01 1967-81 All 1.99 pr.



IK-4351

Rear Window Corners

OE style reproduction lower rear window corners.

IK-4351 1967-69 All 26.99 pr.



ITD-3

Trunk Divider Boards

Correct die-stamped cardboard piece which installs between the rear seat and trunk area.

ITD-3 1967-69 All 25.99 ea.
 ITD-7 1970-81 All 25.99 ea.

Ships Oversize 2. Some trimming will be required for convertible.



ITJ-44

Trunk Divider Insulation

Correct die-stamped jute insulation.

ITJ-44 1967-69 All 15.99 ea.
 ITJ-55 1970-81 All 15.99 ea.



IJU-100

Package Tray Insulation

Correct die-stamped jute insulation.

IJU-100 1967-69 All 15.99 ea.
 IJU-103 1970-81 All 15.99 ea.



INL-15429

Package Tray Hold Down Blow Out Clip

This clip is correct for all Camaro coupes to hold the package tray to the metal underbody.

IRP-CLIP 1967-72 Coupe 7.99 ea.
 IRP-CLIP-KIT 1967-72 Coupe 5pc 35.95 kit



IRE-167



IRD-71M

Package Tray

Correct vinyl covered, die-stamped cardboard package trays. Available in standard or deluxe mesh with speaker cutouts on the underside. Insert color choice in _.

1967-69 Standard

IRE-167 1967-69 Black 24.99 ea.
 IRE-67FP_ 1967-69 Color 22.99 ea.
 Bright Blue_14, 68 Blue_17, Dark Blue_38, 67 Gold_43, Ivy Gold_46, Red_67, Light Blue_69, Light Aqua_74, Light Green_77, Dark Met Green_78.

1970-81 Standard

IRE-71 1970-81 Black 24.99 ea.
 IRE-71_ 1970-81 Color 22.99 ea.
 Bright Blue_14, Jade Green_19, Dark Blue_38, Sandalwood_41, Red_67, Light Blue_69, Light Green_77, Dark Met Green_78, Saddle/Camel_80.

Deluxe

IRD-167M 1967-69 Black Only 74.99 ea.
 IRD-71M 1970-81 Black Only 74.99 ea.

Ships Oversize 2.

Flatline Barriers

Leader in automotive thermal acoustic insulation, offering lightweight solutions that effectively reduce sound and heat. Pre-cut kits and universal options are designed by automotive enthusiasts for easy installation and maximum performance, at a great value.



IFL-TABF2014



IFL-TABF2015

1967 Camaro

IFL-TABF2013	Complete Kit Coupe	350.99 kit
IFL-TABF2016	Complete Kit Convertible	293.99 kit
IFL-TABF2005	Doors/Quarter Panel	151.99 kit
IFL-TABF2001	Roof	67.99 kit
IFL-TABF2011	Floor	178.99 kit
IFL-TABF2007	Trunk	116.99 kit

1968-69 Camaro

IFL-TABF2014	Complete Kit Coupe	333.99 kit
IFL-TABF2017	Complete Kit Convertible	308.99 kit
IFL-TABF2003	Doors/Quarter Panel	143.99 kit
IFL-TABF2001	Roof	67.99 kit
IFL-TABF2011	Floor	178.99 kit
IFL-TABF2008	Trunk	110.99 kit

1970-92 Camaro

IFL-TABF2015	Complete Kit Coupe	394.99 kit
IFL-TABF2029	1982-92 Complete Kit Hardtop	333.99 kit
IFL-TABF2028	1982-92 Complete Kit T-top	333.99 kit
IFL-TABF2023	1993-02 Complete Kit Hardtop	333.99 kit
IFL-TABF2030	1993-02 Complete Kit T-top	293.99 kit
IFL-TABF2004	Doors/Quarter Panel	151.99 kit
IFL-TABF2025	1982-92 Door/Inner Quarter	93.99 kit
IFL-TABF2020	1993-02 Door/Inner Quarter	93.99 kit
IFL-TABF2002	Roof	130.99 kit
IFL-TABF2027	1982-92 Roof	86.99 kit
IFL-TABF2020	1993-02 Roof	93.99 kit
IFL-TABF2012	Floor	194.99 kit
IFL-TABF2024	1982-92 Floor	194.99 kit
IFL-TABF2019	1993-02 Floor	194.99 kit
IFL-TABF2009	Trunk	110.99 kit
IFL-TABF2026	1982-92 Hatch Floor	110.99 kit
IFL-TABF2022	1993-02 Hatch Floor	110.99 kit

QuietRide AcoustiShield

QuietRide AcoustiShield kit is a multi-stage sound dampening system designed to give your muscle car the quiet comfort of modern vehicles. Using advanced acoustic technology, it controls noise, vibration, and heat in the cabin. The pre-cut kits include sound damper pads for key areas, with detailed, easy-to-follow instructions. Complete kits cover the body, cowl, floor, roof (except convertibles), and trunk.

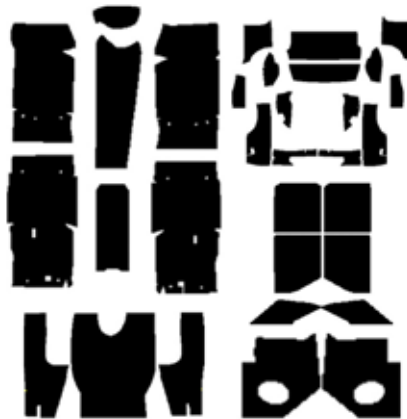

GMF-7074-CAK



GMF-7581-CTCK

1967-69 Camaro Convertible

GMF-6769-CVAK	Complete Kit	715.99 kit
GMF-6769-CVBPK	Body Kit	152.99 kit
GMF-6769-CVCK	Cowl Kit	106.99 kit
GMF-6769-CVFK	Floor Kit	274.99 kit
GMF-6769-CVTFK	Trunk Floor Kit	152.99 kit

1967-69 Camaro Coupe

GMF-6769-CAK	Complete Kit	858.99 kit
GMF-6769-CBPK	Body Kit	152.99 kit
GMF-6769-CCK	Cowl Kit	106.99 kit
GMF-6769-CFK	Floor Kit	274.99 kit
GMF-6769-CRK	Roof Kit	152.99 kit
GMF-6769-CTFK	Trunk Floor Kit	152.99 kit

1970-74 Camaro

GMF-7074-CAK	Complete Kit	858.99 kit
GMF-7074-CBPK	Body Kit	152.99 kit
GMF-7074-CCK	Cowl Kit	106.99 kit
GMF-7074-CFK	Floor Kit	274.99 kit
GMF-7074-CRK	Roof Kit	152.99 kit
GMF-7074-CTFK	Trunk Floor Kit	152.99 kit

1975-81 Camaro w/o T-Tops

GMF-7581-CAK	Complete Kit	858.99 kit
GMF-7581-CBPK	Body Kit	152.99 kit
GMF-7581-CCK	Cowl Kit	106.99 kit
GMF-7581-CFK	Floor Kit	274.99 kit
GMF-7581-CRK	Roof Kit	152.99 kit

1975-81 Camaro w/ T-Tops

GMF-7581-CTAK	Complete Kit	813.99 kit
GMF-7581-CTBPK	Body Kit	152.99 kit
GMF-7581-CTCK	Cowl Kit	106.99 kit
GMF-7581-CTRK	Roof Kit	106.99 kit
GMF-7581-CTTK	Trunk Floor Kit	152.99 kit

Dynamat

Car noise can prevent you from hearing music, conversations and your GPS. As the speed of your car increases, so does the noise from the road. Whether you're a car audio enthusiast or simply looking for a quieter ride to and from work, upgrade your car with our products and make your car drive and feel like a luxury vehicle!

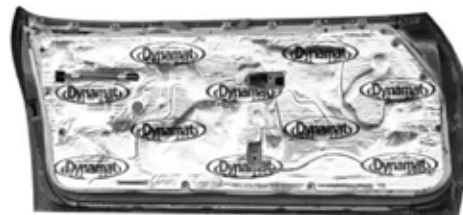

DYN-XGM-F2D



DYN-XGM-F1L

Universal Kits

DYN-10415	Xtreme Speaker Kit	24.95 kit
DYN-10415	Xtreme Squared 18x18 Kit 8pc	24.95 kit
DYN-10435	Xtreme Bulk Pack	104.95 kit
DYN-10465	Xtreme Mega Pack	474.95 ea.
DYN-10648	SuperLite Bulk Pack	278.95 ea.
DYN-11902	DynaCore One Inch Black (12sqft)	94.95 ea.
DYN-11905	Hood Liner (32x54in)	84.95 ea.
DYN-19100	Xtreme License Plate Kit	14.95 kit
DYN-19405	Xtreme Trunk Kit	149.95 kit
DYN-21100	DynaPad (32x54in)	154.95 ea.
DYN-XGM-G-KIT	Xtreme Universal Car Kit	484.85 kit

1967-1969 Custom Cut Kits

DYN-XGM-F1F	1967-69 Xtreme Floor Kit	319.95 kit
DYN-XGM-F1D2	1967 Xtreme Door Kit	159.95 kit
DYN-XGM-F1D	1968-69 Xtreme Door Kit	159.95 kit
DYN-XGM-F1T	1968-69 Xtreme Trunk Floor Kit	127.95 kit
DYN-XGM-F1L	1968-69 Xtreme Trunk Lid Kit	47.95 kit
DYN-XGM-F1P	1967-69 Xtreme Package Tray Kit	47.95 kit
DYN-XGM-F1R	1967-69 Xtreme Roof Kit	87.95 kit
DYN-XGM-F1U	1967-69 Xtreme Under Rear Seat	159.95 kit

1970-1981 Custom Cut Kits

DYN-XGM-F2F	1970-81 Xtreme Floor Kit	279.95 kit
DYN-XGM-F2D	1970-81 Xtreme Door Kit	159.95 kit
DYN-XGM-F2T	1970-81 Xtreme Trunk Floor Kit	127.95 kit
DYN-XGM-F2L	1970-81 Xtreme Trunk Lid Kit	47.95 kit
DYN-XGM-F2P	1970-81 Xtreme Package Tray Kit	47.95 kit
DYN-XGM-F2R	1970-81 Xtreme Roof Kit	87.95 kit
DYN-XGM-F2U	1970-81 Xtreme Under Rear Seat	159.95 kit

1982-1992 Custom Cut Kits

DYN-XGM-F3F	1982-92 Xtreme Floor Kit	279.95 kit
DYN-XGM-F3D	1982-92 Xtreme Door Kit	159.95 kit
DYN-XGM-F3T	1982-92 Xtreme Trunk Floor Kit	199.95 kit
DYN-XGM-F3R	1982-92 Xtreme Roof Kit	87.95 kit
DYN-XGM-F3U	1982-92 Xtreme Under Rear Seat	199.95 kit

Tools & Accessories

TRIM-ROLLER	Sound Deadening Wheel Roller	14.99 ea.
DYN-13100	Sound Deadening Tape	10.95 kit

No Volume Discount.



USA-740AM69

USA 740AM/FM 300 Watt

The USA-740 offers the same classic look that Custom AutoSound has always been known for with today's latest features. Now, with built-in Bluetooth (microphone included), answer calls and get Bluetooth streaming music from your Bluetooth capable phone or Bluetooth compatible device. A solid 300-watt peak power should be all the juice you need, yet the USA-740 has Hi 4 volt, 4 channel RCA pre-outs and a subwoofer RCA pre-out for additional amplifiers. The USB input allows you to plug in a USB flash drive for playback of MP3/WMA/FLAC/WAV song files. A front 3.5mm mini jack auxiliary audio input and a rear RCA auxiliary audio input provide versatility for options like satellite radio, iPod or any portable player you wish to use. Match the dominant color of your instrument cluster with user selectable multiple LCD color choices with LCD dimmer control. The AM/FM RDS tuner shows station, song and artist on the LCD display. For those of us committed to music collections on compact disc, the USA-740 fully controls the optional Custom AutoSound CD-1 CD player. Classic style with today's sound and performance taking every road and curve with you in your Chevrolet.

USA-740CAM67	1967-68 All.....	389.99 ea.
USA-740CAM69	1969-77 All.....	389.99 ea.
USA-740CAM78	1978-81 All.....	389.99 ea.



USA-230CAM67W

USA-230 AM/FM 200 Watts

A great look and sound at an awesome price. This USA-230 radio has no cassette but comes with Auxiliary Input for iPod, MP3, Satellite radio, etc. Classic features with a classic look. These exciting features include:

- AM/FM Stereo - 200 Watts (4 x 50) - Auxiliary Input
- Digital Clock - Electronic Tuner - 30 Pre-sets (12AM-18FM)
- 4 Channel RCA Pre-Outs - 4 Way Fader - Power Antenna Lead

USA-230CAM67	1967-68 Black Bezel.....	229.99 ea.
USA-230CAM67W	1967-68 Walnut Bezel.....	229.99 ea.
USA-230CAM69	1969-77.....	229.99 ea.
USA-230CAM78	1978-81.....	229.99 ea.



CAM-CH92-SBR2

Custom AutoSound Slidebar Radio

The Slidebar Radio provides the best of both worlds, a true working sidebar display and a full-featured digital display in the same stereo. Simply slide the bar in the center of the radio to the right and hide the analog sidebar revealing a full-featured digital display underneath. The sidebar is designed with large OEM style push-buttons to compliment the look of your classic car. Its digital display provides seven backlit color options designed to match the color of your dash instrumentation.

CAM-CH92-SBR2	1969-77 All.....	419.99 kit
---------------	------------------	------------



Custom AutoSound USA-630 AM/FM 240 Watts

The USA-630 is the pinnacle of 30 years of evolution in Custom AutoSound's quest for the perfect classic car radio. This radio has large OEM style push-buttons that give a perfect look in a classic dash. Although it looks classic it has the latest modern features. USB input on the back of the radio. This jack is on an 18" extension which allows you to place it in the glove box or ash tray for easy access (no unsightly wires or plugs hanging out of the front of the radio). The new alpha numeric display (30% larger than previous models) shows the song/artist/album (id3) titles during playback of MP3/WMA files. With the built in CD controller you have complete control (no FM modulation) of CAS's 10 disc CD changer.

With 240 watts the radio should have all the power you may need. If you want more, there are four pre-outs jacks on the back of the radio for optional amplifiers. The back of the radio also has auxiliary audio input for satellite radio or any portable player you may wish to use.

- AM-FM Stereo - USA/Euro Tuner - Power Antenna Lead - Alpha Numeric id3 Display for MP3/WMA files - Electronic Tuning and Volume Control - 4 Way Fader - Left/Right Balance - Digital Clock - 16 Pre-sets (12FM-4AM) - 4 Channel RCA Pre-outs - Separate Bass and Treble - 2 Channel RCA Auxiliary Input for Satellite / iPod etc.

USA-630CAM67	1967-68 Black Bezel.....	319.99 ea.
USA-630CAM67W	1967-68 Walnut Bezel.....	319.99 ea.
USA-630CAM69	1969-77.....	319.99 ea.
USA-630CAM78	1978-81.....	319.99 ea.



USA-850CAM67

Custom AutoSound USA-850 Radio 300 Watts

The USA-850 is the best radio Custom AutoSound has yet to offer! It features today's latest technology in radio that fits your classic perfectly. Comes with built-in Bluetooth, answer calls and get Bluetooth streaming music from your Bluetooth capable phone or Bluetooth compatible device. A solid 300 watt peak power should be all the juice you need; however, also features a set of high output 6 volt RCA pre-outs, 4 channel RCA full range pre-outs, and 2 channel subwoofer RCA pre-outs. The 2 channel RCA auxiliary audio input provides versatility for options like satellite radio, iPod or any portable player you wish to use. Another great feature is that it comes with 4 programmable screen options for you to customize the look of the radio. The AM/ FM RDS PLL tuner shows station, song, and artist on the LCD display.

USA-850CAM67	1967-68 All.....	449.00 ea.
USA-850CAM69	1969-77 All.....	449.00 ea.
USA-850CAM78	1978-81 All.....	449.00 ea.

Note: These radios do not come with a factory radio bezel.



AAR-73CAM

Antique Auto Radios

The Antique Auto Radio combines modern performance with a classic look. It delivers 180 watts RMS with a 45W x 4 MOSFET amp, and features analog controls that mimic the original. The AM/FM dial looks authentic, and it offers digital tuning for stable reception. Includes 3 RCA jacks for left, right, and subwoofer, a 3.5mm aux input, and switchable speaker and region settings. Now with built-in Bluetooth 3.0 for hands-free calling and streaming, while maintaining its vintage appearance.

AAR-67CAM	1967-68 All.....	936.99 ea.
AAR-69-GM	1969 All.....	936.99 ea.
AAR-70-GM	1970 All.....	936.99 ea.
AAR-71CAM	1971 All.....	936.99 ea.
AAR-73CAM	1973 All.....	936.99 ea.



SSK-678F-B



Custom AutoSound Sound System Kits

Crank up the tunes with Ground Up Motors's exclusive Sound System Kits! Each kit comes with an in-dash radio, rear speakers, and dash speakers, making it easy to bundle and save while still looking and sounding great!

Basic Kits

These kits feature a USA-230 radio, front dash speakers, and rear 6x9 speakers.

SSK-678F-B	1967-68 Non AC w/ Black Bezel.....	367.17 kit
SSK-678F-BA	1967-68 w/ AC w/ Black Bezel.....	369.47 kit
SSK-678F-W	1967-68 Non AC w/ Walnut Bezel.....	367.17 kit
SSK-678F-WA	1967-68 w/ AC w/ Walnut Bezel.....	369.47 kit
SSK-69F	1969 Non AC.....	367.17 kit
SSK-69F-A	1969 w/ AC.....	369.47 kit
SSK-707F	1970-77 All.....	364.47 kit
SSK-7881F	1978-81 All.....	364.47 kit

Upgraded Kits

These kits feature a USA-630 radio, front dash speakers, and rear 6x9 speakers.

SSK-678F-B-U	1967-68 Non AC w/ Black Bezel.....	493.47 kit
SSK-678F-BA-U	1967-68 w/ AC w/ Black Bezel.....	493.47 kit
SSK-678F-W-U	1967-68 Non AC w/ Walnut Bezel.....	493.47 kit
SSK-678F-WA-U	1967-68 w/ AC w/ Walnut Bezel.....	493.47 kit
SSK-69F-U	1969 Non AC.....	493.47 kit
SSK-69F-A-U	1969 w/ AC.....	493.47 kit
SSK-707F-U	1970-77 All.....	493.47 kit
SSK-7881F-U	1978-81 All.....	493.47 kit

Premium Kits

These kits feature a USA-740 radio, front dash speakers, and rear 6x9 speakers.

SSK-678F-P	1967-68 Non AC w/ Black Bezel.....	556.47 kit
SSK-678F-A-P	1967-68 With AC w/ Black Bezel.....	556.47 kit
SSK-69F-P	1969 Non AC.....	556.47 kit
SSK-69F-A-P	1969 w/ AC.....	556.47 kit
SSK-707F-P	1970-77 All.....	556.47 kit
SSK-7881F-P	1978-81 All.....	556.47 kit

No Volume Discount.

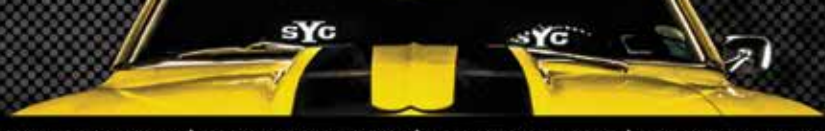

SECRET-SST



BLUKIT



Secret Audio SST

Secretaudio SST is a hidden audio system that offers great flexibility for mounting in any type of vehicle. The main receiver/ amplifier unit is usually hidden under the seat or behind the dash. A 10ft cord from the Tuner/Amp plugs into an LCD display. The system can be operated from up to 40 feet away with the included RF (radio frequency remote.)

Included with the system is a flush mount bezel for console or dash mounting. The small dimensions of the flush mount system allow you to install the LCD display almost anywhere. The LCD also comes with a bracket mount for easy installation in the glove box, under the dash, in the ashtray, sun visor, console or wherever you choose. Since its only 1" deep, it's especially handy for custom or streetrod applications where there may be wiring or ducting routed behind the panels you wish to utilize for mounting. When your installation is finished you'll be rewarded with a quality professionally installed look.

Features:

- AM/FM Stereo 200 watts 4x50 · Auxiliary Audio Input · USB MP3/WMA Flash Drive Player · iPod® Direct Control Interface (built into tuner/amp unit) iPod Docking Cable Included · Alpha Numeric LCD Display Shows Artist / Song Titles for USB, iPod® and Satellite Radio · Satellite Radio Input (for optional Sirius® satellite radio tuner) · Direct CD Changer Control (CD changer optional)
- 4 Channel 3 Volt RCA Pre-Outs (for optional Amplifiers) · Subwoofer Pre-Out (for optional Subwoofer Amplifier)
- Electronic Volume, Bass, Treble, Balance, Fader · 5 Selectable iEQ Curves – pop/jazz/classic/beat/rock
- Zero Memory Current Draw (will not drain car battery when unit not in use) · 24 Station pre-sets (18FM / 6AM) · Power Antenna 12V Trigger Lead

SECRET-SST 1964-72399.99 ea.

Bluetooth Interface for USA-630, Secretaudio

This adapter plugs into the CD changer port of your radio and gives you the ability to do hands free calling from your Bluetooth capable phone. You can listen to music stored on your A2DP enabled Bluetooth device. You can still use your CD changer with the adapter plugged in.

BLUKIT Bluetooth Interface134.99 ea.

Note: Works with Custom Autosound USA-630 and Secretaudio systems.



KPS-F69-80



KPS-F69-300

Premium Quality Kick Panel Speakers

These Ground Up Motors kick panel speakers offer great sound quality for your Camaro. These kick panels are as true to the originals as possible while offering a modern speaker in a convenient location. No cutting of the body required! Made of ABS textured plastic. They can be painted to match any interior for a clean look. All speakers are 6.5" with either a 80 watt three way or a 300 watt two way speaker driver.

- KPS-F678-80 1967-68 w/o AC 80 Watt 3 Way....179.99 pr.
- KPS-F678-300 1967-68 w/o AC 300 Watt 2 Way..195.95 pr.
- KPS-F69-80 1969 w/o AC 80 Watt 3 Way.....159.99 pr.
- KPS-F69-300 1969 w/o AC 300 Watt 2 Way.....195.99 pr.
- KPS-F70-80 1970-81 w/o AC 80 Watt 3 Way....159.95 pr.
- KPS-F70-300 1970-81 w/o AC 300 Watt 2 Way ..199.99 pr.



KCAM-67-8

Kick Panel Speakers

Enhance your sound quality with these custom molded kick panel speakers from Custom Autosound. They are a direct bolt in!

- KCAM-67-8 1967-68 100W159.99 pr.
- PKCAM-67-8 1967-68 250W249.99 pr.



SPUV-693C

Rear Speakers

These rear speakers are a high performance replacement for your originals and include grilles, wires and hardware.

- SPUV-693C 6x9 3 Way 200W124.99 pr.



BKT-6774



IER-70F

1967-81 Speaker Bracket

This often missing bracket secures your speaker in place.

- BKT-6774 1967-69 Dash All34.99 ea.
- IER-70F 1970-81 Rear All.....7.99 ea.



KNW-2001

Kenwood Upgraded Dash Speakers

These Custom Autosound speakers feature Kenwood quality upgrade replacement speakers for your original front in-dash speakers. These great quality speakers can handle up to 60 watts and are built and designed to fit directly under the dash including all correct mounting brackets and wiring. Each assembly includes two speakers.

- KNW-2001 1967-69 w/o AC92.99 ea.
- KNW-2002 1967-69 w/ AC.....92.99 ea.
- KNW-2003 1970-81 Mono92.99 ea.



4007

4023

Dual Voice Coil Speakers

These DVC speakers will give you the best possible sound and power handling from your stock speaker locations. They give up to 70% more cone area than a conventional dual speaker setup with 140 Watt power capacity, left and right channel hookup and tweeters.

- 4001 1967-69 w/o AC73.99 ea.
- 4007 1967-69 w/ AC.....73.99 ea.
- 4023 1970-81 Mono73.99 ea.



1013

Dash Speakers

Since at least 2 speakers are required for true stereo sound, these speakers are a perfect upgrade to OEM and do not require any modification to your dash. The 1000 series are held in place by the original screws and the 2000 series are held in place by the original bracket.

- 2001 1967-69 w/o AC52.99 ea.
- 2002 1967-69 w/ AC.....49.99 ea.
- 2003 1970-81 Mono49.99 ea.
- 1013 1970-81 Two Speakers.....52.99 pr.



UNDERCOVER1

Undercover Speakers

These compact speakers are specifically made for under seat installation and they pack a 120 watt punch! Each unit features a 5 1/2" woofer and piezo tweeter. 3" H X 8-1/4" W X 11-1/4" L

UNDERCOVER1 All..... 149.99 pr.



UNDERCOVER2

Undercover II Speakers

Each unit features an 8" woofer and 2 piezo tweeters. With the 8" woofer in UNDERCOVERII you get a much fuller deeper sound with a 200 watt capability! 11"W x 12.5"D x 3"H

UNDERCOVER2 All..... 189.99 pr.



BSD-CAM-680

Backseat Driver

Add some bottom end power to your system with our custom bass speaker panel. This panel comes equipped with two Custom Autosound 8" subwoofers and the Boss 500 watt amp. Panel mounts to the back of the rear seat from the trunk. All cables & wires needed are included.

BSD-CAM-680 1967-69..... 299.99 ea.



SPG-6480



SPG-7081

Package Tray Speaker Grilles

Often dealer installed and often broken or missing, these OE correct speaker grilles are the perfect finishing touch to your restoration. The grille are designed to fit 6x9 speakers.

SPG-6480 1967-81 Square Sides 44.99 ea.

SPG-7081 1970-81 Round Sides 39.99 ea.

SPG-UNI 1967-79 Universal..... 27.99 ea.

No volume discount.



SPUV-690EM

OEM Style Rear 6X9 Speakers

This is an exact replica of the speaker installed by the GM factory in the dash and/or beneath the rear seat shelf, manufactured to original GM factory specifications. Each speaker is cosmetically correct featuring the proper shape, dimensions, and rectangular magnet for ease of installation in the factory locations. These speakers are to be used with original style radios that require 8-10 Ohm speakers.

SPUV-690EM 1967-81 6X9 124.99 ea.

For OEM power level radios. Do not use with a high power amplifier or radio



ANT-HIDE

Accessories

ANT-HIDE Hidden Antenna-AM/FM 36.99 ea.



ANT-01

Antenna Kits

Our kits come complete with correct cable, antenna base, gasket and mast.

ANT-01 1967-68 Front AM/FM Fixed Mast... 54.99 kit

ANT-0026 1969 Front AM/FM Fixed Mast..... 49.99 kit

ANT-0045 1967-68 Front

AM Telescoping Mast 199.99 kit

ANT-0046 1969 Front AM Telescoping Mast... 199.99 kit

ANT-0047 1967-68 Rear

AM Semi Telescoping..... 199.99 kit

ANT-0047FM 1967-68 Rear AM/FM Fixed Mast... 68.99 ea.

ANT-0048 1969 Rear AM Semi Telescoping 199.99 kit

ANT-0048FM 1969 Rear AM/FM Fixed Mast..... 59.99 ea.

CT-728 1967-68 Front Antenna

Mounting Template 10.99 ea.

CT-729 1969 Front Antenna

Mounting Template 10.99 ea.

CT-726 1967-69 Rear Antenna

Mounting Template 9.99 ea.



GRC-12835



GRC-12834

Radio Capacitor

Came from the factory on all cars with radio. Correct length lead wire & brass connector.

GRC-12834 1967-71 Voltage Regulator 24.99 ea.

Stamped 1964086 "DR" G ".5MF"

GRC-12835 1970-1974 Radio 24.99 ea.

1964452 "DR" G ".3MF"



IK-213

IK-245

IRK-712

Radio Knobs

Correct inner and outer radio knobs.

IK-520 1967-68 Inner (Mono) 8.99 pr.

IK-520S 1967-68 Inner (Stereo) 8.99 pr.

IK-213 1967-68 Outer 23.99 pr.

IK-231 1969-70 Inner (Mono)..... 11.99 pr.

IK-231S 1969-70 Inner (Stereo) 11.99 pr.

IK-245 1969-70 Outer 19.99 pr.

IRT-712 1971-78 Inner (Mono)..... 27.99 pr.

IRT-7S 1971-78 Inner (Stereo)..... 32.99 pr.

IRK-712 1971-78 Outer w/ Logo 27.99 pr.



IRD-69F

1967-69 Radio Delete Plate

Originally used on specially optioned cars that did not come with a factory radio. Injection molded like original with hot stamped chrome on the edge. This is a show quality piece.

IRD-67F 1967-68 All Black 99.99 ea.

IRD-69F 1969 All Black 84.99 ea.

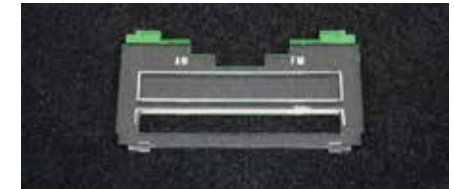

Radio Lenses

IRL-2120

Authentic reproduction radio lenses with correct lettering and colors.

IRL-2120 1969-70 Mono, 1970 AM/FM..... 43.99 ea.

IRL-2121 1969 AM/FM 43.99 ea.

IRL-4615 1971-76 AM/FM Mono 43.99 ea.

IRL-4616 1971-76 AM/FM Stereo 43.99 ea.



IRB-678

Radio Faceplate

Correct reproduction of the original radio bezel plate with chrome outer trim and black semi gloss paint.

IRB-678 1967-68 All 39.99 ea.

IRS-533 1967-68 All Screws..... 4.99 kit

IK-SN Shaft Nuts All 6.99 pr.



MTB-11

Convertible Top Boot

This superior quality boot features the correct HEAVY weight vinyl and original style stitching construction. Please insert your color choice in _.

- | | | |
|-----------|---------------------|------------|
| MTB-11 | 1967-69 Black | 313.99 ea. |
| MTB-67FT_ | 1967-69 Color | 313.99 ea. |
- Light Aqua_02, Light Blue_12, Bright Blue_14, Dark Blue_16, 68 Blue_17, Light Green_23, Dark Met Green_24, Orange_26, Pearl_28, Red_30, White_37, Off White_40, Gold_43, Ivy Gold_46.*



Convertible Tops

OE style reproduction convertible tops with correct grain and weight as well as seam treatment just like factory. Available with plastic window or glass window.

- | | | |
|----------|--|------------|
| MP-331B | 1967-69 Black with Plastic Rear Window | 504.99 ea. |
| MP-331BW | 1967-69 White with Plastic Rear Window | 555.99 ea. |
| MP-441B | 1967-69 Black with Glass Rear Window | 775.99 ea. |
| MP-441W | 1967-69 White with Glass Rear Window | 775.99 ea. |

No Volume Discount. Ships Oversize.



KQ-177



KQ-39

Convertible Header Molding

OE style reproduction header moldings in either chrome for 1967 models or satin for 1968-69 models. Both are interchangeable.

- | | | |
|--------|----------------------------|------------|
| KQ-177 | 1967 Polished Chrome | 169.99 pr. |
| KQ-39 | 1968-69 Satin | 159.99 pr. |
| KQB-33 | Screw Kit | 4.99 kit |



MTB-12538

Top Boot Snap Screws

Correct fine thread convertible top snap screws which are located on the rear interior quarter panels.

- | | | |
|-----------|-------------------|----------|
| MTB-12538 | 1967-69 4pc | 8.99 kit |
|-----------|-------------------|----------|



MBC-67F

Convertible Boot Clips

Correct clips for attaching boot to molding.

- | | | |
|---------|--------------------|-----------|
| MBC-67F | 1967-69 16pc | 46.99 kit |
|---------|--------------------|-----------|

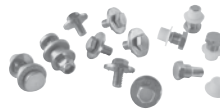

MBS-1000B

Pivot Bolt Set

Correct convertible top pivot bolts.

- | | | |
|-------------|-------------------------------------|-----------|
| MTM-BOLTKIT | 1967-69 | 54.99 set |
| MBS-227 | 1967-69 Main Pivot Bolts Only | 11.99 pr. |



MTB-F679

Top Cylinder To Frame Shoulder Bolts

- | | | |
|----------|-------------------------|-----------|
| MTB-F679 | 1967-69 Power Top | 16.99 pr. |
|----------|-------------------------|-----------|



MTC-9

Convertible Top Cables

Correct top torsion cables in matched pairs.

- | | | |
|-------|---------------------------|-----------|
| MTC-9 | 1967-69 Convertible | 69.99 pr. |
|-------|---------------------------|-----------|



MTP-41

Convertible Top Pads

High quality reinforcement pads which fit between the frame rails and top.

- | | | |
|--------|---------------------------|-----------|
| MTP-41 | 1967-69 Convertible | 89.99 pr. |
|--------|---------------------------|-----------|



JSS-089

Convertible Rear Frame to Body Seals

Seals prevent water drainage into rear of body and trunk area. Molded rubber with stamped steel spine as original.

- | | | |
|---------|---------------------------|-----------|
| JSS-089 | 1967-69 Convertible | 49.99 pr. |
|---------|---------------------------|-----------|



MHB-679

Header Bow

OE style reproduction of the often damaged or rusted header bow which attaches to the top of the frame rails.

- | | | |
|---------|-------------------------------|------------|
| MHB-679 | 1967-69 Convertible | 209.99 ea. |
| MBW-001 | Header Bow Windlace 5ft | 16.99 kit |

Ships Oversize.



GT-159



GW-458

1967-68 Convertible Top Switch

Correct switch and housing for operation of power top.

- | | | |
|--------|--------------------------------|-----------|
| GT-159 | 1967-68 Switch | 36.99 ea. |
| GW-458 | 1967-68 Bracket w/ Clips | 19.99 ea. |



GT-69



MTB-17



GW-082

1969 Convertible Switch & Bezel

Correct switch and die cast bezel.

- | | | |
|--------|-----------------------------|-----------|
| GT-69 | 1969 Switch | 59.95 ea. |
| MTB-17 | 1969 Bezel | 60.99 ea. |
| GW-082 | 1969 Bracket w/ Clips | 19.99 ea. |



GRW-016

Power Top Circuit Breaker

Original GM breaker.

- | | | |
|---------|---------------|-----------|
| GRW-016 | 1967-69 | 20.99 ea. |
|---------|---------------|-----------|



MRS-380

Convertible Top Frame Rubber Stoppers

Used to eliminate top frame pieces rubbing together when folding into the well.

- | | | |
|---------|---------------------------|-----------|
| MRS-380 | 1967-69 Convertible | 12.99 pr. |
|---------|---------------------------|-----------|



POI
Intentions
We turn back the clock.

Convertible Well Liner

Correct vinyl material for "top down" well area.

MWL-67 1967-69 Convertible 100.99 ea.



MTL-479



MHL-701K

Convertible Top Latch Assembly

Quality reproductions of the top latch assembly complete with hook and ready to install.

MTL-479 1967-69 Assembly 99.95 pr.
MHL-701K Hooks & Knuckles Only 42.99 kit



MCT-1

Header Bow End Clip

Correct clip for outside of top.

MCT-1 1967-69 5.99 pr.



MSB-744

Convertible Header Bow Stop Bumpers

Correct high density stop bumpers.

MSB-744 1967-69 Convertible 13.99 pr.



LMC-3640

KW-1041

Convertible Well Molding

OE style reproduction rear body pinch weld moldings in polished stainless steel as original.

KW-1041 1967-69 Convertible 109.99 set
LMC-3640 Attaching Clip Set 39.99 set

No Volume Discount. Ships Oversize.



BRG-723

MRG-115

Well Rain Gutter

Correct plastic gutter that prevents water from entering car.

MRG-115 1967-69 Convertible 199.99 ea.
BRG-723 Installation Screws 14pc 12.99 kit



MTS-67



BTS-62

Convertible Tack Strip

This is an OE style reproduction of the original metal tack strip bar with plastic insert, which attaches the top to the rear trunk well.

MTS-67 1967-69 Convertible 3pc 99.99 ea.
BTS-62 Installation Bolt Kit 17pc 14.99 kit



MHD-169

Manual Hold Down Latch

Correct latches used to hold down the top on manual top models.

MHD-169 1967-69 Manual Top 29.99 pr.



MHD-225

Manual Top Latch Hardware

Reproductions of the original hardware, for manual convertible tops only. Correct industrial chrome plated hardware for mounting the manual top hold down latches. One set will mount both latches.

MHD-225 1967-69 4pc 18.99 kit



KDW-4578

Convertible Wedge Kit

This kit includes shims for doors, brass and teflon wedges and all mounting hardware.

KDW-4578 1967-69 Convertible 63.99 set



MTM-101



MMB-3

Convertible Top Motors

New OEM motors.

MTM-101 1967-69 Convertible 389.99 ea.
MMB-3 Mounting Grommet 6.99 ea.
MMB-4K 1967-69 Motor Bushing Kit 4pc 22.36 kit

No Volume Discount.



MTH-33K

Convertible Top Hose

Correct white hose with original brass fittings.

MTH-33K 1967-69 Convertible 95.95 pr.
No Volume Discount.



MTC-12

Convertible Top Cylinder

Correct replacement cylinder made in USA.

MTC-12 1967-69 Convertible 159.99 ea.
No Volume Discount.



MTM-BOLTKIT

Frame Pivot Bolt & Bushing Set

Reproduction of the rear control link bolt and bushing set.

MTM-BOLTKIT 1967-69 Power Top 54.99 set
MTB-PIVOT 1968-72 Pivot Bolt/Nut/Washer 12.99 ea.

MTH-CLIP



Convertible Top Hose Clip

This is used in the trunk area to hold the convertible top hoses in place. Painted the correct red primer color with #4 in circle, spring steel.

MTH-CLIP 1967-69 8.99 ea.



RKP-245R

Rear Inner Covers

Correct reproduction stamped steel inner quarter window access panel for convertibles. Includes mounting tab to correctly install rear convertible side well covers.

RKP-245L 1967-69 LH 62.99 ea.
RKP-245R 1967-69 RH 62.99 ea.
RKP-245K LH/RH 119.99 kit

Trunk Mats

These new die stamped heavy duty vinyl trunk mats are the perfect finishing touch to your trunk! Constructed of heavy duty vinyl.



PEM-222RA	1967-68 Aqua/Black.....	97.99 ea.
PEM-222R	1967-68 Gray/Black.....	97.99 ea.
PEM-223R	1969 Aqua.....	97.99 ea.
PEM-230R	1970-72 Aqua.....	97.99 ea.
PEM-73V	1973-77 Herringbone.....	97.99 ea.
PEM-81V	1978-81 Herringbone.....	86.99 ea.

Spare Tire Cover

These spare tire covers are constructed of the same durable material as our trunk mats, so they make an excellent finishing touch!



PEM-161A	Aqua Houndstooth 14".....	77.99 ea.
PEM-162	Aqua Houndstooth 15".....	77.99 ea.
PEM-163A	Herringbone 14".....	77.99 ea.
PEM-163B	Herringbone 15".....	77.99 ea.

Trunk Lid Spring with Sleeve

Correct right side torsion rod and heavy spring used on all models with rear spoiler. Includes heavy molded rubber sleeve. Can also be used on models without rear deck lid spoiler.

RLS-693	1967-69.....	30.99 ea.
---------	--------------	-----------



Spare Tire Anchor Plate & Hold Down

Correct spare tire anchor plate and spare tire hold down.

P-2000	1967-74 Anchor Plate.....	11.99 ea.
BHE-1970	1967-81 All Hold Down.....	15.99 set

GWC-SPK



Trunk Wire Clips

This is a pair of correct GM wiring clips which are used to hold the wiring for the power trunk or trunk light wires to the trunk hinge, hold the speaker wires to the package tray or hold the defroster blower motor wire.

GWC-SPK	All.....	6.99 pr.
GWC-01	All Wire Clip.....	1.99 pr.

RDP-100



Trunk Floor Drain Plug

Correct stamped plug for trunk floor.

RDP-100	1967-73 All.....	4.99 ea.
---------	------------------	----------

PLB-141



PLB-175

Jack Load Base

Correct cradle for lifting car which inserts into bumper jack.

PLB-141	1967 All.....	19.99 ea.
PLB-142	1968 All.....	19.99 ea.
PLB-175	1969 All.....	9.99 ea.
PLB-7073	1970-73.....	34.99 ea.

Bumper Jacks

OE style reproduction of this often missing jack. This kit comes complete with jack, base and load base for bumper.

MBJ-67F	1967 All.....	179.98 kit
MBJ-68F	1968 All.....	179.98 kit
MBJ-69F	1969 All.....	170.98 kit
MBJ-703F	1970-73 All.....	193.48 kit

Note: These jacks are for display purposes only and are not intended for use.

PLW-KIT



Lug Nut Wrench & Sleeve

Correct GM lug wrench, rubber sleeve for retaining it to the jack.

PLW-3	1967-81 Wrench.....	19.99 ea.
PLS	1967-81 Sleeve.....	12.99 ea.
PLW-KIT	1967-81 Complete Kit*.....	44.07 kit

**Includes sleeve, wrench and hold down.*

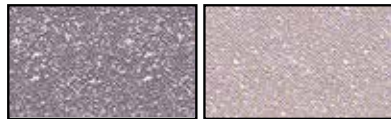

Trunk Spatter Paint

Correct OEM aerosol spray & paint to detail your trunk floor.

DUP-TSP102	Black/Aqua.....	16.99 ea.
DUP-TSP100	Grey/White.....	16.99 ea.
HDP-GW-QT	Grey/White Quart.....	84.99 ea.
HDP-BA-QT	Black/Aqua Quart.....	84.99 ea.
DUP-DAL1695	Clear Coat.....	10.99 ea.

Clear coat must be used to seal paint!



Custom Trunk Panel Kit

Pre-cut custom trunk panel set is easy to clean up your trunk. Includes pre-cut hardboard panels to cover the floor, trunk divider area and the sides of the trunk saving you hours of hand trimming. Add your choice of finishing material such as carpet (not included).

CTPM-317-6	1967-69.....	229.99 kit
------------	--------------	------------

Ships Oversize. Not eligible for free shipping.



RTG-67F

Weatherstrip Gutter

New three piece trunk weatherstrip gutter which is required when replacing your quarters.

RTG-67F	1967-69 3pc.....	66.99 set
RTG-70F	1970-81 2pc.....	79.99 pr.

RLS-539

1970-81 Trunk Hinge Torque Rod

Reproduction trunk hinge torque rod manufactured as original from precision bent steel. Designed to hold the trunk lid up when open.

RLS-539	1970-81 LH.....	29.99 ea.
RLS-538	1970-81 RH w/o Spoiler.....	35.99 ea.
RLS-540	1970-81 RH w/ Spoiler.....	25.99 ea.

Trunk Lock Rods

Correct rod/shaft that connects the cylinder to the lock assembly.

TLR-458	1967-77 All.....	3.99 ea.
---------	------------------	----------

Trunk Lamp Harness Assembly

28175	1967-69 Convertible.....	49.99 ea..
28180	1967-69 Coupe.....	42.99 ea.
28185	1970-81 All.....	45.99 ea.

All include extension

Trunk Lamp Extension Harness

28195	1967-69 Convertible.....	20.99 ea.
28210	1967-69 Coupe.....	15.99 ea.
15225	1970 All.....	20.99 ea.
14535	1971-77 All.....	27.99 ea.



RTC-1067ZA

RTL-1019

Trunk Lid Latch & Lid Catch

OE style reproduction trunk latching device and lid catch.

RTL-1019	1967-69 Lid Latch.....	29.95 ea.
RTC-1067ZA	1967-69 Lid Catch.....	18.95 ea.
RTL-7081	1970-81 Lid Latch.....	26.99 ea.
TLB-716	All Bolts 5pc.....	10.99 set

JSS-203



Trunk Weatherstrip

Correct molded trunk weatherstrip.

JSS-203	1967-81 All.....	14.95 ea.
---------	------------------	-----------

LTB-90



Door/Trunk Lock Bracket

Correct bracket for retaining lock cylinder in place.

LTB-90	1967-81 All.....	2.69 ea.
--------	------------------	----------

LTR-1



Trunk Lock Retainer

OE style reproduction of this hard to find bracket.

LTR-1	1967-68 All.....	22.99 ea.
LTR-3	1969 All.....	23.99 ea.



LLB-628

LLG-946

1970-73 Trunk Lock Bezel & Gasket

OE style reproduction chrome lock bezel and gasket.

LLB-628	1970-73 Bezel.....	34.99 ea.
LLG-946	1970-73 Gasket.....	17.99 ea.



NRK-146



NJ-150K Detail



NJ-152K Detail



Complete Rally Wheel Kits

Why sift through the junkyard for a used set of wheels or try to repair your originals? Ground Up Motors offers complete wheel kits including a complete set of rims, caps, trim rings and a set of lug nuts! These kits include everything you need to get your muscle car rolling in style.

With Chevrolet Motor Division Flat Caps

NRK-146	14 x 6	885.14 kit
NRK-146DB	14 x 6 w/ Factory Disc	1037.14 kit
NRK-147	14 x 7	847.10 kit
NRK-157	15 x 7	732.64 kit
NRK-158	15 x 8	749.64 kit

With Chevrolet Disc Brakes Flat Caps

NRK-246	14 x 6	871.14 kit
NRK-246DB	14 x 6 w/ Factory Disc	1023.14 kit
NRK-247	14 x 7	833.10 kit
NRK-257	15 x 7	718.64 kit
NRK-258	15 x 8	735.64 kit

With Turbine Style Raised Caps (1968+ Style)

NRK-346	14 x 6	1004.11 kit
NRK-346DB	14 x 6 w/ Factory Disc	1156.11 kit
NRK-347	14 x 7	966.07 kit
NRK-357	15 x 7	851.61 kit
NRK-358	15 x 8	868.61 kit

With Chevrolet Motor Division Flat Caps Bowtie Rings

NRK-157-BT	15 X 7	756.14 kit
NRK-158-BT	15 X 8	773.14 kit

With Chevrolet Disc Brakes Flat Caps Bowtie Rings

NRK-257-BT	15 X 7	742.14 kit
NRK-258-BT	15 X 8	759.14 kit

With Chevrolet Turbine Style Raised Caps Bowtie Rings

NRK-357-BT	15 X 7	875.11 kit
NRK-358-BT	15 X 8	892.11 kit

With Police Style Bowtie Flat Caps No Trim Rings

NRK-446	14 X 6	737.15 kit
NRK-447	14 X 7	699.15 kit
NRK-457	15 X 7	605.15 kit
NRK-458	15 X 8	622.15 kit

BUY & SAVE

WITH SS396.COM PRE-BUILT KITS



NVW-70K

Complete SS Wheel Kits

This kit includes a complete set of SS wheels, center caps with retainers, trim rings and a set of lug nuts to get your Super Sport rolling!

NVW-70K	14 x 7	940.66 kit
NVW-71K15	15 x 7	1020.66 kit

No Volume Discount.

All wheel kits ship in multiple Oversize Boxes.



NVW-4837-MAG-KIT4

Retro Magnum Alloy SS Wheels

Constructed of aluminum these brand new retro 15 x 7 Super Sport wheels will give your muscle car a more modern look while keeping the old school styling! These awesome new wheels are black powdercoated on the inside and feature machined lips.

NVW-4837-MAG-KIT4	15 x 7 Kit	867.87 kit
NVW-4837-MAG	15 x 7 Spare	199.99 ea.

Ships Oversize. Not eligible for free shipping. No Volume Discount.



NCE-8984

Rally Wheels

Our rally wheels come correctly powdercoated in Argent Silver assuring you not only a great appearance but quality as well.

NCE-8984	14 x 6, 4" Backspace	159.99 ea.
NCE-8985	14 x 6 Disc, 4" Backspace*	189.99 ea.
NCE-0530	14 x 7, 4-1/4" Backspace	149.99 ea.
NCE-0535	15 x 7, 4-1/4" Backspace	139.99 ea.
NCE-0540	15 x 8, 4-1/4" Backspace	144.99 ea.

*Fits factory disc brakes only. Ships Oversize.



NCE-0530C

Chrome Rally Wheels

This reproduction Camaro Rally Wheel is made in the USA and comes in high quality chrome plated steel for a custom look. This Camaro wheel is ready to install right out of the box.

NCE-8984C	14 x 6, 4" Backspace	186.99 ea.
NCE-0530C	14 x 7, 4-1/8" Backspace	193.99 ea.
NCE-0535C	15 x 7, 4-1/4" Backspace	199.99 ea.
NCE-0540C	15 x 8, 4-1/2" Backspace	216.99 ea.

Fits cars with 5 lug axles. These wheels do not include center caps or lug nuts. Ships Oversize.



NVW-4832

Super Sport Wheels

OE style reproduction SS wheel which comes correctly painted and ready to install.

NVW-4832	14 x 7, 4 1/4" Backspace	179.99 ea.
NVW-4837	15 x 7, 4 1/4" Backspace	189.99 ea.
NVW-4838	14 x 7, 4 1/4" Backspace	179.99 ea.

Ships Oversize.



NVW-4831C

Chrome Super Sport Wheels

This reproduction Camaro Super Sport Wheel is made in the USA and comes in high quality chrome plated steel for a custom look. This Camaro wheel is ready to install right out of the box.

- NVW-4831C 14 x 6, 4" Backspace 184.95 ea.
- NVW-4832C 14 x 7, 4-1/8" Backspace 209.99 ea.
- NVW-4837C 15 x 7, 4-1/4" Backspace 209.99 ea.
- NVW-4838C 15 x 8, 4-1/2" Backspace 229.99 ea.

*These wheels do not include center caps or lug nuts.
Ships Oversize*



NSW-146

Steel COPO Wheels

This is a brand new factory style steel Camaro wheel which was usually standard equipment on six cylinder cars, Special High Performance Cars and COPO cars. These steel wheels were usually discarded over the years in favor of Rally Wheels or Super Sport Wheels and are tough to find. This wheel is perfect for your bone stock restoration, COPO recreation or sleeper.

- NSW-146 14 x 6, 4-1/2" Backspace 159.99 ea.
- NSW-147 14 x 7, 4-3/4" Backspace 159.99 ea.
- NSW-157 15 x 7, 4-3/4" Backspace 169.99 ea.



NCW-147



NCW-12322686

1980-81 Aluminum Wheels

Reproduction of the aluminum wheel for 1980-81 Camaro models. Features the standard GM 5 on 4.75 bolt pattern. 4.25 backspacing.

- NCW-147 14 x 7 208.99 ea.
- NCW-157 15 x 7 249.99 ea.

1982-87 Aluminum Wheel

Quality reproduction 15 x 7 inch wheel which was originally found on Z28 models. This beautiful cast aluminum wheel GM option code N90 features the correct design and coloration. This popular wheel is perfect for any vehicle running 15 inch tires.

- NCW-12322686 15X7 266.99 set



NW1785SLV

17 Inch N90 Wheels

Add a modern stance to your muscle car while keeping with its classic styling! This is a 17 inch version of the N90 wheel that originally came on 1980-1981 Z/28 and 1986-1988 Monte Carlo models. Accepts original style center caps and lug nuts.

- NW1784SLV 17 x 8, 4.25" B/S 257.99 ea.
- NW1785SLV 17 x 8, 5" B/S 254.99 ea.



CMW178BLK

17 Inch SS Mag Wheels

Add a modern stance to your muscle car while keeping with its classic styling! This is a 17 inch version of the Super Sport Wheel that originally came on various GM models. Accepts original style center caps and lug nuts.

- CMW178BLK 17 x 8, 4.5" B/S 289.99 ea.
- CMW179BLK 17 x 9, 5.125" B/S 299.99 ea.
- MWR2 Center Cap Retainers 29.99 set
- C5782 Screws 10pc 4.99 kit

Note: If using your existing center caps you will need to use MWR2 center cap retainers and C5782 screws to fit these retainers.



ZW1784GUN

17 Inch 5 Spoke Rally Wheels

Add a modern stance to your muscle car while keeping with its classic styling! This is a 17 inch version of the 5 spoke Z/28 wheel that originally came on 1970-1981 Camaro. Accepts original style center caps and lug nuts.

- ZW1784GUN 17 x 8, Gunmetal, 4.25" B/S 257.99 ea.
- ZW179GUN 17 x 9, Gunmetal, 5" B/S 257.99 ea.



NJT-716



NJT-665



NJT-665-R



NJT-135

Lug Nuts

Correct style lug nuts for your wheels.

- NJT-716 Acorn 7/16 1.59 ea.
- NJT-665 Stainless SS 2.99 ea.
- NJT-665KIT SS 20pc 53.80 kit
- NJT-665-R Chrome SS 2.99 ea.
- NJT-665-RKIT Chrome SS 20pc 53.80 kit
- NJT-135 All w/ Aluminum Rims 5.99 ea.



NZW-157

1970-81 5 Spoke Rim

Exact reproduction 5 spoke steel wheel originally installed on Z/28 models.

- NZW-157 1970-81 299.99 ea.



NJ-1530

Rally Wheel Center Cap

Correct turbine style raised style center cap with "Chevrolet Motor Division".

- NJ-1530 Motor Division Cap 1968 69.99 ea.
- NJ-1530-BTK Bowtie 1968+ 4pc 199.99 ea.



NJ-151K

Rally Wheel Cap Kits

Ground Up Motors offers complete rally wheel center cap kits which include the center caps, bases, and hardware for all 4 wheels. Chrome plated metal center cap with a polished stainless-steel base.

- NJ-150K Chevrolet Motor Division 139.99 kit
- NJ-151K Chevrolet Disc Brakes 139.99 kit
- NJ-152K Motor Division Raised 251.96 kit



NWB-781

1978-81 Rally Wheel Bezel

This is the correct chrome bezel that inserts into the slots on your ZJ7 6 slot rally wheels. 6 required per wheel.

- NWB-781 1978-81 w/ Rally Wheel 12.99 ea.

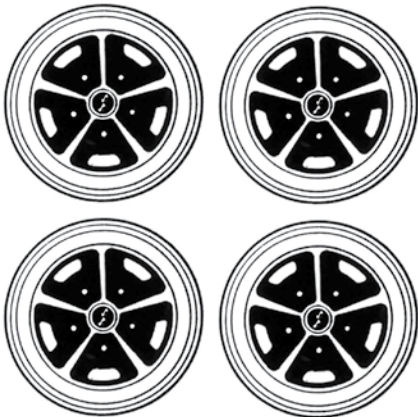

HMK-6970

SS Wheel Restoration Supplies

Ground Up Motors offers everything you need to restore your original Super Sport Wheels. Order our 4 piece paint mask kit along with Argent Silver and SS Insert gray paint for a complete job.

HMK-6970	Paint Mask*	24.99 kit
DUP-HWP101	Argent Silver Paint (11oz. can)	11.99 ea.
HDP-1214	Insert Gray Paint (11oz. can)	15.99 ea.

*Masks 4 Rims



HK
WHEELS

HK Magnum Wheels

HK Magnum wheels offer classic good looks in a larger, more modern 17 inch diameter. HK Magnum wheels are manufactured in cast aluminum with black powder coated inserts and deep diamond machined lip clear powder coated for durability and low maintenance. HK Magnum wheels include a chromed lightweight polymer cone style center with HK Wheels decal with a style that complements the classic looks of the wheel. BS = Back Spacing.

HK-MW1775475	17x7 4.25" BS	229.99 ea.
HK-MW1785475	17x9 4.25" BS	239.99 ea.
HK-MW1795475	17x9 5" BS	259.99 ea.

No Volume Discount.



ER-7014RL



ER-7014RW

Factory Style Radial Tires

If you're going for an authentic Camaro restoration, be sure that you don't overlook the tires! Previously, this meant sacrificing modern ride quality and handling characteristics for an authentic appearance, but now you can have the best of both worlds with these modern radial tires that have a period correct appearance. This factory style Firestone Wide Oval tire is an almost exact replica of the original, engineered from the ground up to provide excellent ride quality, tread life and safety, while retaining the correct tread pattern and raised white lettering.

Firestone Wide Oval

FR-7014RW	FR70-14	435.99 ea.
GR-7014RW	GR70-14	465.99 ea.
FR-7015RW	FR70-15	489.99 ea.
FR-6015RW	FR60-15	587.99 ea.
GR-7015RW	GR70-15	518.99 ea.

Firestone Redline

FR-7014RL	FR70-14	435.99 ea.
GR-7014RL	GR70-14	465.99 ea.
FR-7015RL	FR70-15	489.99 ea.
GR-7015RL	GR70-15	518.99 ea.



Factory Style Tires

If authenticity is your goal, then look no further. All of our tires feature the same tread patterns and raised white lettering as the originals.

Goodyear Polyglas

GE-7014	E70 x 14	347.99 ea.
GF-7014	F70 x 14	371.99 ea.
GF-7114	F70 x 14*	388.99 ea.
GF-7015	F70 x 15	406.99 ea.
GF-6015	F60 x 15	435.99 ea.
GG-7014	G70 x 14	412.99 ea.
GG-6015	G60 x 15	488.99 ea.

*1969 - early 1970 w/o tire size in RWL. No Volume Discount. Ships Oversize.

Firestone Wide Oval

FE-7014	E70 x 14	408.99 ea.
FF-7014	F70 x 14	420.99 ea.
FG-7014	G70 x 14	456.99 ea.
FF-7015	F70 x 15	458.99 ea.
FG-7015	G70 x 15	477.99 ea.
FF-6015	F60 x 15	525.99 ea.

Firestone Redline

RF-7014	F70 x 14	419.99 ea.
RG-7014	G70 x 14	456.99 ea.
RF-7015	F70 x 15	475.99 ea.
RG-7015	G70 x 15	663.99 ea.

American Racing Wheel Kits

American Racing is the brand that started it all with their revolutionary Torq Thrust wheels. For the first time Ground Up Motors® is offering these wheels. BS = BACKSPACE



ARKIT-TT26-147

ARKIT-TTMMG-177

Classic Torq Thrust II One Piece Mag Gray Machined Lip

ARKIT-TT26-146	14x6 3.42"BS	499.96 kit
ARKIT-TT26-147	14x7 4.0"BS	511.96 kit
ARKIT-TT26-157	15x7 3.76"BS	555.96 kit
ARKIT-TT26-158	15x8 4.5"BS	627.96 kit
ARKIT-TT26-1578	15x7 Front 15x8 Rear	591.96 kit

Torq Thrust II One Piece Chrome

ARKIT-TT2C-147	14x7 4.0"BS	987.96 kit
ARKIT-TT2C-157	15x7 3.76"BS	1055.96 kit
ARKIT-TT2C-158	15x8 4.5"BS	1083.96 kit
ARKIT-TT2C-1578	15x7 Front 15x8 Rear	1069.96 kit
ARKIT-TT2C-177	17x7 4.0"BS	1279.96 kit
ARKIT-TT2C-178	17x8 4.81"BS	1299.96 kit
ARKIT-TT2C-1778	17x7 Front 17x8 Rear	1289.96 kit

Torq Thrust II One Piece PVD Chrome

ARKIT-TT2CPVD-157	15x7 3.76"BS	791.96 kit
ARKIT-TT2CPVD-158	15x8 4.5"BS	727.96 kit
ARKIT-TT2CPVD-1578	15x7 Front 15x8 Rear	759.96 kit
ARKIT-TT2CPVD-177	17x7 4.0"BS	883.96 kit
ARKIT-TT2CPVD-178	17x8 4.81"BS	983.96 kit
ARKIT-TT2CPVD-1778	17x7 Front 17x8 Rear	933.96 kit

Torq Thrust II One Piece Polished

ARKIT-TT2POL-157	15x7 3.76"BS	695.96 kit
ARKIT-TT2POL-158	15x8 4.5"BS	703.96 kit
ARKIT-TT2POL-1578	15x7 Front 15x8 Rear	699.96 kit
ARKIT-TT2POL-177	17x7 4.0"BS	1307.96 kit

Torq Thrust D Chrome

ARKIT-TTDC-157	15x7 3.76"BS	1011.96 kit
ARKIT-TTDC-158	15x8 4.5"BS	1051.96 kit
ARKIT-TTDC-1578	15x7 Front 15x8 Rear	1031.96 kit

Torq Thrust D Black w/ Machined Lip

ARKIT-TTDB-157	15x7 3.76"BS	731.96 kit
ARKIT-TTDB-158	15x8 4.5"BS	787.96 kit
ARKIT-TTDB-1578	15x7 Front 15x8 Rear	759.96 kit

Torq Thrust M Anthracite w/ Machined Lip

ARKIT-TTMMG-177	17x7 4.0"BS	811.96 kit
ARKIT-TTMMG-178	17x8 4.5"BS	903.96 kit
ARKIT-TTMMG-1778	17x7 Front 17x8 Rear	857.96 kit

American
Racing
CUSTOM WHEELS



Trim Ring Sets

OE style reproduction trim ring kits at an affordable price.

NTR-146	14 x 6 Rally	119.99 kit
NTR-147	14 x 7 Rally	119.95 kit
NTR-157	15 x 7 Rally	109.99 kit
NTR-157-B	15 x 7 Rally With Bowtie.....	119.99 kit
NTR-158	15 x 8 Rally	109.99 kit
NTR-158-B	15 x 8 Rally With Bowtie	115.99 kit

SS Trim Ring Sets

OE style reproduction trim rings packaged in convenient sets for your Super Sport.

NTW-1090	1969 14 x 7	99.99 kit
NTW-1095	1969 15 x 7	109.99 kit
NTR-70Z	1970-81 15 x 7*	179.99 kit
NTW-7SSZ	1970-81 OE Quality 15 x7*	209.99 kit

*Gray 5 Spoke Style



NJT-671K



NJT-63K

Center Cap Kit

This complete set includes (4) nice reproduction center caps with retainers (where applicable) for your SS wheels.

NJT-671K	1969-70 8pc	107.91 kit
NJT-63K	1971-72 4pc	89.96 kit



NSS-70K

OEM Style SS Center Cap Kit

These center caps are reserved for the true purist because they feature a deep indented SS center cap like factory. These caps are a little pricier but are the obvious choice when going for a totally stock restoration.

NSS-70K	1969-70 Complete	119.99 kit
---------	------------------------	------------



NCE-6770

NCX-396

NCX-454

NCE-700

NCD-396

NCD-454



NCE-671

Super Sport Center Caps

OE style reproduction retainers and caps to freshen up your Super Sport Wheels.

NCE-6770	SS Cap	19.99 ea.
NCX-396	SS396 Cap	19.99 ea.
NCX-454	SS454 Cap	19.99 ea.
NCE-700	SS Decal Only.....	6.99 ea.
NCD-396	SS396 Decal Only.....	7.99 ea.
NCE-671	Retainer	8.99 ea.
NCD-454	SS454 Decal Only.....	7.99 ea.



NCE-312

NCD-313

NCC-358

NCC-632

NCC-8587Z-G

NCC-8587Z-S

1978-87 Center Caps & Emblems

NCE-312	1978 YJ8, 1979 N90 Center Cap	28.99 ea.
NCD-313	1978 YJ8, 1979 N90 Emblem.....	14.99 ea.
NCE-12514403	1982-92 Center Cap Black	32.99 ea.
NCC-358	1980 N90 Emblem Blk Blk	22.99 ea.
NCC-632	1980 N90 Emblem Blk Red	21.99 ea.
NCC-8587Z-G	1985-87 Iroc-Z Gold	19.99 ea.
NCC-8587Z-S	1985-87 Iroc-Z Silver	19.99 ea.



NCC-688

NCC-872

NCE-9479

NCC-688	1977-78 Z/28	32.99 ea.
NCC-872	1979-81 Z/28	42.99 ea.
NCE-9479	1971-72 SS	24.99 ea.



NCD-106

NYC-105

1969 Yenko Wheel Ornament Decal

Correct pressure sensitive decal for use on 1969 Yenko models equipped with Torque Thrust wheels.

NCD-106	1969 Yenko	13.99 ea.
---------	------------------	-----------

1967-69 Yenko Rally II Wheel Cap

OE style reproduction chrome wheel center cap for use with Yenko models equipped with Pontiac Rally II wheels.

NYC-105	1967-69	39.99 ea.
---------	---------------	-----------



NDD-210

NDD-220

NDD-230

Dog Dish Hubcaps

These are OE style reproduction hub cap sets that were commonly found on many high performance cars. They feature excellent stamping, paint and chrome which ensures not only aggressive looks, but excellent quality.

NDD-210	1966 All	439.99 kit
NDD-220	1967 All	439.99 kit
NDD-230	1968-70 All	439.99 kit
NDD-200	1962 All	439.99 kit

These will only fit stock steel wheels. They will not fit Rally Wheels or SS Wheels.



NJ-14

1967 14" Wheel Cover

OE style reproduction stamped from high quality stainless steel and highly polished.

NJ-14	1967	89.99 ea.
NHC-67	1967 4pc	204.99 set

BEST SELLER! \$AVE BIG!

Front Power Disc Brake Conversion Kits

Upgrade your Camaro today with the most complete front disc brake kit on the market. Includes all OEM parts and is available with multiple upgrades. Increase stopping power and give your car that factory stock disc brake appearance. Works with 15" wheels or larger. Includes:

- 11" rotors
- Forged spindles
- Bearings & Seals
- Loaded calipers
- Caliper brackets
- Backing plates
- Flex Hoses & Clips
- Master cylinder
- Power Booster (9" or 11" Gold)
- Combination valve & bracket
- All hardware

FM-1790FS-UP	1967-69 Camaro with 11" Booster	651.14 kit
FM-1790FS9-UP	1967-69 Camaro with 9" Booster	651.14 kit
FM-1790DSF	1967-69 Camaro 2" Drop Spindle - 11" Booster	932.99 kit
FM-1790DSF9	1967-69 Camaro 2" Drop Spindle - 9" Booster	932.99 kit



SHOW N'GO UPGRADE

This package adds drilled and slotted rotors and red or black powdercoated calipers.

FM-1790FS-UP-S	1967-69 D/B Kit with Show N Go Black	666.14 kit
FM-1790FS-UP-Z	1967-69 D/B Kit with Show N Go Red	666.14 kit
FM-1790DSFS	1967-69 2" Drop Kit 11" w/ Show N Go Black	1132.99 kit
FM-1790DSFZ	1967-69 2" Drop Kit 11" w/ Show N Go Red	1132.99 kit

1970-81 Front disc upgrade to drilled and slotted rotors with powdercoated calipers.

This kit contains the rotors and calipers only.

FMC-7077B-UP	1970-77 Black Calipers	332.07 kit
FMC-7077R-UP	1970-77 Red Calipers	332.07 kit
FMC-7078B-UP	1978 Black Calipers	332.07 kit
FMC-7078R-UP	1978 Red Calipers	348.07 kit
FMC-7981B-UP	1979-81 Black Calipers	346.47 kit
FMC-7981R-UP	1979-81 Red Calipers	362.47 kit



BEST OF SHOW UPGRADE

Adds drilled & slotted rotors, 8" chrome master, booster, pro-valve assembly and powdercoated calipers.

FM-1790FS-UP-SX	1967-69 D/B Kit w/ Best of Show Black	794.95 kit
FM-1790FS-UP-ZX	1967-69 D/B Kit w/ Best of Show Red	794.95 kit
FM-1790DSFX	1967-69 2" Drop Kit w/ Best of Show Black	1251.99 kit
FM-1790DZFX	1967-69 2" Drop Kit w/ Best of Show Red	1251.99 kit

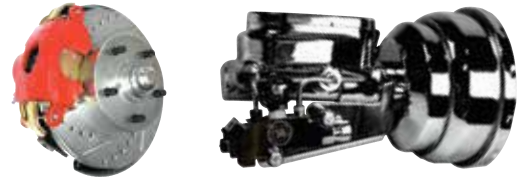

SHOW STOPPER UPGRADE

Adds drilled & slotted rotors and a chrome master, booster, pro-valve assembly.

FM-1790FS-UP-X	1967-69 D/B Kit w/ Show Stopper Chrome	779.95 kit
----------------	--	------------



KEEP YOUR FACTORY 14" WHEELS - POWER FRONT DISC BRAKE KITS

Half the install time & no alignment needed- Bolts directly to stock drum spindles, fits any 14" wheel, uses a proprietary rotor. Includes booster, master, combo valve, rotors, calipers, brackets and hardware.

		<u>MSRP</u>	<u>KIT</u>
AFXDC14-11	1967-69 Camaro 11" Power Booster	575.99	825.99 kit
AFXDC14-9	1967-69 Camaro 9" Power Booster	575.99	825.99 kit

DISC BRAKE CONVERSION LINE KITS - NO BRAINER

Simplify your installation with all the brake lines and clips you will need. Includes: • Front line kit, • Front to rear line, • Clip set

		<u>Original</u>	<u>Stainless</u>
F67DCKIT_ * * *	1967 Camaro	129.99 kit	187.99 kit
F68DCKIT_ * * *	1968 Camaro	187.99 kit	187.99 kit
F69DCKIT_ * * *	1969 Camaro	124.99 kit	187.99 kit
FC67DC	1967-69 All Line Clip Kit	16.99 ea.	

Add to these to the part #'s* above for the following: *M - Manual brakes-No Power booster used
*4 - for 4 wheel disc brakes *SS - for stainless steel lines.



AFXSD42CZ

Four Wheel Power Disc Brake Conversion Kits

Upgrade your classic to the ultimate in stopping power. Our 4 wheel kits are the most complete kits in the industry at rock bottom prices. Upgrade packages available- see ledger below. Add our No Brainer- Disc Brake line kit for a care-free installation.

Stock Height Non-Staggered Rear Shocks

AFXDC42C	1967-69 Camaro 11"PB	1431.99 kit
AFXDC42CS	1967-69 Camaro 11"PB, DS, BPC.....	1634.99 kit
AFXDC42CZ	1967-69 Camaro 11"PB, DS, RPC.....	1634.99 kit
AFXDC42CX	1967-69 Camaro 8" Chrome PB.....	1467.99 kit
AFXDC42CSX	1967-69 Camaro 8" Chrome PB, DS, BPC.....	1736.99 kit
AFXDC42CZX	1967-69 Camaro 8" Chrome PB, DS, RPC.....	1736.99 kit

Stock Height Staggered Rear Shocks

AFXDC45C	1967-69 Camaro 11"PB	1431.99 kit
AFXDC45CS	1967-69 Camaro 11"PB, DS, BPC.....	1629.99 kit
AFXDC45CZ	1967-69 Camaro 11"PB, DS, RPC.....	1634.99 kit
AFXDC45CX	1967-69 Camaro 8" Chrome PB.....	1467.99 kit
AFXDC45CSX	1967-69 Camaro 8" Chrome PB, DS, BPC.....	1736.99 kit
AFXDC45CZX	1967-69 Camaro 8" Chrome PB, DS, RPC.....	1736.99 kit

2" Dropped Spindle Height Non-Staggered Rear Shocks

AFXDC42D	1967-69 Camaro 11"PB	1509.99 kit
AFXDC42DS	1967-69 Camaro 11"PB, DS, BPC.....	1699.99 kit
AFXDC42DZ	1967-69 Camaro 11"PB, DS, RPC.....	1764.99 kit
AFXDC42DX	1967-69 Camaro 8" Chrome PB.....	1538.99 kit
AFXDC42DSX	1967-69 Camaro 8" Chrome PB, DS, BPC.....	1799.99 kit
AFXDC42DZX	1967-69 Camaro 8" Chrome PB, DS, RPC.....	1799.99 kit

Staggered Rear Shocks

AFXDC45D	1967-69 Camaro 11"PB	1509.99 kit
AFXDC45DS	1967-69 Camaro 11"PB, DS, BPC.....	1699.99 kit
AFXDC45DZ	1967-69 Camaro 11"PB, DS, RPC.....	1699.99 kit
AFXDC45DX	1967-69 Camaro 8" Chrome PB.....	1538.99 kit
AFXDC45DSX	1967-69 Camaro 8" Chrome PB, DS, BPC.....	1799.99 kit
AFXDC45DZX	1967-69 Camaro 8" Chrome PB, DS, RPC.....	1799.99 kit

PB- Gold Power Booster, DS- Drilled & Slotted Rotors, BPC-Black Powdercoated Calipers, RPC-Red Powdercoated Calipers OH-Chrome Power Assembly (booster, master, pro-valve) Please call for manual disc brake conversions.

BUY & SAVE
WITH SS396.COM PRE-BUILT KITS



Rear Disc Brake Conversion Kit

Complete rear disc brake conversion kit for the ultimate stopping power. This kit includes rotors, loaded calipers, caliper brackets, bracket hardware, flex hoses and rear brake cables. To add drilled and slotted rotors and painted calipers, add the following letters. S for black calipers, Z for red calipers. Ex. AFXRD01S is 1967-69 with black calipers.

		Black	Red
AFXRD01-	1967-69 w/o Staggered	778.99 kit	778.99 kit
AFXRD05-	1967-69 w/ Staggered	778.99 kit	778.99 kit
AFXRD05-	1970-74 All	778.99 kit	778.99 kit
AFXRD07-	1975-81 All	778.99 kit	778.99 kit
AFXRD78S	1982-92 All.....	902.99 kit	902.99 kit

5 lug only. No Volume Discount. Ships in multiple Oversize boxes. Ships oversize. No Volume Discount.

THE RIGHT Stuff



TRSD performance Series Disc Brake Conversions

These all new disc brake conversions from The Right Stuff feature Wilwood 2 piston calipers, street performance brake pads, stainless braided flex hoses, spindles, caliper brackets, dust shields,

4 Wheel Kits

4 Wheel Kits Non-Staggered Shocks

AFXSD42CS	1967 Black Calipers Manual	1531.99 kit
AFXSD42CZ	1967 Red Calipers Manual	1531.99 kit
AFXDC42CS	1967 Black Calipers 11" Gold Booster	1634.99 kit
AFXDC42CZ	1967 Red Calipers 11" Gold Booster	1634.99 kit
AFXSD22CSX	1967 Black Calipers Manual Chrome Master	2494.99 kit
AFXSD22CZCZ	1967 Red Calipers Manual Chrome Master	2494.99 kit
AFXDC22CSX	1967 Black Calipers 8" Chrome Booster	2629.99 kit
AFXDC22CZCZ	1967 Red Calipers 8" Chrome Booster	2629.99 kit

4 Wheel Kits Staggered Shocks

AFXSD25CS	1968-69 Black Calipers Manual	2419.99 kit
AFXSD25CZ	1968-69 Red Calipers Manual	2419.99 kit
AFXDC25CS	1968-69 Black Calipers 11" Gold Booster	2519.99 kit
AFXDC25CZ	1968-69 Red Calipers 11" Gold Booster	2519.99 kit
AFXSD25CSX	1968-69 Black Calipers Manual Chrome Master	2494.99 kit
AFXSD25CZCZ	1968-69 Red Calipers Manual Chrome Master	2494.99 kit
AFXDC25CSX	1968-69 Black Calipers 8" Chrome Booster	2629.99 kit
AFXDC25CZCZ	1968-69 Red Calipers 8" Chrome Booster	2629.99 kit

4 Wheel Kits Stock Height Non-Staggered Shocks 2" Drop Spindle

AFXSD22DS	1967 Black Calipers Manual	2479.99 kit
AFXSD22DZ	1967 Red Calipers Manual	2479.99 kit
AFXDC22DS	1967 Black Calipers 11" Gold Booster	2589.99 kit
AFXSD22DSX	1967 Black Calipers Manual Chrome Master	2549.99 kit
AFXSD22DZX	1967 Red Calipers Manual Chrome Master	2549.99 kit
AFXDC42DSX	1967 Black Calipers 8" Chrome Booster	1799.99 kit
AFXDC42DZX	1967 Red Calipers 8" Chrome Booster	1799.99 kit

4 Wheel Kits Staggered Shocks 2" Drop Spindle

AFXSD45DS	1968-69 Black Calipers Manual	1665.99 kit
AFXSD45DZ	1968-69 Red Calipers Manual	1608.99 kit
AFXDC45DS	1968-69 Black Calipers 11" Gold Booster	1699.99 kit
AFXDC45DZ	1968-69 Red Calipers 11" Gold Booster	1699.99 kit
AFXSD25DSX	1968-69 Black Calipers Manual Chrome Master	2549.99 kit
AFXSD25DZX	1968-69 Red Calipers Manual Chrome Master	2549.99 kit
AFXDC45DSX	1968-69 Black Calipers 8" Chrome Booster	1799.99 kit
AFXDC45DZX	1968-69 Red Calipers 8" Chrome Booster	1799.99 kit

Front End Kits

AFXDC32S	1967-69 Black Calipers 9" Gold Booster	1513.99 kit
AFXDC32Z	1967-69 Red Calipers 9" Gold Booster	1513.99 kit
AFXDC32SX	1967-69 Black Calipers 8" Chrome Booster	1659.99 kit
AFXDC32ZX	1967-69 Red Calipers 8" Chrome Booster	1659.99 kit

Front End Kits 2" Drop Spindle

AFXDC32DS	1967-69 Black Calipers 9" Gold Booster	1616.99 kit
AFXDC32DZ	1967-69 Red Calipers 9" Gold Booster	1616.99 kit
AFXDC32DSX	1967-69 Black Calipers 8" Chrome Booster	1721.99 kit
AFXDC32DZX	1967-69 Red Calipers 8" Chrome Booster	1721.99 kit

Front End Upgrade Kits

These kits come with drilled and slotted rotors, calipers, spindles and hardware.

AFXWK32S	1967-69 Black Calipers Stock Height	1412.99 kit
AFXWK32Z	1967-69 Red Calipers Stock Height	1412.99 kit
AFXWK32DS	1967-69 Black Calipers 2" Drop Spindle	1469.99 kit
AFXWK32DZ	1967-69 Red Calipers 2" Drop Spindle	1478.99 kit

Rear End Kits Non Staggered Shocks

AFXRDM21S	1967 Black Calipers	1038.99 kit
AFXRDM21Z	1967 Red Calipers	1038.99 kit

Rear End Kits Staggered Shocks

AFXRDM25S	1968-69 Black Calipers	1038.99 kit
AFXRDM25Z	1968-69 Red Calipers	1038.99 kit
AFXRDM26S	1970-74 Black Calipers	1038.99 kit
AFXRDM26Z	1970-74 Red Calipers	1038.99 kit
AFXRDM27S	1975-81 Black Calipers	1038.99 kit
AFXRDM27Z	1975-81 Red Calipers	1038.99 kit
AFXRDM282S	1982-92 Black Calipers	1158.99 kit
AFXRDM282Z	1982-92 Red Calipers	1158.99 kit

Rear Kits With Front Upgrade Kits

These kits come with a complete rear kit and a front kit with drilled and slotted rotors, loaded calipers and hardware.

Staggered Shocks

F69RDM25S	1968-69 Black Calipers	2026.99 kit
F69RDM25Z	1968-69 Red Calipers	2026.99 kit
F70RDM25S	1970-74 Black Calipers	2026.99 kit
F70RDM25Z	1970-74 Red Calipers	2026.99 kit
F75RDM25S	1975-77 Black Calipers	2026.99 kit
F75RDM25Z	1975-77 Red Calipers	2026.99 kit
F78RDM25S	1978 Black Calipers	2026.99 kit
F78RDM25Z	1978 Red Calipers	2026.99 kit
F79RDM25S	1979-81 Black Calipers	2026.99 kit
F79RDM25Z	1979-81 Red Calipers	2026.99 kit
F82RDM78S	1982-87 Black Calipers	1029.99 kit
F82RDM78Z	1982-87 Red Calipers	1029.99 kit

These kits ship oversize. No Volume Discount.

BUY & SAVE
WITH SS396.COM PRE-BUILT KITS

Booster/Master Kits

Replace your old booster and master in one shot and save! These kits are available in many configurations to suit your restoration needs. If you are restoring a car to original specs, the factory style bleeder screws featured in this master cylinder are a must. The booster is available in 9" or 11" configurations and with or without the Delco Moraine stamp. 1967-69 includes round master and 1970-81 includes square master.

BMK-9R	1967-69 with 9" Booster	186.18 kit
BMK-11R	1967-69 with 11" Booster	186.18 kit
BMK-9RD	1967-69 with 9" Booster Delco Stamp	186.18 kit
BMK-11RD	1967-69 with 11" Booster Delco Stamp	186.18 kit
BMK-9RB	1967-69 with Bleeder Screws with 9" Booster	198.98 kit
BMK-11RB	1967-69 with Bleeder Screws with 11" Booster	198.98 kit
BMK-9RBD	1967-69 with Bleeder Screws with 9" Booster Delco Stamp	198.98 kit
BMK-11RBD	1967-69 with Bleeder Screws with 11" Booster Delco Stamp	198.98 kit
BMK-781	1970-81 11" Booster, Master without Bleeders	189.73 kit
BMK-781B	1970-81 11" Booster, Master with Bleeders	189.98 kit

No Volume Discount.



Booster, Master, Valve Kits

Included is a brand new Delco style gold booster, a new master cylinder, a correct style proportioning valve with bracket, distribution block with bracket and correct proportioning valve lines. Simply remove your old assembly and install this new one in place with this convenient kit. Available with or without Delco stamp.

OEM Style

BMK-69F	1967-69 w/o Stamp.....	437.99 kit
BMK-69GM	1967-69 w/ Stamp OEM Style	279.99 kit
BMK-69FD	1967-69 w/ Stamp.....	437.99 kit
BMK-71F	1971-81 w/o Stamp.....	346.99 kit
BMK-71FD	1971-81 w/ Stamp.....	398.99 kit
BMK-7081GM	1970-81 w/ Stamp w/ Bleeders.....	279.99 kit

Chrome

BMK-SHOW9R	1967-69 w/ 9" Power Booster	513.99 kit
BMK-SHOW11R	1967-69 w/ 11" Power Booster	513.99 kit



BMK-424GMK

Booster, Master Pro-valve Kits

If you are looking to replace your worn out original power brake booster or master cylinder, you can now do so in one shot with this power brake booster and master cylinder kit! These kits include an 8" dual diaphragm booster, master cylinder, pro-valve and pro-valve lines.

Gold Cad Plated Booster With OE Style Master Cylinder

BMK-225GMK	1970-81 Disc/Drum.....	291.99 kit
BMK-235GMK	1970-81 Disc/Disc	296.99 kit

Chrome Plated Booster With Chrome Master Cylinder

BMK-370GMK	1970-81 Disc/Drum.....	384.99 kit
BMK-379GMK	1970-81 Disc/Disc	395.99 kit

Black Booster With Black Master Cylinder

BMK-424GMK	1970-81 Disc/Drum.....	318.99 kit
BMK-434GMK	1970-81 Disc/Disc	329.99 kit

No Volume Discount.

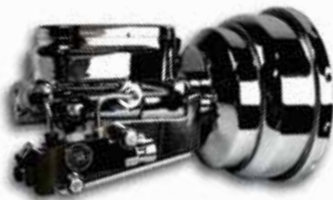

SLIM-8C-2

Slimline Booster, Master, Pro-Valve Kits

These Slimline kits allow you to replace you booster, master cylinder and proportioning valve in one simple step! All kits feature an 8" booster.

SLIM-8G-2	1967-69 Disc/Drum 8" Booster Gold.....	318.99 kit
SLIM-8G-4	1967-69 Disc/Disc 8" Booster Gold.....	318.99 kit
SLIM-8C-2	1967-69 Disc/Drum 8" Booster Chrome.....	419.99 kit
SLIM-8C-4	1967-69 Disc/Disc 8" Booster Chrome	469.99 kit



OEM Style Master Cylinders

Choose from a wide variety of master cylinders to suit your needs. OEM style master cylinders feature cast bodies with caps. Choose a master with bleeders for the ultimate in authenticity.

FMP-1966	1967-81 Dual Drum.....	89.99 ea.
FMP-1967	1967-69 Power Disc	63.99 ea.
FMP-069	1967-69 Power Disc w/ Bleeders.....	79.99 ea.
FMP-1970	1970-81 Power Disc	74.99 ea.
FMP-070	1970-81 Power Disc w/ Bleeders	79.99 ea.

Chrome

FMP-1967C	1967-69 Round Disc/Drum 1-1/8" Bore.....	129.99 ea.
FMP-04C	1967-69 Round Disc/Disc 1" Bore	119.99 ea.
FMP-51C	1967-81 Slimline Disc/Drum 1-1/8" Bore.....	139.99 ea.
FMP-56C	1967-81 Slimline Disc/Disc 1" Bore	139.99 ea.



Master Cylinder Caps & Gaskets

Correct cadmium plated caps.

Caps

FMC-67D	1967-81 Drum	18.95 ea.
FMC-6700	1967-69 Disc.....	16.95 ea.
FMC-6800	1970-81 Disc.....	16.95 ea.

Gaskets

FG-67D	1967-81 Drum	7.99 ea.
FG-67B	1967-69 Disc.....	9.99 ea.
FG-695	1970-81 Disc.....	7.99 ea.



Manual Master Cylinder Hardware

Used only on manual brakes to provide support at the firewall for the master cylinder.

FMP-12046	1967-69 Gasket	9.99 ea.
-----------	----------------------	----------

Correct master cylinder push rod assembly used when converting to manual disc or if the car is manual drum.

FMR-12441	1967-69 Push Rod.....	56.99 ea.
FLN-12968	1967-69 Clevis Lock Nut	2.99 ea.



FBB-6



11" Delco Moraine Booster

Crafted with the same gold cadmium plating as original as well as the Delco Moraine logo stamping for the ultimate in authenticity.

FBB-6 1967-69 179.99 ea.



FBB-3



9" Delco Moraine Booster

Crafted with the same gold cadmium plating and Delco Moraine logo as our 11" booster, this 9" booster allows more clearance when running tall valve covers.

FBB-3 1967-69 179.99 ea.



Detail



FBB-6-UP

11" Delco Booster w/ Upside Down Logo

Features authentic gold cad plating with correct upside down Delco Moraine logo for the purist.

FBB-6-UP 1967-69 219.99 ea.

FPB-7537C



7" Dual Slimline Booster

A good booster when room is tight. Great for big block cars with tall valve covers. Roughly the same assist as a 9" single booster.

FPB-7537 1967-69 Gold 109.95 ea.
 FPB-7537C 1967-69 Chrome 119.95 ea.
 FPB-7537S 1967-69 Stainless 175.99 ea.

FPB-1102



11" Delco Style Booster

This is a brand new power brake booster crafted with the same gold cadmium plating as original.

FPB-1102 1967-69 149.99 ea.

FPB-9022



9" Delco Style Booster

This is a brand new power brake booster crafted with the same gold cadmium plating as original. This 9" booster allows more clearance when running tall valve covers.

FPB-9022 1967-69 198.99 ea.

FPB-801



1970-81 11" Booster

Crafted with the same gold cadmium plating as original.

FPB-801 1970-81 139.99 ea.

FPB-8531



8" Dual Slimline Booster

Our most powerful Slimline booster. 10-15% more assist than a 9" single. Compact enough to fit most applications.

FPB-8531 1967-69 Gold 115.99 ea.
 FPB-8531C 1967-69 Chrome 119.99 ea.
 FPB-8531S 1967-69 Stainless 194.99 ea.

FPB-1003C



Chrome Booster

This is a brand new power brake booster crafted with chrome plating to set your car apart from others.

FPB-9021C 1967-69 9" 288.99 ea.
 FPB-1003C 1967-69 11" 208.99 ea.

FPB-9102



9" Single Slimline Booster

Nice clean looks and performance that won't disappoint. A good choice if you're undecided on which booster to get.

FPB-9102 1967-69 Gold 158.99 ea.



EVP01

Electric Vacuum Kit

A minimum of 16 inches of vacuum is critical to ensure that your power disc brakes are functioning and this kit ensures that your vacuum stays above that level so you will never have to worry about losing your brakes when you need them the most. The system automatically activates when the vacuum falls below that critical level and turns off when the engine is producing enough vacuum. This kit includes an efficient electric pump, relay switch, distributor with vacuum switch, wiring, hoses and brackets. This system requires a 12V negative ground system for operation.

EVP01 Vacuum Pump Kit 229.99 kit



BOOSTERROD-EXTN

Brake Booster Push Rod Extension

This rod is used where the brake booster rod extension has been cut too short it is just too short for your application. 4.75 inch Overall length 4 inch long thread. Cut to fit

BOOSTERROD-EXTN 1967-92 10.99 ea.



FBC-799

Clutch Pedal Booster Rod Clip

Correct clutch pedal rod clip for power disc brake cars.

FBC-799 1967-81 9.99 ea.



BSL-38K

Booster To Master Nut Kit

Hardware to attach the booster to the master cylinder.

BSL-38 All 0.50 ea.



AXP-0656

Power Brake Hose Kit

OEM hose with correct double circle Delco check valve, gasket and black phosphate clamps.

AXP-0656 1967-81..... 21.95 kit



APN-0270

Power Brake Tube

Correct "pre-bent" tube with bracket for cars with power brakes (high quality zinc plated as original).

APN-7938 1968-69 All BB 39.99 ea.
 APN-7072 1970-72 BB 39.99 ea.
 APN-71 1971-72 All BB 23.99 ea.



APJ-1217

Power Brake Hose Bracket

Correct steel stamped retainer for holding power brake hose to valve cover.

APJ-1217 Most 1967-69 Z/28 15.95 ea.



FBB-3715

Power Booster Boot

OE style reproduction of this often missing boot.

FBB-3715 1967-81 All 16.99 ea.



FPV-05

1967-69 Distribution Block

Correct brake distribution block for factory drum or disc brakes. This valve is located under the master cylinder.

FPV-05 1967-69 All 85.99 ea.



FPR-104E

1967-69 Hold Off Valve

Originally used to hold pressure to the rear brakes so the front brakes could engage a split second earlier to prevent fishtailing.

FPR-104E 1967-69 Disc..... 54.99 ea.



FPR-104C

1970 Hold Off Valve

Originally used to hold pressure to the rear brakes so the front brakes could engage a split second earlier to prevent fishtailing.

FPR-104C 1970 Disc..... 54.99 ea.



FPR-114

1967-68 Pro Valve

Correct brake proportioning valve for factory original disc brakes. This valve is located under the master cylinder and includes the bracket.

FPR-114 1967-68 w/ PDB..... 99.99 ea.



FPV-89

1969 Pro Valve

Correct brake proportioning valve for factory original disc brakes. This valve is located under the master cylinder.

FPV-89 1969 w/ PDB..... 69.99 ea.



FPV-7

1970 Pro Valve

Correct brake proportioning valve for factory original disc brakes. This valve is located under the master cylinder.

FPV-7 1970 w/ PDB..... 89.99 ea.



FPR-102

1971-77 Pro Valve

OE style to original concourse level proportioning valve with correct wire lead for direct replacement.

FPR-102 1971-77 w/ PDB..... 69.99 ea.



FBRK-71F

1971-77 Valve Bracket

Correct reproduction of this proportioning valve bracket unique to 1971-77 Camaros.

FBRK-71F 1971-81..... 23.99 ea.



FPVB-3



FPV-BOOT

Proportioning Valve Bracket & Boot

Correct gold plated pro-valve bracket.

FPVB-3 1967-70 Bracket 39.99 ea.
 FPV-BOOT All Boot..... 6.95 ea.



PVK-71COMBOKIT

Proportioning Valve Kit

This is a universal proportioning valve that can be used on all cars when converting to disc brakes. Includes valve, bracket, harness and hardware. Choose from gold or chrome.

PVK-71COMBOKIT 2 Wheel Disc Gold..... 89.99 kit
 PVK-72COMBOKIT 4 Wheel Disc Gold..... 69.99 kit
 PVK-71CK 2 Wheel Disc Chrome 169.99 kit
 PVK-72CK 4 Wheel Disc Chrome 169.99 kit
 MMC002 Brake Lines OM 19.99 kit
 MMC002SS Brake Lines SS 26.99 kit

No Volume Discount.



HURST-1745000

Hurst Roll Control Line Lock

Used primarily in drag racing to provide positive locking action to the front wheels of race cars, reducing the chance of "Rolling the Lights" and producing more effective "Burn Outs" for heating up the tires.

HURST-1745000 All Universal Roll Control ... 195.99 kit
 HURST-5671518 2010-15 Roll Control 363.99 kit
 HURST-5671510 Installation Kit 82.99 kit

No Volume Discount.



FRC4044

Single Piston Brake Calipers

New single piston loaded calipers complete with pads and all new hardware. Ready to install!

FRC4044	1967-69 LH	69.99 ea.
FRC4043	1967-69 RH	69.99 ea.
FRC-4060	1970-77 LH	61.95 ea.
FRC-4059	1970-77 RH	61.95 ea.
FRC-4124	1978-81 LH	84.95 ea.
FRC-4123	1978-81 RH	84.95 ea.

No Volume Discount.



FBC-4PSTL

4 Piston Brake Calipers

All new 4 piston calipers with Delco Moraine logo and casting numbers 5455530 and 5455533. Completely assembled.

FBC-4PSTL	1967-68 LH	369.99 ea.
FBC-4PSTR	1967-68 RH	379.99 ea.

Caliper Inlet Lines

1967-68 4 Piston		OM	SS
FFC6701	3/8 x 3/8 LH	14.99 ea.	17.99 ea.
FFC6702	3/8 x 3/8 RH	14.99 ea.	17.99 ea.
FFC6703	3/8 x 7/16 LH	14.99 ea.	17.99 ea.
FFC6704	3/8 x 7/16 RH	14.99 ea.	17.99 ea.
FFC6705	3/8 x 1/2 LH	14.99 ea.	17.99 ea.
FFC6706	3/8 x 1/2 RH	14.99 ea.	17.99 ea.

1969 JLB

FFCJL8L	3/8 x 1/2 LH	12.99 ea.	15.99 ea.
FFCJL8R	3/8 x 7/16 RH	12.99 ea.	15.99 ea.

No Volume Discount.



FRC-69FR



FRC-69FB

Powdercoated Calipers

These powdercoated calipers are a great finishing touch for any show car!

FRC-69FR	1969 Red*	119.98 kit
FRC-69FB	1969 Black*	119.98 kit
FRC-70FR	1970-77 Red	143.98 kit
FRC-70FB	1970-77 Black	143.98 kit
FRC-78FR	1978-81 Red	159.98 kit
FRC-78FB	1978-81 Black	143.98 kit

*1969 works on 1967-68 with single piston setup.



FMP-0200

Disc Brake Pads

New brake pad set.

FMP-0400	1967-68 4 Piston	44.99 set
F-DP01	1967-68 4 Piston OE Style	69.99 set
FMP-0200	1969-81 1 Piston	29.99 set



FKW-4160

Caliper Backing Plates

OE style reproduction zinc backing plates.

FKW-4160	1967-68 4 Piston	92.99 pr.
FPP-11J	1969 1 Piston	39.99 pr.
FP-1K	1970-81	59.99 pr.
FPP-11GSK	1967-81 All Gasket	8.99 pr.

No Volume Discount.



BCP-373

Backing Plate Bolt

Correct bolt for attaching plate to spindle.

BCP-373	1969 Single Piston	6.99 ea.
---------	--------------------------	----------



FM-2501

Caliper Mounting Brackets

OE style reproduction caliper mounting brackets.

FM-155X	1967-68 4 Piston	164.99 pr.
FM-2501	1969 Single Piston*	69.99 pr.

*15" or larger wheels.



FBP-035

Disc Brake Retaining Pin

Correct pin for retaining 4 piston caliper brake pads to caliper. Two per caliper.

FBP-035	1967-68 4 Piston	6.99 ea.
---------	------------------------	----------



BMP-1000

Brake Caliper Bolts

Correct bolts/pins for mounting caliper to bracket. Two per caliper.

BMP-1000	All Single Piston	2.99 ea.
----------	-------------------------	----------



Deluxe Disc Brake Mini Kit

This deluxe disc brake mini kit contains essential parts to convert to your own disc brake setup or refurbish your factory set up. Includes spindles, caliper brackets, caliper backing plates, flex hoses, pro valve kit, bearing and seal kit and hardware.

FSK-69KIT 1969 with single piston calipers..... 299.99 kit

Can be used on 1967-68 when using 69 single piston calipers. No Volume Discount.



Basic Disc Brake Mini Kit

Basic kit for converting to disc brakes or restoring factory disc brake setup. Complete with 2 spindles, 2 caliper brackets, 2 caliper backing plates and 2 bolts.

FSK-69 1969..... 198.74 kit

Can be used on 1967-68 when using 69-72 single piston calipers. No Volume Discount.



FM-373B

FM-3712

Spindles

New OE spindles.

FM-3712	1967-69 Disc	79.99 ea.
FM-1712	1967-69 Drum	99.99 ea.
FM-3712K	1967-69 Disc Pair	111.98 kit
FM-373B	Attaching Bolts	6.95 pr.
FM-273KIT	1967-69 OE Style Drum 8pc	34.99 kit
FM-373KIT	1967-69 OE Style Disc 10pc	42.99 kit



FSA-02

Steering Arms

OE style reproduction steering arms for your worn or missing originals.

FSA-02	1967-69	69.99 pr.
--------	---------------	-----------



FCDR-66

Drilled & Slotted Rotors

Drilled and slotted for maximum cooling and reduced fade; the ultimate in high performance braking and looks.

FCDR-66	1969*	159.99 pr.
FCDR-7078	1970-78	208.99 pr.
FCDR-7981	1979-81	224.99 pr.

*Works on 1967-68 with Single Piston Calipers.



FBR-880

Rotors

New OEM style rotors.

FBR-780	1967-68 4 Piston	79.99 ea.
FBR-880	1969 All	79.99 ea.
FBR-880KIT	1969 Pair	127.98 pr.
FBR-990	1970-78 All	69.95 ea.
FBR-995	1979-81 All	208.99 ea.

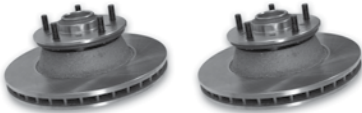

FBR-2P

2 Piece Rotors

Available for the first time! All cars from 1967-69 originally came with 2 piece rotors from the factory. These 2 piece rotors duplicate the originals and are a must for a concours restoration.

FBR-2PK	1967-69 All Pair	379.99 kit
---------	------------------	------------



FNW-103

Bearing Nut - Washer Kit

Correct castle nut, thrust washer and cotter pin. 2 kits are required per car.

FNW-103	1967-81 All	9.99 kit
---------	-------------	----------



FBC-605

FBC-99

Bearing Cap

Original GM bearing & dust shield cap. 1967-69 features correct dimple.

FBC-605	1967-69 All	11.99 ea.
FBC-99	1970-81 All	19.99 ea.



FBK-67D

Bearing & Seal Kit

New GM bearing & seal kit (2) inners, (2) outers and (2) grease seals.

FBK-67D	1967-69 All w/ Disc	53.88 kit
---------	---------------------	-----------

Parking Brake Cable Super Kits

These kits include everything you need to totally replace your old parking brake cables!

These kits come with (1) front cable, (1) intermediate cable (where applicable), (2) rear cables, (1) cable equalizer, (2) cable connectors, (2) frame hooks, (1) crossmember hook, and (3) cable retainer clips.

Available in original material (OM) or stainless steel (SS).

	OM	SS
PBSUKIT-67F	1967-69 All 115.99 kit	115.99 kit
PBSUKIT-70F	1970-74 All 166.99 kit	263.99 kit
PBSUKIT-75F	1975-81 All 166.99 kit	263.99 kit

No Volume Discount.



PBSUKIT-67F

BUY & SAVE
WITH SS396.COM PRE-BUILT KITS



NQ-397

Parking Brake Guide

Correct hooks for supporting cables to crossmember.

NQ-397	1967-69 All	9.99 ea.
--------	-------------	----------



NJ-4675

Brake Cable Connector

Correct U shaped zinc plated connector for connecting intermediate cable to rear cables.

NJ-4675	1967-81 All	6.99 ea.
---------	-------------	----------



NJ-525

Brake Cable Equalizer

Correct support for connecting front cable to intermediate cable and provides equalizing tension for rear cables.

NJ-525	1967-81 All	5.99 ea.
--------	-------------	----------



NX-281

Brake Cable Retainer

Correct clip for all cars (3 required).

NX-281	1967-92 All	3.99 ea.
--------	-------------	----------



FRH-6474HK-OE

Drum Brake Front Hub Kit

OE quality drum brake hub kit. Replace your worn out drum brake hubs with this complete kit.

FRH-6474HK-OE	1967-69 All	129.99 set
---------------	-------------	------------

No volume discount.



Universal Parking Brake Cable Kit

This universal kit is the perfect fit for your modified Camaro. With a 108" total length, you can cut to fit any application with ease. This hassle-free kit is designed for use with either pull handle or foot brake and includes all necessary hardware for a simple installation.

ECRE-ADJ-KIT	1967-20 Universal	109.99 kit
--------------	-------------------	------------



NQ-93

Brake Cable Support

Correct rear cable support bracket which mounts to the lower plates for multi leaf springs.

NQ-93	1967-69 Multi Leaf	19.99 ea.
-------	--------------------	-----------



FPB-12-KIT-R

Parking Brake Shoe Bar

Correct horizontal bar for activating parking brakes.

FPB-11R	1967-81 All Rear	15.99 ea.
FPB-12-KIT-R	Lever/Spring Kit RH	49.99 kit
FPB-12-KIT-L	Lever/Spring Kit LH	49.99 kit



IPB-513

Parking Brake Guide Bar Springs

Correct green springs for 9.5 inch rear drum brakes.

IPB-513	1967-1981	11.99 pr.
---------	-----------	-----------



GBL-9EB

Parking Brake Light Switch

Mounts on the parking brake pedal and activates the light on your dash.

GBL-9EB	1967-69	19.99 ea.
GBL-99PC	1967-69 Bracket	19.99 ea.



IBA-67

E-Brake Assemblies

OE style reproduction parking brake assemblies complete with correct pad and trim.

IBA-67	1967-68 All	59.99 ea.
IBA-69	1969 All	59.99 ea.



FD-95F

Brake Drums

Brand new brake drums.

FBD-95R	1967-81 Rear Finned	64.99 ea.
FD-95F	1967-69 Front Finned	69.99 ea.



F5-64R

Brake Shoes

Complete shoes for 2 drums.

F5-64R	1967-81 All Rear	34.99 pr.
FB5-64F	1967-69 All Front	34.99 pr.



FBP-41L

Backing Plates

New replacement rear drum backing plates.

FBP-41L	All LH	69.99 ea.
FBP-41R	All RH	69.99 ea.
FBP-41K	All LH/RH	125.98 kit
FPB-BOLT	Retaining Bolt/Nut	0.95 ea.



DBK67R2

Rear Drum Brake Kits

Now available as a complete kit! These reproduction kits include all new OEM parts, 9.5" drums, shoes, all hardware, backing plates, wheel cylinders and parking brake cables. They are complete and ready to bolt up. *One kit does both wheels.*

DBK67R2	1967 All	599.99 kit
DBK69R2	1968-69 All	689.99 kit
DBK70R2	1970-74 All	599.99 kit
DBK75R2	1978-81 All	599.99 kit



FPK-1671

Brake Hardware Kit

Correct springs, rods, retainer, adjuster and clamp for mounting shoes to car. Does 2 wheels.

FPK-1671	All Front	52.14 kit
FPK-2642	All Rear	51.27 kit
FPK-REAR-KIT	All 9.5" Drums	216.10 kit



FBG-17



FAP-2R

Drum Brake Guide/Pin

FBG-17	Upper Guide Plate	5.95 ea.
FAP-2R	Attaching Pin Rear	19.99 ea.



FWC-09

Wheel Cylinders

New OEM wheel cylinders exact to original.

FWC-09	1967-69 Front LH	21.99 ea.
FWC-02	1967-69 Front RH	21.99 ea.
FWC-08R	1967-81 All Rear	19.99 ea.
BWC-100	Attaching Bolts	1.95 pr.

Wheel Cylinder Rods

Correct brake shoe thrust rods for engaging shoes. (2) required per cylinder.

FCR-176	1967-81 All	6.99 ea.
---------	-------------	----------



FCR-176

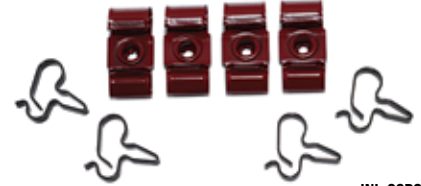

INL-CCB201

Brake Line Clip Kits

Complete brake line clip kits including all of the factory correct clips in the original colors.

INL-CCB201	1967-68 Brake Line Clip Kit 17pc	26.99 kit
INL-CCB202	1969 Brake Line Clip Kit 25pc	39.99 kit
INL-CCB203	1970 Brake Line Clip Kit 21pc	34.99 kit
INL-CCB204	1971-73 Brake Line Clip Kit 25pc	42.99 kit
INL-CCB205	1974-81 Brake Line Clip Kit 25pc	41.99 kit



ELC-316



ELC-1316



ELC-516



ELC-038T



ELC-10P



BLC-056

Brake Line Clips

Correct clips for attaching hard brake lines to frame. (Tabbed clips push into frame holes.)

ELC-316	3/16" Front	2.99 ea.
ELC-1316	3/16" w/ Tab	5.99 ea.
ELC-1516	5/16" Main	1.99 ea.
ELC-516	5/16" w/ Tab	5.99 ea.
ELC-516-GR	5/16" w/ Tab Green	3.99 ea.
ELC-38-90D	3/8" 90 Degree	3.99 ea.
ELC-038T	3/8"* w/ Tab	3.99 ea.
ELC-10P	Double Push In	3.95 ea.
BLC-056	Clip Bolt	0.50 ea.

*Use on main line with armor shielding.



FHB-789

1969 Disc Brake Hose Straps

Correct straps to secure the flex hose to the upper control arm.

FHB-789	1969 Disc	18.99 pr.
---------	-----------	-----------



INL-14999

1970-81 Master Cylinder Line Clamp

Correct sub-frame mounted clamp used to hold the hard brake lines to the hose bracket.

INL-14999	With Disc	12.99 ea.
-----------	-----------	-----------

THE
RIGHT
Stuff



Close up of front lines

Pre-Bent Brake Lines

Our OE style reproduction brake lines are crafted from original GM blueprints as well as from low mileage original cars. All lines feature correct double flared fittings, correct color coded nuts and correct coiled armor shields. Available in original material (OM) or stainless steel (SS). Our line kits are for original factory setups only and will not fit aftermarket conversions!

Front Line Kits

		OM	SS
FKT6702	1967 Manual (serial number below 135,000)	75.99 kit	113.99 kit
FKT6701	1967-68 Manual (serial number above 135,000)	75.99 kit	113.99 kit
FKT6703	1967-68 Power Drum	75.99 kit	113.99 kit
FKT6705	1967-68 Manual Disc	75.99 kit	113.99 kit
FKT6707	1967-68 Power Disc	75.99 kit	113.99 kit
FKT6901	1969 Manual Drum	75.99 kit	113.99 kit
FKT6903	1969 Power Drum & JL8	75.99 kit	113.99 kit
FKT6905	1969 Power Disc	59.99 kit	89.99 kit
FKT6908	1969 Stock Power Disc Brake w/ Booster Removed	75.99 kit	113.99 kit
FKT7004	1970 Standard Manual Disc	88.99 kit	126.99 kit
FKT7005	1970 Power Disc Master Cylinder without Line Armor	88.99 kit	126.99 kit
FKT7006	1970 Power Disc Master Cylinder with Line Armor	88.99 kit	126.99 kit
FKT7101	1971 Manual Disc	75.99 kit	126.99 kit
FKT7102	1971-79 Power Disc	59.99 kit	89.99 kit
FKT8002	1980-81 Power Disc	59.99 kit	89.99 kit

Ships Oversize

Front to Rear Line Kits

		OM	SS
FIN6703	1967 (serial number below 135,000) 1pc	63.99 kit	89.99 kit
FIN6701	1967 (serial number above 135,000) 1pc	63.99 kit	89.99 kit
FIN6702	1967 2pc	63.99 kit	89.99 kit
FIN6801	1968 1pc	63.99 kit	89.99 kit
FIN6802	1968 2pc	63.99 kit	89.99 kit
FIN6901	1969 Power Disc or Drum 1pc	77.99 kit	102.99 kit
FIN6902	1969 Power Disc or Drum 2pc	59.99 kit	69.99 kit
FIN6903	1969 Manual Drum 1pc	77.99 kit	102.99 kit
FIN6906	1969 Manual Drum 2pc	77.99 kit	102.99 kit
FIN7001	1970 Power Disc 1pc	77.99 kit	102.99 kit
FIN7002	1970 Manual Disc 1pc	77.99 kit	102.99 kit
FIN7101	1971-73 Power Disc 1pc	49.99 kit	79.99 kit
FIN7401	1974-76 Power Disc 1pc	59.99 kit	79.99 kit
FIN7801	1977-81 Power Disc 1pc	59.99 kit	79.99 kit

Ship Oversize

Rear Axle Kits (pairs)

		OM	SS
FRA6702	1967 Mono Leaf Springs	24.99 kit	29.99 kit
FRA6802	1968 Mono Leaf Springs	22.99 kit	34.99 kit
FRA6805	1968 Multi Leaf Springs	31.99 kit	44.99 kit
FRA6902	1969 Multi Leaf Springs	24.99 kit	34.99 kit
FRA69JL	1969 JL8	31.99 kit	44.99 kit
FRA7002	1970-74 All	22.99 kit	29.99 kit
FRA7801	1975-81 Std. Rear Suspension	24.99 kit	34.99 kit
FRA8002	1975-81 F-41 Rear Suspension	31.99 kit	44.99 kit



RSBK67

Front Flex Hose Brackets

These brackets hold the front flex hoses to the sub-frame.

FHB-12508	1967-69 Drum	29.99 pr.
RSBK67	1967-68 4 Piston Disc	29.99 pr.
FBC-1001	1969 Disc	51.99 kit
FBC-5000	1970-81 Disc 8pc	44.99 kit
FHB-7081	1970-81 Disc 2pc	36.99 pr.



FXB-105

Rear Flex Hose Brackets

Correct rear axle line flex hose brackets for all 12 bolt rear ends.

FXB-103	1967-68 All	14.99 ea.
FXB-105	1969 All	18.99 ea.
FHB-14409	1970-73 All	18.99 ea.
FHB-14410	1974-81 All	18.99 ea.



Front Flex Hoses

New OEM front flex hoses exact to original.

EBH-002

EBH-002	1967 Drum	13.99 ea.
EBH-002S	1967 Drum SS Braided	39.99 ea.
EBH-012	1968-69 Drum	14.99 ea.
EBH-012S	1968-69 Drum SS Braided	39.99 ea.
EBH-001	1967-68 Disc	14.99 ea.
EBH-001S	1967-68 Disc SS Braided	39.99 ea.
EBH-003	1969 Disc	14.99 ea.
EBH-003S	1969 Disc SS Braided	39.99 ea.
EBH-JL8	1967-68 JL8	20.99 ea.
EBH-69FX	1969-71 Disc Replacement Style	16.99 ea.
EBH-004	1970-71	16.99 ea.
EBH-007	1972-73	14.99 ea.
EBH-006	1974-76	17.99 ea.
EBH-008	1977-78	17.99 ea.
EBH-009	1979-81	14.99 ea.
FH7078S	1970-78 Disc SS Braided	69.99 pr.

Rear Flex Hoses

New OEM rear flex hoses exact to original.

EBH-04	1967 All	14.99 ea.
EBH-04S	1967 All SS Braided	49.99 ea.
EBH-05	1968 All	14.99 ea.
EBH-05S	1968 All SS Braided	54.99 ea.
EBH-06	1969 All	19.99 ea.
EBH-06S	1969 All SS Braided	49.99 ea.
EBH-10	1970-72 All	21.99 ea.
EBH-10S	1970-72 All SS Braided	46.99 ea.
EBH-11	1973 All	29.99 ea.
EBH-11S	1973 All SS Braided	40.99 ea.
EBH-12	1974-75 All	15.99 ea.
EBH-12S	1974-75 All SS Braided	46.99 ea.
EBH-13	1976-81 All	17.99 ea.
EBH-13S	1976-81 All SS Braided	49.99 ea.



EBB-691

Front Flex Hose Banjo Bolts

Correct OEM brake fluid bolt with hollow center and (2) special washers for attaching flex hose to caliper.

EBB-691	1969-92 w/ Disc Brakes	4.99 ea.
---------	------------------------	----------



EBC-22

Flex Hose Clip

Correct clip for retaining flex hose.

EBC-22	All	3.99 ea.
--------	-----	----------



FBLK-1

Flex Hose Block

Correct brass block for rear axle hose.

FBLK-1	1967-68 All	14.99 ea.
--------	-------------	-----------



BRH-11400

Rear Flex Hose Mounting Bolt

Used to secure hose to rear end bracket. 3/8" shank.

BRH-11400	1969	5.99 ea.
-----------	------	----------



Deluxe Front Suspension Kit

DIX-69

This is the ultimate suspension kit!

Each kit includes the finest quality components.

2 Upper Ball Joints, 4 Lower Control Arm Bushings, 2 Lower Ball Joints, 4 Upper Control Arm Bushings, 2 Outer Tie Rods, 2 Stabilizer Ends Links, 2 Inner Tie Rods, 2 Adjuster Sleeves, 1 Idler Arm.

DIX-69 1967-69 All321.37 kit

Ships Oversized. No Volume Discount.



6874SFK-P

Polygraphite Complete Front End Kit

For the ultimate in performance, install a polygraphite front end kit! This kit offers increased longevity and better performance than the stock rubber front end components. Kits includes upper and lower ball joints, inner and outer tie rods, tie rod adjusting sleeves, idler arm and control arm bushing kit and bump stops.

6874SFK-P 1967-69 All415.96 kit

End link kit sold separately. No Volume Discount.



6874FK-P

Polygraphite Basic Front End Kit

Polygraphite bushings used in this kit are the ultimate combination of polyurethane and graphite. You get performance and durability with superior lubricating qualities which provides smooth operation. Kits include upper and lower ball joints, outer tie rods, control arm bushing kit and lower bump stops.

6874FK-P 1967-69 All307.11 kit

No Volume Discount.



3-18119G

Energy Suspension Hyperflex Kit

These complete Hyperflex kits include all the bushings for the suspension, subframe and include a transmission mount.

Add G to the part number for black. Add R to part number for red. Example: 3-18119G is for 67-81 in black.

3-18118_ 1967-69 Multi Leaf339.99 kit

3-18119_ 1967-69 Mono Leaf330.99 kit

3-18116_ 1975-79 All408.99 kit

3-18131_ 1982-92 All204.99 kit

3-18130_ 1993-02 All w/V8*301.99 kit

**Except TLE Suspension*



DJR-69

Junior Front Suspension Kit

This kit is perfect for freshening up your front suspension!

Each kit includes the finest quality components.

2 Upper Ball Joints, 4 Lower Control Arm Bushings, 2 Lower Ball Joints, 4 Upper Control Arm Bushings, 2 Outer Tie Rods, 2 Stabilizer Ends Links.

DJR-69 1967-69 All212.52 kit

Ships Oversized. No Volume Discount.



DSE031301

DSE Speed Kit 1

This exclusive DSE Speed kit is a complete bolt-on suspension upgrade system designed for ease of installation with no modification to subframe.

This kit includes:

• Tubular Upper & Lower Control Arms • Front Sway Bar • Koni Classic Front Shocks • Front 2" Drop Springs

DSE031301 1967-69 SB, LS2859.99 kit

DSE031304 1967-69 BB2859.99 kit

DSE031307 1970-81 SB, LS2936.99 kit

DSE031308 1970-81 BB3035.99 kit

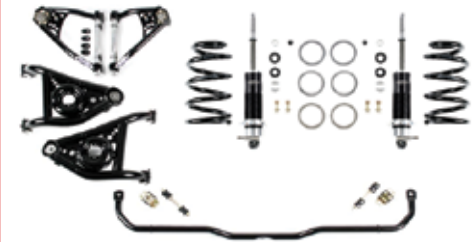

DSE031350

DSE Speed Kit 2

Speed kit 2 improves the handling and performance to the next level and offers ride height adjustment.

This kit includes: • Tubular Upper & Lower Control Arms • Coilover Conversion Kit • Front Sway Bar • Coilover Springs

Base Shock

DSE031350 1967-69 SB, LS3441.99 kit

DSE031351 1967-69 BB3441.99 kit

DSE031354 1970-81 SB, LS3551.99 kit

DSE031355 1970-81 BB3551.99 kit

Single Adjustable Shocks

DSE031350S 1967-69 SB, LS4024.99 kit

DSE031351S 1967-69 BB4024.99 kit

DSE031354S 1970-81 SB, LS4156.99 kit

DSE031355S 1970-81 BB4156.99 kit

Double Adjustable

DSE031350D 1967-69 SB, LS5007.99 kit

DSE031351D 1967-69 BB5029.99 kit

DSE031354D 1970-81 SB, LS3999.99 kit

DSE031355D 1970-81 BB5117.99 kit



DSE030101

DSE Tubular Upper Control Arm Kit

These DSE tubular upper control arms are a direct replacement for your stock control arms and offer better suspension geometry with more strength, which equals better handling and performance. Everything needed to install these new control arms is included in this COMPLETE kit.

- DSE030101 1967-69 All 1066.99 kit
- DSE030102 1970-81 All 1000.99 kit

*Installation should be followed by a professional alignment.
Ships Oversized. No Volume Discount.*



DSE031201

DSE031204

DSE Tubular Lower Control Arm Kit

These DSE tubular lower control arms are a direct replacement for your stock control arms and offer better suspension geometry and more strength which equals better handling and performance. Everything needed to install these new control arms is included in this COMPLETE kit.

- DSE031201 1967-69 w/ Stock Springs 1165.99 kit
- DSE031204 1970-81 All 1209.99 kit

*Installation should be followed by a professional alignment.
Ships Oversized. No Volume Discount.*



DSE030201

DSE030401

Delrin Lower Bushings

These Delrin bushings eliminate deflection and greatly improve response. The steel outer housings can be welded to the control arm.

- DSE030201 1967-69 All 222.99 kit
- Works great for street cars as well as race cars.*

Urethane Upper Bushings

These urethane bushings are designed as an upgrade over stock for improved handling.

- DSE030401 1967-69 All 94.99 kit

DSE Bounce Bumpers

These urethane bumpers can be used for bounce and rebound control for your stock control arms. The bumper dimensions are 1-9/16" tall and 1-5/8" base diameter.

- DSE030501 1967-69 23.99 pr.



DSE090101B

DSE Tubular Adjustment Sleeves

Tubular tie rod adjusters improve the strength and integrity of your steering system over stock. The tubular design is stiffer than the OEM split clamp adjuster and weighs less.

- DSE090101B 1967-69 Black 104.99 kit
- DSE090102B 1970-81 Black 139.99 kit

No Volume Discount.



DSE031101

DSE Coilover Springs

These springs provide an excellent balance of handling, performance and ride quality. They are designed to work with our DSE front coilover conversion bracketry kit.

- DSE031101 1967-69 SB/LSX 312.99 pr.
- DSE031102 1967-69 BB 219.99 pr.

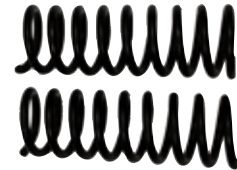

DSE031115

DSE 2" Dropped Front Coil Springs

These DSE 2" drop coil springs will lower the front of your Camaro easily to give it a pro-touring stance. These springs will also provide great ride and handling.

- DSE031115 1967-69 SB, LSX 279.99 pr.
- DSE031118 1967-69 BB 354.99 pr.
- DSE031107PDS 1970-81 SB, LSX 299.99 pr.
- DSE031108PDS 1970-81 BB 321.99 pr.

Ride height may vary depending on weight differences of cars.



DSE010801

DSE010201

DSE Solid Body Mounts

DSE solid body mounts provide a simple approach to eliminating the flex that occurs between the body and sub frame connection. CNC machined from billet aluminum and then hard coated. Stainless bolts sold separately.

- DSE010201 1967-81 Half Height 252.99 kit
- DSE010301 1967-81 Stock Height 299.99 kit
- DSE010801 Stainless Bolts 189.99 kit

No Volume Discount.



DSE031401

Detroit Speed Front Sway Bar Kit

Improve cornering and reduce body roll with this larger diameter hollow sway bar. This larger than stock bar is powdercoated black and comes with everything you need to bolt it on, including greasable polyurethane bushings and end links.

- DSE031401 1967-69 All 1-1/8" Hollow 369.99 kit
- DSE031402 1970-81 All 1-3/8" Hollow 389.99 kit

No Volume Discount. Ships Oversize 2.



DSE041601

DSE Rear Speed Kit 1

This DSE rear leaf spring suspension kit works great with any DSE front suspension kit. These leaf springs improve handling due to the increased spring rate and are available in either a 2" or 3" dropped ride height. Includes DSE rear leaf springs, heavy duty shackle kit and Koni classic rear shocks.

- DSE041601 1967-69 2" Drop Multi 1077.99 kit
- DSE041602 1967-69 3" Drop Multi 1077.99 kit
- DSE041631 1967-69 2" Drop Mono 1127.99 kit
- DSE041632 1967-69 3" Drop Mono 1127.99 kit
- DSE041637 1970-81 2" Drop Multi 1127.99 kit
- DSE041636 1970-81 3" Drop Multi 1127.99 kit

No Volume Discount. Ships Oversize 2. Ride height may vary depending on weight differences of cars.

Control Arms

OE style reproduction upper control arms with ball joint shaft and bushings. OE style reproduction lower control arms are loaded with ball joint and bushings. All control arms are powdercoated in correct semi gloss black and are ready to install. Control arms are available individually or as a specially priced complete kit!



KAR-KIT

OEM

BUY & SAVE

WITH SS396.COM PRE-BUILT KITS

KAR-KIT	1967-69 Complete Control Arm Kit	489.98 kit
KAR-KIT-DLX	1967-69 Control Arm Kit w/ Hardware	533.73 kit
KAU-6L	1967-69 Upper LH Only	115.99 ea.
KAU-6R	1967-69 Upper RH Only	115.99 ea.
KAU-6K	1967-69 Control Arm Upper LH/RH	229.99 kit
KAL-9L	1967-69 Lower LH Only	129.99 ea.
KAL-9R	1967-69 Lower RH Only	129.99 ea.
KAL-9K	1967-69 Control Arm Lower LH/RH	259.99 kit

Ships Oversize. No Volume Discount.



UCA6769-KIT

Tubular Control Arms

Tubular control arms include everything you need to bolt them on and go. They are black powdercoated for a nice looking and long lasting finish. Uppers come loaded with bushings, ball joints and shafts. Lower come loaded with bushings and ball joints.

UCA6769-KIT	1967-69 Uppers/Lowers	269.98 kit
UCA6769-KIT-DLX	1967-1969 w/ Hardware	331.65 kit
TCA-7081K	1970-1981 Uppers/Lowers	799.99 kit
TCA-7081K-DLX	1970-81 w/ Hardware	872.76 kit

With 2" Drop Detroit Speed Springs

TCA-7081K-DSE-SB	1970-1981 Small Block	1099.98 kit
TCA-7081K-DSE-BB	1970-1981 Big Block	1121.98 kit

No volume discount.

ENERGY SUSPENSION

Performance POLYURETHANE Components



9-9151G

9-9154G

Energy Suspension Control Arm Bumpers

These polyurethane control arm bumpers offer increased performance and longevity over stock. Add G to the part number for black. Add R to part number for red. Example. 3-2134G is for 67-81 in black.

9-9151_	1967-69 All Upper	14.99 pr.
9-9154_	1967-69 All Lower	24.99 pr.
ENCKIT-1_	1967-69 Upper & Lower Kit	41.98 kit



DCE-2410

DCE-4220

Control Arm Bumpers

Correct upper and lower control arm bumpers.

DCE-4220K	1967-69 Kit 4pc	27.04 kit
DCE-4220	1967-69 Upper	7.95 ea.
DCE-67L	1967 Lower	13.99 ea.
DCE-2410	1968-69 Lower	7.95 ea.
DCE-2014	1970-81 Upper	7.99 ea.
DCE-9222	1970-92 Lower	14.99 ea.

OEM



FA-1019

Control Arm Shaft Kit

New OEM shaft, bushings, washers & nuts.

FA-1019	1967-69 All	69.99 kit
FA-7073	1970-73 All	59.99 kit
FA-7479	1974-79 All	62.95 kit
FA-8081	1980-81 All	39.95 kit



FB-149

FB-6076

Upper & Lower Arm Bushings

FB-149	1967-69 All Upper	6.99 ea.
FB-329	1970-73 All Upper	16.99 pr.
FB-749	1974-79 All Upper	20.99 pr.
FB-801	1980-81 All Upper	16.99 pr.
FB-6076	1967-72 All Lower	16.99 pr.
FB-7381	1973-81 All Lower	20.99 pr.

ENERGY SUSPENSION

Performance POLYURETHANE Components



3-3101G

Energy Suspension Control Arm Bushings

These polyurethane body bushings offer increased performance and longevity over stock. Add G to the part number for black. Add R to part number for red. Example. 3-2134G is for 67-81 in black.

3-3101_	1967-69 All	119.99 kit
3-3102_	1970-72 All	104.99 kit
3-3103_	1973-74 15/8" Lower	104.99 kit
3-3104_	1973-74 13/8" Lower	104.99 kit
3-3105_	1975-79 All	103.99 kit

DS-594



Control Arm Shims

DS-594	1/16"	2.99 ea.
DS-595	1/8"	2.99 ea.



BPX-8542

Upper Control Arm Bolt & Washer Kit

Correct heavy cup washers and correct OEM bolts for retaining upper bushings into arms.

BPX-8542	1967-69 All	16.99 kit
----------	-------------	-----------



BPX-0918



BPB-1430

Control Arm Bolt Kit

Correct OEM serrated bolts with special locking nuts.

BPX-0918	1967-69 All	19.99 kit
BPB-1430ULK	1967-69 All Upper And Lower	49.99 kit
BPX-0919	1970-81 All	28.99 kit

Lower Control Arm Bolt

Original GM bolt with correct reduced body shaft and pointed end. Includes correct locking nut.

BPB-1430	1967-72 All	7.99 ea.
BPB-1450	1973-81 All	7.99 ea.



BUY & SAVE
WITH SS396.COM PRE-BUILT KITS



DBB-67K

Body Mounting Kits

Complete with everything you need to mount your body to the frame including correct rubber bushings with steel inserts and factory style OEM flanged head frame bolts with washers!

DBB-67K 1967-81 All 62.95 kit



BPB-2230

Body Bolt Kit

Correct OEM body mounting kit complete with (4) correct body bolts, (4) correct large washers, (2) correct radiator support bolts, (2) bushing washers, (2) correct spacer washers and (2) nuts & lock washers.

BPB-2230 1967-81..... 29.99 kit



DCI-3025

Body Mounting Bushing Kit

Correct OEM style rubber bushings with steel inserts for mounting body to frame complete with radiator support bushings.

DCI-3025 1967-81..... 39.95 kit
DCI-3025-HQ 1967-69 w/ GM Numbers..... 149.99 set



DRS-67H



DRS-70K

Radiator Support Bushings

Complete kit with all bushings and hardware for mounting radiator support to car.

DRS-67H 1967-81 All 27.94 kit
DRS-67B 1967-81 Bolts Only Pair 7.95 kit
DRS-70K 1970-73 Side Bushings* 32.99 kit

*Not to Frame. Does Not Include Hardware.



BCN-58

Subframe Body Mount Cage Nut

This body mount cage nut is used to fasten the subframe to the body.

BCN-58 1967-74 All 26.99 set



BPB-67FF

BPB-67FRS

Subframe Mounting Bolts

These bolts are used to fasten the body to the frame and rad support.

BPB-67FF 1967-81 Frame to Body 6.99 ea.
BPB-2230-OE 1967-81 Complete OE Style Kit ... 79.99 kit
BPB-67FRS 1967-81 Frame to Rad Support.... 6.99 ea.

No volume discount.



Performance POLYURETHANE Components



Energy Suspension Body Mounting Kit

These polyurethane body mounts offer increased performance and longevity over stock.

Add G to the part number for black. Add R to part number for red. Example. 3-2134G is for 67-81 in black.

3-4142_ 1967-81 All 118.99 kit

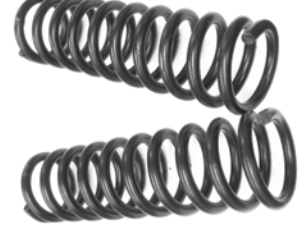

Coil Springs

Brand new OEM replacement coil springs sold in matched pairs. These are not cheap aftermarket springs. These springs will restore your car to the original ride height.

DCS-0009	1967-69 SB w/o AC	109.99 pr.
DCS-0010	1967-69 SB w/ AC	109.99 pr.
DCS-0010	1967-69 BB w/o AC	109.99 pr.
DCS-1160	1967-69 BB w/ AC	129.99 pr.
DCS-5276	1970-74 SB w/o AC	119.99 pr.
DCS-5278	1970-74 SB w/ AC	109.99 pr.
DCS-5006	1975-81 SB w/o AC	139.99 pr.
DCS-576	1975-81 SB w/ AC	99.99 pr.
DCS-586	1977-79 Z/28 and HD w/ AC	119.99 pr.
DCS-6486	1980-81 Z/28 and HD w/ AC	109.99 pr.
DCS-70BB	1970-81 BB w/o AC	124.99 pr.
DCS-70BBAC	1970-81 BB w/ AC	124.99 pr.



DSI-170

Coil Spring Insulators

Correct rubber insulators for the top of the front coils.

DSI-170 1967-81 All 9.99 pr.

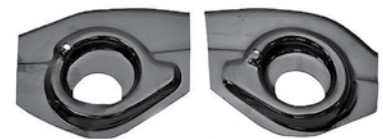

RSM-1003B

Coil Spring Upper Mounts

Replacement coil spring upper mounts which are part of the subframe. Weld in.

RSM-1003B 1967-69 34.95 pr.



RFR-646

SubFrame Repair Plates

Stamped steel plates for repairing your rusted or damaged subframe mounting points. Complete set of (6) includes radiator support.

RFR-646 1967-69* 49.99 kit

*Modifications will be required to fit 70-81 applications.



DPX-310

GM Shock Kit

Complete kit featuring 4 gas charged shocks, correct front & rear hardware & 4 shock ID decals.

DPX-310	1967-69 All w/ Multi Leaf	194.17 kit
DPX-320	1970-81 All	174.17 kit
NT-2005	1967-81 Front Only	39.99 ea.
NR-1010	1968-69 Rear Only for Multi Leaf	44.99 ea.
NT-88R	1970-81 Rear Only	34.99 ea.

No Volume Discount.



KYB-68F

KYB Excel-G Shock Kit

Are you looking for more performance from your shocks and a smooth ride? This KYB shock kit is the answer! They feature velocity sensing valving, hard chrome pistons rods, twin tube design, low pressure nitrogen gas to prevent foaming of the oil, iron pistons & guide tubes. These shocks are great for normal to moderate driving! Our kit includes: 2) front shocks, 2) rear shocks and hardware.

KYB-679F-KIT	1967-69 All Front & Rear	171.85 kit
KYB-781F-KIT	1970-81 All Front & Rear	173.85 kit
KYB-68F	1967-69 Front Only	43.99 ea.
KYB-64F	1970-81 Front Only	41.99 ea.
KYB-679R	1967-69 Rear* Only	36.99 ea.
KYB-64F	1970-81 Front Only	41.99 ea.
KYB-70R	1970-81 Rear Only	39.99 ea.
KYB-107	1967-69 Rear Mono Leaf Adapter	14.95 kit

*Must use KYB-107 for cars with mono leaf springs. No Volume Discount.



DSS-F72

Spiral Shocks

Reproductions of the original spiral twist shocks in correct gray color.

DSS-F72	1967-69 All Front No Part #'s	129.99 ea.
3192419	1967-69 Front GM #3192419	139.99 ea.
3192831	1968-69 Rear Multi No #'s	96.99 ea.
DSS-67M	1967-69 Rear Mono No #'s	96.99 ea.
DR-041	1967-69 Rear Multi GM #3192832	11.99 ea.
3192831	1967-69 Rear Mono GM #3192831	96.99 ea.

No Volume Discount.

BUY & SAVE

WITH SS396.COM PRE-BUILT KITS



AAS-GSK-6769B



Ground Up Motors Exclusive Aldan Front Suspension Kits

Ground Up Motors's exclusive front suspension kit has the parts you need to upgrade your car's handling. We bundle together Ground Up Motors's Tubular Front Control Arms and a set of Aldan American Coil-Overs in a specially discounted package. With this exclusive front suspension kit, you'll be carving the corners in no time!

AAS-GSK-6769S	1967-69 Small Block	989.97 kit
AAS-GSK-6769B	1967-69 Big Block	989.97 kit
AAS-GSK-7081S	1970-1981 Small Block	1519.98 kit
AAS-GSK-7081B	1970-1981 Big Block	1519.98 kit

No Volume Discount.



DSR-384K

Front Shock Mounting Hardware

OE correct front shock mounting kit complete with (4) mounting clips, (4) bolts with washers, (4) rubber bushings with retaining cup washers, and (4) nuts.

DSR-384K	1967-81 All Front	24.99 kit
----------	-------------------------	-----------

9-8101G



Energy Suspension Upper Shock Bushing

These polyurethane body bushings offer increased performance and longevity over stock. Add G to the part number for black. Add R to part number for red. Example: 9-8101G is for 67-81 in black.

9-8101_	1967-81 All 4pc	9.99 kit
---------	-----------------------	----------

BPX-9715



Shock Mounting Kit

Correct GM front shock mounting kit with (4) clips and (4) OEM bolts/washers.

BPX-9715	1967-81 All Front	10.99 kit
----------	-------------------------	-----------



DG-885



DG-724

Shock Mounting Plates

Correct reproduction shock tower plates.

DG-724	1967-69 Bolt In	12.99 ea.
DG-885	1967-69 Weld In	14.99 ea.

DR-041



Shock Mounting Stud

Correct rear shock mounting stud.

DR-041	1967-81 Rear	11.99 ea.
DR-01	1967-81 Rear w/o Bushings	9.99 ea.



AAS-300116

Aldan American Coil Over Kits

Aldan Road Comp kits are designed to convert your suspension to coil-overs. Aldan Phantom Series, single adjustable coil-overs deliver superior handling and ride quality for a drastic improvement over stock suspension. Aldan High tensile, high travel coil-springs provide greater consistency over stock springs. Aldan's rear bolt-on shock absorber kit includes 2 TrueLine Series shocks, 2 brackets, 2 T-Bars and hardware. Uses OEM shock mounting locations. TrueLine adjustable shock absorbers are designed to work with factory and aftermarket springs to add a more consistent, smoother ride.

Complete Front & Rear Kits

AAS-300114	1967-69 SB Mono Leaf	1199.99 kit
AAS-300115	1967-69 BB Mono Leaf	1199.99 kit
AAS-300116	1967-69 SB Multi Leaf	1229.99 kit
AAS-300117	1967-69 BB Multi Leaf	1199.99 kit
AAS-300108	1970-81 SB All	1189.99 kit
AAS-300109	1970-81 BB All	1189.99 kit

Front Coil Over Kits

AAS-AFBFMS	1967-69 450lb Springs	719.99 kit
AAS-AFBFHS	1967-69 550lb Springs	719.99 kit
AAS-AFBFMS3	1970-81 450lb Springs	719.99 kit
AAS-AFBFHS3	1970-81 550lb Springs	719.99 kit

Rear Shock Kits

AAS-100103	1967-69 Mono Leaf	579.99 kit
AAS-100104	1967-69 Multi Leaf	569.99 kit
AAS-100101	1970-81 All	549.99 kit

Thrust Bearing Set

Thrust bearings make it easier to adjust spring tension and ride height when installed at the base of a coil spring and coilover spring seat. Includes 2 thrust bearings and 4 steel washers. 2.5 in. inner diameter, 3.225 in. outer diameter.

AAS-ALD-27	Bearings & Spanner Wrench	99.99 kit
AAS-ALD-26	Bearings Only	49.99 kit
AAS-ALD-1	Spanner Only	39.99 ea.

No Volume Discount.



UMI-266501-B



UMI Corner Max Kit, Race & Street Handling

UMI's Corner Max front end kits for 1970-1981 Camaro are a comprehensive system with our best corner carving parts under one easy to find part number. The Corner Max system combines geometry corrected a-arms with tall ball joints, higher rate springs, UMI rebound adjustable monotube shocks, heavy duty sway bar and a bump steer kit. The foundation of the kit includes our coilover-only lower a-arms featuring caster improvement, tall ball joints and the ability to remove the spring and shock without taking the spindle apart. The upper a-arm features rod ends for smooth operation and the ability to adjust without shims. The 1-5/16th inch sway bar upgrade complete with UMI's fabricated end links reduces body roll and helps speed transitions. Racing coilover springs are paired with UMI's rebound adjustable coilover monotube shocks. Fine-tuning is accomplished with a UMI bump steer kit. The Corner Max kit is built to make the stock GM clip work as well as it possibly can with a true bolt-on kit.

UMI-266501-B	1970-81 Black	2998.99 kit
UMI-266501-R	1970-81 Red	2998.99 kit



DTR-7412

Replacement Leaf Springs

These are excellent OEM replacement leaf springs which will restore the proper rear ride height.

DTR-7910	1967-69 Mono Leaf	499.99 pr.
DTR-RL10	1967-69 Mono Leaf OE Style	499.99 pr.
DTR-7412	1967-81 4 Leaf	229.99 pr.
DTR-7815	1967-81 5 Leaf	299.99 pr.

No Volume Discount. Ships Oversize 2.

Note: Mono leaf springs were originally installed on all 1967 and base 1968-69 Camaro models. The four-leaf springs were used exclusively on 1968-69 Z28 Camaro. Five leaf springs were originally installed on 1969 Super Sport models. Original single rear leaf springs can be replaced with multi leaf springs by simply replacing the U-bolts and adding shock extenders which allow the springs to seat correctly.



DLK-67-SK

Leaf Spring Mounting Super Kit

This kit has everything you need to install your leaf springs. The kit includes spring pads, front eye bolts, front mounting bracket hardware, complete rear shackles, U-bolts and T-bolts.

DLK-67-SK	1967-69 Mono	177.68 kit
DLK-69M-SK	1967-69 Multi	158.98 kit
DLK-70M-SK	1970-81 Multi	162.58 kit

No Volume Discount.



DLK-69M

Leaf Spring Mounting Kit

This kit comes complete with (4) correct pads, (2) U-bolts and (4) T bolts with (8) nuts. Does one car.

DLK-67	1967-69 Mono	69.02 kit
DLK-69M	1967-69 Multi	69.02 kit
DLK-70M	1970-81 Multi	70.82 kit



DTR-4RBK

Leaf Spring Rebuild Kits

Includes the correct hardware to disassemble the leaf springs and put them back together like new.

DTR-4RBK	1967-81 4 Leaf	36.99 kit
DTR-5RBK	1967-81 5 Leaf	49.99 kit



DFB-13K

Chassis Leaf Spring Mounting Kit Front

This is a set of correct leaf spring mounting brackets, mounting hardware, and leaf spring eye. These brackets mount under the body to hold the front of the leaf springs.

DFB-13K	1967-69 All	90.85 kit
DFB-16K	1970-81 All	94.45 kit

No Volume Discount.



DFB-13L

Leaf Spring Mounting Brackets

Correct brackets for mounting the front of the leaf spring to the body.

DFB-13L	1967-69 LH	36.99 ea.
DFB-13R	1967-69 RH	36.99 ea.
DFB-16L	1970-81 LH	38.99 ea.
DFB-16R	1970-81 RH	38.99 ea.

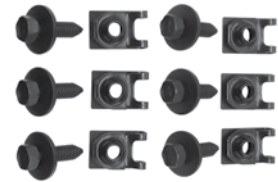

BLS-1130

Front Leaf Spring Bracket Hardware Kit

Correct bolts and special clips for mounting front leaf spring brackets to car. This kit includes (6) OEM bolts and (6) J nuts.

BLS-1130	1967-81 All	18.99 kit
----------	-------------------	-----------



DSB-99

Leaf Spring Eye Bushing

Correct front eye bushing.

DSB-99	1967-81 All	26.99 ea.
--------	-------------------	-----------



BBB-2743

Front Leaf Spring Eye Bolt

Correct OEM bolt with washers and special nut for mounting front leaf spring to car. 2 required.

BBB-2743	1967-81 All	3.99 ea.
----------	-------------------	----------



BPB-4829

U Bolt

Correct U bolt & nuts for multi leaf springs.

BPB-4829	U Bolt	6.99 ea.
----------	--------------	----------



BPB-2949

T Bolt

Correct T bolt & nut for mono leaf springs.

BPB-2949	T Bolt	8.69 ea.
----------	--------------	----------



DTE-67

Leaf Spring Pads

Correct rubber pads for mounting springs.

DTE-7818	1967-69 Mono.....	6.99 ea.
DTE-67	1967-69 Multi.....	6.99 ea.
DTE-70U	1970-81 Upper.....	7.99 ea.
DTE-70L	1970-81 Lower.....	7.99 ea.



3-6112G

Energy Suspension Leaf Spring Pads

Be in control of your suspension while you're maneuvering through turns, doing drag-style launches and braking. Add G to the part number for black. Add R to part number for red. Example. 3-2134G is for 67-81 in black.

3-6112_	1967-69 Multi.....	34.99 kit
3-6113_	1967-69 Mono.....	32.99 kit
3-6111_	1970-81 Multi.....	34.99 kit



NXJ-283

Leaf Spring Plates

Correct lower leaf spring mounting plates.

NXJ-7L	1967 Mono LH.....	44.99 ea.
NXJ-7R	1967 Mono RH.....	42.99 ea.
NXJ-7R	1968-69 Mono LH = RH.....	42.99 ea.
NXJ-283	1968-69 Multi LH = RH.....	44.99 ea.
NXJ-285	1970-81 Multi LH = RH.....	36.99 ea.



DSP-500

Leaf Spring Perch

Correct leaf spring perches for rear axle.

DSP-500	1967-69 Multi.....	79.99 pr.
DSP-501	1967-69 Mono.....	79.99 pr.



NRD-0045



NRD-0050

Leaf Spring Rear Shackle Kit

OE style reproduction shackle kit complete with plates, bushings, bolts and nuts. Does 1 car.

NRD-0045	1967-70 All.....	72.99 kit
NRD-0050	1971-81 All.....	69.99 kit



DSB-8R

Rear Shackle Bushings

OE style reproduction rear shackle bushings.

DSB-8R	1967-69 All.....	39.99 kit
DSB-70	1970-81 All.....	51.99 kit



3-2136G

Energy Suspension Rear Shackle Kits

Be in control of your suspension while you're maneuvering through turns, doing drag-style launches and braking. Add G to the part number for black. Add R to part number for red. Example. 3-2134G is for 67-81 in black.

3-2134_	1967-81 Multi.....	154.99 kit
3-2136_	1967-69 Mono.....	152.99 kit

Bushings only

3-2103_	1970-81 Multi.....	89.99 kit
3-2101_	1967-69 Mono.....	85.99 kit



DSE041101

Mono-to-Multi Leaf Conversion Kit

Use this kit to convert your original mono-leaf spring to multi-leaf spring configuration. Kit includes: U-bolts, a hardcoated steel locating pad, aluminum spacers, washers & nuts.

DSE041101	1967-69.....	159.99 kit
-----------	--------------	------------

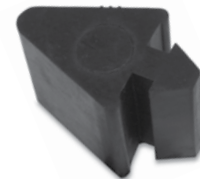

DAB-6X

Rear End Pinion Bumper

Excellent reproduction of the often missing or damaged rear pinion bumper which is required to keep the pinion housing from contacting the floor.

DAB-6X	1967-69.....	14.95 ea.
--------	--------------	-----------



DAB-202



DAB-083L

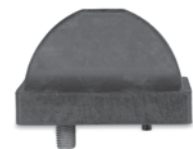

DAB-088

Axle Housing Bumpers

Excellent reproduction of the often missing or damaged axle housing bumper.

DAB-202	1967.....	21.95 ea.
DAB-083L	1968-69 LH.....	36.99 ea.
DAB-083R	1968-69 RH.....	36.99 ea.
DAB-088	1970-81.....	23.99 ea.



DAA-136

Front Sway Bar Kit

Eliminate poor handling by installing one of these sway bars! It includes sway bar, brackets, bushings and end links to replace your old, small bar.

DAA-136	1967-69 All 1"	199.99 kit
DAA-599	1967-69 All 1-1/8" HD	235.99 kit
DAA-1516-Z	1967-69* 13/16" Big Block Z/28 ..	169.99 ea.
DAA-8A	1970-81 1-1/4" (bar only)	164.99 ea.

No Volume Discount. Ships Oversize 2. *All with SHP engines with balancer.



DSB-5814

Rear Sway Bar Kit

This complete direct OEM replacement rear sway bar kit comes complete and ready to install with all brackets, bushings, hardware and sway bar. While not technically correct, this sway bar will fit and function as original and is excellent for street, strip, road racing and everything in between!

DSB-5814	1967-69 All 7/8" Bar	184.99 kit
DSB-6774	1967-69 All 1" Bar	216.99 kit
DSB-81	1970-81 All 1" Bar	208.99 kit

Ships Oversized. No Volume Discount.



DBB-6769K

Sway Bar Bushing & Brackets Kit

Correct mounting brackets, bolts and bushings for the front sway bar.

DBB-6769K	1967-69 1" Bar	49.95 kit
MK52-KIT	1970-81 1-1/4" Bar	22.95 kit

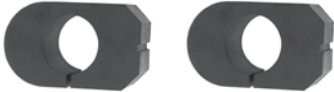

DMG-683

Sway Bar Bushings

Correct bushings for the sway bar.

DHB-69	All with 1-1/16" Bars	15.99 pr.
DCI-679	13/16", 1-1/16" Bars*	9.95 pr.
DMG-647	13/16", 1" Bars*	12.95 pr.
DMG-683	1 1/16", 1-1/8" Bars*	11.95 pr.
DMG-679F	1967-69 OE Style 1 1/16" 2pc	22.99 pr.
DMG-81R	1970-81 Rear	14.99 ea.

*Use DBB-157 bracket.



DBB-655

DBB-656

Sway Bar Sleeve Bracket

These mount on the front sway bar next to the sway bar bracket and mount to the frame. They keep the sway bar from moving side to side.

DBB-655	1967-74 All	23.99 pr.
DBB-656	1967-74 All Bolts	6.95 set



3-52026

Energy Suspension Sway Bar Bushings

These polyurethane body bushings offer increased performance and longevity over stock. Add G to the part number for black. Add R to part number for red. Example. 3-5202G is for 67-69 in black.

3-5202_	1967-69 11/16" Bar	27.99 pr.
3-5203_	1967-69 13/16" Bar	27.99 pr.
9-5164_	1970-81 1-1/8" Bar	26.99 pr.
9-5165_	1970-81 1-1/4" Bar	31.99 pr.

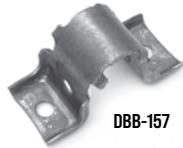

DBB-157



DBB-81R

Sway Bar Brackets

Correct mounting brackets for the sway bar.

DBB-157	1967-81 1-1/6", 1 1/8" Bars	8.99 ea.
DBB-679F	1967-69 OE Style 2pc	23.99 pr.
14073310	1968-81 1-1/4" Bar	11.95 ea.
DBB-81R	1970-81 Rear	12.99 ea.
BAR-1295	1967-81 All Bolt	0.75 ea.



FA-993



FA-487

Ball Joints

FA-487	1967-69 All Upper	28.99 ea.
FA-688	1970-81 All Upper	26.95 ea.
FA-993	1967-69 All Lower	28.99 ea.
FA-291	1970-81 All Lower	26.95 ea.



ES-350

Adjustment Sleeves

Adjustment sleeve for proper adjustment of tie rods.

ES-350	1967-69 LH/RH	12.99 ea.
ES-2004	1970-81 LH/RH	14.99 ea.



ES-381

Outer Tie Rods

Correct OEM cast steel outer tie rods. The highest quality original style suspension products on the market! Fits LH or RH.

ES-381	1967-69	26.99 ea.
ES-404	1970-74	62.95 ea.
ES-441RL	1975-81	29.95 ea.
ES-48DB	1967-92 Tie Rod Dust Boots 4pc	29.99 kit



DSL-90

Stabilizer End Links

Complete kit for one car.

DSL-90	1967-81 All	14.99 kit
--------	-------------------	-----------



9-81256

Energy Suspension Sway Bar End Links

These Polyplus sway bar end links will improve handling and steering response. Add G to the part number for black. Add R to part number for red. Example. 3-2134G is for 67-81 in black.

9-8125_	1967-81	29.99 pr.
---------	---------------	-----------



DS-829

Center Drag Links

DK-0142	1967-69 All	89.99 ea.
DS-829	1970-81 All V8 with P/S	54.99 ea.

No Volume Discount.

OEM



ES-681

Inner Tie Rods

Correct OEM cast steel inner tie rods.

ES-681	1967-69 LH/RH	29.99 ea.
ES-781	1970-74 RH	54.99 ea.
ES-782	1970-74 LH	54.99 ea.
ES-442L	1975-81 LH	34.95 ea.
ES-443L	1975-81 RH	34.95 ea.
ES-48DB	1967-92 Tie Rod Dust Boots 4pc	29.99 kit



BPX-9873



D-18718

Idle Arms

D-18718	1967-69 All	34.99 ea.
D-5212	1970-81 All	59.99 ea.
BPX-9873	Bolts	3.95 pr.



UMI-2102

UMI Tie Rod Adjusters

These Camaro tie rod adjusters from UMI Performance are designed to eliminate the factory clamp style design making adjustments easy and hassle free while adding enhanced steering. CNC machined from solid mild steel hex and feature left and right hand threads for easy on-car adjustments then finished in a durable black powder coat. These tie rod adjusters work with the factory tie rod ends with no modifications.

UMI-2102	1967-69	99.99 kit
UMI-2102HD	1967-69 Heavy Duty	64.99 kit

No Volume Discount.



UMI Bump Steer Adjuster Set

UMI's Camaro bump steer kit is designed to reduce or eliminate toe change during suspension travel (also known as bump steer). Reduction of bump steer improves handling and straight line stability and enhances overall precision of the steering system.



UMI-2660	1972-81 Street Black	241.99 kit
UMI-2660-1	1972-81 Race Black	241.99 kit
UMI-3060	1982-92 Street Black	241.99 kit
UMI-3060-1	1982-92 Race Black	241.99 kit
UMI-2060-1	1993-02 Race Black	384.99 kit

No Volume Discount.

UMI Upper & Lower Tubular A-Arms

Improve the street and track performance of your F-body and achieve that precise Pro-Touring feel by adding a set of fabricated tubular A-Arms. The stock geometry lower a-arms, which work with most popular springs and coilovers, feature tough tubular construction with greaseable polyurethane bushings for precise handling and smooth suspension motion. Optional Delrin® bushings offer additional precision and decreased friction. The ball joint mount is angled slightly from stock to permit usage with lowered vehicles and the design offers additional wheel clearance. The tubular upper a-arms feature Delrin® bushings as well as billet chromoly cross shafts. The relocated ball joint mounting pad increases caster, steering feel and stability without excessive shims and can be loaded with 1/2" taller upper ball joints to improve camber performance. The ultra tough red or black powder coat finish guarantees your performance parts stay beautiful on your street car, drag car, auto crosser or Pro-Touring machine. For the best handling and tire life from UMI designed a-arms, included with each kit are recommended alignment specs along with detailed installation instructions.

1970-1981 Control Arms

Insert color choice in __ R = Red B = Black

Upper A-Arms w/ Delrin® Bushings

UMI-2653-__	1970-81 Standard Ball Joints	599.99 pr.
UMI-2653-1-__	1970-81 1/2" Taller Ball Joints	679.99 pr.

Upper A-Arms w/ Adjustable Bushings

UMI-2656-__	1970-81 Standard Ball Joints	629.99 pr.
UMI-2656-1-__	1970-81 1/2" Taller Ball Joints	699.99 pr.

Lower A-Arms w/ Polyurethane Bushings

UMI-2651-__	1970-81 Standard Ball Joints	699.99 pr.
-------------	------------------------------	-------	------------

Lower A-Arms w/ Delrin® Bushings

UMI-2652-__	1970-81 Standard Ball Joints	779.99 pr.
-------------	------------------------------	-------	------------

Kit: Upper A-Arms w/ Delrin® Bushings, Lower A-Arms w/ Polyurethane Bushings

UMI-265153-__	1970-81 Standard Ball Joints	1299.99 kit
---------------	------------------------------	-------	-------------

Kit: Upper A-Arms w/ Delrin® Bushings, Lower A-Arms w/ Delrin® Bushings

UMI-265253-1-__	1970-81 1/2" Taller Ball Joints	1459.99 kit
-----------------	---------------------------------	-------	-------------

Kit: Upper A-Arms w/ Adjustable Bushings, Lower A-Arms w/ Delrin® Bushings

UMI-265256-1-__	1970-81 1/2" Taller Ball Joints	1479.99 kit
-----------------	---------------------------------	-------	-------------

1982-1992 Control Arms

Insert color choice in __ R = Red B = Black

Lower A-Arms w/ Delrin® Bushings

UMI-3032-__	1982-92 Standard Ball Joints Factory Struts	779.99 pr.
UMI-2052-__	1982-92 Standard Ball Joints Coilover Shocks	679.99 pr.

Lower A-Arms w/ Polyurethane Bushings

UMI-3031-__	1982-92 Standard Ball Joints Factory Struts	699.99 pr.
UMI-2051-__	1982-92 Standard Ball Joints Coilover Shocks	599.99 pr.

Hardware

UMI-2601	1970-81 Upper Control Arm Bolts	29.99 kit
UMI-4001	1970-74 Lower Control Arm Bolts	29.99 kit
UMI-1003	1975-81 Lower Control Arm Bolts	29.99 kit
UMI-3011	1982-92 Lower Control Arm Bolts	29.99 kit
UMI-2302	1993-02 Upper Control Arm Bolts	29.99 kit
UMI-2301	1993-02 Lower Control Arm Bolts	29.99 kit

Tall Ball Joint Option: UMI is proud to offer a number of tall ball joint options. In addition to standard height ball joints, we offer 0.5" tall uppers. Additional ball joint height functions the same as adding a taller spindle at a fraction of the cost. Drag and cruising oriented cars work fine with standard height while tall ball joints optimize cornering ability. No Volume Discount. Not eligible for free shipping.



UMI-2653-R

UMI-2651-B

1993-2002 Control Arms

Insert color choice in __ R = Red B = Black

Upper A-Arms w/ Adjustable Bushings

UMI-2310-__	1993-02 Standard Ball Joints	494.99 kit
-------------	------------------------------	-------	------------

Upper A-Arms w/ Polyurethane Bushings

UMI-2311-__	1993-02 Standard Ball Joints	351.99 kit
-------------	------------------------------	-------	------------

Lower A-Arms w/ Adjustable Rod Ends For Drag Racing

UMI-2300-__	1993-02 Adjustable Race w/ Rod Ends	649.99 kit
UMI-2317-__	1993-02 Adjustable Race w/ Rod Ends Chromoly*	649.99 pr.

*Heavy duty material.

Lower A-Arms w/ Polyurethane Bushings

UMI-2305-__	1993-02 Non Adjustable Street w/ Rod End	619.99 kit
UMI-2306-__	1993-02 Non Adjustable Street w/ Roto-Joint	549.95 kit

Lower A-Arms w/ Delrin® Bushings

UMI-2307-__	1993-02 Non Adjustable Street w/ Rod End	659.99 kit
UMI-2308-__	1993-02 Non Adjustable Street w/ Roto-Joint	569.95 kit

Lower A-Arms w/ Roto-Joint Bushings

UMI-2304-__	1993-02 Non Adjustable Street w/ Roto-Joint Both Ends	599.95 kit
-------------	---	-------	------------

Kit: Upper A-Arms w/ Polyurethane Bushings, Lower A-Arms w/ Polyurethane Bushing and Rod End

UMI-230511-__	1993-02 Standard Ball Joints	939.99 kit
---------------	------------------------------	-------	------------

Kit: Upper A-Arms w/ Polyurethane Bushings, Lower A-Arms w/ Adjustable Rod Ends Budget Drag Race

UMI-230011-__	1993-02 Standard Ball Joints	969.99 kit
---------------	------------------------------	-------	------------

Kit: Upper A-Arms w/ Adjustable Rod Ends, Lower A-Arms w/ Adjustable Rod Ends Drag Race

UMI-230010-__	1993-02 Standard Ball Joints	1099.99 kit
---------------	------------------------------	-------	-------------

*Heavy duty material.





UMI Solid Sway Bars

UMI Performance solid sway bars are designed to reduce body roll, understeer and increase cornering capabilities resulting in a more balanced suspension. UMI Performance sway bars are manufactured from 4140 chrome moly steel and formed as one piece to ensure maximum strength and performance. The rear sway bar is heat treated to maintain longer memory than a cold bent sway bar. The front sway bar is CNC bent for a precision fit. Kit is available powdercoated bright red or gloss black for a durable long lasting finish. Insert color choice in __ R = Red B = Black

UMI-4035- _	1970-81 Front Only 1-1/4"	263.99 kit
UMI-2112- _	1982-02 Front Only 1-3/8"	307.99 kit
UMI-2245-275- _	1982-02 Rear Only 1-1/4"	494.99 kit
UMI-2245-300- _	1982-02 Rear* Only 1-1/4"	494.99 kit
UMI-2245-325- _	1982-02 Rear** Only 1-1/4"	494.99 kit
UMI-211213- _	1982-02 Front/Rear	509.99 kit
UMI-2113- _	2010-11 Rear Only 1-1/4"	274.99 kit
UMI-90048	1970-02 Billet Mounts Front Only 1-3/8" Bar	142.99 pr.

* Fits drag race cars with 3" axle tubes only. ** Fits drag race cars with 3-1/4" axle tubes only. No Volume Discount. Ships Oversize 2. Not eligible for free shipping.



UMI-2004-R

UMI Subframe Connectors

Subframe connectors improve your car's handling ability while reducing t-top squeaks, dash rattles and quarter panel flexing, designed for auto-cross, road race as well as drag race set-ups. By connecting the front and rear subframes together this allows better weight transfer for improved traction and straighter launches.

Insert color choice in __ R = Red B = Black

2 Point Kits

UMI-2002- _	1993-02 Bolt In Tubular Coupe.....	384.99 pr.
UMI-2027- _	1993-02 Bolt In Tubular CVT.....	384.99 pr.
UMI-2001- _	1993-02 Weld In Tubular Coupe ...	362.99 pr.
UMI-2026- _	1993-02 Weld In Tubular CVT	384.99 pr.
UMI-2000- _	1993-02 Weld In Boxed	439.99 pr.

3 Point Kits

UMI-2004- _	1993-02 Bolt In Tubular Coupe.....	619.99 pr.
UMI-2044- _	1993-02 Bolt In Tubular CVT	619.99 pr.
UMI-2003- _	1993-02 Weld In Tubular Coupe ...	599.99 pr.
UMI-2043- _	1993-02 Weld In Tubular CVT	599.99 pr.

No Volume Discount. Ships Oversize 2. Not eligible for free shipping.

UMI Front Crossmember

The UMI Performance tubular K-Member instantly removes up to 25 lbs. from the front of your vehicle while still maintaining strength for streetability and daily use. This item has been designed to handle everything from drag racing, daily driving and even autocross. Our dual tube center section adds increased strength over the competitors' design, making this item far more superior and able to handle every day stress and abuse. Additional front end adjustment can also be achieved with this item, the lower A-Arm slots feature a 1/2 inch adjustment built in and will work with the stock and any aftermarket A-Arm set-up. The front and rear A-Arm slots also feature additional bracing to withstand hard side loads and extreme pressure. This tubular K-Member also features integrated motor mounts eliminating the stock cast iron mounts and for maximum weight savings. Combine this with a set of our lower control arms and expect a weight reduction of up to 33 lbs. Insert color choice in __ R = Red B = Black



UMI-2325- _	1993-97 LT1 Engine Street Version	699.99 ea.
UMI-2326- _	1993-97 LT1 Engine Road Race Version.....	899.99 ea.
UMI-2322- _	1993-97 SBC/BBC Engine Street Version.....	699.99 ea.
UMI-2324- _	1993-97 SBC/BBC Road Race Version.....	899.99 ea.
UMI-2320- _	1998-02 LS1 Engine Street Version	699.99 ea.
UMI-2321- _	1998-02 LT1 Engine Road Race Version	899.99 ea.
UMI-2318-BARE	1993-02 No Engine Mounts Street Version	679.99 ea.
UMI-2318- _	1993-02 No Engine Mounts Street Version	679.99 ea.
UMI-2319-BARE	1993-02 No Engine Mounts Road Race Version.....	779.99 ea.
UMI-2319-BLACK	1993-02 No Engine Mounts Road Race Version.....	779.99 ea.

No Volume Discount. Ships Oversize. Not eligible for free shipping.

UMI LSX Swap Engine Mounts

UMI's LSX adapter plates bolt directly to the frame and allow the installation of any LSX engine. UMI-2406 fits factory LS engine mounts and also works with UMI-2323 solid aluminum motor mounts. UMI's LS mounts place the LS engine in the factory location with the ability to move the engine rear-ward up to 1 in. LS mounts are CNC laser cut from 3/16 in thick steel with MIG welded 1/4 in thick stand offs, high grade mounting hardware included.

UMI-2406-R	1974-92 Red LS Engine Mount	164.99 kit
UMI-2406-B	1974-92 Black LS Engine Mount	164.99 kit
UMI-2323	1998-02 LS Solid Aluminum Engine Mount	175.99 kit
UMI-2328	1998-02 LS Solid Steel Engine Mount	131.99 kit

No Volume Discount.

UMI Solid & HD Motor Mounts

UMI-90058	1974-92 SBC HD Engine Mount On Engine.....	59.99 pr.
UMI-90051	1974-92 SBC Solid Engine Mount On Frame.....	99.99 pr.
UMI-90059	1974-92 SBC Solid Engine Mount	139.99 kit

No Volume Discount.



UMI-2406-R



UMI-90059



UMI-2500-R

UMI Driveshaft Tunnel Brace

The UMI heavy duty tunnel brace reinforces the tunnel area and reduces chassis flex by replacing the weak factory stamped steel brace. Reinforcement of this area is critical because of the drive shaft carrier bearing location. The UMI tunnel brace is fabricated from CNC machined 3/16" thick mounting plates, rectangular tubing and MIG welded. The tunnel brace is a 100% bolt in application and uses existing factory mounting holes. Installation requires basic hand tools and can be completed in less than a half hour.

UMI-2500-R	2010-13 Red.....	109.99 ea.
UMI-2500-B	2010-13 Black.....	109.99 ea.

No Volume Discount.



UMI Strut Tower Brace

The UMI Performance shock tower brace positively connects the front right and left shock towers together for firm handling and improved steering response. The shock tower brace is constructed of DOM mild steel tubing 1.250 inch OD x 0.095 inch wall using CNC machined 0.250 inch thick mounting plates.

UMI-2005-R	1993-02 Red Mild Steel	175.99 ea.
UMI-2005-B	1993-02 Black Mild Steel	175.99 ea.
UMI-2006-R	1993-02 Red Chromoly Steel*	219.99 ea.
UMI-2006-B	1993-02 Black Chromoly Steel*	219.99 ea.

*Chromoly Steel Tubing shock tower braces are constructed of 1.250 inch x 0.083 inch 4130. No Volume Discount. Ships Oversize. Not eligible for free shipping.



UMI Street Performance Mono-tube Shocks

The UMI Performance monotube rear shock is designed to bridge the gap between basic street shocks and aggressive racing shocks. Medium-firm compression valving provides crisp handling and absorbs bumps while still providing a comfortable ride.

UMI-S120	1970-81 Front Shock Non Adjustable*	139.99 ea.
UMI-S121	1970-81 Front Shock 20 Step Adjustable	239.99 ea.
UMI-S140	1970-81 Rear Shock Non Adjustable	139.99 ea.
UMI-S42040	1970-81 Front & Rear Kit	549.99 kit

*These shocks are designed to work with aftermarket tubular control arms only. No Volume Discount.



Koni Shocks & Kits

Koni "Yellow" sport struts and shocks are widely considered to be the best standard mount bolt-on shock for corner carving. This Koni SPORT kit is a direct replacement for the worn factory shocks on your Camaro. Koni Yellows feature excellent handling combined with a sport oriented, corner carver worthy feeling. Yellow shocks and struts are on car adjustable unless otherwise noted. Koni "Orange" STR-T shocks are considered to be a great choice for handling on a budget mount bolt-on shock for corner carving. This Koni STR-T shock kit is a direct replacement for the worn factory shocks on your Camaro. Koni Orange shocks feature excellent handling combined with a smooth ride on the street. Orange shocks are non-adjustable.

Shocks & Struts Only

UMI-8741-1030SPORT	1982-92 Front Yellow	261.00 ea.
UMI-30-1265SPORT	1982-02 Rear* Yellow	171.99 ea.
UMI-207301	1982-92 Front/Rear Yellow	987.04 kit
UMI-207302	1982-92 Front/Rear* Yellow	972.16 kit
UMI-207401	1993-02 Front/Rear Yellow	1190.40 kit
UMI-8241-1139SPORT	1993-02 Front Yellow	309.72 ea.
UMI-8241-1140SPORT	1993-02 Rear Yellow	169.36 ea.
UMI-8250-1005	1993-02 Front Orange	115.32 ea.

Shock Strut & Drop Spring Kits

UMI-207306	1982-92 Front/Rear* Yellow	1289.99 kit
UMI-207305	1982-92 Front/Rear Yellow	1417.99 kit
UMI-2061SPORT	1993-02 Front/Rear Yellow	1377.99 kit
UMI-2061STRT	1993-02 Front/Rear Orange	723.99 kit

*Rear shock must be removed for adjustment.



UMI Front Coilover Shock Kits

UMI's Camaro front coilover kit permits installation of a true 2-1/2 inch racing coilover spring and shock into your 1993-2002 Camaro. Factory style lower t-bar fits factory GM, UMI and most other brands of lower arms intended for stock t-bar.

UMI-2048-300	1993-02 300 lbs Springs 2X Adj.....	869.99 kit
UMI-2048-350	1993-02 350 lbs Springs 2X Adj.....	869.99 kit
UMI-2048-450	1993-02 450 lbs Springs 2X Adj.....	869.99 kit
UMI-2048-550	1993-02 550 lbs Springs 2X Adj.....	869.99 kit
UMI-2053-600T	1993-02 600 lbs Springs 1X Adj.....	1164.97 kit

No Volume Discount.



UMI Rear Coilover Shock Kits

UMI's bolt-in rear coilover kit allows full ride height, spring rate and damping adjustability for your 1982-2002 Camaro. The double shear upper mount is a direct bolt-in and holds a true 2-1/2 inch racing coilover. The FEA designed lower bracket bolts in using the standard shock mounting hole as well as an additional reinforcement hole.

UMI-2046-110	1982-02 110 lbs Springs 2X Adj.....	789.99 kit
UMI-2046-125	1982-02 125 lbs Springs 2X Adj.....	789.99 kit
UMI-2046-150	1982-02 150 lbs Springs 2X Adj.....	789.99 kit
UMI-2054-200	1982-02 200 lbs Springs 1X Adj.....	1154.97 kit

No Volume Discount.



UMI Competition Coilover Shock Kit Complete

UMI's 4th Gen Camaro competition coilover package is built to perform. Developed in conjunction with Sam Strano (14x national SCCA auto-x champion), the Afco built monotube dampers provide race winning performance in auto-x and road race while still providing an awesome street ride.

UMI-20-600200T	1993-02	2384.94 kit
UMI-2045	1982-02 Rear Hardware*	219.99 kit
UMI-2057	1982-02 Spanner Wrench	29.99 ea.

*Mounting Hardware Only. No Volume Discount. Ships Oversize. Not eligible for free shipping.

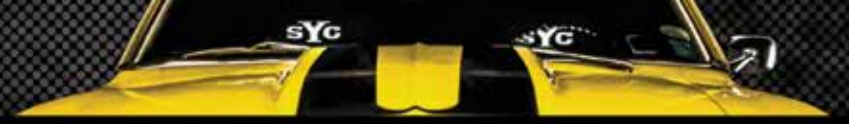

UMI-2015-B



UMI-2017-R

UMI Rear Control Arms

UMI's heavy duty control arms are direct replacements of the weak, factory stamped rear lower control arms. UMI's control arms are constructed of mild steel tubing with CNC machined ends. These direct bolt-on replacements are designed to minimize wheel hop and improve cornering, while lowering track ETs and helping track consistency. Control arms come complete with bushings, grease fittings when applicable, zinc-plated steel sleeves and finished in a gloss powder coat. Insert color choice in __ R = Red B = Black

Non-Adjustable Lower

UMI-2015-__	1982-02 Poly Bushings	109.99 pr.
UMI-2033-__	1982-02 Poly Bushing/RotoJoint	307.99 pr.
UMI-2033-__	1982-02 RotoJoint/RotoJoint	307.99 pr.

Adjustable Lower One End Only

UMI-2018-__	1982-02 Poly Bushings	252.99 pr.
UMI-2016-__	1982-02 Poly Bushing/Rod End HD Chromoly	241.99 pr.
UMI-2013-__	1982-02 Poly Bushing/Rod End Street	285.99 pr.
UMI-2039-__	1982-02 Poly Bushing/RotoJoint	329.99 pr.

Adjustable Lower Both Ends

UMI-2017-__	1982-02 Rod End/Rod End	307.99 pr.
UMI-2017CM-__	1982-02 Rod End/Rod End HD Chromoly	329.99 pr.
UMI-20170F-__	1982-02 Offset Rod End/Rod End	274.99 pr.
UMI-20170FCM-__	1982-02 Offset Rod End/Rod End HD Chromoly	329.99 pr.
UMI-3007	Angle Finder Tool	29.99 ea.

No Volume Discount. Ships Oversize. Not eligible for free shipping.



UMI-2521-B



UMI-2523-R

UMI Rear Toe Rods

The rear toe rods control the camber alignment of the rear end preventing the tire from moving inward or outward during suspension load. The factory toe rods are made from flimsy stamped steel and feature soft rubber bushings causing deflection which leads to erratic handling, poor traction and possible rear tire wear. Replacing the factory arms with heavy duty toe rods makes for a more stable suspension, improved traction and better braking. Insert color choice in __ R = Red B = Black

Non-Adjustable 2 Piece Kit

UMI-2520-__	2010-14 Poly Bushings Boxed	175.99 pr.
UMI-2521-__	2010-14 RotoJoint Bushings Boxed	296.99 pr.

Non-Adjustable With Trailing Arms 4 Piece Kit

UMI-201520-__	2010-14 Poly Bushings Boxed	209.99 kit
---------------	-----------------------------------	------------

Adjustable 2 Piece Kit

UMI-2523-__	2010-14 Poly Bushings Tubular	296.99 pr.
UMI-2522-__	2010-14 Rod End Bushings Tubular Cromoly	318.99 pr.
UMI-2524-__	2010-14 RotoJoint Bushings Tubular Cromoly	384.99 pr.
UMI-2518	2010-14 Anti-Eccentric Washers 4pc	33.99 kit

No Volume Discount.



UMI-2202-R

UMI Torque Arms & Kits

Track abuse, street abuse or just flat-out abuse, this torque arm is designed to handle it all! Eliminate unwanted traction problems by adding a UMI Performance tunnel brace mounted torque arm. This aftermarket torque arm replaces the flimsy factory torque arm while adding strength, rigidity and eliminating suspension flex. Insert color choice in __ R = Red B = Black

Tunnel Brace Mounted Kits

UMI-2202-__	1993-02 w/ Long Tube Headers	529.99 kit
UMI-2200-__	1993-02 w/ Factory Manifolds	529.99 kit

Tunnel Brace Mounted Kits With Drive Shaft loop

UMI-2203-__	1993-02 w/ Long Tube Headers	559.99 kit
UMI-2201-__	1993-02 w/ Factory Manifolds	559.99 kit

Weld In Kits With Crossmember

UMI-2235-__	1993-02 w/ Dipped Crossmember	579.99 kit
UMI-2236-__	1993-02 w/ Straight Crossmember	569.99 kit

No Volume Discount. Ships Oversize 2. Not eligible for free shipping.



UMI-2226-B



UMI Torque Arm Relocations Kits

Installing a TH350 or TH400 Automatic transmission into your 1993-1997 Camaro just got easier. This crossmember with integrated torque arm mount features the correct provisions for mounting the transmission while still allowing the use of a factory style torque arm. The built in torque arm mount will work with virtually any stock style aftermarket torque arm as well as the factory torque arm and features instant center adjustment by moving the front of the torque arm up or down. Insert color choice in __ R = Red B = Black

UMI-2226-__	1993-97 w/ TH350	296.99 kit
UMI-2224-__	1993-97 w/ TH400	296.99 kit
UMI-2208-__	1998-02 w/ Factory Auto	296.99 kit
UMI-2207-__	1998-02 w/ Factory Manual	296.99 kit
UMI-2212-__	1998-02 w/ TH350	296.99 kit
UMI-2213-__	1998-02 w/ TH400	296.99 kit

No Volume Discount. Ships Oversize 2. Not eligible for free shipping.



UMI-2032-B

UMI Driveshaft Safety Loop

This NHRA legal driveshaft safety loop is a bolt-in application for the 1993-2002 Camaro. This item bolts to existing floor pan holes to replace of the factory tunnel brace and requires no welding. This is a must for tracks that require a safety loop for cars running faster than 13.99 in the quarter mile. The loop is constructed of 0.250 inch thick mild steel with CNC machined mounting points for a superb fit. Driveshaft safety loop includes new hardware and installs in 30 minutes using basic hand tools. Driveshaft loop will not work with UMI tunnel mounted torque arms or similar tunnel mounted torque arms. It will clear with the stock torque arm, UMI transmission mounted torque arms and most aftermarket torque arms bolting into the factory location. Insert color choice in __ R = Red B = Black

UMI-2240-__	1993-02 All	186.99 ea.
-------------	-------------------	------------

No Volume Discount.



UMI-2019-R

UMI Rear Panhard Bar

UMI's tubular panhard bar kits are a direct replacement for the flimsy stock stamped panhard bar. They add strength as well as bushing improvement. The panhard bar greatly increases rear stability, controls side movement and body flex; a must when hard driving habits are present. Insert color choice in __ R = Red B = Black

Non-Adjustable

UMI-2020-__ 1982-02 Poly Bushings 109.99 kit

Adjustable

UMI-2019-__ 1982-02 Single Adjustable Poly Bushing/Poly Bushing 142.99 kit
 UMI-2021-__ 1982-02 Single Adjustable Poly Bushing/Rod Ends 142.99 kit
 UMI-2036-__ 1982-02 Single Adjustable Poly Bushing/RotoJoint Ends 175.99 kit
 UMI-2038-__ 1982-02 Double Adjustable RotoJoint/RotoJoint Ends 274.99 kit
 UMI-2037-__ 1982-02 Double Adjustable RotoJoint/RotoJoint Ends 241.99 kit

Adjustable On The Car

UMI-2029-__ 1982-02 Single Adjustable Poly Bushing/Poly Bushing 164.99 kit
 UMI-2022-__ 1982-02 Double Adjustable Poly Bushing/Rod Ends 209.99 kit
 UMI-2023-__ 1982-02 Double Adjustable Rod Ends / Rod Ends Ends 197.99 kit
 UMI-2037-__ 1982-02 Double Adjustable RotoJoint/RotoJoint Ends 241.99 kit

Relocation Kit 2 Piece

UMI-2024-__ 1982-02 209.99 kit

No Volume Discount. Ships Oversize. Not eligible for free shipping.



UMI-2080-275-B



1982-02 Watts Link Kits

The UMI Watts Link is designed as a key component to optimize the 3rd and 4th generation Camaro solid axle rear suspension. The combination of lateral locating ability and roll center height adjustment makes a Watts Link the best choice for axle location in handling cars. Clears up to 5" exhaust.

Kits For Factory Rear Ends

UMI-2080-275-B 1982-02 Black 999.99 ea.
 UMI-2080-275-R 1982-02 Red 999.99 ea.

Kits For Rear Ends With 3" Axle Tubes

UMI-2080-300-B 1982-02 Black 999.99 ea.
 UMI-2080-300-R 1982-02 Red 999.99 ea.

No Volume Discount.



GBK-1SFF



Power Steering Gearbox Kits

Now you can add one of these awesome "close ratio" gear boxes to your conversion. These boxes are original remanufactured GM units and will add the ultimate handling to your ride. Our kit comes with steering box, GM steering coupler (rag joint) and correct attaching bolts. Choose from fast ratio or super fast ratio! No core charge!

1967-69 Camaro

GBK-1F 3 - 3.5 Fast 370.93 kit
 GBK-1SFF 2.5 Super Fast 543.21 kit

1970-76 Camaro

GBK-1A 3 - 3.5 Fast 379.81 kit
 GBK-1XX 1967-76 All 3.25 Fast* 399.99 ea.
 GBK-1SFA 2.5 Super Fast 552.09 kit

No Volume Discount. Ships UPS Oversize.

*Brand new not reman. Box only, no bolts or rag joint.



ARC-12SF

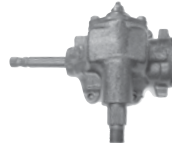

Manual Steering Boxes

Complete remanufactured original Saginaw assemblies. Choose from standard or quick ratio. No core charge.

ARC-12A 1967-69 24:1 Std 299.99 ea.
 ARC-12B 1970-76 24:1 Std 279.99 ea.
 ARC-12SF 1967-76 16:1 Quick 329.99 ea.
 ARC-6481MK 1967-81 All* 375.80 ea.
 ARC-6774MK 1967-69 All* w/ Bolts & Rag Joint 384.42 ea.
 ARC-09FSFK 1967-69 All w/ Hardware & Pitman Arm 467.47 kit
 ARC-6481MK 1970-81 All* w/ Bolts & Rag Joint ..375.80 ea.

*Works with power steering pitman arm only. Note: Use ATE-8869B coupler with ARC-12SF. No Volume Discount. Ships UPS Oversize.

Pitman Arm

D-1870



OEM pitman arm.

Manual Steering

DA-985 1967-69 39.99 ea.
 DA-985-US 1967-69 Made in USA 99.99 ea.
 DA-138Z 1967-69 Z/28 Fast Ratio 179.99 ea.
 DA-811 1970-81 89.95 ea.

Power Steering

D-1870 1967-69 69.95 ea.
 D-1870-USA 1967-69 Made In USA 99.99 ea.
 DA-711 1970-81 119.99 ea.

BX-64K



Pitman Arm Nut

Correct nut with washer.

BX-64K 1967-81 w/ Power 6.95 ea.

TOOL-PITMAN



Pitman Arm Puller

This forged tool is used to remove the pitman arm from your steering box.

TOOL-PITMAN Universal 23.99 ea..

IIS-70F

IIS-78

IIS-78S



Intermediate Steering Shaft

Restore proper steering stability and safety with this newly remanufactured intermediate steering shaft. This shaft goes from the steering column down to the steering box and wears out over time, causing sloppy steering feel.

IIS-70F 1970-76 All 149.99 ea.
 IIS-78 1978-92 All w/o Shroud 129.99 ea.
 IIS-78S 1978-92 All w/ Shroud 199.99 ea.



ATE-8869B

ATE-8871

ATE-8869A

Steering Coupler

Complete joint for connecting column to box. 1967-69 with manual steering features fine spline and 1970-76 with manual steering features coarse spline.

ATE-8869A 1967-69 Manual 49.95 ea.
 ATE-8869B 1970-76 Manual 49.95 ea.
 ATE-8871 1967-76 Power 49.99 ea.



ATJ-411

Steering Coupler Bolt

Correct OEM bolt for coupler.

ATJ-411 1967-76 All 5.99 ea.



BSB-759

Steering Box Bolt

Complete with correct thick washer and bolt.

BSB-757 1967-69 All 4.99 ea.
 BSB-759 1970-76 All 8.69 ea.

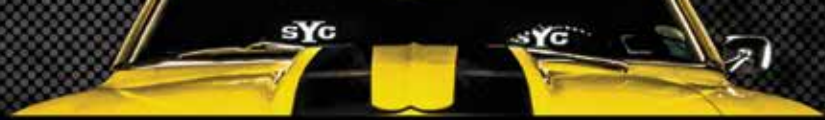

Concourse Series "Banjo" Style Power Steering Pumps

These are brand new banjo style power steering pumps with correct reservoir and inlet and outlet fittings. No Core Charge.



APS-6086	1967-68 All V8	209.99 ea.
APS-6153	1969 SB	209.99 ea.
APS-6151	1969 BB	209.99 ea.
APS-6165	1970-72 All V8*	209.99 ea.

*Use with 1970 hose & brackets. No Volume Discount.



Power Steering Pumps - Replacement

Completely rebuilt second design power steering pumps. These pumps will differ in appearance from our originals, but will fit and function the same. No core charge!



APS-6000R	1969-72 All	115.99 ea.
-----------	-------------------	------------

No Volume Discount.



TUF-6183B

TUF-6195A

Tuff Stuff Power Steering Pumps

GM Saginaw style pumps feature all new components reservoir, pump assembly, cap & dipstick and hardware when it applies. Rated at 1200 psi, rated to work with most gearbox systems.

TUF-6197A	1967-68 SB Chrome Banjo Style	290.99 ea.
TUF-6197B	1967-68 SB Black Banjo Style	230.99 ea.
TUF-6195A	1969 BB Chrome Banjo Style	290.99 ea.
TUF-6195B	1969 BB Black Banjo Style	249.99 ea.
TUF-6193A	1970 All Chrome Banjo Style	290.99 ea.
TUF-6193B	1970 All Black Banjo Style	230.99 ea.
TUF-6183A	1970-74 All Chrome	272.99 ea.
TUF-6183B	1970-74 All Black	215.99 ea.
TUF-6182A	1975-78 All Chrome	272.99 ea.
TUF-6182B	1975-78 All Black	215.99 ea.
TUF-6181A	1979 All Chrome	272.99 ea.
TUF-6181B	1979 All Black	215.99 ea.
TUF-6180A	1980-81 All Chrome	272.99 ea.
TUF-6180B	1980-81 All Black	215.99 ea.
TUF-6179A	1982-87 All Chrome	272.99 ea.
TUF-6179B	1982-87 All Black	215.99 ea.
TUF-6184A	1988-92 All Chrome	272.99 ea.
TUF-6184B	1988-92 All Black	215.99 ea.
TUF-5559	All Inline Filter	32.99 ea.

No Volume Discount.



ADR-077

AZZ-33

Power Steering Pump Cap

Quality replacement power steering pump cap.

ADR-077	1967-81 All	7.99 ea.
---------	-------------------	----------

OE Power Steering Pump Cap

OE style reproduction metal cap.

AZZ-33	OE Style Metal Cap	44.99 ea.
--------	--------------------------	-----------

Power Steering OEM High Pressure Hose

New correctly bent OEM high pressure hoses with correct fittings.



CPX-6616

CPX-6616	1967-68 All V8	26.95 ea.
----------	----------------------	-----------



CPX-6602

CPX-6602	1969 All V8	26.99 ea.
----------	-------------------	-----------



CPX-6618

CPX-6618	1970-72 Big Block	26.99 ea.
----------	-------------------------	-----------



CPX-277

CPX-263	1970-72 SB (All V8 73-76)	26.95 ea.
CPX-277	1977-79 All V8	26.95 ea.



CPX-634

CPX-634	1980-81 All V8	21.95 ea.
---------	----------------------	-----------



ARK-678F



Power Steering Hose Kits

This kit comes with OEM high pressure hose, low pressure return tube, hose and correct clamps.

ARK-678F	1967-68 All V8	44.05 kit
ARK-69F	1969 All V8	44.08 kit
ARK-70F	1970-72 V8	44.08 kit

No Volume Discount.



NPX-16

Power Steering Return Hose

Complete with correct pre bent flared tube, OEM hose and correct clamps.

NPX-16	1967-76 All V8	21.99 kit
CPS-038	OEM Return Hose	2.95 per ft.
CPN-512	OEM Clamps Screw Type	1.95 ea.



CPF-580

Power Steering Pump Fitting

Use this fitting when you need to connect your Camaros factory style power steering pressure hose with female fitting to a Saginaw power steering pump with female fitting.

CPF-580	1967-81 All	6.99 ea.
---------	-------------------	----------



ASC-128

Power Steering Hose Retaining Clip

Correct clip for retaining hose to steering box.

ASC-128	All V8	11.99 ea.
---------	--------------	-----------



AB-31F

Power Steering Hose Retainer

This often missing retainer secures the two steering hoses to the frame.

AB-31F	1967-69 All V8	20.95 ea.
--------	----------------------	-----------



ADP-61

1967-68 396 Driver Pulley

OE style reproduction of the 1967-68 SS396 only power steering driver pulley.

ADP-61 1967-68 BB Driver..... 49.99 ea.



ASP-509



23-28

Power Steering Pump Pulleys

OE style reproduction power steering pulleys.

- ASP-3847 1967-69 1 Groove Deep Cast 302, 396/375, 427.....199.99 ea.
- ASP-509 1967-81 1 Groove..... 39.99 ea.
- ASP-107 1969-81 2 Groove w/ AC..... 26.99 ea.
- ASP-1395 1969-81 1 Groove SHP 54.99 ea.
- 23-28 Pulley Nut..... 3.95 ea.
- 23-28KEY Pulley Nut w/ Key..... 4.99 set

Power Steering Brackets

Original style reproduction and original GM brackets



ASB-366

ASB-366 1967-68 SB Cradle 49.99 ea.
For use with short water pump.



ASB-383

ASB-383 1967-68 Z/28 / SS350 49.99 kit
For use with short water pump.



ASB-184

ASB-184 1967-68 SS396 Cradle..... 69.99 ea.
For use with short water pump.



ASB-186

ASB-186 1967-68 396 Adjuster 39.99 ea.
For use with short water pump.



AQW-1418

AQW-1418 1969 All BB 3pc 69.99 kit
Works with original long water pump & P/S pump.



ASB-3941

ASB-3941 1969-76 All SB Cradle..... 32.99 ea.
For use with long water pump.



ASB-874

ASB-874 1969-72 SB Rear Support..... 32.99 ea.
For use with long water pump.



AAB-2610

AAB-2610 1969-76 SB Adjuster 34.99 ea.
For use with long water pump.



ASB-422

ASB-422 1970-72 All BB Cradle..... 77.99 ea.
For use with long water pump.



ASB-931

ASB-931 1970-81 All BB (adjuster) 29.99 ea.
For use with long water pump.



BSB-671

Power Steering Hardware Kits

Our kits feature all correct hardware to attach power steering brackets to engine. A MUST!

- G-4804 1967 SB 302,350 16.99 kit
- G-4805 1967 BB 396 11.99 kit
- G-4917 1968 SB 302,350 10.99 kit
- G-4918 1968 BB 396 17.99 kit
- G-4805 1967 BB 396 11.99 kit
- BSB-671 1967-68 SB 10.95 kit
- BSB-69SB 1969-74 SB All 24.99 kit
- BSB-1969 1969 All BB 24.99 kit
- BSB-1970 1970+ All BB 12.99 kit
- APS-STUD Pump Housing Stud 3.99 ea.
- BSB-3573 Pump Stud& Bolt Kit 10.99 kit



ASB-7KIT

1969-81 Big Block Power Steering Bracket Kit

Complete kit with cradle, adjustment brackets and hardware.

ASB-7KIT 1969-81 All BB..... 110.37 kit
Will work on most BB engines with 1969 and up style long pump. May need some modification.



ASB-9KIT

1969-72 Small Block Power Steering Bracket Kit

Complete kit with all three brackets.

ASB-9KIT 1969-72 SB 90.87 kit
Will work on most SB engines with 1969 and up style long pump. May need some modification.

BUY & SAVE
WITH SS396.COM PRE-BUILT KITS

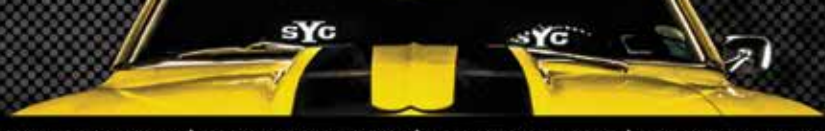

BUY & SAVE
WITH SS396.COM PRE-BUILT KITS

SHIFTKIT-F63

Console Shifter Kit
Complete kit to convert to an automatic console shifter. Kit includes factory style staple shifter, cable, brackets & all correct hardware.

SHIFTKIT-F63	1968-69 TH350	229.42 kit
SHIFTKIT-F64	1968-69 TH400	233.92 kit
SHIFTKIT-F6869-OD	1968-69 700R4/200R4	339.25 kit
SHIFTKIT-F73	1970-72 TH350	247.42 kit
SHIFTKIT-F74	1970-72 TH400	251.92 kit
SHIFTKIT-F7072-OD	1970-72 700R4/200R4	357.25 kit

No Volume Discount.

ISS-6F

1968-69 Staple Shifter
OE style reproduction complete automatic staple shifter assembly for your 1968-69 Camaro.

ISS-6F	1968-69	149.99 ea.
--------	---------	------------

No Volume Discount.

ISH-640

1970-72 Staple Shifter
OE style reproduction complete automatic staple shifter assembly for your 1970-72 Camaro.

ISH-640	1970-72	169.99 ea.
---------	---------	------------

No Volume Discount.

ISH-3X

Staple Shifter Handle
OE style reproduction staple shifter handle complete with spring loaded lock out trigger.

ISH-3X	1968-72	74.99 ea.
--------	---------	-----------



Staple Shifter Repair Kit
All the hardware needed to bring a worn out staple shifter back to life.

ISSFT-HRDW	1968-72 ALL	32.99 kit
------------	-------------	-----------

No Volume Discount.

SW-DT3

Ratchet Shifter Detent
Converts your factory shifter to a ratchet type shifter.

SW-DT3	1968-69 Powerglide, TH350, TH400	130.99 ea.
SW-DT4	1968-69 700-R4, 200-4R, 4L60, 4L65, 4L80	140.99 ea.

SC2244

4 Speed Overdrive Kits
This kit makes it easy to install a modern overdrive automatic in place of your old Powerglide, TH350 or TH400 for improved performance and gas mileage. Each kit includes a new laser cut and hardened detent, indicator plate, hardware and brackets to allow the use of your factory shifter. This kit works with a TH700, TH200 or 4L60 transmission.

S105-DB	1967	258.99 kit
SC2244	1968-69	196.99 kit
SC2614	1968-69 4L60	208.99 kit
SC2245	1970-72	196.99 kit
SC2615	1970-72 4L60	208.99 kit
SC2261	1973-78	168.99 kit
SC2262	1979-81	168.99 kit

SW280-RCT

1967 Universal Shifter Kit
Universal Camaro shifter that has the look of the factory shifter setup for both the 3 speed TH350/TH400 overdrive 700-R4, 200-4R, 4L60, 4L65 and the 4L80. Complete with neutral safety/back up switch, all rod linkage components and factory-like reverse lock out and detents for each gear. Also includes a universal floor mounting bracket kit.

SW280-RCT	1967 All	499.99 kit
-----------	----------	------------



1967 Shifter Conversion Kit
Convert your factory 2 speed PowerGlide console shifter to a 3 or 4 speed shifter.

S105-DA	1967 All w/ TH350/400	258.99 kit
S105-DB	1967 All w/ TH200R4/700R4 4L60E	258.99 kit

This kit uses rod linkage, not a cable.



1967 Auto Shifter Button
This will replace your worn or lost shift handle button perfectly.

ISH-724	Button	19.99 ea.
ISH-724-SPRING	Spring	10.99 ea.

IQ-110P **IQ-110T**

Shift Indicator Lenses
Injection molded clear shift indicator lenses.

IQ-109	1967 Powerglide	9.99 ea.
IQ-127	1967 TH350/TH400	8.99 ea.
S121	1967 700-R4/200-4R	29.99 ea.
IQ-110P	1968-69 Powerglide	11.99 ea.
IQ-110T	1968-69 TH350/TH400	9.99 ea.
S150	1968-69 Reverse Pattern	32.99 ea.
S120	1968-69 700-R4/200-4R	29.99 ea.
S136	1970-72 700R4/200R4	29.99 ea.

IC-123 **IC-45** **IC-124**

Shifter Sliders
Correct die stamped plastic shifter sliders.

IC-123	1967 Manual	13.99 ea.
IC-45	1967 Automatic	7.99 ea.
IW-340	1967 Slider Retainer	7.99 ea.
IC-124	1968 Manual	9.99 ea.
IC-158	1968 Slider Retainer	13.99 ea.



3917438

Hurst Shifter

New Hurst Competition Plus shifter complete with Hurst handle and shifter ball.

3914339	1967-68 Muncie.....	533.99 ea.
3917438	1969 Muncie.....	575.99 ea.
3916848	1970-72 Muncie.....	539.99 ea.
3917438	1973-77 Muncie.....	575.99 ea.
HURST-3917960	1982 Console/Borg Warner.....	580.99 ea.

No Volume Discount.



3734529

Hurst Installation Kits

Complete kit with rods, levers, swivels and hardware.

3734529	1967-68 Muncie.....	315.99 kit
3737437	1969 Muncie.....	336.99 kit
3737897	1970-72 Muncie.....	370.99 kit
3738605	1973-74 Muncie.....	408.99 kit
3738609	1974-81 BW T10.....	347.99 kit
1957773	1967-81 Mounting Plate Only.....	45.99 ea.

No Volume Discount.

FACTORY STYLE



HURST-69

1969 OE Hurst Shifter

OE style reproduction of the highly sought after shifter used on all 1969 Camaro 4 speeds. Features correct style handle exclusive to 1969 Camaros.

HURST-69	1969 All.....	569.99 ea.
----------	---------------	------------



HURST-69BB

1969 OE Hurst Shifter Installation Kits

Correct installation hardware kits for your 1969 Hurst Shifter.

HURST-69SB	1969 SB.....	179.99 ea.
HURST-69BB	1969 BB.....	279.99 ea.

Use with Hurst-69



SH-203-8



SH-202-8



SH-204-10

Billet Shifter Handles

These billet aluminum shifter handles from Clayton Machine work with any Hurst or Tremec, TK0500, TK0600 2 bolt shifter mount and are a great finishing touch for your custom ride! Available in three styles. Basic black anodized, truss style with grey powder coat, truss style adjustable grey powder coat. Shift knob not included. Requires knob with 3/8-16" thread. Same as most Hurst knobs.

SH-203-8	8" Black Anno 30° Kick Back.....	258.99 ea.
SH-203-10	10" Black Anno 30° Kick Back.....	266.99 ea.
SH-202-8	8" Grey PC Truss Style 30° Kick Back..	203.99 ea.
SH-202-10	10" Grey PC Truss Style 30° Kick Back..	211.99 ea.
SH-204-10	10" Grey PC Truss Style Adj Kick Back..	348.99 ea.

No Volume Discount.



FW-115



FZ-1420



FW-157

Shifter Balls

OE style reproduction shifter balls.

FZ-1420	Muncie White 5/16".....	23.99 ea.
FZ-1424	Hurst White 3/8".....	24.99 ea.
FW-115	Chrome 5/16".....	24.99 ea.
FW-117	Chrome 3/8".....	22.99 ea.
FW-157	Black/Chrome 5/16".....	24.99 ea.
FW-159	Black/Chrome 3/8".....	23.99 ea.
FW-38HURST	Hurst White 3/8" 4 Speed.....	55.99 ea.



FZ-8289A



FZ-8289M

1982-89 Z/28 Leather Wrapped Shift Knob

Reproduction of the factory original leather-wrapped shift knob.

FZ-8289A	1982-89 Auto.....	89.99 ea.
FZ-8289M	1982-89 Manual.....	89.99 ea.

No Volume Discount.

FW-HURST



Hurst T Handle Shifter Knob

This brushed aluminum T-handle provides a positive feel for accurate gear selection. Includes adapters for most shift handles.

FW-HURST	T-Handle.....	56.99 ea.
HURST-1530010	T-handle Bushed Alum w/ Button....	118.99 ea.
HURST-1530011	T-handle Polished Alum w/ Button..	122.99 ea.

IQ-341



Shifter Tunnel

Correct molded plastic which installs on inside of console.

IQ-341	1969 4 Speed.....	26.99 ea.
IQ-964	1970-72 4 Speed.....	34.99 ea.
IQ-571	1973-81 4 Speed.....	44.99 ea.



NA-578

Reverse Lockout Kit

Complete with 2 rods and swivel mechanism.

NA-578	1969 All.....	99.99 kit
NA-704	1970-74.....	149.99 kit



REVSKIT-UNI

Universal Reverse Lamp Switch Manual

This kit allows you to add a reverse light switch to non-stock applications. If you have a Hurst shifter this kit is a must.

REVSKIT-UNI	All.....	62.99 ea.
-------------	----------	-----------



ICE-09



ICE-4526



IK-407



ICE-3966



ICE-78UP



ICE-HURST

Shifter Boots

Brand new injection molded boots.

ICE-09	1967-68 w/o Console.....	32.99 ea.
ICE-4526	1967-68 w/ Console.....	17.99 ea.
IK-8UP	1968 Upper w/ Console.....	11.99 ea.
IK-407	1969 All.....	23.99 ea.
ICE-3966	1970-81 Lower.....	24.99 ea.
ICE-78UP	1970-81 Upper.....	27.99 ea.
ICE-HURST	Universal.....	81.99 ea.



IQ-635



IK-476



ICE-1516



IW-764

Shift Boot Retainers

Correct die stamped steel boot retainers.

IQ-635	1967-68 w/o Console 2pc.....	49.99 ea.
IK-476	1967-68 w/ Console.....	19.99 ea.
ICE-1516	1969 w/o Console Black.....	13.99 ea.
ICE-1562	1969 w/ Console Chrome.....	17.99 ea.
IW-764	1970-81 All.....	22.99 ea.

IQ-65



4 Speed Emblem

Correct 4 speed console emblems.

IQ-65	1968-69.....	14.99 ea.
-------	--------------	-----------

ISP-F685R



5 & 6 Speed Emblem

5 or 6 speed emblems that look stock!

ISP-F685T	68-69 Tremec 5 Speed.....	32.99 ea.
ISP-F685R	68-69 Richmond 5 Speed.....	60.99 ea.
ISP-F686T	68-69 Tremec 6 Speed.....	34.99 ea.
ISP-F686R	68-69 Richmond 6 Speed.....	60.99 ea.



FMCK-67S

BUY & SAVE

WITH SS396.COM PRE-BUILT KITS

Manual Transmission Conversion Kit

Planning on swapping from automatic to a 4 speed manual? This kit will take the headache out of the switch by providing you with all of the parts needed to make your conversion simple! This complete kit includes the brake/clutch pedals, Z bar, rods, boots, cross shaft kit, springs, bracket and all hardware!

FMCK-67S	1967-68 SB	241.96 kit
FMCK-67B	1967-68 BB	244.66 kit
FMCK-69S	1969 SB	265.46 kit
FMCK-69B	1969 BB	263.66 kit
FMCK-70S	1970-71 V8	259.07 kit
FMCK-70B	1972-81 V8	264.47 kit

No Volume Discount. *Includes everything that comes in regular kits except for the small spring and extension rod which can't be used with headers.

With Headers*

FMCK-67S-HD	1967-68 SB	235.67 kit
FMCK-67B-HD	1967-68 BB	225.78 kit
FMCK-69S-HD	1969 SB	259.17 kit
FMCK-69B-HD	1969 BB	256.47 kit

BUY & SAVE

WITH SS396.COM PRE-BUILT KITS

FCA-5051



Clutch Linkage Kit

If you're looking to freshen up your original linkage but don't need the pedals, this is perfect!

FCA-5051	1967-69 SB	166.36 kit
FCA-5053	1967-69 BB	164.56 kit
FCA-5050	1970-81 V8	191.52 kit

With Headers

FCA-5051-HD	1967-69 SB*	160.07 kit
FCA-5053-HD	1967-69 BB*	157.37 kit

*Includes everything that comes in regular kits except for the small spring and extension rod which can't be used with headers.



FCI-1860

Clutch & Brake Pedal Assemblies

Complete reproduction brake/clutch pedals.

FCI-1860	1967-68	89.99 ea.
FCI-1869	1969	109.99 ea.
FCI-1870	1970-71	94.99 ea.
FCI-1872	1972-81	99.99 ea.



FCI-1006PA

Clutch & Brake Pedal Complete Assembly

Do you want to convert your Camaro to a 4 speed but are missing the pedals and hanger? This complete 4 speed pedal assembly includes the brake pedal, clutch pedal, pads, rod and hanger which mounts under the dash.

FCI-1006PA	1967-68 4-Speed	284.99 ea.
FCI-1006PB	1967-68 Automatic	249.99 ea.
FCI-69FX	1969 4 Speed*	246.93 kit

*Does not include pedal pads or trim.

BUY & SAVE

WITH SS396.COM PRE-BUILT KITS



FBH-621SUPERKIT

621 Bellhousing Kit

Complete kit with reproduction "621" bellhousing, clutch fork, fork boot, throw-out bearing, bolts and inspection cover. Fits cars with 11" clutch.

FBH-621SUPERKIT	Complete Kit	361.86 kit
FBH-621K	Bellhousing and Cover	234.10 kit
FBH-621	Bellhousing Only	199.99 ea.



FCK-258

Heavy Duty Clutch Kits

Heavy Duty clutch kits include clutch disc, pressure plate, throw out bearing, pilot bushing, alignment tool and grease pack.

FCK-258	11" 10 Spline BB	159.99 kit
FCK-260	11" 26 Spline BB	169.99 kit
FCK-105	10.5" 10 Spline SB	169.99 kit
FCK-108	10.5" 26 Spline SB	199.95 kit
BPP-8386	Flywheel to Pressure Plate Bolts	10.99 kit

No Volume Discount.



BPB-9021

Bellhousing Hardware

BPB-9021	Bellhousing to Block 6pc	8.95 kit
BTE-307	Bellhousing to Trans 4 Speed 4pc	8.95 kit



FFW-105

Flywheels

FFW-105	10.5" w/o 454 GM	279.99 ea.
HAYS-10-130	11" 396/402	438.99 ea.
HAYS-10-020	168t SBC 70-90 BBC**	113.99 ea.
BPB-5116	Flywheel to Crank Bolts 4 Spd 12pc	18.99 kit
BPB-5118	Flex Plate to Crank Bolts Auto 12pc	19.99 kit

*Internally balanced. **Externally balanced. No Volume Discount.



FTE-3943

Flywheel Inspection Covers

OE style reproduction flywheel covers.

FTE-3943	1967-69 Manual 11"	26.99 ea.
NK-4497	1967-69 Manual 10.5"	29.99 ea.
NJ-088	All Powerglide	31.99 ea.
NE-810	All TH350	34.99 ea.
NJ-089	All TH400	31.99 ea.
BFW-506K	Attaching Bolts 4pc	1.95 kit

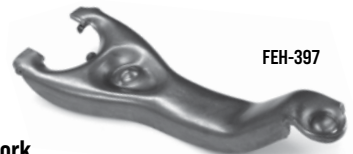

FEH-397

Clutch Fork

New GM clutch fork.

FEH-397	1967-81 All	74.99 ea.
FEH-397-GM	1967-81 All Original "GM"	105.99 ea.



FKW-4999

Clutch Fork Boot

Original clutch fork dust boot.

FKW-4999	1967-81 All	9.99 ea.
FKW-11LW	For Lakewood Scatter Shield Bell Housing	55.99 ea.



FPB-66



FPB-667

Pilot Bushing

Correct GM bearings for input shaft.

FPB-ROLLER	All Roller.....	35.99 ea.
FPB-667	All Brass.....	14.99 ea.



FTO-641

Throw Out Bearing

Original OEM throw out bearing.

FTO-641	All.....	39.99 ea.
---------	----------	-----------



FTE-9000

Clutch Fork Ball

Clutch fork mounting ball for inside of bellhousing.

FTE-9000	All.....	16.99 ea.
FTE-9000-ADJ	Adjustable.....	29.99 ea.



FPX-828

Clutch Cross Shaft Kit

Original GM stud balls, nylon seats, protective felts, retaining clips, nuts and washers.

FPX-828	Complete All V8.....	29.95 kit
FPX-6568	Block Ball Only.....	13.95 ea.
FPX-5289	Frame Ball Only.....	23.99 ea.
FPX-3349	Plastic Seat Only.....	3.99 ea.
FPX-3360	Ball Felt.....	5.99 ea.
FPX-0696	Retaining Clip.....	2.99 ea.
FPX-33K	Cross Shaft Seal and Kit.....	23.49 kit



FK-130

Clutch Frame Brackets

Correct bracket for mounting Z bar to frame.

FK-130	1967-69.....	18.99 ea.
FEH-086	1970-81.....	13.99 ea.
BFB-605	Attaching Bolt.....	0.75 ea.



FCI-501



FCI-108



FTE-3082

Clutch Z Bar

OE style reproduction "zerk" bar.

FCI-501	1967-69 SB.....	49.99 ea.
FCI-108	1967-69 BB.....	51.99 ea.
FTE-3082	1970-81 V8.....	70.99 ea.



FHQ-0239

Firewall Rod Boots

OE style reproduction rubber boots for firewall.

FHQ-0239	1967-69.....	8.99 ea.
FHQ-329	1970-81.....	14.99 ea.



FHQ-0273

Firewall Rod Block Off

Used to block off the clutch firewall rod hole on automatic equipped cars. Includes the plate and seal.

FHQ-0273	1967-81 All With Automatic.....	20.99 ea.
----------	---------------------------------	-----------



Clutch Firewall Rods

FKW-95	1967-69 All V8.....	26.99 ea.
FKW-276	1970-71 All V8.....	25.99 ea.
FKW-277	1972-81 All V8.....	26.99 ea.
FRC-100	Attaching Clip.....	2.19 ea.



Clutch Adjustment Rod Kits

FKW-209	Most SB.....	24.99 kit
FCE-0681	Most BB.....	19.99 kit
FCE-738	Universal Extra Long*.....	19.99 ea.
FRC-100	Attaching Clip.....	2.19 ea.

*Cut to fit.



Clutch Return Springs

Original return springs for clutch fork, etc.

FKW-1461	1967-69 SB.....	7.99 ea.
FPC-520	1967-69 BB.....	7.99 ea.
FCE-3920	1970-81 Most.....	7.99 ea.



Clutch Spring Extension Rod

Correct clutch spring extension rod for small blocks.

FKW-1460	1967-69 SB.....	6.99 ea.
----------	-----------------	----------



FXB-533

Clutch Spring Extension

Correct clutch spring extension which mounts to the exhaust manifold on big blocks.

FXB-533	1967-69 BB.....	7.99 ea.
---------	-----------------	----------



FRB-172

Clutch Pedal Push Rod Bushing

OE style reproduction clutch pedal push rod bushing for various GM models. This injection molded plastic bushing installs on the clutch pedal and retains the clutch push rod. This small bushing is essential for keeping the clutch push rod in the proper location.

FRB-172	1972-83.....	2.99 ea.
---------	--------------	----------



FPB-97



FPB-103

Clutch Pedal Bushing & Bumper

Correct nylon bushing used for ease of pedal.

FPB-97	All Bushing.....	2.99 ea.
FPB-103	All Bumper.....	7.99 ea.

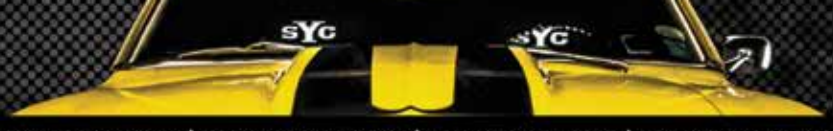

FCM-85B4



FCM-85



FCM-85M



FCM-75



Transmission Crossmember

OE style reproduction crossmembers for mounting your transmission.

FCM-85	1967-69 TH400	79.99 ea.
FCM-85M	1967-69 TH350 or 4 Speed	114.99 ea.
FCM-85B4	1967-69 BB 4 Speed	134.99 ea.
FCM-75	1970-81 TH400	94.99 ea.
BPC-7000	1967-81 Mounting Bolts 16pc	6.95 kit



Hooker Blackheart LS Swap Transmission Crossmembers

- Designed using CAD modeling/FEA analysis for optimal fitment, strength, weight, safety and appearance
- High-strength low-alloy steel construction
- Engineered 3 to 3.5 degree engine/transmission inclination
- Designed in conjunction with Hooker LS engine swap brackets - Will install with either a stock rubber or Energy 3-1108 poly mount - Provides the highest clearance available for up to 3" exhaust system routing

HKR-12625HKR	67-69 4I60E* 4L65/70/75	381.99 ea.
HKR-12626HKR	67-69 T56, T56 Magnum	381.99 ea.
HKR-12616HKR	70-81 4I60E* 4L65/70/75	321.99 ea.
HKR-12614HKR	70-81 T56, T56 Magnum	388.99 ea.

*2 piece case only. No Volume Discount.



FCM-RCF1-350



GForce Transmission Crossmembers

When you need extra exhaust clearance or just want to make your car handle better, these crossmembers are for you!

FCM-RCF1-350	1967-69 TH350, TH200, Muncie, Powerglide, T10, Saginaw	336.99 ea.
FCM-RCF1-400	1967-69 200R4, TH400 Short Tail	336.99 ea.
FCM-RCF1-700	1967-69 700R4, 4L60, Early 4L60E	339.99 ea.
FCM-RCF1-4L80	1967-69 4L80E, 4L85E	397.99 ea.
FCM-RCF1-T56	1967-69 GM T-56 (from a 93-97 F-body)	336.99 ea.
FCM-RCF2E-350	1970-74 TH350, TH200, Muncie, Powerglide, T10, Saginaw	336.99 ea.
FCM-RCF2E-400	1970-74 200R4, TH400 Short Tail	336.99 ea.
FCM-RCF2E-700	1970-74 700R4, 4L60, Early 4L60E	336.99 ea.
FCM-RCF2L-350	1975-81 TH350, TH200, Muncie, Powerglide, T10, Saginaw	336.99 ea.
FCM-RCF2L-400	1975-81 200R4, TH400 Short Tail	336.99 ea.
FCM-RCF2L-700	1975-81 700R4, 4L60, Early 4L60E	336.99 ea.
FCM-RCF2L-4L80	1975-81 4L80E, 4L85E	397.99 ea.
FCM-RCF2L-T56	1975-81 GM T-56 (from a 93-97 F-body)	336.99 ea.

Note: Energy Suspension mounts are required with all GForce crossmembers. No Volume Discount.



NTR-235

Transmission Mounts

NPG-100	All Powerglide	13.99 ea.
NTR-235	All TH350/ Manual	13.99 ea.
NTR-225	All TH400	13.99 ea.
BTE-7939	Mounting Bolt	0.95 ea.



Performance POLYURETHANE Components



3-1108G

Poly Graphite Transmission Mount

Poly mounts outlast OEM mounts and are able to absorb most driveline vibrations.

Add G to the part number for black. Add R to part number for red. Example. 3-1110G is for 82-83 in black.

3-1108G	1967-92 All	44.99 ea.
---------	-------------------	-----------

Torque Arm To Transmission Bushings

3-1112	1984-92 Lips toward drive shaft	22.99 ea.
3-1111	1984-92 Lips away from drive shaft	22.99 ea.
3-1111	1993-02 All	22.99 ea.



HURST-67510012

HURST-67510015

HURST-67510014



Hurst Transmission Swap Crossmembers

These ultra-trick Hurst transmission cross-members have painstakingly been designed and fabricated from thick steel plate and heavy gauge steel tubing for a perfect fit and finish that has no equal. These bolt-in units are much stronger than the factory stock cross-members and help maintain the correct transmission and driveshaft angle. Precision cut and fully mig-welded, then given a durable black powder coating finish to last a lifetime and give you peace of mind knowing you're buying the best parts available for your Tremec TKO 5-Speed or Magnum 6-Speed conversions. You can surely trust the company that originally started out making conversion mounts back in 1958, Hurst Performance.

HURST-67510014	67-69 Magnum 6 Speed LS w/ Small Block Engine Mounts	439.99 ea.
HURST-67510002	67-69 Magnum 6 Speed LS w/ Big Block Engine Mounts	519.99 ea.
HURST-67510008	67-69 TKO 5-6 Speed w/ Small Block Engine Mounts	384.99 ea.
HURST-67510013	67-69 TKO 5-6 Speed w/ Big Block Engine Mounts	388.99 ea.
HURST-67510015	70-74 Magnum 6 Speed LS Swap	458.99 ea.
HURST-67510011	70-74 Magnum 6 Speed LS Swap	519.99 ea.
HURST-67510001	75-81 Magnum 6 Speed LS Swap	400.99 ea.
HURST-67510012	75-81 Magnum 6 Speed LS Swap	439.99 ea.

No Volume Discount.



Brake Pads & Trim

OE style reproduction pads with correct ribs and medallions where applicable.

IHQ-236	All Auto Drum 6.5"	5.99 ea.
IHQ-0163	All Auto Disc 6.5"	12.99 ea.
IBB-8683	Auto Brake Trim	8.99 ea.
IHQ-0191	4 Speed Drum Brake	6.39 ea.
IHQ-0120	4 Speed Disc Brake	13.99 ea.
IHQ-0192	4 Speed Trim	6.99 ea.
IHQ-99F	1972-81 Small Clutch	9.95 ea.
IHQ-0125	1972-81 4 Speed w/ Disc Brake	9.95 ea.



Transmission Cooler Lines

New OE style reproduction transmission cooling lines with flared ends and correct nuts.

	OM	SS
FTC6701	1967-69 Powerglide	57.99 ea. 95.99 ea.
FTC6703	1967-69 TH350	57.99 ea. 95.99 ea.
FTC6705	1967-69 TH400	57.99 ea. 95.99 ea.
FTC6708	1967-69 TH700-R4	57.99 ea. 95.99 ea.
FTC7005	1970-74 TH350	57.99 ea. 95.99 ea.
FTC7005	1970-74 TH400 1/2 Rad Fitting	57.99 ea. 95.99 ea.
FTC7006	1970-74 TH400 5/8 Rad Fitting	57.99 ea. 95.99 ea.
FTC8003	1974-81 TH350	57.99 ea. 95.99 ea.

Ships Oversize.

Transmission Vacuum Lines

New OE style reproduction transmission vacuum lines with flared ends.

	OM	SS
FTV6701	1967-69 Powerglide	37.99 ea. 50.99 ea.
FTV6703	1967-68 TH350 LH Modulator	37.99 ea. 50.99 ea.
FTV6903	1967-69 TH350 RH Modulator	37.99 ea. 50.99 ea.
FTV6705	1967-69 TH400	37.99 ea. 50.99 ea.
FTV7005	1970-74 TH400	37.99 ea. 50.99 ea.
FTV7401	1974 Z/28	37.99 ea. 50.99 ea.
FTV7801	1978-81 TH350	37.99 ea. 50.99 ea.

Ships Oversize.



Modulator Valve

Replacement modulator valve for automatic transmission.

FTM-12903	PG, TH350, TH400	26.99 ea.
-----------	------------------------	-----------

Note: Smaller than original but functions the same.



Kickdown Cable & Bracket

Correct kickdown cable and bracket for cars with a TH350 transmission.

S530KIT	All TH350 Cable/Bracket	46.78 kit
S530	All TH350 Cable	24.99 ea.
S531	All TH350 Bracket	26.99 ea.



Cable Mounting Bracket

Correct bracket for mounting cable to transmission.

FCB-1210	1968-72 TH350	16.99 ea.
FCB-220	1968-72 TH400	21.99 ea.
FCB-193	1973-74 TH400	36.99 ea.



Shifter Cable Lever Brackets

Correct cable lever brackets which mount to transmission.

FCB-322	1968-69 1st Design	16.99 ea.
FCB-222	1970-72 2nd Design	24.99 ea.



Shifter Cable Stud

Correct cable stud which mounts to bracket.

FTH-050	Mounting Stud (to bracket)	11.99 ea.
---------	----------------------------------	-----------



Shifter Cables

Original GM or high quality reproduction shifter cables for floor mounted TH shifter.

FTH-973R	1968-72	34.99 ea.
FTH-773	1973-81	44.99 ea.



Shifter Cable Clip

Correct clip for mounting cable.

EBC-22	Mounting Clip	3.99 ea.
--------	---------------------	----------



Shifter Cable Clip

Correct push on clip which mounts to shifter.

FTH-049	Push on Clip (to shifter)	7.99 ea.
---------	---------------------------------	----------



Clutch Pedal Booster Rod & Clip

For use with power disc brakes.

FBC-799	Booster Rod Clip	9.99 ea.
FBC-606	Booster Rod Fork	14.95 ea.



Column Shift Transmission Bracket

Correct column shift transmission bracket which mounts on all column shift GM cars from 1969-1979.

FTB-13433	1969-79	16.99 ea.
-----------	---------------	-----------



Back Drive Components

Correct bracket, spring, nylon bushing and mounting bolts that mount to the driver's side frame rail. Provides a pivot point for the automatic on the column shift linkage.

NT-391A	1969-72 Complete Kit	29.99 kit
NT-2833	1969-72 Bracket Only	17.99 ea.
NT-69BU	1969-72 Bushing Only	6.99 ea.
FB-69SP	1969-72 Back Drive Spring	5.95 ea.



Column Shift Linkage & Lockout Swivel Assembly

Correct swivel assembly for automatic column shift linkage and lockout.

FSA-ZRLOS	1967-81	26.99 ea.
-----------	---------------	-----------



Steering Column Rods

FCR-3920215	1967-69 Upper PG	24.99 ea.
FCR-3972257	1967-69 Upper TH350/TH400	32.99 ea.
FCR-3945511	1968-69 Lower TH350	24.99 ea.
FCR-3914805	1967-69 Lower TH400	24.99 ea.
FCR-3895294	1967-68 Lower PG	24.99 ea.
FCR-3939743	1969 Lower PG	24.99 ea.
RBS-6781	1967-81 Column Arm Grommet	9.99 ea.



FY-935

Driveshaft Yokes

New front drive shaft yokes.

FY-123	Front Yoke TH400	139.99 ea.
FY-123	Front Yoke 1971-72 M22	139.99 ea.
FY-935	Front Yoke TH350/4 spd	99.99 ea.



FTS-350

Tail Seals

Correct tail shaft yoke seals.

FTS-PG	Powerglide	6.99 ea.
FTS-350	TH350	5.95 ea.
FTS-400	TH400	8.99 ea.



BSB-12925

Tail Shaft Bolts

Correct TR head markings & black phosphate plating.

BSB-12925	PG, TH350, TH400 6pc	9.99 kit
-----------	----------------------	----------



BPU-337

BPU-334

U Joint Attaching Kits

Correct straps and bolts for attaching drive shaft to rear yoke.

BPU-337	All Straps with Bolts	17.99 kit
BPU-334	All U Bolts with Nuts	15.99 kit



FY-2122

Rear Axle Yokes

New rear differential yokes.

FY-2122	Strap Type	149.99 ea.
FY-1330	U-Bolt Type	174.99 ea.



BM-70500

B&M Differential Covers

Designed to strengthen the differential by preventing case distortion, ring gear & bearing cap deflection. Constructed of A356.0-T6 aluminum, these covers significantly increase the fluid capacity and dissipate heat faster than the stock factory unit to prolong the life of your ring and pinion gears.

BM-70500	12 Bolt 8.875" Ring Gear Silver	303.99 ea.
BM-70502	10 Bolt 8.2,5, or 6" Ring Gear Silver	274.99 ea.
BM-71502	10 Bolt 8.2,5, or 6" Ring Gear Black	299.99 ea.
BM-70503	10 Bolt 8.2" BOP Ring Gear Silver	276.99 ea.

No Volume Discount.



MRG-41601MRG

MRG-41603MRG

Mr. Gasket Differential Cover Gaskets

Mr. Gasket Differential Cover Gaskets offer simple, no silicone installation. They use an aluminum carrier, silicone elastomer beading and a rubber coated binder to create a strong, long lasting seal perfect for the demands of factory or high performance front and rear ends. Whether it's your daily driver, race car, or off-road rig, these premium differential cover gaskets from Mr. Gasket have you covered.

MRG-41601MRG	Chevy 8.875" 12 bolt	41.99 ea.
MRG-41603MRG	GM 8.5" 10 bolt	25.99 ea.

No volume discount.



GCS-R0002X

GCS-S4787

Custom Rear End Covers

Choose from high quality chrome or bright polished aluminum. A great finishing touch!

GCS-S4787	12 Bolt Chrome	20.99 ea.
GCS-S5082	12 Bolt Polished	122.99 ea.
GCS-R0002X	Bolt Kit	13.99 kit

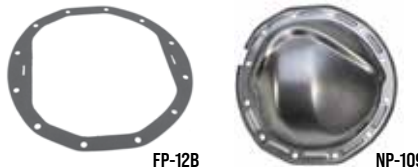

FP-12B

NP-109

Rear End Cover

OE style reproduction rear end covers.

NP-109	12 Bolt Cover	29.99 ea.
FP-10B	10 Bolt Gasket	7.99 ea.
FP-12B	12 Bolt Gasket	7.99 ea.
BRE-2008	Cover Bolt	0.95 ea.



FPF-49



FPF-668

Rear End Fluid

AC Delco rear end fluid and posi additive.

FPF-668	Rear End Fluid	32.99 ea.
FPF-49	Posi Additive	19.99 ea.

Typical GM rear ends require 1 bottle of additive & 3 bottles of fluid.

TTP-68



TTP-71



TTP-70



TTP-6972



Turbo HydraMatic Transmission ID Tags

Turbo HydraMatic transmission ID tag with rivet, measuring 1-1/8 inch x 1-15/16 inch. This installs on the side of the transmission case with the rivet. You must punch your own info onto the tag.

TTP-68	1968 Dark Olive	32.99 ea.
TTP-6972	1969 & 72 Yellow	29.99 ea.
TTP-70	1970 Black	29.99 ea.
TTP-71	1971 Light Blue	29.99 ea.



FDP-5R



HBB-5847



FDP-3R



FPT-3



N-7081

Rear End Plugs & Posi Tag

OE style reproduction plugs and posi tag.

HBB-5847	All Metal Tag	9.99 ea.
FDP-5R	1967-68 Plug 1"	19.99 ea.
FPT-3	1967-68 Posi Tag 1"	14.99 ea.
FDP-3R	1969-72 Plug 3/4"	19.99 ea.
FPT-1	1969-72 Posi Tag 3/4"	14.99 ea.
N-7081	1967-72 Vent Plug	9.99 ea.



ATS-653

TCS Wire Retainer

Correct reproduction for Muncie.

ATS-653	1970-74 w/ Muncie	26.99 ea.
---------	-------------------	-----------



ATS-21MP



ATS-21MS

TCS Transmission Switches

Correct TCS switch located on transmission.

ATS-21MP	1970-75 Pin Style	39.99 ea.
ATS-21MS	1970-75 Spade Style	39.99 ea.



Screw-On up to 1968

Clip-On 1969 & up

Speedometer Cables

Complete cables with casings and correct ends ready to install. 1967-68 Cables came with screw-on fittings on both ends. 1969 and up cables had a screw end on the transmission and a clip-on end on the speedometer.

Check your speedometer fitting and length before ordering.

FCC-006	1967-68 38" Upper (Screw-On).....	18.95 ea.
FCC-201	1967-68 64" LH (Screw-On).....	19.99 ea.
FCC-203	1967-68 83" RH (Screw-On).....	21.99 ea.
FCC-202	1969-92 100" (Clip-On).....	25.99 ea.
FCC-205	1969-92 80" (Clip-On).....	19.99 ea.
FCC-305	1969-92 61" (Clip-On).....	21.99 ea.
FCC-309	1969-92 41" (Clip-On).....	16.99 ea.
FSG-100	1967-69 Grommet.....	7.99 ea.

Longer cables are for cars with a RH passenger side speedometer drive on the transmission.



FCA-877

Speedometer Cable Assembly

Manufactured to OE style original specifications, these assemblies come complete with a high quality firewall grommet already installed to save time and hassles.

FCA-870	1967-68 58".....	44.99 ea.
FCA-871	1967-68 69".....	44.99 ea.
FCA-872	1967-68 73".....	43.99 ea.
FCA-874	1967-68 Upper 37.5".....	46.99 ea.
FCA-876	1969 62".....	46.99 ea.
FCA-877	1969 71".....	46.99 ea.

IRC-006



Speedometer Cable Retaining Clip

Holds the cable to the back of speedometer.

IRC-006	1969-81 All.....	8.99 ea.
---------	------------------	----------

FSG-100



Speedometer Cable Grommet

Correct rubber seal for firewall.

FSG-100	1967-69 All.....	7.99 ea.
FSG-22	1970-81 All.....	7.99 ea.

FSP-10



Speedometer Cable Plug

For 4 Speed Muncie only.

FSP-10	All.....	1.95 ea.
--------	----------	----------



FHB-115

Speedometer Cable Clip

OE style reproduction of the speedometer cable clip that mounts on the firewall and transmission hump.

FHB-115	1967-69 All.....	15.99 ea.
---------	------------------	-----------



6454841

3954257

Speed Warning Indicator Cables

This high quality reproduction speed warning cable was originally found on cars with RPO code U15 (speed warning indicator).

6454841	1967-68 All.....	32.99 ea.
6476813	1969 All.....	29.99 ea.
3954257	1969 Cable Bracket.....	39.99 pr.



FHB-13653

Speedometer Cable Clip

Bolts to the bottom of the transmission tail shaft bolt to keep the speedometer cable from hanging down.

FHB-13653	1970-79.....	14.99 ea.
-----------	--------------	-----------



BM-70242

B&M Throttle Valve Cable TH700R4

These universal fit adjustable cables are less expensive than OE models. They can be used as straight replacement cable, or for ease in the installation of a transmission swap. Adjustable fit from 26 to 49 inches.

BM-70242	All w/ TH700R4.....	59.99 set
----------	---------------------	-----------

No volume discount.



1993413

Reverse Lamp Switch

Correct switch assembly for activating reverse lamps.

1993413	1967-68 w/ Muncie.....	89.99 ea.
GNS-33	1969-73 4 Speed.....	55.99 ea.



10665

Reverse Switch Extension Harness

Correct harness which plugs into firewall.

10665	1967-68.....	39.99 ea.
-------	--------------	-----------

BUY & SAVE

WITH SS396.COM PRE-BUILT KITS



REVSKIT-67F

Reverse Switch Kit

This kit includes all components needed for a complete installation: Switch, extension harness, bracket, shield and rod.

REVSKIT-67F	1967-68.....	170.97 kit
-------------	--------------	------------

No Volume Discount.

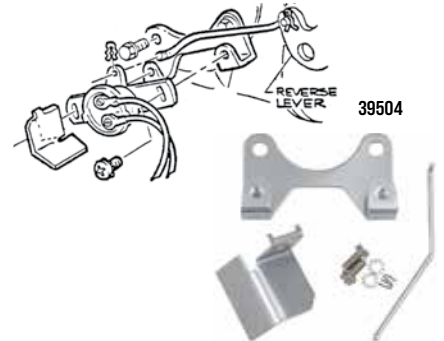

39504

Reverse Switch Mounting Kit

Complete with bracket, shield, rod, clips and hardware for mounting the reverse switch.

39504	1967-68 Complete.....	59.99 kit
GRB-342	1967-68 Bracket Only.....	14.95 ea.
GWT-17	1967-68 Shield Only.....	9.95 ea.
GRR-58	1967-68 Rod/Clips Only.....	17.95 ea.



GNS-1969

Neutral Start Switches

Correct safety switch located at the pedal to prevent the car from starting in gear.

GNS-1969	1969 Manual.....	84.99 ea.
FSR-372	1969 Switch Rod & Clip.....	22.99 ea.



GNS-23

Neutral Start/Reverse Lamp Switch

Correct switch for proper engine and reverse light activation.

GNQ-375	1967 Console.....	44.99 ea.
GNS-23	1967-68 TH350/TH400.....	19.99 ea.
GDR-411	1969-73 Automatic.....	29.99 ea.

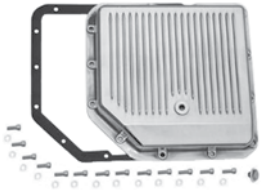

GCS-S8491

Polished Finned Transmission Pans

Show quality polished stock depth pan crafted from cast aluminum and polished to a bright finish. Includes gasket, drain plug and bolts.

GCS-S8491	TH350.....	66.99 ea.
GCS-S8492	TH400.....	79.99 ea.
GCS-S8493	TH700-R4.....	79.99 ea.



GCS-S9074

Chrome Transmission Pans

Stock depth. Chrome plated steel for a show quality finish.

GCS-S9074	TH350.....	23.99 ea.
GCS-S7599	TH700-R4.....	32.99 ea.



GCS-S9124

Chrome Finned Transmission Pans

Stock depth. Chrome plated steel with fins.

GCS-S9124	Powerglide.....	23.99 ea.
GCS-S9122	TH350.....	20.99 ea.
GCS-S9121	TH400.....	23.99 ea.
GCS-S9712	TH700-R4.....	31.99 ea.



GCS-S9197

Chrome Finned Transmission Pans

Same quality show finish as our stock pans but with extra fluid capacity for better cooling.

GCS-S9197	1.5 Extra Qts TH400.....	24.99 ea.
GCS-S9196	2.5 Extra Qts TH400.....	32.99 ea.

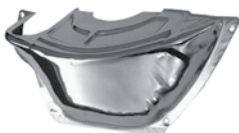

GCS-S9417

Custom Flywheel Inspection Covers

Looks great on any show car!

GCS-S9417	PG Chrome.....	32.99 ea.
GCS-S8607	TH350/TH400 Polished.....	63.99 ea.
GCS-S9588	TH350/TH400 Chrome.....	31.99 ea.
GCS-S9587	TH700-R4 Chrome.....	35.99 ea.



BM-30280

BGM Deep Transmission Pan Cast

These BGM automatic transmission deep pans provide additional fluid capacity and cooling ability. No modifications to the dipstick are needed. They include a drain plug for clean and easy fluid changes. Adds 2-3 quarts to the transmission.

BM-30280	All TH350, TH250 3Qts.....	269.99 ea.
BM-20280	All TH400 2Qts.....	267.99 ea.
BM-70280	All Powerglide 2Qts.....	289.99 ea.
BM-70260	All TH700RH, 4L60/65E 3Qts... ..	349.99 ea.

No Volume Discount.



FDT-350

Dipstick & Tubes

GM replacement dipstick and tubes.

FDT-350	TH350 Tube.....	39.99 ea.
FDT-350K	TH350 Tube & Stick Set.....	22.99 kit
FDT-400	TH400 Tube.....	29.99 ea.
FDT-400K	TH400 Tube & Stick Set.....	36.99 kit
FDS-3	TH350 Stick.....	23.99 ea.
FDS-4	TH400 Stick.....	26.99 ea.



GCS-S9422

Chrome Dipsticks and Tubes

Show quality dipsticks are an excellent upgrade to any engine compartment. Includes dipstick & tube.

GCS-S9422	Powerglide.....	15.99 ea.
GCS-S9421	TH350.....	15.99 ea.
GCS-S9421BA	TH350 Billet Handle.....	24.99 ea.
GCS-S4994	TH350 34".....	16.99 ea.
GCS-S4994BA	TH350 34" Billet Handle.....	19.99 ea.
GCS-S4995	TH400 24".....	13.99 ea.
GCS-S4995BA	TH400 24" Billet Handle.....	17.99 ea.



GCS-S5004

Chrome Dipsticks w/ Braided Tubes

Stainless steel braided tube with chrome handle.

Bellhousing Mount

GCS-S5004	TH350.....	45.99 ea.
GCS-S5005	TH400.....	45.99 ea.
GCS-S5006	TH700-R4.....	45.99 ea.

Firewall Mount

GCS-S5104	TH350/TH400 29".....	58.99 ea.
GCS-S5106	TH700-R4.....	58.99 ea.



GCS-S6053

Stainless Steel Kickdown Cables

Show quality look w/ more adjustability than your factory cable.

GCS-S6053	TH350.....	40.99 ea.
GCS-S6051	TH700-R4.....	46.99 ea.

Note: For carburetor applications only.



Muncie M20, M21, M22

TH350, TH400

Transmission Speedometer Gears

These are the correct speedometer driven gears which go inside the transmission case. Please compare the gear you have to what you are ordering as the color or tooth count may vary from original. We do not have an application chart for these, so if changing axle ratios or tire size, please consult various online resources.

Muncie M20, M21, M22, Saginaw 3 & 4 Speed & Powerglide

FR-158RB	17 Tooth Purple.....	19.99 ea.
FR-158RD	18 Tooth Brown.....	19.99 ea.
FR-158RF	19 Tooth Natural.....	19.99 ea.
FR-158RH	20 Tooth Blue.....	19.99 ea.
FR-158RK	21 Tooth Red.....	19.99 ea.
FR-158RM	22 Tooth Gray.....	19.99 ea.
FR-158RS	23 Tooth Black.....	19.99 ea.
FR-158RV	24 Tooth Orange.....	19.99 ea.

TH350, TH375, TH400, TH475

FR-158SB	35 Tooth Pink.....	19.99 ea.
FR-158SD	36 Tooth White.....	19.99 ea.
FR-158SF	37 Tooth Red.....	19.99 ea.
FR-158SH	38 Tooth Blue.....	19.99 ea.
FR-158SM	40 Tooth Black.....	19.99 ea.
FR-158SP	41 Tooth Yellow.....	19.99 ea.
FR-158SS	42 Tooth Green.....	19.99 ea.
FR-158SV	43 Tooth Purple.....	19.99 ea.
FR-158SX	44 Tooth Dark Gray.....	19.99 ea.
FR-158SZ	45 Tooth Light Green.....	19.99 ea.
FR-RETAINER	1964-88 All w/ Large Gear.....	7.99 ea.



BM-70264

BGM Transmission Coolers & Kits

BGM Super Coolers are 100% aluminum stacked plate style core which is ideal for additional transmission cooling. With oven brazed construction this sturdy cooler design is practically impervious to flying rocks or other debris.

Small

BM-70265	All 7,500 BTU Polished.....	132.99 ea.
BM-70273	All 15,000 BTU Black.....	189.99 ea.

Medium

BM-70268	All 13,000 BTU Black.....	113.99 kit
BM-70266	All 20,500 BTU Black.....	209.99 ea.
BM-70272	All 20,500 BTU Polished.....	254.99 ea.

Large

BM-70264	All 14,400 BTU Black.....	135.99 kit
BM-70274	All 29,200 BTU Black.....	234.99 ea.

No Volume Discount.



BM-70298

BGM HiTek Cooling Systems

Hi-Tek Super Coolers are fitted with a high quality 12 Volt cooling. Suitable for many fluids including ATF, engine oil, differential oil and power steering fluid.

BM-70298	All 350 CFM Black.....	436.99 ea.
BM-70297	All 590 CFM Black.....	484.99 ea.

No Volume Discount.



HAYS-92-1003



Hays Manual Clutches

Hays Street 450 single disc kits are an excellent upgrade offering up to 30% more holding power over your stock clutch. Designed to handle stock to mildly modified engines up to 450 horsepower. This is a great clutch where drivability is the most important factor along with a stock pedal feel.

HAYS-91-1003	10.5" 26 Spline.....	488.99 kit
HAYS-91-1002	10.5" 10 Spline.....	455.99 kit
HAYS-91-1004	11" 10 Spline.....	471.99 kit
HAYS-91-1005	11" 26 Spline.....	493.99 kit

Hays Street 650 single disc kits are designed to handle highly modified naturally aspirated engines up to 650 horsepower. Designed as a true street/strip clutch for spirited high performance driving or frequent track use.

HAYS-92-1003	10.5" 26 Spline.....	768.99 kit
HAYS-92-1002	10.5" 10 Spline.....	933.99 kit
HAYS-92-1004	11" 10 Spline.....	998.99 kit
HAYS-92-1005	11" 26 Spline.....	985.99 kit

No Volume Discount.



LW-15000LKW



FEH-397

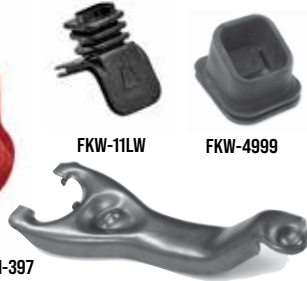

FKW-11LW

FKW-4999

Lakewood Bellhousing

The Lakewood 15000LKW bellhousing connects Chevy small and big block engines to transmissions utilizing the standard GM pattern such as the Muncie, Saginaw, Borg Warner T10 and Tremec TKO transmissions. This bellhousing is hydro formed to fit '58-'87 GM full and midsize cars, 67-81 F-body vehicles and 68-79 Novas. This bellhousing is S.F.I. 6.1 certified which is required by many sanctioning bodies for cars running 11.49 or faster in the quarter mile. The Lakewood 15000 comes complete with engine block plate and Grade 8 mounting hardware.

LW-15000LKW	1962-1979 SBC, BBC.....	840.99 ea.
FEH-397	1968-1979 All Resto Clutch Fork.....	74.99 ea.
FKW-4999	1962-1979 All Clutch Fork Boot OE.....	9.99 ea.
FKW-11LW	1962-1979 All Clutch Fork Boot.....	55.99 ea.
FTE-9000-ADJ	1962-1979 All Adjustable Clutch Fork Ball.....	29.99 ea.

No Volume Discount.



LW-15000LKW-KIT

Lakewood Chevy Bellhousing Kit, Big Block & Small Block

The Lakewood 15000LKW bellhousing connects Chevy small and big block engines to transmissions utilizing the standard GM pattern such as the Muncie, Saginaw, Borg Warner T10 and Tremec TKO transmissions.

LW-15000LKW-KIT	SB BB All.....	997.97 kit
-----------------	----------------	------------



HOL-319-575

LS Clutch And Flywheel Kit

This Kit includes all the hardware and components needed for a complete clutch install on a 6-bolt crank LS engine using a T-56 transmission. A 12-inch organic disc with 6 spring helix sprung hub provides superior grip needed for the strip, while the matched diaphragm style pressure plate provides a pedal feel comfortable enough for the street. This provides 30 percent more clamping pressure and transmits that through a billet steel flywheel.

HOL-319-575	All w/ 6 Bolt Crank LS & T56.....	1219.99 set
-------------	-----------------------------------	-------------

No volume discount.



HOL-319-910

HOL-319-911

Holley Hydraulic Clutch Conversion Kit

The Holley hydraulic conversion kit is engineered to fit each model perfectly, ensuring a trouble-free installation and optimal performance.

HOL-319-910	1967-69.....	342.99 kit
HOL-319-911	1970-81.....	358.99 kit

No volume discount.



HAYS-10-010

Hays Automatic Flexplate

Hays heavy duty Flexplate for high performance competition Chevy engines are constructed of a thicker than stock steel plate. This enables them to withstand the stress of high-stall torque converters and high-RPM engines. These flexplates are supplied with a ring gear that is securely welded in place and feature a dual bolt pattern for use with a Powerglide or Turbo style torque converter.

HAYS-10-010	168t 57-85 SBC 65-70 BBC*.....	159.99 ea.
HAYS-10-020	168t 70-90 SBC BBC**.....	113.99 ea.

*Internally balanced. **Externally balanced.

No Volume Discount.

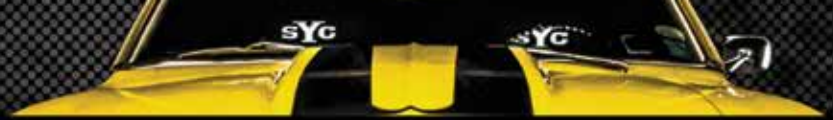

Fuel Tank Super Kits

If your original tank & hardware has seen better days, you can replace everything in one shot with this complete kit! We give you the choice of a beautiful OEM tank (made in North America) for the ultimate in show quality or an IMPROVED QUALITY import tank. Both tanks are galvanized. Each kit includes (1) tank, (1) tank to filler neck (1967-68 only), (1) upper neck (1967-68), (1) neck sleeve, (1) anti-squeak kit, (1) bolt kit, (1) lock ring and (1) o-ring gasket.

Import

XT-67KI	1967-68 All	310.97 kit
XT-69KI	1969 All	213.82 kit

No Volume Discount. Ships Oversize 2.



XT-67KI

BUY & SAVE
WITH SS396.COM PRE-BUILT KITS



HOL-19-100

1967-81 Sniper Fuel Injection Fuel Tanks

Converting the carbureted fuel system on your car or truck over to EFI can be a daunting task. We have made this conversion easy with our complete tank and fuel system kits! When converting to EFI, it is crucial that you do not contaminate your new parts with dirt, rust, and sludge from an old fuel tank. Sniper fuel tanks are designed to meet or exceed the quality of your factory fuel tank. Sniper tanks are made from steel with a galvanized finish that are manufactured to the OEM specifications. Narrow corner tanks offer more room for large tire combos.

Tank With Pump & Sender Stock Width

HOL-19-100	1967-68* 550HP	797.99 ea.
HOL-19-400	1967-68* 750HP	921.99 ea.
HOL-19-104	1969** 550HP	797.99 ea.
HOL-19-404	1969** 750HP	921.99 ea.

Tank With Pump & Sender Narrow Corners

HOL-19-101	1967-68* 550HP	921.99 ea.
HOL-19-401	1967-68* 750HP	944.99 ea.
HOL-19-103	1969** 550HP	921.99 ea.
HOL-19-403	1969** 750HP	944.99 ea.

Install Kit (hose, filter & fittings)

HOL-526-10	Universal For EFI	372.99 ea.
------------	-------------------------	------------

Hose clamps are not included with kits with 2 piece filler necks.

*Steel filler neck that extends to rear valance is not included. You must use your existing stock filler neck or purchase a new one. **You may have to switch to the shallow reach gas cap 1.25 inch depending on your application. No Volume Discount. Ships Oversize. Not eligible for free shipping.

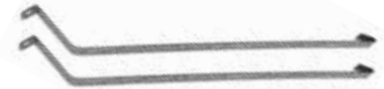

XTS-F67S

Stainless Steel Fuel Tank Straps

Perfect for your new stainless steel tank!

XTS-F67S	1967-69	33.99 pr.
XTS-F70S	1970-73	43.99 pr.
XTS-F768S	1974-81	222.99 pr.



BCI-4753

Fuel Tank Hardware

Correct OEM bolts and clips for mounting fuel tank as original.

BCI-4753	1967-69 All	8.95 kit
----------	-------------------	----------



NH-UNI

Fuel Tank Insulation

Correct foam insulation which is glued to the top of the fuel tank to prevent squeaks and rattles, and tar paper which goes between the tank and the straps.

NH-4381	1967-81	16.99 kit
NH-UNI	1967-01 Universal 36" x 21"	19.99 ea.



XT-67X

Reproduction Fuel Tanks

These new and improved reproduction fuel tanks are galvanized to retain that original shine. These new fuel tanks are of a much better quality than previous reproductions that were out on the market, making them perfect for daily drivers and weekend show cars alike.

XT-67X	1967-68 All (18 gal.)	194.99 ea.
XT-69X	1969 All (18 gal.)	164.99 ea.
XT-70X	1970-73 w/o EEC	159.99 ea.
XT-70XE	1970-73 w/ EEC	199.99 ea.
XT-74X	1974-77 All	199.99 ea.
XT-78X	1978-81 All	199.99 ea.

1969 includes filler neck. Ships Oversize 2.



XTS-69F

Stainless Steel Fuel Tanks

These stainless steel fuel tanks are shiny enough for any show car and rust proof enough for any daily driver! Installation is easy because this tank is a direct bolt-in replacement for your OEM tank.

XTS-67F	1967-68 All	429.99 ea.
XTS-69F	1969 All	419.99 ea.
XTS-70F	1970-73 w/o EEC	474.99 ea.
XTS-71F	1970-73 w/ EEC	419.99 ea.
XTS-74F	1974-77	459.99 ea.
XTS-78F	1978-81	419.99 ea.

Ships Oversize 2.



TANK-3

Fuel Tank Mounting Kit

If your tank is good but you need to replace your hardware, this complete kit has it all! Includes straps, insulation and all hardware.

TANK-3	1967-69 All	44.07 kit
--------	-------------------	-----------



XTS-679

Fuel Tank Straps

OE style reproduction fuel tank straps.

XTS-679	1967-69	22.99 pr.
XTS-703	1970-73	23.99 pr.
XTS-768	1976-81	26.99 pr.
XTS-745	1974-75	34.99 pr.
4022-749-82P	1982-92	23.95 pr.



XT-69K-SS

Stainless Fuel Tank Super Kits

These stainless tank kits will probably outlast your car and still look very close to OEM. Each kit includes (1) tank, (1) tank to filler neck (1967-68 only), (1) upper neck (1967-68), (1) neck sleeve, (1) anti-squeak kit, (1) bolt kit, (1) lock ring and (1) o-ring gasket.

XT-67K-SS	1967-68 All	555.87 kit
XT-69K-SS	1969 All	473.96 kit

No Volume Discount. Ships Oversize 2.



Fuel Tank Caps

OE style reproduction fuel tank caps with correct logos.

XTC-043	1967-68 Paintable	21.99 ea.
XTC-045	1967-68 SS	54.99 ea.
XTC-059	1967 SS 350	59.99 ea.
XTC-057	1967-68 RS	59.99 ea.
XTC-250	1967-68 Bowtie	44.99 ea.
XTC-149	1969-70 Short Cam	12.99 ea.
XTC-807	1971-74 Long Cam	16.99 ea.
XTC-817	1975-81 Non Vented.....	9.95 ea.
XTC-819	1975-81 Vented.....	11.99 ea.



1967-68 Steel Filler Neck

OE style reproduction fuel filler neck assembly.

XN-113	1967-68 All	32.99 ea.
--------	-------------------	-----------



1967-68 Filler Neck Sleeve

Correct rubber sleeve that covers the fuel filler neck assembly.

XNS-517	1967-68 All	29.99 ea.
---------	-------------------	-----------



1967-68 Filler Neck Hose

Correct fuel filler neck hose.

XNH-40	1967-68 All	12.99 ea.
--------	-------------------	-----------



1967-68 Filler Neck Hose Clamp

Correct OEM clamp for filler neck hose.

XNC-300	1967-68 All	3.99 ea.
---------	-------------------	----------



Fuel Tank Doors

Correct spring loaded fuel tank door.

XTD-1630	1969 Door	26.99 ea.
XTD-344	1970-77 Door	19.99 ea.
XTD-10B	Door Bumper	1.95 ea.
BTB-56K	Door Bolt /Nut.....	2.59 pr.
BPA-53K	1967-81 Plate To Bracket Hardware ..	3.95 kit

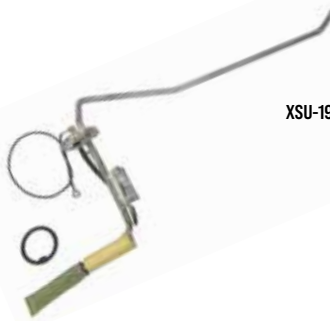

Fuel Tank Sending Units

Original GM or OE style reproduction sending units.

XSU-19	1967-69 3/8" Repro.....	42.99 ea.
XSU-93	1967-69 3/8" w/ 1/4" Return Repro.....	54.99 ea.
XSU-848	1970-73 3/8" Repro.....	54.99 ea.
XSU-846	1970-73 3/8" w/ 1/4" Return Repro.....	54.99 ea.
XSU-741	1976-81 3/8"	73.99 ea.
XSU-742	1976-81 3/8" w/ 1/4" Return ...	73.99 ea.
DSE080201	0-90 Ohm Sending Unit for DSE Tank	59.99 ea.

No Volume Discount.



Sender Filter

Correct mesh filter to keep debris out.

XFF-092	All 3/8"	17.95 ea.
---------	----------------	-----------



Sending Unit Lock Rings

Correct locking rings used to secure the sending unit to the tank.

XLR-937	1967-69 w/ Gasket	5.95 ea.
XLR-999	1970-73 w/ Gasket	5.95 ea.
XLR-7481	1974-81 w/ Gasket	5.95 ea.



Sending Unit Harness

New OE style reproduction with correct boot.

18915	1967-68 All	23.99 ea.
18910	1969 All	23.99 ea.
33825	1970-71 All	23.99 ea.
33835	1972-73 All	23.99 ea.
36272	1974-77 All	23.99 ea.
36269	1978-80 All	31.99 ea.



Fuel Tank Hose Kits

Correct GM style hose and pinch clamps.

AXP-3800	All 3/8"	4.99 kit
AXP-1438	All 3/8" - 1/4"	7.99 kit



Fuel Tank Vent

Correct fuel tank vent.

XTV-689	1968-70	39.99 ea.
---------	---------------	-----------



Fuel Line Clips

Correct clips for attaching fuel lines to frame.

ELC-1516	5/16" Line	1.99 ea.
ELC-516	5/16" w/ Tab	5.99 ea.
ELC-516-GR	5/16" w/ Tab Green	3.99 ea.
ELC-038	3/8" Line	2.99 ea.
ELC-038-INSL	3/18" w/ Rubber Coat	2.99 ea.
ELC-038T	3/8" w/ Tab	3.99 ea.
ELC-1438	1/4" - 3/8" Line	3.99 ea.
ELC-1438T	1/4" - 3/8" w/ Tab	5.99 ea.
BLC-056	Correct Bolt	0.50 ea.
XLB-679	1967-69 Retainer at Rear Frame	15.95 ea.



Fuel Line Clip Kits

These convenient kits include all of the correct clips needed to install a set of factory fuel lines.

INL-CCF201	1967-68 7pc	24.99 kit
INL-CCF202	1969 w/o Return 7pc.....	22.99 kit
INL-CCF203	1969 w/ Return 7pc	28.99 kit
INL-CCF205	1970-71 3/8" w/o Return 10pc	28.99 kit
INL-CCF206	1970-71 3/8" w/ Return 10pc	39.99 kit
INL-CCF207	1972-77 3/8" w/o Return 10pc.....	29.99 kit
INL-CCF208	1972-77 3/8" w/ Return 10pc.....	39.99 kit
INL-CCF209	1978-81 3/8" w/ Return 10pc.....	39.99 kit

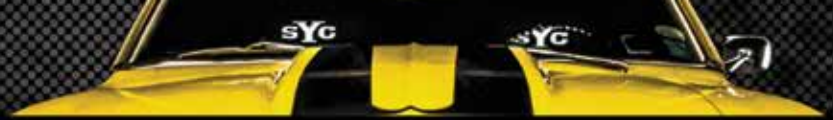

Fuel Lines Front to Rear

OE style reproduction pre-bent fuel lines featuring correct armor shielding and cloth insulation as original. Available in original material (OM) and stainless steel (SS).

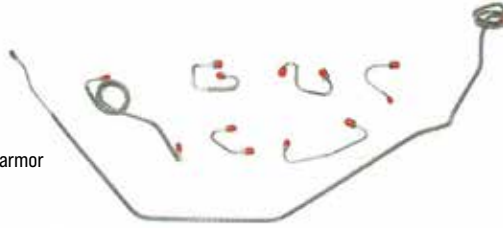

Main Lines

	OM	SS
EGL6703 1967 V8 Small Block 3/8" (1pc.)	83.99 ea.	127.99 ea.
EGL6704 1967 V8 Big Block 3/8" 1pc	83.99 ea.	127.99 ea.
EGL6701 1967-68 5/16" 1pc	83.99 ea.	127.99 ea.
EGL6803 1968 V8 Small Block 3/8" 1pc	83.99 ea.	127.99 ea.
EGL6805 1968 V8 Big Block 3/8" 1pc	83.99 ea.	127.99 ea.
EGL6905 1969 6 Cylinder 5/16" 1pc	83.99 ea.	127.99 ea.
EGL6907 1969 V8 All 3/8" 1pc	83.99 ea.	127.99 ea.
EGL7001 1970-73 3/8" 2pc	83.99 ea.	127.99 ea.
EGL7006 1970-74 6 Cylinder 3/8" 2pc	83.99 ea.	127.99 ea.
EGL7201 1972 396 3/8" 2pc	83.99 ea.	127.99 ea.
EGL7202 1972 396 1/4" Vapor Line 2pc	83.99 ea.	127.99 ea.
EGL7401 1974 3/8" 2pc	83.99 ea.	127.99 ea.
EGL7506 1975-76 3/8" 2pc	83.99 ea.	127.99 ea.
EGL7705 1977 Front 5/16" X-Over 1pc	50.99 ea.	62.99 ea.
EGL7704 1977 5/16" Vapor Line 1pc	83.99 ea.	127.99 ea.
EGL7801 1977-79 3/8" 2pc	83.99 ea.	127.99 ea.
EGL8001 1980-81 (except Z/28) 3/8" 2pc	83.99 ea.	127.99 ea.

Fuel Return Lines

	OM	SS
EGL6909 1969 V8 All 1/4" 1pc	83.99 ea.	127.99 ea.
EGL7002 1970-73 All 1/4" 2pc	83.99 ea.	127.99 ea.
EGL7402 1974 1/4" 2pc	83.99 ea.	127.99 ea.
EGL7504 1975-76 1/4" 2pc	83.99 ea.	127.99 ea.
EGL7802 1977-79 1/4" 2pc	83.99 ea.	127.99 ea.
EGL8002 1980-81 (except Z/28) 1/4" 2pc	83.99 ea.	127.99 ea.
EGL8006 1980-81 Z/28 1/4" 2pc	83.99 ea.	127.99 ea.

Ships Oversize 2.

Vapor Return Lines

	OM	SS
FEM04 1970-73 V8 4pc	126.99 ea.	176.99 ea.
FEM03 1970-74 6 cyl 1pc	126.99 ea.	176.99 ea.
FEM74 1974 V8 4pc	126.99 ea.	176.99 ea.
FEM05 1975-77 1pc	83.99 ea.	176.99 ea.
FEM08 1978 2pc	126.99 ea.	176.99 ea.
FEM10 1979-81 2pc	126.99 ea.	176.99 ea.



AXD-69

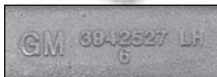

APB-1382

Exhaust Manifolds

New GM restoration manifolds. These brand new manifolds are sold in matched pairs and come with GM cast numbers. AXD-67 features alternator bracket provision as original for some cars.

AXD-67	1967-68 SB non-SMOG	
	3840912 / 3892679*	469.99 pr.
AXD-69	1969-72 SB non-SMOG	
	3932376 / 3942529**	469.99 pr.
AXD-69S	1969-72 SB w/ SMOG	
	3946826 / 3942527	459.99 pr.
AXD-396	BB non-SMOG	
	3916178 / 3909879	469.99 pr.
AXD-396S	BB w/ SMOG	
	3916178 / 3909879	469.99 pr.

*Features alternator mount provision. **Use for early cars without alternator mount provision. No Volume Discount. Ships Oversize.

OEM Exhaust Manifold Bolts

Correct head marked and colored bolts for mounting exhaust manifolds to block.

APB-1382	SB w/ Washers 24pc	42.99 kit
APB-1821	BB Flanged Head 16pc	23.99 kit
APB-3506	BB Loose Washer 32pc	29.99 kit



ALI-2228

Exhaust Stud Kit

Steel studs for attaching pipe to manifolds.

ALI-2228	All V8	24.99 kit
----------	--------	-----------



EXL-200

Exhaust French Locks

This kit is a correct set of four stainless steel stamped french locks for corners of exhaust manifold as installed by factory.

EXL-100	1967-73 SB	16.99 kit
EXL-200	1967-73 BB	16.99 kit



EHS-471



EHS-128



EHS-473

Upper & Lower Heat Stove

Works in conjunction with the air heat tube to preheat the air cleaner thermo-sensor.

EHS-471	1969-76 Upper Heat Stove	9.99 ea.
EHS-473	1969-81 Lower Heat Stove	21.99 ea.
EHS-128	1968-81 Heat Riser Tube	21.99 ea.



AHR-1190

Heat Riser Valves

Correct valve for pre-heating engine on cold start.

AHR-1190	Valve SB 2"	69.99 ea.
AHR-1180	Valve BB 2.5"	89.99 ea.



N-660

Heat Riser Spacers

Takes the place of the heat riser for increased flow.

N-660	2" Spacer SB	54.99 ea.
N-733	2.5" Spacer BB	69.99 ea.



XG-225



XD-500



XE-153

Exhaust Gaskets & Donuts

XG-20	Riser Gasket 2" SB	2.99 ea.
XG-225	Riser Gasket 2.5" BB	2.99 ea.
XD-400	Donut 2" SB	4.99 ea.
XD-500	Donut 2.5" BB	4.99 ea.
XE-152	Extension 2" SB	12.99 ea.
XE-153	Extension 2.5" BB	15.99 ea.



XSF-67

OEM Style Exhaust Systems

These complete aluminized exhaust systems are a perfect replacement for standard dual exhaust. All components are aluminized inside and out for long lasting beauty. Pipes are slightly polished giving a stainless steel-like appearance. Systems are available for big block and small block engines with or without resonators.

XSF-67	1967-68 SB 2"	621.99 kit
XSF-67BB	1967-68 BB 2.5"	538.99 kit
XSF-69	1969 SB 2"	516.99 kit
XSF-69Z	1969 Z/28 2.25"	417.99 kit
XSF-69BB	1969 BB 2.5"	516.99 kit

Ships Oversize 2.



XCE-200K

Chambered Exhaust Systems

OE style reproduction of this radical factory installed high performance exhaust system. This is a high quality aluminized system and features all of the correct features with correct tailpipe exits.

	Aluminized	SS
XCE-80K	1967-68 SB..... 747.99 kit	999.99 kit
XCE-90K	1967-68 BB..... 747.99 kit	999.99 kit
XCE-100K	1969 SB..... 758.99 kit	1099.99 kit
XCE-200K	1969 BB..... 747.99 kit	1099.99 kit

Ships Oversize 2.



XHP-678K

Exhaust Hanger Kits

Complete with all necessary hardware to install your new OEM style dual exhaust system.

XHP-678K	1967-68 Dual.....	109.99 kit
XHP-69K	1969 Dual.....	124.99 kit
XCI-69K	1967-69 Chambered.....	142.99 kit



PVD13

Downturns

These universal downturns are perfect for off road applications when tail pipes are not desired.

PVD10	2.5" 409 Stainless.....	51.99 pr.
PVD13	3" Aluminized.....	83.99 pr.



DGU14S

Downpipes

If you are using stock manifolds, you will need a pair of these downpipes to connect to the system. 409 stainless steel.

DGU14S	1967-81 SB.....	178.99 pr.
DGU20S	1967-81 BB.....	162.99 pr.

PVR19S



Collector Reducers

These act as connectors from your header collectors to intermediate pipes for a clean look.

PVR10S	3" Header to 3" Pipe.....	88.99 pr.
PVR13S	3.5" Header to 3" Pipe.....	90.99 pr.
PVR16S	3" Header to 2.5" Pipe.....	88.99 pr.
PVR19S	3.5" Header to 2.5" Pipe.....	90.99 pr.



EVT59

EVT49

Pypes Exhaust Tips

Add the finishing touch to your exhaust system with a set of triple chrome plated tips from Pypes! All tips are slip fit.

EVT49	2.5" Angle Cut.....	42.99 pr.
EVT50	3" Angle Cut.....	49.99 pr.
EVT59	2.5" Hockey Stick Style.....	108.99 pr.
EVT61	3" Hockey Stick Style.....	114.99 pr.

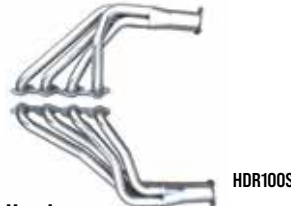

HDR100S

Pypes Big Block Headers

Pypes big block headers feature large 2" primary tubes and 3.5" collectors with power spikes. Constructed of 304 mandrel bent stainless steel and fully TIG welded they include stainless collector reducers, premium hardware and gaskets.

HDR100S	1968-69 BB.....	732.99 ea.
---------	-----------------	------------

No Volume Discount.

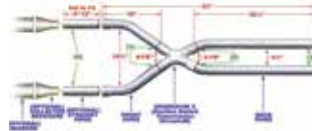

XVA10

Pypes Universal X-Pipes

If you are really looking to give your muscle car an easy 15-30 horsepower boost, toss your old balance tube and go with one of these new X-Crossovers from Pypes. This new siamese design is dyno proven to increase horsepower and torque.

	409	Polished
XVX10	1967-81 2.5"	328.99 ea.N/A
XVX13	1967-81 3"	334.99 ea.N/A
XVA14	1967-81 3.5"	352.99 ea.N/A

Driveshaft Tunnel X-Pipes

XVF10	1967-81 2.5"	220.99 kit ... 309.99 kit
XVF13	1967-81 3"	265.99 kit

Ships Oversize 2.



XVX10F

Pypes Driveshaft Tunnel X-Pipe Legs w/ Dumps

This is a pair of Pypes dump pipes for the XVF10 X-pipe kit. These pipes replace the front legs of the XVF10 and dump straight back.

XVX10F	1967-81 2.5" 409	146.99 kit
XVX13F	1967-81 3" 409	158.99 kit



SGF70

Pypes Crossflow Exhaust System

This crossflow system was designed for incredible clearance but with an ultra high flow crossflow muffler. Includes the ONLY horsepower generating X-pipe kit designed to specifically run in the drive shaft tunnel for extra ground clearance.

SGF70	1970-81 2.5" 409 Stainless.....	694.99 kit
SGF70S	1970-81 2.5" 304 Polished Stainless...	914.99 kit

Ships Oversize 2.



HVE10

Electronic Exhaust Cut Out Kit

This kit comes with 2-electric exhaust cutouts, wiring harness to control both cutouts w/ one switch, stainless steel mounting hardware and extra tight gaskets. This is the most weather resistant and water tight cut out kit on the market!

HVE10	3" All.....	429.99 ea.
-------	-------------	------------

Connects to any standard 3 inch collector including the following Pypes products: XVX10F and XVX13F.



SGF11R

Pypes Performance Exhaust Systems

Fabricated using the highest quality materials, the smooth, 16 gauge, mandrel-bent stainless steel pipe ensures maximum exhaust gas flow, which can significantly boost horsepower. The mufflers are precision matched to deliver the ultimate in sound and performance. Pypes systems come complete with a pair of precision matched Pypes mufflers, correct tailpipes, clamps and hangers. These systems can be installed at home without any special tools.

SGF60R	1967-69 w/ X-Pipe 2.5" w/ Race Pros.....	634.99 kit
SGF60S	1967-69 w/ X-Pipe 2.5" w/ Street Pros.....	634.99 kit
SGF63R	1967-69 w/ X-Pipe 3" w/ Race Pros.....	685.99 kit
SGF63S	1967-69 w/ X-Pipe 3" w/ Street Pros.....	685.99 kit
SGF11R	1970-81 w/ X-Pipe 2.5" w/ Race Pros	570.99 kit
SGF11S	1970-81 w/ X-Pipe 2.5" w/ Street Pros	571.99 kit
SGF13R	1970-81 w/ X-Pipe 3" w/ Race Pros.....	668.99 kit
SGF13S	1970-81 w/ X-Pipe 3" w/ Street Pros.....	659.99 kit
SGF31R	1970-81 w/o X-Pipe 2.5" w/ Race Pros	563.99 kit
SGF31S	1970-81 w/o X-Pipe 2.5" w/ Street Pros ...	563.99 kit

Ships Oversize 2.



COLD-18A



COLD-545AFK



COLD-547AFK

1967-81 Cold Case Radiators

These COLD-CASE radiators are TIG welded 100% aluminum. These radiators have dual oversize 1-1/4" cooling rows making them more efficient than four 1/2" rows seen on 4 row models. Cold Case aluminum radiators cool 20% better than OEM copper radiators and are more than 50% lighter. They are original in appearance with OEM style stamped tanks for strength and that OEM original look. Once painted, they look like originals to all but the concourse fanatic. Each radiator is pressure tested, direct fit and carries a Lifetime Warranty!

COLD-549M	1967-69 SB Manual.....	399.99 ea.
COLD-549A	1967-69 SB Auto.....	409.99 ea.
COLD-11M	1967-69 BB Manual.....	399.99 ea.
COLD-11MB	1967-69 BB Manual Black.....	441.69 ea..
COLD-11A	1967-69 BB Auto.....	409.99 ea.
COLD-18M	1970-81 SB Manual.....	409.99 ea.
COLD-19A	1970-81 SB Auto.....	399.99 ea.
COLD-19AB	1970-81 AB Auto Black.....	454.60 ea.
COLD-547A	1967-69 LS Swap All.....	409.99 ea.
COLD-557A	1970-81 LS Swap All.....	411.99 ea.

Kits With Electric Fans And Shroud

Cold Case made it easy with kits that include the radiator, fan and shroud. All kits come with transmission cooler fittings in the radiator, except LS.

COLD-11AFK	1967-69 BB All Single 16" Fan.....	605.99 kit
COLD-547AFK	1967-69 LS Swap All 16" Fan.....	616.99 kit
COLD-545AFK	1970-81 SB/BB All Dual 12" Fans.....	649.99 kit
COLD-557AFK	1970-81 LS Swap All 16" Fan.....	654.99 kit
COLD-RC100	Radiator Cap All.....	24.99 ea.
COLD-FAN12	12 Inch Cooling Fan 1400 CFM.....	67.99 ea.
COLD-FAN16	16 Inch Cooling Fan 2500 CFM.....	92.99 ea.
COLD-EF1	Fan Wiring Kit All.....	99.99 kit

All radiators are shipped Oversize. Not eligible for free shipping.

Frostbite Performance Cooling

High-Horsepower street cars and race cars can be a challenge to keep cool. A proper cooling system starts with Frostbite. When it comes to keeping your ride cool, Make it Frostbite!



Aluminum Radiators

Our line of Performance Aluminum Radiators are available in 2, 3 and 4-row sizes as well as specific LS-Swap applications.

- 100% TIG welded (brazed) seams
- Aircraft quality aluminum core, fittings and tanks (up to 30% weight savings)
- Billet Aluminum Filler Neck and OEM style Brass Petcock
- Custom Frostbite High Performance 16lb radiator cap
- Polished top and tanks for custom show appearance
- 2-Row Radiators supporting applications with 300-500 horsepower • Transmission cooler provisions

Direct Fit

FROST-FB144	67-69 V8 All 2 Row 20.75" Wide	.337.99 ea.
FROST-FB145	67-69 V8 All 3 Row 20.75" Wide	532.99 ea.
FROST-FB146	67-69 V8 All 4 Row 20.75" Wide	609.99 ea.
FROST-FB147	67-69 V8 All 2 Row 23" Wide	337.99 ea.
FROST-FB148	67-69 V8 All 3 Row 23" Wide	547.99 ea.
FROST-FB149	67-69 V8 All 4 Row 23" Wide	671.99 ea.
FROST-FB162	70-81 V8 All 2 Row 26" Wide	422.99 ea.
FROST-FB163	70-81 V8 All 3 Row 26" Wide	496.99 ea.
FROST-FB164	70-81 V8 All 4 Row 26" Wide	720.99 ea.
FROST-FB188	82-92 All 2 Row 17.25" Tall	425.99 ea.
FROST-FB189	82-92 All 3 Row 17.25" Tall	519.99 ea.
FROST-FB190	82-92 All 4 Row 17.25" Tall	706.99 ea.
FROST-FB185	98-99 All 2 Row 17.75" Tall	425.99 ea.
FROST-FB186	98-99 All 3 Row 17.75" Tall	532.99 ea.

LS Swap

Hose fittings sold separately.

FROST-FB300	67-69 LS All 2 Row 20.75" Wide..	794.99 ea.
FROST-FB301	67-69 LS All 3 Row 23" Wide	794.99 ea.
FROST-FB302	70-81 LS All 3 Row 26.25" Wide..	742.99 ea.
FROST-FB303	82-92 LS All 3 Row 26.25" Wide	852.99 ea.

Electric Fan & Shroud Kits

Fans & Shroud Kits E= Economy H= High Performance

FROST-FB513E	Dual 10" Fits FB	
	144, 145, 146 Radiators.....	532.99 kit
FROST-FB513H	Dual 10" Fits FB	
	147, 148, 149 Radiators.....	634.99 kit
FROST-FB523E	Dual 12" Fits FB	
	188, 189, 190 Radiators.....	417.99 kit
FROST-FB523H	Dual 12" Fits FB	
	FB188, 189, 190 Radiators.....	646.99 kit

Shroud Only Dual Opening

FROST-FB513	Dual 10" Fits FB	
	147, 148, 149, 301 Radiators.....	532.99 ea.
FROST-FB502	Dual 10" Fits FB	
	162, 163, 164, 302 Radiators.....	307.99 ea.
FROST-FB523	Dual 12" Fits FB	
	188, 189, 190, 303 Radiators.....	251.99 ea.

Note: Width and height measurements are for the core not overall. No Volume Discount.

Fan Relay & Wiring Kit

This relay kit will allow you to custom configure your fans as pusher or puller resulting in increased cooling performance and a reduction in noise/vibration in your engine bay. Does 1 or 2 fans.

FROST-FB403	All With Electric Fans.....	140.99 kit
-------------	-----------------------------	------------

No Volume Discount.

Hose Fittings

FROST-FB400	LS Swap 1.25".....	75.99 ea.
FROST-FB401	LS Swap 1.5".....	75.99 ea.
FROST-FB402	LS Swap 1.75".....	81.99 ea.

No Volume Discount.



FROST-FB188



FROST-FB-400



FROST-FB513E



FROST-FB-401



FROST-FB523H



FROST-FB-402



CCS-EC370



CCS-CCFK10



CCS-CCFKRL

Aluminum Radiators by Champion Cooling Systems

These aluminum radiators are made to the highest of standards paired with unequalled quality precision and workmanship. All Champion aluminum radiators are constructed using 100% welded seams brazed core technology and absolutely no epoxy. All Champion radiators come with a lifetime limited warranty and are made to install with little or no modifications using your original mounts, giving you the confidence you deserve. Choose from the following series:

Economy Core Series - 2 Rows of 3/4" Tubes = Approx. 400-600+ HP Cooling Capacity.
Champion Core Series - 3 Rows of 5/8" Tubes = Approx. 600-800+ HP Cooling Capacity.
Monster Core Series - 4 Rows of 5/8" Tubes = Approx. 800-1200+ HP Cooling Capacity.
 SB = Small Block, BB = Big Block

CCS-EC337	1967-69 Economy Core Series SB 19-1/4" x 28-3/4"	239.99 ea.
CCS-EC370	1967-69 Economy Core Series BB 19-1/4" x 30-1/4"	229.99 ea.
CCS-CC337	1967-69 Champion Core Series SB 19-1/4" x 28-3/4"	299.99 ea.
CCS-CC370	1967-69 Champion Core Series BB 19-1/4" x 30-1/4"	281.99 ea.
CCS-MC337	1967-69 Monster Core Series SB 19-1/4" x 28-3/4"	377.99 ea.
CCS-CC337B-M	1967-69 Champion 3 Core Series SB 19-1/4" x 28-3/4"	292.99 ea.
CCS-MC370	1967-69 Monster Core Series BB 19-1/4" x 30-1/4"	377.99 ea.
CCS-EC162	1970-81 Economy Core Series 18-1/4" x 31-5/8"	229.99 ea.
CCS-CC162	1970-81 Champion Core Series 18-1/4" x 31-5/8"	319.99 ea.
CCS-MC162	1970-81 Monster Core Series 18-1/4" x 31-5/8"	377.99 ea.
CCS-CC412	1970-81 Champion 3 Core Series 18 3/4" x 29"	324.99 ea.
CCS-EC951	1982-92 Economy Core Series 20 x 32"	259.99 ea.
CCS-CC951	1982-92 Champion Core Series 20 x 32"	292.99 ea.
CCS-CC951-M	1982-92 Champion 3 Core Series SB 20" x 30"	292.99 ea.
CCS-MC951	1982-92 Monster Core Series 20 x 32"	377.99 ea.

Electric Cooling Fans

Features a reversible swept blade design meaning it can be configured as a puller or pusher. The blades are computer balanced.

CCS-CCFK10	10", 7.5 Amp Draw, 650 CFM	80.99 ea.
CCS-CCFK12	12", 10 Amp Draw, 870 CFM	89.99 ea.
CCS-CCFK14	14", 12 Amp Draw, 1200 CFM	94.99 ea.
CCS-CCFK16	16", 14 Amp Draw, 1600 CFM	105.99 ea.
CCS-CCFKRL	Fan Relay	96.99 ea.

Aluminum Fan Shrouds

Designed to fit Champion aluminum radiators and hold electric fans.

CCS-FS162	Fits 162 Radiators Holds (2) 14" Fans	174.99 ea.
CCS-FS337	Fits 337 Radiators Holds (2) 10" Fans	169.99 ea.
CCS-FS370	Fits 370 Radiators Holds (2) 10" Fans	167.99 ea.
CCS-FS951	Fits 951 Radiators Holds (2) 12" Fans	167.99 ea.



AXX-214A

Factory Replacement Radiators

These direct factory replacement Super Cooler radiators come complete with new high density cores, correct screw-in fittings for automatics, correct mounting brackets where applicable and are ready to install.

AXX-214A	1967-69 SB 3 Row 21" Automatic	627.99 ea.
AXX-214M	1967-69 SB 3 Row 21" Manual	599.99 ea.
AXX-334A	1967-69 BB 4 Row 23" Automatic	685.99 ea.
AXX-334M	1967-69 BB 4 Row 23" Manual	657.99 ea.
AXX-23CA	1967-69 BB 4 Row SHP Bent Neck Automatic	685.99 ea.
AXX-23CM	1967-69 BB 4 Row SHP Bent Neck Manual	657.99 ea.
AXX-263A	1970-73 All 4 Row 26" Automatic	665.99 ea.
AXX-263M	1970-73 All 4 Row 26" Manual	632.99 ea.
VHT-SP139	Radiator Paint	12.99 ea.

All radiators are shipped Oversize. No Volume Discount.



AXX-679A



AXX-679A-KIT



AXX-70R

1967-81 Aluminum Radiator

This Camaro aluminum radiator features an oversized two core design that will keep your high performance engine running cool. The shiny finish of the aluminum will look great on any show car!

AXX-679A	1967-69 23L x 19H x 2.75W	352.99 ea.
AXX-679A-KIT	1967-69 23L x 19H x 2.75W w/ Fan Shroud & Relay	463.99 kit
AXX-70R	1970-81 26"	300.99 ea.

Note: May require modifications to fan shroud. Aftermarket electric fans recommended because of tight clearance issues with stock fan depending on engine application. All radiators are shipped Oversize. No Volume Discount.



PAC-2800BT

Dakota Digital Fan Controller

The PAC-2800BT was designed for the ultimate in flexibility and to be a simple add-on in any application using an electric fan. Included is a 70amp relay, enough for even the most power hungry of cooling fans. Fully programmable, the PAC-2800BT will work with your existing water temp gauge, operating from the temperature sending unit already installed.

PAC-2800BT	All	190.99 kit
------------	-----------	------------

Not eligible for volume discounting.



ACR-001

Universal Coolant Recovery Tank

This compact tank can be mounted anywhere and is used to recover coolant overflow. 6" wide x 4" deep x 5" tall.

ACR-001 Universal..... 16.99 ea.



AOF-172

Stainless Overflow Tank

This polished stainless steel universal fluid reservoir is perfect for older muscle cars that did not come from the factory with a coolant recovery tank.

AOF-103	10" x 3"	52.99 ea.
AOF-132	13" x 2"	52.99 ea.
AOF-152	15" x 2"	52.99 ea.
AOF-172	17" x 2"	52.99 ea.

Note: 1/4 in. Hose Barb Inlet/Outlet



AJC-194



AOJ-153

Radiator Overflow Jars

Overflow jar is manufactured from high grade plastic and features the correct ADD/FULL lines for 1973-77 models and HOT/COLD lines for 1978-79 models as original.

AOJ-153	1973-77 Jar	35.99 ea.
AOJ-563	1978-79 Jar	49.99 ea.
AJC-194	1974-75 Cap	6.99 ea.
AJC-978	1978-81 Cap	9.99 ea.
AOF-78CAP	1978-92 Cap Non-Vented	7.99 ea.
AOF-78VCAP	1978-92 Cap Vented	9.99 ea.
AOJ-175	1989-92 Jar	69.99 ea.



AAC-6072 Detail



AAC-6072

Radiator Caps

Your choice of exact reproduction GM RC15 cap with correct large ears and correct wording or replacement.

AAC-6072	Reproduction	34.99 ea.
AAC-6415	Replacement	21.99 ea.



ATE-4100



ATE-6041

Radiator Mounting Pads

Correct upper and lower rubber pads for mounting your radiator into the support. Lower pads feature steel cores.

ATE-6041	1970-81 HD 4 Core Upper	9.99 pr.
ATE-4100	1970-81 HD 4 Core Lower	9.95 pr.
ATE-6SB	1970-81 SB 3 Core All	9.99 ea.
COLD-GME1C	1970-81 OE Style 4 Core Upper/Lower	27.99 pr.
COLD-IGM03	1970-81 Cold Case 4 Core Upper/Lower	25.99 pr.



AP-70-AC

Radiator Top Panels

Correct reproduction top panels that hold your radiator in place.

AP-70	1970-81 w/o AC 23-3/4" x 5-1/4" 3 Bolt	22.99 ea.
AP-70-AC	1970-81 w/ AC 28-1/2 x 5-5/8" 3 Bolt	39.99 ea.
GCS-S9427	1968-73 Chrome 3 Bolt w/o AC 23-3/4" x 5-1/4"	22.99 ea.
GCS-S9425	1970-81 3 Bolt 23-7/8" Long Chrome	23.99 ea.
GCS-S9426	1970-81 3 Bolt HD Cooling 28-11/16" Long Chrome	24.99 ea.



AB-31X

Radiator Attaching Hardware

Correct OEM hardware for attaching the radiator to the support.

AB-31X	1967-81 All	6.99 kit
--------	-------------	----------



AEF-14

Electric Cooling Fans

This electric cooling fan is perfect for cars where an electric water pump is being used or as supplemental cooling.

AEF-12	12" Universal	53.99 ea.
AEF-14	14" Universal	57.99 ea.
AEF-16	16" Universal	69.99 ea.



FANKIT-7BL



ABR-3996

Fan Blades

Reproduction fan blades to be used with fan clutches only.

APR-705	1967-68 5 Blade 17.5"	109.99 ea.
ABR-7BLD	1967-68 7 Blade 17.5" Curved Tips	109.99 ea.
ABR-3996	1969-72 7 Blade 17.5"	89.99 ea.



AWT-7719



ABR-2710



BKP-516

Fan Clutches

Heavy duty fan clutch with gold cadmium coloring, in limited supply!

AWT-7719	1967-68 Short Pump Replacement	74.99 ea.
ABR-2710	1969-81 Long Pump	74.99 ea.
BKP-516	Correct Attaching Nuts 4pc	1.50 kit



BPX-2792

Fan Attaching Kits

Correct style bolts/studs for attaching fan to water pump.

BPX-2792	Attaching Stud Kit 12pc	6.99 kit
BPX-2791	Attaching Bolt Kit 8pc	5.95 kit

BUY & SAVE
WITH SS396.COM PRE-BUILT KITS

Fan Clutch Kits

Complete kit to convert your car to this heavy duty GM fan clutch option. This kit includes fan, fan clutch and all necessary hardware.

FANKIT-5BR	1967-68 5 Blade SWP	172.77 kit
FANKIT-7BS	1967-68 7 Blade Curved SWP	172.77 kit
FANKIT-7BL	1969-73 7 Blade LWP	154.77 kit

OEM Fan Shrouds

These are OE style fan shrouds unless otherwise stated. These fan shrouds will mount correctly to all original OE radiators and are a must for final engine compartment detailing.

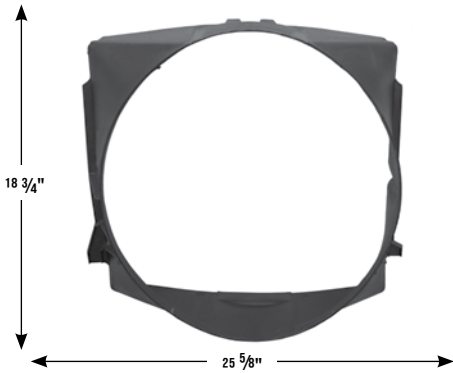

ABC-3812 1967-68 SB w/o AC for 21" Radiator, GM..... 269.99 ea.

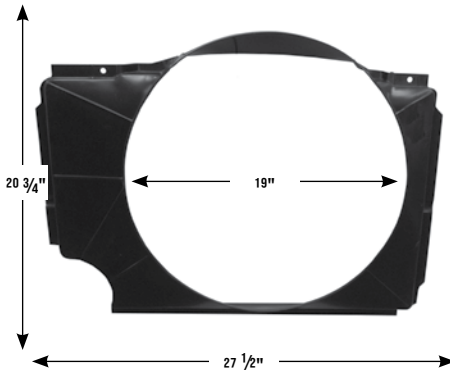

ADR-170 1970-72 All BB..... 92.99 ea.
This is a high quality, concourse quality reproduction which meets or exceeds OEM. Can be used on 1973-81 with modifications.

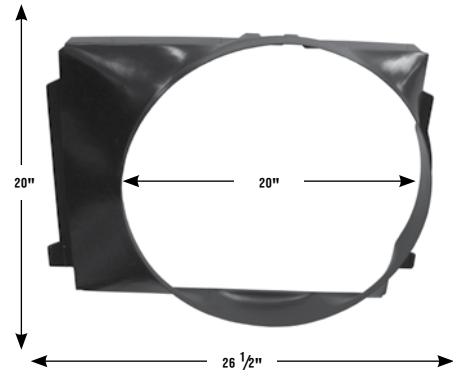

ACL-9956 1967-68 BB, 99.99 ea.
Note: This is a high quality, concourse quality reproduction which meets or exceeds OEM.

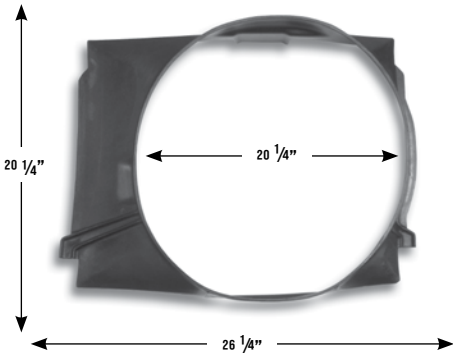

3947619 1969 BB 99.99 ea.
Note: This is a high quality, concourse quality reproduction which meets or exceeds OEM.



Fan Shroud Clip Kit

Correct lower shroud attaching clip set for all 1967-69 Camaros with factory Harrison radiators. (The large clip attaches to the lower right side of the tank.)

AHB-679K 1967-69 All 25.99 kit

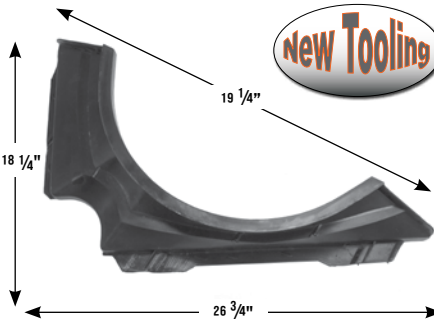
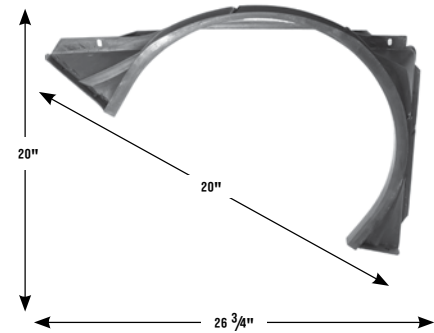

ABC-3910K 1970-81 Small Block HD Cooling 149.99 ea.



Fan Shroud Attaching Bracket

Correct bracket kits for mounting shroud.

AKW-1112 1967-69 SB 13.99 kit
AKW-1112 1967-68 BB 13.99 kit
AKW-0142 1969 BB 9.99 kit

Reproduction Fan Shrouds

These reproduction fan shrouds are good for the daily driver or those restoring on a budget. These fan shrouds are of a lesser quality than our GM fan shrouds and may require some modification to fit properly, but they are a much more economical alternative.

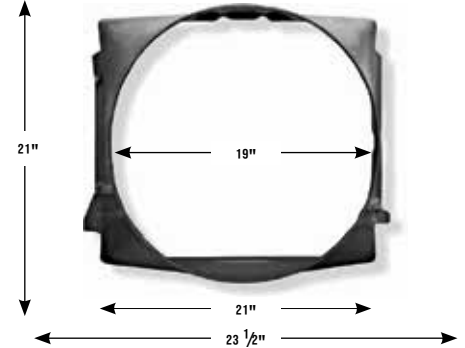

3893812 1967-68 SB w/o AC 109.99 ea.

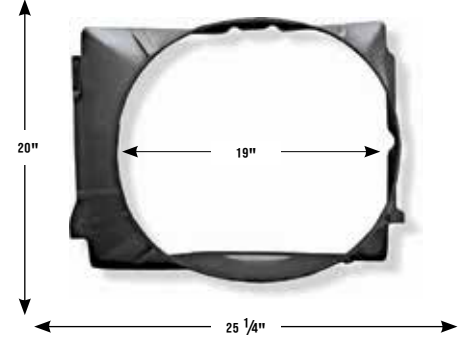

3893814 1967-68 SB w/ AC 129.99 ea.

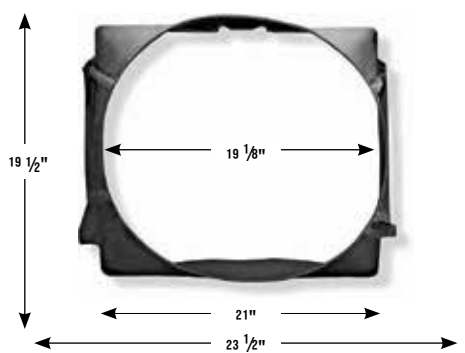

3938615 1969 SB w/o AC 129.99 ea.

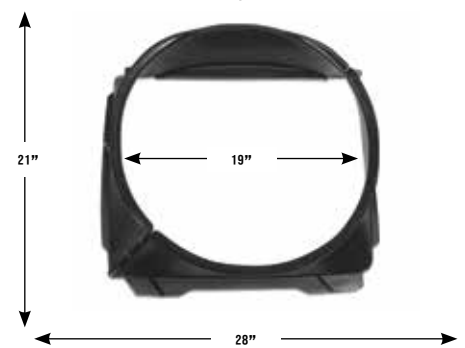

R183 1970-79 SB Assembled 139.99 ea.



CPX-6368

CPX-4796

Tower Clamp Kits

Original Witek Tower style clamps. These factory installed clamps were used on most GM cars. 1967-68 used tower clamps on the radiator hoses and spring clamps on the heater hoses. Cars built 1969 or later used all tower clamps.

- CPX-6368 1967-68 8pc29.99 kit
- CPX-4796 1969-81 8pc.....39.99 kit



CPN-0638

Radiator Overflow Hose OEM

Correct thin walled ribbed hose as original.

- CPN-0638 1967-81.....2.95 per ft.



CPX-8739

Radiator Overflow Hose Clip

Correct clip for retaining overflow hose.

- CPX-8739 All.....13.99 ea.



AXP-1106

Radiator Petcock

Correct gold colored fluted end drain valve for radiator.

- AXP-1106 All.....6.99 ea.



ATE-2059



ATE-5416

Heater Hose Retainers

Correct heater hose retainers for inside of passenger fender and top of alternator bracket.

- ATE-2059 RH Fender.....7.99 ea.
- ATE-5416 ALT Bracket.....7.99 ea.



Upper Radiator Hoses

OE style reproduction upper radiator hoses.



CPH-2626

- CPH-2626 1967 SB21.99 ea.
- CPH-2650 1967-68 Z/2821.99 ea.
- CPH-2684 1968 SB21.99 ea.



CPH-1650

- CPH-1650 1969 SB, Z/28.....21.99 ea.
- CPH-3192 1970-81*21.99 ea.
- CPH-5531 1970-78 SB21.99 ea.

**Use with aftermarket radiator.*



CPN-9866

- CPN-9866 1967-69 BB21.99 ea.



CPH-6039

- CPH-6039 1969 COPO21.99 ea.

For bent neck radiator



CPH-5834

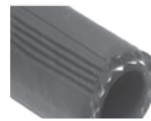

CPR-5834

Heater Hoses

Restoration heater hose sets.

1967-68 hoses feature correct GM with box logo and 1969-81 features correct black ribbed design.

- CPH-5834 1967-6823.99 kit
- CPR-5834 1969-8123.99 kit

Lower Radiator Hoses

OE style reproduction lower radiator hoses.



CPH-2628

- CPH-2628 1967-68 SB21.99 ea.



CPH-2561

- CPH-2561 1969 SB21.99 ea.
- CPH-0122 1970-78 SB21.99 ea.



CPH-9698

- CPH-9698 1967-68 BB21.99 ea.



CPH-6044

- CPH-6044 1969 BB21.99 ea.
- CPH-3193 1970 BB21.99 ea.
- CPH-9486 1971-72 BB*21.99 ea.

**Fits all 1971-81 big block.*



ACV-1901

Heater Control Valve

New GM heater control valve for all Chevys with air conditioning. Correct gold plating.

- ACV-1901 1969-70 w/ AC48.99 ea.
- AV-560 Screws 2pc0.95 ea.



Heater Cores & Box Seal Kits

AHC-KIT3

This kit includes an OEM heater core and neoprene seals. Components also available separately.

Kits	
AHC-KIT1	1967-68 SB w/o AC119.68 kit
AHC-KIT2	1969-81 SB w/o AC119.68 kit
AHC-KIT3	1967-69 BB w/o AC 173.68 kit
Cores	
AHC-9086	1967-68 SB w/o AC104.99 ea.
AHC-9054	1967-68 All w/ AC134.99 ea.
AHC-678BB	1967-68 BB w/o AC139.99 ea.
AHC-9065	1969-81 SB w/o AC104.99 ea.
AHC-9056	1969 All w/ AC 89.99 ea.
AHC-8008	1969 BB w/o AC164.99 ea.
AHC-781ACF	1970-81 All w/AC 79.99 ea.
Seals	
JHC-3064	1967-81 All V8 w/o AC 27.99 kit



AHC-458

Heater Core Retaining Clips

Reproduction heater core clips manufactured from spring steel as original.

AHC-458	1967-69 BB 37.99 pr.
AHC-13641	1967-69 SB29.99 kit



AL-304

Heater Box Cover

Brand new firewall heater box cover for all cars without air conditioning.

AL-304	1967-81 SB w/o AC54.99 ea.
AL-303	1967-69 BB w/o AC54.99 ea.
AL-304-CHROME	1967-81 SB w/o AC Chrome89.99 ea.
AL-303-CHROME	1967-81 BB w/o AC Chrome89.99 ea.
AHC-CLAMP	1967-81 All That Use a Clamp 21.99 pr.
ALS-27	Retaining Nut0.89 ea.
ALS-27K	Retaining Nut 5pc3.99 kit
AL-HRDW-K	Retaining Nut Sealing Washers & Screws 11pc 12.99 kit
JCS-10459	Sealant 10.99 ea.
AL-305	1967-69 BB non-AC Tube Cover Plate ..21.99 ea.
AL-963	Tube Cover Plate Seal Kit 2pc 10.99 kit



Heater Boxes

AHC-691

New complete inner heater box assemblies for under the dash.

AHC-671	1967 Non AC319.99 ea.
AHC-691	1968-69 Non AC 299.99 ea.

No Volume Discount.



ABM-1041W

Heater Blower Motor

New OEM replacement heater blower motor for cars with or without AC.

ABM-870	1967-77 Motor Only 44.99 ea.
ABM-1041W	1967-77 w/ Cage 76.48 ea.
ABM-CAGE	1967-81 Cage Only 39.99 ea.
GWC-SPK	Wire Clips 6.99 pr.



ABR-71

ABR-69AC

ABR-77

Heater Blower Motor Resistors

Correct blower motor resistors.

ABR-71	1967-68 w/ AC 34.99 ea.
ABR-69AC	1969 w/ AC 29.99 ea.
ABR-77	1967-72 w/o AC 26.99 ea.
ABR-7381	1973-81 w/ AC 29.99 ea.
ARS-304	Mounting Screws0.95 pr.



AHD-808

Heater Delete Plate

New factory style firewall heater delete plate set. This set comes with block off plates for firewall heater and blower motor assembly.

AHD-808	1967-69 w/o Orig AC 89.99 ea.
AHD-899	1967-69 w/ Orig AC99.99 set
ABO-417	1967-69 BB Non AC Hose Block Off 24.99 ea.



AHB-330



AHB-329

AC Inner Evaporator Case Covers

Commonly broken inner half of air conditioning case core box. This is a fiberglass reproduction of the inner portion of the air conditioning condenser cover. This item is usually found broken or cracked due to replacement of an engine or the addition of headers. Commonly known as the air conditioning suitcase assembly.

AHB-330	1967-69 Small Block134.99 ea.
AHB-329	1967-69 Big Block134.99 ea.

No volume discount.



AXB-7A

AC Delete Cover

This covers the large hole where your AC used to be and allows you to use your factory heater core when removing your AC.

AXB-7A	1967-69 All 159.99 ea.
AXB-7B	1970-81 All* 159.99 ea.
JCS-10459	Sealant 10.99 ea.

*You must use a non-AC blower motor with this cover. We recommend part ABM-CAGE.



AHG-737

APG-184

AEC-73D

AC Evaporator Seals & Drain

Correct grommets to seal the evap case from the engine compartment. Reproduction drain hose to engine compartment.

AHG-737	1967-68 Heater Hose Grommet 31.99 ea.
APG-184	1967-69 Pipe Grommet17.99 ea.
APG-723	1970-81 Pipe Grommet 34.99 ea.
AEC-73D	1967-81 Drain Grommet 13.99 ea.



AXB-15241

AXB-67-AC DELETE

AC Delete Panels

These are bolt-in panels to block off the AC openings on the firewall.

AXB-67-AC-DELETE	1967-69 69.99 ea.
AXB-15241	1967-81 Steel 55.99 pr.



DSE010901

Detroit Speed Firewall Fill Plate

An excellent way to smooth your firewall! Smooths the passenger side firewall while retaining the stock cowl to firewall seam. Weld-in panel made of 18 gauge steel with a rolled edge. Made in USA.

DSE010901	1967-69129.99 ea.
DSE010904	1970-81129.99 ea.

No Volume Discount.



DSE010902

Detroit Speed Heater Delete Plate

This bolt-in plate is an easy way to smooth your firewall for that heater delete look. 18 gauge steel. Made in USA.

DSE010902	1967-69 79.99 ea.
-----------	-------------------------



DSE010903

Detroit Speed AC Delete Plate

This bolt-in plate is an easy way to smooth your firewall. 18 gauge steel. Made in USA.

DSE010903 1970-81 129.99 ea.

AC Box Under Hood Hardware

All the hardware related to the AC under the hood on the firewall forwards.

67FA-F	1967 37.99 kit
68FA-F	1968 48.99 kit
69FA-F	1969 58.99 kit
70FA-F	1970 53.99 kit
71FA-F	1971 48.99 kit
72FA-F	1972 46.99 kit
73FA-F	1973 50.99 kit

AC Box Under Dash Hardware

All the hardware related to the AC under the dash.

67FA-R	1967 34.99 kit
68FA-R	1968 35.99 kit
70FA-R	1970 21.99 kit
71FA-R	1971 22.99 kit
72FA-R	1972-73 20.99 kit



ATE-3907

Open Element Air Cleaner

Excellent reproduction of the original GM open element air cleaner assembly. Complete base with elbow assembly, chrome plated lid and AC Delco filter. Will fit most V8's with 4 bbl. carburetor.

ATE-3907	Complete Kit 119.99 kit
ATE-3907-GM	1967-69 OE Style Complete Kit	169.99 kit
ACQ-1224	Chrome Lid Only 49.99 ea.
ACQ-1220N	Chrome Lid Only w/ Service Instructions 59.95 ea.
ACQ-212CW	Chrome Lid Only w/ Service Instructions 99.99 ea.
AAC-8864	Base Only w/ Elbow Assembly	.. 79.99 ea.



ATW-3361

1967 Closed Air Cleaner System

New complete closed air cleaner assemblies for your 1967 Camaro complete with base, lid and filter!

ATW-3361	1967 SB Black Lid 199.99 kit
AM-3360	1967 396/325 or 350 HP* 219.99 kit
AM-3368	1967 Chrome Lid Only 79.99 ea.

*Can be used on SS350 models. No Volume Discount.

BUY & SAVE

WITH SS396.COM PRE-BUILT KITS



ACX-687

Complete Cowl Induction Kit

This kit comes complete with every necessary item to install a functional cowl induction system on your 1967-69 Camaro with cowl induction hood. You get an air cleaner base, black lid, filter, steel flange, rubber seal, steel extension (where applicable), wiring harness, hood grommet, throttle arm, relay, electric solenoid, valve frame, flipper door, clips and hardware.

ACX-687	1967-69 Z/28 493.02 kit
ACX-687-C	1967-69 Z28 Chrome Lid 501.02 kit
ACX-688	1967-69 SB or 350 481.33 kit
ACX-688-C	1967-69 SB Or 350 Chrome Lid	489.33 kit
ACX-689	1967-69 BB 457.03 kit
ACX-689-C	1967-69 BB Chrome Lid 465.03 kit

No Volume Discount.



ACX-79



ACX-79S



ACX-79B

Cowl Induction Air Cleaner Kit

OE style reproduction of original GM including base, black lid, filter, flange, extension seal ring (where applicable) and rubber seal.

ACX-79	1967-69 Z/28 / 302 256.46 kit
ACX-79-CH	1967-69 Z28 Chrome Lid 264.46 kit
ACX-79S	1967-69 350 / SB 251.96 kit
ACX-79B	1967-69 BB 220.47 kit
ACX-79C	1967-69 BB Chrome Lid 228.47 kit

No Volume Discount.



GCS-10095

Black Steel Air Cleaner Assembly

This black air cleaner assembly is constructed of steel and is a great inexpensive custom touch to any street machine or sleeper. Includes lid, filter, base and wing nut.

GCS-10095	Holley 39.99 kit
GCS-10099	Edelbrock 42.99 kit



ACQ-1260

Cowl Induction Air Cleaner

OE style reproduction of original GM including base, lid & filter.

ACQ-1260	Complete Kit w/ Black Lid 179.99 kit
ACQ-1260Z	Complete Kit w/ Chrome Lid	... 169.99 kit
ACX-W668	1967-69 Z28 w/ Flange 199.99 kit
ACX-W669	1967-69 350 w/ Flange 199.99 kit
ACX-W669	1967-69 396 w/ Flange 199.99 kit
ACQ-60	Black Lid Only 36.99 ea.
ACQ-1224	Chrome Lid Only 49.99 ea.

No Volume Discount. Will not work with HEI.



ACQ-1460

Dual Snorkel Air Cleaner Kit

OE style reproduction of the original 1970-74 Z/28 dual snorkel air cleaner assembly, complete with base, filter and lid.

ACQ-1460	1970-74 Complete Kit 269.99 ea.
ACQ-1461	1970-74 Chrome 17" Lid Only 59.95 ea.
ACQ-1462	1970-74 Black 17" Lid Only 58.99 ea.

No Volume Discount.



GCS-S6915

Ball Milled Air Cleaners

Highly polished ball milled flames aluminum 14" air cleaner. Includes washable 3" filter.

GCS-S6915	Flat Base w/ Flames 108.99 kit
GCS-S6905X	Drop Base w/ Flames 115.99 kit

Note: 5-1/8" carb opening. Doesn't include stud, wing nut or gasket.



GCS-S6723



GCS-S6320

Finned Aluminum Air Cleaner

Highly polished finned aluminum 14" air cleaner. Includes washable 2" filter.

Round

GCS-S6723 Flat Base 111.99 kit
GCS-S6725 Drop Base 111.99 kit

Oval

GCS-S6320 Flat Base 77.99 kit

Note: 5-1/8" carb opening. Includes mounting stud. Does not include wing nut or gasket.



GCS-S3196X

Stainless Steel Air Cleaner

Highly polished stainless steel 14" air cleaner. Includes washable 3" filter.

GCS-S8005X Drop Base 70.99 kit

Note: 5-1/8" carb opening. Includes mounting stud and chrome wing nut. Does not include gasket.



A212-CW



ACW-212

Air Filter Exact Reproduction

OE style reproduction of the original style with "square mesh" design and original GM wording (silk screened) or AC Delco replacement style air filters.

A212-CW 1970-74 Air Filter Square Mesh 29.99 ea.
ACW-212 All 14" AC Delco 11.99 ea.



FLOW-615101

Flowmaster Delta Force Cold Air Intakes

Unique Slip-Seal housing-filter-tube interface for a seamless installation. 4-layer dry air filter eliminates use of filter oils. Factory mounting locations for simple installation and designed to match the engine compartment for a stealthy appearance. Extensively dyno-tested for maximum performance.

FLOW-615101 2010-15 6.2L Black 409.99 ea.
FLOW-615104 2012-15 3.6L Black 399.99 ea.
FLOW-615102 2016-18 6.2L Black 377.99 ea.
FLOW-615103 2016-18 3.6L Black 409.99 ea.
FLOW-615143 2016-17 2.0L Black 439.99 ea.
FLOW-615025 2016-18 6.2 Air Filter Only 79.99 ea.

*Air filter insert for factory airbox only. No Volume Discount.



ACQ-396



ACQ-396-BLK



ACQ-454-425

Custom "Turbo Jet" Air Cleaner Lids

Our 14" air cleaner lids featuring high quality die cast "Turbo Jet" medallions. These lids can be used with any open element 14 inch air cleaner, or cowl induction air cleaner. Available in chrome or black.

ACQ-396 396 Chrome Lid 132.98 ea.
ACQ-396-BLK 396 Black Lid 119.98 kit
ACQ-454 454 Chrome Lid 132.98 ea.
ACQ-454-BLK 454 Black Lid 119.98 kit
ACQ-396-375 396, 375 HP Chrome Lid 208.97 ea.
ACQ-396-375-BLK 396, 375 HP Black Lid 179.99 kit
ACQ-454-425 454, 425 HP Chrome Lid 208.97 ea.
ACQ-454-425-BLK 454, 425 HP Black Lid 195.97 kit
ACQ-454-450 454, 450 HP Chrome Lid 215.97 ea.
ACQ-454-450-BLK 454, 450 HP Black Lid 202.97 kit

Can be used with open element air cleaners or cowl induction.



APJ-2153



APX-1400



ATE-5695

Wing Nuts, Flame Arrester & Studs

APX-1400 Chrome Wing Nut 5.99 ea.
APX-7700 Black Wing Nut 5.99 ea.
ATE-5695 Flame Arrester 9.99 ea.

Carburetor Studs

APJ-2153 All w/ Holley Open Element, 1.5" 12.95 ea.
APJ-2153K Stud & Chrome Wing Nut
All w/ Holley Open Element 13.99 kit
APJ-4153 All w/ Cowl Induction 12.95 ea.
AP-315 All w/ Q-Jet, 3/3/8" 13.99 ea.
AP-315K Stud & Chrome Wing Nut
All w/ Q-Jet 14.99 kit
ATE-5256 Universal w/ Point End, 4 1/4" 8.99 ea.



HOJ-396-DC

Diecast Air Cleaner Decals

HOJ-[engine]-DC Diecast 82.99 ea.
Ex. HOJ-396-DC for the decal above.



HOJ-375-DC

Diecast Turbo Jet Decals

HOJ-[Horsepower]-DC Diecast 75.99 ea.
Ex. HOJ-375-DC for the decal above



MS142-08CA

Eddie Motorsports Billet Throttle Cable Brackets

These Eddie Motorsports billet GM throttle cable brackets mount to the base of Holley carburetors. The kit includes the cable mount bracket, return springs and bracket and installation hardware.

With 4150/4160 Series Carburetor

MS142-08B 1967-87 Blue 111.99 kit
MS142-08R 1967-87 Red 111.99 kit
MS142-08BA 1967-87 Black Anodized 111.99 kit
MS142-08CA 1967-87 Clear Anodized 111.99 kit

With 4500 Series Carburetor

MS142-09B 1967-87 Blue 146.99 kit
MS142-09R 1967-87 Red 146.99 kit
MS142-09BA 1967-87 Black Anodized 146.99 kit
MS142-09CA 1967-87 Clear Anodized 146.99 kit

No Volume Discount.



ACL-1267

Air Cleaner Rubber Seal

OE style reproduction rubber seal.

ACL-1267 1967-69 29.99 ea.



AQW-293

Extension Seal Ring

OE style reproduction of the correct extension seal ring used for flange and seal.

AQW-293 1967-69 302 39.99 ea.

ACX-673 1967-69 SB except 302 34.99 ea.



ACL-1295

Air Cleaner Flange

Correct steel flange for sealing the top of the air cleaner.

ACL-1295 1967-69 34.99 ea.



AP-4B

Air Cleaner Gasket

Correct paper gasket for sealing air cleaner base to carburetor.

AP-2B All 2 bbl 3.95 ea.

AP-4B All 4 bbl 4.95 ea.



CRC-7074

Cruise Control Servo Actuator Cable

This cable goes from the vacuum servo on the inner fender to the carburetor.

CRC-7074 1970-74 All w/ Cruise 99.99 ea.

No volume discount.



ADR-476

Accelerator Arm & Rod

Correct throttle arm and rod for attaching it to the accelerator pedal for all 1967-69 Camaros.

A-9801 Thru-Rod 33.99 ea.

ADR-096B 1967 Big Block 29.99 ea.

ADR-476 Arm w/o Cowl Induction 24.99 ea.

ACI-3335 Arm w/ Cowl Induction 21.99 ea.



CE CE CE CE CE CE

ATH-3369

AXJ-CE

AZC-88



ATH-99-BOLT

Accelerator Cables

New GM service replacement cables with casings and bushings as original.

ATH-XR 1967-69 Cross Ram 241.99 ea.

ATH-3369 1970-81 All w/ Holley* 54.99 ea.

AZC-88 Cable Clip 6.99 ea.

ATH-STUD Ball Stud & Nut 2pc 6.99 kit

AXJ-CE Cable Decal 4.95 ea.

ATH-99-BOLT 1967-69 0.25 ea.

20-2 1967-88 Ball Stud Assortment... 24.99 set

*For use with ADT-0014 or 3972619 bracket. No Volume Discount.



APJ-1302

1967-69 Accelerator Rod Kits

For those using rods, our kits come complete with pre-bent rod, swivel, grommet, sleeve and hardware.

NA-103 All 4 bbl Q-Jet 36.99 kit

APJ-1302 All Z/28 Holley 42.99 kit

APJ-1369 All BB Holley 42.99 kit



3992376

Accelerator Brackets

Your choice of brackets with GM numbers or without GM numbers. Both fit as original.

3992376 w/ Q-Jet GM #'s 36.99 ea.

3972619 w/ Holley GM #'s 32.99 ea.

AXK-68 w/ Q-Jet No #'s 29.99 ea.

ADT-0014 w/ Holley No #'s 19.99 ea.



ATH-3369KIT-H

Accelerator Cable & Bracket Kit - All BB/SB with SHP Holley

This accelerator cable and bracket kit is the perfect solution for smooth operation when your originals are either worn or missing. This kit includes a reproduction accelerator cable, bracket and retaining clip.

ATH-3369KIT-H 1968-81 All 73.77 kit

No Volume Discount.



GCS-S9619

GCS-S9620

Chrome Throttle Cable Brackets

Designed to work with your GM throttle cable on most carburetor applications. Available with or without kickdown provision.

GCS-S9619 w/o Kickdown 11.99 kit

GCS-S9620 w/ Kickdown 11.99 kit

Note: Due to the universal nature of this part, fitting and/or modifications may be required.



DEMON-1900



Demon Carburetors

WICKED POWER! The ALL NEW Street Demon® redefines the street carburetor with clean looks and ease of use! The Street Demon offers enthusiasts a straight forward carburetor designed to deliver a stable idle, amazingly crisp throttle response and smooth performance. Its optimized calibration and dual mounting pattern make it Run-Ready™ Designed for use on most stock to mildly modified V8s! These carbs feature vacuum secondaries and an electric choke.

625 CFM Carburetors

DEMON-1900 Silver w/ Aluminum Float Bowl . 494.99 ea.

DEMON-1901 Silver w/ Composite Float Bowl . 494.99 ea.

DEMON-1901BK Black w/ Aluminum Float Bowl ... 505.99 ea.

750 CFM Carburetors

DEMON-1903 Silver w/ Aluminum Float Bowl . 548.99 ea.

DEMON-1904 Silver w/ Composite Float Bowl . 548.99 ea.

No Volume Discount.



HOL-0-1850SA



Holley Carburetors

Holley is one of the most trusted carburetors of all time! Its 600 CFM of airflow, vacuum secondaries, single fuel inlet and mechanical or electric choke makes it amazingly universal. The 4160 carbs are constructed from aluminum which compared to its zinc counterpart equates to a weight savings of 40%! Being aluminum also means it will hold its shine and can be hand polished for a custom look! Don't trust your performance to just anyone. Holley is the only modular carburetor company that has been in business for over 100 years and has powered every NASCAR champion since the 60's.

HOL-0-80670 All 4150 670 CFM

Electric Choke 699.99 ea.

No Volume Discount.



AFP-4221

Carburetor Base Gaskets & Shields

Correct "stamped" gasket and stainless steel shield.

Gaskets

AFP-4221	1967-69 4 bbl. Q-Jet.....	7.99 ea.
AFP-4219	1970-72 4 bbl. Q-Jet.....	6.99 ea.
AFP-4222	1967-72 All Holley.....	6.95 ea.

Shield

ABB-7401	1967+ All Q-Jet.....	18.99 ea.
----------	----------------------	-----------



ABB-HOLY

Holley Carburetor Heat Shield

Fits all standard 4150 and 4160 4 bbl Holley carburetors. Features original part number and the common Chevy firing order.

ABB-HOLY	1967-92 w/ Holley.....	49.99 ea.
----------	------------------------	-----------

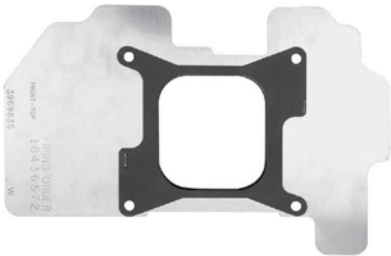

AS-761



AS-166



ACS-0069



ATE-0068



ACS-7454

Carb Return Springs

Color coded springs.

AS-761	1967-69 Q Jet Black.....	9.95 ea.
AS-166	1967-68 Holley Green.....	8.95 ea.
ACS-0069	1969 Holley Green.....	8.95 ea.
ATE-0068	1970-81 Q Jet Black.....	8.95 ea.
ACS-7454	1970-81 Holley Blue.....	9.95 ea.



GCS-S2083

Chrome Holley Carburetor Throttle Return Kit

Designed to make mounting the spring a snap! Works on most Holley carburetor applications. *Modifications may be required.*

GCS-S2083	Holley.....	16.99 kit
-----------	-------------	-----------



BMG-0095

Carb Attaching Kits

Correct OEM bolt kit for attaching carburetor to intake manifold.

BMG-0095	All w/ Holley.....	9.99 ea.
BTE-1475	All w/ Q-Jet.....	8.95 ea.



APX-1115

Engine Block Lifting Ring

These correct steel stamped lifting rings were installed at the engine plant for ease of installation.

APX-1015	Most SB.....	36.99 set
APX-1115	All BB.....	25.99 set
BPX-230	Lifting Ring Bolt.....	0.95 ea.



BPI-9140

BPI-2271

Intake Manifold Bolts OEM

Our OEM intake bolts feature correct size, coloring and head markings.

BPI-4400	All SB "M" Flanged 12pc.....	19.99 kit
NTR-97	All SB "TR" Black 12pc.....	19.99 set
BTR-647	All SB "TR" Silver 12pc.....	29.99 kit
BPI-9140	All BB "M" Cast Intake 16pc.....	21.95 kit
BPI-2271	All BB "A" Aluminum Intake 16pc.....	30.99 kit



BPS-3679



BPS-7432

Intake Studs

Correct intake manifold studs for various uses: alternator, solenoid and power brake tube. Includes correct nut.

BPS-3679	All 3/8" x 3/8" (Zinc).....	6.99 ea.
	<i>(p.s. bracket, alternator mount, etc.)</i>	
BPS-7432	All 5/16" x 3/8" (Black).....	6.99 ea.
	<i>(TCS, P.B. tube, etc.)</i>	



ACK-1679

Choke Kits

New OE style reproductions! Our kits come complete with thermal coil, cover, rod, retaining clip and screw.

ACK-1679	1967-69 SB Q-Jet.....	37.99 kit
ACK-6772	1967-71 Z/28.....	37.99 kit
ACK-8889	1967-69 BB Q-Jet.....	39.99 kit
ACK-1669	1967-69 BB Holley.....	36.95 kit
ACK-7072	1970-72 BB Q-Jet.....	59.99 kit
ACK-7071	1970 BB Holley.....	54.99 kit



APN-0138



APN-0238



APN-0038



APN-638



APN-738



APN-838

Intake Manifold Vacuum Fittings

OE style reproduction. These high quality fittings for rear of intake manifold have correct "slip on" and threaded ends. These fittings have a variety of uses: power brake hose, auto transmission, air conditioning, cruise control, etc. Guaranteed to look, fit and function exactly as original.

APN-0138	(1) Slip-On Fitting.....	26.99 ea.
APN-0238	(2) Slip-On Fittings.....	26.99 ea.
APN-0038	(1) Threaded Port.....	26.99 ea.
APN-638	(1) Threaded (1) Slip-On.....	26.99 ea.
APN-738	(1) Threaded (2) Slip-On.....	26.99 ea.
APN-838	(1) Threaded (3) Slip-On.....	29.95 ea.



AVT-R140

Small Block Crank Case Vent Tube Assembly

This vent installs next to the distributor at the rear of the engine block.

AVT-R140	1967 SB.....	46.99 kit
----------	--------------	-----------

No for use on SHP engines, or block that did not have the provision.



Oil Filler Tube

N-1252

Intake oil filler tube used with screw in PCV filter.

N-2258	1967-68 327 Black	36.95 ea.
N-1252	1967 SS350 / Z/28 Chrome.....	59.99 ea.
N-2290	1968 SS350 / Z/28 Chrome	51.95 ea.



AOC-1254



AOC-1689

Oil Filler Tube Cap

Correct twist on cap with "S" rivet.

AOC-1689	1967-68 327 Black	11.95 ea.
AOC-1254	1967-68 SS350 / Z/28 Chrome	17.95 ea.



AC-69SHP

1969 SHP PCV Valve

Correct purple PCV valve for Special High Performance engines.

CAC-69SHP	1969 w/ SHP	26.99 ea.
-----------	-------------------	-----------

BUY & SAVE

WITH SS396.COM PRE-BUILT KITS

CPX-9038

Our kits come complete with correct GM hose, AC Delco filter and correct black pinch clamp. Pieces also available separately.

CPX-9038	All Complete	17.95 kit
CPH-9038	Hose Only	12.99 ea.
CTC-1132	Pinch Clamp Only.....	0.50 ea.
CAC-3800	PCV Filter Only	5.95 ea.



CPN-3819



AX-2963

PCV Retaining Hose Clip

OE style reproduction of original PCV hose retaining clip, with correct bends and black phosphate coating.

CPN-3819	1967-72 Z/28	26.99 ea.
CPN-3819	1967-69 BB w/ Holley	26.99 ea.
AX-2963	1967 BB Q-Jet.....	32.99 ea.



1114432

TCS Solenoid

Correct TCS solenoid which mounts to the carburetor stud. Includes correct brackets.

1114432	1970-71 350/400.....	114.99 ea.
1114434	1970 BB	119.99 ea.



APX-3002

Vacuum Advance Kits

Our kits come complete with correct pre-bent tapered tube(s), correct white stripe vacuum hose and correct clip.

APX-3002	1967-69 SB 2 bbl.....	34.99 kit
APX-3042	1967-69 SB 4 bbl.....	34.99 kit
APX-2628	1967-71 SB Holley.....	34.99 kit
APX-3940	1967-69 BB Q-Jet	34.99 kit
APX-3946	1967-69 BB Holley.....	34.99 kit



APX-4946K

1970 TCS Vacuum Advance Kits

This one year only design utilized two steel tubes and a double clip.

APX-3944K	1970 BB Q-Jet TCS	31.99 kit
APX-4946K	1970 BB Holley TCS	31.99 kit



APR-4060



AX-301



CPN-100

Vacuum Advance Clips

Correct clip for retaining tube to intake manifold.

APR-4060	All V8	16.99 ea.
AX-301	1970 w/ TCS	13.95 ea.
CPN-100	Hose	2.79 per ft.

Tuff Stuff Performance Thermostats

These thermostats flow up to 56 gallons per minute, to maintain stated temperature. The 50 percent increased coolant flow reduces the delay in engine warm-up times, allowing trapped air in the cooling system to escape and stabilize the pressure of the cooling system. The stainless steel construction with an extra-large center port assures increased coolant flow and bridge design increases strength, stability & reliability and incorporates a bypass valve that allows a small amount of coolant to circulate before fully opening, assuring a fast warm-up. Ideal for high performance muscle cars, street rods and customs.



TUF-900160	160 Degree	19.99 ea.
TUF-900180	180 Degree	19.99 ea.
TUF-900195	195 Degree	19.99 ea.

No Volume Discount.



ACT-180

Thermostat

Original AC-Delco thermostat.

ACT-180	180-85 Degrees	6.99 ea.
ACT-190	190-95 Degrees	6.95 ea.



ABR-7660

Thermostat Housing

Correct thermostat housing for cast iron manifolds. This was the most common housing and was found on most V8's.

ABR-7660	Most V8	14.99 ea.
----------	---------------	-----------



ACI-7660

Thermostat Housing

Correct thermostat housing for high performance engines with aluminum intake manifolds. GM #3877660.

ACI-7660	Aluminum.....	59.99 ea.
----------	---------------	-----------



ATE-7396R

Z/28 Thermostat Housing

This is the correct gooseneck style thermostat housing for your Z/28 engine.

ATE-7396	1967-68 Z/28	119.99 ea.
ATE-7396R	1967-68 Repro No Numbers	24.99 ea.



GCS-S9229

Chrome Thermostat Housing

Chrome steel thermostat housing with o-ring and bolts. Water neck points toward the driver side of the radiator.

GCS-S9229	Most V8	14.99 kit
-----------	---------------	-----------



ATR-1039



ATR-2039

Thermostat Housing Bolts

Correct TR head marked bolts for attaching to intake.

ATR-1039	1969+ SB	8.99 ea.
ATR-2039	1967-74 BB.....	7.99 pr.



1971244

Distributor Cap

Choose from AC Delco replacement distributor cap or exact reproduction distributor cap.

1971244	Black Cap	89.99 ea.
AAD-308	Replacement	22.95 ea.

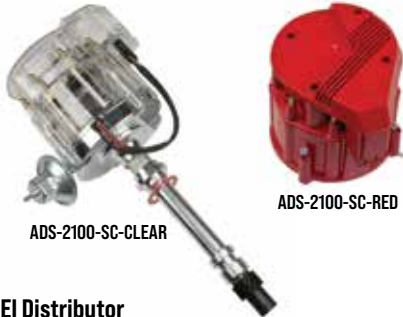

ADS-2100-SC-CLEAR

ADS-2100-SC-RED

HEI Distributor

HEI Electronic Distributor with 50K Coil.

ADS-2100	All	94.99 ea.
ADS-2100-SC-RED	Red Super Cap	94.99 ea.
ADS-2100-SC-CLEAR	Clear Super Cap	94.99 ea.

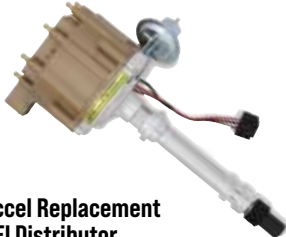

ACCEL-59107

Accel Replacement HEI Distributor

Using all new components, these distributors feature: High performance ACCEL Electronics. All new components-housing castings, ce. Direct plug in replacement with factory type connector. Fits standard deck height small and big block engines. Coil Not Included!

ACCEL-59107	All w/ HEI	190.99 ea.
-------------	------------------	------------

No Volume Discount.



MSD-8360

MSD Pro Billet Distributor

The Pro-Billet Ready-to-Run distributor is the perfect upgrade for outdated points distributors or bulky HEIs. Simply install the distributor in the engine, connect three wires, the coil and fire it up!

MSD-8360	Chevy V8*	517.99 ea.
MSD-85551	Chevy V8**	406.99 ea.

**Does not have nor can accept a vacuum advance canister. **Must be used with a MSD 6.7, or 8 ignition box. Note: Standard deck height blocks only. Will not fit gen 5 and 6 big blocks. No Volume Discount.*



MSD-8362

MSD HEI Distributor

The Street Fire HEI is a great option for value-conscious enthusiasts. It features a centrifugal advance with coated weights and welded weight pins for durability. Plus, it comes with the same high-quality distributor gear as our Pro-Billet models, refined for top performance in tough conditions.

MSD-8362	All, Red Cap 4 Pin*	253.99 ea.
MSD-8365	All Billet, Red Cap 4 Pin*	654.99 ea.

*Note: Standard deck height blocks only. Will not fit gen 5 and 6 big blocks. *Refers to the amount of terminals on the ignition module. No Volume Discount.*



MAL-3748201

Mallory Unilite Distributor

A legend returns - the tried and true Mallory Unilite Distributor line is back! The easy three wire hookup of the Unilite makes running a stock coil, a Mallory performance coil and even a Mallory HyFire CD ignition a snap. Supplied with a quality cap and rotor, the Mallory Unilite also provides a fully adjustable mechanical advance to dial in the perfect timing curve for a multitude of engine combinations. The Unilite features a compact housing that lends itself well to applications where space is a premium due to tight firewall clearance or blower applications.

MAL-3748201	All SBC, BBC*	482.99 ea.
-------------	---------------------	------------

**Standard deck height blocks only. Will not fit gen 5 and 6 big blocks. No Volume Discount.*



ACE-1400

Distributor Hold Down

Correct retaining hardware for distributors.

ACE-1400	All V8	15.99 kit
----------	--------------	-----------



GCS-S4116

GCS-S5116

Custom Distributor Hold Down Kit

Designed to secure your distributor settings and look good doing it. Choose from chrome or billet.

GCS-S4116	Chrome	6.99 ea.
GCS-S5116	Billet	19.99 ea.



N-2441

Tune Up Kit

AC Delco tune up kit with new points, condenser and rotor.

N-2441	1967-74 w/o HEI	49.99 ea.
--------	-----------------------	-----------



1115263 (Top View)



1115270

Coil

Choose from our new exact reproduction Delco coils with GM numbers or GM replacement coil.

1115287	1968-72 BB	139.95 ea.
1115270	1968-72 SB	219.99 ea.
1115293	1970-72 Most V8	139.95 ea.
GAC-505	1967+ Most Replace	29.99 ea.

No Volume Discount.



ALI-3119



BAN-516

Coil Bracket

OE style reproduction of original comes with retaining screw.

ALI-3119	All V8	20.99 ea.
BAN-516	Correct SEMS Bolts	1.99 pr.



GCS-S9366

Chrome Ignition Coil Bracket

This brightly chrome plated ignition coil bracket will look great in your engine compartment. Fits most round cylinder style ignition coils.

GCS-S9366	Coil Bracket	8.99 ea.
-----------	--------------------	----------



MSD-6201



MSD Ignition

An MSD Ignition boosts engine performance with high-output capacitive discharge sparks. Below 3,000 rpm, it delivers multiple sparks for better idle, starting, and throttle response. If you've done modifications like a cam swap, carb, intake, or headers, the 6A helps maximize your engine's potential. Upgrade to the 6AL for an added engine-saving rev limiter.

MSD-6201	Red All 6A	252.99 ea.
MSD-6425	Red All 6AL.....	341.99 ea.
MSD-64253	Black All 6AL.....	341.99 ea.
MSD-6421	Red All 6AL-2.....	451.99 ea.

No Volume Discount.



MSD-31359



MSD Ignition Spark Plug Wires

Engineered from the inside out, the 8.5 offers everything you have ever wanted in a wire; incredibly low resistance without electronic interference! In a single 12 inch length of Super Conductor Wire there is only 40 - 50 ohms of resistance!

Without Headers

MSD-31359	Red, SBC 350 HEI	143.99 kit
-----------	------------------------	------------

With Headers

MSD-35593	Black, SBC 350 HEI* Cap	121.99 kit
MSD-35599	Red, SBC 350 HEI* Cap	155.99 kit
MSD-35603	Black, BBC 350 HEI* Tower Cap ..	171.99 kit
MSD-35609	Red, BBC 350 HEI* Tower Cap ...	164.99 kit
MSD-35653	Black, SBC 350 HEI* Tower Cap..	175.99 kit
MSD-35659	Black, SBC 350 HEI* Cap	175.99 kit

*Works on any HEI or MSD style cap with male terminals. No Volume Discount.



ALL-70BB3Q

"Dated" Spark Plug Wire Set

New OE style reproduction wire set correctly dated for your specific car, pre-cut and ready to install! Each set features correct colored wires and correct angled boots. Please give your sales rep your desired date. For points style, non-HEI cars only.

Here's how to order:

ALL-[year](block)[quarter] 109.99 set

Note: For example, a 1970 Camaro SS396 built on or before Jan. 15, 1970, you would order ALL-70BB3Q wires will have 3-Q-69 stamped on them. If built after Jan. 15, 1970, you would order ALL-70BB1Q.



AHC-1508

Spark Plug Wire Sets

Pre-cut factory replacements.

AHC-1508	1967-73 SB non-HEI.....	34.99 set
AHC-2508	1967-72 BB non-HEI.....	32.99 set
AHC-3508	1974-81 w/ HEI	54.99 set



AC Delco Spark Plugs

This is a brand new set of 8 spark plugs for your Camaro. These high quality reproduction AC Delco spark plugs feature the correct green AC and markings as original.

AC43	1964-70 #43	62.99 set
AC44	1964-70 #44	62.99 set
AC45	1964-70 #45	62.99 set

Note: The number on the plug refers to it's operating temperature. The lower number is a cooler running plug which is typically found on the SHP high performance engines. A hotter, higher numbered plug would be used in engines where plug fouling may be or is a problem.



APX-6584

Spark Plug Heat Shield Kit BB

Correct stamped shields for various Chevrolet cars with BB engines.

APX-6584	1967-72 BB 8pc.....	39.99 kit
----------	---------------------	-----------



AT-3030

OEM Style Spark Plug Heat Shield Kit BB

This is a set of correctly stamped spark plug heat shields which are Silver Cadmium plated.

AT-3030	1967-72 BB.....	69.99 kit
---------	-----------------	-----------



APX-650

Spark Plug Heat Shield Kit SB

Correct die stamped shields and arms for most small blocks without Rams Horn style manifolds. Complete with mounting hardware.

APX-650	1967-74 SB.....	44.99 kit
BXX-650	Bolts (4).....	1.00 kit



APX-5022

Valve Cover Spark Plug Wire Loom Kits

Correct spark plug wire separators for valve covers.

APX-5022	SB 6pc.....	21.99 kit
APX-5023	BB 4pc.....	12.99 kit



APX-1300

APX-8100

APX-1200

Wire Separators

Correct spark plug wire separators.

APX-1845	1967-69 Rear 4 Wire w/ Ramshorn Z28 .	7.99 ea.
APX-1846	1967-69 Side 2 Wire w/ Ramshorn Z28 ..	7.99 ea.
APX-1300	1969-72 SB/BB Left Rear.....	17.99 ea.
APX-1200	1969-74 SB Left Front.....	21.99 ea.
APX-8100	1968+ BB Right Side	17.99 ea.



AX-423

AX-486A

Spark Plug Wire Stands

New OE style reproduction of originals.

AX-423	All SB RH.....	14.95 ea.
AX-67R	1967 SB LH.....	27.99 ea.
AX-486A	1968 All SB LH.....	27.99 ea.
AX-486	1969-72 All SB LH.....	27.99 ea.
AX-ZZ	1969 Z/28 LH.....	28.99 ea.
AX-7Z	1970-73 SB LH.....	27.99 ea.

GCS-S4973



Vacuum Advance Cover

This vacuum advance pod cover will give your distributor that show car look. Fits most GM distributors.

GCS-S4973	Chrome	5.99 ea.
-----------	--------------	----------



APJ-5240

Ground Strap Kit

Correct braided copper wire and ends complete with OEM screws.

APJ-5240	1967-68 3pc	19.99 kit
APJ-5230	1969 4pc	23.95 set



GCS-S6042C

SB Billet Timing Cover Pointer

Provides a convenient way to adjust and verify your engine's ignition timing. Adjustable and can be used with 6" or 7" balancers.

GCS-S6041	Billet	27.99 ea.
GCS-S6041C	Chrome Plated Billet	26.99 ea.
GCS-S6042	Ball Milled	28.99 ea.
GCS-S6042C	Ball Milled Chrome	28.99 ea.
GCS-S4960	Chrome Plated Steel	6.99 ea.



ATP-07

Timing Cover Pointers

Correct pointer for adjustment of engine timing.

ATP-35	1967-68 SB	8.95 ea.
ATP-36	1969-72 SB	7.99 ea.
ATP-47	1967-72 SB w/ 7" Bal	13.99 ea.
ATP-07	1967-72 BB	8.99 ea.



GCS-S9178

Chrome Adjustable Timing Pointers

Provides a convenient way to adjust and verify your engine's ignition timing. Finished brilliant chrome plated steel.

GCS-S9178	SB 7"	9.99 ea.
GCS-S9179	SB 8"	9.99 ea.
GCS-S4961	BB 8" Non Adjustable	5.99 ea.
GCS-S9180	BB 8"	6.99 ea.



AJ-850

Timing Covers

New covers complete with crankshaft seal.

GCS-S4934BK	1969-81 SB LWP Black w/ Gaskets/Bolts	13.99 set
GCS-S4934OR	1969-81 SB LWP Orange w/ Gaskets/Bolts	14.99 set
AJ-SB-8	1969-70 SB w/ 8" Balancer*	99.99 set
AJ-850	1967-72 All Big Block	18.99 ea.
AJ-BB-7	1968-77 BB w/ 7" Balancer*	99.99 set
AJ-BB-8	1968-77 BB w/ 8" Balancer*	99.99 set
BTC-650	Correct Attaching Bolts	8.95 kit

*Factory OEM style.



GCS-S6040C

2 Piece Aluminum Timing Covers

An excellent upgrade for your engine. Rigid sealing surface for positive seal and it looks great, too!

GCS-S6040	SB Polished Billet	32.99 ea.
GCS-S6040C	SB Chrome Billet	55.99 ea.
GCS-S8422	BB Polished Billet	54.99 ea.
GCS-S8422C	BB Chrome Billet	62.99 ea.

Note: These covers may not work with some double roller timing chains. Check clearance before starting engine. Doubling of the gaskets or shims may be required to use cover with a short water pump.



GCS-S4935

Chrome Timing Covers

Brilliantly polished timing cover with a rigid sealing surface.

GCS-S4932	SB SWP Chrome	19.99 ea.
GCS-S4934	SB LWP Chrome	19.99 ea.
GCS-S4935	BB All Chrome	23.99 ea.
GCS-S4935R	BB All Unfinished Steel	18.99 ea.

Note: These covers may not work with some double roller timing chains. Check clearance before starting engine. Doubling of the gaskets or shims may be required to use cover with a short water pump. SWP = Short water pump. LWP = Long water pump.

BUY & SAVE

WITH SS396.COM PRE-BUILT KITS



XA-101

Valve Cover Kit Big Block

Kits come complete with the following items: (2) valve covers, (2) gaskets, valve cover retainers and TR bolts, (2) V.C. grommets, V.C. oil cap, V.C. elbow, hose and V.C. wire separators.

XA-101	w/o Left Slant	155.92 kit
XA-101S	w/ Left Slant*	188.92 kit
XA-701	w/o Left Slant w/o Drippers	152.92 kit
XA-701S	w/ Left Slant w/o Drippers	152.92 kit

OE kits with silver gaskets, correct oil cap and Tonawanda decal.

XA-101-OE	w/o Left Slant	171.91 kit
XA-101S-OE	w/ Left Slant*	206.91 kit

**Use slanted valve covers when brake booster clearance may be an issue.*



Original Style Chrome Valve Covers ACC-3362

OE style reproduction covers offer the highest quality chrome plating, correct wire stands and factory oil deflector "drippers". Available with a left side slant to increase booster clearance in tight engine compartments.

ALS-1065	All BB w/o Slant	84.99 pr.
ALS-1165	All BB w/ Left Side Slant*	99.99 pr.
ACC-3362	All BB w/o Drippers	59.99 pr.
ACC-3365	All BB w/ Slant w/o Drippers*	59.99 pr.
ALS-1065XT	All BB Tall w/o Left Slant w/o Drippers ..	74.99 pr.
ALS-1165XT	All BB Tall w/ Left Slant w/o Drippers* ..	74.99 pr.

**Use slanted valve covers when brake booster clearance may be an issue.*



ALS-1165-OJ

Big Block Valve Covers OE Style Painted

This is a pair of brand new big block valve covers painted in Chevy orange or black. These valve covers are correct for most big blocks. The covers with the slant will fit cars with power brakes.

ALS-1165-OJ	Big Block Orange w/ Slant	89.99 pr.
ALS-1065-OJ	Big Block Orange w/o Slant	89.99 pr.
ALS-1165XT-OJ	Big Block Orange Tall w/ Slant	74.99 pr.
ALS-1165XT-BLK	Big Block Black Tall w/ Slant	74.99 pr.
ALS-1065XT-OJ	Big Block Orange Tall w/o Slant ..	74.99 pr.
ALS-1065XT-BLK	Big Block Black Tall w/o Slant	74.99 pr.

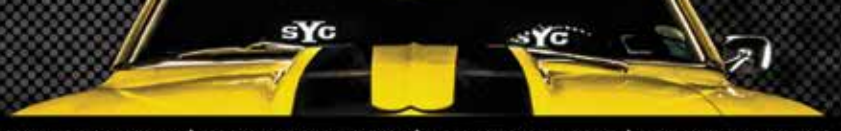

396TJVC-1

"Turbo Jet" Valve Covers

"Cal Custom" finned aluminum covers feature either the 396 or 427 "Turbo Jet" die cast chrome medallions.

396TJVC-1 All BB 396 299.99 pr.
 427TJVC-1 All BB 427 299.99 pr.
 2-5/8" - 3" inside clearance. Will work with most roller rockers.



427VC-1

"427" Valve Covers

Like our "YENKO" covers with cast "427" medallions.

427VC-1 Most BB "427" 299.99 pr.
 427VC-R Most Big Block Red "427" 299.99 pr.
 SS427VC-R Most Big Block Red "SS427" 299.99 pr.
 2-5/8" - 3" inside clearance. Will work with most roller rockers.



SUPERSPORTVC-1

"Super Sport" Valve Covers

This a pair of original style Cal Custom finned polished aluminum valve covers which feature Super Sport chrome medallions with white SS letters.

SUPERSPORTVC-1 Most BB "Super Sport" 229.99 pr.
 No volume discount.



AVC-100

Baldwin-Motion & Yenko Finned Aluminum Valve Covers

We have found these original style "Cal Custom" finned covers commonly used on Yenko, Baldwin Motion, Nickey and other factory super cars.

AVC-100 Most BB 209.99 pr.
 2-5/8" - 3" inside clearance. Will work with most roller rockers.



YSCVC-1

"Yenko" Valve Covers

These limited edition "Cal Custom" style finned aluminum covers feature the notorious "YENKO" Red, White and Blue die cast logos.

YSCVC-1 Most BB "YENKO" 299.99 pr.
 2-5/8" - 3" inside clearance. Will work with most roller rockers.



MOTION-VC-BLACK

"Motion" Valve Covers

Original style Cal Custom finned valve covers featuring the notorious Baldwin Motion die cast logos.

MOTION-VC Most BB "Motion" 289.95 pr.
 MOTION-VC-BLACK Most BB "Motion" Black 179.95 pr.
 Note: 2-5/8" - 3" inside clearance.



HARREL-VC

Dick Harrel Aluminum Valve Covers

"Cal Custom" finned aluminum covers feature the Dick Harrel die cast medallions.

HARREL-VC Most BB 319.99 pr.
 2-5/8" - 3" inside clearance. Will work with most roller rockers.



ATE-4207

Finned Aluminum Valve Covers

OE style reproduction of original GM high performance valve covers.

ATE-4207 SB 259.99 pr.
 ATE-4207-BLK SB Black 254.99 pr.
 HVC-28 Flag Decal 16.99 ea.



AVC-540

1967 Chevrolet Script Valve Covers

Excellent reproductions of the original stamped "Chevrolet" valve covers in chrome or ready to paint EDP coating. These valve covers feature the correct wire retainers and "O" stamp.

AVC-540 Chrome 209.99 pr.
 AVC-541 Paintable 154.99 pr.



AVC-542

1968 SHP Valve Covers

Accurate reproductions of the original 1968 Z/28 or SS350 high performance valve covers in chrome or ready to paint EDP coating.

AVC-542	Chrome	179.99 pr.
AVC-543	Paintable.....	129.99 pr.



GCS-9215B

Black Painted Valve Covers

This is a pair of high quality tall black painted valve covers. A great inexpensive custom touch to any street machine or sleeper!

GCS-9215B	1964-77 SB	39.99 pr.
-----------	------------------	-----------



AT-3666

Small Block Valve Covers

New original style early small block Chevrolet valve covers. These covers come ready to install in correct Chevrolet orange or chrome.

AT-3662	SB Chrome.....	169.99 pr.
AT-3666	SB Orange.....	139.99 pr.



AFI-9797

Valve Cover Gaskets

AFP-057	All SB.....	11.99 pr.
AFP-059	All BB.....	22.99 pr.
AFI-9797	BB w/ Silver Coating	25.99 pr.



APB-1023

Valve Cover Retainers Bolt Kits OEM

Correct steel stamped zinc plated retainers & OEM bolts.

APB-1023	SB TR Bolts 16pc.....	14.95 kit
APB-2023	BB TR Bolts 28pc.....	34.99 kit
APB-1027	SB M Aluminum 8pc.....	18.99 kit



AP0-2043



APR-2136

Valve Cover Oil Caps

Choose from either chrome GM replacement, chrome reproduction with correct "S" or black rubber push in cap.

APX-5763	Replacement.....	6.99 ea.
APX-2136	Reproduction "S"	17.99 ea.
AP0-2043	Rubber "OIL"	5.95 ea.



APB-3508



APB-3509

Valve Cover Grommet

Original GM grommets.

APB-3508	All SB.....	11.99 pr.
APB-3509	All BB.....	12.99 pr.



APT-3509



APT-3960

Valve Cover Elbows

Correct GM steel valve cover elbows.

APT-3960	All SB.....	12.99 ea.
APT-3509	All BB.....	12.99 ea.



APH-3961



APH-2109



APH-3843

Valve Cover Hose

Correct marked OEM hose which extends from valve cover to air cleaner base. Choose from open or closed element.

APH-3961	All SB Open	12.99 ea.
APH-3843	All BB Open	5.99 ea.
APH-2109	1970-72 BB Closed	16.99 ea.



APX-640

Crank Case Breather Oil Cap

This valve cover breather features a twist in mount and will fit where the OE oil fill cap goes.

APX-640	All w/ Twist In Oil Cap.....	6.99 ea.
---------	------------------------------	----------

Holley



HOL-302-2

Holley LS Swap Oil Pan

GM's popular LS engines deliver impressive power, reliability, and durability, making them popular for various vehicles. However, factory LS oil pans can be a poor fit for modern hot rods. Holley's new LS Retro-fit Engine Oil Pan solves this by offering maximum ground and chassis clearance, along with OEM-grade fitment and sealing.

- OEM fitment with factory oil filter mount, oil cooler port, NVH suppression, flange gasket, sealing, structural rigidity, and bell-housing attachments.

- Durable cast aluminum design with a clean, high-quality look.

- Includes sump baffle, pick-up tube, sump plug, oil filter stud, and oil passage cover.

- Compatible with GM rear-wheel-drive vehicles originally equipped with Small or Big Block Chevy engines.

HOL-302-2	1967-81 All	512.99 ea.
-----------	-------------------	------------

Maximum crankshaft stroke = 4.25" *Engine location may need to be adjusted (up / down or fore / aft) for cross member or steering linkage clearance depending on the vehicle, steering configuration and chassis type. No Volume Discount.



AEH-999

Oil Pans

Correct OEM oil pans made in North America.

AJ-221	1967-81 SB w/o SHP.....	84.99 ea.
AEH-151	SB 1pc Rear Main Seal	
	86+ Blocks	89.99 ea.
AEH-999	1967-72 All BB.....	169.99 ea.



ACP-1SB

Oil Pan Gasket Set

Correct OEM gaskets.

ACP-1SB	All SB.....	12.99 ea.
ACP-2BB	All BB.....	18.99 ea.



BOP-2002

Oil Pan Attaching OEM Bolt Kit

Correct "L" head marked bolts for attaching pan to block

BOP-2001	All SB 18pc	9.95 ea.
BOP-2002	All BB 24pc	28.99 ea.



BPO-1988

Oil Drain Bolt / Washer

Original GM

BPO-1988	All SB/BB	6.95 ea.
----------	-----------------	----------



AJ-4

Oil Pan Baffle / Windage Tray

Often installed on most High Performance cars this "windage tray" was used to keep oil from splashing the crankshaft. A MUST!

AJ-4	Small Block	44.99 ea.
AJ-6	Big Block	39.99 ea.



APC-744

Oil Pan Clip

Correct clip for retaining positive battery cable routing to solenoid

APC-744	All SB-BB	7.99 ea.
---------	-----------------	----------



ATE-1576

ATE-1567

Oil Dipstick Kits

Complete with tube and gauge (Stick)

ATE-1567	1967-79 SB (Green Dot)	29.99 ea.
ATE-1576	1967-72 BB (Yellow Dot)	49.99 ea.
ATE-R680	1969-75 SB No Dot	59.99 kit



GCS-S6060

Billet Aluminum Engine Dipstick

Show quality dipstick with billet handle. 11.5" length.

GCS-S6060 Handle..... 16.99 ea.
Note: Oil level varies depending on the oil pan used. You may need to mark the dipstick with your own new full level mark.



GCS-S5002

Billet Engine Dipstick with Braided Tube

Show quality billet aluminum dipstick with braided tube.

GCS-S5002 1955-79 SB
 38.99 ea. || GCS-S5001 | 1980-95 SB | 38.99 ea. |
| GCS-S5003 | 1965-90 BB | 44.99 ea. |

Note: Oil level varies depending on the oil pan used. You may need to mark the dipstick with your own new full level mark.



GCS-S4957BA

Chrome / Billet Dipsticks & Tubes

Show quality dipsticks with matching tubes. A great upgrade to any engine compartment!

GCS-S4957	1955-79 SB, Chrome, 19"	7.99 ea.
GCS-S4957BA	1955-79 SB, Billet, 19"	13.99 ea.
GCS-S9420	1980-82 SB, Chrome, 23"	9.99 ea.
GCS-S9420BA	1980-82 SB, Billet, 23"	15.99 ea.
GCS-S9231	1983-85 SB, Chrome, 24.5"	11.99 ea.
GCS-S9231BA	1983-85 SB, Billet, 24.5"	13.99 ea.
GCS-S4958	1965-90 BB, Chrome, 21"	11.99 ea.
GCS-S4958BA	1965-90 BB, Billet, 21"	12.99 ea.

Note: Oil level varies depending on the oil pan used. You may need to mark the dipstick with your own new full level mark.



NFX-25

Oil Filter

OE style reproduction of early spin on style filter.

NFX-25	PF-25 AC Filter "White"	26.99 ea.
--------	-------------------------------	-----------



GAC-110

Oil Pressure Switch

Correct GM switches for cars without gauges.

GAC-110	All w/o Gauges	11.99 ea.
---------	----------------------	-----------



N-133

N-142



N-137

Oil Pressure Fittings

N-137	1968+ All SB	7.99 ea.
N-133	All BB w/o SHP	24.99 ea.
N-142	All BB w/ SHP	32.99 ea.
N-234	1967-69 SB 3/4" Tall	16.99 ea.



CHQ-3200

Oil Pressure Lines

Correct black plastic line with fittings for most cars with mechanical gauges.

CHQ-3200	Most w/ Gauges	10.99 ea.
----------	----------------------	-----------



NPZ-134

Oil Pressure Line Kit

Correct oil pressure line for console gauges.

NPZ-134	1967-69 w/ Gauges	39.99 kit
NP-1234Z	1967-69 Oil Line	29.99 ea.



ALG-456

Oil Line Grommet

Correct firewall grommet for oil line.

ALG-456	1967-69 All	10.95 ea.
---------	-------------------	-----------



AP-2044

Oil Line Bracket

Correct bracket for retaining line to engine.

AP-2044	1967-69 All	11.95 ea.
---------	-------------------	-----------



ASM-10A



Starter Motor

We carry original AC Delco USA remanufactured starter motors complete with warranty. No core charge.

ASM-10A	1967-81 SB Auto	113.99 ea.
ASM-10M	1967-81 SB Manual	113.95 ea.
ASM-20A	1967-81 BB Auto	109.99 ea.
ASM-20M	1967-81 BB Manual	102.99 ea.

No Volume Discount. No Core Charge.



TUF-3193NB



TUF-3510A

Tuff Stuff Gear Reduction Starters

These gear reduction starters will allow you to easily crank over your high performance engine. They use less draw than traditional replacement starters and gear reduction allows them to crank over engines with higher compression. These starters will work on both Small Block Chevy and Big Block Chevy Engines using 153 or 168 tooth flywheels. Please be sure to check your flywheel tooth count before ordering.

TUF-6550B	1.6 H.P., 11:1 Compression White Zinc	176.99 ea.
TUF-6550A	1.6 H.P., 11:1 Compression Chrome	226.99 ea.
TUF-6584B	1.9 H.P., 12:1 Compression Black	171.99 ea.
TUF-6772B	2.6 H.P., 18:1 Compression Black	217.99 ea.
TUF-3193NB	3 H.P., 18:1 Compression White Zinc	229.99 ea.
TUF-3510A	1.9 H.P., 18:1 Compression Chrome*	205.99 ea.
TUF-3510B	1.9 H.P., 18:1 Compression Black*	152.99 ea.

*Offset mounting bolts, 168 tooth flywheel only.



TUF-7629

Tuff Stuff Hot Start Remote Solenoid Kit

Give your starter an extra 12 V boost with these hot start kits from Tuff Stuff! This kit is designed to eliminate hot start problems that are common with starter-mounted solenoids. Ideal for GM full-size OEM starters.

TUF-7629	1964-77 All	29.99 kit
----------	-------------------	-----------

No Volume Discount.



BV-2070



BV-2072



BV-2074

Starter Motor Bolts OEM

Correct "Knurled" bolts for attaching starter motor to block.

BV-2070	SB 3/8-16 x 17/8" (Short)	5.99 ea.
BV-2072	BB 3/8-16 x 3 5/8" (Long)	5.29 ea.
BV-2074	3/8-16 x 4 11/16" (X-Long)	6.99 ea.



ATE-4353

Starter Motor Brace

Correct brace for attaching starter to block.

ATE-4353	1967-72 SB w/o 350	14.99 ea.
APP-6SB	SB All	16.99 ea.
ABB-9655	1967-72 All BB	13.99 ea.
AP0-516	Attaching Screw	0.50 ea.



APX-1443

Starter Heat Shield

Correct starter heat shield for big block.

APX-1443	All BB	26.99 ea.
GCS-S6077	Satin	17.99 ea.



ALI-1504



A-193

Starter Solenoid Wire Clip

Correct clip for retaining wire harness to solenoid.

ALI-1504	1967 All V8	17.99 ea.
A-193	1968+ All	24.95 ea.



ABR-0898



AC Delco Water Pumps

Brand new AC Delco water pumps.

ABR-0898	1967-68 SB (Short Style)	84.99 ea.
ABR-0918	1967-68 BB (Short Style)	132.99 ea.
ABR-1109	1969-81 SB (Long Style)	84.99 ea.
ABR-1002	1969-72 BB (Long Style)	92.99 ea.

No Core Charge.



TUF-1461N



TUF-1354NAS

Tuff Stuff Water Pumps

Tuff Stuff water pumps are available in multiple different finishes. Available in standard flow or high flow (Super Cool) version for high power applications. Also available in "Smoothie" version, which features flat top casting with no top water port or plug. SS= Short Style LS = Long Style

Small Block

TUF-1354NA	1964-71 SS, Chrome	118.99 ea.
TUF-1354N	1964-71 SS, SC, Cast Finish	99.99 ea.
TUF-1354NC	1964-71 SS, SC, Black	103.99 ea.
TUF-1354NB	1964-71 SS, SC, Chrome	126.99 ea.
TUF-1461N	1964-71 SS, Smoothie, Chrome	119.99 ea.
TUF-1449NA	1969+ SS, Chrome	150.99 ea.
TUF-1511NC	1969+ LS, Platinum, Cast Finish	194.99 ea.
TUF-1449N	1969+ LS, SC, Cast Finish	99.99 ea.
TUF-1449NC	1969+ LS, SC, Black	103.99 ea.
TUF-1449NB	1969+ LS, SC, Chrome	168.99 ea.
TUF-1448NC	1969+ LS, SC, Smoothie, Cast Finish	149.99 ea.
TUF-1448NB	1969+ LS, SC, Smoothie, Polished Aluminium.	192.99 ea.

Big Block

TUF-1494N	1964-72 SS, Cast Finish	111.99 ea.
TUF-1494NC	1964-72 SS, SC, Black	129.99 ea.
TUF-1494NA	1964-72 SS, SC, Chrome	150.99 ea.
TUF-1461NA	1969+ LS, Chrome	177.99 ea.
TUF-1461N	1969+ LS, SC, Cast Finish	119.99 ea.
TUF-1461NC	1969+ LS, SC, Black	130.99 ea.



Heater Hose / Bypass Nipples

OE style reproduction zinc plated fitting.

AWN-058	5/8" Short	7.95 ea.
AWN-034	3/4" Short	7.95 ea.
AWN-134	3/4" Long w/ AC	8.95 ea.
APN-1060	3/4" Bypass Slotted	10.99 ea.
AWN-6367	SB SHP 90°	36.99 ea.



Water Pump Bypass Hose Kits

Correct OEM GM marked bypass hose with correct clamps.

CPH-1637	1967-68 Z/28	12.95 kit
CPH-1658	1967-68 BB (Molded)	16.99 kit
CPH-1672	1969-72 BB (Ribbed)	12.99 kit
CPB-034	1967 BB Clamp	4.99 ea.



Water Pump OEM Attaching Bolt Kits

Correct style attaching bolts with "TR" head markings.

ATR-3232	1967-68 3 Bolts 1 Stud	17.99 kit
ATR-4334	1969-72 All 4 Bolts M Mark	11.99 kit
AWS-301S	Stud Only (Short)	6.99 ea.
AWS-302L	Stud Only (Long)	3.95 ea.



Tuff Stuff Water Pump Bolt Kits

Chrome plated hex head bolts. Includes 4 bolts, 4 flat washers and 4 lock washers.

TUF-7675A	All SB, Short Style	19.99 ea.
TUF-7676A	All BB, Short Style	19.99 ea.
TUF-7678A	All, Long Style	17.99 ea.

Short Water Pump Washer

This washer is for any Chevrolet engine with a short water pump. Since this part can't be seen when the pulley is installed, most people are unaware it exists, but it provides important support for the pulley.



AWW-65	1967-68 All	7.99 ea.
--------	-------------	----------

*Works on all cars with short water pump.



Water Pump Pulley

OE style reproduction of original water pump pulleys.

AWP-796	1969-81 SB 1 Groove Deep	29.99 ea.
AWP-240	1969-81 SB 1 Groove Deep Z/28	80.99 ea.
AWP-9950	1967-68 All BB 1 Groove Deep	49.99 ea.
AWP-656	1967-68 BB 2 Groove Deep	99.99 ea.
AWP-643	1967-68 SB (2 Groove)	31.99 ea.
AWP-256	1967-68 BB (2 Groove)	39.99 ea.
AWP-1394	1969-81 BB 1 Groove Deep	55.99 ea.
AWP-949	1969-81 All 2 Groove Deep w/ AC	69.99 ea.

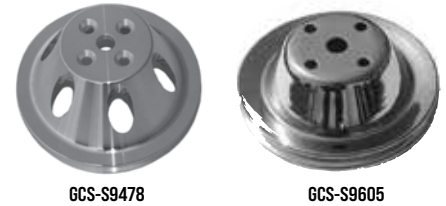

Billet Water Pump Pulleys

These show quality billet aluminum water pump pulleys will set your show car apart from the crowd. Made of high quality aircraft aluminum.

GCS-S9478	SB, SWP, 1 Groove, Satin	42.99 ea.
GCS-S9478POL	SB, SWP, 1 Groove, Polished	45.99 ea.
GCS-S9600	SB, SWP, 1 Groove, Chrome	26.99 ea.
GCS-S9479	SB, SWP, 2 Groove, Satin	58.99 ea.
GCS-S9479POL	SB, SWP, 2 Groove, Polished	67.99 ea.
GCS-S9601	SB, SWP, 2 Groove, Chrome	34.99 ea.
GCS-S9482	SB, LWP, 1 Groove, Satin	43.99 ea.
GCS-S9482POL	SB, LWP, 1 Groove, Polished	49.99 ea.
GCS-S9604	SB, LWP, 1 Groove, Chrome	26.99 ea.
GCS-S9483	SB, LWP, 2 Groove, Satin	68.99 ea.
GCS-S9483POL	SB, LWP, 2 Groove, Polished	65.99 ea.
GCS-S9605	SB, LWP, 2 Groove, Chrome	33.99 ea.
GCS-S8840	BB, SWP, 1 Groove, Satin	45.99 ea.
GCS-S8840POL	BB, SWP, 1 Groove, Polished	54.99 ea.
GCS-S8842	BB, SWP, 2 Groove, Satin	59.99 ea.
GCS-S8842POL	BB, SWP, 2 Groove, Polished	64.99 ea.
GCS-S9815	BB, SWP, 2 Groove, Chrome	36.99 ea.
GCS-S8844	BB, LWP, 2 Groove, Satin	58.99 ea.
GCS-S8844POL	BB, LWP, 2 Groove, Polished	68.99 ea.
GCS-S9723	BB, LWP, 2 Groove, Chrome	36.99 ea.

Note: SWP = Short Water Pump. LWP = Long Water Pump.

Hardware

GCS-S0005	Bolts	4.99 ea.
-----------	-------	----------



Crank Pulleys

All pulleys are original GM or the highest quality reproductions on the market. Each pulley is finished in factory semi gloss black like the originals.

ACP-904	1967-68 327/350 1 Groove	39.99 ea.
ACP-904-2	1967-68 327/350 2 Groove SWP	42.99 ea.
ACP-904-3	1967-68 327/350 3 Groove SWP	68.99 ea.
ACP-833	1967-68 2 Groove Deep	59.99 ea.
ACP-414	1969-81 SB 3 Groove	49.99 ea.
NQ-457	1969-81 350 2 Groove Deep Z/28	89.99 ea.
ACP-313	1969-77 SB 1 Groove LWP	56.99 ea.
ACP-203	1964-68 396 1 Groove*	49.99 ea.
ACP-108	1967-68 396/375 2 Groove Deep**	59.99 ea.
ACP-333	1967-68 396/375 3 Groove Deep Cast	319.99 ea.
ACP-404	1969-79 SB 2 Groove	52.99 ea.
AHQ-1396	1969-81 396 2 Groove Deep	74.99 ea.
ACP-330	1969-81 396/454 3 Groove w/ AC	52.99 ea.

*Without Power Steering **for all with power steering use with ADP-61



GCS-S8845POL

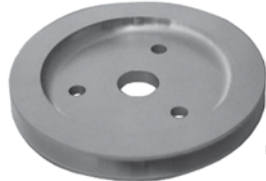

GCS-S9480

Billet Crank Pulleys

These show quality billet aluminum crank pulleys will set your show car apart from the crowd. Made of high quality aircraft aluminum.

GCS-S9480	SB, SWP, 1 Groove, Satin	34.99 ea.
GCS-S9480POL	SB, SWP, 1 Groove, Polished	45.99 ea.
GCS-S9602	SB, SWP, 1 Groove, Chrome	27.99 ea.
GCS-S9481	SB, SWP, 2 Groove, Satin	49.99 ea.
GCS-S9481POL	SB, SWP, 2 Groove, Polished	54.99 ea.
GCS-S9603	SB, SWP, 2 Groove, Chrome	33.99 ea.
GCS-S8858	SB, SWP, 3 Groove, Satin	66.99 ea.
GCS-S8858POL	SB, SWP, 3 Groove, Polished	69.99 ea.
GCS-S8963	SB, SWP, 3 Groove, Chrome	50.99 ea.
GCS-S9484	SB, LWP, 1 Groove, Satin	60.99 ea.
GCS-S9484POL	SB, LWP, 1 Groove, Polished	59.99 ea.
GCS-S9606	SB, LWP, 1 Groove, Chrome	48.99 ea.
GCS-S9485	SB, LWP, 2 Groove, Satin	64.99 ea.
GCS-S9485POL	SB, LWP, 2 Groove, Polished	69.99 ea.
GCS-S9607	SB, LWP, 2 Groove, Chrome	52.99 ea.
GCS-S9486	SB, LWP, 3 Groove, Satin	64.99 ea.
GCS-S9486POL	SB, LWP, 3 Groove, Polished	70.99 ea.
GCS-S9608	SB, LWP, 3 Groove, Chrome	51.99 ea.
GCS-S8841	BB, SWP, 1 Groove, Satin	36.99 ea.
GCS-S8841POL	BB, SWP, 1 Groove, Polished	44.99 ea.
GCS-S9817	BB, SWP, 1 Groove, Chrome	32.99 ea.
GCS-S8843	BB, SWP, 2 Groove, Satin	46.99 ea.
GCS-S8843POL	BB, SWP, 2 Groove, Polished	58.99 ea.
GCS-S9816	BB, SWP, 2 Groove, Chrome	34.99 ea.
GCS-S8849	BB, SWP, 3 Groove, Satin	63.99 ea.
GCS-S8849POL	BB, SWP, 3 Groove, Polished	65.99 ea.
GCS-S8845	BB, LWP, 3 Groove, Satin	99.99 ea.
GCS-S8845POL	BB, LWP, 3 Groove, Polished	114.99 ea.
GCS-S9724	BB, LWP, 3 Groove, Chrome	52.99 ea.

Note: SWP = Short Water Pump, LWP = Long Water Pump.

BFC-333



Crank Pulley Bolt OEM

Attaching bolt kit.

BFC-333	All w/ Fine Thread	6.95 kit
BRB-100	All w/ Coarse Thread	6.95 kit



BPB-5934

Harmonic Balancer Attaching Bolt-Washer

BPB-5933	1964-72 Most SB	9.99 kit
BPB-5934	1965-72 All BB	13.99 kit



Concourse Series "Banjo" Style Power Steering Pumps

These are brand new banjo style power steering pumps with correct reservoir and inlet and outlet fittings. No core charge!

APS-6086	1967-68 All V8	209.99 ea.
APS-6153	1969 SB	209.99 ea.
APS-6151	1969 BB	209.99 ea.
APS-6165	1970-72 All V8*	209.99 ea.

*Use with 1970 hose & brackets. No Volume Discount.



APS-6000R



Power Steering Pumps - Replacement

Completely rebuilt second design power steering pumps. These pumps will differ in appearance from our originals, but will fit and function the same. No core charge!

APS-6000R	1969-72 All	115.99 ea.
-----------	-------------------	------------

No Volume Discount.



TUF-6183B



TUF-6195A

Tuff Stuff Power Steering Pumps

GM Saginaw style pumps feature all new components: reservoir, pump assembly, cap & dipstick and hardware when it applies. Rated at 1200 psi, rated to work with most gearbox systems.

TUF-6197A	1967-68 SB Chrome Banjo Style	290.99 ea.
TUF-6197B	1967-68 SB Black Banjo Style	230.99 ea.
TUF-6195A	1969 BB Chrome Banjo Style	290.99 ea.
TUF-6195B	1969 BB Black Banjo Style	249.99 ea.
TUF-6193A	1970 All Chrome Banjo Style	290.99 ea.
TUF-6193B	1970 All Black Banjo Style	230.99 ea.
TUF-6183A	1970-74 All Chrome	272.99 ea.
TUF-6183B	1970-74 All Black	215.99 ea.
TUF-6182A	1975-78 All Chrome	272.99 ea.
TUF-6182B	1975-78 All Black	215.99 ea.
TUF-6181A	1979 All Chrome	272.99 ea.
TUF-6181B	1979 All Black	215.99 ea.
TUF-6180A	1980-81 All Chrome	272.99 ea.
TUF-6180B	1980-81 All Black	215.99 ea.
TUF-6179A	1982-87 All Chrome	272.99 ea.
TUF-6179B	1982-87 All Black	215.99 ea.
TUF-6184A	1988-92 All Chrome	272.99 ea.
TUF-6184B	1988-92 All Black	215.99 ea.

No Volume Discount.



ADR-077



AZZ-33

Power Steering Pump Cap

Quality replacement power steering pump cap.

ADR-077	1967-81 All Plastic	7.99 ea.
AZZ-33	OE Style Metal Cap	44.99 ea.



GCS-S8947



GCS-S8948

Billet Power Steering Pulleys

These show quality billet power steering pulleys will set your show car apart from the crowd. Made of high quality aircraft aluminum.

GCS-S8848	1 Groove, Satin	49.99 ea.
GCS-S8848POL	1 Groove, Polished	49.99 ea.
GCS-S8948	1 Groove, Chrome	19.99 ea.
GCS-S8847	2 Groove, Satin	54.99 ea.
GCS-S8847POL	2 Groove, Polished	61.99 ea.
GCS-S8947	2 Groove, Chrome	40.99 ea.



ASP-509



23-28

Power Steering Pump Pulleys

OE style reproduction power steering pulleys.

ASP-3847	1967-69 1 Groove Deep Cast 302, 396/375, 427	199.99 ea.
ASP-509	1967-81 1 Groove	39.99 ea.
ASP-107	1969-81 2 Groove w/ AC	26.99 ea.
ASP-1395	1969-81 1 Groove SHP	54.99 ea.
23-28	Pulley Nut	3.95 ea.
23-28KEY	Pulley Nut w/ Key	4.99 set



BUY & SAVE

WITH SS396.COM PRE-BUILT KITS



PSKIT-69FBB

Power Steering Conversion Kit

Are you tired of getting a workout every time you want to turn? Ground Up Motors makes it easy to convert to power steering with this power steering conversion kit! We have taken all of the guesswork out of selecting the parts to convert with this all in one solution! Includes: OEM Banjo Style Power Steering Pump, Pump Cap, Brackets, Hardware, Pulley, Pulley Nut, Pressure Hose and Return Hose.

PSKIT-69FSB	1969 SB w/o AC	420.20 kit
PSKIT-69FSBAC	1969 SB w/ AC	408.50 kit
PSKIT-69FBB	1969 BB w/o AC	413.91 kit
PSKIT-69FBBAC	1969 BB w/ AC	402.21 kit
PSKIT-702FSB	1970-72 SB w/o AC	413.88 kit
PSKIT-702FSBAC	1970-72 SB w/ AC	402.18 kit
PSKIT-702FBB	1970-72 BB w/o AC	407.62 kit
PSKIT-702FBBAC	1970-72 BB w/ AC	395.92 kit



ADP-61

1967-68 396 Driver Pulley

OE style reproduction of the SS396 only power steering driver pulley.

ADP-61 1967-68 BB Driver..... 49.99 ea.

BUY & SAVE

WITH SS396.COM PRE-BUILT KITS



ARK-678F

Power Steering Hose Kits

This kit comes with OEM high pressure hose, low pressure return tube, hose and correct clamps.

ARK-678F	1967-68 All V8	44.05 kit
ARK-69F	1969 All V8	44.08 kit
ARK-70F	1970-72 V8	44.08 kit

No Volume Discount.

Power Steering OEM High Pressure Hose

New correctly bent high pressure hoses with correct fittings.



CPX-6616

CPX-6616 1967-68 All V8 26.95 ea.



CPX-6602

CPX-6602 1969 All V8..... 26.99 ea.



CPX-6618

CPX-6618 1970-72 BB 26.99 ea.



CPX-277

CPX-263 1970-1972 SB 26.95 ea.
 CPX-277 1977-79 All V8 26.95 ea.
 CPX-634 1980-81 All V8 w/ O Rings 21.95 ea.



NPX-16

Power Steering Return Hose

Complete with correct pre bent flared tube, OEM hose and correct clamps.

NPX-16	1967-76 All V8	21.99 kit
CPS-038	OEM Return Hose	2.95 per ft.
CPN-512	OEM Clamps Screw Type	1.95 ea.



ASC-128



AB-31F

Power Steering Hose Retainers

Correct clip for retaining hose to steering box and chassis.

ASC-128	All V8 On Steering Box	11.99 ea.
AB-31F	1967-69 All V8 On Frame	20.95 ea.

Power Steering Brackets

Original style reproduction and original GM brackets



ASB-7KIT

Big Block Power Steering Bracket Kit

Complete kit with cradle, adjustment brackets and hardware.

ASB-7KIT 1969-81 All BB..... 110.37 kit

Will work on most BB engines with long style pump. May need some modification.



ASB-9KIT

1969-72 Small Block Power Steering Bracket Kit

Complete kit with all three brackets.

ASB-9KIT 1969-72 SB 90.87 kit

Will work on most SB engines with long style pump. May need some modification.

BUY & SAVE

WITH SS396.COM PRE-BUILT KITS



ASB-366

ASB-366 1967-68 SB Cradle 49.99 ea.

For use with short water pump.



ASB-383

ASB-383 1967-68 Z/28 / SS350 49.99 kit

For use with short water pump.



ASB-184

ASB-184 1967-68 SS396 Cradle..... 69.99 ea.

For use with short water pump.



ASB-186

ASB-186 1967-68 396 Adjuster 39.99 ea.
For use with short water pump.



AQW-1418

AQW-1418 1969 All BB (3 piece).....69.99 kit
Works with original long water pump & P/S pump..



ASB-3941

ASB-3941 1969-76 All SB Cradle..... 32.99 ea.
For use with long water pump.

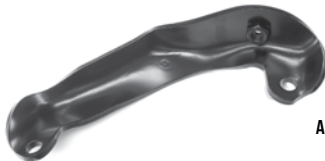

ASB-874

ASB-874 1969-72 SB Rear Support 32.99 ea.
For use with long water pump.



AAB-2610

AAB-2610 1969-76 SB Adjuster 34.99 ea.
For use with long water pump.



ASB-422

ASB-422 1970-72 All BB Cradle.....77.99 ea.
For use with long water pump.



ASB-931

ASB-931 1970-81 All BB Adjuster..... 29.99 ea.
For use with long water pump.



BSB-1970

Power Steering Hardware Kits

Our kits feature all correct hardware to attach power steering brackets to engine. A MUST!

G-4804	1967 SB 302,350 16.99 kit
G-4805	1967 BB 39611.99 kit
G-4917	1968 SB 302,350 10.99 kit
G-4918	1968 BB 39617.99 kit
BSB-69SB	1969-74 SB All24.99 kit
BSB-1969	1969 All BB24.99 kit
BSB-1970	1970+ All BB 12.99 kit
APS-STUD	Pump Housing Stud 3.99 ea.
BSB-3573	Pump Stud & Bolt kit 10.99 kit

BUY & SAVE

WITH SS396.COM PRE-BUILT KITS



GBK-1SFF



Power Steering Gearbox Kits

Now you can add one of these awesome "close ratio" gear boxes to your conversion. These boxes are original remanufactured GM units and will add the ultimate handling to your ride. Our kit comes with steering box, GM steering coupler (rag joint) and correct attaching bolts. Choose from fast ratio or super fast ratio! No core charge!

GBK-1F	1967-69 3 - 3.5 Fast370.93 kit
GBK-1SFF	1967-69 2.5 Super Fast 543.21 kit
GBK-1A	1970-76 3 - 3.5 Fast 379.81 kit
GBK-1SFA	1970-76 2.5 Super Fast552.09 kit
GBK-1XX	1967-76 3.25 Super Fast 399.99 ea.

No Volume Discount. Ships UPS Oversize.



BSB-759

Steering Box Bolt

Complete with correct thick washer and bolt.

BSB-757	1967-69 All 4.99 ea.
BSB-759	1970-76 All 8.69 ea.



D-1870

BX-64K

Pitman Arm

Manual Steering

DA-985	1967-69 39.99 ea.
DA-138Z	1967-69 Z/28 Fast Ratio 179.99 ea.
DA-811	1970-81 89.95 ea.

Power Steering

D-1870	1967-69 69.95 ea.
DA-711	1970-81 119.99 ea.

Pitman Arm Nut

BX-64K	1967-81 6.95 ea.
--------	---------	----------------



ATE-8869A

ATE-8871

ATJ-411

Steering Coupler

Complete joint for connecting column to box. 1967-69 with manual steering features fine spline and 1970-76 with manual steering features coarse spline.

ATE-8869A	1967-69 Manual 49.95 ea.
ATE-8869B	1970-76 Manual 49.95 ea.
ATE-8871	1967-76 Power 49.99 ea.
ATJ-411	1967-76 Bolt All 5.99 ea.



IIS-70F

IIS-78

IIS-78S

Intermediate Steering Shaft

Restore proper steering stability and safety with this newly remanufactured intermediate steering shaft. This shaft goes from the steering column down to the steering box and wears out over time, causing sloppy steering feel.

IIS-70F	1970-76 All149.99 ea.
IIS-78	1978-92 All w/o Shroud129.99 ea.
IIS-78S	1978-92 All w/ Shroud199.99 ea.

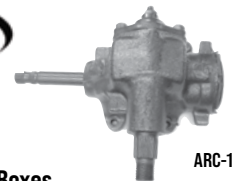

ARC-12SF

Manual Steering Boxes

Complete remanufactured original Saginaw assemblies. Choose from standard or quick ratio. No core charge.

ARC-12A	1967-69 24:1 Std 299.99 ea.
ARC-12B	1970-76 24:1 Std 279.99 ea.
ARC-12SF	1967-76 16:1 Quick 329.99 ea.
ARC-6481MK	1967-81 All* 375.80 ea.

*Works with power steering pitman arm only. Note: Use ATE-8869B coupler with ARC-12SF. No Volume Discount. Ships UPS Oversize.

THE RIGHT Stuff



FPC67ZZSS

PCY03

Fuel Pump to Carburetor Lines

Correct reproductions of the original fuel lines that run from the fuel pump to the carburetor. Each is CNC bent using original factory blueprints. All lines are available in original steel material (OM) or state of the art show quality stainless steel (SS). All lines are made right here in the USA.

		OM	SS
FPC6702	1967 327/210 2bbl Pre-April.....	23.99 ea.	31.99 ea.
FPC6703	1967 After April, 1968 All 327/210.....	23.99 ea.	31.99 ea.
FPC6705	1967-69 350/295, 327/210 5/16".....	23.99 ea.	31.99 ea.
FPC67ZZ	1967-68 Z/28 4 pc.....	61.99 ea.	73.99 ea.
FPC6707	1967-69 327/275, 350/295 3/8".....	23.99 ea.	31.99 ea.
FPC6709	1967-68 396/325.....	23.99 ea.	31.99 ea.
FPC6901	1969 350 2bbl 5/16".....	23.99 ea.	31.99 ea.
FPC6902	1969 307, 327 2bbl 5/16".....	23.99 ea.	31.99 ea.
FPC69XR	1969 Cross Ram, No Block, 3 pc.....	61.99 ea.	73.99 ea.
FPC69ZJ	1969-72 Z/28 w/ Dual Feed Holley.....	61.99 ea.	73.99 ea.
FPC7001	1970-72 350/300.....	23.99 ea.	31.99 ea.
FPC7005	1970 BB Q-Jet.....	23.99 ea.	31.99 ea.
FPC7203	1971-72 BB Q-Jet.....	37.99 ea.	50.99 ea.
FPC72ZZ	1972-74 350 4bbl Z/28 Q-Jet.....	23.99 ea.	31.99 ea.
FPC7801	1978-80 V8 2bbl.....	23.99 ea.	31.99 ea.
FPC7802	1978-80 V8 4bbl.....	23.99 ea.	31.99 ea.
FPC8001	1979-81 350 w/ Q-Jet.....	23.99 ea.	31.99 ea.

Add "SS" to end of part number when ordering stainless.

THE RIGHT Stuff

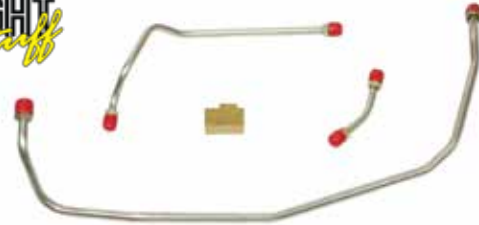

CPC7007-38

Holley Pump to Carb Lines - New

This fuel pump to carburetor line for use with a new Holley carburetor. OEM carburetors used 5/16 inch inlet nuts, but newer carburetors use 3/8 inch inlet nuts. These lines will improve fuel flow and are designed to be used with these new carburetors.

		OM	SS
APC858	1967-68 BB 8-5/8" Spread.....	53.99 ea.	64.99 ea.
BPC858	1969 BB 8-5/8" Spread.....	53.99 ea.	64.99 ea.
BPC938	1969 BB 9-3/8" Spread.....	53.99 ea.	64.99 ea.
CPC7006-38	1970 BB Short # 747 Pump.....	75.99 ea.	88.99 ea.
CPC7007-38	1970 BB Long # 768 Pump.....	75.99 ea.	88.99 ea.

Note: 1970 5/16" lines w/ 3/8" at carb. Add "SS" to end of part number when ordering stainless.

Holley Pump to Carb Lines - Original

Correct reproductions of the original Holley fuel pump to carb lines complete with lines and fuel blocks. These lines are for factory Holleys with 5/16" inlet nuts. These lines will only work on stock engines.

		OM	SS
FPC6775	1967-68 396/375 HP.....	61.99 ea.	73.99 ea.
FPC6975	1969 396/375 HP.....	61.99 ea.	73.99 ea.
PCY03	5/16" inlets, 9-3/8" center to center.....	38.99 ea.	44.99 ea.

Add "SS" to end of part number when ordering stainless.

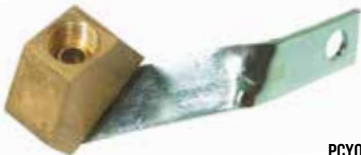

PCY02

Fuel Pump to Carburetor Parts

Correct Y blocks and T blocks for your dual feed Holley carburetor.

PCY01	Y Block w/o Bracket, Brass.....	23.99 ea.
PCY02	Y Block w/ Bracket, Brass.....	35.99 ea.
BPS-7432	Stud for PCY02.....	6.99 ea.
RSBB06	Y Block w/ 3/8" Ports, Used for PCY05.....	30.99 ea.



AHL-516



AHL-38

Carburetor Inlet Fittings

Correct inlet nuts with washers for stock carbs.

AHL-516	5/16".....	20.99 ea.
AHL-38	3/8".....	24.99 ea.



INL-CCF201

Fuel Line Clip Kits

These convenient kits include all of the correct clips needed to install a set of factory fuel lines.

INL-CCF201	1967-68 7pc.....	24.99 kit
INL-CCF202	1969 w/o Return 7pc.....	22.99 kit
INL-CCF203	1969 w/ Return 7pc.....	28.99 kit
INL-CCF205	1970-71 3/8" w/o Return 10pc.....	28.99 kit
INL-CCF206	1970-71 3/8" w/ Return 10pc.....	39.99 kit
INL-CCF207	1972-77 3/8" w/o Return 10pc.....	29.99 kit
INL-CCF208	1972-77 3/8" w/ Return 10pc.....	39.99 kit
INL-CCF209	1978-81 3/8" w/ Return 10pc.....	39.99 kit



AFR-162

1967-68 396 Fuel Line Retainer

Correct fuel line retainer which mounts to the passenger side frame mount on all big blocks.

AFR-162	1967-68 BB.....	10.95 ea.
---------	-----------------	-----------



AFB-239

Z/28 Fuel Line Brace

Correct factory installed brace for carburetor line.

AFB-239	1969-71 Z/28.....	32.99 ea.
---------	-------------------	-----------



AJE-395

ACE-4867

ACE-9599

Fuel Pump Hardware

AJE-395	All Activating Rod.....	16.99 ea.
ACE-9599	All SB Plate.....	10.99 ea.
ACE-4867	Fuel Pump Bolts.....	7.39 kit
ACE-PLUG	Block Plug Under Pump BB All.....	2.99 kit



GCS-S2057

Fuel Pump Block Off Plates

Necessary when using an electric fuel pump.

GCS-S2057	SB, Chrome.....	8.99 ea.
GCS-S2058	BB, Chrome.....	7.99 ea.



AFP-1021

Fuel Pump

Original correct replacement fuel pumps "gold anodized" as original.

AFP-1021	1968-81 All SB 3/8"	39.99 ea.
AFP-1121	1967-81 All BB 3/8"	42.99 ea.
AFP-1124	1968-81 All BB w/ Return	49.99 ea.



GCS-S2302

Chrome Fuel Pump

Show quality chrome plated fuel pump for all small block. Matching chrome mounting plate with gasket sold separately.

GCS-S2302	SB, Pump	59.99 ea.
GCS-S2310	SB, Plate	9.99 kit



QF-30-350QFT

Quick Fuel Technology Fuel Pumps

For the street cruiser, it's tough to beat the simplicity and reliability of a mechanical fuel pump. Quick Fuel Technology's mechanical pumps flow 110 gallons per hour and utilize lightweight aluminum housings. They feature integrated shutoff valves that are preset at 6.5- to 8 psi, eliminating the need for a separate pressure regulator. For added installation flexibility, the pump casting can be rotated to accommodate various plumbing configurations. 3/8" NPT threads. Gasoline only.

QF-30-350QFT	Small Block	148.99 ea.
QF-30-454QFT	Big Block	166.99 ea.

No Volume Discount.

Quick Fuel Technology Electric Fuel Pumps

QFT's electric fuel pumps are perfect for combinations that are neither stock nor all out race cars. These pumps flow more than enough fuel to support between 400-750 hp. Mounting hardware and brackets are included.

- 125 GPH Flow Rate
- 14 PSI Maximum Pressure
- Features 3/8" NPT Inlets and Outlets
- Draws 4 Amps or Less at Full Load
- For Carbureted Gasoline Applications Only



QF-30-125-1QFT

QF-30-125-1QFT	Pump Only	171.99 ea.
QF-30-125-1RQFT	Pump/Regulator	193.99 ea.

No Volume Discount.



FPC6905

1969 Camaro 350 & 396 3 Piece Line Sets

These unique lines are for use with cars equipped with the GF-432 canister filter and bracket.

		OM	SS
FPC6905	1969 350 w/ Q-Jet ...	37.99 ea.	50.99 ea.
FPC6903	1969 396/325	37.99 ea.	50.99 ea.



Fuel Pump Hose Kit

AXP-3800

Correct GM hose for connecting fuel pump to main fuel line. Complete with correct "colored" pinch clamps.

AXP-3800	All 3/8" 3pc	4.99 kit
AXP-1438	All 3/8"-1/4" 6pc	7.99 kit
AXP-6400	All 3/8" 90 Degree Bend 3pc	11.95 kit



GF-432K

GF-432 Fuel Filter & Bracket

This is an OE style reproduction of the original GF-432 fuel filter & bracket for use with 3 piece fuel line. Buy the kit and save!

GF-432K	1969 GF-432 Complete	75.58 kit
AAC-432	1969 GF-432 Filter	59.99 ea.
AFB-234	1969 GF-432 Bracket	23.99 ea.

Holley



HOL-12-803BP



HOL-12-426

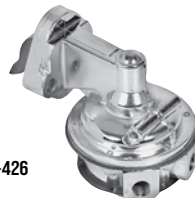

HOL-12834

Holley Chrome Fuel Pumps

Mechanical pumps designed to work with stock or mildly modified engines. Free-flow output of 80 GPH (SB) or 80-130 GPH (BB). Body castings can be rotated 360-degrees to ease mounting in difficult places. Heavy duty construction can withstand long periods at high RPM. 1/4" (SB) 3/8" (BB) pipe thread inlet and outlet ports.

HOL-12834	Small Block	144.99 ea.
HOL-12835	Big Block	149.99 ea.

Note: Not compatible with methanol or alcohol. Cannot be used with fuel injection systems.

Holley Electric Fuel Pumps

Holley is proud to introduce the all new Holley Mighty Mite™ electric fuel pumps! They're big on performance, but small in size! They're quiet, easy to install and work with gas, diesel, blended alcohol and E85!

12 volt operation . 25 gal/hr flow . Good for up to 300HP naturally aspirated. Simple 2 wire hookup. Self-priming and regulating. Quiet operation - 65db. Hose barbs Fit 5/16" Fuel Hose . Made in the USA

HOL-12-426	All 25 GPH 1.5-4 PSI	68.99 ea.
HOL-12-427	All 32 GPH 4-7 PSI	68.99 ea.

No Volume Discount.

Holley Fuel Pressure Regulator

Holley fuel pressure regulators are designed to precisely control the fuel pressure from the fuel pump to the carburetor. Too much fuel pressure for a given needle and seat assembly will overload and may cause flooding or drivability problems. Each Holley fuel pressure regulator is fully adjustable so regulating the fuel pressure to your engines needs is simple.

12 volt operation. Preset to 7psi. 3/8" NPT ports (1 in, 1 out, 1 bypass or return). Used in systems with a return line back to the fuel tank

HOL-12-803BP	All Carbureted	137.99 ea.
--------------	----------------------	------------

No Volume Discount.



AAC-427



AAC-455

Fuel Filters

Original GM AC Delco

AAC-427	Q-Jet Short Style	4.95 ea.
AAC-455	All Holley Brass	6.99 ea.



GCS-S4297



GCS-S9245



GCS-S9407



GCS-S9177

Chrome Inline Fuel Filters

Choose from a variety of show quality chrome fuel filters to dress up your engine.

Carburetor

GCS-S9407	Bronze Element, 3/8"	14.99 ea.
GCS-S9177	Paper Element, 3/8"	9.99 ea.
GCS-S9245	Glass Element, 3/8"	13.99 ea.

Red Top High Capacity Chrome Fuel Filters

Show quality chrome plated fuel filter with paper element and pipe fittings.

GCS-S4297	Small	39.99 ea.
GCS-S4295	Large	42.99 ea.

AIT-6961



Alternators

Professionally rebuilt alternator which is proudly made in the USA. Each alternator is 100% tested and rebuilt to exceed OEM specifications. No Core Charge!

- AIT-6961 41 Amp External Reg89.99 ea.
- AIT-6963 55 Amp External Reg89.99 ea.
- AIT-63X 1967-72 63 Amp External Reg 149.99 ea.
- AIT-3342 63 Amp Internal Reg..... 112.99 ea.

No Volume Discount.

TUF-7127D



Tuff Stuff Internally Regulated Alternators

Tuff Stuff's high powered internally regulated alternators are perfect if you have added a set of high powered headlights or a high powered stereo system or any other electronic systems to your Camaro. Although meant for 1971 and newer, internally regulated setups can be used on older models that have been converted from external to internally regulated.

- TUF-7127D 100 Amp, 1 Wire, Cast Finish110.99 ea.
- TUF-7127NF 100 Amp, 1 Wire, Black..... 155.99 ea.
- TUF-7127NC 100 Amp, 3 Wire, Chrome..... 109.95 ea.
- TUF-7127K 140 Amp, 1 Wire, Cast Finish 169.99 ea.
- TUF-7140FBULL 140 Amp, Silver Bullet, 1 Wire, Black.....222.99 ea.



APX-1724

Alternator Fan Kit

Correct AC Delco fan zinc plated as original. Comes with special nut.

- APX-1724 All Fan / Nut17.99 kit
- APX-301GM 1967-70 Fan OE Style 11 Blade 28.99 ea.



ABN-105



ABB-5790

Alternator Pulleys

- ABB-5799 Standard (2-3/4" OD)20.99 ea.
- ABB-5790 All w/ SHP (3-1/4" OD).....42.99 ea.
- ABN-105 Correct Retaining Nut4.99 ea.



GCS-S9487

Billet Alternator Pulleys

Show quality billet alternator pulleys.

- GCS-S9487 1 Groove, Satin 30.99 ea.
- GCS-S9487POL 1 Groove, Polished 34.99 ea.
- GCS-S9447 2 Groove, Chrome..... 20.99 ea.



AVC-1144



APX-2559

Alternator Pigtail & Boot

Correct plug in "pigtail" for rear of alternator.

- AVC-1144 1967-81 All Pigtail 4.95 ea.
- APX-2559 Rear Alternator Boot 4.95 ea.



GCS-S6679

Alternator Dress Up Kit

This kit is designed to take your stock internally regulated alternator and make it show ready. This kit includes a chrome alternator case, pulley, fan and hardware.

- GCS-S6679 1973-85 GM59.99 kit

Note: For 1973-85 internal regulated alternators only.



AR-0180

1967-68 Z/28

Alternator Bracket Kit

Correct upper and lower bracket stamped "GT".

- AR-0180 1967-68 Z/2884.99 kit



AA-45KIT

Big Block Alternator Bracket Kit

This is a complete set of alternator brackets and hardware for your Camaro big block with short water pump. This kit works on all cars with short water pumps.

- AA-45KIT 1967-68 BB Short Pump 81.56 kit



AKK-301

1969-81 Big Block Alternator Mounting Kit

OE style reproduction of upper-lower brackets, lower mounting stud, lower spacer-brace and upper adjustment bolt w/ special washer.

- AKK-301 1969-81 All BB..... 80.67 kit



AKK-69SB

1969-1972 Small Block Alternator Bracket

OE style reproduction of upper-lower brackets, lower mounting stud, lower spacer-brace and upper adjustment bolt and washer.

- AKK-69SB 1969-72 All Small Block69.99 kit

Small Block Alternator Brackets

OE style reproduction alternator brackets for your small block Chevy.



AAB-3400

- AAB-3400 1967-68 SB Upper37.99 ea.



AAB-64L

- AAB-64L 1967-68 SB Lower 44.99 ea.

For exhaust manifolds.



AAB-65L

- AAB-65L 1967-68 SB Lower18.99 ea.

Use with AAB-64L if you have headers.



ACE-5333

- ACE-5333 1969-81 SB Lower16.95 ea.



ACE-2956

AAB-227

- ACE-2956 1969-75 SB Upper 36.99 ea.

- AAB-227 1976-86 SB Upper 26.99 ea.

Big Block Alternator Brackets

OE style reproduction alternator brackets for your big block Chevy.



AAB-4500

- AAB-4500 1968 BB Upper19.99 ea.



ARZ-0027

- ARZ-0027 1968 BB Lower 49.99 ea.



AK-173

- AK-173 1969-72 BB Upper 24.99 ea.











AK-175

- AK-175 1969-72 BB Lower16.99 ea.

OE Style Chrome Alternator Brackets







These high quality brackets will give your show car that finishing touch!

	GCS-S9315			GCS-S9637			GCS-S9318	
GCS-S9315	SB Upper SWP	17.99 ea.	GCS-S9637	SB Lower LWP (69-75)	8.99 ea.	GCS-S9318	BB Upper LWP (69-92)	17.99 ea.
	GCS-S9316			GCS-S9502			GCS-S9638	
GCS-S9316	SB Upper LWP (69-75).....	17.99 ea.	GCS-S9502	BB Lower SWP	39.99 ea.	GCS-S9638	BB Lower LWP (69-92).....	9.99 ea.
	GCS-S9317			GCS-S9581			GCS-S9254	
GCS-S9317	SB Upper LWP (76-86)	18.99 ea.	GCS-S9581	BB Upper SWP.....	16.99 ea.	GCS-S9254	Bracket for Headers.....	13.99 ea.

Note: SWP = Short Water Pump, LWP = Long Water Pump.





Custom Style Alternator Brackets

These chrome plated steel alternator brackets will give your engine a unique custom look that will stand out from the crowd.

	GCS-S9319			GCS-S9320			GCS-S1637	
GCS-S9319	SB Upper SWP	16.99 ea.	GCS-S9320	V8 Upper LWP (69-75).....	19.99 ea.	GCS-S1637	SB Upper LWP (76-86)	23.99 ea.
	GCS-S9321			GCS-S1647			GCS-S1647	
GCS-S9321	SB Upper LWP (76-86)	15.99 ea.	GCS-S1647	BB Upper LWP (69-92)	23.99 ea.			

Alternator Hardware

All of the correct hardware needed to mount your alternator!

	BRB-938	
BRB-938	1969-72 SB Lower Bolt.....	4.95 ea.
	BN-339	
BN-339	1969-72 BB Lwr Stud/Nut	12.99 ea.
	APX-1138	
APX-1138	1969-72 SB Spacer Brace.....	18.99 ea.
	APX-1038	
APX-1038	1969-72 BB Spacer/Brace	16.99 ea.

	AWB-1114	
AWB-1114	1964-72 Upper Adjustment Kit	5.99 kit
	ABC-23	
ABC-23	1969-72 Bat Cable Clip SB	15.99 ea.
<i>For top of alternator</i>		
	ATE-5416	
ATE-5416	1969-72 Heater Hose Retainer	7.99 ea.
<i>For top of alternator</i>		

	BZ-117	
Alternator Mounting Kits		
These complete kits make installing your alternator and bracket easy.		
G-4828	1967-68 Z/28	15.99 kit
G-4645	1967-68 327, 350	14.99 kit
G-4766	1967-68 396, 427	19.99 kit
BZ-117	1968 BB 396, 427	19.99 kit
G-4962	1969-74 SB All	17.99 kit

	AW-506	
AW-506	1964-72 Neg Cable Ground Bolt/Washer	0.95 ea.



ACL-1430

Hood Valve Frame

Correct steel frame inside of hood to support the flipper door.

- | | | |
|----------|--------------------------------|-----------|
| ACL-1430 | 1967-69 Hood Valve Frame | 32.99 ea. |
| BCX-130 | Attaching Screws 8pc | 5.95 kit |



ACX-012

Valve Frame (Flipper) Door

This is the electrically controlled air door which mounts to the valve frame.

- | | | |
|---------|----------------------------|-----------|
| ACX-012 | 1967-69 Flipper Door | 15.99 ea. |
|---------|----------------------------|-----------|



ACL-1684

Valve Frame Door Clips

Correct clip set to attach the flipper door to the frame.

- | | | |
|----------|-------------------------------------|----------|
| ACL-1684 | 1967-69 Valve Frame Clips 3pc | 6.99 kit |
|----------|-------------------------------------|----------|



AXE-127

Valve Frame Seal

Correct seal used to seal frame to hood.

- | | | |
|---------|--------------------------|----------|
| AXE-127 | 1967-69 Frame Seal | 6.95 ea. |
|---------|--------------------------|----------|



ACG-67F1B

Style 1 in Black Anodized



ACG-67F2B

Style 2 in Black Anodized

Cowl Hood Grilles

If you're tired of looking at the hole in the back side of your cowl hood, this 1967-1969 Camaro cowl hood grille is the answer. Constructed of 16 gauge aluminum, this cowl hood grille will keep things looking neat while keeping out debris.

- | | | |
|-----------|-----------------------------------|-----------|
| ACG-67F1C | 1967-69 Style 1 Clear Anodized .. | 51.99 ea. |
| ACG-67F1B | 1967-69 Style 1 Black Anodized .. | 51.99 ea. |
| ACG-67F1P | 1967-69 Style 1 Polished | 52.99 ea. |
| ACG-67F2C | 1967-69 Style 2 Clear Anodized .. | 51.99 ea. |
| ACG-67F2B | 1967-69 Style 2 Black Anodized .. | 51.99 ea. |
| ACG-67F2P | 1967-69 Style 2 Polished | 52.99 ea. |



ACI-3335

Cowl Induction Throttle Arm

OE style reproduction of arm which is used in conjunction with gas pedal.

- | | | |
|----------|----------------------------------|-----------|
| ACI-3335 | 1967-69 w/ Cowl Induction | 21.99 ea. |
| ADR-476 | 1967-69 w/o Cowl Induction | 24.99 ea. |



AEH-9602

Air Cleaner Valve Relay

This relay sends the "hot" signal to solenoid.

- | | | |
|----------|---------------------|-----------|
| AEH-9602 | 1967-69 Relay | 31.99 ea. |
|----------|---------------------|-----------|



ACI-3685

Cowl Induction Electric Solenoid

Correct electric solenoid with part number stamped on.

- | | | |
|----------|---------------------------|-----------|
| ACI-3685 | 1967-69 w/ GM Stamp | 48.99 ea. |
|----------|---------------------------|-----------|



AD-007



AQW-1176

Cowl Induction Solenoid Switch

Correct throttle switch and clip for activating solenoid.

- | | | |
|----------|----------------------|-----------|
| AQW-1176 | 1967-69 Switch | 20.99 ea. |
| AD-007 | 1967-69 Clip | 7.99 ea. |



AHQ-1143



AQW-296

Cowl Induction Harness & Grommet

OE style reproduction of original GM harness and correct rubber grommet for routing harness through firewall.

- | | | |
|----------|-----------------------|-----------|
| AHQ-1143 | 1967-69 Harness | 59.99 ea. |
| AQW-296 | 1967-69 Grommet | 8.99 ea. |



APJ-1314

Accelerator Rod Grommet Kit

- | | | |
|----------|--------------------|----------|
| APJ-1314 | 1967-69 Most | 7.95 kit |
|----------|--------------------|----------|



APA-69CI

Accelerator Pedal Linkage Kit

New assemblies complete from the pedal to the arm and includes the pedal trim.

- | | | |
|----------|-------------------------------|-----------|
| APA-68 | 1967-69 V8 w/o Cowl Ind | 69.99 kit |
| APA-69CI | 1967-69 w/ Cowl Ind | 62.99 kit |



APA-6CBH

Throttle Linkage To Cable Conversion Kit

Remove the old sticky linkage and upgrade to a smooth operating throttle cable set up. This kit includes the accelerator pedal assembly, accelerator cable, cable bracket and cable retaining clip.

- | | | |
|-----------|----------------------|------------|
| APA-6CBH | 1967-69 Holley | 145.99 kit |
| APA-6CBQJ | 1967-69 Q-Jet | 157.99 kit |



APA-9Z

Cross Ram & 6 Cyl Pedal Linkage

Correct pedal linkage for all cross ram and 6 cylinder cars.

- | | | |
|--------|---------------|-----------|
| APA-9Z | 1967-69 | 89.99 ea. |
|--------|---------------|-----------|



AY-12

Accelerator Rod Support

Correct support bracket used to hold rod in place. Complete with screws.

- | | | |
|-------|-------------------------|-----------|
| AY-12 | 1968-69 (Plastic) | 21.99 ea. |
|-------|-------------------------|-----------|



AEM-67FS

Engine Mounting Kits

Perfect for converting to a V8 or for upgrading your small block to a big block! Each kit includes all of the necessary motor mounts, frame brackets, motor mount thru bolts, frame bracket bolts and motor mount to block bolts so you can do the job right!

AEM-67FS	1967-68 All SB.....	97.15 kit
AEM-67FB	1967-68 All BB	104.50 kit
AEM-67FS	1969 SB except 302 or 350	97.15 kit
AEM-69FZO	1969 302 or 350 OEM	134.89 kit
AEM-69FBO	1969 All BB OEM.....	134.89 kit
AEM-70FBO	1970-81 All BB.....	157.39 kit

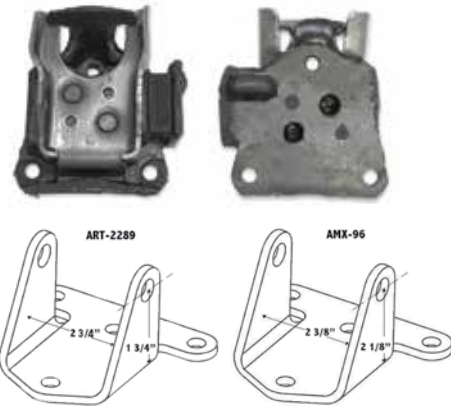

AMX-96

Motor Mounts OEM

These new motor mounts are from GM's original supplier!
MADE IN USA!!!

ART-2289	1967-68 All, 1969 All Except 350	39.99 pr.
AMX-96	1969 302 350, 1969-81 BB.....	69.95 pr.

Please measure your frame brackets before ordering.
Use ART-2289 with AMC-10SB & AMC-103. Use AMX-96 for ACE-9794.



AQW-1339

Frame Brackets

OE style reproduction of the long discontinued GM brackets for mounting the engine to frame of car. Sold in matched pairs.

AQW-1339	1967-68 SB	39.99 pr.
ATE-5978	1967-68 BB	54.99 pr.
AQW-1339	1969 SB except 302 or 350	39.99 pr.
AR-397	1969-70 302 or 350.....	54.99 pr.
ACE-9412	1969 BB	54.99 pr.
AW-324	1970-81 BB	79.99 pr.

ENERGY SUSPENSION

Performance POLYURETHANE Components



3-1116G

3-1117G

Poly Motor Mounts

Energy Suspension motor mounts can take the abuse of today's high performance engines. Poly bushings can last longer than stock rubber mounts while handling more power, yet still able to absorb most driveline vibrations. Add G to the part number for black. Add R to the part number for red.

3-1114_	1967-72 SB 2-5/8" x 3/4" H.....	59.99 ea.
3-1117_	1967-72 BB 2-3/8" x 1-3/16" H..	59.99 ea.
3-1116_	1973-92 SB*	36.99 ea.
3-1120_	1969-72 SB w/ Trans Mount.....	164.97 ea.
3-1122_	1969-72 BB w/ Trans Mount.....	164.97 ea.

Two mounts required per car. *You must reuse your original clamshells on the 1973-92 applications by drilling out the rivets and replacing the rubber insert with the new poly mount.



ENG-67FS-G

Poly Engine Mount Kits

Same as our OE style engine mount kits with upgraded Energy Suspension Poly motor mounts. The poly mounts can take the abuse of today's high performance engines, yet still absorb driveline vibrations. Add G to the part number for black. Add R to the part number for red.

ENG-67FS-_	1967-68 SB Except 302-350	181.14 kit
ENG-67FB-_	1967-68 BB.....	197.39 kit
ENG-69FZO-_	1969 SB 302-350	191.91 kit
ENG-69FBO-_	1969 BB.....	191.91 kit
ENG-70FBO-_	1970-81 BB	214.41 kit

No Volume Discount.



HED-03832

Hedman LS Conversion

These kits are designed to make swapping that LS Series small block Chevy into your Camaro easy. These kits include new frame brackets, motor mounts, a transmission crossmember, hardware and polyurethane bushings where needed. The conversion parts feature a durable silver powdercoated finish to make them look great and protect them from the elements.

HED-03832	1967-69 w/ 4L80E	612.99 kit
HED-03831	1967-69 w/ 4L60E, 4L65E.....	612.99 kit
HED-03830	1967-69 w/ T-56 6 Speed.....	628.99 kit
HED-03834	1970-81 w/ 4L60E, 4L65E.....	628.99 kit
HED-03833	1970-81 w/ T-56 6 Speed	628.99 kit
HED-03836	1982-92 w/ 4L60E, 4L65E.....	615.99 kit
HED-03835	1982-92 w/ T-56 6 Speed.....	615.99 kit

No Volume Discount. Not eligible for free shipping.



UMI-90072

UMI Engine Mounting Kits

UMI's SBC engine mount kits are a bolt-in direct replacement for those worn-out factory rubber and clamshell mounts. Poly engine mounts bridge the gap between race oriented solid mounts and cruiser-oriented rubber mounts.

UMI-90072	1973-81 All V8 Poly.....	142.99 kit
UMI-90075	1973-81 All V8 Solid.....	142.99 kit
UMI-90074	1973-81 All V8 Clam Shell Only	59.99 kit
UMI-90073	1982-92 All V8 Poly	142.99 kit
UMI-90077	1982-92 All V8 Solid	142.99 kit
UMI-90076	1982-92 All V8 Clam Shell Only	142.99 kit

No Volume Discount.



APX-2339

Frame Bracket Attaching Bolt Kit

Correct OEM bolts, washers and locking nuts as original.

APX-2339	1967-81 All V8	7.99 kit
----------	----------------------	----------



BJ-998

Motor Mount Attaching Bolt Kit

Correct style bolts for attaching mount to block.

BJ-998	All 12pc.....	9.99 kit
--------	---------------	----------



APB-7057

Motor Mount "Thru" Bolt Kit

Correct OEM bolts for retaining mount to frame bracket. Comes complete with special high strength washers and cadmium plated locking nuts as original.

APB-9057	4.5"	9.99 kit
APB-7057	3.5"	6.95 kit



ATW-2853

Motor Mount Clip

Correct clip for attaching positive cable to right side motor mount.

ATW-2853	Most V8	21.99 ea.
----------	---------------	-----------



Vintage Air SureFit Kits

Vintage Air SureFit kits are the most complete, bolt-in climate control systems available for your Camaro. SureFit kits install easily and utilizes most of the factory sheet metal and body features and are engineered as "vehicle specific" complete systems. Our SureFit kits are designed to place the evaporator case and air duct hoses behind the dash for a factory-clean look. In most cases, the SureFit system will be controlled by your stock dash controls using our exclusive patented "Cable Converters." In some applications, a new "factory" look control panel is included with the kit. All SureFit systems provide full OEM-style operations including air conditioning, floor or vent exit heating and a powerful dehumidified defroster. To retain a true factory look, the AC air exits through the factory dash louvers, if originally equipped in your car's dash. SureFit kits also offer the most complete and straightforward installations available anywhere. Our award-winning instruction booklets and carefully engineered system packages should make your SureFit installation job simple, fun and very cool! The Gen IV is Vintage Air's most powerful and intelligent climate control system available for your Camaro. The Gen IV uses an exclusive fully electronic microprocessor control system that eliminates cables or vacuum connections. Separate high-capacity copper parallel-flow heat coil and aluminum plate-and fin-cooling coils provide outstanding performance and instant temperature adjustments. Complete kits include the evaporator unit and mounting brackets, louvers (where required), duct hose, wiring harness, patented Electronic Cable Converters, compressor, engine brackets, condenser with brackets, preformed refrigerant lines, drier, fittings, hardware and installation instructions.

Features Include:

- Fly-By-Wire fully electronic servo motor controls with no cables or capillary tube to route
- Infinite just-right-temperature air blending
- Infinite blower fan speed adjustment (3-speed on factory air models)
- High-volume dehumidified defrost mode
- Separate high-capacity aluminum plate & fin cooling coil
- Copper/brass CuproBraz™ parallel-flow heater coil
- Mounts behind the dash
- Uses your factory system controls with our patented Electronic Cable Converters
- Flat steel firewall cover panel
- Replacement molded glove box (reduced capacity)

VA-964244	1967-68 All With Factory Air	2199.99 kit
VA-961244	1967-68 All Without Factory Air.....	2199.99 kit
VA-964245	1969 All w/ Factory Air.....	2199.99 kit
VA-961245	1969 All w/o Factory Air	2199.99 kit
VA-964258	1970-73 All w/ Factory Air	2199.99 kit
VA-961258	1970-73 All w/o Factory Air	2199.99 kit
VA-964259	1974-77 All w/ Factory Air	2199.99 kit
VA-961259	1974-77 All w/o Factory Air	2199.99 kit
VA-964260	1978 All w/ Factory Air	2199.99 kit
VA-961260	1978 All w/o Factory Air	2199.99 kit
VA-964261	1979-81 All w/ Factory Air	2199.99 kit
VA-961261	1979-81 All w/o Factory Air	2199.99 kit

No Volume Discount. Ships oversize. Not eligible for free shipping.



AMK Inc PRODUCTS



Engine Master Hardware Kits

The authentic hardware you need to correctly reassemble the engine components that attach to the long block. Typical kits include fasteners for: air cleaner, carburetor & choke cover, crank pulley & damper, distributor, exhaust manifold, exhaust pipe, engine fan, fuel pump plate & plug, seat shroud, ignition coil & strap, intake manifold & plug, oil filter valve, oil pan, PCV adapter, PCV hose clamps, timing cover, valve covers, water neck, water pump.

67-Z28	1967-68 SB Z/28 174pc	179.99 kit
66-SBS	1968 SB w/o AC 153pc.....	169.99 kit
66-SBA	1968 SB w/ AC 164pc.....	179.99 kit
68-BBH	1968 BB Aluminum Intake 149pc.....	192.99 kit
68-BBS	1968 BB Cast Iron Intake 159pc.....	186.99 kit
69-SB	1969-71 SB 170pc	184.99 kit
69-Z28	1969 SB Z/28 162pc	149.99 kit
69-BBH	1969-72 BB Aluminum Intake 149pc.....	199.99 kit
69-BBS	1969-72 BB Cast Iron Intake 143pc.....	184.99 kit
72-SB	1972-73 SB 139pc.....	159.99 kit
72-Z28	1972-73 Z/28 145pc.....	139.99 kit

No Volume Discount.



ZACL6970A

Air Conditioning Line

New pre-bent compressor line with correct fittings and compressor muffler. All V8.

ZACL-6970SB	1969-70 SB 350.....	189.99 ea.
ZACL6970A	1969-70 BB 396	189.99 ea.

These lines will only work with correct original AC components.



AC Receiver Dryer Brackets

Correct air conditioning receiver dryer brackets.

ADB-117	1967	36.95 pr.
ADB-118	1968-69.....	36.95 pr.

1967 requires a nut and bolt. 1968-69 requires a self tapping bolt.











AC Condenser Brackets

Correct brackets for mounting original air conditioning condenser.

ACB-119	1967-69	23.95 pr.
ACB-679HWK	1967-69 Hardware.....	13.99 set

Air Conditioning Brackets Big Block

OE style reproduction brackets for installing original Delco air conditioning compressors in all 1969-72 Camaros with big blocks using long water pumps.

	ZAC-A1	ZAC-A4	1969-70 Rear Compressor Plate 26.99 ea.		ZAC-B2	1970+ Front Bracket (on head)..... 79.99 ea.
ZAC-A1	1969-70 Rear Compressor Bracket... 55.99 ea.		ZAC-A5	1969-71 Lower Bracket (to head) 49.99 ea.		ZAC-B3
	ZAC-A2	ZAC-A6	1969-70 Rear Compressor Spacer 29.99 ea.		ZAC-B4	1970+ Rear Compressor Plate 59.99 ea.
ZAC-A2	1969-70 Front Bracket (on head) 89.99 ea.		ZAC-B1	1970+ Compressor to Intake Bracket.. 26.99 ea.		ZAC-B5
	ZAC-A3					
ZAC-A3	1969-70 Front Compressor Bracket.. 55.99 ea.					

1969-70 1st Design AC Brackets



1970-75 2nd Design AC Brackets

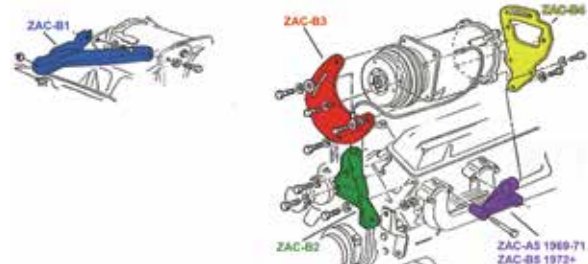

BUY & SAVE
WITH SS396.COM PRE-BUILT KITS

Buy a complete set of big block air conditioning brackets and save! The design changed midway through 1970, so be sure to check your original brackets for early style (ZAC-AKIT) or late style (ZAC-BKIT).

ZAC-AKIT	1969-70 BB	308.94 kit
ZAC-BKIT	1970-71 BB.....	256.95 kit
ZAC-BKIT2	1972 BB	261.95 kit

AC On Engine Hardware

All the hardware related to the AC brackets on the engine.

66AA-SB	1967 SB	30.99 kit
67AA-SSB	1967 SB w/ Smog	27.99 kit
68FA-SB	1968 SB	32.99 kit
68FA-SBB	1968 SB w/ Smog	30.99 kit
68FA-BB	1968 BB	37.99 kit
69AA-SB	1969 SB	42.99 kit
69AA-BB	1969 BB	34.99 kit
70AA-SB	1970 SB	38.99 kit
70AA-BB	1970-72 BB	39.99 kit
71AA-SB	1971 SB	34.99 kit
72AA-SB	1972-73 SB	34.99 kit

AMK inc
PRODUCTS

66AA-SB





AWM-8242



AWM-4169

Windshield Wiper Motors

Correct replacement wiper motors. Great to replace your tired original!

AWM-83T	1967 2 Spd 3 Terminal.....	149.95 ea.
AWM-84T	1967 2 Spd 4 Terminal.....	129.99 ea.
AWM-8242	1968-72 w/o Hidden	129.99 ea.
AWM-4169R	1970-73 w/ Hidden	169.99 ea.
AWM-4169	1970-73 w/ Hidden OE Style.....	169.99 ea.
AWM-168	1977-81 w/ Delay System*	144.99 ea.

*For intermittent or pulse action wipers. No Volume Discount.



APW-2432



APW-2401-XX



APW-2401

Wiper Motor Mounting Kit

Correct steel rubber grommets & screws for mounting motor to firewall.

APW-2432	1967-81 All w/o Hidden Wipers ...	13.99 kit
APW-2401	1970-81 All w/ Hidden Wipers	12.99 kit
APW-2401-XX	1970-81 All w/ Hidden Wipers w/ Ground Strap.....	16.99 kit
APW-STRAP	1967-81 Ground Strap w/o Hidden Wipers.....	4.99 ea.
APW-STRAP-L	1970-81 Ground Strap w/ Hidden Wipers.....	4.99 ea.
FMP-CLIP	1967-81 Clip	5.99 ea.



AWA-085

Wiper Motor Arms with Ball Studs

These are the correct arms with studs that attach to the motor itself.

AWA-085	1967 All	16.99 ea.
AWA-086	1968-69 All.....	16.99 ea.



AWS-992



AWM-SEAL

Wiper Motor Seals

Correct foam rubber seal for wiper motors.

AWS-7	1967 All	6.99 ea.
AWS-792	1968-69 w/o Hidden.....	6.99 ea.
AWS-992	1970-77 w/ Hidden	7.99 ea.
AWM-SEAL	1970-81 w/ Hidden on Motor	7.99 ea.



AWP-6971W



AWP-882D

OEM Style Washer Pump

New OE style reproduction washer pump with correct white nozzles! Fits cars with hidden wipers.

AWP-6971W	1970-74 1 st Design.....	59.99 ea.
AWP-69RS	1969 RS Headlight Washer Pump	189.99 ea.
AWP-64C	1970-74 1 st Design Cover Only	19.99 ea.
AWP-6488	1967-74 Single Speed Cover Only ...	14.99 ea.
AWP-882D	1970-77 2nd Design	109.99 ea.



AWP-6971

Washer Pump

AC Delco replacement washer pumps will fit and function as original. Fits cars without hidden wipers.

AWP-6971	1968-74 w/o Hidden	99.99 ea.
AWP-6971WN	1968-74 w/o Hidden White Nozzle	99.99 ea.



AHL-5400

Washer Pump Repair Kit

Correct white plastic nozzle, rubber seals and screws to repair your original washer pump.

AHL-5400	1967-69	11.99 ea.
----------	---------------	-----------



ACQ-100

Washer Nozzles

OE style reproduction washer nozzles, complete.

ACQ-100	1967-69 All	15.99 pr.
AWN-301	1970-81 All.....	19.99 pr.
AVN-101	Correct Screws	0.95 pr.



APH-1132

Washer Hose Kit

Correct ribbed thin walled style washer hose in pre cut lengths (7/32 - 11/32 diameter).

APH-1132	1967-69 All	11.95 kit
----------	-------------------	-----------



AWJ-0892



AWJ-0083

Washer Jars

Correct white plastic washer jars.

AWJ-0083	1967-69 All	6.99 ea.
AWJ-0892	1970 All	15.99 ea.
AWJ-7038	1975-78*	29.99 ea.
AWJ-7039	1977-81.....	22.99 ea.
AWJ-0892K	1970 w/ Cap	22.03 kit
AWJ-0083-CAP	1967-69 1st Design w/ Cap	13.58 kit
AWJ-8368F	1982-87	39.99 ea.

*Fits 1977-78 models with washer pump mounted on the wiper motor.



AWB-8939

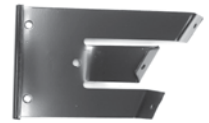

AWB-1206

Washer Jar Bracket

Correct bracket for mounting jar to fender.

AWB-8939	1967-69 Bracket.....	14.99 ea.
AWJ-10M	Mounting Screws	0.95 pr.
AWB-1363	1968 RS Adapter Bracket.....	11.99 ea.
AWB-1206	1969 RS Adapter Bracket.....	12.99 ea.
AVX-97RS	1968-69 RS Bracket Screws	1.00 kit
AWB-527	1977-81 Bracket	14.99 ea.



APX-9738

Washer Cap Kit

Correct GM cap, ribbed hose & pick up screen.

APX-9738	1967-81 All Cap Kit.....	8.99 kit
AWJ-8372	1967-81 Cap Only	4.99 ea.
AWJ-100	1967-81 Screen Only	3.99 ea.



DSE121301



DSE Selecta-Speed Wiper Kits

DSE's wiper kit contains a low profile, seven-speed wiper motor with 5 delays, low speed, high speed, a rotary switch with a billet knob to match your vehicle, adapter plate and wiring harness. The CNC hard coated aluminum adapter plate mounts the wiper motor to the stock firewall bolt pattern.

DSE121001	1967 All676.99 kit
DSE121301	1968 All676.99 kit
DSE121401	1969 All699.99 kit
DSE121402	1970-72 (Non Recess Park)676.99 kit
DSE121404	1973-74 (Non Recess Park)676.99 kit
DSE121406	1975-77 (Non Recess Park)676.99 kit
DSE121408	1978 (Non Recess Park)742.99 kit

No Volume Discount.



R59-TOP



R89-TOP

Battery Toppers

This new plastic injection molded cover will give your modern battery the look and feel of an original! This topper works with Group 24-60 sized batteries only. Inside size = 6-7/8" x 10-3/8".

R59-TOP	1967-72 R-59 59.99 ea.
R89-TOP	1969-72 R-89 Side 59.99 ea.



ASR-678FSB



ASR-69FBB

Spring Ring Cables

OE style reproduction of the original factory installed spring type cables sold as a matched pair with GM numbers.

ASR-678FSB	1967-68 SB159.98 pr.
ASR-678FBB	1967-68 BB159.98 pr.
ASR-69FSB	1969 SB159.98 pr.
ASR-69FBB	1969 BB159.98 pr.
ASR-70F	1970-73 All 89.99 pr.
ELC-38-BATTCLB	3/8" Rubber Coated Cable Clip 3.99 ea.



AST-1001

Side Terminal Battery Cables

Correct cables for cars with the heavy duty R-89 batteries with correct GM part numbers.

AST-1001	1969 R-89 160.00 kit
----------	-----------	------------------



GCS-S6323

Billet Aluminum Battery Trays

Secure your battery in style! Fits Optima batteries.

GCS-S6323	Optima Group	
	34/78 Top/Side Post99.99 kit
GCS-S6324	Optima Group	
	35 Top Post73.99 kit
GCS-S6325	Optima Group	
	75/25 Top/Side Post83.99 kit



ABR-9533



ABT-6006

Battery Trays

OE style reproduction EDP coated battery trays.

ABT-6006	1967-69 All Tray 15.99 ea.
ABT-6006K	1967-69 All Tray Retainer w/ Bolt 16.78 kit
ABT-679KIT	1967-69 Tray Mounting Bolts 9.99 kit
ABT-7081	1970-81 All Tray 15.99 ea.
ABT-7081K	1970-81 All Tray Retainer w/ Bolt 18.63 kit
ABR-9533	1967-81 Retainer w/ Bolt 4.99 kit



GCS-S9323

Universal Stainless Battery Tray

This polished stainless steel tray will secure your battery in style! Fits batteries measuring 7.5" L x 13.25" W x 9.25" tall.

GCS-S9323	Battery Tray43.99 kit
-----------	--------------	----------------



AMH-15

Underhood Lamp

Complete with bracket, hardware, harness and built in switch.

AMH-15	All72.99 kit
--------	-----	----------------



GRC-12835



GRC-12834

Radio Capacitor

Came from the factory on all cars with a radio. Correct length lead wire & brass connector.

GRC-12834	1967-71 Voltage Regulator 24.99 ea.
	Stamped 1964086 "DR" & ".5MF"	
GRC-12835	1970-1974 Radio 24.99 ea.
	1964452 "DR" & ".3MF"	



GAC-515



GAC-5156M

Voltage Regulator

New correct GM replacement.

GAC-515	1967-72 All D635 84.99 ea.
GAC-5156M	1967-71 OE Style Reproduction 99.99 ea.
GAC-515XX	D635 Chrome 59.99 ea.
AVX-515	1967-72 Screws 2pc0.95 kit
AWX-818	1967-72 Mounting Kit6.95 kit



GQH-118

Electric Junction Block

Original GM junction block for attaching positive lead from battery to main harness. Mounts to radiator support. Includes correct nut.

GQH-118 1967-71 All 8.99 ea.



GAC-560

GAC-760

GAC-660

Temp Sending Units

Correct screw-in sending units.

GAC-250 1967-72 w/o Gauges 19.99 ea.
 GAC-560 1967-72 w/ Gauges* 17.99 ea.
 GAC-760 1969-70 w/ Gauges 24.99 ea.
 GAC-660 1970-72 TCS Sender 24.99 ea.

*Can be used with CPX-999 harness.



CPX-999

Temperature Sending Unit Harness

Pre-cut wire section with correct clip and cloth insulator.

CPX-999 1967-72 w/ Gauges* 12.95 ea.

*For use with GAC-560 sender.



ATCS-33R

TCS Littlefuse Relay

This is an OE style reproduction of the correct Camaro littlefuse TCS relay which was discontinued by GM in 1999. This authentic reproduction of the original transmission spark control relay vacuum advance delay features 4 prongs as original and replaces Delco number 3961573.

ATCS-33R 1970-72 59.99 ea.



GWC-70F

1970-81 Firewall Clip

Correct clip bolted or welded to firewall to hold main harness.

GWC-70F 1970-81 21.99 ea.



BCE-9738

APC-744

AHB-1X

Engine Compartment Retaining Hooks

Pre-bent hooks for various wires, cables and hoses.

BCE-9738 Large Rubber Coated 4.99 ea.
 APC-744 Small Hook (oil pan, etc.) 7.99 ea.
 AHB-1X Heater Box Wire Clip 5.99 ea.
 ELC-38-BATTCLB 3/8" Rubber Coated Cable Clip ... 3.99 ea.



AHC-1

AHC-2

Harness Retaining Clips

Correct retaining clips for harness.

AHC-1 Clip Style #1 4.95 ea.
 AHC-2 Clip Style #2 4.95 ea.



BPX-2350

Harness Retaining Straps

Correct push in style plastic retainers

BPX-2350 All 3.95 pr.



BJN-300

Harness Wire Ties

Original GM wire ties used on various hoses, cables and harnesses.

BJN-300 Short 3.99 ea.
 BJN-600 Long 7" 3.99 ea.



GDT-0330

Electrical Harness Tape

Correct non-stick factory style tape. Over 100 feet.

GDT-0330 All 11.95 ea.



ACY-100

Marking Crayons

Original crayons used to mark the frame and firewall. Includes (1) yellow crayon and (1) white crayon.

ACY-100 All 6.99 kit



ACY-KIT

Frame & Body Marking Crayon Kit

These paint sticks are used for final detailing to replicate the marks left on the frame, body and other parts of the car. Just like when it came down the assembly line!

ACY-KIT All 12pc 38.99 kit



ADR-3F

Horns

Choose from either OE style reproduction horns for your 1969 Camaro or reproduction style horns for all Camaros (slightly different from original).

ADR-3F 1967-68 Reproduction Set 144.99 pr.
 ADR-3-GM 1967-81 Delco Horn Replacement .. 154.99 kit
 ADR-3-UNIV 1967-81 Universal Horn Set 119.99 kit
 ADR-3H 1967-81 Replacement* 169.99 kit
 ADR-5F 1969 OE style Reproduction 149.99 pr.
 ADR-3-CHROME 1967-69 Repro Chrome 159.99 pr.

*Brackets may require some modification.



GAC-723



GAC-775

Horn Relay

New reproduction of the original GM Delco style relay.

GAC-723 1967-71 53.99 ea.
 GAC-775 1972-73 59.99 ea.
 AVN-506 Mounting Screw 0.95 ea.



One Piece Design

Radiator Support Show Panels

This radiator support show panel seals up the unsightly area between the front of the radiator support and the header panel. It can be installed in about 15 minutes with no modification and will really make your engine compartment look clean and neat. Available with a number of popular logos. Add the appropriate letter for your choice of finish. B = Black Anodized C = Clear Anodized P = Polished

1967-69 One Piece		B or C	P
ASP-67F1SS	1967-69 SS	187.99 ea.	220.99 ea.
ASP-67F1CA	1967-69 "Camaro"	187.99 ea.	209.99 ea.
ASP-67F1BW	1967-69 Bowtie	187.99 ea.	209.99 ea.
ASP-67F1BC	1967-69 Bowtie/Chevrolet	187.99 ea.	209.99 ea.
ASP-67F1CH	1967-69 Chevrolet	187.99 ea.	209.99 ea.
ASP-67F1HB	1967-69 Heartbeat	187.99 ea.	209.99 ea.
ASP-67F1Z	1967-69 Z/28	187.99 ea.	209.99 ea.
ASP-67F1BM	1967-69 Ball Milled	202.99 ea.	217.99 ea.
ASP-67F1	1967-69 Plain	146.99 ea.	168.99 ea.

1967-69 Two Piece		B or C	P
ASP-67F2SS	1967-69 SS	207.99 ea.	220.99 ea.
ASP-67F2CA	1967-69 "Camaro"	207.99 ea.	220.99 ea.
ASP-67F2BW	1967-69 Bowtie	207.99 ea.	220.99 ea.
ASP-67F2BC	1967-69 Bowtie/Chevrolet	207.99 ea.	220.99 ea.
ASP-67F2Z	1967-69 Z/28	207.99 ea.	220.99 ea.
ASP-67F2	1967-69 Plain	156.99 ea.	190.99 ea.

1970-77 Camaro Non-RS		B or C	P
ASP-70FSS	1970-73 SS	187.99 ea.	209.99 ea.
ASP-_FCA	19_Camaro*	187.99 ea.	209.99 ea.
ASP-70FBW	1970-77 Bowtie	187.99 ea.	209.99 ea.
ASP-70FBC	1970-77 Bowtie/Chevrolet	187.99 ea.	209.99 ea.
ASP-70FCH	1970-77 Chevrolet	187.99 ea.	209.99 ea.
ASP-70FHB	1970-77 Heartbeat	187.99 ea.	209.99 ea.
ASP-70FZ	1970-77 Z/28	187.99 ea.	209.99 ea.
ASP-70F	1970-77 Plain	146.99 ea.	169.99 ea.

1970-77 Camaro Non-RS with HD Cooling		B or C	P
ASP-70FSS_H	1970-73 SS	187.99 ea.	209.99 ea.
ASP-_FCA_H	19_Camaro*	187.99 ea.	209.99 ea.
ASP-70FBW_H	1970-77 Bowtie	187.99 ea.	209.99 ea.
ASP-70FBC_H	1970-77 Bowtie/Chevrolet	187.99 ea.	209.99 ea.
ASP-70FCH_H	1970-77 Chevrolet	187.99 ea.	209.99 ea.
ASP-70FHB_H	1970-77 Heartbeat	187.99 ea.	209.99 ea.
ASP-70FZ_H	1970-77 Z/28	187.99 ea.	209.99 ea.
ASP-70F_H	1970-77 Plain	146.99 ea.	169.99 ea.



Two Piece Design

1970-73 Camaro RS		B or C	P
ASP-70FSS_R	1970-73 SS	187.99 ea.	209.99 ea.
ASP-_FCA_R	19_Camaro*	187.99 ea.	209.99 ea.
ASP-70FBW_R	1970-73 Bowtie	187.99 ea.	209.99 ea.
ASP-70FBC_R	1970-73 Bowtie/Chevrolet	187.99 ea.	209.99 ea.
ASP-70FCH_R	1970-73 Chevrolet	187.99 ea.	209.99 ea.
ASP-70FHB_R	1970-73 Heartbeat	187.99 ea.	209.99 ea.
ASP-70FZ_R	1970-73 Z/28	187.99 ea.	209.99 ea.
ASP-70F_R	1970-73 Plain	146.99 ea.	169.99 ea.

1970-73 Camaro RS with HD Cooling		B or C	P
ASP-70FSS_RH	1970-73 SS	187.99 ea.	209.99 ea.
ASP-_FCA_RH	19_Camaro*	187.99 ea.	209.99 ea.
ASP-70FBW_RH	1970-73 Bowtie	187.99 ea.	209.99 ea.
ASP-70FBC_RH	1970-73 Bowtie/Chevrolet	187.99 ea.	209.99 ea.
ASP-70FCH_RH	1970-73 Chevrolet	187.99 ea.	209.99 ea.
ASP-70FHB_RH	1970-73 Heartbeat	187.99 ea.	209.99 ea.
ASP-70FZ_RH	1970-73 Z/28	187.99 ea.	209.99 ea.
ASP-70F_RH	1970-73 Plain	146.99 ea.	169.99 ea.

1978-81 Camaro		B or C	P
ASP-78FBW	1978-81 Bowtie	187.99 ea.	209.99 ea.
ASP-_FCA	19_Camaro*	187.99 ea.	209.99 ea.
ASP-78FBC	1978-81 Bowtie/Chevrolet	187.99 ea.	209.99 ea.
ASP-78FCH	1978-81 Chevrolet	187.99 ea.	209.99 ea.
ASP-78FHB	1978-81 Heartbeat	187.99 ea.	209.99 ea.
ASP-78FZ	1978-81 Z/28	187.99 ea.	209.99 ea.
ASP-78F	1978-81 Plain	146.99 ea.	169.99 ea.

1978-81 Camaro with HD Cooling		B or C	P
ASP-78FBW_H	1978-81 Bowtie	187.99 ea.	209.99 ea.
ASP-_FCA_H	19_Camaro*	187.99 ea.	209.99 ea.
ASP-78FBC_H	1978-81 Bowtie/Chevrolet	187.99 ea.	209.99 ea.
ASP-78FCH_H	1978-81 Chevrolet	187.99 ea.	209.99 ea.
ASP-78FHB_H	1978-81 Heartbeat	187.99 ea.	209.99 ea.
ASP-78FZ_H	1978-81 Z/28	187.99 ea.	209.99 ea.
ASP-78F_H	1978-81 Plain	146.99 ea.	169.99 ea.

* Please Specify your year. Example: ASP-70FCA = 1970 Camaro.

Note: Non-HD panel measures just under 24 inches. HD panel measures just over 28 inches.



FG2007



FG2005



FG2003



FG2001



FG2042



FG2031



FG2046



FG2044

Fender Gripper

If you spend a lot of time working under the hood but don't want to scratch your paint a Fender Gripper is the answer! Made of non-slip material, the Fender Gripper will not slide off slick surfaces. Soft and cushioned for protection, Tools will not slip off fender cover, Completely washable 22 X 34 standard size, Strong PVC product reinforced with nylon mesh, Impervious to motor oil, coolant, lacquer thinner, brake fluid, etc., Many favorite brand logos are available, Will not harm your paint.

FG2001	Bowtie	34.99 ea.	FG2007	Chevrolet Racing	35.99 ea.	FG2042	General Motors	39.99 ea.
FG2003	Genuine Chevrolet	38.99 ea.	FG2048	El Camino	39.99 ea.	FG2044	SS	29.99 ea.
FG2005	Heartbeat of America	38.99 ea.	FG2031	Chevelle	36.99 ea.	FG2046	Super Sport	29.99 ea.



MS275-18MR

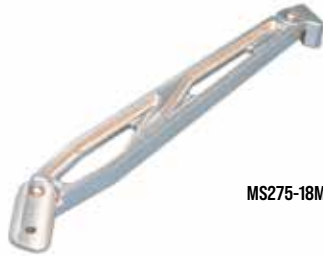

MS275-18M

Eddie Motorsports Billet Fender Braces

Brace Finish:

M = Machined, P = Polished, CL = Clear Coat, BKA = Gloss Black Anodized, CA = Clear Anodized

Insert Finish:

M = Machined, P = Polished, R = Red Fusioncoat, B = Blue Fusioncoat, W = White Fusioncoat, PR = Purple Fusioncoat, BK = Gloss Black Fusioncoat, BKA = Gloss Black Anodized, MB = Matte Black Fusioncoat, MBA = Matte Black Finish, CL = Clear Coat, CA = Clear Anodized

		M.P	All Others
MS275-18	1967-69 Billet Fender Braces	192.99 pr.	259.99 pr.
MS275-13	1070-73 Billet Fender Braces	244.99 pr.	268.99 pr.
MS275-19	1967-69 Fender Brace Inserts	52.99 set	52.99 set
MS275-14	1970-73 Fender Brace Inserts	47.99 set	52.99 set



DSE011801

Detroit Speed Fender Brace Kit

This new DSE Camaro fender brace kit is another way to beautify your engine compartment. The fender braces are 100 percent CNC machined Clevis' from 304 stainless steel. The kit includes fabricated mounting brackets and comes with button head stainless steel mounting bolts. The fender braces triangulate the radiator core support to the fender and are fully adjustable (a benefit not available with your stock fender braces). All mounting brackets come powdercoated satin black.

DSE011801	1967-69 All	256.99 kit
DSE011802	1970-81 All	256.99 kit

No Volume Discount.



RFB-656

Stock Fender Support Bars

OE style reproduction fender support bars in your choice of factory black or show quality chrome.

RFB-656	1967-69 Black	22.99 pr.
RFB-653	1967-69 Chrome	29.99 pr.
RFB-7081B	1970-81 Black	21.99 pr.
RFB-7081C	1970-81 Chrome	19.99 pr.



FDT-350



FDS-3



GCS-S9422

Transmission Dipsticks & Tubes

OE style replacement dipstick and tubes.

FDT-350	TH350 OE Style Tube	39.99 ea.
FDT-400	TH400 OE Style Tube	29.99 ea.
FDS-3	TH350 OE Style Stick	23.99 ea.
FDS-4	TH400 OE Style Stick	26.99 ea.

Chrome

GCS-S9422	Powerglide Chrome	15.99 ea.
GCS-S9421	TH350 Chrome	15.99 ea.
GCS-S9421BA	TH350 Billet Handle Chrome	24.99 ea.
GCS-S4994	TH350 34" Chrome	16.99 ea.
GCS-S4994BA	TH350 34" Billet Handle Chrome ..	19.99 ea.
GCS-S4995	TH400 24" Chrome	13.99 ea.
GCS-S4995BA	TH400 24" Billet Handle Chrome ..	17.99 ea.

Bell Housing Mount

GCS-S5004	TH350 Braided	45.99 ea.
GCS-S5005	TH400 Braided	45.99 ea.
GCS-S5006	TH700-R4 Braided	45.99 ea.

Firewall Mount

GCS-S5104	TH350/TH400 29" Braided	58.99 ea.
GCS-S5106	TH700-R4 Braided	58.99 ea.



NC-125

Hood Insulation

Correct die stamped OEM material for insulating the underside of the hood. A MUST for final detailing!

NC-125	1967-69 w/o Cowl	36.99 ea.
NC-126	1967-69 w/ Cowl	36.99 ea.
NC-135	1970-81 All	36.99 ea.



AMI-3

OE Molded Hood Insulation

Correct die-stamped molded hood insulation just like original GM.

AMI-5	1967-69 w/ Cowl	109.99 ea.
AMI-3	1967-69 w/o Cowl	109.99 ea.
AMI-7	1970-81	139.99 ea.
NQ-243	Clips	28.99 kit

Ships Oversize 2.



Firewall Cover

A quick and easy way to cover up your rough firewall! Constructed of 16 gauge anodized aluminum which is easy to clean and can be painted to match your car. You only need to remove your hood, wiper motor, wire gutter and any accessories you've attached to your firewall and this panel will simply slide right in place. There is no need to remove your engine or even distributor!

AFC-67F	1967-69 Blank	169.99 ea.
AFC-67FW	1967 Wiper Hole	169.99 ea.
AFC-67FWH	1967 Wiper & Heater	169.99 ea.
AFC-68FW	1968-69 Wiper Hole	169.99 ea.
AFC-68FWH	1968-69 Wiper/Heater	169.99 ea.

It is recommended to install with silicone so the panel stays smooth and allows the body to flex behind it. This item ships Oversize.

AMK inc PRODUCTS



67FB-S



Detail shot of a 1968 Camaro Master Body Hardware kit. These kits have all of the hard to find items that are not available anywhere else!

Master Body Kit

Master body kits contain just about every piece of hardware to assemble the body of your Camaro. Each kit contains hardware for your battery tray, bumpers, filler panel, filler panel moldings, bumper brackets, cowl vent panel, door latches, emblems, fender braces, fenders, front tie bar, grille, grille brackets, grille moldings, headlamps, headlamps bezels, hood, hood hinges, hood latch, hood latch support, license plate, mirrors, parking lamps, tail lamps, trunk latch, trunk lid hinges, wheel opening moldings, wheelhouses, radiator support and more! This kit truly has it all!

67FB-S	1967 Standard.....	329.99 kit
67FB-RS	1967 Rally Sport.....	362.99 kit
68FB-S	1968 Standard.....	329.99 kit
68FB-RS	1968 Rally Sport.....	357.99 kit
69FB-S	1969 Standard.....	349.99 kit
69FB-RS	1969 Rally Sport.....	349.99 kit
70FB-S	1970-72 Standard.....	329.99 kit
70FB-RS	1970-72 Rally Sport.....	349.99 kit
73FB-S	1973 Standard.....	307.99 kit
73FB-RS	1973 Rally Sport.....	349.99 kit
74FB	1974-76 All.....	417.99 kit
77FB	1977 All.....	359.99 kit
78FB	1978 All.....	362.99 kit
79FB	1979 All.....	389.99 kit
80FB	1980-81 All.....	369.99 kit

No Volume Discount.



67FS-BB

Master Chassis Kit

Typical kit includes fasteners to attach: accelerator lever & support, axle housing springs, axle retainer plates, brake booster & hose, brake cables, brake plates, brake hose retainers & brackets, brake valve & pressure switch, calipers & brackets & shields, upper & lower control arms, control arm bushings, differential cover, driveshaft, engine mounts, fuel filler neck cover, fuel hoses, gas tank, grease fittings, idler arm, leaf spring hangers & front eye, master cylinder & push rod, parking brake control, pitman arm, radius rod & bracket & bumper, shackles (nuts), shocks & brackets, stabilizer bar brackets and end links (includes rubber), steering gear & rag joint, steering linkage & ball joints, speedometer cable trans, suspension bumper, transmission crossmember & insulator, wheel cylinders.

67FS-BB	1967 BB Disc Brakes Mono Leaf.....	401.99 kit
67FS-DCSB	1967 SB Disc Brakes Mono Leaf.....	406.99 kit
67FS-DRSB	1967 SB Drum Brakes Mono Leaf.....	384.99 kit
67FS-L78	1967 BB L-78 Disc Brakes Mono Leaf.....	428.99 kit
67FS-Z28	1967 SB Z/28 Disc Brakes Mono Leaf.....	428.99 kit
68FS-BB	1968 BB Disc Brakes Multi Leaf.....	428.99 kit
68FS-DCSB1	1968 SB Disc Brakes Mono Leaf.....	428.99 kit
68FS-DCSB4	1968 SB Disc Brakes Multi Leaf.....	428.99 kit
68FS-DRSB1	1968 SB Drum Brakes Mono Leaf.....	395.99 kit
68FS-DRSB4	1968 SB Drum Brakes Multi Leaf.....	417.99 kit
69FS-BB	1969 BB Disc Brakes Multi Leaf.....	450.99 kit
69FS-DCSB1	1969 SB Disc Brakes Mono Leaf.....	439.99 kit
69FS-DCSB4	1969 SB Disc Brakes Multi Leaf.....	450.99 kit
69FS-DRSB1	1969 SB Drum Brakes Mono Leaf.....	389.99 kit
69FS-DRSB4	1969 SB Drum Brakes Multi Leaf.....	406.99 kit
70FS-BB	1970-71 BB Disc Brakes Multi Leaf w/ Swaybar.....	461.99 kit
70FS-F41SB	1970-71 SB Disc Brakes Multi Leaf w/ Swaybar.....	483.99 kit
70FS-SB	1972 SB Disc Brakes Multi Leaf.....	439.99 kit
72FS-BB	1972 Disc Brakes Multi Leaf w/ Swaybar.....	439.99 kit
72FS-F41SB	1972 SB Disc Brakes Multi Leaf w/ Swaybar.....	439.99 kit
72FS-SB	1972 SB Disc Brakes Multi Leaf.....	428.99 kit
73FS-F41SB	1973 SB Disc Brakes Multi Leaf w/ Swaybar.....	439.99 kit
73FS-SB	1973 SB Disc Brakes Multi Leaf.....	439.99 kit
74FS-S	1974 SB Disc Brakes Multi Leaf.....	384.99 kit
75FS-S	1975-76 SB Disc Brakes Multi Leaf.....	395.99 kit
75-FS-F41	1975-76 SB Disc Brakes Multi Leaf F41.....	417.99 kit
77FS-S	1977 SB Disc Brakes Multi Leaf.....	406.99 kit
77-FS-F41	1977 SB Disc Brakes Multi Leaf F41.....	406.99 kit
78FS-S	1978-79 SB Disc Brakes Multi Leaf.....	428.99 kit
78-FS-F41	1978-79 SB Disc Brakes Multi Leaf F41.....	439.99 kit
80FS-S	1980-81 SB Disc Brakes Multi Leaf.....	389.99 kit
80-FS-F41	1980-81 SB Disc Brakes Multi Leaf F41.....	406.99 kit

No Volume Discount.



67FA-F

AC On Engine Hardware

All the hardware related to the AC brackets on the engine.

66AA-SB	1967 SB.....	30.99 kit
67AA-SSB	1967 SB w/ Smog.....	27.99 kit
68FA-SB	1968 SB.....	32.99 kit
68FA-SB	1968 SB w/ Smog.....	32.99 kit
68FA-BB	1968 BB.....	37.99 kit
69AA-SB	1969 SB.....	42.99 kit
69AA-BB	1969 BB.....	34.99 kit
70AA-SB	1970 SB.....	38.99 kit
70AA-BB	1970-72 BB.....	39.99 kit
71AA-SB	1971 SB.....	34.99 kit
72AA-SB	1972-73 SB.....	34.99 kit

AC Box Under Hood Hardware

All the hardware related to the AC under the hood on the firewall forwards.

67FA-F	1967.....	37.99 kit
68FA-F	1968.....	48.99 kit
69FA-F	1969.....	58.99 kit
70FA-F	1970.....	53.99 kit
71FA-F	1971.....	48.99 kit
72FA-F	1972.....	46.99 kit
73FA-F	1973.....	50.99 kit

AC Box Under Dash Hardware

All the hardware related to the AC under the dash.

67FA-R	1967.....	34.99 kit
68FA-R	1968.....	35.99 kit
69FA-R	1969.....	44.99 kit
70FA-R	1970.....	21.99 kit
71FA-R	1971.....	22.99 kit
72FA-R	1972-73.....	20.99 kit

Engine Master Hardware Kits

The authentic hardware you need to correctly reassemble the engine components that attach to the long block. Typical kits include fasteners for: air cleaner, carburetor & choke cover, crank pulley & damper, distributor, exhaust manifold, exhaust pipe, engine fan, fuel pump plate & plug, heat shield, ignition coil & strap, intake manifold & plug, oil filter valve, oil pan, PCV adapter, PCV hose clamps, timing cover, valve covers, water neck, water pump.

67-Z28	1967-68 SB Z/28 174pc.....	179.99 kit
66-SBS	1968 SB w/o AC 153pc.....	169.99 kit
66-SBA	1968 SB w/ AC 164pc.....	179.99 kit
68-BBH	1968 BB Aluminum Intake 149pc.....	192.99 kit
68-BBS	1968 BB Cast Iron Intake 159pc.....	184.99 kit
69-SB	1969-71 SB 170pc.....	184.99 kit
69-Z28	1969 SB Z/28 162pc.....	149.99 kit
69-BBH	1969-72 BB Aluminum Intake 143pc.....	199.99 kit
69-BBS	1969-72 BB Cast Iron Intake 143pc.....	184.99 kit
72-SB	1972-73 SB 139pc.....	159.99 kit
72-Z28	1972-73 Z/28 145pc.....	139.99 kit

No Volume Discount.



APX-1724

Alternator Fan w/ Nut

APX-1724	All.....	17.99 kit
ABN-105	Nut Only	4.99 ea.



BRB-938



BN-339

Alternator Lower Attaching Hardware

BRB-938	1969-81 SB Bolt	4.95 ea.
BN-339	1969-72 BB Stud	12.99 ea.



AWB-1114

Alternator Upper Adjustment Kit

Correct WB head marked bolt with washers.

AWB-1114	1967-72 All.....	5.99 kit
----------	------------------	----------



AW-506

Alternator Neg Cable Bolt

AW-506	All.....	0.95 ea.
--------	----------	----------



APX-1038

Alternator Spacer Brace

APX-1038	1969-72 BB	16.99 ea.
----------	------------------	-----------



BZ-117

Alternator Mounting Kits

These complete kits make installing your alternator and bracket easy.

G-4828	1967-68 Z/28	15.99 kit
G-4645	1967-68 327, 350	14.99 kit
G-4766	1967-68 396, 427	19.99 kit
BZ-117	1968 BB 396, 427	19.99 kit
G-4962	1969-74 SB All.....	17.99 kit



ABR-9533

Battery Retainer Kits

ABR-9533	1967-81 All.....	4.99 kit
----------	------------------	----------

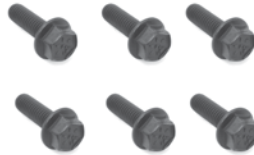

BPB-9021

Bellhouse Attaching Kit

BPB-9021	All 6pc	8.95 kit
----------	---------------	----------



BPB-2230

Body Bolt Kit

Correct black flanged head bolts and washers.

BPB-2230	1967-81 All.....	29.99 kit
----------	------------------	-----------



BPP-092

Body Plug Kits

Correct with numerals and text embossing.

BPP-092	1967-68 12pc	15.99 kit
BPP-093	1969 12pc	21.99 kit



BMP-1000

Brake Caliper Bolt

BMP-1000	All Single Piston	2.99 ea.
----------	-------------------------	----------



BPX-97K

Bumper Bolts

Correct style replacement and OE style bumper bolt kits available.

BPX-97K	1967 All 10pc	21.99 kit
BPX-97KOE	1967 All 20pc	49.99 kit
BPX-99K	1968 -69 All 10pc	21.99 kit
BPX-99KOE	1968 -69 All 20pc	49.99 kit
BPX-2401KIT	1970-73 Std 10pc	21.99 kit
BPX-359	1970-73 RS 12pc	19.99 kit



BBF-13

Bumper Bracket Hardware

BBF-13	Bolt, Nut, Teeth Washers	6.99 ea.
--------	--------------------------------	----------



BCP-373

Caliper Backing Plate Bolt

BCP-373	Plate to Spindle	6.99 ea.
---------	------------------------	----------



BTE-1475

BMG-0095

Carburetor Attaching Kits

BTE-1475	All Q-Jet	8.95 ea.
BMG-0095	All Holley	9.99 ea.



BAN-516

Coil Bracket Screws

BAN-516	All with "L" Headmark	1.99 pr.
---------	-----------------------------	----------



BPX-0918

Control Arm to Frame Bolts

4 serrated bolts and 4 locking nuts for one car.

BPX-0918	1967-69 All	19.99 kit
BPX-0919	1970-81 All.....	28.99 kit



DS-594

Control Arm Shims

DS-594	1/16"	2.99 ea.
DS-595	1/8"	2.99 ea.



Control Arm Upper Washers

Complete kit to do one car.

BPX-8542

BPX-8542 1967-69 All 16.99 kit



Control Arm Bolt Front Lower

BPB-1430

BPB-1430 1967-72 7.99 ea.
BPB-1450 1973-81 7.99 ea.



Convertible Cross Brace Bolt

MCB-BOLT

MCB-BOLT 1967-69 5.95 kit



BPC-7000



BPC-7939

Crossmember Bolts

BPC-7000 To Frame 6.95 kit
BTE-7939 To Transmission 0.95 ea.



NRM-1888



Cylinder Head Bolts

NRM-1888 All BB 32pc 89.99 kit
NRM-115B Most Small Block 89.99 kit



ACE-1400

Distributor Hold Down

Correct retaining hardware for distributor.

ACE-1400 All 15.99 kit



BAV-2622

BAV-2623

Door Hinge Bolts

BAV-2622 1967 Phillips 2.19 ea.
BAV-2623 1968-81 Hex 2.19 ea.



BPX-1225

Door Hinge Pin Kits

BPX-1225 1967-69 All 16.99 ea.
BPX-2225 1970-81 All 16.99 ea.



BPX-1275

BPX-1299

Door Strikers w/ Washer

BPX-1275 GM Replacement 12.99 ea.
BPX-1275-6SKT All 4.99 pr.
BPX-1299 OE Style Reproduction* 13.99 ea.

*Correct Allen Head Zinc Plated



MS277-20P

Door Strikers Stainless

Awesome stainless 7/16" strikers from Eddie Motorsports.

MS277-20M Machined 61.99 pr.
MS277-20P Polished 69.99 pr.



APB-1382



APB-1821

Exhaust Manifold Bolts

With correct double circle logos.

APB-1382 All SB w/ Washers 24pc 42.99 kit
APB-3506 All BB w/ Washers 32pc 29.99 kit
APB-1821 All BB Flanged 16pc 23.99 kit



ALI-2228

Exhaust Stud Kit

ALI-2228 OEM Steel 12pc 24.99 kit



BPX-2792

Fan Attaching Kits

BPX-2792 All w/ Clutch Studs 6.99 kit
BPX-2791 All w/ Clutch Bolts 5.95 kit



APX-2339

Engine Bracket to Frame Bolt Kit

APX-2339 Brackets to Frame 7.99 kit



BPA-5160



BPA-5161



BPA-381



BPA-385

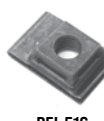

BFJ-516



BJF-038

Fender Front End Bolts

BPA-5160 5/16" Bolt w/o Washer 0.89 ea.
BPA-5161 5/16" Bolt w/ Washer 0.89 ea.
BPA-381 3/8" x 1" Bolt 0.79 ea.
BPA-385 3/8" x 1-1/2" Bolt 0.75 ea.
BFJ-516 Fender J Clip 5/16" 1.99 ea.
BJF-038 Fender J Clip 3/8" 1.50 ea.



BCW-51

Fender Cup Washers

BCW-51 All Zinc 3.99 ea.

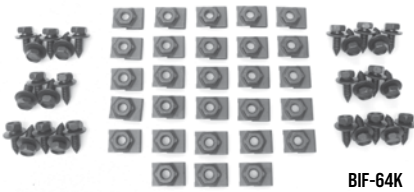

BIF-64K

Fender Inner Bolt Kit To Fender

BIF-64K All (56 pc.) 29.99 ea.



BPB-5116

Flywheel Attaching Kit

BPB-5116 All 4 Speed 18.99 kit
BPB-5118 All Auto 19.99 kit



BFE-9001

Front End Fastener Kit

Over 175 pieces individually bagged! Includes everything you need to assemble your front end!

BFE-9001 1967-68 All 69.99 kit
BFE-9002 1969 All 69.99 kit
BFE-9003 1970-81 69.99 kit



ACE-4867

Fuel Pump Bolts

ACE-4867 All 7.39 kit



BCI-4753

Fuel Tank Attaching Kit

Complete with correct bolts, screws and washers and nuts.

BCI-4753 1967-69 All 8.99 kit



BAG-DLX678

BAG-703FRS

Grille Attaching Kits

Basic service kit for replacing grille hardware.

BAG-D3 1967-68 Bezel 7.99 kit
BAG-69Z 1969 Bezel 9.99 kit
BAG-DLX678 1967-68 All Grille & Bezel 19.99 kit
BAG-DLX69 1969 All Grille & Bezel 41pc 17.99 kit
BAG-703FS 1970-73 Standard Nose 15.99 kit
BAG-703FRS 1970-73 RS Nose 36pc 17.99 kit
BAG-747F 1974-77 Standard Nose 15.99 kit
BAG-746FZ 1974-76 Z/28 Nose 15.99 kit
BAG-77FZ 1977 Z/28 Nose 14.95 kit
BAG-78F 1978 Standard Nose 16.99 kit
BAG-78FZ 1978 Z/28 Nose 16.99 kit
BAG-79F 1979 Standard Nose 14.95 kit
BAG-79FZ 1979 Z/28 Nose 14.99 kit



BPB-5934

Harmonic Balancer Bolt

BPB-5933 All SB w/ Washer 9.99 kit
BPB-5934 All BB w/ Washer 13.99 kit



BPQ-4011

Hood Adjustment Bolts

BPQ-4011 1967-69 9.95 kit
BPQ-4011-70-REAR 1970-81 Rear 16.99 pr.
BPQ-4011-CNTR 1970-81 Rear Center 17.99 kit



MS275-38

Hood Adjustment Bolts Billet Eddie Motorsports

MS275-38 5/16" Machined 42.99 ea.
MS275-38P 5/16" Polished 43.99 ea.



BPA-381

Hood Hinge Bolt

BPA-381 3/8" x 1" 0.79 ea.



BPI-9140

BPI-2271

Intake Manifold Kits

Featuring correct flanged head bolts.

BPI-4400 SB "M" 12pc 19.99 kit
NTR-97 All SB "TR" Black 12pc 19.99 set
BTR-647 All SB "TR" Silver 12pc 29.99 kit
BPI-9140 BB Cast "M" 16pc 21.95 kit
BPI-2271 BB Alum. "A" 16pc 30.99 kit



BPS-3679

BPS-7432

Intake Studs

BPS-3679 3/8" x 3/8" 6.99 ea.
BPS-7432 5/16" x 3/8" 6.99 ea.



BPX-9873

Idle Arm Bolts

BPX-9873 To Frame 3.95 pr.



BCB-12955

1970-81 Hood Bumpers

Correct 13/16" height. Rubber with metal core.

BCB-12955 1970-81 22.99 pr.



BHE-1970

Jack/Tire Retainer Kit

BHE-1970 1967-81 All 15.99 set



BBB-2743

Leaf Spring Front Eye Bolt

BBB-2743 All 3.99 ea.
Two required per car.

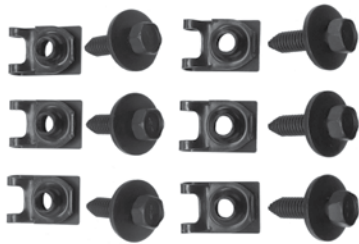

BLS-1130

Leaf Bracket Mounting Kit (to Body)

BLS-1130 1967-81 12pc..... 18.99 kit



BPA-53K

License Plate Attaching Kit

BPA-53K All 4pc..... 3.95 kit



BPB-14

License Plate Bracket Mounting Kit

BPB-14 1967-68..... 4.95 kit
BPB-16 1969..... 4.95 kit



APB-9057

Motor Mount Thru Bolts

APB-9057 4-1/2"..... 9.99 kit
APB-7057 3-1/2"..... 6.95 kit



BSL-516

Nuts Self Locking

BSL-516 5/16" Zinc..... 0.40 ea.
BSL-38 3/8" Zinc..... 0.50 ea.
BSL-716 7/16" Zinc..... 0.75 ea.
BSL-12 1/2" Zinc..... 0.95 ea.



BPO-1988

Oil Drain Bolt w/ Washer

BPO-1988 All..... 6.95 ea.



BOP-2001



BOP-2002

Oil Pan Attaching Bolts

With correct head marked SEMS bolts.

BOP-2001 All SB..... 9.95 ea.
BOP-2002 All BB..... 28.99 ea.



BSB-671

Power Steering Hardware Kits

Our kits feature all correct hardware to attach power steering brackets to engine. A MUST!

G-4804 1967 SB 302,350..... 16.99 kit
G-4805 1967 BB 396..... 11.99 kit
G-4917 1968 SB 302,350..... 10.99 kit
G-4918 1968 BB 396..... 17.99 kit
BSB-671 1967-68 SB..... 10.95 kit
BSB-69SB 1969-74 SB All..... 24.99 kit
BSB-1969 1969 All BB..... 24.99 kit
BSB-1970 1970+ All BB..... 12.99 kit



BPP-12

BPP-34

BPP-10

Push-In Plugs

BPP-12 1/2" Cowl Top, etc..... 0.75 ea.
BPP-34 3/4" Wheelhouse..... 1.00 ea.
BPP-10 1" Trunk Extension..... 1.25 ea.
BPP-138 1-3/8" Rubber Plug..... 1.50 ea.



Pressure Plate Bolt Kit

BPP-8386

BPP-8386 All 12pc..... 10.99 kit



BFC-333

Pulley Attaching Bolts

BFC-333 All Fine 6pc..... 6.95 kit
BRB-100 All Coarse 6pc..... 6.95 kit



BRE-2008

Rear End Cover Bolt

BRE-2008 All Flanged..... 0.95 ea.



BPP-084

Rubber Body Plugs

BPP-084 1"..... 7.99 pr.
BPP-091 3/4"..... 3.99 ea.



BSB-56



BSB-561

Seat Belt Bolts

Correct shanked style seat belt bolts.

BSB-56 All Front Outer..... 6.99 ea.
BSB-56 1967-68 Front Inner..... 6.99 ea.
BSB-561 1969-72 Front Inner..... 6.99 ea.
BSB-561 All Rear..... 6.99 ea.
BSB-5-SBL 1967-81 No Shoulder *..... 6.99 ea.

*Threaded all the way



BSM-516

Seat Mounting Bolts

BSM-516 All Front..... 1.35 ea.
BSM-5NT All Rear..... 1.35 ea.



Sheet Metal Screw Kit BPX-1950
Over 20 pieces for small under hood items.
BPX-1950 All.....5.95 kit



Front Shock Mounting Hardware
OE correct front shock mounting kit complete with (4) mounting clips, (4) bolts with washers, (4) rubber bushings with retaining cup washers, and (4) nuts.
DSR-384K 1967-81 All Front.....24.99 kit



Starter Bolts
BV-2070 3/8" x 17/8" Short 5.99 ea.
BV-2072 3/8" x 3 5/8" Long..... 5.29 ea.
BV-2074 3/8" x 4 11/16" Extra Long..... 6.99 ea.



Steering Box Bolt
BSB-757 1967-69 4.99 ea.
BSB-759 1970-76 8.69 ea.



Subframe Body Mount Cage Nut BCN-58
This body mount cage nut is used to fasten the subframe to the body.
BCN-58 1967-74 All.....26.99 set



Thermostat Housing Bolts
ATR-1039 Most SB Bolt/Stud..... 8.99 ea.
ATR-2039 All SB-BB Bolt7.99 pr.
ATR-3039 1967-68 Gooseneck Z/288.99 kit



Timing Cover Bolt Kit BTC-650
"L" SEMS Bolts.....8.95 kit



Transmission Mounting Hardware
BTE-307 To Bellhousing 8pc8.95 kit
BTE-7939 To Rear Mount 0.95 ea.



Trim Stud Repair Kit OE GM
OEM GM replacement trim studs for mounting front and rear window moldings and some rocker moldings. These studs come with a sealant to prevent corrosion.
KMC-15KWS 1967-92 All 8pc.....39.99 kit



Valve Cover Bolts APB-1023
APB-1023 SB "TR" 16pc 14.95 kit
APB-2023 BB "TR" 28pc.....34.99 kit
APB-1027 SB "M" 8pc..... 18.99 kit
M bolts were used on finned aluminum valve covers.



Voltage Regulator
Well Nuts and Screws
AWX-818 1967-74 All6.95 kit



Water Pump Attaching Kit
ATR-3232 1967-6817.99 kit
ATR-4334 1969-81 M Mark.....11.99 kit



Water Pump Studs
AWS-301S Short Pump 6.99 ea.
AWS-302L Long Pump 3.95 ea.



Wing Nuts
APX-1400 Chrome 5.99 ea.
APX-7700 Black..... 5.99 ea.



Window Molding Kits

This exclusive Ground Up Motors window molding kit includes front windshield molding, rear window molding and all necessary installation clips at a special kit price!

KFX-67K	1967-69	225.17 kit
KXR-70FK	1970-74	294.85 kit
KXR-7074FKBLK	1970-74 All Black	322.98 ea.
KXR-70FKBLK	1975-81 All Black*	322.98 kit

*75-81 kit does not include clips



Front and Rear Window Molding Kits

Choose from either high quality reproduction moldings or our GM Restoration moldings which offer the best fit and finish on the market.

KFX-67R	1967-69 Coupe Front 5pc	105.99 kit
KFX-838	1967-69 Coupe Front 5pc GM Restoration	219.99 kit
KFX-67V	1967-69 Convertible Front 5pc	119.95 kit
KXR-70F	1970-81 All Front 5pc	134.99 kit
KXR-67R	1967-69 Coupe Rear 5pc	119.99 kit
KFX-849	1967-69 Coupe Rear 5pc GM Restoration	259.99 kit
KXR-70R	1970-74 All Rear 5pc	189.99 kit
KXR-70FBLK	1970-81 All Front Black	199.99 kit
KXR-70RBLK	1970-74 All Rear Black	179.99 ea.
KXR-75R	1975-81 All Rear 4pc	179.99 kit
KXR-78B	1975-81 Z/28 Black Rear 4pc	179.99 kit
KXC-7081	1970-81 Lower Corner Moldings	28.99 pr.

All window moldings ship Oversize and well protected.



Wiper Motor Transmission Arm

OE style reproduction of the often missing arm.

LWT-1072C	1967	109.99 ea.
LWT-1072	1968-69	109.99 ea.
LWT-1073H	1970-73 w/o Hidden Wipers	109.99 ea.
FMP-CLIP	1967-81 Clip	5.99 ea.



Windshield Molding Clips

Complete set of clips for one car.

KMC-67KITF	1967-69 Upper/Side	9.95 kit
KMC-79K	1967-69 Lower	14.99 kit
KMC-0069	1970-81	9.95 kit



Rear Window Molding Clips

Complete set of clips for one car.

KMC-67KITR	1967-69 All	13.99 kit
KMC-0070	1970-74 All	11.95 kit
KMC-0211	1975-79 All	11.95 kit



Windshield Glass Stops

OE style reproduction windshield glass stop clip, rubber coated as original.

KW-648	1967-69	9.99 ea.
KW-995	1970-81	12.99 ea.

BUY & SAVE

WITH SS396.COM PRE-BUILT KITS



1967-69 Wiper Arm/Blade Kit

Complete kit with (2) arms and (2) blades.

WIPERKIT-15	1967-69 Coupe	64.56 kit
WIPERKIT-15B	1967-69 Coupe	61.16 kit
WIPERKIT-15V	1967-69 Convertible	61.16 kit
WIPERKIT-15VB	1967-69 Convertible	61.16 kit



1970-81 Wiper Arm/Blade Kit

Complete kit with (2) arms and (2) blades.

LWA-70KB	1970-81 Black	79.99 kit
LWA-70KS	1970-81 Brushed	94.95 kit



Windshield Wiper Arms

LWA-647	1967-69 Coupe Polished	21.99 ea.
LWA-69B	1967-69 Coupe Satin	19.99 ea.
LWA-69V	1967-69 Convrt Polished	19.99 ea.
LWA-69VB	1967-69 Convrt Satin	19.99 ea.
LWA-8286L	1982-86 LH Black	43.99 ea.
LWA-8286R	1982-86 RH Black	43.99 ea.

Wiper Blades

New polished stainless steel and satin blades.

LWB-64	1967-69 Stainless 15"	15.99 ea.
LWB-72	1970-81 Stainless 16"	17.99 ea.
LWB-70FB	1970-81 Black 18"	18.95 ea.
LWB-70FS	1970-81 Silver Brushed 18"	18.95 ea.



Trim Stud Repair Kit OE GM

OEM GM replacement trim studs for mounting front and rear window moldings and some rocker moldings. These studs come with a sealant to prevent corrosion.

KMC-15KWS	1967-92 All 8pc	39.99 kit
-----------	-----------------	-----------

Window Molding Stud/Pin Kit

Self tapping screws replace the original body studs used to retain factory window or vinyl top molding clips.

KMC-15	All 12pc	3.95 kit
--------	----------	----------

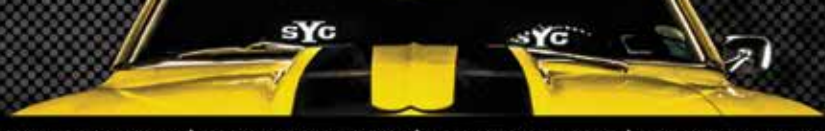

KDX-67R

Roof Drip Molding Kits

Beautiful stainless steel complete reproduction drip rail molding kits.

KDX-67R	1967-69 Reproduction 6pc	84.99 kit
KDX-67G	1967-69 GM Restoration 6pc	124.99 kit
KDX-70R	1970-81 Stainless	209.99 kit
KDX-71L	1971-78 Mylar w/o Vinyl Top LH	62.99 ea.
KDX-71R	1971-78 Mylar w/o Vinyl Top RH	62.99 ea.
KDX-71VL	1971-78 Mylar w/ Vinyl Top LH	78.99 ea.
KDX-71VR	1971-78 Mylar w/ Vinyl Top RH	78.99 ea.

All roof drip moldings ship Oversize and well protected.



RRC-69

Roof Weatherstrip Channel Set

This excellent quality roof weatherstrip channel is produced in a high luster stainless steel material just as the original! This often damaged piece bolts into the roof channel of the car and is used to retain the roof rail weatherstripping. This 6 piece kit even includes the correct blow out clips for the door glass.

RRC-67F	1967 All 6pc	239.99 kit
RRC-69	1968-69 All 6pc	209.99 kit

Roof drip moldings ship Oversize and well protected.



Vinyl Tops

Reproduction style double seamed padded tops.

VT-69BLK	1967-69 Black	219.99 ea.
VT-69WHT	1967-69 White	224.99 ea.
VT-70BLK	1970-81 Black	224.99 ea.

Vinyl Tops OEM

Factory correct non-padded vinyl tops with the correct reverse OE style stitching for the purist.

VT-TT52-B	1967-69 Black	389.99 ea.
VT-TT52-W	1967-69 White	390.99 ea.



K-653

Vinyl Top Molding Sets

OE style reproduction vinyl top molding sets with correct cast and stainless pieces.

K-863	1967-68 2pc	169.99 set
K-653	1969 4pc	189.99 set
K863C	1967-68 All Clips Only	24.99 kit
K653C	1969 All Clips Only	21.99 kit



KPM-739

1967 Door Pillar Molding

OE style reproduction chrome pillar moldings which install on the doors. Constructed of heavyweight cast material with high quality chrome finish.

KPM-739	1967 All	289.99 pr.
---------	----------	------------

Ships Oversize.



KBC-731

Roof Rail Blowout Clips

These rubber dipped spring steel clips retain the roof rail weatherstrip to the pillar and roof stainless trim. Includes correct clips to do one car.

KBC-731	1967-69 All	19.99 kit
KBC-973	1970-81 All	19.99 pr.



KRP-756

1970-81 Vertical Roof Moldings

Heavy chrome plated and polished moldings which install vertically between the door glass and quarter panel.

KRP-756	1970-81	50.99 pr.
---------	---------	-----------



Vent Window Frames & Hardware

Accurate reproduction of 67 Camaro vent window frames. Die stamped steel. Hard chrome plated as original.

KVF-67FL	1967 Vent Window Frame LH	59.99 ea.
KVF-67FR	1967 Vent Window Frame RH	59.99 ea.
RWV-032A	1967 Glass Frame Hardware	14.99 kit
KVF-RVT	1967 Vent Window Rivet	1.95 ea.
RWV-180	1967 Vent Window Hardware	19.99 kit
RWV-184	1967 Assembly Studs	15.99 pr.
IVH-741	1967 Pivot Stud Assembly	24.99 kit
IVH-742	1967 Pivot Stud Nut	8.99 ea.



KW-1041

Convertible Well Molding

OE style reproduction of the rear body "pinch weld" molding in polished stainless steel as original.

KW-1041	1967-69	109.99 set
LMC-3640	1967-69 Clips	39.99 set

No Volume Discount. Ships Oversize.



KQ-177

Convertible Header Molding

OE style reproduction header moldings in either chrome for 1967 models or satin for 1968-69 models. Both are interchangeable.

KQ-177	1967 Polished Chrome	169.99 pr.
KQ-39	1968-69 Satin	159.99 pr.
KQB-33	Screw Kit	4.99 kit



KPL-68R

Convertible Pillar Moldings

Correct polished stainless steel as original.

KPL-68L	1967-69 LH	59.99 ea.
KPL-68R	1967-69 RH	59.99 ea.



KQL-280

1969 Quarter Louvers

New die cast chrome moldings with correct semi-gloss black accenting. Choose from imported reproduction or USA made Trim Parts brand.

KQL-280	1969 Repro	64.99 pr.
KQL-6776	1969 Trim Parts Brand*	74.99 pr.
CT-725	Mounting Template	18.99 ea.

**Made in the USA*



RFL-78K



RFL-80K

1978-81 Z/28 Fender Louvers

High quality fender air vent extractors (louvers) for Z28 models. Manufactured from die-cast zinc. Paint to match.

RFL-78K	1978-79 Louvers	299.99 pr.
RFL-7878	1978-79 Hardware	79.99 pr.
RFL-80K	1980-81 Louvers	319.99 pr.
RFL-8080	1980-81 Hardware	69.99 pr.

No Volume Discount.



MPX-6967

Door Handle Kits

Complete kit with (2) door handles, (1) gasket set, and (1) push button set.

MPX-6967	1967-69 All	49.99 kit
MEH-4551	Gaskets Only	4.99 kit



MPX-6735

Door Handles OE Style

High quality with hardware made exclusively by Trim Parts. Fit and function as original. Highest quality on the market. Replaces GM 5716870.

MPX-6735	1967-69 OE High Quality	69.99 pr.
----------	-------------------------------	-----------



MS277-10

Eddie Motorsports Billet Door Handles

M = Machined, P = Polished, R = Red Fusioncoat, B = Blue Fusioncoat, W = White Fusioncoat, PR = Purple Fusioncoat, BK = Gloss Black Fusioncoat, BKA = Gloss Black Anodized, MB = Matte Black Fusioncoat, MBA = Matte Black Finish, CL = Clear Coat, CA = Clear Anodized

M.P All Others

MS277-10	1967-69 Billet Door Handles ..	414.99 pr.....441.99 pr.
----------	--------------------------------	--------------------------



MEH-254K

1970-81 Door Handles

OE style reproduction chrome door handles. Buy the kit and save! Gaskets not included.

MEH-252L	1970-74 LH (6-1/4" long)	42.99 ea.
MEH-252R	1970-74 RH (6-1/4" long).....	43.99 ea.
MEH-252K	1970-74 Kit (6-1/4" long).....	82.63 kit
MEH-254L	1970-81 LH (5-1/2" long)	16.99 ea.
MEH-254R	1970-81 RH (5-1/2" long)	16.99 ea.
MEH-254K	1970-81 Kit (5-1/2" long).....	30.58 kit
MEH-551	Gasket Only	6.99 ea.

Notes: On GM factory cars 70-74 handles are 6-1/4" long, 75-81 handles are 5-1/2" long.



MCC-5255

Door Handle Push Buttons

This is a complete door handle push button kit. This kit includes (2) buttons, (2) rubber rings, (2) springs and (2) retainers for a complete replacement.

MCC-5255	1967-69 All	19.99 kit
----------	-------------------	-----------



ANT-01

Antenna Kits

Our kits come complete with correct cable, antenna base, gasket and mast.

ANT-01	1967-68 Front AM/FM Fixed Mast	54.99 kit
ANT-0026	1969 Front AM/FM Fixed Mast	49.99 kit
ANT-0045	1967-68 Front AM Telescoping Mast	199.99 kit
ANT-0046	1969 Front AM Telescoping Mast ...	199.99 kit
ANT-0047	1967-68 Rear AM Semi Telescoping	199.99 kit
ANT-0047FM	1967-68 Rear AM/FM Fixed Mast	68.99 ea.
ANT-0048	1969 Rear AM Semi Telescoping.....	199.99 kit
ANT-69AMOE	1969 Mast Only	99.99 ea.
ANT-0048FM	1969 Rear AM/FM Fixed Mast	59.99 ea.
CT-728	1967-68 Front Antenna Mounting Template	10.99 ea.
CT-729	1969 Front Antenna Mounting Template	10.99 ea.
CT-726	1967-69 Rear Antenna Mounting Template	9.99 ea.



ANT-RFF29



ANT-RFF29A



ANT-678FRM

Antenna Bezel

The correct bezel for rear mounted antennas.

ANT-678FRM	1967-68	16.99 ea.
ANT-RFF29	1969 Bezel	15.95 ea.
ANT-RFF29A	1969 Plate	12.95 ea.



MRR-68



MHQ-1316L



MHQ-3171

Side View Mirrors

OE style reproduction, triple chrome plated side view mirror. There are many different mirrors on the market, but these are tried and true. We use them on our own cars! Now Includes Mounting Kit!

MHQ-3171	1967-68 Bowtie All.....	36.99 ea.
MRR-68	1967-68 w/o Bowtie	34.99 ea.
MHQ-1316L	1968-69 LH.....	36.99 ea.
MHQ-1316R	1968-69 RH.....	36.99 ea.
M-1036	1970-81 LH or RH*	24.99 ea.

**Does not include mounting kit.*



MHQ-3171-PQ



MHQ-1316L-PQ

1967-69 Premium Side Mirrors

Round Premium Mirror

Premium upgrade mirror. Features correct rib line on top of the base. Will not droop like aftermarket mirrors. Now Includes Mounting Kit!

MHQ-3171-PQ	1967-69	53.95 ea.
MIR-666MK	1967 GM Resto LH/RH	105.58 pr.

Square Premium Mirror

Premium upgrade mirror. Features correct rib line on top of the base. Will not droop like aftermarket mirrors. Now Includes Mounting Kit!

MHQ-1316R-PQ	1967-69 RH	52.99 ea.
MHQ-1316L-PQ	1967-69 LH	52.99 ea.



MIR-69K

Mirror Kits

Complete kit w/ (2) rear view mirrors and (2) mounting kits.

MIR-71K	1967-68 Bowtie	59.18 kit
MIR-88K	1967-68 w/o Bowtie	62.98 kit
MIR-69K	1968-69 Rectangle.....	59.18 kit



MHQ-1234
Mirror Mounting Kits
 Complete with bracket, gasket and screws.

MHQ-1234	1967-69 w/o Remote.....	5.99 kit
814441	1970-81 Standard Bracket.....	8.99 ea.
9816863	1970-81 Standard Gasket.....	8.99 ea.



1967-69 Remote Rear View Mirror
 OE style reproduction of the ultra rare remote rear view mirror featuring the correct length cable, interior chrome bezel, mounting kit and highly polished triple chrome finish.

MK-907	1967 All	179.99 ea.
3921816	1968 All	179.99 ea.
IMB-833	1968 Bezel Standard Interior.....	36.99 ea.
IMB-450	1968 Bezel Deluxe Interior.....	36.99 ea.
3957203	1969 All	169.99 ea.
IMB-833	1969 Bezel Standard Interior.....	36.99 ea.
IMB-450	1969 Bezel Deluxe Interior.....	36.99 ea.

No Volume Discount.



1993-02 Manual Remote Side View Mirrors
 These mirrors come in black and is ready to paint to the desired color

MK-9302M-L	1993-02 LH Manual	49.99 ea.
MK-9302M-R	1993-02 RH Manual	48.99 ea.
MIR-9302LP	1993-02 LH Power.....	39.99 ea.
MIR-9302RP	1993-02 RH Power	39.99 ea.
MIR-9302RK	1993-02 LH/RH Power	71.98 kit

No volume discount.



Bullet Mirrors, Glass & Hardware
 OE style reproduction of the original die cast bullet style mirrors. The driver side mirror is remote adjustable and includes a pre-installed cable. The passenger mirror is non-remote and is manually adjustable.

MK-801	1970-81 LH Mirror	179.99 ea.
MK-908	1970-81 RH Mirror.....	179.99 ea.
EMG-231	1970-81 LH Glass Only*	29.99 ea.
EMG-156	1970-81 RH Glass Only*	29.99 ea.
20055839	1970-81 Bracket RH	16.99 ea.
20055804	1970-81 Bracket LH	16.99 ea.
9832129	1970-81 Gasket.....	8.99 ea.

No Volume Discount. Note: Does not include lettering on glass.

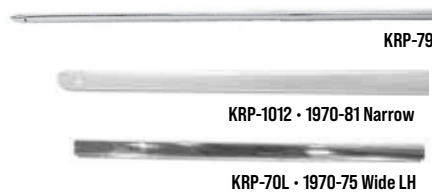

Standard Rocker Panel Moldings
 Excellent reproduction rocker panel moldings manufactured to exact OE thickness. Mounting hardware is included.

KRP-79	1967-69 Reproduction	28.99 ea.
KRP-765GM	1967-69 GM Restoration	59.99 ea.
KRP-765GM-K	1967-69 GM Restoration LH/RH.....	107.98 kit
KRP-1012	1970-81 Narrow	29.99 ea.
KRC-031	1970-81 Clip for Narrow Molding ..	5.99 ea.
KRP-70L	1970-75 Wide LH	99.99 ea.
KRP-70R	1970-75 Wide RH	99.99 ea.

Ships Oversize.



1982-92 Rocker Molding & Hardware
 These reproduction features correct mounting points and is ideal to replace missing or damaged rocker extensions or for use to convert as a standard Camaro into a Z28 with some minor mounting modifications.

KRP-C15285	1982-84 Z28 Lower Extensions.....	519.99 pr.
KRP-C15298	1985-90 Z28 Lower Extensions.....	569.99 pr.
KRP-C15291	1991-92 Z28 Lower Extensions	439.99 pr.
KRP-748792	1982-84 Z28 Main Brackets	209.99 pr.
KRP-748793	1985-90 Z28 Main Brackets	119.99 pr.
KRP-748794	1991-92 Z28 Main Brackets.....	219.99 pr.
KRP-K80072	1991-92 Z28 Side Brackets.....	179.99 set



Rally Sport Rocker Panel Moldings KMX-478
 Highly polished anodized aluminum lower body moldings. This 6 piece kit does one car. Mounting hardware sold separately.

KMX-452	1967 Rally Sport 6pc	179.99 ea.
KMX-478	1968 Rally Sport 6pc.....	169.99 ea.
KCX-453	1967 Mounting Hardware.....	34.99 kit
KCX-101	1968 Mounting Hardware	34.99 kit
CT-704	1967 Molding Mounting Template ...	24.99 ea.
CT-711	1968 Molding Mounting Template ...	25.99 ea.

Ships Oversize.



Z/28 Lower Door Extensions KMX-L9192
 Manufactured in fiberglass, this reproduction features the correct mounting points and is ideal to replace missing or damaged door extensions or for use to convert a standard Camaro into a Z/28 with some minor mounting modifications.

KMX-L8590	1985-90 Z/28	351.99 pr.
KMX-L9192	1991-92 Z/28.....	369.99 pr.



Door Ledge Moldings
 OE style reproduction of the special 1-1/2" molding installed on some specially optioned 1968 Camaros. These moldings can be installed on all 1968 Camaro as an upgrade.

KL-257	1968 Door	139.99 pr.
KL-262	1968 Quarter Ledge Coupe.....	129.99 pr.
KL-263	1968 Quarter Ledge Convertible	129.99 pr.
KL-29V	Door & Quarter Ledge Convertible..	214.99 kit
KL-29CK	Door & Quarter Ledge Coupe	224.99 kit

Ships Oversize.



Wheel Opening Moldings
 OE style reproduction stainless moldings sold in sets of 4.

KW-67R	1967-68 All	89.99 set
KW-68R	1968 RS	89.99 set
KW-69R	1969 All	89.99 set

Ships Oversize. No Volume Discount.



Wheel Opening Moldings
 Wheel Opening moldings OE gauge, excellent fit. Superior workmanship eliminates the scratched and dented appearance of lesser quality imported sets. Officially Licensed GM Restoration Parts.

KW-678GM	1967-68	199.99 kit
KW-68GMRS	1968 RS Only.....	199.99 kit
KW-696M	1969	199.99 kit



Quarter Window Molding
 Our triple chrome moldings come complete with correct rubber seals which seal the glass to the chrome.

KQW-996	1967-69	76.99 pr.
---------	---------------	-----------



Quarter Glass Seals
 Correct rubber seal which slides into the quarter window and seals the front and rear windows. Features steel core with rubber coating as factory.

JSS-3022	1967-69	19.99 pr.
----------	---------------	-----------

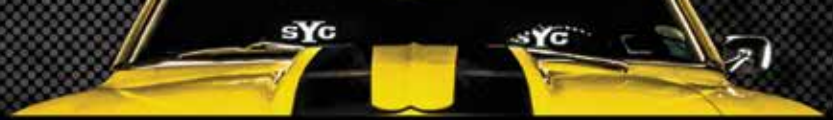

Door Edge Guard KE-1020

OE style reproduction door edge guards.

KE-1020	1967-6819.99 pr.
KE-1022	196919.99 pr.
KE-1024	1970-8119.99 pr.



KR-679

1970-81 Optional Exterior Moldings

The moldings in this set make up the optional exterior molding package available on 1970-81 Camaros. This set includes (2) door reveal moldings, (2) front fender corner edge moldings and (1) rear of hood molding. All moldings are available individually.

KR-679	1970-81 Complete 5pc269.37 kit
KR-677	1970-81 Hood & Corner 3pc119.99 kit
KDM-343	Door Reveal Molding RH82.99 ea.
KDM-344	Door Reveal Molding LH82.99 ea.
KTW-7081	Reveal Molding Clip1.99 ea.



KVS-774

1970-81 Cowl Vent Screen

Injection molded plastic screen which mounts to the top of the upper cowl area on all models.

KVS-774	1970-81 All89.99 ea.
---------	-------------	----------------



NR-46

1967 SS Hood Ornaments

Manufactured with new high quality tooling. These high quality reproduction hood louver ornaments feature the correct chrome raised fins on a semi flat black background.

NR-46	1967 Hood Ornaments169.99 pr.
KHB-S	1967 Correct Hood Seals15.99 pr.



NW-476



KLD-3974

1968-69 SS Hood Ornament Kit

This complete 1968-69 Camaro SS hood ornament kit comes with (2) "stacked" louvers and (2) bezels to give your SS hood that finishing touch. Drains sold separately. (Drains are for original GM hoods only.)

NW-476	1968-69 Ornament Kit199.99 pr.
KLD-3974	1968-69 Drains12.99 pr.

ADDICTIVE FLOW



Flat Black Look!



Carbon Fiber Look!



PTS-F678F



PTS-F69F-CRB



PTS-F69F



PTS-F69F-CRB



Addictive Flow Front Spoilers

These front spoilers are just what your pro-touring or resto-mod Camaro is missing. Brand new to the market & a Ground Up Motors Exclusive, these spoilers are easy on the wallet, easier to install, and designed with enthusiasts in mind. Includes the front spoiler, and mounting hardware for a complete upgrade or replacement, and a detailed set of installation instructions.

PTS-F678F	1967-68 All Front109.99 kit
PTS-F69F	1969 All Front109.99 kit
PTS-F678F-CRB	1967-68 All Front "Carbon Fiber Look"149.99 kit
PTS-F69F-CRB	1969 All Front "Carbon Fiber Look"149.99 kit
PTS-F703FS	1970-73 Standard Front89.99 kit
PTS-F703FS-CRB	1970-73 Standard Front "Carbon Fiber Look"109.99 kit
PTS-F703FRS	1970-73 RS Front89.99 kit
PTS-F703FRS-CRB	1970-73 RS Front "Carbon Fiber Look"109.99 kit



MHQ-0337

1967-69 Front Spoiler

Quality reproduction ABS plastic front spoilers which were originally used by the factory to aid in aerodynamic performance.

MHQ-0336	1967-68 Spoiler24.99 ea.	MHQ-221	1967-69 Brackets16.99 kit
MHQ-0337	1969 Spoiler24.99 ea.	MB-703	1967-69 Hardware6.95 kit

Ships Oversize.



1967-69 Front Spoiler Kit

Complete front spoiler kit including a correct ABS plastic front spoiler, bracket set and attaching hardware.

MSK-67F	1967-68 All41.59 kit
MSK-69F	1969 All41.59 kit

Ships Oversize.



MFS-70



MFS-70R

1970-73 Front Spoiler

Injection molded front spoiler which attaches directly to the lower valance panel.

MFS-70	1970-73 Standard131.99 ea.
MFS-70R	1970-73 Rally Sport119.99 ea.
MB-70F	1970-73 Hardware11.95 kit

Ships Oversize.



MFS-747

1974-77 Front Spoiler

Brand new injection molded front spoiler as original. Includes center, left and right pieces.

MFS-747 1974-77 229.99 kit



MFS-253

1978-81 Front Spoiler & Fender Flares

Reproduction spoiler kit and flare kits complete with welting set. Made of durable high quality urethane as original.

MFS-253 1978-81 Front Spoiler & Flares 459.99 kit
 MFS-270 1978-81 Rear Flares 239.99 kit

Note: Rear flares original for 1980-1981 only but can be used on 1978-1979.



MFS-C15283



MFS-C15292



MFS-K80075

MFS-K80074

1982-92 Front Spoiler & Hardware

These reproduction feature correct mounting points and are ideal to replace missing or damaged spoilers or for use to convert a standard Camaro into a Z28 w/ some minor mounting modifications*.

MFS-C15283 1982-84 Z28 Lower Spoiler 357.99 ea.
 MFS-C15296 1985-90 Z28 Lower Spoiler 384.99 ea.
 MFS-C15292 1991-92 Z28 Lower Spoiler 362.99 ea.
 MFS-C15272 1985-92 Z28 RS Front Support 131.99 ea.
 MFS-K80075 1982-84 Z28 Front Bracket 89.99 pr.
 MFS-K80074 1982-84 Z28 Front Fender Bracket 69.99 pr.

**Some spoilers are specific to a Z28 Front Bumper.*



MSW-047

Welting Set

This welting can generally be used on all GM vehicles with ground effects, flares or spoilers. Includes 15 feet of welting. Cut to desired length.

MSW-047 1978-81 32.99 kit



GRILLE-67S

BUY & SAVE

WITH SS396.COM PRE-BUILT KITS

1967 Standard Grille Kit

This is a complete grille kit for your 1967 standard Camaro. It includes (1) grille, (2) headlamp bezels, (1) upper grille molding and (1) lower grille molding.

GRILLE-67S 1967 Standard 237.11 kit
 No Volume Discount.



GRILLE-68S

BUY & SAVE

WITH SS396.COM PRE-BUILT KITS

1968 Standard Grille Kit

This is a complete grille kit for your 1968 standard Camaro. It includes (1) grille, (2) headlamp bezels, (1) upper grille molding and (1) lower grille molding.

GRILLE-68S 1968 Standard 281.31 kit
 No Volume Discount.



GRILLE-78R

BUY & SAVE

WITH SS396.COM PRE-BUILT KITS

1967-68 Rally Sport Grille Kit

This is a complete grille kit for your 1967-68 Camaro Rally Sport. It includes (1) grille, (1) upper grille molding, (1) lower grille molding and (2) headlamp bezels. Choose with or without chrome trim. 1967 was originally black and 1968 originally had chrome trim.

GRILLE-78R 1967-68 RS w/o Trim 285.28 kit
 GRILLE-88R 1967-68 RS w/ Trim 316.81 kit

No Volume Discount. Ships Oversize.



GRILLE-69SB

BUY & SAVE

WITH SS396.COM PRE-BUILT KITS

1969 Standard Grille Kit

This is a complete grille kit for your 1969 standard Camaro. It includes (1) grille, (2) headlamp bezels and (1) upper grille reinforcement.

GRILLE-69SB 1969 Standard Black 288.87 kit
 GRILLE-69SS 1969 Standard Silver 275.37 kit

No Volume Discount. Ships Oversize.



GRILLE-69RS

1969 Rally Sport Grille Kit

This is a complete grille kit for your 1969 Camaro Rally Sport. It includes (1) grille, (1) grille molding and (1) upper grille reinforcement.

GRILLE-69RS 1969 RS 307.77 kit
No Volume Discount. Ships Oversize.

BUY & SAVE
WITH SS396.COM PRE-BUILT KITS

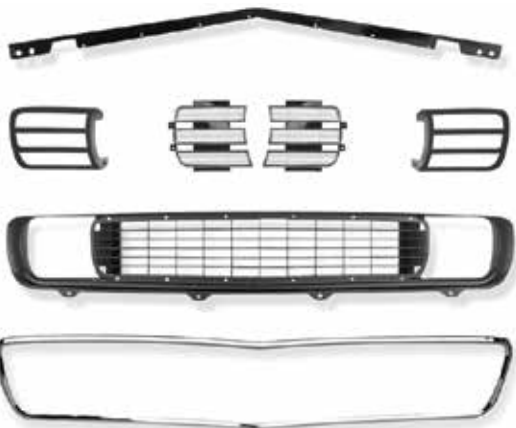

GRILLE-69UP

1969 Rally Sport Grille Kit w/ Headlight Doors

This is a complete 1969 Camaro Rally Sport grille kit which includes (1) grille, (1) grille molding, (1) upper grille stiffener, (2) chrome inner headlight doors and (2) paintable outer headlight doors.

GRILLE-69UP 1969 RS Complete Kit 491.34 kit
No Volume Discount. Ships Oversize.

BUY & SAVE
WITH SS396.COM PRE-BUILT KITS

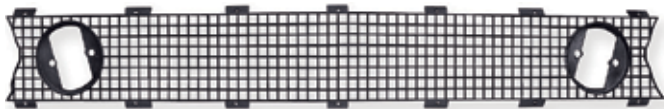

LEH-1693R

1967 Standard Grille

This is an OE style reproduction standard grille manufactured from all new tooling.

LEH-1693R 1967 Standard 54.99 ea.



LEH-4772R

1968 Standard Grille

This is an OE style reproduction standard grille assembly which will replace your cracked or damaged original.

LEH-4772R 1968 Standard 94.99 ea.
LMB-695 1968 Mounting Brackets w/ Rivets 20.99 pr.

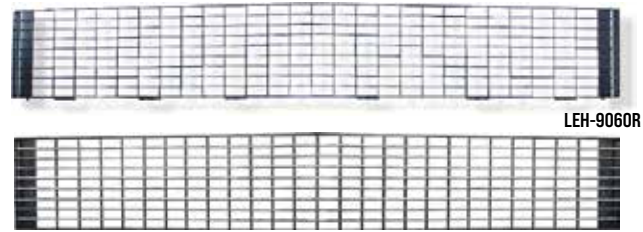

LEH-9060R

3919060C

1967-68 Rally Sport Grille

This is an OE style reproduction Rally Sport grille assembly available in black for 1967 Camaro and black with chrome trim for 1968 Camaros. Both are interchangeable.

LEH-9060R 1967-68 RS Black 49.95 ea.
3919060C 1967-68 Black w/ Chrome Trim 84.99 ea.



LEH-7062R

LEH-7062S

1969 Standard Grille

This is an OE style reproduction standard grille which features the correct chrome trim.

LEH-7062R 1969 Standard Black 159.99 ea.
LEH-7062S 1969 Standard Silver 144.99 ea.

Ships Oversized.



LEH-8641R

1969 Rally Sport Grille

This is an OE style reproduction Rally Sport grille which features the correct black finish.

LEH-8641R 1969 Rally Sport 169.99 ea.
Ships Oversize.



LEH-516

LEH-64JA

1970-73 Standard Grille

This is an OE style reproduction standard grille manufactured from all new tooling.

LEH-516 1970-71 Standard Silver 162.99 ea.
LEH-517 1970-71 Standard Black 159.99 ea.
LEH-64J 1972-73 Standard Silver 119.99 ea.
LEH-64JA 1972-73 Standard Black 129.99 ea.



LEH-1064

1970-73 Rally Sport Grilles

OE style reproduction Rally Sport grilles manufactured in black. Sold as a matched pair.

LEH-1064 1970-73 RS 159.99 ea.

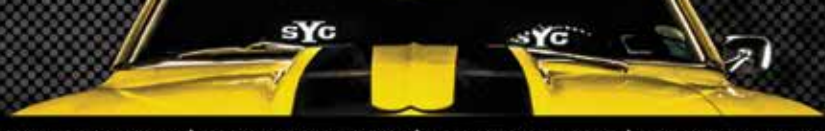

MCI-9447

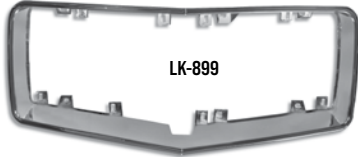

LK-899

1970-73 Rally Sport Nose & Bezel

Correct urethane and chrome bezel for 1970-73 Rally Sport.

MCI-9447	1970-73 RS Nose.....	639.99 ea.
LK-899	1970-73 RS Chrome Bezel.....	499.99 ea.



MK-55



MK-57

1970-73 Rally Sport Divider & Bracket

OE style reproduction Rally Sport divider bracket and insert which install between the LH and RH grilles.

MK-55	1970-73 RS Divider Bracket	59.99 ea.
MK-57	1970-73 RS Rubber Insert	24.99 ea.



LEH-060



LEH-061

1974-77 Upper Grilles

OE style reproduction upper grilles in your choice of black or gray.

LEH-060	1974-77 Gray.....	32.99 ea.
LEH-061	1974-77 Z/28 Black	24.99 ea.



LEH-8593

1974-77 Type LT Grille Molding Kit

Reproduction of the original upper and lower moldings that attach to the header panel and surround the front grill. Manufactured from quality polished aluminum to OEM specifications.

LEH-8593	1974-77 LT	209.99 ea.
----------	------------------	------------



LEH-162



LEH-163

1974-77 Lower Grilles

Correct reproduction lower grilles in your choice of black or gray.

LEH-162	1974-77 Gray.....	89.99 ea.
LEH-163	1974-77 Black.....	89.99 ea.



LEH-062



LEH-063



LEH-064



LEH-064A

1978-81 Grilles

OE style reproduction upper grilles in your choice of black for Z/28 or gray for standard.

LEH-062	1978-79 Gray	29.99 ea.
LEH-063	1978-79 Z/28 Black	32.99 ea.
LEH-064	1980-81 Gray	32.99 ea.
LEH-K191	1980-81 Z/28 Black	43.99 ea.



LEH-170



LEH-36

1978-81 Lower Grilles

OE style reproduction lower grilles in your choice of black for Z/28 or gray for standard.

LEH-170	1978-79 Gray	119.99 ea.
LEH-36	1978-79 Z/28 Black	119.99 ea.
LEH-770	1980-81 Z28 Black	92.99 ea.



4022-050-871

1987-92 Grille

Correct reproduction lower grilles in black.

4022-050-871	1987-92 RS/1988-90 Z/28, IROC* .	29.95 ea.
LEH-14019275	1982-84 Z28 Black LH.....	74.99 ea.
LEH-14019276	1982-84 Z28 Black RH.....	74.99 ea.
LEH-4081332	1985-89 Z/28 w/ Fog Lamp Cut Out Camaro Logo	219.99 ea.
LEH-10139545	1991-92 Z/28 w/ Red Bowtie Logo	219.99 ea.

*For cars without fog lamps.

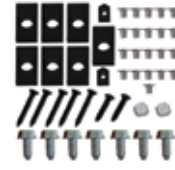

BAG-DLX678



BAG-703FRS

Grille Attaching Kits

Basic service kit for replacing grille hardware.

BAG-D3	1967-68 Bezel.....	7.99 kit
BAG-69Z	1969 Bezel.....	9.99 kit
BAG-DLX678	1967-68 All Grille & Bezel	19.99 kit
BAG-DLX69	1969 All Grille & Bezel 41pc	17.99 kit
BAG-703FRS	1970-73 Standard Nose	15.99 kit
BAG-703FRS	1970-73 RS Nose 36pc	17.99 kit
BAG-747F	1974-77 Standard Nose.....	15.99 kit
BAG-746FZ	1974-76 Z/28 Nose	15.99 kit
BAG-77FZ	1977 Z/28 Nose	14.95 kit
BAG-78F	1978 Standard Nose	16.99 kit
BAG-78FZ	1978 Z/28 Nose	16.99 kit
BAG-79F	1979 Standard Nose	14.95 kit
BAG-79FZ	1979 Z/28 Nose	14.99 kit



LEH-1691

1967 Standard Grille Moldings

OE style reproduction stamped aluminum grille moldings with correct accenting for standard grilles.

LEH-1691	1967 Standard Upper	66.99 ea.
LEH-1692	1967 Standard Lower	66.99 ea.



LEH-4771

1968 Standard Grille Moldings

OE style reproduction stamped aluminum grille moldings with correct accenting for standard grilles.

LEH-4771	1968 Standard Upper	62.99 ea.
LEH-4773	1968 Standard Lower	62.99 ea.



LHQ-1413

1967-68 Rally Sport Grille Moldings

OE style reproduction stamped aluminum grille moldings with correct accenting for Rally Sport grilles.

LHQ-1413	1967-68 Rally Sport Upper.....	74.99 ea.
LHQ-1414	1967-68 Rally Sport Lower.....	72.99 ea.



LEH-8637

1969 Rally Sport Grille Molding

Correct die cast molding installed on all 1969 Camaros with Rally Sport option.

LEH-8637	1969 Rally Sport	139.99 ea.
----------	------------------------	------------

Ships Oversize.



LQK-69

1969 Grille Stiffener

Correct grille stiffener which is inserted between the top of the grille and the header panel and acts as a trim piece to fill the gap.

LQK-69	1969 All	31.99 ea.
--------	----------------	-----------

Ships Oversize.



LHX-151

1967 Standard Headlamp Bezel Kit

OE style reproduction headlamp bezels with correct accenting.

LHX-151 1967 Standard..... 89.99 pr.
No Volume Discount.



LHX-770

1968 Standard Headlamp Bezel Kit

OE style reproduction aluminum headlamp bezels with correct flat black paint.

LHX-770 1968 Standard..... 109.99 pr.
No Volume Discount.



LHX-901

1969 Standard Headlamp Bezel Kit

OE style reproduction headlamp bezels including the correct chrome trim for the optional exterior decor package. Chrome can be removed for standard trim package.

LHX-901 1969 Standard..... 128.99 pr.
No Volume Discount.



LHX-140

1967-68 RS Headlamp Bezel Kit

OE style reproduction aluminum headlamp bezels with correct paint.

LHX-140 1967-68 Rally Sport 104.99 pr.
No Volume Discount.



BAG-D3

Headlamp Bezel Attaching Kit

Basic set of screws and clips to attach headlamp bezels.

BAG-D3 1967-68 All 7.99 kit
BAG-69Z 1969 All 9.99 kit



LHX-BN

1967-68 Headlamp Bezel Nuts

Correct hardware for attaching the bezels.

LHX-BN 1967-68 8pc 11.99 kit



LHB-044

1970-73 Headlamp Bezel Kit

OE style reproduction headlamp bezels constructed out of correct aluminum. These can be mounted on standard or RS front ends.

LHB-044 1970-73 All..... 106.99 pr.
No Volume Discount.



LHB-791

LHB-792



LHB-796

LHB-797

1974-77 Headlamp Bezels

OE style reproduction headlamp bezels for Rally Sport and Z/28 Camaros. The RS bezels feature a polished rim and brushed reflector and the Z/28 bezels feature a polished rim and black reflector.

LHB-792 1974-77 RS RH..... 79.99 ea.
LHB-791 1974-77 RS LH..... 69.99 ea.
LHB-797 1974-77 Z/28 RH..... 79.99 ea.
LHB-796 1974-77 Z/28 LH..... 79.99 ea.



LHB-577

LHB-578



LHB-032

LHB-031

1978-81 Headlamp Bezels

OE style reproduction bezels for standard and Z/28 Camaros. The standard bezels are chrome and the Z/28 bezels are black.

LHB-578 1978-81 RS RH..... 82.99 ea.
LHB-577 1978-81 RS LH..... 82.99 ea.
LHB-032 1978-81 Z/28 RH..... 69.99 ea.
LHB-031 1978-81 Z/28 LH..... 69.99 ea.



LPH-153

LPH-154



LPH-033

LPH-034

1978-81 Parking Lamp Bezels

OE style reproduction parking lamp bezels for standard and Z/28 Camaros. The standard bezels are chrome and the Z/28 bezels are black.

LPH-154 1978-81 Chrome RH 44.99 ea.
LPH-153 1978-81 Chrome LH..... 44.99 ea.
LPH-034 1978-81 Black RH..... 42.99 ea.
LPH-033 1978-81 Black LH..... 42.99 ea.



HLP-882 (Front View)



HLP-882 (Top View)

1982-92 Headlamp Mounting Panel

HLP-882 1982-92 All 79.99 ea.



LBC-305

1978-81 Front Nose/Bumper Cover

Available in OEM style urethane for the purist.

LBC-305 1978-81 Urethane 739.99 ea.
No Volume Discount. This item ships truck freight.



LBC-306

1978-81 Rear Bumper Cover

Available in OEM style urethane for the purist.

LBC-306 1978-81 Urethane 539.99 ea.
No Volume Discount. Oversize 2.

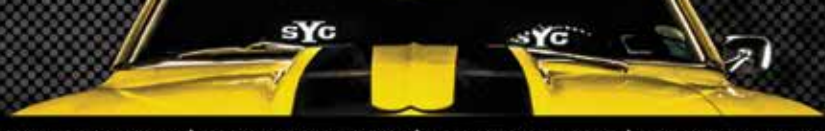

MKY-69K

1967-69 Chrome Bumper Kits

Nothing will freshen up your Camaro more than a new set of front and rear bumpers! These bumpers are triple chrome plated for a beautiful shine. Each kit includes (1) front bumper, (1) rear bumper and a set of correct bumper bolts. All at a special kit price!

MKY-67K	1967 All	294.07 kit
MKY-68K	1968 All	311.37 kit
MKY-69K	1969 All	314.97 kit
MKY-70K	1970-73 Standard	371.27 kit
MKY-70RK	1970-73 Rally Sport	388.47 kit

Oversize 2.



MBP-69F

MBP-67R

Ground Up Motors Premium Bumpers

These Ground Up Motors exclusive premium bumpers feature triple chrome plating with less wrinkled edges and heavy OEM gauge steel for the ultimate in authenticity. Rears include the center support riveted in. This is by far the best bumper on the market.

MBP-67F	1967-68 Front Premium	209.99 ea.
MBP-67R	1967-68 Rear Premium	209.99 ea.
MBP-69F	1969 Front Premium	209.99 ea.
MBP-69R	1969 Rear Premium	209.99 ea.

Oversize 2.



MKY-67FP

Paintable Bumpers

Set your Camaro apart from the crowd and give it a more modern look with these paintable bumpers.

MKY-67RP	1967-68 Rear	124.99 ea.
MKY-69FP	1969 Front	119.99 ea.
MKY-69RP	1969 Rear	119.99 ea.



MBS-74F



MBS-74R

1974-77 Bumper Strips

Correct rubber strips that go on the front and rear bumpers.

MBS-74F	1977-74 All Front	209.99 ea.
MBS-74R	1977-74 All Rear	209.99 ea.

Triple Chrome Plated Bumpers

These are high quality reproduction bumpers which are perfect for daily drivers and show cars alike. Each bumper starts out with a nickel core and is then triple chrome plated for a beautiful shine.



MKY-1220 1967-68 Front 159.99 ea.



MKY-1222 1969 Front 163.99 ea.



3986576 1970-73 Standard Front 189.99 ea.

MKY-7073G 1970-73 Std Front w/ Guards 314.99 ea.



MCI-9230 1970-73 Rally Sport Front 2pc. 209.99 pr.



MKY-1221 1967-68 Rear 163.99 ea.



MKY-7424 1969 Rear 163.99 ea.



MKY-772 1970-73 Rear 189.99 ea.

All bumpers ship Oversize.



MED-456 installed on our own 1969 Camaro.

1969 Endura Front Bumpers

Excellent quality reproduction of the optional endura bumper. This was an option on 1969 Camaros for those who wanted something other than a chrome bumper. The endura bumper was painted the same color as the car with high gloss acrylic lacquer. This will add an awesome "factory customized" look to your Camaro!

MED-456 1969 All 459.99 ea.

MEB-69K-DLX 1969 Complete Front Bracket Kit. 129.99 kit

Ships Oversize.



1982-92 Impact Bars

These are the impact bars which are located underneath the bumper covers.

RIB-82 1982-84 Front 59.95 ea.

RIB-82R 1982-92 Rear 88.99 ea.

No Volume Discount. Ships Oversize 2.



BPX-97KOE



BPX-359

1967-73 Bumper Bolts

Correct OE Bumper Bolts

Correct small head, polished heavy stainless plated bumper bolts. Correct captured washer nuts. Technically correct for concours restorations. Does front and rear bumper.

BPX-97KOE 1967 All 49.99 kit

BPX-99KOE 1968-69 All 49.99 kit

Bolts with Nuts

Complete bumper bolt kits with nuts.

BPX-97K 1967 All 10pc 21.99 kit

BPX-99K 1968-69 All 10pc 21.99 kit

BPX-69FKOE 1969 Front OE Style 16pc 23.99 kit

BPX-69RKOE 1969 Rear OE Style 12pc 23.99 kit

BPX-2401KIT 1970-73 Std 10pc 21.99 kit

BPX-359 1970-73 RS 12pc 19.99 kit



RBF-596

1970-73 Bumper Filler Panels

Die stamped heavy gauge steel panels to replace the often corroded or missing originals. Fits standard or Rally Sport.

RBF-596 1970-73 All 64.99 pr.



MG-35

1970-73 Rear Bumper Gaskets

Molded rubber bumper end fillers.

MG-35 1970-73 29.99 pr.



MBB-555

1970-73 Bumper Bracket Cushions

MBB-555 1970-72 All, 1973 RS 14.99 pr.



BBF-4266

Bumper Bracket Mounting Hardware

Complete hardware kits for mounting the bumper brackets.

BBF-4266 1967 Front 16pc 23.99 kit

BBF-4274 1967-69 Rear 16pc 16.99 kit

BBF-4225 1969 Front Complete 16pc 24.99 kit

BBF-4273 1969 Front Outer 4pc 10.99 kit

BBF-4269 1969 Front Extension 12pc 8.99 kit

BBF-4614 1970-73 Front RS 10pc 17.99 kit

BBF-4131 1970-72 Front Standard 10pc 13.99 kit

BBF-4141 1973 Front Standard 12pc 21.99 kit

BBF-4137 1970 Rear 8pc 21.99 kit

BBF-5207 1971 Rear 8pc 17.99 kit

BBF-5372 1972-73 Rear 8pc 17.99 kit

Bracket to bumper bolts not included.

Front Bumper Brackets

OE style reproduction bumper brackets.

-  MBB-610L
MBB-610R
- MBB-610L 1967-68 Inner LH 29.99 ea.
MBB-610R 1967-68 Inner RH 29.99 ea.
-  MBQ-367L
MBQ-367R
- MBQ-367L 1969 Inner LH 17.99 ea.
MBQ-367R 1969 Inner RH 18.99 ea.
-  MIC-69L
MIC-69R
- MIC-69L 1969 Inner Extension LH 14.99 ea.
MIC-69R 1969 Inner Extension RH 14.99 ea.
-  MOB-67FL
MOB-67FR
- MOB-67FL 1967 Outer LH 20.99 ea.
MOB-67FR 1967 Outer RH 20.99 ea.
-  MOB-68L
MOB-68R
- MOB-68L 1968 Outer LH 14.99 ea.
MOB-68R 1968 Outer RH 14.99 ea.
-  MC-510
- MC-510 1968 Front Corner Mounts 18.99 pr.
-  MCB-68
- MCB-68 1968 Center Valance 15.99 ea.
-  MOB-69K
- MOB-69K 1969 Outer Corners 2pc 19.99 pr.

-  MCM-553
- MCM-553 1969 Outer Corners 2pc 17.99 pr.
-  MEB-69A
- MEB-69A 1969 Inner Endura 54.99 pr.
-  MEB-69K
- MEB-69K 1969 Outer Endura 12pc 39.99 kit
-  MBB-295
- MBB-295 1970-73 RS Urethane 89.99 pr.
-  MBB-554
- MBB-554 1970-72 Std, 1970-73 RS
Front Inner 74.99 pr.
-  MBB-556
- MBB-556 1970-72 Std, 1970-73 RS
Front Outer 64.99 pr.
-  MBB-549
- MBB-549 1970-73 Std 16pc 164.99 kit
-  MBB-987
- MBB-987 1970-73 RS 18pc 259.99 kit
-  MBB-580
- 1970-73 Bumper Bracket Braces**
OE style reproduction front bumper bracket braces.
- MBB-580 1970-73 Standard 54.99 pr.
MBB-580 1970-72 RS 54.99 pr.

Rear Bumper Brackets

OE style reproduction center bumper brackets.

-  MBB-67C
- MBB-67C 1967-68 Rear Center 24.99 ea.
-  MBB-69C
- MBB-69C 1969 Rear Center 24.99 ea.
-  MBB-557
- MBB-557 1970-72 All 5pc 109.99 kit

-  MBB-KIT7
- 1967-69 Bumper Bracket Kits**
Includes all correct bumper brackets.
- MBB-KIT7 1967-68 Rear All 4pc 44.99 kit
MBB-559 1969 Rear All 4pc 54.99 kit
MBB-W778 1969 Rear All 5pc OE Style 54.99 kit
MBB-KIT8F 1968 Front All 4pc 54.99 kit

-  BBF-13
- Bumper Bracket Bolts**
New bumper bracket bolts with correct teeth washers and nut.
- BBF-13 1967-81 Front Inner 6.99 ea.
Note: Fits bracket to subframe only.



1970-73 Front Bumper Brace RBB-1048QD
This is a correct Camaro front bumper brace which acts as a reinforcement for your non-Rally Sport Camaro.

RBB-1048QD 1970-73 Standard 109.95 ea.
Ships Oversize 1.



1967-69 Deluxe Front Bumper Guards
OE style reproduction triple chrome plated front bumper guards, optional on all 1967-68 models. Includes rubber seals and brackets.

MBG-678F 1967-68 139.99 kit
MBG-69F 1969 124.99 kit



1967-68 Deluxe Rear Bumper Guards
OE style reproduction triple chrome plated rear bumper guards optional on all 1967-68 models. Includes brackets & hardware.

MBG-67RX-KIT 1967-68 116.98 pr.
MBG-67RX 1967-68 64.99 ea.



1967-68 Standard Rear Bumper Guards
OE style reproduction lower chrome bumperettes.

MBG-67RL 1967-68 69.95 pr.



1969 Deluxe Rear Bumper Guards
OE style reproduction triple chrome plated rear bumper guards optional on all 1969 models.

MBG-69RX 1969 128.99 kit



1969 Standard Rear Bumper Guards
OE style reproduction lower chrome bumperettes.

MBG-69RL 1969 59.99 pr.



1970-73 Standard Bumper Guards
OE style reproduction lower chrome bumperettes. Standard on all models.

MBG-70FL 1970-72 Front* 249.99 pr.
MBG-70RL 1970-73 Rear 114.99 pr.

* Not for use on split bumper RS models.



Fuel Tank Caps
OE style reproduction fuel tank caps with correct logos.

XTC-043 1967-68 Paintable 21.99 ea.
XTC-045 1967-68 SS 54.99 ea.
XTC-059 1967 SS 350 59.99 ea.
XTC-057 1967-68 RS 59.99 ea.
XTC-250 1967-68 Bowtie w/ Lock 44.99 ea.



1978-92 Tail Panel Applique
OE style reproduction tail lamp applique.

LTA-331 1978-81 Black LH 42.99 ea.
LTA-332 1978-81 Black RH 42.99 ea.
LTA-781 1979-81 Berlinetta LH 54.99 ea.
LTA-782 1979-81 Berlinetta RH 54.99 ea.
5973009 1982-90 w/ Stripe LH 41.99 ea.
5973010 1982-90 w/ Stripe RH 41.99 ea.
16503143 1985-92 w/ Grid LH 47.99 ea.
16503144 1985-92 w/ Grid RH 47.99 ea.



1978-81 Fuel Door with Hinge
OE style reproduction fuel door with correct pre-drilled holes for emblem. Berlinetta features chrome and black center accent bar.

XTD-507 1978-81 Black 120.99 ea.
XTD-789 1979-81 Berlinetta 136.99 ea.



Front License Plate Brackets
OE style reproduction front license plate brackets.

MLB-807 1967-68 All 17.99 ea.
MLB-765 1969 All 17.99 ea.
MLB-839 1970-73 Standard 21.99 ea.
MLB-220 1970-73 RS 29.99 ea.
XTD-8287 1982-83 All 24.99 ea.



Fuel Tank Doors
Correct spring loaded fuel tank door.

XTD-1630 1969 Door 26.99 ea.
XTD-344 1970-77 Door 19.99 ea.
XTD-10B Door Bumper 1.95 ea.
XTD-97B 1969-77 Door Bumper OE Style 5.99 pr.
BTB-56K Door Bolt 2.59 pr.



1978-81 Rear License Plate Bracket
Correct bracket which screws or rivets to the rear bumper cover.

MLB-78R 1978-81 24.99 ea.



Z/28 Spoiler Decal
OE style reproduction Z/28 spoiler decal for your 1970-73 Camaro.

HZ-28 1970-73 Z/28 14.99 ea.

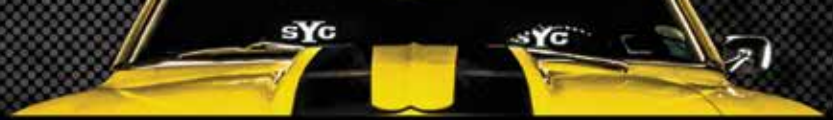

MRS-185-CRB



PTS-RN67



PTS-RN69



PTS-R70



Addictive Flow Rear Spoilers

These spoilers feature a stunning carbon fiber look and correct threaded mounting studs right out of the box. This new and improved spoiler kit comes complete all the hardware needed to replace your boring original rear deck lid spoiler. It also makes a nice upgrade for cars not originally equipped with a spoiler.

MRS-185-CRB	1967-68 All Rear "Carbon Fiber Look"	199.99 ea.
PTS-RN67	1967-68 All Rear Pro-touring Style Black Paintable ...	149.99 kit
PTS-RN67-CF	1967-68 All Rear Pro-touring Style "Carbon Look"	209.99 kit
PTS-RN69	1969 All Rear Pro-touring Style Black Paintable	149.99 kit
PTS-RN69-CF	1969 All Rear Pro-touring Style "Carbon Look"	209.99 kit
MRS-186-CRB	1969 All Rear "Carbon Fiber Look"	199.99 ea.
CT-SPOILER-R	1967-1969 Rear Mounting Template	24.99 ea.
PTS-R70	1970-81 All Rear Pro-touring Style Black Paintable.....	179.99 kit
PTS-R70-CF	1970-81 All Rear Pro-touring Style "Carbon Look"	209.99 kit

Ships Oversize.

Carbon Fiber Look!

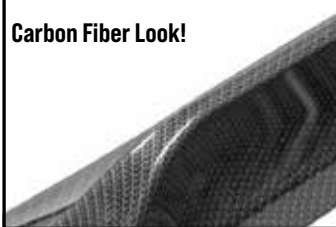

MRS-185



MRS-186

1967-69 Rear Spoiler

OE style reproduction fiberglass rear spoilers with correct threaded studs allowing easy replacement into existing holes.

MRS-185	1967-68 Reproduction w/ mounting template	129.99 ea.	BMS-288	1967-69 Attaching Hardware	6.50 kit
MRS-186	1969 Reproduction w/ mounting template.	129.99 ea.	BSS-391	1967-69 Studs	21.99 kit

Ships Oversize.



MDR-1970

1970-73 Rear Spoiler

OE style reproduction fiberglass rear spoilers with correct threaded studs allowing easy replacement into existing holes.

MDR-1970	1970-73 Z/28 Low Style	179.99 ea.	MR-353	1974-81 3pc	373.32 ea.
MR-352	1970-73 3pc	394.22 ea.	BMS-288	1970-73 Z/28 Low Style Attaching Hardware.....	6.50 kit
			MR-7481	1974-81 Ground Up Brand 3pc	299.97 kit
			BMS-288DLX	1970-73 3pc Spoiler Attaching Hardware	13.99 kit

Ships Oversize.



RSKIT-676

1967 Rally Sport System Kit

Everything you need to completely replace your tired old Rally Sport hidden headlight system.

This kit includes:

- (1) RS Under Dash Diode Harness, (2) RS Fender Adapter Brackets, (2) Headlamp Motors, (1) Delco Remy Relay Board Assembly, (1) Switch Hardware Set, (1) Switch Bracket Hardware Set, (1) Installation Hardware Pack, (1) RS Front Light Harness (2) RS Headlamp Assemblies, (1) Relay Mounting Plate (4) Headlight Limiting Switches, (1) Limit Switch Bracket Set (1) System Circuit Breaker, (1) 1967 Camaro Assembly Manual

RSKIT-676	1967 6 Cylinder.....	1370.99 kit
RSKIT-8W	1967 V8 w/ Warning Lights....	1299.99 kit
RSKIT-8G	1967 V8 w/ Gauges.....	1308.99 kit

No Volume Discount.



RSKIT-68C

1968 Rally Sport System Kit

Everything you need to completely replace your tired old Rally Sport hidden headlight system.

This kit includes:

- (1) RS Headlamp Switch, (2) RS Fender Adapter Brackets (2) Headlamp Assemblies, (1) Vacuum Tank, (1) RS Color Coded Hose Kit, (2) Actuator Rear Support Brackets, (2) Door Bumper Set, (1) Vacuum Relay Switch, (2) Radiator Door Support Stop Brackets, (1) Vacuum Actuators, (2) Vacuum Actuator Shields (2) Actuator Clevis Pin Sets, (1) Actuator Rear Clamp Brackets (1) Installation Hardware Pack, (1) 1968 Camaro Assembly Manual

RSKIT-68	1968 All	1069.16 kit
RSKIT-68C	1968 All w/ Chrome Doors	1126.16 kit

No Volume Discount.



RSKIT-69

1969 Rally Sport System Kit

Everything you need to completely replace your tired old Rally Sport hidden headlight system.

This kit includes:

- (1) RS Headlamp Switch, (2) RS Fender Adapter Brackets (2) Radiator Support Door Stop Brackets, (2) Vacuum Actuators (2) Actuator Shields, (2) Actuator Clevis Pin Sets, (2) Actuator Rear Clamp Brackets, (1) Door Bumper Set, (1) Vacuum Relay Switch, (2) RS Headlamp Assemblies, (1) Vacuum Tank, (1) RS Color Coded Hose Kit, (2) Actuator Rear Support Brackets, (1) Installation Hardware Pack, (1) 1969 Camaro Assembly Manual

RSKIT-69	1969 All	1045.78 kit
----------	----------------	-------------

No Volume Discount.

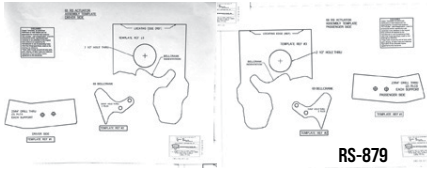

RS-879

Rally Sport Fenderwell Template Kits

These convenient templates accurately locate all needed modification points to standard fenderwells allowing easy and accurate installation of all Rally Sport components.

RS-878	1968 Rally Sport	21.99 ea.
RS-879	1969 Rally Sport	21.99 ea.



RSKIT-68DSE

1968-69 DSE Rally Sport System Kit

Everything you need to completely replace your tired old Rally Sport hidden headlight system. This kit includes:

- (1) DSE Electronic Headlamp Conversion Kit
- (2) RS Fender Adapter Brackets, (2) Radiator Support Door Stop Brackets, (1) Door Bumper Set, (2) RS Headlamp Assemblies (1) 1969 Camaro Assembly Manual

RSKIT-68DSE	1968 All	1011.29 kit
RSKIT-68CDSE	1968 All w/ Chrome Doors	1068.29 kit
RSKIT-69DSE	1969 All	1004.99 kit

No Volume Discount.



DSE122002

DSE Electric Headlight Door Kit

This DSE electric RS headlight door kit replaces the stock vacuum actuated system on your 1968 or 1969 Camaro Rally Sport. When installed, this kit will operate the headlight doors more reliably, smoother and without the complicated and bulky vacuum accessories. This kit comes with everything you need for installation including two electric actuators, a control module, harness, mounting brackets and hardware.

DSE122004	1968 RS	549.99 kit
DSE122003	1969 RS	549.99 kit

No Volume Discount.

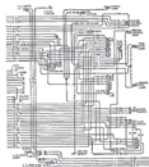

HWD-RS

Rally Sport Wiring Diagram

Original GM wiring schematic for rally sport cars.

HWD-RS	1967-69 RS	13.99 ea.
--------	------------------	-----------



KRS-67K

1967 RS Headlamp Assemblies

Complete headlamp door assemblies including headlamp housings, hinge plates, door backing plates, outer black headlamp door covers with moldings and door stop cushions, pivot arms, motor mounting plates, drive washer and nut set, adjusting screws, bushings and hardware. Completely assembled!

KRS-67KR	1967 RS RH	199.99 ea.
KRS-67KL	1967 RS LH	199.99 ea.
KRS-67K	1967 RS Pair	379.98 kit



KRS-68K

1968 RS Headlamp Assemblies

Complete headlamp door assemblies including headlamp housings, hinge plates, door backing plates, outer black headlamp door covers (with or without trim) moldings and door stop cushions, bellcranks, lower bellcrank support brackets, over center mechanisms with springs, sealed beam adjusting screws and all bushings and hardware. Completely assembled!

KRS-68KR	1968 RS RH	199.99 ea.
KRS-68KL	1968 RS LH	199.99 ea.
KRS-68K	1968 RS Pair	379.98 kit
KRS-68CR	1968 RS w/ Trim RH	229.99 ea.
KRS-68CL	1968 RS w/ Trim LH	229.99 ea.
KRS-68CK	1968 RS w/ Trim Pair	436.98 kit



KRS-69K

1969 RS Headlamp Assemblies

Complete headlamp door assemblies including headlamp housings, hinge plates, door backing plates, bellcranks and bellcrank support brackets, springs, mounting plates, all bushings, sealed beam adjusting screws and needed hardware. Completely assembled.

KRS-69KR	1969 RS RH	199.99 ea.
KRS-69KL	1969 RS LH	199.99 ea.
KRS-69K	1969 RS Pair	379.98 pr.



KRG-06CL

KRG-06CR

1967-68 Headlamp Door Covers

Correct replacement door covers manufactured in the correct "egg crate" pattern. 1968 Models feature silver edging as original.

KRG-063R	1967 w/o Silver RH	12.99 ea.
KRG-063L	1967 w/o Silver LH	12.99 ea.
KRG-06CR	1968 w/ Silver RH	24.99 ea.
KRG-06CL	1968 w/ Silver LH	24.99 ea.
KRS-8B	1967-68 Screws 8pc	2.99 kit



KRQ-425L

KRQ-425R

1967-68 Headlamp Door Moldings

OE style reproduction headlamp door moldings in matte black and finished with a polished aluminum edge.

KRQ-425R	1967-68 RH	34.99 ea.
KRQ-425L	1967-68 LH	34.99 ea.
KRV-916	1967-68 Molding Rivets	5.99 kit



KRQ-102R

KRQ-102L

1969 Outer Headlamp Doors

Accurate fitting die cast outer headlamp door covers coated in black primer for easy painting.

KRQ-102R	1969 RS RH	36.99 ea.
KRQ-102L	1969 RS LH	36.99 ea.

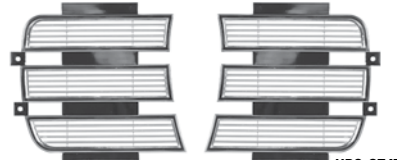

KRC-6747

1969 Chrome Inner Headlamp Doors

Exceptional reproduction cast and chrome plated inner headlamp doors.

KRC-6747	1969 RS	129.99 pr.
----------	---------------	------------



KRQ-261L

1967-68 Headlamp Door Backing Plates

Diecast headlamp door backing plates with black coated phillips machine screws.

KRQ-261R	1967-68 RS RH	33.99 ea.
KRQ-261L	1967-68 RS LH	33.99 ea.



KRQ-172L

KRQ-172R

1969 Headlamp Door Backing Plates

Diecast headlamp door backing plates painted in semi flat black.

KRQ-172R	1969 RS RH	29.99 ea.
KRQ-172L	1969 RS LH	29.99 ea.



KRQ-164

1967-69 Door Hinge Bolt

OE style reproduction plated bolt and nut.

KRQ-164	1967-69 RS	7.99 ea.
---------	------------------	----------



KRQ-389



KRQ-189

1967-69 Headlamp Door Hinge Plates

Die cast hinge plates unpainted as original. Fits LH or RH.

KRQ-389	1967-68 RS	24.99 ea.
KRQ-189	1969 RS	29.99 ea.



KRQ-154

1967-69 Door Shouldered Bolts

Set of three correct plated shouldered bolts for attaching headlight door. Two sets required per car.

KRQ-154	1967-69 RS 3pc.....	8.99 set
---------	---------------------	----------



KRQ-185

Headlamp Bushing Kits

Complete set of upper and lower headlamp door bushings and washers to repair both door assemblies.

KCC-632	1967 RS 14pc	17.99 set
KRQ-185	1968-69 RS 24pc.....	21.99 set



LRT-212L

1967 Headlamp Motors

Excellent replacement headlamp motor featuring sealed housings with an all metal precision gear train. Includes mounting plate and wiring connector.

LRT-212L	1967 RS LH.....	189.99 ea.
LRT-212R	1967 RS RH.....	189.99 ea.
LRT-212K	1967 RS Pair.....	341.98 kit



KRQ-388

1967 Headlamp Motor Drive Arm

Accurate die stamped steel reproduction drive arm, black coated.

KRQ-388	1967 RS	12.99 ea.
---------	---------------	-----------



KRC-962

1967 Motor Nut & Drive Washers Set

Shouldered nuts, large slotted washers and correct large diameter spring steel cone washers to properly tension friction discs.

KRC-962	1967 RS	16.99 set
---------	---------------	-----------



KRQ-205

KRX-398

1967 Rally Sport Headlamp Limiting Switch

Correct headlamp limiting switch with correct attached ground wire.

KRQ-205	1967 RS Switch.....	19.99 ea.
KRX-398	1967 RS Screw Kit.....	8.99 kit



KRQ-398

1967 RS Limiting Switch Bracket Set

Correct limiting switch bracket set used to mount to the headlamp assemblies and core support.

KRQ-398	1967 Bracket Set.....	39.99 set
---------	-----------------------	-----------



KW-806

1967 Rally Sport Relay Board Assembly

Complete reproduction assembly with all correct parts. Die stamped steel relay mounting plate with three installed relays.

KW-806	1967 RS	109.99 kit
--------	---------------	------------



KRQ-398

1967 Rally Sport Headlamp Relay

Excellent reproduction headlamp relay with stamped Delco Remy script. Mounting bracket includes stamped 858 numerals with accurate finish plating.

KRQ-398	1967 Motor Relay.....	33.99 ea.
KRQ-215	1967 Bracket.....	31.99 ea.



KB-10

1967 Rally Sport Circuit Breaker

OE style reproduction 10 amp restoration circuit breaker including correctly plated mounting bracket, two correct style integral washer nuts to attach wiring connectors.

KB-10	1967 RS	29.99 ea.
-------	---------------	-----------



11200

1967 Rally Sport Extension Harness

Correct under dash diode harness.

11200	1967 RS	49.99 ea.
-------	---------------	-----------



KRQ-299

1968-69 RS Vacuum Actuators

Excellent replacement vacuum actuator.

KRQ-299	1968-69 RS.....	84.99 ea.
KRX-299	1968-69 RS Pair.....	152.98 pr.



KRC-623

1968-69 RS Clevis Pin Kit

Correct actuator clevis pins, bushings & clips. Mounts one actuator. Two required per car.

KRC-623	1968-69 RS.....	9.99 kit
---------	-----------------	----------



KRQ-137



KRQ-138

1968-69 RS Actuator Shields

Injection molded ABS actuator shields.

KRQ-137	1968 RS	74.99 pr.
KRQ-138	1969 RS	76.99 pr.
BRQ-13KIT	1968-69 Bolts 8pc.....	5.95 kit



KRQ-24

1968 RS Actuator Support Brackets

Large rear fender brackets in stamped steel, coated black with integral blind nuts.

KRQ-24 1968 RS 49.99 pr.



KRQ-103

1969 RS Actuator Support Brackets

Large rear fender brackets in stamped steel, coated black with integral blind nuts.

KRQ-103R 1969 RS RH 27.99 ea.
 KRQ-103L 1969 RS LH 27.99 ea.
 KRQ-103 1969 RS Pair 44.99 pr.



KRQ-105

1968-69 RS Support Clamp Bracket

Die stamped small rear support clamp bracket. 2 required per car.

KRQ-105 1968-69 RS 11.99 ea.



KRQ-349

1968-69 RS Vacuum Reservoir

OE style reproduction of original 1968 dual tube and 1969 single vacuum reservoirs. Includes mounting tabs, relay valve bracket and seam treatment as original.

KRQ-348 1968 RS 94.99 ea.
 KRQ-349 1969 RS 94.99 ea.
 BRQ-3KIT 1968-69 Bolts 3pc 1.95 kit



KRK-80

1968-69 RS Vacuum Relay Switch

OE style reproduction vacuum relay valve featuring correct raised text. Controls vacuum to headlight doors.

KRK-80 1968-69 RS 74.99 ea.



KRQ-498

KRQ-432

1968-69 RS Check Valve & Filter

Correct vacuum line check valve and hose in-line filter.

KRQ-498 1968-69 Check Valve 14.99 ea.
 KRQ-432 1968-69 Filter 7.99 ea.



NW-733

1968 RS Headlamp Hose Kit

Show quality headlamp hose kit including deep impregnated color stripe coded pre-cut hose. Correct weight, color and diameter. Includes T-fittings, firewall grommet, filter original style straps and instructions.

NW-733 1968 RS 89.99 kit



NW-633

1969 RS Headlamp Hose Kit

Show quality headlamp hose kit including deep impregnated color stripe coded pre-cut hose. Correct weight, color and diameter. Includes T-fittings, firewall grommet, filter, check valve original style straps and instructions.

NW-633 1969 RS 89.99 kit



KRQ-326

1968-69 RS Firewall Hose Grommet

Correct two-hole rubber grommet for firewall.

KRQ-326 1968-69 RS 5.99 ea.



KRQ-181



KRQ-104

1968-69 RS Headlamp Bellcranks

Accurate stamped steel EDP coated.

KRQ-181R 1968 RS RH 23.99 ea.
 KRQ-181L 1968 RS LH 23.99 ea.
 KRQ-181 1968 RS Pair 46.99 pr.
 KRQ-104R 1969 RS RH 26.99 ea.
 KRQ-104L 1969 RS LH 26.99 ea.
 KRQ-104 1969 RS Pair 49.99 pr.



KRQ-161

KRQ-162

1968-69 RS Bellcrank Support Brackets

Excellent quality stamped steel brackets.

KRQ-161 1968 RS 19.99 pr.
 KRQ-162 1969 RS 34.99 pr.



KRC-801

1968-69 RS Radiator Support Stop Brackets

Correct die stamped steel brackets with rubber bumpers installed.

KRC-944 1968 RS Bracket 26.99 ea.
 KRC-801 1969 RS Bracket 26.99 ea.
 KSB-1R 1968-69 Bumper Only 7.99 ea.



KRQ-175

RS Over Center Bracket & Spring Set

8 piece set includes brackets, washers, springs and lock nuts. Does one car.

KRQ-175 1968 RS 12.95 kit
 KRQ-175B 1968 RS (Spring Only) 8.99 ea.
 KRQ-175A 1969 RS (Spring Only) 8.99 ea.



GHS-542

1968-69 RS Headlight Switch

Correct dash mounted vacuum headlight operation switch.

GHS-542 1968-69 RS 49.99 ea.



AWP-69RS

1969 RS Headlight Washer Pump Solenoid

AWP-69RS 1969 RS Headlight Washer Pump .. 189.99 ea.

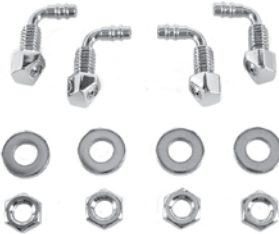

KRQ-158

1969 RS Headlight Washer Nozzles

OE style reproduction, heavy chrome plated headlamp washer nozzles, (4) chrome plated thick washers and (4) chrome plated thin nozzle nuts.

KRQ-158 1969 RS 39.99 kit



NAP-630

1969 RS Headlight Washer Hose Set

Correct OEM ribbed washer hose with correct fittings and straps.

NAP-630 1969 RS 24.99 kit



17585

1969 RS Headlight Washer Pump Harness

Correct washer pump extension harness.

17585 1969 RS 18.99 ea.



KRB-33



KRB-34

RS Fender Adapter Brackets

These are the correct brackets that allow fenders to accept Rally Sport hardware. These are to be used with standard fenders to provide the mounting points for the RS system.

KRB-33 1967-68 36.99 pr.
KRB-34 1969 29.99 pr.



RSX-KIT70

1970-73 Rally Sport Nose Conversion Kit

Do you have a standard Camaro but love the look of the RS? This kit gives you virtually everything you need to convert!

- Front Lower Valance (RVP-7Z)
- Header Panel (RHP-568)
- Hood Release (RHR-73RS)
- Pair of Front Split Bumpers (MCI-9230)
- Bumper Bolt Kit (BPX-359)
- Parking Lamp Housings (LPH-970)
- Bumper Braces Front (MBB-580)
- Urethane Nose (MCI-9447)
- Bumper Brackets for Urethane Nose (MBB-295)
- Grille (LEH-1064)
- Grille Surround Chrome (LK-889)
- Grille Divider Bracket (MK-55)
- Front Bumper Brackets Inner (MBB-554)
- Front Bumper Brackets Outer (MBB-556)
- Grille Divider Insert (MK-57)

RSX-KIT70 1970-73 2610.84 kit

No Volume Discount. Ships Oversize.



Shown installed on our own 70 1/2

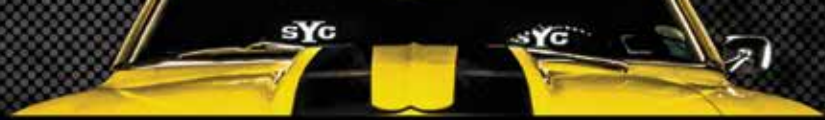

Fenders

Our reproduction fenders are manufactured to duplicate the originals in both fit and appearance. All fenders come EDP coated. Just as with original GM fenders, we recommend test fitting before painting.

No Volume Discount. All fenders ship Truck Freight to a commercial address.

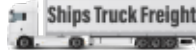

RF-67SL

RF-67SL	1967 Standard LH	259.99 ea.
RF-67SR	1967 Standard RH	259.99 ea.
RF-67RL	1967 Rally Sport LH	259.99 ea.
RF-67RR	1967 Rally Sport RH	259.99 ea.



RF-68RL

RF-68SL	1968 Standard LH	259.99 ea.
RF-68SR	1968 Standard RH	259.99 ea.
RF-68RL	1968 Rally Sport LH	259.99 ea.
RF-68RR	1968 Rally Sport RH	259.99 ea.



RF-69RL

RF-69RL	1969 AII LH	299.99 ea.
RF-69RR	1969 AII RH	299.99 ea.

All fenders include a Rally Sport bracket which can be removed for standard models.



RF-707L

RF-707L	1970-77 AII LH	239.99 ea.
RF-707R	1970-77 AII RH	239.99 ea.



RF-781L

RF-781L	1978-81 w/o Z/28 LH	229.99 ea.
RF-781R	1978-81 w/o Z/28 RH	229.99 ea.



RF-781ZL

RF-781ZL	1978-81 Z/28 LH	219.99 ea.
RF-781ZR	1978-81 Z/28 RH	219.99 ea.



RF-8290L

RF-8290L	1982-90 Z/28 LH	149.99 ea.
RF-8290R	1982-90 Z/28 RH	149.99 ea.



RF-9192L

RF-9192L	1991-92 Z/28 LH	149.99 ea.
RF-9192R	1991-92 Z/28 RH	149.99 ea.



RF-67XL



RF-69XL



RF-67XR



RF-69XR



RF-78XL

RF-78XR

Lower Fender Extensions

OE style reproduction fender extensions which fill the area between the lower valance panel and the fender.

RF-67XL	1967-68 LH	36.99 ea.
RF-67XR	1967-68 RH	36.99 ea.
RF-69XL	1969 LH	36.99 ea.
RF-69XR	1969 RH	36.99 ea.
RF-78XL	1978-81 LH w/o Spoiler Holes* ..	109.99 ea.
RF-78XR	1978-81 RH w/o Spoiler Holes* ..	109.99 ea.

*Must Drill Holes For Spoiler



RFP-69L

Fender Patches

High quality fender patches for this commonly rusted area.

RFP-678L	1967-68 LH	74.99 ea.
RFP-678R	1967-68 RH	74.99 ea.
RFP-69L	1969 LH w/ Brace	74.99 ea.
RFP-69R	1969 RH w/ Brace	74.99 ea.
RFP-781L	1970-81 LH	39.99 ea.
RFP-781R	1970-81 RH	39.99 ea.



RFB-1038R

RFB-1038G

Inner Fender Well Braces

Correct steel curved braces that attach to the rear of the inner fender well to the firewall.

RFB-1038R	1967-69 RH	24.99 ea.
RFB-1038L	1967-69 LH	24.99 ea.
RFB-1038K	1967-69 LH/RH Pair	44.98 kit
RFB-1038G	1970-73 RH	29.99 ea.
RFB-1038H	1970-73 LH	29.99 ea.



BFE-9001

Front End Fastener Kit

Over 175 pieces all individually bagged to attach all of your front end sheet metal including fenders, grille, inner fenders, hood, etc.

BFE-9001	1967-68 All	69.99 kit
BFE-9002	1969 All	69.99 kit
BFE-9003	1970-81 All	69.99 kit



RFB-656

Fender Support Bars

These OE style reproduction fender support bars extend from the side of the fenders to the top of the radiator support. Finished in your choice of black or chrome.

RFB-656	1967-69 Black	22.99 pr.
RFB-653	1967-69 Chrome	29.99 pr.
RFB-7081B	1970-81 Black	21.99 pr.
RFB-7081C	1970-81 Chrome	19.99 pr.



RIF-678L

BUY & SAVE
WITH SS396.COM PRE-BUILT KITS

Front Inner Fenders

Brand new die-stamped inner fender wells. Buy the pair and save.

RIF-678L	1967-68 LH	99.99 ea.
RIF-678R	1967-68 RH	99.99 ea.
RIF-678K	1967-68 LH/RH	209.97 kit
RIF-68RS-L	1968 RS LH	149.99 ea.
RIF-68RS-R	1968 RS RH	149.99 ea.
RIF-69FL	1969 LH	99.99 ea.
RIF-69FR	1969 RH	99.99 ea.
RIF-69FK	1969 LH/RH	219.97 kit
RIF-69RS-L	1969 RS LH	149.99 ea.
RIF-69RS-R	1969 RS RH	149.99 ea.
RIF-7077-3L	1970-77 LH 3 Hole	119.99 ea.
RIF-7077-3R	1970-77 RH 3 Hole	119.99 ea.
RIF-7077FK	1970-77 LH/RH 3 Hole	227.98 kit
RIF-78FL	1978-81 LH 2 Hole	109.99 ea.
RIF-78FR	1978-81 RH 2 Hole	109.99 ea.
RIF-78FK	1978-81 LH/RH 2 Hole	208.98 kit

Ships Oversize 2.



RRS-070R

Radiator Support

Excellent quality reproduction radiator support. Black EDP coated.

RRS-067R	1967-69 All	109.99 ea.
RRS-067R-HQ	1967-67 All High Quality	125.99 ea.
RRS-070R	1970-73 All	139.99 ea.
RRS-77	1974-77	399.99 ea.
RRS-781	1978-81	379.90 ea.
RRSB-10182032	1982-92 X Brace	35.99 pr.

No Volume Discount. Ships Oversize 2.



DRS-67H

DRS-70K

Radiator Support Bushings

Complete kit with all bushings and hardware for mounting radiator support to car.

DRS-67H	1967-81 All	27.94 kit
DRS-70K	1970-73 Side Bushings*	32.99 kit
RRS-070-SB	1970-73 Brackets	59.99 pr.

**Does not fasten to frame and does not include hardware*

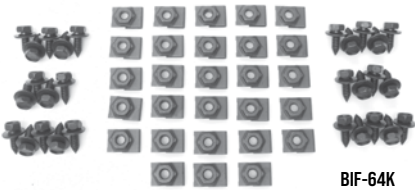

BIF-64K

Fender Inner Bolt Kit To Fender

BIF-64K All 56pc 29.99 ea.



BCW-51

Fender Cup Washers

BCW-51 All Zinc 3.99 ea.



CA109

A-Arm Dust Shields

Correct die stamped material that seals the engine compartment. Mounts to inner fender wells, complete with staples.

CA109	1967-68 Complete 5pc.....	29.99 kit
CA110	1969 Complete 5pc.....	29.99 kit
JHC-105	1967-68 A-Arms Only	16.99 pr.
JHC-106	1969 A-Arms Only	16.99 pr.
JHC-110	1970-81 A-Arms Only.....	17.99 pr.
JHC-108	1967-69 Fender/Cowl.....	9.99 ea.
JHC-107	1967-69 Frame	9.99 pr.



4022-150-82

1982-92 Upper Fender Tie Bar

4022-150-82 All..... 54.95 ea.

Ships Oversize 2.



RFL-78K

1978-81 Fender Louvers

High quality fender vent louvers for Z/28 models. Manufactured in die-cast zinc, paint to match.

RFL-78K	1978-79	299.99 pr.
RFL-7878	1978-79 Mounting Hardware	79.99 pr.
RFL-80K	1980-81	319.99 pr.
RFL-8080	1980-81 Mounting Hardware	69.99 pr.

AMK inc PRODUCTS



Detail shot of a 1968 Camaro Master Body Hardware kit.

These kits have all of the hard to find items that are not available anywhere else!

What Your Body Needs! AMK Products

Master Body Kit

Master body kits contain just about every piece of hardware to assemble the body of your Camaro. Each kit contains hardware for your battery tray, bumpers, filler panel, filler panel moldings, bumper brackets, cowl vent panel, door latches, emblems, fender braces, fenders, front tie bar, grille, grille brackets, grille moldings, headlamps, headlamp bezels, hood, hood hinges, hood latch, hood latch support, license plate, mirrors, parking lamps, tail lamps, trunk latch, trunk lid hinges, wheel opening moldings, wheelhouses, radiator support and more! This kit truly has it all!

67FB-S	1967 Standard	329.99 kit
67FB-RS	1967 Rally Sport.....	362.99 kit
68FB-S	1968 Standard	329.99 kit
68FB-RS	1968 Rally Sport	357.99 kit
69FB-S	1969 Standard	349.99 kit
69FB-RS	1969 Rally Sport	349.99 kit
70FB-S	1970-72 Standard	329.99 kit
70FB-RS	1970-72 Rally Sport.....	349.99 kit
73FB-S	1973 Standard	307.99 kit
73FB-RS	1973 Rally Sport.....	349.99 kit
74FB	1974-76 All.....	417.99 kit
77FB	1977 All.....	359.99 kit
78FB	1978 All.....	362.99 kit
79FB	1979 All.....	389.99 kit
80FB	1980-81 All.....	369.99 kit

No Volume Discount.

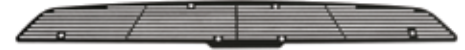

Style 1 in Black Anodized ACG-67F1B



Style 2 in Black Anodized ACG-67F2B

Cowl Hood Grilles

If you're tired of looking at the hole in the back side of your cowl hood, this 1967-69 Camaro cowl hood grille is the answer. Constructed of 16 gauge aluminum, this cowl hood grille will keep things looking neat while keeping out debris.

ACG-67F1C	1967-69 Style 1 Clear Anodized.....	51.99 ea.
ACG-67F1B	1967-69 Style 1 Black Anodized	51.99 ea.
ACG-67F1P	1967-69 Style 1 Polished.....	52.99 ea.
ACG-67F2C	1967-69 Style 2 Clear Anodized	51.99 ea.
ACG-67F2B	1967-69 Style 2 Black Anodized.....	51.99 ea.
ACG-67F2P	1967-69 Style 2 Polished	52.99 ea.



TM-30040

ProStyle Cowl Induction Trim Plates

Dress up the unsightly hole in the back of the hood with a ProStyle cowl induction trim plate from Twist Machine. Airflow is not restricted. Includes stainless steel hardware.

TM-30045	1967-69 Brushed (GM Hood)	80.99 ea.
TM-30145	1967-69 Black (GM Hood)	82.95 ea.



DSE011801

Detroit Speed Fender Brace Kit

This new DSE Camaro fender brace kit is another way to beautify your engine compartment. The fender braces are 100 percent CNC machined Clevis' from 304 stainless steel. The kit includes fabricated mounting brackets and comes with button head stainless steel mounting bolts. The fender braces triangulate the radiator core support to the fender and are fully adjustable (a benefit not available with your stock fender braces). All mounting brackets come powdercoated satin black.

DSE011801	1967-69 All	256.99 kit
DSE011802	1970-81 All.....	256.99 kit

No Volume Discount.

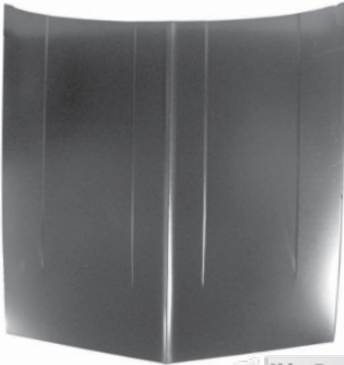
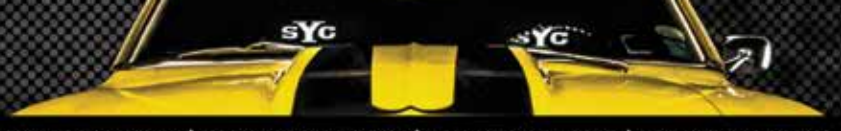

RH-69F

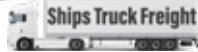

1967-69 Standard Hood

OE style reproduction standard flat hood, perfect for an original restoration.

RH-69F 1967-69 All 279.99 ea.
No Volume Discount. Ships Truck Freight.



RH-69R



1967-69 2" Cowl Induction Hood

Add some muscle to your standard Camaro or replace your original cowl induction hood with this OE style reproduction. This is a factory style steel cowl induction hood.

RH-69R 1967-69 319.99 ea.
No Volume Discount. Ships Truck Freight.



RH-69RS



1967-69 4" Cowl Hood

Let people know that your Camaro means business with this massive 4" steel cowl induction hood. This is not a cheap fiberglass hood. It can be used with your factory hinges and hood latch and is perfect for tall air cleaners or when you want that serious muscle car look.

RH-69RS 1967-69 All 379.99 ea.
No Volume Discount. Ships Truck Freight.



RH-6955

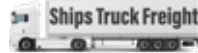

1967-69 Super Sport Hood

OE style reproduction steel Super Sport hood.

RH-6955 1967-69 SS 329.99 ea.
RH-69SSK 1968-69 SS w/ Hood Louvers 476.98 kit
No Volume Discount. Ships Truck Freight.

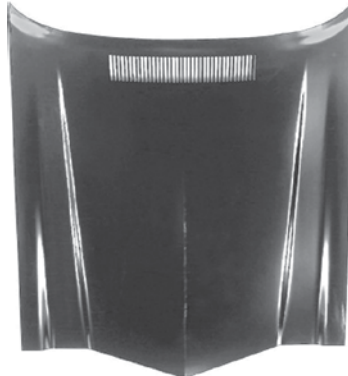

RH-70F

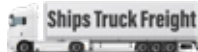

1970-81 Standard Hood

OE style reproduction standard flat hood, perfect for an original restoration.

RH-70F 1970-81 All 369.95 ea.
No Volume Discount. Ships Truck Freight.



RH-78CI

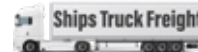

1970-81 Cowl Induction Hood

This is the hood that GM should have made from the factory! Add some muscle to your Camaro with this 2" cowl hood. This hood is perfect for street machines and will really give your ride the ultimate muscle car look!

RH-78CI 1970-81 All 399.99 ea.
No Volume Discount. Ships Truck Freight.



RH-679S

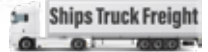

1967-69 Stinger Style Steel Hood

Give your Camaro that big block look with this steel stinger hood similar to the hood equipped on 1967 big block Corvettes and Yenko Camaros. Works with your factory hood hinges.

RH-679S 1967-69 All 629.99 ea.
RH-DANA-679 1967-69 Dana Style Fiberglass ... 899.99 ea.
No Volume Discount. Ships Truck Freight.



RH-679L88

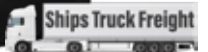

1967-69 L88 Style Steel Hood

Give your Camaro that big block look with this steel stinger hood similar to the hood equipped on 1967-69 L88 Corvettes. Works with your factory hood hinges.

RH-679L88 1967-69 All 629.99 ea.
No Volume Discount. Ships Truck Freight.



RH-82-4



1982-92 Cowl Hood

Give your Camaro that performance look with one of these cowl hoods. Available in 2" and 4" .

RH-82-2 1982-92 2" 519.99 ea.
RH-82-4 1982-92 4" 519.99 ea.
No Volume Discount. Ships Truck Freight.

Eddie Motorsports Billet Hood Hinges

This is a set of awesome Eddie Motorsports billet Camaro hood hinges complete with hardware. These hinges feature modern style struts so no springs or props are required. R=Red, B=Blue, W=White.



Steel 1967-69

MS149-50BKA	Black Anodized.....	721.99 pr.
MS149-50BK	Gloss Black.....	700.99 pr.
MS149-50CA	Clear Anodized.....	721.99 pr.
MS149-50_	Specify Color.....	690.99 pr.
MS149-50CL	Clear Coat.....	721.99 pr.

Fiberglass 1967-69

MS149-50FBA	Black Anodized.....	721.99 pr.
MS149-50FBK	Gloss Black.....	700.99 pr.
MS149-50FCA	Clear Anodized.....	721.99 pr.
MS149-50F_	Specify Color.....	690.99 pr.
MS149-50FCL	Clear Coat.....	721.99 pr.
MS149-50FFM	Machined.....	675.99 pr.
MS149-50FBMB	Matte Black.....	700.99 pr.
MS149-50FP	Polished.....	700.99 pr.

Steel 1970-81

MS149-52BKA	Black Anodized.....	800.99 pr.
MS149-52BK	Gloss Black.....	750.99 pr.
MS149-52CA	Clear Anodized.....	800.99 pr.
MS149-52_	Specify Color.....	745.99 pr.
MS149-52CL	Clear Coat.....	800.99 pr.
MS149-52M	Machined.....	721.99 pr.

Fiberglass 1970-81

MS149-52FBA	Black Anodized.....	800.99 pr.
MS149-52FBK	Gloss Black.....	750.99 pr.
MS149-52FCA	Clear Anodized.....	800.99 pr.
MS149-52F_	Specify Color.....	745.99 pr.
MS149-52FCL	Clear Coat.....	800.99 pr.
MS149-52FFM	Machined.....	721.99 pr.
MS149-52FBMB	Matte Black.....	750.99 pr.
MS149-52FP	Polished.....	750.99 pr.



Hood Hinges

Your choice of high quality, OE style reproduction hood hinges or GM licensed hinges.

GM Licensed

RHG-667L	1967-69 LH.....	124.99 ea.
RHG-667R	1967-69 RH.....	124.99 ea.
RHG-667K	1967-69 LH/RH All.....	229.98 kit
BPA-381KGM	Hinge Bolts 4pc Does 1 Hinge.....	6.99 kit

Reproduction

RHG-142L	1967-69 LH.....	49.99 ea.
RHG-142R	1967-69 RH.....	49.99 ea.
RHG-142K	1967-69 w/ Bolts.....	95.66 kit
RHG-129L	1970-81 LH.....	62.99 ea.
RHG-129R	1970-81 RH.....	62.99 ea.
RHG-129K	1970-81 w/ Bolts.....	119.06 kit
BPA-381KGM	Hinge Bolts 4pc Does 1 Hinge.....	6.99 kit

Universal Chrome Hood Pin Kits Peel N Stick

These hood pin kits are a great way to add that pro-touring/racing looks without drilling or cutting your hood. The pin mounts are either chrome plated or black aluminum with chrome pins and feature rubber coated cables. They attach with high quality double sided 3M adhesive tape.

HPK-BC	Chrome All.....	29.99 kit
HPK-BB	Black All.....	29.99 kit



Chrome Hood Hinges

OE style chrome plated hood hinges stamped from high strength steel.

RHG-955	1967-69 All.....	379.99 pr.
---------	------------------	------------



Billet Hood Hinges

Give your engine bay a custom touch with these affordable billet hood hinges! These hood hinges come complete with heavy duty struts and hardware.

RHG-BH1	1967-69 All.....	479.99 kit
RHG-BH2	1970-81 All.....	499.99 kit

No Volume Discount.



Assembled Hood Hinges

These are OE style reproduction hood hinges which will replace your originals perfectly. These hinges include a pre-installed spring which makes installation a snap.

RHG-142WSL	1967-69 LH All.....	69.99 ea.
RHG-142WSR	1967-69 RH All.....	69.99 ea.
RHG-142WSK	1967-69 Pair All.....	125.98 ea.
BPA-381KGM	Hinge Bolts 4pc Does 1 Hinge.....	6.99 kit



1982-92 Camaro Hood Lift Struts

Replace your work out struts with this pair new OE correct hood lift struts. They are a must have to keep your hood up.

RHL-8292	1982-92 All LH/RH.....	42.99 pr.
----------	------------------------	-----------



Hood Catch

Correct catch which mounts on underside of hood. Chrome or black.

RC-661	1967-81 Black.....	29.99 ea.
GCS-S9473	1967-81 Chrome.....	26.99 kit
RHR-BLTK	Hood Latch/Catch Bolt Kit 8pc.....	10.99 kit



1967-81 Billet Hood Latch Assembly

M = Machined, P = Polished, CL = Clear Coat, BKA = Gloss Black Anodized, CA = Clear Anodized, BK = Gloss Black Finish, MBA = Matte Black Finish

MS276-10_	<u>M</u>	<u>P</u>	<u>All Others</u>
	175.99 ea.	196.99 ea.	167.99 ea.



Hood Latch Support

Correct hood latch support which mounts vertically between the grille and the radiator support.

RLS-225	1967-68 All.....	19.99 ea.
RLS-220	1969 All.....	26.99 ea.
RLS-1068NA	1970-73 All.....	39.99 ea.
RLS-369	1978-81 LH.....	42.99 ea.
RLS-477	1974-81 RH.....	49.99 ea.



Hood Hinge Spring

Brand new GM hood springs.

RHS-25	1967-69 Std/Cowl Ind.....	16.99 ea.
RHS-272	1967-69 SS.....	18.99 ea.
RHS-272	1970-81 All.....	18.99 ea.



Hood Adjustment Bolts

BPQ-4011	1967-69.....	9.95 kit
BPQ-4011-70-REAR	1970-81 Rear.....	16.99 pr.
BPQ-4011-CNTR	1970-81 Rear Center.....	17.99 kit
BCB-12955	1970-81 On Hood Bumper.....	22.99 pr.

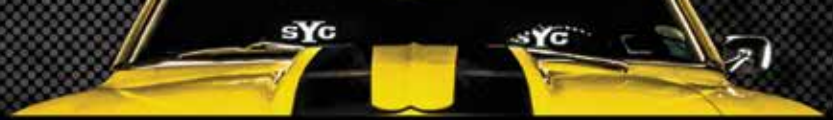

Hood Latches

OE style reproduction hood release assemblies.

RHR-434	1967 Std.....	69.99 ea.
RHR-433	1968 Std	69.99 ea.
RHR-435	1967-68 RS.....	69.99 ea.
RHR-432	1969 All	64.99 ea.
RHL-1068P	1970-73 Std.....	89.99 ea.
RHR-73RS	1970-73 RS	119.99 ea.
RHR-BLTK	Hood Latch/Catch Bolt Kit 8pc	10.99 kit

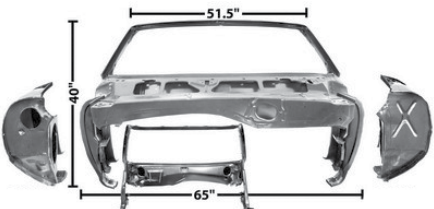

RWC-1073G

Convertible Windshield and Cowl Assembly

This is a complete replacement windshield and cowl assembly area. This massive piece is designed to replace all of this commonly rotted out area on your convertible. This assembly includes the complete cowl area with shoulders and windshield frame.

RWC-1073E	1967 Convertible	1069.99 ea.
RWC-1073F	1968 Convertible	1039.95 ea.
RWC-1073G	1969 Convertible	1039.95 ea.

Note: Will NOT fit coupe.

Ships Truck Freight to a commercial address.

No Volume Discount.



Front Lower Valance Panel

OE style reproduction steel valance panels ready to prep and paint.

RVP-567	1967-68 Standard	75.99 ea.
RVP-671	1967 Rally Sport	69.99 ea.
RVP-681	1968 Rally Sport	74.99 ea.
RVP-686	1969 All	74.99 ea.
RVP-544	1970-73 Standard	234.99 ea.
RVP-7Z	1970-73 Rally Sport	259.99 ea.

Ships Oversize. No Volume Discount.



RBF-596

1970-73 Bumper Filler Panels

Die stamped heavy gauge steel panels to replace the often corroded or missing originals. Fits standard or Rally Sport.

RBF-596	1970-73 All.....	64.99 pr.
---------	------------------	-----------



KVS-774

1970-81 Cowl Vent Screen

A high quality reproduction of the plastic screen that keeps debris out of the cowl.

KVS-774	All.....	89.99 ea.
BPX-7V	Screws	5.95 kit

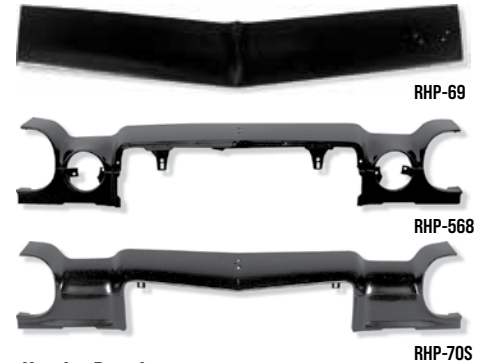

Header Panel

OE style reproduction steel panel which installs directly in front of the hood.

RHP-678	1967-68 All	59.99 ea.
RHP-69	1969 All	69.99 ea.
RHP-568	1970-73 Rally Sport	219.99 ea.
RHP-70S	1970-73 Standard	219.99 ea.

Ships Oversize. No Volume Discount.



RCP-610R



RDP-70



BPX-9V

Cowl Vent Panel

Louvered sheet metal piece which installs directly below the windshield and behind the hood.

RCP-610R	1967-69	129.99 ea.
RDP-70	1970-81	179.99 ea.
BPX-9V	1967-69 Vent Panel Screws	6.99 kit

Ships Oversize. No Volume Discount.

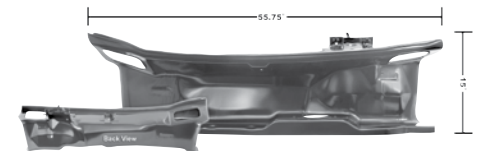

RCP-1072G

1970-73 Lower Cowl Panel Valley

This is an OE style reproduction lower cowl panel valley assembly which will replace this often rotted out area on your Camaro.

RCP-1072G	1970-73	269.99 ea.
-----------	---------------	------------

Ships Oversize 2. No Volume Discount.



Dash Top Panel RDP-439
Correct reproduction of the inner metal dash panel assembly. Extends from the windshield area to the instrument panel assembly where the dash pad mounts. Welding is required when installing this panel.

- RDP-437 1967 All 74.99 ea.
- RDP-437-A 1967 All OE style* 129.99 ea.
- RDP-438 1968 All 74.99 ea.
- RDP-438-A 1968 All OE style* 129.99 ea.
- RDP-439 1969 All 69.99 ea.
- RDP-439-A 1969 All OE style* 114.99 ea.

*Ships Oversize. No Volume Discount. *Adds additional coverage.*



Complete Dash Panel RDP-1068EA
This long awaited dash panel comes fully assembled and ready to install. This is the same piece that is currently being used on the Dynacorn complete Camaro bodies.

- RDP-1068CA 1967 w/ AC 299.99 ea.
- RDP-672C 1967 w/o AC 349.99 ea.
- RDP-1068DA 1968 All 299.99 ea.
- RDP-1068EA 1969 All 299.99 ea.

Ships Oversize. No Volume Discount.



Top Inner Cowl Panel RCP-1072B
This top of cowl assembly features a complete panel with wiper valley all in a sealed unit. A great item to repair your original rusted out piece.

- RCP-1072 1967 w/ AC Only 299.95 ea.
- RCP-1072A 1968 All 299.99 ea.
- RCP-1072B 1969 All 319.99 ea.

Ships Oversize. No Volume Discount.



Upper Inner Cowl Panel RCP-67UP-AC
The perfect replacement for this commonly rotted out area.

- RCP-67UP-AC 1967 w/ AC 219.99 ea.
- RCP-689UP 1968-69 w/o AC 219.99 ea.
- RCP-689UP-AC 1968-69 w/ AC 239.99 ea.

Ships Oversize. No Volume Discount.



Firewall Brackets RFB-1046S
OE style reproduction of the often rotted firewall brackets which provide the mounting points for the body mounts.

- RFB-67FL 1967-69 LH 84.99 ea.
- RFB-67FR 1967-69 RH 84.99 ea.
- RFB-1046S 1970-73 All 144.99 pr.
- RFB-70L 1970-81 LH 69.99 ea.
- RFB-70R 1970-81 RH 69.99 ea.



Firewalls RFW-1046D
Brand new complete firewalls.

- RFW-1046F 1967 Heater Delete 299.99 ea.
- RFW-1046Q 1967 w/ Heater 299.99 ea.
- RFW-1046D 1967 w/ Air Conditioning 299.99 ea.
- RFW-1046H 1968-69 Heater Delete 299.99 ea.
- RFW-1046G 1968-69 w/ Heater 299.99 ea.
- RFW-1046I 1968-69 w/ Air Conditioning 299.99 ea.
- RFW-689FS 1968-69 Smooth No Holes 349.99 ea.
- RFW-1046R 1970-73 w/ Heater w/brackets .. 399.99 ea.

Ships Truck Freight to a commercial address. No Volume Discount.



Custom Firewall Cover RFC-10466A
This weld on cover, covers up the holes in the firewall leaving you with a smooth, custom firewall that is great for your show car or custom Camaro.

- RFC-10466A 1968-69 299.95 ea.

Ships Oversize. No Volume Discount.



1969 Firewall to Floor Pan Braces
These steel pieces extend from the firewall down to the floor cross brace.

- RFB-1046L 1969 RH 54.99 ea.
- RFB-1046M 1969 LH 54.99 ea.



Dash Panel Face RD-67
Great piece for replacing your original rusted dash.

- RD-67 1967 w/o AC 299.99 ea.
- RD-67AC 1967 w/ AC 299.99 ea.
- RD-68 1968 w/o AC 299.99 ea.

Ships Oversize. No Volume Discount.



Door Mounting Hardware Kit IDH-181
Correct Camaro door hardware for mounting door opening mechanism, door latch, window tracks, upper glass sash, inner sash and door opening rod guide bracket. One kit required per door.

- IDH-181 1967 All 20pc 29.99 kit
- IDH-182 1968-69 All 27pc 28.99 kit
- IDH-183 1970-81 All 25pc 31.99 kit



RCP-1073L RCP-1073R RCP-7073L RCP-7073R

Lower Cowl Panel Shoulder Assembly
Our complete 1967-69 assembly will replace your rotted out factory originals. This is a complete replacement panel and features all correct cowl openings and ducting.

- RCP-1073L 1967-69 LH 89.99 ea.
- RCP-1073R 1967-69 RH 89.99 ea.
- RCP-7073L 1970-81 LH* 59.95 ea.
- RCP-7073R 1970-81 RH* 59.95 ea.
- RCS-679L 1967-69 LH Inner/Outer 79.99 ea.
- RCS-679R 1967-69 RH Inner/Outer 79.99 ea.
- RCP-679L 1967-69 LH* 56.99 ea.
- RCP-679R 1967-69 RH* 56.99 ea.
- RCP-679K 1967-69 LH/RH* Pair 113.98 kit

**Outer Skin Only*



Door Shells RSH-67FL
These full door shells feature the outer skin welded to the shell as original. These complete doors are perfect when original doors are rotted all the way through.

- RSH-67FL 1967 All LH 299.99 ea.
- RSH-67FR 1967 All RH 299.99 ea.
- RSH-68FL 1968 All LH 299.99 ea.
- RSH-68FR 1968 All RH 299.99 ea.
- RSH-1076DX 1968 LH Smooth (No Holes) ... 349.95 ea.
- RSH-1076CX 1968 RH Smooth (No Holes) ... 349.95 ea.
- RSH-69FL 1969 All LH 299.99 ea.
- RSH-69FR 1969 All RH 299.99 ea.
- RSH-1076FY 1969 LH Smooth (No Holes) ... 349.95 ea.
- RSH-1076EY 1969 RH Smooth (No Holes) ... 349.95 ea.
- RSH-74FL 1970-74 All LH 589.99 ea.
- RSH-74FR 1970-74 All RH 589.99 ea.
- RSH-75L 1975-81 All LH 699.99 ea.
- RSH-75R 1975-81 All RH 699.99 ea.

Ships Truck Freight to a commercial address.



Door Skins RDS-67FL
Die stamped steel door skins are perfect when your inner door structures are in good shape. These skins weld over your existing inner door.

- RDS-67FL 1967 All LH 119.99 ea.
- RDS-67FR 1967 All RH 119.99 ea.
- RDS-68FL 1968 All LH 119.99 ea.
- RDS-68FR 1968 All RH 119.99 ea.
- RDS-69FL 1969 All LH 119.99 ea.
- RDS-69FR 1969 All RH 119.99 ea.
- RDS-70FL 1970-81 All LH 118.99 ea.
- RDS-70FR 1970-81 All RH 118.99 ea.
- RDB-70FL 1970-81 LH Door Inner Frame Bottom* 129.99 ea.
- RDB-70FR 1970-81 RH Door Inner Frame Bottom* 129.99 ea.

**Works with outer skin to repair your factory door shell. Ships Oversize 2.*



RDF-1023C

Door Inner Frame A-Pillars

OE style reproduction inner door frame and A-pillar assembly. Parts of this area (especially the door hinge mounting locations) are commonly rotted out on Camaros. Complete replacement.

RDF-1021D	1967 LH	339.99 ea.
RDF-1021C	1967 RH	339.99 ea.
RDF-1023H	1968 LH	339.99 ea.
RDF-1023G	1968 RH	339.99 ea.
RDF-1023D	1969 LH	339.99 ea.
RDF-1023C	1969 RH	339.99 ea.

Oversize 2



REG-67FL



REG-68FXL



REG-67FRL



REG-71FR

Window Regulators

OE style reproduction window regulators complete and ready to install. Available for standard and deluxe interiors.

Door Windows

REG-67FL	1967 Standard LH	79.99 ea.
REG-67FR	1967 Standard RH	79.99 ea.
REG-67FK	1967 Standard LH/RH	143.98 kit
REG-67FXL	1967 Deluxe LH	95.99 ea.
REG-67FXR	1967 Deluxe RH	99.99 ea.
REG-68FL	1968-69 Standard LH	79.99 ea.
REG-68FR	1968-69 Standard RH	79.99 ea.
REG-68FK	1968-69 Standard LH/RH	143.98 kit
REG-68FXL	1968-69 Deluxe LH	79.99 ea.
REG-68FXR	1968-69 Deluxe RH	79.99 ea.
REG-71FL	1970-81 All LH*	99.99 ea.
REG-71FR	1970-81 All RH*	99.99 ea.
REG-71FK	1970-81 All LH/RH*	179.98 kit

Quarter Windows

REG-67FRL	1967-69 All LH	69.95 ea.
REG-67FRR	1967-69 All RH	69.95 ea.

*Will not work on 72-73 Deluxe Interior.



RPP-956

Inner Rear Quarter Patch Panels

Correct repair panel for the lower half of the inner body panel that the rear window regulator mounts to. Easily and professionally repairs the commonly rusted area at the floor and rocker panel.

RPP-957	1967-69 LH	109.99 ea.
RPP-956	1967-69 RH	109.99 ea.



RHS-9



BAV-2622



BAV-2623

Door Hinge Hardware

Correct OEM bolts and heavy spring.

BAV-2622	1967 Phillips	2.19 ea.
BAV-2622K	1967 Phillips 24pc	47.28 kit
BAV-2623	1968-81 Hex	2.19 ea.
BAV-2623K	1968-81 Hex 24pc	47.28 kit
RHS-9	1967-81 Spring	8.99 ea.



RDR-67



RDR-689K

Hinge Detent Rollers

Correct machined detent rollers for lower hinges.

RDR-67	1967 All	19.99 kit
RDR-689K	1968-69 All	26.99 pr.



BPX-1225

Door Hinge Pin Kits

Correct hinge pins and brass bushings for repairing all 4 of your door hinges.

BPX-1225	1967-69 12pc	16.99 ea.
BPX-2225	1970-81 12pc	16.99 ea.

*May require slight drilling to hinges.



RDL-70FL

Door Latch Assemblies

OE style reproduction door latch assemblies.

RDL-67FL	1967 All LH	79.99 ea.
RDL-67FR	1967 All RH	79.99 ea.
RDL-67FK	1967 All LH/RH	143.98 kit
RDL-68FL	1968 All LH	79.99 ea.
RDL-68FR	1968 All RH	79.99 ea.
RDL-68FK	1968 All LH/RH	143.98 kit
RDL-69FL	1969 All LH	79.99 ea.
RDL-69FR	1969 All RH	79.99 ea.
RDL-69FK	1969 All LH/RH	143.98 kit
RDL-70FL	1970-81 All LH	79.99 ea.
RDL-70FR	1970-81 All RH	79.99 ea.
RDL-70FK	1970-81 All LH/RH	143.98 pr.
RDL-SCREW	1967-81 All (Set of 3)*	6.95 set
RDL-828L	1982-87 LH	76.99 ea.
RDL-828R	1982-87 RH	76.99 ea.

*Note: Does one door.



RDH-529U



RDH-346LL



RDH-406UL



RDH-211LL

1967 Door Hinges

OE style reproduction replacement door hinges.

RDH-529U	1967 Upper LH & RH	59.99 ea.
RDH-346LL	1967 Lower LH	59.99 ea.
RDH-346LR	1967 Lower RH	59.99 ea.



RDH-120UL



RDH-248LL

1968 Door Hinges

OE style reproduction replacement door hinges.

RDH-120UL	1968 Upper LH	49.99 ea.
RDH-120UR	1968 Upper RH	49.99 ea.
RDH-248LL	1968 Lower LH	54.99 ea.
RDH-248LR	1968 Lower RH	54.99 ea.

1969 Door Hinges

OE style reproduction replacement door hinges.

RDH-406UL	1969 Upper LH	53.99 ea.
RDH-406UR	1969 Upper RH	53.99 ea.
RDH-211LL	1969 Lower LH	55.99 ea.
RDH-211LR	1969 Lower RH	55.99 ea.
RDH-69FX-K	1969 4pc	197.96 kit



RDH-371UR



RDH-926L

1970-81 Door Hinges

OE style reproduction replacement door hinges.

RDH-371UL	1970-81 Upper LH	59.99 ea.
RDH-371UR	1970-81 Upper RH	59.99 ea.
RDH-926L	1970-81 Lower All	49.99 ea.

Quarter Panels

If your original quarter panels are dented or rotted right through to the ground, these exact reproduction quarter panels are the perfect replacement! There is no need to spend a fortune on an NOS quarter because this reproduction features a complete door jamb area, complete trunk jamb area and full roof sail panel. These are extremely high quality pieces, so you can be sure to get the best fit possible. *No Volume Discount. All quarter panels ship Truck Freight to a commercial address.*



RFQ-67FL

- | | | |
|----------|--------------------------|------------|
| RFQ-67FL | 1967 Coupe LH..... | 289.99 ea. |
| RFQ-67FR | 1967 Coupe RH..... | 289.99 ea. |
| RFQ-67VL | 1967 Convertible LH..... | 329.99 ea. |
| RFQ-67VR | 1967 Convertible RH..... | 329.99 ea. |
| RFQ-68FL | 1968 Coupe LH..... | 289.99 ea. |
| RFQ-68FR | 1968 Coupe RH..... | 289.99 ea. |
| RFQ-68VL | 1968 Convertible LH..... | 329.99 ea. |
| RFQ-68VR | 1968 Convertible RH..... | 329.99 ea. |



RFQ-69FL

- | | | |
|----------|--------------------------|------------|
| RFQ-69FL | 1969 Coupe LH..... | 299.99 ea. |
| RFQ-69FR | 1969 Coupe RH..... | 299.99 ea. |
| RFQ-69VL | 1969 Convertible LH..... | 339.95 ea. |
| RFQ-69VR | 1969 Convertible RH..... | 339.95 ea. |



RFQ-70FL

- | | | |
|----------|---------------------|------------|
| RFQ-70FL | 1970-73 AII LH..... | 369.99 ea. |
| RFQ-70FR | 1970-73 AII RH..... | 369.99 ea. |
| RFQ-74FL | 1974 AII LH..... | 419.99 ea. |
| RFQ-74FR | 1974 AII RH..... | 419.99 ea. |



RFQ-75FL

- | | | |
|----------|---------------------|------------|
| RFQ-75FL | 1975-81 AII LH..... | 379.99 ea. |
| RFQ-75FR | 1975-81 AII RH..... | 379.99 ea. |



RQS-1067A

Quarter Panel Skins

These quarter panel repair skins offer a quick and inexpensive way to repair your original factory quarter panels without fully cutting them out. They extend from the upper belt line down. Fits all coupes and convertibles.

- | | | |
|-----------|---------------------|------------|
| RQS-1067A | 1967-68 AII LH..... | 159.99 ea. |
| RQS-1067B | 1967-68 AII RH..... | 159.99 ea. |
| RQS-1067C | 1969 AII LH..... | 159.99 ea. |
| RQS-1067D | 1969 AII RH..... | 159.99 ea. |
| RQS-F70L | 1970-73 LH..... | 109.95 ea. |
| RQS-F70R | 1970-73 RH..... | 109.95 ea. |
| RQS-F74L | 1974-81 LH..... | 109.95 ea. |
| RQS-F74R | 1974-81 RH..... | 109.95 ea. |

Side marker holes will have to be cut out for 1968 models. Ships Truck Freight to a commercial address.

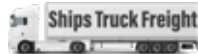

4020-603-68L

80% Quarter Panels

These 80% quarter panels are very similar to our full quarter panels but lack the full door jamb section and roof sail panel area. These panels feature turn downs for rear window felts and extend into the trunk weatherstrip area. The rear curves back inward for easy installation of tail pan.

- | | | |
|--------------|------------------|------------|
| 4020-603-67L | 1967 AII LH..... | 199.99 ea. |
| 4020-603-67R | 1967 AII RH..... | 199.99 ea. |
| 4020-603-68L | 1968 AII LH..... | 199.99 ea. |
| 4020-603-68R | 1968 AII RH..... | 199.99 ea. |
| 4020-603-69L | 1969 AII LH..... | 199.99 ea. |
| 4020-603-69R | 1969 AII RH..... | 199.99 ea. |

Ships Truck Freight to a commercial address.



RSP-976L



RSP-976R

Quarter Trunk Opening Corner Stiffener Plate

This stiffener is welded to the quarter panel on the underside of the trunk lid opening and is commonly missing from previous repairs.

- | | | |
|----------|-----------------|-----------|
| RSP-975L | 1967-68 LH..... | 29.99 ea. |
| RSP-975R | 1967-68 RH..... | 29.99 ea. |
| RSP-976L | 1969 LH..... | 21.99 ea. |
| RSP-976R | 1969 RH..... | 21.99 ea. |



RBB-67B

Rear Bumper Bolt Reinforcement

This piece welds to the inside of the quarter panel and provides support for mounting the rear bumper bolt.

- | | | |
|---------|--------------------|----------|
| RBB-67B | 1967-68 LH/RH..... | 2.95 ea. |
| RBB-69B | 1969 LH/RH..... | 2.95 ea. |



15"

29"

RQR-678L

Quarter Panel Patches

Stamped steel quarter panel patches for repairing the commonly rusted out area behind the wheel opening.

- | | | |
|----------|---------------------------|-----------|
| RQR-678L | 1967-68 LH 15H x 29L..... | 54.99 ea. |
| RQR-678R | 1967-68 RH 15H x 29L..... | 54.99 ea. |
| RQR-69L | 1969 LH 12H x 25L..... | 49.99 ea. |
| RQR-69R | 1969 RH 12H x 25L..... | 49.99 ea. |
| RQR-703L | 1970-73 LH 15H x 31L..... | 54.99 ea. |
| RQR-703R | 1970-73 RH 15H x 31L..... | 54.99 ea. |
| RQR-741L | 1974-81 LH 17H x 21L..... | 54.99 ea. |
| RQR-741R | 1974-81 RH 17H x 21L..... | 54.99 ea. |



RFP-654L

Quarter Window Rear Corner Filler

Supports the edge of the quarter panel where the window felt attaches. Often missing from previous quarter repair, this piece is essential to prevent stress cracks near the end of the drip rail.

- | | | |
|----------|-----------------|-----------|
| RFP-654L | 1967-69 LH..... | 17.99 ea. |
| RFP-654R | 1967-69 RH..... | 17.99 ea. |



RQD-1022

Quarter Panel & Door Frame Assembly

The massive piece of sheet metal includes the entire inner quarter panel and door structure as well as the windshield pillars, rocker panels and wheelhouses just as pictured. This saves you from the headache of fabricating your own pieces of metal.

- | | | |
|-----------|------------------|-------------|
| RQD-1021B | 1967 AII LH..... | 999.95 ea. |
| RQD-1021A | 1967 AII RH..... | 869.99 ea. |
| RQD-1023 | 1968 AII LH..... | 1099.99 ea. |
| RQD-1022 | 1968 AII RH..... | 969.99 ea. |
| RQD-1023B | 1969 AII LH..... | 999.99 ea. |
| RQD-1023A | 1969 AII RH..... | 999.99 ea. |

Ships Truck Freight to a commercial address. No Volume Discount.

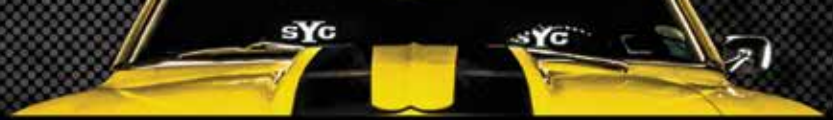

RWH-671L

Inner Wheelhouses

New inner rear section of wheelhouse which installs between the trunk area and seams to the outer wheelhouse. It is always a good idea to replace your wheelhouses when you replace your quarter panels!

RWH-671L	1967 LH	64.99 ea.
RWH-671R	1967-69 RH	64.99 ea.
RWH-681L	1968-69 LH	59.99 ea.
RWH-681K	1968-69 LH/RH	112.48 kit
RWH-701L	1970-81 LH	109.99 ea.
RWH-701R	1970-81 RH	109.99 ea.

Ships Oversize. No Volume Discount.



RWH-670TR

Outer Wheelhouses

Correct steel wheelhouses which attach to the inside of the quarter panel. It is always a good idea to replace your wheelhouses when you replace your quarter panels!

RWH-670TL	1967-68 LH	59.99 ea.
RWH-670TR	1967-68 RH	59.99 ea.
RWH-670K	1967-68 LH/RH	113.98 kit
RWH-690TL	1969 LH	49.99 ea.
RWH-690TR	1969 RH	49.99 ea.
RWH-690K	1969 LH/RH	89.98 kit
RWH-F700TL	1970-81 LH	79.99 ea.
RWH-F700TR	1970-81 RH	79.99 ea.
RWH-F700K	1970-81 LH/RH	151.98 kit

Ships Oversize. No Volume Discount.



DSE040401

DSE Deep Tubs

Detroit Speed & Engineering deep tubs are inner wheel housings designed to accommodate wider wheel and tire packages. They are engineered for a perfect fit, retain a stock appearance and are stamped from 18 gauge steel. They allow for 335mm tires and 13" wide tires. Made in USA.

DSE040401	1967-69 All	494.99 pr.
DSE040403	1970-81 All	577.99 pr.

Ships Oversize 2. No Volume Discount.



RWH-10416C



RWH-10416A

1969 Complete Wheelhouses

Complete wheelhouse assemblies which include the inners and outers already seamed together making installation much easier. Choose from 12.5" stock width or go for 15.25" width to fit larger wheels and tires.

RWH-10416B	1969 LH 12.50"	169.99 ea.
RWH-10416A	1969 RH 12.50"	169.99 ea.
RWH-10416C	1969 LH 15.25"*	179.99 ea.
RWH-1041FC	1969 RH 15.25"*	179.99 ea.

*Note: 12.50" standard size has 3-3/4" inner wheelhouse size. 15.25" wider size has 6" inner wheelhouse width *To be used in conjunction with RFP-1045AXWT or RFP-1046AGWT, RFR-1068SXWT and RFR-1068RXT. Ships Oversize 2. No Volume Discount.*



RPB-69L

1967-69 Convertible Quarter Braces

High quality reproduction convertible quarter panel braces.

RPB-678L	1967-68 LH	169.95 ea.
RPB-678R	1967-68 RH	169.99 ea.
RPB-69L	1969 LH	169.95 ea.
RPB-69R	1969 RH	169.95 ea.



RWQ-1041HA

1970-81 Wheelhouse/Quarter Assembly

Full inner quarter panel structure w/attached complete wheelhouse.

RWQ-1041JA	1970-81 LH	799.95 ea.
RWQ-1041HA	1970-81 RH	799.95 ea.
RWQ-1041JB	1970-81 LH w/o Outer Wheelhouse.	109.95 ea.
RWQ-1041HB	1970-81 RH w/o Outer Wheelhouse	109.95 ea.

Ships Truck Freight to a commercial address. No Volume Discount.



RFB-1046E

Convertible Floor Pan Brace

This one piece brace installs horizontally under the floor for added strength for convertibles.

RFB-1046E	1967-69 Convertible	89.99 ea.
-----------	---------------------	-----------

Ships Oversize



MCB-60

Convertible Floor Pan Cross Brace

OE style reproduction stamped steel transmission tunnel brace for under floor pan.

MCB-60	1967-69	84.99 ea.
MCB-BOLT	Bolt Kit 6pc	5.95 kit



RPP-959



KPS-682L

1967-69 Door Jamb Area Patches

OE style replacement for this often rotted out area in the front of the rocker.

RPP-959	1967-69 LH Outer	109.99 ea.
RPP-958	1967-69 RH Outer	109.99 ea.
KPS-682L	1967-69 LH Inner	59.99 ea.
KPS-682R	1967-69 RH Inner	59.99 ea.



RIP-1067R

Inner Rocker Panels Coupe

OE style reproduction die stamped inner rocker panels for an OE style replacement.

RIP-1067S	1967-69 Coupe LH	89.99 ea.
RIP-1067R	1967-69 Coupe RH	89.99 ea.
RIP-70L	1970-81 LH	99.99 ea.
RIP-70R	1970-81 RH	99.99 ea.
RIP-5970	1967-81 Drain Plugs	7.99 pr.

Ships Oversize



RRP-600L

Outer Rocker Panels Coupe

Correct gauge stamped steel full outer rocker panels with original mounting points.

RRP-600L	1967-69 Coupe LH	69.99 ea.
RRP-600R	1967-69 Coupe RH	69.99 ea.
RRP-700L	1970-81 All LH	109.99 ea.
RRP-700R	1970-81 All RH	94.99 ea.

Ships Oversize



RRP-9VL

Assembled Rocker Panels

Completely assembled rocker panel correctly stamped for an OE style replacement.

RRP-9VL	1967-69 Convertible LH	339.99 ea.
RRP-9VR	1967-69 Convertible RH	339.99 ea.
RRP-9CL	1967-69 Coupe LH	299.99 ea.
RRP-9CR	1967-69 Coupe RH	299.99 ea.

Ships Truck Freight to a Commercial Address. No Volume Discount.

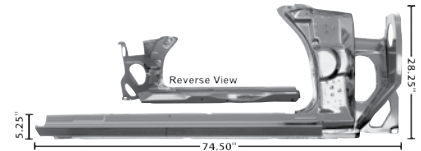

1970-73 Complete Rocker Panels

RRP-1067KA

These complete rocker panel assemblies include both inner rockers and outer rockers making installation much easier than welding together individual pieces.

RRP-1067KB	1970-73 LH	349.95 ea.
RRP-1067KA	1970-73 RH	349.95 ea.

Ships Truck Freight to a Commercial Address. No Volume Discount.

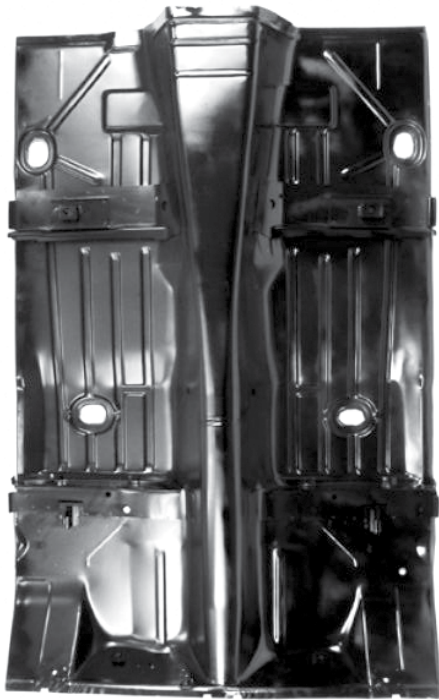

RFP-1046A

1967-69 Full Floor Pan

This full floor pan is the ultimate solution for your rotted out original floor! This piece features all correct subframe/seat mounting brackets with caged nuts and rear seat mounting brackets.

- RFP-1046A 1967-69 All389.99 ea.
- RFP-1046AXWT 1967-69 w/ 6 Inch Cutouts* 459.99 ea.

*To be used in conjunction with RFR-1068SXWT, RFR-1068RXWT, RWH-1041GC and RWH-1041FC. No Volume Discount. Ships Truck Freight to a commercial address.

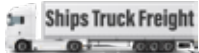

RFP-7074M

1970-81 y

This full floor pan is available either with or without the braces already installed. Using this new complete floor pan to replace your rotted out floor will save you hours of time and money.

- RFP-1046 Camaro/Firebird 70-73 Full Floor Pan Assy. (All w/o Cutout) w/o Braces, w/o Parking Brake Cable Cover. (Please Note: This Does Not Come with The Torque Box Braces.) 429.99 ea.
- RFP-1045Z Camaro/Firebird 70-74 Manual Trans Floor Assy OE Type (w/ Floor Braces, Torque Boxes & Transmission Hump) AMD 599.99 ea.
- RFP-7074A Camaro/Firebird Floor Pan Full OE 70-74 Full Floor Panel, Auto Trans, (w/ Center Braces & Rear Torque Box Braces, Also Includes Toe Board Area), 70-74 Cam/FB 899.99 ea.
- RFP-7074M Camaro/FB Floor Pan Full OE 70-74 w/ Manual Trans Full Floor Panel, Manual Trans, (w/ Center Braces & Rear Torque Box Braces, Also Includes Toe Board Area), 70-74 Cam/FB 899.99 ea.
- RFP-7581A Camaro/Firebird 75-81 Auto Trans Floor Assy -OE Type (w/ Floor Braces & Torque Boxes) 899.99 ea.
- RFP-7581M Camaro/Firebird 75-81 Manual Trans Floor Assy -OE Type (w/ Floor Braces, Torque Boxes & Transmission Hump) 899.99 ea.

No Volume Discount. Ships Truck Freight to a commercial address.

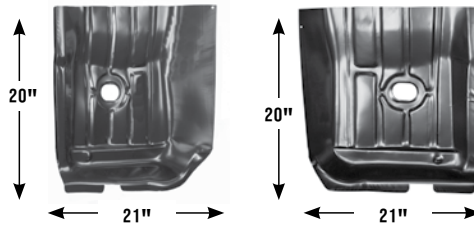

RFP-67RL

RFP-67RR

Floor Pan Patches

These patches are perfect when only small portions of your floor pan have rusted out.

Front

- RFP-67FL 1967-69 21" x 40" LH 69.99 ea.
- RFP-67FR 1967-69 20" x 39" RH 69.99 ea.
- RFP-70FL 1970-81 37" x 22" LH* 99.99 ea.
- RFP-70FR 1970-81 36" x 22" RH* 99.99 ea.

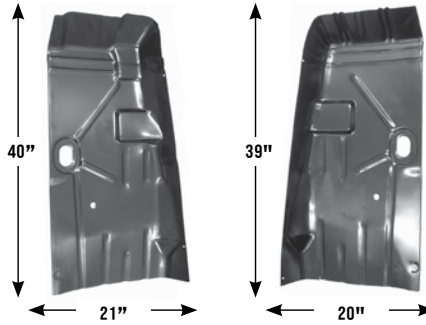

RFP-67FL

RFP-67FR

Rear

- RFP-67RL 1967-69 21" x 20" LH 59.99 ea.
- RFP-67RR 1967-69 21" x 20" RH 59.99 ea.
- RFP-70RL 1970-81 21" x 22" LH* 74.99 ea.
- RFP-70RR 1970-81 21" x 22" RH* 74.99 ea.

*Ships Oversize. *1975-81 may require modification to fit.*

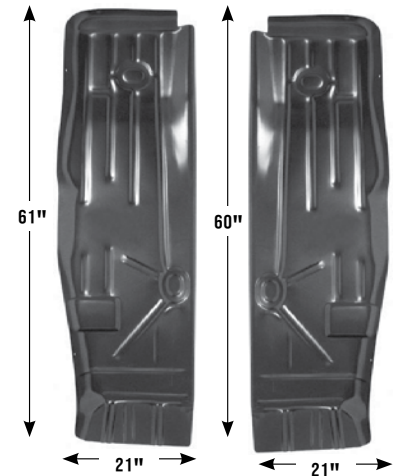

RFP-054L

RFP-054R

Half Side Floor Pans

Full half side floor pans which seam in the middle. Complete with partial toe board (Exc. 70-81).

- RFP-054L 1967-69 LH, 61" X 21" 79.99 ea.
- RFP-054R 1967-69 RH, 60" X 20" 79.99 ea.
- RFP-089L 1970-81 LH, 57" X 22"* 89.99 ea.
- RFP-089R 1970-81 RH, 57" X 22"* 89.99 ea.

*Ships Oversize 2. *1975-81 may require modification to fit.*

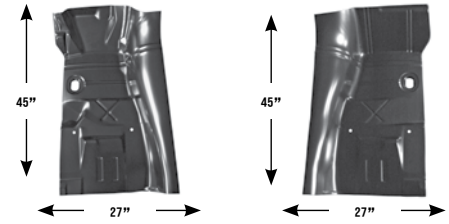

RFP-70FLT

RFP-70FRT

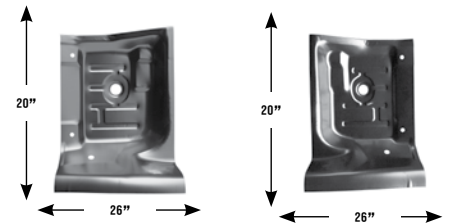

RFP-70RRT

RFP-70RLT

1970-81 Quarter Floor Pans

Quarter floor pans complete with toe board and partial transmission tunnel.

- RFP-70FLT 1970-74 27" X 45" LH Front 1/4 139.99 ea.
- RFP-70FRT 1970-74 27" X 45" RH Front 1/4 139.99 ea.
- RFP-70RLT 1970-74 26" X 20" LH Rear 1/4 72.99 ea.
- RFP-70RRT 1970-74 26" X 20" RH Rear 1/4 72.99 ea.

Ships Oversize 2.



RTB-1260EL

Toe Boards

These complete factory style extensions connect the front floor pan to the firewall.

RTB-1260EL	1967-69 LH	54.99 ea.
RTB-1260ER	1967-69 RH	54.99 ea.
RTB-F70	1970-81 Complete*	219.99 ea.
RTB-70FL	1970-81 LH	99.99 ea.
RTB-70FR	1970-81 RH	99.99 ea.

*Ships Oversize 2.

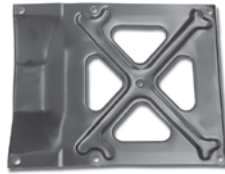

MCB-60

Convertible Floor Pan Cross Brace

OE style reproduction stamped steel transmission tunnel brace for under floor pan.

MCB-60	1967-69	84.99 ea.
MCB-BOLT	Bolt Kit 6pc	5.95 kit



RFB-1046K



RFB-1046J

Front Floor Pan Braces

Stamped steel braces for the front section of the floor pan.

RFB-1046J	1967-69 Convertible RH	54.99 ea.
RFB-1046K	1967-69 Convertible LH	54.99 ea.



RFB-1075H

1970-81 Floor Pan Braces

OE style reproduction braces for under the floor pan. Complete 3 piece kit.

RFB-1075H	1970-74 All	209.99 ea.
RFB-75K	1975-81 All	239.99 kit

Ships Oversize.



IBX-679F

Rear Seat Floor Hook

Correct hook for rear seat which mounts to the floor pan. Two required per car.

IBX-679F	Most GM Cars	9.99 ea.
----------	--------------------	----------



RSB-1051



RSB-1050

Seat Frame Supports

Correct seat frame supports which attach to the front seat floor brackets.

RSB-1051	1967-69 Coupe LH	59.99 ea.
RSB-1050	1967-69 Coupe RH	59.99 ea.
RSB-1050K	Coupe LH/RH	107.98 kit
RSB-1052B	1967-69 Convertible LH	59.95 ea.
RSB-1052A	1967-69 Convertible RH	59.95 ea.
RSB-1050VK	Convertible LH/RH	107.92 kit



RSB-1052L



RSB-1052R

Front Seat Brackets

Correct front seat mounting brackets which spot weld to the floor and also support the rear of the subframe.

RSB-1052L	1967-69 LH	44.99 ea.
RSB-1052R	1967-69 RH	44.99 ea.



RSB-1053L



RSB-1053R

Rear Seat Brackets

Correct rear seat mounting brackets which spot weld to the floor to support the bottom of the rear seat.

RSB-1053L	1967-69 LH	49.99 ea.
RSB-1053R	1967-69 RH	49.99 ea.



RMP-1001



RMP-1001A

Rear Seat Divider Panel

This is the horizontal divider panel that installs between the rear seat and trunk area and retains the rear seat.

RMP-1001	1967-69 Convertible	269.99 ea.
RMP-1001A	1970-73 All	269.99 ea.

Ships Oversize.



RSB-70FRL

Under Rear Seat Brace (Torque Box)

Welds onto the floor under the rear seat and provides the mounting point for the leaf spring perch bolt.

RSB-67FRL	1967-69 LH	69.99 ea.
RSB-67FRR	1967-69 RH	69.99 ea.
RSB-70FRL	1970-81 LH	79.99 ea.
RSB-70FRR	1970-81 RH	79.99 ea.
RSB-70FK	1970-81 LH/RH	151.98 kit

No Volume Discount.



RSB-70L

1967-81 Rear Seat Floor Pan

Correct rear under seat floor pans.

RSP-679	1967-69 Complete All LH & RH 1pc* ..	64.99 ea.
RSP-679L	1967-69 LH All	39.99 ea.
RSP-679R	1967-69 RH All	39.99 ea.
RSP-70L	1970-81 LH	99.99 ea.
RSP-70R	1970-81 RH	99.99 ea.
RFB-751L	1975-81 LH Brace	54.99 ea.
RFB-751R	1975-81 RH Brace	54.99 ea.

*Ships Oversize 2.



RFR-11L

Full Frame Rails

OE style reproduction full frame rail to replace your rotted original.

RFR-7L	1967 LH	139.99 ea.
RFR-7R	1967 RH	139.99 ea.
RFR-11L	1968-69 LH	139.99 ea.
RFR-11R	1968-69 RH	139.99 ea.
RFR-1068SXWT	1968-69 6" Wider LH*	239.99 ea.
RFR-1068RXWT	1968-69 6" Wider RH*	239.99 ea.
RFR-22L	1970-73 LH	279.99 ea.
RFR-22R	1970-73 RH	279.99 ea.

*To be used in conjunction with RFP-1046AXWT or RFP-1046AGWT, RWH-10416C and RWH-10416C. Ships Oversize 2.



RFR-43L



RFR-673

Rear Frame Rail Repair

These are replacement partial frame rails which are perfect for replacing the rear section. This section measures 45" from the rear shackle forward and includes stamped holes to mount the shackle.

RFR-47L	1967 LH	195.99 ea.
RFR-47R	1967 RH	195.99 ea.
RFR-48L	1968-69 LH	184.99 ea.
RFR-48R	1968-69 RH	184.99 ea.
RFR-43L	1970-73 LH	244.99 ea.
RFR-43R	1970-73 RH	244.99 ea.
RFR-81L	1974-81 LH	238.99 ea.
RFR-81R	1974-81 RH	238.99 ea.
RFR-673	1968-69 LH Dual Exhaust Frame Bracket	12.99 ea.

Ships Oversize 2



Installed RWS-1088

Wiring Harness Shield Kit

Correct galvanized steel shields which attach to the rocker panels in order to protect the wiring harness.

RWS-1008	1967-69 All 4pc	109.95 set
----------	-----------------------	------------

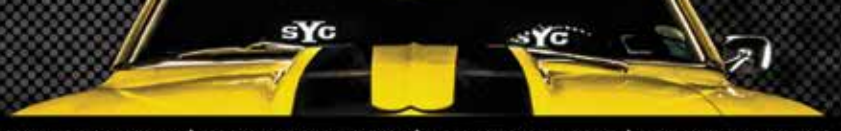

RSF-69F



RSF-69F Detail

1967-69 OEM Style Sub Frame

OEM style subframe which is an OE style replacement for your rusty, dented or bent original. There is no longer any need to waste money trying to repair your damaged original subframe. This subframe features factory style welds for an OEM appearance, extra bracing in the lower crossmember to add strength while jacking the car (but completely invisible on the outside) and holes and brackets as original. This subframe is very hard to tell from OEM due to all of these correct details.

RSF-67F	1967	1499.99 ea.
RSF-68F	1968	1499.99 ea.
RSF-69F	1969	1499.99 ea.

No Volume Discount. Ships Truck Freight to a commercial address.



RST-67F

Shifter Tunnel Repair Plate

This piece allows you to repair the often hacked up shifter tunnel area without having to replace the whole floor.

RST-67F	1967-69 All	77.99 ea.
RST-703	1970-81 All	36.99 ea.



RFR-646

Sub Frame Repair Plates

Stamped steel plates for repairing your rusted or damaged sub frame mounting points. Complete set of (6) includes radiator support.

RFR-646	1967-81*	49.99 kit
---------	----------	-----------

*Modifications will be required to fit 70-81 applications.



RQE-618L

Trunk Drop Offs

These die stamped drop offs connect the inside lower rear of the quarter panel to the outside of the trunk.

RQE-618L	1967-68 LH	36.99 ea.
RQE-618R	1967-68 RH	36.99 ea.
RQE-619L	1969 LH	32.99 ea.
RQE-619R	1969 RH	32.99 ea.
RQE-703L	1970-73 LH	49.99 ea.
RQE-703R	1970-73 RH	49.99 ea.
RQE-74L	1974-81 LH	69.99 ea.
RQE-74R	1974-81 RH	69.99 ea.

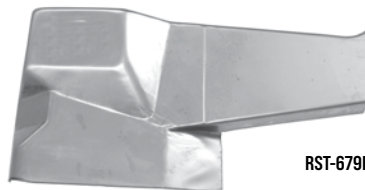

RST-679R

Rear Shock Tower Patch

New shock tower repair sections.

RST-679R	1967-69 RH	79.99 ea.
RST-67L	1967 LH	79.99 ea.
RST-679L	1968-69 LH	79.99 ea.



RDP-100

RDP-7488

Trunk/Floor Pan Drain Plug

Correct die stamped floor drain plug.

RDP-100	1967-73 All	4.99 ea.
RDP-7488	1974-88 All	13.99 ea.

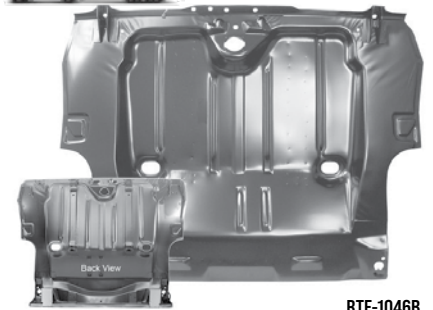

RTF-1046B

Full One Piece Trunk Floor Pans

Like our full floor pans, these trunk floors will save you hours of labor costs and ease to the installation because they include side extensions, trunk to rear body panel braces, fuel tank braces and bumper mounting brackets.

RTF-1046B	1967 w/o Staggered Shocks	339.99 ea.
RTF-1046D	1968 w/ Staggered Shocks	339.99 ea.
RTF-1046C	1969 All	339.99 ea.
RTF-1046CX	1969 w/ Mini Tubs	599.99 ea.
RTF-1048Z	1970-73 All	349.99 ea.
RTF-7481F	1974-81 All	479.99 ea.

No Volume Discount. Ships Truck Freight to a commercial address.



RTF-6782

Center Trunk Floor Pans

Correct die stamped center trunk floor pans are perfect when only the center is rusted out.

RTF-6782	1967-68 45W x 38L	99.99 ea.
RTF-692	1969 47W x 38L	99.99 ea.
RTF-703	1970-73 42W x 37L	139.99 ea.
RTF-7481	1974-81 42W x 69L	169.95 ea.

Ships Truck Freight to a commercial address.



RTF-69C

Center Trunk Floor Patch

Slightly smaller than the center pans above, these patches can be shipped via ground and do not have to ship truck freight.

RTF-678C	1967-68 44W x 35L	99.99 ea.
RTF-69C	1969 44W x 35L	99.99 ea.

Ships UPS Oversize 2

Ships Truck Freight



RTF-7481F

1974-1981 Camaro Full One Piece Trunk Floor w/ Brackets, Braces

Like our full floor pan, this Camaro full trunk floor pan is a one piece unit that will save you hours of labor costs and installation difficulty over piecing together individual components. This trunk pan features side extensions, trunk to rear body panel braces, fuel tank braces, and bumper mounting brackets.

RTF-7481F 1974-81* 479.99 ea.

*Does Not Come with Frame Rails.

No Volume Discount. Ships Truck Freight to a commercial address.



RTE-678L



RTE-69R

Trunk Floor Extensions

Die stamped panels which extend from the trunk floor to the quarter panel drop offs.

RTE-678L 1967-68 LH 99.99 ea.
 RTE-678R 1967-68 RH 99.99 ea.
 RTE-69L 1969 LH 99.99 ea.
 RTE-69R 1969 RH 99.99 ea.



RTF-1058



RTF-679



RTF-1058

Trunk Floor/Fuel Tank Braces

Correct braces which attach to the trunk floor and support the fuel tank straps.

RTF-679 1967-68 LH & RH 59.99 ea.
 RTB-69L 1969 LH 44.99 ea.
 RTB-69R 1969 RH 44.99 ea.
 RTF-1058 1970-73 4pc..... 159.99 kit
 RTF-74 1974-81 4pc..... 179.99 set

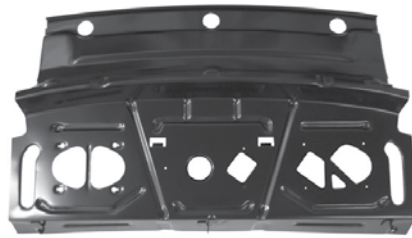

RDP-67

Package Shelf Repair Panel

This is the piece of metal which is located underneath the rear deck package shelf (speaker panel) and under the rear window to trunk panel. This piece will prevent the hassle of hand fabricating a repair panel for this common rust area.

RDP-67 1967 All 199.99 ea.
 RDP-689 1968-69 All 199.99 ea.
 RDP-703 1970-73 239.99 ea.

Ships Oversize 2. No Volume Discount.



RSE-679



RSE-703L



RSE-703R

Package Shelf Extensions

OE style reproduction package shelf extension pieces. A great fix for these commonly rotted out areas!

RSE-679 1967-69 54.99 pr.
 RSE-703L 1970-73 LH..... 59.99 ea.
 RSE-703R 1970-73 RH 59.99 ea.



RSB-1001D

Rear Seat Back Braces

OE style reproduction die stamped braces to support your rear seat.

RSB-1001D 1967-69 69.99 pr.



RCR-70F



RRE-70FL

Rear Cross Rail & Extensions

Correct rear cross rail which is located behind the rear tail light panel. Constructed out of heavy gauge steel as original and EDP coated for rust prevention.

RCR-70F 1970-73 Rear Cross Rail 89.99 ea.
 RRE-70FL 1970-73 Rear Cross Rail Ext LH 32.99 ea.
 RRE-70FR 1970-73 Rear Cross Rail Ext RH 32.99 ea.
 RFR-74F 1974-81 Rear Cross Rail 98.99 ea.

Ships Oversize.



RTL-679

Trunk Lids

OE style reproduction of the often rotted or damaged trunk lid.

RTL-679 1967-69 All w/o Spoiler Holes..... 154.99 ea.
 RTL-679SP 1967-69 All w/ Pre-Drilled Holes.. 159.99 ea.
 RTL-701 1970-81 All w/o Spoiler Holes 119.99 ea.
 RTL-70SP 1970-81 All w/ Pre-Drilled Holes .. 154.99 ea.

No Volume Discount. Ships Oversize 2.



RWP-1075

OE Style Rear Window to Trunk Panel

This is a correct OE style rear window to trunk panel featuring the inner lip area located inside the rear window above the rear seat.

RWP-1075 1967-69 Coupe 79.99 ea.

Ships Oversize.



RWP-70L

Rear Window to Trunk Panel

Reproduction stamped steel panel which fits between the rear window and the trunk lid.

RWP-679 1967-69 Coupe 54.99 ea.
 RWP-679C 1967-69 Convertible 49.99 ea.
 RWP-701 1970-73 Outer 44.99 ea.
 RWP-70L 1970-81 Inner 59.99 ea.

Ships Oversize.



RSP-975L

RSP-975R

Trunk Opening Corner Stiffener Plate

Reproduction coupe quarter panel stiffener which is commonly damaged or missing from previous repair. Welded to the quarter panel on the underside of the trunk lid opening.

RSP-975L 1967-68 Coupe LH 29.99 ea.
 RSP-975R 1967-68 Coupe RH 29.99 ea.
 RSP-976L 1969 Coupe LH 21.99 ea.
 RSP-976R 1969 Coupe RH 21.99 ea.

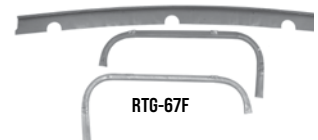

RTG-67F

Weatherstrip Gutter

New three piece trunk weatherstrip gutter which is required when replacing your quarters.

RTG-67F 1967-69 3pc 66.99 set
 RTG-70F 1970-81 2pc 79.99 pr.

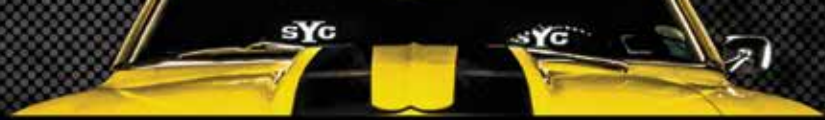

RTL-1019



RTL-7081

Trunk Lid Latch

OE style reproduction of the often damaged or missing trunk latching device.

RTL-1019	1967-69	29.95 ea.
RTL-7081	1970-81	26.99 ea.



RTC-1067ZA

Trunk Lid Catch

OE style replacement. Originally painted body color.

RTC-1067ZA	1967-69 All	18.95 ea.
TLB-716	1967-81 5pc Bolts	10.99 set

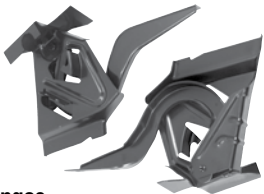

RTH-1049LA

Trunk Hinges

OE style reproduction trunk hinges to replace your damaged originals.

RTH-1049LA	1967-69 All	139.99 pr.
RTH-7081L	1970-81 LH	89.99 ea.
RTH-7081R	1970-81 RH	89.99 ea.



P-2000

Spare Tire Anchor Plates

Correct spare tire hold down and jack floor brackets.

P-2000	1967-69 Anchor Plate	11.99 ea.
--------	----------------------------	-----------



RLS-693

Trunk Lid Spring with Sleeve

Correct right side torsion rod and heavy spring used on all models with rear spoiler. Includes heavy molded rubber sleeve. Can also be used on models without rear deck lid spoiler.

RLS-693	1967-69	30.99 ea.
---------	---------------	-----------



RLS-539

1970-81 Trunk Hinge Torque Rod

Reproduction trunk hinge torque rod manufactured as original from precision bent steel. Designed to hold the trunk lid up when open.

RLS-539	1970-81 LH	29.99 ea.
RLS-538	1970-81 RH w/o Spoiler	35.99 ea.
RLS-540	1970-81 RH w/ Spoiler	25.99 ea.



RTB-1067X

Trunk Torsion Bracket

Correct trunk lid support bracket which the trunk lid bolts to. This piece welds to the body of the car. Complete with tension spring bars.

RTB-1067X	1967-69 Convertible	239.95 ea.
-----------	---------------------------	------------

Ships Oversize



MS149-05M

Eddie Motorsports Billet Trunk Hinges

M = Machined, P = Polished, CA = Clear Anodized, B = Blue, PR = Purple, R = Red, BKA = Gloss Black, MBA = Matte Black
WILL NOT WORK ON CONVERTIBLES

	M	P	Other
MS149-05_	1967-69362.99 pr...	389.99 pr....	340.99 pr.
MS149-06_	1970-81.....268.99 pr...	289.99 pr....	240.99 pr.



R-1067Z

R-1067W

RTB-1067V

Rear Inner Panel Braces

Correct center of inner panel braces which attach to the inner tail light panel for the trunk latch.

R-1067Z	1967-68 All	39.95 ea.
R-1067W	1969 All	39.95 ea.
RTB-1067V	1970-73 All	54.95 ea.
RTB-741F	1974-81 All	54.95 ea.



RTB-4

RTB-3

RTB-1



Trunk Floor Tail Panel Braces

These OE style reproduction braces extend from the rear trunk pan to the tail panel for rear bumper mounting.

RTB-3	1967-68 Large Inner	24.99 ea.
RTB-4	1969 Large Inner	37.99 pr.
RTB-1	1969 Small Corner	24.99 pr.



REP-678



REP-69



REP-703

Rear End Tail Panels

Complete rear panels which extend above and below the rear bumper and from right to left quarter panels.

REP-678	1967-68 Standard	109.99 ea.
REP-678RS	1967-68 RS w/ Pre-Cut Holes.....	159.99 ea.
REP-69	1969 All	139.99 ea.
REP-69-RS	1969 RS w/ Pre-Cut Holes.....	149.99 ea.
REP-703	1970-73 All.....	119.99 ea.

Ships Oversize 2.

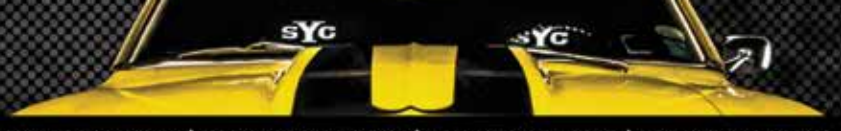

RIP-678



RIP-678RS



RIR-1067



RIP-74

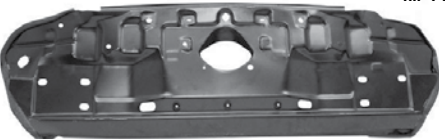

RIP-781

Rear Inner Panels

Stamped rear inner panel. 1967-69 installs behind the rear end tail panel and 1974-81 installs behind the urethane bumper cover.

RIP-678	1967-68 Standard.....	79.99 ea.
RIP-678RS	1967-68 RS w/ Pre-cut Holes....	89.99 ea.
RIR-1067	1969 All	69.99 ea.
RIP-74	1974-77 All.....	99.99 ea.
RIP-781	1978-81 All.....	99.99 ea.

Ships Oversize 2.



RTP-703



RTP-741

Lower Tail Panel Patch

Die stamped steel lower tail panel patches which are perfect when only the lower section of your tail panel is rotted.

RTP-703	1970-73 Approx 9" Tall.....	64.99 ea.
RTP-741	1974-81 Approx 5" Tall	69.99 ea.

Ships Oversize.



CT-727 Detail

RS Reverse Lens Mounting Template

Correct template which shows the tail panel hole locations for the RS backup lamp housings.

CT-724	1967-68 RS	39.99 ea.
CT-727	1969 RS	35.99 ea.



Roof Panel

Excellent reproduction roof panel skin which will replace your rotted out original exactly. 1970-73 comes with or without A-pillars installed.

RA00003	1967-69 All	289.99 ea.
RA7074	1970-74 All.....	369.99 ea.
RP-7073F	1970-73 w/ A-Pillars	1089.99 ea.
RP-1004K	1975-81	369.99 ea.
RP-1004L	1978-81 w/ T-Tops	699.99 ea.

Ships Truck Freight to a commercial address.



RBK-1A



RBK-1B

Roof Panel Braces

Complete set of roof panel reinforcement braces. A must when replacing your roof panel!

RBK-1A	1967-68 7pc.....	209.99 ea.
RBK-1B	1969 14pc.....	209.99 ea.

Ships Oversize 2



KPR-106A

Drip Rail Support

Correct metal support that runs along the edge of the roof and retains the drip rail. This support is painted body color.

KPR-107A	1967-69 LH	79.99 ea.
KPR-106A	1967-69 RH	79.99 ea.
KPR-6769K	1967-69 Complete Kit Upper/Sides 4pc	179.96 kit

Ships Oversize 2



KPR-106

Pillar Drip Rail Support

Correct metal support that runs along the edge of the A-pillar and retains the drip rail. This support is painted body color.

KPR-107	1967-69 LH	39.99 ea.
KPR-106	1967-69 RH	39.99 ea.
KRP-756	1970-81 Rear of Door	50.99 pr.



MCT-1000



RPS-1000A

Convertible Top Frame

This high quality reproduction steel convertible top frame is complete with fully reinforced hinge mechanisms. Designed for power top models.

MCT-1000	1967-69 Convertible Frame ...	1299.99 ea.
RPS-1000A	1967-69 B-Pillar Supports.....	89.95 pr.

Ships Truck Freight to a commercial address. No Volume Discount.



RRC-69

Roof Weatherstrip Channel

High luster stainless steel like original. Bolts onto the roof channel to retain the roof rail weatherstrip.

RRC-67F	1967 Coupe 6pc	239.99 kit
RRC-69	1968-69 Coupe 6pc.....	209.99 kit
RRC-70F	1970-81 All.....	209.99 kit
BRR-221	1970-81 All Screws Screws	32.99 kit
KRP-756	1970-81 B-pillar Only	50.99 pr.

This item ships Oversize. No Volume Discount.

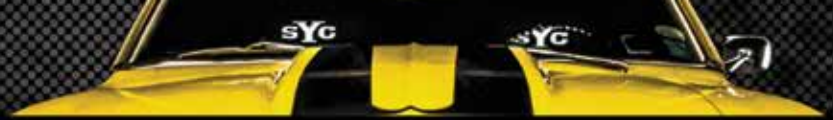

BUY & SAVE
WITH SS396.COM PRE-BUILT KITS

Complete Glass Kits

Save when you buy a complete set of replacement window glass!

GL-F67K	1967 Coupe 8pc	906.92 kit
GL-F67VK	1967 Convertible 7pc.....	730.93 kit
GL-F69K	1968-69 Coupe 6pc.....	862.94 kit
GL-F69VK	1968-69 Convertible 5pc	568.95 kit
GL-70FK	1970-74 All 4pc.....	737.96 kit
GL-75FK	1975-81 All 4pc.....	808.96 kit

No Volume Discount. Ships Truck Freight to a Commercial Address.



GL-67FF

Windshield Glass

Concourse quality tinted windshield glass for an OE style factory replacement.

GL-67FF	1967-69 Coupe	157.99 ea.
GL-67FVF	1967-69 Convrt	174.99 ea.
GL-70FF	1970-81 All.....	158.99 ea.

No Volume Discount. Ships Truck Freight.



GL-67FR

Rear Window Glass

Concourse quality tinted rear window glass for an OE style factory replacement.

GL-67FR	1967-69 Coupe	192.99 ea.
GL-70FR	1970-74 All.....	238.99 ea.
GL-75FR	1975-81 All.....	309.99 ea.

Ships Oversize 2.



GL-68FDL

Door Window Glass

Concourse quality tinted door window glass for an OE style factory replacement.

GL-67FDL	1967 LH	109.99 ea.
GL-67FDR	1967 RH	109.99 ea.
GL-68FDL	1968-69 LH.....	168.99 ea.
GL-68FDR	1968-69 RH.....	168.99 ea.
GL-70FDL	1970-81 LH.....	169.99 ea.
GL-70FDR	1970-81 RH	169.99 ea.

Ships Oversize.

Glass comes standard in green tint. Clear & Smoke Grey are available. Please contact our sales team for more information.

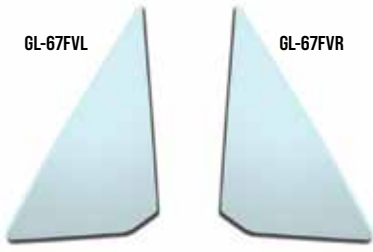

Vent Window Glass

Concourse quality tinted 1967 only vent window glass for an OE style factory replacement.

GL-67FVL	1967 LH	80.99 ea.
GL-67FVR	1967 RH	80.99 ea.

Ships Oversize.



GL-67FQL

Quarter Window Glass

Concourse quality tinted quarter window glass for an OE style factory replacement.

GL-67FQL	1967-69 Coupe LH.....	86.99 ea.
GL-67FQR	1967-69 Coupe RH	86.99 ea.
GL-67FVQL	1967-69 Convrt LH	86.99 ea.
GL-67FVQR	1967-69 Convrt RH	86.99 ea.

Ships Oversize.



GDA-689FL

1967-69 Glass Assemblies Clear

Complete glass assemblies with the glass and hardware.

GDA-689FL	1968-69 LH Front All	349.99 ea.
GDA-689FR	1968-69 RH Front All.....	349.99 ea.
GDA-67RLC	1967-69 LH Rear Coupe.....	219.99 ea.
GDA-67RRC	1967-69 RH Rear Coupe	219.99 ea.
GDA-67RLV	1967-69 LH Rear Conv.....	209.99 ea.
GDA-67RRV	1967-69 RH Rear Conv	209.99 ea.

Ships Oversize 2.



KW-648

Windshield Glass Stop

OE style reproduction windshield glass stop clip rubber coated as original. Two required.

KW-648	1967-69 All	9.99 ea.
KW-995	1970-81 All.....	12.99 ea.



RWS-075

Front Door Window Lower Stop

Plated stamped steel stop with rubber coated tip for forward front window. One required per door.

GGS-548	1967	14.99 pr.
RWS-075	1968-69.....	9.99 ea.
RWS-063	1970-81	9.99 ea.



GWR-740



GWR-744

1970-81 Door Glass Roller Washers

GWR-740	Roller Washer Pear Shape	5.99 ea.
GWR-741	Roller Washer Round	5.99 ea.
GWR-742	Roller Washer Gasket Plastic	4.99 ea.
GWR-743	Roller Washer Gasket Rubber	5.99 ea.
GWR-744	Roller Nut	5.99 ea.
GWR-745	Roller Sash Stud/Washer	6.99 ea.



6GS-059

1967-69 Door Glass Stops

OE style reproduction cast metal stops limit the travel of the RH or LH door glass. These stops fasten to the rearward door glass window track. Mounting hardware is not included.

6GS-548	1967 Front & Rear	14.99 pr.
6GS-059	1968-69 Rear	47.99 pr.

These kits do one door.



7698543

7698542

1968-69 Inner Door Panel Retainer/Window Guide

Used to support the inner door panels and includes the felt pad used to guide the window when rolling up or down.

7698543	1968-69 Front	24.99 ea.
7698542	1968-69 Rear	24.99 ea.

Note: 2 fronts and 2 rears required per car.



RWT-252

Door Window Track Upper Plate

Zinc plated stamped steel plate for mounting the rear door window track. Replaces the often bent or missing originals, and allows mounting of the rear track and proper window alignment.

RWT-252	1968-69 All LH & RH	9.99 ea.
---------	---------------------------	----------



IDH-181

Door Hardware Mounting Kits

Correct Camaro door hardware for mounting door opening mechanism, door latch, window tracks, upper glass sash, inner sash and door opening rod guide bracket. One kit required per door. Fits either LH or RH.

IDH-181	1967 All 20pc	29.99 kit
IDH-182	1968-69 All 27pc	28.99 kit
IDH-183	1970-81 All 25pc	31.99 kit



IRP-685



IRP-760

1970-81 Inner Door Panel Retainer Plate

Used to support inner door panels. Center/rear includes correct felt padding.

IRP-685	1970-78 Forward Plate	19.99 ea.
IRP-760	1970-79 Center/Rear Retainer	18.99 ea.



IVH-733

1967 Vent Window

Vent window pivot stud and handle kit includes: two reproduction vent window stud assemblies with polished stainless caps, two fiber gaskets, two rubber gaskets, two internal plastic bushing spacers, four special wave washers (2 extra). RH and LH vent window chrome die cast handles with roll pins.

IVH-733	Pivot Stud & Handle Kit	94.99 kit
IVH-67	Handles Only	54.99 pr.
IVH-741	Pivot Stud Assembly Only	24.99 kit
IVH-742	Pivot Stud Nut Chrome	8.99 ea.

Pieces also available separately.



GWP-051

Door Window Plate & Roller Set

Correct reproduction galvanized front and rear door glass mounting plates with roller assemblies. Front rubber stop included.

GWP-051	1968-69 All RH	69.99 set
GWP-052	1968-69 All LH	69.99 set



GPG-053

Window Plate Gasket Set

Correct die cut gaskets for front and rear plates of one door glass. Two sets required per car.

GPG-053	1968-69 All	9.99 pr.
---------	-------------------	----------



GMS-054

Door Glass Plate Mount Stud Assembly

Three required per glass. Two for front plate and one for rear.

GMS-054	1968-69 All	9.99 ea.
---------	-------------------	----------



GSM-055

Rear Door Glass Stop Mount & Nut

One required per door glass. Coated bumper stud with nut.

GSM-055	1968-69 All	10.99 ea.
---------	-------------------	-----------



GBA-056

Forward Door Glass Stop Bumper Assembly

Blue coated bumper stop stud with nylon bushing washer and steel nut. One required per door glass.

GBA-056	1968-69 All	10.99 ea.
---------	-------------------	-----------

6GS-703F



Window Guides & Stops

Correct set of door glass guides and stops.

6GS-703F	1970-75	54.99 kit
----------	---------------	-----------



GSM-023

1970-81 Door Glass Stop Bumpers

These stops are often so brittle that they can be removed but not re-installed. These hard plastic bumpers are required for proper door glass alignment.

GSM-023	1970-81 All	9.99 pr.
---------	-------------------	----------



GWR-258

GWR-259

Quarter Window Roller Assembly

Complete assembly to properly mount quarter glass to window regulator and track. Coupe or convertible.

GWR-258	1967-69 LH	49.99 ea.
GWR-259	1967-69 RH	49.99 ea.



GWR-060

1967-69 Quarter Window Roller Assembly

Complete window roller assembly for rear quarter window including center lower guide roller and threaded stud assembly.

GWR-060	Assembly	16.99 ea.
WR-76	Roller Only	6.99 ea.
GWR-060A	Washer Only	3.99 ea.
GWR-060B	Nylon Bushing	4.99 ea.
GWR-060C	1967-69 Rubber Washer	1.99 ea.



GSA-057

Door Glass Sash Mount Stud Assembly

Stud bolt, nylon bushing and backing washers and special steel washer nut. This is used to mount the lower glass sash channel to door glass. Two required per door glass.

GSA-057	1968-69 All	13.99 ea.
---------	-------------------	-----------



GRA-021 GWR-070

1970-81 Door Glass Roller Assembly

Front is galvanized as original with gaskets and retaining nut. Rear is plated as original with gaskets and retaining nut.

GRA-021	1970-81 Front	42.99 ea.
GWR-070	1970-81 Rear	23.99 ea.



WR-76 WR-78

WR-342 WR-907

Window Rollers

Correct replacement window rollers.

WR-76	1967-69 Lower Rear 1/4	6.99 ea.
WR-78	1967-69 Door	13.99 ea.
WR-342	1970-72 Door	9.95 ea.
WR-907	1967-68 1/4 Stud/Spring	14.99 ea.



GWN-185

1967-69 Quarter Window Track Stud

The correct hardware to mount the quarter tracks to the body.

GWN-251	Studs 3pc	21.99 set
GWN-185	Nuts 3pc	9.99 set

Does one window.



GTS-177

Quarter Window Roller Tension Spring

GTS-177	1967-69 All	5.95 ea.
---------	-------------------	----------



RSC-072

1967-69 Glass Inner Sash Channel

Zinc plated inner door sash channel featuring integral blind nuts to replace the commonly damaged or missing original exactly.

RSC-748D	1967 All LH & RH	23.99 ea.
RSC-072	1968-69 All LH & RH	19.99 ea.



RSC-603

Front Door Window Upper Sash Channel

OE style reproduction of this commonly missing piece which the window regulator rollers ride in to raise and lower the door window.

RSC-748C	1967 All LH & RH	24.99 ea.
RSC-603	1968-69* All LH & RH	21.99 ea.

Use GSA-057 to mount to door glass.

IFW-2



Door Panel Washers

Foam washers used under the door panels to seal door handles and window cranks.

IFW-2	1967-81 All	6.99 pr.
-------	-------------------	----------



IPX-67GMKIT-BLK

1967-72 Factory Correct Window Cranks

Quality die cast. Correct spline depth and clip engagement. Shorter and with a flatter curvature than later years, with correct thin knob. All 1968 and 1969 front features cast number 9715291. 1969 rear and all 1970-72 features cast number 9717838. Clips are included.

IPX-67GMKIT-BLK	1967 Black Knob 4pc	61.12 ea.
IPX-67GMKIT-CLR	1967 Clear Knob 4pc	64.52 ea.
IPX-68GMKIT-BLK	1968 Black Knob 4pc	71.32 ea.
IPX-68GMKIT-CLR	1968 Clear Knob 4pc	71.32 ea.
IPX-69GMKIT-BLK	1969 Black Knob 4pc	67.92 ea.
IPX-69GMKIT-CLR	1969 Clear Knob 4pc	71.32 ea.
IPQ-67GMB	1967 Black Knob	15.99 ea.
IPQ-67GMC	1967 Clear Knob	16.99 ea.
IPQ-68GMB	1968-69 Front, 68 Rear Black Knob	18.99 ea.
IPQ-68GMC	1968-69 Front, 68 Rear Clear Knob	18.99 ea.
IPQ-69GMB	1970-72 Front, 69 Rear Black Knob	16.99 ea.
IPQ-69GMC	1970-72 Front, 69 Rear Clear Knob	16.99 ea.



IPX-4078B



IPX-4078C

Window Cranks & Hardware

OE style reproduction window cranks in kits or individually! Include 4 cranks, 4 clips and 4 gaskets.

IPX-4078C	1967-81 Clear Knob	37.32 kit
IPX-4078B	1967-81 Black Knob	37.32 kit
IPQ-4080C	1967-81 Clear Knob	8.99 ea.
IPQ-4080B	1967-81 Black Knob	8.99 ea.
IPQ-82F	1982-92 All Black	5.99 ea.
IPX-3850	All Gasket	1.99 ea.
IPX-39	All Spring	2.19 ea.
IPX-38	All Clip	0.75 ea.

No Volume Discount. on kits.

REG-67FL



REG-68FXL

REG-71FL

REG-67FRL

Window Regulators

OE style reproduction window regulators complete and ready to install. Available for standard and deluxe interiors.

Door Windows

REG-67FL	1967 Standard LH	79.99 ea.
REG-67FR	1967 Standard RH	79.99 ea.
REG-67FXL	1967 Deluxe LH	95.99 ea.
REG-67FXR	1967 Deluxe RH	99.99 ea.
REG-68FL	1968-69 Standard LH	79.99 ea.
REG-68FR	1968-69 Standard RH	79.99 ea.
REG-68FXL	1968-69 Deluxe LH	79.99 ea.
REG-68FXR	1968-69 Deluxe RH	79.99 ea.
REG-71FL	1970-81 All LH	99.99 ea.
REG-71FR	1970-81 All RH	99.99 ea.

Quarter Windows

REG-67FRL	1967-69 All LH*	69.95 ea.
REG-67FRR	1967-69 All RH*	69.95 ea.

**Must Use 1967 Window Cranks.*



RWT-67RL

RWT-67RR

RWT-68LR

RWT-68RF

RWT-679L

RWT-679R

Window Tracks

Finally available! Constructed of heavy gauge stamped steel window track with correct plating.

RWT-67FL	1967 LH Door Front All	124.99 ea.
RWT-67FR	1967 RH Door Front All	124.99 ea.
RWT-67RL	1967 LH Door Rear All	69.99 ea.
RWT-67RR	1967 RH Door Rear All	69.99 ea.
RWT-68LF	1968-69 LH Door Front All	74.99 ea.
RWT-68RF	1968-69 RH Door Front All	74.99 ea.
RWT-68LR	1968-69 LH Door Rear All	69.99 ea.
RWT-68RR	1968-69 RH Door Rear All	64.99 ea.
RWT-679L	1967-69 LH Rear 1/4 Window All ...	62.99 ea.
RWT-679R	1967-69 RH Rear 1/4 Window All ...	62.99 ea.
RWT-679K	1967-69 Rear 1/4 Window All	109.99 kit

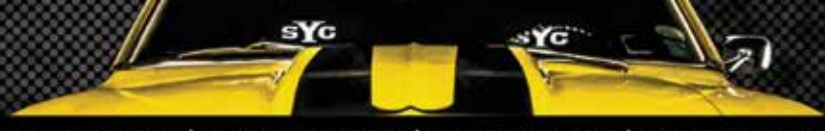

Window Rear Guides

GWG-703FR

Correct 2 pc. guides for rear of door windows.

GWG-703FL	1970-73 LH.....	79.99 pr.
GWG-703FR	1970-73 RH.....	79.99 pr.



4432791



GWS-712

Power Window Switch

Correct OEM style power window switch.

4432790	1967-70 1 Window.....	57.99 ea.
4432791	1967-70 4 Window.....	79.99 ea.
GWS-711	1971-81 1 Window.....	34.99 ea.
GWS-712	1971-81 2 Window.....	59.99 ea.



GHB-68A



GHB-6481

Power Window Grommets

This is the correct grommet that runs from the A-pillar to the door on cars with power windows and/or locks.

GHB-68A	1967-69 Grommet.....	49.99 pr.
GHB-6481	1970-81 Boot Only.....	9.99 ea.



TRIM-01



TRIM-02



TRIM-WR



TRIM-KIT-DLX



TRIM-MAG

Tools

TRIM-01	Door Panel Removal Tool.....	9.97 ea.
TRIM-02	Window Crank/Door Handle Removal..	7.99 ea.
TRIM-WR	Window Roller Removal Tool.....	18.99 ea.
TRIM-MAG	Mirror & Magnet Kit 2pc.....	14.95 set
TRIM-KIT-DLX	Trim Removal Tools 3pc.....	29.99 ea.
TRIM-CVY1	Clip And Moulding Removal Tool.....	14.99 ea.
TOOL-SWPULL	Steering Wheel Puller 11pc.....	18.99 ea.
TOOL-CIRCUIT	Circuit Tester 6-12 Volt.....	6.99 ea.



PWK-67CAM-CRANK



PWK-67CAM-2-BLACK



PWK-68CAM



Power Window Retrofit Kits

Ground Up Motors exclusive power window kits are the best available on the market today! They bolt into the original mounting holes making for a hassle free installation. Using 1018 cold-roll steel, bronze oilite thrust bearings at all the pivot points and heat treated metal for all gears results in a quality smooth operating regulator that will last for many years. The motors are all brand new and have been thoroughly tested for quality and feature a strong dependable motor. Kits include: new regulators, new ACI window motors, a new completed wiring harness, your choice of switches and the conduit from the a-pillar to the door. Our kits feature detailed instructions with helpful diagrams and photos. (F/R = Front and Rear Kit)

PWK-67CAM	1967 All F/R, Chrome Switches.....	1051.99 kit
PWK-67CAM-NOST	1967 All F/R, Nostalgic Switches.....	1182.99 kit
PWK-67CAM-CRANK	1967 All F/R, Crank Switches.....	1418.99 kit
PWK-67CAM-2-CHROME	1967 All Front Only, Chrome Switches.....	545.99 kit
PWK-67CAM-2-BLACK	1967 All Front Only, Black Switches.....	547.99 kit
PWK-67CAM-2-NOST	1967 All Front Only, Nostalgic Switches.....	624.99 kit
PWK-67CAM-2-CRANK	1967 All Front Only, Crank Switches.....	718.99 kit
PWK-68CAM	1968-69 All F/R, Chrome Switches.....	1051.99 kit
PWK-68CAM-NOST	1968-69 All F/R, Nostalgic Switches.....	1182.99 kit
PWK-68CAM-CRANK	1968-69 All F/R, Crank Switches.....	1418.99 kit
PWK-68CAM-2-CHROME	1968-69 All Front Only, Chrome Switches.....	545.99 kit
PWK-68CAM-2-BLACK	1968-69 All Front Only, Black Switches.....	547.99 kit
PWK-68CAM-2-NOST	1968-69 All Front Only, Nostalgic Switches.....	624.99 kit
PWK-68CAM-2-CRANK	1968-69 All Front Only, Crank Switches.....	718.99 kit

Door Mounted Switches

PWK-70CAM-CHROME	1970-81 All Front, Chrome Switches.....	545.99 kit
PWK-70CAM-BLACK	1970-81 All Front, Black Switches.....	547.99 kit
PWK-70CAM-NOST	1970-81 All Front, Nostalgic Switches.....	624.99 kit
PWK-70CAM-CRANK	1970-81 All Front, Crank Switches.....	718.99 kit

Console Mounted Switches

PWK-73CAMC-CHROME	1973-81 All Front, Chrome Switches.....	538.99 kit
PWK-73CAMC-BLACK	1973-81 All Front, Black Switches.....	540.99 kit
PWK-73CAMC-NOST	1973-81 All Front, Nostalgic Switches.....	615.99 kit

No Volume Discount. Not eligible for free shipping.

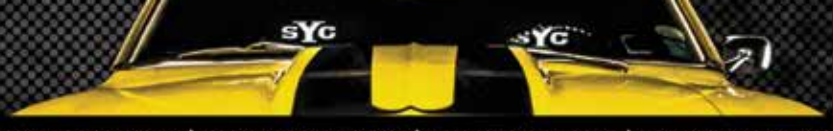

JR-67F

Junior Weatherstrip Kits

Our most popular weatherstrip kit includes all of the basic soft trim components that commonly crack and wear out on your Camaro. Included are (2) door opening weatherstrips, (2) roof rail weatherstrips (coupe only) and (1) trunk weatherstrip.

JR-67F	1967 Coupe.....	124.17 kit
JR-67FV	1967 Convertible	70.18 kit
JR-68F	1968-69 Coupe	124.17 kit
JR-68FV	1968-69 Convertible.....	70.18 kit
JR-70F	1970-81 All.....	141.24 kit
JR-70FT	1978-81 w/ Fisher T-Tops.....	273.77 kit



BUY & SAVE
WITH SS396.COM PRE-BUILT KITS

1967-69 Deluxe Weatherstrip Kits

This NEW and IMPROVED kit now includes OEM factory style window felts. This kit is great when you want to replace all of the major weatherstripping on your car. Included are (2) door weatherstrips, (2) roof rail weatherstrips (coupe only), (1) trunk weatherstrip, (1) OEM style windowfelt set, (2) door "U" rubbers and (2) quarter glass seals.

JDX-67FK8	1967 Coupe 8pc Felts.....	322.14 kit
JDX-67FKV8	1967 Convertible 8pc Felts	254.65 kit
JDX-68FK4	1968-69 Coupe Std Interior 4pc Felts	268.14 kit
JDX-68FK8	1968-69 Coupe Std Interior 8pc Felts	349.14 kit
JDX-68FK8D	1968-69 Coupe Dlx Interior 8pc Felts.....	313.14 kit
JDX-68FKV4	1968-69 Convrt Std Interior 4pc Felts.....	214.15 kit
JDX-68FKV8	1968-69 Convrt Std Interior 8pc Felts.....	254.65 kit
JDX-68FKV8D	1968-69 Convrt Dlx Interior 8pc Felts	254.65 kit
JDX-68FK8S	1968 Coupe Std Int w/ Door Ledge Mld 8pc Felts	313.14 kit
JDX-68FKV8S	1968 Convrt Std Int w/ Door Ledge Mld 8pc Felts.....	254.65 kit
JDX-68FK8DS	1968 Coupe Dlx Int w/ Door Ledge Mld 8pc Felts	286.14 kit
JDX-68FKV8DS	1968 Convrt Dlx Int w/ Door Ledge Mld 8pc Felts.....	241.15 kit

1970-81 Deluxe Weatherstrip Kits

Complete weatherstrip kit including (2) door weatherstrips, (2) roof rail weatherstrips, (1) trunk weatherstrip and original style window felts.

JDX-81	1970-81 2pc Felts w/ Chrome Bead*	215.03 kit
JDX-814	1970-81 4pc Felts w/ Chrome Bead*	255.53 kit
JDX-81C	1970-81 2pc Felts w/o Chrome Bead	215.03 kit
JDX-81C4	1970-81 4pc Felts w/o Chrome Bead	249.23 kit

*Not for use with special chrome exterior door molding. Ships Oversize.

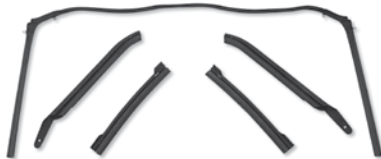

Convertible Top Weatherstrip Kits JSS-3043

New state of the art Metro convertible top weatherstrip kit featuring steel frames with molded rubber, correct seams and extension flaps. Header seal has correct pins and molded corners. Made in USA.

JSS-3043	1967 Convertible.....	229.99 kit
JSS-3043-OE	1968-69 Convertible	349.99 set
JSS-RR1510	1987-92 Sides Only 4pc.....	339.99 kit
JSS-RR1515	1987-92 Side, Header, Bow 6pc ...	619.99 kit
JSS-HD1520	1987-92 Tonneau Panel Seal.....	74.99 ea.



RRC-69

Roof Weatherstrip Channel

High luster stainless steel like original. Bolts onto the roof channel to retain the roof rail weatherstrip.

RRC-67F	1967 Coupe 6pc	239.99 kit
RRC-69	1968-69 Coupe 6pc.....	209.99 kit
RRC-70F	1970-81 Coupe	209.99 kit
RRC-7881T	1978-81 T-Tops A-Pillar.....	115.99 pr.
BRR-221	1970-81 All Screws Screws	32.99 kit
KRP-756	1970-81 B-Pillar Only	50.99 pr.

This item ships Oversize. No Volume Discount.



JSS-203

Trunk Weatherstrip

Correct molded trunk weatherstrip.

JSS-203	1967-69 All	17.99 ea.
JSS-209	1970-81 All	16.99 ea.
JSS-46F	1982-92 Coupe	59.99 pr.
JSS-46FC	1982-92 Convertible.....	69.99 pr.



Roof Rail Weatherstrip JSS-3002

Correct extruded rubber that seals the roof line of the car in from the elements.

JSS-3002	1967 All Premium Quality.....	69.99 pr.
JSS-3002GUP	1967 All	59.99 pr.
JSS-3013	1968-69 Coupe	69.99 pr.
JSS-3100	1970-81 Coupe	79.99 pr.
MM-RR7002	1978-81 T-Tops.....	114.99 pr.
JSS-RR7003	1982-92 Coupe	69.99 pr.
BRR-220	1967-69 Screws 24pc.....	21.99 kit
BRR-221	1970-81 Screws 36pc.....	32.99 kit



JSS-3000

Door Opening Weatherstrip

This brand new state of the art door weatherstrip features correct extruded rubber with correct molded ends and push-in clips just like original.

JSS-3000	1967 1967 All Premium Quality... 69.99 pr.
JSS-3000GUP	1967 All
JSS-3010	1968-69 All
JSS-3015	1970-81 All
JSS-22-C	1982-92 All



JSS-302U

Door Jamb U Rubbers

Correct steel core rubber.

JSS-302U	1967-69 All	19.99 pr.
----------	-------------------	-----------



Vent Window Seals

Correct vent window weatherstrip.

JSS-3125 1967 All 79.99 pr.



Vent Channel Run

Correct rubber flocked weatherstrip that runs vertically in the vent frame.

JSS-7011 1967 All 28.99 pr.



Convertible Header Seal

This seal features correct molded ends.

JSS-3044 1967 Convertible 92.99 ea.
 MM-RR1501 1968-69 Convertible 384.99 ea.
 JSS-HD1510 1987-92 199.99 ea.

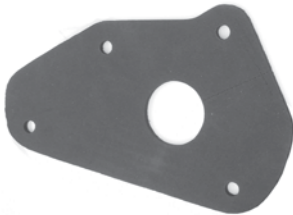

Steering Column Seal

Correct neoprene seal for firewall.

JSS-79 1967-68 All 5.99 ea.
 JSS-69 1969 All 6.99 ea.
 JSS-89 1970-81 All 8.99 ea.



Steering Column Boot

Correct rubber boot that mounts between the steering column and firewall.

JCB-3 1967-69 All 17.99 ea.



CA109

A-Arm Dust Shields

Correct die stamped material that seals the engine compartment. Mounts to inner fender wells, complete with staples.

CA109 1967-68 Complete 5pc 29.99 kit
 CA110 1969 Complete 5pc 29.99 kit
 JHC-105 1967-68 A-Arms Only 16.99 pr.
 JHC-106 1969 A-Arms Only 16.99 pr.
 JHC-110 1970-81 A-Arms Only 17.99 pr.
 JHC-108 1967-69 Fender/Cowl 9.99 ea.
 JHC-107 1967-69 Frame 9.99 pr.



JBH-69

Cowl-Firewall Seal Kit

Correct die-stamped gasket kit containing steering column seal, hood to cowl seal, cowl vent side seals and wiper motor seal. 5 pieces.

JBH-67 1967 All 26.99 kit
 JBH-68 1968 All 39.99 kit
 JBH-69 1969 All 25.99 kit



JSS-3023

Hood to Cowl Seal

Correct rubber seal that mounts to the top edge of the cowl to seal the engine compartment. Each seal is cut to the correct length and is ready to install.

JSS-3023 1967-69 All 14.99 ea.
 JSS-231 1970-81 All 26.99 ea.
 JCS-686 1970-81 Clips 18pc 21.99 kit
 JSS-CS15A 1982-92 All 29.99 ea.



DSB-83

Steering Shaft Boot & Retainer

Correct boot and seal.

DSB-83 1967-69 Boot 34.99 ea.
 DBR-647 1967-79 Retainer 9.99 ea.



JSS-3022

Quarter Glass Seals

Correct rubber seal which attaches to the quarter window and seals the front and rear windows.

JSS-3022 1967-69 OE style w/ Steel Core... 19.99 pr.



Pillar Post Weatherstrip

JSS-67

Correct heavy duty molded rubber that runs vertically on the pillar posts.

JSS-67 1967 Convertible 49.99 pr.
 JSS-68P 1968-69 Convertible 59.99 pr.
 JSS-F 1967-69 Fasteners 2.49 kit



JSS-3388

T-Top Weatherstrip

High quality weatherstrips which will eliminate the rattles and leaks from your factory T-Tops.

JSS-78FS 1978-81 Side Rail Seals Fisher 89.99 pr.
 JSS-3388 1978-81 Main Body Seals Fisher . 229.99 pr.
 MM-RR7002 1978-81 Main Body Seals Fisher .. 114.99 pr.
 JSS-ELP7003 1987-92 Side Rail Seals 89.99 pr.
 JSS-7003 1987-92 Main Body Seals 249.99 pr.
 JSS-ALP11C 1987-92 Door Window Seal 54.99 pr.



LTG-290GM-K

LTG-292GM-K



LTG-291GM-K

LTG-293GM-K



LTG-294GM-K

Lens Gasket Set Molded OEM Style

Superior quality, original style, correct color thick molded rubber.

LTG-290GM-K 1967 Standard 32.99 set
 LTG-291GM-K 1968 Standard 32.99 set
 LTG-292GM-K 1969 Standard 32.99 set
 LTG-293GM-K 1967-68 Rally Sport 44.99 set
 LTG-294GM-K 1969 Rally Sport 36.99 set

No volume discount.



JSS-3M

Weatherstrip Glue

5 ounce tube of 3M weatherstrip glue.

JSS-3M All Yellow 15.99 ea.
 JSS-3M-BLK All Black 19.99 ea.

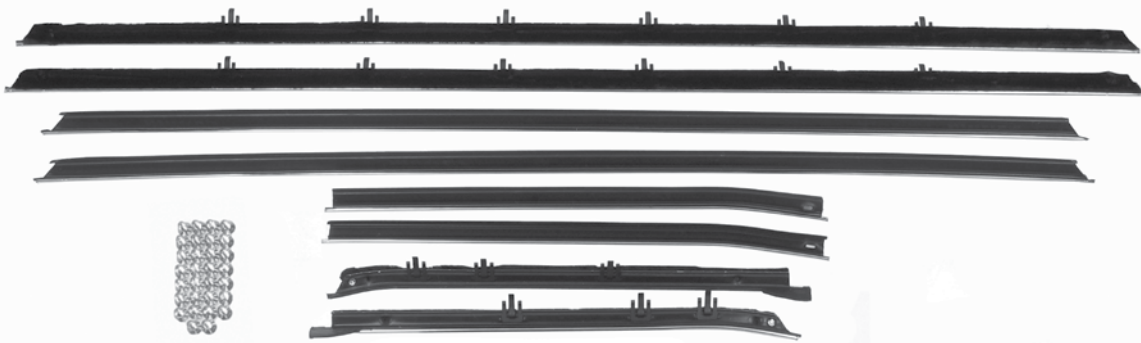
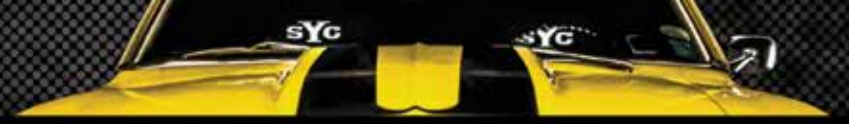

CA166A

Complete Window Felt Kits

These OE style reproduction window felts feature correct stainless round beads with flocked rubber sealing strips. All include the correct anti-rattle bumpers attached.

1967-69 8 Piece Inner & Outer Original Style Kits

CA168A	1967 Coupe	179.99 kit
CA169A	1967 Convertible	164.99 kit
CA146A	1968 Coupe Std w/ Special Molding*	169.99 kit
CA147A	1968 Convertible Std w/ Special Molding*	164.99 kit
CA160	1968 Coupe Dlx w/ Special Molding	139.99 kit
CA161FSM	1968 Convt Dlx w/ Special Molding	149.99 kit
CA166A	1968-69 Coupe Standard	188.99 kit
CA173A	1968-69 Convertible Standard	164.99 kit
CA172A	1968-69 Coupe Deluxe	169.99 kit
CA162A	1968-69 Convertible Deluxe	164.99 kit

*For use with special chrome exterior door ledge moldings.

1967-69 Replacement Style Window Felts Kits

CA142R	1967 Coupe	105.99 kit
CA143R	1967 Convertible	105.99 kit
CA144R	1968-69 Coupe	105.99 kit
CA145R	1968-69 Convertible	105.99 kit

1970-81 4 Piece Inner & Outer Original Style Kits

CA164A	1970-81 w/ Chrome Bead*	126.99 kit
CA165A	1970-81 w/o Chrome Bead	119.99 kit

*Not for use with special exterior chrome door molding.



Top: 1970-81 with Chrome Bead
Bottom: 1970-81 without Chrome Bead

Outer Window Felt Kits

These OE style reproduction window felts feature correct stainless round beads with flocked rubber sealing strips. All include the correct anti-rattle bumpers attached.

1967-69 4 Piece Outer Original Style Kits

CA154A	1967 Coupe	164.99 kit
CA155A	1967 Convertible	119.99 kit
CA156A	1968-69 Coupe	119.99 kit
CA157A	1968-69 Convertible	119.99 kit
CA158A	1968 Coupe w/ Door Ledge Molding	119.99 kit
CA159A	1968 Convt w/ Door Ledge Molding	119.99 kit

1970-81 2 Piece Outer Original Style Kits

CA170A	1970-81 w/ Chrome Bead*	81.99 kit
CA171A	1970-81 w/o Chrome Bead	81.99 kit

*Not for use with special exterior chrome door molding.

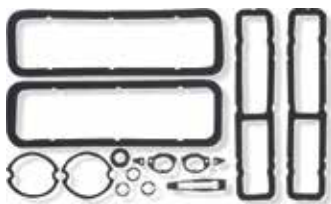

JHC-1127

Paint Seal Kit

This kit is a must for all of those partial or full restorations!

JHC-1127	1967 Standard	18.99 kit
JHC-128	1968 Standard	21.99 kit
JHC-1131	1969 All	22.99 kit
JHC-12RS	1967-68 RS Supplement	9.99 kit



JSS-089

Convertible Rear Frame to Body Seals

Seals prevent water drainage into rear of body and trunk area. Molded rubber with stamped steel spine as original.

JSS-089	1967-69	49.99 pr.
---------	---------	-----------

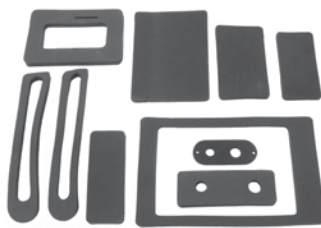

JHC-3064

Heater Box Seal Kit

Correct die stamped neoprene seals for installing your heater core and cover. A must!

JHC-3064	1967-81 All V8 w/o AC	27.99 kit
----------	-----------------------	-----------



JSK-79A

Rubber Stopper Kits

Complete set of rubber stoppers including doors, hood, console, glove box and trunk lid.

JSK-79A	1967-69 All	17.99 kit
JSK-67DR	1967-69 Door Bumper Only	11.99 pr.
JSK-81K	1970-81 All	17.99 kit



MG-35

1970-73 Rear Bumper Gaskets

Molded rubber bumper end fillers.

MG-35	1970-73	29.99 pr.
-------	---------	-----------



MBB-555

1970-73 Bumper Bracket Cushions

MBB-555	1970-72 All, 1973 RS	14.99 pr.
---------	----------------------	-----------



39386

Wiring Harnesses

When you are looking to restore your electrical system, look no further than Ground Up Motors! All of our harnesses are hand assembled in the USA and are guaranteed exactly as original. Our harnesses always match the factory color code and gauge sizes using correct connectors, terminals and non-adhesive cloth tape. Our restoration harnesses are simply the best in the industry.

A/T = Automatic Transmission M/T = Manual Transmission
AC = Air Conditioning Ctr Fuel = Center Fuel Gauge

AC Harness

10750	1967 w/o Low Blower.....	159.99 ea.
29925	1967 w/o Low Blower Early.....	174.99 ea.
12095	1968 Includes Heater Wire.....	159.99 ea.
13015	1969 Includes Heater Wire.....	159.99 ea.
15200	1970 Includes Heater Wire.....	179.99 ea.
15435	1971 Includes Heater Wire.....	194.99 ea.
16395	1972 Includes Heater Wire.....	194.99 ea.
37799	1973 w/ 4 Contact.....	194.99 ea.
37801	1973 w/ 5 Contact.....	184.99 ea.
00990	1973 Extension.....	59.99 ea.
37800	1974 Compressor to AC.....	209.99 ea.
00990	1974 Extension.....	59.99 ea.
16610	1975 w/ Ambient Sensor.....	199.99 ea.
17140	1975 w/ Pressure Cutoff.....	199.99 ea.
00990	1975 Extension Before 6/6/75.....	59.99 ea.
37992	1975 Ext 6 Cyl After 6/6/75.....	22.99 ea.
37993	1975 Ext V8 After 6/6/75.....	22.99 ea.
17140	1976 Includes Heater Wire.....	199.99 ea.
37992	1976 Extension 6 Cyl.....	22.99 ea.
37993	1976 Extension V8.....	22.99 ea.
37992	1977 Extension 6 Cyl.....	22.99 ea.
37994	1977 Extension V8.....	54.99 ea.
37992	1978 Extension 6 Cyl.....	22.99 ea.
37994	1978 Extension V8.....	54.99 ea.
37991	1979 Includes Heater Wire.....	219.99 ea.
37992	1979 Extension 6 Cyl.....	22.99 ea.
37994	1979 Extension V8.....	54.99 ea.

AC Power Feed Wire

Connects horn relay to AC fuse.

10970	1967-71 All.....	23.99 ea.
16405	1972 All.....	23.99 ea.

AC Compressor Ground Wire

12975	1969-76.....	16.99 ea.
37995	1977-79.....	16.99 ea.

Air Induction

36268	1980 Kickdown Harness.....	40.99 ea.
36270	1980 Solenoid Extension.....	23.99 ea.

Clock Harness

10855	1967 Console Clock.....	49.99 ea.
11960	1968-69 Console Clock.....	49.99 ea.
12965	1969 Center Dash Clock.....	49.99 ea.
17500	1970-79 Dash Clock.....	27.99 ea.
36267	1980 Clock & Glove Box.....	43.99 ea.

Console Gauge Harness

Connects gauges to console harness.

32640	1967 A/T Column Shift.....	159.99 ea.
32635	1967 A/T Console Shift.....	139.99 ea.
32630	1967 M/T All.....	139.99 ea.
32655	1968 A/T Column Shift.....	159.99 ea.
32650	1968 A/T Console Shift.....	139.99 ea.
32645	1968 M/T All.....	139.99 ea.
32670	1969 A/T Column Shift.....	159.99 ea.
32665	1969 A/T Console Shift.....	139.99 ea.
32660	1969 M/T All.....	139.99 ea.

A/T = Automatic Transmission M/T = Manual Transmission

Console Harness

10790	1967 A/T.....	79.99 ea.
10795	1967 A/T w/ Gauges.....	109.99 ea.
10800	1967 M/T.....	26.99 ea.
10805	1967 M/T w/ Gauges.....	84.99 ea.
11945	1968 A/T.....	72.99 ea.
11950	1968 A/T w/ Gauges.....	109.99 ea.
11940	1968 M/T.....	26.99 ea.
11955	1968 M/T w/ Gauges.....	84.99 ea.
17510	1969 A/T.....	69.99 ea.
13085	1969 A/T w/ Gauges.....	107.99 ea.
17505	1969 M/T.....	26.99 ea.
13090	1969 M/T w/ Gauges.....	84.99 ea.
17515	1970 A/T.....	59.99 ea.
17505	1970 M/T.....	26.99 ea.
17515	1971 A/T.....	59.99 ea.
17505	1971 M/T.....	26.99 ea.
17515	1972 Early Prod. A/T w/ Neutral Safety Switch in Console.....	59.99 ea.
17505	1972 All M/T, Late Prod A/T w/ Neutral Safety Switch on Column.....	26.99 ea.
15650	1979-80 Auto Shift Indicator.....	26.99 ea.

A/T = Automatic Transmission M/T = Manual Transmission

Courtesy Lamp Harness

13875	1967 Deluxe Side Panels.....	49.99 ea.
13870	1967-69 Roof Dome.....	31.99 ea.
17525	1967 Under Dash, Convert.....	45.99 ea.
08300	1967-68 Under Dash, Coupe.....	42.99 ea.
33820	1968 Under Dash, Convert.....	49.99 ea.
14295	1969 Under Dash, All.....	42.99 ea.
17575	1970-73 Roof Dome.....	38.99 ea.
15170	1970-73 Under Dash.....	45.99 ea.
40042	1974 Roof Dome.....	45.99 ea.
40130	1975-77 Roof Dome.....	45.99 ea.
36230	1974-79 Under Dash.....	49.99 ea.

Courtesy Lamp Switch Jumper Harness

Door jamb switch to dash harness.

36038	1973-80 LH.....	16.99 ea.
36039	1973-80 RH.....	12.99 ea.

Cowl Induction Harness

AHQ-1143	1969.....	59.99 ea.
----------	-----------	-----------

Also works on 67-68 with 69 cowl induction setup.

Cruise Control Harness

10775	1967.....	89.99 ea.
11885	1968.....	95.99 ea.
13185	1969-70.....	89.99 ea.

Dash Harness

10220	1967 A/T Column Shift.....	599.99 ea.
10780	1967 M/T Column Shift.....	599.99 ea.
10785	1967 A/T Console Shift.....	599.99 ea.
17535	1967 A/T Console, Gauges.....	599.99 ea.
10990	1967 M/T Console Shift.....	599.99 ea.
10995	1967 M/T Console, Gauges.....	599.99 ea.
18005	1968 A/T Column Shift.....	629.99 ea.
11840	1968 M/T Column Shift.....	629.99 ea.
11850	1968 A/T Console Shift.....	629.99 ea.
11860	1968 A/T Console, Gauges.....	629.99 ea.
11845	1968 M/T Console Shift.....	629.99 ea.
11855	1968 M/T Console, Gauges.....	629.99 ea.
12065	1968 A/T Floor Shift.....	629.99 ea.
13025	1969 All Column Shift.....	629.99 ea.
13115	1969 All Column Shift w/ AC.....	629.99 ea.
13205	1969 Column, Tach, Ctr Fuel.....	629.99 ea.
13035	1969 A/T Console Shift.....	629.99 ea.
13125	1969 A/T Console, AC.....	629.99 ea.
13225	1969 A/T Con, Gauges, Tach.....	629.99 ea.
13215	1969 A/T Con, Tach/Ctr Fuel.....	629.99 ea.
13030	1969 M/T Console Shift.....	629.99 ea.
13120	1969 M/T Console Shift, AC.....	629.99 ea.
13220	1969 M/T Con Gauges, Tach.....	719.99 ea.
13210	1969 M/T Con, Tach/Ctr Fuel.....	719.99 ea.
35915	1970 A/T Column Shift.....	599.99 ea.
35916	1970 A/T Column Shift w/AC.....	599.99 ea.
35917	1970 A/T Console Shift.....	579.99 ea.
35918	1970 M/T Console Shift.....	579.99 ea.
35919	1970 M/T Floor Shift.....	594.99 ea.
35920	1970 M/T Floor Shift w/ AC.....	579.99 ea.
35921	1971 All.....	579.99 ea.
35922	1972 All.....	599.99 ea.

All, except early production console shift auto trans with neutral safety switch mounted in console.

Early production, console shift, auto trans with neutral safety switch mounted in console.

35923	1972 A/T Console Shift.....	594.99 ea.
16555	1973 w/ Warning Lights.....	699.99 ea.
16560	1973 w/ Gauges.....	644.99 ea.
18700	1974 w/ Warning Lights.....	769.99 ea.
18705	1974 w/ Gauges.....	769.99 ea.
18710	1975 w/ Warning Lights.....	789.99 ea.

With seatbelt interlock ignition relay

36020	1975 w/ Warning Lights.....	769.99 ea.
-------	-----------------------------	------------

Without seatbelt interlock ignition relay

36015	1975 w/ Gauges.....	789.99 ea.
-------	---------------------	------------

With seatbelt interlock ignition relay

36019	1975 w/ Gauges.....	769.99 ea.
-------	---------------------	------------

Without seatbelt interlock ignition relay

38079	1976 w/ Warning Lights.....	769.99 ea.
38080	1976 w/ Gauges.....	769.99 ea.
36018	1977 w/ Warning Lights.....	769.99 ea.
36017	1977 w/ Gauges.....	769.99 ea.
37999	1978 w/ Warning Lights.....	769.99 ea.
37998	1978 w/ Gauges.....	769.99 ea.
38001	1979 A/T w/ Warning Lights.....	769.99 ea.
38000	1979 A/T w/ Gauges.....	769.99 ea.
38003	1979 M/T w/ Warning Lights.....	769.99 ea.
38002	1979 M/T w/ Gauges.....	769.99 ea.

Wiring Diagrams

Original GM wiring schematic from bumper to bumper.

HWD-67F	1967.....	13.99 ea.
HWD-68F	1968.....	13.99 ea.
HWD-69F	1969.....	13.99 ea.
HWD-RS	1967-69 RS.....	13.99 ea.
HWD-70F	1970.....	13.99 ea.
HWD-71F	1971.....	13.99 ea.
HWD-72F	1972.....	13.99 ea.
HWD-73F	1973.....	13.99 ea.



BDH-100K

Dash Harness Screws With Sealant

This is a pair of OE style fuse block dash harness screws coated in the OE style sealant.

BDH-100K 1967-81 All.....6.99 kit



39386
Detail

Dash Harness Classic Auto Fuse Series

Classic Auto Fuse Series dash harnesses allow you to maintain the easy plug and play function of original factory type harnesses, while converting the entire fuse block to an Auto Fuse Series (ATO Type) fuse block. This gives you the flexibility to add additional power circuits without the installation headaches normally associated with this type of fuse box conversion. There is no cutting or modifying of any sort. Just plug it in and turn it on. It is completely compatible with the other original harnesses in your car.

39386	1968 A/T Column Shift	689.99 ea.
39387	1968 M/T Column Shift.....	689.99 ea.
39388	1968 A/T Console Shift.....	689.99 ea.
39389	1968 A/T Console Shift w/ Gauges	689.99 ea.
39390	1968 M/T Console Shift.....	689.99 ea.
39391	1968 M/T Console Shift w/ Gauges	689.99 ea.
39392	1968 A/T Floor Shift w/o Console.....	689.99 ea.
39393	1969 A/T or M/T Column Shift...	689.99 ea.
39394	1969 A/T or M/T Column Shift w/ AC.....	689.99 ea.
39395	1969 Column Shift, A/T or M/T, Tach & Center Fuel Gauge..	689.99 ea.
39396	1969 A/T Console Shift.....	689.99 ea.
39397	1969 A/T Console Shift w/ AC ...	689.99 ea.
39398	1969 A/T Console Shift w/ Gauges & Tach	689.99 ea.
39399	1969 A/T Console Shift, w/ Tach, Ctr Fuel, & Warning Lights	689.99 ea.
39400	1969 M/T Console Shift	689.99 ea.
39401	1969 M/T Console Shift w/ AC...	689.99 ea.
39402	1969 M/T Console Shift w/ Gauges & Tach	779.99 ea.
39403	1969 M/T Console Shift, w/ Tach, Ctr Fuel, & Warning Lights	689.99 ea.

No Volume Discount.

Dash Cluster Harness

14975	1970 w/ Warning Lights	162.99 ea.
14985	1970 w/ Gauges	162.99 ea.
15365	1971 w/ Warning Lights	162.99 ea.
15370	1971 w/ Gauges.....	162.99 ea.
34920	1972 w/ Warning Lights	184.99 ea.
33870	1972 w/ Warning Lights, Belt	199.99 ea.

With seat belt warning light

16325	1972 w/ Gauges	179.99 ea.
16525	1972 w/ Gauges, Seat Belt	184.99 ea.

With seat belt warning light

Engine Harness

11260	1967 6 Cylinder	129.99 ea.
11290	1967 V8 w/o Gauges.....	124.99 ea.
11295	1967 V8 w/ Gauges.....	124.99 ea.
11300	1967 396 w/o Gauges.....	126.99 ea.
11305	1967 396 w/ Gauges.....	126.99 ea.
11815	1968 6 Cylinder	129.99 ea.
11820	1968 V8 w/o Gauges.....	119.99 ea.
12080	1968 396 w/o Gauges.....	119.99 ea.
12025	1968 All V8 w/ Gauges.....	119.99 ea.
11815	1969 6 Cylinder	129.99 ea.
12970	1969 V8 w/o Gauges.....	119.99 ea.
13170	1969 V8 w/ Idle Stop	126.99 ea.
12080	1969 396 w/o Gauges.....	119.99 ea.
13175	1969 396 w/ Idle Stop	126.99 ea.
17545	1969 All V8 w/ Gauges.....	119.99 ea.
13180	1969 All V8 w/ Gauges & Idle	126.99 ea.
14945	1970 A/T 6 Cylinder.....	219.99 ea.
14935	1970 M/T 6 Cylinder.....	219.99 ea.
14955	1970 A/T SB, non-TH400.....	184.99 ea.
15255	1970 A/T SB, TH400	219.99 ea.
14940	1970 M/T SB	184.99 ea.
14960	1970 A/T Big Block	219.99 ea.
14950	1970 M/T Big Block	199.99 ea.
15390	1971 A/T 6 Cylinder	219.99 ea.
15380	1971 M/T 6 Cylinder.....	219.99 ea.
15485	1971 A/T SB non-TH400.....	199.99 ea.
15385	1971 M/T SB	199.99 ea.
15450	1971 A/T SB TH400	219.99 ea.
15445	1971 A/T BB	219.99 ea.
15395	1971 M/T BB	219.99 ea.
16330	1972 6 Cylinder.....	259.99 ea.
16335	1972 SB w/o Gauges.....	239.99 ea.
16350	1972 SB w/ Gauges.....	239.99 ea.

*Manual requires the use of 17355 TCS extension

16355	1972 SB TH400 w/ Gauges.....	249.99 ea.
16345	1972 A/T BB w/o Gauges.....	249.99 ea.
16365	1972 A/T BB w/ Gauges.....	249.99 ea.
16340	1972 M/T BB w/o Gauges	239.99 ea.
16360	1972 M/T BB w/ Gauges	249.99 ea.
17015	1973 6 Cylinder.....	274.99 ea.
15500	1973 V8	249.99 ea.
15505	1973 V8 w/ Gauges.....	249.99 ea.

*Manual requires the use of 17365 TCS extension

16565	1973 V8 TH400 w/o Gauges.....	259.99 ea.
16570	1973 V8 TH400 w/ Gauges.....	259.99 ea.
38008	1974 A/T 6 Cyl W Lights.....	274.99 ea.
16595	1974 M/T 6 Cyl W Lights	274.99 ea.
22605	1974 A/T V8 non-TH400.....	249.99 ea.
22590	1974 A/T V8 w/ Gauges	249.99 ea.
22585	1974 V8 TH400 w/o HEI.....	274.99 ea.
36009	1974 V8 TH400 w/ HEI	259.99 ea.
22600	1974 V8 TH400 HEI Gauges	269.99 ea.
22610	1974 M/T V8 w/o HEI	259.99 ea.
36012	1974 M/T V8 w/ HEI	269.99 ea.
22595	1974 M/T V8 w/ Gauges	259.99 ea.
36013	1974 M/T V8 Gauges HEI	269.99 ea.
18615	1975 6 Cyl w/o Int Cyl Head	289.99 ea.
18610	1975 6 Cyl w/ Int Cyl Head	289.99 ea.
18680	1975 All V8	259.99 ea.
35990	1976 All 6 Cylinder.....	274.99 ea.
18680	1976 All V8	259.99 ea.
35989	1977 6 Cyl w/o CA Emissions	259.99 ea.
35988	1977 6 Cyl w/ CA Emissions	259.99 ea.
36007	1977 All V8	239.99 ea.
35981	1978 6 Cyl w/o CA Emissions	274.99 ea.
35980	1978 6 Cyl w/ CA Emissions	274.99 ea.
36027	1978 V8 w/ CA Emissions	259.99 ea.
36007	1978 V8 w/o CA Emissions.....	239.99 ea.
35986	1979 6 Cyl w/o CA Emissions	299.99 ea.
35985	1979 6 Cyl w/ CA Emissions.....	299.99 ea.

Engine Harness Cont'd

36007	1979 V8 w/o CA Emissions	239.99 ea.
36025	1979 V8 w/ CA Emissions	239.99 ea.
38010	1980 229 6 Cylinder.....	274.99 ea.
36029	1980 All V8	249.99 ea.

A/T = Automatic Transmission M/T = Manual Transmission
CA Emission = California Emissions

Engine Harness For HEI

38926	1967 V8	134.99 ea.
38946	1967 V8 w/ Gauges	139.99 ea.
38966	1967 396	139.99 ea.
39000	1967 396 w/ Gauges	139.99 ea.
38923	1968 V8	134.99 ea.
38930	1968 396	134.99 ea.
38932	1968 V8 & 396 w/ Gauges.....	129.99 ea.
38925	1969 V8	139.99 ea.
39001	1969 V8 w/ Idle Stop	139.99 ea.
38930	1969 396	134.99 ea.
39016	1969 396 w/ Idle Stop	139.99 ea.
38924	1969 V8 & 396 w/ Gauges.....	134.99 ea.
38996	1969 V8 & 396 w/ Gauges & Idle Stop ..	139.99 ea.
38968	1970 V8 Auto Trans.....	199.99 ea.
39052	1970 V8 TH400 Only.....	219.99 ea.
39002	1970 V8 Manual Trans	199.99 ea.
39038	1970 396/454 Auto Trans.....	219.99 ea.
39069	1970 396/454 Manual Trans.....	219.99 ea.
38977	1971 V8 Auto Trans	219.99 ea.
39017	1971 V8 Manual Trans	219.99 ea.
39090	1971 V8 TH400 Only	219.99 ea.
39089	1971 396/454 Auto Trans	219.99 ea.
39070	1971 396/454 Manual Trans	219.99 ea.

Forward Lamp Harness

11425	1967 6 Cyl Rally Sport.....	299.99 ea.
11410	1967 6 Cyl standard	229.99 ea.
11430	1967 V8 Rally Sport	259.99 ea.
11435	1967 V8 RS w/ Gauges.....	269.99 ea.
11415	1967 V8 standard	219.99 ea.
11420	1967 V8 Std w/ Gauges	219.99 ea.
11895	1968 6 Cyl Rally Sport	249.99 ea.
11825	1968 6 Cyl Standard	249.99 ea.
11900	1968 V8 Rally Sport.....	219.99 ea.
11905	1968 V8 RS w/ Gauges	219.99 ea.
11830	1968 V8 Standard.....	219.99 ea.
11835	1968 V8 Std w/ Gauges	219.99 ea.
12995	1969 All 6 Cyl.....	249.99 ea.
13000	1969 V8 w/o Gauges	219.99 ea.
13005	1969 V8 w/ Gauges	219.99 ea.
14865	1970 All 6 Cyl.....	259.99 ea.
14870	1970 V8	239.99 ea.
15195	1970 V8 w/ AC	239.99 ea.
14875	1970 V8 All w/ Gauges.....	239.99 ea.
15320	1971 All 6 Cyl	299.99 ea.
15405	1971 V8	239.99 ea.
15330	1971 V8 w/ Gauges.....	239.99 ea.
16370	1972 All	239.99 ea.
16550	1973 All	239.99 ea.
16585	1974 All	274.99 ea.
36028	1975 w/o Seatbelt Warning.....	259.99 ea.
18685	1975 w/ Seatbelt Warning.....	289.99 ea.
36026	1976-77 All	259.99 ea.
36023	1978 All	259.99 ea.
36021	1979-80 All.....	259.99 ea.
36022	1981 All	259.99 ea.

Fuel Sender Harness

18915	1967-68 All	23.99 ea.
18910	1969 All	23.99 ea.
33825	1970-71 All	23.99 ea.
33835	1972-73 All	23.99 ea.
36272	1974-77 All	23.99 ea.
36269	1978-80 All.....	31.99 ea.

Glove Box Lamp Extension

17530	1970-79 w/o AC	23.99 kit
15290	1970-79 w/ AC	23.99 kit

Headlamp Washer Pump Extension Harness

17585	1969 Rally Sport	18.99 ea.
-------	------------------------	-----------

Heater Harness

33875	1973-80 w/o AC	49.99 kit
-------	----------------------	-----------

Horn Wire

38011	1974-76 Dual Horns	23.99 kit
38012	1977 Dual Horns	23.99 kit
38013	1978-80 Dual Horns	21.99 kit

Kickdown Harness

Connects carburetor switch to transmission.

06085	1967 TH400	49.99 ea.
06145	1968-69 TH400	42.99 ea.

Kickdown Extension

Connect gas pedal switch to engine harness.

17565	1971-74 TH400	31.99 ea.
-------	---------------------	-----------

Power Accessory Feed

10755	1967-71 Horn Relay to Power Windows and Top	15.99 ea.
14040	1967-69 Power Window & Power Top Circuit Break to Kick Panel Relay	24.99 ea.

Power Seat Harness

14260	1968 Adjuster Feed	59.99 ea.
14255	1968-69 4 Way	159.99 ea.

Power Top Harness

14035	1967-68	74.99 ea.
14310	1969	79.99 ea.

Power Window Harness

13790	1967 LH w/ Crossover	219.99 ea.
13795	1967 RH	99.99 ea.
14070	1967-69 1/4 Window	77.99 ea.
14207	1968 LH w/ Crossover	219.99 ea.
14290	1968-69 RH	99.99 ea.
14300	1969 LH w/ Crossover	219.99 ea.

Rally Sport Extension

11200	1967 RS Under Dash Diode	40.95 ea.
-------	--------------------------------	-----------

Rear Window Defroster Harness

13785	1967	54.99 ea.
14180	1968	54.99 ea.
17555	1969	54.99 ea.
14515	1970-78	77.99 ea.
35984	1979 Dash Side	115.99 ea.

Rear Lamp Harness

14080	1967 RS Convertible	179.99 ea.
14075	1967 Standard Convertible	179.99 ea.
14090	1967 RS Coupe*	179.99 ea.

*With Dash Lamps

14085	1967 Standard Coupe	179.99 ea.
14095	1967 Standard Coupe*	179.99 ea.

*With Dash Lamps

14215	1968 RS Convertible	199.99 ea.
14210	1968 Standard Convertible	184.99 ea.
14205	1968 RS Coupe*	199.99 ea.

*With Dash Lamps

14195	1968 Standard Coupe	199.99 ea.
14200	1968 Standard Coupe*	184.99 ea.

*With Dash Lamps

Rear Lamp Harness Cont'd:

14340	1969 Convrt Dash to 1/4*	123.99 ea.
*(intermediate)		
14330	1969 Coupe Dash to 1/4*	99.99 ea.
*(intermediate)		
14335	1969 Coupe Dash to 1/4	109.99 ea.
14350	1969 RS Rear Panel	159.99 ea.
14345	1969 Standard Rear Panel	159.99 ea.
17170	1970-72 Dash to 1/4*	126.99 ea.
*(intermediate)		
14440	1970-73 Rear Panel	174.99 ea.
35924	1973 Dash to 1/4*	144.99 ea.
*(intermediate)		
21240	1974-75 Dash to 1/4 Panel*	269.99 ea.

*You must supply your original connectors.

Speaker Harness

18510	1967-68 Single Speaker	54.99 ea.
33425	1967 Front Stereo Speakers	59.99 ea.
08210	1967 Rear Stereo Speakers	54.99 ea.
33430	1967 4 Speaker, Front & Rear	82.99 ea.
18510	1968 Single Rear Speaker	54.99 ea.
33425	1968 Front Stereo Speakers	59.99 ea.
08210	1968 Rear Stereo Speakers	54.99 ea.
33430	1968 4 Speaker, Front & Rear	82.99 ea.
33425	1969 Front Stereo Speakers	59.99 ea.
08210	1969 Rear Stereo Speakers	54.99 ea.
33430	1969 4 Speaker, Front & Rear	82.99 ea.

Speed Warning Harness

Complete assembly for the desirable speed warning module behind the speedometer.

11050	1967	25.99 ea.
11935	1968	25.99 ea.
13130	1969	25.99 ea.

Stereo Tape/Multiplex Harness

35940	1968 Adapter	42.99 ea.
35939	1968-69 Speaker Extension	54.99 ea.

Tach Conversion Harness

When adding a factory dash tach to your 1969 Camaro, this harness allows you to move the fuel gauge to the center position.

33970	1969	34.99 ea.
-------	------------	-----------

TCS Transmission Switch Extension

From engine harness to transmission switch.

17355	1972 for 16335/16350/16330 ...	49.99 ea.
17365	1973 for 15500/15505	49.99 ea.

Transistor Ignition Extension Harness

33215	1967-68 TI Extension Harness ..	23.99 ea.
36053	1969 TI Amplifier Extension	89.99 ea.
23015	1969 TI Coil Ground Wire	13.99 ea.
23060	1969 TI Extension Harness	23.99 ea.
23140	1969 TI Extension Harness w/ Replacement Amp	15.99 ea.
23020	1969 TI Harness	149.99 ea.

Trunk Lamp Harness Assembly

28175	1967-69 Convertible	49.99 ea.
28180	1967-69 Coupe	42.99 ea.
28185	1970-81 All	45.99 ea.

All include extension

Trunk Lamp Extension Harness

28195	1967-69 Convertible	20.99 ea.
28210	1967-69 Coupe	15.99 ea.
15225	1970 All	20.99 ea.
14535	1971-77 All	27.99 ea.



Spare Fuse Power Wiring Extension

Used to add the functionality of the three extra spare fuses if desired.

39383	1968-69	59.99 ea.
-------	---------------	-----------



TOOL-CIRCUIT

Automotive Circuit Tester

Our circuit tester quickly checks for open circuits and ground faults

TOOL-CIRCUIT	Circuit Tester 6-12 Volt	6.99 ea.
--------------	--------------------------------	----------



39384

Accessory Terminal & Connector Kit

Used to access the front of the ATO fuse block accessory ports, while maintaining the indexing capability of the cavities on the fuse block.

39384	1968-69	21.99 ea.
-------	---------------	-----------



39385

Glass Fuse Series Accessory Adapter Kit

Converts old accessory style indexed connectors to new ATO style connectors so you can plug your old accessories into your ATO fusebox with no modifications to connectors.

39385	1968-69	54.99 ea.
-------	---------------	-----------



39464

Fuse & Flasher Kit

Includes (2) flashers, (1) complete set of ATO fuses, plus (1) spare of each amperage.

39464	1968	26.99 ea.
39466	1969	26.99 ea.



GHB-4412

Power Window Harness Boot

Manufactured from rubber as original these reproduction boots are designed to fit factory type power window harnesses.

GHB-4412	1967-69	59.99 pr.
----------	---------------	-----------

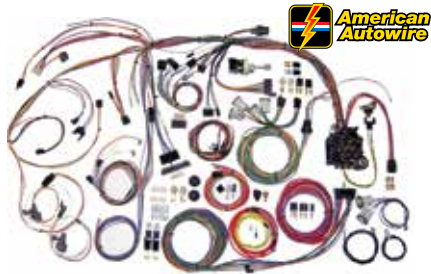

1967-73 Camaro Classic Update Series Kits

NEW compact ATO-Style fuse panel. Original switch connector bodies, Steering column connectors, Instrument cluster wiring, Rear body harness assembly plug, New floor dimmer switch, GM bulkhead connectors, Engine wiring, Front lighting, Original style light sockets!

500661	1967-68	920.99 ea.
500686	1969	978.99 ea.
510034	1970-73	920.99 ea.

Note: Does not support ammeters. Use 510121 voltmeter replacement for 1968 with original ammeter.



510121

1968-69 Console Voltmeter Gauge

Voltmeter gauges are engineered as a direct replacement to install in place of the factory Ammeter gauge that was used in the original saw tooth console gauge packages installed in many 1968-1969 Camaros. This gauge is a must when using American Autowire Classic Update or any other updated wiring harness, because those kits will not support the use of an Ammeter.

510121	1968-69.....	172.99 ea.
--------	--------------	------------



GRA-214

Air Conditioner Relay

OE correct blower motor relay for cars with air conditioning

GRA-214	1973-77 w/AC	28.99 ea.
---------	--------------------	-----------

No volume discount.



35125

Ash Tray Lamp

Includes wire and socket. Does not include ash tray socket retainer. Original bracket and shield assembly must be reused.

35125	1967 All	24.99 kit
-------	----------------	-----------



GBS-689

Blower Motor Switch

GBS-796	1967 w/ AC	79.99 ea.
GBS-68AC	1968 w/ AC	59.99 ea.
GBS-689	1967-68 w/o AC	36.99 ea.
GAC-385	1969 w/ AC	44.99 ea.
GBS-939	1969 w/o AC	42.99 ea.
GBS-70AC	1970-72 w/ AC	62.99 ea.
GBS-7081	1970-81 w/o AC	64.99 ea.
GBS-73AC	1973-81 w/ AC	64.99 ea.



ABR-71



ABR-69AC



ABR-77

Heater Blower Motor Resistors

Correct blower motor resistors.

ABR-71	1967-68 w/ AC	34.99 ea.
ABR-69AC	1969 w/ AC	29.99 ea.
ABR-77	1967-75 w/o AC	26.99 ea.
ARS-304	Mounting Screws	0.95 pr.



GBL-852



GBL-852-CC

Brake Light Switch

OE style brake light switches located above the brake pedal.

GBL-852	1967-81 All w/o Cruise Control ...	6.99 ea.
GBL-852-CC	1967-79 All w/ Cruise Control ..	24.99 ea.
GSR-12999	Retainer	8.99 ea.



GBL-9EB



GBL-99PC

Parking Brake Light Switch & Paddle Clip

Correct switch to activate parking light and special paddle clip to deactivate light when brake is off.

GBL-9EB	1967-69 Switch	19.99 ea.
GBL-99PC	1967-69 Paddle Clip	19.99 ea.



GT-159



GW-458

1967-68 Top Switch

Correct switch and housing for operation of power top.

GT-159	1967-68 Switch	36.99 ea.
GW-458	1967-68 Bracket w/ Clips	19.99 ea.



GT-69



GW-082



MTB-17

1969 Top Switch & Bezel

Correct switch and die cast bezel.

GT-69	1969 Switch	59.95 ea.
MTB-17	1969 Bezel	60.99 ea.
GW-082	1969 Bracket w/ Clips	19.99 ea.



GHD-6472

Body Wiring Hold Down

Used to hold body harness to floor pan.

GHD-6472	All	4.99 ea.
----------	-----------	----------

Note: Typically 3 required.



GDJ-11



GDJ-10



GDJ-3F

Door Jamb Switches

GDJ-11	Dual Pin (Male)	9.99 ea.
GDJ-10	Single Pin (Male)	11.99 ea.
GDJ-3F	Single Pin (Female)	9.99 ea.



GDT-0330

Electrical Harness Tape

Correct non-stick factory style tape. Over 100 feet.

GDT-0330	All	11.95 ea.
----------	-----------	-----------



GQH-118

Electric Junction Block

Original GM junction block for attaching positive lead from battery to main harness. Mounts to radiator support. Includes correct nut.

GQH-118	1967-71 All	8.99 ea.
---------	-------------------	----------



BCE-9738 APC-744 AHB-1X

Engine Compartment Retaining Hooks

Pre-bent hooks for various wires, cables and hoses.

BCE-9738	Large Rubber Coated.....	4.99 ea.
APC-744	Small Hook (Oil Pan, etc.).....	7.99 ea.
AHB-1X	Heater Box Wire Clip.....	5.99 ea.



AHC-1 AHC-2

Harness Retaining Clips

Correct retaining clips for harness.

AHC-1	Clip Style #1.....	4.95 ea.
AHC-2	Clip Style #2.....	4.95 ea.



BPX-2350

Harness Retaining Straps

Correct push in style plastic retainers

BPX-2350	All.....	3.95 pr.
----------	----------	----------



BJN-300

Harness Wire Ties

Original GM wire ties used for various hoses, cables and harnesses.

BJN-300	Short 5"	3.99 ea.
BJN-600	Long 7"	3.99 ea.



18000

Glove Box Lamp

Complete assembly with socket, switch, bulb and correct harness, wires or terminals.

18000	1967-69 All	26.99 kit
36134	1970-79 All	26.99 kit
36136	1980-81 All	24.99 kit



GAC-808

Headlight Dimmer Switch

Correct floor mounted high beam switch.

GAC-808	1967-75 All.....	8.99 ea.
GAC-GRMT	1967-75 Carpet Grommet Black ...	3.99 kit
GAC-808-HARNS	1967-75 All Harness	6.95 ea.
GAC-7802	1982-92 All	14.99 ea.



GHS-588

Headlight Switch

GHS-588	1967 All, 1968 Standard	19.99 ea.
GHS-217	1969-81 Standard	18.99 ea.
GHS-542	1968-69 Rally Sport.....	49.99 ea.



GRC-12834

Voltage Regulator Capacitor

GRC-12834	1967-72	24.99 ea.
-----------	---------------	-----------



GHR-88

Headlamp Switch Nut

Correct special nut used for retaining switch to the dash.

IC-078	1967-68 All	13.99 ea.
GHR-88	1969-81 All	12.99 ea.
GHR-8292	1982-92 All	10.99 ea.



GGS-69F

Headlamp / Wiper Switch Ground Strap

Reproduction of the original headlamp and wiper switch ground strap.

GGS-69F	1969 All	14.99 ea.
---------	----------------	-----------

1967-68 High Beam Indicator

This is a reproduction headlamp hi beam indicator bulb housing, red lens and ground strap. Mounts on the upper portion of the rear section of the plastic instrument carrier. The ground strap is instrumental in grounding the hi beam indicator light and gauge cluster assembly. Includes mounting screws. Bulb and wiring are not included.

GAC-6768	All.....	54.99 set
----------	----------	-----------



GIS-821

GIS-042

Ignition Switch

GIS-821	1967 All	34.99 ea.
GIS-152	1968 All	26.99 ea.
GIS-042	1969-89 w/o Tilt	18.99 ea.
GIS-052	1969-02 w/ Tilt	18.99 ea.



IQ-507

Ignition Switch Nut

Correct heavy chrome nut for retaining switch to dash.

IQ-507	1967-68 All	10.99 ea.
--------	-------------------	-----------



GNS-23

Neutral Safety Switch

Correct switch at base of steering column for proper engine & reverse light activation.

GNQ-375	1967 TH350/400 w/ Console ...	44.99 ea.
GNS-503	1967 Powerglide w/ Console ...	44.99 ea.
GNS-23	1967-68 TH	19.99 ea.
GNS-33	1969-73 4 Speed.....	55.99 ea.
GNS-35	1969-73 On Column	19.99 ea.
GDR-411	1969-73 Auto	29.99 ea.



GNS-1969

Neutral Start Switches

Correct safety switch located at pedal which prevents your car from being started in gear.

GNS-1969	1969 4 Speed.....	84.99 ea.
FSR-372	1969 Rod & Clip.....	22.99 ea.
GNS-X99	1970-78 Manual.....	59.99 ea.



GFS-502

Turn Signal & Hazard Light Switch

Correct flasher switch that plugs into fuse box.

GFS-502	1967-81.....	9.99 ea.
---------	--------------	----------



4432791

GWS-712



GWS-1469L

GWS-1454L

Power Window Switch

Correct OEM style power window switch.

4432790	1967-70 1 Window	57.99 ea.
4432791	1967-70 4 Window	79.99 ea.
GWS-711	1971-81 1 Window.....	34.99 ea.
GWS-712	1971-81 2 Window	59.99 ea.
GWS-1469L	1994-96 LH 2 Window	21.99 ea.
GWS-9496R	1994-96 RH 1 Window	19.99 ea.
GWS-1454L	1997-02 LH 2 Window	16.99 ea.
GWS-9702R	1997-02 RH 1 Window.....	26.99 ea.



1993413

Reverse Lamp Switch

1993413	1967-68 Switch	89.99 ea.
10665	1967-68 Switch Extension	39.99 ea.



GTS-304

Turn Signal Switches

Complete switch assemblies with correct plug in harnesses.

GTS-304	1967-68 All	56.99 ea.
GTS-304-GM	1967-68 GM Tooling	109.99 ea.
GTS-6208-GM	1969-76 All	89.99 ea.
GTS-6208	1969-76 All	43.99 ea.
GTS-974	1989 13 Pin	39.99 ea.



GTR-305

Turn Signal Repair Switch

Correct white plastic repair arm that the turn signal handle attaches to.

GTR-303	1967-68 w/o Tilt	17.99 ea.
GTR-301	1967-68 w/ Tilt	17.99 ea.
GTR-305	1969-76 All	16.99 ea.



GWC-SPK

Speaker/Trunk/Blower Motor Wire Clips

Used to hold the wiring under the dash, power trunk or trunk light wires to hinge, speaker wires to package tray or blower motor wire to vent.

GWC-SPK	1964-77 All	6.99 pr.
---------	-------------------	----------



GPC-68

Printed Circuit Boards

OE style reproduction circuit boards.

GPC-67	1967 All w/ Gauges	59.99 ea.
GPC-67	1968 w/o Tach w/ Gauges	59.99 ea.
GPC-68	1968 w/ Tach w/ Gauges	59.99 ea.
GPC-676	1970-81 All w/ Gauges	59.99 ea.
GPC-67W	1967-69 All w/ Warning Lights	59.99 ea.
GPC-739W	1970-79 All w/ Warning Lights	59.99 ea.
GPC-8016	1980-81 All w/ Warning Lights	82.99 ea.



GRC-12835



GRC-12834

Radio Capacitor

Came from the factory on all cars with a radio. Correct length lead wire & brass connector.

GRC-12834	1967-71 Voltage Regulator	24.99 ea.
<i>Stamped 1964086 "DR" G ".5MF"</i>		
GRC-12835	1970-1974 Radio	24.99 ea.
<i>1964452 "DR" G ".3MF"</i>		



AMH-15

Underhood Lamp

Complete with bracket, hardware, harness and built in switch.

AMH-15	All	72.99 kit
--------	-----------	-----------



GAC-515



GAC-515GM

Voltage Regulator

New correct GM replacement.

GAC-515	1967-72 All D635	84.99 ea.
GAC-515GM	1967-71 OE style Reproduction	99.99 ea.
GAC-515XX	All D635 Chrome	59.99 ea.
AVX-515	1967-72 Screws 2pc	0.95 kit
AWX-818	1967-72 Mounting Kit	6.95 kit



GWS-103

Wiper Switch

GWS-103	1967-68 All	36.99 ea.
GWS-106	1969 All	62.99 ea.
GWS-108	1972-74 w/o Hidden Wipers	89.99 ea.



GRW-016

Circuit Breaker

Correct 30 amp breaker used for power windows, power doors and power tops.

GRW-016	1967-69	20.99 ea.
GRW-016	1973-79	20.99 ea.



ATCS-33R

TCS Littlefuse Relay

Features 4 prongs as original and replaces Delco number 3961573.

ATCS-33R	1970-72	59.99 ea.
----------	---------------	-----------



GRA-8172

Air Conditioner Relay

Correct GM blower motor relay.

GRA-8172	1967-68 w/ AC	24.99 ea.
GRA-885	1969-76 w/ AC	34.99 ea.



AEH-9602

Cowl Induction Relay

New GM relay which mounts to firewall.

AEH-9602	1967-69 w/ CI	31.99 ea.
----------	---------------------	-----------



GAC-723

Horn Relay

New reproduction of the original GM Delco style relay.

GAC-723	1967-71	53.99 ea.
GAC-775	1972-73	59.99 ea.
AVN-506	Mounting Screw	0.95 ea.



GSR-6076

Power Seat Relay

For cars with 4 or 6 way power seat. 6 prong. Replaces GM 5717528.

GSR-6076	1967-76	59.99 ea.
----------	---------------	-----------



GWR-772

Power Window Relay

Correct reproduction of this hard to find relay.

GWR-772	1967-72	29.99 ea.
---------	---------------	-----------



KB-10

1967 Rally Sport Circuit Breaker

OE style reproduction 10 amp circuit breaker including correctly plated mounting bracket, two correct style integral washer nuts to attach wiring connectors.

KB-10 1967 RS 29.99 ea.

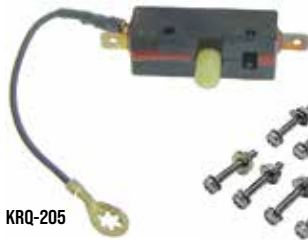

KRQ-205

1967 Rally Sport Headlamp Limiting Switch

Correct headlamp limiting switch with correct attached ground wire.

KRQ-205 1967 RS Switch 19.99 ea.
KRX-398 1967 RS Screw Kit 8.99 kit



KRX-398



APJ-5240

Ground Strap Kit

Correct braided copper wire and ends complete with OEM screws.

APJ-5240 1967-68 3pc 19.99 kit
APJ-5230 1969 4pc 23.95 set



KW-806

1967 Rally Sport Relay Board Assembly

Complete reproduction assembly with all correct parts. Die stamped steel relay mounting plate with three installed relays.

KW-806 1967 RS 109.99 kit



KRG-398

1967 Rally Sport Headlamp Relay

Excellent reproduction headlamp relay with stamped Delco Remy script. Mounting bracket includes stamped 858 numerals with accurate finish plating.

KRG-398 1967 Motor Relay 33.99 ea.
KRG-215 1967 Bracket 31.99 ea.



N-2441

Tune Up Kit

AC Delco tune up kit with new points, condenser and rotor.

N-2441 1962-74 w/o HEI 49.99 ea.



APX-2559

AVC-1144

Alternator Pigtail & Boot

Correct plug in "pigtail" for rear of alternator.

AVC-1144 1967-81 All Pigtail 4.95 ea.
APX-2559 Rear Alternator Boot 4.95 ea.



ASR-69FBB

Spring Ring Cables

OE style reproduction of the original factory installed spring type cables sold as a matched pair.

ASR-678FSB 1967-68 SB 159.98 pr.
ASR-678FBB 1967-68 BB 159.98 pr.
ASR-69FSB 1969 SB 159.98 pr.
ASR-69FBB 1969 BB 159.98 pr.
ASR-70F 1970-73 All 89.99 pr.



AST-1001

Side Terminal Battery Cables

Correct cables for cars with the heavy duty R-89 batteries with correct GM part numbers.

AST-1001 1969 R-89 160.00 kit



1971244

Distributor Cap

Choose from AC Delco replacement distributor cap or exact reproduction distributor cap.

1971244 Black Cap 89.99 ea.
AAD-308 Replacement 22.95 ea.



R59-TOP



R89-TOP

Battery Toppers

This new plastic injection molded cover will give your modern battery the look and feel of an original! This topper works with Group 24-60 sized batteries only. Inside size = 6-7/8 x 10-3/8.

R59-TOP 1967-72 R-59 59.99 ea.
R89-TOP 1969-72 R-89 Side 59.99 ea.



ADS-2100-SC-CLEAR



ADS-2100-SC-RED

HEI Distributor

HEI Electronic Distributor with 50K Coil - Red Cap.

ADS-2100 All 94.99 ea.
ADS-2100-SC-RED Red Super Cap 94.99 ea.
ADS-2100-SC-CLEAR Clear Super Cap 94.99 ea.
ACE-1400 All V8 Hold Down 15.99 kit



1115263 (Top View)



1115270

Coil

Choose from our new exact reproduction Delco coils with GM numbers or GM replacement coil.

1115287	1968-72 BB	139.95 ea.
1115270	1968-72 SB	219.99 ea.
1115293	1970-72 Most V8.....	139.95 ea.
GAC-505	1967+ Most Replace	29.99 ea.

No Volume Discount.



AHC-1508

Spark Plug Wire Sets

Pre-cut factory replacements.

AHC-1508	1967-73 SB non-HEI.....	34.99 set
AHC-2508	1967-72 BB non-HEI.....	32.99 set
AHC-3508	1974-81 with HEI	54.99 set



ALL-70BB3Q

"Dated" Spark Plug Wire Set

New OE style reproduction wire set correctly dated for your specific car, pre-cut and ready to install! Each set features correct colored wires and correct angled boots. Please give your sales rep your desired date. For points style, non-HEI cars only.

Here's how to order:

ALL-(year)(block)(quarter) 109.99 set

*For example, a 1970 Camaro SS396 built on or before Jan. 15, 1970, you would order ALL-70BB3Q wires will have 3-Q-69 stamped on them. If built after Jan. 15, 1970, you would order ALL-70BB1Q.



AC43



AC Delco Spark Plugs

This is a brand new set of 8 spark plugs. These high quality reproduction AC Delco spark plugs feature the correct green AC and markings as original.

AC43	1964-70 #43	62.99 set
AC44	1964-70 #44	62.99 set
AC45	1964-70 #45	62.99 set

Note: The number on the plug refers to it's operating temperature. The lower number is a cooler running plug which is typically found on the SHP high performance engines. A hotter, higher numbered plug would be used in engines where plug fouling may be or is a problem.



ACI-3685

Cowl Induction Electric Solenoid

Correct electric solenoid with part number stamped on.

ACI-3685	1967-69 w/ GM Stamp	48.99 ea.
----------	---------------------------	-----------



AD-007



AQW-1176

Cowl Induction Solenoid Switch

Correct throttle switch and clip for activating solenoid.

AQW-1176	1967-69 Switch	20.99 ea.
AD-007	1967-69 Clip	7.99 ea.



AHQ-1143



AQW-296

Cowl Induction Harness & Grommet

OE style reproduction of original GM harness and correct rubber grommet for routing harness through firewall.

AHQ-1143	1967-69 Harness	59.99 ea.
AQW-296	1967-69 Grommet.....	8.99 ea.



ACY-100

Marking Crayons

Original crayons used to mark the frame and firewall. Includes (1) yellow crayon and (1) white crayon.

ACY-100	All.....	6.99 kit
---------	----------	----------



GAC-560



GAC-760



GAC-660

Temp Sending Units

Correct screw in sending units.

GAC-250	1967-72 w/o Gauges.....	19.99 ea.
GAC-560	1967-72 w/ Gauges.....	17.99 ea.
GAC-760	1969-70 w/ Gauges	24.99 ea.
GAC-660	1970-72 TCS Sender.....	24.99 ea.
CPX-999	1967-72 w/ Gauges.....	12.95 ea.



GSS-883

Side Marker Socket

GSS-883	1968-79	6.99 ea.
GSS-893	90 Degree Side Marker Socket... ..	5.95 ea.



GLS-154

Tail Lamp Socket

GLS-157	1967-68	9.99 ea.
GLS-154	1969-79	11.95 ea.
GLS-70	Tail Lamp Socket 2nd Design.....	11.95 ea.



GLS-71

Power Door Lock Switch

Correct reproduction power door lock switch.

GLS-6570	1967-69 All	79.99 ea.
GLS-71	1971-77	64.99 ea.
GLS-8289R	1982-89 All RH	18.99 ea.



ACY-KIT

Frame & Body Marking Crayon Kit

These paint sticks are used for final detailing to replicate the marks left on the frame, body and other parts of the car. Just like when it came down the assembly line!

ACY-KIT	All 12pc.....	38.99 kit
---------	---------------	-----------

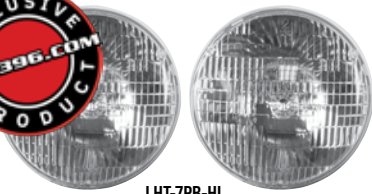

LHT-7PB-HI



FACTORY T3

HI-INTENSITY T3



LHT-7T-HI Detail



LHT-7PB-HI Detail

T-3 Headlamps

Upgrade your weak old original T3 and Power Beam headlights with a pair of high performance headlights from Ground Up Motors! These headlights utilize modern bulb filaments with a much brighter high/low beam, which are considerably brighter than the original factory and Power Beam units. These fit and function exactly as original which makes installing these a breeze. They feature a T3 or Power Beam logo and look just like the originals! We tested these on our own 1969 Camaro in our warehouse and you can really see the difference!

LHT-7PB-HI	1967-81 All Power Beam	164.99 pr.
LHT-7T-HI	1967-81 All T3	164.99 pr.



LHR-663



LHR-10K

Headlamp Retainer

Correct stainless steel rings and attaching screws.

LHR-663	1967-75 All.....	11.99 ea.
LHR-39	1976-81 All.....	26.99 ea.
LHR-10K	Screws 3pc	0.95 kit



LHA-69K

Headlamp Adjustment Kit

Plastic nuts and screws for headlamp adjustment. Each kit does one car.

LHA-678K	1967-1968 10pc.....	15.99 kit
LHA-69K	1969 10pc.....	15.99 kit
LHA-70K	1970-73 10pc.....	16.99 kit
LHA-81K	1974-81 4pc.....	5.95 pr.



LHS-67

Headlamp Spring

Correct spring used for proper adjustment.

LHS-67	1967-69 All	4.99 ea.
LHS-73	1970-73 All.....	3.99 ea.
LHS-81	1974-81 All.....	3.99 ea.



LHB-78FK

Headlamp Mounting Bucket And Hardware Kits

These kits contains a pair of headlamp buckets, headlamp retaining rings, headlamp adjusters, headlamp bucket tension springs. This kit takes all the guesswork out of replacing your headlamp buckets and hardware!

LHB-78FK	1967-68 All	103.45 kit
LHB-69FK	1969 All	103.45 kit

No Volume Discount.



LHH-67SL

LHB-67R

Headlamp Mounting Buckets

OE style reproduction headlamp buckets which attach to the headlamp housings and keep the headlights in place.

LHB-67R	1967-69 RH	33.99 ea.
LHB-67L	1967-69 LH	33.99 ea.
LHB-67R	1967-69 RS RH	33.99 ea.
LHB-67L	1967-69 RS LH.....	33.99 ea.
LHB-67K	1967-69 All	57.78 kit
LHB-988	1970-73 RH	36.99 ea.
LHB-989	1970-73 LH.....	36.99 ea.
LHB-7381	1974-81 LH/RH.....	21.99 ea.

Headlamp Housings

These correct headlight housings attach to the radiator support and hold the headlight components in place. 1967 Rally Sport includes motor plate.

LHH-67SR	1967 Std RH	49.99 ea.
LHH-67SL	1967 Std LH	49.99 ea.
LHH-67RR	1967 RS RH	59.99 ea.
LHH-67RL	1967 RS LH.....	59.99 ea.
LHH-68R	1968 Std RH	49.99 ea.
LHH-68L	1968 Std LH	49.99 ea.
LHH-68RR	1968 RS RH	59.99 ea.
LHH-68RL	1968 RS LH.....	59.99 ea.
LHH-69R	1969 Std RH	49.99 ea.
LHH-69L	1969 Std LH	49.99 ea.
LHH-69RR	1969 RS RH	59.99 ea.
LHH-69RL	1969 RS LH.....	59.99 ea.
LHH-897	1970-73 RH	49.99 ea.
LHH-899	1970-73 LH.....	49.99 ea.



LAMP-KIT67FS



LPH-120KIT



LPH-970K

Parking Lamp Kits

Correct parking lamp assemblies complete with lens, housing and bulb. Kits include one left and one right side assembly.

LAMP-KIT67FS	1967 Standard	125.98 kit
LPH-290K	1967 Rally Sport	127.77 kit
LAMP-KIT68FS	1968 Standard.....	89.98 kit
LPH-350K	1968 Rally Sport.....	109.77 kit
LPH-120KIT	1969 Standard.....	135.98 pr.
LPH-169K	1970-73 Standard.....	189.98 kit
LPH-970K	1970-73 Rally Sport	179.98 kit



LPH-439L

LPH-439R



KC-596

1967 STD Parking Lamp Assembly & Brackets

Complete parking lamp assembly with lens, bulb and socket.

LPH-439L	1967 Std LH	69.99 ea.
LPH-439R	1967 Std RH	69.99 ea.
KC-596	1967 RS Brackets	23.99 pr.
LHS-207	1967 Housing Seals.....	13.99 pr.



LPH-896

1968 STD Parking Lamp Assemblies

Complete parking lamp assembly with clear lens, stainless trim, amber bulb and wire.

LPH-896	1968 Standard.....	49.99 ea.
---------	--------------------	-----------



LPH-120

1969 STD Parking Lamp Assemblies

Complete parking lamp assembly featuring housing, clear lens, amber bulb and wiring with connector. RS trim sold separately.

LPH-120 1969 All 79.99 ea.



LPH-970

LPH-169

1970-73 RS/STD Parking Lamp Assemblies

OE style reproduction parking lamp assembly including the lens, housing, lens gasket, bulb, grommet and wire lead.

LPH-970 1970-73 RS* 99.99 ea.
 LPH-169 1970-73 Std LH 99.99 ea.
 LPH-170 1970-73 Std RH 99.99 ea.
 LPH-7073SK 1970-73 STD LH/RH 149.99 kit

* Correct SAE & Guide Markings



LPH-290L



LPH-290R

1967 RS Parking Lamp Housings

This OE style reproduction housing features the correct color wiring, plug in harness with rubber grommet and bulb.

LPH-290L 1967 RS LH 59.99 ea.
 LPH-290R 1967 RS RH 59.99 ea.



LPH-350L

1968 RS Parking Lamp Housings

OE style reproduction die cast housings with bright white enamel inlay. Includes rubber bumper, bulb, correct color wiring with grommet, crimped harness sleeve and connector.

LPH-350L 1968 LH 49.99 ea.
 LPH-350R 1968 RH 49.99 ea.

Parking Lamp Lenses

If your original housings and wires are okay, we offer replacement lenses so you don't have to replace your whole assembly.



LPL-145

LPL-145 1967 Standard 14.99 ea.



LPL-437

LPL-437 1968 Standard w/ Trim 19.99 ea.



LPL-681

LPL-681 1967-68 Rally Sport 21.99 pr.



LPL-1467



LPT-92

LPL-1467 1969 All 14.99 ea.
 LPT-92 1969 RS Trim 19.99 pr.



LK-332



LPT-393

LK-332 1970-73 Standard 52.99 pr.
 LPT-393 1970-73 Std Trim 48.99 pr.



LPL-70RS

LPL-70RS 1970-73 RS Lens w/ Trim 94.99 ea.



LPL-168



LPT-452

LPL-168 1974-77 All 44.99 ea.
 LPT-452 1974-77 Chrome Trim 26.99 ea.



LPL-683

LPL-913

LPL-683 1978-81 Non Z/28 52.99 ea.
 LPL-913 1978-81 Z/28 59.99 ea.



LG-281

LG-282

Parking Lamp Gaskets

Correct sponge material as original.

LG-281 1967 Standard 6.99 pr.
 LG-282 1968 Standard 6.99 pr.
 LG-227 1967-68 RS 6.99 pr.
 LG-229 1969 All 6.99 pr.
 LG-53 1970-73 Standard 19.99 pr.



LTS-696

Parking Lens Screws

Correct long shaft screws in complete kits.

LTS-11 1967-68 RS All 4pc 7.99 kit
 LTS-16 1969 All 6pc 9.99 kit
 LTS-696 1970-73 Standard 8pc 9.99 kit



DT-2100167



DT-2100267

Digi-Tails LED Parking Light Kits

Enhance your front lights with high intensity LEDs that maximize light output, making your lights safer and brighter.

DT-2100167 1967 Std 109.99 kit
 DT-2100168 1968 Std 109.99 kit
 DT-2100267 1967-68 RS 109.99 kit
 DT-2100169 1969 All 120.99 kit
 DT-2100270 1970-73 RS 120.99 kit

If installing only LED front parking lights, an electronic LED flasher isn't needed. For both LED tail and front lights, two flashers are required. Housing and lenses not included.

ADDICTIVE FLOW

A GROUP UP MOTORS COMPANY



AF-LED1157



AF-LED1157A



AF-LED1156

Addictive Flow LED Turn Signal Bulbs

AF-LED1157 1157 White LED Bulb 9.99 ea.
 AF-LED1157A 1157 Amber LED Bulb 9.99 ea.
 AF-LED1156 1156 White LED Bulb 9.99 ea.

GSS-883



Side Marker Sockets

Correct side marker sockets.

- GSS-883 1968-81 All 6.99 ea.
- GSS-893 1967-92 All Right Angle 5.95 ea.



LPH-120CX

Parking Lamp Harness Clip

Mounts the bumper bracket for standard or RS models.

- LPH-120CX 1969 All 14.99 ea.

DT-200002



Electronic LED Flasher

This electronic LED flasher is recommended for use with LED tail lights and parking lights.

- DT-200002 LED Flasher 2 Prong 21.99 ea.
- DT-200003 LED Flasher 3 Prong 27.99 ea.

ADDICTIVE FLOW
A SUPER BRIGHT LED



AF-LED194R

AF-LED194

Addictive Flow LED Side Marker Bulbs

A simple direct replacement for your side marker light bulb. This LED bulb features 6 super bright LEDs in a 194/T10/160 bulb package. Excellent to increase brightness and reduce heat and power consumption.

- AF-LED194R 194 Red LED Bulb 7.99 ea.
- AF-LED194 194 White LED Bulb 7.99 ea.
- AF-LED194A 194 Amber LED Bulb 7.99 ea.

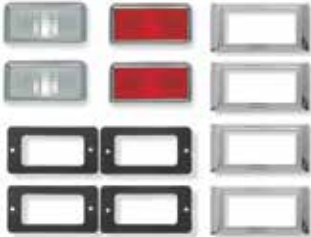

LSM-68K

1968 Side Markers

Our complete side marker kit includes (2) front clear lenses, (2) rear red lenses, (4) chrome bezels and (4) gaskets. Individual components are also available separately.

- LSM-68K Complete 139.41 kit
- LSM-9885 Front Clear Lens 26.99 ea.
- LSM-9916 Rear Red Lens 26.99 ea.
- LSG-X68-INNER Gasket On Lens Inside Fender 6.99 ea.
- LSB-459 Bezel 9.99 ea.
- LSG-X68 Gaskets 4pc 6.99 kit
- CT-826 Rear Template 14.99 ea.

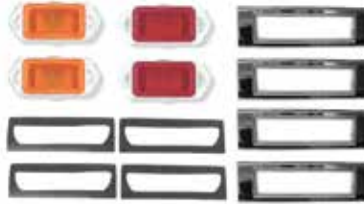

LSM-69K

1969 Side Markers

Our complete side marker kit includes (2) front amber lenses, (2) rear red lenses, (4) chrome bezels and (4) gaskets. Individual components are also available separately.

- LSM-69K Complete 96.21 kit
- LSM-6813 Front Lens 14.99 ea.
- LSM-6847 Rear Lens 14.99 ea.
- LSB-715 Front Bezel 9.99 ea.
- LSB-269 Rear Bezel 9.99 ea.
- LSG-302 Gaskets 4pc 6.99 ea.



LSM-140



LSM-180



LSM-160

1970-78 Side Marker Lenses

Correct reproduction lenses with SAE and Guide lettering.

- LSM-140 1970-77 Front Amber 24.99 ea.
- LSM-180 1978-81 Front Amber 28.99 ea.
- LSM-160 1970-73 Rear Red 24.99 ea.
- TP-A6732 1970-73 Front & Rear 89.99 pr.



LMR-545

1970-81 Side Marker Lamp Retainer

Correct retainer used to hold the side marker lamp assembly to the fender.

- LMR-545 1970-81 All 6.99 ea.



LSB-120

1978-81 Side Marker Lamp Bezel

OE style reproduction side marker lamp bezel.

- LSB-120 1978-81 All 11.99 ea.



LTB-67SK



LTB-68SK

Tail lamp Bezel, And Lens Kits

These kits include, bezels and lenses.

- LTB-67SK 1967 Standard 232.15 kit
- LTB-67RK 1967 RS 206.97 kit
- LTB-68SK 1968 Standard 251.15 kit
- LTB-68RK 1968 RS 225.97 kit

No volume discount.



LTB-7840



LTB-652



LGB-652



1967-68 Tail Light Bezels & Gaskets

Beautiful die cast reproduction tail light bezels featuring bright outer chrome trim and matte black painted inner area as original.

- LTB-7840 1967 All Bezel 189.99 pr.
- LTB-652 1968 All Bezel 189.99 pr.
- LGB-652 1967-68 All Gasket 29.99 pr.

ADDICTIVE FLOW

A GROUP UP MOTORS COMPANY



LTB-7840-BX



LTB-652-BX



LTB-652-BXKR



LTB-652-BXKS

1967-68 Gloss Black Tail Lamp Bezels & Kits

Give the tail panel of your Camaro a modern look without breaking the bank. This pair of beautiful die-cast reproduction bezels feature a durable gloss black finish.

LTB-7840-BX	1967 Black Bezel	219.99 pr.
LTB-652-BX	1968 Black Bezel	219.99 pr.
LTB-652-BXKR	1968 RS Black Bezel w/ Lens	269.95 kit
LTB-652-BXKS	1968 Non RS Black Bezel w/ Lens	295.13 kit

No volume discount.



LBP-088

1967-68 Tail Light Bezel Backing Plates

OE style reproduction stamped steel tail lamp backing plates with text stampings.

LBP-088	1967-68 All	99.99 pr.
---------	-------------	-----------



LTL-392



LTL-193

1967 Standard Brake & Reverse Lens

Correct tail lamp brake and reverse lenses which features the word "Guide".

LTL-392	1967 Brake	16.99 ea.
LTL-193	1967 Reverse	16.99 ea.



LTL-390



LTL-391

1968 Standard Brake Lens

Correct tail lamp brake and reverse lenses which features the word "Guide".

LTL-390	1968 Brake	16.99 ea.
LTL-391	1968 Reverse	16.99 ea.



LTL-118



LTL-130

1967-68 Rally Sport Tail Lens

Correct tail lamp brake lens which features the word "Guide".

LTL-118	1967 Rally Sport	19.99 ea.
LTL-130	1968 Rally Sport	19.99 ea.



LTG-151

1967-68 Tail Lens Gaskets

Correct gaskets to seal the tail lenses to the backing plates.

LTG-151	1967-68	9.99 pr.
LTG-151GM	1967-68 Molded Repro	29.99 pr.



LTK-283K



1969 Standard Tail Lens

Excellent reproduction standard tail lenses which includes the correct stainless trim moldings which separate the three sections.

LTK-283L	1969 Standard LH	69.99 ea.
LTK-283R	1969 Standard RH	69.99 ea.
LTK-283K	1969 Pair	125.98 kit



LTL-114K



1969 Rally Sport Tail Lens

Excellent reproduction Rally Sport tail lenses which includes the correct stainless trim around the outer edge.

LTL-114L	1969 Rally Sport LH	69.99 ea.
LTL-114R	1969 Rally Sport RH	69.99 ea.
LTL-114K	1969 Pair	132.98 kit



LTG-153

1969 Tail Lens Gasket

Used to seal tail lens housing to body and tail lens to housing. Two pairs required per car. Choose from replacement injection molded foam or correct molded reproductions.

LTG-153	Replacement	14.99 pr.
LTG-153GM	Molded Repro	29.99 pr.



LTH-565L

1969 Tail Lamp Housings

OE style reproduction plastic tail lamp housings with correct reflective silver color.

LTH-565L	1969 Std LH	69.99 ea.
LTH-565R	1969 Std RH	69.99 ea.
LTH-6RR	1969 RS LH	69.99 ea.
LTH-6RL	1969 RS RH	69.99 ea.



LSM-777A

1969 Side Marker Nut Set

Eight pal type self threading nuts for side marker post diameters of 3/16 inch.

LSM-777A	1969 All	8.99 ea.
----------	----------	----------



LHK-382

1969 Tail Lamp Stud & Nut Set

This kit contains five screws with nuts to mount one tail lamp housing.

LHK-382	1969 All	21.99 kit
---------	----------	-----------

Note: Two kits required per car.



748809



748810



748811



748812



5973135



5973136 1

1982-92 Lamp lenses & Housings

The lenses are manufactured in high quality injection molded acrylic lens material replicating the original lens design and coloration. The are manufactured from quality injection molded ABS material to original factory specifications for a precise fit and authentic OE appearance.

Lenses Standard

748809	1982-85 LH	351.99 ea.
748810	-85 RH	351.99 ea.
748807	1986-90 LH	362.99 ea.
748808	1986-90 RH	362.99 ea.
Lenses Z28, IROC & RS		
748807	1982-84 LH	362.99 ea.
748808	1982-84 RH	362.99 ea.
748811	1985-92 LH*	373.99 ea.
748812	1985-92 RH*	373.99 ea.

*Correct for 85-92 Z28, 85-90 IROC-Z, and 91-92 RS models.

Housings Standard

5973135	1982-90 LH	109.99 ea.
5973136	1982-90 RH	109.99 ea.

Housings Z28, IROC & RS

5973135	1982-84 LH	109.99 ea.
5973136	1982-84 RH	109.99 ea.
16503125	1985-92 LH	89.99 ea.
16503126	1982-92 RH	89.99 ea.
LTC-R278149	1982-90 Housing Clips 10pc	19.99 set



LTR-530

1970-73 Tail Lamp Kit

Rally sport lenses with a chrome Center Ring.

LTR-530	1970-71 STD 1st Design	169.99 kit
LTR-528	1970-71 RS 1st Design	149.99 kit
LTR-529	1971-73 STD 2nd Design	169.99 set
LTR-531	1971-73 RS 2nd Design	164.99 set



LTH-703R

1970-73 Complete Tail Lamp Housings

OE style set of reproduction complete tail lamp housings to replace your cracked or missing originals.

LTH-703	1970-73 Standard	289.99 set
LTH-703R	1970-73 RS	289.99 set
LTH-K160	1970-73 Housings All	164.99 pr.



LTG-703

1970-73 Tail Lens Gaskets

Correct set of four tail lens gaskets.

LTG-703	1970-73	49.99 set
---------	---------------	-----------



LTR-747FL

LTR-747FR

1974-77 Tail Lamp Lens

Authentic reproduction. Made in USA.

LTR-747FL	1974-77 LH	148.99 ea.
LTR-747FR	1974-77 RH	148.99 ea.



LTG-747FL

LTG-747FR

1974-77 Tail Lamp Gaskets

Correct gaskets. Made in USA.

LTG-747FL	1974-77 LH	36.99 ea.
LTG-747FR	1974-77 RH	36.99 ea.



LTR-313



LTR-777



LTR-259

1978-81 Tail Lamp Lens

OE style reproduction tail lamp lenses for standard/Berlinetta or Z/28. Correct tint as original.

LTR-313	1978-81 Standard LH	180.99 ea.
LTR-314	1978-81 Standard RH	180.99 ea.
LTR-777	1979-81 Berlinetta LH	197.99 ea.
LTR-778	1979-81 Berlinetta RH	197.99 ea.
LTR-259	1978-81 Z/28 LH	179.99 ea.
LTR-260	1978-81 Z/28 RH	179.99 ea.



LTH-5969307



LTH-5969308

1978-81 Tail Lamp Housings

Manufactured in injection molded ABS to original factory specifications for a precise fit and an authentic OE appearance.

LTH-5969307	All LH	111.99 set
LTH-5969308	All RH	111.99 set

No volume discount.



LTG-311



LTG-312



LTG-326



LTG-327

1978-81 Tail Lamp Gaskets

Correct gaskets for sealing your tail lamp housings to the tail panel and tail lenses to tail lens housing.

LTG-312	1978-81 to Housing RH	39.99 ea.
LTG-311	1978-81 to Housing LH	36.99 ea.
LTG-326	1978-81 to Body RH	42.99 ea.
LTG-327	1978-81 to Body LH	42.99 ea.



JSS-C214

1978-81 Tail Lamp Socket Housing Foam Washer Kit

This is a correct 6 piece tail lamp socket housing foam washer kit.

JSS-C214	1978-81	9.99 kit
----------	---------------	----------



JSS-C219

1978-81 Tail Lamp Rear Stud/Wing Nut Kit

This is a correct 24 piece tail lamp stud and wing nut seal kit.

JSS-C219	1978-81 24pc	15.99 kit
----------	--------------------	-----------



GLS-70



GLS-154

Tail Lamp Socket

Correct replacement tail lamp sockets.

GLS-157	1967-68 2 Wire	9.99 ea.
GLS-154	1969-81 3 Wire	11.95 ea.
GLS-70	1969-81 2 Wire Single Element ...	11.95 ea.

ADDICTIVE FLOW

AF-LED1156



Addictive Flow LED Reverse Bulbs

AF-LED1156 1156 White LED Bulb 9.99 ea.



LHA-467L

1967-68 Rally Sport Reverse Lens Housing

OE style reproduction RS backup lamp housings. Housings are polished chrome and include bulb socket with lead and molded boot.

LHA-467L 1967-68 RS LH..... 53.99 ea.
LHA-467R 1967-68 RS RH 53.99 ea.
LHA-467K 1967-68 RS 97.18 kit



LBG-237

1967-68 RS Backup Housing Gasket

Correct die molded neoprene rubber gaskets for sealing back up assembly to tail pan.

LBG-237 1967-68 RS 8.99 pr.



LBS-292

1967-69 RS Backup Lens Screws

OE style reproduction chrome shouldered screws for backup lenses.

LBS-292 1967-68 Rally Sport 4pc 8.99 kit
LTS-11 1969 Rally Sport 4pc 7.99 kit



LBL-81

1967-68 Rally Sport Reverse Lens

Correct clear reverse lens for RS models featuring the word "Guide".

LBL-81 1967-68 RS 10.99 ea.



LBG-284

1967-68 RS Backup Lens Gasket

Correct thick die cut grey rubber for sealing lenses to housings.

LBG-284 1967-68 RS 6.99 pr.



LBG-652

1969 RS Backup Housing Gasket

Correct die molded neoprene rubber gaskets for sealing back up assembly to tail pan.

LBG-652 1969 RS 7.99 pr.



RS Backup Lens Mounting Template

Correct template which shows the correct tail panel hole locations for the RS backup lamp housings.

CT-724 1967-68 RS 39.99 ea.
CT-727 1969 RS 35.99 ea.



LHA-630L

1969 Rally Sport Reverse Lens Housing

Accurate chromed die-cast reproduction with white enamel inlay as original. Includes housing, wiring, rubber boot, grommet, bulb and connector.

LHA-630L 1969 RS LH..... 46.99 ea.
LHA-630R 1969 RS RH 46.99 ea.

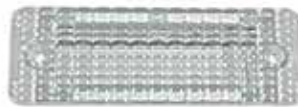

LBL-500

1969 Rally Sport Reverse Lens

Accurate reproduction clear backup lens with correct markings.

LBL-500 1969 Rally Sport 16.99 ea.



LBG-285

1969 RS Backup Lens Gasket

Correct thick die cut grey rubber for sealing lenses to housings.

LBG-285 1969 RS 6.99 pr.



Exterior Bulb Kits

Vehicle specific kits include (2) Stop/Tail/Turn, (2) Reverse, (1) License, (2) Park/Turn Signal, (4) Side Marker (Except 1967).

BULB-67FX 1967 16.99 kit
BULB-71AX 1968 18.99 kit
BULB-69FX 1969-72 18.99 kit
BULB-69AX 1972 18.99 kit

ADDICTIVE FLOW



AF-LED-F67X

AF-LED-F70X-AL

Addictive Flow LED Bulb Kits

These Addictive Flow LED bulb kits contain premium, high-quality replacement for bulbs featuring a stock-style bulb housing with a glass enclosure and LED filament.

AF-LED-F67X 1967 All 39.99 kit
AF-LED-F68X 1968 All 79.99 kit
AF-LED-F69X 1969 All 69.99 kit
AF-LED-F70X-CL 1970-77 Clear Parking Light Bulbs..... 69.99 kit
AF-LED-F70X-AL 1970-77 Amber Parking Light Bulbs..... 69.99 kit

MEH-1576



1967-69 License Plate Lamp

Correct license plate lamps and gaskets.

MEH-1576 1967-69 19.99 ea.
LPL-338 Lens Only 9.99 ea.
LPL-1G Gasket Only 4.99 ea.



LPL-860

1970-73 License Plate Lens

Correct license plate lamp with gasket. *Note: 2 required per car.*

LPL-860 1970-73 17.99 ea.
LPL-7G Gasket Only 7.99 pr.



MEH-703

1970-73 License Lamp Assembly

Correct cadmium plated assemblies.

MEH-703 1970-73 52.99 pr.



LPL-768

1974-77 License Plate Lens

Correct license plate lamp with gasket.

LPL-768 1974-77 30.99 ea.



LPL-7881

1978-81 License Plate Lamp Assembly

LPL-7881 Lens & Housing 18.99 ea.

No volume discount. No bulb or pigtail included.



BULB-67FI

Interior Bulb Kits

Vehicle specific kits include the following bulbs conveniently bagged & labeled.

1967-68

BULB-67FI 1967-6823.99 kit

- (6) Instrument Cluster, (2) Turn Signal Indicator, (1) Oil Pressure Indicator, (1) Headlamp Motor Warning, (1) Temp Indicator, (1) Alternator Indicator, (2) Courtesy Light, (1) Radio, (1) Heater / AC Control, (1) High Beam Indicator, (1) Parking Brake Indicator, (1) Console Lamp, (1) Glovebox Compartment, (1) Underhood Lamp, (1) Dome Lamp

1969

BULB-69FI 196924.99 kit

- (5) Instrument Cluster, (2) Turn Signal Indicator, (1) Oil Pressure Indicator, (1) Temp Indicator, (1) Clock, (1) Alternator Indicator, (1) Map Light, (2) Courtesy Light, (1) Radio, (1) Heater / AC Control, (1) High Beam Indicator, (1) Parking Brake Indicator, (1) Console Lamp, (1) Glovebox Compartment, (1) Underhood Lamp, (1) Trunk Lamp, (1) Dome Lamp

1970

BULB-70FI 1970 21.99 kit

- (3) Instrument Cluster, (2) Turn Signal Indicator, (1) Oil Pressure Indicator, (1) Temp Indicator, (1) Alternator Indicator, (1) Gearshift Indicator, (1) Radio, (1) Radio w/ Tape Player, (1) Heater / AC Control, (1) High Beam Indicator, (1) Parking Brake Indicator, (1) Windshield Washer Indicator, (1) Console Lamp, (1) Glovebox Lamp, (1) Underhood Lamp, (1) Trunk Lamp, (1) Dome Lamp

1971-73

BULB-71FI 1971-7324.99 kit

- (3) Instrument Cluster, (2) Turn Signal Indicator, (1) Oil Pressure Indicator, (1) Temp Indicator, (1) Map Light, (2) Gearshift Indicator, (1) Radio w/ Tape Player, (1) Heater w/ AC Control, (1) High Beam Indicator, (1) Windshield Washer Indicator, (1) Console Lamp, (1) Glovebox Compartment, (1) Underhood Lamp, (1) Trunk Lamp, (1) Dome Lamp



IHQ-0117



ICE-0351

Dome Light Lens Bezel

New plastic molded chrome plated as original.

IHQ-0117 1967-69 Coupe 11.99 ea.
ICE-0351 1970-81 Coupe12.99 ea.



INQ-0203



ICE-2777

Dome Light Lenses

Correct white plastic lenses.

INQ-0203 1967-69 Coupe7.99 ea.
ICE-2777 1970-81 Coupe 5.99 ea.
ICE-2789 1982-92 Coupe10.99 ea.
AF-LED211 211-2 White LED Bulb 6.99 ea.



IHQ-0117K

Dome Lamp Kit

Complete kit with new plastic molded and chrome plated dome light lens bezel, lens, bulb, terminals and harness extension.

IHQ-0117K 1967-69 All35.99 kit
ICE-0351K 1970-81 All36.96 kit



IHQ-0117K-LED



ICE-0351K-LED

LED Dome Lamp Kits

Led dome lamp kit with a direct replacement LED dome light bulb

IHQ-0117K-LED 1967-69 Coupe46.99 kit
ICE-0351K-LED 1970-81 w/o T-Tops 44.99 kit
No volume discount.



AMH-15

Underhood Lamp

Complete with bracket, hardware, harness and built-in switch.

AMH-15 All72.99 kit



LPL-935

LPL-936

1982-92 License Plate Lamp Lens

The correct lens for the license plate lamp assembly.

1982-86 Berlinetta, 1982-84 Sport Coupe and Z/28,

1985-90 All models except Z/28

LPL-935 LH21.99 ea.
LPL-936 RH21.99 ea.

1985-90 Z/28, 1991-92 All

LPL-015 LH 24.99 ea.
LPL-016 RH 24.99 ea.



GPS-558

License Plate Socket

Correct socket for license plate bulb.

GPS-558 1967-69 All 4.95 ea.



AF-LED194R

AF-LED194A

Addictive Flow LED Side Marker Bulbs

A simple direct replacement for your original 194 style side marker light bulbs. Excellent to increase brightness and reduce heat and power.

AF-LED194R 194 Red LED Bulb7.99 ea.
AF-LED194 194 White LED Bulb7.99 ea.
AF-LED194A 194 Amber LED Bulb7.99 ea.

Note: Also can be used for side marker or dash.



I-2194A

1967 Quarter Dome Lamp Kit

Complete quarter dome light kit for 1967 deluxe interior including lenses, bezels, sockets and bulbs for a complete replacement.

I-2194A 1967 w/ Deluxe Interior68.99 kit



BUY & SAVE
WITH SS396.COM PRE-BUILT KITS



LCK-69F

Complete Lock Sets

Our lock kits come complete with ignition and doors keyed alike and glove box and trunk keyed alike just as original. We also include all necessary hardware for a complete job.

LCK-67F	1967 All.....	68.38 kit
LCK-67FR	1967 w/ Repr Tail Panel*	68.38 kit
LCK-68F	1968 All.....	67.48 kit
LCK-69F	1969 All.....	66.58 kit
LCK-70F	1970-73 All.....	81.88 kit

*If the rear panel on your 1967 was ever replaced with GM part #7710985 or a reproduction, use this kit.



LID-69-0E

Concourse Lock Sets

This is a complete ignition and door lock set which includes OEM lock cylinders, keys, clips and gaskets. These concourse correct lock sets are accepted by most judges as original. The keys have the correct knockouts and the code stamped into the key.

LID-67-0E	1967	69.99 kit
LID-68-0E	1968	69.99 kit
LID-69-0E	1969	69.99 kit



LGT-67F

Glove Box & Trunk Locks

Brand new lock cylinders and "keyed" alike keys complete with correct attaching clips and gaskets.

LGT-67F	1967 All	35.99 kit
LGT-67	1967-68 Round Keys.....	26.99 kit
LGT-68F-0E	1967-68 Pear Keys w/ Knock Out	32.99 kit
LGT-68F	1968 All	35.99 kit
LGT-69F	1969 All	35.99 kit
LGT-70F	1970-73 All	46.99 kit
LGT-74F	1974-77 All	32.99 kit
LGT-79F	1978-81 All	39.99 kit

If the rear panel on your 1967 was ever replaced with GM part #7710985 or a reproduction, use 1968 trunk lock.



LG-67-0E

Glove Box Lock Sets

Brand new glove box lock sets.

LG-67-0E	1967-68 Pear Keys w/ Knock Out	22.99 kit
LG-67SK	1967-68 Round Keys w/ Knock Out	18.99 kit
LG-69-0E	1969 Round Keys w/ Knock Out	17.99 kit
LG-70-0E	1970-81 Round Keys w/ Knock Out	17.99 kit
LGC-6881	1969-81 Lock Casing Only.....	11.99 kit



LI-68-0E



LI-83-0E

Ignition Lock Sets

Brand new ignition lock sets. Comes with extra key.

LI-670E	1967 0E Octagon w/ Knockout	15.99 kit
LI-67SK	1967 Square Keys w/ Knock Out	13.99 kit
LI-68-0E	1968 Pear Keys w/ Knock Out	21.99 kit
LI-68SK	1968 Square Keys	19.99 kit
LI-69-0E	1969-78 Square Keys	22.99 kit
LI-69-0EKO	1969-78 Square Keys w/ Knock Out	44.99 kit
LI-79-0E	1979-89 Square Keys	22.99 kit
LI-83-0E	1983-88 Square Keys w/ Knock Out	32.99 kit



LID-69F

Ignition & Door Locks

Brand new lock cylinders and "keyed" alike keys complete with correct attaching clips and gaskets.

LID-67F	1967 All	39.99 kit
LID-67SK	1967 Square Key	36.99 kit
LID-67X	1967 Replacement Style Square Key	28.99 kit
LID-68F	1968 All	38.99 kit
LID-68SK	1968 Square Key	34.99 kit
LID-69F	1969- early 1970*	39.99 kit
LID-70F	1970-78 All	43.99 kit
LID-79F	1979-81 All	36.99 kit
LID-83F	1983-84 Round Keys w/ Black Ign.....	54.99 kit
LID-85F	1985-88 Round Keys w/ Black Ign.....	63.99 kit

*With short cylinder



LCK-67IDGT-RP

Ignition, Door, Glove Box & Trunk Lock Sets

Brand new ignition, door, glove box and trunk lock cylinders keyed alike.

LCK-X667IDGT	1967 Octagon Keys w/ Knock Out.....	62.99 kit
LCK-67IDGT-RP	1967* Octagon Keys w/ Knock Out.....	62.99 kit
LCK-68IDGTX	1968 Octagon Keys w/ Knock Out.....	62.99 kit
LCK-69IDGTX	1969 Square Keys	64.99 kit

*With horizontal trunk lock.



LD-70-0E

Door Lock Sets

Brand new door lock sets.

LDL-XG2A	1967-69 Octagon Key	22.99 kit
LDL-XG2RK	1967-69 Round Key	20.99 kit
LDL-XG2SK	1967-69 Square Key	18.99 kit
LD-70-0E	1970-78 Round Keys	28.99 kit
LD-79-0E	1979-81 Round Keys	24.99 kit
LD-86BC	1986-92 Round Keys w/ Black Cap	23.99 kit
LD-93SK	1993-01 Round Keys w/ Black Cap.....	38.99 kit



LDGT-68

Door, Glove Box, & Trunk Lock Sets

Brand new door, glove box and trunk lock cylinders keyed alike.

LDGT-68	1968 Round Keys	39.99 kit
LDGT-68-0E	1968 Pear Keys w/ Knock Out	42.99 kit
LDGT-69-0E	1969 Round Keys	40.99 kit
LDGT-78	1978 Round Keys w/ Knock Out.....	64.99 kit



LDT-689

Door & Trunk Lock Sets

Brand new door and trunk lock cylinders keyed alike.

LDT-X62	1967 Pearhead Key w/ Knock Out.....	29.99 kit
LDT-X69	1967 Round Key w/ Knock Out.....	28.99 kit
LDT-689	1968-69 Round Key	24.99 kit
LDT-678-0E	1968 Pear Keys w/ Knock Out	35.99 kit
LDT-70-LS	1970-73 Round Key	49.99 kit
LDT-70-SS	1970-73 Round Key Long Cylinder	42.99 kit
LDT-74	1974-77 Round Key	44.99 kit
LDT-78	1978 Round Key	42.99 kit
LDT-79	1979-81 Round Key	44.99 kit
LDT-70B	1970-73 Round Key Black Bezels.....	59.99 kit
LDT-74B	1974-77 Round Key Black Bezels.....	58.99 kit
LDT-79B	1979-81 Round Key Black Bezels.....	56.99 kit
LDT-86	1986-92* Round Key	44.99 kit
LDT-93	1993-01 Round Key	69.99 kit

*Fits cars with power hatch trunk only.

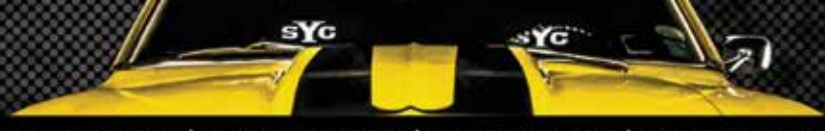

LP-1100



LPC-7

Door Lock Pawls

Correct bracket that attaches to the end tip of the door lock cylinder. The pawl trips the inner door latch assembly to open the door.

LP-1100	1967-78 RH Short Cylinder	6.99 ea.
LP-1101	1967-78 LH Short Cylinder	6.99 ea.
LP-1102	1970-78 RH Long Cylinder	6.99 ea.
LP-1103	1970-78 LH Long Cylinder	6.99 ea.
LP-1104	1979-81 RH	6.99 ea.
LP-1105	1979-81 LH	6.99 ea.
LPC-7	1967-81 All Door Lock Pawl Clip	1.99 pr.



ICF-4411



IFF-401

Door Lock Knobs & Ferrules

OE style reproduction door lock knobs & ferrules.

ICF-4411	1967 Chrome Knob.....	5.99 ea.
IFF-401	1967 Ferrule	6.99 pr.
ICE-6400	1968-81 Chrome Knob.....	2.99 ea.
IFF-600	1968-69 All Ferrule.....	5.99 ea.
IFF-700	1968-81 All Ferrule	5.99 ea.



RDR-67FL



RDR-67FR

Door Opening Rod Assembly

Complete door opening rod assembly with plated rod, anti-rattle sleeve, center guide and end clip.

RDR-67FL	1967 All LH.....	17.99 ea.
RDR-67FR	1967 All RH	17.99 ea.
RDR-68F	1968-69 LH & RH	17.99 ea.
RLR-070L	1970-81 LH.....	17.99 ea.
RLR-070R	1970-81 RH	18.99 ea.



RLR-068

Inner Door Lock Rod

Plated inner door lock rod with threaded end for inner lock knob. Inner end of rod attaches to door latch mechanism actuator arm with clip (sold separately).

RLR-068	1967 All LH & RH	9.99 ea.
RLR-069	1968 All LH & RH.....	9.99 ea.



REC-070B

Door Opening Rod End Clips

Spring steel retaining clips attach the door opening rod to the door opening mechanism and the inner door lock rod end to the latch mechanism.

REC-070B	1967-69 All	4.99 pr.
----------	-------------------	----------



RLR-066

Inner Door Lock Rod & Bellcrank

Plated and threaded inner door lock rod with attached bellcrank.

RLR-066	1969 All LH & RH.....	15.99 ea.
RLR-062	1970-81 All LH & RH	17.99 ea.
RLR-CLIP	1967-69 Anti Rattle Clip.....	4.99 ea.



RBR-067

Bellcrank Retainer

Two required to mount one bellcrank to door frame. 2 per door.

RBR-067	1969 All	6.99 ea.
---------	----------------	----------



RRI-11360

Door Rod Insulators

This is a set of two correct door lock rod insulator shields which protect the long door opening rods in the doors.

RRI-11360	1967-69.....	8.99 set
-----------	--------------	----------



RRH-074

Door Handle Rod

Plated reproduction needed to connect outer door handle to door opening mechanism. Fits RH or LH door.

RRH-074	1970-81 All.....	9.99 ea.
---------	------------------	----------



RDL-70FL

Door Latch Assemblies

OE style reproduction door latch assemblies.

RDL-67FL	1967 All LH.....	79.99 ea.
RDL-67FR	1967 All RH	79.99 ea.
RDL-67FK	1967 All LH/RH.....	143.98 kit
RDL-68FL	1968 All LH.....	79.99 ea.
RDL-68FR	1968 All RH	79.99 ea.
RDL-68FK	1968 All LH/RH	143.98 kit
RDL-69FL	1969 All LH.....	79.99 ea.
RDL-69FR	1969 All RH	79.99 ea.
RDL-69FK	1969 All LH/RH	143.98 kit
RDL-70FL	1970-81 All LH.....	79.99 ea.
RDL-70FR	1970-81 All RH.....	79.99 ea.
RDL-70FK	1970-81 All LH/RH.....	143.98 pr.
RDL-SCREW	1967-81 All (Set of 3)*	6.95 set
RDL-828L	1982-87 LH	76.99 ea.
RDL-828R	1982-87 RH	76.99 ea.

*Note: Does one door.



LTL-67K-0E

Trunk Lock Sets

Brand new trunk lock sets. Comes with extra key.

LT-67B-RD	1967-69 Round Keys.....	18.99 kit
LTL-67K-0E	1967-68 Pear Keys w/ Knock Out	17.99 kit
LT-67-0E	1967-69 Pear Keys w/ Knock Out	18.99 kit
LT-67RD	1967-69 Round Keys.....	15.99 kit
LT-70-0E	1970-73 Round Keys.....	29.99 kit
LT-74-0E	1974-77 Round Keys w/ Knock Out	23.99 kit
LT-78-0E	1978-81 Round Keys w/ Knock Out	26.99 kit
LT-86-0E	1986-92 Round Keys w/ Knock Out	19.99 kit
LT-93-0E	1993-01 Round Keys w/ Knock Out ...	28.99 kit



LLB-628



LLG-946

Trunk Lock Bezel & Gasket

OE style reproduction chrome lock bezel and gasket.

LLB-628	1970-73 Bezel.....	34.99 ea.
LLG-946	1970-73 Gasket.....	17.99 ea.



TLR-458

Trunk Lock Rods

Correct rod/shaft that connects the cylinder to the lock assembly.

TLR-458	1967-77 All.....	3.99 ea.
---------	------------------	----------



LTB-90

Door/Trunk Lock Bracket

Correct bracket for retaining lock cylinder in place.

LTB-90	1967-81 All.....	2.69 ea.
--------	------------------	----------



LTR-1

Trunk Lock Retainer

OE style reproduction of this hard to find bracket.

LTR-1	1967-68 All	22.99 ea.
LTR-3	1969 All	23.99 ea.



RTL-1019



RTL-7081

Trunk Lid Latch

Correct locking latch which installs inside the trunk lid.

RTL-1019	1967-69 All	29.95 ea.
RTL-7081	1970-81 All.....	26.99 ea.



TG-3902



TQ-626



TQ-384



TQ-125

Standard Grille Emblems

High quality replacement grille emblems for your standard Camaro.

TG-3902	1967	39.99 ea.
TG-626	1968	29.95 ea.
TQ-125	1969	49.99 ea.
TG-6840	1974	68.99 ea.
TQ-384	1980-81	44.99 ea.



TC-6715



TK-249



TK-6870



TK-6873

RS Grille Emblems

High quality replacement grille emblems for your Rally Sport Camaro.

TC-6715	1967-68	23.95 ea.
TT-599	1968 RS/SS SS396	49.99 ea.
TQ-249	1969	26.99 ea.
TK-6870	1980-81 RS Silver & Red	45.99 ea.
TK-6873	1980-81 RS Gold & Red	40.99 ea.



T-12SSW



T-12SSR



T-ZL1

5th Gen Camaro Emblems

These peel & stick factory GM emblems can be applied to any vintage muscle car for a powerful modern look.

T-12SSW	SS White	37.99 ea.
T-12SSR	SS Red	39.99 ea.
T-ZL1	ZL1	49.99 ea.



TK-8002



TT-599

TK-6767

SS Grille Emblems

High quality replacement grille emblems for your Super Sport Camaro.

TK-8003	1967-68 All RS/SS Grille	29.99 ea.
TK-8002	1967 SS350	29.99 ea.
TT-599	1967 SS396 RS/SS All	49.99 ea.
TG-015	1968 SS	33.99 ea.
TG-921	1969-71 SS	32.99 ea.
TQ-149	1969 SS w/ RS Grille	32.99 ea.
TG-015	1972 SS	33.99 ea.
TK-6717	"SS427" 1967 Std, 1967-68 RS	87.99 ea.
TK-6743	"SS427" 1968 Std	92.99 ea.
TT-6742	"SS396" 1968 Std	39.99 ea.
TT-6766	"SS396" 1969 Std	89.99 ea.
TK-6767	"SS427" 1969 Std	92.99 ea.
TK-6769	"SS427" 1969 RS	92.99 ea.



TK-359



TK-357



TK-361



TC-6820



TC-7173



THP-6843



THP-6844

Header Panel Emblems

High quality replacement header panel emblems.

TQ-359	1967 Chevrolet Script	14.99 ea.
TQ-357	1967 Camaro	12.99 ea.
TQ-361	1968-69 Camaro	18.99 ea.
TC-6820	1970 C Script	24.99 ea.
TC-7173	1971-73 C Script	54.99 ea.
THP-6843	1975-77 Red, White, Blue	79.99 ea.
THP-6844	1975-77 Orange, Black, Red	79.99 ea.



TG-567



TG-496

Hood Emblems

TG-567	1969 Cowl Induction	36.99 kit
TG-496	1969 302	19.99 ea.



TK-8001

Z/28 Grille Emblems

High quality replacement grille emblems for your Z/28 Camaro.

TK-8001	1969 Z/28	38.99 ea.
TK-239	1970-71 Z/28	42.99 ea.
TK-6823	1972-73 Z/28	52.99 ea.



TK-78BL



TK-786LD



TK-78GR



TK-78OR

1978 Z/28 Grille Emblem

Correct GM licensed reproduction of the hard to find 1978 only Z/28 grille emblem. Includes factory style brace plate and fasteners.

TK-78BL	1978 Blue	90.99 ea.
TK-786LD	1978 Gold	90.99 ea.
TK-78GR	1978 Green	90.99 ea.
TK-78OR	1978 Orange	90.99 ea.
TK-78YL	1978 Yellow	90.99 ea.



TK-6880

1980-81 Z/28 Grille Emblems

Authentic emblem made of a black ABS back plate and clear UV stabilized acrylic front plate that is back painted the original tri-colors.

TK-6880	1980-81 Silver	74.99 ea.
TK-6881	1980-81 Charcoal	74.99 ea.
TK-6882	1980-81 Blue	74.99 ea.
TK-6883	1980-81 Green	74.99 ea.
TK-6884	1980-81 Gold	74.99 ea.
TK-6885	1980-81 Red	69.99 ea.
TK-6886	1980-81 Orange	74.99 ea.



TR-78LT

1978 Type LT Grille Emblem

Features correct script and colors as original and replaces GM number 468595.

TR-78LT	1978 LT	59.99 ea.
---------	---------	-----------

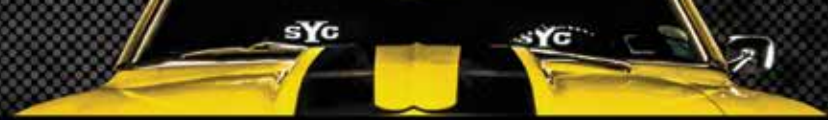

TG-834

TG-058



TT-1430



TQ-246



TQ-247



TD-488



TQ-410



TQ-355



TQ-356



TQ-409



TQ-427



TG-6831

Fender Engine Emblems

TG-834	1967 327	14.99 ea.
TG-058	1967 350	14.99 ea.
TT-1430	1967 396 Turbo Jet	44.99 pr.
TT-427	1967 427 Turbo Jet	39.99 ea.
TQ-246	1968 327	31.99 pr.
TQ-247	1968 350	29.99 pr.
TD-488	1968 396	32.99 pr.
TQ-410	1969 307	29.99 pr.
TQ-355	1969 327	29.99 pr.
TQ-356	1969 350	32.99 pr.
TQ-409	1969 396	34.99 pr.
TQ-427	1969 427	24.99 ea.
TG-5469	1969 454	64.99 pr.
TG-6831	1970-75 350	24.99 ea.
TG-6830	1970-72 396	53.99 pr.

camaro

TQ-358



TG-318



TQ-190



TG-718



TQ-362



TQ-360



TQ-251



Fender Model Emblems

OE style reproduction fender model emblems which designate standard, SS, RS or Z/28.

TQ-358	1967 All Camaro	16.99 ea.
TQ-358K	1967 All Camaro 2pc	30.58 kit
TG-318	1967 V Flags	15.99 ea.
TG-718K	1967 SS 4pc	27.18 kit
TQ-190	1967 RS	13.99 ea.
TG-718	1967 SS	15.99 pr.
TQ-362	1968-69 Camaro Script	19.99 ea.
TQ-362K	1968-69 All Camaro 2pc	35.98 kit
TQ-360	1968 Rally Sport	21.99 ea.
TQ-251	1968 SS	39.99 pr.
TG-045	1968 Z/28	34.99 ea.
TG-633	1969 Rally Sport	36.99 ea.
TQ-69SS	1969-72 SS (one side)	22.99 pr.
TQ-69SSB	1969 SS Black	70.99 pr.
TQ-69SSR	1969 SS Red	69.99 pr.
TG-935	1969 Z/28	35.99 ea.
TG-310	1970-74 Camaro	26.99 ea.
TG-852	1970-73 Rally Sport	36.99 ea.
TG-956	1970-74 Z/28 Peel N Stick	44.99 ea.
TG-956-PIN	1970-74 w/ Mounting Pins	42.99 ea.
TG-798	1975-77 Camaro	29.99 ea.
TG-580	1978-81 Camaro	42.99 ea.
TQ-773-PS	Universal Chrome Peel N Stick ..	23.99 pr.



TG-045

rally-sport

TG-633



TG-935



TG-310

RALLY SPORT

TG-852



TG-956



TG-798



TG-580



TQ-69SS



TQ-69SSB



TQ-69SSR



TQ-359

TQ-361



TQ-357



TQ-361A

TG-701

Trunk Lid Emblems

OE style reproduction emblems for your trunk lid.

TQ-359	1967 Chevrolet Script	14.99 ea.
TQ-357	1967 Camaro	12.99 ea.
TQ-361	1968-69 Camaro	18.99 ea.
TQ-361A	1970 Camaro	28.99 ea.
TG-701	1971-73 Camaro	49.99 ea.
TTE-6838	1975-77 Red, White, Blue	71.99 ea.
TTE-6839	1975-77 Orange, Black, Red	71.99 ea.



TQ-69B

TQ-250



TQ-393

TC-6725



TG-333

TR-74LT

Rear Panel Emblems

OE style reproduction emblems for your rear panel.

TQ-69B	1969 Bowtie	29.99 ea.
TQ-250	1969 RS	29.99 ea.
TQ-393	1969 SS	24.99 ea.
TC-6725	1969 SS396	94.99 ea.
TG-333	1969 Z/28	41.99 ea.
TC-6726	1969 SS427	94.99 ea.
TR-74LT	1974 LT	49.99 ea.



TR-LT-RP

1974-76 Type LT Roof / Rear Panel Emblem

Features correct 1695874 casting number on back.

TR-LT-RP	1974-76 Type LT	59.99 ea.
----------	-----------------	-----------



TG-889

1970-73 Spoiler Emblem

OE style reproduction Z/28 spoiler emblem.

TG-889	1970-73 Z/28	42.99 ea.
HZ-28	1970-73 Z/28 Decal	14.99 ea.



TF-455

TF-557

TF-456

Fuel Door Emblems

OE style reproduction fuel door emblems featuring correct colors.

TF-455	1978-79 All	64.99 ea.
TF-557	1980-81 Berlinetta	69.99 ea.
TF-456	1980-81 w/o Berlinetta	74.99 ea.



TF-78BL

TF-78GLD



TF-78GR

TF-78OR

1978 Z/28 Fuel Door Emblems

Correct GM licensed reproduction of the hard to find 1978 only Z/28 fuel door emblem.

TF-78BL	1978 Blue	49.95 ea.
TF-78GLD	1978 Gold	49.95 ea.
TF-78GR	1978 Green	49.95 ea.
TF-78OR	1978 Orange	49.95 ea.



TF-803

TF-804



TF-805

TF-806



TF-807

TF-808



TF-809

1980-81 Z/28 Fuel Door Emblems

OE style reproduction of the original Z/28 fuel door emblems in the correct colors.

TF-803	Silver	59.99 ea.
TF-804	Charcoal	59.99 ea.
TF-805	Blue	62.99 ea.
TF-806	Green	59.99 ea.
TF-807	Gold	59.99 ea.
TF-808	Red	59.99 ea.
TF-809	Orange	59.99 ea.



DH1018

Dick Harrell Emblem

This universal Diecast emblem is perfect for custom projects.

DH1018	All	64.99 ea.
--------	-----	-----------



TK-8013



TK-8013-C



TK-678

Yenko Emblems

Correct Yenko and 427 emblems which are perfect for an original or recreation.

TK-8013	Yenko OE White	29.99 ea.
TK-8013-C	Yenko Chrome	49.99 ea.
TK-678	427	32.99 ea.



TG-502

Universal Cross Flag Emblems

These universal cross flag emblems can be mounted anywhere on your car for a nice custom touch while still looking vintage. Universal. Measures 2-7/8" x 4-1/2" with 3 pins on back.

TG-454	454	49.99 ea.
TG-502	502	49.99 ea.
TG-572	572	54.99 ea.



TK-427

427 Super Car Emblem

This emblem (GM number 3901932) was originally used on 1967 427 Impalas but it was also used by super car dealers on a lot of their conversions on fenders, hoods and trunk lids. Baldwin Motion used these emblems on the fenders of their super cars.

TK-427	All	21.99 ea.
--------	-----	-----------



TK-SS427

Baldwin Motion SS427 Emblem

This emblem (GM number 7752254) was originally used on the deck lid of 1968 427 Impalas but it was also used by super car dealers on a lot of their conversions on fenders, hoods and trunk lids. Baldwin Motion often used these emblems on the valve covers of their super cars.

TK-SS427	All	39.99 ea.
----------	-----	-----------



TK-MOTION

Motion Emblem

This universal Baldwin Motion die-cast emblem is perfect for custom projects.

TK-MOTION	All	69.99 ea.
-----------	-----	-----------



1967-69 Z/28 Stripes

Stencil kits includes front and rear stencils with (1) 9/32" x 37.5' roll of stripe masking, squeegee and instructions. Stripe kit includes front and rear vinyl stripes w/ squeegee & instructions.

Stencil Kits

MSS-0687	1967-6869.99 kit
MSS-0688	196969.99 kit

Stripe Kits w/o Cowl Induction

MSS-0687W	1967-68 White221.99 kit
MSS-0687B	1967-68 Black221.99 kit
MSS-0687MB	1967-68 Matte Black221.99 kit
MSS-692W	1969 White221.99 kit
MSS-692B	1969 Black221.99 kit
MSS-692MB	1969 Matte Black221.99 kit
MSS-692O	1969 Orange221.99 kit

Stripe Kits w/ Cowl Induction

MSS-692WC	1969 White221.99 kit
MSS-692BC	1969 Black221.99 kit
MSS-692MBC	1969 Matte Black221.99 kit
MSS-692OC	1969 Orange221.99 kit

Note: For 1967-68 with spoiler, use 1969 kit.



1970-73 Z/28 Stripes

This kit contains everything you need to paint Z/28 stripes on your 1970-73 Camaro! Kit includes: (2) front header panel stencils, (2) front upper hood stencils, (2) rear deck lid and spoiler stencils, (1) 9/32" x 50' roll of stripe masking, squeegee and instructions.

MSS-0008	1970 Low Spoiler69.99 kit
MSS-0011	1970 Low Spoiler RS64.95 kit
MSS-0009	1970-72 High Spoiler64.95 kit
MSS-0010	1970-72 High Spoiler RS64.95 kit
MSS-0008	1973 High Spoiler69.99 kit
MSS-0011	1973 High Spoiler RS64.95 kit



1974 Z/28 Stripes

Includes (1) hood decal, (1) rear deck panel decal, (1) rear spoiler decal, squeegee and instructions.

MSS-1974Z	1974 Z/28309.99 kit
-----------	-----------	-----------------



1975-77 Rally Sport Stripes

Includes (2) Rally Sport fender names, (1) Rally Sport spoiler name, (2) fender stripes, (2) door stripes, (1) oval roof stripe, (3) rear spoiler stripes, squeegee and instructions.

MSS-75RS6	Dark Gray/ Medium Gray/Light Gray234.99 kit
MSS-75RS0	Red/Orange/Light Orange234.99 kit
MSS-75RSY	Orange/Yellow-Orange/Yellow234.99 kit
MSS-75RSR	Dark Red/ Medium Red/Light Red234.99 kit
MSS-75RSB1	Dark Blue/ Medium Blue/Light Blue234.99 kit
MSS-75RSB2	Dark Blue/ Medium Blue/Light Blue234.99 kit
MSS-75RSS	Dark Silver/ Medium Silver/Light Silver234.99 kit

MSS-75RSB1 is for 1975-76. MSS-75RSB2 is for 1977.



1977 Z/28 Stripes

Includes (1) hood decal, (2) front valance panel stripes, (2) front fender stripes, (2) door stripes, (2) rear quarter panel stripes, (3) rear spoiler stripes, (2) rear end panel stripes, squeegee and instructions.

MSS-77ZG	Brown/Gold296.99 kit
<i>(For black, brown, orange and white cars.)</i>		
MSS-77ZR	Red/Orange296.99 kit
<i>(With hollow names for silver and white cars.)</i>		
MSS-77ZR2	Red/Orange296.99 kit
<i>(With solid names for black and red cars.)</i>		
MSS-77ZY	Orange/Yellow296.99 kit
<i>(For yellow cars.)</i>		



1978-79 RS Stripes

Includes (2) Rally Sport Camaro fender names, (1) Rally Sport spoiler name, (1) front bumper stripe (1979), (2) front fender stripes, (2) door stripes, (1) oval roof stripe, (3) rear spoiler stripes, squeegee and instructions.

MSS-7879RS-BROWN	Medium Brown/ Dark Brown/Apricot234.99 kit
MSS-7879RS-RED	Orange/Dark Red/Gold234.99 kit
MSS-7879RS-BLUE	Medium Blue/ Dark Blue/Silver234.99 kit
MSS-7879RS-YELLOW	Medium Yellow/ Dark Yellow/Light Yellow234.99 kit
MSS-7879RS-GREEN	Medium Green/ Dark Green/Light Green234.99 kit



1978 Z/28 Stripes

Includes (1) inner hood decal, (1) outer hood decal, (1) front valance panel stripe, (2) front fender extension stripes, (2) front fender stripes, (2) door stripes, (2) rear quarter panel stripes, (3) rear spoiler stripes, squeegee and instructions. Also included are (3) fender Z/28 names in hollow or solid lettering.

MSS-78ZG1	Dark Gold w/ Hollow Names296.99 kit
MSS-78ZG2	Dark Gold w/ Solid Names296.99 kit
MSS-78ZR1	Red/Orange w/ Hollow Names296.99 kit
MSS-78ZR2	Red/Orange w/ Solid Names296.99 kit
MSS-78ZB1	Dark Blue/Blue w/ Hollow Names296.99 kit
MSS-78ZB2	Dark Blue/Blue w/ Solid Names296.99 kit
MSS-78GZ1	Light Green/Green w/ Hollow Names296.99 kit
MSS-78GZ2	Light Green/Green w/ Solid Names296.99 kit
MSS-78ZY	Yellow296.99 kit



1979 Z/28 Stripes

Includes (2) large front door stripes, (2) front fender stripes, (2) front air deflector stripes, (1) front air dam stripe, (3) rear spoiler stripes, (1) inner hood decal, (1) outer hood decal, (1) front header panel Z/28 logo, squeegee and instructions.

MSS-79Z	Light Gold/Dark Gold289.99 kit
MSS-79ZB	Light Blue/Dark Blue299.99 kit
MSS-79ZG	Light Green/Dark Green296.99 kit
MSS-79ZO	Orange/Yellow Orange299.99 kit
MSS-79ZR	Red/Orange296.99 kit
MSS-79ZS	Silver/Charcoal296.99 kit



1980-81 Z/28 Stripes

Includes (2) large front door stripes, (2) front fender stripes, (2) front air deflector stripes, (1) front air dam stripe, (3) rear spoiler stripes, (1) large hood decal, (2) air induction decals, squeegee and instructions.

MSS-8081ZSLV	Light Silver/Medium Silver/ Charcoal296.99 kit
MSS-8081ZGLD	Light Gold/Medium Gold/ Dark Gold296.99 kit
MSS-8081ZRED	Light Red/Medium Red/ Dark Red296.99 kit
MSS-8081ZBLU	Light Blue/Medium Blue/ Dark Blue299.99 kit
MSS-8081ZORG	Light Orange/Dark Orange/ Red296.99 kit
MSS-8081ZGRN	Light Green/Medium Green/ Dark Green296.99 kit



1982-84 Z/28 Stripes

Includes: (2) hood blackout decals, (2) front bumper stripes, (2) front fender stripes, (2) door stripes, (2) rear quarter panel stripes, (2) rear bumper stripes, squeegee and instructions.

MSS-8284Z-GOLDA	1982 Gold	208.99 kit
MSS-8284Z-GOLDB	1983-84 Gold	208.99 kit
MSS-8284Z-SILVER	1982-84 Silver	208.99 kit
MSS-8284Z-CHARCOAL	1982-84 Charcoal	208.99 kit
MSS-8284Z-ORANGE	1982-84 Orange	208.99 kit
MSS-8284Z-MAROON	1982-84 Maroon	208.99 kit
MSS-8284Z-BLUE	1982 Blue	208.99 kit
MSS-8284Z-BLUEMETA	1982 Metallic Blue	208.99 kit
MSS-8284Z-BLUEMETB	1983-84 Metallic Blue ...	208.99 kit



1985-87 IROC-Z Stripes

Includes all lower body side stripes for: front bumper, front fenders, doors, rear quarter panels and rear bumper, 2 IROC-Z door names, squeegee and instructions.

Kits w/ Rolled Decals

MSS-8587IZ-GOLD	1985-87 Gold	153.99 kit
MSS-8587IZ-SILVER	1985-87 Silver	153.99 kit
MSS-8587IZ-RED	1985-87 Red	153.99 kit

Pre-Molded Decals

MSS-8587IZP-GOLD	1985-87 Gold	241.99 kit
MSS-8587IZP-SILVER	1985-87 Silver	241.99 kit
MSS-8587IZP-RED	1985-87 Red	241.99 kit



1988-90 IROC-Z Stripes

Includes: (2) front end stripes, (2) side body stripes, (2) rear end stripes, (2) IROC-Z door names, squeegee and instructions.

MSS-8890IZ-GOLD	1988-90 Gold	241.99 kit
MSS-8890IZ-SILVER	1988-90 Silver	241.99 kit
MSS-8890IZ-RED	1988-90 Red	241.99 kit
MSS-8890IZ-BLUE	1988-90 Blue	241.99 kit
MSS-8890IZ-YELLOW	1988-90 Yellow/Silver ...	241.99 kit



1991-92 Heritage

Includes: (2) front hood/cowl stripes, (2) rear luggage compartment stripes, (2) rear deck lid stripes, (2) rear spoiler stripes, squeegee and instructions.

RS Coupe

MSS-9192H-CPE-BLACK	1991-92 Black	241.99 kit
MSS-9192H-CPE-SILVER	1991-92 Silver	241.99 kit
MSS-9192H-CPE-RED	1991-92 Red	241.99 kit
MSS-9192H-CPE-GOLD	1991-92 Gold	241.99 kit

RS Convertible

MSS-9192H-CVT-BLACK	1991-92 Black	241.99 kit
MSS-9192H-CVT-SILVER	1991-92 Silver	241.99 kit
MSS-9192H-CVT-RED	1991-92 Red	241.99 kit
MSS-9192H-CVT-GOLD	1991-92 Gold	241.99 kit

Z/28 Coupe

MSS-9192H-Z28-BLACK	1991-92 Black	241.99 kit
MSS-9192H-Z28-SILVER	1991-92 Silver	241.99 kit
MSS-9192H-Z28-RED	1991-92 Red	241.99 kit
MSS-9192H-Z28-GOLD	1991-92 Gold	241.99 kit



1993-02 Z/28 & 1997 30th Anniversary Stripes

Includes: (2) front bumper stripes, (2) hood stripes (non SS), (2) roof stripes (coupe only), (2) rear luggage compartment stripes, (2) rear spoiler stripes, squeegee and instructions.

Coupe

MSS-9730TH-CPE-OR	1993-97 Orange	241.99 kit
MSS-9730TH-CPE-BLACK	1993-97 Black	241.99 kit
MSS-9730TH-CPE-WHITE	1993-97 White	241.99 kit
MSS-9730TH-CPE-SIL	1993-97 Silver	241.99 kit
MSS-9730TH-CPE-RED	1993-97 Red	241.99 kit

Convertible & T-Tops

MSS-9730TH-CCT-OR	1993-97 Orange	241.99 kit
MSS-9730TH-CCT-BLACK	1993-97 Black	241.99 kit
MSS-9730TH-CCT-WHITE	1993-97 White	241.99 kit
MSS-9730TH-CCT-SIL	1993-97 Silver	241.99 kit
MSS-9730TH-CCT-RED	1993-97 Red	241.99 kit

Coupe

MSS-9800TH-CPE-ORANGE	1998-02 Orange	241.99 kit
MSS-9800C-CPE-BLACK	1998-02 Black	241.99 kit
MSS-9800C-CPE-WHITE	1998-02 White	241.99 kit
MSS-9800C-CPE-WHITE	1998-02 Silver	241.99 kit
MSS-9800C-CPE-RED	1998-02 Red	241.99 kit

Convertible & T-Tops

MSS-9800C-CCT-ORANGE	1998-02 Orange	241.99 kit
MSS-9800C-CCT-BLACK	1998-02 Black	241.99 kit
MSS-9800C-CCT-WHITE	1998-02 White	241.99 kit
MSS-9800C-CCT-SILVER	1998-02 Silver	241.99 kit
MSS-9800C-CCT-RED	1998-02 Red	241.99 kit



1998-02 35th Anniversary Stripes

Includes: (2) hood decals (L&R), (1) hood blackout decal, (1) front end fascia set upper, (1) front end fascia set lower, (2) rear spoiler stripes (L&R), (2) rear deck stripes (L&R), squeegee and instructions.

Coupe

MSS-0235TH-CPE-SIL	1998-02 Silver	289.99 kit
MSS-0235TH-CPE-BLACK	1998-02 Black	289.99 kit

Convertible

MSS-0235TH-CVT-SIL	1998-02 Silver	289.99 kit
MSS-0235TH-CVT-BLACK	1998-02 Black	289.99 kit



PREAPP

Pre-Application Surface Cleaner

Remove contaminants like silicones, wax, tree sap and bug guts for a clean and adherent surface.

PREAPP	4 oz. Pre-App Cleaner	13.95 ea.
--------	-----------------------------	-----------



SOAG

SLIDE-ON Application Gel

Slide-On contains a special formula that resists drying until you are ready to squeegee the graphic into place. Only then does the decal "set up".

SOAG	16 oz. Application Gel	24.99 ea.
------	------------------------------	-----------



SOPC

SLIDE-OVER UV Protectant

Help protect your decal from harsh elements and natural aging by applying our revolutionary Slide-Over UV Protectant & Conditioner.

SOPC	8 oz. UV Protectant	21.99 ea.
------	---------------------------	-----------



Air Cleaner Decals SB

HOJ-(Engine Horsepower) 8.99 ea.
Ex. HOJ-350250 for decal above.



Cross Flag Decals BB

HOJ-(Engine) 11.99 ea.
Ex. HOJ-396 for decal above.



Turbo Jet Decals BB

HOJ-(Horsepower) 11.99 ea.
Ex. HOJ-375 for decal above.



Air Cleaner Decal

HOJ-476 All w/o Cowl Induction 8.99 ea.
 HOJ-259 All w/ Cowl Induction 8.99 ea.



Diecast Air Cleaner Decals

HOJ-(engine)-DC Diecast 82.99 ea.
Ex. HOJ-396-DC for the decal above.



Diecast Turbo Jet Decals

HOJ-(Horsepower)-DC Diecast 75.99 ea.
Ex. HOJ-375-DC for the decal above.



AC Compressor Decals

HOJ-741 1967-68 Green 8.99 ea.
 HOJ-607 1969-72 Red 8.99 ea.
 HOJ-271 1973-74 4.99 ea.



AC Window Decals

HAC-67 1967 8.99 ea.



AC Box Decals

HOJ-550 All Harrison 6.99 ea.



Brake Bail Decals for PB

HOJ-SR 1967 SR 3.95 ea.
 HOJ-CH 1968 CH 3.95 ea.
 HOJ-CU 1969 CU 3.95 ea.
 HOJ-LB 1970 LB 3.95 ea.



Brake Check Valve Decal

HOJ-330 1967 SR 3.95 ea.
 HOJ-YX 1967 YX 4.95 ea.
 HOJ-331 1968 CH 4.99 ea.
 HOJ-332 1969 CU 4.95 ea.



Caliper Backing Plate Decals

HCT-67 1967 CT 4.95 ea.
 HCS-68 1968 CS 4.95 ea.
 HAI-69 1969 Z/28 AI 4.95 ea.
 HAD-69 1969 BB AD 4.95 ea.



Fan Caution Decal

HFA-930 All 9.99 ea.



Coil Spring Decals

HCS-YC 1967 327 or 350 YC 6.95 pr.
 HCS-YY 1967 SS350 YY 6.95 pr.
 HCS-YG 1967 SS396 YG 6.95 pr.
 HCS-YW 1967 Z/28 YW 6.95 pr.
 HCS-EG 1968 SS396 EG 6.95 pr.
 HCS-EE 1968 Z/28 EE 6.95 pr.
 HCS-YC 1968 327 or 350 YC 6.95 pr.
 HCS-YC 1968 SS350 YC 6.95 pr.
 HCS-EK 1969 350 EK 6.95 pr.
 HCS-EY 1969 Z/28 EY 6.95 pr.
 HCS-YF 1969 Z/28 YF 6.95 pr.
 HCS-YM 1969 Z/28 RS YM 6.95 pr.
 HCS-HG 1969 ZL1 4spd HG 6.95 pr.
 HCS-HQ 1969 396 or 427 HQ 6.95 pr.
 HCS-YP 1969 396 or 427 YP 6.95 pr.
 HCS-YH 1969 396 YH 6.95 pr.
 HCS-EN 1970 Z/28 EN 6.95 pr.

The two letter suffix on each part number is the code that will appear on the decal.



Cooling System Decal

HOJ-144 1967-69 All 8.99 ea.
 HOJ-242 1970-71 All 8.99 ea.
 HOJ-271 1973-74 All 4.99 ea.



Emission Decals

HE-68H All 8.99 ea.
 HE-U 1968 SB, 396/325 or 350 8.99 ea.
 HE-P 1968 Z/28 8.99 ea.
 HE-CH 1969 396/375 CH 8.99 ea.
 HE-CN 1969 427/425 CN 8.99 ea.
 HE-CG 1969 396/325-350 CG 8.99 ea.
 HE-CF 1969 350 & Z/28 8.99 ea.
 HE-CE 1969 307 or 327 8.99 ea.
 HE-AX 1970 350/350 AX 8.99 ea.
 HE-AT 1970 396/350 Auto AT 8.99 ea.
 HE-AR 1970 396/350 Man AR 8.99 ea.

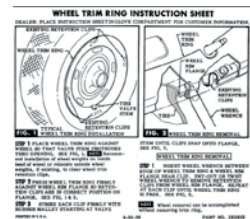

Rally Trim Ring Instructions

These instructions were found in the glove box of cars with rally wheels. They explain the installation and removal of the trim rings.

HTR-806 1967-74 8.99 ea.



Engine Starting Guide

Explains the procedure for starting your new Camaro.
Details the new ignition locking steering columns.

HSS-69 1969 72 All 11.99 ea.



Door Jamb Decals

HDJ-678 1967-68 Green 8.99 ea.
HDJ-69 1969 Blue 8.99 ea.
HDJ-706CA 1970-76 GM of Canada 13.99 ea.

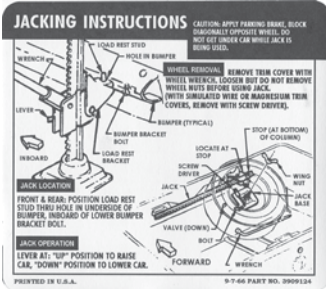

Jacking Instructions

HJC-830 1967-68 All 8.99 ea.
HJC-861 1969 non-SS 8.99 ea.
HJC-838 1969 SS 8.99 ea.
HJC-863 1970-73 All 8.99 ea.
HJC-866 1973 w/ Space Saver 8.99 ea.



Leaf Spring Decals

HLS-BY 1967 Z/28 BY 6.95 pr.
HLS-OH 1967 SS396 OH 6.95 pr.
HLS-OA 1968 Z/28 OA 6.95 pr.
HLS-BX 1968 327 or 350 BX 6.95 pr.
HLS-BH 1969 SS350 BH 6.95 pr.
HLS-BM 1969 350 or Z/28 BM 6.95 pr.
HLS-BK 1969 BB BK 6.95 pr.

The two letter suffix on each part number is the code that will appear on the decal.



Yenko Fan Shroud Decal

HY-164 1969 Yenko S/C 11.99 ea.



Oil Canister Decal

HOC-28 1967 9.99 ea.

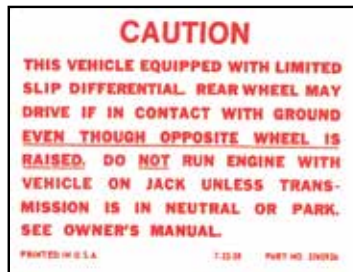

Positraction Decal

HBH-797 1967-81 Most 8.99 ea.



Shock Decals

HSF-PS 1969 Z/28 Front 7.95 pr.
HSR-UN 1969 Z/28 Rear 7.95 pr.
HSF-PW 1969 All BB Front 7.95 pr.
HSR-TN 1969 All BB Rear 7.95 pr.



Z/28 Spoiler Decal

HZ-28 1970-73 Z/28 14.99 ea.



Steering Box Decals

HSB-299 All w/ Power Steering 4.95 ea.



Yenko Window Decal

HY-069 1969 Yenko S/C 10.99 ea.



Tire Pressure Decals

HTP-182 1967 All 8.99 ea.
HTP-172 1968 All 8.99 ea.
HTP-190 1969 SS Code DW 8.99 ea.
HTP-170 1969-70 Code AO 8.99 ea.
HTP-406 1970-73 BP 8.99 ea.
HTP-407 1971-73 Z/28 8.99 ea.



Tonawanda Decal

ATO-3000 All BB 8.99 ea.



Flint Decal

HFT-50 1967 SB 4.99 ea.



Valve Cover Cross Flags Decal

HVC-28 1969-74 Z/28 16.99 ea.



Valve Cover Decals

HJL-69 1969 396/375 Auto 5.95 ea.
HJI-69 1969 396/350 Auto 5.95 ea.
HJH-69 1969 396/375 Manual 5.95 ea.
HJJ-69 1969 L89 396/375 5.95 ea.
HMO-69 1969 427/427 Auto 5.95 ea.
HMN-69 1969 427/427 Manual 5.95 ea.



Yenko Valve Cover Decal

HV-225 1969 Yenko S/C 11.99 ea.

Dupli-Color®



DUP-DAL1695 DUP-DAL1677 VHT-SP5251 VHT-SP995

Engine Paint

VHT-SP995	Nu-Cast Aluminum 11 oz. Aerosol.....	13.99 ea.
VHT-SP997	Cast Iron 11 oz. Aerosol.....	13.99 ea.
VHT-SP123	Chevy Orange 11 oz. Aerosol.....	12.99 ea.
VHT-SP124	Gloss Black 11 oz. Aerosol.....	13.99 ea.
VHT-SP130	Flat Black 11 oz. Aerosol.....	12.99 ea.
VHT-SP135	GM Blue 11 oz. Aerosol.....	10.99 ea.
VHT-SP29	Motor-Brite Clear 11 oz. Aerosol.....	12.99 ea.
VHT-SP201	Black Wrinkle 11 oz. Aerosol.....	15.99 ea.

Trunk Paint

DUP-TSP102	Black/Aqua Aerosol.....	16.99 ea.
DUP-TSP100	Grey/White Aerosol.....	16.99 ea.
HDP-GW-QT	Grey/White Quart.....	84.99 ea.
HDP-BA-QT	Black/Aqua Quart.....	84.99 ea.
DUP-DAL1695	Clear Coat Aerosol.....	10.99 ea.

Primer

DUP-DAP1690	Self-Etching Primer 12 oz. Aerosol.....	13.99 ea.
VHT-SP303	Red Oxide Primer 12 oz. Aerosol.....	9.99 ea.

Detailing Paint

DUP-DAL1607	Flat Black 12 oz. Aerosol.....	10.99 ea.
DUP-DAL1608	Semi-Gloss Black 12 oz. Aerosol.....	9.99 ea.
DUP-DAL1677	Gloss Black 12 oz. Aerosol.....	9.99 ea.
DUP-DAL1695	Clear 12 oz. Aerosol.....	10.99 ea.
DUP-SS100	Stainless Steel 12 oz. Aerosol.....	11.99 ea.
DUP-TP70	Black 11 oz. Aerosol.....	11.99 ea.
DUP-CS101	Chrome 11 oz. Aerosol.....	10.99 ea.

Radiator Paint

VHT-SP139	Radiator Black.....	12.99 ea.
-----------	---------------------	-----------

OER ORIGINAL EQUIPMENT REPRODUCTION



HDP-532 HDP-9577

OER Paint

OER GM Delco Shock Absorber Gray	
HDP-532	Shock Gray.....18.99 ea.
OER Gloss Black High Solids Detail Coating	
HDP-9577	Gloss Black.....19.99 ea.
OER Stainless Steel High Solids Detail Coating	
HDP-9580	Stainless Steel.....14.99 ea.

Dupli-Color®



Duplicolor Interior Paint

Dupli-Colors Vinyl and Fabric Coating is perfect for restoring or customizing your interior vinyl seats, dash boards, door panels, shifter boots and consoles. Formulated with a maximum adhesion promoter so there's no need for primer. Dupli-Color Vinyl & Fabric Coating won't crack, peel or chip.

DUP-HVP104	Gloss Black.....	12.99 ea.
DUP-HVP105	White.....	12.99 ea.

Paint can not be shipped via air. Ground Shipping only.

OER ORIGINAL EQUIPMENT REPRODUCTION



OER Interior Paint

OER's advanced formula offers 40% more coverage than standard dyes, bonding to surfaces for permanent color. It dries to the touch in 45 seconds and fully bonds in 10 minutes. UV stable and colorfast, it resists cracking, flaking, and peeling. Suitable for vinyl, leather, ABS plastic, polycarbonate, and more.

HPP-802RED	M30 Red.....	32.99 ea.
HPP-804BBLU	M14 Bright Blue.....	32.99 ea.
HPP-808MBLU	M17 Medium Blue.....	32.99 ea.
HPP-809IGLD	M46 Ivy Gold.....	32.99 ea.
HPP-810WHITE	M37 White.....	32.99 ea.
HPP-811ORNG	M126 Hugger Orange.....	34.99 ea.
HPP-813DGRN	M24 Dark Green.....	32.99 ea.
HPP-820CAMEL	Z48 Camel Tan.....	34.99 ea.
HPP-829FTHRN	Z45 Firethorn Red.....	32.99 ea.
HPP-830CARME	Z38 Carmine.....	34.99 ea.
HPP-1009	Surface Prep.....	14.99 ea.

Paint can not be shipped via air. Ground shipping only.

Dupli-Color®



Dupli-Color Spray Adhesive

Ideal for use on vehicle carpets, headliners, accessories & more!

DUP-SAR102	Adhesive.....	17.99 ea.
DUP-SAR100	Adhesive Remover.....	14.99 ea.

No volume discount.



DUP-HWP102 Shown



DUP-HT100



HDP-1214

Wheel & Tire Pain

Dupli-Color® Hot Tires Tire Paint; White; 0.5 oz. Paint Pen

Whether your tires are old or new, Dupli-Color® Hot Tires™ gives you a way to add color or personalize your muscle car, truck or sport compact tires. This fast-drying, durable coating allows you to touch-up faded white walls or tattoo your high performance tires. Hot Tires goes on smooth, resists fading and is available in an easy-to-use pen.

DUP-HT100	White Tire Paint.....	15.99 ea.
-----------	-----------------------	-----------

Dupli-Color® Wheel Coating; Silver; 11 oz. Aerosol

Argent Silver for Chevrolet Rally Wheels.

DUP-HWP101	Argent Silver.....	11.99 ea.
------------	--------------------	-----------

Details® 1969-70 SS Wheel Insert Gray Paint

Correct gray for 1969-70 SS wheel inserts.

HDP-1214	1969-70 SS Insert Gray.....	15.99 ea.
----------	-----------------------------	-----------

Dupli-Color® Wheel Coating; Graphite; 11 oz. Aerosol

Dark gray for SS 5 spoke wheels.

DUP-HWP102	1971+ Up SS Gray.....	13.99 ea.
------------	-----------------------	-----------

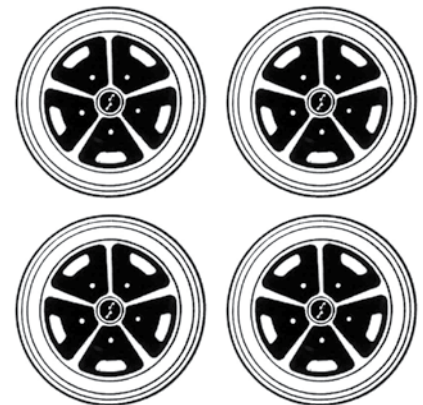

HMK-6970

1969-70 SS Wheel Paint Mask Kit

Die stamped wheel mask kit for correctly painting your SS wheels.

HMK-6970	1969-70 Wheel Mask.....	24.99 kit
----------	-------------------------	-----------

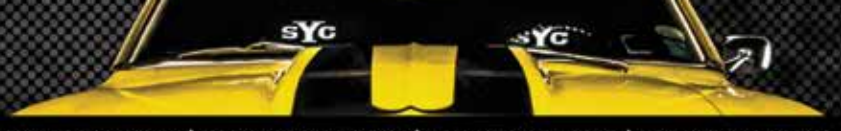

HMS-69F

Shop Manual Set

This set of factory manuals offers all of the information you need when you are restoring or servicing your car. Each manual is full of pictures and tutorials of everything from simple maintenance to complete removal and installation of virtually everything on the car. These are the same manuals that GM dealers used on most repair and warranty work.

HMS-67F	1967 All	82.62 kit
HMS-68F	1968 All	82.62 kit
HMS-69F	1969 All	82.62 kit
HMS-70F	1970 All	81.37 kit
HMS-71F	1971 All	82.62 kit
HMS-72F	1972 All	81.37 kit

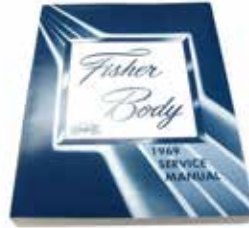

HFB-69

Fisher Body Manuals

Complete information on the actual body of the car including interior, trim, door panels, glass, trunk and more!

HFB-67	1967	28.99 ea.
HFB-68	1968	28.99 ea.
HFB-69	1969	28.99 ea.
HFB-70	1970	28.99 ea.
HFB-70F	1970 Supplement	26.95 ea.
HFB-71	1971	28.99 ea.
HFB-72	1972	28.99 ea.
HFB-73	1973	29.99 ea.



HBS-66



HOB-386

Blank Build Sheet

OE style reproduction of the factory build sheet which allows you to make your own custom paper, perfect for a recreation car!

HBS-66	1966-72 All	10.99 ea.
--------	-------------	-----------

Blank Window Stickers

OE style reproduction of the factory window sticker which allows you to make your own custom paper, perfect for a recreation car!

HOB-386	1967 All	14.99 ea.
HOB-879	1968-69 All	14.99 ea.
HOB-350	1970-72 All	14.99 ea.



HMB-2

Owner's Manual Bags

Correct factory plastic bag for your owners manual and dealer information.

HMB-2	1967-68 All	14.99 ea.
HMB-3	1969-72 All	14.99 ea.
HMB-4	1973-81 All	14.99 ea.



HSM-67

Factory Service Manuals

This manual was used by GM dealers to service your car when new. From simple maintenance to major component repair, this manual has all of the info needed to service your car.

HSM-67	1967 All	32.99 ea.
HSM-68	1968 All	32.99 ea.
HSM-69	1969 All	32.99 ea.
HSM-70	1970 All	32.99 ea.
HSM-70F	1970 Supplement	15.99 ea.
HSM-71	1971 All	32.99 ea.
HSM-72	1972 All	32.99 ea.
HSM-73	1973 All	57.99 ea.
HSM-74	1974 All	40.99 ea.
HSM-75M	1975 All	32.99 ea.
HSM-76M	1976 All	32.99 ea.
HSM-77M	1977 All	44.99 ea.
HSM-78M	1978 All	44.99 ea.
HSM-79M	1979 All	44.99 ea.
HSM-84M	1984 All	66.99 ea.



HA-F67

Assembly Manuals

A must for all restorations! These books were used at the factory plants as a reference guide for linemen. This book features all engineering drawings, GM numbers and torque specs.

HA-F67	1967 All	24.99 ea.
HA-F68	1968 All	24.99 ea.
HA-F69	1969 All	24.99 ea.
HA-F70	1970 All	24.99 ea.
HA-F71	1971 All	24.99 ea.
HA-F72	1972 All	24.99 ea.
HA-F73	1973 All	24.99 ea.
HA-F74	1974 All	24.99 ea.
HA-F75	1975 All	24.99 ea.
HA-F76	1976 All	24.99 ea.
HA-F77	1977 All	24.99 ea.
HA-F78	1978 All	24.99 ea.
HA-F79	1979 All	24.99 ea.
HA-F80	1980 All	24.99 ea.
HA-F81	1981 All	24.99 ea.



TG-889

Chevy Start Sleeve

Authentic reproduction starting instruction sleeve which was installed on the sun visor.

TG-889	1969-72	11.99 ea.
--------	---------	-----------

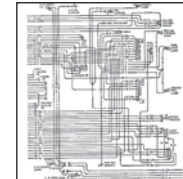

HWD-67F

Wiring Diagrams

Original GM wiring schematic from bumper to bumper.

HWD-67F	1967	13.99 ea.
HWD-68F	1968	13.99 ea.
HWD-69F	1969	13.99 ea.
HWD-RS	1967-69 RS	13.99 ea.
HWD-70F	1970	13.99 ea.
HWD-71F	1971	13.99 ea.
HWD-72F	1972	13.99 ea.
HWD-73F	1973	13.99 ea.



HVT-7

Convertible Top Manuals

Correct convertible top manuals.

HVT-7	1967 All	9.99 ea.
HVT-8	1968 All	9.99 ea.
HVT-9	1969 Convertible	6.95 ea.



Factory Owner's Manual

Authentic reproductions of the original factory owners manuals which came with all cars.

HDG_F	1967-81 All	19.99 ea.
-------	-------------	-----------

Insert your year in the blank.

A

A-ARM DUST SHIELDS.....155, 174
 AC BOX DECALS.....199
 AC BOX UNDER DASH HARDWARE.....101, 130
 AC BOX UNDER HOOD HARDWARE.....101, 130
 ACCELERATOR ARM & ROD.....103
 ACCELERATOR BRACKETS.....103
 ACCELERATOR CABLES.....103
 ACCELERATOR HARDWARE.....33
 ACCELERATOR PAD & TRIM.....33
 ACCELERATOR PEDAL LINKAGE KIT.....33, 121
 ACCELERATOR ROD GROMMET KIT.....121
 ACCELERATOR ROD SUPPORT.....121
 ACCESSORY TERMINAL & CONNECTOR KIT.....178
 AC COMPRESSOR DECALS.....199
 AC COMPRESSOR GROUND WIRE.....176
 AC CONDENSER BRACKETS.....123
 AC DELETE.....100
 AC EVAPORATOR SEALS & DRAIN.....100
 AC HARNESS.....176
 AC INNER EVAPORATOR CASE COVERS.....100
 AC ON ENGINE HARDWARE.....124, 130
 AC POWER FEED WIRE.....176
 ACTUATOR SHIELDS.....148, 150
 ACTUATOR SUPPORT BRACKETS.....151
 AC WINDOW DECALS.....199
 ADDICTIVE FLOW.....22, 43, 140, 148, 185, 186, 189, 190
 ADJUSTABLE TIMING POINTERS.....108
 ADJUSTMENT SLEEVES.....67, 73
 AIR CLEANER.....101, 102, 103, 121, 199
 AIR CLEANER ASSEMBLY.....101
 AIR CLEANER DECALS.....102, 199
 AIR CLEANER FLANGE.....103
 AIR CLEANER GASKET.....103
 AIR CLEANER LIDS.....102
 AIR CLEANER RUBBER SEAL.....103
 AIR CLEANER VALVE RELAY.....121
 AIR CONDITIONER RELAY.....179, 181
 AIR CONDITIONING BRACKETS.....124
 AIR CONDITIONING LINE.....123
 AIR FILTER.....102
 AIR INDUCTION.....176
 AIR VENT CONTROL.....18
 ALTERNATOR BRACKETS.....119, 120
 ALTERNATOR DRESS UP KIT.....119
 ALTERNATOR FAN KIT.....119
 ALTERNATOR FAN W/ NUT.....131
 ALTERNATOR HARDWARE.....120
 ALTERNATOR LOWER ATTACHING HARDWARE.....131
 ALTERNATOR MOUNTING KIT.....119
 ALTERNATOR MOUNTING KITS.....120, 131
 ALTERNATOR NEG CABLE BOLT.....131
 ALTERNATOR PITGAL & BOOT.....119, 182
 ALTERNATOR PULLEYS.....119
 ALTERNATORS.....119
 ALTERNATOR UPPER ADJUSTMENT KIT.....131
 ALUMINUM WHEELS.....53
 AMP/VOLT GAUGE.....21
 ANTENNA KITS.....48, 138
 ARM REST ASH TRAYS.....13
 ARM REST BASES.....13
 ARM REST PADS.....13
 ASH TRAY LAMP.....179
 ASTRO VENT DUCT.....18
 ASTRO VENTILATION EMBLEM.....17
 AUTO SHIFTER BUTTON.....81
 AXLE HOUSING BUMPERS.....72

B

BACK DRIVE COMPONENTS.....86
 BACKING PLATE BOLT.....62, 131
 BACKING PLATES.....39, 62, 64, 149, 187
 BACKSEAT DRIVER.....48
 BACKUP HOUSING GASKET.....189

BACKUP LENS GASKET.....189
 BACKUP LENS MOUNTING TEM-PLATE.....189
 BACKUP LENS SCREWS.....189
 BALL JOINTS.....66, 73, 74
 BASIC FRONT END KIT.....66
 BATTERY RETAINER KITS.....131
 BATTERY TOPPERS.....126, 182
 BATTERY TRAYS.....126
 BEARING CAP.....63
 BEARING NUT - WASHER KIT.....63
 BEARING & SEAL KIT.....63
 BELLCRANK RETAINER.....192
 BELLCRANK SUPPORT BRACKETS.....151
 BELLHOUSE ATTACHING KIT.....131
 BELLHOUSING HARDWARE.....83
 BELLHOUSING KIT.....83
 BILLET THROTTLE ASSEMBLY.....34
 BLANK BUILD SHEET.....202
 BLANK WINDOW STICKERS.....202
 BLOWER MOTOR SWITCH.....179
 BOARD HEADLINER.....40
 BODY BOLT KIT.....69, 131
 BODY MARKING CRAYON KIT.....127, 183
 BODY MOUNTING BUSHING KIT.....69
 BODY MOUNTING KIT.....69
 BODY PLUG KITS.....131
 BODY WIRING HOLD DOWN.....179
 BOOSTER.....56, 57, 58, 59, 60, 61, 65, 86
 BOOSTER/MASTER KITS.....58
 BOOSTER TO MASTER NUT.....60
 BOUNCE BUMPERS.....67
 BRAKE BOOSTER PUSH ROD EXTENSION.....60
 BRAKE CABLE CONNECTOR.....63
 BRAKE CABLE EQUALIZER.....63
 BRAKE CABLE RETAINER.....63
 BRAKE CABLE SUPPORT.....63
 BRAKE CALIPER BOLTS.....62
 BRAKE CALIPERS.....62
 BRAKE CHECK VALVE DECAL.....199
 BRAKE/CLUTCH PADS & TRIM.....34
 BRAKE DRUMS.....64
 BRAKE HARDWARE KIT.....64
 BRAKE LENS.....187
 BRAKE LIGHT SWITCH.....63, 179
 BRAKE LIGHT SWITCHES.....35
 BRAKE LINE CLIPS.....64
 BRAKE PADS & TRIM.....86
 BRAKE PEDAL ASSEMBLY.....35
 BRAKE & REVERSE LENS.....187
 BRAKE SHOES.....64
 BUCKET SEAT BACK RETAINERS.....7
 BUCKET SEAT BACKS.....6
 BUCKET SEAT FRAME.....6
 BUCKET SEAT HEAD RESTS.....10
 BUCKET SEAT SPRINGS.....6
 BUCKET SEAT TRACKS AND BOLTS.....7
 BUMPER BOLT REINFORCEMENT.....161
 BUMPER BOLTS.....131, 145
 BUMPER BRACE.....147
 BUMPER BRACKET CUSHIONS.....145, 175
 BUMPER BRACKET HARDWARE.....131
 BUMPER BRACKET MOUNTING HARDWARE.....145
 BUMPER BRACKETS.....146, 152
 BUMPER FILLER PANELS.....145, 158
 BUMPER GASKETS.....145, 175
 BUMPER GUARDS.....147
 BUMPER KITS.....145
 BUMPERS.....50, 67, 68, 72, 133, 145, 152, 170
 BUMPER STRIPS.....145
 BUMP STEER ADJUSTER SET.....74

C

CABLE MOUNTING BRACKET.....86
 CALIPER BACKING PLATE DECALS.....199
 CALIPER BACKING PLATES.....62
 CALIPER MOUNTING BRACKETS.....62
 CARB ATTACHING KITS.....104

CARB RETURN SPRINGS.....104
 CARBURETOR ATTACHING KITS.....131
 CARBURETOR BASE GASKETS & SHIELDS.....104
 CARBURETOR HEAT SHIELD.....104
 CARBURETOR INLET FITTINGS.....117
 CARBURETORS.....103
 CARBURETOR THROTTLE RETURN KIT.....104
 CARPET FIREWALL GUARD.....36
 CENTER AIR VENTS AC.....19
 CENTER CAPS.....55
 CENTER CAPS & EMBLEMS.....55
 CENTER CLOCK/FUEL CLIPS.....22
 CENTER DASH BEZEL.....19
 CENTER DASH CECEL.....20, 176
 CENTER DASH DIFFUSER.....22
 CENTER DASH PANEL RETAINER.....25
 CENTER DRAG LINKS.....73
 CENTER TRUNK FLOOR PANS.....165
 CENTER TRUNK FLOOR PATCH.....165
 CHECK VALVE & FILTER.....151
 CHOKE KITS.....104
 CIGARETTE LIGHTER ASSEMBLIES.....26
 CIRCUIT BREAKER.....49, 148, 150, 181, 182
 CLEVIS PIN KIT.....150
 CLOCK HARNESS.....176
 CLOCK RESET KNOB.....22
 CLUTCH ADJUSTMENT ROD KITS.....84
 CLUTCH AND FLYWHEEL KIT.....90
 CLUTCH & BRAKE PEDAL ASSEMBLIES.....83
 CLUTCH CROSS SHAFT KIT.....84
 CLUTCHES.....90, 97
 CLUTCH FIREWALL RODS.....84
 CLUTCH FORK.....83, 84, 90
 CLUTCH FORK BOOT.....83, 90
 CLUTCH FRAME BRACKETS.....84
 CLUTCH KITS.....83, 97
 CLUTCH LINKAGE KIT.....83
 CLUTCH PEDAL BOOSTER ROD CLIP.....60
 CLUTCH PEDAL BUSHING & BUMPER.....35, 84
 CLUTCH RETURN SPRINGS.....84
 CLUTCH SPRING EXTENSION.....84
 CLUTCH SPRING EXTENSION ROD.....84
 CLUTCH Z BAR.....84
 COAT HOOKS.....41
 COIL BRACKET.....106, 131
 COIL OVER KITS.....70
 COILOVER SHOCK KITS.....76
 COILOVER SPRINGS.....66, 67
 COIL SPEAKERS.....47
 COIL SPRING DECALS.....199
 COIL SPRING INSULATORS.....69
 COIL SPRINGS.....67, 69
 COIL SPRING UPPER MOUNTS.....69
 COLD AIR INTAKES.....102
 COLLECTOR REDUCERS.....94
 COLUMN SHIFT LINKAGE.....86
 COLUMN SHIFT TRANSMISSION BRACKET.....86
 COMPLETE FRONT END KIT.....66
 COMPLETE WHEELHOUSES.....162
 CONSOLE ASH TRAY HARDWARE.....40
 CONSOLE ASH TRAY INSERT.....40
 CONSOLE ASH TRAY LIDS.....40
 CONSOLE ASSEMBLY.....37
 CONSOLE BRACKETS.....40
 CONSOLE CLOCK.....40, 176
 CONSOLE GAUGE HARDWARE KIT.....40
 CONSOLE GAUGE HARNESS.....37, 176
 CONSOLE GAUGE KIT.....37
 CONSOLE GLOVE BOX ASSEMBLY.....38, 40
 CONSOLE HARDWARE KIT.....40
 CONSOLE HARNESS.....37, 176
 CONSOLE KIT.....37
 CONSOLE LAMP REFLECTOR.....40
 CONSOLE LID.....38, 40
 CONSOLE LID BUTTON SPRING.....40

CONSOLE LID HARDWARE.....38
 CONSOLE MOUNTING KIT.....40
 CONSOLE SHELLS.....37
 CONSOLE SHIFTER.....39, 40, 81
 CONSOLE SHIFT PLATE.....39
 CONSOLE VOLTMETER GAUGE.....179
 CONTROL ARM BOLT.....68, 132
 CONTROL ARM BUMPERS.....68
 CONTROL ARM BUSHINGS.....66, 68
 CONTROL ARMS.....66, 68, 70, 74, 77
 CONTROL ARM SHAFT KIT.....68
 CONTROL ARM SHIMS.....68, 131
 CONTROL ARM TO FRAME BOLTS.....131
 CONTROL ARM UPPER WASHERS.....132
 CONVERTIBLE BOOT CLIPS.....49
 CONVERTIBLE CROSS BRACE BOLT.....132
 CONVERTIBLE FLOOR PAN BRACE.....162
 CONVERTIBLE FLOOR PAN CROSS BRACE.....162, 164
 CONVERTIBLE HEADER BOW STOP BUMPERS.....50
 CONVERTIBLE HEADER MOLDING.....49, 137
 CONVERTIBLE HEADER SEAL.....174
 CONVERTIBLE INNER SIDE PANELS.....13
 CONVERTIBLE PILLAR MOLDINGS.....137
 CONVERTIBLE QUARTER BRACES.....162
 CONVERTIBLE SWITCH & BEZEL.....49
 CONVERTIBLE TACK STRIP.....50
 CONVERTIBLE TOP BOOT.....49
 CONVERTIBLE TOP CABLES.....49
 CONVERTIBLE TOP CYLINDER.....50
 CONVERTIBLE TOP FRAME.....49, 168
 CONVERTIBLE TOP HOSE.....50
 CONVERTIBLE TOP HOSE CLIP.....50
 CONVERTIBLE TOP LATCH ASSEMBLY.....50
 CONVERTIBLE TOP MOTORS.....50
 CONVERTIBLE TOP PADS.....49
 CONVERTIBLE TOPS.....49
 CONVERTIBLE TOP SWITCH.....49
 CONVERTIBLE WEDGE KIT.....50
 CONVERTIBLE WELL LINER.....50
 CONVERTIBLE WELL MOLDING.....50, 137
 CONVERTIBLE WINDSHIELD AND COWL ASSEMBLY.....158
 COOLANT RECOVERY TANK.....97
 COOLING FANS.....96, 97
 COOLING SYSTEM DECAL.....199
 COOLING SYSTEMS.....89, 96
 COPO WHEELS.....53
 COURTESY LAMP HARNESS.....176
 COURTESY LAMP SWITCH JUMPER HARNESS.....176
 COWL-FIREWALL SEAL KIT.....174
 COWL HOOD.....121, 155, 156
 COWL HOOD GRILLES.....121, 155
 COWL INDUCTION AIR CLEANER.....101
 COWL INDUCTION ELECTRIC SOLENOID.....121, 183
 COWL INDUCTION HARNESS.....121, 176, 183
 COWL INDUCTION HARNESS & GROMMET.....121, 183
 COWL INDUCTION HOOD.....156
 COWL INDUCTION KIT.....101
 COWL INDUCTION RELAY.....181
 COWL INDUCTION SOLENOID SWITCH.....121, 183
 COWL INDUCTION THROTTLE ARM.....121
 COWL INDUCTION TRIM PLATES.....155
 COWL PANEL SHOULDER ASSEMBLY.....159
 COWL VENT PANEL.....158
 COWL VENT SCREEN.....140, 158
 CRANK CASE BREATHER OIL CAP.....110
 CRANK PULLEY BOLT.....114
 CRANK PULLEYS.....113, 114
 CROSS FLAG EMBLEMS.....195
 CROSSFLOW EXHAUST SYSTEM.....94
 CROSSMEMBER.....75, 77, 85, 132
 CROSS RAM & 6 CYL PEDAL LINK-

AGE.....121
 CRUISE CONTROL HARNESS.....176
D
 DASH ASH TRAY.....26
 DASH ASH TRAY BRACKET.....26
 DASH ASH TRAY INSERT.....26, 37, 40
 DASH CENTER VENT PLATE EMBLEM.....17
 DASH CLIPS.....17
 DASH CLUSTER HARNESS.....177
 DASH COVERS.....16
 DASH FUEL GAUGE.....20
 DASH GRAB HANDLE.....25
 DASH HARNESS.....176, 177
 DASH INSTRUMENT PANEL.....19
 DASH INSTRUMENT SOCKET AND BULB SET.....22
 DASH KNOB BEZEL SET.....28
 DASH KNOB KIT.....28
 DASH LENS ASSEMBLY.....19
 DASH LENSES.....20
 DASH PADS.....17
 DASH PAD TRIM MOLDING.....17
 DASH PANEL.....25, 159
 DASH PANEL EMBLEM.....25
 DASH PANEL FACE.....159
 DASH PANEL MOLDING CLIP.....25
 DASH SPEAKERS.....47
 DASH TOP PANEL.....159
 DASH TRIM KIT.....25
 DASH VENT BALL RETAINER.....18
 DASH VENT BALLS.....18
 DASH VENT BEZEL.....18
 DASH VENT BEZEL RETAINERS.....18
 DASH VENT KNOB AND FERRULE SET.....18
 DASH VENT SEALS.....18
 DATE CODING SERVICE.....169
 DECALS.....102, 196, 198, 199, 200
 DEEP TUBS.....162
 DEFOGGER.....33
 DEFROSTER VENT.....17
 DELUXE DOOR PANELS.....11
 DIFFERENTIAL COVER GASKETS.....87
 DIFFERENTIAL COVERS.....87
 DIGITAL GAUGE KITS.....22
 DIPSTICKS & TUBES.....111, 129
 DIPSTICKS W/ BRAIDED TUBES.....89
 DIPSTICK & TUBES.....89
 DISC BRAKE CONVERSION KITS.....56, 57
 DISC BRAKE CONVERSIONS.....58
 DISC BRAKE HOSE STRAPS.....64
 DISC BRAKE MINI KIT.....62
 DISC BRAKE PADS.....62
 DISC BRAKE RETAINING PIN.....62
 DISTRIBUTION BLOCK.....61
 DISTRIBUTOR.....106, 132, 182
 DISTRIBUTOR CAP.....106, 182
 DISTRIBUTOR HOLD DOWN.....106, 132
 DIXCO STYLE HOOD TACH.....21
 DOG DISH HUBCAPS.....55
 DOME LAMP HARNESS CLIPS.....43
 DOME LAMP KIT.....43, 190
 DOME LIGHT HARNESSES.....43
 DOME LIGHT LENS BEZEL.....43, 190
 DOME LIGHT LENSES.....43, 190
 DOOR EDGE GUARD.....140
 DOOR GLASS PLATE MOUNT STUD ASSEMBLY.....170
 DOOR GLASS ROLLER ASSEMBLY.....171
 DOOR GLASS ROLLER WASHERS.....170
 DOOR GLASS SASH MOUNT STUD ASSEMBLY.....170
 DOOR GLASS STOP BUMPERS.....170
 DOOR GLASS STOP MOUNT & NUT.....170
 DOOR GLASS STOPS.....170
 DOOR GRAB HANDLES.....15
 DOOR HANDLE ASSEMBLIES.....15
 DOOR HANDLE KITS.....14, 138
 DOOR HANDLE MECHANISMS.....15
 DOOR HANDLE PUSH BUTTONS.....138
 DOOR HANDLE RELEASE.....15
 DOOR HANDLE ROD.....192

DOOR HANDLES.....14, 15, 138
DOOR HARDWARE MOUNTING KITS.....170
DOOR HINGE BOLTS.....132
DOOR HINGE HARDWARE.....160
DOOR HINGE PIN KITS.....132, 160
DOOR HINGES.....160
DOOR INNER FRAME A-PILLARS.....160
DOOR JAMB AREA PATCHES.....162
DOOR JAMB DECALS.....200
DOOR JAMB SWITCHES.....179
DOOR JAMB U RUBBERS.....173
DOOR JAMB VENTS.....15
DOOR JAMB WINDLACE.....16
DOOR LATCH ASSEMBLIES.....160, 192
DOOR LEDGE MOLDINGS.....139
DOOR LOCK KNOBS & FERRULES.....16, 192
DOOR LOCK PAWLS.....192
DOOR MOUNTING HARDWARE KIT.....159
DOOR OPENING ROD END CLIPS.....192
DOOR OPENING WEATHERSTRIP.....173
DOOR PANEL CARPET.....15
DOOR PANEL EMBLEMS.....13
DOOR PANEL MOLDING CLIPS.....15
DOOR PANEL PLUGS & CLIPS.....15
DOOR PANEL RETAINER PLATE.....16, 170
DOOR PANEL RETAINER/WINDOW GUIDE.....16, 170
DOOR PANELS.....11, 12
DOOR PANEL SCREWS.....16
DOOR PANEL WASHERS.....15, 171
DOOR PANEL WATER SHIELDS.....16
DOOR PILLAR MOLDING.....137
DOOR PULL HANDLE INSERTS.....15
DOOR ROD INSULATORS.....192
DOOR SHELLS.....159
DOOR SHOULDERED BOLTS.....150
DOOR SKINS.....159
DOOR/TRUNK LOCK BRACKET.....51, 192
DOOR WINDOW PLATE & ROLLER SET.....170
DOOR WINDOW TRACK UPPER PLATE.....170
DOWNPIPES.....94
DOWNTURNS.....94
DRILLED & SLOTTED ROTORS.....57, 63
DRIP RAIL SUPPORT.....168
DRIVER PULLEY.....80, 115
DRIVESHAFT SAFETY LOOP.....77
DRIVESHAFT TUNNEL BRACE.....75
DRIVESHAFT TUNNEL X-PIPE LEGS.....94
DRIVESHAFT YOKES.....87
DRUM BRAKE FRONT HUB KIT.....63
DRUM BRAKE GUIDE/PIN.....64
DRUM BRAKE KITS.....64

E
E-BRAKE ASSEMBLIES.....35, 64
E-BRAKE KNOBS.....35
E-BRAKE PEDAL.....34
ELECTRICAL HARNESS TAPE.....127, 179
ELECTRIC JUNCTION BLOCK.....127, 179
ELECTRIC VACUUM KIT.....60
ELECTRONIC LED FLASHER.....186
ELECTRONIC SPEEDOMETER SENDER.....24
EMBLEM.....4, 13, 31, 55, 193, 194, 195, 196
EMBLEM TEMPLATE KITS.....196
EMISSION DECALS.....199
ENGINE BLOCK LIFTING RING.....104
ENGINE BRACKET TO FRAME BOLT KIT.....132
ENGINE COMPARTMENT RETAINING HOOKS.....127, 180

ENGINE DIPSTICK.....111
ENGINE HARNESS.....177
ENGINE MASTER HARDWARE KITS.....123, 130
ENGINE MOUNTING KITS.....122
ENGINE STARTING GUIDE.....200
EXHAUST CUT OUT KIT.....94
EXHAUST FRENCH LOCKS.....93
EXHAUST GASKETS & DONUTS.....93
EXHAUST HANGER KITS.....94
EXHAUST MANIFOLD BOLTS.....93, 132
EXHAUST MANIFOLDS.....93
EXHAUST STUD KIT.....93, 132
EXHAUST SYSTEMS.....94
EXHAUST TIPS.....94
EXTENSION SEAL RING.....103
EXTERIOR BULB KITS.....189
EXTERIOR MOLDINGS.....140

F
FAN ATTACHING KITS.....97, 132
FAN BLADES.....97
FAN CAUTION DECAL.....199
FAN CLUTCHES.....97
FAN CLUTCH KITS.....97
FAN SHROUDDER.....96
FAN SHROUD ATTACHING BRACKET.....98
FAN SHROUD CLIP KIT.....98
FAN SHROUDS.....96, 98
FENDER ADAPTER BRACKETS.....148, 149, 152
FENDER BRACE KIT.....129, 155
FENDER BRACES.....129
FENDER CUP WASHERS.....132, 155
FENDER ENGINE EMBLEMS.....194
FENDER FRONT END BOLTS.....132
FENDER INNER BOLT KIT TO FENDER.....133, 155
FENDER LOUVERS.....137, 155
FENDER MODEL EMBLEMS.....194
FENDER PATCHES.....154
FENDERS.....153, 154
FENDER SUPPORT BARS.....129, 154
FENDERWELL TEMPLATE KITS.....149
FIBER OPTIC ASH TRAY SOCKET.....26
FILLER NECK.....92, 95
FILLER NECK HOSE.....92
FILLER NECK SLEEVE.....92
FINNED TRANSMISSION PANS.....89
FIREWALL BRACKETS.....159
FIREWALL CLIP.....127
FIREWALL COVER.....129, 159
FIREWALL FILL PLATE.....100
FIREWALL HOSE GROMMET.....151
FIREWALL INSULATION PAD.....33
FIREWALL INSULATORS.....36
FIREWALL ROD BLOCK OFF.....84
FIREWALL ROD BOOTS.....84
FIREWALLS.....159
FIREWALL TO FLOOR PAN BRACES.....159
FLEX HOSE BANJO BOLTS.....65
FLEX HOSE BLOCK.....65
FLEX HOSE BRACKETS.....65
FLEX HOSE CLIP.....65
FLEX HOSE MOUNTING BOLT.....65
FLEX HOSES.....56, 65
FLEXPLATE.....90
FLOOR MATS.....36
FLOOR PAN.....159, 162, 163, 164, 165
FLOOR PAN BRACES.....159, 164
FLOOR PAN PATCHES.....163
FLYWHEEL ATTACHING KIT.....133
FLYWHEEL INSPECTION COVERS.....83, 89
FLYWHEELS.....83
FORWARD LAMP HARNESS.....177
FORWARD PLATES.....38
FRAME BRACKET ATTACHING BOLT KIT.....122
FRAME BRACKETS.....84, 122

FRAME PIVOT BOLT & BUSHING SET.....50
FRAME RAIL REPAIR.....164
FRONT ARM REST PAD & BASE KIT.....13
FRONT BUMPER BRACKETS.....146, 152
FRONT COIL SPRINGS.....67
FRONT DOOR WINDOW LOWER STOP.....169
FRONT END FASTENER KIT.....133, 154
FRONT INNER FENDERS.....154
FRONT NOSE/BUMPER COVER.....144
FRONT SEAT BRACKETS.....164
FRONT SPOILER.....140, 141
FRONT SPOILER KIT.....140
FRONT SUSPENSION KITS.....70
FRONT SWAY BAR KIT.....67, 73
FUEL DOOR EMBLEMS.....135
FUEL DOOR WITH HINGE.....147
FUEL FILTER & BRACKET.....118
FUEL FILTERS.....118
FUEL GAUGE.....20, 176, 177
FUEL LINE CLIP KITS.....92, 117
FUEL LINE RETAINER.....117
FUEL LINES FRONT TO REAR.....93
FUEL PRESSURE REGULATOR.....118
FUEL PUMP.....117, 118, 133
FUEL PUMP BLOCK OFF PLATES.....117
FUEL PUMP HARDWARE.....117
FUEL PUMP HOSE KIT.....118
FUEL PUMP TO CARBURETOR LINES.....117
FUEL SENDER HARNESS.....177
FUEL TANK ATTACHING KIT.....133
FUEL TANK CAPS.....92, 147
FUEL TANK DOORS.....92, 147
FUEL TANK HARDWARE.....91
FUEL TANK HOSE KITS.....92
FUEL TANK INSULATION.....91
FUEL TANK MOUNTING KIT.....91
FUEL TANKS.....91
FUEL TANK SENDING UNITS.....92
FUEL TANK STRAPS.....91
FUEL TANK SUPER KITS.....91
FUEL TANK VENT.....92
FULL FLOOR PAN.....163
FULL FRAME RAILS.....164
FULL ONE PIECE TRUNK FLOOR PANS.....165
FUSE & FLASHER KIT.....178

G
GAUGE KITS.....22, 23
GAUGE MOUNTING PLATE.....22
GAUGES.....19, 20, 24, 37, 111, 127, 148, 176, 177, 181, 183
GEAR REDUCTION STARTERS.....112
GLASS.....49, 118, 136, 137, 139, 169, 170, 171, 174, 178
GLOVE BOX.....25, 26, 27, 38, 40, 176, 178, 180, 191
GLOVE BOX CATCH PLATE.....27
GLOVE BOX DOOR.....26
GLOVE BOX DOOR ARM BUMPER.....26
GLOVE BOX EMBLEM.....27
GLOVE BOX LAMP.....27, 178, 180
GLOVE BOX LAMP EXTENSION.....178
GLOVE BOX LOCK CASING.....27
GLOVE BOX LOCK STRIKER.....27
GLOVE BOX SCREWS.....27
GLOVE BOX SUPPORT BRACKET.....27
GPS SPEEDOMETER SENSOR.....24
GRILLE.....133, 141, 142, 143, 152, 193
GRILLE ATTACHING KITS.....133, 143
GRILLE KIT.....141, 142
GRILLE MOLDING KIT.....143
GRILLE MOLDINGS.....143
GRILLE STIFFENER.....143
GROUND STRAP KIT.....108, 182

H
HALF SIDE FLOOR PANS.....163

HARMONIC BALANCER ATTACHING BOLT-WASHER.....114
HARMONIC BALANCER BOLT.....133
HARNESS RETAINING CLIPS.....127, 180
HARNESS RETAINING STRAPS.....127, 180
HARNESS WIRE TIES.....127, 180
HAZARD LAMP KNOB.....31
HEADER BOW.....49, 50
HEADER BOW END CLIP.....50
HEADER PANEL.....152, 158, 193
HEADERS.....35, 77, 83, 94, 107, 120
HEADLAMP ADJUSTMENT KIT.....184
HEADLAMP ASSEMBLIES.....148, 149
HEADLAMP BELLCRANKS.....151
HEADLAMP BEZEL ATTACHING KIT.....144
HEADLAMP BEZEL KIT.....144
HEADLAMP BEZEL NUTS.....144
HEADLAMP BEZELS.....144
HEADLAMP BUSHING KITS.....150
HEADLAMP DOOR BACKING PLATES.....149
HEADLAMP DOOR COVERS.....149
HEADLAMP DOOR HINGE PLATES.....150
HEADLAMP DOOR MOLDINGS.....149
HEADLAMP DOORS.....149
HEADLAMP HOUSINGS.....184
HEADLAMP MOTOR DRIVE ARM.....150
HEADLAMP MOTORS.....148, 150
HEADLAMP MOUNTING BUCKET AND HARDWARE.....184
HEADLAMP MOUNTING BUCKETS.....184
HEADLAMP MOUNTING PANEL.....144
HEADLAMP RETAINER.....184
HEADLAMPS.....184
HEADLAMP SPRING.....184
HEADLAMP SWITCH NUT.....180
HEADLAMP / WIPER SWITCH GROUND STRAP.....180
HEADLIGHT DIMMER SWITCH.....180
HEADLIGHT DOOR KIT.....149
HEADLIGHT KNOBS.....27
HEADLIGHT SWITCH.....27, 152, 180
HEADLIGHT SWITCH NUT.....27
HEADLIGHT WASHER HOSE SET.....152
HEADLIGHT WASHER NOZZLES.....152
HEADLIGHT WASHER PUMP HARNESS.....152
HEADLIGHT WASHER PUMP SOLENOID.....152
HEADLINER.....40, 41
HEADLINER BOW CLIPS.....41
HEADLINER CONVERSION KIT.....40
HEADLINER INSULATION.....41
HEADLINER RETAINING STRIPS.....41
HEADLINER SIDE TRIM.....41
HEADLINER TRIM KIT.....41
HEADLINER WIRE BOWS.....41
HEADREST ESCUTCHEON.....10
HEATER BLOWER MOTOR.....100, 179
HEATER BLOWER MOTOR RESISTORS.....100, 179
HEATER BOX COVER.....100
HEATER BOXES.....100
HEATER BOX SEAL KITS.....175
HEATER CABLE RETAINER SET.....33
HEATER CONSOLE DUCT.....38
HEATER CONTROL ASSEMBLY.....32
HEATER CONTROL BACKING PLATE.....32
HEATER CONTROL CABLES.....33
HEATER CONTROL KNOBS.....33
HEATER CONTROL LENSES.....32
HEATER CONTROL VALVE.....99
HEATER CORE RETAINING CLIPS.....100
HEATER CORES & BOX SEAL KITS.....100
HEATER DELETE PLATE.....100

HEATER HARNESS.....178
HEATER HOSE / BYPASS NIPPLES.....113
HEATER HOSE RETAINERS.....99
HEATER HOSES.....99
HEATER LEVER.....33
HEATER LEVER REPAIR KIT.....33
HEAT RISER SPACERS.....93
HEAT RISER VALVES.....93
HIDDEN ANTENNA.....48
HIGH BEAM INDICATOR.....22, 43, 180, 190
HINGE DETENT ROLLERS.....160
HOLD OFF VALVE.....61
HOOD.....21, 101, 121, 129, 130, 133, 140, 152, 155, 156, 157, 158, 174, 193, 196
HOOD ADJUSTMENT BOLTS.....133, 157
HOOD BUMPERS.....133
HOOD CATCH.....157
HOOD HINGE BOLT.....133
HOOD HINGES.....157
HOOD HINGE SPRING.....157
HOOD INSULATION.....129
HOOD LATCH ASSEMBLY.....157
HOOD LATCHES.....158
HOOD LATCH SUPPORT.....157
HOOD LIFT STRUTS.....157
HOOD ORNAMENTS.....140
HOOD PIN KITS.....157
HOOD TO COWL SEAL.....174
HOOD VALVE FRAME.....121
HORN BUTTON.....29, 31
HORN CAP.....31
HORN CONTACT KITS.....31
HORN RELAY.....127, 178, 181
HORNS.....127, 178
HORN WIRE.....178
HOT START REMOTE SOLENOID KIT.....112
HURST INSTALLATION KITS.....34, 82
HURST SHIFTER.....34, 82
HYDRAULIC CLUTCH CONVERSION KIT.....90

I
IDLER ARM BOLTS.....133
IDLER ARMS.....73
IGNITION.....25, 28, 32, 106, 107, 178, 180, 191
IGNITION BEZEL NUT.....25, 28
IGNITION COIL BRACKET.....106
IGNITION SPARK PLUG WIRES.....107
IMPACT BARS.....145
IN DASH CLOCK.....21
INDICATOR LENSES.....22, 39, 81
INNER COWL PANEL.....159
INNER DOOR LOCK ROD.....192
INNER FENDER WELL BRACES.....154
INNER HEADLAMP DOORS.....149
INNER REAR QUARTER PATCH PANELS.....160
INNER REAR WINDOW TRIM.....42
INNER TIE RODS.....66, 73
INNER WHEELHOUSES.....162
INNER WINDSHIELD TRIM.....42
INSTRUMENT CLUSTER CASE.....19
INSTRUMENT SOCKET PLATE.....20
INTAKE MANIFOLD BOLTS.....104
INTAKE MANIFOLD KITS.....133
INTAKE MANIFOLD VACUUM FITTINGS.....104
INTAKE STUDS.....104, 133
INTERIOR BULB KITS.....43, 190
INTERIOR DASH TOOLS.....25
INTERIOR KITS.....2-4
INTERIOR PAINT.....201
INTERIOR SCREW KITS.....14
INTERMEDIATE STEERING SHAFT.....78, 116
IROC-Z STRIPES.....198

J
JACKING INSTRUCTIONS.....200

JACK LOAD BASE.....51
 JACK/TIRE RETAINER KIT.....133
K
 KICKDOWN CABLE & BRACKET.....86
 KICKDOWN EXTENSION.....178
 KICKDOWN HARNESS.....176, 178
 KICK PANELS.....33
 KICK PANEL SPEAKERS.....47
L
 LAKEWOOD BELLHOUSING.....90
 LAMP LENSES & HOUSINGS.....187
 LEAF BRACKET MOUNTING KIT.....134
 LEAF SPRING BRACKET HARDWARE.....71
 LEAF SPRING DECALS.....200
 LEAF SPRING EYE BOLT.....71
 LEAF SPRING EYE BUSHING.....71
 LEAF SPRING FRONT EYE BOLT.....133
 LEAF SPRING MOUNTING BRACKETS.....71
 LEAF SPRING MOUNTING KIT.....71
 LEAF SPRING PADS.....72
 LEAF SPRING PERCH.....72
 LEAF SPRING PLATES.....72
 LEAF SPRING REAR SHACKLE KIT.....72
 LEAF SPRING REBUILD KITS.....71
 LED DASH BULBS.....22
 LED DOME LAMP KITS.....43, 190
 LED DOME LIGHT BULB.....43
 LED LICENSE PLATE BULBS.....190
 LED PARKING LIGHT KITS.....185
 LED REVERSE BULBS.....189
 LED SIDE MARKER BULBS.....186
 LED TURN SIGNAL BULBS.....185
 LENS GASKET SET.....174
 LICENSE LAMP ASSEMBLY.....189
 LICENSE PLATE ATTACHING KIT.....134
 LICENSE PLATE BRACKET.....134, 147
 LICENSE PLATE LAMP.....189, 190
 LICENSE PLATE LAMP LENS.....190
 LICENSE PLATE LENS.....189
 LICENSE PLATE SOCKET.....190
 LID LATCH BUTTON.....40
 LIMITING SWITCH BRACKET SET.....150
 LOCK SETS.....191, 192
 LOWER BUSHINGS.....67
 LOWER COWL PANEL VALLEY.....158
 LOWER DOOR PANELS.....12
 LOWER FENDER EXTENSIONS.....154
 LOWER GRILLES.....143
 LOWER TAIL PANEL PATCH.....168
 LOWER VALANCE PANEL.....158
 LS CONVERSION.....122
 LS MOTOR INSTALLATION KIT.....24
 LS SWAP OIL PAN.....110
 LSX SWAP ENGINE MOUNTS.....75
 LUG NUTS.....53
 LUG NUT WRENCH & SLEEVE.....51
M
 MANIFOLDS.....77, 93
 MANUAL HOLD DOWN LATCH.....50
 MANUALS.....202
 MANUAL TOP LATCH HARDWARE.....50
 MANUAL TRANSMISSION CONVERSION KIT.....35, 83
 MARKING CRAYONS.....127, 183
 MASTER BODY KIT.....130, 155
 MASTER CHASSIS KIT.....130
 MASTER CYLINDER CAPS & GASKETS.....59
 MASTER CYLINDER HARDWARE.....59
 MASTER CYLINDERS.....59
 MIRROR KITS.....138
 MIRROR MOUNTING KITS.....139
 MIRRORS, GLASS & HARDWARE.....139
 MODULATOR VALVE.....86
 MONO-TO-MULTI LEAF CONVERSION KIT.....72
 MONO-TUBE SHOCKS.....76
 MOTOR MOUNT ATTACHING BOLT KIT.....122
 MOTOR MOUNTS.....75, 122

MOTOR MOUNT "THRU" BOLT KIT.....122
 MOTOR MOUNT THRU BOLTS.....134
 MOTOR NUT & DRIVE WASHERS SET.....150
N
 N30 EMBLEMS.....31
 NEUTRAL SAFETY SWITCH.....180
 NEUTRAL START/REVERSE LAMP SWITCH.....88
 NEUTRAL START SWITCHES.....88, 180
 NUTS SELF LOCKING.....134
O
 OIL CANISTER DECAL.....200
 OIL DIPSTICK KITS.....111
 OIL DRAIN BOLT / WASHER.....111
 OIL DRAIN BOLT W/ WASHER.....134
 OIL FILLER TUBE.....105
 OIL FILLER TUBE CAP.....105
 OIL FILTER.....111
 OIL LINE BRACKET.....111
 OIL LINE GROMMET.....111
 OIL PAN ATTACHING BOLTS.....134
 OIL PAN ATTACHING OEM BOLT KIT.....111
 OIL PAN BAFFLE / WINDAGE TRAY.....111
 OIL PAN CLIP.....111
 OIL PAN GASKET SET.....110
 OIL PANS.....110
 OIL PRESSURE FITTINGS.....111
 OIL PRESSURE LINES.....111
 OIL PRESSURE SWITCH.....111
 OUTER HEADLAMP DOORS.....149
 OUTER TIE RODS.....66, 73
 OUTER WHEELHOUSES.....162
 OVER CENTER BRACKET & SPRING SET.....151
 OVERFLOW TANK.....97
P
 PACE CAR DECALS.....196
 PACKAGE SHELF EXTENSIONS.....166
 PACKAGE SHELF REPAIR PANEL.....166
 PACKAGE TRAY.....44, 48
 PACKAGE TRAY HOLD DOWN BLOW OUT CLIP.....44
 PACKAGE TRAY INSULATION.....44
 PACKAGE TRAY SPEAKER GRILLES.....48
 PAINT.....10, 15, 38, 51, 54, 96, 137, 175, 201
 PAINT SEAL KIT.....175
 PARKING BRAKE CABLE KIT.....63
 PARKING BRAKE GUIDE.....63
 PARKING BRAKE GUIDE BAR SPRINGS.....63
 PARKING BRAKE HANDLE.....35
 PARKING BRAKE LIGHT SWITCH.....63, 179
 PARKING BRAKE LIGHT SWITCH & PADDLE CLIP.....179
 PARKING BRAKE SHOE BAR.....63
 PARKING LAMP ASSEMBLIES.....184, 185
 PARKING LAMP BEZELS.....144
 PARKING LAMP GASKETS.....185
 PARKING LAMP HARNESS CLIP.....186
 PARKING LAMP HOUSINGS.....152, 185
 PARKING LAMP KITS.....184
 PARKING LAMP LENSES.....185
 PARKING LENS SCREWS.....185
 PCV HOSE & FILTER KIT.....105
 PCV RETAINING HOSE CLIP.....105
 PCV VALVE.....105
 PEDAL ASSEMBLIES COMPLETE.....35
 PEDAL ASSEMBLY.....35
 PILLAR DRIP RAIL SUPPORT.....168
 PILLAR POST MOLDINGS.....43
 PILLAR POST WEATHERSTRIP.....174
 PILOT BUSHING.....84
 PITMAN ARM.....78, 116
 PIVOT BOLT SET.....49
 POSITRACTION DECAL.....200
 POWER ACCESSORY FEED.....178
 POWER BOOSTER BOOT.....61
 POWER BRAKE HOSE BRACKET.....61
 POWER BRAKE HOSE KIT.....61

POWER BRAKE TUBE.....61
 POWER DOOR LOCK SWITCH.....183
 POWER SEAT HARNESS.....178
 POWER SEAT RELAY.....181
 POWER STEERING BRACKET KIT.....80, 115
 POWER STEERING BRACKETS.....80, 115
 POWER STEERING CONVERSION KIT.....115
 POWER STEERING GEARBOX KITS.....78, 116
 POWER STEERING HARDWARE KITS.....80, 116, 134
 POWER STEERING HOSE KITS.....79, 115
 POWER STEERING HOSE RETAINER.....79
 POWER STEERING HOSE RETAINERS.....115
 POWER STEERING HOSE RETAINING CLIP.....79
 POWER STEERING OEM HIGH PRESSURE HOSE.....79, 115
 POWER STEERING PULLEYS.....114
 POWER STEERING PUMP CAP.....79, 114
 POWER STEERING PUMP FITTING.....79
 POWER STEERING PUMP PULLEYS.....80, 114
 POWER STEERING PUMPS.....79, 114
 POWER STEERING RETURN HOSE.....79, 115
 POWER TOP CIRCUIT BREAKER.....49
 POWER TOP HARNESS.....178
 POWER WINDOW GROMMETS.....172
 POWER WINDOW HARNESS.....178
 POWER WINDOW HARNESS BOOT.....178
 POWER WINDOW RELAY.....181
 POWER WINDOW RETROFIT KITS.....172
 POWER WINDOW SWITCH.....16, 172, 180
 PRE-ASSEMBLED DELUXE SEATS.....2, 2-3
 PRE-ASSEMBLED DOOR PANEL KITS.....10
 PRE-BENT BRAKE LINES.....65
 PRESSURE PLATE BOLT KIT.....134
 PRINTED CIRCUIT BOARDS.....20, 181
 PROPORTIONING VALVE BRACKET.....61
 PROPORTIONING VALVE KIT.....61
 PRO VALVE.....61
 PULLEY ATTACHING BOLTS.....134
 PUMP TO CARB LINES.....117
 PUSH-IN PLUGS.....134
Q
 QUARTER DOME LAMP KIT.....43, 190
 QUARTER FLOOR PANS.....163
 QUARTER GLASS SEALS.....139, 174
 QUARTER LOUVERS.....137
 QUARTER PANEL & DOOR FRAME ASSEMBLY.....161
 QUARTER PANEL PATCHES.....161
 QUARTER PANELS.....161
 QUARTER PANEL SKINS.....161
 QUARTER TRUNK OPENING CORNER STIFFENER PLATE.....161
 QUARTER WINDOW MOLDING.....139
 QUARTER WINDOW REAR CORNER FILLER.....161
 QUARTER WINDOW ROLLER ASSEMBLY.....170
 QUARTER WINDOW ROLLER TENSION SPRING.....171
 QUARTER WINDOW TRACK STUD.....171
R
 RADIATOR ATTACHING HARDWARE.....97
 RADIATOR CAPS.....97
 RADIATOR HOSES.....99
 RADIATOR MOUNTING PADS.....97
 RADIATOR OVERFLOW HOSE.....99
 RADIATOR OVERFLOW HOSE CLIP.....99
 RADIATOR OVERFLOW JARS.....97
 RADIATOR PETCOCK.....99
 RADIATORS.....95, 96
 RADIATOR SUPPORT.....69, 128, 148, 149, 151, 154
 RADIATOR SUPPORT BUSHINGS.....69,

154
 RADIATOR SUPPORT SHOW PANELS.....128
 RADIATOR SUPPORT STOP BRACKETS.....151
 RADIATOR TOP PANELS.....97
 RADIO.....25, 28, 43, 46, 47, 48, 126, 181, 190
 RADIO BEZELS.....25
 RADIO CAPACITOR.....48, 126, 181
 RADIO DELETE PLATE.....28, 48
 RADIO FACEPLATE.....48
 RADIO FACE PLATE.....28
 RADIO KNOBS.....28, 48
 RADIO LENSES.....48
 RADIOS.....46
 RALLY SPORT CIRCUIT BREAKER.....150, 182
 RALLY SPORT DIVIDER & BRACKET.....143
 RALLY SPORT EXTENSION.....150, 178
 RALLY SPORT EXTENSION HARNESS.....150
 RALLY SPORT HEADLAMP LIMITING SWITCH.....150, 182
 RALLY SPORT HEADLAMP RELAY.....150, 182
 RALLY SPORT NOSE CONVERSION KIT.....152
 RALLY SPORT RELAY BOARD ASSEMBLY.....150, 182
 RALLY SPORT REVERSE LENS.....189
 RALLY SPORT REVERSE LENS HOUSING.....189
 RALLY SPORT STRIPES.....197
 RALLY SPORT SYSTEM KIT.....148, 149
 RALLY SPORT TAIL LENS.....187
 RALLY SPORT WIRING DIAGRAM.....149
 RALLY TRIM RING INSTRUCTIONS.....199
 RALLY WHEEL BEZEL.....53
 RALLY WHEEL CAP KITS.....53
 RALLY WHEEL CENTER CAP.....53
 RALLY WHEEL KITS.....53
 RALLY WHEELS.....52, 53, 55, 201
 RATCHET SHIFTER DETENT.....81
 REAR ARM REST PANELS.....13
 REAR ARM REST PISTON COVERS.....14
 REAR AXLE YOKES.....87
 REAR BUMPER BRACKETS.....146
 REAR BUMPER COVER.....144
 REAR CONSOLE COVER PLATE.....40
 REAR CONSOLE LAMP LENS.....40
 REAR CROSS RAIL & EXTENSIONS.....166
 REAR END COVER.....87, 134
 REAR END FLUID.....87
 REAR END PINION BUMPER.....72
 REAR END PLUGS & POSI TAG.....87
 REAR END TAIL PANELS.....167
 REAR FOLD DOWN SEAT BRACKETS.....7
 REAR FOLD DOWN SEAT CARPET.....6
 REAR FOLD DOWN SEAT LATCHES.....7
 REAR FOLD DOWN SEAT PARTITION.....7
 REAR FOLD DOWN SEAT PARTITION HOLDER.....7
 REAR FOLD DOWN SEAT RUBBER STOPPERS.....7
 REAR FRAME TO BODY SEALS.....49, 175
 REAR INNER COVERS.....50
 REAR INNER PANEL BRACES.....167
 REAR INNER PANELS.....168
 REAR LAMP HARNESS.....178
 REAR LOWER SIDE PANELS.....12
 REAR PANEL EMBLEMS.....195
 REAR PANHARD BAR.....78
 REAR SEAT BACK BRACES.....166
 REAR SEAT BRACKETS.....164
 REAR SEAT DIVIDER PANEL.....164
 REAR SEAT FLOOR HOOK.....164
 REAR SEAT FLOOR PAN.....164
 REAR SEAT FRAMES.....6
 REAR SHACKLE BUSHINGS.....72
 REAR SHACKLE KITS.....72
 REAR SHOCK TOWER PATCH.....165

REAR SPEAKERS.....47
 REAR SPEED KIT.....67
 REAR SPOILERS.....148
 REAR VIEW MIRROR.....42, 139
 REAR VIEW MIRROR BRACKET.....42
 REAR VIEW MIRROR W/ MAP LIGHT.....42
 REAR WINDOW CORNERS.....44
 REAR WINDOW DEFROSTER HARNESS.....178
 REAR WINDOW MOLDING CLIPS.....136
 REAR WINDOW TO TRUNK PANEL.....166
 REMOTE MIRROR BEZEL.....16
 REMOTE REAR VIEW MIRROR.....139
 REPLACEMENT LEAF SPRINGS.....71
 RETRO MAGNUM ALLOY SS WHEELS.....52
 REVERSE LAMP SWITCH.....82, 88, 181
 REVERSE LAMP SWITCH MANUAL.....82
 REVERSE LENS MOUNTING TEMPLATE.....168
 REVERSE LOCKOUT KIT.....34, 82
 REVERSE SWITCH EXTENSION HARNESS.....88
 REVERSE SWITCH KIT.....88
 REVERSE SWITCH MOUNTING KIT.....88
 ROCKER PANEL MOLDINGS.....139
 ROCKER PANELS.....162
 ROOF DRIP MOLDING KITS.....137
 ROOF PANEL.....168
 ROOF PANEL BRACES.....168
 ROOF RAIL BLOWOUT CLIPS.....137
 ROOF RAIL WEATHERSTRIP.....173
 ROOF WEATHERSTRIP CHANNEL.....137, 168, 173
 ROTORS.....57, 63
 RS HEADLAMP HOSE KIT.....151
 RUBBER BODY PLUGS.....134
 RUBBER STOPPER KITS.....175
S
 SASH CHANNEL.....171
 SEAT ADJUSTMENT KNOBS.....7
 SEAT BACK CHROME LOCKING KNOB.....7
 SEAT BACK LATCHES.....7
 SEAT BACK LATCH HOOK.....7
 SEAT BACK STOPPERS.....7
 SEAT BELT BLADE & HARDWARE.....10
 SEAT BELT BOLTS.....9, 134
 SEAT BELT COVER TRIM.....10
 SEAT BELT HOLDERS.....10
 SEAT BELT LOOP GUIDES.....10
 SEAT BELT RETAINERS.....9
 SEAT BELT RETRACTOR COVERS.....10
 SEAT BELTS.....8, 9
 SEAT COVER INSTALLATION KIT.....7
 SEAT COVER KITS.....2-4, 4-6
 SEAT FOAMS.....6
 SEAT FRAME SUPPORTS.....164
 SEAT MOUNTING BOLTS.....134
 SEAT RELEASE CABLES.....7
 SELECTA-SPEED WIPER KITS.....126
 SENDER FILTER.....92
 SENDING UNIT HARNESS.....92, 127
 SENDING UNIT LOCK RINGS.....92
 SERVO ACTUATOR CABLE.....103
 SHEET METAL SCREW KIT.....135
 SHIFT BOOT RETAINERS.....39, 82
 SHIFT BULB MOUNTING & BACKING PLATES.....39
 SHIFTER BALLS.....34, 82
 SHIFTER BOOTS.....39, 82
 SHIFTER CABLE CLIP.....86
 SHIFTER CABLE LEVER BRACKETS.....86
 SHIFTER CABLES.....86
 SHIFTER CABLE STUD.....86
 SHIFTER CONVERSION KIT.....81
 SHIFTER HANDLES.....82
 SHIFTER SLIDERS.....39, 81
 SHIFTER TUNNEL.....39, 82, 165
 SHIFTER TUNNEL REPAIR PLATE.....165
 SHIFT INDICATOR LENSES.....39, 81
 SHIFT KNOB.....40, 82
 SHIFT LEVER CLIP.....40

SHIFT PLATES.....38
SHOCK BUSHING.....70
SHOCK DECALS.....200
SHOCK KIT.....70, 76
SHOCK MOUNTING KIT.....70
SHOCK MOUNTING PLATES.....70
SHOCK MOUNTING STUD.....70
SHOCKS & KITS.....76
SHOULDER BELT GUIDE.....10
SHOULDER BELT RETAINERS.....9
SIDE AIR VENT.....18
SIDE AIR VENTS WITH AC.....19
SIDE AIR VENTS WITHOUT AC.....18
SIDE HINGE COVERS.....7
SIDE MARKER LAMP BEZEL.....186
SIDE MARKER LAMP RETAINER.....186
SIDE MARKER LENSES.....186
SIDE MARKER NUT SET.....187
SIDE MARKERS.....186
SIDE MARKER SOCKET.....183
SIDE MARKER SOCKETS.....186
SIDE MIRRORS.....138
SIDE SAILS.....43
SIDE TERMINAL BATTERY CABLES.....126, 182
SIDE VENT SHUTOFF.....18
SIDE VIEW MIRRORS.....138, 139
SILL PLATES.....36
SOLID BODY MOUNTS.....67
SOUND SYSTEM KITS.....46
SPARE FUSE POWER WIRING EXTENSION.....178
SPARE TIRE ANCHOR PLATE & HOLD DOWN.....51
SPARE TIRE ANCHOR PLATES.....167
SPARE TIRE COVER.....51
SPARK PLUG HEAT SHIELD KIT.....107
SPARK PLUGS.....107, 183
SPARK PLUG WIRE SET.....107, 183
SPARK PLUG WIRE STANDS.....107
SPEAKER BRACKET.....47
SPEAKER HARNESS.....178
SPEAKERS.....1, 47, 48, 178
SPEAKER/TRUNK/BLOWER MOTOR WIRE CLIPS.....44, 181
SPEED KIT.....66, 67
SPEEDO/FUEL LENS ASSEMBLIES.....20
SPEEDOMETER.....20, 21, 22, 24, 88, 89
SPEEDOMETER CABLE CLIP.....22, 88
SPEEDOMETER CABLES.....88
SPEED WARNING CABLES.....22
SPEED WARNING HARNESS.....178
SPINDLES.....62
SPIRAL SHOCKS.....70
SPOILER EMBLEM.....195
SPOILERS.....140, 148
SPRING RING CABLES.....126, 182
SS STEERING WHEEL.....28
SS WHEEL KITS.....52
STANDARD DOOR HANDLES.....14
STANDARD DOOR PANELS.....11, 12
STANDARD SEAT BELT COVERS.....9
STANDARD SEAT COVERS.....3-5
STANDARD SHROUD.....31
STAPLE SHIFTER.....39, 81
STAPLE SHIFTER HANDLE.....81
STAPLE SHIFTER REPAIR KIT.....81
STARTER BOLTS.....135
STARTER HEAT SHIELD.....112
STARTER MOTOR.....112
STARTER MOTOR BOLTS.....112
STARTER MOTOR BRACE.....112
STARTER SOLENOID WIRE CLIP.....112
STEERING ARMS.....62
STEERING BOX BOLT.....78, 116, 135
STEERING BOX DECALS.....200
STEERING BOXES.....78, 116
STEERING COLUMN BOOT.....174
STEERING COLUMN CAP.....32

STEERING COLUMN COVER & SHIM.....32
STEERING COLUMN
LOWER BEARING.....32
STEERING COLUMN PANEL.....19
STEERING COLUMN RODS.....87
STEERING COLUMNS.....32
STEERING COLUMN SEAL.....174
STEERING COLUMN SUPPORT.....32
STEERING COLUMN UPPER BEARING.....32
STEERING COUPLER.....78, 116
STEERING COUPLER BOLT.....78
STEERING SHAFT.....78, 116, 174
STEERING SHAFT BOOT & RETAINER.....174
STEERING WHEEL.....28, 29, 30, 31
STEERING WHEEL HUBS.....31
STEERING WHEEL KITS.....28, 29, 30
STRIKERS.....16, 132
STRIPE KIT.....196
STRUT TOWER BRACE.....76
SUB FRAME.....165
SUBFRAME BODY MOUNT CAGE NUT.....69, 135
SUBFRAME CONNECTORS.....75
SUBFRAME MOUNTING BOLTS.....69
SUB FRAME REPAIR PLATES.....165
SUBFRAME REPAIR PLATES.....69
SUNVISOR BUSHING TIP KIT.....42
SUNVISORS.....41, 42
SUNVISOR SUPPORTS.....42
SUPER SPORT WHEELS.....52, 53, 54, 55
SUPPORT CLAMP BRACKET.....151
SUREFIT KITS.....123
SUSPENSION KIT.....66
SWAY BAR BRACKETS.....73
SWAY BAR BUSHINGS.....73
SWAY BAR END LINKS.....73
SWAY BAR KIT.....67, 73
SWAY BARS.....75
SWAY BAR SLEEVE BRACKET.....73
T
TACH CONVERSION HARNESS.....178
TACHOMETER.....21
TAIL LAMP BEZEL, AND LENS KITS.....186
TAIL LAMP BEZELS & KITS.....187
TAIL LAMP GASKETS.....188
TAIL LAMP HOUSINGS.....187, 188
TAIL LAMP KIT.....188
TAIL LAMP LENS.....188
TAIL LAMP REAR STUD/WING NUT KIT.....188
TAIL LAMP SOCKET.....183, 188
TAIL LAMP STUD & NUT SET.....187
TAIL LENS.....187, 188
TAIL LENS GASKETS.....187, 188
TAIL LIGHT BEZEL BACKING PLATES.....187
TAIL LIGHT BEZELS & GASKETS.....186
TAIL PANEL APPLIQUE.....147
TAIL SEALS.....87
TAIL SHAFT BOLTS.....87
T BOLT.....71
TCS LITTLE FUSE RELAY.....127, 181
TCS SOLENOID.....105
TCS TRANSMISSION SWITCHES.....87
TCS TRANSMISSION SWITCH EXTENSION.....178
TCS VACUUM ADVANCE KITS.....105
TCS WIRE RETAINER.....87
TEMPERATURE SENDING UNIT HARNESS.....127
TEMP GAUGE.....21
TEMP SENDING UNITS.....127, 183
T HANDLE SHIFTER KNOB.....82
T-HANDLE SHIFTER KNOB.....34
THERMOSTAT HOUSING.....105, 135
THERMOSTAT HOUSING BOLTS.....105, 135
THERMOSTATS.....105

THROTTLE CABLE BRACKETS.....102, 103
THROTTLE LINKAGE TO CABLE CONVERSION.....33
THROTTLE LINKAGE TO CABLE CONVERSION KIT.....121
THROTTLE VALVE CABLE.....88
THROW OUT BEARING.....84
TIE ROD ADJUSTERS.....74
TILT IGNITION SWITCH ACTUATOR GEAR.....32
TILT STEERING COLUMN HOUSING SLEEVE.....32
TILT WHEEL LEVERS.....32
TIMING COVER BOLT KIT.....135
TIMING COVER POINTER.....108
TIMING COVER POINTERS.....108
TIMING COVERS.....108
TIRE PRESSURE DECALS.....200
TIRES.....54, 201
TOE BOARDS.....164
TOE RODS.....77
TOOLS.....14, 25, 128, 172
TOP BOOT SNAP SCREWS.....49
TOP SWITCH.....49, 179
TORQUE ARM RELOCATIONS KITS.....77
TORQUE ARMS & KITS.....77
TOWER CLAMP KITS.....99
TRANSISTOR IGNITION EXTENSION HARNESS.....178
TRANSMISSION COOLER LINES.....86
TRANSMISSION CROSSMEMBERS.....75, 85
TRANSMISSION MOUNTS.....85
TRANSMISSION PANS.....89
TRANSMISSION SPEEDOMETER GEARS.....89
TRANSMISSION VACUUM LINES.....86
TRIM REMOVAL TOOLS.....14, 172
TRIM RING SETS
OE STYLE REPRODUCTION.....55
TRIM STUD REPAIR KIT.....135, 136
TRUNK DIVIDER BOARDS.....44
TRUNK DIVIDER INSULATION.....44
TRUNK DROP OFFS.....165
TRUNK FLOOR DRAIN PLUG.....51
TRUNK FLOOR EXTENSIONS.....166
TRUNK FLOOR/FUEL TANK BRACES.....166
TRUNK/FLOOR PAN DRAIN PLUG.....165
TRUNK FLOOR TAIL PANEL BRACES.....167
TRUNK FLOOR W/ BRACKETS, BRACES.....166
TRUNK HINGES.....167
TRUNK HINGE TORQUE ROD.....51, 167
TRUNK LAMP EXTENSION HARNESS.....51, 178
TRUNK LAMP HARNESS ASSEMBLY.....51, 178
TRUNK LID CATCH.....167
TRUNK LID EMBLEMS.....195
TRUNK LID LATCH.....51, 167, 192
TRUNK LIDS.....166
TRUNK LID SPRING WITH SLEEVE.....51, 167
TRUNK LOCK BEZEL & GASKET.....51, 192
TRUNK LOCK RETAINER.....51, 192
TRUNK LOCK RODS.....51, 192
TRUNK MATS.....51
TRUNK OPENING CORNER STIFFENER PLATE.....161, 166
TRUNK PANEL KIT.....51
TRUNK SPATTER PAINT.....51
TRUNK TORSION BRACKET.....167
TRUNK WEATHERSTRIP.....51, 173
TRUNK WIRE CLIPS.....51
T-TOP BAG.....44
T-TOP CLIP.....44
T-TOP FRONT INSERT TRIMS.....44
T-TOP GROMMET.....43
T-TOP HANDLES.....44

T-TOP MOLDING & END CAPS.....43
T-TOP RAIL TRIM COVERS.....44
T-TOP REAR INSERT TRIMS.....44
T-TOP SUN SHADE.....44
T-TOP WEATHERSTRIP.....174
T-TOP Y MOLDINGS.....44
TUBULAR A-ARMS.....74
TUBULAR ADJUSTMENT SLEEVES.....67
TUBULAR CONTROL ARMS.....68
TUBULAR LOWER CONTROL ARM KIT.....67
TUBULAR UPPER CONTROL ARM KIT.....67
TUNE UP KIT.....106, 182
TURBO HYDRAMATIC TRANSMISSION ID TAGS.....87
TURN SIGNAL CANCEL CAM.....31
TURN SIGNAL & HAZARD LIGHT SWITCH.....180
TURN SIGNAL LEVERS.....32
TURN SIGNAL REPAIR SWITCH.....181
TURN SIGNAL SWITCHES.....181
U
U BOLT.....71
U JOINT ATTACHING KITS.....87
UNDERHOOD LAMP.....43, 126, 181, 190
UNDER REAR SEAT BRACE.....164
UNIVERSAL SHIFTER KIT.....34, 81
UPPER BUSHINGS.....67
UPPER CONTROL ARM BOLT & WASHER KIT.....68
UPPER DOOR PANEL MOLDING.....11
UPPER DOOR PANEL RAIL TRIM.....12
UPPER FENDER TIE BAR.....155
UPPER GRILLES.....143
UPPER & LOWER ARM BUSHINGS.....68
UPPER & LOWER HEAT STOVE.....93
V
VACUUM ACTUATORS.....148, 150
VACUUM ADVANCE CLIPS.....105
VACUUM ADVANCE COVER.....107
VACUUM ADVANCE KITS.....105
VACUUM RELAY SWITCH.....148, 151
VACUUM RESERVOIR.....151
VALVE BRACKET.....61
VALVE COVER BOLTS.....135
VALVE COVER ELBOWS.....110
VALVE COVER GASKETS.....110
VALVE COVER GROMMET.....110
VALVE COVER HOSE.....110
VALVE COVER KIT.....108
VALVE COVER OIL CAPS.....110
VALVE COVER RETAINERS BOLT KITS.....110
VALVE COVERS.....108, 109, 110
VALVE COVER SPARK PLUG WIRE LOOM.....107
VALVE FRAME DOOR CLIPS.....121
VALVE FRAME (FLIPPER) DOOR.....121
VALVE FRAME SEAL.....121
VENT CHANNEL RUN.....174
VENT WINDOW.....14, 16, 137, 169, 170, 174
VENT WINDOW FRAMES & HARDWARE.....137
VENT WINDOW RIVET.....16, 137
VENT WINDOW SEALS.....174
VERTICAL ROOF MOLDINGS.....137
VFD3 SYSTEM.....23, 24
VHX SYSTEM.....23, 24
VINYL TOP MOLDING SETS.....137
VINYL TOPS.....137
VOLTAGE REGULATOR.....48, 126, 135, 180, 181
W
WASHER CAP KIT.....125
WASHER HOSE KIT.....125
WASHER JAR BRACKET.....125
WASHER JARS.....125
WASHER NOZZLES.....125, 152

WASHER PUMP.....125, 152, 178
WASHER PUMP REPAIR KIT.....125
WATER PUMP ATTACHING KIT.....135
WATER PUMP BOLT KITS.....113
WATER PUMP BYPASS HOSE KITS.....113
WATER PUMP OEM ATTACHING BOLT KITS.....113
WATER PUMP PULLEY.....113
WATER PUMPS.....112
WATER PUMP STUDS.....135
WATER PUMP WASHER.....113
WATTS LINK KITS.....78
WEATHERSTRIP GLUE.....174
WEATHERSTRIP GUTTER.....51, 166
WEATHERSTRIP KITS.....173
WELL RAIN GUTTER.....50
WELTING SET.....141
WHEEL COVER.....55
WHEEL CYLINDER RODS.....64
WHEEL CYLINDERS.....64
WHEELHOUSE/QUARTER ASSEMBLY.....162
WHEEL KITS.....28, 29, 30, 52, 54, 58
WHEEL OPENING MOLDINGS.....139
WHEEL ORNAMENT DECAL.....55
WHEELS.....1, 30, 52, 53, 54, 55, 201
WINDLACE BY THE FOOT.....16
WINDLACE END CAPS.....16
WINDOW CRANK & DOOR HANDLE KITS.....14
WINDOW CRANKS.....14, 171
WINDOW CRANKS & HARDWARE.....14, 171
WINDOW FELT KITS.....175
WINDOW GLASS.....169
WINDOW GUIDES & STOPS.....170
WINDOW MOLDING KITS.....136
WINDOW MOLDING STUD/PIN KIT.....136
WINDOW PLATE GASKET SET.....170
WINDOW REAR GUIDES.....172
WINDOW REGULATORS.....160, 171
WINDOW ROLLERS.....171
WINDOW TRACKS.....171
WINDSHIELD GLASS.....136, 169
WINDSHIELD GLASS STOP.....169
WINDSHIELD MOLDING CLIPS.....136
WINDSHIELD WIPER ARMS.....136
WINDSHIELD WIPER MOTORS.....125
WING NUTS, FLAME ARRESTER & STUDS.....102
WIPER ARM/BLADE KIT.....136
WIPER BLADES.....136
WIPER KNOBS.....27
WIPER MOTOR ARMS WITH BALL STUDS.....125
WIPER MOTOR MOUNTING KIT.....125
WIPER MOTOR SEALS.....125
WIPER MOTOR TRANSMISSION ARM.....136
WIPER PLATE.....25
WIPER SWITCH.....27, 180, 181
WIPER SWITCH NUT.....27
WIRE SEPARATORS.....107
WIRING DIAGRAMS.....176, 202
WIRING HARNESSES.....176
WIRING HARNESS SHIELD KIT.....164
X
X-PIPES.....94
Y
YENKO EMBLEMS.....195
Z
Z/28 FENDER LOUVERS.....137
Z/28 FUEL DOOR EMBLEMS.....195
Z/28 FUEL LINE BRACE.....117
Z/28 LOWER DOOR EXTENSIONS.....139
Z/28 SPOILER DECAL.....147, 200
Z/28 STRIPES.....197, 198

Company Policies

Hassle Free Returns

Products may be returned for a full refund, credit, or exchange within 30 days of receipt, provided that the product is in its original shipping condition and has not been modified, altered, painted, installed, or damaged. Products returned after 30 days can only be returned for exchange, store credit, or refund check. All returns after 30 days are subject to a 25% restocking fee. Ground Up Motors - SS396.com will not accept returned goods without prior authorization, any returns without prior authorization will be subject to a 25% restocking fee. The customer is responsible for shipping charges on returned merchandise unless otherwise indicated by Ground Up Motors - SS396.com.

Ground Up Motors - SS396.com always recommends professional installation for all the products we sell. Any item that has been altered, painted, installed, or deemed non-resalable by Ground Up Motors - SS396.com will be returned to the customer at the customer's expense. If the customer does not want to pay for return shipping, the item will be field destroyed. Ground Up Motors - SS396.com is not responsible or liable for any labor fees associated with the installation, removal, modification, or repair of any product purchased, regardless of the circumstances. Additionally, Ground Up Motors - SS396.com is not responsible for any damage or discoloration incurred in relation to chemical products, including cleaners, waxes, polishes, paints, and/or similar items.

Product Availability & Pricing

The availability of all items on SS396.com and in our print catalogs is subject to change without prior notice. Ground Up Motors - SS396.com reserves the right to discontinue products, services, accessories, and substitute products of a similar nature (i.e., different manufacturers/brands) without notice. While Ground Up Motors - SS396.com strives to maintain accurate pricing, please note that prices are subject to change due to factors such as increased costs in manufacturing and materials. For the most up-to-date pricing information, please visit our website 24/7 or contact a Ground Up Motors - SS396.com customer service representative by phone or email.

Backorders

Ground Up Motors - SS396.com will try to notify you in the event backorders are present on your order. While back orders are often beyond the control of Ground Up Motors - SS396.com, most out of stock items are shipped within two (2) to six (6) weeks. We generally ship back ordered items as soon as they arrive at our warehouse, without notification. If one of your items has been out of stock for more than 90 days, we will try to contact you before shipping. If you wish to cancel a back order, please contact us as soon as possible to avoid return shipping charges and restocking fees.

Ground Up Motors - SS396.com will keep track of all backorders on products that are "out-of-stock" or unavailable at the time the order is placed. The pricing on a back-ordered product is not guaranteed due to labor, manufacturing, materials, shipping costs, and other unforeseeable issues that may arise requiring a price adjustment. We will maintain the price on any backorder product for 60 days after the order is placed. After 60 days, the product may be subject to a price adjustment. If a price adjustment is necessary on a particular product, we will do our best to inform the customer before the product is shipped.

Kit Products

Our Parts and Accessories catalogs, as well as SS396.com, offer kits that include a variety of products to provide you with the best value. Please note that most of these kit items are exclusive to Ground Up Motors - ss396.com and are not eligible for further discounting or price matching against our competitor's kits.

Occasionally, we may run out of a specific item that is included in a kit. In such cases, we will generally ship the items that are in stock and backorder the ones that are currently unavailable. You can contact our sales department by phone to verify which items are out of stock at the time of placing your order. As our customer, you have the option to accept a partial kit delivery or choose to have the entire kit backordered until it is ready to ship in its entirety, be sure this is either verbally communicated over the phone or specified when placing an order online. Please note that additional freight fees may apply for multiple shipments, if applicable.

Color Matches

Please note that due to multiple manufacturers of products provided by Ground Up Motors - ss396.com, color variations may occur. Slight color variations, especially among interior products, are common and do not constitute a defect. These products are not eligible for return shipping solely based on color variations.

Additionally, there are products noted online and, in our catalog, as non-returnable. This primarily includes colored products such as interior items, as well as special order or built-to-order products like date-coded glass and custom gauge clusters. If you are unsure whether a product is non-returnable, please contact a us via phone or email for clarification. Please be aware that colors displayed on computer monitors and, in our print, catalogs may differ slightly from the actual color of the product. If precise color matching on interior items is a concern, we recommend ordering black and color matching using interior paint or dyes. Returns of colored, special order, or non-returnable items are not permitted and will be subject to 25% restocking fee.

Sales Tax Information

If you live in a state that requires sales tax, Ground Up Motors - SS396.com will collect the appropriate sales tax for your shipping location. Most states currently require sales tax and Ground Up Motors - SS396.com is compliant with all the latest laws associated with state sales tax. Due to regular variations in state sales tax, rates are subject to change without notice based on state and zip code. State sales tax is applied to products as well as shipping fees, handling fees, etc

For more policies and information on discounts/eligibility please see ss396.com for more information.

Ordering Lefts and Rights

Items in this catalog are presented as right hand (RH) or left hand (LH). RH and LH sides are determined by sitting in the vehicle. RH = passenger and LH = driver.

Trademark and Copyright

The content of Ground Up Motors - SS396.com, including the Ground Up Motors - SS396.com Parts and Accessories catalog is copyright 2024, all rights are reserved. No part of this publication including text, photos or illustrations may be reproduced without the prior written permission of Ground Up Motors - SS396.com.

International Orders

Ground Up Motors - SS396.com is happy to ship parts to international customers via International Economy shipping. Shipping can also be arranged per the customer and the packages will be boxed at our dock. Please call our sales department or send an email to logistics@ss396.com to get a shipping quote for the parts that you wish to order.

Oversize Items

We offer shipping for items that are considered Oversize. These items can be shipped via UPS Ground at an Oversize rate, which entails a minimum dimensional weight fee of 30 lbs. for Oversize or 70 lbs. for Oversize 2.

It's important to note that Ground Up Motors - SS396.com reserves the right to charge an Oversize fee on any item that is deemed Oversize, even if it is not explicitly indicated as such. This ensures that the shipping costs associated with handling and transporting these larger items are adequately covered. If a shipping adjustment is necessary on a particular product, we will do our best to inform the customer before the product is shipped.

Truck Freight

Ground Up Motors - SS396.com recognizes that certain products are too large or heavy to be shipped via Ground freight and must be shipped using truck freight. Efforts are made to clearly indicate these items in the print catalogs and website, but there may be instances where an item not specifically marked for truck freight may still require or benefit from this shipping method.

To ensure we are providing our customers with the best possible shipping rate all orders are subject to review by our Truck Department for adequate freight quoting. When placing an order online or over the phone you will not be charged any shipping, and a quote will be provided for your approval which is valid for 10 days from the date it was provided. Orders will remain as a quote until the order has been approved by the customer. Note that products are not reserved until the quote has been approved. Due to the quoting process PayPal payment is not accepted for truck orders. It is crucial to provide us with accurate information regarding the delivery destination. Any fees or charges resulting from the provision of false information or failure to comply with Ground Up Motors - SS396.com's policies are the sole responsibility of the customer and may be applied without notice.

Expedited Shipping

Ground Up Motors - SS396.com provides various expedited shipping options for customers' convenience. To ensure timely delivery, orders must be placed by 2:00 pm from Monday to Thursday, and by 12:00 pm on Fridays. Please note that weekends and holidays are not considered shipping days. It is important to mention that we recommend contacting our sales department to obtain the expedited shipping rates for your order. They will be able to provide you with accurate pricing information based on your specific requirements to ensure you are receiving your expedited order in a timely manner.

AP0/FPO Shipping

Please note that for APO or FPO addresses, USPS is the only available shipping method. If you are military personnel with an APO or FPO address, it is important to contact Ground Up Motors - SS396.com prior to placing your order. This will allow them to verify that the desired parts do not exceed the size limit and ensure a smooth shipping process for you. You can reach out to our customer service team by writing, calling, or emailing, be sure to also ask about our Military discounts which we are honored to offer to both active and retired military personnel.

Product Damages & Shortages

We understand that errors and issues can sometimes occur during the fulfillment, shipping, or manufacturing process. If you receive a product that is damaged, missing, or incorrectly shipped, it is important to notify us within three (3) business days of receiving the order. You can do so by contacting us via phone or email. If you are present at the time of delivery and notice any carrier damage it is recommended that you refuse the shipment with the reason of carrier damage. If this is the case notify our customer service team so we can rectify this issue in a timely manner and ensure you are not charged any additional fees.

To ensure a prompt resolution on a damaged or missing claim, we may request additional information, such as images or details about the damaged, missing, or incorrectly shipped product. In most cases, we will provide you with a pre-paid shipping label to return the damaged or incorrectly sent product. Once we receive and inspect the returned item, we will issue a refund or send a replacement, depending on your preference.

Please note that if you report damage, missing items, or incorrect shipments after the 3-day window, you may still be able to make a claim, but will not be eligible for a pre-paid shipping label.

Refusals

In the event of a refused delivery, please note that a restocking fee of 25% will be applied, along with applicable return shipping charges, unless the refusal was due to damage that occurred during shipping (refer to our Damage Claim policy).

PDF CATALOGS

View Our Online PDF Flip book with Links!



Scan the
QR Code
with Your
Phone!



The PDF version is accessible anywhere—on your desktop, laptop, tablet, or mobile phone. It includes clickable links to our website for easy navigation, and you can print any page you need. Check them out today!

DISCOVER MORE RESOURCES ONLINE!

Browse our collection of guides, technical resources, and articles to get the job done right the first time! At ss396.com, our goal is to keep the passion for classic American muscle alive. As part of this mission, we have curated an extensive library of content for our valued customers. Visit our website to learn more!

PART NOT IN OUR CATALOG?

Visit ss396.com or give us a call to shop for thousands of parts & accessories for your ride!



#builtfromthegroundup



"ALWAYS GET A
FRIENDLY CSR WHEN I CALL!"
- JOHN W
1972 CAMARO

We take pride in our customers' vehicles and the tales behind them. Submit your own story today, and you could be featured in our quarterly customer car email, showcasing your prized ride! Visit ss396.com to share your story now.

Ground Up Motors - SS396.COM
2 Commerce Blvd
Palm Coast, FL 32164

PRSR STD
U.S. POSTAGE PAID
PALM COAST FL 32164
PERMIT NO. 114

CURRENT RESIDENT OR:



1967-1981 Pro-Touring Rear Spoilers



Starting At \$149.99

1967-1968 Tail Lamp Bezels



Starting At \$219.99

1967-1973 Pro-Touring Front Spoilers



Starting At \$149.99

1967-1968 Tail Lamp Kits



Starting At \$299.55

GROUND UP
MOTORS

Addictive Flow is a proud part of the Ground Up Motors family of brands.