

# OUTDOOR CATALOG

GREATER THAN YESTERDAY



2024

7' BESTSTRONG



# BESTRONG

# GREATER THAN YESTERDAY

DESIGNED AND MANUFACTURED  
IN EUROPE

VERSATILE  
CONFIGURATIONS

HIGH-QUALITY  
MATERIALS

ROBUST SPORTS  
EQUIPMENT

ASSEMBLED  
WITHIN THE EU

STATE-OF-THE-ART  
TECHNOLOGY

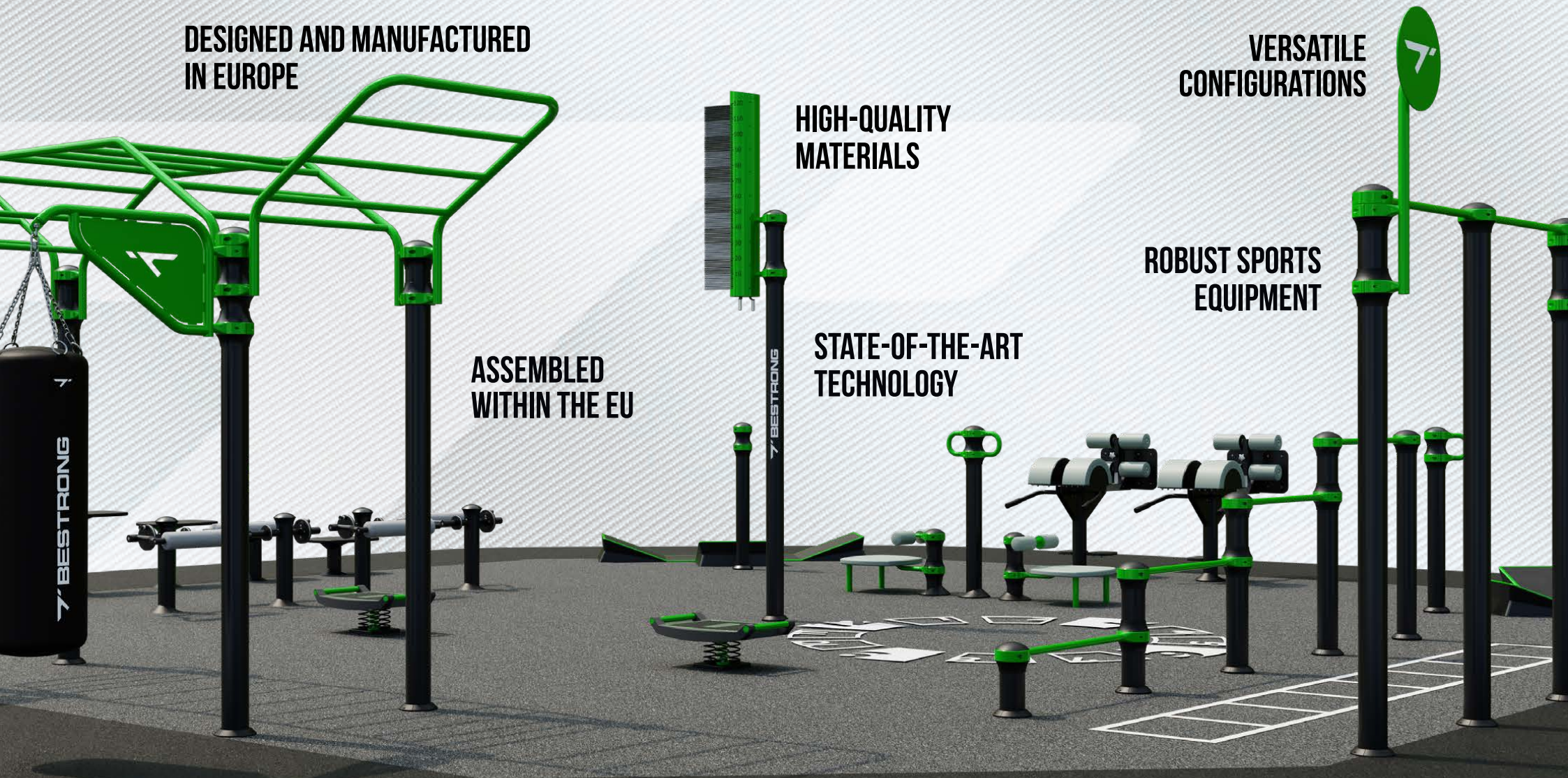



# TABLE OF CONTENTS



<b>04</b> About Us	<b>09</b> Designed For Champions	<b>18</b> Recreational	<b>24</b> Accessible Equipment	<b>30</b> Padel	<b>36</b> Material Specification
<b>05</b> BESTRONG U.S.A.	<b>10</b> FitCampus	<b>20</b> Calisthenics	<b>25</b> Accessories	<b>32</b> 3D & AR	<b>37</b> Warranty
<b>06</b> Mission	<b>12</b> FitLiving	<b>21</b> Cross-Training	<b>26</b> Football Specific	<b>33</b> Design Your Fitness Park	<b>38</b> Contacts
<b>07</b> Values	<b>14</b> FitSociety	<b>22</b> Fitness	<b>28</b> Sporting Kansas	<b>34</b> Craftsmanship	
<b>08</b> Accomplishments	<b>16</b> FitStay	<b>23</b> Adjustable Weight	<b>29</b> Arenas	<b>35</b> Manufacturing	

## Story

In 2007, our owner Zoltán Katona embarked on a journey to Australia for a much-needed vacation. While wandering through the picturesque landscapes of Australia, Zoltán noticed a unique trend that captured his attention – the widespread use of outdoor fitness equipment in parks and public spaces. Intrigued by the idea of combining exercise with the beauty of nature, he saw an opportunity to bring this concept back to Hungary.

## The company

KATKER 2005 Ltd, the owner of the BESTRONG brand, has been a prominent player in the Hungarian sports industry for over 20 years. Our company is involved in designing, manufacturing, installing, and selling outdoor and indoor sports equipment, sports parks, sports fields, and outdoor furniture. Our dedicated team of over 80 professionals continuously works to expand our product range, tailoring it to various sports, age groups, and fitness levels.



A world map with a dark background and light gray landmasses. The United States and Hungary are highlighted in bright green. A dashed yellow line connects a label 'BESTRONG USA, INC.' to a location in the United States. Another dashed yellow line connects a label 'BESTRONG FACTORY' to a location in Hungary. There are also two orange location pins: one in the United States and one in Hungary.

**BESTRONG USA, INC.**

**BESTRONG FACTORY**

## Vision

Zoltán envisioned BESTRONG as more than just a fitness brand. He saw it as a movement that would inspire individuals to break free from sedentary lifestyles, embrace their inner strength, and achieve their full potential. BESTRONG's mission was simple yet profound: to make strength accessible to everyone, regardless of their background, fitness level, or age. The story of BESTRONG is not just about building muscles. It's about building stronger, more resilient communities, united by the common goal of living life to its fullest potential.

## Portfolio

BESTRONG offers a diverse range of products, including sport-specific fitness, cardio, calisthenics, and recreational fitness equipment systems, as well as multifunctional sports fields and arenas. Starting in 2024, we will introduce outdoor adjustable load sports equipment, solutions for people with disabilities, and state-of-the-art padel courts in our portfolio.





# USA

After receiving positive feedback and experiencing successful market expansion in Europe, we turned our attention to the lucrative US market. The introduction of our unique, football-specific equipment led to a fruitful partnership with Sporting Kansas City, one of the most well-known MLS teams. This partnership will soon result in the construction of our own soccer-specific fitness park and arena at Sporting Kansas City's facility, which will also serve as the home for the U.S. National Soccer Team. This significant milestone marked the establishment of our subsidiary, BESTRONG USA, Inc.

## **BESTRONG USA, INC.**

To solidify our presence in the US market, we planned to build an assembly hall in Port Orange, Florida, with groundbreaking having occurred in the fall of 2023 followed by construction starting in the summer of 2024, a fully equipped BESTRONG office center will be ready to provide high-quality services to our US customers and distributors.





# OUR MISSION

Through daily physical activity and outdoor exercise, we strive to educate individuals on how to lead healthy lifestyles. We are dedicated to assisting people in achieving better health, increased strength, and enhanced fitness levels through the use of high-quality sports equipment.



04.

Self-control



06.

Development



05.

Community



# VALUES

As a result of recognizing the diverse needs of sports enthusiasts, we continuously develop and improve our products and services. We have great confidence in seeking and incorporating the advice of renowned professionals and athletes in the design of our products. We genuinely value and attentively listen to the communities' perspectives that utilize our sports equipment and parks. Innovation in sports remains one of our top priorities.





# INTERNATIONAL EXPERIENCE

We have faith in the unifying power of sports and believe that a shared love for sports brings people together. In addition to our many locations in Hungary, our nearly 2000 sports fields and parks have already been installed in over 27 countries in Europe, Africa, Asia, and North America. Furthermore, we are very proud that athletes attending the 2023 World Athletics Championships took advantage of our training center during the event.

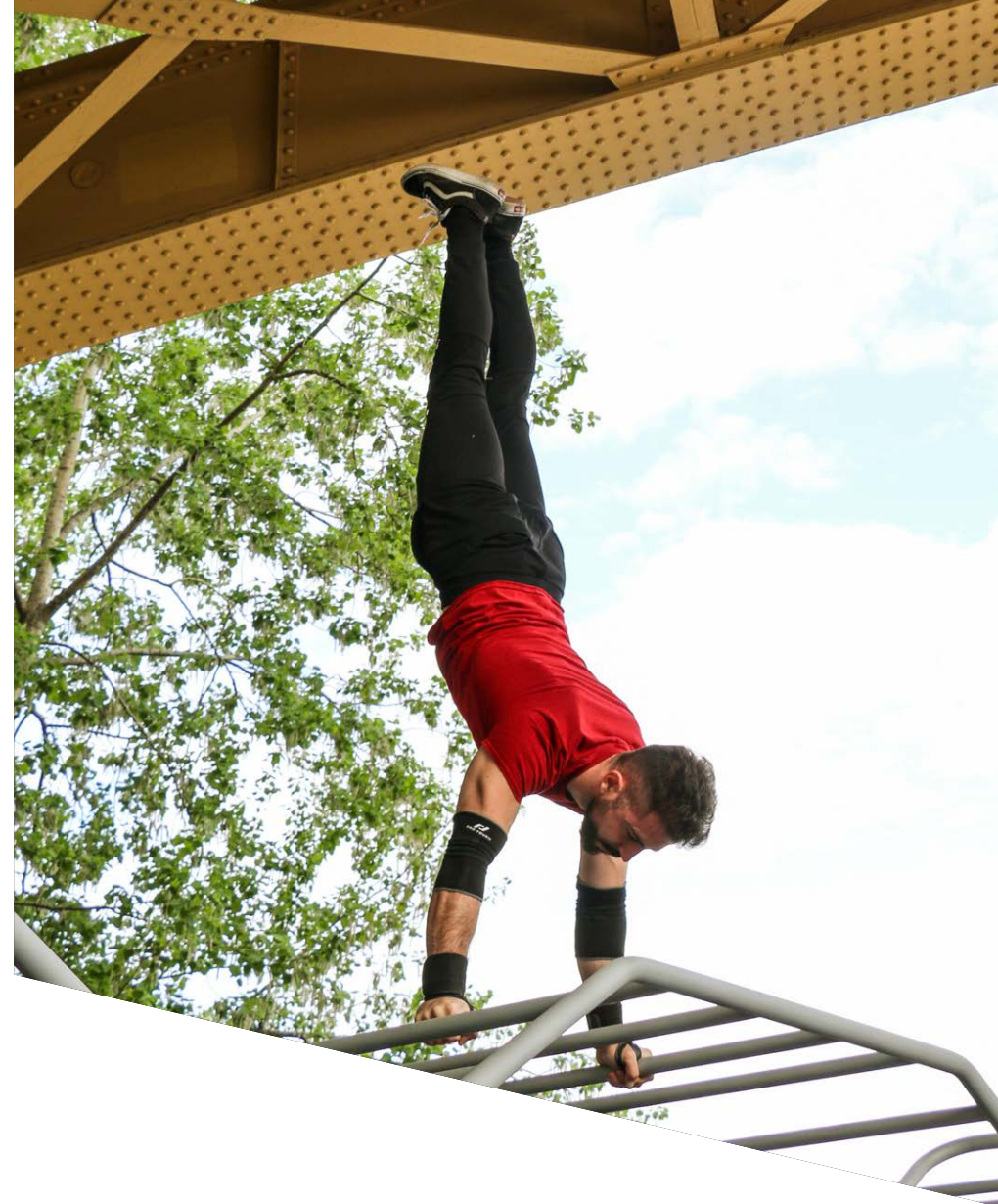

# OUR VISION



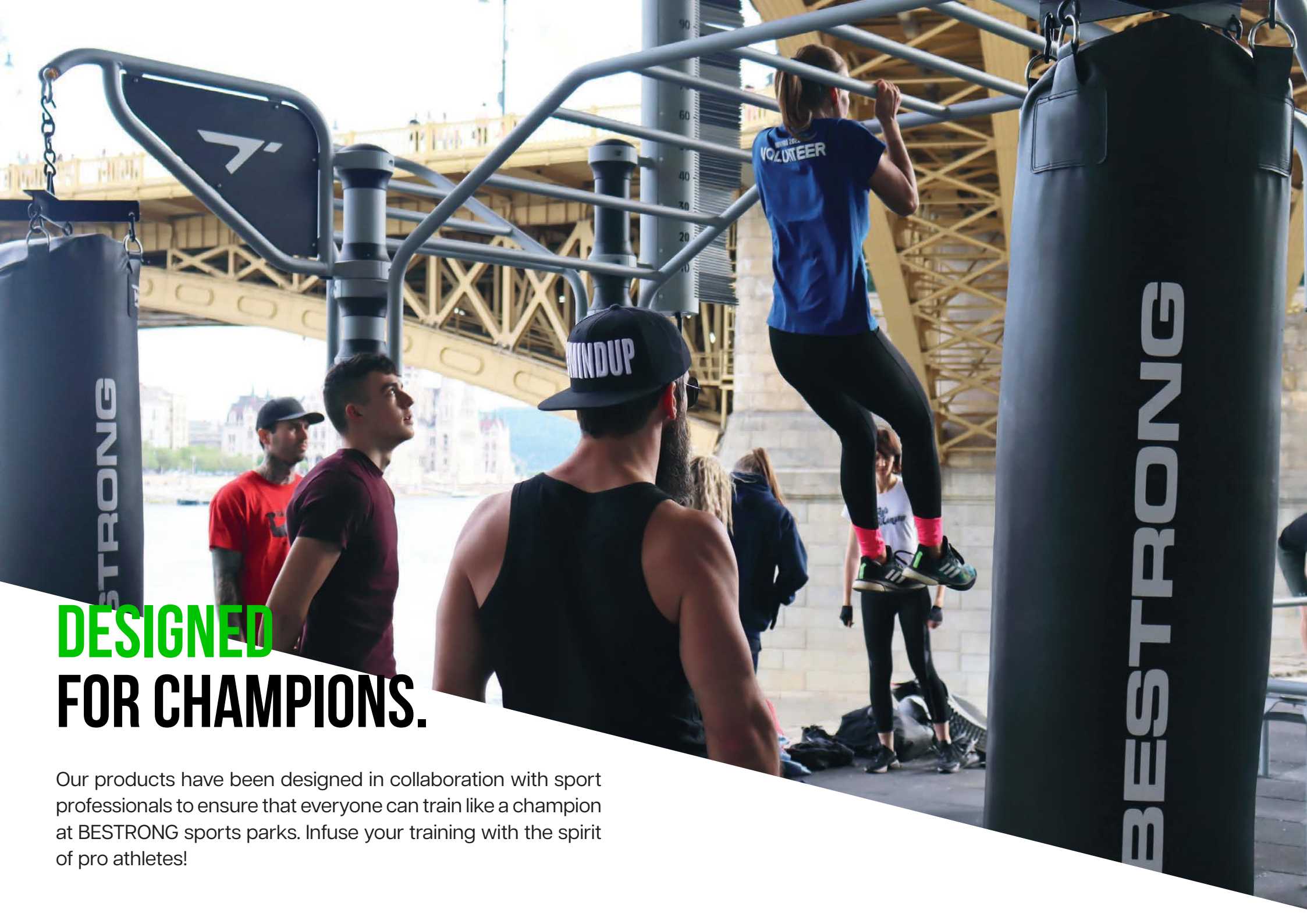

# DESIGNED FOR CHAMPIONS.

Our products have been designed in collaboration with sport professionals to ensure that everyone can train like a champion at BESTRONG sports parks. Infuse your training with the spirit of pro athletes!



# FITCAMPUS

For the full range of FitCampus

- < click on the QR code, or
- < scan with your mobile device







The BESTRONG FitCampus introduces a new dimension to sports in schools and educational centers. Our sport equipment in this setup promotes an active and health-conscious culture, contributing to the diversification of daily physical education. With FitCampus, you can underscore the significance of physical well-being in a holistic education approach and establish an environment that fosters the balanced development of both body and mind.

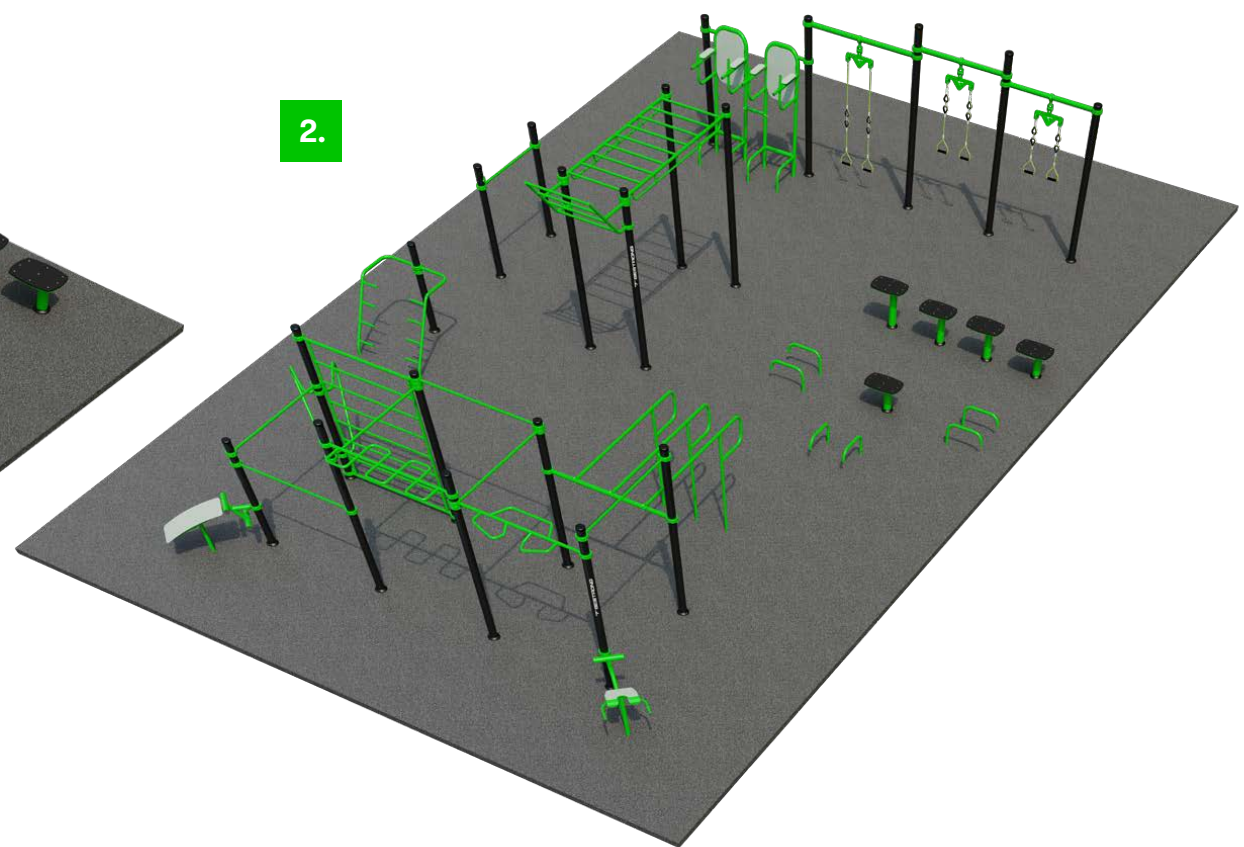
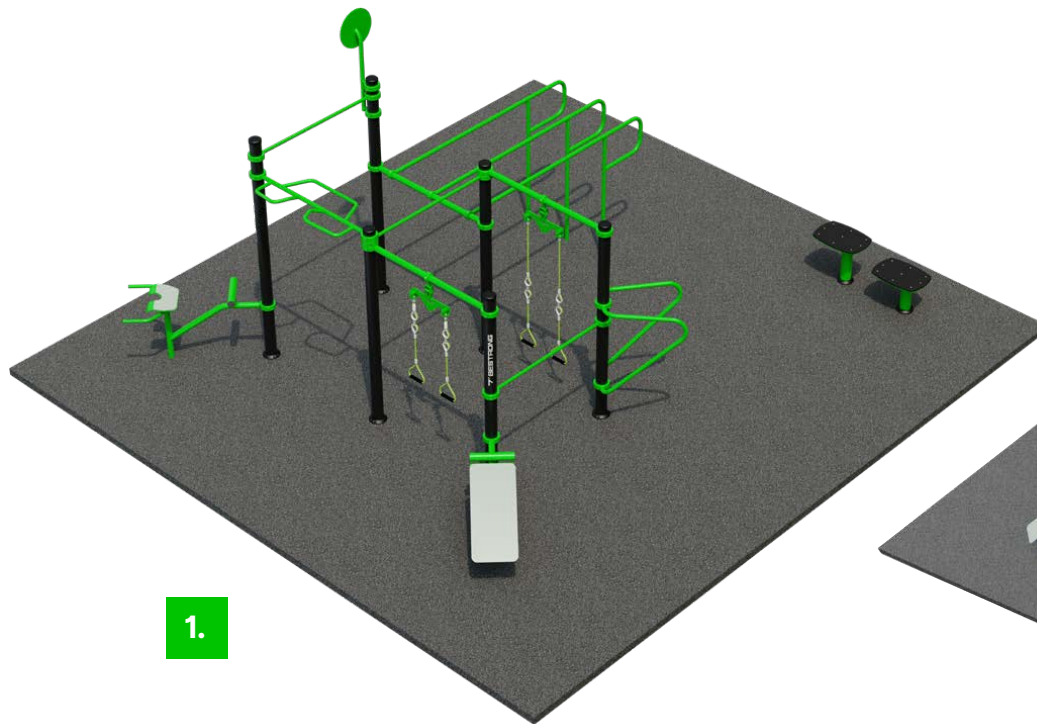

	ID.	Product Name	Certificate	Age Group	Capacity	Total Area	Number of equipment	Fall height	Net weight
1.	1-3-233	FitCampus 1	EN 16630, ASTM F3101	14 + years	24 people	52,5 m <sup>2</sup>	12	1,5 m	475 kg
2.	1-3-249	FitCampus 5	EN 16630, ASTM F3101	14 + years	46 people	203,5 m <sup>2</sup>	23	2,1 m	1477 kg



# FITLIVING

For the full range of FitLiving

- < click on the QR code, or
- < scan with your mobile device







We designed the BESTRONG FitLiving configuration to enhance the quality of life in residential complexes. Our fitness equipment, integrated into communal spaces, allows residents to conveniently embrace an active lifestyle. FitLiving parks offer an excellent solution for investors in residential projects, as they combine functionality, a unique lifestyle experience, and design, all with an attractive cost-to-value ratio and low maintenance requirements. The appearance and active use of our parks facilitate social interaction among residents, promoting the development of a harmonious and healthy community.



	ID.	Product Name	Certificate	Age Group	Capacity	Total Area	Number of equipment	Fall height	Net weight
1.	1-3-232	FitLiving 1	EN 16630, ASTM F3101	14 + years	34 people	67,5 m <sup>2</sup>	17	1,5 m	690 kg
2.	1-3-252	FitLiving 3	EN 16630, ASTM F3101	14 + years	24 people	95 m <sup>2</sup>	12	2,1 m	885 kg
3.	1-3-253	FitLiving 5	EN 16630, ASTM F3101	14 + years	28 people	140 m <sup>2</sup>	14	2,1 m	1191 kg



# FITSOCIETY

For the full range of FitSociety

- < click on the QR code, or
- < scan with your mobile device







BESTRONG's FitSociety configuration features an impressive range of fitness equipment designed to revitalize public spaces and foster community engagement. Our experience has demonstrated that making sports accessible in public parks and other outdoor areas encourages active lifestyles. This configuration promotes comprehensive exercise, caters to various fitness levels and age groups, and fosters increased community interaction.

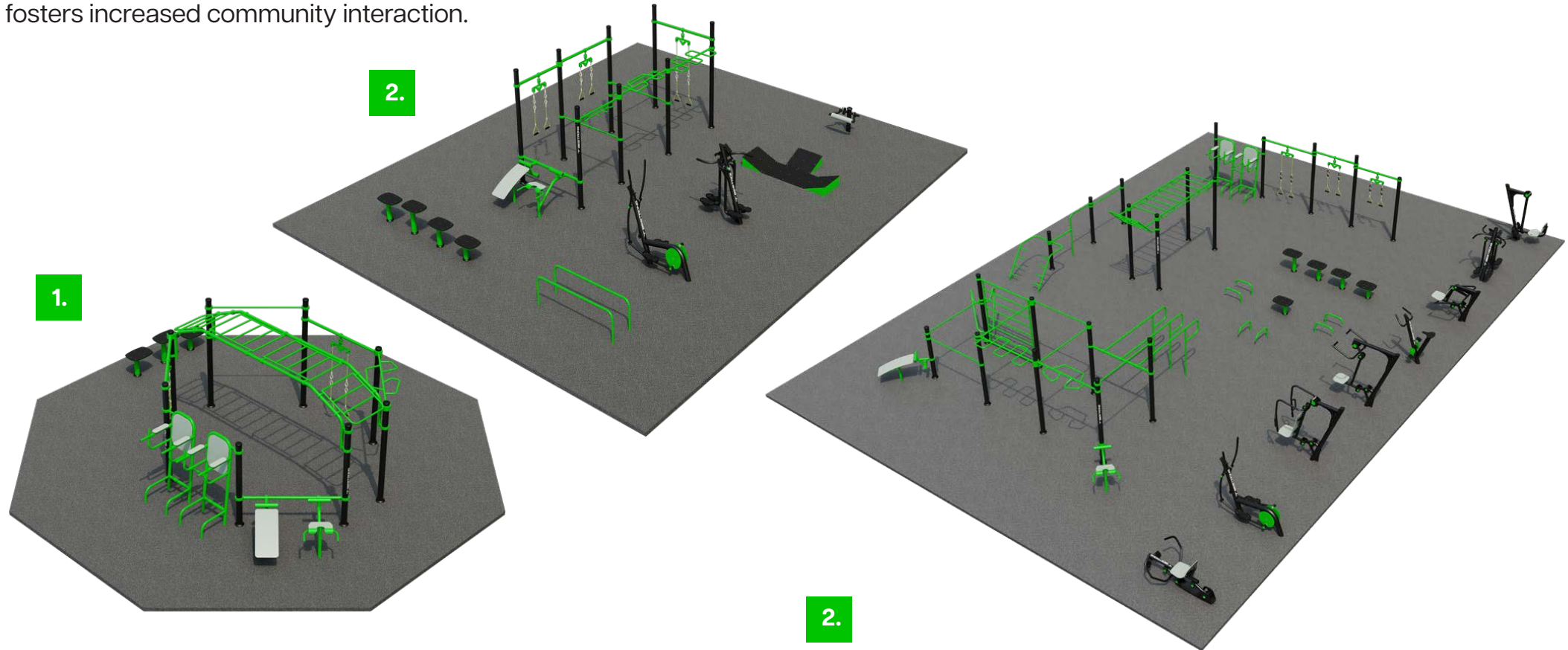

	ID.	Product Name	Certificate	Age Group	Capacity	Total Area	Number of equipment	Fall height	Net weight
1.	1-3-238	FitSociety 2	EN 16630, ASTM F3101	14 + years	24 people	70 m <sup>2</sup>	12	1,6 m	717 kg
2.	1-3-260	FitSociety 5	EN 16630, ASTM F3101	14 + years	32 people	148,5 m <sup>2</sup>	16	0,95 m	1156 kg
3.	1-3-248	FitSociety 8	EN 16630, ASTM F3101	14 + years	62 people	180 m <sup>2</sup>	31	1,5 m	1684 kg



# FITSTAY

For the full range of FitStay  
◀ click on the QR code, or  
◀ scan with your mobile device







With our FitStay configuration, BESTRONG provides hotels and resorts with premium-quality outdoor fitness equipment. Beyond offering visually striking designs, we present a comprehensive solution for guests seeking exercise and mobility. FitStay enables you to broaden the wellness offerings of your hotels, significantly enhancing the overall guest experience.

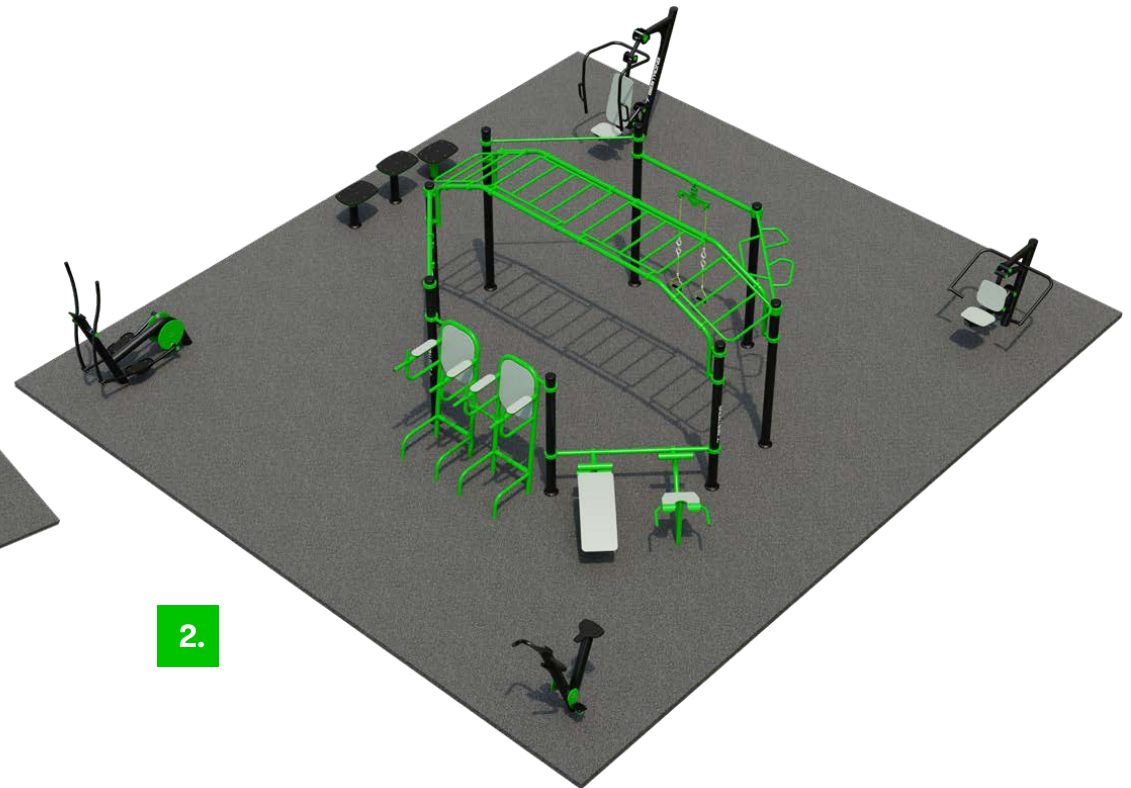
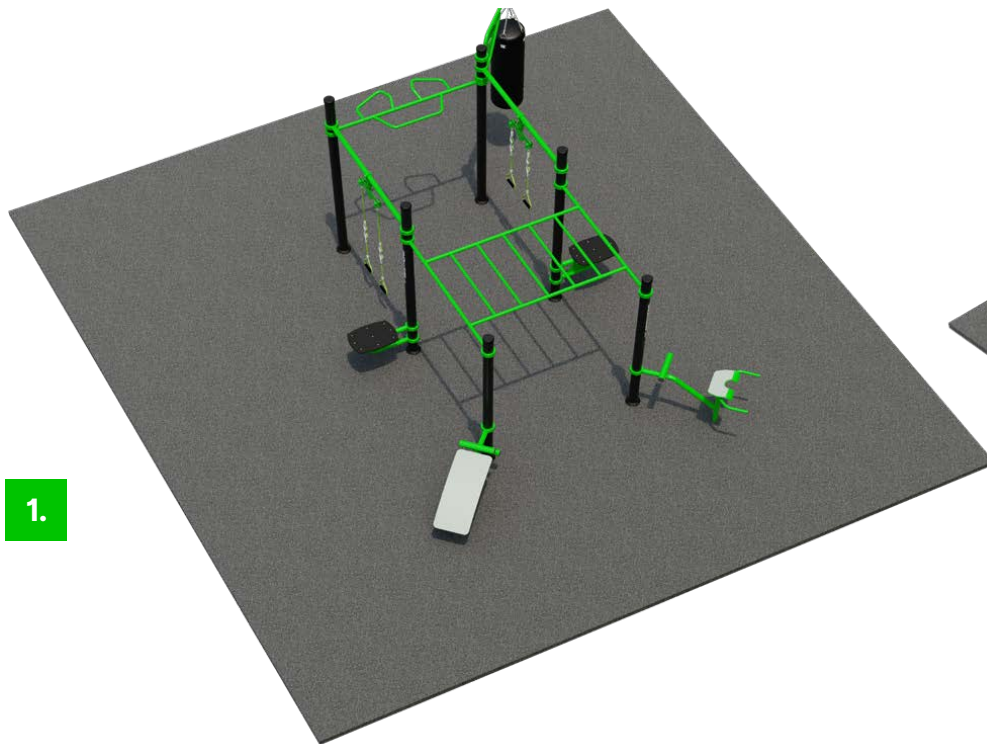

	ID.	Product Name	Certificate	Age Group	Capacity	Total Area	Number of equipment	Fall height	Net weight
1.	1-3-258	FitStay 2	EN 16630, ASTM F3101	14 + years	14 people	68 m <sup>2</sup>	7	0,95 m	355 kg
2.	1-3-239	FitStay 5	EN 16630, ASTM F3101	14 + years	28 people	100 m <sup>2</sup>	14	1,6 m	1084 kg



# RECREATIONAL

For the full range of Recreational

- < click on the QR code, or
- < scan with your mobile device







Experience an exhilarating outdoor cardio workout with BESTRONG recreational cardio equipment! In designing our collection, our top priority was to provide an effective and enjoyable workout suitable for all age groups. These ergonomic products are especially advantageous for seniors, as they support the maintenance of fitness and mobility through low-impact exercises. The diversity and versatility of our outdoor cardio collection cater to all fitness levels and preferences, promoting and sustaining a healthy lifestyle.



	ID.	Product Name	Certificate	Age Group	Capacity	Difficulty level	Concrete volume	Anchoring options	Critical fall height
1.	1-3-300	Elliptical Trainer	EN 16630, ASTM F3101	14 + years	1 person	Easy	1,15 m <sup>3</sup>	Surface mounted	580 mm
2.	1-1-303	Leg Abductor And Hip Swing	EN 16630, ASTM F3101	14 + years	2 people	Easy	0,65 m <sup>3</sup>	Surface mounted	800 mm
3.	1-1-313	Chest Press	EN 16630, ASTM F3101	14 + years	1 person	Medium	0,96 m <sup>3</sup>	Surface mounted	800 mm
4.	1-1-316	Tai Chi Wheel	EN 16630, ASTM F3101	14 + years	2 people	Easy	0,5 m <sup>3</sup>	Surface mounted	-



# CALISTHENICS

For the full range of Calisthenics

- < click on the QR code, or
- < scan with your mobile device



Elevate your outdoor training with BESTRONG's innovative calisthenics equipment! Meticulously designed by our team of qualified engineers and renowned athlete advisors. Using this collection will enhance your weight training experience. We offer a wide range of shapes and sizes to accommodate individuals of all skill levels, from beginners to professionals. Our calisthenics equipment embodies the perfect blend of durability, aesthetic appeal, and functional efficiency, providing a versatile platform for configuring any fitness park.



	ID.	Product Name	Certificate	Age Group	Capacity	Difficulty level	Concrete volume	Anchoring options	Critical fall height
1.	1-1-021	Three Element Parallel Bar 1500	EN 16630, ASTM F3101	14 + years	2 people	Medium	0,2 m <sup>3</sup>	In-ground or surface	1500 mm
2.	1-1-028	Wall Bars 1500	EN 16630, ASTM F3101	14 + years	1 person	Hard	0,4 m <sup>3</sup>	In-ground or surface	2075 mm
3.	1-1-033	Combined Pull-Up Bar 1500	EN 16630, ASTM F3101	14 + years	1 person	Hard	0,4 m <sup>3</sup>	In-ground or surface	1100 mm
4.	1-1-035	Maximum Ladder	EN 16630, ASTM F3101	14 + years	2 people	Hard	0,8 m <sup>3</sup>	In-ground or surface	1620 mm



# CROSS-TRAINING

For the full range of Cross-Training

- < click on the QR code, or
- < scan with your mobile device



Embark on a journey toward enhanced functional fitness with BESTRONG's dynamic Cross-training tools! This collection is meticulously designed to target various muscle groups, enrich the workout experience, and boost endurance and flexibility. The sturdy design of our equipment ensures safety during use. The array of exercises that can be performed makes it an ideal choice for both beginners and advanced athletes. Enjoy an outdoor training experience that harnesses the power of tools to elevate your performance to new heights!



	ID.	Product Name	Certificate	Age Group	Capacity	Difficulty level	Concrete volume	Anchoring options	Critical fall height
1.	1-1-020	Climbing Rope Frame	EN 16630, ASTM F3101	14 + years	1 person	Medium	0,4 m <sup>3</sup>	In-ground or surface	3200 mm
2.	1-1-054	Boxing Bag Holder	EN 16630, ASTM F3101	14 + years	1 person	Easy	0,2 m <sup>3</sup>	In-ground or surface	-
3.	1-1-055	Medicine Ball Target	EN 16630, ASTM F3101	14 + years	1 person	Hard	0,2 m <sup>3</sup>	In-ground or surface	-
4.	1-1-227	Suspension Trainer 1500 930	EN 16630, ASTM F3101	14 + years	1 person	Easy	0,4 m <sup>3</sup>	In-ground or surface	-



# FITNESS

For the full range of Fitness

- < click on the QR code, or
- < scan with your mobile device



Unlock the advantages of comprehensive outdoor training with BESTRONG's general fitness equipment! By utilizing a combination of our equipment, co-designed by our team of professional fitness experts and engineers, you can craft a fitness regimen that targets all major muscle groups. Whether your focus is on strengthening core muscles, sculpting muscle tone, or improving flexibility, our equipment will support your fitness objectives. Explore a new dimension of outdoor fitness with our collection, which intensifies your workouts while ensuring safety, and allows you to customize your fitness equipment to meet your specific needs.



ID.	Product Name	Certificate	Age Group	Capacity	Difficulty level	Concrete volume	Anchoring options	Critical fall height	
1.	1-1-167	Hyperbending Bench	EN 16630, ASTM F3101	14 + years	1 person	Medium	0,4 m <sup>3</sup>	In-ground or surface	1000 mm
2.	1-1-129	Stepper on Pillar 400	EN 16630, ASTM F3101	14 + years	1 person	Easy	0,2 m <sup>3</sup>	In-ground or surface	485 mm
3.	1-1-041	Ab & Back Trainer 1500	EN 16630, ASTM F3101	14 + years	2 people	Easy	0,8 m <sup>3</sup>	In-ground or surface	800 mm
4.	1-1-044	Multifunctional Trainer On Pillar	EN 16630, ASTM F3101	14 + years	1 person	Medium	1,3 m <sup>3</sup>	In-ground or surface	1380 mm



# ADJUSTABLE WEIGHT



Elevate your outdoor workouts with our adjustable load outdoor collection! Offering versatility and resilience in the face of today's extreme weather conditions, this range is tailored for the contemporary fitness enthusiast. Whether your goal is to build muscle, tone, lose weight, or enhance endurance, the adjustable weight features enable you to customize the direction and intensity of your workout effortlessly. Our collection blends innovative design with robust construction, ensuring that you can experience the functionality and versatility of an indoor gym in the great outdoors, closer to nature. Join us as we redefine your outdoor exercise experience together!

1.



2.



3.

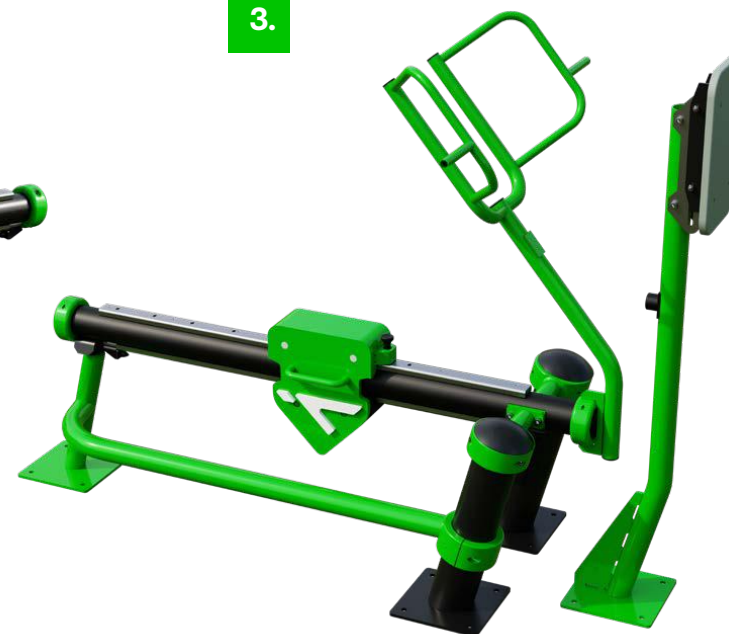

	ID.	Product Name	Certificate	Age Group	Capacity	Difficulty level	Concrete volume	Anchoring options	Critical fall height
1.	1-1-321	Biceps Curl	EN 16630, ASTM F3101	14 + years	1 person	-	0,4 m <sup>3</sup>	Surface mounted	-
2.	1-1-320	Low Row	EN 16630, ASTM F3101	14 + years	1 person	-	1 m <sup>3</sup>	Surface mounted	-
3.	1-1-319	Bench Press	EN 16630, ASTM F3101	14 + years	1 person	-	1,2 m <sup>3</sup>	Surface mounted	500 mm



# ACCESSIBLE EQUIPMENT



Our message at BESTRONG is simple: sport is for everyone. From 2024 we are proud to offer accessible outdoor exercise equipment for everyone, including disabled individuals. In addition to strengthening different parts of the body, physical activity improves your mental health, overall fitness, and quality of life. Our innovative outdoor fitness equipment is designed to be accessible, safe, and easy to use.

1.

2.

3.



	ID.	Product Name	Certificate	Age Group	Capacity	Difficulty level	Concrete volume	Anchoring options	Critical fall height
1.	1-1-331	Shrug	EN 16630, ASTM F3101	14 + years	1 person	Medium	0,5 m <sup>3</sup>	Surface mounted	460 mm
2.	1-1-332	Lateral Pull-Down	EN 16630, ASTM F3101	14 + years	1 person	Medium	0,5 m <sup>3</sup>	Surface mounted	460 mm
3.	1-1-333	Chest Press	EN 16630, ASTM F3101	14 + years	1 person	Medium	0,5 m <sup>3</sup>	Surface mounted	460 mm



# ACCESSORIES



1.



2.

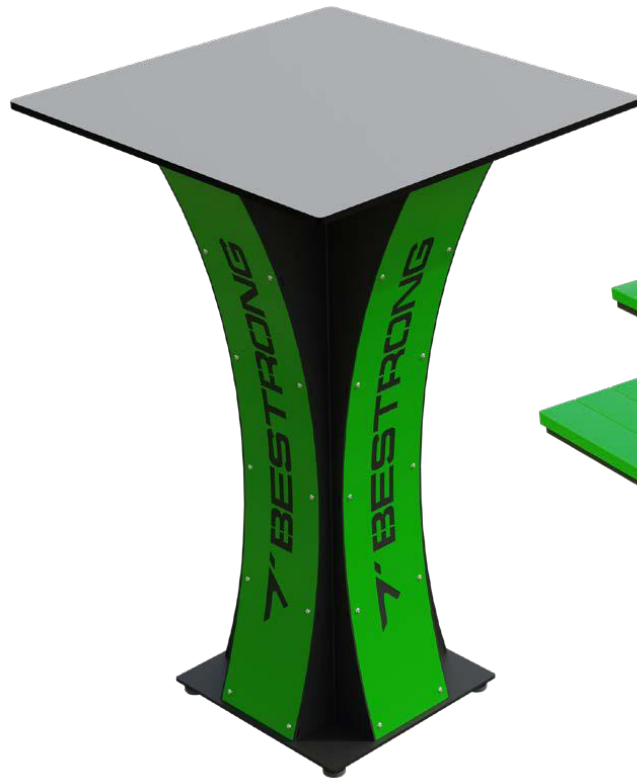

3.



ID.	Product Name	Height	Width	Description	
1.	1-0-002	Waste Bin	836 mm	780 mm	Our outdoor waste bins are finished with a durable powder coating and have curved columns for greater stability.
2.	1-0-008	Outdoor Bar Table	1097 mm	700 mm	Aesthetically pleasing and robust bar table, perfect for enhancing outdoor social spaces.
3.	1-0-003	Parkside Table Bench	800 mm	2960 mm	Elegant outdoor bench with a powder-coated frame and WPC trim, featuring a convenient table.



# FOOTBALL SPECIFIC

For the full range of Football Specific

- < click on the QR code, or
- < scan with your mobile device







BESTRONG's exclusive, football-specific equipment adds a new dimension to the sport's training culture. Developed with input from a wide range of professional athletes, our carefully designed equipment is intended to enhance athletes' skill development and overall performance. Whether it's for stabilization or mobilization, strength training, or simple warm-ups, our sport-specific equipment can meet the needs of any performance level. Our football-specific solutions are crafted with extreme precision to fulfill your high-quality training requirements.

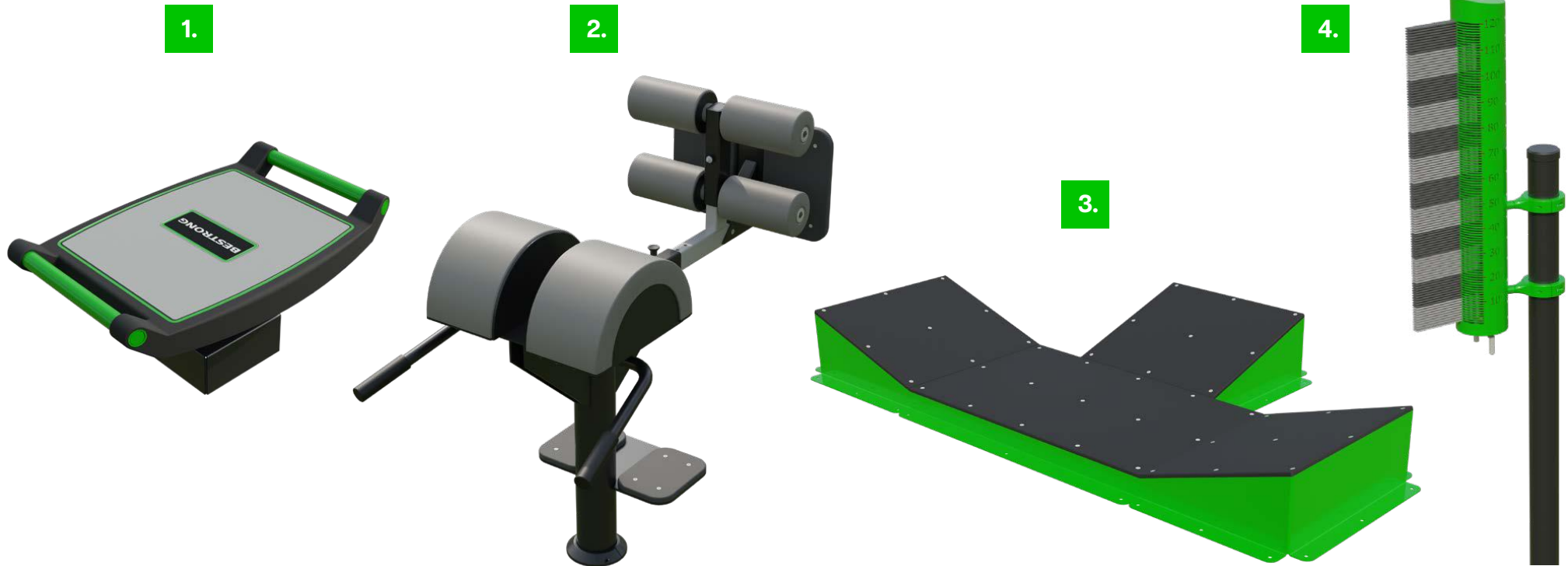

	ID.	Product Name	Certificate	Age Group	Capacity	Difficulty level	Concrete volume	Anchoring options	Critical fall height
1.	1-1-161	Balance Board Pro	EN 16630, ASTM F3101	14 + years	1 person	Medium	0,2 m <sup>3</sup>	In-ground or surface	338 mm
2.	1-1-162	Glute-Ham Developer Pro	EN 16630, ASTM F3101	14 + years	1 person	Medium	0,5 m <sup>3</sup>	In-ground or surface	1216 mm
3.	1-1-186	Lateral Plyo Box Pro	EN 16630, ASTM F3101	14 + years	1 person	Easy	1,4 m <sup>3</sup>	In-ground or surface	303 mm
4.	1-1-189	Vertec Pro	EN 16630, ASTM F3101	14 + years	1 person	Easy	0,5 m <sup>3</sup>	In-ground or surface	-



# SPORTING KANSAS CITY





# ARENAS

For the full range of Arenas  
 < click on the QR code, or  
 < scan with your mobile device



1.



2.

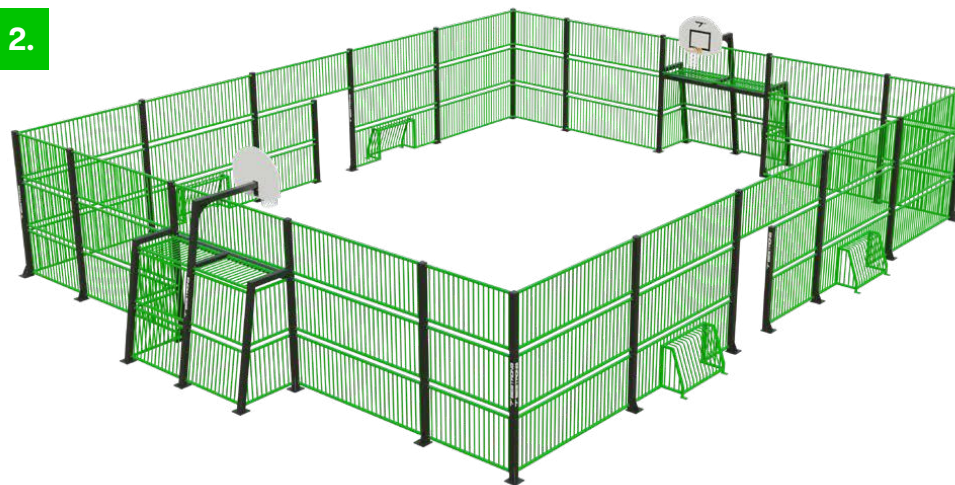

3.

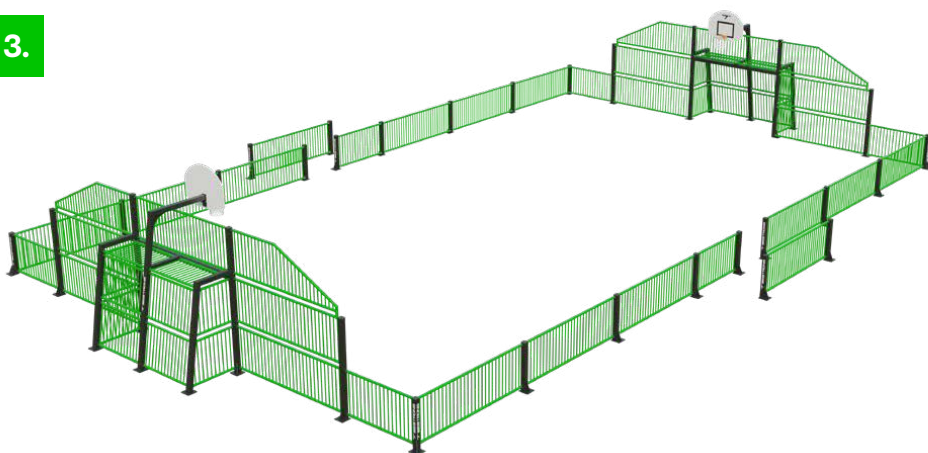

4.

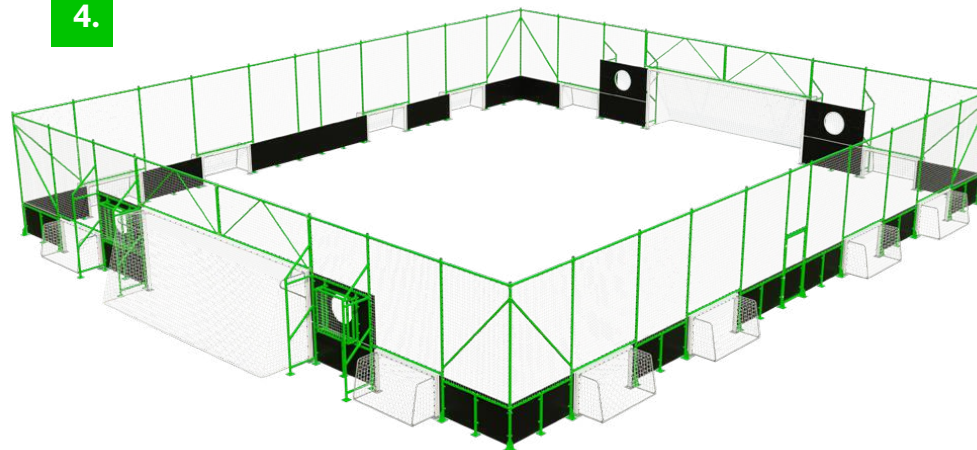

ID.	Product Name	Type	Age Group	Fence height	Length	Width	Height	Total area	Anchoring options	Anti-corrosion possibility	
1.	4-3-036	Ellipse	PANNA	3 + years	2000 mm	9564 mm	8180 mm	2007 mm	78 m <sup>2</sup>	Surface mounted	Galvanized
2.	4-3-032	Aquincum	MUGA	3 + years	3000 mm	17618 mm	13593 mm	3771 mm	239 m <sup>2</sup>	Surface mounted	Galvanized
3.	4-3-014	Athens	MUGA	3 + years	1000 mm	23618 mm	15340 mm	3771 mm	362 m <sup>2</sup>	Surface mounted	Galvanized
4.	1-1-189	SKC ARENA	FOOTBALL ARENA	3 + years	3000 mm	24550 mm	21770 mm	3000 mm	78 m <sup>2</sup>	Surface mounted	Galvanized



# PADEL







Padel was invented in 1969 in Mexico. Today it is a highly popular sport in Spain and Latin America and is rapidly gaining popularity in other parts of the world: there are over 25 million active padel players in over 110 countries. Come and join one of the world's fastest-growing sports with BeStrong. Starting in the fourth quarter of 2024, we will introduce our state-of-the-art padel courts in our portfolio. Our courts are carefully designed, and made from exceptional and durable materials, ensuring safety and security in any weather conditions. Our padel courts are the result of a combination of aesthetics, innovation, and a high-tech manufacturing process using only the highest-quality materials. Padel is a unique and exciting sport that offers a range of physical and social benefits for players of all ages and skill levels.

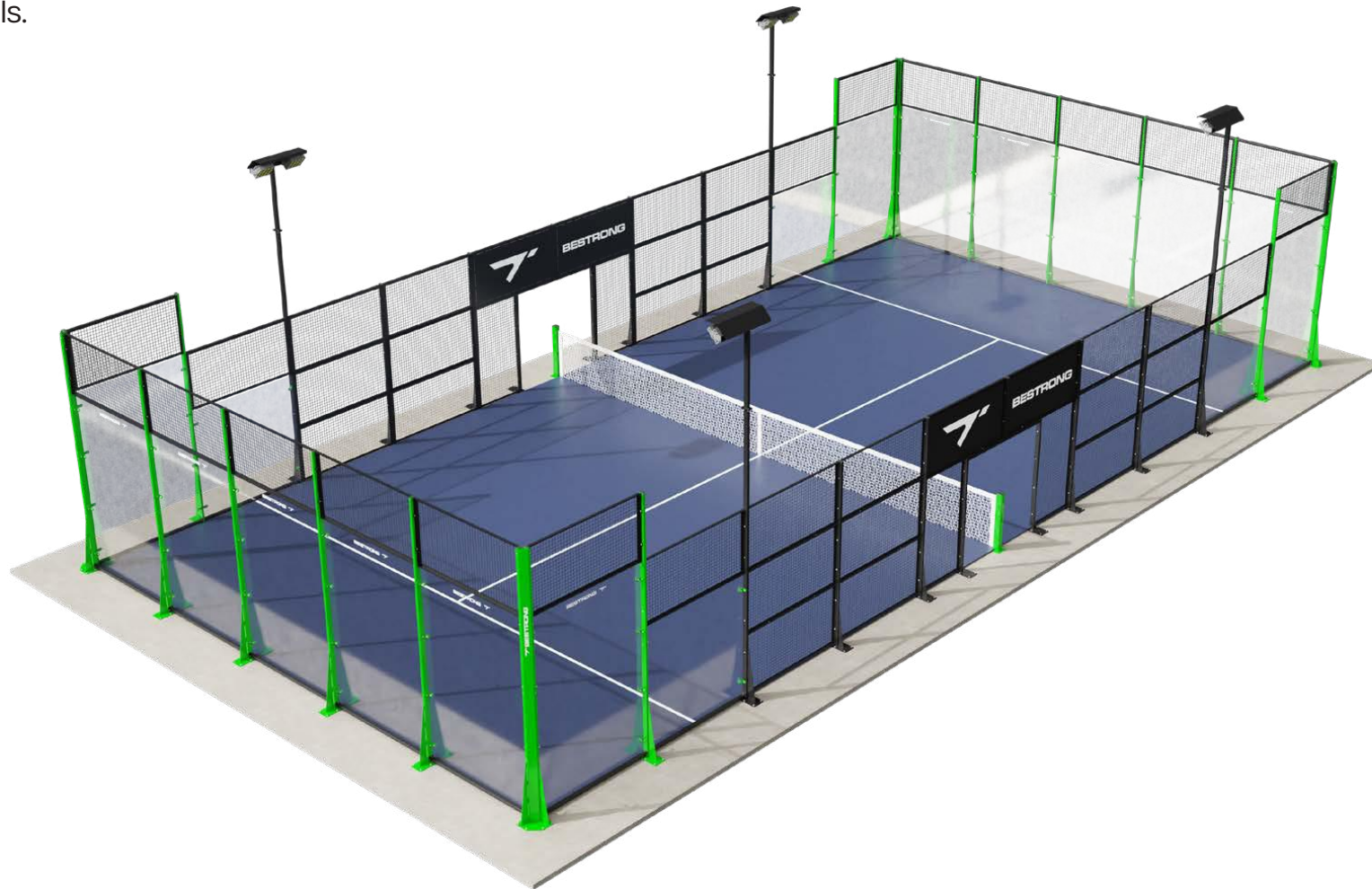



# VIEW IT IN 3D & AR



Users can now explore our sports parks not only through conventional images but also in 3D and within an augmented reality (AR) environment. Through AR, you can not only obtain a close-up view of the finest details and dimensions of our sports equipment but also interactively zoom into any location in real-time using your mobile device's camera to view 3D renditions of our designed collections and assemblies. Our innovation enables you to enter, experiment with, and explore your future sports park within a virtual environment of your choosing. Try our new AR functionality today and discover the most suitable sports park for you in a truly unique experience.





# DESIGN YOUR FITNESS PARK

Full support  
for your needs

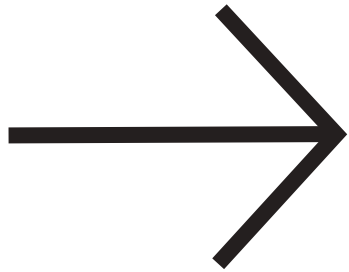

BESTRONG 3D PLANNER is a user-friendly 3D software that enables you to design and visualize your very own outdoor fitness park with remarkable precision. Our complete array of sports equipment and accessories is at your disposal for custom design. High-quality 3D models can be viewed from various angles, freely combined, and colorized using the software. Craft your unique sports park with BESTRONG 3D PLANNER!

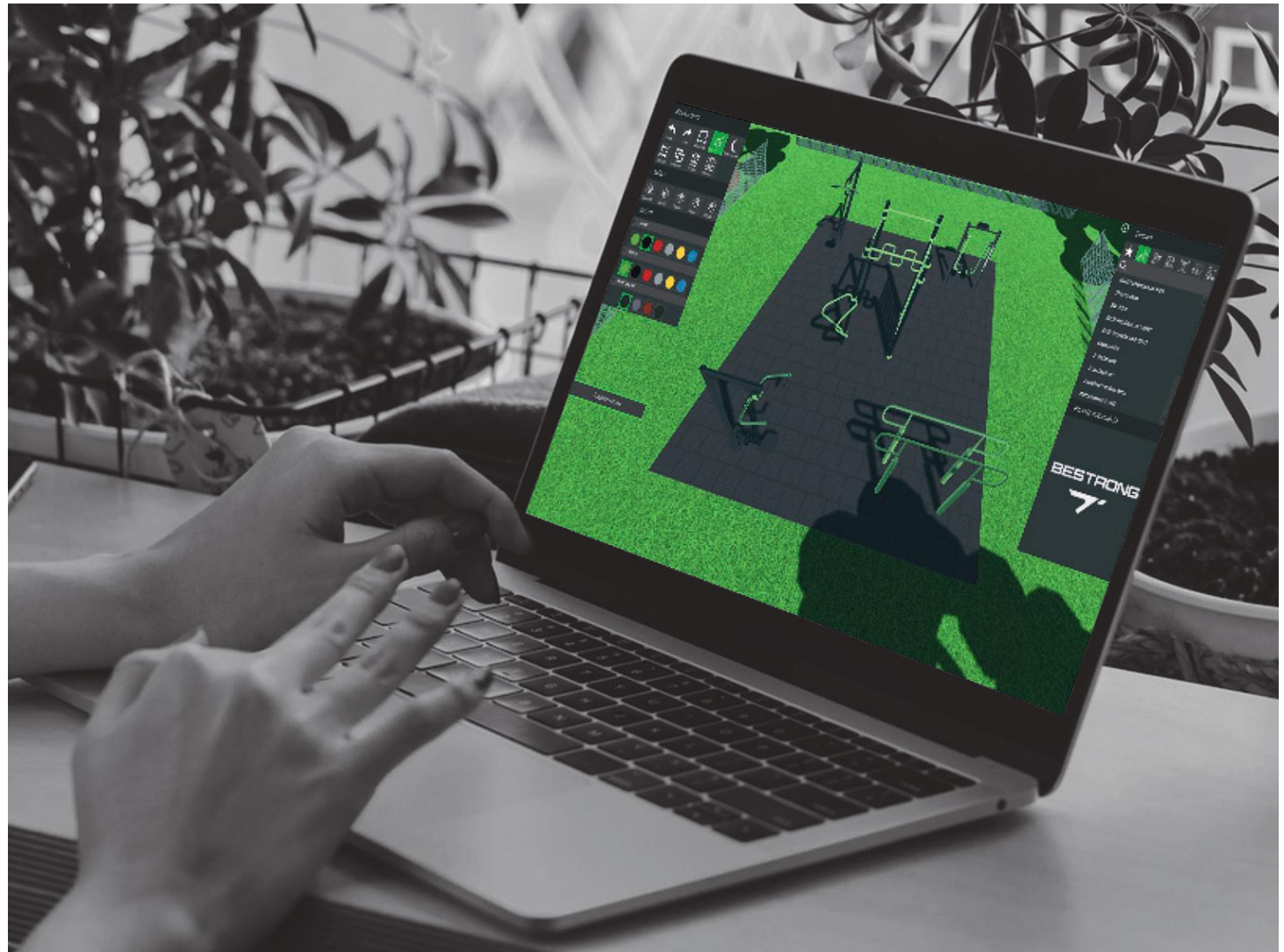



# CRAFTSMANSHIP

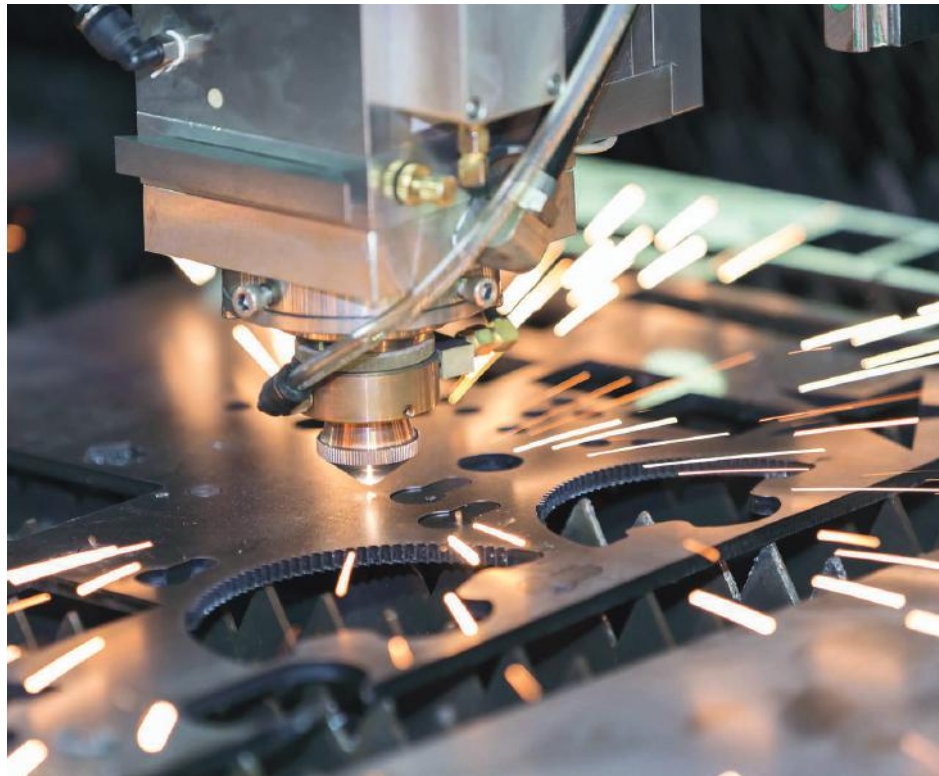

At our manufacturing facility, we employ state-of-the-art technology such as laser cutting, edge bending, and CNC machining to produce our sports equipment. Skilled technicians oversee welding operations with rigorous quality control.



The majority of surface treatments are conducted in-house. In addition to our shot blasting chambers, our facility houses a high-capacity powder coating unit and a solvent paint booth that complement the manufacturing process. We ensure corrosion protection through methods such as hot-dip galvanizing or EPD technology, a widely-used process in the automotive industry worldwide.

## INNOVATIVE



# MANUFACTURING

Function

Aesthetic

Safety

Quality

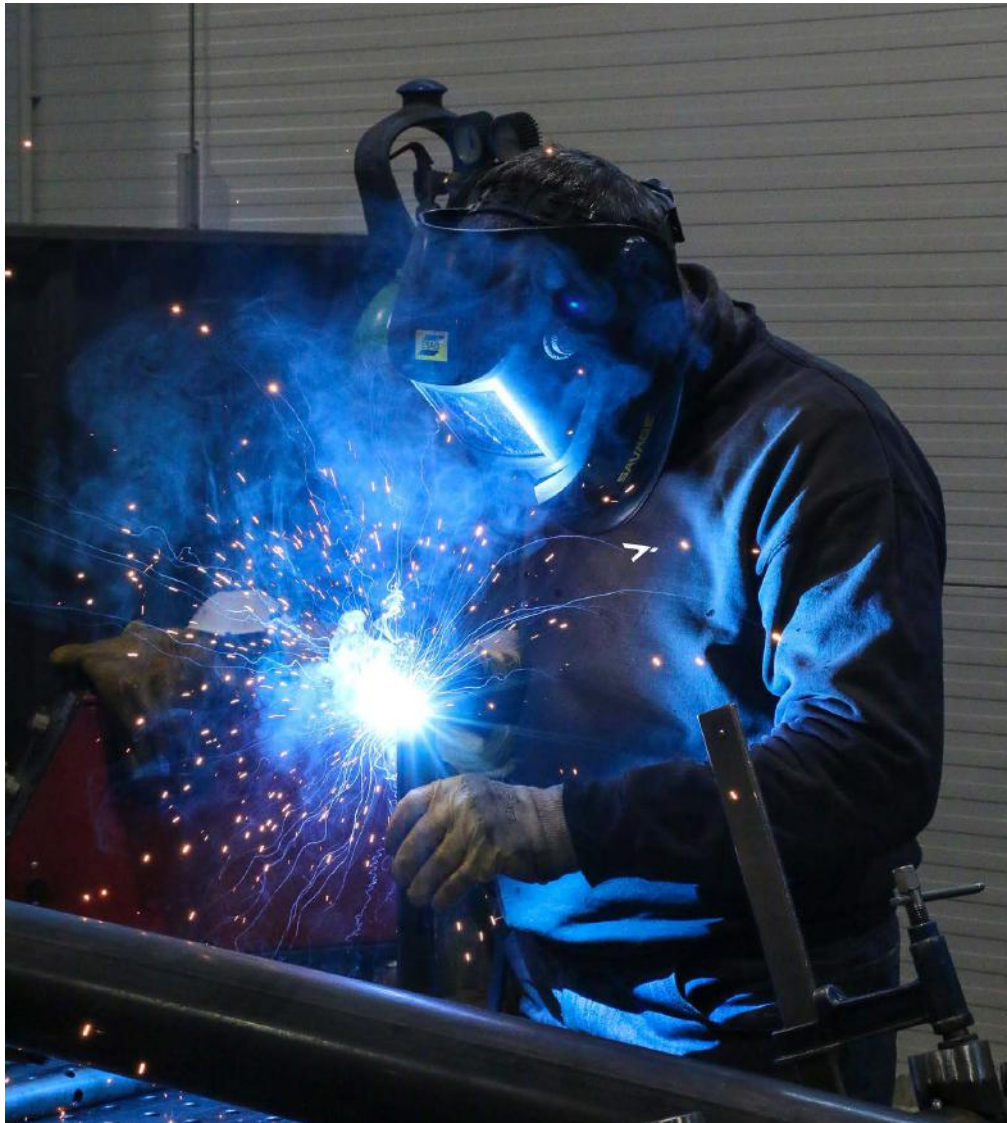

## PRODUCTION

Our foremost priority is to ensure that our products meet the highest standards of functionality, aesthetics, and safety. To achieve this, we maintain meticulous oversight of our manufacturing and quality control processes, which adhere to the MSZ EN ISO 9001:2015 standard, audited by TÜV SÜD.

Environmental preservation holds significant importance for us, and as such, our production and installation processes are aligned with the EN ISO 14001:2015 environmental management system standard.



# MATERIAL SPECIFICATION



At the end of the arms, the handle is rubber-coated for a more comfortable and secure grip.



The seats and backrests are made of strong HDPE material. Which is fully heat, moisture and UV resistant.

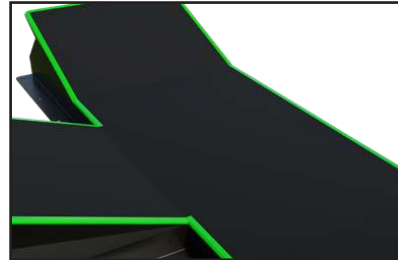

The top surface of the Lateral Plyo Box is covered with the highest quality non-slip HDPE.



The bumpers of the devices are made of durable rubber material.

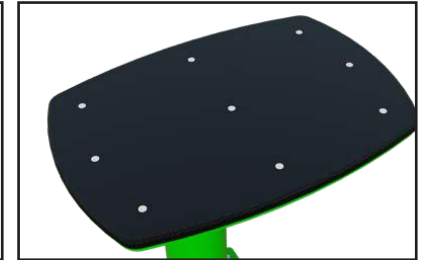

The top surface of the device is covered with the highest quality non-slip HDPE.



The clamp system allows for easy assembly and extreme stability.



The top surface of the Balance Board Pro is covered with the highest quality non-slip HDPE.

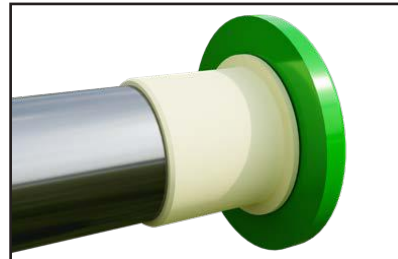

The recreational and cardio devices are fitted with composite bearings that are weather-resistant. The bearing does not require regular maintenance.



The rope is fully heat, moisture and UV resistant.



The ends of the bars and posts are sealed with injection-moulded plastic caps.



Steel ropes with a 0.63" mm diameter, galvanized and sheathed in nylon, are joined using connectors made of plastic. These ropes are UV radiation, abrasion, and rot-resistant.



The device is equipped with an ergonomic non-slip HDPE phone holder for convenience.



The footrests are made of premium quality non-slip HDPE with a high wear resistance.

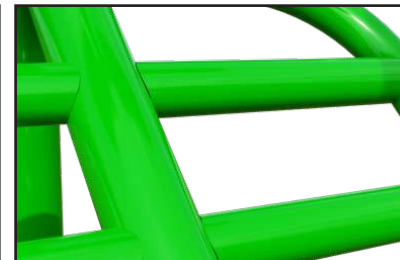

The element is made of high quality S235 steel, which has been cleaned via sandblasting. A corrosion resistant powder coating finish is then applied. Also available with galvanized surface for even greater protection and longevity!



The internal structure has 120 moveable plastic "bars". The levers are rubber-coated for a more comfortable grip and to prevent head injuries

# WARRANTY

---



**15-year** limited warranty on failures of steel elements and steel components due to material or manufacturing defects and **25 years** on structural integrity.

**10-year** limited warranty for defects in plastic HDPE components due to material or workmanship and **5 years** for defects in all other plastic components (except colour fading).

**5-year** limited warranty for significant corrosion of painted metal parts that inhibit the use of the equipment and **10 years** warranty for galvanized and cathodic painted steel parts.

**3-year** limited warranty on failure of all rubber based parts and **1 year** on rubber bumpers.

**2-year** limited warranty on powder coated paint integrity.

**2-year** limited warranty for bearings of moving elements.

For the full range of Warranty

- < click on the QR code, or
- < scan with your mobile device





# CONTACTS

**BESTRONG**



**@bestrongworld**



**@bestrongworld**



**BeStrong-world**



**global.bestrong.com**



**Debrecen Pallag 044/1 hrsz.  
Ipari park, 4002**



**info@bestrong.com**



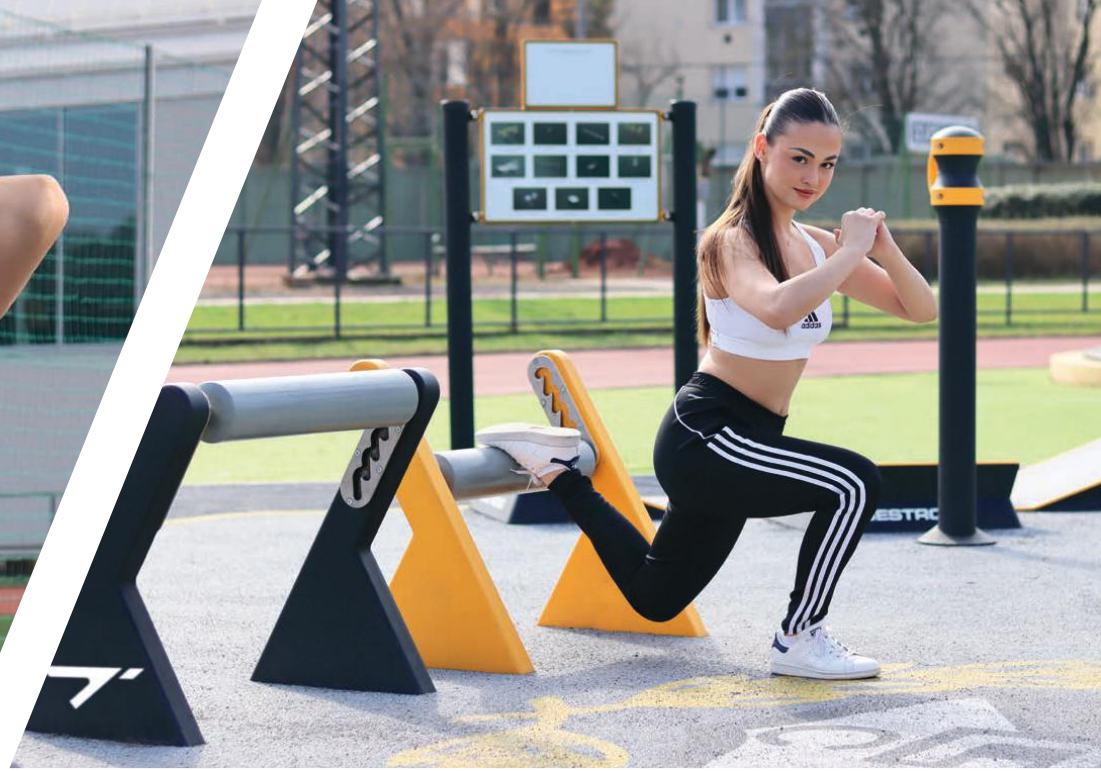





7. BESTRONG