

E-MAGAZINE

JANUARY 2023



A Message From Guidely To All Serious Bank Aspirants

Hai all,

Our Guidely platform has been doing a great job for the past eight years in supporting the banking aspirants. In this beautiful journey, we have been providing quality mock test packages, bundle PDF courses, and various other study materials at affordable prices. This journey will continue for the upcoming years to uplift all the banking aspirants.

Lakhs of students come into this competition with a passion to become bankers. In this battle, a majority of people have been starving for success for a long period of time. They have been facing failures for many years. Due to continuous failures, many are thinking of quitting this competition.

In reality, success will not come to you overnight. You must handle your failures in a calm and composed manner. More importantly, you have to learn more from your failures. Only after a fine-tuned practice and a perfect preparation for the long term can you attain success. In this period, you have to be motivated, work hard, and use smart strategies to find progress in your success journey

For that, Guidely will provide you with an enormous amount of quality study materials. You can rely on Guidely for standard mock test packages, bundle PDFs, and other materials at affordable price ranges. The only thing you have to do is follow us and work hard with a hundred percent hope. Guidely will end your journey with fruitful success. So, don't feel bad for your failures. Guidely will show you the best ways to crack the upcoming bank exams.

- Team Guidely



Index

Previous year (2022)exams current affairs analysis based on Topic wise	3
Previous year (2022) exams Current Affairs analysis based on Month wise	5
Success Story	7
Booster Dose (Top 100 Important Current Affairs)	9
Important News Topic wise - Jan 2023	27
Article related to most important news of the month	82
Current Affairs Crossword Puzzle Activity	85
RBI Assistant Pre Practice set With Free video Solution	88
Zero to Infinity with Free Video Solution	114
RBI Assistant Pre Memory Based Paper	179
Hindu Editorial Vocabulary	204



**Previous year(2022)
exams current affairs
analysis based on**

Topic wise

Previous year (2022) exams current affairs analysis based on Topic wise

Topic	IBPS RRB PO 2022	IBPS RRB Assistant	IBPS PO 2022	IBPS Clerk	SBI PO 2022	SBI Clerk
National	4	7	3	4	6	5
State	5	2	6	1	-	-
International	3	3	-	5	3	-
Banking	4	4	17	12	22	15
Economy	1	2	5	3	2	3
Appointments	4	9	1	2	1	2
Awards	2	1	1	1	1	6
Defence	-	-	-	-	1	1
Science & Tech	-	-	-	1	-	1
Acquisitions	-	-	-	-	-	-
MoUs	-	-	1	1	-	-
Days	-	1	-	1	-	-
Sports	2	3	1	1	4	-
Obituaries	-	-	-	-	1	-
Static GK Current Affairs related	5	-	-	-	-	2
Static Banking	5	-	2	-	-	4
Abbreviations	1	-	-	2	1	2
Schemes	4	5	-	2	4	4

Note: In some exams few questions were asked from 2021 current affairs.



**Previous year(2022)
exams Current Affairs
analysis based on
Month wise**

Previous Year(2022) Exams Current Affairs Analysis Based on Month Wise

Month	IBPS RRB PO 2022	IBPS RRB Assistant	IBPS PO 2022	IBPS Clerk	SBI PO 2022	SBI Clerk
	24 th Sep 2022	1 st Oct 2022	26 th Nov 2022	8 th Oct 2022	30 th Jan 2022	15 th Jan 2022
January 2022	-	4	-	1	-	-
February	-	-	-	1	-	-
March	1	1	-	1	-	1
April	-	5	-	4	-	-
May	10	16	-	2	-	-
June	5	1	-	9	2	1
July	5	2	-	19	1	4
August	4	-	-	5	1	6
September	-	-	13	4	2	21
October	-	-	24	-	3	10
November	-	-	-	-	16	-
December	-	-	-	-	18	2
Jan 2023	-	-	-	-	3	-

Note: In some exams few questions were asked from 2021 current affairs.

SUCCESS STORY

Name : Ravinder Singh
Email ID : ravindermakkar187@gmail.com
DOB : 04-09-1999
State : Punjab
Edu Qualification : Bachelor of Commerce
Final Selection : RRB Clerk, SBI Clerk,
 RRB PO waiting list.



1

What is your special strategy that you followed to crack the bank exam ?

I do lot of mocks for Maths and Reasoning. English is my weak part. So, I prefer only reading. For Current Affairs, I follow video source for better retention. My special strategy is for just a day before the exam. On that day, I revise basic concepts of maths and reasoning in a short way, which is very helpful for me. But I do daily full mock tests of math and reasoning to get the real exam feeling. Due to less time before the mains exams, I only analyze the completed mock tests, to improve my accuracy.

2

What would you advise the banking aspirants to prepare seriously for exams ?

First of all, give priority to the health. Because, healthy mind resides in a healthy body. Second is, you should understand the exam pattern, syllabus, and all the basic things related to the bank exam. Watch topper videos to learn the importance of consistent current affairs preparation. Prepare for prelims and mains together. Clear the basics first. Don't run behind the tricks. Make your own strategy for each exam, according to your strength and weakness. Most important thing is that don't be panic before the exam day or in exam hall. For this, you must tell one day before the exam, "mera ton exam fail hai". With this your expectation comes down and you can perform brilliantly in the exam.

3

What is the contribution of Guidely to your success ?

Guidely Mocks are very helpful in this success. The mocks are at a higher level than the real exam. My speed got increased in real exams.

4

What is your real feeling after achieving your dream bank job ?

I am selected in Bank Clerical Job. But I need a Bank P.O. or a job in RBI. As of now I am feeling safe and secure. These positive vibes motivating me to do bigger things in life.

5

To whom will you dedicate your success ?

I dedicate my success to my mother, Father and Brother because they always support me in difficult times. My Mother always support me emotionally and she always reminds me of my target. My Father and Brother support me financially.

guidely

Huge Selections in SBI Clerk 2022-23

Prime Bundle PDF Course 2023

ASPIRANTS FIRST CHOICE

Daily Targets | English & Hindi | Detailed Video Solutions* | PDF & Quiz Format*

12 Months Validity + 1 Year Mock Test + PDF Course 2022 (3 Months)

EXAMS COVERED: SBI, IBPS, RBI, LIC, SSC, UPSC

- ✓ Beginners Bundle Course
- ✓ Topic wise Bundle PDF Course
- ✓ Exam wise Bundle PDF Course
- ✓ Section wise Bundle PDF Course
- ✓ Memory Based Question Bundle Course
- ✓ Special Prelims Part Bundle PDF Course
- ✓ Mains Booster PDF Course

120K Questions

FLAT 70% OFF

Extra 10% Off

USE CODE **GUIDELY10**

One Time Offer Ends Soon - Hurry !!

BUY NOW

Did you know? Guidely Users are finding pdf course very helpful in increasing their Accuracy and to boost up their preparation.

* Price will not be decreased below Rs. 1199/- | Special discount for Ultimate Bundle Users



BOOSTER DOSE

January 2023





Koustav Chatterjee became **India's 78th Grandmaster** in MPL 59th National Senior Chess Championship in New Delhi. He hailing from **Kolkata** becomes West Bengal's tenth Grandmaster.

1



MPranesh clinched the title in the Rilton Cup, the first tournament of the FIDE Circuit, here to become India's **79th chess Grandmaster**.

2



The top three Indian lenders - **State Bank of India, ICICI Bank, and HDFC Bank** continue to be **domestic systemically important banks (D-SIBs)**.

3



State Bank of India (SBI) has launched **e-Bank Guarantee (e-BG)** facility in association with National e-Governance Services Limited (NeSL).

4



State Bank of India (SBI) raised **Rs 9,718 crore** through the issuance of **15-year** infrastructure debt with the bonds bearing a coupon of **7.70 per cent**.

5



Croatia adopted the euro as its official currency on 1 January 2023. It has become the **20th** member of the Eurozone and it is the first expansion of the Eurozone after 2015.

6



Captain Shiva Chauhan became the first woman officer to be operationally deployed at the Siachen glacier. The Siachen Glacier is the highest battleground on the earth. It is spread over an area of **76 kilometres**.

7



Squadron Leader Avani Chaturvedi became the first female Indian Air Force (IAF) fighter pilot to take part in an international exercise. She will fly the Su-30 MKI in 'Veer Guardian' exercises.

8



The **RBI** has asked banks to make enhanced disclosures relating to material items in their notes to accounts wherever any item under the head "**Other Liabilities and Provisions**" and "**Other Assets**" exceeds one per cent of the total assets.

9



The RBI has approved a proposal of **SBI Funds Management** to acquire **9.99 per cent** equity shares in **Equitas Small Finance Bank** through various schemes managed by it. Equitas Small Finance Bank is a small finance bank founded in **2016** as a microfinance lender

10



The Cabinet Committee on Economic Affairs chaired by Prime Minister Narendra Modi has approved the investment for **382 MW Sunni Dam Hydro Electric Project in Himachal Pradesh** by **SJVN Ltd**, for an estimated cost of Rs 2,614.51 crore.

11



The **RBI** allowed Mahindra and **Mahindra Financial Services (M&M Financial)** to resume loan recovery and repossession activities through third parties. MMFSL is an Indian rural non-banking financial company headquartered in **Mumbai, Maharashtra**.

12



The Uttar Pradesh (UP) government received investment proposals worth ₹9000 crores at the eighth (8th) and last domestic roadshow organized in Chandigarh ahead of the Global Investors Summit to be held in Lucknow.

13



India has identified two **lithium mines** and **one copper mine in Argentina** for a possible acquisition or long-term lease. Commercial evaluation of the mines has begun and a report regarding this is expected by end February.

14



Dhanlaxmi Bank has launched a new retail internet banking – **DhanDelight**, and a retail mobile banking app – **DhanSmart**. This new services are built on Omni channel platform having various features covering different banking needs of customers.

15



Lionel Messi has been chosen as the **Best Player** for the calendar year of **2022** by the **International Football Federation History and Statistics (IFFHS)**. He had also won the player of the tournament award back in 2014 when Argentina lost in the final to Germany

16



RBI has selected **six entities** for the ‘**Test Phase**’ under the Fourth Cohort under Regulatory Sandbox for theme ‘**Prevention and Mitigation of Financial Frauds**’ was announced by **RBI** in June 2022.

17



The **ISRO** announced a collaboration with **Microsoft** to promote the development of space technology startups in **India**. Through this collaboration, ISRO-identified spacetech startups will be on-boarded onto the ‘**Microsoft for Startups Founders Hub**’ platform

18



Odisha CM **Naveen Patnaik** inaugurated **India's Largest Hockey stadium at Rourkela, Odisha**. The stadium is named after the famous freedom fighter **Birsa Munda**. The stadium has been constructed in just 15 months at a cost of Rs 261 crore.

19



For the first time, **India** has surpassed **Japan** to become the third largest auto market. India's total sales of new vehicles stood at around **4.25 million** units compared to 20.4.2 million sold in Japan.

20



Standard Chartered became the first foreign bank to trade **treasury bond** futures in **China**.

21



Former Australia captain **Belinda Clark** became the first woman cricketer to have a sculpture unveiled in her honour. She became the first person to score an **ODI double century** when she smashed 229 runs from just 155 balls against Denmark in 1997.

22



India's former doubles world no 1, **Sania Mirza** has announced her retirement after Dubai Tennis Championships. She has won **six Grand slam doubles titles**.

23



Paytm Payments Bank Limited (**PPBL**) has appointed **Surinder Chawla** as its new Managing Director & Chief Executive Officer

24



Paytm Payments Bank has secured final clearance from the Reserve Bank of India (RBI) to function as a **Bharat Bill Payment Operating Unit (BBPOU)**.

25



Madhya Pradesh is hosting the **Mandu Festival** and **Skydiving Festival** and the Hriday Drishyam Kala Utsav in January 2023, and the Chanderi Mahotsav in February 2023.

26



Stock exchange BSE has partnered with the **Goa** government to create awareness amongst SMEs in the state on the benefits of listing and also guide them on raising capital through **equity infusion**.

27



India's squash player **Anahat Singh** has won the **girls' Under-15 title** at the prestigious British Junior Open tournament in Birmingham.

28



Former **West Bengal** Governor **Keshari Nath Tripathi** passed away. He also served as the additional charge as Governor of **Bihar, Meghalaya and Mizoram** for short period.

29



The Ministry of Finance said that the **first G20 Global Partnership for Financial Inclusion (GPII)** meeting under G20 India Presidency is to be held in **Kolkata**.

30



Power Grid Corporation of India Limited has ranked first in the services sector, in the Public Enterprises Survey 2021-22 by Department of Public Enterprises (DPE), Ministry of Finance.

31



Youth Affairs and Sports Minister **Anurag Singh Thakur** have said **India** will bid for hosting the Olympic Games in 2036.

32



RS Sodhi, managing director of **Gujarat Cooperative Milk Marketing Federation (GCMMF)** has stepped down, four decades after he joined the federation. GCMMF has named chief operating officer **Jayen Mehta** as interim managing director.

33



Garuda Aerospace, the Chennai-based drone manufacturing company has signed a Memorandum of Understanding (MoU) with **Rallis India Ltd**, a subsidiary of Tata Chemicals.

34



Chennai's drone startup **Garuda Aerospace** has partnered with the **Union Bank of India** with **150 Garuda Agri Kisan drones** receiving sanction for a loan under the Kisan Pushpak Scheme.

35



The Government has extended the tenure of **Dr Michael Debabrata Patra** as Deputy Governor of the Reserve Bank of India by one year. Other 3 Deputy Governor are **Mahesh Kumar Jain, M. Rajeshwar Rao, T. Rabi Sankar.**

36



The **Indian passport** is ranked **85th** in the World's Most Powerful Passports Index 2023 and gives visa-free entry to 59 destinations across the world. **Japan** ranked first on the list of the most powerful passports in the world.

37



Delhi was the most **polluted** city in India in 2022 with PM 2.5 levels more than double the safe limit and the third highest average PM10 concentration, according to an analysis of **Central Pollution Control Board data**.

38



The **world's longest river cruise MV Ganga Vilas** will be flagged off by PM Narendra Modi in **Varanasi, Uttar Pradesh**.

39



Gareth Bale, Wales men's all-time leading goal scorer and a five-time Champions League winner with Real Madrid, has announced his retirement from football.

40



World Bank has kept growth forecast for India at **6.9%** for FY23 and **6.6%** for FY24.

41

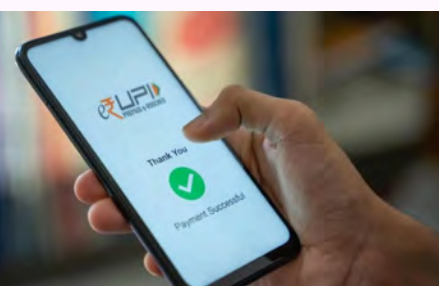

NPCI has permitted UPI transactions for non-resident bank accounts connected to mobile numbers of **10 countries**.

42



Hitachi Payment Services has received RBI's in-principle approval to act as a payments aggregator. EnKash has received RBI's in-principle approval for payments aggregator (PA) licence.

43



Indian Bank has received the Reserve Bank of India (RBI) regulatory approval to hold special rupee Vostro accounts of three banks from Sri Lanka.

44



Manpreet Monica Singh has taken oath as a Harris county judge in Texas. She has become the first female Sikh judge in the US.

45



AC Charania, Indian-American space expert, appointed as new chief technologist of NASA. He replaced fellow Indian-American scientist Bhavya Lal, who was serving as acting chief technologist.

46



Prime Minister Narendra Modi has announced a new 'Aarogya Maitri' project under which India will provide essential medical supplies to any developing country affected by natural disasters or humanitarian crisis.

47



Two more tourism destinations in Kerala have made it to the list of places selected for the Swadesh Darshan 2.0 scheme of the Union Ministry of Tourism.

48



The government has extended the term of **State Bank of India** Managing Director **Challa Sreenivasulu Setty** by two years with effect from January 20.

49



BCCI acknowledged **Rishabh Pant** and **Jasprit Bumrah** as the top batter-bowler pair in Test cricket for India in 2022. **Shreyas Iyer** and **Siraj** as the top batter-bowler pair in ODIs. **Suryakumar Yadav** and **Bhuvneshwar Kumar** as both emerged as the best batter-bowler performers for the team in 2022.

50



Suryakumar Yadav created history by becoming the first Indian player to win the **ICC Men's T20 Cricketer of the Year** award.

51



America's **R Bonnie Gabriel** won **Miss Universe 2022** **A**crowns. Amanda Dudamel of Venezuela became the first runner-up, while **Andrea Martínez** of the Dominican Republic was the second runner-up.

52



Uttarakhand Governor has approved a bill to grant **30% reservation for women** in government jobs.

53



World Bank has sent agricultural officers from Sub-Saharan countries to **Karnataka** to learn from its successful implementation of the **Rejuvenating Watershed for Agricultural Resilience through Innovative Development (REWARD)** scheme.

54



The BCCI announced that **Viacom 18** have grabbed the media rights for the upcoming Women's IPL for a whopping **951 crore for five years**.

55



The **Reserve Bank of India (RBI)** stated that any person looking to acquire more than **5 per cent** stake in a bank will need prior approval from the regulator.

56



South Africa all-rounder **Dwaine Pretorius** announced his retirement from international cricket with immediate effect.

57



South Indian Bank has signed an MoU with **Steel Authority of India Ltd (SAIL)** to provide financial assistance to the dealers of SAIL across India.

58



Tata Boeing Aerospace Limited (TBAL) provided the first fuselage for six **AH-64 Apache helicopters** from its modern facility in **Hyderabad, Telangana**.

59



Wayanad district in Kerala has become the first district in **India** to provide basic documents to all tribal people. These services include ration cards, Aadhar cards, birth certificates, voters' identity cards and digital locker facilities.

60



Chris Hipkins to replace **Jacinda Ardern** as New Zealand Prime Minister.

61



Election Commission of India (ECI) hosted the 2nd International Conference on 'Use of Technology and Elections Integrity' in New Delhi.

62



India's deepest Metro station will be part of the ambitious **Pune Metro project**. This will be the Interchange station for the Pimpri Chinchwad-Swargate (16km) and **Vanaz-Ramwadi** (17 km) routes.

63



Thailand's **Kunlavut Witidsarn** won the men's singles title in the India Open Badminton tournament.

64



The **World Economic Forum (WEF)** signed a new partnership with the **Indonesian** government to support its ambitions to scale **blue carbon restoration** and **ocean conservation efforts**.

65



Canara Bank has transferred to SBI its entire **40%** stake in **Commercial Indo Bank LLC (CIBL), Moscow**.

66



Life Insurance Corporation of India (LIC) has launched **Jeevan Azad** which is aimed at individual savings and life insurance.

67



SIDBI has partnered with the **Association of Microfinance Institutions of India (AMFI)** to support women entrepreneurs in the backward districts of **West Bengal**.

68



According to the **ISRO Chairman S. Somanath**, India's first solar mission - **Aditya-L1 mission**, is likely to be launched by June-July 2023.

69



The inaugural edition of the **Air Defence exercise** between India and Japan '**Veer Guardian 2023**' concluded in **Japan**.

70



The **Secretary of the Ministry of Culture** recently said that the government will hand over around **1,000 monuments** under the control of the Archaeological Survey of India to the private sector for their upkeep under the **Monument Mitra Scheme**.

71



The Centre spent a total of **Rs 3.43 trillion** for the seven-phase implementation of **Pradhan Mantri Garib Kalyan Anna Yojana (PMGKAY)** between April, 2020 and December 2022, as per provisional data.

72



Employees' Provident Fund Organization has launched a massive outreach program in all districts through 'Nidhi Aapke Nikat' program to expand its presence across India.

73



Bengaluru, Delhi and Mumbai ranked among the top global cities for women entrepreneurs, according to the Dell Technologies report.

74



KTM bikes will be introducing the electric Chetak in the European automobile market early in 2024.

75



Indian-American astronaut Raja J Chari has been nominated by President Mr. Joe Biden for the appointment to the grade of Air Force brigadier general.

76



Dell Technologies has acquired Israeli startup Cloudify which is known for cloud orchestration and infrastructure automation.

77



IT giant Cognizant has announced Ravi Kumar as its new Chief Executive Officer, replacing the outgoing Brian Humphries, effective immediately.

78



State-run **Bharat Petroleum Corporation (BPCL)** said it has signed a memorandum of understanding (MoU) with Rajasthan to set up a 1-gigawatt (GW) renewable energy (RE) plant in **Rajasthan**.

79



Vaccine major **Bharat Biotech International Limited (BBIL)** has launched iCOVACC (BBV154), the world's first intranasal vaccine for Covid-19

80



The government has extended the tenure of **Sangeeta Verma** as the acting Chairperson of the **Competition Commission of India (CCI)**.

81



Warehousing Development Regulatory Authority (WDRA) has signed a memorandum of understanding with **State Bank of India** to help farmers in getting low interest rate loans.

82

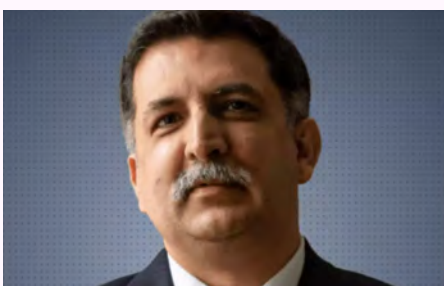

The Trustees of **Tata Trusts** have appointed **Siddharth Sharma** as the Chief Executive Officer (CEO) of the Trusts, and **Aparna Uppaluri** as the Chief Operating Officer (COO).

83



The **Ministry of Road Transport and Highways (MoRTH)** has notified that all the vehicles owned by central and state governments, which are **older than 15 years**, will be deregistered and scrapped, starting from **April 1, 2023**.

84



The iconic **Mughal Gardens** at the Rashtrapati Bhavan (President's House) in Delhi have been renamed as **Amrit Udyan**.

85



Star Health and Allied Insurance said it has renewed its corporate agency tie-up with **Punjab National Bank (PNB)** for a long-term period.

86



Germany defeated **Belgium** by 5-4 in the penalty shootout to win the **Hockey World Cup** held in **Bhubaneswar**. It is Germany's **third world cup title**.

87



Indian women's team defeated **England** in the final of the **U-19 Women's T20 World Cup** at Senwes Park in Potchefstroom, **South Africa**.

88



Veteran actress and former MP Jamuna passed away at the age of 86 in **Hyderabad, Telangana**.

89



President **Droupadi Murmu** approved **412 Gallantry Awards** and other Defence decorations to Armed Forces personnel and others on the eve of the **74th Republic Day**.

90



Union Bank of India (UBI) has put its **Rs 2,077 crore** loan to KSK Mahanadi Power on sale for the second time in less than six months, after the unsuccessful attempt in August last year.

91



National Stock Exchange of India (NSE) has emerged as the **3rd largest exchange in the world** in the equity segment by the number of trades (electronic order book) in 2022.

92



Russia has displaced **Taiwan** to be amongst the top four **importers of steel to India** for the April – December 2022 period.

93



India has signed an MoU with **Egypt** to strengthen the cultural cooperation between the two countries.

94



India and **Asian Development Bank (ADB)** have signed **\$1.22 billion** loan agreements for infrastructure projects in several states.

95



The **Reserve Bank of India (RBI)** conducted the auction of green bonds, with a total of **8,000 crore** worth of two securities, a **5-year bond** and a **10-year bond** being sold.

96



Tata Consultancy Services said that CTBC Bank, Taiwan, has selected TCS BaNCS for Banking and Wealth Management to digitally transform its business.

97



Union Minister **Sarbananda Sonowal** inaugurated **National Logistics Portal (Marine)**. NLP-Marine is a single-window portal to reduce logistics costs.

98



Chetan Sharma returned as **Chairman** of the senior men's national selection committee, according to the **Board of Control for Cricket in India**.

99



Arunachal Pradesh Chief Minister **Pema Khandu** virtually launched the official logo and website of **Parshuram Kund Festival-2023**.

100

Best Practice Materials to Crack Bank Exams 2023

Topic-Wise Bundle PDF Course 2023

- ✓ 15,000+ questions (Prelims + Mains)
- ✓ Covered questions from individual topics in each subject
- ✓ Explanations with Detailed Video Solutions

12 MONTHS VALIDITY

Exams Covered: IBPS RRB PO/ Clerk, IBPS PO/ Clerk, SBI PO/ Clerk & Other important Bank & Insurance Exams

FLAT 70% OFF Extra **10% Off** **USE CODE GUIDELY10**

BUY NOW

E-MAGAZINE

JANUARY 2023



NATIONAL

Government launch fund for Catalysing deep tech start-ups

The government will launch a **Digital India Innovation Fund** which will support deep tech startups.

Deep technology (deep tech) or hard tech is a classification of organisation, or more typically startup company, with the expressed objective of providing technology solutions based on substantial scientific or engineering challenges.

India had over 3,000 deep-tech start-ups, dabbling in new-age technologies like **Artificial Intelligence, Machine Learning (ML), the Internet of Things, Big Data, quantum computing, robotics, etc., at the end of 2021.**

India's deep-tech ecosystem has grown 53% in the last decade and is now at par with that in developed economies like the US, China, Israel, and Europe.

Bengaluru accounts for 25-30% of India's deep-tech start-ups, followed by Delhi-NCR (15-20%) and Mumbai (10-12%). Overall, the share of deep-tech start-ups in India's overall entrepreneurial ecosystem stands at 12% now.

25% - 30%

India's deep-tech start-ups, followed by Delhi-NCR (15-20%) and Mumbai (10-12%).

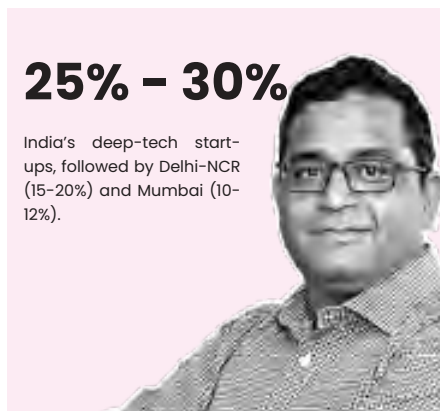

Union Government Offices likely to go fully Digital by February

As most Central government offices are expected to go fully digital by the end of February 2023, several security measures have been put in place to avoid any cybersecurity incidents such as the recent cyber and ransomware attack at the **All India Institute of Medical Sciences (AIIMS) in Delhi.**

E-Office is designed and developed by the National Informatics Centre, **Ministry of Electronics & Information Technology (MEITY).**

The e-Office aims to support Governance by ushering in more effective and transparent inter and Intra-Government processes. The vision of e-Office is to achieve a simplified, responsive, effective and transparent working of all Government Offices

So far, 74 ministries and departments have migrated to e-office version 7.0

DIGITAL

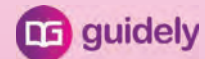

PRIME BUNDLE PDF COURSE

FLAT **70%** OFF

Extra **10%** OFF

USE CODE:
GUIDELY10

BUY NOW

NTPC Starts India's First green Hydrogen Blending Operation In PNG NETWORK

NTPC Ltd commissions India's first green hydrogen blending project. The green hydrogen blending has been started in the **piped natural gas (PNG) network** of NTPC Kawas township, Surat. The project is a joint effort of NTPC and Gujarat Gas Limited (GGL).

The first molecule of green hydrogen from the project was set in motion by Shri P Ram Prasad, head of project, Kawas in

presence of other senior executives of NTPC Kawas and GGL.

After the start of blending operation, NTPC Kawas held awareness workshops for township residents with help of GGL officials

Petroleum and Natural Gas Regulatory Board (PNGRB), the regulatory body has given approval for 5% vol./vol. blending of green hydrogen with PNG to

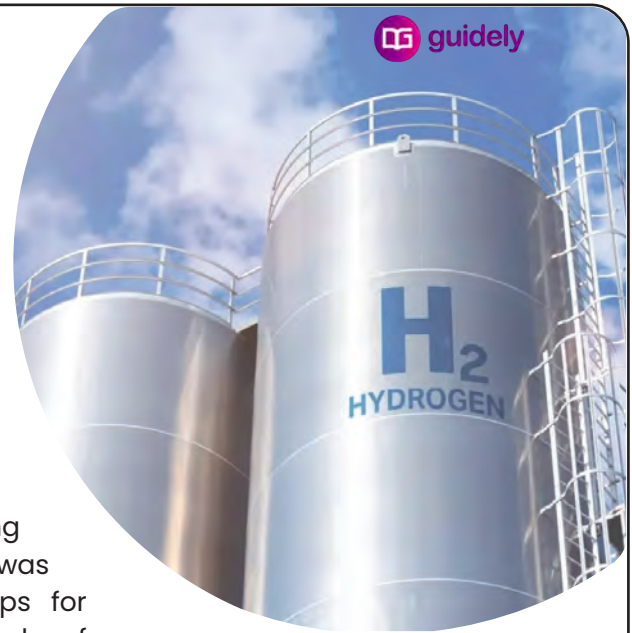

start with and the blending level would be scaled phase wise to reach 20%. Green hydrogen when blended with natural gas reduces CO2 emissions keeping net heating content same.



Rajnath Dedicates Rs. 724 Crore Infra Projects to Nation

Defence Minister inaugurated **Siyom Bridge in Arunachal Pradesh.**

He also inaugurated 27 infrastructure projects completed by the Border Roads Organisation. These projects built at a cost of Rs 724 crore.

It will expand infrastructure along India's border, especially from Ladakh to Arunachal, along with China.

Siyom Bridge is a state-of-the-art 100 m long, Class 70 steel arch superstructure Siyom Bridge

over the Siyom River in Arunachal Pradesh.

The Siyom Bridge on the Alang-Yinkiong road will facilitate movement of army vehicles and weapons to Upper Siang District, Tuting and Yinkiong regions along the Line of Actual Control.

Rajnath Singh also virtually inaugurated 21 other bridges, three roads and three infrastructure projects in Arunachal Pradesh, Jammu and Kashmir, Ladakh, Uttarakhand, Sikkim, Punjab and Rajasthan from Siyom Bridge site.

Centre Clears Rs. 19,744 Cr Green Hydrogen Mission

The **Cabinet Committee on Economic Affairs (CCEA)** recently approved the **National Green Hydrogen Mission (NGHM)**, with an initial outlay of **Rs 19,744 crore**, with the goal of making India energy independent and decarbonising major sectors of the economy. The PM first announced the NGHM in his Independence Day speech in **2021**, after which the

Ministry of New and Renewable Energy (MNRE) was tasked with developing a draft plan.

India had committed to reduce the emissions intensity of GDP by 45% by 2030 (from its 2005 level) and achieve about 50% cumulative electric power installed capacity from non-fossil fuel-based energy resources by 2030.

52 Days of Luxury: World's Longest River Cruise Set for maiden Voyage

The world's longest river cruise MV Ganga Vilas will be flagged off by PM Narendra Modi in Varanasi on the 13th January.

The Prime Minister will also inaugurate and lay foundation stones for several other inland waterways projects worth over Rs 1000 crore during the event.

On January 12, the Ministry of Culture organized a grand cultural program 'Sur Sarita - Symphony of Ganga' on the eve of the launch of the world's longest river cruise in Varanasi.

MV Ganga Vilas will start its

journey from Varanasi and travel approximately 3,200 km in 51 days crossing 27 river systems in India and

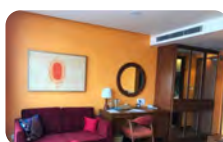

Bangladesh to reach Dibrugarh in Assam via Bangladesh.

MV Ganga Vilas has three decks with all luxury amenities, 18 suites with a capacity of 36 tourists. In the first trip, 32 tourists from Switzerland are going for the entire trip.



The Ministry of Minority Affairs (MoMA) has discontinued the scheme of interest subsidy on education loans for overseas studies for students belonging to minority communities (Padho Pardesh).

Ministry of Minority Affairs ends Padho Pardesh Scheme

All banks were notified by the Indian Banks' Association last month about the discontinuation of the Padho Pardesh Interest Subsidy Scheme from 2022-23. The scheme so far was being implemented through Canara Bank, the designated nodal bank.

The existing beneficiaries as on March 31, 2022, will continue to receive the interest subsidy during the moratorium period of the loan, subject to compliance with the extant guidelines, according to the Association's communication to Banks.

Govt Sets Up G20 task Force to Push India's Digital Agenda

India's G20 Task Force on Digital Public Infrastructure for Economic Transformation, Financial Inclusion and Development has been set up by the government. The task force will be co-chaired by India's G20 sherpa Amitabh Kant and Infosys chairman Nandan Nilekani.

The Ministry of Finance has issued an order regarding the setting of the task force on 21 January, 2023.

The task force will help India in achieving its G20 Presidency agenda related to digital public infrastructure, financial inclusion, digital identity, and innovative technology based services.

The task force will create a detailed map of India's digital infrastructure across different sectors like finance, health, education, skilling, data, taxation, digital commerce, mobility, and

beyond.

Secretaries of the department of economic affairs, department of financial services, ministry of electronics and information technology and external affairs ministry will be the other members of this task force.

In the Sherpa track, the task force's work will also facilitate the Global Partnership for Financial Inclusion (GPFII) working group in G20's finance track and the Digital Working Group (DEWG).

The government of India is committed to transforming India into a digitally empowered society.



Private Firms to be part of Monument Mitra Scheme

The Secretary of the Ministry of Culture recently said that the government will hand over around 1,000 monuments under the control of the Archaeological Survey of India to the private sector for their upkeep under the Monument Mitra Scheme.

Nodal Ministry: Ministry of Culture in respect of the monuments under the Archaeological Survey of India.

It applies to all centrally protected heritage properties.

Aim: Ensuring quality & inclusive provision of amenities and facilities across heritage, natural, & tourist sites through the active participation of private and public sector organizations and individuals.

Govt Spent Rs.3.43 Trillion on Free ration Scheme

The Centre spent a total of **Rs. 3.43 trillion** for the seven-phase implementation of **Pradhan Mantri Garib Kalyan Anna Yojana (PMGKAY)** between April, 2020 and December 2022, as per provisional data.

This expenditure is against an earlier estimate of Rs 3.9 trillion for the free ration scheme, because off-take of grains by the states at 9.17 million tonne was

23% less than the initial estimate in the seventh phase (October-December, 2022) of the scheme.

The expenses on PMGKAY's last phase were Rs 34,208 crore against an earlier estimate of Rs 44,762 crore.

The Centre has distributed more than 100 MT of foodgrains under the free ration scheme since its launch in April 2020 to reduce hardships of people during the



Covid-19 pandemic.

The food ministry had informed states that lifting of foodgrain under the scheme would be allowed only till December 31, 2022. Last month, the Cabinet decided against extending the scheme.

From April 1, Govt Vehicles over 15 yrs to be scrapped



The Ministry of Road Transport and Highways (MoRTH) has notified that all the vehicles owned by central and state governments, including buses owned by transport corporations and public sector undertakings, which are older than 15 years,

will be deregistered and scrapped, starting from April 1, 2023.

However, this rule will not apply to special-purpose vehicles like armoured vehicles or any other specialised vehicles, which are used for the operational purpose for the defence of the country and for maintaining law and order and internal security.



Sonowal Inaugurates National Logistics Portal

Union Minister Sarbananda Sonowal inaugurated National Logistics Portal (Marine). NLP-Marine is a single-window portal to reduce logistics costs. The Union Minister called the portal a one-step platform aimed at connecting all the stakeholders of the logistics community using Information Technology.

He said NLP will be a single window for all trade processes of the logistics sector spread across the country. The activities of NLP Marine are categorised into four distinct verticals: i) Carrier, ii) Cargo, iii) Banking and finance, iv) Regulatory bodies and participating government agencies (PGAs).

Mughal Gardens is Now Amrit Udyan

The iconic Mughal Gardens at the Rashtrapati Bhavan (President's

House) in Delhi have been renamed as Amrit Udyan.



The cluster of about 15 gardens will collectively be known as Amrit Udyan.

Individual gardens within the sprawling Presidential Estate – Herbal Garden, Musical Garden and Spiritual Garden – will retain their names. The Mughals were known to appreciate gardens. In Babur Nama, Babur says that his favourite kind of garden is the Persian Charbagh style (literally, four gardens).

**Huge Selections in
SBI Clerk 2022-23**

PLATINUM MOCK TEST SERIES

Complete Mock Test Series for All Major
Bank Exams 2023

**9 Years of Paving the Students
Towards Their
Success & Still Counting**

✔ 3000+ Mock Tests |
✔ Language (Eng + Hindi)

Extra **10% OFF**

USE COUPON
GUIDELY10

BUY NOW



Fastag Toll Collections rose 46% to Rs. 50,855 Cr in 2022

Electronic Toll Collection (ETC) through FASTag has witnessed constant growth over last few years. Total toll collection via FASTag

on fee plazas, including State Highway fee plazas during calendar year 2022 was Rs. 50,855 crore, which is an increase of approx. 46% as compared to Rs. 34,778 crore in 2021.

The average daily toll collection through FASTag on NH fee plazas

in December 2022 was Rs 134.44 Crore, and the single day highest collection touched Rs.144.19 Crore on 24 December 2022.

Similarly, the number of FASTag transactions also witnessed a growth of approx. 48% in 2022 as compared to that in 2021. The number of FASTag transactions in 2021 and 2022 was 219 crores and 324 crores respectively.

“Aarogya Maitri

Project to Provide Medical Supplies to Developing Nations

Prime Minister Narendra Modi has announced a new ‘Aarogya Maitri’ project under which India will provide essential medical supplies to any developing country affected by natural disasters or humanitarian crisis.

India will also establish a ‘Global-South Center of Excellence’ to undertake research on development solutions or best-practices of any



developing nation, which can be scaled and implemented in other members of the Global South.

During the Covid pandemic, India’s ‘Vaccine Maitri’ initiative supplied made-in-India vaccines to over 100 nations, the PM pointed out indicating that ‘Aarogya Maitri’ would be continuation of the initiative.

The union cabinet has approved the naming of the airport at Mopa, Goa as Manohar International Airport. The union cabinet has approved

the naming of Greenfield International Airport at Goa’s Mopa as Manohar International Airport. The airport will be known as Manohar International Airport Mopa, Goa. Manohar Parrikar was the former defence minister and Goa chief minister. Prime Minister Narendra Modi inaugurated the airport at Mopa, Goa in December 2022.

Nod To Rename Mopa Airport after Manohar parrikar



Rs 2,614 Crore Investment Approved For Sunni Dam Hydro Project

The Cabinet Committee on Economic Affairs chaired by Prime Minister Narendra Modi has approved the investment for **382 MW Sunni Dam Hydro Electric Project in Himachal Pradesh** by SJVN Ltd, for an estimated cost

of Rs 2,614.51 crore, including Rs 13.80 crore as budgetary support from Government of India for the cost of enabling infrastructure. Ex-post facto approval is given for cumulative expenditure incurred amounting to Rs

246 crore till January 2022. The project cost of Rs 2,614 crore included hard cost amounting to Rs 2,246.40 crore, Interest During Construction (IDC) and Financing Charges (FC) of Rs 358.96 crore and 9.15 crore, respectively.



In a First, Kerala Sets Up Welfare Board to provide Pension to MGNREGS Workers

For the first time in the country, Kerala government has launched a welfare fund board for the workers registered for the MGNREGS and the state's urban job guarantee scheme — Ayyankali Urban Employment Guarantee Scheme.

This will facilitate the workers to get a monthly pension from the board on they turn 60.

Rajendran, who is the state general secretary of NREGS Workers' Union (a trade union of workers affiliated to CITU)

This is the first time that a state government has formed a welfare fund board for MGNREGS workers.

As per the norm, any worker between the age of 18 and 55 can take the membership in the fund board.

They have to pay an amount as premium (Rs 50 tentatively fixed) every month until the age of 55 and a member who has paid the contribution for at least 10 years will be eligible for pension.



Kolkata to host G20 Global Financial Inclusion Meeting from January 9-11

Recently, the Ministry of Finance said that the first G20 Global Partnership for Financial Inclusion (GPII) meeting under G20 India Presidency is to be held in Kolkata.

The meeting will be attended by G20 member countries, guest countries and international organizations invited by India.

It will focus on topics like digital financial inclusion, reducing remittance costs, and finance for the SME sector.

12 international speakers will attend the G20 meeting. Institutions like NABARD will highlight the rural area coverage of innovative financial products and services.

Kollam is first Constitution Literate District

Kollam will be officially declared India's first Constitution literate district by Chief Minister Pinarayi Vijayan and the authorities say the

RAJASTHAN

FIRST TO

IMPLEMENT

A BLINDNESS

CONTROL

POLICY



Rajasthan has become the first State to implement a policy to control blindness, with the objective of ensuring the "right to sight". A massive drive will be undertaken in the State to reduce the rate of blindness, and bring light into the lives of over 3 lakh people suffering from visual impairment.

The State government's Medical & Health Department released

the policy document here over the week-end.

The prevalence rate of blindness, which was 1.1% in 2020, will be brought down to 0.3%, through the policy.

Under the policy, the Rajasthan government will mandatorily run Keratoplasty Centres and Eye Banks at all the government medical colleges. Also, cornea collected by private organisations and NGOs getting financial help from the government will have to be provided to the government institutions on priority.

constitution literacy campaign will continue even after that.

The campaign is launched to educate the residents of the Kollam district of Kerala about the basics of constitution.

It aims to make Kollam district a constitutionally literate district.

Over seven lakh families in the district will be educated on the basic principles of the Constitution as part of The Citizen Constitution Literacy Campaign.

The campaign is jointly organised by the Kollam district panchayat,

District Planning Committee, and the Kerala Institute of Local Administration (KILA).

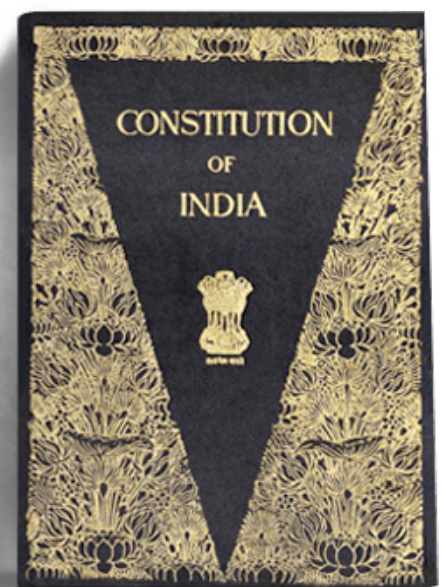

Wayanad becomes Country's First District to Provide Basic Documents to all Tribal People



beneficiaries under the Akshaya Big Campaign for Document Digitisation (ABCD).



Wayanad district in Kerala has become the first district in India to provide basic documents to all tribal people.

Wayanad district administration has provided 1,42,563 services to a s many a s 64,670 t r i b a l

The services include ration cards, Aadhar cards, birth certificates, voters' identity cards and digital locker facilities.

The campaign was introduced in November 2021 at Thondarnadu grama panchayat.

Pune to get India's Deepest Metro Station

India's deepest Metro station will be part of the ambitious Pune Metro project.

The Civil Court Metro station will be the Interchange station for the Pimpri Chinchwad-Swargate (16km) and Vanaz-Ramwadi (17 km) routes.

The Civil Court Metro station will be constructed at a depth of 33.1 metres (108.59 feet deep). It will be constructed in such a way that it will receive natural light during

the daytime. It will be connected with the Pune Mahanagar Parivahan Mahamandal Limited bus stop and have five entries.

The station will be spread over 11 acres and it will also have a skywalk connecting with the third Metro route (Civil Court to Hinjewadi).



The design of the station will follow the green norms and Indian Green Building Council rankings.

UP Govt Gets Rs 9000 Cr Investment Proposals

The Uttar Pradesh (UP) government received investment proposals worth ₹9000 crores at the eighth (8th) and last domestic roadshow

organized in Chandigarh ahead of the Global Investors Summit to be held in Lucknow on February 10-12, 2023.

The investors' summit is an

initiative by the chief minister (CM) Shri Yogi Adityanath to make UP a trillion-dollar economy in the next 5 years.

The UP government team held Business to Government (B2G) meetings with the investors before and after the roadshow.



Madhya Pradesh is hosting the Mandu Festival and Skydiving Festival and the Hriday Drishyam Kala Utsav and the Chanderi Mahotsav

Madhya Pradesh is hosting the Mandu Festival and Skydiving Festival and the Hriday Drishyam Kala Utsav in January, and the Chanderi Mahotsav in February

The Skydiving Festival in Ujjain has already started, whereas the Mandu Festival will be held from January 7 to 11, 2023.

This will be the fourth edition of Mandu's mega festival, which aims to showcase the destination's historic heritage blended with modern vibrancy.



Huge Selections in SBI Clerk 2022-23 Prime Bundle PDF Course 2023

Daily Targets	English & Hindi	Detailed Video Solutions*	PDF & Quiz Format*
---------------	-----------------	---------------------------	--------------------

12 Months Validity + 1 Year Mock Test + PDF Course 2022 (3 Months)

EXAMS COVERED:



- ✓ Beginners Bundle Course
- ✓ Topic wise Bundle PDF Course
- ✓ Exam wise Bundle PDF Course
- ✓ Section wise Bundle PDF Course
- ✓ Memory Based Question Bundle Course
- ✓ Special Prelims Part Bundle PDF Course
- ✓ Mains Booster PDF Course



FLAT **70% OFF** Extra **10% Off**
USE CODE **GUIDELY10**

One Time Offer Ends Soon - Hurry !!!

BUY NOW

DID YOU KNOW?

Guidely Users are finding pdf course very helpful in increasing their Accuracy and to boost up their preparation.

* Price will not be decreased below Rs. 1199/- | Special discount for Ultimate Bundle Users



INTER NATIONAL

Current Affairs Magazine
Jan 2023



Croatia becomes Fully Integrated EU Member

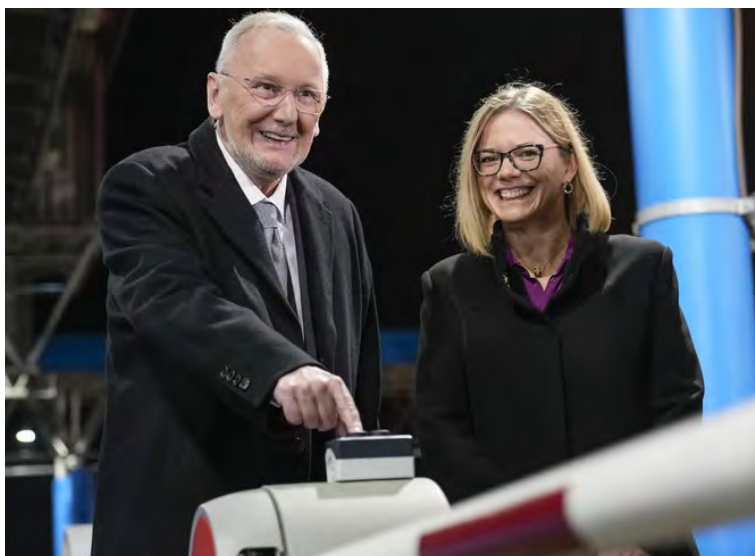

Croatia entered into the borderless Europe club and became the 27th nation of the passport-free Schengen zone.

Schengen Area zone facilitates free and unrestricted movement of people.

It has become the 20th member of the Eurozone and it is the first expansion of the Eurozone after 2015. There is a fear that the adoption of euro can increase the cost of living as businesses round up prices when they convert them.

Euro is commonly used in Croatia and around 80% of bank deposits are in euros.

Internal air borders checks will be lifted from 26 March 2023.

Croatia adopted the Euro as its official currency on 1 January 2023.

Croatia joined the European Union in 2013.

India identifies Two Lithium, One Copper Mine In Argentina; Evaluation Report by end FEB

India has identified two lithium mines and one copper mine in Argentina for a possible acquisition or long-term lease. Commercial evaluation of the mines has begun and a report regarding this is expected by end February.

KABIL, a joint venture formed through the participation of National Aluminium Company (Nalco), Hindustan Copper (HCL) and MECL, aims to ensure consistent supply of critical and strategic minerals in the domestic market.

It may be recalled that the Centre had sent a team of three geologists to the Latin American nation "to assess potential lithium deposits" and possible acquisition opportunities in November last year.

The team comprised of one geologist each from the Mineral Exploration Corporation Ltd (MECL), KABIL (Khanij Bidesh India Ltd) and the Geological Survey of India (GSI).



The top three Indian lenders - State Bank of India, ICICI Bank, and HDFC Bank continue to be domestic systemically important banks (D-SIBs).

RBI places these banks in appropriate buckets upon their Systemic Importance Scores (SISs).

ICICI Bank and HDFC Bank have been placed in the first bucket while the SBI has been placed in the third bucket.

ICICI Bank and HDFC Bank have to maintain additional CET1 at 0.20 per cent of their RWAs.

SBI, ICICI Bank , HDFC Bank Stay On RBI's 'Systematically Important' List

SBI has to maintain Additional Common Equity Tier 1 (CET1) at 0.60 per cent of its Risk Weighted Assets (RWAs).

In 2014, RBI issued the framework for dealing with Domestic Systemically Important Banks.

RBI is required to disclose the name of the bank designated as D-SIB under the D-SIB framework.

SBI and ICICI Bank had become D-SIBs in 2015 and 2016. HDFC Bank was also classified as a D-SIB in 2017.

SIBs are perceived as 'Too Big To Fail' and their functioning is critical for essential banking services in the Indian Economy.



RBI tightens Disclosure norms on Banks Financial Statements

The Reserve Bank of India (RBI) has asked banks to make enhanced disclosures relating to material items in their notes to accounts wherever any item under the head "Other Liabilities and Provisions" and "Other Assets" exceeds one per cent of the total assets.

This is aimed at enhancing

transparency in bank's financial statements through disclosures.

Currently, if any item under the subhead "Miscellaneous Income" under the head "Other Income" exceeds one per cent of total income, banks have to give particulars in the notes to accounts. Similar instructions exist in case of subhead "Other

expenditure" under the head "Operating Expenses".

The RBI also asked payments banks to disclose particulars of all such items in the notes to accounts, wherever any item under "Other Income" - "Commission, Exchange and Brokerage" - exceeds one per cent of the total income.



SBI Mutual gets RBI nod to buy 9.99% in Equitas SFB for various schemes



The Reserve Bank of India has approved a proposal of SBI Funds Management to acquire 9.99 per cent equity shares in Equitas Small Finance Bank through various schemes managed by it.

Equitas Small Finance Bank is a small finance bank founded in 2016 as a microfinance lender. The bank has its headquarters in Chennai, and is a subsidiary of holding company Equitas Holdings Ltd. Vasudevan P N (MD & CEO).



M&M Financial : RBI Lifts ban on recovery via 3rd Party Agents

activities through third parties.

The RBI has informed M&M Financial of its decision to lift restrictions following submissions made by the company, its commitment to strengthen recovery practices and outsourcing arrangements, tighten the process of onboarding third party agents and strengthen accountability framework.

The Reserve Bank of India (RBI) allowed Mahindra and Mahindra Financial Services (M&M Financial) to resume loan recovery and repossession

Annapurna Finance applies for Licence to set up Universal Bank



The **Reserve Bank of India** has received an application from Annapurna Finance Pvt Ltd (AFPL), formerly known as Annapurna Microfinance Pvt Ltd, under the Guidelines for 'on tap' Licensing of Universal Banks in the Private Sector. The microfinance institution was the only entity to apply for a universal bank licence during the quarter ended December 31, 2022.

AFPL was initially promoted in 1990 as a society by the name of People's Forum (PF) by Gobinda Chandra Pattanaik in Odisha, according to a CARE Ratings report.

RBI to Raise Rs 16,000 Cr Via Sover- eign Green Bonds in Two Tenors, 2 Tranches, First Issue on Jan 25

The Reserve Bank of India (RBI) said that the maiden Sovereign Green Bonds (SGRBs) would be issued in two tranches for an aggregate amount of Rs 16,000 crore.

The RBI will auction 5-year and 10-year green bonds worth Rs 4,000 crore each on 25 January and on 9 February.

The proceeds will be utilised for funding public sector projects seeking to reduce carbon

emissions.

In Union Budget 2022-23, Finance Minister Nirmala Sitharaman had announced that sovereign green bonds will be issued for mobilising resources for 'green projects'.

Green bonds are issued by companies, countries and multilateral organisations to exclusively fund projects that have positive environmental or climate benefits and provide investors with fixed income payments.

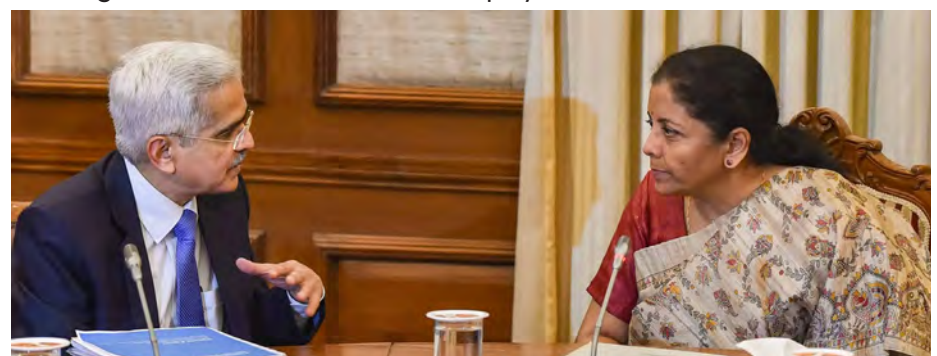



Hitachi Payment Service Gets Payment Aggregator Licence

Hitachi Payment Services has received RBI's in-principle approval to act as a payments aggregator.

EnKash has received RBI's in-

principle approval for payments aggregator (PA) licence.

Hitachi Payment Services is an end-to-end payment solutions provider. EnKash is a business spend management platform.

The aggregator license will augment Hitachi Payment Services' digital solutions stack with online payment solutions such as UPI, netbanking, cards and wallets.



State Bank of India (SBI), the country's largest lender, has launched e-Bank Guarantee (e-BG) facility in association with National e-Governance Services Limited (NeSL).

This facility will bring about a revolutionary change in the banking ecosystem, where bank guarantee is frequently used in large volumes. Currently, the bank issues these guarantees with physical stamping and wet signatures.

The introduction of e-BG will replace this function with e-stamping and e-signature.



Indian Bank has received the Reserve Bank of India (RBI) regulatory approval to hold special rupee vostro accounts of three banks from Sri Lanka.

The Chennai-headquartered public sector bank, which has had a long presence in the South Asian island nation, is expected to activate the special vostro accounts in about a week.

A vostro account in local currency would allow Sri Lanka to import from India without dipping into its declining dollar supply. The INR vostro facility is part of the special trade settlement mechanism finalised by the RBI in July 2022. Indian Bank opened its first overseas branch in Colombo in 1932. Till now, State of India (SBI) is the other domestic institution with which a Sri Lankan bank has opened a vostro account.



Public sector Indian Bank has stepped up its offerings on its digital transformation initiative 'Project WAVE' with the launch of Kisan Credit Card loans to farmers.

Agri-jewelry loans up to Rs 4 lakh with a re-pledging scheme and Kisan Credit Card loans up to Rs 1.60 lakh are now available online from the city-based bank.

The bank announced in a statement that it has teamed up with auto giant Maruti Suzuki India Ltd to offer consumers digital lead generation for vehicle loans. Customers applying for foreign remittances can do so through the dedicated portal 'IND Trade NXT'.

Paytm Bank gets Nod as Bharat Bill Pay Operator

Paytm Payments Bank has secured final clearance from the Reserve Bank of India (RBI) to function as a Bharat Bill Payment Operating Unit (BBPOU).



The approval allows the firm to offer various bill payment services, including electricity, phone, DTH, water, gas insurance, loan repayments, FASTag recharge, education fees, credit card bill along with municipal taxes.

These services come under Bharat Bill Payment System (BBPS), which is owned by the National Payments Corporation of India.

Prior to the latest approval, Paytm

Payments Bank has been offering the services through an in-principle consent from RBI.

PPBL has got the final approval from RBI to operate as Bharat Bill Payment Operating Unit (BBPOU) under the Payment and Settlement Systems Act, 2007.

RBI prior approval now a must for picking up over 5% in banks

The Reserve Bank of India (RBI) said any person looking to acquire more than 5 per cent stake in a bank will need prior approval from the regulator.

Any person who intends to make an acquisition, which is likely to result in major shareholding in a banking company, is required to seek previous approval of the RBI

by submitting an application.

The regulator said in the master direction on Acquisition and Holding of Shares or Voting Rights in Banking Companies.

The RBI has defined "major shareholding" as "aggregate holding" of 5 per cent or more of the paid-up share capital or voting rights in a banking company by a person.



Picking Up Over **5%** In Banks





NIIF to invest **Rs 400 Crore** in Lighthouse India's Fourth fund

National Investment and Infrastructure Fund Limited (NIIF) Fund of Funds announced an anchor commitment of ₹400 crore to Lighthouse India Fund IV AIF.

With a target size of up to ₹3,500 crore, Lighthouse Fund IV will invest in high-growth businesses in sectors such as healthcare, specialty manufacturing, digital transformation, and consumer products and services.

NIIF's participation as an anchor investor in Lighthouse Fund IV makes it the first domestic institutional investor and is expected to help the fund catalyse further capital from high-quality domestic and global institutions.

HC sets aside RBI order to write off Yes Bank's Rs **8,300-Crore** AT -1 Bonds

Bombay High Court has declared RBI order to write off ₹8,300 crore AT-1 bonds of YES Bank as invalid.

Earlier, administrator of YES Bank has directed write-off of ₹8,300 crore additional tier-I (AT-1) bonds of the bank as part of its reconstruction. The Bombay HC has given YES Bank six weeks for the implementation of this order.

The bank will need to arrange the required funds in this period to make the payments after six weeks.

Under plan to revive YES Bank, a State Bank of India led consortium of 10 institutional investors has invested ₹10,000 crore in YES Bank.





Canara Bank transfers entire stake in Russian JV to SBI

Canara Bank has transferred to SBI its entire 40% stake in Commercial Indo Bank LLC (CIBL), Moscow.

This has come after the bank has entered into a share sale agreement with State Bank of India (SBI) in relation to sale of equity shares held by it in CIBL.

The entire 40% stake held by Canara Bank was transferred to SBI on November 30, 2022 based on the share sale agreement and with the consent of the Central Bank of Russia. The transaction is expected to be completed on or before March-

end 2023. Commercial Indo Bank LLC (CIBL) is a Joint Venture in Russia between SBI (60%) and Canara Bank (40%).

SIDBI to Partner with AMFI to Support Bengal's Women Entrepreneurs



Small Industries Development Bank of India (SIDBI) will partner with the Association of Microfinance Institutions of India (AMFI) to support women entrepreneurs in the backward districts of West Bengal.

Deputy Managing Director of SIDBI, Sudatta Mandal, said that the women entrepreneurs will also be helped in terms of getting market and credit linkages.

SIDBI has already spearheaded the project in Odisha and it has been

very successful. Six backward districts of West Bengal have been identified for this purpose and 12,000 women will be given credit so that their incomes rise. This will be a two-year intervention by SIDBI. West Bengal is a leading state for the micro-finance industry. The smaller MFIs have done a good job in terms of recovery when the collection efficiency ratio declined during the pandemic

PSBs Insurers Likely Drove India's First Green Bond Auction

The maiden SGRB auction of Rs 8,000 crore, held on January 25, got oversubscribed owing to robust demand from various market participants, primarily banks. This is part of the Rs 16,000 crore Sovereign Green Bond auction that the RBI will conduct in the current financial year. The second green bond auction will be conducted on February 9. A sovereign bond is a specific debt instrument issued by the government. Just like other bonds, these also promise to pay the buyer a



certain amount of interest for a stipulated number of years and repay the face value on maturity. These bonds are a source of government financing alongside tax revenue. The 5-year and 10-year green bonds were issued at a premium compared to the similar existing maturity sovereign regular bonds. The securities which do not have any restrictions on holdings by foreign investors come under the fully accessible route.



SBI raises Rs 9,718 Cr . Via 2nd Infra Bond Issue

State Bank of India (SBI), the country's largest lender, raised Rs 9,718 crore through the issuance of 15-year infrastructure debt with the bonds bearing a coupon of 7.70 per cent.

The coupon is the rate of interest that is periodically paid out to investors. The investors included mutual funds, provident and

pension funds and insurance companies.

SBI's latest bond sale marks the first time an Indian bank has issued infrastructure bonds with a tenure of 15 years. The bank said that the sale would aid in the development of a long-term infrastructure bond curve and encourage banks to issue such debt for longer maturities.



Rudra Mini 2023 Quants Batch (Pre to Mains)

- ✓ Basic to Advance Quant Course
- ✓ Live + Recorded Classes + PDFs
- ✓ Weekly Assessment
- ✓ 1 year Validity
- ✓ Covers All subtopics

FREE

LAUNCHING OFFER
RUDRA VIKRAM DI BATCH

SPECIAL OFFER

Extra **10% Off**

USE CODE
GUIDELY10

Grab It Now

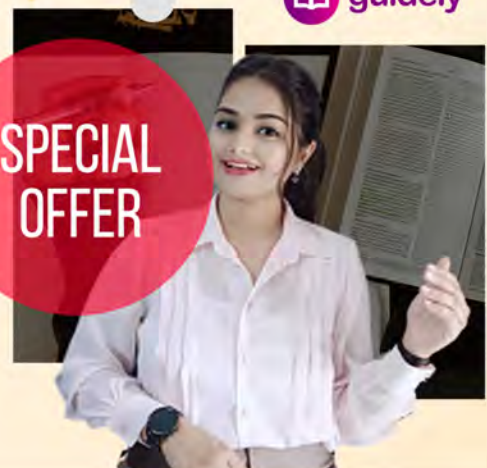

ECONOMY





India, ADB sign \$1.2-Bn Loan Agreements for Infra Projects

In d i a and Asian Development Bank (ADB) have signed \$1.22 billion loan agreements for infrastructure projects in several states.

The agreements would cover projects for improving the power sector and highways in the northeastern states of Tripura and Assam, respectively.

The agreements include a \$350 million loan to expand the metro rail network in Chennai. It would support the development of three new metro lines—3, 4, and 5. A \$350 million loan agreement

has been signed to improve the connectivity of key economic areas in the state of Maharashtra. At least 319 km of state highways and 149 km of district roads will be upgraded to strengthen the state's core road network in the 10 districts.

A \$300 million loan agreement has been signed to upgrade over 300 kilometres of state highways and major district roads (MDRs) in Assam.

At Rs 1.50-Lakh Cr, GST Mop-Up in Dec is 3rd Highest in FY 23



The goods and services tax (GST) collections came in at Rs 1.49 trillion in December 2022 (largely November transactions), up 15.2% on year and a modest 2.5% increase sequentially, reflecting the festive sales and a somewhat steady pace of economic revival.

The collections, which are the third-highest this fiscal, are in line with the average monthly mop-up of Rs 1.49 trillion so far this fiscal against the average Rs 1.23 trillion in 2021-22.

Monthly GST revenues have been higher than Rs 1.4 trillion for the 10th month in a row.

Standard Chartered becomes 1st Foreign Bank to Trade Bond Futures in China

Standard Chartered Plc's China unit said it had become the first foreign bank to trade treasury bond futures in the country which is deregulating capital markets.

The move comes as China steps up efforts to draw global investors amid months of foreign money outflows from its \$20-trillion bond

market.

Standard Chartered Bank (China)

Ltd said it had completed its first treasury bond futures transaction in China, with the permission of regulators.



BSE ties up with Goa Govt On SMEs

Stock exchange BSE has partnered with the Goa government to create awareness amongst SMEs in the state on the benefits of listing and also guide them on raising capital through equity infusion.

Under the memorandum of understanding (MoU) signed between BSE and state government, the Department of Industries and Commerce, Goa will support in "mobilizing the

SME representatives through the District Industries Centre as well as the state/regional associations/chambers encouraging their SME members to attend capacity-building programs organized by the Exchange.

BSE had earlier also entered into similar partnerships with multiple state governments viz., Maharashtra, Chhattisgarh, Tamil Nadu, etc., to promote listings among local SMEs.

Inflation Cools to One-Year Low of 5.7 % in December

India's retail inflation eased to 5.72% in December 2022 primarily on the back of decline in food prices.

The consumer price index (CPI)-based inflation has remained below RBI's upper tolerance band

of 6% for the second consecutive month.

The retail inflation stood at 5.88% in November last year.

The Consumer Price Index is a comprehensive measure used for the estimation of price changes

in a basket of goods and services representative of consumption expenditure in an economy.

World Bank retains India's Growth Forecast



World Bank has kept growth forecast for India at **6.9%** for FY23 and **6.6%** for FY24.

Recently released Global Economic Prospects report said that India is expected to be the fastest-growing economy of the seven largest EMDEs (Emerging Markets and Developing

Economies). The report said that global economy is projected to grow by 1.7% in 2023 and 2.7% in 2024. The report mentioned any adverse development could push the global economy into recession. This would be the first time in more than 80 years that two



global recessions have occurred within the same decade.

The report said that India's growth expanded by 9.7% on an annual basis in the first half of fiscal year 2022/23.

Inflation in Rural India above urban in 23 States/UTs; Mizoram tops with 13.9%

Rural retail inflation in 23 States/UTs is higher than urban. **Mizoram** recorded the highest rate of retail inflation at **13.94%**. Tripura recorded the maximum urban inflation at 10.43%

Consumer Price Index-based retail inflation for December was highest in two north-eastern

States. **Telangana, Madhya Pradesh, Uttar Pradesh, Haryana and Punjab** are the large states, which have high rural inflation

Four of these five States have high dependency on the farm sector. According to expert, the main reason for higher retail inflation



is the larger weightage of food and beverage components in the rural CPI basket (54.18%).

Inflation in rural areas (6.05%) is still higher than urban area (5.39%).



India-China Trade Deficit crosses \$100 Bn for 1st time

The bilateral trade between India and China has reached highest value- \$ 135.98 billion in 2022. It has surpassed the 2021 record.

The rise in bilateral trade is due to recovery in demand in India and surge in Chinese goods import-import of intermediate goods, new category of goods such as

medical supplies. As compared to 2021, the import of Chinese goods in India increased by more than 21%.

Appointments



Sanjiv Kapoor is CEO-Designate, Not CEO, Says Jet AIRWAYS 'RP

Grounded carrier **Jet Airways** said **Sanjiv Kapoor** remains the CEO-designate of the company till the



airline's ownership is transferred to the consortium by the lenders. In October 2020, the airline's committee of creditors (CoC) approved the revival plan submitted by the consortium of Dubai-based Murari Lal Jalan and the UK's Kalrock Capital. The consortium had in March last year announced the appointment of Kapoor as the CEO of the airline with effect from April 4, 2022.



Captain **Shiva Chauhan** became the first woman officer to be operationally deployed at the Siachen glacier. Shiva Chauhan is an officer of the Fire and Fury Corps.

She will be deployed at the Kumar Post in the Siachen glacier.

In September 2021, a team of eight specially-abled people created a world record by reaching Kumar Post at 15,632 feet height.

The Siachen Glacier is the highest battleground on the earth. It is spread over an area of 76 kilometres.

Under Operation Meghdoot, the Indian Army took control of the entire Siachen glacier in 1984.

Since 1984 India and Pakistan maintain a permanent military presence in the Siachen glacier.

Captain Shiva Chauhan is First Woman Officer to be Deployed at Siachen



Paytm Payments Bank appointed MD and CEO, Surinder Chawla

Paytm Payments Bank Limited (PPBL) has appointed Surinder Chawla as its new Managing Director & Chief Executive Officer. This appointment has been approved by RBI, said a regulatory filing by One 97 Communications .

PPBL is an associate company of One 97 Communications, which owns the Paytm brand. He replaces Satish Kumar Gupta who retired in October 2022. Since then Deependra Singh Rathore has been serving as the interim CEO of PPBL. Chawla, who has nearly three decades of experience in retail banking, was previously the Head of Branch Banking at RBL Bank. Vijay Shekhar Sharma, Chairman of Paytm Payments Bank Board.

Govt Re-Appoints Patra as RBI Deputy Governor

The government has extended the tenure of **Dr Michael Debabrata Patra** as **Deputy Governor** of the **Reserve Bank of India** by one year.

Michael Debabrata Patra took over as Deputy Governor of the Reserve Bank of India (RBI) on January 15 2020. He was an Executive Director of India's central bank before being elevated to the post of Deputy Governor.

Patra, a career central banker since 1985, has worked in various positions in the Reserve Bank of India.

Other 3 Deputy Governor are **Shri Mahesh Kumar Jain, Shri M. Rajeshwar Rao, Shri T. Rabi Sankar**.



AC Charania, Indian-American is **NASA** Chief Technologist

AC Charania, Indian-American space expert, appointed as new **chief technologist of NASA**.

Charania will serve as principal advisor to Administrator Bill Nelson on technology policy and programs.

He replaced fellow Indian-American scientist Bhavya Lal, who was serving as acting chief technologist.

This position works within NASA's Office of Technology, Policy, and



SBI MD Setty's Term Extended by 2 Years

The government has extended the term of **State Bank of India** Managing Director **Challa Sreenivasulu Setty** by two years with effect from January 20.

SBI on 3 January said that its board has considered raising funds through issue of infrastructure bonds worth up to ₹10,000 crore during financial year 2023. In December last year, SBI had raised ₹10,000 crore through its maiden infrastructure bond issue.

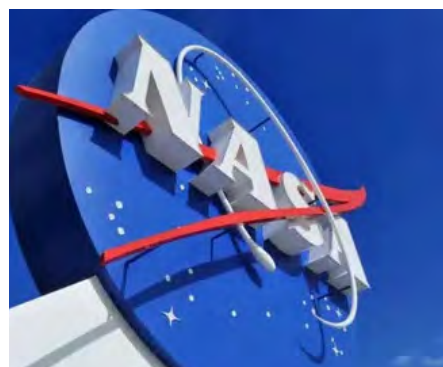

Infy Veteran Ravi Kumar S Joins Cognizant as CEO

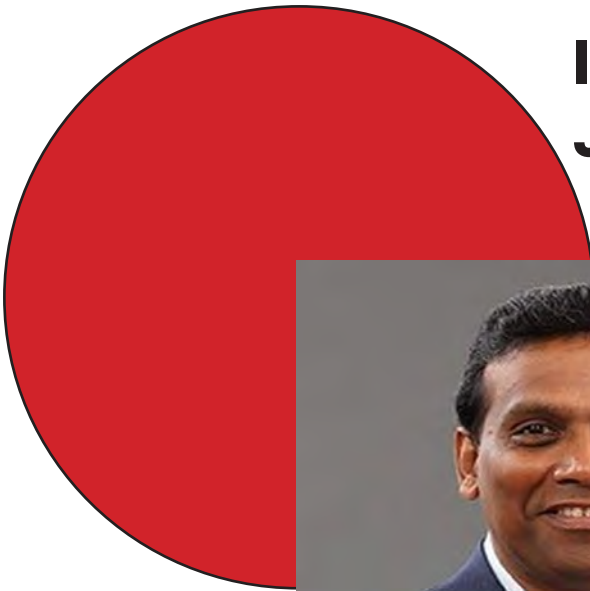

IT giant **Cognizant** has announced **Ravi Kumar** as its new Chief Executive Officer, replacing the outgoing Brian Humphries, effective immediately. Mr. Kumar was the president and COO of Infosys until October 2022, before leaving the company to join Cognizant the following week as President of Cognizant Americas.

Mr. Humphries had resigned from the post that he held for four years, a move that has been linked to Cognizant's recent underperformance, including revenue decline in the third quarter of 2022.

Ex-BSF DG Pankaj Kumar Singh is Deputy National Security Adviser

Pankaj Kumar Singh has been appointed Deputy National Security Adviser (NSA).

He is a 1988-batch IPS officer of the Rajasthan cadre. He retired as the Director General of BSF on December 31, 2022.

He has been appointed as Deputy NSA in National Security Council Secretariat for a period of two years.



Chris Hipkins to Succeed Ardern as New Zealand's Next Prime Minister

Chris Hipkins to replace **Jacinda Ardern** as New Zealand Prime Minister.

After the resignation of Jacinda Ardern, Chris Hipkins will become the new Prime Minister of New Zealand.

He is the current minister for police, education and public

service.

He is the only nominee to become the next leader. He is a mild-mannered but talented politician.



Govt Extends Tenure of CCI Acting Chief

The government has extended the tenure of Sangeeta Verma as the acting Chairperson of the Competition Commission of India (CCI).

Ms. Verma has been the acting Chairperson of the anti-trust regulator since October last year after Ashok Kumar Gupta demitted office as the full-time Chairperson.

Tata Trusts: Sharma named CEO , Uppaluri COO

The Trustees of Tata Trusts have appointed Siddharth Sharma as the Chief Executive Officer (CEO) of the Trusts, and Aparna Uppaluri as the Chief Operating Officer (COO).

This comes after N Srinath retired as the CEO of Tata Trusts in October last year.



Indian-American Astronaut nominated By Biden for Appointment to Grade of an Air Force Brigadier General

Indian-American astronaut **Raja J Chari** has been nominated by President Mr. Joe Biden for the appointment to the grade of **Air Force brigadier general**. The nomination will have to be confirmed by the Senate. Chari served as the commander of the 461st Flight Test Squadron. In 2020, he was selected as the Commander of the SpaceX Crew-

3 mission to the International Space Station (ISS) by NASA and the European Space Agency. He was the commander of the Crew Dragon spacecraft and the Crew-3 mission. He was one of the four astronauts that were part of the SpaceX spacecraft which docked successfully at the orbiting lab in May 2022.



AWARDS



RRR's Super Hit Song Naatu Naatu Wins Prestigious Golden Globe Award for Best Original Song

Indian film **RRR's** super hit song **Natu Natu** has won the prestigious **Golden Globe award** for Best Original Song.

The history creating track from the director **SS Rajamouli's** blockbuster movie is composed by **MM Keeravani**.

The singers are **Kaala Bhairava** and **Rahul Sipligunj**. "Naatu Naatu," which became an anthem of sorts for the **Rajamouli** fans is a dance number featuring **Jr NTR** and **Ram Charan**.

The historical epic, **RRR** was also nominated in the **Best Non-English Language Film** category at the **80th Golden Globes**. The awards are considered as a precursor for the **Oscars**.



Mumbai's Chhatrapati Shivaji Maharaj International Airport's: Best Sustainable Airport

In recognition of Mumbai's Chhatrapati Shivaji Maharaj International Airport's (CSMIA) efforts in contributing to make aviation sustainability a reality, the airport has been awarded the 'Best Sustainable Airport of the Year' by the Associated Chambers of Commerce & Industry of India (ASSOCHAM) in its 14th International ASSOCHAM Conference & Awards for Civil Aviation.

The coveted award was presented by Union Minister of Civil Aviation, Jyotiraditya M. Scindia.

The ASSOCHAM 'Best Sustainable Airport of the Year' award is another addition to various prestigious laurels received by CSMIA in the past.

Recently, Mumbai's Chhatrapati Shivaji Maharaj International Airport (CSMIA) achieved the Highest-Level 4+ "Transition" of Airport Carbon Accreditation (ACA) program of Airport Council International (ACI), making it only the 3rd airport to achieve the esteemed certification in the Asia-Pacific region

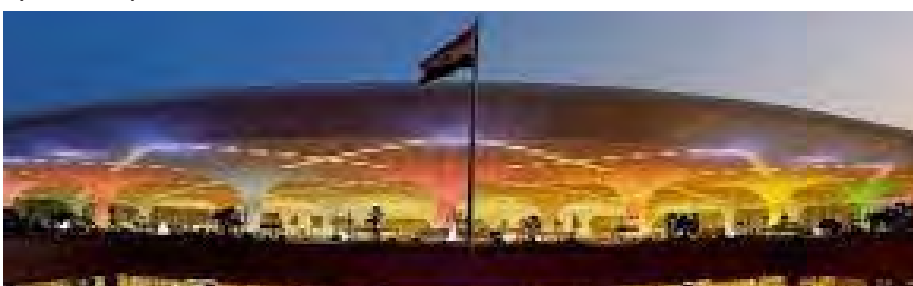

Godrej Agrovet gets Palm Oil Sustainability Certification

Godrej Agrovet Ltd. has become the first company in the country to be awarded a verification Certification under the Indian Palm Oil Sustainability (IPOS) Framework, issued by an independent international certification body, in recognition of the sustainable practices adopted by its oil palm business.

The certification was presented to the Chief Executive Officer of Godrej Agrovet's Oil Palm Plantation business Mr. Sougata Niyogi.



America's 28-Year -Old R Bonnie Gabriel won Miss Universe 2022 Crown



America's 28-year-old R Bonnie Gabriel won Miss Universe 2022 crown.

Miss Universe 2021 Harnaaz Sandhu crowned Miss Universe R Bonnie Gabriel. Amanda Dudamel of Venezuela became the first runner-up, while Andrea Martínez of the Dominican Republic was the second runner-up.

R Bonnie Gabriel, 28, is a model, fashion designer, and sewing instructor who makes the environment a priority in her work.

Gabriel is the first American of Filipino descent to win Miss USA.

The 71st Miss Universe pageant was held in New Orleans, Louisiana.

84 women from all over the world competed for the crown in this competition.

In 1952, Armi Kuusela from Finland won the first Miss Universe title

CEAT gets 'Lighthouse Certification' from WE

CEAT CEAT Becomes World's First Tyre Brand To Get Lighthouse Certification

The Global Lighthouse Network

Know Why is it Important?

CEAT Ltd's Halol plant has been awarded the 'Lighthouse Certification' by the World Economic Forum.

The certification is given to manufacturers that use fourth-industrial revolution technologies to transform factories, value chains, and business models for sustainability, empowering the workforce and increase in productivity.

The technologies are used to improve equality, efficiency, factory parameters, and productivity of the plant.

CEAT Ltd is the first tyre company in the world to get the certification and this journey started 3-4 years back.

Anant Goenka, Managing Director, CEAT Ltd.



Ahom Burial Sites to Vie for UNESCO Tag

Moidams/maidams have been finalised as India's sole nomination for consideration as UNESCO World Heritage Site for the year 2023-2024.

Charaideo commonly known as 'Pyramids of Assam' was the original capital of the Ahom Kings.

Charaideo remained the symbolic center of Ahom Kingdom even though the capital of the kingdom moved many times.

It was built by Chaolung Sukhapa the founder of the dynasty in about 1229 CE. It is located at the foothills of Nagaland, it's situated at a distance of around 30 KM from the historical Sivsagar town in Assam

India has 40 world heritage sites, including 32 cultural properties, 7 natural properties and 1 mixed site.

The 40th being the Harappan City, Dholavira in Gujarat, in 2021. Assam's Kaziranga National Park and Manas National Park are among the seven natural sites.

It is a specialised agency of the United Nations (UN), headquartered at the World Heritage Centre in Paris, France.

It was founded in 1945 as the successor to the League of Nations' International Committee on Intellectual Cooperation..

901 Police Medals to Celebrate Bravery, Distinguished Service

Police Medals were given to 901 police personnel on the occasion of Republic Day, 2023.

140 personnel have been awarded the Police Medal for Gallantry (PMG), 93 the President's Police Medal (PPM) and 668 the Police Medal (PM) for Meritorious Service.

Out of 140 personnel awarded for their gallant action, 80 personnel are from Left Wing Extremism affected areas and 45 personnel

from the J&K region.

Among the personnel who received gallantry awards, 48 are from CRPF, 31 from Maharashtra, 25 from J&K Police, 09 from Jharkhand, 7 each from Delhi, Chhattisgarh and BSF and the rest from other States/UTs and CAPFs.

Police Medal for Gallantry (PMG) is awarded on the basis of conspicuous gallantry in saving life and property or preventing crime or arresting criminals.



The President's Police Medal for Distinguished Service (PPM) is awarded for a particularly distinguished record in police service.

Police Medal for Meritorious Service (PM) is awarded for valuable service characterized by resourcefulness and devotion to duty.



President Droupadi Murmu Approved 412 Gallantry Awards

President Droupadi Murmu approved 412 Gallantry awards and other Defence decorations to Armed Forces personnel and others on the eve of the 74th Republic Day. According to a release by the

Ministry of Defence, the recipients of the award this year include six Kirti Chakras, including four posthumous; 15 Shaurya Chakras, including two posthumous; one Bar to Sena Medal (Gallantry); 92 Sena Medals, including four



posthumous; one Nao Sena Medal (Gallantry) (posthumous); seven Vayu Sena Medals (Gallantry); and 29 Param Vishisht Seva Medals.



NSE is now the 3rd Largest Exchange in Equity Trading

National Stock Exchange of India (NSE) has emerged as the 3rd largest exchange in the world in the equity segment by the number of trades (electronic order book)

in 2022, an advancement from the previous year when it ranked 4th as per statistics maintained by the World Federation of Exchanges (WFE). NSE has also maintained its

position as the world's largest derivatives exchange in 2022 by the number of contracts traded based on statistics maintained by Futures Industry Association (FIA), a derivatives trade body.

RANKING

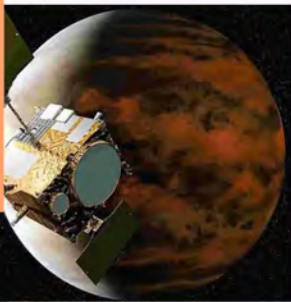



India has Surpassed Japan to become the 3rd Largest Auto Market

For the first time, India has surpassed Japan to become the third largest auto market. In terms of auto sales last year, India is ahead of Japan. India's total sales of new vehicles

stood at around 4.25 million units compared to 4.2 million sold in Japan. The auto market in India is improving after the fluctuations seen between 2018-2020.

RBI Assistant 2023 Prelims + Mains Combo Mock+PDF Course

- ✔ 20 RBI Assistant Prelims Mock Tests
- ✔ 10 RBI Assistant Mains Mock Tests
- ✔ 50+25 Days PDF Course for Pre+Mains
- ✔ Available in Bilingual (Hindi & English)
- ✔ Video Solution for PDF Course
- ✔ 1 year validity

Extra **10%** Off

USE CODE
GUIDELY

Grab It Now



FLYING HIGH

Top airlines in Asia-Pacific

#	Airline	On-time arrivals (%)
5	IndiGo	84.11
6	AirAsia India	83.70
9	Vistara	80.98

Top global airports

#	Airport	On-time departures (%)
2	Kempegowda Airport, Bengaluru	84.08
7	Indira Gandhi International Airport, Delhi	81.84

Source: Cirium

Top Performing Global Airports In 2022: Bengaluru, Delhi On The List

list.

The report has ranked Bengaluru's Kempegowda International Airport at the second spot in the best-performing airports in the last year. Delhi's Indira Gandhi International (IGI) Airport gets the seventh position.

Similarly, three Indian airlines – IndiGo, AirAsia India, and Vistara – have been listed among the top ten airlines in Asia-Pacific, according to aviation analytics company Cirium.

Cirium, the global aviation analytics company, has released its list of the top-performing airports in 2022. Two Indian airports feature in this



Powergrid ranks 1st in the Services Sector across Categories in PE Survey

Maharatna central public sector undertaking (CPSE), Power Grid Corporation of India Limited, under the Union ministry of power, has ranked first in the services sector, in the Public Enterprises Survey 2021-22 by Department of Public Enterprises (DPE), Ministry of Finance.

The PSU has ranked first across categories like Gross Block, Value Addition, Net Profit, Net Worth, Dividend Declaration and Contribution to Central Exchequer.

Power Grid Corporation of India has also been ranked third amongst the top ten profit making Central Public Sector Enterprises in the survey.

Delhi still most polluted city, 3 from Bihar Placed in Top 10

Delhi was the most polluted city in India in 2022 with PM 2.5 levels more than double the safe limit and the third highest average PM10 concentration, according to an analysis of Central Pollution Control Board data

According to the NCAP tracker PM2.5 pollution in the national capital has reduced by over 7 per cent in four years, from 108 micrograms per cubic metre in 2019 to 99.71 micrograms per

cubic metre in 2022.

NCAP Tracker is a joint project of news portal Carbon Copy and a Maharashtra-based start-up 'Respirer Living Sciences' and is designed to track India's progress in achieving clean air targets.

THE CHOKING REALITY

MOST POLLUTED CITIES (For PM 2.5)
Delhi, Faridabad, Ghaziabad, Patna, Muzaffarpur, Noida, Meerut, Goidngarh, Gaya and Jodhpur

MOST POLLUTED CITIES (For PM 10)
Ghaziabad, Faridabad, Delhi, Noida, Patna, Meerut, Muzaffarpur, Durgapur, Jodhpur and Aurangabad

CLEANEST CITIES

Srinagar (J&K)
Records PM 2.5 concentration of 26.33 ug/m³

Kohima (Nagaland)
Records PM 10 concentration of 26.77 ug/m³

CURRENT ANNUAL AVERAGE SAFE LIMITS

PM 2.5	PM 10
40 ug/m ³	60 ug/m ³

₹6,897cr in 4 yrs have been spent by the Centre's National Clean Air Programme, but cities are still choking

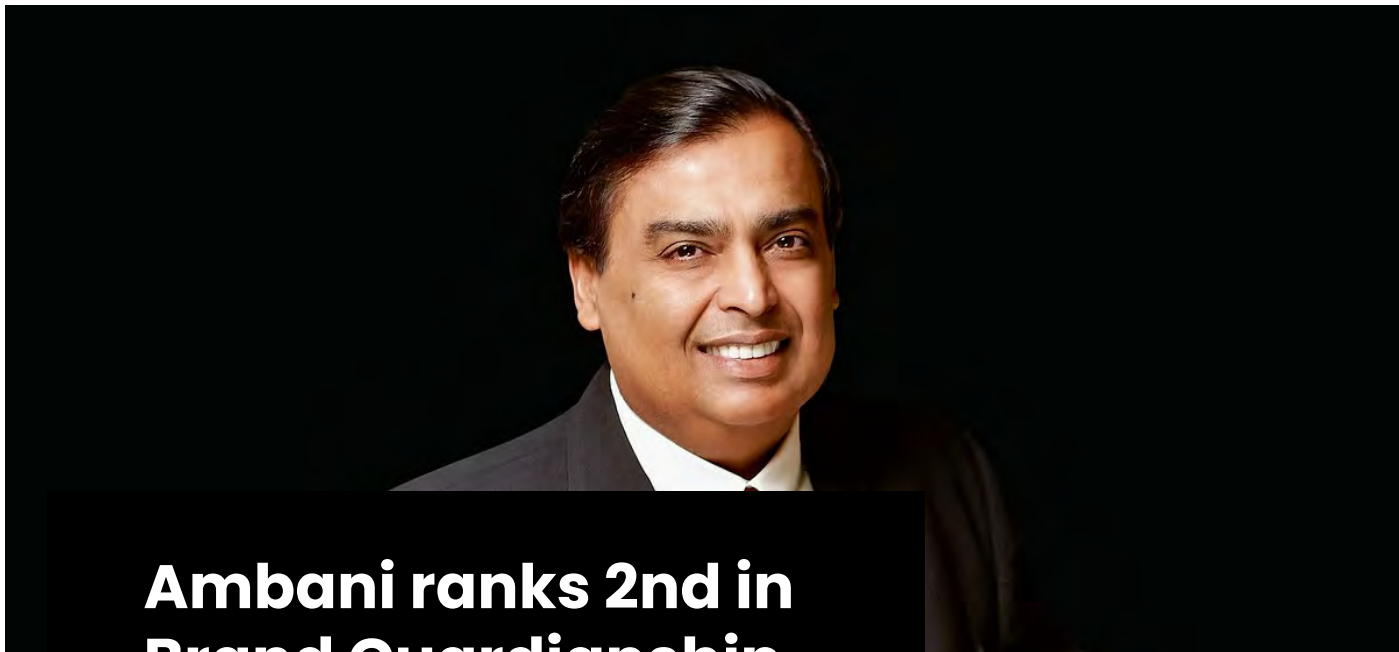

Ambani ranks 2nd in Brand Guardianship Index



Mukesh Ambani has been placed first in India and second in the world in the Brand Guardianship Index 2023.

He has also left behind Microsoft CEO Bharatvanshi Satya Nadella and Google's Indian-origin CEO Sundar Pichai.

Reliance Chairman Mukesh Ambani got a BGI score of 81.7 in the Brand Finance Index, just below American tech giant Nvidia's Jensen Huang, who scored 83.

With this score, Huang is number one in the world. Microsoft's Satya Nadella ranked third place in index.

The Brand Guardianship Index and Brand Guardianship Rankings have been prepared on the basis of a survey conducted by over 1,000 market analysts. This index is prepared by Brand Finance. The

Adobe's Shantanu Narayen is fourth, Google's Sundar Pichai is fifth, Deloitte's Puneet Rajan is sixth, and Tata Group chairman Natarajan Chandrasekaran is eighth.

Anand Mahindra, Chairman of Mahindra & Mahindra Group, is ranked 23rd in the index.





Delhi ,Bengaluru, Mumbai among Top 55 Global Cities for Women Entrepreneurs

Bengaluru, Delhi and Mumbai ranked among the top global cities for women entrepreneurs.

Dell Technologies' new study has ranked them. Bengaluru is for the first time ranked fifth in the top 10

operating environments list. It is ranked ahead of Paris, Washington DC and other cities. Dell said Bengaluru, Delhi and Mumbai were featured among the top 50 in the list. The report ranked 55 global cities on the basis of their ability

to attract high-potential women entrepreneurs who are willing to start and scale a business.

Dell Technologies is an American multinational technology company headquartered in Texas.



Russia displaces Taiwan as 4th Largest Steel Exporter to India in April-December

Russia has displaced Taiwan to be amongst the top four importers of steel to India for the April – December 2022 period.

Shipments, from Russia increased nearly 500 per cent in these nine months, year-on-year (YoY), to 0.26 million tonnes (mt). Imports in year-ago-period were 0.043 mt.

The country has also seen the highest increase percentage-wise.

Russian shipments coming in are valued at ₹2,250 crore.

SCIENCE

&

T E C H N O L O G Y



India Successfully Carries Out Test Launch of Prithvi-II

On 10 January, a successful training launch of Prithvi-II missile was carried out by DRDO from Integrated Test Range, Chandipur.

It is an indigenous ballistic missile developed by DRDO under the Integrated Guided Missile Development Programme (IGMDP). IGMDP started in 1982-83 and completed in 2008.

It has been an integral part of India's nuclear deterrence.

It is a surface-to-surface short-range ballistic missile.

It has a range of about 350 kms. It can carry payloads of 500-1000 kg.

It was first tested in 1996. It got inducted into the Indian armed forces in 2003.

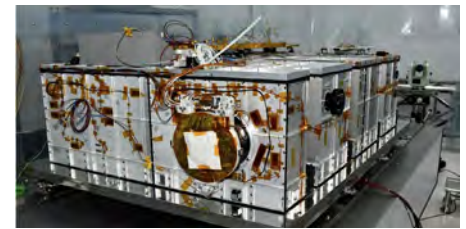

Indias 1st Mission to Study the Sun to Begin by June-July

According to the Indian Space Research Organisation (ISRO) chairman S. Somanath, the country's first solar mission - Aditya-L1 mission, is likely to be launched by June-July this year.

He was speaking at the handover ceremony of the Visible Line Emission Coronagraph (VELC) payload - one of seven payloads (instruments) on board Aditya - L1.

In total Aditya-L1 has seven payloads, of which the primary payload - the VELC, is designed and fabricated by the Indian Institute of Astrophysics (IIA, Bengaluru).

The payload will be taken to the R. Rao Satellite Centre (Bengaluru), where it will be integrated with the Aditya-L1 satellite and will undergo further testing, evaluation and finally launched using the PSLV.

In total Aditya-L1 has seven payloads, of which the primary payload - the VELC, is designed and fabricated by the Indian Institute of Astrophysics (IIA, Bengaluru).

The payload will be taken to the R. Rao Satellite Centre (Bengaluru), where it will be integrated with the Aditya-L1 satellite and will undergo further testing, evaluation and finally launched using the PSLV.

Aditya (in Sanskrit means Sun) is a planned coronagraphy spacecraft to study solar atmosphere (solar corona - outermost part).

Isro Likely to Push Venus Mission 'Shukrayan I' to 2031

An advisor to the space science programme recently said that the Indian Space Research Organisation is yet to receive approval from the Indian government for the Venus mission and that the mission could as a result be postponed to 2031.

ISRO's Venus mission, called Shukrayaan I, was expected to be launched in December 2024.

The idea was born in 2012; five years later, ISRO commenced preliminary studies after the Department of Space received a 23% hike in the 2017-2018 budget.

It is also called the Venus Mission. The Shukrayaan I mission will be

an orbiter mission.

Its scientific payloads currently include a high-resolution synthetic aperture radar and a ground-penetrating radar.

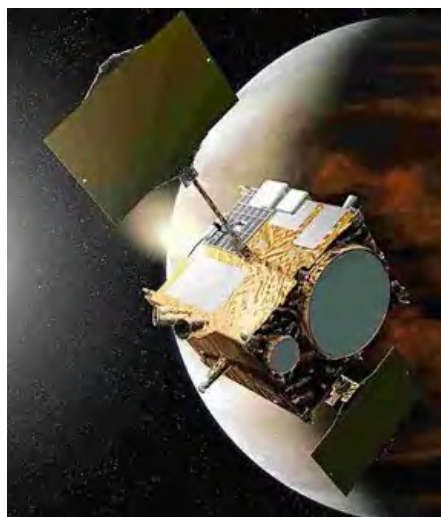



DEFENCE





India, France commence 21st 5-day naval exercise 'Varuna'

It will witness advanced air defence exercises, tactical manoeuvres, surface firings, and

In 21st edition, indigenous guided missile stealth destroyer INS Chennai, guided missile frigate INS Teg, maritime patrol aircraft P-8I and Dornier, integral helicopters and MiG29K fighter aircraft are taking part.

21st edition of **Exercise Varuna** commenced on the western sea-board on 16 January 2023. The exercise will be conducted till 20 January 2023.

other maritime operations. It facilitates operational-level interaction between the two navies to foster mutual cooperation for good order at sea.

The bilateral exercise between two navies was started in 1993. It was renamed as 'VARUNA' in 2001.

Exercise 'Ops Alert' has been carried out by the BSF to step up security along the Indo-Pak border with Gujarat and Rajasthan ahead of the Republic Day.

The exercise will enhance security along the India-Pakistan border in Kutch district of Gujarat and Barmer in Rajasthan.

On January 21, the exercise has been started to "thwart any ill designs of anti-national elements" during the Republic Day celebrations.

The exercise will continue till January 28 along the Indo-Pak International Border from Sir Creek (swampy area) to Rann of Kutch in Gujarat and Barmer district of Rajasthan.

Official data show that in 2022, the BSF apprehended 22 Pakistani fishermen and seized



BSF Starts 'Ops Alert' Exercise ahead Of Republic Day

79 fishing boats, 250 crore rupees worth of heroin, and 2.49 crore rupees worth of charas from this region of Gujarat.

A fund of Rs 50 crore has been approved by the Union Home Ministry for the construction of eight multi-storied bunker cum observation posts in this area.



1st Indo-Japan Air Force Exercise 'Veer Guardian' ends

The inaugural edition of the air defence exercise 'Veer Guardian 2023' concluded in Japan on 26 January 2023.

Veer Guardian 2023 was a joint air defence exercise between the Indian Air Force (IAF) and Japan Air Self Defence Force (JASDF). Japan Air Self Defence Force took part in the exercise with its F-2 and F-15 aircraft.

The IAF contingent took part in the exercise with the Su-30 MKI aircraft.



SPORTS



Koustav Chatterjee became India's 78th Grandmaster in MPL 59th National Senior Chess Championship in New Delhi.

Koustav earned his maiden GM-norm in 2021 October at Sheikh Russel GM 2021 in Bangladesh.

Koustav hailing from **Kolkata** becomes West Bengal's tenth Grandmaster. Koustav has managed his chess and studies well on his journey from IM to GM title.



Koustav Chatterjee becomes 78th Chess Grand Master of India



Mens World Best Player 2022 by IFFHS

Lionel Messi has been chosen as the best player for the calendar year of 2022 by the International Football Federation History and Statistics (IFFHS).

The 35-year-old won the crown by a whopping 275 points.

Second in the tally is Kylian Mbappe, who became only the first man to score a hat-trick in the World Cup final after Geoff Hurst in 1966. The

Frenchman secured 35 points in the tally.

At the World Cup, the Argentine scored seven goals and assisted thrice at Qatar to win the golden ball for the second time in his career.

Messi had also won the player of the tournament award back in 2014 when Argentina lost in the final to Germany

Hyderabad to host First-Ever ABB FIA Formula E Championship Race

The first-ever ABB FIA Formula E World Championship race in India will be held in Hyderabad, Telangana. The race in Hyderabad will be the fourth race of season 9 of Formula E.

The first three races include Mexico City and Riyadh (second and third).

The track is about 2.8 kms. A total of 11 teams with 22 cars would be participating in racing in Hyderabad.



Country's Largest Hockey Stadium opens at Rourkela on 5 January 2023



Odisha CM Naveen Patnaik inaugurated the world class hockey stadium at Rourkela.

The stadium is named after the famous freedom fighter Birsa Munda.

The stadium has been constructed in just 15 months at a cost of Rs 261 crore.

The stadium is being billed as the largest in the world, with a seating capacity of twenty thousand spectators.

The Hockey World Cup is being hosted by Odisha for the second time, which will also be played at the prestigious Kalinga Stadium in the capital Bhubaneswar.

M Pranesh wins Rilton Cup, becomes India's 79th Grandmaster

MPranesh clinched the title in the Rilton Cup, the first tournament of the FIDE Circuit, here to become India's 79th chess Grandmaster. The 16-year-old Pranesh crossed the 2500-rating threshold and became a GM, having completed his three norms before the Rilton Cup.

To become a GM, a player has to secure three GM norms and cross the live rating of 2,500 Elo points. Nineteen-year-old Koustav Chatterjee had recently become the country's 78th Grandmaster during the National Senior Chess Championship.



Former Australian Captian Belinda Clark Gets Statue Honour



Former Australia captain Belinda Clark became the first woman cricketer to have a sculpture unveiled in her honour.

The World Cup-winning captain, prolific run scorer and key figure in the off-field development of the sport was immortalised in bronze outside the Sydney Cricket

Ground.

Her sculpture stands alongside other Australian greats including Richie Benaud and Steve Waugh. Clark also famously became the first person to score an ODI double century when she smashed 229 runs from just 155 balls against Denmark in 1997.

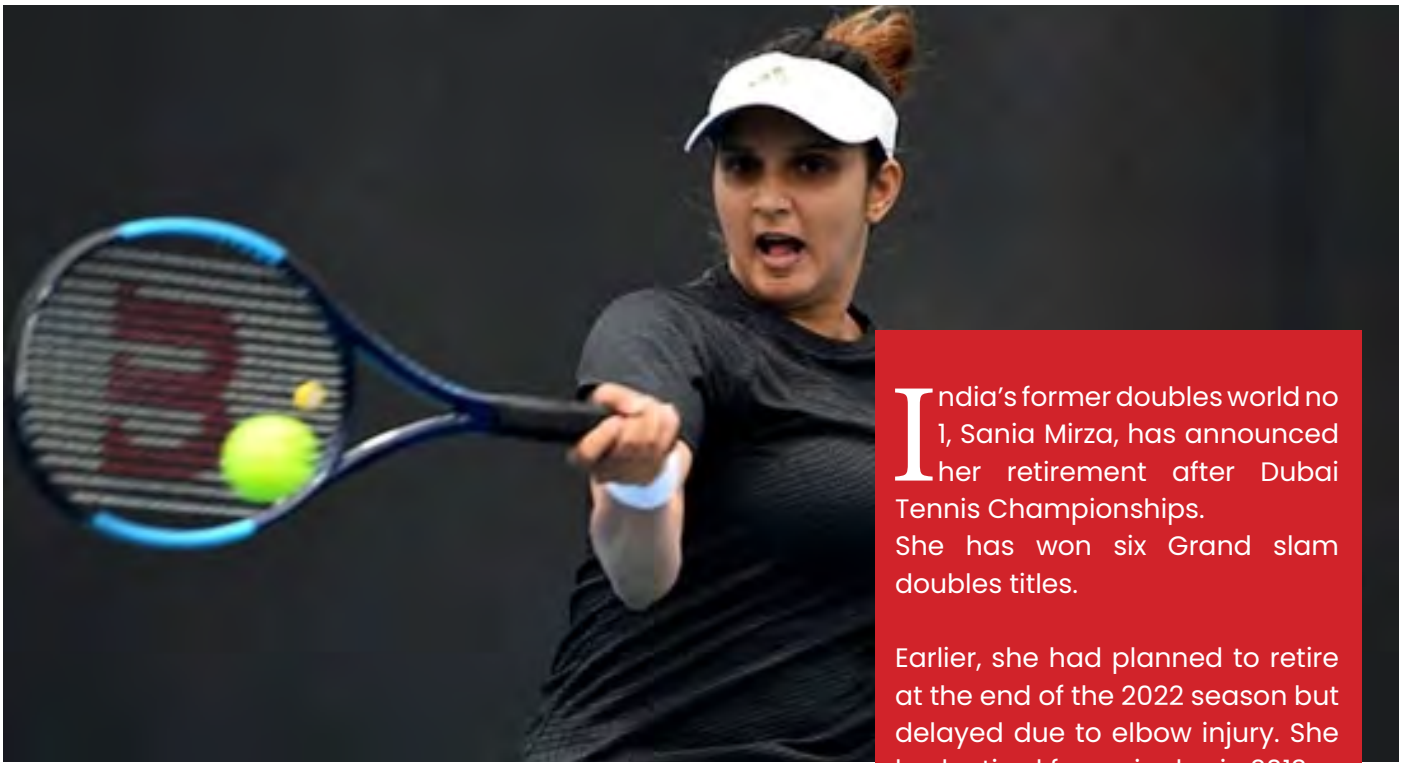

India's Former Doubles World No 1, Sania Mirza to Retire at Dubai Tournament next month

India's former doubles world no 1, Sania Mirza, has announced her retirement after Dubai Tennis Championships. She has won six Grand slam doubles titles.

Earlier, she had planned to retire at the end of the 2022 season but delayed due to elbow injury. She had retired from singles in 2013. She became the first Indian to win a WTA singles title in Hyderabad in 2005.

She is the only Indian to be ranked within top 100 in singles.

Gareth Bale announces Retirement from Football



Gareth Bale, Wales men's all-time leading goalscorer and a five-time Champions League winner with Real Madrid, has announced his retirement from football.

Bale, one of Britain's most decorated players, has left Los Angeles FC midway through his contract, which was set to end this summer. Other Retirement In Football Hugo Lloris, France's captain, announced his retirement from international football on January 9, 2023, at the age of 36.

France forward Karim Benzema has announced his retirement from international football.

South Africa All – Rounder Dwaine Pretorius announced his retirement from International Cricket

South Africa all-rounder Dwaine Pretorius announced his retirement from international cricket with immediate effect.

Since making his international debut in 2016, the 33-year-old has represented South Africa across all three formats – 30 T20Is, 27 ODIs and three Tests. He was a part of the 2019 ICC Men’s Cricket World Cup and the 2021 T20 World Cup squads.

After his international retirement, Pretorius will be seen in action at the inaugural SA20, where he is plying his trade for Durban Super Giants.



Anahat Singh wins U-15 British Open Squash Title

Anahat Singh won the Under-15 British Junior Open Squash Tournament title in Birmingham. India’s squash player Anahat Singh has won the girls’ Under-15 title at the prestigious British Junior Open tournament in Birmingham.

14-year-old Anahat Singh defeated Egypt’s Sohela Hazem 3-1 in the final

Earlier, Anahat won the Girls Under 11 title in 2019 and became the runner-up in the Girls Under 13 category in 2020.



India to Bid for Hosting 2036 Olympic Games, says Union Sports Minister Anurag Thakur

Youth Affairs and Sports Minister Anurag Singh Thakur have said India will bid for hosting the Olympic Games in 2036.

Mr Thakur said that government

will present a roadmap before the full members of the International Olympic Committee (IOC) during the IOC session in Mumbai in September 2023.



Rishabh Pant BCCI's best Test Batter Of 2022

Board of Control for Cricket in India (BCCI) has acknowledged the top performers for Team India across all three formats- Test, One-Day International and T20 cricket.

BCCI acknowledged **Rishabh Pant** and **Jasprit Bumrah** as the top batter-bowler pair in Test cricket for India in 2022.

BCCI hailed **Shreyas Iyer** and **Siraj** as the top batter-bowler pair in One-Day Internationals (ODIs).

Suryakumar and Bhuvneshwar

Kumar as both emerged as the best batter-bowler performers for the team in 2022.

The Board of Control for Cricket in India is the national governing body of cricket in India. Its headquarters are situated at Cricket centre, Wankhede Stadium in Mumbai. President: Roger Binny, Founded: December 1928



Viacom 18 bags Women's IPL Media Rights for Rs 951 Crore

The BCCI announced that Viacom 18 have grabbed the media rights for the upcoming Women's IPL for a whopping `951 crore for five years after pipping other bidders, including Disney Star and Sony, in a closed-bid auction.

was conducted by the cricket board in Mumbai. The inaugural Women's IPL is likely to begin in the first week of March. Five teams will compete and all the matches will be held in Mumbai.

The global rights comprise three categories – linear (TV), digital and combined (TV and digital) and Viacom 18 successfully bid for the combined rights.

According to BCCI secretary Jay Shah, the fee per match will come to `7.09 crore for the next five years

Viacom18 had won the IPL digital rights for `23,758 crore while Disney Star had retained the TV rights for `23,575 crore for a five-year period starting 2023 during a three-day auction held in June, 2022.

The auction for the T20 league





Germany dethrones Belgium ,Wins 3rd Title

Germany defeated Belgium by 5-4 in the penalty shootout to win the Hockey World Cup in Bhubaneswar.

Both the teams scored three goals each at the end of normal time. The result of the match came from penalty shootout.

It is Germany's third world cup title. Earlier, it has won the World Cup in 2002 and 2006.

The Netherlands won the bronze medal by defeating Australia.

Niklas Wellen of Germany got the 'Best Player Award' while Vincent Vanasch of Belgium won the 'Best Goalkeeper Award'.

India's Teenage Talent Scripts Fantastic Triumph

India defeated England in the first-ever ICC U-19 Women's T20 World Cup final

Indian women's team defeated England in the final of the U-19 Women's T20 World Cup at Senwes Park in Potchefstroom, South Africa.

India Women U19 won by 7 wickets. Indian women's team has won a World Cup title at any level for the first time

Titans Sadhu of India poses after being named Player of the Match following the ICC Women's U19 T20 World Cup 2023 Final match between India and England at JB Marks Oval on January 29, 2023 in Potchefstroom, South Africa.

England captain and stellar all-rounder Grace Scrivens has been named Player of the Tournament after a run of outstanding performances with bat and ball.



guidely

Raftaar Reasoning Batch 1.0

1 Year Validity

- ✓ 40+ Class of Live Session
- ✓ Topic PDF By Faculty
- ✓ 5 Days Class (Mon - Fri)
- ✓ Class Time 5 Pm
- ✓ Content English & Hindi
- ✓ Exam Covered SBI, IBPS PO / Clerk, RRB PO Clerk
- ✓ Zoom 1 - 1 Interaction

Extra **10% Off**

USE CODE **GUIDELY**

BUY NOW →

Mr. Rohit Sir
Reasoning Expert
5+ Years



Djokovic back on Top of the World, Level with Nadal After Perfect 10 Down Under



India defeated England in the first-ever ICC U-19 Women's T20 World Cup final

Indian women's team defeated England in the final of the U-19 Women's T20 World Cup at Senwes Park in Potchefstroom, South Africa.

India Women U19 won by 7 wickets. Indian women's team has won a World Cup title at any level for the first time

Titus Sadhu of India poses after being named Player of the Match following the ICC Women's U19

T20 World Cup 2023 Final match between India and England at JB Marks Oval on January 29, 2023 in Potchefstroom, South Africa.

England captain and stellar all-rounder Grace  Scrivens has been named Player of the Tournament after a run of outstanding performances with bat and ball.





OBITUARY

Former Pepsico India Chairman PM Sinha Passes Away at 82

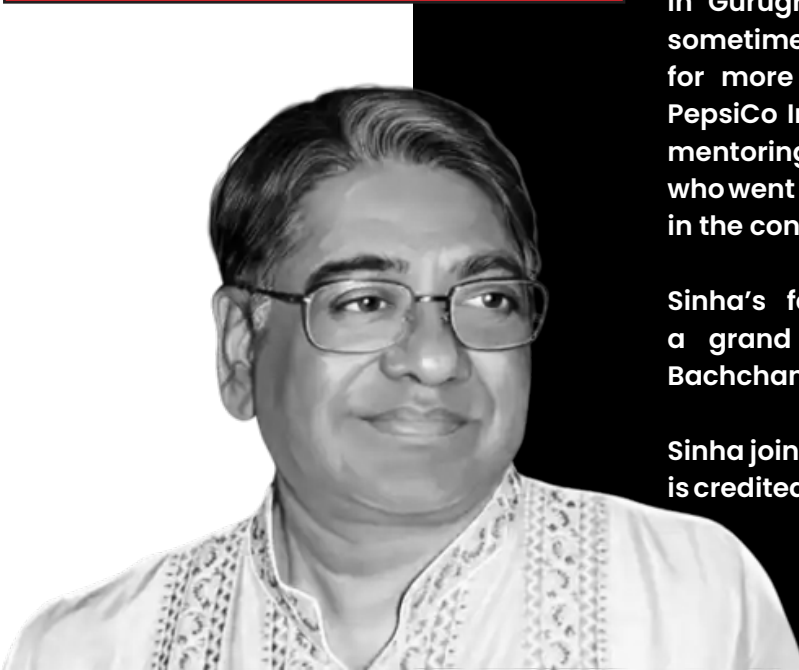

PM Sinha, 82, popularly known as Suman, former chairman of PepsiCo, India, and South Asia, passed away in Gurugram. Sinha, who was ailing for sometime, worked with Hindustan Unilever for more than a decade before joining PepsiCo India in 1993 and is credited with mentoring a generation of professionals who went on to head successful companies in the consumer space.

Sinha's farewell at Pepsi in 2002 was a grand affair, attended by Amitabh Bachchan and Shah Rukh Khan.

Sinha joined Bata as chairman in 2004 and is credited with restructuring the company.

Krishna Kumar , Man behind Tata's Tetley Buy, dies at 84

Tata Group veteran and former Tata Sons director R K Krishna Kumar passed away in Mumbai suffering a cardiac arrest.

Krishna Kumar, who was a close associate of Tata Sons Chairman Emeritus Ratan Tata, was involved in Tata's consultancy firm, RNT Associates, and the group's charitable trusts, which hold 66 per cent stake in Tata Sons, the holding company of the Tata group.

He served as the managing director (MD) of Tata Global Beverages from May 1991 to January 1998.

He was appointed the vice-chairman and managing director in 1997 of the company and retired in 2013. Krishna Kumar was also involved in Indian Hotels as vice chairman till 2013.



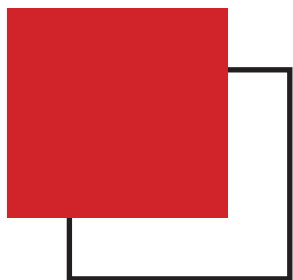

Former West Bengal Governor Keshari Nath Tirupathi passed away

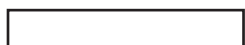

Senior Bharatiya Janata Party leader and former Bengal Governor Keshari Nath Tirupathi passed away at his residence in Prayagraj, Uttar Pradesh.

Tirupathi served as the Governor of West Bengal from July 2014 to July 2019.

Prior to this, he also held the additional charge as Governor of Bihar, Meghalaya and Mizoram for short period.

He was a member of the Uttar Pradesh Legislative Assembly for six terms.

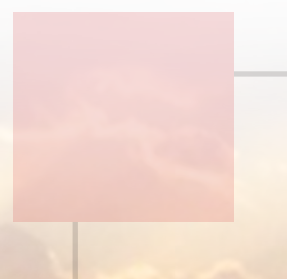

ARTICLE RELATED TO MOST IMPORTANT NEWS OF THE MONTH

J A N U A R Y 2 0 2 3

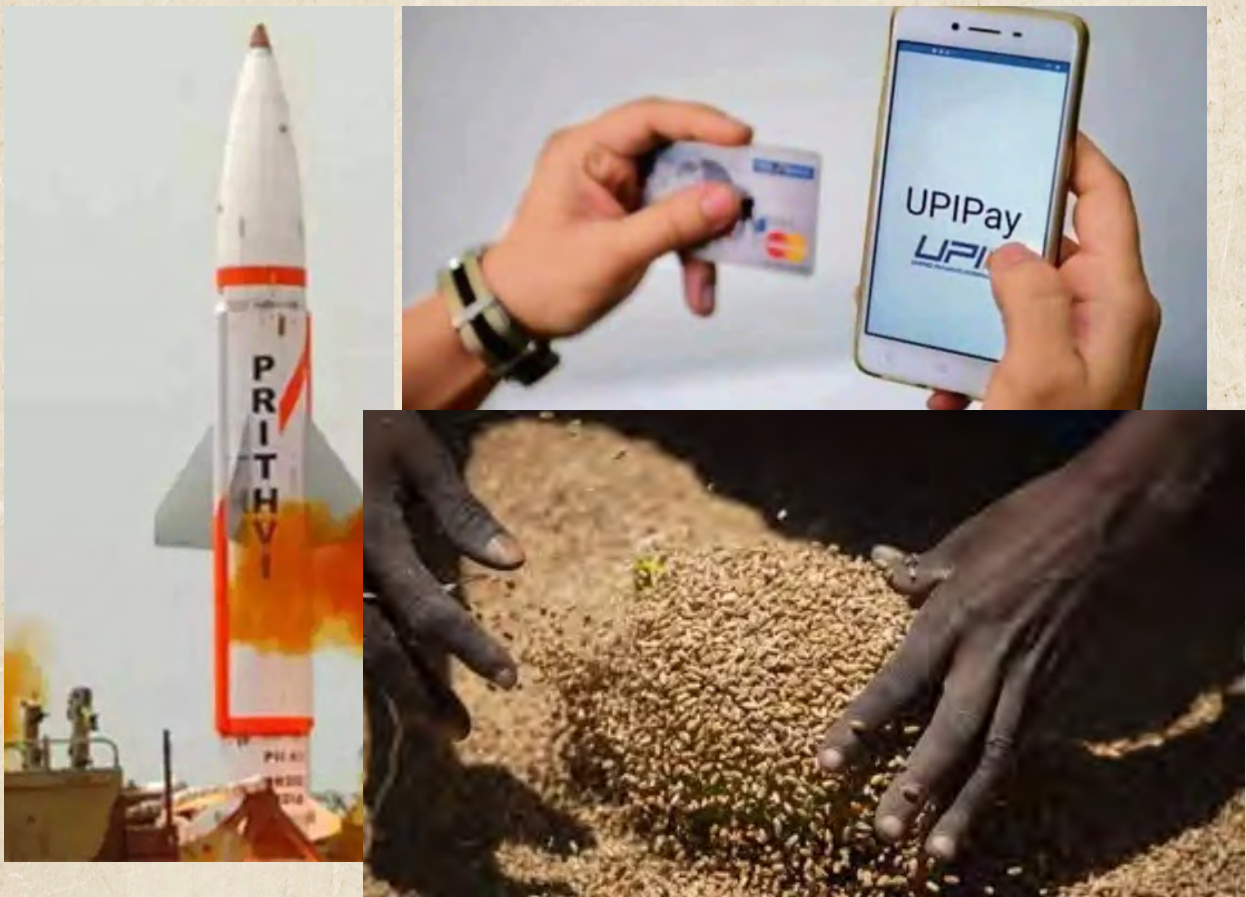



Henley & Partners, a London-based global citizenship and residency advisory firm, has released the Henley Passport Index for the year 2023.

JAPAN TOPS WORLDS MOST POWERFUL PASSPORTS LIST

The Indian passport is ranked 85th in the World's Most Powerful Passports Index 2023 and gives visa-free entry to 59 destinations across the world.

Earlier, India was ranked 82nd in 2019, 84th in 2020, 85th in 2021, and 83rd in 2022.

Indian passport holders can travel visa-free to 59 destinations such as Bhutan, Cambodia, Indonesia, Macau, Maldives, Nepal, Sri Lanka, Thailand, Kenya,

Mauritius, Seychelles, Zimbabwe, Uganda, Iran, Qatar, etc.

Japan ranked first on the list of the most powerful passports in the world. Japanese citizens can travel to visa-free or on-arrival access destinations in 193 countries around the world.

The second spot is shared by **Singapore and South Korea**, and third spot is shared by Germany, Spain.

Afghanistan's passport is ranked 109th with a visa-free score of 27, the worst passport in the world.

Iraq ranked 108th with a visa-free score of 29, second-worst passport in the world.

Henley Passport Index was launched in 2006.

The index covers 199 passports and 227 travel destinations.

It is based on the data collected from the International Air Transport Association (IATA).

FREE GRAIN SCHEME NAMED PMGKAY

New Integrated Food Security Scheme has been named Pradhan Mantri Garib Kalyan Ann Yojana (PMGKAY).

Earlier, Union Cabinet had approved this scheme for providing free food grains to Antodaya Ann Yojna (AAY) and Primary Household (PHH) beneficiaries. Implementation of the new scheme has started from 1st January 2023.

All Primary Household and Antodaya Ann Yojna beneficiaries

would receive free food grains under PMGKAY in 2023, as per entitlement under

National Food Security Act (NFSA).

PMGKAY

subsumes the two subsidy schemes of the Department of Food & Public Distribution.

These schemes are Food Subsidy to FCI and Food Subsidy for decentralized procurement



states dealing with procurement, allocation and delivery of free foodgrains to the states under NFSA.

The Central Government will spend over two lakh crore rupees in 2023 as food subsidies under NFSA and other welfare schemes.

NRIs WITH INTERNATIONAL MOBILE NUMBERS CAN MAKE UPI TRANSACTIONS

NPCI has permitted UPI transactions for non-resident bank accounts connected to mobile numbers of **10 countries**.

The 10 countries are Singapore, Australia, Canada, Hong Kong, Oman, Qatar, USA, Saudi Arabia, UAE and United Kingdom.

Non-resident account types such as NRE/NRO accounts having international mobile numbers have been permitted to transact in UPI.



transactions to and from NRO/NRE accounts linked to Indian numbers in October 2018.

All UPI members, including banks

and payments platforms, have been mandated by NPCI to comply with the norms by April 30.

NPCI had permitted UPI



Huge Selections in **SBI Clerk 2022-23** Prime Bundle PDF Course 2023

Daily Targets	English & Hindi	Detailed Video Solutions*	PDF & Quiz Format*
---------------	-----------------	---------------------------	--------------------

12 Months Validity + 1 Year Mock Test + PDF Course 2022 (3 Months)

EXAMS COVERED:



- ✓ Beginners Bundle Course
- ✓ Topic wise Bundle PDF Course
- ✓ Exam wise Bundle PDF Course
- ✓ Section wise Bundle PDF Course
- ✓ Memory Based Question Bundle Course
- ✓ Special Prelims Part Bundle PDF Course
- ✓ Mains Booster PDF Course



FLAT **70% OFF** Extra **10% Off**
USE CODE **GUIDELY10**

One Time Offer Ends Soon - Hurry !!!

BUY NOW



Guidely Users are finding pdf course very helpful in increasing their Accuracy and to boost up their preparation.

* Price will not be decreased below Rs. 1199/- | Special discount for Ultimate Bundle Users

Current Affairs

CROSSWORD

PUZZLE



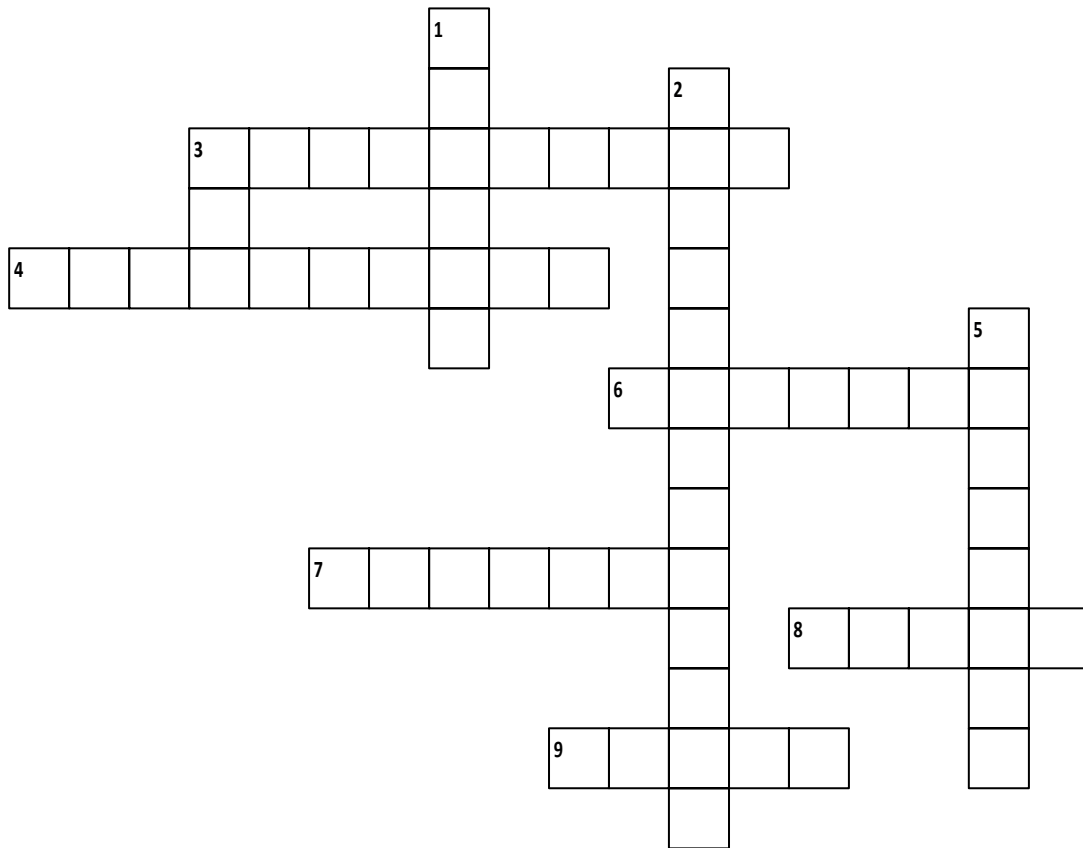

Across

3. First Indian player to win the ICC Men's T20 Cricketer of the Year award.

- a) Virat Kohli
- b) Surya Kumar
- c) Subman Gill
- d) Ishan Kisan
- e) Umesh Yadav

6. First district in India to provide basic documents to all tribal people

- a) Wayanad
- b) Madurai
- c) Chennai
- d) Alapuzha
- e) Gangtok

8. Country ranked first on the list of the most powerful passports in the world

- a) India
- b) China
- c) Japan
- d) France
- e) Egypt

4. Bank received RBI approval to hold special rupee Vostro accounts of three banks from Sri Lanka

- a) Canara Bank
- b) Indian Bank
- c) State Bank
- d) Bandhan Bank
- e) ICICI Bank

7. 20th member of the Eurozone and Country adopted the euro as its official currency

- a) Ethiopia
- b) Tanzania
- c) Croatia
- d) Mongolia
- e) Kuwait

9. Best Player for the calendar year of 2022 by IFFHS

- a) Messi
- b) Ronaldo
- c) Pele
- d) Neymar
- e) Muller

Down

1. India's 79th chess Grandmaster

- a) Rahul
- b) Pravin
- c) Pranav
- d) Vignesh
- e) Kausav

2. State hosting Mandu Festival and Skydiving Festival and the Hriday Drishyam Kala Utsav

- a) Madhya Pradesh
- b) Uttar Pradesh
- c) Andhra Pradesh
- d) Uttarakhand
- e) Tamil Nadu

3. Bank launched e-Bank Guarantee (e-BG) facility with NeSL

- a) UCO
- b) Axis
- c) HDFC
- d) SBI
- e) UBI

5. India's first solar mission

- a) Prithvi II
- b) Prithvi I
- c) Aditya LI
- d) Aditya II
- e) Aditya V

[Click here for Current Affairs Crossword Puzzle Answer](#)



RBI Assistant Prelims 2023 Practice Set

Reasoning Ability

Directions (1-5): Study the following information carefully and answer the questions given below.

Seven persons – A, B, C, D, E, F and G joined the Yoga class in seven different months viz. January, March, April, July, September, October and December of the same year.

D joined the Yoga class in the month having 30 days. Only three persons joined between D and B. As many persons joined before B as after G. Only two persons joined between G and A. C joined two persons before A. F joined before E, who doesn't join immediately after F.

1. If all the persons joined the Yoga class in alphabetical order from January, then who among the following person remains unchanged in their position?

- a) B
- b) D
- c) E
- d) G
- e) C

2. Who among the following person joined the Yoga class in September?

- a) F
- b) G
- c) D
- d) E
- e) B

3. How many persons joined between E and G?

- a) Five
- b) Four
- c) Two
- d) Three
- e) No one

4. F joined the Yoga class in which of the following month?

- a) September
- b) April
- c) January
- d) December
- e) July

5. Who among the following person joined immediately after B?

- a) The one who joined in March
- b) F
- c) A
- d) E
- e) The one who joined in December

Direction (6-9): Study the following information carefully and answer the questions given below.

A G @ T # M H % * E Q & ^ D B X ! U L > + Z
I € W © V ~ R

6. If all the letters which come before M in the alphabetical series are dropped from the given series, then which of the following element is seventeenth from the right end?

- a) W
- b) %
- c) M
- d) T
- e) +

7. Which of the following element is fifteenth to the right of the tenth element from the left end of the given series?

- a) ©
- b) V
- c) @
- d) W
- e) ~

8. How many such symbols are there in the given series each of which is immediately preceded as well as immediately followed by a consonant?

- a) Two
- b) None
- c) Three
- d) Six
- e) Four

9. The number of letters to the left of * is the same as the number of symbols to the right of ___ in the given series.

- a) L
- b) B
- c) E
- d) X
- e) I

Directions (10-14): Study the following information carefully and answer the questions given below.

Eight boxes - P, Q, R, S, T, U, V and W are kept one above another in a single stack, but not necessarily in the same order.

Only two boxes are kept between boxes Q and W. Only one box is kept between boxes Q and U, which is kept below box Q. Box T is kept three boxes above box U. Only two boxes are kept between boxes T and S. Box V is kept immediately below box S. Box R is kept above box P.

10. Which of the following box is kept two boxes below box R?

- a) Box T
- b) Box Q
- c) Box W
- d) Box U
- e) Box V

11. Four of the following five are alike in a certain way based on the given arrangement and thus form a group. Which one of the following does not belong to the group?

- a) SV
- b) RW
- c) PQ
- d) QT
- e) UW

12. Which of the following statement(s) is/are true based on the given information?

- I. No box is kept below box U
 - II. Only one box is kept between boxes V and T
 - III. Box Q is kept immediately below box R
- a) Only II and III
 - b) Only I
 - c) Only III
 - d) Only II
 - e) All I, II and III

13. As many boxes kept above box S as below ____.

- a) Box U
- b) Box T
- c) Box W
- d) Box V
- e) Box R

14. How many boxes are kept between boxes R and W?

- a) As many boxes kept above box Q
- b) Five
- c) Two
- d) Three
- e) As many boxes kept between T and R

Directions (15-18): In the given questions, the relationship between different elements is shown in the statements followed by some conclusions. Find the conclusion which is definitely true.

15. Statements:

$W > K \geq S < J$; $T \leq S = D < H$

Conclusions:

- I. $W > H$
- II. $T \leq K$

- a) Only conclusion II is true
- b) Either conclusion I or II is true
- c) Both conclusions I and II are true
- d) Only conclusion I is true
- e) Neither conclusion I nor II is true

16. Statements:

$Y > I = K \leq E < M$; $H = C \geq K > G$

Conclusions:

I. $H \geq I$

II. $G < Y$

- a) Only conclusion II is true
- b) Either conclusion I or II is true
- c) Both conclusions I and II are true
- d) Only conclusion I is true
- e) Neither conclusion I nor II is true

17. Statements:

$X \geq Y = P < B$; $P < D \leq A = O$

Conclusions:

I. $A > Y$

II. $X > O$

- a) Only conclusion II is true
- b) Either conclusion I or II is true
- c) Both conclusions I and II are true
- d) Only conclusion I is true
- e) Neither conclusion I nor II is true

18. Statements:

$A = I < M \leq R$; $V > K = M > J$

Conclusions:

I. $R \geq V$

II. $J > A$

- a) Only conclusion II is true
- b) Either conclusion I or II is true
- c) Both conclusions I and II are true
- d) Only conclusion I is true
- e) Neither conclusion I nor II is true

19. If all the letters in the word "VOLUNTARY" are arranged in alphabetical order from the left end, then which of the following letter remain unchanged in its original position?

- a) Y
- b) R

- c) T
- d) U
- e) Both a and c

Directions (20-24): Study the following information carefully and answer the questions given below.

Eight persons - D, E, F, G, H, I, J and K are sitting around a square table in such a way that four of them are sitting at the corners and facing away from the centre while four of them are sitting in the middle of the sides and facing towards the centre.

J sits second to the right of D, who doesn't sit at the corner of the table. Two persons sit between J and H. K sits immediate right of H. G sits third to the left of K. One person sits between G and E. Both E and I are immediate neighbours. I doesn't sit opposite to D.

20. Who among the following person sits opposite to D?

- a) The one who sits second to the right of J
- b) H
- c) The one who sits second to the left of G
- d) E
- e) None of these

21. Who among the following person does not sit at the corner of the table?

- a) H
- b) F
- c) K
- d) G
- e) E

22. What is the position of E with respect to F?

- a) Immediate right
- b) Second to the left
- c) Third to the right
- d) Immediate left
- e) Fourth to the right

23. If all the persons are made to sit as per alphabetical series from D in a clockwise direction, then the position of how many persons remains unchanged (excluding D)?

- a) One
- b) Three
- c) None
- d) Two
- e) Four

24. Which of the following pairs of persons sit immediate right of each other?

- a) D and F
- b) H and K
- c) J and E
- d) F and I
- e) G and H

Directions (25-28): Study the following information carefully and answer the questions given below.

In a certain code language, "Vegetables edible fresh oil" is coded as "iu rc qw lk"

"Fat fresh water quality" is coded as "jm iu gf qg"

"Molecules enzyme oil quality" is coded as "lk gf tr ez"

"Products edible water fat" is coded as "rc ab jm qg"

(Note: All the given codes are two letter codes only)

25. What is the code for the word "Fresh" in the given code language?

- a) jm
- b) iu
- c) lk
- d) rc
- e) gf

26. What is the phrase for the code "qw lk" in the given code language?

- a) Fresh enzyme
- b) Oil Quality

c) Edible Molecules

d) Vegetables oil

e) Oil enzyme

27. If "Water quality" is coded as "jm gf", then what is the code for the phrase "Fat products" in the given code language?

- a) jm tr
- b) gf ab
- c) qg ab
- d) ez qw
- e) gf rc

28. What is the code for the phrase "Edible molecules" in the given code language?

- a) rc tr
- b) iu ez
- c) rc ez
- d) gf lk
- e) Either a or c

Directions (29-31): Study the following statements and then decide which of the given conclusions logically follows from the given statements disregarding the commonly known facts.

29. Statements:

Only a few buttons are straps

No strap is stand

All stands are pin

Conclusions:

I. Some pins are not strap

II. All buttons can be stand

- a) Only conclusion I follows
- b) Only conclusion II follows
- c) Either conclusion I or II follows
- d) Neither conclusion I nor II follows
- e) Both conclusions I and II follow

30. Statements:

Only a few sheep are vultures

Few sharks are vultures

No shark is wolf

Conclusions:

I. Some sheep can be shark

II. All vultures can never be wolf

- a) Only conclusion I follows
- b) Only conclusion II follows
- c) Either conclusion I or II follows
- d) Neither conclusion I nor II follows
- e) Both conclusions I and II follow

31. Statements:

All sections are unit

Only a few units are part

At least some parts are branch

Conclusions:

I. No unit is branch

II. All parts being section is a possibility

- a) Only conclusion I follows
- b) Only conclusion II follows
- c) Either conclusion I or II follows
- d) Neither conclusion I nor II follows
- e) Both conclusions I and II follow

32. How many such pairs of digits are there in the number "85293164" each of which has as many digits between them in the number as there are in the natural number series (both forward and backward directions)?

- a) One
- b) Two
- c) Three
- d) More than three
- e) None

Directions (33-35): Study the following information carefully and answer the questions given below.

Point H is 6m north of point R, which is 12m south of point Y. Point G is 4m east of point Y. Point B is 8m south of point G. Point U is 5m west of point B. Point A is 10m south of point U and 2m west of point V.

33. What is the distance and direction of point Y with respect to point H?

- a) 5m, west
- b) 6m, North
- c) 6m, South
- d) 12m, South

- e) 4m, East

34. If point X is 6m south of point G, then the distance between points X and B is equal to the distance between which of the following points?

- a) YG
- b) UA
- c) RY
- d) BU
- e) AV

35. Four of the following five pairs of points are alike in a certain way based on the directions in the given arrangement and thus form a group. Which one of the following does not belong to the group?

- a) BY
- b) AR
- c) UG
- d) VB
- e) UY

Quantitative Aptitude

Directions (36-40): Study the following information carefully and answer the questions.

The given bar graph shows the total number of water bottles (steel+plastic) sold by five different shops i.e. A, B, C, D and E and also given the number of steel water bottles sold by these five shops.

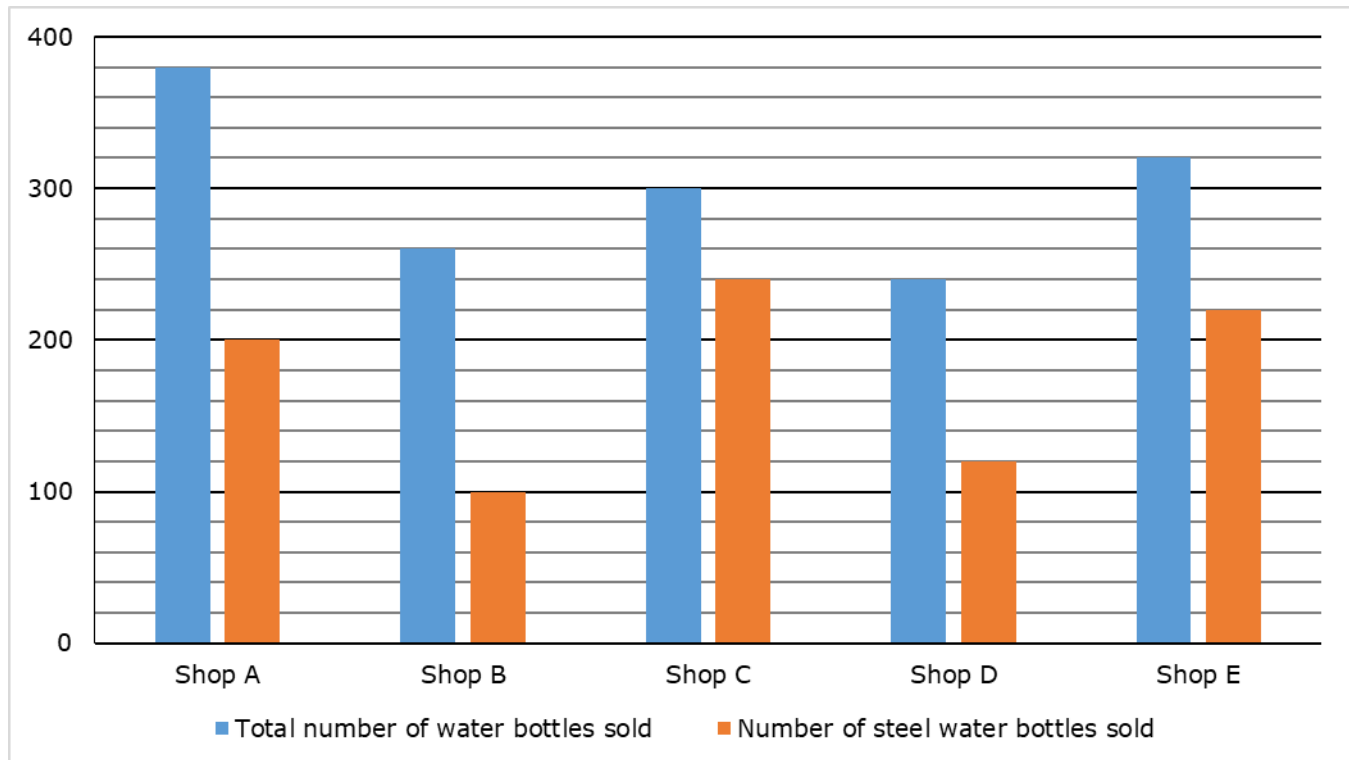

36) If the number of glass water bottles sold by shop F is 25% more than the number of plastic water bottles sold by shop D and the number of steel water bottles sold by shop C to F is 4:3, then find the total number of steel and glass water bottles together sold by shop F.

- a) 450
- b) 380
- c) 500
- d) 420
- e) 330

37) The number of plastic water bottles sold by shop E is how much more/less than the number of steel water bottles sold by shop A?

- a) 150 more
- b) 100 less
- c) 80 more

- d) 120 less
- e) 160 more

38) Find the ratio of the number of plastic water bottles sold by shop A to the number of steel water bottles sold by shop D.

- a) 5:4
- b) 9:8
- c) 7:4
- d) 3:2
- e) 6:5

39) If the ratio of the total number of water bottles sold to unsold by shop B is 13:4 and the number of steel water bottles unsold by shop B is half of the number of steel water bottles sold in that shop, then find the total number of plastic water bottles manufactured by shop B.

- a) 160
- b) 220

- c) 190
- d) 200
- e) 180

40) The number of plastic water bottles sold by shop C is what percentage of the total number of water bottles sold by shop D?

- a) 25%
- b) 40%
- c) 30%
- d) 15%
- e) 60%

Directions (41-45): What value should come in the place of (?) in the following number series?

41) 12, ?, 42, 82, 162, 322

- a) 26
- b) 24
- c) 20
- d) 22
- e) 18

42) 400, 403, 412, 439, 520, ?

- a) 763
- b) 601
- c) 664
- d) 689
- e) 716

43) 94, 106, 123, 145, ?, 204

- a) 170
- b) 172
- c) 168
- d) 174
- e) 171

44) 243, 162, 108, 72, 48, ?

- a) 24
- b) 72
- c) 36
- d) 18
- e) 32

45) ?, 714, 702, 684, 660, 630

- a) 726

- b) 717
- c) 720
- d) 732
- e) 722

46) The time taken by the boat to cover 84 km upstream is 2 hours more than the time taken by the same boat to cover 90 km downstream. If the speed of the boat in still water is five times the speed of the stream, then find the speed of the stream

- a) 4 km/hr
- b) 5 km/hr
- c) 6 km/hr
- d) 3 km/hr
- e) None of these

47) 4 years ago, the ratio of the age of A to B is 2:1. One year hence, the ratio of the age of A to B is 5:3. If C is 6 years elder than B, then find the present age of C.

- a) 26 years
- b) 32 years
- c) 16 years
- d) 18 years
- e) 20 years

48) A shopkeeper sold a bag at a discount of 25% on its marked price and he gets a profit of 5%. If the bag is sold without discount, then he gets a profit of Rs.160. Find the marked price of the bag.

- a) Rs.400
- b) Rs.320
- c) Rs.560
- d) Rs.450
- e) None of these

49) A vessel contains a mixture of milk and water in the ratio of 5:3. If 15 liters of milk and 10 liters of water is added to the mixture, then the ratio of milk and water becomes 8:5. How much amount of water is added to the initial mixture, so the ratio of milk and water is reversed?

- a) 41.5 liters

- b) $33\frac{1}{3}$ liters
- c) 27.8 liters
- d) $80\frac{1}{3}$ liters
- e) None of these

50) A and B alone can complete the work in 18 days and 9 days respectively. If A, B and C started the work together and after 4 days, A and B left from the work, then C alone complete the remaining work in 8 days. In how many days C alone can complete the whole work?

- a) 36 days
- b) 24 days
- c) 18 days
- d) 12 days
- e) 30 days

Directions (51-55): Study the following information carefully and answer the given questions.

There are three different companies namely X, Y and Z and the total number of employees in company X is 40% of the total number of employees in all three companies. The total number of employees in companies Y and Z are equal and the difference between the total number of employees in companies X and Z is 150. Ratio of the number of male to female employees in company X is 2:1 and the number of female employees in company X is double the number of female employees in company Y.

51) Find the difference between the number of male employees in company X and the number of male employees in company Y.

- a) 80
- b) 60
- c) 70
- d) 50
- e) 90

52) If the number of female employees in company Z is 50% more than that of male

employees, then find the total number of female employees in all three companies.

- a) 840
- b) 570
- c) 660
- d) 720
- e) 540

53) If the average number of employees in companies Y and W is 350 and the ratio of the number of male employees in company Y to W is 7:4, then find the number of female employees in company W.

- a) 30
- b) 70
- c) 50
- d) 90
- e) 40

54) Find the ratio of the number of male employees in company X to the total number of employees in company Z.

- a) 8:9
- b) 5:4
- c) 6:7
- d) 9:10
- e) 7:12

55) The number of male employees in company Y is what percentage more than the number of female employees in company X?

- a) 25%
- b) 10%
- c) 75%
- d) 50%
- e) 20%

Directions (56-65): What value should come in the place of (?) in the following questions?

56) $(20^2 - \sqrt{100} + 130) \div 13 * ? = 320$

- a) 20
- b) 11
- c) 8
- d) 15

e) 16

57) $(1440 \div 24) + (30 * 12) = 30^2 - ?$

- a) 700
- b) 480
- c) 340
- d) 560
- e) 650

58) 35% of 2000 - 50% of 960 = ?³ + 95

- a) 7
- b) 2
- c) 9
- d) 5
- e) 4

59) $(8 \div 26) * 130 + 75 = \sqrt{?} + 105$

- a) 100
- b) 121
- c) 196
- d) 169
- e) 144

60) $? = 70 - [(-12)^2 - \{40 + (110 - 50)\}]$

- a) 15
- b) 34
- c) 26
- d) 42
- e) 18

61) $(1200 \div 11) * (198 \div 20) = ? * \sqrt{400}$

- a) 45
- b) 62
- c) 75
- d) 33
- e) 54

62) $? - 210 = (30\% \text{ of } 400) * 15 \div 20$

- a) 300
- b) 120
- c) 330
- d) 260
- e) None of these

63) $3/7 + 9/14 + ? = 5/7 + 11/14 - 1/7$

- a) 1/14

b) 2/7

c) 3/14

d) 1/2

e) 5/14

64) $404.84 + 44.40 - 400.44 = ? + 4.80$

- a) 40
- b) 34.04
- c) 14.40
- d) 4.84
- e) 44

65) 15% of $(150 + ?) + \sqrt{225} = 180 \div 4$

- a) 40
- b) 70
- c) 30
- d) 50
- e) 90

66) A train crosses 1/3rd of the platform in 12 seconds and the same train crosses a pole in 10 seconds. Find the length of the platform, if the length of the train is 200 m.

- a) 120 m
- b) 90 m
- c) 150 m
- d) 60 m
- e) None of these

67) Kani and Savi started a business with an investment of Rs.4500 and Rs.3000 and the investment period of Kani and Savi is x months and (x-6) months respectively. If the ratio of the profit share of Savi to Kani is 5:12, then find the investment period of Savi.

- a) 9 months
- b) 16 months
- c) 10 months
- d) 12 months
- e) None of these

68) Amir invested a certain amount in SI at the rate of R% per annum for 4 years and the simple interest received by Amir is 4/5th of his investment. If he invested Rs.1500 in CI

at the same rate of interest for 2 years, then find the total amount received by Amir in CI.

- a) Rs.2760
- b) Rs.3040
- c) Rs.1980
- d) Rs.2160
- e) None of these

69) The average weight of n students in a class is 40 kg. If one student having weight of 35 kg is replaced by another student having weight of 50 kg, then the average weight of the class becomes 41 kg. Find the value of n .

- a) 15
- b) 20
- c) 12
- d) 16
- e) None of these

70) The length of the rectangle is 3 cm more than its breadth. If the length and breadth of the rectangle is increased by 25% and 20% respectively, then the area of the rectangle becomes 60 cm^2 . Find the original perimeter of the rectangle

- a) 16 cm
- b) 38 cm
- c) 44 cm
- d) 26 cm
- e) None of these

English Language

Directions (71-77): Read the given passage carefully and answer the questions that follow.

The national assessment regulator Parakh (Performance, Assessment, Review and Analysis of Knowledge for Holistic Development) is reportedly considering “similar type of questions” in exams across school boards in the country. It is a welcome move in the context of the need for standardisation of education across the

country, a key goal of the National Education Policy (NEP) 2020. The need for this has been felt for decades in view of the sharp variation in the way boards assess students. This is evident from the wide gap in performance of students from some state boards compared with others in the National Assessment Survey. This is particularly necessary for science and mathematics, given the continued importance of STEM (science, technology, engineering, and mathematics) subjects.

The US Bureau of Labour Statistics projects employment in STEM occupations to grow by 10.8% between 2021 and 2031, versus 4.9% for that in non-STEM occupations. The median wages for the former are likely to be more than 2x of what can be expected for the latter. The country can, thus, ill-afford to have even one school board lag the others in terms of learning outcomes in these subjects. A big problem that stemmed from the disparate assessment routes followed by the boards was grade inflation, which privileged students from boards that assessed students very liberally over those that were more conservative. This had led to competitive inflation that had seen Delhi University cut-offs reach absurd levels. The Centre’s push to Common University Entrance Test (CUET), with increasing adoption by state universities, seems to have largely taken care of that problem.

Parakh will of course need to walk a tightrope that delivers the desired end without sacrificing the boards’ (pan-India and those of the states) autonomy. The states’ autonomy on school education allows them to prioritise not just the language of instruction and assessment, but also certain curricular elements. Any move towards standardisation of examination questions would inevitably have implications for curriculum design and content, and that is where the autonomy of the boards/states could get infringed. More importantly, when

it comes to the social sciences, the lofty aim of standardisation of assessment must not become a Trojan Horse for undermining independence on curricular content. While experts welcomed the government's decision to revise the National Curriculum Framework (NCF) as this had been _____ for long, they had also warned against making the exercise another tool to drive one ideology or the other. At the time the committee to review the NCF was formed in 2021, experts had pointed out the "stunning" omission of experts from the domain of school education. The government's record on **honouring** autonomy of boards/educational institutions—under the past dispensations and the present one—have been less than exemplary. So, even as it moves on the important goal of assessment reform, Parakh will need to make its regulation more principles-based rather than prescriptive. There are many areas of assessment reforms, such as distribution of weightage between classroom assessment and examinations, assessing conceptual understanding versus memory-based learning that need work, almost as much as ensuring some degree of homogeneity on exam design across boards. Assessment reform at the school level should concern itself with getting to a consensus on improving learning outcomes across boards. Perhaps one way to get to this would be to seek inputs from the Central Advisory Board of Education (CABE), a federal body, along with independent experts, as education remains a concurrent subject.

71. Which of the given options would be the best title for the given passage?

- A. Similar type of questions
- B. Board Exams
- C. A fair assessment
- D. Analysis of knowledge
- E. Gap in student performance

72. What are the benefits of states' autonomy on school education?

- A. It helps them prioritise the language of instruction and assessment
- B. Because not doing so would be considered an interference in their roles
- C. The states' can decide the curriculums better than the central authority
- D. Having the same rules for every state is not practical as the capacity is different
- E. None of these

73. What should be the prime focus of the assessment reforms?

- A. That students can get through Delhi University
- B. That the assessments should be based on principles
- C. Focus should be on the concepts and not rules only
- D. Improving the learning outcomes across boards
- E. Both (c) and (d)

74. What all problems are faced due to disparate assessments?

- A. An evenness in the exam designing pattern created a bias
- B. Students from boards that assessed the students liberally were at an advantage
- C. It led to the cut offs of renowned universities reach absurd levels
- D. All (a), (b) and (c)
- E. Both (b) and (c)

75. Choose the part of the sentence that carries an error in it.

- A. The government's record on
- B. honouring autonomy of
- C. institutions—under the past
- D. dispensations and the present one—
- E. have been less than exemplary.

76. The word that correctly fills the blank in the passage is?

- A. Pending
- B. Discussing
- C. Waited
- D. Consideration
- E. None of these

77. The word that is the correct antonym to 'honouring' in the passage is?

- A. Admire
- B. Respect
- C. Praise
- D. Criticise
- E. Value

Directions (78-82):Four words have been highlighted in the sentence below which are not in their proper positions. Choose an option that provides the best sequence of the words to form a meaningful sentence.

78. India hasn't **(A) deals** much **(B) like** its trade **(C) from** with countries **(D) gained** South Korea.

- A. ACBD
- B. DCAB
- C. CBAD
- D. DBAC
- E. No rearrangement needed

79. A few days ago, the government **(A) revocation** a large number of **(B) lending** apps, but then it was followed by the **(C) banned** of the ban on **(D) some** of the apps.

- A. ABDC
- B. BDCA
- C. CBAD
- D. CADB
- E. No rearrangement needed

80. One has to **(A) make** one's own luck and India **(B) should** look back at **(C) their** shoddy fielding **(D) effort**.

- A. CADB
- B. BDCA
- C. BDAC
- D. CDBA
- E. ABCD

81. Smuggling is a **(A) economy** issue that has a detrimental **(B) security** on the **(C) multidimensional** and national **(D) impact**.

- A. CDAB
- B. BDAC
- C. ABDC
- D. ACDB
- E. No rearrangement needed

82. The **(A)deal** is that policymakers will have to **(B) upshot** with the reality of climate change on a war-footing in the larger **(C) security** of food **(D) interests**.

- A. ACDB
- B. BADC
- C. CDAB
- D. CBDA
- E. No rearrangement needed

Directions (83-87):The questions given below carry sentences. One of these is grammatically correct. Choose the same as your answer.

83.

- A. Most than half of the world's population will be overweight or obese by 2035.
- B. We now look forward for some great achievements.
- C. As they climb higher, the air became cooler.
- D. The manager is having his problems but we have ours as well.
- E. None is correct

84.

- A. From DBT for poor households to investing in school infrastructure, the state is doing many things right.
- B. 'Education is most powerful weapon you can use to change the world'
- C. Artificial intelligence be able to perform many tasks that humans might find difficult to achieve.
- D. The incident happened at a village called Madoli near Kanpur.

E. All are erroneous

85.

- A. High unemployment rates are creeping in the educated middle class.
- B. Services trade-surplus have increased to \$16.5 billion in January.
- C. A record number of MoUs are good news for India's most populous state.
- D. The cases of Sweden and Australia are both similar to and different than Japan's.
- E. None is correct

86.

- A. Countries like India should take lessons from the colossal tragedy in Turkiye and Syria.
- B. Costlier money for a long time can be bad news for the economy.
- C. Sebi's latest proposals need to have more balanced provisions.
- D. There's no certainty if RBI will be able to replenish its forex reserve stocks.
- E. All are correct

87.

- A. They have 14 days if they wish to appeal for the sanction.
- B. Several people were reportedly injured, despite one person was found dead.
- C. She added that 80% of women have to justify how she deal with money.
- D. The absconding duo had been trying to extort the 36-years-old complainant.
- E. All of these

Directions (88-92):The sentences given below carry a blank each of which can be filled with one of the words from the options given below them. You must read the same carefully and choose the most appropriate choice as your answer.

88. Amazon Pay_____ ₹3.06 crore by RBI for flouting norms.

- A. Paying
- B. Fined

- C. Imposing
- D. Calculated
- E. Diluted

89. Education and health should have got a push, but higher capex will _____ welfare gains.

- A. lead to
- B. brought
- C. follow
- D. conclude
- E. result from

90. The goal of this internship is to _____ participants with an opportunity to learn.

- A. Follow
- B. Provide
- C. Offer
- D. Give
- E. Avail

91. The CM stated that the state government's main _____ is to ensure quality education for students.

- A. Opportunities
- B. Agendas
- C. Focus
- D. Appeal
- E. None of these

92. There is no doubt that the education sector has been_____ affected by the pandemic.

- A. Badly
- B. Severely
- C. Adversely
- D. Largely
- E. All of these

Directions (93-97):The given sentences have been taken from a paragraph but they are not in their proper order. You must rearrange them into a meaningful paragraph before answering the questions that follow.

- A. Now, a new study has revealed another golden benefit of walking.

- B. one in 10 deaths could be prevented if people manage at least half the recommended level of physical activity.
- C. The simple act of walking has numerous health benefits.
- D. If done correctly and consistently, it can help in losing weight, and maintaining blood pressure and cholesterol.
- E. According to a team of researchers from the University of Cambridge,

93. Which of the given options would come first after rearrangement?

- A. D
- B. E
- C. C
- D. B
- E. A

94. The sentence that should come second in the sequence is?

- A. A
- B. E
- C. B
- D. D
- E. C

95. Which of the given sentences would come third after rearrangement?

- A. A
- B. E
- C. C
- D. D
- E. B

96. Choose the most logical conclusion for the paragraph above.

- A. A
- B. D
- C. E
- D. C
- E. B

97. Which of the given options will come fourth after rearrangement?

- A. D
- B. E
- C. C
- D. A
- E. B

Directions (98-100):The questions given below carry a word based on which sentences have been given. You have to find the options in which the usage of the word is not correct and mark the same as your answer.

98. REVEAL

- A. The test **revealed** the true cause of death.
- B. I'm not in a position to **reveal** any of the details of the project.
- C. Her biography **revealed** that she was not as rich as everyone thought.
- D. We're campaigning for the **reveal** of the abortion laws.
- E. All usages are correct

99. GUIDE

- A. She **guided** her team to victory.
- B. Custom is the **guide** of the ignorant.
- C. He **guided** us around the city.
- D. This book is an essential **guide** for international travellers.
- E. All usages are correct

100. LEAD

- A. That game puts her back into the **lead**.
- B. It can **led** us to victory.
- C. The accident **led** to an astonishing discovery.
- D. He is a **leading** authority in his field.
- E. All usages are correct

ANSWER WITH EXPLANATION

[Click Here to Get the Detailed Video Solution for the above given Reasoning Questions](#)

Or Scan the QR Code to Get the Detailed Video Solutions



Directions (1-5):

1. Answer: D
2. Answer: C
3. Answer: E
4. Answer: B
5. Answer: A

Final arrangement

Month	Persons
January	B
March	C
April	F
July	A
September	D
October	E
December	G

We have,

- D joined the Yoga class in the month having 30 days.
- Only three persons joined between D and B.

From the above conditions, there are two possibilities

	Case-1	Case-2
Month	Persons	Persons
January		B
March		
April	D	
July		
September		D
October		
December	B	

Again we have,

- As many persons joined before B as after G.
- Only two persons joined between G and A.

	Case-1	Case-2
Month	Persons	Persons
January	G	B
March		
April	D	
July	A	A
September		D
October		
December	B	G

Again, we have

- C joined two persons before A.
- F joined before E, who doesn't join immediately after F.

After applying the above conditions case-1 gets eliminated because E joined immediately after F, hence case-2 shows the final arrangement

[Get our Prime Bundle PDF Course](#)

[Get our Mock Test Series e-Magazine Jan 2023](#)

	Case-1	Case-2
Month	Persons	Persons
January	G	B
March	C	C
April	D	F
July	A	A
September	F	D
October	E	E
December	B	G

6) Answer: B

Given series:

A G @ T # M H % * E Q & ^ D B X ! U L > + Z
I € W © V ~ R

Required series : @ T # M % * Q & ^ X ! U >
+ Z € W © V ~ R

Seventeenth from the right end is %

7) Answer: D

Given series:

A G @ T # M H % * E Q & ^ D B X ! U L > + Z
I € W © V ~ R

Tenth element from the left end is **E** and then fifteenth element to the right of E is **W**.

8) Answer: E

Given series:

A G @ T # M H % * E Q & ^ D B X ! U L > + Z
I € W © V ~ R

9) Answer: A

Given series:

A G @ T # M H % * E Q & ^ D B X ! U L > + Z
I € W © V ~ R

Five letters are there to the left of * in the given series, which is same as the number of symbols to the right of L.

Directions (10-14):

10) Answer: B

11) Answer: B (No box is kept between both the boxes except option b)

12) Answer: D

13) Answer: C

14) Answer: A

Final arrangement

Boxes
S
V
R
T
Q
P
U
W

Common explanation

We have,

- Only two boxes are kept between boxes Q and W.
 - Only one box is kept between boxes Q and U, which is kept below box Q.
- From the above conditions, there are two possibilities

Case-1	Case-2
Boxes	Boxes
Q	W
U	
W	Q
	U

Again we have,

- Box T is kept three boxes above box U.
- Only two boxes are kept between boxes T and S.

Case-1	Case-2
Boxes	Boxes
S	S
	W
T	T
Q	Q
U	U
W	

Again we have,

- Box V is kept immediately below box S.
- Box R is kept above box P.

After applying the above conditions case-2 gets eliminated because there is no possibility to place box V, hence case-1 shows the final arrangement.

Case-1	Case-2
Boxes	Boxes
S	S
V	W
R	
T	T
Q	Q
P	
U	U
W	

15) Answer: A

$W > K \geq S < J$; $T \leq S = D < H$

Conclusions:

I. $W > H$ ($W > K \geq S = D < H$) ->False

II. $T \leq K$ ($K \geq S \geq T$) ->True

16) Answer: C

$Y > I = K \leq E < M$; $H = C \geq K > G$

Conclusions:

I. $H \geq I$ ($H = C \geq K = I$) ->True

II. $G < Y$ ($Y > I = K > G$) ->True

17) Answer: D

$X \geq Y = P < B$; $P < D \leq A = O$

Conclusions:

I. $A > Y$ ($A \geq D > P = Y$) ->True

II. $X > O$ ($X \geq Y = P < D \leq A = O$) ->False

18) Answer: E

$A = I < M \leq R$; $V > K = M > J$

Conclusions:

I. $R \geq V$ ($R \geq M = K < V$) ->False

II. $J > A$ ($J < M > I = A$) ->False

19. Answer: E

VOLUNTARY

ALNORTUVY

Directions (20-24):

20) Answer: A

21) Answer: C

22) Answer: E

23) Answer: D (Only E and J)

24) Answer: B

Final arrangement

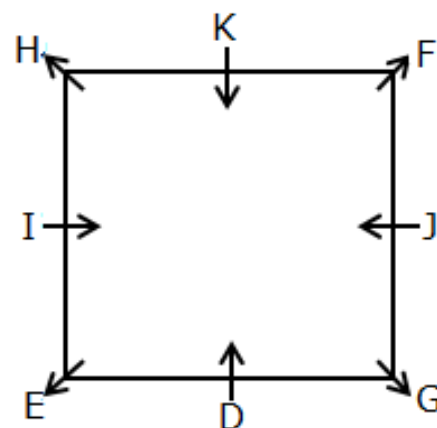

We have,

- J sits second to the right of D, who doesn't sit at the corner of the table.
- Two persons sit between J and H.

From the above conditions, there are two possibilities

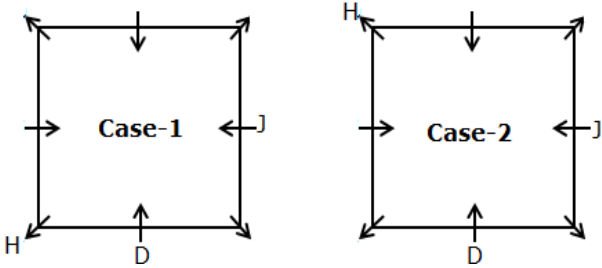

Again we have,

- K sits immediate right of H.
- G sits third to the left of K.

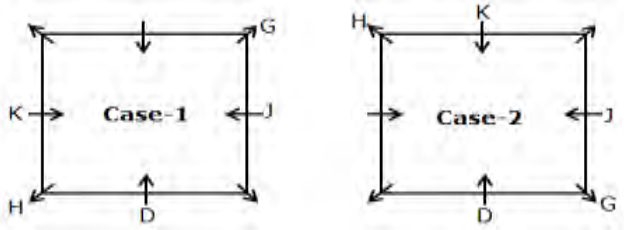

Again we have,

- One person sits between G and E.
- Both E and I are immediate neighbours.
- I doesn't sit opposite to D.

After applying the above conditions case-1 gets eliminated because I sits opposite to D, hence case-2 shows the final arrangement.

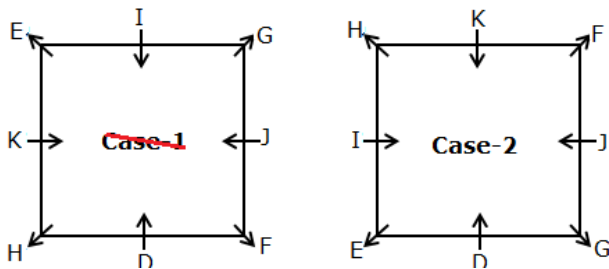

Directions (25-28):

- 25) Answer: B
- 26) Answer: D
- 27) Answer: C
- 28) Answer: E

Words	Codes
Vegetables	qw
Edible	rc
Fresh	iu

Oil	lk
Fat/water	jm/qg
Quality	gf
Molecules/Enzyme	tr/ez
Products	ab

29) Answer: A

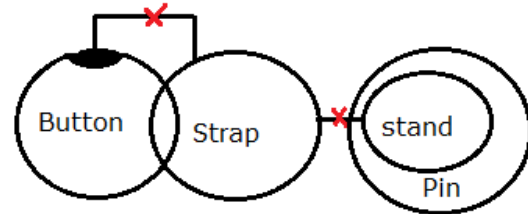

30) Answer: E

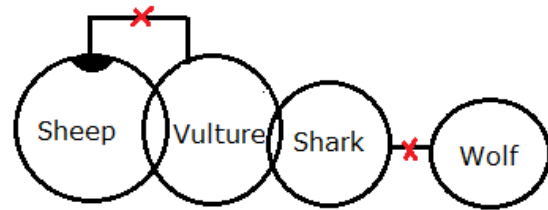

31) Answer: B

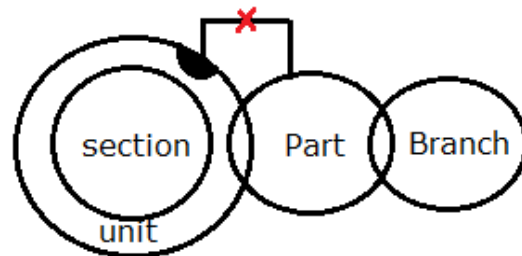

32. Answer: C

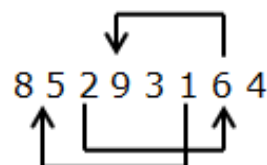

Directions (33-35):

33) Answer: B

34) Answer: E

35) Answer: A (First point is southwest of the second point except option a)

Explanation

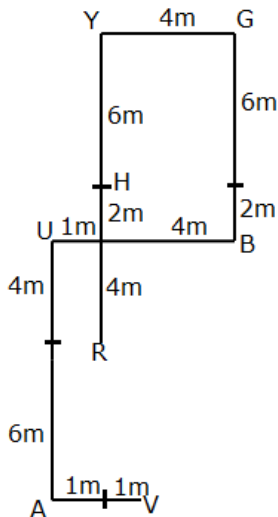

Shops	Total number of water bottles sold	Number of steel water bottles sold	Number of plastic water bottles sold
A	380	200	180
B	260	100	160
C	300	240	60
D	240	120	120
E	320	220	100

36. Answer: E

Number of glass water bottles sold by shop F = $120 * 125/100 = 150$

Number of steel water bottles sold by shop F = $240 * 3/4 = 180$

Required total = $150 + 180 = 330$

37. Answer: B

Required difference = $200 - 100 = 100$ less

38. Answer: D

Required ratio = $180:120 = 3:2$

39. Answer: C

Total number of water bottles unsold by shop B = $260 * 4/13 = 80$

Number of steel water bottles unsold by shop B = $100/2 = 50$

Number of plastic water bottles unsold by shop B = $80 - 50 = 30$

Total number of plastic water bottles manufactured by shop B = $160 + 30 = 190$

40. Answer: A

Required percentage = $60/240 * 100 = 25\%$

41. Answer: D

$12 * 2 - 2 = 22$

$22 * 2 - 2 = 42$

$42 * 2 - 2 = 82$

$82 * 2 - 2 = 162$

$162 * 2 - 2 = 322$

42. Answer: A

[Click Here to Get the Detailed Video Solution for the above given Quants Questions](#)

Or Scan the QR Code to Get the Detailed Video Solutions



Directions (36-40):

Number of plastic water bottles sold by shop

A = $380 - 200 = 180$

Number of plastic water bottles sold by shop

B = $260 - 100 = 160$

Number of plastic water bottles sold by shop

C = $300 - 240 = 60$

Number of plastic water bottles sold by shop

D = $240 - 120 = 120$

Number of plastic water bottles sold by shop

E = $320 - 220 = 100$

$$400 + 3^1 = 403$$

$$403 + 3^2 = 412$$

$$412 + 3^3 = 439$$

$$439 + 3^4 = 520$$

$$520 + 3^5 = 763$$

43. Answer: B

94	106	123	145	172	204
+12	+17	+22	+27	+32	
+5	+5	+5	+5		

44. Answer: E

$$243 * 2/3 = 162$$

$$162 * 2/3 = 108$$

$$108 * 2/3 = 72$$

$$72 * 2/3 = 48$$

$$48 * 2/3 = 32$$

45. Answer: C

$$720 - 6 * 1 = 714$$

$$714 - 6 * 2 = 702$$

$$702 - 6 * 3 = 684$$

$$684 - 6 * 4 = 660$$

$$660 - 6 * 5 = 630$$

46. Answer: D

Let the speed of the stream = x km/hr
 And the speed of the boat in still water = 5x km/hr

$$84/(5x - x) - 90/(5x + x) = 2$$

$$84/4x - 90/6x = 2$$

$$2x = 21 - 15$$

$$x = 6/2 = 3 \text{ km/hr}$$

47. Answer: E

$$(2x + 4 + 1)/(1x + 4 + 1) = 5/3$$

$$6x + 15 = 5x + 25$$

$$x = 10$$

The present age of B = 10 + 4 = 14 years
 The present age of C = 14 + 6 = 20 years

48. Answer: C

Let the marked price of the bag = 100x
 The selling price of the bag = 100x * 75/100 = 75x
 The cost price of the bag = 75x * 100/105

$$100x - 75x * 100/105 = 160$$

$$10500x - 7500x = 160 * 105$$

$$x = 160 * 105/3000 = 5.6$$

The marked price of the bag = 100 * 5.6 = Rs.560

49. Answer: D

$$(5x + 15)/(3x + 10) = 8/5$$

$$25x + 75 = 24x + 80$$

$$x = 5$$

The initial quantity of milk = 5 * 5 = 25 liters
 The initial quantity of water = 3 * 5 = 15 liters
 Let the quantity of water is added to the initial mixture = a

$$25/(15 + a) = 3/5$$

$$125 = 45 + 3a$$

$$a = 80/3$$

50. Answer: A

Let C alone complete the whole work = x days

$$(1/18 + 1/9 + 1/x) * 4 + 1/x * 8 = 1$$

$$4/x + 8/x = 1 - 8/36 - 16/36$$

$$12/x = (36 - 24)/36$$

$$x = 12 * 36/12 = 36$$

C alone complete the work = 36 days

Directions (51-55):

Let the total number of employees in all three companies = a

$$a * 40/100 - a * (100 - 40)/100 * 1/2 = 150$$

$$2a/5 - a * 60/100 * 1/2 = 150$$

$$a = 1500$$

Total number of employees in company X = 1500 * 40/100 = 600
 Total number of employees in company Y = (1500 - 600)/2 = 900/2 = 450
 Total number of employees in company Z = 900 - 450 = 450
 Number of male employees in company X = 600 * 2/(2 + 1) = 600 * 2/3 = 400
 Number of female employees in company X = 600 - 400 = 200
 Number of female employees in company Y = 200/2 = 100

Number of male employees in company Y =
 $450 - 100 = 350$

Companies	Total number of employees	Number of male employees	Number of female employees
X	600	400	200
Y	450	350	100
Z	450	-	-

51. Answer: D

Required difference = $400 - 350 = 50$

52. Answer: B

Number of female employees in company Z =
 $450 * 150 / (100 + 150) = 450 * 150 / 250 = 270$
 Required answer = $200 + 100 + 270 = 570$

53. Answer: C

Total number of employees in company W =
 $350 * 2 - 450 = 700 - 450 = 250$
 Number of male employees in company W =
 $350 * 4/7 = 200$
 Number of female employees in company W =
 $250 - 200 = 50$

54. Answer: A

Required ratio = $400:450 = 8:9$

55. Answer: C

Required percentage = $(350 - 200) / 200 * 100$
 $= 150 / 200 * 100 = 75\%$

56. Answer: C

$(20^2 - \sqrt{100} + 130) \div 13 * ? = 320$
 $(400 - 10 + 130) / 13 * ? = 320$
 $? = 320 * 13 / 520 = 8$

57. Answer: B

$(1440 \div 24) + (30 * 12) = 30^2 - ?$
 $? = 900 - 60 - 360 = 480$

58. Answer: D

$35\% \text{ of } 2000 - 50\% \text{ of } 960 = ?^3 + 95$
 $?^3 = 35 * 2000 / 100 - 50 * 960 / 100 - 95$
 $?^3 = 700 - 480 - 95 = 125 = 5^3$
 $? = 5$

59. Answer: A

$(8 \div 26) * 130 + 75 = \sqrt{?} + 105$
 $\sqrt{?} = 40 + 75 - 105 = 10$
 $? = 10^2 = 100$

60. Answer: C

$? = 70 - [(-12)^2 - \{40 + (110 - 50)\}]$
 $? = 70 - [144 - \{40 + 60\}]$
 $? = 70 - [144 - 100] = 70 - 44 = 26$

61. Answer: E

$(1200 \div 11) * (198 \div 20) = ? * \sqrt{400}$
 $? = 60 * 18 / 20 = 54$

62. Answer: A

$? - 210 = (30\% \text{ of } 400) * 15 \div 20$
 $? = (30 * 400 / 100) * 3/4 + 210$
 $? = 120 * 3/4 + 210 = 90 + 210 = 300$

63. Answer: B

$3/7 + 9/14 + ? = 5/7 + 11/14 - 1/7$
 $6/14 + 9/14 + ? = 10/14 + 11/14 - 2/14$
 $? = 19/14 - 15/14 = 4/14 = 2/7$

64. Answer: E

$404.84 + 44.40 - 400.44 = ? + 4.80$
 $? = 48.8 - 4.80 = 44$

65. Answer: D

$15\% \text{ of } (150 + ?) + \sqrt{225} = 180 \div 4$
 $15 * (150 + ?) / 100 = 45 - 15$
 $150 + ? = 30 * 100 / 15 = 200$
 $? = 200 - 150 = 50$

66. Answer: A

Let the length of the platform = x
 The speed of the train = $200 / 10 = 20 \text{ m/sec}$
 $200 + x/3 = 20 * 12$
 $x/3 = 240 - 200$
 $x = 40 * 3 = 120$

67. Answer: C

$$(4500 * x)/(3000 * (x - 6)) = 12/5$$

$$x = 8/5 * (x - 6)$$

$$5x = 8x - 48$$

$$x = 48/3 = 16$$

The investment period of Savi = $16 - 6 = 10$ months

68. Answer: D

Let the amount invested by Amir in SI = x

$$x * R * 4/100 = x * 4/5$$

$$R = 20$$

Total amount received by Amir in CI = $1500 * (1 + 20/100)^2 = 1500 * (120/100)^2 = \text{Rs.}2160$

69. Answer: A

$$n * 40 + 50 - 35 = n * 41$$

$$n = 15$$

70. Answer: D

Let the breadth of the rectangle = x

And the length of the rectangle = $x + 3$

$$(x + 3) * 125/100 * (x * 120/100) = 60$$

$$(x + 3) * x = 40$$

$$x^2 + 3x - 40 = 0$$

$$x^2 + 8x - 5x - 40 = 0$$

$$x(x + 8) - 5(x + 8) = 0$$

$$x = + 5, - 8 = + 5$$

The length of the rectangle = $5 + 3 = 8$

The original perimeter of the rectangle = $2 * (5 + 8) = 2 * 13 = 26$ cm

[Click Here to Get the Detailed Video Solution for the above given English Questions](#)

Or Scan the QR Code to Get the Detailed Video Solutions



71. Answer: C

The first option is tricky as it has been mentioned in the introduction only but, this is being discussed as a means to attain the actual goal which has been given in the following lines that talk about a standardisation in education. This is the ultimate focus of the author. So, the title should reflect the same. (a) hence, can be eliminated.

The second option is too general and the passage specifically talks about assessment so (b) can be ruled out as well. The third option helps us get an overview of what the author would be discussing so, this is apt. The fourth option is a bit vague and (e) is also not the central idea of the discussion because the system has to be improved so that there is no gap in the performance is actually the point.

So, the correct answer should be option (c).

72. Answer: A

The given question has been discussed in the third paragraph's initial part where it has been mentioned that the states can decide the medium of instruction and assessment better which helps them decide curriculums and activities. This is the benefit as per the author. The first option says exactly the same thing. The second option is right but it is not a benefit so can be ruled out. The third option is a result of the benefit and not the benefit

itself so (a) should be preferred to (c). (d) has nowhere been discussed so can be eliminated.

Therefore, the correct answer is option (a).

73. Answer: D

The lines given below from the last paragraph help us understand the exact answer:

Assessment reform at the school level **should concern** itself with getting to a consensus on improving learning outcomes across boards.

The only option that matches the reason above is (d).

The first option is not merely one thing in focus and it has been used just as an example. (b) is a distorted idea taken from the passage. (c) has nowhere been said. Thus, option (d) should be the most appropriate.

74. Answer: E

The first option has not been mentioned anywhere. In fact, it is the opposite of what is being discussed in the passage which says there should be an even-ness. So, (a) and (d) as well can be left out.

The remaining two options can be upheld from the lines given below:

A big problem that stemmed from the disparate assessment routes followed by the boards was grade inflation, **which privileged students from boards that assessed students very liberally** over those that were more conservative. This had led to competitive inflation that had seen Delhi University **cut-offs reach absurd levels**.

The best would be to mark option (e) as the answer.

75. Answer: E

The main subject of the sentence given above is **record** which is singular which means it should be followed by a singular verb **has** and not **have**.

This means that the fifth part of the sentence carries an error making option (e) the most appropriate answer.

76. Answer: A

Discussing is grammatically misfit for the blank as it needs an adjective which tells us the state of the decision being taken in the line. **Discussing** is a verb and can be ruled out. **Waited** can also be eliminated for the same reason and not being fit contextually as well. The word **consideration** should have been preceded by **under** in order for the sentence to be correct.

We can rightly say that the decision was pending since long...

So, the best would be to mark option (a) as the answer.

77. Answer: D

The word 'honouring' means respecting or regarding. The words in (a), (b), (c) and (e) explain the given word perfectly as these are synonyms to the given word.

But, **criticise** means to say what is bad or wrong with somebody/something. This is something we never do with those we honour.

So, the only option that fits as an antonym is (d).

78. Answer: B

'...**gained** much **from** its trade...' should make sense in the sentence above which means the word **gained** should be the first in the arrangement. This makes options (a) and (c) incorrect.

The second word should be C which clarifies that out of the remaining two, option (b) should be the correct answer.

79. Answer: C

When we read carefully we find that 'banned of the ban' near (C) creates an ambiguity. This means that the word in C is misplaced for sure.

The 'government banned a large number of apps' will make it correct so, C should be the first word in the arrangement. B is correct in its position. D is also correct. So, the only sequence that matches the logic is given in option (c).

80. Answer: E

The words given in the sentence above are in their correct positions and need no rearrangement.

Therefore, the correct answer is option (e).

81. Answer: A

Two phrases can help us easily arrange the words in this.

'National security' and 'detrimental impact' The word in A should come in C so that it would complete the phrase 'economy and national security'

We can find that C should come first as D, A and B have been fixed at the above explained positions.

Therefore, the correct answer should be option (a).

82. Answer: B

The word **deal** should come second which means A should be the second word in the sequence. The word **security** should follow **food** which tells us that C should come last in the sequence.

These two can together be found only in option (b).

83. Answer: E

The first sentence should be corrected as; '**more** than half' and not **most**. In the second option, the correct phrase to be used is; 'we look forward **to**' and not for. The third sentence should use the verb **climbed** to make it parallel with **became**. The fourth sentence should use the manager **has his** problems so that it becomes parallel to the **have** used in the latter part of the sentence.

Since all the given sentences are erroneous, we must mark (e) as the answer.

84. Answer: A

The first sentence is correct.

The second sentence has the article **the** missing before **most** (superlative degree) which is wrong.

The third sentence needs **will** before **beas**; **will be able to** should be the correct usage.

The fourth sentence uses **at** incorrectly. **In a village** should be the correct usage.

This makes option (a) the most appropriate answer option.

85. Answer: D

The first sentence has an error of preposition. We must use **into** in place of **in**. We use **into** with verbs that show movement.

The main subject in the second sentence is **surplus** which should be followed by a singular verb **has** so, **have** should be replaced in the same.

The third sentence also carries a subject-verb mismatch. A record **number** --- **is** good and not are.

So, the correct answer is (d) as it is the only error-free sentence.

86. Answer: E

All the given sentences are correct and need no grammatical improvement. This makes option (e) the most logical answer option.

87. Answer: E

The first sentence uses **for** incorrectly. One would appeal **against** a sanction and not in favour of the same.

Despite is making the second sentence ambiguous so, it should be changed to **and** or **while**.

The third sentence uses **she** (singular pronoun) for 80% women (plural noun). It should be changed to **they**.

The fourth sentence should use either 36-year-old or **36 years old** as the correct phrase.

This makes us mark option (e) as the correct answer.

88. Answer: B

The sentence states that Amazon has flouted (violated) the norms so it would obviously be fined for the same.

Diluted means made thinner or lessened in percentage. This does not fit the context of the sentence so can be eliminated.

We must mark option (b) as the answer as, all others are not as appropriate as that one.

89. Answer: A

The flow of the idea in the sentence is; capex will **lead to/result in/ensure/bring** welfare gains.

If we check the options, the first one is grammatically correct.

The second is incorrect tense so can be left out.

The third one will change the flow of the idea so can be eliminated.

The fourth is out of context and the fifth is grammatically incorrect.

This makes option (a) the most logical choice.

90. Answer: B

The word **provide** should be used to fill the blank as **provide with** is the correct usage.

The other words like **follow, offer, give, avail** cannot be followed by **with**. Also, these words are contextually incorrect as well.

So, the correct answer should be option (b).

91. Answer: C

Words like **aim, focus, agenda** can be used to fill the blank to make a meaningful sentence.

The words in (a) and (b) are grammatically incorrect and hence, can be eliminated.

Appeal is out of context.

So, the correct answer is option (c).

92. Answer: E

The sentence can take any word from the options given above as all of these are grammatically and contextually appropriate. The best would hence be option (e).

93. Answer: C

A cannot start as it mentions 'another benefit' so the one before this should have been discussed. B seems like an incomplete sentence so cannot be the introduction. C should definitely precede D as D says **it** which is being used for the act of walking. E can follow after it has been introduced that walking is being talked about.

So, the first sentence should be **C**.

This makes option (c) the most appropriate answer option.

94. Answer: D

A cannot start as it mentions 'another benefit' so the one before this should have been discussed. B seems like an incomplete sentence so cannot be the introduction. C should definitely precede D as D says **it** which is being used for the act of walking. E can follow after it has been introduced that walking is being talked about.

So, the first sentence should be C and D should follow as discussed above. So, D is the second sentence as given in option (d).

95. Answer: A

A cannot start as it mentions 'another benefit' so the one before this should have been discussed. B seems like an incomplete sentence so cannot be the introduction. C should definitely precede D as D says **it** which is being used for the act of walking. E can follow after it has been introduced that walking is being talked about.

So, the first sentence should be C and D should follow as discussed above. A should come before E as it introduces by mentioning

'a new study' which is further being named in E and explained in B making the sequence CDAEB the correct arrangement.

Therefore, the correct answer is option (a).

96. Answer: E

A cannot start as it mentions 'another benefit' so the one before this should have been discussed. B seems like an incomplete sentence so cannot be the introduction. C should definitely precede D as D says **it** which is being used for the act of walking. E can follow after it has been introduced that walking is being talked about.

So, the first sentence should be C and D should follow as discussed above. A should come before E as it introduces by mentioning 'a new study' which is further being named in E and explained in B making the sequence CDAEB the correct arrangement.

Therefore, the correct answer is option (e).

97. Answer: B

A cannot start as it mentions 'another benefit' so the one before this should have been discussed. B seems like an incomplete sentence so cannot be the introduction. C should definitely precede D as D says **it** which is being used for the act of walking. E can follow after it has been introduced that walking is being talked about.

So, the first sentence should be C and D should follow as discussed above. A should come before E as it introduces by mentioning 'a new study' which is further being named in E and explained in B making the sequence CDAEB the correct arrangement.

Therefore, the correct answer is option (b).

98. Answer: D

The word **reveal** means to show something that was hidden before. It fits in all the sentences above but it fails to make sense in the fourth sentence.

Taking back the imposed laws is being talked about in that sentence which means that the word **repeal** should be correct in place of **reveal**.

The best would be to mark option (d) as the answer.

99. Answer: E

The word **guide** means to show the way or help someone with understanding or doing something.

These meanings can be understood from the sentences above.

So, the correct answer is option (e).

100. Answer: B

The word **lead** means to show the way or the direction. It also means to be on the top or ahead of everyone else.

The first sentence takes the second meaning to be correct. The second sentence uses the wrong form of the given verb. **Can lead** will be correct.

The other sentences are correct.

Therefore, the best would be to mark option (b) as the answer.

Zero to Infinity

Importance of Zero to Infinity:

Seating arrangement and Puzzles are the most important topics that need more practice for every “**Banking Aspirant**”. Here, we are providing the content for all topics in a monthly basis for regular practice. It consists of the questions from “**Basics to Hard level**” (Prelims-Mains level), also we add some extra notes in a detailed manner to avoid confusion in the statements of seating arrangement and puzzles, this will help you to get a crystal-clear view of each and every topic. We are providing questions based on the recent exam analysis, so that you can be the “**Expert**” in a particular topic if you are practicing the complete questions provided by us.

Linear Arrangement

Linear arrangement is one of the frequently asked topics in all major bank exams. Some of you are lagging in some statements of linear arrangement, so we are adding the most confusing statements for your clarification. Go through it once before solving practice questions.

Confusing Statement In Linear Arrangement:

Statement – 1: B sits three places away from A.

The above statement implies the following possible statements:

- Two persons sit between A and B.
- A sits third to the left of B or B sits third to the left of A.
- B sits third to the right of A or A sits third to the right of B.

Short Hint: Subtract one from the number of places according to the respective statements.

Three places away $\rightarrow 3-1=2$ persons sit between them

Four places away $\rightarrow 4-1=3$ persons sit between them

This is similar for the remaining cases.

Case-1:



Case-2:



Statement – 2: Atleast two persons sit to the left of A.

The above statement implies the following possible statements:

- Two persons sit to the left of A.
- Three/Four/Five/Six persons sit to the left of A.

Note: The number of persons may be varied based on the total number of persons sitting in the row.

Short Hint: Atleast= Minimum, so as per the statement minimum of two persons sit to the left of A.

Case-1:

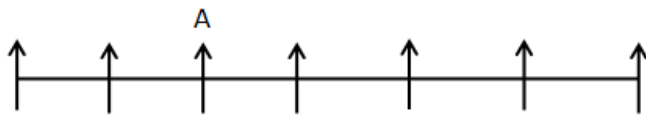

Case-2 :

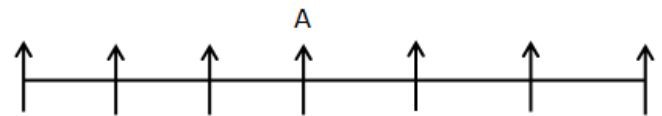

Case-3:

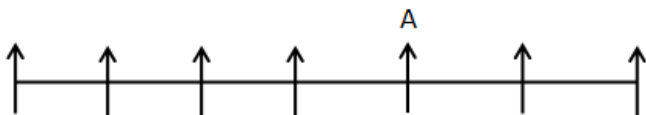

Case-4:

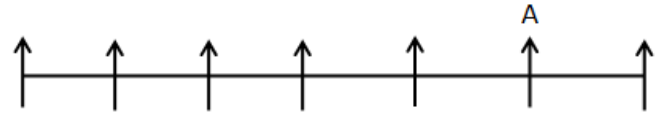

Case-5:

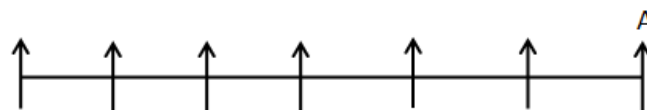

Statement – 3: Atmost three persons sit to the right of A.

The above statement implies the following possible statements:

- No person sits to the right of A.
- One/Two/Three persons sit to the right of A.

Short Hint: Atmost=Maximum, so as per the statement maximum of three persons sit to the right of A.

Case-1:

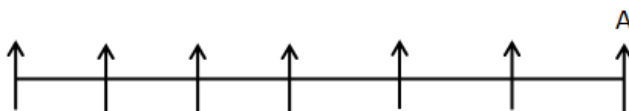

Case-2 :

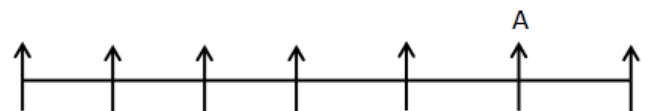

Case-3:

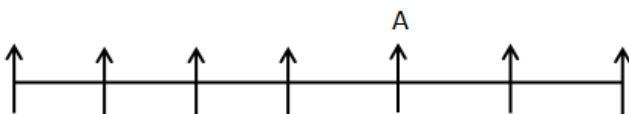

Case-4:



Statement – 4: Not more than two persons sit to the right of A.

The above statement implies the following possible statements:

- No person sits to the right of A.
- One/Two persons sit to the right of A.

Short Hint: Not more than=Atmost=Maximum, so as per the statement maximum two persons sit to the right of A.

Case-1:

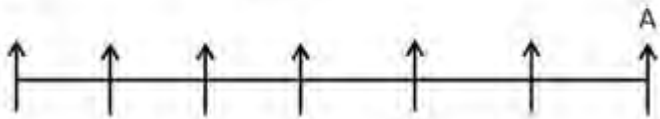

Case-2:



Case-3:



Statement – 5: Atleast two persons sit between A and B.

The above statement implies the following possible statements:

- Two persons sit between A and B.
- Three/Four/Five persons sit between A and B.

Note:

- The number of persons may be varied based on the total number of persons sitting in the row.
- The position of A with respect to B may be left or right.

Short Hint: Atleast= Minimum, so as per the statement minimum of two persons sit between A and B.

Case-1:

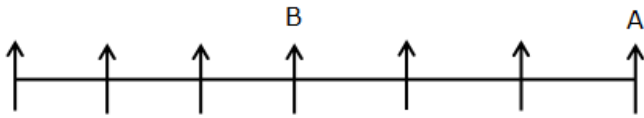

Case-2 :



Case-3:



Case-4:



Statement – 6: Atmost/not more than three persons sit between A and B.

The above statement implies the following possible statements:

- No person sits between A and B.
- One/Two/Three persons sit between A and B.
- The position of A with respect to B may be left or right.

Short Hint: Not more than/Atmost=Maximum, so as per the statement maximum of three persons sit between A and B.

Case-1:

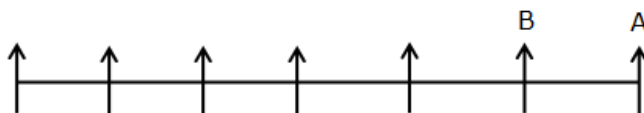

Case-2 :

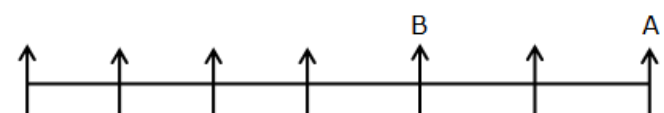

Case-3:

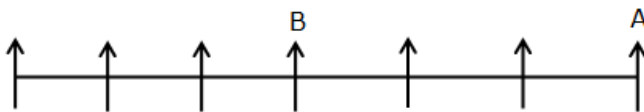

Case-4:

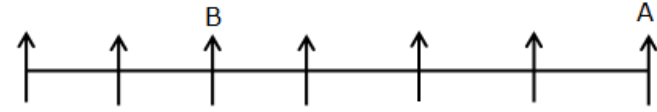

Statement – 7: C sits between B and A.

- Here, it is mentioned C sits between B and A, which means C can be seated at any position between A and B.

Short Hint: Between= In the space of middle two persons, so C can be seated at a gap of None/one/two/three persons between B and A, based on the number of persons sitting in the row.

Case-1:

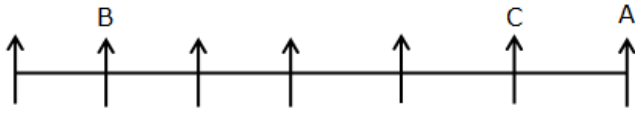

Case-2 :

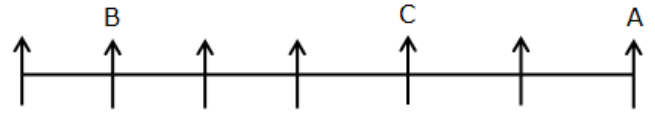

Case-3:



Case-4:

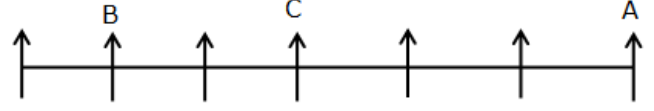

Statement – 8: C sits exactly between B and A.

Here, it is mentioned C sits exactly between B and A, which means there must be equal number of persons sitting between C and B and C and A.

Case-1:

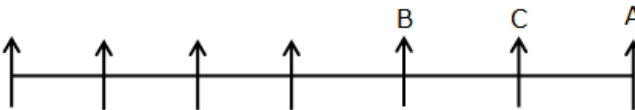

Case-2 :

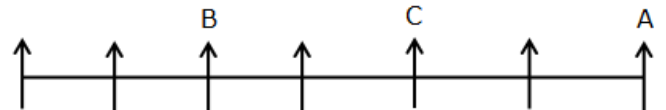

Case-3:

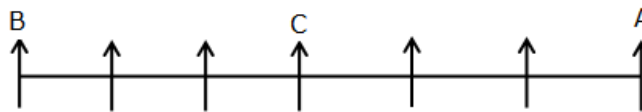

Statement – 9: As many persons sit to the left of A as to the right of B.

- Here, the number of persons sitting to the left of A should be equal to the number of persons sitting to the right of B. It can be one/two/three persons seated towards the left of A so the same number of persons should be seated towards the right of B.

Short Hint: Persons to the left of A = Persons to the right of B

Case-1:

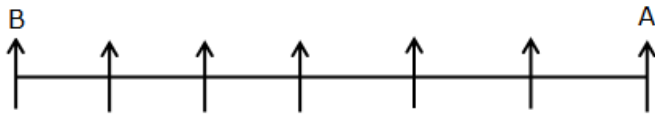

Case-2 :



Case-3:

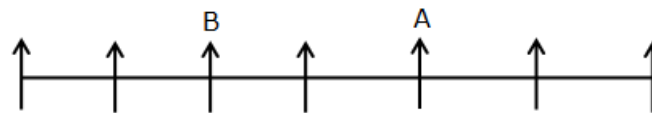

Statement – 10: As many persons sit between A and C as between C and B.

- Here, the number of persons sitting between A and C should be equal to the number of persons sitting between C and B. It can be one/two/three persons seated between A and C so the same number of persons should be seated between C and B.

Short Hint:

- I. Persons between A and C = Persons between B and C.
- II. C must be seated exactly between A and B.

Case-1:

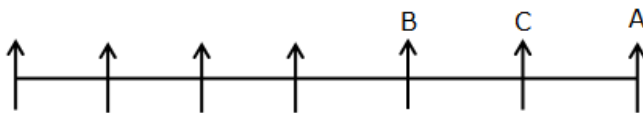

Case-2 :

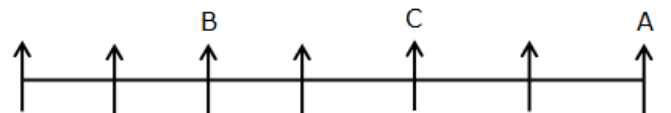

Case-3:

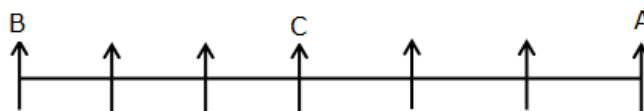

Statement – 11: The number of persons sitting between A and B is one less than the number of persons sitting between B and C.

Short Hint: Persons between A and B = (Persons between B and C) – 1

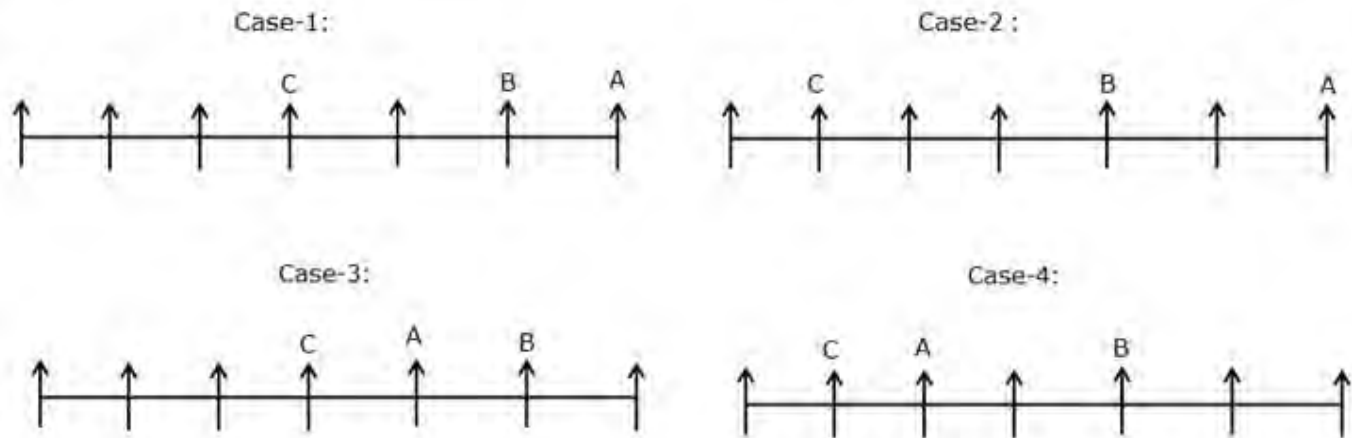

Note: This is similar for the number of persons sitting between A and B is **two/three less** than the number of persons sitting between B and C.

$$\text{Persons between A and B} = (\text{Persons between B and C}) - 2$$

$$\text{Persons between A and B} = (\text{Persons between B and C}) - 3$$

Statement – 12: The number of persons sitting between B and C is one more than the number of persons sitting between A and B.

Short Hint: Persons between B and C = (Persons between A and B)+1

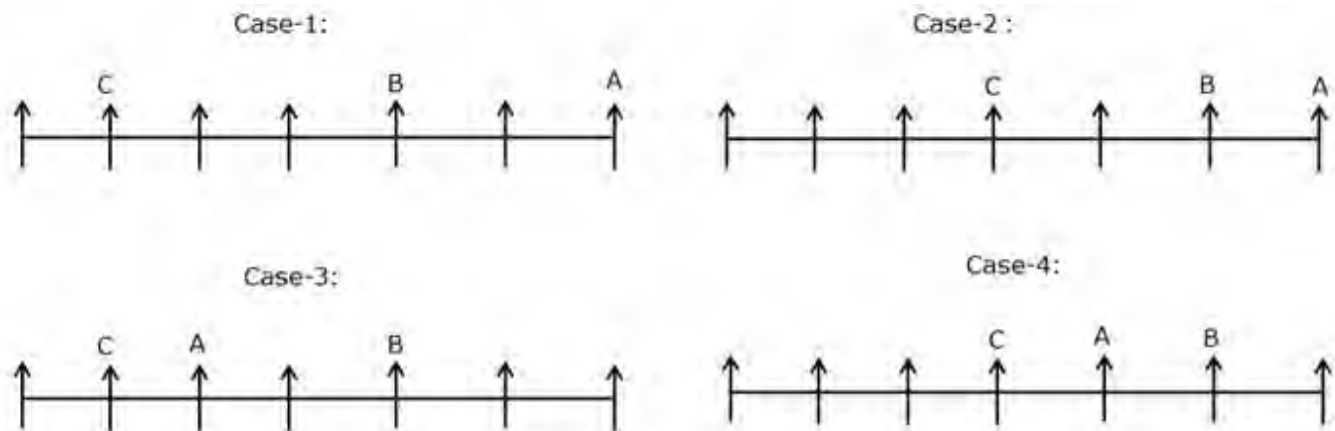

Note: The number of persons sitting between B and C is **two/three more** than the number of persons sitting between A and B.

$$\text{Persons between B and C} = (\text{Persons between A and B})+2$$

$$\text{Persons between B and C} = (\text{Persons between A and B})+3$$

Statement – 13: Not more than two persons sitting together are facing the same direction. A and G are facing the same direction but opposite direction of E. A and D are facing the same direction. D and E are facing opposite directions.

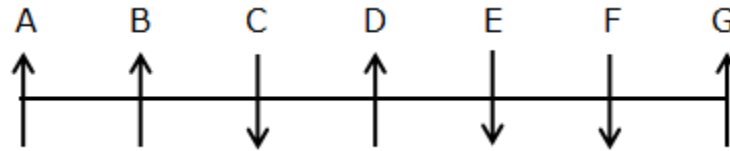

Short note: Only two adjacent persons are facing the same direction, the third person must face the opposite direction of that two persons.

If A and B are facing north, then C must be facing south and vice versa.

If A and G are facing north, then E must be facing south and vice versa.

If A is facing north, then D must be facing south and vice versa.

If E facing south, then D must be facing north and vice versa.

Statement – 14: A is the only neighbour of B or B is the only neighbour of A

- If A is the only neighbour of B, then B must be seated on the extreme end
- If B is the only neighbour of A, then A must be seated on the extreme end

Case-1:

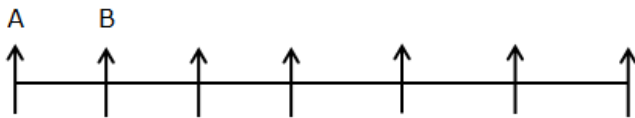

Case-2:

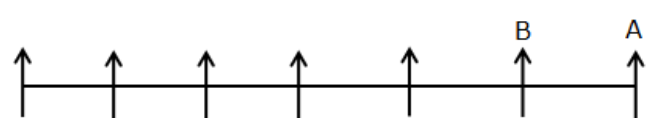

Case-3:



Case-4:



Statement – 15: C is an immediate neighbour of both B and A

The above statement implies the following possible statements:

- Only C sits between B and A.
- No other persons sit between B and A other than C.

Case-1:

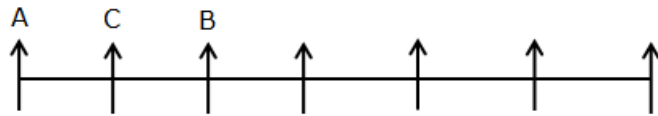

Case-2:



[Click Here to Get the Detailed Video Solution for the above given Questions](#)

Or Scan the QR Code to Get the Detailed Video Solutions



Practice Questions

Set 1 (Clerk Pre)

Direction (1-5): Study the following information carefully and answer the questions given below.

Seven persons - A, B, C, D, E, F and G are standing in a linear row and all of them are facing towards the north, but not necessarily in the same order.

Only two persons stand between B and E, where neither of them stands at the end of the row. A stands second to the right of B. D is an immediate neighbour of A. G stands second to

the left of D. F stands to the immediate right of C.

1) Who among the following person stands exactly between D and F?

- a) The one who stands second to the right of D
- b) G
- c) The one who stands immediate right of B
- d) C
- e) None of these

2) How many persons stand between B and F?

- a) One
- b) Two
- c) Three
- d) Four
- e) None of these

3) If all the persons are made to stand in alphabetical order from left to right, then how many persons remain unchanged in their position?

- a) One
- b) Four
- c) Two
- d) Three
- e) None of these

4) If G is related to F, D is related to E, in a certain way, then who among the following person is related to C?

- a) A
- b) F
- c) E
- d) B
- e) None of these

5) Who among the following person stands third to the left of F?

- a) E
- b) C
- c) A
- d) G
- e) B

[Click Here to Get the Detailed Video Solution for the above given Questions](#)

Or Scan the QR Code to Get the Detailed Video Solutions



Answer Key with Explanation

Directions (1-5):

1. Answer: A
2. Answer: D
3. Answer: C (B and E)

[Get our Prime Bundle PDF Course](#)

[Get our Mock Test Series](#)

[e-Magazine Jan 2023](#)

4. Answer: D

5. Answer: C

Final arrangement:

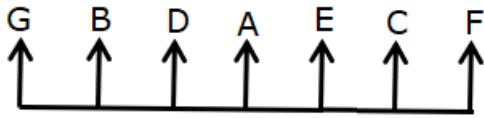

We have,

- Only two persons stand between B and E, where neither of them stands at the end of the row.

From the above conditions, there are two possibilities

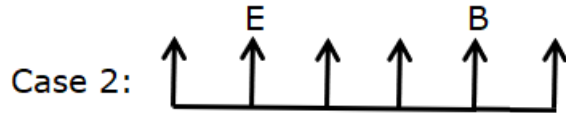
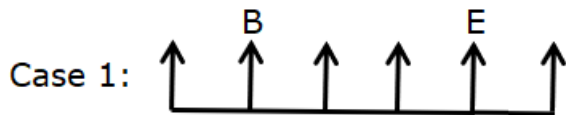

Again we have,

- A stands second to the right of B.
- D is an immediate neighbour of A.

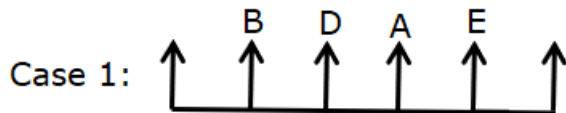

Again we have,

- G stands second to the left of D.
- F stands to the immediate right of C.

So Case 2 gets eliminated, hence Case1 shows the final arrangement

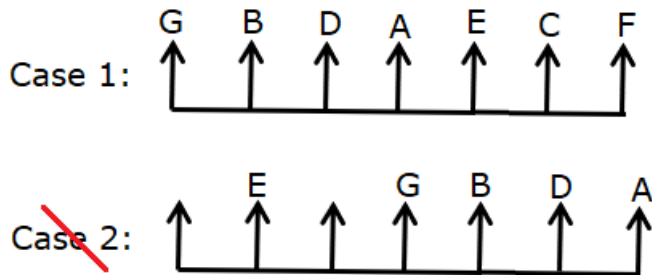

Set 2 (Clerk Pre)

Directions (6-10): Study the following information carefully and answer the questions given below.

A certain number of persons are standing in a linear row facing south. C stands at one of the extreme ends of the row. Only one person stands between C and E. Only eight persons stand between E and B. As many persons stand to the right of E as to the left of B. F stands three places away from B. D stands exactly between E and F. A stands fifth to the right of D.

6) How many persons stand in a row?

- a. 20
- b. 17
- c. 23
- d. 14
- e. 15

7. Who among the following person stands third to the right of F?

- a. B
- b. D
- c. C
- d. E

e. None of these

8. How many persons stand between A and D?

- a. One
- b. Two
- c. Three
- d. Four
- e. Six

9. Which of the following statement(s) is/are true based on the given information?

- a. D stands third to the left of F
- b. A stands at the extreme right end
- c. B stands to the immediate left of A
- d. Only one person stands between F and E
- e. All the statements are true

10. What is the position of E with respect to C?

- a. Third to the right
- b. Second to the right
- c. Third to the left
- d. Second to the left
- e. Fourth to the right

[Click Here to Get the Detailed Video Solution for the above given Questions](#)

Or Scan the QR Code to Get the Detailed Video Solutions



Answer Key with Explanation

Directions (6-10):

- 6. Answer: D**
- 7. Answer: A**
- 8. Answer: D**
- 9. Answer: A**
- 10. Answer: B**

Final arrangement:

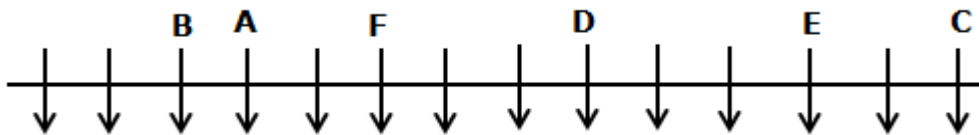

We have,

- C stands at one of the extreme ends of the row.
- Only one person stands between C and E.
- Only eight persons stand between E and B.
- As many persons stand to the right of E as to the left of B.

From the above conditions, there are two possibilities



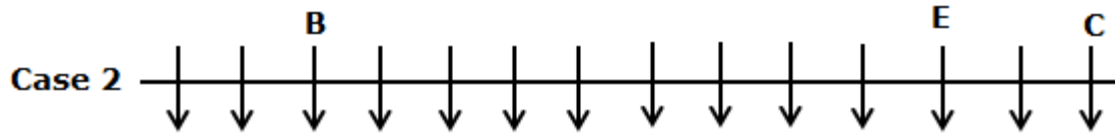

Again we have,

- F stands three places away from B.
- D stands exactly between E and F.
- A stands fifth to the right of D.

So Case1 gets eliminated. Hence Case2 shows the final arrangement.

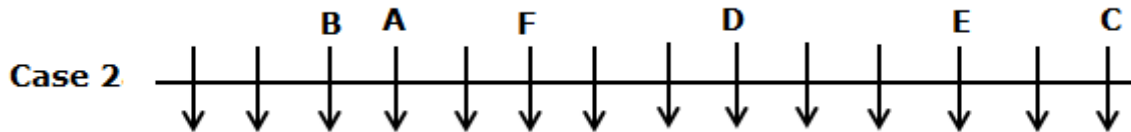
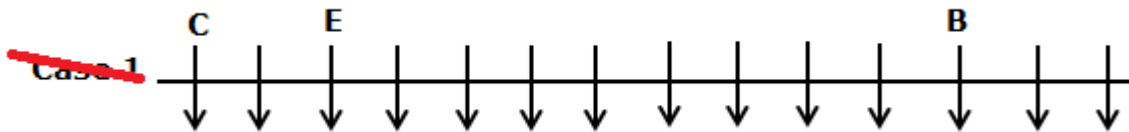

Set 3 (PO Pre)

Directions (11-15): Study the following information carefully and answer the questions given below.

Nine persons - L, M, N, O, P, Q, R, S, and T are sitting in a straight line such that all of them are facing towards the South, but not necessarily in the same order.

S sits fourth to the right of M, where none of them sits at the end of the row. Only one person sits between S and R, who sits to the left of S. The number of persons sitting to the right of S is one less than the number of persons sitting to the left of O. Only two persons sit between O and P. As many persons sit between P and S as between Q and T. L sits second to the left of Q.

11. Who among the following person sits second to the left of N?

- The one who sits immediate right of R
- T
- The one who sits third to the right of O
- P
- Both c and d

12. As many persons sit to the left of L as to the right of ____.

- O
- T
- M
- S
- Q

13. What is the position of T with respect to R?

- a) Second to the left
- b) Immediate right
- c) Second to the right
- d) Fourth to the right
- e) Third to the left

14. If all the persons are made to sit in the alphabetical order from the left end, then how many persons remain unchanged in their position?

- a) One

- b) Two
- c) Three
- d) More than three
- e) No one

15. Who among the following person sits immediate left of the one who sits second to the right of P?

- a) L
- b) T
- c) N
- d) S
- e) Q

[Click Here to Get the Detailed Video Solution for the above given Questions](#)

Or Scan the QR Code to Get the Detailed Video Solutions



Answer Key with Explanation

Directions (11-15):

11. Answer: C

12. Answer: A

13. Answer: E

14. Answer: A

15. Answer: B

Final arrangement

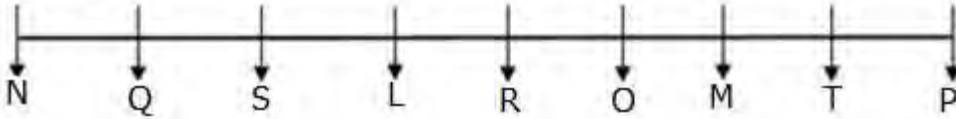

We have,

- S sits fourth to the right of M, where none of them sits at the end of the row.
- Only one person sits between S and R, who sits to the left of S.

From the above condition, there are three possibilities

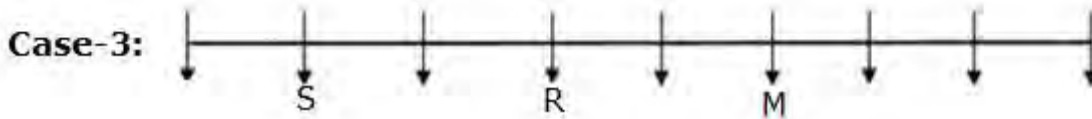
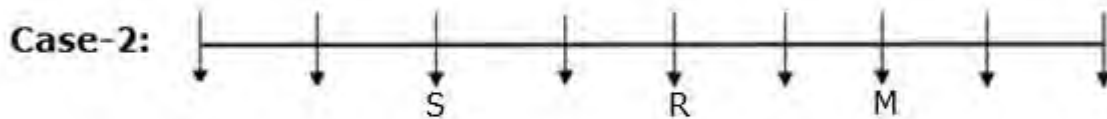
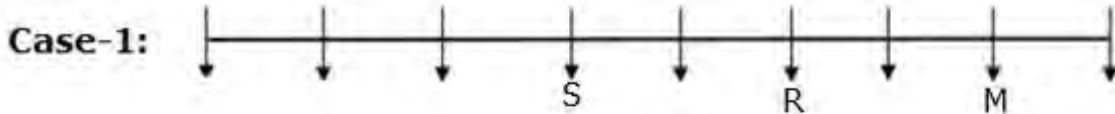

Again we have,

- The number of persons sitting to the right of S is one less than the number of persons sitting to the left of O.
- Only two persons sit between O and P.

From the above condition, case3 gets eliminated.

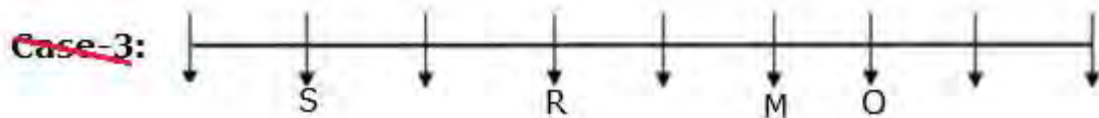
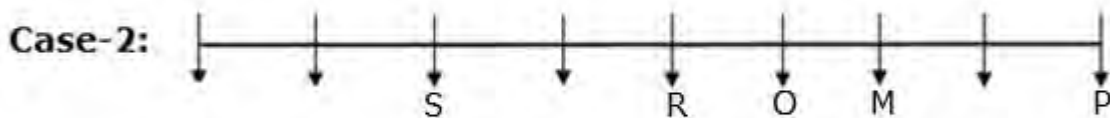
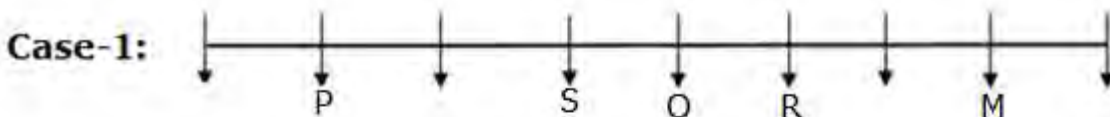

Again we have,

- As many persons sit between P and S as between Q and T.
- L sits second to the left of Q.

From the above condition, case1 gets eliminated. Hence, case 2 shows the final arrangement.

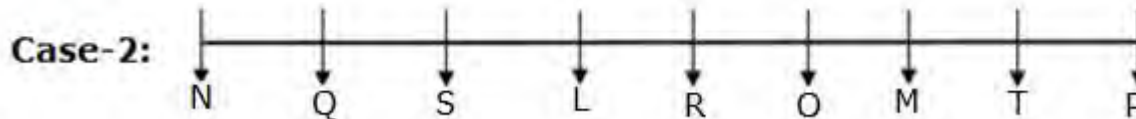
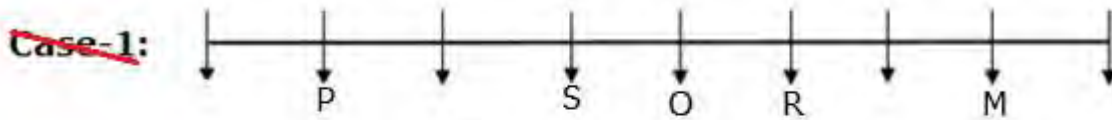

Set 4 (PO Pre)

Directions (16-20): Study the following information carefully and answer the questions given below.

Seven persons - L, M, N, O, P, Q, and R are sitting in a linear row facing north. All of them like different colours viz. white, grey, green, red, black, yellow, and blue. All the information is not necessarily in the same order.

P likes red colour and sits at one of the extreme ends of the row. Only two persons sit between P and the one who likes yellow. R sits immediate right of the one who likes yellow. L is an immediate neighbour of R but is not an immediate neighbour of P. Only one person sits between L and N, who neither likes blue and black nor is an immediate neighbour of R. Q sits third to the left of M, who likes white. O sits immediate right of M and likes grey. The one who likes black colour is not an immediate neighbour of M.

16) Who among the following person likes green colour?

- N
- Q
- R

- L
- None of these

17) How many persons sit between the one who likes black and O?

- One
- Two
- Three
- Four
- None

18) If all the persons are made to sit in alphabetical order from right to left, then how many persons remain in the same position?

- One
- Two
- Three
- Four
- No one

19) Four of the following five are alike in a certain way based on the given arrangement and thus form a group. Which one of the following does not belong to the group?

- O
- N

- c) Q
- d) L
- e) R

- a) Second to the left
- b) Second to the right
- c) Third to the left
- d) Immediate left
- e) None of these

20) What is the position of Q with respect to R?

[Click Here to Get the Detailed Video Solution for the above given Questions](#)

Or Scan the QR Code to Get the Detailed Video Solutions



Answer Key with Explanation

Directions (16-20):

- 16. Answer: A
- 17. Answer: C
- 18. Answer: A
- 19. Answer: A(O sits at the end of the row)
- 20. Answer: A

Final arrangement:

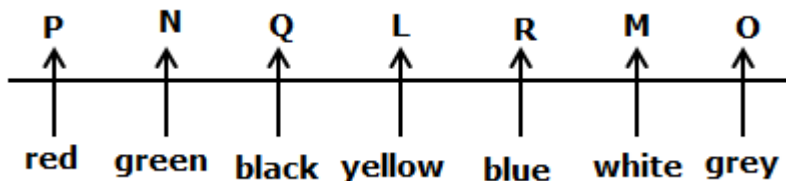

We have,

- P likes red colour and sits at one of the extreme ends of the row.
- Only two persons sit between P and the one who likes yellow.
- R sits immediate right of the one who likes yellow.

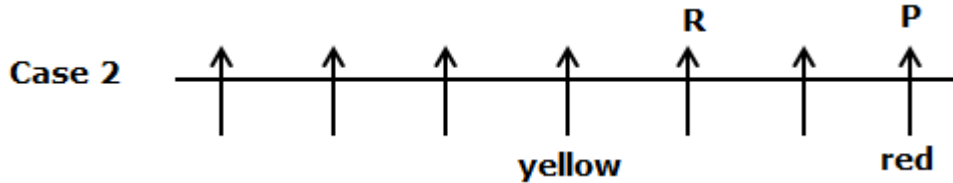
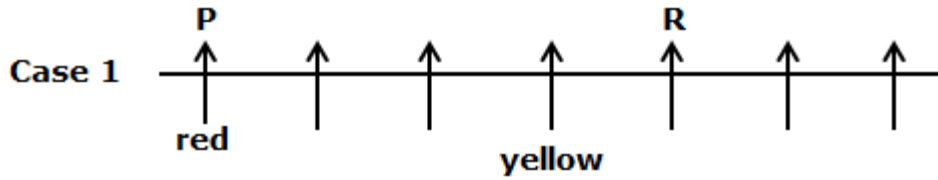

Again we have,

- L is an immediate neighbour of R but is not an immediate neighbour of P.
- Only one person sits between L and N, who neither likes blue and black nor is an immediate neighbour of R.

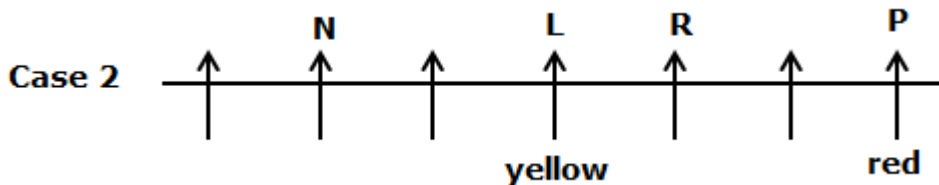
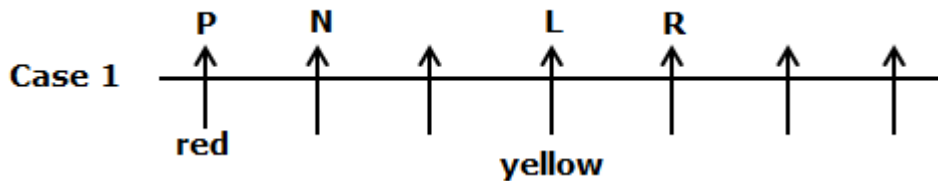

Again we have,

- Q sits third to the left of M, who likes white.
- O sits immediate right of M and likes grey.
- The one who likes black colour is not an immediate neighbour of M.

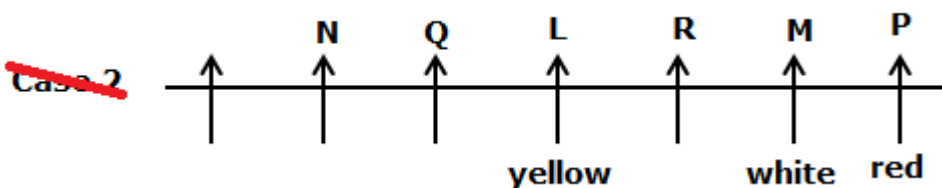
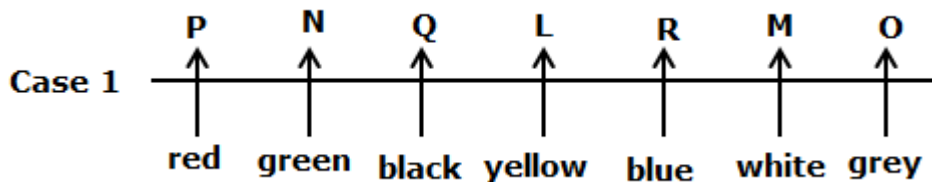

Set 5 (PO Pre)

Direction (21-25): Study the following information carefully and answer the questions given below.

Six persons - L, M, N, O, P, and Q ordered six different items viz., cake, pastry, bread, chips, pizza and toffee from a restaurant and they all are standing in the queue in a horizontal way facing towards the south direction.

Only one person stands between L and the one who ordered toffee, where neither of them stands at the end of the row. N stands third to the right of the one who ordered chips who stands adjacent to the one who ordered toffee. As many persons stand to the left of Q as to the right of N. Only two persons stand between the one who ordered bread and the one who ordered pizza. L doesn't order pizza. The one who ordered pastry stands third to the right of M, who stands to the immediate left of P. Q doesn't order cake.

21) Who among the following person stands immediate left of the one who ordered Cake?

- a) The one who ordered Pastry
- b) N
- c) L
- d) The one who ordered Pizza
- e) M

22) Which of the following item is ordered by Q?

- a) Bread

- b) Pizza
- c) Pastry
- d) Cake
- e) None of these

23) How many persons stand between the one who ordered toffee and O?

- a) One
- b) Two
- c) Three
- d) Four
- e) None

24) Who among the following person ordered Bread?

- a) P
- b) Q
- c) M
- d) N
- e) L

25) Which of the following statement(s) is/are true based on the given information?

- a) O stands to the immediate right of N
- b) M stands adjacent to the one who ordered cake
- c) P stands second to the right of the one who ordered pizza
- d) All are true
- e) None is true

[Click Here to Get the Detailed Video Solution for the above given Questions](#)

Or Scan the QR Code to Get the Detailed Video Solutions



Answer Key with Explanation

Direction (21-25):

- 21. Answer: A**
- 22. Answer: B**
- 23. Answer: B**
- 24. Answer: E**
- 25. Answer: c**

Final arrangement:

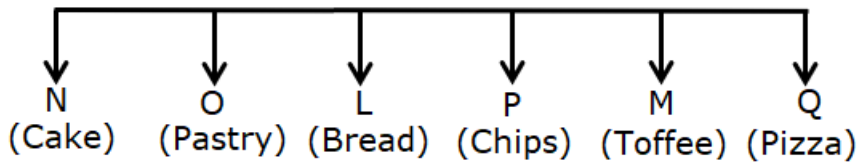

We have,

- Only one person stands between L and the one who ordered toffee, neither of them stands at the end of the row.

From the above conditions, there are two possibilities

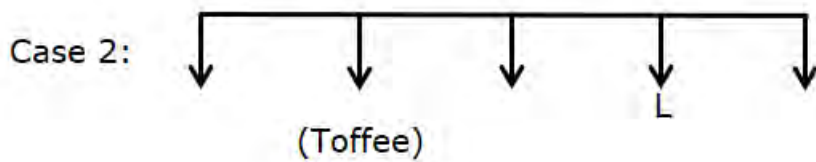
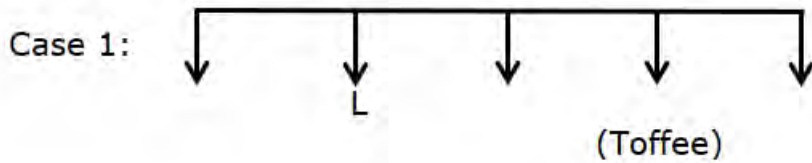

Again we have,

- N stands third to the right of the one who ordered chips who stands adjacent to the one who ordered toffee.
- As many persons stand to the left of Q as to the right of N.

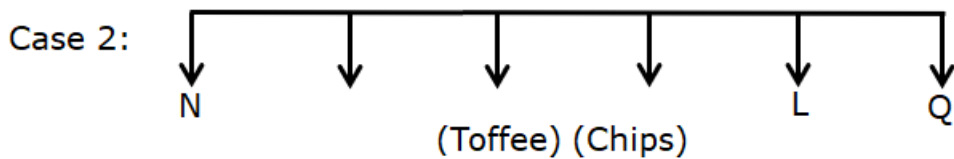
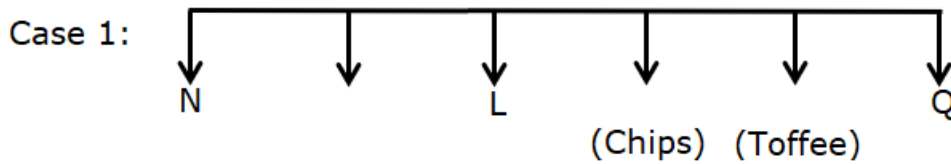

Again we have,

- Only two persons stand between the one who ordered bread and the one who ordered pizza.
- L doesn't order pizza.

the same direction as I. K sits immediate left of O. As many persons sit between K and M as between M and L, who is not an immediate neighbour of N. The persons sitting at the extreme ends are facing opposite directions. Both M and L are facing north.

26. Who among the following person sits second to the left of J?

- a) O
- b) N
- c) K
- d) M
- e) No one

27. Four of the following five are alike in a certain way based on the given arrangement and thus form a group. Which one of the following does not belong to the group?

- a) L
- b) N
- c) O
- d) K
- e) M

28. Which among the following pair of persons sit at the extreme ends?

- a) JI
- b) JL
- c) KM
- d) NO
- e) IK

29. Which of the following option will fill the blank space: J, N :__ , L.

- a) O
- b) M
- c) I
- d) K
- e) None of these

30. How many persons are sitting between K and I?

- a) As many persons sit to the left of M
- b) No one
- c) One
- d) As many persons sit between J and O
- e) Three

[Click Here to Get the Detailed Video Solution for the above given Questions](#)

Or Scan the QR Code to Get the Detailed Video Solutions



Answer Key with Explanation

Directions (26-30):

26. Answer: C

27. Answer: D (In the given options, all the persons are facing north, except option d)

28. Answer: B

29. Answer: C

30. Answer: D

Final arrangement:



We have,

- O sits second to the right of N, who sits second from one of the extreme ends.
- Only three persons sit between I and N and both face opposite directions.
- Both K and J face the same direction as I.

From the above conditions, we have two possibilities:

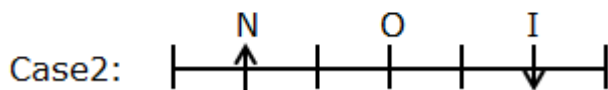
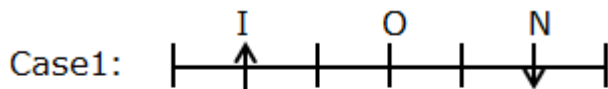

Again we have,

- K sits immediate left of O.
- As many persons sit between K and M as between M and L, who is not an immediate neighbour of N.

- The persons sitting at the extreme ends are facing opposite directions.
- Both M and L are facing north.

While applying the above conditions, case 1 gets eliminated. Thus, case 2 gives the final arrangement.

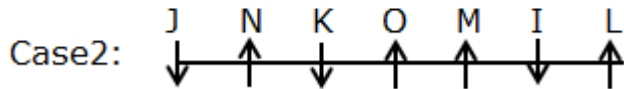

Set 7 (PO Pre)

Direction (31-35): Study the following information carefully and answer the questions given below.

A certain number of persons are sitting in a linear row facing North.

Only three persons sit between P and A, who sits fifth to the left of O. As many persons sit between P and O as between A and Q, who sits to the right of A. Q sits exactly between O and L, who sits third from one of the extreme ends. The number of persons sitting to the right of L is one more than the number of persons sitting to the left of M, who sits second to the left of B. Only one person sits between P and B.

31. How many persons are sitting in the linear row?

- 22
- 21
- 23
- 25
- 20

32. What is the position of P with respect to M?

- Seventh to the left

- Fourth to the right
- Sixth to the right
- Sixth to the left
- Third to the left

33. How many persons sit to the left of A?

- Six
- Five
- Four
- Seven
- Nine

34. Who among the following person sits fourth to the right of Q?

- L
- M
- B
- A
- Unknown person

35. Which of the following statement(s) is/are true based on the given information?

- No one sits between P and O.
- O sits to the right of M.
- Only two persons sit between O and Q.
- Six persons sit between M and A.

- a) Only III
- b) Only III and IV
- c) Only I and III

- d) Only II
- e) All I, II, III and IV

[Click Here to Get the Detailed Video Solution for the above given Questions](#)

Or Scan the QR Code to Get the Detailed Video Solutions



Answer Key with Explanation

Direction (31-35):

- 31. Answer: D
- 32. Answer: B
- 33. Answer: E
- 34. Answer: A
- 35. Answer: D

Final arrangement

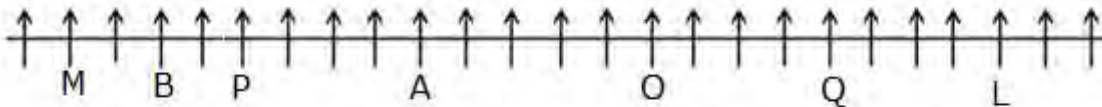

We have,

- Only three persons sit between P and A, who sits fifth to the left of O.
- As many persons sit between P and O as between A and Q, who sits to the right of A.

From the above condition, there are two possibilities.

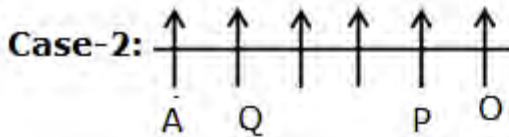
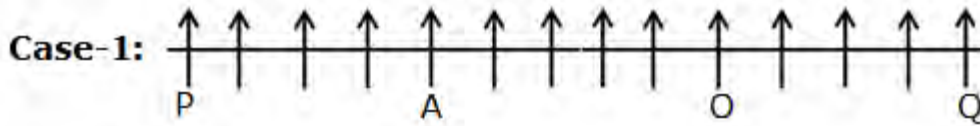

Again we have,

- Q sits exactly between O and L, who sits third from one of the extreme ends.
- The number of persons sitting to the right of L is one more than the number of persons sitting to the left of M, who sits second to the left of B.
- Only one person sits between P and B.

From the above condition, case 2 gets eliminated. Hence, case 1 shows the final arrangement.

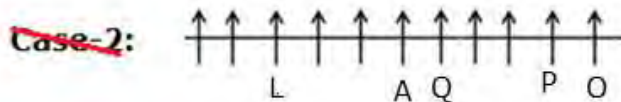
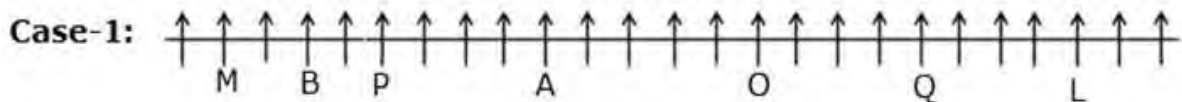

Set 8 (PO Pre)

Directions (36-40): Study the following information carefully and answer the questions given below.

Eight persons viz., D, E, F, G, H, I, J and L are sitting in a linear row which has nine seats. All the seats are facing north. One of the seats is vacant

L sits fourth to the left of D but none of them sits at the extreme ends of the row. F sits immediate left of L. Only two persons sit between F and I, who sits immediate right of

H. L doesn't sit on the adjacent seat of H. E sits immediate right of G. The number of persons sitting to the right of J is one more than the number of persons sitting to the left of G.

36. Who among the following person sits immediate right of the vacant seat?

- D
- J
- G
- H

e) F

37. What is the position of J with respect to F?

- a) Second to the right
- b) Immediate left
- c) Fifth to the left
- d) Fourth to the right
- e) Second to the left

38. If a new person X sits at the vacant seat, then the number of persons sitting to the right of X is the same as the number of persons sitting to the left of ____.

- a) G
- b) E
- c) J
- d) F
- e) I

39. Who among the following pair of persons sits at the extreme ends of the row?

- a) FE
- b) GJ
- c) JE
- d) FJ
- e) EL

40. Which of the following statement(s) is/are true based on the given information?

- I. Only two persons sit between L and J
 - II. One of the adjacent seats of I is vacant
 - III. D sits immediate left of G
- a) Only I
 - b) Only II
 - c) Only II and III
 - d) Only III
 - e) All I, II and III

[Click Here to Get the Detailed Video Solution for the above given Questions](#)

Or Scan the QR Code to Get the Detailed Video Solutions



Answer Key with Explanation

Directions (36-40):

36) Answer: D

37) Answer: B

38) Answer: E

39) Answer: C

40) Answer: D

Final arrangement

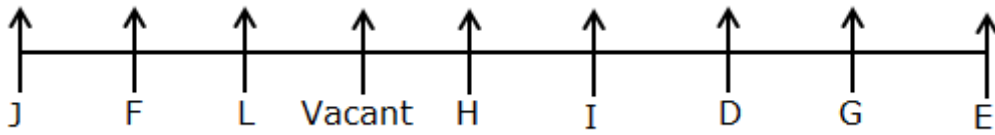

We have,

- L sits fourth to the left of D but none of them sits at the extreme ends of the row.
- F sits immediate left of L.

From the above conditions, there are three possibilities

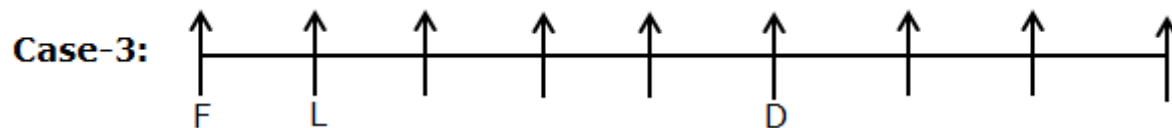

Again we have,

- Only two persons sit between F and I, who sits immediate right of H.
- L doesn't sit on the adjacent seat of H.

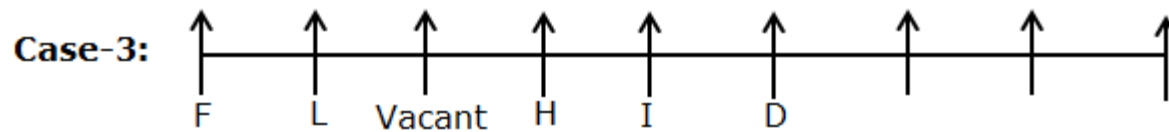
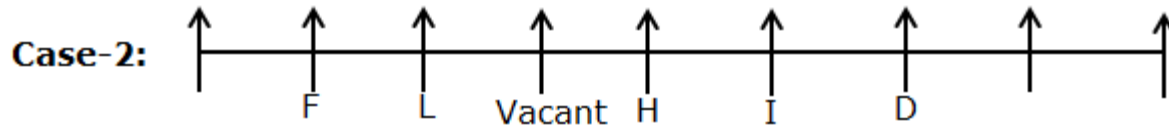
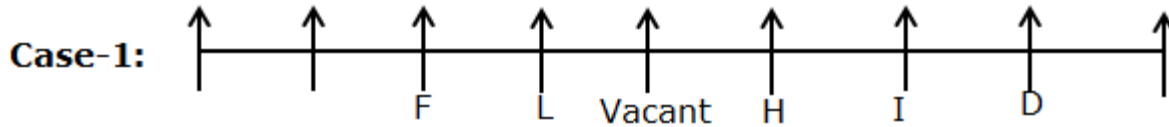

Again we have,

- E sits immediate right of G.
- The number of persons sitting to the right of J is one more than the number of persons sitting to the left of G.

After applying the above conditions, case-1 and case-3 get eliminated, hence case-2 shows the final arrangement

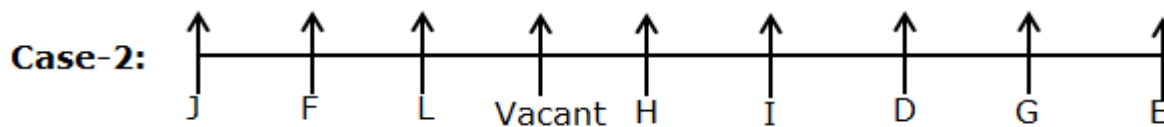
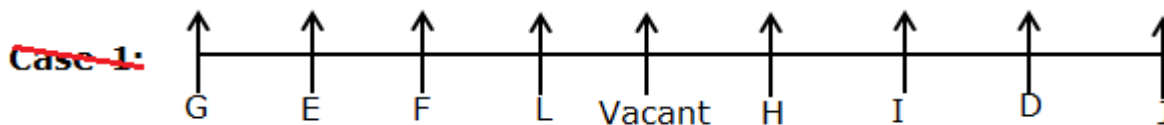

Set 9 (Clerk Mains)

Directions (41-45): Study the following information carefully and answer the questions given below.

Eight persons A, C, F, H, K, M, O and S are sitting in a linear row facing towards the north. Each of them is an expert in different fields viz. Fitness, Beauty, Medical, Fashion, Agriculture, Teaching, Arts, and Science. All the information is not necessarily in the same order.

M sits third to the right of the one who is expert in Fashion but neither of them sits at the end of the row. O sits immediate right of the one who is expert in fashion. H sits immediate left of the one who is expert in agriculture. Only one person sits between H and S, who doesn't sit adjacent to M. As many persons sit to the right of S as to the left of the science expert. F sits second to the right of the one who is expert in Science. The fitness expert sits immediate right of C. Only one person sits between C and the one who is expert in Arts. As many persons sit to the right of the medical expert as to the left of A, who is not expert in arts. The beauty expert sits immediate right of K.

41. Who among the following person sits immediate right of the one who is expert in teaching?

- a) The one who sits second to the left of F
- b) The one who sits third to the right of M
- c) K
- d) O
- e) A

42. What is the position of S with respect to the medical expert?

- a) Second to the left
- b) Third to the right
- c) Immediate right
- d) Immediate left
- e) Fifth to the left

43. Who among the following person sits third to the left of the one who is expert in arts?

- a) The one who sits immediate right of C
- b) The one who sits immediate right of A
- c) S
- d) H
- e) The one who sits third to the left of O

44. If all the persons are made to sit in alphabetical order from right to left, then who among the following person is the Fashion expert? (the field of experts are not changed)

- a) S
- b) C
- c) A
- d) K
- e) F

45. Four of the following five are alike in a certain way as per the given arrangement and hence form a group. Find the one that doesn't belong to that group.

- a) S-Fashion Expert
- b) K-Beauty expert
- c) M-Arts expert
- d) H-Agricultural expert
- e) O-Medical expert

[Click Here to Get the Detailed Video Solution for the above given Questions](#)

Or Scan the QR Code to Get the Detailed Video Solutions



Answer Key with Explanation

Directions (41-45):

41. Answer: C

42. Answer: A

43. Answer: B

44. Answer: D(After the rearrangement **K** becomes the **Fashion** expert)

45. Answer: E(Only option e shows the correct combination pair)

Final arrangement

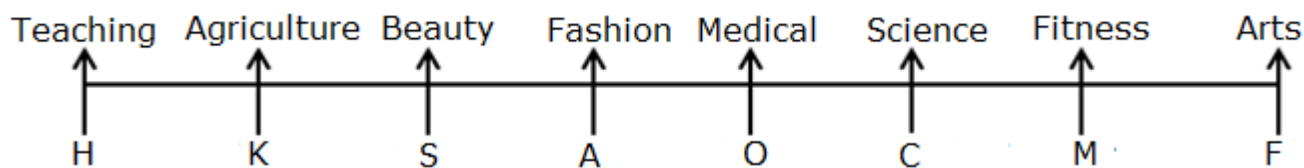

We have,

- M sits third to the right of the one who is expert in Fashion but neither of them sits at the end of the row.
- O sits immediate right of the one who is expert in fashion.

From the above conditions, there are three possibilities

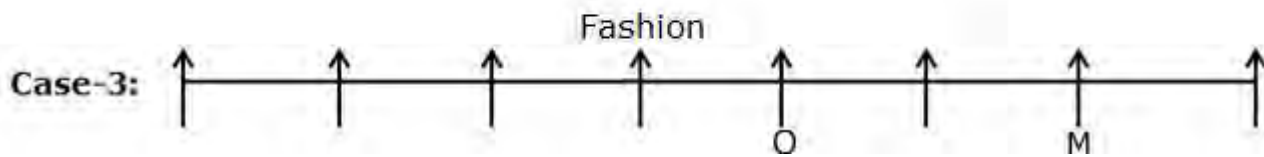
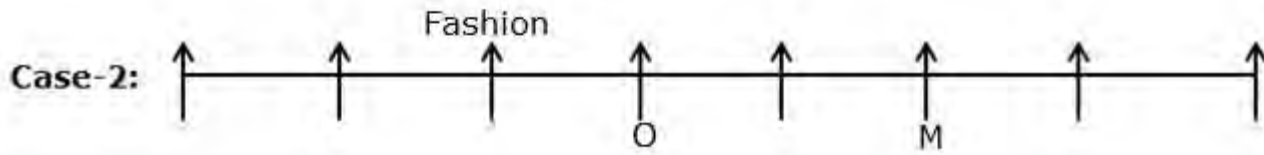
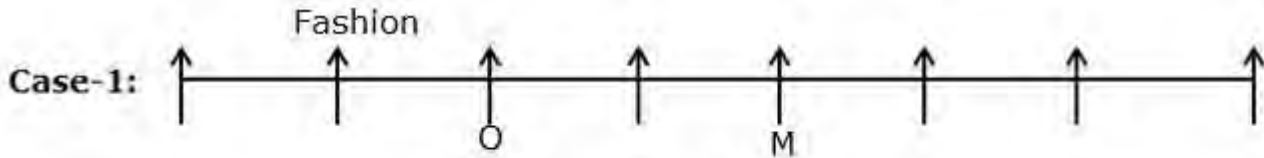

Again we have,

- H sits immediate left of the one who is expert in agriculture.
- Only one person sits between H and S, who doesn't sit adjacent to M.
- As many persons sit to the right of S as to the left of the science expert.
- F sits second to the right of the one who is expert in Science.

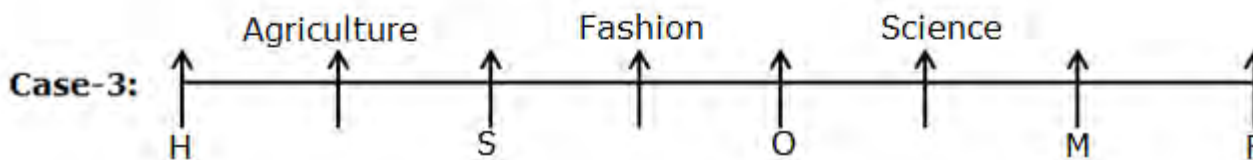
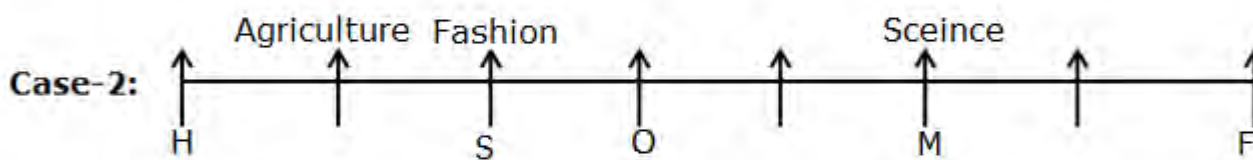
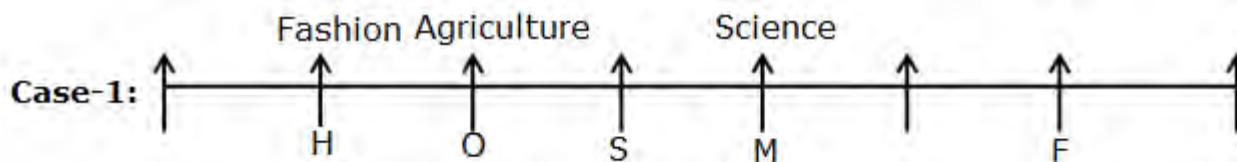

Again we have,

- The fitness expert sits immediate right of C.
- Only one person sits between C and the one who is expert in Arts.

- As many persons sit to the right of the medical expert as to the left of A, who is not expert in arts.
- The beauty expert sits immediate right of K.

After applying the above conditions case-1 and case-2 get eliminated, hence case-3 shows the final arrangement

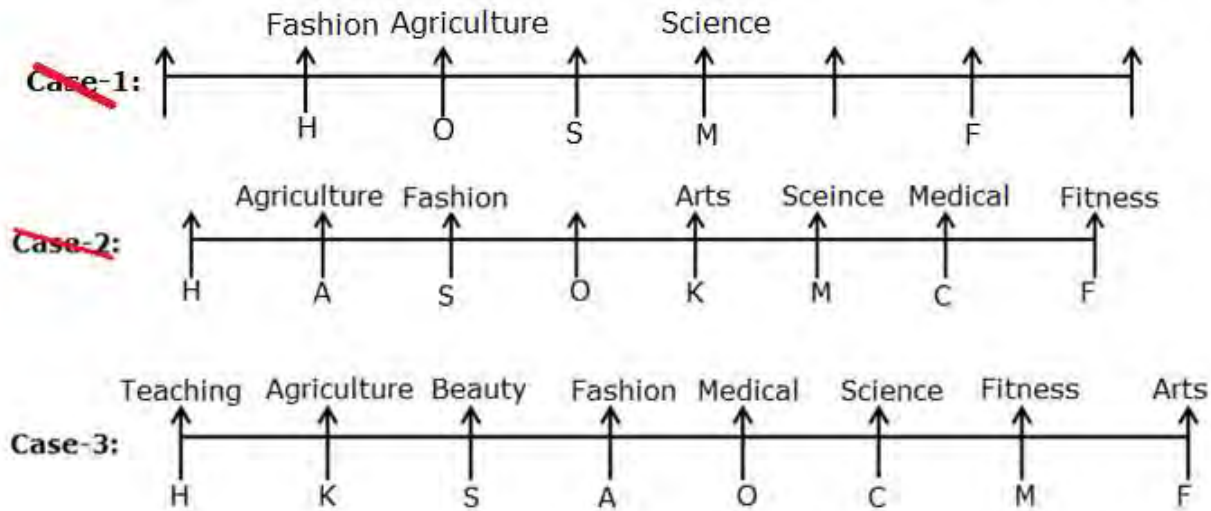

Set 10 (Clerk Mains)

Directions (46-50): Study the following information carefully and answer the questions given below

A certain number of persons are sitting in a row and all are facing north. Only eight persons sit between D and the one who likes dog. The one who likes rat sits three places away from D. The one who likes duck sits immediate left of the one who likes rat. C, who sits at one of the extreme ends of the row and sits sixth to the left of the one who likes duck. Only eleven persons sit between C and the one who likes cat. P sits third to the right of the one who likes cat. As many persons sit between the one who likes dog and P as between P and the one who likes horse. T sits four places away from the one who likes horse

and sits immediate left of B, who sits third from one of the extreme ends. More than fifteen persons sit between T and the one who likes cat.

46. How many persons are sitting in the row?

- 35
- 36
- 37
- 38
- 39

47. Who sits third to the right of the one who sits immediate right of the one who likes duck?

- The one who sits third to the left of P
- The one who sits second to the right of the one who likes cat.

- c) T
- d) The one who sits third to the right of the one who likes rat
- e) B

48. Which of the following statement is not false with respect to the final arrangement?

- a) The one who likes dog sits immediate left of C
- b) Only two persons sit to the left of the one who likes dog
- c) Two persons sit between D and P
- d) All the given statements are false
- e) All the given statements are true.

49. If Q sits exactly between P and the one who likes horse, then how many persons sits between Q and B?

- a) As many persons sit to the left of D
- b) Eleven
- c) As many persons sit between P and the one who likes cat
- d) Eight
- e) Both b and c

50. If the one who likes dog is related to the one who likes duck, D is related to P, then who/which is related to B?

- a) The one who likes dog
- b) T
- c) The one who likes horse
- d) C
- e) The one who likes cat

[Click Here to Get the Detailed Video Solution for the above given Questions](#)

Or Scan the QR Code to Get the Detailed Video Solutions



Answer Key with Explanation

Directions (46-50):

46. Answer: C

47. Answer: D

48. Answer: D

49. Answer: B

50. Answer: C

Final arrangement:

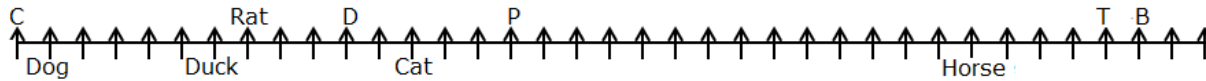

We have,

- Only eight persons sit between D and the one who likes dog.
- The one who likes rat sits three places away from D.
- The one who likes duck sits immediate left of the one who likes rat.
- C, who sits at one of the extreme ends and sits sixth to the left of the one who likes duck.

From above conditions, we have three possibilities:

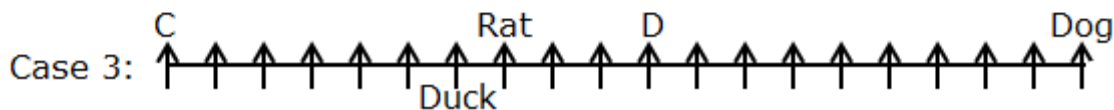
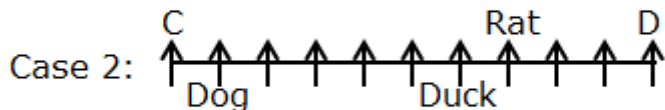
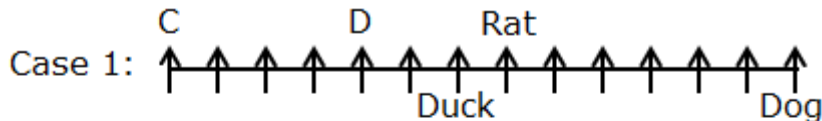

Again we have,

- Only eleven persons sit between C and the one who likes cat.
- P sits third to the right of the one who likes cat. As many persons sit between the one who likes dog and P as between P and the one who likes horse.

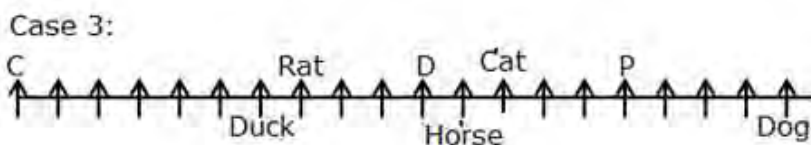
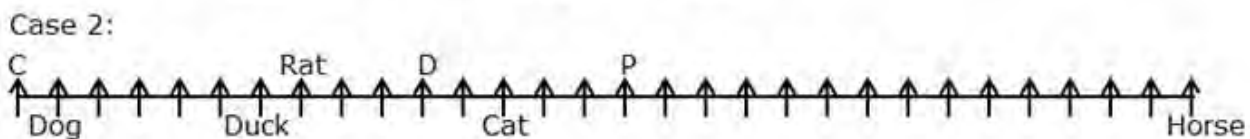
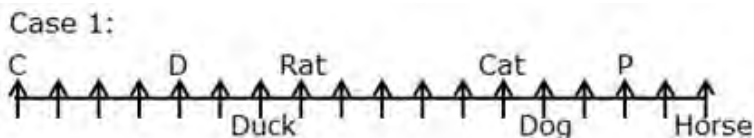

Again we have,

- T sits four places away from the one who likes horse and sits immediate left of B, who sits third from one of the extreme ends.
- More than fifteen persons sit between T and the one who likes cat.

While applying above conditions, case 1 and 3 gets eliminated. Thus, case 2 gives the final arrangement.

~~Case 1:~~

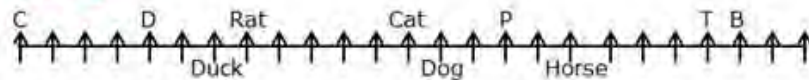

Case 2:

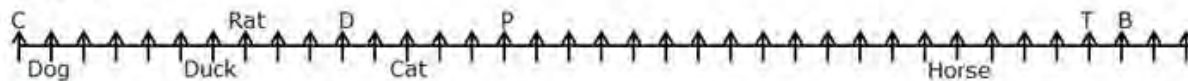

~~Case 3:~~

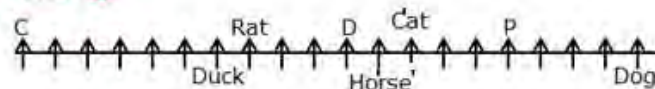

Set 11 (Clerk Mains)

Directions (51-55): Study the following information carefully and answer the questions given below.

Eight persons - B, D, H, K, P, R, V and Z are sitting in an eleven seated row such that there are three vacant seats and all of them are facing towards south, but not necessarily in the same order. None of the adjacent seats are vacant.

Z sits sixth to the right of P, where neither of them sits at the extreme ends of the row. Only two persons sit to the left of P. Neither Z nor P sits adjacent to D. K sits second to the right of D but doesn't sit adjacent seat of Z. D doesn't sit to the left of P. Only one person sits between P and R, who doesn't sit adjacent to K. The number of persons sitting between R and H is one less than the number of persons sitting between K and V, who sits adjacent to

one of the vacant seats. The number of persons sitting between Z and V is one more than the number of persons sitting between B and H. Not more than two vacant seats are there between B and V.

51. Who among the following person sits immediate right of K?

- Vacant seat
- The one who sits second to the left of R
- H
- The one who sits second to the right of P
- P

52. What is the position of V from the left end?

- Eighth
- Sixth
- Fourth
- Seventh

e) Third

53. How many persons are sitting between B and H?

- a) Two
- b) Four
- c) Three
- d) Six
- e) Five

54. Who among the following person sits adjacent to the vacant seat?

- a) The one who sits immediate right of V

b) B

- c) The one who sits second to the left of B
- d) The one who sits second to the right of P
- e) Both a and d

55. Which of the following statement(s) is/are true with respect to the final arrangement?

- a) Z sits adjacent to D
- b) Only two persons sit between D and V
- c) R sits immediate right of B
- d) One of the vacant seats is adjacent to H
- e) None of the statements is true

[Click Here to Get the Detailed Video Solution for the above given Questions](#)

Or Scan the QR Code to Get the Detailed Video Solutions



Answer Key with Explanation

Directions (51-55):

51. Answer: A

52. Answer: E

53. Answer: c

54. Answer: D

55. Answer: B

Final arrangement

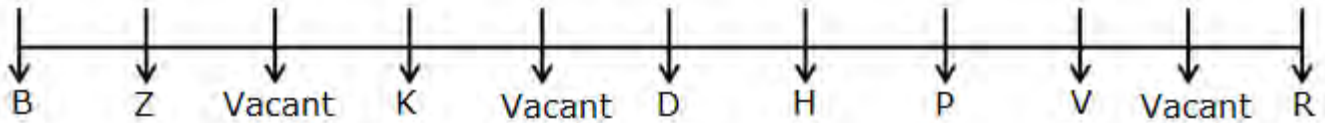

We have,

- Z sits sixth to the right of P, where neither of them sits at the extreme ends of the row.
- Only two persons sit to the left of P.

From the above conditions, there are four possibilities.

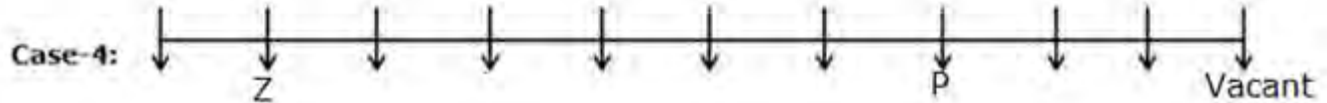
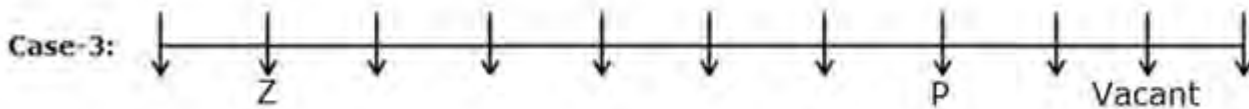
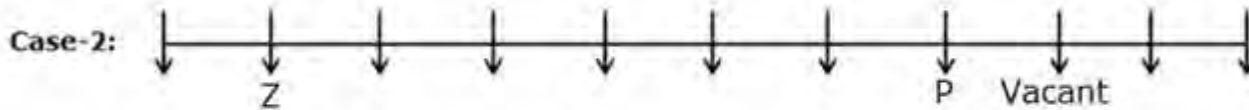
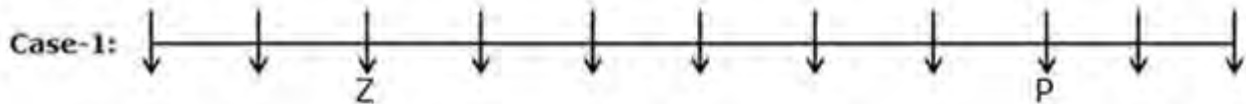

Again we have,

- Neither Z nor P sits adjacent to D.
- K sits second to the right of D but doesn't sit adjacent seat of Z.
- D doesn't sit to the left of P.
- Only one person sits between P and R, who doesn't sit adjacent to K.
- The number of persons sitting between R and H is one less than the number of persons sitting between K and V, who sits adjacent to one of the vacant seats.

From the above conditions, case 4 gets eliminated.

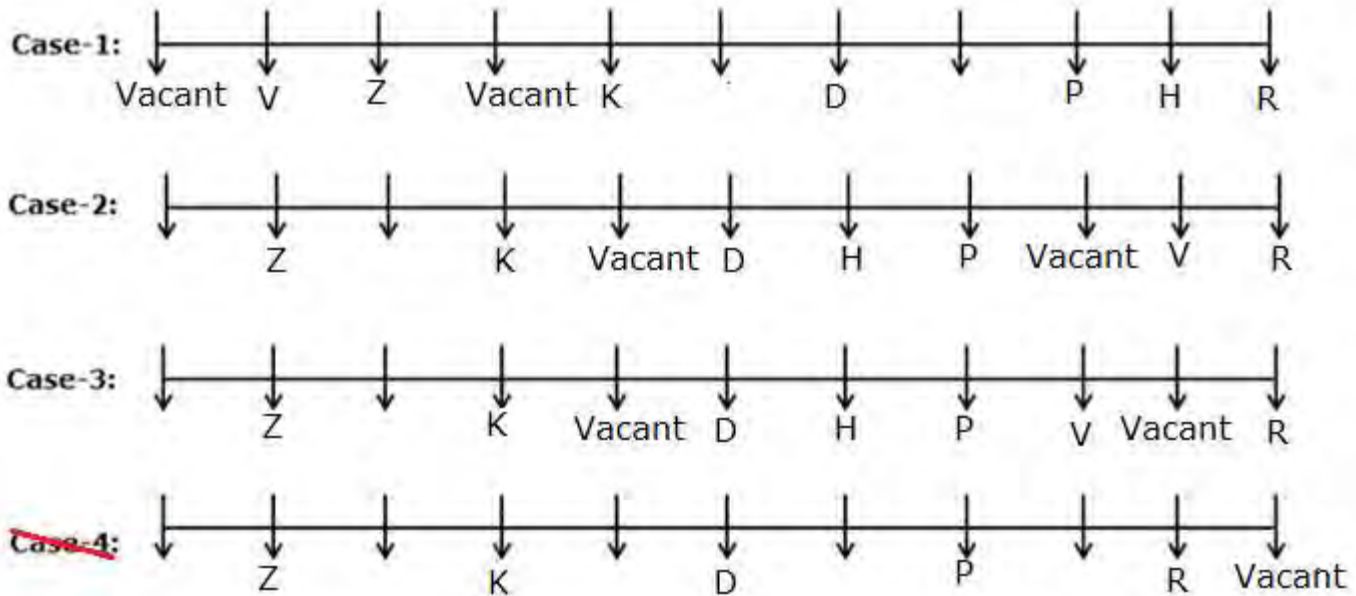

Again we have,

- The number of persons sitting between Z and V is one more than the number of persons sitting between B and H.
- Not more than two vacant seats are there between B and V.

From the above conditions, case 1 and case 2 get eliminated. Hence, case 3 shows the final arrangement.

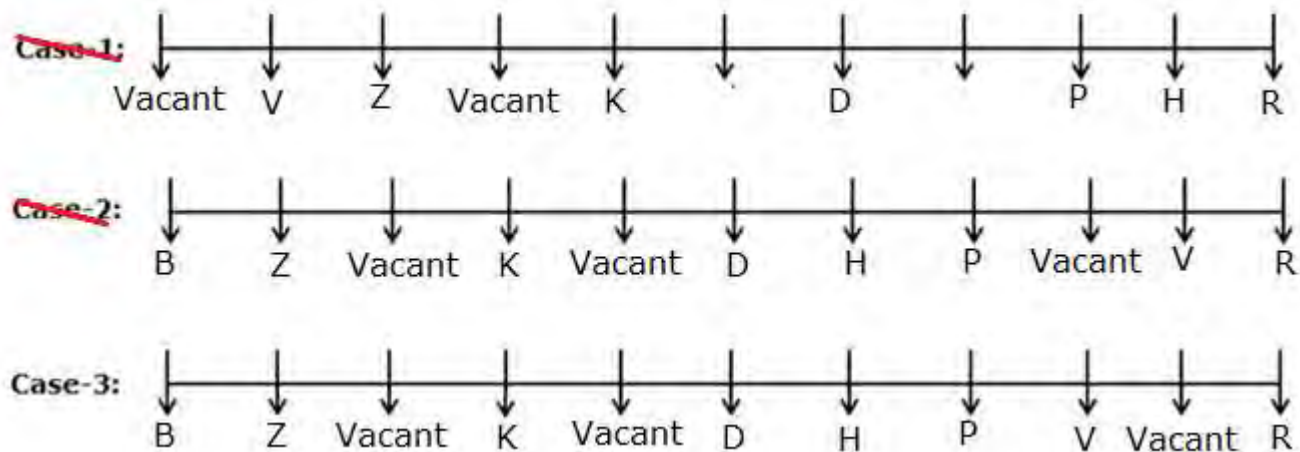

Set 12 (PO Mains)

Direction (56-60): Study the following information carefully and answer the given below.

Nine persons P, Q, R, S, T, U, V, W and X are sitting in a linear row facing towards the north. Distance between the adjacent persons is a

consecutive multiple of "5m" from the left end. The distance between the adjacent persons is not more than "45m".

The distance between V and U is 35m. S sits second to the right of U. The number of persons sitting between S and V is one less than the number of persons sitting between U and P. W sits 45m away from P. Q sits second to the right of T and the distance between Q and T is not more than 40m. As many persons sit between P and Q as between T and R. The distance between X and V is less than 75m. W walks for 30m towards south then takes a right turn of 25m to reach W'. S walks for 15m towards north and then takes a right turn of 50m to reach S'. U walks for 35m towards east and then takes a left turn and walks for 10m and then turns to the right and walks for 15m to reach U'. V walks for 40m towards south and then takes a left turn of 20m and then turns to the left and walks for 20m to reach V'.

56. What is the shortest distance between U and V'?

- a) 18
- b) 25
- c) 21
- d) 15
- e) 10

57. Who among the following person sits third to the right of X?

- a) The one who sits immediate left of T

- b) The one who sits 65m away from V
- c) P
- d) The one who sits second to the left of Q
- e) The one who sits 75m away from S

58. What is the direction and distance of S' with respect to W' in the final arrangement?

- a) 40m, North
- b) 40m, South
- c) 45m, North
- d) 42m, South
- e) None of these

59. How many persons sit to the left of S?

- a) Five
- b) Six
- c) Three
- d) Seven
- e) Two

60. Who among the following person sits immediate left of the one who sits northwest of V'?

- I. The one who sits third to the left of R
 - II. The one who sits 15m away from Q
 - III. The one who sits third to the left of U
- a) Only I and II
 - b) Only II and III
 - c) Only I
 - d) Only I and III
 - e) All I, II and III

[Click Here to Get the Detailed Video Solution for the above given Questions](#)

Or Scan the QR Code to Get the Detailed Video Solutions



Answer Key with Explanation

Direction (56-60):

56. Answer: B

57. Answer: E

58. Answer: C

59. Answer: A

60. Answer: B

Final arrangement

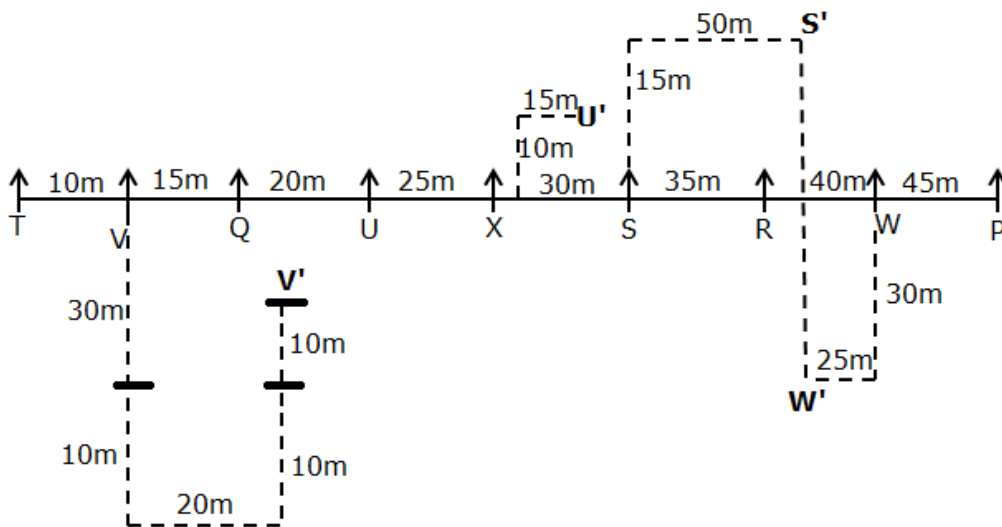

We have,

- The distance between V and U is 35m.
- S sits second to the right of U.

From the above condition, there are five possibilities

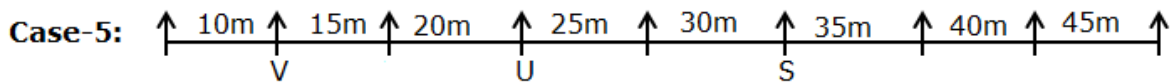
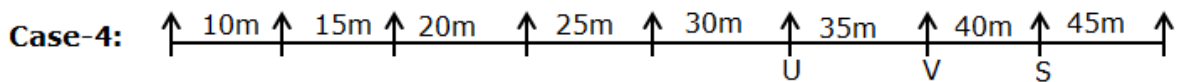
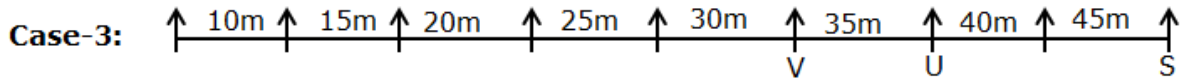
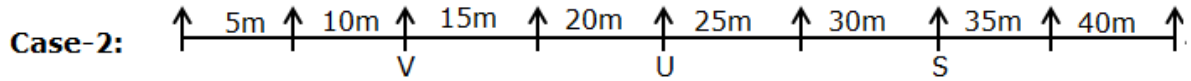
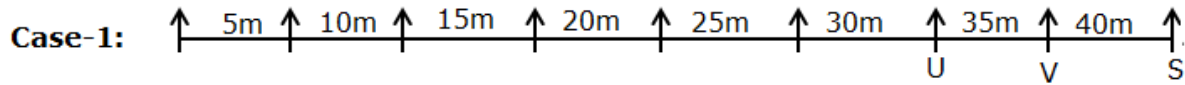

Again we have,

- The number of persons sitting between S and V is one less than the number of persons sitting between U and P.
- W sits 45m away from P.
- Q sits second to the right of T and the distance between Q and T is not more than 40m.

Here Case2 and 4 get eliminated

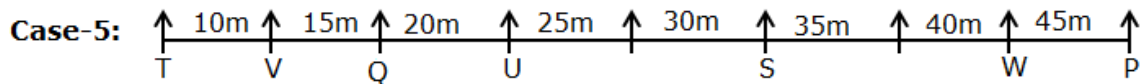
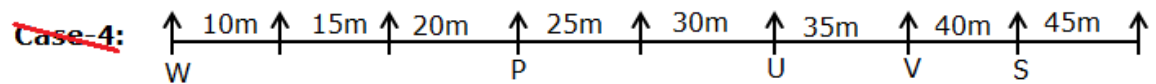
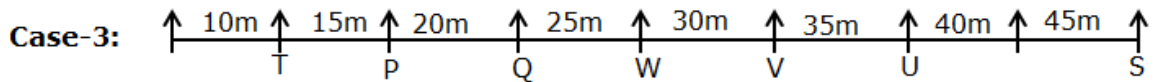
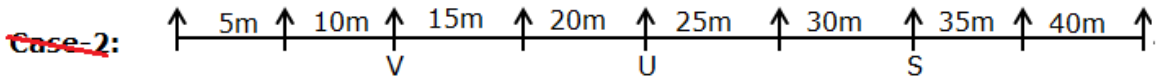
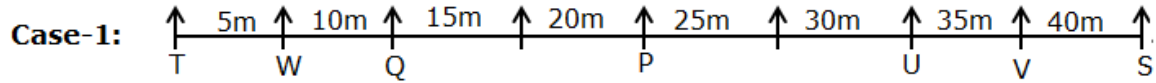

Again we have,

- As many persons sit between P and Q as between T and R.
- The distance between X and V is less than 75m.

So Case1 and 3 get eliminated, hence Case5 shows the final arrangement

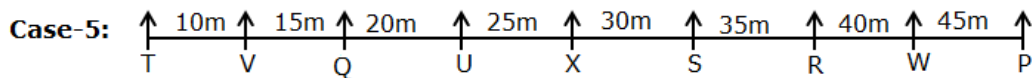
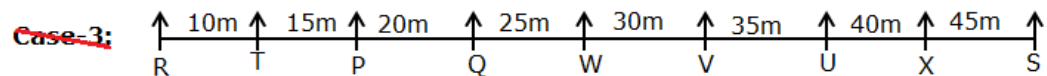
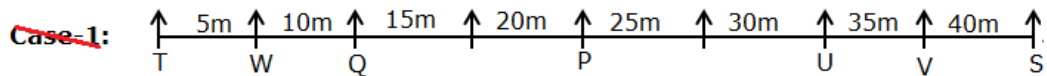

Again we have,

- W walks for 30m towards south then takes a right turn of 25m to reach W'.
- S walks for 15m towards north and then takes a right turn of 50m to reach S'.
- U walks for 35m towards east and then takes a left turn and walks for 10m and then turns to the right and walks for 15m to reach U'.

- V walks for 40m towards south and then takes a left turn of 20m and then turns to the left and walks for 20m to reach V'.

Based on the above given information we have the final arrangement as follows.

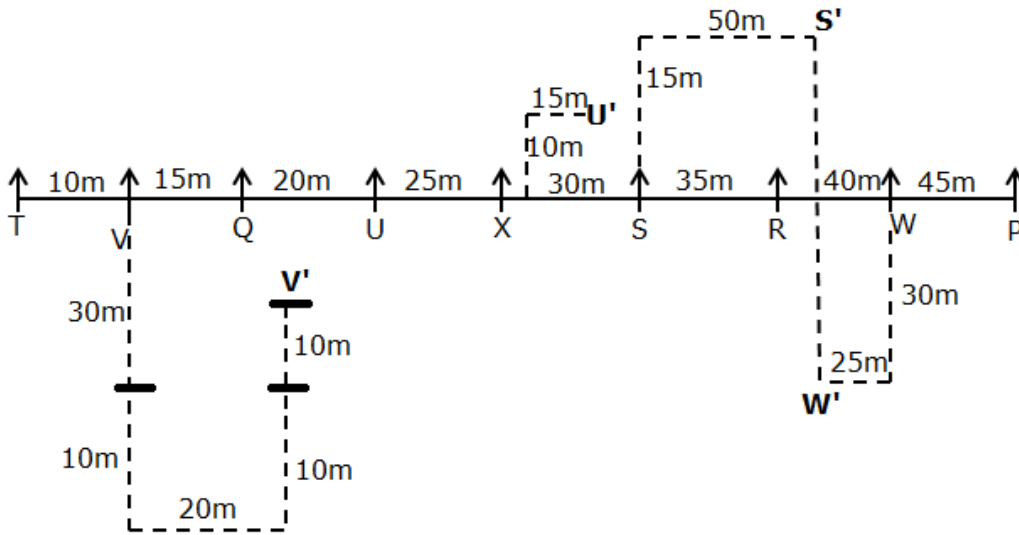

Set 13 (PO Mains)

Directions (61-65): Study the following information carefully and answer the questions given below.

Eight persons D, V, P, C, R, K, Z and X are sitting in a straight line and all are facing north but not necessarily in the same order. Each of them won different amounts which are in the multiples of 1000s. Their prize amount is mentioned in the coded format as follows.

A@B Means the prize amount of A is half of the prize amount of B.

A*B Means the prize amount of A is 20,000 more than that of B

A&B Means the difference between the prize amounts of A and B is 12,000(A>B)

A#B Means the sum of the prize amounts of A and B is 67,000

Only four persons sit between V and Z. R sits second to the left of Z, where R@Z. The prize amount of Z is Rs.46,000. The number of

persons sitting between R and V is one more than the number of persons sitting between D and P, where K&D. Neither R nor Z sits adjacent to P. Only two persons sit between P and K, who doesn't sit to the left of R. K's prize amount is 1000 less than the R's prize amount. The number of persons sitting to the right of P is one more than the number of persons sitting to the right of C, where P*X and C#V. The difference between the prize amounts of Z and D is same as the prize amount of P. C's prize amount is 3000 less than D. X doesn't sit adjacent to D.

61. What is the prize amount of the person who sits immediate left of X?

- Rs.50,000
- Rs.22000
- Rs.46000
- Rs.10000
- Rs.37000

62. Who among the following person sits second to the right of K?

- a) The one who won Rs.7000
- b) The one who sits immediate right of Z
- c) V
- d) The one who sits second to the right of P
- e) The one who won Rs.10000

63. The number of persons sitting between Z and D is same as ____.

- a) The number of persons sitting between K and R
- b) The number of persons sitting between C and K
- c) The number of persons sitting between X and R
- d) The number of persons sitting between V and X
- e) The number of persons sitting between P and Z

64. What is the sum of the prize amounts of the person who sits immediate left of R and the person who sits at the extreme right end?

- a) Rs.22000
- b) Rs.10000
- c) Rs.23000
- d) Rs.45000
- e) Rs.34500

65. Which of the following statement(s) is/are true with respect to the final arrangement?

I. V's prize amount is more than P's prize amount

II. Only two persons sit between V and D

III. X sits immediate right of Z

- a) Only I
- b) Only II and III
- c) Only III
- d) Only I and III
- e) All I, II and III

[Click Here to Get the Detailed Video Solution for the above given Questions](#)

Or Scan the QR Code to Get the Detailed Video Solutions



Answer Key with Explanation

Directions (61-65):

- 61. Answer: C
- 62. Answer: B
- 63. Answer: D
- 64. Answer: C
- 65. Answer: D

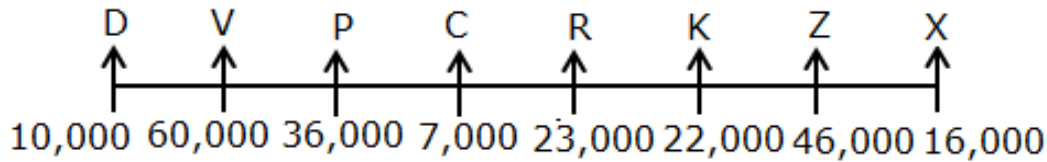

We have,

- Only four persons sit between V and Z.
- R sits second to the left of Z, where $R@Z$.
- The prize amount of Z is Rs.46,000.

Here Z's prize amount is Rs.46,000, so R's prize amount is Rs. 23000

From the above conditions, there are four possibilities

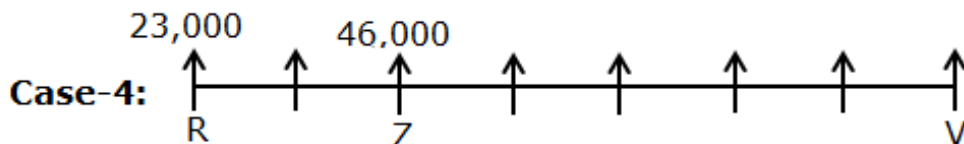
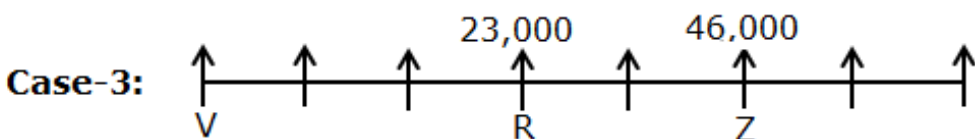

Again we have,

- The number of persons sitting between R and V is one more than the number of persons sitting between D and P, where $K\&D$.

- Neither R nor Z sits adjacent to P.
- Only two persons sit between P and K, who doesn't sit to the left of R.
- K's prize amount is 1000 less than the R's prize amount.

K's prize amount is 1000 less than the R's prize amount. So K's prize amount is 22,000, if K's prize amount is 22,000, then D's prize amount is 10,000

After applying the above conditions, Case3, 4 get eliminated

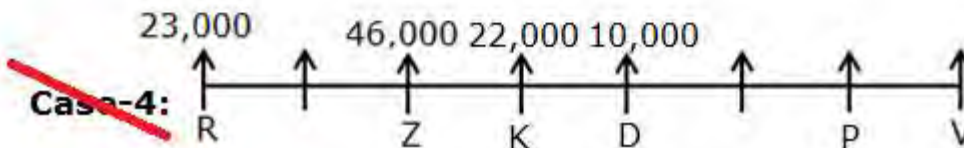
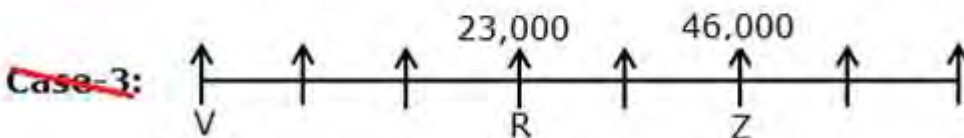
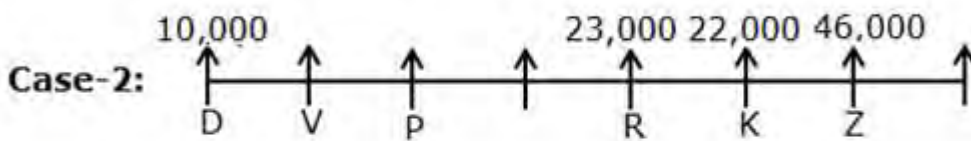
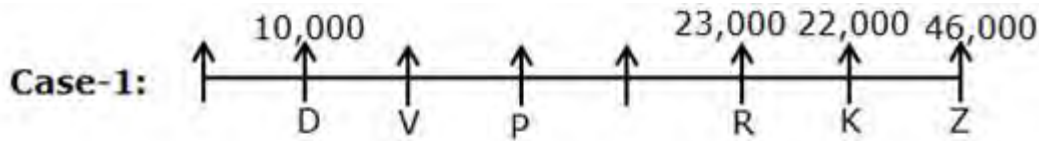

Again we have,

- The number of persons sitting to the right of P is one more than the number of persons sitting to the right of C, where $P \neq X$ and $C \neq V$.
- The difference between the prize amount of Z and D is same as the prize amount of P.
- C's prize amount is 3000 less than D.
- X doesn't sit adjacent to D.

Here, C's prize amount is 3000 less than that of D. Then C's prize amount is 7000. If C's prize amount is 7000, then V's prize amount is 60,000

The difference between the prize amounts of Z and D is 36000, then P's prize amount is 36,000, then X's prize amount is 16,000.

So Case1 gets eliminated, hence Case2 shows the final arrangement

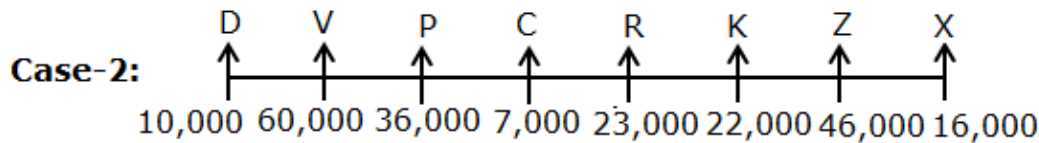
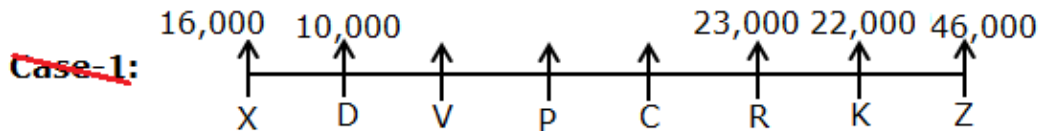

Set 14 (PO Mains)

Direction (66-70): Study the following information carefully and answer the given below.

Seven persons B, D, J, L, Q, V and Y are sitting in a linear row such that all of them are facing north. Distance between adjacent persons is a consecutive multiple of "6" from the left end. The distance between the adjacent persons is not more than "48m". All are of different ages.

Note: The ages of the person sitting together are neither a common factor nor a common multiple.

The distance between L and the one whose age is 14 is 42m. L sits second to the left of the one whose age is 9. Y sits 54m away from the one whose age is 22. Only two persons sit between D and the one whose age is 27. The number of persons sitting to the left of the one whose age is 27 is one more than the number of persons sitting to the right of Y. The distance between Q and D is not more than 40m. The number of persons sitting to the right of Q is one more than the number of persons sitting to the left of the one whose age is 17. The sum of the ages of J and Y is

57 years. The number of persons sitting between J and V is one less than the number of persons sitting between B and the one whose age is 35 years. The age of D is not 35 years.

66. As many persons sit to the left of B as to the right of ____.

- a) The one whose age is 22 years
- b) The one who sits 24m away from L
- c) D
- d) The one who sits second to the right of Q
- e) L

67. Who among the following person sits third to the right of the one whose age is 35 years?

- a) The one who sits 78m away from D
- b) B
- c) The one whose age is 27 years
- d) The one who sits immediate right of Y
- e) Both c and d

68. How many persons sit between the one whose age is 14 years and Q?

- a) No one

- b) Four
- c) Three
- d) One
- e) Two

- d) 57
- e) 44

69. What is the sum of the ages of the one who sits immediate left of D and Q?

- a) 41
- b) 32
- c) 22

70. What is the distance between Y and J?

- a) 120m
- b) 108m
- c) 152m
- d) 132m
- e) 90m

[Click Here to Get the Detailed Video Solution for the above given Questions](#)

Or Scan the QR Code to Get the Detailed Video Solutions



Answer Key with Explanation

Direction (66-70):

66. Answer: D

67. Answer: A

68. Answer: C

69. Answer: E

70. Answer: D

Final arrangement

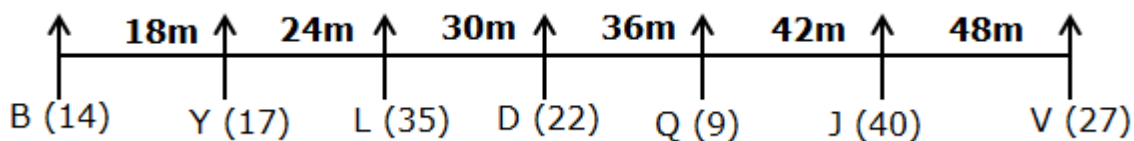

We have,

- The distance between L and the one whose age is 14 is 42m.
- L sits second to the left of the one whose age is 9.

From the above condition, there are four possibilities

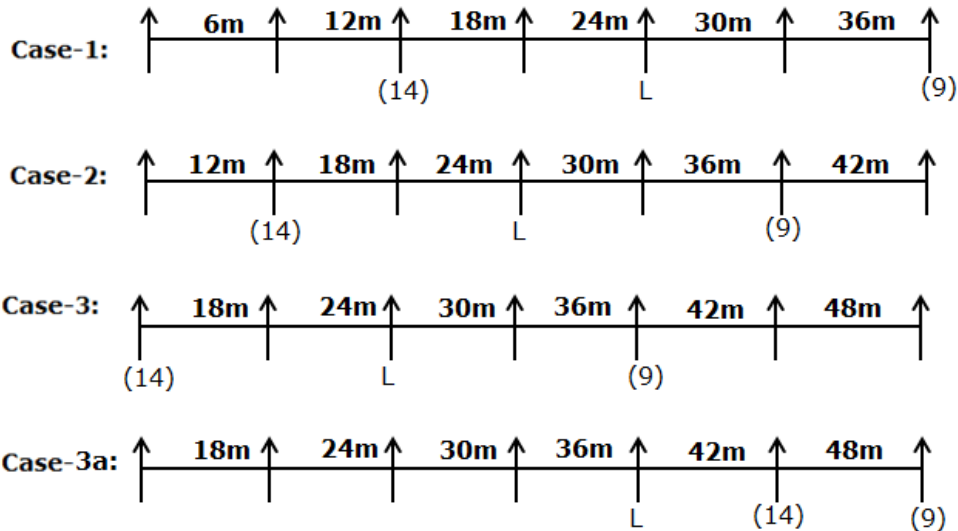

Again we have,

- Y sits 54m away from the one whose age is 22.
- Only two persons sit between D and the one whose age is 27.
- The number of persons sitting to the left of the one whose age is 27 is one more than the number of persons sitting to the right of Y.
- The distance between Q and D is not more than 40m.
- The number of persons sitting to the right of Q is one more than the number of persons sitting to the left of the one whose age is 17.

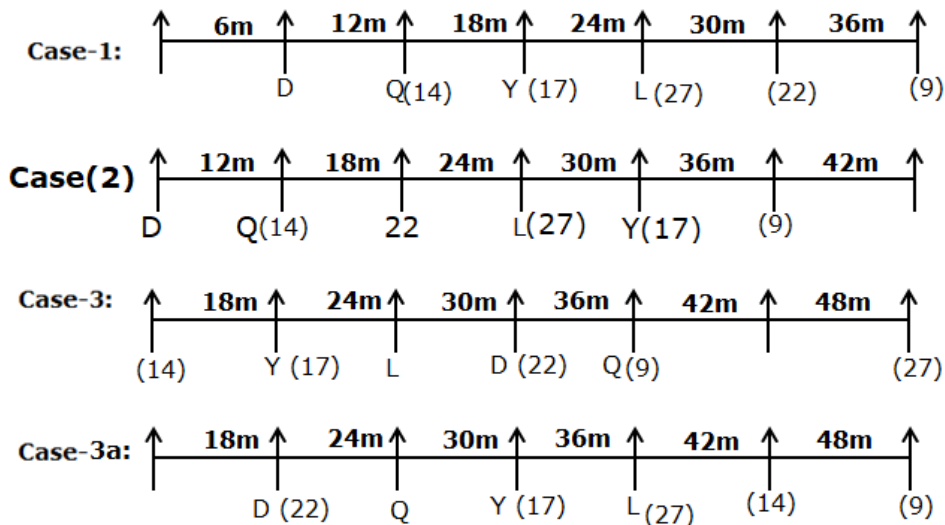

Again we have,

- The sum of the ages of J and Y is 57 years.
Since, age of Y in all above case is 17 years, thus age of J must be 40 years.
- The number of persons sitting between J and V is one less than the number of persons sitting between B and the one whose age is 35 years.
- The age of D is not 35 years.

From the above condition Case-1, case 2 and 3a get eliminated, hence Case-3 shows the final arrangement

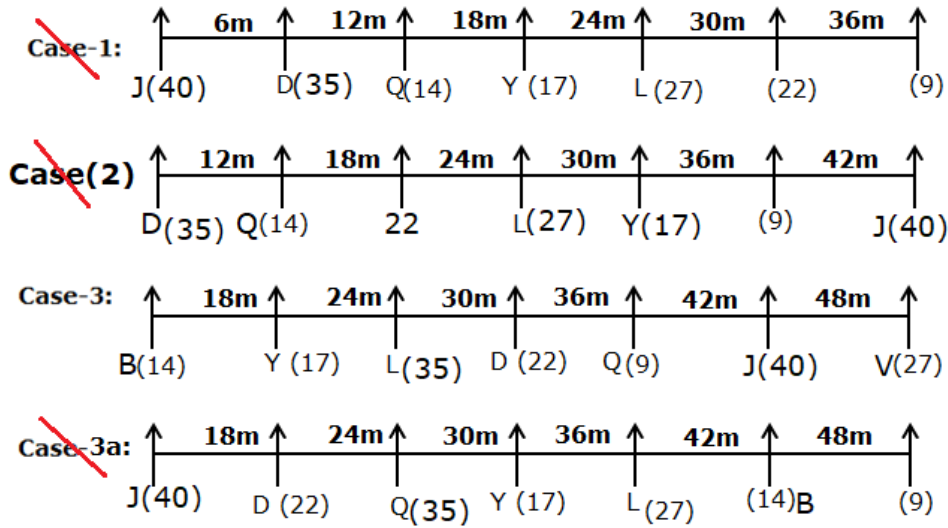

Set 15 (PO Mains)

Directions (71-75): Study the following information carefully and answer the below questions

A certain number of persons are sitting in a linear row facing the north. A family of nine members from three generations are sitting in a linear row. Information about only the family members is known.

Only five seats are between S and his father-in-law. S is the son-in-law of both Q and R. Only four seats are between R and his granddaughter, who is not P. R's granddaughter doesn't sit adjacent to S, who does not have any siblings. V's nephew sits to the immediate right of V's husband. Only two

seats are between V and her husband. V sits exactly in the middle of S and R. Y is from the second generation. Q, who is not the father-in-law of S, has two children both of them are married. T sits fifth to the right of Y's sister. T is the sister-in-law of V. Y and his maternal uncle are sitting at the extreme ends. Q sits second to the right of her son and second to the left of P's uncle. P is the child of Y and does not have any siblings. W has one niece and one nephew. U sits fourth to the left of W.

71) Who among the following sits second to the left of Q's daughter?

- V's spouse
- R's daughter in law

- c) T's son
- d) S's spouse
- e) V's father

72) How many seats are in the row?

- a) Nineteen
- b) Sixteen
- c) Twenty one
- d) Eighteen
- e) Twenty

73) Who among the following persons are the grandson and granddaughter of Q respectively?

- a) Y and V
- b) T and S
- c) U and T
- d) P and U
- e) W and V

74) Four of the following five are alike in a certain way as per the given arrangement and hence form a group. Find the one who doesn't belong to that group.

- a) The child of S
- b) The mother of P
- c) The sibling of W
- d) The sibling of Y
- e) The sibling of Q

75) What is the position of Y's wife with respect to V's uncle?

- a) Fourth to the left
- b) Third to the right
- c) Seventh to the left
- d) Ninth to the left
- e) Sixth to the right

[Click Here to Get the Detailed Video Solution for the above given Questions](#)

Or Scan the QR Code to Get the Detailed Video Solutions



Answer Key with Explanation

Directions (71-75):

71) Answer: C

72) Answer: E

73) Answer: D

74) Answer: E (W is different gender from all other options)

75) Answer: C

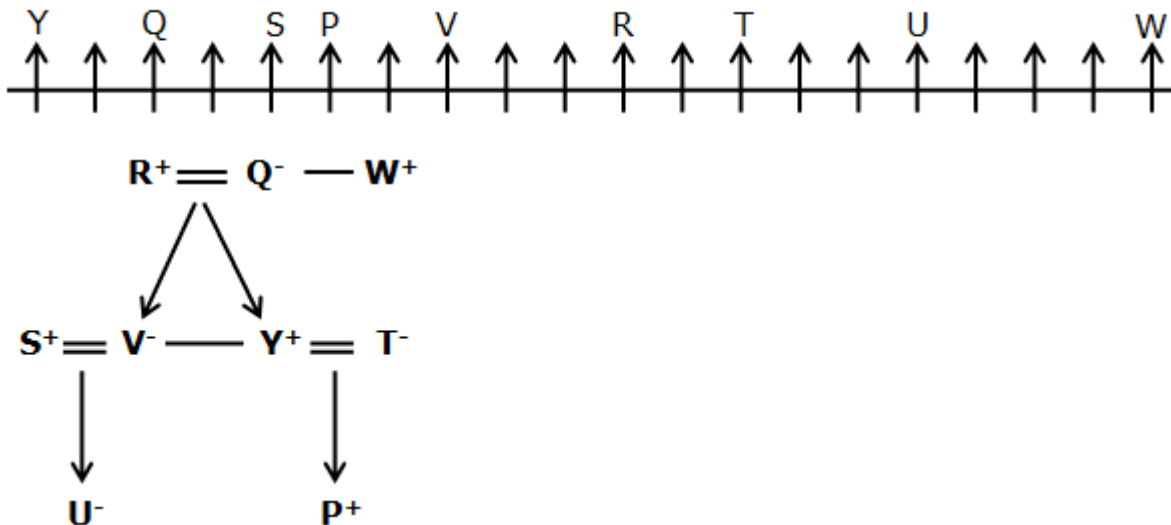

We have,

- Only five seats are between S and his father-in-law.
- S is the son-in-law of both Q and R.
- Only four seats are between R and his granddaughter who is not P.
- R's granddaughter doesn't sit adjacent to S, who does not have any siblings.
- V's nephew sits to the immediate right of V's husband.

guidely

Huge Selections in **SBI Clerk 2022-23**

Prime Bundle PDF Course 2023

Daily Targets

English & Hindi

Detailed Video Solutions*

PDF & Quiz Format*

12 Months Validity + 1 Year Mock Test + PDF Course 2022 (3 Months)

- ✓ Beginners Bundle Course
- ✓ Topic wise Bundle PDF Course
- ✓ Exam wise Bundle PDF Course
- ✓ Section wise Bundle PDF Course
- ✓ Memory Based Question Bundle Course
- ✓ Special Prelims Part Bundle PDF Course
- ✓ Mains Booster PDF Course

EXAMS COVERED:

120K

Questions

FLAT

70% OFF

Extra

10% Off

USE CODE
GUIDELY10

One Time Offer Ends Soon - Hurry !!!

Did You Know? → Guidely Users are finding pdf course very helpful in increasing their Accuracy and to boost up their preparation.

* Price will not be decreased below Rs. 1199/- | Special discount for Ultimate Bundle Users

From the above conditions there are four possibilities such that either R or Q will be the Father in

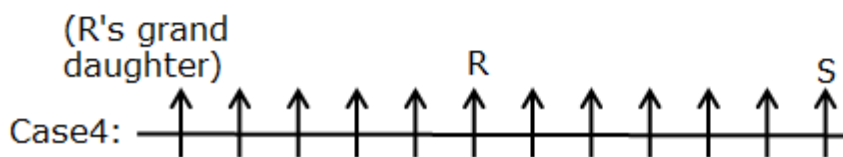
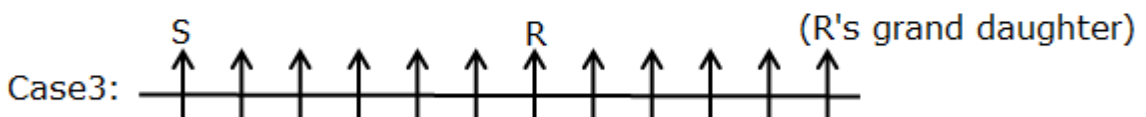
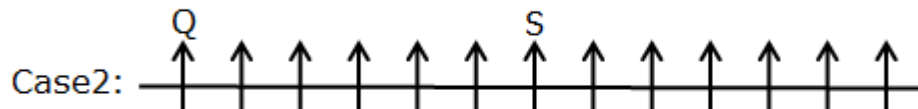

law of S.

Again we have,

- Only two seats are between V and her husband.
- V sits exactly in the middle of S and R.
- Y is from the second generation.
- Q who is not the father-in-law of S, has two children both of them are married.
- T sits fifth to the right of Y's sister.
- T is the sister-in-law of V.

From the above conditions case1 and case2 get eliminated because Q is not the father-in-law of S. In addition to that Y is from the second generation and V has a nephew. Hence V will be in second generation and V is the wife of S.

T is the sister-in-law of V hence Y and T are couples.

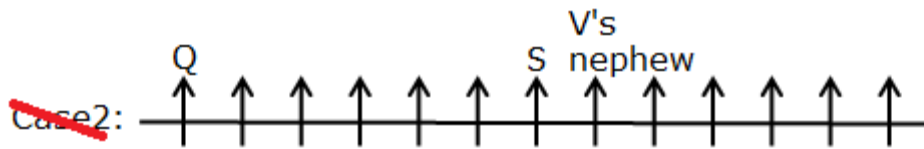
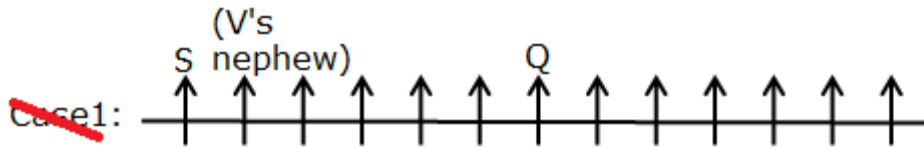

Again we have,

- Y and his maternal uncle are sitting at the extreme ends.
- Q sits second to the right of her son and second to the left of P's uncle.
- P is the child of Y and does not have any siblings.
- W has one niece and one nephew.
- U sits fourth to the left of W.

From the above conditions, Case4 gets eliminated.

Y's maternal uncle is W because he has one niece and nephew. W is the brother of Q. Y is the son of Q.

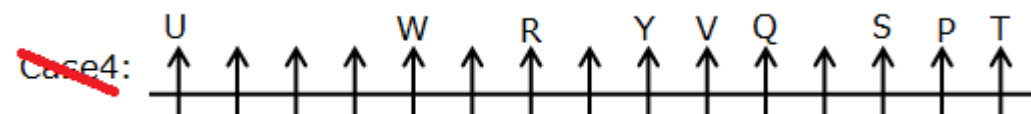
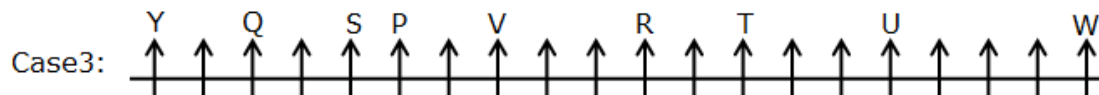

Family tree:

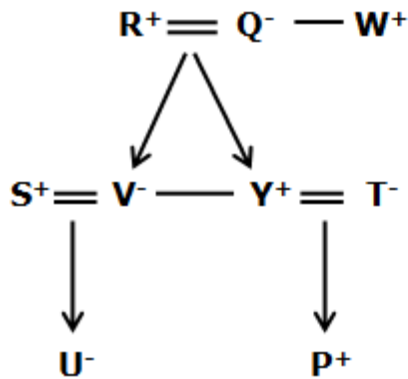

- Siblings
- == Married Couples
- (-) Female
- (+) Male

Set 16 (Clerk Mains)

Directions (76-80): Study the following information carefully and answer the below questions.

Seven persons – P, Q, R, S, T, U, and V are from the same family of three generations and sitting in a linear row facing the north. Two married couples are there in the family. Either both or none of the parents are alive.

U is the sister-in-law of V, and vice-versa. P's father sits second from the left end. Only two persons are sitting between P's father and U. One person sits between U and P, who is the father of S. S sits third to the left of T and is the only son of V's brother. Only one person sits between S and Q, who is the granddaughter of T. The gender of T and S is not the same. P's wife and V's mother are not sitting together.

76) What is the position of S with respect to P's sister?

- a) Immediate left
- b) Third to the right
- c) Second to the left
- d) Fourth to the right
- e) None of these

77) How S is related to U?

- a) Daughter-in-law
- b) Nephew
- c) Son
- d) Brother-in-law
- e) None of these

78) How many persons are sitting between P and R's wife?

- a) As many persons are sitting between U and Q's aunt
- b) One
- c) As many persons are sitting to the right of R
- d) Two
- e) None of these

79) Who among the following is the daughter of T?

- a) The one who sits immediate left of R
- b) The one who sits second to the right of S
- c) The one who sits at the left end
- d) Both A and C
- e) None of these

80) Which of the following statement is true?

- a) P is the father of the one who sits third to the right of R
- b) S is the sister-in-law of V

- c) Q sits immediate right of R's daughter-in-law
- d) Four persons are sitting between S and V
- e) None of the statements are true

[Click Here to Get the Detailed Video Solution for the above given Questions](#)

Or Scan the QR Code to Get the Detailed Video Solutions



Answer Key with Explanation

Directions (76-80):

- 76. Answer: B
- 77. Answer: C
- 78. Answer: A
- 79. Answer: D
- 80. Answer: C

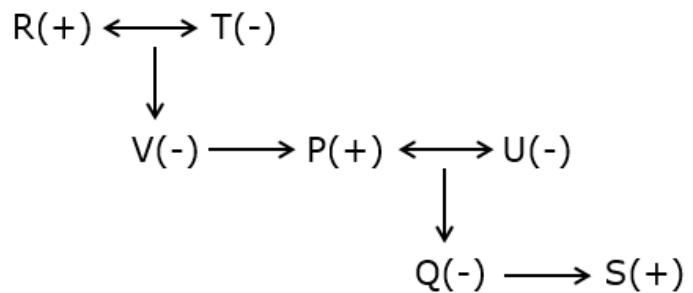
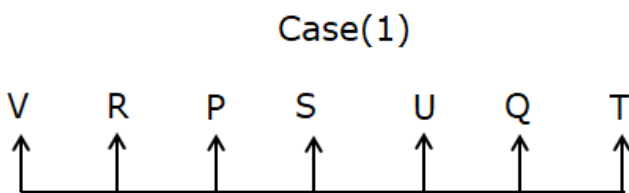

We have:

- U is the sister-in-law of V, and vice-versa.
- P's father sits second from the left end.
- Only two persons are sitting between P's father and U.
- One person sits between U and P, who is the father of S.

That means, in case (1) P sits second to the left of U, in case (2) P sits second to the right of U.

Based on the above given information we have:

Case(1)

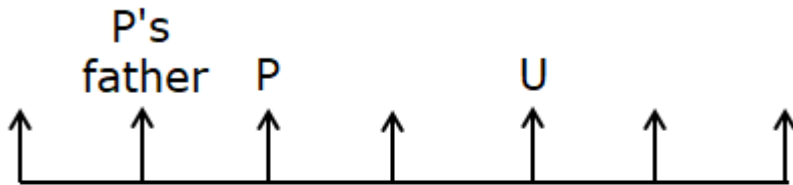

Case(2)

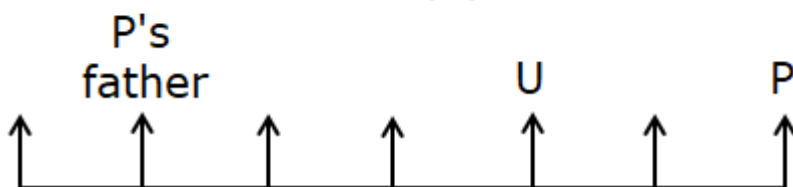

Again, we have:

- S sits third to the left of T and is the only son of V's brother.
- Only one person sits between S and Q, who is the granddaughter of T.
- The gender of T and S is not the same.
- P's wife and V's mother are not sitting together.

That means, in case (1) T sits at the right end, and Q must be the sister of S, case (2) is not valid.

Based on the above given information we have:

Case(1)

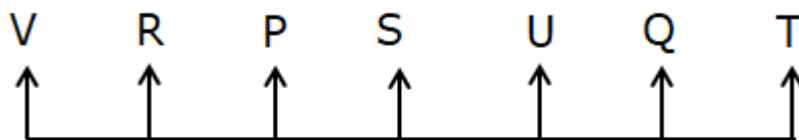

~~Case(2)~~

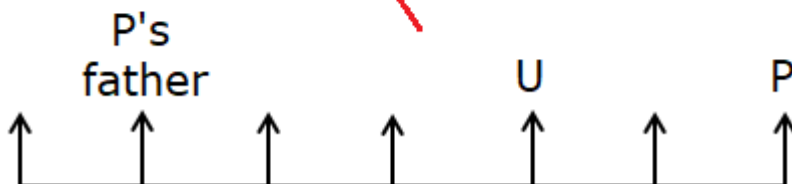

Case (2) is not valid as T and U are not sitting together.

For Blood Relation:

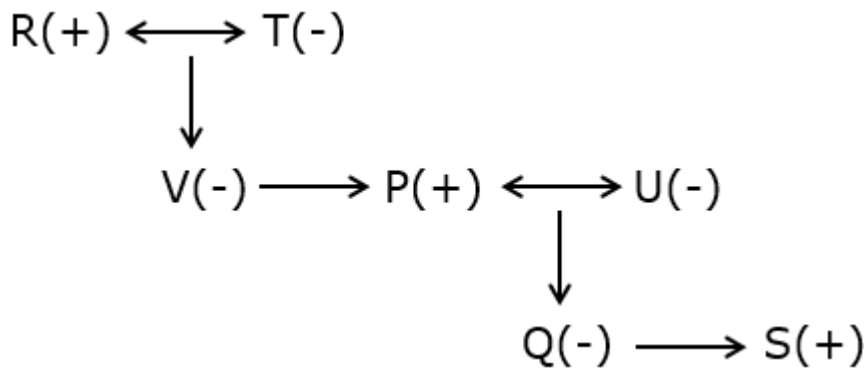

Set 17 (PO Mains)

Directions (81-85): Study the following information carefully and answer the below questions.

A certain number of persons are sitting in a linear row from north to south facing towards east. The distance between the adjacent persons from the north end is a consecutive multiple of '3' in meters. The distance between none of the adjacent persons is more than 54m. The total length of the row is not more than 232m.

M sits 45m to the left of the one who likes Tea. The one who likes Tea sits fifth to the left of K, who likes Soda. The one who sits to the immediate left of M, sits three places away from the one who likes Chips. N sits fourth to the left of the one who likes Kheer, where none of them sits adjacent to M. Not more than three persons are sitting between the one who likes Kheer and the one who likes Chips. The number of persons sitting between M and the one who likes Kheer is two more than the number of persons sitting to the right of the one who likes Kheer. Only four persons are

sitting between H and W, where none of them sits at the end of the row. Neither N nor M sits adjacent to W. W doesn't like Kheer. The number of persons sitting between K and W is one more than the number of persons sitting between the one who likes Tea and the one who likes Halwa.

81) What is the position of N with respect to the one who likes Halwa?

- a) Immediate right
- b) Second to the right
- c) Fourth to the left
- d) Third to the right
- e) None of these

82) How many persons are sitting in the row?

- a) Twelve
- b) Nine
- c) Fifteen
- d) Eleven
- e) None of these

83) Who among the following persons are sitting between M and the one who sits fourth to the right of N?

I. The one who sits to the immediate left of the one who likes Tea.

II. W

III. The one who likes Kheer.

- a) Only III
- b) Both II and III
- c) Both I and II
- d) All I, II, and III
- e) None of these

84) Who among the following person sits to the immediate left of the one who likes Kheer?

- a) The one who sits second to the right of W
- b) The one who likes Tea

- c) The one who sits third to the left of the one who likes Soda
- d) Either A or C
- e) None of these

85) Which of the following statement is/are not true with respect to the final arrangement?

I. The one who likes Halwa sits fourth from the left end.

II. Only one person sits between the one who likes Kheer and the one who likes Chips.

III. N sits 21m away from the one who likes Chips.

- a) Both I and III
- b) All I, II, and III
- c) Only II
- d) Only III
- e) None of these

[Click Here to Get the Detailed Video Solution for the above given Questions](#)

Or Scan the QR Code to Get the Detailed Video Solutions



Answer Key with Explanation

Direction (81-85):

81. Answer: B
 82. Answer: A
 83. Answer: C
 84. Answer: C
 85. Answer: B

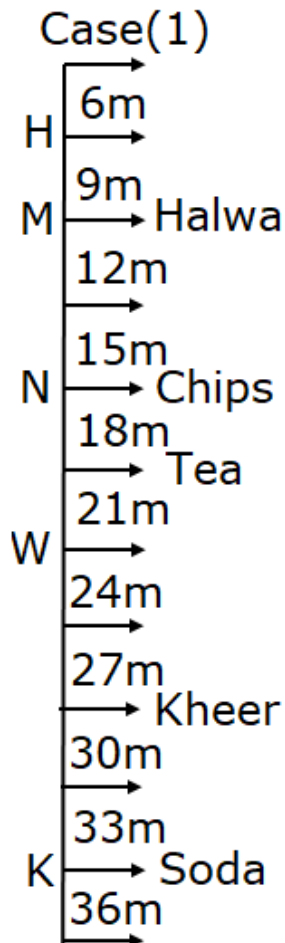

We have:

- M sits 45m to the left of the one who likes Tea.
- The one who likes Tea sits fifth to the left of K, who likes Soda.
- The one who sits to the immediate left of M, sits three places away from the one who likes Chips.

Since, only such possible combinations are (12, 15, 18)m, (21, 24)m, and 45m. That means, in case (1), M sits second to the left of the one who likes chips, who sits to the immediate left of the one who likes Tea, in case (2), the one who likes Chips sits fourth to the left of M, who sits second to the left of the one who likes Tea. Case (2) is not valid since the total length of the row is not more than 232m.

Based on the above given information we have:

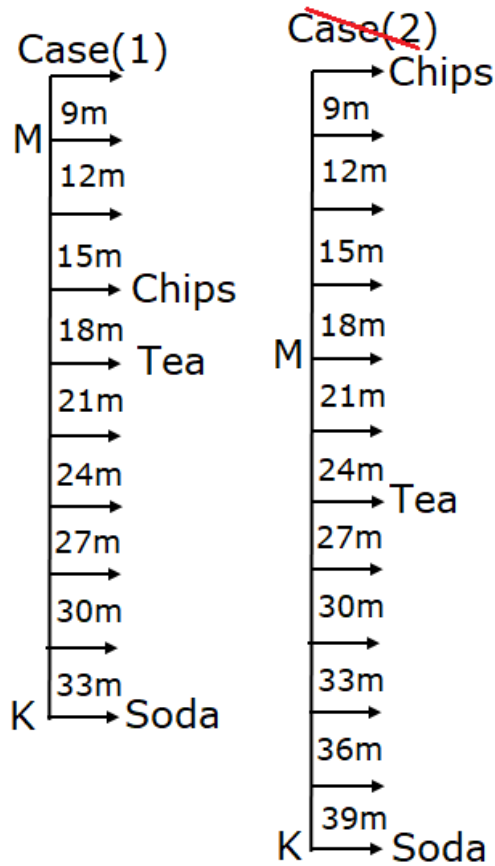

Again, we have:

- N sits fourth to the left of the one who likes Kheer, where none of them sits adjacent to M.
- Not more than three persons are sitting between the one who likes Kheer and the one who likes Chips.
- The number of persons sitting between M and the one who likes Kheer is two more than the number of persons sitting to the right of the one who likes Kheer.

That means, in case (1) N likes Chips, and the one who likes Kheer sits second to the left of K.

- Only four persons are sitting between H and W, where none of them sits on the end of the row.
- Neither N nor M sits adjacent to W.
- W doesn't like Kheer.

That means, in case (1) H sits to the immediate left of M

- The number of persons sitting between K and W is one more than the number of persons sitting between the one who likes Tea and the one who likes Halwa.

That means, M likes Halwa.

Based on the above given information we have:

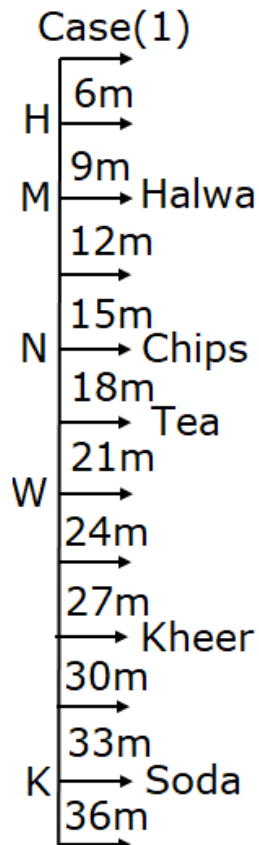





Huge Selections in **SBI Clerk 2022-23**

Prime Bundle PDF Course 2023

Daily Targets

English & Hindi

Detailed Video Solutions*

PDF & Quiz Format*

EXAMS COVERED:





- ✓ Beginners Bundle Course
- ✓ Topic wise Bundle PDF Course
- ✓ Exam wise Bundle PDF Course
- ✓ Section wise Bundle PDF Course
- ✓ Memory Based Question Bundle Course
- ✓ Special Prelims Part Bundle PDF Course
- ✓ Mains Booster PDF Course

120K

Questions

FLAT

70% OFF

Extra 10% Off

USE CODE

GUIDELY10

One Time Offer Ends Soon - Hurry !!!

DID YOU KNOW? Guidely Users are finding pdf course very helpful in increasing their Accuracy and to boost up their preparation.

* Price will not be decreased below Rs. 1199/- | Special discount for Ultimate Bundle Users

RBI Assistant Prelims Memory Based Paper

(Memory Based Paper Held on 26th March 2022)

Reasoning Ability

Directions (1-5): Study the following information carefully and answer the questions given below.

Eight persons - L, M, N, O, P, Q, R and S are living in a four storey building where the lowermost floor is numbered as one and the floor immediately above it is numbered as two and so on.

Note-I: Each floor has two flats viz., Flat-A and Flat-B, where Flat A is to the west of flat B.

Note-II: Flat B of floor 2 is immediately above Flat B of floor 1 and immediately below Flat B of floor 3 and so on.

Q lives on a prime numbered floor of Flat A. The one who lives immediately above Q lives to the west of R. Only one floor is between R and N. S lives immediate northeast of N. As many floors above S as below M. L lives above O, where both of them live in the same flat. P doesn't live on the same floor as O.

1. Who among the following person lives on the topmost floor?

- a) The one who lives immediately above O
- b) R
- c) M
- d) The one who lives northwest of R
- e) N

2. In which of the following floor and flat does P live?

- a) Flat B, Floor 4
- b) Flat B, Floor 3
- c) Flat A, Floor 4
- d) Flat B, Floor 2
- e) Flat A, Floor 1

3. Four of the following five are alike in a certain way based on the given

arrangement and thus form a group. Which one of the following does not belong to the group?

- a) M
- b) S
- c) N
- d) Q
- e) P

4. As many floors above O as below_____.

- a) P
- b) Q
- c) S
- d) L
- e) Both a and d

5. Which of the following statement(s) is/are true with respect to the final arrangement?

- a) Q lives immediate northwest of O
- b) Only one floor is between M and P
- c) No one lives below S
- d) L lives immediate northeast of Q
- e) None is true

6. How many such pairs of letters are there in the word "PRESTIGE" each of which has as many letters between them in the word as there are in the English alphabetical series (both forward and backward directions)?

- a) One
- b) Two
- c) Three
- d) More than three
- e) None

Directions (7-11): Study the following information carefully and answer the questions given below.

B 7 A S & K 2 E C # 1 6 * M \$ X D 3 V 5 % 4 0
J 9 Y 1 © 8 L

7. If all the symbols in the given series are dropped, then which of the following element will be twelfth from the right end?

- a) X
- b) 3
- c) V
- d) 5
- e) D

8. How many such vowels are there in the given series each of which is immediately preceded by a number and immediately followed by a consonant?

- a) Two
- b) Four
- c) Three
- d) One
- e) None

9. Which of the following element is eighth to the right of the twenty-first element from the right end in the given series?

- a) *
- b) M
- c) V
- d) 3
- e) 2

10. Find the next element in the series.

7AS, K2E, I6*,?

- a) 3V5
- b) D3V
- c) *M\$
- d) V5%
- e) VE3

11. How many letters which come before M in the alphabetical series are between the elements which are eighth from both left and right ends of the given series?

- a) Two
- b) One
- c) Three
- d) More than three

e) None

Directions (12-16): Study the following information carefully and answer the questions given below.

Seven persons - A, B, C, D, E, F and G are visiting a shop on seven different days of the same week starting from Monday to Sunday.

Only three persons visit between G and D, where G visits before D. E visits immediately after D. As many persons visit before E as after B. Only one person visits between B and C. A visits either immediately before or immediately after C. F doesn't visit the shop on Sunday.

12. Who among the following person visits the shop on Thursday?

- a) G
- b) E
- c) C
- d) A
- e) B

13. How many persons visit between F and G?

- a) One
- b) As many persons visit between A and E
- c) Three
- d) More than three
- e) As many persons visit between B and G

14. On which of the following day does D visit the shop?

- a) Monday
- b) Wednesday
- c) Friday
- d) Tuesday
- e) Saturday

15. Which of the following combination is true?

- a) B-Thursday
- b) G-Monday
- c) C-Wednesday
- d) D-Friday

e) E-Saturday

16. If B is related to A and C is related to D in a certain way, then in the same way who among the following person is related to F?

- a) E
- b) D
- c) A
- d) G
- e) C

Directions (17-21): Study the following information carefully and answer the questions given below.

Eight persons - P, Q, R, S, T, U, V and W bought the products one after another but not necessarily in the same order.

Only two persons bought between V and S. U bought immediately after S. As many persons bought between U and V as between S and R. T bought two persons after R. Only four persons bought between T and W. Q bought immediately before W. P bought three persons before Q.

17. Who among the following person bought three persons after V?

- a) R
- b) Q
- c) W
- d) S
- e) P

18. Which of the following statement(s) is/are not true with respect to the final arrangement?

- a) U bought immediately after R
- b) W bought two persons after U
- c) Only two persons bought between P and R
- d) Q bought after P
- e) All the statements are not true

19. Who among the following person bought immediately before V?

- a) W
- b) S
- c) U

d) R

e) Q

20. Four of the following five are alike in a certain way based on the given arrangement and thus form a group. Which one of the following does not belong to the group?

- a) VT
- b) SW
- c) QW
- d) RV
- e) PS

21. If all the persons bought the products in alphabetical order from the first, then how many persons remain unchanged in their position?

- a) Four
- b) Three
- c) One
- d) None
- e) Two

Directions (22-25): Study the following information carefully and answer the questions given below.

In a certain code language,

“Dance song tradition well” is coded as “qw lt er bn”

“Cultural function dance level” is coded as “ui yh lt pl”

“Tradition dress offer function” is coded as “sd pl mj bn”

“Song cultural well organizer” is coded as “yh qw er mn”

(Note: All the given codes are two letters code only)

22. What does the code “mn” represents in the given code language?

- a) Song
- b) Well
- c) Cultural
- d) Organizer
- e) None of these

23. What is the code for the phrase “Level well” in the given code language?

- a) qw ui
- b) yh qw
- c) ui er
- d) pl lt
- e) Cannot be determined

24. What does the code “bn lt” represents in the given code language?

- a) Cultural organizer
- b) Dress function
- c) Level well
- d) Function song
- e) Tradition dance

25. If “Offer level” is coded as “ui sd” in the given code language, then what is the code for the phrase “cultural dress” in the given code language?

- a) pl mn
- b) ui sd
- c) yh mj
- d) bn sd
- e) Cannot be determined

26. If it is possible to make a four letter meaningful word from the second, fourth, sixth and tenth letters of the word “ABSORPTION” using each letter only once, then which of the following will be the third letter from the right end of the newly formed word? If more than one such word can be formed, your answer is “X” and if no such word can be formed, your answer is “Y”.

- a) P
- b) X
- c) Y
- d) O
- e) B

27. If 1 is added to the even digits of the given number “548576231” and the odd digits remain unchanged, then what is the

sum of the highest and lowest digit of the newly formed number?

- a) 12
- b) 16
- c) 20
- d) 10
- e) 11

Directions (28-31): Study the following information carefully and answer the questions given below.

Eight persons - D, E, F, G, H, I, J and K are sitting in a linear row and facing north but not necessarily in the same order.

D sits second from one of the extreme ends. Only three persons sit between D and J, who sits second to the left of G. As many persons sit to the left of G as to the right of F. K sits fourth to the right of I. H is an immediate neighbour of I. E doesn't sit at the extreme end of the row.

28. How many persons sit between E and I?

- a) One
- b) Two
- c) Three
- d) More than three
- e) None

29. Who among the following person sits second to the left of H?

- a) F
- b) I
- c) D
- d) K
- e) J

30. If all the persons are made to sit in the alphabetical order from the right end, then who among the following person remain unchanged in their position?

- a) J
- b) H
- c) K
- d) I
- e) Both b and d

31. If D is related to H and E is related to K in a certain way, then in the same way who among the following person is related to I?

- a) H
- b) E
- c) G
- d) F
- e) J

Directions (32-33): Study the following information carefully and answer the questions given below.

D is the mother of O, who is the brother-in-law of J. J doesn't have any siblings. B is the father-in-law of J. M is married to J. B has only one son. F is the daughter of M.

32. If T is the spouse of F, then how is M related to T?

- a) Mother
- b) Father
- c) Nephew
- d) Mother-in-law
- e) Cannot be determined

33. How is O related to F?

- a) Brother-in-law
- b) Sister-in-law
- c) Maternal uncle
- d) Paternal uncle
- e) Brother

Directions (34-35): Study the following information carefully and answer the questions given below.

Point B is 10m west of point C, which is 4m north of point D. Point D is 12m east of point E. Point F is 4m south of point B and 8m north of point G.

34. What is the direction and distance of point B with respect to point G?

- a) North-east, 8m
- b) South, 10m
- c) South-east, 4m
- d) North, 12m
- e) None of these

35. If point R is 4m north of point G, then the distance between points R and F is equal to the distance between which of the following points?

- a) BC
- b) EF
- c) GF
- d) FC
- e) CD

Quantitative Aptitude

Directions (36-45): What value should come in the place of (?) in the following questions?

36. $35\% \text{ of } 80 + 42\% \text{ of } 150 = ?^2 - 9$

- a) 9
- b) 11
- c) 10
- d) 8
- e) None of these

37. $5/12 * 96 + 56 = ? * 2^3$

- a) 12
- b) 8
- c) 22
- d) 18
- e) None of these

38. $(\sqrt{2304} - \sqrt{2704}) = \sqrt{?} + \sqrt{361}$

- a) 1089
- b) 289
- c) 729
- d) 529
- e) None of these

39. $112 * 15 + 40\% * 330 = ? * 4 * 3$

- a) 141
- b) 151
- c) 121
- d) 161
- e) None of these

40. $280\% \text{ of } 15 * 19 \div 21 = ?$

- a) 48
- b) 58

- c) 28
- d) 38
- e) None of these

41. $5892 - 3648 + 1288 = 2598 + ?$

- a) 854
- b) 1054
- c) 934
- d) 1234
- e) None of these

42. $(43 * 18 \div 6 + 6) - ? = 95$

- a) 40
- b) 50
- c) 80
- d) 20
- e) None of these

43. $[90\% \text{ of } 90] - [30\% \text{ of } 350 \div ?] = 66$

- a) 9
- b) 5
- c) 7
- d) 11
- e) None of these

44. $17^2 - 208 \div 26 = ? \div 3$

- a) 653
- b) 933
- c) 753
- d) 843
- e) None of these

45. $21 - [5 - \{8 - (18-7)\}] = ?$

- a) 23
- b) 13
- c) 17
- d) 27
- e) None of these

Directions (46-50): The following question contains two equations as I and II. You have to solve both equations and determine the relationship between them and give the answer as.

46.

I. $x^2 - 27x + 182 = 0$

II. $y^2 - 20y + 96 = 0$

- a) $x > y$
- b) $x \geq y$
- c) $x = y$ or relationship can't be determined
- d) $x < y$
- e) $x \leq y$

47.

I. $x^2 + 12x + 32 = 0$

II. $y^2 - 14y + 45 = 0$

- a) $x > y$
- b) $x \geq y$
- c) $x < y$
- d) $x = y$ or relationship can't be determined
- e) $x \leq y$

48.

I. $x^2 - 22x + 120 = 0$

II. $y^2 - 8y - 20 = 0$

- a) $x > y$
- b) $x \geq y$
- c) $x < y$
- d) $x \leq y$
- e) $x = y$ or relationship can't be determined

49.

I. $x^2 + 10x + 24 = 0$

II. $y^2 - 17y + 66 = 0$

- a) $x = y$ or relationship can't be determined
- b) $x \geq y$
- c) $x < y$
- d) $x \leq y$
- e) $x > y$

50.

I. $x^2 - 37x + 336 = 0$

II. $y^2 - 12y - 325 = 0$

- a) $x > y$
- b) $x \geq y$
- c) $x < y$
- d) $x \leq y$
- e) $x = y$ or the relationship can't be determined

Directions (51-55): Read the following information carefully and answer the

questions.

The given table shows the number of basketballs, footballs and rackets available in four different schools A, B, C and D.

Schools	Number of basketballs	Number of footballs	Number of Rackets
A	10	13	150
B	5	8	120
C	8	10	130
D	6	4	110

51. The number of basketballs available in school A is what percent more/less than the number of footballs available in school D?

- a) 150% more
- b) 130% more
- c) 170% more
- d) 120% more
- e) None of these

52. In which school, total number of basketballs and footballs are high?

- a) D
- b) C
- c) B
- d) A
- e) None of these

53. What is the average number of footballs available in all four schools?

- a) 9.45
- b) 10.95
- c) 8.75
- d) 11.65
- e) None of these

54. Find the difference between the number of basketballs and rackets available in school C and the number of basketballs and rackets available in school A.

- a) 22
- b) 15

- c) 28
- d) 11
- e) None of these

55. What is the ratio of the total number of balls available in school B to the total number of balls available in school D?

- a) 9: 14
- b) 13: 10
- c) 8: 7
- d) 11: 9
- e) None of these

Directions (56-60): Read the following information carefully and answer the questions.

In a village, there are four types of married couples. 40% of the total number of married couples has only male children. The number of married couples who have both male and female children is half of the number of married couples who have only male children. The number of married couples who have only female child is 30% of the total number of married couples. The difference between the number of married couples who have only male children and the number of married couples who have only female children is 160. The remaining number of married couples has no children.

56. Find the number of married couples who have no children.

- a) 190
- b) 140
- c) 180
- d) 160
- e) None of these

57. What is the difference between the number of married couples who have only female children and the number of married couples who have both male and female children?

- a) 160
- b) 130
- c) 90
- d) 110

e) None of these

58. The number of married couples who have both male and female children is what percentage of the total number of married couples?

- a) 15%
- b) 30%
- c) 20%
- d) 25%
- e) None of these

59. What is the ratio of the number of married couples who have only male children to the number of married couples who have only female children?

- a) 4: 3
- b) 3: 2
- c) 2: 1
- d) 5: 6
- e) None of these

60. What is the total number of married couples who have both male and female children and the number of married couples who have no children?

- a) 450
- b) 420
- c) 430
- d) 480
- e) None of these

61. The present age of A is 12 years more than the present age of B. The ratio of age of B and C is 5: 4. Find the present age of A, if the present age of A is twice the present age of C.

- a) 38 years
- b) 36 years
- c) 32 years
- d) 35 years
- e) None of these

62. A shopkeeper sold an article at Rs.1800 and received a profit of 20%. If the selling

price the article is 80% of its marked price, then find the discount made by the shopkeeper.

- a) Rs.450
- b) Rs.350
- c) Rs.250
- d) Rs.550
- e) None of these

63. Pipe P can fill a tank in 6 hours and Pipe Q can fill the tank in 12 hours, while another pipe R can empty the tank in 24 hours. If 25% of the tank is already filled, then find how long it takes to fill the remaining tank when all three pipes are opened.

- a) 2.6 hours
- b) 4.6 hours
- c) 3.6 hours
- d) 5.6 hours
- e) None of these

64. A man invested some sum at 14% rate of interest for 5 years and received Rs. 2100 as simple interest. Find the compound interest, if the same sum is invested for 2 years at the same rate of interest.

- a) Rs.898.8
- b) Rs.893.5
- c) Rs.890
- d) Rs.880
- e) None of these

65. From Lucknow to Varanasi, the train fare is Rs.180 per person. For the same distance, if the bus fare for 3 persons is half the train fare for one person, then find the bus fare for 4 persons.

- a) Rs.150
- b) Rs.130
- c) Rs.145
- d) Rs.120
- e) None of these

66. A container contains 120 litres of pure milk. 48 litres of pure milk is removed and 24 litres of water is added to the container.

Now the quantity of water in the container is what percent less than the quantity of milk.

- a) 66.66%
- b) 65%
- c) 67.5%
- d) 78%
- e) None of these

67. The ratio of the diameter of the circle to the breadth of the rectangle is 7: 4 respectively and the area of the circle is 616 cm^2 . If the length of the rectangle is 6 cm more than the radius of the circle, then find the area of the rectangle. (Level: Easy - moderate)

- a) 350 cm^2
- b) 300 cm^2
- c) 320 cm^2
- d) 420 cm^2
- e) None of these

68. The speed of the stream is $\frac{1}{3}$ rd of the speed of the boat in still water. How long the boat takes to cover 54 km downstream and 42 km upstream, if the speed of the boat in still water is 48 km/hr?

- a) 2.15625 hours
- b) 3.1015 hours
- c) 2.4530 hours
- d) 3.15250 hours
- e) None of these

69. Ankita spends 20% of her income on rent and 25% of the remaining amount on groceries. If she spends half of the remaining amount for car loan which is Rs.18000, then find the income of Ankita. (Level: Easy - moderate)

- a) Rs.55000
- b) Rs.60000
- c) Rs.35000
- d) Rs.25000
- e) None of these

70. A and B started a business by investing

totally Rs.80000 in the ratio of 3: 5 respectively. After 6 months, C joined them with the double of A's investment. If the overall profit in a year is Rs.33000, then find the profit of B.

- a) Rs.18000
- b) Rs.13000
- c) Rs.14500
- d) Rs.15000
- e) None of these

English Language

Directions (71-75): In the following passage, some of the words have been left out. Each of the blank is indicated by a letter. Find the suitable choice for each blank.

Russia and Iran's relationship has warmed to a ____ (A)____ defence partnership, the US has said. Russia is giving an _____(B)_____ level of military support, said US national security council spokesman John Kirby. The US has seen reports that the two countries are considering joint production of lethal drones, he added. Australia has announced it is ____ (C)____ three Iranians and one Iranian business for supplying Russia with drones to use against Ukraine. Co-operation between Russia and Iran has been _____(D)_____ recently, with Ukraine ____ (E)____ Russia of using Iranian drones in its attacks.

71) Which of the following Words can appropriately fit in **position A**?

- a) fully fledged
- b) completely developed
- c) completely retarded
- A) Only a and b
- B) Only a and c
- C) Only b and c
- D) All a, b, and c
- E) None of the above.

72) Which of the following Words can appropriately fit in **position B**?

- a) extraordinary

- b) prodigious
 c) unprecedented
 A) Only a and b
 B) Only a and c
 C) Only b and c
 D) All a, b, and c
 E) None of the above.

73) Which of the following Words can appropriately fit in **position C**?

- a) penalising
 b) consolidating
 c) sanctioning
 A) Only a and b
 B) Only a and c
 C) Only b and c
 D) All a, b, and c
 E) None of the above.

74) Which of the following Words can appropriately fit in **position D**?

- a) highlighted
 b) condemned
 c) criticized
 A) Only a
 B) Only a and c
 C) Only c
 D) All a, b, and c
 E) None of the above.

75) Which of the following Words can appropriately fit in **position E**?

- a) exonerating
 b) incriminating
 c) accusing
 A) Only a and b
 B) Only b and c
 C) Only a and c
 D) All a, b, and c
 E) None of the above.

Direction (76-80): Which of the phrases **A, B, C and D** given below each sentence should replace the phrase printed in bold in the sentence to make it grammatically correct? If the sentence is correct as it is given and

'No correction is required', mark E as the answer. (Moderate level)

76) Michael Gove has approved the first new UK coal mine in 30 years **despite concern about its climate impacts** among Conservative MPs and experts.

- A) despite of concern about its climate impacts
 B) inspite concerning about its climate impacts
 C) despite concern about their climate impacts
 D) despite concerning about its climate impacts
 E) no correction required

77) The government **has approve the UK's first newly deep** coal mine for 30 years.

- A) has approved the UK's first new deep
 B) has furnished the UK's first newly deep
 C) has approved UK's first new deep
 D) is being approving the UK's first new deep
 E) no correction required

78) World temperatures are rising because of human activity, and climate change **now threatening every aspects of human life.**

- A) now threatening every aspect of human life
 B) now threatens every aspects of human life
 C) now threaten every aspect of human life
 D) now threatens every aspect of human life
 E) no correction required

79) Extreme weather events are already more intense across the globe, **redistributing lives and livelihoods.**

- A) imperiling lives and livelihoods
 B) threatening lives and livelihoods
 C) endangering lives and livelihoods
 D) jeopardizing lives and livelihoods
 E) all can replace

80) People living in developing countries are expected to suffer the most as they have fewer resources **to adopt to climate change.**

- A) to adept from climate change
- B) to adapt to climate change
- C) to adept to climate change
- D) to adapt from climate change
- E) no correction required

Direction (81-85): In the following question, some parts of the sentence may have errors. Find out which part of the sentence has error free and select the appropriate option. If the sentence is free from error, select 'E' (all are correct) as your answer.

81) The spaceship, which has been (A)/ on a three-week journey around (B)/ the Moon, is targeting a splashdown (C)/ in the Pacific Ocean off California (D)/ No error (E).

- A) A
- B) B
- C) C
- D) D
- E) E

82) The Russian co-winner of this (A)/ year Nobel Peace Prize has said (B)/ Kremlin authorities told his (C)/ to turn around the award (D)/ No error (E).

- A) A
- B) B
- C) C
- D) D
- E) E

83) Methane is second most abundant (A)/ greenhouse gas after carbon dioxide, but a most (B) potent contribute to the climate crisis (C)/ because methane traps more heat (D)/ No error (E).

- A) A
- B) B
- C) C
- D) D
- E) E

84) Mr Trump had claimed national security (A)/ concerns when he announces the new (B)/ border taxes in 2018, spark a wave (C)/

- in trade fights around the world (D)/ No error (E).
- A) A
- B) B
- C) C
- D) D
- E) E

85) The Scottish governments has set a (A)/ legally-binding target to cut greenhouse (B)/ gas emissions to net zero in 2045, five years (C)/ ahead of the date set on the UK as a whole (D)/ No error (E).

- A) A
- B) B
- C) C
- D) D
- E) E

Direction (86-90): In each of the following questions four words are highlighted which may or may not be in their proper place. You are required to interchange the incorrect words in order to make the paragraph both grammatically and contextually correct.

86) The effects of increased (A) temperature yield (B) a larger impact on grain exhibit (C) than on vegetative growth because of the increased minimum (D) temperatures.

- A) Both A-D and B-C
- B) Only B-C
- C) Only B-D
- D) Both A-C and B-D
- E) No swapping is required.

87) The country's security forces moved swiftly to appease (A) the protests, while health officials tried to snuff out (B) the public by soften (C) to promising (D) tough Covid measures.

- A) Both A-D and B-C
- B) Only C-D
- C) Both A-B and C-D
- D) Both A-C and B-D
- E) No swapping is required.

88) The overconfidence **tendency (A)** is the **bias (B)** for people to be more confident in their own abilities, such as driving, teaching, or spelling, than is **objectively (C) reasonable (D)**.

- A) Both A-D and B-C
- B) Only C-D
- C) Both A-B and C-D
- D) Only A-B
- E) No swapping is required.

89) We should **ethnicity (A)** diversity and inclusion, **generational (B)** junior and senior staff not only across **pairing (C)** divides but also gender and **encourage (D)**.

- A) Both A-D and B-C
- B) Only C-D
- C) Both A-B and C-D
- D) Only A-B
- E) No swapping is required.

90) Winter sports fans are **drawn (A)** to the mountains for the **pristine (B)** wild environments, **energizing (C)** views, pure air and **hearty (D)** fun in the snow.

- A) Both A-D and B-C
- B) Only C-D
- C) Both A-B and C-D
- D) Only A-B
- E) No swapping is required.

Direction (91-92): In the following questions, each question is divided into five parts. Rearrange the following parts into a meaningful sentence and mark the option accordingly. (Moderate level)

91) Xi Jinping's authority since he came to power, (A)/ the unprecedented protests that swept China late last month, (B)/ a Chinese Twitter account with a cat avatar (C)/ posing the biggest challenge to leader (D)/ had a peculiar focal point (E).

- A) ABCED
- B) BADEC
- C) CEADB
- D) BDAEC
- E) No arrangement required

92) win in Prime Minister Narendra Modi's home state (A)/ ahead of the 2024 general election (B)/ the leader and his Hindu-nationalist party (C)/ India's ruling Bharatiya Janata Party (BJP) scored a landslide election (D)/ of Gujarat on Thursday, in a boost for (E).

- A) DAECB
- B) BADEC
- C) CEADB
- D) BDAEC
- E) No arrangement required

Directions (93-90): Read the passage and answer the questions that follow: (Easy - moderate level)

Help with energy costs will be less generous from April, with bills for a typical household going up to £3,000, Chancellor Jeremy Hunt has announced. However, there will be additional support for the most vulnerable. Under the current energy price guarantee, a household using a typical amount of gas and electricity can expect to pay £2,500 annually. The guarantee began in October, and was originally meant to last for two years, before the government announced it would end in April 2023. Mr Hunt has now said the guarantee will continue, increasing by £500 to £3,000 from April. Without government support, the average energy bill would have risen to £4,279 in January 2023, regulator Ofgem says. Previously, Ofgem set the maximum suppliers could charge households per unit of energy. But after prices soared in the wake of Russia's invasion of Ukraine, the government announced its price guarantee would replace this energy cap.

A National Grid scheme running between November and March will reward households and businesses using less peak-time electricity. Not using high-energy appliances such as washing machines in the late afternoon or early evening could generate

discounts of up to £100. Customers need a smart meter to sign up for the trial, which will run on 12 "test days". People will be asked not to use high-energy appliances for one hour of each test day, probably between 16:00 and 19:00. In return, they will get up to £3 per kilowatt hour off their bill.

Unlike domestic customers, businesses were only ever promised help for six months. The government says any **subsequent** help will be "targeted to those most affected".

Under the energy bill relief scheme: businesses get a discount based on a "government supported price" of 21.1p per kWh for electricity and 7.5p per kWh for gas; the government says this is less than half the wholesale prices which had been **predicted** for this winter; organisations on fixed price contracts are eligible if their deal started after 1 April 2022; those on variable tariffs will receive an automatic discount for each unit of energy used; the savings will begin to appear in November's bills (backdated to October) and will be applied automatically; a review will be published after three months time to identify "vulnerable" organisations needing further support after March 2023.

The scheme applies to all non-domestic energy customers in England, Scotland and Wales, with a parallel scheme in Northern Ireland. *Energy costs have **ended** (P) because the conflict in Ukraine has **rocketed** (Q) supplies of Russian gas. Prices also rose because demand for energy **reduced** (R) after Covid restrictions **soared** (S).*

All households are automatically getting a one-off £400 discount on their fuel bills from October, although it is still not clear how the help will be delivered in Northern Ireland. Eight million low-income households who receive certain benefits or tax credits are getting £650 in two payments. Pensioner households are being given £300 and some disabled people will be paid £150. This help is being partly funded by a temporary windfall tax on oil and gas companies.

Vulnerable families can also claim help through the Household Support Fund, and the Warm Home Discount scheme. Energy companies also run hardship funds, although the regulator Ofgem warned that most firms need to do more to help customers who are struggling.

93) Which of the following word (s) is/are **synonym** (s) of the highlighted word "**subsequent**"?

- a) former
- b) ensuing
- c) following
- A) Only a and b
- B) Only b and c
- C) Only a and c
- D) All a, b, and c
- E) None of the above.

94) Which of the following word (s) is/are **antonym** (s) of the highlighted word "**predicted**"?

- a) prophesied
- b) anticipated
- c) prognosticate
- A) Only a and b
- B) Only b and c
- C) Only a and c
- D) All a, b, and c
- E) None of the above.

95) According to the above passage, why have energy prices gone up?

- a) because the use of coal rather than natural gas
- b) because of the Russia-Ukraine war
- c) because prices are rebounded strongly post-pandemic
- A) Only a and b
- B) Only b and c
- C) Only a and c
- D) All a, b, and c
- E) None of the above.

96) What is the National Grid doing to reduce bills?

- a) providing free electricity to the people who regularly use smart meters
- b) giving a smart meter to each household
- c) Households will be offered discounts on their electricity bills if they cut peak-time use
- A) Only a and b
- B) Only b and c
- C) Only c
- D) All a, b, and c
- E) None of the above.

97) According to the given passage, what is the energy price guarantee?

- a) The Energy Price Guarantee sets the maximum amount you'll be charged for a kWh of gas and electricity.
- b) The Energy Price Guarantee is a cap on the unit prices of energy and it lasts until April next year.
- c) The energy price guarantee is a temporary additional measure to protect consumers from the recent significant increases in wholesale gas prices.
- A) Only a and b
- B) Only b and c
- C) Only a and c
- D) All a, b, and c
- E) None of the above.

98) What help are businesses getting?

- a) The government has set a Supported Wholesale Price, which is expected to be £211 per MWh for electricity and £75 per MWh for gas.
- b) Qualifying businesses can claim for 40% of the increases in their energy bills.

- c) gaining some discounts under the energy bill relief scheme
- A) Only a and b
- B) Only b and c
- C) Only a and c
- D) All a, b, and c
- E) None of the above.

99) What help have people already had?

- a) Anyone who doesn't use mains gas and electricity - such as those using heating oil - will receive an extra £100 on top of the £400.
- b) Everyone's energy bill will be cut by £400 this winter.
- c) Most low-income households eligible for extra help with energy bills
- A) Only a and b
- B) Only b and c
- C) Only a and c
- D) All a, b, and c
- E) None of the above.

100) Energy costs have **ended (P) because the conflict in Ukraine has **rocketed (Q)** supplies of Russian gas. Prices also rose because demand for energy **reduced (R)** after Covid restrictions **soared (S)**.**

Rearrange the highlighted words and make meaningful sentence:

- A) Both P-Q and R-S
- B) Only Q-S
- C) Both P-R and Q-S
- D) Both P-S and Q-R
- E) No arrangement is needed

ANSWER WITH EXPLANATION

Directions (1-5):

1) Answer: D

2) Answer: C

3) Answer: B (All the persons live in flat A except option b)

4) Answer: E

5) Answer: A

Final arrangement

	Flat A	Flat B
4	P	L
3	M	R
2	Q	S
1	N	O

We have,

- Q lives on a prime numbered floor of Flat A.
- The one who lives immediately above Q lives to the west of R.

From the above conditions, there are two possibilities

	Case-1		Case-2	
	Flat A	Flat B	Flat A	Flat B
4				R
3		R	Q	
2	Q			
1				

Again we have,

- Only one floor is between R and N.
- S lives immediate northeast of N.
- As many floors above S as below M.

	Case-1		Case-2	
	Flat A	Flat B	Flat A	Flat B
4				R

3	M	R	Q	S
2	Q	S	N	M
1	N			

Again we have,

- L lives above O where both of them live in the same flat.
- P doesn't live on the same floor as O.

After applying the above conditions case-2 gets eliminated because P lives on the same floor as O, hence case-1 shows the final arrangement.

	Case-1		Case-2	
	Flat A	Flat B	Flat A	Flat B
4	P	L	L	R
3	M	R	Q	S
2	Q	S	N	M
1	N	O	O	P

6. Answer: C



7) Answer: E

Given series

B 7 A S & K 2 E C # I 6 * M \$ X D 3 V 5 % 4 O J
9 Y 1 © 8 L
B 7 A S K 2 E C I 6 M X D 3 V 5 4 O J 9 Y 1 8 L

8) Answer: C

Given series

B 7 A S & K 2 E C # I 6 * M \$ X D 3 V 5 % 4 O J
9 Y 1 © 8 L
B 7 A S & K 2 E C # I 6 * M \$ X D 3 V 5 % 4 O J
9 Y 1 © 8 L

9) Answer: D

Given series

B 7 A S & K 2 E C # I 6 * M \$ X D 3 V 5 % 4 O J
9 Y 1 @ 8 L

10) Answer: B

Given series

B 7 A S & K 2 E C # I 6 * M \$ X D 3 V 5 % 4 O J
9 Y 1 @ 8 L

B 7 A S & K 2 E C # I 6 * M \$ X D 3 V 5 % 4 O J
9 Y 1 @ 8 L

7AS, K2E, I6*, D3V

11) Answer: C

Given series

B 7 A S & K 2 E C # I 6 * M \$ X D 3 V 5 % 4 O J
9 Y 1 @ 8 L

B 7 A S & K 2 E C # I 6 * M \$ X D 3 V 5 % 4 O J
9 Y 1 @ 8 L

Between E and O -> C, I and D come before M
as per the alphabetical series.

Directions (12-16):

12) Answer: D

13) Answer: B

14) Answer: E

15) Answer: C

16) Answer: D

Final arrangement

Days	Persons
Monday	B
Tuesday	G
Wednesday	C
Thursday	A
Friday	F
Saturday	D
Sunday	E

We have,

- Only three persons visit between G and D, where G visits before D.
- E visits immediately after D.

From the above conditions, there are two possibilities

	Case-1	Case-2
Days	Persons	Persons
Monday	G	
Tuesday		G
Wednesday		
Thursday		
Friday	D	
Saturday	E	D
Sunday		E

Again we have,

- As many persons visit before E as after B.
- Only one person visits between B and C.

	Case-1	Case-2
Days	Persons	Persons
Monday	G	B
Tuesday	B	G
Wednesday		C
Thursday	C	
Friday	D	
Saturday	E	D
Sunday		E

Again we have,

- A visits either immediately before or immediately after C.
- F doesn't visit the shop on Sunday.

After applying the above conditions case-1 gets eliminated because F visits the shop on Sunday, hence case-2 shows the final arrangement.

	Case-1	Case-2
Days	Persons	Persons
Monday	G	B
Tuesday	B	G

Wednesday	A	C
Thursday	C	A
Friday	D	F
Saturday	E	D
Sunday	F	E

Directions (17-21):

17) Answer: D

18) Answer: A

19) Answer: D

20) Answer: B (No one bought between both persons except option b)

21) Answer: E(Only U and W)

Final arrangement

Persons
R
V
T
P
S
U
Q
W

We have,

- Only two persons bought between V and S.
- U bought immediately after S.

From the above conditions, there are two possibilities

Case-1	Case-2
Persons	Persons
V	S
	U
S	V
U	

Again we have,

- As many persons bought between U and V as between S and R.
- T bought two persons after R.
- Only four persons bought between T and W.

Case-1	Case-2
Persons	Persons
R	W
V	S
T	U
	R
S	V
U	T
W	

Again we have,

- Q bought immediately before W.
- P bought three persons before Q.

After applying the above conditions case-2 gets eliminated because there is no possibility to place P, hence case-1 shows the final arrangement.

Case-1	Case-2
Persons	Persons
R	Q
V	W
T	S
P	U
S	R
U	V
Q	T
W	

Directions (22-25):

22) Answer: D

23) Answer: E

24) Answer: E

25) Answer: C

Word	Code
Dance	Lt
Tradition	Bn
Function	Pl
Song	Qw/ er
Well	Er/ qw
Cultural	yh
Level	ui
Dress	mj/sd
Offer	mj/sd
Organizer	mn

26. Answer: C

Chosen letters:

B, O, P and N

There is no meaningful word can be formed

27. Answer: D

548576231

5 5 9 5 7 7 3 3 1

9+1=10

Directions (28-31):

28) Answer: A

29) Answer: C

30) Answer: E

31) Answer: D

Final arrangement

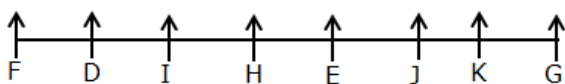

We have,

- D sits second from one of the extreme ends.
- Only three persons sit between D and J, who sits second to the left of G.

From the above conditions, there are two possibilities

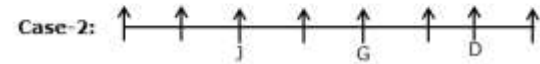
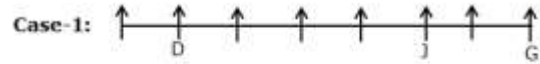

Again we have,

- As many persons sit to the left of G as to the right of F.
- K sits fourth to the right of I.
- H is an immediate neighbour of I.
- E doesn't sit at the extreme end of the row.

After applying the above conditions, case-2 gets eliminated because E sits at the end of the row, hence case-1 shows the final arrangement.

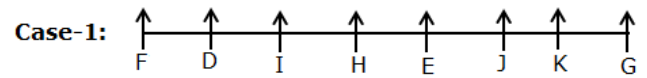

Directions (32-33):

32) Answer: D

33) Answer: C

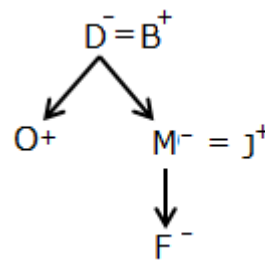

Directions (34-35):

34) Answer: D

35) Answer: E

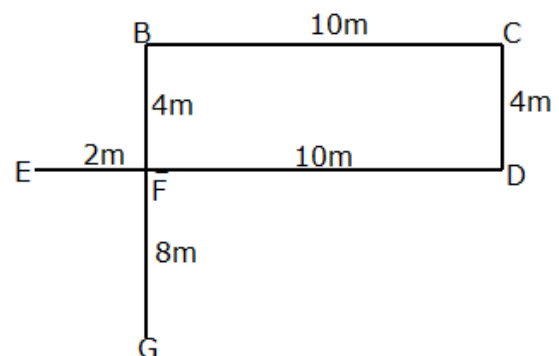

36. Answer: C

$$35\% \text{ of } 80 + 42\% \text{ of } 150 = x^2 - 9$$

$$28 + 63 = x^2 - 9$$

$$91 = x^2 - 9$$

$$x = 10$$

37. Answer: A

$$5/12 * 96 + 56 = x * 2^3$$

$$40 + 56 = x * 8$$

$$96/8 = x$$

$$x = 12$$

38. Answer: D

$$(\sqrt{2304} - \sqrt{2704}) = \sqrt{x} + \sqrt{361}$$

$$48 - 52 = \sqrt{x} + 19$$

$$-23 = \sqrt{x}$$

$$x = 529$$

39. Answer: B

$$112 * 15 + 40\% * 330 = x * 12$$

$$1680 + 132 = x * 12$$

$$1812 = x * 12$$

$$x = 151$$

40. Answer: D

$$280\% \text{ of } 15 * 19 \div 21 = x$$

$$42 * 19 \div 21 = x$$

$$x = 38$$

41. Answer: C

$$5892 - 3648 + 1288 = 2598 + x$$

$$3532 = 2598 + x$$

$$x = 934$$

42. Answer: A

$$(43 * 18 \div 6 + 6) - x = 95$$

$$135 - x = 95$$

$$x = 40$$

43. Answer: C

$$[90\% \text{ of } 90] - [30\% \text{ of } 350 \div x] = 66$$

$$81 - [105 \div x] = 66$$

$$15 = 105 \div x$$

$$x = 7$$

44. Answer: D

$$17^2 - 208 \div 26 = x \div 3$$

$$289 - 8 = x \div 3$$

$$281 = x \div 3$$

$$x = 843$$

45. Answer: B

$$21 - [5 - \{8 - (18-7)\}] = x$$

$$21 - [5 - \{8 - 11\}] = x$$

$$21 - [5 - \{-3\}] = x$$

$$21 - 8 = x$$

$$x = 13$$

46. Answer: A

$$x^2 - 27x + 182 = 0$$

$$x^2 - 14x - 13x + 182 = 0$$

$$(x-14)(x-13) = 0$$

$$x = 14, 13$$

$$y^2 - 20y + 96 = 0$$

$$y^2 - 8y - 12y + 96 = 0$$

$$(y-8)(y-12) = 0$$

$$y = 8, 12$$

Hence, $x > y$

47. Answer: C

$$x^2 + 12x + 32 = 0$$

$$x^2 + 4x + 8x + 32 = 0$$

$$(x+4)(x+8) = 0$$

$$x = -4, -8$$

$$y^2 - 14y + 45 = 0$$

$$y^2 - 5y - 9y + 45 = 0$$

$$(y-5)(y-9) = 0$$

$$y = 5, 9$$

Hence, $x < y$

48. Answer: B

$$x^2 - 22x + 120 = 0$$

$$x^2 - 10x - 12x + 120 = 0$$

$$(x-10)(x-12) = 0$$

$$x = 10, 12$$

$$y^2 - 8y - 20 = 0$$

$$y^2 - 10y + 2y - 20 = 0$$

$$(y-10)(y+2) = 0$$

$$y = 10, -2$$

Hence, $x \geq y$

49. Answer: C

$$x^2 + 10x + 24 = 0$$

$$x^2 + 4x + 6x + 24 = 0$$

$$(x+4)(x+6) = 0$$

$$x = -4, -6$$

$$y^2 - 17y + 66 = 0$$

$$y^2 - 11y - 6y + 66 = 0$$

$$(y-11)(y-6) = 0$$

$$y = 11, 6$$

Hence, $x < y$

50. Answer: E

$$x^2 - 37x + 336 = 0$$

$$x^2 - 16x - 21x + 336 = 0$$

$$(x-16)(x-21) = 0$$

$$x = 16, 21$$

$$y^2 - 12y - 325 = 0$$

$$y^2 + 13y - 25y - 325 = 0$$

$$(y+13)(y-25) = 0$$

$$y = -13, 25$$

Hence, the relationship between x and y can't be determined

51. Answer: A

Required percentage = $(10-4) / 4 * 100 = 150\%$ more

52. Answer: D

In school A = 23

In school B = 13

In school C = 18

In school D = 10

53. Answer: C

Required average = $[13+8+10+4]/4 = 35/4 = 8.75$

54. Answer: A

Required difference = $(160 - 138) = 22$

55. Answer: B

Required ratio = 13: 10

Directions (56-60):

Let x be the number of married couples in the village

$$40\% \text{ of } x - 30\% \text{ of } x = 160$$

$$x = 1600$$

Number of married couples who have only male children = $1600 * 40 / 100 = 640$

Number of married couples who have only female children = $1600 * 30 / 100 = 480$

Number of married couples who have both male and female children = $640 / 2 = 320$

Number of married couples who have no children = $1600 - [640 + 480 + 320] = 160$

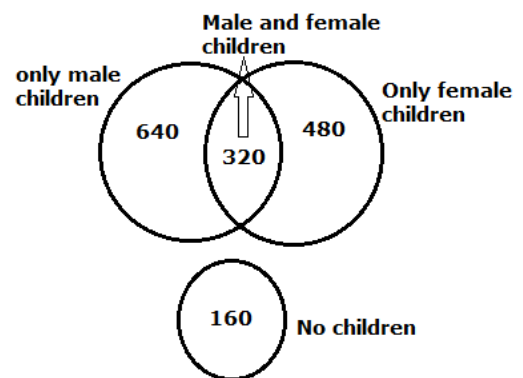

56. Answer: D

Required number = 160

57. Answer: A

Required difference = $480 - 320 = 160$

58. Answer: C

Required percentage = $320 * 100 / 1600 = 20\%$

59. Answer: A

Required ratio = $640 : 480 \Rightarrow 4 : 3$

60. Answer: D

Required total = $320 + 160 = 480$

61. Answer: C

$$A = 12 + B$$

$$A = 2C$$

$$B/C = 5/4$$

$$B = 5C/4$$

$$2C = 12 + 5C/4$$

$$8C = 48 + 5C$$

$$3C = 48$$

$$C = 16$$

Present age of A = $16 \times 2 = 32$ years

62. Answer: A

The Selling Price of an article = Rs.1800

Selling Price = $80/100 \times MP$

Marked Price = $1800 \times 100 / 80 = \text{Rs.}2250$

Required Discount = $2250 - 1800 = \text{Rs.}450$

63. Answer: C

$P + Q + R = 1/6 + 1/12 - 1/24 = 5/24 \Rightarrow 24/5$
hours.

$$100\% = 24/5$$

$$75\% = ?$$

Required hours = $24/5 \times 75 / 100 = 3.6$ hours

64. Answer: A

$$2100 = P \times 14/100 \times 5$$

$$P = \text{Rs.}3000$$

$$CI = 3000(114/100 \times 114/100) - 3000$$

$$CI = \text{Rs.}898.8$$

65. Answer: D

Train fare per person = Rs.180

3 Person's bus fare = $180/2 = \text{Rs.}90$

Bus fare per person = $90/3 = \text{Rs.}30$

Required bus fare for 4 person = $\text{Rs.}30 \times 4 = \text{Rs.}120$

66. Answer: A

Ratio of milk to water = 72: 24 $\Rightarrow 3: 1$

Required percentage = $(3-1)/3 \times 100 = 66.66\%$
less

67. Answer: C

$$\pi r^2 = 616$$

$$r^2 = 196$$

$$r = 14 \text{ cm}$$

$$\text{Length, } l = 6+14 = 20 \text{ cm}$$

$$\text{Diameter of circle} = 2 \times 14 = 28 \text{ cm}$$

$$28/b = 7/4$$

$$b = 16 \text{ cm}$$

$$\text{Area of the rectangle} = 20 \times 16 = 320 \text{ cm}^2$$

68. Answer: A

$$u = 48 \text{ km/hr}$$

$$v = 48/3 = 16 \text{ km/hr}$$

Upstream speed = $48 - 16 = 32 \text{ km/hr}$

Downstream speed = $48 + 16 = 64 \text{ km/hr}$

Required time = $54/64 + 42/32 = 2.15625$
hours

69. Answer: B

Let x be the income of Ankita

$$80/100 \times x \times 75/100 \times 1/2 = 18000$$

$$x = \text{Rs.} 60000$$

70. Answer: D

A's investment = $80000 \times 3/5 = \text{Rs.}30000$

B's investment = $80000 - 30000 = \text{Rs.}50000$

Ratio of investment = $30000 \times 12: 50000 \times 12:$
 60000×6

$$\Rightarrow 3: 5: 3$$

Profit of B = $5/11 \times \text{Rs.}33000 = \text{Rs.}15000$

71. Answer: A

We need an adjective to modify the noun "defence partnership". The sentence seeks to convey that the relationship between Russia and Iran is changed into a defence partnership.

Words' meanings:

Fully fledged: completely developed or trained

Retarded: Immature (**contextually incorrect**)

Hence, option A is the correct answer.

72. Answer: B

We need an adjective to modify the noun "level of military support". The sentence says that Russia gives outstanding military support to Iran.

All the given words are **synonyms** of each other. But we need a **vowel phrase** as the blank is preceded by the article "an". So, "prodigious" is incorrect here.

Words' meanings:

unprecedented: never having happened or existed in the past; **prodigious; extraordinary**

Hence, option B is the correct answer.

73. Answer: B

We need a verb here with its "ing" form, as the blank is preceded by the helping verb "is". The sentence seeks to convey that Australia imposed some sanctions on Iran.

Words' meanings:

Sanctioning: impose a sanction or penalty on;
penalising

Consolidating: to join things together into one; to be joined into one (contextually incorrect)

Hence, option B is the correct answer.

74. Answer: A

We need a **third form of the verb**. The sentence seeks to convey that the relation between Iran and Russia is not previously rooted. It recently came to light.

Words' meanings:

highlighted: come to light; become known publicly

criticized: to say what is bad or wrong with somebody/something; **condemned** (contextually incorrect)

Hence, option A is the correct answer.

75. Answer: B

We need a verb here. The sentence says that Ukraine condemned Russia for using Iranian drones in the War.

Words' meanings:

Accusing: to say that somebody has done something wrong or broken the law; incriminating.

Exonerating: to say officially that somebody was not responsible for something bad that happened (contextually incorrect)

Hence, option B is the correct answer.

76. Answer: E

The given sentence is correct in its present form.

Hence, option E is the correct answer.

77. Answer: A

Option B: furnished: to provide with what is needed (contextually incorrect)

Option C: we use the article "the" before the "UK".

Option D: "is+ being" is present continuous (incorrect structure here)

Hence, option A is the correct answer.

78. Answer: D

Option A: threatening: wrongly used form of a verb.

Option B: every+ singular noun: correct structure (aspect is correct here)

Option C: threaten must be replaced by "threatens" (as "climate change" is a singular noun)

Hence, option D is the correct answer.

79. Answer: E

All the given words are synonyms of one another, which mean "species is at risk to go extinct in these areas".

redistributing: to share something out among people in a different way from before (totally out of context)

Hence, option E is the correct answer.

80. Answer: B

Adept means "good at doing something." **Adapt** means "to change for a new situation." **Adopt** usually means "to take something legally as your own."

Only "adapt" will contextually fit here.

From: incorrect proposition here.

Hence, option B is the correct answer.

81. Answer: E

The given sentence is error free.

Hence, option E is the correct answer.

82. Answer: A

Part B: year must be replaced by "year's". As we need to show possession.

Part C: his must be replaced by **him**.

Part D: turn around is an incorrect phrase here. The correct **phrasal verb** is "turn down".

turn around: the amount of time you take to complete a task and return it

turn down:reject something offered or proposed.

Hence, option A is the correct answer.

83. Answer: D

Part A: the should be placed before "ordinal numbers". The **second** is the correct phrase here.

Part C: we need a noun to modify the adjective "potent". **Contribute** is a verb. **Contribute** must be replaced by "**contributor**".

Part B:"most" must be replaced by "**more**".

Hence, option D is the correct answer.

84. Answer: A

Part B: **announces** must be replaced by "**announced**". As the given sentence is in the **past tense**.

Part C: **spark** must be replaced **sparking**.

Part D: **in** must be replaced by "**of**".

Hence, option A is the correct answer.

85. Answer: B

Part A: **governments** must be replaced by **government**.

Part C: **in** must be replaced by "**by**". **By 2045** is the **correct** phrase.

Part D: **set on** is an incorrect **phrasal** verb here. "**Set for**" is the correct phrase.

Set on: attack someone violently.

Set for: to begin and seem likely to continue.

Hence, option B is the correct answer.

86. Answer: B

The correct sentence:

The effects of **increased** temperature **exhibit** a larger impact on grain **yield** than on vegetative growth because of the increased **minimum** temperatures.

Hence, option B is the correct answer.

87. Answer: C

The correct sentence:

The country's security forces moved swiftly to **snuff out** the protests, while health

officials tried to **appease** the public by **promising** to **soften** tough Covid measures.

To **snuff out** something such as a disagreement means to stop it, usually in a forceful or sudden way.

Hence, option C is the correct answer.

88. Answer: D

The correct sentence:

The overconfidence **bias** is the **tendency** for people to be more confident in their own abilities, such as driving, teaching, or spelling, than is **objectively reasonable**.

Hence, option D is the correct answer.

89. Answer: A

The correct sentence:

We should **encourage** diversity and inclusion, **pairing** junior and senior staff not only across **generational** divides but also gender and **ethnicity**.

Hence, option A is the correct answer.

90. Answer: E

The sentence is correct.

Hence, option E is the correct answer.

91. Answer: D

The correct sentence would be:

The **unprecedented** protests that swept China late last month,/ posing the biggest challenge to leader/ Xi Jinping's authority since he came to power,/ had a peculiar focal point:/ a Chinese Twitter account with a cat avatar.

Hence, option D is the correct answer.

92. Answer: A

The correct sentence would be:

India's ruling Bharatiya Janata Party (BJP) scored a landslide election/ win in Prime Minister Narendra Modi's home state/ of Gujarat on Thursday, in a boost for/ the leader and his Hindu-nationalist party/ ahead of the 2024 general election.

Hence, option A is the correct answer.

93. Answer: B

Subsequent: coming after or later; **following;** **ensuing.**

Former: opposite

Hence, option B is the correct answer.

94. Answer: E

Predicted: to say that something will happen in the future; **anticipated;** **prognosticate;** **prophesied**

All the given words are **synonyms** of the above highlighted word.

Hence, option E is the correct answer.

95. Answer: B

Refer to: Energy costs have soared **because the conflict in Ukraine** has reduced supplies of Russian gas.

Prices also rose because demand for energy rocketed after Covid restrictions ended.

Statement a: out of context.

Hence, option B is the correct answer.

96. Answer: C

Refer to: A National Grid scheme running between November and March **will reward households and businesses using less peak-time electricity.** Not using high-energy appliances such as washing machines in the late afternoon or early evening could generate discounts of up to £100. **Customers need a smart meter to sign up for the trial (contradict statement b),** which will run on 12 "test days". People will be asked not to use high-energy appliances for one hour of each test day, probably between 16:00 and 19:00. In return, **they will get up to £3 per kilowatt hour off their bill.**

We can only say **statement c** as per the given information.

statement a: free electricity (wrong)

Hence, option C is the correct answer.

97. Answer: D

Refer to: Under the current energy price guarantee, a household using a typical amount of gas and electricity can expect to pay £2,500 annually. The guarantee began in October, and was originally meant to last for two years, before the **government announced it would end in April 2023 (statement b).** Mr Hunt has now said the guarantee will continue, increasing by £500 to £3,000 from April. **Without government support, the average energy bill would have risen to £4,279 in January 2023** (we can easily infer **statement c**), regulator Ofgem says. Previously, **Ofgem set the maximum suppliers could charge households per unit of energy (statement a).** But after prices soared in the wake of Russia's invasion of Ukraine, the government announced its price guarantee would replace this energy cap. **Hence, option D is the correct answer.**

98. Answer: C

Refer to: Under the energy bill relief scheme: **businesses get a discount based (statement c) on a "government supported price" of 21.1p per kWh for electricity and 7.5p per kWh for gas (statement a);** the government says this is less than half the wholesale prices which had been predicted for this winter; organisations on fixed price contracts are eligible if their deal started after 1 April 2022; those on variable tariffs will receive an automatic discount for each unit of energy used; the savings will begin to appear in November's bills (backdated to October) and will be applied automatically; a review will be published after three months time to identify "vulnerable" organisations needing further support after March 2023

statement b: out of context

Hence, option C is the correct answer.

99. Answer: B

Refer to: **All households are automatically getting a one-off £400 discount on their fuel bills from October (statement b),** although it is

still not clear how the help will be delivered in Northern Ireland. **Eight million low-income households who receive certain benefits or tax credits are getting £650 in two payments (statement c).**

Hence, option B is the correct answer.

100. Answer: D

The correct sentence:

Energy costs have **soared** because the conflict in Ukraine has **reduced** supplies of Russian gas. Prices also rose because demand for energy **rocketed** after Covid restrictions **ended**.

Hence, option D is the correct answer.

Huge Selections in **SBI Clerk 2022-23**

Prime Bundle PDF Course 2023

Daily Targets

English & Hindi

Detailed Video Solutions*

PDF & Quiz Format*

12 Months Validity + 1 Year Mock Test + PDF Course 2022 (3 Months)

EXAMS COVERED:

- ✓ Beginners Bundle Course
- ✓ Topic wise Bundle PDF Course
- ✓ Exam wise Bundle PDF Course
- ✓ Section wise Bundle PDF Course
- ✓ Memory Based Question Bundle Course
- ✓ Special Prelims Part Bundle PDF Course
- ✓ Mains Booster PDF Course

120K

Questions

FLAT **70% OFF**

Extra **10% Off**

USE CODE **GUIDELY10**

One Time Offer Ends Soon - Hurry !!!

DID YOU KNOW? Guidely Users are finding pdf course very helpful in increasing their Accuracy and to boost up their preparation.

* Price will not be decreased below Rs. 1199/- | Special discount for Ultimate Bundle Users

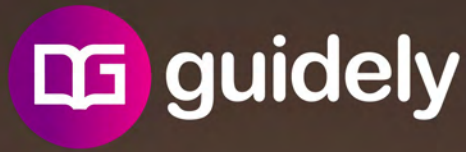

ENGLISH VOCABULARY

JANUARY 2023



1 NEXUS (NOUN)



An important connection between the parts of a system or a group of things.

Synonyms - connection, link, network, tie, bond

Antonyms - Exteriority, divorce

Example The nexus between industry and political power.



2 ANGST (NOUN)



A feeling of anxiety, insecurity or fear.

Synonyms - Dread, Apprehension, Foreboding, trepidation

Antonyms - Calmness, Composure, Patience

Example My hair causes me angst.



3 OUTRAGE (NOUN)



An act of violence or brutality.

Synonyms - Anger, enrage, infuriate, tick off

Antonyms - Delight, gratify, pleasure

Example Her voice trembled with outrage.



4

ACCREDIT (VERB)



To give official authorization to or approval of

Synonyms - Ratify, Sanction, Homologating, license, approbate

Antonyms - Reject, Turn down, Deny, Decline

Example An accredited practitioner.



5

SURREAL (ADJECTIVE)



The irrational reality of dream.

Synonyms - Unreal, Bizarre, Unusual

Antonyms - Real

Example A surreal mix of fact and fantasy.



6

INTRUSIVE (ADJECTIVE)



Affecting someone in a way that annoys them and makes them feel uncomfortable.

Synonyms - Intruding, Invasive

Antonyms - Reticent

Example That was an intrusive question.



7

IMPEACHED (VERB)



To charge with a crime.

Synonyms - Indict, Charge, Accuse, Misdemeanor (a minor wrong doing)

Antonyms - Compliment, Flattery, Commendation, Exculpation

Example Presidents removed from office when they are impeached.



8

CONCEDE (VERB)



Admit or agree that something is true after first denying or resisting it.

Synonyms - Acknowledge, Accept, Confess

Antonyms - Deny

Example I had to concede that I had overreacted.

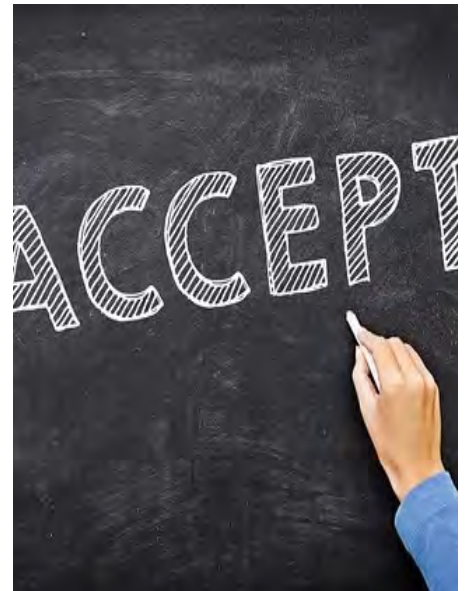

9

POLARIZED (ADJECTIVE, VERB)



Caused something, especially something that contained different people or opinions, to divide into two completely opposing groups.

Synonyms - Unite, Consolidate, Compact

Antonyms - Segregate, Decentralize

Example The polarization of society between rich and poor.



10

ARBITRARY (ADJECTIVE)



Based on a desire or idea or chance rather than reason.

Synonyms - Capricious, Whimsical, Erratic, Illogical

Antonyms - Rational, Reasoned, Accountable

Example An arbitrary decision.



11

DEBILITATING (ADJECTIVE)



Tending to weaken something.

Synonyms - Enervating, Enfeebling, Draining, Devitalizing, Crippling

Antonyms - Invigorate, Strengthen, Restorative

Example Debilitating back pain.



12

DEFER (VERB)



To delay something until a later time.

Synonyms - Postpone, Put off, Adjourn, Put back, Remit, Respite, Shelve, Put over

Antonyms - Stand up to, Disobey

Example They deferred the decision until March.



13 PALPABLY (ADVERB)

 Noticeably or clearly, in a way that is able to be touched or felt.

Synonyms - Tangible, Detectable, Discernible, Transparent

Antonyms - Intangible, Imperceptible

Example Palpably false claims

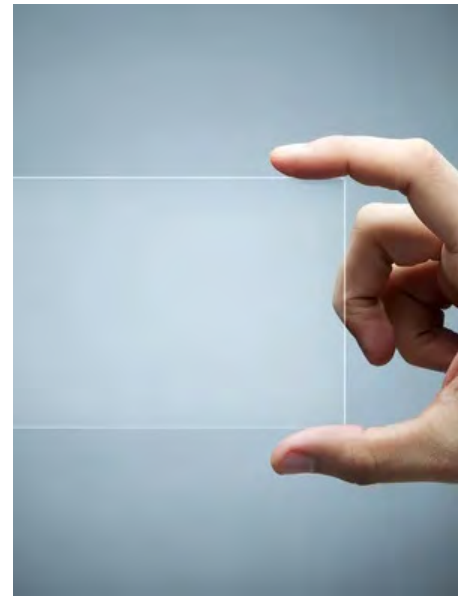

14 OSTENSIBLY (ADVERB)

 As appears to be true, though not necessarily so.

Synonyms - Apparently, Purportedly, Pretendedly, Outwardly

Antonyms - Genuinely, Truly, Really

Example The Teacher resigned, ostensibly from ill health.



15 PARLEY (NOUN, VERB)

 Hold a conference with the opposing side to discuss terms

Synonyms - Negotiation, Meeting, Dialogue, Summit

Antonyms - Quiet, Silence

Example A parley is in progress and the invaders may withdraw.



16

ALLEVIATE (VERB)



Make a problem less severe

Synonyms - Tone down, Assuage, Diminish, Soothe

Antonyms - Aggravate

Example He could not prevent her pain, only alleviate it.



17

HARBINGER (NOUN)



Something that foreshadows a future event, something that gives an anticipatory sign of what is to come.

Synonyms - Precursor, Herald, Outrider, Adumbrate, Augury, Portent

Antonyms - Descendant, Scion

Example Only a few understood that they were a harbinger of things to come.



18

INVERTED (VERB)



To reverse in position, order or relationship

Synonyms - Flip, Turn over

Antonyms - Systematic, Organized

Example Press into an inverted U shape.

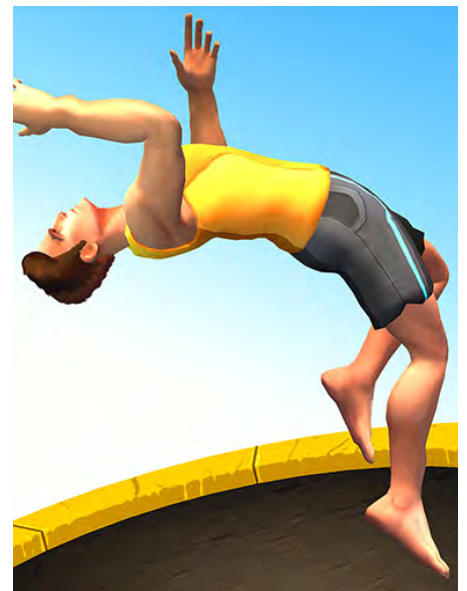

19 DISSENT (NOUN)



The holding or expression of opinions at variance with those commonly or officially held.

Synonyms - Conflict, Bickering, Demur, Disput

Antonyms - Agreement, Acceptance

Example There was no dissent from this view.



20 DEFERENTIAL (ADJECTIVE)



Polite and showing respect.

Synonyms - Humble, courteous, submissive, complaisant

Antonyms - Arrogant, impolite

Example People were always deferential to him.



21 SPANNING (VERB)



Extending across a period of time or a range of subjects.

Synonyms - Continuing, Lengthening, Stretching

Antonyms - Unlink, Compress, Concentrate

Example The stream was spanned by a narrow bridge.



22

TRACTION (NOUN)



The extent to which an idea, a product, etc. becomes popular or gains support.

Synonyms - Adherence, Absorption, Drag, Grip

Antonyms - Slipperiness

Example His car hit a patch of ice and lost traction.

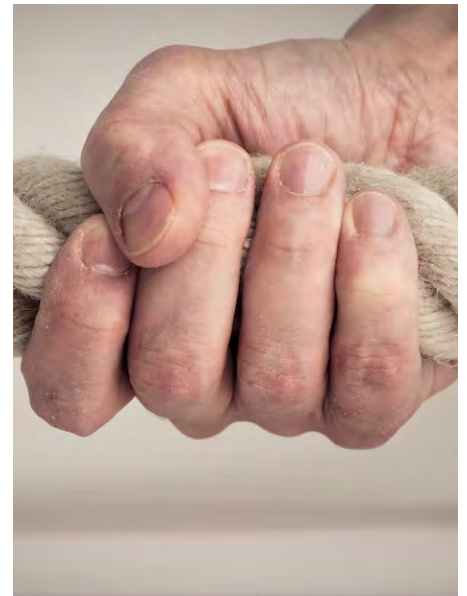

23

AMBIGUOUS (ADJECTIVE)



Having or expressing more than one possible meaning ,sometimes intentionally

Synonyms - Obscure, Opaque, Dubious, Vague

Antonyms - Determined, Sure, Clear

Example Ambiguous phrases.

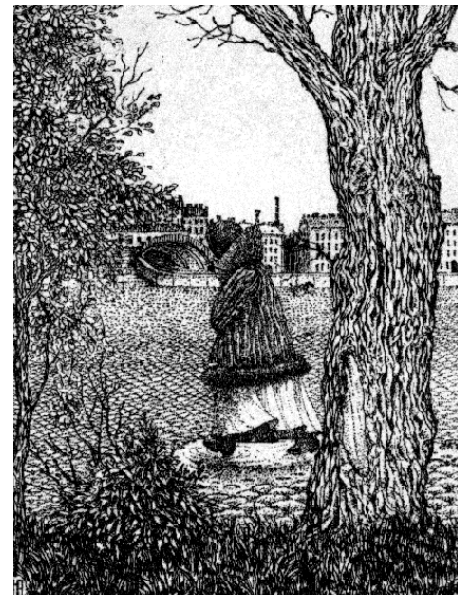

24

AUGURY (NOUN)



A sign of what might happen in the future

Synonyms - Herald, Boding, Portent, Forewarning

Antonyms - Suffer, Stay, Inexperience

Example They heard the sound as an augury of death.



25 HEARTENING (ADJECTIVE, VERB)

Making you feel happier and more positive

Synonyms - Energize, Console, Revitalize, Invigorate

Antonyms - Dishearten

Example This is the most heartening news of all.



26 PONDERING (VERB)

Thinking carefully about something, especially for a noticeable length of time.

Synonyms - Contemplate, Mull over, Think about

Antonyms - Ignore, Neglect, Forget, Discard

Example I pondered why the baby is crying.

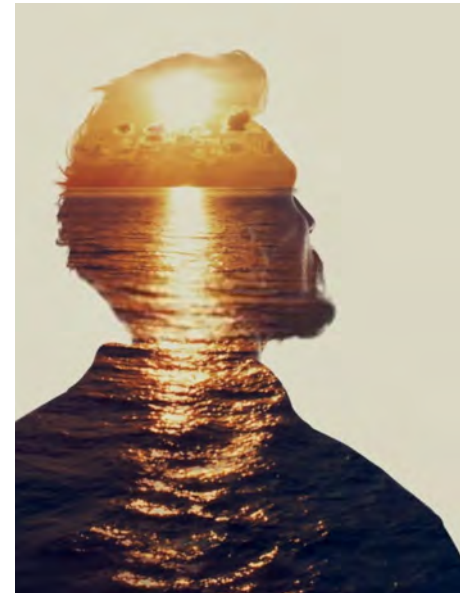

27 TENUOUS (ADJECTIVE)

So weak or uncertain that it hardly exists.

Synonyms - Flimsy, Insubstantial, Fragile, Shaky

Antonyms - Convincing, Substantial, Strong

Example The tenuous link between interest rate and investment.



28

HINDER (VERB)



Make it difficult for someone to do something or something to happen.

Synonyms - Hamper, Obstruct, Retard, Impede

Antonyms - Help, Facilitate

Example I hinder my savings from my brother.



29

IMPERATIVES (NOUN, ADJECTIVE)



Of vital importance, crucial.

Synonyms - Critical, All-Important

Antonyms - Unimportant, Optional

Example The eye operation imperatives for the old lady.



30

UNDERGIRD (VERB, NOUN)



To support something by forming a strong base.

Synonyms - Fortify, Strengthen

Antonyms - Undermine, Contradict, Fall

Example The mentor undergirds a student.



31 HAVOC (ADJECTIVE, VERB)

Widespread destruction

Synonyms - Devastation, ruin, disaster, catastrophe, calamity, demolition

Antonyms - Building, saving, rescue

Example The havoc caused many people to die.

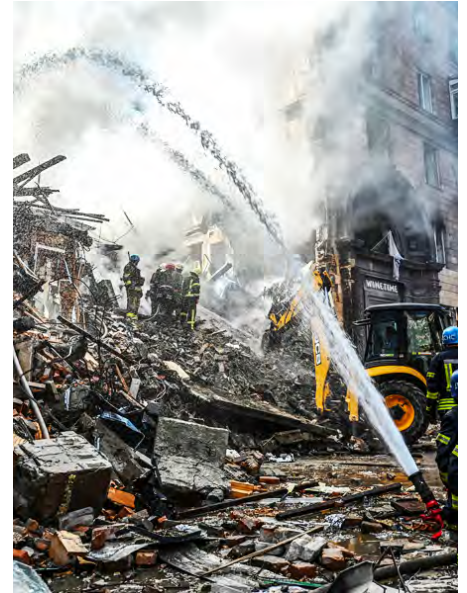

32 CLUTCH (NOUN)

A collection of things or persons to be handled together.

Synonyms - Cluster, Batch, Collection, Accumulation

Antonyms - Single, Unit, Entity

Example He stood clutching a microphone.



33 PREJUDICE (NOUN)

Preconceived opinion that is not based on reason or actual experience

Synonyms - Bias, partiality, favoritism, nepotism, cronyism, chauvinism

Antonyms - Neutrality, Impartiality, Indifference

Example Prejudice against people from minority groups.



34 AMBIT (NOUN)

 **The scope, extent or bounds of something**

Synonyms - Confines, Realm, Span, Widt

Antonyms - Defeat, Lose, Equal

Example A discussion of this complex issue was beyond the ambit of one book.



35 SPREE (NOUN)

 **An unrestrained outburst of an activity.**

Synonyms - Splurge, Binge

Antonyms - Discipline, Discontent, Temperance

Example He went on six-month crime spree.



36 HEED (NOUN, VERB)

 **Pay attention to.**

Synonyms - Regard, Notice, Thought, Care

Antonyms - Disregard

Example The student heeds his teacher speech.



37 STAVED OFF (PHRASAL VERB)

 Prevented something bad from affecting you for a period of time, delayed something.

Example The police staved off the terrorist from bombing.



38 GRAPPLED WITH (PHRASAL VERB)

 Trying to deal with or understand a difficult problem or subject

Example He grappled with the aptitude.

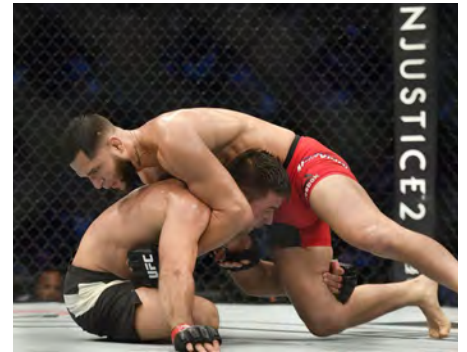

39 RESTRAINT (NOUN)

 Calm and controlled behaviour

Synonyms - Self-control, Self-resistant, Self-discipline

Antonyms - Outspokenness, Abandon

Example The parent restrains the child behavior.



40 INTEMPERATE (ADJECTIVE)

 Showing anger or violence that is too extreme and not well

Synonyms - Unreasonable, Inordinate, Undue

Antonyms - Moderate

Example An intemperate social occasion.



41 EMBRACE (VERB)

To accept something enthusiastically

Synonyms - Hug, Hold, Take up, Clasp

Antonyms - Reject, Exclude

Example The child embraced his daddy gift.

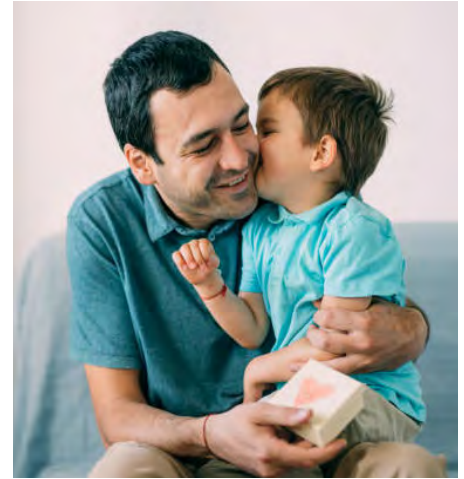

42 CARVE OUT (PHRASAL VERB)

To create or obtain something that helps you by skillful activities

Example The company hopes to carve out a greater share in the market.



43 SPELT OUT (PHRASAL VERB)

Explained something in detail.

Example The mentor spelt out the math's problem.

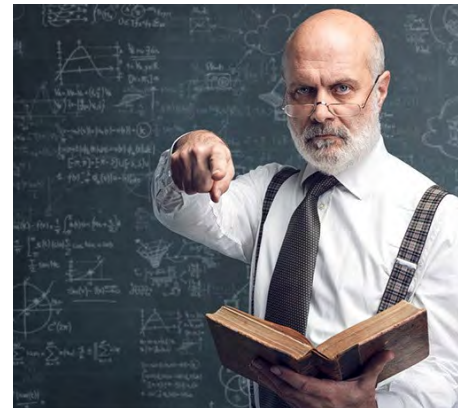

44 HAMPERING (VERB)

Slowing the movement, progress of someone or something.

Synonyms - Hinder, Impede, Obstruct

Antonyms - Help

Example The work is hampered by lack of funds.



45 PERILOUS (ADJECTIVE)

 **Extremely dangerous.**

Synonyms - Hazardous, Risky, Unsafe

Antonyms - Safe, Secure

Example A perilous journey south.



46 INTRANSIGENCE (NOUN)

 **The quality of refusing to change your opinions or behavior.**

Synonyms - Unruliness, Narrow-mindedness, insubordination

Antonyms - Soft, Yielding, Willing

Example Opponents accused him of intransigence

"NO, AND THAT IS FINAL!"

INTRANSIGENT



47 PERSISTED (VERB)

 **Continue in an opinion or course of action in spite of difficulty or opposition**

Synonyms - Preserve, Keep on, Carry on

Antonyms - Abandon, Stop

Example The minority of drivers who persist in drinking.



48

ADJUDICATION (NOUN)



The act of judging a case.

Synonyms - Adjudge, Arbitrate, Determine

Antonyms - Hesitate, Defer, Dodge

Example The matter go to court for adjudication.



49

RHETORIC (NOUN)



Speech or writing that is intended to influence the people, but that is not completely honest.

Synonyms - Expression, Power of speech

Antonyms - Quiet, Conciseness

Example He is using a common figure of rhetoric, hyperbole.



50

FLANK (NOUN)



The side of something

Synonyms - Edge, Line, Fringe, Surround

Antonyms - Free, unlimited

Example Learning against his horse's flanks

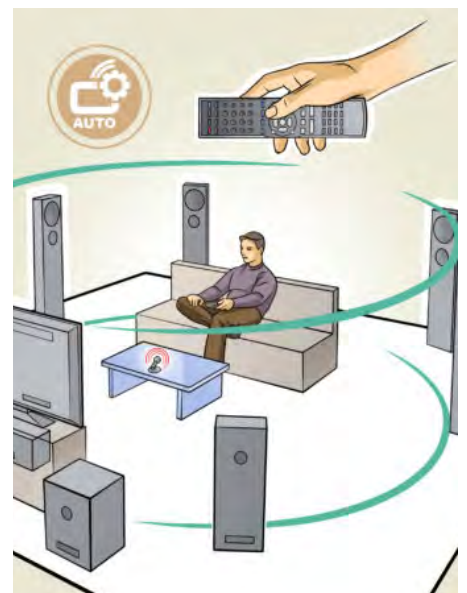

51 EXEMPLIFIED (VERB)

 **Being or giving a typical example of something**

Synonyms - Illustrate, Demonstrate

Antonyms - Conceal, hide

Example Anecdotes exemplifying virtues.



52 BELEAGUERED (ADJECTIVE)

 **Having a lot of problems or difficulties**

Synonyms - Troubled, Besieged

Antonyms - Friendly, Sociable

Example He handled beleaguered situation cleverly

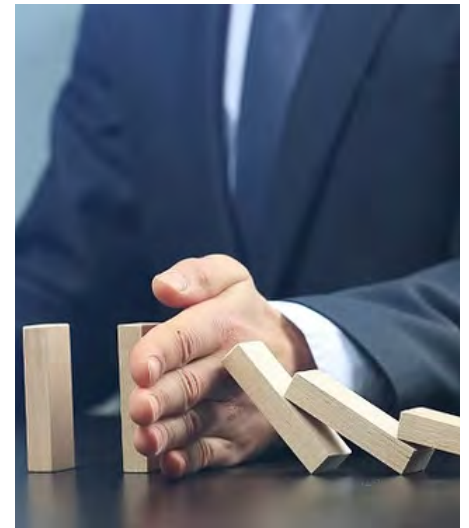

53 ARDUOUS (ADJECTIVE)

 **Difficult and tiring , or needing a great deal of effort**

Synonyms - Burdensome, Laborious, Onerous

Antonyms - Easy, Effortless

Example An arduous journey

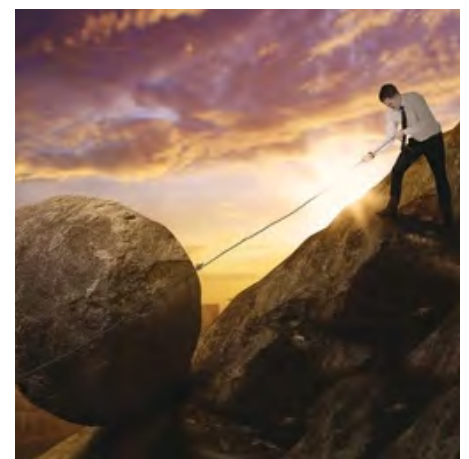

54 RUDIMENTARY (ADJECTIVE)

Only basic , and not deep or detailed

Synonyms - Basic, Elementary, Primary

Antonyms - Advanced

Example He received rudimentary education



55 PREVAIL OVER (PHRASAL VERB)

To persuade someone to do something that they do not want to do.

Example If they prevail in the court case, they could pay fine



56 ROUT (NOUN)

A situation in which somebody is defeated easily and completely in a battle or competition.

Synonyms - Put to flight

Antonyms - Calm, At a standstill

Example The retreat degenerated into a rout



57

GYRATIONS (NOUN)



The act of repeatedly and quickly changing.

Synonyms - Rotate, Revolve

Antonyms - Steady

Example The gyrations of the dancers 'arms and legs



58

RUBBISHED (NOUN)



Criticized somebody/something severely or treated them as though they were of no value.

Synonyms - Refuse, Garbage, Debris

Antonyms - Sense, Praise

Example People might say I was a rubbish manager



59

CHARY (ADJECTIVE)



Uncertain and frightened to take risks or unwilling to do

Synonyms - On one's guard, heedful, wary

Antonyms - Heedless

Example She had been chary of telling the truth



60 DOWNPLAY (VERB)

To make something seem less

Synonyms - Lessen, Devalue, Play down

Antonyms - Amplify, Exaggerate, Overstate

Example This report downplays the seriousness of global warming



61 CONTAGION (NOUN)

The fact of economic problems in one country, region, etc. spreading to another

Synonyms - Infection, Transmission

Antonyms - Purification, Good luck

Example The rooms held no risk of contagion



62 REPOSED (VERB)

Placed trust, hope in someone/something.

Synonyms - Recline, Rest

Antonyms - Work, Stress, Strain

Example How sweetly he reposes in the bed

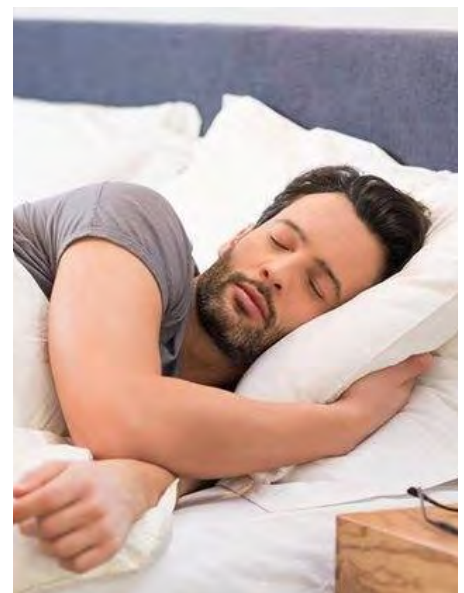

63

MALA FIDE (ADJECTIVE)



Carried out in bad faith or with intent to deceive

Synonyms - Illegal, Dishonest

Antonyms - In good faith, bona fid

Example

The foreign associates acted with mala fide inten



64

STEPPED UP (PHRASAL VERB)



Increased the size, amount or speed of a process that is intended to achieve something.

Example

The enemy stepped up their attacks



65

AMALGAMATION (NOUN, VERB)



The act of putting two or more things together so that they form one(new thing)

Synonyms - Blend, Merger, Union

Antonyms - Separate

Example

He amalgamated his company with another



66 ETCHED (VERB)

 **Fixed permanently or implanted firmly.**

Synonyms - Inscribe, Engrave, Cut in

Antonyms - Build, Confuse, Neglect

Example Etched figure



67 EMBLEMATIC (NOUN)

 **Representing a particular person, idea or group.**

Synonyms - Symbolic, Demonstrative

Antonyms - Representational, Realistic

Example This case is emblematic of larger problem



68 SHACKLE (NOUN, VERB)

 **To put many limits on what someone can do**

Synonyms - Bonds, Bind, Secure, Fetter

Antonyms - Free

Example The prisoner was shackled to the heavy steel chair



69

VIGILANT (ADJECTIVE)



Keeping careful watch for possible danger or difficulties

Synonyms - Watchful, Keen-eyed

Antonyms - Negligent, Inattentive

Example The burglar spotted by vigilant neighbors



70

PRUDENCE (NOUN)



A sensible and careful attitude when you make judgments and decisions

Synonyms - Wisdom, Sagacity, Shrewdness

Antonyms - Secklessness

Example We need to exercise prudence in such matters



71

SANCTITY (NOUN)



The state of being very important and worth protecting.

Synonyms - Holiness, Blessedness, Sacredness

Antonyms - Wickedness

Example The sanctity of human life



72

VOCIFEROUS (ADJECTIVE)



Expressing your opinions or feelings in a loud and confident way

Synonyms - Vehement, Frank, Outspoken

Antonyms - Silent, Quiet

Example

He was a vociferous opponent of the takeover



73

CONGREGATING (VERB)



Coming together in a group

Synonyms - Gathering, Assembly

Antonyms - Division, Separation

Example

Army officers had congregated at a border point



74

EARMARKED (ADJECTIVE, VERB)



Kept or intended something for a particular purpose

Synonyms - Reserve, Appropriate

Antonyms - Familiar, Insignificant, Imprope

Example

The cash has been earmarked for road project



75

UNENVIABLE (ADJECTIVE)



Difficult or unpleasant

Synonyms - Disagreeable, Horrible, Undesirable

Antonyms - Envidable, Desirable

Example An unenviable reputation for drunkenness



76

PRETEXT (NOUN)



A pretended reason for doing something is used to hide the real reason

Synonyms - Excuse, Plea

Antonyms - Reality, Back, Rear

Example The rebels had perfect pretext for making their move



77

PORTENTOUS (ADJECTIVE)



Too serious and trying to be very important.

Synonyms - Ominous, Warning, Premonitory

Antonyms - Modest, Humble, Self-effacing

Example The author's portentous moralizing



78 ARBITRARILY (ADVERB)



In a way that is based on chance rather than being planned or based on reason

Synonyms - Unpredictable, Capricious, Random

Antonyms - Rational, Accountable

Example He selected arbitrarily his dress

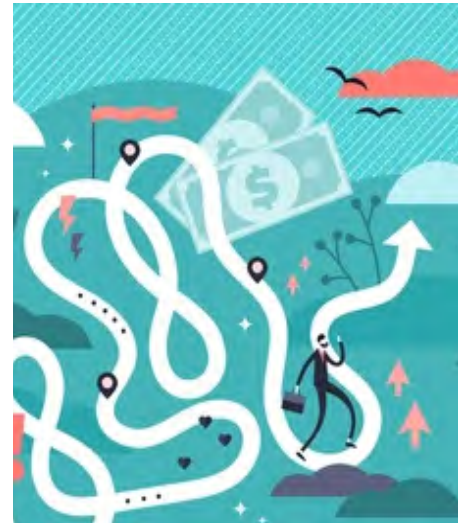

79 LAMENT (NOUN, VERB)



An expression of sadness over something, or a complaint

Synonyms - Weeping, Crying, Bemoan

Antonyms - Celebrate, Rejoice

Example There were constant laments about unemployment



80 STALLED (VERB)



Stop or cause to stop making progress

Synonyms - Obstruct, Impede, Hamper

Antonyms - Hastened, Advanced, Furthered

Example The project has stalled



81 CALLOUSNESS (NOUN)

 **Insensitive and cruel disregard for others**

Synonyms - Heartlessness, Indifference, Obduracy

Antonyms - Compassionate, Sympathetic

Example The callousness of using children to send a political message

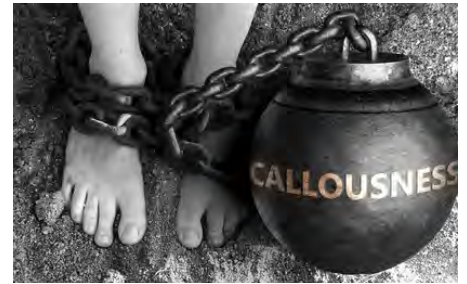

82 DEVIIOUS (ADJECTIVE)

 **Showing a skillful use of underhand tactics to achieve goals**

Synonyms - Deceitful, Insidious

Antonyms - Honest, Forthright

Example They arrived at a town by a devious route

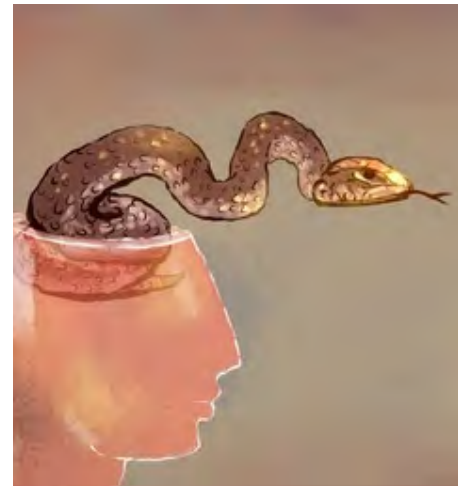

83 BANKRUPT (ADJECTIVE)

 **A person or organization declared in law as unable to pay their debts**

Synonyms - Insolvent, Failed

Antonyms - Solvent

Example His father went bankrupt and had to sell his home

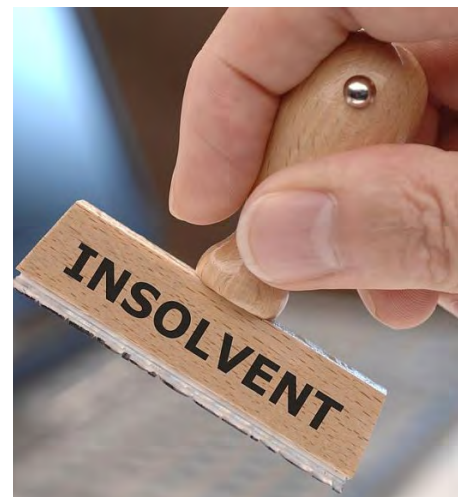

84 ACQUIT (VERB)

 **Free someone from a criminal charge by a verdict of not guilty**

Synonyms - Absolve, Clear, Exonerate

Antonyms - Convict

Example He acquitted from the case



85 OUST (VERB)

 **Drive out or expel someone from a position or place.**

Synonyms - Expel, Force out

Antonyms - Readmit

Example The government ousted nirav modi



86 ENTANGLE (VERB)

 **Cause to become twisted together with.**

Synonyms - Confuse, Complicate, Entwine

Antonyms - Clarify, Exclude

Example The bird entangled with the net

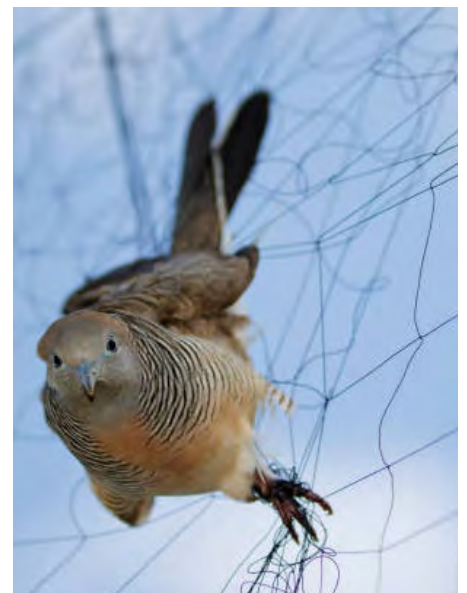

87

PREMEDITATED (ADJECTIVE)



Of an action, especially a crime thought out or planned beforehand.

Synonyms - Planned, Deliberate, Calculated

Antonyms - Accidental, Casual

Example Premeditated murder



88

THRIVE (VERB)



Grow or develop well or vigorously

Synonyms - Flourish, Burgeon, Prosper

Antonyms - Cease, Fail, Shrink, Shivel

Example The fruits price thrived



89

AFFORDABLE (ADJECTIVE)



Reasonably priced

Synonyms - Inexpensive, Cheap

Antonyms - Expensive

Example The bag is affordable to buy



90

COMPLACENCY (NOUN)



Self satisfaction especially when accompanied by unawareness of actual dangers.

Synonyms - Self-satisfaction, Self-approval

Antonyms - Dissatisfaction

Example

The figures are better, but there are no grounds for complacency



91

SPUR (VERB)



A thing that prompts or encourages someone

Synonyms - Stimulate, Encourage, Prompt

Antonyms - Discourage

Example

The staff has spurred the students to study



92

CRITICAL (ADJECTIVE)



Inclined to criticize severely

Synonyms - Vital, Essential

Antonyms - Trivial

Example

I was very critical of the previous regime



93 ENIGMATIC (ADJECTIVE)

Difficult to interpret/understand

Synonyms - Mysterious, Confusing

Antonyms - Straightforward

Example He took the money with an enigmatic smile



94 RELUCTANT (ADJECTIVE)

Feeling / Showing aversion

Synonyms - Unwilling, Inclined

Antonyms - Disinclined

Example He was reluctant to leave



95 ABOLISH (VERB)

Formally put an end to a system/practice/ institution

Synonyms - Do away with, get rid of

Antonyms - Retain.

Example The government has abolished the money bill



96 OPPRESSIVE (ADJECTIVE)

Inflicting harsh and authoritarian treatment

Synonyms - Harsh, Cruel, Brutal

Antonyms - Lenient

Example An oppressive dictatorship

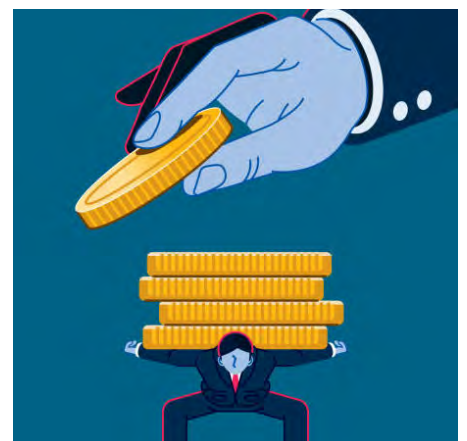

97

STATUS QUO (FOREIGN WORD)



The existing state of affairs, especially regarding social or political issues.

Example

They have vested interest in maintaining the status quo



98

BACK DOWN (PHRASAL VERB)



Withdraw a claim or assertion in the face of opposition.

Example

The party leaders back down from the resolution



99

THRONGS (NOUN)



A large, densely packed crowd of people or animals.

Synonyms - Legion, Swarm, Array, Mass

Antonyms - Deserted, Empty, Loose

Example

A crowd thronged the station



100

DISAVOW (VERB)



Deny any responsibility or support for.

Synonyms - Eschew, Abjure, Renounce, Forswear

Antonyms - Go along, Agree, Claim

Example

The union leaders resisted pressure to disavow picket-line violence



Current Affairs
CROSSWORD
PUZZLE

ANSWERS



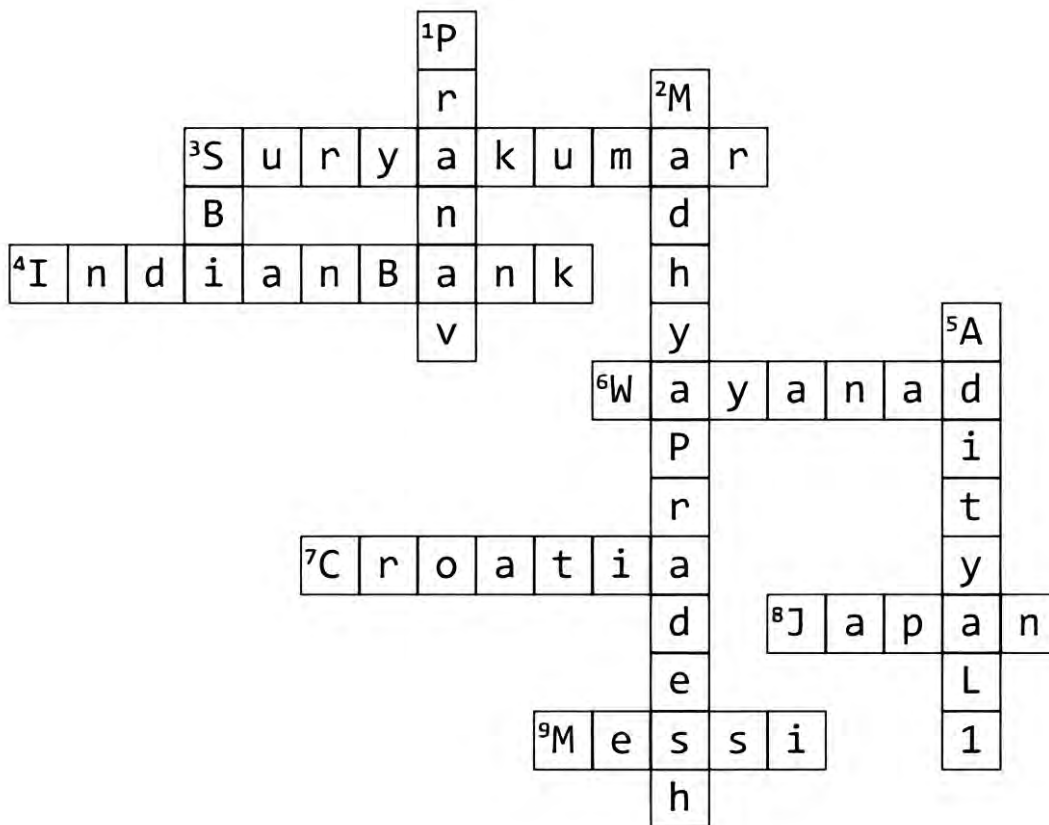

Across

3

First Indian player to win the ICC Men's T20 Cricketer of the Year award.

4

Bank received RBI approval to hold special rupee Vostro accounts of three banks from Sri Lanka

6

First district in India to provide basic documents to all tribal people

7

20th member of the Eurozone and Country adopted the euro as its official currency

8

Country ranked first on the list of the most powerful passports in the world

9

Best Player for the calendar year of 2022 by IFFHS

Down

1

India's 79th chess Grandmaster

2

State hosting Mandu Festival and Skydiving Festival and the Hriday Drishyam Kala Utsav

3

Bank launched e-Bank Guarantee (e-BG) facility with NeSL

5

India's first solar mission