

Steroplast® Buyers Guide

NEW 2-in-1 Catalogue for Professional Healthcare Buyers

Workplace First Aid

The Definitive Guide for First Aid Buyers

Starts on page 6

 **Free Delivery**
On web orders over £40

Buy From a
UK-Based Supplier

Page 25

NEW Cycling First Aid Kits

Specialist compact first aid kits for cyclists

Page 18

First Aid Stations

Make workplace first aid kits highly visible

Page 74

Bleed Control & Trauma

Life-saving supplies for professional medics

Page 98

Pharmaceutical Supplies

From a MHRA Registered Supplier

Need Assistance?

 **Speak to our Sales Team**

Helpful support with *no automated phone menus*

Rated "Excellent"



by our customers

Advanced Life Support

The Trusted Guide for Emergency Buyers

Starts on page 66

Suppliers to the
British Red Cross



Order online 24/7 at
Steroplast.co.uk



Find all products online at steroplast.co.uk

Find Articles, Product Guides, Videos & Special Offers

Call or email us to order direct

+44 (0)161 902 3030 | sales@steroplast.co.uk



Free delivery on web orders above £40 (Excl. VAT)



VISIT WEBSITE



You can order quickly and easily through our **SUPERB** website — and get next day delivery!

You can also view product videos, read informative blogs and once you contact us, you'll experience Steroplast's excellent customer care.

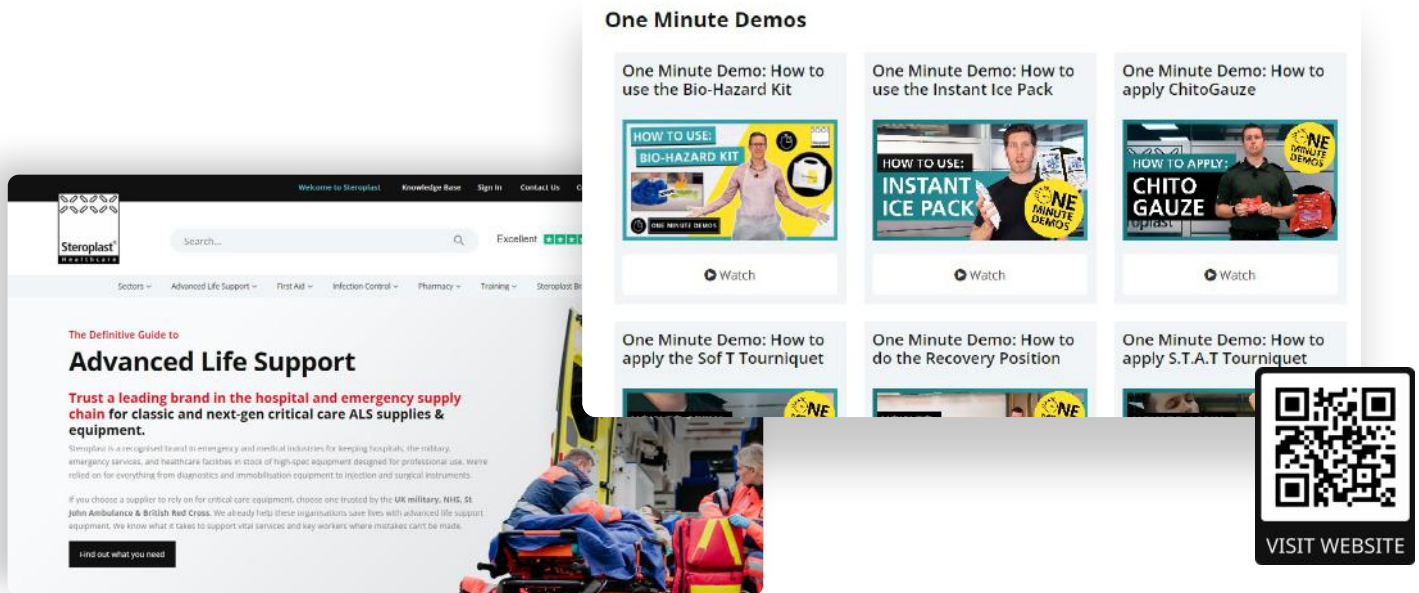

Order 24/7 online at steroplast.co.uk



- Easy-to-shop Product Categories
- Engaging Videos
- Articles from our Knowledge Base
- Customer Reviews
- Downloadable Brochures
- Interactive Guides
- Track Orders Online
- Exclusive Offers & Discounts

Explore our **Online Buying Guides**

Buying guides detail each product's features, benefits, and applications, helping you make informed decisions suited to your specific requirements.

Whether you are a healthcare professional, a retail partner, or someone looking to enhance your first aid knowledge and resources, our Buying Guides are designed to streamline your selection process, ensuring you receive high-quality, industry-leading products tailored to you.

Explore these resources today to discover how Steroplast can support your healthcare objectives with confidence and clarity.

- Interactive assessments
- Page navigation
- Direct product links
- Expert insights

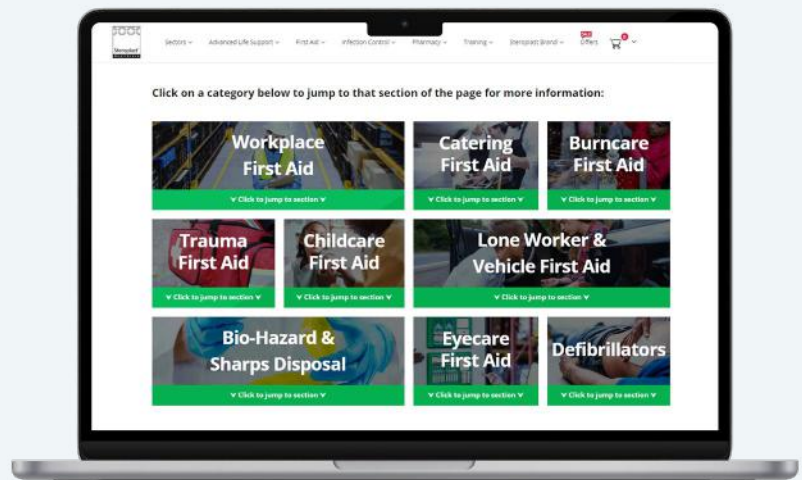

Which?

#1 in the UK: Which? Recommended

Our **Elastic Fabric Plaster (Page 24)** was put through a series of tough tests by Which?, the 100% independent UK consumer champion, to find out which plaster from major UK brands was the most reliable and cost-effective.

Read more in our article online:

Steroplast Fabric Plasters Voted Best in the UK by Which?

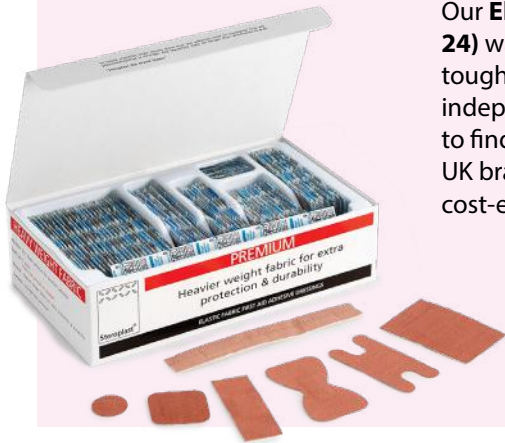

100% satisfaction guarantee! Zero risk to you.

We're so confident in the products we offer, we guarantee every purchase you make. If for any reason you're not entirely satisfied with any part of your order, once delivered, just let us know and we'll put it right, no matter what it is.

Risk FREE purchasing with Steroplast – every time!

Rated "Excellent"



by our customers



"Good value products. Solid customer service. Recommended!"



"Very quick delivery and was really pleased with the quality of items, better than expected, will definitely use again."



"Super fast delivery and informative from start to finish. Highly recommend."



"Great products and good prices. Easy to use web page. Fast delivery."

We can provide your **Pharmaceutical Supplies**

We supply essential over-the-counter medicines and POM supplies for pharmacies, hospitals, and ambulances.

Go to **page 99** to complete our authorisation form.

Licensed by the



Put us to the test, make contact, we think you'll be pleased you did.



At Steroplast, you'll always be greeted by a friendly voice!

▶ Call us on **+44(0)161 902 3030**

No long-winded phone menus to navigate, when all you want is to talk to someone who is friendly, courteous and helpful!



Email us your order requirements and we'll take care of the rest.

▶ Email **sales@steroplast.co.uk**

Simply send the product details, quantities, and any delivery information, and our team will reply with a custom quote and lead time to suit your needs.

Workplace First Aid | Contents

06-07	Introduction to Workplace First Aid
08-09	Take our Workplace First Aid Assessment

Shop Workplace First Aid

10-25	Workplace First Aid
26-29	Catering First Aid
30-33	Lone Worker & Vehicle First Aid
34-37	Burncare First Aid
38-43	Trauma First Aid
44-49	Childcare First Aid
50-51	Eyecare
52-55	Biohazard & Sharps Disposal
56-59	Defibrillators

Educational Resources

60	Health & Safety at Work
61	Understanding the Law
62	Information for Employers
63	Risk Assessments
64	Workplace-Specific Hazards

Looking for something specific?
 Visit our complete product index on page **100** to find all products listed alphabetically.

Rated "Excellent"

★★★★★
 "Excellent customer service that goes hand in hand with their knowledge."

★★★★★
 "Had what I wanted and at a reasonable price. Easy to order and good delivery time."

★★★★★
 "Easy to use website, and quick delivery of goods ordered. Very good service."

by our customers



Page 16
Eco-friendly First Aid Kit



Page 18
First Aid Stations



Page 27
Catering First Aid Kits



Page 31
Vehicle Kits



Page 34
Burncare Kits

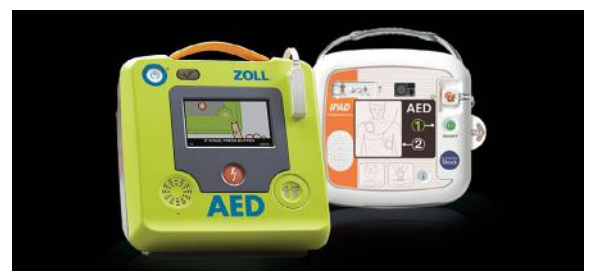

Page 58 - 59
Defibrillators for your Workplace



Page 53
Biohazard Kits



Page 42
The Public Access Trauma (PACT) Kit

Advanced Life Support | Contents

66-67	Introduction to Advanced Life Support
68-71	Airway Management
72-73	Bandages & Dressings
74-76	Bleed Control & Trauma Equipment
77	Blizzard Survival & Emergency Lighting
78-79	Burns
80-82	Defibrillators
83-85	Diagnostic Equipment
86-88	Emergency Bags
89-91	Evacuation, Immobilisation & Patient Handling
92-93	Injection & Infusion
94	Maternity Equipment
95	Surgical Instruments
96	Training Equipment



Page 77
Emergency Lighting



Page 74
Trauma Dressings



Page 80 - 82
Defibrillators & Accessories



Page 90
Neck Collars



Page 75
Tourniquets

97 **Distributor & Delivery Information**
Find out how we work with distributors

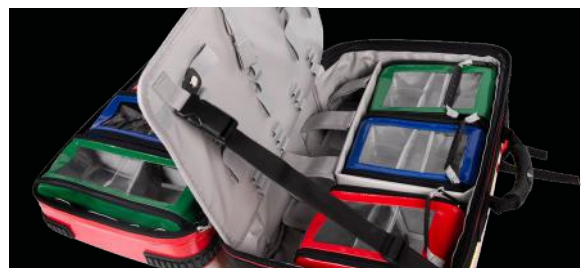

Page 86 - 88
WaterStop® Bags

98-99 **Pharmaceutical Supplies**
From an MHRA Approved Supplier

MHRA

Complete the Form on page 99



Page 92
Syringes



Page 96
CPR Manikins

102 **KNIFE CRIME IS ON THE RISE**
If you want to be more prepared, here's how...



Workplace First Aid

First aid buyers — find out exactly what supplies you need for your workplace

This guide is designed to help you understand the essentials of workplace first aid, from assessing your specific needs to complying with legal requirements. By using this guide, you'll be able to assess the risks in your workplace and make informed decisions about the first aid supplies and training your business requires.

Don't let a lack of preparedness get the better of you. Without proper first aid provisions, you are putting yourself and anyone else you're responsible for at risk. If you're an employer, this also means you're breaking the law. Steroplast can help you put the proper precautions in place for peace of mind.

We specialise in developing health and safety risk-preventative measures that all kinds of businesses need to take. Whether you run an international operation or are a self-employed tree surgeon, we've worked with someone in your position before to supply all the workplace first aid you need to confidently carry on business.

Not what you're looking for?

Our range of **Advanced Life Support** products starts on page 66.



ONLINE GUIDE

Find all the products mentioned on our online guide: The Definitive Guide to Workplace First Aid

Scan the QR code to directly access our first aid product selection and benefit from our expert advice and product insights, ensuring you get the most appropriate solutions for your workplace first aid requirements.



Complete the Workplace First Aid Assessment to find what you need



Step 1:

Start with a **Workplace First Aid Assessment**

Before browsing our product selection, start by completing the Workplace First Aid Assessment found on pages 8 & 9.

This will help you identify the specific risks present in your workplace to inform exactly which first aid supplies you need.

Make a list of the products in your assessment results before moving onto the next section.

Step 2:

Select the Right **First Aid Products**

After completing your assessment, you'll be ready to choose the most suitable first aid supplies for your workplace.

Using your assessment results, you can browse the product catalogue with confidence and select items that match your specific requirements, helping ensure your site is properly prepared.

Visit www.steroplast.co.uk or contact us directly to purchase your selected products.

Step 3:

Learn more through **Educational Resources**

Once you've completed the assessment, move on to the Education Section, where you'll find valuable information to guide your decisions.

Learn about your legal responsibilities and ensure your business complies with UK health and safety regulations.

- Health and Safety at Work
- Understanding the Law
- Information & Training
- Risk Assessments
- Workplace-Specific Hazards

Workplace First Aid Assessment

Find out what first aid supplies your workplace requires...

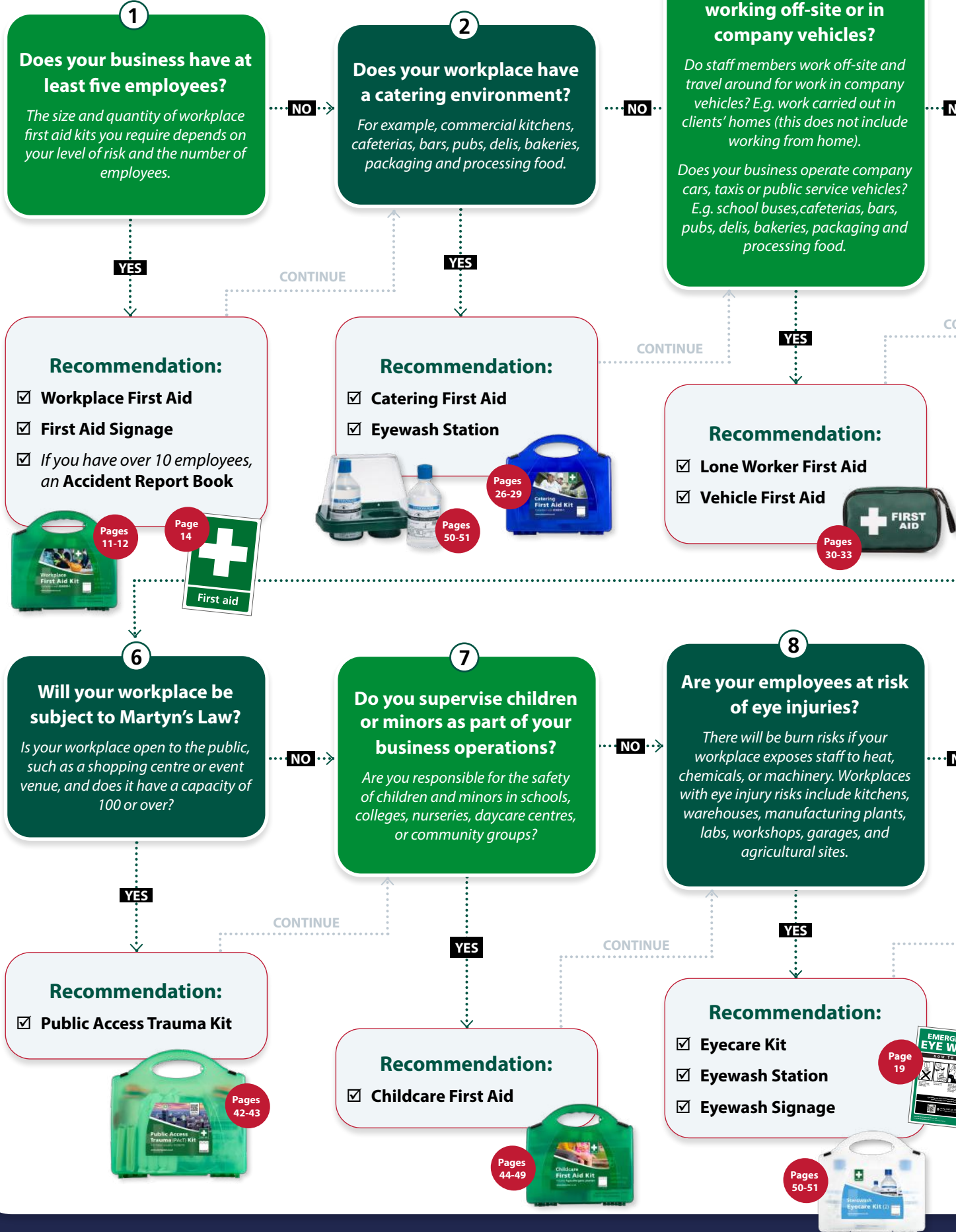



Take the **Workplace Interactive Assessment** online

VIEW ONLINE

4

Does your workplace have burn risks?

Exposure to naked flames, electronic tools, ovens, steam, and certain chemicals puts your staff at risk of burns. Examples of workplaces with burn risks are kitchens, labs, manufacturing, construction, and engineering.

NO

YES

Recommendation:

- Burncare First Aid**

Pages 34-37



5

Does your workplace have the risk of trauma?

If your workplace has heavy movable objects, sharp or electronic tools, moving or automatic machines, or you work at height, there is a risk of trauma (severe injury).

Examples of workplaces with trauma risk are factories, warehouses, construction sites, garages, agricultural or forestry workplaces, and oil rigs.

YES

Recommendation:

- Additional Trauma Supplies**
- Bleed Control Kit**

Pages 38-39



First aid supplies I need for my workplace:

-
-
-
-
-
-
-
-
-
-
-
-
-
-
-
-
-
-
-
-
-

9

Are your staff ever exposed to biohazards?

Body fluids include urine, faeces, blood, vomit, saliva, and semen, which are classed as biohazards and potentially infectious.

Examples of workplaces include kitchens, restaurants, care homes, and schools.

NO

YES

Recommendation:

- Biohazard Kit**

Page 55



10

Are your staff ever exposed to sharps?

This pertains to work that involves handling sharp objects like needles, razors, and pins or encountering broken glass that could become contaminated with body fluids.

Examples of workplaces with this risk are care homes, labs, workshops, salons and tattoo shops.

YES

Recommendation:

- Sharps Disposal Kit**
- Sharps Disposal Bins**

Page 54



11

Do you operate a business involving high-risk electrical environments or interactions with individuals prone to heart complications?

Do you work with vulnerable people with pre-existing heart conditions? Or do you work in environments like manufacturing, engineering, workshops, and labs which have a heightened electric shock risk?

YES

Recommendation:

- Defibrillator**
- Defibrillator Accessories**

Pages 56-59



Workplace First Aid

It is the LAW for employers to ensure that employees receive help immediately if they are ill or injured at work



Every business must have:

- A suitably stocked first aid kit
- An appointed person to take charge of first aid requirements
- A number of staff trained in first aid at work and there must always be a trained first aider on site
- Provide information for all employees informing them of first aid arrangements



How to choose the correct workplace first aid kit:

Using our selection chart below makes choosing the right first aid kit is now as easy as 1, 2, 3.

- 1 Is your work environment **LOW HAZARD** or **HIGH HAZARD**
- 2 How many employees there are in your workplace?
- 3 Which of the three sizes of kit you will need, e.g. **small, medium** or **large**

Number of significant areas in your workplace	Degree of hazard	Number of employees	Minimum requirements
<p>A significant area is an individual floor or building. You should be able to reach a casualty within 60 seconds of an initial call for assistance.</p> <p>E.g. An office and a warehouse on the same site constitutes as 2 significant areas.</p> <p>Each area needs to be assessed on it's own merits.</p> <p>Sports clubs/facilities: we recommend one small kit on each floor.</p>	1 LOW HAZARD - Office (e.g. shops, offices and all sports facilities).	2 Less than 25	3 At least one small kit
		25 - 50	At least one medium kit
		More than 50	At least one large kit
	1 HIGH HAZARD - Warehouse (e.g. light engineering and assembly work, food processing, warehousing, dangerous machinery, construction, harmful chemicals etc.).	2 Less than 5	3 At least one small kit
		5 - 25	At least one medium kit
		More than 25	At least one large kit

Workplace First Aid Kits

No matter how low-risk your workplace is, if you employ at least one person, you'll need a first aid kit on your premises per the Health and Safety (First-Aid) Regulations 1981. Find the ideal first aid kit here to suit your needs, whether a state-of-the-art BS8599-1 Workplace First Aid Kit or a cost-efficient HSE First Aid Kit.

Choose from large, medium, and small kits, hardshell boxes, or soft bags. Kit refills are also available for all our workplace first aid kit products, so you can keep them well-stocked without breaking the bank.



Scan the QR code or visit www.steroplast.co.uk/first-aid-products.html to view these products online.

VIEW ONLINE

What's the difference between HSE and British Standard?

HSE kits and British Standard kits are compliant with health and safety laws, but there are several differences between them, with British standard kits being improved to meet current hazards and risks.

Here are the main differences between them:

? HSE First Aid Kits

The standard guidance on first aid kits under the HSE has remained the same since 1981. The HSE provides some guidance on the type of items that should be in a first aid kit, but not the quantities.

HSE first aid kits are perfect as an entry-level kit and ideal for an office or low-hazard environment.

? British Standard First Aid Kits

BS8599-1 compliant kits have been expanded to meet modern hazards and rules. They include modern products and consider updated first aid practices. The BS8599-1 kits make first aid compliance easy and are **ideal for both low-risk and high-risk work environments.**

Premier BS8599-1 Workplace First Aid Kit

- Complies with UK Health and Safety laws, meeting BS8599-1 specifications
- Quick and easy access to contents with organised compartments and a placement diagram
- Includes Burnshield Hydrogel dressings for effective burn treatment
- Durable hard-shell Premier box protects contents from damage and keeps them dry
- Available with an industrial-strength wall-mounted bracket for easy installation
- Cost-effective refills available to maintain compliance and readiness

Kit Includes:

- Burn Dressing
- Conforming Bandage
- Eyepad Dressing - Sterile
- Finger Dressing - Sterile
- Foil Blanket
- Gloves - Pairs
- Guidance Leaflet
- Large Dressing - Sterile
- Medium Dressing - Sterile
- Microporous Tape
- Washproof Plasters
- Resusciate CPR Face Shield
- Saline Sterile Wipes
- Triangular Bandage
- Tuff Cut Scissors
- Wall Bracket

Item quantities vary based on size of kit



OWN BRANDING AVAILABLE



MADE TO BRITISH STANDARDS



SKU	SIZE
8599-PS19	Small Kit in Premier Box
8599-RS19	Small First Aid Kit - Refill
8599-PM19	Medium First Aid Kit in Premier Box
8599-RM19	Medium First Aid Kit - Refill
8599-PL19	Large Kit in Premier Box
8599-RL19	Large First Aid Kit - Refill

BS8599-1 Workplace First Aid Kits

- Complies with BS8599-1, the British Standard for workplace first aid kits, ensuring high-level protection
- Suitable for both low and high-risk areas, covering a wide range of common workplace injuries
- Comes in a deluxe hard-shell green box with the signature white cross and 'first aid' label for easy identification
- Features an integrated carrying handle for quick and easy transport within the premises
- Cost-effective refills available to maintain compliance and readiness for any situation
- Kit storage box has no compartments, offering flexibility for larger items or customisation

Kit Includes:

- Conforming Bandage
- Burn Dressing
- First Aid Emergency Leaflet
- Foil Blanket
- Nitrile Gloves - In Pairs
- Microporous Tape
- Washproof Plasters
- Resusciate Face Shield
- TuffCut Scissors
- Triangular Bandage
- Wall Bracket
- Safety Pins
- Saline Wipes
- Wound Dressing - Eye
- Wound Dressing - Finger
- Wound Dressing - Large
- Wound Dressing - Medium

Item quantities vary based on size of kit



MADE TO BRITISH STANDARDS



SKU	SIZE
8599-S	Small Kit in First Aid Box
8599-RS19	Small First Aid Kit - Refill
8599-M	Medium Kit in First Aid Box
8599-RM19	Medium First Aid Kit - Refill
8599-L	Large First Aid Kit in First Aid Box
8599-RL19	Large First Aid Kit - Refill

? Why do I need a wall bracket?

Installing a wall bracket for your first aid kit is crucial to ensure it is both **clearly visible** and **easily accessible**.

Whether it's in an office, warehouse, school, community centre, or sports facility, using a wall bracket to house your first aid kit ensures that it is both safe from harm and positioned where it can be most effective during a crisis.



First Aid Box Wall Bracket — Green
SKU: 8121WB
£0.65



First Aid Box Wall Bracket — Black
SKU: 8138WB
£0.65



Premier First Aid Box Wall Bracket — Medium
SKU: 8148WB
£1.15



Premier First Aid Box Wall Bracket — Large
SKU: 8149WB
£1.50



Standard Box Bracket
SKU: 8119WB
£2.55



HSE Approved



Includes hook-style wall bracket

HSE First Aid Kit in Box 1-10 Person | 11-20 Person | 21-50 Person

- Compliant with HSE regulations, designed for up to 50 people in low-hazard environments
- Encased in a robust moulded case, ensuring durability and protection of contents
- Includes a wall bracket for easy mounting and access
- Clearly marked with a white cross and 'First Aid' for quick identification
- Contains a guidance leaflet to assist in first aid
- Offers high-quality, medical-grade products at great value
- Refills available to maintain readiness and save costs
- Ideal for medium-sized businesses or offices, designed for frequent use and larger workplaces

Kit Includes:

- First Aid Emergency Leaflet
- Gloves - Vinyl in Pairs
- Washproof Plasters
- Safety Pins
- Triangular Bandage
- Alcohol-Free Wipes
- Wound Dressing - Eyepad
- Wound Dressing - Medium
- Wound Dressing - Large
- Wall Bracket

Item quantities vary based on size of kit

SKU	SIZE
8018	1-10 Person Kit
8018RP	1-10 Person - Refill
8019	11-20 Person Kit
8019RP	11-20 Person - Refill
8020	21-50 Person Kit
8020RP	21-50 Person Kit - Refill

HSE First Aid Kit Bag — 1-5 Person | 1-10 Person

- Meets all requirements set by the Health and Safety Executive, ensuring full compliance with workplace safety regulations
- Comes in a soft, lightweight nylon bag marked with a white cross and 'First Aid' for easy identification and portability
- Designed to serve up to 10 persons, providing all necessary items to manage various emergencies for small groups or teams
- Lightweight and compact, this kit is easy to store in a car or carry along on trips

Kit Includes:

- First Aid Emergency Leaflet
- Gloves - Nitrile in Pairs
- Washproof Plasters
- Safety Pins
- Triangular Bandage
- Alcohol-Free Wipes
- Wound Dressing - Eyepad
- Wound Dressing - Medium
- Wound Dressing - Large

SKU	SIZE
8129	1-5 Person Kit
8013	1-10 Person Kit
8018RP	1-10 Person Kit - Refill



HSE Approved

70 Piece First Aid Kit

- A compact and practical first aid kit for small workplaces, personal desks, home offices, or shared staff areas
- Includes a wide range of quality supplies for treating everyday injuries, from cuts and scrapes to sprains and eye injuries



SKU	SIZE
8128	70 Piece First Aid Kit

40 Piece First Aid Kit

- Although not comprehensive enough for large workplaces, it's perfect for personal use or in a small office environment
- Contains essential items to manage everyday injuries like cuts, grazes, and minor burns



SKU	SIZE
8133	40 Piece First Aid Kit

Build your own First Aid Kit

Our range of empty bags and boxes offers a flexible solution for building your own first aid kits. Designed for practicality and durability, these containers are ideal for organising your essential supplies in any workplace setting.

Whether you're looking for a compact option or something with more capacity, we have various sizes to meet your specific requirements.

Creating a custom first aid kit based on your workplace's individual risk assessments could be a more cost-effective way to provide staff with exactly what they need when in a first aid emergency. You can ensure your kit is tailored to the specific risks and requirements of your environment.

For assistance in selecting the best option for your needs, or to discuss feel free to get in touch with us.

Call: +44(0)161 902 3030

Email: sales@steroplast.co.uk

ABS Plastic Large Empty First Aid Box
SKU: 8116EB

Fill with the first aid kit contents of your choice



Scan the QR code or visit steroplast.co.uk/first-aid-products/bags-boxes.html to view these products online.

VIEW ONLINE

Our range of empty first aid bags and boxes:



Green Premier First Aid Box
SKU: 8710EB



Red Premier First Aid Box
SKU: 8140EBC



Blue Premier First Aid Box
SKU: 8146EBC



Clear Premier First Aid Box
SKU: 8152EB



Orange First Aid Box
SKU: 8172EB



Green Large First Aid Box
SKU: 8120EB



Green Medium First Aid Box
SKU: 8118EB



Blue Activ Series 5 First Aid Bag
SKU: 9675



Green Activ Series 5 First Aid Bag
SKU: 9675/GR



Red Activ Series 5 First Aid Bag
SKU: 9675/RED



First Aid Rucksack
SKU: 9670/GRE



First Aid Shoulder Bag
SKU: 9654



First Response Kit Bag
SKU: 9657



Green First Aid Belt Pouch
SKU: 9652

Black version available



Green First Aid Bum Bag
SKU: 9659

Own Label First Aid Kits

Custom glossy labels printed and professionally applied to any of our hard-shell first aid boxes.

Make your first aid kits easily recognisable to staff and visitors on your premises with an own branded first aid kit, complete with your business's logo.

Enquire Today!



LEARN MORE

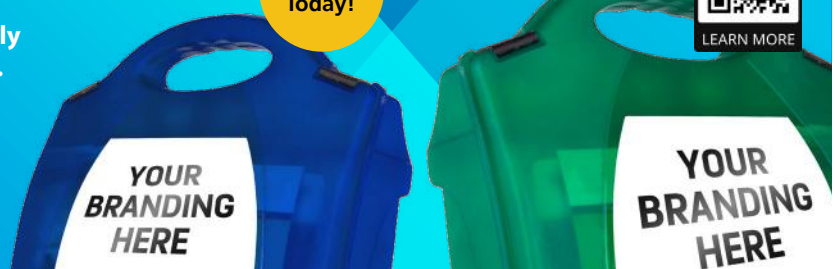

First Aid Supplies & Disposables

Our range of first aid supplies and disposables includes everything needed to keep your workplace prepared for everyday incidents. These essential items support effective first aid response and help maintain hygiene standards.

Suitable for topping up existing kits or keeping in a first aid room.



Scan the QR code or visit www.steroplast.co.uk/first-aid-products.html to view these products online.

VIEW ONLINE

Security Tamperproof Seals

- Self-locking tags
- Use on workplace first aid kits, fire extinguishers and other kit to indicate use
- Facilitates quick removal
- Polypropylene material



SKU	COLOUR	QTY
1221OR/50	Orange	50
1221RE/50	Red	50
1221GR/50	Green	50



Ferno® Saver Evacuation Chair

- Designed to assist in safely moving individuals downstairs during an emergency
- Lightweight compact for easy storage
- The secure patient retaining straps to support safe and controlled evacuation



SKU	COLOUR
WSTE0128	Blue



Paramedic Tuff Cut Scissors — 7.5 inch

- Scissors designed for quick, safe cutting in emergencies
- Available in eight colours, they can be matched to departments or kept as spares for different kits across the site

SKU	COLOUR
1512	Black
1512/GRE	Green
1512/BLU	Blue
1512/PUR	Purple
1512/PIN	Pink
1512/RED	Red
1512/ORA	Orange
1512/YEL	Yellow



Rociale Suture Pack

- For hygienic suturing procedures
- Presented in a sterile pouch that's effortless to open
- Contains all essentials for suturing, neatly arranged on a poly tray with integrated gallipots
- Fully compliant with the MDD

SKU
1274

Left-Handed Bandage Scissors

- Ergonomic 18cm left-handed bandage scissors
- Featuring a safe rounded tip and precision cutting
- Made from surgical-grade stainless steel



SKU
WSTE0155



Medisnip First Aid Scissors

- The perfect size for various medical tasks
- Easy to use addition to your medical toolkit
- Ambidextrous design
- Various styles available



SKU
1509



First Aid Guidance Leaflets

Pocket sized emergency guides providing essential life saving resuscitation techniques. Ideal for keeping with first aid supplies to ensure users are well informed to perform emergency procedures.

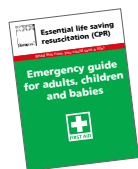

First Aid CPR Leaflet

SKU
LEAFIR007/10

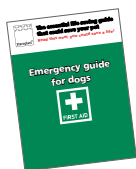

First Aid CPR Leaflet for Pets

SKU
LEAPE001



First Aid CPR Leaflet for Cyclists

SKU
LEAFIR008



Accident Report Book

A must-have accident report book required by law in all UK workplaces. Simple and easy to complete, record all workplace accidents and incidents in one place. Contains 40 report forms.

SKU
9661

First Aid Armbands

- Velcro fastening for a secure fit
- High-vis helps to indicate a qualified first aider
- Durable ripstop nylon material
- One size fits all



SKU	COLOUR
9676	Yellow
9677	Green



Resusciade CPR Face Shield

- Creates a barrier to reduce infection risk during mouth-to-mouth resuscitation
- Compact and easy to store in workplace first aid kits or with defibrillators
- Pack of 10 shields



SKU
9589/10

Pen Torch With Pupil Gauge

- Useful for checking pupil response following a head injury or suspected concussion
- Pupil gauge on the side for extra clarity
- Integrated pocket clip



PRODUCT	SKU
Pen Torch With Pupil Gauge	1074/1
Deluxe Stainless Steel Reusable Pen Torch	1079

Deluxe Stainless Steel Pen Torch

- Supplied with 2 x AAA batteries
- Pupil gauge on the side for extra clarity

First Aid Emergency Blanket

- Helps maintain body temperature in injured or shocked individuals
- Withstands regular laundering, suitable for repeated workplace use
- 150cm x 200cm



Also available in blue

SKU
1806

Mediwrap High Protection Blanket

- Helps maintain body temperature in injured or shocked individuals
- Easy to store in workplace first aid kits or emergency grab bags



SKU
MW1002

Foil Blanket—Pack of 25

- Perfectly sized and compact for easy inclusion in all first aid kits
- Capable of reflecting over 90% of radiated body heat
- Essential for emergency evacuations



SKU
1805/25

Reusable Ice Pack

- Reduces pain & swelling
- Accommodates up to 1000ml of ice cubes
- Fill with ice cubes, crushed ice, or ice water and apply directly to the affected area



SKU
9640

Calico Triangular Bandage

- Made from a durable, reusable, and washable calico material
- Ideal for supporting arms in slings, immobilising limbs, and applying dressings
- Also available in a non-woven material



Visit page 20 for more Bandages



SKU	PACK SIZE
9562/1	1
9562	50

Hot & Cold Pack

- A cost-effective addition to your first aid kit that you can reuse
- Dual-action, reusable hot and cold pack soothes pain and reduces swelling



SKU	PACK SIZE
9612/1	Single
9612/3	Pack of 3
9612	Pack of 14
9660	Nylon Sleeve



Sterofreeze Instant Ice Packs

- For employees experiencing pain or minor injuries
- Offers immediate relief without the need for refrigeration
- Long-lasting chill



SKU	SIZE	PACK SIZE
9592/5	Short (24cm x 12cm)	5
9592	Short (24cm x 12cm)	25
9630	Long (29cm x 14cm)	20

Cotton Wool Balls—250 Balls

- Useful for cleaning surfaces or skin during first aid
- Exceptional absorbency
- 100% Pure cotton



SKU
3001/250

Wound Care Procedure Pack

- The handy pack for use in aseptic procedures and wound care in hospitals
- Contains no hazardous or medicinal substances



SKU
1893

Cotton Wool Buds

- Ideal for applying ointments, antiseptics or creams to small areas
- Helpful for gently cleaning the skin around minor cuts or abrasions



SKU
2998/200

Embag Vomit Bag—Pack of 50

- An effective way to dispose of vomit without the risk of contamination
- Reduces cleaning costs
- Protects staff



SKU
1148

Vomit Bag—Pack of 100

- Reduces the risk of contamination
- Ideal in medical rooms
- Strong lined paper bags



SKU
1149/100

Vomit Bowl—Pack of 200

- Wide rim to protect hands and clothing
- Grey paper construction
- Chin cut to ensure no spill



SKU
WSTE0037

NEW

Eco-Friendly First Aid Kit

SKU: 9018



Scan QR code to find online



Easy to carry handle



Removable wall bracket

Our **NEW** first aid kit is like none other in the UK!

Not only does it come in a **100% recycled box** made from compressed wood & plastic composite, but it also contains **94% less plastic packaging**.

The first of its kind in the UK that's kind to the environment.

SKU	PRODUCT
9018	Eco-Friendly First Aid Kit
9018RP	Eco-Friendly First Aid Kit - Refill

What's in this kit?

This kit is based on our best-selling HSE First Aid Kit, which was made especially for low-risk businesses to take care of all their first aid needs in one go.

The items in this kit are recommended by the Health and Safety Executive to ensure regular businesses without any outstanding risks are covered and compliant with health and safety laws.



Contents	Packaging	Quantity
First Aid Emergency Leaflet	N/A	1
Vinyl Gloves (Pair)	Paper Wallet	1
Washproof Plasters	Card Wallet	20
Safety Pins (Pack)	Pinned Together	1
Triangular Bandage	Loose Paper Wrap	4
Alcohol-Free Wipes	Laminate Sachet	10
Wound Dressing (Large)	Paper Packet	2
Wound Dressing (Medium)	Paper Packet	6
Wound Dressing (Eyepad)	Paper Packet	2



✓ **100% Recycled Box**

Durable, high-quality box made from compressed wood & plastic composite.

✓ **94% Less Plastic Packaging**

Includes paper-wrapped bandages and a massive 94% less plastic packaging.

✓ **Highly Visible**

Supplied with a removable wall bracket for better visibility in the home or workplace.

✓ **Professional Grade Supplies**

First aid kit made to HSE recommendations including high quality products used in hospitals.

✓ **Refills Available**

Refills readily available, buy online or direct.

✓ **CE-Marked & MHRA Approved**

The dressings and bandages in this kit are CE-marked & approved by the MHRA.



Search for this product online or contact us today to order yours!

Tel: +44(0)161 902 3030 | **Email:** firstaid@steroplast.co.uk

First Aid Stations

First aid kits should be:

1. Easily accessible
2. Clearly visible
3. Signposted with a "first aid kit" sign above or nearby

Installing a first aid station makes your kit instantly visible, even from far away.

Choose from our single kit stations or combined all-in-one solutions to display multiple kits in your workplace.

Please note: First Aid Stations are NOT supplied with kits. Please purchase kits separately.



Scan the QR code or visit www.steroplast.co.uk/first-aid-products.html to view these products online.

VIEW ONLINE

First Aid and Eyewash Kit Station with Mirror

- Combines first aid and eyewash supplies into a single, easily accessible station, ideal for workplaces with a high risk of eye contamination
- Features mirror for users to identify eye injuries and flush out objects using the eyewash provided

SKU	SIZE
1425	1m x 1m



Corex Plastic

First Aid and Eyewash Kit Station

- Combines first aid and eyewash supplies into a single, easily accessible station, ideal for workplaces with a high risk of eye contamination
- Designed with distinct colour coding and a generous size to ensure it can be quickly identified, even from a distance
- Strong, front-facing brackets ensure that both kits are easily and swiftly removable in an emergency

SKU	SIZE
1418	1m x 1m



Corex Plastic

Complete Your Station with a Workplace First Aid Kit

Kits sold separately

Availability: In stock
SKU: First Aid Kit Station

Choose Option *

Choose an Option...

Choose an Option...

Do Not Include Kit

Include Small Kit +£24.12

Include Medium Kit +£34.56

Add to Cart Pay with link

Our first aid stations are available to buy on their own, or in a bundle with the size kit(s) you require for your workplace.

If you require a custom configuration or would like to add your company's branding to your first aid station, please get in touch:

Call: +44 (0)161 902 3030

Email: enquiries@steroplast.co.uk

First Aid and Burncare Kit Station

- Combines essential first aid and specialised burncare supplies in one centralised location, ideal for environments where burn injuries are a risk
- Includes clear, step-by-step burncare instructions directly on the station, with illustrations to aid when under pressure
- Can be tailored to specific workplace requirements, with options for different kit combinations

SKU	SIZE
1419	1m x 1m



Corex Plastic

First Aid, Eyewash and Burncare Kit Station

- Combines first aid, eyewash, and burncare supplies in a single, centralised station
- Includes easy-to-follow, illustrated instructions for using eyewash and burncare supplies, helping users respond effectively under pressure

SKU	SIZE
1424	90cm x 122cm



Corex Plastic

Single Kit Stations

- The station provides a dedicated central point for essential first aid supplies, ensuring they are always within reach during emergencies
- Designed for maximum visibility, the station makes it easy to locate first aid supplies quickly, even in high-pressure situations
- The station features strong brackets and a clear, front-facing design, making it simple to grab and remove the kit in an emergency
- Meets the Health and Safety (First-Aid) Regulations 1981, ensuring your business adheres to UK standards for workplace safety
- Keeps the kit in optimal condition, protecting supplies from damage and contamination while ensuring they remain fully functional
- Fully customisable to suit specific workplace needs, including the option to incorporate company branding on the station plaque
- Designs feature illustrations of kit contents and how to use them

Kits sold separately.

SKU	PRODUCT
1420	Burncare Kit Station
1421	Bio Hazard Kit Station
1422	Eyewash Kit Station
1423	First Aid Kit Station



Corex Plastic

Bandages & Wound Dressings

Our range of bandages and dressings provides essential wound care for workplace injuries, helping employers meet health and safety requirements. Designed for quick and effective treatment, these products support first aiders in treating cuts, grazes, and other injuries until further care is available.

With a focus on ease of use, durability, and comfort, they are a vital addition to any workplace first aid kit, ensuring employees receive prompt and reliable treatment when accidents happen.



Scan the QR code or visit www.steroplast.co.uk/first-aid-products.html to view these products online.

VIEW ONLINE

Sterotrac Adhesive Skin Traction Medical Kit

- Used to gain and maintain bone alignment after dislocation and correct mild deformity
- Ideal for fixed or balanced traction



Sterotrac Adhesive Skin Traction Medical Kit

SKU	SIZE	PACK SIZE
9516/LF	Child	24
9515/LF	Adult	18

Sterotrac Non-Adhesive Skin Traction Medical Kit

SKU	SIZE	PACK SIZE
9518/LF	Child	24
9517/LF	Adult	18

Steroswab Gauze Swabs

- Premium gauze dressing for wounds, used as an additional absorbent layer for bodily fluids in wound dressing procedures
- Sterile and non-sterile options available



SKU	STERILITY	PACK SIZE
1900	Non-Sterile	100
1901	Non-Sterile	100
1902	Non-Sterile	100
1903	Sterile	25 Packs Of 5
1904	Sterile	25 Packs Of 5
1905	Sterile	25 Packs Of 5

Steropad Non-Adhesive Wound Dressings

- Double-sided, low-adherent, non-adhesive wound dressing pads
- Cushioned protection for healing wounds
- Supplied in a clearly-labelled box with a perforated cut for easy access

SKU	SIZE
3006/1	5cm x 5cm
3007/1	7.5cm x 7.5cm
3008/1	10cm x 10cm
2994BS	10cm x 20cm



Zetuvit® E High Absorbent Dressing Pads

- Highly absorbent, non-irritant dressing pad for moderate to heavy exudation
- Features a protective, hydrophobic backing
- High level of absorbency thanks to its soft cellulose fluff core and exudate-distributing tissue layer



SKU	SIZE	PACK SIZE
6820	10cm x 10cm	25
6821	10cm x 20cm	25



Sterostrip Sutures

- Strong adhesive and 'butterfly' stitch design
- Versatile and easy to cut down to the required size
- Formulated to ensure long-lasting adhesion
- Available in two sizes
- Hypoallergenic for a reduced risk of allergic reactions

SKU	SIZE	PACK SIZE
7858	3mm	10 x Pouches of 5
7859	6mm	10 x Pouches of 3



Steropore Adhesive Wound Dressings

- The most flexible adhesive wound dressing available on the market
- Sterile and individually wrapped
- Long-lasting protection no matter where on the body
- Used to treat larger wounds where plasters are too small
- Features a highly absorbent wound pad to soak up exudate and help the wound heal faster
- The non-adherent wound pad makes for painless removal when changing the dressing
- Available in a range of sizes to conform to different areas on the body prone to continuous movement

SKU	SIZE	PACK SIZE
6807/1	6cm x 7cm	25
6805/1	8.6cm x 6cm	25
6806/1	10cm x 9cm	25
6808/1	15cm x 9cm	25
6810/WAL	6cm x 7cm 8.6cm x 6cm	Wallet of 4



Available in a handy wallet



Available as a hospital or clinical pack of 4 x 25 pieces, or in a retail pack of 4 in a wallet.

Steropax Wound Dressings

- Used by paramedics, nurses, and the military for dressing wounds, as well as by first aiders, vets and care home staff
- Features a high-stretch conforming bandage for prompt, effortless and secure application
- Individually wrapped dressings minimise infection risk compared to non-sterile alternative
- Meets HSE first aid guidelines and hospital standards
- Can be supplied in an eco-friendly paper wrapping to minimise plastic waste



SKU	SIZE	PACKAGING TYPE
1911B/1	Medium — 12cm x 12cm	Plastic wrapped
2013/1	Medium — 12cm x 12cm	Paper wrapped
1910B/1	Large — 18cm x 18cm	Plastic wrapped
2014/1	Large — 18cm x 18cm	Paper wrapped



Absorbent Pad

Steropax Finger Dressings

- Sterile finger wound dressing pads with an attached conforming bandage for easy application
- Ideal for emergency use, hospital care, and to top-up first aid kits



SKU	PACK SIZE
1915B/12	12
1915B	100



Available in blue
See page 28

Steropax PLUS Wound Dressings

- Premium quality, extra absorbent Steropax wound dressings
- Available in two sizes
- Individually wrapped and sterile



SKU	SIZE
4702B/1	Medium No.8 — 12cm x 12cm
4703B/1	Large No.9 — 18cm x 18cm

Wound Care Procedure Pack

- The handy pack for use in aseptic procedures and wound care in hospitals
- Contains no hazardous or medicinal substances



SKU
1893

Steroban Finger Bob Bandage

- Quick and easy to apply finger bandages secure in place simply with no knot, pin or tapes required
- Measures 24cm x 2cm — One size fits all
- Made with a cotton/spandex blend

SKU	PACK SIZE
3061WH/10	10



Calico Triangular Bandage

- Made from a durable, reusable, and washable calico material
- Ideal for supporting arms in slings, immobilising limbs, and applying dressings



SKU	PACK SIZE
9562/1	1
9562	50



Non-Woven Triangular Bandage

- Lightweight and breathable,
- Ensures optimal comfort and airflow
- Multi-functional bandage can be used as a sling, dressing or tourniquet



SKU	PACK SIZE
9560/10	10
9560	50



Sterostrip Ultra – The Clear, Protective ‘Second Skin’ Dressing

An ultra-thin dressing that covers a larger wound area, completely sealing it off. Ideal for recovering surgical wounds and similar minor wounds.

- ☑ Comfortable and breathable film promotes natural healing
- ☑ Each dressing is sterile and individually wrapped
- ☑ Sticks to the skin but not the wound
- ☑ Available in small and large packs

SKU	SIZE	PACK SIZE
7675/7	6cm x 7cm	Pack of 7
7676/7	8cm x 10cm	Pack of 7
7677/7	10cm x 12cm	Pack of 7
7675/25	6cm x 7cm	Pack of 25
7676/25	8cm x 10cm	Pack of 25
7677/25	10cm x 12cm	Pack of 25

NEW PACKAGING



Ambulance Dressings

- A sterile, individually wrapped emergency dressing designed for quick and effective management of severe wounds with heavy bleeding
- Trusted by UK emergency services and hospitals
- Features an extra-thick, highly absorbent wound pad that rapidly absorbs blood and exudate while reducing the risk of infection or allergic reactions
- Suitable for treating a wide range of injuries, including punctures, cuts, gunshot wounds etc.
- Available in five sizes from small to XX Large



Extra Thick Wound Pad

SKU	SIZE
7000B/1	Small No. 7 5.2cm x 6.0cm
7001B/1	Medium No. 1 12cm x 10cm
7002B/1	Large No.2 20cm x 15cm
7003B/1	X Large No.3 28cm x 20cm
7004B/1	XX Large No.4 32cm x 20cm



Steropax Eyepad Wound Dressings

Extra Thick Wound Pad

- High stretch conforming bandage with absorbent cotton wound pad
- Provides exemplary wound coverage, ensuring the initial barrier against infection

SKU	PACKAGING TYPE
1912B/1	Plastic
2012/1	Paper
1912BX/1	Boxed

Sterogauz Tubular Gauze Bandages

- Provides gentle pressure while allowing the bandage to conform to body contours and stay in place
- Made with premium gauze material
- Easier to apply than flat bandages

SKU	SIZE
9545/1	00 — 1cm
9540/1	01 — 1.5cm
9541/1	12 — 2.5cm
9542	34 — 3.5cm
9543	56 — 5cm
9544	78 — 8cm



Sterogrip Elasticated Tubular Support Bandage

For complete protection of injuries, dressings, joints, and delicate areas of the body.

- Stay in place without needing tapes or pins, providing support all the way around a limb or digit
- Can be applied in multiple layers for tailored levels of support to sprains, strains, and over joints
- Reusable and washable, making it an excellent cost-effective option for personal use
- Made from a combination of a cotton rib-stockinette and covered latex rubber for ultimate support and longevity

SKU	SIZE	SUITABLE FOR
9500	A: 5cm x 10m	Small child limbs
9501	B: 6.25cm x 10m	Small/medium Limbs
9502	C: 6.75cm x 10m	Small arms & legs
9503	D: 7.5cm x 10m	Large arms & legs
9504	E: 8.75cm x 10m	Legs or small thighs
9505	F: 10cm x 10m	Large knees or thighs
9506	G: 12cm x 10m	Large thighs
9513	L: 30cm x 10m	Lower back

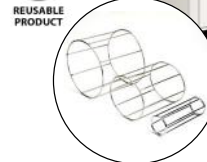

Even easier to apply with the Sterogrip Tubular Bandage Wire Frame Applicator



Steroply Conforming Bandage

- High stretch elastic conforming bandage allows for optimal mobility when wearing
- Conforms easily to all body areas, even awkward joints
- The bandage is light and soft, permitting air circulation

SKU	SIZE
3051/1	5cm x 4m
3052/1	7.5cm x 4m
3053/1	10cm x 4m
3054/1	15cm x 4m



High-quality woven stretch material

Sterocrepe Crepe Bandage

- A stretchy, cotton woven bandage ideal for giving light support to sprains and strains in joints and muscles
- Moderate compression bandage to alleviate swelling
- Provides padding and protection

SKU	SIZE
3056/6	5cm x 4.5m
3057/6	7.5cm x 4.5m
3058/6	10cm x 4.5m
3059/6	15cm x 4.5m



White-Open-Weave Bandage

- Loose weave construction allows wounds to breathe, promoting faster healing
- For a wide range of applications
- 100% Cotton
- Non-elastic

SKU	SIZE
3048	5cm x 5m
3049	7.5cm x 5m



Tapes & Strappings

Our range of tapes and strappings supports bandages and dressings in workplace first aid, helping to secure wound coverings and stabilise injuries.

Useful for keeping dressings in place or providing light support, they help first aiders manage sprains, strains, and other minor injuries until further treatment is available. Designed for ease of use, strength, and comfort, they're a practical addition to any workplace first aid kit.



Scan the QR code or visit www.steroplast.co.uk/first-aid-products.html to view these products online.

VIEW ONLINE

Sterotape-Z.O. Zinc Oxide Tape

A rigid adhesive zinc oxide tape that gives uncompromised protection and support to skin, muscles, tendons, and bones.

- Ideal for smaller areas such as fingers, toes, and other intricate body parts
- Guaranteed to give directional support and immobilisation
- Narrow tape provides precision support and protection
- Maintaining full dexterity and movement of injured area
- Serrated tape tears easily by hand along length or width
- Conforms well to body contours



Easy to tear serrated edge



SKU	SIZE	PACK SIZE
4051	1.25cm x 5m	24 Rolls
4056	1.25cm x 10m	24 Rolls
4052	2.5cm x 5m	12 Rolls
4057	2.5cm x 10m	12 Rolls
4050	4cm x 5m	8 Rolls
4058	4cm x 10m	8 Rolls
4053	5cm x 5m	6 Rolls
4059	5cm x 10m	6 Rolls

Fabric Strapping Tape

Multi-functional premium fabric strapping tape wound onto a simple-to-use spool with a handy cap.

- Heavyweight fabric strapping for strength and durability
- Even pressure when applied

SKU	SIZE	QTY
8100FC/1	2.5cm x 1.5m	Pack of 12
8100FC/8	2.5cm x 1.5m	8 x Packs of 12

Spool & cap keeps tape dry & clean



Microporous Tape

Porous white paper tape to hold dressings on place on the body. Suitable for sensitive skin and available in an easy to store spool & cap system.

- Hand-tearable and easy to apply without scissors
- Strong medical-grade adhesive bonds well, even on damp skin
- Conforms to body contours, ideal for tricky areas
- Quality assured and suitable for professional healthcare use
- Breathable microporous design allows air through, reducing skin irritation

Available in boxed quantities, or as a handy spool & cap.

SKU	SIZE	QTY
6874	1.25cm x 5m	Pack of 24
6871	1.25cm x 10m	Pack of 24
6873	2.5cm x 5m	Pack of 12
6872	2.5cm x 10m	Pack of 12
6875	5cm x 10m	Pack of 6
8105FC/1	2.5cm x 5m - Spool & Cap	Pack of 12

Spool & cap keeps tape dry & clean



Sterifix Dressing Retention Tape

- Fixes dressings, secures devices, and works as a base layer for sports taping
- Pliable for use on awkward or contoured areas
- Reduces pain and skin irritation
- Permeable to air & vapour to support a healthy wound environment



SKU	SIZE	PACK SIZE
6854	2.5cm x 10m	4
6855	5cm x 10m	3
6856	10cm x 10m	1

Sterotape Silk

Silk-finished, non-stretch, water-repellent tape for securing dressings and gauze.

- Hand-tearable with serrated edges for quick use without scissors, ideal for fast first aid response
- Available in multiple pack sizes – Ideal for restocking workplace first aid kits with single rolls or cost-effective multipacks
- Medical-grade acrylic adhesive ensures secure hold

SKU	SIZE	PACK SIZE
4581/1	1.25cm x 5m	Single
4581	1.25cm x 5m	24 Rolls
4582/1	2.5cm x 5m	Single
4582	2.5cm x 5m	24 Rolls
4583/1	5cm x 5m	Single
4583	5cm x 5m	24 Rolls



Premium Elastic Fabric Plasters

- Outperforms alternative brands in adhesion and durability
- Featuring a high-tac, medical-grade zinc oxide adhesive for unbeatable sticking power
- Shelf life of 5 years from the date of manufacture
- Superior elastic fabric moulds perfectly to your body, offering a snug fit even in awkward areas
- All plasters are CE Marked ensuring they meet the highest safety and quality standards for the UK market
- Our variety pack includes seven distinct plaster designs, from fingertip to fabric strips, ensuring the right fit for every wound



"Best plasters for staying power—incredibly long-lasting, water resistant, sweat resistant, great value."



SKU	SIZE	QUANTITY
6021/1	4cm x 4cm	1 Box of 50 Plasters
6022/1	6cm x 2cm	1 Box of 100 Plasters
6023/1	7.5cm x 2.5cm	1 Box of 100 Plasters
6025/1	7.5cm x 5cm	1 Box of 50 Plasters
6035/1	7.5cm x 5cm (Knuckle)	1 Box of 50 Plasters
6036/1	7.2cm x 4.2cm (Fingertip)	1 Box of 50 Plasters
6059F/1	5 Assorted Sizes	1 Box of 100 Plasters
60385	7 Assorted Sizes	1 Box of 100 Plasters

100 Assorted Fabric Plasters in Clear Fast Check Box

Offering quick access to premium fabric plasters for treating minor cuts and grazes. This option provides organised sizes and hygienic storage until needed.

SKU	SIZE	QUANTITY
6060	5 Assorted Sizes	1 Box of 100 Plasters

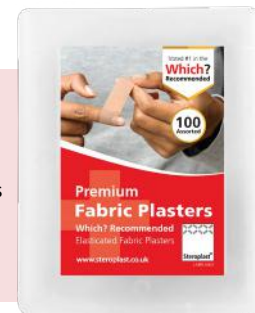

Which?

#1 in the UK: Which? recommended

Our Elastic Fabric Plaster was put through a series of tough tests by Which?, the 100% independent UK consumer champion, to find out which plaster from major UK brands was the most reliable & cost-effective.

A Plaster Range That Benefits from Over 30 years of Medical Manufacturing Knowledge and Expertise

Designed to suit a wide range of clinical and workplace needs, our plaster selection is available with options across multiple sizes, shapes and materials to suit different applications.

- Choose from single boxes or convenient hospital packs
- Every plaster is CE marked and made to a consistently high standard
- Sizes and shapes include fingertip, knuckle and spot plasters
- X-ray detectable** options are also available — Go to **page 26**

Alongside the products featured here, many more plaster types can be found online. View the entire range at:

www.steroplast.co.uk/first-aid-products/plasters-dressings-strips.html



Various sizes available

- WASHPROOF
- PREMIUM FABRIC
- FLEX FABRIC
- STEROCHEF BLUE
- HYDROCOLLOID
- CLEAR
- CUSHIONED
- BLISTER
- SENSITIVE
- BLISTER FOAM



VIEW ONLINE

Still not sure what you need?



Book a consultation

Don't delay and contact our friendly team today:
0161 902 3030 | firstaid@steroplast.co.uk



Visit our Online Buying Guide

Designed to de-mystify workplace first aid:
www.steroplast.co.uk/workplace-first-aid-guide



Scan the QR code to view our full range of sports first aid kits online.

VIEW ONLINE

//STEROSPORT ACTIV Cycling First Aid Kits

Compact first aid kits designed for cyclists and outdoor activities.

Encourage active travel and improve workplace safety initiatives by offering these kits as part of a **Cycle to Work package**, keeping them in office receptions, or providing them to employees who commute by bike. A small investment in first aid can help promote safer cycling and reduce the risk of injuries affecting work attendance.

These pocket-sized kits are suitable for basic cover when commuting, frequent cyclists, and those taking longer or more challenging routes.



Essentials First Aid Kit
SKU: SSA0001



Commuter First Aid Kit
SKU: SSA0002



Explorer First Aid Kit
SKU: SSA0003



Pouch Kit

Larger travel kits offer comprehensive first aid for employees cycling in more remote areas or for workplaces supporting outdoor staff.



Light Outdoor First Aid Kit
SKU: SSA0004



Adventurer First Aid Kit
SKU: SSA0005



Expedition First Aid Kit
SKU: SSA0006



Travel Pouch



Catering First Aid Kits & Supplies

Don't let high-pressure kitchen environments get in the way of safety

Includes



Who needs to use blue plasters?

Blue plasters are essential for anyone working in **catering, kitchens, canteens, or food preparation areas**. The bright blue colour makes them easily visible, reducing the risk of contamination in food, as blue is not a natural food colour.

Sterochef Blue Plasters

Our Sterochef Blue Plasters are metal detectable, which helps when using machinery or equipment with metal detection systems, adding another layer of safety. For any first aid kit in these environments, blue plasters are a must to ensure hygiene standards are maintained and to quickly identify and address any minor cuts or injuries without compromising food safety.

!
Don't risk a batch recall or putting your customers in danger.
Choose the most reliable blue plaster on the market.



Sterochef Blue Plasters

- Designed for sensitive skin, ensuring that they can be used by anyone without causing irritation
- Made to withstand frequent hand washing, maintaining their adhesion and protective barrier throughout a busy shift in food handling environments
- Equipped with superior medical-grade adhesive, Sterochef plasters stay securely in place, even in the demanding conditions of a food processing environment
- Metal-detectable with 100% aluminium foil (20µm), these plasters are easily detectable by safety equipment, reducing the risk of contamination in food production
- Fully compliant with the Food Safety (General Food Hygiene) Regulations 1995, making them the best choice for maintaining health and safety standards in food handling environments

	SKU	SIZE	QUANTITY
1	5601R/1	4cm x 4cm	1 Box of 50 Plasters
2	5602R/1	6cm x 2cm	1 Box of 100 Plasters
3	5603R/1	7.5cm x 2.5cm	1 Box of 100 Plasters
4	5605/1	7.5cm x 5cm	1 Box of 50 Plasters
5	5912/1	7.2cm x 4.2cm (Fingertip)	1 Box of 50 Plasters
6	5913/1	7.5cm x 5cm (Knuckle)	1 Box of 50 Plasters
7	5914S/1	15cm x 2cm (Fingertip Extension)	1 Box of 50 Plasters
	5629F/1	5 Assorted Sizes	1 Box of 100 Plasters
	5660	5 Assorted Sizes (Clear Plastic Case)	1 Box of 100 Plasters
	5638S	7 Assorted Sizes	1 Box of 100 Plasters

Catering First Aid Kits

Catering first aid kits are designed to meet the specific needs of busy kitchen and food preparation environments. Along with the standard first aid essentials, such as bandages and antiseptic wipes, these kits also include specialised items like Burnshield® dressings.

Blue plasters are included for easy visibility in food prep areas, helping to maintain hygiene and safety.

Ideal for cafés, restaurants, bars, canteens, food vans and any workplace with food preparation areas.



Scan the QR code or visit www.steroplast.co.uk/first-aid-products.html to view these products online.

VIEW ONLINE



Case measures 27cm x 27cm x 9cm

Visit page 13 for all Empty Boxes

Blue Premier First Aid Plastic Box Empty | Build your own kit

A premier empty First Aid Box in blue, specifically tailored for the catering sector. This high-quality box ensures that you have the essential tools at hand in any culinary emergency.

- Includes fixed compartments
- Water-resistant
- Hard shell box protects contents
- Ready to fill with any catering first aid supplies you require

SKU
8146EBC

Are you looking for a bespoke Catering First Aid Kit specific to your needs?

If you're not sure what needs to go in yours, give us a call. An advisor will be able to help you determine exactly what you need and get your order completed. We also create a bespoke first aid kit for you, package it, and even print your branding before sending it to you.

Call **0161 902 3030** to tell us what you need for your bespoke kit.

Premier British Standard SteroChef Catering First Aid Kit

- Meets British Standard BS8599-1, ensuring that your kitchen is equipped with first aid supplies for a safe workplace
- Specifically created for commercial kitchens and catering environments, providing protection against common hazards like cuts, burns, and chemical injuries
- Includes blue, electromagnetically detectable plasters, essential for food safety, making it easy to identify and prevent contamination
- Features high-quality burn care products from Burnshield®, designed to treat kitchen-specific burn injuries effectively
- Coloured blue to easily distinguish it as a catering-related first aid kit, ensuring that staff can quickly locate it
- Available in two sizes for up to 20 people

SKU	SIZE
8599CT-S	Small (1-10 Person) Catering Kit
8599CT-S/RP	Small Catering Kit - Refill
8599CT-M	Medium (10-20 Person) Catering Kit
8599CT-M/RP	Medium Catering Kit - Refill

Kit Includes:

- 10cm Burnshield Dressings
- Conforming Bandage
- Foil Blanket
- Gloves - In Pairs
- First Aid CPR Leaflet
- Resus Device
- Standard Dressing - Finger
- Standard Dressing - Medium
- Standard Dressing - Large
- Sterile Saline Wipes
- Microporous Tape
- Triangular Bandage
- Tuffcut Scissors
- SteroChef Blue Plasters

Item quantities vary based on size of kit



Compliant with BS8599-1



Premier wall bracket sold separately
See all wall brackets on page 12

HSE Catering First Aid Kit | 1-10 Person

- Ensures full compliance with the Health and Safety Executive's first aid regulations, specifically tailored for food handling and catering environments
- Equipped with blue, washproof plasters that are highly visible and detectable by automated machines, reducing the risk of food contamination
- Contains all the necessary first aid items, including dressings, bandages, and wipes, designed to address common injuries in a kitchen setting, such as cuts, burns, and eye injuries
- Housed in a durable plastic case with a secure clasp closure, ensuring that all items remain protected and easily accessible when needed
- Neatly packed in a compact kit, measuring 27 x 27 x 9cm, making it easy to store in kitchens and other food preparation areas without taking up valuable space

SKU	SIZE
9125	Small HSE Catering Kit
8025RP	Small HSE Catering Kit - Refill

Kit Includes:

- First Aid CPR Leaflet
- Nitrile Gloves - In Pairs
- SteroChef Blue Plasters
- Safety Pins
- Triangular Bandage
- Alcohol-Free Wipes
- Wound Dressing - Eyepad
- Wound Dressing - Medium
- Wound Dressing - Large



Premier wall bracket sold separately
See all wall brackets on page 12



HSE Approved

Catering Plasters & Bandages

Our range of catering plasters and bandages is specially designed for kitchen environments, offering blue-coloured dressings that are ideal for treating common kitchen injuries

These include cuts, scrapes, and burns that often occur in food preparation areas. The blue colour ensures high visibility to prevent contamination, while the durable materials provide reliable protection and comfort.

These bandages and dressings are essential for keeping kitchen staff safe and maintaining hygiene standards during busy shifts.



Scan the QR code or visit www.steroplast.co.uk/first-aid-products.html to view these products online.

VIEW ONLINE

Leukoplast X-Ray Detectable Coverplast Assorted Plasters

- Detectable in three ways; metal detectable, visually detectable & X-ray detectable
- Features a bacterial barrier helping to prevent wound infection

SKU	SIZE	PACK SIZE
5609	7.2cm x 2.2cm	100
5610	7.2cm x 5cm	100



Sterochef Blue PE Strapping

- Made in high-visibility blue to comply with food hygiene regulations in the UK
- The tape is 2.5cm x 5m, making it wide enough to cover most pieces of jewellery and long enough for multiple uses
- Prevent items from falling into food and keep health and safety compliant

SKU	PACK SIZE
5682	12



Sterogrip Blue Elasticated Tubular Support Bandage

For complete protection of injuries, dressings, joints, and delicate areas of the body. An essential support bandage for injuries sustained in a food and catering environment.

- Stay in place without needing tapes or pins, providing support all the way around a limb or digit
- Can be applied in multiple layers for tailored levels of support to sprains, strains, and over joints
- Reusable and washable, making it an excellent cost-effective option for personal use
- Made from a combination of a cotton rib-stockinette and covered latex rubber for ultimate support and longevity
- Available in four sizes for various areas of use and limb sizes



Sterogrip Tubular Bandage Wire Frame Applicator

- For easy application of tubular bandage over bulky dressings and double laying over sensitive joints
- Made from high-grade stainless steel, the applicator is durable, long-lasting and easy to keep clean
- Available in six sizes



SKU	SIZE	SUITABLE FOR
9501BL	B: 6.25cm x 10m	Small/Medium Limbs
9502BL	C: 6.75cm x 10m	Small arms & legs
9503BL	D: 7.5cm x 10m	Large arms & legs
9504BL	E: 8.75cm x 10m	Legs or small thighs



Even easier to apply with the Sterogrip Tubular Bandage Wire Frame Applicator

SKU	SIZE	SUITABLE FOR
9536	C: 3.4cm x 15.2cm	Toes and fingers
9510	D: 4.5cm x 15.2cm	Fingers
9511	E: 9cm x 15.2cm	Hands, wrists, children's limbs
9537	F: 12cm x 15.2cm	Ankles, arms, children's limbs
9538	G: 17cm x 15.2cm	Arms, ankles, knees, legs, thighs
9539	H: 19cm x 15.2cm	Arms, ankles, knees, legs, thighs

Sterochef Blue Vinyl Finger Stalls

- Hold dressings in place for safeguarding cuts, burns, and blisters on fingers
- The blue colour aligns with food hygiene legislation
- Available in two sizes

SKU	PACK SIZE
2007M	10
2007L	10



Blue Finger Bob Standard Bandage

- Quick and easy to apply finger bandages secure in place simply with no knot, pin or tapes required
- Measures 24cm x 2cm — One size fits all
- Made with a cotton/spandex blend

SKU	PACK SIZE
3061BL/10	10



Additional Catering First Aid Supplies

Find all the catering first aid and infection control supplies you need here and get your complete checklist ticked off.

Other considerations for catering environments include:

Eyewash & Eyecare

In environments with heat, machinery, and chemical exposure risks, eyewash stations are always required.

Sterowash Eyewash 20ml Pods Pack of 25
SKU: 1400W/1

Sterowash 20ml Eyewash Station
SKU: 1410

Visit page 50 for all Eyecare



Sharps Disposal

Dispose of sharps, including broken glass, properly and ensure dangerous edges and potentially infectious agents are contained.

Visit page 54 for all Sharps Disposal



Visit page 34 for all Burncare

Premier Steroburn Burns First Aid Kit | 11-20 People Kit
SKU: 8232

Burncare Supplies

Deal with burns from hotplates, ovens, naked flames, and steam fast with burncare solutions. If you operate a food handling business, your risk assessment will say you need burncare provision.



Vehicle & Lone Worker First Aid

First aid responsibilities don't stop at the door to your premises



Provide your Off-Site Employees with First Aid Supplies

The Health and Safety (First-Aid) Regulations 1981 require employers to provide appropriate provisions if employees are taken ill or injured at work, including employees working off-site and in company vehicles.

The Approved Code of Practice (ACoP), which accompanies the regulations, details that employees should have first aid needs met wherever they work for the business, including away from main sites.

What is a lone worker?

The HSE defines a lone worker as ***“those who work by themselves without close or direct supervision”***.

Examples of lone workers in fixed establishments are:

- A person working alone in a small shop or petrol station
- People who work from home other than in low-risk, office-type work
- People working alone for long periods, e.g. in factories, warehouses, leisure centres or fairgrounds
- People working on their own outside normal hours, e.g. cleaners and security, maintenance, or repair staff

Examples of mobile workers working away from their fixed base are:

- Workers involved in construction, maintenance and repair, plant installation and cleaning work
- Agricultural and forestry workers
- Service workers, including postal staff, social workers, engineers, estate agents, and sales representatives visiting domestic and commercial premises

How to Choose the Correct Vehicle First Aid Kit:

If your company has vehicles you are also legally responsible to provide first aid kits for these too, the table below will help you with selecting the right kit:

Number of passengers	Vehicle examples	Number and size of first aid kits required
1 to 3	Mopeds, motorcycles, motortricycles and quadricycles	One small kit
1 to 8	Cars, taxis, commercial vehicles	One medium kit
1 to 16	Mini buses, small buses	One large kit
17+	Buses, coaches	Two large kits*

**Multi-level vehicles require at least two kits*

Travel & Vehicle First Aid Kits

Vehicle first aid kits are essential for ensuring the safety of staff who spend significant time on the road. Accidents and minor injuries can happen at any time, making it crucial to have the right supplies readily available.

Our vehicle first aid kits are specifically designed for use in cars, vans, and other work-related vehicles, providing the necessary equipment to handle common injuries while travelling.



Scan the QR code or visit www.steroplast.co.uk/first-aid-products.html to view these products online.

VIEW ONLINE

Taxi and PSV First Aid Kit

- Supplied in a rigid, reinforced box that protects contents from being squashed or knocked around
- Small, compact, and easy to store underneath a car seat or in the boot
- Kit refills available to save time and money
- Individually wrapped kit contents are kept protected and dry until used
- Contents put together by first aid experts to consider all the common road traffic accidents and injuries that taxi and PSV drivers can face



SKU	SIZE
8155	Taxi & PSV First Aid Kit - Medium
8155RP	Taxi & PSV First Aid Kit - Medium - Refill
8160	Taxi & PSV First Aid Kit - Small
8160RP	Taxi & PSV First Aid Kit - Small - Refill

Designed for:

- Taxis
- Minibuses
- Coaches



Wall bracket included

BS8599-2 British Standard Motor Vehicle First Aid Kits

A compact vehicle first aid kit for commercial and private vehicles, including cars, trucks, vans, and taxis. Compliant with BS8599-2:2019 to support you in any road traffic accident.

- Available in three sizes in a box or bag for small and larger vehicles from motorcycles, cars, vans and buses
- Compact and easy to store under a seat
- The hard box container is made from strong, waterproof plastic and protects items from being damaged
- Ensures you have all the right equipment for the most common injuries on the road

SKU	SIZE
8599MV-S	Vehicle First Aid Kit Box - Small
8599MV-S/RP	Vehicle First Aid Kit Box - Small - Refill
8599MV-M	Vehicle First Aid Kit Box - Medium
8599MV-M/RP	Vehicle First Aid Kit Box - Medium - Refill
8599MVB-M	Vehicle First Aid Kit Bag - Medium
8599MVB-M/RP	Vehicle First Aid Kit Bag - Medium - Refill
8599MVB-L	Vehicle First Aid Kit Bag - Large
8599MVB-L/RP	Vehicle First Aid Kit Bag - Large - Refill

Kit Includes:

- Burn Dressing
- First Aid Emergency Leaflet
- Foil Blanket
- Gloves - Nitrile in Pairs
- Waterproof Plasters
- Resus Device/ Face Shield
- Scissors
- Triangular Bandage
- Saline Wipes
- Adhesive Wound Dressing
- Wound Dressing - Trauma (M)
- Wound Dressing - First aid (M)

Item quantities vary based on size of kit



Compliant with BS8599-2:2019

The hard box option is ideal for work vans that regularly transport materials and hard objects.

Compliant with BS8599-2:2019

The soft bag option is a good first aid kit for cars and other vehicles like taxis that need to conserve space.

Protect Drivers & Passengers

The Public Service Vehicles (Safety) Regulations 1981 require all public service vehicles, including taxis, minibuses, and public transport, to carry first aid kits. British standard BS8599-2:2019 provides guidance on the standard a vehicle first aid kit should uphold.

Do you drive a Public Service Vehicle?

If you drive a public service vehicle (PSV) such as a taxi, mini bus, or coach, you are legally required to carry a first aid kit on board for your and your passengers' safety.

Our BS8599-2 Vehicle First Aid Kit has been developed in accordance with British Standards guidance and provides everything required for complete legal compliance.

It's also a legal requirement that all PSVs carry a fire extinguisher on board.



Compliant with BS8599-2:2019



Basic Vehicle First Aid Kit Bag

- Supplied in a lightweight nylon bag with clear labelling making it easy to find in your car
- Includes guidance leaflet to help support anyone through administering first aid
- Sterile dressings and cleansing wipes make it easy to clean wounds when you don't have access to soap and water

SKU	SIZE
8123	Basic Vehicle First Aid Kit in Bag
8123RP	Basic Vehicle First Aid Kit in Bag - Refill

Off-site & Lone Worker First Aid Kits

Ensuring off-site staff and lone workers have access to appropriate first aid provisions is a key responsibility for employers.

Our range of off-site and lone worker first aid kits is designed to meet the varying needs of professionals working in remote or isolated environments.

Whether in construction, field-based roles, or other industries, these kits offer essential supplies to help manage minor injuries until further assistance is available.



Scan the QR code or visit www.steroplast.co.uk/first-aid-products.html to view these products online.

VIEW ONLINE

HSE One Person Lone Worker First Aid Kit

- Providing you with all the compliance benefits of HSE standards in a durable, compact bag
- Stocked with top-quality first aid supplies for treating first aid injuries
- Fits into most work bags or backpacks
- Choose from a bum bag, pouch or small zip nylon bag depending on the nature of work

SKU	SIZE
8124	One Person First Aid Kit - Bag
8127	One Person First Aid Kit - Pouch
8130	One Person First Aid Kit - Bum bag
8124RP	One Person First Aid Kit - Refill



HSE Approved



The **nylon bag** option is ideally suited for outdoor and rugged work environments, such as construction sites, in industrial settings, and even while doing field work in remote locations.

The **pouch** option is designed for employees who spend lots of time in vehicles or need to maximize space, such as truck drivers, delivery personnel, or travelling sales representatives.

The **bum bag** option is ideal for people working at heights, like window cleaners or tree surgeons, or people in active roles such as event coordinators, security personnel, or fitness instructors.



BS8599-1 Off-Site Lone Worker First Aid Kit

Whether working from home, volunteering alone, or travelling for work, this kit caters to all needs.

- BS8599-1 Certified: Compliant with British Standards' quality expectations, ensuring a reliable and quality product
- Suitable for lone and off-site workers
- Covers the most common and critical injuries lone workers may face
- Choose between a bag or a box

Compliant with BS8599-1



SKU	PRODUCT
8599-T/BX	Off-Site Lone Worker First Aid Kit Box
8599-T	Off-Site Lone Worker First Aid Kit Bag
8599-T/RP	Off-Site Lone Worker First Aid Kit - Refill

Where should a Lone Worker First Aid Kit be supplied?

The Health and Safety Executive requires business owners to meet regulations of the Health and Safety at Work etc. Act and the Management of Health and Safety at Work Regulations sufficiently protect their workforce and others who interact with the business.

People are employed as lone workers in multiple different situations.

See if any of these apply to you or your staff:

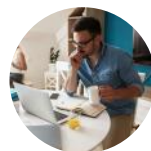

Working at Home Alone

Given that accidents can occur anywhere, even at home, a first aid kit is crucial for those working from home.



Volunteering

Volunteers often work in varying indoor or outdoor environments where they might face minor injuries.



Work at a Separate Base

In remote or hard-to-reach areas of a premises, having a kit allows for quick treatment, bridging the gap until help arrives.



Working at a Fixed Location Alone

In workplaces like shops or warehouses, where lone workers may encounter various risks, a first aid kit is essential. Provide equipment to treat a wide range of injuries, from minor cuts to severe wounds.



Work that Requires Staff to Travel

Traveling workers are often far from immediate help if an injury occurs. A portable first aid kit allows for immediate response to injuries, ensuring their safety on the move.

“You are responsible for the health, safety and welfare at work of all your workers, and this applies to any contractors, volunteers or self-employed people” — HSE.

Forestry Critical Injury First Aid Kit

Equip your arborists with our Forestry First Aid Kit, ideal for severe bleeding incidents. Designed for high-risk outdoor work environments like forestry, farming, and construction.

- The large kit is homed in a wipe-clean PVC bag with WaterStop® technology, ensuring the contents stay clean and dry under all condition
- Offers peace of mind by equipping workers with necessary tools to address both minor injuries and major trauma incidents
- Choose from medium or large depending on the quantity of people you expect to treat based on profession and number of employees

SKU	PRODUCT
6715	Large Forestry First Aid Kit
6714	Medium Forestry First Aid Kit



The medium size of this kit is supplied in a smaller orange nylon bag

Perfect for smaller teams working outdoors, offering a portable solution that's equipped to handle severe bleeding incidents on the go.

? What is the UK guidance on forestry worker safety?

In the UK, businesses must equip their workspaces with suitable first aid kits, with forestry work demanding a comprehensive risk assessment due to its isolated and perilous nature. When evaluating forestry work needs, consider:

- What are the specific threats, such as injuries from chainsaws, falls, or falling objects?
- Is the worker trained to self-administer first aid, especially in isolated locations?
- How can the worker communicate or signal for help if injured and alone, considering the remote nature of forest areas?

Failure to provide the appropriate first aid supplies and training can lead to fines or prosecution. Forestry workers, often working in challenging and isolated environments, are at a heightened risk of injury. It's essential to equip them with the necessary tools and knowledge to respond effectively to injuries, safeguarding their health.

Burns Supplies

Burns are a common risk for off-site workers. Quick, effective treatment is essential to minimise damage and discomfort when far from medical assistance.

Steroburn Burns Kit
SKU: 8233



Visit page 78
for all
Burncare

Bleed Control

Road traffic accidents can be severe and fatal. Lone workers in high-risk environments might also need extra protection for extreme bleeding.

SOF Tactical Tourniquet | Orange
SKU: WSTE0401

Visit page 74 for all
Trauma Supplies



Burncare First Aid

Deal with burns in the precious seconds that cause the most damage following an accident



Burns can be catastrophic and even fatal

Proper handling of a burn can significantly reduce healing time and complications afterwards, not to mention make the casualty feel more comfortable and calm. If your workplace operates machinery that generates heat, naked flames, ovens, hotplates, electric tools like soldering irons or hair straighteners, or risks exposure to certain chemicals, it's likely you need a burn kit.

Burns in the workplace could be caused by:

- Burns caused by direct heat (e.g. fire, steam, boiling water, molten metal)
- Chemical burns
- Radiological burns

A burn or a scald is one of the UK's most common injuries that require emergency treatment.

The law requires you to assess risks and provide suitable equipment for your employees

That could include treatment for burns

If your workplace risk assessment determines the need for burncare supplies, then a burncare kit will help you comply with UK Health and Safety (First-Aid) Regulations 1981 as part of your wider first aid protection. Allowing you to provide staff with **adequate** and **appropriate** supplies as outlined in your risk assessment.

If you require a more comprehensive burncare solution, browse our full range of burncare kits, or check out our British Standard First Aid Kits (Page 11), which include burncare supplies in the contents.

In environments where there is a higher risk of burns (e.g., kitchens, manufacturing, or chemical handling), it would be considered good practice to have burn-specific first aid provisions, such as burn dressings or gels.

Risk Assessments		Company name <i>ChemSafe Manufacturing Ltd.</i>		Date of assessment <i>21/10/2024</i>		For first aid products visit www.steroplast.co.uk		
Location <i>main production facility</i>		Task/operation being assessed <i>decanting/mixing chemicals</i>						
Identify the hazard	Who could be harmed	Existing controls	Risk rating H/M/L	Further action to control risk	Risk rating H/M/L	Action by	Action when	Completed
<i>Chemical burns, thermal burns</i>	<i>Employees handling chemicals & visitors</i>	<i>PPE, first aid training</i>	<i>High</i>	<i>signage, burncare kits</i>	<i>High</i>	<i>Health & safety manager</i>	<i>within a month</i>	<i>✓</i>

Burncare Kits

Our burncare kits are essential for workplaces where there is a risk of burns from heat, chemicals, or hot equipment.

These kits are equipped with specialised dressings and treatments to provide immediate relief and protection for burn injuries. Designed to meet workplace safety standards, the kits help manage burns quickly and effectively, minimising the risk of infection and promoting recovery.

Suitable for a range of industries, they are a vital addition to any workplace first aid provision.



VIEW ONLINE

Scan the QR code or visit www.steroplast.co.uk/advanced-life-support-equipment.html to view these products online.

Steroburn Burncare Kit

Quality burncare kit for urgent treatment of burns at home, work, school, or on the move.

- Supplied in a durable plastic box with snap-fit closure
- Attach to a wall for visibility & ease of access
- Contains everything you need to treat burn or scald wounds safely and effectively

SKU

8233

Kit Includes:

- x2 Burnshield® Dressings
- x8 Burnshield® Blott Sachets
- x1 Guidance Leaflet
- x1 Microporous Tape
- x1 Tuff Cut Scissors
- x1 Vinyl Gloves (Pairs)
- x2 Wound Dressing



CONTAINS Burnshield® DRESSINGS & GELS

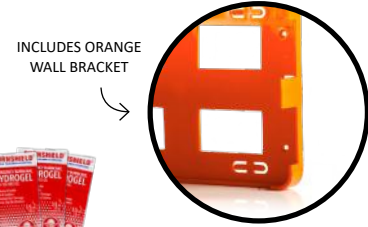
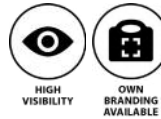

INCLUDES ORANGE WALL BRACKET



10cm x 10cm

Paraffin Gauze Dressing BP

- For minor burns, scalds, abrasions, and superficial wounds
- Impregnated with white soft paraffin BP to help soothe and protect the wound
- Supports a moist healing environment

SKU
4900

PACK SIZE
10

Burnshield® Emergency Burncare Rescue Kit

These kits provide equipment to immediately respond to life-threatening burns

- The nylon bag is ideal for on-the-go, such as outdoor activities, vehicles & first responders
- Provides instant relief by cooling, moisturising & soothing the burn on application
- Appropriate for treating 1st, 2nd, and 3rd degree burns

SKU

90834

Kit Includes:

- x7 Burnshield® Dressings
- x1 Burnshield® Hydrogel Spray
- x1 Clear Tape
- x2 Conforming Bandage
- x2 Cohesive Bandage
- x1 Foil Blanket
- x1 Nitrile Gloves (Large Pair)
- x1 Tuff Cut Scissors



CONTAINS Burnshield® DRESSINGS & GELS

Mini Burn Kit

- Contains Burnshield® dressings & treatments
- Small enough to fit in your handbag or glove box and ideal for travel
- Treat burns including thermal, electric, chemical and sunburn

SKU

90842

Kit Includes:

- x1 Burnshield® Dressing
- x2 Burnshield® Blott Sachets
- x1 Steroban Cohesive Bandage



Premier Steroburn Burns First Aid Kit

A burns first aid kit complete with everything required to treat burns in the workplace or at home effectively.

- Contains Burnshield® dressings & treatments
- Put together under the guidance of first aid experts
- Comes in a robust, durable polypropylene 'premier box' to keep the contents safe from water or being crushed
- Wall bracket is available to mount kit to a wall
- Available in two sizes for 1-10 to 11-20 people

SKU

SIZE

8231

1-10 People

8232

11-20 People

Kit Includes:

- | 1-10 | 11-20 | |
|------|-------|--------------------------------|
| x6 | x4 | Burnshield® Burn Blott Sachets |
| x2 | x6 | Burnshield® 10cm Dressings |
| x1 | x1 | Burnshield® Digit Dressings |
| x5 | x3 | Sterowash 20ml Eyewash Pods |
| x2 | x4 | Steroply Conforming Bandage |
| x2 | x2 | Nitrile Gloves (Pairs) |
| x1 | x1 | Microporous Tape |
| x1 | x1 | Tuff Cut Scissors |



CONTAINS Burnshield® DRESSINGS & GELS



Burncare Kit

- Contains Burnshield® dressings & treatments
- Clear "Burn Kit" labelling for swift identification
- Supplied in compact and portable nylon bag



NEW



CONTAINS Burnshield® DRESSINGS & GELS

SKU

8235

Kit Includes:

- x1 Conforming Bandage
- x2 Burnshield® Hydrogel 3.5ml
- x1 Burnshield® Hydrogel 50ml
- x2 Burnshield® Burn Dressing
- x1 Burnshield® Digit Dressing
- x1 Blue Nitrile Gloves (Pair)

Burncare Dressings & Gels

Our burncare dressings and gels provide effective relief and protection for burns commonly encountered in workplace settings.

Designed to cool the skin and prevent further tissue damage, these products are essential for treating burns from heat, chemicals, or scalds.

The dressings and gels help minimise discomfort while supporting the healing process, ensuring quick and efficient care for injured staff. Ideal for use in environments where burn risks are present.



VIEW ONLINE

Scan the QR code or visit www.steroplast.co.uk/advanced-life-support-equipment.html to view these products online.

Jelonet® Paraffin Gauze Burn Dressings

Jelonet Paraffin Gauze Burn Dressing

- Non-medicated tulle gras dressings made with open weave gauze
- Impregnated with paraffin
- Low adherent
- Available in three sizes

SKU	SIZE	PACK SIZE
JEL004	10cm x 10cm	10
JEL003	10cm x 40cm	10
JEL002	5cm x 5cm	50
JEL005	5cm x 5cm	5

Jelonet Paraffin Gauze Burn Roll

- Cut to custom size
- Open-weave gauze soaked in paraffin
- Wicks exudate away from the wound into a secondary dressing

SKU	SIZE	PACK SIZE
JEL001/1	15cm x 2m	1



LATEX FREE



DISPOSABLE FOR SINGLE USE



smith&nephew

Burnshield® Emergency Burns Dressings

- Available in six sizes to treat small to large burns
- Soothing tea-tree oils cool the skin
- Non-adhesive and can be removed with cool water or saline solution
- For use on 1st, 2nd or 3rd degree burns

Burnshield® Emergency Contour Dressings

- Available in two large sizes to provide maximum coverage
- Supplied in a nylon bag
- Designed to soothe and protect burns or scalds too large for smaller dressings
- Fibreless cotton reduces the risk of contamination and residue
- Shelf life of five years from the date of manufacture

Burnshield Emergency Burns Dressings

SKU	APPLICATION	SIZE
BD90825	Digits	2.5cm x 50cm
BD90822/1	Small Surface	10cm x 10cm
BD90826	Limb/Neck	5cm x 1m
BD90823/1	Large Limb	20cm x 20cm
BD90827	Face Mask	20cm x 45cm
BD90824	Torso/Back	60cm x 40cm



Burnshield Emergency Contour Dressings

SKU	APPLICATION	SIZE
BD881006	Large Limb	1m x 1m
BD881007	Large Limb	1m x 2m



SUITABLE FOR ADULTS & CHILDREN



DISPOSABLE FOR SINGLE USE



Calcium Gluconate Gel (C-Gel) 40g Tube

- Water based gel used to treat hydrofluoric acid burns
- Handy 40g gel tube fits into first aid kits & pockets



SKU
1959

Guarantee your emergency response is effective enough to **save a life, stop infection, and soothe painful burns** with medical-grade burncare bandages, gels & kits



Burnshield® Hydrogel

- For treatment of 1st, 2nd, and 3rd-degree burns and sunburn
- Contains tea-tree oil, quickly cooling a burn area, forming a protective barrier
- Designed for application directly onto skin as well as for use over burn dressings
- Available in sachets, squeeze bottles & sprays

Burnshield Hydrogel Burn Blott Sachets

SKU	SIZE	PACK SIZE
BD90830/10	3.5ml	10
BD90830/100	3.5ml	100

Burnshield Hydrogel Bottles

SKU	SIZE	PACK SIZE
BD90828/1	50ml	1
BD90828/6	50ml	6
BD90829/1	125ml (Spray)	1
BD90829/6	125ml (Spray)	6



SUITABLE FOR ADULTS & CHILDREN



DISPOSABLE FOR SINGLE USE

Additional Burns First Aid Supplies

Ensure your workforce and customers are completely protected from the threat of burn-related injuries.

Supplementary burncare and fire protection supplies include:

Fire Extinguishers

The Regulatory Reform (Fire Safety) Order 2005 requires employers to put fire safety measures in place, including means to fight small fires, such as extinguishers.

Portable Fire Extinguisher

SKU: 1975



Own Branded First Aid Supplies

Adding your logo to burns kit bags or boxes presents a professional image and ensures that your supplies are easily recognisable to your staff.

Contact us to enquire.

Premier Steroburn Burns First Aid Kit | Medium
SKU: 8232



Visit page 18 for all First Aid Stations

First Aid Kit, Eyewash Kit and Burncare Kit Station
SKU: 1424



Burncare Stations

Employers are required to make first aid kits visible and accessible in their premises. Consider installing a burncare kit station to make sure you've got this covered.

Trauma First Aid

High-risk workplaces demand extra safety measures to keep lives safe



Deal with major bleeding and injuries that standard first aid kits aren't equipped to handle

If you operate premises with machinery, sharp and electronic tools, heavy movable objects, and working at height or in dangerous environments, it's highly likely you need to trauma first aid provisions.

Some industries that typically need trauma first aid provision include:

- Construction
- Mining
- Offshore
- Agriculture
- Deep Sea Fishing
- Waste Management

Bridging the Care Gap - *What happens before ambulances arrive?*

Our bleed control and trauma equipment give casualties the chance of survival when the care gap is their greatest enemy. The care gap is the time between injury occurrence and the arrival of professional medical assistance. When mass injury strikes like that of a natural disaster or terrorist attack, that's when the care gap is at its more threatening.



Equip your Venue for Martyn's Law

Following the Manchester Arena Attack, Martyn's Law will require certain organisations to better prepare for terrorist threats by training, planning, and supplying the right equipment for anyone to use in an emergency, when the care gap could be the thing that kills.

Taking effect in the near future, the new legislation sees businesses that operate public spaces required to put protective measures in place by law. Publicly Accessible Locations (PALs) with a capacity of 100 or over must adopt risk management activities and a preparedness plan, with those of below 100 capacity highly recommended to do so too.

Any business that operates on public premises must be fully equipped to handle a terrorist attack. Even if Martyn's Law doesn't apply to you, you'll never regret having bleed control and severe injury first aid measures in place. Ensure you have all the workplace first aid supplies your risk assessment requires, install a **Public Access Trauma Kit (page 42)**, and find exactly what you need here to ensure you're fully prepared for the worst.

Trauma Kits

All UK workplaces are required by law to provide staff with access to a first aid kit, including all the supplies needed to face potential risks. Workplaces like factories, warehouses, production lines, agriculture, and construction are environments we find often need a bleed control kit.

A public access bleeding control kit means not only staff are protected, but you're giving members of the public that use your business space the chance to save a life too. You never know when a crisis could strike. You'll never regret being prepared.



Scan the QR code or visit www.steroplast.co.uk/advanced-life-support-equipment.html to view these products online.

VIEW ONLINE

Visit our

Trauma Supplies Online Buying Guide

Explore our user-friendly Trauma Guide page for a breakdown of our advanced trauma supplies.

- ✓ Refine your search
- ✓ Intuitive page navigation
- ✓ Related videos & articles
- ✓ Find detailed information and specifications to meet your needs
- ✓ Learn more about **Martyn's Law** & **the Care Gap** to find out how your business can be better prepared



Scan the QR code to visit our online guide

ONLINE GUIDE



Critical Injury First Aid Kit

The Steroplast Critical Injury First Aid Kit is specifically designed to control and stop severe blood loss in the event of a stabbing or similar serious injury.

- Supplied in a durable nylon zip-secured bag
- Includes PPE, dressings and tourniquet to stop bleeding and treat a casualty hygienically
- Can be used by anyone without prior training

SKU
8599-C



Kit Includes:

- x1 First Aid Emergency Leaflet
- x2 Haemostatic Dressing
- x1 Foil Blanket
- x2 Disposable Gloves (Pairs)
- x2 Trauma Dressing
- x1 S.T.A.T Tourniquet
- x1 Tuff Cut Scissors



Compliant with BS8599-1

Includes Life-saving Instruction Leaflet



Visit our YouTube Channel for quick video demonstrations to use the contents of our trauma kits

[youtube.com/@Steroplast](https://www.youtube.com/@Steroplast)



IFAK Individual First Aid Kit

A compact, fully equipped trauma kit designed for emergency first aid in critical situations.

- Supplied in a durable MOLLE pouch for easy attachment and rapid access
- Suitable for a wide range of users and situations, from outdoor adventurers to office and home settings

SKU
6852

Kit Includes:

- x1 CAT Tourniquet (Black)
- x1 Trauma 6" Dressing
- x1 Foxseal Vented Chest Seal
- x1 Haemostatic Gauze
- x2 Nitrile Gloves (Pairs)
- x1 7.5" Paramedic Scissors
- x1 Emergency Foil Blanket
- x1 Resusciate Face Shield
- x2 Nasopharyngeal Airways
- x2 Optilube 5g Sachets
- x1 6" Red Lightstick



NEW



Includes orange wall bracket



Sterostop Bleed Control Kit

A bleeding control kit to treat catastrophic injury and sustain a casualty until they receive proper medical attention. This kit includes the necessary items to create a tourniquet, dress a wound, and give hygienic CPR.

- Supplied in a durable plastic box with snap-fit closure
- Attach to a wall with wall bracket included for visibility & ease of access
- Includes premium quality trauma bandage & tourniquet to control severe bleeding in seconds
- Our resusciate face shield protects both the casualty and the responder from cross-contamination, meaning CPR can be given safely and quickly



SKU
6824

Kit Includes:

- x1 Trauma Bandage
- x1 Compressed Gauze
- x1 Resusciate
- x1 S.T.A.T Tourniquet
- x2 Disposable Gloves (Pairs)
- x1 Scissors

Forestry First Aid Kit

Page 35

This is an ideal first aid kit for chainsaw users and those working with high-risk tools and machinery.



Haemostats & Tourniquets

Our selection of haemostats and tourniquets is essential for managing severe bleeding.

Designed for rapid and effective control of bleeding, these tools are crucial in emergencies where immediate action is required. Having these products readily available ensures staff can respond quickly, reducing the risk of blood loss while waiting for professional medical assistance.

With easy-to-use designs, they provide reliable support in high-pressure situations, helping maintain safety standards across various industries.



Scan the QR code or visit www.steroplast.co.uk/advanced-life-support-equipment.html to view these products online.

VIEW ONLINE

Celox™ Z-Fold Haemostatic Gauze

- Designed to control moderate to severe traumatic bleeding
- Celox Rapid stops severe arterial bleeding in just 60 seconds
- Revolutionary haemostatic technology
- Simplified packing and application due to its Z-folded design



PRODUCT	SKU
Celox Z-Fold Gauze	6850
Celox Rapid Z-Fold Gauze	6832

Celox™ Haemostatic Granules

- Rapidly control bleeding in emergencies
- It excels in stemming severe blood flow, which can be life-saving in certain situations
- The applicator is specifically designed to handle deep, penetrating trauma wounds
- Forms a robust clot in just 30 seconds



PRODUCT	SKU
15g Pouch	6837
6g Pre-filled Applicator	6833

Tactical Medical Tourniquet™ (TMT)

- Developed with US military expertise
- Used by militaries, medical professionals, and public safety agencies worldwide



SKU

WSTE0678

SAM® ChitoSAM 100



- 100% Chitosan haemostatic dressing
- Tear anywhere packaging
- Can be used in conjunction with pressure bandages



SKU

1357

ChitoGauze® XR Pro



- Specially designed to control severe bleeding quickly
- Easily identifiable in X-rays
- Z-folded in a sterile package for rapid deployment



SKU

PROM006



S.T.A.T.® Tourniquet

- Simple & easy 5 second application
- For limb sizes as small as 20mm
- Automatic self locking system
- Easy to follow instructions printed on tourniquet
- Blue training tourniquet available



SUITABLE FOR ADULTS & CHILDREN



LATEX FREE



DISPOSABLE FOR SINGLE USE

SKU

COLOUR

1146

Orange

1146/BLU

Blue



SOF Tactical Tourniquet

- High-strength, one-handed SOF Tactical Tourniquet for rapid arterial compression
- Furnished with a true 1.5" strap, ensuring superior arterial compression
- Snap-lock buckle specially designed to wrap around trapped limbs

SKU

COLOUR

WSTE0401/BLK Black

WSTE0401 Orange



SWAT-T™ Tourniquet Orange

- Stretch, Wrap And Tuck Tourniquet
- Multi-function life saving device
- Compact, lightweight and economical
- Easy to learn and train with instructions printed directly on the tourniquet
- Can be wrapped over a gauze or haemostats

SKU

1141

C-A-T Combat Application Tourniquet GEN7

- Effective and user-friendly
- Single application protocol and single buckle routing system
- Cutting-edge design controls life-threatening bleeding
- Clinically proven effectiveness
- Official endorsement by the U.S. Army



Windlass Rod



Windlass Clip



Single Routing Buckle



Internal Free-Moving Band



SKU

COLOUR

1142 Black

1143 Orange



Trauma Bandages & Dressings

Supplement your trauma kits with additional bandages and dressings as per your risk assessment.

In high-risk workplaces, trauma bandages and dressings are essential for managing severe injuries such as deep cuts or heavy bleeding.

Designed for quick and efficient application, these products offer critical care in emergency situations, helping to control bleeding and stabilise wounds until further medical help arrives.



Scan the QR code or visit www.steroplast.co.uk/advanced-life-support-equipment.html to view these products online.

VIEW ONLINE

The Emergency Bandage®

- Heavy-duty compression bandage
- Provides direct, constant pressure to wound
- For personal or professional application



SKU	SIZE
6843	4in
6844	6in

Compressed Gauze

- High-quality, 6-ply cotton construction
- Essential for wound packing and bleeding control
- Z-fold layers release smoothly



SKU
6835

Steroplast Trauma Dressing

- Expertly engineered to manage intense bleeding during emergency situations
- Super-absorbent pad capable of absorbing over 2x its weight in fluid
- Vacuum-packed for easy storage



SKU	SIZE
6830	Medium (10cm x 18cm)
6831	Large (15cm x 18cm)



VIDEO DEMO



CE MARKED

TacMed Solutions Olaes® Modular Bandage

- Newest generation of trauma bandage
- Pressure bar that doubles as an eyecup
- Plastic occlusive sheet included in dressing pocket

SKU	SIZE
PROM001	4in/10cm
PROM002	6in/10cm



VIDEO DEMO



VIDEO DEMO

Prometheus Trauma Dressing

- Features a 17cm x 10cm low-adherent absorbent pad
- Elastic wrap with built-in hook control strips for secure compression
- 5-year shelf life for long-term storage and reliability
- Mechanical stretch wrap (150cm x 10cm) for effective wound binding
- Compact design for easy storage in medical bags and kits

SKU
PROM011



LIGHTWEIGHT



LATEX FREE

TacMed Solutions Tactical Blast Bandage®

- Durable, rapid-application bandage for trauma wounds
- Large non-adherent wound pad facilitates sustained bleeding control
- Provides a 50 x 50cm treatment area

SKU	SIZE
PROM003	10cm x 10cm (Packed)

Celox FoxSeal™

Occlusive dressing for the treatment of open wounds, design for ease of use and consistent performance in the field.

Contains 2x chest seals.

SKU
6834



CE MARKED



Corius Seal

- Covers both large and small wounds whilst absorbing wound exudate
- Can be used for up to 24 hours
- Non-sterile adhesive hydrogel wound dressing
- 20cm x 15cm. Single use

SKU
PROM009



LATEX FREE



DISPOSABLE FOR SINGLE USE

Celox FoxSeal™ Vented

The Celox FoxSeal™ Vented is the first chest seal with 512 vents, providing more ways to release pressure and prevent blockages.

13cm x 13.3cm.

SKU
6851



CE MARKED



Russell Chest Seal

- Covers penetrating chest wounds allowing air to escape from the pleural cavity without being drawn back in
- Hydrogel-based dressing with an integral low-profile valve

SKU
WSTE0380



SAM® Chest Seal 2.0 — Valved Occlusive Dressing

- Engineered to treat, seal, and reseal open chest wounds
- Exceptional sealing ability holds fast in extreme temperatures

SKU
WSTE0392



CE MARKED



Public Access Trauma (PACT) Kit

Now in **Hundreds of** Hospitality Venues in Manchester



RESTAURANTS
& PUBS



NIGHTCLUBS
& BARS



SPORTS &
PUBLIC VENUES



TRANSPORT
HUBS



PLACES
OF WORSHIP



SCHOOLS



Featured on BBC's *The One Show*

On 3 September 2024, BBC's *The One Show* featured a segment about a partnership between Manchester City Council, CityCo, and Steroplast Healthcare, which saw hundreds of Public Access Trauma (PACT) Kits distributed across venues in Manchester's hospitality and entertainment sectors.

This initiative addresses the "care gap" – the crucial period between a serious incident, such as a terrorist attack, and the arrival of emergency services.

At the event, a Steroplast healthcare professional led a training session for venue staff, showing them how to use the PACT Kit's contents, including easy-to-use tourniquets and trauma dressings. The session demonstrated how even those without medical experience can effectively manage life-threatening injuries using the kit.



Scan the QR code to watch the PACT Kit feature on *The One Show*

The Public Access Trauma Kit: Help Before Paramedics Arrive

As businesses across Manchester and beyond face increasing pressure to supply more safety measures in public venues, it's essential to begin preparing for forthcoming legislation that will soon require more robust security protocols for businesses.

Following several recent incidents where businesses were found unprepared, the urgency for effective emergency preparedness has never been clearer. While specific laws and policies are yet to be fully implemented, it's evident that compliance with new safety standards will soon be mandatory.

One proactive step businesses can take is investing in a PACT kit—developed by medical experts and recognised by emergency services—to ensure they are equipped to handle severe injuries in high-risk situations.

The PACT kit was developed by the National Counter Terrorism Security Office (NaCTSO) with critical input from medical experts and first aid professionals. On July 31st, Manchester City Council, in partnership with Steroplast Healthcare and CityCo, distributed hundreds of PACT kits across venues throughout the city as part of an initiative to address the care gap during emergencies.

As seen on
**BBC's
The One
Show**



Choose from three tourniquet types

We offer three variations of the PACT kit, supplied with different types of tourniquet for different levels of training:

S.T.A.T Tourniquet

Users with no prior experience/training



C-A-T Tourniquet

Users with some experience/training



SOF-T Tourniquet

Users with some experience/training



SKU	KIT VARIATION
6825	PACT Kit With S.T.A.T Tactical Tourniquet
6825RP	PACT Kit With S.T.A.T Tactical Tourniquet - <i>Refill</i>
6825/CAT	PACT Kit With C-A-T Tactical Tourniquet
6825/SOF	PACT Kit With SOF Tactical Tourniquet

Kit Includes:

x4 Trauma Dressings	x2 Triangular Bandage
x2 Resuscitade	x2 Tourniquet
x4 Nitrile Gloves Pairs	x4 Face Masks
x2 Scissors	x4 Safety Goggles



Scan the QR code to learn more about the benefits of a PACT Kit



Scan the QR code to view this product on our website

Childcare First Aid

Supervise children with complete confidence when you have the right first aid supplies



British childcare first aid kit requirements are stipulated by the UK Board of Education

Under the Early Years Foundation Stage (EFYS) Statutory Framework that covers children from birth to five years old, the paediatric first aid requirements for all organisations, businesses, or individuals who take care of young children advise that:

*'Providers must ensure there is a **first aid box** accessible at all times with **appropriate content for use with children**. Providers must keep a **written record of accidents or injuries and first aid treatment**.'*



Childcare First Aid Kit



Assorted Washproof Plasters



Accident Report Book

The first aid kit contents for childminders, nurseries and primary schools need to be suitable for minors, so choosing a specially designed paediatric first aid kit containing products appropriate to treat children is essential.

The EFYS guidelines also state that all early year childcare providers must:

- Make suitable first aid arrangements for off-site activities as well as the main premises.
- Ensure that at least one person with a current paediatric first aid (PFA) certificate is available at all times when children are present, including on outings.
- Childminders or any assistant in sole charge of children for any period should hold at current PFA.
- In the event of an injured child, a trained paediatric first aider and the necessary paediatric first aid kit contents must be accessible within 60 seconds.
- Where schools or childcare environments have more than one floor, you must have multiple kits—at least one on each floor.

Access to the right first aid kit contents for nursery and childcare environments and at home or school could save a life.

Childcare First Aid Kits

It's important to have a good idea of what paediatric first aid kit contents you should keep within reach in case of a child-related emergency.

Parents, teachers, and childminders should never underestimate the importance of having a paediatric first aid kit specially designed for treating children. Our children's first aid kits contain hypoallergenic items like plasters, designed to minimise the chance of an allergic reaction on sensitive skin.



Scan the QR code or visit www.steroplast.co.uk/first-aid-products.html to view these products online.

VIEW ONLINE

HSE Mini Childcare First Aid Kit | PVC Pouch

- Meets guidance from HSE and the UK government, suitable for childminders, schools, nurseries, preschools, childcare centres & parents

SKU	PRODUCT
8195	Premier HSE Childcare First Aid Kit Pouch
8170RP	Premier HSE Childcare First Aid Kit - Refill



School Classroom First Aid Kit

- Water-resistant, green bag with a double zip and white first aid cross
- Easy to store in classroom and carry to emergencies within schools
- Equipped to treat common classroom injuries like cuts, burns, and eye irritation

SKU	PRODUCT
8196	School Classroom First Aid Kit



School Trip Travel Kit

- Designed for school trips, this first aid kit is equipped to handle various injuries, from minor cuts to more serious incidents
- Compact hard shell case fits easily into a backpack or can be carried on a school bus and can also be customised with your schools logo
- Includes eyewash and sterile wipes, useful when soap and clean water aren't available

SKU	SIZE
8173	School Trip Travel Kit
8173RP	School Trip Travel Kit - Refill

Kit Includes:

- x1 Steropax Dressings
- x1 Eyepad Dressing
- x1 Triangular Bandage
- x4 Sterile saline wipes
- x10 Assorted plasters
- x1 Nitrile gloves
- x1 Microporous tape
- x6 Safety pins
- x1 Finger dressing
- x1 Resusciate
- x1 Foil blanket
- x1 Burn dressing
- x1 Tuff Cut scissors
- x1 Conforming bandage
- x1 500ml eyewash
- x1 Guidance leaflet



P.E. Teacher First Aid Kit

- Includes hypoallergenic plasters suitable for children's sensitive skin
- The hard-shell case is designed for easy storage and transport, making it ideal for use in sports halls, gyms, or on the field
- Contains essential first aid items, including plasters, bandages, burn dressings, and a guidance leaflet, prepared for various sports injuries

SKU
8198



Kit Includes:

- x1 Steropax Dressings
- x1 Eyepad Dressing
- x1 Triangular Bandage
- x4 Sterile saline wipes
- x10 Assorted plasters
- x1 Nitrile gloves
- x1 Microporous tape
- x6 Safety pins
- x1 Finger dressing
- x1 Resusciate
- x1 Foil blanket
- x1 Burn dressing
- x1 Tuff Cut scissors
- x1 Conforming bandage
- x1 500ml eyewash
- x1 Guidance leaflet

Premier HSE Childcare First Aid Kit

Designed for parents and childcare professionals to treat all common injuries and accidents

- Suitable for parents, childminders, schools, nurseries, preschools, and babysitters
- Designed with guidance from HSE, UK government, and childcare specialists
- Includes hypoallergenic, washproof plasters and alcohol-free sterile wipes suitable for children
- Features a CPR guidance leaflet specifically for use with children
- Premier Box can be wall-mounted using a compatible bracket
- Refill packs are available, making it easy to keep the kit stocked

SKU	PRODUCT
8170	Premier HSE Childcare First Aid Kit
8170RP	Premier HSE Childcare First Aid Kit - Refill

Kit Includes:

- x10 Alcohol-Free Cleansing Wipes
- x1 CPR Guidance Leaflet
- x3 Gloves
- x2 Large Sterile Dressing
- x1 Microporous Tape 1.25cm
- x2 Medium Sterile Dressing
- x1 Resusciate - 1 Way Valve
- x1 Scissors
- x1 Sterogauz Applicator
- x1 Sterogauz Tubular Bandage
- x2 Sterile Eye Dressing
- x5 Steropad (5cm x 5cm)
- x5 Steroswab (5cm x 5cm)
- x4 Triangular Bandage
- x20 Washproof Plasters



Consider these additional kits to supplement your first aid provisions when working with children...



Visit page 50 for all **Eyecare**

Sterowash Eyecare Kit 2

Eyecare Kit

Children often experience minor eye issues, such as irritations or **foreign particles in the eye**, which can be quickly addressed with the right tools. Having an eyecare kit on hand enables schools to respond promptly to these situations, reducing discomfort and minimising disruptions to learning. It also helps to avoid unnecessary trips to healthcare facilities for minor issues, providing a practical solution for everyday eyecare needs.



Visit page 42 to learn about **PACT Kits**

Public Access Trauma (PACT) Kit

Public Access Trauma (PACT) Kit

A Public Access Trauma Kit provides immediate assistance in emergencies, such as **severe injuries or accidents**, before medical professionals arrive.

These kits can help address critical situations like severe bleeding, which requires quick intervention to increase the chances of survival. Having a trauma kit on hand ensures that staff and bystanders are equipped with the necessary tools to provide basic but potentially life-saving care.



Visit page 27 for all **Catering**

Catering First Aid Kit

Catering First Aid Kit

A Catering First Aid Kit is the perfect addition for school **canteens**, **food preparation areas**, and **certain lessons** where food is handled to ensure safe and efficient food handling.

It helps maintain hygiene standards, reducing the risk of contamination and food-borne illnesses. A catering kit also makes it easier for staff and students to access the right tools for various food-related activities, such as cooking lessons or special events.



Visit page 34 for all **Burncare**

Steroburn Burns Kit

Burns First Aid Kit

A Burns First Aid Kit ensures school staff can respond quickly and effectively to incidents involving heat or chemical burns. **Classrooms**, **kitchens**, and **science labs** are environments where such accidents can happen, and having a specialised kit on hand means immediate treatment can begin before further medical help arrives.

These kits contain items like burn dressings and cooling gels, specifically designed to relieve pain and minimise injury.



Steroguard Biohazard Kit



Steroguard Bio-Hazard Spill Kit

Visit page 55 for all **Biohazard**

Biohazard Kit

All schools should consider having a biohazard kit on hand, as children are prone to accidents and illnesses that can result in **exposure to bodily fluids** like vomit, blood, urine, and faeces.

A Biohazard Kit ensures that staff can manage these situations promptly with proper PPE, reducing the risk of cross-contamination. The kit's ease of use and quick deployment make it an essential addition to any school's safety equipment.



Sterosafe Sharps Disposal Kit

Visit page 56 for all **Sharps Disposal**

Sharps Disposal Kit

A Sharps Disposal Kit ensures the **safe handling and disposal of needles and other sharp objects** that may be found on the premises.

This reduces the risk of injury and potential exposure to infections for students, staff, and visitors. Having a dedicated kit also ensures that any sharps can be handled promptly and correctly, maintaining a safer environment and complying with health and safety regulations.

Plasters & Bandages for Children

Our range of child-friendly plasters and bandages are designed with gentle materials and fun designs, helping to calm children while offering effective protection for cuts and grazes.

These products ensure that minor injuries are treated quickly and comfortably in environments where children's well-being is a priority. Hypoallergenic plasters designed by experts to be kind to sensitive skin and painless to remove. Choose from various designs, shapes, and sizes.



Scan the QR code or visit www.steroplast.co.uk/first-aid-products.html to view these products online.

VIEW ONLINE

Teachers, parents and childcare professionals: do you look after children with allergies or sensitive skin?

Our plasters range of hypoallergenic plasters are kind to young peoples' skin and painless to remove.



Cederroth Textile Plasters

- 6 boxes of 40 plasters
- Allergy tested and hypoallergenic
- Convenient and easy to use
- Includes two sizes
- Non-sterile



SKU	QTY
CE6444	6 Boxes of 40

Cederroth Plastic Plasters

- 6 boxes of 45 plasters
- Allergy tested and hypoallergenic
- Convenient and easy to use
- Includes two sizes
- Non-sterile



SKU	QTY
CE6036	6 Boxes of 45

Steroplast Sensitive Plasters

- Gentle on sensitive and allergy-prone skin, minimising the risk of irritation
- Flexes with the skin, offering comfort even in tricky areas like between fingers
- Low-adherent wound pad ensures easy removal without pulling or discomfort
- Thick, non-stick wound pad absorbs impacts and keeps wounds dry and free from dirt

SKU	QTY
8042FC/6	6 Boxes of 16



Steroplast Washproof Plasters

- Made with gentle, hypoallergenic acrylic adhesive, suitable for sensitive skin, children, and those prone to allergies
- Includes a range of plasters for various injuries, such as small spots, long rectangular plasters, and round options for injection sites
- Each plaster is individually wrapped to maintain hygiene and sterility until use

SKU	QTY
8009FC/1	Box of 16



Sterostrip Washproof Plasters

- Hypoallergenic & latex-free makes it safe for all skin types, including children and sensitive skin, minimising irritation and allergic reactions
- Superior medical-grade adhesive ensures secure placement, even during activities like showering, swimming, or frequent hand washing
- Washproof to keep wounds dry and protected in wet conditions
- Individually wrapped plasters remains sterile until opened, ensuring cleanliness and safety
- CE Marked & quality tested for safety and compliance with stringent standards, trusted by UK healthcare professionals
- Available in a wide range of shapes and sizes suitable for a range of injuries

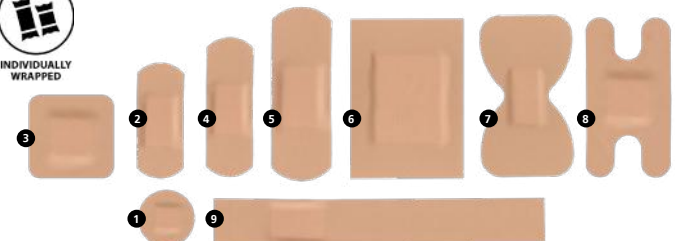

Leukoplast Kids Hero Edition Plasters

- Designed for sensitive children's skin, minimising the risk of irritation and allergic reactions
- Fun & engaging superhero graphics help distract children from the discomfort of minor injuries
- Range includes assorted plasters and dressing strip

SKU	SIZE	QTY
7685/1	Superman Plasters	Box of 12
7687/1	Wonder Woman Dressing Strip	Single



SKU	SIZE	QUANTITY
1 7165R/1	2.4cm (Round)	Box of 100 Plasters
2 7140R/1	4cm x 2cm	Box of 100 Plasters
3 7141R/1	4cm x 4cm	Box of 50 Plasters
4 7142R/1	6cm x 2cm	Box of 100 Plasters
5 7143/1	7.5cm x 2.5cm	1 Box of 100 Plasters
6 7145/1	7.5cm x 5cm	1 Box of 50 Plasters
7 7911/1	7.2cm x 4.2cm (Fingertip)	1 Box of 50 Plasters
8 7157/1	7.5cm x 4cm (Knuckle)	1 Box of 50 Plasters
9 7914/1	15cm x 2cm (Fingertip Extension)	1 Box of 50 Plasters
7184/1	2 Assorted Sizes	Wallets of 20 Plasters
7160/1	5 Assorted Sizes (Clear Plastic Case)	1 Box of 100 Plasters
7149F/1	5 Assorted Sizes	1 Box of 100 Plasters
71585	7 Assorted Sizes	1 Box of 100 Plasters

Sterogauz Tubular Gauze Bandages

- Provides gentle pressure while allowing the bandage to conform to body contours and stay in place
- Made with premium gauze material
- Easier to apply than flat bandages

SKU	SIZE
9545/1	00 – 1cm
9540/1	01 – 1.5cm
9541/1	12 – 2.5cm
9542	34 – 3.5cm
9543	56 – 5cm
9544	78 – 8cm



Sterogrip Elasticated Tubular Support Bandages

- For complete protection of injuries, dressings, joints, and delicate areas of the body
- Can be applied in multiple layers for tailored levels of support to sprains and strains

SKU	SIZE
9500	A – 5cm x 10m
9501	B – 6.25cm x 10m
9502	C – 6.75cm x 10m
9503	D – 7.5cm x 10m
9504	E – 8.75cm x 10m
9505	F – 10cm x 10m
9506	G – 12cm x 10m

Also available in 1m

1m retail packaged Elasticated Tubular Support Bandage, ranging in size to cover ankles, knees, thighs, wrists and elbow joints.



SKU	SIZE
9520/1	B – 6.25cm x 1m
9521/1	C – 6.75cm x 1m
9522/1	D – 7.5cm x 1m
9523/1	E – 8.75cm x 1m
9524/1	F – 10cm x 1m
9525/1	G – 12cm x 1m

Steroswab Gauze Swabs

- Premium gauze dressing for wounds, used as an additional absorbent layer for bodily fluids in wound dressing procedures
- Sterile and non-sterile options available



SKU	STERILITY	PACK SIZE
1900	Non-Sterile	100
1901	Non-Sterile	100
1902	Non-Sterile	100
1903	Sterile	25 Packs Of 5
1904	Sterile	25 Packs Of 5
1905	Sterile	25 Packs Of 5

Steropax Finger Dressings

- Sterile finger wound dressing pads with an attached conforming bandage for easy application
- Ideal for emergency use, hospital care, and to top-up first aid kits

SKU	SIZE
1915B/1	3.5cm



Steroply Conforming Bandage

- High stretch elastic conforming bandage allows for optimal mobility when wearing
- Conforms easily to all body areas, even awkward joints
- The bandage is light and soft, permitting air circulation

SKU	SIZE
3051/1	5cm x 4m
3052/1	7.5cm x 4m
3053/1	10cm x 4m
3054/1	15cm x 4m



Calico Triangular Bandage

- Made from a durable, reusable, and washable calico material
- Ideal for supporting arms in slings, immobilising limbs, and applying dressings

SKU	PACK SIZE
9562/1	1
9562	50



Non-Woven Triangular Bandage

- Lightweight and breathable,
- Ensures optimal comfort and airflow
- Multi-functional bandage can be used as a sling, dressing or tourniquet

SKU	PACK SIZE
9560/10	10
9560	50

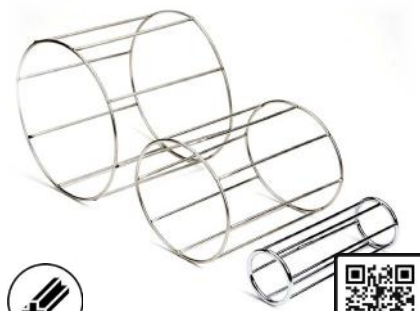

Sterogrip Tubular Bandage Wire Frame Applicator

- For easy application of tubular bandage over bulky dressings and double laying over sensitive joints
- Made from high-grade stainless steel, the applicator is durable, long-lasting and easy to keep clean
- Available in six sizes

SKU	SIZE	SUITABLE FOR
9536	C: 3.4cm x 15.2cm	Toes and fingers
9510	D: 4.5cm x 15.2cm	Fingers
9511	E: 9cm x 15.2cm	Hands, wrists, children's limbs
9537	F: 12cm x 15.2cm	Ankles, arms, children's limbs
9538	G: 17cm x 15.2cm	Arms, ankles, knees, legs, thighs
9539	H: 19cm x 15.2cm	Arms, ankles, knees, legs, thighs

Steropad Non-Adhesive Double Sided Wound Dressings

- Double-sided, low-adherent, non-adhesive wound dressing pads are highly absorbent
- Formulated to prevent adhesion to the skin or the wound



SKU	SIZE	PACK SIZE
2994BS	10cm x 20cm	25
3008/1	10cm x 10cm	25
3006/1	5cm x 5cm	25
3007/1	7.5cm x 7.5cm	25

Additional Childcare First Aid Supplies

Ensure children are protected from the different types of injuries which could occur under your responsibility.

Other considerations for childcare environments include:

Sports First Aid Equipment

Sports first aid equipment will equip teachers and students at risk of injury during physical education classes and sporting activities.



VIEW ALL SPORTS



Boxing Corner Medical Kit
SKU: 8277

Sports First Aid Kit | Medium Kit in Nylon Bag
SKU: 8090

Visit page 21 for all Signage

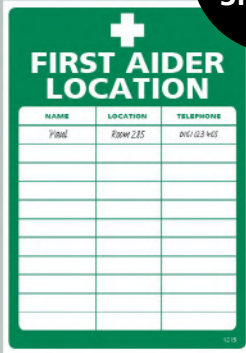

First Aider Location Sign
SKU: 1215

First Aid Signage

Clear signage helps staff, students, and visitors quickly locate first aid kits, defibrillators, or designated first aid rooms, saving valuable time when someone is injured or unwell.

Personal Protective Equipment

By using PPE like masks, gloves, and hand sanitisers, schools can reduce the risk of illness, ensuring a safer environment and minimising disruptions to learning.



VIEW ALL PPE



Blue Vinyl Gloves AQL 1.5 - Pack of 100
SKU: 1981

Eyecare First Aid

Deal with eye injuries and accidents fast and save someone's sight



Guidance on Eye First Aid

Supplying your staff with first aid provisions isn't enough to ensure they're ready when an accident occurs.

Thorough and ongoing training, with regular access to training materials is as important to ensure they are confident, prepared, and forthcoming with help if a teammate gets injured.

There's no limit to how much first aid training you need to provide or how many members of staff need first aid training, this will all depend on your risk assessment and how much you determine necessary.

However, **the HSE states that the minimum requirements of businesses are:**

- "An appointed person or people to take charge of first aid arrangements"
- "Information for all employees telling them about first aid arrangements"

While not all members of staff are likely to require formal first aid training, everyone should be aware of basic emergency procedures. This means that no matter who is present and who becomes injured, team members will have the fundamental training to help.

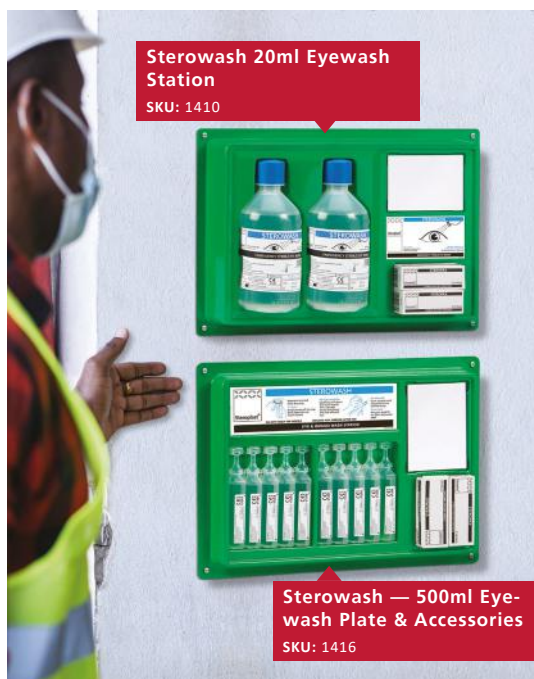

UK Regulations and Laws on Eye First Aid

All UK businesses have a duty of care under the Health and Safety (First-Aid) Regulations 1981 to provide access to first aid provisions and training that ensure all individuals who interact with the business are safe from harm.

The Management of Health and Safety at Work Regulations 1999 requires risk assessments to be carried out to determine precisely what measures need to be put in place.

Exactly where eyewash stations should be installed depends on the risks in the surrounding environment. Your risk assessment will tell you whether you need to install eye first aid supplies. If so, the HSE guidance on eyewash stations is:

"If mains tap water is not readily available for eye irritation, at least a litre of sterile water or saline (0.9% w/v) in sealed, disposable containers should be provided. Once the seal has been broken, the containers should not be kept for reuse. The container should not be used after the expiry date."

Eyecare Kits & Eyewash

Additional first aid supplies are required for eyecare in labs, catering and food handling environments, around machinery, and in workshops. If your business involves handling tools, materials, and machinery, uses open flames, steam, or ovens, or puts people at risk of exposure to chemicals, there's a heightened risk of eye injury.

Invest in an eyecare kit to keep on your premises and stay compliant. If someone gets debris or chemicals in their eye it must be flushed immediately. Give your staff a chance to save someone's sight with an eyecare kit.



Scan the QR code or visit www.steroplast.co.uk/first-aid-products.html to view these products online.

VIEW ONLINE

Sterowash Eyewash 20ml Pods

- Sterile, Single-Use 20ml Saline Pods
- 0.9% Sodium Chloride solution, compliant with ACOP L74 health and safety regulations
- Slim neck for targeted application
- Suitable for eye irrigation and allergy relief



SKU	PACK SIZE
1400W/1	Pack of 25
1400W	10 Packs of 25



DISPOSABLE FOR SINGLE USE



Steropax Eyepad Wound Dressings

Extra Thick Wound Pad

- High stretch conforming bandage with absorbent cotton wound pad
- Provides exemplary wound coverage, ensuring the initial barrier against infection

SKU	PACKAGING TYPE
1912B/1	Plastic
2012/1	Paper
1912BX/1	Boxed

Sterowash Eyewash 500ml Bottle

- Complies with ACOP L74 and Health and Safety (First-Aid) Regulations 1981, CE marked, and classified as a Class IIA medical device
- Contains a sterile 0.9% sodium chloride solution in purified water
- Ergonomic 500ml bottle with an easy-to-open twist cap and precision opening
- Sterile until use, reducing the need for frequent checks and maintenance



Use with an Eye Bath
SKU: 1404



SKU	PACK SIZE
1405/1	Single
1405	Pack of 10



Sterowash Eyecare Kits

- A versatile range of three eyecare kits offering tailored solutions for various workplace needs
- Includes Sterowash solution in bottles or pods to flush irritants from the eye
- Essential in workplaces dealing with chemicals, heat sources, and machinery, including manufacturing plants, labs, construction sites, and more

SKU	SIZE
9114	Eyecare Kit 1
9115	Eyecare Kit 2
9116	Eyecare Kit 3



OWN BRANDING AVAILABLE

Kit Includes:

	Eye & Wound Care Kit	Eyecare Kit 2	Eyecare Kit 3
500ml Sterowash Bottle	x2	x2	x3
20ml Sterowash Pods	x10	-	x5
Eyepad Dressings	x2	x2	x2
Shatter-proof Mirror	x1	x1	x1



Premier wall bracket sold separately
See all wall brackets on page 12



View all Eyewash Stations & Signage on page 19

Dual Drop 2 Eye Wash Chemical Station Splash Solution Bottle Kit (Bottles Included)

- Wall-mountable design with a transparent, dust-proof cover for easy visibility and protection
- Includes 500ml Sterile Single-Use Saline Solution and 250ml Sterile Neutral PH Solution
- Equipped with a mirror for self-administration in emergencies
- Made with durable plastic for long-lasting use

SKU
WSTE0633



Cederroth Eyewash 500ml

- Neutralises eye pH value faster than standard sodium chloride solutions
- 100% phosphate-free for effective eye rinsing
- Functional design for effective flushing



SKU
CE725200

Sterile Neutral pH Eye Wash Saline Solution — 250ml

- Used to neutralise the eye pH against acid or alkaline
- Supplied with a dust-proof eye cup
- It can be used individually or placed in an eyewash station



SKU
WSTE0635

PVS Sterile Eye Wash Saline Solution — 500ml

- Sterile 0.9% Saline Solution
- Perfect for individual use or as part of an eyewash station
- Suitable for workplaces, remote sites, labs, and hazardous environments



SKU
WSTE0634

Biohazards & Sharps

Handle biohazard spills and hazardous sharp objects the right way



Spilt bodily fluids pose a serious health risk if they're not cleaned up with a Biohazard Kit. Ensure you have one on hand when you need it

Body fluid spills (urine, faeces, blood, vomit, saliva, semen) are classed as biohazards and potentially infectious. They must be cleaned up in a certain way to ensure the biohazard is neutralised and people in the environment are kept safe.

Where can our biohazard kits be used?

Medical Environments

Biohazard spill kits play a crucial role in various healthcare settings, such as hospitals, clinics, dental surgeries, care homes, and veterinary practices. These kits are essential in maintaining a sterile environment and preventing cross-contamination between patients and healthcare workers.

Workplaces and Education

In workplaces like laboratories, schools, offices, and factories, safety is a primary concern. Biohazard kits provide an effective solution for potential biohazard spillages, ensuring rapid, safe, and sanitary clean-up, thus contributing to a safer, healthier work and learning environment.

Public Spaces

Public spaces like hospitality and entertainment venues, beauty salons, spas, sports facilities, and event spaces often see a high footfall and are, therefore, more prone to accidental spillages. Biohazard kits facilitate swift containment and clean-up of such spills, ensuring public safety.

Public Transport

Similarly, public transport systems, including buses, trains, boats, airports, and aeroplanes, which serve a large number of people daily, can also greatly benefit from these kits, preventing the spread of potentially harmful pathogens.



Adhere to waste disposal regulations from proper sharps waste disposal supplies to protect yourself and others

Sharps bins for healthcare, nursing, beauty, veterinary, and at-home use. Sharps disposal kits and bins should be used to safely dispose of objects like needles, razors, and pins, or face the risk of broken glass contaminated with body fluids so they don't tear clinical waste bags and cause potential infection or injury.

Biohazard Kits & Supplies

Workplaces that handle potentially infectious materials or bodily fluids must be equipped with appropriate biohazard kits and supplies.

These kits contain everything needed to manage and clean up hazardous spillages, protecting staff from exposure to harmful pathogens.

From absorbent powders to disposal bags, these supplies ensure that biohazards are contained and disposed of safely, following strict safety guidelines.



VIEW ONLINE

Scan the QR code or visit www.steroplast.co.uk/infection-control-disposables/bio-hazard-kits.html to view these products online.

Steroguard Biohazard Spill Kit 3 & 5 Pack Application

- High-quality absorbent powder quickly solidifies liquids into a gel, ensuring safe and easy clean-up
- Includes Disinfectant Spray and Wipes for effective sanitisation of the spill area
- Compliant with HSE biohazard kit standards
- Suitable for a wide range of environments like hospitals, workplaces & public spaces



HSE Approved

SKU	SIZE
BIO3	3 Application
BIO5	5 Application

Kit Includes:

3 Pack	5 Pack	
x3	x5	Steroclenz Rapid Disinfectant Spray
x3	x5	Super Absorbent Powder Sachets
x3	x5	Biohazard Waste Bag
x6	x10	Hygea Disinfectant Wipes
x3	x5	Disposable Gloves in Pairs — Medium
x3	x5	Disposable Polythene Apron
x3	x5	Disposable Plastic Scoop & Scraper



OWN BRANDING AVAILABLE



YouTube @Steroplast

VernaGel Super Absorbent Powder — 100 Sachets



- Quickly solidify potentially harmful liquids
- Each sachet can absorb up to 1.2 litres of liquid within seconds
- Eliminates odours

SKU
8228

Steroguard Biohazard Spill Kit — Single Application

- Ideal for hospitals, schools, and workplaces
- For times when a single, efficient clean up is needed
- Includes Disinfectant Spray and Wipes for effective sanitisation of the spill area

SKU	SIZE
BIO2	Single
BIO1-R	Single - Refill



OWN BRANDING AVAILABLE



LIGHTWEIGHT



Haz-Tab Granules — 500g

- An effective method to safely and efficiently contain, disinfect, and remove blood spillage
- Effective against fungi, viruses, mycobacteria, bacteria and spores



SKU
8230/1

Super Absorbent Powder — 100g Tub

- Transforms liquids into a solid gel within seconds for easy disposal, minimising mess and risk of infection
- More effective and safer than traditional methods like mops
- Suitable for biohazard spills (e.g., blood, urine, vomit) as well as non-biohazard spills like oil, chemicals, and beverages
- Ideal for healthcare settings and emergency services



SKU
8213



VIDEO DEMO

Biohazard Kit Station

- Ensures bio hazard clean up equipment is located in a convenient location and is easy to see and access
- Includes clear step-by-step bio hazard kit instructions printed directly above the kit
- We recommend installing a Biohazard Kit Station on high-risk premises, such as schools, transport hubs, sports grounds, hospitals, factories, warehouses, manufacturing plants and waste management facilities

SKU
1421



OWN BRANDING AVAILABLE



Transforms liquid into solid gel within seconds!

Clinical Waste Bags

- Clinical waste bags for businesses that must adhere to stringent hygiene protocols
- Yellow waste bags are for potentially infectious waste disposal that requires incineration
- UN-approved and CE-marked for reliability
- Durable bags won't easily burst or be torn
- Choose bag thickness, size and colour



SKU	PRODUCT	SIZE	QTY
2025	Yellow Medium-Duty Clinical Waste Bags	108cm x 76cm	1
2020	Yellow Medium-Duty Clinical Waste Bags	28cm x 19cm	50
1974	Yellow Heavy-Duty Clinical Waste Bags	63cm x 42cm	25
WSTE0119	Orange Heavy-Duty Clinical Waste Bags	71cm x 97cm	25

Sharps Disposal

Proper sharps disposal is critical in workplaces where needles, scalpels, or other sharp instruments are used. Our range of sharps kits, bins and accessories ensures safe handling and disposal, helping to reduce the risk of injury and maintain a hygienic workplace.

Accidental needle-stick injuries can pose serious health risks, making the need for secure, easy-to-use sharps disposal containers a priority.

All public-facing businesses should have access to a sharps disposal kit in order to comply with the UK's Health and Safety at Work Act (1974).

? Would you know how to dispose of drug-related litter safely?

Used syringes, needles, blades and other sharp items can pose a serious risk to your health through an infection. Surveys have shown that 70% of managers faced with drug-related litter such as syringes, needles and blades at work would have no idea how to dispose of them safely.

It is the manager's job to look after his/her staff by maintaining the highest standards of cleanliness and hygiene to be compliant with the Health & Safety at Work Act (1974).

Single Use Sharps Disposal Kit

- Safe disposal of syringes, needles, blades, and other sharp objects to prevent infection risks
- Fast-acting sporidical disinfection spray kills 99.9999% of bacteria
- Includes vinyl gloves, tweezers, antibacterial wipe, sharps bin (0.08L), yellow disposal bag, and Steroclenz Rapid 50 spray
- Lightweight, easy-to-store kit for workplaces, addressing drug-related litter safely

SKU

8205



DISPOSABLE FOR SINGLE USE

Kit Includes:

- x1 Vinyl Gloves
- x1 Disposable Plastic Tweezers
- x1 0.08L Sharpsafe Rigid Plastic Sharps Bin
- x1 Antibacterial Hand Wipe
- x1 Yellow Disposable Waste Bag
- x1 Steroclenz Rapid 50ml Disinfectant Spray



VIEW ONLINE

Scan the QR code or visit www.steroplast.co.uk/infection-control-disposables/sharps-disposal-kits.html to view these products online.



Sterosafe Sharps Disposal Kit

- Safely disposes of sharp objects like needles, syringes, blades, and broken glass
- Suitable for up to five uses
- Includes a 0.6L lockable, tamper-resistant sharps bin made from durable polypropylene which is puncture, impact, fluid and solvent resistant
- Supplied in a rigid plastic case with a wall bracket for easy storage and accessibility
- Trusted by medical professionals, suitable for various industries including healthcare, tattoo artists, school staff and veterinary care

SKU

8410

Kit Includes:

- x5 Vinyl Gloves
- x5 Disposable Plastic Tweezers
- x1 0.6L Sharpsafe Rigid Plastic Sharps Bin
- x5 Sterowipe Alcohol-Free Cleansing Wipes
- x5 Yellow Disposable Waste Bags
- x1 Black Plastic Wall Bracket



Sharpsafe Medical Sharps Bins | Various Sizes

Sharps disposal bins should be used to safely dispose of objects like needles, razors, and pins, or face the risk of broken glass contaminated with body fluids so they don't tear clinical waste bags and cause potential infection or injury.

- Made from durable polypropylene, resistant to punctures, impacts, fluids, and solvents
- Secure, fully lockable lids to prevent tampering
- Suitable for the safe disposal of various sharps, including needles, syringes, scalpels, and broken glass
- Available in a range of sizes to meet different disposal needs in home and professional environments

SKU	SIZE
8400	0.08L
8401R	0.2L
8405R	0.6L
8406R	1L
8407	2L
8412R	5L
8212R	7L

! The NHS advice for safe sharps disposal is to put sharp objects into the sharps bin immediately after using them and not to try to take them out again.



0.08 Litre Sharpsafe Medical Sharps Bin
SKU: 8400 | **£3.65**



0.2 Litre Sharpsafe Medical Sharps Bin
SKU: 8401R | **£3.00**



0.6 Litre Sharpsafe Medical Sharps Bin
SKU: 8405R | **£4.60**



1 Litre Sharpsafe Medical Sharps Bin
SKU: 8406R | **£3.30**



2 Litre Sharpsafe Medical Sharps Bin
SKU: 8407 | **£3.50**



5 Litre Sharpsafe Medical Sharps Bin
SKU: 8412R | **£5.45**



7 Litre Sharpsafe Medical Sharps Bin
SKU: 8212R | **£6.95**

Wipes & Disinfectants

Maintaining hygiene is essential in any workplace to prevent the spread of infection and illness. Our range of wipes and disinfectants provides effective solutions for sanitising hands, surfaces, and equipment. Whether it's routine cleaning or addressing specific contamination risks, these products are a vital part of any first aid kit to keep your environment safe and compliant with health standards.

Our wide range of disinfectants including surface sprays, disposable wipes and sterilants helps you uphold cleaning protocols.



Scan the QR code or visit www.steroplast.co.uk/infection-control-disposables.html to view these products online.

VIEW ONLINE

Sterowipe Sterile Saline Cleansing Wipes

- Individual foil wrapped sachets
- Convenient and fast wound and skin cleaning
- Non-linting wipes to leave no fibres behind
- Impregnated with a 0.9% sodium chloride solution

SKU	PACK SIZE
9021	100

Fully compliant with MHRA and UKHSA guidance and safe to use for cleaning wound areas



Milton Sterilising Fluid

- Effective disinfectant solution for sterilising baby equipment and surfaces
- Kills 99.9% of germs, including bacteria, fungi, and viruses

SKU	SIZE	PACK SIZE
1430	500ml	Pack of 12
1433	1 Litre	Single



Hospec Liquid Detergent

- Unperfumed, pH-neutral
- Perfect for diverse cleaning needs
- Comes in a practical 740ml bottle

SKU
1435



PDI Sani-Cloth® Germicidal Disposable Wipes

- Suitable for non-invasive medical devices and general hard surfaces
- Safe for use on plastics, stainless steel, electronics, sealed wood, laminates, and over 800 medical devices
- Pre-dosed wipes with one-at-a-time dispensing
- Low-lint, latex-free wipes



SKU	QUANTITY	PACK SIZE
PDESC1622	160	Pack of 6
PDESC1600	200	Pack of 6

PDI Sani-Cloth® AF Wipes

- Alcohol-free wipes effective against bacteria, viruses (including COVID-19), fungi, TB, and norovirus
- Meets British standards, with certification as a Class IIA medical device
- Durable, non-linting, and suitable for almost all hard surfaces and non-invasive devices
- Quick disinfection with as little as 15 seconds contact time; non-flammable and gentle for sensitive environments

SKU	PRODUCT	PACK SIZE
PD1140	Sani-Cloth® AF - 40 Wipes in Flow Wrap	24
PD1100	Sani-Cloth® AF - 100 Wipes in Flow Wrap	12
PD1120	Sani-Cloth® AF - 200 Wipes in Canister	6
PD1110	Sani-Cloth® AF - 225 Wipes in Bucket	4
PD1140/1	Sani-Cloth® AF - 40 Wipes in Flow Wrap	Single
PDXP00299-G	Bracket - for Canister - Green	Single
PDXP00411	Bracket - for Flow Wrap - Green	Single
PD3001/1	Sani-Cloth® AF ³ - 200 Wipes in Flow Wrap	Single
PD3001	Sani-Cloth® AF ³ - 200 Wipes in Flow Wrap	6



PD1140



PD1100



PD1110



PD1120



Grey is the new way... Sani-Cloth® AF³ Wipes

Alcohol-free, dual-purpose cleaning and disinfectant wipes. Designed to kill bacteria, viruses, yeast and tuberculosis in just 60 seconds.



NEW

PDI Sani-Cloth® 70% Alcohol Wipes

- 70% Isopropyl Alcohol wipes with a 15-second contact time for rapid disinfection
- Ideal for use in hospitals, GP surgeries, dental clinics, and nursing homes, ensuring quick and efficient cleaning in high-demand areas

SKU	PRODUCT	PACK SIZE
PD7010	70% Wipes 125 Canister	6
PD1020	70% Wipes 200 Canister	6
PDXP00299-R	Canister Bracket - Red	Single



Mount to wall using Canister Bracket



PDI Sani-Cloth® Chlor Sporidical Wipes

- Low-linting, durable wipes suitable for cleaning non-porous
- Approved for use against emerging pathogens like SARS-CoV-2
- Canister includes 50 wipes

SKU	PACK SIZE
PD1400	Pack of 6



PDI Sani-Cloth® Detergent Wipes

- Detergent wipes ideal for spot cleaning and damp dusting across various surfaces
- Available in two ergonomic dispensers — canisters for easy pull-and-tear access and buckets for high volume areas

SKU	PRODUCT	PACK SIZE
PDXP00301	Detergent Wipes 150 Canister	6
PD1210	Detergent Wipes 225 Bucket	4
PDXP00299-Y	Canister Bracket - Yellow	Single



Mount to wall using Canister Bracket



PDI Hygea® Hand Wipes

- Ready-to-use, pre-moistened wipes for immediate hygiene
- Contains vitamin E, aloe vera, and moisturizers for healthy skin
- Canister includes 200 wipes
- Fragranced

SKU	PACK SIZE
PD5540	Pack of 6



Defibrillators & Accessories

Using a defibrillator in under ten minutes is the only way to save someone in cardiac arrest



Protect your staff and the public

Cardiac arrest can strike anyone, anywhere, anytime, and when it does, you have just ten minutes to start using a defibrillator. This is the only way to save someone's life. The sooner you use one, the more likely the person will survive. With ambulances in the UK arriving on average within 15 minutes to category one emergencies, a casualty in cardiac arrest relies on people nearby to help them survive.

If you operate a business where employees are at **risk of electrical shocks** or one with **heightened exposure to individuals with heart complications**, you might already need to install a defibrillator. But the more defibrillators available for public use, the better chance everyone has if cardiac arrest occurs.

Responsible businesses install defibrillators in publicly accessible areas and register them with *The Circuit* so emergency call handlers can direct the call maker to the nearest one available.

Order your defibrillator today for complete peace of mind. We stock defibrillators with visual and audible prompts for use by untrained people.

Visit our

Defibrillator Online Buying Guide

Explore our Defibrillator Buying Guide to learn more about choosing the right defibrillator equipment.



Scan the QR code to visit our online guide

? Fully or Semi-Automatic?

Fully-Automatic

- Analyses the heart's rhythm and automatically delivers a shock if needed, without requiring the user to press a button.
- Once the pads are applied to the person, the device will give clear voice prompts and decide if a shock is necessary. If so, it will automatically deliver the shock after warning the user to stand clear.
- These devices are extremely user-friendly, ideal for situations where the rescuer may be panicking or inexperienced.

Semi-Automatic

- Analyses the heart's rhythm and prompts the user to press a button to deliver the shock if necessary.
- After placing the pads on the patient, the device assesses the heart's rhythm and instructs the rescuer when to press a button to deliver the shock.
- This gives the rescuer more control over the process, which may be preferred by trained professionals or in scenarios where someone is following the prompts of a call handler.

Defibrillators & Accessories

Our defibrillators, suitable for both professionals and laypersons, are essential in various settings, including healthcare, public spaces, and emergency services.

They're user-friendly for public use in places like airports and schools, and come with necessary accessories and robust storage solutions like the DefibSafe cabinets for all environments.

Designed for immediate use, they also support paramedics upon arrival.



Scan the QR code or visit www.steroplast.co.uk/advanced-life-support-equipment/defibrillators.html to view these products online.

VIEW ONLINE



SUITABLE FOR ADULTS & CHILDREN



INCLUDES BATTERIES

iPAD® NFK200 Semi-Automatic Defibrillator

- Includes iPAD NFK200 battery, carry case, AED starter kit & a pair of adult/child pads
- Equipped with a CPR metronome, voice guidance, and graphical instructions
- Swift adult / paediatric mode change to respond to various emergency situations

SKU

1716



SUITABLE FOR ADULTS & CHILDREN



INCLUDES BATTERIES

iPAD® SPR Semi-Automatic Defibrillator

- Includes iPAD SPR battery, carry case, AED starter kit & a pair of adult/child pads
- Status readily displayed through LED screen
- Swift adult / paediatric mode change to respond to various emergency situations
- Robust construction and durability ensure reliability in demanding environments

SKU

1708

iPAD Saver Defibrillator Adult Replacement Pads

- Compatible with NF1200 and NF120
- Clear visual guides
- Pre-Connected



SUITABLE FOR ADULTS & CHILDREN

SKU

1843

iPAD NFK200 Replacement Electrode Pads

- Specifically designed for use with the iPAD NFK200
- Can be used for both adult and paediatric patients



SUITABLE FOR ADULTS & CHILDREN

SKU

1717

iPAD SPR Dual Adult & Child Electrode Pads

- Specifically designed for use with the iPAD SPR
- Can be used for both adult and paediatric patients



SUITABLE FOR ADULTS & CHILDREN

SKU

1709

iPAD SP1 Wall Bracket

- Compatible with all iPAD-SP1 AEDs
- Made from sturdy metal
- Velcro strap enables quick, easy release of defibrillator



SKU

1851



SUITABLE FOR ADULTS & CHILDREN



INCLUDES BATTERIES



7 YEAR WARRANTY

iPAD® SP1 Semi-Automatic Defibrillator

- Includes iPAD SP1 battery, carry case, AED starter kit & a pair of adult/child pads
- Ambient noise sensors ensure the volume of voice instructions automatically adjusts to your surroundings
- Swift adult / paediatric mode change to respond to various emergency situations

SKU

1844



SUITABLE FOR ADULTS & CHILDREN



INCLUDES BATTERIES



7 YEAR WARRANTY

iPAD® SP1 Fully-Automatic Defibrillator

- Includes iPAD SP1 battery, carry case, AED starter kit & a pair of adult/child pads
- Smart features like pad repositioning prompts, 'handover information' for paramedics, and verbal & visual guidance at every step of use
- Swift adult / paediatric mode change to respond to various emergency situations

SKU

1875

iPAD® SP1 Orange Carry Case

- Designed for use with the iPAD SP1 semi-automatic & fully-automatic defibrillators
- Reinforced shell design
- Internal pockets to store replacement equipment



SKU

1856

iPAD® SP1 Replacement Battery

- Replacement battery for the iPAD SP1 fully-automatic & semi-automatic defibrillators
- Capacity for 200 shocks



SKU

1855

iPAD® SP1 & SP2 Child/ Adult Replacement Electrode Pads

- Specifically designed for use with the iPAD SP1 & SP2
- Can be used for both adult and paediatric patients



SUITABLE FOR ADULTS & CHILDREN

SKU

1845

iPAD SPR Training Device

NEW

- Simulates a real emergency response
- Adult-to-Paediatric switch
- Illuminated CPR guide and feedback
- Includes eight pre-programmed scenarios



SKU

1707



ZOLL® AED Plus Semi Automatic Defibrillator

- Includes 10x lithium batteries, first responder kit, dual-function passive airway support cover, instruction manual, carry case & a pair of adult pads
- Five year standard warranty
- Graphic user interface displays large, easy-to-understand visual icons illuminated by LEDs

SKU: ZOLL0001

Includes Batteries | 5 Year Warranty



ZOLL® AED 3 Automatic Defibrillator

- Provides real-time CPR feedback
- Fully or semi automatic models available
- Features Real CPR Help® technology with a colour display
- One set of pads for both adults and children, with a 5-year shelf life
- Simple child mode activation for treating younger patients

SKU: ZOLL0019 (Semi-Automatic), ZOLL0017 (Fully-Automatic)

Includes Batteries | Suitable for Adults & Children



ZOLL® Powerheart G5 Semi Automatic AED with ICPR

- Includes long-life Intellisense® lithium battery
- Real-time CPR feedback (Intellisense™ CPR / iCPR)
- Rescue Ready® status indicator
- Step-by-step RescueCoach® prompts
- Dual-language functionality

SKU: ZOLL0026

Includes Batteries



The ZOLL Content Hub

ARTICLE DEFIBRILLATORS

Learn more about ZOLL Defibrillators & Accessories in our Knowledge Base article: The ZOLL Content Hub

Find product information, make purchases, watch how-to videos showing products in use, and download free posters & flyers.

- How-to videos
- Articles & guides
- Free downloads

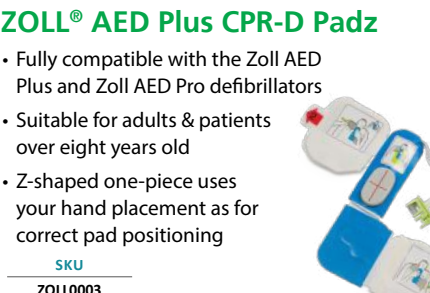

ZOLL® AED Plus CPR-D Padz

- Fully compatible with the Zoll AED Plus and Zoll AED Pro defibrillators
- Suitable for adults & patients over eight years old
- Z-shaped one-piece uses your hand placement as for correct pad positioning

SKU: ZOLL0003



ZOLL® AED 3 Battery Pack

- For use with the ZOLL AED 3 defibrillators
- Functions reliably in a wide temperature range
- Display alerts users when replacement is needed

SKU: ZOLL0015



ZOLL® CPR Uni-Padz™ Universal Electrodes

- Engineered for exclusive compatibility with the ZOLL AED 3 defibrillator
- Dual functionality

SKU: ZOLL0014



ZOLL® Plus Stat Padz II — Adult

- For use with the Zoll AED Plus & Zoll AED Pro defibrillators
- Features a central energy feed which distributes energy equally

SKU: ZOLL0007

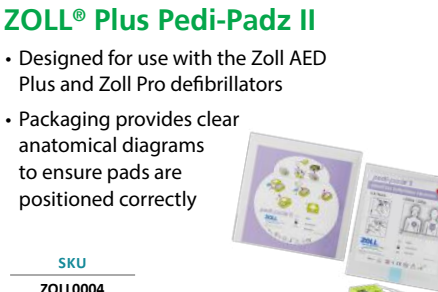

ZOLL® Plus Pedi-Padz II

- Designed for use with the Zoll AED Plus and Zoll Pro defibrillators
- Packaging provides clear anatomical diagrams to ensure pads are positioned correctly

SKU: ZOLL0004

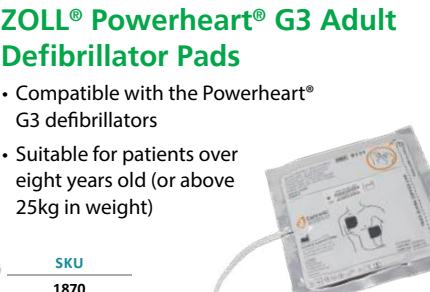

ZOLL® Powerheart® G3 Adult Defibrillator Pads

- Compatible with the Powerheart® G3 defibrillators
- Suitable for patients over eight years old (or above 25kg in weight)

SKU: 1870



ZOLL® Powerheart® G5 Adult Defibrillator Pads

- Pre-gelled self-adhesive pads
- Suitable for patients over 8 years old or over 25kg
- Features clear anatomical placement diagrams

SKU: 1879



ZOLL® Powerheart G3 IntelliSense Lithium Battery

- Designed for the ZOLL® Powerheart AED G3 series
- Ensures your device is always rescue-ready
- Non-rechargeable

SKU: 1867



Remember to regularly check the expiration of your defibrillator pads and batteries and replace them if needed.

Defibrillator batteries should be replaced every 2-5 years and pads every 2 years, or as per manufacturer's guidelines; ensure regular checks for expiry and functionality.

Schiller® FRED Easyport Adult Electrode Pads

- Designed for use with the Schiller FRED Easyport AED
- Pre-gelled & ready for use



SKU
1733

Schiller® FRED Easy Defibrillator Battery

- Replacement battery for FRED Easy & Easyport defibrillators
- Capacity for 180 shocks at maximum energy



SKU
1726

Schiller® FRED Easy Adult Pre-Connected Electrode Pads

- Designed for use with the Schiller FRED Easy AEDs
- Pre-gelled & ready for use



SKU
1727

DefibSafe 2 External Cabinet with Lock

The only external defibrillator cabinet available in the UK that is IP66-rated, giving the best protection on the market for external AED storage.

- Metal hinges to reduce the risk of damage or vandalism
- LED lighting illuminated the interior for high visibility at night and make it easier to access and remove the AED
- Low running costs at an average of £2-3 per year
- Unique location code enables emergency services to find your location
- Excellent thermal insulation and thermostatic heater controlled to prevent any frost damage
- Internal size of 33cm x 28.5cm x 16cm

SKU
1882



Corrosion Resistant Lock

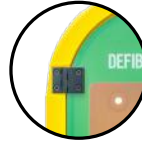

Metal Hinges Reduce Damage



Unique Location Code



Internal Air Circulation Fan



Clear Printed Instructions



Riot Shield Material



Indoor Defibrillator Cabinet with Alarm

- Easy to install on your wall for high visibility and to protect your device
- Clear acrylic front shows AED is in the cabinet at all times
- Made from robust metal to protect your defibrillator from knocks & general wear

SKU
1850



LEAFIR007/10



1216

First Aid CPR Leaflet

- Pocket sized emergency guide
- Provides essential life-saving resuscitation techniques
- 8 page guide measuring just 105mm x 148mm

Essential Life-Saving CPR Resuscitation Sign

- Includes a detailed description of how to administer chest presses
- Each step is accompanied by a simple illustration to help with understanding

PRODUCT	SKU
Essential Life-Saving CPR Resuscitation Sign	1216
First Aid CPR Leaflet	LEAFIR007/10

AED Defibrillation Starter Kit

High-quality contents with everything needed to prepare a cardiac arrest victim for AED shocks.

- Helps ensure strong pad contact by removing clothing, chest hair, sweat or water
- Supports hygiene and safety with disposable, sterile items to reduce cross-contamination risk
- Compact sealed polybag for easy storage
- Cost-effective and compact



Kit includes:

- x1 Bio-hazard self-seal bag
- x2 Disposable nitrile gloves (pair)
- x1 Disposable Gallant prep razor
- x1 Tuff Cut Scissors
- x1 Resuscitation face shield
- x1 Absorbent cloth

SKU
8322



DISPOSABLE FOR SINGLE USE

Health & Safety at Work

Health and Safety is a requirement by Law. But it does not need to be complicated, however it must be taken seriously if you are to meet your legal responsibilities and duties as an employer.

We have put together some hints and tips to help you unravel the complexities of health & safety at work.

These will help point out the precautions you need to take to meet your obligations.

Health & Safety Policy

A health & safety policy sets out:

- The business’s approach to health and safety
- How health & safety will be managed
- Persons responsible for doing what and when

Begin by writing a statement of intent:

- Here you will demonstrate your commitment to health & safety at work
- Write your aims
- Detail names of staff and roles who will take responsibility for health & safety in the workplace
- Record what is currently in place

Plan how you will achieve your health & safety aims e.g.:

- Risk assessments
- Staff training
- Safety signs
- Equipment required

Sign & Review:

- The most senior person in the company must sign the health & safety policy and reviews are to take place regularly.



Every business with more than five employees must have a written health & safety policy.

It is not a requirement for businesses with less than five employees for this to be a written policy, but it is advisable to give clear guidance.



Scan the QR code to download a Health & Safety policy forms for your workplace.

Workplace Injury Statistics for Great Britain 2023/24



0.6M

Workers sustaining a workplace non-fatal injury in 2023/24.

61,663

Work-related non-fatal injuries to employees reported by employers in 2023/24

33.7M

Working days lost due to work-related ill health and non-fatal workplace injury in 2023/24.

£7.1B

Annual costs of workplace injury in 2023/2024.

12,000

Lung disease deaths each year estimated to be linked to past exposures at work.

1.7M

Workers suffering from work related ill health (new or long-standing) in 2023/24.

138

Workers killed in work-related accidents in 2023/24.

0.5M

Workers suffering from work-related musculoskeletal disorders in 2023/24.

£21.6B

Annual costs of workplace injury and new cases of work related ill health in 2022/23.

Source: HSE Health and safety at work Summary statistics for Great Britain 2024

Understanding the Law

Criminal and Civil Law both apply to workplace health & safety. If you do not protect your employees and others from getting hurt or ill through work then regulators such as The Health & Safety Executive or your local authority could take action against you under **criminal law**. However, the person affected may also take action under **civil law** and make a claim for compensation.

Both of which can prove to be costly to a business, so it is extremely important you do all you can and have recorded evidence that you have correct procedures in place to protect your workforce and anyone visiting your premises.

The Health & Safety at Work Act 1974 (HSWA) is the main legislation, read this in detail visit www.legislation.gov.uk

What laws must businesses comply with?

	Purpose:	Applies to:	Implications:
The Health & Safety at Work act 1974	Requires employers to uphold a duty of care that ensures reasonable steps are taken to keep those who interact with the business (employees, customers, contractors, etc.) safe from harm.	<ul style="list-style-type: none"> • Employers • Employees • Self-employed people 	Take steps to provide a safe working environment.
The Health and Safety (First-Aid) Regulations 1981	Require employers to take appropriate steps to ensure those who interact with the business can receive immediate attention if injured or taken ill.	<ul style="list-style-type: none"> • Employers 	Take steps to ensure first aid supplies and training are in place to mitigate all health and safety risks present.
The Management of Health and Safety at Work Regulations 1999	Require employers to conduct risk assessments to determine workplace hazards and put measures in place to mitigate them.	<ul style="list-style-type: none"> • Employers • Self-employed people 	Provide access to first aid supplies in response to hazards identified in risk assessments.
The Reporting of Injuries, Diseases and Dangerous Occurrences Regulations (RIDDOR) 2013	Require employers to report major injuries, deaths, and dangerous occurrences in the workplace.	<ul style="list-style-type: none"> • Employers • Self-employed people 	Keep records of workplace injuries and illnesses and report those relevant to RIDDOR.
The Regulatory Reform (Fire Safety) Order 2005	Provide minimum fire safety standards required in all non-domestic premises.	<ul style="list-style-type: none"> • Employers 	Provide access to relevant fire safety and burncare supplies to handle fire-related injuries.

In short, if you own a business, you must:

- Have first aid supplies installed on your premises by law in the UK.
- Depending on your first aid risk assessment, Have the exact first aid supplies you need.
- Ensure first aid supplies are kept up-to-date and in good working condition.

Appoint a Competent Person

Carefully select a responsible, competent member of staff to help manage health & safety within your company.

No formal training is required but this person must be confident in recognising hazards and implementing procedures and controls to ensure the safety of staff and anybody visiting your company.

This can be outsourced to a health & safety consultant but it can be managed in-house if you have the right person to help you, after all you and your staff know your business best.

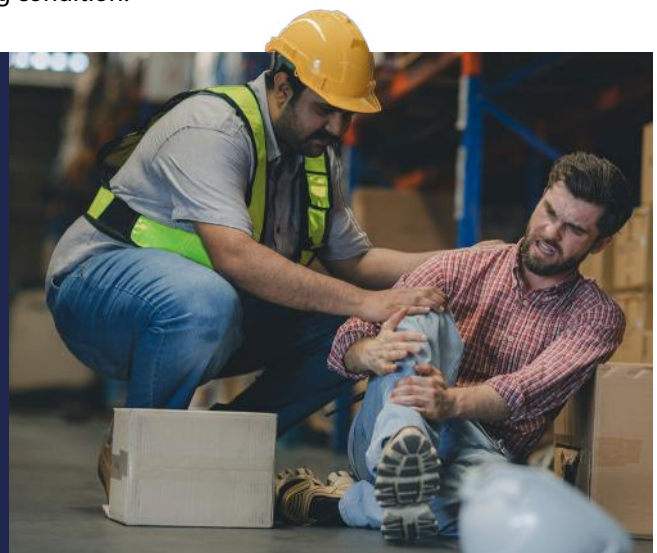

Information for Employers

Workplace First Aid Training

All of your employees must be given advice on how to work safely and reduce risk in the workplace, along with clear instructions.

Training also needs to be regularly assessed. Employees will need to know the hazards, risks and what measures are in place in your workplace. Plus employees are to be made aware of emergency procedures.

- New staff are to be given H&S advice and information during their induction.
- Health and safety representatives are to have regular training to keep up to date with any changes in regulations.
- This training must be provided free to employees and carried out during normal working hours.
- Your staff will need extra training for new equipment or changes in your working practices.
- Training records to be kept up-to-date and discuss health and safety training needs with your staff.



Workplace Facilities

It is the employer's responsibility to provide adequate welfare facilities and a healthy and safe working environment for everyone in the workplace, inclusive of those with disabilities.

This includes:

- The right number of toilets and hand wash basins
- Drinking water
- A rest room for somewhere to eat food
- The workplace must be clean
- The working environment must have a reasonable temperature with good ventilation
- Suitable seating, workspace and lighting must also be provided
- Equipment must be well maintained
- Floors and traffic routes to be kept clear
- Windows must easily be opened and kept clean

Insurance

As an employer, you will need to purchase employers' liability insurance.

This will provide cover should an employee claim compensation from you if they were to become ill or injured as a result of the work they do.

Are you covered?

Employer's liability insurance can be purchased from brokers, trade associations or direct with insurance companies and it must be with an authorised insurer of the FCA.

! For businesses with 10 or more employees then you must keep an accident book as required by law

Report

By keeping records you will be able to respond to patterns of accidents and better manage risk in workplace.

All workplace injuries and near misses must be recorded. For work related diseases must also be reported and is a duty under RIDDOR (Reporting of Injuries, Diseases and Dangerous Occurrences Regulations).

Reports must be stored confidentially to protect employee's personal data.

More detailed information is available at www.hse.gov.uk.

You will also find templates for Safety Policy, Risk Assessments and what and how to report to RIDDOR.

Sources: HSE, British Safety Council, RIDDOR



Accident Report Book

SKU: 9661

Risk Assessments

Managing health & safety within your business is controlling the risks in your workplace.

You will need to think about what could cause harm to your employees and all visitors to your business and then take reasonable steps to prevent that harm.

Risk assessments are required by law and records are to be kept and reviewed regularly. However, if you have less than five employees then you do not have to keep written records.

Risk assessments do not need to be complicated, they are designed so that you can implement sensible measures for the control of risks within your business. To begin, you will firstly need to...



Workplace-Specific Hazards

Specific workplace hazards require different types of first aid.

Below are the common types of workplace hazards that appear in risk assessments, and the supplies you need to safeguard against them.

Remember: every workplace is different. Rely on your risk assessment to determine your first aid needs.



	Includes	Hazards	First Aid Supplies
Hospitality & Entertainment	<p>Hospitality Hotels Theatres Cinemas Retail</p>	<ul style="list-style-type: none"> • Manual handling injuries • Slips, trips, and falls • Food safety issues • Exposure to hazardous substances • Fire hazards • Manual handling injuries • Slips, trips, and falls • Falls from heights 	<ul style="list-style-type: none"> • Workplace First Aid Kits (Pages 10 - 17) • Catering First Aid Kits (Pages 26 - 29) • Burncare Kits (Pages 34 - 37) • Vehicle First Aid Kits (Pages 30 - 31)
Offices & Call Centres	<p>Offices Call centres</p>	<ul style="list-style-type: none"> • Ergonomic hazards from poor workstation setup • Electrical hazards • Slips, trips, and falls 	<ul style="list-style-type: none"> • Workplace First Aid Kits (Pages 10 -17) • Vehicle First Aid Kits (Pages 30 - 31)
Construction	<p>Factories Warehouses Garages Manufacturing plants Construction sites Manual labour</p>	<ul style="list-style-type: none"> • Exposure to hazardous substances • Manual handling injuries • Machinery and equipment injuries • Noise and vibration • Slips, trips, and falls • Electrical hazards • Fire and heat hazards 	<ul style="list-style-type: none"> • Workplace First Aid Kits (Pages 10 -17) • Burncare Kits (Pages 34 - 37) • Trauma Kits (Pages 38 - 39) • Lone Worker First Aid Kits (Pages 30 - 33) • Vehicle First Aid Kits (Pages 30 - 31) • Biohazard Kits & Sharps Disposal (Pages 52 - 54) • Eyecare Kits (Page 50 - 51)
Restaurants & Eateries	<p>Restaurants Cafes Bakeries Bars Pubs</p>	<ul style="list-style-type: none"> • Burns and scalds • Cuts from knives • Slips, trips, and falls • Manual handling injuries • Exposure to hazardous substances (e.g., cleaning chemicals) 	<ul style="list-style-type: none"> • Workplace First Aid Kits (Pages 10 -17) • Catering First Aid Kits (Pages 26 - 29) • Burncare Kits (Pages 34 - 37) • Vehicle First Aid Kits (Pages 30 - 31) • Biohazard Kits & Sharps Disposal (Pages 52 - 54) • Eyecare Kits (Page 50 - 51)

Hospitals & Clinics	<p>Hospitals Clinics GP surgeries Dental clinics Nursing homes</p>	<ul style="list-style-type: none"> • Exposure to infectious diseases • Manual handling injuries (e.g., lifting patients) • Exposure to hazardous substances (e.g., drugs, chemicals, waste) • Needlestick injuries 	<ul style="list-style-type: none"> • Workplace First Aid Kits (Pages 10 -17) • Catering First Aid Kits (Pages 26 - 29) • Trauma Kits (Pages 38 - 39) • Biohazard Kits & Sharps Disposal (Pages 52 - 54) • Eyecare Kits (Page 50 - 51)
Education	<p>Schools Daycare centres Nurseries Laboratories</p>	<ul style="list-style-type: none"> • Trips and falls • Manual handling injuries • Exposure to infectious diseases • Allergic reactions • Exposure to hazardous substances • Fire and explosion risks • Electrical shock injuries • Manual handling injuries • Injuries from equipment 	<ul style="list-style-type: none"> • Workplace First Aid Kits (Pages 10 -17) • Catering First Aid Kits (Pages 26 - 29) • Childcare First Aid Kits (Pages 46-51) • Vehicle First Aid Kits (Pages 30 - 31) • Biohazard Kits & Sharps Disposal (Pages 52 - 54) • Eyecare Kits (Page 50 - 51) • Burncare Kits (Pages 34 - 37) • Trauma Kits (Pages 38 - 39)
Beauty Salons & Tattoo Parlours	<p>Beauty salons Tattoo shops Hair salons</p>	<ul style="list-style-type: none"> • Exposure to hazardous substances (e.g., dyes, solvents) • Cuts and puncture wounds • Ergonomic hazards • Exposure to biological agents (e.g., bloodborne pathogens) 	<ul style="list-style-type: none"> • Workplace First Aid Kits (Pages 10 -17) • Vehicle First Aid Kits (Pages 30 - 31) • Biohazard Kits & Sharps Disposal (Pages 52 - 54) • Eyecare Kits (Page 50 - 51)
Sports Facilities	<p>Sports facilities Gyms</p>	<ul style="list-style-type: none"> • Manual handling injuries • Trips and falls • Injuries from equipment • Allergic reactions • Over-exertion or strain injuries 	<ul style="list-style-type: none"> • Workplace First Aid Kits (Pages 10 -17) • Biohazard Kits & Sharps Disposal (Pages 52 - 54)
Retail & Leisure	<p>Airports Train stations Shopping centres Arenas Galleries Museums Theme parks</p>	<ul style="list-style-type: none"> • Slips, trips, and falls • Manual handling injuries • Crowd control issues, terrorist attacks • Fire hazards 	<ul style="list-style-type: none"> • Workplace First Aid Kits (Pages 10 -17) • Catering First Aid Kits (Pages 26 - 29) • Burncare Kits (Pages 34 - 37) • Trauma Kits (Pages 38 - 39) • Vehicle First Aid Kits (Pages 30 - 31) • Biohazard Kits & Sharps Disposal (Pages 52 - 54)
Animal Care	<p>Veterinary clinics Animal shelters</p>	<ul style="list-style-type: none"> • Animal bites and scratches • Exposure to infectious diseases • Exposure to hazardous substances (e.g., drugs, chemicals) • Allergic reactions • Manual handling injuries (e.g., when lifting animals) 	<ul style="list-style-type: none"> • Workplace First Aid Kits (Pages 10 -17) • Trauma Kits (Pages 38 - 39) • Vehicle First Aid Kits (Pages 30 - 31) • Biohazard Kits & Sharps Disposal (Pages 52 - 54) • Eyecare Kits (Page 50 - 51)

Still not sure what you need?



Book a consultation

Don't delay and contact our friendly team today:
0161 902 3030 | firstaid@steroplast.co.uk



Visit our Online Buying Guide

Designed to de-mystify workplace first aid:
www.steroplast.co.uk/workplace-first-aid-guide



Advanced Life Support

Premium supplies from one of the most trusted names in emergency care

Steroplast is a recognised brand in emergency and medical industries for keeping hospitals, the military, emergency services, and healthcare facilities in stock of high-spec equipment designed for professional use. We're relied on for everything from diagnostics and immobilisation equipment to injection and surgical instruments.

If you choose a supplier to rely on for critical care equipment, choose one trusted by the UK military, NHS, St John Ambulance & British Red Cross. We already help these organisations save lives with advanced life support equipment. We know what it takes to support vital services and key workers where mistakes can't be made.

We're positioned as your dedicated supplier, acting fast to support you in emergency care and life-support situations. Capabilities like fast shipping turnaround, stock reserves, and restocking and expiry date reminders mean we've got your back at all times. We're ready to be the support you need at a moment's notice, ensuring your operations stay sharp and responsive.

Not what you're looking for?

Our range of **Workplace First Aid** products starts on page 6.



ONLINE GUIDE

Find all the products mentioned on our online guide: The Definitive Guide to Advanced Life Support

Scan the QR code to directly access our advanced life support selection and benefit from our expert advice and product insights, ensuring you get the most appropriate solutions for your advanced life support needs.



How our customers know we meet their needs

Our medical, emergency, and military customers must adhere to strict quality standards and assurances when choosing advanced life support suppliers. Our 30+ years of experience working alongside industry professionals means that we understand these expectations and ensure our product range meets them.

We fulfil the following quality markers when selecting products for our advanced life support range:

☑ ISO Certification

All manufacturing and distribution follow ISO 13485:2016 for medical device quality management, alongside compliance with MDD 93/42/EEC, EU MDR 2017/745, and UK Medical Device Regulations 2002.

☑ MHRA Approval and CE Mark

All products meet MHRA requirements and EU standards, with the full range CE marked for UK use.

☑ British Standards Compliance

Our first aid kits are made to meet British Standards to demonstrate high levels of safety, quality, and performance wherever possible.

☑ IP (Ingress Protection) Ratings

Our ALS equipment is designed for demanding environments, with IP-rated devices offering protection against dust, water, and general wear.

☑ Biocompatibility Testing

Materials in direct contact with consumers, such as dressings, plaster adhesive, and intravenous tubing, are tested for biocompatibility as often as possible to minimise the risk of adverse reactions.

☑ Clinical Evaluations and Trials

Although we don't directly carry out clinical trials, we do have clinical evaluations in place to demonstrate that there is sufficient evidence to verify the safety and performance of the device, including any benefits or claims made when the device is used as intended.

☑ Data Security and Compliance

ISO 13485 requirements support the confidentiality of patient and user information. Devices that collect or store patient data are GDPR compliant, and we supply equipment that supports our customers' data security needs where possible.

Premium ALS brands we supply:

OMRON

Ambu

BURNSHIELD

CELOX

TIMESCO

ZOLL

IPAD

SCIAN

FERNO

Laerdal
helping save lives

PROMETHEUS
MEDICAL LTD

SAM
MEDICAL

SCHILLER
The Art of Diagnostics

smith&nephew

ACCU-CHEK

PROACT

Airway Management

We provide essential tools like high-performance BVMs and endotracheal tubes, crucial for rapid response and paramedic teams who need equipment as effective as their intervention.

Our range also includes specialised intubation adjuncts and oral airways, trusted by anaesthesiologists and surgeons for critical care and routine treatment.

Designed for durability and ease of use, our products help you save lives in demanding environments. Choose our expertise for top-tier airway management solutions.



Scan the QR code or visit www.steroplast.co.uk/advanced-life-support-equipment.html to view these products online.

VIEW ONLINE

Nasosafe Assorted Nasopharyngeal Airways (NPA)



COLOUR CODED

- An efficient and safe nasopharyngeal airway device with unique swivel grip
- Thermo-sensitive material adapts to body temperature
- Colour-coded sizes for optimal patient comfort and ease of use

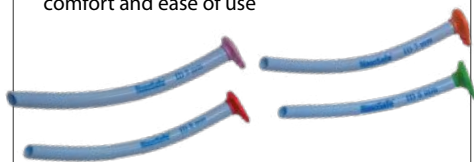

SKU	SIZE	COLOUR
WSTE0202	4mm	Dark Green
WSTE0422	5mm	Black
WSTE0148	6mm	Green
WSTE0149	7mm	Orange
WSTE0150	8mm	Dark Red
WSTE0221	9mm	Purple



COLOUR CODED



DISPOSABLE FOR SINGLE USE

Suction Catheters

Expertly designed for efficient respiratory secretion removal, ensuring patient comfort. Seven colour-coded sizes available.

SKU	SIZE	COLOUR
WSTE0103	8FR	Blue
WSTE0104	10FR	Black
WSTE0105	12FR	White
WSTE0106	14FR	Green
WSTE0107	16FR	Orange
WSTE0108	18FR	Red

Yankauer Vented Suction Tube

SKU	COLOUR
WSTE0394	Transparent

DART™ Intranasal Mucosal Atomisation Device (MAD300)

- Allows for meticulous measurement and administration of medication
- The atomisation feature converts medication into a fine mist to ensure rapid and efficient absorption



SKU
WSTE0627/1

Flexible Catheter Mount

- Designed for secure and hygienic connections in anaesthetic breathing systems
- Offers universal compatibility with all ET tubes, allowing versatility in use



DISPOSABLE FOR SINGLE USE

SKU
WSTE0113

Suction Pumps

Versatile, portable suction tool for emergency medical scenarios.

Timesco EVAC-S Suction Pump

- Compact, single-use, and CE-marked, ensuring safety and reliability
- Comes with both adult & paediatric catheters, catering to a range of patients

Rescuer MVP Suction Pump

- An efficient, portable suction pump with high vacuum capability, one-hand operation, and adjustable settings

Suctionlite Suction Pump

- Ideal for quick, effective emergency suctioning & can hold up to 1 litre of fluid, making it suitable for extensive use

PRODUCT	SKU
Timesco EVAC-S Suction Pump	1195
Rescuer MVP Suction Pump	1048
Suctionlite Suction Pump	1276



SUITABLE FOR ADULTS & CHILDREN



CE MARKED

Boscarol OB3000 Portable Suction Unit

- Lightest in class at <2.6kg with integrated handle and strap storage
- Crash-tested, IP34D rated, with non-toxic, fireproof exterior
- Compatible with reusable canisters and Serres liners
- Extended battery life of 60+ minutes use at full vacuum



SKU
WSTE0711



LIGHTWEIGHT



5 YEAR WARRANTY

Laerdal® Suction Unit with Serres Canister System

- Portable & robust, ideal for emergency medical situations to ensure efficient, safe airway clearance
- Achieves a high vacuum of over 500 mmHg and a flow rate exceeding 25 LPM, outperforming international standards

PRODUCT	SKU
Laerdal Suction Unit with Serres Canister System	L3003



Laerdal® Suction Unit Accessories

Enhance your Laerdal Suction Unit with our range of essential accessories designed for efficient, hygienic, and reliable emergency respiratory care, including:

PRODUCT	SKU
Serres Suction Pouch - 1000ml	L7151
Serres Canister 1000ml	L7300
Suction Tube	L3181
Battery	L0800



Endotracheal Tubes (ET Tubes) — Cuffed & Uncuffed

- Crafted from soft, flexible, thermosensitive medical-grade PVC, ensuring optimum comfort and safety during intubation
- Each tube features a pilot balloon, clearly marked with the size, providing easy identification and ensuring accurate, efficient placement
- Equipped with an ISO standard 15mm connector, enhancing compatibility and usability in varied medical scenarios

Endotracheal Tubes — Cuffed

SKU	SIZE
WSTE0364	5.5mm
WSTE0365	6mm
WSTE0370	6.5mm
WSTE0156	7mm
WSTE0366	7.5mm
WSTE0157	8mm
WSTE0367	8.5mm
WSTE0158	9mm
WSTE0368	9.5mm
WSTE0369	10mm

Endotracheal Tubes — Uncuffed

SKU	SIZE
WSTE0164	2.5mm
WSTE0165	3mm
WSTE0166	3.5mm
WSTE0167	4mm
WSTE0168	4.5mm
WSTE0169	5mm
WSTE0170	5.5mm

Endotracheal (ET) Tube Introducer

SKU	SIZE
WSTE0175	60cm



Endotracheal (ET) Tube Introducer — Curved Tip Bougie 15FR

- Serves as a guiding aid during challenging intubations
- Enhanced with memory reinforcement
- Angled Coudé Tip aids in facilitating a smoother and more efficient intubation process
- At 60cm, it provides adequate reach, which is essential during the intubation process

Entonox Pain Relief Demand Head Only

- Fully rotational 360-degree integral handle, allowing for unparalleled control & manoeuvrability
- Designed to administer Entonox with precision & ease
- Includes a 1.5-metre hose assembly and secure probe for effective gas delivery
- Adult facemask provided



SKU
1059

Oxygen Tubing — Single Use

- Kink-resistant and flexible, with universal fittings for various masks and oxygen sources
- Extends to 2.1 metres, providing length for comfortable movement
- The tubing features soft end pieces that allow for easy and secure connections to oxygen delivery systems
- Made with high-quality, medical-grade material



SKU
WSTE0120

Peak Flow Meter — Adult

- Easy-to-read graduations for quick assessment
- Regular use assists in the early detection of potential asthma attacks
- Conforms to the approved EU scale for reliability & consistency

Peak Flow Meter

SKU	PACK SIZE
WSTE0051	1

Peak Flow Meter Mouthpieces — Disposable

SKU	PACK SIZE
WSTE0067	20
WSTE0060	500



LIGHTWEIGHT



OptiLube™ Sterile Lubricating Jelly

- Choose from 42g tubes or 5g easy-to-open sachets
- Water-soluble medical lubricant



SKU	PACK SIZE
9606/10	10 (Sachets)
9606/150	150 (Sachets)
9607	Single (Tube)



pH BALANCED

Cirrus 2 Nebuliser Easy Fill Pot

- Designed explicitly for common respiratory medications
- Offers compatibility with a variety of accessories, including masks, T-pieces & mouthpieces



SKU
OXYNEB001/10

Oxygen Venturi Valves — Pack of 10

- Complies with BS EN 13544-3:2001 standards
- Precision flow with printed details for accurate 40 L/min delivery
- Colour-coded for easy oxygen rate identification
- Delivers variable oxygen levels between 24-50% for diverse medical needs



SKU	COLOUR	FLOW RATE
OXYVEN035/10	Yellow	35%
OXYVEN050/10	Blue	24%
OXYVEN024/10	Pink	50%

Jet Nebuliser Set

- For effective treatment of asthma, COPD, and other respiratory conditions
- Administers medication as an inhalable mist, delivering treatment directly to the lungs for effective results

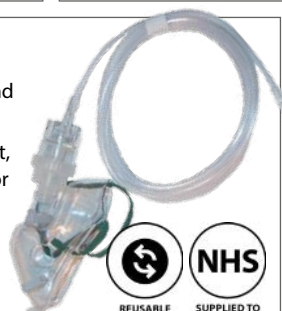

SKU	SIZE
WSTE0065	Adult
WSTE0066	Child



Scian Compressor Nebuliser NB-210C

- Compact & streamlined design makes it an unobtrusive addition to any setting
- The 6ml medicine chamber, ensuring a sufficient amount of medication is available for each treatment session.



SKU
WSTE0673



Intersurgical EcoLite™ Adult Tracheostomy Mask

An eco-friendly, lightweight tracheostomy mask with a 360-degree swivel connector for secure, comfortable respiratory support.



SKU
WSTE0665

Medium Concentration Oxygen Mask

A medium-concentration oxygen mask with 2.1m tubing, ensuring comfortable, safe, effective oxygen therapy. Available in two sizes.



SKU	SIZE
WSTE0263	Adult
WSTE0362	Child

High Concentration Oxygen Mask

- A high-efficiency 100% oxygen mask for adults
- Provides near 100% oxygen purity
- Comfortable fit & clear monitoring capabilities



SKU
WSTE0100



Venturi Adult Oxygen Mask with 28% Valve & Tube

A precision-fit Venturi Oxygen Mask with 28% valve, offering efficient delivery & clear monitoring for enhanced patient comfort.



SKU
OXYVEN001

Ambu® King Mask

- Latex-free & unscented, providing optimal comfort for users with sensitive skin/allergies
- Guarantees a secure, comfortable face seal, maintaining excellent grip & consistent sealing
- Available in six sizes ranging from infant to adult, ensuring suitability for all patient types

SKU	SIZE
WSTE0084/K	1 (Neonate)
WSTE0551/K	2 (Infant)
WSTE0552/K	3 (Toddler)
WSTE0378/K	4 (Child/Small Adult)
WSTE0085/K	5 (Medium Adult)
WSTE0086/K	6 (Large Adult)



Ambu



Adult 1500ml Bag-Valve Mask (BVM) Single-Use Resuscitator

- Features a non-slip, textured grip for assured handling during pivotal moments
- 360° Swivel connector enabling versatile positioning
- Formulated to minimise cross-contamination risks, it upholds hygiene and infection control standards
- Design encourages easy compression, allowing caregivers to maintain precise control over the ventilation rate and volume
- Packaged for easy deployment, ensuring instant accessibility
- Crafted from latex-free medical-grade PVC, fortified with a polycarbonate shell
- Three sizes available for children & adults

SKU	SIZE
1089	Infant
1088	Child (Size 1&2)
1049	Adult (Size 5)



Ambu® SPUR II — Adult Disposable Resuscitator BVM & Mask

- SafeGrip™ surface guarantees secure handling, even in high-stress environments
- Ergonomic design provides optimal user handling & support, even during extended ventilations, making it suitable for users with smaller hands
- Made from SEBS material instead of PVC, it is fully disposable, eliminating all cross-contamination risks and causing no negative environmental impact
- 100% FiO2 Supply Capability means when used with an oxygen source, it can supply 100% fraction of inspired oxygen, ensuring optimal oxygen delivery to the patient

SKU	SIZE
WSTE0047	Adult
WSTE0048	Child



Ambu

Intersurgical Clear-Guard™ 3 Breathing Filter

An efficient, lightweight breathing filter for anaesthetic and respiratory systems, with >99.99% microbial filtration and minimal dead space.



PRODUCT	SKU
Intersurgical Clear Guard Midi Low Volume Breathing Filter & Mouthpiece	WSTE0337
Intersurgical Clear Guard 3 Breathing Filter	WSTE0584/1
Intersurgical Clear Guard Midi Low Volume Breathing Filter with Luer Port	WSTE0585/1

Pocket BVM Micro Mask

- A compact manual resuscitator for emergency respiratory support, saving 75% space
- Designed for quick deployment in urgent situations
- Cushioned mask ergonomically designed to fit securely over facial contours
- Used by airlines, EMS units, and fire-fighters



SKU
1060

Disposable Entonox Mouthpiece with Viral/Bacterial Filter

Efficiently designed, this disposable mouthpiece with viral/bacterial filter is optimal for administering analgesic gases like Entonox.



SKU
1257/1

Miller Laryngoscope Blades

- Used for endotracheal intubation
- Sterile packed, ensuring safe and hygienic usage
- All metal one-piece blade

Miller Laryngoscope Blades

SKU	SIZE
WSTE0162	Size 0
WSTE0163	Size 1
WSTE0372	Size 2
WSTE0373	Size 3



Miller



SUITABLE FOR ADULTS & CHILDREN

Macintosh Laryngoscope Blades

- Streamlined design for easier manoeuvrability & access
- Non-touch hinge mechanism minimises contamination
- Compatible with major brands of standard laryngoscopes

Macintosh Laryngoscope Blades

SKU	SIZE
WSTE0152	Size 2
WSTE0153	Size 3
WSTE0154	Size 4



Macintosh



STAINLESS STEEL

Callisto Blade & Preloaded Compact Handle Laryngoscope Set

Experience clinical excellence with Callisto Blades & Compact Preloaded Handle Sets—your single-use laryngoscope solution, expertly designed for optimal hygiene, affordability, and minimal maintenance.

Callisto Miller Blade & Preloaded Compact Handle Laryngoscope Set

SKU	SIZE
WSTE0488/1	00
WSTE0487/1	0
WSTE0486/1	1
WSTE0485/1	2



Callisto Macintosh Blade & Preloaded Compact Handle Laryngoscope Set

SKU	SIZE
WSTE0484/1	1
WSTE0483/1	2
WSTE0482/1	3
WSTE0481/1	4



DISPOSABLE FOR SINGLE USE

TIMESCO

BritePro Solo Laryngoscope Handle

- Ergonomic tool with bright LED light
- Comes sterile and packed with fitted batteries & a changeable blade
- Easy disposal after use



SKU	SIZE
WSTE0004	Adult
WSTE0005	Child

Covidien Nellcor™ Colourimetric Easy Cap End Tidal CO2 Detector

Confirms correct placement of endotracheal tubes by monitoring ETCO2 levels with precise breath-to-breath response.



SKU	SIZE
WSTE0334	Adult
WSTE0391	Paediatric

Nasal Oxygen Cannula — 2.1m

- Comfortable, latex-free, and kink-resistant
- Each cannula is designed for single use to negate cross-infection & contamination risks
- Each cannula comes with its own 7' kink-resistant tubing

SKU	SIZE
WSTE0050	Adult
WSTE0293	Child



SUITABLE FOR ADULTS & CHILDREN



LATEX FREE

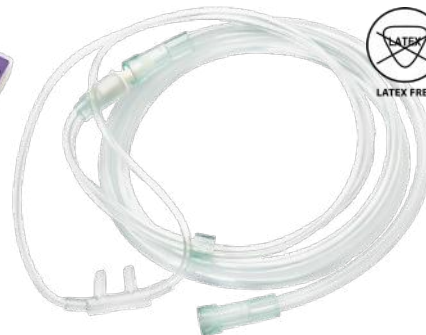

Guedel Airways

- Individually wrapped for hygiene and convenience
- Free from latex and phthalates, minimising allergic reactions
- Sterilised through gamma irradiation for safe, single-use application
- Features a colour-coded bite block for quick size identification in compliance with ISO 5364:2016



COLOUR CODED



LATEX FREE

SKU	SIZE	COLOUR
AIRWAY005	000 (40mm)	Pink
WSTE0177	00 (50mm)	Blue
WSTE0176	0 (60mm)	Black
AIRWAY001	1 (70mm)	White
AIRWAY002	2 (80mm)	Green
AIRWAY003	3 (90mm)	Yellow
AIRWAY004	4 (100mm)	Red
AIRWAY006	5 (110mm)	Orange
AIRWAY007	6 (120mm)	Purple
9580	00-4	Multi —Pack Of 6
WSTE0049	1-4	Multi —Pack Of 4

i-gel® Supraglottic Airway

- Anatomically precise shape ensures an exact fit within the patient's airway
- Non-inflatable cuff eliminates the need for cuff inflation, streamlining the procedure
- Each unit is sterile, safeguarding against infection and contamination
- Sizes cater to neonatal emergency care and adult emergency care & anaesthesia



SKU	SIZE
1570	1 (Neonate)
1571	1.5 (Infant)
1572	2 (Small Paediatric)
1573	2.5 (Large Paediatric)
WSTE0068	3.0 (Small Adult)
WSTE0069	4.0 (Medium Adult)
WSTE0070	5.0 (Large Adult)

i-gel® O2 Supraglottic Resus Packs

- Each pack is a complete kit with all the necessary elements for resuscitation
- Sterile and ready to use
- Made from medical-grade thermoplastic elastomer for an optimal pharyngeal, laryngeal & perilaryngeal seal
- For emergency and anaesthetic use



SKU	SIZE	PACK SIZE
1566-SGL	3.0 (Small Adult)	Single
1566	3.0 (Small Adult)	6
1567-SGL	4.0 (Medium Adult)	Single
1567	4.0 (Medium Adult)	6
1568-SGL	5.0 (Large Adult)	Single
1568	5.0 (Large Adult)	6

Thomas Select Tube Holder

- Large mouthpiece surface area accommodates patients with missing teeth or facial trauma
- Suction port offers easy access for suctioning and essential oral care
- Aligns with EN 1789-2007



SKU
WSTE0553

Laerdal® Thomas ET Tube Holders — Child

- Designed to accommodate multiple-sized ET tubes, laryngeal masks & other tubes



SKU	SIZE
WSTE0180	Child

Bandages & Wound Dressings

Our range of bandages and dressings is expertly crafted to meet the high standards required by emergency medical services.

Each item in our collection is designed for effective wound care, ensuring rapid response and optimal healing in urgent situations.

Our products prioritise ease of use, durability, and patient comfort, making them essential tools for medical professionals during emergencies. Reliable and high quality bandages and dressings ensure that healthcare providers have the resources to manage and stabilise injuries at the scene.



VIEW ONLINE

Scan the QR code or visit www.steroplast.co.uk/first-aid-products.html to view these products online.

Sterotrac Adhesive Skin Traction Medical Kit

- Used to gain and maintain bone alignment after dislocation and correct mild deformity
- Ideal for fixed or balanced traction



Sterotrac Adhesive Skin Traction Medical Kit

SKU	SIZE	PACK SIZE
9516/LF	Child	24
9515/LF	Adult	18

Sterotrac Non-Adhesive Skin Traction Medical Kit

SKU	SIZE	PACK SIZE
9518/LF	Child	24
9517/LF	Adult	18

Steropore Adhesive Wound Dressings

- The most flexible adhesive wound dressing available on the market
- Used to treat larger wounds where plasters are too small



SKU	SIZE	PACK SIZE
6807/1	6cm x 7cm	25
6805/1	8.6cm x 6cm	25
6806/1	10cm x 9cm	25
6808/1	15cm x 9cm	25
6810/WAL	6cm x 7cm & 8.6cm x 6cm	Wallet of 4

Steroswab Gauze Swabs

- Premium gauze dressing for wounds, used as an additional absorbent layer for bodily fluids in wound dressing procedures
- Sterile and non-sterile options available



SKU	STERILITY	PACK SIZE
1900	Non-Sterile	100
1901	Non-Sterile	100
1902	Non-Sterile	100
1903	Sterile	25 Packs Of 5
1904	Sterile	25 Packs Of 5
1905	Sterile	25 Packs Of 5

Steroply Conforming Bandage

- High stretch elastic conforming bandage allows for optimal mobility when wearing
- Conforms easily to all body areas, even awkward joints
- The bandage is light and soft, permitting air circulation

SKU	SIZE
3051	5cm x 4m
3052	7.5cm x 4m
3053	10cm x 4m
3054	15cm x 4m



Zetuvit® E High Absorbent Dressing Pads

- Highly absorbent, non-irritant dressing pad for moderate to heavy exudation
- Features a protective, hydrophobic backing
- High level of absorbency thanks to its soft cellulose fluff core and exudate-distributing tissue layer



SKU	SIZE	PACK SIZE
6820	10cm x 10cm	25
6821	10cm x 20cm	25



Steropad Non-Adhesive Wound Dressings

- Double-sided, low-adherent, non-adhesive wound dressing pads
- Cushioned protection for healing wounds
- Supplied in a clearly-labelled box with a perforated cut for easy access

SKU	SIZE
3006/1	5cm x 5cm
3007/1	7.5cm x 7.5cm
3008/1	10cm x 10cm
2994BS	10cm x 20cm



Sterogauf Tubular Gauze Bandages

- Provides gentle pressure while allowing the bandage to conform to body contours and stay in place
- Made with premium gauze material
- Easier to apply than flat bandages

SKU	SIZE
9545/1	00 — 1cm
9540/1	01 — 1.5cm
9541/1	12 — 2.5cm
9542	34 — 3.5cm
9543	56 — 5cm
9544	78 — 8cm



Sterogrip Elasticated Tubular Support Bandages

- For complete protection of injuries, dressings, joints, and delicate areas of the body
- Can be applied in multiple layers for tailored levels of support to sprains and strains

SKU	SIZE
9500	A — 5cm x 10m
9501	B — 6.25cm x 10m
9502	C — 6.75cm x 10m
9503	D — 7.5cm x 10m
9504	E — 8.75cm x 10m
9505	F — 10cm x 10m
9506	G — 12cm x 10m
9513	L — 30cm x 10m

Ambulance Dressings

- A sterile, individually wrapped emergency dressing designed for quick and effective management of severe wounds with heavy bleeding
- Trusted by UK emergency services and hospitals
- Features an extra-thick, highly absorbent wound pad that rapidly absorbs blood and exudate while reducing the risk of infection or allergic reactions
- Suitable for treating a wide range of injuries, including punctures, cuts, gunshot wounds etc.
- Available in five sizes from small to XX Large



SKU	SIZE
7000B/1	Small No. 7 5.2cm x 6.0cm
7001B/1	Medium No. 1 12cm x 10cm
7002B/1	Large No.2 20cm x 15cm
7003B/1	X Large No.3 28cm x 20cm
7004B/1	XX Large No.4 32cm x 20cm



Steropax Eyepad Wound Dressings

Extra Thick Wound Pad

- High stretch conforming bandage with absorbent cotton wound pad
- Provides exemplary wound coverage, ensuring the initial barrier against infection

SKU	PACKAGING TYPE
1912B/1	Plastic
2012/1	Paper
1912BX/1	Boxed

Steropax Wound Dressings

- Used by paramedics, nurses, and the military for dressing wounds, as well as by first aiders, vets and care home staff
- Features a high-stretch conforming bandage for prompt, effortless and secure application
- Individually wrapped dressings minimise infection risk compared to non-sterile alternative
- Meets HSE first aid guidelines and hospital standards
- Can be supplied in an eco-friendly paper wrapping to minimise plastic waste

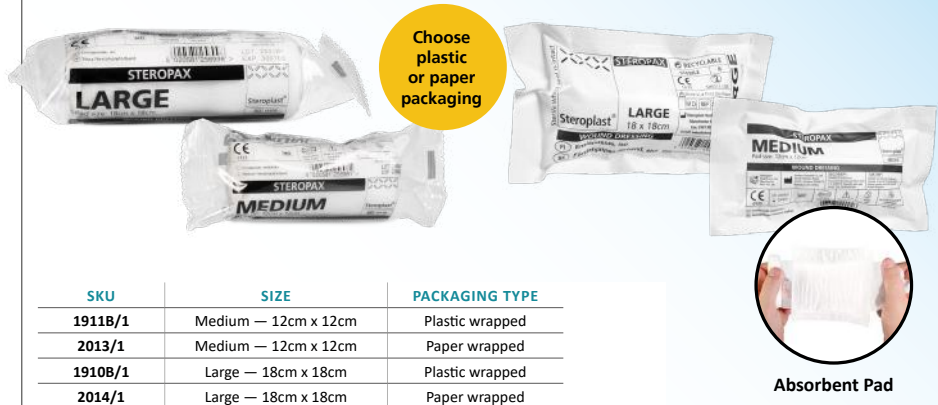

SKU	SIZE	PACKAGING TYPE
1911B/1	Medium — 12cm x 12cm	Plastic wrapped
2013/1	Medium — 12cm x 12cm	Paper wrapped
1910B/1	Large — 18cm x 18cm	Plastic wrapped
2014/1	Large — 18cm x 18cm	Paper wrapped

Steropax Finger Dressings

- Sterile finger wound dressing pads with an attached conforming bandage for easy application
- Ideal for emergency use, hospital care, and to top-up first aid kits

SKU	SIZE
1915B/1	3.5cm



Sterocrepe Crepe Bandage

- A stretchy, cotton woven bandage ideal for giving light support to sprains and strains in joints and muscles
- Moderate compression bandage to alleviate swelling
- Provides padding and protection

SKU	SIZE
3056/6	5cm x 4.5m
3057/6	7.5cm x 4.5m
3058/6	10cm x 4.5m
3059/6	15cm x 4.5m



Steropax PLUS Wound Dressings

- Premium quality, extra absorbent Steropax wound dressings
- Available in two sizes
- Individually wrapped and sterile



SKU	SIZE
4702B/1	Medium No.8 — 12cm x 12cm
4703B/1	Large No.9 — 18cm x 18cm

Wound Care Procedure Pack

- The handy pack for use in aseptic procedures and wound care in hospitals
- Contains no hazardous or medicinal substances



SKU
1893

Calico Triangular Bandage

- Made from a durable, reusable, and washable calico material
- Ideal for supporting arms in slings, immobilising limbs, and applying dressings



SKU	PACK SIZE
9562/1	1
9562	50



Non-Woven Triangular Bandage

- Lightweight and breathable,
- Ensures optimal comfort and airflow
- Multi-functional bandage can be used as a sling, dressing or tourniquet



SKU	PACK SIZE
9560/10	10
9560	50



Bleed Control & Trauma

Our trauma and bleed control supplies are specifically designed for professionals in healthcare, emergency services, and the military.

These products are crucial for EMTs, paramedics, and emergency room personnel dealing with life-threatening injuries.

Our range also caters to the unique demands of military operations and law enforcement, providing robust and easy-to-use options, including chest seals and blast bandages, essential in combat and field scenarios.



VIEW ONLINE

Scan the QR code or visit www.steroplast.co.uk/advanced-life-support-equipment.html to view these products online.



LiquiBand Optima Wound Closure Glue

- 10-Second set time
- Water-resistant barrier
- Precise application tip for controlled delivery

SKU
WSTE0526

Smart Triage™ First Response Kit

- Easily attachable to body armour or a waist belt for quick access
- Striking visibility for rapid identification

SIZE	SKU
+12 Sticks	WSTE0656
+20 Sticks	WSTE0681



WATERPROOF



Steroplast Trauma Dressing

- Expertly engineered to manage intense bleeding during emergency situations
- Super-absorbent pad capable of absorbing over 2x its weight in fluid
- Vacuum-packed for easy storage

SKU	SIZE
6830	Medium (10cm x 18cm)
6831	Large (15cm x 18cm)



VIDEO DEMO



CE MARKED



VIDEO DEMO

TacMed Solutions Olaes® Modular Bandage

- Newest generation of trauma bandage
- Pressure bar that doubles as an eyecup
- Plastic occlusive sheet included in dressing pocket

SKU	SIZE
PROM001	4in/10cm
PROM002	6in/10cm

The Emergency Bandage®

- Heavy-duty compression bandage
- Provides direct, constant pressure to wound
- For personal or professional application

SKU	SIZE
6843	4in
6844	6in



TacMed Solutions Tactical Blast Bandage®

- Durable, rapid-application bandage for trauma wounds
- Large non-adherent wound pad facilitates sustained bleeding control
- Provides a 50 x 50cm treatment area

SKU
PROM003



VIDEO DEMO

Prometheus Trauma Dressing

- Features a 17cm x 10cm low-adherent absorbent pad
- Elastic wrap with built-in hook control strips for secure compression

SKU
PROM011



LATEX FREE

Celox FoxSeal™

Occlusive dressing for the treatment of open wounds, design for ease of use and consistent performance in the field. Contains 2x chest seals.

SKU
6834



CE MARKED



Corius Seal

- Covers both large and small wounds whilst absorbing wound exudate
- Can be used for up to 24 hours
- Non-sterile adhesive hydrogel wound dressing
- 20cm x 15cm. Single use

SKU
PROM009



LATEX FREE



DISPOSABLE FOR SINGLE USE

Celox FoxSeal™ Vented

The Celox FoxSeal™ Vented is the first chest seal with 512 vents, providing more ways to release pressure and prevent blockages. 13cm x 13.3cm.

SKU
6851



CE MARKED



Russell Chest Seal

- Covers penetrating chest wounds allowing air to escape from the pleural cavity without being drawn back in
- Hydrogel-based dressing with an integral low-profile valve

SKU
WSTE0380



PROMETHEUS MEDICAL LTD



SAM® Chest Seal 2.0 — Valved Occlusive Dressing

- Engineered to treat, seal, and reseal open chest wounds
- Exceptional sealing ability holds fast in extreme temperatures

SKU
WSTE0392



CE MARKED



Tactical Medical Tourniquet™ (TMT)

- Developed with US military expertise
- Used by militaries, medical professionals, and public safety agencies worldwide



SKU
WSTE0678

Compressed Gauze

- High-quality, 6-ply cotton construction
- Essential for wound packing and bleeding control
- Z-fold layers release smoothly



SKU
6835

Rhino Pinch Nasal Clip

- Cushioned, adjustable plastic clip helps to stop blood flow during a nosebleed
- Ten adjustable points to fit all nose sizes



SKU
3039



S.T.A.T.® Tourniquet

- Simple & easy 5 second application
- For limb sizes as small as 20mm
- Automatic self locking system
- Easy to follow instructions printed on tourniquet
- Blue training tourniquet available



SUITABLE FOR ADULTS & CHILDREN



LATEX FREE



DISPOSABLE FOR SINGLE USE

SKU	COLOUR
1146	Orange
1146/BLU	Blue



SOF Tactical Tourniquet

- High-strength, one-handed SOF Tactical Tourniquet for rapid arterial compression
- Furnished with a true 1.5" strap, ensuring superior arterial compression
- Snap-lock buckle specially designed to wrap around trapped limbs

SKU	COLOUR
WSTE0401/BLK	Black
WSTE0401	Orange



SWAT-T™ Tourniquet Orange

- Stretch, Wrap And Tuck Tourniquet
- Multi-function life saving device
- Compact, lightweight and economical
- Easy to learn and train with instructions printed directly on the tourniquet
- Can be wrapped over a gauze or haemostats

SKU
1141

C-A-T Combat Application Tourniquet GEN7

- Effective and user-friendly
- Single application protocol and single buckle routing system
- Cutting-edge design controls life-threatening bleeding
- Clinically proven effectiveness
- Official endorsement by the U.S. Army



Windlass Rod



Windlass Clip



Single Routing Buckle



Internal Free-Moving Band



SKU	COLOUR
1142	Black
1143	Orange

C.A.T. COMBAT APPLICATION TOURNIQUET.

SAM® ChitoSAM 100

- 100% Chitosan haemostatic dressing
- Tear anywhere packaging
- Can be used in conjunction with pressure bandages



SKU
1357

Celox™ Z-Fold Haemostatic Gauze

- Designed to control moderate to severe traumatic bleeding
- Celox Rapid stops severe arterial bleeding in just 60 seconds
- Revolutionary haemostatic technology
- Simplified packing and application due to its Z-folded design



PRODUCT	SKU
Celox Z-Fold Gauze	6850
Celox Rapid Z-Fold Gauze	6832

Celox™ Haemostatic Granules

- Rapidly control bleeding in emergencies
- It excels in stemming severe blood flow, which can be life-saving in certain situations
- The applicator is specifically designed to handle deep, penetrating trauma wounds
- Forms a robust clot in just 30 seconds



PRODUCT	SKU
15g Pouch	6837
6g Pre-filled Applicator	6833

ChitoGauze® XR Pro

- Specially designed to control severe bleeding quickly
- Easily identifiable in X-rays
- Z-folded in a sterile package for rapid deployment



SKU
PROM006

Public Access Trauma (PACT) First Aid Kit

Public Access Trauma (PACT) First Aid Kit designed for non medical trained use to support life-threatening injuries.

- Carefully planned by experts in medicine, first aid & counter-terrorism policing
- Includes military-grade wound dressings & supplies
- Housed in a sturdy, easily identifiable case
- Clear visual and written instructions inside

SKU	KIT VARIATION
6825	PACT Kit With S.T.A.T Tactical Tourniquet
6825/CAT	PACT Kit With C-A-T Tactical Tourniquet
6825/SOF	PACT Kit With SOF Tactical Tourniquet

Kit Includes:

- x4 Trauma Dressings
- x2 Triangular Bandage - Calico
- x2 Resusciate
- x2 Tourniquets
- x4 Nitrile Gloves - in Pairs
- x4 Face Masks
- x2 Scissors
- x4 Safety Goggles



INCLUDES WATERPROOF INSTRUCTION LEAFLET



Does your business operate on **public premises**?

Prepare for Martyn's Law

Any business that operates on public premises must be fully equipped to handle a terrorist attack.

Ensure you have all the workplace first aid supplies your risk assessment requires, install a public access trauma kit, and find exactly what you need to ensure you're fully prepared for the worst.

Steroplast Bleed Control Kit

A bleeding control kit to treat catastrophic injury and sustain a casualty until they receive proper medical attention. This kit includes all the necessary items to create a tourniquet, dress a wound, and give hygienic CPR.

- Supplied in a durable plastic box with snap-fit closure
- Attach to a wall for visibility & ease of access
- Includes premium quality trauma bandage & tourniquet to control severe bleeding in seconds
- Our resusciate face shield protects both the casualty and the responder from cross-contamination, meaning CPR can be given safely and quickly

SKU
6824

Kit Includes:

- x1 Trauma Bandage
- x2 Compressed Gauze
- x2 Resusciate
- x1 S.T.A.T Tourniquet
- x2 Disposable Gloves (Pairs)
- x1 Scissors



INCLUDES ORANGE WALL BRACKET



Critical Injury First Aid Kit

The Steroplast Critical Injury First Aid Kit is specifically designed to control and stop severe blood loss in the event of a stabbing or similar serious injury.

- Supplied in a durable nylon zip-secured bag
- Complies with BS8599-1:2019
- Can be used by anyone without prior training

SKU
8599-C

Kit Includes:

- x1 First Aid Emergency Leaflet
- x2 Haemostatic Dressing
- x1 Foil Blanket
- x2 Disposable Gloves (Pairs)
- x2 Trauma Dressing
- x1 S.T.A.T Tourniquet
- x1 Tuff Cut Scissors



First on Scene Trauma Kit | Motorcycle First Aid Kit

- Tailored to meet the unique needs of motorcyclists who face higher road risks
- Useful for personal emergencies or assisting other riders in need
- Suitable for riders, clubs, training schools, emergency responders, and general road users
- **The Plus Kit includes an additional S.T.A.T Tourniquet for severe blood loss injuries**



SIZE	SKU
First on Scene Trauma Kit	8156
First on Scene Trauma Kit Plus	8157

Visit our Trauma Supplies Online Buying Guide

Explore our user-friendly Trauma Guide page for a breakdown of our advanced trauma supplies.

- ✓ Refine your search
- ✓ Intuitive page navigation
- ✓ Related videos & articles
- ✓ Find detailed information and specifications to meet your needs
- ✓ Learn more about **Martyn's Law** & **the Care Gap** to find out how your business can be better prepared



Scan the QR code to visit our online guide



Blizzard Survival & Emergency Lighting

Our Blizzard Survival range delivers essential warmth and protection for extreme conditions for EMS, mountain rescue, and military use.

Key items like the Blizzard 3-Layer Survival Bag and Blizzard 2-Layer Jacket are designed with innovative materials for optimal hypothermia prevention, crucial in maintaining operational readiness in cold terrains.

Ideal for search and rescue, as well as for outdoor guides, law enforcement, maritime workers, winter sports organisers and personal safety kits.



Scan the QR code or visit www.steroplast.co.uk/advanced-life-support-equipment.html to view these products online.

VIEW ONLINE

Blizzard EMS Blanket

- Incorporates advanced Reflexcell™ material, ensuring comprehensive warmth and protection against hypothermia under various conditions.
- Designed and widely utilised by Emergency Services globally
- Elasticity allows the material to hug the body, preventing drafts, reducing convection, and ensuring the material stays close to where it's most effective

Blizzard Compact 2 Layer Blanket

- 5 Tog - Unrivalled thermal quality
- Fully waterproof and windproof
- Made from Ultra-Light 2 layer Reflexcell™
- Comes with self-adhesive tape to secure
- Effective tool in the prevention and treatment of hypothermia



PRODUCT	SKU
Blizzard EMS Blanket	BLIZ002
Blizzard Compact 2 Layer Blanket	BLIZ001



Blizzard IFAK Emergency Blanket – Reflexcell™ Insulated

- Compact, individual-use emergency blanket designed for managing cold exposure and shock
- Reflexcell™ insulated construction traps air and reflects body heat for effective thermal retention
- Fast deployment with generous coverage



NEW



SKU
BLIZ011

Blizzard 2 Layer Active Range Survival Jacket

- Features Reflexcell™ technology for unparalleled warmth
- Features a draw-cord with a spring toggle for easy closure and adjustment
- Effective in a wide range of temperatures, down to -40°C, and maintains performance even when wet
- Less bulky compared to traditional insulating materials, yet provides substantial warmth
- The bright orange colour enhances visibility, aiding in rescue scenarios

SKU
BLIZ006



Blizzard 3 Layer Survival Bag

- Compact, lightweight, and versatile
- Perfect for emergency and outdoor use
- Made from a waterproof & windproof three-layer Reflexcell™ material
- Designed to be compatible with CT scans and X-rays, facilitating medical examinations without removal
- Boasts a 7.6 tog rating, providing thermal quality equivalent to a medium-weight regular sleeping bag

SKU
BLIZ004



Cyalume® 6" (15cm) Snaplight Lightsticks

- Long-lasting, safe illumination for various settings
- No batteries needed, simply activate & use
- Non-toxic and non-flammable lightsticks
- Waterproof for underwater use
- Its design emits light in a 360-degree radius, enhancing visibility up to 1 mile

SKU	COLOUR	DURATION
1021/BLU	Blue	8 Hours
1021/WHI	White	8 Hours
1021/GRE	Green	12 Hours
1021/ORA	Orange	12 Hours
1021/RED	Red	12 Hours
1021/YEL	Yellow	12 Hours



Burncare

Recognising the urgency of treating burns effectively, reducing infection risk, and soothing pain, we provide a selection of advanced products, including Burnshield® Hydrogels and a variety of Burnshield dressings, designed for immediate application to burn injuries and proven more effective than water at cooling burns.

These medical-grade products are used by EMTs, paramedics, and emergency room staff, ensuring rapid and effective treatment at the scene or in hospital settings. Firefighters, industrial safety officers, and military personnel also rely on our comprehensive kits.



Scan the QR code or visit www.steroplast.co.uk/advanced-life-support-equipment.html to view these products online.

VIEW ONLINE



10cm x 10cm

Paraffin Gauze Dressing BP

- For minor burns, scalds, abrasions, and superficial wounds
- Impregnated with white soft paraffin BP to help soothe and protect the wound
- Supports a moist healing environment

SKU	PACK SIZE
4900	10

Calcium Gluconate Gel (C-Gel) 40g Tube

- Water based gel used to treat hydrofluoric acid burns
- Handy 40g gel tube fits into first aid kits & pockets



SKU
1959

Portable Fire Extinguisher

- Stored pressure BC dry powder aerosol extinguisher
- BS6165 Approved
- Lightweight aluminium body



SKU
1975

Burnshield® Emergency Burns Dressings

- Available in six sizes to treat small to large burns
- Soothing tea-tree oils cool the skin
- Non-adhesive and can be removed with cool water or saline solution
- For use on 1st, 2nd or 3rd degree burns

Burnshield® Emergency Contour Dressings

- Available in two large sizes to provide maximum coverage
- Supplied in a nylon bag
- Designed to soothe and protect burns or scalds too large for smaller dressings
- Fibreless cotton reduces the risk of contamination and residue
- Shelf life of five years from the date of manufacture

Burnshield Emergency Burns Dressings

SKU	APPLICATION	SIZE
BD90825	Digits	2.5cm x 50cm
BD90822/1	Small Surface	10cm x 10cm
BD90826	Limb/Neck	5cm x 1m
BD90823/1	Large Limb	20cm x 20cm
BD90827	Face Mask	20cm x 45cm
BD90824	Torso/Back	60cm x 40cm



Burnshield Emergency Contour Dressings

SKU	APPLICATION	SIZE
BD881006	Large Limb	1m x 1m
BD881007	Large Limb	1m x 2m



Guarantee your emergency response is effective enough to **save a life,** **stop infection,** and **soothe painful burns** with medical-grade burncare bandages, gels & kits



Burnshield® Hydrogel

- For treatment of 1st, 2nd, and 3rd-degree burns and sunburn
- Contains tea-tree oil, quickly cooling a burn area, forming a protective barrier
- Designed for application directly onto skin as well as for use over burn dressings
- Available in sachets, squeeze bottles & sprays

Burnshield Hydrogel Burn Blott Sachets

SKU	SIZE	PACK SIZE
BD90830/10	3.5ml	10
BD90830/100	3.5ml	100

Burnshield Hydrogel Bottles

SKU	SIZE	PACK SIZE
BD90828/1	50ml	1
BD90828/6	50ml	6
BD90829/1	125ml (Spray)	1
BD90829/6	125ml (Spray)	6



Burnshield® Emergency Burncare Rescue Kit

These kits provide equipment to immediately respond to life-threatening burns

- The nylon bag is ideal for on-the-go, such as outdoor activities, vehicles & first responders
- Provides instant relief by cooling, moisturising & soothing the burn on application
- Appropriate for treating 1st, 2nd, and 3rd degree burns

SKU
90834



Kit Includes:

- x7 Burnshield® Dressings
- x1 Burnshield® Hydrogel Spray
- x1 Clear Tape
- x2 Conforming Bandage
- x2 Cohesive Bandage
- x1 Foil Blanket
- x1 Nitrile Gloves (Large Pair)
- x1 Tuff Cut Scissors

Jelonet® Paraffin Gauze Burn Dressings

Jelonet Paraffin Gauze Burn Dressing

- Non-medicated tulle gras dressings made with open weave gauze
- Impregnated with paraffin
- Low adherent
- Available in three sizes

SKU	SIZE	PACK SIZE
JEL004	10cm x 10cm	10
JEL003	10cm x 40cm	10
JEL002	5cm x 5cm	50
JEL005	5cm x 5cm	5

Jelonet Paraffin Gauze Burn Roll

- Cut to custom size
- Open-weave gauze soaked in paraffin
- Wicks exudate away from the wound into a secondary dressing

SKU	SIZE	PACK SIZE
JEL001/1	15cm x 2m	1



Steroburn Burncare Kit

Quality burncare kit for urgent treatment of burns at home, work, school, or on the move.

- Supplied in a durable plastic box with snap-fit closure
- Attach to a wall for visibility & ease of access
- Contains everything you need to treat burn or scald wounds safely and effectively

SKU
8233



Kit Includes:

- x2 Burnshield® Dressings
- x8 Burnshield® Blott Sachets
- x1 Guidance Leaflet
- x1 Microporous Tape
- x1 Tuff Cut Scissors
- x1 Vinyl Gloves (Pairs)
- x2 Wound Dressing



Mini Burn Kit

- Contains Burnshield® dressings & treatments
- Small enough to fit in your handbag or glove box and ideal for travel
- Treat burns including thermal, electric, chemical and sunburn

SKU
90842

Kit Includes:

- x1 Burnshield® Dressing
- x2 Burnshield® Blott Sachets
- x1 Steroban Cohesive Bandage



Premier Steroburn Burns First Aid Kit

A burns first aid kit complete with everything required to treat burns in the workplace or at home effectively.

- Contains Burnshield® dressings & treatments
- Put together under the guidance of first aid experts
- Comes in a robust, durable polypropylene 'premier box' to keep the contents safe from water or being crushed
- Wall bracket is available to mount kit to a wall
- Available in two sizes for 1-10 to 11-20 people

SKU	SIZE
8231	1-10 People
8232	11-20 People

Kit Includes:

- | 1-10 | 11-20 | |
|------|-------|--------------------------------|
| x6 | x4 | Burnshield® Burn Blott Sachets |
| x2 | x6 | Burnshield® 10cm Dressings |
| x1 | x1 | Burnshield® Digit Dressings |
| x5 | x3 | Sterowash 20ml Eyewash Pods |
| x2 | x4 | Steroply Conforming Bandage |
| x2 | x2 | Nitrile Gloves (Pairs) |
| x1 | x1 | Microporous Tape |
| x1 | x1 | Tuff Cut Scissors |



Defibrillators & Accessories

Our defibrillators, suitable for both professionals and laypersons, are essential in various settings, including healthcare, public spaces, and emergency services.

They're user-friendly for public use in places like airports and schools, and come with necessary accessories and robust storage solutions like the DefibSafe cabinets for all environments.

Designed for immediate use, they also support paramedics upon arrival.



Scan the QR code or visit www.steroplast.co.uk/advanced-life-support-equipment.html to view these products online.

VIEW ONLINE



iPAD® NFK200 Semi-Automatic Defibrillator

- Includes iPAD NFK200 battery, carry case, AED starter kit & a pair of adult/child pads
- Equipped with a CPR metronome, voice guidance, and graphical instructions
- Swift adult / paediatric mode change to respond to various emergency situations

SKU
1716



iPAD® SPR Semi-Automatic Defibrillator

- Includes iPAD SPR battery, carry case, AED starter kit & a pair of adult/child pads
- Status readily displayed through LED screen
- Swift adult / paediatric mode change to respond to various emergency situations
- Robust construction and durability ensure reliability in demanding environments

SKU
1708

iPAD SPR Training Device

- Simulates a real emergency response
- Adult-to-Paediatric switch
- Illuminated CPR guide and feedback
- Includes eight pre-programmed scenarios



NEW

SKU
1707

iPAD NFK200 Replacement Electrode Pads

- Specifically designed for use with the iPAD NFK200
- Can be used for both adult and paediatric patients



SKU
1717

iPAD SPR Dual Adult & Child Electrode Pads

- Specifically designed for use with the iPAD SPR
- Can be used for both adult and paediatric patients



SKU
1709

iPAD® SP1 & SP2 Child/ Adult Replacement Electrode Pads

- Specifically designed for use with the iPAD SP1 & SP2
- Can be used for both adult and paediatric patients



SKU
1845



iPAD® SP1 Semi-Automatic Defibrillator

- Includes iPAD SP1 battery, carry case, AED starter kit & a pair of adult/child pads
- Ambient noise sensors ensure the volume of voice instructions automatically adjusts to your surroundings
- Swift adult / paediatric mode change to respond to various emergency situations

SKU
1844



iPAD® SP1 Fully-Automatic Defibrillator

- Includes iPAD SP1 battery, carry case, AED starter kit & a pair of adult/child pads
- Smart features like pad repositioning prompts, 'handover information' for paramedics, and verbal & visual guidance at every step of use
- Swift adult / paediatric mode change to respond to various emergency situations

SKU
1875

iPAD Saver Defibrillator Adult Replacement Pads

- Compatible with NF1200 and NF120
- Clear visual guides
- Pre-Connected



SKU
1843

iPAD SP1 Wall Bracket

- Compatible with all iPAD-SP1 AEDs
- Made from sturdy metal
- Velcro strap enables quick, easy release of defibrillator



SKU
1851

iPAD® SP1 Orange Carry Case

- Designed for use with the iPAD SP1 semi-automatic & fully-automatic defibrillators
- Reinforced shell design
- Internal pockets to store replacement equipment



SKU
1856

iPAD® SP1 Replacement Battery

- Replacement battery for the iPAD SP1 fully-automatic & semi-automatic defibrillators
- Capacity for 200 shocks



SKU
1855



ZOLL® AED Plus Semi Automatic Defibrillator

- Includes 10x lithium batteries, first responder kit, dual-function passive airway support cover, instruction manual, carry case & a pair of adult pads
- Five year standard warranty
- Graphic user interface displays large, easy-to-understand visual icons illuminated by LEDs

SKU: ZOLL0001

Includes Batteries | 5 Year Warranty



ZOLL® AED 3 Automatic Defibrillator

- Fully or semi automatic models available
- Features Real CPR Help® technology with a colour display
- One set of pads for both adults and children, with a 5-year shelf life
- Simple child mode activation for treating younger patients

Provides real-time CPR feedback

SKU	MODEL TYPE
ZOLL0019	Semi-Automatic
ZOLL0017	Fully-Automatic

Includes Batteries | Suitable for Adults & Children



ZOLL® Powerheart G5 Semi Automatic AED with ICPR

- Includes long-life Intellisense® lithium battery
- Real-time CPR feedback (Intellisense™ CPR / iCPR)
- Rescue Ready® status indicator
- Step-by-step RescueCoach® prompts
- Dual-language functionality

SKU: ZOLL0026

Includes Batteries



The ZOLL Content Hub

ARTICLE DEFIBRILLATORS

Learn more about ZOLL Defibrillators & Accessories in our Knowledge Base article: The ZOLL Content Hub

Find product information, make purchases, watch how-to videos showing products in use, and download free posters & flyers.

- How-to videos
- Articles & guides
- Free downloads

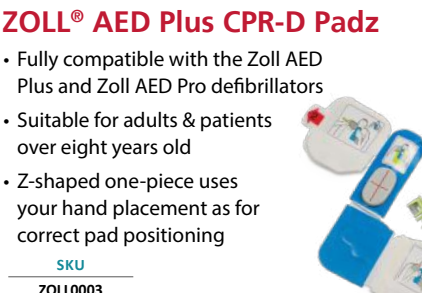

ZOLL® AED Plus CPR-D Padz

- Fully compatible with the Zoll AED Plus and Zoll AED Pro defibrillators
- Suitable for adults & patients over eight years old
- Z-shaped one-piece uses your hand placement as for correct pad positioning

SKU: ZOLL0003



ZOLL® AED 3 Battery Pack

- For use with the ZOLL AED 3 defibrillators
- Functions reliably in a wide temperature range
- Display alerts users when replacement is needed

SKU: ZOLL0015



ZOLL® CPR Uni-Padz™ Universal Electrodes

- Engineered for exclusive compatibility with the ZOLL AED 3 defibrillator
- Dual functionality

SKU: ZOLL0014



ZOLL® Plus Stat Padz II — Adult

- For use with the Zoll AED Plus & Zoll AED Pro defibrillators
- Features a central energy feed which distributes energy equally

SKU: ZOLL0007

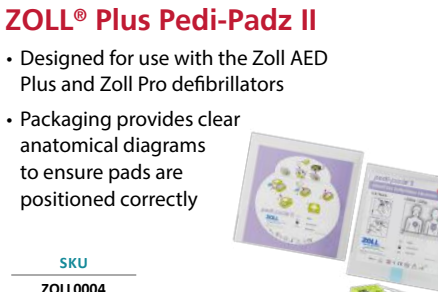

ZOLL® Plus Pedi-Padz II

- Designed for use with the Zoll AED Plus and Zoll Pro defibrillators
- Packaging provides clear anatomical diagrams to ensure pads are positioned correctly

SKU: ZOLL0004



ZOLL® Powerheart® G3 Adult Defibrillator Pads

- Compatible with the Powerheart® G3 defibrillators
- Suitable for patients over eight years old (or above 25kg in weight)

SKU: 1870



ZOLL® Powerheart® G5 Adult Defibrillator Pads

- Pre-gelled self-adhesive pads
- Suitable for patients over 8 years old or over 25kg
- Features clear anatomical placement diagrams

SKU: 1879



ZOLL® Powerheart G3 IntelliSense Lithium Battery

- Designed for the ZOLL® Powerheart AED G3 series
- Ensures your device is always rescue-ready
- Non-rechargeable

SKU: 1867



Remember to regularly check the expiration of your defibrillator pads and batteries and replace them if needed.

Defibrillator batteries should be replaced every 2-5 years and pads every 2 years, or as per manufacturer's guidelines; ensure regular checks for expiry and functionality.

Schiller® FRED Easyport Adult Electrode Pads

- Designed for use with the Schiller FRED Easyport AED
- Pre-gelled & ready for use



SKU
1733

Schiller® FRED Easy Defibrillator Battery

- Replacement battery for FRED Easy & Easyport defibrillators
- Capacity for 180 shocks at maximum energy



SKU
1726

Schiller® FRED Easy Adult Pre-Connected Electrode Pads

- Designed for use with the Schiller FRED Easy AEDs
- Pre-gelled & ready for use



SKU
1727

DefibSafe 2 External Cabinet with Lock

The only external defibrillator cabinet available in the UK that is IP66-rated, giving the best protection on the market for external AED storage.

- Metal hinges to reduce the risk of damage or vandalism
- LED lighting illuminated the interior for high visibility at night and make it easier to access and remove the AED
- Low running costs at an average of £2-3 per year
- Unique location code enables emergency services to find your location
- Excellent thermal insulation and thermostatic heater controlled to prevent any frost damage
- Internal size of 33cm x 28.5cm x 16cm



Corrosion Resistant Lock



Metal Hinges Reduce Damage



Unique Location Code



Internal Air Circulation Fan



Clear Printed Instructions



Riot Shield Material



SKU
1882



Indoor Defibrillator Cabinet with Alarm

- Easy to install on your wall for high visibility and to protect your device
- Clear acrylic front shows AED is in the cabinet at all times
- Made from robust metal to protect your defibrillator from knocks & general wear

SKU
1850



LEAFIR007/10



1216

First Aid CPR Leaflet

- Pocket sized emergency guide
- Provides essential life-saving resuscitation techniques
- 8 page guide measuring just 105mm x 148mm

Essential Life-Saving CPR Resuscitation Sign

- Includes a detailed description of how to administer chest presses
- Each step is accompanied by a simple illustration to help with understanding

PRODUCT	SKU
Essential Life-Saving CPR Resuscitation Sign	1216
First Aid CPR Leaflet	LEAFIR007/10

AED Defibrillation Starter Kit

High-quality contents with everything needed to prepare a cardiac arrest victim for AED shocks.

- Helps ensure strong pad contact by removing clothing, chest hair, sweat or water
- Supports hygiene and safety with disposable, sterile items to reduce cross-contamination risk
- Compact sealed polybag for easy storage
- Cost-effective and compact



Kit includes:

- x1 Bio-hazard self-seal bag
- x2 Disposable nitrile gloves (pair)
- x1 Disposable Gallant prep razor
- x1 Tuff Cut Scissors
- x1 Resuscitation face shield
- x1 Absorbent cloth

SKU
8322



DISPOSABLE FOR SINGLE USE

Diagnostic Equipment

Our advanced diagnostic equipment is essential for accurate patient assessments, ideal for emergency situations and routine check-ups alike.

Key products like digital blood pressure monitors and fingertip pulse oximeters are crucial for EMTs, paramedics, and GP clinics.

Hospitals rely on our comprehensive selection, including the Emerald, Sapphire & Topaz Aneroid Sphygmomanometers and various stethoscope models, to deliver thorough patient care.



Scan the QR code or visit www.steroplast.co.uk/advanced-life-support-equipment.html to view these products online.

VIEW ONLINE



Cardiology Stethoscope

- Provides outstanding acoustic sensitivity to help you perform detailed diagnostic auscultation
- Supplied with spare ear tips
- Reinforced stainless steel inner-spring
- Anti-chill rim

SKU	COLOUR
1063	Black
1063/BLU	Blue



Ruby Single Head Stethoscope

- Designed for easy listening to patient breathing
- Single head model
- Available in additional colours on request
- Convenient and reliable



SKU
1180/BLACK

Ruby Dual Head Stethoscope

- Chrome-plated zinc alloy chest piece
- Excellent sound transmission
- Plastic retaining ring
- All in one moulded PVC tubing



SKU
WSTE0139

Timesco® Twin-Tube Nurses Sprague Rappaport Type Stethoscope

- Traditional design stethoscope with two tubes connecting the chest piece to the head frame
- Supplied with interchangeable chest pieces for adult and paediatric use
- Two tubes connecting the chest piece to the head frame
- Made from zinc alloy

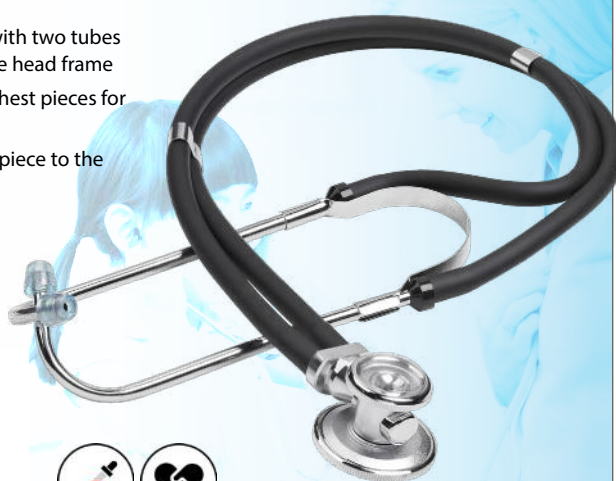

TIMESCO

SKU	COLOUR
WSTE0116	Black
WSTE0116/BLU	Blue
WSTE0116/GRE	Green
WSTE0116/ORA	Orange
WSTE0116/PIN	Pink
WSTE0116/PUR	Purple
WSTE0116/RED	Red



MULTIPLE COLOURS AVAILABLE

SUITABLE FOR ADULTS & CHILDREN

Ruby Teaching Stethoscope

- Two binaural headsets with tubing to a single chest piece
- Allows a teacher & student to listen to heart and chest simultaneously



SKU
WSTE0117

Unistik 3 Safety Lancet

- Control via activation button and alignment guide
- Comfort Zone Technology maximises comfort during the sampling procedure



SKU	PACK SIZE
WSTE0282	100



DISPOSABLE FOR SINGLE USE



Accu-Chek® Instant Blood Glucose Monitoring System

- Offers an efficient, user-friendly way for those with diabetes to monitor blood glucose
- Enhanced by integration with the mySugr® app — a complete solution for modern diabetes management
- Includes 10 test strips

PRODUCT	SKU
Blood Glucose Monitoring System	WSTE0588
Blood Glucose Test Strips (Pack of 50)	WSTE0589

Accu-Chek® Safe-T-Pro Lancets — Pack of 200

- Accu-Chek Safe-T-Technology with automatic needle retraction before and after use
- Sterile, ready-to-use format with no loading or assembly required
- Multiple sampling sites: fingertip sampling for most patients and heel sampling for infants under 1 year
- Professional clinical use in settings where hygiene and safety are required
- Fast activation delivering a precise puncture in approximately 3 milliseconds
- Suitable for right- and left-handed users
- ISO-compliant materials

LANCET TYPE	SKU
Uno Fixed Depth	1529/UNO
Plus Adjustable Depth	1529



SUITABLE FOR ADULTS & CHILDREN

Topaz Aneroid Sphygmomanometer

- 54mm dial
- Combined bellows and gauge tube
- 1 tube system



SKU
1052

Topaz Deluxe Aneroid Sphygmomanometer

- 58mm dial
- Combined bellows and gauge tube
- 1 tube system



SKU
1053

Topaz Multi-Cuff Aneroid Sphygmomanometer

- Comes with 3x cuff sizes
- 54mm dial
- Combined bellows and gauge tube
- 1 tube system



SKU
1305

Coral Shockproof Aneroid Sphygmomanometer

- 59.5mm dial
- Combined bellow and gauge tube
- 1 tube system



SKU
1054

Emerald Aneroid Sphygmomanometer

- 48mm dial
- Separate bellows and gauge tube
- 2 tube system



SKU
1050

Sapphire Aneroid Sphygmomanometer

- 48mm dial
- Combined bellows and gauge tube
- 1 tube system



SKU
1051

Tongue Depressors

- Flat and smooth wooden depressor
- Rounded tips and high tensile strength
- 150mm x 20mm



DISPOSABLE FOR SINGLE USE



SKU
1895

Pen Torch With Pupil Gauge

- Designed for single use, ensuring a fresh, uncontaminated tool every time
- Pupil gauge on the side for extra clarity
- Integrated pocket clip



1079



1074/1

Deluxe Stainless Steel Pen Torch

- Supplied with 2 x AAA batteries
- Pupil gauge on the side for extra clarity

PRODUCT	SKU
Pen Torch With Pupil Gauge	1074/1
Deluxe Stainless Steel Reusable Pen Torch	1079

Nonin® 2500 PalmSAT Pulse Oximeter

- Uses Nonin PureSat SpO2 technology for the most accurate pulse oximeter
- Battery life lasts up to 80 hours using AA alkaline batteries
- Three-year warranty



SKU
1184



Two-Button Operation



3 YEAR WARRANTY



SUITABLE FOR ADULTS & CHILDREN

Ambu® BlueSensor P ECG Electrodes

- Pack of 50
- Non-Radiolucent and X-Ray Compatible
- High-grade Ag/AgCl sensor ensures excellent signal quality



SKU
1881/50



Creative Medical Fingertip Pulse Oximeter

- Includes 2 x AAA batteries
- Super tough EMS/Military model
- 4 Direction dual colour LCD display
- Accurately measures spO2, Pulse Rate and Perfusion Index Values
- Large backlit display



3 YEAR WARRANTY



INCLUDES BATTERIES



SUITABLE FOR ADULTS & CHILDREN

SKU
WSTE0077



C19 Finger Tip Pulse Oximeter

- Includes 2 x AAA batteries
- Auto power down & low battery indicator
- One colour LED display
- 30 hours of continuous use
- SpO2 measurement range: 70%-99%: ±3% accuracy



2 YEAR WARRANTY



INCLUDES BATTERIES



SUITABLE FOR ADULTS & CHILDREN

SKU
1198

300M Hand Held Pulse Oximeter

- Includes 2 x AAA batteries
- Adjustable audio and visual alarms
- High resolution 2.8" TFT display
- 72 Hour storage and review
- Patient ID ranges from 1 to 127



3 YEAR WARRANTY



INCLUDES BATTERIES



SUITABLE FOR ADULTS & CHILDREN

SKU
1191



Scian® Digital Blood Pressure Monitor Adult Cuff

- To fit the Scian Digital Blood Pressure Monitor & Scian Deluxe Digital Blood Pressure Monitor
- Instructions on the cuff
- Adjustable and soft

SKU	SIZE
WSTE0569/SA	Standard
WSTE0569	Large

Scian® Digital Blood Pressure Monitor

- Large LCD display
- Automatic power off after 3 minutes of no use
- One button operation
- Powered by 4 x AA batteries (supplied)
- For use on 1st, 2nd or 3rd degree burns

Scian® Deluxe Digital Blood Pressure Monitor

- Featuring time, date and ambient temperature display
- Up to 120 reading memory capacity
- Powered by 4 x AA batteries
- Ambient temperature display (during sleep mode)



PRODUCT	SKU
Digital Blood Pressure Monitor	WSTE0567
Deluxe Digital Blood Pressure Monitor	WSTE0568



Omron® Easy Cuff

An easy-to-fit replacement cuff for a range of Omron Blood Pressure monitors.

- Easily fits on your arm
- Soft material
- Comfortable fit

SKU	SIZE
WSTE0109	Small
WSTE0110	Medium
WSTE0111	Large

Digital Thermometer

- A safe, accurate and simple way to check and monitor your body temperature
- No glass or mercury
- Accurate and easy to read display
- Covers available to prevent cross-contamination
- Rapid thermometer reads in 10 seconds
- Economy option reads in 60 seconds



PRODUCT	SKU
Rapid Digital Thermometer	1818
Economy Digital Thermometer	1818/ECO



Braun ThermoScan 3 Ear Thermometer

- Digital ear thermometer measures the infrared heat generated by the eardrum and surrounding tissue
- Dual scale (celsius or fahrenheit)
- Feedback system confirms correct position and accurate reading taken



PRODUCT	SKU
Braun ThermoScan 3 Ear Thermometer	1817
Braun ThermoScan 3 Ear Thermometer Probe Covers (Pack of 200)	1801



Ideal for ultrasonic diagnosis

Ultrasound Gel

- For diagnosis and therapy procedures such as ultrasonic diagnosis, ECG, defibrillation and cavitation
- Completely aqueous, will not stain clothing or damage transducers
- Non-sticky, and latex-free formula for easy clean-up and patient comfort

PRODUCT	SKU
Vue Ultrasound Gel 250ml	9632
Anagel Ultrasound Gel 5 Litre	9635

Digital Timesco Tympanic Ear Thermometer

- Rapid, precise in-ear thermometer. Ergonomic design for comfort, with 10-reading memory
- Ideal for professional and home use
- Ensures up to 4,000 uses
- Advised use with probe covers for consistent cleanliness



PRODUCT	SKU
Digital Ear Thermometer	1128
Digital Ear Thermometer Probe Covers (Pack of 40)	1808

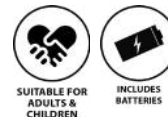

Emergency Bags

Ensure preparedness in any emergency with our specialised emergency bags and backpacks.

Designed to store life-saving equipment, these bags are essential for medics, first responders and emergency service personnel operating in critical situations.

Our emergency bags are durable, highly organised, and equipped with multiple compartments to ensure easy access to vital medical supplies.



VIEW ONLINE

Scan the QR code or visit www.steroplast.co.uk/advanced-life-support-equipment.html to view these products online.



WaterStop® Emergency Bag

- Tear-resistant tarpaulin designed to protect contents against moisture and everyday wear
- 17-litre storage capacity
- Fold-out main compartment providing clear visibility and structured access to contents
- Detachable modular pouch for carrying essential items separately
- Reflective white stripes with edge protection to support visibility

SKU
PARBAG016



WaterStop® FREE Emergency Bag

- Water-resistant, wipe-clean exterior suitable for regular use in clinical, workplace, or response settings
- Main storage compartment with padded, three-part internal layout to support organised equipment storage
- Measures 44cm x 30cm x 18cm

SKU
PARBAG008



WaterStop® Module Bag — Inner Pouch for Emergency Backpacks

This pouch provides an excellent way for medical staff and emergency services to organise and transport critical surgical items. They can be used individually or together to store medical items within a larger emergency bag.

- Measures 30cm x 13cm x 10cm
- Colour-coded following the standard colour-coding system for emergency medical bags

- **Red:** Circulatory system
- **Blue:** Respiratory system
- **Green:** Surgical materials
- **Yellow:** Paediatrics



COLOUR	SKU
Green	PARBAG009/GRE
Blue	PARBAG009/BLU
Red	PARBAG009/RED
Yellow	PARBAG009/YEL

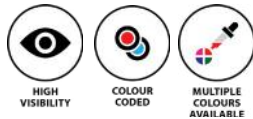

WaterStop® LIGHT Ampoule Holder

- Holds up to 40 ampoules
- Water and dirt repellent material
- Grey inner lining for a better overview



SKU
AMPHOL002



WaterStop® Small Module Bag

- Durable, wipe-clean PVC
- Available in two colours
- Easily stowed in Waterstop emergency backpacks & bags



Store inside WaterStop® backpacks

COLOUR	SKU
Red	PARBAG014/RED
Yellow	PARBAG014/YEL

WaterStop® PRO Ampoule Holder

- Holds up to 100 ampoules
- Water and dirt repellent material
- Grey inner lining for a better overview



SKU
AMPHOL001



Hi-vis Paramedic Rucksack

- Large front pocket with reflective strips and velcro seal for easy access
- Heavy duty cordura fabric
- Built to withstand heavy, daily wear
- Measures 56cm x 30cm x 45cm



SKU
9668



WaterStop® ULTRA Emergency Bag

- PVC-coated exterior providing a wipe-clean surface with added strength
- Water-resistant construction with heavy-duty zips suitable for use during heavy rain
- Reinforced base to support durability when placed on hard or uneven surfaces
- Measures 44cm x 34cm x 30 cm



SKU
PARBAG005

WaterStop® PRO Emergency Backpacks | Fabric

Waterstop® polyester fabric bags are made of heavy-duty fibre.

- Available in black and red
- Bag exterior undergoes a permanent Teflon impregnation
- Powerful zippers for use in heavy rain
- Two divided main compartments and two side pockets (suitable for AED)
- Measuring 20cm x 40cm x 48cm
- Reinforced bottom
- Includes five modular bags with transparent fronts



5x Modular Bags Inside

COLOUR	SKU
Black (Fabric)	PARBAG001F/BK
Red (Fabric)	PARBAG001/F



WaterStop® MULTI Emergency Bag

- Structured internal storage, including main compartment with a fixed interior layout
- Features two side compartments for separated organisation
- Compact holdall format suited to clinics, vehicles, and rapid-response kits
- Measures 45cm x 24cm x 20 cm



SKU
PARBAG004

WaterStop® F1 Emergency Backpack

- Hard-wearing tarpaulin construction repels dirt and liquids during regular professional use
- Seven colour-coded modular pockets with clear viewing windows for fast identification
- Comfort-focused carry system, featuring reinforced padded shoulder straps and a removable waist belt for weight distribution
- Spacious internal layout, supported by an additional front pocket for expanded storage
- Measures 52cm x 30cm x 25 cm



NEW



7x Modular Bags Inside

SKU	COLOUR
PARBAG019/RED	RED
PARBAG019/BLU	BLUE
PARBAG019/YEL	YELLOW
PARBAG019/BLK	BLACK



WaterStop® PRO Emergency Backpacks | PVC Coated

The choice of the professionals, a high end PVC emergency backpack with waterstop technology material and zips.

- Available in four colours
- Coated with two layers of polyurethane
- Bag exterior undergoes a permanent Teflon impregnation
- Two divided main compartments and two side pockets (suitable for AED)
- Wipe clean PVC material
- Powerful zippers for use in heavy rain
- Reinforced bottom
- Measuring 20cm x 40cm x 48cm

COLOUR	SKU
Blue	PARBAG001/BLU
Yellow	PARBAG001/YEL
Red	PARBAG001
Green	PARBAG001/GRE



NEW



5x Modular Bags Inside



WaterStop® Paramedic Emergency Backpack

- Removable partitions, and internal rubber straps for securing airways and accessories
- WaterStop® technology to repel dirt and liquid
- Teflon® SHIELD+ treated material combined with a wipe-clean tarpaulin surface
- Reflective tapes with edge protection as a warning triangle
- External side and front pockets
- Integrated oxygen bottle mounting system for carrying O₂ equipment securely
- Measures 65cm x 42cm x 23 cm



SKU	COLOUR
PARBAG002	RED
PARBAG002/GRE	GREEN



4x Modular Bags Inside



Oxygen Barrel Bags

- For transporting most standard sized oxygen cylinders
- Carry over the shoulder with the detachable strap or with one hand using the handles
- Interior pockets ideal for storing filters and mouthpieces
- Strong zip openings

PRODUCT	SKU
Entonox Barrel Bag	9684
Oxygen Barrel Bag	9688



WaterStop® X1 Slim Emergency Backpack

- Slim profile design, offering a more compact alternative to the standard X1 model
- WaterStop® technology to repel dirt and liquid
- Seven colour-coded modular pockets with clear viewing windows for fast identification
- Removable oxygen cylinder holder, suitable for O₂ bottles up to 2L with space for a pressure reducer
- Approximate empty weight of 5.2 kg, supporting portability for mobile responders
- Reflective yellow safety stripes with edge protection to support visibility in low-light conditions
- Measures 52cm x 42cm x 23 cm



SKU	COLOUR
PARBAG018/BLU	BLUE
PARBAG018/BLK	BLACK
PARBAG018/YEL	YELLOW
PARBAG018/RED	RED

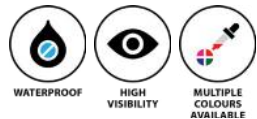

NEW



WaterStop® Oxygen Emergency Bag

- Suitable for O₂ cylinders up to 2 litres when used with a pressure reducer
- Hard-wearing PVC tarpaulin is wipe-clean and suitable for clinical or emergency use
- 11-litre total capacity with structured internal layout for organised storage
- Hinged transparent viewing window with grey pull tab

SKU
PARBAG017



Premier Emergency Backpack – PVC Tarpaulin

Suitable for paramedics, first responders, clinics, and organisations that require a dependable and well-organised solution for transporting emergency medical equipment.

- Available in three colours
- Dual-use design that works as both a backpack and a carry bag, with removable and stowable shoulder straps
- Integrated O₂ bottle holder suitable for oxygen cylinders up to 2 litres, secured with Velcro
- Reinforced PVC tarpaulin construction for strength and resistance to water and dirt
- Seven removable, colour-coded modular pouches
- Full 180° clamshell opening
- Measuring 52cm x 30cm x 25cm



COLOUR	SKU
Yellow	PARBAG007/YEL
Red	PARBAG007
Green	PARBAG007/GRE

7x Modular Bags Inside

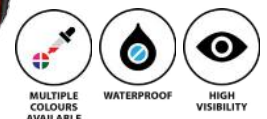

Evacuation, Immobilisation & Patient Handling

Our evacuation and immobilisation gear, including chairs, stretchers, and more, is essential for safely moving casualties in emergencies.

Key products like the Prometheus Traction Splint and SAM Pelvic Sling II support EMS teams, while the Spencer Basket Stretcher and Ferno Scoop 65 EXL aid in rescue operations.

Facilities utilise our equipment, like the Banana Board, for ease in patient handling, prioritising durability, versatility, and comfort.



VIEW ONLINE

Scan the QR code or visit www.steroplast.co.uk/advanced-life-support-equipment.html to view these products online.

SAM® Splints

The SAM® Splint, is a globally recognised innovation in emergency care and support. Trusted by professionals across the spectrum including NASA and the military, the SAM® Splint stands out for its revolutionary design.

- Tailor the splint to any size with simple scissors for a custom fit
- X-Rays and CT scans can be performed without removing the splint, preserving the integrity of the immobilised limb
- Can be cleaned, re-rolled, and reused, making it a cost-effective and sustainable option
- Deal for immediate use in emergencies, it's an essential component of any first-aid provision
- Available in five sizes



PRODUCT	SIZE	SKU
SAM® Splint 36" Standard Flatfold	91.4cm x 10.8cm	1380
SAM® Splint 36" Standard Roll	91.4cm x 10.8cm	1381
SAM® Splint 18" Junior Flat	45.7cm x 10.8cm	1382
SAM® Splint 36" Flatfold XL	91.4cm x 14cm	1383
SAM® Splint 4" Finger	9.4cm x 4.6cm	1384



1380



1381



1382

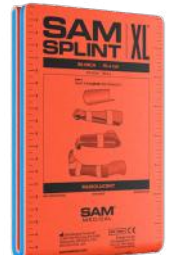

1383



1384

BSN Delta Thermoplastic

- Ideal for creating precise, effective splints for both upper and lower limbs
- Self-finishing edges create a neat finish
- Offers 100% elastic memory
- Working time of 3-4 minutes



SKU

WSTE0655

Prometheus® Traction Splint

- Designed to be applied by a single person in under two minutes
- Ideal for pre-hospital emergency use
- Can be used in conjunction with the Prometheus Pelvic Splint
- Features an adjustable traction pole for adult or paediatric use
- Weighs under 250g, making it easy to carry and store



SKU

PROM008



Prometheus® Pelvic Splint

- Easy to adjust and suitable for all sizes
- Constructed of lightweight neoprene
- Minimised pressure points with no internal stitching
- Reduces bleeding and stabilises clot formation
- 6mm stretch neoprene fabric

SKU
PROM005

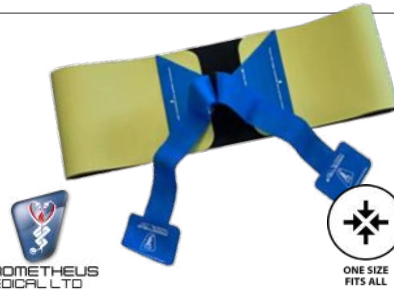

PROMETHEUS MEDICAL LTD



SAM® Pelvic Sling II

- Provides stabilisation for pelvic fractures, whilst applying the correct amount of force
- Scientifically proven to provide effective and safe force to stabilise pelvic fractures
- Low friction slider facilitates the safe transfer of patients
- Non stretch fabric is easy to clean

SIZE	SKU
Small (69-119cm)	1385
Medium (81-127cm)	1386
Large (91-152cm)	1387



SAM MEDICAL



Spinal Board

- Lightweight and smooth tapered backboard for spinal motion restriction
- Compatible with most head immobilisers
- Durable and easily cleaned
- Offset pins allow the use of straps that use loop end or speed clips

SKU
WSTE0003

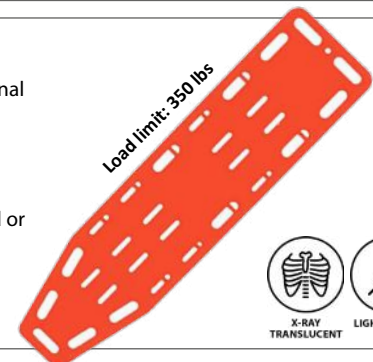

Spider Straps

- Strap system primarily for use with spinal boards
- High strength velcro
- Made from Polypropylene
- Machine washable

SKU
WSTE0075

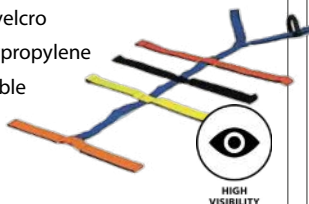

Spinal Board Strap with Buckle/Metal Loop Lock

- Bright fluorescent colour
- Suitable for use with spinal boards and immobilisers
- Metal loop lock

SKU
WSTE0096



Spinal Board Strap with Buckle/Swivel Speed Clip

- Bright fluorescent colour
- Metal loop lock
- Suitable for use with spinal boards and immobilisers

SKU
WSTE0072





Loxley Box Splints

- Available in three sizes
- Set of 3 hard wearing PVC Loxley Box Splints for leg immobilisation
- High frequency welds seal the splint and makes it impervious to bodily fluids
- Unique figure of 8 ankle and foot plate
- Easy to store — folding flat

SKU
1335

Ambu® Perfit ACE Collar

- Helps maintain neutral alignment
- Precision settings for a customised fit
- Easy access for pulse checks and advanced airways procedures
- Adult and paediatric size available

SIZE	SKU
Paediatric	9644
Adult	9643



Printed Steps for Adjustment



Adult



Paediatric

Ambu

Laerdal® Stifneck Collars

- Sizing options to fit all patients
- Instructions moulded into collar
- Radiolucent, MRI and CT scan compatible
- Easy access for pulse checks and advanced airways procedures

SIZE	SKU
Paediatric	9641
Adult	9634



Adjust Collar to Correct Size



Adult



Paediatric

Laerdal
helping save lives

Universal Head Immobiliser

- Versatile design allows it to be used with most scoops and spine boards
- Accommodates most extrication collars
- Non absorbent material

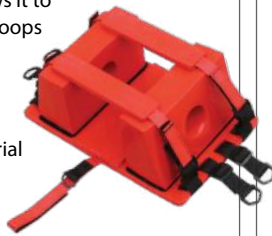

SKU
1339

Multi-Grip Disposable Head Immobiliser

- Unit comes with head & chin straps
- Compatible with all C-collars & spine boards
- Radiolucent



SKU
1340

Prometheus® Steady Head Immobiliser

- Can be used with most orthopaedic stretchers and extrication boards
- Comfortable and strong support



SKU
PROM007

PROMETHEUS MEDICAL LTD



FERNO

Ferno® Vacuum Splints

- Suitable for X-rays
- Provide the necessary comfort required before treatment
- Stabilise injured patients during transport
- Supplied with pump

SIZE	SKU
Short Arm	1390
Long Arm	1391
Leg	1392
Complete Set	1491



FERNO

Ferno® Frac-Immobiliser Splint

- Patient comfort is maintained with the use of further padding
- Velcro strapping secures the splint
- Complete with storage wallet
- Easy to clean & reusable

SIZE	SKU
2 Strap (51cm)	1330
4 Strap (74cm)	1331
5 Strap (109cm)	1332
Complete Set	WSTE0223



FERNO

Ferno® Combi Adult Head Immobiliser Splint

- X-Ray translucent and MRI compatible
- Seamless construction makes cleaning easy
- Easy to store - designed to save on valuable ambulance space
- CEN compliant

SKU
1277



Ferno® Scoop 65 EXL Paramedic Stretcher

- Enables easy access to awkward low spaces and makes the movement of the body easy in confined areas
- Load capacity of up to 227kg
- CEN compliant

SKU
WSTE0294



Designed to work with the Combi Head Immobiliser



FERNO

Plastic Scoop Stretcher

- Equipped with easy-to-use opening and closing locks
- Non-slip surface and straps ensure the patient is securely in place
- Comes with 3 safety straps

SKU
WSTE0622



Banana Board

- Exceptionally lightweight, weighing just 1kg
- Non-slip pads guarantee secure and stable movement
- Supports up to 200kg

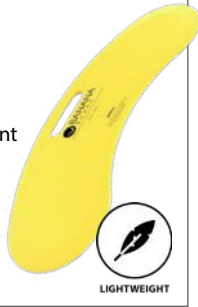

SKU
WSTE0397

Folding Transfer Board

- Made of strong, flexible plastic
- Elongated oval shape with holders
- It can be folded for storing and carrying
- Designed for lateral slide transfers



SKU
WSTE0034

Patient Transfer Slider Board

- Bright fluorescent colour
- Metal loop lock
- Suitable for use with spinal boards and immobilisers



SKU
WSTE0336

Thermafect Flectalon Rescue Stretcher Blanket

- Designed to combat hypothermia and treat shock in adverse weather conditions
- Allows a safe body temperature to be restored and maintained



SKU
1348

Premium Vacuum Mattress

- Features safety straps with quick release buckles
- Includes pump & carry case
- Wipe down polyurethane material
- X-ray translucent



SKU
1489

Bariatric Multi-Mover Patient Transfer Sheet

- Safe lift capacity up to 460 kg
- Measures 200 cm x 100 cm
- Made from latex-free, silicone-coated polyester

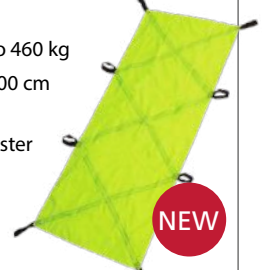

SKU
WSTE0012/YEL

Poc-Kit Evacuation Stretcher

- Pocket-sized & rolled-up
- Supports up to 23 stone (146 kg)
- Can also be used as a bivvy, basha or ground sheet
- Features six strong carrying handles



SKU
WSTE0682



Paraguard Excel Rescue Stretcher

This compact stretcher is ideal for search and rescue operations and can be used for both horizontal and vertical lifting. Perfect for use underground, in confined spaces and high buildings.

Paraguard Four Point Sling

This four-point lifting harness is designed to aid rescue workers during the vertical lifting of the Paraguard Excel Rescue Stretcher.



PRODUCT	SKU
Paraguard Excel Rescue Stretcher	1370
Paraguard Four Point Sling	1370/SLI

Duo-Fold Stretcher

- Folds both horizontally and vertically for easy portability and storage
- Includes 2 patient securing straps for maximum support
- Includes carrying bag



SKU
1342



Spencer Basket Rescue Stretcher & PVC Bag

- Basket shell is built from high density cross-linked polyethylene to avoid splintering
- Easy-clean surface, as it is impervious to body fluids and petroleum products
- Especially usable rescue operations in mines and in water
- Spencer Basket Stretcher Bag makes the stretcher easy to transport
- The bag is made from fabric PVC ensuring it is easy to clean

PRODUCT	SKU
Spencer Basket Stretcher	WSTE0311
Spencer Basket Stretcher Bag	WSTE0311BAG

Ferno® Compact 1 Carry Chair

- Folds to a slim profile for convenient storage
- 2 piece seat and back panel
- Finished in high quality epoxy cream paint

Ferno® Compact 2 Track Chair

- Designed to be quick and easy to use in emergencies
- Stainless steel construction, designed to minimise weight

Ferno® Saver Evacuation Chair

- Lightweight, with compact profile
- Comes with wall bracket, dust cover and user guidance signage
- Removable, adjustable head pad and comprehensive patient retaining straps

PRODUCT	SKU
Ferno Compact 1 Carry Chair	WSTE0131
Ferno Compact 2 Track Chair	WSTE0360
Ferno Saver Evacuation Chair	WSTE0128



Injection & Infusion

We provide essential injection and infusion products such as needles, IV cannulas, and tourniquets to healthcare and emergency services.

Our range, vital for medication delivery and IV set-ups, includes specialised tools like bone injection guns and chest decompression needles for urgent care.

We focus on safety and efficiency with our products which are selected for their precise application and patient comfort. They are also integral in non-hospital settings like diabetes care, sports medicine, and cosmetic clinics.



VIEW ONLINE

Scan the QR code or visit www.steroplast.co.uk/advanced-life-support-equipment.html to view these products online.

Leukomed® IV Film

- A sterile, transparent dressing for IV sites
- Secure fixation and infection protection
- Robust adhesive ensures that the dressing remains in place for up to 7 days
- Clear design allows for continuous monitoring of the IV site
- Available in two sizes



U-Cut shape for cannulas



SKU	SIZE	PACK SIZE
1247L	6cm x 8cm	50
1250L	7cm x 9cm	50

Disposable Gallant Preparation Razor

- For pre-operational procedures
- Contoured handle with ribbed grip
- Detachable blade



SKU	PACK SIZE
1071	Single
1071/50	Pack of 50

IV Dressing Pack

- Everything you need for dressing cannulae and infusion lines
- Meets standard infection control guidelines



SKU
1245

IV Cannula Winged with Injection Port

- Perfect for both emergency kits and everyday use in various medical settings
- Designed with a back-cut needle bevel and a tapered PTFE end
- Specifically designed to mitigate needlestick injuries

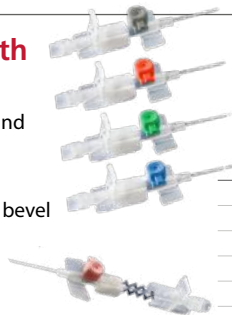

Super Sharp Needle with Dual Cutting Edge

SKU	GAUGE	COLOUR
9595/14	14g	Orange
9595/16	16g	Grey
9595/18	18g	Green
9595/20	20g	Pink
9595/22	22g	Blue
9595/24	24g	Yellow

Quick Release Tourniquet

- One-handed operation with automatic release
- Easy to clean and facilitates maintenance and hygiene in medical settings
- Non-pinching design increases patient comfort during application and removal



SKU	COLOUR
WSTE0145/RED	Red
WSTE0145/YEL	Yellow
WSTE0145/PUR	Purple
WSTE0145/PIN	Pink
WSTE0145/GRE	Green
WSTE0145/BLU	Blue

Tournibutton Tourniquet

- Button fastening system allows simple tightening, repositioning, and single-handed release
- UKCA marked and CE certified for use in professional medical settings
- Designed to help reduce cross-infection risk



SKU	SIZE	PACK SIZE
WSTE0489/PAE	Paediatric	200
WSTE0489	Standard	100
WSTE0489/BAR	Bariatric	30

Alcotip Pre-Injection Skin Cleansing Swabs

- Pre-dosed with 70% isopropyl alcohol
- Compact 30mm x 60 mm
- Non-maceratable for safe disposal



SKU	PACK SIZE
9062	100

PolyFlush Pre-Filled Saline Syringes

- PVC-free, DEHP-free, and latex-free materials
- Pre-assembled format to reduce preparation steps & handling
- Contains 0.9% sodium chloride



SKU	SIZE	PACK SIZE
WSTE0578	3ml	30
WSTE0579	5ml	30
WSTE0580	10ml	30

Luer Syringes

- For precise medication administration and injections
- Syringes for precise medication administration and injections
- Clear millilitre scale markings for accurate measurement
- Choice of Luer Lock or Luer Slip connection
- Luer Slip versions available with concentric or eccentric tips

Luer Slip Tip Syringe

TIP TYPE	SKU	PACK SIZE	SIZE
Concentric	9558/10	Pack Of 10	1ml
Concentric	9620	Pack Of 10	2ml
Concentric	9621	Pack Of 10	5ml
Concentric	9622	Pack Of 10	10ml
Eccentric	9559	Single	20ml
Eccentric	9574	Single	50ml

Luer Lock Syringe

TIP TYPE	SKU	PACK SIZE	SIZE
Concentric	9578	Single	50ml



Standard Hypodermic Sterile Needles for Injection — Pack of 100

- Used for a variety of injection methods, incl. intradermal, subcutaneous, intramuscular, intravenous injection & aspiration
- Suitable for use with both luer and luer lock syringes
- Featuring an extremely sharp needle point and stainless steel construction

SKU	COLOUR	SIZE
9628	Pink	18g - 1.5"
9526	Yellow	20g - 1.5"
9532	Green	21g - 1"
9617	Green	21g - 1.5"
9533	Blue	23g - 1"
9554	Blue	23g - 1.25"
9616	Orange	25g - 5/8"

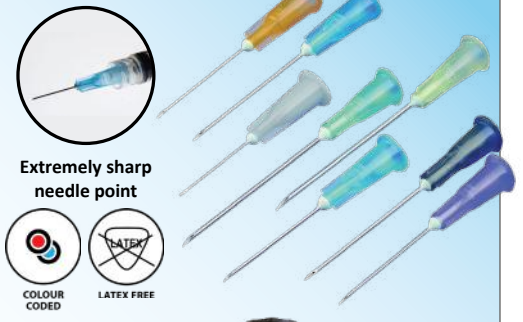

Blunt Fill Needle with 5 Micron Filter — Box of 100

- Latex, PVC, DEHP, and BPA free
- 18G x 1.5" (1.2 x 38 mm)
- Blunt bevel design



SKU
9629

NIO™ Intraosseous Access Device

- Automatic, spring-powered
- Fast insertion in around 10 seconds
- Adjustable penetration depth
- Intended for use by trained healthcare professionals only

SKU	SIZE
WSTE0750	Paediatric — 18g
WSTE0749	Adult — 15g



2.4cm Post-Injection Spot/Dot Plasters

- Small, round 'spot' injection plasters for dressing needle puncture wounds
- Keep injection and phlebotomy safe, hygienic, and efficient in healthcare



SKU	PACK SIZE
7165R	1 Box of 100 Plasters

Persys Bone Injection Gun (B.I.G) Adult — 15G

- User-friendly automatic IO device can be used in under 60 seconds
- Suitable for blood transfusion
- Features a simple "position and press" mechanism

SKU
WSTE0296



TPAK Chest Decompression Needle

A 14 gauge, 3.25" needle designed for effective and safe treatment of tension pneumothorax.



SKU
9561

Single IV Air Venting Needle

- For treating Pneumothorax and managing fluid flow in rigid IV containers
- Individually wrapped in a peel pouch for convenience and sterility

SKU
9626

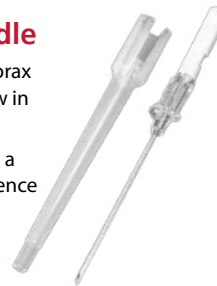

ExactaMed Oral-Enteral Dispenser — 5ml

- Features a female Luer tip, along with a clear barrel marked for accurate dosage
- Reverse Luer Connector prevents accidental IV connections

SKU	PACK SIZE
1259	10



Obturator Male/Female Luer Lock Caps

Sterile, latex-free luer lock caps for secure IV and syringe connections, ensuring safety sterility.



SKU
1251

3 Way Tap with Extension Tube

A versatile, sterile 3-way stopcock system with extension tube for efficient infusion therapy and accurate pressure monitoring.

SKU
9579



SOL-M Oral Dispensing Syringe — 10ml

- 3-Piece Syringe with O-Ring
- Features a safety design and clear measurement markings of fluid delivery

SKU	PACK SIZE
1256	10



Blood Transfusion Giving Set

- For single-patient use
- Suitable for IV administration of blood, albumin, and IVIG, enhancing transfusion versatility
- Embedded 200-micron bacterial filter ensures high safety by blocking bacterial entry during transfusions



SKU
WSTE0173

Sterile IV Fluid Giving Set

- Features standard components for safe and effective fluid delivery
- Allows for precise control over the volume and rate of fluid delivery
- Suitable for hospitals, clinics, and home care for administering fluids, medications, and blood products



SKU
WSTE0200

Maternity Equipment

Ensure safe childbirth in any setting with our emergency maternity equipment. Including umbilical clamps, hygiene essentials, and scissors, our kits are vital for care outside hospitals, especially in areas with limited medical access.

We are proud to supply our high-quality maternity equipment to the emergency services, ensuring that paramedics, first responders, and other emergency personnel are equipped to provide essential care during childbirth emergencies.



VIEW ONLINE

Scan the QR code or visit www.steroplast.co.uk/advanced-life-support-equipment.html to view these products online.

Emergency Maternity Obstetrical Kit

An essential emergency maternity kit with 11 items designed for safe, hygienic, and efficient pre-hospital childbirth assistance.

- Tailored for emergency deliveries
- Offers excellent value
- Designed for easy storage & portability
- Sealed polybag packaging ensures sterility



Includes Umbilical Cord Clamps



Includes Umbilical Cord Scissors



Includes Maternity Pads

SKU
8693

Kit Includes:

- x1 Absorbent Square
- x1 Baby Fleece Blanket
- x1 Disposable Towel
- x2 Maternity Pads
- x1 Blue Nitrile Gloves
- x4 Umbilical Cord Clamps
- x1 Umbilical Cord Cutting Scissors

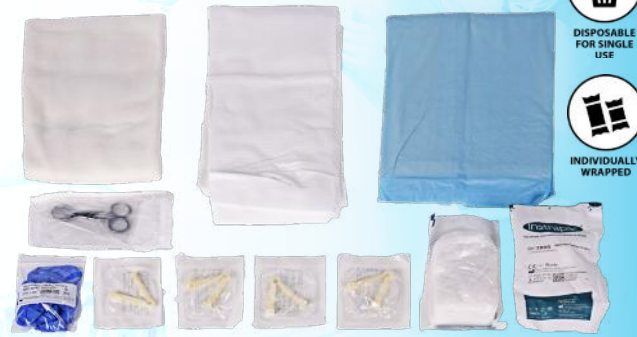

DISPOSABLE FOR SINGLE USE



INDIVIDUALLY WRAPPED

Aurelia® Nitrile Gloves

Durable and hypoallergenic Aurelia Nitrile Gloves are ideal for maternity care and childbirth assistance, providing superior protection.



LATEX FREE



MULTIPLE COLOURS AVAILABLE



SKU	COLOUR	SIZE
1995	Blue	Small
1996	Blue	Medium
1997	Blue	Large
1998	Blue	Extra Large
1995/BLACK	Black	Small
1996/BLACK	Black	Medium
1997/BLACK	Black	Large
1998/BLACK	Black	Extra Large
1941	Purple	Small
1942	Purple	Medium
1943	Purple	Large
1944	Purple	Extra Large

Umbilical Cord Clamps

- Suitable for both medical and veterinary environments
- Dual grip feature offers enhanced control and stability during application



DISPOSABLE FOR SINGLE USE



SKU
WSTE0333

Umbilical Cord Scissors

- Broad, flat, and curved blades designed for precise and clean cutting of umbilical cords
- Designed for precision and longevity



STAINLESS STEEL

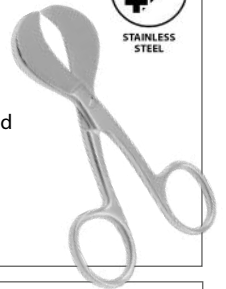

SKU
1548

Disposable Fleece Blanket

- Disposable blanket to reduce cross-contamination
- 100% recyclable - Single use blanket
- Fleece finish for added warmth
- Cost effective option - No laundry costs
- 1.3m x 1.7m soft fleece



DISPOSABLE FOR SINGLE USE

SKU	PACK SIZE
1812	SINGLE
1812/30	30

Wall-Mounted Disposable Glove Dispenser Rack

- A great dispensing and storage solution for nitrile gloves
- Hygienic storage
- Store up to three boxes

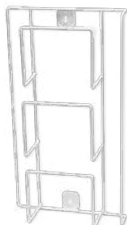

SIZE	SKU
SINGLE	1044
TRIPLE	1045



Surgical Instruments

We provide a wide range of surgical tools for professionals from general surgeons to veterinarians, including essential items like Spencer Wells Artery Forceps and Rociale Suture Packs.

Our inventory supports specialised fields such as ENT, ophthalmology, dentistry, and veterinary surgery, offering precision and reliability.

Additionally, our durable instruments, such as Paramedic Tuff Cut Scissors, are trusted by ER doctors and field surgeons in various settings for critical interventions.



Scan the QR code or visit www.steroplast.co.uk/advanced-life-support-equipment.html to view these products online.

VIEW ONLINE



ERGONOMIC DESIGN



STAINLESS STEEL



MULTIPLE COLOURS AVAILABLE



Paramedic Tuff Cut Scissors — 7.5 inch

- Ideal for emergency responders, with safety features for quick and safe material cutting
- Serrated edge on the lower blade ensures a firm grip on materials during cutting
- Specially designed lower blade: hooked with a rounded tip
- Available in eight different colours for preference or coded departmental use

SKU	COLOUR
1512	Black
1512/GRE	Green
1512/BLU	Blue
1512/PUR	Purple
1512/PIN	Pink
1512/RED	Red
1512/ORA	Orange
1512/YEL	Yellow

Rociale Skin Staple and Clip Remover

- Ergonomic, curved handles for a secure, comfortable grip
- Individually packed for hygienic clinical use

NEW



SKU

WSTE0732



Swann-Morton Disposable Sterile Scalps

- Sterile, single-use design, individually sealed in transparent thermo-formed trays
- Suitable for hospital, GP, A&E, clinic, and procedure pack use
- Colour-changing seal indicator to show if sterility has been compromised
- Graduated markings on handle

NEW



SKU	SIZE	PACK SIZE
SCAL001/1	No. 10	Single
SCAL001	No. 10	Pack of 10
SCAL002/1	No. 11	Single
SCAL002	No. 11	Pack of 10
SCAL005/1	No. 14	Single
SCAL005	No. 14	Pack of 10
SCAL003/1	No. 15	Single
SCAL003	No. 15	Pack of 10
SCAL004/1	No. 21	Single
SCAL004	No. 21	Pack of 10



ERGONOMIC DESIGN



CE MARKED



STAINLESS STEEL



DISPOSABLE FOR SINGLE USE



LATEX FREE

Rociale Suture Pack

- For hygienic suturing procedures
- Presented in a sterile pouch that's effortless to open
- Contains all essentials for suturing, neatly arranged on a poly tray with integrated gallipots
- Fully compliant with the MDD

SKU

1274

Left-Handed Bandage Scissors

- Ergonomic 18cm left-handed bandage scissors
- Featuring a safe rounded tip and precision cutting
- Made from surgical-grade stainless steel

SKU

WSTE0155



STAINLESS STEEL

Spencer Wells Artery Forceps — Straight 7" (18cm)

- Designed for precise intubation procedures
- Compliant with the Medical Devices Directive
- Premium stainless steel

SKU

WSTE0160



STAINLESS STEEL

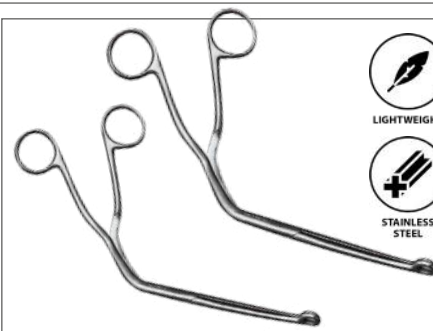

LIGHTWEIGHT



STAINLESS STEEL

Magill Intubation Angled Forceps

- For safe intubation and effective extraction of foreign bodies in the mouth-throat region
- Angled construction offers a clear view of the patient's airway
- High-quality, lightweight stainless steel

SKU

WSTE0155

SIZE

Adult

WSTE0178

Child

Training Equipment for Emergency Response



VIEW ALL

Scan the QR code
to view all
Training Equipment

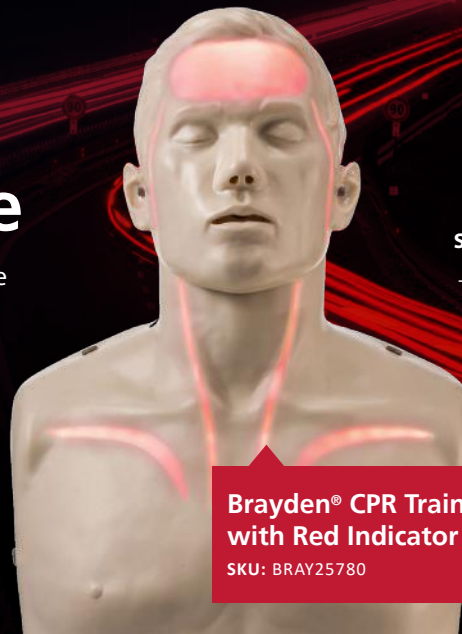

**Brayden® CPR Training Manikin
with Red Indicator Lights**

SKU: BRAY25780

Our training equipment and supplies are made to be as lifelike as possible and used to train responders for the real thing when the time comes.

Our training equipment includes:

- Manikins for practicing CPR and choking rescue
- Dressings, bandages, and slings for wound management and resuscitades for hygienic CPR
- Defibrillator training units for treating cardiac arrest
- Training S.T.A.T. Tourniquets

CPR Manikins

AmbuMan® Training Manikin
SKU: AMBU005



**Laerdal® Q CPR Training
Manikin**
SKU: 1094



Various models are available including
Little Anne, Little Junior and Little Baby.

Choking Charlie Manikin
SKU: 1350



**Adult ActFast® Anti
Choking Rescue Trainer**
SKU: 1349



**Child ActFast® Anti Choking
Rescue Trainer**
SKU: 1349/CH 1349/CH

**Brayden® CPR Advanced
Carry Bag & Mat**
SKU: BRAY25632



Brayden® PRO CPR Manikin
SKU: BRAY25786

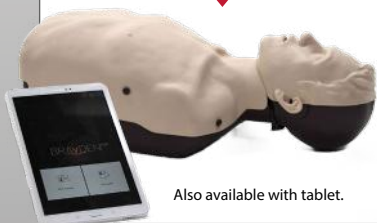

Also available with tablet.



Brayden® CPR Manikin
SKU: BRAY25785



Training Disposables



Resuscitade Keyring
SKU: 9567



Medium Training Dressing
SKU: FFK1001



Resuscitade CPR Face Shield
SKU: 9589/10



Training Pack (Pack of 10)
SKU: 8698/10



Resuscitade Face Shield (36 Roll)
SKU: 9590

Training S.T.A.T. Tourniquets



S.T.A.T. Tourniquet Trainer
SKU: 1146/BLU

Defibrillator Training Units



Zoll® AED Plus — Trainer 2
SKU: ZOLL0002



**iPAD®-SP1 Trainer
Defibrillator**
SKU: 1849

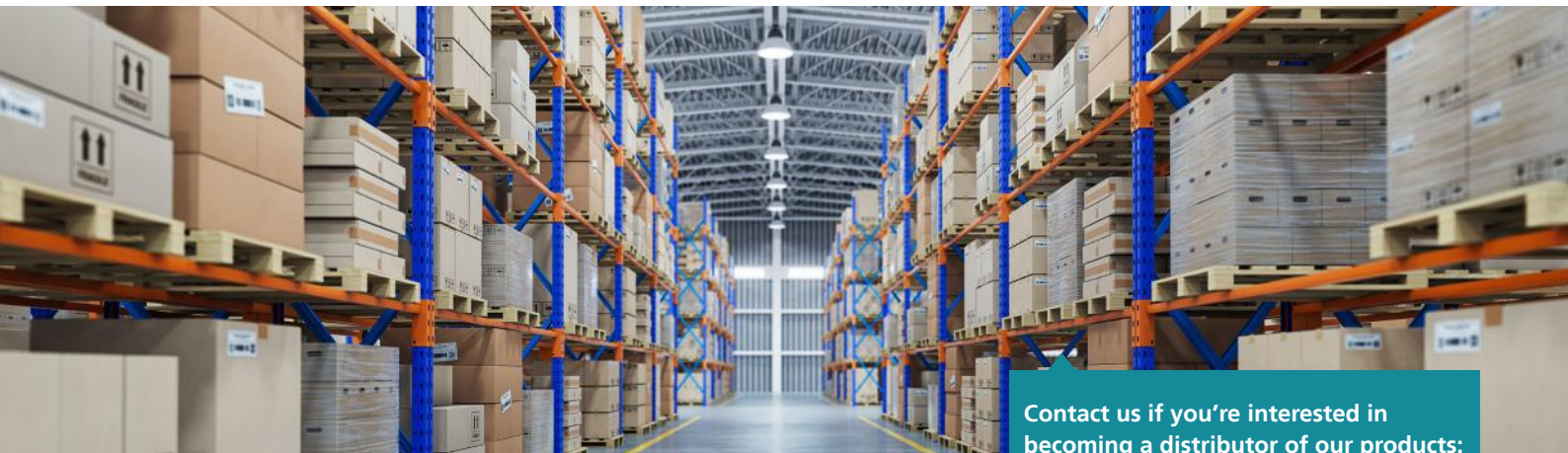

Contact us if you're interested in becoming a distributor of our products:

Call: 0161 902 3030

Email: info@steroplast.co.uk

Steroplast's Global Network: Delivery, Export, and Distribution

Efficient and secure delivery services

We aim to ensure prompt and secure delivery of your healthcare and medical supplies through trusted courier services, with efficient 1–2 working day delivery across the UK mainland. Delivery is free of charge on all website orders over £40 (excl. VAT).

For those near South Manchester, a free collection service from our warehouse is offered, with an option for contactless pickup. Please note, shipping to the Channel Islands, Shetland Islands, Hebrides, and other specified regions requires special arrangements due to extra fees and logistical complexities.

For additional services including early morning and Saturday delivery, please contact us directly.

From the UK, to 57 countries worldwide

Understanding the complexities of international regulations is the key to the dependable service customers turn to for peace of mind.

Export to Europe: As our main export region, we're acutely familiar with all key regulations you must meet for healthcare, pharmaceutical, and medical equipment exports to the EU.

Export to the USA: If you're a US distributor interested in getting FDA approval to supply our products in the US, we're ready to work with you.

Export to the rest of the world: Leveraging our 25 years of industry expertise, we collaborate closely with our US customers to ensure adherence to all necessary regulations for seamless, compliant international trade.



25% of our turnover comes from medical equipment exports to **57 countries** worldwide.

We help distributors build credibility at no extra cost

We are one of the leading suppliers for distributors of medical equipment, consumables & disposables. A partnership with Steroplast can help you increase revenue and build your brand into the one your clients go to whenever they need premium medical and emergency supplies.

Partner with us and benefit from:



Own Branding



Compliance Guidance



Reliable Shipping



Custom Catalogues



Distributor Discounts



Drop-Shipping to Your Customers



Professional Product Photography



Pharmaceutical Supplies

Did you know that Steroplast can supply all your pharmaceuticals and medicines?

You can now buy all your pharmaceuticals and medicines from one location, saving you time and money.

Steroplast stocks everything from GLS products to P-Meds and POM supplies.

POM - Prescription Only Medicines

Any medicine classified as a POM is restricted for use under medical supervision on a prescription only.

P lines - Pharmacy medicines

Medicines classified as "P" lines are restricted for use under the supervision of a pharmacist.

GSL - General Sales List products

Available for sale in general retail outlets (restricted by pack size). These items are considered safe for use without medical supervision.

We guarantee quality assurance and security screening

Our high quality and safety standards extend to everyone who has access to our products, and it's paramount that we uphold this responsibility to our clients.



Our quality system is fully compliant with the MHRA

Medicines and Healthcare products Regulatory Agency

View our full range of pharmacy products online

Scan the QR code to view all of our pharmaceuticals.

www.steroplast.co.uk/our-products/pharmaceuticals.html

Complete our Pharmaceuticals Qualification Form



We can supply POMs to holders of a valid Wholesale Dealer's Licence, OR on receipt of a POM Authorisation Form.

Scan the QR code to complete our Pharmaceuticals Qualification Form online. A member of our team will review your details and be back in touch with further instructions.

Alternatively, fill out the physical version of the form on the next page

Send the completed form to our postal address:

Steroplast Healthcare Ltd,
Unit 2, Alpha Point,
Bradnor Road, Manchester, M22 4TE



Steroplast Healthcare Limited

Customer Qualification / Re-Qualification Form

Customer **MUST** complete where applicable*

Please photocopy for multiple uses.

Form-004

Version No.
03

CUSTOMER QUALIFICATION / RE-QUALIFICATION

Customer Name*	
Corporate/Invoice Address*	
Delivery Address*	
Contact Person (Name, Contact Details):*	
Customer Type:*	<input type="checkbox"/> Hospital <input type="checkbox"/> Pharmacy <input type="checkbox"/> Wholesale Distributor <input type="checkbox"/> Healthcare Professional <input type="checkbox"/> Other (Specify): <input type="checkbox"/> Pre-wholesale Distributor
Product Categories / Service Authorised:*	<input type="checkbox"/> GSL (4.2) <input type="checkbox"/> POM (4.1) <input type="checkbox"/> Pharmacy (4.4) <input type="checkbox"/> Medical Devices <input type="checkbox"/> Other:

Pin/Registration Number*	Nurse / Paramedic DOB*
Expiry Date*	Specimen Signature*
Qualification*	

AUTHORISATION	GMC / GDC Number*
Surname*	Signature*
First Name*	

QUALIFICATION STATUS - for office use only

<input type="checkbox"/> Qualified	<input type="checkbox"/> Conditionally Qualified (Reason):	<input type="checkbox"/> Disqualified (Reason):
------------------------------------	--	---

APPROVALS - for office use only

QA Personnel (Name and Signature):		Date:	
Re-Qualification Due Date			
Added to Approved Customer Index	<input type="checkbox"/> Yes Comments: <input type="checkbox"/> No		
Added to Approved Customer Index By (Name and Signature):		Date:	
Customer Type			

A	
Applicators, Bandage	48
Armbands	14
B	
Bags & Boxes, Empty	13
Bandages	20, 21, 22, 48
Conforming Bandages	22, 48
Crepe Bandages	22
Triangular Bandages	15, 21, 48
Tubular Bandages	22, 48
WOW Bandages	22
Blankets	15
Biohazard Kits	52, 53
Burns	34, 35, 36
Burncare Kits	35
Burncare Dressings & Gels	36
Calcium Gluconate Gel	36
C	
Catering	26, 27, 28, 29
Catering First Aid Kits	27
Blue Plasters & Bandages	28
Cotton Wool - Balls, Buds	15
Blue Plasters & Bandages	28
Critical Injury Kit	33, 39
NEW Cycling First Aid Kits // STEROSPORT ACTIV	25
D	
Defibrillators	56, 57, 58, 59
Disinfectants	55
Dressings	20, 21, 22, 40, 41
Adhesive Dressings, Sutures	20
Ambulance Dressings	22
Steropax Dressings	21

Trauma Dressings	40, 41
Finger Dressings	21
E	
Eyewash Solutions	50, 51
Eyecare Kits	51
Eyewash	51
F	
First Aid Adhesive Label	19
First Aid Kits	50, 51
British Standard (BS8599) First Aid Kits	11
Catering First Aid Kits	27
Childcare First Aid Kits	45, 46
Eco-Friendly First Aid Kit	16, 17
 HSE First Aid Kits (40 Piece, 70 Piece)	11
Lone Worker First Aid Kits	32, 33
Vehicle First Aid Kits	31
First Aid Guidance Leaflets	14
First Aid Kit Wall Brackets	12
First Aid - Childcare	44, 45, 46, 47, 48
Childcare First Aid Kits	45, 46
Children's Plasters & Dressings	47, 48
First Aid Signage	19
First Aid Stations	18
NEW Forestry First Aid	33
Forestry First Aid Kit	33
Trauma, Critical Injury Kit	38, 39, 40, 41
H	
Haemostats & Tourniquets	40
Hot & Cold Packs	15
Ice Packs	15
P	
NEW Paraffin Gauze	19
Pen Torch with Pupil Gauge	15

Pharmaceutical Supplies 98, 99

Plasters 24, 28, 47

Cederroth Plasters 47

Fabric Plasters **Which? Recommended** 24

Hypoallergenic & Children's Plasters 47

X-Ray Detectable Plasters 28

R

Resus Face Shield 15

S

Scissors 14

Seals - Tamper-proof 14

Sharps Disposal 54

Sharps Disposal Kits 54

Sharps Bins 54

Sutures 20

Suture Pack 14

T

Tapes 23

Fabric Strapping Tape 23

Microporous Tape 23

Silk Tape 23

Zinc Oxide Tape 23

Traction Kit 20

Training Supplies 96

Defibrillator Training Units 57, 96

Training Disposables 96

Training Manikins 96

V

Vomit Bags, Bowls 15

W

Wipes 55

PDI Wipes 55

Wound Treatments 20, 21

Ultra-Thin "Second Skin" Wound Dressings 21

Wound Dressings 20, 21



Hospital Specific

Maternity 94

Traction Kits, Bone Alignment, Dislocation 20



Specialist Products

Blast Bandage (Olaes, TacMed) 41

Celox 41

Compressed Gauze 41

Chest Seals (Russell / SAM) 41

Corius Seal 41

Defibrillators 56, 57, 58, 59

Jelonet 36

PACT Kits 42, 43

Tourniquets 40

Trauma Dressing (Prometheus / Steroplast) 41

Zetuvit Absorbent Dressing 20



Advanced Life Support

Airway Management 68, 69, 70, 71

Emergency WaterStop Bags 86, 87, 88

Bandages & Wound Dressings 72, 73

Bleed Control & Trauma 74, 75, 76

Blizzard Survival & Emergency Lighting 77

Burncare 78, 79

Defibrillators & Accessories 80, 81, 82

Diagnostic Equipment 83, 84, 85

Evacuation, Immobilisation & Patient Handling 89, 90, 91

Injection & Infusion 92, 93

Surgical Instruments 95



Knife Crime Related Products

Bleed Control Kit 102

Critical Injury Kit 103

KNIFE CRIME IS ON THE RISE

If you want to be more prepared, here's how...

Following a serious injury causing severe blood loss — you only have minutes!

That's why you must have a Critical Injury Kit or Bleed Control Kit. Supplied with specialist dressings to treat traumatic wounds.

Steroplast's "Bleed Control Kits" are specifically designed to control and stop severe blood loss

In the event of a stabbing or similar injury. The kit is equipped with tried and tested products (see contents) that will enable you to help save a friend, a colleague or loved one's life.

A life saver designed for anyone to use

Supplied with easy to follow instructions so that anyone can help out in a crisis.



53,047

offences involving knives or sharp instruments between 2024 and 2025.

44%

of homicides involved a knife or sharp instrument as the method of killing.

4%

increase in knife-enabled crime recorded by police from 2023 to 2024.

4,986

recorded hospital admissions in England for sharp object assault in the YE Mar 2024.

Source: Office for National Statistics (ONS), Crime in England and Wales bulletins for the years ending March 2024 and March 2025.



Bleed Control Kit (SKU: 6824)

CONTENTS	QTY
First Aid Guidance Leaflet	1
Foil Blanket	1
Nitrile Gloves in Pairs	2
Tuff Cut Scissors	1
Tourniquet	1
Haemostatic Wound Dressing	2
Large Trauma Dressing	2

Order your life-saving kit today!

Call: +44 (0)161 902 3030

Email: sales@steroplast.co.uk

Made to
British
Standard
8599-1



If someone gets stabbed you might only have **3 minutes** to stem the blood flow!

How? By using a Critical Injury Kit (SKU: 8599-C)

Critical Injury Kit (SKU: 8599-C)

CONTENTS	QTY
Chito-Sam 100 Haemostatic Dressing	2
Foil Blanket	1
First Aid Guidance Leaflet	1
Nitrile Gloves in Pairs	2
Trauma Dressing	2
S.T.A.T. Tourniquet	1
Tuff Cut Scissors	1

These kits contain three items specifically for severe blood loss caused by serious injuries:

- ☑ Tourniquet
- ☑ Haemostatic wound dressing
- ☑ Trauma dressing

They are meant for employees that are exposed to greater risk of serious injury.



SKU: 1146

S.T.A.T. Tourniquet

- ☑ Timer starts counting once activated
- ☑ Rounded edges avoid skin cuts, less trauma to the patient
- ☑ No skin reactions – it's latex-free



SKU: 6830

Trauma Dressing

- ☑ Applies instant direct pressure
- ☑ Quickly stems major blood loss
- ☑ Quick to secure with Velcro fastening

"First aid" is just that

The first form of aid when someone gets injured! You can help someone who's injured while waiting for medical professionals to arrive on scene!



SCAN ME

Watch our quick how-to videos on using products from our trauma range

▶ YouTube @Steroplast

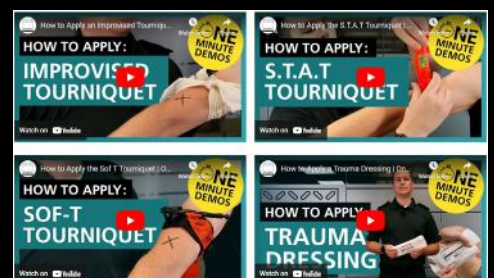

Sterosport.co.uk – your ultimate destination for sports essentials

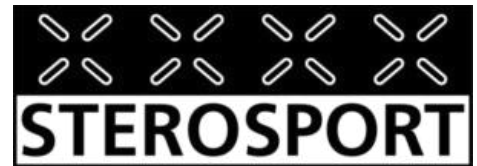

A division of Steroplast Healthcare

Exclusive bespoke pricing for all Sterosport members

Like other sports medical companies, we provide bespoke pricing with a dedicated account manager. **However, what sets us apart is the convenience we offer.** Once you've established your bespoke price list, you have the option to bypass the traditional quote requests.

Our website sterosport.co.uk grants direct access to your personalised prices through your online account, letting you place orders at your pace and price, directly online, whenever you choose.

Organisations that put their trust in us...

Trust is earned, and we've spent **over 30 years** building that trust through our parent company Steroplast Healthcare, and more recently through its sports division Sterosport.

We're proud to partner with and supply products to:

- ✓ Professional sports teams
- ✓ National Governing Bodies
- ✓ Community sports clubs, sports physiotherapists and a range of sports and leisure facilities.



Get your FREE Club-Branded Sports First Aid Kit

Spend over **£40*** on sterosport.co.uk and we'll include a **FREE sports first aid kit, customised with your club or team logo.** Perfect for match days and training sessions.

Contact Andrew to request yours: ☎ **07395 796801** ✉ andrew@sterosport.co.uk

Limited to one kit per club. Custom label subject to artwork approval. *Minimum £40 spend excl. VAT.

The Injury Rehab Network:

Hosting unmissable events in partnership with BASRaT

(British Association of Sport Rehabilitators)

The "Injury Rehab Network's" reputation and the calibre of expert guest speakers has seen the events really take off. BASRaT's members, and the quality of the events gains large audiences with unique, insightful and evidence-based presentations from world-class sports medicine professionals, the popularity continues to gain momentum.

In person and Zoom attendance available



Create an account to get access to the **Injury Rehab Network**

Visit www.sterosport.co.uk to register your interest in upcoming events