

Be safe. Be sure



SHOCKS, STRUTS, CARTRIDGES & GASLIFTS

2022 EDITION

GABRIEL PRODUCT RANGE:

TECHNOMATIC

FLEETRYDER

GASRYDER

SAFARI 

SAFARI HDP 

GASLIFT 

8 SIGNS OF WORN SHOCKS



STEERING WHEEL
VIBRATES



CAR VEERS EXCESSIVELY
IN SIDE WINDS



CAR NOSE-DIVES
WHEN BRAKING



CAR DOES NOT HUG THE
ROAD ON BENDS



DENTED OR
DAMAGED HOUSING



OIL SEEPS FROM YOUR
SHOCK ABSORBERS



BALD PATCHES
ON TYRES



EXCESSIVE BOUNCE ON
ROUGH SURFACES



Be safe. Be sure

Gabriel



www.gabriel.co.za







GabrielShocksZA



[gabrielshocksza](https://twitter.com/gabrielshocksza)



CONTENTS

How to use the Catalogue		2
SHOCKS, STRUTS & CARTRIDGES		
Key Descriptions – Icons		4
Fitment Guide Instruction Notes		5
OVERVIEW		7
Product Range		8
VEHICLE LISTING		13
	• Passenger Vehicles	13
	• Heavy Commercial Vehicles (HCV)	55
PARTS LISTING		79
	Parts Listing	79
	Parts Finder	145
TECHNICAL INFORMATION		175
	• Key to Mounting Codes	176
	• How to Measure Extended and Collapsed Lengths	176
	• How to Protect your Struts	176
	• Technical guide to drawings	177
	• Removal and fitment of shocks	178
	• Removal and fitment of struts	179
	• Parts Listing	180
GASLIFTS & STEERING DAMPERS		198
	Product Range and General Information	198
	Gas Filling Machine	200
	Gaslifts Custom Range	200
	Vehicle Listing	202
	Parts Listing	205
	Extended & Collapsed Lengths	208
	Steering Dampers	214
TERMS & CONDITIONS		
Warranty Policy		215
Processing a Warranty		216



HOW TO USE THE CATALOGUE

VEHICLE LISTING

Vehicle make sorted in alpha-numeric order

Vehicle model sorted in alpha-numeric order

Model derivative sorted in alpha-numeric order

Vehicle or shock specific information (refer to the fitment guide on page 4)

Front part numbers

Back part numbers

Icon indicates shock type. Refer to page 3 for more details

The first part number is for the left hand side and the second part number for right hand side

Derivative	Year	Vehicle Type	Fitment Guide #	FRONT				REAR				GASLIFT		
				Shock Info	Part #	L/R	Range	Shock Info	Part #	L/R	Range	Front	Rear	
AUDI														
80														
B1 (1600 GL, GLS)	75-81				44602	↔	Technomatic		G45715	↔	Technomatic		1234	
100, 200														
C2	77-84		14		61303	↔	Gas Ryder		36853	↔	Technomatic	1234		
A3														
Excl. S3 (8L1)	98-03				55872	↔	Gas Ryder		61262	↔	Gas Ryder	↔		
50mm Strut Body. All (8P1) - Excl. Quattro, sport susp. & S3	03-12				70546	↔	Technomatic		69507	↔	Technomatic	↔		

Vehicle introduction year to replacement year. For open ended periods (19...) search by model, not period

Vehicle type. Refer to page 3 for more information

Fitment position (L - Left, R - Right) or both sides (↔)

Range options available for the same vehicle model. The first listed is the preferred brand and those that follow are the alternatives.

PARTS LISTING

Part numbers in alpha-numerical order

Product range

Icon and figure indicates shock type. Refer to page 3 for more details

Refer to vehicle listing keys as per above

Part #	Range	Superceding Part #/Status	Product Type	Make	Model	Derivative	Year	Position	L/R	Fitment Guide #
18727	Technomatic		8, 5	Volkswagen	Beetle	MK I	52-79	Front	↔	4
				Volkswagen	Kombi	Microbus, Fleetline (swing axle rear)	55-78	Front	↔	
				Volkswagen	Kombi	Microbus, Fleetline (swing axle rear)	55-78	Rear	↔	
35117	Gas Ryder		1, 1	Renault	Laguna	I (Excl. Station Wagon)	96-00	Front	↔	
35816	Technomatic		1, 1	Ford	Bantam	1300, 1600	83-86	Front	↔	
				Ford	Escort	Mk III Fwd L, GL, GLE	81-86	Front	↔	
				Ford	Escort	Mk III Fwd XR3, Sport	81-86	Front	↔	
				Mazda	Rustler	130, 160	85-86	Front	↔	

HOW TO USE THE CATALOGUE

PARTS FINDER

Reference to brands, trademarks or manufacturers part numbers are for reference and identification purposes only

Part #	Manufacturer	Gabriel	
		Primary	Alternative
AUTOCOM			
PL15001	Autocom	55818	
PL15002	Autocom	55819	
PL15003	Autocom	G45869	G56309
PL15004	Autocom	G45873	36875
PL15005	Autocom	G56211	
PL15006	Autocom	G56209	69415
PL15008	Autocom	G45871	69924

Annotations for the Parts Finder table:

- Vehicle make sorted in alpha-numeric order (points to 'AUTOCOM' header)
- Vehicle make sorted in alpha-numeric order (points to 'Autocom' manufacturer)
- Manufacturers part numbers in alpha-numerical order (points to '55818', '55819', 'G45869', 'G45873')
- The primary recommended alternative (points to 'G56211')
- An additional recommended alternative (points to '69415')

TECHNICAL INFORMATION - Extended & Collapsed Lengths

Collapsed Length	Extended Length	Upper Mounting	Lower Mounting	Accessory Pack Part No.	Shock Type			Part #
					Icon	Fig	Code	
Gabriel Gas Ryder								
SHOCK ABSORBERS - Stud upper, Bar pin lower								
222	335	S	BPx70.0	⊥	4	S/BP	61283
235	467	S	BPx75.0	⊥	4	S/BP	61243
SHOCK ABSORBERS - Stud upper and lower								
243	383	S	S	⊥	5	S/S	G63920
262	390	S	S	⊥	5	S/S	G63799
228	348	S	SE12x32	⊕	6.2	S/SE	61287
231	348	S	SE12x34.0	⊕	6.2	S/SE	G63933



















Annotations for the Technical Information table:

- The listings are segmented by range (points to 'SHOCK ABSORBERS - Stud upper, Bar pin lower')
- Type of damper by figure number, icon and code (refer to page 177 for more information) (points to '4', '⊥', 'S/BP')
- Damper part numbers (points to '61283', '61243')
- The different type of dampers in each range are listed by type (points to 'SHOCK ABSORBERS - Stud upper and lower')
- The dampers are listed by their fully collapsed lengths (points to '243', '262')
- Length of damper when fully extended (points to '390')
- Mounting Code at the top of the damper - refer to list in technical section (points to 'S/SE')















KEY DESCRIPTIONS - Mounting Codes

Rubber Eyes	Sleeved Eyes	Other		
RE 16 = 16 mm I.D	SE 9 = 9 mm I.D	SE 16 = 16 mm I.D	B = Bracket	P = Plate
RE 17 = 17 mm I.D	SE 10 = 10 mm I.D	SE 19 = 19 mm I.D	BP = Bar Pin	S = Stud
RE 20 = 20 mm I.D	SE 11 = 11 mm I.D	SE 20 = 20 mm I.D	BT = Bolt	SM = Special Mounting
RE 22 = 22 mm I.D	SE 12 = 12 mm I.D	SE 22 = 22 mm I.D	C = Cartridge	SS = Spring Seat Stud
RE 25 = 25 mm I.D	SE 13 = 13 mm I.D	SE 24 = 24 mm I.D	DS = Dual Stud	SSE = Spring Seat Sleeved Eye
	SE 14 = 14 mm I.D	SE 25 = 25 mm I.D	I.D = Inner Diameter	UB = U Bracket
	SE 15 = 15 mm I.D	SE 31 = 31 mm I.D		

KEY DESCRIPTIONS – ICONS

	All models		Electronically adjustable suspension
	Passenger Car/Sedan (4 door)		Sport suspension
	Hatchback/Fastback		Self levelling suspension
	Estate/Station wagon	L / Left	Left hand side
	Coupe	R / Right	Right hand side
	Convertible	←→	Both Left and Right Hand Side
	LCV/Pick-up/Bakkie	Excl.	Excluding
	Panel van/Commercial	Incl.	Including
	Minibus	Susp.	Suspension
	MPV	Part #	Part number
	SUV	Fig 1	Gabriel® MacPherson Strut
	Panel van/Truck	Fig 2	Gabriel® MacPherson Cartridge
	Chassis Cab	Fig 3	Gabriel® Springseat Shock Absorber
	Truck	Fig 4 to 13	Gabriel® Shock Absorbers
	Trailer	Fig 14	Gabriel® Gaslift®
	Bus	Fig 15	Gabriel® Steering Damper

Refer to technical guide to drawings on page 171 for more information

	Gabriel® MacPherson strut		Eye and stud shock absorber
	Gabriel® MacPherson cartridge		Eye and barpin shock absorber
	Gabriel® Springseat shock absorber		Eye and special mounting shock absorber
	Stud and barpin shock absorber		Barpin and stud shock absorber
	Stud and stud shock absorber		Barpin and eye shock absorber
	Stud and eye shock absorber (with or without dust cover)		Gabriel® Gaslift®
	Stud and special mounting shock absorber		Gabriel® Steering damper
	Eye and eye shock absorber		

FITMENT GUIDE INSTRUCTION NOTES*

Note	Fitment Guide
1	Fit 2.5mm spacer either side lower sleeve front mounting
2	For rear use 414075 for lower mounting
3	For rear use sleeve 414164 and 414081 - top and bottom
4	Imported Beetle front use 19289, remove bar pin, fit 404702 + 414167
5	Remove lower sleeve
6	Remove top front shock bushing - fit 404702 plus 414167 remove sleeve lower mount
7	Re-use rear lower mounting bushes
8	Re-use rear lower mounting bushes. Using G45874 OR 61242 upside down does not work
9	Re-use spring seat upper mounting and bump rubber for rear shock
10	Use 414371 retainer (M48 x 1.0) for front
11	Use existing rear mounting
12	Use existing upper front mounting
13	Use existing upper rear assembly
14	Use existing upper rear mounting
15	Use kit 140729 for rear
16	Use kit 144028 x 2 for front and rear mountings
17	Use retainer 414334 with RS2000
18	Use retainer 414363 (M48 x 1.5) when replacing Bilstein O.E. front units. Use existing upper rear mounting

Note	Fitment Guide
19	Use sleeve 414167 lower for rear mounting
20	Use sleeve 414167 upper and lower for rear
21	When replacing struts with welded brake brackets use 414480 & 414481 brackets for rear
22	With rear lower eye mounting
23	With rear lower mounting bracket
24	Only fits applications with one pin at the bottom strut mounting
25	Re-use spring seat, upper mounting and bump rubber for rear shock
26	76042 for models with 25mm rubber bushes upper and lower. 76017 for models with 20mm sleeves upper and lower
27	77022 with Neway ARD 125/244 air suspension. 77018 with Hendrickson TA 460 air suspension
28	O.E. 16-13947-000 or 6913260400 for 85319 and O.E. 16-13957-000 or 680339 for 85724
29	Some use G56102 with 16mm eyes
30	Use 20mm spacer on lower mounting
31	Use 4 x 401754 rubber bushes
32	Use rubber bush 414323 x 2 for front and rear
33	Refer to fitment instructions located inside the box

* Should a fitment guide number not be specified, please revert to the standard fitment instructions on pages 178 and 179



OVERVIEW

Gabriel designs, engineers and manufactures shock absorbers for both the South African and international markets.

Gabriel's state of the art manufacturing facility (based in Retreat, Cape Town) houses its own product development, engineering and manufacturing divisions whereby products are designed and manufactured to the highest quality standards and distributed throughout the African continent.

All genuine Gabriel products are comprehensively tested by a team of qualified engineers and Gabriel's comprehensive range of shock absorbers are specifically designed and engineered to suit local South African conditions.

The Gabriel range includes:

- Gas and hydraulic shock absorbers
- MacPherson struts and cartridges
- Steering dampers
- Gaslifts®
- Accessories

The Gabriel product range is supplied through its wide distribution network under the following well known brands:

- Gabriel® Gas Rider™,
- Gabriel® Safari™
- Gabriel® Safari HDP™
- Gabriel® Technomatic™
- Gabriel® Fleet Ryder®
- Gabriel® Gaslifts®

Drivers who use Gabriel shock absorbers comment on the smooth ride of their vehicles, however shock absorbers are not just for comfort – their primary purpose is to keep the wheels in contact with the road surface. Shock Absorbers also affect the steering, handling and braking of your vehicle, which is why they are vital for your safety.

Our years of research and testing have resulted in Gabriel developing shock absorbers that are firm enough to prevent the wheels from leaving the road surface, but also flexible enough to ensure that the occupants are not directly subjected to the vehicle's forces.

Gabriel shock absorbers limit the bounce of the wheels by controlling the rate at which the suspension springs compress and extend. In doing so, the shock absorbers help maintain traction and control of the body, as well as the pitch and roll of the car during cornering, braking and acceleration. With more accurate control and steering, Gabriel shock absorbers enhance safety through good road holding.

PRODUCT FEATURES & BENEFITS

Product Area	Product Type	Product Feature and Benefits	Brand:	GASRYDER	TECHNOMATIC	SAFARI	SAFARI HDP	FLEETRYDER	GASLIFT
			Vehicle Type:	Passenger vehicles, MPV & SUV		MPV, SUV, LDV, MCV & Older Passenger Cars		MCV, HCV	Vehicle & Industrial
			Range:	Premium Range	Standard Range	On & Off Road Range	On & Off Road Heavy Duty Range	Heavy Duty Truck and Bus Range	Vehicle & Industrial Gas Stay Range
Design Type	Shock Absorber	Designed for all types of vehicles	✓	✓	✓	✓	✓	✓	
	Spring Seat	Designed for mainly passenger and SUV's	✓	✓	✓	✓			
	Gaslift	Designed for automotive and industrial applications							✓
	Twin Tube	Designed for all types of vehicles	✓	✓	✓	✓	✓	✓	
	Mono Tube	Designed for mainly SUV's and MPV's	✓		✓	✓			
	MacPherson Struts	Designed for mainly passenger vehicles	✓	✓					
Suspensions	Standard	The vast majority of vehicles in South Africa	✓	✓	✓	✓	✓	✓	
	Air Suspensions	A limited amount of vehicles in South Africa						✓	
	Raised	Specialist vehicle applications, mainly custom 4x4's				✓			
Bore Size	Working Cylinder Bore Size (mm)	The larger the bore size the better the energy dissipation	27/30/32/36	27/32	32	35/41/46	41/52	19/22	
Oil	Custom Formulated Oil	Specially formulated oil to meet Gabriel's specifications	1200 C	1200 C	1200 C	1800 C	1200 C	80°C	
Gas and Pressures	Hydraulic	Standard feature on most shocks		✓				✓	
	Low Pressure gas	Gives a faster response time and less chance of the oil foaming		✓	✓				Variable pressure
	Nitrogen infused	Gives a much faster response time and less chance of the oil foaming	✓	✓	✓	✓			
	High Pressure	Gives exceptional ride control and a quicker response time	✓			✓			
Bushing	Natural Rubber	Designed to match original equipment durability properties	✓	✓	✓	✓	✓	✓	
	Polyurethane	Designed to exceed original equipment durability properties			✓	✓			
Seals	Viton or rubber rod seals	Designed to withstand high operating temperatures	✓	✓	✓	✓			
	Single lip rod seals	Designed as a standard feature with good wear properties	✓		✓			✓	✓
	Multi lip rod seals	Specifically designed for better sealing and longer life expectancy	✓	✓	✓			✓	
	Rubber o-ring piston seals	Designed as a standard feature with good wear properties	✓						
	PTFE band o-ring piston seals	Specifically designed for reducing friction and providing longer product usage	✓	✓	✓				
	Cast iron o-ring piston seals	Specifically designed for reducing friction and providing longer product usage					✓	✓	
Rods and Product Finishing	Chrome plated & trication of zinc phosphate shaft (piston rod)	Highest quality finish on rods to reduce wear and protect against rust	✓	✓	✓	✓	✓	✓	✓
	Sintered (combination of metals) metal rod guides	Standard feature on most Gabriel shocks	✓	✓	✓				

PRODUCT FEATURES & BENEFITS

Product Area	Product Type	Product Feature and Benefits	Brand:	GASRYDER	TECHNOMATIC	SAFARI	SAFARI HDP	FLEETRYDER	GASLIFT
			Vehicle Type:	Passenger vehicles, MPV & SUV		MPV, SUV, LDV, MCV & Older Passenger Cars		MCV, HCV	Vehicle & Industrial
			Range:	Premium Range	Standard Range	On & Off Road Range	On & Off Road Heavy Duty Range	Heavy Duty Truck and Bus Range	Vehicle & Industrial Gas Stay Range
Additional Design Criteria	Cast iron piston ring	Allows for greater durability in high operating temperatures than the alternative Teflon type ring					✓	✓	
	Teflon DU piston band insert	Designed to reduce friction between the rod and rod guide	✓	✓	✓				
	Bump Stop support	Designed to stop metal to metal contact and such damage to the shock	✓	✓					
	Strike Plate bump stop support	Designed to stop metal to metal contact and such damage to the shock		✓	✓				
	Velocity sensitive valving	Specifically designed to adjust the ride and handling performance based on differing factors such as road surface and speed	✓				✓		
	Hydraulic lock	Designed to prevents metal to metal contact under full extension and such damage to the shock					✓		
	360° Reinforce welded mounts	Increased weld strength for extreme conditions as opposed to 180 and tack welds					✓		
	Solid machined eye rings	Provides for stronger and more durable mountings as opposed to split types	✓				✓		
Colouring	White	Electrostatically applied paint (cosmetic)		✓	✓				✓
	Black	Electrostatically applied paint (cosmetic)	✓					✓	✓
	Green	Electrostatically applied paint (cosmetic)				✓			
Dust Covers	Metal	A Standard feature that protects your product from damage	✓	✓	✓			✓	
	Rubber/Plastic	A Standard feature that protects your product from damage	✓	✓		✓			
Accreditation	ISO 9000	Piece of mind that our quality production standards are met (International)	✓	✓	✓	✓		✓	✓
	ISO 14001	Piece of mind that our quality production standards are met (International)	✓	✓	✓	✓		✓	✓
	BSI (British Standards Institution)	Piece of mind that our quality production standards are met (local RSA)	✓	✓	✓	✓		✓	✓
Warranty Period	Standard - Time (Years)	Gabriel quality guarantee	3	3	3	3		1	1
	Standard - Distance (Km)	Gabriel quality guarantee	Unlimited	Unlimited	Unlimited	Unlimited		20 000	Unlimited
	Extended 3 to 5 Year	Gabriel quality guarantee	✓	✓	✓	✓			

PRODUCT RANGE

GASRYDER

The Gabriel Gas Ryder Series offers an extensive range of South African shock absorbers, spring seat shock absorbers, MacPherson struts and MacPherson cartridges for passenger cars, sports cars, station wagons, small LCV's, MPV's and SUV's.

With the unique nitrogen gas-pressured dynamic response design, Gabriel Gas Ryder gives both an exceptional ride as well as a quicker response time compared to ordinary shock absorbers – the ultimate in both comfort and safety.

Allowing for greater ride control and performance, comfort and ultimately safety, the Gabriel Gas Ryder and its Gabriel warranty delivers up to its historical South African pedigree and provides for total driving peace of mind.



GABRIEL® GAS RYDER™ STRUT



GABRIEL® GAS RYDER™ SPRING SEAT



GABRIEL® GAS RYDER™ SHOCK



GABRIEL® GAS RYDER™ CARTRIDGE

TECHNOMATIC

The Gabriel Technomatic Series offers an extensive range of robust and genuine South African shock absorbers, spring seat shock absorbers, MacPherson struts and MacPherson cartridges for today's passenger cars. Station wagons, MPV and LCV applications for use on both tar and gravel road surfaces.

Providing a firm yet comfortable ride with a fast response time, the Gabriel Technomatic Series and its Gabriel warranty delivers up to its historical South African pedigree and provides for total driving peace of mind.



GABRIEL® TECHNOMATIC™ STRUT CARTRIDGE



GABRIEL® TECHNOMATIC™ STRUT



GABRIEL® TECHNOMATIC™ SPRING SEAT



GABRIEL® TECHNOMATIC™ SHOCK

PRODUCT RANGE



The Gabriel Safari Series offers an extensive range of genuine, robust large bore South African oil and gas shock absorbers catering for the demanding requirements of today's light commercial, heavy passenger vehicles, station wagon, South African taxi's, SUV and MPV applications both on and off-road.

Allowing for greater ride control, comfort and ultimately safety, the Gabriel Safari Series and its Gabriel warranty delivers up to its historical South African pedigree and provides for total driving peace of mind.



GABRIEL® SAFARI™ SPRING SEAT SHOCK



GABRIEL® SAFARI™ GAS SHOCK

SAFARI HDP

The Gabriel Safari HDP is a genuine robust, technologically advanced, big bore shock absorber specifically designed and manufactured in South Africa to cater for the heavy-duty performance requirements of today's SUV, 4x4 and light commercial applications.

Allowing for greater ride control and increased comfort over other comparative shock absorbers in the market, the Gabriel Safari HDP and its 3 year unlimited kilometer warranty delivers up to its historical Gabriel pedigree and also sets a new standard for performance based shock absorber applications.



GABRIEL® SAFARI HDP™ SHOCK



GABRIEL® SAFARI HDP™ SPRING SEAT SHOCK

PRODUCT RANGE

FLEETRYDER

The Gabriel Fleet Ryder Series offers an extensive range of robust and genuine extra large bore South African shock absorbers designed to meet the pressing requirement of today's heavy commercial vehicle and fleet applications.

Providing a firm yet comfortable ride with a fast response time the Gabriel Fleet Ryder Series and its Gabriel warranty delivers up to its historical South African pedigree and provides for total driving peace of mind.



THE GABRIEL® FLEET RYDER® SHOCK

GASLIFT

The Gabriel® Gaslift® series is designed to be a hassle free and customisable solution to assist in many various applications from, bonnet and boot applications, opening, holding open and closing doors to canopies, sun beds and window solution.

The Gabriel® Gaslift® range is also available in extensive automotive and industrial applications.

The range is supported through a variety of connection end fittings. Further, there is a national gas filling solution to fill units to a specific pressure to meet the required weight, angle and solution.

All of the range is covered by the Gabriel warranty and delivers up to its historical South African pedigree and provides for total peace of mind.



GABRIEL® GASLIFT®



GABRIEL® GASLIFT®



VEHICLE LISTING

SHOCKS, STRUTS & CARTRIDGES



PASSENGER & LCV

The Vehicle Listing section is an easy to use vehicle reference to all Gabriel part numbers, product ranges and technical information according to the specific vehicle make, model, derivative and year: This Includes all passenger cars, MPVs, SUVs, 4X4s, Pick-ups, Trucks and Busses.

The product ranges that are highlighted in this section include the Gabriel Gas Ryder™, Safari™, Safari HDP™, Technomatic™, Fleet Ryder® and Heavy Duty Shocks, Struts and Cartridges.

Where a vehicle is referenced to more than one part number/range of Gabriel product, please refer to the section at the beginning of the catalogue (beginning on page 3) where we define the main features, benefits, placement and warranty of each range offered.

The preferred part number/range for each application listing is always listed at the top with preferred alternatives below.

Section Content	Page
 Passenger & Light Commercial Vehicles	13
 Heavy Commercial Vehicles	55



Derivative	Year	Vehicle Type	Fitment Guide #	FRONT				REAR				GASLIFT		
				Shock Info	Part #	L/R	Range	Shock Info	Part #	L/R	Range	Front	Rear	
ALFA ROMEO														
147														
1.6, 2.0 (937)	01-10				G51231	↔	Gas Ryder							
155														
2.0 (Excl.	96-98								69919	↔	Gas Ryder			
2.5 (Excl.	96-98								69919	↔	Gas Ryder			
156														
2.0 Twin Spark (932) (Excl. (VETO116246→)	98-06				G51217	↔	Gas Ryder							
2.5 V6 (932) (VETO116246→)	98-06				G51231	↔	Gas Ryder							
2.0 Twin Spark (932) (Excl. (←VETO116245)	97-98				G51217	↔	Gas Ryder							
2.5 V6 (932) (←VETO116245)	97-98				G51231	↔	Gas Ryder							
ALFETTA, GIULIETTA, SUPER														
Incl (159i, 1600, 1800, GT 1.8, 2000, 2000 GTV)	73-86				G45666	↔	Technomatic		G45667	↔	Technomatic			
OTHER														
Incl Giulia	66-77				G45122	↔	Technomatic							
AUDI														
80														
B1 (1600 GL, GLS)	75-81				44602	↔	Technomatic		G45715	↔	Technomatic			
100, 200														
Excl. Coupe (C1)	72-74		12						36854	↔	Technomatic			
Excl. Coupe (C1)	75-77		12						36854	↔	Technomatic			
C2	77-84		14		61303	↔	Gas Ryder		36853	↔	Technomatic			
400, 500														
C3, C4	83-94		14		61303	↔	Gas Ryder		69072	↔	Gas Ryder	4081		
A1														
Hatch 1.2 TFSI, 1.4 TFSI, 1.6 Tdi (8X1, 8XA) incl. Sport Susp. Excl. 4WD	11-19				70714	↔	Gas Ryder		G45879	↔	Technomatic			
A3														
Excl. S3 (8L1)	98-03				55872	↔	Gas Ryder		61262	↔	Gas Ryder			
50mm Strut Body. All (8P1) - Excl. Quattro, sport susp. & S3	03-12				70546	↔	Gas Ryder		69507	↔	Gas Ryder			
55mm Strut Body. All (8P1) - Excl. Quattro, sport susp. & S3	03-12				70640	↔	Gas Ryder		69507	↔	Gas Ryder			
50mm Strut Body. Sportback (8PA) Excl. Quattro, sport susp. & S3	05-12				70546	↔	Gas Ryder		69507	↔	Gas Ryder			
55mm Strut Body. Sportback (8PA) Excl. Quattro, sport susp. & S3	05-12				70640	↔	Gas Ryder		69507	↔	Gas Ryder			

Derivative	Year	Vehicle Type	Fitment Guide #	FRONT				REAR				GASLIFT	
				Shock Info	Part #	L/R	Range	Shock Info	Part #	L/R	Range	Front	Rear
AUDI (Continued)													
A4													
1.8, 2.4, 2.6, 2.8 Excl. Quattro (B5)	94-01				69087	↔	Gas Ryder		G51023	↔	Gas Ryder		
Quattro Excl. sport Susp. (B5)	94-01				69087	↔	Gas Ryder						
Excl. sport Susp. (B6)	01-05				69101	↔	Gas Ryder	$\frac{1}{\circ}$	61298	↔	Gas Ryder		
Excl. sport Susp. (B7)	05-08				69101	↔	Gas Ryder	$\frac{1}{\circ}$	62024	↔	Gas Ryder		
Sport Susp. Incl. Avant & Quattro (Excl. All Road, S4 & RS4) B7 model	05-08							$\frac{1}{\circ}$	62003	↔	Gas Ryder		
B8 (Excl. Sport Susp, Quattro & S4)	08 on							$\frac{1}{\circ}$	62057	↔	Gas Ryder		
A6													
Incl Avant. Excl. Quattro (C4)	94-97		14		61303	↔	Gas Ryder		69072	↔	Gas Ryder		
Excl. & Quattro (C5)	97-04				G51101	↔	Gas Ryder	$\frac{1}{\circ}$	69946	↔	Gas Ryder		
Quattro (C5)	97-04				G51101	↔	Gas Ryder						
All Excl. Air susp. - C6 (Type 4F)	04-11							$\frac{1}{\circ}$	62034	↔	Gas Ryder		
AUSTIN, MORRIS													
MINI													
Incl Cooper	59-80			$\frac{1}{\circ}$	19021	↔	Technomatic	$\frac{1}{\circ}$	19022	↔	Technomatic		
Excl. Hydrolastic Susp	59-85			$\frac{1}{\circ}$	19021	↔	Technomatic	$\frac{1}{\circ}$	19022	↔	Technomatic		
Incl Mk III	61-79			$\frac{1}{\circ}$	19021	↔	Technomatic	$\frac{1}{\circ}$	19022	↔	Technomatic		
BMW													
1 SERIES													
E87 5-Door (Excl. Sport susp. & 135i)	04-11				70577	L	Gas Ryder	$\frac{1}{\dagger}$	69102	↔	Gas Ryder		
					70578	R	Gas Ryder						
E81 3-Door (Excl. Sport susp. & 135i)	07-11				70577	L	Gas Ryder	$\frac{1}{\dagger}$	69102	↔	Gas Ryder		
					70578	R	Gas Ryder						
E82 Coupe (Excl. Sport susp. & 135i)	08 on				70577	L	Gas Ryder	$\frac{1}{\dagger}$	69102	↔	Gas Ryder		
					70578	R	Gas Ryder						
E88 Cabriolet (Excl. Sport susp. & 135i)	08 on				70577	L	Gas Ryder	$\frac{1}{\dagger}$	69102	↔	Gas Ryder		
					70578	R	Gas Ryder						
2 SERIES													
1502, 2002 Ti Lux (E10)	66-77							$\frac{1}{\circ}$	36857	↔	Technomatic		
1802, 2002 (E10)	68-75			$\frac{1}{\circ}$	G45532	↔	Technomatic	$\frac{1}{\circ}$	G45861	↔	Technomatic		



A



PASSENGER & LCV

Derivative	Year	Vehicle Type	Fitment Guide #	FRONT				REAR				GASLIFT	
				Shock Info	Part #	L/R	Range	Shock Info	Part #	L/R	Range	Front	Rear
BMW (Continued)													
3 SERIES													
E30 series (Excl. iS & Cabriolet)	83-91		14		44085	↔	Technomatic		36857	↔	Technomatic	4060	
E36 series Imported 320i, 325i, 325td (long Stud) (Excl. M-series)	91-92				70587	L	Gas Ryder		61248	↔	Gas Ryder	4270	4269
					70588	R	Gas Ryder						
E36 Cabriolet	91-99				55835	R	Gas Ryder		61248	↔	Gas Ryder		
E36 series (Excl. M3)	91-99				55834	L	Gas Ryder		61248	↔	Gas Ryder	4270	4269
					55835	R	Gas Ryder						
E36 series (imported 4- and 6 cyl. models)	91-99								61248	↔	Gas Ryder	4270	4269
E36 Cabriolet	93-99				55834	L	Gas Ryder		61248	↔	Gas Ryder		
E46 series (Excl. ++ Touring) one pin at the bottom strut mounting	99-05		24		70508	L	Gas Ryder		61248	↔	Gas Ryder		
					70509	R	Gas Ryder						
E90 series (Excl. +)	05-12				70577	L	Gas Ryder		69102	↔	Gas Ryder		
					70578	R	Gas Ryder						
E91 series	05-12								69102	↔	Gas Ryder		
E92 series	07-14				70789	L	Gas Ryder		69102	↔	Gas Ryder		
					70790	R	Gas Ryder						
E93 series	07-14				70577	L	Gas Ryder		69102	↔	Gas Ryder		
					70578	R	Gas Ryder						
5 SERIES													
E12 series	74-76				44601	↔	Technomatic						
E12 series	76-85		18		44601	↔	Technomatic		51309	↔	Technomatic		
E28 series (Excl. +)	85-89		14		61914	↔	Gas Ryder		62352	↔	Gas Ryder		
E34 series (Excl. +)	89-96		14		61302	↔	Gas Ryder		62353	↔	Gas Ryder		
E39 series (520i, 523i, 525i, 525TDS, 528i, 530i, 530D) (Excl. +)	96-04				G35228	↔	Gas Ryder		G51216	↔	Gas Ryder		
E39 series (535i, 540i) (Excl. +)	96-04				G35227	↔	Gas Ryder		G51216	↔	Gas Ryder		
E60 series	04-10				70815	R	Gas Ryder						
					70814	L	Gas Ryder						
7 SERIES													
E23 series (Excl. +)	77-86		18						62351	↔	Gas Ryder	4061	
E32 series	87-94				61302	↔	Gas Ryder					4060	
X1													
All (E84)	10-16				70845	↔	Gas Ryder		62028	↔	Gas Ryder		
					70846	↔	Gas Ryder						



Derivative	Year	Vehicle Type	Fitment Guide #	FRONT				REAR				GASLIFT		
				Shock Info	Part #	L/R	Range	Shock Info	Part #	L/R	Range	Front	Rear	
BMW (Continued)														
X3														
E83 2.5i, 3.0i, 2.0d and 3.0d	04-10		F		70642	L	Gas Ryder		62021	↔	Gas Ryder			
					70643	R	Gas Ryder							
X5														
E53 3.0i, 3.0d, 4.4iV8, 4.8 V8 4X4	01-07				70542	L	Gas Ryder		61292	↔	Gas Ryder			
					70543	R	Gas Ryder							
Z3														
E36/4 (E36/7 roadster) (E36/8 coupé).	98-03				EG35046	L	Gas Ryder		69948	↔	Gas Ryder			
					EG35047	R	Gas Ryder							
CAM														
INYATHI														
Minibus	07 on				G56244	↔	Safari		G56245	↔	Safari			
CHANA														
STAR														
Bakkie, Panel van, Minibus (Incl Maxi Star)	06 on				35953	L	Technomatic		G45896	↔	Technomatic			
					35954	R	Technomatic							
CHERRY														
QQ3														
0.8, 1.1 (S11)	08 on				35955	L	Technomatic		36875	↔	Technomatic			
					35956	R	Technomatic							
TIGGO														
All	08 on				70628	L	Gas Ryder		62105	↔	Gas Ryder			
					70629	R	Gas Ryder							
CHEVROLET														
2500, 3800, 4100														
2.5, 3.8, & 4.1 Sedan	72-78				G45212	↔	Technomatic		G45489	↔	Technomatic			
2.5, 3.8, & 4.1 Estate	75-78				G45212	↔	Technomatic		G45399	↔	Technomatic			
AVEO														
T200 (Kalos) Hatch Gen1	02-11				35941	L	Technomatic		36866	↔	Technomatic		4340	
					35942	R	Technomatic							

Derivative	Year	Vehicle Type	Fitment Guide #	FRONT				REAR				GASLIFT	
				Shock Info	Part #	L/R	Range	Shock Info	Part #	L/R	Range	Front	Rear
CHEVROLET (Continued)													
C SERIES													
C10, C20	63-73			☉	G56106	↔	Safari	☉	G56107	↔	Safari		
C30	63-73			☉	G56106	↔	Safari	☉	G56126	↔	Safari		
C10, C20	74-83			☉	G56106	↔	Safari						
C30	74-83			☉	G56106	↔	Safari						
CHEVELLE													
Mk I	64-70			⊥	G45466	↔	Technomatic						
CRUZE													
(J 300) Gen 2	09 on			⤴	70706	L	Gas Ryder	⊥	62052	↔	Gas Ryder		
				⤵	70707	R	Gas Ryder						
EL CAMINO													
Incl El Toro	71-72			⊥	G45255	↔	Technomatic	⊥	G56118	↔	Safari		
								⊥	G45533	↔	Technomatic		
Incl El Toro	72-78			⊥	G45532	↔	Technomatic	☉	G45534	↔	Technomatic		
FIRENZA													
Coupe	71-78		2	☉	G45447	↔	Technomatic	⊥	G45533	↔	Technomatic		
LUV													
Faster	73-78			⊥	G45535	↔	Technomatic	☉	G56116	↔	Safari		
				⊥	G45535	↔	Technomatic	☉	G45006	↔	Technomatic		
NOMAD													
LDV	75-78			☉	G45447	↔	Technomatic						
OPTRA (LACETTI)													
1.6 & 1.8 (Mk I)	02 on			⤴	70563	L	Gas Ryder	⤴	70566	L	Gas Ryder		
				⤵	70564	R	Gas Ryder	⤵	70565	R	Gas Ryder		
SPARK (MATIZ)													
Spark (M100, M150)	03-05			⤴	G35295	L	Gas Ryder	☉	36875	↔	Gas Ryder		
				⤵	G35300	R	Gas Ryder	☉	36875	↔	Gas Ryder		
SPARK													
M200, M250	06-10			⤴	70800	L	Gas Ryder	☉	62089	↔	Gas Ryder		
				⤵	70801	R	Gas Ryder	☉	62089	↔	Gas Ryder		
M300 (Excl Lite)	10 on			⤴	70596	L	Gas Ryder	⊥	G45897	↔	Technomatic		4341
				⤵	70597	R	Gas Ryder	⊥	G45897	↔	Technomatic		4341
UTILITY													
Montana LDV	11 on			⤴	70757	↔	Gas Ryder	⊥	G56278	↔	Safari		

Derivative	Year	Vehicle Type	Fitment Guide #	FRONT				REAR				GASLIFT	
				Shock Info	Part #	L/R	Range	Shock Info	Part #	L/R	Range	Front	Rear
CHEVROLET (Continued)													
ASCONA, CHEVAIR													
B, (Mk I Cavalier)	76-82							$\frac{1}{0}$	G45489	↔	Technomatic		
(C)	82-85			/	44615	↔	Technomatic	$\frac{1}{0}$	G45839	↔	Technomatic		
(Short strut) (C)	84-86							$\frac{1}{0}$	G45839	↔	Technomatic		
CHRYSLER													
VOYAGER													
Gen I (Incl Grand Voyager) (Excl.)	86-95							$\frac{0}{0}$	G63690	↔	Gas Ryder		
Gen II (Incl Grand Voyager) (Excl.)	95-00			/	G55697	↔	Gas Ryder	$\frac{0}{0}$	G63690	↔	Gas Ryder		
Gen III (Incl Grand Voyager) (Excl.)	01-07							$\frac{0}{0}$	G63690	↔	Gas Ryder		
CITROEN													
C1													
1.0 & 1.4 Hdi (Gen1)	08-14			/	70723	L	Gas Ryder	$\frac{1}{0}$	62062	↔	Gas Ryder		
				/	70724	R	Gas Ryder						
XSARA													
Mark 2 (Incl Picasso Excl. VTS) (1.4, 1.6, 2.0, 2.0HDI)	00-07							$\frac{0}{0}$	69965	↔	Gas Ryder		
DAEWOO													
CIELO													
Nexia	95-98		14	/	61909	↔	Gas Ryder	$\frac{1}{0}$	G45874	↔	Technomatic		
				/	44607	↔	Technomatic						
ESPERO													
Aranos	95-99		14	/	61909	↔	Gas Ryder	$\frac{1}{0}$	G45874	↔	Technomatic		
				/	44607	↔	Technomatic						
LANOS													
Sens	97-03		14	/	61909	↔	Gas Ryder	$\frac{1}{0}$	G45874	↔	Technomatic		
				/	44607	↔	Technomatic						
MATIZ													
Spark (M100)	99-03			/	G35295	L	Gas Ryder	$\frac{0}{0}$	36875	↔	Gas Ryder		
				/	G35300	R	Gas Ryder						
DAIHATSU													
CHARADE													
Incl Coupe (G11)	83-87							$\frac{1}{0}$	G45861	↔	Technomatic		
SIRION													
1.3, 1.5 (Mk II) (Boon)	05-10			/	70700	↔	Gas Ryder	$\frac{0}{0}$	62040	↔	Gas Ryder		



Derivative	Year	Vehicle Type	Fitment Guide #	FRONT				REAR				GASLIFT	
				Shock Info	Part #	L/R	Range	Shock Info	Part #	L/R	Range	Front	Rear
DAIHATSU (Continued)													
TERIOS II													
4X2, 4X4	6/06 on				70695	↔	Gas Ryder		62038	↔	Gas Ryder		
DODGE													
JOURNEY													
2.0 CRD, 2.7 (JC49) (Excl. Self Levelling)	06-on				70847	L	Gas Ryder		69135	↔	Gas Ryder		
					70848	R	Gas Ryder						
DODGE (CHRYSLER)													
DODGE													
Caliber	06 on				70711	L	Gas Ryder		69117	↔	Gas Ryder		
					70712	R	Gas Ryder						
DODGE HUSKY													
LDV	74-78		3						G45006	↔	Technomatic		
FIAT													
124													
Station Wagon	69-77								G45006	↔	Technomatic		
125													
Sedan	69-75								G45423	↔	Technomatic		
132													
1.6GL, 1.6 GLS, 1.8 GLS (Argenta)	79-81								G45810	↔	Technomatic		
500													
All (excl. Abrath & Sport)	08-on				70858	L	Gas Ryder		62111	↔	Gas Ryder		
					70859	R	Gas Ryder						
PALIO													
Type 1X	00-01				G35214	↔	Gas Ryder		61270	↔	Gas Ryder		
Weekend (Type PY)	00-01				G35214	↔	Gas Ryder		69919	↔	Gas Ryder		
Expresso Panel van	02 on				70583	↔	Gas Ryder		62005	↔	Gas Ryder		
Type 2H	02 on				70583	↔	Gas Ryder		62005	↔	Gas Ryder		
Weekend (Type 2G)	02 on								69919	↔	Gas Ryder		
PANDA													
1.2, 1.3 (Excl. AWD & 1.4 100HP)	04-10				70781	↔	Gas Ryder		62080	↔	Gas Ryder		
					70782	↔	Gas Ryder						
PUNTO													
Mk II	04-12				70710	↔	Gas Ryder						
SEICENTO													
600	99-03				G35279	↔	Gas Ryder		69921	↔	Gas Ryder		



Derivative	Year	Vehicle Type	Fitment Guide #	FRONT				REAR				GASLIFT	
				Shock Info	Part #	L/R	Range	Shock Info	Part #	L/R	Range	Front	Rear
FIAT (Continued)													
STRADA													
3/4 ton LDV (Mk II)	05 on				70594	↔	Gas Ryder		G56258	↔	Safari		
UNO													
Incl Turbo (Series 2)	90-06				55854	↔	Gas Ryder		61241	↔	Gas Ryder		4063
FORD													
BANTAM													
1.3	83-86				35816	↔	Technomatic		G45875	↔	Technomatic		
1.6	83-86				35816	↔	Technomatic		G45875	↔	Technomatic		
1.4	86-94				35844	↔	Technomatic		G45875	↔	Technomatic		
1.6	86-94				35844	↔	Technomatic		G45875	↔	Technomatic		
1.3	94-02				35927	↔	Technomatic		G45878	↔	Technomatic		
1.6	94-02				35927	↔	Technomatic		G45878	↔	Technomatic		
1.8D	02				70510	↔	Gas Ryder		G45878	↔	Technomatic		
1.3	03-06				70510	↔	Gas Ryder		G45878	↔	Technomatic		
1.6	03-06				70510	↔	Gas Ryder		G45878	↔	Technomatic		
1.3	06 on				70510	↔	Gas Ryder		G45878	↔	Technomatic		
1.6	06 on				70510	↔	Gas Ryder		G45878	↔	Technomatic		
CAPRI													
Mk I	69-73				44516	↔	Technomatic		36854	↔	Technomatic		
CORSAIR													
1.6	64-66								36854	↔	Technomatic		
1.6, 2.0	66-69								36854	↔	Technomatic		
CORTINA													
Mk I	64-66								36854	↔	Technomatic		
Mk II	67								36854	↔	Technomatic		
Mk II	68-70								36854	↔	Technomatic		
Mk III	71-77				G45503	↔	Technomatic		G45520	↔	Technomatic		
Mk III, IV	71-78		20		G56153	↔	Safari		G45418	↔	Technomatic		
Mk III, IV LDV	71-78		20		G56153	↔	Safari		G56103	↔	Safari		
Mk IV	77-80				G45503	↔	Technomatic		G45520	↔	Technomatic		
Mk IV LDV	78-80				G56153	↔	Safari		G56156	↔	Safari		
Mk V LDV	80-82				G56160	↔	Safari		G56156	↔	Safari		
Mk V Estate	80-83				G45837	↔	Technomatic		G45520	↔	Technomatic		
Mk V Sedan	80-83		14		G45837	↔	Technomatic		G45838	↔	Technomatic		
Mk V LDV	83-86				G56160	↔	Safari		G56159	↔	Safari		



Derivative	Year	Vehicle Type	Fitment Guide #	FRONT				REAR				GASLIFT	
				Shock Info	Part #	L/R	Range	Shock Info	Part #	L/R	Range	Front	Rear
FORD (Continued)													
COURIER													
4X2 (Std. Susp.)	86-06				G56173	↔	Safari		G56116	↔	Safari		
					G45871	↔	Technomatic		G45872	↔	Technomatic		
4X4, 4X2 Hi-Trail (Raised Susp.)	86-06				GS56233	↔	Safari HDP		GS78014	↔	Safari HDP		
					G56169	↔	Safari		G56170	↔	Safari		
ECOSPORT													
All	13 on				70835	L	Gas Ryder		62103	↔	Gas Ryder		
					70836	R	Gas Ryder						
ESCORT													
Mk I	68-73				44505	↔	Technomatic		G45413	↔	Technomatic		
Mk I 1100, 1300	70-75				44505	↔	Technomatic		G45413	↔	Technomatic		
Mk I 1600, GT	70-75				44516	↔	Technomatic		G45413	↔	Technomatic		
Mk I, II	74-81				44505	↔	Technomatic		G45413	↔	Technomatic		
Mk II	75-81		17		44505	↔	Technomatic		G45742	↔	Technomatic		
Mk III Fwd L, GL, GLE	81-86				35816	↔	Technomatic		55802	↔	Gas Ryder		4063
					35816	↔	Technomatic		35817	↔	Technomatic		
Mk III Fwd XR3, Sport	81-86				35816	↔	Technomatic		55802	↔	Gas Ryder		4064
					35816	↔	Technomatic		35817	↔	Technomatic		
Mk V, VI, VII	95-99				G35146	↔	Gas Ryder		G51082	↔	Gas Ryder		4272
					G35146	↔	Gas Ryder		69423	↔	Gas Ryder		
EVEREST													
4X2 & 4X4	09-15				G56222	↔	Safari		G56298	↔	Safari		
F SERIES													
F100	65-67				G56119	↔	Safari		G56102	↔	Safari		
F100	68-69				G56123	↔	Safari		G56102	↔	Safari		
F100	70-81		5		G56123	↔	Safari		G56118	↔	Safari		
F250 4X2	65-67				G56119	↔	Safari		G56102	↔	Safari		
F250 4X2	68-69				G56123	↔	Safari		G56102	↔	Safari		
F250 4X4	68-77				G45667	↔	Safari						
F250 4X2	70-81		5		G56123	↔	Safari		G56118	↔	Safari		
F250 4X4	78-81								G56155	↔	Safari		
F350	67-81				G56123	↔	Safari		G56102	↔	Safari		
FIESTA													
Mark IV (Excl. 1.6 Rsi 3-door) (U Bracket)	97-99		23		55865	↔	Gas Ryder		69082	↔	Gas Ryder		
Mark IV (Excl. 1.6 Rsi 3-door) (Sleeve eye) (Facelift)	99-03		22		55865	↔	Gas Ryder		69095	↔	Gas Ryder		4063
Mark V Hatch & Sedan	04-08				70567	L	Gas Ryder		62117	↔	Gas Ryder		4362 (Hatch Only)
					70568	R	Gas Ryder						
Mark VI	08-18				70600	L	Gas Ryder		62009	↔	Gas Ryder		4337
					70601	R	Gas Ryder						



Derivative	Year	Vehicle Type	Fitment Guide #	FRONT				REAR				GASLIFT	
				Shock Info	Part #	L/R	Range	Shock Info	Part #	L/R	Range	Front	Rear
FORD (Continued)													
FIGO													
1.4	10-15				70567	L	Gas Ryder		62117	↔	Gas Ryder		4336
					70568	R	Gas Ryder						
FOCUS													
Mk I Hatch & Sedan	98-04				G35296	L	Gas Ryder		69422	↔	Gas Ryder		4316
					G35301	R	Gas Ryder						
Mk II Hatch & Sedan (Excl. 2.5 RS & ST)	04-11				70584	L	Gas Ryder		G45894	↔	Technomatic		4339 (Hatch Only)
					70585	R	Gas Ryder						
Mk III Hatch & Sedan (Excl. 2.5 ST & RS)	11 on				70771	L	Gas Ryder		62073	↔	Gas Ryder		
					70772	R	Gas Ryder						
GRANADA													
Mk I, Mk II	72-86				G45503	↔	Technomatic		G45651	↔	Technomatic		
HUSKY													
Minibus, LDV, Panelvan	85-98				G56185	↔	Safari		G56102	↔	Safari		
					G45466	↔	Technomatic		G45051	↔	Technomatic		
IKON													
(B3)	00-06		22		55865	↔	Gas Ryder		69095	↔	Gas Ryder		
Mark V Hatch & Sedan	07 on				70567	L	Gas Ryder		62117	↔	Gas Ryder		
					70568	R	Gas Ryder						
KA													
1.3 (Mk I)	05-09				G35326	↔	Gas Ryder		G51275	↔	Gas Ryder		
KUGA													
4X4 & 4X2 SUV (Gen2) C250	13 on				70837	L	Gas Ryder		62107	↔	Gas Ryder		
					70838	R	Gas Ryder						
LASER,METEOR,TRACER													
Familia	69-76								G45078	↔	Technomatic		
KC/KE, GC	86-91				35832	↔	Technomatic		55804	↔	Gas Ryder		4087
									35833	↔	Technomatic		
KF/KH	91-01				55825	↔	Gas Ryder		55804	↔	Gas Ryder		4087
					35848	↔	Technomatic		35833	↔	Technomatic		
MONDEO													
Mk II	96-01				G35189	↔	Gas Ryder		G35112	↔	Gas Ryder		
RANCHERO													
Falcon	69-76								G56105	↔	Safari		
									G45078	↔	Technomatic		

Derivative	Year	Vehicle Type	Fitment Guide #	FRONT				REAR				GASLIFT	
				Shock Info	Part #	L/R	Range	Shock Info	Part #	L/R	Range	Front	Rear
FORD (Continued)													
RANGER													
4X2 (Std. Susp.)	86-06			⊥	G56173	↔	Safari	⊙	G56116	↔	Safari		
				⊙	G45871	↔	Technomatic	⊙	G45872	↔	Technomatic		
4X4,4X2 Hi-Trail (Raised Susp.)	86-06			⊥	GS56233	↔	Safari HDP	⊙	GS78014	↔	Safari HDP		
				⊥	G56169	↔	Safari	⊙	G56170	↔	Safari		
4X2 (Std. Susp.)	07-12			⊥	G56235	↔	Safari	⊙	G56228	↔	Safari		
4X4,4X2 Hi-Trail (Raised Susp.)	07-12			⊥	GS56233	↔	Safari HDP	⊙	GS78014	↔	Safari HDP		
				⊥	G56222	↔	Safari	⊙	G56223	↔	Safari		
4X2 (Std. Susp.)	12 on			⊥	G56290	↔	Safari	⊙	G56291	↔	Safari		
4x4,4x2 Hi-Trail T6 (excl 2019-on Raptor)	12 on			⊥	GS46013	↔	Safari HDP	⊙	GS78032	↔	Safari HDP	4356	
				⊥	G56276	↔	Safari	⊙	G56277	↔	Safari	4356	
SAPPHIRE													
1.6, 2.0, 2.3, 3.0 (Incl XR6, Excl. XR8 & Estate)	83-93			⊥	35842	↔	Technomatic	⊙	G45860	↔	Technomatic		
SIERRA													
1.6, 2.0, 2.3, 3.0 (Incl XR6, Excl. XR8 & Estate)	83-93			⊥	35842	↔	Technomatic	⊙	G45860	↔	Technomatic		
1.6, 2.0, 2.3, 3.0 Estate	83-93			⊥	35842	↔	Technomatic	⊥	G45858	↔	Technomatic		
SPECTRON													
Minibus, Van	91-03			⊥	G45876	↔	Technomatic	⊙	G56186	↔	Safari		4131
								⊙	G45870	↔	Technomatic		
TAUNUS													
17M, 20M	61-73		19					⊥	G45423	↔	Technomatic		
TELSTAR													
Incl TX5	93-99			⊥	55843	L	Gas Ryder	⊥	55845	↔	Gas Ryder		4502
				⊥	55844	R	Gas Ryder						
TRITON													
0510, 0610	85-87			⊥	55088	↔	Safari	⊙	G56102	↔	Safari		
0608, 0610	87 on			⊥	55211	↔	Safari						
GWM													
FLORID													
All	09-on			⊥	35957	↔	Technomatic	⊥	36877	↔	Technomatic		
GWM													
2.2, 2.8TDi (4X2)	07 on			⊥	G45862	↔	Technomatic	⊙	G45870	↔	Technomatic		
STEED													
4X2	08-11			⊥	G45904	↔	Technomatic	⊙	G45905	↔	Technomatic		
STEED 5													
4X2	08 on							⊙	G45905	↔	Technomatic		

Derivative	Year	Vehicle Type	Fitment Guide #	FRONT				REAR				GASLIFT		
				Shock Info	Part #	L/R	Range	Shock Info	Part #	L/R	Range	Front	Rear	
HILLMAN														
VOGUE, HUNTER														
Incl Sceptre, Arrow	67-77							$\frac{1}{0}$	36854	↔	Technomatic			
Safari	67-77							$\frac{0}{0}$	G45051	↔	Technomatic			
HONDA														
ACCORD														
Gen 8 (Excl ABS)	09-12				69137	L	Gas Ryder		69139	↔	Gas Ryder			
					69138	R	Gas Ryder							
BALLADE														
Mk II	82-84				35830	↔	Technomatic							
Mk III 130, 150, 150i (SC9) (Civic)	84-88		14		55810	↔	Gas Ryder		69067	↔	Gas Ryder			
Mk IV 160i (SH4) (Civic)	87-89		14						69067	↔	Gas Ryder			
Mk IV 150, 160i (SH4) (Civic)	89-92				69075	↔	Gas Ryder		69076	↔	Gas Ryder			
Mk V 150, 160i (SR4) (Civic)	92-96				69079	↔	Gas Ryder		69076	↔	Gas Ryder			
Mk VI 150i, 160i, 180i Excl. Vtech (Civic)	96-01				69084	↔	Gas Ryder		G55910	↔	Gas Ryder			
BRIO														
All	12-on				70828	L	Gas Ryder		62101	↔	Gas Ryder			
					70829	R	Gas Ryder							
CIVIC														
Mk VI	96-01				69084	↔	Gas Ryder		G55910	↔	Gas Ryder		4289	
Mk VII Hatch	01-05				70648	L	Gas Ryder		G51298	↔	Gas Ryder			
					70649	R	Gas Ryder							
Mk VII Sedan	01-05				70648	L	Gas Ryder		G51298	↔	Gas Ryder			
					70649	R	Gas Ryder							
Mk VIII Sedan	06-11				70598	L	Gas Ryder	$\frac{1}{0}$	62011	↔	Gas Ryder			
					70599	R	Gas Ryder							
CR-V														
RD1-RD3	95-01				G51255	↔	Gas Ryder		G51256	↔	Gas Ryder			
Mk II 4X4 2.0, 2.2D (RD4, RD5, RD6, RD7)	02-06				70612	L	Gas Ryder	$\frac{1}{0}$	69104	↔	Gas Ryder			
					70613	R	Gas Ryder							
Mk III RE	07-12				70718	L	Gas Ryder		69120	↔	Gas Ryder			
					70719	R	Gas Ryder							
FIT														
Gen 1 (GD1)	07 on				70749	L	Gas Ryder	$\frac{1}{0}$	61296	↔	Gas Ryder			
					70750	R	Gas Ryder							



Derivative	Year	Vehicle Type	Fitment Guide #	FRONT				REAR				GASLIFT		
				Shock Info	Part #	L/R	Range	Shock Info	Part #	L/R	Range	Front	Rear	
HONDA (Continued)														
JAZZ														
1.4Dsi, 1.5 Gen 1 (Fit)	03-07				70610	L	Gas Ryder		61296	↔	Gas Ryder			
					70611	R	Gas Ryder							
Gen 2 (Fit)	08-13				70715	L	Gas Ryder		62058	↔	Gas Ryder			
					70716	R	Gas Ryder							
ODYSSEY														
RA1-RA5	97-99				G55877	↔	Gas Ryder		G55821	↔	Gas Ryder			
PRELUDE														
Coupe	83-87				G55723	↔	Gas Ryder							
HYUNDAI														
ACCENT														
X3	94-97				55869	↔	Gas Ryder		55868	↔	Gas Ryder			
X3	98-00				55869	↔	Gas Ryder		55870	↔	Gas Ryder			
LC (Mk2)	00-05				70624	L	Gas Ryder		55870	↔	Gas Ryder			
					70625	R	Gas Ryder							
MC. 1.6 (Mk3)	05-11				G54023	L	Gas Ryder		62016	↔	Gas Ryder			
					G54024	R	Gas Ryder							
ATOS														
Mk I	97-99								36837	↔	Gas Ryder			
Prime (Mk II)	00-08				35951	L	Technomatic		36837	↔	Gas Ryder			
					35952	R	Technomatic		36867	↔	Technomatic		4359	
ELANTRA														
J1 series (Avante)	91-96				G55592	↔	Gas Ryder		G51059	↔	Gas Ryder			
J2 & J3 series (Avante)	96-00				70519	L	Gas Ryder		70544	L	Gas Ryder			
					70520	R	Gas Ryder						70545	R
XD (J4) (Avante)	00-06				70519	L	Gas Ryder		70521	L	Gas Ryder			
					70520	R	Gas Ryder						70522	R
HD Sedan	06-10				70793	L	Gas Ryder		62085	↔	Gas Ryder			
					70794	R	Gas Ryder							
GETZ														
3 & 5-door	03-11				70548	L	Gas Ryder		61285	↔	Gas Ryder		4347	
					70549	R	Gas Ryder							
H100														
Bakkie, minibus, van	96-05				G56176	↔	Safari		G56102	↔	Safari			
					G45535	↔	Technomatic		G45051	↔	Technomatic			

Derivative	Year	Vehicle Type	Fitment Guide #	FRONT				REAR				GASLIFT		
				Shock Info	Part #	L/R	Range	Shock Info	Part #	L/R	Range	Front	Rear	
HYUNDAI (Continued)														
i10														
Hatch Gen1	08-13				70569	L	Gas Ryder		62053	↔	Gas Ryder			
					70570	R	Gas Ryder							
i20														
Gen 1 (PB) Pre-Facelift	09-12				70696	L	Gas Ryder		62086	↔	Gas Ryder		4349	
					70697	R	Gas Ryder							
Gen 1 (PB) Facelift	13-15												4349	
Gen 2 (GB)	15 on												4348	
i30														
All (FD & GD)	09-12				70824	L	Gas Ryder		62099	↔	Gas Ryder			
					70825	R	Gas Ryder							
iX35														
4X2 (Excl. AWD)	10-16				70691	L	Gas Ryder		62036	↔	Gas Ryder			
					70692	R	Gas Ryder							
MATRIX														
(Lavita) Mini MPV	02 on				70550	L	Gas Ryder		70530	L	Gas Ryder			
					70551	R	Gas Ryder		70531	R	Gas Ryder			
SANTA FE														
SM (Mk I)	01-06				70554	L	Gas Ryder		61289	↔	Gas Ryder			
					70555	R	Gas Ryder							
SONATA														
Y3 (Mk III)	95-98				G55673	↔	Gas Ryder		G51186	↔	Gas Ryder			
EF (MK IV)	03.01-02.05				69099	↔	Gas Ryder		69100	↔	Gas Ryder			
EF (MK IV)	09.98-03.01				69099	↔	Gas Ryder							
TERRACAN														
2.9, 3.5	01-09				61287	↔	Gas Ryder		61288	↔	Gas Ryder			
TIBURON														
RD & RD2	96-01				70519	L	Gas Ryder							
					70520	R	Gas Ryder							
TUCSON														
All	04-11				70637	L	Gas Ryder		70635	L	Gas Ryder		4360	
					70638	R	Gas Ryder		70636	R	Gas Ryder		4361	



Derivative	Year	Vehicle Type	Fitment Guide #	FRONT				REAR				GASLIFT	
				Shock Info	Part #	L/R	Range	Shock Info	Part #	L/R	Range	Front	Rear
ISUZU													
FRONTIER													
4X4, 4X2	98-02				G56173	↔	Safari		55088	↔	Safari		
KB (D-MAX), TF SERIES													
(Mk I)	78-80				G56176	↔	Safari		G56116	↔	Safari		
					G45535	↔	Technomatic		G45006	↔	Technomatic		
4X2 (Mk II)	80-88				G45893	↔	Technomatic		G56186	↔	Safari		
					G45844	↔	Technomatic		G45870	↔	Technomatic		
4X4 (Mk II)	80-88				G56176	↔	Safari		G56186	↔	Safari		
					G45535	↔	Technomatic		G45870	↔	Technomatic		
4X2 (Std. Height) (TF)	89-04				G45893	↔	Technomatic		G56103	↔	Safari		
					G45844	↔	Technomatic		G45008	↔	Technomatic		
4X4, 4X2 (Raised Height) (TF)	89-04				GS56225	↔	Safari HDP		GS78006	↔	Safari HDP		
					G56173	↔	Safari		G56103	↔	Safari		
					G45871	↔	Technomatic		G45008	↔	Technomatic		
4X2 (Std. Height) (P190) (Mk V)	04-13 (Q1)				G56212	↔	Safari		G56213	↔	Safari		
					GS56225	↔	Safari HDP		GS78006	↔	Safari HDP		
4X4, 4X2 (Raised Height) (P190) (Mk V)	04-13 (Q1)				G56214	↔	Safari		G56215	↔	Safari		
					GS46014	↔	Safari HDP		GS78038	↔	Safari HDP		
WFR, RELAY													
Fargo	80-95				G56185	↔	Safari		G45006	↔	Technomatic		4129
IVECO													
DAILY													
Panel Van 92Kw_D (35S13, 50C13)	01-08				76208	↔	Fleet Ryder		76209	↔	Fleet Ryder		
Panel Van 107Kw_D (50C15, 65C15, 70C15)	04 on				76208	↔	Fleet Ryder		76209	↔	Fleet Ryder		
DAILY, TURBO DAILY													
49.10, 49.12, 59.12	19...				42772	↔	Technomatic		42772	↔	Technomatic		
42.12, 45.12, 54.12, 66.12	19...								42773	↔	Fleetryder		
35.10V, 45.10, A45.10, 40.10, 49.12, 59.12	95-00				42772	↔	Technomatic		42772	↔	Technomatic		
45.10, A45.10, 49.10	95-00				42772	↔	Technomatic		42772	↔	Technomatic		

Derivative	Year	Vehicle Type	Fitment Guide #	FRONT				REAR				GASLIFT	
				Shock Info	Part #	L/R	Range	Shock Info	Part #	L/R	Range	Front	Rear
JAGUAR													
JAGUAR													
Mk II	61-69		1		G45535	↔	Technomatic		G56119	↔	Safari		
Mk X, 420, 420G, S Type (4 shocks at rear)	65-72		1		G45535	↔	Technomatic						
XJ6, XJ12 (4 shocks at rear) (Series 1, 2 and 3)	70-87				69677	↔	Gas Ryder						
JEEP (CHRYSLER)													
JEEP													
Cherokee (XJ)	96-01				GS78025	↔	Safari HDP		GS56261	↔	Safari HDP		
Compass Mk2 (Facelift)	11-16				70868	L	Gas Ryder		69141	↔	Gas Ryder		
					70869	R	Gas Ryder						
Wrangler 4X4 (TJ)	96-06				GS78025	↔	Safari HDP		GS78026	↔	Safari HDP		
					G63721	↔	Gas Ryder						
Cherokee (KJ) 2.5D, 2.8D, 3.7	01-07				GS46011	↔	Safari HDP		GS56267	↔	Safari HDP	4344	4345
					G56262	↔	Safari						
Patriot (MK)	07 on				70711	L	Gas Ryder		69117	↔	Gas Ryder		
					70712	R	Gas Ryder						
Wrangler 4X4 (JK) incl Rubicon	07-on				GS56288	↔	Safari HDP		GS56289	↔	Safari HDP		
CJ Series (Willys)(CJ5, CJ6, CJ7)	54-86				G56102	↔	Safari		G56116	↔	Safari		
					G45051	↔	Technomatic						
KIA													
CERATO													
Hatch & Sedan	09-13				70795	L	Gas Ryder		62086	↔	Gas Ryder		
					70796	R	Gas Ryder						
CLARUS													
2.0 GLX (Credos)	98-06				35943	L	Technomatic		35945	L	Technomatic		
					35944	R	Technomatic						
K2700													
Bongo (Gen 3)	00-04				G56178	↔	Safari		G56103	↔	Safari		
Bongo (Gen 4)	05 on				G56251	↔	Safari		G56252	↔	Safari		
PICANTO													
Mk 1 Incl '07 & '10 facelift (SA)	04-11				70569	L	Gas Ryder		62000	↔	Gas Ryder		4373
					70570	R	Gas Ryder						
Mk 2 (TA)	11-17								62084	↔	Gas Ryder		4374



Derivative	Year	Vehicle Type	Fitment Guide #	FRONT				REAR				GASLIFT		
				Shock Info	Part #	L/R	Range	Shock Info	Part #	L/R	Range	Front	Rear	
KIA (Continued)														
PREGIO														
Bongo	00-04			⊥	G56178	↔	Safari							
RIO														
1.3 & 1.6 (DC)	03-06				70620	L	Gas Ryder	⊖	62015	↔	Gas Ryder			
					70621	R	Gas Ryder							
1.3 & 1.6 (DC)	00-03							⊖	61295	↔	Gas Ryder			
Rio 1.4 & 1.6 Gen2 (JB)	06-11				G54023	L	Gas Ryder	⊖	62016	↔	Gas Ryder			
					G54024	R	Gas Ryder							
Gen 3 (UB)	11 on				70851	L	Gas Ryder	⊖	62108	↔	Gas Ryder			
					70852	R	Gas Ryder							
SORENTO														
2.5D & 3.5 (Mk I)	02-06				G45898	L	Technomatic	⊖	G56266	↔	Safari			
					G45899	R	Technomatic							
2.5D & 3.8 (Mk II)	07-09				G45898	L	Technomatic							
					G45899	R	Technomatic							
SPORTAGE														
2.0, 2.0D (Mk I)	93-04							⊖	G63720	↔	Gas Ryder			
2.0, 2.7, 2.0D (Mk II)	04-10				70637	L	Gas Ryder		70635	L	Gas Ryder			
					70638	R	Gas Ryder							
4X2 2.0, 2.4 - Gen2 (Excl. AWD)	10-16				70691	L	Gas Ryder	⊖	62036	↔	Gas Ryder			
					70692	R	Gas Ryder							
LADA														
NIVA														
VAZ-2121	87-92		16	⊖	G45893	↔	Technomatic	⊖	G56102	↔	Safari			
LAND ROVER														
DEFENDER														
109 WB, Series I	54-65			⊖	G56112	↔	Safari	⊖	G56126	↔	Safari			
88 WB	54-80			⊖	G56112	↔	Safari	⊖	G56126	↔	Safari			
109, 110 WB forward control	65-83			⊖	G56162	↔	Safari	⊖	G56163	↔	Safari			
109 WB, Series II, III	65-84			⊖	G56112	↔	Safari	⊖	G56113	↔	Safari			
90, 110, 130 (Incl County & LDV)	84 on			⊖	G56164	↔	Safari	⊖	G56165	↔	Safari			
90, 110, 130 (Incl County & LDV)	84-94			⊖	GS78007	↔	Safari HDP	⊖	GS78008	↔	Safari HDP			
90, 110, 130 (Incl County & LDV)	95 on			⊖	GS78007	↔	Safari HDP	⊖	GS78039	↔	Safari HDP			



Derivative	Year	Vehicle Type	Fitment Guide #	FRONT				REAR				GASLIFT	
				Shock Info	Part #	L/R	Range	Shock Info	Part #	L/R	Range	Front	Rear
LAND ROVER (Continued)													
DISCOVERY													
Series II. 4.0 V8, 2.5TD5	98-04			☉	GS78029	↔	Safari HDP	☉	GS78030	↔	Safari HDP		
				☉	G56246	↔	Safari	☉	G56247	↔	Safari		
Series I	89-98			⊥	GS78007	↔	Safari HDP	☉	GS78008	↔	Safari HDP		
				⊥	G56164	↔	Safari	☉	G56165	↔	Safari		
FREELANDER													
Mk I (1.8, 2.0Td4, 2.5 V6)	98-3/07			⚡	70614	L	Gas Ryder	⚡	70616	L	Gas Ryder		
				⚡	70615	R	Gas Ryder	⚡	70617	R	Gas Ryder		
RANGE ROVER													
Excl. air susp. (Mk I)	70-96			⊥	GS78007	↔	Safari HDP	☉	GS78008	↔	Safari HDP		4205
				⊥	G56164	↔	Safari	☉	G56165	↔	Safari		4205
Air Susp. (Mk I)	92-96			⊥	G56180	↔	Safari	☉	G56165	↔	Safari		
MAHINDRA													
BOLERO													
4X2	05-15			⊥	61283	↔	Technomatic	☉	G45886	↔	Technomatic		
				☉	61282	↔	Technomatic	☉	61281	↔	Technomatic		
SCORPIO													
4X4	06-15			☉	G45885	↔	Technomatic	☉	G45886	↔	Technomatic		
4X4, 4X2 Raised. (Mk I) 2.2, 2.4D	06-15			☉	GS56264	↔	Safari HDP	☉	GS56265	↔	Safari HDP		
				☉	G56203	↔	Safari	☉	G56204	↔	Safari		
MAZDA													
1200,1300													
Familia (Mk II)	72-75							⊥	G45078	↔	Technomatic		
323													
Rwd (imported strut)	77-78							☉	G45810	↔	Technomatic		
Rwd (local strut)	78-81			⚡	44535	↔	Technomatic	☉	G45810	↔	Technomatic		
(BD) Incl S (non sealed strut)	81-83		21	⚡	35832	↔	Technomatic	⚡	35833	↔	Technomatic		
(BF) Incl S, EG, Sport	82-91			⚡	55803	↔	Gas Ryder	⚡	55804	↔	Gas Ryder		4087
				⚡	35832	↔	Technomatic	⚡	35833	↔	Technomatic		
(Familia) Incl Midge & Sting	91-04			⚡	55825	↔	Gas Ryder	⚡	55804	↔	Gas Ryder		
				⚡	35848	↔	Technomatic	⚡	35833	↔	Technomatic		



Derivative	Year	Vehicle Type	Fitment Guide #	FRONT				REAR				GASLIFT	
				Shock Info	Part #	L/R	Range	Shock Info	Part #	L/R	Range	Front	Rear
MAZDA (Continued)													
626													
Incl Coupe (Mk II, Mk III)(GC & GD)	83-92				55806	↔	Gas Ryder		55807	↔	Gas Ryder		
Zimbabwe model	87-91				G55600	↔	Gas Ryder		G55601	↔	Gas Ryder		
2.0, 2.5 (Incl MX-6) (Mk IV)	92-98				55843	L	Gas Ryder		55845	↔	Gas Ryder		
					55844	R	Gas Ryder		55845	↔	Gas Ryder		4071
1.8, 2.0 (Mk V), Y5 Sedan	99-03				70654	L	Gas Ryder		70656	L	Gas Ryder		
					70655	R	Gas Ryder		70657	R	Gas Ryder		4271
B SERIES, DRIFTER, MAGNUM													
Mk II, III & IV	64-86				G45212	↔	Technomatic		G56105	↔	Safari		
					G45212	↔	Technomatic		G45078	↔	Technomatic		
4X2 Std. Susp.	86-07				G56173	↔	Safari		G56116	↔	Safari		
					G45871	↔	Technomatic		G45872	↔	Technomatic		
4X4, 4X2 Hi-Trail (Raised Susp.)	86-07				GS56233	↔	Safari HDP		GS78014	↔	Safari HDP		
					G56169	↔	Safari		G56170	↔	Safari		
BT-50													
4X2 Std. Susp.	07-12				G56235	↔	Safari		G56228	↔	Safari		
4X4, 4X2 Raised Susp.	07-12				GS56233	↔	Safari HDP		GS78014	↔	Safari HDP		
					G56222	↔	Safari		G56223	↔	Safari		
4X2 Std. Susp.	12-on				G56290	↔	Safari		G56291	↔	Safari		
4X4, 4X2 Raised Susp.	12-on				GS46013	↔	Safari HDP		GS78032	↔	Safari HDP		
					G56276	↔	Safari		G56277	↔	Safari		
DEMIO													
Hatch DY	03-15				70816	L	Gas Ryder		62117	↔	Gas Ryder		
					70817	R	Gas Ryder						
E2000, E2700, E3000													
LDV	66-83				G45667	↔	Technomatic		G56105	↔	Safari		
					G45667	↔	Technomatic		G45078	↔	Technomatic		
E2000, E3000													
LDV	67-81				G45667	↔	Technomatic		G45078	↔	Technomatic		
ETUDE													
1.6 litre (BJ) (Familia)	00 - 09/02								55890	L	Gas Ryder		
									55891	R	Gas Ryder		
1.6 litre (BJ) (Familia)	10/02 - 04				55888	L	Gas Ryder		55890	L	Gas Ryder		
					55889	R	Gas Ryder		55891	R	Gas Ryder		

Derivative	Year	Vehicle Type	Fitment Guide #	FRONT				REAR				GASLIFT		
				Shock Info	Part #	L/R	Range	Shock Info	Part #	L/R	Range	Front	Rear	
MAZDA (Continued)														
F1000, F1300														
LDV	81-86			⊥	G45523	↔	Technomatic	⊥	G56105	↔	Safari			
								⊥	G45078	↔	Technomatic			
FAMILIA														
BJE	99-00			⚡	70745	L	Gas Ryder	⚡	70747	L	Gas Ryder			
				⚡	70746	R	Gas Ryder	⚡	70748	R	Gas Ryder			
BJ	00-04			⚡	70741	L	Gas Ryder	⚡	70743	L	Gas Ryder			
				⚡	70742	R	Gas Ryder	⚡	70744	R	Gas Ryder			
MARATHON (FORD HUSKY)														
Van, Bus	92-03			⊥	G45876	↔	Technomatic	⊙	G56186	↔	Safari		4131	
								⊙	G45870	↔	Technomatic			
MAZDA 2														
Hatch DE (Demio)	07 on			⚡	70600	L	Gas Ryder	⊙	62009	↔	Gas Ryder		4379	
				⚡	70601	R	Gas Ryder							
MAZDA 3														
1.6, 2.0 Excl. 2.3 MPS (Mk I) (BK) (Axela)	04-09			⚡	70592	L	Gas Ryder	⊙	G45892	↔	Technomatic		4375	
				⚡	70593	R	Gas Ryder							
MAZDA 6														
All Excl. MPS (GG/GY)	03-07			⚡	69107	L	Gas Ryder							
				⚡	69108	R	Gas Ryder							
RUSTLER														
130, 160	85-86			⚡	35816	↔	Technomatic	⊙	G45875	↔	Technomatic			
1400, 1600	86-94			⚡	35844	↔	Technomatic	⊙	G45875	↔	Technomatic			
1300, 1600	94-02			⚡	35927	↔	Technomatic	⊙	G45878	↔	Technomatic			
SOHO														
121 (Sleeved-Eye)	99-06		22	⚡	55865	↔	Gas Ryder	⚡	69095	↔	Gas Ryder		4063	
121 (U-Bracket)	97-99		23	⚡	55865	↔	Gas Ryder	⚡	69082	↔	Gas Ryder			
T2000, T3000														
LDV, Truck	81-86			⊙	55211	↔	Safari	⊙	G56177	↔	Safari			
LDV, Truck	83 on			⊙	55211	↔	Safari	⊙	G56177	↔	Safari			



Derivative	Year	Vehicle Type	Fitment Guide #	FRONT				REAR				GASLIFT	
				Shock Info	Part #	L/R	Range	Shock Info	Part #	L/R	Range	Front	Rear
MERCEDES													
114, 115 SERIES													
220, 230, 240D, 280E, 280 (Excl. )	68-77				61201	↔	Gas Ryder		55208	↔	Safari		
A CLASS													
(W168) A160, A190, 170CDI	00-04				G35365	↔	Gas Ryder		69444	↔	Gas Ryder		
(W169) A170, A180Cdi, A200	05-12				70659	↔	Gas Ryder		62030	↔	Gas Ryder		
B CLASS													
(W245) B150, B160, B170, B200, B180 Cdi, B200 Cdi	05-11								62030	↔	Gas Ryder		
W245	05-12				70659	↔	Gas Ryder		62030	↔	Gas Ryder		
C CLASS													
200, 230E, 240D, 250, 280E, 300D (Excl. ) (W123)	77-86				61202	↔	Gas Ryder		55208	↔	Safari		
190 Series (Excl. ) (W201)	83-94				55815	↔	Gas Ryder		69744	↔	Gas Ryder		
200, 230E, 260E, 300D, 300E (Excl. ) (W124)	86-95				55815	↔	Gas Ryder		69744	↔	Gas Ryder		
C180, C200, C220, C230, C250 (Excl. C280 & Sport Susp.) (W202)	94-00				61253	↔	Gas Ryder		61254	↔	Gas Ryder		
C280 (W202)	94-00								61254	↔	Gas Ryder		
C180, C200, C220CDi, C230, C270CDi, C280, C320CDi, C350 (W203)	00-07				70602	↔	Gas Ryder		62004	↔	Gas Ryder		
(CLC 203)	00-11				70808	↔	Gas Ryder		62092	↔	Gas Ryder		
C180, C200, C220CDi, C230, C270CDi, C280, C320CDi, C350 (W203)	07 on								62032	↔	Gas Ryder		
C180, C200, C220CDi, C230, C250, C250CDi, C300, C320CDi, C350 (W204) (Excl. S/W; AMG; Elec. & Air Susp.)	07-14				70658	↔	Gas Ryder		62032	↔	Gas Ryder		
E CLASS													
E230, E250D (W210)	95-99				69952	↔	Gas Ryder						
E200, E220D, E280, E280TD, E290TD (Excl.  , ) (W210)	95-02				69952	↔	Gas Ryder		69966	↔	Gas Ryder		
E200K; E220 Cdi; E240; E270Cdi; E280, E320, E350, E320Cdi; E350; E500, E320 (W211) (Excl. S/W; AMG; Elec. & Air Susp.)	02-09				69105	↔	Gas Ryder		62013	↔	Gas Ryder		
(W212) excl. Coupe, AMG, (Excl. )	09-15				70786	↔	Gas Ryder		62083	↔	Gas Ryder		
S CLASS													
220, 250, 280 (W111 Series)	60-68								36761	↔	Technomatic		
190, 200, 230 (W110 Series)	62-67								36761	↔	Technomatic		
W108 Series	68-73								36761	↔	Technomatic		
280SE, 280S, 350SE (Excl. ) (W116 Series)	73-81				61202	↔	Gas Ryder		55208	↔	Safari		
280SE, 300SE, 380SE, 420SE, 500SE, 560SE Incl SEL & SEC (Excl. ) (W126)	81-93				61202	↔	Gas Ryder		55208	↔	Safari		



Derivative	Year	Vehicle Type	Fitment Guide #	FRONT				REAR				GASLIFT		
				Shock Info	Part #	L/R	Range	Shock Info	Part #	L/R	Range	Front	Rear	
MERCEDES														
SL CLASS														
280 SL, SLC, 350 SL, SLC (Excl. )	71-81			$\frac{1}{S}$	61201	↔	Gas Ryder							
450 SL, SLC (Excl. )	73-81			$\frac{1}{S}$	61201	↔	Gas Ryder							
SPRINTER														
308D (903) Cargo van	95-06								42864	↔	Technomatic			
308D, 312D (903) Passenger van	95-06								42864	↔	Technomatic			
312D Panel Van (body length = 319.5mm)	95-06								42864	↔	Technomatic			
312D Panel Van (body length = 345.5mm)	95-06								42864	↔	Technomatic			
412D (903) Cargo van	95-06								83450	↔	Heavy Duty			
412D (903) Passenger van	95-06								83450	↔	Heavy Duty			
Panel Van	06 on				70506	↔	Gas Ryder		62008	↔	Gas Ryder			
UNIMOG														
414, 416	19...				76014	↔	Fleet Ryder		76014	↔	Fleet Ryder			
VITO														
112 CDi 2.2 P-Van Dsl (W638)	02-04				70538	↔	Gas Ryder		61294	↔	Gas Ryder			
112 CDi 2.2 Cr-Cab P-Van Dsl (W638)	03-04				70538	↔	Gas Ryder		61294	↔	Gas Ryder			
115 (W629 Gen2)	04-10				70713	↔	Gas Ryder							
115 CDi 2.2 Bus MPV Dsl (W639)	04-15								G56268	↔	Safari			
115 CDi 2.2 Cr-Cab P-Van Dsl (W639)	04-15								G56268	↔	Safari			
115 CDi 2.2 P-Van Dsl (W639)	04-15								G56268	↔	Safari			
W110 SERIES														
190, 200, 230	62-67							$\frac{1}{O}$	36761	↔	Technomatic			
220, 250, 280	60-68							$\frac{1}{O}$	36761	↔	Technomatic			
MINI														
COOPER														
One, Cooper & Cooper S (R50, R53)	02-06				70679	L	Gas Ryder		69109	↔	Gas Ryder			
One, Cooper & Cooper S (R50, R53)	02-06				70680	R	Gas Ryder		69109	↔	Gas Ryder			



Derivative	Year	Vehicle Type	Fitment Guide #	FRONT				REAR				GASLIFT		
				Shock Info	Part #	L/R	Range	Shock Info	Part #	L/R	Range	Front	Rear	
MITSUBISHI														
ASX														
All	11 on				70831	L	Gas Ryder		69134	↔	Gas Ryder			
					70832	R	Gas Ryder							
COLT														
Galant MkIII (imported strut)	77-78								G45812	↔	Technomatic			
Galant MkIII (local strut)	78-83				44612	↔	Technomatic		G45812	↔	Technomatic			
COLT BAKKIE														
L200 (1.6, 2.0, 2.5D 4X2)	94-98				G56185	↔	Technomatic		G56116	↔	Safari			
L200 (2.6, 3.0, V6 4X4, 4X2 Raised height)	94-98				GS56234	↔	Safari HDP		GS78016	↔	Safari HDP			
					G56185	↔	Safari		G56184	↔	Safari			
L200 (4X2 Raised height)	98-07				GS56220	↔	Safari HDP		GS78003	↔	Safari HDP			
					G56172	↔	Safari		G56184	↔	Safari			
					G45893	↔	Technomatic		G56184	↔	Safari			
L200 (4X2 Std. height)	98-07				G56185	↔	Technomatic		G56116	↔	Safari			
					G56185	↔	Technomatic		G45872	↔	Technomatic			
L200 (4X4)	98-07				GS56220	↔	Safari HDP		GS78003	↔	Safari HDP			
					G56241	↔	Safari		G56184	↔	Safari			
					G56172	↔	Safari		G56184	↔	Safari			
L300 (DELICA)														
Incl Starwagon, Express	82-03				G56185	↔	Safari		G56102	↔	Safari			
					G45466	↔	Technomatic		G45051	↔	Technomatic			
PAJERO														
V Series (Mk II)	91-99				GS56220	↔	Safari HDP		GS78019	↔	Safari HDP			
					46004	↔	Safari		46005	↔	Safari			
4X4 3.2 Di-D & 3.8 (Mk III) (SWB & LWB)	99-07				GS46006	↔	Safari HDP		GS78020	↔	Safari HDP			
					G56237	↔	Safari		G56274	↔	Safari			
3.0, 3.8, 3.2 Di-D (Mk IV NS, SWB & LWB)	07 on				GS46006	↔	Safari HDP		GS78020	↔	Safari HDP			
					G56237	↔	Safari		G56274	↔	Safari			
Sport Gen2 (Challenger)	09 on				G56205	↔	Safari		G56269	↔	Safari			
TREDIA														
Excl. Turbo	83-86				35836	↔	Technomatic		G45824	↔	Technomatic			
Turbo	83-86								G45824	↔	Technomatic			
TRITON														
4X4, 4X2 Raised height	07-17				GS46009	↔	Safari HDP		GS78021	↔	Safari HDP			
					G56205	↔	Safari		G56210	↔	Safari			



Derivative	Year	Vehicle Type	Fitment Guide #	FRONT				REAR				GASLIFT		
				Shock Info	Part #	L/R	Range	Shock Info	Part #	L/R	Range	Front	Rear	
NISSAN														
1/2 TON BAKKIE														
1400,1200, 120Y	71-09			/	44217	↔	Technomatic	☉	G45051	↔	Technomatic			
120Y (12" wheels)	76-83			/	44217	↔	Technomatic	☉	G45051	↔	Technomatic			
1400 (13" wheels)	80-83			/	44510	↔	Technomatic	☉	G45051	↔	Technomatic			
1 TON BAKKIE														
620, 680, 1300, 1500	66-80			☉	G56171	↔	Safari	☉	G56157	↔	Safari			
				☉	G45842	↔	Technomatic	☉	G45432	↔	Technomatic			
720 4X2	80-88			☉	G56171	↔	Safari	☉	G56102	↔	Safari			
				☉	G45842	↔	Technomatic	☉	G45051	↔	Technomatic			
Hardbody 4X2 (Excl. Hi Rider) (D21)	88-02			☉	G45893	↔	Technomatic	☉	G56116	↔	Safari			
				☉	G45869	↔	Technomatic	☉	G45872	↔	Technomatic			
Hardbody 4X2 Hi Rider Incl Sani (D21)	88-02			☉	G45893	↔	Technomatic	☉	G56116	↔	Safari			
				☉	G45893	↔	Technomatic	☉	G45872	↔	Technomatic			
Hardbody 4X4 (Incl Sani, Patrol) (D21)	88-02			☉	G56171	↔	Safari	☉	G56116	↔	Safari			
				☉	G56171	↔	Safari	☉	G45872	↔	Technomatic			
Hardbody 4X4 (D22)	98 on			☉	GS56221	↔	Safari HDP	☉	GS78018	↔	Safari HDP			
				☉	G56171	↔	Safari	☉	G56190	↔	Safari			
Hardbody 4X4, 4X2 Hi Rider (D22)	02 on			☉	G56171	↔	Safari	☉	G56190	↔	Safari			
				☉	GS56221	↔	Safari HDP	☉	GS78018	↔	Safari HDP			
Hardbody 4X2 (Excl. Hi Rider) (D22)	02 on			☉	G45893	↔	Technomatic	☉	G56190	↔	Safari			
				☉	G45869	↔	Technomatic							
1/2 TON BAKKIE														
1400,1200, 120Y	71-09			/	44217	↔	Technomatic	☉	G45051	↔	Technomatic			
120Y (12" wheels)	76-83			/	44217	↔	Technomatic	☉	G45051	↔	Technomatic			
1400 (13" wheels)	80-83			/	44510	↔	Technomatic	☉	G45051	↔	Technomatic			
ALMERA														
Gen2 Excl. ABS (N16)	01-07				70500	L	Gas Ryder		69093	↔	Gas Ryder			
					70501	R	Gas Ryder							
1.5 (N17) Gen 3	13 on				70806	L	Gas Ryder		62091	↔	Gas Ryder			
					70807	R	Gas Ryder							
E20 (URVAN, CARAVAN)														
Ekonowagon, Ekonovan (Urvan, Caravan)	73-81			☉	G45122	↔	Technomatic	☉	G56157	↔	Safari		4162	
				☉	G45122	↔	Technomatic	☉	G45432	↔	Technomatic			
Ekonowagon, Ekonovan (Urvan, Caravan)	81-95			☉	G56176	↔	Safari	☉	G56157	↔	Safari			
				☉	G45535	↔	Technomatic	☉	G45432	↔	Technomatic			
JUKE														
(F15) All	11 on				70833	L	Gas Ryder	☉	62102	↔	Gas Ryder			
					70834	R	Gas Ryder							



Derivative	Year	Vehicle Type	Fitment Guide #	FRONT				REAR				GASLIFT		
				Shock Info	Part #	L/R	Range	Shock Info	Part #	L/R	Range	Front	Rear	
NISSAN (Continued)														
LANGLEY														
Incl Panache (N10, MkI)	80-83				44227	↔	Technomatic		19289	↔	Technomatic			
Incl Exa (sealed strut) (N12, MkII)	83-88				35847	↔	Technomatic		G45859	↔	Technomatic		4099	
LAUREL														
2000, 2300, 2400 (C30)	68-72				G45255	↔	Technomatic		G45423	↔	Technomatic			
240, 260, 300 (C130)	72-78		13		G45255	↔	Technomatic		G45008	↔	Technomatic			
C230	78-87		13		44608	↔	Technomatic		69074	↔	Gas Ryder			
LIVINA														
Incl. X-Gear & Grand Livina (XJ)	06 on				70589	L	Gas Ryder		62094	↔	Gas Ryder			
					70590	R	Gas Ryder							
MICRA														
Gen 3 5-Door (K12)	04-11				70575	L	Gas Ryder		62001	↔	Gas Ryder		4363	
					70576	R	Gas Ryder							
Gen 4 (K13)	11-18				70806	L	Gas Ryder		62091	↔	Gas Ryder		4364	
					70807	R	Gas Ryder							
NAVARA														
4X4 & 4X2 (D40)	05-09				GS46010	↔	Safari HDP		GS56259	↔	Safari HDP			
					46003	↔	Safari							
NP200														
1.5, 1.6	08 on				70586	↔	Gas Ryder		62012	↔	Gas Ryder			
NP300														
4X2 (Excl. Hi Rider) (D22)	08 on				G45893	↔	Technomatic		G56190	↔	Safari			
					G45869	↔	Technomatic							
4X4 & 4X2 Hi Rider (D22)	08 on				GS56221	↔	Safari HDP		GS78018	↔	Safari HDP			
					G56171	↔	Safari							
NV350														
All	13 on				G56299	↔	Safari		G56300	↔	Safari			
PATHFINDER														
2.5 Dci, 4.0 (Mk III R51 series)	05-12				GS46010	↔	Safari HDP		GS56260	↔	Safari HDP			
PATROL														
4X4 (WG60)	72-80				G56119	↔	Safari		G56119	↔	Safari			
4X4 (G160)	80-89				G56119	↔	Safari							
S/W 4X4 (Y60, Y61, Rear for Y60 only)	89-01				G56105	↔	Safari		G56174	↔	Safari			
PRIMERA														
P11	98-02				G51213	↔	Gas Ryder		G51214	↔	Gas Ryder			
PULSAR														
Incl Panache (N10, MkI)	80-83				44227	↔	Technomatic		19289	↔	Technomatic			
(Sealed strut) (N12, MkII)	83-88				35847	↔	Technomatic		G45859	↔	Technomatic			

Derivative	Year	Vehicle Type	Fitment Guide #	FRONT				REAR				GASLIFT		
				Shock Info	Part #	L/R	Range	Shock Info	Part #	L/R	Range	Front	Rear	
NISSAN (Continued)														
QASHQAI														
1.6, 2.0, 1.5DCI (J10, JJ10)	07-14				70661	L	Gas Ryder		62026	↔	Gas Ryder		4365	
					70662	R	Gas Ryder							
SABRE														
160, 200 (Excl. ABS)	92-01				55838	L	Gas Ryder		55855	L	Gas Ryder		4515	
					55839	R	Gas Ryder		55856	R	Gas Ryder		4516	
SAFARI														
S/W (G160/G161) & Pickup	82-90				G56119	↔	Safari		G56168	↔	Safari			
SANI														
4X2	90-99				G56172	↔	Safari		G56116	↔	Safari			
					G56172	↔	Safari		G45872	↔	Technomatic			
4X4	90-99				G56171	↔	Safari		G56116	↔	Safari			
					G45842	↔	Technomatic		G45872	↔	Technomatic			
SENTRA														
Sedan, Coupe (B12)	87-92				55816	↔	Gas Ryder		55817	↔	Gas Ryder			
140	92-01				55838	L	Gas Ryder		55840	↔	Gas Ryder		4268	
					55839	R	Gas Ryder							
160, 200 (Excl. STi)	92-01				55838	L	Gas Ryder		55855	L	Gas Ryder			
					55839	R	Gas Ryder		55856	R	Gas Ryder			
SKYLINE														
1800, 2000 (R30)	82-87		13		44608	↔	Technomatic		69074	↔	Gas Ryder			
2800 GLX, GTX (R30)	82-87		13		44608	↔	Technomatic		69073	↔	Gas Ryder			
R31	87-92		13		61915	↔	Gas Ryder		69073	↔	Gas Ryder		4068	
STANZA														
1600J, 1800J Stanza, Resort A10	78-83				44510	↔	Technomatic		36854	↔	Technomatic			
1600J, 1800J, Stanza S/W A10	79-83				44510	↔	Technomatic		G45006	↔	Technomatic			
TERRANO II														
R20 LWB	98-03				G56173	↔	Safari		G56184	↔	Safari			
R20 SWB	98-04				G56173	↔	Safari		G56184	↔	Safari			
TIIDA														
1.6i & 1.8i Hatch & Sedan	06-13				70589	L	Gas Ryder		62006	↔	Gas Ryder			
					70590	R	Gas Ryder							
TRACKER														
4X4	80-82				G56171	↔	Safari		G56168	↔	Safari			
					G45842	↔	Technomatic							
4X4 (Incl. Sani)	82-88				G56171	↔	Safari		G56186	↔	Safari			



Derivative	Year	Vehicle Type	Fitment Guide #	FRONT				REAR				GASLIFT	
				Shock Info	Part #	L/R	Range	Shock Info	Part #	L/R	Range	Front	Rear
NISSAN (Continued)													
U' SERIES													
1600, 1800 (Incl. Coupe)	72-73				44500	↔	Technomatic		G45423	↔	Technomatic		
160U, 180U	74-78				44500	↔	Technomatic		G45423	↔	Technomatic		
VANETTE													
C22	85-85		6		G45447	↔	Technomatic		G45051	↔	Technomatic		
X-TRAIL													
4X4 & 4X2 (Mk I)	01-07				70556	L	Gas Ryder		70558	L	Gas Ryder		
					70557	R	Gas Ryder		70559	R	Gas Ryder		
4X4 & 4X2 (Mk II)	08-14				70663	L	Gas Ryder		62033	↔	Gas Ryder		
					70664	R	Gas Ryder						
Y SERIES													
1200	71-75				44217	↔	Technomatic		36767	↔	Technomatic		
1200 LCV	72-75				44217	↔	Technomatic		G45122	↔	Technomatic		
120Y, 140 SDX, (12" wheels)	75-80				44217	↔	Technomatic		36767	↔	Technomatic		
140 SDX (13"), 140Y, 160Y	75-80				44510	↔	Technomatic		36767	↔	Technomatic		4068
140Y, 160Y	75-80				44510	↔	Technomatic		G45051	↔	Technomatic		
140Y, 160Y LCV	75-80				44510	↔	Technomatic		G45533	↔	Technomatic		
Z SERIES													
240Z, 260Z, 280Z (S30)	70-81												
OPEL													
ASTRA													
F (Sedan)	93-99		14		61918	↔	Gas Ryder		G45874	↔	Technomatic		
					44411	↔	Technomatic						
F (Estate)	94-01		8		61918	↔	Gas Ryder		61252	↔	Gas Ryder		4221
					44411	↔	Technomatic						
Caravan, Excl. 2.0 OPC (G)	98-04				70505	↔	Gas Ryder		69987	↔	Gas Ryder		4308
Excl. 2.0 OPC (G) Hatch	99-03				70505	↔	Gas Ryder		G45881	↔	Technomatic		4272
(H) 1.8 & 1.9 CDTi Incl GTC (Excl. 2.0 Turbo Sport & OPC)	04-09								62019	↔	Gas Ryder		
(J) Excl. OPC, GTC, & Elec Susp.	10-16				70706	L	Gas Ryder		62052	↔	Gas Ryder		
					70707	R	Gas Ryder						62052
COMMODORE													
C (Sedan)	78-88				44611	↔	Technomatic		G45489	↔	Technomatic		
C (Estate)	78-92				44611	↔	Technomatic		G45399	↔	Technomatic		
CONSTANTIA, KOMMANDO													
Brougham	69-72				G45255	↔	Technomatic		G45533	↔	Technomatic		
Incl., Caprice, De Ville (AQ)	72-79				G45532	↔	Technomatic		G45533	↔	Technomatic		

Derivative	Year	Vehicle Type	Fitment Guide #	FRONT				REAR				GASLIFT	
				Shock Info	Part #	L/R	Range	Shock Info	Part #	L/R	Range	Front	Rear
OPEL (Continued)													
CORSA													
(B) Lite	96-07				55858	↔	Gas Ryder	$\frac{1}{\circ}$	61256	↔	Gas Ryder		4277
(B) Utility	96-04				55858	↔	Gas Ryder	$\frac{\circ}{\circ}$	61257	↔	Gas Ryder		
(B) Lite	02-07				55858	↔	Gas Ryder	$\frac{1}{\circ}$	61256	↔	Gas Ryder		
(C) Excl. Corsa Lite	02-07				70504	↔	Gas Ryder	$\frac{1}{\circ}$	61256	↔	Gas Ryder		
(B) Utility	04-12				70527	↔	Gas Ryder	$\frac{\circ}{\circ}$	G56224	↔	Safari		
(D)	07-15				70708	L	Gas Ryder	$\frac{1}{\circ}$	62044	↔	Gas Ryder		4366 (3 Door)
					70709	R	Gas Ryder						4367 (5 Door)
KADETT													
(B)	66-74							$\frac{1}{\circ}$	G45533	↔	Technomatic		4079
(D) Estate	80-85		7		61909	↔	Gas Ryder	$\frac{\circ}{\Gamma}$	G45432	↔	Gas Ryder		4069
(D) Hatch	80-85				61909	↔	Gas Ryder	$\frac{1}{\circ}$	G45839	↔	Technomatic		4079
(E) T-car	85-89				61909	↔	Gas Ryder	$\frac{1}{\circ}$	G45839	↔	Technomatic		4260
					44607	↔	Technomatic						
(E) T-car	89-93		14		61909	↔	Gas Ryder	$\frac{1}{\circ}$	G45874	↔	Technomatic		
					44607	↔	Technomatic						
Astra	93-99		14		61918	↔	Gas Ryder	$\frac{1}{\circ}$	G45874	↔	Technomatic		
					44411	↔	Technomatic						
MONZA													
Incl GSi	86-89				61909	↔	Gas Ryder	$\frac{1}{\circ}$	G45839	↔	Technomatic		
					44607	↔	Technomatic						
Incl Cub	89-93		14		61909	↔	Gas Ryder	$\frac{1}{\circ}$	G45874	↔	Technomatic		
					44607	↔	Technomatic						
OMEGA													
Sedan, Estate (B)	01-04				EG35115	↔	Gas Ryder						
REKORD													
C	67-73			$\frac{1}{\circ}$	G45212	↔	Technomatic	$\frac{1}{\circ}$	G45533	↔	Technomatic		
Caravan (E)	78-92				44611	↔	Technomatic	$\frac{1}{\circ}$	G45138	↔	Technomatic		
Sedan (Excl. V6) (E)	78-97				44611	↔	Technomatic	$\frac{1}{\circ}$	G45489	↔	Technomatic		
380i V6	91-97				44611	↔	Technomatic	$\frac{1}{\circ}$	61230	↔	Gas Ryder		
SENATOR													
A	79-86				44611	↔	Technomatic	$\frac{1}{\circ}$	61230	↔	Gas Ryder		
ZAFIRA													
A	01-06				G35289	L	Gas Ryder	$\frac{\circ}{\circ}$	69415	↔	Gas Ryder		
					G35290	R	Gas Ryder						



Derivative	Year	Vehicle Type	Fitment Guide #	FRONT				REAR				GASLIFT		
				Shock Info	Part #	L/R	Range	Shock Info	Part #	L/R	Range	Front	Rear	
PEUGEOT														
107														
1.0	07-15				70723	L	Gas Ryder	∅	62062	↔	Gas Ryder			
					70724	R	Gas Ryder							
206														
1.4	01-06				70539	L	Gas Ryder	∅	69401	↔	Gas Ryder		4330	
					70540	R	Gas Ryder							
1.6	01-06				70539	L	Gas Ryder	∅	69401	↔	Gas Ryder		4333	
					70540	R	Gas Ryder							
CC 1.6, CC 2.0	01-07							∅	69446	↔	Gas Ryder			
1.6 Estate	03-07				G35338	L	Gas Ryder	∅	69446	↔	Gas Ryder			
					G35337	R	Gas Ryder							
1.4HDi, 2.0HDi	04-07				G35338	L	Gas Ryder	∅	69446	↔	Gas Ryder		4330	
					G35337	R	Gas Ryder							
2.0 GTi	00-06				G35338	L	Gas Ryder	∅	69446	↔	Gas Ryder			
					G35337	R	Gas Ryder							
207														
CC 1.6 Sport 2 EU5	06 on				70763	L	Gas Ryder							
					70764	R	Gas Ryder							
GT 1.6 3-dr	06 on				70763	L	Gas Ryder							
					70764	R	Gas Ryder							
Hatch	06 on				70763	L	Gas Ryder	∅	69446	↔	Gas Ryder			
					70764	R	Gas Ryder							
306														
Hatchback, saloon & cabriolet (Excl. Estate)	93-02							∅	69965	↔	Gas Ryder			
307														
1.6, 2.0 (Excl. CC)	01-08				G35369	L	Gas Ryder	∅	61286	↔	Gas Ryder		4331	
					G35370	R	Gas Ryder							
Estate	02-08				G35369	L	Gas Ryder							
					G35370	R	Gas Ryder							
404														
Saloon	60-78							†	G45258	↔	Technomatic			
Estate	69-78							∅	G45470	↔	Technomatic			
406														
Saloon	96-04							∅	69926	↔	Gas Ryder			
504														
GL, GLD, Ti	73-80				44604	↔	Technomatic	∅	G45470	↔	Technomatic			
Estate	74-85				44606	↔	Technomatic	∅	G45470	↔	Technomatic			
L, GR	76-85				44604	↔	Technomatic	†	G45258	↔	Technomatic			



Derivative	Year	Vehicle Type	Fitment Guide #	FRONT				REAR				GASLIFT	
				Shock Info	Part #	L/R	Range	Shock Info	Part #	L/R	Range	Front	Rear
PEUGEOT (Continued)													
505													
Saloon	80-85			/	44606	↔	Technomatic	⊖	G45450	↔	Technomatic		
RAMBLER													
HORNET & SPORTABOUT													
AMC	70-76							+	G45258	↔	Technomatic		
RENAULT													
CLIO													
Clio II 1.4, 1.5dCi & 1.6 (Excl. 1.2, 1.6 Sport, 2.0 & 3.0)	00-06			/	70512	↔	Gas Ryder	⊖	69989	↔	Gas Ryder		4298
Clio II 1.6 16V Sport	00-06			/	70809	↔	Gas Ryder	⊖	69425	↔	Gas Ryder		
Clio III Hatch	06-13			/	70682	↔	Gas Ryder	⊖	62043	↔	Gas Ryder		4368
GRAND SCENIC													
Grand Scenic II	04-09			/	G35451	↔	Gas Ryder						
LAGUNA													
I (Excl. Station Wagon)	96-00			/	35117	↔	Technomatic						
LOGAN													
U90	08 on			/	70639	↔	Gas Ryder	⊖	62025	↔	Gas Ryder		
MEGANE													
I (Excl. Coupe)	96-03			/	70511	↔	Gas Ryder	⊖	69927	↔	Gas Ryder		
II Hatch (Excl. 2.0 T Sport)	04-08			/	G35421	↔	Gas Ryder	⊖	69538	↔	Gas Ryder		
R5													
Mk I Hatchback	72-85			⊖	36850	↔	Technomatic	⊖	36851	↔	Technomatic		
Mk I panel van	80-85			⊖	36850	↔	Technomatic	⊖	36851	↔	Technomatic		
R8,R10													
Small sedan	62-70			⊖	19022	↔	Technomatic	⊖	19022	↔	Technomatic		
R9,R11													
Saloon, hatchback	83-86			/	35824	↔	Technomatic	⊖	36851	↔	Technomatic		
SANDERO													
5-door hatchback	09-14			/	70639	↔	Gas Ryder	⊖	62025	↔	Gas Ryder		
SCENIC													
Scenic I (Excl. 4X4)	98-04			/	70511	↔	Gas Ryder	⊖	62035	↔	Gas Ryder		
Scenic II	04-09			/	G35451	↔	Gas Ryder	⊖	69512	↔	Gas Ryder		



Derivative	Year	Vehicle Type	Fitment Guide #	FRONT				REAR				GASLIFT	
				Shock Info	Part #	L/R	Range	Shock Info	Part #	L/R	Range	Front	Rear
SSANGYONG													
MUSSO													
602TDi, E230EL, E320EL	95-06				G56173	↔	Safari		55088	↔	Safari		
MUSSO SPORT													
DC Bakkie	04 on				G56173	↔	Safari						
SUZUKI													
ALTO													
Gen 7	09-15				70693	L	Gas Ryder		62037	↔	Gas Ryder		
					70694	R	Gas Ryder						
JIMNY													
Gen 3 - (SN413 / JA/JB33)	98-18				GS56283	↔	Safari HDP		GS56284	↔	Safari HDP		
					G45901	↔	Technomatic						
Gen 4 - (JB64W/JB74W)	18-on								GS56284	↔	Safari HDP		
SJ410/413, SAMURAI													
4X4, S/W	82-87				G45122	↔	Technomatic		G45054	↔	Technomatic		
					G45122	↔	Technomatic						
SWIFT													
Gen 1 (RS413; RS415)	08-10				70689	L	Gas Ryder		62055	↔	Gas Ryder		
					70690	R	Gas Ryder						
SX4													
4X2	08 on				70687	L	Gas Ryder						
					70688	R	Gas Ryder						
VITARA													
5 door (Excl. V6) (Mk I)	94-98				G56518	↔	Gas Ryder		G63799	↔	Gas Ryder		
TATA													
INDICA													
1.4 Hatch (V2) (Incl. B-Line, Excl. Tdi & ABS)	04 on				35934	L	Technomatic		51168	↔	Technomatic		
					35935	R	Technomatic						
TELCOLINE													
4X4, 4X2 Incl Worker	04 on				55231	↔	Safari		36860	↔	Technomatic		
XENON													
3.0 4X2 & 4X4	07 on				G56249	↔	Safari		G56250	↔	Safari		

Derivative	Year	Vehicle Type	Fitment Guide #	FRONT				REAR				GASLIFT		
				Shock Info	Part #	L/R	Range	Shock Info	Part #	L/R	Range	Front	Rear	
TOYOTA														
1200														
LDV	78-82				44226	↔	Technomatic		19290	↔	Technomatic			
AURIS														
1.4, 1.6, 1.8, 2.0 Hatch (330N/E150) Excl. TRD	07-12				70561	L	Gas Ryder		62022	↔	Gas Ryder		4369	
					70562	R	Gas Ryder							
E180	13-19				70561	L	Gas Ryder		62022	↔	Gas Ryder			
					70562	R	Gas Ryder							
AVANZA														
1.3 & 1.5 (Xenia) Excl. ABS	06-12				70579	L	Gas Ryder		G45891	↔	Technomatic		4380 (L) 4381 (R)	
					70580	R	Gas Ryder							
AVENSIS														
Gen 2 (T250)	06-10				70701	L	Gas Ryder							
					70702	R	Gas Ryder							
AYGO														
Gen 1 (B1 & KGB10)	11-15				70723	L	Gas Ryder		62062	↔	Gas Ryder			
					70724	R	Gas Ryder							
BUBBLE														
(1NZ)	02-07				70752	L	Gas Ryder		69092	↔	Gas Ryder			
					70753	R	Gas Ryder							
CAMRY														
(Gen 5) (SV20)	96-01				70727	L	Gas Ryder		55848	L	Gas Ryder			
					70728	R	Gas Ryder							
XV20	97-01				55886	L	Gas Ryder		55848	L	Gas Ryder	4165		
					55887	R	Gas Ryder							
XV10	93-97				55846	L	Gas Ryder		55848	L	Gas Ryder	4165		
					55847	R	Gas Ryder							
CELICA, SUPRA														
A60 Series (MK III)	81-85								61228	↔	Gas Ryder			
CHASER														
Mark II	92-02								69123	↔	Gas Ryder			
CONDOR														
4X2 Mk IV	00-05				G45466	↔	Technomatic		G45872	↔	Technomatic		4521/2	
4X4 Mk IV	00-05				G45535	↔	Technomatic		G45006	↔	Technomatic			
CONQUEST														
FWD (E80)	85-88				55812	↔	Gas Ryder		55813	↔	Gas Ryder		4063	
FWD (E90)	89-07				55818	↔	Gas Ryder		55819	↔	Gas Ryder		4273	



Derivative	Year	Vehicle Type	Fitment Guide #	FRONT				REAR				GASLIFT	
				Shock Info	Part #	L/R	Range	Shock Info	Part #	L/R	Range	Front	Rear
TOYOTA (Continued)													
COROLLA													
Imported strut (E30, E40, E50, E60)	74-80		10		44614	↔	Technomatic		G45399	↔	Technomatic		
RWD (Excl. Van, S/W) (E70)	80-85				44614	↔	Technomatic		G45841	↔	Technomatic		
Imported strut (E30, E40, E50, E60)	82-85		10		44614	↔	Technomatic		G45399	↔	Technomatic		
FWD (Incl. Avante) (E80)	85-89				55812	↔	Gas Ryder		55813	↔	Gas Ryder		
FWD (E90)	89-96				55818	↔	Gas Ryder		55819	↔	Gas Ryder		
Excl. RSi (E100)	96-02				55861	↔	Gas Ryder		55863	↔	Gas Ryder		
RSi (E100)	96-02				55861	↔	Gas Ryder						
1.3, 1.4, 1.6, 1.8, & 2.0 (E120), (E130)	02-07				55892	L	Gas Ryder		69092	↔	Gas Ryder		
					55893	R	Gas Ryder						
NZE120/121, ZZE121	02 on								69103	↔	Gas Ryder		
1.3, 1.4, 1.6, 1.8, & 2.0 D4D (E140, E150) Incl. Quest	07-14				70561	L	Gas Ryder		61297	↔	Gas Ryder		
					70562	R	Gas Ryder						
NRE18, ZRE17, NDE18 (E18)	14-on				70561	L	Gas Ryder		61297	↔	Gas Ryder		
					70562	R	Gas Ryder						
COROLLA CARRI													
T40, T50 Series (Incl. 2000 GSL)	64-74				G45398	↔	Technomatic		G45399	↔	Technomatic		
T60, T70 Series (Mark II 1900)	69-73				G45398	↔	Technomatic		G45006	↔	Technomatic		
Mk II 2000	72-78				G45398	↔	Technomatic		G45399	↔	Technomatic		
Imported strut	73-79								G45399	↔	Technomatic		
T100 series	74-80				G45398	↔	Technomatic		G45841	↔	Technomatic		
Local strut (E30, E40, E50, E60)	79-89				44614	↔	Technomatic		G45399	↔	Technomatic		
ST210, CT210 2.0 & 2.0 Diesel Sedan	01.96-12.01				70571	L	Gas Ryder		70573	L	Gas Ryder		
					70572	R	Gas Ryder		70574	R	Gas Ryder		
E90	98-05				55818	↔	Gas Ryder		55819	↔	Gas Ryder		4273
ST215G/W (2.0 & 2.0 Turbo 4WD GT & GTT)	12.99-09.02				70571	L	Gas Ryder						
					70572	R	Gas Ryder						
COROLLA CARRI e													
AT190, ST191, CT190 Sedan made in the UK	01.96-10.97				70571	L	Gas Ryder						
					70572	R	Gas Ryder						
ST191, CT190 2.0 & 2.0 Diesel Sedan & LB:5 Door Hatchback with Harsh Road Package	02.96-05.98				70571	L	Gas Ryder						
					70572	R	Gas Ryder						
ST191 2.0 Sedan & LB:5 Door Hatchback	03.92-02.96								70573	L	Gas Ryder		
									70574	R	Gas Ryder		
ST191, CT190 2.0 & 2.0 Diesel Sedan & LB:5 Door Hatchback	03.92-05.98				70571	L	Gas Ryder		70573	L	Gas Ryder		
					70572	R	Gas Ryder		70574	R	Gas Ryder		
ST191 2.0 Station Wagon	11.92-01.96				70571	L	Gas Ryder					4084	4083
					70572	R	Gas Ryder						

Derivative	Year	Vehicle Type	Fitment Guide #	FRONT				REAR				GASLIFT		
				Shock Info	Part #	L/R	Range	Shock Info	Part #	L/R	Range	Front	Rear	
TOYOTA (Continued)														
CRESSIDA														
X30, X32 (imported strut) (Mk I)	77-79							⊘	61228	↔	Gas Ryder			
								⊘	G45813	↔	Technomatic			
X35, X36 (imported strut) (Mk I)	78-79							⊘	G45399	↔	Technomatic			
X30, X32 (local strut) (Mk I)	79-81			⚡	44613	↔	Technomatic	⊘	61228	↔	Gas Ryder			
				⚡	44613	↔	Technomatic	⊘	G45399	↔	Technomatic			
MX63 (Mk II)	81-93			⚡	61903	↔	Gas Ryder	⊘	G45469	↔	Technomatic	4084		
				⚡	44603	↔	Technomatic	⊘	G45469	↔	Technomatic			
Non IRS+, MX63 (Mk II)	81-93			⚡	61903	↔	Gas Ryder	⊘	61228	↔	Gas Ryder			
				⚡	44603	↔	Technomatic	⊘	G45813	↔	Technomatic			
With IRS+, MX73 (Mk III)	83-93			⚡	61903	↔	Gas Ryder	⊘	61212	↔	Gas Ryder			
				⚡	44603	↔	Technomatic	⊘	61212	↔	Gas Ryder			
ETIOS														
All (NGK15R, NGK12R)	12-on			⚡	70826	↔	Gas Ryder	⊘	62100	↔	Gas Ryder		4352	
FJ CRUISER														
4X4 SUV	11 on			⚡	GS46012	↔	Safari HDP	⊘	GS78037	↔	Safari HDP			
FORTUNER														
4X4, 4X2 Raised Susp.	06-16			⚡	GS46007	↔	Safari HDP	⊘	GS78010	↔	Safari HDP			
				⚡	G56218	↔	Safari	⊘	G56219	↔	Safari			
2.4GD, 2.7, 2.8GD, 4.0L V6, 4X2 & 4X4	16 on			⚡	G56314	↔	Safari	⊘	G56315	↔	Safari			
HARRIER														
SXU 10 (Gen 1)	97-03			⚡	70729	L	Gas Ryder	⚡	70735	L	Gas Ryder			
				⚡	70730	R	Gas Ryder	⚡	70736	R	Gas Ryder	4083		
SXU 15 (Gen 1)	97-03			⚡	70729	L	Gas Ryder	⚡	70737	L	Gas Ryder			
				⚡	70730	R	Gas Ryder	⚡	70738	R	Gas Ryder			
HI-ACE														
East Africa	19....							⊘	G56187	↔	Safari			
H10	69-84			⊘	G45466	↔	Technomatic	⊘	G56102	↔	Safari			
				⊘	G45466	↔	Technomatic	⊘	G45006	↔	Technomatic			
SWB (H20, H30, H40)	84-88			⊘	G56241	↔	Safari	⊘	G56177	↔	Safari	4163		
				⊘	G56172	↔	Safari	⊘	G56177	↔	Safari	4163		
				⊘	G45893	↔	Technomatic	⊘	G45054	↔	Technomatic	4163		
				⊘	G45869	↔	Technomatic	⊘	G45054	↔	Technomatic	4163		
LWB (H20, H30, H40)	84-93			⊘	G56241	↔	Safari	⊘	G56175	↔	Safari	4163		
				⊘	G56172	↔	Safari	⊘	G56175	↔	Safari	4163		
				⊘	G45893	↔	Technomatic	⊘	G45873	↔	Technomatic	4163		
				⊘	G45869	↔	Technomatic	⊘	G45873	↔	Technomatic	4163		



Derivative	Year	Vehicle Type	Fitment Guide #	FRONT				REAR				GASLIFT	
				Shock Info	Part #	L/R	Range	Shock Info	Part #	L/R	Range	Front	Rear
TOYOTA (Continued)													
HI-ACE													
SWB (H50)	88-93			⊥	G56241	↔	Safari	⊙	G56175	↔	Safari		4163
				⊥	G56172	↔	Safari	⊙	G56175	↔	Safari		4163
				⊥	G45893	↔	Technomatic	⊙	G45873	↔	Technomatic		4163
				⊥	G45869	↔	Technomatic	⊙	G45873	↔	Technomatic		4163
Super T (H100)	93-10			⊥	G56173	↔	Safari	⊙	G56175	↔	Safari		4163
HILUX													
4X2	69-84			⊥	G45398	↔	Technomatic	⊙	G45006	↔	Technomatic		
4X4	79-84			⊥	G56158	↔	Safari	⊙	G56103	↔	Safari		
				⊥	G56158	↔	Safari	⊙	G45008	↔	Technomatic		
4X2	84-98			⊥	G56178	↔	Safari	⊙	G56186	↔	Safari		
				⊥	G45862	↔	Technomatic	⊙	G45870	↔	Technomatic		
4X4	84-98			⊥	GS78000	↔	Safari HDP	⊙	GS78001	↔	Safari HDP		
				⊥	G56158	↔	Safari	⊙	G56167	↔	Safari		
4X2 Raised Susp.	99-05			⊥	GS56232	↔	Safari HDP	⊙	GS78004	L	Safari HDP		
								⊙	GS78005	R	Safari HDP		
				⊥	G56189	↔	Safari	⊙	G56167	L	Safari		
								⊙	G56174	R	Safari		
4X2 Std. Susp.	99-05			⊥	G56178	↔	Safari	⊙	G56190	↔	Safari		
				⊥	G45862	↔	Technomatic	⊙	G45008	↔	Technomatic		
4X4 Raised Susp.	99-05			⊥	GS56232	↔	Safari HDP	⊙	GS78004	L	Safari HDP		
								⊙	GS78005	R	Safari HDP		
				⊥	G56189	↔	Safari	⊙	G56167	L	Safari		
								⊙	G56174	R	Safari		
4X2 Raised Susp. (Vigo)	05-16			⊥	GS46007	↔	Safari HDP	⊙	GS78009	↔	Safari HDP		
				⊥	G56218	↔	Safari	⊙	G56207	↔	Safari		
4X2 Std. Susp. (Vigo)	05-16			†	G45888	L	Technomatic	⊙	G56208	↔	Safari		
				†	G45889	R	Technomatic						
4X4 Raised Susp. (Vigo)	05-16			⊥	GS46007	↔	Safari HDP	⊙	GS78009	↔	Safari HDP		
				⊥	G56218	↔	Safari	⊙	G56207	↔	Safari		
4X2 Std. Susp.	16 on			†	G45888	L	Technomatic	⊙	G56167	↔	Safari		
				†	G45889	R	Technomatic						
4X4 & 4X2 Raised Susp. (2.4L; 2.7L; 2.8L; 4.0L V6)	16-on			†	G56308	↔	Safari	⊙	G56309	↔	Safari		
IPSUM													
Picnic (E110) (SM10)	96-01			†	70725	L	Gas Ryder	⊥	36876	↔	Technomatic		
				†	70726	R	Gas Ryder						
Avenis Verso (E121) (ACM2)	01-06			†	70754	L	Gas Ryder	⊥	62061	↔	Gas Ryder		
				†	70755	R	Gas Ryder						



Derivative	Year	Vehicle Type	Fitment Guide #	FRONT				REAR				GASLIFT		
				Shock Info	Part #	L/R	Range	Shock Info	Part #	L/R	Range	Front	Rear	
TOYOTA (Continued)														
LAND CRUISER														
70SW	07 on			†	GS78002	↔	Safari HDP	∅	GS78013	↔	Safari HDP			
75SW	07 on			†	GS78002	↔	Safari HDP	∅	GS78013	↔	Safari HDP			
76SW	07 on			†	GS78002	↔	Safari HDP	∅	GS78013	↔	Safari HDP			
79 series	99 on			†	G56239	↔	Safari	∅	G56240	↔	Safari			
				†	GS78002	↔	Safari HDP	∅	GS78013	↔	Safari HDP			
80	90-98			†	GS78011	↔	Safari HDP	∅	GS78012	↔	Safari HDP			
100 series	90-98							∅	G56231	↔	Safari			
105	99-07			†	GS78011	↔	Safari HDP	∅	GS78012	↔	Safari HDP			
200	08 on			†	GS78033	↔	Safari HDP	∅	GS78034	↔	Safari HDP			
DLX, BJ75	85-99			∅	G56179	↔	Safari	∅	G56174	↔	Safari			
FJ45, BJ45	71-85			∅	G56177	↔	Safari	∅	G56186	↔	Safari			
				∅	G45051	↔	Technomatic	∅	G45008	↔	Technomatic			
FJ62, BJ60 S/W	83-89			∅	G56166	↔	Safari	∅	G56186	↔	Safari			
HDJ100, UZJ100 (Excl. air Susp.)	98-02			∅	83455	↔	Heavy Duty	∅	83456	↔	Heavy Duty			
								∅	83456	↔	Heavy Duty			
HZJ70	89-99			∅	G56179	↔	Safari	∅	G56167	↔	Safari			
HZJ80 S/W, HZJ105 S/W	90-98			†	G56230	↔	Safari	∅	G56231	↔	Safari			
PRADO														
90 SWB & 95 LWB	96-02			†	GS46008	↔	Safari HDP	∅	GS78015	↔	Safari HDP			
				†	46001	↔	Safari	∅	46002	↔	Safari			
				†	51240	↔	Technomatic	∅	83454	↔	Heavy Duty			
120/125	02-09			†	GS46007	↔	Safari HDP	∅	GS78017	↔	Safari HDP			
				†	G56226	↔	Safari	∅	G56227	↔	Safari			
J150 (Excl. 15)	09 on			†	GS46012	↔	Safari HDP	∅	GS78037	↔	Safari HDP			
				†	G56292	↔	Safari	∅	G56293	↔	Safari			
QUANTUM														
2.5 D-4D, 2.7 Minibus & Van Incl Sesfikile (H200)	05 on			∅	G56211	↔	Safari	∅	G56209	↔	Safari		4538 (L) 4539 (R) High Roof Only	
RAV4														
Serviceable front struts (XA10) Mk I	95-98			†	G44782	↔	Gas Ryder	∅	G63940	↔	Gas Ryder			
								∅	36865	↔	Technomatic			
Sealed struts (XA10) Mk I	98-00			†	70523	L	Gas Ryder	∅	G63940	↔	Gas Ryder			
				†	70524	R	Gas Ryder	∅	36865	↔	Technomatic			
Sealed struts (XA10) Mk I	98-00			†	70523	L	Gas Ryder	∅	G63940	↔	Gas Ryder			
				†	70524	R	Gas Ryder	∅	36865	↔	Technomatic			
XA20 (Mk II)	01-06			†	70628	L	Gas Ryder	∅	62020	↔	Gas Ryder			
				†	70629	R	Gas Ryder							
XA30 (Mk III)	06-12			†	70673	L	Gas Ryder	∅	62014	↔	Gas Ryder			
				†	70674	R	Gas Ryder							



Derivative	Year	Vehicle Type	Fitment Guide #	FRONT				REAR				GASLIFT		
				Shock Info	Part #	L/R	Range	Shock Info	Part #	L/R	Range	Front	Rear	
TOYOTA (Continued)														
RUNX														
E120, E130	06-12				55892	L	Gas Ryder		69092	↔	Gas Ryder			
					55893	R	Gas Ryder							
SPACEO														
(AE114) (Mk I) (E110)	97-01				70731	L	Gas Ryder	$\frac{1}{\circ}$	70733	L	Gas Ryder			
					70732	R	Gas Ryder	$\frac{1}{\circ}$	70734	R	Gas Ryder			
STALLION														
KF40	87-00			$\frac{1}{\perp}$	G56185	↔	Safari	$\frac{\circ}{\circ}$	G56102	↔	Safari			
								$\frac{\circ}{\circ}$	G45051	↔	Technomatic			
STOUT														
RK 101	61-89			$\frac{1}{\circ}$	G45138	↔	Technomatic	$\frac{\circ}{\circ}$	G56116	↔	Safari			
								$\frac{\circ}{\circ}$	G45006	↔	Technomatic			
TAZZ														
FWD (E90)	96-07				55818	↔	Gas Ryder		55819	↔	Gas Ryder		4273	
TERCEL														
Starlet (EL4/NL4)	90-96				70739	L	Gas Ryder		69122	↔	Gas Ryder			
					70740	R	Gas Ryder							
TUV														
LDV	82-87			$\frac{1}{\perp}$	G45001	↔	Technomatic	$\frac{\circ}{\circ}$	G45006	↔	Technomatic			
VENTURE														
KF40 (Minibus)	91-00			$\frac{1}{\perp}$	G56185	↔	Safari	$\frac{\circ}{\circ}$	G56102	↔	Safari		4199	
								$\frac{\circ}{\circ}$	G45051	↔	Technomatic			
VERSO														
1.6, 1.8, 2.0 (Mk III) (Spacio) (AR 10)	04-09				70618	L	Gas Ryder	$\frac{1}{\circ}$	69106	↔	Gas Ryder		4370	
					70619	R	Gas Ryder							
VIGO														
(CGN25) (Rear not suitable for RSA models)	05 on				G56218	↔	Safari	$\frac{\circ}{\circ}$	G56281	↔	Safari			
(LAN25) (Rear not suitable for RSA models)	05 on				G56218	↔	Safari	$\frac{\circ}{\circ}$	G56281	↔	Safari			
YARIS														
Vitz	99-05				70751	↔	Gas Ryder	$\frac{1}{\circ}$	62060	↔	Gas Ryder			
T1 1.0L, T3 1.3L (Mk II)	05-11				70608	L	Gas Ryder	$\frac{1}{\circ}$	G45890	↔	Technomatic		4350	
					70609	R	Gas Ryder							
T3 1.3L (Mk II)	06-11				70608	L	Gas Ryder	$\frac{1}{\circ}$	G45890	↔	Technomatic			
					70609	R	Gas Ryder							
Hatch (Gen 3)	11-17				70608	L	Gas Ryder	$\frac{1}{\circ}$	62090	↔	Gas Ryder		4351	
					70609	R	Gas Ryder							

Derivative	Year	Vehicle Type	Fitment Guide #	FRONT				REAR				GASLIFT	
				Shock Info	Part #	L/R	Range	Shock Info	Part #	L/R	Range	Front	Rear
TRIUMPH													
CHICANE													
2000, 2500	65-78							⊥	G45078	↔	Technomatic		
VOLKSWAGEN													
CHIC1500,1600													
Type 3 car	63-69			∞	G45417	↔	Technomatic	∞	G45419	↔	Technomatic		
AMAROK													
4x4; 4x2 D/C & S/C (2+1 Trapezoidal spring)	10-17							∞	G56255	↔	Safari		
4x4; 4x2 D/C & S/C (3+2 Trapezoidal spring)	10-17							∞	G56254	↔	Safari		
BETLE													
MK I	52-79		4	∞	G45419	↔	Technomatic	∞	G45419	↔	Technomatic		
				∞	18727	↔	Technomatic	∞	18727	↔	Technomatic		
Mk II	99-12			†	55872	↔	Gas Ryder	⊥	61262	↔	Gas Ryder		
CADDY													
All 50mm OD strut	04 on			†	70546	↔	Gas Ryder	∞	62010	↔	Gas Ryder		
All 55mm OD strut	04 on			†	70560	↔	Gas Ryder	∞	62010	↔	Gas Ryder		
CARAVELLE													
Caravelle T4	99-04			⊥	83373	↔	Heavy Duty	∞	83367	↔	Heavy Duty		
CITI													
Incl Chicco (Excl. Sonic, Life & VeloCiti)	84-11		9	†	55833	↔	Gas Ryder	†	69050	↔	Gas Ryder		4065
				†	35849	↔	Technomatic	†	51006	↔	Technomatic		
Sonic, Life & VeloCiti	98-11		9	†	55833	↔	Gas Ryder	†	69089	↔	Gas Ryder		4065
				†	35849	↔	Technomatic						
CITI LOWERED SUSP.													
Incl Chicco (Excl. Sonic, Life & VeloCiti)	84-11		9	†	L55833	↔	Gas Ryder	†	L69050	↔	Gas Ryder		4065
CRAFTER													
3 ton, 3,5 ton (Excl. 4X4 & 5 ton) (LT3)	06 on			†	70506	↔	Gas Ryder	∞	62008	↔	Gas Ryder		
FOX													
Incl. Shuttle	87-95		9	†	55833	↔	Gas Ryder	†	69050	↔	Gas Ryder		
				†	35849	↔	Technomatic	†	51006	↔	Technomatic		



Derivative	Year	Vehicle Type	Fitment Guide #	FRONT				REAR				GASLIFT	
				Shock Info	Part #	L/R	Range	Shock Info	Part #	L/R	Range	Front	Rear
VOLKSWAGEN (Continued)													
GOLF													
Mk I (imported strut)	78-79		9		35849	↔	Technomatic		69050	↔	Gas Ryder		4065
					55833	↔	Gas Ryder		51006	↔	Technomatic		
Mk I (local strut)	79-84		9		35849	↔	Technomatic		69050	↔	Gas Ryder		4065
					44511	↔	Technomatic		51006	↔	Technomatic		
Mk I Lowered Susp.	79-84		9		L55833	↔	Gas Ryder		L69050	↔	Gas Ryder		4065
Mk II All (Excl. Cabriolet)	84-92		9		55811	↔	Gas Ryder		69068	↔	Gas Ryder		4082
Mk II Lowered Susp.	84-92		9		L55811	↔	Gas Ryder		L69068	↔	Gas Ryder		4082
Mk III (Excl. VR6 & Cabriolet)	93-94		9		55811	↔	Gas Ryder		69068	↔	Gas Ryder		4082
Mk III VR6	93-99		9		55841	↔	Gas Ryder		69068	↔	Gas Ryder		4082
Mk III GTi	94-99		9		55841	↔	Gas Ryder		69068	↔	Gas Ryder		4082
Mk III All (Excl. cabriolet)	95-99		9		55841	↔	Gas Ryder		69068	↔	Gas Ryder		
Mk IV 1.6 (Estate)	99-04				55881	↔	Gas Ryder		G45900	↔	Technomatic		
Mk IV 1.6 (Hatch with 20mm strut rod)	99-04				55881	↔	Gas Ryder		61262	↔	Gas Ryder		
Mk IV 1.8, GTi, 1.9 Tdi, 2.0, 2.3V5	99-04				55872	↔	Gas Ryder						4314
Mk IV 1.8, GTi, 1.9 Tdi, 2.0, 2.3V5 (with 22mm strut rod)	99-04				55872	↔	Gas Ryder		61262	↔	Gas Ryder		4314
Mk IV 1.9 Tdi (Estate)	99-04								G45900	↔	Technomatic		
Mk V 2.0 GTi	04-09				70581	↔	Gas Ryder		62002	↔	Gas Ryder	4312	4313
Mk V 50mm Strut Body (Excl. GTi)	04-09				70546	↔	Gas Ryder		61293	↔	Gas Ryder	4312	4313
Mk V 55mm Strut Body (Excl. GTi)	04-09				70560	↔	Gas Ryder		61293	↔	Gas Ryder	4312	4313
Mk VI 50mm Strut Body (Excl. GTi)	09-13				70546	↔	Gas Ryder		61293	↔	Gas Ryder		
Mk VI 55mm Strut Body (Excl. GTi)	09-13				70560	↔	Gas Ryder		61293	↔	Gas Ryder		
Mk VII (5G1;BE1) Excl. R32, AWD 7 Sport Susp. (50mm Strut Dia)	13-19				70853	↔	Gas Ryder		62109	↔	Gas Ryder		
GOLF PICK-UP (CADDY I)													
Pick-up (Caddy I) Incl. Sport (serviceable strut) (Typ 14)	81-93				44511	↔	Technomatic		G45877	↔	Technomatic		
Pick-up (Caddy I) (sealed strut)	93 on				55833	↔	Gas Ryder		G45877	↔	Technomatic		
Pickup (sealed strut)	93 on				35849	↔	Technomatic		G45877	↔	Technomatic		
JETTA													
Mk I (imported strut)	78-85		9		35849	↔	Technomatic		69050	↔	Gas Ryder		
					55833	↔	Gas Ryder		51006	↔	Technomatic		
Mk I (local strut)	79-85		9		35849	↔	Technomatic		69050	↔	Gas Ryder		
					44511	↔	Technomatic		51006	↔	Technomatic		
Mk II	85-92		9		55811	↔	Gas Ryder		69068	↔	Gas Ryder		



Derivative	Year	Vehicle Type	Fitment Guide #	FRONT				REAR				GASLIFT		
				Shock Info	Part #	L/R	Range	Shock Info	Part #	L/R	Range	Front	Rear	
VOLKSWAGEN (Continued)														
JETTA (CONTINUED)														
Mk III (Excl. VR6), Mk II	93-94		9		55811	↔	Gas Ryder		69068	↔	Gas Ryder		4501	
Mk III VR6	93-99		9		55841	↔	Gas Ryder		69068	↔	Gas Ryder			
Mk III CLi	94-99		9		55841	↔	Gas Ryder		69068	↔	Gas Ryder		4501	
Mk III	95-99		9		55841	↔	Gas Ryder		69068	↔	Gas Ryder		4501	
Mk IV (with 22mm strut rod)	99-06				55872	↔	Gas Ryder		61262	↔	Gas Ryder			
Mk IV 1.6 (with 20mm strut rod)	99-06				55881	↔	Gas Ryder		61262	↔	Gas Ryder			
Mk V 50mm OE Strut Body (Excl. V5 & sport susp.)	06-11				70546	↔	Gas Ryder		62018	↔	Gas Ryder			
Mk V 55mm OE Strut Body (Excl. V5 & sport susp.)	06-11				70560	↔	Gas Ryder		62018	↔	Gas Ryder			
Mk VI (50mm OE Strut Body)	11 on				70546	↔	Gas Ryder		62018	↔	Gas Ryder			
Mk VI (55mm OE Strut Body)	11 on				70775	↔	Gas Ryder		62018	↔	Gas Ryder			
KOMBI														
T1/T2 Microbus, Fleetline (swing axle rear)	55-78				G45419	↔	Technomatic		G45419	↔	Technomatic			
T1/T2 Microbus, Fleetline (swing axle rear)	55-78				18727	↔	Technomatic		18727	↔	Technomatic			
T2 Microbus (double jointed axle rear)	68-80				G45417	↔	Technomatic		G45418	↔	Technomatic			
T3 Microbus (Excl. Synchro 4X4)	80-02		12		55227	↔	Safari		G56161	↔	Safari		4076	
T4 Transporter: Mini bus, Pickup & Panel van Excl. synchro	99-04				83373	↔	Heavy Duty		83367	↔	Heavy Duty			
T5 Kombi, Caravelle (Excl. 4-Motion)	04 on				70591	↔	Gas Ryder		62007	↔	Gas Ryder			
T5 Transporter: Crew bus, Pickup & Panel van (Excl. 4-Motion)	05 on				70591	↔	Gas Ryder		62007	↔	Gas Ryder			
PASSAT														
B1	74-81				44602	↔	Technomatic		G45715	↔	Technomatic			
B2	82-87		9		44602	↔	Technomatic		51016	↔	Technomatic	4067	4068	
1.6, 1.8, 1.8T, 2.0, 1.9TDI Excl. 4X4 (B5)	99-05				69087	↔	Gas Ryder		69946	↔	Gas Ryder			
2.3VR5 Excl. 4X4 (B5)	99-05				69087	↔	Gas Ryder		69946	↔	Gas Ryder			
2.8 V6 (B5)	99-05				69087	↔	Gas Ryder		69946	↔	Gas Ryder			
B5 2.3 V5 & 2.8 4WD 4-Motion Syncro	99-05				69087	↔	Gas Ryder							
B6 All (Excl. Sport Susp. & 4WD 4-Motion Syncro)	05-11				70560	↔	Gas Ryder							
POLO														
Classic (MkIII)	96-02		9		55841	↔	Gas Ryder		69081	↔	Gas Ryder		4291	
Playa (9N)	98-02		9		55841	↔	Gas Ryder		69081	↔	Gas Ryder			
MkIV 9N Hatch (Excl. GTI)	02-09				70503	↔	Gas Ryder		G45879	↔	Technomatic	4353	4338	
MkIV Sedan	02-09				70503	↔	Gas Ryder		G45879	↔	Technomatic		4544	
MkV Hatch (Type 6R; 6C) (Excl. GTi, Sport & Cross)	10-18				70714	↔	Gas Ryder		G45879	↔	Technomatic		4343	
MkV Sedan (Type 6R; 6C)	10-19				70714	↔	Gas Ryder			↔	Technomatic			



Derivative	Year	Vehicle Type	Fitment Guide #	FRONT				REAR				GASLIFT	
				Shock Info	Part #	L/R	Range	Shock Info	Part #	L/R	Range	Front	Rear
VOLKSWAGEN (Continued)													
POLO (CONTINUED)													
Vivo MkIV 9N3 Hatch	10-18				70714	↔	Gas Ryder	$\frac{1}{0}$	G45879	↔	Technomatic		4338
Vivo MkIV Sedan	10-18				70714	↔	Gas Ryder	$\frac{1}{0}$	G45879	↔	Technomatic		4544
Vivo Hatch (MkV model)	18-on				70714	↔	Gas Ryder	$\frac{1}{0}$	G45879	↔	Technomatic		4343
SHARAN													
Mk I, Mk IA, Mk IB	95-10				G35190	↔	Gas Ryder	$\frac{0}{0}$	69924	↔	Gas Ryder		
TIGUAN													
4-Motion AWD & FWD Excl. Elec. Susp.	08-15				70703	↔	Gas Ryder	$\frac{1}{0}$	62050	↔	Gas Ryder		
TOURAN													
Type 1T	04-10				70703	↔	Gas Ryder	$\frac{1}{0}$	69506	↔	Gas Ryder		
VOLVO													
122													
Amazon, B18	59-71			$\frac{1}{1}$	G45001	↔	Technomatic	$\frac{1}{1}$	G56119	↔	Safari		
Amazon	62-71			$\frac{1}{1}$	G45001	↔	Technomatic	$\frac{0}{0}$	G45054	↔	Technomatic		
850													
Excl. self levelling & sport Susp.	94-97				G35128	↔	Gas Ryder	$\frac{1}{0}$	69901	↔	Gas Ryder		
144, 164													
B20, B30	68-71		15	$\frac{1}{1}$	G45398	↔	Technomatic						
B20E, B30	72-74			$\frac{1}{1}$	G45398	↔	Technomatic						
C30													
All	07 on				70633	L	Gas Ryder	$\frac{1}{0}$	62023	↔	Gas Ryder		
					70634	R	Gas Ryder						
C70													
Excl. T5 (Mk I)	97-05				G35292	↔	Gas Ryder	$\frac{1}{0}$	69901	↔	Gas Ryder		
S40													
(Mk II) Incl T5	04-11				70633	L	Gas Ryder	$\frac{1}{0}$	62023	↔	Gas Ryder		
					70634	R	Gas Ryder						
(Mk I) Excl. & T4 rear	00-04				70683	L	Gas Ryder	$\frac{1}{0}$	69110	↔	Gas Ryder		
					70684	R	Gas Ryder						
(Mk I) Excl. & T4 rear	95-00				G35220	L	Gas Ryder		G51269	↔	Gas Ryder		
					G35225	R	Gas Ryder						
S60													
Sedan	00-10				70785	↔	Gas Ryder	$\frac{1}{0}$	62082	↔	Gas Ryder		
S70, V70													
Excl.	97-00				G35292	↔	Gas Ryder	$\frac{1}{0}$	69901	↔	Gas Ryder		



VEHICLE LISTING

SHOCKS, STRUTS & CARTRIDGES

COMMERCIAL HCV & MCV

The Vehicle Listing section is an easy to use vehicle reference to all Gabriel part numbers, product ranges and technical information according to the specific vehicle make, model, derivative and year: This includes all Heavy Commercial (HCV) Medium Commercial (MCV) Trucks Busses & Trailers.

The product ranges that are highlighted in this section include the Safari™, Technomatic™, Fleet Ryder® and Heavy Duty Shocks, Struts and Cartridges.

Where a vehicle is referenced to more than one part number/range of Gabriel product, please refer to the section at the beginning of the catalogue (beginning on page 3) where we define the main features, benefits, placement and warranty of each range offered.

The preferred part number/range for each application listing is always listed at the top with preferred alternatives below.

Section Content

Page



Heavy Commercial Vehicles

55



Derivative	Year	Vehicle Type	Fitment Guide #	FRONT				REAR				GASLIFT		
				Shock Info	Part #	L/R	Range	Shock Info	Part #	L/R	Range	Front	Rear	
BEDFORD														
4X4														
Truck	70-80			⊖	76015	↔	Fleet Ryder	⊖	76015	↔	Fleet Ryder			
CF SERIES														
Van, Truck	70-84							⊖	G56102	↔	Safari			
ELR4, ELR 6, ELR A, ELR 8														
Truck	75-79			⊖	76015	↔	Fleet Ryder							
J2-4														
Truck	65 on			⊕	G56119	↔	Safari	⊖	G56116	↔	Safari			
J5-6														
Truck	65 on			⊕	G56119	↔	Safari	⊖	G56126	↔	Safari			
KE, KG, KH All														
Truck	64 on			⊖	76015	↔	Fleet Ryder	⊖	76015	↔	Fleet Ryder			
Truck	64 on			⊖	G56126	↔	Safari	⊖	G56126	↔	Safari			
KM All														
Truck	72 on			⊖	76042	↔	Fleet Ryder							
MFR														
Truck	67-71			⊖	76015	↔	Fleet Ryder	⊖	76015	↔	Fleet Ryder			
Truck	67-71			⊖	G56126	↔	Safari	⊖	G56126	↔	Safari			
Truck	72 on			⊖	G56174	↔	Safari	⊖	G56174	↔	Safari			
VAL														
Bus	66 on			⊖	76015	↔	Fleet Ryder							
Bus	66 on			⊖	G56126	↔	Safari							
VAM														
Bus	73-75			⊖	G56174	↔	Safari	⊖	G56174	↔	Safari			
Bus	76 on			⊕	76009	↔	Fleet Ryder							
YRT														
Bus	19...			⊖	76103	↔	Fleet Ryder							
BUSSING														
14,15 AK														
Truck	19...							⊖	76019	↔	Fleet Ryder			
16L, LBL, LU, UK														
Truck	19...			⊖	76033	↔	Fleet Ryder							
22L, BLL (Tag axle)														
Truck	19...							⊕	76034	↔	Fleet Ryder			



Derivative	Year	Vehicle Type	Fitment Guide #	FRONT				REAR				GASLIFT	
				Shock Info	Part #	L/R	Range	Shock Info	Part #	L/R	Range	Front	Rear
CASSPIR													
CASSPIR													
Amoured Vehicle	19...			∅	77007	↔	Fleet Ryder	∅	77008	↔	Fleet Ryder		
DAF													
AT1900													
Truck	19...			∅	76007	↔	Fleet Ryder	∅	76007	↔	Fleet Ryder		
FA2200, F2200													
Truck	72-80			∅	76035	↔	Fleet Ryder	†	76034	↔	Fleet Ryder		
FT 2200 DU													
Truck	72-80			†	77004	↔	Fleet Ryder						
FTT 2800 DKTD													
Truck	75-82			∅	76035	↔	Fleet Ryder	†	76020	↔	Fleet Ryder		
ERF													
E6 (Air Susp.)													
Truck	19...			†	76006		Fleet Ryder						
ERF													
Truck	19...			∅	76035	↔	Fleet Ryder						
TRAILBLAZER													
Trailblazer Bus	19...		32	∅	76103	↔	Fleet Ryder	∅	76103	↔	Fleet Ryder		
FIAT													
130NR													
Truck	77-83			∅	76017	↔	Fleet Ryder						
619T1													
Truck	69-80			∅	77022	↔	Fleet Ryder						
682 SWB													
Truck	19...			∅	76017	↔	Fleet Ryder						
684N , 684T													
Truck	71-81			∅	76017	↔	Fleet Ryder						

Derivative	Year	Vehicle Type	Fitment Guide #	FRONT				REAR				GASLIFT	
				Shock Info	Part #	L/R	Range	Shock Info	Part #	L/R	Range	Front	Rear
FORD													
CARGO													
0608 , 0808	82-86			+	76034	↔	Fleet Ryder	⊖	76042	↔	Fleet Ryder		
0912 , 1112 , 1113	82-86			+	76034	↔	Fleet Ryder	⊖	76042	↔	Fleet Ryder		
1212 , 1213	82-85			+	76034	↔	Fleet Ryder	⊖	76042	↔	Fleet Ryder		
1312 , 1313	82-86			+	76034	↔	Fleet Ryder	⊖	76042	↔	Fleet Ryder		
2217	82-86			+	76034	↔	Fleet Ryder	⊖	76042	↔	Fleet Ryder		
1317 , 1517	82-86			+	76034	↔	Fleet Ryder	⊖	76042	↔	Fleet Ryder		
D1210 , D1211													
Truck	78-82			+	76009	↔	Fleet Ryder	⊖	76007	↔	Fleet Ryder		
D1311 , D1414													
Truck	72-82			+	76009	↔	Fleet Ryder	⊖	76007	↔	Fleet Ryder		
DA 2114													
Truck	74-82			+	76009	↔	Fleet Ryder	⊖	76007	↔	Fleet Ryder		
DO 607, DO 807													
Truck	73-82			+	76009	↔	Fleet Ryder	⊖	76007	↔	Fleet Ryder		
DO 910 , D1010													
Truck	71-82			+	76009	↔	Fleet Ryder	⊖	76007	↔	Fleet Ryder		
TRITON													
0510, 0610	85-87			⊖	55088	↔	Safari	⊖	G56102	↔	Safari		
0608, 0610	87 on			⊖	55211	↔	Safari						
FREIGHTLINER													
ARGOSY 90 (Air Susp.)													
Truck	19...			⊖	85918	↔	Heavy Duty	⊖	85724	↔	Heavy Duty		
FL112 SERIES													
Truck	19...		28	⊖	85320	↔	Heavy Duty	⊖	85724	↔	Heavy Duty		
Truck	19...		28	⊖	85320	↔	Heavy Duty	⊖	85319	↔	Heavy Duty		
FL50, FL60, FL70, FL80													
Truck	19...			⊖	77022	↔	Fleet Ryder						



Derivative	Year	Vehicle Type	Fitment Guide #	FRONT				REAR				GASLIFT		
				Shock Info	Part #	L/R	Range	Shock Info	Part #	L/R	Range	Front	Rear	
HINO														
300														
1626 Series	97 on				76207	↔	Fleet Ryder							
55/330, 55/350														
Truck	85-94				76042	↔	Fleet Ryder							
9-136														
Truck	02 on				55211	↔	Safari							
C40														
Truck	93 on				76042	↔	Fleet Ryder							
FD 10-135														
Truck	83-94				76132	↔	Fleet Ryder							
FE														
Truck	83 on				76102	↔	Fleet Ryder							
FF13-133, FF14-173														
Truck	83-94				76042	↔	Fleet Ryder							
GD, SUPER DOLPHIN														
Truck	19...				76042	↔	Fleet Ryder							
KB 302, 342, 14-177														
Truck	72-84				76042	↔	Fleet Ryder							
KL 340 , KL360														
Truck	72-83				76132	↔	Fleet Ryder							
KR 320, 360														
Truck	74-84				76102	↔	Fleet Ryder							
INTERNATIONAL (TYCO)														
4700, 4900(4x2), 4900 (6x4)														
Truck	93 on				76009	↔	Fleet Ryder							
9800 EAGLE														
Truck (Set back axle)	19...		27		76151	↔	Fleet Ryder		77018	↔	Fleet Ryder			
Truck (Set forward axle)	19...		27						77018	↔	Fleet Ryder			
ACCO 1600,1830C														
Truck	84-85				76042	↔	Fleet Ryder							



Derivative	Year	Vehicle Type	Fitment Guide #	FRONT				REAR				GASLIFT	
				Shock Info	Part #	L/R	Range	Shock Info	Part #	L/R	Range	Front	Rear
INTERNATIONAL (TYCO) (CONTINUED)													
ACCO 1840D MK11													
Truck	79-83			∞	76042	↔	Fleet Ryder						
E-LINE													
Truck	19...			∞	76008	↔	Fleet Ryder						
FLEETSTAR													
Truck	19...			∞	76015	↔	Fleet Ryder						
LOADSTAR 1850													
Truck	71-78			∞	76015	↔	Fleet Ryder						
PAYSTAR F5070/350													
Truck	73-84			∞	76042	↔	Fleet Ryder						
S2670-407T, S SERIES													
Truck	80-85			†	76006	↔	Fleet Ryder						
TRANSTAR COF-4070													
Truck	75-79			∞	76042	↔	Fleet Ryder						
UNISTAR R91													
Truck	19...			∞	76042	↔	Fleet Ryder	∞	76042	↔	Fleet Ryder		
ISUZU													
BD													
Bus	74 on			∞	76042	↔	Fleet Ryder	†	76006	↔	Fleet Ryder		
CVR, 49N													
Truck	79-89			∞	76102	↔	Fleet Ryder						
CVR, EXR, FT													
Truck	89 on			∞	76016	↔	Fleet Ryder						
DAILY													
Panel Van 107Kw_D (50C15, 65C15, 70C15)	04 on			∞	76208	↔	Fleet Ryder	∞	76209	↔	Fleet Ryder		
Panel Van 92Kw_D (35S13, 50C13)	01-08			∞	76208	↔	Fleet Ryder	∞	76209	↔	Fleet Ryder		
DAILY, TURBO DAILY													
35.10V, 45.10, A45.10, 40.10, 49.12, 59.12	95-00			∞	42772	↔	Technomatic	∞	42773	↔	Fleetryder		
42.12, 45.12, 54.12, 66.12	19...							∞	42773	↔	Fleetryder		
45.10, A45.10, 49.10	95-00			∞	42772	↔	Technomatic	∞	42772	↔	Technomatic		
49.10, 49.12, 59.12	19...			∞	42772	↔	Technomatic	∞	42772	↔	Technomatic		



Derivative	Year	Vehicle Type	Fitment Guide #	FRONT				REAR				GASLIFT	
				Shock Info	Part #	L/R	Range	Shock Info	Part #	L/R	Range	Front	Rear
ISUZU (CONTINUED)													
EUROTECH													
MPL440E42T, 440E 34,38,42,52	92 on			$\frac{1}{0}$	76156	↔	Fleet Ryder	$\frac{0}{0}$	76157	↔	Fleet Ryder		
Truck	88 on			$\frac{1}{0}$	76102	↔	Fleet Ryder						
F8000 (TN), F9000 (TT)													
Truck	88 on			$\frac{1}{0}$	76016	↔	Fleet Ryder						
FRR500													
Truck	19...			$\frac{1}{0}$	55211	↔	Safari						
FSR700													
Truck	96 on			$\frac{1}{0}$	76016	↔	Fleet Ryder						
FTR800													
Truck	96 on			$\frac{1}{0}$	76043	↔	Fleet Ryder						
FTR800 4X2 FC													
Truck	97 on			$\frac{1}{0}$	76204	↔	Fleet Ryder						
FVR2200 TURBO													
Truck	93 on			$\frac{1}{0}$	76103	↔	Fleet Ryder						
FVR900 TURBO													
Truck	93 on			$\frac{1}{0}$	76103	↔	Fleet Ryder						
FVZ1400													
Truck	94 on			$\frac{1}{0}$	76043	↔	Fleet Ryder						
JCR 360, FTR													
Truck	79-86			$\frac{1}{0}$	G56166	↔	Safari						
JCR 500													
Truck	19...			$\frac{1}{0}$	76108	↔	Fleet Ryder						
N2800 P													
Truck	93 on		29	$\frac{1}{0}$	55211	↔	Safari	$\frac{0}{0}$	76015	↔	Fleet Ryder		
Truck	93 on		29	$\frac{1}{0}$	55211	↔	Safari	$\frac{0}{0}$	G56126	↔	Safari		
N3000 P													
Truck	87-90		29	$\frac{1}{0}$	55211	↔	Safari	$\frac{0}{0}$	76015	↔	Fleet Ryder		
Truck	87-90		29	$\frac{1}{0}$	55211	↔	Safari	$\frac{0}{0}$	G56126	↔	Safari		
N3500D FN 3.5T LWB 4x2 F-C													
Truck	88-99							$\frac{0}{0}$	55242	↔	Safari		
N3500D, N4000 D													
Truck	86 on			$\frac{1}{0}$	76108	↔	Fleet Ryder	$\frac{0}{0}$	76110	↔	Fleet Ryder		
N4000D FT LWB Turbo 4x2 F-C													
Truck	88-99							$\frac{0}{0}$	55242	↔	Safari		



Derivative	Year	Vehicle Type	Fitment Guide #	FRONT				REAR				GASLIFT	
				Shock Info	Part #	L/R	Range	Shock Info	Part #	L/R	Range	Front	Rear
ISUZU (CONTINUED)													
NKR													
Truck	96 on			$\frac{1}{0}$	76132	↔	Fleet Ryder						
NKR													
NKR55/99													
NKR55/99													
Truck	19...		29	$\frac{1}{0}$	55211	↔	Safari	$\frac{0}{0}$	76015	↔	Fleet Ryder		
Truck	19...		29	$\frac{1}{0}$	55211	↔	Safari	$\frac{0}{0}$	G56126	↔	Safari		
NPR 300, 400													
Truck	86 on			$\frac{1}{0}$	76108	↔	Fleet Ryder	$\frac{0}{0}$	76110	↔	Fleet Ryder		
Truck	84-03			$\frac{1}{0}$	55243	↔	Safari						
NPR 400 4x2 F-C													
Truck	98 on							$\frac{0}{0}$	55240	↔	Safari		
NQR 500T 4X2 F-C													
Truck	98-06							$\frac{0}{0}$	55240	↔	Safari		
SBR 422, FJR													
Truck	76-83			$\frac{1}{0}$	76132	↔	Fleet Ryder	$\frac{1}{0}$	76043	↔	Fleet Ryder		
Truck	76-83			$\frac{1}{0}$	55088	↔	Safari	$\frac{1}{0}$	76043	↔	Fleet Ryder		
SFR, TD													
Truck	72 on		31	$\frac{0}{0}$	76007	↔	Fleet Ryder						
SLR, VPR													
Truck	72 on			$\frac{0}{0}$	76042	↔	Fleet Ryder						
SPZ													
Truck	73-80			$\frac{0}{0}$	76042	↔	Fleet Ryder						
SPZ , SHZ, SPR, SHR													
Truck	80 on			$\frac{1}{0}$	76016	↔	Fleet Ryder						
TL40-50													
Truck	75 on		29	$\frac{1}{0}$	55211	↔	Safari	$\frac{0}{0}$	76015	↔	Fleet Ryder		
Truck	75 on		29	$\frac{1}{0}$	55211	↔	Safari	$\frac{0}{0}$	G56126	↔	Safari		
TLD 24													
Truck	77-88			$\frac{1}{0}$	55211	↔	Safari	$\frac{0}{0}$	G56186	↔	Safari		
TLD44, TLD54													
Truck	77-89		29	$\frac{1}{0}$	55211	↔	Safari	$\frac{0}{0}$	76015	↔	Fleet Ryder		
Truck	77-89		29	$\frac{1}{0}$	55211	↔	Safari	$\frac{0}{0}$	G56126	↔	Safari		













Derivative	Year	Vehicle Type	Fitment Guide #	FRONT				REAR				GASLIFT			
				Shock Info	Part #	L/R	Range	Shock Info	Part #	L/R	Range	Front	Rear		
LEYLAND															
AEC MK IV															
Bus	19...			+	76009	↔	Fleet Ryder								
AEC MK IV (WITH Air CUSHIONS)															
Bus	19...			∞	76042	↔	Fleet Ryder	∞	76042	↔	Fleet Ryder				
AEC MK IV (WITHOUT Air CUSHIONS)															
Bus	19...			∞	76042	↔	Fleet Ryder								
BUFFALO															
Truck	19...			+	76006	↔	Fleet Ryder								
CHIEFTAIN CH 4013, 14.10															
Truck	79-86			∞	76042	↔	Fleet Ryder								
CLYDESDALE CD23															
Bus	19...			+	76009	↔	Fleet Ryder								
CRUSADER															
Truck	19...			+	76020	↔	Fleet Ryder								
ELAND															
Bus	19...			+	76006	↔	Fleet Ryder	+	76006	↔	Fleet Ryder				
ELAND EL 4114, 14.12															
Truck	73-85			+	76009	↔	Fleet Ryder	∞	76042	↔	Fleet Ryder				
FG 550, FG 420															
Truck	68-77			∞	G56102	↔	Safari	∞	55088	↔	Safari				
GUY VICTORY J, MK1															
Bus	19...			+	76041	↔	Fleet Ryder	∞	76042	↔	Fleet Ryder				
GUY VICTORY J, MK2															
Bus	19...			+	76020	↔	Fleet Ryder	+	76006	↔	Fleet Ryder				
KUDU 352 RA, A691															
Bus	19...			+	76041	↔	Fleet Ryder	+	76006	↔	Fleet Ryder				
LEOPARD															
Truck	19...			+	76041	↔	Fleet Ryder	+	76020	↔	Fleet Ryder				
MAMMOTH MAJOR, MANDATOR															
Truck	19...			+	76009	↔	Fleet Ryder								
MARATHON															
Truck	76-83			∞	76016	↔	Fleet Ryder	∞	76103	↔	Fleet Ryder				



Derivative	Year	Vehicle Type	Fitment Guide #	FRONT				REAR				GASLIFT		
				Shock Info	Part #	L/R	Range	Shock Info	Part #	L/R	Range	Front	Rear	
LEYLAND (CONTINUED)														
MASTIFF														
Truck	19...			∞	76042	↔	Fleet Ryder							
MONARCH, 2TG4RE														
Truck	19...			†	76009	↔	Fleet Ryder							
PIONEER PLUS														
Truck	19...			†	76006	↔	Fleet Ryder							
ROAD TRAIN														
Truck	19...			†	76006	↔	Fleet Ryder							
SUPER COMET														
Truck	19...			†	76041	↔	Fleet Ryder							
SUPER ELAND 22.12, 24.12														
Truck	75-85			†	76041	↔	Fleet Ryder							
SWIFT														
Bus	19...			∞	76043	↔	Fleet Ryder							
TIGER														
Bus	19...			†	76020	↔	Fleet Ryder	†	76009	↔	Fleet Ryder			
WORLDMASTER														
Bus	19...			†	76009	↔	Fleet Ryder							
MACK														
786FS														
Truck	19...			∞	76014	↔	Fleet Ryder							
R600RST, F700RST SERIES														
Truck	73-85			∞	76040	↔	Fleet Ryder							
MAGNIS														
SAMIL														
20	19...			∞	77003	↔	Fleet Ryder	†	77004	↔	Fleet Ryder			
50	19...			∞	77005	↔	Fleet Ryder	†	77006	↔	Fleet Ryder			
100	19...			∞	77005	↔	Fleet Ryder							



Derivative	Year	Vehicle Type	Fitment Guide #	FRONT				REAR				GASLIFT		
				Shock Info	Part #	L/R	Range	Shock Info	Part #	L/R	Range	Front	Rear	
MAN														
16,201														
Truck	19...			∅	76021	↔	Fleet Ryder	†	76020	↔	Fleet Ryder			
16,220														
Bus	19...			∅	76021	↔	Fleet Ryder	†	76020	↔	Fleet Ryder			
16,281														
Bus	19...			∅	76019	↔	Fleet Ryder							
27,463														
Truck	19...			∅	76131	↔	Fleet Ryder							
16.240 FT/FTS/HT/HL/HAL/HAK														
Truck	76-89			∅	77003	↔	Fleet Ryder							
19.280 FT/FTS														
Truck	78-90			∅	77003	↔	Fleet Ryder							
19.292 FT/FTS														
Truck	90-94			∅	76131	↔	Fleet Ryder							
19.300FT,19.320, 19.321 FT/FTS														
Truck	85-90			∅	76131	↔	Fleet Ryder							
19.362 FTS														
Truck	89-93			∅	76131	↔	Fleet Ryder							
22.192, 24.192 DHK, DHL														
Truck	76-87			∅	77003	↔	Fleet Ryder							
26.292 DFT/DFTS/DFL/DFK														
Truck	89 on			∅	76131	↔	Fleet Ryder							
26.362 DFTS/DFLS														
Truck	90 on			∅	76131	↔	Fleet Ryder							
26.372 DFT/DFTS														
Truck	90-95			∅	76131	↔	Fleet Ryder							
26.402 DFTS, 422														
Truck	93 on			∅	76131	↔	Fleet Ryder							

Derivative	Year	Vehicle Type	Fitment Guide #	FRONT				REAR				GASLIFT	
				Shock Info	Part #	L/R	Range	Shock Info	Part #	L/R	Range	Front	Rear
MAN (CONTINUED)													
26.442, 26.552 DFTS													
Truck	90 on			$\frac{1}{0}$	76131	↔	Fleet Ryder						
29.292 DFT/DFTS/DFL/DFK													
Truck	89-92			$\frac{1}{0}$	76131	↔	Fleet Ryder						
30.280 DHT													
Truck	78-84			$\frac{0}{0}$	76021	↔	Fleet Ryder						
30.365 DFT/DFTS/DFL													
Truck	86-89			$\frac{1}{0}$	76131	↔	Fleet Ryder						
30.380 DFT/DFTS/DFL													
Truck	84-89			$\frac{1}{0}$	76131	↔	Fleet Ryder						
30.440 DFTS/DFL													
Truck	87-90			$\frac{1}{0}$	76131	↔	Fleet Ryder						
F2000 27.463TS, 27.464 TS													
Truck	19...			$\frac{1}{0}$	76131	↔	Fleet Ryder						
F2000 33.373KN,TN													
Truck	19...			$\frac{1}{0}$	76131	↔	Fleet Ryder						
F2000 33.374K,L,T													
Truck	19...			$\frac{1}{0}$	76131	↔	Fleet Ryder						
F2000 33.423TS													
Truck	19...			$\frac{1}{0}$	76131	↔	Fleet Ryder						
F2000 40.464 TS													
Truck	19...			$\frac{1}{0}$	76131	↔	Fleet Ryder						
M2000 14.153 L													
Truck	19...			$\frac{0}{0}$	77003	↔	Fleet Ryder						
M2000 15.223L, 16.223L,K,LA													
Truck	19...			$\frac{1}{0}$	76103	↔	Fleet Ryder						



Derivative	Year	Vehicle Type	Fitment Guide #	FRONT				REAR				GASLIFT		
				Shock Info	Part #	L/R	Range	Shock Info	Part #	L/R	Range	Front	Rear	
MERCEDES														
1735														
Truck	19...			☉	76033	↔	Fleet Ryder	☉	76033	↔	Fleet Ryder			
0.302, 0.305 (Air Susp.)														
Bus	19...			⊕	76009	↔	Fleet Ryder	⊕	76009	↔	Fleet Ryder			
0.309D														
Bus	19...			☉	55210	↔	Safari	☉	55210	↔	Safari			
1113, L, LK, LF, LP, LPK														
Truck	68-94		30	☉	76039	↔	Fleet Ryder	☉	76021	↔	Fleet Ryder			
1113B, L, LK														
Truck	68-94			☉	76019	↔	Fleet Ryder							
1113B, LA, LAK														
Truck	73-83			☉	76033	↔	Fleet Ryder							
Truck	73-83			☉	77007	↔	Fleet Ryder							
1113B, LAS														
Truck	73-83			☉	76033	↔	Fleet Ryder	☉	76104	↔	Fleet Ryder			
Truck	73-83			☉	77007	↔	Fleet Ryder	☉	76104	↔	Fleet Ryder			
1113B, LS														
Truck	68-94			☉	76019	↔	Fleet Ryder	☉	76104	↔	Fleet Ryder			
1213, 1213K, 1217, 1217K														
Truck	79-94			☉	76033	↔	Fleet Ryder	☉	77001	↔	Fleet Ryder			
1213AK														
Truck	79-94			☉	76106	↔	Fleet Ryder	☉	77001	↔	Fleet Ryder			
1313, L, LK														
Truck	72-76			☉	76019	↔	Fleet Ryder	☉	76022	↔	Fleet Ryder			
1313, LAK, LAS, LA														
Truck	19...			☉	76033	↔	Fleet Ryder	☉	76104	↔	Fleet Ryder			
Truck	19...			☉	77007	↔	Fleet Ryder	☉	76104	↔	Fleet Ryder			
1313LS														
Truck	19...			☉	76019	↔	Fleet Ryder	☉	76104	↔	Fleet Ryder			
1313LS														
Truck	19...			☉	76019	↔	Fleet Ryder	☉	76022	↔	Fleet Ryder			
1317LP, LPK														
Truck	19...							☉	76022	↔	Fleet Ryder			



Derivative	Year	Vehicle Type	Fitment Guide #	FRONT				REAR				GASLIFT	
				Shock Info	Part #	L/R	Range	Shock Info	Part #	L/R	Range	Front	Rear
MERCEDES (CONTINUED)													
1319LP, LPK													
Truck	19....							∅	76022	↔	Fleet Ryder		
1413L, 1413K, 1417, 1417K													
Truck	82-93			∅	77007	↔	Fleet Ryder	∅	77001	↔	Fleet Ryder		
Truck	82-93			∅	76033	↔	Fleet Ryder	∅	77001	↔	Fleet Ryder		
1413L, LK, LS													
Truck	76-82							∅	76022	↔	Fleet Ryder		
1418, L, LK													
Truck	68-79			∅	76021	↔	Fleet Ryder						
1418, LP, LPS													
Truck	19....			∅	76039	↔	Fleet Ryder						
1419, 1419K, 1419S													
Truck	77-88			∅	77007	↔	Fleet Ryder	∅	77001	↔	Fleet Ryder		
Truck	77-88			∅	76033	↔	Fleet Ryder	∅	77001	↔	Fleet Ryder		
1513, 1517LP, LPK													
Truck	19....							∅	76022	↔	Fleet Ryder		
1513, 1517LS													
Truck	19....			∅	76019	↔	Fleet Ryder	∅	76104	↔	Fleet Ryder		
1513L, LK													
Truck	70-75			∅	76019	↔	Fleet Ryder	∅	76022	↔	Fleet Ryder		
1513LA, LAK													
Truck	19....			∅	77007	↔	Fleet Ryder	∅	76104	↔	Fleet Ryder		
Truck	19....			∅	76033	↔	Fleet Ryder	∅	76104	↔	Fleet Ryder		
1517, 1519, L, LK													
Truck	75-80			∅	76019	↔	Fleet Ryder	∅	76022	↔	Fleet Ryder		
1517, 1519, LA, LAK													
Truck	76-94			∅	77007	↔	Fleet Ryder	∅	76104	↔	Fleet Ryder		
Truck	76-94			∅	76033	↔	Fleet Ryder	∅	76104	↔	Fleet Ryder		
1517, 1519, LAS													
Truck	19....			∅	77007	↔	Fleet Ryder	∅	76022	↔	Fleet Ryder		
Truck	19....			∅	76033	↔	Fleet Ryder	∅	76022	↔	Fleet Ryder		
1617, LP, LPK													
Truck	19....			∅	76033	↔	Fleet Ryder	∅	76022	↔	Fleet Ryder		



Derivative	Year	Vehicle Type	Fitment Guide #	FRONT				REAR				GASLIFT		
				Shock Info	Part #	L/R	Range	Shock Info	Part #	L/R	Range	Front	Rear	
MERCEDES (CONTINUED)														
1618, L, LK														
Truck	19....				76021	↔	Fleet Ryder							
1619, LP														
Truck	19....				76033	↔	Fleet Ryder		76022	↔	Fleet Ryder			
1620, L, LK														
Truck	19....				76021	↔	Fleet Ryder							
1621, L, LK, LS														
Truck	77-79				76019	↔	Fleet Ryder							
1623, L, LK, LAK														
Truck	19....				76021	↔	Fleet Ryder							
1624, L, LK, LAK, LS, LAS														
Truck	19....				76019	↔	Fleet Ryder							
1813L														
Truck	19....				77007	↔	Fleet Ryder							
Truck	19....				76033	↔	Fleet Ryder							
1817, 1819, L														
Truck	19....				77007	↔	Fleet Ryder							
Truck	19....				76033	↔	Fleet Ryder							
1918, 1920, L, LK														
Truck	19....				76021	↔	Fleet Ryder							
1921, L, LK, LS														
Truck	70-77				76019	↔	Fleet Ryder							
1923L, LK														
Truck	19....				76021	↔	Fleet Ryder							
1924, L, LK, LA, LAK, LS, LAS														
Truck	19....				76019	↔	Fleet Ryder							
1926S, 1928, 1928S, 1933S														
Truck	81-92				77007	↔	Fleet Ryder		76033	↔	Fleet Ryder			
Truck	81-92				76033	↔	Fleet Ryder		76033	↔	Fleet Ryder			
2017, 2019, L, LB														
Truck	19....				77007	↔	Fleet Ryder							
Truck	19....				76033	↔	Fleet Ryder							



Derivative	Year	Vehicle Type	Fitment Guide #	FRONT				REAR				GASLIFT			
				Shock Info	Part #	L/R	Range	Shock Info	Part #	L/R	Range	Front	Rear		
MERCEDES (CONTINUED)															
2219, 2219K, 2224															
Truck	82-93				76106	↔	Fleet Ryder								
2220, L, LA, LS, LAS															
Truck	19...				76021	↔	Fleet Ryder								
2224B, 2225B															
Truck	86-93				76106	↔	Fleet Ryder								
2233S															
Truck	82-86				76033	↔	Fleet Ryder								
2620, L, LA, LS, LAS															
Truck	19...				76021	↔	Fleet Ryder								
2623, L, LS, LK, LA, LAS, LAK															
Truck	19...				76021	↔	Fleet Ryder								
2624, A, AK, K, S															
Truck	81-88				77007	↔	Fleet Ryder								
Truck	81-88				76033	↔	Fleet Ryder								
2624, L, LS, LK, LAK, LAS, LB, LAB															
Truck	70-81				76033	↔	Fleet Ryder								
2628K, A, S															
Truck	81-93				77007	↔	Fleet Ryder								
Truck	81-93				76033	↔	Fleet Ryder								
2629, LA, LAK, LAS															
Truck	19...				76021	↔	Fleet Ryder								
2632, L, K, AK, S, AS															
Truck	75-83				77007	↔	Fleet Ryder								
Truck	75-83				76033	↔	Fleet Ryder								
2633S, 2636S, 2638S															
Truck	83-93				77007	↔	Fleet Ryder								
Truck	83-93				76033	↔	Fleet Ryder								
2644S/32															
Truck	94 on				76033	↔	Fleet Ryder								
3328S, 3333S															
Truck	87-92				77007	↔	Fleet Ryder								
Truck	87-92				76033	↔	Fleet Ryder								



Derivative	Year	Vehicle Type	Fitment Guide #	FRONT				REAR				GASLIFT		
				Shock Info	Part #	L/R	Range	Shock Info	Part #	L/R	Range	Front	Rear	
MERCEDES (CONTINUED)														
352 F														
Bus	19...			∅	76036	↔	Fleet Ryder	∅	76022	↔	Fleet Ryder			
608 LP, LPK, LPS, LPO														
Truck	19...							∅	55210	↔	Safari			
609,811 LP, LPS, LPK														
Truck	19...							∅	55210	↔	Safari			
808 LP, LPS, LPK														
Truck	19...							∅	55210	↔	Safari			
911B, L, LK														
Truck	19...			∅	76019	↔	Fleet Ryder							
911B, LA, LAK														
Truck	19...			∅	77007	↔	Fleet Ryder							
Truck	19...			∅	76033	↔	Fleet Ryder							
911B, LAS														
Truck	19...			∅	77007	↔	Fleet Ryder	∅	76104	↔	Fleet Ryder			
Truck	19...			∅	76033	↔	Fleet Ryder	∅	76104	↔	Fleet Ryder			
911B, LS														
Truck	19...			∅	76019	↔	Fleet Ryder	∅	76104	↔	Fleet Ryder			
ACTROS														
1831LS/36, 1835/36	19...			∅	76033	↔	Fleet Ryder							
2031 S/36	99 on			∅	76033	↔	Fleet Ryder							
2643 LS/33, 2649LS/32	99 on			∅	76033	↔	Fleet Ryder							
3335 S/33	99 on			∅	76033	↔	Fleet Ryder							
3343 S/33	99 on			∅	76033	↔	Fleet Ryder							
ATEGO														
1017/48, 48AK,/36	19...			∅	76033	↔	Fleet Ryder							
ECONOLINER														
1014/48, 1214/48	95 on			∅	76033	↔	Fleet Ryder							
1414K/36, 1414/48	92 on			∅	76033	↔	Fleet Ryder							
1617/48 & 52	94 on			∅	76033	↔	Fleet Ryder	∅	77001	↔	Fleet Ryder			
1617A/36, 1617K/36	92 on			∅	76033	↔	Fleet Ryder	∅	77001	↔	Fleet Ryder			
1623S/36	96 on			∅	76033	↔	Fleet Ryder							

Derivative	Year	Vehicle Type	Fitment Guide #	FRONT				REAR				GASLIFT	
				Shock Info	Part #	L/R	Range	Shock Info	Part #	L/R	Range	Front	Rear
MERCEDES (CONTINUED)													
L1013, 1013K,1014													
Truck	81-87				76033	↔	Fleet Ryder		77001	↔	Fleet Ryder		
L408, L508, L608													
Truck	79 on				55210	↔	Safari		55210	↔	Safari		
LA1213B													
Truck	79-89				77007	↔	Fleet Ryder		76104	↔	Fleet Ryder		
Truck	79-89				76033	↔	Fleet Ryder		76104	↔	Fleet Ryder		
MB 800													
Bus	19...				55210	↔	Safari						
Truck	19...				55210	↔	Safari						
OF 1113, 1313, 1317/51, 1413, 1417/52, 1617													
Bus	19...				76036	↔	Fleet Ryder		76022	↔	Fleet Ryder		
OF 1621, 1624													
Bus	86 on				76109	↔	Fleet Ryder		76104	↔	Fleet Ryder		
OH 1725L/59													
Bus	19...				76033	↔	Fleet Ryder		76020	↔	Fleet Ryder		
OH 1835L/30													
Bus	19...				76033	↔	Fleet Ryder		76020	↔	Fleet Ryder		
POWERLINER													
1735S/35	92 on				76033	↔	Fleet Ryder		76019	↔	Fleet Ryder		
2426B/32 & 52	92 on				76033	↔	Fleet Ryder						
2535S/32	94 on				76033	↔	Fleet Ryder						
2545S/32	96 on				76033	↔	Fleet Ryder						
2629K/32, 2629S/32, 2629/45	92 on				76033	↔	Fleet Ryder						
2635S/32, 2635/45	92 on				76033	↔	Fleet Ryder						
2638S/32	95 on				76033	↔	Fleet Ryder						
3836K/38	19...				76033	↔	Fleet Ryder						
UNIMOG													
414, 416	19...				76014	↔	Fleet Ryder		76014	↔	Fleet Ryder		



Derivative	Year	Vehicle Type	Fitment Guide #	FRONT				REAR				GASLIFT	
				Shock Info	Part #	L/R	Range	Shock Info	Part #	L/R	Range	Front	Rear
MITSUBISHI													
CANTER													
Truck	80 on			$\frac{1}{\text{O}}$	55088	↔	Safari	$\frac{1}{\text{O}}$	G56102	↔	Safari		
FK Series													
FK 115J/K	80-86			$\frac{1}{\text{O}}$	G56118	↔	Safari						
FM Series													
FM215F/L	79-86			$\frac{1}{\text{O}}$	G56118	↔	Safari						
NISSAN													
CABALL													
Truck	64-78			$\frac{1}{\text{O}}$	G45138	↔	Technomatic	$\frac{1}{\text{O}}$	G56102	↔	Safari		
Truck	64-78			$\frac{1}{\text{O}}$	G45138	↔	Technomatic	$\frac{1}{\text{O}}$	G45051	↔	Technomatic		
Truck	78-84			$\frac{1}{\text{O}}$	G45138	↔	Technomatic	$\frac{1}{\text{U}}$	G56157	↔	Safari		
Truck	78-84			$\frac{1}{\text{O}}$	G45138	↔	Technomatic	$\frac{1}{\text{U}}$	G45432	↔	Technomatic		
Truck	96 on			$\frac{1}{\text{O}}$	G56179	↔	Safari	$\frac{1}{\text{O}}$	G56162	↔	Safari		
CABSTAR													
20,35,40	96 on							$\frac{1}{\text{O}}$	G56162	↔	Safari		
Truck	84-90			$\frac{1}{\text{O}}$	G56166	↔	Safari						
CB 20													
Bus	19...			$\frac{1}{\text{O}}$	76103	↔	Fleet Ryder	$\frac{1}{\text{O}}$	76035	↔	Fleet Ryder		
CK10 K/A													
Truck	74-86			$\frac{1}{\text{O}}$	76103	↔	Fleet Ryder						
CK20 D/L/N													
Truck	73-83			$\frac{1}{\text{O}}$	76103	↔	Fleet Ryder						
CK25D/N													
Truck	83-84			$\frac{1}{\text{O}}$	76103	↔	Fleet Ryder						
CK41 CT													
Truck	80-85			$\frac{1}{\text{O}}$	76103	↔	Fleet Ryder						
CM 10 F													
Truck	87 on			$\frac{1}{\text{O}}$	55088	↔	Safari						
CM 12/CM14													
Truck	87 on			$\frac{1}{\text{O}}$	76016	↔	Fleet Ryder						
CM 15 E													
Truck	87-92			$\frac{1}{\text{O}}$	76103	↔	Fleet Ryder						



Derivative	Year	Vehicle Type	Fitment Guide #	FRONT				REAR				GASLIFT		
				Shock Info	Part #	L/R	Range	Shock Info	Part #	L/R	Range	Front	Rear	
NISSAN (CONTINUED)														
CM 16 N														
Truck	90 on			$\frac{1}{0}$	76016	↔	Fleet Ryder							
CM 8 F														
Truck	87-95			$\frac{1}{0}$	55088	↔	Safari							
CM 90														
Truck (Condor)	19...			$\frac{1}{+}$	76041	↔	Fleet Ryder							
CW 350 HTA, HTF														
Truck	93 on			$\frac{1}{0}$	76103	↔	Fleet Ryder							
CW290 HDN , PHN														
Truck	93 on			$\frac{1}{0}$	76103	↔	Fleet Ryder							
CW290 PPA,HTA,HTF, CK290 CTA														
Truck	93-95			$\frac{1}{0}$	76103	↔	Fleet Ryder							
CW41 H/P														
Truck	77-85			$\frac{1}{0}$	76103	↔	Fleet Ryder							
CW45 HD/PA														
Truck	82-89			$\frac{1}{0}$	76103	↔	Fleet Ryder							
CW46 HDN, HTF, HMF, HTA, PAN														
Truck	89-93			$\frac{1}{0}$	76103	↔	Fleet Ryder							
CW46 PAF, PAA														
Truck	89-92			$\frac{1}{0}$	76103	↔	Fleet Ryder							
CW47 HDN, HTA, HTF, PAF, PAN														
Truck	93-95			$\frac{1}{0}$	76103	↔	Fleet Ryder							
CW55 HTF, CW56 HTF														
Truck	89-95			$\frac{1}{0}$	76103	↔	Fleet Ryder							
UD 35														
4X2 F-C	96-10			$\frac{1}{0}$	55236	↔	Safari	$\frac{0}{0}$	55237	↔	Safari			
UD 35A														
4X2 F-C	96-10			$\frac{1}{0}$	55236	↔	Safari	$\frac{0}{0}$	55237	↔	Safari			
UD 35A														
Truck	96 on			$\frac{1}{0}$	55236	↔	Safari	$\frac{0}{0}$	55237	↔	Safari			
UD 80														
4X2 F-C	97 on			$\frac{1}{0}$	76205	↔	Fleet Ryder	$\frac{1}{+}$	76206	↔	Fleet Ryder			

























Derivative	Year	Vehicle Type	Fitment Guide #	FRONT				REAR				GASLIFT		
				Shock Info	Part #	L/R	Range	Shock Info	Part #	L/R	Range	Front	Rear	
NISSAN (CONTINUED)														
UD780														
Truck	69 on			$\frac{1}{0}$	76102	↔	Fleet Ryder							
UG 80														
Bus	19...			$\frac{1}{0}$	76102	↔	Fleet Ryder							
UG780														
Truck	69 on			$\frac{1}{0}$	76102	↔	Fleet Ryder							
E - 1344 T 290														
Truck	78-83			$\frac{0}{0}$	76017	↔	Fleet Ryder							
E - 1446 T 350														
Truck	80-83			$\frac{0}{0}$	76017	↔	Fleet Ryder							
R SERIES														
Truck	19...			$\frac{0}{0}$	76042	↔	Fleet Ryder							
320														
Truck	95 on			$\frac{0}{0}$	76015	↔	Fleet Ryder							
362 E 436, 460, 550														
Truck	95 on			$\frac{0}{0}$	77018	↔	Fleet Ryder							
377A/E														
Truck	95 on			$\frac{0}{0}$	76015	↔	Fleet Ryder							
CBH 385														
Truck	96 on			$\frac{1}{1}$	77006	↔	Fleet Ryder							
SCANIA														
Bus														
Bus	19...							$\frac{1}{1}$	76020	↔	Fleet Ryder			
K94														
Bus	19...			$\frac{1}{0}$	76035	↔	Fleet Ryder							
LB 81 HS-31/50 4X2														
Truck	75-82			$\frac{1}{0}$	76016	↔	Fleet Ryder	$\frac{1}{1}$	76006	↔	Fleet Ryder			
LBT 111-HS31 6X4														
Truck	75-82			$\frac{1}{0}$	76016	↔	Fleet Ryder	$\frac{1}{1}$	76006	↔	Fleet Ryder			
LBT 111-HS31 6X4														
LBT 141 HS-31/46 6X4														



Derivative	Year	Vehicle Type	Fitment Guide #	FRONT				REAR				GASLIFT	
				Shock Info	Part #	L/R	Range	Shock Info	Part #	L/R	Range	Front	Rear
SCANIA (CONTINUED)													
LBT 141 HS-31/46 6X4													
Truck	78-82			$\frac{1}{0}$	76016	↔	Fleet Ryder	$\frac{1}{1}$	76006	↔	Fleet Ryder		
P112H (6X2)													
Truck	82-89			$\frac{1}{0}$	76035	↔	Fleet Ryder	$\frac{1}{1}$	76034	↔	Fleet Ryder		
P114GA 6x4 NZ 380													
Truck	19...			$\frac{1}{0}$	76035	↔	Fleet Ryder						
P124 CB 6x4 NZ 470													
Truck	19...			$\frac{1}{0}$	76035	↔	Fleet Ryder						
P124GA 400													
Truck	19...			$\frac{1}{0}$	76035	↔	Fleet Ryder						
P124GA 6x4 NZ 420, 470													
Truck	19...			$\frac{1}{0}$	76035	↔	Fleet Ryder						
P124LA 6x2 NA 420													
Truck	19...			$\frac{1}{0}$	76035	↔	Fleet Ryder						
P142H (6X2)													
Truck	82-89			$\frac{1}{0}$	76035	↔	Fleet Ryder	$\frac{1}{1}$	76034	↔	Fleet Ryder		
P82ML 4x2(S) 4X2													
Truck	82-89			$\frac{1}{0}$	76035	↔	Fleet Ryder	$\frac{1}{1}$	76006	↔	Fleet Ryder		
P94LA 4x2 NA 310													
Truck	19...			$\frac{1}{0}$	76035	↔	Fleet Ryder						
R112HL 6X4(S)													
Truck	82-89			$\frac{1}{0}$	76035	↔	Fleet Ryder	$\frac{1}{1}$	76034	↔	Fleet Ryder		
R142H (6X4)													
Truck	82-89			$\frac{1}{0}$	76035	↔	Fleet Ryder	$\frac{1}{1}$	76034	↔	Fleet Ryder		
SILVER EAGLE													
SAR Coach													
Bus	19...			$\frac{0}{0}$	77002	↔	Fleet Ryder	$\frac{0}{0}$	76042	↔	Fleet Ryder		



Derivative	Year	Vehicle Type	Fitment Guide #	FRONT				REAR				GASLIFT	
				Shock Info	Part #	L/R	Range	Shock Info	Part #	L/R	Range	Front	Rear
TATA													
LPT 1518TC													
Truck	05 on			∅	76185	↔	Fleet Ryder	∅	76186	↔	Fleet Ryder		
LPT 509M 4x2 F-C													
Truck	19...			∅	36863	↔	Technomatic	∅	55232	↔	Safari		
LPT 709 3T 4x2 F-C													
Truck	19...			∅	55233	↔	Safari	∅	55234	↔	Safari		
LPT 713 S 4x2 F-C													
Truck	19...			∅	55233	↔	Safari	∅	55234	↔	Safari		
LPT 713 S Chassis 4x2 Bus													
Truck	19...			∅	55233	↔	Safari	∅	55234	↔	Safari		
SFC 407 2T 4x2 F-C													
Truck	19...			∅	36863	↔	Technomatic	∅	55232	↔	Safari		
TOYOTA													
DA 110, 116													
Truck	73 on			∅	76016	↔	Fleet Ryder						
DA/ KA													
Truck	00 on			∅	76043	↔	Fleet Ryder						
DYNA													
4-093 4x2 F-C	02 on			∅	36868	↔	Technomatic	∅	36869	↔	Technomatic		
5-103 4x2	08 on			∅	36872	↔	Technomatic	∅	55241	↔	Safari		
5-104 4x2	03 on			∅	36872	↔	Technomatic						
6-104 4x2	04 on							∅	36873	↔	Technomatic		
6-104 4x2	96-03							∅	36874	↔	Technomatic		
7-094	89-00			∅	G45908	↔	Technomatic	∅	G45909	↔	Technomatic		
7-095 F-C, 4x2 (ADE364C)	89-00			∅	G45908	↔	Technomatic	∅	G45909	↔	Technomatic		
7-105	03-on							∅	55239	↔	Safari		
7-105 LWB 4T 4x2 F-C	89-00							∅	36873	↔	Technomatic		
7-145	08-on			∅	55238	↔	Safari	∅	55239	↔	Safari		
8-145	03-on							∅	55239	↔	Safari		
Coaster	66-77			∅	G56102	↔	Safari	∅	G56116	↔	Safari		
Coaster	78-95							∅	G56102	↔	Safari		
Truck	94 on							∅	G56102	↔	Safari		

Derivative	Year	Vehicle Type	Fitment Guide #	FRONT				REAR				GASLIFT	
				Shock Info	Part #	L/R	Range	Shock Info	Part #	L/R	Range	Front	Rear
UNIMOG													
BUFFEL													
414, 416 Truck	19...				76014	↔	Fleet Ryder		76014	↔	Fleet Ryder		
VOLVO													
B7F													
Bus	19...				76042	↔	Fleet Ryder		76042	↔	Fleet Ryder		
F12, FL12, FH12													
Truck	19...				76008	↔	Fleet Ryder						
F88, G88													
Truck	19...				76042	↔	Fleet Ryder						
WESTERN STAR													
3842S													
Truck	19...		26		76042	↔	Fleet Ryder						
Truck	19...		26		76017	↔	Fleet Ryder						
4842S, 4864S													
Truck	19...		26		76042	↔	Fleet Ryder						
Truck	19...		26		76017	↔	Fleet Ryder						
5964F, 5964F													
Truck	19...		26		76042	↔	Fleet Ryder						
Truck	19...		26		76017	↔	Fleet Ryder						

























PARTS LISTING

SHOCKS & STRUTS

The Parts Listing highlights our products in alpha numerical order according to their part number. This allows for easy reference to the applicable make and model of the vehicles when finding an application or applications which use that Gabriel part number.



The product ranges for each part number is indicated. For product dimensions and end-mountings refer to the Technical Section starting from page 175.

Some Gabriel Europe imports are stamped with a manufacturing number and are not listed in this section and these will be found in our Parts Finder section starting from page 145.

Part #	Range	Superceding Part #/Status	Product Type	Make	Model	Derivative	Year	Position	L/R	Fitment Guide #
14004	Steering Damper		 15	Volkswagen	Beetle	All	52-79	Front		
14011	Steering Damper		 15	Land Rover	Range Rover	SUV	76-94	Front		
				Land Rover	Range Rover, Discovery	SUV	76-98	Front		
14012	Steering Damper		 15	Audi	100, 200	PC	81-84	Front		
				Isuzu	KB, TF Series	4X2, 4X4	81-03	Front		
14013	Steering Damper		 15	Land Rover	Defender	109, 110 WB, Series 11, 111	65-84	Front		
14014	Steering Damper		 15	Opel	Commodore, Rekord	Incl. 2500, 3800, 4100	78-97	Front		
14021	Steering Damper		 15	Toyota	Hilux	4X4	79-98	Front		
14022	Steering Damper		 15	Nissan	Patrol	4X4	82-90	Front		
				Nissan	Safari	SUV	82-90	Front		
14023	Steering Damper		 15	Toyota	Land Cruiser	FJ45, BJ45	71-85	Front		
14024	Steering Damper		 15	Toyota	Land Cruiser	FJ62, BJ60, BJ75	83-99	Front		
				Toyota	Land Cruiser	HZJ 80	90-98	Front		
14032	Steering Damper		 15	Land Rover	Defender	90, 110, 130 (Incl. Defender, County)	84-07	Front		
14033	Steering Damper		 15	Toyota	Hilux	4X4	99-05	Front		
14040	Steering Damper		 15	Jeep (Chrysler)	Jeep	Cherokee	93-01	Front		
18727	Technomatic		 8, 5	Volkswagen	Beetle	MK I	52-79	Front	↔	4
				Volkswagen	Kombi	Microbus, Fleetline (swing axle rear)	55-78	Front	↔	
				Volkswagen	Kombi	Microbus, Fleetline (swing axle rear)	55-78	Rear	↔	
19021	Technomatic		 8, 5	Austin, Morris	Mini	Excl. Hydrolastic Susp.	59-85	Front	↔	
				Austin, Morris	Mini	Incl. Cooper	59-80	Front	↔	
				Austin, Morris	Mini	Incl. Mk III	61-79	Front	↔	
19022	Technomatic		 6, 2	Renault	R8, R10	Small Sedan	62-70	Front	↔	
				Austin, Morris	Mini	Excl. Hydrolastic Susp.	59-85	Rear	↔	
				Austin, Morris	Mini	Incl. Cooper	59-80	Rear	↔	
				Austin, Morris	Mini	Incl. Mk III	61-79	Rear	↔	
				Renault	R8, R10	Small Sedan	62-70	Rear	↔	
19289	Technomatic		 4	Nissan	Langley, Pulsar	Incl. Panache (N10)	80-83	Rear	↔	
19290	Technomatic		 13, 2	Toyota	1200	LDV	78-82	Rear	↔	
35117	Technomatic		 1, 1	Renault	Laguna	I (Excl. Station Wagon)	96-00	Front	↔	
35816	Technomatic		 1, 1	Ford	Bantam	1300, 1600	83-86	Front	↔	
				Ford	Escort	Mk III Fwd L, GL, GLE	81-86	Front	↔	
				Ford	Escort	Mk III Fwd XR3, Sport	81-86	Front	↔	
				Mazda	Rustler	130, 160	85-86	Front	↔	
35817	Technomatic		 1, 2	Ford	Escort	Mk III Fwd L, GL, GLE	81-86	Rear	↔	
				Ford	Escort	Mk III Fwd XR3, Sport	81-86	Rear	↔	
35824	Technomatic		 1, 1	Renault	R9, R11	Saloon, Hatch	83-86	Front	↔	
35830	Technomatic		 1, 1	Honda	Ballade	Civic	82-84	Front	↔	

Part #	Range	Superceding Part #/Status	Product Type	Make	Model	Derivative	Year	Position	L/R	Fitment Guide #
35832	Technomatic		1, 1	Ford	Laser, Meteor, Tracer	KC/KE, GC	86-91	Front	↔	
				Mazda	323	Incl. S (non sealed Strut)	81-83	Front	↔	
				Mazda	323	Incl. S, EGi, Sport	82-91	Front	↔	
35833	Technomatic		1, 1	Ford	Laser, Meteor, Tracer	KC/KE, GC	86-91	Rear	↔	
				Ford	Laser, Meteor, Tracer	KF/KH	91-01	Rear	↔	
				Mazda	323	Incl. Midge	91-04	Rear	↔	
				Mazda	323	Incl. S (non sealed Strut)	81-83	Rear	↔	21
				Mazda	323	Incl. S, EGi, Sport	82-91	Rear	↔	
35834	Technomatic	55806	1, 1	Mazda	626	Incl. Coupe (Mk II, Mk III)	83-92	Front	↔	
35836	Technomatic		1, 1	Mitsubishi	Tredia	Excl. Turbo	83-86	Front	↔	
35842	Technomatic		1, 1	Ford	Sierra, Sapphire	2300, 2000, 1600	83-93	Front	↔	
				Ford	Sierra, Sapphire	3000 (Incl. XR6)	83-93	Front	↔	
				Ford	Sierra, Sapphire	Estate	83-93	Front	↔	
35843	Technomatic	55810	1, 1	Honda	Ballade	130, 150, 150i (SC9) (Civic)	84-87	Front	↔	
35844	Technomatic		1, 1	Ford	Bantam	1400, 1600	86-94	Front	↔	
				Mazda	Rustler	1400, 1600	86-94	Front	↔	
35845	Technomatic	55812	1, 1	Toyota	Conquest	FWD (E80)	85-89	Front	↔	
				Toyota	Corolla	FWD (Incl. Avante) (E80)	85-89	Front	↔	
35846	Technomatic	55813	1, 1	Toyota	Conquest	FWD (E80)	85-89	Rear	↔	
				Toyota	Corolla	FWD (Incl. Avante) (E80)	85-89	Rear	↔	
35847	Technomatic		1, 1	Nissan	Langley, Pulsar	Incl. Exa (sealed Strut) (N12)	83-88	Front	↔	
35848	Technomatic		1, 1	Ford	Laser, Meteor, Tracer	KF/KH	91-01	Front	↔	
				Mazda	323	Incl. Midge	91-04	Front	↔	
35849	Technomatic		1, 1	Volkswagen	Citi	Incl. Chicco (Excl. Sonic, Life & VeloCiti)	84 on	Front	↔	
				Volkswagen	Citi	Sonic, Life & VeloCiti	98 on	Front	↔	
				Volkswagen	Fox	Incl. Shuttle	87-95	Front	↔	
				Volkswagen	Golf	Mk I (imported Strut)	78-79	Front	↔	
				Volkswagen	Golf	Mk I (Local Strut)	79-84	Front	↔	
				Volkswagen	Golf	Pickup (sealed Strut)	93-03	Front	↔	
				Volkswagen	Jetta	Mk I (imported Strut)	78-85	Front	↔	
				Volkswagen	Jetta	Mk I (Local Strut)	79-85	Front	↔	
35916	Technomatic	55816	1, 1	Nissan	Sentra	Sedan, Coupe (B12)	87-92	Front	↔	
35917	Technomatic	55817	1, 1	Nissan	Sentra	Sedan, Coupe (B12)	87-92	Rear	↔	
35920	Technomatic	55854	1, 1	Fiat	Uno	Incl. Turbo (Series 2)	90-06	Front	↔	
35922	Technomatic	55811	1, 1	Volkswagen	Golf	Mk III (Excl. VR6 & Cabriolet), Mk II All (Excl. Cabriolet)	93-94	Front	↔	
				Volkswagen	Jetta	Mk III (Excl. VR6), Mk II	93-94	Front	↔	
35923	Technomatic	55838	1, 1	Nissan	Sabre	160, 200 (Excl. ABS)	92-01	Front	L	
				Nissan	Sentra	140	92-01	Front	L	
				Nissan	Sentra	160, 200 (Excl. STi)	92-01	Front	L	

Part #	Range	Superceding Part #/Status	Product Type	Make	Model	Derivative	Year	Position	L/R	Fitment Guide #
35924	Technomatic	55839	1, 1	Nissan	Sabre	160, 200 (Excl. ABS)	92-01	Front	R	
				Nissan	Sentra	140	92-01	Front	R	
				Nissan	Sentra	160, 200 (Excl. STi)	92-01	Front	R	
35925	Technomatic	55840	1, 1	Nissan	Sentra	140	92-01	Rear	↔	
35926	Technomatic	55841	1, 1	Volkswagen	Golf	Mk III All (Excl. Cabriolet)	95-99	Front	↔	
				Volkswagen	Golf	Mk III GTi	94-99	Front	↔	
				Volkswagen	Jetta	Mk III	95-99	Front	↔	
				Volkswagen	Jetta	Mk III Cli	94-99	Front	↔	
				Volkswagen	Polo	Classic (Mk III)	96-02	Front	↔	
				Volkswagen	Polo	Playa (9N)	98-02	Front	↔	
35927	Technomatic		1, 1	Ford	Bantam	1300, 1600	94-02	Front	↔	
				Mazda	Rustler	1300, 1600	94-02	Front	↔	
35934	Technomatic		1, 1	Tata	Indica	1.4 Hatch (V2) (Incl. B-Line, Excl. TDi & ABS)	04 on	Front	L	
35935	Technomatic		1, 1	Tata	Indica	1.4 Hatch (V2) (Incl. B-Line, Excl. TDi & ABS)	04 on	Front	R	
35941	Technomatic		1, 1	Chevrolet	Aveo	T200 (Kalos) Gen 1	02-11	Front	L	
35942	Technomatic		1, 1	Chevrolet	Aveo	T200 (Kalos) Gen 1	02-11	Front	R	
35943	Technomatic		1, 1	Kia	Clarus	2.0 GLX (Credos)	98-06	Front	L	
35944	Technomatic		1, 1	Kia	Clarus	2.0 GLX (Credos)	98-06	Front	R	
35945	Technomatic		1, 1	Kia	Clarus	2.0 GLX (Credos)	98-06	Rear	L	
35946	Technomatic		1, 1	Kia	Clarus	2.0 GLX (Credos)	98-06	Rear	R	
35951	Technomatic		1, 1	Hyundai	Atos	Includes Prime (Mk II)	99 on	Front	L	
35952	Technomatic		1, 1	Hyundai	Atos	Includes Prime (Mk II)	99 on	Front	R	
35953	Technomatic		1, 1	Chana	Star	Bakkie, Panel van, Minibus (Incl. Maxi Star)	06 on	Front	L	
35954	Technomatic		1, 1	Chana	Star	Bakkie, Panel van, Minibus (Incl. Maxi Star)	06 on	Front	R	
35955	Technomatic		1.1	Chery	QQ3 0.8, 1.1 (S11)	Hatch	08 on	Front	L	
35956	Technomatic		1.1	Chery	QQ3 0.8, 1.1 (S11)	Hatch	08 on	Front	R	
35957	Technomatic		1, 1	GWM	Florid	All	09 on	Front	↔	
36759	Technomatic	61201	7, 1	Mercedes	114, 115 Series	220, 230, 240D, 280E, 280 (Excl. )	68-77	Front	↔	
36761	Technomatic		6, 1	Mercedes	110 Series	190, 200, 230	62-67	Rear	↔	
				Mercedes	111 Series	220, 250, 280	60-68	Rear	↔	
				Mercedes	S Class	108 Series	68-73	Rear	↔	
36767	Technomatic		6, 2	Nissan	Y Series	1200	71-75	Rear	↔	
				Nissan	Y Series	120Y, 140 SDX, (12" wheels)	75-80	Rear	↔	
				Nissan	Y Series	140 SDX (13" wheels), 140Y, 160Y	75-80	Rear	↔	

Part #	Range	Superceding Part #/Status	Product Type		Make	Model	Derivative	Year	Position	L/R	Fitment Guide #
36847	Technomatic	61202	1/8	7, 1	Mercedes	C Class	(W123) 200, 230E, 240D, 250, 280E, 300D (Excl. )	77-86	Front	↔	
					Mercedes	S Class	(116 Series) 280SE, 280S, 350SE (Excl. )	73-81	Front	↔	
					Mercedes	S Class	(W126) 280SE, 300SE, 380SE, 420SE, 500SE, 560SE Incl. SEL & SEC (Excl. )	81-93	Front	↔	
36850	Technomatic		1/8	6, 2	Renault	R5	Mk I Hatch	72-85	Front	↔	
					Renault	R5	Mk I panel van	80-85	Front	↔	
36851	Technomatic		1/8	6, 2	Renault	R5	Mk I Hatch	72-85	Rear	↔	
					Renault	R5	Mk I panel van	80-85	Rear	↔	
					Renault	R9, R11	Saloon, Hatch	83-86	Rear	↔	
36853	Technomatic		1/8	6, 2	Audi	100, 200	C2	77-84	Rear	↔	14
36854	Technomatic		1/8	6, 2	Audi	100, 200	Excl. Coupe (C1)	72-74	Rear	↔	
					Audi	100, 200	Excl. Coupe (C1)	75-77	Rear	↔	
					Ford	Capri	Mk I	69-73	Rear	↔	
					Ford	Corsair	1.6	64-66	Rear	↔	
					Ford	Corsair	1.6, 2.0	66-69	Rear	↔	
					Ford	Cortina	Mk I	64-66	Rear	↔	
					Ford	Cortina	Mk II	67	Rear	↔	
					Ford	Cortina	Mk II	68-70	Rear	↔	
					Hillman	Vogue, Hunter	Incl. Sceptre, Arrow	67-77	Rear	↔	
Nissan	Stanza	1600J, 1800J Stanza, Resort (A10)	78-83	Rear	↔						
36857	Technomatic		1/8	6, 2	BMW	2 Series	1502, 2002 Ti Lux (E10)	66-77	Rear	↔	
					BMW	3 Series	E30 Series (Excl. iS & Cabriolet)	83-91	Rear	↔	14
36859	Technomatic	G56185	1/4	4	Isuzu	WFR, Relay	Fargo	80-95	Front	↔	
					Mitsubishi	Colt Bakkie	L200 (2.6, 3.0, V6 4X4, 4X2 Raised Height)	94-98	Front	↔	
					Toyota	Stallion	KF40	87-00	Front	↔	
					Toyota	Venture	KF40	91-00	Front	↔	
36860	Technomatic		8/8	8, 5	Tata	Telcoline	4X4, 4X2	04 on	Rear	↔	
36862	Technomatic	G45886	8/8	8, 4	Mahindra	Scorpio	4X2	05 on	Rear	↔	
					Mahindra	Scorpio	4X4	05 on	Rear	↔	
36863	Technomatic		8/8	8, 5	Tata	LPT 509M 4X2 F-C	Truck	19...	Front	↔	
					Tata	SFC 407 2T 4X2 F-C	Truck	19...	Front	↔	
36865	Technomatic		1/8	6, 1	Toyota	Rav 4	Sealed struts (XA10)	98-00	Rear	↔	
					Toyota	Rav 4	Serviceable struts (XA10)	96-98	Rear	↔	
36866	Technomatic		1/8	6, 2	Chevrolet	Aveo	T200 (Kalos)	02 on	Rear	↔	
36867	Technomatic		8/8	8, 5	Hyundai	Atos	Includes Prime (Mk II); (Mk I)	99 on	Rear	↔	
36868	Technomatic		1/8	6, 2	Toyota	Dyna	4-093 4X2 F-C	02 on	Front	↔	
36869	Technomatic		8/8	8, 3	Toyota	Dyna	4-093 4X2 F-C	02 on	Rear	↔	



Part #	Range	Superceding Part #/Status	Product Type	Make	Model	Derivative	Year	Position	L/R	Fitment Guide #
36870	Technomatic		1/0 6, 1	Toyota	Dyna	7-094	89-00	Front	↔	
				Toyota	Dyna	7-095 F-C	89-00	Front	↔	
				Toyota	Dyna	7-095 4X2 (ADE364C)	89-00	Front	↔	
36871	Technomatic	G45908	0/0 8, 2	Toyota	Dyna	7-094	89-00	Rear	↔	
				Toyota	Dyna	7-095 F-C	89-00	Rear	↔	
				Toyota	Dyna	7-095 4X2 (ADE364C)	89-00	Rear	↔	
36872	Technomatic	G45909	0/0 8, 2	Toyota	Dyna	5-103 4X2	08 on	Front	↔	
				Toyota	Dyna	5-104 4X2	03 on	Front	↔	
36873	Technomatic		0/0 8, 2	Toyota	Dyna	7-105 LWB 4T 4X2 F-C	89-00	Rear	↔	
				Toyota	Dyna	6-104 4X2	03 on	Rear	↔	
36874	Technomatic		0/0 8, 2	Toyota	Dyna	6-104 4X2	96-03	Rear	↔	
36875	Technomatic		0/0 8.5	Chery	QQ3 0.8, 1.1 (S11)	Hatch	08 on	Rear	↔	
36876	Technomatic		1/0 6.1	Toyota	Ipsum	(SM10)	96-01	Rear	↔	
36877	Technomatic			GWM	Florid	All	09 on	Rear	↔	
42772	Technomatic		0/0 8, 5	Iveco	Daily	49.10, 49.12, 59.12	19...	Front	↔	
				Iveco	Daily, Turbo Daily	35.10V, 45.10, A45.10, 40.10, 49.12, 59.12	95-00	Front	↔	
				Iveco	Daily, Turbo Daily	45.10, A45.10, 49.10	95-00	Front	↔	
				Iveco	Daily	49.10, 49.12, 59.12	19...	Rear	↔	
				Iveco	Daily, Turbo Daily	45.10, A45.10, 49.10	95-00	Rear	↔	
42773	FleetRyder		0/0 8, 5	Iveco	Daily, Turbo Daily	35.10V, 45.10, A45.10, 40.10, 49.12, 59.12	95-00	Rear	↔	
				Iveco	Turbo Daily	42.12, 45.12, 54.12, 66.12	19...	Rear	↔	
42864	Technomatic		0/0 8, 5	Mercedes	Sprinter	308D, 312D (903)	95 on	Rear	↔	
				Mercedes	Sprinter 308D	Truck	96 on	Rear	↔	
				Mercedes	Sprinter 312D	Truck	96 on	Rear	↔	
42942	Technomatic	G56268	0/0 8, 5	Mercedes	Vito	115 CDi 2.2 Bus MPV Dsl (W639)	04 on	Rear	↔	
				Mercedes	Vito	115 CDi 2.2 Cr-Cab P-Van Dsl (W639)	04 on	Rear	↔	
				Mercedes	Vito	115 CDi 2.2 P-Van Dsl (W639)	04 on	Rear	↔	
44085	Technomatic		/ 2	BMW	3 Series	E30 Series (Excl. iS & Cabriolet)	83-90	Front	↔	
44217	Technomatic		/ 2	Nissan	1/2 Ton Bakkie	120Y (12" wheels)	76-83	Front	↔	
				Nissan	1/2 Ton Bakkie	1400, 1200, 120Y	71-08	Front	↔	
				Nissan	Y Series	1200	71-75	Front	↔	
				Nissan	Y Series	1200	72-75	Front	↔	
				Nissan	Y Series	120Y, 140 SDX, (12" wheels)	75-80	Front	↔	
44226	Technomatic		/ 2	Toyota	1200	LDV	78-82	Front	↔	
44227	Technomatic		/ 2	Nissan	Langley, Pulsar	Incl. Panache (N10)	80-83	Front	↔	
44411	Technomatic		/ 2	Opel	Astra	Estate (F)	94-01	Front	↔	
				Opel	Astra	F	93-99	Front	↔	
				Opel	Kadett	Astra	93-99	Front	↔	

Part #	Range	Superceding Part #/Status	Product Type	Make	Model	Derivative	Year	Position	L/R	Fitment Guide #
44500	Technomatic		/ 2	Nissan	U Series	1600, 1800 (Incl. Coupe)	72-73	Front	↔	
				Nissan	U Series	160U, 180U	74-78	Front	↔	
44505	Technomatic		/ 2	Ford	Escort	Mk I	68-73	Front	↔	
				Ford	Escort	Mk I 1100, 1300	70-75	Front	↔	
				Ford	Escort	Mk I, II	74-81	Front	↔	
				Ford	Escort	Mk II	75-81	Front	↔	17
44510	Technomatic		/ 2	Nissan	1/2 Ton Bakkie	1400 (13" wheels)	80-83	Front	↔	
				Nissan	Stanza	1600J, 1800J Stanza, Resort (A10)	78-83	Front	↔	
				Nissan	Stanza	1600J, 1800J, Stanza S/W (A10)	79-83	Front	↔	
				Nissan	Y Series	140 SDX (13" wheels), 140Y, 160Y	75-80	Front	↔	
				Nissan	Y Series	140Y, 160Y	75-80	Front	↔	
				Nissan	Y Series	140Y, 160Y	75-80	Front	↔	
44511	Technomatic		/ 2	Volkswagen	Golf	Incl. Sport (serviceable Strut) (Typ 14)	81-93	Front	↔	
				Volkswagen	Golf	Mk I (Local Strut)	79-84	Front	↔	
				Volkswagen	Jetta	Mk I (Local Strut)	79-85	Front	↔	
44516	Technomatic		/ 2	Ford	Capri	Mk I	69-73	Front	↔	
				Ford	Escort	Mk I 1600, GT	70-75	Front	↔	
44535	Technomatic		/ 2	Mazda	323	Rwd (Local Strut)	78-81	Front	↔	
44554	Technomatic	55811	/ 1, 1	Volkswagen	Golf	Mk II (serviceable Strut)	84-92	Front	↔	
				Volkswagen	Jetta	Mk II	85-92	Front	↔	
44601	Technomatic		/ 2	BMW	5 Series	E12 Series	74-76	Front	↔	
				BMW	5 Series	E12 Series	76-85	Front	↔	18
44602	Technomatic		/ 2	Audi	80	B1	75-81	Front	↔	
				Volkswagen	Passat	B1	74-81	Front	↔	
				Volkswagen	Passat	B2	82-87	Front	↔	
44603	Technomatic		/ 2	Toyota	Cressida	MX63 (Mk II)	81-93	Front	↔	
				Toyota	Cressida	Non IRS+, MX63 (Mk II)	81-93	Front	↔	
				Toyota	Cressida	With IRS+, MX73 (Mk III)	83-93	Front	↔	
44604	Technomatic		/ 2	Peugeot	504	GL, GLD, Ti	73-80	Front	↔	
				Peugeot	504	L, GR	76-85	Front	↔	
44606	Technomatic		/ 2	Peugeot	504	Estate	74-85	Front	↔	
				Peugeot	505	Saloon	80-85	Front	↔	

















Part #	Range	Superceding Part #/Status	Product Type	Make	Model	Derivative	Year	Position	L/R	Fitment Guide #
44607	Technomatic		/ 2	Daewoo	Cielo	Nexia	95-98	Front	↔	
				Daewoo	Espero	Aranos	95-98	Front	↔	
				Daewoo	Lanos	Sens	97-03	Front	↔	
				Opel	Kadett	D	80-85	Front	↔	
				Opel	Kadett	Estate (D)	80-85	Front	↔	
				Opel	Kadett	T-car (E)	85-89	Front	↔	
				Opel	Kadett	T-car (E)	89-93	Front	↔	
				Opel	Monza	Incl. Cub	89-93	Front	↔	
				Opel	Monza	Incl. GSi	86-89	Front	↔	
44608	Technomatic		/ 2	Nissan	Laurel	C230	78-87	Front	↔	
				Nissan	Skyline	1800, 2000 (R30)	82-87	Front	↔	
				Nissan	Skyline	2800 GLX, GTX (R30)	82-87	Front	↔	
44611	Technomatic		/ 2	Opel	Commodore	C	78-88	Front	↔	
				Opel	Commodore	C	78-92	Front	↔	
				Opel	Rekord	380i V6	91-97	Front	↔	
				Opel	Rekord	Caravan (E)	78-92	Front	↔	
				Opel	Rekord	Sedan (Excl. V6) (E)	78-97	Front	↔	
				Opel	Senator	A	79-86	Front	↔	
44612	Technomatic		/ 2	Mitsubishi	Colt	Galant (Local Strut)	78-83	Front	↔	
44613	Technomatic		/ 2	Toyota	Cressida	X30, X32 (Local Strut) (Mk I)	79-81	Front	↔	
				Toyota	Cressida	X35, X36 (Local Strut) (Mk I)	79-81	Front	↔	
44614	Technomatic		/ 2	Toyota	Corolla	Imported Strut (E30, E40, E50, E60)	74-80	Front	↔	10
				Toyota	Corolla	Imported Strut (E30, E40, E50, E60)	82-85	Front	↔	
				Toyota	Corolla	RWD (Excl. Van, S/W) (E70)	80-85	Front	↔	
				Toyota	Corolla Carri	Local Strut (E30, E40, E50, E60)	79-89	Front	↔	
44615	Technomatic		/ 2	Chevrolet / Opel	Ascona, Chevaïr	Incl. Coupe (C)	82-85	Front	↔	
44616	Technomatic	61915	/ 2	Nissan	Skyline	R31	87-92	Front	↔	
45171	Technomatic	81469	1/6 6,2	Chrysler	Valiant	Incl. Dodge SE, Chrysler L	60-81	Front	↔	
				Chrysler	Valiant	Rustler	72-78	Front	↔	
46001	Safari		1/6 6,1	Toyota	Prado	90 SWB & 95 LWB	96-02	Front	↔	
46002	Safari		1/6 6,1	Toyota	Prado	90 SWB & 95 LWB	96-02	Rear	↔	
46003	Safari		1/6 6,2	Nissan	Navara	4X4 & 4X2 (D40)	05 on	Front	↔	
46004	Safari		1/6 6,2	Mitsubishi	Pajero	V Series (Mk II)	91-99	Front	↔	
46005	Safari		1/6 6,2	Mitsubishi	Pajero	V Series (Mk II)	91-99	Rear	↔	

Part #	Range	Superceding Part #/Status	Product Type	Make	Model	Derivative	Year	Position	L/R	Fitment Guide #	
51006	Technomatic		†	3, 2	Volkswagen	Citi	Incl. Chicco (Excl. Sonic, Life & VeloCiti)	84 on	Rear	↔	9
					Volkswagen	Fox	Incl. Shuttle	87-95	Rear	↔	9
					Volkswagen	Golf	Mk I (imported Strut)	78-79	Rear	↔	9
					Volkswagen	Golf	Mk I (Local Strut)	79-84	Rear	↔	9
					Volkswagen	Golf	Mk I (Local Strut)	79-84	Rear	↔	9
					Volkswagen	Jetta	Mk I (imported Strut)	78-85	Rear	↔	9
					Volkswagen	Jetta	Mk I (Local Strut)	79-85	Rear	↔	9
					Volkswagen	Jetta	Mk I (Local Strut)	79-85	Rear	↔	9
51016	Technomatic		†	3, 2	Volkswagen	Passat	B2	82-87	Rear	↔	9
51021	Technomatic	69067	†	3, 2	Honda	Ballade	130, 150, 150i (SC9) (Civic)	84-87	Rear	↔	
51022	Technomatic	69068	†	3, 2	Volkswagen	Golf	Mk II (serviceable Strut)	84-92	Rear	↔	
					Volkswagen	Golf	Mk III (Excl. VR6 & Cabriolet), Mk II All (Excl. Cabriolet)	93-94	Rear	↔	
					Volkswagen	Golf	Mk III All (Excl. Cabriolet)	95-99	Rear	↔	
					Volkswagen	Golf	Mk III GTi	94-99	Rear	↔	
					Volkswagen	Jetta	Mk II	85-92	Rear	↔	
					Volkswagen	Jetta	Mk III	95-99	Rear	↔	
					Volkswagen	Jetta	Mk III Cli	94-99	Rear	↔	
					Volkswagen	Jetta	Mk III (Excl. VR6), Mk II	93-94	Rear	↔	
51158	Technomatic	69074	†	3, 2	Nissan	Laurel	C230	78-87	Rear	↔	
					Nissan	Skyline	1800, 2000 (R30)	82-87	Rear	↔	
51165	Technomatic	69072	†	3, 2	Audi	400, 500	C3, C4	83-94	Rear	↔	
51168	Technomatic		†	3, 2	Tata	Indica	1.4 Hatch (V2) (Incl. B-Line, Excl. TDi)	04 on	Rear	↔	
51240	Technomatic		⊖	6, 1	Toyota	Prado	90 SWB & 95 LWB	96-02	Front	↔	
51309	Technomatic		†	3, 2	BMW	5 Series	E12 Series	76-85	Rear	↔	18
55088	Safari		⊖	6, 1	Ford	Triton 0510, 0610	Truck	85-87	Front	↔	
					Isuzu	SBR 422, FJR	Truck	76-83	Front	↔	
					Mitsubishi	Canter	Truck	80 on	Front	↔	
					Nissan	CM 10 F	Truck	87 on	Front	↔	
					Nissan	CM 8 F	Truck	87-95	Front	↔	
					Isuzu	Frontier	4X4, 4X2	98-02	Rear	↔	
					Leyland	FG 550, FG 420	Truck	68-77	Rear	↔	
					Ssangyong	Musso	602TDi, E230EL, E320EL	95-06	Rear	↔	
55208	Safari		⊥	4	Mercedes	114, 115 Series	220, 230, 240D, 280E, 280 (Excl. ⓈI)	68-77	Rear	↔	
					Mercedes	C Class	(W123) 200, 230E, 240D, 250, 280E, 300D (Excl. ⓈI)	77-86	Rear	↔	
					Mercedes	S Class	(116 Series) 280SE, 280S, 350SE (Excl. ⓈI)	73-81	Rear	↔	
					Mercedes	S Class	(W126) 280SE, 300SE, 380SE, 420SE, 500SE, 560SE Incl. SEL & SEC (Excl. ⓈI)	81-93	Rear	↔	

Part #	Range	Superceding Part #/Status	Product Type	Make	Model	Derivative	Year	Position	L/R	Fitment Guide #
55210	Safari		8, 5	Mercedes	0.309D	Bus	19...	Front	↔	
				Mercedes	L408, L508, L608	Truck	79 on	Front	↔	
				Mercedes	MB 800	Bus	19...	Front	↔	
				Mercedes	MB 800	Truck	19...	Front	↔	
				Mercedes	0.309D	Bus	19...	Rear	↔	
				Mercedes	608 LP, LPK, LPS, LPO	Truck	19...	Rear	↔	
				Mercedes	609, 811 LP, LPS, LPK	Truck	19...	Rear	↔	
				Mercedes	808 LP, LPS, LPK	Truck	19...	Rear	↔	
				Mercedes	L408, L508, L608	Truck	79 on	Rear	↔	
55211	Safari		6, 1	Ford	Triton 0608, 0610	Truck	87 on	Front	↔	
				Isuzu	FRR500	Truck	19...	Front	↔	
				Isuzu	N2800 P	Truck	93 on	Front	↔	29
				Isuzu	N3000 P	Truck	87-90	Front	↔	29
				Isuzu	NKR55/99	Truck	19...	Front	↔	29
				Isuzu	TL40-50	Truck	75 on	Front	↔	29
				Isuzu	TLD 24	Truck	77-88	Front	↔	29
				Isuzu	TLD44, TLD54	Truck	77-89	Front	↔	
				Mazda	T2000, 3000	LDV	83 on	Front	↔	
				Mazda	T2000, T3000	Truck	81-86	Front	↔	
55227	Safari		6, 2	Volkswagen	Kombi	Microbus (Excl. Synchro 4X4)	80-02	Front	↔	12
55231	Safari		6, 2	Tata	Telcoline	4X4, 4X2	04 on	Front	↔	
55232	Safari		8, 5	Tata	LPT 509M 4X2 F-C	Truck	19...	Rear	↔	
				Tata	SFC 407 2T 4X2 F-C	Truck	19...	Rear	↔	
55233	Safari		8, 5	Tata	LPT 709 3T 4X2 F-C	Truck	19...	Front	↔	
				Tata	LPT 713 S 4X2 F-C	Truck	19...	Front	↔	
				Tata	LPT 713 S Chassis 4X2 Bus	Truck	19...	Front	↔	
55234	Safari		8, 5	Tata	LPT 709 3T 4X2 F-C	Truck	19...	Rear	↔	
				Tata	LPT 713 S 4X2 F-C	Truck	19...	Rear	↔	
				Tata	LPT 713 S Chassis 4X2 Bus	Truck	19...	Rear	↔	
55236	Safari		6, 2	Nissan	UD 35	4X2 F-C	96-10	Front	↔	
				Nissan	UD 35A	4X2 F-C	96-10	Front	↔	
				Nissan	UD 40L	Truck	96 on	Front	↔	
55237	Safari		8, 2	Nissan	UD 40L	Truck	96 on	Rear	↔	
55238	Safari		6, 1	Toyota	Dyna	7-145	08 on	Front	↔	
55239	Safari		8, 2	Toyota	Dyna	7-105	03-on	Rear	↔	
				Toyota	Dyna	7-145	08 on	Rear	↔	
				Toyota	Dyna	8-145	03-on	Rear	↔	

Part #	Range	Superceding Part #/Status	Product Type	Make	Model	Derivative	Year	Position	L/R	Fitment Guide #
55240	Safari		8, 2	Isuzu	N Series	NQR500T & NPR400	98-06	Rear	↔	
55241	Safari		8, 2	Toyota	Dyna	5-103 4X2	19...	Rear	↔	
55242	Safari		8, 2	Isuzu	N Series	N4000D & N3500D	88-99	Rear	↔	
55243	Safari		8.5	Isuzu	N Series	NPR 300, 400	84-03	Front	↔	
55800	Gas Ryder	35842	1, 1	Ford	Sierra, Sapphire	2300, 2000, 1600	83-93	Front	↔	
				Ford	Sierra, Sapphire	3000 (Incl. XR6)	83-93	Front	↔	
				Ford	Sierra, Sapphire	Estate	83-93	Front	↔	
55801	Gas Ryder	35816	1, 1	Ford	Escort	Mk III Fwd L, GL, GLE	81-86	Front	↔	
				Ford	Escort	Mk III Fwd XR3, Sport	81-86	Front	↔	
55802	Gas Ryder		1, 2	Ford	Escort	Mk III Fwd L, GL, GLE	81-86	Rear	↔	
				Ford	Escort	Mk III Fwd XR3, Sport	81-86	Rear	↔	
55803	Gas Ryder		1, 1	Mazda	323	Incl. S, EGi, Sport	82-91	Front	↔	
55804	Gas Ryder		1, 1	Ford	Laser, Meteor, Tracer	KC/KE, GC	86-91	Rear	↔	
				Ford	Laser, Meteor, Tracer	KF/KH	91-01	Rear	↔	
				Mazda	323	(Familia) Incl. Midge & Sting	91-04	Rear	↔	
				Mazda	323	Incl. S, EGi, Sport	82-91	Rear	↔	
55806	Gas Ryder		1, 1	Mazda	626	Incl. Coupe (Mk II, Mk III)	83-92	Front	↔	
55807	Gas Ryder		1, 1	Mazda	626	Incl. Coupe (Mk II, Mk III)	83-92	Rear	↔	
55810	Gas Ryder		1, 1	Honda	Ballade	130, 150, 150i (SC9) (Civic)	84-87	Front	↔	
55811	Gas Ryder		1, 1	Volkswagen	Golf	Mk II (serviceable Strut)	84-92	Front	↔	
				Volkswagen	Golf	Mk III (Excl. VR6 & Cabriolet), Mk II All (Excl. Cabriolet)	93-94	Front	↔	
				Volkswagen	Jetta	Mk II	85-92	Front	↔	
				Volkswagen	Jetta	Mk III (Excl. VR6), Mk II	93-94	Front	↔	
55812	Gas Ryder		1, 1	Toyota	Conquest	FWD (E80)	85-89	Front	↔	
				Toyota	Corolla	FWD (Incl. Avante) (E80)	85-89	Front	↔	
55813	Gas Ryder		1, 1	Toyota	Conquest	FWD (E80)	85-89	Rear	↔	
				Toyota	Corolla	FWD (Incl. Avante) (E80)	85-89	Rear	↔	
55815	Gas Ryder		1, 1	Mercedes	C Class	(W201) 190E (Excl. )	83-94	Front	↔	
				Mercedes	C Class	(W124) 200, 230E, 260E, 300D, 300E (Excl. )	86-95	Front	↔	
55816	Gas Ryder		1, 1	Nissan	Sentra	Sedan, Coupe (B12)	87-92	Front	↔	
55817	Gas Ryder		1, 1	Nissan	Sentra	Sedan, Coupe (B12)	87-92	Rear	↔	

Part #	Range	Superceding Part #/Status	Product Type	Make	Model	Derivative	Year	Position	L/R	Fitment Guide #
55818	Gas Ryder		1, 1	Toyota	Conquest	FWD (E90)	85-88	Front	↔	
				Toyota	Corolla	FWD (E90)	89-96	Front	↔	
				Toyota	Corolla Carri	E90	98-05	Front	↔	
				Toyota	Tazz	FWD (E90)	96-07	Front	↔	
55819	Gas Ryder		1, 1	Toyota	Corolla Carri	E90	98-05	Rear	↔	
				Toyota	Tazz	FWD (E90)	96-07	Rear	↔	
55825	Gas Ryder		1, 1	Ford	Laser, Meteor, Tracer	KF/KH	91-01	Front	↔	
				Mazda	323	(Familia) Incl. Midge & Sting	91-04	Front	↔	
55833	Gas Ryder		1, 1	Volkswagen	Citi	Incl. Chicco (Excl. Sonic, Life & VeloCiti)	84 on	Front	↔	
				Volkswagen	Citi	Sonic, Life & VeloCiti	98 on	Front	↔	
				Volkswagen	Fox	Incl. Shuttle	87-95	Front	↔	
				Volkswagen	Golf	Mk I (Local Strut)	79-84	Front	↔	
				Volkswagen	Golf	Pickup (sealed Strut)	93-03	Front	↔	
				Volkswagen	Jetta	Mk I (Local Strut)	79-85	Front	↔	
55834	Gas Ryder		1, 1	BMW	3 Series	E36 Series (Excl. M3)	91-99	Front	L	
				BMW	3 Series	E36 Series Cabriolet	93-99	Front	L	
55835	Gas Ryder		1, 1	BMW	3 Series	E36 Series (Excl. M3)	91-99	Front	R	
				BMW	3 Series	E36 Series Cabriolet	93-99	Front	R	
55838	Gas Ryder		1, 1	Nissan	Sabre	160, 200 (Excl. ABS)	92-01	Front	L	
				Nissan	Sentra	140	92-01	Front	L	
				Nissan	Sentra	160, 200 (Excl. STi)	92-01	Front	L	
55839	Gas Ryder		1, 1	Nissan	Sabre	160, 200 (Excl. ABS)	92-01	Front	R	
				Nissan	Sentra	140	92-01	Front	R	
				Nissan	Sentra	160, 200 (Excl. STi)	92-01	Front	R	
55840	Gas Ryder		1, 1	Nissan	Sentra	140	92-01	Rear	↔	
55841	Gas Ryder		1, 1	Volkswagen	Golf	Mk III All (Excl. Cabriolet)	95-99	Front	↔	
				Volkswagen	Golf	Mk III GTi	94-99	Front	↔	
				Volkswagen	Golf	Mk III VR6	93-99	Front	↔	
				Volkswagen	Jetta	Mk III	95-99	Front	↔	
				Volkswagen	Jetta	Mk III Cli	94-99	Front	↔	
				Volkswagen	Jetta	Mk III VR6	93-99	Front	↔	
				Volkswagen	Polo	Classic (Mk III)	96-02	Front	↔	
				Volkswagen	Polo	Playa (9N)	98-02	Front	↔	
55843	Gas Ryder		1, 1	Ford	Telstar	Incl. TX5	93-99	Front	L	
				Mazda	626	2.0, 2.5 (Incl. MX-6) (Mk IV)	92-98	Front	L	
55844	Gas Ryder		1, 1	Ford	Telstar	Incl. TX5	93-99	Front	R	
				Mazda	626	2.0, 2.5 (Incl. MX-6) (Mk IV)	92-98	Front	R	
55845	Gas Ryder		1, 1	Ford	Telstar	Incl. TX5	93-99	Rear	↔	
				Mazda	626	2.0, 2.5 (Incl. MX-6) (Mk IV)	92-98	Rear	↔	
55846	Gas Ryder		1, 1	Toyota	Camry	XV10	93-97	Front	L	

Part #	Range	Superceding Part #/Status	Product Type	Make	Model	Derivative	Year	Position	L/R	Fitment Guide #
55847	Gas Ryder		 1, 1	Toyota	Camry	XV10	93-97	Front	R	
55848	Gas Ryder		 1, 1	Toyota	Camry	XV10	93-97	Rear	L	
				Toyota	Camry	SV20	96-01	Rear	L	
				Toyota	Camry	XV20	97-01	Rear	L	
55849	Gas Ryder		 1, 1	Toyota	Camry	XV10	93-97	Rear	R	
				Toyota	Camry	SV20	96-01	Rear	R	
				Toyota	Camry	XV20	97-01	Rear	R	
55854	Gas Ryder		 1, 1	Fiat	Uno	Incl. Turbo (Series 2)	90-06	Front	↔	
				Fiat	Uno	Panel Van (Series 2)	90-06	Front	↔	
55855	Gas Ryder		 1, 1	Nissan	Sabre	160, 200 (Excl. ABS)	92-01	Rear	L	
				Nissan	Sentra	160, 200 (Excl. STi)	92-01	Rear	L	
55856	Gas Ryder		 1, 1	Nissan	Sabre	160, 200 (Excl. ABS)	92-01	Rear	R	
				Nissan	Sentra	160, 200 (Excl. STi)	92-01	Rear	R	
55858	Gas Ryder		 1, 1	Opel	Corsa	(B) Utility	96-04	Front	↔	
				Opel	Corsa	B	96-02	Front	↔	
				Opel	Corsa	Corsa Lite (B)	02-07	Front	↔	
55861	Gas Ryder		 1, 1	Toyota	Corolla	Excl. RSi (E100)	96-02	Front	↔	
				Toyota	Corolla	RSi (E100)	96-02	Front	↔	
55863	Gas Ryder		 1, 1	Toyota	Corolla	Excl. RSi (E100)	96-02	Rear	↔	
55865	Gas Ryder		 1, 1	Ford	Fiesta	Mark IV (Excl. 1.6 RSi 3-door) (Sleeve eye)	99-03	Front	↔	
				Ford	Fiesta	Mark IV (Excl. 1.6 RSi 3-door) (U Bracket)	97-99	Front	↔	
				Ford	Ikon	B3 (Sleeve eye)	00-06	Front	↔	
				Ford	Ikon	B3 (U Bracket)	00-06	Front	↔	
				Mazda	Soho	121 (Bracket)	97-99	Front	↔	23
				Mazda	Soho	121 (Eye)	97-99	Front	↔	22
55868	Gas Ryder		 1, 1	Hyundai	Accent	X3	94-97	Rear	↔	
55869	Gas Ryder		 1, 1	Hyundai	Accent	X3	94-97	Front	↔	
				Hyundai	Accent	X3	98-00	Front	↔	
55870	Gas Ryder		 1, 1	Hyundai	Accent	X3	98-00	Rear	↔	
55872	Gas Ryder		 1, 1	Audi	A3	Excl. S3 (8L1)	98-03	Front	↔	
				Volkswagen	Beetle	Mk II	99 on	Front	↔	
				Volkswagen	Golf	Mk IV 1.8, GTi, 1.9TDi, 2.0, 2.3V5	99-04	Front	↔	
				Volkswagen	Golf	Mk IV 1.8, GTi, 1.9TDi, 2.0, 2.3V5 (with 22mm Strut rod)	99-04	Front	↔	
				Volkswagen	Jetta	Mk IV (with 22mm Strut rod)	99-06	Front	↔	
55881	Gas Ryder		 1, 1	Volkswagen	Golf	Mk IV 1.6	99-04	Front	↔	
				Volkswagen	Golf	Mk IV 1.6 (with 20mm Strut rod)	99-04	Front	↔	
				Volkswagen	Jetta	Mk IV 1.6 (with 20mm Strut rod)	99-06	Front	↔	
55886	Gas Ryder		 1, 1	Toyota	Camry	XV20	97-01	Front	L	

Part #	Range	Superceding Part #/Status	Product Type	Make	Model	Derivative	Year	Position	L/R	Fitment Guide #
55887	Gas Ryder		1, 1	Toyota	Camry	XV20	97-01	Front	R	
55888	Gas Ryder		1, 1	Mazda	Etude	1.6 litre (BJ)	10.02-04	Front	L	
55889	Gas Ryder		1, 1	Mazda	Etude	1.6 litre (BJ)	10.02-04	Front	R	
55890	Gas Ryder		1, 1	Mazda	Etude	1.6 litre (BJ)	00-09.02	Rear	L	
				Mazda	Etude	1.6 litre (BJ)	10.02-04	Rear	L	
55891	Gas Ryder		1, 1	Mazda	Etude	1.6 litre (BJ)	00-09.02	Rear	R	
				Mazda	Etude	1.6 litre (BJ)	10.02-04	Rear	R	
55892	Gas Ryder		1, 1	Toyota	Corolla	E120, E130	02-07	Front	L	
				Toyota	RunX	E120, E130	02-07	Front	L	
55893	Gas Ryder		1, 1	Toyota	Corolla	E120, E130	02-07	Front	R	
				Toyota	RunX	E120, E130	02-07	Front	R	
61200	Gas Ryder	G45839	6, 2	Chevrolet / Opel	Ascona, Chevaïr	Incl. Coupe (C)	82-85	Rear	↔	
				Chevrolet / Opel	Ascona, Chevaïr	Incl. Coupe (short Strut) (C)	84-86	Rear	↔	
				Opel	Kadett	D	80-85	Rear	↔	
				Opel	Kadett	T-car (E)	85-89	Rear	↔	
				Opel	Monza	Incl. GSi	86-89	Rear	↔	
61201	Gas Ryder		7, 1	Mercedes	114, 115 Series	220, 230, 240D, 280E, 280 (Excl. I)	68-77	Front	↔	
				Mercedes	SL Class	280 SL, SLC, 350 SL, SLC (Excl. I)	71-81	Front	↔	
				Mercedes	SL Class	450 SL, SLC (Excl. I)	73-81	Front	↔	
61202	Gas Ryder		7, 1	Mercedes	E Class	(W123) 200, 230E, 240D, 250, 280E, 300D (Excl. I)	77-87	Front	↔	
				Mercedes	S Class	(116 Series) 280SE, 280S, 350SE (Excl. I)	73-81	Front	↔	
				Mercedes	S Class	(W126) 280SE, 300SE, 380SE, 420SE, 500SE, 560SE Incl. SEL & SEC (Excl. I)	81-93	Front	↔	
61212	Gas Ryder		6, 1	Toyota	Cressida	With IRS+, MX73 (Mk III)	83-93	Rear	↔	
61213	Gas Ryder	G45503	10	Ford	Cortina	Mk III	71-77	Front	↔	
				Ford	Cortina	Mk III, IV	71-78	Front	↔	
				Ford	Cortina	Mk IV	77-80	Front	↔	
				Ford	Cortina	Mk IV	78-80	Front	↔	
61214	Gas Ryder	G45520	8, 5	Ford	Cortina	Mk III	71-77	Rear	↔	
				Ford	Cortina	Mk IV	77-80	Rear	↔	
				Ford	Cortina	Mk V	80-83	Rear	↔	



Part #	Range	Superceding Part #/Status	Product Type	Make	Model	Derivative	Year	Position	L/R	Fitment Guide #
61228	Gas Ryder		⊖ 6, 1	Toyota	Celica, Supra	A60 Series (MK III)	81-85	Rear	↔	
				Toyota	Cressida	Non IRS+, MX63 (Mk II)	81-93	Rear	↔	
				Toyota	Cressida	X30, X32 (imported Strut) (Mk I)	77-79	Rear	↔	
				Toyota	Cressida	X30, X32 (Local Strut) (Mk I)	79-81	Rear	↔	
61230	Gas Ryder		⊖ 6, 1	Opel	Rekord	380i V6	91-97	Rear	↔	
				Opel	Senator	A	79-86	Rear	↔	
61232	Gas Ryder	G45837	≡ 10	Ford	Cortina	Mk V	80-83	Front	↔	
				Ford	Cortina	Mk V	80-82	Front	↔	
				Ford	Cortina	Mk V	80-83	Front	↔	
				Ford	Cortina	Mk V	83-86	Front	↔	
61233	Gas Ryder	G45838	⊖ 6, 2	Ford	Cortina	Mk V	80-83	Rear	↔	
61234	Gas Ryder	G45212	⊥ 4	Opel	2500, 3800, 4100	2.5, 3.8, & 4.1 Estate	75-78	Front	↔	
				Opel	2500, 3800, 4100	2.5, 3.8, & 4.1 Sedan	73-78	Front	↔	
				Opel	Rekord	C	67-73	Front	↔	
61235	Gas Ryder	G45841	⊖ 6, 1	Toyota	Corolla	RWD (Excl. Van, S/W) (E70)	80-85	Rear	↔	
				Toyota	Corona	Mk I	74-80	Rear	↔	
61238	Gas Ryder	G45860	⊖ 8, 5	Ford	Sierra, Sapphire	2300, 2000, 1600	83-93	Rear	↔	
				Ford	Sierra, Sapphire	3000 (Incl. XR6)	83-93	Rear	↔	
61239	Gas Ryder	36857	⊖ 6, 2	BMW	3 Series	E30 Series (Excl. iS & Cabriolet)	83-91	Rear	↔	
61241	Gas Ryder		⊖ 6, 2	Fiat	Uno	Incl. Turbo (Series 2)	90-06	Rear	↔	
				Fiat	Uno	Panel Van (Series 2)	90-06	Rear	↔	
61242	Gas Ryder	G45874	⊖ 6, 2	Daewoo	Cielo	Nexia	95-98	Rear	↔	
				Daewoo	Espero	Aranos	95-98	Rear	↔	
				Daewoo	Lanos	Sens	97-03	Rear	↔	
				Opel	Astra	F	93-99	Rear	↔	
				Opel	Kadett	Astra	93-99	Rear	↔	
				Opel	Kadett	T-car (E)	89-93	Rear	↔	
				Opel	Monza	Incl. Cub	89-93	Rear	↔	
61243	Gas Ryder	G45858	⊥ 4	Ford	Sierra, Sapphire	Estate	83-93	Rear	↔	
61248	Gas Ryder		⊖ 6, 2	BMW	3 Series	E36 Series (Excl. M3)	91-99	Rear	↔	
				BMW	3 Series	E36 Series (imported 4 cyl. models)	91-99	Rear	↔	
				BMW	3 Series	E36 Series (imported 6 cyl. models)	91-99	Rear	↔	
				BMW	3 Series	E36 Series (Imported Excl. M-Series) 320i, 325i, 325td (Long Stud)	91-92	Rear	↔	
				BMW	3 Series	E36 Series Cabriolet	93-99	Rear	↔	
				BMW	3 Series	E46 Series (Excl. M3, + Touring) one pin at the bottom Strut mounting	99-05	Rear	↔	
61252	Gas Ryder		⊖ 9, 2	Opel	Astra	Estate (F)	94-01	Rear	↔	7
				Opel	Kadett	Estate (D)	80-85	Rear	↔	7

Part #	Range	Superceding Part #/Status	Product Type	Make	Model	Derivative	Year	Position	L/R	Fitment Guide #
61253	Gas Ryder		1 0 6, 2	Mercedes	C Class	(W202) C180, C200, C220, C230, C250 (Excl. C280 & Sport Susp.)	94-00	Front	↔	
61254	Gas Ryder		1 0 6, 2	Mercedes	C Class	(W202) C180, C200, C220, C230, C250, C280 (Excl. Sport Susp.)	94-00	Rear	↔	
61256	Gas Ryder		1 0 6, 2	Opel	Corsa	B	96-02	Rear	↔	
				Opel	Corsa	Corsa Lite (B)	02-07	Rear	↔	
				Opel	Corsa	Excl. Corsa Lite (C)	02-07	Rear	↔	
61257	Gas Ryder		0 0 8, 5	Opel	Corsa	(B) Utility	96-04	Rear	↔	
61262	Gas Ryder		1 0 6, 2	Audi	A3	Excl. S3 (8L1)	98-03	Rear	↔	
				Volkswagen	Beetle	Mk II	99 on	Rear	↔	
				Volkswagen	Golf	Mk IV 1.6 (with 20mm Strut rod)	99-04	Rear	↔	
				Volkswagen	Golf	Mk IV 1.8, GTi, 1.9 TDi, 2.0, 2.3V5 (with 22mm Strut rod)	99-04	Rear	↔	
				Volkswagen	Jetta	Mk IV (with 22mm Strut rod)	99-06	Rear	↔	
				Volkswagen	Jetta	Mk IV 1.6 (with 20mm Strut rod)	99-06	Rear	↔	
61270	Gas Ryder		1 0 6, 2	Fiat	Palio	Type 1X	00-02	Rear	↔	
				Fiat	Siena	Type 2A	00-02	Rear	↔	
61281	Technomatic		0 0 8, 2	Mahindra	Bolero	4X4	05 on	Rear	↔	
61282	Technomatic		1 0 6, 2	Mahindra	Bolero	4X4	05 on	Front	↔	
61283	Technomatic		1 1 4	Mahindra	Scorpio	4X2	05 on	Front	↔	
61285	Gas Ryder		1 0 6, 2	Hyundai	Getz	3 & 5-door	03 on	Rear	↔	
61286	Gas Ryder		1 0 6, 2	Peugeot	307	1.6, 2.0 Excl. CC	01-08	Rear	↔	
61287	Gas Ryder		1 0 6, 2	Hyundai	Terracan	2.9, 3.5	01-09	Front	↔	
61288	Gas Ryder		1 0 6, 2	Hyundai	Terracan	2.9, 3.5	01-09	Rear	↔	
61289	Gas Ryder		1 0 6, 2	Hyundai	Santa Fe	SM	01-06	Rear	↔	
61292	Gas Ryder		1 0 6, 2	BMW	X5	E53 3.0i, 3.0d, 4.4iV8, 4.8 V8 4X4	01-07	Rear	↔	
61293	Gas Ryder		1 0 6, 2	Volkswagen	Golf	Mk V 1.6l	04-09	Rear	↔	
				Volkswagen	Golf	Mk V 1.9T Di, 2.0 FSi	04-09	Rear	↔	
				Volkswagen	Golf	Mk VI (Excl. GTi, V5, R32, AWD & Sport Susp.)	09-13	Rear	↔	
61294	Gas Ryder		0 0 8, 5	Mercedes	Vito	112 CDi Bus	03-04	Rear	↔	
				Mercedes	Vito	112 CDi 2.2 Cr-Cab P-Van Dsl	03	Rear	↔	
				Mercedes	Vito	112 CDi 2.2 P-Van Dsl	02-04	Rear	↔	
61295	Gas Ryder		0 0 13, 2	Kia	Rio	1.3 & 1.6 (DC)	00-03	Rear	↔	
61296	Gas Ryder		1 0 6, 2	Honda	Jazz	1.4Dsi, 1.5 Gen 1	03-07	Rear	↔	
61297	Gas Ryder		1 0 6, 2	Toyota	Corolla	1.3, 1.4, 1.6 & 1.8 (E140, E150) Incl. Quest	07-14	Rear	↔	
				Toyota	Corolla	2.0 D4D (E140, E150) Incl. Quest	07-14	Rear	↔	
				Toyota	Corolla	NRE18, ZRE17, NDE18 (E18)	14 on	Rear	↔	

Part #	Range	Superceding Part #/Status	Product Type	Make	Model	Derivative	Year	Position	L/R	Fitment Guide #
61298	Gas Ryder		⊖ 6, 2	Audi	A4	Excl. sport Susp. (B6)	01-05	Rear	↔	
61299	Gas Ryder	62117	⊖ 6, 2	Ford	Fiesta	Mark V Hatch & Sedan	02-08	Rear	↔	
				Ford	Figo	1.4	10 on	Rear	↔	
				Ford	Ikon	Sedan All	07 on	Rear	↔	
				Mazda	Demio	Hatch DY	02-07	Rear	↔	
				Mazda	Mazda 2	Hatch DY (Demio)	02-07	Rear	↔	
61302	Gas Ryder		/ 2	BMW	5 Series	E34 Series (Excl.  , M5)	89-96	Front	↔	
				BMW	7 Series	E32 Series	87-94	Front	↔	
61303	Gas Ryder		/ 2	Audi	100, 200	C2	77-84	Front	↔	
				Audi	400, 500	C3, C4	83-94	Front	↔	
				Audi	A6	Incl. Avant. Excl. Quattro (C4)	94-97	Front	↔	
61403	Gas Ryder	44511	/ 2	Volkswagen	Golf	Incl. Sport (serviceable Strut) (Typ 14)	81-93	Front	↔	
61404	Gas Ryder	44085	/ 2	BMW	3 Series	E30 Series (Excl. iS & Cabriolet)	83-91	Front	↔	
61900	Gas Ryder	44611	/ 2	Opel	Commodore	C	78-88	Front	↔	
				Opel	Commodore	C	78-92	Front	↔	
				Opel	Rekord	380i V6	91-97	Front	↔	
				Opel	Rekord	Caravan (E)	78-92	Front	↔	
				Opel	Rekord	Sedan (Excl. V6) (E)	78-97	Front	↔	
				Opel	Senator	A	79-86	Front	↔	
61901	Gas Ryder	44614	/ 2	Toyota	Corolla	Imported Strut (E30, E40, E50, E60)	82-85	Front	↔	
				Toyota	Corolla	RWD (Excl. Van, S/W) (E70)	80-85	Front	↔	
61902	Gas Ryder	44601	/ 2	BMW	5 Series	E12 Series	74-76	Front	↔	
				BMW	5 Series	E12 Series	76-85	Front	↔	
61903	Gas Ryder		/ 2	Toyota	Cressida	MX63 (Mk II)	81-93	Front	↔	
				Toyota	Cressida	Non IRS+, MX63 (Mk II)	81-93	Front	↔	
				Toyota	Cressida	With IRS+, MX73 (Mk III)	83-93	Front	↔	
61904	Gas Ryder	44608	/ 2	Nissan	Laurel	C230	78-87	Front	↔	
				Nissan	Skyline	1800, 2000 (R30)	82-87	Front	↔	
				Nissan	Skyline	2800 GLX, GTX (R30)	82-87	Front	↔	
61909	Gas Ryder		/ 2	Daewoo	Cielo	Nexia	95-98	Front	↔	
				Daewoo	Espero	Aranos	95-98	Front	↔	
				Daewoo	Lanos	Sens	97-03	Front	↔	
				Opel	Kadett	D	80-85	Front	↔	
				Opel	Kadett	Estate (D)	80-85	Front	↔	
				Opel	Kadett	T-car (E)	85-89	Front	↔	
				Opel	Kadett	T-car (E)	89-93	Front	↔	
				Opel	Monza	Incl. Cub	89-93	Front	↔	
Opel	Monza	Incl. GSi	86-89	Front	↔					





Part #	Range	Superceding Part #/Status	Product Type	Make	Model	Derivative	Year	Position	L/R	Fitment Guide #
61914	Gas Ryder		1/2	BMW	5 Series	E28 Series (Excl. M5)	85-89	Front	↔	
61915	Gas Ryder		1/2	Nissan	Skyline	R31	87-92	Front	↔	
61918	Gas Ryder		1/2	Opel	Astra	Estate (F)	94-01	Front	↔	
				Opel	Astra	F	93-99	Front	↔	
				Opel	Kadett	Astra	93-99	Front	↔	
62000	Gas Ryder		1/6,2	Kia	Picanto	Mk 1 Incl. 2007 & 2010 facelift (SA)	04-11	Rear	↔	
62001	Gas Ryder		1/6,2	Nissan	Micra	5-Door (K12)	04 on	Rear	↔	
62002	Gas Ryder		1/6,2	Volkswagen	Golf	Mk V 2.0 GTi	04-09	Rear	↔	
62003	Gas Ryder		1/6,2	Audi	A4	Sport Susp. Incl. Avant & Quattro (Excl. AllRoad, S4 & RS4) B7 model	05-08	Rear	↔	
62004	Gas Ryder		1/6,2	Mercedes	C Class	(W203) C180, C200, C220 CDI, C230, C270 CDI, C280, C320 CDI, C350	00-07	Rear	↔	
62005	Gas Ryder		1/6,2	Fiat	Palio	Expresso Panel van	01 on	Rear	↔	
				Fiat	Palio	Type 2H	01 on	Rear	↔	
62006	Gas Ryder		1/6,2	Nissan	Tiida	1.6i & 1.8i Hatch & Sedan	06 on	Rear	↔	
62007	Gas Ryder		1/1,1	Volkswagen	Kombi	T5 Kombi, Caravelle (Excl. 4-Motion)	04 on	Rear	↔	
				Volkswagen	Kombi	T5 Transporter: Crew bus, Pickup & Panel van (Excl. 4-Motion)	05 on	Rear	↔	
62008	Gas Ryder		1/8,2	Mercedes	Sprinter	Panel Van	06 on	Rear	↔	
				Volkswagen	Crafter	3 Ton, 3, 5 Ton (Excl. 4X4 & 5 Ton) (LT3)	06 on	Rear	↔	
62009	Gas Ryder		1/6,2	Ford	Fiesta	Mk VI	08-18	Rear	↔	
				Mazda	Mazda 2	DE (Demio)	07-18	Rear	↔	
62010	Gas Ryder		1/8,5	Volkswagen	Caddy	50mm OD & 55mm OD struts	04 on	Rear	↔	
62011	Gas Ryder		1/6,2	Honda	Civic	Mk VIII	06 on	Rear	↔	
62012	Gas Ryder		1/6,2	Nissan	NP200	1.5, 1.6	08 on	Rear	↔	
62013	Gas Ryder		1/6,2	Mercedes	E-Class (W211)	E200K; E220 CDI; E240; E270Cdi; E280, E320Cdi; E350; E500, E320 (Excl. S/W; AMG; Elec. & Air Susp.)	02-09	Rear	↔	
62014	Gas Ryder		1/8,5	Toyota	Rav 4	XA30	06 on	Rear	↔	
62015	Gas Ryder		1/13,2	Kia	Rio	1.3 & 1.6 (DC)	03-06	Rear	↔	
62016	Gas Ryder		1/6,2	Hyundai	Accent	MC. 1.6	05-11	Rear	↔	
62018	Gas Ryder		1/6,2	Volkswagen	Jetta	Mk V	06 on	Rear	↔	
				Volkswagen	Jetta	6 Sedan	11 on	Rear	↔	
62019	Gas Ryder		1/8,5	Opel	Astra	(H) 1.8 & 1.9 CDTi Incl. GTC (Excl. 2.0 Turbo Sport & OPC)	04-09	Rear	↔	
				Opel	Astra	(H) 1.8 & 1.9 CDTi Incl. GTC (Excl. 2.0 Turbo Sport & OPC)	04-09	Rear	↔	
62020	Gas Ryder		1/6,1	Toyota	Rav 4	XA20 (Mk II)	01-06	Rear	↔	



















Part #	Range	Superceding Part #/Status	Product Type	Make	Model	Derivative	Year	Position	L/R	Fitment Guide #
62021	Gas Ryder		1/0 6,2	BMW	X3	E83 2.5, 3.0 & 2.0D	04-10	Rear	↔	
62022	Gas Ryder		1/0 6,2	Toyota	Auris	1.4, 1.6, 1.8 & 2.0 (330N)	07 on	Rear	↔	
62023	Gas Ryder		1/0 6,2	Volvo	C30	Hatch	04-11	Rear	↔	
				Volvo	S40	MK II Incl. T5	04-11	Rear	↔	
62024	Gas Ryder		1/0 6,2	Audi	A4	Excl. sport Susp. (B7)	05-08	Rear	↔	
62025	Gas Ryder		0/0 8,5	Renault	Logan	U 90	08 on	Rear	↔	
				Renault	Sandero	5-door Hatch	09-14	Rear	↔	
62026	Gas Ryder		0/0 8,5	Nissan	Qashqai	1.6, 2.0, 1.5DCI (J10, JJ10)	07-14	Rear	↔	
62028	Gas Ryder		5	BMW	X1	E84 All	10-15	Rear	↔	
62030	Gas Ryder		5	Mercedes	A Class	(W169) A150, A160, A170, A200, A160 CDi, A200 CDi	04-12	Rear	↔	
				Mercedes	B Class	(W245) B150, B160, B170, B200, B180 CDi, B200 CDi	05-11	Rear	↔	
62032	Gas Ryder		1/0 6,2	Mercedes	C Class	C180, C200, C220CDi, C230, C270CDi, C280, C320CDi, C350 (W203 & W204)	07 on	Rear	↔	
62033	Gas Ryder		0/0 8,5	Nissan	X-Trail	4X4 & 4X2 (Mk II)	08 on	Rear	↔	
62034	Gas Ryder		1/0 6,2	Audi	A6 - C6 (Type 4F)	All Excl. Air Susp.	04-11	Rear	↔	
62035	Gas Ryder		0/0 6,2	Renault	Scenic	Scenic I (Excl. 4X4)	98-04	Rear	↔	
62036	Gas Ryder		1/5 7,1	Hyundai	iX35	SUV 4X2	10-16	Rear	↔	
				Kia	Sportage	SUV 4X2	10-16	Rear	↔	
62037	Gas Ryder		0/0 8,5	Suzuki	Alto	Gen 7	09 on	Rear	↔	
62038	Gas Ryder		0/0 8,5	Daihatsu	Terios II	4X2, 4X4	6/06 - on	Rear	↔	
62040	Gas Ryder		0/0 8,5	Daihatsu	Sirion	(Mk II) (Boon) Hatch	05-10	Rear	↔	
62043	Gas Ryder		1/0 6,2	Renault	Clio	Clio Mk III Hatch	06-13	Rear	↔	
62044	Gas Ryder		1/0 6,2	Opel	Corsa	(D) Hatch	07 on	Rear	↔	
62046	Gas Ryder		0/0 8,5	Peugeot	207	Hatch	06 on	Rear	↔	
62050	Gas Ryder		6,2	Volkswagen	Tiguan	4 Motion AWD & FWD Excl. Elec Susp.	08-15	Rear	↔	
62052	Gas Ryder		1/0 6,2	Chevrolet	Cruze	Sedan	09-16	Rear	↔	
				Opel	Astra	(J) Excl. OPC, GTC & Elec. Susp.	10-16	Rear	↔	
62053	Gas Ryder		0/0 8,5	Hyundai	i10	Hatch	08 on	Rear	↔	
62055	Gas Ryder		1/0 6,2	Suzuki	Swift	Hatch	08-10	Rear	↔	
62057	Gas Ryder		1/0 6,2	Audi	A4	Sedan	08 on	Rear	↔	
62058	Gas Ryder		1/ 3,2	Honda	Jazz	Hatch	08-13	Rear	↔	
62060	Gas Ryder		1/0 6,2	Toyota	Yaris / Vitz	Yaris / Vitz	99-05	Rear	↔	
62061	Gas Ryder		1/0 6,2	Toyota	Ipsium	(ACM 2)	01 on	Rear	↔	

Part #	Range	Superceding Part #/Status	Product Type	Make	Model	Derivative	Year	Position	L/R	Fitment Guide #
62062	Gas Ryder		1/0 6,2	Toyota	Aygo	Gen 1 (B1 & KGB10)	11-15	Rear	↔	
				Citroen	C1	1.0 & 1.4 Hdi	08-15	Rear	↔	
				Peugeot	107	1.0	07-15	Rear	↔	
62073	Gas Ryder		1/0 6,2	Ford	Focus	Mk III Hatch & Sedan (Excl. 2.5 ST & RS)	11 on	Rear	↔	
62080	Gas Ryder		0/0 8,5	Fiat	Panda	1.2, 1.3, Excl. AWD & 1.4 100Hp	04-10	Rear	↔	
62082	Gas Ryder		1/0 6,2	Volvo	S60	Sedan Excl. Elec. & Air Susp.	00-10	Rear	↔	
62083	Gas Ryder		1/0 6,2	Mercedes	E Class	(W212) Sedan	09 on	Rear	↔	
62084	Gas Ryder		1/0 8,5	Kia	Picanto	Hatch	11 on	Rear	↔	
62085	Gas Ryder		1/5 7,1	Hyundai	Elantra	HD Sedan	06-10	Rear	↔	
62086	Gas Ryder		0/0 8,5	Hyundai	i20	Hatch	09-13	Rear	↔	
				Kia	Cerato	Hatch & Sedan	09-13	Rear	↔	
62089	Gas Ryder		0/0 8,5	Chevrolet	Spark	M200, M250 Hatch	06-10	Rear	↔	
62090	Gas Ryder		1/0 6,2	Toyota	Yaris	Hatch	11-17	Rear	↔	
62091	Gas Ryder		1/0 6,2	Nissan	Micra	Hatch	11 on	Rear	↔	
				Nissan	Almera	1.5(N17) Gen3	13-on	Rear	↔	
62092	Gas Ryder		1/0 6,2	Mercedes	C Class	(CLC 203) Coupe	00-11	Rear	↔	
62094	Gas Ryder		1/0 6,2	Nissan	Livina	Incl. X-Gear & Grand Livina (XJ)	06 on	Rear	↔	
62099	Gas Ryder		1/ 3,3	Hyundai	i30	All	09-12	Rear	↔	
62100	Gas Ryder		1/0 6,2	Toyota	Etios	All (NGK15R, NGK12R)	12-on	Rear	↔	
62101	Gas Ryder		1/0 6,2	Honda	Brio	All	12 on	Rear	↔	
62102	Gas Ryder		1/0 6,2	Nissan	Juke	(F15) All	11 on	Rear	↔	
62103	Gas Ryder		1/0 6,2	Ford	Ecosport	SUV 1.0T, 1.5 & 1.5TDCi	13-on	Rear	↔	
62105	Gas Ryder		1/0 6,2	Chery	Tiggo	All	08 on	Rear	↔	
62107	Gas Ryder		1/0 6,2	Ford	Kuga	4X4, 4X2 SUV (Gen2) C250	13-on	Rear	↔	
62108	Gas Ryder		8,5	KIA	RIO	Gen 3 (UB)	11-on	Rear	↔	
62111	Gas Ryder			FIAT	500	ALL (Excl. Abrath & Sport)	08-on	Rear	↔	
62351	Gas Ryder		1/ 3,2	BMW	7 Series	E23 Series (Excl. )	77-86	Rear	↔	18
62352	Gas Ryder		1/ 3,2	BMW	5 Series	E28 Series (Excl. M5)	85-89	Rear	↔	14
62353	Gas Ryder		1/ 3,2	BMW	5 Series	E34 Series (Excl.  , M5)	89-96	Rear	↔	14
69050	Gas Ryder		1/ 3,2	Volkswagen	Citi	Incl. Chicco (Excl. Sonic, Life & VeloCiti)	84 on	Rear	↔	9
				Volkswagen	Fox	Incl. Shuttle	87-95	Rear	↔	9
				Volkswagen	Golf	Mk I	78-79	Rear	↔	9
				Volkswagen	Golf	Mk I	79-84	Rear	↔	9
				Volkswagen	Jetta	Mk I	78-85	Rear	↔	9
				Volkswagen	Jetta	Mk I	79-85	Rear	↔	9
69067	Gas Ryder		1/ 3,2	Honda	Ballade	130, 150, 150i (SC9) (Civic)	84-87	Rear	↔	14

Part #	Range	Superceding Part #/Status	Product Type	Make	Model	Derivative	Year	Position	L/R	Fitment Guide #
69067	Gas Ryder		† 3, 2	Honda	Ballade	160i (SH4) (Civic)	87-89	Rear	↔	14
69068	Gas Ryder		† 3, 2	Volkswagen	Golf	Mk II	84-92	Rear	↔	9
				Volkswagen	Golf	Mk III (Excl. VR6 & Cabriolet), Mk II All (Excl. Cabriolet)	93-94	Rear	↔	9
				Volkswagen	Golf	Mk III All (Excl. Cabriolet)	95-99	Rear	↔	9
				Volkswagen	Golf	Mk III GTi	94-99	Rear	↔	9
				Volkswagen	Golf	Mk III VR6	93-99	Rear	↔	9
				Volkswagen	Jetta	Mk II	85-92	Rear	↔	9
				Volkswagen	Jetta	Mk III	95-99	Rear	↔	9
				Volkswagen	Jetta	Mk III Cli	94-99	Rear	↔	9
				Volkswagen	Jetta	Mk III (Excl.VR6), Mk II	93-94	Rear	↔	9
				Volkswagen	Jetta	Mk III VR6	93-99	Rear	↔	9
69069	Gas Ryder	G45469	⊖ 6, 1	Toyota	Cressida	MX63 (Mk II)	81-93	Rear	↔	
69072	Gas Ryder		† 3, 2	Audi	400, 500	C3, C4	83-94	Rear	↔	14
69072	Gas Ryder		† 3, 2	Audi	A6	Incl. Avant. Excl. Quattro (C4)	94-97	Rear	↔	14
69073	Gas Ryder		† 3, 2	Nissan	Skyline	R31	87-92	Rear	↔	13
				Nissan	Skyline	2800 GLX, GTX (R30)	82-87	Rear	↔	13
69074	Gas Ryder		† 3, 2	Nissan	Laurel	C230	78-87	Rear	↔	13
				Nissan	Skyline	1800, 2000 (R30)	82-87	Rear	↔	13
69075	Gas Ryder		† 3, 1	Honda	Ballade	150, 160i (SH4) (Civic)	89-92	Front	↔	
69076	Gas Ryder		† 3, 2	Honda	Ballade	150, 160i (SH4) (Civic)	89-92	Rear	↔	
				Honda	Ballade	150, 160i (SR4) (Civic)	92-96	Rear	↔	
69079	Gas Ryder		† 3, 1	Honda	Ballade	150, 160i (SR4) (Civic)	92-96	Front	↔	
69081	Gas Ryder		† 3, 2	Volkswagen	Polo	Classic (Mk III)	96-02	Rear	↔	9
				Volkswagen	Polo	Playa (9N)	98-02	Rear	↔	9
69082	Gas Ryder		† 3, 3	Ford	Fiesta	Mark IV (Excl. 1.6 RSi 3-door) (U Bracket)	97-99	Rear	↔	23
				Ford	Ikon	B3 (U Bracket)	00-06	Rear	↔	23
69084	Gas Ryder		† 3, 1	Honda	Ballade	150i, 160i, 180i Excl. Vtech (Mk VI) (Civic)	96-01	Front	↔	
				Honda	Civic	Mk VI	96-01	Front	↔	
69087	Gas Ryder		† 3, 3	Audi	A4	1.8, 2.4, 2.6, 2.8 Excl. Quattro (B5)	94-01	Front	↔	
				Audi	A4	Quattro Excl. sport Susp. (B5)	94-01	Front	↔	
				Volkswagen	Passat	1.6, 1.8, 1.8T, 2.0, 1.9TDI Excl. 4X4 (B5)	99-05	Front	↔	
				Volkswagen	Passat	B5 2.3 V5 & 2.8 4WD 4-Motion Syncro	99-05	Front	↔	
69089	Gas Ryder		† 3, 2	Volkswagen	Citi	Sonic, Life & VeloCiti	98 on	Rear	↔	9
69092	Gas Ryder		† 3, 2	Toyota	Bubble	(1NZ)	02-07	Rear	↔	
				Toyota	Corolla	E120, E130	02-07	Rear	↔	
				Toyota	RunX	E120, E130	02-07	Rear	↔	
69093	Gas Ryder		† 3, 2	Nissan	Almera	Excl. ABS (N16)	01-07	Rear	↔	









Part #	Range	Superceding Part #/Status	Product Type	Make	Model	Derivative	Year	Position	L/R	Fitment Guide #
69095	Gas Ryder		† 3, 2	Ford	Fiesta	Mark IV (Excl. 1.6 RSi 3-door) (Sleeve eye)	99-03	Rear	↔	22
				Ford	Ikon	B3 (Sleeve eye)	00-06	Rear	↔	22
				Mazda	Soho	121 (Eye)	97-99	Rear	↔	22
69099	Gas Ryder		† 3, 1	Hyundai	Sonata	EF	03.01-02.05	Front	↔	
				Hyundai	Sonata	EF	09.98-03.01	Front	↔	
69100	Gas Ryder		† 3, 2	Hyundai	Sonata	EF	03.01-02.05	Rear	↔	
69101	Gas Ryder		† 3, 3	Audi	A4	Excl. sport Susp. (B6)	01-05	Front	↔	
				Audi	A4	Excl. sport Susp. (B7)	05-08	Front	↔	
69102	Gas Ryder		† 5	BMW	1 Series	E81 3-Door	07-11	Rear	↔	
				BMW	1 Series	E82 Coupe	08 on	Rear	↔	
				BMW	1 Series	E87 5-Door	04-11	Rear	↔	
				BMW	1 Series	E88 Cabriolet	08 on	Rear	↔	
				BMW	3 Series	E90 Series (Excl. M3, Cabrio & Coupe)	05-12	Rear	↔	
				BMW	3 Series	E91 Series	05-12	Rear	↔	
				BMW	3 Series	E92 Series	07 on	Rear	↔	
				BMW	3 Series	E93 Series	07 on	Rear	↔	
69103	Gas Ryder		† 6, 2	Toyota	Corolla	NZE120/121, ZZE121	02 on	Rear	↔	
69104	Gas Ryder		† 6, 2	Honda	CR-V	Mk II 4x4 2.0, 2.2D (RD4, RD5, RD6, RD7)	02-06	Rear	↔	
69106	Gas Ryder		† 6, 2	Toyota	Verso	1.6, 1.8, 2.0 (Mk III) (Spacio)	04-09	Rear	↔	

Part #	Range	Superceding Part #/Status	Product Type	Make	Model	Derivative	Year	Position	L/R	Fitment Guide #
69107	Gas Ryder		8.5	Mazda	Mazda 6	All Excl. MPS (GG/GY)	03 on	Front	L	
69108	Gas Ryder		8.5	Mazda	Mazda 6	All Excl. MPS (GG/GY)	03 on	Front	R	
69109	Gas Ryder		3.2	Mini	Cooper	(R50, R53) One, Cooper & Cooper S	02-06	Rear	↔	
69110	Gas Ryder		6, 2	Volvo	S40	Excl.  & T4 rear (Mk I)	00-04	Rear	↔	
69117	Gas Ryder		3.2	Jeep (Chrysler)	Jeep	Patriot (MK) SUV	07 on	Rear	↔	
				Dodge (Chrysler)	Caliber	Hatch	06-12	Rear	↔	
69120	Gas Ryder		3.2	Honda	CR-V	SUV 4X4 (Mk III) RE	07-12	Rear	↔	
69122	Gas Ryder		3.2	Toyota	Tercel	(Starlet) (EL4 / NL4)	90-96	Rear	↔	
69123	Gas Ryder		0	Toyota	Chaser	(Mk2) (G100)	92-02	Rear	↔	
69134	Gas Ryder		3,2	Mitsubishi	ASX	All	11 on	Rear	↔	
69135	Gas Ryder		3,2	Dodge	Journey	2.0 CRD, 2.7	08-on	Rear	↔	
69137	Gas Ryder		3,1	Honda	Accord	Gen 8 (Excl. ABS)	09-12	Front	L	
69138	Gas Ryder		3,1	Honda	Accord	Gen 8 (Excl. ABS)	09-12	Front	R	
69139	Gas Ryder		3,3	Honda	Accord	Gen 8 (Excl. ABS)	09-12	Rear	↔	
69141	Gas Ryder		3,3	Jeep (Chrysler)	Compass	Compass Mk2 (Facelift)	11-16	Rear	↔	
69401	Gas Ryder		8, 5	Peugeot	206	1.4, 1.6	01-06	Rear	↔	
69412	Gas Ryder	36867	8, 5	Hyundai	Atoz	Mk I	97-98	Rear	↔	
69415	Gas Ryder		8, 5	Opel	Zafira	A	01-06	Rear	↔	
69422	Gas Ryder		6, 2	Ford	Focus	Mk I Hatch & Sedan	98-04	Rear	↔	
69423	Gas Ryder		13, 2	Ford	Escort	Mk V	95-99	Rear	↔	
69425	Gas Ryder		6, 2	Renault	Clio	Clio II 1.6 16V Sport	00-06	Rear	↔	
69431	Gas Ryder	36875	8, 5	Daewoo	Matiz	Spark	99-03	Rear	↔	
69444	Gas Ryder		8, 5	Mercedes	A Class	(W168) A160, A190, 170CDI	00-04	Rear	↔	
69446	Gas Ryder		8, 5	Peugeot	206	1.4Hdi, 2.0Hdi	04-07	Rear	↔	
				Peugeot	206	1.6 Estate	03-07	Rear	↔	
				Peugeot	206	2.0 GTi	00-06	Rear	↔	
				Peugeot	206	CC 1.6, CC 2.0	01-07	Rear	↔	
69487	Gas Ryder	G45879	6, 2	Volkswagen	Polo	Mk IV	02-09	Rear	↔	
69506	Gas Ryder		6, 2	Volkswagen	Touran	Typ 1T	04-10	Rear	↔	
69507	Gas Ryder		6, 2	Audi	A3	3-Door (8P1)	04 on	Rear	↔	
				Audi	A3	Sportback 4X2, Sportback Quattro 4X4 (8PA)	05 on	Rear	↔	
69512	Gas Ryder		11	Renault	Scenic	Scenic II	04-09	Rear	↔	
69538	Gas Ryder		11	Renault	Megane	II Hatch (Excl. 2.0T Sport)	04-08	Rear	↔	
				Renault	Megane	II Sedan (Excl. 2.0T Sport)	04-08	Rear	↔	
69677	Gas Ryder		6, 2	Jaguar	Jaguar	XJ6, XJ12 (4 shocks at rear)	70-87	Front	↔	
69744	Gas Ryder		6, 2	Mercedes	C Class	(W201) 190E (Excl. )	83-94	Rear	↔	
				Mercedes	C Class	(W124) 200, 230E, 260E, 300D, 300E (Excl. )	86-95	Rear	↔	
69807	Gas Ryder	69744	6, 2	Mercedes	C Class	(W201) 190E (Excl. )	83-94	Rear	↔	
				Mercedes	E Class	(W124) 200, 230E, 260E, 300D, 300E (Excl. )	86-95	Rear	↔	



























Part #	Range	Superceding Part #/Status	Product Type	Make	Model	Derivative	Year	Position	L/R	Fitment Guide #	
69901	Gas Ryder		1/0	6, 2	Volvo	850	Excl.  , 	94-97	Rear	↔	
					Volvo	850	Excl.  , 	94-97	Rear	↔	
					Volvo	C70	Excl. T5 (Mk I)	97-00	Rear	↔	
					Volvo	S70, V70	Excl.  , 	97-00	Rear	↔	
69919	Gas Ryder		0/0	8, 5	Alfa-Romeo	155	2.0 (Excl. )	96-98	Rear	↔	
					Alfa-Romeo	155	2.5 (Excl. )	96-98	Rear	↔	
					Fiat	Palio	Weekend (Type 2G)	02 on	Rear	↔	
					Fiat	Palio	Weekend (Type PY)	00-02	Rear	↔	
69921	Gas Ryder		0/0	8, 5	Fiat	Seicento	600	99-03	Rear	↔	
69924	Gas Ryder		0/0	8, 5	Volkswagen	Sharan	Mk I, Mk IA, Mk IB	95-10	Rear	↔	
69926	Gas Ryder		1/0	6, 2	Peugeot	406	Saloon	96-04	Rear	↔	
69927	Gas Ryder		0/0	8, 5	Renault	Megane	I (Excl. Coupe)	96-03	Rear	↔	
					Renault	Megane	I (Excl. Coupe)	96-03	Rear	↔	
69928	Gas Ryder	62035	0/0	6, 2	Renault	Scenic	Scenic I (Excl. 4X4)	98-04	Rear	↔	
69946	Gas Ryder		1/0	6, 2	Audi	A6	Excl.  & Quattro (C5)	97-04	Rear	↔	
					Volkswagen	Passat	1.6, 1.8, 1.8T, 2.0, 1.9TDI Excl. 4X4 (B5)	96-99	Rear	↔	
					Volkswagen	Passat	2.3VR5 Excl. 4X4 (B5)	99-05	Rear	↔	
					Volkswagen	Passat	2.8 V6 (B5)	99-05	Rear	↔	
69948	Gas Ryder		1/0	6, 2	BMW	Z3	E36/4	98-03	Rear	↔	
69952	Gas Ryder		1/0	6, 2	Mercedes	E Class	(W210) E200, E220D, E280, E280TD, E290TD (Excl.  , )	95-02	Front	↔	
					Mercedes	E Class	(W210) E230, E250D	95-99	Front	↔	
69965	Gas Ryder		0/0	8, 5	Citroen	Xsara	Mark 2 (Excl. VTS)	00-06	Rear	↔	
					Peugeot	306	Hatchback, saloon & Cabriolet (Excl. Estate)	93-02	Rear	↔	
69966	Gas Ryder		1/0	6, 2	Mercedes	E Class	(W210) E200, E220D, E280, E280TD, E290TD (Excl.  , )	95-02	Rear	↔	
69986	Gas Ryder	G45881	0/0	8, 5	Opel	Astra	Excl. 2.0 OPC (G)	99-03	Rear	↔	
					Opel	Astra	Excl. 2.0 OPC (G)	99-03	Rear	↔	
69987	Gas Ryder		0/0	8, 5	Opel	Astra	Caravan, Excl. 2.0 OPC (G)	98-04	Rear	↔	
69989	Gas Ryder		1/0	6, 2	Renault	Clio	Clio II 1.4, 1.5dCi & 1.6 (Excl. 1.2, 1.6 Sport, 2.0 & 3.0)	00-06	Rear	↔	
70500	Gas Ryder			1, 1	Nissan	Almera	Excl. ABS (N16)	01-07	Front	L	
70501	Gas Ryder			1, 1	Nissan	Almera	Excl. ABS (N16)	01-07	Front	R	
70503	Gas Ryder			1, 1	Volkswagen	Polo	Mk IV	02-09	Front	↔	
70504	Gas Ryder			1, 1	Opel	Corsa	Excl. Corsa Lite (C)	02-07	Front	↔	
70505	Gas Ryder			1, 1	Opel	Astra	Caravan, Excl. 2.0 OPC (G)	98-04	Front	↔	
					Opel	Astra	Excl. 2.0 OPC (G)	99-03	Front	↔	
					Opel	Astra	Excl. 2.0 OPC (G)	99-03	Front	↔	

Part #	Range	Superceding Part #/Status	Product Type	Make	Model	Derivative	Year	Position	L/R	Fitment Guide #
70506	Gas Ryder		1, 1	Mercedes	Sprinter	Panel Van (Excl. 312, 515, 518 & 519)	06 on	Front	↔	
				Volkswagen	Crafter	3 Ton, 3, 5 Ton (Excl. 4X4 & 5 Ton) (LT3)	06 on	Front	↔	
70508	Gas Ryder		1, 1	BMW	3 Series	E46 Series (Excl. M3, + Touring) one pin at the bottom Strut mounting	99-05	Front	L	24
70509	Gas Ryder		1, 1	BMW	3 Series	E46 Series (Excl. M3, + Touring) one pin at the bottom Strut mounting	99-05	Front	R	24
70510	Gas Ryder		1, 1	Ford	Bantam	1.3, 1.6	03-06	Front	↔	
				Ford	Bantam	1.3, 1.6 (Mk III)	06 on	Front	↔	
				Ford	Bantam	1.3, 1.6, 1.8D	02	Front	↔	
70511	Gas Ryder		1, 1	Renault	Megane	I (Excl. Coupe)	96-03	Front	↔	
				Renault	Scenic	Scenic I (Excl. 4X4)	98-04	Front	↔	
70512	Gas Ryder		1, 1	Renault	Clio	Clio II 1.4, 1.5dCi & 1.6 (Excl. 1.2, 1.6 Sport, 2.0 & 3.0)	00-06	Front	↔	
70519	Gas Ryder		1, 1	Hyundai	Elantra	J2 & J3 Series (Avante)	96-00	Front	L	
				Hyundai	Elantra	XD (J4) (Avante)	01-07	Front	L	
				Hyundai	Tiburon	RC	96-00	Front	L	
70520	Gas Ryder		1, 1	Hyundai	Elantra	J2 & J3 Series (Avante)	96-00	Front	R	
				Hyundai	Elantra	XD (J4) (Avante)	01-07	Front	R	
				Hyundai	Tiburon	RC	96-00	Front	R	
70521	Gas Ryder		1, 1	Hyundai	Elantra	XD (J4) (Avante)	01-07	Rear	L	
70522	Gas Ryder		1, 1	Hyundai	Elantra	XD (J4) (Avante)	01-07	Rear	R	
70523	Gas Ryder		1, 1	Toyota	Rav 4	Sealed struts (XA10)	98-00	Front	L	
70524	Gas Ryder		1, 1	Toyota	Rav 4	Sealed struts (XA10)	98-00	Front	R	
70527	Gas Ryder		1, 1	Opel	Corsa	Utility	04 on	Front	↔	
70528	Gas Ryder	35941	1, 1	Chevrolet	Aveo	T200 (Kalos)	02 on	Front	L	
70529	Gas Ryder	35942	1, 1	Chevrolet	Aveo	T200 (Kalos)	02 on	Front	R	
70530	Gas Ryder		1, 1	Hyundai	Matrix	(Lavita) Mini MPV	02 on	Rear	L	
70531	Gas Ryder		1, 1	Hyundai	Matrix	(Lavita) Mini MPV	02 on	Rear	R	
70538	Gas Ryder		1, 1	Mercedes	Vito	112 CDi Bus	03-04	Front	↔	
				Mercedes	Vito	112 CDi 2.2 Cr-Cab P-Van Dsl	03	Front	↔	
				Mercedes	Vito	112 CDi 2.2 P-Van Dsl	02-04	Front	↔	
70539	Gas Ryder		1, 1	Peugeot	206	1.4, 1.6	01-06	Front	L	
70540	Gas Ryder		1, 1	Peugeot	206	1.4, 1.6	01-06	Front	R	
70542	Gas Ryder		1, 1	BMW	X5	E53 3.0i, 3.0d, 4.4iV8, 4.8 V8 4X4	01-07	Front	L	
70543	Gas Ryder		1, 1	BMW	X5	E53 3.0i, 3.0d, 4.4iV8, 4.8 V8 4X4	01-07	Front	R	
70544	Gas Ryder		1, 1	Hyundai	Elantra	J2 & J3 Series (Avante)	96-00	Rear	L	
70545	Gas Ryder		1, 1	Hyundai	Elantra	J2 & J3 Series (Avante)	96-00	Rear	R	



































Part #	Range	Superceding Part #/Status	Product Type	Make	Model	Derivative	Year	Position	L/R	Fitment Guide #	
70546	Gas Ryder		1	1.1	Volkswagen	Jetta	VI Sedan (50mm OD)	11-13	Front	↔	
					Audi	A3	50mm Strut Body. All (8P1) - Excl. Quattro, sport Susp. & S3.	03-12	Front	↔	
					Audi	A3	50mm Strut Body. Sportback (8PA) Excl. Quattro, sport Susp. & S3.	05-12	Front	↔	
					Volkswagen	Caddy	All 50mm OD Strut	04 on	Front	↔	
					Volkswagen	Golf	Mk V 50mm Strut Body (Excl. GTi)	04-09	Front	↔	
					Volkswagen	Golf	Mk V 50mm Strut Body (Excl. GTi)	09 on	Front	↔	
					Volkswagen	Jetta	Mk V 50mm OE Strut Body (Excl. V5 & sport Susp.)	06-11	Front	↔	
70547	Gas Ryder	70608	1	1, 1	Toyota	Yaris	T1 1.0L, T3 1.3L (Mk II) Hatch & T3 1.3L (Mk II) Sedan	05-11	Front	L	
					Toyota	Yaris	Hatch Gen 3	11-17	Front	L	
70548	Gas Ryder		1	1, 1	Hyundai	Getz	3 & 5-door	03 on	Front	L	
70549	Gas Ryder		1	1, 1	Hyundai	Getz	3 & 5-door	03 on	Front	R	
70550	Gas Ryder		1	1, 1	Hyundai	Matrix	(Lavita) Mini MPV	02 on	Front	L	
70551	Gas Ryder		1	1, 1	Hyundai	Matrix	(Lavita) Mini MPV	02 on	Front	R	
70554	Gas Ryder		1	1, 1	Hyundai	Santa Fe	SM	01-06	Front	L	
70555	Gas Ryder		1	1, 1	Hyundai	Santa Fe	SM	01-06	Front	R	
70556	Gas Ryder		1	1, 1	Nissan	X-Trail	4X4 & 4X2 (Mk I)	01-07	Front	L	
70557	Gas Ryder		1	1, 1	Nissan	X-Trail	4X4 & 4X2 (Mk I)	01-07	Front	R	
70558	Gas Ryder		1	1, 1	Nissan	X-Trail	4X4 & 4X2 (Mk I)	01-07	Rear	L	
70559	Gas Ryder		1	1, 1	Nissan	X-Trail	4X4 & 4X2 (Mk I)	01-07	Rear	R	
70560	Gas Ryder		1	1, 1	Volkswagen	Caddy	All 55mm OD Strut	04 on	Front	↔	
					Volkswagen	Golf	Mk V 55mm Strut Body (Excl. GTi)	04-09	Front	↔	
					Volkswagen	Golf	Mk VI 55mm Strut Body (Excl. GTi)	09-13	Front	↔	
					Volkswagen	Jetta	Mk V 55mm OE Strut Body (Excl. V5 & sport Susp.)	06-11	Front	↔	
					Volkswagen	Passat	B6 All (Excl. Sport Susp. & 4WD 4-Motion Syncro)	05-11	Front	↔	
70561	Gas Ryder		1	1, 1	Toyota	Auris	1.4 & 1.6 (330N)	07-12	Front	L	
					Toyota	Corolla	1.3, 1.4, 1.6, 1.8, & 2.0 D4D (E140, E150) Incl. Quest	07-14	Front	L	
					Toyota	Corolla	NRE18, ZRE17, NDE18 (E18)	14 on	Front	L	
70562	Gas Ryder		1	1, 1	Toyota	Auris	1.4 & 1.6 (330N)	07-12	Front	R	
					Toyota	Corolla	1.3, 1.4, 1.6, 1.8, & 2.0 D4D (E140, E150)	07-14	Front	R	
					Toyota	Corolla	NRE18, ZRE17, NDE18 (E18)	14 on	Front	R	
70563	Gas Ryder		1	1, 1	Chevrolet	Optra (Lacetti)	1.6 & 1.8 (Mk I)	02-08	Front	L	
70564	Gas Ryder		1	1, 1	Chevrolet	Optra (Lacetti)	1.6 & 1.8 (Mk I)	02-08	Front	R	
70565	Gas Ryder		1	1, 1	Chevrolet	Optra (Lacetti)	1.6 & 1.8 (Mk I)	02-08	Rear	R	

Part #	Range	Superceding Part #/Status	Product Type	Make	Model	Derivative	Year	Position	L/R	Fitment Guide #
70566	Gas Ryder		 1, 1	Chevrolet	Optra (Lacetti)	1.6 & 1.8 (Mk I)	02-08	Rear	L	
70567	Gas Ryder		 1, 1	Ford	Fiesta	Mark V Hatch & Sedan	02-08	Front	L	
				Ford	Figgo	1.4	10 on	Front	L	
				Ford	Ikon	Sedan All	07 on	Front	L	
				Mazda	Demio	Hatch DY	02-07	Front	L	
70568	Gas Ryder		 1, 1	Ford	Fiesta	Mark V Hatch & Sedan	02-08	Front	R	
				Ford	Figgo	1.4	10 on	Front	R	
				Ford	Ikon	Sedan All	07 on	Front	R	
				Mazda	Demio	Hatch DY	02-on	Front	R	
				Mazda	Mazda 2	Hatch DY (Demio)	02-07	Front	R	
70569	Gas Ryder		 1, 1	Hyundai	i10	Hatch	08 on	Front	L	
				Kia	Picanto	Mk 1 Incl. 2007 & 2010 facelift (SA)	04-11	Front	L	
70570	Gas Ryder		 1, 1	Hyundai	i10	Hatch	08 on	Front	R	
				Kia	Picanto	Mk 1 Incl. 2007 & 2010 facelift (SA)	04-11	Front	R	
70571	Gas Ryder		 1, 1	Toyota	Corona/Caldina	ST210, CT210 2.0 & 2.0 Diesel Sedan	01.96-12.01	Front	L	
				Toyota	Corona/Caldina	ST215G/W (2.0 & 2.0 Turbo 4WD GT & GTT)	12.99-09.02	Front	L	
				Toyota	Corona/Carina e	AT190, ST191, CT190 Sedan made in the UK	01.96-10.97	Front	L	
				Toyota	Corona/Carina e	ST191 2.0 Station Wagon	11.92-01.96	Front	L	
				Toyota	Corona/Carina e	ST191, CT190 2.0 & 2.0 Diesel Sedan & LB:5 Door Hatch	03.92-05.98	Front	L	
				Toyota	Corona/Carina e	ST191, CT190 2.0 & 2.0 Diesel Sedan & LB:5 Door Hatch with Harsh Road Package	02.96-05.98	Front	L	
70572	Gas Ryder		 1, 1	Toyota	Corona/Caldina	ST210, CT210 2.0 & 2.0 Diesel Sedan	01.96-12.01	Front	R	
				Toyota	Corona/Caldina	ST215G/W (2.0 & 2.0 Turbo 4WD GT & GTT)	12.99-09.02	Front	R	
				Toyota	Corona/Carina e	AT190, ST191, CT190 Sedan made in the UK	01.96-10.97	Front	R	
				Toyota	Corona/Carina e	ST191 2.0 Station Wagon	11.92-01.96	Front	R	
				Toyota	Corona/Carina e	ST191, CT190 2.0 & 2.0 Diesel Sedan & LB:5 Door Hatch	03.92-05.98	Front	R	
				Toyota	Corona/Carina e	ST191, CT190 2.0 & 2.0 Diesel Sedan & LB:5 Door Hatch with Harsh Road Package	02.96-05.98	Front	R	
70573	Gas Ryder		 1, 1	Toyota	Corona/Caldina	ST210, CT210 2.0 & 2.0 Diesel Sedan	01.96-12.01	Rear	L	
				Toyota	Corona/Carina e	ST191 2.0 Sedan & LB:5 Door Hatch	03.92-02.96	Rear	L	
				Toyota	Corona/Carina e	ST191, CT190 2.0 & 2.0 Diesel Sedan & LB:5 Door Hatch	03.92-05.98	Rear	L	





































Part #	Range	Superceding Part #/Status	Product Type	Make	Model	Derivative	Year	Position	L/R	Fitment Guide #
70574	Gas Ryder		1, 1	Toyota	Corona/Caldina	ST210, CT210 2.0 & 2.0 Diesel Sedan	01.96-12.01	Rear	R	
				Toyota	Corona/Carina e	ST191 2.0 Sedan & LB:5 Door Hatch	03.92-02.96	Rear	R	
				Toyota	Corona/Carina e	ST191, CT190 2.0 & 2.0 Diesel Sedan & LB:5 Door Hatch	03.92-05.98	Rear	R	
70575	Gas Ryder		1, 1	Nissan	Micra	5-Door (K12)	04 on	Front	L	
70576	Gas Ryder		1, 1	Nissan	Micra	5-Door (K12)	04 on	Front	R	
70577	Gas Ryder		1, 1	BMW	1 Series	E81 3-Door (Excl. Sport Susp. & 135i)	07-11	Front	L	
				BMW	1 Series	E82 Coupe (Excl. Sport Susp. & 135i)	08 on	Front	L	
				BMW	1 Series	E87 5-Door (Excl. Sport Susp. & 135i)	04-11	Front	L	
				BMW	1 Series	E88 Cabriolet (Excl. Sport Susp. & 135i)	08 on	Front	L	
				BMW	3 Series	E90 Series (Excl. M3, Y)	05-12	Front	L	
70578	Gas Ryder		1, 1	BMW	1 Series	E81 3-Door ((Excl. Sport Susp. & 135i)	07-11	Front	R	
				BMW	1 Series	E82 Coupe (Excl. Sport Susp. & 135i)	08 on	Front	R	
				BMW	1 Series	E87 5-Door (Excl. Sport Susp. & 135i)	04-11	Front	R	
				BMW	1 Series	E88 Cabriolet (Excl. Sport Susp. & 135i)	08 on	Front	R	
				BMW	3 Series	E90 Series (Excl. M3, )	05-12	Front	R	
70579	Gas Ryder		1, 1	Toyota	Avanza	1.3 & 1.5 (Xenia) Excl. ABS	06-12	Front	L	
70580	Gas Ryder		1, 1	Toyota	Avanza	1.3 & 1.5 (Xenia) Excl. ABS	06-12	Front	R	
70581	Gas Ryder		1, 1	Volkswagen	Golf	Mk V 2.0 GTi	04-09	Front	↔	
70583	Gas Ryder		1, 1	Fiat	Palio	Expresso Panel van	02 on	Front	↔	
				Fiat	Palio	Type 2H	02 on	Front	↔	
70584	Gas Ryder		1, 1	Ford	Focus	Mk II Hatch & Sedan (Excl. 2.5 RS & ST)	04-11	Front	L	
70585	Gas Ryder		1, 1	Ford	Focus	Mk II Hatch & Sedan (Excl. 2.5 RS & ST)	04-11	Front	R	
70586	Gas Ryder		1, 1	Nissan	NP200	1.5, 1.6	08 on	Front	↔	
70587	Gas Ryder		1, 1	BMW	3 Series	E36 Series (Imported Excl. M-Series) 320i, 325i, 325td (long Stud)	91-92	Front	L	
70588	Gas Ryder		1, 1	BMW	3 Series	E36 Series (Imported Excl. M-Series) 320i, 325i, 325td (long Stud)	91-92	Front	R	
70589	Gas Ryder		1, 1	Nissan	Livina	Incl. X-Gear & Grand Livina (XJ)	06-14	Front	L	
				Nissan	Tiida	1.6i & 1.8i Hatch & Sedan	06 on	Front	L	
70590	Gas Ryder		1, 1	Nissan	Livina	Incl. X-Gear & Grand Livina (XJ)	06-14	Front	R	
				Nissan	Tiida	1.6i & 1.8i Hatch & Sedan	06 on	Front	R	
70591	Gas Ryder		1, 1	Volkswagen	Kombi	T5 Transporter: Caravelle, Crew bus, Pickup & Panel van (Excl. 4-Motion)	04 on	Front	↔	
70592	Gas Ryder		1, 1	Mazda	Mazda 3	1.6, 2.0 Excl. 2.3 MPS (Mk I)	04-09	Front	L	

Part #	Range	Superceding Part #/Status	Product Type	Make	Model	Derivative	Year	Position	L/R	Fitment Guide #
70593	Gas Ryder		 1, 1	Mazda	Mazda 3	1.6, 2.0 Excl. 2.3 MPS (Mk I)	04-09	Front	R	
70594	Gas Ryder		 1, 1	Fiat	Strada	3/4 Ton LDV (Mk II)	05 on	Front	←→	
70596	Gas Ryder		 1, 1	Chevrolet	Spark	M300 (Excl. Lite)	10 on	Front	L	
70597	Gas Ryder		 1, 1	Chevrolet	Spark	M300 (Excl. Lite)	10 on	Front	R	
70598	Gas Ryder		 1, 1	Honda	Civic	Mk VIII	06-11	Front	L	
70599	Gas Ryder		 1, 1	Honda	Civic	Mk VIII	06-11	Front	R	
70600	Gas Ryder		 1, 1	Ford	Fiesta	Mk VI	08-18	Front	L	
				Mazda	Mazda 2	Hatch DE (Demio)	07-18	Front	L	
70601	Gas Ryder		 1, 1	Ford	Fiesta	Mk VI	08-18	Front	R	
				Mazda	Mazda 2	Hatch DE (Demio)	07-18	Front	R	
70602	Gas Ryder		 2, 1	Mercedes	C Class	(W203) C180, C200, C220CDi, C230, C270CDi, C280, C320CDi, C350	00-07	Front	←→	
70608	Gas Ryder		 1, 1	Toyota	Yaris	T1 1.0L, T3 1.3L (Mk II) Hatch	05-11	Front	L	
				Toyota	Yaris	T3 1.3L (Mk II) Sedan	06-11	Front	L	
				Toyota	Yaris Mk III	Hatch	11-17	Front	L	
70609	Gas Ryder		 1, 1	Toyota	Yaris	T1 1.0L, T3 1.3L (Mk II) Hatch	05-11	Front	R	
				Toyota	Yaris	T3 1.3L (Mk II) Sedan	06-11	Front	R	
				Toyota	Yaris Mk III	Hatch	11-17	Front	R	
70610	Gas Ryder		 1, 1	Honda	Jazz	1.4Dsi, 1.5 Gen 1	03-07	Front	L	
70611	Gas Ryder		 1, 1	Honda	Jazz	1.4Dsi, 1.5 Gen 1	03-07	Front	R	
70612	Gas Ryder		 1, 1	Honda	CR-V	Mk II 4X4 2.0, 2.2D	00-04	Front	L	
70613	Gas Ryder		 1, 1	Honda	CR-V	Mk II 4X4 2.0, 2.2D	00-04	Front	R	
70614	Gas Ryder		 1, 1	Land Rover	Freelander	Mk I (1.8, 2.0Td4, 2.5 V6)	98-3/07	Front	L	
70615	Gas Ryder		 1, 1	Land Rover	Freelander	Mk I (1.8, 2.0Td4, 2.5 V6)	98-3/07	Front	R	
70616	Gas Ryder		 1, 1	Land Rover	Freelander	Mk I (1.8, 2.0Td4, 2.5V6)	98-3/07	Rear	L	
70617	Gas Ryder		 1, 1	Land Rover	Freelander	Mk I (1.8, 2.0Td4, 2.5V6)	98-3/07	Rear	R	
70618	Gas Ryder		 1, 1	Toyota	Verso	1.6, 1.8, 2.0 (Mk III) (Spacio)	04-09	Front	L	
70619	Gas Ryder		 1, 1	Toyota	Verso	1.6, 1.8, 2.0 (Mk III) (Spacio)	04-09	Front	R	
70620	Gas Ryder		 1, 1	Kia	Rio	1.3 & 1.6 (DC)	03-06	Front	L	
70621	Gas Ryder		 1, 1	Kia	Rio	1.3 & 1.6 (DC)	03-06	Front	R	
70624	Gas Ryder		 1, 1	Hyundai	Accent	LC. 1.6	00-05	Front	L	
70625	Gas Ryder		 1, 1	Hyundai	Accent	LC. 1.6	00-05	Front	R	
70628	Gas Ryder		 1, 1	Toyota	Rav 4	XA20 (Mk II)	01-06	Front	L	
				Chery	Tiggo	All	08-on	Front	L	
70629	Gas Ryder		 1, 1	Toyota	Rav 4	XA20 (Mk II)	01-06	Front	R	
				Chery	Tiggo	All	08-on	Front	R	

Part #	Range	Superceding Part #/Status	Product Type	Make	Model	Derivative	Year	Position	L/R	Fitment Guide #
70631	Gas Ryder		1, 1	Opel	Astra	(H) 1.8 & 1.9 CDTi Incl. GTC (Excl. 2.0 Turbo Sport & OPC)	04-09	Front	L	
70632	Gas Ryder		1, 1	Opel	Astra	(H) 1.8 & 1.9 CDTi Incl. GTC (Excl. 2.0 Turbo Sport & OPC)	04-09	Front	R	
70633	Gas Ryder		1, 1	Volvo	C30	Hatch	07 on	Front	L	
				Volvo	S40	MK II Incl. T5	04-11	Front	L	
70634	Gas Ryder		1, 1	Volvo	C30	Hatch	07 on	Front	R	
				Volvo	S40	MK II Incl. T5	04-11	Front	R	
70635	Gas Ryder		2, 1	Hyundai	Tucson	All	04-11	Rear	L	
				Kia	Sportage	2.0, 2.7, 2.0D (Mk II)	04-10	Rear	L	
70636	Gas Ryder		4, 1	Hyundai	Tucson	All	04-11	Rear	R	
				Kia	Sportage	2.0, 2.7, 2.0D (Mk II)	04-10	Rear	R	
70637	Gas Ryder		6, 1	Hyundai	Tucson	All	04-11	Front	L	
				Kia	Sportage	2.0, 2.7, 2.0D (Mk II)	04-10	Front	L	
70638	Gas Ryder		8, 1	Hyundai	Tucson	All	04-11	Front	R	
				Kia	Sportage	2.0, 2.7, 2.0D (Mk II)	04-10	Front	R	
70639	Gas Ryder		1, 1	Renault	Logan	U 90	08 on	Front	↔	
				Renault	Sandero	5-door Hatch	09-14	Front	↔	
70640	Gas Ryder		1, 1	Audi	A3	55mm Strut Body. All (8P1) - Excl. Quattro, sport Susp. & S3.	03-12	Front	↔	
				Audi	A3	55mm Strut Body. Sportback (8PA) Excl. Quattro, sport Susp. & S3.	05-12	Front	↔	
70642	Gas Ryder		1.1	BMW	X3	E83 2.5i, 3.0i, 2.0d & 3.0d	04 on	Front	L	
70643	Gas Ryder		1.1	BMW	X3	E83 2.5i, 3.0i, 2.0d & 3.0d	04 on	Front	R	
70648	Gas Ryder		1.1	Honda	Civic	Mk VII	01-05	Front	L	
				Honda	Civic	Mk VII Sedan	01-05	Front	L	
70649	Gas Ryder		1.1	Honda	Civic	Mk VII	01-05	Front	R	
				Honda	Civic	Mk VII Sedan	01-05	Front	R	
70654	Gas Ryder		1.1	Mazda	626	1.8, 2.0 (Mk V), Y5 Sedan	99-03	Front	L	
70655	Gas Ryder		1.1	Mazda	626	1.8, 2.0 (Mk V), Y5 Sedan	99-03	Front	R	
70656	Gas Ryder		1.1	Mazda	626	1.8, 2.0 (Mk V), Y5 Sedan	99-03	Rear	L	
70657	Gas Ryder		1.1	Mazda	626	1.8, 2.0 (Mk V), Y5 Sedan	99-03	Rear	R	
70658	Gas Ryder		1.1	Mercedes	W204	C180, C200, C220CDi, C230, C250, C250CDi, C300, C320CDi, C350 (W204) (Excl. S/W; AMG; Elec. & Air Susp.)	07-14	Front	↔	
70659	Gas Ryder		1.1	Mercedes	W245	(W169) A170, A180Cdi, A200, (W245) B150, B160, B170, B200, B180 Cdi, B200 Cdi	05-11	Front	↔	
70661	Gas Ryder		1.1	Nissan	Qashqai	1.6, 2.0, 1.5DCI (J10, JJ10)	07-14	Front	L	
70662	Gas Ryder		1.1	Nissan	Qashqai	1.6, 2.0, 1.5DCI (J10, JJ10)	07-14	Front	R	
70663	Gas Ryder		8, 5	Nissan	X-Trail	4X4 & 4X2 (Mk II)	08 on	Front	L	
70664	Gas Ryder		8, 5	Nissan	X-Trail	4X4 & 4X2 (Mk II)	08 on	Front	R	

Part #	Range	Superceding Part #/Status	Product Type	Make	Model	Derivative	Year	Position	L/R	Fitment Guide #
70673	Gas Ryder		 1.1	Toyota	Rav 4	All XA30	06-12	Front	L	
70674	Gas Ryder		 1.1	Toyota	Rav 4	All XA30	06-12	Front	R	
70679	Gas Ryder		 1.1	Mini	Cooper	(R50, R53) One, Cooper & Cooper S	02-06	Front	L	
70680	Gas Ryder		 1.1	Mini	Cooper	(R50, R53) One, Cooper & Cooper S	02-06	Front	R	
70682	Gas Ryder		 1.1	Renault	Clio	Clio III Hatch	06-13	Front	←→	
70683	Gas Ryder		 1, 1	Volvo	S40	Excl.  I,  & T4 rear (Mk I)	00-04	Front	L	
70684	Gas Ryder		 1, 1	Volvo	S40	Excl.  I,  & T4 rear (Mk I)	00-04	Front	R	
70687	Gas Ryder		 1.1	Suzuki	SX4	SX4	08 on	Front	L	
70688	Gas Ryder		 S	Suzuki	SX4	SX4	08 on	Front	R	
70689	Gas Ryder		 1.1	Suzuki	Swift	Hatch	08-10	Front	L	
70690	Gas Ryder		 1.1	Suzuki	Swift	Hatch	08-10	Front	R	
70691	Gas Ryder		 1.1	Hyundai	iX35	4X4, 4X2 (Excl. AWD)	10 on	Front	L	
				Kia	Sportage	SUV 4X2	10 on	Front	L	
70692	Gas Ryder		 1.1	Hyundai	iX35	4X4, 4X2 (Excl. AWD)	10 on	Front	R	
				Kia	Sportage	SUV 4X2	10 on	Front	R	
70693	Gas Ryder		 1, 1	Suzuki	Alto	1.0 - Gen 7	09 on	Front	L	
70694	Gas Ryder		 1, 1	Suzuki	Alto	1.0 - Gen 7	09 on	Front	R	
70695	Gas Ryder		 1, 1	Daihatsu	Terios II	4X2, 4X4	6/06 on	Front	←→	
70696	Gas Ryder		 1.1	Hyundai	i20	Hatch	09 on	Front	L	
70697	Gas Ryder		 1.1	Hyundai	i20	Hatch	09 on	Front	R	
70700	Gas Ryder		 1.1	Daihatsu	Sirion	(Mk II) (Boon) Hatch	05-10	Front	←→	
70701	Gas Ryder		 1.1	Toyota	Avensis	Gen 2 (T250)	06-10	Front	L	
70702	Gas Ryder		 1.1	Toyota	Avensis	Gen 2 (T250)	06-10	Front	R	
70703	Gas Ryder		 1.1	Volkswagen	Touran	MPV	04-10	Front	←→	
				Volkswagen	Tiguan	SUV	08-15	Front	←→	
70706	Gas Ryder		 1.1	Chevrolet	Cruze J300 (Gen two)	Sedan & Hatch	09 on	Front	L	
70707	Gas Ryder		 1.1	Chevrolet	Cruze J300 (Gen two)	Sedan & Hatch	09 on	Front	R	
70708	Gas Ryder		 1.1	Opel	Corsa	(D) Hatch	07 on	Front	L	
70709	Gas Ryder		 1.1	Opel	Corsa	(D) Hatch	07 on	Front	R	
70710	Gas Ryder		 1.1	Fiat	Punto	Mk II	04-12	Front	←→	
70711	Gas Ryder		 1.1	Jeep (Chrysler)	Jeep	Patriot (MK) SUV	07 on	Front	L	
				Dodge (Chrysler)	Caliber	Hatch	06-12	Front	L	
70712	Gas Ryder		 1, 1	Jeep (Chrysler)	Jeep	Patriot (MK) SUV	06-12	Front	R	
				Dodge (Chrysler)	Caliber	Hatch	06-12	Front	R	
70713	Gas Ryder		 1, 1	Mercedes	Vito	115 (629 Gen2)	04-on	Front	←→	

Part #	Range	Superceding Part #/Status	Product Type	Make	Model	Derivative	Year	Position	L/R	Fitment Guide #
70714	Gas Ryder		✂ 1.1	Audi	A1	Hatch 1.2 TFSI, 1.4 TFSI, 1.6 Tdi (8X1, 8XA)icnl. Sport Susp. Excl. 4WD	11-19	Front	↔	
				Volkswagen	Polo	Hatch	10 on	Front	↔	
				Volkswagen	Polo	Vivo Hatch	10 on	Front	↔	
				Volkswagen	Polo	Sedan	11 on	Front	↔	
70715	Gas Ryder		✂ 1.1	Honda	Jazz	Hatch	08-13	Front	L	
70716	Gas Ryder		✂ 1.1	Honda	Jazz	Hatch	08-13	Front	R	
70718	Gas Ryder		✂ 1.1	Honda	CR-V	SUV 4X4 (Mk III) RE	07-12	Front	L	
70719	Gas Ryder		✂ 1.1	Honda	CR-V	SUV 4X4 (Mk III) RE	07-12	Front	R	
70722	Gas Ryder		✂ 1.1	BMW	5 Series	E60 Series Sedan	04-10	Front	↔	
70723	Gas Ryder		✂ 1.1	Toyota	Aygo	Gen 1 (B1 & KGB10)	11-15	Front	L	
				Citreon	C1	1.0 & 1.4 Hdi	08-15	Front	L	
				Peugeot	107	1.0	07-15	Front	L	
70724	Gas Ryder		✂ 1.1	Toyota	Aygo	Gen 1 (B1 & KGB10)	11-15	Front	R	
				Citreon	C1	1.0 & 1.4 Hdi	08-15	Front	R	
				Peugeot	107	1.0	07-15	Front	R	
70725	Gas Ryder		✂ 1.1	Toyota	Ipsum	(SM10)	96-01	Front	L	
70726	Gas Ryder		✂ 1.1	Toyota	Ipsum	(SM10)	96-01	Front	R	
70727	Gas Ryder		✂ 1.1	Toyota	Camry	(Gen 5)(SV20)	96-01	Front	L	
70728	Gas Ryder		✂ 1.1	Toyota	Camry	(Gen 5)(SV20)	96-01	Front	R	
70729	Gas Ryder		✂ 1.1	Toyota	Harrier	SXU 10, SXU 15 (Gen 1)	97-03	Front	L	
70730	Gas Ryder		✂ 1.1	Toyota	Harrier	SXU 10, SXU 15 (Gen 1)	97-03	Front	R	
70731	Gas Ryder		✂ 1.1	Toyota	Spaceo	(AE114)	97-01	Front	L	
70732	Gas Ryder		✂ 1.1	Toyota	Spaceo	(AE114)	97-01	Front	R	
70733	Gas Ryder		✂ 1.1	Toyota	Spaceo	(AE114)	97-01	Rear	L	
70734	Gas Ryder		✂ 1.1	Toyota	Spaceo	(AE114)	97-01	Rear	R	
70735	Gas Ryder		✂ 1.1	Toyota	Harrier	XU 10 (Gen 1)	97-03	Rear	L	
70736	Gas Ryder		✂ 1.1	Toyota	Harrier	XU 10 (Gen 1)	97-03	Rear	R	
70737	Gas Ryder		✂ 1.1	Toyota	Harrier	SXU 15 (Gen 1)	97-03	Rear	L	
70738	Gas Ryder		✂ 1.1	Toyota	Harrier	SXU 15 (Gen 1)	97-03	Rear	R	
70739	Gas Ryder		✂ 1.1	Toyota	Tercel	(Starlet)(EL4 / NL4)	90-96	Front	L	
70740	Gas Ryder		✂ 1.1	Toyota	Tercel	(Starlet)(EL4 / NL4)	90-96	Front	R	
70741	Gas Ryder		✂ 1.1	Mazda	Familia	(BJ)	00-04	Front	L	
70742	Gas Ryder		✂ 1.1	Mazda	Familia	(BJ)	00-04	Front	R	
70743	Gas Ryder		✂ 1.1	Mazda	Familia	(BJ)	00-04	Rear	L	
70744	Gas Ryder		✂ 1.1	Mazda	Familia	(BJ)	00-04	Rear	R	
70745	Gas Ryder		✂ 1.1	Mazda	Familia	(BJE)	99-00	Front	L	
70746	Gas Ryder		✂ 1.1	Mazda	Familia	(BJE)	99-00	Front	R	
70747	Gas Ryder		✂ 1.1	Mazda	Familia	(BJE)	99-00	Rear	L	
70748	Gas Ryder		✂ 1.1	Mazda	Familia	(BJE)	99-00	Rear	R	
70749	Gas Ryder		✂ 1.1	Honda	Fit	(Gen 1)(GD1)	07 on	Front	L	

Part #	Range	Superceding Part #/Status	Product Type	Make	Model	Derivative	Year	Position	L/R	Fitment Guide #
70750	Gas Ryder		 1.1	Honda	Fit	(Gen 1)(GD1)	07 on	Front	R	
70751	Gas Ryder		 1.1	Toyota	Yaris Vitz	Yaris / Vitz	99-05	Front	←→	
70752	Gas Ryder		 1.1	Toyota	Bubble	(1NZ)	02-07	Front	L	
70753	Gas Ryder		 1.1	Toyota	Bubble	(1NZ)	02-07	Front	R	
70754	Gas Ryder		 1.1	Toyota	Ipsum	(ACM 2)	01 on	Front	L	
70755	Gas Ryder		 1.1	Toyota	Ipsum	(ACM 2)	01 on	Front	R	
70757	Gas Ryder		 1.1	Chevrolet	Utility	Utility Pick-Up	11 on	Front	←→	
70763	Gas Ryder		 1.1	Peugeot	207	Hatch, CC 1.6 Sport 2 EU5, GT 1.6 3-dr	06 on	Front	L	
70764	Gas Ryder		 1.1	Peugeot	207	Hatch, CC 1.6 Sport 2 EU5, GT 1.6 3-dr	06 on	Front	R	
70771	Gas Ryder		 1.1	Ford	Focus	Mk III Hatch & Sedan (Excl. 2.5 ST & RS)	11 on	Front	L	
70772	Gas Ryder		 1.1	Ford	Focus	Mk III Hatch & Sedan (Excl. 2.5 ST & RS)	11 on	Front	R	
70775	Gas Ryder		 1.1	Volkswagen	Jetta	6 Sedan (55mm OD)	11 on	Front	←→	
70781	Gas Ryder		 1.1	Fiat	Panda	1.2, 1.3 (Excl. AWD & 1.4 100HP)	04-10	Front	L	
70782	Gas Ryder		 1.1	Fiat	Panda	1.2, 1.3 (Excl. AWD & 1.4 100HP)	04-10	Front	R	
70785	Gas Ryder		 1.1	Volvo	S60	Sedan	00-10	Front	←→	
70786	Gas Ryder		 1.1	Mercedes	E Class	(W212) Sedan	09 on	Front	←→	
70793	Gas Ryder		 1.1	Hyundai	Elantra	HD Sedan	06-10	Front	L	
70794	Gas Ryder		 1.1	Hyundai	Elantra	HD Sedan	06-10	Front	R	
70795	Gas Ryder		 1.1	Kia	Cerato	Hatch & Sedan	09-13	Front	L	
70796	Gas Ryder		 1.1	Kia	Cerato	Hatch & Sedan	09-13	Front	R	
70800	Gas Ryder		 1.1	Chevrolet	Spark	M200, M250 Hatch	06-10	Front	L	
70801	Gas Ryder		 1.1	Chevrolet	Spark	M200, M250 Hatch	06-10	Front	R	
70806	Gas Ryder		 1.1	Nissan	Micra	Hatch	11 on	Front	L	
				Nissan	Almera	1.5 (N17) Gen3	13 on	Front	L	
70807	Gas Ryder		 1.1	Nissan	Micra	Hatch	11 on	Front	R	
				Nissan	Almera	1.5 (N17) Gen3	13 on	Front	R	
70808	Gas Ryder		 1.1	Mercedes	C Class	(CLC 203) Coupe	00-11	Front	←→	
70809	Gas Ryder		 1.1	Renault	Clio	Clio II 1.6 16V Sport	00-06	Front	←→	
70814	Gas Ryder		 1.1	BMW	5 Series	E60 Series Sedan	04-10	Front	L	
70815	Gas Ryder		 1.1	BMW	5 Series	E60 Series Sedan	04-10	Front	R	
70816	Gas Ryder		 1.1	Mazda	Demio	DF	03-15	Front	L	
70817	Gas Ryder		 1.1	Mazda	Demio	DF	03-15	Front	R	
70822	Gas Ryder		 1, 1	Ford	Fiesta	Mk VI	08 on	Front	L	
70823	Gas Ryder		 1, 1	Mazda	Mazda 2	Hatch DE (Demio)	07 on	Front	L	
70824	Gas Ryder		 1, 1	Hyundai	i30	All (FD & GD)	09-12	Front	L	
70825	Gas Ryder		 1, 1	Hyundai	i30	All (FD & GD)	09-12	Front	R	
70826	Gas Ryder		 1, 1	Toyota	Etios	All (NGK15R, NGK12R)	12-on	Front	←→	
70828	Gas Ryder		 1, 1	Honda	Brio	All	12 on	Front	L	

Part #	Range	Superceding Part #/Status	Product Type	Make	Model	Derivative	Year	Position	L/R	Fitment Guide #	
70829	Gas Ryder		† 1,1	Honda	Brio	All	12 on	Front	R		
70831	Gas Ryder		† 1,1	Mitsubishi	ASX	ALL	11 on	Front	L		
70832	Gas Ryder		† 1,1	Mitsubishi	ASX	ALL	11 on	Front	R		
70833	Gas Ryder		† 1,1	Nissan	Juke	(F15) All	11 on	Front	L		
70834	Gas Ryder		† 1,1	Nissan	Juke	(F15) All	11 on	Front	R		
70835	Gas Ryder		† 1,1	Ford	Ecosport	All (FD & GD)	13-on	Front	L		
70836	Gas Ryder		† 1,1	Ford	Ecosport	All (FD & GD)	13-on	Front	R		
70837	Gas Ryder		† 1,1	Ford	Kuga	4X4 & 4X2 SUV (Gen2) C250	13-on	Front	L		
70838	Gas Ryder		† 1,1	Ford	Kuga	4X4 & 4X2 SUV (Gen2) C250	13-on	Front	R		
70845	Gas Ryder		† 1,1	BMW	X1	All (E84)	10-16	Front	L		
70846	Gas Ryder		† 1,1	BMW	X1	All (E84)	10-16	Front	R		
70847	Gas Ryder		† 1,1	Dodge	Journey	2.0 CRD, 2.7	06-on	Front	L		
70848	Gas Ryder		† 1,1	Dodge	Journey	2.0 CRD, 2.7	06-on	Front	R		
70851	Gas Ryder		† 1.1	Kia	Rio	GEN 3 (UB)	13-on	Front	L		
70852	Gas Ryder		† 1.1	Kia	Rio	GEN 3 (UB)	13-on	Front	R		
70853	Gas Ryder		† 1.1	Volkswagen	Golf	Golf VII Excl. Elec. Susp. (50mm dia)	13-19	Front	↔		
70858	Gas Ryder		† 1.1	FIAT	500	All (Excl. Abrath & Sport	08-on	Front	L		
70859	Gas Ryder		† 1.1	FIAT	500	All (Excl. Abrath & Sport	08-on	Front	R		
70868	Gas Ryder		† 1.1	Jeep (Chrysler)	Compass	Mk2 (Facelift)	11-16	Front	L		
70869	Gas Ryder		† 1.1	Jeep (Chrysler)	Compass	Mk2 (Facelift)	11-16	Front	R		
76006	Fleet Ryder		†	5	Bussing	19L, BBL	Truck	19...	Front	↔	
					ERF	E6 (Air Susp.)	Truck	19...	Front	↔	
					International	S2670-407T, S Series	Truck	80-85	Front	↔	
					Leyland	Buffalo	Truck	19...	Front	↔	
					Leyland	Eland	Bus	19...	Front	↔	
					Leyland	Pioneer Plus	Truck	19...	Front	↔	
					Leyland	Road Train	Truck	19...	Front	↔	
					Isuzu	BD	Bus	74 on	Rear	↔	
					Leyland	Eland	Bus	19...	Rear	↔	
					Leyland	Guy Victory J, MK2	Bus	19...	Rear	↔	
					Leyland	Kudu 352 RA, A691	Bus	19...	Rear	↔	
					Scania	LB 81 HS-31/50 4X2	Truck	75-82	Rear	↔	
					Scania	LBT 111-HS31 6X4	Truck	75-82	Rear	↔	
					Scania	LBT 141 HS-31/46 6X4	Truck	78-82	Rear	↔	
					Scania	P82ML 4X2(S) 4X2	Truck	82-89	Rear	↔	
76007	Fleet Ryder		∅	8, 2	DAF	AT1900	Truck	19...	Front	↔	
					Isuzu	SFR, TD	Truck	72 on	Front	↔	31
					DAF	AT1900	Truck	19...	Rear	↔	
					Ford	D1210, D1211	Truck	78-82	Rear	↔	
					Ford	D1311, D1414	Truck	72-82	Rear	↔	
					Ford	DA 2114	Truck	74-82	Rear	↔	
					Ford	DO 607, DO 807	Truck	73-82	Rear	↔	
					Ford	DO 910, D1010	Truck	71-82	Rear	↔	
					Ford	DT 2014	Truck	72-82	Rear	↔	

Part #	Range	Superceding Part #/Status	Product Type		Make	Model	Derivative	Year	Position	L/R	Fitment Guide #
			oo	8, 2							
76008	Fleet Ryder		oo	8, 2	International	E - LINE	Truck	19...	Front	↔	
					Volvo	F12, FL12, FH12	Truck	19...	Front	↔	
76009	Fleet Ryder		T	5	Bedford	Vam	Bus	76 on	Front	↔	
					Ford	D1210, D1211	Truck	78-82	Front	↔	
					Ford	D1311, D1414	Truck	72-82	Front	↔	
					Ford	DA 2114	Truck	74-82	Front	↔	
					Ford	DO 607, DO 807	Truck	73-82	Front	↔	
					Ford	DO 910, D1010	Truck	71-82	Front	↔	
					Ford	DT 2014	Truck	72-82	Front	↔	
					International	4700, 4900(4X2), 4900 (6x4)	Truck	93 on	Front	↔	
					Leyland	AEC MK IV	Bus	19...	Front	↔	
					Leyland	Clydesdale CD23	Bus	19...	Front	↔	
					Leyland	Eland EL 4114, 14.12	Truck	73-85	Front	↔	
					Leyland	Mammoth Major, Mandator	Truck	19...	Front	↔	
					Leyland	Monarch, 2TG4RE	Truck	19...	Front	↔	
					Leyland	Worldmaster	Bus	19...	Front	↔	
					Mercedes	0, 317	Bus	19...	Front	↔	
					Mercedes	0.302, 0.305 (Air Susp.)	Bus	19...	Front	↔	
					Leyland	Tiger	Bus	19...	Rear	↔	
Mercedes	0.302, 0.305 (Air Susp.)	Bus	19...	Rear	↔						
76014	Fleet Ryder		oo	8, 5	Mack	786FS	Truck	19...	Front	↔	
					Unimog	Buffel	414, 416 Truck	19...	Front	↔	
					Unimog	Buffel	414, 416 Truck	19...	Rear	↔	
76015	Fleet Ryder		oo	8, 2	Bedford	4X4	Truck	70-80	Front	↔	
					Bedford	ELR4, ELR 6, ELR A, ELR 8	Truck	75-79	Front	↔	
					Bedford	KE, KG, KH All	Truck	64 on	Front	↔	
					Bedford	MFR	Truck	67-71	Front	↔	
					Bedford	VAL	Bus	66 on	Front	↔	
					International	Fleetstar	Truck	19...	Front	↔	
					International	Loadstar 1850	Truck	71-78	Front	↔	
					Peterbilt	320	Truck	95 on	Front	↔	
					Peterbilt	377A/E	Truck	95 on	Front	↔	
					Bedford	4X4	Truck	70-80	Rear	↔	
					Bedford	KE, KG, KH All	Truck	64 on	Rear	↔	
					Bedford	MFR	Truck	67-71	Rear	↔	
					Isuzu	N2800 P	Truck	93 on	Rear	↔	29
					Isuzu	N3000 P	Truck	87-90	Rear	↔	29
					Isuzu	NKR55/99	Truck	19...	Rear	↔	29
Isuzu	TL40-50	Truck	75 on	Rear	↔	29					
Isuzu	TLD44, TLD54	Truck	77-89	Rear	↔	29					

Part #	Range	Superceding Part #/Status	Product Type	Make	Model	Derivative	Year	Position	L/R	Fitment Guide #
76016	Fleet Ryder		6, 1	Isuzu	CVR, EXR, FT	Truck	89 on	Front	↔	
				Isuzu	F8000 (TN), F9000 (TT)	Truck	88 on	Front	↔	
				Isuzu	FSR700	Truck	96 on	Front	↔	
				Isuzu	SPZ, SHZ, SPR, SHR	Truck	80 on	Front	↔	
				Leyland	Marathon	Truck	76-83	Front	↔	
				Nissan	CM 12/CM14	Truck	87 on	Front	↔	
				Nissan	CM 16 N	Truck	90 on	Front	↔	
				Scania	80, 110	Truck	19...	Front	↔	
				Scania	LB 81 HS-31/50 4X2	Truck	75-82	Front	↔	
				Scania	LBT 111-HS31 6X4	Truck	75-82	Front	↔	
				Scania	LBT 141 HS-31/46 6X4	Truck	78-82	Front	↔	
				Toyota	DA 110, 116	Truck	73 on	Front	↔	
76017	Fleet Ryder		8, 2	Western Star	3842S	Truck	19...	Front	↔	26
				Western Star	4842S, 4864S	Truck	19...	Front	↔	26
				Western Star	5964F, 5964F	Truck	19...	Front	↔	26
				Fiat	130NR	Truck	77-83	Front	↔	
				Fiat	682 SWB	Truck	19...	Front	↔	
				Fiat	684N, 684T	Truck	71-81	Front	↔	
				Oshkosh	E - 1344 T 290	Truck	78-83	Front	↔	
				Oshkosh	E - 1446 T 350	Truck	80-83	Front	↔	
76019	Fleet Ryder		8, 5	Man	16, 281	Bus	19...	Front	↔	
				Mercedes	1113B, L, LK	Truck	68-94	Front	↔	
				Mercedes	1113B, LS	Truck	68-94	Front	↔	
				Mercedes	1313, L, LK	Truck	72-76	Front	↔	
				Mercedes	1313LS	Truck	19...	Front	↔	
				Mercedes	1317L, LK	Truck	19...	Front	↔	
				Mercedes	1513, 1517LS	Truck	19...	Front	↔	
				Mercedes	1513L, LK	Truck	70-75	Front	↔	
				Mercedes	1517, 1519, L, LK	Truck	75-80	Front	↔	
				Mercedes	1621, L, LK, LS	Truck	77-79	Front	↔	
				Mercedes	1624, L, LK, LAK, LS, LAS	Truck	19...	Front	↔	
				Mercedes	1921, L, LK, LS	Truck	70-77	Front	↔	
				Mercedes	1924, L, LK, LA, LAK, LS, LAS	Truck	19...	Front	↔	
				Mercedes	911B, L, LK	Truck	19...	Front	↔	
				Mercedes	911B, LS	Truck	19...	Front	↔	
				Bussing	14, 15 AK	Truck	19...	Rear	↔	
Mercedes	Powerliner 1729S/32	Truck	94 on	Rear	↔					
Mercedes	Powerliner 1735S/35	Truck	92 on	Rear	↔					

Part #	Range	Superceding Part #/Status	Product Type	Make	Model	Derivative	Year	Position	L/R	Fitment Guide #
76020	Fleet Ryder		† 5	Leyland	Crusader	Truck	19...	Front	↔	
				Leyland	Guy Victory J, MK2	Bus	19...	Front	↔	
				Leyland	Tiger	Bus	19...	Front	↔	
				DAF	FTT 2800 DKTD	Truck	75-82	Rear	↔	
				Leyland	Leopard	Truck	19...	Rear	↔	
				Man	16, 201	Truck	19...	Rear	↔	
				Man	16.220	Bus	19...	Rear	↔	
				Mercedes	0, 317	Bus	19...	Rear	↔	
				Mercedes	OH 1725L/59	Bus	19...	Rear	↔	
				Mercedes	OH 1835L/30	Bus	19...	Rear	↔	
				Scania	Bus	Bus	19...	Rear	↔	
76021	Fleet Ryder		oo 8, 5	Man	16, 201	Truck	19...	Front	↔	
				Man	16.220	Bus	19...	Front	↔	
				Man	30.280 DHT	Truck	78-84	Front	↔	
				Mercedes	1418, L, LK	Truck	68-79	Front	↔	
				Mercedes	1618, L, LK	Truck	19...	Front	↔	
				Mercedes	1620, L, LK	Truck	19...	Front	↔	
				Mercedes	1623, L, LK, LAK	Truck	19...	Front	↔	
				Mercedes	1918, 1920, L, LK	Truck	19...	Front	↔	
				Mercedes	1923L, LK	Truck	19...	Front	↔	
				Mercedes	2220, L, LA, LS, LAS	Truck	19...	Front	↔	
				Mercedes	2620, L, LA, LS, LAS	Truck	19...	Front	↔	
				Mercedes	2623, L, LS, LK, LA, LAS, LAK	Truck	19...	Front	↔	
				Mercedes	2629, LA, LAK, LAS	Truck	19...	Front	↔	
				Mercedes	1113, L, LK, LF, LP, LPK	Truck	68-94	Rear	↔	30
76022	Fleet Ryder		oo 8, 5	Mercedes	1313, L, LK	Truck	72-76	Rear	↔	
				Mercedes	1317L, LK	Truck	19...	Rear	↔	
				Mercedes	1317LP, LPK	Truck	19...	Rear	↔	
				Mercedes	1319LP, LPK	Truck	19...	Rear	↔	
				Mercedes	1413L, LK, LS	Truck	76-82	Rear	↔	
				Mercedes	1513, 1517LP, LPK	Truck	19...	Rear	↔	
				Mercedes	1513L, LK	Truck	70-75	Rear	↔	
				Mercedes	1517, 1519, L, LK	Truck	75-80	Rear	↔	
				Mercedes	1517, 1519, LAS	Truck	19...	Rear	↔	
				Mercedes	1617, LP, LPK	Truck	19...	Rear	↔	
				Mercedes	1619, LP	Truck	19...	Rear	↔	
				Mercedes	352 F	Bus	19...	Rear	↔	
				Mercedes	OF 1113, 1313, 1317/51, 1413, 1417/52, 1617	Bus	19...	Rear	↔	

Part #	Range	Superceding Part #/Status	Product Type	Make	Model	Derivative	Year	Position	L/R	Fitment Guide #
76033	Fleet Ryder		00 8, 5	Bussing	16L, LBL, LU, UK	Truck	19...	Front	↔	
				Man	30.330 DFT/DFTS/DFL	Truck	84-89	Front	↔	
				Mercedes	1735	Truck	19...	Front	↔	
				Mercedes	1113B, LA, LAK	Truck	73-83	Front	↔	
				Mercedes	1113B, LAS	Truck	73-83	Front	↔	
				Mercedes	1213, 1213K, 1217, 1217K	Truck	79-94	Front	↔	
				Mercedes	1313, LAK, LAS, LA	Truck	19...	Front	↔	
				Mercedes	1413L, 1413K, 1417, 1417K	Truck	82-93	Front	↔	
				Mercedes	1419, 1419K, 1419S	Truck	77-88	Front	↔	
				Mercedes	1513LA, LAK	Truck	19...	Front	↔	
				Mercedes	1517, 1519, LA, LAK	Truck	76-94	Front	↔	
				Mercedes	1517, 1519, LAS	Truck	19...	Front	↔	
				Mercedes	1617, LP, LPK	Truck	19...	Front	↔	
				Mercedes	1619, LP	Truck	19...	Front	↔	
				Mercedes	1813L	Truck	19...	Front	↔	
				Mercedes	1817, 1819, L	Truck	19...	Front	↔	
				Mercedes	1926S, 1928, 1928S, 1933S	Truck	81-92	Front	↔	
				Mercedes	2017, 2019, L, LB	Truck	19...	Front	↔	
				Mercedes	2233S	Truck	82-86	Front	↔	
				Mercedes	2624, A, AK, K, S	Truck	81-88	Front	↔	
				Mercedes	2624, L, LS, LK, LAK, LAS, LB, LAB	Truck	70-81	Front	↔	
				Mercedes	2628K, A, S	Truck	81-93	Front	↔	
				Mercedes	2632, L, K, AK, S, AS	Truck	75-83	Front	↔	
				Mercedes	2633S, 2636S, 2638S	Truck	83-93	Front	↔	
				Mercedes	2644S/32	Truck	94 on	Front	↔	
				Mercedes	3328S, 3333S	Truck	87-92	Front	↔	
				Mercedes	911B, LA, LAK	Truck	19...	Front	↔	
				Mercedes	911B, LAS	Truck	19...	Front	↔	
				Mercedes	Actros 1831LS/36, 1835/36	Truck	19...	Front	↔	
				Mercedes	Actros 2031 S/36	Truck	99 on	Front	↔	
				Mercedes	Actros 2643 LS/33, 2649LS/32	Truck	99 on	Front	↔	
				Mercedes	Actros 3335S/33	Truck	99 on	Front	↔	
				Mercedes	Actros 3343 S/33	Truck	99 on	Front	↔	
				Mercedes	Atego 1017/48, 48AK, /36	Truck	19...	Front	↔	
				Mercedes	Econoliner 1014/48, 1214/48	Truck	95 on	Front	↔	
				Mercedes	Econoliner 1414K/36, 1414/48	Truck	92 on	Front	↔	
				Mercedes	Econoliner 1617/48 & 52	Truck	94 on	Front	↔	
				Mercedes	Econoliner 1617A/36, 1617K/36	Truck	92 on	Front	↔	
				Mercedes	Econoliner 1623S/36	Truck	96 on	Front	↔	

Part #	Range	Superceding Part #/Status	Product Type	Make	Model	Derivative	Year	Position	L/R	Fitment Guide #	
76033	Fleet Ryder		oo	8, 5	Mercedes	L1013, 1013K, 1014	Truck	81-87	Front	↔	
					Mercedes	LA1213B	Truck	79-89	Front	↔	
					Mercedes	OH 1725L/59	Bus	19...	Front	↔	
					Mercedes	OH 1835L/30	Bus	19...	Front	↔	
					Mercedes	Powerliner 1729S/32	Truck	94 on	Front	↔	
					Mercedes	Powerliner 1735S/35	Truck	92 on	Front	↔	
					Mercedes	Powerliner 2426B/32 & 52	Truck	92 on	Front	↔	
					Mercedes	Powerliner 2535S/32	Truck	94 on	Front	↔	
					Mercedes	Powerliner 2545S/32	Truck	96 on	Front	↔	
					Mercedes	Powerliner 2629K/32, 2629S/32, 2629/45	Truck	92 on	Front	↔	
					Mercedes	Powerliner 2635S/32, 2635/45	Truck	92 on	Front	↔	
					Mercedes	Powerliner 2638S/32	Truck	95 on	Front	↔	
					Mercedes	Powerliner 3836K/38	Truck	19...	Front	↔	
					Mercedes	1735	Truck	19...	Rear	↔	
76034	Fleet Ryder		T	5	Ford	Cargo 0608, 0808	Truck	82-86	Front	↔	
					Ford	Cargo 0912, 1112, 1113	Truck	82-86	Front	↔	
					Ford	Cargo 1212, 1213	Truck	82-85	Front	↔	
					Ford	Cargo 1312, 1313	Truck	82-86	Front	↔	
					Ford	Cargo 1317, 1517	Truck	82-86	Front	↔	
					Ford	Cargo 2217	Truck	82-86	Front	↔	
					Bussing	22L, BLL (Tag axle)	Truck	19...	Rear	↔	
					DAF	FA2200, F2200	Truck	72-80	Rear	↔	
					Scania	P112H (6X2)	Truck	82-89	Rear	↔	
					Scania	P142H (6X2)	Truck	82-89	Rear	↔	
					Scania	R112HL 6X4(S)	Truck	82-89	Rear	↔	
					Scania	R142H (6X4)	Truck	82-89	Rear	↔	
76035	Fleet Ryder		o	6, 1	DAF	FA2200, F2200	Truck	72-80	Front	↔	
					DAF	FTT 2800 DKTD	Truck	75-82	Front	↔	
					ERF	ERF	Truck	19...	Front	↔	
					Scania	112, 142	Truck	19...	Front	↔	
					Scania	K94	Bus	19...	Front	↔	
					Scania	P112H (6X2)	Truck	82-89	Front	↔	
					Scania	P114GA 6x4 NZ 380	Truck	19...	Front	↔	
					Scania	P124 CB 6x4 NZ 470	Truck	19...	Front	↔	
					Scania	P124GA 400	Truck	19...	Front	↔	
					Scania	P124GA 6x4 NZ 420, 470	Truck	19...	Front	↔	
					Scania	P124LA 6x2 NA 420	Truck	19...	Front	↔	
					Scania	P142H (6X2)	Truck	82-89	Front	↔	
					Scania	P82ML 4X2(S) 4X2	Truck	82-89	Front	↔	
					Scania	P94LA 4X2 NA 310	Truck	19...	Front	↔	
					Scania	R112HL 6X4(S)	Truck	82-89	Front	↔	
					Scania	R142H (6X4)	Truck	82-89	Front	↔	
Nissan	CB 20	Bus	19...	Rear	↔						

Part #	Range	Superceding Part #/Status	Product Type		Make	Model	Derivative	Year	Position	L/R	Fitment Guide #
76036	Fleet Ryder		0/0	8, 5	Mercedes	352 F	Bus	19...	Front	↔	
					Mercedes	OF 1113, 1313, 1317/51, 1413, 1417/52, 1617	Bus	19...	Front	↔	
76039	Fleet Ryder		0/0	8, 5	Mercedes	1113, L, LK, LF, LP, LPK	Truck	68-94	Front	↔	30
					Mercedes	1418, LP, LPS	Truck	19...	Front	↔	
76040	Fleet Ryder		0/0	8, 5	Mack	R600RST, F700RST Series	Truck	73-85	Front	↔	
76041	Fleet Ryder		1/1	5	Leyland	Guy Victory J, MK1	Bus	19...	Front	↔	
					Leyland	Kudu 352 RA, A691	Bus	19...	Front	↔	
					Leyland	Leopard	Truck	19...	Front	↔	
					Leyland	Super Comet	Truck	19...	Front	↔	
					Leyland	Super Eland 22.12, 24.12	Truck	75-85	Front	↔	
					Nissan	CM 90	Truck (Condor)	19...	Front	↔	
76042	Fleet Ryder		0/0	8, 2	Bedford	KM All	Truck	72 on	Front	↔	
					Ford	Cargo 0608, 0808	Truck	82-86	Rear	↔	
					Ford	Cargo 0912, 1112, 1113	Truck	82-86	Rear	↔	
					Ford	Cargo 1212, 1213	Truck	82-85	Rear	↔	
					Ford	Cargo 1312, 1313	Truck	82-86	Rear	↔	
					Ford	Cargo 1317, 1517	Truck	82-86	Rear	↔	
					Ford	Cargo 2217	Truck	82-86	Rear	↔	
					Hino	55/330, 55/350	Truck	85-94	Front	↔	
					Hino	C40	Truck	93 on	Front	↔	
					Hino	FF13-133, FF14-173	Truck	83-94	Front	↔	
					Hino	GD, Super Dolphin	Truck	19...	Front	↔	
					Hino	KB 302, 342, 14-177	Truck	72-84	Front	↔	
					International	Acco 1600, 1830C	Truck	84-85	Front	↔	
					International	Acco 1840D MK11	Truck	79-83	Front	↔	
					International	Paystar F5070/350	Truck	73-84	Front	↔	
					International	Transtar COF-4070	Truck	75-79	Front	↔	
					International	Unistar R91	Truck	19...	Front	↔	
					International	Unistar R91	Truck	19...	Rear	↔	
					Isuzu	BD	Bus	74 on	Front	↔	
					Isuzu	SLR, VPR	Truck	72 on	Front	↔	
					Isuzu	SPZ	Truck	73-80	Front	↔	
					Leyland	AEC MK IV (With Air Cushions)	Bus	19...	Front	↔	
					Leyland	AEC MK IV (Without Air Cushions)	Bus	19...	Front	↔	
					Leyland	Chieftain CH 4013, 14.10	Truck	79-86	Front	↔	
					Leyland	Mastiff	Truck	19...	Front	↔	
					Leyland	AEC MK IV (With Air Cushions)	Bus	19...	Rear	↔	
					Leyland	Eland EL 4114, 14.12	Truck	73-85	Rear	↔	
					Leyland	Guy Victory J, MK1	Bus	19...	Rear	↔	

Part #	Range	Superceding Part #/Status	Product Type	Make	Model	Derivative	Year	Position	L/R	Fitment Guide #
76042	Fleet Ryder		8, 2	Silver Eagle	SAR Coach	Bus	19...	Rear	↔	
				Oshkosh	R Series	Truck	19...	Front	↔	
				Volvo	B7F	Bus	19...	Front	↔	
				Volvo	F88, G88	Truck	19...	Front	↔	
				Volvo	B7F	Bus	19...	Rear	↔	
				Western Star	3842S	Truck	19...	Front	↔	26
				Western Star	4842S, 4864S	Truck	19...	Front	↔	26
				Western Star	5964F, 5964F	Truck	19...	Front	↔	26
76043	Fleet Ryder		6, 1	Isuzu	FTR800	Truck	96 on	Front	↔	
				Isuzu	FVZ1400	Truck	94 on	Front	↔	
				Leyland	Swift	Bus	19...	Front	↔	
				Toyota	DA/ KA	Truck	00 on	Front	↔	
				Isuzu	SBR 422, FJR	Truck	76-83	Rear	↔	
76102	Fleet Ryder		6, 1	Hino	FE	Truck	83 on	Front	↔	
				Hino	KR 320, 360	Truck	74-84	Front	↔	
				Isuzu	CVR, 49N	Truck	79-89	Front	↔	
				Isuzu	F5000 (FN), F6599 (FN)	Truck	88 on	Front	↔	
				Nissan	UG 80	Bus	19...	Front	↔	
				Nissan	UG780, UD780	Truck	69 on	Front	↔	
76103	Fleet Ryder		6, 1	Bedford	YRT	Bus	19...	Front	↔	
				ERF	Trailblazer	Truck	19...	Front	↔	32
				Isuzu	FVR2200 Turbo	Truck	93 on	Front	↔	
				Isuzu	FVR900 Turbo	Truck	93 on	Front	↔	
				Man	M2000 15.223L, 16.223L, K, LA	Truck	19...	Front	↔	
				Nissan	CB 20	Bus	19...	Front	↔	
				Nissan	CK10 K/A	Truck	74-86	Front	↔	
				Nissan	CK20 D/L/N	Truck	73-83	Front	↔	
				Nissan	CK25D/N	Truck	83-84	Front	↔	
				Nissan	CK41 CT	Truck	80-85	Front	↔	
				Nissan	CM 15 E	Truck	87-92	Front	↔	
				Nissan	CW 350 HTA, HTF	Truck	93 on	Front	↔	
				Nissan	CW290 HDN, PHN	Truck	93 on	Front	↔	
				Nissan	CW290 PPA, HTA, HTF, CK290 CTA	Truck	93-95	Front	↔	
				Nissan	CW41 H/P	Truck	77-85	Front	↔	
				Nissan	CW45 HD/PA	Truck	82-89	Front	↔	
				Nissan	CW46 HDN, HTF, HMF, HTA, PAN	Truck	89-93	Front	↔	
				Nissan	CW46 PAF, PAA	Truck	89-92	Front	↔	
				Nissan	CW47 HDN, HTA, HTF, PAF, PAN	Truck	93-95	Front	↔	
				Nissan	CW55 HTF, CW56 HTF	Truck	89-95	Front	↔	
ERF	Trailblazer	Truck	19...	Rear	↔	32				
Leyland	Marathon	Truck	76-83	Rear	↔					

Part #	Range	Superceding Part #/Status	Product Type	Make	Model	Derivative	Year	Position	L/R	Fitment Guide #	
76104	Fleet Ryder		00	8, 5	Mercedes	1113B, LAS	Truck	73-83	Rear	↔	
					Mercedes	1113B, LS	Truck	68-94	Rear	↔	
					Mercedes	1313, LAK, LAS, LA	Truck	19...	Rear	↔	
					Mercedes	1313LS	Truck	19...	Rear	↔	
					Mercedes	1513, 1517LS	Truck	19...	Rear	↔	
					Mercedes	1513LA, LAK	Truck	19...	Rear	↔	
					Mercedes	1517, 1519, LA, LAK	Truck	76-94	Rear	↔	
					Mercedes	911B, LAS	Truck	19...	Rear	↔	
					Mercedes	911B, LS	Truck	19...	Rear	↔	
					Mercedes	LA1213B	Truck	79-89	Rear	↔	
					Mercedes	OF 1621, 1624	Bus	86 on	Rear	↔	
76106	Fleet Ryder		00	8, 5	Mercedes	1213AK	Truck	79-94	Front	↔	
					Mercedes	2219, 2219K, 2224	Truck	82-93	Front	↔	
					Mercedes	2224B, 2225B	Truck	86-93	Front	↔	
76108	Fleet Ryder		01	6, 1	Isuzu	JCR 500	Truck	19...	Front	↔	
					Isuzu	N 3500 D, N4000 D	Truck	86 on	Front	↔	
					Isuzu	NPR 300, 400	Truck	86 on	Front	↔	
76109	Fleet Ryder		00	8, 5	Mercedes	OF 1621, 1624	Bus	86 on	Front	↔	
76110	Fleet Ryder		00	8, 2	Isuzu	N 3500 D, N4000 D	Truck	86 on	Rear	↔	
					Isuzu	NPR 300, 400	Truck	86 on	Rear	↔	
76131	Fleet Ryder		01	6, 2	Man	27, 463	Truck	19...	Front	↔	
					Man	19.292 FT/FTS	Truck	90-94	Front	↔	
					Man	19.300FT, 19.320, 19.321 FT/FTS	Truck	85-90	Front	↔	
					Man	19.362 FTS	Truck	89-93	Front	↔	
					Man	26.292 DFT/DFTS/DFL/DFK	Truck	89 on	Front	↔	
					Man	26.362 DFTS/DFLS	Truck	90 on	Front	↔	
					Man	26.372 DFT/DFTS	Truck	90-95	Front	↔	
					Man	26.402 DFTS, 422	Truck	93 on	Front	↔	
					Man	26.442, 26.552 DFTS	Truck	90 on	Front	↔	
					Man	29.292 DFT/DFTS/DFL/DFK	Truck	89-92	Front	↔	
					Man	30.365 DFT/DFTS/DFL	Truck	86-89	Front	↔	
					Man	30.380 DFT/DFTS/DFL	Truck	84-89	Front	↔	
					Man	30.440 DFTS/DFL	Truck	87-90	Front	↔	
					Man	F2000 27.463TS, 27.464 TS	Truck	19...	Front	↔	
					Man	F2000 33.373KN, TN	Truck	19...	Front	↔	
					Man	F2000 33.374K, L, T	Truck	19...	Front	↔	
					Man	F2000 33.423TS	Truck	19...	Front	↔	
Man	F2000 40.464 TS	Truck	19...	Front	↔						
76132	Fleet Ryder		01	6, 1	Hino	FD 10-135	Truck	83-94	Front	↔	
					Hino	KL 340, KL360	Truck	72-83	Front	↔	
					Isuzu	NKR	Truck	96 on	Front	↔	
					Isuzu	SBR 422, FJR	Truck	76-83	Front	↔	

Part #	Range	Superceding Part #/Status	Product Type	Make	Model	Derivative	Year	Position	L/R	Fitment Guide #
76151	Fleet Ryder		⊥ 6, 2	International	9800 Eagle	Truck (Set back axle)	19...	Front	↔	
76156	Fleet Ryder		⊥ 6, 2	Iveco	Eurotech	MPL440E42T, 440E 34, 38, 42, 52	92 on	Front	↔	
76157	Fleet Ryder		⊙ 8, 5	Iveco	Eurotech	MPL440E42T, 440E 34, 38, 42, 52	92 on	Rear	↔	
76185	Fleet Ryder		⊙ 8, 5	Tata	LPT 1518TC	Truck	05 on	Front	↔	
76186	Fleet Ryder		⊙ 8, 5	Tata	LPT 1518TC	Truck	05 on	Rear	↔	
76204	Fleet Ryder		⊥ 6, 1	Isuzu	FTR800 4X2 FC	Truck	97 on	Front	↔	
76205	Fleet Ryder		⊥ 6, 1	Nissan	UD 80 4X2 F-C	Truck	97 on	Front	↔	
76206	Fleet Ryder		⊥ 5	Nissan	UD 80 4X2 F-C	Truck	97 on	Rear	↔	
76207	Fleet Ryder		⊙ 8, 2	Hino	500	1626 Series	97 on	Front	↔	
76208	Fleet Ryder		⊙ 8, 5	Iveco	Daily	Panel Van 107Kw_D (50C15, 65C15, 70C15)	04 on	Front	↔	
				Iveco	Daily	Panel Van 92Kw_D (35S13, 50C13)	01-08	Front	↔	
76209	Fleet Ryder		⊙ 8, 5	Iveco	Daily	Panel Van 107Kw_D (50C15, 65C15, 70C15)	04 on	Rear	↔	
				Iveco	Daily	Panel Van 92Kw_D (35S13, 50C13)	01-08	Rear	↔	
77000	Fleet Ryder		⊥ 5	Neoplan	Cityliner	Bus	19...	Front	↔	
				Neoplan	Cityliner	Bus	19...	Rear	↔	
77001	Fleet Ryder		⊥ 6, 2	Mercedes	1213, 1213K, 1217, 1217K	Truck	79-94	Rear	↔	
				Mercedes	1213AK	Truck	79-94	Rear	↔	
				Mercedes	1413L, 1413K, 1417, 1417K	Truck	82-93	Rear	↔	
				Mercedes	1419, 1419K, 1419S	Truck	77-88	Rear	↔	
				Mercedes	Econoliner 1617/48 & 52	Truck	94 on	Rear	↔	
				Mercedes	Econoliner 1617A/36, 1617K/36	Truck	92 on	Rear	↔	
77002	Fleet Ryder		⊙ 8, 2	Silver Eagle	SAR Coach	Bus	19...	Front	↔	
77003	Fleet Ryder		⊙ 8, 5	Man	16.240 FT/FTS/HT/HL/ HAL/HAK	Truck	76-89	Front	↔	
				Man	19.280 FT/FTS	Truck	78-90	Front	↔	
				Man	22/24.192 DHK, DHL	Truck	76-87	Front	↔	
				Man	M2000 14.153 L	Truck	19...	Front	↔	
77004	Fleet Ryder		⊥ 5	DAF	FT 2200 DU	Truck	72-80	Front	↔	
77005	Fleet Ryder		⊙ 8, 5	Magnis	Msiza	Truck	19...	Front	↔	
77006	Fleet Ryder		⊥ 5	Renault	CBH 385	Truck	96 on	Front	↔	
77007	Fleet Ryder		⊙ 8, 5	Mercedes	1113B, LA, LAK	Truck	73-83	Front	↔	
				Mercedes	1113B, LAS	Truck	73-83	Front	↔	
				Mercedes	1313, LAK, LAS, LA	Truck	19...	Front	↔	
				Mercedes	1413L, 1413K, 1417, 1417K	Truck	82-93	Front	↔	
				Mercedes	1419, 1419K, 1419S	Truck	77-88	Front	↔	

Part #	Range	Superceding Part #/Status	Product Type	Make	Model	Derivative	Year	Position	L/R	Fitment Guide #
77007	Fleet Ryder		8, 5	Mercedes	1513LA, LAK	Truck	19...	Front	↔	
				Mercedes	1517, 1519, LA, LAK	Truck	76-94	Front	↔	
				Mercedes	1517, 1519, LAS	Truck	19...	Front	↔	
				Mercedes	1813L	Truck	19...	Front	↔	
				Mercedes	1817, 1819, L	Truck	19...	Front	↔	
				Mercedes	1926S, 1928, 1928S, 1933S	Truck	81-92	Front	↔	
				Mercedes	2017, 2019, L, LB	Truck	19...	Front	↔	
				Mercedes	2624, A, AK, K, S	Truck	81-88	Front	↔	
				Mercedes	2628K, A, S	Truck	81-93	Front	↔	
				Mercedes	2632, L, K, AK, S, AS	Truck	75-83	Front	↔	
				Mercedes	2633S, 2636S, 2638S	Truck	83-93	Front	↔	
				Mercedes	3328S, 3333S	Truck	87-92	Front	↔	
				Mercedes	911B, LA, LAK	Truck	19...	Front	↔	
				Mercedes	911B, LAS	Truck	19...	Front	↔	
Mercedes	LA1213B	Truck	79-89	Front	↔					
77008	Fleet Ryder		8, 5	Caspir	Caspir	Truck	19...	Rear	↔	
77018	Fleet Ryder		8, 5	Peterbilt	362 E 436, 460, 550	Truck	95 on	Front	↔	
				International	9800 Eagle	Truck (Set back axle)	19...	Rear	↔	27
				International	9800 Eagle	Truck (Set forward axle)	19...	Rear	↔	27
77022	Fleet Ryder		8, 5	Fiat	619T1	Truck	69-80	Front	↔	
				Freightliner	FL50, FL60, FL70, FL80	Truck	19...	Front	↔	
77024	Fleet Ryder		5	Train Shock	-	-	-	-		
81270	Heavy Duty	G56119	5	Nissan	Patrol	4X4 (G160)	80-89	Front	↔	
				Nissan	Patrol	4X4 (WG60)	72-80	Front	↔	
				Nissan	Patrol	4X4 (WG60)	72-80	Rear	↔	
83367	Heavy Duty		9, 2	Volkswagen	Caravelle	Caravelle T4	99-04	Rear	↔	
				Volkswagen	Kombi	Transporter T4: Mini bus, Pickup & Panel van Excl. syncro	99-04	Rear	↔	
83373	Heavy Duty		6, 2	Volkswagen	Caravelle	Caravelle T4	99-04	Front	↔	
				Volkswagen	Kombi	Transporter T4: Mini bus, Pickup & Panel van Excl. syncro	99-04	Front	↔	
83450	Heavy Duty		8, 5	Mercedes	Sprinter	412D (903)	95 on	Rear	↔	
				Mercedes	Sprinter 412D	Truck	96 on	Rear	↔	
83454	Heavy Duty		6, 1	Toyota	Prado	90 SWB & 95 LWB	96-02	Rear	↔	
83455	Heavy Duty		6, 2	Toyota	Land Cruiser	HDJ100, UZJ100 (Excl. Air Susp.)	98-02	Front	↔	
83456	Heavy Duty		6, 2	Toyota	Land Cruiser	HDJ100, UZJ100 (Excl. Air Susp.)	98-02	Rear	↔	
				Toyota	Land Cruiser	HDJ100/105, UZJ100/105 (Excl. Air Susp.)	98-02	Rear	↔	
85319	Heavy Duty		8, 5	Freightliner	FL112 Series	Truck	19...	Rear	↔	28
85320	Heavy Duty		8, 2	Freightliner	FL112 Series	Truck	19...	Front	↔	

Part #	Range	Superceding Part #/Status	Product Type		Make	Model	Derivative	Year	Position	L/R	Fitment Guide #
85724	Heavy Duty		⊘	8, 5	Freightliner	Argosy 90 (Air Susp.)	Truck	19...	Rear	↔	28
					Freightliner	FL112 Series	Truck	19...	Rear	↔	
85918	Heavy Duty		⊘	8, 5	Freightliner	Argosy 90 (Air Susp.)	Truck	19...	Front	↔	
143057	Gabriel					Strut Cushion					
144273	Gabriel					Gas Filling Machine	Gaslifts				
144283	Gabriel					Hoses, Fittings & Trigger Valve	Gaslifts				
EG35046	Gas Ryder		⚡	1, 1	BMW	Z3	E36/4	98-03	Front	L	
EG35047	Gas Ryder		⚡	1, 1	BMW	Z3	E36/4	98-03	Front	R	
EG35115	Gas Ryder		⚡	1, 1	Opel	Omega	Sedan, Estate (B)	01-04	Front	↔	
EG63659	Gas Ryder		⊘	8, 4	Isuzu	Trooper	Mk II	92-96	Rear	↔	
G35112	Gas Ryder		⚡	1, 1	Ford	Mondeo	Mk II	96-01	Rear	↔	
G35128	Gas Ryder		⚡	1, 1	Volvo	850	Excl. Ⓢ, Ⓣ	94-97	Front	↔	
					Volvo	850	Excl. Ⓢ, Ⓣ	94-97	Front	↔	
G35146	Gas Ryder		⚡	1, 1	Ford	Escort	Mk V, VI, VII	95-99	Front	↔	
					Ford	Escort	Mk V, VI, VII	95-99	Front	↔	
G35189	Gas Ryder		⚡	1, 1	Ford	Mondeo	Mk II	96-01	Front	↔	
					Ford	Mondeo	Mk II (Excl. self levelling)	96-01	Front	↔	
G35190	Gas Ryder		⚡	1, 1	Volkswagen	Sharan	Mk I, Mk IA, Mk IB	95-10	Front	↔	
G35214	Gas Ryder		⚡	1, 1	Fiat	Palio	Type 1X	00-02	Front	↔	
					Fiat	Palio	Weekend (Type PY)	00-02	Front	↔	
					Fiat	Siena	Type 2A	00-02	Front	↔	
G35220	Gas Ryder		⚡	1, 1	Volvo	S40	Excl. Ⓢ, Ⓣ & T4 rear (Mk I)	95-04	Front	L	
G35225	Gas Ryder		⚡	1, 1	Volvo	S40	Excl. Ⓢ, Ⓣ & T4 rear (Mk I)	95-04	Front	R	
G35227	Gas Ryder		⚡	1, 1	BMW	5 Series	E39 Series (535i, 540i) (Excl. ⚡)	96-04	Front	↔	
G35228	Gas Ryder		⚡	1, 1	BMW	5 Series	E39 Series (520i, 523i, 525i, 525TDS, 528i, 530i, 530D) (Excl. ⚡)	96-04	Front	↔	
G35279	Gas Ryder		⚡	1, 1	Fiat	Seicento	600	99-03	Front	↔	
G35289	Gas Ryder		⚡	1, 1	Opel	Zafira	A	01-06	Front	L	
G35290	Gas Ryder		⚡	1, 1	Opel	Zafira	A	01-06	Front	R	
G35292	Gas Ryder		⚡	1, 1	Volvo	C70	Excl. T5 (Mk I)	97-05	Front	↔	
					Volvo	S70, V70	Excl. Ⓢ, Ⓣ	97-00	Front	↔	
G35295	Gas Ryder		⚡	1, 1	Daewoo	Matiz	Spark	99-03	Front	L	
G35296	Gas Ryder		⚡	1, 1	Ford	Focus	Mk I Hatch & Sedan	98-04	Front	L	
G35300	Gas Ryder		⚡	1, 1	Daewoo	Matiz	Spark	03-05	Front	R	
G35301	Gas Ryder		⚡	1, 1	Ford	Focus	Mk I Hatch & Sedan	98-04	Front	R	
G35305	Gas Ryder	70511	⚡	1	Renault	Megane	Mk I (Excl. Coupe)	96-03	Front	↔	
					Renault	Scenic	Mk I (Excl. 4X4)	98-04	Front	↔	
G35326	Gas Ryder		⚡	1, 1	Ford	KA	1.3 (Mk I)	05-08	Front	↔	

Part #	Range	Superceding Part #/Status	Product Type	Make	Model	Derivative	Year	Position	L/R	Fitment Guide #
G35337	Gas Ryder		1, 1	Peugeot	206	1.4HDi, 2.0HDi	04-07	Front	R	
				Peugeot	206	1.6 Estate	03-07	Front	R	
				Peugeot	206	2.0 GTi	00-06	Front	R	
G35338	Gas Ryder		1, 1	Peugeot	206	1.4HDi, 2.0HDi	04-07	Front	L	
				Peugeot	206	1.6 Estate	03-07	Front	L	
				Peugeot	206	2.0 GTi	00-06	Front	L	
G35365	Gas Ryder		1, 1	Mercedes	A Class	(W168) A160, A190, 170CDI	00-04	Front	↔	
G35369	Gas Ryder		1, 1	Peugeot	307	1.6, 2.0 Excl. CC	01-08	Front	L	
				Peugeot	307	Estate	02-08	Front	L	
G35370	Gas Ryder		1, 1	Peugeot	307	1.6, 2.0 Excl. CC	01-08	Front	R	
				Peugeot	307	Estate	02-08	Front	R	
G35421	Gas Ryder		1, 1	Renault	Megane	II Hatch (Excl. 2.0 T Sport)	04-08	Front	↔	
G35451	Gas Ryder		1, 1	Renault	Scenic	Grand Scenic II	04-09	Front	↔	
				Renault	Scenic	Scenic II	04-09	Front	↔	
G44450	Gas Ryder	61303	2	Audi	100, 200	C2	77-84	Front	↔	
G44782	Gas Ryder		2	Toyota	Rav 4	Serviceable struts (XA10)	96-98	Front	↔	
G45001	Technomatic		5	Toyota	TUV	LDV	82-87	Front	↔	
				Volvo	122	Amazon	62-71	Front	↔	
				Volvo	122	Amazon, B18	59-71	Front	↔	
G45006	Technomatic		8, 2	Chevrolet	LUV	Faster	73-78	Rear	↔	
				Dodge (Chrysler)	Husky	LDV	74-78	Rear	↔	3
				Jeep (Chrysler)	Jeep	CJ Series (Willys) (CJ5, CJ6, CJ7)	54-86	Rear	↔	
				Fiat	124	Station Wagon	69-77	Rear	↔	
				Isuzu	KB (D-Max), TF Series	(Mk I)	78-80	Rear	↔	
				Isuzu	WFR, Relay	Fargo	80-95	Rear	↔	
				Nissan	Stanza	1600J, 1800J, Stanza S/W (A10)	79-83	Rear	↔	
				Toyota	Condor	4X4 Mk IV	00-05	Rear	↔	
				Toyota	Corona	T60, T70 Series (Mark II 1900)	69-73	Rear	↔	
				Toyota	Hiace	H10	69-84	Rear	↔	
				Toyota	Hilux	4X2	69-84	Rear	↔	
				Toyota	Stout	RK 101	61-89	Rear	↔	
G45008	Technomatic		8, 2	Isuzu	KB (D-Max), TF Series	4X2 (Standard Height) (TF)	89-04	Rear	↔	
				Isuzu	KB (D-Max), TF Series	4X4, 4X2 (Raised Height) (TF)	89-04	Rear	↔	
				Nissan	Laurel	240, 260, 300 (C130)	72-78	Rear	↔	13
				Toyota	Hilux	4X2 Standard Susp.	99-05	Rear	↔	
				Toyota	Hilux	4X4	79-84	Rear	↔	
				Toyota	Land Cruiser	FJ45, BJ45	71-85	Rear	↔	

Part #	Range	Superceding Part #/Status	Product Type	Make	Model	Derivative	Year	Position	L/R	Fitment Guide #
G45051	Technomatic		8, 2	Jeep (Chrysler)	Jeep	CJ Series (Willys) (CJ5, CJ6, CJ7)	54-86	Front	↔	
				Toyota	Land Cruiser	FJ45, BJ45	71-85	Front	↔	
				Ford	Husky	LDV, Panelvan	86-93	Rear	↔	
				Hillman	Vogue, Hunter	Safari	67-77	Rear	↔	
				Hyundai	H100	Bakkie	96-05	Rear	↔	
				Mitsubishi	L300 (Delica)	Incl. Starwagon, Express	82-03	Rear	↔	
				Nissan	1 Ton Bakkie	720 4X2	80-88	Rear	↔	
				Nissan	1/2 Ton Bakkie	120Y (12" wheels)	76-83	Rear	↔	
				Nissan	1/2 Ton Bakkie	1400 (13" wheels)	80-83	Rear	↔	
				Nissan	1/2 Ton Bakkie	1400, 1200, 120Y	71-08	Rear	↔	
				Nissan	Caball	Truck	64-78	Rear	↔	
				Nissan	Vanette	C22	85-85	Rear	↔	
				Nissan	Y Series	140Y, 160Y	75-80	Rear	↔	
				Toyota	Stallion	KF40	87-00	Rear	↔	
Toyota	Venture	KF40	91-00	Rear	↔					
G45054	Technomatic		8, 2	Suzuki	SJ410/413, Samurai	4X4, S/W	82-87	Rear	↔	
				Toyota	Hiace	SWB (H20, H30, H40)	84-88	Rear	↔	
				Volvo	122	Amazon	62-71	Rear	↔	
G45078	Technomatic		5	Ford	Laser, Meteor, Tracer	Familia	69-76	Rear	↔	
				Ford	Ranchero	Falcon	69-76	Rear	↔	
				Mazda	1200, 1300	Familia (Mk II)	72-75	Rear	↔	
				Mazda	B Series, Drifter, Magnum	Mk II, II & IV	64-86	Rear	↔	
				Mazda	E2000, E2700, E3000	LDV	64-83	Rear	↔	
				Mazda	E2000, E3000	Truck	67-81	Rear	↔	
				Mazda	F1000, F1300	LDV	81-86	Rear	↔	
				Triumph	Chicane	2000, 2500	65-78	Rear	↔	
G45122	Technomatic		6, 1	Alfa-Romeo	Other	Incl. Giulia	66-77	Front	↔	
				Nissan	E20 (Urvan, Caravan)	Ekonowagon, Ekonovan	73-81	Front	↔	
				Suzuki	SJ410/413, Samurai	4X4, S/W	82-87	Front	↔	
				Suzuki	SJ410/413, Samurai	4X4, S/W	87-90	Front	↔	
				Nissan	Y Series	1200	72-75	Rear	↔	
G45138	Technomatic		6, 1	Nissan	Caball	Truck	64-78	Front	↔	
				Nissan	Caball	Truck	78-84	Front	↔	
				Toyota	Stout	RK 101	61-89	Front	↔	
				Opel	Rekord	Caravan (E)	78-92	Rear	↔	
G45212	Technomatic		4	Mazda	B Series, Drifter, Magnum	Mk II, II & IV	64-86	Front	↔	
				Chevrolet	2500, 3800, 4100	2.5, 3.8, & 4.1 Estate	75-78	Front	↔	
				Chevrolet	2500, 3800, 4100	2.5, 3.8, & 4.1 Sedan	73-78	Front	↔	
				Opel	Rekord	C	67-73	Front	↔	

Part #	Range	Superceding Part #/Status	Product Type	Make	Model	Derivative	Year	Position	L/R	Fitment Guide #
G45255	Technomatic		⊥ 4	Chevrolet	El Camino	Incl. El Toro	71-72	Front	↔	
				Nissan	Laurel	2000, 2300, 2400 (C30)	68-72	Front	↔	
				Nissan	Laurel	240, 260, 300 (C130)	72-78	Front	↔	
				Opel	Constantia, Kommando	Brougham	69-72	Front	↔	
G45258	Technomatic		⊥ 5	Peugeot	404	Saloon	60-78	Rear	↔	
				Peugeot	504	L, GR	76-85	Rear	↔	
				Rambler	Hornet & Sportabout	AMC	70-76	Rear	↔	
G45398	Technomatic		⊥ 4	Toyota	Corona	T100 Series	74-80	Front	↔	
				Toyota	Corona	Mk II 2000	72-78	Front	↔	
				Toyota	Corona	T60, T70 Series (Mk II 1900)	69-73	Front	↔	
				Toyota	Corona	T40, T50 Series (Incl. 2000 GSL)	64-74	Front	↔	
				Toyota	Hilux	4X2	69-84	Front	↔	
				Volvo	144, 164	B20, B30	68-71	Front	↔	
				Volvo	144, 164	B20E, B30	72-74	Front	↔	
G45399	Technomatic		⊥ 6, 1	Chevrolet	2500, 3800, 4100	2.5, 3.8, & 4.1 Estate	75-78	Rear	↔	
				Chevrolet	Commodore	C	78-92	Rear	↔	
				Opel	2500, 3800, 4100	2.5, 3.8, & 4.1 Estate	75-78	Rear	↔	
				Opel	Commodore	C	78-92	Rear	↔	
				Toyota	Corolla	Imported Strut (E30, E40, E50, E60)	74-80	Rear	↔	
				Toyota	Corolla	Imported Strut (E30, E40, E50, E60)	82-85	Rear	↔	
				Toyota	Corolla Carri	Imported Strut	73-79	Rear	↔	
				Toyota	Corolla Carri	Local Strut (E30, E40, E50, E60)	79-89	Rear	↔	
				Toyota	Corona	Mk II 2000	72-78	Rear	↔	
				Toyota	Corona	T40, T50 Series (Incl. 2000 GSL)	64-74	Rear	↔	
				Toyota	Cressida	X35, X36 (imported Strut) (Mk I)	78-79	Rear	↔	
				Toyota	Cressida	X35, X36 (Local Strut) (Mk I)	79-81	Rear	↔	
G45413	Technomatic		⊥ 8, 5	Ford	Escort	Mk I	68-73	Rear	↔	
				Ford	Escort	Mk I 1100, 1300	70-75	Rear	↔	
				Ford	Escort	Mk I 1600, GT	70-75	Rear	↔	
				Ford	Escort	Mk I, II	74-81	Rear	↔	
G45417	Technomatic		⊥ 8, 5	Volkswagen	1500, 1600	Type 3 car	63-69	Front	↔	
				Volkswagen	Kombi	Microbus (double jointed axle rear)	68-80	Front	↔	
G45418	Technomatic		⊥ 8, 2	Ford	Cortina	Mk III, IV	71-78	Rear	↔	20
				Volkswagen	Kombi	Microbus (double jointed axle rear)	68-80	Rear	↔	

Part #	Range	Superceding Part #/Status	Product Type	Make	Model	Derivative	Year	Position	L/R	Fitment Guide #
G45419	Technomatic		8, 5	Volkswagen	Beetle	MK I	52-79	Front	↔	4
				Volkswagen	Kombi	Microbus, Fleetline (swing axle rear)	55-78	Front	↔	
				Volkswagen	1500, 1600	Type 3 car	63-69	Rear	↔	
				Volkswagen	Beetle	MK I	52-79	Rear	↔	4
				Volkswagen	Kombi	Microbus, Fleetline (swing axle rear)	55-78	Rear	↔	
G45423	Technomatic		6, 1	Fiat	125	Sedan	69-75	Rear	↔	
				Ford	Taurus	17M, 20M	61-73	Rear	↔	19
				Nissan	Laurel	2000, 2300, 2400 (C30)	68-72	Rear	↔	
				Nissan	U Series	1600, 1800 (Incl. Coupe)	72-73	Rear	↔	
				Nissan	U Series	160U, 180U	74-78	Rear	↔	
G45432	Technomatic		9, 1	Nissan	1 Ton Bakkie	620, 680, 1300, 1500	66-80	Rear	↔	
				Nissan	Caball	Truck	78-84	Rear	↔	
				Nissan	E20 (Urvan, Caravan)	Ekonowagon, Ekonovan	73-81	Rear	↔	
				Nissan	E20 (Urvan, Caravan)	Ekonowagon, Ekonovan	81-95	Rear	↔	
G45447	Technomatic		8, 5	Chevrolet	Nomad	LDV	75-78	Front	↔	
				Nissan	Vanette	C22	85-85	Front	↔	6
				Opel	Firenza	Coupe	71-78	Front	↔	
G45450	Technomatic		6, 2	Peugeot	505	Saloon	80-85	Rear	↔	
G45466	Technomatic		4	Chevrolet	Chevelle	Mk I	64-70	Front	↔	
				Ford	Husky	LDV, Panelvan	86-93	Front	↔	
				Mitsubishi	L300 (Delica)	Incl. Starwagon, Express	82-03	Front	↔	
				Toyota	Condor	4X2 Mk IV	00-05	Front	↔	
				Toyota	Hiace	H10	69-84	Front	↔	
G45469	Technomatic		6, 1	Toyota	Cressida	MX63 (Mk II)	81-93	Rear	↔	
G45470	Technomatic		8, 5	Peugeot	404	Estate	69-78	Rear	↔	
				Peugeot	504	Estate	74-85	Rear	↔	
				Peugeot	504	GL, GLD, Ti	73-80	Rear	↔	
G45489	Technomatic		6, 2	Opel	2500, 3800, 4100	2.5, 3.8, & 4.1 Sedan	73-78	Rear	↔	
				Chevrolet / Opel	Ascona, Chevair	B, (Mk I Cavalier)	76-82	Rear	↔	
				Opel	Commodore	C	78-88	Rear	↔	
				Opel	Rekord	Sedan (Excl. V6) (E)	78-97	Rear	↔	
G45503	Technomatic		10	Ford	Cortina	Mk III	71-77	Front	↔	
				Ford	Cortina	Mk IV	77-80	Front	↔	
				Ford	Granada	Mk I, Mk II	72-86	Front	↔	
G45520	Technomatic		8, 5	Ford	Cortina	Mk III	71-77	Rear	↔	
				Ford	Cortina	Mk IV	77-80	Rear	↔	
				Ford	Cortina	Mk V	80-83	Rear	↔	
G45523	Technomatic		4	Mazda	F1000, F1300	LDV	81-86	Front	↔	













Part #	Range	Superceding Part #/Status	Product Type		Make	Model	Derivative	Year	Position	L/R	Fitment Guide #
G45532	Technomatic		⊥	4	BMW	2 Series	1802, 2002 (E10)	68-75	Front	↔	
					Chevrolet	El Camino	Incl. El Toro	72-78	Front	↔	
					Opel	Constantia, Kommando	Incl., Caprice, De Ville (AQ)	72-79	Front	↔	
G45533	Technomatic		⊥	6, 1	Nissan	Y Series	140Y, 160Y	75-80	Rear	↔	
					Opel	Constantia, Kommando	Brougham	69-72	Rear	↔	
					Opel	Constantia, Kommando	Incl., Caprice, De Ville (AQ)	72-79	Rear	↔	
					Opel	Firenza	Coupe	71-78	Rear	↔	2
					Opel	Kadett	B	66-74	Rear	↔	
					Opel	Rekord	C	67-73	Rear	↔	
					Chevrolet	El Camino	Incl. El Toro	71-72	Rear	↔	
G45534	Technomatic		⊙	8, 4	Chevrolet	El Camino	Incl. El Toro	72-78	Rear	↔	
G45535	Technomatic		⊥	6, 2	Chevrolet	LUV	Faster	73-78	Front	↔	
					Hyundai	H100	Bakkie	96-05	Front	↔	
					Isuzu	KB (D-Max), TF Series	(Mk I)	78-80	Front	↔	
					Isuzu	KB (D-Max), TF Series	4X4 (Mk II)	80-88	Front	↔	
					Jaguar	Jaguar	Mk II	61-69	Front	↔	1
					Jaguar	Jaguar	Mk X, 420, 420G, S Type (4 shocks at rear)	65-72	Front	↔	1
					Nissan	E20 (Urvan, Caravan)	Ekonowagon, Ekonovan	81-95	Front	↔	
					Toyota	Condor	4X4 Mk IV	00-05	Front	↔	
G45651	Technomatic		⊥	4	Ford	Granada	Mk I, Mk II	72-86	Rear	↔	
G45666	Technomatic		⊥	4	Alfa-Romeo	Alfetta, Giulietta, Super, 159i	Incl. GT, GTV	73-86	Front	↔	
G45667	Technomatic		⊥	5	Mazda	E2000, E2700, E3000	LDV	64-83	Front	↔	
					Mazda	E2000, E3000	Truck	67-81	Front	↔	
					Alfa-Romeo	Alfetta, Giulietta, Super, 159i	Incl. GT, GTV	73-86	Rear	↔	
G45715	Technomatic		⊙	8, 5	Audi	80	B1	75-81	Rear	↔	
					Volkswagen	Passat	B1	74-81	Rear	↔	
G45742	Technomatic		⊥	6, 2	Ford	Escort	Mk II	75-81	Rear	↔	
G45810	Technomatic		⊙	8, 4	Fiat	132	Supermirafiori	79-81	Rear	↔	
					Mazda	323	Rwd (imported Strut)	77-78	Rear	↔	
					Mazda	323	Rwd (Local Strut)	78-81	Rear	↔	
G45812	Technomatic		⊙	8, 4	Mitsubishi	Colt	Galant (imported Strut)	77-78	Rear	↔	
					Mitsubishi	Colt	Galant (Local Strut)	78-83	Rear	↔	
G45813	Technomatic		⊥	6, 1	Toyota	Cressida	Non IRS+, MX63 (Mk II)	81-93	Rear	↔	
					Toyota	Cressida	X30, X32 (imported Strut) (Mk I)	77-79	Rear	↔	
					Toyota	Cressida	X30, X32 (Local Strut) (Mk I)	79-81	Rear	↔	
G45824	Technomatic		⊙	8, 5	Mitsubishi	Tredia	Excl. Turbo	83-86	Rear	↔	
					Mitsubishi	Tredia	Turbo	83-86	Rear	↔	

Part #	Range	Superceding Part #/Status	Product Type		Make	Model	Derivative	Year	Position	L/R	Fitment Guide #
G45837	Technomatic		10	10	Ford	Cortina	Mk V	80-83	Front	↔	
					Ford	Cortina	Mk V	80-83	Front	↔	
G45838	Technomatic		6, 2	6, 2	Ford	Cortina	Mk V	80-83	Rear	↔	14
G45839	Technomatic		6, 2	6, 2	Chevrolet / Opel	Ascona, Chevair	Incl. Coupe (C)	82-85	Rear	↔	
					Chevrolet / Opel	Ascona, Chevair	Incl. Coupe (short Strut) (C)	84-86	Rear	↔	
					Opel	Kadett	D	80-85	Rear	↔	
					Opel	Kadett	T-car (E)	85-89	Rear	↔	
					Opel	Monza	Incl. GSi	86-89	Rear	↔	
G45841	Technomatic		6, 1	6, 1	Toyota	Corolla	RWD (Excl. Van, S/W) (E70)	80-85	Rear	↔	
					Toyota	Corona	T100 Series	74-80	Rear	↔	
G45842	Technomatic		6, 2	6, 2	Nissan	1 Ton Bakkie	620, 680, 1300, 1500	66-80	Front	↔	
					Nissan	1 Ton Bakkie	720 4X2	80-88	Front	↔	
					Nissan	1 Ton Bakkie	Hardbody 4X4 (Incl. Sani, Patrol) (D21)	88-02	Front	↔	
					Nissan	Sani	4X4	90-99	Front	↔	
					Nissan	Tracker	4X4	80-82	Front	↔	
					Nissan	Tracker	4X4 (Incl. Sani)	82-88	Front	↔	
G45844	Technomatic		6, 2	6, 2	Isuzu	KB (D-Max), TF Series	4X2 (Mk II)	80-88	Front	↔	
					Isuzu	KB (D-Max), TF Series	4X2 (Standard Height) (TF)	89-04	Front	↔	
G45858	Technomatic		4	4	Ford	Sierra, Sapphire	Estate	83-93	Rear	↔	
G45859	Technomatic		6, 2	6, 2	Nissan	Langley, Pulsar	Incl. Exa (sealed Strut) (N12)	83-88	Rear	↔	
G45860	Technomatic		8, 5	8, 5	Ford	Sierra, Sapphire	2300, 2000, 1600	83-93	Rear	↔	
					Ford	Sierra, Sapphire	3000 (Incl. XR6)	83-93	Rear	↔	
G45861	Technomatic		6, 2	6, 2	BMW	2 Series	1802, 2002 (E10)	68-75	Rear	↔	
					Daihatsu	Charade	Incl. Coupe (G11)	83-87	Rear	↔	
G45862	Technomatic		4	4	GWM	GWM	2.2, 2.8TDi (4X2)	07 on	Front	↔	
					Toyota	Hilux	4X2	84-98	Front	↔	
					Toyota	Hilux	4X2 Standard Susp.	99-05	Front	↔	
G45869	Technomatic		6, 2	6, 2	Nissan	1 Ton Bakkie	Hardbody 4X2 (Excl. Hi Rider) (D21)	88-02	Front	↔	
					Nissan	1 Ton Bakkie	Hardbody 4X2 (Excl. Hi Rider) (D22)	02 on	Front	↔	
					Nissan	NP300	4X2 (Excl. Hi Rider) (D22)	08 on	Front	↔	
					Toyota	Hiace	LWB (H20, H30, H40)	84-93	Front	↔	
					Toyota	Hiace	SWB (H20, H30, H40)	84-88	Front	↔	
					Toyota	Hiace	SWB (H50)	88-93	Front	↔	

Part #	Range	Superceding Part #/Status	Product Type	Make	Model	Derivative	Year	Position	L/R	Fitment Guide #	
G45870	Technomatic		oo	8, 2	Ford	Spectron	Minibus, Van	91-03	Rear	↔	
					GWM	GWM	2.2, 2.8TDi (4X2)	07 on	Rear	↔	
					Isuzu	KB (D-Max), TF Series	4X2 (Mk II)	80-88	Rear	↔	
					Isuzu	KB (D-Max), TF Series	4X4 (Mk II)	80-88	Rear	↔	
					Mazda	Marathon (Ford Husky)	Van, Bus	91-03	Rear	↔	
					Nissan	Tracker	4X4 (Incl. Sani)	82-88	Rear	↔	
					Toyota	Hilux	4X2	84-98	Rear	↔	
G45871	Technomatic		o	6, 2	Ford	Courier	4X2 (Standard Susp.)	86-06	Front	↔	
					Ford	Ranger	4X2 (Standard Susp.)	86-06	Front	↔	
					Isuzu	KB (D-Max), TF Series	4X4, 4X2 (Raised Height) (TF)	89-04	Front	↔	
					Mazda	B Series, Drifter, Magnum	4X2 Standard Susp.	86-06	Front	↔	
G45872	Technomatic		oo	8, 2	Ford	Courier	4X2 (Standard Susp.)	86-06	Rear	↔	
					Ford	Ranger	4X2 (Standard Susp.)	86-06	Rear	↔	
					Mazda	B Series, Drifter, Magnum	4X2 Standard Susp.	86-06	Rear	↔	
					Mitsubishi	Colt Bakkie	L200 (4X2 Standard Height)	98-07	Rear	↔	
					Nissan	1 Ton Bakkie	Hardbody 4X2 (Excl. Hi Rider) (D21)	88-02	Rear	↔	
					Nissan	1 Ton Bakkie	Hardbody 4X2 Hi Rider (D21)	88-02	Rear	↔	
					Nissan	1 Ton Bakkie	Hardbody 4X4 (Incl. Sani, Patrol) (D21)	88-02	Rear	↔	
					Nissan	Sani	4X2	90-99	Rear	↔	
					Nissan	Sani	4X4	90-99	Rear	↔	
					Toyota	Condor	4X2 Mk IV	00-05	Rear	↔	
					G45873	Technomatic		oo	8, 2	Toyota	Hiace
Toyota	Hiace	SWB (H50)	88-93	Rear						↔	
G45874	Technomatic		o	6, 2	Daewoo	Cielo	Nexia	95-98	Rear	↔	14
					Daewoo	Espero	Aranos	95-98	Rear	↔	14
					Daewoo	Lanos	Sens	97-03	Rear	↔	14
					Opel	Astra	F	93-99	Rear	↔	14
					Opel	Kadett	Astra	93-99	Rear	↔	14
					Opel	Kadett	T-car (E)	89-93	Rear	↔	14
					Opel	Monza	Incl. Cub	89-93	Rear	↔	14
G45875	Technomatic		oo	8, 5	Ford	Bantam	1300, 1600	83-86	Rear	↔	
					Ford	Bantam	1400, 1600	86-94	Rear	↔	
					Mazda	Rustler	130, 160	85-86	Rear	↔	
					Mazda	Rustler	1400, 1600	86-94	Rear	↔	
G45876	Technomatic		=	4	Ford	Spectron	Minibus, Van	91-03	Front	↔	
					Mazda	Marathon (Ford Husky)	Van, Bus	91-03	Front	↔	
G45877	Technomatic		oo	8, 5	Volkswagen	Golf	Incl. Sport (Typ 14)	81-93	Rear	↔	
					Volkswagen	Golf	Pickup	93-03	Rear	↔	

Part #	Range	Superceding Part #/Status	Product Type	Make	Model	Derivative	Year	Position	L/R	Fitment Guide #
G45878	Technomatic		⊘ 8, 5	Ford	Bantam	1.3, 1.6	03-06	Rear	↔	
				Ford	Bantam	1.3, 1.6 (Mk III)	06 on	Rear	↔	
				Ford	Bantam	1.3, 1.6, 1.8D	02	Rear	↔	
				Ford	Bantam	1300, 1600	94-02	Rear	↔	
				Mazda	Rustler	1300, 1600	94-02	Rear	↔	
G45879	Technomatic		⊘ 6, 2	Audi	A1	Hatch 1.2 TFSI, 1.4 TFSI, 1.6 Tdi (8X1, 8XA)incl. Sport Susp. Excl. 4WD	11-19	Rear	↔	
				Volkswagen	Polo	Mk IV	02-09	Rear	↔	
				Volkswagen	Polo	Mk V (Typ 6R) (Excl GTi)	10 on	Rear	↔	
				Volkswagen	Polo	Vivo (Mk IV)	10 on	Rear	↔	
G45881	Technomatic		⊘ 8, 5	Opel	Astra	Excl. 2.0 OPC (G)	99-03	Rear	↔	
G45885	Technomatic		⊘ 6, 2	Mahindra	Scorpio	4X4	05 on	Front	↔	
G45886	Technomatic		⊘ 8, 4	Mahindra	Scorpio	4X2	05 on	Rear	↔	
				Mahindra	Scorpio	4X4	05 on	Rear	↔	
G45888	Technomatic		† 3, 2	Toyota	Hilux	4x2 Standard Susp.	05-16	Front	L	
				Toyota	Hilux	4x2 Standard Susp.	16 on	Front	R	
G45889	Technomatic		† 3, 2	Toyota	Hilux	4X2 Standard Susp.	05-16	Front	R	
				Toyota	Hilux	4X2 Standard Susp.	16-on	Front	R	
G45890	Technomatic		⊘ 6, 2	Toyota	Yaris	T1 1.0L, T3 1.3L (Mk II)	05-11	Rear	↔	
				Toyota	Yaris	T3 1.3L (Mk II)	06-11	Rear	↔	
G45891	Technomatic		⊘ 8, 5	Toyota	Avanza	1.3 & 1.5 (Xenia)	06 on	Rear	↔	
G45892	Technomatic		⊘ 6, 2	Mazda	Mazda 3	1.6, 2.0 Excl. MPS (Mk I)	04-09	Rear	↔	
G45893	Technomatic		⊘ 6, 2	Isuzu	KB (D-Max), TF Series	4X2 (Mk II)	80-88	Front	↔	
				Isuzu	KB (D-Max), TF Series	4X2 (Standard Height) (TF)	89-04	Front	↔	
				Lada	Niva	VAZ-2121	87-92	Front	↔	16
				Mitsubishi	Colt Bakkie	L200 (4X2 Raised Height)	98-07	Front	↔	
				Nissan	1 Ton Bakkie	Hardbody 4X2 (Excl. Hi Rider) (D21)	88-02	Front	↔	
				Nissan	1 Ton Bakkie	Hardbody 4X2 (Excl. Hi Rider) (D22)	02 on	Front	↔	
				Nissan	1 Ton Bakkie	Hardbody 4X2 Hi Rider (D21)	88-02	Front	↔	
				Nissan	1 Ton Bakkie	Hardbody 4X2 Hi Rider (D22)	02 on	Front	↔	
				Nissan	NP300	4X2 (Excl. Hi Rider) (D22)	08 on	Front	↔	
				Nissan	NP300	4X2 Hi Rider (D22)	08 on	Front	↔	
				Toyota	Hiace	LWB (H20, H30, H40)	84-93	Front	↔	
				Toyota	Hiace	SWB (H20, H30, H40)	84-88	Front	↔	
				Toyota	Hiace	SWB (H50)	88-93	Front	↔	
G45894	Technomatic		⊘ 6, 2	Ford	Focus	Mk II Hatch & Sedan (Excl. Sti)	04-11	Rear	↔	
G45896	Technomatic		⊘ 8, 5	Chana	Star	Bakkie, Panel van, Minibus (Incl. Maxi Star)	06 on	Rear	↔	
G45897	Technomatic		⊘ 6, 2	Chevrolet	Spark	M300 (Excl. Lite)	10 on	Rear	↔	
G45898	Technomatic		† 3, 2	Kia	Sorento	2.5D, 3.5 & 3.8 (Mk I)	02-09	Front	L	
G45899	Technomatic		† 3, 2	Kia	Sorento	2.5D, 3.5 & 3.8 (Mk I)	02-09	Front	R	

Part #	Range	Superceding Part #/Status	Product Type	Make	Model	Derivative	Year	Position	L/R	Fitment Guide #
G45900	Technomatic		⊖ 6,2	Volkswagen	Golf IV	Estate	99-06	Rear	↔	
G45901	Technomatic		⊖ 6,2	Suzuki	Jimny	Gen 3 - (SN413 / JA/JB33)	98 on	Front	↔	
G45902	Technomatic		⊖ 8.5	Suzuki	Jimny	Gen 3 - (SN413 / JA/JB33)	98 on	Rear	↔	
G45904	Technomatic		† 3,2	GWM	Steed	Pick-Up 4X2	08-11	Front	↔	
G45905	Technomatic		⊖ 8.2	GWM	Steed	Pick-Up 4X2	08-11	Rear	↔	
G51023	Gas Ryder		† 3,2	Audi	A4	1.8, 2.4, 2.6, 2.8 Excl. Quattro (B5)	94-01	Rear	↔	
G51059	Gas Ryder		† 3,2	Hyundai	Elantra	J1 Series (Avante)	94-96	Rear	↔	
G51082	Gas Ryder		† 3,2	Ford	Escort	Mk V	95-99	Rear	↔	
G51089	Gas Ryder	69082	† 3,3	Mazda	Soho	121 (Bracket)	97-99	Rear	↔	
G51101	Gas Ryder		† 3,3	Audi	A6	Excl. ⓈI & Quattro (C5)	97-04	Front	↔	
				Audi	A6	Quattro (C5)	97-04	Front	↔	
G51186	Gas Ryder		† 3,2	Hyundai	Sonata	Y3	95-98	Rear	↔	
G51213	Gas Ryder		† 3,2	Nissan	Primera	P11-144	98-02	Front	↔	
G51214	Gas Ryder		† 3,2	Nissan	Primera	P11-144	98-02	Rear	↔	
G51216	Gas Ryder		† 3,2	BMW	5 Series	E39 Series (520i, 523i, 525i, 525TDS, 528i, 530i, 530D) (Excl. Ⓢ)	96-04	Rear	↔	
				BMW	5 Series	E39 Series (535i, 540i) (Excl. Ⓢ)	96-04	Rear	↔	
G51217	Gas Ryder		† 3,1	Alfa-Romeo	156	2.0 Twin Spark (932) (Excl. Ⓢ) (←VETO116245)	97-98	Front	↔	
				Alfa-Romeo	156	2.0 Twin Spark (932) (Excl. Ⓢ) (VETO116246→)	98-06	Front	↔	
G51231	Gas Ryder		† 3,1	Alfa-Romeo	147	1.6 (937), 2.0	01 on	Front	↔	
				Alfa-Romeo	156	2.5 V6 (932) Ⓢ (←VETO116245)	97-98	Front	↔	
				Alfa-Romeo	156	2.5 V6 (932) Ⓢ (VETO116246→)	98-06	Front	↔	
G51235	Gas Ryder	69095	† 3,2	Ford	Fiesta	Mark IV (Excl. 1.6 RSi 3-door) (Sleeve eye)	99-03	Rear	↔	22
				Ford	Ikon	B3 (Sleeve eye)	00-06	Rear	↔	22
				Mazda	Soho	121 (Eye)	97-99	Rear	↔	22
G51255	Gas Ryder		† 3,1	Honda	CR-V	RD1-RD3	95-01	Front	↔	
G51256	Gas Ryder		† 3,2	Honda	CR-V	RD1-RD3	95-01	Rear	↔	
G51269	Gas Ryder		† 3,2	Volvo	S40	Excl. ⓈI, Ⓢ & T4 rear (Mk I)	95-04	Rear	↔	
G51275	Gas Ryder		† 3,2	Ford	KA	1.3 (Mk I)	05-08	Rear	↔	
G51298	Gas Ryder		† 3,2	Honda	Civic	Mk VII	01-05	Rear	↔	
G54023	Gas Ryder		† 1,1	Kia	Rio	Rio 1.4 & 1.6 Gen2 (JB)	06-11	Front	L	
				Hyundai	Accent	MC. 1.6	05-11	Front	L	
G54024	Gas Ryder		† 1,1	Kia	Rio	Rio 1.4 & 1.6 Gen2 (JB)	06-11	Front	R	
				Hyundai	Accent	MC. 1.6	05-11	Front	R	
G55592	Gas Ryder		† 1,1	Hyundai	Elantra	J1 Series (Avante)	94-96	Front	↔	
G55600	Gas Ryder		† 1,1	Mazda	626	Zimbabwe model	87-91	Front	↔	

Part #	Range	Superceding Part #/Status	Product Type	Make	Model	Derivative	Year	Position	L/R	Fitment Guide #
G55601	Gas Ryder		 1, 1	Mazda	626	Zimbabwe model	87-91	Rear	↔	
G55613	Gas Ryder	G56518	 1, 1	Suzuki	Vitara	5 door (Excl. V6) (Mk I)	94-98	Front	↔	
G55614	Gas Ryder	G56518	 1, 1	Suzuki	Vitara	5 door (Excl. V6) (Mk I)	94-98	Front	↔	
G55673	Gas Ryder		 1, 1	Hyundai	Sonata	Y3	95-98	Front	↔	
G55697	Gas Ryder		 1, 1	Chrysler	Voyager	Gen III (Incl Grande Voyager) (Excl. )	96-00	Front	↔	
G55723	Gas Ryder		 1, 1	Honda	Prelude	Coupe	83-87	Front	↔	
				Honda	Prelude	Coupe (sealed struts rear)	83-87	Front	↔	
G55821	Gas Ryder		 1, 1	Honda	Odyssey	RA1-RA5	97-99	Rear	↔	
G55877	Gas Ryder		 1, 1	Honda	Odyssey	RA1-RA5	97-99	Front	↔	
G55910	Gas Ryder		 1, 1	Honda	Ballade	150i, 160i, 180i Excl. Vtech (Mk VI) (Civic)	96-01	Rear	↔	
				Honda	Civic	Mk VI	96-01	Rear	↔	
G56102	Safari		 8, 2	Jeep (Chrysler)	Jeep	CJ Series (Willys) (CJ5, CJ6, CJ7)	54-86	Front	↔	
				Leyland	FG 550, FG 420	Truck	68-77	Front	↔	
				Toyota	Dyna	Coaster	66-77	Front	↔	
				Bedford	CF Series	Van, Truck	70-84	Rear	↔	
				Ford	F Series	F100, F250 4X2	65-67	Rear	↔	
				Ford	F Series	F100, F250 4X2	68-69	Rear	↔	
				Ford	F Series	F350	67-81	Rear	↔	
				Ford	Husky	LDV, Panelvan	86-93	Rear	↔	
				Ford	Triton 0510, 0610	Truck	85-87	Rear	↔	
				Hyundai	H100	Bakkie	96-05	Rear	↔	
				Lada	Niva	2121	87-92	Rear	↔	16
				Mitsubishi	Canter	Truck	80 on	Rear	↔	
				Mitsubishi	L300 (Delica)	Incl. Starwagon, Express	82-03	Rear	↔	
				Nissan	1 Ton Bakkie	720 4X2	80-88	Rear	↔	
				Nissan	Caball	Truck	64-78	Rear	↔	
				Toyota	Dyna	All	94 on	Rear	↔	
				Toyota	Dyna	Coaster	78-95	Rear	↔	
				Toyota	Hiace	H10	69-84	Rear	↔	
Toyota	Stallion	KF40	87-00	Rear	↔					
Toyota	Venture	KF40	91-00	Rear	↔					
G56103	Safari		 8, 2	Ford	Cortina	Mk III, IV	71-78	Rear	↔	20
				Isuzu	KB (D-Max), TF Series	4X2 (Standard Height) (TF)	89-04	Rear	↔	
				Isuzu	KB (D-Max), TF Series	4X4, 4X2 (Raised Height) (TF)	89-04	Rear	↔	
				Kia	K2700	Bongo (Gen 3)	00-04	Rear	↔	
				Toyota	Hilux	4X4	79-84	Rear	↔	

Part #	Range	Superceding Part #/Status	Product Type	Make	Model	Derivative	Year	Position	L/R	Fitment Guide #
G56105	Safari		† 5	Nissan	Patrol	S/W 4X4 (Y60, Y61, Rear for Y60 only)	89-01	Front	↔	
				Ford	Ranchero	Falcon	69-76	Rear	↔	
				Mazda	B Series, Drifter, Magnum	Mk II, II & IV	64-86	Rear	↔	
				Mazda	E2000, E2700, E3000	LDV	64-83	Rear	↔	
				Mazda	E2000, E3000	Truck	67-81	Rear	↔	
				Mazda	F1000, F1300	LDV	81-86	Rear	↔	
G56106	Safari		∅ 8, 1	Chevrolet	C Series	C10, C20	63-73	Front	↔	
				Chevrolet	C Series	C10, C20	74-83	Front	↔	
				Chevrolet	C Series	C30	63-73	Front	↔	
				Chevrolet	C Series	C30	74-83	Front	↔	
G56107	Safari		∅ 8, 5	Chevrolet	C Series	C10, C20	63-73	Rear	↔	
G56112	Safari		∅ 8, 2	Land Rover	Defender	109 WB, Series I	54-65	Front	↔	
				Land Rover	Defender	109 WB, Series II, III	65-84	Front	↔	
				Land Rover	Defender	88 WB	54-80	Front	↔	
G56113	Safari		∅ 9, 1	Land Rover	Defender	109 WB, Series II, III	65-84	Rear	↔	
G56116	Safari		∅ 8, 2	Bedford	J2-4	Truck	65 on	Rear	↔	
				Chevrolet	LUV	Faster	73-78	Rear	↔	
				Jeep (Chrysler)	Jeep	CJ Series (Willys) (CJ5, CJ6, CJ7)	54-86	Rear	↔	
				Ford	Courier	4X2 (Standard Susp.)	86-06	Rear	↔	
				Ford	Ranger	4X2 (Standard Susp.)	86-06	Rear	↔	
				Isuzu	KB (D-Max), TF Series	(Mk I)	78-80	Rear	↔	
				Mazda	B Series, Drifter, Magnum	4X2 Standard Susp.	86-06	Rear	↔	
				Mitsubishi	Colt Bakkie	L200 (1.6, 2.0, 2.5D 4X2)	94-98	Rear	↔	
				Mitsubishi	Colt Bakkie	L200 (4X2 Standard Height)	98-07	Rear	↔	
				Nissan	1 Ton Bakkie	Hardbody 4X2 (Excl. Hi Rider) (D21)	88-02	Rear	↔	
				Nissan	1 Ton Bakkie	Hardbody 4X2 Hi Rider (D21)	88-02	Rear	↔	
				Nissan	1 Ton Bakkie	Hardbody 4X4 (Incl. Sani, Patrol) (D21)	88-02	Rear	↔	
				Nissan	Sani	4X2	90-99	Rear	↔	
				Nissan	Sani	4X4	90-99	Rear	↔	
				Toyota	Dyna	Coaster	66-77	Rear	↔	
Toyota	Stout	RK 101	61-89	Rear	↔					
G56118	Safari		∅ 6, 2	Mitsubishi	FK Series	FK 115J/K	80-86	Front	↔	
				Mitsubishi	FM Series	FM215F/L	79-86	Front	↔	
				Chevrolet	El Camino	Incl. El Toro	71-72	Rear	↔	
				Ford	F Series	F100, F250 4X2	70-81	Rear	↔	5

Part #	Range	Superceding Part #/Status	Product Type	Make	Model	Derivative	Year	Position	L/R	Fitment Guide #	
G56119	Safari		⊥	5	Bedford	J2-4	Truck	65 on	Front	↔	
					Bedford	J5-6	Truck	65 on	Front	↔	
					Ford	F Series	F100, F250 4X2	65-67	Front	↔	
					Nissan	Patrol	4X4 (G160)	80-89	Front	↔	
					Nissan	Patrol	4X4 (WG60)	72-80	Front	↔	
					Nissan	Safari	S/W (G160/G161) & Pickup	82-90	Front	↔	
					Volvo	122	Amazon, B18	59-71	Front	↔	
					Jaguar	Jaguar	Mk II	61-69	Rear	↔	
					Nissan	Patrol	4X4 (WG60)	72-80	Rear	↔	
G56120	Safari	G45667	⊥	5	Ford	F Series	F250 4X4	68-77	Front	↔	
					Mazda	E2000, E2700, E3000	LDV	64-83	Front	↔	
					Mazda	E2000, E3000	Truck	67-81	Front	↔	
G56123	Safari		⊖	6, 2	Ford	F Series	F100, F250 4X2	68-69	Front	↔	
					Ford	F Series	F100, F250 4X2	70-81	Front	↔	5
					Ford	F Series	F350	67-81	Front	↔	
G56126	Safari		⊖	8, 2	Bedford	KE, KG, KH All	Truck	64 on	Front	↔	29
					Bedford	MFR	Truck	67-71	Front	↔	29
					Bedford	VAL	Bus	66 on	Front	↔	
					Bedford	J5-6	Truck	65 on	Rear	↔	29
					Bedford	KE, KG, KH All	Truck	64 on	Rear	↔	29
					Bedford	MFR	Truck	67-71	Rear	↔	29
					Chevrolet	C Series	C30	63-73	Rear	↔	
					Isuzu	N2800 P	Truck	93 on	Rear	↔	
					Isuzu	N3000 P	Truck	87-90	Rear	↔	
					Isuzu	NKR55/99	Truck	19...	Rear	↔	
					Isuzu	TL40-50	Truck	75 on	Rear	↔	
					Isuzu	TLD44, TLD54	Truck	77-89	Rear	↔	
					Land Rover	Defender	109 WB, Series I	54-65	Rear	↔	
					Land Rover	Defender	88 WB	54-80	Rear	↔	
G56153	Safari		≡	10	Ford	Cortina	Mk III, IV	71-78	Front	↔	
					Ford	Cortina	Mk IV	78-80	Front	↔	
G56155	Safari		⊖	6, 2	Ford	F Series	F250 4X4	78-81	Rear	↔	
G56156	Safari		⊖	9, 2	Ford	Cortina	Mk IV	78-80	Rear	↔	
					Ford	Cortina	Mk V	80-82	Rear	↔	
G56157	Safari		⊖	9, 1	Nissan	1 Ton Bakkie	620, 680, 1300, 1500	66-80	Rear	↔	
					Nissan	Caball	Truck	78-84	Rear	↔	
					Nissan	E20 (Urvan, Caravan)	Ekonowagon, Ekonovan	73-81	Rear	↔	
					Nissan	E20 (Urvan, Caravan)	Ekonowagon, Ekonovan	81-95	Rear	↔	
G56158	Safari		⊖	6, 2	Toyota	Hilux	4X4	79-84	Front	↔	
					Toyota	Hilux	4X4	84-98	Front	↔	
G56159	Safari		⊖	9, 2	Ford	Cortina	Mk V	83-86	Rear	↔	

Part #	Range	Superceding Part #/Status	Product Type		Make	Model	Derivative	Year	Position	L/R	Fitment Guide #
			Icon	Code							
G56160	Safari		∞	10	Ford	Cortina	Mk V	80-82	Front	↔	
					Ford	Cortina	Mk V	83-86	Front	↔	
G56161	Safari		∞	8, 5	Volkswagen	Kombi	Microbus (Excl. Synchro 4X4)	80-02	Rear	↔	
G56162	Safari		∞	8, 2	Land Rover	Defender	109, 110 WB forward control	65-83	Front	↔	
					Nissan	Caball	Truck	96 on	Rear	↔	
					Nissan	Cabstar 20, 35, 40	Truck	96 on	Rear	↔	
G56163	Safari		♀	9, 1	Land Rover	Defender	109, 110 WB forward control	65-83	Rear	↔	
G56164	Safari		†	5	Land Rover	Defender	90, 110, 130 (Incl. County & LDV)	84 on	Front	↔	
					Land Rover	Discovery	Series I	89-98	Front	↔	
					Land Rover	Range Rover	Excl. Air Susp. (Mk I)	70-96	Front	↔	
G56165	Safari		♀	9, 1	Land Rover	Defender	90, 110, 130 (Incl. County & LDV)	84 on	Rear	↔	
					Land Rover	Discovery	Series I	89-98	Rear	↔	
					Land Rover	Range Rover	Excl. Air Susp. (Mk I)	70-96	Rear	↔	
					Land Rover	Range Rover	Air Susp. (Mk I)	92-96	Rear	↔	
G56166	Safari		∞	6, 1	Isuzu	JCR 360, FTR	Truck	79-86	Front	↔	
					Nissan	Cabstar	Truck	84-90	Front	↔	
					Toyota	Land Cruiser	FJ62, BJ60 S/W	83-89	Front	↔	
G56167	Safari		∞	8, 2	Toyota	Hilux	4X4	84-98	Rear	↔	
					Toyota	Land Cruiser	HZJ70	89-99	Rear	↔	
					Toyota	Hilux	4X4, 4X2 Raised Susp.	99-05	Rear	L	
					Toyota	Hilux	4X2 Standard Susp.	16-on	Rear	↔	
G56168	Safari		♀	9, 1	Nissan	Safari	S/W (G160/G161)	82-90	Rear	↔	
					Nissan	Tracker	4X4	80-82	Rear	↔	
G56169	Safari		∞	6, 2	Ford	Courier	4X4, 4X2 Hi-Trail (Raised Susp.)	86-06	Front	↔	
					Ford	Ranger	4X4, 4X2 Hi-Trail (Raised Susp.)	86-06	Front	↔	
					Mazda	B Series, Drifter, Magnum	4X4, 4X2 Hi-Trail (Raised Susp.)	86-06	Front	↔	
					Tata	Telcoline	4X4, 4X2	04 on	Front	↔	
G56170	Safari		∞	8, 5	Ford	Courier	4X4, 4X2 Hi-Trail (Raised Susp.)	86-06	Rear	↔	
					Ford	Ranger	4X4, 4X2 Hi-Trail (Raised Susp.)	86-06	Rear	↔	
					Mazda	B Series, Drifter, Magnum	4X4, 4X2 Hi-Trail (Raised Susp.)	86-06	Rear	↔	

Part #	Range	Superceding Part #/Status	Product Type	Make	Model	Derivative	Year	Position	L/R	Fitment Guide #	
G56171	Safari		1 0	6, 2	Nissan	1 Ton Bakkie	620, 680, 1300, 1500	66-80	Front	↔	
					Nissan	1 Ton Bakkie	720 4X2	80-88	Front	↔	
					Nissan	1 Ton Bakkie	Hardbody 4X2 Hi Rider (D21)	88-02	Front	↔	
					Nissan	1 Ton Bakkie	Hardbody 4X2 Hi Rider (D22)	02 on	Front	↔	
					Nissan	1 Ton Bakkie	Hardbody 4X4 (D22)	98 on	Front	↔	
					Nissan	1 Ton Bakkie	Hardbody 4X4 (Incl. Sani, Patrol) (D21)	88-02	Front	↔	
					Nissan	NP300	4X2 Hi Rider (D22)	08 on	Front	↔	
					Nissan	NP300	4X4 (D22)	08 on	Front	↔	
					Nissan	Sani	4X4	90-99	Front	↔	
					Nissan	Tracker	4X4	80-82	Front	↔	
					Nissan	Tracker	4X4 (Incl. Sani)	82-88	Front	↔	
G56172	Safari		1 0	6, 2	Mitsubishi	Colt Bakkie	L200 (4X2 Raised Height)	98-07	Front	↔	
					Mitsubishi	Colt Bakkie	L200 (4X4)	98-07	Front	↔	
					Nissan	Sani	4X2	90-99	Front	↔	
					Toyota	Hiace	LWB (H20, H30, H40)	84-93	Front	↔	
					Toyota	Hiace	SWB (H20, H30, H40)	84-88	Front	↔	
					Toyota	Hiace	SWB (H50)	88-93	Front	↔	
G56173	Safari		1 0	6, 2	Ford	Courier	4X2 (Standard Susp.)	86-06	Front	↔	
					Ford	Ranger	4X2 (Standard Susp.)	86-06	Front	↔	
					Isuzu	Frontier	4X4, 4X2	98-02	Front	↔	
					Isuzu	KB (D-Max), TF Series	4X4, 4X2 (Raised Height) (TF)	89-04	Front	↔	
					Isuzu	Trooper	Mk II	92-96	Front	↔	
					Mazda	B Series, Drifter, Magnum	4X2 Standard Susp.	86-06	Front	↔	
					Nissan	Terrano II	R20 LWB & SWB	99-04	Front	↔	
					Ssangyong	Musso	602TDi, E230EL, E320EL	95-06	Front	↔	
					Ssangyong	Musso Sport	DC Bakkie	04 on	Front	↔	
					Toyota	Hiace	Super T (H100)	93-10	Front	↔	
G56174	Safari		0 0	8, 2	Bedford	MFR	Truck	72 on	Front	↔	
					Bedford	Vam	Bus	73-75	Front	↔	
					Bedford	MFR	Truck	72 on	Rear	↔	
					Bedford	Vam	Bus	73-75	Rear	↔	
					Nissan	Patrol	S/W 4X4 (Y60, Y61, Rear for Y60 only)	89-01	Rear	↔	
					Toyota	Land Cruiser	DLX, BJ75	85-99	Rear	↔	
					Toyota	Hilux	4X4, 4X2 Raised Susp.	99-05	Rear	R	
G56175	Safari		0 0	8, 2	Toyota	Hiace	LWB (H20, H30, H40)	84-93	Rear	↔	
					Toyota	Hiace	Super T (H100)	93-10	Rear	↔	
					Toyota	Hiace	SWB (H50)	88-93	Rear	↔	

Part #	Range	Superceding Part #/Status	Product Type	Make	Model	Derivative	Year	Position	L/R	Fitment Guide #
G56176	Safari		1/6 6, 2	Hyundai	H100	Bakkie	96-05	Front	↔	
				Isuzu	KB (D-Max), TF Series	(Mk I)	78-80	Front	↔	
				Isuzu	KB (D-Max), TF Series	4X4 (Mk II)	80-88	Front	↔	
				Isuzu	Trooper	Mk I	81-91	Front	↔	
				Nissan	E20 (Urvan, Caravan)	Ekonowagon, Ekonovan	81-95	Front	↔	
G56177	Safari		0/0 8, 2	Toyota	Land Cruiser	FJ45, BJ45	71-85	Front	↔	
				Mazda	T2000, 3000	LDV	83 on	Rear	↔	
				Mazda	T2000, T3000	Truck	81-86	Rear	↔	
				Toyota	Hiace	SWB (H20, H30, H40)	84-88	Rear	↔	
G56178	Safari		1/1 4	Kia	K2700	Bongo (Gen 3)	00-04	Front	↔	
				Kia	Pregio	Bongo	00-04	Front	↔	
				Toyota	Hilux	4X2	84-98	Front	↔	
				Toyota	Hilux	4X2 Standard Susp.	99-05	Front	↔	
G56179	Safari		1/6 6, 1	Nissan	Caball	Truck	96 on	Front	↔	
				Toyota	Land Cruiser	DLX, BJ75	85-99	Front	↔	
				Toyota	Land Cruiser	HZJ70	89-99	Front	↔	
G56180	Safari		1/1 5	Land Rover	Range Rover	Air Susp. (Mk I)	92-96	Front	↔	
G56184	Safari		0/0 8, 2	Mitsubishi	Colt Bakkie	L200 (2.6, 3.0, V6 4X4, 4X2 Raised Height)	94-98	Rear	↔	
				Mitsubishi	Colt Bakkie	L200 (4X2 Raised Height)	98-07	Rear	↔	
				Mitsubishi	Colt Bakkie	L200 (4X4)	98-07	Rear	↔	
				Nissan	Terrano II	R50	99-04	Rear	↔	
G56185	Safari		1/1 4	Ford	Husky	LDV, Panelvan	86-93	Front	↔	
				Isuzu	WFR, Relay	Fargo	80-95	Front	↔	
				Mitsubishi	Colt Bakkie	L200 (2.6, 3.0, V6 4X4, 4X2 Raised Height)	94-98	Front	↔	
				Mitsubishi	L300 (Delica)	Incl. Starwagon, Express	82-03	Front	↔	
				Toyota	Stallion	KF40	87-00	Front	↔	
				Toyota	Venture	KF40	91-00	Front	↔	
G56186	Safari		0/0 8, 2	Ford	Spectron	Minibus, Van	91-03	Rear	↔	
				Isuzu	KB (D-Max), TF Series	4X2 (Mk II)	80-88	Rear	↔	
				Isuzu	KB (D-Max), TF Series	4X4 (Mk II)	80-88	Rear	↔	
				Isuzu	TLD 24	Truck	77-88	Rear	↔	
				Isuzu	Trooper	Mk I	81-91	Rear	↔	
				Mazda	Marathon (Ford Husky)	Van, Bus	91-03	Rear	↔	
				Nissan	Tracker	4X4 (Incl. Sani)	82-88	Rear	↔	
				Toyota	Hilux	4X2	84-98	Rear	↔	
				Toyota	Land Cruiser	FJ45, BJ45	71-85	Rear	↔	
				Toyota	Land Cruiser	FJ62, BJ60 S/W	83-89	Rear	↔	
G56187	Safari		0/0 8, 2	Toyota	Hiace	East Africa	-	Rear		
G56189	Safari		1/6 6, 2	Toyota	Hilux	4X4, 4X2 Raised Susp.	99-05	Front	↔	

Part #	Range	Superceding Part #/Status	Product Type	Make	Model	Derivative	Year	Position	L/R	Fitment Guide #
G56190	Safari		⊗ 8, 2	Nissan	1 Ton Bakkie	Hardbody 4X2 (Excl. Hi Rider) (D22)	02 on	Rear	↔	
				Nissan	1 Ton Bakkie	Hardbody 4X2 Hi Rider (D22)	02 on	Rear	↔	
				Nissan	1 Ton Bakkie	Hardbody 4X4 (D22)	98 on	Rear	↔	
				Nissan	NP300	4X2 (Excl. Hi Rider) (D22)	08 on	Rear	↔	
				Nissan	NP300	4X2 Hi Rider (D22)	08 on	Rear	↔	
				Nissan	NP300	4X4 (D22)	08 on	Rear	↔	
				Toyota	Hilux	4X2 Standard Susp.	99-05	Rear	↔	
G56203	Safari		⊗ 6, 2	Mahindra	Scorpio	4X4 (Mk I)	06 on	Front	↔	
G56204	Safari		⊗ 8, 4	Mahindra	Scorpio	4X4 (Mk I)	06 on	Rear	↔	
G56205	Safari		† 3, 2	Mitsubishi	Triton	4X4, 4X2 Raised Height	07-17	Front	↔	
G56207	Safari		⊗ 8, 2	Toyota	Hilux	4X4, 4X2 Raised Susp.	05-16	Rear	↔	
G56208	Safari		⊗ 8, 2	Toyota	Hilux	4X2 Standard Susp.	05-16	Rear	↔	
G56209	Safari		⊗ 8, 2	Toyota	Quantum	2.5 D-4D, 2.7 Minibus & Van Incl. Sesfikile (H200)	05 on	Rear	↔	
G56210	Safari		⊗ 8, 2	Mitsubishi	Triton	4X4, 4X2 Raised Height	07 on	Rear	↔	
G56211	Safari		⊗ 6, 2	Toyota	Quantum	2.5 D-4D, 2.7 Minibus & Van Incl. Sesfikile (H200)	05 on	Front	↔	
G56212	Safari		† 3, 2	Isuzu	KB (D-Max), TF Series	4X2 (Standard Height) (P190)	04 on	Front	↔	
G56213	Safari		⊗ 8, 2	Isuzu	KB (D-Max), TF Series	4X2 (Standard Height) (P190)	04 on	Rear	↔	
G56214	Safari		⊗ 6, 2	Isuzu	KB (D-Max), TF Series	4X4, 4X2 (Raised Height) (P190)	04 on	Front	↔	
G56215	Safari		⊗ 8, 2	Isuzu	KB (D-Max), TF Series	4X4, 4X2 (Raised Height) (P190)	04 on	Rear	↔	
G56218	Safari		† 3, 2	Toyota	Fortuner	4X4, 4X2 Raised Susp.	06-16	Front	↔	
				Toyota	Hilux	4X4, 4X2 Raised Susp.	05-16	Front	↔	
G56219	Safari		⊗ 6, 1	Toyota	Fortuner	4X4, 4X2 Raised Susp.	06-16	Rear	↔	
G56222	Safari		⊗ 6, 2	Ford	Everest	4X2 & 4X4	09-15	Front	↔	
				Ford	Ranger	4X4, 4X2 Hi-Trail (Raised Susp.)	07-12	Front	↔	
				Mazda	BT-50	4X4, 4X2 Raised Susp.	07-12	Front	↔	
G56223	Safari		⊗ 8, 5	Ford	Ranger	4X4, 4X2 Hi-Trail (Raised Susp.)	07-12	Rear	↔	
				Mazda	BT-50	4X4, 4X2 Raised Susp.	07-12	Rear	↔	
G56224	Safari		⊗ 8, 5	Opel	Corsa	Utility	04 on	Rear	↔	
G56226	Safari		† 3, 2	Toyota	Prado	120/125	02-09	Front	↔	
G56227	Safari		⊗ 6, 1	Toyota	Prado	120/125	02-09	Rear	↔	
G56228	Safari		⊗ 8, 5	Ford	Ranger	4X2 (Standard Susp.)	07-12	Rear	↔	
				Mazda	BT-50	4X2 Standard Susp.	07-12	Rear	↔	
G56230	Safari		† 5	Toyota	Land Cruiser	HZJ80 S/W, 105	90-98	Front	↔	
G56231	Safari		⊗ 6, 1	Toyota	Land Cruiser	100 Series	90-98	Rear	↔	
				Toyota	Land Cruiser	HZJ80 S/W, 105	90-98	Rear	↔	

Part #	Range	Superceding Part #/Status	Product Type	Make	Model	Derivative	Year	Position	L/R	Fitment Guide #
G56235	Safari		⊕ 6,2	Ford	Ranger	4X2 (Standard Susp.)	07-12	Front	↔	
				Mazda	BT-50	4X2 Standard Susp.	07-12	Front	↔	
G56236	Safari		⊙ 8,3	Nissan	Navara	4X4 & 4X2 (D40)	05 on	Rear	↔	
G56237	Safari		⚡ 3,2	Mitsubishi	Pajero	4X4 3.2 Di-D & 3.8 (Mk III)	99-07	Front	↔	
G56239	Safari		⊕ 5	Toyota	Land Cruiser	79 Series	09 on	Front	↔	
G56240	Safari		⊙ 8,2	Toyota	Land Cruiser	79 Series	09 on	Rear	↔	
G56241	Safari		⊕ 6,2	Mitsubishi	Colt Bakkie	L200 (4X4)	98-07	Front	↔	
				Toyota	Hiace	LWB (H20, H30, H40)	84-93	Front	↔	
				Toyota	Hiace	SWB (H20, H30, H40)	84-88	Front	↔	
				Toyota	Hiace	SWB (H50)	88-93	Front	↔	
G56244	Safari		⊕ 6,2	Cam	Inyathi	Minibus	07 on	Front	↔	
G56245	Safari		⊙ 8,2	Cam	Inyathi	Minibus	07 on	Rear	↔	
G56246	Safari		⊙ 10	Land Rover	Discovery	Series II. 4.0 V8, 2.5TD5	98-04	Front	↔	
G56247	Safari		⊙ 8,2	Land Rover	Discovery	Series II. 4.0 V8, 2.5TD5	98-04	Rear	↔	
G56249	Safari		⊕ 6,2	Tata	Xenon	3.0 4X2 & 4X4	07 on	Front	↔	
G56250	Safari		⊙ 8,2	Tata	Xenon	3.0 4X2 & 4X4	07 on	Rear	↔	
G56251	Safari		⊕ 4	Kia	K2700	Bongo (Gen 4)	05 on	Front	↔	
G56252	Safari		⊙ 8,2	Kia	K2700	Bongo (Gen 4)	05 on	Rear	↔	
G56254	Safari		⊙ 8,5	Volkswagen	Amarok	4X4; 4X2 D/C & S/C (3+2 Trapezoidal spring)	10 on	Rear	↔	
G56255	Safari		⊙ 8,5	Volkswagen	Amarok	4X4; 4X2 D/C & S/C (2+1 Trapezoidal spring)	10 on	Rear	↔	
G56258	Safari		⊕ 7,1	Fiat	Strada	3/4 Ton LDV (Mk II)	05 on	Rear	↔	
G56262	Safari		⚡ 3,1	Jeep (Chrysler)	Jeep	Cherokee (KJ) 2.5D, 2.8D, 3.7	01-07	Front	↔	
G56263	Safari		⊙ 8,5	Jeep (Chrysler)	Jeep	Cherokee (KJ) 2.5D, 2.8D, 3.7	01-07	Rear	↔	
G56266	Safari		⊙ 8,5	Kia	Sorento	2.5D, 3.5 & 3.8 (Mk I)	02-09	Rear	↔	
G56268	Safari		⊙ 8,5	Mercedes	Vito	115 CDi 2.2 Bus MPV Dsl (W639)	04 on	Rear	↔	
				Mercedes	Vito	115 CDi 2.2 Cr-Cab P-Van Dsl (W639)	04 on	Rear	↔	
				Mercedes	Vito	115 CDi 2.2 P-Van Dsl (W639)	04 on	Rear	↔	
G56274	Safari		⊕ 6,2	Mitsubishi	Pajero	4X4 3.2 Di-D & 3.8 (Mk III)	99-07	Rear	↔	
G56276	Safari		⚡ 3,2	Ford	Ranger	Pick-Up 4X4, 4X2 Raised T6	12 on	Front	↔	
				Mazda	BT-50	4X4, 4X2 Raised Susp.	12 on	Front	↔	
G56277	Safari		⊙ 8,5	Ford	Ranger	Pick-Up 4X4, 4X2 Raised T6	12 on	Rear	↔	
				Mazda	BT-50	4X4, 4X2 Raised Susp.	12 on	Rear	↔	
G56278	Safari		⊙ 6,2	Chevrolet	Utility	Utility Pick-Up	11 on	Rear	↔	
G56281	Safari		⊙ 8,2	Toyota	Vigo	(CGN25)	05 on	Rear	↔	
				Toyota	Vigo	(LAN25)	05 on	Rear	↔	
G56282	Safari	G56218	⚡ 3,2	Toyota	Vigo	(LAN25)	05 on	Front	↔	

Part #	Range	Superceding Part #/Status	Product Type	Make	Model	Derivative	Year	Position	L/R	Fitment Guide #
G56290	Safari		🔧 3.2	Ford	Ranger	Pick-Up 4X2 T6	12-15	Front	↔	
				Mazda	BT-50	4X2 Standard Susp.	12-15	Front	↔	
G56291	Safari		🌀 8.5	Ford	Ranger	Pick-Up 4X2 T6	12-15	Rear	↔	
				Mazda	BT-50	4X2 Standard Susp.	12-15	Rear	↔	
G56292	Safari		🔧 3.2	Toyota	Prado	SUV 4X4 J150 (Excl. 🚚)	09 on	Front	↔	
G56293	Safari		🌀 6.2	Toyota	Prado	SUV 4X4 J150 (Excl. 🚚)	09 on	Rear	↔	
G56298	Safari		🌀 8,5	Ford	Everest	4x2 & 4x4	09-16	Rear	↔	
G56299	Safari		🌀 6,2	Nissan	NV350	All	13-on	Front	↔	
G56300	Safari		🌀 8,3	Nissan	NV350	All	13-on	Rear	↔	
G56308	Safari		🔧 3,2	Toyota	Hilux	4x4 & 4x2 Raised Suspension (2.4L; 2.7L; 2.8L; 4.0L V6) 4x2 & 4x4	16-on	Front	↔	
G56309	Safari		🌀 8,2	Toyota	Hilux	4x4 & 4x2 Raised Suspension (2.4L; 2.7L; 2.8L; 4.0L V6) 4x2 & 4x4	16-on	Rear	↔	
G56314	Safari		🔧 3,2	Toyota	Fortuner	SUV 2.4GD, 2.7, 2.8GD & 4.0L V6 4x4 & 4x2	16-on	Front	↔	
G56315	Safari		🌀 3,2	Toyota	Fortuner	SUV 2.4GD, 2.7, 2.8GD & 4.0L V6 4x4 & 4x2	16-on	Rear	↔	
G56518	Safari		🔧 1,1	Suzuki	Vitara	5 door (Excl. V6) (Mk I)	94-98	Front	↔	
G63690	Gas Ryder		🌀 8,5	Chrysler	Voyager	Gen III (Incl. Grande Voyager) (Excl. 🚚)	96-00	Rear	↔	
				Chrysler	Voyager	Gen IV (Incl. Grande Voyager) (Excl. 🚚)	01-07	Rear	↔	
G63720	Gas Ryder		🌀 6,2	Kia	Sportage	2.0, 2.0D (Mk I)	93-04	Rear	↔	
G63721	Gas Ryder		🌀 4	Jeep (Chrysler)	Jeep	Wrangler 4X4 (TJ)	96-06	Front	↔	
G63722	Gas Ryder		🌀 13,2	Jeep (Chrysler)	Jeep	Wrangler 4X4 (TJ)	96-06	Rear	↔	
G63799	Gas Ryder		🌀 5	Suzuki	Vitara	5 door (Excl. V6) (Mk I)	94-98	Rear	↔	
G63940	Gas Ryder		🌀 6,1	Toyota	Rav 4	Sealed struts (XA10)	98-00	Rear	↔	
				Toyota	Rav 4	Serviceable front struts (XA10) Mk I	95-98	Rear	↔	
GS46006	Safari HDP		🔧 3,2	Mitsubishi	Pajero	3.0, 3.8, 3.2 Di-D (Mk IV NS, SWB & LWB)	07 on	Front	↔	
				Mitsubishi	Pajero	4X4 3.2 Di-D & 3.8 (Mk III)	99-07	Front	↔	
GS46007	Safari HDP		🔧 3,2	Toyota	Fortuner	4X4, 4X2 Raised Susp.	06-16	Front	↔	33
				Toyota	Hilux	4X4, 4X2 Raised Susp.	05-16	Front	↔	33
				Toyota	Prado	120/125	02-09	Front	↔	33
GS46008	Safari HDP		🔧 3,2	Toyota	4-Runner/ Hilux Surf	VZN185	95-02	Front	↔	
				Toyota	Prado	Land Cruiser 90 SWB	96-02	Front	↔	
				Toyota	Prado	Land Cruiser 95 LWB	96-02	Front	↔	
GS46009	Safari HDP		🔧 3,2	Mitsubishi	Triton	4X4, 4X2 Raised Height	07 on	Front	↔	
GS46010	Safari HDP		🔧 3,2	Nissan	Navara	4X4 & 4X2 (D40)	05-09	Front	↔	
				Nissan	Pathfinder	2.5 Dci, 4.0 (Mk III R51 Series)	05-12	Front	↔	
GS46011	Safari HDP		🔧 3,1	Jeep (Chrysler)	Jeep	Cherokee (KJ) 2.5D, 2.8D, 3.7	01-07	Front	↔	

Part #	Range	Superceding Part #/Status	Product Type		Make	Model	Derivative	Year	Position	L/R	Fitment Guide #
GS46012	Safari HDP		†	3,2	Toyota	FJ Cruiser	FJ Cruiser	11 on	Front	↔	
					Toyota	Prado	SUV 4X4 J150 (Excl. ⚡)	09 on	Front	↔	
GS46013	Safari HDP		†	3,2	Ford	Ranger	Pick-Up 4X4, 4X2 Raised T6	12-15	Front	↔	
					Mazda	BT-50	4X4, 4X2 Raised Susp.	12-15	Front	↔	
GS46014	Safari HDP		†	3,2	Isuzu	KB (D-Max), TF Series	KB (D-Max), TF Series 4X4, 4X2 (Raised Height) (Mk VI)	13 on	Front	↔	
GS56220	Safari HDP		⊖	6,2	Mitsubishi	Colt Bakkie	L200 (4X2 Raised Height)	98-07	Front	↔	
					Mitsubishi	Colt Bakkie	L200 (4X4)	98-07	Front	↔	
					Mitsubishi	Pajero	V Series (Mk II)	91-99	Front	↔	
GS56221	Safari HDP		⊖	6,2	Nissan	1 Ton Bakkie	Hardbody 4X2 Hi Rider (D22)	02 on	Front	↔	
					Nissan	1 Ton Bakkie	Hardbody 4X4 (D22)	98 on	Front	↔	
					Nissan	NP300	4X4 (D22)	08 on	Front	↔	
GS56225	Safari HDP		⊖	6,2	Isuzu	KB (D-Max), TF Series	4X4, 4X2 (Raised Height) (P190)	04 on	Front	↔	
					Isuzu	KB (D-Max), TF Series	4X4, 4X2 (Raised Height) (TF)	89-04	Front	↔	
GS56232	Safari HDP		⊖	6,2	Toyota	Hilux	4X4, 4X2 Raised Susp.	99-05	Front	↔	
GS56233	Safari HDP		⊖	6,2	Ford	Courier	4X4, 4X2 Hi-Trail (Raised Susp.)	86-06	Front	↔	
					Ford	Ranger	4X4, 4X2 Hi-Trail (Raised Susp.)	86-06	Front	↔	
					Ford	Ranger	4X4, 4X2 Hi-Trail (Raised Susp.)	07-12	Front	↔	
					Mazda	B Series, Drifter, Magnum	4X4, 4X2 Hi-Trail (Raised Susp.)	86-06	Front	↔	
					Mazda	BT-50	4X4, 4X2 Raised Susp.	07-12	Front	↔	
GS56234	Safari HDP		⊖	4	Mitsubishi	Colt Bakkie	L200 (2.6, 3.0, V6 4X4, 4X2 Raised Height)	94-98	Front	↔	
GS56259	Safari HDP		⊖	8,2	Nissan	Navara	4X4 & 4X2 (D40)	05-09	Rear	↔	
GS56260	Safari HDP		⊖	8,5	Nissan	Pathfinder	2.5 Dci, 4.0 (Mk III R51 Series)	05-12	Rear	↔	
GS56261	Safari HDP		⊖	13,1	Jeep (Chrysler)	Jeep	Cherokee (XJ)	96-01	Rear	↔	
GS56264	Safari HDP		⊖	6,2	Mahindra	Scorpio	4X4, 4X2 Raised. (Mk I) 2.2, 2.4D	06 on	Front	↔	
GS56265	Safari HDP		⊖	8,4	Mahindra	Scorpio	4X4, 4X2 Raised. (Mk I) 2.2, 2.4D	06 on	Rear	↔	
GS56267	Safari HDP		⊖	8,5	Jeep (Chrysler)	Jeep	Cherokee (KJ) 2.5D, 2.8D, 3.7	01-07	Rear	↔	
GS56283	Safari HDP		⊖	6,2	Suzuki	Jimny	Gen 3 - (SN413 / JA/JB33)	98-18	Front	↔	
GS56284	Safari HDP		⊖	8,5	Suzuki	Jimny	Gen 3 - (SN413 / JA/JB33)	98-18	Rear	↔	
					Suzuki	Jimny	Gen 4 - (JB64W/JB74W)	18 on	Rear	↔	
GS56288	Safari HDP		⊖	6,2	Jeep (Chrysler)	Jeep	Wrangler 4X4 (JK)	07-11	Front	↔	
GS56289	Safari HDP		⊖	13,2	Jeep (Chrysler)	Jeep	Wrangler 4X4 (JK)	07-11	Rear	↔	
GS78000	Safari HDP		⊖	6,2	Toyota	Hilux	4X4	84-98	Front	↔	
GS78001	Safari HDP		⊖	8,2	Toyota	Hilux	4X4	84-98	Rear	↔	

Part #	Range	Superceding Part #/Status	Product Type		Make	Model	Derivative	Year	Position	L/R	Fitment Guide #
GS78002	Safari HDP		†	5	Toyota	Land Cruiser	76SW	07 on	Front	↔	
					Toyota	Land Cruiser	70/75 SW	07 on	Front	↔	
					Toyota	Land Cruiser	Pickup	99 on	Front	↔	
GS78003	Safari HDP		∞	8, 2	Mitsubishi	Colt Bakkie	L200 (4X2 Raised Height)	98-07	Rear	↔	
					Mitsubishi	Colt Bakkie	L200 (4X4)	98-07	Rear	↔	
GS78004	Safari HDP		∞	8, 2	Toyota	Hilux	4X4, 4X2 Raised Susp.	99-05	Rear	↷	
GS78005	Safari HDP		∞	8, 2	Toyota	Hilux	4X4, 4X2 Raised Susp.	99-05	Rear	↶	
GS78006	Safari HDP		∞	8, 2	Isuzu	KB (D-Max), TF Series	4X4, 4X2 (Raised Height) (P190)	04 on	Rear	↔	
					Isuzu	KB (D-Max), TF Series	4X4, 4X2 (Raised Height) (TF)	89-04	Rear	↔	
GS78007	Safari HDP		†	5	Land Rover	Defender	90, 110, 130 (Incl. County & LDV)	84 on	Front	↔	
					Land Rover	Discovery	Series I	89-98	Front	↔	
					Land Rover	Range Rover	Excl. Air Susp. (Mk I)	70-96	Front	↔	
GS78008	Safari HDP		∞	9, 1	Land Rover	Defender	90, 110, 130 (Incl. County & LDV)	84 on	Rear	↔	
					Land Rover	Discovery	Series I	89-98	Rear	↔	
					Land Rover	Range Rover	Excl. Air Susp. (Mk I)	70-96	Rear	↔	
GS78009	Safari HDP		∞	8, 2	Toyota	Hilux	4X4, 4X2 Raised Susp.	05-16	Rear	↔	
GS78010	Safari HDP		∞	6, 1	Toyota	Fortuner	4X4, 4X2 Raised Susp.	06-16	Rear	↔	
GS78011	Safari HDP		†	5	Toyota	Land Cruiser	80	90-98	Front	↔	
					Toyota	Land Cruiser	105	99-07	Front	↔	
GS78012	Safari HDP		∞	6, 1	Toyota	Land Cruiser	80	90-98	Rear	↔	
					Toyota	Land Cruiser	105	99-07	Rear	↔	
GS78013	Safari HDP		∞	8, 2	Toyota	Land Cruiser	76SW	07 on	Rear	↔	
					Toyota	Land Cruiser	70/75 SW	07 on	Rear	↔	
					Toyota	Land Cruiser	Pickup	99 on	Rear	↔	
GS78014	Safari HDP		∞	8, 5	Ford	Courier	4X4, 4X2 Hi-Trail (Raised Susp.)	86-06	Rear	↔	
					Ford	Ranger	4X4, 4X2 Hi-Trail (Raised Susp.)	86-06	Rear	↔	
					Ford	Ranger	4X4, 4X2 Hi-Trail (Raised Susp.)	07-12	Rear	↔	
					Mazda	B Series, Drifter, Magnum	4X4, 4X2 Hi-Trail (Raised Susp.)	86-06	Rear	↔	
					Mazda	BT-50	4X4, 4X2 Raised Susp.	07-12	Rear	↔	
GS78015	Safari HDP		∞	6, 1	Toyota	4-Runner/ Hilux Surf	VZN185	95-02	Rear	↔	
					Toyota	Prado	90 SWB & 95 LWB	96-02	Rear	↔	
GS78016	Safari HDP		∞	8, 2	Mitsubishi	Colt Bakkie	L200 (2.6, 3.0, V6 4X4, 4X2 Raised Height)	94-98	Rear	↔	
GS78017	Safari HDP		∞	6, 1	Toyota	Prado	120/125	02-09	Rear	↔	
GS78018	Safari HDP		∞	8, 2	Nissan	1 Ton Bakkie	Hardbody 4X2 Hi Rider (D22)	02 on	Rear	↔	
					Nissan	1 Ton Bakkie	Hardbody 4X4 (D22)	98 on	Rear	↔	
					Nissan	NP300	4X4 (D22)	08 on	Rear	↔	
GS78019	Safari HDP		∞	6, 2	Mitsubishi	Pajero	V Series (Mk II)	91-99	Rear	↔	

Part #	Range	Superceding Part #/Status	Product Type		Make	Model	Derivative	Year	Position	L/R	Fitment Guide #
GS78020	Safari HDP		1/0	6, 2	Mitsubishi	Pajero	3.0, 3.8, 3.2 Di-D (Mk IV NS, SWB & LWB)	07 on	Rear	↔	
					Mitsubishi	Pajero	4X4 3.2 Di-D & 3.8 (Mk III)	99-07	Rear	↔	
GS78021	Safari HDP		0/0	8, 2	Mitsubishi	Triton	4X4, 4X2 Raised Height	07-17	Rear	↔	
GS78025	Safari HDP		1/1	4	Jeep (Chrysler)	Jeep	Cherokee (XJ)	96-01	Front	↔	
					Jeep (Chrysler)	Jeep	Wrangler 4X4 (TJ)	96-06	Front	↔	
GS78026	Safari HDP		0/0	13, 2	Jeep (Chrysler)	Jeep	Wrangler 4X4 (TJ)	96-06	Rear	↔	
GS78029	Safari HDP		0/0	10	Land Rover	Discovery	Series II. 4.0 V8, 2.5TD5	98-04	Front	↔	
GS78030	Safari HDP		0/0	8, 2	Land Rover	Discovery	Series II. 4.0 V8, 2.5TD5	98-04	Rear	↔	
GS78032	Safari HDP		0/0	8.5	Ford	Ranger	Pick-Up 4X4, 4X2 Raised T6	12-15	Rear	↔	
					Mazda	BT-50	4X4, 4X2 Raised Susp.	12-15	Rear	↔	
GS78033	Safari HDP		1/1	3.2	Toyota	Land Cruiser	200 Series	08 on	Front	↔	
GS78034	Safari HDP		1/0	6.2	Toyota	Land Cruiser	200 Series	08 on	Rear	↔	
GS78037	Safari HDP		1/0	6.2	Toyota	FJ Cruiser	FJ Cruiser	11 on	Rear	↔	
					Toyota	Prado	SUV 4X4 J150 (Excl. 45)	09 on	Rear	↔	
GS78038	Safari HDP		0/0	8.2	Isuzu	KB (D-Max), TF Series	KB (D-Max), TF Series 4X4, 4X2 (Raised Height) (Mk VI)	13 on	Rear	↔	
GS78039	Safari HDP		0/1	9, 1	Land Rover	Defender	90, 110, 130 (Incl. County & LDV)	95 on	Rear	↔	
L55811	Gas Ryder		1/1	1, 1	Volkswagen	Golf	Mk II	84-92	Front	↔	
L55833	Gas Ryder		1/1	1, 1	Volkswagen	Citi	Incl. Chicco (Excl. Sonic, Life & VeloCiti)	84-11	Front	↔	
L69050	Gas Ryder		1/1	3, 2	Volkswagen	Citi	Incl. Chicco (Excl. Sonic, Life & VeloCiti)	84-11	Rear	↔	9
L69068	Gas Ryder		1/1	3, 2	Volkswagen	Golf	Mk II	84-92	Rear	↔	9



PARTS FINDER

SHOCKS, STRUTS & CARTRIDGES

PARTS FINDER 

The Parts Finder is designed to simplify the selection of an alternative manufacturer's part by listing other part numbers in alpha numeric sequence and not by manufacturer.

Where a manufacturer's part number has various Gabriel part numbers that may be used, these are listed as alternatives.

The Gabriel Europe & Gabriel India manufacturing numbers are also listed with the part numbers given as alternatives.

Please note that any reference to brands, trademarks or Manufacturer's part numbers is for reference and identification purposes only.

Part #	Manufacturer	Gabriel	
		Primary	Alternative
AUTOCOM			
PL15001	Autocom	55818	
PL15002	Autocom	55819	
PL15003	Autocom	G45869	
PL15004	Autocom	G45873	
PL15005	Autocom	G56211	
PL15006	Autocom	G56209	
PL15008	Autocom	G45871	
PL15009	Autocom	G45872	
PL15010	Autocom	55861	
PL15011	Autocom	55863	
PL15012	Autocom	55833	
PL15013	Autocom	69050	
PL15014	Autocom	69068	
PL15015	Autocom	G45862	
PL15016	Autocom	G45008	
PL15018	Autocom	G56190	
PL15021	Autocom	G45466	
PL15022	Autocom	70714	
PL15023	Autocom	G45879	
PL15024	Autocom	70527	
PL15025	Autocom	G56224	
PL15026	Autocom	G45844	
PL15027	Autocom	G45870	
PL15028	Autocom	G56189	
PL15029	Autocom	55893	
PL15030	Autocom	55892	
PL15031	Autocom	69092	
PL15032	Autocom	G56169	
PL15033	Autocom	G56170	
PL15034	Autocom	G56214	
PL15035	Autocom	G56215	
FEMO			
SH136001	FEMO	61909	
SH136555	FEMO	61918	
SH140521	FEMO	44217	
SH141571	FEMO	61903	
SH151720	FEMO	G45051	
SH155210	FEMO	61256	
SH155490	FEMO	G45879	
SH185515	FEMO	61248	
SH186060	FEMO	69050	

Part #	Manufacturer	Gabriel	
		Primary	Alternative
SH186066	FEMO	69068	
SH186132	FEMO	69089	
SH186578	FEMO	69092	
SH205510	FEMO	G56211	
SH212020	FEMO	55865	
SH212030	FEMO	70510	
SH235623	FEMO	55858	
SH236569	FEMO	70503	
SH236625	FEMO	55812	
SH236626	FEMO	55813	
SH236737	FEMO	55825	
SH236797	FEMO	55854	
SH236811	FEMO	55839	
SH236812	FEMO	55838	
SH237245	FEMO	55804	
SH237338	FEMO	55811	
SH237339	FEMO	55818	
SH237340	FEMO	55819	
SH237341	FEMO	55833	
SH237344	FEMO	55861	
SH237345	FEMO	55863	
SH237384	FEMO	55841	
SH241850	FEMO	35927	
SH255430	FEMO	55088	
SH255730	FEMO	G56116	
SH865690	FEMO	G45873	
SH865700	FEMO	G45869	
SH865710	FEMO	G45535	
SH866530	FEMO	G45813	
SH866550	FEMO	G45844	
SH866730	FEMO	G45870	
SH866735	FEMO	G45871	
SH866740	FEMO	G45872	
SH866750	FEMO	G45878	
SH867510	FEMO	G45008	
SH872080	FEMO	G56172	
SH872085	FEMO	G56171	
SH872090	FEMO	G56173	
SH872100	FEMO	G56178	
SH876510	FEMO	G45862	
SH876710	FEMO	G56103	
SH876715	FEMO	G45466	
SH876720	FEMO	G56167	

Part #	Manufacturer	Gabriel	
		Primary	Alternative
SH876725	FEMO	G56158	
SH876730	FEMO	G56169	
SH876735	FEMO	G56170	
SH876745	FEMO	G56175	
SH876750	FEMO	G56186	
SH876755	FEMO	G56184	
SH876760	FEMO	G56190	
SH876765	FEMO	G56189	
GABRIEL EUROPE			
721001	Gabriel Europe	14016	
721002	Gabriel Europe	14017	
721050	Gabriel Europe	14011	
721051	Gabriel Europe	14021	
721052	Gabriel Europe	14022	
721053	Gabriel Europe	14023	
721054	Gabriel Europe	14024	
721057	Gabriel Europe	14032	
721058	Gabriel Europe	14033	
721063	Gabriel Europe	14040	
721583	Gabriel Europe	55872	
722870	Gabriel Europe	42314	
723212	Gabriel Europe	35117	
723501	Gabriel Europe	51006	
723527	Gabriel Europe	51026	
723534	Gabriel Europe	51160	
723538	Gabriel Europe	51310	
723617	Gabriel Europe	G35146	
731085	Gabriel Europe	G51059	
731102	Gabriel Europe	G51217	
731103	Gabriel Europe	G51216	
731133	Gabriel Europe	G51275	
733256	Gabriel Europe	G55760	
733303	Gabriel Europe	G55757	
733306	Gabriel Europe	G55760	
733313	Gabriel Europe	G55774	
733321	Gabriel Europe	G51186	
733329	Gabriel Europe	G55723	
733335	Gabriel Europe	G55795	
733341	Gabriel Europe	G55805	
733460	Gabriel Europe	G51227	
734372	Gabriel Europe	G55723	
734404	Gabriel Europe	G44706	

Part #	Manufacturer	Gabriel	
		Primary	Alternative
734409	Gabriel Europe	G44735	
734420	Gabriel Europe	G44705	
734425	Gabriel Europe	G44733	
734514	Gabriel Europe	G44773	
734534	Gabriel Europe	G44782	
734602	Gabriel Europe	G44869	
734607	Gabriel Europe	G44850	
734609	Gabriel Europe	G44895	
734650	Gabriel Europe	G44938	
734651	Gabriel Europe	G44939	
736001	Gabriel Europe	G51195	
736002	Gabriel Europe	G51196	
736020	Gabriel Europe	G51059	
736055	Gabriel Europe	G51082	
736551	Gabriel Europe	G44450	
736558	Gabriel Europe	G44461	
736701	Gabriel Europe	G56504	
736721	Gabriel Europe	G56504	
736722	Gabriel Europe	G55516	
736727	Gabriel Europe	G55514	
737519	Gabriel Europe	G63410	
737522	Gabriel Europe	G63414	
737532	Gabriel Europe	G63422	
737533	Gabriel Europe	G63423	
737535	Gabriel Europe	G63425	
737904	Gabriel Europe	G63423	
739457	Gabriel Europe	G51255	
739605	Gabriel Europe	G51089	
739607	Gabriel Europe	G51099	
739608	Gabriel Europe	G51100	
739609	Gabriel Europe	G51101	
739614	Gabriel Europe	G51097	
739617	Gabriel Europe	G51269	
746540	Gabriel Europe	G35216	
746541	Gabriel Europe	G35217	
746545	Gabriel Europe	G35220	
746546	Gabriel Europe	G35225	
746561	Gabriel Europe	G35222	
746566	Gabriel Europe	G35256	
746567	Gabriel Europe	G35261	
746568	Gabriel Europe	G35227	
746569	Gabriel Europe	G35228	
746570	Gabriel Europe	G35214	

Part #	Manufacturer	Gabriel	
		Primary	Alternative
746573	Gabriel Europe	G35221	
746578	Gabriel Europe	G35234	
746594	Gabriel Europe	G35288	
746598	Gabriel Europe	G35279	
746631	Gabriel Europe	G35289	
746632	Gabriel Europe	G35290	
746634	Gabriel Europe	G35292	
746635	Gabriel Europe	G35284	
746640	Gabriel Europe	G35295	
746641	Gabriel Europe	G35296	
746644	Gabriel Europe	G35299	
746645	Gabriel Europe	G35300	
746646	Gabriel Europe	G35301	
746650	Gabriel Europe	G35305	
746678	Gabriel Europe	G35326	
746705	Gabriel Europe	G55586	
746713	Gabriel Europe	G55592	
746721	Gabriel Europe	G55601	
746724	Gabriel Europe	G55600	
746773	Gabriel Europe	G55614	
746874	Gabriel Europe	G55652	
746875	Gabriel Europe	G55653	
746879	Gabriel Europe	G35037	
746880	Gabriel Europe	G35038	
746941	Gabriel Europe	G55614	
746962	Gabriel Europe	G55673	
746971	Gabriel Europe	G35013	
746994	Gabriel Europe	G55679	
746995	Gabriel Europe	G55680	
747021	Gabriel Europe	G35101	
747030	Gabriel Europe	G35112	
747036	Gabriel Europe	G35118	
747037	Gabriel Europe	G35119	
747038	Gabriel Europe	G35120	
747046	Gabriel Europe	G35128	
747086	Gabriel Europe	G35146	
747090	Gabriel Europe	G35150	
747110	Gabriel Europe	G55697	
747115	Gabriel Europe	G35185	
747123	Gabriel Europe	G55910	
747157	Gabriel Europe	G35160	
747171	Gabriel Europe	G35177	
747187	Gabriel Europe	G35189	

Part #	Manufacturer	Gabriel	
		Primary	Alternative
747188	Gabriel Europe	G35190	
747191	Gabriel Europe	G35193	
747192	Gabriel Europe	G35194	
747196	Gabriel Europe	G35199	
747512	Gabriel Europe	G63508	
747552	Gabriel Europe	G63612	
747567	Gabriel Europe	G63626	
747576	Gabriel Europe	G63636	
747584	Gabriel Europe	G63659	
747588	Gabriel Europe	G63663	
747603	Gabriel Europe	G63679	
747613	Gabriel Europe	G63694	
747620	Gabriel Europe	G63737	
747939	Gabriel Europe	G63679	
747943	Gabriel Europe	G63690	
747968	Gabriel Europe	G63720	
747969	Gabriel Europe	G63721	
747970	Gabriel Europe	G63722	
748120	Gabriel Europe	G63914	
748141	Gabriel Europe	G63920	
748217	Gabriel Europe	G63935	
748242	Gabriel Europe	G63940	
748609	Gabriel Europe	G63914	
750803	Gabriel Europe	G35337	
750804	Gabriel Europe	G35338	
750809	Gabriel Europe	G35343	
750810	Gabriel Europe	G35344	
750813	Gabriel Europe	G35347	
750814	Gabriel Europe	G35348	
750827	Gabriel Europe	G35361	
750828	Gabriel Europe	G35362	
750982	Gabriel Europe	G35412	
750983	Gabriel Europe	G35413	
750993	Gabriel Europe	G35361	
750994	Gabriel Europe	G35362	
755539	Gabriel Europe	G55514	
755560	Gabriel Europe	G35347	
755574	Gabriel Europe	G35365	
755580	Gabriel Europe	G35369	
755581	Gabriel Europe	G35370	
755586	Gabriel Europe	G35421	

Part #	Manufacturer	Gabriel	
		Primary	Alternative
GABRIEL INDIA			
400033	Gabriel India	55231	
400033	Gabriel India	55231	
700060	Gabriel India	61281	
700168	Gabriel India	36860	
700177	Gabriel India	36861	
700178	Gabriel India	36862	
700184	Gabriel India	61283	
700193	Gabriel India	61282	
700979	Gabriel India	36863	
800375	Gabriel India	55232	
800391	Gabriel India	55233	
800398	Gabriel India	55234	
G0169	Gabriel India	35934	
G0170	Gabriel India	35935	
G0176	Gabriel India	51168	
W01217	Gabriel India	35936	
W01218	Gabriel India	35937	
W01243	Gabriel India	35938	
W01244	Gabriel India	35939	
GABRIEL MNF#			
5003211-0301	Gabriel mnf #	76113	
GABRIEL OE			
93599614	Gabriel OE	4277	
KYB			
33917	KYB	70588	
44516	KYB	G55600	
70693	KYB	632141	
70694	KYB	632140	
234901	KYB	G55680	
234902	KYB	G55679	
235627	KYB	55898	
235628	KYB	55900	
235629	KYB	55899	
243025	KYB	G56210	
243033	KYB	36865	
270248	KYB	G56258	
323041	KYB	70519	
331008	KYB	70649	

Part #	Manufacturer	Gabriel	
		Primary	Alternative
331009	KYB	70648	
331017	KYB	G56262	GS446011
331050	KYB	70612	
331051	KYB	70613	
331702	KYB	70506	
331900	KYB	G51217	
332007	KYB	35847	
332009	KYB	55804	
332010	KYB	55804	
332011	KYB	55813	
332012	KYB	55813	
332026	KYB	G45859	
332027	KYB	55817	
332029	KYB	35847	
332054	KYB	55865	
332057	KYB	55856	
332081	KYB	55868	
332088	KYB	55863	
332094	KYB	55870	
332095	KYB	55870	
332100	KYB	G35300	
332101	KYB	G35295	
332108	KYB	55870	
332109	KYB	55870	
332116	KYB	55838	
332117	KYB	55839	
332120	KYB	70700	
332141	KYB	70807	
332142	KYB	70806	
332152	KYB	70806	
332153	KYB	70807	
332152	KYB	70806	
332153	KYB	70807	
332500	KYB	70570	
332501	KYB	70569	
332504	KYB	70801	
332505	KYB	70800	
332807	KYB	70724	
332808	KYB	70723	
333007	KYB	35832	
333021	KYB	35830	
333022	KYB	35831	
333025	KYB	35832	

Part #	Manufacturer	Gabriel	
		Primary	Alternative
333027	KYB	55807	
333028	KYB	55806	
333030	KYB	55810	
333031	KYB	55810	
333051	KYB	55819	
333052	KYB	55819	
333090	KYB	55855	
333114	KYB	55856	
333115	KYB	55812	
333118	KYB	55818	
333119	KYB	55818	
333126	KYB	55825	
333127	KYB	55825	
333179	KYB	55825	
333205	KYB	70520	
333206	KYB	70519	
333211	KYB	55869	
333212	KYB	55869	
333236	KYB	55861	
333237	KYB	55861	
333244	KYB	70535	
333245	KYB	70534	
333246	KYB	70533	
333247	KYB	70532	
333256	KYB	35952	
333257	KYB	35951	
333264	KYB	70526	
333265	KYB	70525	
333274	KYB	55825	
333276	KYB	55890	
		55891	
333298	KYB	35951	
333299	KYB	35952	
333304	KYB	70625	
333305	KYB	70624	
333308	KYB	70500	
333309	KYB	70501	
333314	KYB	70537	
333315	KYB	70536	
333331	KYB	70610	
333332	KYB	70611	
333338	KYB	55892	
333339	KYB	55893	

Part #	Manufacturer	Gabriel	
		Primary	Alternative
333350	KYB	55889	
333351	KYB	55888	
333366	KYB	70551	
333367	KYB	70550	
333368	KYB	70751	
333383	KYB	70568	
333384	KYB	70567	
333390	KYB	70590	
333391	KYB	70589	
333400	KYB	70568	
333401	KYB	70567	
333410	KYB	70611	
333411	KYB	70610	
333417	KYB	35942	
333418	KYB	35941	
333419	KYB	70566	
333420	KYB	70565	
333453	KYB	70580	
333454	KYB	70579	
333464	KYB	35927	
		70510	
333490	KYB	70796	
333491	KYB	70795	
333499	KYB	55833	
333500	KYB	70522	
333501	KYB	70521	
333504	KYB	70531	
333505	KYB	70530	
333506	KYB	70549	
333507	KYB	70548	
333512	KYB	70621	
333513	KYB	70620	
333516	KYB	G54024	
333517	KYB	G54023	
333614	KYB	G35365	
333615	KYB	70600	
333616	KYB	70601	
333709	KYB	G35301	
333710	KYB	G35296	
333712	KYB	55811	
333713	KYB	55881	
333718	KYB	G35421	
333721	KYB	70576	

Part #	Manufacturer	Gabriel	
		Primary	Alternative
333722	KYB	70575	
333727	KYB	G35193	
333728	KYB	G35199	
333729	KYB	G35348	
		70539	
333730	KYB	G35347	
333741	KYB	62025	
		70639	
333744	KYB	70682	
333753	KYB	70688	
333754	KYB	70687	
333755	KYB	70504	
		70527	
333756	KYB	55858	
		70527	
333757	KYB	G35369	
333758	KYB	G35369	
		G35370	
333759	KYB	G35326	
333760	KYB	G35326	
333763	KYB	70781	
333764	KYB	70782	
333802	KYB	35816	
333831	KYB	55858	
333832	KYB	35842	
333833	KYB	55854	
333841	KYB	35816	
333870	KYB	G35279	
333917	KYB	55835	
333918	KYB	55834	
		70587	
333930	KYB	G35412	
333942	KYB	G35214	
333942	KYB	70594	
333944	KYB	G35365	
333946	KYB	70504	
334017	KYB	55815	
334056	KYB	55840	
334082	KYB	55844	
334083	KYB	55843	
334084	KYB	55845	
334088	KYB	G55592	

Part #	Manufacturer	Gabriel	
		Primary	Alternative
334139	KYB	G56518	
		G63799	
334141	KYB	G55673	
334154	KYB	G35225	
334155	KYB	G35220	
334170	KYB	55847	
334171	KYB	55846	
334178	KYB	55863	
334179	KYB	55863	
334188	KYB	G55697	
334197	KYB	70655	
334198	KYB	70654	
334201	KYB	70657	
334202	KYB	70656	
334231	KYB	35944	
334232	KYB	35943	
334233	KYB	35946	
		35946	
334234	KYB	35945	
334241	KYB	70523	
		70524	
334251	KYB	70524	
334252	KYB	70523	
334331	KYB	70629	
334332	KYB	70628	
334354	KYB	G35225	
334360	KYB	70557	
334361	KYB	70556	
334362	KYB	70559	
334363	KYB	70558	
334376	KYB	55893	
334377	KYB	55892	
334424	KYB	70728	
334425	KYB	70727	
334438	KYB	70684	
334439	KYB	70683	
334472	KYB	70609	
334473	KYB	70608	
334473	KYB	70608	
334478	KYB	55849	
334479	KYB	55848	
334500	KYB	70555	
334501	KYB	70554	

Part #	Manufacturer	Gabriel	
		Primary	Alternative
334602	KYB	G35290	
		G35289	
334603	KYB	G35289	
334604	KYB	EG35047	
334605	KYB	EG35046	
334607	KYB	70505	
334608	KYB	70505	
334611	KYB	70785	
334615	KYB	70508	
334620	KYB	70538	
334621	KYB	70548	
		70680	
334622	KYB	70548	
		70679	
334623	KYB	70617	
334624	KYB	70616	
334625	KYB	70577	
334642	KYB	70869	
334626	KYB	70578	
334627	KYB	70578	
334628	KYB	70577	
334642	KYB	70869	
334642	KYB	70712	
334643	KYB	70711	
334644	KYB	70868	
334660	KYB	70511	
334700	KYB	70593	
334701	KYB	70592	
334801	KYB	G35101	
334807	KYB	35117	
334810	KYB	55841	
334811	KYB	62022	
334812	KYB	55872	
334815	KYB	70702	
334816	KYB	70701	
334831	KYB	G35451	
334832	KYB	70619	
334833	KYB	70618	
334834	KYB	70546	
334835	KYB	70503	
334842	KYB	70634	
334843	KYB	70633	
334847	KYB	61918	

Part #	Manufacturer	Gabriel	
		Primary	Alternative
334864	KYB	70710	
334903	KYB	EG35115	
334913	KYB	G35216	
334917	KYB	G35160	
334921	KYB	G35189	
334922	KYB	69922	
334925	KYB	70588	
334926	KYB	70587	
334939	KYB	70509	
334946	KYB	70508	
334947	KYB	G35190	
335032	KYB	G56173	
335042	KYB	70518	
335043	KYB	70517	
335607	KYB	70591	
335808	KYB	70546	
		70640	
335810	KYB	70506	
335811	KYB	G35228	
335812	KYB	G35228	
335815	KYB	70815	
335816	KYB	70814	
335833	KYB	70643	
335834	KYB	70642	
335920	KYB	70602	
335924	KYB	70542	
		70543	
335925	KYB	70542	
335931	KYB	70713	
338001	KYB	70716	
338002	KYB	70715	
338022	KYB	70794	
338023	KYB	70793	
338024	KYB	70824	
338025	KYB	70825	
338064	KYB	70690	
338065	KYB	70689	
338106	KYB	70852	
338107	KYB	70851	
338106	KYB	70852	
338107	KYB	70851	
338713	KYB	70586	
339029	KYB	70564	

Part #	Manufacturer	Gabriel	
		Primary	Alternative
339030	KYB	70563	
339031	KYB	70674	
339032	KYB	70673	
339074	KYB	70598	
339075	KYB	70599	
339086	KYB	55887	
339087	KYB	55886	
339196	KYB	70662	
339197	KYB	70661	
339198	KYB	70664	
339199	KYB	70663	
339249	KYB	70847	
339250	KYB	70848	
339253	KYB	70831	
339254	KYB	70832	
339261	KYB	70719	
339262	KYB	70718	
339700	KYB	70562	
339701	KYB	70561	
339702	KYB	70631	
		70632	
339703	KYB	70631	
339707	KYB	70764	
339708	KYB	70763	
339716	KYB	70709	
339717	KYB	70708	
339727	KYB	70509	
339728	KYB	70508	
339741	KYB	70714	
339742	KYB	70637	
339743	KYB	70638	
339746	KYB	70636	
339747	KYB	70535	
339754	KYB	70834	
339755	KYB	70833	
339852	KYB	70659	
340015	KYB	G56290	
340023	KYB	G56222	
340023	KYB	G56276	
340031	KYB	62139	
340034	KYB	G56205	
340036	KYB	69137	
340037	KYB	69138	

Part #	Manufacturer	Gabriel	
		Primary	Alternative
340060	KYB	69134	
340076	KYB	69117	
341001	KYB	36760	
341002	KYB	61201	
341031	KYB	69074	
341043	KYB	62351	
341050	KYB	69067	
341080	KYB	62352	
341081	KYB	62353	
341085	KYB	69075	
341088	KYB	55820	
341094	KYB	69076	
341120	KYB	G51213	
341133	KYB	69072	
341144	KYB	62352	
341145	KYB	69110	
341147	KYB	G51059	
341166	KYB	69965	
341189	KYB	69921	
341190	KYB	G51227	
341192	KYB	G51186	
341198	KYB	G55910	
341204	KYB	G51269	
341227	KYB	G51214	
341232	KYB	51240	
341234	KYB	69084	
341239	KYB	69914	
341247	KYB	G56178	
341249	KYB	69401	
		69446	
341250	KYB	69446	
341251	KYB	G56237	
341260	KYB	G51255	
341261	KYB	G51256	
341279	KYB	69093	
341280	KYB	69099	
341281	KYB	69100	
341282	KYB	69093	
341311	KYB	G51298	
341322	KYB	69092	
		69103	
341338	KYB	69092	
341340	KYB	G56226	

Part #	Manufacturer	Gabriel	
		Primary	Alternative
341355	KYB	G56212	
341364	KYB	G45899	
341365	KYB	G45898	
341372	KYB	G56218	
341395	KYB	G51227	
341397	KYB	G45889	
341398	KYB	G45888	
341463	KYB	69104	
341492	KYB	69120	
341499	KYB	69135	
341654	KYB	69141	
341654	KYB	69141	
341684	KYB	46003	GS46010
341717	KYB	69119	
341814	KYB	61298	
		62024	
341817	KYB	G51275	
341821	KYB	69106	
341840	KYB	G51216	
341842	KYB	69087	
341845	KYB	69101	
341846	KYB	83367	
341904	KYB	G51101	
341910	KYB	G51238	
341911	KYB	G51239	
341924	KYB	69109	
341952	KYB	G51089	
341953	KYB	69082	
342001	KYB	19021	
342009	KYB	19022	
343005	KYB	G45489	
343007	KYB	G45399	
343017	KYB	82608	
343022	KYB	36850	
343036	KYB	G45841	
343044	KYB	61230	
343046	KYB	36854	
343047	KYB	G45874	
343087	KYB	G45419	
343097	KYB	G45893	
343098	KYB	G45006	
343099	KYB	61252	
343116	KYB	G45078	

Part #	Manufacturer	Gabriel	
		Primary	Alternative
343127	KYB	G45255	
343150	KYB	61200	
343152	KYB	36851	
343154	KYB	G45466	
343157	KYB	G45534	
343169	KYB	69050	
		69089	
343181	KYB	G45417	
343183	KYB	G45824	
343185	KYB	G45122	
343187	KYB	G45860	
343189	KYB	61241	
343191	KYB	69068	
343195	KYB	G56158	
343198	KYB	G45905	
343199	KYB	G45870	
		G56186	
343200	KYB	G56102	
343208	KYB	G56171	
343214	KYB	G56116	
343215	KYB	G45871	
		G56173	
343216	KYB	69460	
343228	KYB	G45878	
343231	KYB	36855	
343246	KYB	G56167	
343251	KYB	G45006	
		G56116	
343252	KYB	G56116	G45871
343253	KYB	G56167	
		G578001	
343255	KYB	61248	
343265	KYB	61256	
343271	KYB	G51023	
343272	KYB	G63940	
343274	KYB	69081	
343281	KYB	69946	
343287	KYB	G45901	
343288	KYB	G45902	
343289	KYB	69989	
343290	KYB	69422	
343292	KYB	G56116	
343295	KYB	62060	

Part #	Manufacturer	Gabriel	
		Primary	Alternative
343298	KYB	G45900	
343299	KYB	G56309	
343304	KYB	36875	
343308	KYB	G56224	
		69415	
343319	KYB	69924	
343326	KYB	G56116	
343328	KYB	G45879	
343330	KYB	69948	
343334	KYB	G45844	
343336	KYB	G45869	
343337	KYB	G56186	G45870
343338	KYB	G56171	
343342	KYB	G56172	G45869
343343	KYB	G56116	
343344	KYB	G45008	
343346	KYB	G56167	
343348	KYB	61262	
343350	KYB	61256	
343352	KYB	61248	
343353	KYB	61295	
		G56103	
343366	KYB	G56171	
343367	KYB	G56116	G45872
		G56190	
343369	KYB	G56171	
343381	KYB	61296	
343388	KYB	G556260	
343398	KYB	61285	
343405	KYB	62000	
343406	KYB	62040	
343412	KYB	G45892	
343413	KYB	G45894	
		70584	
343415	KYB	62080	
343419	KYB	62023	
343420	KYB	62055	
343424	KYB	62015	
343432	KYB	36867	
343442	KYB	G45890	
343459	KYB	62044	
343465	KYB	62006	
343472	KYB	G45891	62038

Part #	Manufacturer	Gabriel	
		Primary	Alternative
343478	KYB	G45897	62089
		62089	
343479	KYB	62011	
343482	KYB	62012	
343484	KYB	62008	
343491	KYB	62094	
343807	KYB	62001	
343808	KYB	62062	
343809	KYB	G45890	
		62090	
343824	KYB	G45879	
344001	KYB	36761	
344004	KYB	G45450	
344031	KYB	G45418	
344041	KYB	G63423	
344044	KYB	G56116	
344058	KYB	G56172	G45869
344059	KYB	G56175	G45873
		G45873	
344060	KYB	G56179	
344063	KYB	G56116	G45006
344064	KYB	G45466	
		G56185	
344085	KYB	G56116	
344088	KYB	G578025	
344102	KYB	G45051	
344105	KYB	G63612	
344115	KYB	69919	
344200	KYB	G45871	
344202	KYB	G56189	
344203	KYB	G56173	
344204	KYB	G56209	
344207	KYB	G56179	
344217	KYB	G56166	
344222	KYB	46004	
344223	KYB	46005	
344229	KYB	EG63659	
344230	KYB	69901	
344257	KYB	G63935	
344288	KYB	83454	
344288	KYB	83456	
344297	KYB	61284	
344300	KYB	G56274	

Part #	Manufacturer	Gabriel	
		Primary	Alternative
344302	KYB	G56178	
		G56251	
344304	KYB	G56170	G56298
344305	KYB	G56169	
344314	KYB	61289	
344318	KYB	55088	
344320	KYB	G56177	
344325	KYB	G56102	
344334	KYB	G56102	
		G56116	
344346	KYB	G56172	
344359	KYB	G63720	
344361	KYB	G56174	
344389	KYB	36859	
344392	KYB	G63721	
344393	KYB	GS78025	
344404	KYB	G56263	
344409	KYB	83450	
344410	KYB	G56227	
344418	KYB	GS56261	
344420	KYB	G56214	
344421	KYB	G56213	
344446	KYB	62019	
344451	KYB	G56266	
344453	KYB	61287	
344454	KYB	61288	
344456	KYB	62007	
344458	KYB	62010	
344459	KYB	62018	
		62002	
344485	KYB	G56209	
344487	KYB	62021	
344493	KYB	G56211	
344800	KYB	69538	
		69538	
344804	KYB	69512	
344807	KYB	61298	
		62003	
344808	KYB	62003	
344810	KYB	62043	
344816	KYB	62102	
345005	KYB	G56165	
		GS78008	

Part #	Manufacturer	Gabriel	
		Primary	Alternative
345006	KYB	55227	
345010	KYB	G56231	
345014	KYB	G56164	
		GS78007	
345023	KYB	83456	
		GS78012	
345035	KYB	G56230	
345044	KYB	G56239	
345056	KYB	GS56260	
345076	KYB	62046	
348007	KYB	62016	
348016	KYB	62058	
348027	KYB	G56236	
348028	KYB	62037	
348029	KYB	62091	
348032	KYB	62052	
348053	KYB	62084	
348062	KYB	62091	
349015	KYB	G56207	
349017	KYB	GS78010	
349018	KYB	69415	
349023	KYB	G56208	
349024	KYB	62014	
349035	KYB	61297	
349042	KYB	69102	
349052	KYB	61270	
349063	KYB	69107	
		69108	
349067	KYB	62050	
349078	KYB	62033	
349079	KYB	62026	
349087	KYB	62053	
349090	KYB	G56269	
349098	KYB	62086	
349106	KYB	62107	
349122	KYB	62082	
349133	KYB	62057	
349138	KYB	62083	
349162	KYB	G56102	
		55088	
349189	KYB	62036	
349194	KYB	62073	
349200	KYB	62028	

Part #	Manufacturer	Gabriel	
		Primary	Alternative
349207	KYB	62015	
351700	KYB	G51099	
354003	KYB	G556261	
362001	KYB	44217	
363014	KYB	G44850	
363017	KYB	G44733	
363023	KYB	44614	
363060	KYB	55818	
363500	KYB	44085	
364001	KYB	44602	
364014	KYB	55811	
365007	KYB	44611	
365015	KYB	44614	
365021	KYB	44601	
365024	KYB	61906	
365043	KYB	61914	
365054	KYB	44933	
365069	KYB	61302	
365076	KYB	44603	
365093	KYB	G44782	
365501	KYB	61909	
		44607	
365504	KYB	61918	
		44411	
366002	KYB	61303	
366012	KYB	G44461	
441017	KYB	51309	
441021	KYB	61201	
441042	KYB	51310	
441079	KYB	G51059	
441960	KYB	51310	
442027	KYB	G45861	
443016	KYB	G56153	
443017	KYB	G56156	
443018	KYB	G45837	
443020	KYB	44505	
443022	KYB	44516	
443023	KYB	44514	
443045	KYB	G45419	
443046	KYB	18727	
443078	KYB	G56171	
443079	KYB	G45432	
443080	KYB	G56171	

Part #	Manufacturer	Gabriel	
		Primary	Alternative
443081	KYB	G56105	
443085	KYB	G45523	
443093	KYB	G45812	
443105	KYB	G45813	
443107	KYB	G45008	
443108	KYB	G45398	
443127	KYB	G45666	
443134	KYB	G45874	
443164	KYB	51016	
443172	KYB	69050	
443181	KYB	G45466	
443186	KYB	G45870	
		G56186	
443188	KYB	G45844	
443190	KYB	G45869	
443206	KYB	69654	
443207	KYB	36857	
443214	KYB	G45862	
443217	KYB	G45870	
443225	KYB	61256	
443226	KYB	G56116	
443236	KYB	69081	
443238	KYB	G56172	G45869
443239	KYB	G56171	
443240	KYB	G56116	G45872
		G56190	
443241	KYB	G56167	
443258	KYB	G56116	
443259	KYB	G56116	G45871
443290	KYB	G56116	
443293	KYB	G56171	
443295	KYB	G56103	
443301	KYB	36875	
443305	KYB	G56116	
443400	KYB	69412	36867
443800	KYB	69068	
444023	KYB	G45051	
		G56102	
444025	KYB	G56116	G45006
444026	KYB	G56162	
444028	KYB	36872	
444036	KYB	G45450	
444039	KYB	G45535	

Part #	Manufacturer	Gabriel	
		Primary	Alternative
444042	KYB	G56162	
444043	KYB	G56126	
444054	KYB	G56166	
444062	KYB	G45667	
444077	KYB	G45258	
444083	KYB	76132	
444085	KYB	G56172	G45869
444096	KYB	G56161	
444097	KYB	G56219	
444103	KYB	G56189	
444104	KYB	G56173	
444118	KYB	G45447	
444129	KYB	G56119	
444130	KYB	G56168	
444135	KYB	G56169	
444136	KYB	G56170	
444150	KYB	G56172	
444162	KYB	G56178	
444172	KYB	G56175	G45873
444225	KYB	G56157	
444257	KYB	G56185	
444268	KYB	76110	
444308	KYB	76042	
445005	KYB	G56112	
445009	KYB	G56113	
445010	KYB	83233	
445020	KYB	G56161	
445026	KYB	G56164	
445034	KYB	G56164	
445035	KYB	G56246	GS78029
445036	KYB	G56247	GS78030
445038	KYB	G56180	
445064	KYB	76016	76043
445064	KYB	76043	
446065	KYB	76207	
551013	KYB	61902	
551018	KYB	61202	
551019	KYB	36849	
551022	KYB	69066	
551061	KYB	69966	
551805	KYB	42826	
551807	KYB	69928	
551900	KYB	G51217	

Part #	Manufacturer	Gabriel	
		Primary	Alternative
551921	KYB	69444	
553060	KYB	G56116	
553074	KYB	69677	
553085	KYB	G45523	
553137	KYB	61252	
553177	KYB	69744	
553183	KYB	61253	
553185	KYB	61254	
553200	KYB	69966	
553206	KYB	61262	
553218	KYB	69922	
553219	KYB	69938	
553225	KYB	69989	
553237	KYB	69956	
553241	KYB	62019	
553243	KYB	69507	
553245	KYB	69957	
		62092	
553306	KYB	62004	
553308	KYB	61299	
553337	KYB	42942	
553338	KYB	G56268	
553340	KYB	62030	
553356	KYB	62013	
553365	KYB	62011	
554003	KYB	36761	
554004	KYB	55208	
554006	KYB	G45423	
554017	KYB	G45078	
554036	KYB	G56119	
554038	KYB	G56168	
554063	KYB	G56173	
554094	KYB	G63720	
554095	KYB	G56176	
554101	KYB	G56298	
554338	KYB	61287	
555004	KYB	G56165	
555608	KYB	61292	
632004	KYB	55804	
632005	KYB	55804	
632040	KYB	55816	
632073	KYB	55855	
632116	KYB	35955	

Part #	Manufacturer	Gabriel	
		Primary	Alternative
632117	KYB	35956	
633004	KYB	44221	
633041	KYB	69095	
633137	KYB	55825	
633138	KYB	55825	
633179	KYB	70519	
633181	KYB	70545	
		70521	
633182	KYB	70544	
		70522	
633204	KYB	35952	
633205	KYB	35951	
633274	KYB	55833	
633712	KYB	55811	
633718	KYB	G35421	
633730	KYB	70540	
633744	KYB	70682	
633807	KYB	35824	
633827	KYB	70511	
633831	KYB	55858	
634001	KYB	35836	
634026	KYB	G55601	
634073	KYB	G56518	
634100	KYB	35944	
634101	KYB	35943	
634102	KYB	35946	
634103	KYB	35945	
634810	KYB	55841	
662001	KYB	44227	
663016	KYB	44532	
663017	KYB	44225	
663018	KYB	44535	
664003	KYB	44510	
664007	KYB	44604	
664010	KYB	44564	
665011	KYB	44608	
665015	KYB	G44869	
665020	KYB	44612	
665037	KYB	G44939	
665038	KYB	44613	
665042	KYB	44615	
665050	KYB	44601	
665058	KYB	61915	

Part #	Manufacturer	Gabriel	
		Primary	Alternative
3320006	KYB	70829	
3320007	KYB	70828	
3358001	KYB	70845	
3358002	KYB	70846	
3430015	KYB	62101	
3440025	KYB	G56299	
3440026	KYB	G56300	
333492/3	KYB	62086	
MONROE			
AU160766	Monroe	G578034	
R1000	Monroe	G45006	
R1581	Monroe	G63423	
R1610	Monroe	G56175	
R1611	Monroe	G56119	
R1613	Monroe	G45871	
R1643	Monroe	36875	
R2029	Monroe	36760	
R2030	Monroe	36761	
R2592	Monroe	G45417	
R2602	Monroe	G45503	
R2605	Monroe	44516	
R2617	Monroe	G45837	
R2632	Monroe	61252	
R2646	Monroe	61256	
R2659	Monroe	G45535	
R2713	Monroe	69050	
R2714	Monroe	69068	
R2715	Monroe	14032	
R2716	Monroe	14011	
R2719	Monroe	51016	
R2720	Monroe	51168	
R2721	Monroe	G56203	GS56264
R2722	Monroe	G56204	GS56265
R2724	Monroe	61202	
R2773	Monroe	61283	
R2775	Monroe	36862	
R2778	Monroe	61281	
R3216	Monroe	G45533	
R3269	Monroe	36849	
R3277	Monroe	19289	
R3282	Monroe	36853	
R3405	Monroe	G45861	

Part #	Manufacturer	Gabriel	
		Primary	Alternative
R3410	Monroe	G45858	
R3469	Monroe	70532	
R3472	Monroe	69921	
R3702	Monroe	36851	
R3724	Monroe	36851	
R3726	Monroe	51016	
R3729	Monroe	69067	
R3737	Monroe	G55723	
R3750	Monroe	69076	
R3758	Monroe	G45861	
R3759	Monroe	55810	
R3769	Monroe	G55910	
R3776	Monroe	G51186	
R4434	Monroe	G56179	
R5410	Monroe	G45258	
R5522	Monroe	61282	
R6507	Monroe	51310	
R6519	Monroe	51310	
R7001	Monroe	55870	
R7002	Monroe	55869	
R7101	Monroe	55869	
R7202	Monroe	55811	
R7203	Monroe	35935	
R7204	Monroe	35934	
R7210	Monroe	55833	
R7213	Monroe	35941	
R7214	Monroe	35942	
R7613	Monroe	70549	
R7614	Monroe	70548	
R8001	Monroe	G35348	
R8002	Monroe	G35347	
10014	Monroe	35831	
10016	Monroe	35817	
10049	Monroe	55868	
10053	Monroe	G35279	
11003	Monroe	44221	
11036	Monroe	35824	
11039	Monroe	35847	
R11040	Monroe	35832	
11069	Monroe	55807	
11261	Monroe	35833	
11273	Monroe	70512	
11339	Monroe	70624	

Part #	Manufacturer	Gabriel	
		Primary	Alternative
11340	Monroe	70625	
11377	Monroe	35955	
11378	Monroe	35956	
11519	Monroe	G35101	
11545	Monroe	G55600	
11546	Monroe	G55601	
11654	Monroe	44502	
11743	Monroe	35117	
11779	Monroe	35944	
11780	Monroe	35943	
11781	Monroe	35946	
11782	Monroe	35945	
16211	Monroe	35816	
16242	Monroe	70511	
16244	Monroe	55896	
16245	Monroe	55897	
16248	Monroe	55895	
16249	Monroe	55894	
16304	Monroe	G35299	
16305	Monroe	G35284	
16331	Monroe	70526	
16332	Monroe	70525	
16343	Monroe	70537	
16344	Monroe	70536	
16361	Monroe	70551	
16362	Monroe	70550	
16381	Monroe	70781	
16382	Monroe	70782	
16411	Monroe	70654	
16412	Monroe	70655	
16440	Monroe	G35338	
16441	Monroe	G35337	
16471	Monroe	70648	
16472	Monroe	70649	
16508	Monroe	35836	
16511	Monroe	55815	
16639	Monroe	55834	
16640	Monroe	55835	
16657	Monroe	EG35115	
16681	Monroe	44227	
16734	Monroe	G55673	
16776	Monroe	G35214	
16796	Monroe	70683	

Part #	Manufacturer	Gabriel	
		Primary	Alternative
16797	Monroe	70684	
19501	Monroe	42942	
22045	Monroe	19021	
23248	Monroe	36850	
23267	Monroe	G45666	
23404	Monroe	G45824	
23436	Monroe	61248	
23442	Monroe	69689	
23810	Monroe	G51186	
23829	Monroe	69110	
23858	Monroe	69084	
23859	Monroe	G55910	
23871	Monroe	G55821	
23875	Monroe	G55877	
23895	Monroe	G51214	
23896	Monroe	69425	
23904	Monroe	69422	
23910	Monroe	62060	
23932	Monroe	G51269	
23935	Monroe	G51275	
23951	Monroe	G51238	
23957	Monroe	69924	
23965	Monroe	61270	
23967	Monroe	69538	
23968	Monroe	61296	
23969	Monroe	61295	
23970	Monroe	G51298	
23972	Monroe	62001	
23974	Monroe	61284	
23977	Monroe	62080	
23979	Monroe	62050	
23982	Monroe	62019	
23988	Monroe	G45894	
23989	Monroe	69109	
23990	Monroe	62010	
23992	Monroe	G45892	
25504	Monroe	61286	
26327	Monroe	69072	
26340	Monroe	69072	
26624	Monroe	62352	
26635	Monroe	62353	
34905	Monroe	G56102	
34963	Monroe	G45051	

Part #	Manufacturer	Gabriel	
		Primary	Alternative
37026	Monroe	G63721	
37027	Monroe	G556261	
37083	Monroe	G578025	
37122	Monroe	G56169	
37135	Monroe	G63722	
37203	Monroe	G56263	
376041SP	Monroe	G45879	
42021	Monroe	G45841	
42041	Monroe	69965	
42058	Monroe	69965	
42060	Monroe	69922	
43001	Monroe	61201	
43009	Monroe	61202	
43013	Monroe	69066	
43027	Monroe	69677	
43050	Monroe	36855	
43070	Monroe	69744	
43082	Monroe	61253	
43095	Monroe	69927	
43109	Monroe	69446	
43110	Monroe	69401	
43125	Monroe	61299	
44001	Monroe	62009	
52003	Monroe	36854	
53005	Monroe	55208	
53007	Monroe	61230	
55016	Monroe	61248	
55019	Monroe	69928	
65107	Monroe	76009	
65139	Monroe	85320	
65490	Monroe	85724	
66147	Monroe	85320	
66601	Monroe	76110	
66618	Monroe	76110	
66626	Monroe	55232	
66653	Monroe	76108	
66675	Monroe	55243	
66886	Monroe	76007	
71326	Monroe	69099	
71380	Monroe	69104	
71406	Monroe	70522	
71407	Monroe	70521	
71417	Monroe	69099	

Part #	Manufacturer	Gabriel	
		Primary	Alternative
71435	Monroe	70554	
71436	Monroe	70555	
71577	Monroe	G56263	
71578	Monroe	55899	
71579	Monroe	55900	
71580	Monroe	55898	
71599	Monroe	69099	
71837	Monroe	G55600	
71959	Monroe	G55679	
71960	Monroe	G55680	
71964	Monroe	G55697	
72170	Monroe	70518	
72171	Monroe	70517	
72222	Monroe	70635	
72286	Monroe	70598	
72287	Monroe	70599	
72288	Monroe	70609	
72289	Monroe	70608	
72295	Monroe	35941	
72296	Monroe	35941	
72297	Monroe	G54023	
72298	Monroe	G54024	
72950ST	Monroe	70868	
72951ST	Monroe	70869	
72952ST	Monroe	69141	
74028	Monroe	77018	
74074	Monroe	55233	
74076	Monroe	76016	
74081	Monroe	76204	
742036SP	Monroe	70714	
742053SP	Monroe	70659	
74425	Monroe	85724	
77721	Monroe	70636	
358010	Monroe	70828	
358011	Monroe	70829	
911123	Monroe	G63690	
931964	Monroe	G55697	
0C970	Monroe	44611	
15-0202	Monroe	69664	
150804R	Monroe	G56269	
158009R	Monroe	62101	
16-0132	Monroe	G56119	
16-0300	Monroe	GS78019	

Part #	Manufacturer	Gabriel	
		Primary	Alternative
16-0366	Monroe	G56169	GS56233
16-0367	Monroe	G56170	GS78014
16-0369	Monroe	EG63659	
16-0460	Monroe	G56246	GS78029
16-0461	Monroe	GS78030	
16-0466	Monroe	G56239	
16-0500	Monroe	G56230	
16-0630	Monroe	G56205	
16-0640	Monroe	G56236	GS56259
16-1712	Monroe	G56168	
35-0550	Monroe	70557	
35-0551	Monroe	70556	
35-0552	Monroe	70559	
35-0553	Monroe	70558	
350749R	Monroe	70608	
350750R	Monroe	70609	
350809R	Monroe	70716	
350810R	Monroe	70715	
37123ST	Monroe	G63690	
37289ST	Monroe	62014	
5609ST	Monroe	62011	
5621ST	Monroe	62016	
5622ST	Monroe	62085	
5645ST	Monroe	62073	
5794ST	Monroe	36866	
5799ST	Monroe	62015	
65411MM	Monroe	77018	
66107MM	Monroe	76151	
66626MM	Monroe	55232	
66675MM	Monroe	55243	
66886MM	Monroe	76040	
71406ST	Monroe	70522	
71407ST	Monroe	70521	
71578ST	Monroe	55899	
71579ST	Monroe	55900	
72143ST	Monroe	70612	
72144ST	Monroe	70613	
72219ST	Monroe	70635	
72220ST	Monroe	70636	
72246ST	Monroe	70620	
72247ST	Monroe	70621	
72275ST	Monroe	70673	
72276ST	Monroe	70674	

Part #	Manufacturer	Gabriel	
		Primary	Alternative
72286ST	Monroe	70598	
72287ST	Monroe	70599	
72295ST	Monroe	35942	
72296ST	Monroe	35941	
72305ST	Monroe	70793	
72306ST	Monroe	70794	
72367ST	Monroe	70711	
72368ST	Monroe	70712	
72401ST	Monroe	69117	
72491ST	Monroe	70718	
72492ST	Monroe	70719	
72497ST	Monroe	69120	
72509ST	Monroe	70847	
72510ST	Monroe	70848	
72522ST	Monroe	70771	
72523ST	Monroe	70772	
72896ST	Monroe	69135	
74076MM	Monroe	77000	
742026SP	Monroe	G35228	
742071SP	Monroe	70658	
742072SP	Monroe	70658	
742116SP	Monroe	70853	
72562ST	Monroe	69137	
72562ST	Monroe	69138	
72563ST	Monroe	69139	
74466MM	Monroe	55233	
83831EA	Monroe	62058	
83833EA	Monroe	G56255	
84751EA	Monroe	70759	
94144A-B	Monroe	70583	
94155A	Monroe	70583	
94176A	Monroe	70594	
94185A	Monroe	70715	
94186A	Monroe	70716	
AU160132	Monroe	G56119	
AU160460	Monroe	G56246	
AU160461	Monroe	G56247	
AU160466	Monroe	G56239	
AU160604	Monroe	G56236	
AU160844	Monroe	G546009	
AU160894	Monroe	G56230	
AU160895	Monroe	G578011	
AU161704	Monroe	G56166	

Part #	Manufacturer	Gabriel	
		Primary	Alternative
AU161712	Monroe	G56168	
AU350550	Monroe	70557	
AU350551	Monroe	70556	
AU350552	Monroe	70559	
AU350553	Monroe	70558	
AU360590	Monroe	G56237	
AU360886	Monroe	G56205	
B0001	Monroe	76017	
B0004	Monroe	76009	
B0005	Monroe	77011	
D0003	Monroe	70614	
D0009	Monroe	70523	
D0011	Monroe	70628	
D0019	Monroe	70556	
D0021	Monroe	70558	
D0023	Monroe	70661	
D0027	Monroe	70663	
D0038	Monroe	70845	
D0201	Monroe	G56518	
D0202	Monroe	44532	
D0405	Monroe	70642	
D0407	Monroe	70542	
D0801	Monroe	51309	
D2653	Monroe	G45398	
D4003	Monroe	61292	
D4005	Monroe	62021	
D4044	Monroe	G56163	
D4426	Monroe	G56219	
D4445	Monroe	G56167	
D4462	Monroe	G56171	
D4463	Monroe	G45872	
D4473	Monroe	G556260	
D4482	Monroe	G56185	
D4484	Monroe	G56113	
D4486	Monroe	G56171	
D5467	Monroe	G56158	
D5470	Monroe	46004	
D5471	Monroe	46005	
D5475	Monroe	36761	
D5476	Monroe	G63935	
D6415	Monroe	G56162	
D6437	Monroe	G56164	
D6643	Monroe	G56165	

Part #	Manufacturer	Gabriel	
		Primary	Alternative
D7003	Monroe	G56274	
D7004	Monroe	G63720	
D7005	Monroe	G51255	
D7006	Monroe	G51256	
D7007	Monroe	G51227	
D7018	Monroe	62026	
D7019	Monroe	62033	
D7021	Monroe	62038	
D7029	Monroe	G45122	
D7561	Monroe	G45432	
D7633	Monroe	G63799	
D7694	Monroe	G63940	
D7703	Monroe	G56184	
D7705	Monroe	G45901	
D7706	Monroe	G45902	
D7841	Monroe	G51227	
D8005	Monroe	G56237	
D8014	Monroe	61287	
D8015	Monroe	61288	
D8016	Monroe	G56239	
D8019	Monroe	G56227	
D8020	Monroe	61289	
D8022	Monroe	83455	
D8023	Monroe	83456	
D8024	Monroe	G56218	
D8026	Monroe	G45898	
D8028	Monroe	G56266	
D8070	Monroe	46003	
D8343	Monroe	46002	
D8344	Monroe	46001	
D8443	Monroe	G45054	
D8465	Monroe	G56173	
D8467	Monroe	G56167	
D8483	Monroe	G56105	
D8641	Monroe	G56180	
D8902	Monroe	G56184	
D9013	Monroe	GS78034	
D9014	Monroe	G56293	
E1007	Monroe	69050	
E1008	Monroe	69068	
E1020	Monroe	61248	
E1042	Monroe	69901	
E1071	Monroe	69081	

Part #	Manufacturer	Gabriel	
		Primary	Alternative
E1088	Monroe	G51023	
E1089	Monroe	G51023	
E1095	Monroe	61256	
E1104	Monroe	69921	
E1115	Monroe	61239	
E1162	Monroe	G51089	
E1166	Monroe	G51023	
E1180	Monroe	G55910	
E1189	Monroe	G51214	
E1192	Monroe	G51213	
E1203	Monroe	69948	
E1205	Monroe	61262	
E1233	Monroe	69425	
E1239	Monroe	G51235	
E1242	Monroe	69422	
E1259	Monroe	69507	
E1274	Monroe	G45879	
E1276	Monroe	G51238	
E1278	Monroe	G51239	
E1284	Monroe	61298	
E1285	Monroe	61298	
E1286	Monroe	69924	
E1289	Monroe	G51275	
E1292	Monroe	69093	
E1293	Monroe	69415	
E1295	Monroe	G45900	
E1312	Monroe	69092	
E1319	Monroe	69538	
E1325	Monroe	69109	
E1331	Monroe	69512	
E1335	Monroe	62050	
E1336	Monroe	69507	
E1337	Monroe	61293	
E1338	Monroe	69987	
E1340	Monroe	70584	
E1341	Monroe	62018	
E1342	Monroe	62023	
E1354	Monroe	62044	
E1355	Monroe	61298	
E1356	Monroe	62003	
E2001	Monroe	62353	
E2020	Monroe	69087	
E2029	Monroe	69926	

Part #	Manufacturer	Gabriel	
		Primary	Alternative
E2034	Monroe	G51101	
E2040	Monroe	G51216	
E2041	Monroe	G51216	
E2042	Monroe	69087	
E2048	Monroe	69087	
E2051	Monroe	69946	
E2055	Monroe	69101	
E2056	Monroe	G56214	
E2058	Monroe	G56213	
E2068	Monroe	69102	
E3411	Monroe	44085	
E3454	Monroe	G44461	
E3802	Monroe	61302	
E4201	Monroe	55811	
E4211	Monroe	55854	
E4273	Monroe	55863	
E4341	Monroe	55816	
E4342	Monroe	55817	
E4364	Monroe	55858	
E4370	Monroe	70511	
E4386	Monroe	G35296	
E4390	Monroe	G35365	
E4410	Monroe	55815	
E4424	Monroe	55840	
E4489	Monroe	55861	
E4493	Monroe	G35112	
E4499	Monroe	G35128	
E4508	Monroe	EG35115	
E4513	Monroe	55841	
E4555	Monroe	G35160	
E4562	Monroe	G35190	
E4583	Monroe	G35216	
E4585	Monroe	G35189	
E4622	Monroe	G35228	
E4624	Monroe	G35228	
E4628	Monroe	G35227	
E4630	Monroe	70602	
E4631	Monroe	70808	
E4642	Monroe	70633	
E4644	Monroe	70814	
E4712	Monroe	70710	
E4719	Monroe	70500	
E4733	Monroe	70519	

Part #	Manufacturer	Gabriel	
		Primary	Alternative
E4743	Monroe	G35300	
E4749	Monroe	G35451	
E4750	Monroe	G35421	
E4879	Monroe	G35288	
E4882	Monroe	70505	
E4886	Monroe	G35199	
E4908	Monroe	61918	
E4910	Monroe	70508	
E4912	Monroe	70508	
E4963	Monroe	G35289	
E4972	Monroe	69922	
E4973	Monroe	G35348	
E4991	Monroe	G35347	
E4997	Monroe	70503	
E5005	Monroe	69965	
E5026	Monroe	61253	
E5027	Monroe	61254	
E5038	Monroe	69919	
E5065	Monroe	69966	
E5066	Monroe	69423	
E5067	Monroe	69952	
E5068	Monroe	69966	
E5069	Monroe	62035	
E5083	Monroe	69956	
E5084	Monroe	69957	
E5087	Monroe	69946	
E5090	Monroe	69444	
E5091	Monroe	G51217	
E5098	Monroe	62004	
E5099	Monroe	69446	
E5109	Monroe	61299	
E5116	Monroe	62030	
E5117	Monroe	62032	
E5303	Monroe	69460	
E5309	Monroe	42826	
E5317	Monroe	69938	
E5609	Monroe	69928	
E5615	Monroe	62082	
E7008	Monroe	55892	
E7026	Monroe	70703	
E7029	Monroe	70546	
E7030	Monroe	70546	
E7032	Monroe	55834	

Part #	Manufacturer	Gabriel	
		Primary	Alternative
E7036	Monroe	70587	
E7038	Monroe	EG35046	
E7045	Monroe	70631	
E7047	Monroe	70631	
E7057	Monroe	70581	
E7068	Monroe	70708	
E7070	Monroe	70577	
E7082	Monroe	70679	
E7808	Monroe	62057	
E8502	Monroe	69119	
G1037	Monroe	62044	
G1055	Monroe	62003	
G1074	Monroe	G45890	
G1075	Monroe	62062	
G1084	Monroe	62089	
G1094	Monroe	62099	
G1095	Monroe	62022	
G1102	Monroe	62000	
G1111	Monroe	62053	
G1134	Monroe	62091	
G1154	Monroe	62052	
G1227	Monroe	62107	
G1248	Monroe	62100	
G16248	Monroe	55901	
G16249	Monroe	55902	
G16275	Monroe	G35301	
G16276	Monroe	G35296	
G16289	Monroe	70751	
G16312	Monroe	35952	
G16313	Monroe	35951	
G16320	Monroe	55891	
G16321	Monroe	55890	
G16345	Monroe	55889	
G16346	Monroe	55888	
G16347	Monroe	55890	
G16351	Monroe	70520	
G16352	Monroe	70519	
G16385	Monroe	70567	
G16386	Monroe	70567	
G16387	Monroe	G35421	
G16446	Monroe	70540	
G16447	Monroe	70539	
G16555	Monroe	G55592	

Part #	Manufacturer	Gabriel	
		Primary	Alternative
G16783	Monroe	G35220	
G16784	Monroe	G35225	
G2097	Monroe	G45896	
G2101	Monroe	62018	
G2108	Monroe	62046	
G21582	Monroe	G45399	
G21659	Monroe	61285	
G2174	Monroe	62102	
G22709	Monroe	36867	
G23101	Monroe	69107	
G2525	Monroe	62103	
G7019	Monroe	70723	
G7020	Monroe	70724	
G7027	Monroe	70806	
G7028	Monroe	70807	
G7203	Monroe	70639	
G72072	Monroe	G45413	
G7265	Monroe	G35370	
G7266	Monroe	G35369	
G7271	Monroe	70611	
G7272	Monroe	70610	
G7273	Monroe	70689	
G7274	Monroe	70690	
G7275	Monroe	70611	
G7276	Monroe	70610	
G7277	Monroe	70682	
G7288	Monroe	70566	
G7289	Monroe	70565	
G7292	Monroe	70576	
G7293	Monroe	70575	
G7298	Monroe	70530	
G7299	Monroe	70531	
G7302	Monroe	G35326	
G7303	Monroe	70600	
G7304	Monroe	70601	
G7338	Monroe	70824	
G7339	Monroe	70825	
G7398	Monroe	70579	
G7399	Monroe	70580	
G7421	Monroe	70852	
G7422	Monroe	70851	
G7479	Monroe	70826	
G8001	Monroe	70631	

Part #	Manufacturer	Gabriel	
		Primary	Alternative
G8002	Monroe	70632	
G8005	Monroe	70546	
G8006	Monroe	70560	
G8063	Monroe	70708	
G8064	Monroe	70709	
G8089	Monroe	70564	
G8090	Monroe	70563	
G8091	Monroe	70701	
G8092	Monroe	70702	
G8109	Monroe	70714	
G8119	Monroe	70561	
G8120	Monroe	70562	
G8121	Monroe	70618	
G8122	Monroe	70619	
G8126	Monroe	69106	
G8314	Monroe	70835	
G8315	Monroe	70836	
G8801	Monroe	70584	
G8802	Monroe	70585	
G8803	Monroe	70593	
G8804	Monroe	70592	
G8807	Monroe	70837	
G8808	Monroe	70838	
GA2006	Monroe	G45051	
GA2007	Monroe	G45078	
GA2008	Monroe	G45006	
GA2009	Monroe	G45535	
GA2010	Monroe	G45398	
GA2011	Monroe	G45419	
GA2012	Monroe	G45466	
GA2015	Monroe	G45813	
GA2016	Monroe	G56160	
GA2018	Monroe	G45875	
GA2019	Monroe	G56161	
GA2020	Monroe	G45877	
GA2021	Monroe	G45844	
GA2022	Monroe	61212	
GA2023	Monroe	G45862	
GA2024	Monroe	G45870	
GA2025	Monroe	G45869	G56172
GA2041	Monroe	69069	
GA2054	Monroe	G45001	
GA2056	Monroe	G45399	

Part #	Manufacturer	Gabriel	
		Primary	Alternative
GA2057	Monroe	G45399	
GA2058	Monroe	G45417	
GA2061	Monroe	G56157	
GA2062	Monroe	G45447	
GA2063	Monroe	G56104	
GA2064	Monroe	G45503	
GA2065	Monroe	G45520	
GA2066	Monroe	G45523	
GA2067	Monroe	G45255	
GA2072	Monroe	G45742	
GA2074	Monroe	18727	
GA2075	Monroe	G45812	
GA2077	Monroe	G45810	
GA2078	Monroe	G45838	
GA2080	Monroe	G56159	
GA2081	Monroe	G56177	
GA2097	Monroe	G45470	
GA72073	Monroe	G45715	
GT0102	Monroe	44602	
GT0104	Monroe	44614	
GT0106	Monroe	44608	
GT0107	Monroe	44510	
GT0111	Monroe	44606	
GT0112	Monroe	44615	
GT0114	Monroe	61915	
GT0115	Monroe	44603	
GT0116	Monroe	44611	
GT0117	Monroe	44607	
GT0118	Monroe	61914	
GT0119	Monroe	61918	
GT0120	Monroe	44603	
GT0401	Monroe	44217	
GT0402	Monroe	44535	
GT0701	Monroe	44505	
GT0702	Monroe	44085	
GT0720	Monroe	61903	
GT1001	Monroe	G51023	
GT1002	Monroe	61262	
GT1002	Monroe	61262	
GT1003	Monroe	G45879	
GT1004	Monroe	69082	
GT1006	Monroe	61298	
GT1008	Monroe	G45859	

Part #	Manufacturer	Gabriel	
		Primary	Alternative
GT1011	Monroe	51006	
GT1012	Monroe	69068	
GT1013	Monroe	69092	
GT1014	Monroe	19022	
GT1015	Monroe	19021	
GT1016	Monroe	69081	
GT1017	Monroe	G51082	
GT1018	Monroe	69082	
GT1021	Monroe	61257	
GT1024	Monroe	G45839	
GT1025	Monroe	G45874	
GT1026	Monroe	61241	
GT1027	Monroe	G45874	
GT1028	Monroe	61252	
GT1029	Monroe	61256	
GT1030	Monroe	G45881	
GT1033	Monroe	69075	
GT1034	Monroe	55820	
GT1035	Monroe	69093	
GT1059	Monroe	69089	
GT1069	Monroe	G45891	
GT1072	Monroe	62006	
GT2001	Monroe	G45878	
GT2002	Monroe	G45869	
GT2006	Monroe	G45051	
GT2007	Monroe	G45078	
GT2008	Monroe	G45006	
GT2010	Monroe	G45398	
GT2011	Monroe	G45419	
GT2012	Monroe	G56185	
GT2015	Monroe	G45813	
GT2018	Monroe	G45875	
GT2019	Monroe	G56161	
GT2020	Monroe	G45877	
GT2021	Monroe	G45844	
GT2022	Monroe	61212	
GT2023	Monroe	G45862	
GT2024	Monroe	G45870	
GT2025	Monroe	G45469	
GT2026	Monroe	55088	
GT2027	Monroe	36857	
GT2028	Monroe	G45466	
GT2030	Monroe	G45871	

Part #	Manufacturer	Gabriel	
		Primary	Alternative
GT2031	Monroe	G45872	
GT2032	Monroe	G45876	
GT2033	Monroe	36859	
GT2035	Monroe	G56178	
GT2036	Monroe	G45008	
GT2039	Monroe	G56172	
GT2042	Monroe	61230	
GT2042	Monroe	61230	
GT2043	Monroe	61248	
GT2044	Monroe	G56103	
GT2045	Monroe	G56189	
GT2046	Monroe	G56167	
GT2050	Monroe	69073	
GT2051	Monroe	69075	
GT2052	Monroe	69075	
GT2053	Monroe	69076	
GT2074	Monroe	18727	
GT2082	Monroe	G56224	
GT2083	Monroe	G45860	
GT2084	Monroe	G45535	
GT2085	Monroe	36767	
GT2090	Monroe	69074	
GT2091	Monroe	G45889	
GT2092	Monroe	G45888	
GT2093	Monroe	G56208	
GT2094	Monroe	G45535	
GT2096	Monroe	G45873	
GT2102	Monroe	G56209	
GT2107	Monroe	G56212	
GT2109	Monroe	G56252	
GT2202	Monroe	69101	
GT2203	Monroe	51309	
GT2210	Monroe	69507	
GT2213	Monroe	61293	
GT7001	Monroe	35847	
GT7002	Monroe	35847	
GT7005	Monroe	55813	
GT7006	Monroe	55813	
GT7007	Monroe	55813	
GT7008	Monroe	55813	
GT7101	Monroe	55841	
GT7206	Monroe	55865	
GT7207	Monroe	70510	

Part #	Manufacturer	Gabriel	
		Primary	Alternative
GT7208	Monroe	70504	
GT7209	Monroe	70504	
GT7210	Monroe	55858	
GT7211	Monroe	35832	
GT7216	Monroe	55806	
GT7217	Monroe	55807	
GT7218	Monroe	55812	
GT7219	Monroe	55812	
GT7220	Monroe	35830	
GT7225	Monroe	55810	
GT7226	Monroe	55812	
GT7227	Monroe	55812	
GT7228	Monroe	55803	
GT7229	Monroe	35833	
GT7230	Monroe	35816	
GT7231	Monroe	55817	
GT7232	Monroe	55816	
GT7233	Monroe	55854	
GT7234	Monroe	55840	
GT7235	Monroe	55840	
GT7236	Monroe	35816	
GT7237	Monroe	35817	
GT7238	Monroe	35842	
GT7239	Monroe	55838	
GT7240	Monroe	55839	
GT7241	Monroe	G35146	
GT7242	Monroe	55819	
GT7243	Monroe	55819	
GT7244	Monroe	55863	
GT7245	Monroe	55863	
GT7249	Monroe	55811	
GT7251	Monroe	35848	
GT7252	Monroe	35927	
GT7255	Monroe	55804	
GT7259	Monroe	70501	
GT7260	Monroe	70500	
GT7261	Monroe	70500	
GT7262	Monroe	70501	
GT7263	Monroe	70527	
GT7264	Monroe	70527	
GT7278	Monroe	35849	
GT7279	Monroe	70590	
GT7280	Monroe	70589	

Part #	Manufacturer	Gabriel	
		Primary	Alternative
GT7292	Monroe	70575	
GT7298	Monroe	70531	
GT8020	Monroe	55872	
GT8021	Monroe	55893	
GT8022	Monroe	55892	
GT8023	Monroe	70503	
GT8024	Monroe	70505	
GT8025	Monroe	70505	
GT8026	Monroe	55856	
GT8028	Monroe	55843	
GT8029	Monroe	55843	
GT8030	Monroe	55845	
GT8031	Monroe	55840	
GT8032	Monroe	55855	
GT8033	Monroe	55848	
GT8034	Monroe	55848	
GT8035	Monroe	55846	
GT8036	Monroe	55847	
GT8037	Monroe	55841	
GT8038	Monroe	55886	
GT8039	Monroe	55887	
GT8042	Monroe	55861	
GT8043	Monroe	55861	
GT8044	Monroe	55818	
GT8046	Monroe	55818	
GT8047	Monroe	55818	
GT8050	Monroe	55835	
GT8051	Monroe	70587	
GT8057	Monroe	70560	
GT8058	Monroe	70546	
GT8059	Monroe	35937	
GT8060	Monroe	35936	
GT8061	Monroe	35939	
GT8062	Monroe	35938	
GT8123	Monroe	70503	
M0201	Monroe	G56518	
M1971	Monroe	61902	
M315	Monroe	61303	
M4434	Monroe	G56179	
M4441	Monroe	G45006	
M4445	Monroe	G56167	
M4462	Monroe	G45842	
M4463	Monroe	G45872	

Part #	Manufacturer	Gabriel	
		Primary	Alternative
M4464	Monroe	55088	
M4465	Monroe	G63612	
M4479	Monroe	EG63659	
M5454	Monroe	G56158	
M5464	Monroe	G56173	
M5468	Monroe	G56178	
M5470	Monroe	46004	
M6409	Monroe	G56240	
M6432	Monroe	G56189	
M6433	Monroe	G56231	
M6440	Monroe	G56165	
M6628	Monroe	GS78007	
M6629	Monroe	G56165	
M6902	Monroe	36860	
M7299	Monroe	46004	
M7300	Monroe	46005	
M7366	Monroe	55231	
M7367	Monroe	G56170	
M8029	Monroe	G56190	
M8030	Monroe	G56171	
M8031	Monroe	G56214	
M8032	Monroe	G56213	
M8034	Monroe	G56123	
M8035	Monroe	G56155	
M8036	Monroe	G56112	
M8037	Monroe	G56126	
M8038	Monroe	G45006	
M8039	Monroe	G45051	
M8041	Monroe	55227	
M8042	Monroe	G56102	
M8046	Monroe	G45869	
M8047	Monroe	G56176	
M8048	Monroe	G45873	
M8049	Monroe	G45432	
M8050	Monroe	G56172	
M8052	Monroe	GS78003	
M8055	Monroe	G56218	
M8056	Monroe	G56207	
M8058	Monroe	G45871	
M8059	Monroe	G56116	
M8067	Monroe	G56219	
M8073	Monroe	G56116	
M8074	Monroe	G56209	

Part #	Manufacturer	Gabriel	
		Primary	Alternative
M8075	Monroe	36865	
M8077	Monroe	46001	
M8089	Monroe	GS56265	
MG310	Monroe	61303	
MG318	Monroe	61302	
MG971	Monroe	44601	
MG998	Monroe	61914	
ML0023	Monroe	4081	
ML0250	Monroe	4312	
ML0265	Monroe	4321	
ML0299	Monroe	4324	
ML1133	Monroe	4332	
ML1233	Monroe	4320	
ML1250	Monroe	4260	
ML1361	Monroe	4328	
ML1413	Monroe	4063	
ML1418	Monroe	4333	
ML1485	Monroe	4064	
ML1514	Monroe	4221	
ML1653	Monroe	4277	
ML1881	Monroe	4079	
ML2029	Monroe	4272	
ML2125	Monroe	4291	
ML2173	Monroe	4330	
ML2209	Monroe	4076	
ML2231	Monroe	4289	
ML2417	Monroe	4325	
ML2469	Monroe	4082	
ML2477	Monroe	4065	
ML2489	Monroe	4314	
ML2670	Monroe	4329	
ML2800	Monroe	4316	
ML2841	Monroe	4327	
ML3007	Monroe	4331	
ML3095	Monroe	4313	
ML3397	Monroe	4298	
ML3657	Monroe	4270	
ML4149	Monroe	4284	
ML4257	Monroe	4060	
MR315	Monroe	61303	
MR819	Monroe	44225	
MR839	Monroe	44564	
MR916	Monroe	44604	

Part #	Manufacturer	Gabriel	
		Primary	Alternative
MR937	Monroe	44612	
MR951	Monroe	44614	
MR969	Monroe	G44850	
MR993	Monroe	44615	
RS5602	Monroe	GS56234	
RS999010	Monroe	GS78003	
RS999039	Monroe	GS56233	
RS999113	Monroe	GS78018	
RS999113	Monroe	GS78018	
RS999116	Monroe	GS56225	
RS999129	Monroe	GS56261	
RS999136	Monroe	GS78000	
RS999144	Monroe	GS78001	
		GS78009	
RS999145	Monroe	GS56232	
RS999158	Monroe	GS78002	
RS999187	Monroe	GS46008	
RS999188	Monroe	GS56221	
RS999202	Monroe	G56240	
RS999207	Monroe	GS78011	
RS999213	Monroe	GS78019	
RS999223	Monroe	GS56220	
RS999240	Monroe	GS78025	
RS999284	Monroe	G56263	
RS999311	Monroe	G56236	
RS999312	Monroe	GS56260	
RS999321	Monroe	GS78014	
RS999328	Monroe	GS56289	
RS999352	Monroe	GS78015	
RS999357	Monroe	GS78017	
RS999360	Monroe	G56246	
RS999361	Monroe	G56247	
RS999365	Monroe	GS78020	
RS999764	Monroe	G56263	
RS999766	Monroe	GS46008	
RS999777	Monroe	G56226	
RS999787	Monroe	46003	
RS999802	Monroe	GS46006	
S1003	Monroe	G45874	
S1007	Monroe	69050	
S1042	Monroe	69901	
S1043	Monroe	61252	
S1047	Monroe	G45860	

Part #	Manufacturer	Gabriel	
		Primary	Alternative
S1148	Monroe	G45893	
S1203	Monroe	69948	
S1233	Monroe	69989	
S1242	Monroe	69422	
S1251	Monroe	69431	36875
S1264	Monroe	61262	
S3009	Monroe	55811	
S3404	Monroe	61918	
S3405	Monroe	61909	
S3804	Monroe	61302	
S4010	Monroe	55868	
S4031	Monroe	G35279	
S4032	Monroe	55870	
S4252	Monroe	55813	
S4255	Monroe	55856	
S4277	Monroe	55812	
S4299	Monroe	55807	
S4334	Monroe	55869	
S4342	Monroe	55817	
S4343	Monroe	G45859	
S4386	Monroe	G35301	
S4388	Monroe	G35295	
S4424	Monroe	55840	
S4441	Monroe	G55592	
S4545L	Monroe	55846	
S4547	Monroe	55848	
S4562	Monroe	G35190	
S4571	Monroe	G55601	
S4572	Monroe	55843	
S4596	Monroe	EG35046	
S4853	Monroe	G55673	
S4858	Monroe	55872	
S4865	Monroe	55844	
S4886	Monroe	G35193	
S4910	Monroe	70509	
S4914	Monroe	70508	
S5017	Monroe	61202	
S5057	Monroe	69677	
S5082	Monroe	G45078	
S5085	Monroe	69401	
S5087	Monroe	69946	
SA1942	Monroe	14023	
SC2914	Monroe	14021	

Part #	Manufacturer	Gabriel	
		Primary	Alternative
SC2946	Monroe	14023	
SC2947	Monroe	14033	
T0006	Monroe	76039	
		76033	
T0008	Monroe	76103	
T0009	Monroe	76007	
T0010	Monroe	76039	
T1016	Monroe	76019	
T1179	Monroe	76008	
T1185	Monroe	76103	
T1190	Monroe	76131	
T1197	Monroe	76033	
T1200	Monroe	76020	
T1204	Monroe	76106	
T1215	Monroe	76035	
T1246	Monroe	76036	
T1249	Monroe	76043	
T1250	Monroe	76102	
T5054	Monroe	76022	
		76104	
T5056	Monroe	76021	
T5059	Monroe	76034	
T5090	Monroe	76021	
T5242	Monroe	76034	
T5252	Monroe	76157	
V1018	Monroe	G45418	
V1034	Monroe	G45417	
V1037	Monroe	G56172	
V1055	Monroe	42772	
V1060	Monroe	G45447	
V1063	Monroe	G45212	
V1086	Monroe	G56166	
V1102	Monroe	76208	
V1103	Monroe	42773	
V1114	Monroe	G56185	
V1116	Monroe	42864	
V1118	Monroe	G56116	
V1125	Monroe	G45844	
V1166	Monroe	83450	
V1169	Monroe	62007	
V1170	Monroe	62007	
V1177	Monroe	62008	
V1501	Monroe	61294	

Part #	Manufacturer	Gabriel	
		Primary	Alternative
V2008	Monroe	55227	
V2009	Monroe	G56161	
V2014	Monroe	G56157	
V2058	Monroe	76014	
V2065	Monroe	83373	
V2065	Monroe	83373	
V2066	Monroe	83367	
V2077	Monroe	83367	
V2210	Monroe	76209	
V2510	Monroe	69914	
V4301	Monroe	70538	
V4505	Monroe	70591	
V4510	Monroe	70506	
V5007	Monroe	42942	
V5997	Monroe	G56268	
TITAN			
SF2401T	Titan	55834	
SF2402T	Titan	55835	
SF2403T	Titan	70508	
SF2404T	Titan	70509	
SF2405T	Titan	70577	
SF2406T	Titan	70578	
SF3701T	Titan	55854	
SF3702T	Titan	70583	
SF4004T	Titan	G45871	
SF4005T	Titan	G56169	
SF4006T	Titan	70510	
SF4009T	Titan	55825	
SF4011T	Titan	70567	
SF4012T	Titan	70568	
SF4013T	Titan	70600	
SF4014T	Titan	70601	
SF4015T	Titan	70592	
SF4016T	Titan	70593	
SF4017T	Titan	G56276	
SF4018T	Titan	70836	
SF4019T	Titan	70835	
SF4020T	Titan	70600	
SF4021T	Titan	70601	
SF4022T	Titan	G56290	
SF4023T	Titan	G546013	
SF4024T	Titan	35927	

Part #	Manufacturer	Gabriel	
		Primary	Alternative
SF4501T	Titan	70527	
SF4502T	Titan	55858	
SF4505T	Titan	44607	
SF4506T	Titan	61918	
SF4507T	Titan	35941	
SF4508T	Titan	35942	
SF4509T	Titan	70800	
SF4510T	Titan	70801	
SF4511T	Titan	70596	
SF4512T	Titan	70597	
SF4514T	Titan	70504	
SF4515T	Titan	70504	
SF4516T	Titan	70757	
SF4517T	Titan	70505	
SF4518T	Titan	70505	
SF4519T	Titan	70706	
SF4520T	Titan	70707	
SF4521T	Titan	70708	
SF4522T	Titan	70709	
SF4602T	Titan	G56173	
SF4605T	Titan	G56214	
SF4606T	Titan	G45844	
SF4611T	Titan	G56176	
SF4612T	Titan	G56212	
SF4613T	Titan	G546014	
SF4701T	Titan	70610	
SF4702T	Titan	70611	
SF4703T	Titan	70715	
SF4704T	Titan	70716	
SF5402T	Titan	G56178	
SF5403T	Titan	70696	
SF5404T	Titan	70697	
SF5405T	Titan	70548	
SF5406T	Titan	70549	
SF5407T	Titan	70569	
SF5408T	Titan	70570	
SF5410T	Titan	G54023	
SF5411T	Titan	G54024	
SF5412T	Titan	N/A	
SF5413T	Titan	N/A	
SF5414T	Titan	70691	
SF5415T	Titan	70692	
SF5416T	Titan	35951	
SF5417T	Titan	35952	
SF5418T	Titan	70810	

Part #	Manufacturer	Gabriel	
		Primary	Alternative
SF5419T	Titan	70811	
SF5901T	Titan	70602	
SF6001T	Titan	G56172	
SF6003T	Titan	44217	
SF6004T	Titan	G56171	
SF6005T	Titan	70586	
SF6012T	Titan	70661	
SF6013T	Titan	70662	
SF6014T	Titan	55838	
SF6015T	Titan	55839	
SF6017T	Titan	G56299	
SF6018T	Titan	70556	
SF6019T	Titan	70557	
SF6020T	Titan	70663	
SF6021T	Titan	70664	
SF6022T	Titan	70833	
SF6023T	Titan	70834	
SF6024T	Titan	70589	
SF6025T	Titan	70590	
SF6201T	Titan	70695	
SF6601T	Titan	35934	
SF6602T	Titan	35935	
SF7002T	Titan	70682	
SF8001T	Titan	G45869	
SF8002T	Titan	55818	
SF8003T	Titan	55818	
SF8005T	Titan	G45862	
SF8006T	Titan	G56211	
SF8007T	Titan	G45466	
SF8011T	Titan	55861	
SF8012T	Titan	55861	
SF8013T	Titan	G56189	
SF8014T	Titan	55893	
SF8015T	Titan	55892	
SF8016T	Titan	G56218	
SF8017T	Titan	70579	
SF8018T	Titan	70580	
SF8019T	Titan	G56185	
SF8020T	Titan	70826	
SF8021T	Titan	70608	
SF8022T	Titan	70609	
SF8023T	Titan	70561	
SF8024T	Titan	70562	
SF8026T	Titan	G578010	
SF8027T	Titan	70674	

Part #	Manufacturer	Gabriel	
		Primary	Alternative
SF8028T	Titan	70673	
SF8301T	Titan	55833	
SF8302T	Titan	70503	
SF8303T	Titan	69101	
SF8306T	Titan	55841	
SF8307T	Titan	70714	
SF8308T	Titan	55811	
SF8310T	Titan	55872	
SF8312T	Titan	70581	
SR2401T	Titan	61248	
SR2402T	Titan	69102	
SR3701T	Titan	61241	
SR3702T	Titan	62005	
SR4001T	Titan	G45051	
SR4002T	Titan	G45872	
SR4003T	Titan	G45878	
SR4007T	Titan	55804	
SR4008T	Titan	G56170	
SR4011T	Titan	G56223	
SR4012T	Titan	61299	
SR4013T	Titan	62009	
SR4014T	Titan	G45892	
SR4015T	Titan	62103	
SR4020T	Titan	62009	
SR4021T	Titan	G56291	
SR4022T	Titan	G578032	
SR4503T	Titan	61256	
SR4504T	Titan	G56224	
SR4505T	Titan	G45874	
SR4506T	Titan	36866	
SR4507T	Titan	62089	
SR4508T	Titan	G45897	
SR4509T	Titan	62052	
SR4510T	Titan	G45881	
SR4601T	Titan	G56116	
SR4603T	Titan	G45870	
SR4604T	Titan	G45008	
SR4608T	Titan	G45006	
SR4610T	Titan	G56213	
SR4701T	Titan	61296	
SR4702T	Titan	62058	
SR5401T	Titan	G56103	
SR5403T	Titan	62053	
SR5404T	Titan	61285	
SR5405T	Titan	62086	

Part #	Manufacturer	Gabriel	
		Primary	Alternative
SR5407T	Titan	62084	
SR5408T	Titan	62036	
SR5409T	Titan	36867	
SR5410T	Titan	G56294	
SR5901T	Titan	62004	
SR5902T	Titan	62032	
SR6002T	Titan	G56190	
SR6005T	Titan	G56184	
SR6006T	Titan	62012	
SR6009T	Titan	62026	
SR6010T	Titan	55855	
SR6011T	Titan	55856	
SR6012T	Titan	G56300	
SR6013T	Titan	70558	
SR6014T	Titan	70559	
SR6015T	Titan	62033	
SR6016T	Titan	62102	
SR6017T	Titan	62091	
SR6018T	Titan	G56236	
SR6019T	Titan	G556259	
SR6020T	Titan	N/A	
SR6201T	Titan	62038	
SR6601T	Titan	51168	
SR7002T	Titan	62043	
SR8002T	Titan	55819	
SR8003T	Titan	55819	
SR8004T	Titan	G45873	
SR8008T	Titan	55863	
SR8009T	Titan	G56209	
SR8010T	Titan	G56167	
SR8012T	Titan	69092	
SR8017T	Titan	G56207	
SR8018T	Titan	G45891	
SR8019T	Titan	62100	
SR8020T	Titan	G45890	
SR8021T	Titan	62022	
SR8022T	Titan	G56208	
SR8303T	Titan	G45879	
SR8304T	Titan	69068	
SR8305T	Titan	69050	
SR8306T	Titan	62024	
SR8307T	Titan	69081	
SR8308T	Titan	61262	
SR8310T	Titan	62002	
SR8311T	Titan	69507	



TECHNICAL INFORMATION

SHOCKS, STRUTS & CARTRIDGES

This section gives you detailed technical information on our shocks, struts and cartridges. This includes technical guides, drawings, and end mounting details, all of which is referenced to and from the vehicle listing and the parts listing.

Included in this section is a Fitment Guide which provides additional information on the removal, fitment and disposal of our products, as well as a section on extended and collapsed lengths that gives you the dimensions of our products as well as the end mountings and accessory packs that come with the product.

Section Content	Page
Key to Mounting Codes	176
How to Measure Extended and Collapsed Lengths	176
How to Protect your Struts	176
Technical guide to drawings	177
Removal and fitment of shocks	178
Removal and fitment of struts	179
Parts Listing	180



KEY TO MOUNTING CODES

Rubber Eyes	Sleeved Eyes	Other		
RE 16 = 16 mm I.D	SE 9 = 9 mm I.D	SE 16 = 16 mm I.D	B = Bracket	P = Plate
RE 17 = 17 mm I.D	SE 10 = 10 mm I.D	SE 19 = 19 mm I.D	BP = Bar Pin	S = Stud
RE 20 = 20 mm I.D	SE 11 = 11 mm I.D	SE 20 = 20 mm I.D	BT = Bolt	SM = Special Mounting
RE 22 = 22 mm I.D	SE 12 = 12 mm I.D	SE 22 = 22 mm I.D	C = Cartridge	SS = Spring Seat Stud
RE 25 = 25 mm I.D	SE 13 = 13 mm I.D	SE 24 = 24 mm I.D	DS = Dual Stud	SSE = Spring Seat Sleeved Eye
	SE 14 = 14 mm I.D	SE 25 = 25 mm I.D	I.D = Inner Diameter	UB = U Bracket
	SE 15 = 15 mm I.D	SE 31 = 31 mm I.D		

HOW TO MEASURE EXTENDED AND COLLAPSED LENGTHS

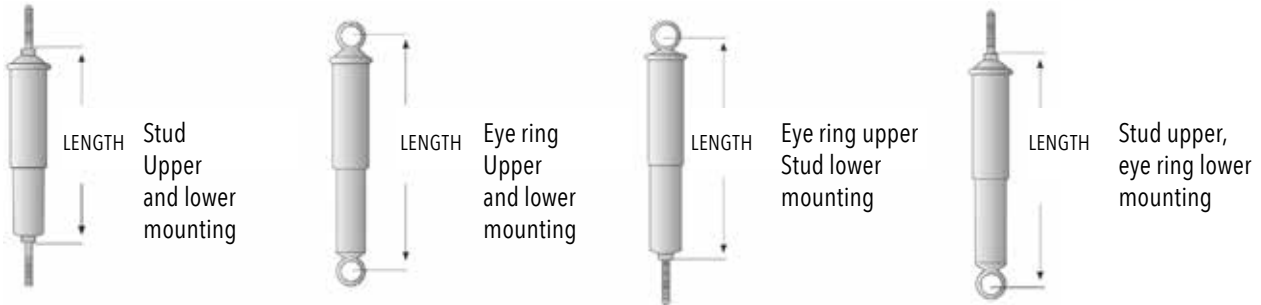

HOW TO PROTECT YOUR STRUTS

PART NO: 143057



GABRIEL STRUT CUSHION

Torre Parts and Components wants to emphasize the importance of renewing damaged or missing strut cushions (bump rubbers).











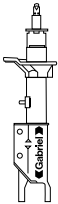





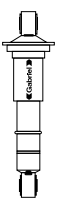

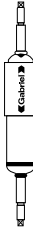



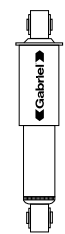
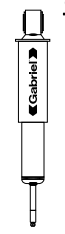
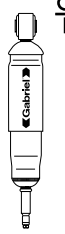
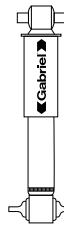

Damaged or missing strut cushions that are not replaced during strut and cartridge fitments can cause premature strut failure.

A strut cushion consists of a convoluted rubber boot or gaiter and a urethane compression bumper. These fit together and slide over the piston rod to rest on the strut's body.

The gaiter protects the strut's chrome piston rod from damage, keeps dirt out of the seal, pitting from stone chippings and corrosion from whatever the road may throw up.

The compression bumper, which fits into the boot, avoids internal damage being caused by preventing metal-to-metal contact under severe compression of the piston rod.

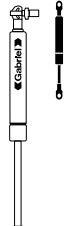
TECHNICAL GUIDE TO DRAWINGS

FIG 1 MacPherson Struts		FIG 2 MacPherson Cartridges		FIG 3 Spring Seat Shock			
Fig 1.1	Fig 1.2	Fig 2		Fig 3.1	Fig 3.2	Fig 3.3	Fig 3.4
							
With spring seat	Without spring seat	MacPherson Cartridges		With Bracket	With Sleeved Eye With/Without Seat	With U Bracket	With Sleeved Eye & Sleeved Eye
FIG 4 Stud & Barpin Shock		FIG 5 Stud & Stud Shock		FIG 6 Stud & Eye Shock (With or Without Dust Cover)		FIG 7 Stud & Special Mounting Shock	
Fig 4		Fig 5		Fig 6.1	Fig 6.2	Fig 7	
							
Stud & Barpin Shock Absorbers		Stud & Stud Shock Absorbers		Stud & Rubber Eye	Stud & Sleeved Eye	NB: Special mountings come in numerous forms. e.g with special bracket as illustrated.	
FIG 8 Eye & Eye Shock					FIG 9 Eye & Stud Shock		FIG 10 Eye & Barpin Shock
Fig 8.1	Fig 8.2	Fig 8.3	Fig 8.4	Fig 8.5	Fig 9.1	Fig 9.2	Fig 10
							
Bolt & Sleeved eye	Rubber Eye & Rubber Eye	Rubber eye & Sleeved eye	Sleeved Eye & Rubber Eye	Sleeved Eye & Sleeved Eye	Rubber Eye & Stud	Sleeved Eye & Stud	Sleeved Eye & Barpin
FIG 11 Eye & Special Mounting Shock		FIG 12 Barpin & Stud Shock		FIG 13 Barpin & Eye Shock		FIG 14 Gaslifts	FIG 15 Steering Dampers
Fig 11.1	Fig 11.2	Fig 12		Fig 13.1	Fig 13.2	Fig 14	Fig 15
							
NB: Special mountings come in numerous forms. e.g with special bracket as illustrated		Barpin & Stud Shock Absorbers		Rubber eye	Sleeved eye	Gaslifts	Steering Dampers



REMOVAL AND FITMENT OF SHOCKS

REMOVAL OF SHOCKS

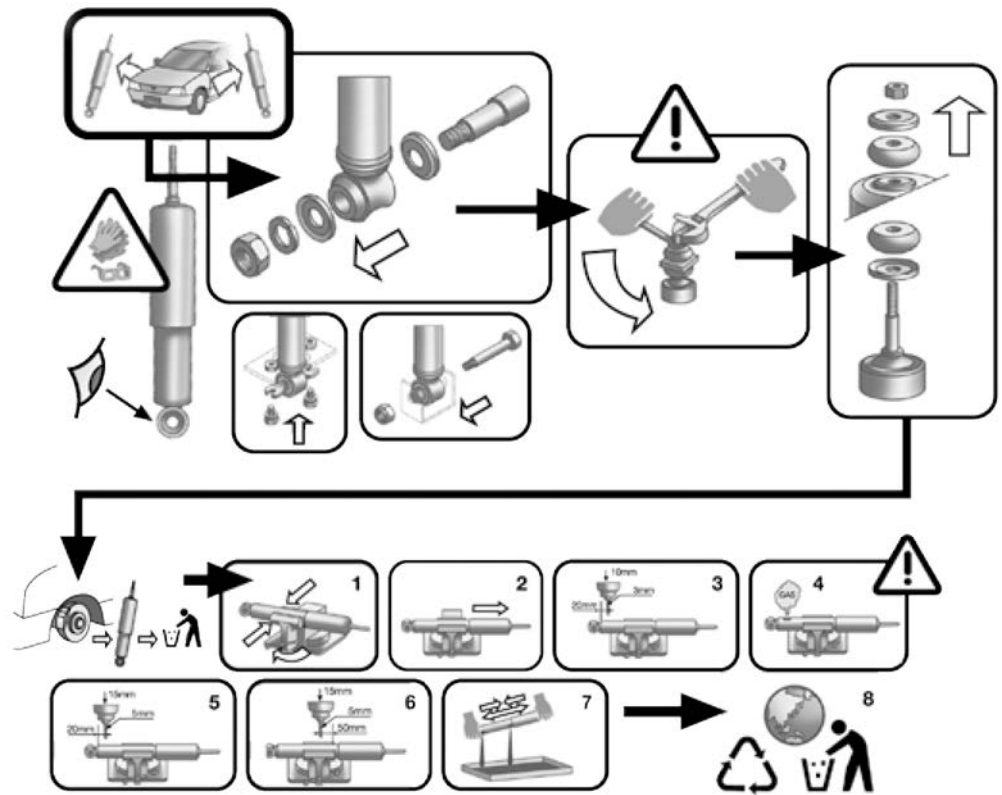

DISPOSAL OF SHOCKS

FITMENT OF SHOCKS

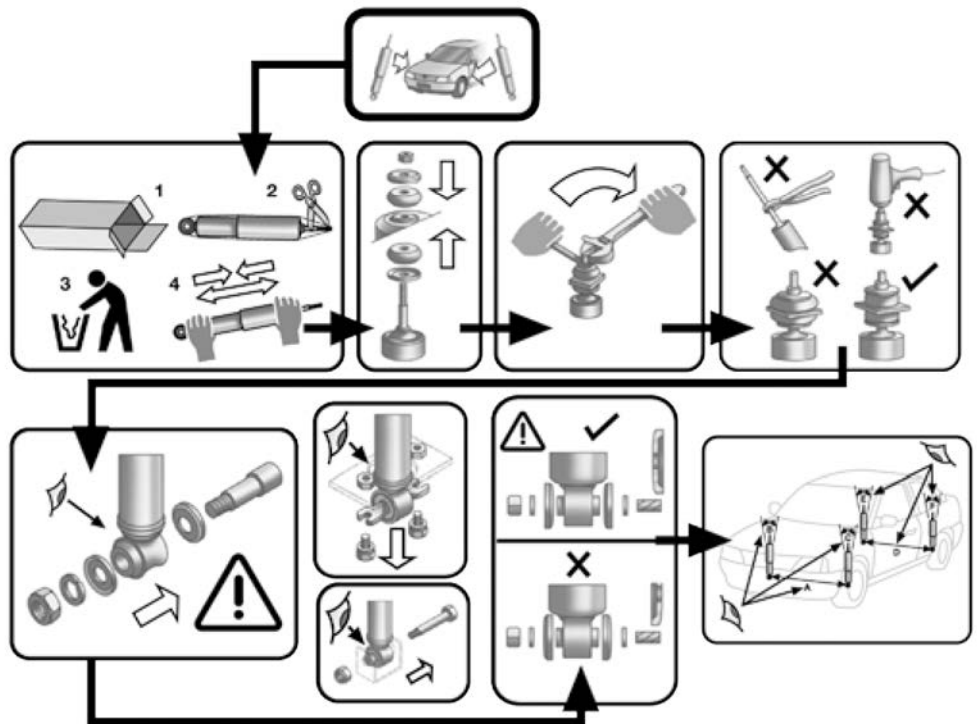

DISCLAIMER: Gabriel cannot be held liable in the event of injury or damage to property during assembly/disassembly/disposal process, if the product is not assembled/disassembled/disposed of at a fitment centre by a trained professional. This is a generic representation, and not all vehicles will have this type of shock configuration.

REMOVAL AND FITMENT OF STRUTS

REMOVAL OF STRUTS

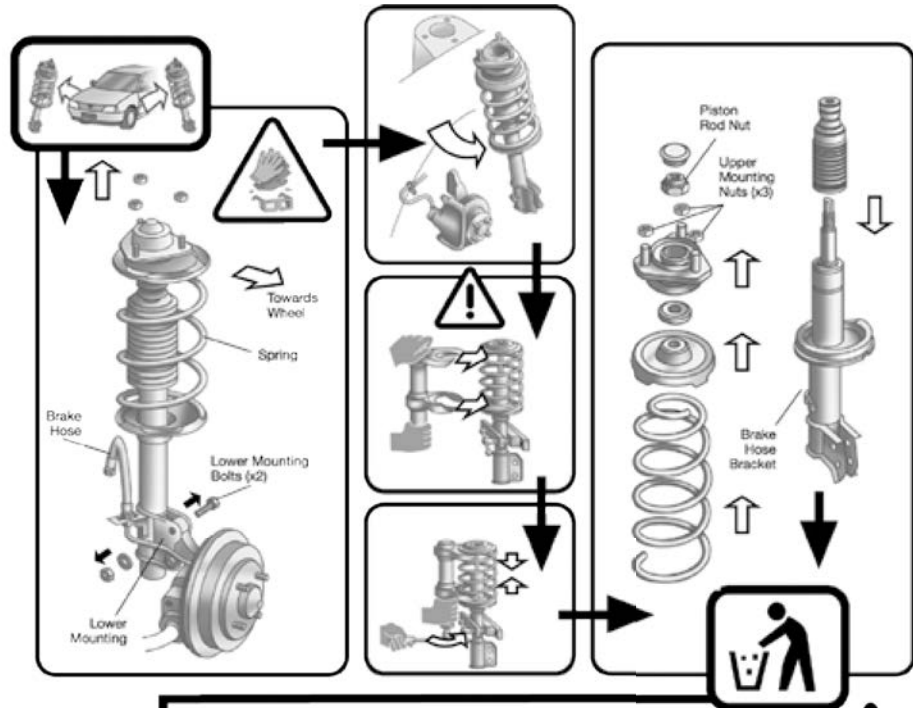

DISPOSAL OF STRUTS

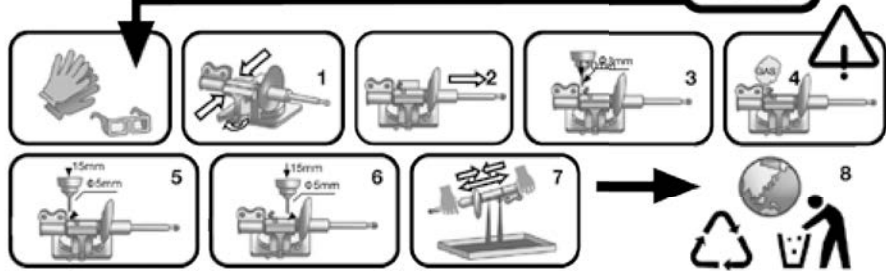



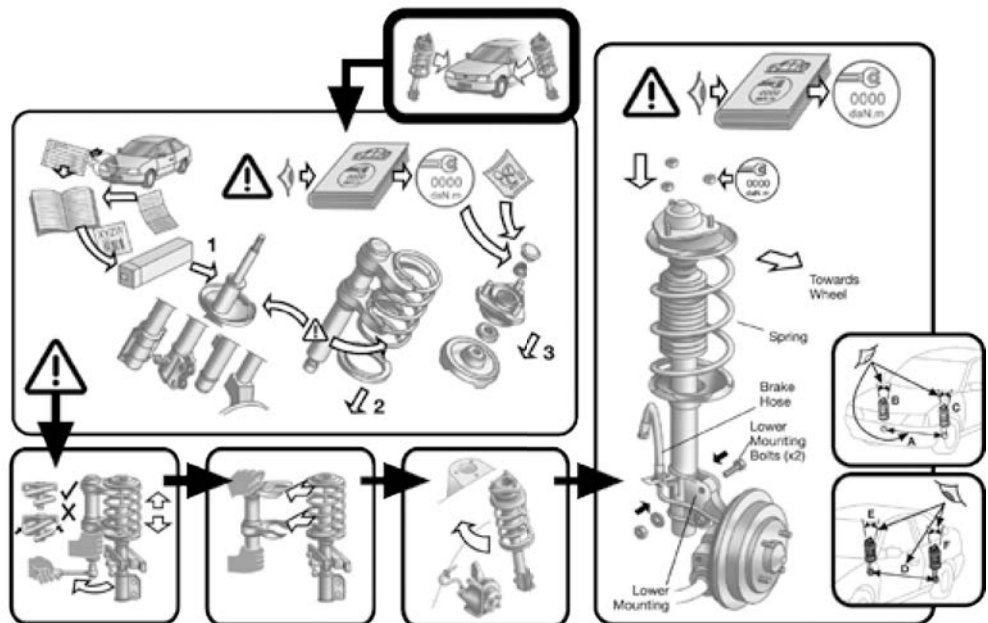







































FITMENT OF STRUTS



DISCLAIMER: Gabriel cannot be held liable in the event of injury or damage to property during assembly/disassembly/disposal process, if the product is not assembled/disassembled/disposed of at a fitment centre by a trained professional. This is a generic representation, and not all vehicles will have this type of shock configuration.











































PARTS LISTING































Collapsed Length	Extended Length	Upper Mounting	Lower Mounting	Accessory Pack Part No.	Shock Type			Part #
					Icon	Fig	Code	
GABRIEL GAS RYDER								
SHOCK ABSORBERS - STUD UPPER, BAR PIN LOWER								
222	335	S	BPx70.0	⊥	4	S/BP	61283
235	467	S	BPx75.0	⊥	4	S/BP	61243
312	516	S	BPx64.0	⊥	4	S/BP	G63721
314	510	S	BPx63.5	⊥	4	S/BP	G63424
343	458	S	BPx63.5	⊥	4	S/BP	G63678
SHOCK ABSORBERS - STUD UPPER AND LOWER								
243	383	S	S	⊕	5	S/S	G63920
262	390	S	S	⊕	5	S/S	G63799
287	486	S	S	⊕	5	S/S	69742
308	522	S	S	⊕	5	S/S	61702
401	560	S	S	...	⊕	5	S/S	69102
406	611	S	S	⊕	5	S/S	69654
436	585	S	S	144308	⊕	5	S/S	62028
SHOCK ABSORBERS - STUD UPPER, RUBBER EYE LOWER								
291	474	S	RE16	⊕	6.1	S/RE	69069
295	469	S	RE16	⊕	6.1	S/RE	G63410
302	477	S	RE16	⊕	6.1	S/RE	G63508
333	557	S	RE16	⊕	6.1	S/RE	61235
355	601	S	RE16	144070	⊕	6.1	S/RE	61228
358	615	S	RE16	⊕	6.1	S/RE	G63940
362	620	S	RE16	⊕	6.1	S/RE	62020
371	633	S	RE16	144069	⊕	6.1	S/RE	61212
396	648	S	RE12	⊕	6,1	S/RE	62044
396	684	S	RE16	144069	⊕	6.1	S/RE	61230
SHOCK ABSORBERS - STUD UPPER, SLEEVED EYE LOWER								
228	348	S	SE12x32	⊕	6.2	S/SE	61287
231	348	S	SE12x34.0	⊕	6.2	S/SE	G63933
244	386	S	SE12x38.0	⊕	6.2	S/SE	G63935
246	367	S	SE12x32.0	⊕	6.2	S/SE	G63612
255	378	S	SE13x38.0	⊕	6.2	S/SE	G63414
258	392	S	SE12x32.0	⊕	6.2	S/SE	G63737
262	390	S	SE8x58.0	⊕	6,2	S/SE	G63799
265	432	S	SE14x41.0	⊕	6.2	S/SE	69901
272	439	S	SE10x36.0	⊕	6.2	S/SE	61256
279	396	S	SE14x45.0	⊕	6.2	S/SE	69120
286	456	S	SE12x74.0	⊕	6,2	S/SE	62082

Collapsed Length	Extended Length	Upper Mounting	Lower Mounting	Accessory Pack Part No.	Shock Type			Part #
					Icon	Fig	Code	
GABRIEL GAS RYDER (CONT...)								
SHOCK ABSORBERS - STUD UPPER, SLEEVED EYE LOWER (CONT...)								
288	400	S	SE14x44.5		6.2	S/SE	69104
288	468	S	SE11x32.5	144073		6.2	S/SE	69677
294	473	S	SE12x38.0		6.2	S/SE	G63663
295	454	S	SE12x47.0		6.2	S/SE	69134
297	496	S	SE10x40.0	144152		6.2	S/SE	61241
299	458	S	SE16x36.0		6.2	S/SE	G63930
309	551	S	SE10x36.0		6.2	S/SE	69891
312	525	S	SE13x53.0		6.2	S/SE	69633
313	510	S	SE20x42.0		6.2	S/SE	61288
315	502	S	SE10x40.0	144151		6.2	S/SE	61254
315	505	S	SE10x40.0	144153		6.2	S/SE	69744
321	486	S	SE11x56.0		6.2	S/SE	69664
324	543	S	SE12x50.0		6.2	S/SE	69948
325	537	S	SE12x32.0		6.2	S/SE	69674
326	514	S	SE10x40.0		6.2	S/SE	61296
326	553	S	SE10x36.0		6.2	S/SE	61242
327	543	S	SE13x32.0		6.2	S/SE	G63720
331	551	S	SE12x32.0		6.2	S/SE	61233
335	550	S	SE12x40.0		6.2	S/SE	61239
339	575	S	SE14x37.0		6.2	S/SE	69507
342	576	S	SE10x36.0		6.2	S/SE	61200
343	537	S	SE12x45.5		6.2	S/SE	69135
348	598	S	SE14x40		6.2	S/SE	62043
351	575	S	SE16		6.2	S/SE	G63636
354	567	S	SE12x40.0		6.2	S/SE	69989
356	577	S	SE16x58.0		6.2	S/SE	G63483
358	602	S	SE12x42		6.2	S/SE	62100
359	535	S	SE12x40.0		6.2	S/SE	69425
359	595	S	SE14x37		6.2	S/SE	62050
359	608	S	SE14x40		6.2	S/SE	62025
362	608	S	SE 12.2x60		6.2	S/SE	62022
362	608	S	SE12.2x60		6.2	S/SE	61297
363	583	S	SE15.6		6.2	S/SE	62024
363	600	S	SE14x40		6.2	S/SE	62001
363	612	S	SE10x40		6.2	S/SE	62062
364	553	S	SE15.6x55		6.2	S/SE	62003
364	612	S	SE12x38.0		6.2	S/SE	G63936
365	471	S	SE15.5x65.5		6.2	S/SE	61292
368	617	S	SE12x40.0		6.2	S/SE	61248
369	569	S	SE10x40.0		6.2	S/SE	61270
370	604	S	SE12x55		6.2	S/SE	62016
370	630	S	SE16x38		6.2	S/SE	62105









































































TECHNICAL

Collapsed Length	Extended Length	Upper Mounting	Lower Mounting	Accessory Pack Part No.	Shock Type			Part #
					Icon	Fig	Code	
GABRIEL GAS RYDER (CONT...)								
SHOCK ABSORBERS - STUD UPPER, SLEEVED EYE LOWER (CONT...)								
372	586	S	SE14x40		6.2	S/SE	62002
372	586	S	SE14x40		6.2	S/SE	62018
372	587	S	SE14x40		6.2	S/SE	61293
374	569	S	SE10.2x40		6.2	S/SE	62005
374	585	S	SE14.2x36.9		6.2	S/SE	62018
375	532	S	SE10x40.0	144151		6.2	S/SE	61253
375	538	S	SE12x40		6.2	S/SE	62006
375	605	S	SE		6.2	S/SE	69942
375	605	S	SE10		6.2	S/SE	69946
381	565	S	SE12x55		6.2	S/SE	62000
383	634	S	SE14x37.0		6.2	S/SE	62050
385	603	S	SE15.6		6.2	S/SE	61298
386	646	S	SE12x55		6.2	S/SE	61286
388	673	S	SE		6.2	S/SE	69460
389	595	S	SE16x38		6.2	S/SE	61289
390	470	S	SE10x40.0		6.2	S/SE	69957
390	620	S	SE12x36	144312		6.2	S/SE	62107
393	588	S	SE12x60.0		6.2	S/SE	69926
394	656	S	SE10x45.0	413049		6.2	S/SE	61262
396	603	S	SE10x40		6.2	S/SE	62058
396	648	S	SE12x52		6.2	S/SE	62044
397	634	S	SE12x55		6.2	S/SE	61285
398	659	S	SE16x40		6.2	S/SE	62060
399	610	S	SE12x35.0		6.2	S/SE	69422
400	585	S	SE10x48	144303		6.2	S/SE	62032
400	652	S	SE14x39.5		6.2	S/SE	62052
402	492	S	SE10x40	144303		6.2	S/SE	62030
403	588	S	SE12x60.0		6.2	S/SE	69940
406	583	S	SE10x48	144303		6.2	S/SE	62013
411	468	S	SE 12.5x61		6.2	S/SE	69928
411	637	S	SE10x41.0		6.2	S/SE	69964
413	673	S	SE22x40		6.2	S/SE	62061
414	536	S	SE10x41.0		6.2	S/SE	G63914
416	529	S	SE10x41.0		6.2	S/SE	69723
425	672	S	SE12x40		6.2	S/SE	62009
432	672	S	SE12x45.5		6.2	S/SE	61299
435	673	S	SE12x45.0		6.2	S/SE	62102
437	557	S	SE12x39.5		6.2	S/SE	62011
437	665	S	SE14x37		6.2	S/SE	62057
440	604	S	SE 12x43		6.2	S/SE	62021
446	473	S	SE10x40.0		6.2	S/SE	69956
465	569	S	SE10x40		6.2	S/SE	62004

































Collapsed Length	Extended Length	Upper Mounting	Lower Mounting	Accessory Pack Part No.	Shock Type			Part #
					Icon	Fig	Code	
GABRIEL GAS RYDER (CONT...)								
SHOCK ABSORBERS - STUD UPPER, SLEEVED EYE LOWER (CONT...)								
467	545	S	SE10x40.0		6.2	S/SE	69952
467	545	S	SE10x40.0		6.2	S/SE	69966
467	566	S	SE10		6.2	S/SE	69953
469	700	S	SE12x36		6.2	S/SE	62023
472	723	S	SE12x40		6.2	S/SE	62103
481	624	S	SE15.5x40		6.2	S/SE	62012
547	673	S	SE10x40		6,2	S/SE	62101
SHOCK ABSORBERS - STUD UPPER, U-BRACKET LOWER								
389	470	S	B			S/B	62035
382	572	S	B			S/B	62036
SHOCK ABSORBERS - STUD UPPER, SPECIAL MOUNTING LOWER								
283	462	S	SM	144014		7.1	S/SM	61202
353	483	S	SM	144014		7.1	S/SM	61201
SHOCK ABSORBERS - RUBBER EYE UPPER, SLEEVED EYE LOWER								
339	537	RE16	SE13x35.0		8.3	RE/SE	G63683
339	550	RE16	SE12x38.0		8.3	RE/SE	G63626
383	643	RE16	SE12x38.0		8.3	RE/SE	G63461
SHOCK ABSORBERS - SLEEVED EYE UPPER, RUBBER EYE LOWER								
271	386	SE10x34	RE16		8.4	SE/RE	69938
318	490	SE14x40	RE19x40	144031		8.4	SE/RE	EG63659
SHOCK ABSORBERS - SLEEVED EYE UPPER AND LOWER								
205	339	SE10x38.0	SE10x38.0		8.5	SE/SE	69921
219	323	SE10x38.0	SE12x35.0		8.5	SE/SE	69934
219	323	SE10x38.0	SE12x35.0		8.5	SE/SE	69935
224	321	SE10x38.0	SE12x36.0		8.5	SE/SE	69919
240	333	SE12x40.0	SE14x40.0		8.5	SE/SE	69965
250	370	SE10x32.0	SE12x44.0		8,5	SE/SE	62111
251	382	SE10x32.0	SE12x45.0		8.5	SE/SE	62080
255	405	SE12.0	SE12.0		8.5	SE/SE	69769
256	392	SE12x48.0	SE14x40.0		8.5	SE/SE	69986
258	397	SE12x32.0	SE12x32.0		8.5	SE/SE	69431
259	373	SE12x48	SE12x40		8.5	SE/SE	61284
259	370	SE14x40	SE14x40		8,5	SE/SE	62086
260	360	SE12x40	SE14x62		8.5	SE/SE	69446
260	365	SE12x40.0	SE14x62.0		8.5	SE/SE	69401
261	401	SE12x48.0	SE14x40.0		8.5	SE/SE	69415
261	403	SE12x32.0	SE12x32		8,5	SE/SE	62037



Collapsed Length	Extended Length	Upper Mounting	Lower Mounting	Accessory Pack Part No.	Shock Type			Part #
					Icon	Fig	Code	
GABRIEL GAS RYDER (CONT...)								
SHOCK ABSORBERS - SLEEVED EYE UPPER AND LOWER (CONT...)								
262	383	SE12x35.0	SE12x36.0		8.5	SE/SE	69412
266	387	SE12x47.0	SE12x40.0		8,5	SE/SE	62108
268	403	SE12x60.0	SE12x32.0		8.5	SE/SE	69689
269	416	SE12x48.0	SE14x40.0		8.5	SE/SE	69987
270	385	SE12x46.0	SE12x46.0		8.5	SE/SE	69914
271	421	SE12.4x48	SE14.2x40		8.5	SE/SE	62019
271	422	SE12x42.0	SE12x48.0		8.5	SE/SE	69616
272	418	SE13x42.5	SE13x42.5		8.5	SE/SE	G63423
283	449	SE12x32.0	SE12x32		8,5	SE/SE	62089
289	456	SE10x36.0	SE10x36.0		8.5	SE/SE	61257
290	433	SE12.2x44	SE12.2x44		8.5	SE/SE	62014
291	457	SE12x42.0	SE12x42.0		8.5	SE/SE	G63690
309	449	SE12x55.0	SE14x41.0		8.5	SE/SE	69922
309	495	SE12x32.0	SE12x36.0		8,5	SE/SE	62038
310	509	SE10x32.0	SE12x32.0		8.5	SE/SE	61214
311	473	SE12x40.0	SE12x40.0		8.5	SE/SE	62007
313	343	SE10x78	SE12x43.5		8.5	SE/SE	69444
318	503	SE14x39.5	SE14x39.0		8.5	SE/SE	G63738
320	413	SE12x42.0	SE14x35.0		8.5	SE/SE	69760
321	471	SE14x40	SE12x40		8.5	SE/SE	62010
323	508	SE12.5x65	SE12.3x44.5		8.5	SE/SE	62033
326	477	SE12.5x65	SE12.3x44.5		8.5	SE/SE	62026
330	472	SE10x55	SE12x48.0		8,5	SE/SE	62046
330	519	SE14x40.0	SE14x40.0		8.5	SE/SE	62008
339	526	SE12x40.0	SE14x39.5		8.5	SE/SE	69924
346	570	SE12x28	SE12x32		8,5	SE/SE	62040
362	497	SE14x40	SE14x40		8.5	SE/SE	61294
380	464	SE14x40.0	SE13x52.0		8,5	SE/SE	69932
387	640	SE10x32.0	SE10x51.0		8.5	SE/SE	61238
389	470	SE14.5x58.5	SE12.5x60.5		8.5	SE/SE	62035
400	465	SE14.5x34.0	SE14.5x59.0		8.5	SE/SE	69927
SHOCK ABSORBERS - SLEEVED EYE UPPER, STUD LOWER								
290	479	SE10x40.0	S	144216		9.2	SE/S	61252
340	563	SE19x39.5	S		9.2	SE/S	G63694
381	628	SE16x40.0	S		9.2	SE/S	G63482
SHOCK ABSORBERS - SLEEVED EYE UPPER, BAR PIN LOWER								
232	345	SE10x58.0	BPx86.5		10	SE/BP	61232
232	345	SE10x75.0	BPx86.5		10	SE/BP	61213

Collapsed Length	Extended Length	Upper Mounting	Lower Mounting	Accessory Pack Part No.	Shock Type			Part #
					Icon	Fig	Code	
GABRIEL GAS RYDER (CONT...)								
SHOCK ABSORBERS - SLEEVED EYE UPPER, SPECIAL MOUNTING LOWER								
234	324	SE10x38.0	SM		11	SE/SM	69983
244	355	SE12x46.0	SM		11	SE/SM	62053
259	370	SE12x47	SM		11	SE/SM	62086
311	479	SE10.3x75	SM		11	SE/SM	69538
323	478	SE10.3x75	SM		11	SE/SM	69512
SHOCK ABSORBERS - BAR PIN UPPER, RUBBER EYE LOWER								
320	516	BPx79.0	RE16		13.1	BP/RE	G63425
SHOCK ABSORBERS - BAR PIN UPPER, SLEEVED EYE LOWER								
264	605	BPx73.0	SE14x41.0		13.2	BP/SE	G63422
301	482	BPx75.0	SE12x32.0		13.2	BP/SE	69423
302	482	BPx75.0	SE12x32.0		13.2	BP/SE	69875
311	495	BPx80.0	SE13x35.0		13.2	BP/SE	G63722
353	561	BPx76.0	SE12x42		13.2	BP/SE	62015
353	569	BPx76.0	SE12x42		13.2	BP/SE	61295
380	762	BPx73.0	SE12x38.0		13.2	BP/SE	G63679
GABRIEL® SAFARI™								
SPRING SEAT SHOCK ABSORBERS - STUD UPPER, BAR PIN LOWER								
219	331	S	BPx55.9	144073		4	S/BP	G56104
231	352	S	BPx66.5	144068		4	S/BP	G56185
235	363	S	BPx72.5	144068		4	S/BP	G56178
238	375	S	BPx81	144068		4	S/BP	G56251
SHOCK ABSORBERS - STUD UPPER AND LOWER								
268	441	S	S	144073, 144073		5	S/S	G56119
294	492	S	S	144073, 144073		5	S/S	G56105
303	511	S	S	144073, 144074		5	S/S	G56154
312	483	S	S	144287		5	S/S	G56239
326	552	S	S	144071, 144071		5	S/S	G56164
332	568	S	S	144073, 144074		5	S/S	G56120
340	591	S	S	144071, 144071		5	S/S	G56230
345	590	S	S	144071, 144071		5	S/S	G56180
SHOCK ABSORBERS - STUD UPPER, RUBBER EYE LOWER								
324	535	S	RE20	144068, 144031		6.1	S/RE	G56166
326	537	S	RE20	144282, 144031		6.1	S/RE	46002
328	555	S	RE16	144073		6.1	S/RE	55088
332	555	S	RE20	144068, 144031		6.1	S/RE	G56219
344	582	S	RE20	144071, 144031		6.1	S/RE	G56231
348	581	S	RE20	144071, 144031		6.1	S/RE	G56179
352	599	M10x1.25	RE20	144068, 144031		6.1	S/RE	55238
353	606	S	RE16	144037		6.1	S/RE	55211
375	646	S	RE19.5x44.2	144068, 144031		6,1	S/RE	55243



Collapsed Length	Extended Length	Upper Mounting	Lower Mounting	Accessory Pack Part No.	Shock Type			Part #
					Icon	Fig	Code	
GABRIEL® SAFARI™ (CONT...)								
SHOCK ABSORBERS - STUD UPPER, SLEEVED EYE LOWER								
211	314	S	SE12x32.0	144068		6.2	S/SE	G56171
218	333	S	SE12x32.0	144068		6.2	S/SE	G56241
221	333	S	SE12x32.0	144068		6.2	S/SE	G56172
230	350	S	SE12x32.0	144069		6.2	S/SE	46004
231	352	S	SE12x32.0	144068		6.2	S/SE	G56176
232	350	S	SE16x38.0	144068		6.2	S/SE	G56189
233	363	S	SE12x32.0		6.2	S/SE	G56235
234	359	S	SE12x40.0	144068		6.2	S/SE	G56169
234	365	S	SE12x32.0	144068		6.2	S/SE	G56244
237	371	S	SE12.2x32	144068		6.2	S/SE	G56211
239	364	S	SE12.2x40		6.2	S/SE	G56249
240	372	S	SE12x32.0	144068		6.2	S/SE	G56173
240	377	S	SE12x32.0		6.2	S/SE	G56203
241	347	S	SE12x40.0		6.2	S/SE	55231
243	364	S	SE12x40.0	144068		6.2	S/SE	G56222
248	395	S	SE12x32.0		6.2	S/SE	G56299
252	382	S	SE14x80.0		6.2	S/SE	55227
259	416	S	SE12x32	144068		6.2	S/SE	G56214
272	434	S	SE13x37.5	144074		6.2	S/SE	G56123
272	435	S	SE12x32.0	144068		6.2	S/SE	G56158
297	486	S	SE13x37.5	144021		6.2	S/SE	G56118
300	458	S	SE16x38.0	144069		6.2	S/SE	46005
342	578	S	SE14x48.0		6.2	S/SE	G56274
348	587	S	SE13x37.5	144021		6.2	S/SE	G56155
354	574	S	SE19x45		6.2	S/SE	G56293
355	578	S	SE19.2x44.5	144282		6.2	S/SE	G56227
365	590	S	SE14		6.2	S/SE	G56238
428	555	S	SE14x41.0	144071, 144274		6.2	S/SE	G56292
SHOCK ABSORBERS -STUD UPPER, SPECIAL MOUNTING LOWER								
257	417	M14x1.5	SM		7.1	S/SM	G56258
SHOCK ABSORBERS -BOLT UPPER, SLEEVED EYE LOWER								
249	379	BT	SE13x35.0	144028		8.1	BT/SE	G56106
250	378	BT	SE13x35.0	144028		8.1	BT/SE	G56106
355	589	BT	SE14.5x42.5	144028		8.1	BT/SE	G56147

TECHNICAL 

Collapsed Length	Extended Length	Upper Mounting	Lower Mounting	Accessory Pack Part No.	Shock Type			Part #
					Icon	Fig	Code	
GABRIEL® SAFARI™ (CONT...)								
SHOCK ABSORBERS – RUBBER EYE UPPER AND LOWER								
278	432	RE20	RE20	144031 144031	☉	8.2	RE/RE	G56112
279	436	RE16	RE16	☉	8.2	RE/RE	G56177
281	431	RE20	RE20	144031 144031	☉	8.2	RE/RE	G56112
283	440	RE16	RE20	144031	☉	8.2	RE/RE	G56175
306	482	RE20	RE20	144031	☉	8.2	RE/RE	G56162
307	489	RE31	RE31	☉	8.2	RE/RE	55241
308	489	RE19	RE19	☉	8.2	RE/RE	55237
314	505	RE16	RE16	☉	8.2	RE/RE	G56102
322	514	RE20	RE20	144031	☉	8.2	RE/RE	G56126
326	533	RE16	RE19	☉	8.2	RE/RE	G56245
327	538	RE16	RE16	☉	8.2	RE/RE	G56213
330	537	RE16	RE16	☉	8.2	RE/RE	G56116
335	551	RE16	RE16	144072	☉	8.2	RE/RE	G56210
336	550	RE16	RE16	☉	8.2	RE/RE	55222
336	550	RE16	RE16	☉	8.2	RE/RE	G56186
337	550	RE 19.5x44.2	RE 19.5x44.2	144031	☉	8.2	RE/RE	55240
337	548	RE16	RE20	☉	8.2	RE/RE	G56187
341	561	RE16	RE19	☉	8.2	RE/RE	G56209
343	549	RE20	RE20	144242, 144242	☉	8.2	RE/RE	G56208
348	558	RE19	RE19	☉	8.2	RE/RE	G56252
349	575	RE16	RE16	☉	8.2	RE/RE	G56190
349	582	RE16	RE16	☉	8.2	RE/RE	G56215
351	571	RE19x45	RE19x45	144031, 144031	☉	8.2	RE/RE	G56167
353	575	RE20	RE20	144242	☉	8.2	RE/RE	G56281
353	575	RE20	RE20	144242, 144242	☉	8.2	RE/RE	G56207
355	588	RE16	RE16	☉	8.2	RE/RE	G56103
361	582	RE12.2x43.5	RE12.2x43.5	☉	8.2	RE/RE	G56247
365	607	RE16	RE16	☉	8.2	RE/RE	G56184
365	611	RE16	RE16	☉	8.2	RE/RE	G56250
375	620	RE19x45	RE19x45	144242	☉	8.2	RE/RE	G56309
376	622	RE20	RE20	144031, 144031	☉	8.2	RE/RE	G56174
376	629	RE20x44.2	RE 19.5x44.2	☉	8.2	RE/RE	55239
387	651	RE20x44.2	RE 19.5x44.2	144031	☉	8.2	RE/RE	55242
394	640	RE20	RE20	144031	☉	8.2	RE/RE	G56240
SHOCK ABSORBERS – RUBBER EYE UPPER, SLEEVED EYE LOWER								
317	511	RE16	SE16 x 38	☉	8,3	RE/SE	G56269
322	520	RE16	SE16x42.0	☉	8,3	RE/SE	G56300
346	572	RE16x37.0	SE14.2x42.0	☉	8.3	RE/SE	G56236
355	588	RE16	SE13x37.5	☉	8.3	RE/SE	G56121



TECHNICAL

Collapsed Length	Extended Length	Upper Mounting	Lower Mounting	Accessory Pack Part No.	Shock Type			Part #
					Icon	Fig	Code	
GABRIEL® SAFARI™ (CONT...)								
SHOCK ABSORBERS - SLEEVED EYE UPPER, RUBBER EYE LOWER								
330	538	SE12	RE16	☉	8.4	SE/RE	G56204
SHOCK ABSORBERS - SLEEVED EYE UPPER AND LOWER								
262	394	SE 14x46	SE 14x40	☉	8.5	SE/SE	G56268
277	427	SE12x48	SE15x40	☉	8,5	SE/SE	G56278
278	429	SE12x48.0	SE15x40	☉	8.5	SE/SE	G56224
285	448	SE13x57.0	SE13x35.0	☉	8.5	SE/SE	G56149
306	478	SE14.1x42.5	SE14.1x42.5	☉	8.5	SE/SE	G56266
317	512	SE13x35.0	SE13x35.0	☉	8.5	SE/SE	G56107
327	528	SE12x42.0	SE12x42.0	☉	8.5	SE/SE	G56161
341	540	SE20x40.0	SE16x48.0	144272	☉	8.5	SE/SE	G56228
351	565	SE12x45.5	SE12x40.0	☉	8.5	SE/SE	G56263
354	577	SE20x40.0	SE12x40.0	144272	☉	8,5	SE/SE	G56291
355	588	SE15x42.0	SE15x42.0	☉	8.5	SE/SE	G56148
362	582	SE12x40.0	SE12x40.0	☉	8,5	SE/SE	G56254
363	583	SE12x40.0	SE12x40.0	☉	8,5	SE/SE	G56255
369	600	SE20x30.0	SE12x40.0	144272	☉	8.5	SE/SE	G56223
369	600	SE20x40.0	SE20x40.0	144272	☉	8,5	SE/SE	G56298
369	612	SE20x43.0	SE12x40.0	☉	8.5	SE/SE	G56170
373	617	SE20x40	SE12x40	☉	8,5	SE/SE	G56277
373	633	SE14x40.0	SE14x40.0	☉	8.5	SE/SE	55210
381	619	SE16x40	SE14x40	☉	8.5	SE/SE	55234
386	623	SE16x52	SE16x52	☉	8.5	SE/SE	55232
424	705	SE16x40	SE16x40	☉	8.5	SE/SE	55233
425	717	SE16x40.0	SE16x40.0	☉	8.5	SE/SE	55224
SHOCK ABSORBERS - RUBBER EYE UPPER, STUD LOWER								
290	466	RE20	S	144031	☽	9.1	RE/S	G56113
291	473	RE16	S	144068	☽	9.1	RE/S	G56157
309	504	RE20	S	144031, 144071	☽	9.1	RE/S	G56163
329	549	RE16	S	144068	☽	9.1	RE/S	G56168
SHOCK ABSORBERS - SLEEVED EYE UPPER, STUD LOWER								
300	492	SE12x32.0	S	144073	☽	9.2	SE/S	G56156
300	492	SE14x32.0	S	144073	☽	9.2	SE/S	G56159
335	555	SE19x44.5	S	144031, 144071	☽	9.2	SE/S	G56165
SHOCK ABSORBERS - SLEEVED EYE UPPER, BAR PIN LOWER								
232	344	SE10x58.0	BPx86.5	☽	10	SE/BP	G56160
232	344	SE10x75.0	BPx86.5	☽	10	SE/BP	G56153
354	584	SE12x45	BP	☽	10	SE/BP	G56246

TECHNICAL

Collapsed Length	Extended Length	Upper Mounting	Lower Mounting	Accessory Pack Part No.	Shock Type			Part #
					Icon	Fig	Code	
GABRIEL® SAFARI HDP™								
SPRING SEAT SHOCK ABSORBERS - STUD UPPER, SLEEVED EYE LOWER								
258	386	S	SE14x40		3.2	SS/SE	GS46010
297	427	S	SE14x48	144274		3.2	SS/SE	GS46009
325	470	S	SE14x50.0	NUT 413053		3.2	SS/SE	GS46006
340	470	S	SE14.2x39.4	144274 144288		3.2	SS/SE	GS46008
410	573	S	SE14.2x39.4	144071		3.2	SS/SE	GS46007
t228	351	S	BP	144274 144277		4	S/BP	GS56234
340	555	S	BP	144274		4	S/BP	GS56261
SHOCK ABSORBERS - STUD UPPER AND LOWER								
318	538,6	S	S	144274		5	S/S	GS78002
327	553	S	S	144071, 144071		5	S/S	GS78007
359	616	S	S	144071, 144071		5	S/S	GS78011
SHOCK ABSORBERS - STUD UPPER, RUBBER EYE LOWER								
329	539	S	RE19	144282 144274		6.1	S/RE	GS78015
348	582	S	RE19	144068		6.1	S/RE	GS78010
368	619	S	RE19	144282		6.1	S/RE	GS78017
368	620	S	RE19	144071		6.1	S/RE	GS78012
SHOCK ABSORBERS - STUD UPPER, SLEEVED EYE LOWER								
210	314	S	SE12	144068		6.2	S/SE	GS56221
228	351	S	SE12	144068		6.2	S/SE	GS56220
239	372	S	SE12x40	144277 144274		6.2	S/SE	GS56233
244	380	S	SE16	144068		6.2	S/SE	GS56232
244	381	S	SE12	144068		6.2	S/SE	GS56225
244	387	S	SE12.2x32	144277 144274		6.2	S/SE	GS56264
297	485	S	SE12	144068		6.2	S/SE	GS78000
303	494	S	SE16	144068		6.2	S/SE	GS78019
350	575	S	SE14	144068		6.2	S/SE	GS78020
SHOCK ABSORBERS - RUBBER EYE UPPER AND LOWER								
351	577	RE16	RE16		8.2	RE/RE	GS78018
355	585	RE16	RE16	144274		8.2	RE/RE	GS78021
359	585	RE19	RE19		8.2	RE/RE	GS78001
361	596	RE16	RE16		8.2	RE/RE	GS78006
365	594	RE19	RE19		8.2	RE/RE	GS78009
380	631	RE16	RE16	144274		8.2	RE/RE	GS78016
381	626	RE19	RE19		8.2	RE/RE	GS78004
381	639	RE16	RE16		8.2	RE/RE	GS78003
394	653	RE19	RE19		8.2	RE/RE	GS78005
395	657	RE19	RE19		8.2	RE/RE	GS78013



TECHNICAL





































Collapsed Length	Extended Length	Upper Mounting	Lower Mounting	Accessory Pack Part No.	Shock Type			Part #
					Icon	Fig	Code	
GABRIEL® SAFARI HDP™ (CONT...)								
SHOCK ABSORBERS - RUBBER EYE UPPER, SLEEVED EYE LOWER								
350	572	RE16	SE14	144274	☉	8.3	RE/SE	GS56259
SHOCK ABSORBERS - SLEEVED EYE UPPER, RUBBER EYE LOWER								
338	554	SE13.2x40	RE16	144274	☉	8.4	SE/RE	GS56265
SHOCK ABSORBERS - SLEEVED EYE UPPER AND LOWER								
314	501	SE12x32.0	SE12x32.0	☉	8,5	SE/SE	GS56284
359	577	SE12x46	SE 12x37.0	144274	☉	8.5	SE/SE	GS56267
361	587	SE12.2x43.5	SE12.2x43.5	144274	☉	8.5	SE/SE	GS78030
381	632	SE12x40	SE12x40	144274	☉	8.5	SE/SE	GS78014
382	627	SE20x40	SE12x40	144274, 144272	☉	8,5	SE/SE	GS78032
SHOCK ABSORBERS - RUBBER EYE UPPER, STUD LOWER								
344	563	RE19	S	☉	9.1	RE/S	GS78008
SHOCK ABSORBERS -SLEEVED EYE UPPER, BAR PIN LOWER								
360	586	SE	BP	144274	☉	10	SE/BP	GS78029
SHOCK ABSORBERS -BAR PIN UPPER, SLEEVED EYE LOWER								
338	553	BP	SE12x37	144274		13	BP/SE	GS78026
373	617	BP	SE13x40	144274		13	BP/SE	GS56289
GABRIEL® TECHNOMATIC™								
SHOCK ABSORBERS - STUD UPPER, BAR PIN LOWER								
213	326	S	BPx58.5	144069	⊥	4	S/BP	G45532
219	339	S	BPx49.0	144070	⊥	4	S/BP	G45523
219	339	S	BPx56.0	144076	⊥	4	S/BP	G45212
226	352	S	BPx58.5	144070	⊥	4	S/BP	G45398
226	352	S	BPx60.5	144070	⊥	4	S/BP	G45466
228	357	S	BPx66.5	144070	⊥	4	S/BP	36859
232	364	S	BPx72.5	144070	⊥	4	S/BP	G45862
238	377	S	BPx60.5	144076	⊥	4	S/BP	G45876
241	383	S	BPx58.5	144070	⊥	4	S/BP	G45255
258	403	S	BPx75.0	144138	⊥	4	S/BP	G45858
266	430	S	BPx85.0	144078	⊥	4	S/BP	G45651
267	424	S	BPx60.5	144069	⊥	4	S/BP	19289
270	441	S	BPx67.0	144070	⊥	4	S/BP	G45666



TECHNICAL

Collapsed Length	Extended Length	Upper Mounting	Lower Mounting	Accessory Pack Part No.	Shock Type			Part #
					Icon	Fig	Code	
GABRIEL® TECHNOMATIC™ (CONT...)								
SHOCK ABSORBERS - STUD UPPER AND LOWER								
214	340	S	S	144070	†	5	S/S	G45001
290	493	S	S	144070, 144070	†	5	S/S	G45078
316	544	S	S	144070, 144070	†	5	S/S	G45258
328	556	S	S	144070, 144070	†	5	S/S	G45667
402	598	S	S	144077	†	5	S/S	36764
SHOCK ABSORBERS - STUD UPPER, RUBBER EYE LOWER								
263	424	S	RE16	144070	⊕	6.1	S/RE	G45122
291	481	S	RE16	144069	⊕	6.1	S/RE	G45469
297	493	S	RE16	144069	⊕	6.1	S/RE	G45533
304	506	S	RE16	144070	⊕	6.1	S/RE	G45399
310	519	S	RE16	144070	⊕	6.1	S/RE	G45138
324	545	S	RE16	144015	⊕	6.1	S/RE	36761
326	534	S	RE19.5x44	144031, 144288	⊕	6.1	S/RE	36872
332	563	S	RE16	144070	⊕	6.1	S/RE	G45841
340	579	S	RE16	⊕	6.1	S/RE	G45908
345	576	S	RE16	144076	⊕	6.1	S/RE	G45423
351	601	S	RE16	144070	⊕	6.1	S/RE	G45813
354	588	S	RE16	144076	⊕	6.1	S/RE	36876
362	617	S	RE16	144076	⊕	6.1	S/RE	36865
SHOCK ABSORBERS - STUD UPPER, SLEEVED EYE LOWER								
209	316	S	SE12x32.0	144068	⊕	6.2	S/SE	G45842
212	322	S	SE12x32.0	144070	⊕	6.2	S/SE	G45844
213	314	S	SE10x53.0	144070	⊕	6.2	S/SE	45410
218	335	S	SE12x32.0	144070	⊕	6.2	S/SE	G45869
219	334	S	SE12x32.0	144068	⊕	6.2	S/SE	G45893
228	354	S	SE12x32.0	144070	⊕	6.2	S/SE	G45535
228	358	S	SE 12x32	⊕	6.2	S/SE	G45885
232	367	S	SE10x24.0	144029	⊕	6.2	S/SE	19022
237	373	S	SE12x32.0	144070	⊕	6.2	S/SE	G45871
244	378	S	SE12x32	⊕	6.2	S/SE	61282
246	392	S	SE12x32	144068	⊕	6.2	S/SE	36868
259	404	S	SE12x59.5	144070	⊕	6.2	S/SE	G45459
272	430	S	SE12x74.0	144023	⊕	6.2	S/SE	G45450
279	400	S	SE12x32	144076	⊕	6.2	S/SE	G45901
286	338	S	SE10x32.0	144075	⊕	6.2	S/SE	36850
291	481	S	SE12x32.0	144069	⊕	6.2	S/SE	G45861
294	487	S	SE13x33.0	144021	⊕	6.2	S/SE	G45742
320	452	S	SE12x66.0	⊕	6.2	S/SE	36844
326	551	S	SE12x32.0	144069	⊕	6.2	S/SE	G45859





















Collapsed Length	Extended Length	Upper Mounting	Lower Mounting	Accessory Pack Part No.	Shock Type			Part #
					Icon	Fig	Code	
GABRIEL® TECHNOMATIC™ (CONT...)								
SHOCK ABSORBERS - STUD UPPER, SLEEVED EYE LOWER (CONT...)								
329	554	S	SE12x32.0	144078		6.2	S/SE	G45838
335	554	S	SE12x40.0		6.2	S/SE	36857
339	576	S	SE10x36.0	144069		6.2	S/SE	G45839
339	576	S	SE10x36.0		6.2	S/SE	G45874
343	516	S	SE12x32.0	144070		6.2	S/SE	36767
345	493	S	SE12x66.0		6.2	S/SE	36826
363	597	S	SE10x51		6.2	S/SE	36866
367	633	S	SE10x36.0	144069		6.2	S/SE	G45489
368	528	S	SE12x32.0	144065		6.2	S/SE	36854
369	562	S	SE10x36.0		6.2	S/SE	G45897
370	620	S	SE10		6.2	S/SE	G45890
371	541	S	SE13x32.0		6.2	S/SE	36748
388	540	S	SE9x38.0	144030		6.2	S/SE	36855
394	631	S	SE10x36		6.2	S/SE	G45900
395	631	S	SE10x45.0		6.2	S/SE	G45879
404	560	S	SE14x32.0	144075		6.2	S/SE	36851
415	647	S	SE16x40		6.2	S/SE	36877
427	608	S	SE10x50.0		6.2	S/SE	36853
433	624	S	SE9x32.0	144030		6.2	S/SE	36849
479	674	S	SE12.2x51		6.2	S/SE	G45892
479	709	S	SE12.2x36		6.2	S/SE	G45894
SHOCK ABSORBERS - STUD UPPER, SPECIAL MOUNTING LOWER								
317	467	S	SM		7.1	S/SM	36847
330	557	S	SM	144014		7.1	S/SM	36760
331	477	S	SM		7.1	S/SM	36759
SHOCK ABSORBERS - RUBBER EYE UPPER AND LOWER								
280	441	RE16	RE16		8.2	RE/RE	G45054
281	431	RE16	RE20	144031		8.2	RE/RE	G45873
305	499	RE16	RE16		8.2	RE/RE	G45909
306	482	RE16	RE16	144031		8.2	RE/RE	G45051
306	498	RE16x36	RE16x36	144245		8,6	RE/RE	36874
314	514	RE16	RE16		8.2	RE/RE	61281
322	514	RE16	RE16	144031		8.2	RE/RE	G45006
327	526	RE16	RE16		8.2	RE/RE	G45872
336	558	RE16	RE16		8.2	RE/RE	G45870
341	549	RE16	RE16		8,2	RE/RE	G45905
349	583	RE16	RE16		8.2	RE/RE	G45008
379	633	RE20	RE20	144031		8.2	RE/RE	36873

Collapsed Length	Extended Length	Upper Mounting	Lower Mounting	Accessory Pack Part No.	Shock Type			Part #
					Icon	Fig	Code	
GABRIEL® TECHNOMATIC™ (CONT...)								
SHOCK ABSORBERS - RUBBER EYE UPPER, SLEEVED EYE LOWER								
295	475	RE16	SE12x32	☉	8.3	RE/SE	36869
SHOCK ABSORBERS - SLEEVED EYE UPPER, RUBBER EYE LOWER								
304	494	SE12x59.5	RE16	☉	8.4	SE/RE	G45810
308	504	SE12x40	RE16	☉	8.4	SE/RE	G45886
315	517	SE11x65.5	RE16	☉	8.4	SE/RE	G45534
318	524	SE12x49.5	RE16	☉	8.4	SE/RE	G45538
368	609	SE12x49.5	RE16	☉	8.4	SE/RE	G45812
SHOCK ABSORBERS - SLEEVED EYE UPPER AND LOWER								
216	317	SE11x61.5	SE11x32.5	☉	8.5	SE/SE	G45447
218	328	SE10x24.0	SE10x24.0	☉	8.5	SE/SE	19021
254	393	SE12x32.0	SE12x32.0	☉	8.5	SE/SE	18727
254	393	SE12x32.0	SE12x32.0	☉	8.5	SE/SE	G45419
256	392	SE12x48.0	SE10x40.0	☉	8.5	SE/SE	G45881
260	405	SE12x59.5	SE12x32.0	☉	8.5	SE/SE	G45824
261	390	SE12 (Flares to 15)	SE12	☉	8.5	SE/SE	36867
263	405	SE12x32.0	SE12x32	☉	8,5	SE/SE	36875
266	418	SE12x32.0	SE12x32.0	144044	☉	8.5	SE/SE	G45417
270	390	SE14x40	SE14x40	☉	8.5	SE/SE	42942
279	443	SE10x32.0	SE10x32.0	☉	8.5	SE/SE	G45877
283	454	SE12.2X32	SE12.2X32	☉	8.5	SE/SE	G45896
284	445	SE16x38.0	SE16x38.0	☉	8.5	SE/SE	42772
286	456	SE10x32.0	SE10x58.0	☉	8.5	SE/SE	G45715
286	456	SE13x32.0	SE13x32.0	☉	8.5	SE/SE	G45413
297	466	SE12x32.0	SE12x32	☉	8,5	SE/SE	G45902
298	482	SE12x30.0	SE12x30.0	☉	8.5	SE/SE	G45470
301	488	SE10x32.0	SE10x50.0	☉	8.5	SE/SE	G45878
317	520	SE10x32.0	SE12x32.0	☉	8.5	SE/SE	G45520
318	502	SE12x32.0	SE12x36.0	☉	8.5	SE/SE	G45891
323	524	SE14x40.0	SE12x40.0	☉	8.5	SE/SE	42864
327	539	SE12x40	SE12x40	☉	8.5	SE/SE	36862
330	545	SE10x32.0	SE10x32.0	☉	8.5	SE/SE	G45875
352	589	SE12x32.0	SE12x32.0	☉	8.5	SE/SE	G45418
363	617	SE14x30.0	SE14x30.0	☉	8.5	SE/SE	G45468
366	606	SE16x40	SE16x40	☉	8.5	SE/SE	36860
374	621	SE14x40	SE14x40	☉	8.5	SE/SE	36863
377	464	SE14x40.0	SE12X49	☉	8.5	SE/SE	42826
397	660	SE10x32.0	SE10x51.0	☉	8.5	SE/SE	G45860



TECHNICAL



































Collapsed Length	Extended Length	Upper Mounting	Lower Mounting	Accessory Pack Part No.	Shock Type			Part #
					Icon	Fig	Code	
GABRIEL® TECHNOMATIC™ (CONT...)								
SHOCK ABSORBERS - RUBBER EYE UPPER, STUD LOWER								
285	468	RE16	S	144068		9.1	RE/S	G45432
SHOCK ABSORBERS - SLEEVED EYE UPPER, STUD LOWER								
266	430	SE13x32.00	S		9.2	SE/S	42447
SHOCK ABSORBERS - SLEEVED EYE UPPER, BAR PIN LOWER								
229	346	SE10x58.0	BPx86.5		10	SE/BP	G45837
229	346	SE10x75.0	BPx86.5		10	SE/BP	G45503
SHOCK ABSORBERS - BAR PIN UPPER, SLEEVED EYE LOWER								
285	461	BPx 58.5	SE12x25.0		13.2	BP/SE	19290
GABRIEL® HEAVY DUTY								
SHOCK ABSORBERS - STUD UPPER, RUBBER EYE LOWER								
318	506	S	RE20		6.1	S/RE	83454
SHOCK ABSORBERS - STUD UPPER, SLEEVED EYE LOWER								
201	287	S	SE14x55.0		6.2	S/SE	83373
291	439	S	SE20		6.2	S/SE	83455
354	564	S	SE19x60.0		6.2	S/SE	85319
362	588	S	SE19		6.2	S/SE	83456
437	589	S	SE14x35.0		6.2	S/SE	82606
SHOCK ABSORBERS - RUBBER EYE UPPER AND LOWER								
415	664	RE25	RE25		8.2	RE/RE	85320
SHOCK ABSORBERS - SLEEVED EYE UPPER AND LOWER								
187	238	SE11x35.0	SE11x35.0		8.5	SE/SE	83021
291	518	SE14x55.0	SE14x40.0		8.5	SE/SE	83450
368	579	SE19x96.5	SE19x81.5		8.5	SE/SE	85724
370	583	SE19x60.0	SE19x60.0		8.5	SE/SE	85918
SHOCK ABSORBERS - SLEEVED EYE UPPER, STUD LOWER								
223	322	SE12x52.0	S		9.2	SE/S	83367
SHOCK ABSORBERS - BAR PIN UPPER, RUBBER EYE LOWER								
337	562	BPx72.9	RE16		13.1	BP/RE	81514

TECHNICAL

Collapsed Length	Extended Length	Upper Mounting	Lower Mounting	Accessory Pack Part No.	Shock Type			Part #
					Icon	Fig	Code	
GABRIEL® FLEET RYDER®								
SHOCK ABSORBERS - STUD UPPER AND LOWER								
298	486	S	S	144036	⊥	5	S/S	76003
311	514	S	S	144036	⊥	5	S/S	76041
327	546	S	S	⊥	5	S/S	76133
336	565	S	S	144036	⊥	5	S/S	76009
349	590	S	S	144036	⊥	5	S/S	76020
365	600	S	S	144036, 144036	⊥	5	S/S	77000
368	628	S	S	⊥	5	S/S	76006
380	633	S	S	144036, 144036	⊥	5	S/S	77012
395	682	S	S	144036	⊥	5	S/S	76206
406	683	S	S	144067, 144067	⊥	5	S/S	77004
419	730	S	S	144036	⊥	5	S/S	76034
448	767	S	S	144067, 144067	⊥	5	S/S	77006
SHOCK ABSORBERS - STUD UPPER, RUBBER EYE LOWER								
334	547	S	RE16	144068	⊕	6.1	S/RE	76132
335	538	S	RE22	144036, 144000	⊕	6.1	S/RE	76043
360	599	S	RE20	144037, 144031	⊕	6.1	S/RE	76102
360	599	S	RE20	⊕	6.1	S/RE	76155
373	614	S	RE22	144036, 144000	⊕	6.1	S/RE	76016
375	617	S	RE20	142095 144000	⊕	6.1	S/RE	76205
381	637	S	RE20	142095 144031	⊕	6.1	S/RE	76204
382	643	S	RE20	⊕	6.1	S/RE	76153
392	652	S	RE25	144067, 144011	⊕	6.1	S/RE	76103
399	646	S	RE22	⊕	6.1	S/RE	77011
408	652	S	RE20	144068	⊕	6.1	S/RE	76108
430	729	S	RE25	144067, 144011	⊕	6.1	S/RE	76035
430	729	S	RE25	⊕	6.1	S/RE	76112
SHOCK ABSORBERS - STUD UPPER, SLEEVED EYE LOWER								
326	513	S	SE20x46.0	144036	⊕	6.2	S/SE	76151
384	645	S	SE14x40.0	144037	⊕	6.2	S/SE	76037
392	659	S	SE16x48.0	144036	⊕	6.2	S/SE	76131
430	725	S	SE16x50.0	144036	⊕	6.2	S/SE	76156
487	823	S	SE20x62.0	144067	⊕	6.2	S/SE	77001
SHOCK ABSORBERS - RUBBER EYE UPPER AND LOWER								
327	514	RE20	RE20	144031	⊕	8.2	RE/RE	76015
345	546	RE20	RE20	⊕	8.2	RE/RE	76135
362	565	RE22	RE22	144011	⊕	8.2	RE/RE	76007
383	612	RE25	RE25	144011	⊕	8.2	RE/RE	76207
384	613	RE22	RE22	144000	⊕	8.2	RE/RE	76042
390	641	RE20	RE20	144031	⊕	8.2	RE/RE	76110
404	610	RE25	RE25	144011	⊕	8.2	RE/RE	77002
435	730	RE20	RE20	144031	⊕	8.2	RE/RE	76100
441	727	RE22	RE22	144000	⊕	8.2	RE/RE	76008



TECHNICAL

Collapsed Length	Extended Length	Upper Mounting	Lower Mounting	Accessory Pack Part No.	Shock Type			Part #
					Icon	Fig	Code	
GABRIEL® FLEET RYDER® (CONT...)								
SHOCK ABSORBERS - SLEEVED EYE UPPER AND LOWER								
284	443	SE16x38.0	SE16x38		8,5	SE/SE	76208
307	448	SE20x55.0	SE20x55.0		8.5	SE/SE	77013
310	439	SE24x59.5	SE24x59.5		8.5	SE/SE	77020
326	476	SE24x55.0	SE24x55.0		8.5	SE/SE	77019
330	515	SE20x46.0	SE20x46.0		8.5	SE/SE	76152
346	549	SE16x40.0	SE14x40.0		8.5	SE/SE	76039
346	549	SE20x46.0	SE20x46.0		8.5	SE/SE	76150
351	567	SE16x38.0	SE16x38		8,5	SE/SE	76209
361	586	SE16x38.0	SE16x38.0		8.5	SE/SE	42773
384	626	SE16x40.0	SE14x40.0		8.5	SE/SE	76038
396	650	SE20x52.0	SE20x52.0		8.5	SE/SE	76017
400	635	SE20x46.0	SE20x46.0		8.5	SE/SE	77018
418	660	SE20x55.0	SE20x55.0		8.5	SE/SE	76014
429	715	SE16x48.0	SE16x48.0		8.5	SE/SE	76021
429	715	SE16x48.0	SE16x48.0		8.5	SE/SE	76149
430	695	SE16x48.0	SE16x48.0		8.5	SE/SE	77010
430	695	SE16x50.0	SE16x50.0		8.5	SE/SE	77003
437	714	SE20x50	SE20x50		8.5	SE/SE	76185
442	719	SE20x46.0	SE20x46.0		8.5	SE/SE	77022
443	739	SE16x50.0	SE16x50.0		8.5	SE/SE	76019
443	739	SE20x55.0	SE20x55.0		8.5	SE/SE	76157
463	755	SE20x50	SE20x50		8.5	SE/SE	76186
463	784	SE20x46.0	SE20x46.0		8.5	SE/SE	76040
466	752	SE16x50.0	SE16x50.0		8.5	SE/SE	77005
473	794	SE20x62.0	SE16x63.0		8.5	SE/SE	76036
475	785	SE16x50.0	SE16x50.0		8.5	SE/SE	77007
475	805	SE16x50.0	SE16x50.0		8.5	SE/SE	76033
476	797	SE22x55.0	SE22x55.0		8.5	SE/SE	76109
480	801	SE20x62.0	SE20x62.0		8.5	SE/SE	76022
519	894	SE16x50.0	SE16x50.0		8.5	SE/SE	76106
534	909	SE20x62.0	SE20x62.0		8.5	SE/SE	76104
542	903	SE20x62.0	SE20x62.0		8.5	SE/SE	77008
SHOCK ABSORBERS - SLEEVED EYE UPPER, STUD LOWER								
345	564	SE20x45.0	S		9.2	SE/S	76134
SHOCK ABSORBERS - SLEEVED EYE UPPER, BAR PIN LOWER								
421	653	SE20x62.0	BPx100.0		10	SE/BP	77009
472	758	SE20x62.0	BPx100.0		10	SE/BP	77023



GASLIFTS & STEERING DAMPERS

The Gabriel® Gaslift® range is locally designed and developed to be a simple, hassle free, cost effective and customisable solution, that will allow you to take the lift out of lifting.

Used to open and close various items, the Gabriel® Gaslift® range is used on vehicle bonnets and -boots, doors, canopies, trailers, sunbeds, windows and many more applications.

Available in both an extensive automotive and industrial range, the Gabriels® Gaslift solution via a variety of high quality, long lasting end fittings that will best suite your application and lift angle. Also through our national gas filling solution, you can fill the differing units to the specific pressure that you will need to meet the required weight, angle and application.

Section Content	Page
Product Range and General Information	198
Gas Filling Machine	200
Gaslifts Custom Range	200
Vehicle Listing	202
Parts Listing	205
Extended & Collapsed Lengths	208
Steering Dampers	214



GASLIFTS

PRODUCT RANGE

GASLIFT

The Gabriel® Gaslift® series is designed to be a hassle free and customisable solution to assist in many various applications from, bonnet and boot applications, opening, holding open and closing doors to canopies, sun beds and window solution.

The Gabriel® Gaslift® range is also available in extensive automotive and industrial applications.

The range is supported through a variety of connection end fittings. Further, there is a national gas filling solution to fill units to a specific pressure to meet the required weight, angle and solution.

All of the range is covered by the Gabriel warranty and delivers up to its historical South African pedigree and provides for total peace of mind.



Gabriel® Gaslift®



Gabriel® Gaslift®

Product Features

- Ø16 and Ø19 Bore working cylinder
- Designed to be used to a pressure of up to 1000N (rod size applicable)
- Uses specific oil infused with nitrogen which is designed to work in South African and African climates
- Single lip rod seals
- Sintered metal rod guides
- NBR rod seals
- Gabriel® 12 month warranty

Product Benefits

- A hassle-free ready to use solution for both industrial and automotive requirements
- The industrial range can be customised for particular applications:
 - 4000 Series can be pressurised to 500N
 - 4100 Series can be pressurised to 1000N
- Plastic or metal end fittings to suit specific applications and cost options
- Universal canopy replacements
- Manufactured locally to the highest quality standards using premium quality components

The Gaslift® spring consists of a cylinder, piston and rod assembly able to extend and contract telescopically. The cylinder is filled with nitrogen gas at a very high pressure. It is this gas pressure which creates the lifting ability of the Gaslift® and the force exerted is proportional to the gas pressure.

A measured quantity of oil inside the Gaslift® lubricates the piston assembly and provides damping at the end of the extension movement. The damping imparts a more gentle action to the object being moved. Therefore, the Gaslift® should always be mounted with the rod in a downward position, when the door is fully opened.

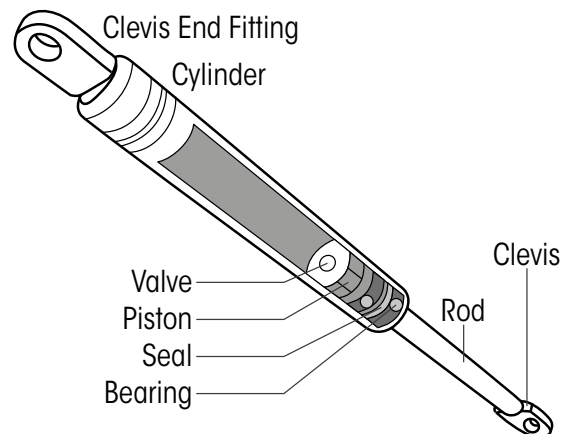

GASLIFTS

PRODUCT RANGE

CALCULATING THE FORCE (F1)

Required to hold the lid in the Open position

Refer to the diagram:

- F1 - Force exerted by Gaslift® in Fully Extended Condition
- U - Upper Mounting Point
- L - Lower Mounting Point
- P - Pivot Point
- CG - Centre of Gravity
- A - Horizontal Distance from CG to Pivot Point P
- B - Perpendicular Distance from axis U-L to Pivot Point P
- W - Weight/Mass of lid

If the position of the CG of the lid is not known, then a spring balance or similar can be used to measure the force required to hold the door open. If the force is measured at the upper mounting point U this force plus 10 – 15% safety factor is the F1 required. If the force is measured at any other point, use the perpendicular distance from the pivot point P to the attachment point of the spring balance as A and the spring balance reading as W in the formula.

Diagram of typical application

(*Refer formula to calculate)

$$F1 = W \times \frac{A}{B} + 10 \text{ to } 15\% \text{ safety factor}$$

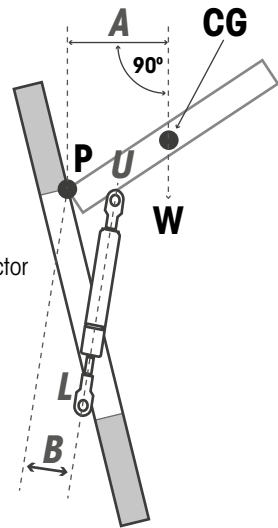

Note:

By changing the Gaslift® axis U - L the lid can be made to open automatically once the catch is released, or stay closed so that no catch is required. The calculated force is only enough to balance the mass – add more to keep the flap firmly in place. Work to low side of the calculated pressure at first because additional gas can be added, but pressure cannot be reduced.

Gaslift application (A selection of examples)

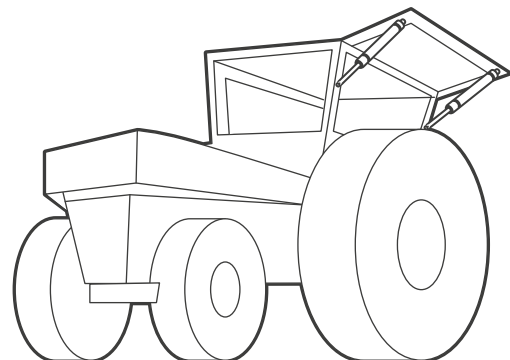
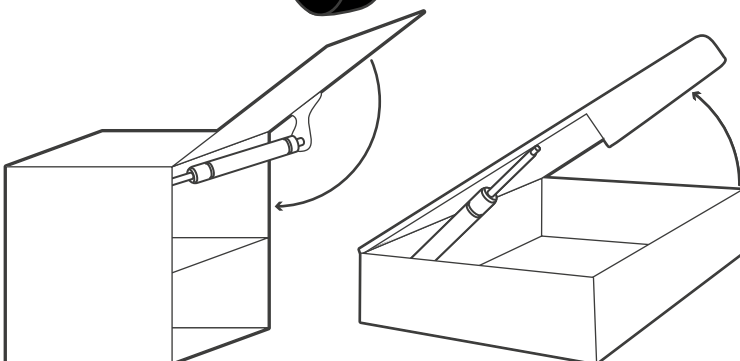
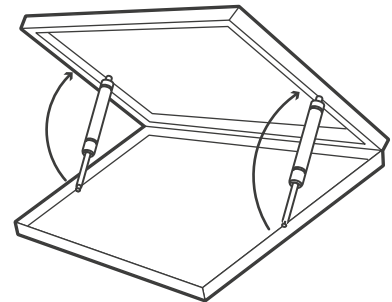
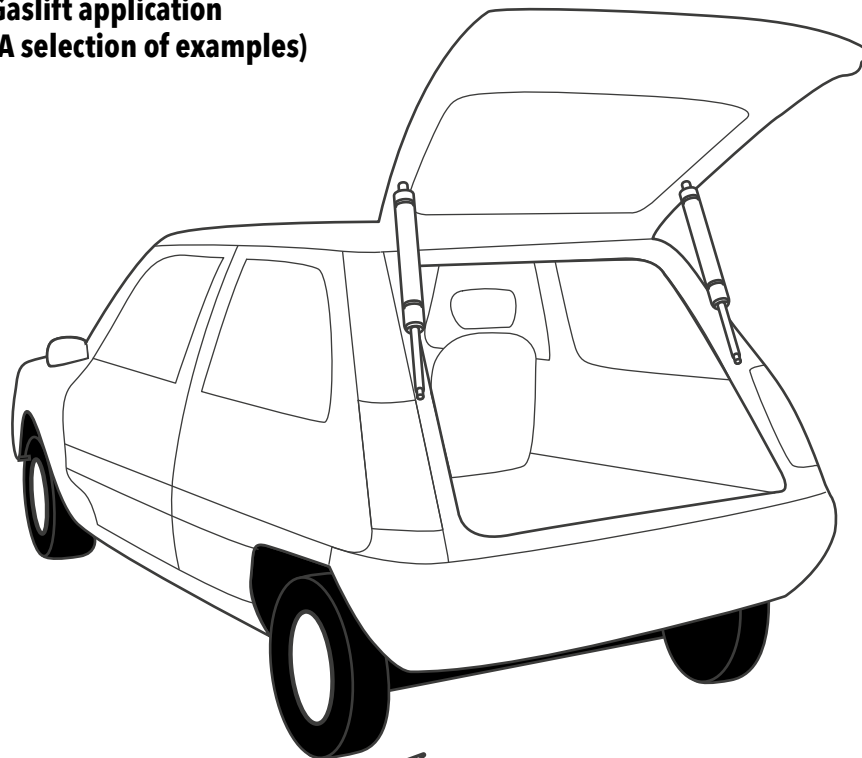

GAS FILLING MACHINE

Part #	Model	Derivative
144273	Gas Filling Machine	Gaslifts
144283	Hoses, Fittings & Trigger Valve	Gaslifts
144284	Harris High Pressure Regulator 987-170 Series	Gaslifts
144285	Harris Medium Pressure Regulator 987-100 Series	Gaslifts
144301	19mm gas springs. 8mm rods, 16mm seals	Black seals
144302	22mm gas springs. 10mm rods, 19mm seals	Black seals
S6-9-18306	19mm gas springs. 8mm rods, 16mm seals	Red seals
S6-9-21.5346	22mm gas springs. 10mm rods, 19mm seals	Red seals

The Gabriel gas filling machine offers you the convenience of pressurizing the Gabriel industrial Gaslift to the application force required. The gas filling machine may be purchased complete with regulators, hoses and fittings or these accessories may be bought separately.

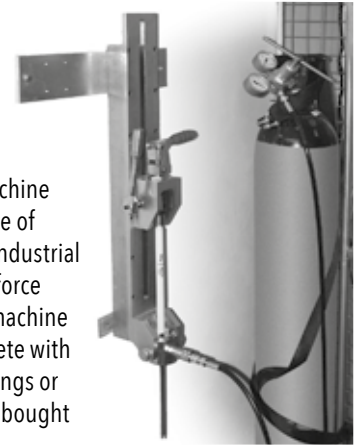

GASLIFTS

Custom Range

The Gabriel Gaslift Custom Range caters for but is not limited to non-automotive applications. These custom units are only pressurised to a nominal 50N gas force with the intent that the enduse application dictates a calculated gas force requirement to be filled post purchase (see "Calculating the Force" formula on page 199 of this catalogue).

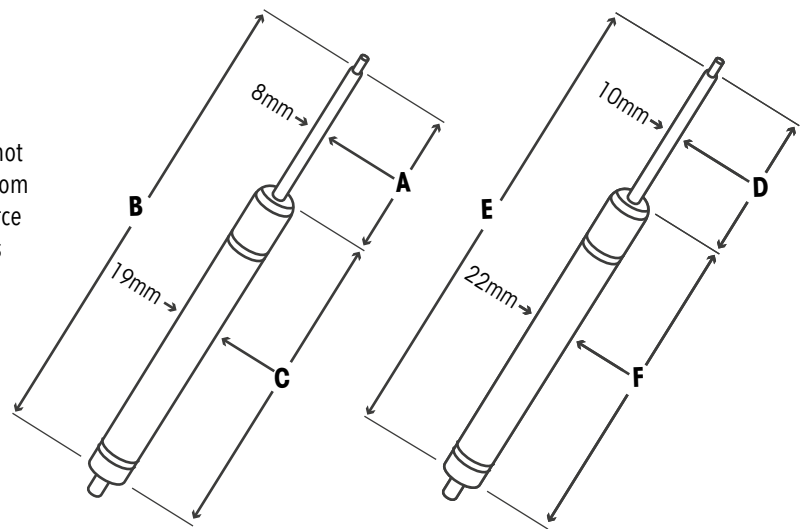

4000 Series 6mm End Fittings*



Clevis 5mm wide
358021
8mm hole

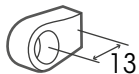

Clevis 8mm wide
358028 6mm hole
358119 8mm hole

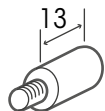

Spacer
358011
15mm

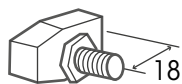

Ball and plastic
socket ass
358001
10mm ball M8 tread

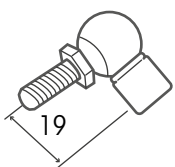

Ball and steel
socket ass
258003
10mm ball M8 tread

4100 Series 8mm End Fittings*



Spacer
358257
17mm

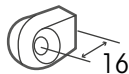

Clevis
358264 10mm hole
358265 8mm hole

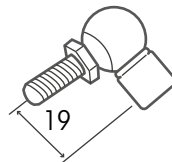

Ball and steel
socket ass
358252
10mm ball M8 thread

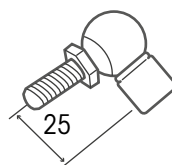

Ball and steel
socket ass
358251
13mm ball M8 thread



Clevis 5mm wide
358270
8mm hole



Clevis 10mm wide
358270
8mm hole



Double Clevis
358271
8mm hole 8mm gap

GASLIFTS

Custom Range

4000 series 6mm End Threads

Can be pressurised as required up to 500N

Gas Lift	A	B	C	Nominal Force
Part #	Stroke	Ext Length	Coll Length	Newtons
4040	82	200	118	50
4041	107	250	143	50
4042	132	300	168	50
4043	157	350	193	50
4044	182	400	218	50
4045	204	450	246	50
4046	230	500	270	50
4047	257	550	293	50
4048	282	600	318	50
4049	307	650	343	50
4050	332	700	368	50
4051	357	750	393	50
4052	382	800	418	50

4100 series 8mm End Threads

Can be pressurised as required up to 1000N

Gas Lift	A	B	C	Nominal Force
Part #	Stroke	Ext Length	Coll Length	Newtons
4140	157	350	193	50
4141	182	400	218	50
4142	207	450	243	50
4143	232	500	268	50
4144	257	550	293	50
4145	282	600	318	50
4146	307	650	343	50
4147	332	700	368	50
4148	357	750	393	50
4149	382	800	418	50
4150	407	850	443	50
4151	432	900	468	50
4152	457	950	493	50
4153	482	1000	518	50
4164	86	209	123	50

4000 series - 8mm Rod

Required Force (N)	Pressure Settings (kPa)	mPa	Bar
100	1989	2.0	20
150	2983	3.0	30
200	3977	4.0	40
250	4972	5.0	50
300	5966	6.0	60
350	6960	7.0	70
400	7955	8.0	80
450	8949	8.9	89
500	9943	9.9	99

4100 series - 10mm Rod







Required Force (N)	Pressure Settings (kPa)	mPa	Bar
100	1273	1.3	12.7
150	1909	1.9	19.1
200	2545	2.5	25.5
250	3182	3.2	31.8
300	3818	3.8	38.2
400	5091	5.1	50.9
450	5727	5.7	57.3
500	6364	6.4	63.6
550	7000	7.0	70.0
600	7636	7.6	76.4
650	8273	8.3	82.7
700	8909	8.9	89.1
750	9545	9.5	95.5
800	10182	10.2	101.8
850	10818	10.8	108.2
900	11455	11.5	114.5
950	12091	12.1	120.9
1000	12727	12.7	127.3



GASLIFTS

GASLIFTS

Vehicle listing



Model	Derivative	Vehicle Type	Year	Front	Rear	Position/Side
AUDI						
400, 500	(C3, C4)		83-94	4081		
A4	1.8, 2.4, 2.8 (8D2)		94-01		4284	
BMW						
3 Series	E30 Series, Sedan		83-92	4060		
3 Series (With end-fittings)	E36 Series (excl. M3)		92-99		4269	
3 Series (Without end-fittings)	E36 Series (excl. M3)		92-99		4285	
3 Series	E36 Series (excl. M3)		92-99	4270		
7 Series	E32 Series, Sedan		87-94	4060		
7 Series	E23 Series, Sedan		78-87	4061		
CHEVROLET						
Spark	M300 (Excl Lite)		10 on		4341	
FIAT						
Uno	All incl. Turbo		90-04		4063	
FORD						
Escort	FWD L, GL, GLE P/C		81-86		4063	
Escort	FWD XR3, Sport		81-86		4064	
Escort	Mk V, Estate		95-99		4272	
Fiesta	All		97-03		4063	
Fiesta	Hatchback		97-03		4063	
Fiesta	Mk V Hatch (JH, JD), 5door (Excl. 2.5 ST & 3 door)		04-08		4362	
Fiesta	All		08-18		4337	
Figo	All		10 on		4336	
Focus	Mk I		98-04		4316	
Focus	Mk II		04-11		4339	
Laser, Meteor, Tracer	Sedan		86-01		4087	
Ranger	TKE 4x2 & 4x4		12 on	4356		
Sierra, Sapphire	2300, 2000, 1600, Sedan		83-93		4080	
Sierra, Sapphire	2300, 2000, 1600 Estate		83-93		4080	
Sierra, Sapphire	3000 (incl. XR6) PC		83-93		4127	
Spectron	Minibus		91-03		4131	
Telstar	Sedan		93-99		4502	
HONDA						
Civic	Hatchback		96-01		4289	
HYUNDAI						
Atos	Prime		00-08		4359	
Getz	Hatchback		03-11		4347	
i20	Hatchback		09-12		4349	
i20	Hatchback		13-15		4349	
i20	Gen 2 (GB) Hatch		15 on		4348	
Tucson	JM		04-11		4360 Door	
Tucson	JM		04-11		4361 Glass	
ISUZU						
WFR, Relay	Panel van, Bus		84-95		4129	
JEEP						
Cherokee	KJ Series		02-07	4344	4345	
Cherokee	KK Series		08-13		4542/4346	Door/Glass



GASLIFTS

GASLIFTS

Vehicle listing





































Model	Derivative	Vehicle Type	Year	Front	Rear	Position/Side
KIA						
Picanto	MkI (SA; BA)		04-11		4373	
Picanto	MkII (TA)		11-17		4374	
LAND ROVER						
Range Rover	Mk I		76-96		4205	
MAZDA						
2	DE (Demio)		07-15		4379	
3	BK		04-09		4375	
3	BL		09-14		4378	
323	(excl. S, EGi, Sport)		81-91		4071	
323	(S, EGi, Sport)		81-91		4087	
323	(incl. Midge)		91-04		4087	
626	(Mk II, Mk III)		83-93		4071	
626	Mk IV		92-98		4271	
Marathon	Minibus, Van		91-03		4131	
Soho	Hatchback		97-99		4063	
MERCEDES-BENZ						
A Class	(W168) A160, A190, 170CDI		00-04		4329	
NISSAN						
E20	Ekonovan, Ekonowagon		73-95		4162	
Langley, Pulsar	Incl. Panache (N10)		80-83		4099	
Micra	Gen 3 (K12)		04-11		4363	
Micra	Gen 4 (K13)		11-18		4364	
Qashqai	J10, JJ10		07-14		4365	
Sabre	160,2		92-01		4515	
Sabre	160,2		92-01		4516	
Sentra	140, 160, 200		78-83		4268	
Stanza, Resort	1600J, 1800J		70-81		4068	
OPEL						
Astra	(G)		99-03		4272	
Astra	Estate (F)		94-01		4221	
Chevair, Ascona	(C)		82-86		4080	
Corsa	(B)		96-02		4277	
Corsa	Corsa Lite (B)		02-07		4277	
Corsa	Excl. Corsa Lite (C)		03-07		4308	
Corsa	D (Excl. Lite), 3doors		07-15		4366	
Corsa	D (Excl. Lite), 5 doors		07-15		4367	
Kadett	(Astra)		93-99		4260	
Kadett	Hatchback		80-85		4069	
Kadett	T-car (E)		85-93		4079	
PEUGEOT						
206	Estate		02 on		4333	
306	Estate		98-02		4332	
307	Hatchback		02 on		4331	
504	Estate		74-85		4065	



GASLIFTS

GASLIFTS

Vehicle listing

Model	Derivative	Vehicle Type	Year	Front	Rear	Position/Side
RENAULT						
Clio	Clio II		00-06		4298	
Clio	Clio III		06-13		4368	
TOYOTA						
Avanza	1.3 & 1.5 (Xenia)		06-12		4380	Left
Avanza	1.3 & 1.5 (Xenia)		06-12		4381	Right
Auris	1.4, 1.6, 1.8, 2.0 hatch (330N/E150)		07-12		4369	
Camry	(XV10), (XV20)		93-01	4165		
Carri	(E90)		98-05		4273	
Condor	MPV Mk IV		00-05		4521	Right
Condor	MPV Mk IV		00-05		4522	Left
Conquest, Tazz	FWD (E80)		85-89		4063	
Conquest, Tazz	FWD (E90)		89-05		4273	
Corolla	Estate (E70)		80-85		4207	
Corolla	Verso MkIII (Spacio) (AR10)		04-09		4370	
Cressida	MX63 (Mk II)		81-93		4083	
Cressida	Mk II Sedan, Wagon		81-93	4084		
Etios	Hatchback		12 on		4352	
Hi-Ace	Super T (Minibus, Van)		69-02		4163	
Quantum	High Roof Only (Length 785mm)		05 on		4538	Left
Quantum	High Roof Only (Length 785mm)		05 on		4539	Right
Venture	(KF40)		91-00		4199	
Yaris	Mk II Hatch		06-11		4350	
Yaris	Mk III Hatch		11-17		4351	
VOLKSWAGEN						
Citi	All		84 on		4065	
Golf	Mk I,		84 on		4065	
Golf	Mk II		84-92		4082	
Golf	Mk III		93-99		4082	
Golf	Mk IV		99-04		4314	
Golf	Mk V		04-09	4312	4313	
Jetta	Mk III		93-99		4501	
Kombi	Microbus		80-02		4076	
Passat	(B2)		82-87	4067	4068	
Polo	Classic (MkIII)		96-02		4291	
Polo	MkIV 9N Hatch (Excl. GTI)		02-09	4353	4338	
Polo	Vivo MkIV 9N3 Hatch		10-18		4338	
Polo	Mk IV Classic		10 on		4544	
Polo	VIVO Hatch (MkV model)		18 on		4343	
Polo	MkV Hatch (Type 6R; 6C) (Excl. Gti, Sport & Cross)		10-18		4343	
Up	Hatchback		13 on		4354	



GASLIFTS

GASLIFTS

Parts listing

Part #	Range	Fitment Guide #	Position	Make	Model	Derivative	Year
4060	Gaslift®	Fig. 14	Front	BMW	3 Series	E30 Series, Sedan	83-92
4060	Gaslift®	Fig. 14	Front	BMW	7 Series	E32 Series, Sedan	87-94
4061	Gaslift®	Fig. 14	Front	BMW	7 Series	E23 Series, Sedan	78-87
4063	Gaslift®	Fig. 14	Rear	Fiat	Uno	All incl. Turbo	90-04
4063	Gaslift®	Fig. 14	Rear	Ford	Escort	FWD L, GL, GLE P/C	81-86
4063	Gaslift®	Fig. 14	Rear	Ford	Fiesta	ALL	97-03
4063	Gaslift®	Fig. 14	Rear	Ford	Fiesta	Hatchback	97-03
4063	Gaslift®	Fig. 14	Rear	Mazda	Soho	Hatchback	97-99
4063	Gaslift®	Fig. 14	Rear	Toyota	Conquest, Tazz	FWD (E80)	85-89
4064	Gaslift®	Fig. 14	Rear	Ford	Escort	FWD XR3, Sport	81-86
4065	Gaslift®	Fig. 14	Rear	Peugeot	504	Estate	74-85
4065	Gaslift®	Fig. 14	Rear	Volkswagen	Citi	All	84 on
4065	Gaslift®	Fig. 14	Rear	Volkswagen	Golf	Mk I,	78-84
4067	Gaslift®	Fig. 14	Front	Volkswagen	Passat	B2	82-87
4068	Gaslift®	Fig. 14	Rear	Nissan	Stanza, Resort	1600J, 1800J	78-83
4068	Gaslift®	Fig. 14	Rear	Volkswagen	Passat	B2	82-87
4069	Gaslift®	Fig. 14	Rear	Opel	Kadett	Hatchback	80-85
4071	Gaslift®	Fig. 14	Rear	Mazda	323	Excl. S, EGi, Sport	81-91
4071	Gaslift®	Fig. 14	Rear	Mazda	626	Mk II, Mk III	83-93
4076	Gaslift®	Fig. 14	Rear	Volkswagen	Kombi	Microbus	80-02
4079	Gaslift®	Fig. 14	Rear	Opel	Kadett	T-car (E)	85-93
4080	Gaslift®	Fig. 14	Rear	Ford	Sierra, Sapphire	2300, 2000, 1600, Sedan	83-93
4080	Gaslift®	Fig. 14	Rear	Ford	Sierra, Sapphire	2300, 2000, 1600 Estate	83-93
4080	Gaslift®	Fig. 14	Rear	Opel	Chevaïr, Ascona	C	82-86
4081	Gaslift®	Fig. 14	Front	Audi	400, 500	C3, C4	83-94
4082	Gaslift®	Fig. 14	Rear	Volkswagen	Golf	Mk III	93-99
4082	Gaslift®	Fig. 14	Rear	Volkswagen	Golf	Mk II	84-92
4083	Gaslift®	Fig. 14	Rear	Toyota	Cressida	X30, X32 (Mk I)	81-93
4084	Gaslift®	Fig. 14	Front	Toyota	Cressida	X35, X36 (Mk I)	81-93
4087	Gaslift®	Fig. 14	Rear	Ford	Laser, Meteor, Tracer	Sedan	86-01
4087	Gaslift®	Fig. 14	Rear	Mazda	323	S, EGi, Sport	81-91
4087	Gaslift®	Fig. 14	Rear	Mazda	323	Incl. Midge	91-04
4098	Gaslift®	Fig. 14	Lid	Venter	Trailer	All	N-A
4099	Gaslift®	Fig. 14	Rear	Nissan	Langley, Pulsar	Incl. Panache (N10)	80-83
4127	Gaslift®	Fig. 14	Rear	Ford	Sierra, Sapphire	3000 (incl. XR6) PC	83-93
4129	Gaslift®	Fig. 14	Rear	Isuzu	Wfr, Relay	Panel van, Bus	84-95
4131	Gaslift®	Fig. 14	Rear	Ford	Spectron	Minibus	91-03
4131	Gaslift®	Fig. 14	Rear	Mazda	Marathon	Minibus, Van	91-03
4162	Gaslift®	Fig. 14	Rear	Nissan	E20	Ekonovan, Ekonowagon	73-95
4163	Gaslift®	Fig. 14	Rear	Toyota	Hi-Ace	Super T (Minibus, Van)	69-02
4165	Gaslift®	Fig. 14	Front	Toyota	Camry	XV10, XV20	93-01
4199	Gaslift®	Fig. 14	Rear	Toyota	Venture	KF40	91-00
4205	Gaslift®	Fig. 14	Rear	Land Rover	Range Rover	Mk I	76-96
4207	Gaslift®	Fig. 14	Rear	Toyota	Corolla	Estate (E70)	80-85
4221	Gaslift®	Fig. 14	Rear	Opel	Astra	Estate (F)	94-01
4260	Gaslift®	Fig. 14	Rear	Opel	Kadett	Astra	93-99
4268	Gaslift®	Fig. 14	Rear	Nissan	Sentra	140, 160, 200	92-01
4269	Gaslift®	Fig. 14	Rear	Bmw	3 Series	E36 Series (excl. M3)	92-99
4270	Gaslift®	Fig. 14	Front	Bmw	3 Series	E36 Series (excl. M3)	92-99
4271	Gaslift®	Fig. 14	Rear	Mazda	626	Mk IV	92-98
4272	Gaslift®	Fig. 14	Rear	Ford	Escort	Mk V, Estate	95-99
4272	Gaslift®	Fig. 14	Rear	Opel	Astra	G	99-03

GASLIFTS

GASLIFTS

Parts listing

Part #	Range	Fitment Guide #	Position	Make	Model	Derivative	Year
4273	Gaslift®	Fig. 14	Rear	Toyota	Carri	E90	98-05
4273	Gaslift®	Fig. 14	Rear	Toyota	Conquest, Tazz	FWD (E90)	89-05
4277	Gaslift®	Fig. 14	Rear	Opel	Corsa	B	96-02
4277	Gaslift®	Fig. 14	Rear	Opel	Corsa	Corsa Lite (B)	02-07
4284	Gaslift®	Fig. 14	Rear	Audi	A4	1.8, 2.4, 2.8 (8D2)	96-01
4285	Gaslift®	Fig. 14	Rear	Bmw	3 Series	E36 Series	91-99
4289	Gaslift®	Fig. 14	Rear	Honda	Civic	Hatchback	96-01
4291	Gaslift®	Fig. 14	Rear	Volkswagen	Polo	Classic (MkIII)	96-02
4294	Gaslift®	Fig. 14	Universal	Universal	Canopies	& Trailers	N-A
4295	Gaslift®	Fig. 14	Universal	Universal	Canopies	& Trailers	N-A
4296	Gaslift®	Fig. 14	Universal	Universal	Canopies	& Trailers	N-A
4297	Gaslift®	Fig. 14	Universal	Universal	Canopies	& Trailers	N-A
4298	Gaslift®	Fig. 14	Rear	Renault	Clio	CLIO II	00-06
4308	Gaslift®	Fig. 14	Rear	Opel	Corsa	Excl. Corsa Lite (C)	03-07
4312	Gaslift®	Fig. 14	Front	Volkswagen	Golf	Mk V	04-09
4313	Gaslift®	Fig. 14	Rear	Volkswagen	Golf	Mk V	04-09
4314	Gaslift®	Fig. 14	Rear	Volkswagen	Golf	Mk IV	99-04
4316	Gaslift®	Fig. 14	Rear	Ford	Focus	Mk I	98-04
4319	Gaslift®	Fig. 14	Rear	Renault	Scenic	Mk I (Rear Window)	96-03
4322	Gaslift®	Fig. 14	Rear	Ford	Fiesta	Mk V, Tailgate	04-08
4329	Gaslift®	Fig. 14	Rear	Mercedes-Benz	A Class	(W168) A160, A190, 170CDI	00-04
4331	Gaslift®	Fig. 14	Rear	Peugeot	307	Hatchback	02 on
4332	Gaslift®	Fig. 14	Rear	Peugeot	306	Estate	98-02
4333	Gaslift®	Fig. 14	Rear	Peugeot	206	Estate	02 on
4337	Gaslift®	Fig. 14	Rear	Ford	Fiesta	All	08-18
4336	Gaslift®	Fig. 14	Rear	Ford	Figgo	All	10 on
4338	Gaslift®	Fig. 14	Rear	Volkswagen	Polo	Mk IV (9N) Hatch	02-09
4338	Gaslift®	Fig. 14	Rear	Volkswagen	Polo	Vivo MkIV 9N3 Hatch	10-18
4339	Gaslift®	Fig. 14	Rear	Ford	Focus	Mk II Hatch (Excluding 2.5 RS & ST)	04-11
4341	Gaslift®	Fig. 14	Rear	Chevrolet	Spark	Hatchback	10 on
4343	Gaslift®	Fig. 14	Rear	Volkswagen	Polo	MkV Hatch (Type 6R; 6C) (Excl. Gti, Sport & Cross)	10 on
4344	Gaslift®	Fig. 14	Front	Jeep	Cherokee	(KJ) 2.5D, 2.8D, 3.7	02-07
4345	Gaslift®	Fig.14	Rear	Jeep	Cherokee	KJ Series	02-07
4346	Gaslift®	Fig.14	Glass	Jeep	Cherokee	KK Series	08-13
4347	Gaslift®	Fig.14	Rear	Hyundai	Getz	3&5 Door	03-11
4348	Gaslift®	Fig.14	Rear	Hyundai	i20	Gen2 (GB)	15 on
4349	Gaslift®	Fig.14	Rear	Hyundai	i20	Gen1 (PB) Incl. Facelift	09-15
4351	Gaslift®	Fig.14	Rear	Toyota	Yaris	Mk III Hatch	11-17
4352	Gaslift®	Fig.14	Rear	Toyota	Etios	Hatchback	12 on
4353	Gaslift®	Fig.14	Bonnet	Volkswagen	Polo	MkIV 9N Hatch (Excl. GTI)	02-09
4354	Gaslift®	Fig.14	Rear	Volkswagen	Up	Hatchback	13 on
4356	Gaslift®	Fig.14	Bonnet	Ford	Ranger	T5, TKE 4x2 & 4x4	12 on
4359	Gaslift®	Fig.14	Rear	Hyundai	Atos	Prime	00-08
4360	Gaslift®	Fig.14	Rear Door	Hyundai	Tuscon	JM	04-11
4361	Gaslift®	Fig.14	Rear Glass	Hyundai	Tuscon	JM	04-11
4362	Gaslift®	Fig.14	Rear	Ford	Fiesta	Mk V Hatch (JH, JD), 5door (Excl. 2.5 ST & 3 door)	04-08
4363	Gaslift®	Fig.14	Rear	Nissan	Micra	Gen 3 (K12)	04-11
4364	Gaslift®	Fig.14	Rear	Nissan	Micra	Gen 4 (K13)	11-18
4365	Gaslift®	Fig.14	Rear	Nissan	Qashqai	J10, J110	07-14
4366	Gaslift®	Fig.14	Rear	Opel	Corsa	D (Excl. Lite), 3doors	07-15
4367	Gaslift®	Fig.14	Rear	Opel	Corsa	D (Excl. Lite), 5 doors	07-15
4368	Gaslift®	Fig.14	Rear	Renault	Clio	MkIII	06-13

GASLIFTS

GASLIFTS

Parts listing

Part #	Range	Fitment Guide #	Position	Make	Model	Derivative	Year
4369	Gaslift®	Fig.14	Rear	Toyota	Auris	1.4, 1.6, 1.8, 2.0 hatch (330N/E150)	07-12
4370	Gaslift®	Fig.14	Rear	Toyota	Corolla	Verso MkIII (Spacio) (AR10)	04-09
4373	Gaslift®	Fig.14	Rear	Kia	Picanto	MkI (SA; BA)	04-11
4374	Gaslift®	Fig.14	Rear	Kia	Picanto	MkII (TA)	11-17
4375	Gaslift®	Fig.14	Rear	Mazda	3	BK	04-09
4378	Gaslift®	Fig.14	Rear	Mazda	3	BL	09-14
4379	Gaslift®	Fig.14	Rear	Mazda	2	DE (Demio)	07-15
4380	Gaslift®	Fig.14	Rear Left	Toyota	Avanza	1.3 & 1.5 (Xenia)	06-12
4381	Gaslift®	Fig.14	Rear Right	Toyota	Avanza	1.3 & 1.5 (Xenia)	06-12
4501	Gaslift®	Fig. 14	Rear	Volkswagen	Jetta	Mk III	93-99
4502	Gaslift®	Fig. 14	Rear	Ford	Telstar	Sedan	93-99
4515	Gaslift®	Fig. 14	Rear Right	Nissan	Sabre	160,2	92-01
4516	Gaslift®	Fig. 14	Rear Left	Nissan	Sabre	160,2	92-01
4521	Gaslift®	Fig. 14	Rear Right	Toyota	Condor	MPV Mk IV	00-05
4522	Gaslift®	Fig. 14	Rear Left	Toyota	Condor	MPV Mk IV	00-05
4538	Gaslift®	Fig. 14	Rear Left	Toyota	Quantum	High Roof Only (Length 785mm)	05 on
4539	Gaslift®	Fig. 14	Rear Right	Toyota	Quantum	High Roof Only (Length 785mm)	05 on
4542	Gaslift®	Fig. 14	Rear Door	Jeep	Cherokee	KK Series	08-13
4544	Gaslift®	Fig. 14	Rear	Volkswagen	Polo	Mk IV Sedan	02-09

Pack (Single Part number)							
144221	Gaslift®	End Fittings	Top/Bottom	Custom	10 of	258251
144222	Gaslift®	End Fittings	Top/Bottom	Custom	10 of	358265
144223	Gaslift®	End Fittings	Top/Bottom	Custom	10 of	358264
144224	Gaslift®	End Fittings	Top/Bottom	Custom	10 of	258252
144225	Gaslift®	End Fittings	Top/Bottom	Custom	10 of	358270
144226	Gaslift®	End Fittings	Top/Bottom	Custom	10 of	358253
144227	Gaslift®	End Fittings	Top/Bottom	Custom	10 of	358271
144228	Gaslift®	End Fittings	Top/Bottom	Custom	10 of	358011
144229	Gaslift®	End Fittings	Top/Bottom	Custom	10 of	358257
144230	Gaslift®	End Fittings	Top/Bottom	Custom	10 of	258001
144231	Gaslift®	End Fittings	Top/Bottom	Custom	10 of	358028
144232	Gaslift®	End Fittings	Top/Bottom	Custom	10 of	258003
144233	Gaslift®	End Fittings	Top/Bottom	Custom	10 of	358021
144234	Gaslift®	End Fittings	Top/Bottom	Custom	10 of	358119
Single							
258251	Gaslift®	End Fittings	Top/Bottom	Custom	144221	258251 x 10
358265	Gaslift®	End Fittings	Top/Bottom	Custom	144222	358265 x 10
358264	Gaslift®	End Fittings	Top/Bottom	Custom	144223	358264 x 10
258252	Gaslift®	End Fittings	Top/Bottom	Custom	144224	258252 x 10
358270	Gaslift®	End Fittings	Top/Bottom	Custom	144225	358270 x 10
358253	Gaslift®	End Fittings	Top/Bottom	Custom	144226	358253 x 10
358271	Gaslift®	End Fittings	Top/Bottom	Custom	144227	358271 x 10
358011	Gaslift®	End Fittings	Top/Bottom	Custom	144228	358011 x 10
358257	Gaslift®	End Fittings	Top/Bottom	Custom	144229	358257 x 10
258001	Gaslift®	End Fittings	Top/Bottom	Custom	144230	258001 x 10
358028	Gaslift®	End Fittings	Top/Bottom	Custom	144231	358028 x 10
258003	Gaslift®	End Fittings	Top/Bottom	Custom	144232	258003 x 10
358021	Gaslift®	End Fittings	Top/Bottom	Custom	144233	358021 x 10
358119	Gaslift®	End Fittings	Top/Bottom	Custom	144234	358119 x 10

GASLIFTS

Sorted by Collapsed and Extended Lengths

Collapsed Length	Extended Length	Body End	Rod End	Stroke	Force in Newtons	Part #
118	200	None	None	82	50	4040
123	209	None	None	86	50	4164
143	250	None	None	107	50	4041
150	227	Clevis	Clevis	77	470	4268
163	258	Clevis	Clevis	95	350	4060
168	258	M6 Stud	M6 Stud	90	480	4285
168	300	None	None	132	50	4042
169	255	Socket	Socket	86	600	4544
170	256	Socket	Socket	86	700	4501
175	255	Ball & Socket Assembly	Ball & Socket Assembly	80	650	4544
181	288	Clevis	Socket	107	500	4284
181	288	Ball Stud	Ball Stud	107	300	4291
193	350	None	None	157	50	4043
193	350	None	None	157	50	4140
206	296	Socket	Socket	90	480	4269
215	353	Clevis	Clevis	138	320	4270
218	400	None	None	182	50	4044
218	400	None	None	182	50	4141
225	362	Ball & Socket Assembly	Ball & Socket Assembly	137	470	4354
230	387	Socket	Socket	157	350	4341
231	388	Ball & Socket Assembly	Ball & Socket Assembly	158	250	4295
231	388	Ball & Socket Assembly	Ball & Socket Assembly	158	350	4297
231	381	Ball & Socket Assembly	Ball & Socket Assembly	150	140	4361
232	380	Ball Stud	Socket	148	360	4084
240	365	Bracket	Ball/Socket	125	450	4165
243	450	None	None	207	50	4142
244	376	Socket	Socket	132	400	4341
244	404	Socket	Socket	160	390	4323
246	450	None	None	204	50	4045
253	388	Ball Stud	Ball Stud	135	350	4298
256	438	Socket	Socket	182	300	4344
257	427	Ball & Socket Assembly	Ball & Socket Assembly	170	370	4350
258	415	Ball & Socket Assembly	Ball & Socket Assembly	157	405	4351
260	432	Ball & Socket Assembly	Ball & Socket Assembly	172	660	4352
267	450	Socket	Socket	183	550	4313
268	500	None	None	232	50	4143
270	500	None	None	230	50	4046
270	420	Ball & Socket Assembly	Ball & Socket Assembly	150	450	4349
270	450	Ball & Socket Assembly	Ball & Socket Assembly	180	385	4368
271	370	Ball & Socket Assembly	Ball & Socket Assembly	99	480	4374
272	469	Clevis	Clevis	197	320	4081
272	443	Ball & Socket Assembly	Ball & Socket Assembly	171	455	4369
274	472	Socket	Socket	198	330	4308
281	488	Ball Stud	Ball Stud	207	750	4127
282	458	Socket	Socket	176	430	4331
282	486	Socket	Socket	204	510	4080
282	486	Ball Stud	Ball Stud	204	250	4205

GASLIFTS

GASLIFTS

Sorted by Collapsed and Extended Lengths

Collapsed Length	Extended Length	Body End	Rod End	Stroke	Force in Newtons	Part #
282	436	Ball & Socket Assembly	Bracket	154	480	4380
282	436	Bracket	Bracket	154	480	4381
283	487	Plastic Socket	Metal Socket	205	170	4098
284	488	Ball & Socket Assembly	Ball & Socket Assembly	205	250	4294
284	488	Ball & Socket Assembly	Ball & Socket Assembly	205	350	4296
285	493	Bracket	Ball Stud	208	800	4502
285	485	Ball & Socket Assembly	Ball & Socket Assembly	200	530	4339
285	480	Ball & Socket Assembly	Ball & Socket Assembly	195	335	4373
287	497	Ball Stud	Ball Stud	210	150	4271
289	477	Socket	Socket	188	360	4328
289	485	Socket	Socket	196	530	4316
290	496	Socket	Socket	206	500	4314
290	500	Socket	Socket	210	270	4082
290	497	Ball & Socket Assembly	Ball & Socket Assembly	207	270	4364
291	460	Socket	Socket	169	100	4319
291	500	Clevis	Clevis	209	510	4065
293	550	None	None	257	50	4047
293	550	None	None	257	50	4144
293	483	Ball & Socket Assembly	Ball & Socket Assembly	190	370	4347
295	500	Socket	Socket	205	420	4325
295	513	Clevis	Socket	218	560	4076
300	500	Socket	Socket	200	690	4326
300	510	Socket	Socket	210	340	4330
300	500	Ball & Socket Assembly	Ball & Socket Assembly	200	400	4338
300	500	Ball & Socket Assembly	Ball & Socket Assembly	200	360	4363
300	500	Ball & Socket Assembly	Ball & Socket Assembly	200	310	4353
302	500	Clevis	Clevis	198	230	4061
304	514	Ball Stud	Ball Stud	210	550	4221
305	515	Ball & Socket Assembly	Ball & Socket Assembly	210	425	4365
307	525	Socket	Clevis	218	600	4515
307	525	Socket	Clevis	218	600	4516
310	520	Socket	Socket	210	570	4327
312	524	Ball & Socket Assembly	Ball & Socket Assembly	212	260	4356
315	525	Socket	Socket	210	140	4333
315	515	Ball & Socket Assembly	Ball & Socket Assembly	200	585	4360
315	540	Ball & Socket Assembly	Ball & Socket Assembly	225	390	4375
317	551	Socket	Socket	234	450	4079
318	600	None	None	282	50	4048
318	600	None	None	282	50	4145
322	532	Socket	Socket	210	400	4272
322	526	Ball & Socket Assembly	Ball & Socket Assembly	204	325	4343
324	549	Clevis	Clevis	225	350	4068
332	543	Socket	Socket	211	340	4277
340	540	Socket	Socket	200	400	4329
340	515	Ball & Socket Assembly	Ball & Socket Assembly	175	460	4359
343	650	None	None	307	50	4049
343	650	None	None	307	50	4146



GASLIFTS

GASLIFTS

Sorted by Collapsed and Extended Lengths

Collapsed Length	Extended Length	Body End	Rod End	Stroke	Force in Newtons	Part #
345	595	Socket	Socket	250	515	4320
345	601	Ball & Socket Assembly	Ball & Socket Assembly	256	240	4366
346	597	Socket	Socket	251	350	4260
346	610	Ball & Socket Assembly	Ball & Socket Assembly	264	245	4367
346	554	Ball & Socket Assembly	Ball & Socket Assembly	208	400	4378
348	513	Ball & Socket Assembly	Ball & Socket Assembly	165	335	4379
351	577	Socket	Socket	226	325	4063
351	577	Socket	Socket	226	405	4064
353	578	Bracket	Bracket	225	300	4273
355	530	Ball & Socket Assembly	Ball & Socket Assembly	175	545	4370
356	638	Ball Stud	Ball Stud	282	400	4207
362	572	Clevis	Clevis	210	250	4099
364	624	Socket	Socket	260	340	4332
368	700	None	None	332	50	4050
368	700	None	None	332	50	4147
372	625	Socket	Socket	253	575	4322
374	625	Clevis	Socket	251	300	4289
382	552	Socket	Socket	180	680	4542
386	702	Clevis	Clevis	316	240	4067
393	750	None	None	357	50	4051
393	750	None	None	357	50	4148
397	662	Bracket	Ball Stud	265	500	4162
400	600	Ball & Socket Assembly	Ball & Socket Assembly	200	440	4362
404	735	Socket	Socket	332	340	4069
407	723	Socket	Socket	316	250	4312
416	722	Socket	Socket	306	280	4324
417	699	Socket	Socket	282	350	4071
418	800	None	None	382	50	4052
418	800	None	None	382	50	4149
442.5	800	Ball Stud	Ball Stud		800	4129
443	669	Socket	Socket	226	390	4087
443	850	None	None	407	50	4150
448	673	Socket	Socket	225	460	4083
468	900	None	None	432	50	4151
492	713	Clevis	Clevis	221	600	4521
492	713	Clevis	Clevis	221	600	4522
493	950	None	None	457	50	4152
508	700	Clevis	Clevis	192	825	4163
518	1000	None	None	482	50	4153
520	843	Ball Stud	Clevis	323	675	4131
525	777	Socket	Bracket	252	550	4199

GASLIFTS

GASLIFTS

Sorted by Part Numbers

Part #	Collapsed Length	Extended Length	Body End	Rod End	Stroke	Force in Newtons
4003	116	166	Clevis	Clevis	50	130
4040	118	200	None	None	82	50
4041	143	250	None	None	107	50
4042	168	300	None	None	132	50
4043	193	350	None	None	157	50
4044	218	400	None	None	182	50
4045	246	450	None	None	204	50
4046	270	500	None	None	230	50
4047	293	550	None	None	257	50
4048	318	600	None	None	282	50
4049	343	650	None	None	307	50
4050	368	700	None	None	332	50
4051	393	750	None	None	357	50
4052	418	800	None	None	382	50
4060	163	258	Clevis	Clevis	95	350
4061	302	500	Clevis	Clevis	198	230
4063	351	577	Socket	Socket	226	325
4064	351	577	Socket	Socket	226	405
4065	291	500	Clevis	Clevis	209	510
4067	386	702	Clevis	Clevis	316	240
4068	324	549	Clevis	Clevis	225	350
4069	404	735	Socket	Socket	332	340
4071	417	699	Socket	Socket	282	350
4076	295	513	Clevis	Socket	218	560
4079	317	551	Socket	Socket	234	450
4080	282	486	Socket	Socket	204	510
4081	272	469	Clevis	Clevis	197	320
4082	290	500	Socket	Socket	210	270
4083	448	673	Socket	Socket	225	460
4084	232	380	Ball Stud	Socket	148	360
4087	443	669	Socket	Socket	226	390
4098	283	487	Plastic Socket	Metal Socket	205	170
4099	362	572	Clevis	Clevis	210	250
4127	281	488	Ball Stud	Ball Stud	207	750
4129	442.5	800	Ball Stud	Ball Stud		800
4131	520	843	Ball Stud	Clevis	323	675
4140	193	350	None	None	157	50
4141	218	400	None	None	182	50
4142	243	450	None	None	207	50
4143	268	500	None	None	232	50
4144	293	550	None	None	257	50
4145	318	600	None	None	282	50
4146	343	650	None	None	307	50
4147	368	700	None	None	332	50
4148	393	750	None	None	357	50



GASLIFTS

GASLIFTS

Sorted by Part Numbers

Part #	Collapsed Length	Extended Length	Body End	Rod End	Stroke	Force in Newtons
4149	418	800	None	None	382	50
4150	443	850	None	None	407	50
4151	468	900	None	None	432	50
4152	493	950	None	None	457	50
4153	518	1000	None	None	482	50
4162	397	662	Bracket	Ball Stud	265	500
4163	508	700	Clevis	Clevis	192	825
4164	123	209	None	None	86	50
4165	240	365	Bracket	Ball/Socket	125	450
4199	525	777	Socket	Bracket	252	550
4205	282	486	Ball Stud	Ball Stud	204	250
4207	356	638	Ball Stud	Ball Stud	282	400
4221	304	514	Ball Stud	Ball Stud	210	550
4260	346	597	Socket	Socket	251	350
4268	150	227	Clevis	Clevis	77	470
4269	206	296	Socket	Socket	90	480
4270	215	353	Clevis	Clevis	138	320
4271	287	497	Ball Stud	Ball Stud	210	150
4272	322	532	Socket	Socket	210	400
4273	353	578	Bracket	Bracket	225	300
4277	332	543	Socket	Socket	211	340
4284	181	288	Clevis	Socket	107	500
4285	168	258	M6 Stud	M6 Stud	90	480
4289	374	625	Clevis	Socket	251	300
4291	181	288	Ball Stud	Ball Stud	107	300
4294	284	488	Socket	Socket	205	250
4295	231	388	Socket	Socket	158	250
4296	284	488	Socket	Socket	205	350
4297	231	388	Socket	Socket	158	350
4298	253	388	Ball Stud	Ball Stud	135	350
4308	274	472	Socket	Socket	198	330
4312	407	723	Socket	Socket	316	250
4313	267	450	Socket	Socket	183	550
4314	290	496	Socket	Socket	206	500
4316	289	485	Socket	Socket	196	530
4319	291	460	Socket	Socket	169	100
4321	416	722	Clevis	Clevis	306	310
4322	372	625	Socket	Socket	253	575
4323	244	404	Socket	Socket	160	390
4324	416	722	Socket	Socket	306	280
4325	295	500	Socket	Socket	205	420
4326	300	500	Socket	Socket	200	690
4327	310	520	Socket	Socket	210	570
4328	289	477	Socket	Socket	188	360
4329	340	540	Socket	Socket	200	400

GASLIFTS

GASLIFTS

Sorted by Part Numbers

















Part #	Collapsed Length	Extended Length	Body End	Rod End	Stroke	Force in Newtons
4330	300	510	Socket	Socket	210	340
4331	282	458	Socket	Socket	176	430
4332	364	624	Socket	Socket	260	340
4333	315	525	Socket	Socket	210	140
4338	300	500	Ball & Socket Assembly	Ball & Socket Assembly	200	400
4339	285	485	Ball & Socket Assembly	Ball & Socket Assembly	200	530
4343	322	526	Ball & Socket Assembly	Ball & Socket Assembly	204	325
4347	293	483	Ball & Socket Assembly	Ball & Socket Assembly	190	370
4349	270	420	Ball & Socket Assembly	Ball & Socket Assembly	150	450
4351	258	415	Ball & Socket Assembly	Ball & Socket Assembly	157	405
4352	260	432	Ball & Socket Assembly	Ball & Socket Assembly	172	660
4353	300	500	Ball & Socket Assembly	Ball & Socket Assembly	200	310
4354	225	362	Ball & Socket Assembly	Ball & Socket Assembly	137	470
4356	312	524	Ball & Socket Assembly	Ball & Socket Assembly	212	260
4359	340	515	Ball & Socket Assembly	Ball & Socket Assembly	175	460
4360	315	515	Ball & Socket Assembly	Ball & Socket Assembly	200	585
4361	231	381	Ball & Socket Assembly	Ball & Socket Assembly	150	140
4362	400	600	Ball & Socket Assembly	Ball & Socket Assembly	200	440
4363	300	500	Ball & Socket Assembly	Ball & Socket Assembly	200	360
4364	290	497	Ball & Socket Assembly	Ball & Socket Assembly	207	270
4365	305	515	Ball & Socket Assembly	Ball & Socket Assembly	210	425
4366	345	601	Ball & Socket Assembly	Ball & Socket Assembly	256	240
4367	346	610	Ball & Socket Assembly	Ball & Socket Assembly	264	245
4368	270	450	Ball & Socket Assembly	Ball & Socket Assembly	180	385
4369	272	443	Ball & Socket Assembly	Ball & Socket Assembly	171	455
4370	355	530	Ball & Socket Assembly	Ball & Socket Assembly	175	545
4373	285	480	Ball & Socket Assembly	Ball & Socket Assembly	195	335
4374	271	370	Ball & Socket Assembly	Ball & Socket Assembly	99	480
4375	315	540	Ball & Socket Assembly	Ball & Socket Assembly	225	390
4378	346	554	Ball & Socket Assembly	Ball & Socket Assembly	208	400
4379	348	513	Ball & Socket Assembly	Ball & Socket Assembly	165	335
4380	282	436	Ball & Socket Assembly	Bracket	154	480
4381	282	436	Ball & Socket Assembly	Bracket	154	480
4521	492	713	Clevis	Clevis	221	600
4522	492	713	Clevis	Clevis	221	600
4544	175	255	Ball & Socket Assembly	Ball & Socket Assembly	80	650



GASLIFTS

STEERING DAMPER

Parts Listing

Part #	Product Type	Position	Make	Model	Derivative	Year
14004	 Fig 15	Front	Volkswagen	Beetle	PC	52-79
14011	 Fig 15	Front	Land Rover	Range Rover, Discovery	SUV	76-98
	 Fig 15	Front	Land Rover	Range Rover	SUV	76-94
14012	 Fig 15	Front	Audi	100,2	PC	81-84
	 Fig 15	Front	Isuzu	KB, TF Series	4x2, 4x4	Mar-81
14013	 Fig 15	Front	Land Rover	Defender	109",110" WB, Series 11, 111	65-84
14014	 Fig 15	Front	Opel	Commodore, Rekord	(Incl. 2500,3800,4100)	78-97
	 Fig 15	Front	Toyota	Hilux	4x4	79-98
14022	 Fig 15	Front	Nissan	Patrol	4x4	82-90
14022	 Fig 15	Front	Nissan	Safari	SUV	82-90
14023	 Fig 15	Front	Toyota	Landcruiser	FJ45, BJ45	71-85
14024	 Fig 15	Front	Toyota	Landcruiser	HZJ 80	90-98
14024	 Fig 15	Front	Toyota	Landcruiser	FJ62, BJ60, BJ75	83-99
14032	 Fig 15	Front	Land Rover	Defender	90, 110, 130 (incl. Defender,County)	84-07
14033	 Fig 15	Front	Toyota	Hilux	4x4	99-05
14040	 Fig 15	Front	Chrysler	Jeep	Cherokee	93-01
14040	 Fig 15	Front	Chrysler	Jeep	Wrangler 4x4 (TJ)	96-06

STEERING DAMPER

Technical Information

Collapsed Length	Upper Mounting	Lower Mounting	Accessory Kit	Product Type	Part #
287	SE	SM	Fig. 15	14004
306	9.5mm Stud	9.5mm Stud	Fig. 15	14011
308	RE16	SE10x35	500498	Fig. 15	14040
313	11mm Stud	11mm Stud	Fig. 15	14013
313	9.5mm Stud	9.5mm Stud	140126	Fig. 15	14016
318	10mm Stud	SE10x24	Fig. 15	14014
322	RE16	RE16	Fig. 15	14023
328	RE16	RE16	Fig. 15	14022
335	SE10x24	SE10x24	144215	Fig. 15	14012
340	9.5mm Stud	RE17	Fig. 15	14021
360	RE16	RE16	142387	Fig. 15	14017
363	SE10x24	RE16	Fig. 15	14033
411	RE16	RE16	Fig. 15	14024
439	9.5mm Stud	SE10x26	Fig. 15	14032

WARRANTY POLICY

WARRANTY ON GABRIEL SHOCK ABSORBERS

1. This warranty is expressed in lieu of All other warranties and representations express or implied.
2. Gabriel SA warrants that All products supplied to its customers comply with the relevant industry quality standards.
3. The Gabriel shock absorbers warranty is in accordance to the following schedule, subject to the specific restrictions and or warranty limitations which are detailed below.
 - 3.1 Gabriel® shock absorbers used on passenger cars and light commercial vehicles (up to 1 000 kg load capacity), are warranted for a period of 36 (thirty six) months from the date of purchase. This only applies in South Africa, Botswana, Namibia, Swaziland and Lesotho. Zimbabwe, Zambia, Malawi and Mozambique have a warranty as per 3.2 below on All vehicle types. All other countries terms and conditions are available on enquiry.
 - 3.2 Gabriel® shock absorbers used on All other types of vehicles are warranted for a period of 12 (twelve) months from date of sale to user, or 20 000 km, whichever occurs first.
 - 3.3 Gabriel® gas-springs (Gabriel Gaslift®), both industrial and automotive are warranted for a period of 12 (twelve) months from date of sale to user.
 - 3.4 From time to time, Gabriel SA may run promotions or programs that strengthen the standard Gabriel Warranty Policy. In All circumstances, Gabriel SA will clearly state any changes to the Original Warranty in All of its communications. If a warranty is requested under the provisions of one of these programs or promotions, Gabriel SA will always ensure that it is processed in line with the specific terms and conditions stated.
4. The Gabriel SA warranty covers All manufacturing defects, but does not cover normal deterioration of product through normal use. Gabriel SA warrants that the products manufactured and or distributed shall be free from defects in material and workmanship.
5. Any product, in respect of which a manufacturing defect has been found, may be returned to Gabriel SA within its warranty period in order for it to be repaired or replaced or to have the purchase price of the product repaid, at Gabriel SA's discretion. The replacement unit will be similarly warranted but only for the balance of the duration of the original warranty.

CONSUMER PROTECTION ACT WARRANTIES

6. In terms of the Consumer Protection Act No. 68 of 2008 (CPA), in the event that a product supplied by Gabriel SA is unsuitable for its intended purpose, of poor quality, not in a good working order, defective, sub-standard or wears out before the reasonable service life of the product and the product is returned to Gabriel SA within six months after delivery of the product to the buyer, Gabriel SA will:
 - a) Repair the product;
 - b) Replace the product; or
 - c) Refund the price of the product.
7. In terms of the CPA, if Gabriel SA is directed to repair the product and within 3 months after that repair, that repair is ineffective or a further problem with the product is discovered, Gabriel SA will then replace the product or refund the price of the product.
8. Gabriel SA will have the right not to provide the remedies set out above to the extent that the CPA does not oblige Gabriel SA to do so in the circumstances of a particular case.

GENERAL CONDITIONS, RESTRICTIONS AND LIMITATIONS

9. The buyer of the product must make use of Gabriel SA's returns policy and claims procedure, available on the Gabriel website www.gabriel.co.za, or available directly from the company or any of its representatives. Except to the extent impermissible in terms of the CPA, no warranty claims will be approved by Gabriel SA unless these returns policy and claims procedures are followed.
10. Notwithstanding the returns policy but subject to the CPA, Gabriel SA reserves the right to at any stage reject the return of goods, should it feel that the goods have been abused or that the goods have deteriorated through excessive use within the warranty period. Gabriel SA shall then have the option to return the rejected goods to the buyer.
11. Gabriel SA shall not be liable for damages resulting from delays in shipment or inability to ship due to normal production and shipment delays or those resulting from acts of God, fires, floods, wars, sabotage, accidents, labour disputes or shortages, plant shutdown or equipment failure, voluntary or involuntary compliances with any law, order, rule or regulation of governmental agency or authority; or inability to obtain material (including power and fuel), equipment or transportation, or arising from any other contingency, circumstances or event beyond the control of Gabriel SA.
12. All Gabriel products are fit for purpose for which they have been supplied. In the case of products listed in this catalogue, products should only be used on the vehicles described and under operating conditions appropriate to these vehicles. The warranty does not extend to vehicles with lowered or modified suspensions and only to goods where the user can prove that such goods became defective in normal and proper use.
13. Except to the extent permissible in terms of the CPA, Gabriel SA will not be liable for any loss of profit or any consequential loss or damage, from whatever cause arising, including loss of any labour or fitment costs.
14. The above warranty only applies within the warranty period and when proof of purchase can be verified. A copy of the customer's original purchase invoice is required for All warranty claims. The customer's details should be provided with the claim.
15. Under no circumstances will warranty claims be entertained if the piston rod of the faulty unit has sustained any damage that appears to have been inflicted by tools
16. The warranty will be void if bump rubbers are not used.

WARRANTY POLICY (CONTINUED)

PROCESSING WARRANTIES

1. To assist in the quick processing of claims, it is important to have the following information.
 - a) The vehicle make, model and year that the part was fitted to.
 - b) The claimed product part number
 - c) The claimed manufacturing date code (required unless the product is still fitted)
 - d) The original invoice with date of issue and invoice number
 - e) The type of fault or customer complaint (this relates to the documented fault codes presented in the catalogue)
 - f) The motorists name and phone number (optional)
2. Your regional Sales Representative will ask you the questions stated in No.1 above and should the answers fall in line with our warranty policy, a claim number will be issued (RMA Number). It is this number that is to be recorded along with your request for credit documentation (RFC). We advise that this RMA number is physically written on the product with either a Black or White paint pen prior to returning the product.
3. Gabriel SA can allow you the option to submit your requests for credit with your supplier, however there are no guarantees that the claim will be honoured, as this is based on an inspection required by a Gabriel Representative who may reject the claim.
4. In line with its Warranty Policy, Gabriel honours All of its product from any store that a warranty is claimed from, irrespective of where the customer initially purchased the product from. If you are not the original sell, it is still your responsibility to validate if a customer has a valid claim and to process the claim in line with this procedure. We so advise that you make a copy of the claimed invoice for your records.
5. For further enquiries, please feel free to contact our offices or your Gabriel Representative.
6. See below for warranty fault codes required for your registration.

GABRIEL WARRANTY FAULT CODES		
NO	NAME	DESCRIPTION
0	No fault found	There is nothing functionally wrong With the shocks
1	Fluid leak (Bottom)	Oil leak through bottom mounting/weld (Very rare)
2	Fluid leak (Top)	Oil leak through top seal
3	Mounting Bracket, Spring Seat or Rod broken	Visual inspection to see if one of the three is broken
4	Mounting rubber/sleeve failure	Worn out rubbers or rubber mountings that have moved out of the mounting
5	Loose dust cover/cap	Only applies to metal dust covers that rattle if weld has broken
6	No resistance	The rod will move up & down With no resistance
7	Low resistance/Soft (Check whether gas or non-gas)	It will take a little effort to compress
8	Seized/binding	Shaft will not move at all - in or out
9	Knocking Noise (Lag Effect)	Can only be checked off the vehicle. Takes experience to pick this up.
10	High resistance	Will take a lot of effort to move but could be in spec
11	Gas loss	Rod will not extend on its own
12	Squeaking noise	Dry squeaking sound coming from the shock
13	Grunting noise	More or less same as squeak but deeper
14	Safety critical fault	Anything broken on a strut or spring seat unit only
15	Failed By A Tester	Shocks have been failed by some type of suspension/shock testing equipment

2022
EDITION

76 White Road, Retreat,
Cape Town, South Africa

PO Box 30214,
Tokai, Cape Town,
7966



Tel: +27(21) 710 6800

information@gabriel.co.za

www.gabriel.co.za



Download a recognised QR reader on your mobile device for quick SCAN ME access to the Gabriel web page.

   Join us on SOCIAL MEDIA

