

一 硬管内窥镜 (Rigid endoscopes)

耳内窥镜 Otoloscope

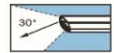
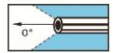

- | | |
|--------------------------------|------------------------------|
| J030 0° ϕ 2.7 × 90mm | J016 30° ϕ 3 × 90mm |
| J030F 0° ϕ 2.7 × 90mm高亮度 | J016F 30° ϕ 3 × 90mm高亮度 |
| J052 0° ϕ 2.7 × 50mm | J035 30° ϕ 4 × 50mm |
| J052F 0° ϕ 2.7 × 50mm高亮度 | |
| J028 0° ϕ 2.7 × 105mm | |
| J028F 0° ϕ 2.7 × 105mm高亮度 | |
| J015 0° ϕ 3 × 90mm | |
| J015F 0° ϕ 3 × 90mm高亮度 | |
| J034 0° ϕ 4 × 50mm | |
| J034F 0° ϕ 4 × 50mm高亮度 | |
| J057 0° ϕ 4 × 90mm | |
| J057F 0° ϕ 4 × 90mm高亮度 | |

- ① 连接“福澳”导光束
Connecting to "FA" optical Cable
② 连接“史崔克”导光束
Connecting to "STRYKER" Optical Cable
③ 连接“WOLF”导光束
Connecting to "WOLF" Optical Cable

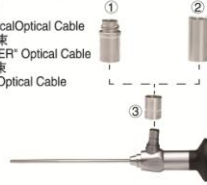

鼻窦内窥镜 Sinuscope

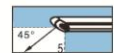
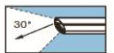
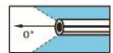

- | | | | |
|----------------------------------|-----------------------------------|-----------------------------------|--------------------------|
| J001 0° ϕ 4 × 170mm | J002 30° ϕ 4 × 170mm | J003 70° ϕ 4 × 170mm | J063 4° ϕ 4 × 175mm |
| J001F 0° ϕ 4 × 170mm高亮度 | J002F 30° ϕ 4 × 170mm高亮度 | J003F 70° ϕ 4 × 170mm高亮度 | |
| J001-1 0° ϕ 4 × 170mm广角 | J002-1 30° ϕ 4 × 170mm广角 | J003-1 70° ϕ 4 × 170mm广角 | |
| J001-1F 0° ϕ 4 × 170mm高亮度广角 | J002-1F 30° ϕ 4 × 170mm高亮度广角 | J003-1F 70° ϕ 4 × 170mm高亮度广角 | |
| J006 0° ϕ 3 × 170mm | J007 30° ϕ 3 × 170mm | | |
| J006F 0° ϕ 3 × 170mm高亮度 | J007F 30° ϕ 3 × 170mm高亮度 | | |
| J010 0° ϕ 2.7 × 175mm广角 | J012 30° ϕ 2.7 × 175mm广角 | | |
| J010F 0° ϕ 2.7 × 175mm高亮度广角 | J012F 30° ϕ 2.7 × 175mm高亮度广角 | | |



喉内窥镜 Laryngoscope

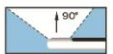

- | | |
|----------------------------|-----------------------------|
| J011 90° ϕ 8 × 176mm | J043-1 70° ϕ 8 × 176mm |
| J009 90° ϕ 10 × 176mm | J044 70° ϕ 6 × 176mm |

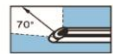

HDJ043-1 70° ϕ 8 × 176mm高清



支撑喉内窥镜 Self-retaining Laryngoscope

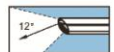
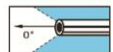

- | | |
|----------------------------|-----------------------------|
| J047 0° ϕ 4.8 × 179mm | J048 12° ϕ 4.8 × 179mm |
|----------------------------|-----------------------------|



小儿支气管内窥镜 Pediatric bronchoscope

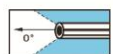

- | |
|----------------------------|
| J013 0° ϕ 2.7 × 352mm |
| J014 0° ϕ 4 × 310mm |



一 BDJ 型鼻窦镜及配套手术器械 E BDJ Sinuscope set E
BDJ 型鼻窦镜及配套手术器械 F(小儿) BDJ Sinuscope set F

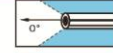

- | |
|------------------------------|
| J001 0° ϕ 4 × 170mm |
| J006(小儿) 0° ϕ 3 × 170mm |

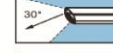

- | |
|-------------------------------|
| J002 30° ϕ 4 × 170mm |
| J007(小儿) 30° ϕ 3 × 170mm |



- | |
|---------------------------|
| J003 70° ϕ 4 × 170mm |
|---------------------------|



鼻窦内窥镜 Sinuscope



- | |
|-----------------------------|
| 杯形口0°
cup-shaped jaw 0° |
| E108 ϕ 5 × 125mm |
| E-F108(小儿) ϕ 4 × 110mm |



鼻窦光学钳
Sinus optical forceps



- | |
|----------------------------------|
| 100° 横开口
100° Horizontal open |
| E101 ϕ 3 × 95mm |
| E-F101(小儿) ϕ 3 × 70mm |



- | |
|------------------------------|
| 70° 直开口
70° straight open |
| E102 ϕ 3 × 85mm |
| E-F102(小儿) ϕ 3 × 70mm |



- | |
|--------------------------------|
| 70° 横开口
70° Horizontal open |
| E103 ϕ 3 × 85mm |
| E-F103(小儿) ϕ 3 × 70mm |



鼻窦息肉钳
polypus forceps



- | | |
|---------------------------------|-------------------------------|
| 吸引管 Suction tube | |
| E015 ϕ 3.6 × 175mm | E-F015(小儿) ϕ 3 × 160mm |
| E016 ϕ 3 × 175mm | E-F016(小儿) ϕ 2.5 × 160mm |
| E017 ϕ 2.5 × 175mm | E-F017(小儿) ϕ 2 × 160mm |
| 选配件: E015B-软 ϕ 3.6mm 软性异形管 | |
| E016B-软 ϕ 3mm 软性异形管 | |
| E011-软 ϕ 4mm 软性管 | |



鼻窦穿刺器
Maxillary sinus drilling needle
E013 ϕ 4 × 100mm
E-F013(小儿) ϕ 3 × 100mm

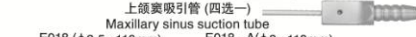

- | | |
|---|----------------------------|
| 上颌窦吸引管(四选一)
Maxillary sinus suction tube | |
| E018 (ϕ 2.5 × 110mm) | E018-A (ϕ 3 × 110mm) |
| E018-B (ϕ 3.5 × 110mm) | E018-C (ϕ 4 × 110mm) |
| E-F018 (ϕ 2.5 × 95mm) | |
| 选配件: E018-C-软 ϕ 4mm 软性管 | |



剥离子 Detacher
E021 80mm
E-F021(小儿) 70mm



鼻窦刮匙 Nasal curette
E019 80mm
E-F019(小儿) 70mm



鼻窦刮匙 Nasal curette
E020 80mm
E-F020(小儿) 70mm



鼻窦粘膜刀(钝头镰状)
Sickle knife (blunt head)
E022 ϕ 1.8 × 170mm
E-F022(小儿) ϕ 1.8 × 160mm

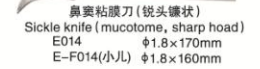

鼻窦粘膜刀(锐头镰状)
Sickle knife (mucotome, sharp head)
E014 ϕ 1.8 × 170mm
E-F014(小儿) ϕ 1.8 × 160mm

<p>鼻窦剪 (左弯) Sinus scissor (left bent) E105 4×125mm E-F105(小儿) 3×110mm</p>	<p>鼻窦咬骨钳 (中号头) Ethmoidal rongeur (medium head) E208 4×125mm E-F208(小儿) 3×110mm</p>	
<p>鼻窦剪 (右弯) Sinus scissor (right bent) E106 4×125mm E-F106(小儿) 3×110mm</p>	<p>鼻窦咬骨钳 (大号头) Ethmoidal rongeur (large head) E209 4×125mm E-F209(小儿) 3×110mm</p>	
<p>鼻窦剪 (直) Sinus scissor (straight) E107 4×125mm E-F107(小儿) 3×110mm</p>	<p>鼻窦咬骨钳 (上弯30°) Ethmoidal rongeur (Maxillary head, medium, upward bent 30°) E301 4×125mm E-F301(小儿) 3×110mm</p>	<p>鼻窦咬骨钳 (上弯45°) Ethmoidal rongeur (45° Maxillary head, medium, upward bent) E307 4×125mm E-F307(小儿) 3×110mm</p>
<p>鼻窦咬骨钳 (后开口) Ethmoidal rongeur (back open) E203 4×125mm E-F203(小儿) 3×110mm</p>	<p>鼻窦咬骨钳 (上弯90°) Ethmoidal rongeur (upward bent 90°) E303 4×125mm E-F303(小儿) 3×110mm</p>	<p>鼻窦咬骨钳 (中空前开咬切) Ethmoidal rongeur (hollow front open, cutting) E309 4×125mm E-F309(小儿) 3×110mm</p>
<p>鼻窦咬骨钳 (90° 直开口) Ethmoidal rongeur (90° straight open) E204 4×125mm E-F204(小儿) 3×110mm</p>	<p>鼻窦咬骨钳 (前开中空) Ethmoidal rongeur (front open, hollow) E304 4×125mm E-F304(小儿) 3×110mm</p>	

<p>带吸引管鼻窦钳 Nasal forceps with suction tube</p>	<p>上颌鼻窦咬骨钳 Maxillary sinus rongeur</p>
<p>直有孔 straight with hole E401 ϕ4×95mm E-F401(小儿) ϕ3.5×95mm</p>	<p>直上切口 straight upward cutting mouth E144 3×6×150mm E-F144(小儿) 2.5×6×150mm</p>
<p>上弯45° upward bent 45° E403 ϕ4×110mm E-F403(小儿) ϕ3.5×95mm</p>	

二 SSC型手术吸引切割器 SSC Shaver system

脚踏控制器 Foot switch

电器控制器 Power controller

手机 hand piece

直刀具 (straight blades)

直有齿 Straight with teeth

直无齿 Straight without teeth

直球形 Straight ball-shaped (选配件)

三 鼻科选购器材 Nasal optional instruments

弯刀具 (bend blades) 45°、30°、15°

弯刀具 (bend blades) 45°、30°

内弯无齿 Inner bend, without teeth

外弯无齿 Outer bend, without teeth

内弯有齿 Inner bend, with teeth

外弯有齿 Outer bend, with teeth

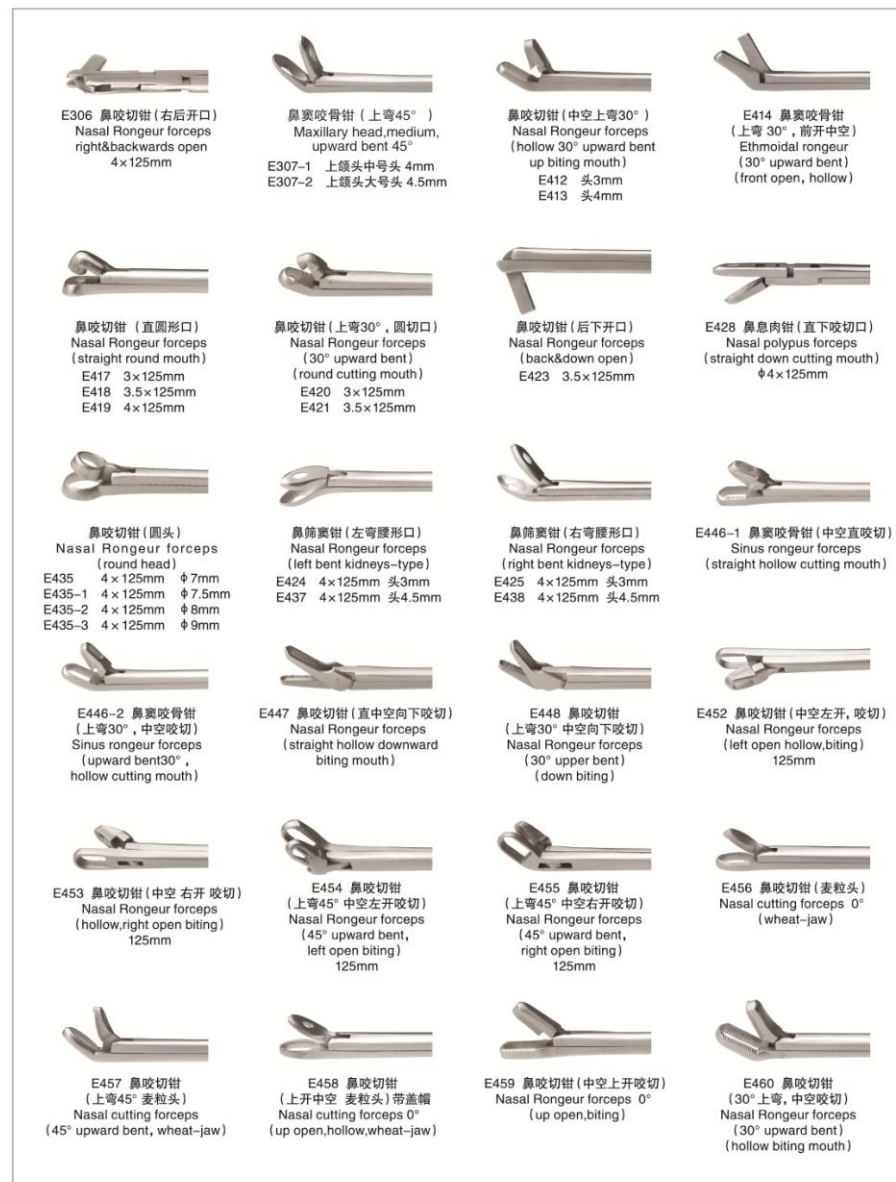
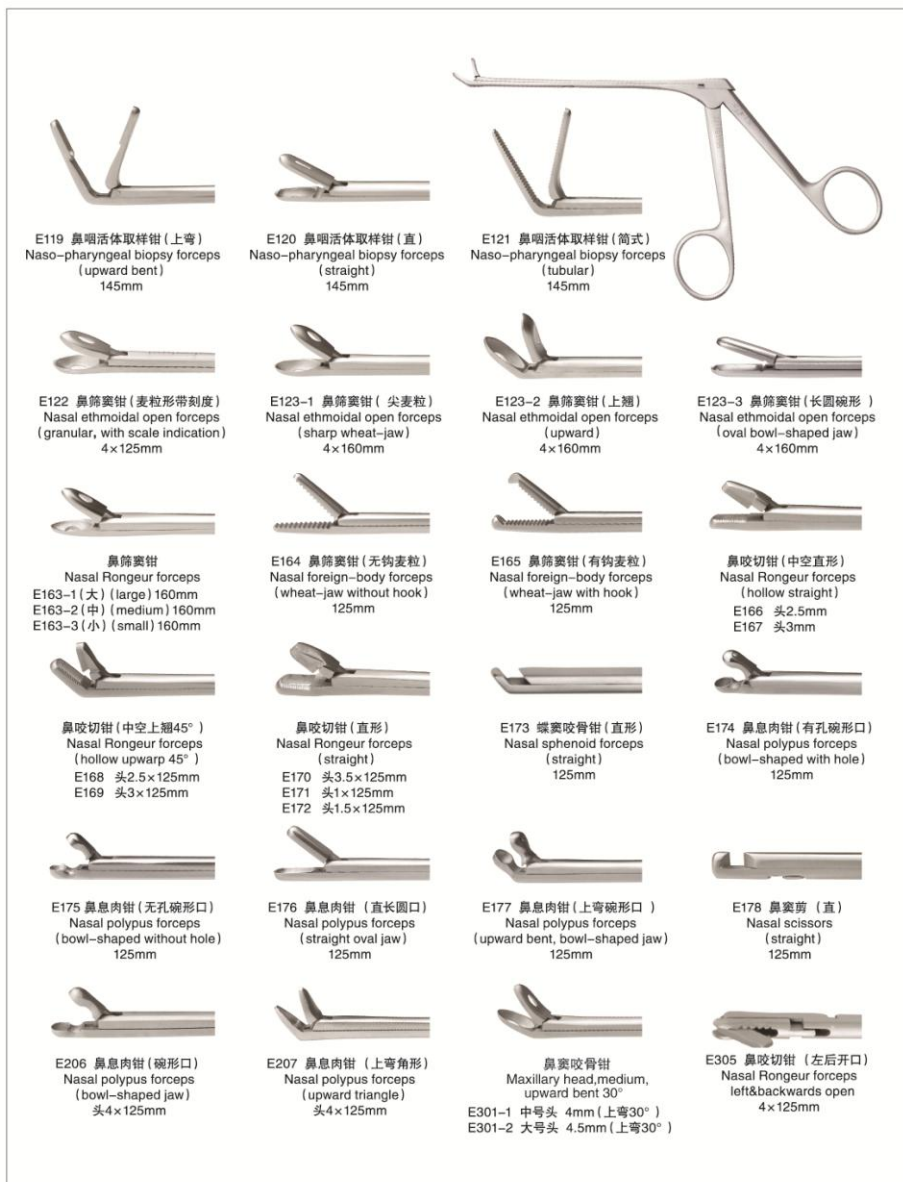

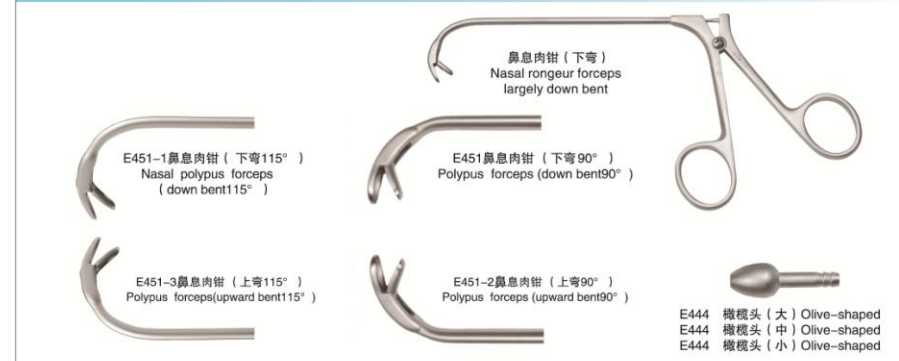
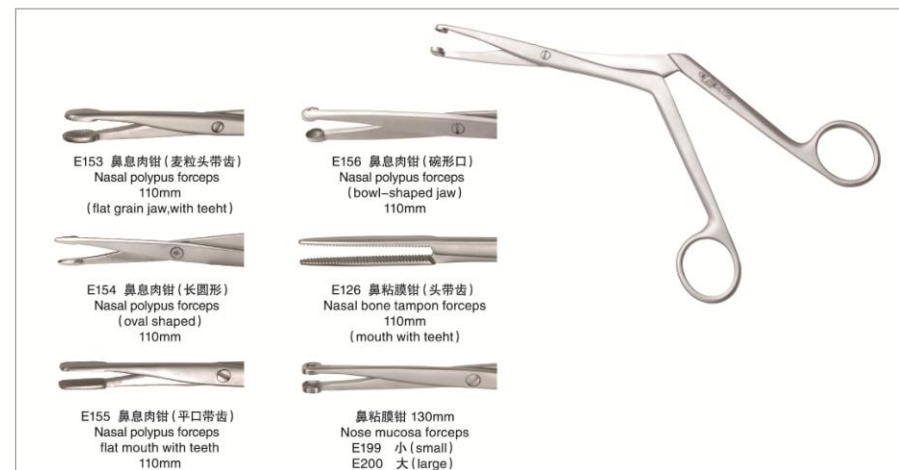
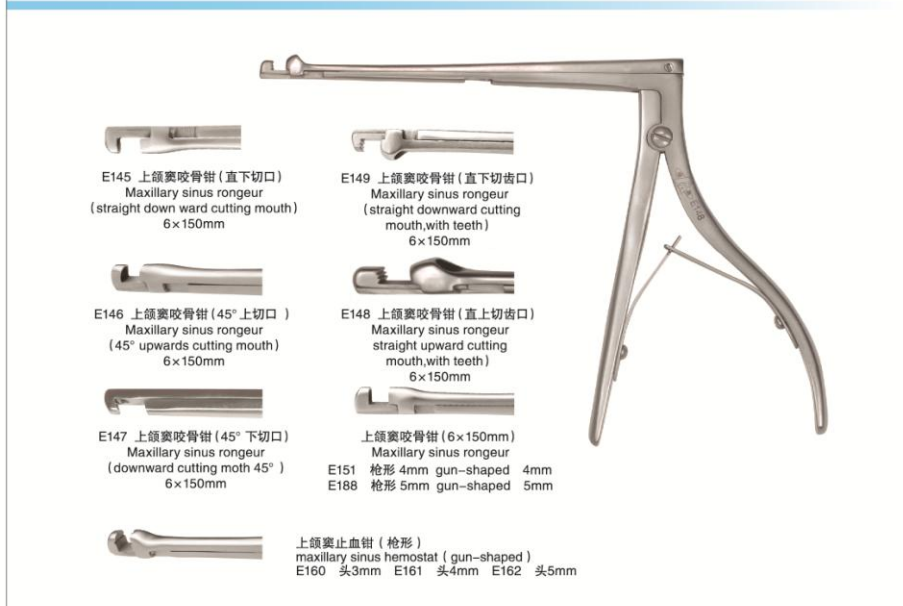
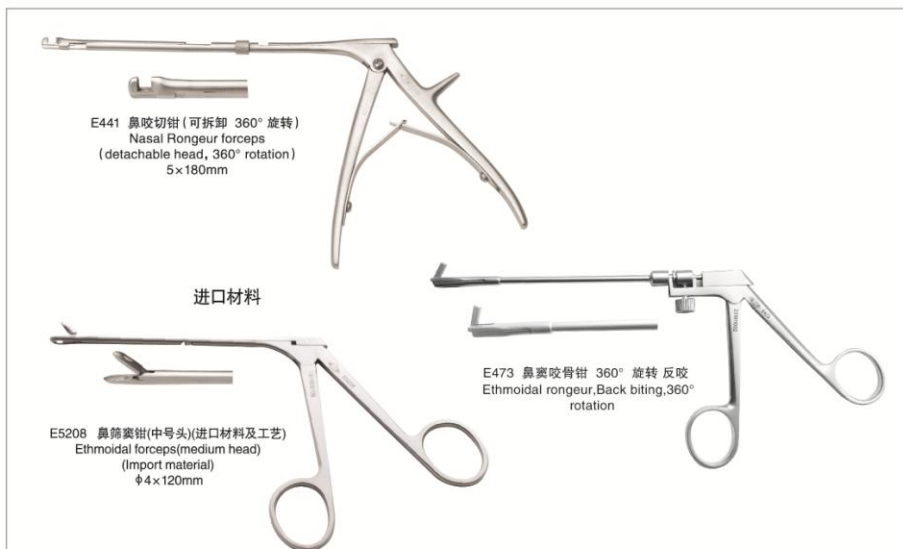

E035 上颌窦吸引管 $\Phi 2.5 \times 140\text{mm}$ 钩状
E036 上颌窦吸引管 $\Phi 3.0 \times 140\text{mm}$ 钩状
E037 上颌窦吸引管 $\Phi 3.5 \times 140\text{mm}$ 钩状
Maxillary sinus suction tube, Hook shaped

E038 上颌窦吸引管 $\Phi 2.5 \times 140\text{mm}$ 钩状 (方手柄)
Maxillary sinus suction tube, Hook shaped, Square handle

E030 吸引管 (治疗台用)
Suction tube (ENT treatment unit)
E030 $\Phi 4.0$
E031 $\Phi 2.5$
E032 $\Phi 2.0$
E033 $\Phi 1.5$
E034 $\Phi 3.0$

E201 鼻中隔咬骨钳 (咬合口双关节)
Nasal septum rongeur forceps (cutting mouth, double joints) 5x95mm

E202 鼻中隔咬骨钳 (咬切口双关节)
Nasal septum rongeur forceps (biting mouth, double joints) 5x95mm

E111 鼻息肉圈 (直弯二头双用)
Nasal polypus snare (straight, bent)

盒式切除刀 (腺样体)
Adenoid box dissecting knife (large)
E141 (大) $20 \times 240\text{mm}$ (large)
E142 (中) $17 \times 230\text{mm}$ (medium)
E143 (小) $15 \times 210\text{mm}$ (small)

鼻穿刺针
Sinuses drilling needle
E211 16号
E439 19号
E216 25号

E223 鼻镜
Plastic nasoscope
25x140mm

E220 鼻腔撑开器 (鼻中隔镜)
Nasal septum scope

E227 鼻穿刺器 (大)
New puncture needle (large) $\Phi 8 \times 100\text{mm}$
E226 鼻穿刺器 (中)
New puncture needle (medium) $\Phi 7 \times 100\text{mm}$
E225 鼻穿刺器 (小)
New puncture needle (small) $\Phi 6 \times 100\text{mm}$

E127 鼻骨复位钳 Nasal bone restorer

E124 鼻骨复位器 Nasal bone restorer

鼻中隔旋转刀 (直形) Nasal septum rotary knife
E215 3mm
E194 4mm
E195 5mm

鼻中隔旋转刀 (枪形) Nasal septum rotary knife
E212 3mm
E213 4mm
E214 5mm

鼻中隔凿 (枪形鱼尾凿)
Fish-tail chisel
E115 3mm
E116 4mm

鼻中隔凿 (直形鱼尾凿)
Fish-tail chisel
E431 3mm
E432 4mm

鼻中隔凿 (枪形圆凿) Nadal septum round chisel
E117 3mm
E118 4mm

鼻中隔凿 (直形圆凿) Nadal septum round chisel
E433 3mm
E434 4mm

鼻窦刮匙
Sinus curette

E027 (前向) 190mm
E028 (后向) 190mm

E189 (大无孔) (large, without hole) 190mm
E190 (中无孔) (middle, without hole) 190mm
E191 (小无孔) (small, without hole) 190mm

E192 (大有孔) (large, with hole) 190mm
E193 (小有孔) (small, with hole) 190mm

E152-1
E152-2 上翘15°
E152-3 上翘15° 103mm(大)

E152-4 上翘15° 95mm(大)
E152-5 上翘15° 103mm(小)
E152-6 上翘15° 95mm(小)

E152 鼻窦刮匙 Nasaethmoidal curette 6X1

E128 鼻骨膜剥离器 (双头直形)
Nasal periosteum detacher (double heads, straight) 190mm

E130 鼻骨膜剥离器 (弯) 190mm
Nasal periosteum detacher

E131 鼻粘膜刀 (单头)
Nasal mucosa knife single head 170mm

E132 鼻粘膜刀 (双头)
Nasal mucosa knife (double heads) 170mm

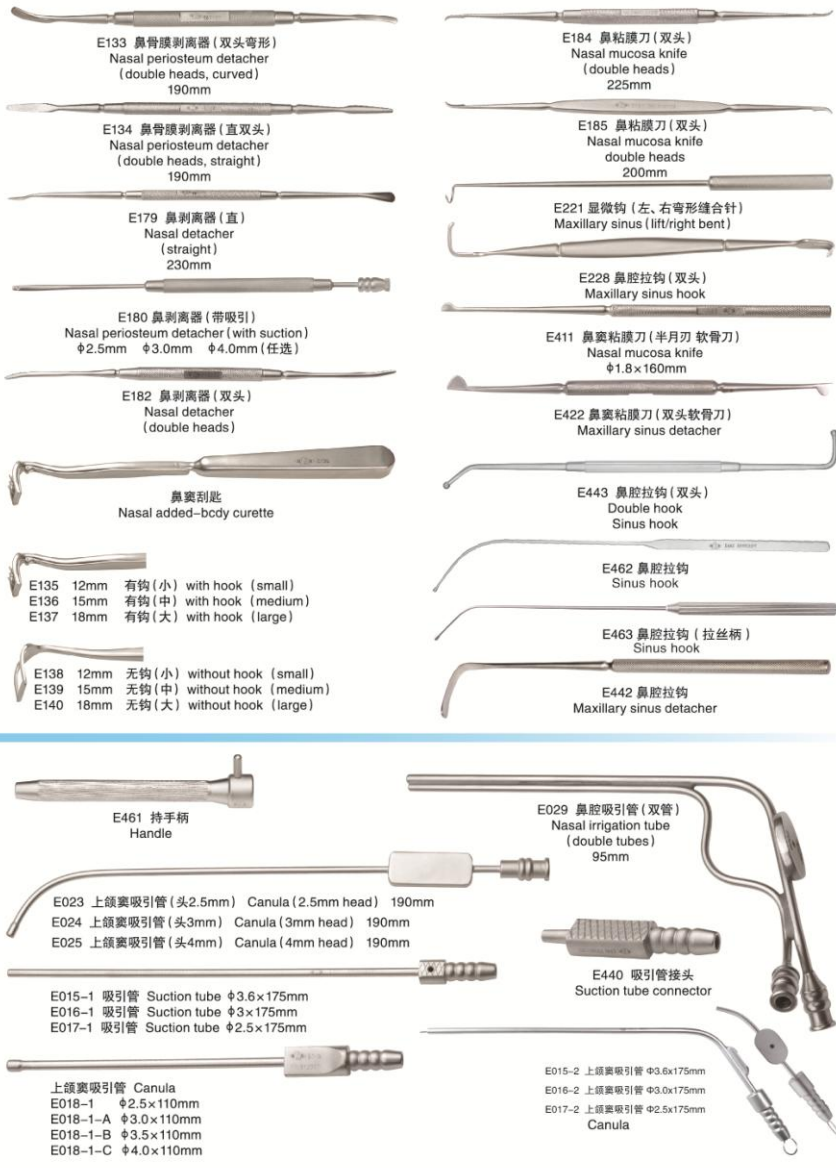

— ZHJ 型支撑喉镜成套器械 (H) ZHJ Bearing Laryngoscope Set (H)

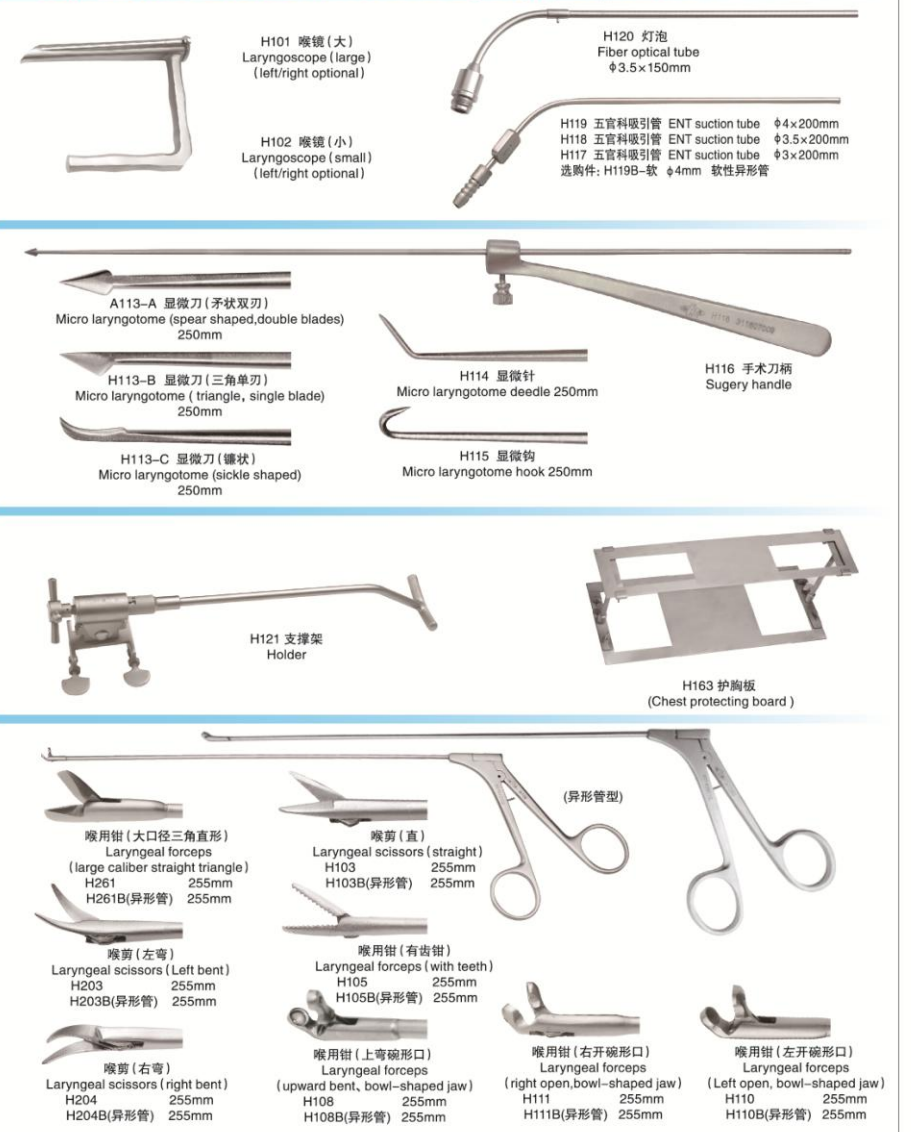

二 ZHJ 型支撑喉镜成套器械 (F) ZHJ Bearing Laryngoscope (F)

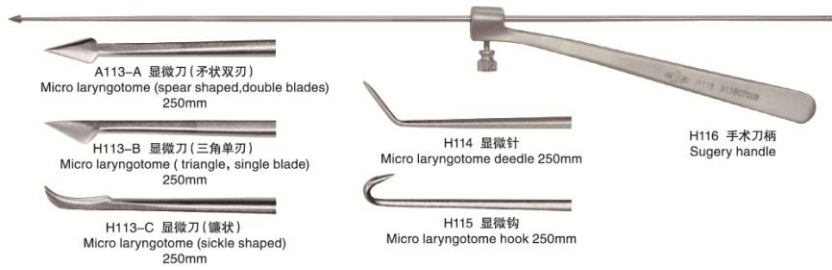
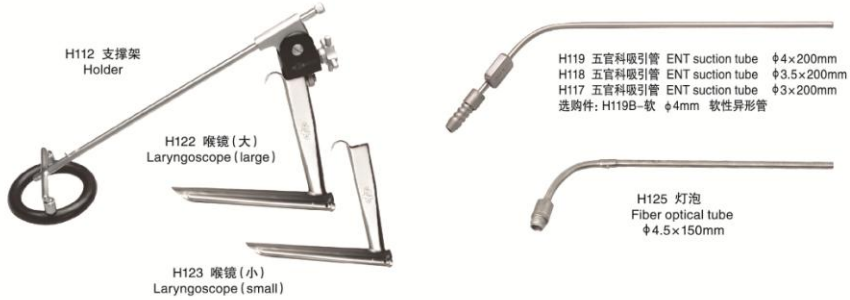

三 ZHJ 型支撑喉镜及成套器械 (E型) ZHJ Bearing Laryngoscope (E)

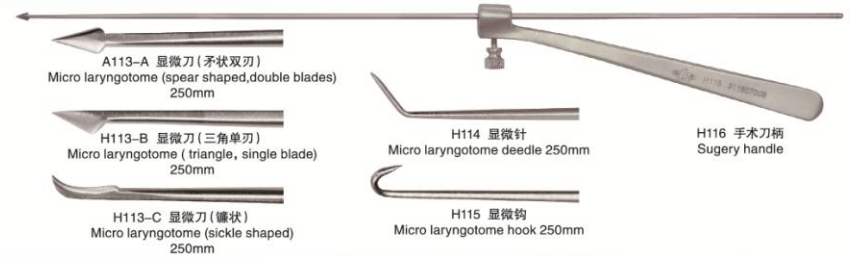

四 ZHJ 型支撑喉镜成套器械 (III) ZHJ Bearing Laryngoscope Set (III)



五 XHJ 纤维咽喉镜 Fiber Laryngoscope



喉科

六 喉科选购器械 (Laryngeal optional instruments)



H169-1 喉镜 (前联合直达喉镜 大)
Laryngoscope (front jointed directive laryngeal forceps large)



H169-2 喉镜 (前联合直达喉镜 小)
Laryngoscope (front jointed directive laryngeal forceps small)



H170-1 喉镜 (侧开式 大)
Laryngoscope (side open, large)



喉镜 (侧开式)
Laryngoscope (side open)
H170-2 小 (small)
H170-3 中 (medium)



喉镜 (小儿镜)
Laryngoscope (pediatric)
H01 28×13×170mm
H02 26×12×160mm
H03 24×11×150mm
H04 23×10×150mm
H05 22×9×130mm



喉镜 (带光纤)
Laryngoscope (with fibre)
H027 (大) (large)
H028 (小) (small)



H171 耳鼻喉用开口器 (左方向)
Mouth gag
6×1
(left)



H171-1 带光纤耳鼻喉用开口器 (左方向)
Mouth gag with fiber
6×1
(left)



H173 耳鼻喉用开口器 (戴维氏张口器)
Mouth gag
4×1



H172 耳鼻喉用开口器 (右方向)
Mouth gag
6×1
(right)



H172-1 带光纤耳鼻喉用开口器 (右方向)
Mouth gag with fiber
6×1
(right)



H174 带光纤耳鼻喉用开口器 (戴维氏张口器)
Mouth gag with fiber
4×1



H301 耳鼻喉用开口器
Mouth gag
5×1



H302 耳鼻喉用开口器 (左开口)
Mouth gag (left open)
H303 耳鼻喉用开口器 (右开口)
Mouth gag (right open)
6×1



灯泡
Fiber optical tube
H06-1 $\phi 3.5 \times 140\text{mm}$
H06-2 $\phi 3.5 \times 132\text{mm}$
H06-3 $\phi 3.5 \times 123\text{mm}$
H06-4 $\phi 3.5 \times 114\text{mm}$
H06-5 $\phi 3.5 \times 105\text{mm}$



五官科吸引管
ENT suction tube
H229 $\phi 1.8\text{mm}$
H230 $\phi 2\text{mm}$
H231 $\phi 3\text{mm}$
H232 $\phi 4\text{mm}$

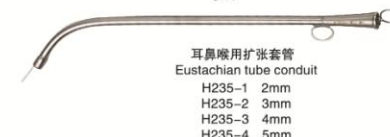

耳鼻喉用扩张套管
Eustachian tube conduit
H235-1 2mm
H235-2 3mm
H235-3 4mm
H235-4 5mm



H256 卷棉子
Cotton applicator
 $\phi 2 \times 240\text{mm}$



H190 异物喉钳 (右开口取鱼骨喉钳) 220mm
fish bone taking laryngeal forceps (right open)



H189 异物喉钳 (左开口取鱼骨喉钳) 220mm
fish bone taking laryngeal forceps (left open)



H191 异物喉钳 (前开口取鱼骨喉钳)
fish bone taking laryngeal forceps (front open)



H193 异物喉钳 (后开口取鱼骨喉钳)
fish bone taking laryngeal forceps (back ward open)

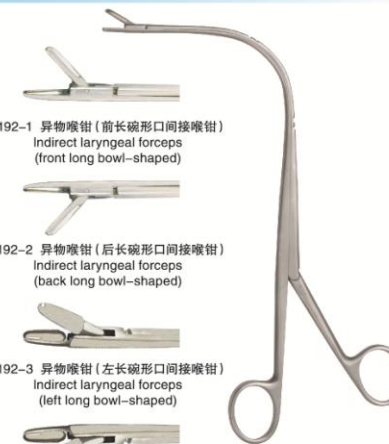

H192-1 异物喉钳 (前长碗形间接喉钳)
Indirect laryngeal forceps (front long bowl-shaped)



H192-2 异物喉钳 (后长碗形间接喉钳)
Indirect laryngeal forceps (back long bowl-shaped)



H192-3 异物喉钳 (左长碗形间接喉钳)
Indirect laryngeal forceps (left long bowl-shaped)



H192-4 异物喉钳 (右长碗形间接喉钳)
Indirect laryngeal forceps (right long bowl-shaped)

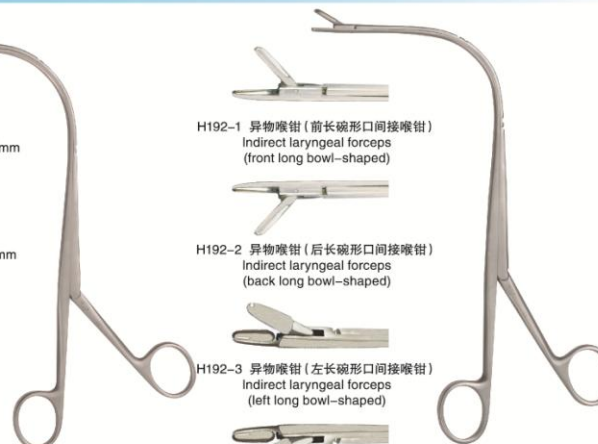

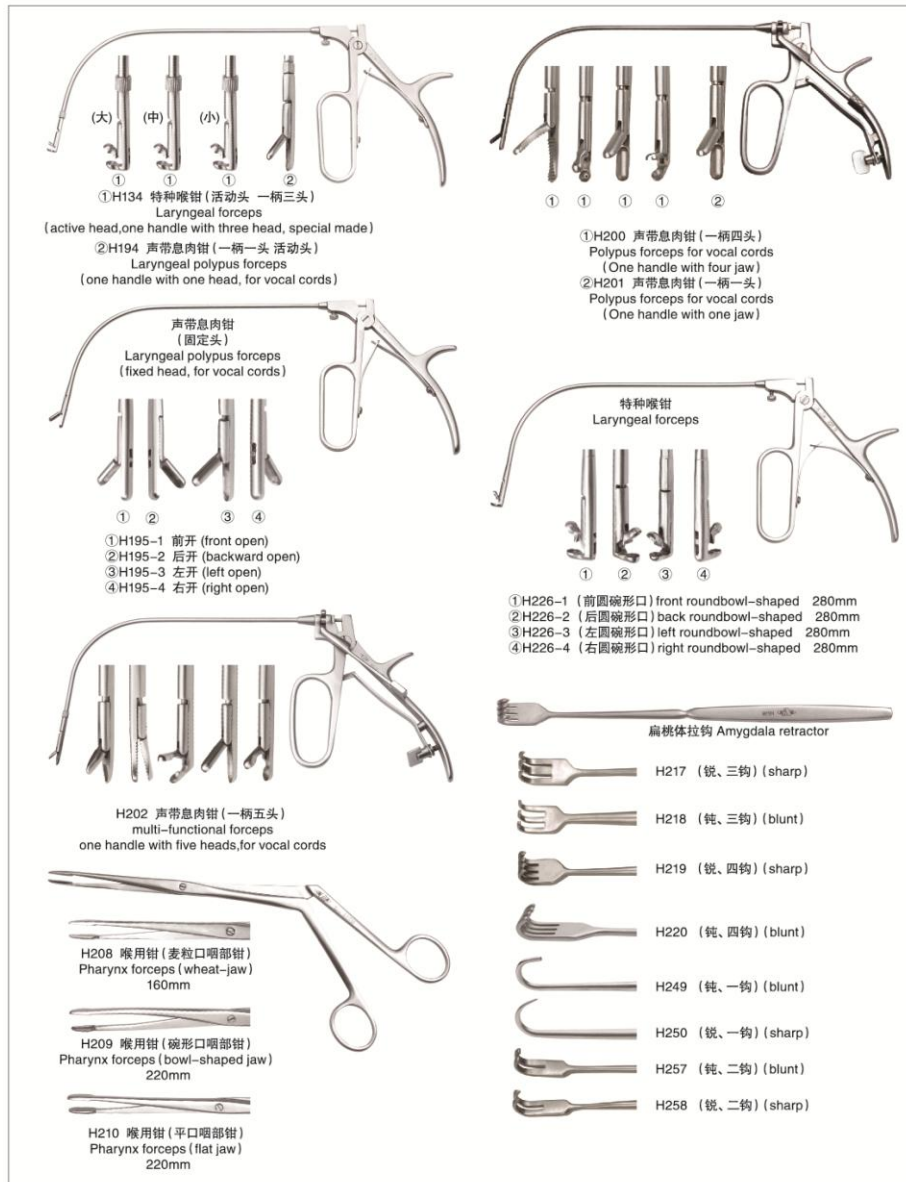
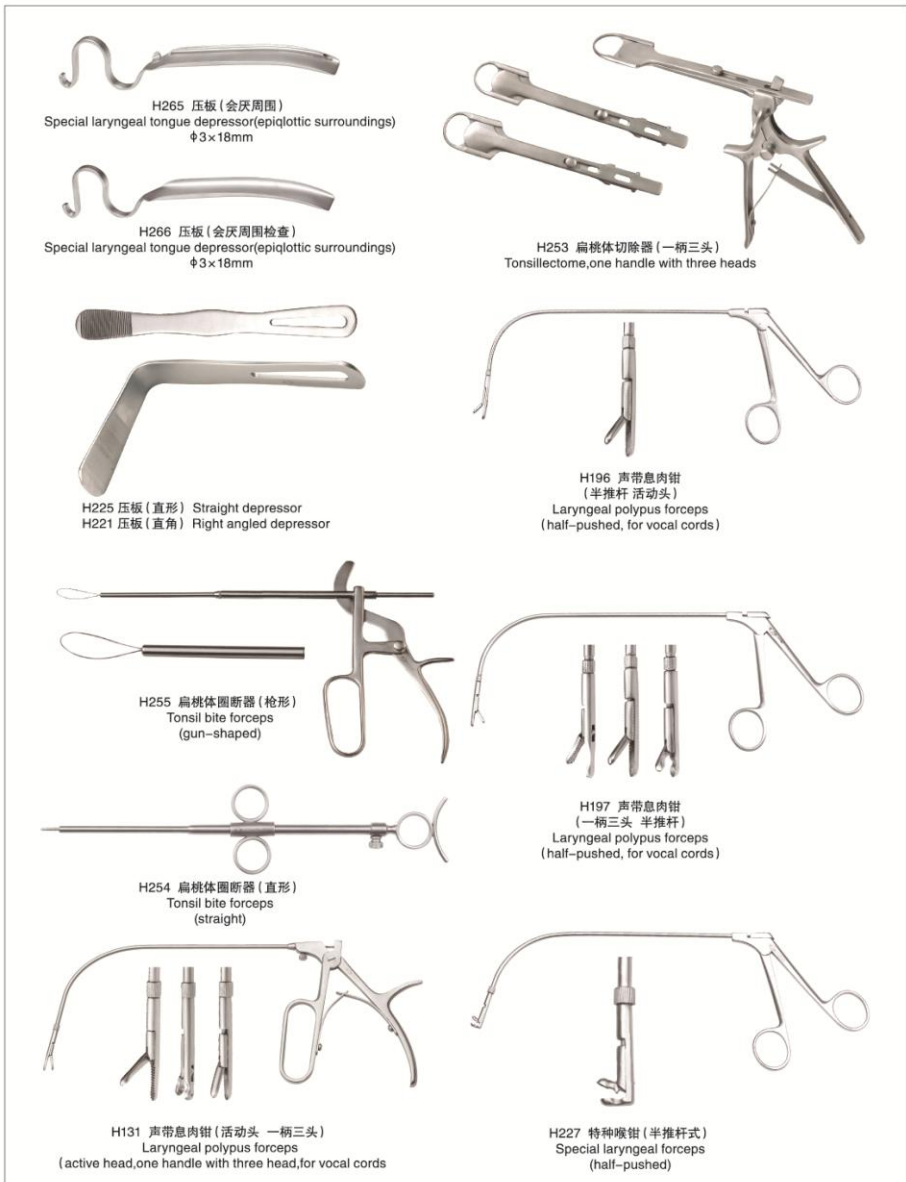

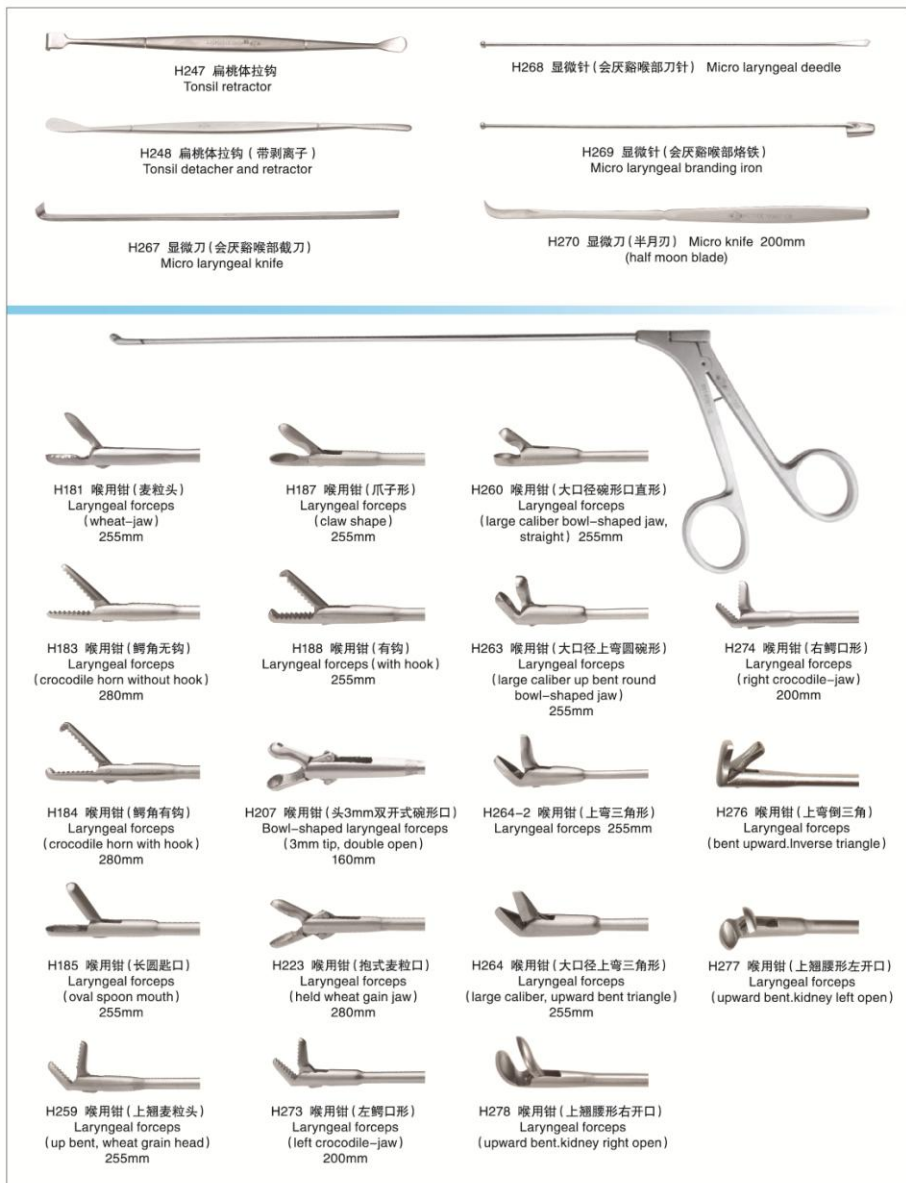

— ZEB 型中耳显微手术器械包 ZEB Eardrum micro operating set

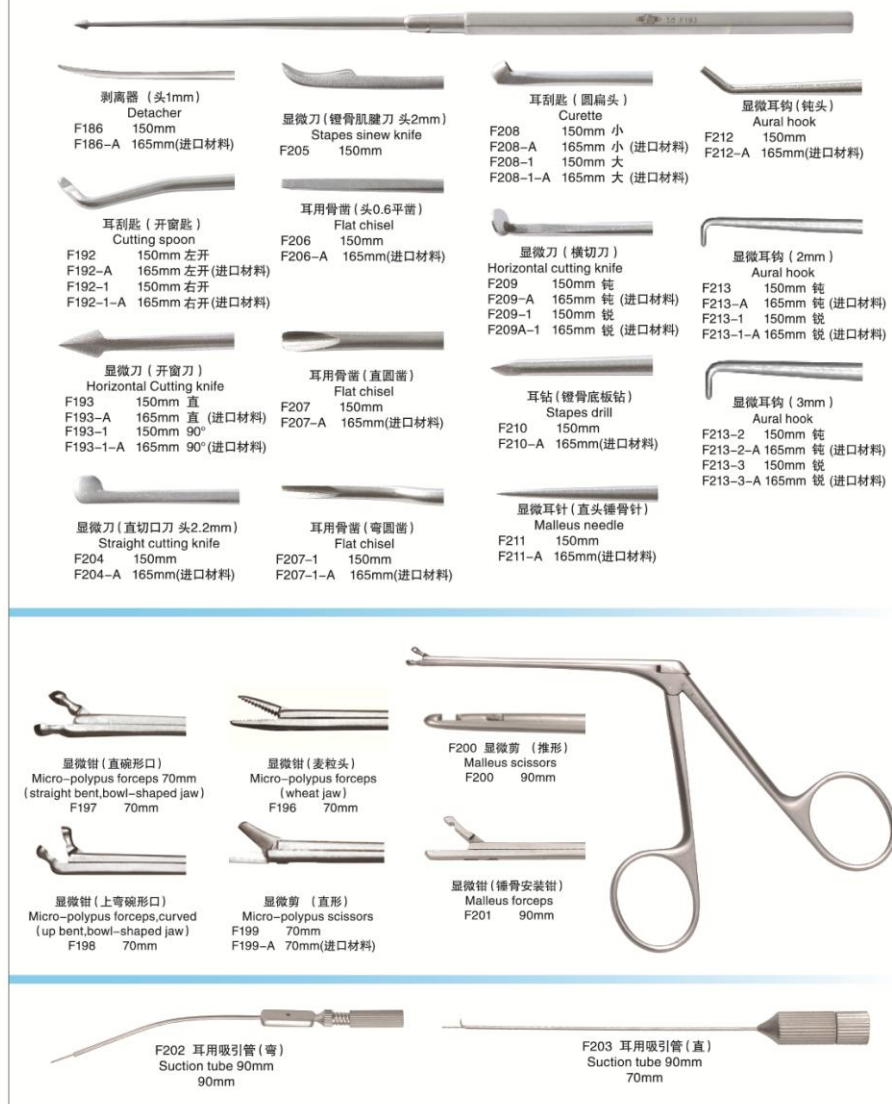

二 耳科选购器械 (Otologic optional instruments)

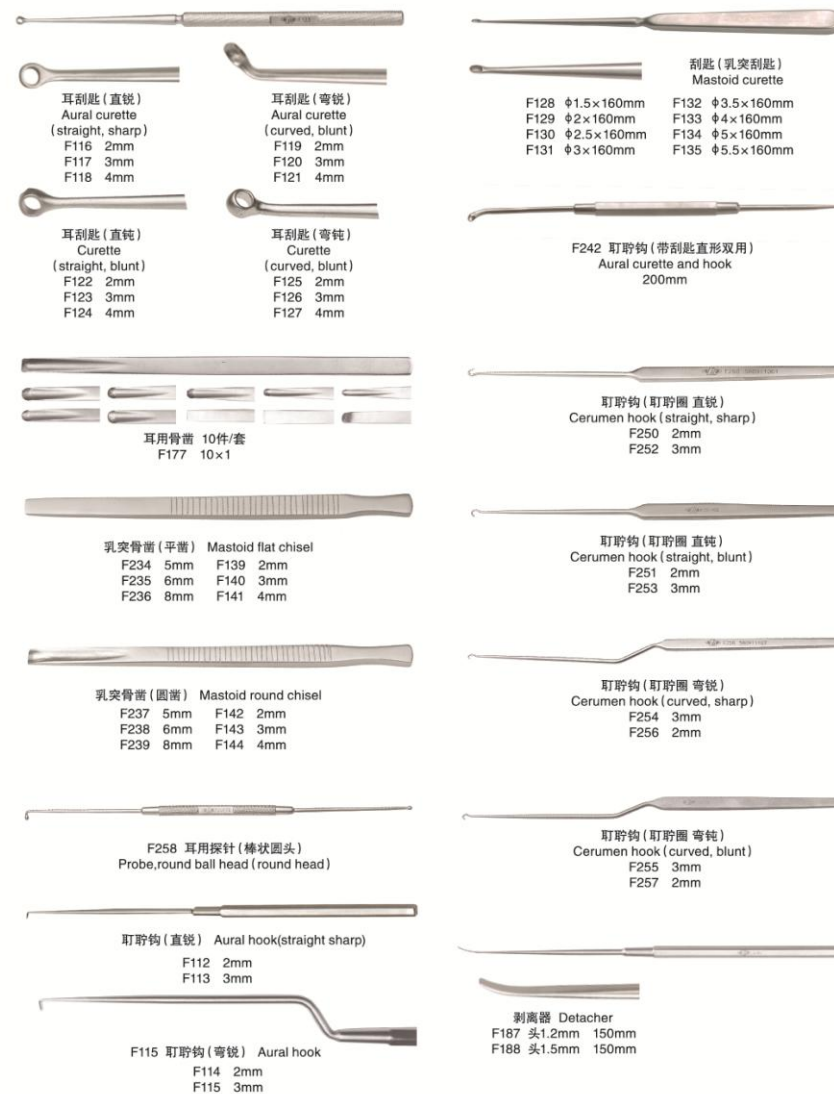
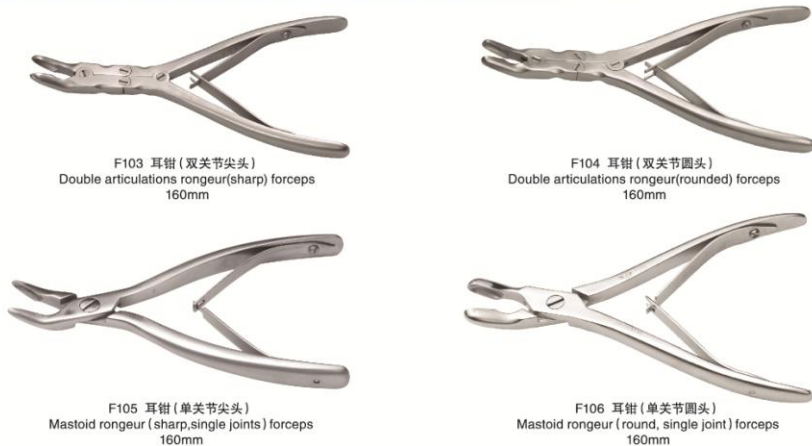
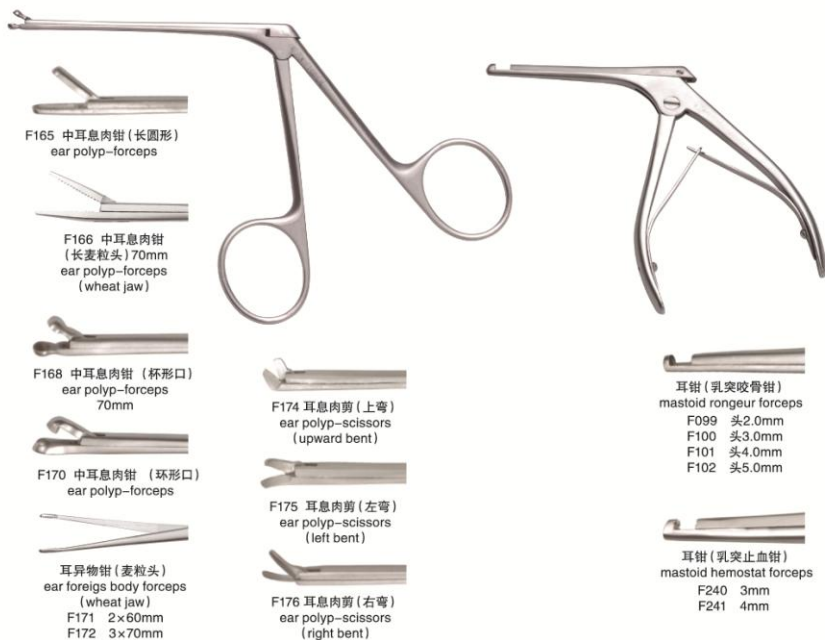

耳科



五官科吸引管
ENT suction tube
F136 $\phi 3 \times 185\text{mm}$
F137 $\phi 4 \times 185\text{mm}$
F138 $\phi 5 \times 185\text{mm}$



五官科吸引管
ENT suction tube
F180 $\phi 1.5 \times 100\text{mm}$
F181 $\phi 2 \times 100\text{mm}$
F182 $\phi 2.5 \times 100\text{mm}$
F216 $\phi 1.2 \times 100\text{mm}$
F217 $\phi 3 \times 100\text{mm}$

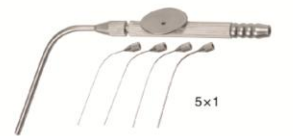

$\phi 1.0\text{mm}$ $\phi 1.2\text{mm}$ $\phi 1.5\text{mm}$ $\phi 2.0\text{mm}$ $\phi 2.5\text{mm}$
5x1
F259 五官科吸引管
ENT suction tube



10x1
 $\phi 0.8\text{mm}$ $\phi 1.0\text{mm}$ $\phi 1.2\text{mm}$ $\phi 1.5\text{mm}$ $\phi 1.6\text{mm}$
 $\phi 1.8\text{mm}$ $\phi 2.0\text{mm}$ $\phi 2.5\text{mm}$ $\phi 3.0\text{mm}$ $\phi 3.2\text{mm}$
F260 五官科吸引管
ENT suction tube



五官科吸引管 ENT suction tube
F229 $\phi 1.5 \times 120\text{mm}$
F230 $\phi 1 \times 120\text{mm}$
F231 $\phi 2 \times 120\text{mm}$
F232 $\phi 2.5 \times 120\text{mm}$
F233 $\phi 3 \times 120\text{mm}$



乳突牵开器 Mastoid retractor
F145 140mm (3x4钝口)
F146 140mm (3x4锐口)



乳突牵开器 Mastoid retractor
F244 (二齿钝口) 140mm
(two teeth, blunt)
F245 (二齿钝口) 140mm
(two teeth, blunt)



乳突牵开器 Mastoid retractor
F178 (双关节) 3x4锐口
(sharp, double joints)
F179 (双关节) 3x4钝口
(sharp, double joints)



F147 乳突牵开器 (内耳牵开器) Inner ear retractor



F148 耳息肉圈断器 (一柄二头)
Biter for aural polypus
160mm



F149 卷棉子 Cotton applicator



F151 耳用探针 (膝状)
Probe (knee shaped)
180mm



耳鼓膜刀 170mm
Eardrum knife
170mm

① F191 (角型三角刃) (Angle-shaped triangled blade)
② F161 (角型镰状刃) (Angle-shaped falcated blade)
③ F159 (角型半月刃) (Angle-shaped half-moon blade)



F150 耳用探针 (枪状)
Probe for ear (gun shape)



耳鼓膜刀 Eardrum knife 190mm

F160 (枪形半角刃)
(bayonet shaped)

F162 (枪形三角刃)
(gun-shaped, half-angled blade)



F183 乳突器械敲击锤 (大) Ear bone mallet (large)
80mm



F184 乳突器械敲击锤 (中) Ear bone mallet (middle)
40mm



F185 乳突器械敲击锤 (小) Ear bone mallet (small)
30mm



F261 耳用镜鞘 Aural sheath



配耳用内窥镜使用



F262 耳用镜鞘 (配耳内窥镜 $\phi 2.7$)
Aural sheath (connect with $\phi 2.7\text{mm}$ endoscope)

一 EQJ 小儿支气管镜成套器械 (F) EQJ Pediatric bronchoscope set (F)

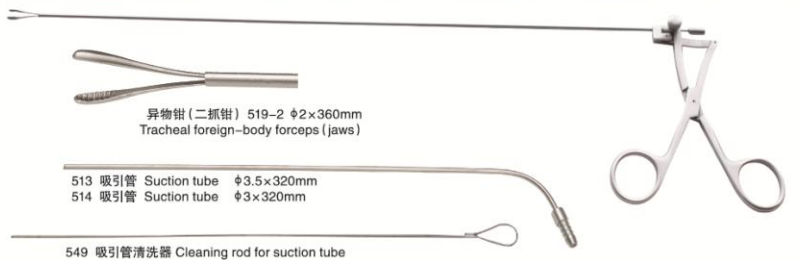

二 EQJ 支气管镜成套器械 (C) QGJ Pediatric bronchoscope set (C)



气管科

三 EQJ 支气管镜成套器械 (H) QGJ Pediatric bronchoscope set (H)

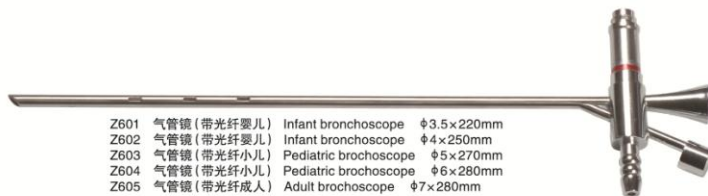

- Z601 气管镜 (带光纤婴儿) Infant bronchoscope $\phi 3.5 \times 220\text{mm}$
- Z602 气管镜 (带光纤婴儿) Infant bronchoscope $\phi 4 \times 250\text{mm}$
- Z603 气管镜 (带光纤小儿) Pediatric bronchoscope $\phi 5 \times 270\text{mm}$
- Z604 气管镜 (带光纤小儿) Pediatric bronchoscope $\phi 6 \times 280\text{mm}$
- Z605 气管镜 (带光纤成人) Adult bronchoscope $\phi 7 \times 280\text{mm}$



538 异物钳 (麦口)
Foreign body forceps
(wheat-jaw)
 $\phi 2 \times 320\text{mm}$

539 异物钳 (鳄鱼口)
Foreign body forceps
(crocodile-jaw)
 $\phi 2 \times 320\text{mm}$



515 异物钳 (花生双开)
Foreign body forceps
(peanut-jaw)
 $\phi 1.8 \times 360\text{mm}$



511-1 异物钳 (麦口单开)
Foreign body forceps
(wheat-jaw)
 $\phi 1.8 \times 360\text{mm}$



512-1 异物钳 (鳄鱼口单开)
Foreign body forceps
(crocodile-jaw)
 $\phi 1.8 \times 360\text{mm}$



520-1 异物钳 (三抓钳)
Foreign body forceps (three jaws)
 $\phi 2 \times 360\text{mm}$



- 513 吸引管 Suction tube $\phi 3.5 \times 320\text{mm}$
- 514 吸引管 Suction tube $\phi 3 \times 320\text{mm}$
- 550 吸引管 Suction tube $\phi 4 \times 320\text{mm}$

549 吸引管清洗器 Cleaning rod for suction tube

四 气管科选购件 Tracheal optional instruments



- 气管镜 Bronchoscope
- 507 $\phi 4 \times 200\text{mm}$
- 508 $\phi 3.5 \times 200\text{mm}$
- 537 (小儿) (pediatric) $\phi 3 \times 200\text{mm}$
- 540 (小儿) (pediatric) $\phi 4.5 \times 250$
- 541 (小儿) (pediatric) $\phi 5 \times 500\text{mm}$
- 542 (小儿) (pediatric) $\phi 5.5 \times 300\text{mm}$
- 543 (小儿) (Pediatric) $\phi 5.5 \times 350\text{mm}$
- 545 (成人) (Pediatric) $\phi 6.5 \times 400\text{mm}$
- 546 (成人) (adult) $\phi 7 \times 450\text{mm}$
- 547 (成人) (adult) $\phi 8 \times 450$
- 548 (小儿) (adult) $\phi 4 \times 250$



612 显微钩 (气管切开拉钩) 2x1 Tracheal cutting hook



512-2 异物钳 (鳄鱼口 单开口)
Foreign body forceps
(crocodile-jaw, single open)
 $\phi 2.5 \times 360\text{mm}$

异物钳 (花生 双开口)
Foreign body forceps
(peanut-jaw, double open)
515-2 $\phi 2.5 \times 360\text{mm}$
515-3 $\phi 2 \times 480\text{mm}$

异物钳 (反抓 双开口)
Foreign body forceps
(Inverse grasp, double open)
521 $\phi 1.8 \times 360\text{mm}$
529 $\phi 1.8 \times 500\text{mm}$



异物钳 (鳄鱼口 双开口)
Foreign body forceps
(crocodile-jaw, double open)
524-1 $\phi 1.8 \times 500\text{mm}$
524-2 $\phi 2.5 \times 500\text{mm}$
516 $\phi 1.8 \times 360\text{mm}$



525 异物钳 (麦口 双开口)
Foreign body forceps
(wheat-jaw, double open)
525 $\phi 2.5 \times 500\text{mm}$
517 $\phi 1.8 \times 360\text{mm}$
517-2 $\phi 2.5 \times 360\text{mm}$



526 异物钳 (花生 横双开口)
Foreign body forceps
(peanut-jaw, double open)
 $\phi 2.5 \times 500\text{mm}$



532 异物钳 (杯形口 单开口)
Foreign body forceps
(cup-shaped jaw, double open)
 $\phi 1.8 \times 360\text{mm}$



异物钳 (尖头)
Foreign body forceps
(sharp tip)
523 $\phi 1.8 \times 360\text{mm}$
523-2 $\phi 2.5 \times 360\text{mm}$



533 异物钳 (杯形口 双开口)
Foreign body forceps
(cup-shaped jaw, double open)
 $\phi 1.8 \times 360\text{mm}$



559 异物钳 (鳄鱼口 单开口)
Foreign body forceps
(crocodile-jaw, single open)
 $\phi 1.8 \times 360\text{mm}$



异物钳 (带钩鳄鱼口)
Foreign body forceps
(crocodile-jaw, with hook)
603 $\phi 1.8 \times 420\text{mm}$
604 $\phi 1.8 \times 320\text{mm}$
605 $\phi 1.8 \times 360\text{mm}$



异物钳 (鳄鱼口)
Foreign body forceps
(crocodile-jaw)
632 $\phi 1.8 \times 480\text{mm}$

气管科

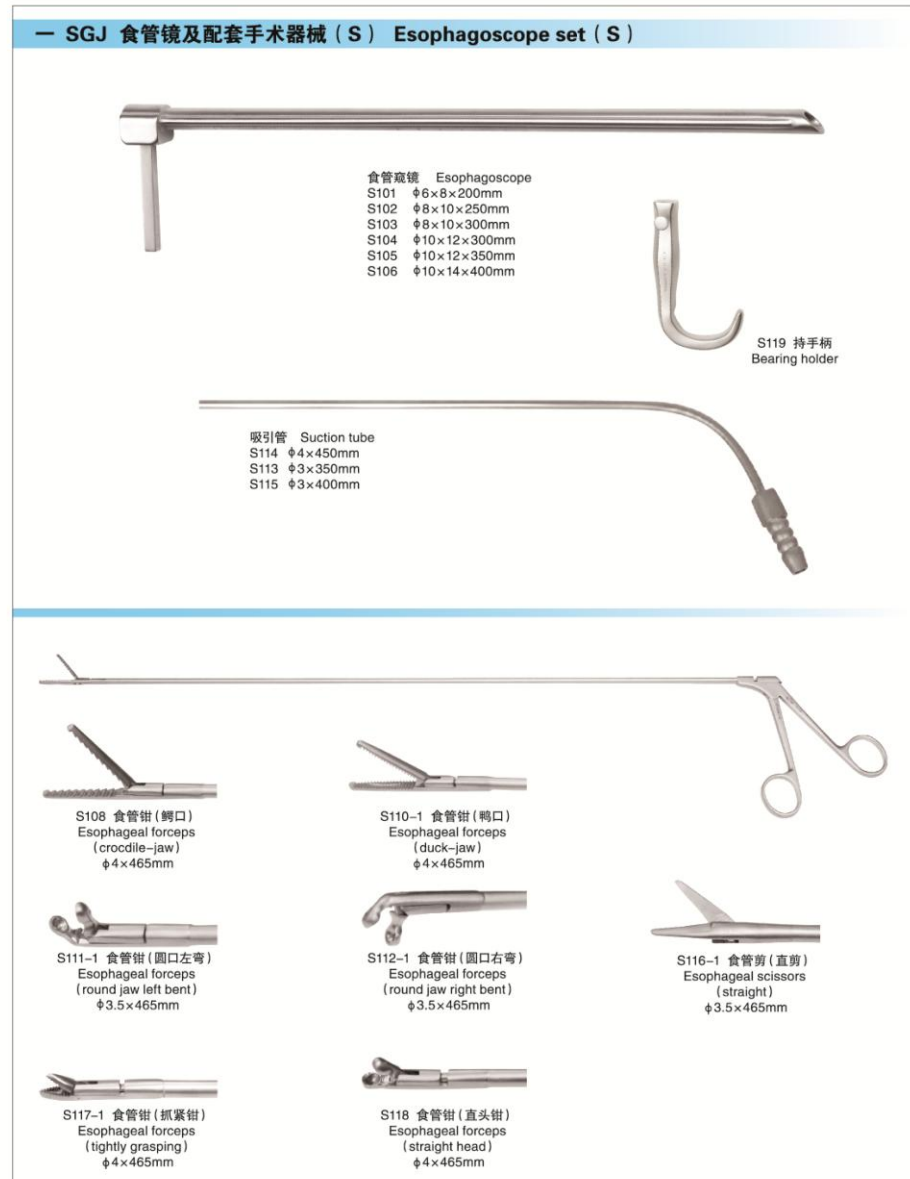
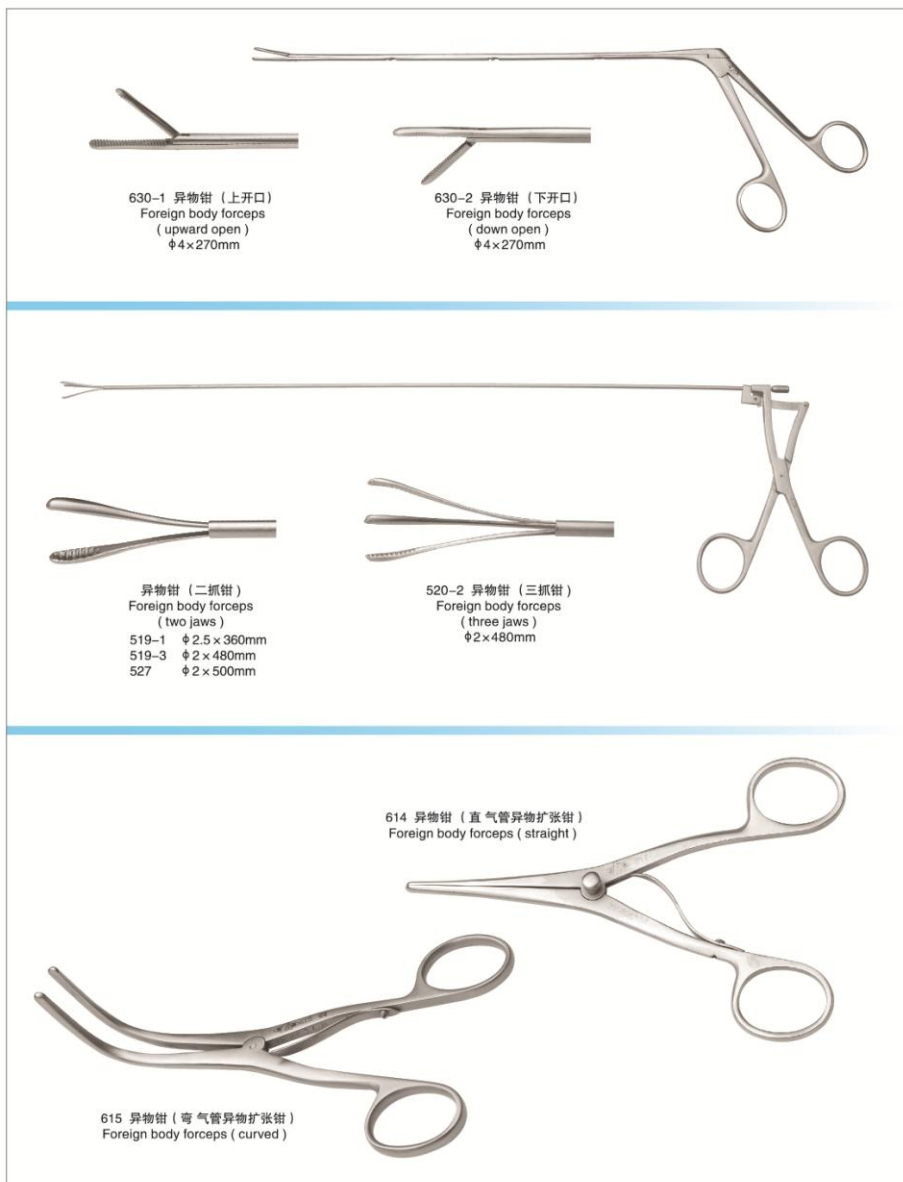

二 SGJ 食管镜及配套手术器械 (F) Esophagoscope set (with fiber) (F)



食管窥镜 Esophagoscope
S121 $\phi 9 \times 13 \times 250\text{mm}$
S122 $\phi 11 \times 15 \times 300\text{mm}$
S123 $\phi 10 \times 16 \times 350\text{mm}$
S124 $\phi 13 \times 17 \times 385\text{mm}$
S125 $\phi 12 \times 18 \times 400\text{mm}$



吸引管 Suction tube
S114-1 $\phi 4 \times 480\text{mm}$
S113 $\phi 3 \times 350\text{mm}$
S115 $\phi 3 \times 400\text{mm}$



S108 食管钳 (鳄鱼口)
Esophageal forceps
(crocodile-jaw)
 $\phi 4 \times 465\text{mm}$

S110-1 食管钳 (鸭口)
Esophageal forceps
(duck-jaw)
 $\phi 4 \times 465\text{mm}$

S111-1 食管钳 (圆口左弯)
Esophageal forceps
(round jaw left bent)
 $\phi 3.5 \times 465\text{mm}$

S112-1 食管钳 (圆口右弯)
Esophageal forceps
(round jaw right bent)
 $\phi 3.5 \times 465\text{mm}$

S116-1 食管剪 (直剪)
Esophageal scissors
(straight)
 $\phi 3.5 \times 465\text{mm}$

S117-1 食管钳 (抓紧钳)
Esophageal forceps
(tightly grasping)
 $\phi 4 \times 465\text{mm}$

S118 食管钳 (直头钳)
Esophageal forceps
(straight head)
 $\phi 4 \times 465\text{mm}$

三 食管科选购器械 Esophageal optional instruments

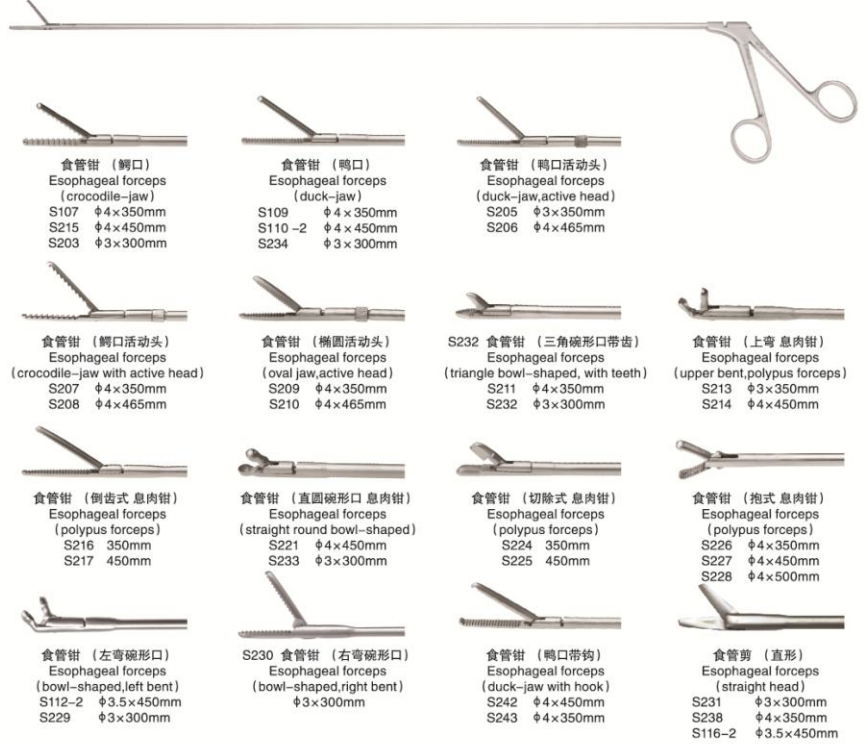

食管钳 (鳄鱼口)
Esophageal forceps
(crocodile-jaw)
S107 $\phi 4 \times 350\text{mm}$
S215 $\phi 4 \times 450\text{mm}$
S203 $\phi 3 \times 300\text{mm}$

食管钳 (鸭口)
Esophageal forceps
(duck-jaw)
S109 $\phi 4 \times 350\text{mm}$
S110-2 $\phi 4 \times 450\text{mm}$
S234 $\phi 3 \times 300\text{mm}$

食管钳 (鸭口活动头)
Esophageal forceps
(duck-jaw, active head)
S205 $\phi 3 \times 350\text{mm}$
S206 $\phi 4 \times 465\text{mm}$

食管钳 (鳄鱼口活动头)
Esophageal forceps
(crocodile-jaw with active head)
S207 $\phi 4 \times 350\text{mm}$
S208 $\phi 4 \times 465\text{mm}$

食管钳 (椭圆活动头)
Esophageal forceps
(oval jaw, active head)
S209 $\phi 4 \times 350\text{mm}$
S210 $\phi 4 \times 465\text{mm}$

S232 食管钳 (三角碗形口带齿)
Esophageal forceps
(triangle bowl-shaped, with teeth)
S211 $\phi 4 \times 350\text{mm}$
S232 $\phi 3 \times 300\text{mm}$

食管钳 (上弯息肉钳)
Esophageal forceps
(upper bent, polypus forceps)
S213 $\phi 3 \times 350\text{mm}$
S214 $\phi 4 \times 450\text{mm}$

食管钳 (倒齿式息肉钳)
Esophageal forceps
(polypus forceps)
S216 350mm
S217 450mm

食管钳 (直圆碗形口息肉钳)
Esophageal forceps
(straight round bowl-shaped)
S221 $\phi 4 \times 450\text{mm}$
S233 $\phi 3 \times 300\text{mm}$

食管钳 (切除式息肉钳)
Esophageal forceps
(polypus forceps)
S224 350mm
S225 450mm

食管钳 (抱式息肉钳)
Esophageal forceps
(polypus forceps)
S226 $\phi 4 \times 350\text{mm}$
S227 $\phi 4 \times 450\text{mm}$
S228 $\phi 4 \times 500\text{mm}$

食管钳 (左弯碗形口)
Esophageal forceps
(bowl-shaped, left bent)
S112-2 $\phi 3.5 \times 450\text{mm}$
S229 $\phi 3 \times 300\text{mm}$

S230 食管钳 (右弯碗形口)
Esophageal forceps
(bowl-shaped, right bent)
 $\phi 3 \times 300\text{mm}$

食管钳 (鸭口带钩)
Esophageal forceps
(duck-jaw with hook)
S242 $\phi 4 \times 450\text{mm}$
S243 $\phi 4 \times 350\text{mm}$

食管剪 (直形)
Esophageal forceps
(straight head)
S231 $\phi 3 \times 300\text{mm}$
S238 $\phi 4 \times 350\text{mm}$
S116-2 $\phi 3.5 \times 450\text{mm}$



S201 食管钳 (二爪)
Esophageal forceps (two jaws)
 $\phi 3 \times 350\text{mm}$

S202 食管钳 (三爪)
Esophageal forceps (three jaws)
 $\phi 3 \times 350\text{mm}$

食管科



食管窥镜 Esophagoscope
S128 $\phi 14 \times 22 \times 350\text{mm}$



食管窥镜 Esophagoscope
S246 $\phi 8 \times 12 \times 270\text{mm}$
S247 $\phi 8 \times 12 \times 300\text{mm}$
S248 $\phi 9 \times 13 \times 270\text{mm}$
S249 $\phi 9 \times 13 \times 300\text{mm}$
S250 $\phi 10 \times 14 \times 270\text{mm}$
S251 $\phi 10 \times 14 \times 300\text{mm}$



S235 食管钳 (一柄三头)
Esophageal forceps
(one handle with three jaws)
 $\phi 4 \times 450\text{mm}$

一 导光束及光学接口 Endoscope system



导光束 (螺口)
Optical cable (screwing)
 $\phi 4 \times 1800\text{mm}$
 $\phi 4 \times 2000\text{mm}$
 $\phi 4 \times 2500\text{mm}$
 $\phi 5 \times 2500\text{mm}$



导光束 (螺口) 导光束 (插口)
Optical cable (screwing) Optical cable (inserted)
 $\phi 1.8 \times 1700\text{mm}$ $\phi 1.8 \times 1700\text{mm}$
 $\phi 2.5 \times 1700\text{mm}$ $\phi 2.5 \times 1700\text{mm}$



光学接口
Eyepiece coupler

二 冷光源 Cold light source



150W卤钨灯冷光源
150W Halogen cold light source



300W氙灯冷光源
300W Xenon cold light source

三 SZJ 内窥镜数字图像处理系统 Endoscopic Imaging System



型号 Model	FA-C311	
性能 Performance	扫描方式 Scanning Mode	60/50Hz 逐行扫描 (Progressive scanning)
	水平分辨率 Resolution	≥ 1000 线 (lines)
	有效像素 Effective Pixels	1980 (H) \times 1080 (V)
外观尺寸 Dimension	摄像头尺寸 L \times W \times H	97mm \times 41mm \times 52mm
	摄像头线缆 Camera Cable	$\phi 6\text{mm} \times 3\text{m}$
	重量 Weight	135g

型号 Model	FA-P311	
性能 Performance	用户场景 Scene	支持5种场景 Support 5 scene files
	白平衡 White balance	AWB、ATW、手动白平衡 AWB、ATW、MANU
	电子放大 Zoom	X1.0 - X5.0
	图像处理 Image Processing	数字降噪、去摩尔纹、暗区改善 Digital Noise Reduction, De-moire, Dark Improvement
	双键显示 Dual Display	关闭/并列/左上/左下/右上/右下 OFF/POP/Left-Top/Left-Bottom/Right-Top/Right-Bottom
	录像存储 Record	USB3.0接口, 支持MP4格式 USB3.0 interface, support MP4 format
	可编程按键 Programmable buttons	每个按键均支持12种功能定义 Support up to 12 functions for each button
外观尺寸 Dimension	L \times W \times H	324mm \times 300mm \times 114.7mm
电源 Power	100V-220V, 50/60Hz	



电气类