

ENGELS

serving logistics and the environment

www.engels.eu

ZELL

Ideas for better solutions.





**Are you looking for automated production,
cleaning and storage in a single workpiece
carrier system?**

ZELL Systemtechnik GmbH has been developing and manufacturing reliable transportation systems for the industry, made from both stainless steel and plastic, for many years.

Since 2022, we are pleased to offer our customers the new **ZELL® Factory System**. This system includes parts carriers, baskets, Multiclips, tension clamps, cleaning adapters, and various other accessories. In addition to this system, we have introduced in 2023 our new **ZELL® Carrier & ZELL® BOX System**. By coordinating all components, you can transport your workpieces more affordably, efficiently, and sustainably.



ZELL® Factory System

Workpiece carriers

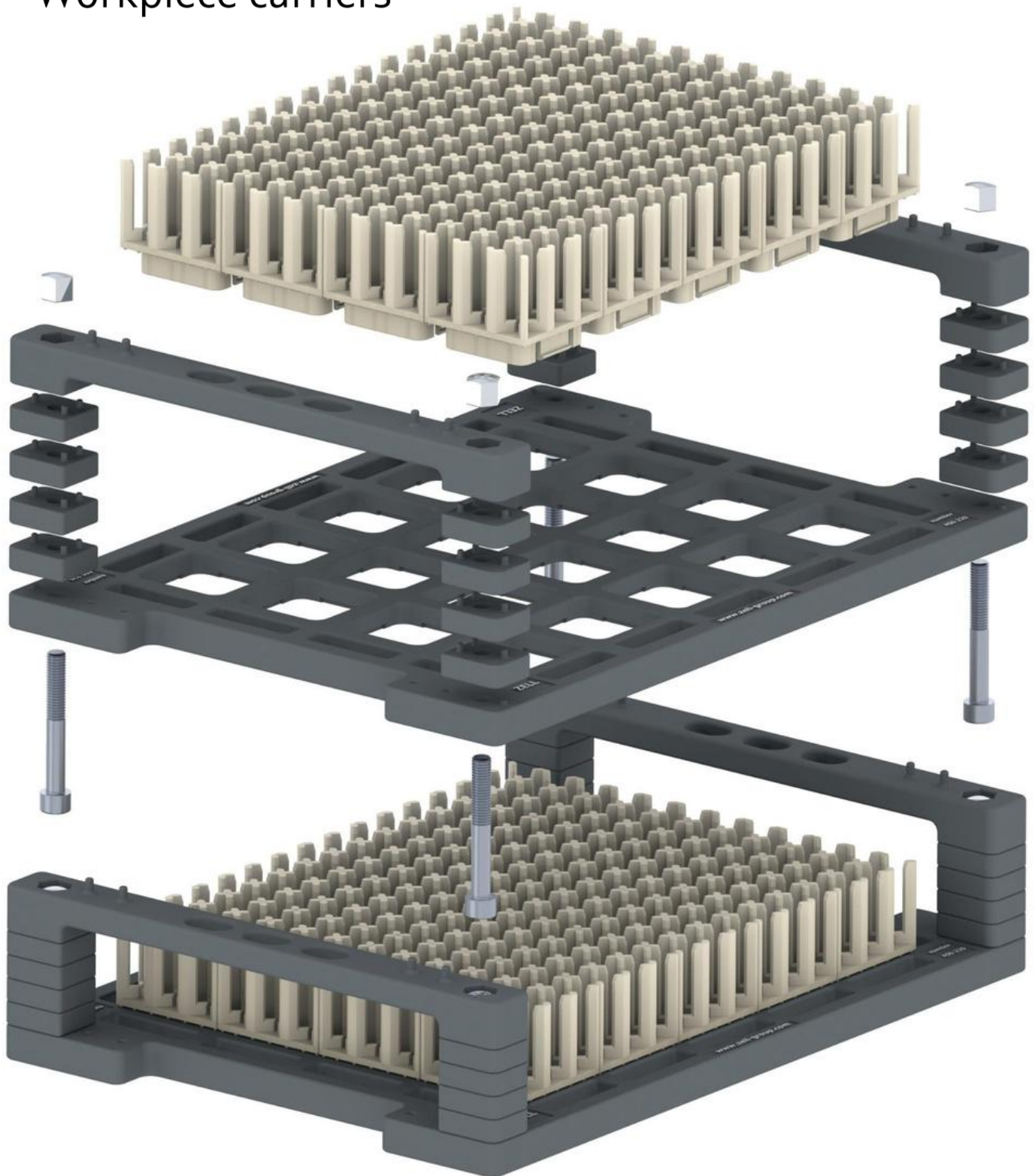

Our workpiece carriers are made of high-quality polyamide and are designed to be highly stable and accurate. All additional components such as handles, multiclips etc. are optimally coordinated and can also be made of antistatic plastic.

our standard sizes

255x155 mm
capacity:
6 Multiclips

275x190 mm
capacity:
12 Multiclips

355x255 mm
capacity:
20 Multiclips

425x275 mm
capacity:
35 Multiclips

555x355 mm
capacity: 54 Multiclips

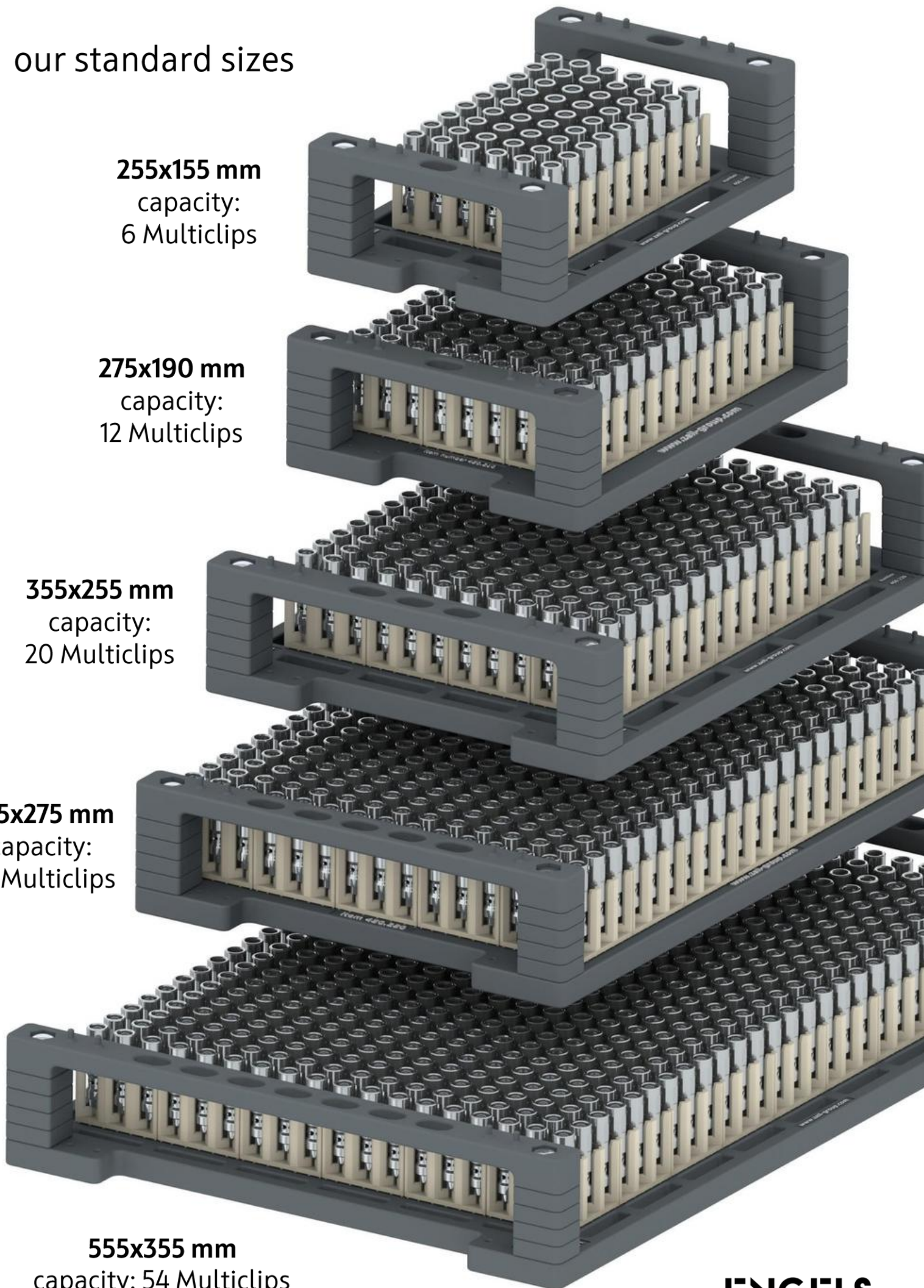

ENGELS

ZELL® Factory System

Multiclips

We use high-quality polyamide as the material for our multiclips. Alternatively, we can manufacture all multiclips in antistatic material.

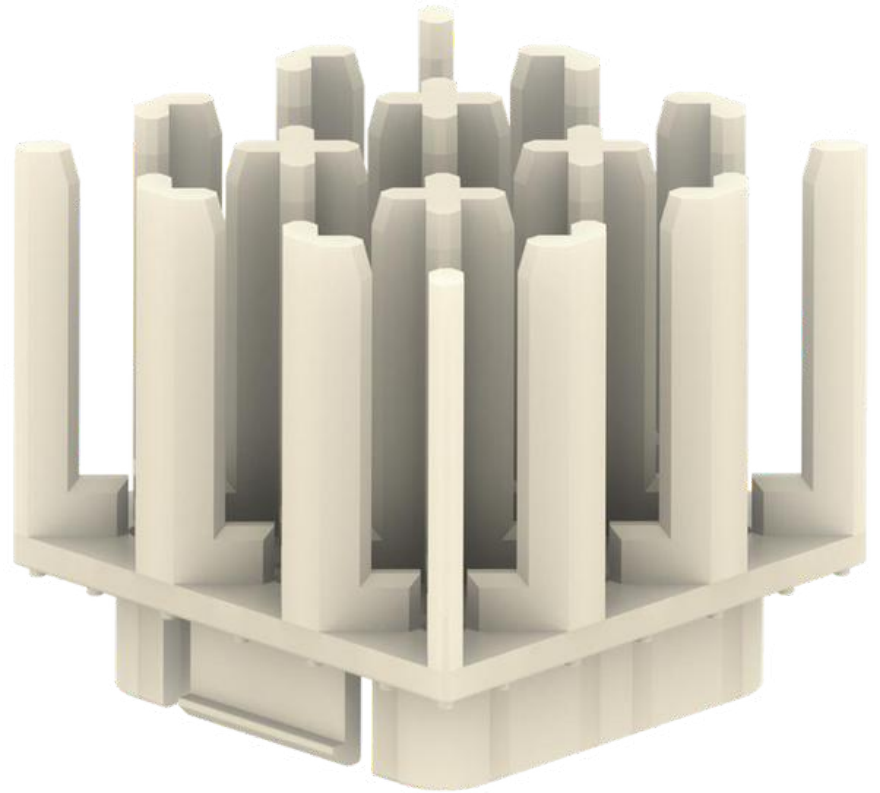

All multiclips are provided with a snap lock which is coordinated to the workpiece carrier. By coordinating all components, we are able to ensure high accuracy of the entire system.

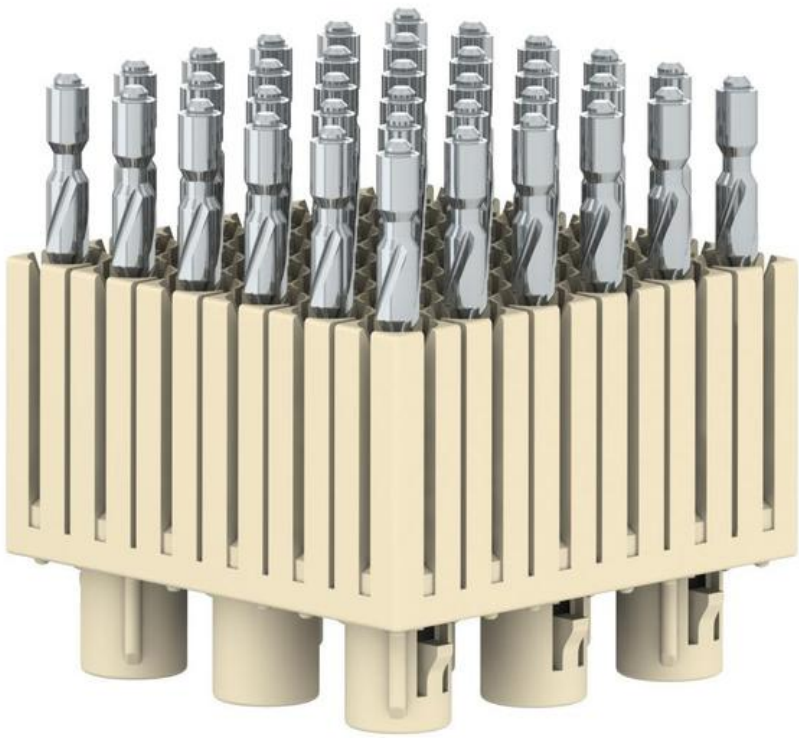

Multiclips are flexible in terms of their design. Almost any geometry can be produced to match the component.

Thanks to their construction, a large number of components can be transported on a small base area.

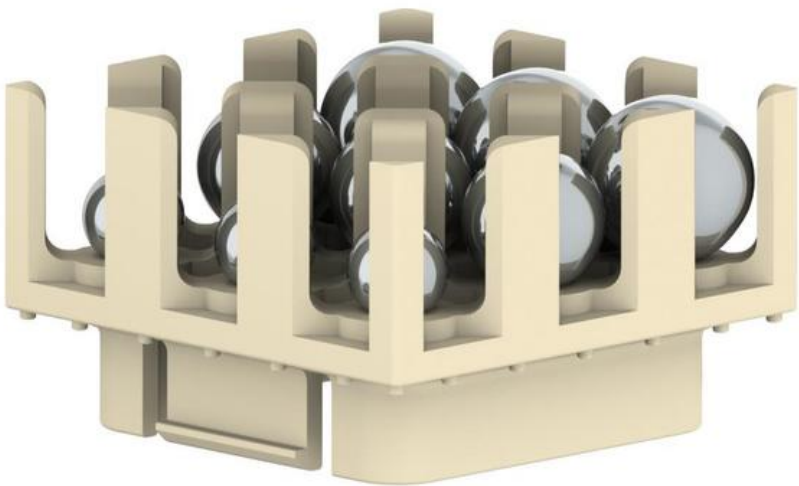

ENGELS

ZELL® Factory System

Transport baskets

We use polyamide as the standard material for our plastic components. Alternatively, we also offer all components in antistatic plastic.

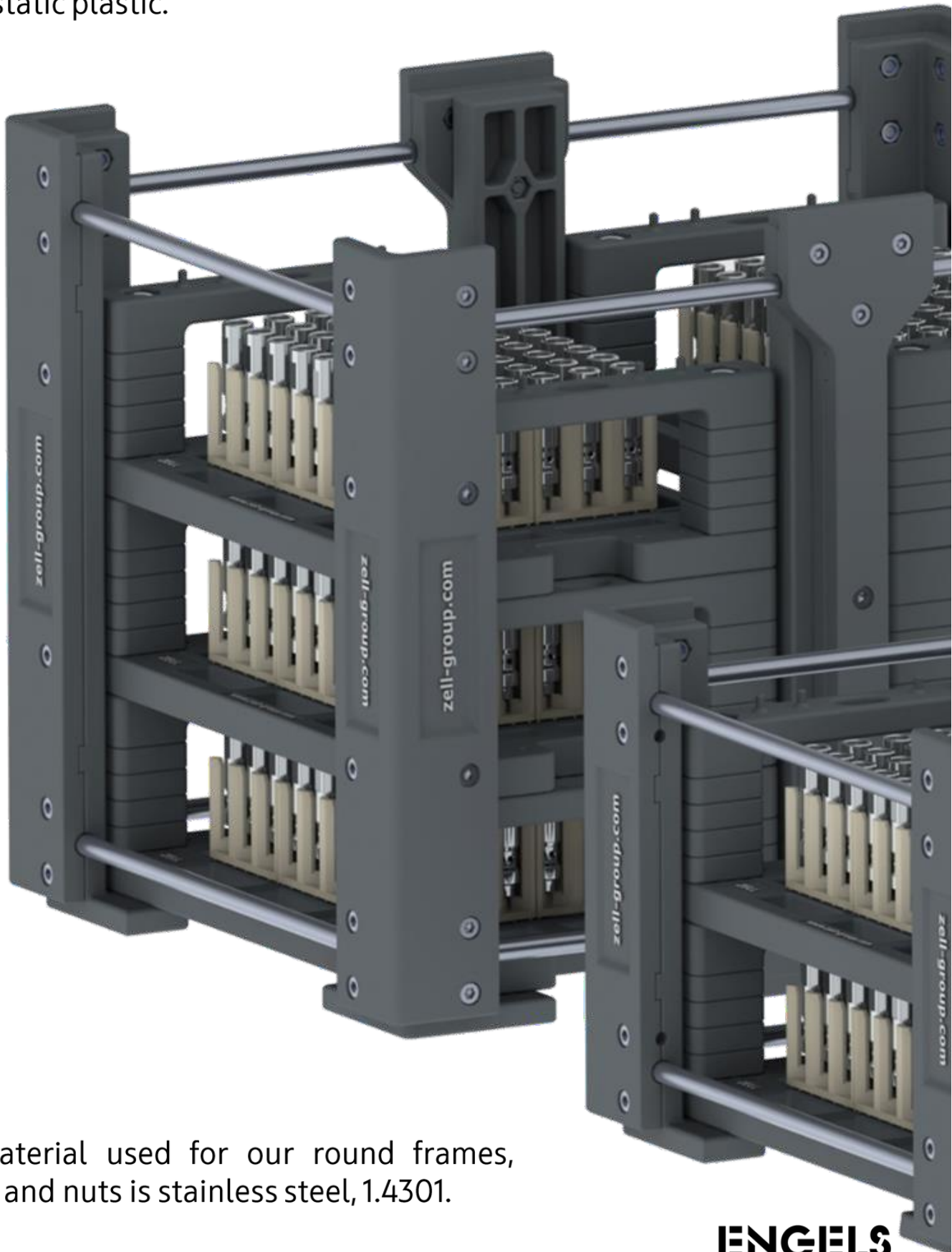

The material used for our round frames, screws and nuts is stainless steel, 1.4301.

ENGELS

Our transport baskets consist of corner and side parts which are bolted to a welded stainless steel frame. The size of the base area thus corresponds to the frame size. This means that all desired base areas can be produced without additional effort or expense.

As standard, we supply components for **basket heights** of **200 mm** and **300 mm**.

As standard, we supply the following external dimensions as base areas in both heights:

- **300 x 200 mm**
- **320 x 235 mm**
- **400 x 300 mm**
- **470 x 320 mm**
- **600 x 400 mm**
- **800 x 600 mm**

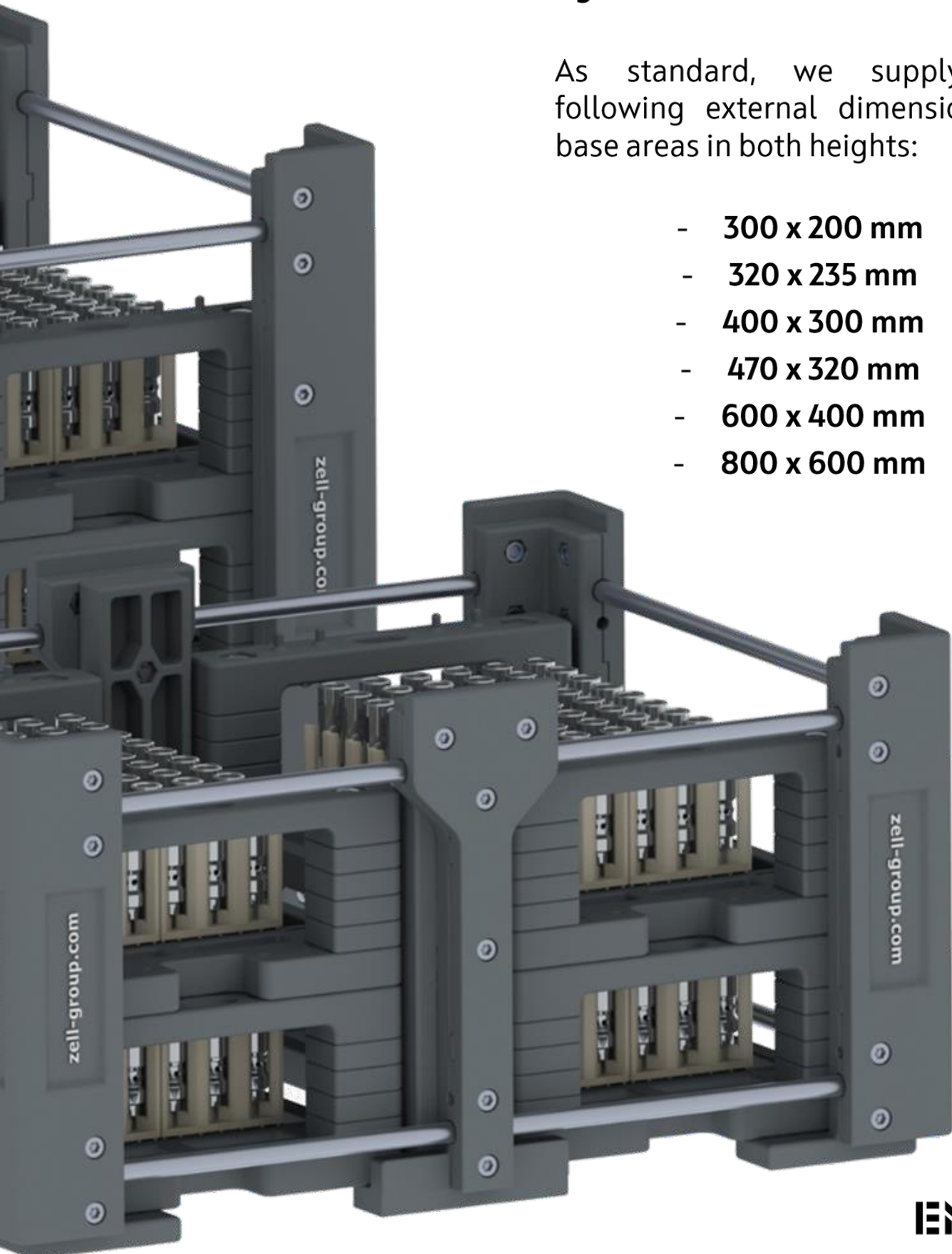

Plastic baskets

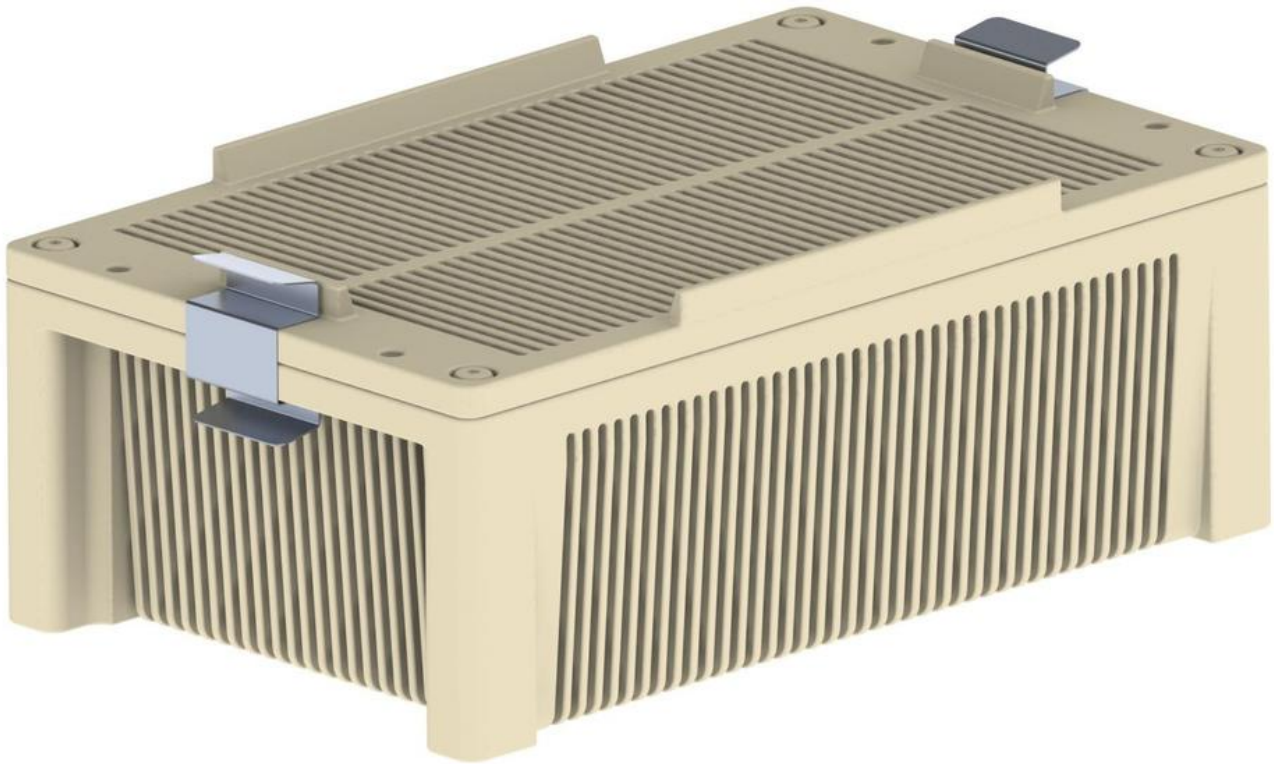

Our plastic baskets made of high-quality polyamide are ideal for transporting and cleaning sensitive bulk goods. They are suitable for transporting small parts with a minimum size of 3mm. Each basket is supplied with a coordinated cover. A locking clip is optionally available. The external dimensions of the basket including cover are: 255 x 155 x 90 mm (L x W x H).

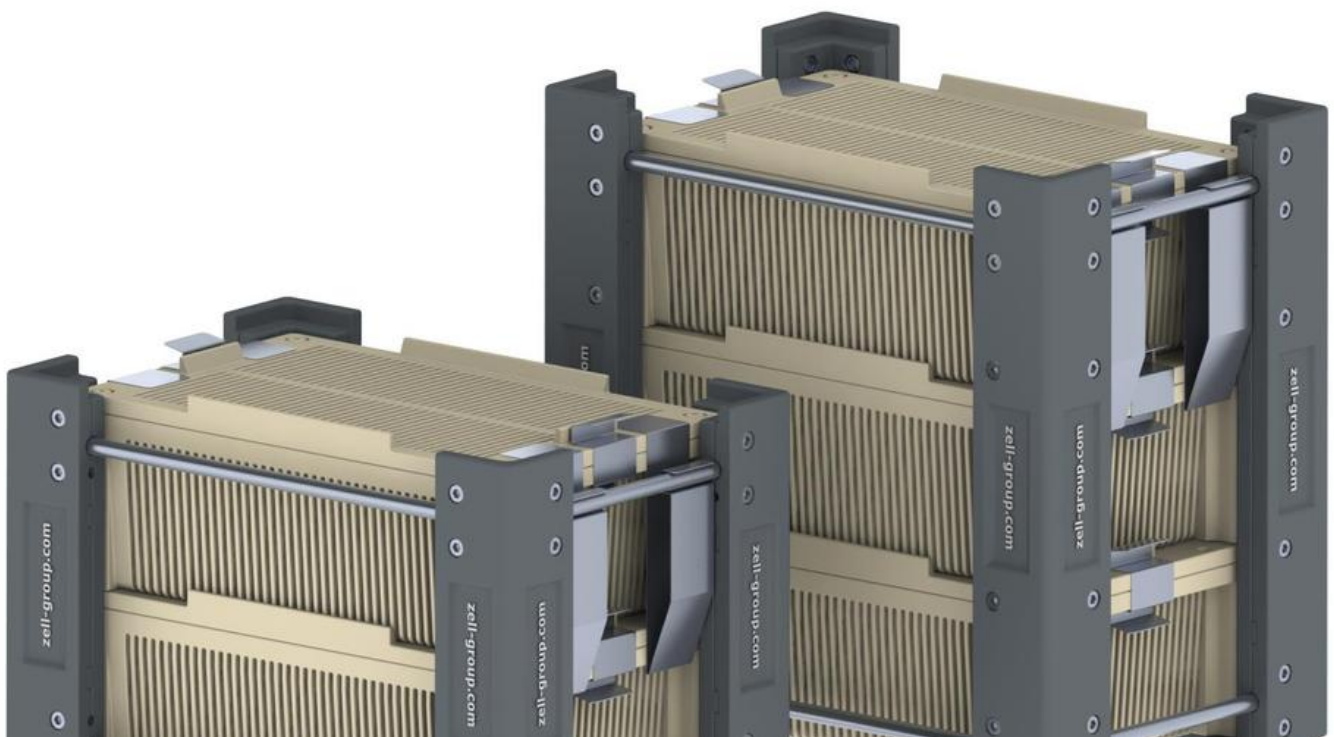

The plastic baskets coordinate ideally with our transport baskets. The plastic baskets can be clamped to the transport baskets using an optionally available clamp.

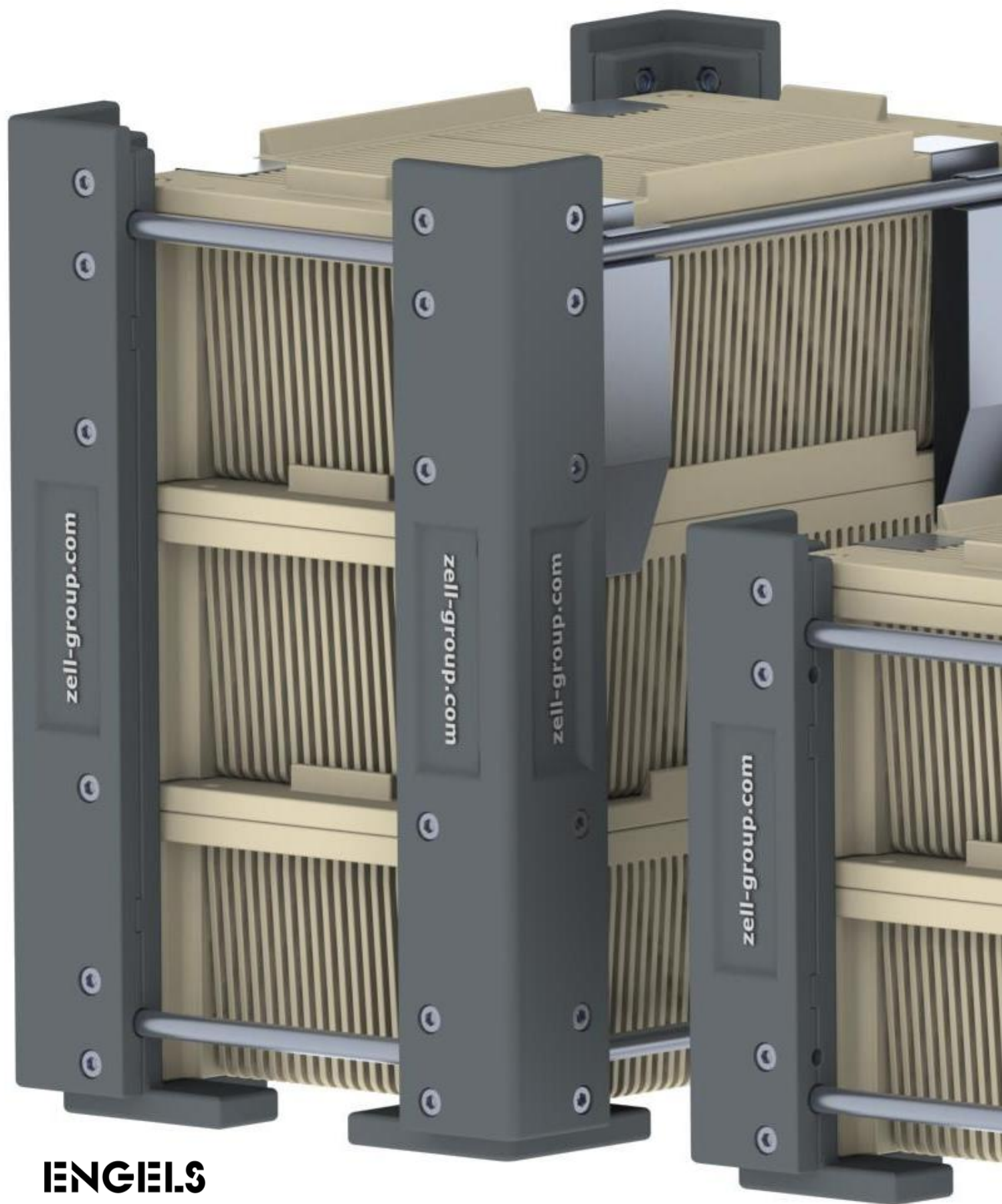

ENGELS

ZELL® Carrier System

Our plastic carriers can be used to construct another system with corner pieces. In this configuration, we merge a washing basket and a part carrier, providing a stable overall solution suitable not only for particularly heavy components but also compatible with conveyor systems in both directions. The use of a separate washing basket is therefore no longer necessary.

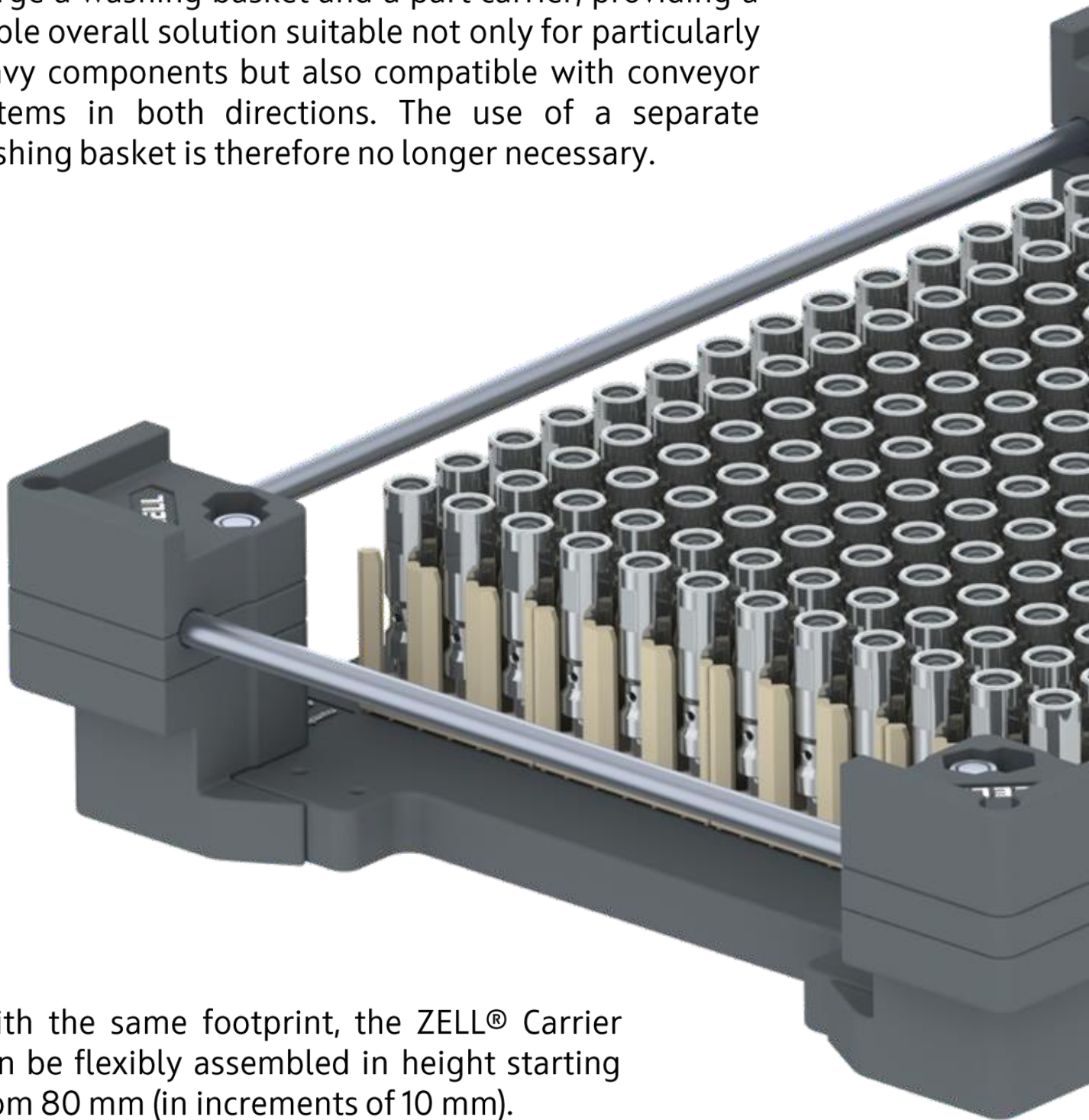

With the same footprint, the ZELL® Carrier can be flexibly assembled in height starting from 80 mm (in increments of 10 mm).

For lightweight components, two handles can be alternatively mounted instead of the welded round frame.

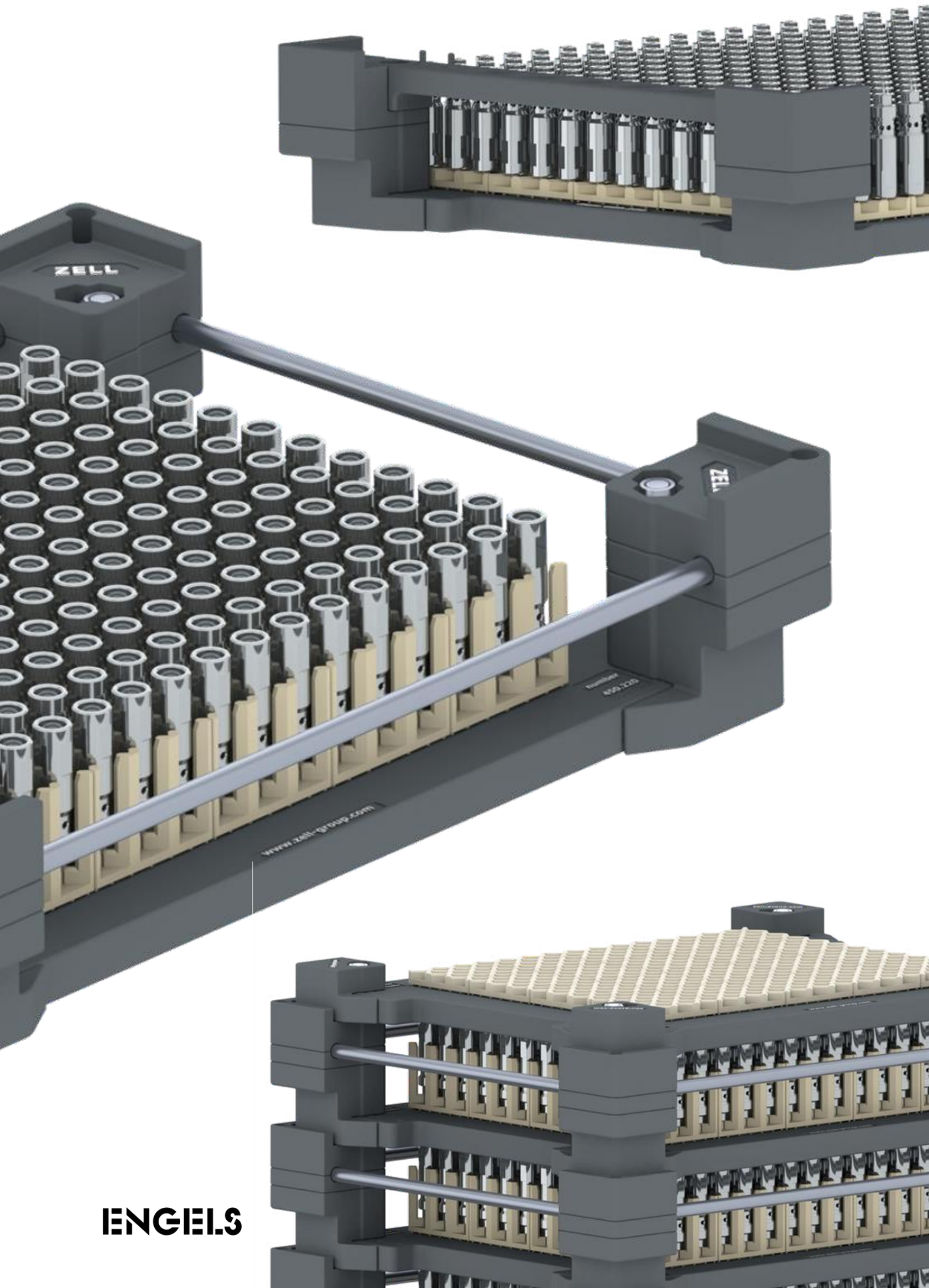

ENGELS

ZELL® BOX System

Customers with a high component variance benefit from the flexible ZELL® BOX System.

Our ZELL® BOX System is available for both our ZELL Factory and ZELL Carrier Systems.

As a foundation, all standard parts carriers and corresponding components can be utilized.

The height of the dividers is 45 mm, and the spacing between dividers is set at 17.5 mm.

For the transport of large or heavy parts, we offer a heavy-duty version of dividers. These can be used in conjunction with the ZELL® Carrier System, with a divider height of 65 mm. The dividers are available for sizes 400x300 mm, 470x320 mm, and 600x400 mm.

All components of this system are made of polyamide.

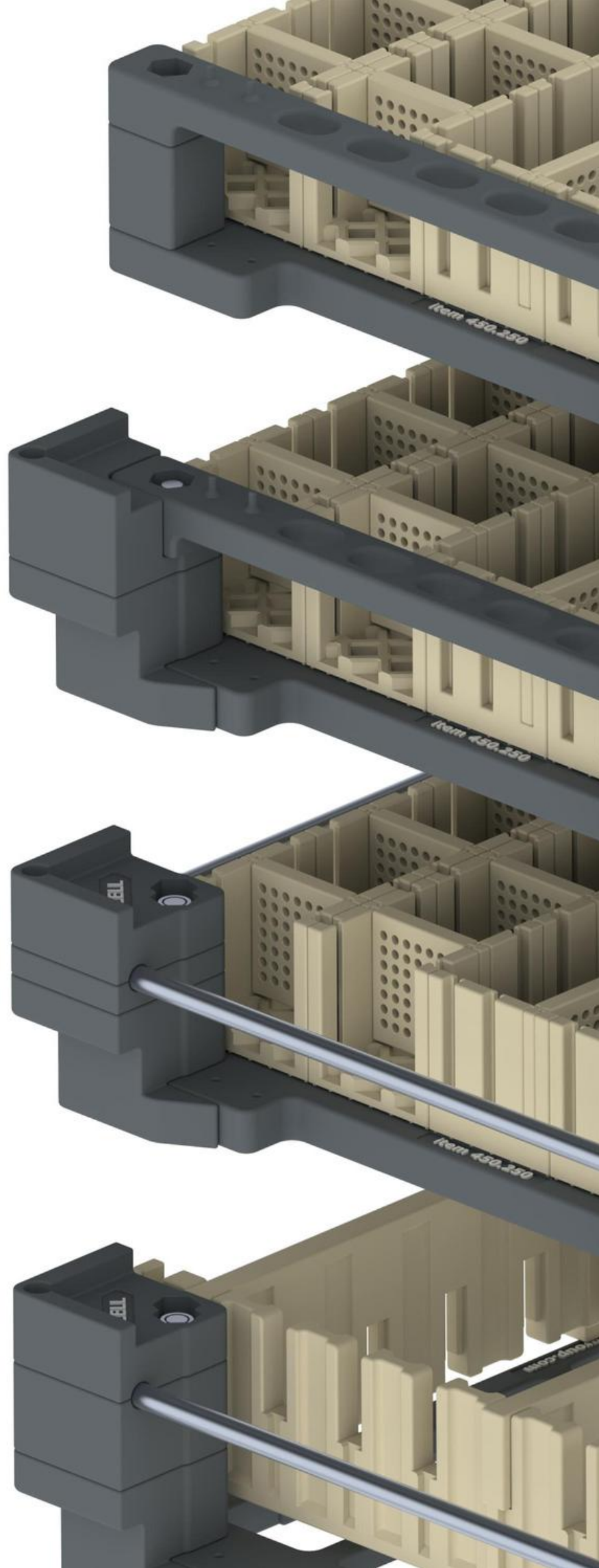

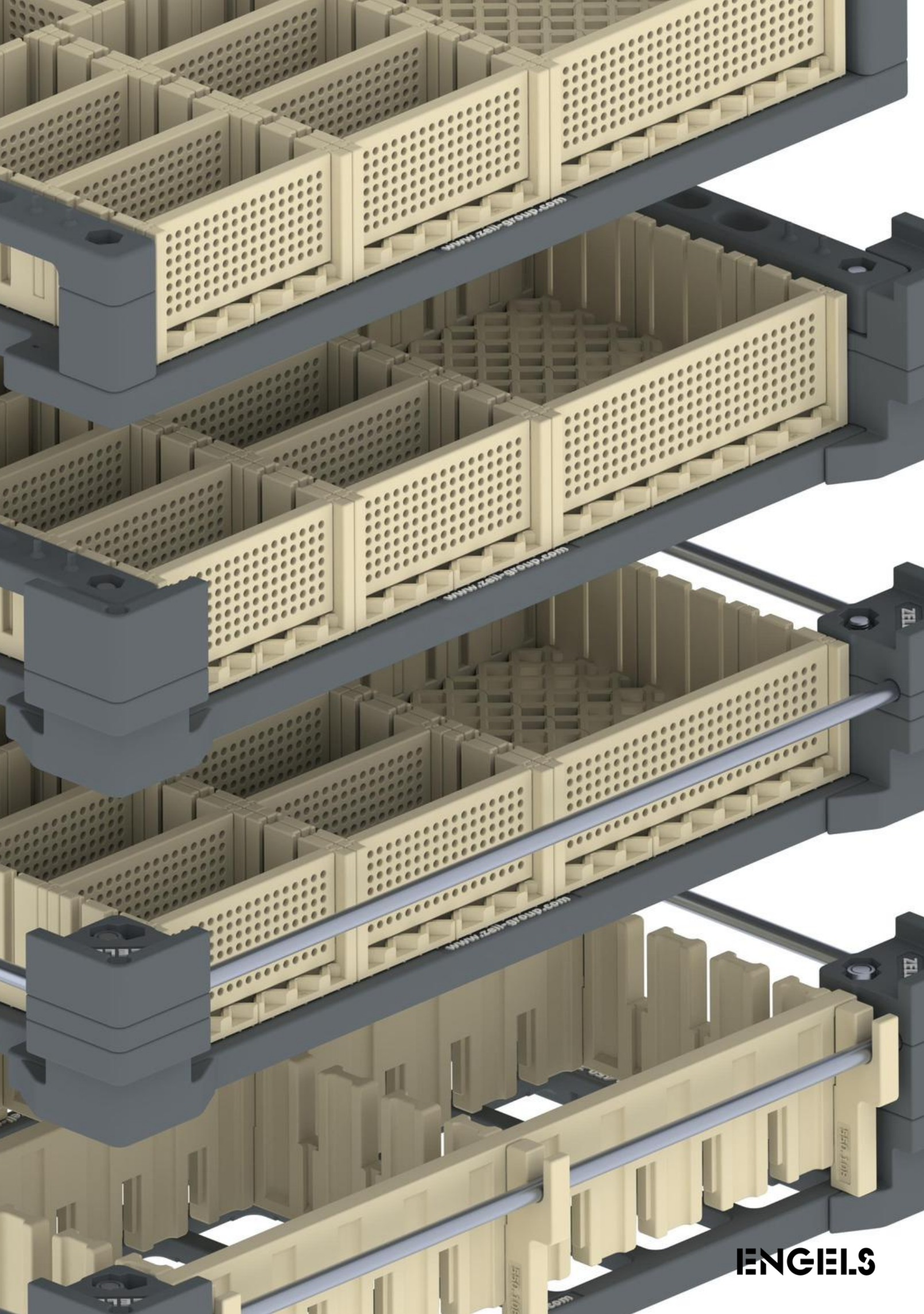

www.zell-group.com

www.zell-group.com

www.zell-group.com

ZEL

ZEL

ENGELS

ZELL® Factory System

Accessories

In order to provide our customers with the best possible parts handling system, we offer a wide range of accessories for our standard components.

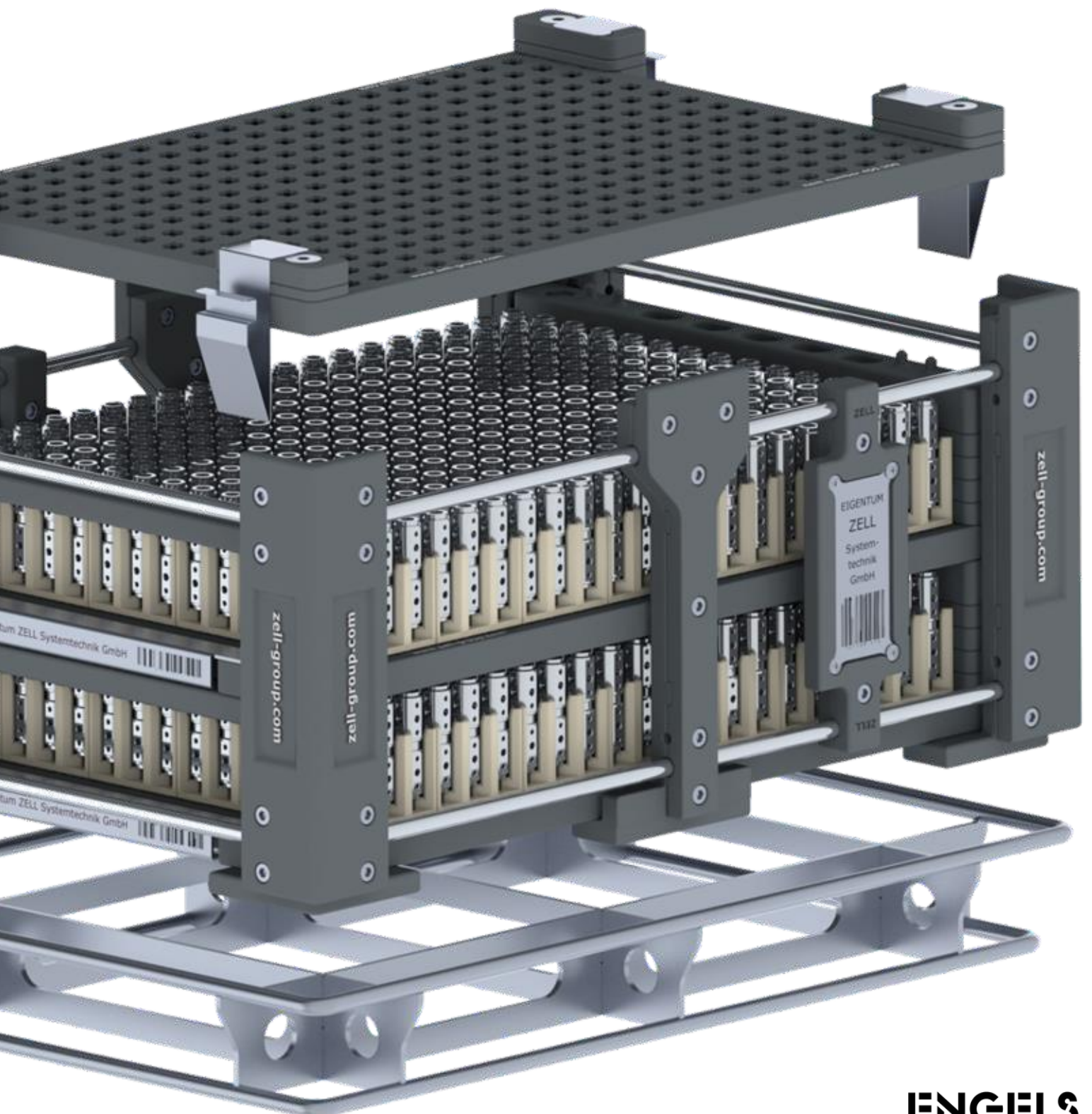

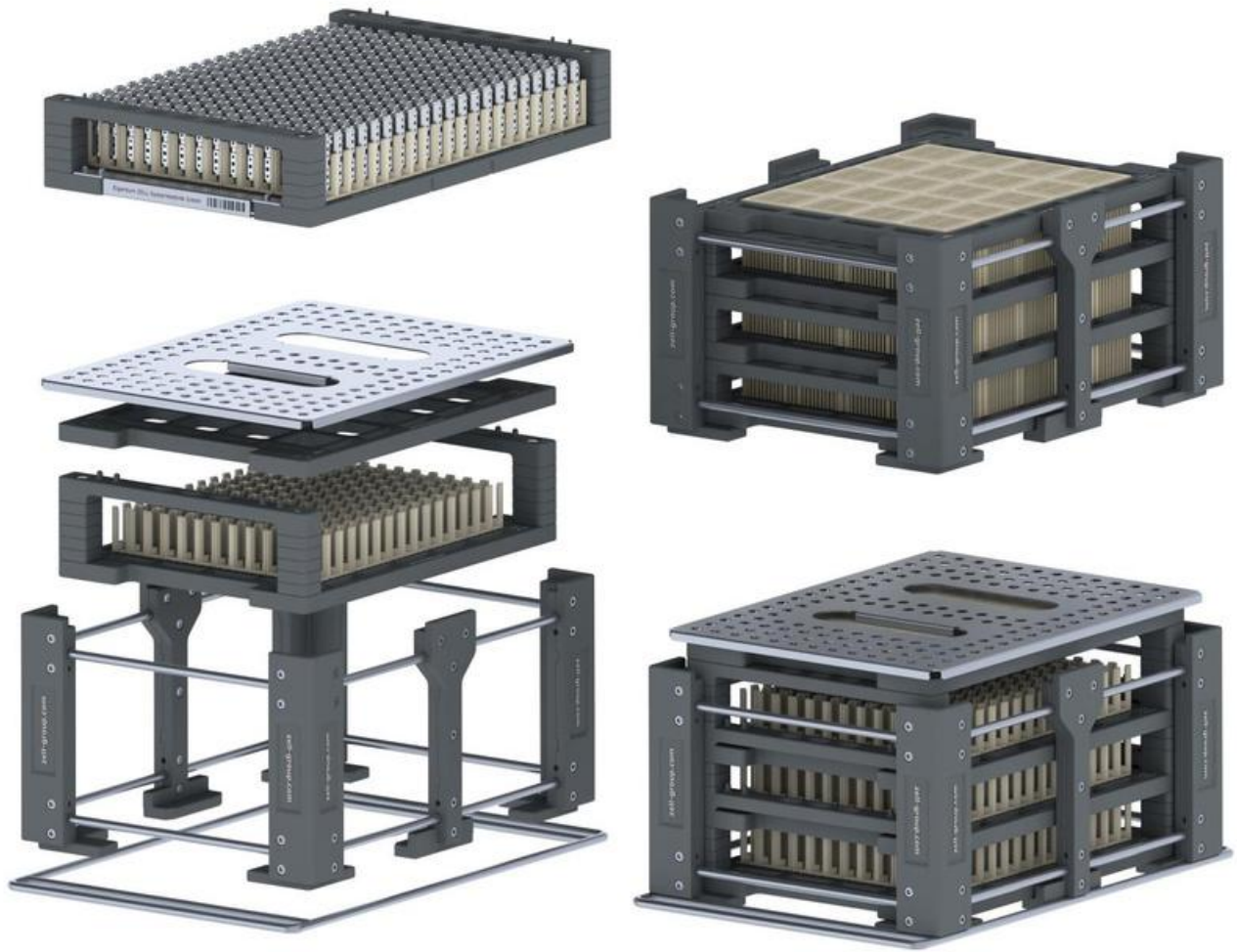

For example, adapter frames and covers can be used to clean the components. To ensure safe transport, use clamps to secure the basket contents upright. Both the workpiece carriers and the transport baskets can be customised using our accessories.



ZELL Systems 2020

Here we offer our customers a variety of options for transporting, cleaning and automating their components.

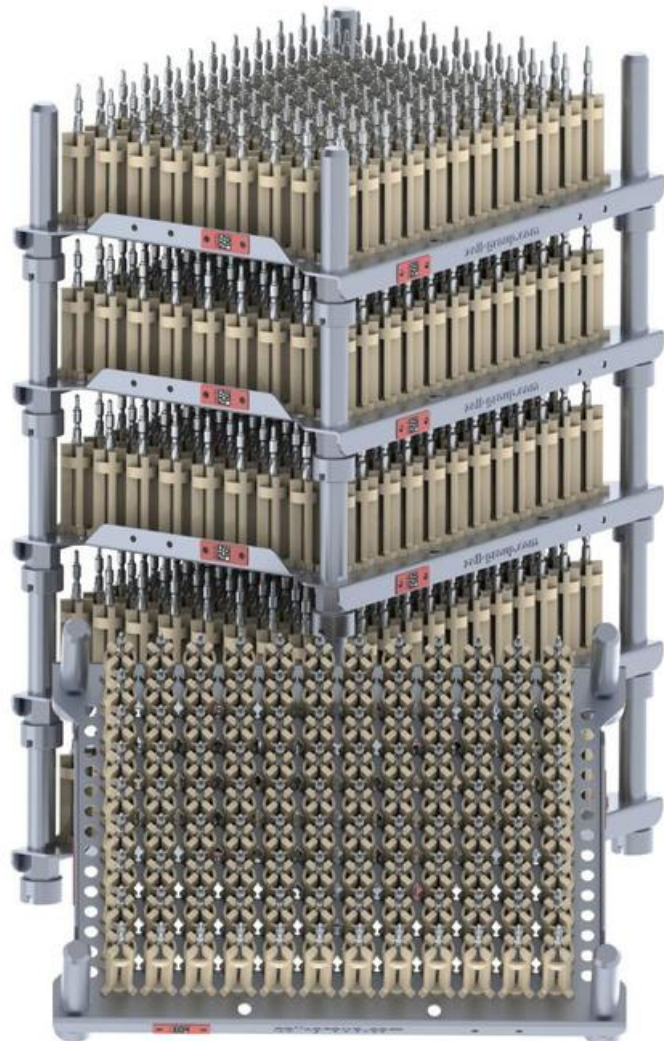
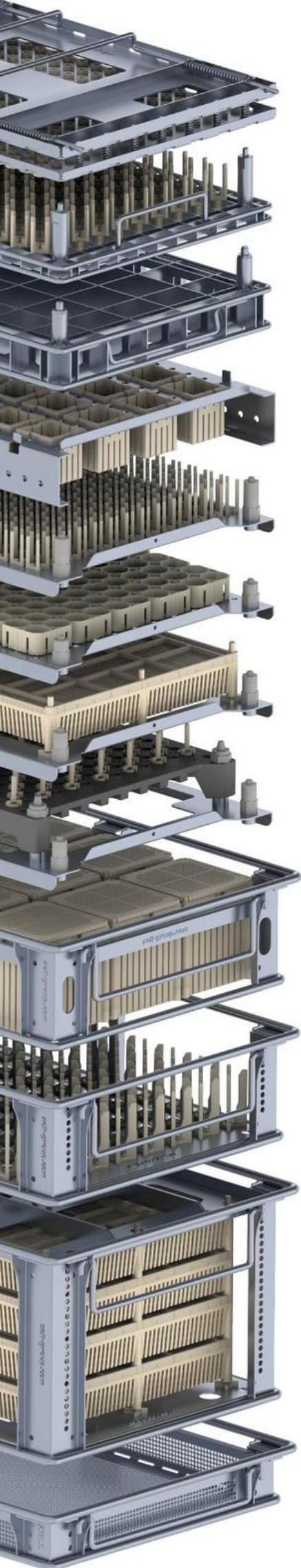

ENGELS

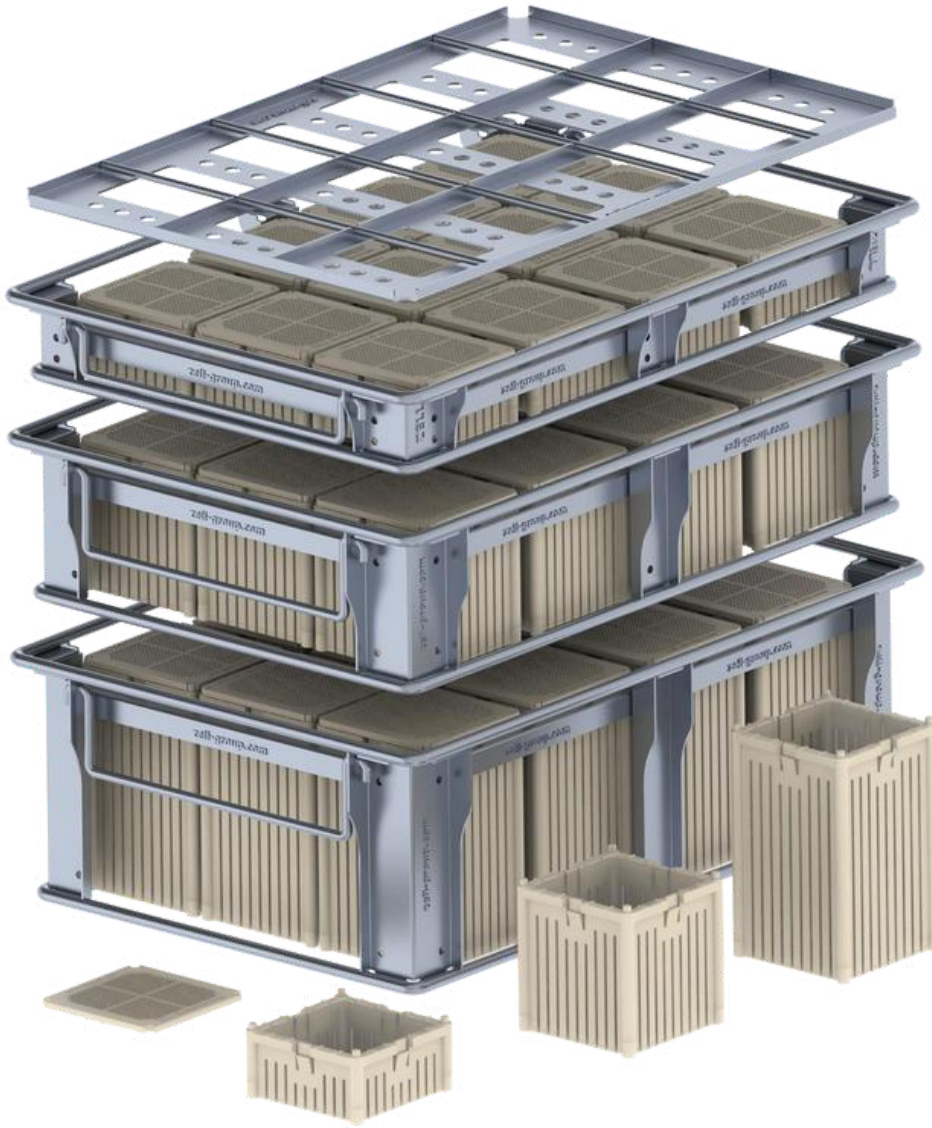

In addition to a comprehensive selection of high-quality standard products, we also develop customised **special solutions** for our customers.

Over the years, we have developed a large number of customer-specific solutions. Here you can see a selection of these solutions.

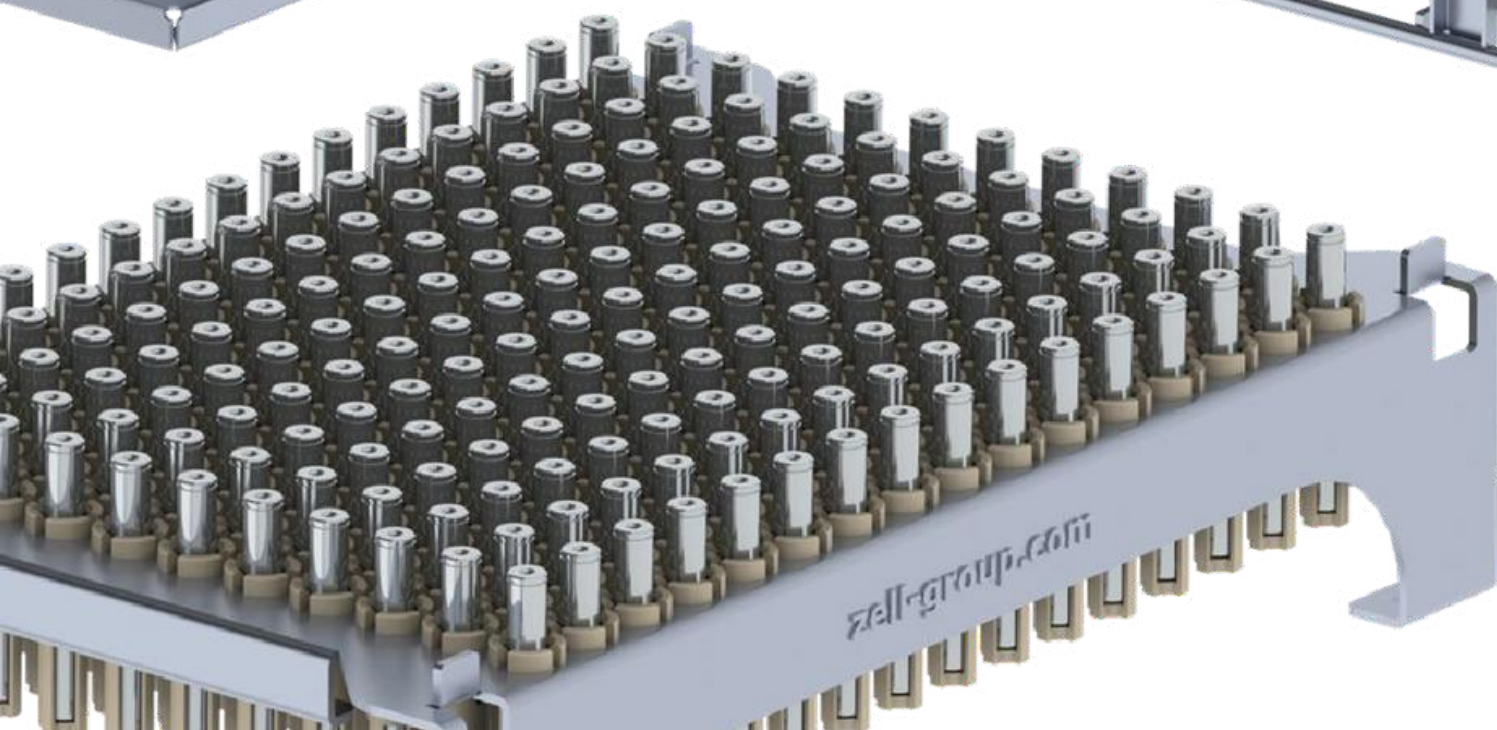
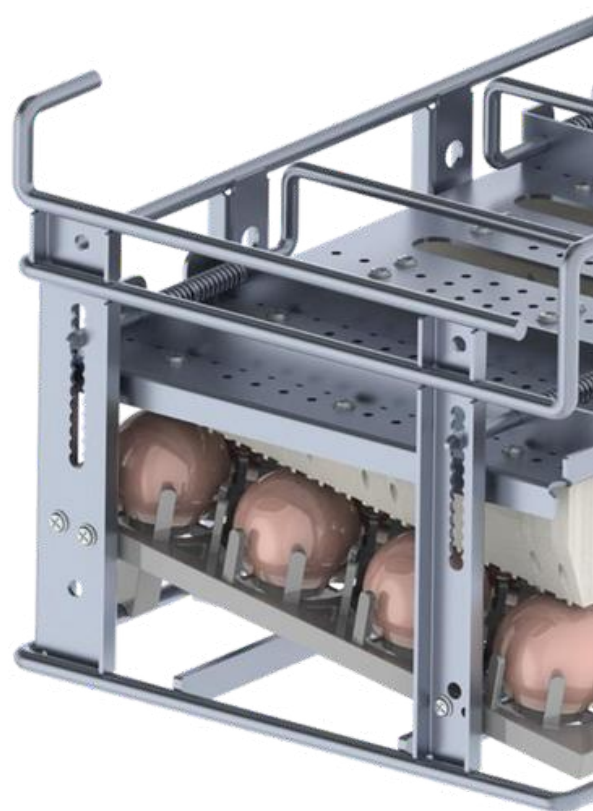

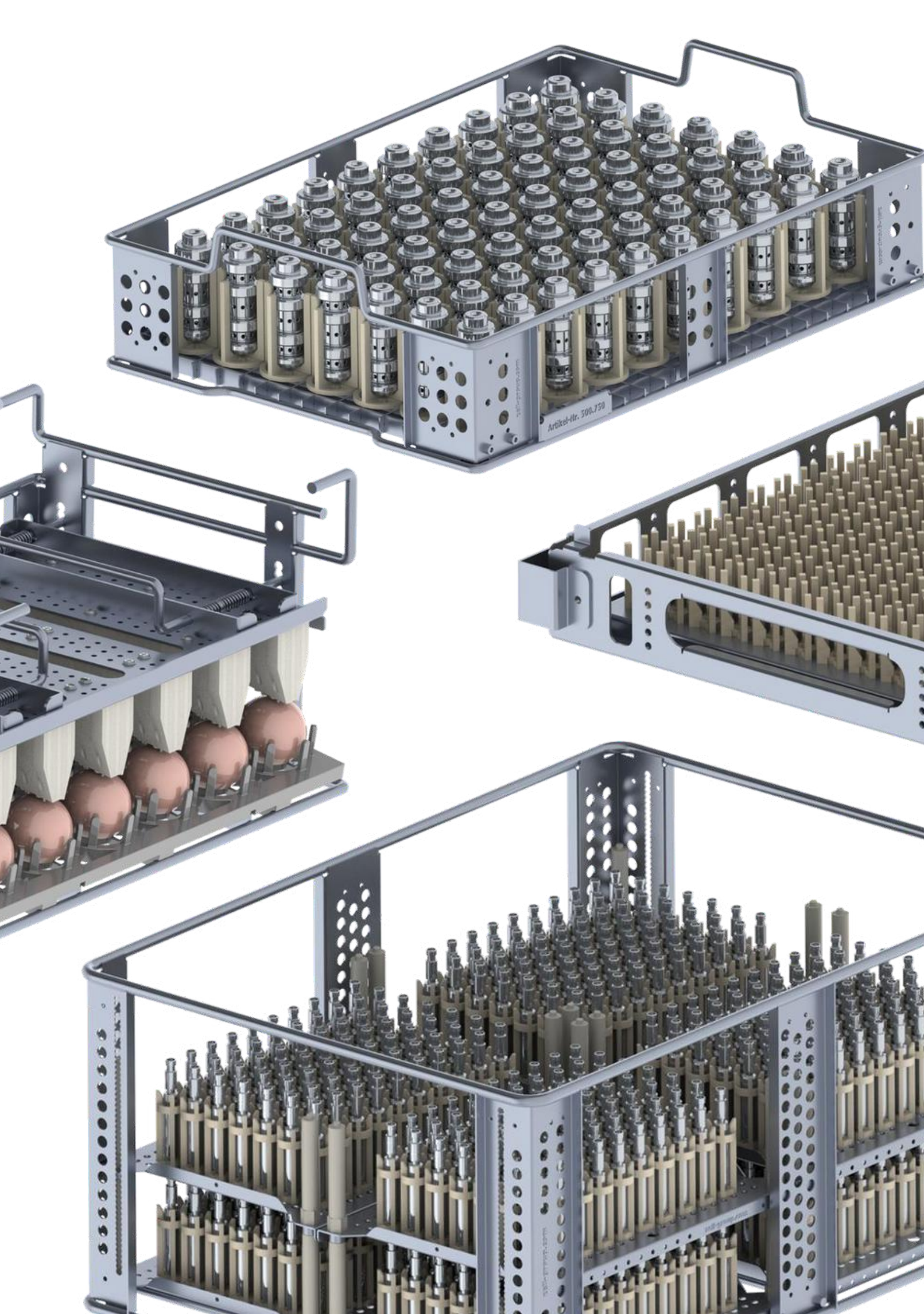



Contact us at:



HEADQUATERS Netherlands

Mr. Jos van Bergen

Park Forum 1139

NL-5657 HK Eindhoven,

+31 40 2629254

j.bergen@engels.eu



HEADQUATERS Belgium

Mr. Pascal Swinnen

Schemkensstraat 15

Poort West-Limburg 2478

3583 Beringen, Belgium

p.swinnen@engels.eu

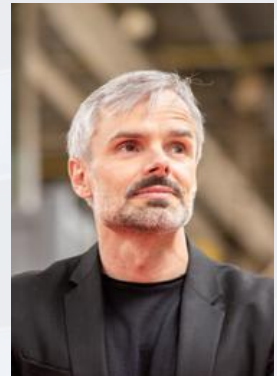

ENGELS

serving logistics and the environment

www.engels.eu

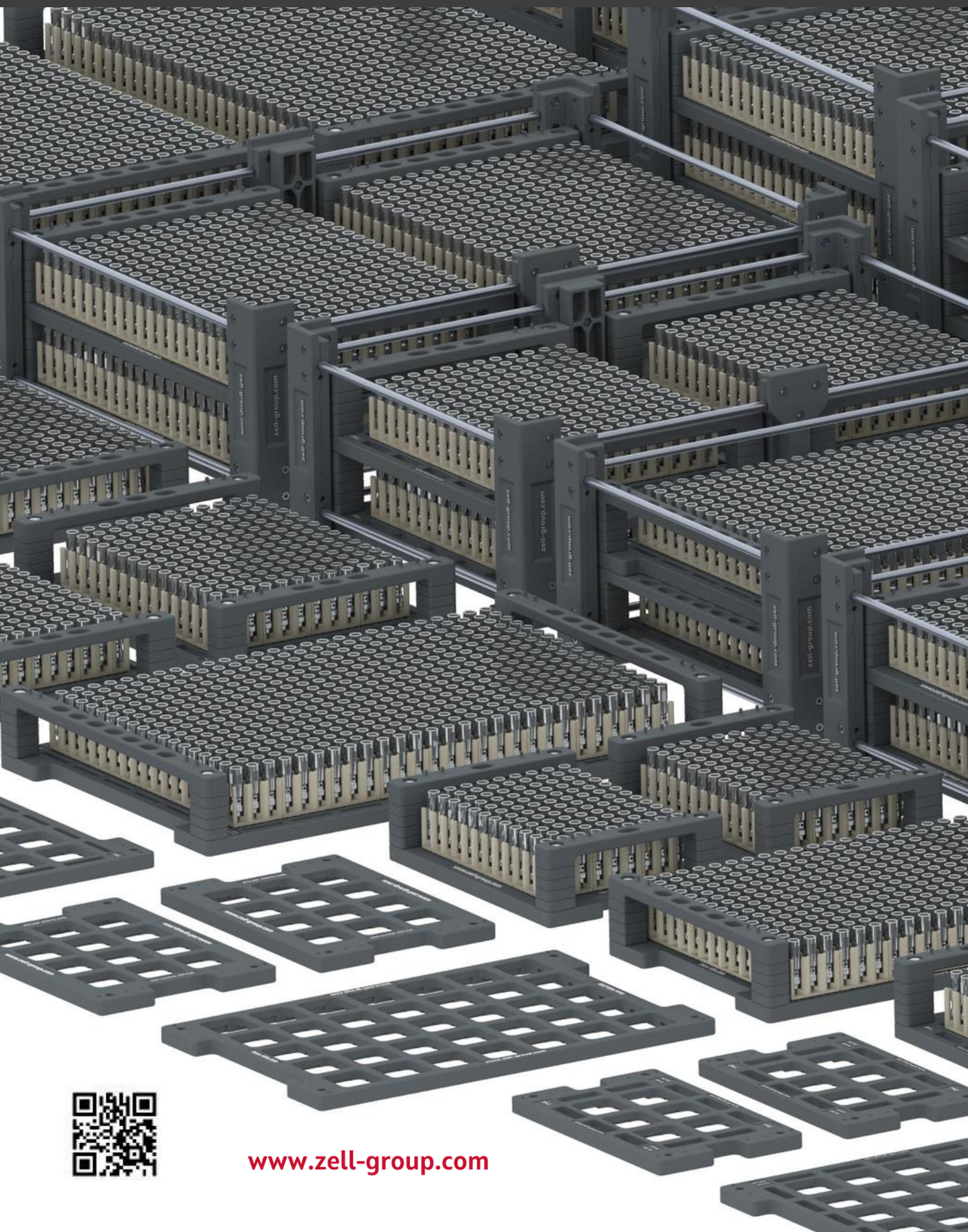

www.zell-group.com