



- Workbenches
- Euroslide
- Cupboards
- Lockers
- Workstations
- Cycle Parking
- Smoking Shelters
- Trucks & Trolleys
- Canteen Furniture
- Pallets & Drum Storage
- Barriers





Workbenches

- 2** Square Tube Workbenches
- 6** Mobile Square Tube Workbenches
- 8** Cantilever Workbenches
- 12** Premium Height-Adjustable Workbenches
- 14** Premium Electric Height-Adjustable Workbenches
- 18** Square Tube ESD Workbenches
- 20** Cantilever ESD Workbenches
- 24** Premium Height-Adjustable ESD Workbenches
- 26** Heavy-Duty Workbenches
- 30** Mobile Heavy-Duty Workbenches
- 32** Workbench Accessories
- 34** Electric Height-Adjustable Binary Workbenches
- 36** Manual Height-Adjustable Binary Workbenches
- 37** Fixed-Height Binary Workbenches
- 38** Mailroom Workbenches
- 40** Pack Tek Dual Workbenches
- 44** Pack Tek Dual Workbench Accessories
- 46** Pack Tek Individual Workbenches
- 49** Cutting & Workbench Protection Mats
- 50** Pack Tek Individual Workbench Accessories
- 52** Sliding Door Heavy-Duty Workbenches
- 53** Stainless Steel Workbenches
- 54** Cost Saver Height-Adjustable Workbenches
- 54** Plastic Open Fronted Containers





5 DAY
DELIVERY

£395 FROM
.86

BEST SELLER

250KG
UDL
EVENLY DISTRIBUTED

- General workshop bench suitable for use in assembly, production and light engineering.
- Height-adjustable feet for easy levelling.
- Powder-coated light grey framework.
- MFC, Linoleum, Solid Beech and Laminate worktop options available.
- Full range of accessories available including drawers, cupboards, shelves, louvre panels and service ducts.
- Standard bench height: 840mm - 760mm and 920mm also available.
- Delivered in knock-down form.
- Order quantities may apply, please speak to the sales team.

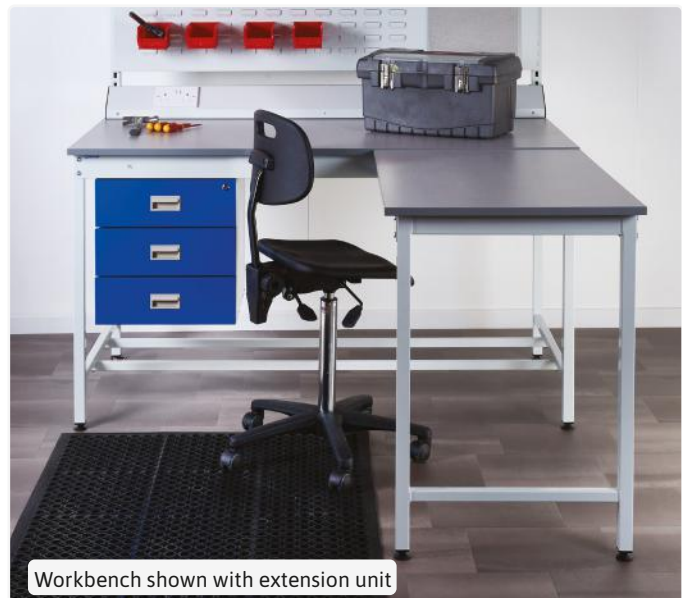

Workbench shown with extension unit

Solid Beech Worktop 27mm thick



All **RED** product codes are available on 5-Day Delivery

Solid Beech Worktop - Dimensions/Codes

Size H.W.D.	Code	Price
840.900.600	BQ849060BLXX	£420.60
840.1200.600	BQ841260BLXX	£486.09
840.1200.750	BQ841275BLXX	£526.84
840.1200.900	BQ841290BLXX	£574.87
840.1500.600	BQ841560BLXX	£665.10

Solid Beech Worktop - Dimensions/Codes

Size H.W.D.	Code	Price
840.1500.750	BQ841575BLXX	£743.69
840.1500.900	BQ841590BLXX	£807.72
840.1800.600	BQ841860BLXX	£676.74
840.1800.750	BQ841875BLXX	£806.27
840.1800.900	BQ841890BLXX	£835.38

MFC Worktop 18mm thick



Size H.W.D.	Code	Price
840.900.600	BQ849060GLXX	£395.86
840.1200.600	BQ841260GLXX	£422.05
840.1200.750	BQ841275GLXX	£451.16
840.1200.900	BQ841290GLXX	£459.89
840.1500.600	BQ841560GLXX	£550.13
840.1500.750	BQ841575GLXX	£579.23
840.1500.900	BQ841590GLXX	£587.96
840.1800.600	BQ841860GLXX	£563.22
840.1800.750	BQ841875GLXX	£592.33
840.1800.900	BQ841890GLXX	£608.34

Linoleum Worktop 20mm thick



Size H.W.D.	Code	Price
840.900.600	BQ8490608LXX	£424.96
840.1200.600	BQ8412608LXX	£458.44
840.1200.750	BQ8412758LXX	£475.90
840.1200.900	BQ8412908LXX	£542.85
840.1500.600	BQ8415608LXX	£574.87
840.1500.750	BQ8415758LXX	£624.35
840.1500.900	BQ8415908LXX	£729.13
840.1800.600	BQ8418608LXX	£619.98
840.1800.750	BQ8418758LXX	£635.99
840.1800.900	BQ8418908LXX	£749.51

Laminate Worktop 20mm thick



Size H.W.D.	Code	Price
840.900.600	BQ849060PLXX	£424.96
840.1200.600	BQ841260PLXX	£458.44
840.1200.750	BQ841275PLXX	£475.90
840.1200.900	BQ841290PLXX	£542.85
840.1500.600	BQ841560PLXX	£574.87
840.1500.750	BQ841575PLXX	£624.35
840.1500.900	BQ841590PLXX	£729.13
840.1800.600	BQ841860PLXX	£619.98
840.1800.750	BQ841875PLXX	£635.99
840.1800.900	BQ841890PLXX	£749.51

MFC - Extension Benches

Size H.W.D.	Code	Price
840.900.600	BQ849060GLET	£324.54
840.1200.600	BQ841260GLET	£371.12
840.1200.750	BQ841275GLET	£400.22

Linoleum - Extension Benches

Size H.W.D.	Code	Price
840.900.600	BQ8490608LET	£371.12
840.1200.600	BQ8412608LET	£407.50
840.1200.750	BQ8412758LET	£423.51

Laminate - Extension Benches

Size H.W.D.	Code	Price
840.900.600	BQ849060PLET	£371.12
840.1200.600	BQ841260PLET	£407.50
840.1200.750	BQ841275PLET	£423.51

MFC Lower Shelves - 450mm Deep

To Fit W.	Code	Price
1200	BELS1145GXXX	£116.43
1500	BELS1445GXXX	£130.98
1800	BELS1745GXXX	£146.99

Linoleum Lower Shelves - 450mm Deep

To Fit W.	Code	Price
1200	BELS11458XXX	£170.28
1500	BELS14458XXX	£184.83
1800	BELS17458XXX	£199.38

Laminate Lower Shelves - 450mm Deep

To Fit W.	Code	Price
1200	BELS1145PXXX	£170.28
1500	BELS1445PXXX	£184.83
1800	BELS1745PXXX	£199.38

Drawer & Cupboard Options

Description	Code	Price
Single Drawer 220 x 420 x 420	BEDR04021	£256.14
Triple Drawer 435 x 420 x 420	BEDR04043	£487.54
Cupboard Unit 435 x 420 x 420	BECU04041	£229.95

Please Note: Only Blue Drawers & Cupboards are available on 5-Day Delivery

Colour Options

Please add corresponding letters to the end of the code.



Square Tube Workbench - Accessories

Key	Description	Code	Price
A	760mm Rear Support Posts	BESP760SXXXX	£109.15
A	1180mm Rear Support Posts	BESP1180SXXXX	£132.44
B	Upper Shelf 300mm MFC for 1200mm Bench	BEUS1200GXXX	£146.99
B	Upper Shelf 300mm Linoleum for 1200mm Bench	BEUS12008XXX	£152.81
B	Upper Shelf 300mm Laminate for 1200mm Bench	BEUS1200PXXX	£152.81
B	Upper Shelf 300mm Beech for 1200mm Bench	BEUS1200BXXX	£176.10
B	Upper Shelf 300mm MFC for 1500mm Bench	BEUS1500GXXX	£176.10
B	Upper Shelf 300mm Linoleum for 1500mm Bench	BEUS15008XXX	£181.92
B	Upper shelf 300mm Laminate for 1500mm Bench	BEUS1500PXXX	£181.92
B	Upper Shelf 300mm Beech for 1500mm Bench	BEUS1500BXXX	£213.94
B	Upper Shelf 300mm MFC for 1800mm Bench	BEUS1800GXXX	£200.84
B	Upper Shelf 300mm Linoleum for 1800mm Bench	BEUS18008XXX	£216.85
B	Upper Shelf 300mm Laminate for 1800mm Bench	BEUS1800PXXX	£216.85
B	Upper Shelf 300mm Beech for 1800mm Bench	BEUS1800BXXX	£259.05
C	Light/Tool Rail Support for 1200mm Bench	BERS1200XLXX	£114.97
C	Light/Tool Rail Support for 1500mm Bench	BERS1500XLXX	£122.25
C	Light/Tool Rail Support for 1800mm Bench	BERS1800XLXX	£126.62
D	3 Setting LED Light	BE3SETL1200X	£88.78
	Tilting LED Light - 30 Watt	BELED3012XXX	£235.77
E	Louvred Back Panel with Pinboard for 1200mm Bench	BELO4812IXXX	£211.03
E	Louvred Back Panel with Pinboard for 1500mm Bench	BELO4815IXXX	£219.76
E	Louvred Back Panel with Pinboard for 1800mm Bench	BELO4818IXXX	£256.14
F	Worktop Service Duct for 1200mm Bench	BESDWT122XXX	£176.10
F	Worktop Service Duct for 1500mm Bench	BESDWT15XXXX	£180.46
F	Worktop Service Duct for 1800mm Bench	BESDWT18XXXX	£189.20
G	Post Fitted Service Duct for 1200mm Bench	BESDSP12XXXX	£193.56
G	Post Fitted Service Duct for 1500mm Bench	BESDSP15XXXX	£202.29
G	Post Fitted Service Duct for 1800mm Bench	BESDSP18XXXX	£215.39
H	Monitor and Keyboard Support Arm	BEMONARMFMG	£256.14
	Flat Screen Support Arm	BEMONARMFSC	£101.88

Accessories

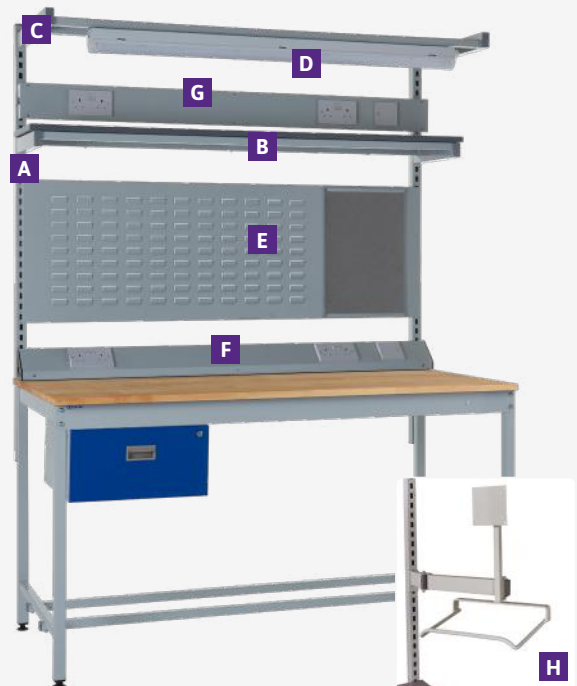



Kit A - Laminate Worktop

Size H.W.D.	Code	Price
840.1200.750	BQ841275PX1A	£961.99
840.1500.750	BQ841575PX1B	£1,108.98
840.1800.750	BQ841875PX1C	£1,122.08

5 DAY DELIVERY



Kit B - Laminate Worktop

Size H.W.D.	Code	Price
840.1200.750	BQ841275PX3A	£1,191.94
840.1500.750	BQ841575PX3B	£1,338.93
840.1800.750	BQ841875PX3C	£1,352.03



Kit C - Laminate Worktop

Size H.W.D.	Code	Price
1600.1200.750	BQ841275PX5A	£1,432.07
1600.1500.750	BQ841575PX5B	£1,628.55
1600.1800.750	BQ841875PX5C	£1,701.31



Kit D - Laminate Worktop

Size H.W.D.	Code	Price
1600.1200.750	BQ841275PX7A	£1,662.02
1600.1500.750	BQ841575PX7B	£1,858.49
1600.1800.750	BQ841875PX7C	£1,931.26



Kit E - Laminate Worktop

Size H.W.D.	Code	Price
2020.1200.750	BQ841275PX9A	£1,833.75
2020.1500.750	BQ841575PX9B	£2,043.32
2020.1800.750	BQ841875PX9C	£2,129.19



Kit F - Laminate Worktop

Size H.W.D.	Code	Price
2020.1200.750	BQ841275P11A	£2,063.70
2020.1500.750	BQ841575P11B	£2,272.27
2020.1800.750	BQ841875P11C	£2,359.13



Kit A - Beech Worktop

Size H.W.D.	Code	Price
840.1200.750	BQ841275BX2A	£1,012.93
840.1500.750	BQ841575BX2B	£1,228.32
840.1800.750	BQ841875BX2C	£1,292.36



Kit B - Beech Worktop

Size H.W.D.	Code	Price
840.1200.750	BQ841275BX4A	£1,242.88
840.1500.750	BQ841575BX4B	£1,459.72
840.1800.750	BQ841875BX4C	£1,522.30



Kit C - Beech Worktop

Size H.W.D.	Code	Price
1600.1200.750	BQ841275BX6A	£1,483.01
1600.1500.750	BQ841575BX6B	£1,747.88
1600.1800.750	BQ841875BX6C	£1,871.59



Kit D - Beech Worktop

Size H.W.D.	Code	Price
1600.1200.750	BQ841275BX8A	£1,712.96
1600.1500.750	BQ841575BX8B	£1,979.29
1600.1800.750	BQ841875BX8C	£2,101.54

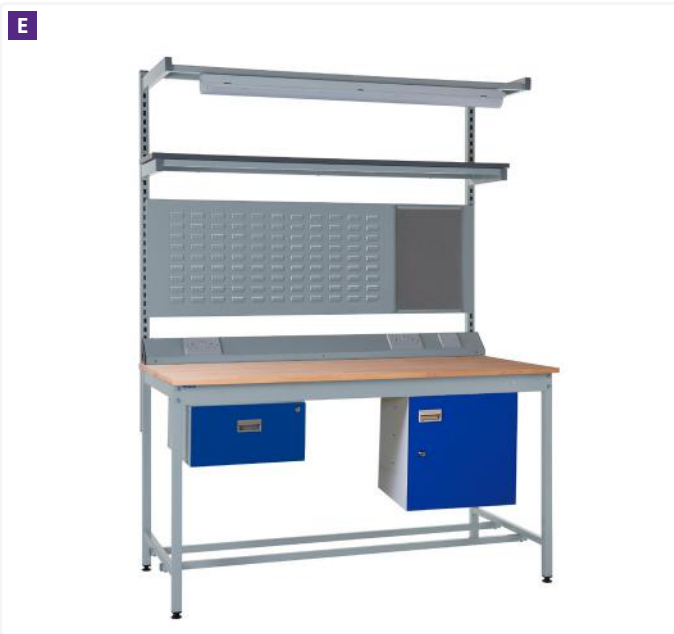

Kit E - Beech Worktop

Size H.W.D.	Code	Price
2020.1200.750	BQ841275B10A	£1,884.69
2020.1500.750	BQ841575B10B	£2,162.66
2020.1800.750	BQ841875B10C	£2,299.46

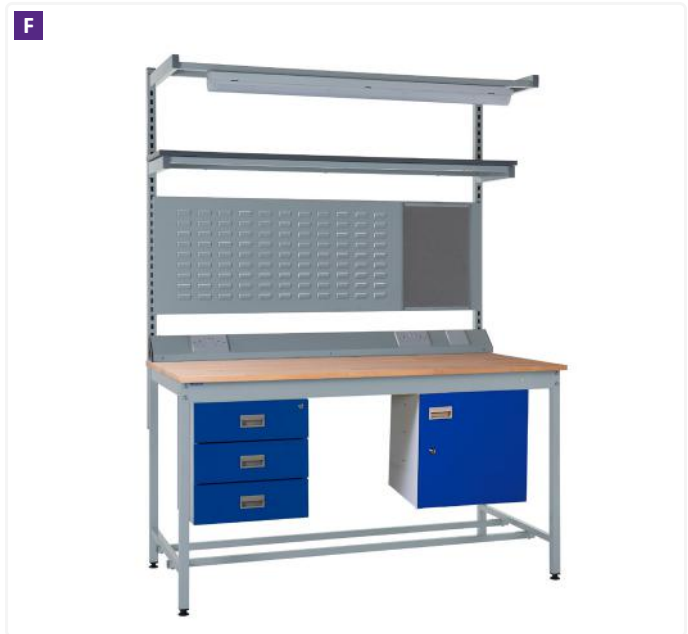

Kit F - Beech Worktop

Size H.W.D.	Code	Price
2020.1200.750	BQ841275B12A	£2,114.63
2020.1500.750	BQ841575B12B	£2,392.61
2020.1800.750	BQ841875B12C	£2,529.41

- Equipped with 4 swivel-braked castors for improved mobility, making it easy to manoeuvre around assembly, production, or light-engineering environments.
- Powder-coated light grey framework.
- MFC, Linoleum, Solid Beech and Laminate worktop options available.
- Full range of accessories available including drawers, cupboards, shelves, louvre panels and service ducts.
- Mobile bench height: 840mm, other heights available - please speak to sales.
- Delivered in knock-down form.



£502.70 FROM

300KG UDL
EVENLY DISTRIBUTED

Workbench shown with laminate worktop, other options are also available

Workbenches



Solid Beech Worktop 27mm thick



Size H.W.D.	Code	Price
840.900.600	BQ849060BLMX	£527.44
840.1200.600	BQ841260BLMX	£592.93
840.1200.750	BQ841275BLMX	£633.68
840.1200.900	BQ841290BLMX	£681.71
840.1500.600	BQ841560BLMX	£771.94
840.1500.750	BQ841575BLMX	£850.53
840.1500.900	BQ841590BLMX	£914.57
840.1800.600	BQ841860BLMX	£783.58
840.1800.750	BQ841875BLMX	£913.11
840.1800.900	BQ841890BLMX	£942.22

Linoleum Worktop 20mm thick



Size H.W.D.	Code	Price
840.900.600	BQ849060GLMX	£531.81
840.1200.600	BQ841260GLMX	£565.28
840.1200.750	BQ841275GLMX	£582.74
840.1200.900	BQ841290GLMX	£649.69
840.1500.600	BQ841560GLMX	£681.71
840.1500.750	BQ841575GLMX	£731.19
840.1500.900	BQ841590GLMX	£835.98
840.1800.600	BQ841860GLMX	£726.82
840.1800.750	BQ841875GLMX	£742.83
840.1800.900	BQ841890GLMX	£856.35



Fitted with 4 heavy-duty swivel-braked castors

Laminate Worktop 20mm thick



Size H.W.D.	Code	Price
840.900.600	BQ849060PLMX	£531.81
840.1200.600	BQ841260PLMX	£565.28
840.1200.750	BQ841275PLMX	£582.74
840.1200.900	BQ841290PLMX	£649.69
840.1500.600	BQ841560PLMX	£681.71
840.1500.750	BQ841575PLMX	£731.19
840.1500.900	BQ841590PLMX	£835.98
840.1800.600	BQ841860PLMX	£726.82
840.1800.750	BQ841875PLMX	£742.83
840.1800.900	BQ841890PLMX	£856.35

MFC Worktop 18mm thick



Size H.W.D.	Code	Price
840.900.600	BQ849060GLMX	£502.70
840.1200.600	BQ841260GLMX	£528.90
840.1200.750	BQ841275GLMX	£558.00
840.1200.900	BQ841290GLMX	£566.73
840.1500.600	BQ841560GLMX	£656.97
840.1500.750	BQ841575GLMX	£686.07
840.1500.900	BQ841590GLMX	£694.81
840.1800.600	BQ841860GLMX	£670.07
840.1800.750	BQ841875GLMX	£699.17
840.1800.900	BQ841890GLMX	£715.18

Drawer & Cupboard Options

Description	Code	Price
Single Drawer 220 x 420 x 420	BEDR04021	£256.14
Triple Drawer 435 x 420 x 420	BEDR04043	£487.54
Cupboard Unit 435 x 420 x 420	BECU04041	£229.95

Colour Options

Please add corresponding letters to the end of the code



Our versatile Mobile Square Tube Workbenches come in six kits, with the option of solid beech or laminate worktops.



Size H.W.D.	Solid Beech	Price	Laminate	Price
840.1200.750	BM841275BX2A	£1,119.77	BM841275PX1A	£1,068.83
840.1500.750	BM841575BX2B	£1,335.16	BM841575PX1B	£1,215.82
840.1800.750	BM841875BX2C	£1,399.20	BM841875PX1C	£1,228.92



Size H.W.D.	Solid Beech	Price	Laminate	Price
840.1200.750	BM841275BX4A	£1,349.72	BM841275PX3A	£1,298.78
840.1500.750	BM841575BX4B	£1,566.57	BM841275PX3B	£1,445.77
840.1800.750	BM841875BX4C	£1,629.15	BM841275PX3C	£1,458.87



Size H.W.D.	Solid Beech	Price	Laminate	Price
840.1200.750	BM841275BX6A	£1,589.85	BM841275PX5A	£1,538.91
840.1500.750	BM841575BX6B	£1,854.73	BM841575PX5B	£1,735.39
840.1800.750	BM841875BX6C	£1,978.43	BM841875PX5C	£1,808.15



Size H.W.D.	Solid Beech	Price	Laminate	Price
840.1200.750	BM841275BX8A	£1,819.80	BM841275PX7A	£1,768.86
840.1500.750	BM841575BX8B	£2,086.13	BM841575PX7B	£1,965.33
840.1800.750	BM841875BX8C	£2,208.38	BM841875PX7C	£2,038.10



Size H.W.D.	Solid Beech	Price	Laminate	Price
840.1200.750	BM841275B10A	£1,991.53	BM841275PX9A	£1,940.59
840.1500.750	BM841575B10B	£2,269.50	BM841575PX9B	£2,150.16
840.1800.750	BM841875B10C	£2,406.31	BM841875PX9C	£2,236.03



Size H.W.D.	Solid Beech	Price	Laminate	Price
840.1200.750	BM841275B12A	£2,221.48	BM841275P11A	£2,170.54
840.1500.750	BM841575B12B	£2,499.45	BM841575P11B	£2,380.11
840.1800.750	BM841875B12C	£2,636.25	BM841875P11C	£2,465.98

Workbenches



5 DAY
DELIVERY

£490 FROM
.46

BEST SELLER

250KG
UDL
EVENLY DISTRIBUTED

Workbench shown with optional drawer units and a range of accessories

- General workshop bench suitable for use in assembly, production and light engineering.
- Cantilever construction allows for maximum leg room.
- Height-adjustable feet for easy levelling.
- Powder-coated light grey framework.
- Linoleum, MFC, Solid Beech and Laminate worktop options available.
- Full range of accessories available including drawers, cupboards, shelves, louvre panels and service ducts.
- Standard bench height: 840mm - 760mm and 920mm also available.
- Delivered in knock-down form.
- Order quantities may apply, please speak to the sales team.



Workbench shown with extension unit

Solid Beech Worktop 27mm thick



Size H.W.D.	Code	Price
840.1200.750	BC841275BLXX	£573.41
840.1200.900	BC841290BLXX	£621.44
840.1500.750	BC841575BLXX	£796.08
840.1500.900	BC841590BLXX	£825.19
840.1800.750	BC841875BLXX	£870.30
840.1800.900	BC841890BLXX	£899.41



All RED product codes are available on 5-Day Delivery

MFC Worktop 18mm thick



Size H.W.D.	Code	Price
840.1200.750	BC841275GLXX	£490.46
840.1200.900	BC841290GLXX	£558.86
840.1500.750	BC841575GLXX	£643.27
840.1500.900	BC841590GLXX	£750.96
840.1800.750	BC841875GLXX	£656.37
840.1800.900	BC841890GLXX	£772.79

Linoleum Worktop 20mm thick



Size H.W.D.	Code	Price
840.1200.750	BC8412758LXX	£522.47
840.1200.900	BC8412908LXX	£589.42
840.1500.750	BC8415758LXX	£675.29
840.1500.900	BC8415908LXX	£781.53
840.1800.750	BC8418758LXX	£700.03
840.1800.900	BC8418908LXX	£813.54

Laminate Worktop 20mm thick



Size H.W.D.	Code	Price
840.1200.750	BC841275PLXX	£522.47
840.1200.900	BC841290PLXX	£589.42
840.1500.750	BC841575PLXX	£675.29
840.1500.900	BC841590PLXX	£781.53
840.1800.750	BC841875PLXX	£700.03
840.1800.900	BC841890PLXX	£813.54

MFC - Extension Benches

Size H.W.D.	Code	Price
840.900.600	BC849060GLET	£308.54
840.1200.600	BC841260GLET	£336.19
840.1200.750	BC841275GLET	£366.75

Linoleum - Extension Benches

Size H.W.D.	Code	Price
840.900.600	BC8490608LET	£443.88
840.1200.600	BC8412608LET	£464.26
840.1200.750	BC8412758LET	£500.64

Laminate - Extension Benches

Size H.W.D.	Code	Price
840.900.600	BC849060PLET	£443.88
840.1200.600	BC841260PLET	£464.26
840.1200.750	BC841275PLET	£500.64

Drawer & Cupboard Options



Description	Code	Price
Single Drawer 220 x 420 x 420	BEDR04021	£256.14
Triple Drawer 435 x 420 x 420	BEDR04043	£487.54
Cupboard Unit 435 x 420 x 420	BEUC04041	£229.95

Colour Options

Please add corresponding letters to the end of the code.



Please Note: Only Blue Drawers & Cupboards are available on 5-Day Delivery

Cantilever Workbench - Accessories

Key	Description	Code	Price
A	760mm Rear Support Posts	BESP760SXXXX	£109.15
A	1180mm Rear Support Posts	BESP1180XXXX	£132.44
B	Upper shelf 300mm MFC for 1200mm Bench	BEUS1200GXXX	£146.99
B	Upper shelf 300mm Linoleum for 1200mm Bench	BEUS12008XXX	£152.81
B	Upper shelf 300mm Laminate for 1200mm Bench	BEUS1200PXXX	£152.81
B	Upper shelf 300mm Beech for 1200mm Bench	BEUS1200BXXX	£176.10
B	Upper Shelf 300mm MFC for 1500mm Bench	BEUS1500GXXX	£176.10
B	Upper Shelf 300mm Linoleum for 1500mm Bench	BEUS15008XXX	£181.92
B	Upper shelf 300mm Laminate for 1500mm Bench	BEUS1500PXXX	£181.92
B	Upper Shelf 300mm Beech for 1500mm Bench	BEUS1500BXXX	£213.94
B	Upper Shelf 300mm MFC for 1800mm Bench	BEUS1800GXXX	£200.84
B	Upper Shelf 300mm Linoleum for 1800mm Bench	BEUS18008XXX	£216.85
B	Upper Shelf 300mm Laminate for 1800mm Bench	BEUS1800PXXX	£216.85
B	Upper Shelf 300mm Beech for 1800mm Bench	BEUS1800BXXX	£259.05
C	Light/Tool Rail Support for 1200mm Bench	BERS1200XLXX	£114.97
C	Light/Tool Rail Support for 1500mm Bench	BERS1500XLXX	£122.25
C	Light/Tool Rail Support for 1800mm Bench	BERS1800XLXX	£126.62
D	3 Setting LED Light	BE3SETL1200X	£88.78
	Tilting LED Light - 30 Watt	BELED3012XXX	£235.77
E	Louvred Back Panel with Pinboard for 1200mm Bench	BELO4812IXXX	£211.03
E	Louvred Back Panel with Pinboard for 1500mm Bench	BELO4815IXXX	£219.76
E	Louvred Back Panel with Pinboard for 1800mm Bench	BELO4818IXXX	£256.14
F	Worktop Service Duct for 1200mm Bench	BESDWT122XXX	£176.10
F	Worktop Service Duct for 1500mm Bench	BESDWT15XXXX	£180.46
F	Worktop Service Duct for 1800mm Bench	BESDWT18XXXX	£189.20
G	Post Fitted Service Duct for 1200mm Bench	BESDSP12XXXX	£193.56
G	Post Fitted Service Duct for 1500mm Bench	BESDSP15XXXX	£202.29
G	Post Fitted Service Duct for 1800mm Bench	BESDSP18XXXX	£215.39
	Monitor and Keyboard Support Arm	BEMONARMFMG	£256.14
H	Flat Screen Support Arm	BEMONARMLSC	£101.88

Accessories





5 DAY DELIVERY

Kit A - Laminate Worktop

Size H.W.D.	Code	Price
840.1200.750	BC841275PX1A	£1,008.56
840.1500.750	BC841575PX1B	£1,161.38
840.1800.750	BC841875PX1C	£1,186.12



Kit B - Laminate Worktop

Size H.W.D.	Code	Price
840.1200.750	BC841275PX3A	£1,264.71
840.1500.750	BC841575PX3B	£1,418.97
840.1800.750	BC841875PX3C	£1,442.26



Kit C - Laminate Worktop

Size H.W.D.	Code	Price
1600.1200.750	BC841275PX5A	£1,478.64
1600.1500.750	BC841575PX5B	£1,680.94
1600.1800.750	BC841875PX5C	£1,765.35



Kit D - Laminate Worktop

Size H.W.D.	Code	Price
1600.1200.750	BC841275PX7A	£1,708.59
1600.1500.750	BC841575PX7B	£1,910.88
1600.1800.750	BC841875PX7C	£1,995.30



Kit E - Laminate Worktop

Size H.W.D.	Code	Price
2020.1200.750	BC841275PX9A	£1,880.32
2020.1500.750	BC841575PX9B	£2,095.71
2020.1800.750	BC841875PX9C	£2,193.22



Kit F - Laminate Worktop

Size H.W.D.	Code	Price
2020.1200.750	BC841275P11A	£2,110.27
2020.1500.750	BC841575P11B	£2,325.66
2020.1800.750	BC841875P11C	£2,423.17

Workbenches



Kit A - Beech Worktop

Size H.W.D.	Code	Price
840.1200.750	BC841275BX2A	£1,059.50
840.1500.750	BC841575BX2B	£1,280.71
840.1800.750	BC841875BX2C	£1,356.39



Kit B - Beech Worktop

Size H.W.D.	Code	Price
840.1200.750	BC841275BX4A	£1,315.64
840.1500.750	BC841575BX4B	£1,538.31
840.1800.750	BC841875BX4C	£1,612.54



Kit C - Beech Worktop

Size H.W.D.	Code	Price
1600.1200.750	BC841275BX6A	£1,529.58
1600.1500.750	BC841575BX6B	£1,800.28
1600.1800.750	BC841875BX6C	£1,935.63



Kit D - Beech Worktop

Size H.W.D.	Code	Price
1600.1200.750	BC841275BX8A	£1,759.53
1600.1500.750	BC841575BX8B	£2,030.22
1600.1800.750	BC841875BX8C	£2,165.57



Kit E - Beech Worktop

Size H.W.D.	Code	Price
2020.1200.750	BC841275B10A	£1,931.26
2020.1500.750	BC841575B10B	£2,215.05
2020.1800.750	BC841875B10C	£2,363.50



Kit F - Beech Worktop

Size H.W.D.	Code	Price
2020.1200.750	BC841275B12A	£2,161.21
2020.1500.750	BC841575B12B	£2,445.00
2020.1800.750	BC841875B12C	£2,593.45

£1,145 FROM **.37**



Height-adjustable bench shown with laminate worktop and optional accessories

200KG UDL
EVENLY DISTRIBUTED

- Height-adjustable bench suitable for heavy-duty use in assembly, production and engineering.
- Adjustable in height from 730mm to 950mm.
- Powder-coated light grey framework.
- Full range of accessories available including drawers, cupboards, shelves, louvre panels and service ducts.
- Linoleum, Laminate and Solid Beech worktop options available.
- ESD height-adjustable workbench available - please see page 24.



Height-adjustable bench shown with Beech worktop

**Linoleum Worktop
20mm thick**



Size W.D.	Code	Price
900.600	BA7990608LXX	£1,212.31
1200.600	BA7912608LXX	£1,382.59
1200.750	BA7912758LXX	£1,398.60
1500.600	BA7915608LXX	£1,449.54
1500.750	BA7915758LXX	£1,496.11
1800.600	BA7918608LXX	£1,500.47
1800.750	BA7918758LXX	£1,519.39

**Laminate Worktop
20mm thick**



Size W.D.	Code	Price
900.600	BA799060PLXX	£1,212.31
1200.600	BA791260PLXX	£1,382.59
1200.750	BA791275PLXX	£1,398.60
1500.600	BA791560PLXX	£1,449.54
1500.750	BA791575PLXX	£1,496.11
1800.600	BA791860PLXX	£1,500.47
1800.750	BA791875PLXX	£1,519.39

**Solid Beech Worktop
27mm thick**



Size W.D.	Code	Price
900.600	BA799060BLXX	£1,145.37
1200.600	BA791260BLXX	£1,239.96
1200.750	BA791275BLXX	£1,433.53
1500.600	BA791560BLXX	£1,541.22
1500.750	BA791575BLXX	£1,616.90
1800.600	BA791860BLXX	£1,557.23
1800.750	BA791875BLXX	£1,689.67

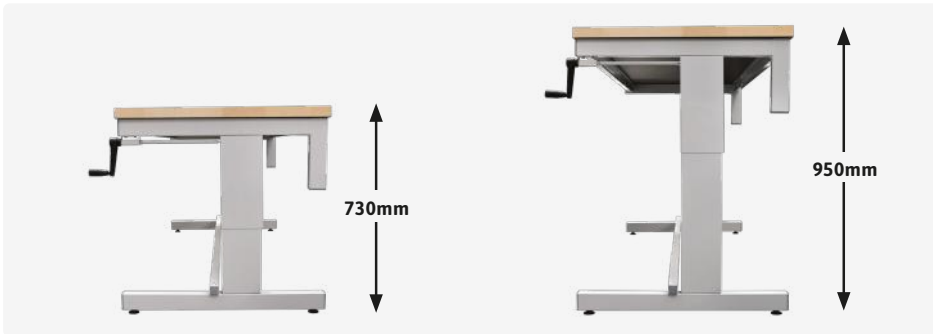

Height adjustable bench shown with Linoleum worktop

Drawer & Cupboard Options

Description	Code	Price
Single Drawer 220 x 420 x 420	BEDR04021	£256.14
Triple Drawer 435 x 420 x 420	BEDR04043	£487.54
Cupboard Unit 435 x 420 x 420	BECU04041	£229.95



Colour Options

Please add corresponding letters to the end of the code.



Premium Height-Adjustable Workbench - Accessories

Key	Description	Code	Price
A	760mm Rear Support Posts	BESP760SXXXX	£109.15
A	1180mm Rear Support Posts	BESP1180XXXX	£132.44
B	Upper Shelf 300mm Beech for 1200mm Bench	BEUS1200BXXX	£176.10
B	Upper Shelf 300mm Linoleum for 1200mm Bench	BEUS12008XXX	£152.81
B	Upper Shelf 300mm Laminate for 1200mm Bench	BEUS1200PXXX	£152.81
B	Upper Shelf 300mm Beech for 1500mm Bench	BEUS1500BXXX	£213.94
B	Upper Shelf 300mm Linoleum for 1500mm Bench	BEUS15008XXX	£181.92
B	Upper shelf 300mm Laminate for 1500mm Bench	BEUS1500PXXX	£181.92
B	Upper Shelf 300mm Beech for 1800mm Bench	BEUS1800BXXX	£259.05
B	Upper Shelf 300mm Linoleum for 1800mm Bench	BEUS18008XXX	£216.85
B	Upper Shelf 300mm Laminate for 1800mm Bench	BEUS1800PXXX	£216.85
C	Light/Tool Rail Support for 1200mm Bench	BERS1200XLXX	£114.97
C	Light/Tool Rail Support for 1500mm Bench	BERS1500XLXX	£122.25
C	Light/Tool Rail Support for 1800mm Bench	BERS1800XLXX	£126.62
D	3 Setting LED Light	BE3SETL1200X	£88.78
	Tilting LED Light - 30 Watt	BELED3012XXX	£235.77
E	Louvred Back Panel with Pinboard for 1200mm Bench	BELO4812IXXX	£211.03
E	Louvred Back Panel with Pinboard for 1500mm Bench	BELO4815IXXX	£219.76
E	Louvred Back Panel with Pinboard for 1800mm Bench	BELO4818IXXX	£256.14
F	Worktop Service Duct for 1200mm Bench	BESDWT122XXX	£176.10
F	Worktop Service Duct for 1500mm Bench	BESDWT15XXXX	£180.46
F	Worktop Service Duct for 1800mm Bench	BESDWT18XXXX	£189.20
G	Post Fitted Service Duct for 1200mm Bench	BESD5P12XXXX	£193.56
G	Post Fitted Service Duct for 1500mm Bench	BESD5P15XXXX	£202.29
G	Post Fitted Service Duct for 1800mm Bench	BESD5P18XXXX	£215.39
	Monitor and Keyboard Support Arm	BEMONARMFMG	£256.14
H	Flat Screen Support Arm	BEMONARMFSC	£101.88

Accessories





£1,466.73 FROM

200KG UDL
EVENLY DISTRIBUTED

Height-adjustable bench shown with laminate worktop and optional accessories

- Height-adjustable bench suitable for heavy-duty use in assembly, production and engineering.
- Adjustable in height from 650mm to 1290mm with a two-button switch.
- Powder-coated light grey framework with black legs.
- Full range of accessories available including drawers, cupboards, shelves, louvre panels and service ducts.
- Linoleum, Laminate and Solid Beech worktop options available.
- ESD height adjustable workbench available - please see page 24.



**Linoleum Worktop
20mm thick**



Size W.D.	Code	Price
900.600	BAE6590608LX	£1,533.67
1200.600	BAE6512608LX	£1,703.95
1200.750	BAE6512758LX	£1,719.96
1500.600	BAE6515608LX	£1,770.90
1500.750	BAE6515758LX	£1,817.47
1800.600	BAE6518608LX	£1,821.83
1800.750	BAE6518758LX	£1,840.75

**Laminate Worktop
20mm thick**



Size W.D.	Code	Price
900.600	BAE659060PLX	£1,533.67
1200.600	BAE651260PLX	£1,703.95
1200.750	BAE651275PLX	£1,719.96
1500.600	BAE651560PLX	£1,770.90
1500.750	BAE651575PLX	£1,817.47
1800.600	BAE651860PLX	£1,821.83
1800.750	BAE651875PLX	£1,840.75

**Solid Beech Worktop
27mm thick**



Size W.D.	Code	Price
900.600	BAE659060BLX	£1,466.73
1200.600	BAE651260BLX	£1,561.32
1200.750	BAE651275BLX	£1,754.89
1500.600	BAE651560BLX	£1,862.58
1500.750	BAE651575BLX	£1,938.26
1800.600	BAE651860BLX	£1,878.59
1800.750	BAE651875BLX	£2,011.03

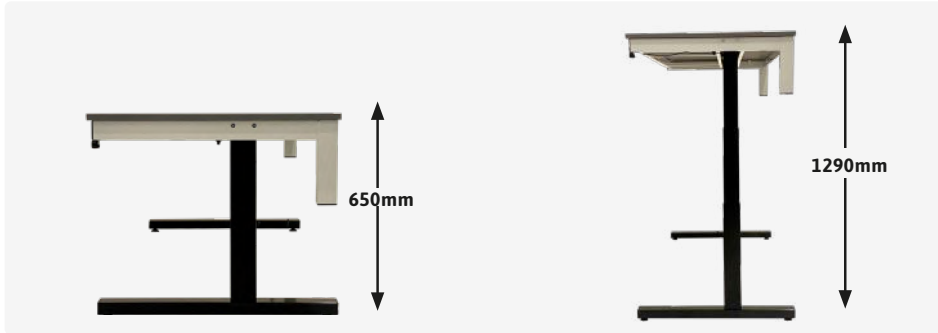

Height adjustable with a two-button adjustment switch

Drawer & Cupboard Options

Description	Code	Price
Single Drawer 220 x 420 x 420	BEDR04021	£256.14
Triple Drawer 435 x 420 x 420	BEDR04043	£487.54
Cupboard Unit 435 x 420 x 420	BECU04041	£229.95



Colour Options

Please add corresponding letters to the end of the code.



Premium Electric Height-Adjustable Workbench - Accessories

Key	Description	Code	Price
A	760mm Rear Support Posts	BESP760SXXXX	£109.15
A	1180mm Rear Support Posts	BESP1180XXXX	£132.44
B	Upper shelf 300mm Beech for 1200mm Bench	BEUS1200BXXX	£176.10
B	Upper shelf 300mm Linoleum for 1200mm Bench	BEUS1200LXXX	£152.81
B	Upper shelf 300mm Laminate for 1200mm Bench	BEUS1200PXXX	£152.81
B	Upper Shelf 300mm Beech for 1500mm Bench	BEUS1500BXXX	£213.94
B	Upper Shelf 300mm Linoleum for 1500mm Bench	BEUS1500LXXX	£181.92
B	Upper shelf 300mm Laminate for 1500mm Bench	BEUS1500PXXX	£181.92
B	Upper Shelf 300mm Beech for 1800mm Bench	BEUS1800BXXX	£259.05
B	Upper Shelf 300mm Linoleum for 1800mm Bench	BEUS1800LXXX	£216.85
B	Upper Shelf 300mm Laminate for 1800mm Bench	BEUS1800PXXX	£216.85
C	Light/Tool Rail Support for 1200mm Bench	BERS1200XLXX	£114.97
C	Light/Tool Rail Support for 1500mm Bench	BERS1500XLXX	£122.25
C	Light/Tool Rail Support for 1800mm Bench	BERS1800XLXX	£126.62
D	3 Setting LED Light	BE3SETL1200X	£88.78
	Tilting LED Light - 30 Watt	BELED3012XXX	£235.77
E	Louvred Back Panel with Pinboard for 1200mm Bench	BELO4812XXXX	£211.03
E	Louvred Back Panel with Pinboard for 1500mm Bench	BELO4815XXXX	£219.76
E	Louvred Back Panel with Pinboard for 1800mm Bench	BELO4818XXXX	£256.14
F	Worktop Service Duct for 1200mm Bench	BESDWT122XXX	£176.10
F	Worktop Service Duct for 1500mm Bench	BESDWT15XXXX	£180.46
F	Worktop Service Duct for 1800mm Bench	BESDWT18XXXX	£189.20
	Post Fitted Service Duct for 1200mm Bench	BESDSP12XXXX	£193.56
	Post Fitted Service Duct for 1500mm Bench	BESDSP15XXXX	£202.29
	Post Fitted Service Duct for 1800mm Bench	BESDSP18XXXX	£215.39
	Monitor and Keyboard Support Arm	BEMONARMFMG	£256.14
G	Flat Screen Support Arm	BEMONARMLSC	£101.88

Accessories





Kit A - Laminate Worktop

Size W.D.	Code	Price
1200.750	BH651275PX1A	£2,206.50
1500.750	BH651575PX1B	£2,303.55
1800.750	BH651875PX1C	£2,326.84



Kit B - Laminate Worktop

Size W.D.	Code	Price
1200.750	BH65127PX2A	£2,437.45
1500.750	BH651575PX2B	£2,534.95
1800.750	BH651875PX2C	£2,558.24



Kit C - Laminate Worktop

Size W.D.	Code	Price
1200.750	BH651275PX3A	£2,679.05
1500.750	BH651575PX3B	£2,814.39
1800.750	BH651875PX3C	£2,908.98



Kit D - Laminate Worktop

Size W.D.	Code	Price
1200.750	BH651275PX4A	£2,910.45
1500.750	BH651575PX4B	£3,045.79
1800.750	BH651875PX4C	£3,140.38



Kit E - Laminate Worktop

Size W.D.	Code	Price
1200.750	BH651275PX5A	£3,082.17
1500.750	BH651575PX5B	£3,229.15
1800.750	BH651875PX5C	£3,336.86



Kit F - Laminate Worktop

Size W.D.	Code	Price
1200.750	BH651275PX6A	£3,339.78
1500.750	BH651575PX6B	£3,486.76
1800.750	BH651875PX6C	£3,594.47



Kit A - Beech Worktop

Size W.D.	Code	Price
1200.750	BH651275BX1A	£2,240.97
1500.750	BH651575BX1B	£2,424.35
1800.750	BH651875BX1C	£2,497.12



Kit B - Beech Worktop

Size W.D.	Code	Price
1200.750	BH651275BX2A	£2,472.37
1500.750	BH651575BX2B	£2,655.75
1800.750	BH651875BX2C	£2,728.52



Kit C - Beech Worktop

Size W.D.	Code	Price
1200.750	BH651275BX3A	£2,713.97
1500.750	BH651575BX3B	£2,935.18
1800.750	BH651875BX3C	£3,079.26



Kit D - Beech Worktop

Size W.D.	Code	Price
1200.750	BH651275BX4A	£2,945.37
1500.750	BH651575BX4B	£3,166.59
1800.750	BH651875BX4C	£3,310.66



Kit E - Beech Worktop

Size W.D.	Code	Price
1200.750	BH651275BX5A	£3,117.10
1500.750	BH651575BX5B	£3,349.95
1800.750	BH651875BX5C	£3,507.14



Kit F - Beech Worktop

Size W.D.	Code	Price
1200.750	BH651275BX6A	£3,374.70
1500.750	BH651575BX6B	£3,607.56
1800.750	BH651575BX6C	£3,764.74



5 DAY DELIVERY

£569 FROM .04



250KG UDL
EVENLY DISTRIBUTED

Static Dissipative bench shown with extension bench and a range of accessories

- General workshop bench with static dissipative properties.
- Suitable for use as an assembly or repair bench in the electrical and electronic industries.
- A leg in each corner gives firm support.
- Powder-coated light grey framework.
- Neostat or Lamstat worktop options available.
- Full range of accessories available including wrist straps, circuit breakers and earth/ground leads.
- Standard bench height: 840mm - 760 and 920mm also available.
- Delivered in knock-down form.
- Order quantities may apply, please speak to the sales team.

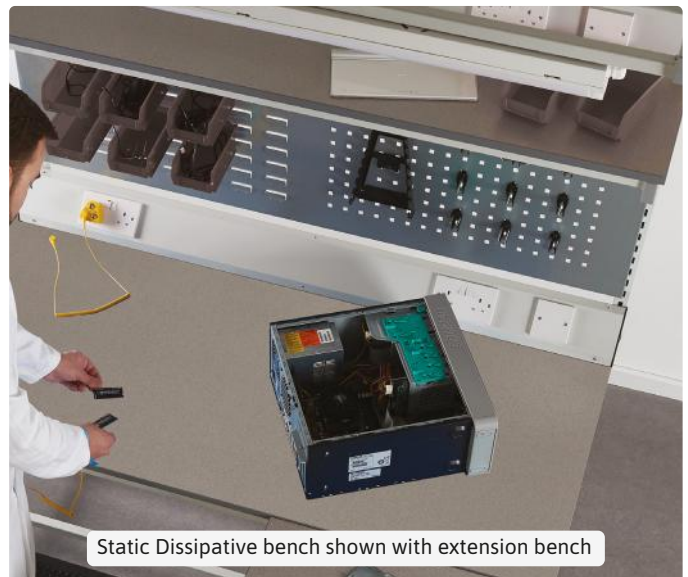

Static Dissipative bench shown with extension bench

Neostat Worktop 20mm thick 10⁵ 10⁷ ohms

Size H.W.D.	Code	Price
840.900.600	BQ849060NLXX	£570.50
840.1200.600	BQ841260NLXX	£659.28
840.1200.750	BQ841275NLXX	£729.13
840.1200.900	BQ841290NLXX	£809.18
840.1500.600	BQ841560NLXX	£833.92
840.1500.750	BQ841575NLXX	£1,017.29
840.1500.900	BQ841590NLXX	£1,059.50
840.1800.600	BQ841860NLXX	£937.25
840.1800.750	BQ841875NLXX	£1,119.17
840.1800.900	BQ841890NLXX	£1,168.65

Neostat - Extension Benches

Size H.W.D.	Code	Price
840.900.600	BQ849060NLET	£554.49
840.1200.600	BQ841260NLET	£608.34
840.1200.750	BQ841275NLET	£675.29

Neostat Lower Shelves - 450mm Deep

To Fit W.	Code	Price
1200	BELS1145NLXX	£254.69
1500	BELS1445NLXX	£330.37
1800	BELS1745NLXX	£343.46

Lamstat Worktop 20mm thick 10⁶ 10⁸ ohms

Size H.W.D.	Code	Price
840.900.600	BQ849060LLXX	£569.04
840.1200.600	BQ841260LLXX	£625.80
840.1200.750	BQ841275LLXX	£694.21
840.1200.900	BQ841290LLXX	£806.27
840.1500.600	BQ841560LLXX	£793.17
840.1500.750	BQ841575LLXX	£1,068.23
840.1500.900	BQ841590LLXX	£1,110.44
840.1800.600	BQ841860LLXX	£1,062.41
840.1800.750	BQ841875LLXX	£1,127.90
840.1800.900	BQ841890LLXX	£1,175.93

Lamstat - Extension Benches

Size H.W.D.	Code	Price
840.900.600	BQ849060LLET	£544.30
840.1200.600	BQ841260LLET	£573.41
840.1200.750	BQ841275LLET	£643.27

Lamstat Lower Shelves - 450mm Deep

To Fit W.	Code	Price
1200	BELS1145LLXX	£228.49
1500	BELS1445LLXX	£289.62
1800	BELS1745LLXX	£318.72



All RED product codes are available on 5-Day Delivery

Drawer & Cupboard Options

Description	Code	Price
Single Drawer 220 x 420 x 420	BEDR04021	£256.14
Triple Drawer 435 x 420 x 420	BEDR04043	£487.54
Cupboard Unit 435 x 420 x 420	BECU04041	£229.95



Please Note: Only Blue Drawers & Cupboards are available on 5-Day Delivery

Colour Options

Please add corresponding letters to the end of the code.



Square Tube Static Dissipative Workbench - Accessories

Key	Description	Code	Price
A	760mm Rear Support Posts	BESP760SXXX	£109.15
A	1180mm Rear Support Posts	BESP1180SXXX	£132.44
B	Upper shelf 300mm Neostat for 1200mm Bench	BEUS1200NXXX	£254.69
B	Upper shelf 300mm Lamstat for 1200mm Bench	BEUS1200LXXX	£228.49
B	Upper shelf 300mm Neostat for 1500mm Bench	BEUS1500NXXX	£330.37
B	Upper shelf 300mm Lamstat for 1500mm Bench	BEUS1500LXXX	£289.62
B	Upper shelf 300mm Neostat for 1800mm Bench	BEUS1800NXXX	£343.46
B	Upper shelf 300mm Lamstat for 1800mm Bench	BEUS1800LXXX	£318.72
C	Light/Tool Rail Support for 1200mm Bench	BERS1200LX	£114.97
C	Light/Tool Rail Support for 1500mm Bench	BERS1500LX	£122.25
C	Light/Tool Rail Support for 1800mm Bench	BERS1800LX	£126.62
D	3 Setting LED Light	BE3SETL1200X	£88.78
	Tilting LED Light - 30 Watt	BELED3012XXX	£235.77
E	Louvred Galv back panel with pinboard for 1200mm Bench	BELO4812ZXXX	£211.03
E	Louvred Galv back panel with pinboard for 1500mm Bench	BELO4815ZXXX	£219.76
E	Louvred Galv back panel with pinboard for 1800mm Bench	BELO4818ZXXX	£256.14
F	Worktop Service Duct for 1200mm Bench	BESDWT122XXX	£176.10
F	Worktop Service Duct for 1500mm Bench	BESDWT15XXX	£180.46
F	Worktop Service Duct for 1800mm Bench	BESDWT18XXX	£189.20
G	Post Fitted Service Duct for 1200mm Bench	BESDSP12XXXX	£193.56
G	Post Fitted Service Duct for 1500mm Bench	BESDSP15XXXX	£202.29
G	Post Fitted Service Duct for 1800mm Bench	BESDSP18XXXX	£215.39
	RCB circuit breaker	BERCBCIBXXXX	£135.35
	Wrist strap with 10mm stud or 4mm banana	BEWRISTRXXXX	£45.12
	Earth/ground lead with 1m ohm resistor	BEEARGROXXXX	£27.65
	Earth/ground lead with 3 pin plug	BEEALEAD3PIN	£42.21
	Insulating strip - required for Worktop Service Ducts	BESERINSXXXX	£14.55
	Double Data Socket	BEDDSBPPXXXX	£69.86
	Flat Screen Support Arm	BEMONARMFLSC	£101.88
	Anti-Static Floor Mat 1200mm x 1500mm	BEFLMA15XXXX	POA
	Anti-Static Floor Mat 1200mm x 2000mm	BEFLMA20XXXX	POA
	Anti-Static Floor Mat 1200mm x 3000mm	BEFLMA30XXXX	POA

Accessories

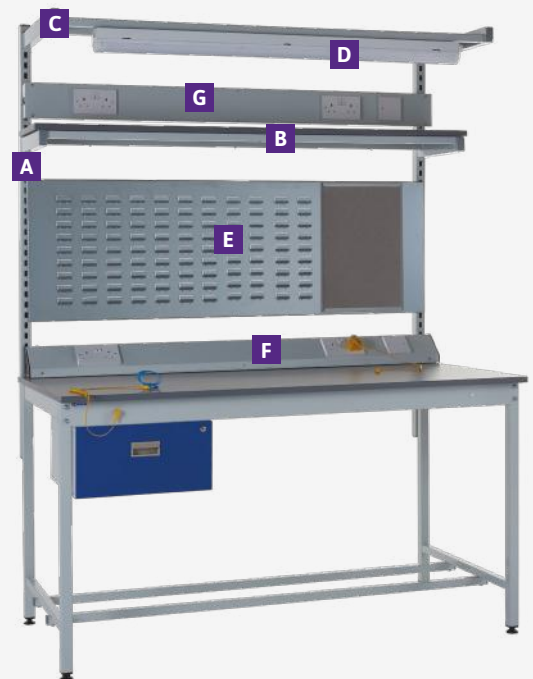

5 DAY
DELIVERY

£554 FROM
.49



250KG
UDL
EVENLY DISTRIBUTED

Static Dissipative bench shown with extension bench and a range of accessories



Workbenches

- General workshop bench with static dissipative properties.
- Suitable for use as an assembly or repair bench in the electrical and electronic industries.
- Cantilever construction allows for maximum leg room.
- Powder-coated light grey framework.
- Neostat or Lamstat worktop options available.
- Full range of accessories available including wrist straps, circuit breakers and earth/ground leads.
- Standard bench height: 840mm - 760mm and 920mm also available.
- Delivered in knock-down form.
- Order quantities may apply, please speak to the sales team.



20

Neostat Worktop 20mm thick 10⁵ 10⁷ ohms

Size H.W.D.	Code	Price
840.1200.750	BC841275NLXX	£554.49
840.1200.900	BC841290NLXX	£855.75
840.1500.750	BC841575NLXX	£1,069.69
840.1500.900	BC841590NLXX	£1,111.89
840.1800.750	BC841875NLXX	£1,183.21
840.1800.900	BC841890NLXX	£1,232.69

Lamstat Worktop 20mm thick 106 108 ohms

Size H.W.D.	Code	Price
840.1200.750	BC841275LLXX	£740.78
840.1200.900	BC841290LLXX	£852.84
840.1500.750	BC841575LLXX	£1,120.63
840.1500.900	BC841590LLXX	£1,162.83
840.1800.750	BC841875LLXX	£1,191.94
840.1800.900	BC841890LLXX	£1,238.51

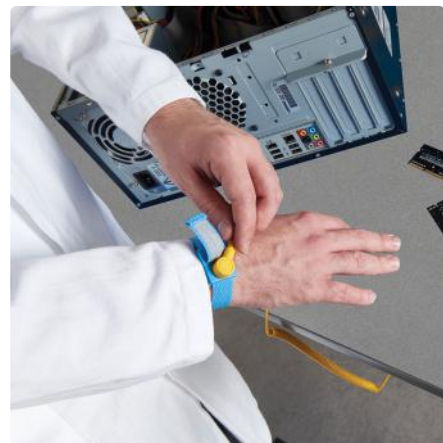

Neostat - Extension Benches

Size H.W.D.	Code	Price
840.900.600	BC849060NLET	£665.10
840.1200.600	BC841260NLET	£689.84
840.1200.750	BC841275NLET	£724.77

Lamstat - Extension Benches

Size H.W.D.	Code	Price
840.900.600	BC849060LLET	£628.71
840.1200.600	BC841260LLET	£650.54
840.1200.750	BC841275LLET	£688.38

Drawer & Cupboard Options

Description	Code	Price
Single Drawer 220 x 420 x 420	BEDR04021	£256.14
Triple Drawer 435 x 420 x 420	BEDR04043	£487.54
Cupboard Unit 435 x 420 x 420	BECU04041	£229.95



Please Note: Only **Blue** Drawers & Cupboards are available on 5-Day Delivery

Colour Options

Please add corresponding letters to the end of the code.



All **RED** product codes are available on 5-Day Delivery

Cantilever Static Dissipative Workbench - Accessories

Key	Description	Code	Price
A	760mm Rear Support Posts	BESP760SXXX	£109.15
A	1180mm Rear Support Posts	BESP1180SXXX	£132.44
B	Upper shelf 300mm Neostat for 1200mm Bench	BEUS1200NXXX	£254.69
B	Upper shelf 300mm Lamstat for 1200mm Bench	BEUS1200LXXX	£228.49
B	Upper shelf 300mm Neostat for 1500mm Bench	BEUS1500NXXX	£330.37
B	Upper shelf 300mm Lamstat for 1500mm Bench	BEUS1500LXXX	£289.62
B	Upper shelf 300mm Neostat for 1800mm Bench	BEUS1800NXXX	£343.46
B	Upper shelf 300mm Lamstat for 1800mm Bench	BEUS1800LXXX	£318.72
C	Light/Tool Rail Support for 1200mm Bench	BERS1200LXX	£114.97
C	Light/Tool Rail Support for 1500mm Bench	BERS1500LXX	£122.25
C	Light/Tool Rail Support for 1800mm Bench	BERS1800LXX	£126.62
D	3 Setting LED Light	BE3SETL1200X	£88.78
	Tilting LED Light - 30 Watt	BELED3012XXX	£235.77
E	Louvred Galv back panel with pinboard for 1200mm Bench	BELO4812ZXXX	£211.03
E	Louvred Galv back panel with pinboard for 1500mm Bench	BELO4815ZXXX	£219.76
E	Louvred Galv back panel with pinboard for 1800mm Bench	BELO4818ZXXX	£256.14
F	Worktop Service Duct for 1200mm Bench	BESDWT122XXX	£176.10
F	Worktop Service Duct for 1500mm Bench	BESDWT15XXX	£180.46
F	Worktop Service Duct for 1800mm Bench	BESDWT18XXX	£189.20
	Post Fitted Service Duct for 1200mm Bench	BESDSP12XXX	£193.56
	Post Fitted Service Duct for 1500mm Bench	BESDSP15XXX	£202.29
	Post Fitted Service Duct for 1800mm Bench	BESDSP18XXX	£215.39
	RCB circuit breaker	BERCBCIBXXX	£135.35
	Wrist strap with 10mm stud or 4mm banana	BEWRISTRXXX	£45.12
	Earth/ground lead with 1m ohm resistor	BEEARGROXXX	£27.65
	Earth/ground lead with 3 pin plug	BEEALEAD3PIN	£42.21
	Insulating strip - required for Worktop Service Ducts	BESERINSXXX	£14.55
	Double Data Socket	BEDDSBPXXX	£69.86
G	Flat Screen Support Arm	BEMONARMLSC	£101.88
	Anti-Static Floor Mat 1200mm x 1500mm	BEFLMA15XXX	POA
	Anti-Static Floor Mat 1200mm x 2000mm	BEFLMA20XXX	POA
	Anti-Static Floor Mat 1200mm x 3000mm	BEFLMA30XXX	POA

Accessories





5 DAY DELIVERY

ESD Wrist Straps Sold Separately

Kit A - Lamstat Worktop

Size H.W.D.	Code	Price
840.1200.750	BQ841275LX1A	£1,178.84
840.1500.750	BQ841575LX1B	£1,554.32
840.1800.750	BQ841875LX1C	£1,613.99



ESD Wrist Straps Sold Separately

Kit B - Lamstat Worktop

Size H.W.D.	Code	Price
840.1200.750	BQ841275LX3A	£1,410.24
840.1500.750	BQ841575LX3B	£1,784.32
840.1800.750	BQ841875LX3C	£1,843.94



ESD Wrist Straps Sold Separately

Kit C - Lamstat Worktop

Size H.W.D.	Code	Price
1600.1200.750	BQ841275LX5A	£1,733.33
1600.1500.750	BQ841575LX5B	£2,194.68
1600.1800.750	BQ841875LX5C	£2,309.65



ESD Wrist Straps Sold Separately

Kit D - Lamstat Worktop

Size H.W.D.	Code	Price
1600.1200.750	BQ841275LX7A	£1,964.73
1600.1500.750	BQ841575LX7B	£2,424.63
1600.1800.750	BQ841875LX7C	£2,541.05



ESD Wrist Straps Sold Separately

Kit E - Lamstat Worktop

Size H.W.D.	Code	Price
2020.1200.750	BQ841275LX9A	£2,135.01
2020.1500.750	BQ841575LX9B	£2,608.00
2020.1800.750	BQ841875LX9C	£2,737.53



ESD Wrist Straps Sold Separately

Kit F - Lamstat Worktop

Size H.W.D.	Code	Price
2020.1200.750	BQ841275L11A	£2,364.96
2020.1500.750	BQ841575L11B	£2,839.40
2020.1800.750	BQ841875L11C	£2,967.47



Kit A - Lamstat Worktop

Size H.W.D.	Code	Price
840.1200.750	BC841275LX1A	£1,225.41
840.1500.750	BC841575LX1B	£1,606.71
840.1800.750	BC841875LX1C	£1,678.03



Kit B - Lamstat Worktop

Size H.W.D.	Code	Price
840.1200.750	BC841275LX3A	£1,456.81
840.1500.750	BC841575LX3B	£1,836.66
840.1800.750	BC841875LX3C	£1,907.97



Kit C - Lamstat Worktop

Size H.W.D.	Code	Price
1600.1200.750	BC841275LX5A	£1,778.45
1600.1500.750	BC841575LX5B	£2,245.62
1600.1800.750	BC841875LX5C	£2,372.23



Kit D - Lamstat Worktop

Size H.W.D.	Code	Price
1600.1200.750	BC841275LX7A	£2,009.85
1600.1500.750	BC841575LX7B	£2,477.02
1600.1800.750	BC841875LX7C	£2,603.63



Kit E - Lamstat Worktop

Size H.W.D.	Code	Price
2020.1200.750	BC841275LX9A	£2,181.58
2020.1500.750	BC841575LX9B	£2,660.39
2020.1800.750	BC841875LX9C	£2,801.56



Kit F - Lamstat Worktop

Size H.W.D.	Code	Price
2020.1200.750	BC841275L11A	£2,411.53
2020.1500.750	BC841575L11B	£2,891.80
2020.1800.750	BC841875L11C	£3,031.51

£1,309.82 FROM



200KG UDL
 EVENLY DISTRIBUTED



Static Dissipative bench shown with a range of above bench accessories

- Height-adjustable workshop bench with static dissipative properties.
- Suitable for use as an assembly or repair bench in the electrical and electronic industries.
- Powder-coated light grey framework.
- Neostat or Lamstat worktop options available.
- Full range of accessories available including wrist straps, circuit breakers and earth/ground leads.
- Adjustable in height from 730mm to 950mm.
- Workbench height can be easily adjusted with a crank handle.



Neostat Worktop 20mm thick 10⁵ 10⁷ ohms

Size W.D.	Code	Price
900.600	BA799060NLXX	£1,311.28
1200.600	BA791260NLXX	£1,528.13
1200.750	BA791275NLXX	£1,596.53
1500.600	BA791560NLXX	£1,651.83
1500.750	BA791575NLXX	£1,826.47
1800.600	BA791860NLXX	£1,756.62
1800.750	BA791875NLXX	£1,934.17

Lamstat Worktop 20mm thick 10⁶ 10⁸ ohms

Size W.D.	Code	Price
900.600	BA799060LLXX	£1,309.82
1200.600	BA791260LLXX	£1,497.56
1200.750	BA791275LLXX	£1,561.60
1500.600	BA791560LLXX	£1,612.54
1500.750	BA791575LLXX	£1,875.96
1800.600	BA791860LLXX	£1,878.87
1800.750	BA791875LLXX	£1,944.36

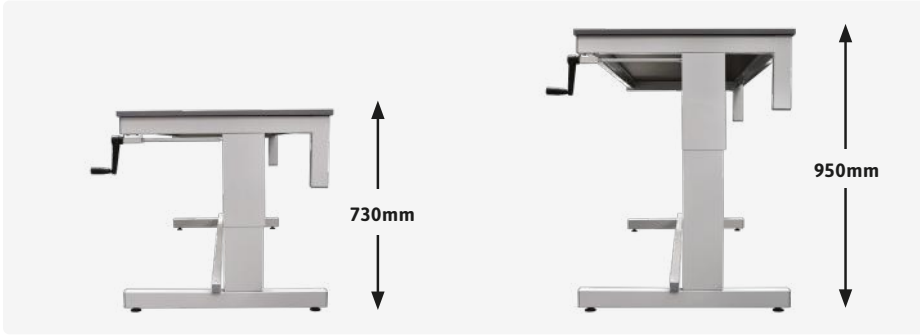
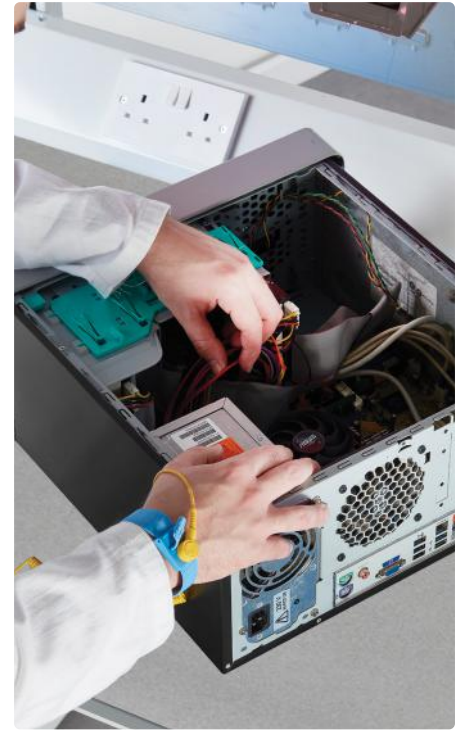

Drawer & Cupboard Options

Description	Code	Price
Single Drawer 220 x 420 x 420	BEDR04021	£256.14
Triple Drawer 435 x 420 x 420	BEDR04043	£487.54
Cupboard Unit 435 x 420 x 420	BECU04041	£229.95



Colour Options

Please add corresponding letters to the end of the code.

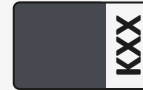

Premium Height-Adjustable ESD Workbench - Accessories

Key	Description	Code	Price
A	760mm Rear Support Posts	BESP760SXXXX	£109.15
A	1180mm Rear Support Posts	BESP1180XXXX	£132.44
B	Upper shelf 300mm Neostat for 1200mm Bench	BEUS1200NXXX	£254.69
B	Upper shelf 300mm Lamstat for 1200mm Bench	BEUS1200LXXX	£228.49
B	Upper shelf 300mm Neostat for 1500mm Bench	BEUS1500NXXX	£330.37
B	Upper shelf 300mm Lamstat for 1500mm Bench	BEUS1500LXXX	£289.62
B	Upper shelf 300mm Neostat for 1800mm Bench	BEUS1800NXXX	£343.46
B	Upper shelf 300mm Lamstat for 1800mm Bench	BEUS1800LXXX	£318.72
C	Light/Tool Rail Support for 1200mm Bench	BERS1200XLXX	£114.97
C	Light/Tool Rail Support for 1500mm Bench	BERS1500XLXX	£122.25
C	Light/Tool Rail Support for 1800mm Bench	BERS1800XLXX	£126.62
D	3 Setting LED Light	BE3SETL1200X	£88.78
	Tilting LED Light - 30 Watt	BELED3012XXX	£235.77
E	Louvred Galv back panel with pinboard for 1200mm Bench	BELO4812ZXXX	£211.03
E	Louvred Galv back panel with pinboard for 1500mm Bench	BELO4815ZXXX	£219.76
E	Louvred Galv back panel with pinboard for 1800mm Bench	BELO4818ZXXX	£256.14
F	Worktop Service Duct for 1200mm Bench	BESDWT122XXX	£176.10
F	Worktop Service Duct for 1500mm Bench	BESDWT15XXXX	£180.46
F	Worktop Service Duct for 1800mm Bench	BESDWT18XXXX	£189.20
G	Post Fitted Service Duct for 1200mm Bench	BESDSP12XXXX	£193.56
G	Post Fitted Service Duct for 1500mm Bench	BESDSP15XXXX	£202.29
G	Post Fitted Service Duct for 1800mm Bench	BESDSP18XXXX	£215.39
	RCB circuit breaker	BERCBCIBXXXX	£135.35
	Wrist strap with 10mm stud and 4mm banana	BEWRISTRXXXX	£45.12
	Earth/ground lead with 1m ohm resistor	BEEARGROXXXX	£27.65
	Earth/ground lead with 3 pin plug	BEEALEAD3PIN	£42.21
	Insulating strip - required for Worktop Service Ducts	BESERINSXXXX	£14.55
	Double Data Socket	BEDDSBBPXXXX	£69.86
	Flat Screen Support Arm	BEMONARMLSC	£101.88
	Anti-Static Floor Mat 1200mm x 1500mm	BEFLMA15XXXX	POA
	Anti-Static Floor Mat 1200mm x 2000mm	BEFLMA20XXXX	POA
	Anti-Static Floor Mat 1200mm x 3000mm	BEFLMA30XXXX	POA

Accessories

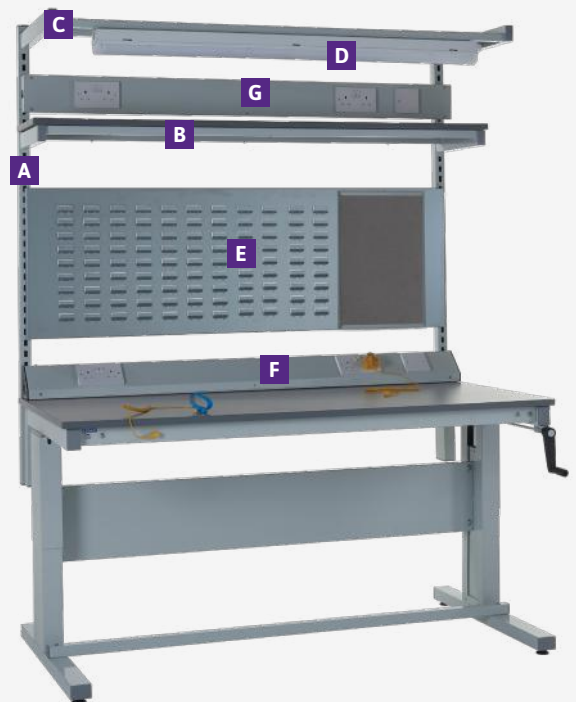

5 DAY DELIVERY

£515.20 FROM

Workbenches



BEST SELLER

1200KG UDL
EVENLY DISTRIBUTED

Workbench shown with optional triple drawer, cupboard unit and accessories

- Heavy-duty bench suitable for heavy-duty applications such as engineering and manufacturing.
- Fully welded construction for extra strength.
- Powder-coated dark grey framework.
- 5-Day Delivery only available on Light Grey cupboard and drawer units.
- Steel plate, beech, linoleum and laminate worktop options.
- Full range of accessories available including drawers, cupboards and shelves.
- Standard bench height: 840mm - 760mm and 920mm also available.
- Order quantities may apply, please speak to the sales team.

Drawer & Cupboard Options

Description	Code	Price
Single Drawer 220 x 420 x 420	BXDR04021	£272.15
Triple Drawer 435 x 420 x 420	BXDR04043	£467.17
Cupboard Unit 560 x 420 x 420	BXCU04051	£296.89



Please Note: Only Light Grey Drawers & Cupboards are available on 5-Day Delivery

Colour Options

Please add corresponding letters to the end of the code.



Steel Plate Worktop 2mm thick



Size H.W.D.	Code	Price
840.1200.600	BJ841260SKXX	£515.20
840.1200.750	BJ841275SKXX	£574.87
840.1200.900	BJ841290SKXX	£589.42
840.1500.600	BJ841560SKXX	£592.33
840.1500.750	BJ841575SKXX	£701.48
840.1500.900	BJ841590SKXX	£716.04
840.1800.600	BJ841860SKXX	£628.71
840.1800.750	BJ841875SKXX	£737.87
840.1800.900	BJ841890SKXX	£765.52

Linoleum Worktop 20mm thick



Size H.W.D.	Code	Price
840.1200.600	BJ8412608KXX	£614.16
840.1200.750	BJ8412758KXX	£637.45
840.1200.900	BJ8412908KXX	£708.76
840.1500.600	BJ8415608KXX	£737.87
840.1500.750	BJ8415758KXX	£793.17
840.1500.900	BJ8415908KXX	£903.78
840.1800.600	BJ8418608KXX	£790.26
840.1800.750	BJ8418758KXX	£813.54
840.1800.900	BJ8418908KXX	£938.71

Solid Beech Worktop 27mm thick



Size H.W.D.	Code	Price
840.1200.600	BJ841260BKXX	£618.53
840.1200.750	BJ841275BKXX	£659.28
840.1200.900	BJ841290BKXX	£721.86
840.1500.600	BJ841560BKXX	£793.17
840.1500.750	BJ841575BKXX	£838.29
840.1500.900	BJ841590BKXX	£918.33
840.1800.600	BJ841860BKXX	£832.46
840.1800.750	BJ841875BKXX	£919.79
840.1800.900	BJ841890BKXX	£1,020.21

Laminate Worktop 20mm thick

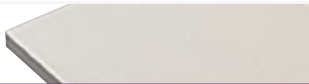

Size H.W.D.	Code	Price
840.1200.600	BJ841260PKXX	£614.16
840.1200.750	BJ841275PKXX	£637.45
840.1200.900	BJ841290PKXX	£708.76
840.1500.600	BJ841560PKXX	£737.87
840.1500.750	BJ841575PKXX	£793.17
840.1500.900	BJ841590PKXX	£903.78
840.1800.600	BJ841860PKXX	£790.26
840.1800.750	BJ841875PKXX	£813.54
840.1800.900	BJ841890PKXX	£938.71

Lower Shelves - 1.5mm thick

Factory Fitted Steel Plate Only



To Fit W.D.	Code	Price
1200.600	BXLS1206XXXX	£130.98
1200.750	BXLS1207XXXX	£157.18
1200.900	BXLS1209XXXX	£157.18
1500.600	BXLS1506XXXX	£152.81
1500.750	BXLS1507XXXX	£180.46
1500.900	BXLS1509XXXX	£180.46
1800.600	BXLS1806XXXX	£174.64
1800.750	BXLS1807XXXX	£197.93
1800.900	BXLS1809XXXX	£197.93

All **RED** product codes are available on 5-Day Delivery

Heavy-Duty Bench - Accessories

Key	Description	Code	Price
A	760mm Rear Support Posts	BESP760SXXXX	£109.15
A	1180mm Rear Support Posts	BESP1180XXXX	£132.44
B	Upper Shelf 300mm Laminate for 1200mm Bench	BEUS1200PXXX	£152.81
B	Upper Shelf 300mm Beech for 1200mm Bench	BEUS1200BXXX	£176.10
B	Upper Shelf 300mm Laminate for 1500mm Bench	BEUS1500PXXX	£181.92
B	Upper Shelf 300mm Beech for 1500mm Bench	BEUS1500BXXX	£213.94
B	Upper Shelf 300mm Laminate for 1800mm Bench	BEUS1800PXXX	£216.85
B	Upper Shelf 300mm Beech for 1800mm Bench	BEUS1800BXXX	£259.05
C	Light/Tool Rail Support for 1200mm Bench	BERS1200XLXX	£114.97
C	Light/Tool Rail Support for 1500mm Bench	BERS1500XLXX	£122.25
C	Light/Tool Rail Support for 1800mm Bench	BERS1800XLXX	£126.62
D	3 Setting LED Light	BE3SETL1200X	£88.78
	Tilting LED Light - 30 Watt	BELED3012XXX	£235.77
E	Louvred Back Panel with Pinboard for 1200mm Bench	BELO4812IXXX	£211.03
E	Louvred Back Panel with Pinboard for 1500mm Bench	BELO4815IXXX	£219.76
E	Louvred Back Panel with Pinboard for 1800mm Bench	BELO4818IXXX	£256.14
F	Worktop Service Duct for 1200mm Bench	BESDWT122XXX	£176.10
F	Worktop Service Duct for 1500mm Bench	BESDWT15XXX	£180.46
F	Worktop Service Duct for 1800mm Bench	BESDWT18XXX	£189.20
G	Post Fitted Service Duct for 1200mm Bench	BESDSP12XXXX	£193.56
G	Post Fitted Service Duct for 1500mm Bench	BESDSP15XXXX	£202.29
G	Post Fitted Service Duct for 1800mm Bench	BESDSP18XXXX	£215.39
H	Monitor and Keyboard Support Arm	BEMONARMFMSG	£256.14
	Flat Screen Support Arm	BEMONARMFSLC	£101.88

Accessories



Heavy-Duty Bench - Retaining Lips & Vice Plate

Key	Description	Code	Price
I	Retaining Lip for 1200 x 600mm Bench	BXRL1206XXXX	£77.13
I	Retaining Lip for 1200 x 750mm Bench	BXRL1208XXXX	£88.78
I	Retaining Lip for 1200 x 900mm Bench	BXRL1209XXXX	£98.96
I	Retaining Lip for 1500 x 600mm Bench	BXRL1506XXXX	£88.78
I	Retaining Lip for 1500 x 750mm Bench	BXRL1507XXXX	£98.96
I	Retaining Lip for 1500 x 900mm Bench	BXRL1509XXXX	£106.24
I	Retaining Lip for 1800 x 600mm Bench	BXRL1806XXXX	£98.96
I	Retaining Lip for 1800 x 750mm Bench	BXRL1807XXXX	£106.24
I	Retaining Lip for 1800 x 900mm Bench	BXRL1809XXXX	£117.88
J	Vice Plate	BXVICEPLXXXX	£34.93

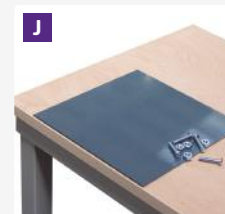



5 DAY DELIVERY

Kit A - Laminate Worktop

Size H.W.D.	Code	Price
840.1200.750	BJ841275PX1A	£1,203.58
840.1500.750	BJ841575PX1B	£1,359.30
840.1800.750	BJ841875PX1C	£1,379.68



Kit B - Laminate Worktop

Size H.W.D.	Code	Price
840.1200.750	BJ841275PX3A	£1,398.60
840.1500.750	BJ841575PX3B	£1,554.32
840.1800.750	BJ841875PX3C	£1,574.70



Kit C - Laminate Worktop

Size H.W.D.	Code	Price
1600.1200.750	BJ841275PX5A	£1,673.66
1600.1500.750	BJ841575PX5B	£1,878.87
1600.1800.750	BJ841875PX5C	£1,960.37



Kit D - Laminate Worktop

Size H.W.D.	Code	Price
1600.1200.750	BJ841275PX7A	£1,868.68
1600.1500.750	BJ841575PX7B	£2,073.88
1600.1800.750	BJ841875PX7C	£2,155.38



Kit E - Laminate Worktop

Size H.W.D.	Code	Price
2020.1200.750	BJ841275PX9A	£2,075.34
2020.1500.750	BJ841275PX9B	£2,293.64
2020.1800.750	BJ841875PX9C	£2,386.79



Kit F - Laminate Worktop

Size H.W.D.	Code	Price
2020.1200.750	BJ841275P11A	£2,270.36
2020.1500.750	BJ841575P11B	£2,488.66
2020.1800.750	BJ841875P11C	£2,581.80

Workbenches



Kit A - Beech Worktop

Size H.W.D.	Code	Price
840.1200.750	BJ841275BX2A	£1,225.41
840.1500.750	BJ841575BX2B	£1,405.88
840.1800.750	BJ841875BX2C	£1,487.38



Kit B - Beech Worktop

Size H.W.D.	Code	Price
840.1200.750	BJ841275BX4A	£1,376.77
840.1500.750	BJ841575BX4B	£1,599.44
840.1800.750	BJ841875BX4C	£1,680.94



Kit C - Beech Worktop

Size H.W.D.	Code	Price
1600.1200.750	BJ841275BX6A	£1,695.49
1600.1500.750	BJ841575BX6B	£1,925.44
1600.1800.750	BJ841875BX6C	£2,066.61



Kit D - Beech Worktop

Size H.W.D.	Code	Price
1600.1200.750	BJ841275BX8A	£1,890.51
1600.1500.750	BJ841575BX8B	£2,119.00
1600.1800.750	BJ841875BX8C	£2,261.63



Kit E - Beech Worktop

Size H.W.D.	Code	Price
2020.1200.750	BJ841275B10A	£2,097.17
2020.1500.750	BJ841575B10B	£2,338.76
2020.1800.750	BJ841875B10C	£2,494.48

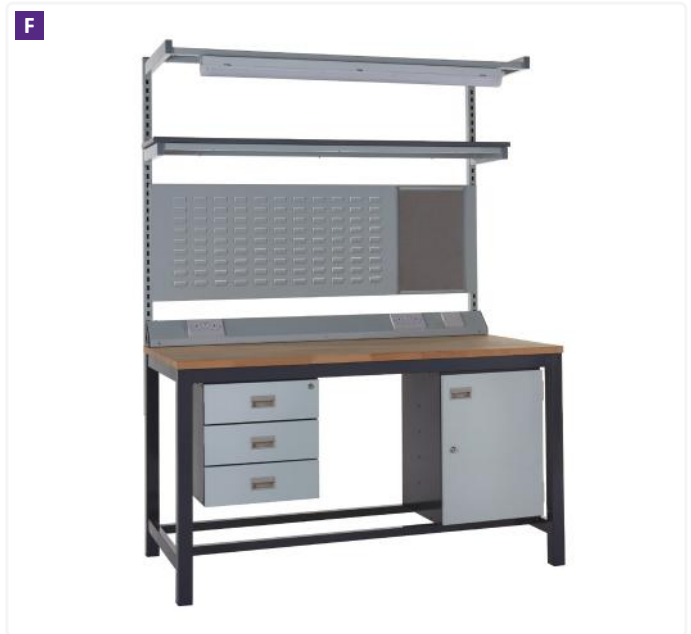

Kit F - Beech Worktop

Size H.W.D.	Code	Price
2020.1200.750	BJ841275B12A	£2,292.19
2020.1500.750	BJ841575B12B	£2,533.78
2020.1800.750	BJ841875B12C	£2,688.05

- Equipped with 4 swivel-braked castors for improved mobility, making it easy to manoeuvre around engineering and manufacturing environments.
- Powder-coated dark grey framework.
- Fully welded construction for extra strength.
- Linoleum, Solid Beech, Laminate and Steel Plate worktop options available.
- Full range of accessories available including drawers, cupboards and shelves.
- Mobile bench height: 840mm, other heights available - please speak to sales.



£625 FROM **07**

600KG UDL
EVENLY DISTRIBUTED

Workbenches



Solid Beech Worktop 27mm thick

Size H.W.D.	Code	Price
840.1200.600	BJ841260BKMX	£728.40
840.1200.750	BJ841275BKMX	£769.15
840.1200.900	BJ841290BKMX	£831.73
840.1500.600	BJ841560BKMX	£903.04
840.1500.750	BJ841575BKMX	£948.16
840.1500.900	BJ841590BKMX	£1,028.20
840.1800.600	BJ841860BKMX	£942.33
840.1800.750	BJ841875BKMX	£1,029.66
840.1800.900	BJ841890BKMX	£1,130.08

Linoleum Worktop 20mm thick

Size H.W.D.	Code	Price
840.1200.600	BJ8412608KMX	£724.03
840.1200.750	BJ8412758KMX	£747.32
840.1200.900	BJ8412908KMX	£818.63
840.1500.600	BJ8415608KMX	£847.74
840.1500.750	BJ8415758KMX	£903.04
840.1500.900	BJ8415908KMX	£1,013.65
840.1800.600	BJ8418608KMX	£900.13
840.1800.750	BJ8418758KMX	£923.41
840.1800.900	BJ8418908KMX	£1,048.58



Laminate Worktop 20mm thick

Size H.W.D.	Code	Price
840.1200.600	BJ841260PKMX	£724.03
840.1200.750	BJ841275PKMX	£747.32
840.1200.900	BJ841290PKMX	£818.63
840.1500.600	BJ841560PKMX	£847.74
840.1500.750	BJ841575PKMX	£903.04
840.1500.900	BJ841590PKMX	£1,013.65
840.1800.600	BJ841860PKMX	£900.13
840.1800.750	BJ841875PKMX	£923.41
840.1800.900	BJ841890PKMX	£1,048.58

Steel Plate Worktop 2mm thick

Size H.W.D.	Code	Price
840.1200.600	BJ841260SKMX	£625.07
840.1200.750	BJ841275SKMX	£684.74
840.1200.900	BJ841290SKMX	£699.29
840.1500.600	BJ841560SKMX	£702.20
840.1500.750	BJ841575SKMX	£811.35
840.1500.900	BJ841590SKMX	£825.91
840.1800.600	BJ841860SKMX	£738.58
840.1800.750	BJ841875SKMX	£847.74
840.1800.900	BJ841890SKMX	£875.39

Drawer & Cupboard Options

Description	Code	Price
Single Drawer 220 x 420 x 420	BXDR04021	£272.15
Triple Drawer 435 x 420 x 420	BXDR04043	£467.17
Cupboard Unit 560 x 420 x 420	BXCU04051	£296.89

Colour Options

Please add corresponding letters to the end of the code.



Our versatile Mobile Heavy-Duty Workbenches come in six kits, with the option of solid beech or laminate worktops.

Kit A



Size H.W.D.	Solid Beech	Price	Laminate	Price
840.1200.750	BJM81275BX2A	£1,335.28	BJM81275PX1A	£1,313.45
840.1500.750	BJM81275BX2B	£1,515.75	BJM81275PX1B	£1,469.17
840.1800.750	BJM81275BX2C	£1,597.25	BJM81275PX1C	£1,489.55

Kit B



Size H.W.D.	Solid Beech	Price	Laminate	Price
840.1200.750	BJM81275BX4A	£1,486.64	BJM81275PX3A	£1,508.47
840.1500.750	BJM81275BX4B	£1,709.31	BJM81275PX3B	£1,664.19
840.1800.750	BJM81275BX4C	£1,790.81	BJM81275PX3C	£1,684.57

Kit C



Size H.W.D.	Solid Beech	Price	Laminate	Price
840.1200.750	BJM81275BX6A	£1,805.36	BJM81275PX5A	£1,783.53
840.1500.750	BJM81275BX6B	£2,035.31	BJM81275PX5B	£1,988.74
840.1800.750	BJM81275BX6C	£2,176.48	BJM81275PX5C	£2,070.24

Kit D



Size H.W.D.	Solid Beech	Price	Laminate	Price
840.1200.750	BJM81275BX8A	£2,000.38	BJM81275PX7A	£1,978.55
840.1500.750	BJM81275BX8B	£2,228.87	BJM81275PX7B	£2,183.75
840.1800.750	BJM81275BX8C	£2,371.50	BJM81275PX7C	£2,265.25

Kit E



Size H.W.D.	Solid Beech	Price	Laminate	Price
840.1200.750	BJM81275B10A	£2,207.04	BJM81275PX9A	£2,185.21
840.1500.750	BJM81275B10B	£2,448.63	BJM81275PX9B	£2,403.51
840.1800.750	BJM81275B10C	£2,604.35	BJM81275PX9C	£2,496.66

Kit F



Size H.W.D.	Solid Beech	Price	Laminate	Price
840.1200.750	BJM81275B12A	£2,402.06	BJM81275P11A	£2,380.23
840.1500.750	BJM81275B12B	£2,643.65	BJM81275P11B	£2,598.53
840.1800.750	BJM81275B12C	£2,797.92	BJM81275P11C	£2,691.67

Bench Key Guide:

ST - Square Tube Workbench - Pages 2 & 3

CL - Cantilever Workbench - Pages 8 & 9

PHA - Premium Manual & Electric Height-Adjustable Bench - Pages 12 - 17

SGP - Square Tube ESD Workbench - Pages 18 & 19

SCL - Cantilever ESD Workbench - Pages 20 & 21

SHA - Premium Height-Adjustable ESD Bench - Pages 24 & 25

HD - Heavy-Duty Workbench - Pages 26 & 27



Back Panel - Louvred/Pinboard		To suit benches							Code	Price
For 1200mm Bench		ST	CL	HD	PHA				BELO4812IXXX	£211.03
For 1500mm Bench		ST	CL	HD	PHA				BELO4815IXXX	£219.76
For 1800mm Bench		ST	CL	HD	PHA				BELO4818IXXX	£256.14

Back Panel - Louvred/Perforated/Pinboard		To suit benches							Code	Price
For 1200mm Bench		ST	CL	HD	PHA				BECP4812I3XX	£229.95
For 1500mm Bench		ST	CL	HD	PHA				BECP4815I3XX	£245.96
For 1800mm Bench		ST	CL	HD	PHA				BECP4818I3XX	£273.61

Back Panel - Louvred/Perforated		To suit benches							Code	Price
For 1200mm Bench		ST	CL	HD	PHA				BECP4812IXXX	£209.57
For 1500mm Bench		ST	CL	HD	PHA				BECP4815IXXX	£229.95
For 1800mm Bench		ST	CL	HD	PHA				BECP4818IXXX	£256.14

Back Panel - Pinboard		To suit benches							Code	Price
For 1200mm Bench		ST	CL	HD	PHA				BENP4812XXXX	£142.63
For 1500mm Bench		ST	CL	HD	PHA				BENP4815XXXX	£155.72
For 1800mm Bench		ST	CL	HD	PHA				BENP4818XXXX	£163.00

Back Panel - Anti-Static Louvred/Pinboard		To suit benches							Code	Price
For 1200mm Bench						SGP	SCL	SHA	BELO4812ZXXX	£219.76
For 1500mm Bench						SGP	SCL	SHA	BELO4815ZXXX	£243.04
For 1800mm Bench						SGP	SCL	SHA	BELO4818ZXXX	£270.70

Storage Bin Rails		To suit benches							Code	Price
For 1200mm Bench		ST	CL	HD	PHA	SGP	SCL	SHA	BESTBR12XXXX	£85.87
For 1500mm Bench		ST	CL	HD	PHA	SGP	SCL	SHA	BESTBR15XXXX	£103.33
For 1800mm Bench		ST	CL	HD	PHA	SGP	SCL	SHA	BESTBR18XXXX	£119.34

Storage Boxes - Anti-Static		To suit benches							Code	Price
100.90.55 - Single Compartment						SGP	SCL	SHA	BESB90551XXX	£10.19
100.90.55 - Double Compartment						SGP	SCL	SHA	BESB90552XXX	£10.19
100.160.75 - Single Compartment						SGP	SCL	SHA	BESB6075XXXX	£13.10
100.160.125 - Single Compartment						SGP	SCL	SHA	BESB6025XXXX	£21.83

Tool Clips		To suit benches							Code	Price
Clip Mix 6		ST	CL	HD	PHA	SGP	SCL	SHA	BETCLIPSXXXX	£38.84
Clip Mix 53		ST	CL	HD	PHA	SGP	SCL	SHA	RTCLIPMIX53X	£111.43
Clip Mix 84		ST	CL	HD	PHA	SGP	SCL	SHA	RTCLIPMIX84X	£175.84

Shelf Backstop - 50mm High		To suit benches							Code	Price
For 1200mm Bench		ST	CL	HD	PHA	SGP	SCL	SHA	BESB1200XLXX	£45.12
For 1500mm Bench		ST	CL	HD	PHA	SGP	SCL	SHA	BESB1500XLXX	£52.39
For 1800mm Bench		ST	CL	HD	PHA	SGP	SCL	SHA	BESB1800XLXX	£61.13

Workbenches

Bench Key Guide:

ST - Square Tube Workbench - Pages 2 & 3
 CL - Cantilever Workbench - Pages 8 & 9
 PHA - Premium Manual & Electric Height-Adjustable Bench - Pages 12-17

SGP - Square Tube ESD Workbench - Pages 18 & 19
 SCL - Cantilever ESD Workbench - Pages 20 & 21
 SHA - Premium Height-Adjustable ESD Bench - Pages 24 & 25
 HD - Heavy-Duty Workbench - Pages 26 & 27



Height-Adjustable Leg Inserts

To suit benches

Code

Price

Pack Of 4



ST

SGP

BEHADJLIXXXX

£85.87

Tool Hanging Track - To be used in conjunction with light and tool rail

To suit benches

Code

Price

1200mm Long With Sliding Hooks

ST

CL

HD

PHA

SGP

SCL

SHA

BETR1200XLXX

£145.54

1500mm Long With Sliding Hooks



ST

CL

HD

PHA

SGP

SCL

SHA

BETR1500XLXX

£167.37

1800mm Long With Sliding Hooks

ST

CL

HD

PHA

SGP

SCL

SHA

BETR1800XLXX

£189.20

Extra Roll Wheels For Tool Rails

ST

CL

PHA

SGP

SCL

SHA

BEEXR0WHXLXX

£24.74

Spring Tool Balance

To suit benches

Code

Price

Max Load 2kg



ST

CL

HD

PHA

SGP

SCL

SHA

BESPRBALXLXX

POA

RCD Circuit Breaker

To suit benches

Code

Price

Circuit Breaker



ST

CL

HD

PHA

SGP

SCL

SHA

BERCBCIBXXXX

£135.35

Anti-Static Floor Mat

To suit benches

Code

Price

1200 x 1500mm

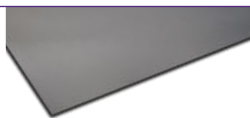

PHA

SGP

SCL

SHA

BEFLMA15XXXX

POA

1200 x 2000mm

PHA

SGP

SCL

SHA

BEFLMA20XXXX

POA

1200 x 3000mm

PHA

SGP

SCL

SHA

BEFLMA30XXXX

POA

Cupboards & Drawers - 560.420.420

To suit benches

Code

Price

Three Drawers



ST

CL

HD

PHA

SGP

SCL

SHA

BEDR04053

£537.03

Single Drawer & Cupboard

ST

CL

HD

PHA

SGP

SCL

SHA

BEDC04052

£372.57

Storage Cupboard

ST

CL

HD

PHA

SGP

SCL

SHA

BECU04051

£250.32

Cupboards & Drawers (Mobile) - 685.420.420

To suit benches

Code

Price

Three Drawers



ST

CL

HD

PHA

SGP

SCL

SHA

BEDR04053M*X

£605.43

Single Drawer & Cupboard

ST

CL

HD

PHA

SGP

SCL

SHA

BEDC04052M*X

£522.47

Storage Cupboard

ST

CL

HD

PHA

SGP

SCL

SHA

BECU04051M*X

£330.37

Tilting LED Light

To suit benches

Code

Price

30 Watt



ST

CL

HD

PHA

SGP

SCL

SHA

BELED3012XXX

£235.77

3-Setting LED Light

To suit benches

Code

Price

3 Setting LED



ST

CL

HD

PHA

SGP

SCL

SHA

BE3SETL1200X

£88.78

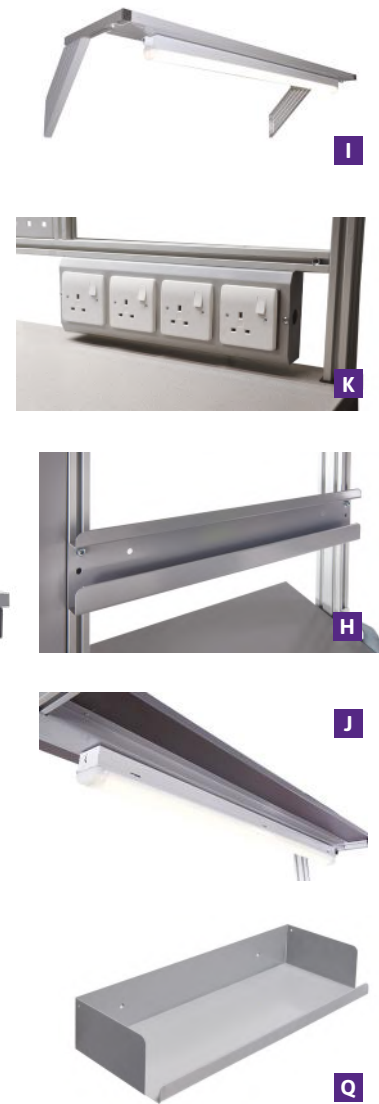

Electric Height-Adjustable Binary Workbench - Accessories

Key	Description	Code	Price
A	Aluminium Accessory Frame For 1200mm Bench	BIALBFME12XX	£275.06
A	Aluminium Accessory Frame For 1500mm Bench	BIALBFME15XX	£309.99
A	Aluminium Accessory Frame For 1800mm Bench	BIALBFME18XX	£358.02
B	Laminate Upper Shelf For 1200mm Bench	BIUS3012PLXX	£177.55
B	Laminate Upper Shelf For 1500mm Bench	BIUS3015PLXX	£211.03
B	Laminate Upper Shelf For 1800mm Bench	BIUS3018PLXX	£243.04
C	Peg Back Panel For 1200mm & 1800mm Bench	BIBPPEG18-12	£107.70
C	Peg Back Panel For 1500mm Bench	BIBPPEG15LXX	£103.33
D	Louvre Back Panels For 1200mm & 1800mm Bench	BIBPLOV18-12	£107.70
D	Louvre Back Panels For 1500mm Bench	BIBPLOV15LXX	£103.33
E	Magnetic Back Panels For 1200mm & 1800mm Bench	BIBPMAG18-12	£107.70
E	Magnetic Back Panels For 1500mm Bench	BIBPMAG15LXX	£103.33
F	Shelf Dividers (Pack of 5)	BIDIVPK5LXXX	£91.69
G	Modular Half Shelf For 1200mm Bench	BIMDS1200PLX	£129.53
G	Modular Half Shelf For 1500mm Bench	BIMDS1500PLX	£119.34
G	Modular Half Shelf For 1800mm Bench	BIMDS1800PLX	£129.53
H	Modular Bin Rail For 1200mm Bench	BIBINRL12LXX	£46.57
H	Modular Bin Rail For 1500mm Bench	BIBINRL15LXX	£53.85
H	Modular Bin Rail For 1800mm Bench	BIBINRL18LXX	£59.67
I	Above Bench Light Rail For 1200mm Bench	BILIGHTRL12LX	£161.54
I	Above Bench Light Rail For 1500mm Bench	BILIGHTRL15LX	£165.91
I	Above Bench Light Rail For 1800mm Bench	BILIGHTRL18LX	£170.28
J	Above Bench LED Light (30 Watt)	BILED30WXXX	£229.95
K	Frame Mounted Service Duct	BISERVDTLXX	£129.53
L	Side Panel Support Arm	BISUPARM530L	£125.16
M	Centre Panel Support Arm	BISUPARM305L	£113.52
N	Side Peg Board	BISPPEG4429L	£80.04
O	Side Louvre Panel	BISPLOV4429L	£80.04
P	Side Magnetic Panel	BISPMAG4429L	£77.13
Q	Container Storage Self	BICONSH51LXX	£113.52
R	Monitor Support Arm (Centre Fitter)	BIMONARM305L	£119.34
S	Monitor Support Arm (Side Fitted)	BIMONARM530L	£141.17
T	Adjustable Tilting Shelf For 1200mm & 1800mm Bench	BIADJSH18-12	£211.03
T	Adjustable Tilting Shelf For 1500mm Bench	BIADJSH15LXX	£205.21

The Electric Height-Adjustable Binary Workbench offers a premium solution to your workshop. Each bench comes fitted with a two-button adjustment switch which quickly and effortlessly adjusts the height of the bench. Also available is the premium adjustment module, which can store up to 3 heights in memory allowing for easy adjustment between users.

- Height can be adjusted between 660mm and 1300mm.
- Available in widths of 1200mm, 1500mm, & 1800mm.
- A range of accessories are available please see page 34.
- All above-bench accessories are fully modular & adjustable.
- Available with either a 30mm laminate top or a 27mm beech top.
- UDL of 240kg evenly distributed.



240KG UDL
EVENLY DISTRIBUTED

Workbenches

Laminate Worktop 30mm thick



Size H.W.D.	Code	Price
660-1300.1200.755	BIE661275PLX	£2,228.15
660-1300.1500.755	BIE661575PLX	£2,334.39
660-1300.1800.755	BIE661875PLX	£2,453.73

Solid Beech Worktop 27mm Thick



Size H.W.D.	Code	Price
660-1300.1200.755	BIE661275BLX	£2,314.02
660-1300.1500.755	BIE661575BLX	£2,410.07
660-1300.1800.755	BIE661875BLX	£2,495.94



Premium Height-Adjustable Module



Upgrade your Binary workbench with the 'Premium Height-Adjustable Module' which can store up to 3 heights in memory.

Description	Code	Price
3 position memory function with height displayed on digital screen	BIHADJ3MODXX	£78.59



£707 FROM **.30**

The Manual Height-Adjustable Binary Workbench offers the versatility of a height-adjustable bench without the premium cost. Each workbench can be adjusted with an Allen key and can be set at a variety of heights between 730mm and 960mm.

- Simple height adjustment with the provided Allen key.
- Available with a range of accessories, please see page 34.
- Available with either a 30mm Laminate or a 27mm Beech top.
- Various widths available including 1200mm, 1500mm & 1800mm.
- Height can be adjusted between 730mm and 960mm.
- Workbench leg frames constructed from oval-shaped tube.
- UDL of 240kg, evenly distributed.
- All above-bench accessories are fully modular and adjustable.

Workbenches



Laminate Worktop 30mm thick



Size H.W.D.	Code	Price
730-960.1200.755	BIM731275PLX	£707.30
730-960.1500.755	BIM731575PLX	£765.52
730-960.1800.755	BIM731875PLX	£986.73

Solid Beech Worktop 27mm Thick



Size H.W.D.	Code	Price
730-960.1200.755	BIM731275BLX	£758.24
730-960.1500.755	BIM731575BLX	£873.21
730-960.1800.755	BIM731875BLX	£1,056.59



£638.90 FROM

240KG
UDL
EVENLY DISTRIBUTED

Workbenches

The Fixed-Height Binary Workbench is a hard-wearing, contemporary workbench that is perfect for a variety of workplace environments. Each workbench can be supplied with either a Solid Beech or Laminate Worktop. The framework is powder coated black to provide a sleek finish and a wide variety of accessories are available to customise your workbench.

- Available in widths of 1200mm, 1500mm & 1800mm.
- Range of accessories available including aluminium back frames, back panels, light fittings and service ducts. Please see page 34.

- All above-bench accessories are fully modular & adjustable.
- Available with either a 30mm Laminate top or a 27mm Beech top.
- Workbench leg frames constructed from oval-shaped tube.
- Fixed-height benches are available in heights of 750mm, 840mm & 920mm.
- UDL of 240kg evenly distributed.

Laminate Worktop 30mm thick



Size H.W.D.	Code	Price
750.1200.755	BIF751275PLX	£638.90
840.1200.755	BIF841275PLX	£638.90
920.1200.755	BIF921275PLX	£638.90
750.1500.755	BIF751575PLX	£697.12
840.1500.755	BIF841575PLX	£697.12
920.1500.755	BIF921575PLX	£697.12
750.1800.755	BIF751875PLX	£790.26
840.1800.755	BIF841875PLX	£790.26
920.1800.755	BIF921875PLX	£790.26

Solid Beech Worktop 27mm Thick



Size H.W.D.	Code	Price
750.1200.755	BIF751275BLX	£688.38
840.1200.755	BIF841275BLX	£688.38
920.1200.755	BIF921275BLX	£688.38
750.1500.755	BIF751575BLX	£778.62
840.1500.755	BIF841575BLX	£778.62
920.1500.755	BIF921575BLX	£778.62
750.1800.755	BIF751875BLX	£889.22
840.1800.755	BIF841875BLX	£889.22
920.1800.755	BIF921875BLX	£889.22



£557 FROM **.40**



Open bench shown with mailroom post box lockers with sloping tops

Mailroom Workbenches provide stylish and high-quality mail sorting solutions suitable for offices and post rooms. A variety of accessories are available to complement this range of mailroom furniture, including a Single Drawer unit, a Drawer & Cupboard unit, and a Storage Cupboard. Additionally, we offer Mailroom Post Box Lockers which can be equipped with optional sloping tops to prevent items from being placed on top of the lockers.

- Adjustable feet for easy levelling.
- MFC 18mm worktop supplied as standard. Round edge worktop for safety with a durable scratch-resistant wipe clean surface.
- Back and side panels and lower shelves are also available.
- Standard bench height: 840mm. 760mm and 920mm heights also available.
- Delivered in knock-down form for easy on-site assembly.
- Mobile bench height: 965mm.

Mobile Mailroom Bench



MR841575PLMX



MR841875PLMX

Size H.W.D.	Code	Price
965.1230.750	MR841275PLMX	£700.03
965.1230.900	MR841290PLMX	£714.58
965.1530.750	MR841575PLMX	£727.68

Size H.W.D.	Code	Price
965.1530.900	MR841590PLMX	£748.05
965.1830.750	MR841875PLMX	£777.16
965.1830.900	MR841890PLMX	£803.36

Open Bench



Size H.W.D.	Code	Price
840.1230.750	MR841275PLXX	£557.40
840.1230.900	MR841290PLXX	£571.96
840.1530.750	MR841575PLXX	£583.60

Size H.W.D.	Code	Price
840.1530.900	MR841590PLXX	£605.43
840.1830.750	MR841875PLXX	£633.08
840.1830.900	MR841890PLXX	£659.28

Open Bench With Steel Lower Shelf



Available with castors, please speak to sales for details

Available with castors, please speak to sales for details

Size H.W.D.	Code	Price
840.1230.750	MR841275SLXX	£666.55
840.1230.900	MR841290SLXX	£695.66
840.1530.750	MR841575SLXX	£727.68

Size H.W.D.	Code	Price
840.1530.900	MR841590SLXX	£755.33
840.1830.750	MR841875SLXX	£804.81
840.1830.900	MR841890SLXX	£829.55



Sloping Tops to be ordered separately from Post Box Lockers

Description	Dimension H.W.D	Code	Price
Sloping Top for post box locker	150.300.385	LZSLT3038LXX	£13.10
Post Box Locker 5 comp grey with light grey doors	External 900.300.385 Internal 160.290.350	LXMR90305LXX	£248.87
Post Box Locker 5 comp grey without doors	External 900.300.385 Internal 160.290.350	LXMR90300LXX	£197.93



Description	Code	Price
Single Drawer 220 x 420 x 420	BEDMR4021LXX	£256.14
Drawer & Cupboard 655 x 420 x 420	BEDMR4052LXX	£521.02
Storage Cupboard 435 x 420 x 420	BECMR4041LXX	£229.95



£825 FROM **.19**

250KG UDL
EVENLY DISTRIBUTED

Workbenches

Pack Tek Dual Workbenches are designed for a variety of applications in the packaging industry. They are available in two widths: 1800mm and 2100mm. A wide range of accessories is also available, allowing you to customise the workbench to meet your specific needs.

- Pack Tek Dual Workbenches are specifically designed for the packaging industry, ideal for use in assembly areas, manufacturing facilities and production lines.
- All benches are supplied with laminate worktops.

- Height-adjustable legs to allow the user to either sit or stand at the workbench.
- Delivered in knock-down form for easy on-site assembly.
- The bench frame is coated with a light grey powder paint that features Germ Guard Active Technology.
- Each Pack Tek Workbench has a weight capacity of 250kg, evenly distributed.
- Clip kits available on page 32.
- Plastic Open Fronted Containers are also available, please see page 54.



Pack Tek Computer Accessories

Pack Tek Dual Workbenches - Dimensions/Codes			
Size H.W.D.	Worktop	Code	Price
840-1100.1800.750	Laminate	BPD841875PLX	£825.19
840-1100.2100.750	Laminate	BPD842175PLX	£928.52

Description	Code	Price
CPU Holder	BECPUHOUBBXX	£77.13
Keyboard Shelf	BEKEYBDSHBXX	£117.88
Monitor Arm	BEMONARMFSAX	£250.32
Monitor & Keyboard Support Arm	BEMONARMFMSG	£256.14



Pack Tek Dual Kit 1

Pack Tek Dual Kit 1 comes complete with the following accessories:

- Back Panel Frame
- Laminate Upper Shelf x 2
- Perforated Back Panel
- Louvre Back Panel
- Magnetic Back Panel
- Adjustable Side Shelf
- Upper Shelf Dividers (Pack of 5)
- Under Bench Table
- Cones For Roll Holder (Pack of 2)
- Side Mounted Roll Holder
- Cutting Knife

Pack Tek Dual Kit 1 - Dimensions/Codes

Size H.W.D.	Code	Price
840-1100.1800.750 (Includes Cutting Knife - Will Over Hang By 30mm)	BPD841875PL1	£3,846.51
840-1100.2100.750	BPD842175PL1	£4,307.86



Pack Tek Dual Kit 2

Pack Tek Dual Kit 2 comes complete with the following accessories:

- Back Panel Frame
- Laminate Upper Shelf x 2
- Upper Shelf Dividers (Pack of 5)
- Perforated Back Panel
- Louvre Back Panel
- Magnetic Back Panel
- Adjustable Side Shelf
- Under Bench Table
- Half Depth Lower Shelf x 2
- Short Half Depth Lower Shelf Dividers (Pack of 5)
- Side Mounted Roll Holder

Pack Tek Dual Kit 2 - Dimensions/Codes

Size H.W.D.	Code	Price
840-1100.1800.750	BPD841875PL2	£3,179.96
840-1100.2100.750	BPD842175PL2	£3,537.97



Pack Tek Dual Kit 3

Pack Tek Dual Kit 3 comes complete with the following accessories:

- Rear Support Posts
- Light/Tool Rail Support
- LED Light - 30 Watt
- Laminate Upper Shelf
- Upper Shelf Dividers (Pack of 5)
- Above Bench Roll Holder
- Cones For Roll Holder (Pack of 2) x2
- Cutting Knife
- Adjustable Side Shelf
- Under Bench Roll Holder
- Under Bench Table
- Side Mounted Roll Holder

Pack Tek Dual Kit 3 - Dimensions/Codes

Size H.W.D.	Code	Price
840-1100.1800.750 (Includes Cutting Knife - BPD841875PL3 Will Over Hang By 30mm)	BPD841875PL3	£3,556.89
840-1100.2100.750	BPD842175PL3	£3,901.81

Fitted with cutting knife



Pack Tek Dual Kit 4

Pack Tek Dual Kit 4 comes complete with the following accessories:

- Rear Support Posts
- Light/Tool Rail Support
- Led Light - 30 Watt
- Laminate Upper Shelf
- Upper Shelf Dividers (Pack of 5)
- Louvred /Perforated Back Panel
- Full Depth Lower Shelf x 2
- Short Full Depth Lower Dividers (Pack of 5)
- Adjustable Side Shelf
- Mini Under Bench Roll Holder
- Side Mounted Roll Holder
- Clip Kits available on page 32.
- Plastic Open Fronted Containers are also available, see page 54.

Pack Tek Dual Kit 4 - Dimensions/Codes

Size H.W.D.	Code	Price
840-1100.1800.750	BPD841875PL4	£2,929.63
840-1100.2100.750	BPD842175PL4	£3,105.73

Split Panel Accessories

Back Panel Frame			Code	Price
To suit 1800mm Bench			BPKBACKF18LX	£228.49
To suit 2100mm Bench			BPKBACKF21LX	£241.59
Laminate Upper Shelf			Code	Price
To suit 1800mm Bench			BPUS900LXXXX	£184.83
To suit 2100mm Bench			BPUS1050LXXX	£215.39
Perforated Panel			Code	Price
To suit 1800mm Bench			BPPERF900LXX	£208.12
To suit 2100mm Bench			BPPERF1050LX	£243.04
Louvre Panel			Code	Price
To suit 1800mm Bench			BPLOV900LXXX	£208.12
To suit 2100mm Bench			BPLOV1050LXX	£243.04
Magnetic Panel			Code	Price
To suit 1800mm Bench			BPMAG900LXXX	£195.02
To suit 2100mm Bench			BPMAG1050LXX	£229.95

Full Panel Accessories

Rear Support Posts			Code	Price
760mm			BESP760SXXXX	£109.15
1180mm			BESP1180SXXXX	£132.44
Light/Tool Rail Support			Code	Price
To suit 1800mm Bench			BERS1800XLXX	£126.62
To suit 2100mm Bench			BERS2100XLXX	£148.45
Laminate Upper Shelf			Code	Price
To suit 1800mm Bench			BEUS1800PXXX	£216.85
To suit 2100mm Bench			BPUS2100LXXX	£247.41
Above Bench Roll Holder			Code	Price
To suit 1800mm Bench			BGPAR18AXXXX	£77.13
To suit 2100mm Bench			BGPAR21AXXXX	£88.78
Louvred/Perforated Back Panel			Code	Price
To suit 1800mm Bench			BPLVPF1800LX	£273.61
To suit 2100mm Bench			BPLVPF2100LX	£291.07
Tilting LED Light			Code	Price
30 Watt			BELED3012XXX	£235.77
3-Setting LED Light			Code	Price
3 Setting LED			BE3SETL1200X	£88.78

Workbenches

Universal Pack Tek Accessories

Upper Shelf Dividers		Code	Price
Pack of 5		BGSHDVHOXXXX	£61.13
Cutting Knife		Code	Price
1530mm Length		BPKCUTK15XXX	£954.71
1830mm Length		BPKCUTK18XXX	£1,092.97
Adjustable Side Shelf		Code	Price
W.500 D.750		BPADJSSHELFL	£213.94
Under Bench Table		Code	Price
To suit 1800mm Bench		BPUBT677245B	£309.99
To suit 2100mm Bench		BPUBT677270B	£337.64
Under Bench Roll Holder		Code	Price
To suit 1800mm Bench		BGPARG18BXXXX	£69.86
To suit 2100mm Bench		BGPARG21BXXXX	£81.50
Cones For Roll Holder		Code	Price
Pack Of 2		BGSPARECONES	£128.07
Side Mounted Roll Holder		Code	Price
W.710 D.300		BPSMONRHOLXX	£87.32
Half Depth Lower Shelf		Code	Price
To suit 1200 x 450 x 20mm Bench		BPHDLS1200PL	£197.94
To suit 1260 x 450 x 20mm Bench		BPHDLS1260PL	£224.11
Short Half Depth Lower Shelf Dividers		Code	Price
Pack of 5		BPSHLSDIVP5L	£82.96
Full Depth Lower Shelf		Code	Price
To suit 1200 x 640 x 20mm Bench		BPFDLS1200PL	£235.76
To suit 1260 x 640 x 20mm Bench		BPFDLS1260PL	£264.87
Tall Full Depth Lower Shelf Dividers		Code	Price
Pack of 5		BPTLLSDIVP5L	£125.16
Mini Under Bench Roll Holder		Code	Price
To suit 1800mm Bench		BPMINRHUB18L	£53.85
To suit 2100mm Bench		BPMINRHUB21L	£59.67
Short Full Depth Lower Shelf Dividers		Code	Price
Pack of 5		BPSDLSDIVP5L	£113.52



£582.14 FROM

250KG UDL
EVENLY DISTRIBUTED

Workbenches

Pack Tek Individual Workbenches are designed to cover a multitude of uses within the packaging industry. Available in either 1200mm, 1500mm or 1800mm widths with a vast range of accessories available to allow you to customise the bench to meet your requirements.

- Pack Tek Individual Workbenches are specifically designed for the packaging industry and are ideal for use in assembly areas, manufacturing facilities and production lines.

- All benches supplied with laminate worktops.
- Height-adjustable legs to allow the user to either sit or stand at the workbench.
- Delivered in knock-down form for easy on-site assembly.
- The bench frame is coated with a light grey powder paint that features Germ Guard Active Technology.
- Clip kits available on page 32.
- Plastic Open Fronted Containers are also available, see page 54.



Pack Tek Individual Workbenches - Dimensions/Codes

Size H.W.D.	Worktop	Code	Price
840-1100.1200.750	Laminate	BPI841275PLX	£582.14
840-1100.1500.750	Laminate	BPI841575PLX	£730.59
840-1100.1800.750	Laminate	BPI841875PLX	£810.63

Pack Tek Computer Accessories

Description	Code	Price
CPU Holder	BECPUHOUBBXX	£77.13
Keyboard Shelf	BEKEYBDSHBXX	£117.88
Monitor Arm	BEMONARMFSA	£250.32
Monitor & Keyboard Support Arm	BEMONARFMFG	£256.14



Pack Tek Individual Kit 1

Pack Tek Individual Kit 1 comes complete with the following accessories:

- Back Panel Frame
- Laminate Upper Shelf x 2
- Upper Shelf Dividers (Pack of 5)
- Perforated Back Panel
- Louvre Back Panel
- Magnetic Back Panel
- Cutting Knife
- Under Bench Roll Holder
- Cones for Roll Holder (Pack of 2)
- Clip Kits available on page 32
- Plastic Open Fronted Containers available on page 54

Pack Tek Individual Kit 1 - Dimensions/Codes

Size H.W.D.	Code	Price
840-1100.1200.750 (Does not include cutting knife)	BPI841275PL1	£1,765.35
840.1100.1500.750 (includes cutting knife-will over hang by 30mm)	BPI841575PL1	£2,958.74
840.1100.1800.750 (includes cutting knife-will over hang by 30mm)	BPI841875PL1	£3,348.78



Pack Tek Individual Kit 2

Pack Tek Individual Kit 2 comes complete with the following accessories:

- Back Panel Frame
- Laminate Upper Shelf x 2
- Upper Shelf Dividers (Pack of 5)
- Perforated Back Panel
- Louvre Back Panel
- Magnetic Back Panel
- Full Depth Lower Shelf x 2
- Short Full Depth Lower Self Dividers (Pack of 5) x2

Pack Tek Individual Kit 2 - Dimensions/Codes

Size H.W.D.	Code	Price
840-1100.1200.750	BPI841275PL2	£2,217.96
840-1100.1500.750	BPI841575PL2	£2,485.75
840-1100.1800.750	BPI841875PL2	£2,766.63



Pack Tek Individual Kit 3

Pack Tek Individual Kit 3 comes complete with the following accessories:

- Rear Support Posts
- Laminate Upper Shelf
- Upper Shelf Dividers (Pack of 5)
- Above Bench Roll Holder
- Cones For Roll Holder (Pack of 2)
- Cutting Knife
- Full Depth Lower Shelf
- Short Full Depth Lower Shelf Dividers (Pack of 5)

Pack Tek Individual Kit 3 - Dimensions/Codes

Size H.W.D.	Code	Price
840-1100.1200.750 (Does Not Include Cutting Knife)	BPI841275PL3	£1,427.71
840-1100.1500.750 (Includes Cutting Knife - Will Over Hang By 30mm)	BPI841575PL3	£2,587.63
840-1100.1800.750 (Includes Cutting Knife - Will Over Hang By 30mm)	BPI841875PL3	£2,872.88



Pack Tek Individual Kit 4

Pack Tek Individual Kit 4 comes complete with the following accessories:

- Rear Support Posts
- Light/Tool Rail Support
- LED Light - 30 Watt
- Laminate Upper Shelf
- Upper Shelf Dividers (Pack of 5)
- Half Depth Lower Shelf x 2
- Short Half Depth Lower Shelf Dividers (Pack of 5) x 2
- Louvre Back Panel with Pin Board
- Clip Kits available on page 32
- Plastic Open Fronted Containers available on page 54

Pack Tek Individual Kit 4 - Dimensions/Codes

Size H.W.D.	Code	Price
840-1100.1200.750	BPI841275PL4	£1,990.93
840-1100.1500.750	BPI841575PL4	£2,216.51
840-1100.1800.750	BPI841875PL4	£2,375.14

Protect the surface of your workbench and tools from damage with a highly-durable, self-healing cutting mat. Each cutting mat is designed to provide a long-lasting surface suitable for any workshop or industrial environment.

Choose from this wide selection of materials and sizes.

Medium-Duty 3mm

A perfect solution for small or medium application environments.

- 3.0mm thick semi-opaque white medium-duty cutting mat.
- Solvent proof and lightly textured anti-glare surface.

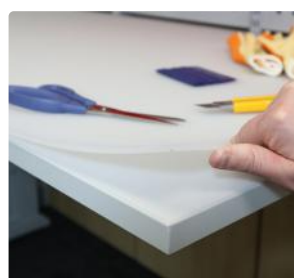

Heavy-Duty 4.5mm

A great solution for larger applications and fabricating environments.

- 4.5mm thick semi-opaque white heavy-duty cutting mat.
- Solvent proof and lightly textured anti-glare surface.

Supaseal Clear 5mm

Long-term durability and excellent self-healing properties. Suitable for medium to heavy-duty applications.

- 5mm thick and double-sided, completely clear with a slight blue tint.
- Features hygienic 'easy clean' and waterproof properties.



Supaseal Grey 5mm

Long-term durability and excellent self-healing properties. Offers the same properties as Supaseal Clear with a solid grey colour.

- 5mm thick and double-sided.
- Ideal mat to provide a smart clean bench finish to hide a worn bench surface.

Ultraseal Grey 6mm

Designed and manufactured for hi-tech industries where there is extreme and constant cutting.

- 6mm thick grey smooth finish.
- Exceptional self-healing and wear properties.



Green 3mm

The perfect cutting mat for craft, textiles, and quilting applications.





- 3mm premium 5-layer self-healing cutting mat.
- Double-sided and comes complete with printed grid on both sides.

Size	MEDIUM-DUTY 3mm	Price	HEAVY-DUTY 4.5mm	Price	SUPASEAL CLEAR 5mm	Price	SUPASEAL GREY 5mm	Price	ULTRASEAL GREY 6mm	Price
1200x600mm	TM4545M	£73.28	TM4545	£93.88	TM4545S	£87.99	TM4545G	£139.88	TM4545U	£591.38
1200x750mm	TM4544M	£89.54	TM4544	£109.37	TM4544S	£102.00	TM4544G	£166.87	TM4544U	£731.24
1200x900mm	TM4543M	£114.63	TM4543	£124.84	TM4543S	£125.33	TM4543G	£211.84	TM4543U	£871.10
1500x600mm	TM4540M	£90.30	TM4540	£109.37	TM4540S	£110.88	TM4540G	£145.73	TM4540U	£731.24
1500x750mm	TM4569M	£104.91	TM4569	£130.41	TM4569S	£130.59	TM4569G	£174.17	TM4569U	£906.08
1500x900mm	TM4539M	£129.23	TM4539	£148.07	TM4539S	£163.49	TM4539G	£221.58	TM4539U	£1,080.89
1800x600mm	TM4538M	N/A	TM4538	£124.84	TM4538S	£148.20	TM4538G	£178.14	TM4538U	£871.10
1800x750mm	TM4537M	N/A	TM4537	£148.07	TM4537S	£177.28	TM4537G	£214.70	TM4537U	£1,080.89
1800x900mm	TM4536M	N/A	TM4536	£171.31	TM4536S	£225.70	TM4536G	£275.60	TM4536U	£1,290.68

Size	GREEN 3mm	Price
A4 with grid	TM4503	£42.65
A3 with grid	TM4504	£53.11
A2 with grid	TM4505	£73.04
A1 with grid	TM4506	£90.92
A0 with grid	TM4507	£152.29
1800x900mm with grid	TM4509	£262.28

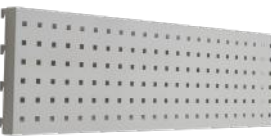

Split Panel Accessories

Back Panel Frame		Code	Price
To suit 1200mm Bench		BPKBACKF12LX	£221.21
To suit 1500mm Bench		BPKBACKF15LX	£224.13
To suit 1800mm Bench		BPKBACKF18LX	£228.49
Laminate Upper Shelf		Code	Price
To suit 1200mm Bench		BPUS600LXXXX	£129.53
To suit 1500mm Bench		BPUS750LXXXX	£154.27
To suit 1800mm Bench		BPUS900LXXXX	£184.83
Perforated Panel		Code	Price
To suit 1200mm Bench		BPPERF600LXX	£163.00
To suit 1500mm Bench		BPPERF750LXX	£173.19
To suit 1800mm Bench		BPPERF900LXX	£208.12
Louvre Panel		Code	Price
To suit 1200mm Bench		BPLOV600LXXX	£163.00
To suit 1500mm Bench		BPLOV750LXXX	£173.19
To suit 1800mm Bench		BPLOV900LXXX	£208.12
Magnetic Panel		Code	Price
To suit 1200mm Bench		BPMAG600LXXX	£151.36
To suit 1500mm Bench		BPMAG750LXXX	£161.54
To suit 1800mm Bench		BPMAG900LXXX	£195.02

Full Panel Accessories

Rear Support Posts		Code	Price
760mm		BESP760SXXXX	£109.15
1180mm		BESP1180XXXX	£132.44
Laminate Upper Shelf		Code	Price
To suit 1200mm Bench		BEUS1200PXXX	£152.81
To suit 1500mm Bench		BEUS1500PXXX	£181.92
To suit 1800mm Bench		BEUS1800PXXX	£216.85
Above Bench Roll Holder		Code	Price
To suit 1200mm Bench		BGPAR12AXXXX	£52.39
To suit 1500mm Bench		BGPAR15AXXXX	£62.58
To suit 1800mm Bench		BGPAR18AXXXX	£77.13
Louvred/Pinboard Back Panel		Code	Price
To suit 1200mm Bench		BELO4812IXXX	£211.03
To suit 1500mm Bench		BELO4815IXXX	£219.76
To suit 1800mm Bench		BELO4818IXXX	£256.14

Workbenches

Universal Pack Tek Accessories

Upper Shelf Dividers		Code	Price
Pack of 5		BGSHDVHOXXXX	£61.13
Cutting Knife		Code	Price
1530mm Length		BPKCUTK15XXX	£954.71
1830mm Length		BPKCUTK18XXX	£1,092.97
Under Bench Roll Holder		Code	Price
To suit 1200mm Bench		BGPAR12BXXXX	£45.12
To suit 1500mm Bench		BGPAR15BXXXX	£50.94
To suit 1800mm Bench		BGPAR18BXXXX	£69.86
Cones For Roll Holder		Code	Price
Pack Of 2		BGSPARECONES	£128.07
Full Depth Lower Shelf		Code	Price
To suit 1200mm Bench		BPLS1200PLXX	£199.38
To suit 1500mm Bench		BPLS1500PLXX	£216.85
To suit 1800mm Bench		BPLS1800PLXX	£235.77
Short Full Depth Lower Shelf Dividers		Code	Price
Pack of 5		BPSDLSDIVP5L	£113.52
Tall Full Depth Lower Shelf Dividers		Code	Price
Pack of 5		BPTLLSDIVP5L	£125.16
Tilting LED Light		Code	Price
30 Watt		BELED3012XXX	£235.77
Half Depth Lower Shelf		Code	Price
To suit 1200mm Bench		BPHDLS4512PL	£170.28
To suit 1500mm Bench		BPHDLS4515PL	£186.29
To suit 1800mm Bench		BPHDLS4518PL	£200.84
Short Half Depth Lower Shelf Dividers		Code	Price
Pack of 5		BPSHLSDIVP5L	£82.96
3-Setting LED Light		Code	Price
3 Setting LED		BE3SETL1200X	£88.78



£960 FROM **.46**

1200KG UDL
EVENLY DISTRIBUTED

Our fully welded heavy-duty workbench now features under-bench storage, ideal for industrial, engineering, or manufacturing facilities. The spacious two-level storage compartment is equipped with a sturdy sliding door that is lockable for enhanced safety and security.

- Fitted with heavy-duty sliding door and featuring two internal storage compartments.
- 840mm bench height.
- Available in three depths - 600mm, 750mm and 900mm.

- Fitted with standard mastered cam lock, with 2,000 differs.
- Powder-coated dark grey framework.
- Fully welded construction for extra strength and durability with a weight load of 1200kg.
- Linoleum, Solid Beech, Laminate and Steel Plate worktop options available.
- Full range of above bench accessories available including shelves, service ducts, support posts and light/tool rails. See page 32 for our full range.

Steel Plate Worktop 2mm thick

Size H.W.D.	Code	Price
840.1200.600	BJSD841260SKX	£960.46
840.1200.750	BJSD841275SKX	£1,037.15
840.1200.900	BJSD841290SKX	£1,051.70
840.1500.600	BJSD841560SKX	£1,127.82
840.1500.750	BJSD841575SKX	£1,236.97
840.1500.900	BJSD841590SKX	£1,251.52
840.1800.600	BJSD841875SKX	£1,181.60
840.1800.750	BJSD841860SKX	£1,290.74
840.1800.900	BJSD841890SKX	£1,318.40

Linoleum Worktop 20mm thick

Size H.W.D.	Code	Price
840.1200.600	BJSD8412608KX	£1,059.42
840.1200.750	BJSD8412758KX	£1,099.73
840.1200.900	BJSD8412908KX	£1,171.04
840.1500.600	BJSD8415608KX	£1,273.35
840.1500.750	BJSD8415758KX	£1,328.66
840.1500.900	BJSD8415908KX	£1,439.26
840.1800.600	BJSD8418758KX	£1,343.14
840.1800.750	BJSD8418608KX	£1,366.43
840.1800.900	BJSD8418908KX	£1,491.59

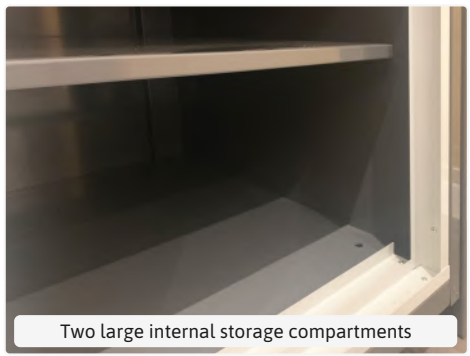

Laminate Worktop 20mm thick

Size H.W.D.	Code	Price
840.1200.600	BJSD841260PKX	£1,059.42
840.1200.750	BJSD841275PKX	£1,099.73
840.1200.900	BJSD841290PKX	£1,171.04
840.1500.600	BJSD841560PKX	£1,273.35
840.1500.750	BJSD841575PKX	£1,328.66
840.1500.900	BJSD841590PKX	£1,439.26
840.1800.600	BJSD841875PKX	£1,343.14
840.1800.750	BJSD841860PKX	£1,366.43
840.1800.900	BJSD841890PKX	£1,491.59

Solid Beech Worktop 27mm thick

Size H.W.D.	Code	Price
840.1200.600	BJSD841260BKX	£1,063.79
840.1200.750	BJSD841275BKX	£1,121.56
840.1200.900	BJSD841290BKX	£1,184.14
840.1500.600	BJSD841560BKX	£1,328.66
840.1500.750	BJSD841575BKX	£1,373.77
840.1500.900	BJSD841590BKX	£1,453.82
840.1800.600	BJSD841875BKX	£1,385.35
840.1800.750	BJSD841860BKX	£1,472.67
840.1800.900	BJSD841890BKX	£1,573.09

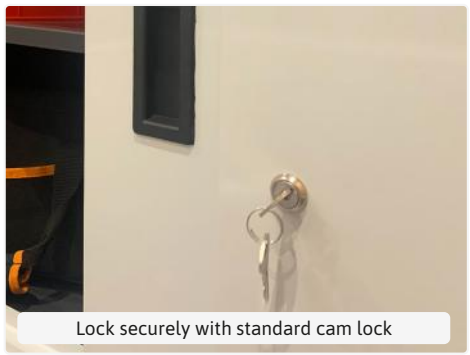

250KG UDL
EVENLY DISTRIBUTED



£979.46 FROM



- Stainless Steel Workbenches are ideal for food preparation, hospitals and any other environment where hygiene is essential.
- Easy-to-clean removable worktops and shelves.
- A range of accessories is available including drawers, cupboards and upper and lower shelves.
- Adjustable levelling feet for uneven surfaces.
- Made from 1.5mm thick steel.

Stainless Steel Workbenches



Stainless Steel Work Table Only

Size H.W.D.	Code	Price
840.1200.600	BT841260XSXX	£979.46
840.1200.750	BT841275XSXX	£1,055.13
840.1200.900	BT841290XSXX	£1,132.27
840.1500.600	BT841560XSXX	£1,123.54
840.1500.750	BT841575XSXX	£1,229.78
840.1500.900	BT841590XSXX	£1,255.97
840.1800.600	BT841860XSXX	£1,255.97
840.1800.750	BT841875XSXX	£1,331.65
840.1800.900	BT841890XSXX	£1,426.25

Stainless Steel Work Table & Lower Shelf

Size H.W.D.	Code	Price
840.1200.600	BT841260JSXX	£1,257.43
840.1200.750	BT841275JSXX	£1,346.21
840.1200.900	BT841290JSXX	£1,424.79
840.1500.600	BT841560JSXX	£1,439.35
840.1500.750	BT841575JSXX	£1,563.05
840.1500.900	BT841590JSXX	£1,589.25
840.1800.600	BT841860JSXX	£1,586.34
840.1800.750	BT841875JSXX	£1,689.67
840.1800.900	BT841890JSXX	£1,781.36

Stainless Steel Drawer

Size H.W.D.	Code	Price
150.420.420	BRDRAWERXXXX	£544.30

Stainless Steel Cupboard

Size H.W.D.	Code	Price
435.420.420	BRUCUPBRDXXXX	£554.49

Single Tier Upper Shelf - 300mm High

Size H.W.D.	Code	Price
300.1200.300	BRUS123SXXXX	£317.27
300.1500.300	BRUS153SXXXX	£369.66
300.1800.300	BRUS183SXXXX	£407.50

Double Tier Upper Shelf - 600mm High

Size H.W.D.	Code	Price
600.1200.300	BRUS126DXXXX	£481.72
600.1500.300	BRUS156DXXXX	£523.93
600.1800.300	BRUS186DXXXX	£589.42



£606 FROM .88

- Height-adjustable workbench suitable for general use in assembly, light engineering and laboratories.
- Adjustable in height from 730mm to 950mm.
- Powder-coated dark grey framework.
- No more banged knuckles - desk can even be adjusted when positioned flush against a wall.
- Removable adjustment handle.
- Does not accept bench accessories.

Laminate Worktop 20mm thick

Size W.D.	Code	Price
600.600	DA796060PLXX	£606.88
1200.600	DA791260PLXX	£701.48
1200.750	DA791275PLXX	£732.04
1800.600	DA791860PLXX	£804.81
1800.750	DA791875PLXX	£823.73

100KG UDL
EVENLY DISTRIBUTED

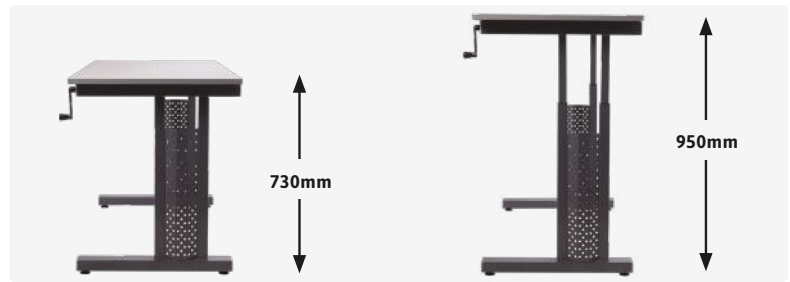

Plastic Open Fronted Containers

- Industry standard storage and louvre panels.
- Stackable with safe access to contents.
- Strong - crate grade polypropylene - virtually indestructible.
- Non-Toxic - suitable for foodstuffs.
- Recyclable - environmentally friendly.
- Self stack or use on louvre panels or shelves.
- Ideal for use with our range of Workbenches (Page 1) and Container Storage Cupboards (Page 115).

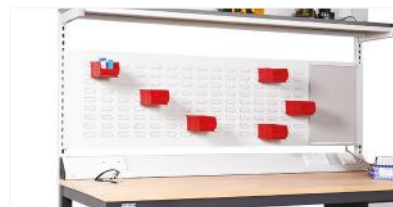

£68 FROM .40

Plastic Open Fronted Containers - Dimensions/Codes

Size No.	L x W x H	Qty	Blue Code	Price	Red Code	Price	Green Code	Price	Yellow Code	Price
2	165 x 100 x 75	20	LVRC161075BE	£68.40	LVRC161075RD	£68.40	LVRC161075GN	£68.40	LVRC161075YW	£68.40
3	240 x 150 x 132	20	LVRC241513BE	£72.77	LVRC241513RD	£72.77	LVRC241513GN	£72.77	LVRC241513YW	£72.77
4	350 x 205 x 132	10	LVRC352013BE	£129.53	LVRC352013RD	£129.53	LVRC352013GN	£129.53	LVRC352013YW	£129.53
5	350 x 205 x 182	10	LVRC352018BE	£181.92	LVRC352018RD	£181.92	LVRC352018GN	£181.92	LVRC352018YW	£181.92
6	375 x 420 x 182	5	LVRC374218BE	£174.64	LVRC374218RD	£174.64	N/A	-	N/A	-
7	520 x 310 x 200	5	LVRC523120BE	£208.12	LVRC523120RD	£208.12	N/A	-	N/A	-

Euroslide

- 56** Euroslide Cabinets
- 70** Steel Drawer Divider Kits
- 72** Plastic Drawer Divider Kits
- 73** Euroslide Cupboard Accessories
- 74** Euroslide Mobile Cabinets
- 76** Euroslide Under Bench Cabinets
- 78** Euroslide Modular Kits
- 83** Euroslide 2m High Cupboards
- 83** Euroslide Multi-Storage Cupboards
- 84** Euroslide System Tek Kits
- 86** Euroslide System Tek
- 88** Euroslide Workbenches
- 90** Euroslide Superbenches
- 92** Euroslide System Flow Trolleys





EUROSLIDE

£194.75 FROM

100KG
DRAWER CAPACITY

Euroslide Cabinets offer a versatile method of storage for industrial and workshop environments. The cabinets are specially designed with high-load bearing drawers, making them ideal for storing heavy tools and equipment safely and securely.

- All-steel construction.
- Beech, Laminate, Linoleum and Tool Tray worktop options are available.
- Cabinets are available in widths of 600mm & 900mm, and

heights of 825mm & 1200mm

- Full-width, precision ball race slides with anti-tilt feature.
- Load capacity of 100kg per drawer.
- 100% drawer extension on 650 deep cabinets, and 90% drawer extension on 750 deep cabinets.
- Central locking for extra security.
- Cupboard doors are fitted with interior perforated panels to fit tool clips.
- A range of drawer divider kits and extra shelves are available.

600 Cupboard Accessories

Key	Description	650 Code	650 Price	750 Code	750 Price
A	Pull Out Drawer	ES600PULLDRW	£104.12	ES675PULLDRW	£141.72
B	Pull Out Shelf	ES600PULLSHF	£95.45	ES675PULLSHF	£129.19
-	Galvanised Shelf	ES600GASHELF	£29.89	ES675GASHELF	£40.49



• Supplied with 1 Galvanised shelf as standard.



• Supplied with 1 Galvanised shelf as standard.



Cupboard			
Cupboard Height	Size H.W.D.	Code	Price
1x750mm	825.600.650	EUC18260651	£194.75
	825.600.750	EUC18260751	£204.39

2 Drawer & Cupboard			
Drawer/Cupboard Heights	Size H.W.D.	Code	Price
2x100mm, 1x500mm	825.600.650	EUC18260652	£408.79
	825.600.750	EUC18260752	£487.84

4 Drawer			
Drawer Heights	Size H.W.D.	Code	Price
1x150mm, 3x200mm	825.600.650	EUC1826065A	£608.36
	825.600.750	EUC1826075A	£639.21



5 Drawer

Drawer Heights	Size H.W.D.	Code	Price
1x100mm, 2x125mm, 1x150mm, 1x250mm	825.600.650	EUC18260654	£696.09
	825.600.750	EUC18260754	£730.80



5 Drawer

Drawer Heights	Size H.W.D.	Code	Price
5x150mm	825.600.650	EUC1826065C	£688.38
	825.600.750	EUC1826075C	£722.12



5 Drawer

Drawer Heights	Size H.W.D.	Code	Price
2x100mm, 2x150mm, 1x200mm	825.600.650	EUC18260655	£675.85
	825.600.750	EUC18260755	£709.59



5 Drawer

Drawer Heights	Size H.W.D.	Code	Price
2x100mm, 2x125mm, 1x300mm	825.600.650	EUC18260656	£697.06
	825.600.750	EUC18260756	£731.76



6 Drawer

Drawer Heights	Size H.W.D.	Code	Price
4x100mm, 1x150mm, 1x200mm	825.600.650	EUC1826065E	£760.69
	825.600.750	EUC1826075E	£799.25



7 Drawer

Drawer Heights	Size H.W.D.	Code	Price
7x100mm	825.600.650	EUC1826065V	£826.25
	825.600.750	EUC1826075V	£867.70



Disposal Unit

Description	Size H.W.D.	Code	Price
Supplied with internal plastic bin	825.600.650	EUCDISB6065	£283.45
	825.600.750	EUCDISB6075	£297.91

600 Worktop Options

Worktop Options - Suitable for 600.650 Cabinets

Description	Size H.W.D.	Code	Price
Beech	27.600.650	ESBEETOP6065	£75.20
Laminate	20.600.650	ESLAMTOP6065	£124.37
Linoleum	40.600.650	ESLINTOP6065	£145.88
Tool Tray	24.600.650	ESTLTTOP6065	£28.92

Worktop Options - Suitable for 600.750 Cabinets

Description	Size H.W.D.	Code	Price
Beech	27.600.750	ESBEETOP6075	£96.41
Laminate	20.600.750	ESLAMTOP6075	£134.98
Linoleum	40.600.750	ESLINTOP6075	£153.86
Tool Tray	24.600.750	ESTLTTOP6075	£39.53

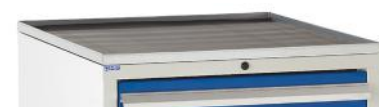

Colour Options

To select drawer & door colours please add corresponding letters to the end of the code.





• Supplied with 2 Galvanised shelves as standard.

Cupboard

Cupboards Heights	Size H.W.D.	Code	Price
	1200.600.650	EUC12060651	£302.73
1x1150mm	1200.600.750	EUC12060751	£321.05



• Supplied with 2 Galvanised shelves as standard.

1 Drawer & Cupboard

Drawer/Cupboard Heights	Size H.W.D.	Code	Price
	1200.600.650	EUC1206065B	£416.50
1x100mm, 1x1010mm	1200.600.750	EUC1206075B	£441.56



• Supplied with 2 Galvanised shelves as standard.

2 Drawer & Cupboard

Drawer/Cupboard Heights	Size H.W.D.	Code	Price
	1200.600.650	EUC12060652	£509.05
2x100mm, 1x910mm	1200.600.750	EUC12060752	£539.90



• Supplied with 2 Galvanised shelves as standard.

1 Drawer & Cupboard

Drawer/Cupboard Heights	Size H.W.D.	Code	Price
	1200.600.650	EUC1206065A	£432.89
1x200mm, 1x910mm	1200.600.750	EUC1206075A	£458.92



• Supplied with 1 Galvanised shelf as standard.

2 Drawer & Cupboard

Drawer/Cupboard Heights	Size H.W.D.	Code	Price
	1200.600.650	EUC12060653	£542.80
2x200mm, 1x710mm	1200.600.750	EUC12060753	£575.58



• Supplied with 1 Galvanised shelf as standard.

4 Drawer & Cupboard

Drawer/Cupboard Heights	Size H.W.D.	Code	Price
	1200.600.650	EUC12060654	£695.13
4x100mm, 1x710mm	1200.600.750	EUC12060754	£736.58

Colour Options

To select drawer & door colours please add corresponding letters to the end of the code.





6 Drawer

Drawer Heights	Size H.W.D.	Code	Price
1x150mm, 5x200mm	1200.600.650	EUC1206065E	£827.21
	1200.600.750	EUC1206075E	£876.38

7 Drawer

Drawer Heights	Size H.W.D.	Code	Price
1x100mm, 3x150mm, 3x200mm	1200.600.650	EUC1206065V	£892.77
	1200.600.750	EUC1206075V	£946.76

8 Drawer

Drawer Heights	Size H.W.D.	Code	Price
3x100mm, 3x150mm, 2x200mm	1200.600.650	EUC1206065X	£975.68
	1200.600.750	EUC1206075X	£1,034.50



8 Drawer

Drawer Heights	Size H.W.D.	Code	Price
1x100mm, 7x150mm	1200.600.650	EUC12060658	£979.54
	1200.600.750	EUC12060758	£1,038.35

8 Drawer

Drawer Heights	Size H.W.D.	Code	Price
5x100mm, 3x200mm	1200.600.650	EUC1206065W	£965.08
	1200.600.750	EUC1206075W	£1,022.93

11 Drawer

Drawer Heights	Size H.W.D.	Code	Price
11x100mm	1200.600.650	EUC1206065Y	£1,187.79
	1200.600.750	EUC1206075Y	£1,258.17

Colour Options

To select drawer & door colours please add corresponding letters to the end of the code.





• Supplied with 2 Galvanised shelves as standard

Cupboard

Cupboards Heights	Size H.W.D.	Code	Price
1x1450mm	1500.600.650	EUC15060651	£435.45



• Supplied with 2 Galvanised shelves as standard

1 Drawer & Cupboard

Drawer/Cupboard Heights	Size H.W.D.	Code	Price
1x200mm, 1x1250mm	1500.600.650	EUC1506065A	£577.28



• Supplied with 2 Galvanised shelves as standard

2 Drawer & Cupboard

Drawer/Cupboard Heights	Size H.W.D.	Code	Price
2x100, 1x1250mm	1500.600.650	EUC15060652	£669.32



• Supplied with 1 Galvanised shelf as standard

2 Drawer & Cupboard

Drawer/Cupboard Heights	Size H.W.D.	Code	Price
2x200mm, 1x1110mm	1500.600.650	EUC15060653	£684.11



• Supplied with 1 Galvanised shelf as standard

4 Drawer & Cupboard

Drawer/Cupboard Heights	Size H.W.D.	Code	Price
4x100mm, 1x1110mm	1500.600.650	EUC15060654	£895.31



8 Drawer

Drawer/Cupboard Heights	Size H.W.D.	Code	Price
4x150mm, 4x200mm	1500.600.650	EUC1506065E	£1,435.92

Colour Options

To select drawer & door colours please add corresponding letters to the end of the code.





9 Drawer

Drawer Heights	Size H.W.D.	Code	Price
4x100mm, 5x200mm	1500.600.650	EUC1506065B	£1,560.68

10 Drawer

Drawer Heights	Size H.W.D.	Code	Price
1x100mm, 9x150mm	1500.600.650	EUC1506065C	£1,748.18

10 Drawer

Drawer Heights	Size H.W.D.	Code	Price
4x100mm, 4x150mm, 2x200mm	1500.600.650	EUC1506065F	£1,645.09



11 Drawer

Drawer Heights	Size H.W.D.	Code	Price
4x100mm, 7x150mm	1500.600.650	EUC1506065D	£1,745.67

14 Drawer

Drawer Heights	Size H.W.D.	Code	Price
14x100mm	1500.600.650	EUC1506065Y	£2,110.41



Colour Options

To select drawer & door colours please add corresponding letters to the end of the code.



£252 FROM
.60



EUROSLIDE

100KG
DRAWER CAPACITY



• Supplied with 1 Galvanised shelf as standard.

Cupboard

Cupboard Height	Size H.W.D.	Code	Price
1x750mm	825.900.650	EUC18290651	£252.60
	825.900.750	EUC18290751	£268.02



• Supplied with 1 Galvanised shelf as standard.

2 Drawer & Cupboard

Drawer/Cupboard Heights	Size H.W.D.	Code	Price
2x100mm, 1x500mm	825.900.650	EUC18290653	£455.06
	825.900.750	EUC18290753	£482.06



4 Drawer

Drawer Heights	Size H.W.D.	Code	Price
1x150mm, 3x200mm	825.900.650	EUC1829065A	£631.50
	825.900.750	EUC1829075A	£670.06



5 Drawer

Drawer Heights	Size H.W.D.	Code	Price
1x100mm, 2x125mm, 1x150mm, 1x250mm	825.900.650	EUC18290654	£735.62
	825.900.750	EUC18290754	£779.97



5 Drawer

Drawer Heights	Size H.W.D.	Code	Price
5x150mm	825.900.650	EUC18290655	£724.05
	825.900.750	EUC18290755	£764.44



5 Drawer

Drawer Heights	Size H.W.D.	Code	Price
2x100mm, 2x150mm, 1x200mm	825.900.650	EUC18290655	£707.66
	825.900.750	EUC18290755	£750.08



5 Drawer

Drawer Heights	Size H.W.D.	Code	Price
2x100mm, 2x125mm, 1x300mm	825.900.650	EUC18290658	£732.73
	825.900.750	EUC18290758	£776.11



6 Drawer

Drawer Heights	Size H.W.D.	Code	Price
4x100mm, 1x150mm, 1x200mm	825.900.650	EUC1829065E	£795.40
	825.900.750	EUC1829075E	£843.60



7 Drawer

Drawer Heights	Size H.W.D.	Code	Price
7x100mm	825.900.650	EUC1829065V	£865.78
	825.900.750	EUC1829075V	£917.84

Worktop Options



Worktop Options

Description	Size H.W.D.	Code	Price
Beech	27.900.650	ESBEETOP9065	£112.80
Laminate	20.900.650	ESLAMTOP9065	£145.58
Linoleum	40.900.650	ESLINTOP9065	£190.94
Tool Tray	24.900.650	ESTLTTOP9065	£41.46

Worktop Options

Description	Size H.W.D.	Code	Price
Beech	27.900.750	ESBEETOP9075	£144.62
Laminate	20.900.750	ESLAMTOP9075	£177.40
Linoleum	40.900.750	ESLINTOP9075	£202.61
Tool Tray	24.900.750	ESTLTTOP9075	£54.95

900 Cupboard Accessories

Key	Description	650 Code	650 Price	750 Code	750 Price
A	Pull Out Drawer	ES900PULLDRW	£118.59	ES975PULLDRW	£160.04
B	Pull Out Shelf	ES900PULLSHF	£107.02	ES975PULLSHF	£144.62
-	Galvanised Shelf	ES900GASHELF	£44.35	ES975GASHELF	£59.78



A



B

Colour Options

To select drawer & door colours please add corresponding letters to the end of the code.





• Supplied with 2 Galvanised shelves as standard.

Cupboard

Cupboard Height	Size H.W.D.	Code	Price
1x1150mm	1200.900.650	EUC12090651	£378.90
	1200.900.750	EUC12090751	£401.07



• Supplied with 2 Galvanised shelves as standard.

1 Drawer & Cupboard

Drawer/Cupboard Heights	Size H.W.D.	Code	Price
1x100mm, 1x1010mm	1200.900.650	EUC1209065B	£456.03
	1200.900.750	EUC1209075B	£483.99



• Supplied with 2 Galvanised shelves as standard.

2 Drawer & Cupboard

Drawer/Cupboard Heights	Size H.W.D.	Code	Price
2x100mm, 1x910mm	1200.900.650	EUC12090652	£509.05
	1200.900.750	EUC12090752	£539.90



• Supplied with 2 Galvanised shelves as standard.

1 Drawer & Cupboard

Drawer/Cupboard Heights	Size H.W.D.	Code	Price
1x200mm, 1x910mm	1200.900.650	EUC1209065A	£432.89
	1200.900.750	EUC1209075A	£458.92



• Supplied with 1 Galvanised shelf as standard.

2 Drawer & Cupboard

Drawer/Cupboard Heights	Size H.W.D.	Code	Price
2x200mm, 1x710mm	1200.900.650	EUC12090653	£610.29
	1200.900.750	EUC12090753	£646.92



• Supplied with 1 Galvanised shelf as standard.

4 Drawer & Cupboard

Drawer/Cupboard Heights	Size H.W.D.	Code	Price
4x100mm, 1x710mm	1200.900.650	EUC12090654	£775.15
	1200.900.750	EUC12090754	£821.43

Colour Options

To select drawer & door colours please add corresponding letters to the end of the code.





6 Drawer

Drawer Heights	Size H.W.D.	Code	Price
1x150mm, 5x200mm	1200.900.650	EUC1209065E	£954.47
	1200.900.750	EUC1209075E	£1,011.36



7 Drawer

Drawer Heights	Size H.W.D.	Code	Price
1x100mm, 3x150mm, 3x200mm	1200.900.650	EUC1209065V	£1,043.17
	1200.900.750	EUC1209075V	£1,113.55



8 Drawer

Drawer Heights	Size H.W.D.	Code	Price
1x100mm, 7x150mm	1200.900.650	EUC12090658	£1,126.09
	1200.900.750	EUC12090758	£1,194.54



11 Drawer

Drawer Heights	Size H.W.D.	Code	Price
11x100mm	1200.900.650	EUC1209065Y	£1,312.16
	1200.900.750	EUC1209075Y	£1,391.22

Worktop Options

Worktop Options - Suitable for 900.650 Cabinets

Description	Size H.W.D.	Code	Price
Beech	27.900.650	ESBEETOP9065	£112.80
Laminate	20.900.650	ESLAMTOP9065	£145.58
Linoleum	40.900.650	ESLINTOP9065	£190.94
Tool Tray	24.900.650	ESTLTTOP9065	£41.46

Worktop Options - Suitable for 900.750 Cabinets

Description	Size H.W.D.	Code	Price
Beech	27.900.750	ESBEETOP9075	£144.62
Laminate	20.900.750	ESLAMTOP9075	£177.40
Linoleum	40.900.750	ESLINTOP9075	£202.61
Tool Tray	24.900.750	ESTLTTOP9075	£54.95



900 Cupboard Accessories

Key	Description	650 Code	650 Price	750 Code	750 Price
A	Pull Out Drawer	ES900PULLDRW	£118.59	ES975PULLDRW	£160.04
B	Pull Out Shelf	ES900PULLSHF	£107.02	ES975PULLSHF	£144.62
-	Galvanised Shelf	ES900GASHELF	£44.35	ES975GASHELF	£59.78



A



B



• Supplied with 2 Galvanised shelves as standard

Cupboard

Cupboards Heights	Size H.W.D.	Code	Price
1x1450mm	1500.900.650	EUC15090651	£526.50



• Supplied with 2 Galvanised shelves as standard

1 Drawer & Cupboard

Drawer/Cupboard Heights	Size H.W.D.	Code	Price
1x200mm, 1x1250mm	1500.900.650	EUC1509065A	£702.63



• Supplied with 2 Galvanised shelves as standard

2 Drawer & Cupboard

Drawer/Cupboard Heights	Size H.W.D.	Code	Price
2x100mm, 1x1250mm	1500.900.650	EUC15090652	£825.17



• Supplied with 1 Galvanised shelf as standard

2 Drawer & Cupboard

Drawer/Cupboard Heights	Size H.W.D.	Code	Price
2x200mm, 1x1110mm	1500.900.650	EUC15090653	£814.74



• Supplied with 1 Galvanised shelf as standard

4 Drawer & Cupboard

Drawer/Cupboard Heights	Size H.W.D.	Code	Price
4x100mm, 1x1110mm	1500.900.650	EUC15090654	£1,008.66



8 Drawer

Drawer/Cupboard Heights	Size H.W.D.	Code	Price
4x150mm, 4x200mm	1500.900.650	EUC1509065E	£1,572.82

Colour Options

To select drawer & door colours please add corresponding letters to the end of the code.





9 Drawer

Drawer Heights	Size H.W.D.	Code	Price
4x100mm, 5x200mm	1500.900.650	EUC1509065B	£1,704.26



10 Drawer

Drawer Heights	Size H.W.D.	Code	Price
1x100mm, 9x150mm	1500.900.650	EUC1509065C	£1,785.90



10 Drawer

Drawer Heights	Size H.W.D.	Code	Price
4x100mm, 4x150mm, 2x200mm	1500.900.650	EUC1509065F	£1,797.07



11 Drawer

Drawer Heights	Size H.W.D.	Code	Price
4x100mm, 7x150mm	1500.900.650	EUC1509065D	£1,908.46



14 Drawer

Drawer Heights	Size H.W.D.	Code	Price
14x100mm	1500.900.650	EUC1509065Y	£2,300.14



Colour Options

To select drawer & door colours please add corresponding letters to the end of the code.





• Supplied with 1 Galvanised shelf as standard

Cupboard

Drawer Heights	Size H.W.D.	Code	Price
1x750mm	825.1200.650	EUC18212651	£555.28



• Supplied with 1 Galvanised shelf as standard

2 Drawer & Cupboard

Drawer Heights	Size H.W.D.	Code	Price
2x100mm, 1x500mm	825.1200.650	EUC18212652	£812.77



4 Drawer

Drawer Heights	Size H.W.D.	Code	Price
1x150mm, 3x200mm	825.1200.650	EUC1821265A	£1,013.24



5 Drawer

Drawer Heights	Size H.W.D.	Code	Price
5x150mm	825.1200.650	EUC1821265C	£1,181.71



5 Drawer

Drawer Heights	Size H.W.D.	Code	Price
2x100mm, 2x150mm, 1x200mm	825.1200.650	EUC1821265S	£1,170.11



5 Drawer

Drawer Heights	Size H.W.D.	Code	Price
1x100mm, 2x125mm, 1x150mm, 1x250mm	825.1200.650	EUC18212654	£1,170.11

Colour Options

To select drawer & door colours please add corresponding letters to the end of the code.





5 Drawer

Drawer Heights	Size H.W.D.	Code	Price
2x100mm, 2x125mm, 1x300mm	825.1200.650	EUC18212658	£1,167.23



6 Drawer

Drawer Heights	Size H.W.D.	Code	Price
4x100mm, 1x150mm, 1x200mm	825.1200.650	EUC1821265E	£1,324.43



7 Drawer

Drawer Heights	Size H.W.D.	Code	Price
7x100mm	825.1200.650	EUC1821265V	£1,481.94



• Supplied with 1 Galvanised shelf as standard.

Sliding Door Cupboard

Drawer Heights	Size H.W.D.	Code	Price
1x750mm	825.1200.650	EUC182125SD	£730.76

1200 Worktop Options

Worktop Options - Suitable for 1200.650 Cabinets

Description	Size H.W.D.	Code	Price
Beech	27.1200.650	ESBEETOP1265	£126.99
Laminate	20.1200.650	ESLAMTOP1265	£164.86
Linoleum	40.1200.650	ESLINTOP1265	£250.51
Tool Tray	24.1200.650	ESTLITOP1265	£57.85



1200 Cupboard Accessories

Key	Description	Code	Price
A	Pull Out Drawer	ES120PULLDRW	£163.24
B	Pull Out Shelf	ES120PULLSHF	£145.89
-	Galvanised Shelf	ES120GASHELF	£88.52





600 Cabinet Drawer Inserts - Dimensions/Codes

Option	650 Code	Price	750 Code	Price
A (100mm Height)	ESDINSERT61A	£43.39	ESDINSERT71A	£45.31
A (125mm Height)	ESDINSERT12A	£45.31	ESDINSERT17A	£48.21
A (150mm Height)	ESDINSERT65A	£46.28	ESDINSERT75A	£48.21
A (200mm Height)	ESDINSERT62A	£50.13	ESDINSERT72A	£52.06
A (250mm Height)	ESDINSERT25A	£59.78	ESDINSERT27A	£62.67
A (300mm Height)	ESDINSERT30A	POA	ESDINSERT70A	POA
B (100mm Height)	ESDINSERT61B	£26.03	ESDINSERT71B	£27.00
B (125mm Height)	ESDINSERT25B	£28.92	ESDINSERT27B	£29.89
B (150mm Height)	ESDINSERT65B	£30.85	ESDINSERT75B	£32.78
B (200mm Height)	ESDINSERT62B	£31.82	ESDINSERT72B	£32.78
B (250mm Height)	ESDINSERT20B	£35.67	ESDINSERT70B	£36.64
B (300mm Height)	ESDINSERT30B	POA	ESDINSERT37B	POA
C (100mm Height)	ESDINSERT61C	£26.03	ESDINSERT71C	£27.96
C (125mm Height)	ESDINSERT20C	£27.00	ESDINSERT70C	£27.96
C (150mm Height)	ESDINSERT65C	£27.96	ESDINSERT75C	£28.92
C (200mm Height)	ESDINSERT62C	£29.89	ESDINSERT72C	£31.82
C (250mm Height)	ESDINSERT12C	£33.74	ESDINSERT17C	£35.67
C (300mm Height)	ESDINSERT30C	POA	ESDINSERT73C	POA
D (100mm Height)	ESDINSERT61D	£53.03	ESDINSERT71D	£55.92
D (125mm Height)	ESDINSERT12D	£54.95	ESDINSERT17D	£57.85
D (150mm Height)	ESDINSERT65D	£56.88	ESDINSERT75D	£59.78
D (200mm Height)	ESDINSERT62D	£62.67	ESDINSERT72D	£65.56
D (250mm Height)	ESDINSERT25D	£66.52	ESDINSERT13D	£59.78
D (300mm Height)	ESDINSERT30D	POA	ESDINSERT73D	POA



900 Cabinet Drawer Inserts - Dimensions/Codes

Option	650 Code	Price	750 Code	Price
A (100mm Height)	ESDINSERT91A	£51.10	ESDINSERT97A	£53.99
A (125mm Height)	ESDINSERT15A	£45.31	ESDINSERT79A	£54.95
A (150mm Height)	ESDINSERT95A	£54.95	ESDINSERT96A	£57.85
A (200mm Height)	ESDINSERT92A	£54.95	ESDINSERT29A	£56.88
A (250mm Height)	ESDINSERT9A5	£57.85	ESDINSERT7A5	£60.74
A (300mm Height)	ESDINSERT93A	POA	ESDINSERT37A	POA
B (100mm Height)	ESDINSERT91B	£32.78	ESDINSERT17B	£34.71
B (125mm Height)	ESDINSERT12B	£35.67	ESDINSERT22B	£32.78
B (150mm Height)	ESDINSERT95B	£36.64	ESDINSERT59B	£38.56
B (200mm Height)	ESDINSERT92B	£38.56	ESDINSERT52B	£40.49
B (250mm Height)	ESDINSERT9B5	£41.46	ESDINSERT7B5	£43.39
B (300mm Height)	ESDINSERT93B	POA	ESDINSERT73B	POA
C (100mm Height)	ESDINSERT91C	£31.82	ESDINSERT97C	£33.74
C (125mm Height)	ESDINSERT22C	£32.78	ESDINSERT77C	£33.74
C (150mm Height)	ESDINSERT95C	£33.74	ESDINSERT11C	£33.74
C (200mm Height)	ESDINSERT92C	£36.64	ESDINSERT15C	£36.64
C (250mm Height)	ESDINSERT9C5	£39.53	ESDINSERT16C	£33.74
C (300mm Height)	ESDINSERT93C	POA	ESDINSERT99C	POA
D (100mm Height)	ESDINSERT91D	£64.60	ESDINSERT70D	£55.92
D (125mm Height)	ESDINSERT22D	£67.49	ESDINSERT77D	£70.38
D (150mm Height)	ESDINSERT95D	£69.42	ESDINSERT57D	£59.78
D (200mm Height)	ESDINSERT92D	£76.17	ESDINSERT97D	£80.02
D (250mm Height)	ESDINSERT9D5	£80.02	ESDINSERT7D5	£83.88
D (300mm Height)	ESDINSERT93D	POA	ESDINSERT73D	POA



Euroslide

Plastic Drawer Divider Kits - Dimensions/Codes

Key	Width	650 Depth Kit	650 Depth Code	650 Price	750 Depth Kit	750 Depth Code	750 Price
A	600mm	24 (6 Packs of 4 x BA8-2) 8 (1 Pack of 8 x BA8-1)	ESPINSER660A	£69.42	24 (6 Packs of 4 x BA8-2) 16 (2 Pack of 8 x BA8-1)	ESPINSER675A	£80.02
B	600mm	12 (6 Packs of 2 x BA6-1) 2 (1 Pack of 2 x BA7-2)	ESPINSER660B	£61.70	12 (6 Packs of 2 x BA6-1) 2 (2 Pack of 2 x BA7-2)	ESPINSER675B	£70.38
C	900mm	24 (8 Packs of 3 x BA8-3) 12 (3 Packs of 4 x BA7-1)	ESPINSER960A	£125.34	24 (8 Packs of 3 x BA8-3) 20 (5 Packs of 4 x BA7-1)	ESPINSER975A	£138.83
D	900mm	18 (9 Packs of 2 x BA7-2) 12 (3 Packs of 4 x BA7-1)	ESPINSER960B	£99.30	18 (9 Packs of 2 x BA7-2) 20 (5 Packs of 4 x BA7-1)	ESPINSER975B	£111.84



Euroslide Cupboard Accessories - Dimensions/Codes

Key	Width	Description	650 Code	650 Price	750 Code	750 Price
A	600mm	Pull Out Drawer	ES600PULLDRW	£104.21	ES675PULLDRW	£141.72
B	600mm	Pull Out Shelf	ES600PULLSHF	£95.45	ES675PULLSHF	£129.19
-	600mm	Galvanised Shelf	ES600GASHELF	£29.89	ES675GASHELF	£40.49
C	900mm	Pull Out Drawer	ES900PULLDRW	£118.59	ES975PULLDRW	£160.04
D	900mm	Pull Out Shelf	ES900PULLSHF	£107.02	ES975PULLSHF	£144.62
-	900mm	Galvanised Shelf	ES900GASHELF	£44.35	ES975GASHELF	£59.78



FROM
£344.19

EUROSLIDE



• Supplied with 1 Galvanised shelf as standard.

Worktop Options



Description	Size H.W.D.	Code	Price
Beech	27.600.650	ESBEETOP6065	£75.20
Laminate	20.600.650	ESLAMTOP6065	£124.37
Linoleum	40.600.650	ESLINTOP6065	£145.88
Tool Tray	24.600.650	ESTLTTOP6065	£28.92

Mobile Cupboard

Cupboard Height	Size H.W.D.	Code	Price
1x750mm	980.600.650	EUC9860651M	£344.19



• Supplied with 1 Galvanised shelf as standard.

Mobile 2 Drawer & Cupboard

Drawer/Cupboard Heights	Size H.W.D.	Code	Price
2x100mm, 1x500mm	980.600.650	EUC9860652M	£558.22



Mobile 4 Drawer

Drawer Heights	Size H.W.D.	Code	Price
1x150mm, 3x200mm	980.600.650	EUC986065AM	£737.55



Mobile 5 Drawer

Drawer Heights	Size H.W.D.	Code	Price
5x150mm	980.600.650	EUC986065CM	£816.61



Mobile 5 Drawer

Drawer Heights	Size H.W.D.	Code	Price
2x100mm, 2x150mm, 1x200mm	980.600.650	EUC9860655M	£804.07



Mobile 6 Drawer

Drawer Heights	Size H.W.D.	Code	Price
4x100mm, 1x150mm, 1x200mm	980.600.650	EUC986065EM	£889.88



Mobile 7 Drawer

Drawer Heights	Size H.W.D.	Code	Price
7x100mm	980.600.650	EUC986065VM	£955.44

Colour Options

To select drawer & door colours please add corresponding letters to the end of the code.





• Supplied with 1 Galvanised shelf as standard.

Mobile Cupboard

Cupboard Height	Size H.W.D.	Code	Price
1x750mm	980.900.650	EUC9890651M	£402.04



• Supplied with 1 Galvanised shelf as standard.

Mobile 2 Drawer & Cupboard

Drawer/Cupboard Heights	Size H.W.D.	Code	Price
2x100mm, 1x500mm	980.900.650	EUC9890652M	£604.50



Mobile 4 Drawer

Drawer Heights	Size H.W.D.	Code	Price
1x150mm, 3x200mm	980.900.650	EUC989065AM	£780.93



Mobile 5 Drawer

Drawer Heights	Size H.W.D.	Code	Price
5x150mm	980.900.650	EUC989065CM	£873.49



Mobile 5 Drawer

Drawer Heights	Size H.W.D.	Code	Price
2x100mm, 2x150mm, 1x200mm	980.900.650	EUC9890655M	£857.10



Mobile 6 Drawer

Drawer Heights	Size H.W.D.	Code	Price
4x100mm, 1x150mm, 1x200mm	980.900.650	EUC989065EM	£944.83



Mobile 7 Drawer

Drawer Heights	Size H.W.D.	Code	Price
7x100mm	980.900.650	EUC989065VM	£1,015.21

Worktop Options

Description	Size H.W.D.	Code	Price
Beech	27.900.650	ESBEETOP9065	£112.80
Laminate	20.900.650	ESLAMTOP9065	£145.58
Linoleum	40.900.650	ESLINTOP9065	£190.94
Tool Tray	24.900.650	ESTLTTOP9065	£41.46



Colour Options

To select drawer & door colours please add corresponding letters to the end of the code.





• Supplied with 1 Galvanised shelf as standard.

Under Bench Cupboard

Cupboard Height	Size H.W.D.	Code	Price
1x550mm	780.600.650	EUN7860651M	£276.70

Under Bench 2 Drawer & Cupboard

Drawer/Cupboard Heights	Size H.W.D.	Code	Price
2x100mm, 1x300mm	780.600.650	EUN7860652M	£480.13

Under Bench 3 Drawer

Drawer Heights	Size H.W.D.	Code	Price
1x150mm, 2x200mm	780.600.650	EUN7860653M	£577.51



Under Bench 4 Drawer

Drawer Heights	Size H.W.D.	Code	Price
1x100mm, 3x150mm	780.600.650	EUN7860654M	£655.60

Under Bench 4 Drawer

Drawer Heights	Size H.W.D.	Code	Price
2x100mm, 1x150mm, 1x200mm	780.600.650	EUN7860654M	£653.67

Under Bench 5 Drawer

Drawer Heights	Size H.W.D.	Code	Price
4x100mm, 1x150mm	780.600.650	EUN786065CM	£730.80

Worktop Options



Description	Size H.W.D.	Code	Price
Beech	27.600.650	ESBEETOP6065	£75.20
Laminate	20.600.650	ESLAMTOP6065	£124.37
Linoleum	40.600.650	ESLINTOP6065	£145.88
Tool Tray	24.600.650	ESTLTTOP6065	£28.92

Colour Options

To select drawer & door colours please add corresponding letters to the end of the code.





• Supplied with 1 Galvanised shelf as standard.

Under Bench Cupboard

Cupboard Heights	Size H.W.D.	Code	Price
1x550mm	780.900.650	EUN7890651M	£327.80

Under Bench 2 Drawer & Cupboard

Drawer/Cupboard Heights	Size H.W.D.	Code	Price
2x100mm, 1x300mm	780.900.650	EUN7890652M	£528.34

Under Bench 3 Drawer

Drawer Heights	Size H.W.D.	Code	Price
1x150mm, 2x200mm	780.900.650	EUN7890653M	£601.61



Under Bench 4 Drawer

Drawer Heights	Size H.W.D.	Code	Price
1x100mm, 3x150mm	780.900.650	EUN789065AM	£679.70

Under Bench 4 Drawer

Drawer Heights	Size H.W.D.	Code	Price
2x100mm, 1x150mm, 1x200mm	780.900.650	EUN7890654M	£677.77

Under Bench 5 Drawer

Drawer Heights	Size H.W.D.	Code	Price
4x100mm, 1x150mm	780.900.650	EUN789065CM	£753.94



Worktop Options

Description	Size H.W.D.	Code	Price
Beech	27.900.650	ESBEETOP9065	£112.80
Laminate	20.900.650	ESLAMTOP9065	£145.58
Linoleum	40.900.650	ESLINTOP9065	£190.94
Tool Tray	24.900.650	ESTLTTOP9065	£41.46

Colour Options

To select drawer & door colours please add corresponding letters to the end of the code.



Euroslide



EURO SLIDE



DRAWER CAPACITY



£2,250.53 FROM

Create the ultimate workshop or garage fit-out with our extensive range of Modular Euroslide Kits.

There is a Euroslide Modular Kit to suit every environment and budget. Choose from our wide choice of Modular Kits or create the workshop of your dreams with our impressive Corner Modular Kits!

- All-steel construction.
- Beech, Laminate and Linoleum worktop options are available.
- Full-width, full-extension precision ball race slides with anti-tilt feature.
- Central locking for extra security.
- Load capacity of 100kg per drawer.



Modular Kit 1

- 1 x 600mm width 2-Drawer & Storage Cupboard Cabinet.
- 1 x 600mm width Storage Cupboard.
- 1 x 600mm width 5-Drawer Cabinet.
- Worktop (Laminate, Beech or Linoleum).
- 1 x 1800mm width Service Duct.
- 3 x 600mm width Perforated Back Panels.
- 3 x 600mm width Overhead Storage Cupboards.
- 1 x Pack of 53 Clip Mix Kit (Suitable for Perforated Back Panel).

Kit 1 - Dimensions/Codes

Worktop	Size H.W.D.	Code	Price
Beech	2000.1800.650	EUCMODKTBS1	£2,841.03
Laminate	2000.1800.650	EUCMODKTPS1	£2,827.53
Linoleum	2000.1800.650	EUCMODKT8S1	£2,950.25



Modular Kit 2

- 1 x 1200mm width 2m high Storage Cupboard.
- 1 x 600mm width 7-drawer Cabinet.
- 1 x 600mm width Disposal Unit Cabinet.
- Worktop (Laminate, Beech or Linoleum).
- 1 x 1200mm width Service Duct.
- 2 x 600mm width Perforated Back Panels.
- 2 x 600mm width Overhead Storage Cupboards.
- 1 x Pack of 53 Clip Mix Kit (Suitable for Perforated Back Panel).

Kit 2 - Dimensions/Codes

Worktop	Size H.W.D.	Code	Price
Beech	2000.2400.650	EUCMODKTBS2	£3,165.17
Laminate	2000.2400.650	EUCMODKTPS2	£3,203.04
Linoleum	2000.2400.650	EUCMODKT8S2	£3,288.69



Modular Kit 3

- 1 x 1200mm width / 2m high Storage Cupboard.
- 1 x 900mm width 5-drawer Cabinet.
- Worktop (Laminate, Beech or Linoleum).
- 1 x 900mm width Service Duct.
- 1 x 900mm width Perforated Back Panel.
- 1 x 900mm width Overhead Storage Cupboards.
- 1 x Pack of 53 Clip Mix Kit (Suitable for Perforated Back Panel).

Kit 3 - Dimensions/Codes

Worktop	Size H.W.D.	Code	Price
Beech	2000.2100.650	EUCMODKTBS3	£2,250.53
Laminate	2000.2100.650	EUCMODKTPS3	£2,283.31
Linoleum	2000.2100.650	EUCMODKT8S3	£2,328.66



Modular Kit 4

- 1 x 600mm width 2m high Storage Cupboard.
- 1 x 600mm width 5-drawer Cabinet.
- 1 x 600mm width Storage Cupboard.
- 1 x 600mm width 2-drawer & Cupboard Cabinet.
- Worktop (Laminate, Beech or Linoleum).
- 1 x 1800mm width Service Duct.
- 3 x 600mm width Perforated Back Panels.
- 3 x 600mm width Overhead Storage Cupboards.
- 1 x Pack of 84 Clip Mix Kit (Suitable for Perforated Back Panel).

Kit 4 - Dimensions/Codes

Worktop	Size H.W.D.	Code	Price
Beech	2000.2400.650	EUCMODKTBP4	£3,360.69
Laminate	2000.2400.650	EUCMODKTTP4	£3,347.19
Linoleum	2000.2400.650	EUCMODKT8P4	£3,469.91



Modular Kit 5

Modular Kit 5 comes complete with the following components:

- 1 x 1200mm width 2m high Storage Cupboard.
- 1 x 600mm width 2m high Storage Cupboard.
- 1 x 900mm width 6-drawer Cabinet.
- 1 x 600mm width 2 drawer & Cupboard Cabinet.
- Worktop (Laminate, Beech or Linoleum).
- 1 x 1500mm width Service Duct.
- 1 x 600mm width Perforated Back Panel.
- 1 x 900mm width Perforated Back Panel.
- 1 x 600mm width Overhead Storage Cupboards.
- 1 x 900mm width Overhead Storage Cupboards.
- 1 x Pack of 53 Clip Mix Kit (Suitable for Perforated Back Panel).

Modular Kit 5 - Dimensions/Codes

Worktop	Size H.W.D.	Code	Price
Beech	2000.3300.650	EUCMODKTBP5	£4,015.52
Laminate	2000.3300.650	EUCMODKTPP5	£4,036.73
Linoleum	2000.3300.650	EUCMODKT8P5	£4,141.19



Modular Kit 6

Modular Kit 6 comes complete with the following components:

- 2 x 1200mm width 2m high Storage Cupboards.
- 1 x 600mm width 2-drawer & Storage Cupboard Cabinet.
- 1 x 600mm width Storage Cupboard.
- 1 x 600mm width 5-drawer Cabinet.
- Worktop (Laminate, Beech or Linoleum).
- 1 x 1800mm width Service Duct.
- 3 x 600mm width Perforated Back Panels.
- 3 x 600mm width Overhead Storage Cupboards.
- 1 x Pack of 84 Clip Mix Kit (Suitable for Perforated Back Panel).

Modular Kit 6 - Dimensions/Codes

Worktop	Size H.W.D.	Code	Price
Beech	2000.4200.650	EUCMODKTBP6	£4,120.37
Laminate	2000.4200.650	EUCMODKTPP6	£4,106.87
Linoleum	2000.4200.650	EUCMODKT8P6	£4,229.59

Colour Options

To select drawer & door colours please add letters to the end of the code.



Worktop Options





Corner Kit 1

Corner Kit 1 comes complete with the following components:

- 1 x 600mm width 2-drawer & Storage Cupboard Cabinet.
- 1 x 600mm width 4-drawer Cabinet.
- 1 x 600mm width 7-drawer Cabinet.
- Laminate, Linoleum or Black Laminate Worktop.
- 2 x Service Ducts.
- Perforated Back Panels.
- 2 x 600mm width Overhead Storage Cupboards.
- 2 x 900mm width Overhead Storage Cupboards.
- 1 x Pack of 84 Clip Mix Kit (Suitable for Perforated Back Panel).

Corner Kit 1 - Dimensions/Codes

Worktop	Size H.W.D.	Code	Price
Laminate	2000.650	EUCMODSCR1	£5,014.49
Linoleum	2000.650	EUCMODSCR81	£5,113.14
Black Laminate	2000.650	EUCMODSCRA1	£5,014.41



Corner Kit 2

Corner Kit 2 comes complete with the following components:

- 1 x 600mm width 2m high Storage Cupboard.
- 1 x 1200mm width 2m high Storage Cupboard.
- 1 x 600mm width 6-drawer Cabinet.
- 1 x 600mm width 7-drawer Cabinet.
- 1 x 600mm width 5-drawer Cabinet.
- 1 x 600mm width 2-drawer & Storage Cupboard Cabinet.
- 1 x 600mm width Disposal Unit Cabinet.
- Laminate, Linoleum or Black Laminate Worktop.
- Service Ducts.
- Perforated Back Panels.
- 4 x 600mm width Overhead Storage Cupboards.
- 2 x 900mm width Overhead Storage Cupboards.
- 1 x Pack of 84 Clip Mix Kit (Suitable for Perforated Back Panel).

Corner Kit 2 - Dimensions/Codes

Worktop	Size H.W.D.	Code	Price
Laminate	2000.650	EUCMODPCBP2	£8,411.15
Linoleum	2000.650	EUCMODPC8P2	£8,545.94
Black Laminate	2000.650	EUCMODPCAP2	£8,411.15

Colour Options

To select drawer & door colours please add letters to the end of the code.



Worktop Options

Laminate Worktop
30mm thick



Solid Beech Worktop
27mm thick



Black Laminate Worktop
30mm thick





Our 2-metre tall Euroslide Cupboards bring a combination of storage and security to any workshop fit-out. A weld and rivet construction provides all-round robustness.

- “No Snag” handles with 2-point locking.
- Strengthened doors.
- 3 adjustable galvanised interior shelves included as standard, additional sold separately.
- Powder coated with Germ Guard Active Technology anti-bacterial paint.
- Cupboard shelves have a UDL of 50kg.



EUC2060651D - 600mm wide

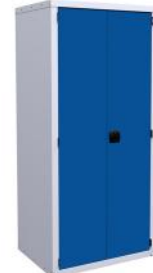

EUC2090652D - 900mm wide

Euroslide Cupboards - Dimensions/Codes

Description	Size H.W.D.	Code	Price
1200mm wide Cupboard	2000.1200.650	EUC2012652D	£596.86
900mm wide Cupboard	2000.900.650	EUC2090652D	£515.30
600mm wide Cupboard	2000.600.650	EUC2060651D	£434.04

Multi-Storage Cupboards

A range of heavy-duty cupboards ideal for all your storage requirements.

- The welded construction offers high strength and durability.
- 2000mm high x 940mm wide x 710mm deep gives a very large storage capacity.
- Either with solid doors or vision doors which allow you to inspect the contents of the cupboard.
- Each cupboard comes with adjustable feet for levelling.
- Drawers have a heavy-duty slide system giving 100% extension and a capacity of 100kg.
- Drawers can be fitted with a range of dividers, please see page 70.

Multi-Storage Cupboard Accessories

Description	Code	Price
100mm Deep Drawer	C6MSDRW100D	£164.58
150mm Deep Drawer	C6MSDRW150D	£181.04
200mm Deep Drawer	C6MSDRW200D	£204.97
Galvanised Shelf	C6MSSHELFXXX	£50.87

Half Height Back Panel

Perforated Panel (Tools Not Included)	C6MSTOOLPANX	£64.33
Louvre Panel	C6MSLOUVREPX	£64.33
Dual Panel (Perforated/Louvre)	C6MSDUALPANX	£64.33
Noticeboard Panel	C6MSNOTICEBX	£53.86

Full Height Back Panel

Perforated Panel (Tools Not Included)	C6MSPRFPANXX	£74.81
Dual Panel (Perforated/Louvre)	C6MSLOVPANXX	£74.81



Multi-Storage Cupboard shown with 150mm deep drawers, Full Height Tool Panel and Shelf (tools and clip kits not included).

Multi-Storage Cupboards - Dimensions/Codes

Description	Size H.W.D.	Code	Price
Vision Door Cupboard Only	2000.940.710	C6MSV209471	£1,418.36
Solid Door Cupboard Only	2000.940.710	C6MSS209471	£1,146.06



G

£907 FROM **.58**

Each kit comes complete with the following accessories:

- Worktop and Post fitted service ducts
- Perforated Back Panel
- Rear Support Posts
- Upper Shelf
- Tool Rail

600 System Tek - Extra Accessories

Description	Code	Price
Track (To Fit Tool Rail)	BETR600XLXXX	£66.52
Spring Tool Balance	BESPRBALXLXX	POA
Louvred Back Panel	BELO48600IXX	£94.48
Worktop Mounted Service Duct	BESDWT600XXX	£177.39
760mm Rear Support Posts	BESP760SXXXX	£109.15
1180mm Rear Support Posts	BESP1180XXXX	£132.44
Post Mounted Service Duct	BESDP600XXXX	£100.27
Perforated Back Panel	BEBP4860PFXX	£94.48
Light and Tool Rail	BERS600LXXXX	£65.56
Beech Upper Shelf	BEUS600BXXXX	£67.49
Laminate Upper Shelf	BEUS600PXXXX	£71.34



A



B



C



D



E



F

600 System Tek Kits

Key	Description	Drawer/Cupboard Depths	Beech Top Code	Price	Laminate Top Code	Price
A	Cupboard with Accessories	1x 750mm	EST600BKIT1	£907.58	EST600PKIT1	£960.61
B	2 Drawer & Cupboard with Accessories	2x 100mm, 1x 500mm	EST600BKIT2	£1,121.61	EST600PKIT2	£1,174.64
C	4 Drawer with Accessories	1x 150mm, 3x 200mm	EST600BKIT3	£1,321.18	EST600PKIT3	£1,374.21
D	5 Drawer with Accessories	5x 150mm	EST600BKIT4	£1,401.21	EST600PKIT4	£1,454.23
E	5 Drawer with Accessories	2x 100mm, 2x 150mm, 1x 200mm	EST600BKIT5	£1,388.67	EST600PKIT5	£1,441.70
F	6 Drawer with Accessories	4x 100mm, 1x 150mm, 1x 200mm	EST600BKIT6	£1,473.52	EST600PKIT6	£1,526.54
G	7 Drawer with Accessories	7x 100mm	EST600BKIT7	£1,539.07	EST600PKIT7	£1,592.10

Colour Options

To select drawer & door colours please add corresponding letters to the end of the code.



Each kit comes complete with the following accessories:

- Worktop and Post fitted service ducts
- Perforated Back Panel
- Rear Support Posts
- Upper Shelf
- Tool Rail



900 System Tek - Extra Accessories

Description	Code	Price
Track (To Fit Tool Rail)	BETR900XLXXX	£81.95
Spring Tool Balance	BESPRBALXLXX	POA
Louvred Back Panel	BELO48900IXX	£107.02
Worktop Mounted Service Duct	BESDWT900XXX	£101.23
760mm Rear Support Posts	BESP760SXXXX	£109.15
1180mm Rear Support Posts	BESP1180XXXX	£132.44
Post Mounted Service Duct	BESDP900XXX	£112.80
Perforated Back Panel	BEBP4890PFXX	£107.02
Light and Tool Rail	BERS900LXXX	£71.34
Beech Upper Shelf	BEUS900BXXXX	£85.81
Laminate Upper Shelf	BEUS900PXXXX	£77.13



900 System Tek Kits

Key	Description	Drawer/Cupboard Depths	Beech Top Code	Price	Laminate Top Code	Price
A	Cupboard with Accessories	1x 750mm	EST900BKIT1	£976.04	EST900PKIT1	£1,000.14
B	2 Drawer & Cupboard with Accessories	2x 100mm, 1x 500mm	EST900BKIT2	£1,178.50	EST900PKIT2	£1,202.61
C	4 Drawer with Accessories	1x150mm, 3x200mm	EST900BKIT3	£1,354.94	EST900PKIT3	£1,379.09
D	5 Drawer with Accessories	5x150mm	EST900BKIT4	£1,447.49	EST900PKIT4	£1,471.59
E	5 Drawer with Accessories	2x100mm, 2x150mm, 1x200mm	EST900BKIT5	£1,431.10	EST900PKIT5	£1,455.20
F	6 Drawer with Accessories	4x 100mm, 1x 150mm, 1x 200mm	EST900BKIT6	£1,518.84	EST900PKIT6	£1,542.94
G	7 Drawer with Accessories	7x 100mm	EST900BKIT7	£1,589.22	EST900PKIT7	£1,613.32

Colour Options

To select drawer & door colours please add corresponding letters to the end of the code.





2. Choose Your Worktop

Worktop Options - Dimensions/Codes

Description	Size H.W.D.	Code	Price
Beech Top	27.1200.650	ESBEETOP1265	£127.26
Laminate Top	20.1200.650	ESLAMTOP1265	£164.86
Linoleum Top	40.1200.650	ESLINTOP1265	£250.51
Beech Top	27.1500.650	ESBEETOP1565	£181.25
Laminate Top	20.1500.650	ESLAMTOP1565	£202.46
Linoleum Top	40.1500.650	ESLINTOP1565	£306.92
Beech Top	27.1800.650	ESBEETOP1865	£216.93
Laminate Top	20.1800.650	ESLAMTOP1865	£203.43
Linoleum Top	40.1800.650	ESLINTOP1865	£326.15



1. Choose one 600 Cabinet

System Tek Cabinets - Dimensions/Codes

Key	Description	Drawer/Cupboard Depths	Code	Price
A	Cupboard	1x 750mm	EUC18260651	£194.75
B	2 Drawer & Cupboard	2x 100mm, 1x 500mm	EUC18260652	£408.79
C	4 Drawer	1x150mm, 3x200mm	EUC1826065A	£608.36
D	5 Drawer	5x150mm	EUC1826065C	£688.38
E	5 Drawer	2x100mm, 2x150mm, 1x200mm	EUC1826065S	£675.85
F	6 Drawer	4x 100mm, 1x 150mm, 1x 200mm	EUC1826065E	£760.69
G	7 Drawer	7x 100mm	EUC1826065V	£826.25



A



B



C



D



E



F



G

Colour Options

To select drawer colours please add letters to the end of the code.



3. Choose Your Accessories

Accessories - Dimensions/Codes

Description	Code	Price
760mm Rear Support Posts	BESP760SXXXX	£109.15
1180mm Rear Support Posts	BESP1180XXXX	£132.44
Upper Shelf 300mm Solid Beech - 1200mm	BEUS1200BXXX	£176.10
Upper Shelf 300mm Solid Beech - 1500mm	BEUS1500BXXX	£213.94
Upper Shelf 300mm Solid Beech - 1800mm	BEUS1800BXXX	£259.05
Upper Shelf 300mm Laminate - 1200mm	BEUS1200PXXX	£152.81
Upper Shelf 300mm Laminate - 1500mm	BEUS1500PXXX	£181.92
Upper Shelf 300mm Laminate - 1800mm	BEUS1800PXXX	£216.85
Light/Tool Rail Support - 1200mm	BERS1200XLXX	£114.97
Light/Tool Rail Support - 1500mm	BERS1500XLXX	£122.25
Light/Tool Rail Support - 1800mm	BERS1800XLXX	£126.62
1200 Track (To Fit Tool Rail)	BETR1200LXX	£145.54
1500 Track (To Fit Tool Rail)	BETR1500LXX	£167.37
1800 Track (To Fit Tool Rail)	BETR1800LXX	£189.20
Spring Tool Balance	BESPRBALXLXX	POA
3 Setting LED Light - 1200mm	BE3SETL1200X	£88.78
Louvred/Perforated Back Panel - 1200mm	BECP4812IXXX	£209.57
Louvred/Perforated Back Panel - 1500mm	BECP4815IXXX	£229.95
Louvred/Perforated Back Panel - 1800mm	BECP4818IXXX	£256.14
Louvred/Pin Back Panel - 1200mm	BELO4812IXXX	£211.03
Louvred/Pin Back Panel - 1500mm	BELO4815IXXX	£219.76
Louvred/Pin Back Panel - 1800mm	BELO4818IXXX	£256.14
Combi Back Panel - 1200mm	BECP4812I3XX	£229.95
Combi Back Panel - 1500mm	BECP4815I3XX	£245.96
Combi Back Panel - 1800mm	BECP4818I3XX	£273.61
Worktop Service Duct - 1200mm	BESDWT122XXX	£176.10
Worktop Service Duct - 1500mm	BESDWT15XXX	£180.46
Worktop Service Duct - 1800mm	BESDWT18XXX	£189.20
Post Fitted Service Duct - 1200mm	BESDSP12XXXX	£193.56
Post Fitted Service Duct - 1500mm	BESDSP15XXXX	£202.29
Post Fitted Service Duct - 1800mm	BESDSP18XXXX	£215.39
Support Leg & Modesty Panel - 1200mm	E2LEGMOD6560	£84.84
Support Leg & Modesty Panel - 1500mm	E2LEGMOD6515	£84.84
Support Leg & Modesty Panel - 1800mm	E2LEGMOD6518	£84.84



2. Choose Your Worktop

Worktop Options - Dimensions/Codes

Description	Size H.W.D.	Code	Price
Beech Top	27.1200.650	ESBEETOP1265	£127.26
Laminate Top	20.1200.650	ESLAMTOP1265	£164.86
Linoleum Top	40.1200.650	ESLINTOP1265	£250.51
Beech Top	27.1500.650	ESBEETOP1565	£181.25
Laminate Top	20.1500.650	ESLAMTOP1565	£202.46
Linoleum Top	40.1500.650	ESLINTOP1565	£306.92
Beech Top	27.1800.650	ESBEETOP1865	£216.93
Laminate Top	20.1800.650	ESLAMTOP1865	£203.43
Linoleum Top	40.1800.650	ESLINTOP1865	£326.15



1. Choose one 900 Cabinet

System Tek Cabinets - Dimensions/Codes

Key	Description	Drawer/Cupboard Depths	Code	Price
A	Cupboard	1x 750mm	EUC18290651	£252.60
B	2 Drawer & Cupboard	2x 100mm, 1x 500mm	EUC18290653	£455.06
C	4 Drawer	1x 150mm, 3x 200mm	EUC1829065A	£631.50
D	5 Drawer	5x 150mm	EUC1829065C	£724.05
E	5 Drawer	2x 100mm, 2x 150mm, 1x 200mm	EUC18290655	£707.66
F	6 Drawer	4x 100mm, 1x 150mm, 1x 200mm	EUC1829065E	£795.40
G	7 Drawer	7x 100mm	EUC1829065V	£865.78



A



B



C



D



E



F



G

Colour Options

To select drawer colours please add letters to the end of the code.



3. Choose Your Accessories

Accessories - Dimensions/Codes

Description	Code	Price
760mm Rear Support Posts	BESP760SXXXX	£109.15
1180mm Rear Support Posts	BESP1180SXXXX	£132.44
Upper Shelf 300mm Solid Beech - 1200mm	BEUS1200BXXX	£176.10
Upper Shelf 300mm Solid Beech - 1500mm	BEUS1500BXXX	£213.94
Upper Shelf 300mm Solid Beech - 1800mm	BEUS1800BXXX	£259.05
Upper Shelf 300mm Laminate - 1200mm	BEUS1200PXXX	£152.81
Upper Shelf 300mm Laminate - 1500mm	BEUS1500PXXX	£181.92
Upper Shelf 300mm Laminate - 1800mm	BEUS1800PXXX	£216.85
Light/Tool Rail Support - 1200mm	BERS1200XLXX	£ 114.97
Light/Tool Rail Support - 1500mm	BERS1500XLXX	£122.25
Light/Tool Rail Support - 1800mm	BERS1800XLXX	£126.62
1200 Track (To Fit Tool Rail)	BETR1200XLXX	£145.54
1500 Track (To Fit Tool Rail)	BETR1500XLXX	£167.37
1800 Track (To Fit Tool Rail)	BETR1800XLXX	£189.20
Spring Tool Balance	BESPRBALXLLX	POA
3 Setting LED Light - 1200mm	BE3SETL1200X	£88.78
Louvred/Perforated Back Panel - 1200mm	BECP4812IXXX	£209.57
Louvred/Perforated Back Panel - 1500mm	BECP4815IXXX	£229.95
Louvred/Perforated Back Panel - 1800mm	BECP4818IXXX	£256.14
Louvred/Pin Back Panel - 1200mm	BELO4812IXXX	£211.03
Louvred/Pin Back Panel - 1500mm	BELO4815IXXX	£219.76
Louvred/Pin Back Panel - 1800mm	BELO4818IXXX	£256.14
Combi Back Panel - 1200mm	BECP4812I3XX	£229.95
Combi Back Panel - 1500mm	BECP4815I3XX	£245.96
Combi Back Panel - 1800mm	BECP4818I3XX	£273.61
Worktop Service Duct - 1200mm	BESDWT122XXX	£176.10
Worktop Service Duct - 1500mm	BESDWT15XXXX	£180.46
Worktop Service Duct - 1800mm	BESDWT18XXXX	£189.20
Post Fitted Service Duct - 1200mm	BESDSP12XXXX	£193.56
Post Fitted Service Duct - 1500mm	BESDSP15XXXX	£202.29
Post Fitted Service Duct - 1800mm	BESDSP18XXXX	£215.39
Support Leg & Modesty Panel - 1200mm	E2LEGMOD6560	£84.84
Support Leg & Modesty Panel - 1500mm	E2LEGMOD6515	£84.84
Support Leg & Modesty Panel - 1800mm	E2LEGMOD6518	£84.84



- Heavy-duty bench suitable for heavy-duty applications such as engineering and manufacturing.
- All-steel construction.
- Beech, Laminate, Linoleum and Steel worktop options available.
- Workbenches are available in 1200mm, 1500mm and 1800mm widths.
- Full-width, full-extension precision ball race slides with anti-tilt feature.
- Central-locking for extra security.
- Load capacity of 100kg per drawer.
- Cupboard doors are fitted with an interior perforated panel to fit tool clips.
- A range of drawer divider kits and extra shelves are available.
- Full range of above bench accessories are available.

£430 FROM **96**



DRAWER CAPACITY

Euroslide



Beech Worktop



Laminate Worktop



Linoleum Worktop



Steel Worktop

Bench Dimensions	Beech Top		Laminate Top		Linoleum Top		Steel Top	
	Size H.W.D.	Beech Top Code	Price	Laminate Top Code	Price	Linoleum Top Code	Price	Steel Top Code
920.1200.750	BE921275BLXX	£430.96	BE921275PLXX	£452.17	BE921275LXX	£452.17	BE921275SKXX	£497.39
920.1200.900	BE921290BLXX	£473.38	BE921290PLXX	£498.45	BE921290LXX	£498.45	BE921290SKXX	£550.27
920.1500.750	BE921575BLXX	£548.58	BE921575PLXX	£553.40	BE921575LXX	£553.40	BE921575SKXX	£603.21
920.1500.900	BE921590BLXX	£600.64	BE921590PLXX	£622.82	BE921590LXX	£622.82	BE921590SKXX	£678.87
920.1800.750	BE921875BLXX	£602.57	BE921875PLXX	£566.90	BE921875LXX	£566.90	BE921875SKXX	£617.92
920.1800.900	BE921890BLXX	£667.17	BE921890PLXX	£755.87	BE921890LXX	£755.87	BE921890SKXX	£816.34

Colour Options

To select drawer & door colours please add corresponding letters to the end of the code.



600 Workbench Cabinets

(600 Cabinet Size - H.825 W.600 D.650)



Key	Description	Drawer/Cupboard Depths	Code	Price
A	Single Cupboard	1x 750mm	EUC18260651	£194.75
B	2 Drawer & Cupboard	2x 100mm, 1x 500mm	EUC18260652	£408.79
C	4 Drawer	1x 150mm, 3x 200mm	EUC1826065A	£608.36
D	5 Drawer	5x 150mm	EUC1826065C	£688.38
E	5 Drawer	2x 100mm, 2x 150mm, 1x 200mm	EUC18260655	£675.85
F	6 Drawer	4x 100mm, 1x 150mm, 1x 200mm	EUC1826065E	£760.69
G	7 Drawer	7x 100mm	EUC1826065V	£826.25
H	2 Drawer	2x 100mm	EUC276065DS	£301.77

900 Workbench Cabinets

(900 Cabinet Size - H.825 W.900 D.650)

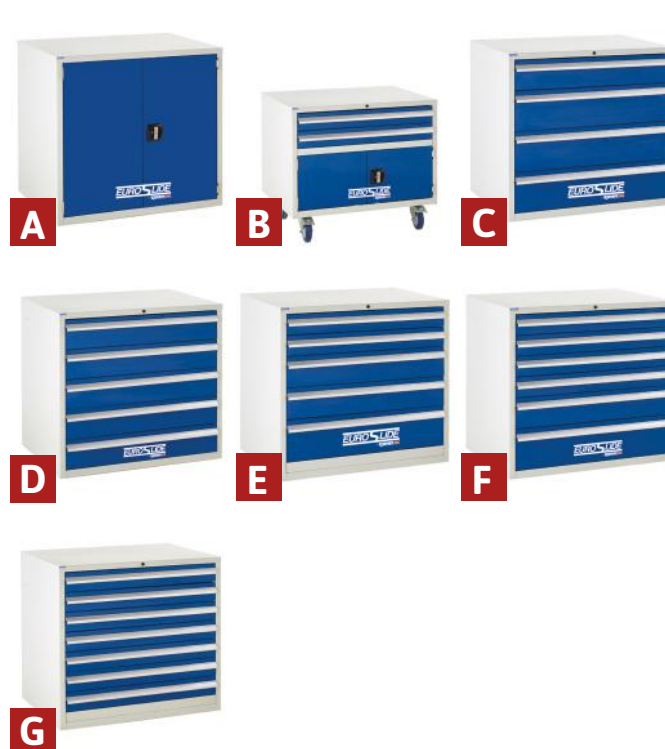

Key	Description	Drawer/Cupboard Depths	Code	Price
A	Double Cupboard	1x 750mm	EUC18290651	£252.60
B	2 Drawer & Cupboard	2x 100mm, 1x 500mm	EUC18290653	£455.06
C	4 Drawer	1x150mm, 3x200mm	EUC1829065A	£631.50
D	5 Drawer	5x150mm	EUC1829065C	£724.05
E	5 Drawer (2x100mm)	2x100mm, 2x150mm, 1x200mm	EUC18290655	£707.66
F	6 Drawer	4x100mm, 1x 150mm, 1x 200mm	EUC1829065E	£795.40
G	7 Drawer	7x 100mm	EUC1829065V	£865.78

Key	Description	Code	Price
A	760mm Rear Support Posts	BESP760SXXXX	£109.15
A	1180mm Rear Support Posts	BESP1180XXXX	£132.44
B	Upper Shelf 300mm Solid Beech - 1200mm	BEUS1200BXXX	£176.10
B	Upper Shelf 300mm Solid Beech - 1500mm	BEUS1500BXXX	£213.94
B	Upper Shelf 300mm Solid Beech - 1800mm	BEUS1800BXXX	£259.05
B	Upper Shelf 300mm Laminate - 1200mm	BEUS1200PXXX	£152.81
B	Upper Shelf 300mm Laminate - 1500mm	BEUS1500PXXX	£181.92
B	Upper Shelf 300mm Laminate - 1800mm	BEUS1800PXXX	£216.85
C	Light/Tool Rail Support - 1200mm	BERS1200XLXX	£114.97
C	Light/Tool Rail Support - 1500mm	BERS1500XLXX	£122.25
C	Light/Tool Rail Support - 1800mm	BERS1800XLXX	£126.62
D	3 Setting LED Light - 1200mm	BE3SETL1200X	£88.78
E	Combi Back Panel - 1200mm	BECP4812I3XX	£229.95
E	Combi Back Panel - 1500mm	BECP4815I3XX	£245.96
E	Combi Back Panel - 1800mm	BECP4818I3XX	£273.61
F	Worktop Service Duct - 1200mm	BESDWT122XXX	£176.10
F	Worktop Service Duct - 1500mm	BESDWT15XXXX	£180.46
F	Worktop Service Duct - 1800mm	BESDWT18XXXX	£189.20
G	Post Fitted Service Duct - 1200mm	BESDSP12XXXX	£193.56
G	Post Fitted Service Duct - 1500mm	BESDSP15XXXX	£202.29
G	Post Fitted Service Duct - 1800mm	BESDSP18XXXX	£215.39

Above Bench Accessories

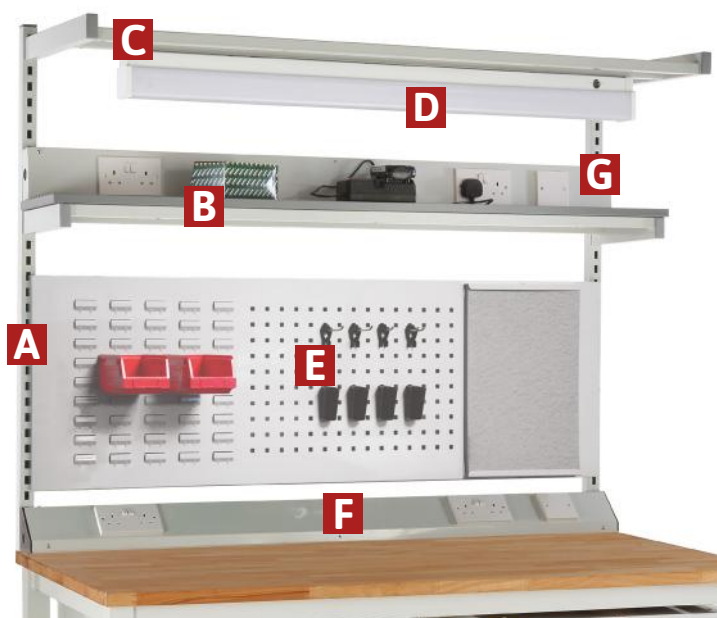



EUROSLIDE

£430.96 FROM

1200KG UDL
EVENLY DISTRIBUTED

Euroslide Superbench shown with optional accessories.

- High-quality workbench, fully welded for extra strength.
- Tough light grey powder-coated finish.
- Various worktop surfaces available including Beech, Laminate, Linoleum and Steel Top.
- A range of drawer divider kits and extra shelves are available.
- Fully welded framework, 50mm x 50mm and 50mm x 25mm section.
- Above bench accessories are also available.



Beech Worktop



Laminate Worktop



Linoleum Worktop



Steel Worktop

Bench Dimensions	Beech Top		Laminate Top		Linoleum Top		Steel Top	
	Beech Top Code	Price	Laminate Top Code	Price	Linoleum Top Code	Price	Steel Top Code	Price
840.1200.750	BSE841275BLX	£430.96	BSE841275PLX	£452.17	BSE841275SLX	£452.17	BSE841275SLX	£432.89
840.1200.900	BSE841290BLX	£472.42	BSE841290PLX	£499.41	BSE841290SLX	£499.41	BSE841290SLX	£480.13
840.1500.750	BSE841575BLX	£548.58	BSE841575PLX	£553.40	BSE841575SLX	£553.40	BSE841575SLX	£536.05
840.1500.900	BSE841590BLX	£600.64	BSE841590PLX	£622.82	BSE841590SLX	£622.82	BSE841590SLX	£546.65
840.1800.750	BSE841875BLX	£602.57	BSE841875PLX	£623.78	BSE841875SLX	£623.78	BSE841875SLX	£575.58
840.1800.900	BSE841890BLX	£667.17	BSE841890PLX	£755.87	BSE841890SLX	£755.87	BSE841890SLX	£598.72

600 Superbench Cabinets

(600 Cabinet Size - H.620 W.600 D.650)



900 Superbench Cabinets

(900 Cabinet Size - H.620 W.900 D.650)



Colour Options

To select drawer colours please add letters to the end of the code.



600 Superbench Cabinets - H.620 W.600 D.650

Key	Description	Drawer/Cupboard Depths	Model	Price
A	Single Cupboard	1x 550mm	EUC6760651	£164.86
B	2 Drawer & Cupboard	2x 100mm, 1x 300mm	EUC6760652	£378.90
C	3 Drawer	1x 150mm, 2x 200mm	EUC6760653	£475.31
D	4 Drawer	1x 100mm, 3x 150mm	EUC676065A	£551.47
E	4 Drawer	2x 100mm, 1x 150mm, 1x 200mm	EUC6760654	£552.44
F	5 Drawer	4x 100mm, 1x 150mm	EUC676065C	£626.68
G	2 Drawer	2x 100mm	EUC276065DS	£301.77

900 Superbench Cabinets - H.620 W.900 D.650

Key	Description	Drawer/Cupboard Depths	Model	Price
A	Double Cupboard	1x 550mm	EUC6790651	£227.53
B	2 Drawer & Cupboard	2x 100mm, 1x 300mm	EUC6790652	£419.39
C	3 Drawer	1x150mm, 2x200mm	EUC6790653	£499.41
D	4 Drawer	1x100mm, 3x 150mm	EUC679065A	£575.58
E	4 Drawer	2x100mm, 1x150mm, 1x200mm	EUC6790655	£576.54
F	5 Drawer	4x 100mm, 1x 150mm	EUC679065C	£650.78

Above Bench - Accessories

Key	Description	Model	Price
A	760mm Rear Support Posts	BESP760SXXX	£109.15
A	1180mm Rear Support Posts	BESP1180SXXX	£132.44
B	Upper Shelf 300mm Solid Beech - 1200mm	BEUS1200BXXX	£176.10
B	Upper Shelf 300mm Solid Beech - 1500mm	BEUS1500BXXX	£213.94
B	Upper Shelf 300mm Solid Beech - 1800mm	BEUS1800BXXX	£259.05
B	Upper Shelf 300mm Laminate - 1200mm	BEUS1200PXXX	£152.81
B	Upper Shelf 300mm Laminate - 1500mm	BEUS1500PXXX	£181.92
B	Upper Shelf 300mm Laminate - 1800mm	BEUS1800PXXX	£216.85
C	Light/Tool Rail Support - 1200mm	BERS1200XLXX	£114.97
C	Light/Tool Rail Support - 1500mm	BERS1500XLXX	£122.25
C	Light/Tool Rail Support - 1800mm	BERS1800XLXX	£126.62
D	3 Setting LED Light - 1200mm	BE3SETL1200X	£88.78
E	Combi Back Panel - 1200mm	BECP4812I3XX	£229.95
E	Combi Back Panel - 1500mm	BECP4815I3XX	£245.96
E	Combi Back Panel - 1800mm	BECP4818I3XX	£273.61
F	Worktop Service Duct - 1200mm	BESDWT122XXX	£176.10
F	Worktop Service Duct - 1500mm	BESDWT15XXX	£180.46
F	Worktop Service Duct - 1800mm	BESDWT18XXX	£189.20
G	Post Fitted Service Duct - 1200mm	BESDSP12XXXX	£193.56
G	Post Fitted Service Duct - 1500mm	BESDSP15XXXX	£202.29
G	Post Fitted Service Duct - 1800mm	BESDSP18XXXX	£215.39

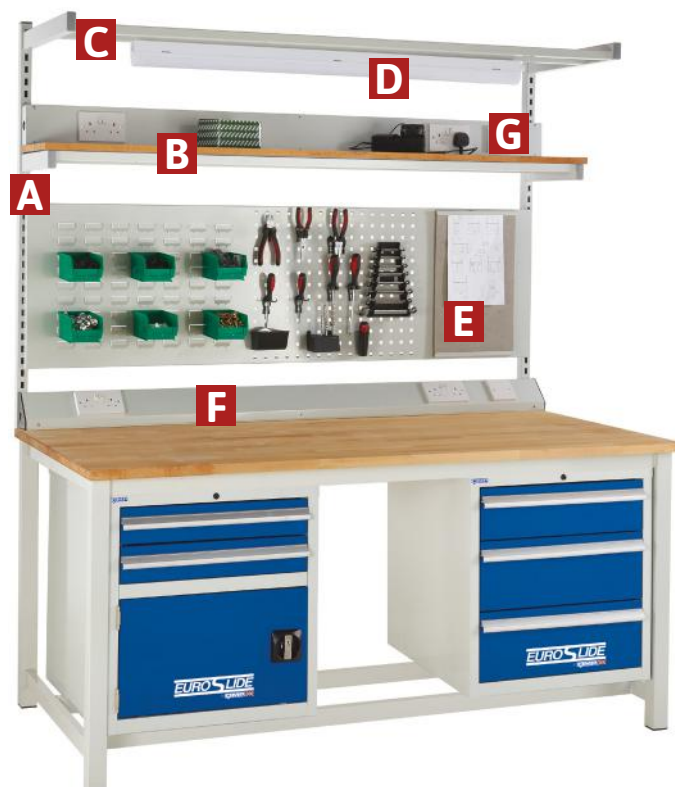

'A Frame' Trolley (1230mm high)

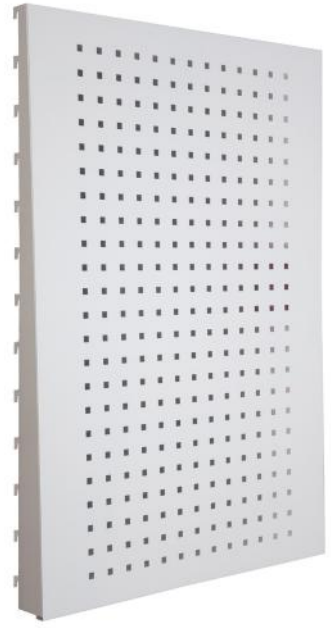

1. Choose Your Trolley

System Flow Trolley - Basic Frame

Description	Size H.W.D.	Code	Price
With Castors	1230.680.260	RTSYF1268M*X	£284.41
With Castors	1230.1000.260	RTSYF1210M*X	£307.55
Without Castors	1090.680.260	RTSYF1268U*X	£238.14
Without Castors	1090.1000.260	RTSYF1210U*X	£261.28

2. Choose Your Panels

Panels & Shelves - Dimensions/Codes

Description	Size H.W.D.	Code	Price
Perforated Panel (To suit 1230.680 Trolley)	910.630.60	RTPERF12*XX	£65.56
Perforated Panel (To suit 1230.1000 Trolley)	910.930.60	RTPERF16*XX	£70.38
Louvred Panel (To suit 1230.680 Trolley)	910.630.60	RTLQVR12*XX	£68.45
Louvred Panel (To suit 1230.1000 Trolley)	910.930.60	RTLQVR16*XX	£74.24

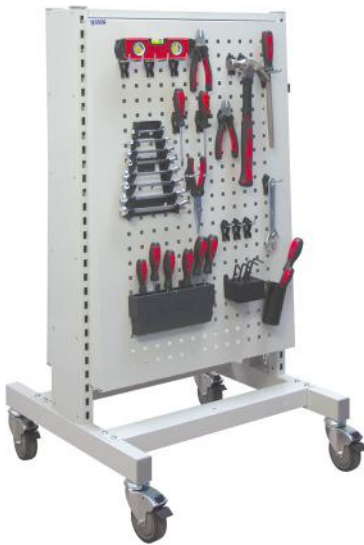

Clip Kits available on page 94. Plastic Containers available on page 54.



Colour Options

To select panel colours please add corresponding letters to the end of the code.



'A Frame' Trolley (1650mm high)

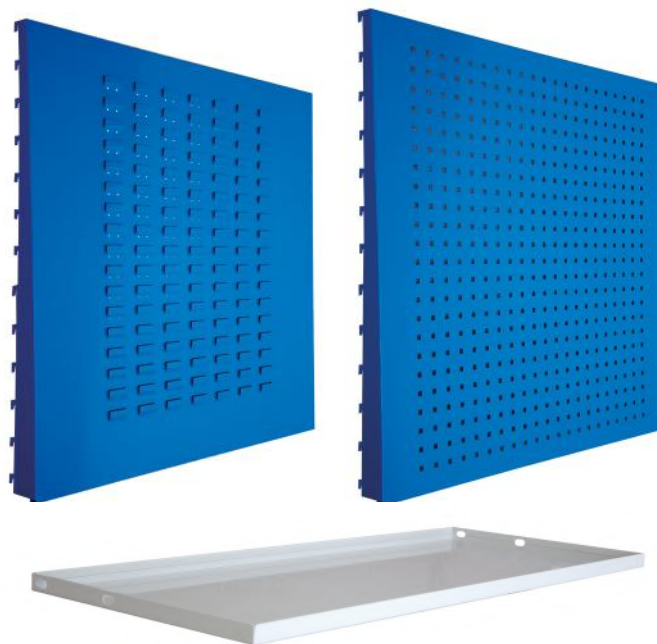

1. Choose Your Trolley

System Flow Trolley - Basic Frame

Description	Size H.W.D.	Code	Price
With Castors	1650.680.260	RTSYF1668M*X	£312.37
With Castors	1650.1000.260	RTSYF1610M*X	£358.65
Without Castors	1520.680.260	RTSYF1668U*X	£266.10
Without Castors	1520.1000.260	RTSYF1610U*X	£312.37

2. Choose Your Panels/Shelves

Panels & Shelves - Dimensions/Codes

Description	Size H.W.D.	Code	Price
Perforated Panel (To suit 1230.680 Trolley)	910.630.60	RTPERF12*XX	£65.56
Perforated Panel (To suit 1230.1000 Trolley)	910.930.60	RTPERF16*XX	£70.38
Louvre Panel (To suit 1230.680 Trolley)	910.630.60	RTLQVR12*XX	£68.45
Louvre Panel (To suit 1230.1000 Trolley)	910.930.60	RTLQVR16*XX	£74.24
Shelf	20.600.350	RTSHLU80LXX	£31.82
Shelf	20.900.350	RTSHLU10LXX	£38.56

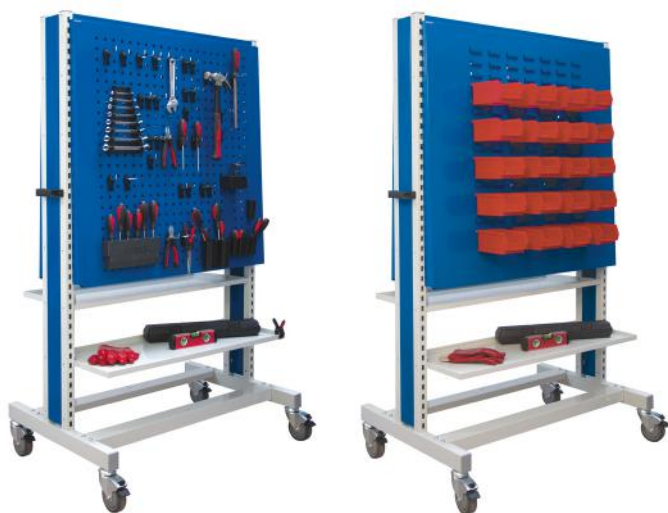

Clip Kits available on page 94. Plastic Containers available on page 54.



Colour Options

To select panel colours please add corresponding letters to the end of the code.



Tool Trolleys

- Quick and easy identification of storage location or missing tools.
- 2 x 75mm Nylon swivel castors and 2 x 75 Nylon swivel castors with brakes.
- Made from 60 x 40 x 1.5mm ERW tube.
- Channel made from 1.5mm mild steel.
- Pegboard back panel made from 1.2mm mild steel.
- Pegboard available 500mm and 750mm wide.
- Adjustable bin rails made from 50 x 25 x 1.5 mild steel.

Shelf & Panel Trolleys

- 2 x 75mm Nylon swivel castors and 2 x 75mm Nylon swivel castors with brakes.
- Made from 60mm x 40mm x 1.5mm ERW tube.
- Channel made from 1.5mm mild steel.
- Magnetic back panel made from 1.2mm mild steel, available 500mm and 750mm wide.
- Adjustable bin rails made from 50mm x 25mm x 1.5mm mild steel.
- Shelves are adjustable and can be flat or at an angle.

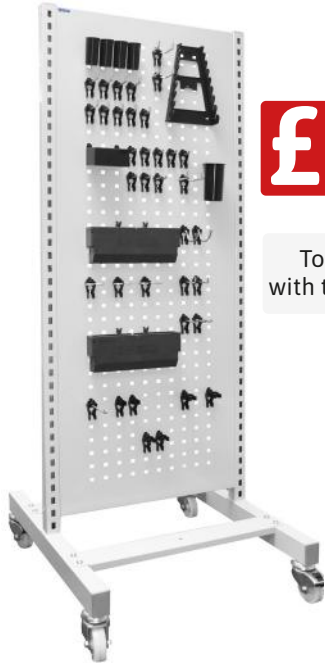

£564.97 FROM

Tool Panel Trolley shown with tool clips, sold separately.



Shelf & Panel Trolley shown with Adjustable Bin Rails, Plastic Containers and Extra Shelves, sold separately.

£564.97 FROM

1. Choose Your Trolley

Tool Panel Trolleys - Dimensions/Codes

Description	Size H.W.D.	Code	Price
Pegboard Width 500mm	1600.580.660	RTTP165866LX	£564.97
Pegboard Width 750mm	1600.830.660	RTTP168366LX	£605.46

2. Choose Your Accessories

Adjustable Bin Rails - Dimensions/Codes

Width	Code	Price
500	RTSPADBINR5X	£43.39
750	RTSPADBINR7X	£47.24

Clip Mix 53



10x Single Hook (Length 30mm), 2x Single Hook (Length 60mm), 1x Single Hook (Length 90mm), 1x Double Hook (Length 30mm), 1x Double Hook (Length 60mm), 6x Single Angled Hook (Length 25mm), 3x Single Angled Hook (Length 50mm), 2x Hammer Holder (Length 40mm), 1x Hammer Holder (Length 50mm), 2x Pliers Holder (Length 17mm), 1x Pliers Holder (Length 20mm), 4x Spring Clip (Diameter 12mm), 4x Spring Clip (Diameter 18mm), 4x Spring Clip (Diameter 24mm), 6x Pipe Holder (Diameter 30mm), 1x Pipe Holder (Diameter 50mm), 2x Power Drill Holder, 1x Spanner Holder, 1x Drill Bit Holder

RTCLIPMIX53X **£111.43**

1. Choose Your Trolley

Shelf & Panel Trolleys - Dimensions/Codes

Description	Size H.W.D.	Code	Price
Magnetic Panel Width 500mm	1600.580.660	RTSP165866LX	£564.97
Magnetic Panel Width 750mm	1600.830.660	RTSP168366LX	£576.54

2. Choose Your Accessories

Accessories - Dimensions/Codes

Description	Size H.W.D.	Code	Price
Adjustable Bin Rails	500mm Width	RTSPADBINR5X	£43.39
Adjustable Bin Rails	750mm Width	RTSPADBINR7X	£47.24
Extra Shelf	500mm Width	RTEXSHELF50X	£77.13
Extra Shelf	750mm Width	RTEXSHELF75X	£89.66

Clip Mix 84



18x Single Hook (Length 30mm), 2x Single Hook (Length 60mm), 1x Single Hook (Length 90mm), 2x Double Hook (Length 30mm), 2x Double Hook (Length 60mm), 12x Single Angled Hook (Length 25mm), 3x Single Hook (Length 50mm), 2x Single Angled Hook (Length 75mm), 2x Hammer Holder (Length 40mm), 2x Hammer Holder (Length 50mm), 4x Pliers Holder (Length 17mm), 2x Pliers Holder (Length 20mm), 6x Spring Clip (Diameter 12mm), 6x Spring Clip (Diameter 18mm), 6x Spring Clip (Diameter 24mm), 8x Pipe Holder (Diameter 30mm), 1x Pipe Holder (Diameter 50mm), 1x Box, 2x Power Drill Holder, 1x Spanner Holder, 1x Drill Bit Holder

RTCLIPMIX84X **£175.84**

Cupboards

- | | |
|--|--|
| 96 Hazardous Substance Cupboards | 109 SpillZone® Absorbent Stations |
| 98 CoSHH Cupboards | 110 Vision Door Cupboards |
| 100 Acid/Alkali Cupboards | 111 Perforated Door Cupboards |
| 101 Pesticide & Agrochemical Cupboards | 112 Modular Cupboards |
| 102 Pesticide & Agrochemical Security Cupboards | 113 Workplace Cupboards |
| 102 Acid/Alkali Security Cupboards | 114 Clothing & Utility Cupboards |
| 103 Hazardous Security Cupboards | 115 Container Storage Cupboards |
| 103 CoSHH Security Cupboards | 116 Perforated Tool Cupboards |
| 104 Petroleum & Flammable Liquid Cupboards | 117 First Aid Cupboards |
| 105 Flammable Liquid Cupboards | 118 PPE Cupboards |
| 106 HazSafe® Site Security Boxes | 119 Security Cupboards |
| 107 FlamSafe® Site Security Boxes | 120 Stainless Steel Cupboards |
| 108 ToolSafe® Site Security Boxes | 120 Cupboard & Euroslide Lock Options |



£238 FROM .85

BEST SELLER



FIRE GUARD
TESTED & CERTIFIED
EN 13501-1

3-5 DAY
DELIVERY

It is vital that employers and employees comply with the control of hazardous substances in all working environments. This range of cupboards and cabinets enables the separate storage and transportation of hazardous substances as demanded by the CoSHH regulations.

- “No snag” handles with 2-point locking.
 - Adjustable spill-retaining galvanised shelves for superior spill management*.
 - Integral liquid-tight sump encourages the correct handling of spills through the use of absorbents*.
 - Wall cupboards are pre-drilled for mounting (fixings not included).
 - Floor chests have a welded integrated sump, angled lid to discourage article placement and a hasp and staple lock - padlock not supplied.
 - New regulation labels enclosed to be fitted by customer to suit regulations.
 - Stands raise cupboards by 543mm with an adjustable foot for uneven surfaces.
 - Powder coated with Germ Guard Active Technology Anti-Bacterial Paint.
 - Reaction to Fire Classification EN 13501-1.
 - Cupboard shelves have a UDL of 50kg.
 - Order quantities may apply, please speak to the sales team.
- *Except wall mounted cupboards.



Floor Cupboards



CZ909046ZYXX



CZ703530ZYXX



CZ189046ZYXX

Floor Cupboards - Dimensions/Codes

Size H.W.D.	Galvanised Shelves	Code	Price	Extra Shelves	Code	Price
1800.1200.460	3	CZ181246ZYXX	£632.51	W.1200 x D.460	CUPDHLF1246	£65.83
1800.900.460	3	CZ189046ZYXX	£536.67	W.900 x D.460	CUPDHLF9046	£56.85
1200.900.460	2	CZ129046ZYXX	£455.58	W.900 x D.460	CUPDHLF9046	£56.85
900.900.460	1	CZ909046ZYXX	£361.22	W.900 x D.460	CUPDHLF9046	£56.85
900.460.460	1	CZ904646ZYXX	£281.61	W.460 x D.460	CUPDHLF4646	£43.39
700.900.460	1	CZ709046ZYXX	£330.26	W.900 x D.460	CUPDHLF9046	£56.85
700.350.300	1	CZ703530ZYXX	£238.85	W.350 x D.300	CUPDHLF3530	£35.91

Mobile Cupboards



Mobile Cupboards - Dimensions/Codes

Size H.W.D.	Shelves	Code	Price
1010.900.460	1	CZ109046MYXX	£573.53
810.900.460	1	CZ849046MYXX	£526.35

Floor Chests



Floor Chests - Dimensions/Codes

Size H.W.D.	Code	Price
610.1170.460	CZ611146ZYXX	£610.39
510.610.340	CZ516134ZYXX	£389.23

Wall Cupboards



Wall Cupboards - Dimensions/Codes

Size H.W.D.	Shelves	Code	Price
570.850.255	1	CZ855725ZYXX	£312.57

Stands



Stands - Dimensions/Codes

Size H.W.D.	Code	Price
543.900.460	CZST9046ZYXX	£144.49
543.460.460	CZST4646ZYXX	£128.27
543.350.300	CZST3530ZYXX	£123.85

£242.38 FROM

FIRE GUARD
TESTED & CERTIFIED
EN 13501-1

It is vital that employers and employees comply with the control of hazardous substances in all working environments. This range of cupboards and cabinets enables the separate storage and transportation of hazardous substances as demanded by the CoSHH regulations.

- “No snag” handles with 2-point locking.
- Adjustable spill-retaining galvanised shelves for superior spill management*.
- New regulation labels enclosed to be fitted by customers to suit regulations.
- Integral liquid-tight sump encourages the correct handling of spills through the use of absorbents*.
- Wall cupboards are pre-drilled for mounting (fixings not included).
- Floor chests have a welded integrated sump, angled lid to discourage article placement and a hasp and staple lock - padlock not supplied.
- Stands raise cupboards by 543mm with an adjustable foot for uneven surfaces.
- Powder coated with Germ Guard Active Technology Anti-Bacterial Paint.
- Reaction to Fire Classification EN 13501-1.
- Cupboard shelves have a UDL of 50kg.

*Except wall mounted cupboards.



Floor Cupboards



CZ709046ZKXX



CZ703530ZKXX



CZ189046ZKXX

Floor Cupboards - Dimensions/Codes

Size H.W.D.	Shelves	Galvanised Code	Price	Extra Shelves	Code	Price
1800.1200.460	3	CZ181246ZKXX	£641.85	W.1200 x D.460	CUPDShLF1246	£65.83
1800.900.460	3	CZ189046ZKXX	£544.60	W.900 x D.460	CUPDShLF9046	£56.85
1200.900.460	2	CZ129046ZKXX	£462.31	W.900 x D.460	CUPDShLF9046	£56.85
900.900.460	1	CZ909046ZKXX	£366.56	W.900 x D.460	CUPDShLF9046	£56.85
900.460.460	1	CZ904646ZKXX	£285.77	W.460 x D.460	CUPDShLF4646	£43.39
700.900.460	1	CZ709046ZKXX	£335.14	W.900 x D.460	CUPDShLF9046	£56.85
700.350.300	1	CZ703530ZKXX	£242.38	W.350 x D.300	CUPDShLF3530	£35.91

Mobile Cupboards



Mobile Cupboards - Dimensions/Codes

Size H.W.D.	Shelves	Code	Price
1010.900.460	1	CZ109046MKXX	£582.01
810.900.460	1	CZ849046MKXX	£534.13

Floor Chests



Floor Chests - Dimensions/Codes

Size H.W.D.	Code	Price
610.1170.460	CZ611146ZKXX	£619.41
510.610.340	CZ516134ZKXX	£394.99

Wall Cupboards



Wall Cupboards - Dimensions/Codes

Size H.W.D.	Shelves	Code	Price
570.850.255	1	CZ855725ZKXX	£317.19

Stands



Stands - Dimensions/Codes

Size H.W.D.	Code	Price
543.900.460	CZST9046ZKXX	£146.62
543.460.460	CZST4646ZKXX	£130.17
543.350.300	CZST3530ZKXX	£125.68

£263.32 FROM

FIRE GUARD
TESTED & CERTIFIED
EN 13501-1



Liquid Tight Sump Included



Use of caustic materials in the workplace can present many hazards, particularly if acids and alkalis are stored incorrectly or with other chemicals. These storage cabinets enable safe and identifiable storage in the workplace.

- “No snag” handles with 2-point locking.
- New regulation labels enclosed to be fitted by customer.
- Adjustable spill-retaining shelves for superior spill management*.
- Integral liquid-tight sump encourages the correct handling of spills through the use of absorbents*.

- Wall cupboards are pre-drilled for mounting (fixings not included).
 - Stands raise cupboards by 543mm with an adjustable foot for uneven surfaces.
 - Powder coated with white Germ Guard Active Technology Anti-Bacterial Paint.
 - Reaction to Fire Classification EN 13501-1.
 - It is not recommended to store acids and alkalis together in a single unit as corrosion may occur.
 - Cupboard shelves have a UDL of 50kg.
- *Except wall mounted cupboards.

Floor Cupboards - Dimensions/Codes

Size H.W.D.	Shelves	Code	Price
1800.1200.460	3	CA181246ZWXX	£721.15
1800.900.460	3	CA189046ZWXX	£608.94
1200.900.460	2	CA129046ZWXX	£526.65
900.900.460	1	CA909046ZWXX	£402.27
900.460.460	1	CA904646ZWXX	£314.19
700.900.460	1	CA709046ZWXX	£369.55
700.350.300	1	CA703530ZWXX	£263.32

Extra Shelves - Dimensions/Codes

To Fit	Code	Price
W.1200 x D.460	CAES1246ZWXX	£98.75
W.900 x D.460	CAES9046ZWXX	£85.28
W.460 x D.460	CAES4646ZWXX	£65.83
W.350 x D.300	CAES3530ZWXX	£52.37

Wall Cupboards - Dimensions/Codes

Size H.W.D.	Shelves	Code	Price
570.850.255	1	CA855725ZWXX	£350.10

Mobile Cupboards - Dimensions/Codes

Size H.W.D.	Shelves	Code	Price
1010.900.460	1	CA109046MWXX	£595.47
810.900.460	1	CA849046MWXX	£562.56

Stands - Dimensions/Codes

Size H.W.D.	Code	Price
543.900.460	CAST9046ZWXX	£151.11
543.460.460	CAST4646ZWXX	£137.65
543.350.300	CAST3530ZWXX	£127.17



£263.32 FROM



- Perforated doors for extra ventilation.
- "No snag" handles with 2-point locking.
- Adjustable spill-retaining shelves for superior spill management.
- New regulation labels enclosed to be fitted by customer to suit regulations.
- Integral liquid-tight sump encourages the correct handling of spills through the use of absorbents.
- Stands raise cupboards by 543mm with an adjustable foot for uneven surfaces.
- Powder coated with Germ Guard Active Technology Anti-Bacterial Paint.
- Reaction to Fire Classification EN 13501-1.
- Cupboard shelves have a UDL of 50kg.



Stand with adjustable foot for uneven surfaces.

Floor Cupboards - Dimensions/Codes

Size H.W.D.	Shelves	Code	Price
1800.1200.460	3	CP181246ZRXX	£721.15
1800.900.460	3	CP189046ZRXX	£608.94
1200.900.460	2	CP129046ZRXX	£526.65
900.900.460	1	CP909046ZRXX	£402.47
900.460.460	1	CP904646ZRXX	£314.19
700.900.460	1	CP709046ZRXX	£369.55
700.350.300	1	CP703530ZRXX	£263.32

Mobile Cupboards - Dimensions/Codes

Size H.W.D.	Shelves	Code	Price
1010.900.460	1	CP109046MRXX	£629.88
810.900.460	1	CP849046MRXX	£598.46

Extra Shelves - Dimensions/Codes

To Fit	Code	Price
W.900 x D.460	CUPDSHLF9046	£56.85
W.1200 x D.460	CUPDSHLF1246	£65.83
W.460 x D.460	CUPDSHLF4646	£43.39
W.350 x D.300	CUPDSHLF3530	£35.91

Stands - Dimensions/Codes

Size H.W.D.	Code	Price
543.900.460	CPST9046ZRXX	£151.11
543.460.460	CPST4646ZRXX	£133.16
543.350.300	CPST3530ZRXX	£130.17



£881.24 FROM



Pesticide & Agrochemical Security Cupboards - Dimensions/Codes

Size H.W.D.	Shelves	Code	Price
1800.1200.460	3	CSP181246ZRX	£2,310.07
1800.900.460	3	CSP189046ZRX	£1,889.65
1200.1200.460	2	CSP121246ZRX	£1,876.19
1200.900.460	2	CSP129046ZRX	£1,228.35
900.460.460	1	CSP904646ZRX	£881.24

This range of Pesticide & Agrochemical Cupboards enables the secure storage of hazardous substances as demanded by the CoSHH regulations. Powder coated in high-visibility red with perforated ventilation in each door panel.

- Welded all-steel structure for extra strength.
- Seven-lever safe lock for high security.
- Full-length heavy-duty hinges with concealed fixings to prevent forced entry.
- Adjustable spill-retaining galvanised shelves for superior spill management.
- New regulation labels enclosed to be fitted by customer to suit regulations.
- Made from 1.5mm steel.
- Integral liquid-tight sump encourages the correct handling of spills through the use of absorbents.
- Reaction to Fire Classification EN 13501-1.
- Cupboard shelves have a UDL of 140kg.

Extra Shelves - Dimensions/Codes

To Fit	Code	Price
W.1200 x D.460	CSES1246ZRXX	£110.72
W.900 x D.460	CSES9046ZRXX	£79.30
W.460 x D.460	CSES4646ZRXX	£50.87

Acid/Alkali Security Cupboards

Use of caustic materials in the workplace can present many hazards, particularly if acids and alkalis are stored incorrectly or with other chemicals. These storage cabinets enable secure and identifiable storage in the workplace.

- Welded 1.5mm all-steel structure for extra strength.
- Seven-lever safe lock for high security.
- Full-length heavy-duty hinges with concealed fixings to prevent forced entry.
- Adjustable spill-retaining galvanised shelves for superior spill management.
- New regulation labels enclosed to be fitted by customer.
- Integral liquid-tight sump encourages the correct handling of spills through the use of absorbents.
- Reaction to Fire Classification EN 13501-1.
- It is not recommended to store acids and alkalis together in a single unit as corrosion may occur.
- Cupboard shelves have a UDL of 140kg.



£881.24 FROM

Acid/Alkali Security Cupboards - Dimensions/Codes

Size H.W.D.	Shelves	Code	Price
1800.1200.460	3	CSA181246ZWX	£2,310.07
1800.900.460	3	CSA189046ZWX	£1,889.65
1200.1200.460	2	CSA121246ZWX	£1,876.19
1200.900.460	2	CSA129046ZWX	£1,228.35
900.460.460	1	CSA904646ZWX	£881.24

Extra Shelves - Dimensions/Codes

To Fit	Code	Price
W.1200 x D.460	CSES1246ZWXX	£110.72
W.900 x D.460	CSES9046ZWXX	£79.30
W.460 x D.460	CSES4646ZWXX	£50.87

It is vital that employers and employees comply with the control of hazardous substances in all working environments. This range of cupboards and cabinets enables the separate storage of hazardous substances as demanded by the CoSHH regulations. They are constructed from welded 1.5mm steel for strength, combined with a superior anti-pick locking mechanism, to ensure security.

- Welded all-steel structure for extra strength.
- Seven-lever safe lock for high security.
- New regulation labels enclosed to be fitted by customer.
- Full-length heavy-duty hinges with concealed fixings to prevent forced entry.
- Adjustable spill-retaining galvanised shelves for superior spill management.
- Integral liquid-tight sump encourages the correct handling of spills through the use of absorbents.
- Reaction to Fire Classification EN 13501-1.
- Cupboard shelves have a UDL of 140kg.



£869.27 FROM



Hazardous Substance Security Cupboards - Dimensions/Codes

Size H.W.D.	Shelves	Code	Price
1800.1200.460	3	CSH181246ZYX	£2,277.16
1800.900.460	3	CSH189046ZYX	£1,862.72
1200.1200.460	2	CSH121246ZYX	£1,849.26
1200.900.460	2	CSH129046ZYX	£1,210.39
900.460.460	1	CSH904646ZYX	£869.27

Extra Shelves - Dimensions/Codes

To Fit	Code	Price
W.1200 x D.460	CSES1246ZYXX	£110.72
W.900 x D.460	CSES9046ZYXX	£79.30
W.460 x D.460	CSES4646ZYXX	£50.87



£869.27 FROM



CoSHH Security Cupboards - Dimensions/Codes

Size H.W.D.	Shelves	Code	Price
1800.900.460	3	CSC189046ZKX	£1,862.72
1800.1200.460	3	CSC181246ZKX	£2,277.16
1200.1200.460	2	CSC121246ZKX	£1,849.26
1200.900.460	2	CSC129046ZKX	£1,210.39
900.460.460	1	CSC904646ZKX	£869.27

CoSHH Security Cupboards

This range of cupboards and cabinets enables the secure storage of hazardous substances as demanded by the CoSHH regulations.

- Welded all-steel structure for extra strength.
- Seven-lever safe lock for high security.
- Full-length heavy-duty hinges with concealed fixings to prevent forced entry.
- New regulation labels enclosed to be fitted by the customer to suit regulations.
- Adjustable spill-retaining galvanised shelves for superior spill management.
- Made from 1.5mm powder-coated mild steel.
- Integral liquid-tight sump encourages the correct handling of spills through the use of absorbents.
- Reaction to Fire Classification EN 13501-1.
- Cupboard shelves have a UDL of 140kg.

Extra Shelves - Dimensions/Codes

To Fit	Code	Price
W.1200 x D.460	CSES1246ZKXX	£110.72
W.900 x D.460	CSES9046ZKXX	£79.30
W.460 x D.460	CSES4646ZKXX	£50.87



£433.89 FROM



If stored incorrectly, flammable liquids, pesticides and agrochemicals can leak or spill causing damage and pollution. These cupboards promote safe storage, handling and disposal practice.

- High-security 7-lever lock with full-height door hinges.
- Liquid-tight integral sumps with plug for easy drainage.
- Fully adjustable, spill-retaining galvanised shelves.
- Supplied with stand to raise cupboards by 543mm.
- New regulation labels enclosed to be fitted by customer to suit regulations.
- Floor chests have a welded integrated sump, angled lid to discourage article placement and a hasp and staple lock - padlock not supplied.
- Powder coated with red Germ Guard Active Technology anti-bacterial paint.
- Cupboard shelves have a UDL of 140kg.

Floor Cupboards - Dimensions/Codes

Size H.W.D.	Shelves	Code	Price
1200.1200.610	2	CT121261ZHXX	£1,755.00
1200.900.610	2	CT129061ZHXX	£1,560.50

Extra Shelves - Dimensions/Codes

To Fit	Code	Price
W.1200 x D.610	CTES1260ZHXX	£118.20
W.900 x D.610	CTES9060ZHXX	£89.77

Floor Chests - Dimensions/Codes

Size H.W.D.	Code	Price
610.1170.460	CT611146ZHXX	£682.25
510.610.340	CT516134ZHXX	£433.89

Stands - Dimensions/Codes

Size H.W.D.	Code	Price
543.1200.610	CTST12612RXX	£190.01
543.900.610	CTST90612RXX	£169.07



£254.35 FROM



- "No Snag" handles with 2-point locking.
- Adjustable spill-retaining shelves for superior spill management.
- Integral liquid-tight sump encourages the correct handling of spills through the use of absorbents.
- New regulation labels enclosed to be fitted by customer to suit regulations.
- Stands raise cupboards by 543mm with an adjustable foot for uneven surfaces.
- Floor chests have a welded integrated sump and angled lid to discourage article placement and a hasp and staple lock - Padlock not supplied.



Stand with adjustable foot for uneven surfaces.

- Powder coated with Germ Guard Active Technology anti-bacterial paint.
- Reaction to Fire Classification EN 13501-1.
- Cupboard shelves have a UDL of 50kg.

Floor Cupboards - Dimensions/Codes

Size H.W.D.	Shelves	Code	Price
1800.1200.460	3	CFL181246ZRX	£712.17
1800.900.460	3	CFL189046ZRX	£599.96
1200.900.460	2	CFL129046ZRX	£517.67
900.900.460	1	CFL909046ZRX	£393.49
900.460.460	1	CFL904646ZRX	£303.72
700.900.460	1	CFL709046ZRX	£360.58
700.350.300	1	CFL703530ZRX	£254.35

Extra Shelves - Dimensions/Codes

To Fit	Code	Price
W.1200 x D.460	CUPDSHLF1246	£65.83
W.900 x D.460	CUPDSHLF9046	£56.85
W.460 x D.460	CUPDSHLF4646	£43.39
W.350 x D.300	CUPDSHLF3530	£35.91

Floor Chests - Dimensions/Codes

Size H.W.D.	Code	Price
610.1170.460	CFL611460ZRX	£682.25
510.610.340	CFL516134ZRX	£433.89

Mobile Cupboards - Dimensions/Codes

Size H.W.D.	Shelves	Code	Price
1010.900.460	1	CFL109046MRX	£629.88
810.900.460	1	CFL849046MRX	£598.46

Stands - Dimensions/Codes

Size H.W.D.	Code	Price
543.900.460	CFLST9046ZRX	£151.11
543.460.460	CFLST4646ZRX	£133.16
543.350.300	CFLST3530ZRX	£133.16

HAZSAFE®



48 HOUR DELIVERY

£195 FROM .66

Cupboards

Our HazSafe® Site Security Box is the perfect solution for the storage and transportation of hazardous substances and materials, onsite and on the road - delivered in just 48 hours! The HazSafe® is manufactured from a high gauge of steel, features a well-ventilated system and is designed with a fully-welded construction in five sizes.

- Fully welded construction suitable for the safe transportation and storage of hazardous substance materials.
- Catch lock fitting for the customer to use their own padlock.
- Powder coated high-visibility yellow with Germ Guard Active Technology paint.
- Internal ventilation to prevent build-up of fumes.
- Hard-wearing black plastic handles at both side points.
- Warning labels included as standard.
- Security catch to secure the lid whilst open.
- Reaction to Fire Classification EN 13501-1.



HazSafe® Site Security Boxes - Dimensions/Codes

Size H.W.D.	Code	Price
380.360.370	SHS383637ZYX	£195.66
555.460.420	SHS554642ZYX	£290.46
555.660.420	SHS556642ZYX	£354.14
555.890.420	SHS558942ZYX	£408.51
555.1190.420	SHS551142ZYX	£576.26



FLAMSAFE®



48 HOUR DELIVERY

£195 FROM .66

Our FlamSafe® Site Security Box is the perfect solution for the storage and transportation of chemicals and flammable liquids, onsite and on the road - delivered in just 48 hours! The FlamSafe® is manufactured from a high gauge of steel, features a well-ventilated system and is designed with a fully-welded construction in five sizes.

- Fully welded construction suitable for the safe transportation and storage of hazardous substance materials.
- Catch lock fitting for the customer to use their own padlock.
- Powder coated high-visibility red with Germ Guard Active Technology paint.
- Internal ventilation to prevent build-up of fumes.
- Hard-wearing black plastic handles at both side points.
- Warning labels included as standard.
- Security catch to secure the lid whilst open.
- Reaction to Fire Classification EN 13501-1.



FIRE GUARD
TESTED & CERTIFIED
EN 13501-1

FlamSafe® Site Security Boxes - Dimensions/Codes

Size H.W.D.	Code	Price
380.360.370	SFS383637ZR	£195.66
555.460.420	SFS554642ZR	£290.46
555.660.420	SFS556642ZR	£354.14
555.890.420	SFS558942ZR	£408.51
555.1190.420	SFS551142ZR	£576.26

Our ToolSafe® Site Security Box is the ideal solution for storing and transporting tools and equipment, whether on-site or on the road. Plus, it's delivered within just 48 hours. Manufactured from robust heavy-gauge steel, our ToolSafe® is built to last. It features strong gas struts for safe, effortless opening, ensuring security and safety. Choose from six versatile sizes to meet all your needs.

- Made from robust 1.5mm thick mild steel for outstanding strength.
- Fully welded construction ensures superior security for your peace of mind.
- Features an internally fixed hinge to eliminate the risk of disassembly and unauthorised access.
- Equipped with a high-security 8-lever safe lock.
- Designed with gas struts for smooth, ergonomic, and safe opening.
- Customise your unit with optional fork pockets or castors for exceptional versatility and mobility - contact our sales team for details.
- Finished with a durable powder-coated dark grey paint for long-lasting resilience.

TOOLS SAFE®



STC501250KXX

Cupboards



48 HOUR DELIVERY

£299 FROM .73



STC501850KXX



STC651265KMX

Shown with optional castors



STC121265KXX



FIRE GUARD TESTED & CERTIFIED EN 13501-1



STC408550KFX

Shown with optional fork pockets

ToolSafe® Site Security Boxes - Dimensions/Codes

Size H.W.D.	Code	Price	Code	Price (with Fork Pockets)	Code	Price (Mobile)
400.850.500	STC408550KXX	£299.73	STC408550KFX	£356.86	STC408550KMX	£431.02
500.900.500	STC509050KXX	£362.90	STC509050KFX	£419.55	STC509050KMX	£493.71
500.1200.500	STC501250KXX	£496.75	STC501250KFX	£553.40	STC501250KMX	£627.56
650.1200.650	STC651265KXX	£634.55	STC651265KFX	£691.20	STC651265KMX	£809.65
1200.1200.650	STC121265KXX	£1,260.86	STC121265KFX	£1,317.51	STC121265KMX	£1,435.96
500.1800.500	STC501850KXX	£1,296.38	STC501850KFX	£1,353.03	STC501850KMX	£1,471.48

Our SpillZone® Absorbent Stations provide an effective solution for storing absorbent kits within the workplace. Each SpillZone® includes various roll holders and compartments designed to hold absorbent rolls, sheets, and socks. Additionally, there is a lockable cupboard at the bottom for storing replenished stock. Contents within imagery are not included - only the SpillZone® Absorbent Station is available to purchase.

- Made from robust thick mild steel for outstanding strength.
- Three configurations available.
- H1820 x W550 x D550mm.
- Lockable storage cupboard for storing stock absorbent sheets/rolls.
- Fitted as standard with cam locks, supplied with 2 keys. Latch locks are also available as an alternative.
- Finished with a durable powder-coated dark blue paint with yellow door fronts.
- Reaction to Fire Classification EN 13501-1.
- SpillZone units with cam locks are available for express delivery. Latch lock options are on extended lead time.



Cupboards



Station 1 - LSZ18555FD2X



Station 2 - LSZ18555HD3X



Station 3 - LSZ18555QD3X

SpillZone® Absorbent Stations - Dimensions/Codes

Size H.W.D.	Description	Code (with cam locks)	Price	Code (with latch locks)	Price
1820.550.550	Absorbent Station 1 - with lockable cupboard and internal shelf	LSZ18555FD2X	£232.02	LSZ18555FD2Z	£232.02
1820.550.550	Absorbent Station 2 - with lockable cupboard and 2 internal shelves	LSZ18555HD3X	£189.04	LSZ18555HD3Z	£189.04
1820.550.550	Absorbent Station 3 - with lockable quick-reach half door and 2 internal shelves	LSZ18555QD3X	£221.31	LSZ18555QD3Z	£221.31

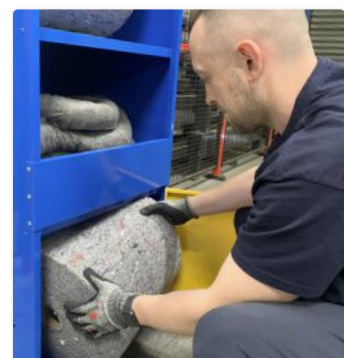

£372.54 FROM



Cupboards

These cupboards and cabinets bring a combination of storage, mobility, security and a touch of style to the workplace. The perspex doors allow managers and supervisors to be able to see the contents whilst the cupboard is locked.

- Flush "No Snag" handles with 2-point locking.
- Mobile and static options available.
- Strengthened doors.
- Extra adjustable shelves available.
- Secure locking mechanism for extra security.
- Powder coated with Germ Guard Active Technology anti-bacterial paint.
- Cupboard shelves have a UDL of 50kg.



Wall Mounted Cupboard Unit

Colour Options

Please add corresponding letters to the end of the code.



Vision Door Cupboards - Dimensions/Codes

Size H.W.D.	Shelves	Code	Price	Extra Shelf	Price
1800.1200.460	3	CV181246Z	£1,053.30	CUPDSHLF1246	£65.83
1800.900.460	3	CV189046Z	£924.63	CUPDSHLF9046	£56.85
1200.900.460	2	CV129046Z	£764.54	CUPDSHLF9046	£56.85
900.900.460	2	CV909046Z	£662.80	CUPDSHLF9046	£56.85
900.460.460	1	CV904646Z	£432.39	CUPDSHLF4646	£43.39
700.900.460	2	CV709046Z	£570.04	CUPDSHLF9046	£56.85
700.350.300	2	CV703530Z	£372.54	CUPDSHLF3530	£35.91
570.850.255 (Wall Mounted)	1	CV578525Z	£462.31	N.A.	N.A.

£423.41 FROM



These cupboards and cabinets bring a combination of storage, mobility, security and a touch of style to the workplace. The perforated doors allow managers and supervisors to be able to see the contents whilst the cupboard is locked.

- Perforated, reinforced doors for visual security.
- Flush "No Snag" handles.
- Mobile and static options.
- Adjustable shelves.
- Secure locks.
- Reaction to Fire Classification EN 13501-1.
- Powder coated with Germ Guard Active Technology anti-bacterial paint.
- Cupboard shelves have a UDL of 50kg.

Mobile Perforated Cupboards - Dimensions/Codes

Size H.W.D.	Shelves	Code	Price	Extra Shelf	Price
1010.900.460	2	C6109046M	£679.26	CUPDShLF9046	£56.85
1010.900.610	2	C6109061M	£848.32	CUPDShLF9060	£50.87

Colour Options

Please add corresponding letters to the end of the code.

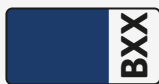
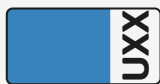
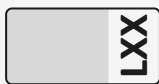

Perforated Cupboards - Dimensions/Codes

Size H.W.D.	Shelves	Code	Price	Extra Shelf	Price
1800.1200.610	3	C6181261P	£927.62	CUPDShLF1260	£74.81
1800.900.610	3	C6189061P	£788.48	CUPDShLF9060	£50.87
1800.1200.460	3	C6181246P	£783.99	CUPDShLF1246	£65.83
1800.900.460	3	C6189046P	£590.98	CUPDShLF9046	£56.85
1800.600.460	3	C6186046P	£561.06	CUPDShLF6046	£32.92
900.900.610	2	C6909061P	£567.05	CUPDShLF9060	£50.87
1200.900.460	2	C6129046P	£565.55	CUPDShLF9046	£56.85
900.900.460	2	C6909046P	£472.79	CUPDShLF9046	£56.85
900.460.460	1	C6904646P	£423.41	CUPDShLF4646	£43.39



Cupboards

This is a versatile all-steel system of units designed to meet workplace demands. It allows you to utilise the space above the cupboard, creating a safe and secure work environment that promotes good housekeeping practices. The construction features a weld and rivet design, ensuring durability and strength.

- “No Snag” handles with 2-point locking.
- Adjustable powder-coated shelves.
- Powder coated with Germ Guard Active Technology anti-bacterial paint.
- Top unit does not include shelf.
- Reaction to Fire Classification EN 13501-1.
- Cupboard shelves have a UDL of 50kg.

Colour Options

Please add corresponding letters to the end of the code.



Modular Cupboards - Dimensions/Codes

Unit 1 Size H.W.D.	Shelves	Code	Price	Extra Shelf	Price
2300.1200.650	3	CM1812602	£1,434.82	CUPDSHLF1260	£74.81
2300.900.650	3	CM1890602	£1,089.21	CUPDSHLF9060	£50.87
2300.1200.460	3	CM1812462	£1,084.72	CUPDSHLF1246	£65.83
2300.900.460	3	CM1890462	£818.40	CUPDSHLF9046	£56.85



5 DAY DELIVERY

BEST SELLER

FIRE GUARD
TESTED & CERTIFIED
EN 13501-1

Cupboards



These general workplace cupboards and cabinets offer storage, mobility, and security for the workplace. The welded and riveted construction ensures overall durability.

- “No Snag” handles with 2-point locking.
- Strengthened Doors.
- Adjustable powder-coated shelves.
- Wall cupboards are pre-drilled for mounting - fixings not supplied.
- Powder coated with Germ Guard Active Technology anti-bacterial paint.
- Interior shelves supplied galvanised.
- 5-Day Delivery only applies to Light Grey and Dark Blue doors.
- Reaction to Fire Classification EN 13501-1.
- Cupboard shelves have a UDL of 50kg.
- Order quantities may apply, please speak to the sales team.

Colour Options

Please add corresponding letters to the end of the code.



Workplace Cupboards - Dimensions/Codes

Size H.W.D.	Shelves	Code	Price	Extra Shelf	Price
1800.600.460	3	CG186046Z	£481.76	CUPDShLF6046	£32.92
1800.900.460	3	CG189046Z	£532.63	CUPDShLF9046	£56.85
1800.1200.460	3	CG181246Z	£704.69	CUPDShLF1246	£65.83
1800.900.610	3	CG189061Z	£710.68	CUPDShLF9060	£50.87
1800.1200.610	3	CG181261Z	£848.32	CUPDShLF1260	£74.81
1200.900.460	2	CG129046Z	£486.25	CUPDShLF9046	£56.85
900.900.460	2	CG909046Z	£393.49	CUPDShLF9046	£56.85
900.900.610	2	CG909061Z	£487.75	CUPDShLF9060	£50.87
900.460.460	1	CG904646Z	£314.19	CUPDShLF4646	£43.39

Mobile Workplace Cupboards - Dimensions/Codes

Size H.W.D.	Shelves	Code	Price	Extra Shelf	Price
1010.900.460	2	CG109046M	£568.54	CUPDShLF9046	£56.85
1010.900.610	2	CG109061M	£797.45	CUPDShLF9060	£50.87

All RED product codes are available on 5-Day Delivery

Wall Cupboards - Dimensions/Codes

Size H.W.D.	Shelves	Code	Price	Extra Shelf	Price
570.850.255	1	CG855725Z	£297.74	N.A.	N.A.



£543.11 FROM



£604.45 FROM



Cupboards

Clothing Cupboards

- "No Snag" handles with 2-point locking.
- Strengthened doors.
- Top shelf and hanging garment rail.
- Powder coated with Germ Guard Active Technology anti-bacterial paint.
- Reaction to Fire Classification EN 13501-1.
- Cupboard shelves have a UDL of 50kg.

Utility Cupboards

- "No Snag" handles with 2-point locking.
- Strengthened doors.
- Powder coated with Germ Guard Active Technology anti-bacterial paint.
- Central divider with removable rail on one side and 3 adjustable shelves on the other.
- Reaction to Fire Classification EN 13501-1.
- Cupboard shelves have a UDL of 50kg.

Colour Options

Please add corresponding letters to the end of the code.



Clothing Cupboards - Dimensions/Codes

Size H.W.D.	Shelves	Code	Price
1800.1200.460	1	CC181246Z	£721.15
1800.900.460	1	CC189046Z	£577.52
1800.600.460	1	CC186046Z	£543.11

Utility Cupboards - Dimensions/Codes

Size H.W.D.	Shelves	Code	Price
1800.1200.460	3	CU181246Z	£797.45
1800.900.460	3	CU189046Z	£604.45

Extra Shelves - Dimensions/Codes

To Fit	Code	Price
W.1200 x D.460	CCES1246ZLXX	£58.35
W.900 x D.460	CCES9046ZLXX	£44.88
W.600 x D.460	CCES6046ZLXX	£37.40

Extra Shelves - Dimensions/Codes

To Fit	Code	Price
W.1200 x D.460	CUES1246ZLXX	£37.40
W.900 x D.460	CUES9046ZLXX	£34.41

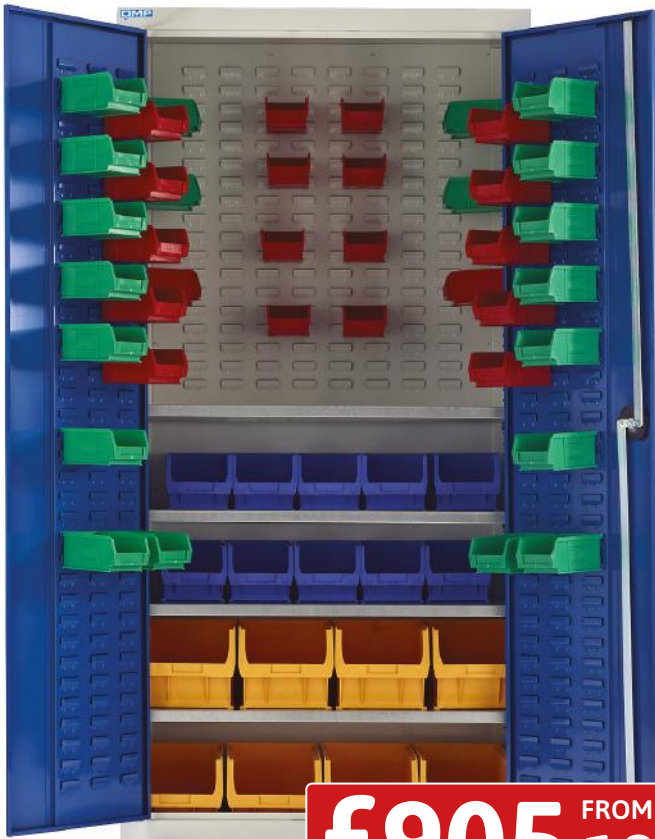

£905.18 FROM

These Container Storage Cupboards offer a variety of storage options. The louvre panels on the doors and carcass allow users to conveniently store containers within reach. Their weld and rivet construction ensures overall durability.

- Reinforced doors.
- "No Snag" handles with 2-point locking.
- 1800mm high, 900mm wide, 460mm deep.
- For our full Plastic Open Fronted Container range, please refer to page 54.
- Reaction to Fire Classification EN 13501-1.
- Extra shelves available - Please speak to our sales team.
- 50kg UDL capacity galvanised shelves.



Without Door - 1800.900.460

Option 1A	Code	Price	Option 1B	Code	Price	Option 1C	Code	Price	Option 1D	Code	Price
36 x size 4 8 shelves	CY189046836X	£1,122.12	28 x size 4 4 x size 6 8 shelves	CY189046832X	£1,141.57	24 x size 4 6 x size 6 6 shelves	CY189046630X	£1,078.73	8 x size 4 12 x size 6 7 shelves	CY189046720X	£1,117.64



With Door - 1800.900.460

Option 2A	Code	Price	Option 2B	Code	Price	Option 2C	Code	Price	Option 2D	Code	Price
Build Your Own	CYD189046BBX	£905.18	10 x size 3 8 x size 5 41 x size 2 4 shelves	CYD189046461	£1,340.56	16 x size 4 41 x size 2 4 shelves	CYD189046457	£1,334.57	10 x size 6 41 x size 2 1 shelf	CYD189046151	£1,304.65



CPF578225Z

£499 FROM
.72

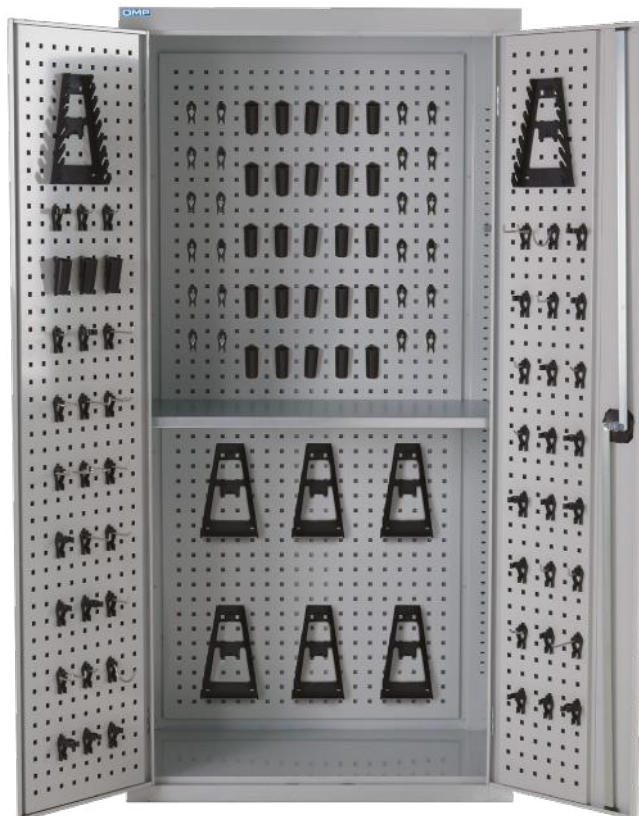

CPF189046Z



Cupboards

Perforated Tool Cupboards are the ideal storage solution for tools and equipment in your workshop. This high-quality cupboard comes fitted with internal perforated panels which can be used in conjunction with our clip kits to hang tooling and equipment. A secure 2-point locking mechanism ensures that the cupboard contents are kept secure when not in use.

- "No Snag" handles with 2-point locking.
- Comes with 1 shelf as standard.
- Additional shelves can be ordered, please speak to our sales team.
- Designed for use with our Clip Kits, please see page 94.
- Reaction to Fire Classification EN 13501-1.
- Cupboard shelves have a 50kg UDL capacity.

Perforated Tool Cupboards - Dimensions/Codes

Description	Size H.W.D.	Code	Price
Perforated Door Panels & Back Panel	1800.900.460	CPF189046Z	£894.70
Wall Mounted	570.850.255	CPF578225Z	£499.72

Clip Kits

Description	Code	Price
Clip Mix 53	RTCLIPMIX53X	£163.08
Clip Mix 84	RTCLIPMIX84X	£257.34

Colour Options

Please add corresponding letters to the end of the code.





Also available as First Aid Security Cupboards - please speak to the sales team

Our First Aid Cupboards are manufactured from high-quality steel with instantly recognisable identification symbols and a clean white powder-coated finish. They are designed to meet a wide range of first aid requirements.

- “No Snag” handles with 2-point locking.
- Adjustable spill-retaining galvanised shelves for superior spill management*.
- Integral liquid-tight sump encourages the correct handling of spills through the use of absorbents*.
- Wall cupboards are pre-drilled for mounting (fixings not included).
- Stands raise cupboards by 543mm with an adjustable foot for uneven surfaces.
- Powder coated with white Germ Guard Active Technology anti-bacterial paint.
- Supplied with first aid stickers.
- Reaction to Fire Classification EN 13501-1.
- Cupboard shelves have a UDL of 50kg.

*Except wall mounted cupboards

Floor Cupboards - Dimensions/Codes

Size H.W.D.	Shelves	Code	Price
1800.1200.460	3	CF181246ZWXX	£680.75
1800.900.460	3	CF189046ZWXX	£595.47
900.900.460	1	CF909046ZWXX	£393.49
900.460.460	1	CF904646ZWXX	£306.71
700.900.460	1	CF709046ZWXX	£360.58
700.350.300	1	CF703530ZWXX	£257.34

Extra Shelves - Dimensions/Codes

To Fit	Code	Price
W.900 x D.460	CUPDSHLF9046	£56.85
W.460 x D.460	CUPDSHLF4646	£43.39
W.350 x D.300	CUPDSHLF3530	£35.91

Mobile Cupboards - Dimensions/Codes

Size H.W.D.	Shelves	Code	Price
1010.900.460	1	CF109046ZWXX	£592.48
810.900.460	1	CF849046MWXX	£585.00

Wall Cupboards - Dimensions/Codes

Size H.W.D.	Shelves	Code	Price
570.850.255	1	CF855725MWXX	£341.12

Stands - Dimensions/Codes

Size H.W.D.	Code	Price
543.900.460	CFST9046ZWXX	£181.04
543.460.460	CFST4646ZWXX	£155.60
543.350.300	CFST3530ZWXX	£149.62

£303.72 FROM



Our Personal Protective Equipment Cupboards enable the safe and separate storage of protective equipment and clothing in the workplace.

- "No Snag" handles with 2-point locking.
- All-steel structure with strengthened doors.
- Adjustable powder-coated shelves.
- PPE Clothing Cupboard comes with adjustable hanging garment rail.
- Powder coated with Germ Guard Active Technology anti-bacterial paint.
- Supplied with PPE labels.
- Reaction to Fire Classification EN 13501-1
- Cupboard shelves have a UDL of 50kg.



CR1890464BXX



CR1890461BXX

PPE Cupboards - Dimensions/Codes

Size H.W.D.	Shelves	Code	Price
1800.1200.460	3	CB1812463BXX	£704.69
1800.900.460	3	CB1890463BXX	£532.63
900.900.460	1	CB9090462BXX	£393.49
900.460.460	1	CB9046461BXX	£303.72

Extra Shelves - Dimensions/Codes

To Fit	Code	Price
W.900 x D.460	CUPDSHLF9046	£56.85
W.1200 x D.460	CUPDSHLF1246	£65.83

PPE Clothing Cupboards - Dimensions/Codes

Size H.W.D.	Shelves	Code	Price
1800.1200.460	4	CR1812464BXX	£864.78
1800.900.460	4	CR1890464BXX	£537.12
1800.1200.460	1	CR1812461BXX	£718.16
1800.900.460	1	CR1890461BXX	£580.51
1800.600.460	1	CR1860461BXX	£492.24

Extra Shelves - Dimensions/Codes

To Fit	Code	Price
W.1200 x D.460	CCES1246ZLXX	£58.35
W.600 x D.460	CCES6046ZLXX	£37.40
W.900 x D.460	CCES9046ZLXX	£44.88

£839 FROM **.35**



BEST SELLER



Our Security Cupboards offer enhanced security for storing high-value equipment and materials. They are made of welded heavy-gauge steel, combining strength with a superior anti-pick locking mechanism.

- Welded all-steel structure for extra strength.
- Seven-lever safe lock for high security.
- Full-length heavy-duty hinges with concealed fixings to prevent forced entry.
- Adjustable powder-coated shelves.
- Powder coated with Germ Guard Active Technology anti-bacterial paint.
- Made from 1.5mm powder coated mild steel.
- Reaction to Fire Classification EN 13501-1.
- Cupboard shelves have a UDL of 140kg.

Colour Options

Please add corresponding letters to the end of the code.

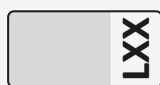

Security Cupboards - Dimensions/Codes

Size H.W.D.	Shelves	Code	Price
1800.1200.460	3	CS181246Z	£2,199.36
1800.900.460	3	CS189046Z	£1,799.88
1200.1200.460	2	CS121246Z	£1,786.42
1200.900.460	2	CS129046Z	£1,170.00
900.460.460	1	CS904646Z	£839.35

Extra Shelves - Dimensions/Codes

To Fit	Code	Price
W.1200 x D.460	CSES1246ZLXX	£110.72
W.900 x D.460	CSE59046ZLXX	£79.30
W.460 x D.460	CSE54646ZLXX	£50.87

These stainless steel cupboards are designed and manufactured for use in clean environments. They are excellent for food, pharmaceutical, and medical operations, particularly in settings where dampness and corrosion are concerns.

- "No Snag" handles with 2-point locking.
- Adjustable stainless steel shelves.
- Strengthened doors.
- Corrosion resistant carcass and shelves.
- Floor chests have a riveted structure with angled lid to discourage article placement and a hasp and staple lock - Padlock not supplied.



Floor Chests



CL181246ZSXX

£965.02 FROM

Stainless Steel Cupboards - Dimensions/Codes

Size H.W.D.	Shelves	Code	Price
1800.1200.460	3	CL181246ZSXX	£2,431.26
1800.900.460	3	CL189046ZSXX	£1,853.74
1200.900.460	2	CL129046ZSXX	£1,473.72
900.900.460	1	CL909046ZSXX	£1,217.88
900.460.460	1	CL904646ZSXX	£965.02

Extra Shelves - Dimensions/Codes

To Fit	Code	Price
W.1200 x D.460	CLES1246ZSXX	£179.54
W.900 x D.460	CLES9046ZSXX	£158.59
W.460 X D.460	CLES4646ZSXX	£131.69

Floor Chests - Dimensions/Codes

Size H.W.D.	Code	Price
610.1170.460	CV611146ZSXX	£1,705.62
510.610.340	CV516134ZSXX	£1,277.72

Cupboard & Euroslide Lock Options

We offer two new lock options to meet the specific needs of our cupboard products. These locks are also compatible with our Euroslide range (Page 55). Please keep in mind that not all locks are compatible with every cupboard design. If you have any questions about the compatibility of these lock options, our sales department is here to help.

Digital Key Pad



NEW PRODUCT

Code	Price
C2KEYPADLXXX	POA

Digital RFID Key Card



NEW PRODUCT

Code	Price
C2CARDLOCKXX	POA

Lockers

- 122** Standard Lockers
- 123** Express Lockers
- 124** School Lockers
- 125** Spectrum Lockers
- 125** Spectrum School Lockers
- 126** Executive Lockers
- 127** Office Lockers
- 127** Smart Lockers
- 128** Timber Door Lockers
- 129** Plant-On Door Lockers
- 130** Laminate Door Lockers
- 130** Laminate Splash Lockers
- 131** Steel Splash Lockers
- 132** Perforated Door Lockers
- 133** Z-Door Lockers
- 134** Cube Lockers
- 134** Perspex Door Lockers
- 135** Stainless Steel Lockers
- 136** PPE Lockers
- 137** Multi-Compartment Lockers
- 138** Emergency Service Lockers
- 140** Padlock Lockers
- 140** Secure Lockers
- 141** Personal Effects Lockers
- 141** Wall-Mounted Personal Effects Lockers
- 142** Garment & Garment Disposal Lockers
- 143** Laptop & Tablet Storage Lockers
- 144** Laptop & Tablet Charging Lockers
- 144** Laptop & Tablet Charging Trolleys
- 145** Dual USB Charging Lockers
- 146** Fire Suppression Charging Lockers
- 147** Tool Charging Lockers
- 148** Post Box Lockers
- 149** Cloakroom Furniture
- 154** Lock Options
- 155** Locker Accessories





5-7 DAY DELIVERY

FIRE GUARD
TESTED & CERTIFIED
EN 13501-1

£134.68 FROM

BEST SELLER



Interior Coat Hook



Door Ventilation



Door Stiffener

Quality compartment lockers suitable for a multitude of storage applications. Standard Lockers provide the flexibility of four sizes with six door options.

The Standard Locker design means it's easily adapted in height, width and depth to suit your individual requirements. Choice of 300mm, 380mm and 450mm widths.

- 2, 3, 4, 5 and 6 door lockers fitted with galvanised security shelf to prevent unauthorised access to the compartment below.
- Fitted with standard mastered cam locks with 2,000 differs.
- Single-tier lockers fitted with top shelf and coat hook.
- Two-tier lockers fitted with coat hook in each compartment.
- Strengthened and ventilated doors with rubber buffers.
- Reaction to Fire Classification EN 13501-1.
- 5-7 Day Delivery available on 300x300 and 300x450 lockers.

Colour Options

Please add corresponding letters to the end of the code.



Standard Lockers - Dimensions/Codes

Compartments	H.1800 W.300 D.300	Price	H.1800 W.300 D.450	Price	H.1800 W.380 D.380	Price	H.1800 W.450 D.450	Price
1	LS1830301	£134.68	LS1830451	£156.88	LS1838381	£162.80	LS1845451	£177.60
2	LS1830302	£165.76	LS1830452	£185.00	LS1838382	£180.56	LS1845452	£201.28
3	LS1830303	£186.48	LS1830453	£205.72	LS1838383	£195.36	LS1845453	£230.88
4	LS1830304	£192.40	LS1830454	£223.48	LS1838384	£222.00	LS1845454	£257.52
5	LS1830305	£214.60	LS1830455	£239.76	LS1838385	£248.64	LS1845455	£261.96
6	LS1830306	£236.80	LS1830456	£256.04	LS1838386	£259.00	LS1845456	£267.88



Our Express Lockers feature the same high-quality design as our Standard Lockers, but they come with a quicker delivery time of 3-5 days. We keep a selection of these lockers in stock, offering four compartment options and the choice of either Light Grey or Dark Blue doors.

- Choice of 300mm and 450mm depths.
- 2, 4 and 6 door lockers fitted with galvanised security shelf to prevent any unauthorised access to the compartment below.
- Fitted with standard, mastered cam locks with 2,000 differs.
- Single-tier lockers fitted with top shelf and coat hook.
- Two-tier lockers fitted with coat hook in each compartment.
- Strengthened and ventilated doors with rubber buffers.
- Powder coated with Germ Guard Active Technology paint.
- Order quantities may apply, please speak to sales.



Colour Options

Please add corresponding letters to the end of the code.



Express Lockers - H.1800 W.300 D.300

Compartments	Code	Price
1	LQ1830301	£134.68
2	LQ1830302	£165.76
4	LQ1830304	£192.40
6	LQ1830306	£236.80

Express Lockers - H.1800 W.300 D.450

Compartments	Code	Price
1	LQ1830451	£156.88
2	LQ1830452	£185.00
4	LQ1830454	£223.47
6	LQ1830456	£256.04



1380mm high Locker

£129.57 FROM



955mm high Locker



1235mm high Locker

High-quality School Lockers are ideal for use in primary and junior Schools. These lockers are available in a range of depths and compartment options. School Lockers can be fitted with sloping tops and a multitude of lock options. Designed to withstand the general wear and tear of daily usage.

- Choice of 300mm, 380mm and 450mm depths.
- 2,3 and 4 door lockers fitted with galvanised security shelf

to prevent unauthorised access to the compartment below.

- Fitted with standard mastered cam locks with 2,000 differs.
- Single-tier lockers fitted with top shelf and coat hook.
- Two-tier lockers fitted with coat hook in each compartment.
- Strengthened and ventilated doors with rubber buffers.
- Powder coated with Germ Guard Active Technology paint.
- Minimum order quantity of 8 lockers.

Colour Options

Please add corresponding letters to the end of the code.



School Lockers - Dimensions/Codes

Height	Compartments	W.300 D.300	Price	W.300 D.450	Price	W.380 D.380	Price
H.955	1	LD9030301	£129.57	LD9030451	£150.91	LD9038381	£155.49
	2	LD9030302	£160.06	LD9030452	£178.35	LD9038382	£172.26
	3	LD9030303	£178.35	LD9030453	£196.65	LD9038383	£187.50
H.1235	1	LD1130301	£132.62	LD1130451	£155.49	LD1138381	£160.06
	2	LD1130302	£163.11	LD1130452	£182.93	LD1138382	£176.83
	3	LD1130303	£182.93	LD1130453	£202.74	LD1138383	£193.60
	4	LD1130304	£190.55	LD1130454	£221.04	LD1138384	£217.99
H.1380	1	LD1330301	£143.29	LD1330451	£166.16	LD1338381	£172.26
	2	LD1330302	£175.31	LD1330452	£195.12	LD1338382	£190.55
	3	LD1330303	£196.65	LD1330453	£216.46	LD1338383	£207.32
	4	LD1330304	£204.27	LD1330454	£236.28	LD1338384	£234.76



Many organisations, schools and workplace environments wish to make their premises as attractive as possible for employees, students and visitors alike. The Spectrum Locker range offers the strength and durability of the Standard Locker range but with a variety of exciting colour options.

- Lateral security beam enhances the durability of the locker.
- Hinges are 40mm deep. This again offers greater quality and durability.
- Ideal for schools, universities and public authorities where long-lasting durability is required.
- Frame constructed from 0.7mm steel which ensures strength and security.
- Powder Coated with Germ Guard Active Technology paint.
- Reaction to Fire Classification EN 13501-1.
- Minimum order quantity of 8 lockers, one-door colour.



Spectrum Lockers - Dimensions/Codes

Comps	H.1800 W.300 D.300	Price	H.1800 W.300 D.450	Price	H.1800 W.380 D.380	Price	H.1800 W.450 D.450	Price
1	LSPC30301	£181.40	LSPC30451	£211.89	LSPC38381	£217.99	LSPC45451	£239.33
2	LSPC30302	£222.56	LSPC30452	£248.48	LSPC38382	£240.85	LSPC45452	£271.34
3	LSPC30303	£250.00	LSPC30453	£275.91	LSPC38383	£263.72	LSPC45453	£307.93
4	LSPC30304	£259.15	LSPC30454	£300.31	LSPC38384	£297.26	LSPC45454	£344.51
6	LSPC30306	£317.07	LSPC30456	£344.51	LSPC38386	£346.04	LSPC45456	£358.23

Spectrum School Lockers

Our vibrant Spectrum Lockers are also available in 3 reduced heights, 955mm, 1235mm and 1380mm, making them perfect for primary and junior schools and a choice of 300mm, 380mm and 450mm depths

Spectrum School Lockers - Dimensions/Codes

Height	Comps	W.300 D.300	Price	W.300 D.450	Price	W.380 D.380	Price
H.955	1	LDS9030301	£179.88	LDS9030451	£208.84	LDS9038381	£216.46
	2	LDS9030302	£221.04	LDS9030452	£245.43	LDS9038382	£239.33
	3	LDS9030303	£246.95	LDS9030453	£272.87	LDS9038383	£260.67
H.1235	1	LDS1130301	£182.93	LDS1130451	£213.41	LDS1138381	£219.51
	2	LDS1130302	£224.09	LDS1130452	£250.00	LDS1138382	£243.90
	3	LDS1130303	£251.52	LDS1130453	£277.44	LDS1138383	£265.24
	4	LDS1130304	£260.67	LDS1130454	£303.35	LDS1138384	£300.31
H.1380	1	LDS1330301	£181.40	LDS1330451	£211.89	LDS1338381	£217.99
	2	LDS1330302	£222.56	LDS1330452	£248.48	LDS1338382	£240.85
	3	LDS1330303	£250.00	LDS1330453	£275.91	LDS1338383	£263.72
	4	LDS1330304	£259.15	LDS1330454	£300.31	LDS1338384	£297.26



Colour Options

Please add corresponding letters to the end of the code.

SL Sublime Lime	PP Pitahaya Pink	BB Berry Burst	LB Lagoon Blue	TR Tamarillo Red	GG Guava Green	CP Chilli Pepper Orange	TO Tangelo Orange	LI Summer Lilac
---------------------------	----------------------------	--------------------------	--------------------------	----------------------------	--------------------------	-----------------------------------	-----------------------------	---------------------------



£387 FROM **.20**

Executive Locker Panels



Our range of Executive Lockers combine high-quality design with attractive door fascias and end panels. The locker design has a premium feel and would fit into any high-end executive office, reception area or foyer. The range of lockers can be nested together to form a variety of combinations.

- Fitted with standard mastered cam locks with 2,000 differs.
- Steel body for maximum strength and durability.
- Lockers are pre-drilled for nesting.
- Fitted with soft-close hinges.
- Minimum order quantity of 8 lockers.

Executive Lockers - Dimensions/Codes

Size	Compartments	Pearl White	Price	Kashmir	Price	Sand Beige	Price
H.1800 W.300 D.450	1	LEX1830451PW	£387.20	LEX1830451KA	£387.20	LEX1830451SB	£387.20
	2	LEX1830452PW	£417.68	LEX1830452KA	£417.68	LEX1830452SB	£417.68
	3	LEX1830453PW	£458.84	LEX1830453KA	£458.84	LEX1830453SB	£458.84
	4	LEX1830454PW	£503.05	LEX1830454KA	£503.05	LEX1830454SB	£503.05
H.1800 W.380 D.380	1	LEX1838381PW	£445.12	LEX1838381KA	£445.12	LEX1838381SB	£445.12
	2	LEX1838382PW	£483.23	LEX1838382KA	£483.23	LEX1838382SB	£483.23
	3	LEX1838383PW	£539.63	LEX1838383KA	£539.63	LEX1838383SB	£539.63
	4	LEX1838384PW	£580.79	LEX1838384KA	£580.79	LEX1838384SB	£580.79

End Panels - Dimensions/Codes

Description	To Fit	Hacienda Black	Price
End Panel	H.1800 W.380 D.380	LEX1838EPHBX	£240.85
	H.1800 W.300 D.450	LEX1845EPHBX	£265.24

Discover the perfect blend of style and function with our modern office lockers, designed for a wide range of storage needs. Available in sleek black or white finishes, these lockers not only enhance your workspace aesthetic but also offer top-notch security with options for cam locks or advanced digital keypad locks.

£160 FROM **.43**

- 2,3,4,5 and 6 door lockers fitted with galvanised security shelf to prevent access to the compartment below.
- Fitted with either a standard mastered cam lock with 2,000 differs or digital keypad.
- Carcass and doors fully painted in either Black or White.
- Strengthened and ventilated doors with rubber buffers.
- Also available in W380 x D380mm and W450 x D450mm configurations. Please speak to sales for further information.



Colour Options

Please add corresponding letters to the end of the code.



Office Lockers - Dimensions/Codes

Lock Type	Cam Lock				Digital Keypad Lock			
	Comps	H.1800 W.300 D.300	Price	H.1800 W.300 D.450	Price	H.1800 W.300 D.300	Price	H.1800 W.300 D.450
1	LOF1830301*X	£160.43	LOF1830451*X	£182.63	LOF1830301*D	£203.17	LOF1830451*D	£225.37
2	LOF1830302*X	£191.51	LOF1830452*X	£210.75	LOF1830302*D	£277.00	LOF1830452*D	£296.24
3	LOF1830303*X	£212.23	LOF1830453*X	£231.47	LOF1830303*D	£340.46	LOF1830453*D	£359.70
4	LOF1830304*X	£218.15	LOF1830454*X	£249.23	LOF1830304*D	£389.13	LOF1830454*D	£420.21
5	LOF1830305*X	£240.35	LOF1830455*X	£265.51	LOF1830305*D	£454.07	LOF1830455*D	£479.23
6	LOF1830306*X	£262.55	LOF1830456*X	£281.79	LOF1830306*D	£519.02	LOF1830456*D	£538.26

Smart Lockers

Enhance your workspace by upgrading to our premium smart lockers, featuring two cutting-edge smart lock options designed for the modern office.

Key Card Lock - Experience the convenience of a contactless digital lock that lets you effortlessly secure and access your locker with a simple key card. **Echo Smart Lock** - Unlock and lock with just the tap of a smartphone - no keys, no batteries and no maintenance.

Our Smart Lockers require the use of a simple app and subscription. Please speak to sales for further details and pricing.

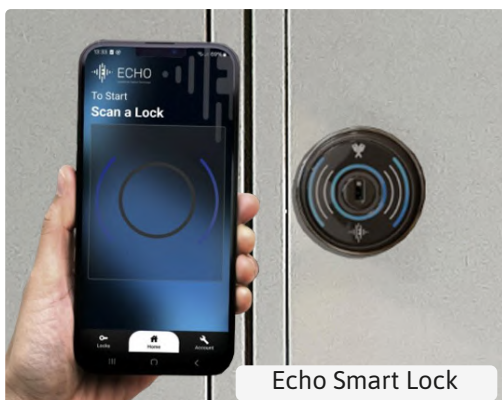

Echo Smart Lock

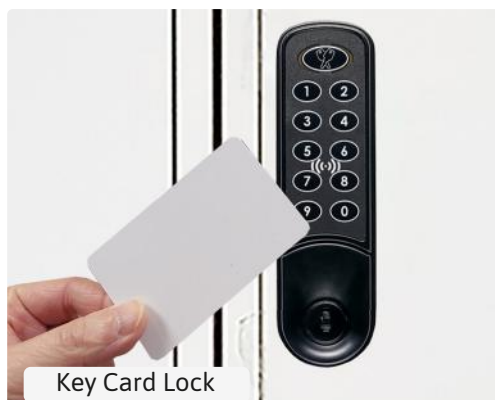

Key Card Lock



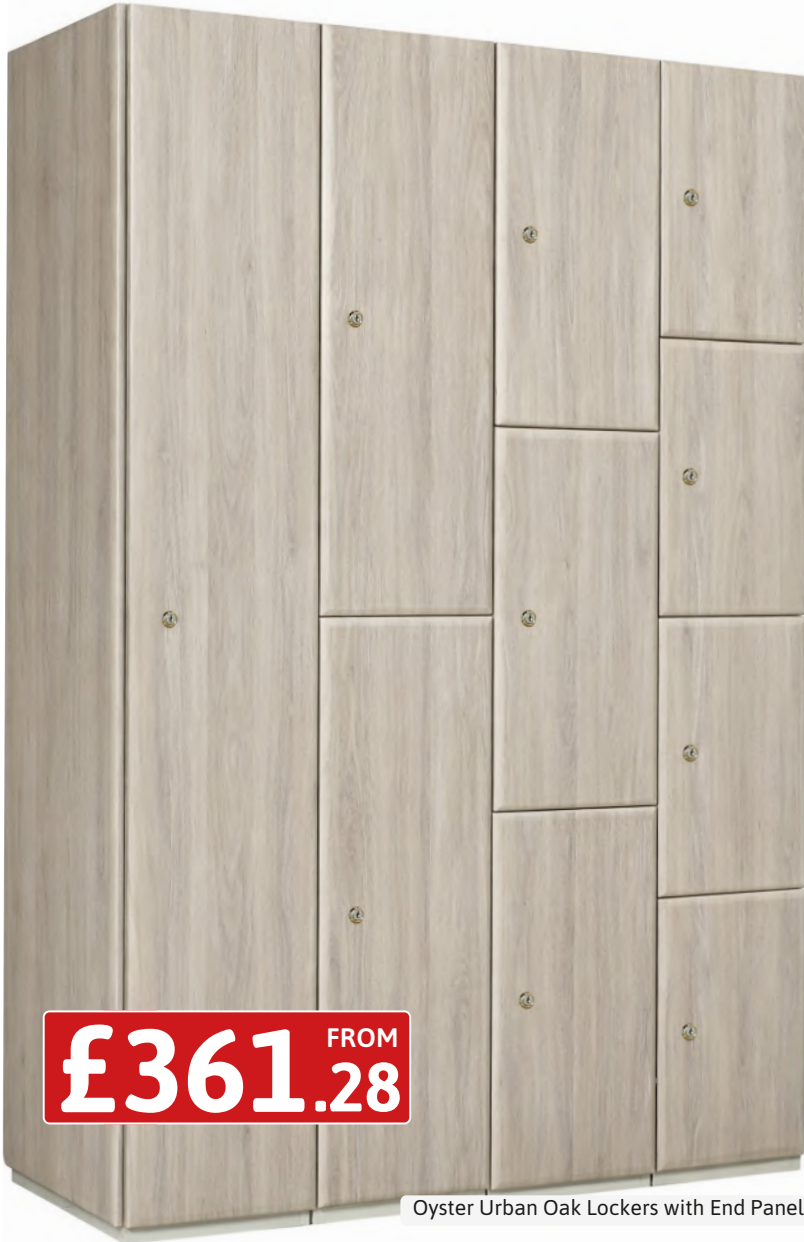

£361.28 FROM

Oyster Urban Oak Lockers with End Panel



Natural Lancaster Oak Patterned



Light Springfield Oak Door Patterned

The Timber Door Locker range provides maximum strength and durability, featuring a robust powder-coated steel frame with timber-effect doors. These lockers are perfect for public spaces, leisure facilities, and office environments.

- End panels available for that final touch.
- Pre-drilled for nesting.
- Plain or patterned doors, available in Light Springfield Oak,

Natural Lancaster Oak or Oyster Urban Oak finishes.

- Fitted with standard mastered cam locks with 2,000 differs.
- Single-tier lockers fitted with top shelf and coat hook.
- Two-tier lockers fitted with coat hook in each compartment.
- Steel body for maximum strength and durability.
- Fitted with soft-close hinges.
- Minimum order quantity of 8 lockers.

Colour Options

Please add corresponding letters to the end of the code.



Timber Door Lockers - H.1800 W.300 D.450

Compartments	Code	Price
1	LT1830451	£361.28
2	LT1830452	£390.24
3	LT1830453	£431.40
4	LT1830454	£471.04
End Panel	LT1845EPZ	£248.48

Timber Door Lockers - H.1800 W.380 D.380

Compartments	Code	Price
1	LT1838381	£416.16
2	LT1838382	£452.74
3	LT1838383	£506.10
4	LT1838384	£544.21
End Panel	LT1838EPZ	£225.61



MFC Door

Combining the strength of steel with the robust durability of cost-effective MFC. Featuring plant-on doors that cover the face of the carcass, offering a more attractive option than traditional inset doors.

- Available with Light Grey or Dust Grey plant-on doors, or upgrade to a premium colour - POA.
- Fitted with standard mastered cam locks with 2,000 differs.
- Available in two sizes and four door configurations.
- 1,2,3 and 4 door lockers fitted with a security shelf to prevent unauthorised access to the compartment below.
- Minimum order quantity of 8 lockers.

Colour Options

Please add corresponding letters to the end of the code.

LG
Light Grey

DG
Dust Grey

£179.⁹⁵ FROM

Premium Colours

Our premium colour door options are available on POA.

CG
Congo

BG
Basalt Grey

GB
Gentian Blue

IC
Icy White

MA
Mountain Ash

OW
Okapi Walnut

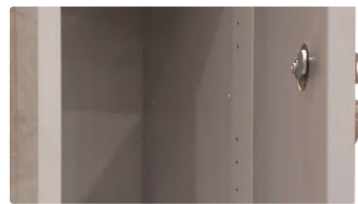

MFC Plant-On Door Lockers H.1800 W.300

Comps	300mm depth	Price	450mm depth	Price
1	LPM1830301**	£179.95	LPM1830451**	£212.19
2	LPM1830302**	£260.33	LPM1830452**	£272.69
3	LPM1830303**	£347.88	LPM1830453**	£360.24
4	LPM1830304**	£378.97	LPM1830454**	£391.33
End Panel	LME18301X	£POA	LME18451X	£POA

Above prices for standard colour doors, premium colours are POA

Laminate Door

Our premium Plant-On Door Locker is fitted with a hard-wearing laminate door for unmatched versatility. Available in a wide range of stylish colours that enhance any environment.

- Fitted with standard mastered cam locks with 2,000 differs.
- Available in two sizes and four door configurations.
- 1,2,3 and 4 door lockers fitted with a security shelf to prevent unauthorised access to the compartment below.
- Steel carcass powder coated in standard light grey.
- Minimum order quantity of 8 lockers.

Laminate Plant-On Door Lockers H.1800 W.300

Comps	300mm depth	Price	450mm depth	Price
1	LPL1830301**	£280.37	LPL1830451**	£310.95
2	LPL1830302**	£325.12	LPL1830452**	£356.02
3	LPL1830303**	£393.42	LPL1830453**	£424.32
4	LPL1830304**	£455.35	LPL1830454**	£486.25
End Panel	LPE18301X	£POA	LPE18451X	£POA



Colour Options

Please add corresponding letters to the end of the code.

CA
Campanula

QX
Aquamarine

LG
Light Grey

GG
Graphite Grey

OX
Oak

SR
Spectrum Red

SY
Spectrum Yellow

CG
Chartreuse Green

CL
Clementine

WX
Pure White

AX
Jet Black

Our premium Laminate Door Lockers provide exceptional quality without the high price tag. The door is designed to fit perfectly within the frame and opens 180 degrees for easy access. Made from durable laminate, these doors are highly resistant to dents, scratches, and rust. They are perfect for high-traffic environments such as schools and colleges, where lockers are frequently used.

- Please check laminate colour availability with sales prior to ordering.
- Fitted with standard mastered cam locks with 2,000 differs.
- 2, 3, 4 and 6 door lockers fitted with security shelf to prevent unauthorised access to the compartment below.
- End panels also available.
- Pre-drilled for nesting.
- Steel carcass powder coated in our standard Light Grey.
- Minimum order quantity of 8 lockers.



BEST SELLER

£288.11 FROM



Laminate Door Lockers

Comps	H.1800 W.300 D.300mm	Price	H.1800 W.300 D.450mm	Price
1	LU1830301	£288.11	LU1830451	£300.31
2	LU1830302	£335.37	LU1830452	£349.09
3	LU1830303	£382.62	LU1830453	£397.87
4	LU1830304	£429.88	LU1830454	£446.65
6	LU1830306	£487.81	LU1830456	£507.92
End Panel	LVEP18301	£242.38	LVEP18451	£339.94



Moisture Resistant Cam Lock

Laminate Splash Lockers

Our robust Laminate Splash Lockers are highly resistant to dents and scratches and will not rust making them perfect for placing in wet areas such as leisure centres and changing rooms.

- Pre-galvanised steel carcass.
- Fitted with moisture resistant cam locks.
- Two sizes and four door configurations.
- Minimum order quantity of 8 lockers.

£303.35 FROM

Laminate Splash Lockers

Comps	H.1800 W.300 D.300mm	Price	H.1800 W.300 D.450mm	Price
1	LZ1830301	£303.35	LZ1830451	£318.60
2	LZ1830302	£361.28	LZ1830452	£375.00
3	LZ1830303	£417.68	LZ1830453	£434.45
4	LZ1830304	£475.61	LZ1830454	£492.38
6	LZ1830306	£539.82	LZ1830456	£539.63
End Panel	LVEP18301	£242.38	LVEP18451	£339.94

Colour Options

Available for both Laminate and Laminate Splash Lockers. Please add corresponding letters to the end of the code.

CAX Campanula	QXX Aquamarine	LGX Light Grey	GGX Graphite Grey	OXX Oak	SRX Spectrum Red	SYX Spectrum Yellow	CGX Chartreuse Green	CLX Clementine
-------------------------	--------------------------	--------------------------	-----------------------------	-------------------	----------------------------	-------------------------------	--------------------------------	--------------------------



These lockers are manufactured from pre-coated galvanised steel for damp environments or where frequent washing down is required.

- Strengthened and ventilated doors with rubber buffers.
- Single-tier lockers fitted with top shelf and coat hook.
- Two-tier lockers fitted with coat hook in each compartment.
- Powder coated with Germ Guard Active Technology anti-bacterial paint.
- Hinges are 75mm deep. This offers greater quality and durability.
- Ideal for changing rooms, saunas and food preparation plants.
- 2, 3 and 4 door lockers fitted with security shelf to prevent unauthorised access to the compartment below.
- Moisture-resistant cam locks are fitted as standard for superior lock durability in moist environments.
- Lateral security beam enhances the security of the product.

Colour Options

Please add corresponding letters to the end of the code.

RXX

GXX

LXX

UXX

BXX

YXX

Steel Splash Lockers - H.1800 W.300 D.300

Compartments	Code	Price
1	LW1830301	£207.32
2	LW1830302	£237.81
3	LW1830303	£268.29
4	LW1830304	£298.78

Steel Splash Lockers - H.1800 W.300 D.450

Compartments	Code	Price
1	LW1830451	£219.51
2	LW1830452	£248.48
3	LW1830453	£283.54
4	LW1830454	£315.55

Lockers



£163.11 FROM



Lockers

Our perforated door lockers are designed for situations where efficient ventilation and maximum visibility, combined with security, are essential.

- 2, 3, 4, 5 and 6 door lockers fitted with security shelf to prevent unauthorised access to the compartment below.
- Fitted with standard mastered cam locks with 2,000 differs.

- Single-tier lockers fitted with top shelf and coat hook.
- Two-tier lockers fitted with coat hook in each compartment.
- Strengthened and ventilated doors with rubber buffers.
- Powder coated with Germ Guard Active Technology paint.
- Reaction to Fire Classification EN 13501-1.
- Minimum order quantity of 8 lockers.

Colour Options

Please add corresponding letters to the end of the code.



Perforated Door Lockers - H.1800 W.300 D.300

Compartments	Code	Price
1	LS1830301*PX	£163.11
2	LS1830302*PX	£196.65
3	LS1830303*PX	£207.32
4	LS1830304*PX	£239.33
5	LS1830305*PX	£250.00
6	LS1830306*PX	£262.20

Perforated Door Lockers - H.1800 W.300 D.450

Compartments	Code	Price
1	LS1830451*PX	£190.55
2	LS1830452*PX	£202.74
3	LS1830453*PX	£222.56
4	LS1830454*PX	£269.82
5	LS1830455*PX	£283.54
6	LS1830456*PX	£298.78

Perforated Door Lockers - H.1800 W.380 D.380

Compartments	Code	Price
1	LS1838381*PX	£189.02
2	LS1838382*PX	£196.65
3	LS1838383*PX	£217.99
4	LS1838384*PX	£236.28
5	LS1838385*PX	£254.57
6	LS1838386*PX	£274.39

Perforated Door Lockers - H.1800 W.450 D.450

Compartments	Code	Price
1	LS1845451*PX	£221.04
2	LS1845452*PX	£248.48
3	LS1845453*PX	£257.62
4	LS1845454*PX	£274.39
5	LS1845455*PX	£285.06
6	LS1845456*PX	£295.73



£434 FROM
.45

FIRE GUARD
TESTED & CERTIFIED
EN 13501-1

1800.450.450 Steel Door Option Shown



1800.300.450 Laminate Door Option Shown



1800.300.450 Steel Door Option Shown

This attractive and highly durable locker is perfect for areas where space is limited. Each compartment is designed to comfortably hold a coat on the built-in hook, and there is also ample space for storing small personal items.

- Doors are available in steel or high-quality laminate for extra durability.
- Fitted with standard mastered cam locks, with 2,000 differs.
- Choice of 300mm or 450mm widths.
- Powder coated with Germ Guard Active Technology Anti-Bacterial paint.
- Reaction to Fire Classification EN 13501-1 (on steel door lockers only).
- Minimum order quantity of 8 lockers.

Laminate Door Colour Options

Please add corresponding letters to the end of the code.

CAX Campanula	QXX Aquamarine	LGX Light Grey	GGX Graphite Grey	OXX Oak
SRX Spectrum Red	SYX Spectrum Yellow	CGX Chartreuse Green	CLX Clementine	

Steel Door Colour Options

UXX Light Blue	BXX Blue	LXX Light Grey
RXX Red	YXX Yellow	GXX Green

Z-Door Lockers - Dimensions/Codes

Size H.W.D	Door	Code	Price
1800.300.450	Steel	LZD183045	£434.35
1800.450.450	Steel	LZD184545	£477.13
1800.300.450	Laminate	LZU183045	£614.33
1800.450.450	Laminate	LZU184545	£667.68

Cube Lockers

£79 FROM **.27**



Cube Lockers provide secure, space-saving storage for personal items in offices, call centres, and schools where space is limited.

- Fitted with standard mastered cam locks with 2,000 differs.
- Ventilated locker doors.
- Rubber door buffers.
- Powder coated with Germ Guard Active Technology paint.
- Pre-drilled for nesting or wall mounting.
- Available with an extra shelf - this is suitable for the 450x450x450 Cube Locker.
- Reaction to Fire Classification EN13501-1.
- Dark Blue & Light Grey door colours available on 5-Day Delivery.

Cube Lockers - Dimensions/Codes

Size H.W.D.	Code	Price
300.300.300	UG303030Z	£79.27
380.380.380	UG383838Z	£92.99
450.450.450	UG464646Z	£100.61

Internal Shelf - Galvanised - 450.450.450 Cube Locker

Size H.W.D.	Code	Price
170.450.450	UGES4646ZLXX	£42.68

Colour Options

Please add corresponding letters to the end of the code.



Perspex Door Lockers

Perspex Door Lockers offer secure storage for personal belongings while allowing visibility of the contents. They are perfect for staff rooms in retail outlets, venues, public areas, or any location where it is necessary to see the stored items.

- Choice of 300mm or 450mm depths available.
- Fitted with security shelf to prevent unauthorised access to compartment below.
- Fitted with standard mastered cam locks with 2,000 differs.
- Two-tier lockers fitted with coat hook in each compartment.
- Quality clear perspex door - shaded perspex options available, please call our sales team for details.
- Carcass powder coated with Germ Guard Active Technology anti-bacterial paint.
- Minimum order quantity of 8 lockers.

£333 FROM **.84**

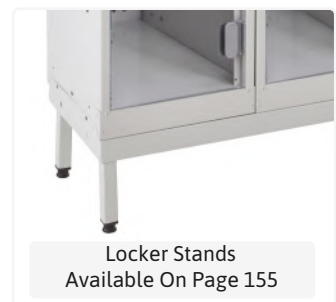
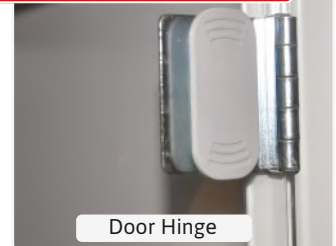

Perspex Door Lockers

Compartments	H.1800 W.300 D.300	Price	H. 1800 W.300 D. 450	Price
2	LP1830302CXX	£333.84	LP1830452CXX	£347.56
3	LP1830303CXX	£365.85	LP1830453CXX	£381.10
4	LP1830304CXX	£397.87	LP1830454CXX	£416.16
6	LP1830306CXX	£463.41	LP1830456CXX	£483.23



Our range of Stainless Steel Lockers are designed and manufactured for hygienic areas such as catering, industrial, construction and healthcare environments. These are available in 1,2,3,4 and 6 compartment sizes with the choice of either 300mm and 450mm depths.

- High-quality 304 stainless steel units that will not rust or tarnish easily.
- Each compartment is fitted with an adjustable stainless

steel security shelf to prevent unauthorised access to the compartment below.

- Choice of 300mm and 450mm depths.
- Fitted with standard, mastered cam locks with 2,000 differs.
- Strengthened doors.
- Single-tier lockers fitted with top shelf and coat hook.
- Pre-drilled for nesting.

Locker Sloping Tops

Locker Sloping Tops discourage the placement of unwanted articles on top of the locker unit.

Size W.D	Code	Price:
300.300	L2SLT3030SSX	£45.25
300.450	L2SLT3045SSX	£63.75

Locker Stands

Stands raise the locker height by 150mm, helping to promote hygiene levels by allowing access to floor for cleaning.

Configuration (To Fit)	Size H.W.D	Code	Price:
1 Locker	150.300.300	L2ST153030SS	£54.95
2 Lockers	150.600.300	L2ST156030SS	£87.37
3 Lockers	150.900.300	L2ST159030SS	£119.80
4 Lockers	150.1200.300	L2ST151230SS	£152.22
1 Locker	150.300.450	L2ST153045SS	£61.43
2 Lockers	150.600.450	L2ST156045SS	£119.80
3 Lockers	150.900.450	L2ST159045SS	£152.22
4 Lockers	150.1200.450	L2ST151245SS	£217.08

£669 FROM **.08**

Stainless Steel Lockers - H.1800 W.300 D.450

Compartments	Code	Price
1	LSS1830451SX	£694.93
2	LSS1830452SX	£748.59
3	LSS1830453SX	£830.90
4	LSS1830454SX	£918.83
6	LSS1830456SX	£1,157.52

Stainless Steel Lockers - H.1800 W.300 D.300

Compartments	Code	Price
1	LSS1830301SX	£669.08
2	LSS1830302SX	£722.63
3	LSS1830303SX	£795.54
4	LSS1830304SX	£883.46
6	LSS1830306SX	£1,048.35



5-7 DAY DELIVERY

£149.39 FROM



Our PPE Locker range enables employees to safely store their personal protective equipment within the workplace. PPE Lockers allow employers to comply with regulations regarding the safe storage of protective equipment. These lockers are powder-coated blue and clearly marked with PPE labels.

- Fitted with standard mastered cam locks with 2,000 differs.
- Single-tier lockers fitted with top shelf and coat hook.
- Two-tier lockers fitted with coat hook.
- Strengthened doors with rubber buffers.
- Supplied with PPE labels for identification.
- Reaction to Fire Classification EN 13501-1.
- Powder coated with Germ Guard Active Technology paint with Dark Blue doors.

PPE Lockers - H.1800 W.300 D.300

Compartments	Code	Price
1	LP1830301BXX	£149.39
2	LP1830302BXX	£187.50
3	LP1830303BXX	£214.94
4	LP1830304BXX	£228.66
6	LP1830306BXX	£286.59

PPE Lockers - H.1800 W.300 D.450

Compartments	Code	Price
1	LP1830451BXX	£172.26
2	LP1830452BXX	£208.84
3	LP1830453BXX	£234.76
4	LP1830454BXX	£260.67
6	LP1830456BXX	£307.93



Duo Lockers



Twin Lockers



Staff Lockers



Clean & Dirty Lockers



£234.76 FROM

BEST SELLER

These Multi-Compartment Lockers provide alternatives to the usual locker formats. Clean & Dirty Lockers offer two compartments with a top shelf for the storage of clean and dirty workwear. Twin Lockers provide full-length storage for hanging clothing from an internal fitted hook. Staff Lockers contain integral fitted shelves for the storage of small items, along with a full-length compartment for hanging a coat. Duo Lockers are made up of multiple compartments with separate lockable compartments for shared access.

- All lockers are 1800mm high.
- Strengthened and ventilated doors with rubber buffers.
- Powder coated with Germ Guard Active Technology paint.
- Available in our range of standard colours.
- Reaction to Fire Classification EN 13501-1.

To accommodate a motorcycle helmet in the top compartment of the Clean & Dirty Locker, the following must be ordered: **LG184545H**. This model has a lower top shelf than shown.

Colour Options

Please add corresponding letters to the end of the code.



Clean and Dirty Lockers - Dimensions/Codes

Description	Width	Depth	Code	Price
Top Shelf & Central Divider	450	450	LG184545G	£234.76

Staff Lockers - Dimensions/Codes

Description	Width	Depth	Code	Price
3 Shelves	450	450	LG184545S	£265.24

Duo Lockers - Dimensions/Codes

Description	Width	Depth	Code	Price
2 Full Width Tiers	450	300	LG184530D	£271.34
& 2 Slim Tiers	450	450	LG184545D	£304.88

Twin Lockers - Dimensions/Codes

Description	Width	Depth	Code	Price
2 Full Height Tiers	600	450	LG186045T	£291.16



Ambulance Service Locker



Police Service Locker



Fire Service Locker

Sloping top versions shown, also available with flat tops.

£282.99 FROM

These extra-wide Emergency Service Lockers are specifically designed to securely store a large amount of equipment. They are available with a choice of solid or perforated doors.

- Extra-wide size with double doors offering premium storage space, 1800mm in height.
- Fitted with 3-point locking mechanism for extra security.
- Choice of standard or sloping top and three internal

configurations as shown below.

- Available in two sizes - H1800mm x W600mm x D450mm and H1800mm x W600mm x D600mm.
- Powder coated with Germ Guard Active Technology paint.
- Reaction to Fire Classification EN 13501-1.
- Other colours available - please speak to sales.



Solid or perforated doors

Colour Options

- RED**
- BLUE**
- GREEN**



2-compartment with coat rail



1 compartment with 3 shelves



2 comp with coat rail and lower shelf

Combi Seat/Storage & Stands



Upgrade your Emergency Service Locker with convenient extra storage consisting of a seat, stand and lockable under bench box. Choose from either solid or perforated doors and Oak slat or MFC bench seat options.

Combi Storage - Dimensions/Codes

Door Type	Bench Seat Option	H.W.D	Code	Price:
Solid	Oak	450.600.300	L2SE45604OS*	£399.34
Solid	MFC	450.600.300	L2SE45604MS*	£266.09
Perforated	Oak	450.600.300	L2SE45604OP*	£423.98
Perforated	MFC	450.600.300	L2SE45604MP*	£287.51



Fire Service Lockers - Solid Door - Dimensions/Codes

Description	Size H.W.D	Code	Price
2-comp w/ coat rail	1800.600.450	LFR186045RS2	£282.99
2-comp w/ coat rail	1800.600.600	LFR186060RS2	£374.65
1-comp w/ 3 shelves	1800.600.450	LFR186045RS1	£309.58
1-comp w/ 3 shelves	1800.600.600	LFR186060RS1	£370.60
2-comp w/ coat rail/lower shelf	1800.600.450	LFR186045RSC	£291.85
2-comp w/ coat rail/lower shelf	1800.600.600	LFR186060RSC	£365.66

Police Service Lockers - Solid Door - Dimensions/Codes

Description	Size H.W.D	Code	Price
2-comp w/ coat rail	1800.600.450	LPO186045BS2	£282.99
2-comp w/ coat rail	1800.600.600	LPO186060BS2	£374.65
1-comp w/ 3 shelves	1800.600.450	LPO186045BS1	£309.58
1-comp w/ 3 shelves	1800.600.600	LPO186060BS1	£370.60
2-comp w/ coat rail/lower shelf	1800.600.450	LPO186045BSC	£291.85
2-comp w/ coat rail/lower shelf	1800.600.600	LPO186060BSC	£365.66

Ambulance Service Lockers - Solid Door - Dimensions/Codes

Description	Size H.W.D	Code	Price
2-comp w/ coat rail	1800.600.450	LAM186045GS2	£282.99
2-comp w/ coat rail	1800.600.600	LAM186060GS2	£374.65
1-comp w/ 3 shelves	1800.600.450	LAM186045GS1	£309.58
1-comp w/ 3 shelves	1800.600.600	LAM186060GS1	£370.60
2-comp w/ coat rail/lower shelf	1800.600.450	LAM186045GSC	£291.85
2-comp w/ coat rail/lower shelf	1800.600.600	LAM186060GSC	£365.66

Fire Service Lockers - Perforated Door - Dimensions/Codes

Description	Size H.W.D	Code	Price
2-comp w/ coat rail	1800.600.450	LFR186045RP2	£304.41
2-comp w/ coat rail	1800.600.600	LFR186060RP2	£396.08
1-comp w/ 3 shelves	1800.600.450	LFR186045RP1	£331.00
1-comp w/ 3 shelves	1800.600.600	LFR186060RP1	£392.03
2-comp w/ coat rail/lower shelf	1800.600.450	LFR186045RPC	£313.27
2-comp w/ coat rail/lower shelf	1800.600.600	LFR186060RPC	£387.09

Police Service Lockers - Perforated Door - Dimensions/Codes

Description	Size H.W.D	Code	Price
2-comp w/ coat rail	1800.600.450	LPO186045BP2	£304.41
2-comp w/ coat rail	1800.600.600	LPO186060BP2	£396.08
1-comp w/ 3 shelves	1800.600.450	LPO186045BP1	£331.00
1-comp w/ 3 shelves	1800.600.600	LPO186060BP1	£392.03
2-comp w/ coat rail/lower shelf	1800.600.450	LPO186045BPC	£313.27
2-comp w/ coat rail/lower shelf	1800.600.600	LPO186060BPC	£387.09

Ambulance Service Lockers - Perforated Door - Dimensions/Codes

Description	Size H.W.D	Code	Price
2-comp w/ coat rail	1800.600.450	LAM186045GP2	£304.41
2-comp w/ coat rail	1800.600.600	LAM186060GP2	£396.08
1-comp w/ 3 shelves	1800.600.450	LAM186045GP1	£331.00
1-comp w/ 3 shelves	1800.600.600	LAM186060GP1	£392.03
2-comp w/ coat rail/lower shelf	1800.600.450	LAM186045GPC	£313.27
2-comp w/ coat rail/lower shelf	1800.600.600	LAM186060GPC	£387.09

Locker Stands

Stands raise the locker height by 150mm, helping to promote hygiene levels by allowing access to floor for cleaning.



Configuration (To Fit)	Size H.W.D	Code	Price:
1 Locker	150.600.450	L2ST156045LX	£33.54
2 Lockers	150.1200.450	L2ST151246LX	£51.82
3 Lockers	150.1800.450	L2ST151845LX	£76.22
1 Locker	150.600.600	L2ST156060LX	£41.19
2 Lockers	150.1200.600	L2ST151260LX	£68.60
3 Lockers	150.1800.600	L2ST151860LX	£81.57

Locker Sloping Tops

Locker Sloping Tops discourage the placement of unwanted articles on top of the locker unit.



Size W.D	Code	Price:
600.450	L2SLT6045LXX	£26.20
600.600	L2SLT6060LXX	£29.88

Padlock Lockers

Padlock Lockers are designed for users to securely store their belongings using their own padlock. This feature is particularly useful in public spaces such as leisure centres, gyms, and schools. The lockers are powder-coated in a selection of standard colours and have strengthened doors. Each door panel is vented and equipped with rubber buffers. Additionally, they are fitted with a hasp and staple to accommodate padlocks.

- Single-tier lockers fitted with top shelf and coat hook.
- Two-tier lockers fitted with coat hook in each compartment.
- Strengthened and ventilated doors with rubber buffers.
- Powder coated with Germ Guard Active Technology paint.
- Minimum order quantity of 8 lockers.



Padlock Lockers - Dimensions/Codes

Comps	H.1800 W.300 D.300	Price	H.1800 W.300 D.450	Price	H.1800 W.380 D.380	Price	H.1800 W.450 D.450	Price
1	LPD1830301	£152.44	LPD1830451	£176.83	LPD1838381	£182.93	LPD1845451	£198.17
2	LPD1830302	£195.12	LPD1830452	£214.94	LPD1838382	£210.37	LPD1845452	£233.23
3	LPD1830303	£225.61	LPD1830453	£245.43	LPD1838383	£236.28	LPD1845453	£272.87
4	LPD1830304	£240.85	LPD1830454	£274.39	LPD1838384	£271.34	LPD1845454	£309.45
6	LPD1830306	£297.26	LPD1830456	£318.60	LPD1838386	£320.12	LPD1845456	£329.27



Secure Lockers



£204.27 FROM

Secure Lockers - Dimensions/Codes

Comps	H.1800 W.300 D.300	Price	H.1800 W.300 D.450	Price	H.1800 W.380 D.380	Price	H.1800 W.450 D.450	Price
1	LSC1830301	£204.27	LSC1830451	£233.23	LSC1838381	£239.33	LSC1845451	£259.15
2	LSC1830302	£227.13	LSC1830452	£251.52	LSC1838382	£245.43	LSC1845452	£272.87
3	LSC1830303	£265.24	LSC1830453	£289.63	LSC1838383	£277.44	LSC1845453	£321.65

Secure Lockers feature a high-security 3-point locking mechanism, making them ideal for storing valuable items in offices, industrial workplaces, schools and public buildings. The locker doors come in a variety of standard colours and include door strengtheners, vents, and rubber buffers for added functionality.

- Fitted with 3-point locking mechanism for extra security.
- Single-tier lockers fitted with top shelf and coat hook.
- Two-tier lockers fitted with coat hook in each compartment.
- Strengthened and ventilated doors with rubber buffers.
- Powder coated with Germ Guard Active Technology paint.
- Minimum order quantity of 8 lockers.

Colour Options

Please add corresponding letters to the end of the code.



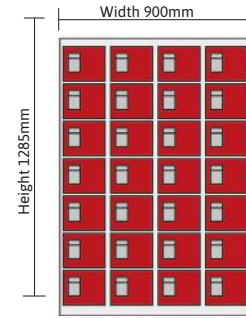

28 Compartment

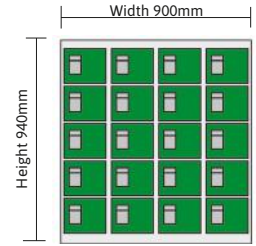

20 Compartment

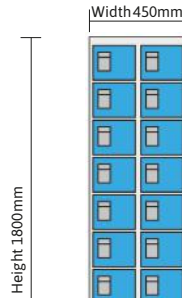

20 Compartment

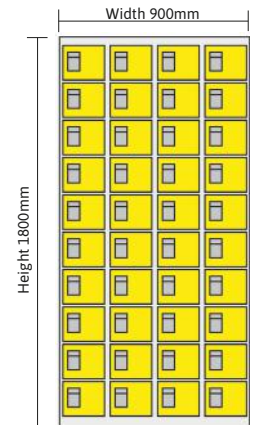

40 Compartment

Our floor-standing and wall-mounted Personal Effects Lockers provide secure storage for small items such as mobile phones, wallets, and keys. These lockers offer employees a reliable storage solution for valuable belongings.

- Fitted with standard mastered cam locks with 2,000 differs.
- Available as floor-standing and wall-mounted in various compartment sizes.

- Compartment entry aperture: H.150mm x W.163mm x D360mm.
- Dark Blue & Light Grey door colours available on 5-Day Delivery.
- Powder coated with Germ Guard Active Technology paint.
- Pre-drilled for nesting.
- Reaction to Fire Classification EN 13501-1.
- Fitted with a security shelf to prevent unauthorised access to the compartment below.

Floor-Standing Personal Effects Lockers - Dimensions/Codes

Size H.W.D.	Compartments	Code	Price
1285.900.380	28	LR129038H	£721.04
940.900.380	20	LR909038Y	£507.62
1800.450.380	20	LR184538Y	£507.62
1800.900.380	40	LR189038F	£977.13

Wall-Mounted Personal Effects Lockers

Colour Options

Please add corresponding letters to the end of the code.

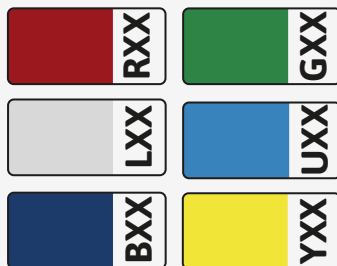

Wall-Mounted Personal Effects Lockers - Dimensions/Codes

Size H.W.D.	Compartments	Code	Price
940.450.190	10	LR944519W*XX	£155.30
940.900.190	20	LR949019W*XX	£306.14
940.1130.190	25	LR941119W*XX	£406.82



12 Compartment



15 Compartment



20 Compartment



Garment Disposal

£326.22 FROM



The Garment Locker range enables work clothing to be issued when clean and exchanged when dirty. Clothing compartments can be accessed individually or collectively using the master door.

- Fitted with standard mastered cam locks with 2,000 differs.
- Powder-coated internal shelves.
- Ideal for use with Garment Disposal Lockers.

- The Garment series is recommended for ironed garments.
- Doors fitted with rubber buffers to prevent scratching.
- Pre-drilled for nesting.
- Powder coated with Germ Guard Active Technology paint.
- Reaction to Fire Classification EN 13501-1.
- Garment Disposal option available with letter box opening.
- Other door colours available - minimum order quantity of 8.

Colour Options

Please add corresponding letters to the end of the code.

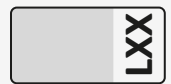

Garment Lockers - Dimensions/Codes

Size H. W. D.	Compartments	Code	Price
1800.380.450	5	LF1838455	£355.18
	10	LF183845N	£434.45
	12	LF183845W	£472.56
	15	LF183845Q	£518.29
	20	LF183845Y	£602.13
1800.450.380	5	LF1845385	£355.18
	10	LF184538N	£434.45
	12	LF184538W	£472.56
	15	LF184538Q	£518.29

Garment Disposal Lockers - Dimensions/Codes

Size H. W. D.	Code	Price
1800.380.450	LL1838451	£326.22
1800.450.450	LL1845451	£341.46



BEST SELLER

£407.01 FROM



Lockers

As the use of laptops and tablets grows in businesses and schools, this line of device storage products offers affordable, lockable storage for laptops, tablets, and accessories.

- High-quality, cost-effective storage.
- Choose from a single door or individual compartments.
- A range of compartment options available from 8 to 15 tiers.
- Powder coated with Germ Guard Active Technology paint.
- Pre-drilled for nesting.



Colour Options

Please add corresponding letters to the end of the code.



Laptop & Tablet Storage Lockers - Dimensions/Codes

H.W.D.	Configuration	Code	Price
1000.500.500	8 Compartments, 8 Doors	L71050508	£507.62
	8 Compartments, 1 Door	L71050501	£407.01
1460.500.500	12 Compartments, 12 Doors	L7145050W	£579.27
	12 Compartments, 1 Door	L71450501	£463.41

Laptop & Tablet Storage Lockers - Dimensions/Codes

H.W.D.	Configuration	Code	Price
1800.450.450	10 Compartments, 10 Doors	L7184545N	£564.02
1800.380.450	15 Compartments, 15 Doors	L7183845Q	£634.15
	15 Compartments, 1 Door	L71838451	£509.15



This range of charging lockers is designed to provide secure charging facilities for laptops and tablets. This product is CE tested and meets EU safety requirements.

- Each compartment is equipped with a 3-pin plug socket to permit charging using each laptop's own main lead.
- Ventilated compartments for heat dissipations.
- Compartment aperture (H x W x D) 100mm x 375mm x 470mm.
- Whole unit is powered by a simple kettle lead (supplied), plugged into the mains.
- Powder coated with Germ Guard Active Technology paint.
- Fitted with piano hinges to provide durability and extra security.

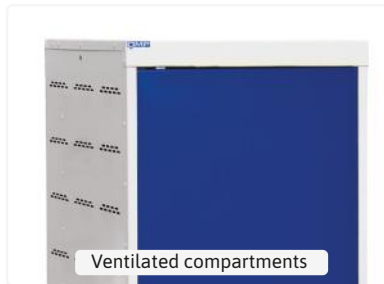

Laptop & Tablet Charging Lockers - Dimensions/Codes

H.W.D.	Configuration	Code	Price
1000.500.500	8 Compartments, 8 Doors	L7C10505088	£847.56
	8 Compartments, 1 Door	L7C10505081	£795.73
1460.500.500	12 Compartments, 12 Doors	L7C145050WW	£1,109.76
	12 Compartments, 1 Door	L7C145050W1	£1,053.35

Laptop & Tablet Charging Trolleys

Our Laptop and Tablet Charging Trolleys provide a secure way to store and charge devices while allowing for easy movement between rooms. They are equipped with high-quality braked castors for smooth mobility. This product is CE tested and complies with EU safety requirements.

- Ventilated compartments for heat dissipation.
- Each compartment is equipped with a 3-pin plug socket to permit charging using each laptop/tablet's own mains lead.
- Whole unit powered by a simple kettle lead plugged into the mains (supplied).
- Compartment aperture size (H x W x D) 100mm x 375mm x 465mm.
- Narrow aisle trolleys are just 525mm wide to allow easy loading and unloading between rows of desks.



Laptop & Tablet Storage Trolley - Dimensions/Codes

H.W.D.	Configuration	Code	Price
1200.1040.660	16 Compartments, 2 Doors	L7M121066X2	£1,676.83

Narrow Aisle Laptop & Tablet Storage Trolleys - Dimensions/Codes

H.W.D.	Configuration	Code	Price
1200.525.670	8 Compartments, 2 Doors	L7M12526782	£935.98
1200.525.1220	16 Compartments, 4 Doors	L7M125212X4	£1,676.83

Colour Options

Please add corresponding letters to the end of the code.



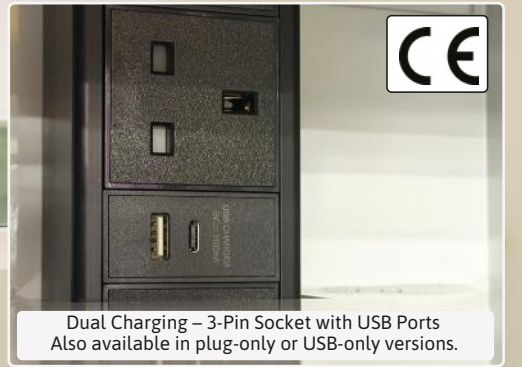

Our Dual USB Charging Lockers provide secure storage with built-in charging for tablets, mobile phones, and other handheld devices. Each compartment includes a standard 3-pin plug plus USB-A and USB-C ports for versatile, direct charging. A plug-only and a USB-only version are also available.

Configuration options:

- **Dual** - Features a 3-pin socket plus USB-A and USB-C ports for versatile, direct charging.
- **3-Pin Plug** - Provides only a 3-pin socket for charging via the device's own mains adapter.
- **USB** - Provides only a USB-A and USB-C port.
- Unit is powered by a simple fly lead (supplied) plugged into the mains.
- Also available with perspex doors for increased visibility of contents.

Dual USB Charging Lockers - Dimensions/Codes

Size H.W.D.	Door Type	Configuration	Dual	Price	3-Pin Plug only	Price	USB only	Price
1800.450.380	Solid	10 Comp, 20 Door	LRC184538YS*	£1,291.27	LR3184538YS*	£818.35	LRU184538YS*	£1,236.60
940.900.380	Solid	5 Comp, 20 Door	LRC909038YS*	£1,311.86	LR3909038YS*	£850.39	LRU909038YS*	£1,256.72
940.450.380	Solid	5 Comp, 10 Door	LRC904538YS*	£681.24	LR3904538YS*	£457.32	LRU904538YS*	£660.30
1800.450.380	Perspex	10 Comp, 20 Door	LRC184538YP*	£1,720.02	LR3184538YPX	£1,247.10	LRU184538YPX	£1,665.35
940.900.380	Perspex	5 Comp, 20 Door	LRC909038YP*	£1,728.62	LR3909038YPX	£1,267.15	LRU909038YPX	£1,673.49
940.450.380	Perspex	5 Comp, 10 Door	LRC904538YP*	£901.57	LR3904538YPX	£677.66	LRU904538YPX	£880.63

Size H.W.D.	Configuration	Dual	Price	3-Pin Plug only	Price	USB only	Price
1800.380.380	8 Comp, 8 Door	LDU1838388W*	£668.62	LD31838388W*	£452.40	LUS1838388W*	£610.58
1800.380.380	8 Comp, 1 Door	LDU18383881*	£596.92	LD318383881*	£376.25	LUS18383881*	£538.87
1800.380.380	10 Comp, 10 Door	LDU1838381W*	£739.04	LD31838381W*	£487.09	LUS1838381W*	£693.08
1800.380.380	10 Comp, 1 Door	LDU18383810*	£656.48	LD318383810*	£401.88	LUS18383810*	£610.52
1800.380.380	15 Comp, 15 Door	LDU1838385W*	£916.03	LD31838385W*	£547.10	LUS1838385W*	£882.48
1800.380.380	15 Comp, 1 Door	LDU18383815*	£782.30	LD318383815*	£417.81	LUS18383815*	£748.74

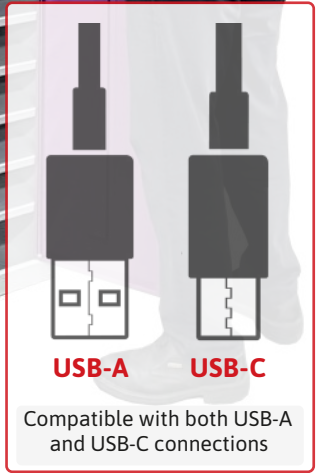

Colour Options

Please add corresponding letters to the end of the code.

S Sublime Lime	P Pitahaya Pink	B Berry Burst	L Lagoon Blue	T Tamarillo Red	G Guava Green	C Chilli Pepper Orange	O Tangelo Orange	I Summer Lilac
--------------------------	---------------------------	-------------------------	-------------------------	---------------------------	-------------------------	----------------------------------	----------------------------	--------------------------

Lockers

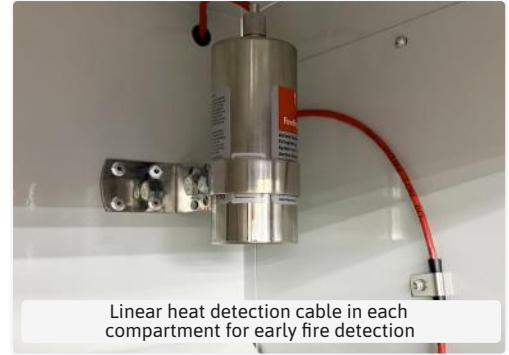

Linear heat detection cable in each compartment for early fire detection



Perforated shelves for ventilation and suppression



3-pin plug or 3-pin plug with USB-C port in each compartment

The Fire Suppression Charging Locker is a high-safety solution for securely charging and storing electronic devices in shared spaces. Featuring integrated FirePro fire suppression technology, it offers enhanced protection when charging batteries, power tools, laptops, and other portable devices. With 4, 6, 8 or 10-door configurations, each equipped with individually lockable compartments, it provides organized, secure storage for multiple users. The lockers are designed with quick fire detection and rapid suppression capabilities to minimise damage, protecting both equipment and surrounding areas.

- Integrated FirePro fire suppression system for enhanced safety.
- Available in 4, 6, 8 and 10-door configurations.
- Perforated 1.2mm shelves for ventilation and effective fire suppression.
- CE tested and compliant with EU safety standards.
- Each compartment includes a 3-pin plug or 3-pin plug with USB-C port for device-specific charging.
- Control unit positioned on top of locker for easy access.
- Fire suppression activates at 68°C.
- Fitted with standard mastered cam locks with 2,000 differs.
- Ventilated, reinforced doors with rubber buffers for durability.
- Powder-coated with Germ Guard Active Technology and distinctive red doors.

Fire Suppression Charging Lockers

External H.W.D.	Compartments	Standard Plug	Price	Standard Plug w/ USB-C port	Price
1800.300.450	4	LFS1830454RX	£2,060.68	LFC1830454RX	£2,285.27
1800.300.450	6	LFS1830456RX	£2,083.55	LFC1830456RX	£2,436.33
1800.300.450	8	LFS1830458RX	£2,159.92	LFC1830458RX	£2,623.98
1800.300.450	10	LFS1830450RX	£2,202.43	LFC1830450RX	£2,758.28
1800.450.450	4	LFS1845454RX	£2,110.68	LFC1845454RX	£2,335.27
1800.450.450	6	LFS1845456RX	£2,133.55	LFC1845456RX	£2,486.34
1800.450.450	8	LFS1845458RX	£2,209.91	LFC1845458RX	£2,673.99
1800.450.450	10	LFS1845450RX	£2,252.43	LFC1845450RX	£2,808.28



Our Tool Charging Lockers are designed for the secure charging of batteries and power tools. They come in various design options to suit your needs, including perforated and solid door styles, along with a selection of lock types. This product has been CE tested and meets all EU safety requirements.

- 4, 5, 6, and 8 door lockers fitted with galvanised security shelf to prevent any unauthorised access to the compartment below.
- Fitted with standard, mastered cam locks with 2,000 differs.
- Strengthened and ventilated doors with rubber buffers.
- Powder coated with Germ Guard Active Technology paint.
- Supplied with rust resisting galvanised shelves.
- Available with either perforated doors or solid doors.

£628.05 FROM **CE**



Also available with solid doors

Perforated Door Tool Charging Lockers

External H.W.D.	Internal H.W.D.	Compartments	Standard Plug	Price	RCD Plug	Price
1800.300.450	450.300.390	4	BL1830454*PX	£628.05	BR1830454*PX	£878.05
1800.300.450	360.300.390	5	BL1830455*PX	£737.81	BR1830455*PX	£1,051.83
1800.300.450	260.300.390	6	BL1830456*PX	£829.27	BR1830456*PX	£1,204.27
1800.300.450	190.300.390	8	BL1830458*PX	£995.43	BR1830458*PX	£1,495.43
1800.450.450	450.395.360	4	BL1845454*PX	£713.42	BR1845454*PX	£964.94
1800.450.450	360.395.360	5	BL1845455*PX	£841.46	BR1845455*PX	£1,153.96
1800.450.450	260.395.360	6	BL1845456*PX	£945.12	BR1845456*PX	£1,321.65
1800.450.450	190.395.360	8	BL1845458*PX	£1,134.15	BR1845458*PX	£1,634.15

Solid Door Tool Charging Lockers

External H.W.D.	Internal H.W.D.	Compartments	Standard Plug	Price	RCD Plug	Price
1800.300.450	450.300.390	4	BL1830454*SX	£628.05	BR1830454*SX	£878.05
1800.300.450	360.300.390	5	BL1830455*SX	£737.81	BR1830455*SX	£1,051.83
1800.300.450	260.300.390	6	BL1830456*SX	£829.27	BR1830456*SX	£1,204.27
1800.300.450	190.300.390	8	BL1830458*SX	£995.43	BR1830458*SX	£1,495.43
1800.450.450	450.395.360	4	BL1845454*SX	£713.42	BR1845454*SX	£964.94
1800.450.450	360.395.360	5	BL1845455*SX	£841.46	BR1845455*SX	£1,153.96
1800.450.450	260.395.360	6	BL1845456*SX	£945.12	BR1845456*SX	£1,321.65
1800.450.450	190.395.360	8	BL1845458*SX	£1,134.15	BR1845458*SX	£1,634.15

Colour Options

Please add corresponding letters to the end of the code.



£298 FROM



100 Series Post Box Locker



140 Series Post Box Locker



240 Series Post Box Locker

Lockers

Designed for use in offices, flats, schools, colleges and hospitals for central mail and internal post systems.

- Fitted with standard mastered cam locks with 2,000 differs.
- Each compartment has its own posting slot.
- Powder coated with Germ Guard Active Technology paint.
- Pre-drilled for nesting.
- Reaction to Fire Classification EN 13501-1.
- Other colours available, with a minimum order quantity of 8.

100 Series - Post Box Lockers

Size H.W.D.	Configuration	Code	Price
1325.230.255	10 Boxes - 15mm Slots	LX132325N	£397.87
1075.230.255	8 Boxes - 15mm Slots	LX1023258	£367.38

140 Series - Post Box Lockers

Size H.W.D.	Configuration	Code	Price
1725.300.380	10 Boxes - 25mm Slots	LX173038N	£449.70
1230.300.380	7 Boxes - 25mm Slots	LX1230387	£382.62

240 Series - Post Box Lockers

Size H.W.D.	Configuration	Code	Price
1665.300.380	6 Boxes - 40mm Slots	LX1630386	£382.62
870.300.380	3 Boxes - 40mm Slots	LX8730383	£298.78

Colour Options

Please add corresponding letters to the end of the code.

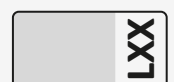

Island Benches

- Available as single or double-sided.
- Optional under-seat basket.
- Durable solid oak slatted seat.
- Supplied with aluminium coat hooks or captive coat hangers.
- Available in a range of designs to suit your needs.
- Option to have with shoe storage which has a capacity of 10 or 20 pairs of shoes.



£397 FROM **.87**

Island Benches - Single-Sided

Size H. W. D.	Hanger Options	Code	Price
1630.1500.300	5 Hooks	FCCRSI05F	£629.57
	5 Hooks & Basket	FCCRSI05B	£727.13
1830.1500.300	10 Hangers	FCCRSI10F	£701.22

Island Bench With Clothes Rail & Shoe Storage



Island Benches - with Clothes Rail and Shoe Storage

Size H. W. D.	Description	Hanger Options	Code	Price
1630.1500.300	Single Sided	10 Hangers	FCCRSI10B	£795.73
1630.1500.600	Double Sided	20 Hangers	FCCRDO20B	£1,125.00

Single/Double-Sided Island Bench



Island Benches - Double-Sided

Size H. W. D.	Hanger Options	Code	Price
1630.1500.600	10 Hooks	FCCRDO10F	£777.44
	10 Hooks & Basket	FCCRDO10B	£972.56
1630.1500.600	20 Hangers	FCCRDO20F	£922.26

Wall-Mounted Hanging Garment Rail



- Durable rail with solid oak slats.
- Ideal when larger units are impractical.
- Supplied with 12 captive coat hangers.
- Wall fixings not supplied.
- Powder-coated Dark Grey frame.

Wall-Mounted - Hanging Garment Rail

Size H. W. D.	Code	Price
315.1500.300	FCHANGRLX	£437.50

Wall-Mounted Bench



- Durable bench with solid oak slats.
- Provides a practical solution where floor space is at a premium.
- Wall fixings not supplied.
- Powder-coated Dark Grey frame.

Wall-Mounted - Bench

Size W. D.	Code	Price
1500.300	FCWMTBENX	£397.87

Single Bench Seat With Shoe Storage



- Single-depth unit.
- Supplied with shoe storage with capacity for 12 pairs of shoes.
- Powder-coated Dark Grey frame.

Single-Depth Bench - Shoe Storage

Size H. W. D.	Description	Code	Price
450.1500.300	Single Depth	FCBENSS3B	£544.21

Double Bench Seat With Shoe Storage



- Double-depth unit.
- Supplied with shoe storage with capacity for 24 pairs of shoes.
- Powder-coated Dark Grey frame.

Double-Depth Bench - Shoe Storage

Size H. W. D.	Description	Code	Price
450.1500.600	Double Depth	FCBENS6B	£850.61

Single-Depth Bench - Standard



- Single-depth unit.
- Powder-coated Dark Grey frame.

Single-Depth Bench - Standard

Size H. W. D.	Option	Code	Price
450.1500.300	Standard Bench	FCBENSS3F	£431.40

Single-Depth Bench & Under Seat Tray



- Single-depth unit.
- Powder-coated Dark Grey frame.

Single-Depth Bench - Under Seat Tray

Size H. W. D.	Option	Code	Price
450.1500.300	Bench & Under Seat Tray	FCBENSS3T	£461.89

Double-Depth - Standard Bench



- Optional under-seat shoe storage available.
- Durable solid oak slatted seat.

Double-Depth - Standard Bench

Size H. W. D.	Option	Code	Price
450.1500.600	Standard Bench	FCBENDS6F	£532.01

Double-Depth Bench & Under Seat Tray



- Optional under-seat shoe storage available.
- Durable solid oak slatted seat.

Double-Depth - Bench & Under-Seat Tray

Size H. W. D.	Option	Code	Price
450.1500.600	Bench & Under-Seat Tray	FCBENDS6T	£682.93

Wall-Mounted Coat Rails - 6 Hooks



- Durable solid oak coat rail.
- Fitted with 6 double aluminium hooks.
- Supplied with key hole fixing plate.

Wall-Mounted Coat Rails - 6 Hooks

Width	Hooks	Code	Price
1200	6	FCHKRL12X	£100.61

Wall-Mounted Coat Rails - 8 Hooks



- Durable solid oak coat rail.
- Fitted with 8 double aluminium hooks.
- Supplied with key hole fixing plate.

Wall-Mounted Coat Rails - 8 Hooks

Width	Hooks	Code	Price
1800	8	FCHKRL18X	£117.38

School Wall-Mounted Coat Rails - 6 Hooks



- Durable solid oak coat rail.
- Fitted with 6 durable plastic coloured double hooks.
- Supplied with key hole fixing plate.

School Wall-Mounted Coat Rails - 6 Hooks

Width	Hooks	Code	Price
1200	6	FCJNRL12XXXX	£115.85

School Wall-Mounted Coat Rails - 8 Hooks



- Durable solid oak coat rail.
- Fitted with 8 durable plastic coloured double hooks.
- Supplied with key hole fixing plate.

School Wall-Mounted Coat Rails - 8 Hooks

Width	Hooks	Code	Price
1800	8	FCJNRL8XXXX	£135.67



£423 FROM **.78**

Lockers

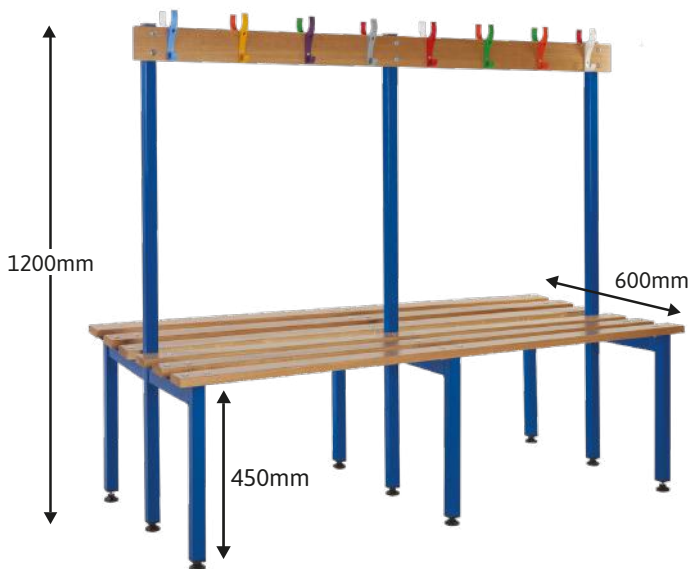
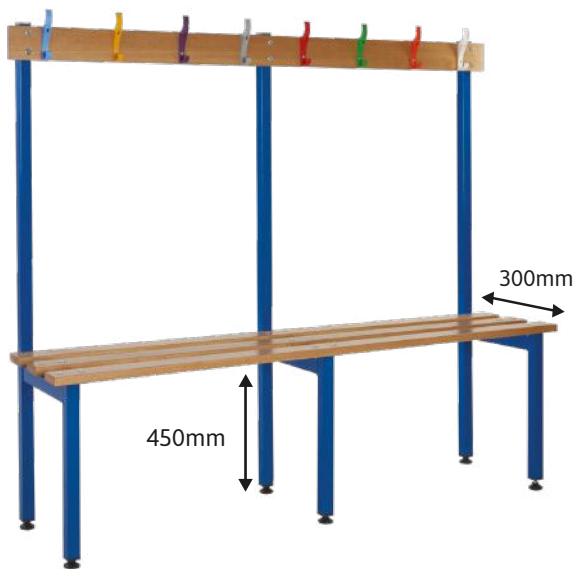

Our School Cloakroom Benches offer any primary school or nursery a fully-welded robust bench with an overall height of 1200mm. This range comes in either a single or double-depth bench with heavy-duty colourful plastic coat hooks, and hard-wearing 20mm solid oak slats providing durability throughout the bench.

- Fully-welded robust frames.
- Durable, hard-wearing 20mm solid oak slats.
- Bright and bold heavy-duty plastic hooks in a mix of colours.
- Powder-coated framework in a range of vibrant colours with Germ Guard Active Technology anti-bacterial paint.
- Adjustable feet for easy levelling.

School Single-Depth Island Bench - Overall Height 1200mm / Seat Height 450mm

Size L. W. D.	Hooks	Code	Price
1200.1000.300	5	FCJUN121030	£423.78
1200.1500.300	8	FCJUN121530	£483.23
1200.2000.300	12	FCJUN122030	£640.24

School Double-Depth Island Bench - Overall Height 1200mm / Seat Height 450mm

Size H. W. D.	Hooks	Code	Price
1200.1000.600	10	FCJUN121060	£644.82
1200.1500.600	16	FCJUN121560	£810.98
1200.2000.600	24	FCJUN122060	£1,091.46

Colour Options

Please add corresponding letters to the end of the code.





FROM
£202.74

Island Benches

A robust and economic range of Cloakroom Furniture, with solid oak slats. Powder coated in colours to match or contrast your locker doors.

- Welded frames.
- 20mm solid oak slats.
- Powder coated with Germ Guard Active Technology paint.
- Adjustable feet for easy levelling.
- Fitted with aluminium hooks.

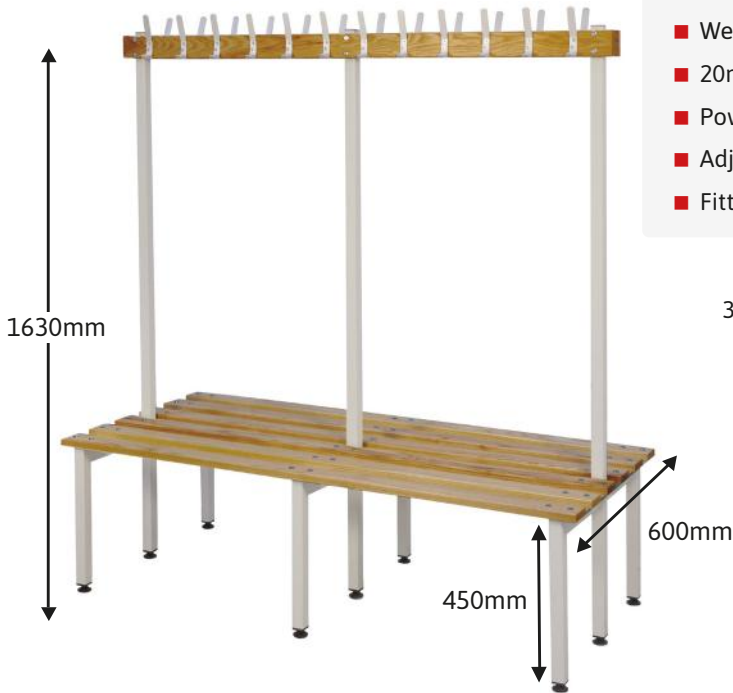

Bench Seating - Seat Height 450mm

Size H. W. D.	Single Unit	Price	Size H. W. D.	Double Unit	Price
450.1000.300	FBSFP103045	£202.74	450.1000.600	FBDFP106045	£352.13
450.1500.300	FBSFP153045	£246.95	450.1500.600	FBDFP156045	£448.17
450.2000.300	FBSFP203045	£387.20	450.2000.600	FBDFP206045	£611.28

Island Benches - Overall Height 1630mm / Seat Height 450mm

Size H. W. D.	Hooks	Single Unit	Price	Size H. W. D.	Hooks	Double Unit	Price
1630.1000.300	5	FCSFP103045	£384.15	1630.1000.600	10	FCDFP106045	£557.93
1630.1500.300	8	FCSFP153045	£425.31	1630.1500.600	16	FCDFP156045	£701.22
1630.2000.300	12	FCSFP203045	£557.93	1630.2000.600	24	FCDFP206045	£932.93

Colour Options

Please add corresponding letters to the end of the code.



We offer a variety of lock options to meet the specific needs of our locker products. Please keep in mind that not all locks are compatible with every locker design. If you have any questions about the compatibility of these lock options, our sales department is here to help.



Lock Options

	Lock Type	Code	Price
A	QMP Mechanical Combination	L2COMLKA2800	POA
B	Digital Keypad	L2ELECOMBLCK	POA
C	Combination Padlock	L2UPROGCOMLK	£25.91
D	Cam Lock with 2 Keys	L2CAMLCKZZXX	£9.15
E	Swivel Latch	L2LATCHLOCKX	£9.15
F	Moisture Resistant Cam Lock	L2CAMLOCKWET	POA
G	Dual Pound Coin Return Lock	L2COINRT1XXX	£48.78
H	Dual Pound Coin Retain Lock	L2CNRETAIN1X	POA

Locker Sloping Tops

Keep staff rooms and locker rooms neat and tidy by upgrading your lockers with a sloping top.

- Locker sloping tops discourage the placement of unwanted articles on top of the locker unit.
- Powder coated Light Grey with Germ Guard Active Technology paint.
- Standard sloping top or galvanised sloping tops available, ideal for areas with high levels of moisture such as shower rooms or areas where regular cleaning is required.
- Sloping tops can be specified at time of order or retro fitted later.

Please Note: A rivet gun is required to install sloping tops.



Locker Sloping Tops - Dimensions/Codes

Height	To Fit	Powder Coated	Price	Galvanised & Powder Coated	Price
150	W. 300 D. 300	L2SLT3030LXX	£13.72	L2SLT3030LGV	£13.72
	W. 300 D. 450	L2SLT3045LXX	£15.24	L2SLT3045LGV	£16.77
	W. 380 D. 380	L2SLT3838LXX	£16.77	L2SLT3838LGV	£16.77
	W. 450 D. 450	L2SLT4545LXX	£19.82	L2SLT4545LGV	£21.34

Locker Stands

Locker stands raise the height of locker nests by 150mm.

- Locker stands promote cleanliness and hygiene levels by allowing access to floor for cleaning.
- Fitted with adjustable feet making them ideal for nesting lockers on uneven floors.
- Up to 6 sizes available to suit your locker room configuration.
- Powder coated Light Grey with Germ Guard Active Technology paint.
- Standard or Splash Locker Stands available, ideal for areas with high levels of moisture such as shower rooms or areas where regular cleaning is required.

Locker Stands

To Suit	Configuration (To Fit)	H.W.D	Code	Price:
300.300	1 Locker	150.300.300	L2ST153030LX	£27.44
	2 Lockers	150.600.300	L2ST156030LX	£33.54
	3 Lockers	150.900.300	L2ST159030LX	£41.16
	4 Lockers	150.1200.300	L2ST151230LX	£51.83
	5 Lockers	150.1500.300	L2ST151530LX	£68.60
	6 Lockers	150.1800.300	L2ST151830LX	£76.22
300.450	1 Locker	150.300.450	L2ST153045LX	£27.44
	2 Lockers	150.600.450	L2ST156045LX	£33.54
	3 Lockers	150.900.450	L2ST159045LX	£41.16
	4 Lockers	150.1200.450	L2ST151245LX	£51.83
	5 Lockers	150.1500.450	L2ST151545LX	£68.60
	6 Lockers	150.1800.450	L2ST151845LX	£76.22
380.380	1 Locker	150.380.380	L2ST153838LX	£28.96
	2 Lockers	150.750.380	L2ST157638LX	£36.59
	3 Lockers	150.1140.380	L2ST151138LX	£56.40
	4 Lockers	150.1520.380	L2ST151538LX	£71.65
450.450	1 Locker	150.450.450	L2ST154545LX	£32.01
	2 Lockers	150.900.450	L2ST159045LX	£41.16
	3 Lockers	150.1350.450	L2ST151345LX	£59.45
	4 Lockers	150.1800.450	L2ST151844LX	£77.74



Splash Locker Stands

To Suit	Configuration (To Fit)	H.W.D	Code	Price:
300.300	1 Locker	150.300.300	L2ST153030LG	£44.21
	2 Lockers	150.600.300	LTST156030LG	£50.30
	3 Lockers	150.900.300	LTST159030LG	£56.40
	4 Lockers	150.1200.300	LTST151230LG	£67.07
	5 Lockers	150.1500.300	LTST151530LG	£83.84
	6 Lockers	150.1800.300	LTST151830LG	£92.99
300.450	1 Locker	150.300.450	L2ST153045LG	£44.21
	2 Lockers	150.600.450	L2ST156045LG	£50.30
	3 Lockers	150.900.450	L2ST159045LG	£56.40
	4 Lockers	150.1200.450	L2ST151245LG	£67.07
	5 Lockers	150.1500.450	L2ST151545LG	£83.84
	6 Lockers	150.1800.450	L2ST151845LG	£92.99
380.380	1 Locker	150.380.380	L2ST153838LG	£45.73
	2 Lockers	150.750.380	L2ST157638LG	£53.35
	3 Lockers	150.1140.380	L2ST151138LG	£71.65
	4 Lockers	150.1520.380	L2ST151538LG	£88.41
450.450	1 Locker	150.450.450	L2ST154545LG	£48.78
	2 Lockers	150.900.450	L2ST159045LG	£56.40
	3 Lockers	150.1350.450	L2ST151345LG	£76.22
	4 Lockers	150.1800.450	L2ST151844LG	£79.27



	Type	To Fit	Powder Coated	Price
A	Coat Hook	-	L2COATHOZZXX	£4.57
B	Coat Hook & Rail	-	L2COATRLZZXX	£9.15
C	Vertical Divider	D. 300	CVD/30	£38.11
		D. 380	CVD/38	£47.26
		D. 450	CVD/46	£53.35

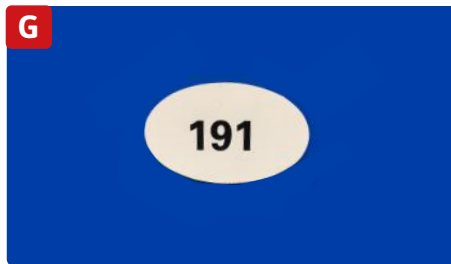
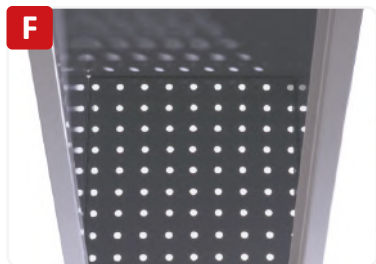

	Type	To Fit	Code	Price
D	Additional Locker Shelves	W. 300 D. 300	L2LS30301LXX	£16.77
		W. 300 D. 450	L2LS30451LXX	£19.82
		W. 380 D. 380	L2LS38381LXX	£19.82
		W. 450 D. 450	L2LS45451LXX	£24.39
E	Perforated Shelf	-	PS	POA
F	Perforated Base	-	PB	POA
G	Number Plates - Self Adhesive Batch of 50	-	LNP	£140.24



Type	300mm	Price	600mm	Price:	900mm	Price	1200mm	Price	1500mm	Price	1800mm	Price
H Skirted Electric Heater	-	-	SLS/600	£202.74	SLS/900	£216.46	SLS/1200	£256.10	SLS/1500	£301.83	SLS/1800	£338.41
I Combi Seat and Stand	L2SE333030LX	£89.94	L2SE336030LX	£99.09	L2SE339030LX	£115.85	L2SE331230LX	£134.15	L2SE331530LX	£207.32	L2SE331830LX	£246.95
J Locker Seat	LSS/300	£115.85	LSS/600	£132.62	LSS/900	£157.01	LSS/1200	£184.45	LSS/1500	£275.91	LSS/1800	£323.17

Workstations

- 158 Team Leader Workstations
- 162 Flat & Sloping Top Workstations
- 164 Computer Workstations





5 DAY DELIVERY

£354.25 FROM

A range of robustly constructed Workstations designed for Team Leaders, Supervisors or Line Managers. Fully welded steel framework ideal for tough environments. The compact design recognises the pressure on factory workspace but still allows the Team Leader to have a workstation with everything they need.

- Two depths available, 460mm and 600mm.
- Full range of accessories.
- Sloping and Flat Top versions available.
- Fully welded robust frame.
- Ideal for standing at to improve health and fitness, but can be used in conjunction with an industrial stool or chair.
- Order quantities may apply, please speak to the sales team.
- 5-day delivery available on Dark Blue cupboard doors only.

BEST SELLER

Team Leader Workstation shown with Dark Blue Triple Drawer & Cupboard Unit



Team Leader Workstation - Sloping Top

Description	Size H.W.D.	Code	Price
Sloping Top	1060.1000.460	TLS1010461LX	£354.25
Sloping Top	1060.1000.600	TLS1010601LX	£374.44

Team Leader Workstation - Flat Top

Description	Size H.W.D.	Code	Price
Flat Top	920.1000.460	TLF9210461LX	£354.25
Flat Top	920.1000.600	TLF9210601LX	£374.44



5 DAY DELIVERY

Team Leader Workstation - Single Drawer

Description	Size H.W.D.	Code	Price
Sloping Top	1060.1000.460	TLS1010462LX	£591.96
Sloping Top	1060.1000.600	TLS1010602LX	£612.16
Flat Top	920.1000.460	TLF9210462LX	£591.96
Flat Top	920.1000.600	TLF9210602LX	£612.16

Team Leader Workstation - Two Single Drawers

Description	Size H.W.D.	Code	Price
Sloping Top	1060.1000.460	TLS1010463LX	£829.68
Sloping Top	1060.1000.600	TLS1010603LX	£849.88
Flat Top	920.1000.460	TLF9210463LX	£829.68
Flat Top	920.1000.600	TLF9210603LX	£849.88



5 DAY DELIVERY

Team Leader Workstation - Cupboard

Description	Size H.W.D.	Code	Price
Sloping Top	1060.1000.460	TLS1010464LX	£567.10
Sloping Top	1060.1000.600	TLS1010604LX	£624.59
Flat Top	920.1000.460	TLF9210464LX	£567.10
Flat Top	920.1000.600	TLF9210604LX	£624.59

Team Leader Workstation - Single Drawer & Cupboard

Description	Size H.W.D.	Code	Price
Sloping Top	1060.1000.460	TLS1010465LX	£804.82
Sloping Top	1060.1000.600	TLS1010605LX	£825.02
Flat Top	920.1000.460	TLF9210465LX	£804.82
Flat Top	920.1000.600	TLF9210605LX	£825.02



5 DAY DELIVERY

Team Leader Workstation - Triple Drawer

Description	Size H.W.D.	Code	Price
Sloping Top	1060.1000.460	TLS1010466LX	£806.37
Sloping Top	1060.1000.600	TLS1010606LX	£825.02
Flat Top	920.1000.460	TLF9210466LX	£806.37
Flat Top	920.1000.600	TLF9210606LX	£825.02

Team Leader Workstation - Triple Drawer & Single Drawer

Description	Size H.W.D.	Code	Price
Sloping Top	1060.1000.460	TLS1010467LX	£1,044.09
Sloping Top	1060.1000.600	TLS1010607LX	£1,064.29
Flat Top	920.1000.460	TLF9210467LX	£1,044.09
Flat Top	920.1000.600	TLF9210607LX	£1,064.29



5 DAY DELIVERY

Team Leader Workstation - Double Cupboard

Description	Size H.W.D.	Code	Price
Sloping Top	1060.1000.460	TLS1010468LX	£713.15
Sloping Top	1060.1000.600	TLS1010608LX	£731.80
Flat Top	920.1000.460	TLF9210468LX	£713.15
Flat Top	920.1000.600	TLF9210608LX	£731.80

Team Leader Workstation - Triple Drawer & Cupboard

Description	Size H.W.D.	Code	Price
Sloping Top	1060.1000.460	TLS1010469LX	£1,019.23
Sloping Top	1060.1000.600	TLS1010609LX	£1,039.43
Flat Top	920.1000.460	TLF9210469LX	£1,019.23
Flat Top	920.1000.600	TLF9210609LX	£1,039.43



Our Team Leader Workstation range lets you customise your workstation with the exact accessories and colour combinations you need for your factory environment. We offer a wide selection of both above and below workstation accessories for you to choose from.

Drawer & Cupboard Options and Accessories

Single Drawer

Triple Drawer

Cupboard Unit

Double Cupboard Unit



Drawer & Cupboard Options

Description	Size H.W.D.	Code	Price
Single Drawer	220.420.420	BEDR04021	£275.01
Triple Drawer	435.420.420	BEDR04043	£522.05
Cupboard Unit	435.420.420	BECU04041	£247.04
Double Cupboard Unit	570.850.450	CG8557451	£371.34

Team Leader Workstations - Accessories

Description	Code	Price
760mm Rear Support Posts	BESP760SXXXX	£118.08
1180mm Rear Support Posts	BESP1180XXXX	£142.94
Upper shelf 300mm Laminate for 1000mm desk	BEUS1000PXXX	£152.26
Shelf Backstop for 1000m desk	BESB1000XLXX	£43.50
Louvred back panel for 1000mm desk (Light Grey)	BELO4810IXXX	£208.20
Pin Board attachment (For Louvred back panel)	BENP3037XXXX	£76.13
Magnetic back panel (Light Grey)	MGBACKBDXXXX	£144.49
Tool Panel (Light Grey)	BELO4810ALSH	£208.20

Drawer & Cupboards Colour Options

Please add corresponding letters to the end of the drawer/cupboard code.

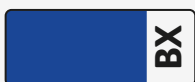

Drawer & Shelf Workstation



• Supplied with 2 shelves as standard.

- Ideal for paperwork based environments including goods inwards, dispatch and assembly areas.
- Available with cupboard or open shelves.
- Fitted with lockable storage drawer and two powder-coated adjustable shelves.
- Accessories available including backboard, tool clips, extra shelves, mobile bases and ringbinder holder.
- Sloping top available for ease of use as a writing station.
- Available with various drawer options including, single drawer, double drawer and double length drawer.
- Other colours available, minimum order quantity applies.

Sloping Top Workstation - Drawer & Shelf

Size H.W.D.	Code	Price
1100.920.450	DW119245DS	£621.48

Flat Top Workstation - Drawer & Shelf

Size H.W.D.	Code	Price
980.920.450	DW989245DS	£581.09

Colour Options

Please add corresponding letters to the end of the code.



Double Drawer Workstation



• Supplied with 2 shelves as standard.

Single Drawer Workstation



• Supplied with 2 shelves as standard.

Sloping Top Workstation - Double Drawer

Size H.W.D.	Code	Price
1100.920.450	DW119245DD	£786.18

Sloping Top Workstation - Single Drawer

Size H.W.D.	Code	Price
1100.920.450	DW119245SD	£929.12

Flat Top Workstation - Double Drawer

Size H.W.D.	Code	Price
980.920.450	DW989245DD	£745.78

Flat Top Workstation - Single Drawer

Size H.W.D.	Code	Price
980.920.450	DW989245SD	£888.72

Single Width Workstation



• Supplied with 2 shelves as standard.

Open Fronted Workstation



• Supplied with 2 shelves as standard.

Sloping Top Workstation - Single Width

Size H.W.D.	Code	Price
1100.600.450	DW116045SW	£508.06

Sloping Top Workstation - Open Fronted

Size H.W.D.	Code	Price
1100.920.450	DW119246X	£591.96

Flat Top Workstation - Single Width

Size H.W.D.	Code	Price
980.600.450	DW986045SW	£456.79

Flat Top Workstation - Open Fronted

Size H.W.D.	Code	Price
980.920.450	DW989246O	£536.03

Workstation Accessories

Standard Workstation - Accessories

Key	Description	Code	Price
A	Backboard - Single Magnetic	DKBACKSMAGXX	£150.71
B	Backboard - Single Peg Board	DKBACKSPEGXX	£186.44
C	Backboard - Double Magnet & Peg	DKBACKBDXXXX	£239.27
-	Tool Clip Kit (Pack Of 6)	BETCLIPSXXXX	£38.84
-	Magnetic Pins (Pack Of 6)	DKMAGPINQXXX	£43.50
-	Double Width Mobile Base With Castors	DKCASTORXXXX	£113.42
D	Extra Shelf - Single Width	ITWFSSHELF48	£38.84
D	Extra Shelf - Double Width	ITWFDSHELF90	£65.26
E	Ring Binder Holder - Double Width	ITWRHOLDER82	£338.71

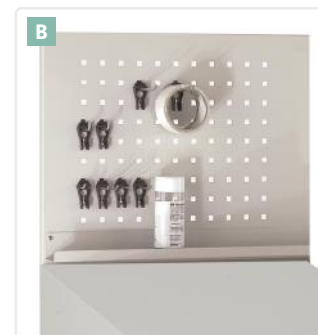

Colour Options

Please add corresponding letters to the end of the code.

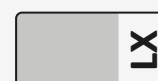
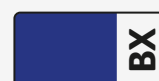



£581.09 FROM

• Supplied with 2 shelves as standard.

- Ideal for storing IT equipment in industrial workplace environments.
- Open drawer for easy access to keyboard.
- Provides security and protection for computer systems in the workplace.
- All-in-one storage for industrial computer workstations.
- Accessories available including, monitor unit, pull out shelf, internal drawer, extra shelf, sloping top and ringbinder holder.
- Other colours available, minimum order quantity applies.

Single-Width Flat Top Computer Workstations

Description	Size H.W.D.	Code	Price
Including Monitor Holder	1580.600.450	ITSM986045	£720.92
Without Monitor Holder	980.600.450	ITWS986045	£581.09

Double-Width Flat Top Computer Workstations

Description	Size H.W.D.	Code	Price
Including Monitor Holder	1580.920.450	ITDM989245	£929.12
Without Monitor Holder	980.920.450	ITWD989245	£772.19

Sloping Top - To Fit Workstation

Size W.D.	Code	Price
320.450	ITSLOPT3245X	£68.36

Colour Options

Please add corresponding letters to the end of the code.

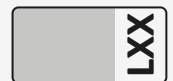

Single/Double Workstation Accessories



Drawer - Single-Width

Size H.W.D.	Code	Price
80.420.400	ITWDRWRS42	£166.25



Fixed Shelf - Single-Width

Size H.W.D.	Code	Price
25.480.400	ITWFSSHELF48	£38.84



Pull Out Shelf - Single-Width

Size H.W.D.	Code	Price
45.420.400	ITWPSSHELF42	£118.08

Drawer - Double-Width

Size H.W.D.	Code	Price
80.840.400	ITWDRWRD84	£212.86

Fixed Shelf - Double-Width

Size H.W.D.	Code	Price
25.900.400	ITWFDSHELF90	£65.26

Pull Out Shelf - Double-Width

Size H.W.D.	Code	Price
45.840.400	ITWPDSHELF84	£166.25

Computer Workstation - Accessories

Description	Code	Price
Backboard - Single Magnetic	DKBACKSMAGXX	£150.71
Backboard - Single Peg Board	DKBACKSPGXX	£186.44
Backboard - Double Magnet & Peg	DKBACKBDXXXX	£239.27
Tool Clip Kit (Pack Of 6)	BETCLIPSXXXX	£38.84
Magnetic Pins (Pack Of 6)	DKMAGPINQXXX	£43.50
Mobile Base With Castors - To Suit Double Width Workstation	DKCASTORXXXX	£113.42
Ring Binder Holder - Double Width	ITWRHOLDER82	£338.71

Cycle Parking

166 Premier Cycle Shelters

167 Dudley Cycle Shelters

168 Kenilworth Cycle Shelters

169 Traditional Cycle Shelters

170 Compound Cycle Shelters

171 Wall-Mounted Cycle Shelters

171 Folding Bike Lockers

172 Traditional Cycle Racks

172 Scooter Racks

173 Sheffield Cycle Loops & Racks

174 Cost Saver Cycle Racks





Comes complete with twin-level integrated bike rack

The Premier Cycle Shelter features a modern design that seamlessly blends into both traditional and contemporary settings, offering organised and secure bicycle storage on any site.

- Choice of perspex or powder-coated steel side & back panels.
- Adjustable feet for on-site positioning.
- Parabolts for surface mounting included. Must be bolted to 250mm thick concrete for stability.
- Comes complete with twin-level integrated bike rack for 8 bikes.
- Powder coated finish with a range of colours available.
- When ordering extension frame, please refer to colour code at bottom right of the page.
- On-site installation available - please speak to sales.



Shelter Colour Options

Please add corresponding letters to the end of the code.

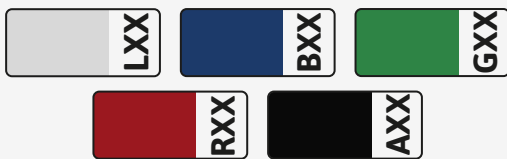

Extension Colour Options

Please add corresponding letters to the end of the code.



Premier Cycle Shelter - Clear Perspex Sides

Size H.W.D.	Code	Initial	Extension
2320.3000.2100	SC223021X	£5,122.52	£4,669.19

Premier Cycle Shelter - Perforated Steel Sides

Size H.W.D.	Code	Initial	Extension
2320.3000.2100	SC223021P	£4,613.29	£4,280.85



Dudley Shelter shown with optional Sheffield Rack

The Dudley Cycle Shelter features a modern design at a competitive price. It is available with a perspex roof and optional end panels in a galvanised and powder-coated finish.

- Leg frames can either be bolted to the floor or grouted into the ground.
- Designed for use with our Sheffield Loops and Racks, please see page 173.
- Initial shelters can be linked side by side to form longer runs.
- Adjustable feet for on-site positioning.
- Supplied with a 4mm PETG perspex roof.
- Available in galvanised or galvanised and powder-coated finish.
- Optional perspex end panels available.



Sheffield Loops also available, please see Page 173

Colour Options

Please add corresponding letters to the end of the code.

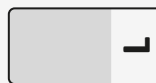

Dudley Cycle Shelter - Dimensions/Codes

Height x Depth	Width	End Panel Options	Galvanised	Price	Galvanised & Powder Coated	Price
2230mm high 2150mm deep	2000	Without Perspex	SCDUD2020VXX	£2,101.89	SCDUD2020JX	£2,372.37
	4000		SCDUD4020VXX	£2,523.48	SCDUD4020JX	£2,837.78
	2000	With Perspex	SCDUD2020VPX	£2,552.19	SCDUD2020JP	£2,822.67
	4000		SCDUD4020VPX	£2,973.78	SCDUD4020JP	£3,288.08

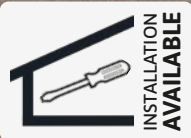

Kenilworth Shelter shown with 4 optional Sheffield Loops

The Kenilworth is an attractive, curved cycle shelter, popular with schools and colleges and offers floor to roof level protection from the prevailing elements. This is a tough, robust structure with vandal resistant features.

- Powder coated finish in a range of RAL colours - also available fully galvanised.
- Leg frames can either be bolted to the floor or grouted into the ground.
- Designed for use with our Sheffield Loops and Racks, please see page 173.
- Initial shelters can be linked side by side to form longer runs.
- Supplied with a 5mm PETG perspex roof and sides.
- On site installation available - please speak to sales.

Colour Options

Please add corresponding letters to the end of the code.



Kenilworth Cycle Shelter - Dimensions/Codes

Height x Depth	Width	Galvanised	Price	Galvanised & Powder Coated	Price
2230mm high 2150mm deep	2000	SCKN2020OVXX	£3,479.99	SCKN2020OJ	£3,479.99
	3000	SCKN3020OVXX	£3,810.91	SCKN3020OJ	£3,810.91
	4000	SCKN4020OVXX	£4,143.34	SCKN4020OJ	£4,143.34
	5000	SCKN5020OVXX	£4,474.27	SCKN5020OJ	£4,474.27



Traditional shelter shown with optional Traditional Rack

If sited within 5 miles of the coast, we strongly recommend an additional weather treatment for the steel work. This is available for a modest additional charge.

The Traditional Cycle Shelter offers secure storage with a screened design, suitable for landscaped areas. Some selected shelters can also accommodate mixed parking for both bicycles and motorcycles by including bike racks in one section.

- Robust all-weather construction.
- Choice of galvanised or powder-coated sheet steel side & back panels.

- Adjustable feet for on-site positioning.
- Parabolts for surface mounting included. Must be bolted to 250mm thick concrete for stability.
- Perforated panels are supplied powder-coated in light grey as standard.
- Cycle racks sold separately, please see page 172.
- Site survey and erection service available.

Shelter Colour Options

Please add corresponding letters to the end of the code.



Extension Colour Options

Please add corresponding letters to the end of the code.



Traditional Cycle Shelter - Galvanised Sides, Open Back

Size H.W.D.	Code	Initial	Extension
2180.2450.1900	SC211924G	£1,938.70	£1,678.79
2180.2450.2500	SC212524G	£2,104.92	£1,775.50
2180.3060.1900	SC211930G	£2,493.26	£2,327.04
2180.3060.2500	SC212530G	£2,704.81	£2,520.46

Traditional Cycle Shelter - Perforated Sides, Open Back

Size H.W.D.	Code	Initial	Extension
2180.2450.1900	SC211924B	£2,766.76	£2,485.70
2180.2450.2500	SC212524B	£3,029.69	£2,694.23
2180.3060.1900	SC211930B	£3,336.43	£3,111.29
2180.3060.2500	SC212530B	£3,720.25	£3,415.01

Traditional Cycle Shelter - Galvanised Sides, Closed Back

Size H.W.D.	Code	Initial	Extension
2180.2450.1900	SC211924K	£2,233.36	£1,911.50
2180.2450.2500	SC212524K	£2,367.84	£2,009.72
2180.3060.1900	SC211930K	£2,772.81	£2,479.66
2180.3060.2500	SC212530K	£2,988.89	£2,571.83

Traditional Cycle Shelter - Perforated Sides, Closed Back

Size H.W.D.	Code	Initial	Extension
2180.2450.1900	SC211924C	£3,214.04	£2,863.47
2180.2450.2500	SC212524C	£3,461.85	£3,141.51
2180.3060.1900	SC211930C	£3,824.51	£3,546.47
2180.3060.2500	SC212530C	£4,229.47	£3,886.46

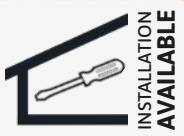

Shown with security canopy

If sited within 5 miles of the coast, we strongly recommend an additional weather treatment for the steel work. This is available for a modest additional charge.

Cycle Parking

A stylish compound with facilities to house up to 48 bikes. Fitted with a curved roof, made from UV resistant opaque polycarbonate panels and optional central canopy for extra security and weather protection.

- Covered shelter for a minimum of 16 bikes - larger sizes available to accommodate numbers.
- Attractive gate with hasp to take padlock - Padlock not

provided.

- Side panels made from tough clear perspex.
- Optional central security canopy.
- Comes complete with twin level bike racks.
- Must be bolted to 250mm thick concrete (fixings included).
- Powder coated finish with a range of colour available.
- Delivered in knock-down form.
- On-site installation available - please speak to sales.

Colour Options

Please add corresponding letters to the end of the code.

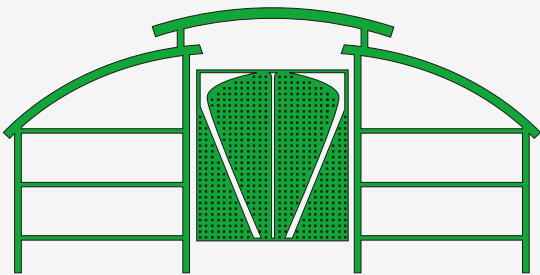

Compound with lockable gate and security canopy

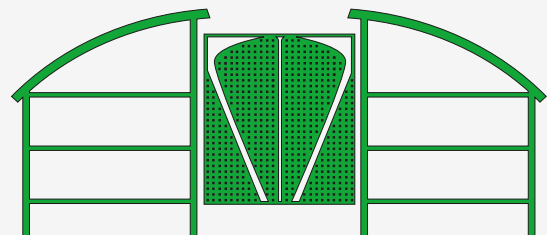

Compound with lockable gate

Cycle Compound With Lockable Gate & Canopy - Dimensions/Codes

Size H.W.D.	Stores	Code	Price
2625.5500.3000	16 Bikes	SWC215530S2	£12,067.38
2625.5500.6000	32 Bikes	SWC215560S4	£19,305.38
2625.5500.9000	48 Bikes	SWC215590S6	£26,106.69

Cycle Compound With Lockable Gate - Dimensions/Codes

Size H.W.D.	Stores	Code	Price
2325.5500.3000	16 Bikes	SWC215530G2	£11,299.75
2325.5500.6000	32 Bikes	SWC215560G4	£17,768.63
2325.5500.9000	48 Bikes	SWC215590G6	£23,920.18

Wall-Mounted Cycle Shelters

A cost-effective means of storing up to 6 bikes undercover, without the need for extensive ground works. Apart from the two front supporting legs, all parts mount to a suitable brick or stone wall.

- Robust all-weather construction.
- Comes complete with 3 Sheffield Loops for storing up to 6 bikes.
- Supplied in kit form with easy-to-follow instructions for on-site assembly and installation.
- Parabolts for front support legs included. Must be bolted to 250mm thick concrete - wall fixings not included.



If sited within 5 miles of the coast, we strongly recommend an additional weather treatment for the steel work. This is available for a modest additional charge.



Wall-Mounted Cycle Shelter

Size H.W.D.	Code	Price
2270.3000.1900	SCW223019*1X	£2,165.36

Extension - For 6 Bikes

Size H.W.D.	Code	Price
2270.3000.1900	SCW223019*1E	£2,052.03

Colour Options

Please add corresponding letters to the end of the code.



Folding Bike Lockers

Designed for folding and Brompton-style bikes, our Folding Bike Lockers provide secure, space-saving storage in a compact 450mm x 650mm footprint. Each UK-made unit has three compartments for your bike, helmet, and small personal items — ideal for workplaces, apartments, and public facilities where space is limited. Available in a range of colours and finishes, lockers come with cam locks as standard, with upgrade options including hasp and staple, combination locks, and digital keypads for added security.

- Locker dimensions: H2150mm x W450mm x D650mm.
- Internal locker dimensions: H630mm x W440mm x D650mm.
- Door clearance: 650mm x 370mm.
- Fitted with standard mastered cam locks with 2,000 differs.
- Available with solid or perforated doors.
- Strengthened and ventilated doors with rubber buffers.
- Holes at the base of the locker allow it to be securely fastened to the floor and wall for extra stability.
- Powder coated with Germ Guard Active Technology paint.

Folding Bike Lockers (3 compartment)

Door Type	Size H.W.D.	Code	Price
Solid	2150.450.650	LBK214565S*X	£395.00
Perforated	2150.450.650	LBK214565P*X	£405.00

£395.00 FROM



Shown with solid doors

Colour Options

Please add corresponding letters to the end of the code.



A sturdy twin-level rack designed to fit in a Traditional Cycle Shelter - see page 169. Up to 8 bikes can be stored by bars that grip the bike wheels.

- Made from tubular steel.
- Simply bolts to floor.
- Fully welded - no assembly required.
- Suitable for use in a Traditional Shelter.
- Secure storage for up to 8 bikes.
- Powder-coated dark Grey.



Traditional Cycle Racks - Dimensions/Codes

Size H.W.D.	Stores	Code	Price
935.1750.600	6 Bikes	SRTRADCR6KXX	£424.61
935.2350.600	8 Bikes	SRTRADCR8KXX	£530.38

Scooter Racks

These stylish and robust Scooter Racks feature a simple, user-friendly design. Available in dark blue, they are especially popular in schools and public places where security is a concern.

- Powder-coated Dark Blue.
- Galvanised finish also available - please speak to sales.
- Supplied with floor bolts for concrete fixing.
- Single and double-sided option available.

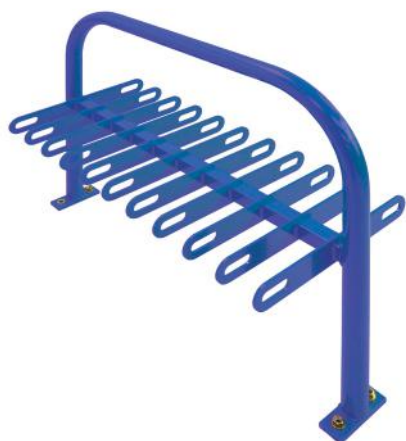

Scooter Racks - Dimensions/Codes

Size H.W.	Description	Stores	Code	Price
800.1050	Single-Sided	10	SCOO18010BXX	£536.43
800.1050	Double-Sided	20	SCOO28010BXX	£654.29



All RED product codes are available on 5-Day Delivery



5 DAY DELIVERY

Our range of Sheffield Loops are a classic design which allows the bicycle wheel and frame to be locked securely onto the stand by the user's own lock.

- Grouted loops are provided with 250mm length below ground as standard; longer lengths can be provided on request.
- Available as galvanised or galvanised and powder-coated to

any RAL colour - Non standard colours available at additional cost.

- Adult loops are 800mm high x 715mm wide.
- Junior loops are 600mm high x 715mm wide.
- Sheffield loops can be surface mounted or grouted underground.
- Order quantities may apply, please speak to sales.

Sheffield Cycle Loops - Dimensions/Codes

Size	Mount Options	Galvanised	Price	Galvanised & Powder Coated	Price
Adult	Floor Mounted	SRSHL8071FVX	£107.29	SRSHL8071FJ	£132.97
	Grouted	SRSHL1071GVX	£107.29	SRSHL1071GJ	£132.97
Junior	Floor Mounted	SRSHL6071FVX	£107.29	SRSHL6071FJ	£132.97
	Grouted	SRSHL8571GVX	£107.29	SRSHL8571GJ	£132.97



Colour Options

Please add corresponding letters to the end of the code.



Sheffield Cycle Racks



All RED product codes are available on 5-Day Delivery



5 DAY DELIVERY

BEST SELLER

Sheffield Racks offer secure parking for four or more bikes. They are a popular choice for use with our cycle shelters and compounds.

- Racks comprised of two or more Sheffield Loops.
- Units of five or more loops are available as galvanised only.

- Two to five loop units available as either galvanised or galvanised and powder coated.
- Sheffield racks are available using either Sheffield Adult or Junior Loops.
- Order quantities may apply, please speak to sales.

Sheffield Cycle Racks - Dimensions/Codes

Size	Loops	Galvanised	Price	Galvanised & Powder Coated	Price
Adult	2	SRSHT80712VX	£415.54	SRSHT80712J	£415.54
	3	SRSHT80713VX	£624.07	SRSHT80713J	£624.07
	4	SRSHT80714VX	£832.60	SRSHT80714J	£832.60
	5	SRSHT80715VX	£1,041.12	SRSHT80715J	£1,041.12
Junior	2	SRSHT60712VX	£415.54	SRSHT60712J	£415.54
	3	SRSHT60713VX	£624.07	SRSHT60713J	£624.07
	4	SRSHT60714VX	£832.60	SRSHT60714J	£832.60
	5	SRSHT60715VX	£1,041.12	SRSHT60715J	£1,041.12

Cycle Parking

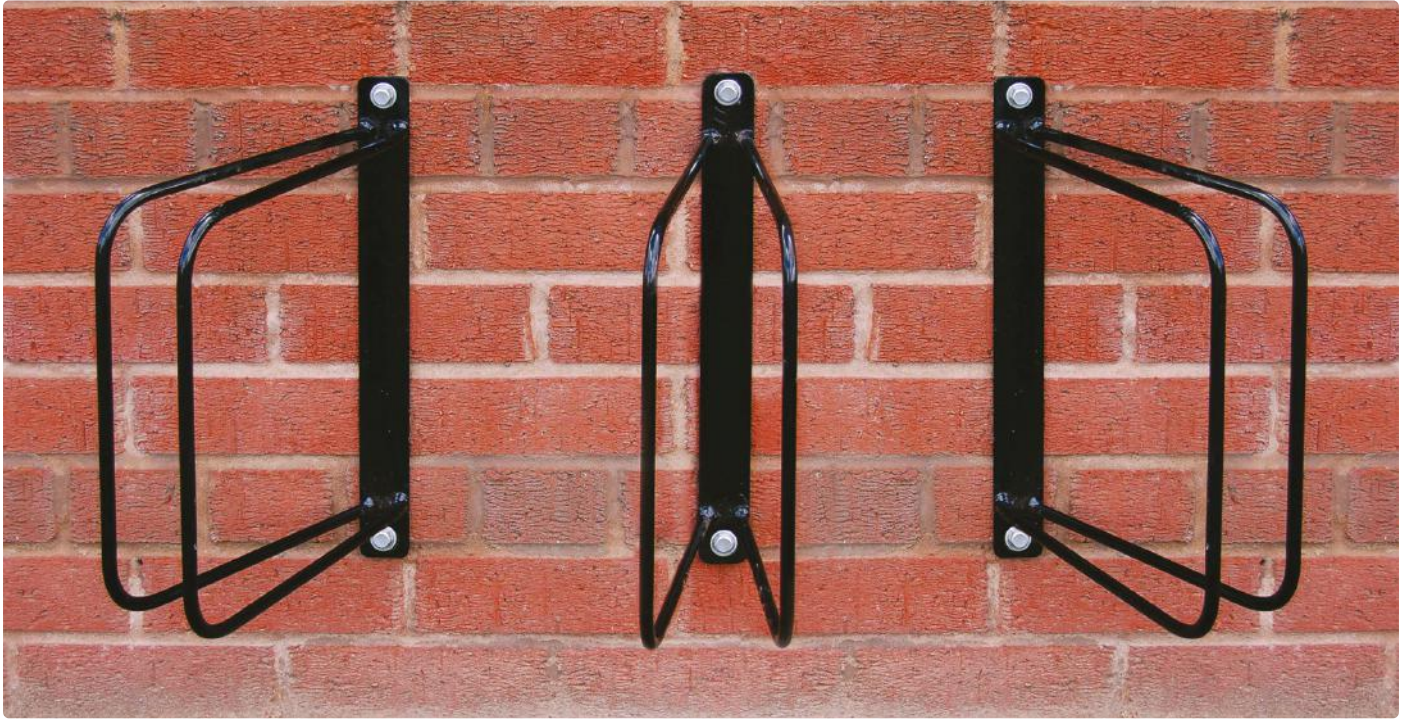

Wall-Mounted

These affordable cycle racks for a single bike are available in three designs, with options for a 90-degree or 60-degree angle to the wall.



- Fully welded construction.
- Made from mild steel.
- Choice of 90° or 60° angles.
- Powder coated exterior grade black.
- Order quantities may apply, please speak to the sales team.

Wall-Mounted Cost Saver Bike Racks - H.400 x W.100 x D.260

Angle	Code	Price
90 Degrees	SRCSM904011A	£58.93
60 Degrees	SRCSM604011A	£58.93

Floor-Mounted

These cost-effective cycle racks for one or two bikes are available for floor mounting onto concrete.



Double-Sided - H.560 x W.570 x D.120

Angle	Code	Price
2 Bikes	SRCSFM25656A	£117.86



Single-Sided - H.560 x W.310 x D.120

Capacity	Code	Price
1 Bike	SRCSFM15631A	£83.11

Smoking Shelters

- 176 Premier Smoking Shelters
- 177 Traditional Smoking Shelters
- 178 Wall-Mounted Smoking Shelters

- 179 Smoking Canopies
- 180 Smoking Shelter Accessories



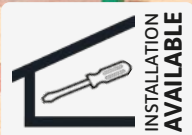

Premier Shelter shown with clear perspex sides

If sited within 5 miles of the coast, we strongly recommend an additional weather treatment for the steel work. This is available for a modest additional charge.

The Premier Smoking Shelter features a curved roof constructed from translucent polycarbonate panels, offering up to 97% UV protection. This contemporary design allows employers to create a modern and visually appealing smoking area that is separate from main entrances and exits.

- Robust all-weather construction.
- Choice of clear perspex or powder-coated steel perforated side & back panels.
- Adjustable feet for on-site positioning.
- More than 50% open area to allow rapid dispersal of cigarette fumes.
- Suitable for up to 9 people.
- Parabolts for surface mounting included. Must be bolted to 250mm thick concrete for stability.
- Frame-mounted seats available - Please see page 180.
- Site survey and installation service available.



Premier shelter shown with perforated steel sides

Colour Options

Please add corresponding letters to the end of the code.



Premier Smoking Shelters - Perforated Steel Sides			
Size H.W.D.	Capacity	Code	Price
2320.3000.2100	9 People	SS223021P	£5,894.67

Premier Smoking Shelters - Clear Perspex Sides			
Size H.W.D.	Capacity	Code	Price
2320.3000.2100	9 People	SS223021X	£6,420.52

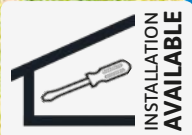

Traditional shelter shown with optional bench seating and smoking bin

If sited within 5 miles of the coast, we strongly recommend an additional weather treatment for the steel work. This is available for a modest additional charge.

Legislation throughout the UK banning smoking in public places including the workplace has resulted in employers adopting new codes of practice to accommodate smokers. These shelters enable employers and establishments to create a designated smoking area away from main entrances and exits.

- Robust all-weather construction.
- 6mm clear perspex sides with choice of perforated steel or perspex back.
- Adjustable feet for on-site positioning.
- More than 50% open area to allow rapid dispersal of cigarette fumes.
- Smaller shelters suitable for up to 9 people, larger shelters for up to 12 people.
- Parabolts for surface mounting included. Must be bolted to 250mm thick concrete for stability.



Traditional shelter with extension P.O.A

Colour Options

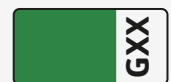

Traditional Smoking Shelters - Perforated Steel Back

Size H.W.D.	Capacity	Code	Price
2180.2450.1900	7 People	SS212419P	£4,548.31
2180.2450.2500	9 People	SS212425P	£5,356.73
2180.3060.1900	9 People	SS213019P	£5,142.16
2180.3060.2500	12 People	SS213025P	£6,848.15

Traditional Smoking Shelters - Clear Perspex Back

Size H.W.D.	Capacity	Code	Price
2180.2450.1900	7 People	SS212419X	£4,891.32
2180.2450.2500	9 People	SS212425X	£5,757.16
2180.3060.1900	9 People	SS213019X	£5,536.55
2180.3060.2500	12 People	SS213025X	£7,281.83



If sited within 5 miles of the coast, we strongly recommend an additional weather treatment for the steel work. This is available for a modest additional charge.

This shelter is designed for locations where space is limited, providing cover for up to 8 smokers.

- Robust all-weather construction.
- Greater than 50% open.
- Translucent polycarbonate roof provides up to 97% UV protection.
- Fixes to a suitable wall on one side (fixings not included) with supporting legs bolted to floor (parabolts included). Must be bolted to 250mm thick concrete for stability.
- Site survey and erection service available.

Wall-Mounted Smoking Shelters

Size H.W.D.	Capacity	Code	Price
2270.3000.1900	8 People	SS241930CWM	£1,713.55

Colour Options

Please add corresponding letters to the end of the code.





This shelter helps smaller companies comply with smoking legislation by providing cover for up to three smokers.

- Robust all-weather construction.
- Greater than 50% open.
- Translucent polycarbonate roof provides up to 97% UV protection.
- Simply bolts to a suitable wall (fixings not included).
- Order quantities may apply, please speak to sales.
- Site survey and erection service available.

Smoking Canopies

Size H.W.D.	Capacity	Code	Price
1000.2000.1100	3 People	SS102011WM2	£1,027.53

Colour Options

Please add corresponding letters to the end of the code.





Smoking Bins

A. Smokers Pole

Size H.D.	Colour	Code	Price
1041.324	Black	SMOKEPOLEBXX	£205.51
1041.324	Silver	SMOKEPOLESXX	

B. Wall Mounted Stainless Steel Bin

Size H.W.D.	Code	Price
280.265.110	SSWMTBINZZXX	£136.00

C. Tuscan Smoking Bin

Size H.W.D.	Code	Price
1001.311.311	TUSCANSMBINB	£219.10

Frame Mounted Seats For Premier Shelter

D. Frame Mounted Seat - Front

Length	Code	Price
1260mm	S2INTPER1210	£296.17

D. Frame Mounted Seat - Rear

Length	Code	Price
1400mm	S2INTPER1310	£330.92

Lighting

E. Bulkhead Light Unit

Size H.W.D.	Code	Price
110.210.210	SSBHLGHTZZXX	£243.28

Perch Seats

F. Stainless Steel Perch Seat

Size H.W.D.	Code	Price
900.1150.300	SSSSPSETZZXX	£524.34

F. Powder Coated Perch Seat - Light Grey

Size H.W.D.	Code	Price
900.1150.300	SSPAPSETZLXX	£323.37

Trucks & Trolleys

- 182** Boxwell Trolleys
- 183** Hazardous Boxwell Trolleys
- 184** Plywood Sided Trucks
- 185** Mesh Sided Trucks
- 186** Order Picking Trolleys
- 187** Mailroom Trolleys
- 187** Economy Shelf Trucks
- 188** Shelf Trucks
- 190** Platform Trucks
- 191** Packaging Trolleys
- 192** Sack Trucks
- 192** Mobile Maintenance Trolleys





£822.22 FROM

BEST SELLER

Boxwell shown with doors



Boxwell shown without doors

Our Boxwell Trolleys offer shelving and transportation for warehouses, workshop storage and work in transit.

- Available with or without fitted doors.
- 2 adjustable plywood or steel shelves - 100kg UDL load capacity per shelf.
- 500kg maximum load capacity.
- Fitted with 2 fixed and 2 swivel heavy-duty castors.
- Powder coated in our range of standard colours.
- Overall height includes castors.



Colour Options

Please add corresponding letters to the end of the code.



Boxwell Trolleys - Without Doors

Size H.W.D.	Shelf Option	Code	Price
1355.900.600	Plywood	XW139060P	£867.99
	Steel	XW139060M	£822.22
1355.1200.600	Plywood	XW131260P	£936.63
	Steel	XW131260M	£887.82
1655.900.600	Plywood	XW169060P	£912.22
	Steel	XW169060M	£869.51
1655.1200.600	Plywood	XW161260P	£985.45
	Steel	XW161260M	£939.68
1955.900.600	Plywood	XW199060P	£951.89
	Steel	XW199060M	£907.65
1955.1200.600	Plywood	XW191260P	£1,026.63
	Steel	XW191260M	£980.87
Extra Shelf 900.600	Plywood	XWES9060PB	£91.53
	Steel	XWES9060M	£76.27
Extra Shelf 1200.600	Plywood	XWES1260PB	£94.58
	Steel	XWES1260M	£79.32

Boxwell Trolleys - With Doors

Size H.W.D.	Shelf Option	Code	Price
1355.900.600	Plywood	XD139060P	£1,080.02
	Steel	XD139060M	£1,037.31
1355.1200.600	Plywood	XD131260P	£1,166.97
	Steel	XD131260M	£1,119.69
1655.900.600	Plywood	XD169060P	£1,137.99
	Steel	XD169060M	£1,093.75
1655.1200.600	Plywood	XD161260P	£1,227.99
	Steel	XD161260M	£1,182.23
1955.900.600	Plywood	XD199060P	£1,195.96
	Steel	XD199060M	£1,150.19
1955.1200.600	Plywood	XD191260P	£1,292.06
	Steel	XD191260M	£1,243.25
Extra Shelf 900.600	Plywood	XWES9060PB	£91.53
	Steel	XWES9060M	£76.27
Extra Shelf 1200.600	Plywood	XWES1260PB	£94.58
	Steel	XWES1260M	£79.32



Our Hazardous Boxwell Trolleys are ideal for the transportation and storage of parts and equipment. Used for the safe and secure storage of valuable and hazardous items between storage, production and work areas.

- Available with or without fitted doors.
- 2 adjustable plywood or steel shelves - 100kg UDL load capacity per shelf.
- 500kg maximum load capacity.
- Fitted with 2 fixed and 2 swivel heavy-duty castors.
- Pressed metal top base for strength.

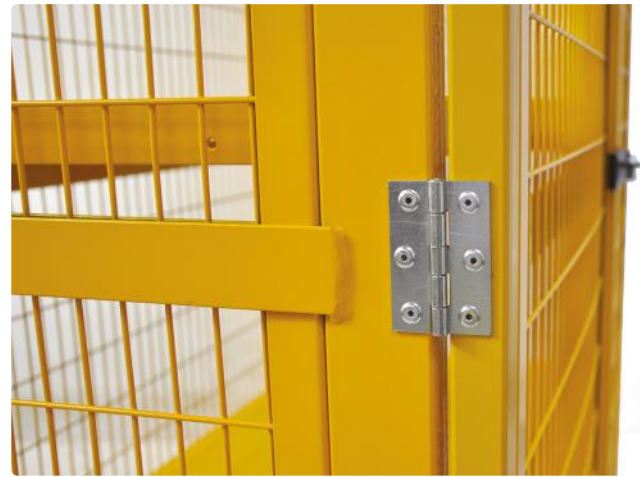

Hazardous Boxwell Trolleys - Without Doors

Size H.W.D.	Shelf Option	Code	Price
1355.900.600	Plywood	XW139060HZPY	£916.80
	Steel	XW139060HZMY	£871.04
1355.1200.600	Plywood	XW131260HZPY	£962.56
	Steel	XW131260HZMY	£913.75
1655.900.600	Plywood	XW169060HZPY	£961.04
	Steel	XW169060HZMY	£918.33
1655.1200.600	Plywood	XW161260HZPY	£1,009.85
	Steel	XW161260HZMY	£964.09
1955.900.600	Plywood	XW199060HZPY	£1,000.70
	Steel	XW199060HZMY	£956.46
1955.1200.600	Plywood	XW191260HZPY	£1,049.51
	Steel	XW191260HZMY	£1,005.28
Extra Shelf 900.600	Plywood	XWES9060PBXX	£91.53
	Steel	XWES9060MYXX	£76.27
Extra Shelf 1200.600	Plywood	XWES1260PBXX	£94.58
	Steel	XWES1260MBXX	£79.32

Hazardous Boxwell Trolleys - With Doors

Size H.W.D.	Shelf Option	Code	Price
1355.900.600	Plywood	XD139060HZPY	£1,128.84
	Steel	XD139060HZMY	£1,086.13
1355.1200.600	Plywood	XD131260HZPY	£1,185.28
	Steel	XD131260HZMY	£1,141.04
1655.900.600	Plywood	XD169060HZPY	£1,186.81
	Steel	XD169060HZMY	£1,142.57
1655.1200.600	Plywood	XD161260HZPY	£1,244.77
	Steel	XD161260HZMY	£1,200.53
1955.900.600	Plywood	XD199060HZPY	£1,244.77
	Steel	XD199060HZMY	£1,200.53
1955.1200.600	Plywood	XD191260HZPY	£1,307.32
	Steel	XD191260HZMY	£1,260.03
Extra Shelf 900.600	Plywood	XWES9060PBXX	£91.53
	Steel	XWES9060MYXX	£76.27
Extra Shelf 1200.600	Plywood	XWES1260PBXX	£94.58
	Steel	XWES1260MBXX	£79.32

**350KG
UDL**
EVENLY DISTRIBUTED



£729.17 FROM

Plywood sided trucks are available with open, half, or fully closed sides for load retention and safety. They are designed with handles to allow users to easily move the trolley from room to room. These trucks are ideal for storing and transporting goods, with a maximum weight capacity of 350kg. High-quality castors ensure easy manoeuvrability of the trolley, even when it is at maximum capacity.

- Designed for doorway and narrow aisle access.
- Removable long side panels.
- 350kg capacity UDL.
- Fitted with 2 fixed and 2 swivel heavy-duty castors.
- Fully welded construction.



3-Sided Plywood Truck



3 & 1/2-Sided Plywood Truck



4-Sided Plywood

Colour Options

Please add corresponding letters to the end of the code.



Plywood Sided Trucks - Dimensions/Codes

Size H.W.D.	3-Sided Trucks	Price	3 1/2-Sided Trucks	Price	4-Sided Trucks	Price
830.600.900	RTBT3690P	£729.17	RTBT3569P	£756.63	RTBT4690P	£793.24
830.600.1200	RTBT3612P	£791.71	RTBT3561P	£820.70	RTBT4612P	£866.46

350KG UDL
EVENLY DISTRIBUTED



£753.58 FROM

Mesh sided trucks feature open, half-open, or fully closed sides to ensure load retention and safety. They are designed with handles for easy manoeuvrability, allowing users to move the trolley from one room to another. They are ideal for storing and transporting goods with a maximum weight capacity of 350kg. High-quality castors facilitate smooth movement of the trolley, even when loaded to its maximum capacity.

- Designed for doorway and narrow aisle access.
- Removable long side panels.
- 350kg capacity UDL.
- Fitted with 2 fixed and 2 swivel heavy duty castors.
- Fully welded construction.



3-Sided Mesh Truck



3 & 1/2-Sided Mesh Truck



4-Sided Mesh Truck

Colour Options

Please add corresponding letters to the end of the code.



Mesh Sided Trucks - Dimensions/Codes

Size H.W.D.	3-Sided Trucks	Price	3 1/2-Sided Trucks	Price	4-Sided Trucks	Price
830.600.900	RTBT3690M	£753.58	RTBT3569M	£793.24	RTBT4690M	£846.63
830.600.1200	RTBT3612M	£828.32	RTBT3561M	£869.51	RTBT4612M	£938.16

Our order picking trolleys with integrated steps provide a safe and efficient solution for warehouse operations, allowing staff to easily access higher shelves and streamline the order picking process.

- Made from robust thick mild steel for outstanding strength.
- Four configurations available.
- Overall size of each trolley: H1670 x W1595 x D650mm.
- Weight-reactive steps lower when body weight is applied.
- Equipped with four nylon castors for easy mobility, enabling push/pull movement.
- Features two fixed front castors and two swivel rear castors with brakes for added stability.
- High handrails enhance safety while picking stock.
- The upper shelf has a lipped edge to retain loads securely.
- Finished with a durable powder-coated dark blue framework.



3 Shelves - RTOR16153BXX

Trucks & Trolleys



2 Shelves - RTOR16152BXX



2 and a Half Shelves - RTOR1612HBXX



4 Shelves - RTOR16154BXX

Order Picking Trolleys

Description	Code	Price
2 Shelves including 3 steps	RTOR16152BXX	£851.47
2 and a half Shelves including 3 steps	RTOR1612HBXX	£897.45
3 Shelves including 3 steps	RTOR16153BXX	£936.07
4 Shelves including 3 steps	RTOR16154BXX	£1,033.52



Our selection of mailroom trolleys provides an easy and convenient solution for transporting mail and packages throughout the workplace. These trolleys come with easily removable side panels to facilitate loading and unloading. The 3 and a half sided trolleys include a convenient storage tray. They are manufactured from strong tubular steel with a reinforced base, ensuring durability.

- Trolleys supplied with 2 fixed and 2 swivel braked castors.
- Tough and durable powder-coated finish.
- Fully welded construction.
- UK-manufactured.
- Designed for doorways and narrow aisle access.



Mailroom Trolley with Half Side and Shelf
 RTMR3569MLXX

£678.83 FROM

Mailroom Trolleys - Half Side

Size H.W.L.	Code	Price
830.600.900	RTMR3569MLXX	£716.96
830.600.1200	RTMR3561MLXX	£755.10

Mailroom Trolleys - Full Side

Size H.W.L.	Code	Price
830.600.900	RTMR4690MLXX	£678.83
830.600.1200	RTMR4612MLXX	£716.96

Economy Shelf Trucks provide an affordable solution for transporting items in schools, offices, or workplaces. They are available in a variety of colours and come with either two or three shelves.

- Capable of holding 60kg (UDL) per shelf.
- Choice of two or three shelves.
- Fitted with four swivel castors.
- A choice of three colour options available.
- Fully welded construction.
- Order quantities may apply, please speak to the sales team.

Economy Shelf Trucks



Economy Shelf Trucks - Dimensions/Codes

Size H.W.L.	Tiers	Code	Price
960.495.1100	2	RTLD9649112	£321.87
	3	RTLD9649113	£372.21

All RED product codes are available on 5-Day Delivery when ordered in Blue

£321.87 FROM

Colour Options

Please add corresponding letters to the end of the code.





RTST90603S

RTTST90602

RTPTS6900
Available on page 190

£694.08 FROM



Hand trucks with multiple shelves designed for general commercial and heavy-duty use. They are ideal for storing work in progress and transporting items between areas.

- Recessed steel shelves for load retention.
- Fitted with 2 fixed and 2 swivel 6" heavy-duty castors.
- Fully-welded construction.
- Powder coated in either light grey, yellow, blue or green.

Shelf Trucks - Dimensions/Codes

O/A Dims.mm H x W x D	Description	Steel Top Code	Price
1050. 900. 600	2-tier	RTTST90602	£694.08
1050. 1200. 600		RTTST12602	£813.07
1050. 900. 600	3-tier	RTST90603S	£750.53
1050. 1200. 600		RTST12603S	£877.14
1050. 900. 600	3-tier with mesh	RTTST90603M	£790.19
1050. 1200. 600		RTTST12603M	£915.27
1220. 900. 600	4-tier	RTST1290604	£808.49
1220. 1200. 600		RTST1212604	£954.94
1500. 900. 600	5-tier	RTST1290605	£877.14
1500. 1200. 600		RTST1212605	£1,009.85

Colour Options

Please add corresponding letters to the end of the code.



**350KG
UDL**
EVENLY DISTRIBUTED



2-Tier Shelf Truck - Dimensions/Codes

O/A Dims.mm H x W x D	Steel Top Code	Price
1050. 900. 600	RTTST90602	£694.08
1050. 1200. 600	RTTST12602	£813.07

3-Tier Shelf Truck - Dimensions/Codes

O/A Dims.mm H x W x D	Steel Top Code	Price
1050. 900. 600	RTST90603S	£750.53
1050. 1200. 600	RTST12603S	£877.14

3-Tier Mesh Sides Shelf Truck - Dimensions/Codes

O/A Dims.mm H x W x D	Steel Top Code	Price
1050. 900. 600	RTTST90603M	£790.19
1050. 1200. 600	RTTST12603M	£915.27



**350KG
UDL**
EVENLY DISTRIBUTED



4-Tier Shelf Truck - Dimensions/Codes

O/A Dims.mm H x W x D	Steel Top Code	Price
1220. 900. 600	RTST1290604	£808.49
1220. 1200. 600	RTST1212604	£954.94

5-Tier Shelf Truck - Dimensions/Codes

O/A Dims.mm H x W x D	Steel Top Code	Price
1500. 900. 600	RTST1290605	£877.14
1500. 1200. 600	RTST1212605	£1,009.85

Colour Options

Please add corresponding letters to the end of the code.





£343 FROM **.23**

Twin Handle Platform Truck with Plywood End

Open-Ended Twin Handle Platform Truck

These quality platform trucks are available in single or twin handle designs and are ideal for general commercial use.

- Optional open, plywood or mesh ends.
- Fitted with 2 fixed and 2 swivel heavy-duty castors.
- Fully welded construction.
- Order quantities may apply, please speak to the sales team.

All RED product codes are available on 5-Day Delivery when ordered in Blue

Colour Options

Please add corresponding letters to the end of the code.



Open-Ended Single Handle Platform Truck

Single Handle Platform Trucks - Open End

Size H.W.L.	Code	Price
1050.600.900	RTPTS6900	£471.37
1050.600.1200	RTPTS6120	£507.98

Single Handle Platform Trucks - Plywood End

Size H.W.L.	Code	Price
1050.600.900	RTPTS690C	£507.98
1050.600.1200	RTPTS612C	£544.59

Single Handle Platform Trucks - Mesh End

Size H.W.L.	Code	Price
1050.600.900	RTPTS690M	£343.23
1050.600.1200	RTPTS612M	£375.26

Twin Handle Platform Trucks - Open End

Size H.W.L.	Code	Price
1050.600.900	RTPTD6900	£506.45
1050.600.1200	RTPTD6120	£541.54

Twin Handle Platform Trucks - Plywood End

Size H.W.L.	Code	Price
1050.600.900	RTPTD690C	£591.88
1050.600.1200	RTPTD612C	£626.96

Twin Handle Platform Trucks - Mesh End

Size H.W.L.	Code	Price
1050.600.900	RTBT2690M	£393.57
1050.600.1200	RTBT2612M	£433.23



Cardboard Trolleys

Cardboard Box Trolleys are ideal for the storage and transport of cardboard sheets and flat-pack cardboard boxes. These trolleys can be loaded with cardboard and positioned alongside our packing workbenches.

- A selection of standard colour options are available, please speak to our sales team.
- Designed with 5 slots to facilitate the storage and transportation of cardboard sheets.
- Fitted with 2 fixed and 2 swivel braked castors.
- Fully welded frame to ensure durability.

Cardboard Trolleys - Dimensions/Codes

Size H.W.L.	Code	Price
1030.900.940	RTCBD109046B	£564.42

Double Tier Trolleys

Double Tier Trolleys are designed to hold 2 rolls of packing material and are ideal for rolls of stretch wrap, bubble wrap or paper. This trolley is fitted with 2 fixed and 2 swivel braked castors which allow the user to secure the trolley.

- Powder coated in Light Grey with Germ Guard Active Technology Paint.
- Designed to hold 2 rolls of packing material.
- Fitted with 2 fixed and 2 swivel braked castors.
- Fully welded frame to ensure durability.
- Supplied without plastic cones, these are available to be purchased separately.

Double Tier Trolleys - Dimensions/Codes

Size H.W.L.	Description	Code	Price
1280.710.1200	-	RTPD127112LX	£225.77
-	Cones (Pack of 2)	BGSPARECONES	£134.24
-	Extra Spindle	RTPACTROLBAR	£51.12

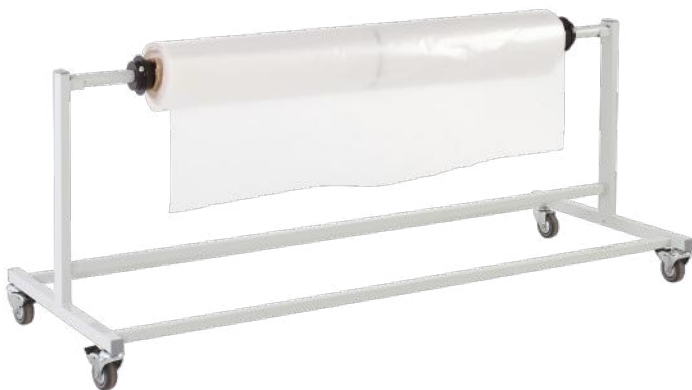

Single Tier Trolleys - Dimensions/Codes

Size H.W.L.	Description	Code	Price
700.710.1800	-	RTPS70711BLX	£234.92
-	Cones (Pack of 2)	BGSPARECONES	£134.24
-	Extra Spindle	RTPACTROLBAR	£51.12



Single Tier Trolleys

Single Tier Trolleys are designed to hold a single roll of packing material and are ideal for rolls of stretch wrap, bubble wrap and paper. This trolley is fitted with 2 fixed and 2 swivel braked castors which allow the user to secure the trolley once positioned in place.

- Powder coated in Light Grey with Germ Guard Active Technology Paint.
- Designed to hold 1 roll of packing material.
- Fitted with 2 fixed and 2 swivel braked castors.
- Fully welded frame to ensure durability.
- Supplied without plastic cones, these are available to be purchased separately.

This practical and versatile Sack Truck is constructed from welded tubular steel for high levels of strength and durability.

- Fully welded construction with an impressive 500kg load capacity.
- Manufactured with a 250mm shoe baseplate.
- Powder coated Dark Blue with Germ Guard Active Technology Paint.
- Fitted with hard-wearing castors.
- Designed with welded steel plate to guard castors from accidental damage.
- Handles include hooded grips for hand protection.
- Order quantities may apply, please speak to the sales team.



FROM £212.04

5 DAY DELIVERY

500KG UDL
EVENLY DISTRIBUTED

Sack Trucks - 500kg Load Capacity

Shoe Size	Option	Code	Price
250mm	Open Back	RTOB2550XBXX	£212.04

Mobile Maintenance Trolleys

Ideal for mobile maintenance stations and for mobile fitting and assembly work. Available with cupboard or drawer for secure storage of tools and equipment.

- Lockable drawers and cupboards.
- Recessed steel top.
- Durable welded steel construction.
- Fitted with 2 fixed and 2 swivel heavy-duty castors.
- Powder coated Light Grey cupboard drawer front.
- Available with either steel plate or MDF worktop.



FROM £675.78

Cupboard with side shelf
RTCS109060S

Mobile Maintenance Trolleys

Size H.W.D.	Option	Steel Worktop Code	Price	MDF Worktop Code	Price
1050.900.600	Cupboard & Side Shelf	RTCS109060S	£733.74	RTCS109060M	£773.41
1050.1200.600		RTCS101260S	£773.41	RTCS101260M	£813.07
1050.900.600	Drawer & 3 Shelves	RTDS109060S	£675.78	RTDS109060M	£715.44
1050.1200.600		RTDS101260S	£715.44	RTDS101260M	£753.58
1050.900.600	Double Cupboard	RZCS109060S	£852.73	R2CS109060M	£890.87

Colour Options

Please add corresponding letters to the end of the code.

Truck Colour



Cupboard & Drawer Colour Options



Canteen Furniture

- 194 Standard Canteen Furniture
- 195 Spectrum Canteen Furniture
- 196 Beam Seating





Our canteen furniture range offers affordable seating options for vending, refreshment, and rest areas. The high-quality seats are easy to clean and made from one-piece moulded polypropylene, available in three colour options: blue, red, and black.

- Blue seats available on 5 Day Delivery.
- Fully welded canteen unit with polypropylene seat shells.
- Framework powder coated black with Germ Guard Active Technology paint.
- MFC table tops come in a light grey, with PVC edging for extra strength and protection.
- Optional floor fixings available.
- Order quantities may apply, please speak to the sales team.

Canteen Furniture



■ Table Top: 535mm x 600mm

Standard Canteen Furniture - 2 Seat Single-Entry		
Size H.W.L.	Code	Price
725.1690.530	B6FASTFD2SE	£345.50



■ Table Top: 1070mm x 600mm

Standard Canteen Furniture - 4 Seat Double-Entry		
Size H.W.L.	Code	Price
725.1690.1070	B6FASTFD4DE	£502.67



■ Table Top: 1070mm x 600mm

Standard Canteen Furniture - 4 Seat Single-Entry		
Size H.W.L.	Code	Price
725.1690.1070	B6FASTFD4SE	£502.67

All RED product codes are available on 5-Day Delivery (when ordered with Blue seats)



■ Table Top: 1580mm x 600mm

Standard Canteen Furniture - 6 Seat Double-Entry		
Size H.W.L.	Code	Price
725.1690.1580	B6FASTFD6DE	£693.96



■ Table Top: 1580mm x 600mm

Standard Canteen Furniture - 6 Seat Single-Entry		
Size H.W.L.	Code	Price
725.1690.1580	B6FASTFD6SE	£693.96

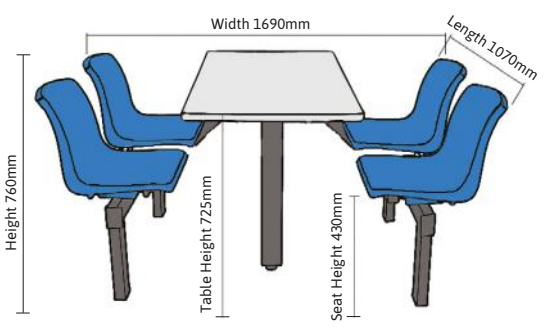

Colour Options

Please add corresponding letters to the end of the code.





£704.34 FROM

- Fully welded robust canteen unit with seats made from 1.2mm mild steel.
- MFC table tops come in a light Grey, with PVC edging for extra strength and protection.
- Frames powder coated with light Grey Germ Guard Active Technology paint.
- Seats available in green, red, blue and dark Grey. Any RAL colour available to suit corporate colours, £POA.

Colour Options

Please add corresponding letters to the end of the code.



- Table Top: 535mm x 600mm
- Overall Size: 790mm x 1755mm x 570mm

Spectrum Canteen Furniture - 2 Seater

Size H.W.L.	Code	Price
790.1755.570	B6SPFAST2SE	£704.34



- Table Top: 1070mm x 600mm
- Overall Size: 790mm x 1755mm x 1100mm

Spectrum Canteen Furniture - 4 Seater

Size H.W.L.	Description	Code	Price
790.1755.1100	Single-Entry	B6SPFAST4SE	£1,006.83
790.1755.1100	Double-Entry	B6SPFAST4DE	£1,006.83



- Table Top: 1580mm x 600mm
- Overall Size: 790mm x 1755mm x 1600mm

Spectrum Canteen Furniture - 6 Seater

Size H.W.L.	Description	Code	Price
790.1755.1600	Single-Entry	B6SPFAST6SE	£1,285.60
790.1755.1600	Double-Entry	B6SPFAST6DE	£1,285.60



**NEW
PRODUCT**

£216.67 FROM

Standard seating shown with integrated table

Our Beam Seating is the perfect choice for waiting areas, offices, shops and schools. Our collection includes a variety of options across both our Standard and Spectrum ranges. Choose from 2, 3, or 4 seat units, with the 2 and 3-seat models also available with an integrated table.

- Standard range fully welded with polypropylene seat shells, and the Spectrum range is fully welded with seats

made from 1.2mm mild steel.

- Framework powder coated with Germ Guard Active Technology paint. Standard range in Black and the Spectrum range in Light Grey.
- Available in 2, 3 and 4 seat configurations.
- An integrated MFC table can also be added to the 2 and 3-seat configurations.
- Integrated table dimensions - 400mm x 450mm.



Standard Beam Seating

Size H.W.L.	Description	Code	Price
830.510.990	2-Seater	B6FASTBEAM2*	£216.67
830.510.1540	3-Seater	B6FASTBEAM3*	£263.33
830.510.2060	4-Seater	B6FASTBEAM4*	£328.33
830.510.1540	2-Seater with table	B6FASTBEMT2*	£313.33
830.510.2060	3-Seater with table	B6FASTBEMT3*	£378.33



Spectrum Beam Seating

Size H.W.L.	Description	Code	Price
860.510.1100	2-Seater	B6SPFABEAM2*	£233.33
860.510.1670	3-Seater	B6SPFABEAM3*	£286.67
860.510.2310	4-Seater	B6SPFABEAM4*	£353.33
860.510.1670	2-Seater with table	B6SPFABEMT2*	£336.67
860.510.2310	3-Seater with table	B6SPFABEMT3*	£403.33

Standard Colour Options

Please add corresponding letters to the end of the code.



Spectrum Colour Options



Pallets & Drum Storage

198 Detachable Side Pallets

198 Open Fronted Pallets

198 Chute Pallets

198 Box Pallets

199 Half-Drop Side Pallets

199 Post Pallets

199 Drum Storage Shelters

199 Drum Racks & Heavy-Duty Sumps

200 Gas Cylinder Cages





Our heavy-duty steel pallets support loads from 500kg to 1000kg and are available in a range of practical configurations to suit different storage and handling needs. Choose from mesh infill or solid steel side and back panels for added security and durability. Ideal for warehouses and industrial environments, they're perfect for storing boxes and small items and can be stacked up to 5 high (load dependent) to maximise and improve efficiency.

Detachable Side Pallets

- Detachable mesh or steel panel.
- Up to 1000kg capacity.
- Choice of mesh or steel sides.
- Powder coated in dark blue.
- Dimensions show the interior usable space.

Detachable Side Pallets - Dimensions/Codes

Size H.W.D.	Mesh Sides	Steel Sides	Price
460.610.610	PDS616146MBX	PDS616146SBX	£440.86
610.610.610	PDS616161MBX	PDS616161SBX	£457.64
460.915.610	PDS916146MBX	PDS916146SBX	£472.89
610.915.610	PDS916161MBX	PDS916161SBX	£489.67
460.915.915	PDS919146MBX	PDS919146SBX	£504.93
610.915.915	PDS919161MBX	PDS919161SBX	£524.76
760.915.915	PDS919176MBX	PDS919176SBX	£540.01
460.1220.915	PDS129146MBX	PDS129146SBX	£559.84
610.1220.915	PDS129161MBX	PDS129161SBX	£581.20
760.1220.915	PDS129176MBX	PDS129176SBX	£599.50



610.915.610 Size Shown

Open Fronted Pallets

- Completely open front.
- Up to 1000kg capacity.
- Choice of mesh or steel sides.
- Powder coated dark blue.
- Dimensions show the interior usable space.

Open Fronted Pallets - Dimensions/Codes

Size H.W.D.	Mesh Sides	Steel Sides	Price
460.610.610	POF616146MBX	POF616146SBX	£346.28
610.610.610	POF616161MBX	POF616161SBX	£356.96
460.915.610	POF916146MBX	POF916146SBX	£370.69
610.915.610	POF916161MBX	POF916161SBX	£384.42
460.915.915	POF919146MBX	POF919146SBX	£398.14
610.915.915	POF919161MBX	POF919161SBX	£411.87
760.915.915	POF919176MBX	POF919176SBX	£424.08
460.1220.915	POF129146MBX	POF129146SBX	£440.86
610.1220.915	POF129161MBX	POF129161SBX	£457.64
760.1220.915	POF129176MBX	POF129176SBX	£469.84



610.915.610 Size Shown

Chute Pallets

- Heavy-duty chute front.
- Easy access to stacked materials.
- Up to 500kg capacity.
- Can be stacked up to 5 pallets high.
- Powder coated dark blue.
- Dimensions show the interior usable space.

Chute Pallets - Dimensions/Codes

Size H.W.D.	Code	Price
305.610.610	PCH616130BXX	£250.18
305.915.610	PCH916130BXX	£305.09



305.915.610 Size Shown

305.610.610 Size Shown

Box Pallets

- Ideal for stacking.
- Up to 1000kg capacity.
- Choice of mesh or steel sides.
- Powder coated dark blue.
- Dimensions show the interior usable space.

Box Pallets - Dimensions/Codes

Size H.W.D.	Mesh Sides	Steel Sides	Price
460.610.610	PBX616146MBX	PBX616146SBX	£399.67
610.610.610	PBX616161MBX	PBX616161SBX	£413.40
460.915.610	PBX916146MBX	PBX916146SBX	£430.18
610.915.610	PBX916161MBX	PBX916161SBX	£443.91
460.915.915	PBX919146MBX	PBX919146SBX	£459.16
610.915.915	PBX919161MBX	PBX919161SBX	£475.94
760.915.915	PBX919176MBX	PBX919176SBX	£492.72
460.1220.915	PBX129146MBX	PBX129146SBX	£507.98
610.1220.915	PBX129161MBX	PBX129161SBX	£527.81
760.1220.915	PBX129176MBX	PBX129176SBX	£546.11



610.915.610 Size Shown

Half-Drop Side Pallets

- Half-drop side for easier access.
- Up to 1000kg capacity.
- Choice of mesh or steel sides.
- Powder coated dark blue.
- Dimensions show the interior usable space.

Half-Drop Side Pallets - Dimensions/Codes

Size H.W.D.	Mesh Sides	Steel Sides	Price
460.610.610	PHD616146MBX	PHD616146SBX	£446.96
610.610.610	PHD616161MBX	PHD616161SBX	£462.21
460.915.610	PHD916146MBX	PHD916146SBX	£478.99
610.915.610	PHD916161MBX	PHD916161SBX	£494.25
460.915.915	PHD919146MBX	PHD919146SBX	£511.03
610.915.915	PHD919161MBX	PHD919161SBX	£529.33
760.915.915	PHD919176MBX	PHD919176SBX	£549.16
460.1220.915	PHD129146MBX	PHD129146SBX	£567.47
610.1220.915	PHD129161MBX	PHD129161SBX	£587.30
760.1220.915	PHD129176MBX	PHD129176SBX	£608.66



610.915.610 Size Shown

Post Pallets

- Angled steel corner posts.
- Easier access to stacked materials.
- Powder coated dark blue.
- Dimensions show the interior usable space.

Post Pallets - Dimensions/Codes

Size H.W.D.	Code	Price
460.610.610	PPO616146BXX	£259.33
610.610.610	PPO616161BXX	£270.01
460.915.610	PPO916146BXX	£279.16
610.915.610	PPO916161BXX	£289.84
760.915.610	PPO916176BXX	£300.52
915.915.610	PPO916191BXX	£311.19
460.915.915	PPO919146BXX	£321.87
610.915.915	PPO919161BXX	£335.60
760.915.915	PPO919176BXX	£346.28
915.915.915	PPO919191BXX	£360.01
460.1220.915	PPO129146BXX	£370.69
610.1220.915	PPO129161BXX	£385.94
760.1220.915	PPO129176BXX	£399.67
915.1220.915	PPO129191BXX	£413.40



610.915.610 Size Shown

Drum Storage Shelters

Designed for the secure storage of cylinders, drums, components, and products, these covered shelters allow safe outdoor storage. Constructed with a square steel frame and galvanised steel panels on the sides and rear, they are robust and weather-resistant.

- Feet supplied for surface mounting as standard.
- Internal storage area is 2.35 wide x 2.1 high x 1.27 metres deep.
- Powder coated dark blue with Germ Guard Active Technology paint.
- Corrosion resistant galvanised panels.
- Full site survey and erection service available.

Drum Storage Shelters - Dimensions/Code

Key	Description	Size H.W.D.	Code	Price
A	Single Gated Open Front	2100. 2500. 1900	SODRUMSHLTBX	£2,492.60
B	Double Gated Open Front	2100.2500.1900	DODRUMSHLTBX	£2,616.16
C	Single Gated Mesh Infill Door	2100. 2500. 1900	SOMSHDRSHLXB	£2,663.45
D	Double Gated Mesh Infill Door	2100. 2500. 1900	DOMSHDRSHLXB	£2,767.69
E	Single Gated Galvanised Panel Fronted	2100. 2500. 1900	SOGLVFNTSHBX	£2,663.45
F	Double Gated Galvanised Panel Fronted	2100. 2500. 1900	DOGLVFNTSHBX	£2,797.69



Drum Racks - Dimensions/Code

Size H.W.D.	Code	Price
400. 1450. 600	DRACK40145BX	£517.13

Heavy-Duty Sump - Dimensions/Code

Size H.W.D.	Code	Price
360. 1250. 950	DSHDSUMPLGBX	£506.45



Drum Racks



Heavy-Duty Sump

**NEW
PRODUCT**



**800KG
UDL**
EVENLY DISTRIBUTED

£1,251.82 FROM

Pallets & Drum Storage

Keep gas cylinders secure and your site compliant with our Gas Cylinder Storage Cages. These tough, box-section steel enclosures are built for busy workshops and industrial areas where safe, tidy cylinder storage is essential.

Choose from four configurations in either mobile or static options. Mobile cages are fitted with two swivel and two fixed castors for easy movement, while static versions come with pallet feet for stable, practical positioning. Every cage includes hinged doors with a padlock-ready hasp (padlock not included) plus a gas storage warning label for clear identification.

- Fully-welded heavy-duty box section steel.
- Holds up to 8 propane cylinders or 16 smaller bottles in four different configurations.
- Internal dimensions: H1585mm x W1710mm x D810mm.
- Load capacity - 800kg.
- Hinged doors with padlock-ready hasp for secure access (padlock not included).
- Powder coated dark blue with Germ Guard Active Technology paint or galvanised finish.
- Supplied with warning identification label.



Fitted with pallet feet or castors

Static Gas Cylinder Cages - Dimensions/Codes

Size H.W.D.	Description	Standard	Price	Galvanised	Price
1820.1820.980	Standard	PGC181898SBX	£1,251.82	PGC181898SGX	£1,585.15
1820.1820.980	w/ shelf	PGC181898WBX	£1,355.02	PGC181898WGX	£1,688.35
1820.1820.980	w/ centre divider	PGC181898CBX	£1,327.35	PGC181898CGX	£1,660.68
1820.1820.980	w/ shelf+divider	PGC181898DBX	£1,390.97	PGC181898DGX	£1,724.30

Mobile Gas Cylinder Cages - Dimensions/Codes

Size H.W.D.	Description	Standard	Price	Galvanised	Price
1880.1820.910	Standard	PGM181898SBX	£1,350.67	PGC181898SGX	£1,684.00
1880.1820.910	w/ shelf	PGM181898WBX	£1,468.58	PGC181898WGX	£1,801.92
1880.1820.910	w/ centre divider	PGM181898CBX	£1,452.47	PGC181898CGX	£1,785.80
1880.1820.910	w/ shelf+divider	PGM181898DBX	£1,496.02	PGC181898DGX	£1,829.35



Standard
PGM181898SBX



w/ Shelf
PGM181898WBX



w/ Centre Divider
PGM181898CBX



w/ Shelf & Divider
PGM181898DBX

Barriers

- 202** Protective Posts
- 202** Low Level Barriers
- 203** Fully Welded Barriers
- 204** Self-Closing Gate Barriers

- 206** Lift-Out Rail Barriers
- 207** Round Tube Rail Barriers
- 207** Pallet Racking Protectors
- 208** Guard Barriers



Protective Posts

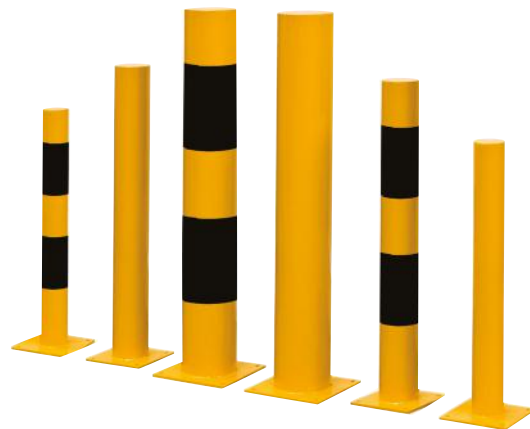

- Designed to protect building doorways from accidental damage.
- Fully welded construction for floor mounting.
- Extra height posts available on request for embedding into concrete.
- Powder coated in Yellow or Yellow & Black.
- Order quantities may apply, please speak to the sales team.

Protective Posts - Dimensions/Codes

Size H. W.	Colour Option	Code	Price
1100.170	Yellow	RBPP110170YX	£311.19
	Yellow & Black	RBPP110170WX	£3311.19
915.115	Yellow	RBPP915115YX	£207.46
	Yellow & Black	RBPP915115WX	£207.46
760.90	Yellow	RBPP76090YX	£180.00
	Yellow & Black	RBPP76090WX	£180.00

Low Level Barriers



- Designed to protect machinery from damage by fork lift or pallet trucks.
- Order quantities may apply, please speak to the sales team.
- Fully-welded construction from box section.
- Powder coated in high-visibility yellow Germ Guard Active Technology paint.
- Angled steel corner protectors.

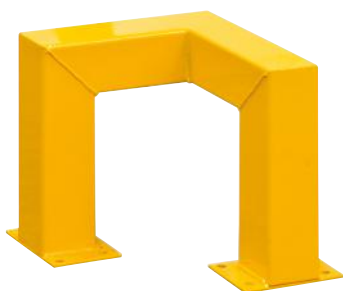

Corner Protectors - Dimensions/Codes

Size H.W.D.	Colour Option	Code	Price
300.300.300	Yellow	RBLLSCX300YX	£128.14

Low Level Barriers - Dimensions/Codes

Size H.W.	Colour Option	Code	Price
300.1200	Yellow	RBLLSB1200YX	£213.56
300.800	Yellow	RBLLSBX800YX	£167.80
300.400	Yellow	RBLLSBX400YX	£147.97



Corner Barrier Unit



Gate Barrier Unit

These safety barriers are designed for creating protective barriers around machinery and equipment and for defining walkways through industrial, manufacturing and warehousing areas.

- Choice of open or mesh infill panels.
- Fully welded construction.
- Powder coated in high-visibility yellow Germ Guard Active Technology paint.
- Order quantities may apply, please speak to the sales team.

All RED product codes are available on 5-Day Delivery



Corner Barrier Units - Dimensions/Codes

Size L.H.	Mesh Infill	Price	Open Barrier	Price
1000.900	RBCU1090MYXX	£562.89	RBCU1090OYXX	£381.36
1000.1100	RBCU1011MYXX	£562.89	RBCU1011OYXX	£385.94

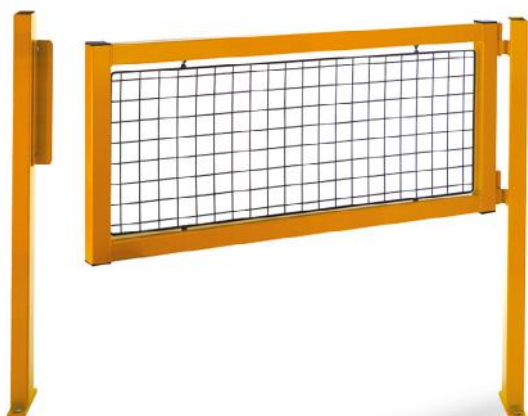

Gate Barrier Units - Dimensions/Codes

Size L.H.	Mesh Infill	Price	Open Barrier	Price
900.900	RBGU9090MYXX	£320.35	RBGU9090OYXX	£250.18
900.1100	RBGU9011MYXX	£334.08	RBGU9011OYXX	£266.96
1200.900	RBGU1290MYXX	£350.86	RBGU1290OYXX	£263.90
1200.1100	RBGU1211MYXX	£375.26	RBGU1211OYXX	£285.26



5 DAY DELIVERY

Straight Barrier Units - Dimensions/Codes

Size L.H.	Mesh Infill	Price	Open Barrier	Price
1000.900	RBST1090MYXX	£355.43	RBST1090OYXX	£270.01
1000.1100	RBST1011MYXX	£448.48	RBST1011OYXX	£346.28
2000.900	RBST2090MYXX	£569.00	RBST2090OYXX	£401.20
2000.1100	RBST2011MYXX	£594.93	RBST2011OYXX	£414.92

Barriers

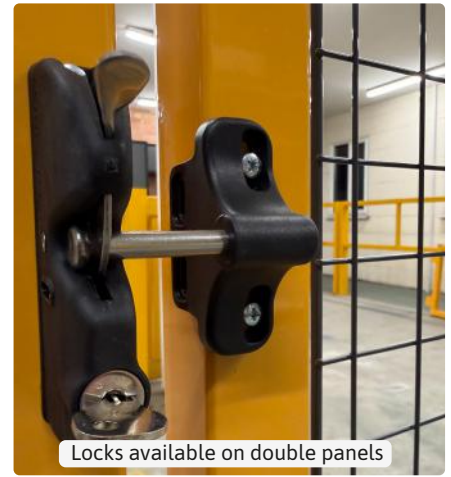

£337 FROM **.57**

NEW PRODUCT

Barriers

These gate barriers feature a durable, soft-close hinge that automatically returns the gate to its closed position after each use. This ensures the gate barrier is always secured once someone passes through.

Available in both single and double panel configurations, they offer the flexibility to suit a wide range of applications. Whether you're working on a new build or upgrading an existing site, our self-close gate barriers are a practical, reliable solution for almost any access point.

- Fully-welded construction.
- Available with single or double panels.
- Available either open or with mesh infills.
- Saloon and Double Gate Barriers can be fitted with a lock for additional safety and security.
- Powder coated in high visibility yellow Germ Guard Active Technology paint.
- Order quantities may apply, please speak to the sales team.

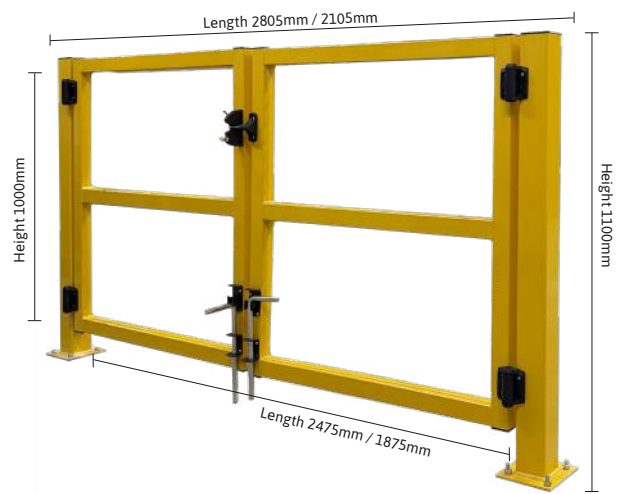

Saloon Gate Barrier - Mesh - Dimensions/Codes

Size H.L	Lock/Latch	Code	Price
1100.2475	w/ lock	RSG1124LOMYX	£1,094.22
1100.2475	w/ latch	RSG1124LAMYX	£1,016.45
1100.1875	w/ lock	RSG1118LOMYX	£1,053.63
1100.1875	w/latch	RSG1118LAMYX	£975.88

Saloon Gate Barrier - Open - Dimensions/Codes

Size H.L	Lock/Latch	Code	Price
1100.2475	w/ lock	RSG1124LOOYX	£1,006.63
1100.2475	w/ latch	RSG1124LAOYX	£765.20
1100.1875	w/ lock	RSG1118LOOYX	£987.30
1100.1875	w/latch	RSG1118LAOYX	£745.88



Single Panel Gate Barrier - Mesh - Dimensions/Codes

Size H.L	Code	Price
1100.1200	RSPG1112MYXX	£437.68
1100.900	RSPG1190MYXX	£417.73
900.1200	RSPG9012MYXX	£427.33
900.900	RSPG9090MYXX	£407.38

Single Panel Gate Barrier - Open - Dimensions/Codes

Size H.L	Code	Price
1100.1200	RSPG1112OYXX	£362.55
1100.900	RSPG1190OYXX	£347.90
900.1200	RSPG9012OYXX	£352.20
900.900	RSPG9090OYXX	£337.57



Double Panel Gate Barrier - Mesh - Dimensions/Codes

Size H.L	Lock	Code	Price
1100.1200	w/ lock	RDPG1112MYXX	£816.90
1100.1200	no lock	RDPG1190MYXX	£571.62
1100.900	w/ lock	RDPG9012MYXX	£799.82
1100.900	no lock	RDPG9090MYXX	£554.53

Double Panel Gate Barrier - Open - Dimensions/Codes

Size H.L	Lock	Code	Price
1100.1200	w/ lock	RDPG1112OYXX	£691.07
1100.1200	no lock	RDPG1190OYXX	£445.77
1100.900	w/ lock	RDPG9012OYXX	£684.25
1100.900	no lock	RDPG9090OYXX	£436.83

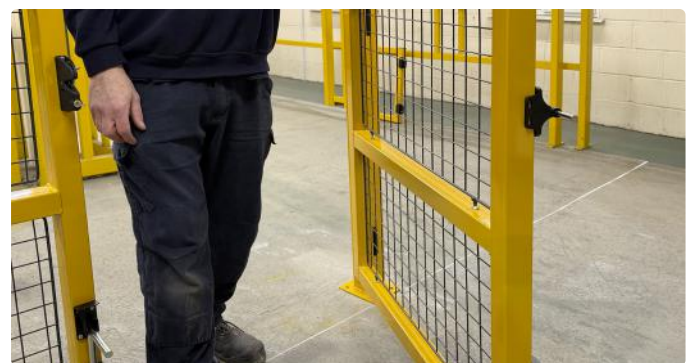



- Modular design at either 500, 900 or 1100mm tall with easily removable rails to allow access if required.
- Constructed from tough mild-steel box section.
- Supplied in component form for easy on-site assembly.
- Powder coated in high-visibility yellow Germ Guard Active Technology Paint.
- For greater accessibility, a Barrier Gate can be seamlessly added to the Lift Out Rail Barrier system.



Lift Out Single Rail Barrier Posts - Dimensions/Codes

Size H.W.D.	Option	Code	Price
500.80.80	End Post	RBSRBBEX500Y	£134.24
	Standard Post	RBSRBBSX500Y	£155.60
	Corner Post	RBSRBBXC500Y	£155.60

Lift Out Single Rail Barrier Gates - Dimensions/Codes

Size H.L	Code	Price
900.900	RLOG9090OYXX	£390.47
900.1200	RLOG9012OYXX	£401.02
1100.900	RLOG1190OYXX	£409.00
1100.1200	RLOG1112OYXX	£420.97

Lift Out Barrier Rails - Universal - Dimensions/Codes

Size L.	Code	Price
3000	RBTRBBB3000Y	£181.53
2400	RBTRBBB2400Y	£154.07
1200	RBTRBBB1200Y	£120.51
600	RBTRBBB600Y	£80.85
300	RBTRBBB300Y	£56.44

Lift Out Twin Rail Barrier Posts - Dimensions/Codes

Size H.W.D.	Option	Code	Price
1100.80.80	End Post	RBTRBBE1100Y	£173.90
900.80.80		RBTRBBEX900Y	£152.55
1100.80.80	Standard Post	RBTRBBS1100Y	£195.26
900.80.80		RBTRBBSX900Y	£175.43
1100.80.80	Corner Post	RBTRBBC1100Y	£195.26
900.80.80		RBTRBBCX900Y	£175.43

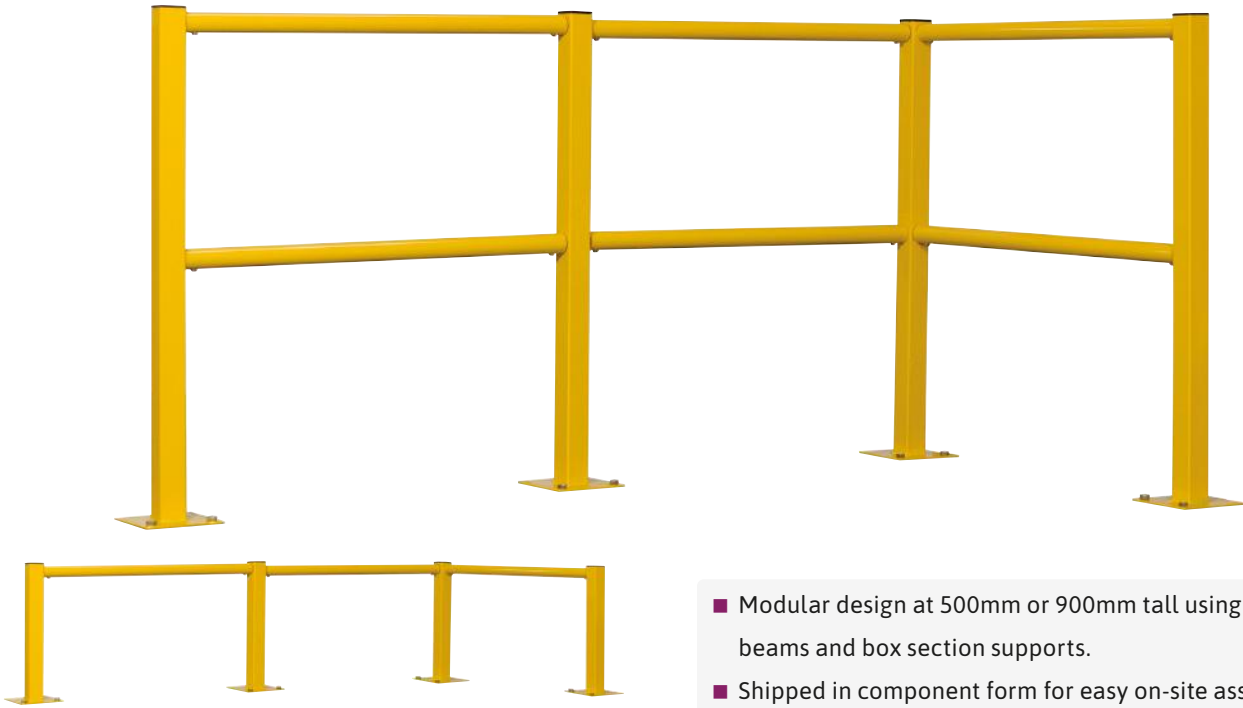

Round Tube Single Barrier Posts - Dimensions/Codes

Size H.	Option	Code	Price
500	End Post	RBSRBREX500Y	£128.14
	Standard Post	RBSRBRSX500Y	£160.17
	Corner Post	RBSRBRCX500Y	£160.17

Round Tube Twin Barrier Posts - Dimensions/Codes

Size H.	Option	Code	Price
900	End Post	RBTRBREX900Y	£204.41
	Standard Post	RBTRBRSX900Y	£247.12
	Corner Post	RBTRBRCX900Y	£247.12

- Modular design at 500mm or 900mm tall using round tube beams and box section supports.
- Shipped in component form for easy on-site assembly.
- Powder coated in high-visibility yellow Germ Guard Active Technology paint.

Round Tube Barrier Rails - Universal - Dimensions/Codes

Size (Length)	Code	Price
2000	RBTRBRB2000Y	£93.05
1600	RBTRBRB1600Y	£74.75
800	RBTRBRB800Y	£56.44
400	RBTRBRB400Y	£38.14

Pallet Racking Protectors



- An economical range of protection barriers for the end of pallet racking bays.
- Made from heavy-gauge steel tubing and fully welded, this item requires no on-site assembly.
- Powder coated with Germ Guard Active Technology paint.
- Designed with heavy-duty floor fixing plate.
- 6 sizes for single or double bays.
- Order quantities may apply, please speak to the sales team.

Pallet Racking Protectors - Dimensions/Codes

Size H.L.	Code	Price
620.700	RBMOBX700YX	£247.12
620.900	RBMOBX900YX	£276.11
620.1100	RBMOB1100YX	£314.24
620.1500	RBMOB1500YX	£341.70
620.1900	RBMOB1900YX	£417.98
620.2300	RBMOB2300YX	£465.26

All **RED** product codes are available on 5-Day Delivery



These attractive tubular, safety barriers are ideal for protecting walkways around machinery and shelving and for defining walkways through industrial, manufacturing and warehouse areas.

- Fully-welded construction.
- Powder coated in high visibility yellow Germ Guard Active Technology paint.
- Order quantities may apply, please speak to the sales team.





£259 FROM **.33**



5 DAY DELIVERY

All RED product codes are available on 5-Day Delivery



Long Guard Barrier - Dimensions/Codes

Size H.L	Code	Price
940.2000	RBLGB9420YXX	£338.65



Short Guard Barrier - Dimensions/Codes

Size H.L	Code	Price
940.1000	RBSGB9410YXX	£259.33

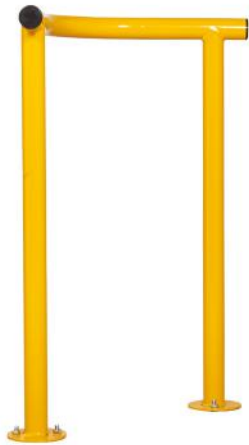

Corner Guard Barrier - Dimensions/Codes

Size H.W.D	Code	Price
940.530.530	RBCGB9453YXX	£289.84



■ Maximum pillar size; W600 x D480

Pillar Guard Barrier - Dimensions/Codes

Size H.W.D	Code	Price
850.750.700	RBPG8857YXX	£332.55

Special Products

Although we offer a wide range of products, we understand that some users may have specific needs that can only be met by a custom-designed solution. In such cases, our technical team would be happy to discuss how we can adapt our standard design to meet those unique requirements. This could involve accommodating existing features or equipment safely, as well as modifying dimensions, colours, and material specifications from our standard options.

Our Special Product Design Service includes:

- Examining the original sketch or idea.
- Developing the concept in alignment with QMP manufacturing methods.
- Producing a drawing or sample for approval prior to production.
- The expertise of an in-house designer utilising SolidWorks and Radon software.
- Comprehensive project management covering the entire process from concept to design, delivery, and installation.

Special Colours and Finishes

To personalise a product and ensure it matches your organisation's logo, brand, or corporate colour scheme, you can select from a wide variety of colours and finishes. Most RAL colours can be applied to our product ranges. In addition to gloss finishes, we also offer matte and metallic options. Please note that these choices are subject to a modest additional charge and have a minimum order requirement.



Made in Great Britain





Installation

In addition to designing, manufacturing, and delivering your QMP product, we also offer installation services at your customers' premises. For a reasonable fee, our expert installation team, supported by our professional project management staff, will ensure that your order is installed on-site at a convenient time and to high standards.

Please note: If you need to cancel or change an installation date for any reason, we require 48 hours' notice. Otherwise, additional charges may apply.

Our experienced and fully trained installation team:

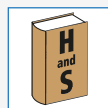

Work safely within current Health & Safety regulations and willingly comply with site rules and regulations.



Work quickly to minimise any disruption.



Bring all necessary tools and equipment with them.



Are courteous and friendly at all times.



Carry ID if required.



Ask for a signature to confirm complete satisfaction with work.

Our service includes:



Moving the order from point of delivery to point of use.



Unpacking the order from its protective transit packaging.

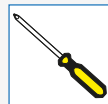

Assembling all product supplied in flat-pack format.

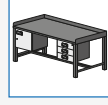

Positioning the product in the correct place.

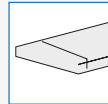

Securing product to wall or floor as applicable.



By prior arrangement, carrying out any selected groundworks.

Small Order Charges - Orders of less than £350 excluding VAT after any applicable discounts may, at our discretion, attract a small order charge of £35 per delivery to mainland UK addresses. Certain low value orders may be made available only on an ex-works basis.

Call-Off Orders - We accept call-off orders provided the delivery date for all call-offs is confirmed in writing on the purchase order. Once the order is placed, call off dates may not be changed except by prior agreement. Should call-off dates not be confirmed at the time of order, QMP will price and manufacture the call-offs as separate orders.

Offshore Deliveries - We can arrange delivery at extra cost to offshore locations. Details are available on request from our sales office.

Payment Terms - QMP payment terms are 30 days net end of month following the month of invoice for credit accounts. Credit accounts are available subject to status.

Returns - In the unlikely event of you wishing to return goods, please contact the QMP sales department for authorisation. Manufactured to order and bespoke products cannot be returned into stock.

Selected items from our 'Express Delivery' range can be returned to stock, please contact sales for more information.

Please note that a re-stocking fee of 25% of the invoice value plus delivery costs will apply. Customers are expected to arrange transport of goods at their own expense.

Damages - If an item is delivered damaged we ask that the customer does not sign to accept the delivery, deliveries should only be signed for once inspected by the customer for signs of damage.

We ask that any damages be reported to QMP Sales immediately who will arrange for a replacement to be dispatched.

Shortages - If items are missing from the delivery customers must notify QMP Sales immediately who will arrange for the missing items to be dispatched.

Refusal of Goods - If delivery of goods is refused, then a re-delivery will be arranged by our sales department and customers will be notified of the re-delivery costs.

Cancelling Orders - Please call us immediately should you wish to cancel an order. We accept order cancellations without charge provided we have not started to make your order. If production has started, cancelling your order will be subject to a cancellation charge in proportion to our incurred costs.

Product Design - QMP reserves the right to change the design of our products from time to time without prior notice. Images within this catalogue are correct at time of going to press, but may differ at point of order. We also reserve the right to discontinue products. If you require a product to exactly match a particular design, please contact us before placing an order to ensure this is possible.

Colour Matching - Whilst we will always use paints manufactured to specified RAL numbers, no guarantee can be given to provide an exact match of colour or finish with previously made products. This also applies to worktops for workbenches and compact laminate for locker doors.

Retention of Title - Goods remain the property of QMP until paid for in full.



Workbenches

Euroslide

Cupboards

Lockers

Workstations

Cycle Parking

Smoking Shelters

Trucks & Trolleys

Canteen Furniture

Pallets & Drum Storage

Barriers



UK MANUFACTURED



100% Recycleable



Distributed By

STORAGE DESIGN LIMITED

Primrose Hill

Cowbridge

South Wales

CF71 7DU

Tel: 01446 772614

email: info@storage-design.ltd.uk

web: www.storage-design.ltd.com

Printed on paper made from totally chlorine free pulp (TCF) from sustainable sources