

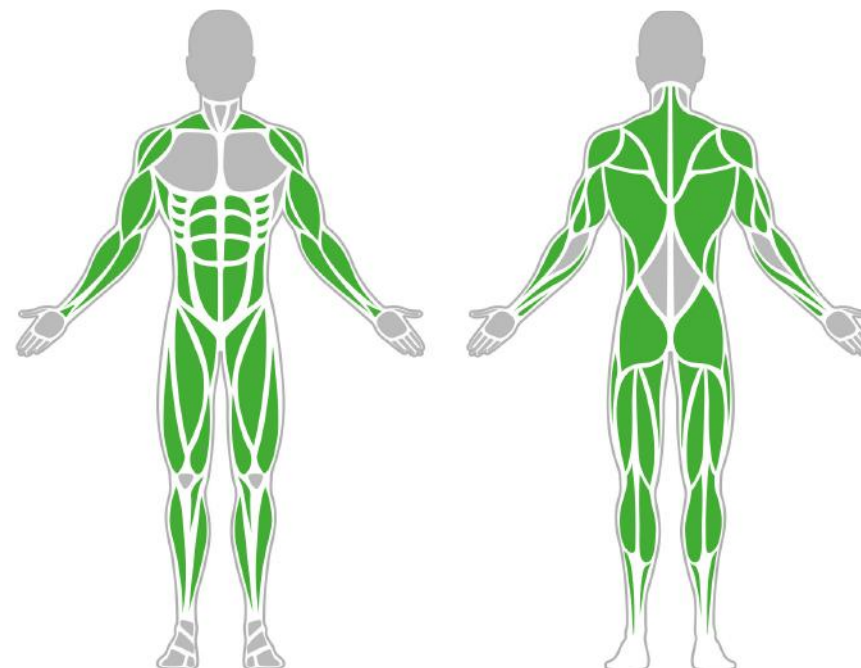

## Muscle Groups Focus



### Rower

Aspectacular rowing device for training your entire back muscles, but also arms, shoulders & neck. The mechanism uses your own body weight as lifting weight and the movement is very simple and functional.

### Attributes

Product code	1-1-312
Certificate	EN 16630, ASTM F3101
Age group	14 + years
Capacity	1 person
Max. weight load	286.60 lbs
Type	Recreational
Difficulty level	Medium

## Side View

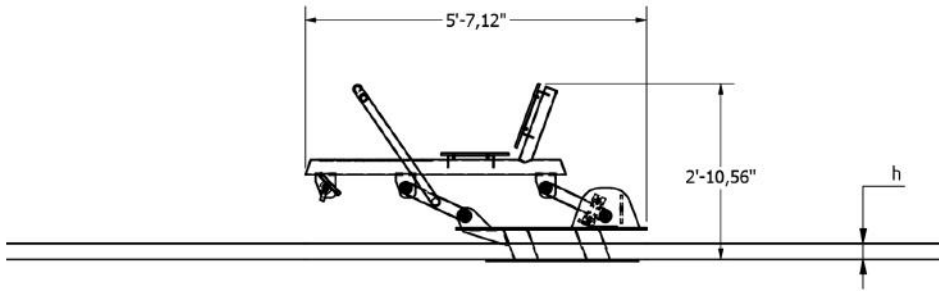

## Plan View

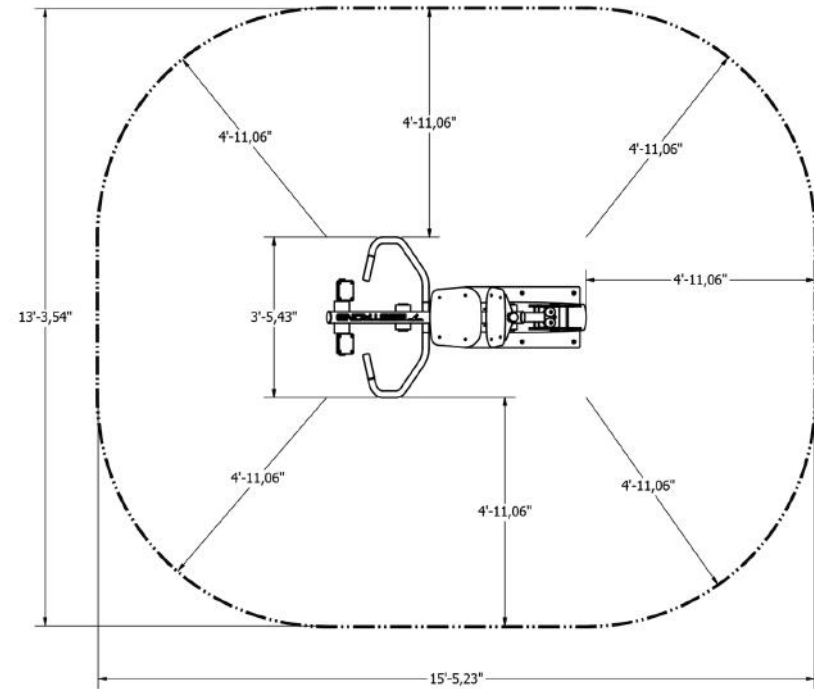

### Installation information

Number of installers (concrete)	At least 2 people
Total installation time (concrete)	60-120 min.
Number of installers (equipment)	At least 2 people
Total installation time (equipment)	90-120 min.
Excavation volume	26,84 ft <sup>3</sup>
Concrete volume	26,84 ft <sup>3</sup>
Size of the base structure	31.5 x 47.24 x 31.5 „
Anchoring options	Surface mounted
In combined structures, the volume of concrete required varies.	

### Technical specification

Safety surface area	Around 4.92 ft radius
Net weight	227.07 lbs
Material	S235, KO33
Critic fall height	35.43"
Color options	<span style="color: green;">●</span> <span style="color: black;">●</span> <span style="color: red;">●</span> <span style="color: gray;">●</span> <span style="color: yellow;">●</span> <span style="color: blue;">●</span>

For more color options, discuss with your sales representative.

### Warranty

Structure	25 years
Steel	15 years
Paint	2 years
Plastic	5-10 years
Rubber	1-3 years
Moving parts	2 years
Detailed information in the warranty document	

# Material specification

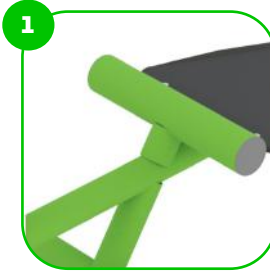

The element is made of high quality S235 steel, which has been cleaned via sandblasting. A corrosion resistant powder coating finish is then applied. Also available with galvanized surface for even greater protection and longevity!



The bumpers of the devices are made of durable rubber material.

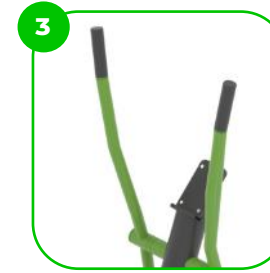

At the end of the arms, the handle is rubber-coated for a more comfortable and secure grip.

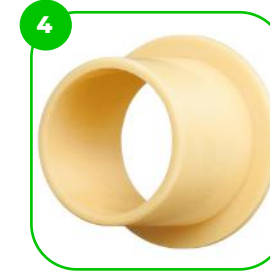

The device is fitted with composite bearings that are weather-resistant. The bearing does not require regular maintenance.

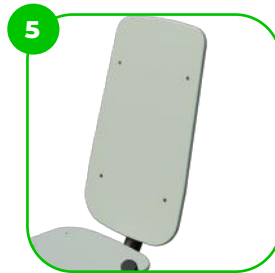
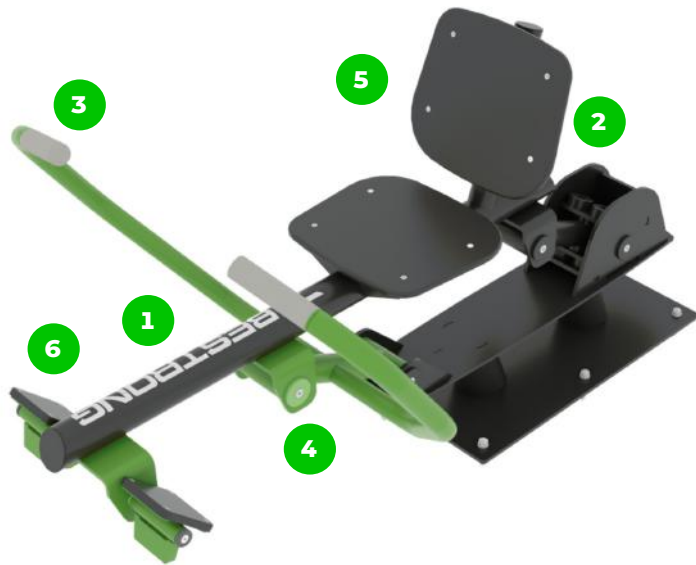

The seats and backrests are made of strong HDPE material. Which is fully heat, moisture and UV resistant.



The footrests are made of premium quality non-slip HDPE with a high wear resistance.

# BESTRONG

 [bestrongworld](#)  [bestrongworld](#)  [usa.bestrong.com](#)  [usa@bestrong.com](mailto:usa@bestrong.com)

