

A Lot To Do In Spring

ROOT
PUBLICATIONS

Bee Culture's
BEE Keeping
Your First Three Years
Spring 2021®

Is Honey A Superfood?
**Building Five
Frame Nucs**

ROOT PUBLICATIONS \$6.99
Leave on Newsstand Through May 15



0 74470 29478 8 01 >

BEEKeeping[®] Spring '21[®]

Your First Three Years

Inside

Editor	Jerry Hayes	4
Spring Honey Report		6
Coming Up		7
Book Reviews		9
What Your Mentor Forgot To Tell You	Ed Simon	45
Splits And Finding The Queen	David E. MacFawn	59

Page 6

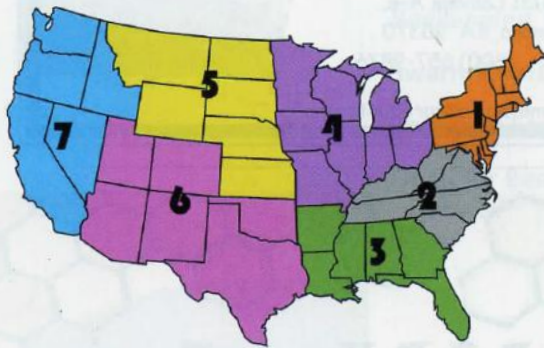

Page 45



Page 9

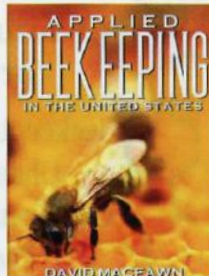

Page 59

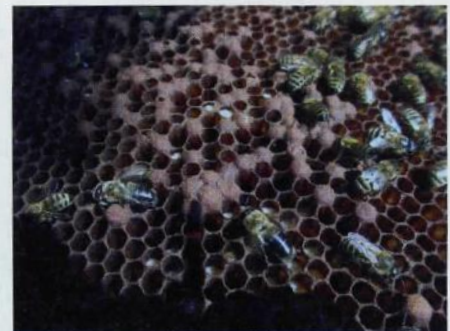

800.289.7668

Executive Publisher – John Root

Associate Publisher, Senior Editor – Jerry Hayes, Jerry@BeeCulture.com, Ext. 3214

Assistant Editor, Design – Kathy Summers, Kathy@BeeCulture.com, Ext. 3215

Social Media & Event Specialist – Amanda DeSimone, Amanda@BeeCulture.com, Ext. 3255

Advertising – Jean Newcombe, JNewcombe@BeeCulture.com, Ext. 3216

Design/Layout – Brenda Tharp Bray

POSTMASTER: Send address changes to BEEKEEPING, The A.I. Root Co., 623 W. Liberty St., Medina, OH 44256

Subscription Information

U.S., one year, \$20. Newsstand price: \$6.99. All other countries, (U.S. Currency only), \$20.00 per year. Send remittance by money order, bank draft, express money order, or check or credit card. BEEKeeping (ISSN 2475-4854), Spring 2021, Volume 6, Issue 1, is published quarterly by The A.I. Root Co., 623 W. Liberty Street, Medina, OH 44256. Periodicals Postage Paid at Medina, OH and additional mailing offices.

Subscriptions, Book Orders – 800.289.7668, Ext. 3220 • www.Beekeeping3.com

Advertising – 800.289.7668, Ext. 3216; JNewcombe@BeeCulture.com

Published by The A.I. Root Co. Copyright© 2021. All rights reserved.

BEEKeeping ^{Spring '21}[®]

Your First Three Years

Inside

A Lot To Do In Spring	Zac Lamas	12
Integrated Pest Management	Charlie Vanden Heuvel	17
Is Honey A Super Food?	Scot Hotaling	22
An Early Swarm	Stephen Bishop	23
Building Five Frame Nucs	Jim Berndt	25
The Clovers	Leah Smith	34
Can You Make Varroa Sick?	Bill Ruzicka	40
Beekeeping. Keep It Simple	Suzanne D. Cohen	49
Swarm Capture Net - Make Your Own	Bill Patton	54
Shopping For Bee Equipment	Jim Thompson	56
Open Air Beauty	Jackie Currie	62

Page 12



Page 22



Page 49



Page 62

Page 34



Page 54



FROM THE EDITOR



I want to take a moment to be sure you understand how important you are. There is no other industry that provides so much to the general public and the environment as the managed Beekeeping Industry. There are not too many positive societal or cultural relationships with an insect. Silkworm Moths, Crickets and some Wasp pupae to eat maybe. We are all 'entomophobes,' having a fear or disgust of most insects. Nobody wants roaches in their kitchen. We beekeepers are very unique and appreciate and are impressed with this insect, the honey bee. An insect that may hurt you as well. Commercial beekeeping is one of the last hard dirty jobs around. A job that produces fruits, nuts and vegetables to feed the world. A job that produces seeds to grow foods that feed the world. And food itself in the form of honey. Add in beeswax, propolis and venom for medical use and you would think beekeepers would get more pats on the back. You deserve more recognition.

Before *Varroa*, it was easier to be a Beekeeper in comparison to 2021. Back in the day we had AFB that antibiotics would control easily, maybe some EFB that would go away on its own many times and Nosema as a temporary issue for northern beekeepers. Severe pesticide exposure issues at times. Location availability on other's property for decent forage was always a challenge.

Our world changed with *Varroa*. We had no idea all the honey bee health issues that would appear under the *Varroa* umbrella. There were lots of research funds given to explore *Varroa* control. The public has been engaged in honey bee health and the loss of this insect in the environment. But we are still talking about the same things as we were at the beginning of *Varroa* introduction in the US in 1987. Commercial beekeeping has not yet benefited from the digital takeover of society that we all have been a part of. Yes we have mobile phones and computers but we have not seen or experienced the technology transition that Production Ag. has seen: Huge equipment, GPS capability, GMOs, Targeted pesticides/herbicides/ fungicides, fertilizers, drip irrigation, and now remote sensing using drones. As an example read, "How Artificial Intelligence will Drive the Future of Agriculture", https://www.growingproduce.com/farm-management/how-artificial-intelligence-will-drive-the-future-of-agriculture/?e=jerry@beeculture.com&utm_source=omail&utm_medium=newsletter&utm_campaign=afgenews09022020

That is primarily because we have always been seen as an overhead to growers or an interloper looking for a free place to put colonies. Beekeepers with the help of honey bee biology regardless of pest, parasites and diseases always show up at the right time and get out of the way when told. But its getting harder and harder and we need the input of 21st Century technology coupled with better and more honey bee medical help.

Remote sensing: The buzz words. Several years ago I was involved in field research that used remote sensing for hive weight, temperature and humidity. It would

identify, record and transmit what happened with hive weight and temperature but not why it was happening or when it was going to happen. It was not predictive. We still

had to open the boxes and look and see. Beekeeping is a visual sport and you have to learn how to compare and contrast what you see. And those features of hive weight, temp. and humidity are not what we need to know primarily to maintain or restore colony health. Cost of similar technology now is very high when you think we have no consistency in honey bee genetics that if you test one hive it might be predictive of the others. It isn't 5,000 acres of one GMO corn hybrid. Or 1000 head of Black Angus cattle who all have the same Sire from artificial insemination. Others are looking at sound technology and camera technology that goes on hive entrances or inside the hive to see and use a laser to zap mites. It is a cobbled together product market currently. It will get better I am sure, but not soon. We have a ready market but a tough practical focus and user acquisition cost issues plus the learning curve – is there internet in the remote yard?

Varroa control: USDA, University researchers and IR-4 are very involved in trying to identify chemical Varroacides that are more efficacious so that multiple treatments are reduced and collateral damage to the colony is minor. Killing a Little bug on a Big bug is tough, as you know, without hurting the Big Bug. Chronic collateral damage needs to be reduced. Acids such as Oxalic and Formic have taken center stage recently. They are low cost and delivery can be more efficient than other products. Control outcomes are variable because of these caustic acids sensitivity to temperature and humidity. Data show that multiple treatments damage honey bees especially the Queen who gets hit every time. The honey bees 'nose' is at the tip of its antenna. This can be damaged with multiple caustic acid treatments. One way Honey Bees communicate is with odors – pheromones. Damage their 'nose' and communication is disrupted and hive organization is compromised. Premature Queen supercedure is one result.

Breeding honey bees to become more resistant of *Varroa* is tough when you cannot control the other 50% of the genetics contributed from the 15-20 drones mating with the virgin queen in the DCA. Remote locations and artificial insemination are possible with a cost issue involved for bulk queen purchases.

What old, new and existing products we have currently available need to be part of an IPM strategy with Rotation, Rotation, Rotation as the mantra.

Nosema: Fumagillin is back but data show that for *Nosema ceranae*, which is dominating now, there is little or no control. Lots of essential oil, algae, probiotic products are available but little data other than anecdotal to confirm or deny efficacy. Buyer beware.

Bees on the Move



Acres of pollinated crops per square mile by state
 33 8 to 11 1 to 5 Less than 1
 One square mile equals 640 acres.
 Typical commercial honeybee trucking routes
 States with bee colony loss over 50 percent

AFB/EFB/PMS: Antibiotics are under the control of the VFD (Veterinary Feed Directive) now. See; <https://www.fda.gov/animal-veterinary/development-approval-process/fact-sheet-veterinary-feed-directive-final-rule-and-next-steps>. The reason for the VFD is resistance control as so many antibiotics were used prophylactically in the past when no infection was apparent hastening resistance.

Natural/Biopesticide/Biorational: The definition of these is: "A pesticide or herbicide having relatively or no toxicity to non- targets and causing relatively little or no damage to the environment." These can be Botanicals, Microbial pesticides, minerals. Examples of these would be for us, Bt, Caustic Acids, Thymol, other Essential Oils, Nematodes, Pheromones, fungus, bacteria and bacteriophages. On the horizon we will most likely see more of these individually or part of a systems approach where these are included in a mix of active ingredients. The day of a long term silver bullet for honey bee health issues may be past.

One of the more interesting is the use of Bacteriophages. These are viruses that are everywhere that attack and feed on specific individual bacteria strains. They are specific and do the same thing antibiotics would do - they disrupt bacterial cell walls. Not the cells of our bodies, or animals or plants or Honey Bees. There was a startup company in the U.S. that identified a Bacteriophage that used AFB exclusively as its prey, if you will. They were trying to bring this to market but ran out of resources to get it through FDA. There was an article recently that highlighted work in New Zealand on the same bacteriophage and the success they were having within a research project. This use of 'phages therapy' has already expanded to address plants and humans, <https://www.ncbi.nlm.nih.gov/pmc/articles/PMC5977211/#:~:text=Phages%20developed%20for%20the%20control,and%20on%20non%2Dtarget%20microorganisms>

Veterinarian Educational Outreach: There is a Honey Bee Veterinary Consortium, <https://www.hbvc.org/>, that is working with Veterinarians who already have honey bee interest and for training the next generation of Veterinarians. KSA (Knowledge, Skills and Ability) for individual Vets is in short supply but we need them long term if they can increase their Honey Bee IQ and simultaneously lower their costs.

Indoor Wintering: For many years some commercial beekeepers had access to unused potato cellars to over Winter honey bee colonies to moderate outdoor Winter weather effects. This concept has advanced and there are specially constructed above ground warehouses with a suite of indoor environmental controls in which to overwinter honey bee colonies. With the lack of consistent honey bee *Varroa* controls and the immune burden of viruses this seems to be a better method of reducing these temperature extreme stressors over some northern Winter conditions.

Indoor *Varroa* Control: The above indoor climate controlled warehouses are being tested and used to place colonies in during warmer months, stopping or slowing brood production, causing *Varroa* to become phoretic (exposed) and then applying treatments for better control. Ongoing research.

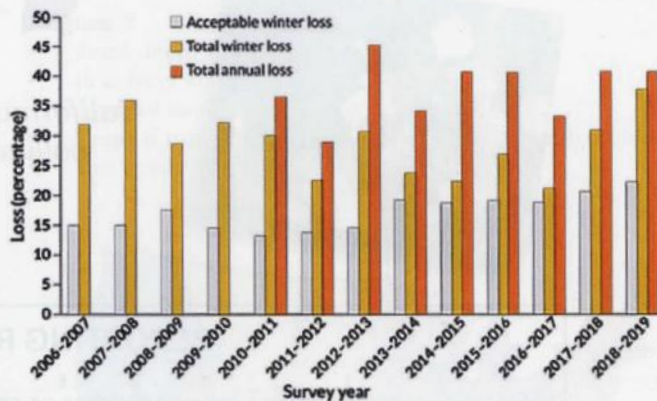

Grower Appreciation of Beekeepers: As mentioned, Beekeepers and the colonies they manage are considered a production input overhead no different than fertilizers, or pest control or irrigation. Beekeepers and their managed honey bees show up, they are used to create a crop and then they go away until next year when this cycle repeats itself, putting all the burden on the beekeeper to produce a significant income crop for someone else. There are some organizations such as the HBHC (Honey Bee Health Coalition) that have partnered with others to improve and understand the important and unique characteristics of commercial beekeeping

Opportunities for significant business power if managed by organized beekeepers.

Jerry

SPRING REGIONAL HONEY REPORT

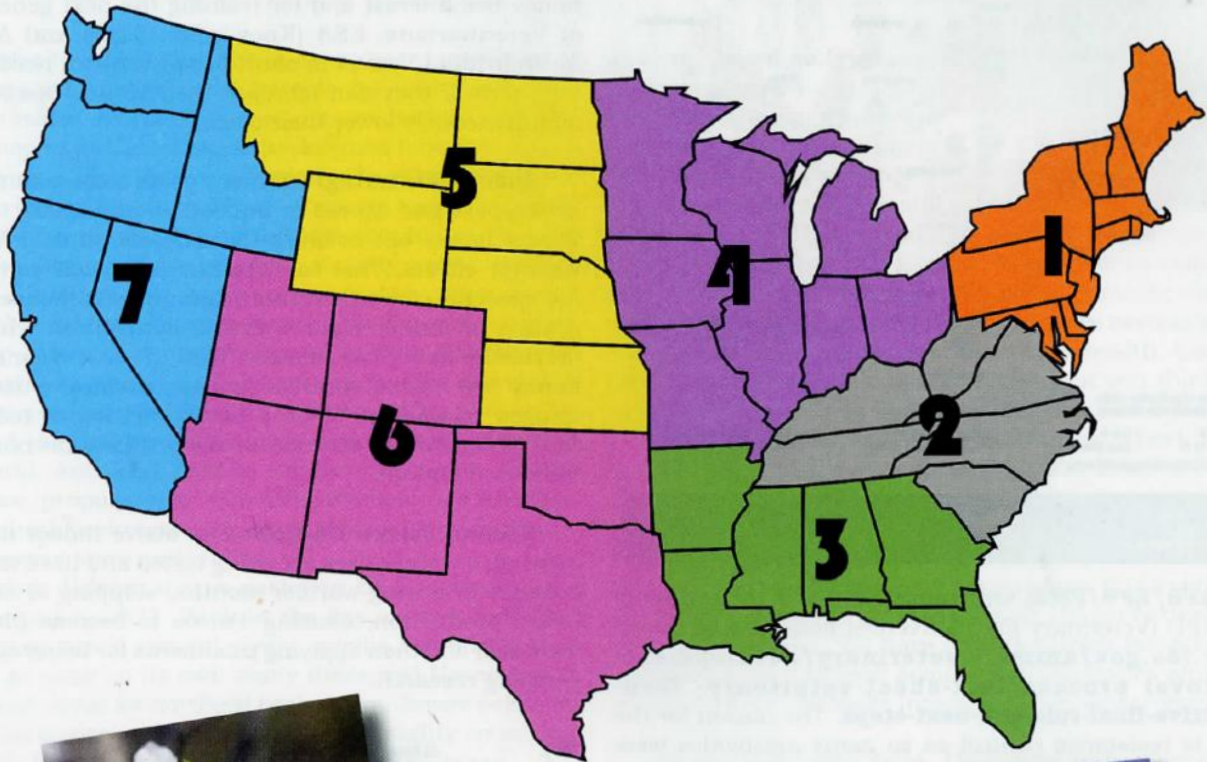

California almond
pollination.

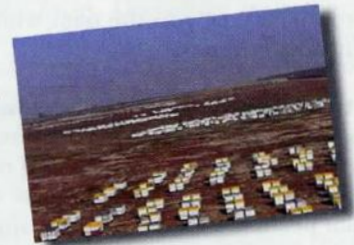

REPORTING REGIONS								SUMMARY			History	
	1	2	3	4	5	6	7	Range	Avg.	\$/lb	Last Month	Last Year
EXTRACTED HONEY PRICES SOLD BULK TO PACKERS OR PROCESSORS												
55 Gal. Drum, Light	1.96	2.17	2.15	1.96	1.75	1.90	2.00	1.70-2.17	1.98	1.98	2.21	2.24
55 Gal. Drum, Ambr	1.67	2.14	2.00	1.67	1.67	1.44	1.85	1.00-2.14	1.77	1.77	2.12	2.09
60# Light (retail)	176.86	188.00	190.00	165.00	175.00	168.50	202.50	138.00-205.00	182.22	3.04	207.21	211.90
60# Amber (retail)	188.28	186.00	190.00	188.28	188.28	170.33	212.47	132.00-240.00	190.55	3.18	209.81	209.94
WHOLESALE PRICES SOLD TO STORES OR DISTRIBUTORS IN CASE LOTS												
1/2# 24/case	101.20	74.50	99.75	88.00	75.50	89.75	88.50	72.00-140.55	106.15	9.42	92.31	96.89
1# 24/case	116.34	109.40	100.00	130.00	152.50	106.95	120.00	45.00-185.00	117.68	4.90	140.38	139.60
2# 12/case	111.57	98.00	94.00	123.00	111.57	114.00	132.00	94.00-132.00	110.14	4.59	125.67	125.19
12.oz. Plas. 24/cs	74.08	109.75	80.00	101.00	120.00	53.40	69.67	54.00-120.00	83.66	4.65	103.44	100.86
5# 6/case	109.15	110.50	129.00	110.85	112.51	140.25	174.21	99.00-240.00	105.45	4.55	147.90	131.36
Quarts 12/case	158.01	143.88	125.00	95.00	187.50	157.20	183.00	95.00-231.00	153.01	4.25	162.94	146.56
Pints 12/case	93.28	80.70	65.00	93.28	105.00	108.00	96.00	60.00-138.00	87.55	4.86	99.86	103.72
RETAIL SHELF PRICES												
1/2#	5.50	5.30	4.25	5.00	7.85	5.47	5.60	3.00-8.00	5.44	10.88	5.51	5.27
12 oz. Plastic	6.77	6.87	6.19	6.00	5.50	5.44	6.93	4.50-10.00	6.29	8.38	6.62	6.17
1# Glass/Plastic	8.67	8.40	9.17	8.00	10.00	7.72	8.50	5.89-12.00	8.39	8.39	8.48	8.08
2# Glass/Plastic	14.36	14.50	17.33	14.00	14.36	12.63	14.80	6.89-21.50	14.53	7.27	14.59	13.36
Pint	10.42	9.83	9.00	11.00	12.25	9.60	12.30	6.00-15.00	10.34	6.89	11.29	10.03
Quart	18.19	17.75	16.75	18.00	21.00	15.98	18.58	12.00-25.00	17.88	5.96	18.56	16.72
5# Glass/Plastic	31.97	27.00	42.50	29.00	31.97	27.63	31.97	17.89-50.00	29.99	6.00	31.85	29.27
1# Cream	10.73	8.75	14.00	10.00	10.73	10.73	12.00	8.00-14.00	10.46	10.46	10.92	9.90
1# Cut Comb	14.00	10.25	13.98	20.00	10.00	15.50	17.00	8.00-25.00	13.49	13.49	13.99	11.72
Ross Round	12.25	6.99	12.25	19.00	10.00	12.25	12.50	6.99-19.00	11.50	15.33	11.73	11.33
Wholesale Wax (Lt)	8.07	5.29	7.00	8.07	6.00	4.00	8.33	4.00-15.00	6.65	-	6.91	7.11
Wholesale Wax (Dk)	8.21	5.00	6.00	8.21	6.00	2.75	18.00	2.00-18.00	6.43	-	5.06	6.21
Pollination Fee/Col.	92.05	60.00	52.50	65.00	200.00	92.05	50.00	30.00-200.00	69.09	-	93.57	95.43



Coming Up **Work To Do**

For some of you Spring has Sprung and for others we are still in the depths of – explicative deleted- Winter. What are the first things you absolutely must do and will do when temperatures get above 57°F?

Region One

- Check food supply
- Clean entrance of dead bees
- Watch if bees are flying
- Alcohol wash for mites, treat if above threshold of three per 100 bees
- Hope for consistent low temps

Region Two

- Is the queen still alive?
- Is there any brood?
- Feed sugar syrup
- Put on pollen sub.
- Start replacing queens
- Continue to monitor food resources
- Ensure moisture condensation doesn't create problems
- Hive inspection and assessment.
- Check candy boards
- Build nucs
- Sample and treat for *Varroa*

Region Three

- Check food stores, feed if needed
- Are they queen-rite?
- Feed liquid syrup to stimulate queen laying
- Make splits
- Equalize colonies

Region Four

- Feed if needed
- Manage better in 2021
- Check for *Varroa*, and diseases
- Order nucs or packages
- Check food quantity and positioning
- Reverse boxes if brood in top box

Region Five

- Check mite levels with alcohol wash
- Treat for mites
- Feed syrup
- Put on pollen sub. patties
- Make splits
- Check mite levels, treat if needed
- Clean out dead bees on bottom board
- Check to see if any mice are living in hive

Region Six

- Check for colony activity, or not, at entrance
- Feed syrup and patties
- Remove dead-outs
- Feed and feed some more
- Sample and treat for mites

Region 7

- Feed, feed, feed
- Is colony still alive?
- Alcohol wash mite count
- Treat if mite count is above three per hundred bees
- Get ready to split

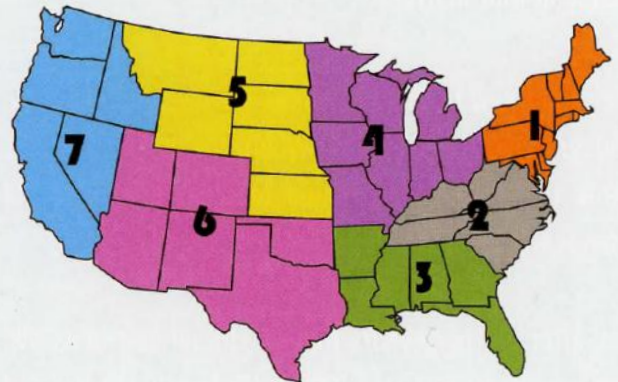

Honey Reporters Wanted

We are expanding our Honey Reporter population and need new reporters in EVERY region. We ask that you fill in most of the wholesale or retail or both sections, most months, and our short survey on the back. We give you a FREE subscription for your service. So if you are interested send an email to Amanda@BeeCulture.com and put REPORTER in the subject line. Include name, email, phone number and mailing address and we'll get you the next Honey Report form. Sign up today and be a part of the BEST Monthly Honey Price and Beekeeping Management Report in the industry.

Never Stop Reading



Applied Beekeeping In The United States, by David MacFawn. Published by and available from Outskirts Press Inc., www.outskirtspress.com/appliedbeekeepingintheus. ISBN 9781977232564. Electronic versions available. 342 pages, 8.5" x 11", color throughout, hard cover. \$55.95.

You probably recognize the author of this work as he is a regular contributor to *Bee Culture*, *Beekeeping Your First Three Years*, and the *American Bee Journal* magazines. The contents of this book are taken from contributions to those journals, plus contributions to his local beekeeping newsletter. There is also a good deal of information not previously published and is new to the reader. He is active in the Master Beekeeping world, having reached that title in several organizations. He has been active with bees for over 50 years, primarily in the southeastern U.S.

The topics covered, and the information provided in this book are pretty straight forward, but the detail surrounding most of these is pretty intense. On the 342 pages there are 246 photos, showing and explaining the topics of the 49 chapters. Some chapters are actually only photos and the captions that go with them. This book is rich in making sure the reader understands every step of each procedure or technique that is explained. More, I can easily say, than any book on bees and beekeeping I've reviewed on these pages in over 34 years.

Though many of the chapters have been published previously, almost always the magazines they appeared in did not have the room to publish all of the photos sent with the article, and certainly not the room to use several full page photos. I quit counting after only a short time the number of full page photos in this book. As an example, the chapter on installing a package is 15 pages long, and 14 of them are only a huge photo and the caption. I'm impressed with the publisher who designed this book.

This book isn't just for beginners though. I goes all the way from smoker fuel, to moving hives, to in-

stalling packages to Summer management to overwintering nucs to laying workers to making candles collecting pollen, to sales and marketing and beekeeping finance. Even if you'll never consider beekeeping as a business, the chapter on finance is worth the time because you can easily get lost in how much money this hobby can cost. There's something here for every level beekeeper. And, if you're just starting out, you'll have advice for every step of your journey.

Though the author has spent most of his beekeeping time in the SE part of the U.S., the information in this book pretty much covers the whole U.S. If there is any area not fully covered, it would be the desert SW part of the country, but most of this can be applied even there.

Kim Flottum

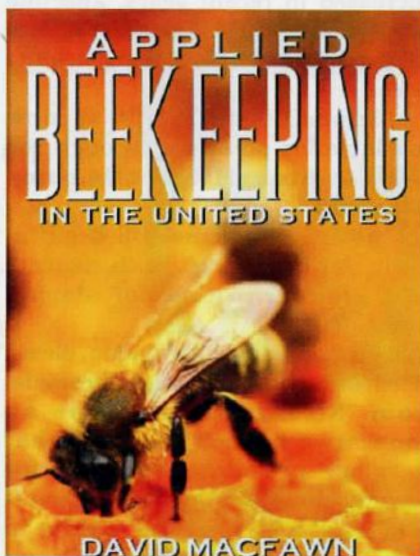

Kaia and the Bees. Written by Maribeth Boelts and illustrated by Angela Dominguez. Published by Candlewick Press. ISBN 978-1-5362-0105-5. 10" x 9", 33 pages, hardcover with dust jacket, color throughout. \$22.99, available wherever books are sold.

This is a book for children who haven't yet been introduced to bees and beekeeping, or may have had an unpleasant experience with a bee in the past that caused them to be afraid of bees, or at least to view them unfavorably. The author is a beekeeper, and in the book *Kaia's* father is a beekeeper and they live in the city with several hives on the roof of their home. But *Kaia* isn't part of that activity, by choice, because she was stung long ago and is afraid of being stung again. However, in all other things *Kaia* is BRAVE, and claims to not be afraid of bees to her friends, until one day at school she is frightened by a bee and her friends then tease her about being afraid.

To change that, *Kaia* goes to the roof with her dad, enjoys the wonder of bees, but gets stung, again, and that's it for bees and beekeeping for the rest of the Summer. Brave girl or not.

But then it's time to harvest, and the wonders of honey once again convince *Kaia* to try bees and beekeeping. You can relate to the issues with harvesting... "there's honey on the floor, on the table, on my elbow, on the door knobs." This will convince you of the author's experience with bees and honey.

What happens then is what makes this such a good story for almost anybody, but especially children with issues with bees. "I'll go to the roof again, because bees are amazing and scary and mysterious. And we need them, and now something inside me is....BRAVE!"

Kim Flottum

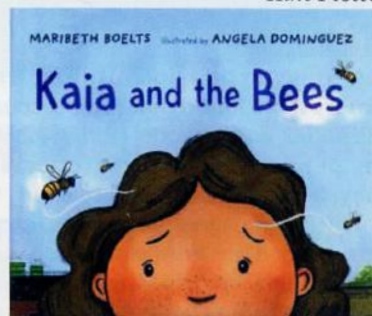

NEW

STRONG MICROBIALS LAUNCHES NEW PROBIOTIC TO PROTECT HONEY BEES FROM PESTICIDES

New Scientific Research Shows That *Pediococcus* (P801) Improves The Survival of Honey bees Exposed to Pesticides

Strong Microbials, the original creators of the first probiotic for honey bees, have improved the already successful, **SuperDFM®-Honeybee™** est. in 2014; based on exciting scientific research that shows *Pediococcus acidilactici* (P801) helps rescue honey bees who have suffered pesticide exposure. That's why Strong Microbials researched and developed SuperDFM®+P801™ for commercial pollination.

According to a USDA survey¹, 98% of honey bee comb and foundation in North America were contaminated with an average of six different pesticides. Exposure to sublethal concentrations of pesticides can significantly shorten honey bee lifespan, weaken immunity, decrease colony population, and cause precocious foraging.

There is an accumulation of evidence supporting probiotic bacteria's benefits, specifically, lactic acid bacteria's ability to strengthen and stimulate the immune system while aiding optimal nutrient absorption. The bacterial composition of **SuperDFM®+P801™** is a massive breakthrough in combating the "4Ps" that are harming honey bees: parasites, pesticides, poor nutrition, and pathogens.

A new study² published in February 2020 found that *Pediococcus acidilactici* can rescue honey bees from pesticides' adverse effects. Honey bees exposed to boscalid + thiamethoxam, a few of the pesticides formulated into products such as Cruiser® and Pristine®, resulted in a 41% mortality rate. In comparison,

honey bees exposed to these pesticides and treated with *Pediococcus* only saw a 15% mortality rate.

"We've been testing this strain of *Pediococcus acidilactici* since 2017. This publication was important because it emphasized the connections between pesticides and pathogens," said Slava Strogolov, the CEO of Strong Microbials.

In March 2020, the University of Florida conducted a field trial with Strong Microbials' SuperDFM®+P801™. This study followed sixty hives for two months. In the end, it showed that hives treated with SuperDFM®+P801™ showed a significant improvement in hive weight and a tendency towards better survivorship. Twice as many colonies in the control group died compared to the hives supplemented with SuperDFM®+P801™.

EAS Master Beekeeper Carol Hoffman said that "The fungicide use in the California Central Valley increased in recent years, affecting bee health. Beekeepers need to find new approaches to keeping healthy bees."

SuperDFM®+P801™ is now available for pre-order through the website StongMicrobials.com/superdfm-

p801. Shipments will begin in early January 2021, with delivery to California in time for almond pollination.

For additional information, please reach out to info@strongmicrobials.com. Strong Microbials is an innovative biotech company that develops premium probiotics for agriculture known as DFMs (Directed Microbes) and soil and crop inoculants. Strong Microbials knows that microbes are crucial to re-establishing the harmonious balance eroded by pesticides, fungicides, herbicides, antibiotics, and other modern farming practices. Visit StrongMicrobials.com to learn more about microbes and how to test DFM quality.

1. <https://journals.plos.org/plosone/article/file?id=10.1371/journal.pone.0009754&type=printable>
2. <https://www.sciencedirect.com/science/article/abs/pii/S0048357519304894?via%3Dihub>

Project Apis m. Your "go-to" non-profit honey bee research organization, with programs in the USA & Canada

PAm is dedicated to enhancing the health of honey bees while improving crop and honey production.



PAm has infused over \$6 million to support honey bee health since 2006:

- * Funded BIP Tech Transfer Teams
- * Produced BMPs
- * Scholarships for PhD students
- * Expanding forage resources
- * Invested in new technologies
- * Discovered new pathogens
- * Supporting long term stock improvement, bee germplasm preservation, new Varroa controls

You can help support PAm
www.ProjectApis.org

Project Apis m.



A LOT TO DO IN SPRING

Zac Lamas

You can do a lot of beekeeping management when the weather is cold in the early Spring. Commercial beekeepers have to. We have too much work, and too little time to wait and only work bees on fair weather days. But isn't this exactly what we have been told not to do? Bee books or beginner beekeeping classes are full of warnings about opening hives below certain temperatures and the risks of chilled brood.

Well, there is a lot we can do in cold weather, that doesn't involve pulling out frames. In fact, by being a little creative, we can do a lot of management from early Spring onward without pulling a single frame.

Pollen Sub

I worked at French Hill Apiaries in Saint Albans, Vermont for several years. There we applied pollen sub in the early Spring (late March). Colonies were given pollen sub just once. We placed the pollen sub directly onto the Winter cluster. At this time of the year, the Winter cluster had migrated up to the top box where the last honey stores remained. We did observations while adding the pollen sub.

First, we visually inspected if the Winter cluster was in contact with honey stores. This was easy. All one has to do is peer past the top bars, on the outside frames and look for capped cells. If we did not see any, then we would check with our hive tool.

Just take your hive tool and prod it into the cells at the top of several frames. Doing this will puncture some cells. If honey is present, the hive tool should be slightly goeey. If the hive tool comes out dry, we will be concerned. We then do a heft test by tipping the colony to see if there is any weight to the colony. If not, we will give an emergency feeding of fondant.

Colonies risk starving to death in the early Spring. They are rearing brood and quickly consume their Winter honey reserves. We can prevent starved colonies by doing this simple observation, and then prodding while adding pollen sub.

While adding pollen sub the Winter cluster is exposed. We take this opportunity to quickly grade the colony: Strong, medium, weak. This is not a perfect system. We are looking at how many frames are covered by bees, and the density of the cluster. The grading is simply relative to other colonies in the apiary. We write the total number of strong, medium and weak colonies down in the yard book before leaving the apiary. Each colony is marked in some way to indicate its strength. In my operation I write S, M or W on the back of the hive. Michael keeps bricks on top of his covers. A brick in the front is strong, middle is medium, in the back is weak. This is a simple, visual method to identify the relative strength of colonies.

It may not sound like much, but this is a simple way to organize our beekeeping for the remainder of the Spring. Soon all the colonies will have pollen sub added to them. The few colonies that were at risk of starvation

will have been fed, and we will also have a tally of the condition of all the colonies in the business. Now we know how many strong and medium colonies we have, and how many weak colonies eventually need fixing.

Supering

The next time we return to the apiaries it will be to add honey supers. In some areas the Maple flows can be intense. We super at maples by adding two medium supers to each colonies. This has worked well in NY and Vermont, and also worked well for me in coastal North Carolina where the early maple flow can be intense. Strong and medium colonies will store maple nectar upwards in these supers. Keeping this nectar out of the brood chamber is good early swarm control. The queens are not restricted at all, and will expand their brood chamber as they see fit.



Early February in Whiteville, NC. The outside temperature is a raw 41 degrees. The bees are not flying, yet hive inspections can be done. Here I crack the colony and inspect the brood chamber. I am peering in between frames. By doing so I can see some capped worker brood. Drone larva are exposed on the top bars. We know the colony is queenright, brooding up, and can guesstimate the overall strength of the colony by the cluster size. Part of the brood chamber is in the upper (unpainted) box, and the other part is in the white box. It is early in the season and this colony is just mediocre. I would not anticipate the bottommost (unpainted) box to have brood in it.

Reversing

As soon as we finish supering, we begin reversing. (I follow the same routine whether in NC or with Michael in Vermont. Super, and then reverse two weeks later). We don't have to remove frames to reverse. We are rotating



The drone brood here was exposed when the boxes were cracked apart. Believe it or not, this can be a very useful tool when judging a colony. This colony has both worker and drone brood, and is calm. It is queenright and brooding up early in the season. This is normal, and we expect to see it in all colonies in the apiary. When we open a colony that is not rearing drones, then we will use that as an indicator to check for other issues. Is the colony hungry? Did it Winter as a small cluster? With repetition we learn how to judge colonies without pulling frames.

the top brood box, where most of the resources are in the colony, and placing that box on the bottom board, and then placing the box that was originally on the bottom board, which has the fewest resources and should be the lightest, on the top of the brood chamber. The honey supers are then returned to the colony. An additional honey super is placed on the colony if needed.

Now remember how we marked colonies strong, medium and weak early in the season when we added pollen sub? And remember how that grading system was relative to colonies in the apiary? Well, now it's a few weeks after pollen sub has been added. There have been a couple nectar flows. Some colonies are storing



Here I am holding a box like in photo one, while snapping a quick photo. By peering through the frames we can see both worker and drone brood. We feel the weight of the box, telling us how many food stores are left. There are no indications of disease. Great! Why pull any frames, and risk rolling a queen? At this early time of the year, I got all the info I need.

honey at this point. Some need more space. Some aren't doing much at all. We would expect the strong to still be strong, the mediums still mediums and the weak colonies to be puttering around. This is usually what happens. Sometimes a colony will surprise us, and that is ok. As beekeepers the simple grading system records the strength of each colony over time. By doing this we are able to make good decisions in the present.

If a colony was weak in March when we added pollen sub, and then still weak when supers were added, and still small at reversal, do I really expect it to be bustling and strong by the main flow? No! It is weak. There is some issue with it. The colony told us it was weak during each of our three inspections. We will mark the colony to be requeened, and we won't second guess our decision to requeen later in the season.



Top view of a colony when adding pollen sub. Here I see the cluster on a moderate day is covering 9 frames. I peer as best I can through the frames and judge the density/cluster of the bees. I then label the colony as strong, medium or weak. When I arrive at my next visit, I will make a similar assessment. These assessments made over time tell us the true condition of a colony. When a colony consistently underperforms in the early Spring visits, then we label it as a requeen.

At reversal we are really going to check a frame or two from these weak colonies. We want to first make sure there is no brood disease. Then we will inspect quickly for indications the queen is failing. Maybe she is laying inconsistently or starting to lay drones in her worker pattern.

Recap

Early in the season we are doing a lot of bee work, but we have removed very few frames for inspection. Instead we rely on simple observation cues to manage the operation. We compare the cluster size, activity at the entrances, weight of the supers, presence of drones, wax drawing, etc. relative to neighboring colonies. We expect to see a pattern in a colony's strength from visit to visit. Strong colonies usually remain strong, weak usually remain weak. When a colony repeatedly underperforms it neighbors, we mark it for requeening.

This methodology really works for us because we have experience and repetition working many colonies. It is unfair to expect a new beekeeper or someone who only works one or two hives a year to be able to do the same type of management. Inspecting frames is an integral part of learning. So go and take out a couple frames when the weather is good. But I would also implore you to make whole box assessments first. We begin these inspections as we approach a hive. The bottom board can speak volumes. We learn what a strong cluster looks like first from a whole box perspective, and then we pull a frame. It's a great way to judge a colony as a whole. 

Michael Palmer is an excellent beekeeper in northern Vermont. Much of this article is based off from management first learned working with Michael at French Hill Apiaries. The management can be adapted for other climates; like in central Maryland and coastal North Carolina where the author continues to keep bees.

Integrated Pest Management

Charlie Vanden Heuvel

Minimizing or reducing environmental risks to humans, plants and insects reduces costs while effectively mitigating the pest problem (Agriculture and Natural Resources). Essentially, insects are divided into two categories: 1) harmful, and 2) beneficial. Out of the nearly million known insects, somewhere between 1% and 3% are considered harmful. Types of insects that are considered 'beneficial' include:

- Preying – spiders devour insects for nourishment. Beetles, flies, true bugs, and lacewings also are predators to insects.
- Parasitizing – wasps lay their eggs inside insects.
- Birds and bats – feed on pest insects.

Integrated Pest Management (IPM) concept entails the softest method be used first progressing up the pyramid to the most aggressive (Agriculture and Natural Resources) (Hood).

- Biological – natural enemies such as predators, parasites, pathogens, and competitors are the first step.
- Cultural – practices intended to reduce pest's establishment, reproduction, dispersal, or survival. Reducing root disease or supporting weed production through a change in irrigation.
- Mechanical / Physical – use of traps, mulch for weed control, soil management through steam sterilization, or screens as barriers keeping birds out.
- Chemical – pesticides should only be used as needed and in combination with lesser management practices. Through the use of selective pesticides directed to specific pests rather than a broad-spectrum application.

In the past, agricultural practices focused on the eradication of pests, all pests, consider DDT. As the effects to the environment became known, alternatives were sought to effectively control the known pests but also to reduce costs. Use of chemical intervention does eliminate the pest, but has the added disadvantage of ridding all insects and unfortunately effecting biological processes.

Farmers shifted their management practices toward an Integrated Pest Management regime. The first step, Cultural, entails creating good sanitation in the surrounding area. Pests need specific habitat to thrive. As research shifted toward expanding knowledge in this arena, the view of 'beneficial' insects came to light (National Pest Information). Yellow Jackets are a great example. Humans despise these aggressive insects, yet they are terrific in ridding the area of insects in their thirst for protein nourishment.

Agricultural practices have taken a dramatic shift in recent years as identification of the pest culprit becomes the first step prior to chemical applications. For the home garden separating the beneficial from the unwanted becomes paramount. Trap one or more for your local Extension Service to identify.

A few pests in the garden may be tolerable while an overwhelming number need tending. Dousing the few eliminates food needed in support of 'beneficial' insects.

Allowing Yellow Jacket nests to thrive within the agricultural space yet away from any BBQ event goes a long way toward reducing pest infestations.

Cultural Controls include using *Varroa* Resistant Queen stock (Connor, 2015) or creating a brood break. Selecting stock demonstrating grooming behavior, hygienic, enhances the removal of mites from the bees within the colony. Two major categories of grooming behavior in honey bees are: 1) autogrooming or self-grooming and 2) inter-bee grooming (Pritchard).

Inter-bee grooming, called allogrooming, is evidenced by one-on-one nestmates cleaning other bees within the colony. Some workers evolve into allogrooming specialists for the majority of their lifespan.

Creating a break in the honey bee brood cycle as the *Varroa* reproduction is closely associated or interlinked with the honey bee reproduction. The *Varroa* destructor mite's Foundress, mother, is reliant on the honey bee brood cell capping where she enters just prior to the cap being creating in order to deter detection by worker bees. Interrupting the queen's egg laying thus prevents the mite from also reproducing.

Creating colony splits serves several purposes: 1) increase apiary number of hives, and 2) create a brood break. In terms of *Varroa* control, it is the brood break which prevents the Foundress (mother) mite to produce thus reducing the percent of infestation. Numerous methods exist in the splitting of honey beehives.

The natural hive behavior of swarming effectively splits the hive while creating a break in the brood

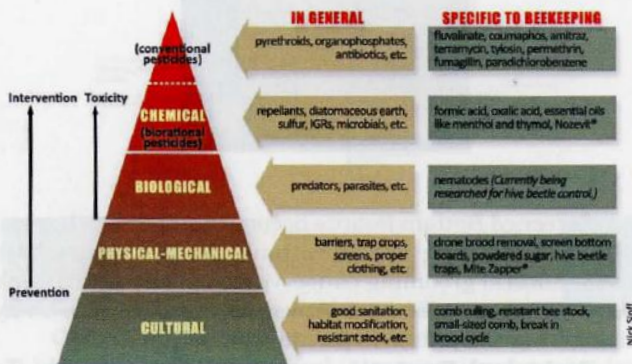

Pyramid of IPM Tactics

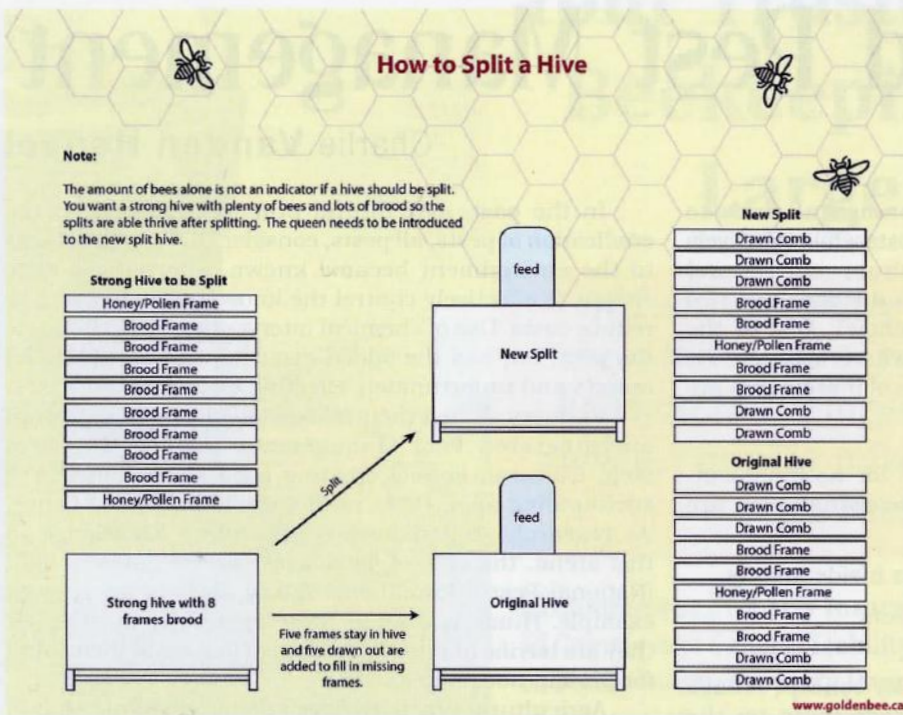

edge of the honey bee brood oval. In a typical Langstroth hive, the central frames within the box are used by the queen for egg laying. Selecting the outer edge or frame location for placement of the Drone Frame encourages Workers to build drone comb. As the Drone life cycle from egg to hatching is a bit longer than the Worker, by four days, it allows the *Varroa* brood to mature from egg to mated adult producing two daughters versus one in the Worker brood. Removing the Drone Frame once the Brood is capped, decapping all the cells, freezing the entire frame, and finally defrosting it to be used again reduces mite loads (Gross, 2018).

Sticky boards placed under a Screened Bottom Board in the hive captures mites that have fallen off honey bees (Calderone) (Chapman, 2020). In the absence of the sticky board, these wayward mites merely

production. Until the swarmed hive's queen has mated, the hive experiences a period of bloodlessness. Captured swarms should be assessed for mite infestation. It becomes an opportunity to chemically treat, for instance Oxalic Acid Dribble, the colony in the absence of brood where the *Varroa* reside under the brood capping, thus precluding most miticides from being effective.

wait for another passerby bee to jump on continuing in the mite's effort to survive. Through the use of the Sticky Board, the mites are unable to reengage bees, thus eliminating their food source and viability to survive.

Another method of eliminating Drone Brood is through the use of medium size frames within the deep Langstroth Hive. Bees have a tendency to construct Drone Cells on the medium frame in the space between the bottom of the frame and the box below. This free hanging comb can easily be chopped off.



*Sequestering the Queen, or setting her in a cage, preventing egg laying from occurring becomes another management practice frustrating the mother *Varroa* from producing new brood.*

Sequestering or caging the queen creates another brood break scenario simultaneously frustrating the *Varroa* Foundress. (Jack, van Santen, & Ellis, 2020). Sequestering the Queen, or setting her in a cage, preventing egg laying from occurring becomes another management practice frustrating the mother *Varroa* from producing new brood.

Mechanical Controls of reducing or eliminating *Varroa* destructor mites from honey beehives may entail several choices. Drone Brood removal through the use of Drone Frames. These frames are entirely plastic, stamped with the cell design size for the larger drone cell directing worker bees to create drone comb in which the queen lays drone eggs. The Drone Frame is placed at the



Screened Bottom Boards become another mechanical means of reducing *Varroa* within a colony. Honey bees in the natural grooming cause *Varroa* to fall off the bee's body. With the screen the *Varroa* falls out of harm's way disallowing the critter to reenter the hive.

Biological Controls are a focus on research. To date, no promising natural enemies of *Varroa* have been identified. The search includes predatory mites, parasitoids and entomopathogens (nematodes, protozoa, viruses, *Bacillus thuringiensis*, rickettsiae, and fungi (Chandler, Sunderland, Ball, & Davidson).



ESSENTIAL RESOURCES

Learn About Soybean Best Management Practices

The Coalition has established/developed best management practices to help protect honey bees and other pollinators in and around soybean fields.

ACCESS THE BEE MANAGEMENT PRACTICES GUIDE

See How We Are Fostering Collaboration

The Bee Integrated Demonstration Project brings together beekeepers and producers to share best practices in agricultural landscapes across honey bee health.

LEARN MORE ABOUT THIS COLLABORATIVE PROJECT

View Our Free Guide for Varroa Management

Practical effective methods that beekeepers can use to measure Varroa mite infestations in their hives and select appropriate control methods.

DOWNLOAD THE GUIDE



HOW YOU CAN HELP

Everyone has a role in protecting bee health - whether you are a beekeeper, farmer, pesticide applicator, home gardener, or someone just looking to learn more about bees. You can plant bee forage, follow pollinator-friendly pest management practices, control varroa mites in your hives, and spread the word about bee health.

LEARN MORE ABOUT HOW YOU CAN HELP

HOW WE HELP BEES

FORAGE AND NUTRITION

We are looking at ways to improve honey bee nutrition to provide diversity in honey bee forage.

LEARN MORE

HIVE MANAGEMENT

We are making investments to understand and improve varroa mite and virus susceptibility and developing best management practices (BMPs) for beekeepers.

LEARN MORE

CROP PEST MANAGEMENT

We are developing crop- and product-specific best management practices and messaging.

LEARN MORE

OUTREACH, EDUCATION AND COMMUNICATION

We are working across the public and private sector to coordinate on solutions that work.

LEARN MORE

COALITION UPDATES

Ag AM in Kansas Interview Spotlights Honey Bee Health Coalition

Two episodes of the Honey Bee Health Coalition, as interviewed by Ag.

Honey Bee Health Coalition Partners Beekeepers and Landowners Together to Enhance Pollinator Health

The Honey Bee Health Coalition is leading national efforts partnering beekeepers and

Honey Bee Health Coalition Urges Utilizing Best Practices, Collaborations, and Integrated Pest Management Strategies Following Release of Bee National Survey of Colony Losses

The Honey Bee Health Coalition is a diverse group of over 30 organizations.

Pollinator Week starts today

15 Pollinator Week, which means it's time to celebrate pollinators and spread the

SIGN UP FOR COALITION UPDATES

Learn about the latest Coalition efforts to improve honey bee health.

First Name:

Last Name:

Email Address:

Organization:

Chemical Controls are separated into two categories:

1) biorational pesticides and 2) conventional pesticides.

A helpful reference is located at the Honey Bee Health Coalition website where three opportunities are provided. 1) Tools for *Varroa* Management Guide – an excellent source of information about *Varroa*, monitoring techniques, and control methods. 2) *Varroa* Videos

demonstrating monitoring and treatment techniques. 3) *Varroa* Management Decision Tool – provides a quick means to identify the most appropriate treatment given the season, colony status and other particulars. These can be accessed at: <https://honeybeehealthcoalition.org/varroa/>.

Biorational pesticides relates to pesticides that relatively cause no harm to humans, animals, or has little effect to the environment. Examples of these miticides approved for use by the EPA are formic acid, oxalic acid, Api Life Var, and Apiguard.

Examples of conventional pesticides include amitraz, terramycin, tylosin, and fumagillin.

Whether the beekeeper falls within the commercial, sideline, or backyard arena; colony management should incorporate effective means while maintaining expenses at their lowest level. A proactive stance is wise, while the use of chemicals in the absence of pest or disease identification leads to increased costs as well as potential side effects to the colony being managed.

Be proactive through inspections! Brood assessment in determining diseases on a minimum of monthly basis along with a *Varroa* sampling become prudent.



References:

Chandler, D., Sunderland, K. D., Ball, B. V., & Davidson, G. (n.d.). Prospective Biological Control Agents of *Varroa destructor* n. sp., an Important Pest of the European Honeybee, *Apis mellifera*. Retrieved November 04, 2020, from <https://www.tandfonline.com/doi/abs/10.1080/09583150120067472>

Chapman, N. (2020, September 18). Screened bottom boards. Retrieved November 02, 2020, from <https://extensionaus.com.au/professionalbeekeepers/screened-bottom-boards/>

Connor, L. (2015, December 10). Integrated Pest Management of *Varroa* in North America. Retrieved November 02, 2020, from <https://americanbeejournal.com/integrated-pest-management-of-varroa-in-north-america/>

Gross, B. (2018). Drone Brood Removal: A bee-utiful form of *Varroa* control and source of edible insect protein (Tech.). Wooster, OH: Department of Environmental Studies Independent Study Thesis.

Integrated pest control for *Varroa* mites in honey bees. Various example of this observed. (n.d.). Retrieved November 04, 2020, from <https://beekeep.info/a-treatise-on-modern-honey-bee-management/managing-diseases-and-pests/varroa-short-history/integrated-pest-management-for-varroa/>

IPM Action Plan for Honey Bees. (2019, July 12). Retrieved November 02, 2020, from <https://schoolipm.tamu.edu/forms/pest-management-plans/ipm-action-plan-for-honey-bees/> (Texas A&M, 2019)

Jack, C., Van Santen, E., & Ellis, J. (2020, January 07). Evaluating the Efficacy of Oxalic Acid Vaporization and Brood Interruption in Controlling the Honey Bee Pest *Varroa destructor* (Acari: Varroidae). Retrieved November 04, 2020, from <https://academic.oup.com/jee/article/113/2/582/5697464>

National Pest Information. (n.d.). Beneficial Insects. Retrieved November 02, 2020, from <http://npic.orst.edu/envir/beneficial/index.html>

Pritchard, D. (n.d.). Grooming by honey bees as a component of *varroa* resistant behavior. Retrieved November 04, 2020, from <https://www.tandfonline.com/doi/abs/10.1080/00218839.2016.1196016>

What Is Integrated Pest Management (IPM)? (n.d.). Retrieved November 02, 2020, from <https://www2.ipm.ucanr.edu/What-is-IPM/>

What Integrated Pest Management Means For Today's Beekeeper. (n.d.). Retrieved November 02, 2020, from <https://www.clemson.edu/extension/beekeepers/fact-sheets-publications/pest-management-publication.html>

Is Honey A Superfood ?



Scott Hotaling

Our ancestors have a long history of eating honey. It has been a common staple of our diet for thousands of years not only because it tastes great but because of the many health benefits that it provides. But with recent health concerns regarding sugars, some are starting to believe honey isn't healthy for you anymore. So what exactly are the benefits of honey and why are they so important?

Here are several of them:

- Rich in antioxidants
- Natural prebiotic
- Natural antibacterial/antiseptic
- May lower cholesterol levels
- Effective at healing burns and wounds
- Rich in vitamins and minerals
- May help lower triglycerides
- Cough Suppressant

Raw honey contains healthy antioxidants that help protect us against free radicals. Some varieties can contain as much as certain fruits and vegetables, depending on the source.

Buckwheat honey for example, has been shown to significantly increase the antioxidant capacity in men compared with black tea and sugar.

Honey contains hydrogen peroxide, a natural antiseptic. This helps contribute to honey's strong antibacterial/antifungal properties. It's been found to help treat and heal wounds and burns because it's such an effective bacteria and germ killer.

However, its effectiveness as an antibacterial solution varies depending once again on the source of the honey. This is a reoccurring theme and something to think about when deciding where and how to buy your honey.

Phytonutrients found in honey contribute to its antioxidant properties as well as its antibacterial and antifungal effects. They're also thought to be the reason raw honey has been shown to boost your immune system and help prevent cancer.

It's also a potent prebiotic, nourishing the beneficial bacteria of your intestines which are crucial for properly digesting food. Studies

also show that honey may improve your cholesterol levels. One study showed that when compared to table sugar, honey reduced LDL levels by 5.8% and increased HDL levels by 3.3%. HDL is considered the good cholesterol. LDL is bad. By reducing LDL and increasing your HDL levels you can effectively improve your cholesterol level.

Studies have also shown that honey can lower triglyceride levels by up to 19% compared with sucrose.

Honey contains vitamins and minerals which obviously contribute to better overall health.

The vitamins and minerals present in honey are:

- Thiamin
- Niacin
- Phosphorous
- Calcium
- Riboflavin
- Pantothenic Acid
- Folic Acid
- Copper
- Iron
- Magnesium
- Zinc



Honey also has a healthy glycemic index, meaning that it's gradually absorbed into the bloodstream so as not to trigger the pancreas to unload insulin into the system to combat the "sugar rush" you may experience when eating processed sugar.

It's also low in calories compared to healthy fats such as avocado, olive and fish oils. These fats provide many health benefits but for weight loss we have to remember it's calories in vs. calories out. Fat provides 9 calories per 1g of fat vs. 4 calories per 1g of sugar. Both should be eaten to provide a well-balanced diet, but when taken in similar amounts, fats contribute much more heavily to weight gain than sugars.

A 2005 study on the effect of honey on cough and sleep quality for children and their parents concluded that honey may be a preferable treatment for the cough and sleep difficulty associated with childhood upper respiratory tract infection.

With all of these health benefits, there is one important question to ask. Where does the honey come from? Most of the honey available

in grocery and other stores undergo extensive processing. Chinese honey is a prime example of this. This "honey" isn't real honey. Chinese producers often process their honey through ultra-filtration, a process which removes all of the beneficial pollen from the honey. This also removes any way to tell where it came from originally. Due to the fact it contains no pollen, it's actually illegal to sell as real honey but oftentimes it's marketed as such in stores.

Other commercial honey is pasteurized with excessive heat and also mixed with filtered honey, stripping away honey's potential health benefits. Not only does filtration remove the pollen from honey, but it can also remove beneficial enzymes and antioxidants, again reducing the overall health benefits. Sugar and other sweeteners may also be added to reduce costs so the honey can be sold more inexpensively.

Chinese honey has also been found to contain rice syrup, high-fructose corn syrup and chloramphenicol, an antibiotic banned in the United States because it may cause gene damage and ultimately lead to cancer. It's also the leading cause of drug-induced aplastic anemia, an extremely serious and fatal disease.

Buy local, raw honey whenever possible. That way you'll get all of the potential health benefits and you'll never have to worry about what's really in your honey. If you choose to buy from a store, buy honey that's True Source Certified. True Source Honey is an American honey industry organization that protects consumers from illegal practices and supports transparent, legal and ethical sourcing of honey.



References:

- <https://pubmed.ncbi.nlm.nih.gov/12590505/>
- <https://pubmed.ncbi.nlm.nih.gov/15117561/>
- <https://pubmed.ncbi.nlm.nih.gov/19817641/>
- <https://pubmed.ncbi.nlm.nih.gov/18454257/>
- <https://pubmed.ncbi.nlm.nih.gov/18056558/>

An Early Swarm

Stephen Bishop



Sometimes life, like swarm season, comes at you fast. I caught my first swarm of the year on March 23rd. I got the swarm call right before a department head conference call concerning our county's response to the coronavirus. As the head of our local Soil and Water Conservation District, a county department of two, I'm required to attend these meetings. To be honest, it's not my favorite job responsibility, and I feel a little out of place with the county higher-ups who wear neckties and shiny shoes. Once having spent too long providing technical assistance (official government term for chatting) at a dairy farm, I made it to the county department head meeting just in the nick of time, right before the county manager gave some important update, the details of which I currently don't remember. Mostly, I remember the sight of the Register of Deeds and Library Director sniffing inquisitively, and the smell of cow manure wafting from my boot. But I digress.

On March 23rd, about 10 minutes before a county department head teleconference (in lieu of a physical meeting because of coronavirus), Lowry, my wife's poppap and my next-door neighbor, called me and said one of my hives had swarmed – "a biggun in the crotch of an apple tree." Admittedly, my swarm control provisions had been little to none this Spring. The bees had been on the back burner, as my wife and I are expecting a baby, our first after nine years of marriage. According to my wife, I now have other priorities than beekeeping, like insulating walls of our old farmhouse to make sure our offspring has comfortable environs outside the womb. At the rate I'm going, I figure our child will be thirty-four by the time I finish this task.

Before Lowry's call, I hadn't thought much about the possibility of catching a swarm this early. Seemingly, at that time, all my brain could focus on was the possibility of catching coronavirus. But after Lowry's excited dispatch, worries of catching coronavirus suddenly evaporated. The great philosopher Patrick McManus had his own theory for this phenomenon, a theory which he called the "worry-

box" and summed up as follows:

"I have this theory that people possess a certain capacity for worry, no more, no less. It's as though a person has a little psychic box that he feels compelled to keep filled with worries. When one worry disappears from the box, he immediately replaces it with another worry, so the box is always full. He is never short of worries. If a new crop of worries comes in, the person sorts through the box for lesser worries and kicks them out, until he has enough room for the new worries. The lesser worries just lie around on the floor, until there's room in the box for them again, and then they're put back in." (From *The Good Samaritan Strikes Again*)

Swarm catching had suddenly returned to prominence as the main worry in my worry box, displacing coronavirus for the time being.

Of course, everybody who keeps bees knows that swarm calls always come at the worst time possible. There's an old story that circulates about a beekeeper who got a swarm call an hour before his only daughter's wedding. After weighing his options, the father made the only rational decision a beekeeper in his situation could. Since he didn't have time to run home for his beekeeping stuff, he borrowed his daughter's wedding veil to catch the swarm.

Like that father, I solved my swarm dilemma with similar aplomb. I stuck in my earbuds, dialed into the teleconference on my cell phone, and hightailed it home to recapture my AWOL bees. I suppose many of us have recently learned the advantages of teleconferences—you can attend meetings in pajamas (or while swarm catching), plus the smell of manure doesn't waft through the phone.

I'm happy to report that I did catch that swarm, a "biggun" as Lowry would say, and that for a while, even though I was dialed into a coronavirus teleconference, my mind was on something completely unrelated to COVID-19.

And that, I'm learning as I get older, is the real value of beekeeping. When life, and worries, came fast – a baby on the way, a subsequent major house project, a deadly pandemic – a swarm of bees provided a much-needed diversion.



Stephen Bishop writes humor and keeps bees in Shelby, NC. You can see more of his work at misfitfarmer.com.

BUILDING

Five Frame Nucs

Jim Berndt

Spring and early Summer is the time for thinking about making splits and filling nuc boxes. I don't build much of my hive equipment because I have found that the cost of materials and labor involved in making good equipment makes manufactured equipment a pretty good deal for me. One exception for me is nuc boxes. I like to overwinter multi-story nucs and this can demand a lot of nuc boxes. Quality nuc boxes are relatively easy to make in quantity and use inexpensive materials. Four boxes can be made from a single sheet (4' x 8') of plywood.

There are lots of plans for plywood nuc boxes on the web, many of them resembling the design attributed to D. Coates. The plans I use are similar to a lot of other designs, the most significant differences are that the bottom of the box is designed to make stacking of nuc boxes easy so I can have multi-box nucs for overwintering. In addition, the lids of my boxes are designed to accept a Mason jar feeder. While these plans are for Langstroth 5-frame deep nuc boxes, they could be easily modified to build boxes for medium frame nucs as well.

These boxes can be assembled with nails, screws or staples. I use a pneumatic stapler which is fast and secure, nails would work just as well. If you use screws you will need to be a bit more careful as you will be screwing into plywood end-grain; pre-drilling of holes may be necessary. I glue the joints (except for the removable bottom) with waterproof glue to make the boxes a bit more durable.

Layout of Parts

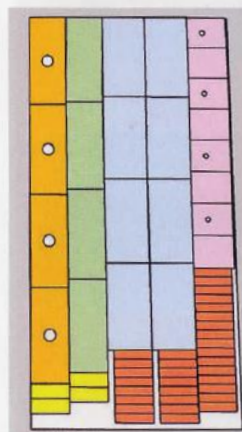

Figure 1

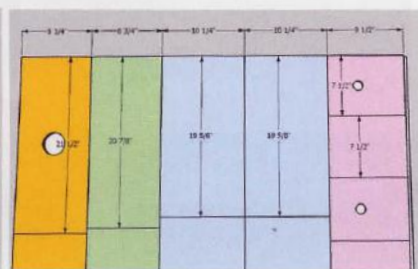

Figure 2

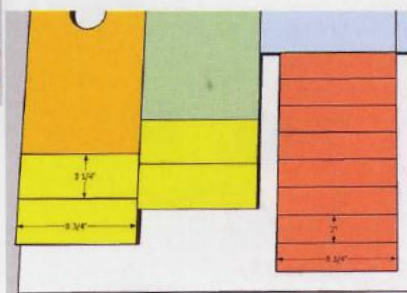

Figure 3

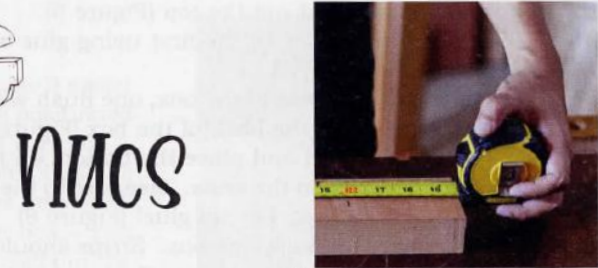

Photo by Ono Kosuki from Pexels

The drawings in Figures 1, 2, and 3 show the basic layout for the parts for four nuc boxes cut from one 4' x 8' sheet of $\frac{5}{8}$ " plywood. Other thickness of plywood or lumber can be used but the dimensions of the end pieces would have to be adjusted to keep the box interior size the same. The table below lists the dimensions of the parts:

Dimensions for 5-Frame Nuc Box Parts Using $\frac{5}{8}$ " Plywood			
Part	Color Code	Number Needed for Each Nuc	Dimensions
Lid	Orange	1	8 $\frac{3}{4}$ " x 21 $\frac{1}{2}$ "
Bottom	Green	1	8 $\frac{3}{4}$ " x 20 $\frac{5}{8}$ "
Side	Blue	2	10 $\frac{1}{4}$ " x 19 $\frac{5}{8}$ "
End	Pink	2	9 $\frac{1}{2}$ " x 7 $\frac{1}{2}$ "
Cleat	Red	8	8 $\frac{3}{4}$ " x 2"
Feeder hold cover	Yellow	1	8 $\frac{3}{4}$ " x 3 $\frac{1}{4}$ "
Spacer Strip	*	2	7 $\frac{1}{2}$ " x $\frac{3}{4}$ " x $\frac{1}{4}$ "
Entrance hole is 1 $\frac{1}{4}$ " diameter, located 3 $\frac{3}{4}$ " from side and 3 $\frac{3}{4}$ " up from bottom of front end			
Feeder hole is 2 $\frac{3}{4}$ " diameter, located in the center of the lid			
Dado for lid cleat: $\frac{1}{4}$ " deep x $\frac{5}{8}$ " wide, $\frac{5}{8}$ " down from the top of the cleat			
* Spacer strip is not cut from plywood; cut from wood scrap			

Assemble the Box

Drill an entrance hole in half of the end pieces. Measure 3 $\frac{3}{4}$ " from the bottom and side; drill a hole 1 $\frac{1}{4}$ " in diameter (Figure 4). The diameter of the hole is not critical, although this size works well with an entrance disk.

Attach one front end and one back end to one of the sides. Apply glue to the joint and fasten with staples, nails or screws. Note that the front is oriented such that the entrance hole is closer to the bottom than the top. Also note that the ends are flush

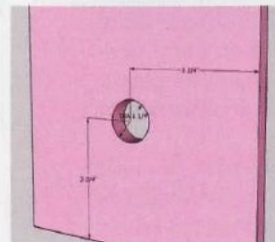

Figure 4

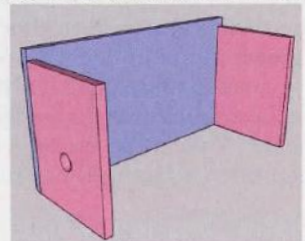

Figure 5

with the bottom of the side but not the top (Figure 5).

Attach the second side as with the first using glue and fasteners. Check to make sure that the box is square (Figure 6).

Attach two cleats to the front of the box, one flush with the bottom of the sides and one flush with the top of the sides. Repeat the process for the back of the box (Figure 7).

Turn the box upside down and place the bottom on the box. The bottom should be roughly flush on the edges with the sides and the cleats on the ends. Measure to the middle of the sides and ends of the bottom and use screws to fasten the bottom to the box. Do not glue! (Figure 8)

Cut two spacer strips for each nuc box. Strips should be $7\frac{1}{2}$ " long, $\frac{3}{4}$ " wide and $\frac{1}{4}$ " thick. The strips are placed on the inside ledges of the box, flat against the inside face of the cleats. Glue and staple the strips in place. These spacers keep the frames aligned evenly in the box (Figure 9).

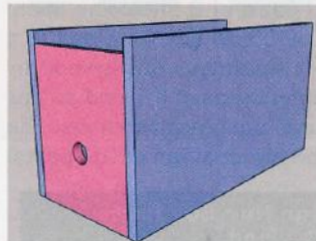

Figure 6

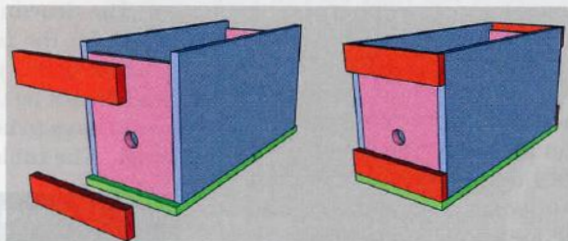

Figure 7

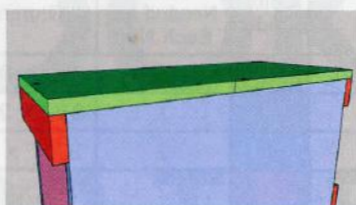

Figure 8

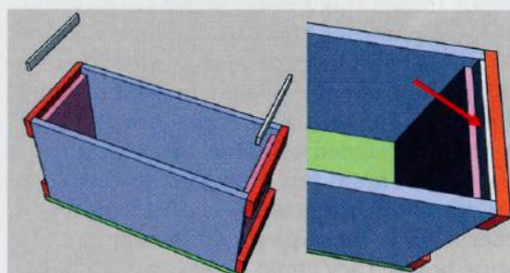

Figure 9

Assemble the Lid

Draw two lines on a lid, from opposite corner to opposite corner to locate the center of the lid. Drill a $2\frac{3}{4}$ " hole in the center of the lid. This size of hole will snugly fit a standard Mason jar feeder lid. Modify the hole size if your feeder size is different. Save the cut-out circle of wood (Figure 10).

For each lid, two of the cleats need to have slots cut as shown on the right, to fit on the ends of the lid. A dado head cutter or router works well for these cuts. The slots make the ends on the lid more durable, however the lid can be made without cutting slots. If you do not cut the slots then the length of the lid should be shortened by $\frac{1}{2}$ ". Attach the cleats to the ends of the lid with staples and glue (Figure 11).

Attach two additional cleats to the top of the lid with glue and staples as shown on the right. The cleats should be flush with the end cleats and the sides of the lid (Figure 12).

Take the cut-out disc from the lid and attach it to the feeder cover with staples and glue. The cover goes over the feeder hole as shown. This will not be a tight fit but will serve to keep rain out of the box when a feeder jar is not in place. The bees will propolize this cover in place when a feeder is not in use (Figure 13).

A small piece of #8 ($\frac{1}{8}$ " holes) hardware cloth can be stapled over the feeder hole on the inside of the lid. This keeps the bees from flying out when the feeder is changed or removed.



Figure 10

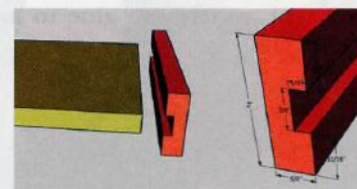

Figure 11



Figure 12

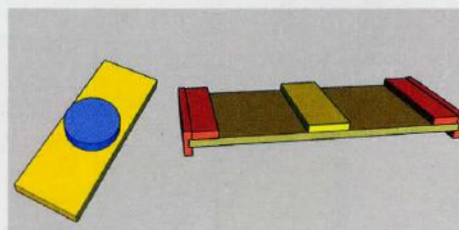

Figure 13

Finished Box

The nuc box is now complete (Figure 14).

An entrance disc can be attached over the entrance to make it easier to close the nuc up for transportation. The entrance hole is positioned to allow a standard 4 3/4" entrance disc to fit on the front of the box.

The completed nuc box must be painted or waterproofed in some way. Uncoated plywood does not hold up to the weather very well. Several coats of good exterior latex paint will protect the box – pay special attention to the edges of the wood, especially any voids in the edges.

This box is designed to allow several nuc boxes to be stacked to make double-deep nucs. Remove the screws from the bottom of the upper box (this is why it is not glued) to allow the boxes to be stacked. If you were careful in locating your screws for the bottom, any bottom should fit on any box.

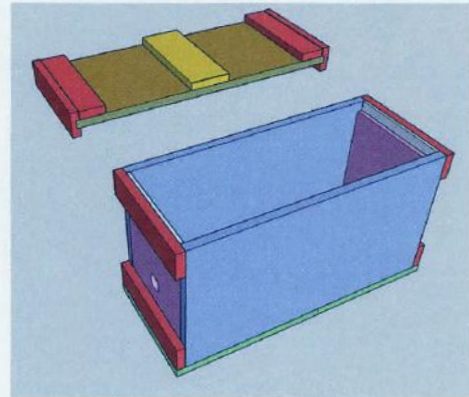
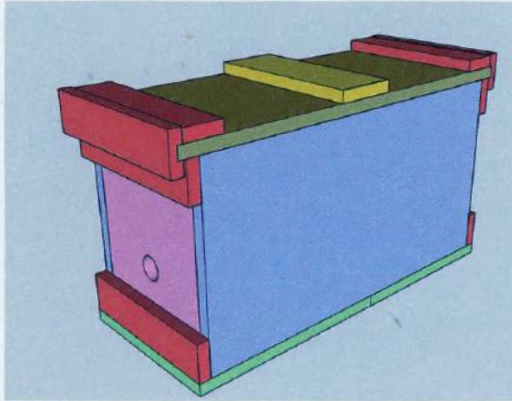

Figure 14

COWEN
MANUFACTURING CO. INC.

Save Money
Pumps and Spinners

2" Gear
3" Progressive Cavity
Cappings Spinner

Buy Cowen

www.cowenmfg.com 800-257-2894

OxaVap.com

Your Best Source for Oxalic Acid Vaporizers

Don't let mites kill your bees!
Vaporize them with an OxaVap Vaporizer!

Featuring the Award Winning All Steel / Stainless Steel Water "Dunkable" Varroax and the 20 Second, 110 Volt ProVap Vaporizers! Most Cost Effective Varroa Treatment Available and the Only One Where You Don't Need to Open the Hive to Treat!

The only good mite is a "vaporized" one!

In CLOVER

*"The pedigree of honey
Does not concern the bee;
A clover, any time, to him
Is aristocracy."—Emily Dickinson*

Leah Smith

How true! If you consult any number of sources that report on plants which provide the most nectar to honey bees, clovers will be crowding out most others for the top slots on the list. True clovers are members of the genus *Trifolium*. There are roughly 300 species in this genus of the Fabaceae (legume) family. Clovers, in addition to their familiar and occasionally lucky foliage, have flower heads that are, in fact, very dense spikes of many flowers, either red, purple, white, or yellow in color. As members of the legume family, they are known collectively for their nitrogen fixation capabilities; however, the amount of nitrogen fixed varies from species to species. All clovers are also well known for their usefulness in pastures; they grow abundantly and re-grow readily, and are palatable and nutritious to livestock. You should also note that clover pastures themselves benefit from the activities of honey bees; their pollination means an increase in seed production by the clover, providing dependable reseeding for the coming years.

Productiveness as pasture and providing nectar (and pollen) to honey bees are desirable reasons to plant clover, but which clover should you plant? As a homesteader, I appreciate that each clover has its own unique traits; it is in comparing these differences that you will be able to make a decision. Some clovers are annuals, while others are biennials and still others perennials. They display different tolerances for growth in shade as well as the soil types and moisture levels they thrive in. And many of them have additional side benefits. The following are a handful of the wonderful clovers you have to choose from, with a few varieties highlighted specifically.

The Clovers

Trifolium pratense—Red Clover

Red clover is a favorite for hay production due to its rapid growth, its popularity making it easy to source and low cost. Though many clover flower heads can be used for teas (and leaves are edible as well), the sweet and mild red clover is the preferred and traditional clover used by herbalists. A perennial plant that produces runners, it is therefore necessary to mow it for long-term management. A variety called medium red clover can be used as a cover crop over whole fields, but is also understated enough that it can be planted between rows of crops. Or...

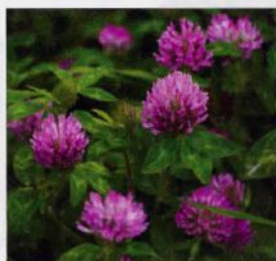

Mammoth Red Clover

As a more assertive option, choose mammoth red clover. It also has strong and rapid growth, and an ultimate height of roughly 3 feet; also a favorite for hay. It

can be planted almost any time of year, another attractive characteristic. Mammoth red clover really distinguishes itself because of its tolerance of poor and acidic soils. This tolerance of poor soils can no doubt be partly attributed to its long taproots which can both loosen soil and recover phosphorus and other nutrients from the lower soil layers, and also to its high nitrogen fixation rate.

Trifolium repens—White or Dutch White

White clover is a perennial and very low-growing for a clover (typically 8 to 12 inches in height). Its height is a real distinction between it and other clovers, and the reason why it is not planted in hay fields. It is also why it excels at its principle uses, which are as a lawn replacement and



living mulch or green manure. Its ability to withstand mowing and its growth with runners make it ideal not simply as a lawn replacement but to endure areas of heavy traffic. Not only can it be planted as a straightforward Spring or Fall cover crop or green manure, but its manageable size makes it well suited to plant in between row crops as a living mulch. It is more tolerant of heat than other clovers, but it prefers cooler climates and, therefore, is fairly adaptable. It is also important to note that white clover honey is considered by many to be the benchmark of honeys. There are a number of varieties of white clover. Those of the ladino-type group do well on poorly drained soil, and though less durable than other white clovers are taller and exceptional nitrogen fixers, and so great choices for cover crop or green manure. Varieties of like "Rivendel" and "Dragon's Blood" are excellent as ground covers in areas not necessarily for mowing but which require low-growing plants with decorative flair, due to their exceptionally attractive appearance. "Dragon's Blood" has a green and white variegated leaf with a touch of red. Or...

New Zealand White Clover

Try a notable variety of white clover, namely New Zealand white clover. It has the same basic characteristics, but it is yet more heat tolerant than other clovers, white or otherwise. It is also more vigorous and tolerant of a wider variety of soil types than other white clovers. New Zealand white clover is often used for erosion control, for which its root system is particularly well suited; though it is a traditional leguminous taproot-type system as it begins to grow, it is replaced with a rather fibrous system after a few years when the taproot dies off. This root system also helps to contribute to its high organic matter production. Recent studies have shown that while aboveground plant growth plays a role

in carbon sequestration and organic matter production, of course, the extent of these activities below ground is more significant to a plant's ultimate totals.

Trifolium incarnatum—Crimson or Italian Clover



Sown in late Summer, crimson clover spends the Winter dormant and resumes growth in Spring, providing flowers in May; it is therefore in place to provide a nitrogen boost to full-season crops.

This planting schedule allows it to grow in the cool, humid weather it prefers and avoid the heat of Summer (yet it could be planted for Summer as well). Crimson clover is an annual that does not spread by runners and so is relatively easy to eliminate by tillage, though if allowed to it will readily reseed itself. Its plant growth is very upright, reaching at least 18 inches in height, and this is an advantage when used for hay production. However, its erect habit and the incredibly striking appearance of the crimson clover flower (elongated spike and vivid red color) has also gained it favor as a roadside planting for highway beautification, and also as filler for fresh-cut flower bouquets. It prefers soils with good organic matter content (and will add value to the soil with its own high nitrogen fixation rate), but it will not thrive in acidic, sandy, or waterlogged soils. It is shade tolerant and so grows well if its seed is sown beneath other plants, which no doubt is why it is recommended for weed control. Its attraction for honey bees make it additionally useful if sown for weed control between suitably tall crop rows as a method to increase pollination (it is used in this way in blueberry fields).

Trifolium hybridum—Swedish or Alsike Clover

A perennial clover with white or lightly blushed flowers, Swedish or alsike clover is very Winter hardy and happy in generally cool conditions. It has a non-creeping growth habit; however, it grows from 2 to 4 feet tall, but will sprawl and display an apparently shorter profile. It prefers acidic soils, but is tolerant of more alkaline ones. An excellent choice for low and poorly drained ground, both of which it well tolerates (a characteristic that sets it apart from other clovers), Swedish clover, quite naturally, can also tolerate flooding but performs very poorly during periods of drought. It also prefers full sun and is not shade tolerant. Greatly liked by honey bees and other pollinators, this clover is often used in wildlife food plots. Note that it can be prone to dying out and so must be monitored.



Trifolium rubens—Pink, Ornamental, or Red Feather Clover

Also called red trefoil, pink clover could be the most attractive of the clovers (though crimson clover gives it some stiff competition). It is therefore no surprise that it is generally considered purely ornamental. Attaining 18

to 24 inches in height, its large magenta to pink flowers emerge from attractive, silvery buds. This perennial prefers to grow in the full sun. Another non-creeping clover that stays in its place, this beauty is at home in flower beds to which it attracts both butterflies and hummingbirds (and honey bees, of course) and from which it is harvested for floral arrangements. However, not without a "practical" side, pink clover has aggressive roots that allow it to penetrate denser soil and that can even prevent erosion on ground as vulnerable as banks.



Trifolium alexandrinum—Berseem or Egyptian Clover



Another annual, berseem clover is a productive plant (typically achieving 18 to 30 inches in height) with ivory colored blossoms and a high rate of nitrogen fixation. Tolerant of a range of soil types (not including sand) and environmental temperatures, it is considered a high quality forage on par with alfalfa. It has the ability to withstand drought conditions, excess soil moisture (more so than alfalfa or sweet clover), and excess salinity (more so than alfalfa or red clover), and it will positively thrive

in a loam soil which is slightly alkaline. Often planted as ground cover, a green manure, or as part of a wildlife food plot, berseem clover is additionally used for a late Summer planting to be a cover crop for Winter.

The Counterfeit Clovers

As you suspected, I couldn't let the subject of clovers pass without mentioning two plants which, though not of the genus *Trifolium* and therefore not true clovers, are members of the Fabaceae family and have common names which allude to this familial connection. They are also quite pertinent to the subject of plants for happy honey bees.

Melilotus officinalis—Yellow Sweet Clover



Yellow sweet clover is another top honey bee plant. Its appearance is dramatically different from that of the true clovers. It possesses bilateral flowers of a very similar appearance to that of true clovers, yet these

flowers are not on a very dense flower spike but rather on very airy spacious spikes, giving them an elongated appearance. Unlike many of the true clovers, yellow sweet clover is very drought and heat tolerant, often growing in poor soils with no irrigation. Though it can be sown from Spring to Summer, early planting is often important as it can be slow to establish in general (at times requiring a nurse crop) and benefits from more favorable conditions.

Once established, its deep taproot allows it to mine insoluble minerals like potassium and phosphorus from the lower regions of the soil profile, which combined with its high nitrogen fixation rate is why it is an excellent conditioner for poor soils. Once considered a weed, this valuable biennial produces blossoms heavy in pollen and nectar from April until July during its second year of growth, as well as reaching its ultimate height of up to six feet. Yellow sweet clover has better drought tolerance and greater biomass production than...

Melilotus alba—White Sweet Clover

White sweet clover looks quite similar to yellow sweet clover except that, yes, it has little white flowers instead of yellow ones. The white flowers of this biennial bloom slightly later than their yellow counterparts, but for a longer season. White sweet clover needs help to attain its maximum biomass production (more so than the yellow), and must be supplied with sufficient moisture and/or planted early in order to become established prior to the onset of drought conditions. Though its biomass production isn't quite as large as that of yellow



sweet clover, it is a taller and "stemmier" plant, which some people feel leads to better soil improvement when incorporated into the soil. As with the yellow, white sweet clover has an impressive taproot; thus, both are known for nutrient mining, lessening the impacts of compaction, great productivity in hot weather, and for being able to grow almost anywhere (though they are not overly fond of acid soils).

And there you have it, a collection of clovers. Bear in mind that for them to be of advantage to your bees in addition to offering their other benefits, they must be managed in a way that allows them to flower, which is not necessarily observing the same schedule as when they are used solely for soil improvement, as a forage, etc. But with the appropriate management, clovers can provide your bees with a nectar source and pollen from April to November. "To live in clover" means to have a carefree life of ease and prosperity. The question with clovers, then, is not if you should provide your bees with these valuable plants, but which one(s) to choose. 



Leah Smith works on her family's organic farm in mid-Michigan, called Nodding Thistle. She has been involved in home and market gardening since she was very young. After graduating from Michigan State University, she returned to the family farm to continue the farming life.

2MILLION *pollinating our pollinators*
BLOSSOMS 

Beekeeping: Nature Up Close

Welcome to the fascinating club of managing your own hive.

Did you know there are over 4,000 species of bees in North America?







Discover the incredible diversity of bees and other pollinators in our quarterly magazine.

2MillionBlossoms.com/Subscribe

Bee Culture

The Magazine Of American Beekeeping



GET ONE YEAR OF

Bee Culture

FOR \$25.00

ONLY

To subscribe visit: www.bee-culture.com
or call 800.289.7668 x3220

Successful Beekeeping - CAN YOU MAKE VARROA SICK?

Bill Ruzicka

Abstract:

It is not necessary to eliminate 100% of the *Varroa* mites in your hives. If you can make them sick or infertile, their population will slowly die. This method will keep your *Varroa* level and the damage that the *Varroa* mite can do at a threshold that will not negatively impact your hives. Biopesticides and applications of natural substances such as formic acid can achieve this.

BIOPESTICIDES

Biopesticides are organisms that have the ability to affect pests. The most common of these organisms are fungi. Most scientists believed that fungi can kill mites on plants only.

I hold the US 6,277,371B1 patent to using the fungus *Hirsutella thompsonii* to kill *Varroa* mites on bees.

How this fungus was discovered is an interesting story. My co-inventor, a Czech honey bee researcher Oldrich Haradzim was working in southern Slovakia on *Varroa* infested hives in 1982. By a series of interesting coincidences, Dr. McCoy of the Citrus Research Centre in Florida developed a method of attacking the Citrus Rust Mite on orange groves using the *H. thompsonii* fungus and passed his research on to Abbott Laboratories in Chicago. Abbott Laboratories developed it into a biopesticide called MYCAR. In 1981 Abbot Labs then sent MYCAR to Dr. Veiser at the Czech Academy of Science. Dr Veiser was, at that time, considered a leading worldwide authority on insect pathology. Dr. Veiser was going to test MYCAR on mites that were damaging cherry orchards.

Before Dr. Veiser ran any tests in the Cherry Orchards, he gave a sample of MYCAR to O. Haradzim to verify that MYCAR would not harm bees as they are important pollinators of cherries. O. Haradzim took the MYCAR dust with him to Slovakia where he was working on *Varroa* infested hives. He applied the MYCAR dust to the brood of *Varroa* infested hives. While observing the effect of MYCAR on bees and brood in the cells (which were dusted by MYCAR before capping), he was surprised to find no mortality or damage either to brood or bees. More interestingly, he observed that in 18-day old larva infected with *Varroa* he found only founder *Varroa* mites but no young *Varroa* of any kind. He repeated his tests several times and determined that something in the MYCAR dust made *Varroa* mites infertile and unable to reproduce.

He brought his discoveries forward to the appropriate authorities, but it was 1982 and the middle of the Cold War. At the time, Czechoslovakia was under an American embargo. It was decided that while his discovery was important, buying MYCAR would be a drain on the limited amount of US dollars the country had, and the funds must be used to buy more important things.

In 1992, 10 years later, *Varroa* mites were approaching the valley where O Haradzim had his Summer home and his own bees. He told me about his discovery, and asked me to get him some MYCAR and send it to

him. (As an interesting side note, it took *Varroa* mites 10 years to migrate naturally a distance of 300 km in a country where there are no natural barriers to the *Varroa* nor does migratory beekeeping take place. Additionally, there are villages roughly three miles apart in every direction each with honey bee hive.)

As my bees are packed for the Winter by end of September, I always drove south to spend the Fall in Florida. Not only did I get to enjoy the Florida sunshine but I was also able to investigate what beekeepers were doing with mites there. In 1992, on my way to Florida, armed with O. Haradzim's story, I drove to Abbott Laboratories and found that they had discontinued their Agriculture section and had stopped making MYCAR. It took another 5 years to find the people involved in the original research and find Dr. Clay McCoy. Fortunately, Dr. McCoy found some *H. thompsonii* spores stored in his freezer and he give them to me in 1997. I spent the eight years from 1992 to 2000 researching and documenting patentable proof that *H. thompsonii* is effective in reducing *Varroa* mite populations in beehives.

In 1997 I established my research in Florida, and then State Apiarist Laurence Cuts arranged to have Gainesville Labs to produce *H. thompsonii* spore wash that we sprayed into the brood. While driving each Fall to and from Florida, I visited research centers in Weslaco Texas, Baton Rouge Louisiana, and Tucson Arizona. The scientists in those centers became my mentors. I learned how to scientifically and statistically conduct tests, how to judge the reproduction rate of *Varroa*, and learned many other strategies for future research. In 1999 in Florida, with David Westervelt, we for many hours were examining 18-day old honey bee larva. In our control hives, we found that 80% of the adult *Varroa* reproduced. In the hives applied with *H. thompsonii* spore wash, only 20% of the adult *Varroa* reproduced. You can read how to evaluate reproduction rates at:

<http://www.mitegone.com/pdfpages/Varroa%20Reproductions%20Guideline.pdf>

VARROA MITE REPRODUCTION GUIDELINES

Courtesy of Jeff Harris & Robert Danka USDA Honey Bee Breeding, Genetics and Physiology Lab
1157 Ben Hur Road, Baton Rouge, LA 70820

ABSTRACT: The foundress mite is reproductive if she produces 1 adult daughter and 1 adult son before the bee emerges. A mite is infertile if she produces no offspring. Adult male tan color, body is longer than wide; lower left of Picture #14. Adult female tan or light brown, body is wider than long; lower right of Picture #14. At 18 days old



(black eyes), a bee pupae should have one adult daughter *Varroa* mite if things are on schedule. You can tell the daughter is an adult if you can find her shed skin, which is triangular and mostly transparent (but with one white point, more or less).

In 1998, I was able to give vials of *H. thompsonii* and to pass on our discovery to other scientists for research. Brenda Ball in England, and Dr. Peng in California both researched and wrote papers on *H. thompsonii*. In Weslaco Texas, Bill Wilson introduced me to Rosalind James who confirmed Gainesville's Nabih E El Gholl's Laboratory proofs that *H. thompsonii* will kill *Varroa*. She also involved Lambert Kanga in the project. They all wrote papers proving that the fungi will kill the *Varroa*. During the 1999 Apimondia Conference in Vancouver, Robert Danka arranged for me to present a slide of a *Varroa* mite being consumed by *H. thompsonii* to the rest of the scientists.

In 2000, after 120 hive field tests in Kelowna and all of the associated costs, I had to give up. I left the research to Rosalind James and Lambert Kanga. You can read about it at:

<http://www.mitegone.com/pdfpages/2002%20Kanga%20James%20Boucias%20Fungi%20Pdf%20A.pdf>

Unfortunately, the manufacturing of spores and making them stable to produce a marketable and inexpensive medicine for beekeepers to use is still being worked on. In the meantime, beekeepers need to look at other alternatives.

USING LOW DOSE CONTINUOUS RELEASE OF FORMIC ACID BY MITEGONE METHOD AND DISPENSER. US 6,837,700, B2 Patent.

Fact: Formic acid on its own does not do anything. Depending on the concentration of formic acid and the dispenser's method used, you will get either beneficial or negative side effects.

I started my battle against the mites like all others in early 1990s with the same question. What have the Europeans done to treat hives since they have had Tracheal and *Varroa* mites for so many years? Being Czech by birth I turned to my friend Oldrich Haradzim. At that time, he was the head of Bee Pathology at the Czech Bee Research Institute. He provided all literature I needed to start.

Concentration of Formic Acid - Europeans use 85% concentration of formic acid to treat their hives. Thanks to Kerry Clark at the Bee Research Center in Dawson Creek Canada who researched what concentration is most effective and least harmful to honey bees. Here is what he found:

We use 65% formic acid for a number of reasons. At 72%, the molecules of water and acid evaporate at same rate. With higher concentrations, acid molecules have to evaporate first until the surface concentration reaches 72%. This high rate of acid evaporation causes harmful blasts of acid to the bees. At 65%, the molecules of water must evaporate first until the evaporating surface reaches 72%.

This is gentler on the bees and does not cause harmful side effects. In the USA 95% acid is a common

concentration to purchase. It needs to be diluted when treating honey bees. Stronger is not better in this case.

THERE ARE TWO BASIC DISTRIBUTION METHODS FOR FORMIC ACID.

Blast /Flash Methods - The only European dispenser to work in North American beekeeping methods was the Kramer plate. Dr. Nasr converted this product into the commercially available *Miteaway*. Many homemade applicators are used including folded blue shop towels, or butcher pads called mite wipes. Other flash methods spraying 30 cc or 1 oz. of acid on the bottom board were also used. All of these methods overdose the hives and rely on the bees to ventilate the hive and lower the concentration of fumes so it kills the mites but not the adult bees. These methods are outside-weather dependent and cause all of the negative side effects that you hear about.

Low Dose Continuous Release Methods - Dispensers like the Nsenhider, Propodi, and Burmister emit a steady but low dose flow of formic acid for 21 days or more and do not cause any damage to bees, brood, or queens. They are very effective at controlling mites. Unfortunately, they were all little plastic gadgets judged unusable in North American commercial beekeeping.

After researching a variety of treatment methods, I decided that I did not like the side effects of blast method treatments. I really liked how gentle low dose continuous methods were on the bees, but I could not use any of the existing dispensers in my 500-hive operation. It took two years of development to come up with dispenser that I could use in my operation. My dispenser would have to be adaptable to any size and strength of colony and not susceptible to outside weather conditions. The dispensing pads I developed do all of this because they fit vertically in bee space of the brood box where bees maintain constant brood temperature and humidity. The pad's capillary tubes hold in the liquid without dripping and gravity pulls the acid down to the evaporating surface ensuring steady evaporation. For details and answers to any question visit www.mitegone.com/ click on FAQ.

My original intent was to create a Spring *Varroa* and Tracheal mite treatment as a companion treatment to Fluvalinate in the late Summer. In 1994 we made our first batch of pads and used them successfully.

In 1995 a few more beekeeper friends joined me in making more pads by hand in my workshop.

In 2000, our British Columbia Apiary Technician convinced me to go commercial. The method and dispenser were patented and we named it *MiteGone*.

By 2002, *Varroa* mites resistant to Fluvalinate started spreading throughout British Columbia and reached my area by the Summer of 2005. Knowing the origins of the other harsh chemicals used to treat the *Varroa*, I decided to use my *MiteGone* treatment in late Summer as well. I monitored the success of this Fall treatment using drop testing before, at the first 24-48 hours, and after the treatment. For details of testing efficacy and resistance see: <http://www.mitegone.com/pdfpages/Methods%20of%20Testing.pdf>

I used 20 hives, brought from different bee yards, into a test circle in my home wintering yard. We used the 3-5-day natural drop count using a full bottom size

⇒

sticky board, covered by 1/8" screen raised 3/8" above the sticky board, and prorated this count to 24 hours. Our before treatment test drops were 10-15 mites per day. After the first 24 to 48 hours of acid treatment the drops were 20 times higher. These results were great. Our after treatment test a month later was 15-20 mites per day. This result was higher than our before treatment results. These results did not seem right. We tested the hives again before our mid-April formic treatment, using the same method, and the drops were 5 mites per day.

I repeated the test for several years with the natural drop before the treatment in the Spring decreasing each year. I was starting to think that the *MiteGone* treatment was making mites sick and then they were dying in large numbers long after treatment.

To answer my questions, I arranged for a 30-hive treatment test to be completed in Brandon Florida in October of 2007. We were recording the effects of the *MiteGone* treatment on *Varroa* mites, and its reproduction, but also its effect on the small hive beetle. In this test, we placed the pads in various places in the hive. The test was scientifically and statistically correct, as treatments and controls were assigned by using a drop test counts.

After setting up the test, we went to the beekeeper's home location where he asked if we had extra pads to treat his few remaining hives. He had an extra 6 hives, 3 boxes high to treat. With so many bees per hive, I decided to use 4 *MiteGone* pads on each hive. When we first opened these hives, the top covers were black with beetles. When I returned 7 days later to proceed with examining 18-day old larvae that had been capped before *MiteGone* treatment, I found that 80% of the mites reproduced. A week later I examined another 500 cells that were capped 5 days after the *MiteGone* treatment was applied. I found only 20% of the mites reproduced.

Most interestingly, there were beetles in the control hives. I found only a few living beetles in the test hives after the treatment. They were hiding under the horizontally laid pads on skewers on bottom boards. To our surprise the six hives in the beekeeper's home yard had no beetles at all! The beetles had left the hives as no beetles were found. I began to wonder if *MiteGone* repelled the small hive beetle. Unfortunately, 2007 was the last year of testing in Florida.

During 2009 and 2010 we completed two *MiteGone* treatment tests each year and all of our drop tests were supervised by our local bee inspector. We tested 20 hives each year. In our August test, the mite count before treatment was 10-15 mites per day. We stopped testing after the treatment as tests in mid-April were steadily decreasing in mites found. In the Spring of 2009 and 2010 our inspector found on all 20 drop boards, in the hives for 3-day drop a total of 2 mites. Statistically, this is a result of zero mites in Spring. Treatment in Spring even with zero mites prevents re-infestation during pollination, and keeps mites in manageable level. **Details:** <http://www.mitegone.com/pdfpages/HOW%20WE%20GOT%20TO%20ZERO%20MITES%20Jan.2015%20D-1%20doc.pdf>

In 2011, I sold the bulk of my beekeeping operation to a young beekeeper but I kept 50 hives in my ownership, operated by the buyer in exchange for teaching him my way of beekeeping for 2 years.

In 2013, these 50 hives were returned back to me. Heading to my high 70s, I sold half of these hives to various new beekeepers and kept 24 hives. I use these remaining 24 hives as breeders of Vernon stock to keep reproducing this line of locally improved honey bees. I use these hives to run practical beekeeping courses and for queen production. From these hives I also create 120 mating nucs each year from which 24 are again selected and wintered as future breeders.

This allowed me, in 2019, to select 4 hives in late Summer with highest mite drop of 15-20 mites per day to test. We did not treat these four hives with *MiteGone* in the Fall and by the Spring of 2020 they were in 20-25 mites per day range. We treated these hives with *MiteGone* in mid-April and I followed the test routine that was used in Brandon Florida in 2007. I was able to reproduce the results with 80% of mites reproducing before the treatment and then only 20% reproducing after the treatment was applied.

I am now 80 years old and do not have the ability to complete large scientifically and statistically correct tests and trials. I'm hopeful that a USDA Lab or University may choose to continue to study these topics. Please contact me if you would like any more information about these topics.

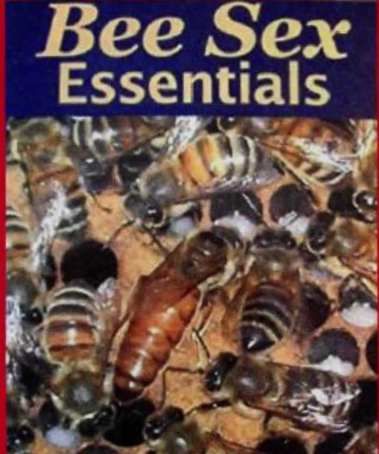
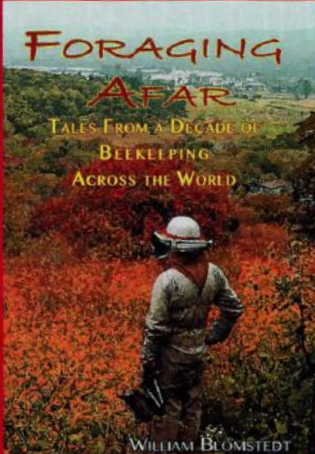
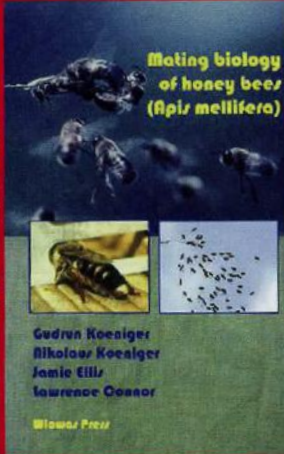
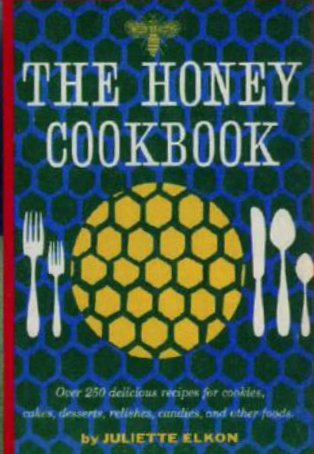

\$25 POSTPAID	FIRST EDITION \$29 PP	\$34 POSTPAID	Classic Reprint \$25 PP
 <p>Bee Sex Essentials</p>	 <p>FORAGING AFAR TALES FROM A DECADE OF BEEKEEPING ACROSS THE WORLD WILLIAM BLOMSTEDT</p>	 <p>Mating biology of honey bees (Apis mellifera) Gudrun Koeniger Nikolaus Koeniger Jamie Ellis Lawrence Connor Wiley-Blackwell</p>	 <p>THE HONEY COOKBOOK Over 250 delicious recipes for cookies, cakes, desserts, relishes, condiments, and other foods by JULIETTE ELKON</p>
<p>WWW.WICWAS.COM ORDERS@WICWAS.COM WICWAS PRESS 1620 MILLER ROAD, KALAMAZOO MI 49001 USA</p>			

What Your Mentor Forgot To Tell You!

Ed Simon



The conventional wisdom about beekeeping is that there are no pat answers. Whatever works for you is the right way for you to do something. Of course, most beekeepers are never satisfied and are sure there is always a better way of accomplishing a task or solving a problem. Consequently, if you ask five beekeepers the best way to accomplish something you get seven or more answers. None are wrong just different. It is what works for that beekeeper at that time. Here is a collection of hints that may help you in your beekeeping endeavor.

Air Conditioning – Hot Hives

On a hot day or when the nectar needs to be dehydrated, bees will form at the entrance to the hive and force air through the hive to cool the insides.

Note: All the bees are facing one direction.



There is an observed phenomenon of the bees lining up at the entrance to a hive and rocking backing and forth. It looks like a bunch of washerwomen scrubbing the floor. As of this publication date, I know of no explanation for this behavior.

Ants – They will find an easy meal.

Cinnamon sprinkled around the feeder rim and on the inner cover takes care of the ant problem. (Most of the time)

Attaching Wild Comb – Attaching comb to a frame.

After you have collected a wild colony and need to attach the wild comb to a frame, be sure to keep the top at the top. Comb cells have a definite slope to them. The outer edge of the cell is higher than the bottom of the cell. When you attach comb to your frame use rubber bands. They work great and will eventually be removed by the bees.



Cows/Horses – Hives make good scratching posts.

Cows are curious and like to scratch themselves. A beehive is just about the right height. Unfortunately, they are not very stable when a 1,200-pound cow has an

itchy butt. Horses also like to scratch. If your hives are in a pasture or where a farmer may release cattle into the area, then string an electric fence up to keep them away from the hives. Usually the farmer will let you tap into their electric fence to power your hive fence.

Crystallized Honey – Mix it up.

Creamed honey is honey that has been forced to crystallize in a controlled state. When starting a new batch, incorporating it into the liquid honey can be a tiring process. Instead of mixing a couple of pounds of starter culture into 40 or 50 pounds of honey, start by mixing it into a small amount of honey (4 to 5 lbs.) until it's thoroughly mixed with no lumps. Then add the small amount to the larger amount.

Crystallized Honey – Shake the bear up.

Crystallized honey in a plastic bear can be liquified in the microwave. The outside of the honey will heat faster than the inside of the honey. To stop the plastic from melting and causing the bear to nod its head, only heat the bear 20-30 seconds at a time. Between each heating shake the bear/honey up to distribute the hot honey. It may take four or five repetitions to completely liquify the honey. But it is still quicker than sitting the bear in hot water.

Entrance Reducer – Openings up.

When installing a wooden entrance reducer, make sure the opening is up. That way the entrance will be least likely to get clogged with dead bees and debris. This is very important when closing the hives up for the Winter.

Entrance Reducer – They never fit correctly.

When building a wooden entrance reducer, make sure the entrance reducer is smaller than the smallest opening you have on your bottom boards. Use a wad of newspaper on one end to work as a Spring and force a tight fit of the reducer.



Extraction Clean Up – Let the bees do the work.

Extraction is a sticky mess and your helpers tend to disappear when it's clean up time. Move your equipment outside of the extraction area and let it set for a couple of

days. All the junk honey that you would normally wash away will be reused by your bees. Wipe up the thicker/deeper puddles of honey with a wet rag so the bees won't drown and then hang the rags up for the bees to clean the honey off. Cover the equipment so if it rains the bees can still get to it but the rain can't wash all the honey away.



The removal of honey from cappings is easily accomplished by spreading the capping wax out on a cookie sheet (I use commercial cookie sheets) and letting the bees reclaim the honey. It's best to take them in at night as raccoons also like the honey. As a side note, a five-gallon bucket of moderately packed capping wax will yield about five pounds of cleaned wax.

Feeder Jar Holes – If they are too big, they'll leak syrup.



When punching holes in a jar lid to make a jar feeder use a brad gun with 18-gauge brad. The 18-gauge brad is a nice convenient size for a feeder hole. The brad gun allows for making quick and non-finger smashing hole. Place the jar lid on a

soft surface like a piece of insulating foam, so the brads won't nail the lid to the workbench. Removal of the brads is then quite easy. If the holes are to big then use a nail and hammer and put the lid on something solid so just the tip of the nail penetrates the lid.

Festoons – Yep, there is a name for it.

When the bees develop a chain where one bee hangs from another bee is called a festoon. This often occurs when the heat inside the hive is too high and the workers go outside to cool off.



Frame Feeder – Bees will drown or get stuck in honey.

When using the one or two-gallon frame feeders or division feeders that sit inside a super, add straw before filling the feeder. The straw provides a foot hold for the bees. It will allow them to escape if they get stuck in the syrup. The straw needs to come to the top of the syrup.

Hive Air Flow – A stick will do it.

Placing a stick or a piece of wood between the inner cover and the top cover will allow a better flow of hot air from the hive during the Summer months.

Hive Body Separation – Add a gargoyle.

Most hive bodies rot at the lower and upper corners. This is where the hive tool has gouged the wood and water has collected. Use a belt sander to bevel the top corners of your boxes, this provides an easy lip for your hive tool to find to separate the boxes.

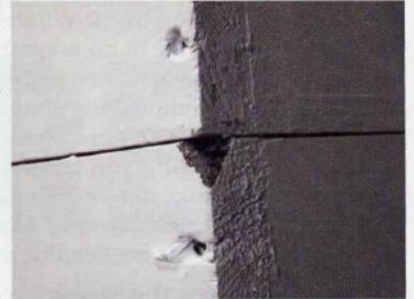

Hive Placement 1 – Do not place your hives in straight rows.

If hives are placed in a row, the end hives will eventually have more bees. If you have your hives in a row, your bees will tend to drift to the hives at the ends. Place your hives at irregular distances and at angles to one another. This past year I was standing by the end hive in a row. Within 30 seconds there were bees returning to me - not to the hive.



Hive Placement 2 – Not in a damp valley.

Hives should not be placed in an area where there is a lot of fog or the possibility of a creek overflowing. A friend looked out his kitchen window one morning and saw the bottom brood box of one of his hives under water. Not a good thing to see first thing in the morning. It makes for a bad day.

Honey Storage – Five-gallon pails

Five-gallon pails are a very easy to use and a great way to store honey. If you fill them full, they weigh about sixty pounds. Before placing the lid on make sure the rubber gasket is in place. Then put a piece of food storage plastic (Saran Wrap) over the top before sealing the pail. This will keep the honey off the top of the pail when you move it. It is also easier to scrape clean than the lid of the pail. Sixty pounds is a lot of weight for the more mature (politically correct) person. Each pound of honey weighs about 12 pounds. Reducing the volume to four gallons can make lifting the pails a lot easier.

As was noted at a bee club meeting, when selecting pails for honey storage do not and I repeat do NOT, NOT,

NOT use pails that were used to store dill pickles.

Hive Stand – Keep your stands low.

Be careful when placing your hive stands. Think about the following items.

The higher your hives, the higher your supers are when you want to remove them. When full they weigh about fifty pounds each. You do not want to climb a ladder to retrieve a super.

Hive Stand – Make sure your hive stands have a solid base.

Spend the extra time to ensure your hive stands are on a solid/level base. You don't want them to tip over as you add hive bodies and supers.



Honey Wax Removal – Wax floats on honey.

After extraction is finished and your new honey has sat for a while, the wax and other debris will float to the top. To remove this scum, use a piece of plastic food wrap. Lay it on the surface of the honey and pat it down gently. When you carefully remove it, much of the wax and other debris will come off with it. I haven't tried this yet, but it sure sounds promising.

Hot hive – This is not, and I repeat not swarm preparation.

On a hot day the bees will congregate on the front of the hive. They are not getting ready to swarm. It is hot inside, so they decided to cool themselves off and reduce the heat being produced inside the hive. It's like you sitting on the front porch in a cool breeze.

Inner Covers 1 – The thick and thin of it.

Some inner covers have a thick rim side and a thin rim side. The thick rim side faces the bees during the



Winter. This allows the bees to navigate above the frames. The thin rim side faces the bees during the Summer. In theory, the thin side is small enough to the bees won't build comb between the frames and the inner cover.

Inner Covers 2 – Why use them?

Inner covers allow the top cover to remain loose. The construction of the top cover with the dropped down sides would be very difficult to remove if it was glued down with propolis or comb. By using the inner cover, you can remove the top cover with ease and the use a hive tool to un-stick the inner cover.

Installing Bee Packages – They will miss the hive.



Even though you spray down the bees before shaking your new package into the hive, they seem to miss where you want them to go and spill out over the sides of the hive. To eliminate some of this, use an empty hive body and place it on top of the target hive. Then keep the shipping box inside the top hive body while shaking the bees into the bottom box. This will help channel the bees into the lower hive box. You can then use your brush to force the bees clinging to the top box down to the hive.

I hope this helps. These hints and shortcuts have been collected from experienced and neophyte beekeepers. Additional hints would be appreciated. Please send them to: SimonEdwin41@gmail.com.



Get a copy of Ed Simon's book *Bee Equipment Essentials* with detailed drawings, construction hints and how-to-use instructions for dozens of beekeeping tools and equipment from www.wicwas.com. Ed can be contacted through SimonEdwin41@gmail.com.

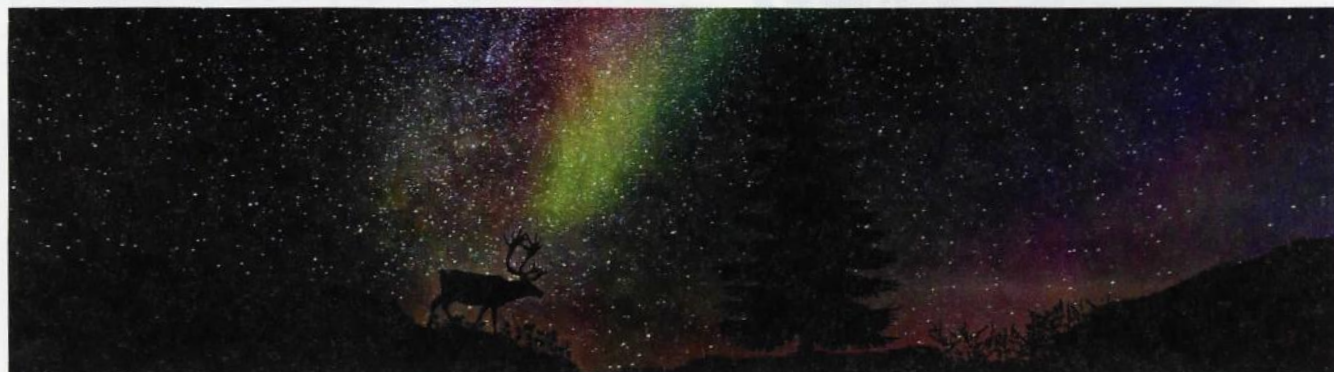

BEEKEEPING: KEEP IT SIMPLE! JUST KEEP THEM ALIVE!

Suzanne D. Cohen

I'm a fretter, from a long line of fretters. So, I can absolutely understand people worrying over every aspect of beekeeping, and especially over the survivability of their bees. There is limitless information out there about bees and beekeeping, contradictory and seemingly contradictory advice from beekeepers, and all the other sources for help to choose from. There are online videos, books, magazines, websites, classes, bee clubs, conferences. It can be overwhelming. But, one thing to remember is that there often isn't only one correct answer. There are a few basic absolutes necessary to keeping your honey bees healthy and productive. But, beyond that there is lots of wiggle room...or should I say waggle room?!



Dust Bunny gets all excited when I climb down off the roof. Maybe he thinks I'm a giant white rabbit!

As a customer service representative in a busy bee company, I spend a lot of time answering people's questions about beekeeping. Plus, I have had my own hives for the past four seasons. I have three hives, which was my goal and is my maximum, as they are up on our back roof. And, to answer the concerns of readers who have worried about the stability of our roof, it is very stable and we are very careful!

So, I have been living and breathing beekeeping for the past six years (although it really seems much longer), surrounded by a multitude of brilliant and experienced beekeepers who have been keeping bees for many, many years, and who patiently share their knowledge. Plus, I regularly hear of the beekeeping successes and failures of friends and customers. I congratulate new and old beekeepers on their successes, and I even sometimes cry with new beekeepers over their losses. For many, including myself, their bees are like their children, and they want to see them healthy and happy! In my four seasons of beekeeping I have only had one colony of bees die, and I have only had one hive swarm. My hive dying was devastating. My hive swarming I thought was kind of exciting. Swarming is a natural thing colonies of bees do, that helps multiply their species, and it was pretty

cool taking a few minutes off the phone, when I was still working from home, to look out our upstairs window at the frenzy happening over one of my three hives.

Anyway, I thought I'd use this space to help sort through some of the basic decisions a new beekeeper has to make in getting started, and what I believe is most necessary to keep those bees alive. I'm not going to go into any of the later stuff, like extracting honey or cleaning your wax for use. This is just about getting started, and helping your bees survive their first Winter.

So, the first question is, do you really want to have bees? If your main question as a new beekeeper is, "How much honey can I expect to get my first year?" you might not want to be a beekeeper. If you're stressing over how to get started by spending the least amount of money possible -- say, starting with just one hive body, and a solid pine bottom board with no *Varroa* tray -- unless you're expecting to get a major inheritance from a rich aunt very soon, you probably don't want to get into beekeeping. Having honey bees is expensive. And, by my way of thinking, you're going to have to paint the exteriors of all your bits with latex paint to prevent sun damage, both wood and polystyrene hives. So you might as well take the plunge and get a kit that comes with two deeps and two medium supers. It's just nice to have it all painted and available when you need it, as your bees start filling their way out of one box and into the next. That way you're not sweating it, maybe having to wait for an order to arrive, worrying that the bees are too crowded and likely to swarm.

I should interject here that my experience with hives has been pretty much exclusively with wooden and polystyrene Langstroth hives. And I'll go into more details about the various choices to do with these later. I can't advise you on any of the multitude of other human-made hives out there. And I am impressed by the many functional bee homes people have created. I am wary, however, of any hives that are marketed in a way to make beekeeping look simple and easy. It isn't. I have had a few questions on the long hives, of late, and those look



Climbing down off my roof. I usually climb out of the upstairs window, and then climb down the ladder when I'm done.

really intriguing. But, I don't have room in my tiny yard, and I don't think my roof would be stable enough to try one there!

Question two, should I start with one hive or two? New beekeepers are often advised to start with two hives. The advantage is that every colony has its own unique personality, and it is fun to be able to see the differences and similarities in their behaviors. You may also feel that having two hives increases your chances of having one survive the Winter. And that may be true. But, it is as easy to kill two hives as one. And even if you do have the financial security to keep bees, you have nonetheless wasted a lot of money and a lot of bees have died. But, if you are going to be a hands on beekeeper, and follow a few basic steps to keep your bees alive and healthy, you can start with either one hive or two. I started with one, and I found that one hive was plenty to keep me occupied my first season, and to get used to handling and managing my bee friends.

Question three, should I get a wooden hive or a polystyrene hive? The decisions to be made about the type of hive and equipment to purchase are relatively easy, and one thing is as good as another. A lot simply depends on what YOU like to work with. Assembled or unassembled...do you like putting things together, or would you rather someone else do that? Do you like all the whistles and bells, or do you prefer simplicity? Are you a purist, preferring to do everything the traditional way, or do you prefer to do things the least expensive, most practical, and/or easiest way. The bees don't care. What would make your beekeeping experience more pleasurable for you?

I love my two 10 frame polystyrene hives for the fact that they keep my bees more toasty in the Winter, and cooler in the Summer. They also naturally prevent moisture from building up in the hive. But, I recognize that traditional wood hives seem more appealing to many for the fact that they are wood, and seem more natural. And when I wedge my hive tool in between my 8 frame boxes and lift one off the lighter box feels heavenly after lifting one of my full 10 frame boxes. And simply inserting a piece of foam board up inside my telescoping outer cover solves the moisture problem, without having to mess with putting together a quilt box. A polystyrene outer cover also prevents potential moisture problems, but they are very light weight so they need something heavy to keep them from blowing off during storms. Again, there are other choices, but these are the ones I am most familiar with and have had positive experiences using.



My eight frame wooden hive, with added hive wrap, and one of my polystyrene hives, self insulated without a wrap.

I remember the first time beekeeper Tim Banfield asked me to pick up a medium super full of honey, with a twinkle in his eye, so I could see how heavy they are. It was like picking up a medium super of solid LEAD! And I was still a young thing in my 50's! So, more and more beekeepers are opting for 8 frame hives, or all medium hives, or other similar options, to save their bodies some strain. I have some lower spine and arthritis issues now, so if I had it to do over I might have gone all 8 frame. But, thankfully, I have my honey Dennis as my sidekick these days.

Question four, what type of frames and foundation should I use for my hive? Do I want to use crimp wire foundation and wire my frames, the traditional and most labor intensive by far, or do I want to use wood bound plastic frames, or solid plastic frames? If you have a very available, involved mentor who uses crimp wire foundation, you might want to go for it. But, if you use plastic frames or foundation you definitely want the heavy wax option, or paint on extra beeswax if you have some kicking around. The bees prefer to have the extra wax to move around as they choose. I have seen with my own hives, when I put in a plastic frame or foundation that only has a regular wax coating (all plastic frames/foundation come with at least a thin coating of wax) the bees leave it alone until it is their very last option. I, personally, started off with wood bound plastic and am gradually switching out for the solid plastic frames with heavy wax. And different types of frames can commingle. The bees don't care. I'm rough on things, and I'm constantly breaking the wooden frames when I pry them apart. Then you have this mess of a broken thing sort of dangling in your hive, and difficult to remove and then extract. Dennis can usually repair them, but....



Dennis checking a frame in our polystyrene hive that swarmed earlier in the season. (You can tell from these photos that Dennis and I both need smaller gloves! Haha! Gloves should fit snugly, so you have maximum dexterity.)

Question five, what sort of bottom board should I purchase? Now, this is very, very important. The polystyrene hives I'm familiar with automatically come with a screened bottom board and *Varroa* mite tray. And that's what you want. I'll harp on this more in a minute, but you absolutely want the *Varroa* monitoring system from the beginning. Because then when all else fails, as it did for me this Summer, you still have an easy way to check your mite levels. It may not be as accurate as some other tests, like the sugar roll or the V-Check, but it's EASY.

Last question, do I really have time, with my already busy schedule, to have honey bees? Well that, I believe, is pretty much always a yes. Then again, I'm a person who likes to stay busy! Haha! But, bare in mind that you don't have to have twenty hives. You can start small and stay small. And there is a fair amount of work involved in the Spring, Summer, and Fall, but then you pretty much get your Winter off to ski and prepare wonderful holiday dinners...although you want to do periodic checks to make sure your bees haven't been glutted, and eaten through their stores and need feeding. Or maybe you took just a wee bit too much honey, and that's why they've eaten through their stores and need feeding. Again, each hive has its own characteristics, so this hive may require feeding while that one does not.

But, talk about lack of time, my mother died this past July, at the age of 90. She took a major turn for the worse just before her 90th birthday, so we were all glad we at least got to have a small, pandemic aware, informal celebration with her four children, several grandchildren, and the two great grandchildren by video, in June. My mother was very fortunate to die in her own home, with a wonderful staff of home helpers. But, needless to say, with all the months of having one foot out the door to help my mother, and then the last few weeks of her approaching death, my bees kind of took a back seat! I had planned on doing alternating sugar rolls throughout the Spring and Summer, one of my three hives per week, to keep an accurate, steady mite count. Well, I did do one sugar roll early on, anyway! I did, however, check my *Varroa* trays with some regularity. And I couldn't have done that if I didn't have screened bottom boards and trays on all my hives. My mite numbers started very low this year, but then gradually increased. I ended up treating with formic acid three times throughout the Spring and Summer.



Treating with formic acid is easy and inexpensive.

The morning my mother died I treated my hives with formic acid before we left for the Adirondacks. Yes, I am that dedicated! We had been driving back and forth (just over an hour) to sleep at home each night, and my siblings texted that she had died in the wee hours of the morning. To me she had been gone for days. To add to my sadness we had a heatwave that day, and my beloved chinchilla Lilly died on my lap, shortly after we got home from my mother's that night. It was a very bad day. But, at least not for my honey bees.

My girls seem to be doing great, now as we head into the Winter. The hive that swarmed back in May did not produce their own queen (or I was too impatient to let

them), so I had introduced a new queen thereafter. They have been putting as much honey on as the other two hives, and we extracted over 60 pounds of honey this Summer. My mother was my biggest customer, so now what am I going to do with all this honey?!



A bee friendly garden allows our bees to forage into the Fall months. I love seeing the pollen collecting on their legs!

So, now for the harping. The primary goal for us tree hugging, granola eating (with an obligatory spoonful of irradiated bee pollen), back to nature beekeepers is to keep our bees healthy and alive, especially through the long Winter. Our secondary goal, which results from keeping our honey bees alive and healthy, is to have some honey to extract and enjoy...and maybe even share and sell.

The three most essential management practices for a beekeeper to achieve these goals are:

1. Monitoring and treating for *Varroa* mites...and the lesser threat from other pests and diseases.
2. Feeding as needed to avoid starvation and boost production.
3. Avoiding excess moisture in your hive(s)/



My girls enjoying their new upper entrance, with the plug removed from the shim for later Winter feeding. If they feel it is too large a hole they will propolize it into a smaller one.

providing ventilation.

I understand that new beekeepers, and even some long term beekeepers, are reluctant to "disturb" the bees. Sometimes I feel that way myself. But, it's a choice between a little periodic intrusion and dead, or certainly unproductive, weakened colonies. I often talk to beekeepers in the Fall who are seeking advice for treating for *Varroa* mites who haven't treated all Spring and Summer. And hand in hand with that they are often complaining that there is hardly any capped honey in their hive(s). Or they're stressing over the brood pattern

⇒

in their hive, and should they replace their queen for a better one, when they haven't monitored and treated for *Varroa* mites all season. Or it is October and they treated back in June. They didn't see any mites. And should they feed them more, maybe, or add some sort of supplement? Well, more often than not the problem is *Varroa*, *Varroa*, *Varroa*. How productive would you be with a giant rat feeding up under your armpit? Not least withstanding there are the diseases that are caused by the mites. A healthy hive will usually be able to fight off such nuisances as wax moths or hornets. An unhealthy hive is in a downhill spiral to disaster.

I don't fret the small stuff. Bees are natural creatures, and as long as we do our part to keep them healthy they will gather in what they need to survive, and even provide a little extra for us. I, personally, usually only feed sugar syrup in the Spring until the first honey super goes on, and some Winter patties if they need them in the late Winter. I don't lose sleep over brood patterns and I rarely use supplements. If I find signs of a laying queen I'm happy. And if I don't, I check again in a week or two. The one hive I lost was because I hadn't been as on top of my *Varroa* checks as I'd meant to be. *Varroa*, *Varroa*, *Varroa*. And it is an awful feeling when we know we could have done more.

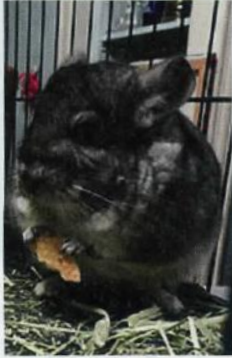

Dedicated to Lilly Langtree, the sweetest chinchilla that ever lived...and also my mother, Doris Darlington Cohen.

HONEYBEE FACT #21 by John Martin

BEES HAVE A STRAW-LIKE TONGUE CALLED A PROBOSCIS TO SUCK UP LIQUIDS.



THEY LOVE TO MAKE THAT SLURPY SOUND AT THE BOTTOM OF A DRINK!



© 2021 John Martin Features

MARTIN

SWARM CAPTURE NET - MAKE YOUR OWN

Bill Patton

As a beekeeper for a few years, I have always enjoyed catching swarms primarily spawned by the desire to get free bees instead of buying. Via neighborhood postings and notices on local social media, I got tons of inquiries and captured 10-12 swarms last Spring. But over the years I learned some lessons. I found holding a box or something under the swarm and shaking or brushing the limb to be awkward. Once you shake or brush, lots of bees begin flying and if your intentions are to locate them away from the swarm perch, a great many bees will not find the queen after you have taken her away. Your efforts might get most of the bees but you can only hope the queen is captured. You might have to return and do it again - I have. After a few captures, I said to myself "There has to be a better way!"

So, I designed a rectangular net that would encompass the entire swarm without disturbing many bees. After closing the net, you can shake the swarm, clip the limbs away and easily relocate the bees!

My capture net has two adjustable sides and the top is closed by dowels inserted in the top edge of the net. The design allows the net to wrap around a horizontal limb by adjusting the side zippers depth when the top is closed. It also includes a rope to wrap around a tree trunk or any structure to allow easy brushing bees off their perch. It is helpful before netting them (if you do not already), spray the cluster with sugar water to minimize disturbing the bees and then spend a few minutes clipping away small branches that would keep you from easily using the net to surround them. Carefully reach out and approach the swarm from the bottom. Once the swarm is enclosed, bring the dowels together and shake the swarm off the limb and clip any vegetation away. Once you are free from the bee perch, curl the top dowels to shut the net. When the swarm is relocated, the side zippers and/or bottom zipper can be opened to dump the bees into your hive or opened all sides and lay the net flat creating a ramp to allow the bees to march into the hive.

You can view a YouTube demonstration video by typing onto the browser line tinyurl.com/swarmnet.

See the diagram below for assembly. Approximate costs of the materials are about \$25 and is very easily assembled with the help of someone that sews. All dimensions given can be adjusted as you wish or find necessary.

The only materials needed:

6' x 48" nylon window screening material. Any color is fine but I preferred light gray. It allows you to see the swarm better.

- 2 - 22" (size #5) zippers
- 1 - 34" (size #5) zipper
- 2 - 5' - 6' sturdy dowels
- 1 - piece of rope about 10 feet long

Assembly instructions:

With a 48" wide and 6' long piece of nylon window screening, fold lengthwise to form a 24" x 6' shape. This

is the basic shape of the net. (# 1)

Along the top of one side, fold the top edge down about 1½' and sew the full length of the net. Repeat for the other top edge. These are the channels the dowels are inserted into allowing you to reach out and to open and close the net. (# 2)

On each side of the top, sew the channels closed on one end only. This prevents the net from sliding up the dowels when you push the net into a bush. (# 3)

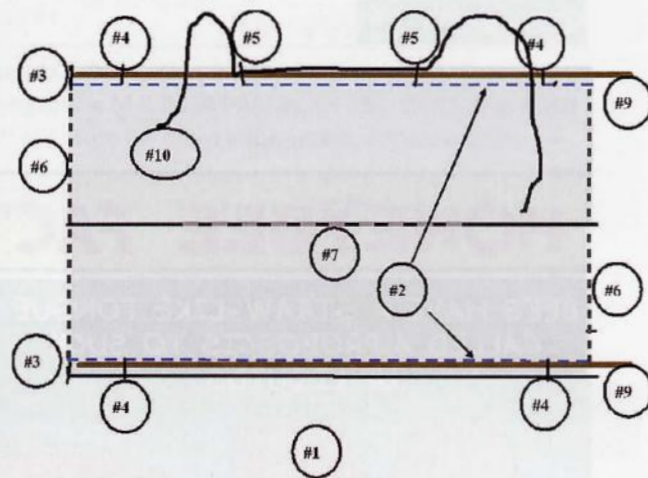

Along the top of both looped channels, cut the looped channel (but not through the stitching) at about 6" from each end. These cuts will allow you to insert or remove the dowels through these slits. (# 4)

Along only one top side and approximately the middle third of the length, cut two holes in the channel. These slits are for the rope to be threaded through the channel. (# 5)

Sew onto each narrow side of the net a 22" (size #5) zipper with the pull tab at the top and to be pulled downward to open from the outside. These zippers allow you to adjust the depth of the opening and allows the net to be laid flat on the ground. (# 6)

In the middle of the bottom fold of the net, sew the 34" (size #5) zipper with the pull tab on the outside. Then cut the net to provide a hole. (# 7)

With each of the 3 zippers sewn in steps 6 and 7, trim off any excess netting inside the zippers to prevent the netting being caught in the teeth.

Insert the dowels. (# 9)

Thread the rope through the channel via the openings along the top. (#10)

Now, go catch a swarm!



Cooking With Hone

Shana Archibald

HONEY CHOCOLATE COOKIES

2½ C of flour
½ C quick oats
1 tsp baking powder
½ tsp baking soda
1-1/3 C of brown sugar
1/3 C of sugar
½ C Crisco
8 tbsp butter
3 tbsp of honey
2 tsp vanilla
2 eggs
½ C of chocolate chips. (Or put as many as you want! I won't judge)

Mix flour, oats, baking powder & baking soda in a bowl. In a separate bowl, combine brown sugar, sugar, butter, honey, vanilla & crisco. Add eggs one at a time while mixing. Add dry ingredients, while mixing slowly. Next, using a spatula, fold in chocolate chips. Ball the dough into your desired size and bake for 8-11 mins on 350°F. Let cool, and enjoy!



WINTER ENERGY BITES

For those Dark Gloomy Days of Winter you might need a little energy push and the Flavor and Savor of these easy 'Winter Energy bites'

2/3 cup creamy peanut butter
½ cup semi-sweet chocolate chips
1 cup old fashioned oats
½ cup ground flax seeds
2 tablespoons honey

These are so easy to make & make a great healthy snack. Combine all ingredients in a bowl & stir. Place them in the fridge for 15-20 minutes. That will make them easier to roll into balls. Roll them & there ya go! You can keep them in a bowl in the fridge for up to a week



SHOPPING FOR BEE EQUIPMENT?



Jim Thompson

I help run a bee museum and thus buy all kinds of bee equipment. Some of the equipment is good, some of it is trash, and once in a while it is a pure rip off. Back when A.I. Root was alive, he published a column entitled "Humbugs and Swindles" in *Gleanings*. That column averaged about two situations per year. He had definite proof of the things that were going on and gave the individuals involved ample time to respond to his letters.

I form display boards of the different pieces of bee equipment so a beekeeper can see if it is something that fits their situation. Remember that in other countries bee equipment may not be the same size. In Canada, the hives are 1/4" wider than in the United States. In China, the hives are definitely a different size and type the eyelets they use to protect the frames are slightly smaller. Then there is a difference in the hives that are being used around the world and don't forget that in some cases there is a language problem and the translation is not necessarily correct.

I have purchased over 2,000 bee items that were on Ebay and only once have I had a problem. The item was not what it was advertised to be. It was written as an "Electric Bee Smoker Professional Transmitter Kit Apiculture Beekeeping Accessory." After waiting several months for it to arrive, it was too late to leave feedback. What did I get? A glorified plastic smoker bellows. There was no electrification, no wires, no off-on



Blue flexible plastic material for bellows and plastic end pieces with fancy cut-outs.

switch and certainly no instructions. When I complained to the seller, he told me that it was electric. I responded that it had no wires etc His response "Why did you buy it then?" Then he said send it back and he would refund my money. I said that I would gladly send it back but I would like some assurance that I would be paid for the return postage and would be sending it to the correct address. I sent him the address that was on the package. His response was that it was the wrong address and he would send me the correct address. He never did. Thus I went through Ebay and fortunately I had paid by PayPal so eventually I got my money back. It only took another 6 months. They had to get a response from the seller. I noticed that the seller still advertised the item for a couple of months afterwards and used the same wording.

I know that there are some electric bee smokers and I have one that emits a supposedly high pitched sound that only dogs can hear, two smokers that have batteries that power a fan, another smoker with a wind up motor, another one powered by a propane cylinder and several others operated by bellows. It is hard to beat the bellows powered smoker.

Sometimes bee clubs have their members form a large equipment order so they can get a quantity discount. This sounds good but in practice there is usually someone that can't get their order or money together and that person normally has the biggest order. It is best to order equipment by yourself.

Have you ever noticed the bundled units of equipment that dealers put together? I'll address the beginner outfit for now. It will have the basic equipment plus a small hive tool, bee brush, frame grip, and the most inexpensive gloves and veil. Why? Those things are cheaper and help keep the cost down plus some of the items you don't need or use. Why not order the kit locally or by telephone?

That way you can talk to the people and ask how much the kit would be if you substituted or eliminated some items. If they won't substitute items, are they someone you want to deal with? The same sort of reasoning goes with bee keeping advice. Are they beekeepers or strictly sales people?

If you are buying bees, are there any guarantees? What if your bees or the queen arrive dead? If you are buying a hive, how many frames are you getting? Some sellers claim that nine frames per super are enough. What they are actually doing is getting an extra hive to sell after they have sold nine and you may have to deal with burr comb. Ask around to see if the dealer is reliable and has a replacement or partial refund and if so, for how long. There were a few people that would take your money and not send the bees. People in the local bee club can tell you, as this information usually isn't written.

Stay away from buying used equipment until you have had experience in diagnosing and treating disease. Often someone has a deal that seems too good to be true and likes to deal with new beekeepers. I have seen a few beekeepers get out of beekeeping because they had to burn their equipment.

Be leery of some of the advice that is offered on the internet as there are people with many different backgrounds giving advice. Couple with that the locations where the people live. A common tendency of human nature is not to brag or admit mistakes. Thus if a person invests in a type of expensive equipment and it doesn't work well, they seem to relish seeing others purchase the same type of equipment. I guess that they call it "Misery loves company."

Several firms advertise on the internet in such places as: Ebay, Alibaba, Amazon, Walmart, Otto, Flipkart, Rakuten, Newegg, and others. I would suggest that you pick the ones that operate in the country

where you live and avoid the ones in foreign countries. Pick those that have some sort of guarantee that you will get the item ordered or your money back.

With people buying half of their needs off the internet it seems a common practice and there are lists of things to always buy on the internet as: electronics, medicines, luggage, baby supplies, books, pet food, exercise gear, and clothing basics. Also there are lists of items to never purchase on the internet such as: art & decor items, furniture, mattresses, large appliances, cars, musical instruments, groceries, and make up. Although I don't completely agree with either of these lists, I feel that you lose the personal touch of seeing, touching, and discussing the product and could be cheated.

I have noticed several bee items on the internet and some of the items can be purchased cheaper than you can buy elsewhere. However you may have to wait a long time before the item is delivered. Sometimes the item that you purchase is a replica or a knock off of the original. Other times you may encounter an item that is way too expensive for the job to be done. For example a box that you put a frame in and it will blow the bees off or a device that will clamp onto a frame and shake it for



Device that clamps on frame and then shakes it.

you. Remember that some things may not be legal for use or not really beekeeping items.

What should you do? Find a local beekeeper that has kept bees for a few years. Attend local bee club meetings. Most bee clubs will let you attend without joining right away. Volunteer your services to help an experienced beekeeper. That way you will get some experience, knowledge of what equipment is needed, what type of hive is preferred, where to purchase equipment and whether or not you like beekeeping.



HONEY BEE FACT #38

By John Martin

DURING THE COLD SEASON, HONEY BEES WILL GATHER TOGETHER IN A TIGHT BALL AND VIBRATE THEIR WINGS TO KEEP WARM.



© 2019 John Martin

BACK IN THE LATE 70'S THEY ALSO ADDED LIGHTS AND MIRROR BALLS AND DISCOED THE WINTER AWAY!

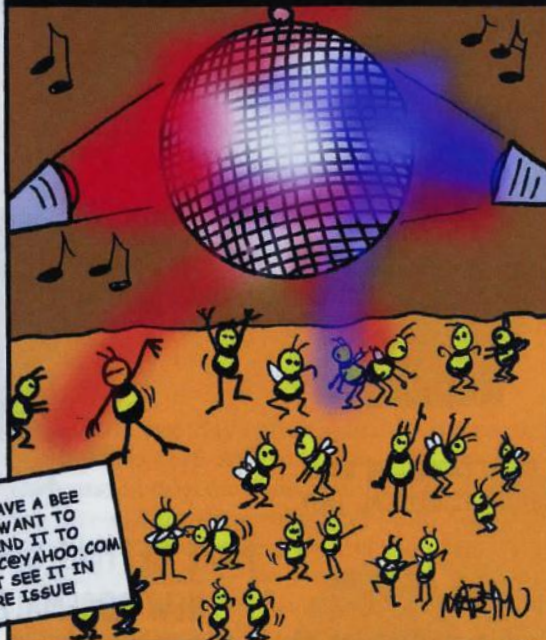

DO YOU HAVE A BEE FACT YOU WANT TO SHARE? SEND IT TO BEEZWAXCOMIC@YAHOO.COM YOU MIGHT SEE IT IN A FUTURE ISSUE!

Splits And Finding The Queen

David E. MacFawn



Splitting colonies is one method to control swarming. Walk-away splits (where you make sure each split half contains less than three-day-old larvae, honey, and pollen and let the queenless

split raise another queen), or installing queen cells or a mated queen are all ways to split a colony for a colony increase. Demaree is another technique to simulate a split but keep all the worker bees in the same hive. If looking for the queen, she is usually found on a frame with freshly laid eggs.

In the Columbia, South Carolina area, colonies can often be split at the end of February/ first of March at the earliest. Adding empty supers with frames will not relieve the congestion in the brood nest that usually causes swarming. Frames with brood and bees need to be removed in the congested brood nest. If colonies are fed sugar syrup mid to the end of January, most colonies will be ready to split from the end of February to the first of March at the earliest (approximately two brood cycles). Usually, only healthy colonies that are well provisioned with honey and pollen build up sufficiently to split. The maples bloom end of January to the first of February in the Columbia area. The maples are considered a major pollen source and a minor nectar source. The nectar flow usually starts around the first of April and continues through the first part of June in this region .

If a walk-away split is done at the end of February, it takes approximately three weeks to raise a queen, and a week or so to mate and start laying, and another three weeks for the first workers to emerge. This puts the first workers emerging mid-April with the nectar flow starting around the first of April. Another approximately three weeks are required for the house worker bees to mature into field bees putting the nectar gathering field bees for the walk-away split being ready first to mid-May. The nectar flow is over usually around the first of June, so the walk-away split has missed most of the Spring nectar flow. This means a walk-away split will need to be fed during the Summer dearth that starts mid-June and runs through around the first of August. Unless the colony is taken to cotton for nectar that blooms mid-July through September or Sourwood bloom in the higher mountain elevations. It should be noted that sometimes an inferior queen may result from a walk-away split. A walk-away split queen can be evaluated and replaced if this occurs. A walk-away split may be required in South Carolina at the end of February due to a lack of mated queen availability. The split-half with the original queen should continue to build up properly and often you will get a reasonable honey crop.

When splitting a colony, I usually do not find the queen. I make sure both split halves have plenty of honey, pollen, and less than three-day-old larvae. This results in the split that does not have the old queen to start raising a queen and the worker brood from the original queen will

emerge in approximately one to two weeks. The split-half without worker brood in approximately two weeks will be the queenless split. It takes a lot of time to find queens. Hence, I minimize my labor costs. The colony should be monitored for laying worker activity. Usually, you have three to six weeks before a laying worker occurs.



Figure 1. Laying worker frame. (Photo courtesy Mark Sweatman.)



Figure 2. Laying worker closeup. (Photo courtesy Mark Sweatman.)

One to two days after splitting, queen cell(s) can be installed in both splits. Queen cells are much cheaper than mated queens. This results in an approximate one-week head start on a walk-away split. A mated queen can also be installed in the split-half that does not have brood after approximately 1½ weeks.

Whether you do a walk-away split or use queen cells or mated queen or a Demaree depends on what your strategy is. A walk-away split and queen cells can be used to get half your genetics from the local area if you are interested in local area genetics. A mated queen, if not raised from local colonies, can be used to replace

100% of your colony genes from the queen mated area of the mated queen. A Demaree is when all the brood in the bottom brood chamber is moved above a queen excluder and a super with frames. The queen is left on a frame of drawn comb in the bottom brood chamber. In a week to ten days, the brood above the queen excluder is checked for queen cells and the queen cells are destroyed to inhibit swarming. The colony believes it has swarmed and you have retained all your field bees for honey production. After several weeks the Demaree colony can be recombined.



Figure 3. A mated queen in a Benton queen cage. (Photo courtesy David MacFawn.)

The first of June is also an excellent time to split colonies. There are a lot of bees available right after the nectar flow and mated queens and queen cells are available. One of the issues is getting the colony to draw out comb over the Summer dearth. Often the colony will need to be put on cotton in mid-July or taken to the mountains for the sourwood flow. It should be noted that drawn comb, especially in the brood chamber, improves overwintering success. Drawn comb is required to ensure the cluster is in the bottom of the hive with plenty of honey and pollen going into Winter. If the colony does not draw out the comb after a June split, the brood nest will remain in the hive areas where the drawn comb occurs. This may be a feed chamber super or honey super. Feeding sugar syrup rarely enhances drawing out comb. Normally a nectar flow is required. The colony normally needs to have about 80% comb utilization before they draw out more comb.



Figure 4. Festooning chain /drawing out comb. (Photo courtesy David MacFawn.)

After splitting, the split can be moved three to five miles away or left in the original yard. Moving the split works better since the field bees will stay with the moved split. If the split is left in the original yard, an extra frame of bees and brood should be placed in the split. Often it is better to locate the split directly next to or in front of the original location to minimize losing field bees in the split.

A frame of various age bees is best to place in both half splits. This will ensure that you do not have all the same age workers and minimizes requiring to need a lot of nurse bees initially.



Figure 5. A frame of various age brood. (Photo courtesy David MacFawn.)



Figure 6. Swarm cells on the bottom of a frame. (Photo courtesy Kathy Carpineto.)

Utilizing swarm cells to place in each split half may also be considered. This will shorten your queen development time by about a week or so. However, some beekeepers believe utilizing swarm cells propagates swarm tendencies. It should also be noted that leaving swarm cells in the half with the original queen may result in a swarm being issued from that split half.

There are several ways to avoid swarming. Making splits and utilizing a walk-away split, queen cells, mated queen, or swarm cells all have their benefits. Demaree may also be utilized to simulate a swarm condition in the colony and save all your bees for honey production. Moving the split three to five miles from the original bee yard works best. Whether you split or not gets back to what your needs and strategy are. If you need to make increases due to losses, splitting may be the way to go.

However, if you want to make a honey crop, then Demaree may be the way to go.



David MacFawn is an Eastern Apiculture Society Master Beekeeper and a North Carolina Master Craftsman beekeeper living in the Columbia, South Carolina, area. He has his third book being published in January 2021, *Applied Beekeeping in the United States*. He is the author of two other books,

<https://outskirtspress.com/BeekeepingTipsandTechniquesfortheSoutheastUnitedStatesBeekeepingFinance>
<https://outskirtspress.com/gettingthebestfromyourbees>



The Best BEEKEEPING Magazine In AMERICA!

- 12 Big Issues A Year
- Beekeeping How To, When To, Where To
- Urban Beekeeping Explained
- Paper or Digital Editions
- Web Page • Email Blasts • Blog • Twitter
- All Free

Keeping Bees Helping Beekeepers For Over **148 Years**

\$25

Save 70% Off The Newsstand Price!
 + \$20 postage for Canadian Subscription

To Order Visit www.BeeCulture.com



SuperDFM[®]-HoneyBee[™]
 The World's First Probiotic for Honeybees[™]



Benefits

- Digestion
- Nutrient Absorption
- Immunity
- Colony Health

Completely Safe

(even during the honey flow!)

All-natural
 We never add silicon dioxide (sand)

NO Harmful Residue • No Resistance Build-up • No GMOs

Trusted & tested by beekeepers since 2014.



STRONG MICROBIALS





StrongMicrobials.com 1-(844)-MY-MICRO 1-(844)-696-4276

Open Air Beauty

Jackie Currie
David Arnal

Our local club, the Beaufort-Jasper Beekeepers Association, meets monthly at the Coastal Discovery Museum located on Hilton Head Island, South Carolina. We gather to learn beekeeping skills and share our stories. The President of our Association, David Arnal, tends the hives on-site, and we usually inspect these hives each time we meet to gain practical beekeeping experience.

This past Spring we had a project of great interest come our way. David was contacted regarding a bee removal on the Island and discovered it was an open air nest, teeming with bees. Knowing that removing it would be a great learning experience, he presented the opportunity to remove the colony to the bee club. We eagerly responded and about two weeks later, several of us headed over to the location, bringing along extension ladders, ropes, saws, and smokers.



(Fig. 1) The nest was located 20 feet high in a live oak tree.

The nest was in a live oak tree, hanging from a limb about 20 feet off the ground (Fig. 1). The nest was substantial, about eight combs in size and very quiet with only a few bees flying in and out. We positioned a ladder and climbed up for a closer look and discovered a handful of calm bees on the combs and two open queen cells (Fig. 2). There didn't appear to be any brood present - the bees had apparently swarmed since David's initial visit.

(Fig. 2) A closer look revealed a handful of calm bees and two open queen cells.



The western honey bee, *Apis mellifera*, is a cavity dweller. Thus when a colony swarms, they almost always move into what they would consider to be the most ideal choice for a new home; one that provides protection from the elements, has enough inner space for the construction of adequate comb for brood rearing and food storage, and has a small nest entrance that can be easily guarded². However, on rare occasions, *A. mellifera* will construct a nest in the open.^{1, 3} The Africanized honey bee (*Apis mellifera scutellata*) is even more likely to have an exposed nest, but in more temperate climates, these open-air colonies usually do not survive the colder Winters³. The Winter had been mild this year so these honey bees had survived.

We then got down to the business at hand. The roof was too steep from which to work, so we braced a second ladder against a large limb of the tree. We looped the ropes over higher limbs, and tied them off close to the nest. David climbed up with a hand saw and cut through the limb about three feet from where the nest was attached. We then lowered the nest to the ground, taking care not to damage the fragile combs.

Once down, we inspected the nest more closely and discovered it to be beautiful (Fig. 3). We confirmed no brood was present in the outer combs and then directed our attention to two swarm cells. One was split up the side and the other was open on the bottom. This evidence seemed to suggest that the surviving virgin queen had emerged, possibly returned from her mating flights, but the prime swarm had left her behind with only a handful of worker bees.



(Fig 3) On the ground inspection confirmed no brood present on the combs.

We were certain the nest would make an ideal home for the virgin's colony or a replacement colony, so we cut the limb to a more manageable length and carefully loaded it into a truck bed for transport. We had originally planned to bring the nest back to the Coastal Museum apiary, but lacked necessary equipment at that location. Instead, we took it to one of David's bee yards where member James Walker and David constructed a nest box out of plywood and scrap lumber. Openings were cut for the limb's ends and an outer cover was made. Within a

few hours, the combs were hanging in the new brood box, hoping that the colony had a queen (Fig 4).

In fact, the colony did have a queen and developed nicely over the rest of the season and overwintered successfully. Our long term plan is to remove the colony from these combs and donate the original nest to the Museum where it can be put on display. We all learned so much from this unique experience (Fig. 5) and know all who see it will surely marvel at the beautiful handiwork of the honey bee!



(Fig. 4) Newly constructed brood box with hive in place, built by club member James Walker (shown) and David Arnal.



(Fig. 5) Team members, left to right: David McAlister, Pam Swift, David Arnal, Nancy Hibbitt, Jackie Currie, and James Walker.

REFERENCES:

Schneider, Stanley S. "The Honey Bee Colony: Life History." *The Hive and the Honey Bee*. Revised Edition. Hamilton, IL: Dadant & Sons, 2015.

Seeley, Thomas D. "The Nest." *The Lives of Bees*.

Princeton, NJ: Princeton University Press, 2019.

"Basic Bee Biology for Beekeepers". Fact Sheet. MAAREC Publication 1.4: beehealth.extension.org; The MidAtlantic Apiculture Research & Extension Consortium, 2004.

Author bio:

Jackie is a Journeyman beekeeper and a passionate student of the honey bee. She currently has 6 beehives located on the May River in Bluffton, SC. When not "learning" from her bees, she enjoys mentoring other beekeepers and speaking to schools and community groups about honey bees and beekeeping. She also is an avid birder, organic gardener, and golfer.



Quality Queens & Packages
Since 1975



COMPETITIVELY PRICED PACKAGES AND QUEENS

BZ-Bee Pollination, Inc.
P.O. Box 69 Esparto, CA 95627
530-787-3044
E-mail: orders@bz-bee.com

Specializing in
Italians, Carniolans & Buckfast

Our queens are A rated by NC State University
Apiculture Program
Health Certificate available upon request
Certified Canadian Queen Supplier