

# GLOBAL OCEAN LIMITED



**GLOBAL OCEAN**



# HOME

We are a supplier of building materials with extensive experience in the American market. Over the years, we have established a strong presence in the USA, South Asia, the Middle East, and East Africa.

# **Our One-Stop Construction Materials Company**

**Welcome to your one-stop shop for all construction needs! As your trusted supplier, we provide high-quality materials for home remodeling and construction. Our skilled team delivers customized solutions to match your unique vision and requirements.**

**At our company, we embrace the principles of open communication, transparency, and building lasting relationships. We believe that understanding your goals is the key to transforming your ideas into reality. Our collaborative approach ensures that we work closely with you every step of the way.**

**Our mission is to exceed your expectations. From the initial concept to the final creation, we aim to provide a seamless and enjoyable construction experience. With a focus on high-quality materials and exceptional service, we are dedicated to helping you achieve outstanding results.**

**Unleash your creativity and explore endless possibilities with us. Our extensive selection of construction materials is designed to meet all your needs, from the smallest renovation to the largest construction project. Let us help you turn your dreams into reality.**

*Thank you for choosing us as your partner in construction.*

*Together, let's build something extraordinary.*

# content



**KITCHEN CABINET  
& CLOSETS**

**03**



**BATHROOM**

**31**



**DOORS & WINDOWS**

**71**



**FLOORING**

**101**



**LIGHTING &  
ELECTRICAL  
FIXTURES**

**115**



**AIR CONDITIONING  
& ELEVATORS**

**135**

# KITCHEN CABINET & CLOSETS

*Discover  
Cabinets*



# Customized Kitchen & Closets



Explore our diverse range of appliances, cabinetry, and kitchen components designed to inspire your creativity. Whether you prefer modern simplicity or timeless elegance, we specialize in crafting Kitchen Cabinets and Closets from a variety of materials to meet your budget while maintaining superior quality.

- **Solid Wood**
- **MDF**
- **Plywood**
- **Paint or PVC Cover**
- **Counter top**
- **kitchen sink**
- **Accessories**

Each material is selected meticulously to uphold our highest standards of quality and durability. Our offerings extend beyond cabinets to include meticulously crafted countertops, sinks, and a selection of essential accessories.

Let us transform your vision into reality with our expertise in custom-made solutions that elevate your living spaces.

*with Solid Wood Natural*



**KH-4101**

# Beauty, Lasting Quality



**KH-C1**



**KH-C2**



**KH-C3**



**CL-7501**







**CL-7502**



**CL-01**



**CL-02**

*Enhance Your Home with*



**KH-4102**

# *Stylish M&D Solutions*





**CL-7503**





**KH-4103**







**CL-7504**



# KITCHEN COUNTER TOP





# SECTION PROFILE SELECTION



**Amore**

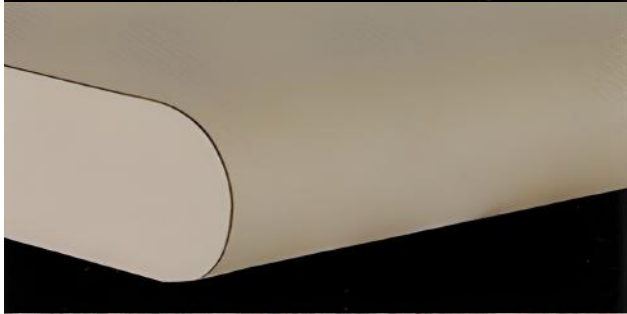

**E-Top 1500**



**Diamond Top**



**No-Drip**



**Aegean**



**Vida**



**E-Top 2000**



**Dura-Top**

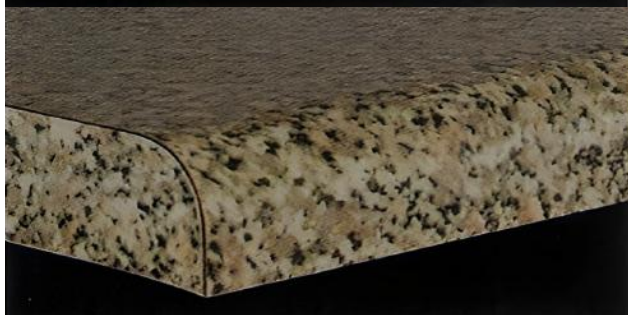

**Waterfall**

# KITCHEN SINK



**KV-7801**



**KV-7803**

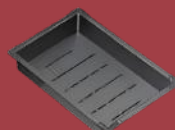





**KV-7802**



**KV-7804**

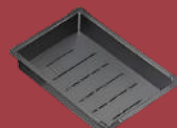

# KITCHEN SINK



**KV-7805**



**KV-7807**

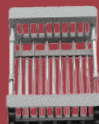



**KV-7806**



**KV-7808**

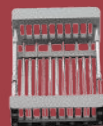

# KITCHEN ACCESSORIES

*Elevate your  
essential kitchen*



*functionality and style with  
kitchen accessories*



# KITCHEN ACCESSORIES

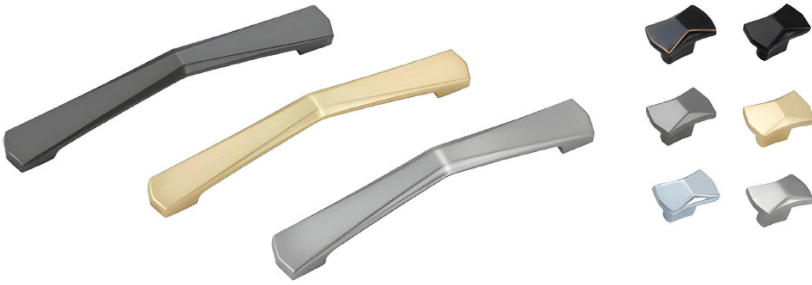

KS-4001



KS-4002



KS-4003

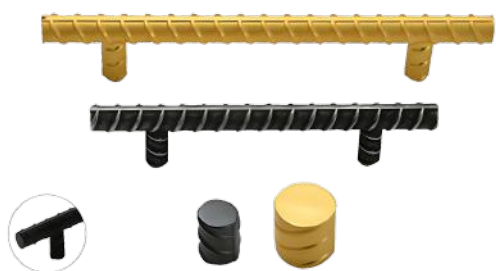

**KS-4004**



**KS-4005**



**KS-4006**



**KS-4007**



**KS-4008**

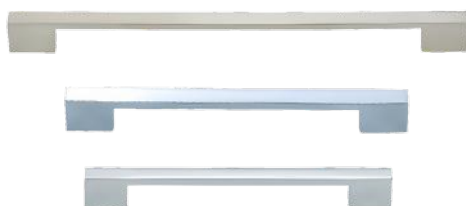

**KS-4009**

# BATHROOM

*Elevate Your  
Tailored to*





# *Home with Exquisite Bathroom, Your Style and Comfort*



Whether you're creating a luxurious primary spa bathroom from scratch or updating a compact apartment wet room on a budget, our range of bathroom solutions ensures functionality, beauty, and enjoyment. We specialize in everything from optimizing layouts to integrating smart storage solutions. Choose from a variety of options including tiles, sink vanities, window treatments, plumbing and lighting fixtures, bathtub and shower styles, and color schemes. Transform your bathroom into a designer-worthy space that complements your home style, whether traditional, modern, industrial, or farmhouse.

- **VANITY**
- **TOILETS**
- **BATHTUB**
- **SHOWER CABINET\***
- **FAUCETS**
- **BATHROOM ACCESSORIES**



**VT-6001**



**VT-6002**



**VT-6003**



**VT-6004**



**VT-6005**



**VT-6006**



**VT-6007**



**VT-6008**

# TOILET SERIES







**TS-8001**



**TS-8002**



**TS-8003**



**TS-8004**



**TS-8005**



**TS-8006**



**TS-8007**



**TS-8008**



**TS-8009**

# SHOWER CABINET



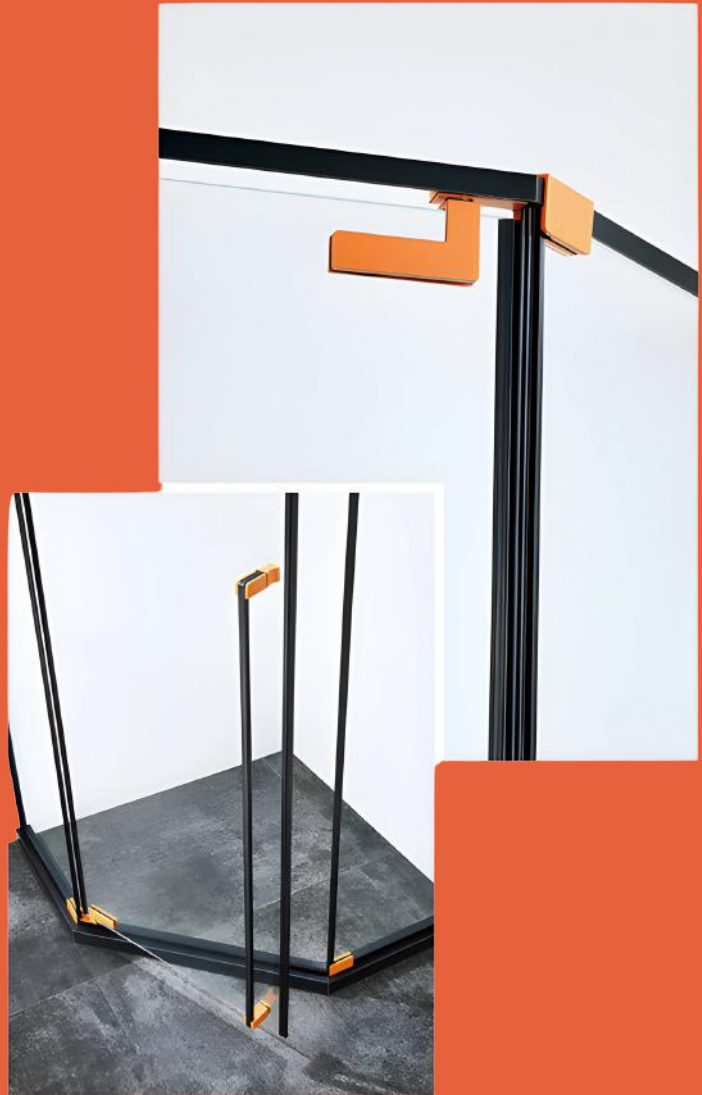

- STAINLESS STEEL
- ALUMINUM



**SC-3501**





**SC-3502**



**SC-3503**



**SC-3504**





**SC-3505**

ANY SHOWER CABINET SHAPE , SIZE , COLOR OR MATERIAL CAN BE  
CUSTOMISE



**SH-2001**





**SH-2002**



**SH-2003**



**SH-2003**



**SH-2004**



**SH-2005**



**SH-2006**



**SH-2007**



**SH-2008**



**SH-2009**



**SH-2010**



**SH-2011**



**SH-2012**



**SH-2013**



**SH-2014**



**SH-2015**



**SH-2016**



**SH-2017**



**SH-2018**



**SH-2019**



**SH-2020**



**SH-2022**



**SH-2023**

# BATHTUB







## Acrylic Bathtubs

- Durable and Long-Lasting
- Available in various shapes, sizes, and colors.
- Easy to Maintain and clean



**BH-8001**

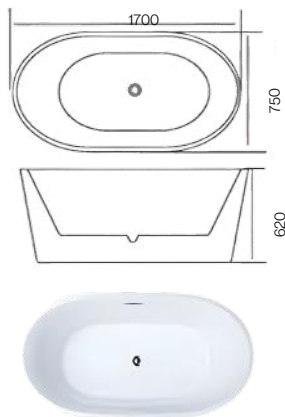

**BH-8002**



**BH-8003**

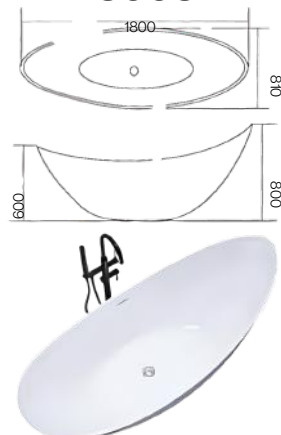



## BH-8004

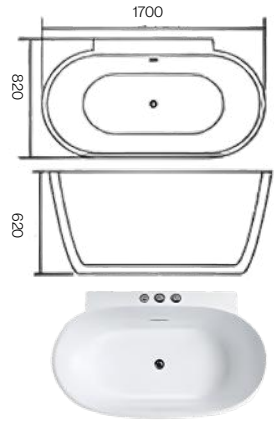

## BH-8005

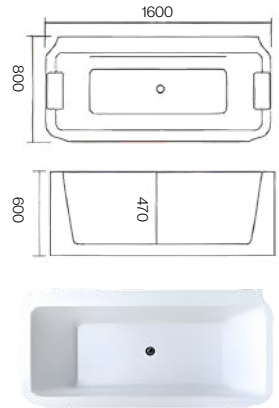

## BH-8006

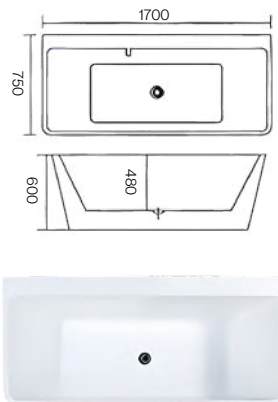



## BH-8007

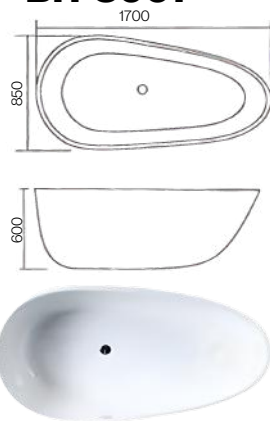

## BH-8008

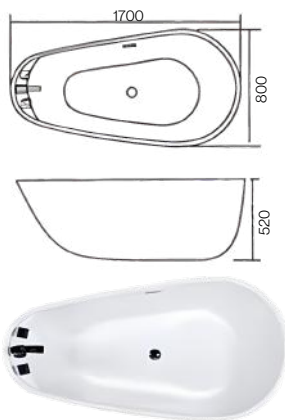

## BH-8009

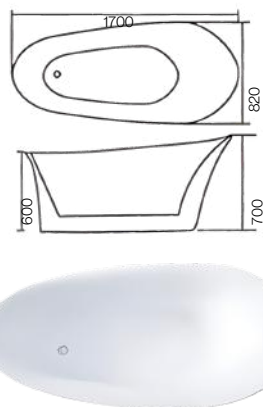



## BH-8010

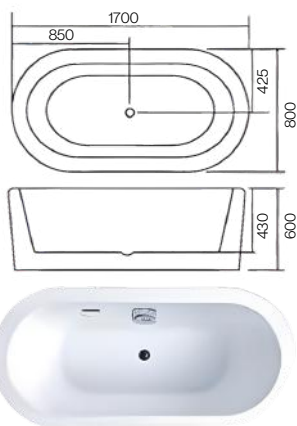

## BH-8011

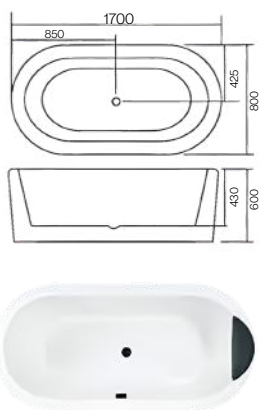

## BH-8012

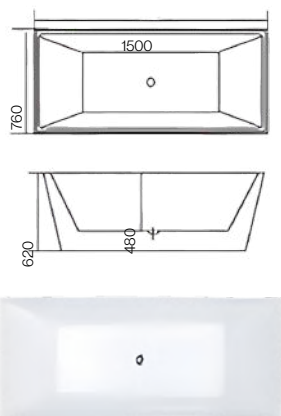

# FAUCETS

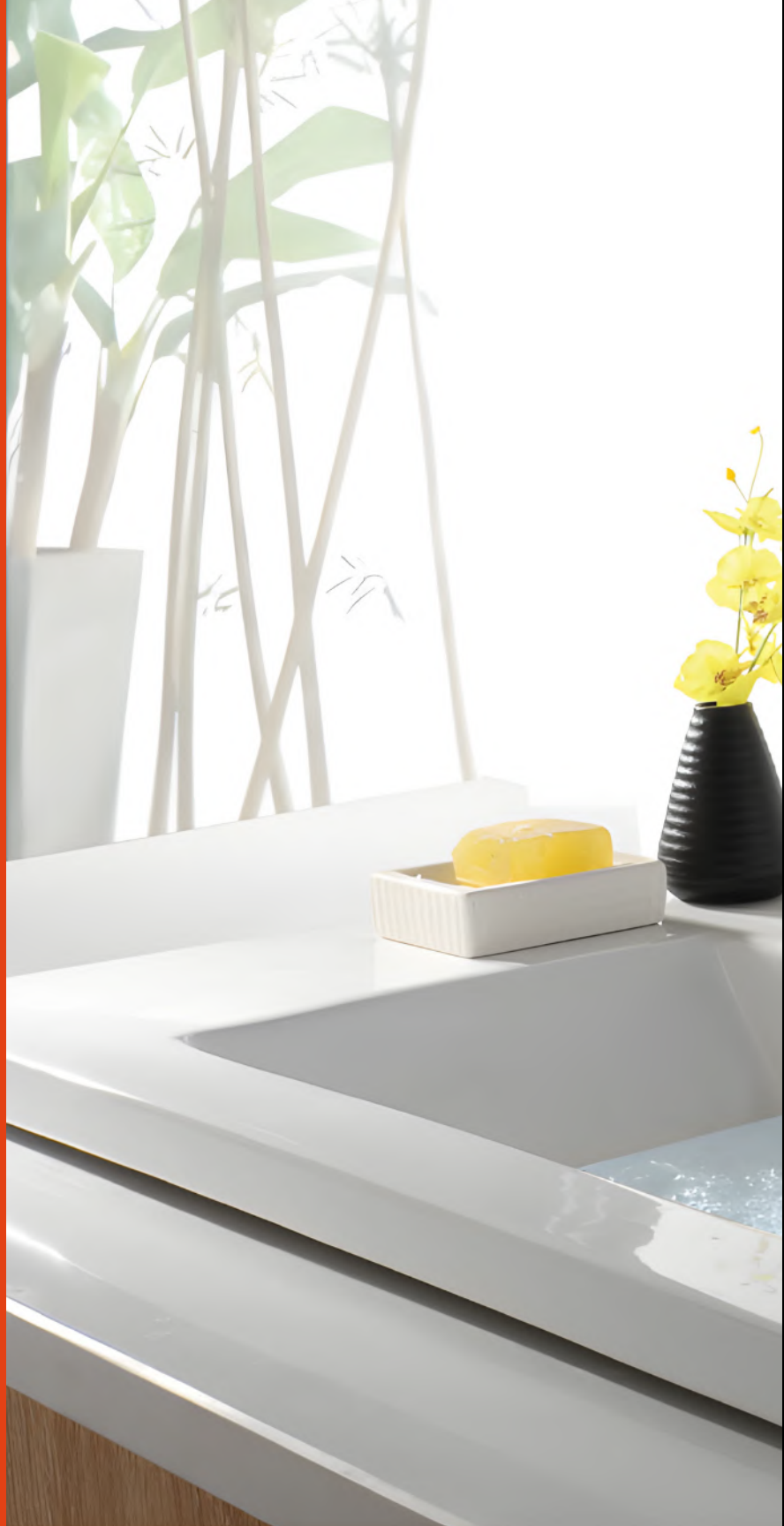



**FA-9001**



**FA-9002**



**FA-9003**



**FA-9004**



**FA-9005**



**FA-9006**



**FA-9007**



**FA-9008**



**FA-9005H**



**FA-9006H**



**FA-9007H**



**FA-9008H**





**FA-9009**



**FA-9011**



**FA-9013**



**FA-9010**



**FA-9012**



**FA-9014**

# BATHROOM ACCESSORIES





- **Stainless steel**
- **ABS**



**BA-4801**



**BA-4802**



**BA-4803**



**BA-4807**



**BA-4808**



**BA-4809**



**BA-4813**



**BA-4814**



**BA-4815**



**BA-4804**



**BA-4805**



**BA-4806**



**BA-4810**

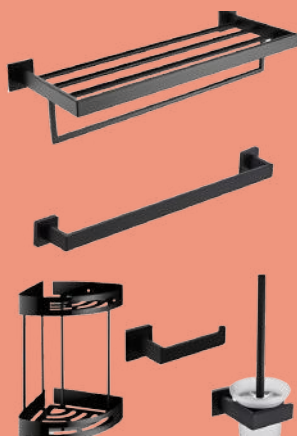

**BA-4811**



**BA-4812**



**BA-4816**



**BA-4817**



**BA-4818**

## BA-4901

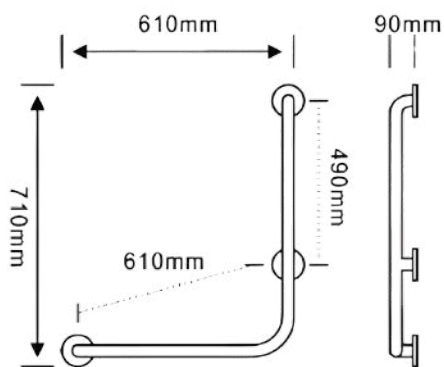
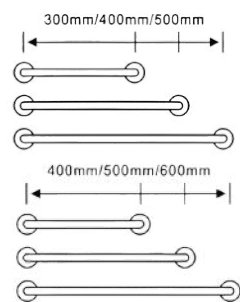

## BA-4902



## BA-4903

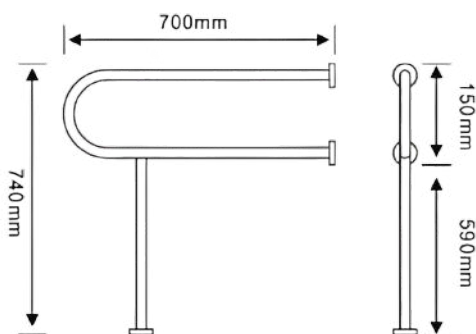

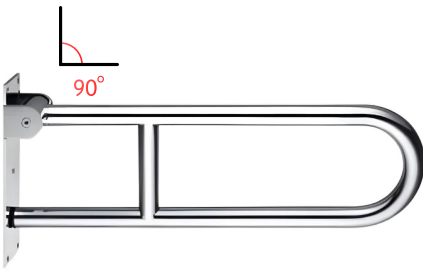

### BA-4904

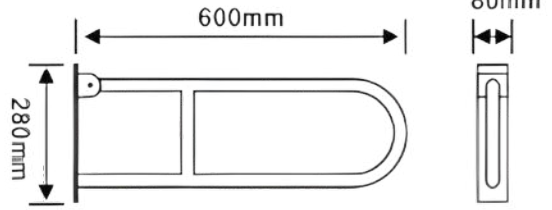

### BA-4905

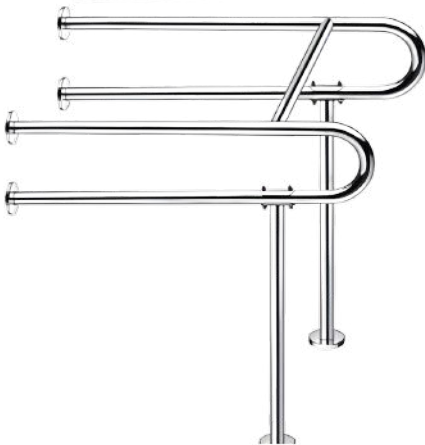
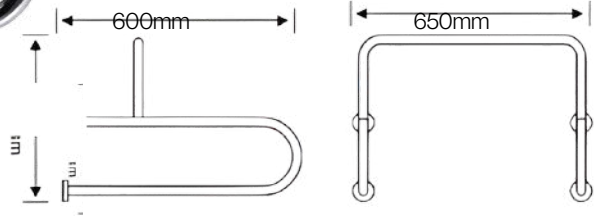

### BA-4906

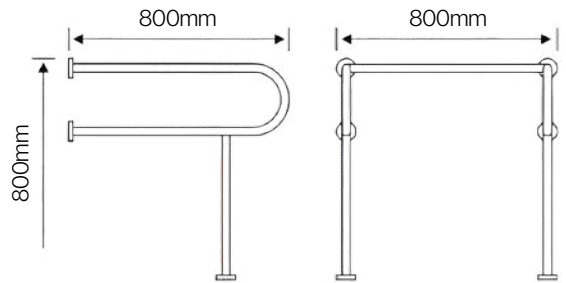

# DOORS

*Discover*





# *Our Range of Doors*



Elevate your design with our diverse door collection. Choose from premium materials to suit your budget while ensuring top-quality standards.

- **Solid Wood Door**
- **MDF Door**
- **WPC Door**
- **Steel Door**

Each door is crafted for durability and style. Let us find the perfect door to enhance your space.

# DOOR CORE DETAILS

## SOLID WOOD

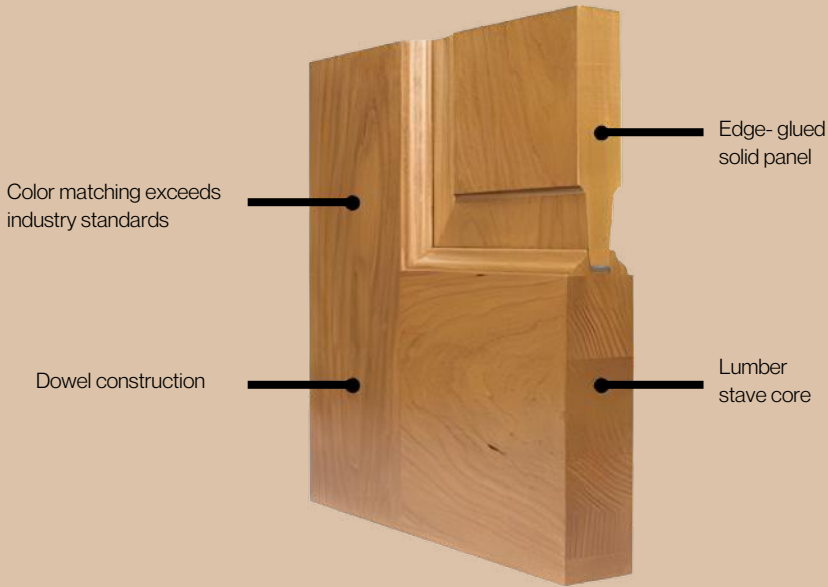

## WPC



## MDF

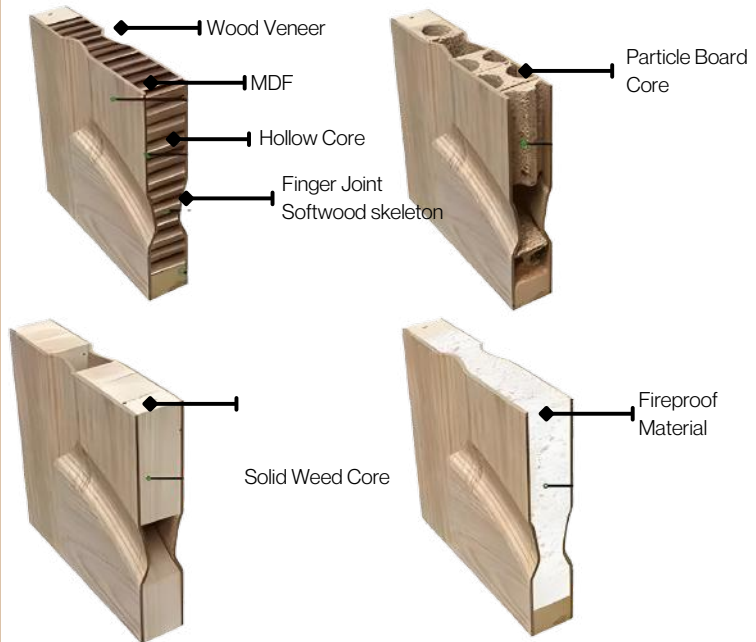

# SELECT YOUR DESIRED COLORING



**DR-C01**



**DR-C02**



**DR-C03**



**DR-C04**



**DR-C05**

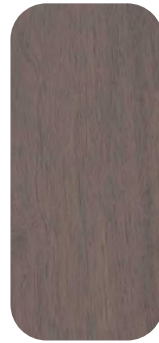

**DR-C06**



**DR-C07**



**DR-C08**

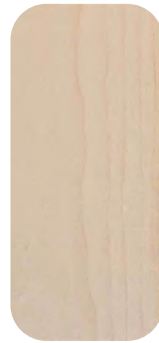

**DR-C09**



**DW-1001**



**DW-1002**



**DW-1003**



**DW-1004**



**DW-1005**





**DW-1006**



DW-1007



**DW-1008**



**DW-1009**



**DW-1010**



**DW-1011**



**DW-1012**



**DW-1013**



**DW-1014**



**DW-1015**



**DW-1016**



**DW-1017**





**DW-1018**

# STEEL FIRE-RATED ENTRANCE DOORS



**HARDWARE  
INCLUDED**

**GALVANNEALED  
STEEL**

**90  
MINUTE  
FIRE RATED**

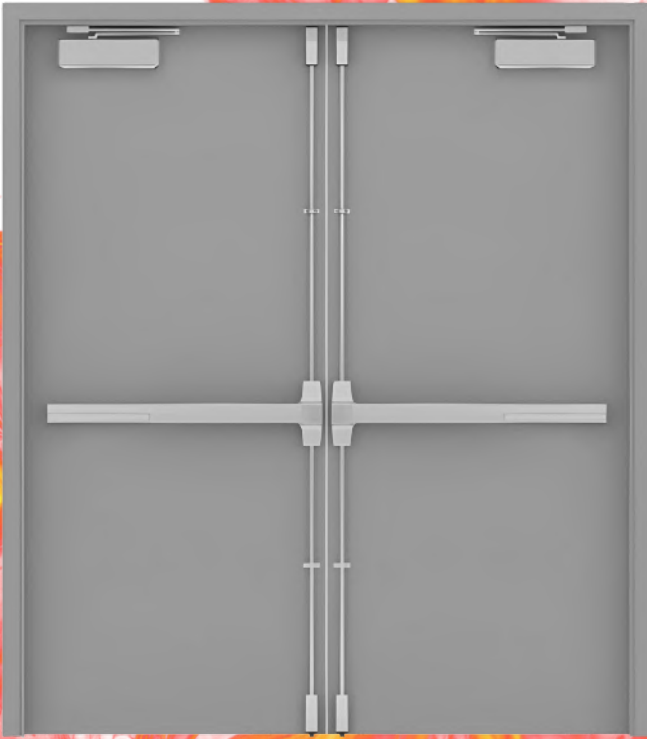

**DS-2001**



**DS-2002**



**DS-2003**

**SECURE YOUR  
SPACE WITH HIGH-  
QUALITY STEEL  
FIRE-RATED  
DOORS.**



**Door Closer**



**Hinge**



**Smoke strip**



**Door Silencer**



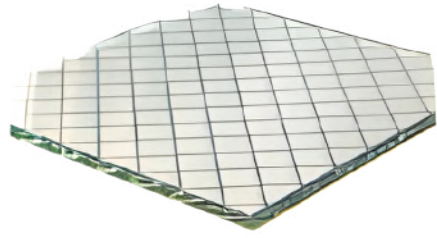

**Wire Glass**



**Panic Bar Exit Device**



**outside Lever Trim**



**Door Bottom Strip**



**Door Closer**



**Door Frame**



**Hinge**

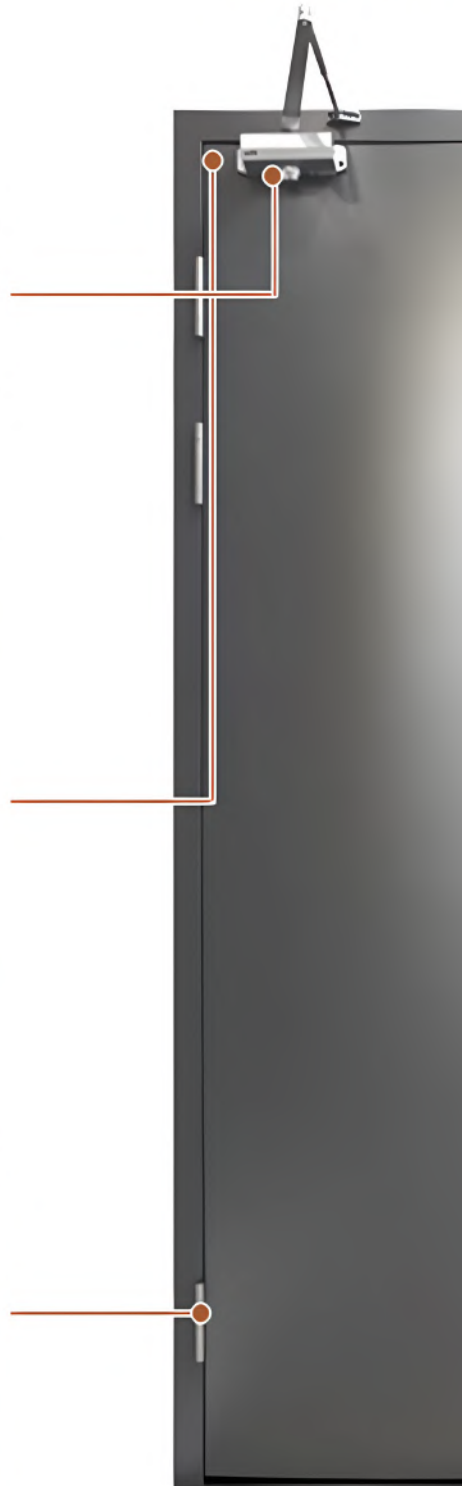

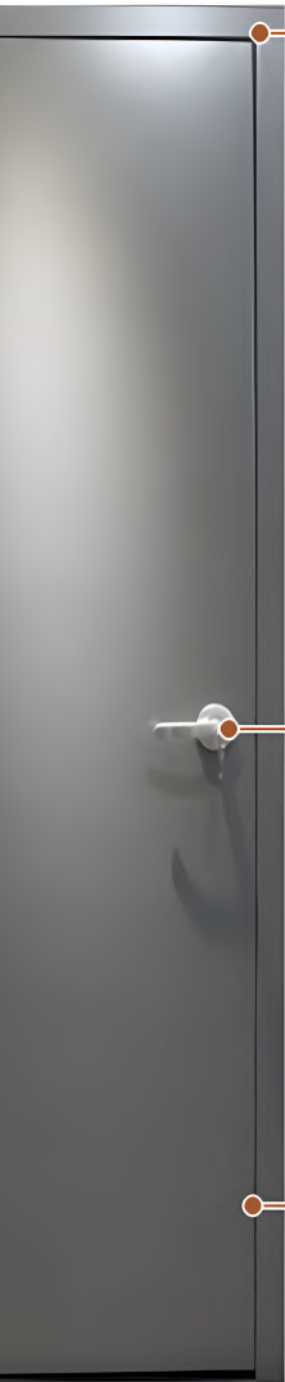

**Seamless  
joining**



**Handle**



**Panic bar**



**Smoke strip**

# WINDOWS







Transform your space with our versatile aluminum window collection. Select from a variety of styles and configurations to complement your aesthetic preferences and functional needs.

- **Sliding Aluminum Windows**
- **Casement Aluminum Windows**
- **Awning Aluminum Windows**
- **Fixed Aluminum Windows**

Each window is designed for durability and style, tailored to elevate your living environment. Discover the ideal aluminum window solution to enhance your home.



**WS-3002**





**WS-3003**





# FLOORING

*Discover a variety of flooring options for every room in your home.*



*variety of flooring options to suit  
your home*



Whether it's the kitchen, bedroom, or any other space, we have a flooring type that fits your needs perfectly. Whatever your preference, we're committed to supporting your dreams and bringing them to life with a range of materials:

- **SPC (Stone Plastic Composite)**
- **Solid Wood**
- **Porcelain**
- **Vinyl Tile**

**Choose the perfect flooring material to enhance your living spaces with style and durability.**

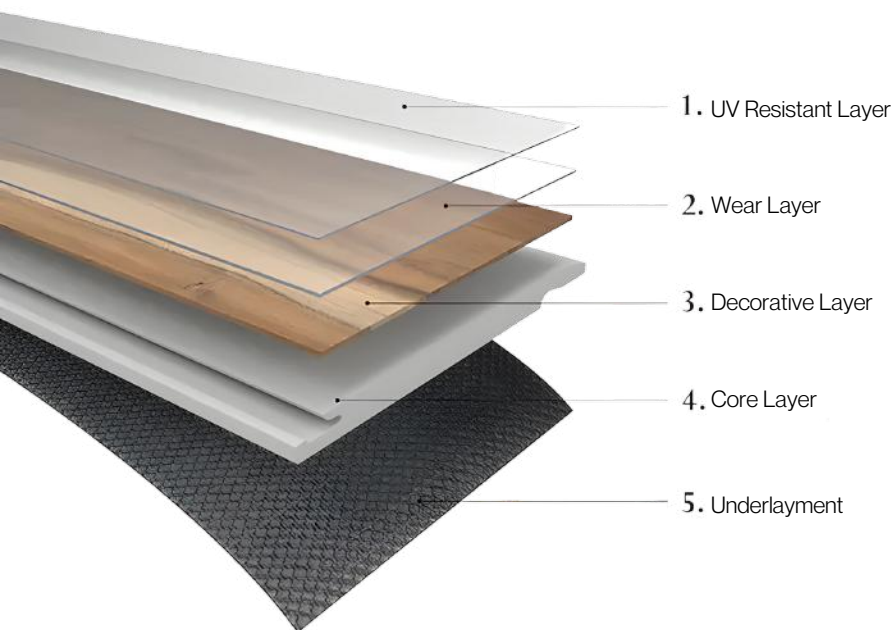



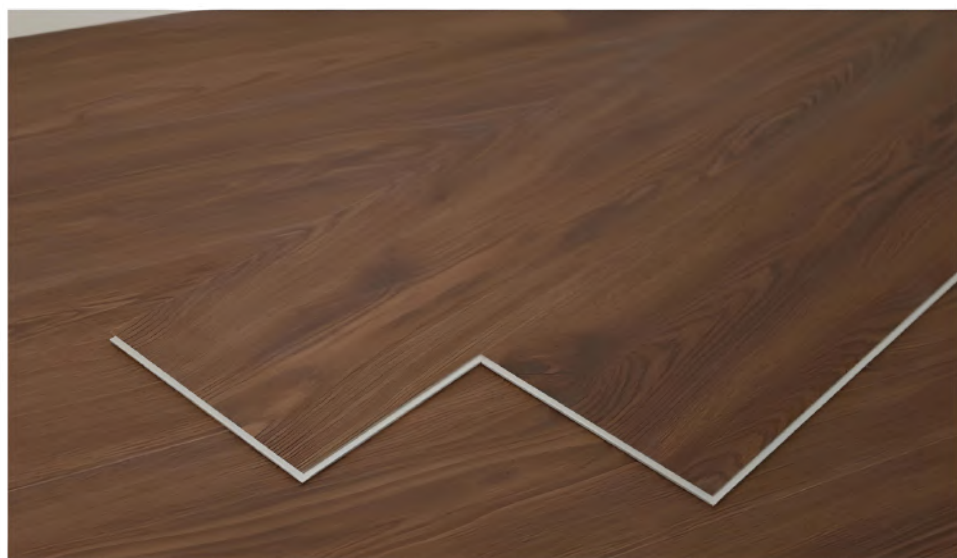

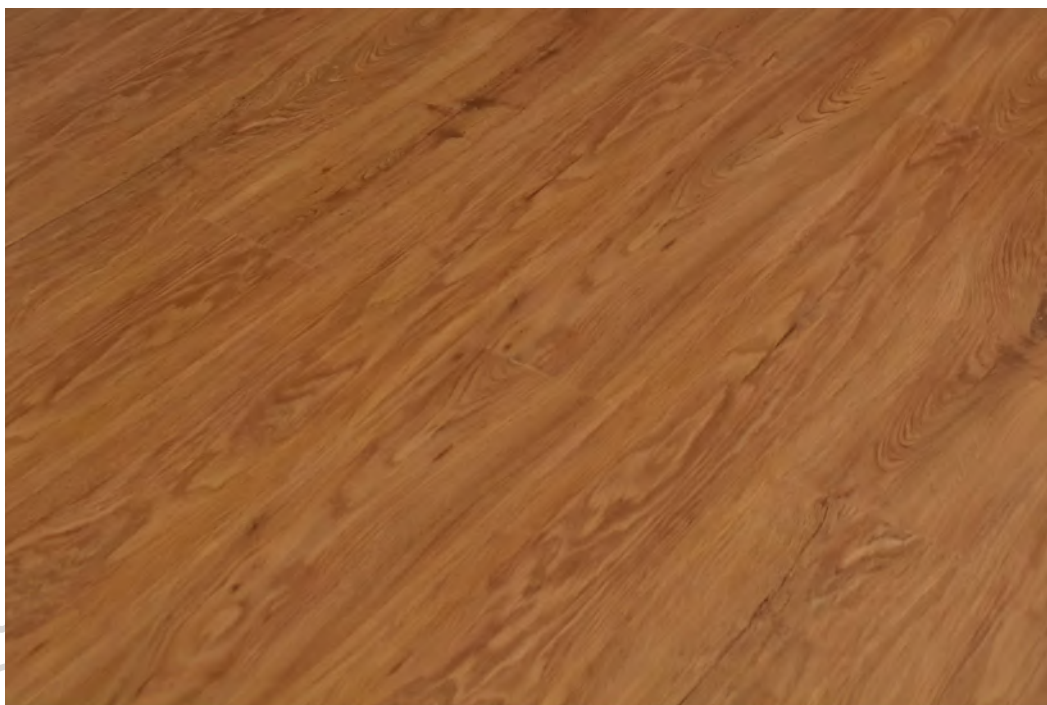









ASH



OAK

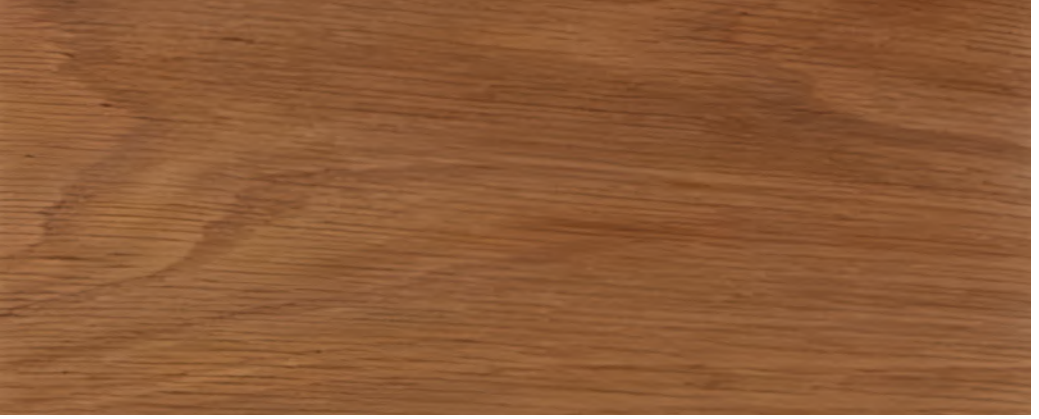

BEECH



WALNUT



THAT WAS THE MOST POPULAR WOODEN FLOOR TYPES

# VINYL TILE

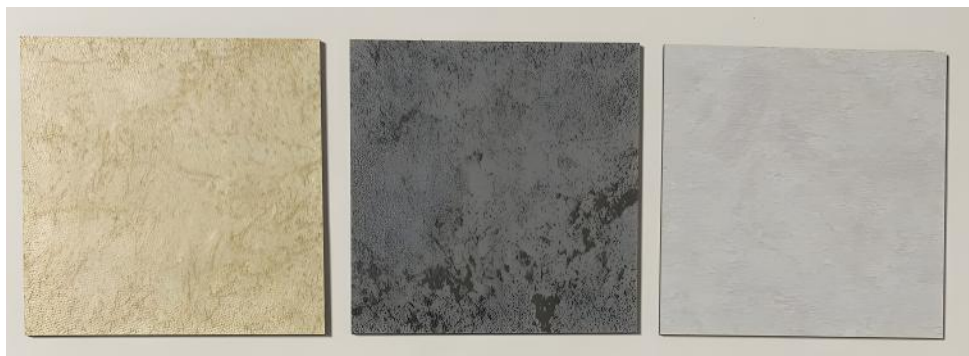

**LVT-5001**

457.2 x 457.2 mm  
457.2 x 914.4 mm  
600 x 600

**LVT-5002**

457.2 x 457.2 mm  
457.2 x 914.4 mm  
600 x 600

**LVT-5003**

457.2 x 457.2 mm  
457.2 x 914.4 mm  
600 x 600



**LVT-5004**

457.2 x 457.2 mm  
457.2 x 914.4 mm  
600 x 600

**LVT-5005**

457.2 x 457.2 mm  
457.2 x 914.4 mm  
600 x 600

**LVT-5006**

457.2 x 457.2 mm  
457.2 x 914.4 mm  
600 x 600

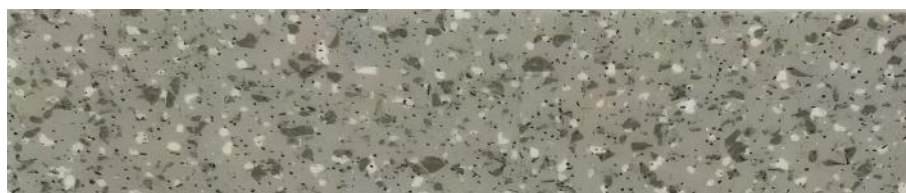

**LVT-5007**

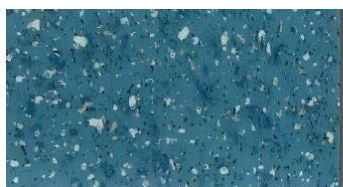

**LVT-5008**



**LVT-5009**



**LVT-5010**





**LVT-5011** 457.2 x 457.2 mm  
600 x 600

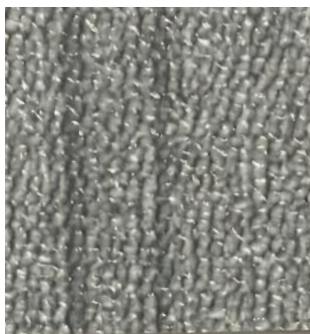

**LVT-5012** 457.2 x 457.2 mm  
600 x 600

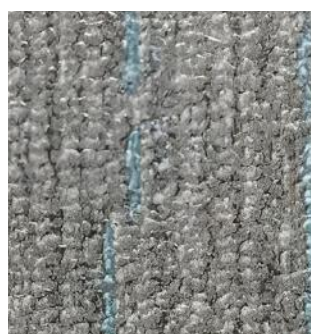

**LVT-5013** 457.2 x 457.2 mm  
600 x 600



**LVT-5014** 457.2 x 457.2 mm  
600 x 600



**LVT-5015** 457.2 x 457.2 mm  
600 x 600



**LVT-5016** 457.2 x 457.2 mm  
600 x 600



**LVT-5017**

457.2 x 457.2 mm

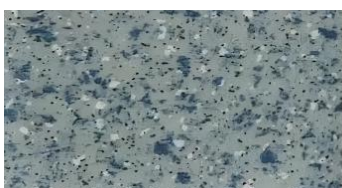

**LVT-5018**

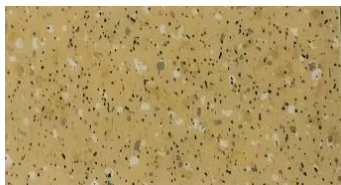

**LVT-5019**



**LVT-5020**

# VINYL TILE



**LVT-5021**

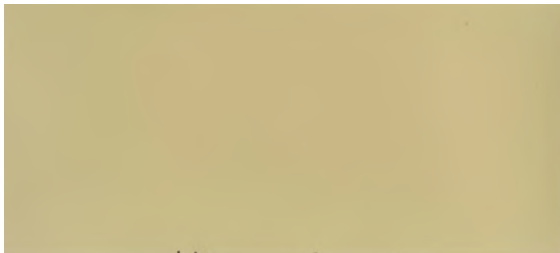

**LVT-5022**

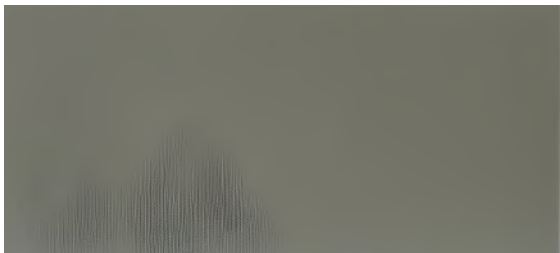

**LVT-5023**



**LVT-5024**



**LVT-5025**

**LVT-5026**



**LVT-5027**



**LVT-5028**



**LVT-5029**



**LVT-5030**

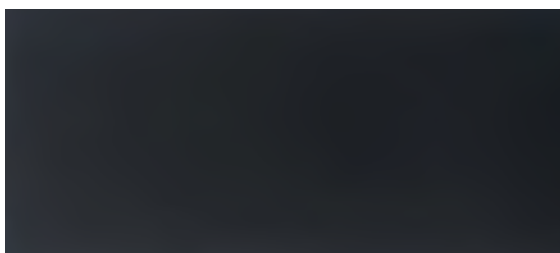

# LIGHTING & ELECTRICAL FIXTURES

*Transform your  
of lighting and*



*our space with our diverse collection  
of electrical fixtures.*



Choose from a variety of options to suit every room in your home, ensuring both style and functionality.

- Versatile lighting solutions to illuminate your space effectively.
- Reliable electrical outlets crafted for safety and convenience.
- Stylish and functional electrical switches to complement your decor
- Efficient electrical heaters designed to keep your home comfortable.



**EL-2420**



**EL-2421**



**EL-2422**



**EL-2423**



**EL-2424**



**EL-2425**



**EL-2426**



**EL-2428**



**EL-2427**



**EL-2429**



**EL-2431**



**EL-2430**



**EL-2432**



**EL-2432**



**EL-2433**



**EL-2433A**





**EL-2434**



**EL-2435**





**EL-2442**



**EL-2443**





**EL-2444**



**EL-2445**



**EL-2446**



**EL-2447**



**EL-2448**



**EL-2449**



**EL-2450**

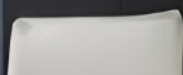



**EL-2451**



**EL-2452**



**EL-2453**



**EL-2454**



**EL-2455**



**EL-2456**



**EL-2457**



**EL-2458**



**EL-2459**



**EL-2460**



**EL-2461**



**EL-2462**



**EL-2463**



**EL-2464**





**EL-2465** ✂



**EL-2466**



**EL-2467**



**EL-2469**



**EL-2470**



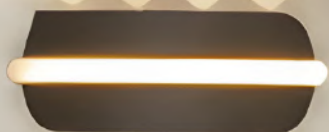

**EL-2481**

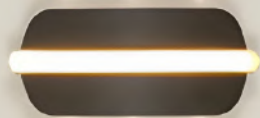

**EL-2481A**



**EL-2482**



**EL-2483A**



**EL-2484**



**EL-2485**



**EL-2484A**





**EL-2476**

**EL-2477**

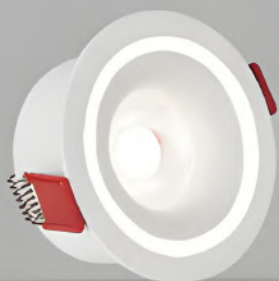

**EL-2478**



**EL-2479**



**EL-2450**



**EL-2480**

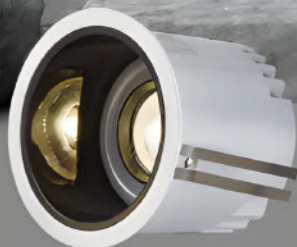



**E-7820**  
15A 125V



**E-7821**  
20A 125V



**E-7822**  
20A 250V



**E-7823**  
20A 250V



**E-7824**  
15A 125V



**E-7825**  
20A 125V



**E-7826**  
15A 250V



**E-7827**  
20A 250V



**E-7828**  
20A 250V



**E-7829**  
20A 125V



**E-7830**  
20A 250V



**E-7831**  
10A 250V



**E-7832**  
15A 125V



**E-7833**  
15A 125V



**E-7834**  
20A 125V



**E-7835**  
20A1 25V



**E-7836**  
15A 125V



**E-7837**  
15A 125V



**E-7838**  
20A 125V



**E-7839**  
20A 125V



**E-7801**  
15A 120/277V  
Single Pole



**E-7802**  
15A 120/277V  
Three Way



**E-7803**  
15A 120/277V  
Four-way



**E-7804**  
20A 120/277V  
Single Pole



**E-7804**  
15A 120/277V  
Three Way



**E-7805**  
15A 120/277V  
Single Pole



**E-7806**  
15A 120V  
Single Pole



**E-7807**  
15A 120V  
Single Pole



**E-7808**  
15A 120V  
Three Way



**E-7809**  
15A 120V



**E-7810**  
15A 125V  
Single Pole



**E-7811**  
15A 120/277V  
Duplex Single pole



**E-7812**  
15A 120V



**E-7813**  
15A 120V



**E-7814**  
15A 120V



**E-7815**  
20A 125V



**E-7816**  
15A 125V



**E-7817**  
20A 125V



**E-7818**  
15A 250V



**E-7819**  
20A 250V



Certified by Underwriters Laboratories (UL) for superior electrical product safety.



**E-7840**  
15A 125V



**E-7841**  
20A 125V



**E-7842**  
15A125V



**E-7843**  
20A125V



**E-7844**  
15A 125V



**E-7845**  
20A 125V



**E-7846**  
15A 125V  
(USB 5V 4.0A)



**E-7847**  
20A 125V  
(USB 5V 4.0A)



**E-7848**  
15A 125V  
(USB 5VDC 2.1A)



**E-7849**  
15A 125V  
(USB 5VDC 4.0A)



**E-7850**  
15A 125V  
(USB 5V 4.2A)



**E-7851**  
15A 125V  
(USB 5V 4.8A)



**E-7852**  
20A 125V  
(USB 5VDC 2.1A)



**E-7853**  
20A 125V  
(USB 5V 4.0A)



**E-7854**  
20A 125V  
(USB 5VDC 4.2A)



**E-7855**  
20A 125V  
(USB 5V 4.8A)



**E-7856**  
15A 125V  
(USB 5V 3.6A)



**E-7857**  
20A125V  
(USB 5V 3.6A)



**E-7858**  
15A 125V



**E-7860**  
20A 125V



# TANKLESS WATERHEATER



**WH-7301**

**Voltage : AC220-240V/110V**  
**Power: 2.0-8.0kW**  
**Rated pressure: 0.02-0.6Pa**



**WH-7302**

**Voltage : AC220-240V/110V**  
**Power: 3.0-6.0kW**  
**Rated pressure: 0-0.6MPa**

Bathtub water cycle use

**Voltage : AC220-240V/110V**  
**Power: 5.0-8.0kW**  
**Rated pressure: 0.02-0.6MPa**



**WH-7303**

**Voltage : AC220-240V/110V**  
**Power: 8.0-12.0kW**  
**Rated pressure: 0.02-0.6MPa**



**WH-7304**

**Voltage : AC220-240V/110V**  
**Power: 6.0-12.0kW**  
**Rated pressure: 0.02-0.6MPa**



**WH-7305**

# AIR CONDITIONING

*Transform your  
range of air co*





*our building with our versatile  
conditioning solutions*



Choose from a variety of options to suit every space, ensuring both functionality and comfort.

- **Puremind Center Air Conditioner**
- **Puremind Split Air Conditioner**

Discover a comprehensive selection of products designed to enhance your environment with efficiency and reliability.

# Central Air Conditioners VRF System



## PGKV

### Product Features

- Free match with fan coil indoor unit
- Capable of heating and cooling
- Full DC inverter technologies
- Intelligent temperature control technology
- Centralized control
- Small installation space and quiet operation
- Ultra-long connection pipe



Energy saving function



High efficiency



Refrigerant  
R32/R410a

## Puremind Split Air Conditioner



## PTW-A

### Product Features

- **Smart Air Flow**
- **Safety First Design**
- **Long Distance Air Supply**
- **Auto Restart**
- **Self-clean**
- **Self-diagnosis**
- **Sleep Mode**
- **Remote Control**



#### Functions

Cooling/Heating/Dehumidifying

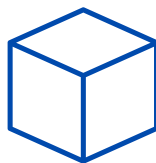

#### Functions

9000/12000/18000/24000Btu



#### Refrigerant

R32/R410a

# ELEVATORS

*Effortless At  
Building with*



# Ascents: Streamline Your with Our Range of Elevators

Choose Your Ascent :



- Passenger elevator



- Villa elevator



- Hospital elevator



- Sightseeing elevator



- Cargo elevator



- Movable escalator



- Escalator

Discover a comprehensive selection of products designed to enhance your environment with efficiency and reliability.



**EV-8401**



**EV-8402**



**EV-8403**



**EV-8404**



**EV-8405**



**ES-3001**



# GLOBAL OCEAN LIMITED

Our brand, created for American standard materials and furnishing components, was registered in the USA market in 2018/2019



**Foshan Global Ocean Trading Limited, located at:**

1307, Beverley Commercial Centre,  
Chatham Road South,  
Tsim Sha Tsui,  
Hong Kong.  
ongjiang, Shunde,  
Foshan.