

ADRIANA HOYOS



TEN
COLLECTION



Do you feel
TENTED?



it's ABOUT *being*



enlightened

ADRIANA HOYOS represents luxury through designs created for people who enjoy life with splendor and avant-garde trends.

inspired by



fashion



amazonia

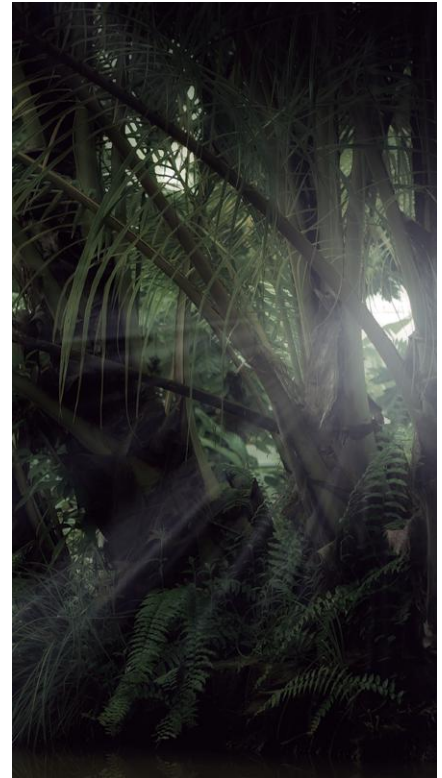



technology



architectural movements

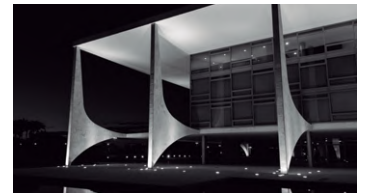
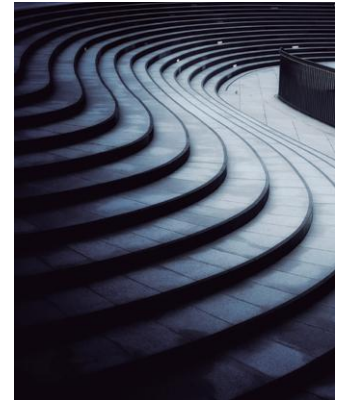

daring silhouettes



design
WITHOUT
boundaries

TEN

COLLECTION

Furniture pieces made with the finest materials and paying close attention to details. Our design team worked diligently on various prototypes to render perfection in each product.





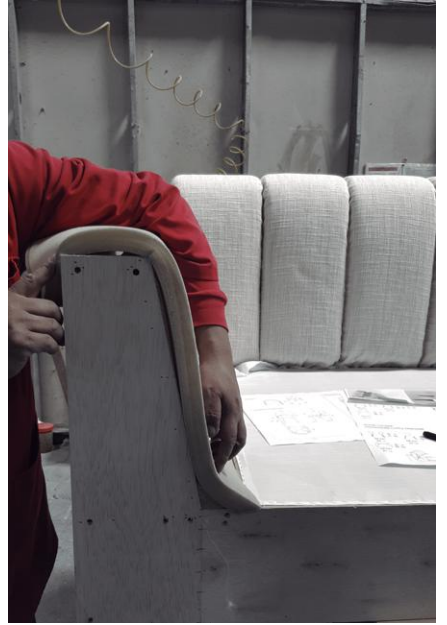

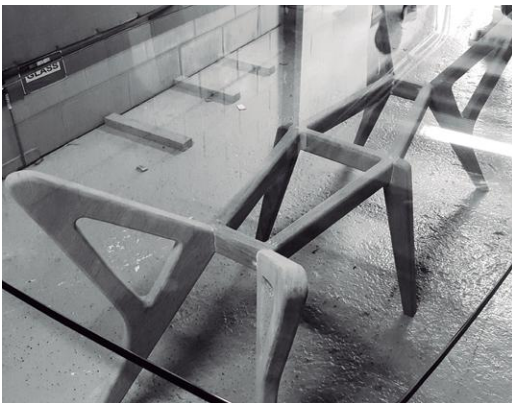

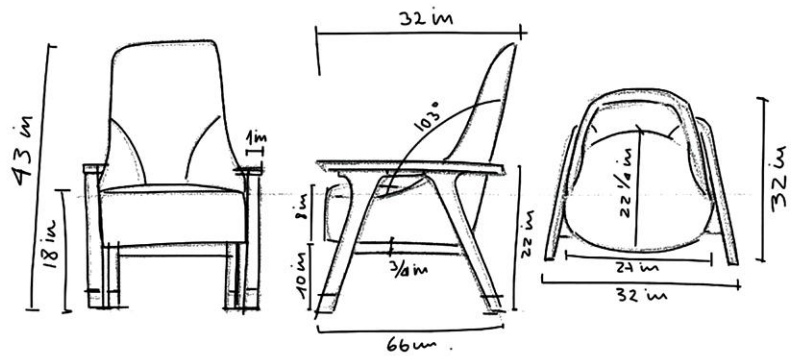

Modern architecture
is reinterpreted

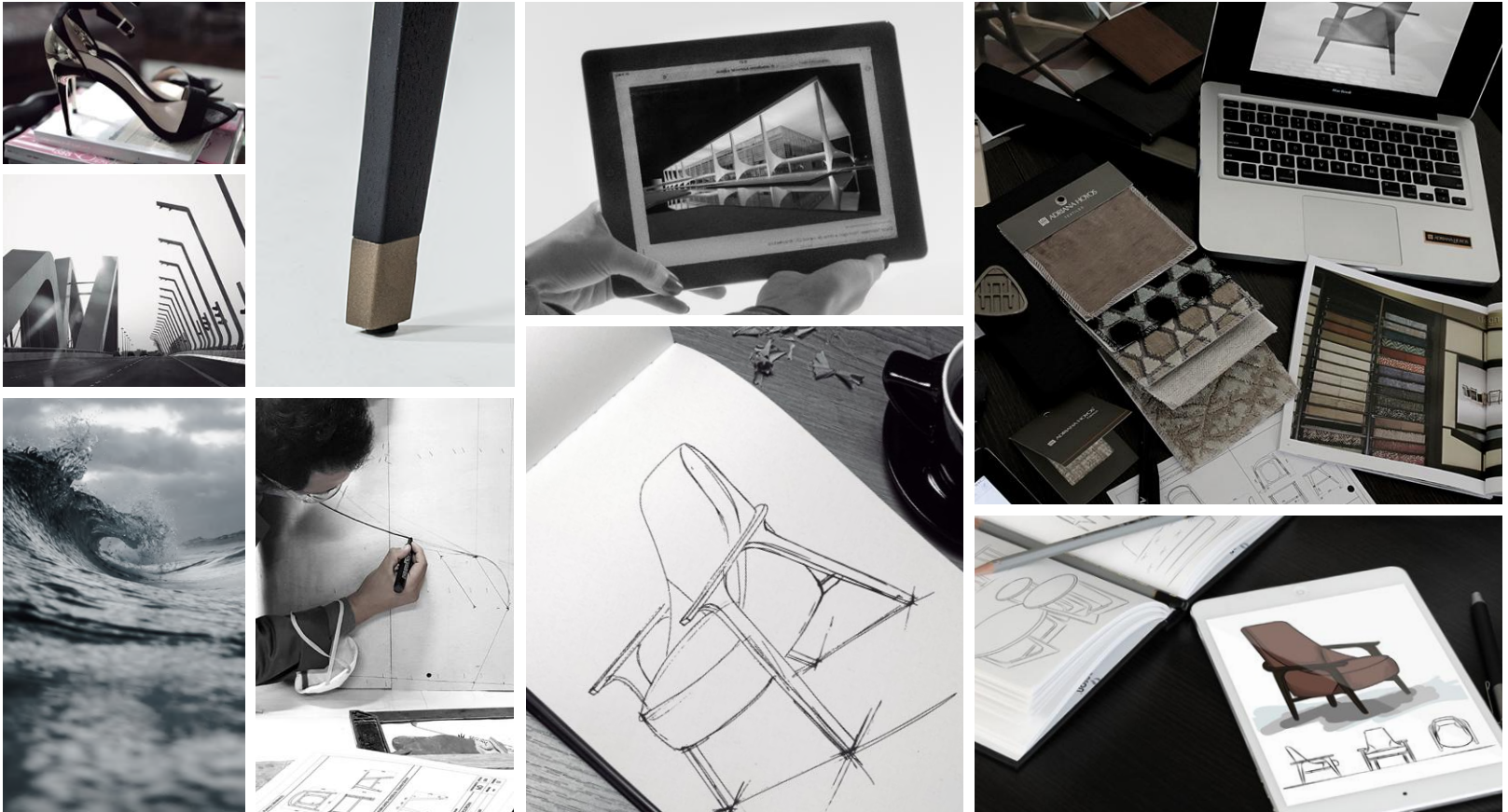

A reinvention of modern architecture in furniture design. Inspired by masterpieces of two creative geniuses such as Oscar Niemeyer and Zaha Hadid. Niemeyer's designs characterized by the propensity towards curves, attracted by free-flowing and sensual movements found in ocean waves; were one of our conceptual milestones.

Curved legs with delicate metal accessories,
a medium wood finish and fabrics with a neutral color
palette are exquisite details of the collection.







ten chair 210 (low back) • ten cocktail tables 100, 111 • chocolate 1 seat 200 • ten entertainment • chocolate corner 200



style AND

sophistica

Geometry adapted to the current lifestyle.



tion

ten cocktail tables 100, 111, 120 • chocolate 1 seat 200 • chocolate corner 200

think bold

to successfully create ground breaking pieces





ten sofa 110





ten side chair 210 (wood back) • africa cocktail table • ten sofa 100 • ten daybed 100

design AND *movement*







ten side chair 100 · ten rectangular dining table base 110 · ten buffet 100

Our Tenth Collection has a meaningful metaphor that defines the Adriana Hoyos brand. 'Ten', is 'Deca', in the ancient Greek language with a triangle as its sacred symbol.

Our logo and design elements incorporate this symbol to illustrate our evolution of designing artful pieces with the grace of simplicity and the passion of innovation that work together to complete our collection TEN.

*Leather wrapped legs
with metal end caps*





The contemporary organic style of TEN portrays
different shapes found in nature.
An intimate collection in close relation with the
movement of nature.





medium finish



ten dining table base 100 • ten side chair 110 • ten buffet 100



Strokes adapt



each piece designed as an art composition

ten side chair 110

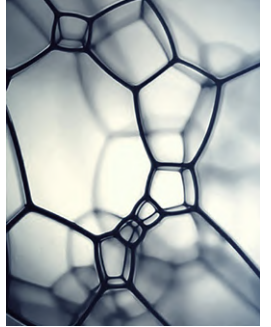

The meandering movements of rivers and the windows created when you look up at the sky and you find yourself gazing through sun rays in the trees. In TEN, nature is our muse to create decorative elements that blend into the environment. Furniture turns into a mesmerizing accessory made up of flowing angles that represent the very latest innovations in design and fashion.



flow

daring silhouettes merged with straight lines creating iconic pieces.

ten barstool chair 110

relax
and fall in love with a look made of moments.

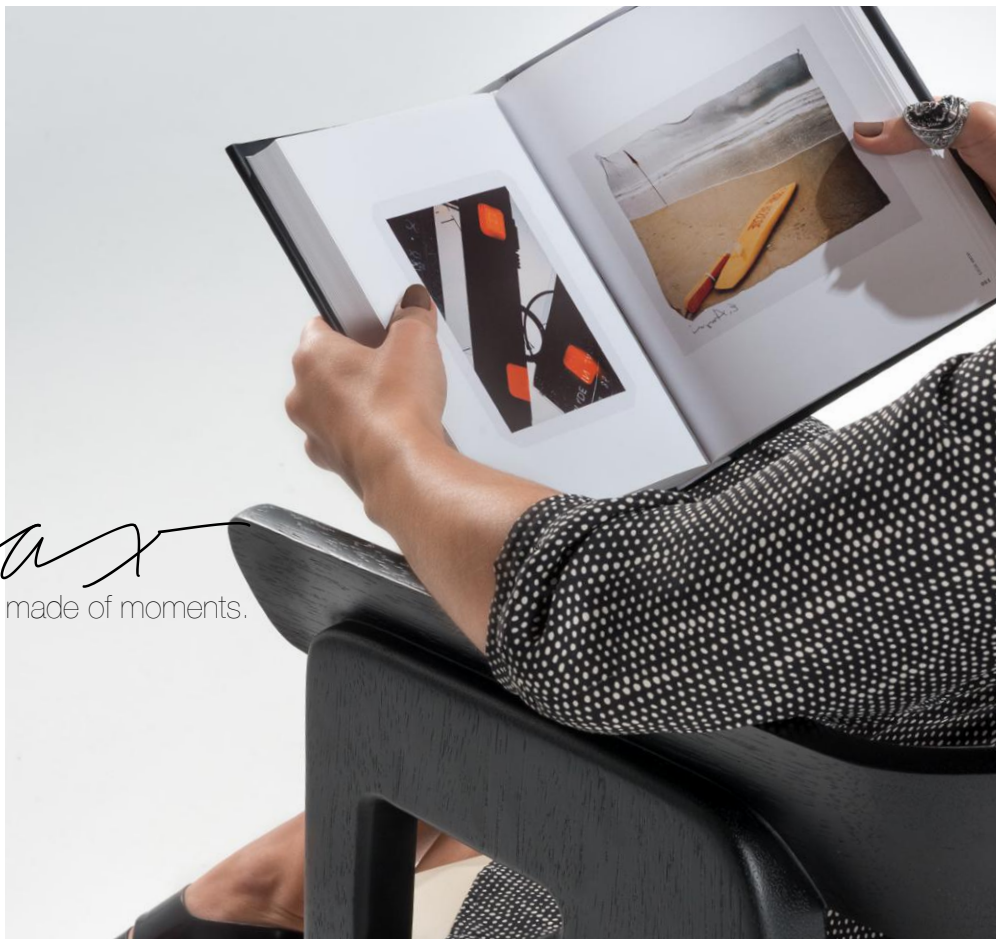



ten side chair 100 · ten side chair 110



ten upholstered chair 200 · ten dresser 100 · ten king/queen bed 100 · ten nightstand 100



ten king/queen bed 100 · ten nightstand 100

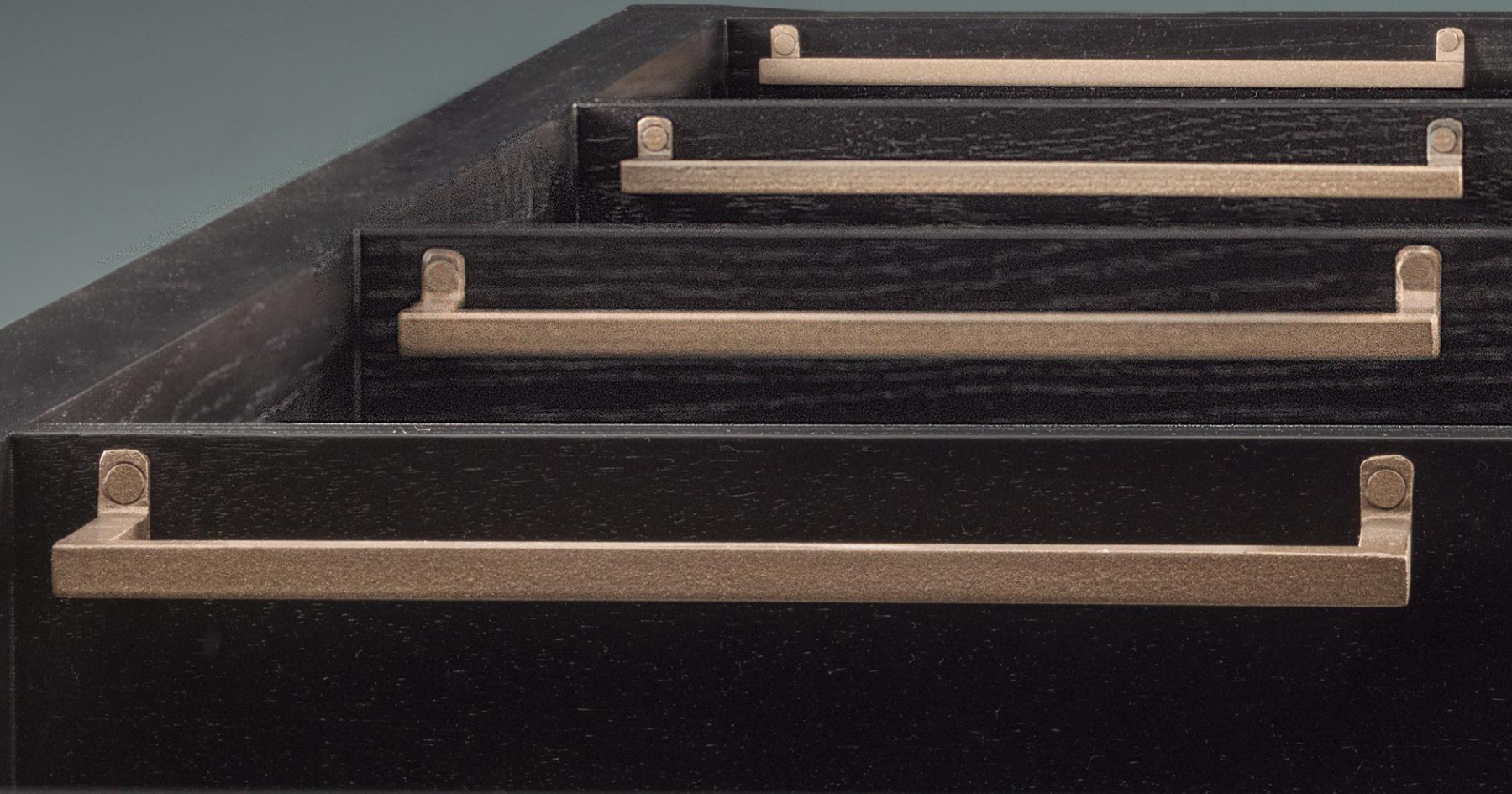

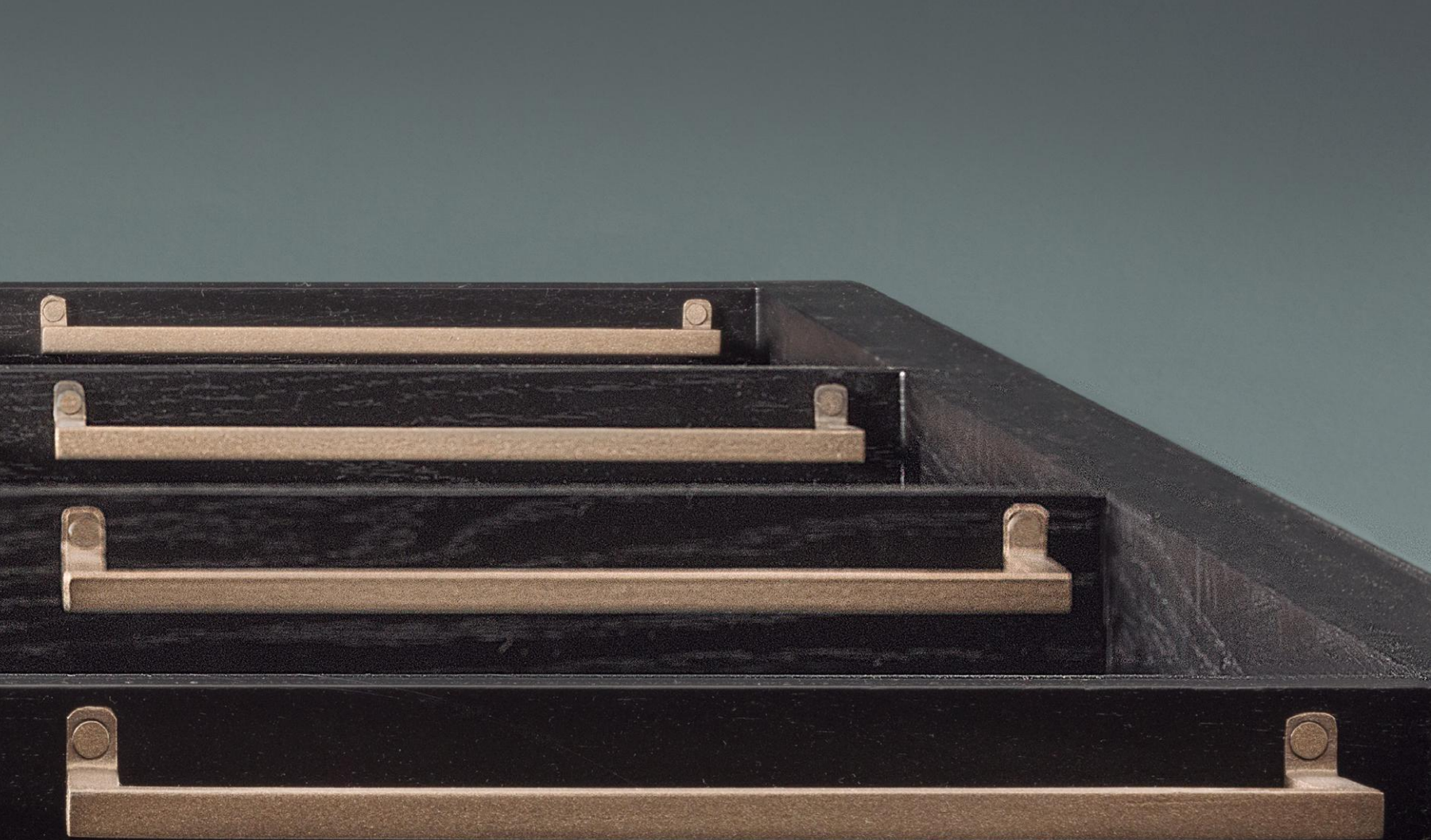







it's ABOUT *luxury...*

TEN is not only a style in design, is a lifestyle expressing the New AH.



FOLLOW US ON:

 [adriana hoyos official](#) |  [adriana hoyos official](#) |  [Adriana_Hoyos](#)
 [Adriana Hoyos](#) |  [ADRIANA HOYOS Furnishings](#) |  [ADRIANA HOYOS](#)

FOR DISTRIBUTION AND TO INQUIRE ON HOW TO BECOME A DEALER:

distribution@adriana hoyos.com



COME VISIT OUR **NEW CONCEPT**

Miami Design District, USA 4100 NE 2nd Ave. Suite 105. Miami, FL 33137 **P** 305 572 9052

Santiago, CHILE Av. del Valle Sur 576, local 102, Ciudad Empresarial. Huechuraba **P** 562 2948 7940

Caracas, VENEZUELA New York y Londres, Edificio Feran, PB. Las Mercedes **P** 582 1299 36343 - 584 1497 81401

Isla de Margarita, VENEZUELA Av. Terranova, C.C. Punto Casa, local 4, Porlamar **P** 584 248248680

Lima, PERÚ Av. Mariscal La Mar #1265, Edificio Nexo, PB, Local No. 1, Miraflores **P** 51 965 408 360

Quito, ECUADOR Alonso de Torres OE7-12 y Av. Al Parque, Edificio Centrum, local 205 **P** 5932 2258 379

Av. Pampite Oe4-16, Cumbayá **P** 5932 600 1725

Guayaquil, ECUADOR Vía Puntilla Km 6.5, Samborondón, Plaza Lagos Town Center, Edificio Molinos, local 2 | 1er Piso oficina 1-4 **P** 5934 512 6633
adrianahoyos.com