



YATO

**ZNAJDŹ NAS TUTAJ:
FIND US HERE:**

 [linkedin.com/company/toya-s-a-](https://www.linkedin.com/company/toya-s-a-)

 [instagram.com/yato_polska](https://www.instagram.com/yato_polska)

 [facebook.com/yatopolska](https://www.facebook.com/yatopolska)

 [youtube.com/yatoteam](https://www.youtube.com/yatoteam)



JEDNA BATERIA – WIELE MOŻLIWOŚCI

System 18 V to moc, swoboda i oszczędność!

Seria narzędzi akumulatorowych YATO zasilana jest tą samą wytrzymałą baterią 18 V, a ich szeroki wybór sprawia, że możesz wyposażyć profesjonalny warsztat, zadbać o dom i ogród. Narzędzia są dostępne w dwóch wersjach: w zestawie z akumulatorami i szybką ładowarką oraz solo, co jest idealnym rozwiązaniem, gdy powiększasz swoją serię urządzeń działających na wspólnej baterii. Gdziekolwiek jesteś, z baterią 18 V pracujesz z pełną swobodą!

www.yato.com

18V
Li-Ion



ONE BATTERY, LOTS OF POSSIBILITIES

The 18 V system means power, freedom and savings!

This series of YATO cordless tools is powered by the same type of heavy-duty 18 V battery and thanks to their extensive selection you can equip a professional workshop, as well as take care of your home and garden. These devices are available in two versions: in a set with batteries and quick charger or without them, which is a perfect solution if you are expanding your collection of tools powered by the same battery. Wherever you are, the 18 V battery allows you to work with complete freedom!

więcej na stronach:
more on pages:
545-566

1

SPANNERS / KLUCZE

6-21



2

SOCKETS, ACCESSORIES & SETS / KLUCZE NASADOWE, AKCESORIA I ZESTAWY

22-63

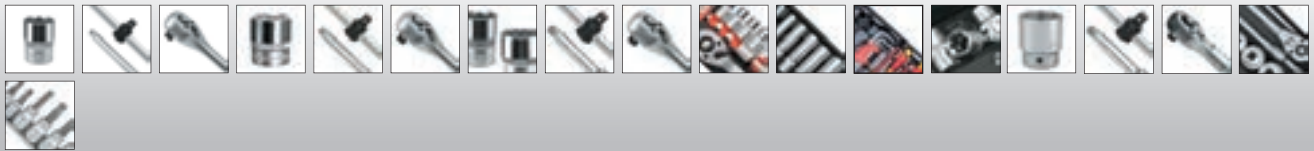

3

IMPACT SOCKETS, ACCESSORIES & SETS / UDAROWE KLUCZE NASADOWE, AKCESORIA I ZESTAWY

64-73



4

TORQUE WRENCHES & TORQUE MULTIPLIERS / KLUCZE DYNAMOMETRYCZNE I WZMACNIACZE MOMENTU

74-79



5

SCREWDRIVERS & SCREWDRIVER BITS / WKRĘTAKI I KOŃCÓWKI WKRĘTAKOWE

80-109



6

PLIERS & PIPE WRENCHES / SZCZYPCE I KLUCZE DO RUR

110-125

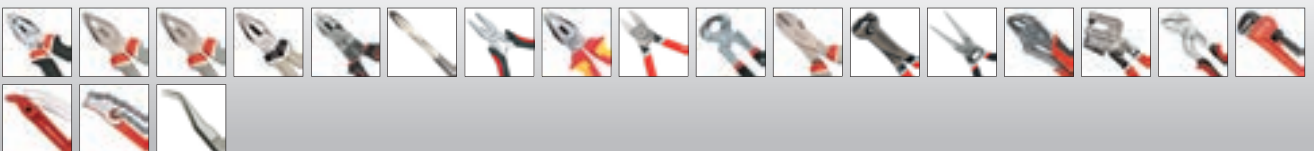

7

ELECTRICIAN TOOLS / NARZĘDZIA DLA ELEKTRYKÓW

126-155

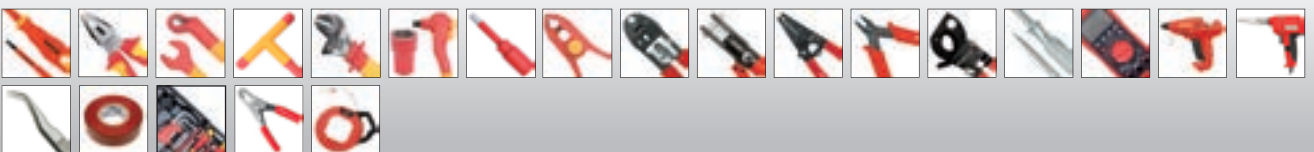

8

HAMMERS, CHISELS, PUNCHES & AXES / MŁOTKI, DŁUTA, PRZECINAKI I SIEKIERY

156-167



9

CLAMPS, VICES & HOLDERS / ŚCISKI, IMADŁA I WSPORNIKI

168-175



10

CUTTING TOOLS / NARZĘDZIA TNĄCE

176-261

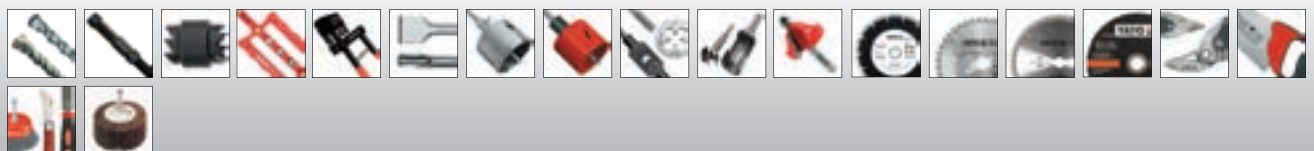

11

PLUMBING TOOLS / NARZĘDZIA HYDRAULICZNE

262-279

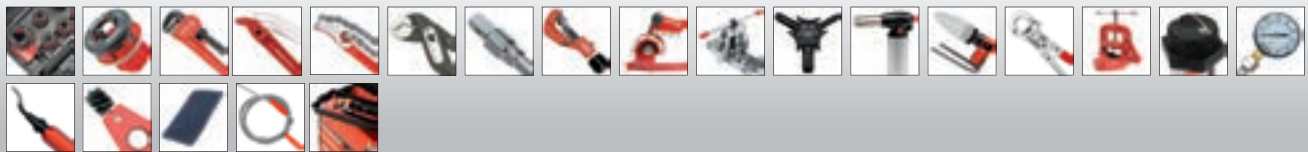

12

FASTENING TOOLS / NARZĘDZIA DO ŁĄCZENIA

280-303



13

CONSTRUCTION TOOLS / NARZĘDZIA BUDOWLANE

304-333

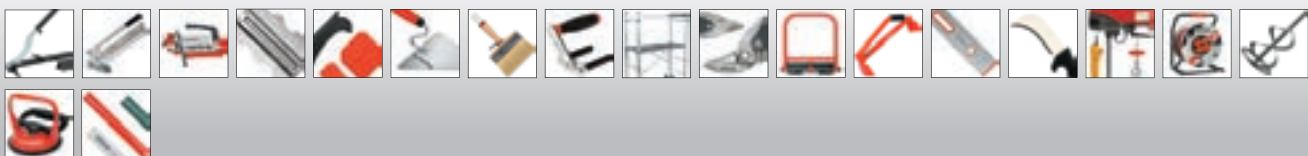

14

MEASURING TOOLS / NARZĘDZIA MIERNICZE

334-351



15

PNEUMATIC TOOLS / NARZĘDZIA PNEUMATYCZNE

352-377



16

SPECIAL AUTOMOTIVE TOOLS & EQUIPMENT / NARZĘDZIA I WYPOSAŻENIE WARSZTATU SAMOCHODOWEGO

378-527

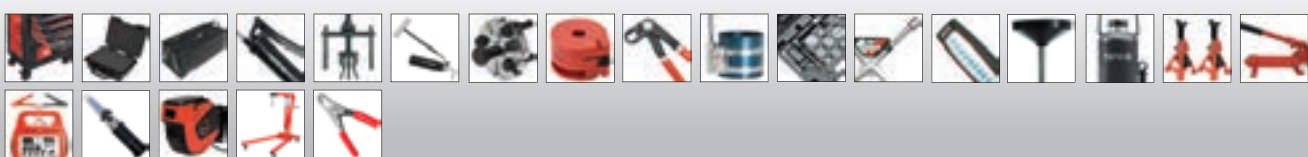

17

WELDING EQUIPMENT & ACCESSORIES / NARZĘDZIA SPAWALNICZE I AKCESORIA

528-541



18

POWER & GASOLINE TOOLS / ELEKTRONARZĘDZIA I NARZĘDZIA SPALINOWE

542-611

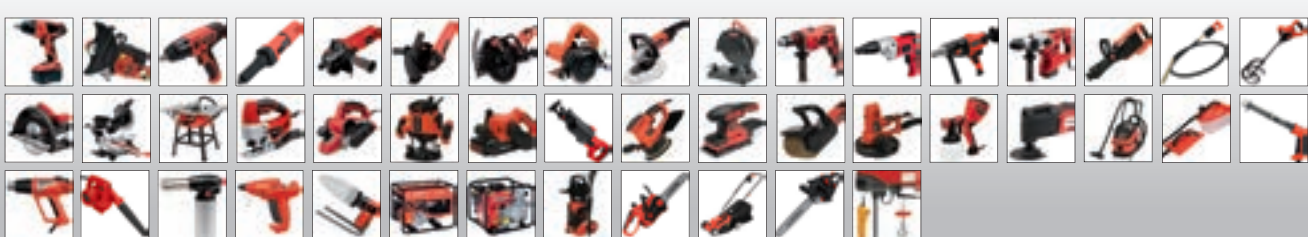

19

ACCESSORIES / AKCESORIA

612-623



20

HEALTH & SAFETY ARTICLES / ARTYKUŁY BHP

624-649

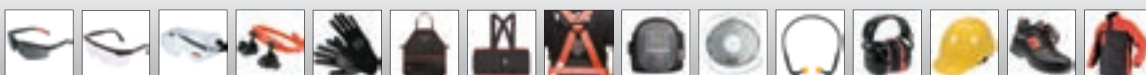

21

ELECTRIC PRODUCTS / ARTYKUŁY ELEKTRYCZNE

650-667



22

GARDEN TOOLS / NARZĘDZIA OGRODNICZE

668-699



1

Spanners
Klucze



Combination spanners Klucze płasko-oczkowe	8-9		Half-moon spanners Klucze oczkowe typu „C”	15	
Combination spanners & sets, polished head Klucze płasko-oczkowe i zestawy, polerowana główka	8		Flare nut wrenches & sets Klucze oczkowe półotwarte i zestawy	15	
Stubby combination spanners, polished head Klucze płasko-oczkowe krótkie, polerowana główka	9		Torx ring spanner sets Zestawy kluczy oczkowych „Torx”	15	
Combination ratchet wrenches Klucze płasko-oczkowe z grzechotką	9-10		Torx type double head flexible wrenches & sets Klucze przegubowe „Torx” i zestawy	16	
Combination ratchet wrenches & sets Klucze płasko-oczkowe z grzechotką i zestawy	9		L-type socket wrenches Klucze nasadowe typu „L”	16	
Flexible ratchet combination wrenches Klucze płasko-oczkowe z grzechotką i przegubem	10		Double ratchet wrenches Dwustronne klucze nasadowe z grzechotką	17	
X-handle combination wrenches Klucze płasko-oczkowe skręcone	10-11		T-type socket wrenches Klucze nasadowe typu „T”	17-19	
X-handle combination wrenches & sets Klucze płasko-oczkowe skręcone i zestawy	10		Socket wrenches with handle Klucze nasadowe z rękojeścią	17	
X-handle combination ratchet wrenches Klucze płasko-oczkowe skręcone z grzechotką	11		T-type deep socket wrenches with rotary handle Klucze nasadowe typu „T” z obrotową rączką	17	
Double open end spanners Klucze płaskie	11		T-type adapters with rotary handle Adaptery typu „T” z obrotową rączką	18	
Double open end spanners & sets, polished head Klucze płaskie i zestawy, polerowana główka	11		Insulated T-handle wrenches Rękojeści typu „T” z zabierakiem izolowane	18	
Double ratchet spanner sets Zestawy kluczy oczkowych z grzechotką	12		T-type deep socket wrenches Klucze nasadowe typu „T”	18	
Bi-hexagonal ring spanners Klucze oczkowe odgięte	12-13		T-handle swivel socket wrenches Klucze nasadowe typu „T” z przegubem	19	
Bi-hexagonal ring spanners & sets, polished head Klucze oczkowe odgięte i zestawy, polerowana główka	12		Adjustable wrenches Klucze nastawne	19-20	
Combination ratchet wrenches Klucze oczkowe odgięte z grzechotką	13		Flexible hook wrenches Klucze hakowe	20	
Insulated ring & open end wrenches Klucze oczkowe i płaskie izolowane	13-14				
Insulated ring wrenches Klucze oczkowe izolowane	13				
Insulated open end wrenches Klucze płaskie izolowane	14				
Impact wrenches Klucze do pobijania	14				
Ring impact wrenches Klucze oczkowe do pobijania	14				
Open end impact wrenches Klucze płaskie do pobijania	14				

1

- EN Combination spanner
- PL Klucz płasko-oczkowy
- DE Maulringschlüssel
- RU Ключ комбинированный
- CZ Plochý a očkový klíč
- HU Kulcs villás-csillag
- RO Cheie combinată
- FR Clé mixte
- IT Chiave combinata
- ES Combinada con llave de estrella
- CN 两用扳手



DIN 3113 CrV AS-DRIVE

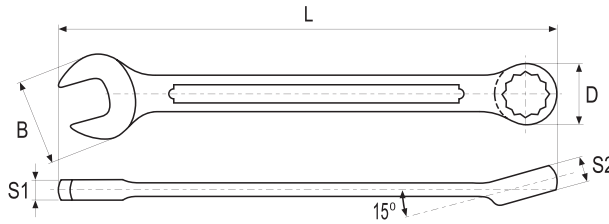

- Application: workshop
- Head offset: 15°
- Surface finish: chromed, satin
- Przeznaczenie: warsztat
- Kąt odchylenia główek: 15°
- Wykończenie powierzchni: chromowana, satynowa

YATO	Ø [mm]	L [mm]	B [mm]	D [mm]	S1 [mm]	S2 [mm]	PCS ROZB.	📦
YT-0335	6	110	14.8	10.5	3.7	4.9	10	300/600
YT-0336	7	120	16.1	11.3	4.0	5.3	10	300/600
YT-0337	8	130	18.5	12.9	4.2	5.0	10	180/360
YT-0338	9	140	20.5	14.6	4.2	5.0	10	180/360
YT-0339	10	150	22.2	16.2	4.9	6.4	10	180/360
YT-0340	11	160	25.5	17.3	4.9	7.0	10	180/360
YT-0341	12	170	26.7	18.7	5.3	7.6	10	120/240
YT-0342	13	180	28.0	19.6	5.5	8.2	10	120/240
YT-0343	14	190	30.3	21.4	5.9	7.7	10	50/100
YT-0344	15	200	32.8	22.8	6.2	8.5	10	50/100
YT-0345	16	210	33.9	23.7	6.1	9.1	10	50/100
YT-0346	17	220	35.9	24.7	6.5	9.1	10	50/100
YT-0347	18	230	37.8	26.9	6.9	10.0	10	50/100

YATO	Ø [mm]	L [mm]	B [mm]	D [mm]	S1 [mm]	S2 [mm]	PCS ROZB.	📦
YT-0348	19	235	38.9	27.7	7.0	10.1	10	50/100
YT-0349	20	250	41.4	29.2	7.3	11.0	10	40/80
YT-0350	21	260	43.4	31.0	7.1	10.9	10	40/80
YT-0351	22	270	45.9	32.2	8.1	11.2	5	20/40
YT-0352	23	280	47.8	34.3	7.8	11.1	5	20/40
YT-0353	24	290	49.9	34.8	9.2	11.2	5	20/40
YT-0354	25	300	51.2	36.6	9.2	12.4	5	20/40
YT-0355	26	310	53.2	37.4	9.2	12.9	5	20/40
YT-0356	27	320	55.9	39.3	9.3	12.7	5	15/30
YT-0357	28	330	56.5	40.9	9.9	13.5	5	15/30
YT-0358	29	340	60.0	42.4	10.0	13.6	5	15/30
YT-0359	30	350	60.9	43.8	10.0	14.7	5	10/20
YT-0360	32	370	64.5	46.6	11.3	14.9	5	10/20

- EN Combination spanner
- PL Klucz płasko-oczkowy
- DE Maulringschlüssel
- RU Ключ комбинированный
- CZ Plochý a očkový klíč
- HU Kulcs villás-csillag
- RO Cheie combinată
- FR Clé mixte
- IT Chiave combinata
- ES Combinada con llave de estrella
- CN 两用扳手



AS-DRIVE

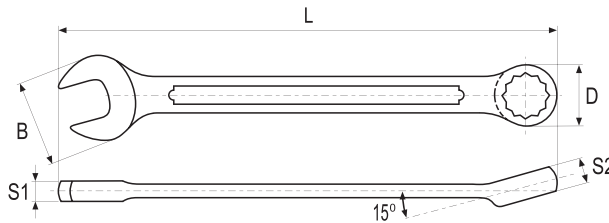

- Application: workshop
- Head offset: 15°
- Surface finish: chromed, satin
- Przeznaczenie: warsztat
- Kąt odchylenia główek: 15°
- Wykończenie powierzchni: chromowana, satynowa

YATO	Ø [mm]	L [mm]	B [mm]	D [mm]	S1 [mm]	S2 [mm]	PCS ROZB.	📦
YT-00760	34	425	65.2	51.0	13.0	16.0	5	5/20
YT-00761	36	460	73.0	57.0	14.0	17.5	5	5/15
YT-00762	38	460	73.0	57.0	14.0	17.5	5	5/15
YT-00763	41	500	83.0	61.5	15.0	19.0	5	5/10
YT-00764	46	540	88.3	69.0	16.5	21.0	5	5/10

YATO	Ø [mm]	L [mm]	B [mm]	D [mm]	S1 [mm]	S2 [mm]	PCS ROZB.	📦
YT-00765	48	570	92.0	72.0	16.5	22.0	5	5/10
YT-00766	50	598	96.0	74.0	18.0	23.5	2	2/8
YT-00767	55	620	105.6	82.4	19.0	25.0	2	2/6
YT-00768	60	660	115.2	89.8	21.0	27.0	2	2/6
YT-00769	65	680	124.8	97.3	23.0	29.0	2	2/4

- EN Combination spanner set
- PL Komplet kluczy płasko-oczkowych
- DE Maulringschlüsselsatz
- RU Набор ключей комбинированных
- CZ Souprava plochých a očkových klíčů
- HU Kulcskészlet, villás-csillag
- RO Set chei combinate
- FR Set de clés mixtes
- IT Set chiave combinata
- ES Juego de combinadas con llave de estrella
- CN 两用扳手组套

DIN 3113 CrV AS-DRIVE



12 PCS



17 PCS



25 PCS

YATO	Ø [mm]	📦
YT-0362	8, 9, 10, 11, 12, 13, 14, 15, 17, 19, 22, 24	6

YATO	Ø [mm]	📦
YT-0363	8, 9, 10, 11, 12, 13, 14, 15, 16, 17, 18, 19, 22, 24, 27, 30, 32	3

YATO	Ø [mm]	📦
YT-0365	6, 7, 8, 9, 10, 11, 12, 13, 14, 15, 16, 17, 18, 19, 20, 21, 22, 23, 24, 25, 26, 27, 28, 30, 32	3

EN Stubby combination spanner
PL Klucz płasko-oczkowy krótki
DE Maulringschlüssel
RU Ключ комбинированный
CZ Plochy a očkový klíč
HU Kulcs villás-csillag
RO Cheie combinată
FR Clé mixte courte
IT Chiave combinata corta
ES Combinada con llave de estrella
CN 两用短扳手



CrV AS-DRIVE

1



- Application: workshop
- Head offset: 15°
- Surface finish: chromed

- Przeznaczenie: warsztat
- Kąt odchylenia główki: 15°
- Wykończenie powierzchni: chromowana

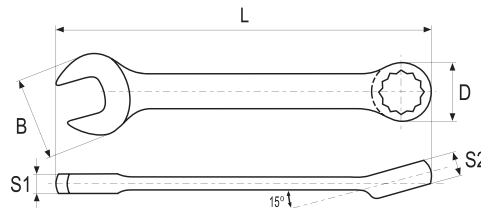

YATO	Ø [mm]	L [mm]	B [mm]	D [mm]	S1 [mm]	S2 [mm]	PCS ROZB.	Box
YT-4901	8	91	19.2	13.9	5.0	6.3	10	120/240
YT-4902	9	97	21.7	16.4	5.4	6.4	10	120/240
YT-4903	10	97	21.9	16.6	5.2	6.4	10	120/240
YT-4904	11	100	23.2	18.3	5.9	7.2	10	120/240
YT-4905	12	108	27.4	20.2	6.4	7.6	10	120/240
YT-4906	13	109	27.9	20.7	6.7	7.7	10	120/240

YATO	Ø [mm]	L [mm]	B [mm]	D [mm]	S1 [mm]	S2 [mm]	PCS ROZB.	Box
YT-4907	14	115	29.3	22.1	6.1	8.3	10	60/120
YT-4908	15	120	31.2	24.0	6.8	9.6	10	60/120
YT-4909	16	121	32.0	24.3	6.8	9.6	10	60/120
YT-4910	17	128	36.6	27.1	7.4	9.9	10	60/120
YT-4911	18	127	36.2	26.8	7.4	9.9	10	60/120
YT-4912	19	135	39.2	19.5	8.8	10.8	10	60/120

EN Combination ratchet wrench
PL Klucz płasko-oczkowy z grzechotką
DE Ratschenringmaulschlüssel
RU Ключ комбинированный с трещоткой
CZ Klíč očkoplochy ráčnový
HU Csillag-villás kulcs racsnis
RO Cheie combinată cu crichet
FR Clé mixte à cliquet
IT Chiave combinata a cricchetto reversibile
ES Llave combinada fija abierta y carraca
CN 棘轮两用扳手

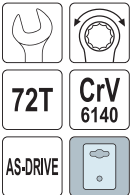

- Application: service
- 72 teeth ratchet
- Minimum operation angle: 5°
- Surface finish: chromed, mirror

- Przeznaczenie: serwis
- Grzechotka 72 zębów
- Minimalny kąt pracy: 5°
- Wykończenie powierzchni: chromowana, polerowana

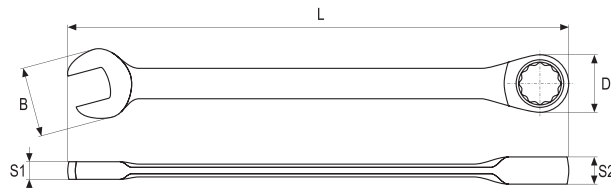

YATO	Ø [mm]	L [mm]	B [mm]	D [mm]	S1 [mm]	S2 [mm]	PCS ROZB.	Box
YT-01906	6	120	14.7	18.0	4.0	6.5	10	50/100
YT-01907	7	130	16.2	18.0	4.3	7.0	10	50/100
YT-01908	8	141	17.6	18.2	4.8	7.2	10	50/100
YT-01909	9	151	19.4	20.4	4.8	7.4	10	50/100
YT-0191	10	160	22.1	22.2	6.0	7.8	10	50/100
YT-0192	11	165	24.7	24.2	6.6	8.5	10	50/100
YT-0193	12	170	26.4	25.5	6.7	8.9	10	50/100
YT-0194	13	180	27.5	26.7	6.6	9.2	10	50/100
YT-0195	14	190	30.8	29.0	7.4	9.4	10	50/100
YT-0196	15	200	32.9	30.8	7.7	10.1	10	50/100
YT-0197	16	210	34.3	31.5	7.8	10.3	10	50/100

YATO	Ø [mm]	L [mm]	B [mm]	D [mm]	S1 [mm]	S2 [mm]	PCS ROZB.	Box
YT-0198	17	225	36.8	33.6	8.4	10.6	10	50/100
YT-0199	18	235	39.2	35.6	9.1	10.8	10	50/100
YT-0200	19	245	40.1	37.3	9.5	11.3	10	50/100
YT-0189	21	290	45.2	43.0	9.9	13.3	6	30/60
YT-0201	22	290	45.6	44.2	10.5	13.4	6	24/48
YT-0202	24	335	52.8	50.0	11.3	14.5	6	48
YT-0203	25	335	52.0	47.4	10.2	14.3	6	48
YT-0204	27	355	55.6	52.7	10.9	15.7	6	30
YT-0205	30	400	62.5	57.7	12.2	17.1	6	24
YT-0206	32	420	65.0	61.7	13.2	17.9	6	24

EN Combination ratchet wrench set
PL Komplet kluczy płasko-oczkowych z grzechotką
DE Knarrenringmaulschlüssel-Satz
RU Набор комбинированных ключей с трещоткой
CZ Klíče ráčnové sada
HU Racsnis csillag-villás kulcs készlet
RO Set chei combinată
FR Set de clés mixte à cliquet
IT Set chiavi combinate a cricchetto
ES Juego de llaves planas con matraca
CN 棘轮扳手组套



YATO	Ø [mm]	Box
YT-0208	10, 12, 13, 14, 15, 17, 19	10/20

- EN Combination ratchet wrench
- PL Klucz płasko-oczkowy z grzechotką
- DE Ratschenringmaulschlüssel
- RU Ключ комбинированный с трещоткой
- CZ Klíč očkoločkový ráčnový
- HU Csillag-villás kulcs racsnis
- RO Cheie combinată cu crichet
- FR Clé mixte à cliquet
- IT Chiave combinata a cricchetto reversibile
- ES Llave combinada fija abierta y carraca
- CN 双向棘轮两用扳手

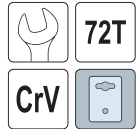
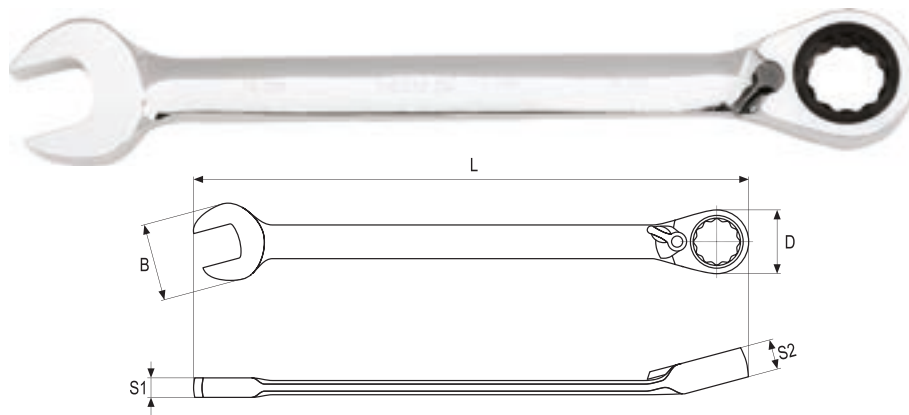

YATO	Ø [mm]	L [mm]	B [mm]	D [mm]	S1 [mm]	S2 [mm]	PCS ROBIE	☐
YT-1651	8	140	17.5	19.0	6.0	7.2	10	50/100
YT-1652	9	150	19.8	20.7	6.4	7.5	10	50/100
YT-1653	10	160	22.1	23.1	6.4	7.9	10	50/100
YT-1654	11	165	23.9	25.0	6.6	8.4	10	50/100
YT-1655	12	170	27.1	26.0	6.5	8.9	10	50/100
YT-1656	13	180	27.9	27.6	7.1	9.1	10	50/100
YT-1657	14	190	31.6	28.3	7.3	9.5	10	50/100
YT-1658	15	200	32.8	31.4	8.1	9.8	10	50/100
YT-1659	16	210	33.9	32.9	8.4	10.3	10	50/100
YT-1660	17	225	38.0	34.5	8.7	10.5	10	50/100
YT-1661	18	235	39.8	36.9	9.3	10.7	10	50/100

YATO	Ø [mm]	L [mm]	B [mm]	D [mm]	S1 [mm]	S2 [mm]	PCS ROBIE	☐
YT-1662	19	245	41.8	38.3	9.5	11.3	10	50/100
YT-1663	20	245	41.9	38.1	9.7	11.4	6	30/60
YT-1664	21	290	44.9	43.0	9.8	13.6	6	30/60
YT-1665	22	290	44.8	43.8	10.0	13.6	6	30/60
YT-1666	23	290	44.9	43.3	10.3	13.7	6	24/48
YT-1667	24	330	52.0	49.4	10.2	14.5	6	24/48
YT-1669	26	360	56.3	53.6	12.1	15.7	6	30
YT-1670	27	360	55.6	52.9	12.2	16.1	6	30
YT-1671	28	360	56.1	53.6	12.6	16.0	6	24
YT-1672	30	400	62.1	58.0	11.9	17.2	6	24
YT-1673	32	420	64.1	62.0	12.9	17.7	6	24

- EN Flexible ratchet combination wrench
- PL Klucz płasko-oczkowy z grzechotką i przegubem
- DE Ratschenringmaulschlüssel
- RU Ключ комбинированный с трещоткой
- CZ Klíč očkoločkový ráčnový
- HU Csillag-villás kulcs racsnis
- RO Cheie combinată cu crichet
- FR Clé mixte à cliquet tête articulée
- IT Chiave combinata a cricchetto testa mobile
- ES Llave combinada fija abierta y carraca
- CN 活头棘轮两用扳手

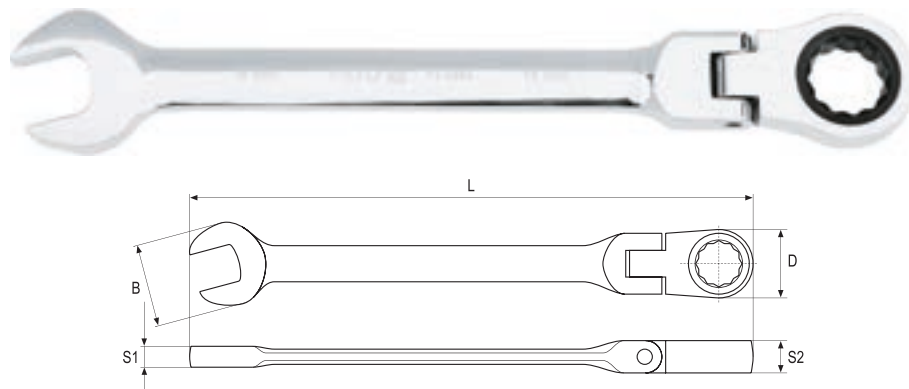

YATO	Ø [mm]	L [mm]	B [mm]	D [mm]	S1 [mm]	S2 [mm]	PCS ROBIE	☐
YT-1674	8	140	18.0	19.6	6.3	7.3	10	50/100
YT-1675	9	145	19.7	21.1	4.7	7.6	10	50/100
YT-1676	10	160	22.8	23.2	6.3	7.8	10	50/100
YT-1677	11	160	24.0	24.7	5.4	8.5	10	50/100
YT-1678	12	170	26.4	26.7	6.8	8.8	10	50/100
YT-1679	13	180	28.4	27.3	7.2	9.1	10	50/100
YT-1680	14	185	29.5	28.7	6.8	9.4	10	50/100
YT-1681	15	195	32.9	30.8	7.2	9.8	10	50/100

YATO	Ø [mm]	L [mm]	B [mm]	D [mm]	S1 [mm]	S2 [mm]	PCS ROBIE	☐
YT-1682	16	210	34.4	33.3	7.6	10.3	10	50/100
YT-1683	17	230	36.7	35.7	8.3	10.5	10	50/100
YT-1684	18	235	39.0	35.9	8.0	10.8	10	50/100
YT-1685	19	245	40.8	37.6	9.5	11.2	10	50/100
YT-1686	20	245	40.9	38.2	8.8	11.1	6	30/60
YT-1687	21	290	45.0	42.8	9.8	13.6	6	30/60
YT-1688	22	290	45.2	42.7	9.8	13.5	6	30/60
YT-1690	24	330	51.3	48.7	10.4	14.5	6	24/48

- EN Combination spanner
- PL Klucz płasko-oczkowy
- DE Maulringschlüssel
- RU Ключ комбинированный
- CZ Plochy a očkový klíč
- HU Kulcs villás-csillag
- RO Cheie combinată
- FR Clé mixte
- IT Chiave combinata
- ES Combinada con llave de estrella
- CN 两用扳手

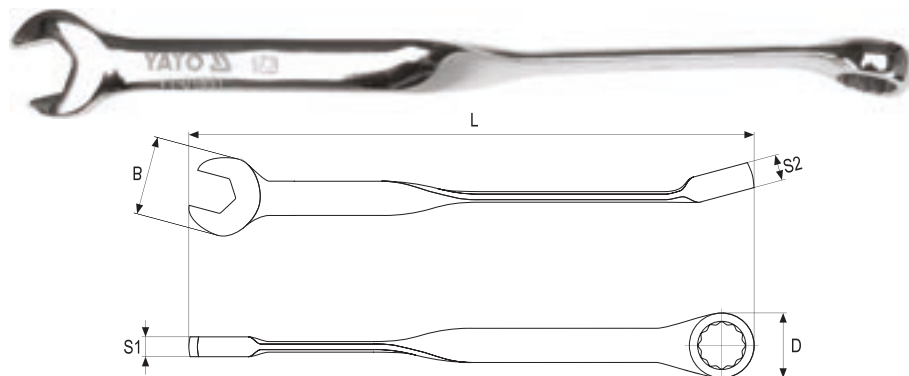

YATO	Ø [mm]	L [mm]	B [mm]	D [mm]	S1 [mm]	S2 [mm]	☐
YT-01851	10	165	20.6	15.7	5.9	7.1	100/200
YT-01852	12	204	25.6	20.2	7.0	8.0	40/120
YT-01853	13	204	25.5	20.0	6.8	8.2	40/120
YT-01854	14	216	28.4	21.4	7.2	8.4	40/120
YT-01855	15	230	30.9	25.1	7.4	9.4	40/120
YT-01856	17	244	34.5	26.8	7.7	10.0	40/80
YT-01857	18	245	34.6	27.9	8.0	9.5	40/80

YATO	Ø [mm]	L [mm]	B [mm]	D [mm]	S1 [mm]	S2 [mm]	☐
YT-01858	19	259	38.4	28.9	8.0	9.9	40/80
YT-01859	21	283	40.9	32.7	8.5	10.6	20/80
YT-01860	22	305	44.4	35.1	9.8	12.0	20/80
YT-01861	24	329	48.7	36.2	9.5	11.6	20/40
YT-01862	27	359	54.5	40.4	11.0	12.3	20/40
YT-01863	30	398	57.2	44.4	12.5	14.0	10/20
YT-01864	32	435	62.9	47.6	14.0	15.5	10/20

- EN Combination spanner set
 PL Komplet kluczy plasko-oczkowych
 DE Maulringschlüsselsatz
 RU Набор ключей комбинированных
 CZ Souprava plochých a očkových klíčů
 HU Kulcskészlet, villás-csilag
 RO Set chei combinate rasucite
 FR Set de clés mixtes
 IT Set di chiavi combinate
 ES Juego de combinadas con llave de estrella
 CN 两用扳手组套



14
PCS



1

YATO	⌀ [mm]	
YT-01865	10, 12, 13, 14, 15, 17, 18, 19, 21, 22, 24, 27, 30, 32	4

- EN Combination ratchet wrench
 PL Klucz plasko-oczkowy z grzechotką
 DE Ratschenringmaulschlüssel
 RU Ключ комбинированный с трещоткой
 CZ Klíč otkoplochý ráčnový
 HU Csilag-villás kulcs racsnis
 RO Cheie combinată răsuicită cu clichet
 FR Clé mixte à cliquet
 IT Chiave combinata a cricchetto
 ES Llave combinada fija abierta y carraca
 CN X柄两用棘轮扳手

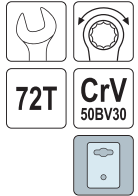
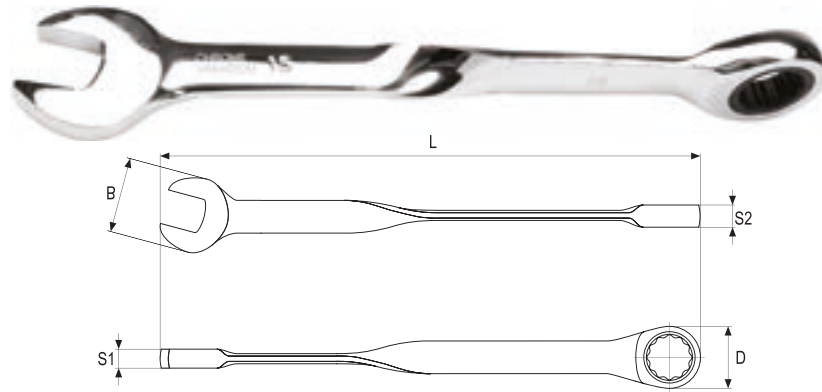

YATO	⌀ [mm]	L [mm]	B [mm]	D [mm]	S1 [mm]	S2 [mm]	
YT-01870	8	153	20.0	21.2	5.0	8.2	25/200
YT-01871	9	160	20.1	22.5	5.3	8.0	25/200
YT-01872	10	167	24.8	24.9	6.3	9.0	25/200
YT-01873	11	172	25.1	25.7	6.0	9.0	25/200
YT-01874	12	177	27.7	27.1	6.5	9.5	25/150
YT-01875	13	182	29.5	28.3	7.1	9.5	25/150

YATO	⌀ [mm]	L [mm]	B [mm]	D [mm]	S1 [mm]	S2 [mm]	
YT-01876	14	192	32.3	31.5	7.7	9.6	25/100
YT-01877	15	201	34.3	30.9	7.3	9.6	25/100
YT-01878	16	228	38.9	35.6	8.2	10.6	20/80
YT-01879	17	228	38.7	35.3	8.0	10.7	20/80
YT-01880	18	240	40.8	35.9	9.0	10.8	20/60
YT-01881	19	239	39.6	36.2	8.6	11.0	20/60

- EN Double open end spanner
 PL Klucz plaski
 DE Doppelmaulschlüssel
 RU Ключ рожковый
 CZ Plochý klíč
 HU Villáskulcs
 RO Cheie fixă
 FR Clé plate
 IT Chiave piatta
 ES Llave fija
 CN 双头呆扳手

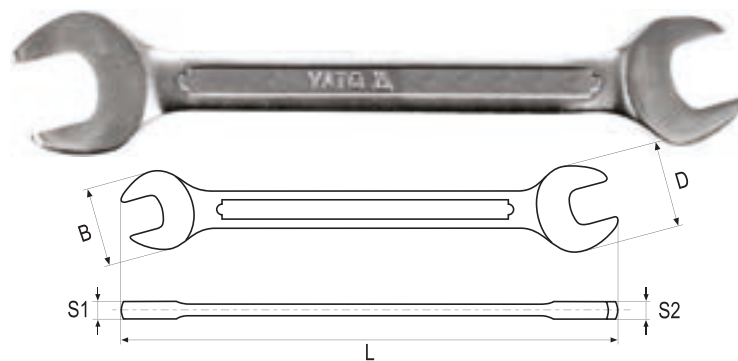

* Surface finish: chromed, satin / mirror

* Wykończenie powierzchni: chromowana, satynowa / polerowana

YATO	⌀ [mm]	L [mm]	B [mm]	D [mm]	S1 [mm]	S2 [mm]	PCS PER SET	
YT-0367	6x7	120	15.1	16.8	3.5	3.6	10	360/720
YT-0368	8x9	140	18.7	20.8	3.7	3.6	10	180/360
YT-0369	10x11	155	22.4	25.5	4.6	4.6	10	150/300
YT-0332	10x13	170	22.5	29.3	4.6	5.3	10	150/300
YT-0370	12x13	170	27.1	29.3	4.9	5.3	10	80/160
YT-0333	13x17	180	29.3	37.5	5.3	6.3	10	50/100
YT-0371	14x15	180	31.0	33.0	5.3	5.4	10	80/160
YT-0372	16x17	200	34.9	37.5	6.5	6.3	10	50/100

YATO	⌀ [mm]	L [mm]	B [mm]	D [mm]	S1 [mm]	S2 [mm]	PCS PER SET	
YT-0334	17x19	220	37.5	38.7	6.3	6.3	10	50/100
YT-0373	18x19	220	38.7	41.0	6.6	6.3	10	50/100
YT-0374	20x22	230	42.1	46.8	7.1	6.8	10	30/60
YT-0375	21x23	245	44.4	48.6	7.3	6.9	10	30/60
YT-0376	24x27	260	51.6	56.9	8.1	8.1	5	20/40
YT-0377	25x28	270	52.3	57.9	8.4	8.3	5	20/40
YT-0378	30x32	295	61.4	65.1	8.0	8.6	5	15/30

- EN Double open end spanner set
 PL Komplet kluczy plaskich
 DE Doppelmaulschlüsselsatz
 RU Набор рожковых ключей
 CZ Souprava plochých klíčů
 HU Kulcskészlet, villás
 RO Set chei fixe
 FR Set de clés à tête fendue
 IT Set di chiavi piatte
 ES Juego de llaves fijas
 CN 双头呆扳手套套



DIN 3110 CrV

10
PCS

12
PCS

YATO	⌀ [mm]	
YT-0380	6x7, 8x9, 10x11, 12x13, 14x15, 16x17, 18x19, 20x22, 21x23, 24x27	6

YATO	⌀ [mm]	
YT-0381	6x7, 8x9, 10x11, 12x13, 14x15, 16x17, 18x19, 20x22, 21x23, 24x27, 25x28, 30x32	8

1

EN Double ratchet spanner set
 PL Klucze oczkowe z grzechotką
 DE Ringschlüsselsatz
 RU Набор ключей накидных
 CZ Očkové klíče
 HU Csillagkulcs készlet
 RO Set chei inelare
 FR Set de clés à oeil à cliquet
 IT Set chiavi a cricchetto
 ES Llaves de anillo
 CN 双头梅花棘轮扳手组套



5
PCS

72T

CrV
6140

EN Bi-hexagonal ring spanner
 PL Klucz oczkowy odgięty
 DE Doppelringschlüssel
 RU Ключ накидной изогнутый
 CZ Očkový klíč ohnutý
 HU Hajlítottszárú csillagkulcs

RO Cheie inelaro-curbată
 FR Clé contre-coudée
 IT Chiave poligonale doppio piegato
 ES Llave de estrella
 CN 双头高颈梅花扳手

DIN
838

CrV

AS-DRIVE

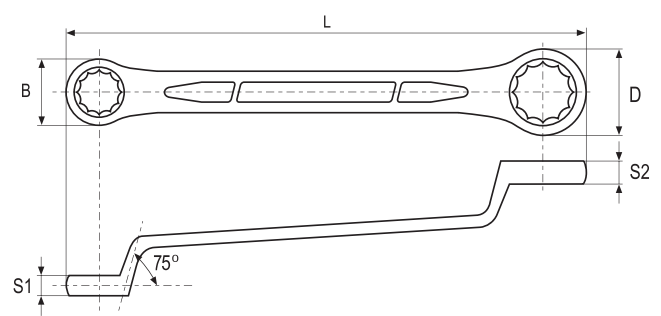

• Application: industry
 • Surface finish: chromed, satin / mirror
 • Przeznaczenie: przemysł
 • Wykończenie powierzchni: chromowana, satynowa / polerowana

YATO	Ø [mm]	L [mm]	B [mm]	D [mm]	S1 [mm]	S2 [mm]	PCS
YT-03950	6x7	165	11.0	12.7	5.4	5.5	10/400
YT-03951	8x9	185	13.9	15.5	6.8	7.2	10/200
YT-03952	10x11	200	16.3	17.6	6.8	7.2	10/200
YT-03953	12x13	220	19.6	21.5	7.2	7.7	10/120
YT-03954	14x15	230	23.6	21.9	8.9	9.1	10/100
YT-03955	16x17	255	24.6	26.4	8.6	9.3	10/60
YT-03956	18x19	270	27.5	28.8	10.5	10.2	5/50

YATO	Ø [mm]	PCS
YT-5038	8x9, 10x11, 12x13, 14x15, 17x19	10/30

EN Bi-hexagonal ring spanner
 PL Klucz oczkowy odgięty
 DE Doppelringschlüssel
 RU Ключ накидной изогнутый
 CZ Očkový klíč ohnutý
 HU Hajlítottszárú csillagkulcs
 RO Cheie inelaro-curbată
 FR Clé contre-coudée
 IT Chiave poligonale doppio piegato
 ES Llave de estrella
 CN 双头高颈梅花扳手

DIN
838

CrV

AS-DRIVE

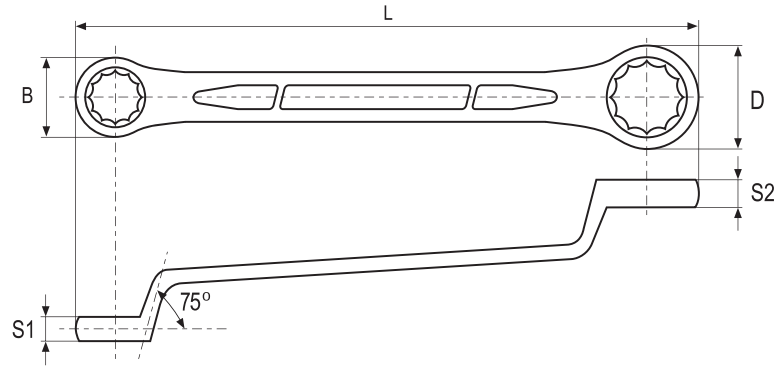

• Application: industry
 • Surface finish: chromed, satin / mirror
 • Przeznaczenie: przemysł
 • Wykończenie powierzchni: chromowana, satynowa / polerowana

YATO	Ø [mm]	L [mm]	B [mm]	D [mm]	S1 [mm]	S2 [mm]	PCS
YT-0383	6x7	165	11.0	12.7	5.4	5.5	10
YT-0384	8x9	185	13.9	15.5	6.8	7.2	10
YT-0385	10x11	200	16.3	17.6	6.8	7.2	10
YT-0386	12x13	220	19.6	21.5	7.2	7.7	10
YT-0387	14x15	230	23.6	21.9	8.9	9.1	10
YT-0388	16x17	255	24.6	26.4	8.6	9.3	10

YATO	Ø [mm]	L [mm]	B [mm]	D [mm]	S1 [mm]	S2 [mm]	PCS
YT-0389	18x19	270	27.5	28.8	10.5	10.2	5
YT-0390	20x22	290	30.9	33.4	10.5	11.4	5
YT-0391	21x23	310	31.9	34.4	11.8	12.4	5
YT-0392	24x27	330	36.2	40.6	11.5	13.2	5
YT-0394	30x32	390	44.0	47.1	13.8	14.9	3

- EN Bi-hexagonal ring spanner set
- PL Komplet kluczy oczkowych odgiętych
- DE Doppelringsschlüsselsatz
- RU Набор ключей накидных изогнутых
- CZ Klíče očkové vřutnuté sada
- HU Csillagkulcs készlet
- RO Set chei inelare cu cot
- FR Set de clés contre-coudées
- IT Set chiavi poligonali doppie piegate
- ES Juego de llaves de estrella acodadas
- CN 双头高颈梅花扳手套套



8
PCS

12
PCS

YATO	Ø [mm]	Icon
YT-0396	6x7, 8x9, 10x11, 12x13, 14x15, 16x17, 18x19, 20x22	6

YATO	Ø [mm]	Icon
YT-0398	6x7, 8x9, 10x11, 12x13, 14x15, 16x17, 18x19, 20x22, 21x23, 24x27, 25x28, 30x32	4

- EN Combination ratchet wrench
- PL Klucz oczkowy odgięty z grzechotką
- DE Kombinationsratchetschlüssel
- RU Трещотка для бит
- CZ Kombinovaný rohatkový klíč
- HU Kombinált racsnis kulcs
- RO Antrenor cu clichet combinat
- FR Clé mixte à cliquet
- IT Chiave ad anello piegata a cricchetto
- ES Llave de trinquete combinada
- CN 双向棘轮扳手



72T

HRC
42-48

CrV
50BV30

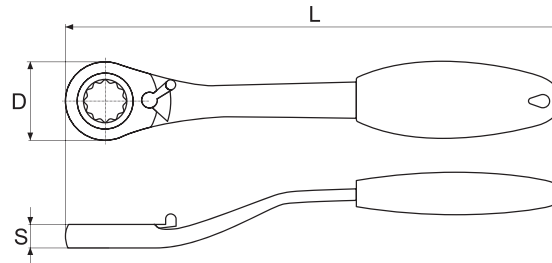

YATO	Ø [mm]	L [mm]	D [mm]	S [mm]	Icon
YT-02370	8	140	18	8	10/200
YT-02371	9	145	22	8	10/200
YT-02372	10	145	23	8	10/200
YT-02373	11	170	24	9	10/100
YT-02374	12	175	24	9	10/100
YT-02375	13	190	30	9	10/100
YT-02376	14	195	31	10	10/100
YT-02377	15	195	31	10	10/100
YT-02378	16	195	31	11	10/100
YT-02379	17	225	35	11	10/60

YATO	Ø [mm]	L [mm]	D [mm]	S [mm]	Icon
YT-02380	18	225	35	11	10/60
YT-02381	19	225	36	11	10/60
YT-02382	20	250	43	13	5/40
YT-02383	21	250	43	14	5/40
YT-02384	22	250	43	14	5/40
YT-02385	24	265	47	15	5/40
YT-02386	27	280	50	15	5/20
YT-02387	30	290	57	17	5/20
YT-02388	32	290	57	18	5/20

- EN Insulated ring wrench
- PL Klucz oczkowy odgięty izolowany
- DE Einringsschlüssel vollisoliert
- RU Ключ накидной односторонний изолированный
- CZ Očkový klíč izolovaný
- HU Hajlíttszárú csillagkulcs
- RO Cheie inelara izolata
- FR Clé polygonale coudée isolée
- IT Chiave poligonale piegata isolata
- ES Llave de estrella acodada aislante
- CN 双色柄绝缘梅花扳手



CrV

1000
V

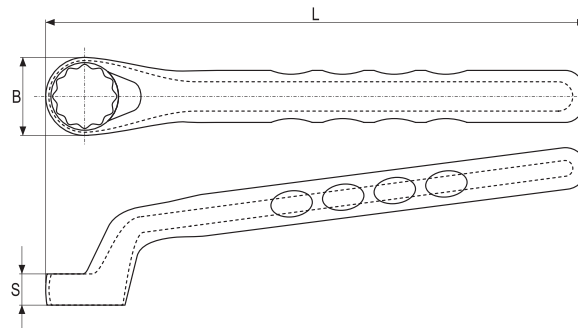

1000 V
VDE CERTIFICATE
EN 60900:2012

YATO	Ø [mm]	L [mm]	B [mm]	S [mm]	Icon
YT-20980	6	150	16.0	5.5	6/126
YT-20981	7	150	18.0	5.7	6/126
YT-20982	8	155	19.0	6.1	6/126
YT-20983	9	155	20.0	7.2	6/126
YT-20985	11	170	22.5	7.7	6/90
YT-20986	12	190	22.5	8.5	6/90
YT-20987	13	190	26.5	9.0	6/90
YT-20988	14	205	28.0	9.5	6/90
YT-20989	15	205	29.0	9.5	6/90
YT-20990	16	215	31.0	10.2	6/90

YATO	Ø [mm]	L [mm]	B [mm]	S [mm]	Icon
YT-20991	17	215	32.0	10.7	6/90
YT-20992	18	230	35.0	11.5	6/90
YT-20993	19	230	36.0	12.0	6/90
YT-20994	21	245	39.0	13.0	6/48
YT-20995	22	245	41.0	12.2	6/48
YT-20996	24	265	44.0	13.0	6/48
YT-20997	27	290	48.0	14.5	4/40
YT-20998	30	310	52.0	15.2	4/40
YT-20999	32	310	55.0	16.5	4/40

EN Insulated open end wrench
 PL Klucz płaski izolowany
 DE Doppelmaulschlüssel isoliert
 RU Ключ рожковый односторонний изолированный

CZ Otevřený klíč izolovaný
 HU Villáskulcs
 RO Cheie fixă izolată
 FR Clé plate isolée

IT Chiave piatta isolato
 ES Llave fija aislante
 CN 双色柄绝缘开口扳手

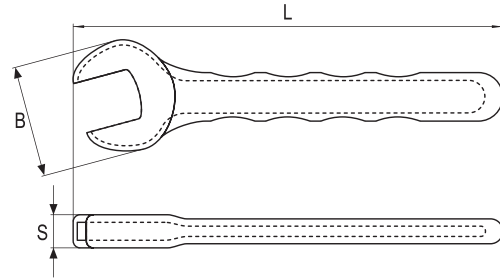
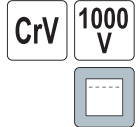

1000 V
 VDE CERTIFICATE
 EN 60900:2012

YATO	Ø [mm]	L [mm]	B [mm]	S [mm]	
YT-20950	6	90	23	7.0	6/108
YT-20951	7	90	25	7.0	6/108
YT-20953	9	100	29	7.5	6/108
YT-20954	10	110	31	8.0	6/108
YT-20955	11	110	34	8.5	6/108
YT-20957	13	135	39	10.5	6/72
YT-20958	14	145	40	10.5	6/72
YT-20959	15	150	42	11.5	6/72
YT-20960	16	160	43	11.5	6/72
YT-20961	17	160	47	12.5	6/72

YATO	Ø [mm]	L [mm]	B [mm]	S [mm]	
YT-20962	18	175	50	13.0	6/72
YT-20963	19	175	53	14.0	6/72
YT-20964	21	195	55	14.0	6/66
YT-20965	22	195	58	14.0	6/66
YT-20966	24	225	62	16.5	6/66
YT-20967	27	250	69	18.0	4/60
YT-20968	30	290	75	19.0	4/48
YT-20969	32	310	79	20.0	4/48

EN Ring impact wrench
 PL Klucz do pobijania oczkowy
 DE Schlagringschlüssel
 RU Ключ закрытый для растряски
 CZ Klíč maticový očkový rázový
 HU Útőcsillagkulcs
 RO Cheie inelară cu bătător
 FR Clé à frapper à oeil
 IT Chiave poligonale semplice a percussione
 ES Llave de muletilla para usarse dando golpes
 CN 敲击梅花扳手



- Application: industry
- 12 point profile
- AS-DRIVE system
- Drop forged
- Surface finish: black oxidised
- Przeznaczenie: przemysł
- Profil 12-kątny
- System AS-DRIVE
- Kute
- Wykończenie powierzchni: czarna, oksydowana

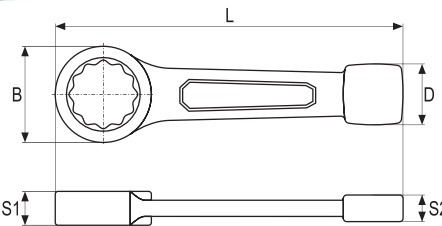

YATO	Ø [mm]	L [mm]	B [mm]	D [mm]	S1 [mm]	S2 [mm]	
YT-1601	24	160	41	31	15.0	10	5/25
YT-1602	27	185	47	33	15.0	12	5/25
YT-1603	30	190	51	35	16.5	14	5/25
YT-1604	32	195	54	37	16.5	15	5/25
YT-1605	36	210	60	39	20.0	17	5/10
YT-1606	38	210	60	39	20.0	17	5/10
YT-1607	41	225	66	42	20.0	18	5/10

YATO	Ø [mm]	L [mm]	B [mm]	D [mm]	S1 [mm]	S2 [mm]	
YT-1608	46	240	74	44	22.0	19	5/10
YT-1609	50	250	80	45	23.0	20	5/10
YT-1610	55	270	86	55	25.0	22	5/10
YT-1611	58	270	86	55	25.0	22	5
YT-1612	60	270	92	60	25.0	23	5
YT-1613	65	290	100	65	30.0	24	5
YT-1614	70	310	108	70	32.0	25	5

EN Open end impact wrench
 PL Klucz do pobijania płaski
 DE Schlagschraubenschlüssel
 RU Ключ плоский для растряски
 CZ Klíč maticový plochý rázový
 HU Útőlaposkulcs
 RO Cheie fixă cu bătător
 FR Clé à frapper plate
 IT Chiave a forchetta semplice a percussione
 ES Llave de boca abierta para usarse dando golpes
 CN 敲击开口扳手



- Application: industry
- Head offset: 15°
- Drop forged
- Surface finish: black oxidised
- Przeznaczenie: przemysł
- Kąt odchylenia główki: 15°
- Kute
- Wykończenie powierzchni: czarna, oksydowana

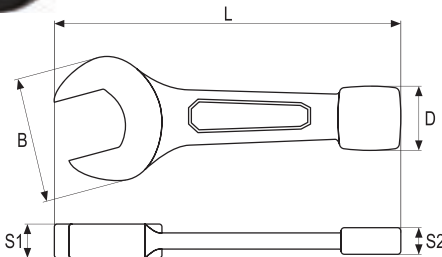

YATO	Ø [mm]	L [mm]	B [mm]	D [mm]	S1 [mm]	S2 [mm]	
YT-1615	27	180	55	33	15	12	5/25
YT-1616	30	187	63	35	17	14	5/25
YT-1617	32	195	67	37	18	15	5/25
YT-1618	36	210	77	39	18	17	5/10

YATO	Ø [mm]	L [mm]	B [mm]	D [mm]	S1 [mm]	S2 [mm]	
YT-1619	41	225	89	42	20	18	5/10
YT-1620	46	255	98	44	20	19	5/15
YT-1621	50	280	107	45	22	20	5
YT-1622	55	310	118	55	25	22	5

- EN Half-moon spanner
PL Klucz oczkowy typu „C”
DE Starter- und Blockschlüssel
RU Ключ накладной изогнутый „С”
CZ Klíč očkovložený typ „C”
HU Félhold alakú csillagkulcs
- RO Cheie inelara semi-luna
FR Clé à oeil „C”
IT Chiave poligonale doppio speciale tipo „C”
ES Llave de estrella tipo „C”
CN C型梅花扳手

CrV 6140 AS-DRIVE



- Application: industry
 - Excellent for work in tight spaces
 - Used for dismantling of collector tubes, alternators and starters
 - Surface finish: chromed, satin
- Przeznaczenie: przemysł
• Do pracy w miejscach szczególnie trudno dostępnych
• Ułatwia odkręcanie kolektorów, alternatorów i rozruszników samochodowych
• Wykończenie powierzchni: chromowana, satynowa



YATO	Ø [mm]	L [mm]	B [mm]	D [mm]	S1 [mm]	S2 [mm]	PCS
YT-0170	10x12	145	16.8	19.2	6.8	6.8	10/60
YT-0171	11x13	170	18.5	21.2	8.4	8.6	10/60
YT-0172	14x15	195	22.8	25.8	9.2	9.9	10/60

YATO	Ø [mm]	L [mm]	B [mm]	D [mm]	S1 [mm]	S2 [mm]	PCS
YT-0173	16x17	220	26.2	28.6	9.9	10.5	10/60
YT-0175	19x22	260	28.7	32.9	10.4	10.9	10/60

- EN Flare nut wrench
PL Klucz oczkowy półotwarty
DE Schraubenschlüssel, halboffen
RU Ключ накладной полуоткрытый
CZ Klíč prstencový polootevřený
HU Csuklós, nyitott
RO Cheie inelară semideschisă
FR Clé mixte à cliquet
IT Chiave poligonale semiaperto
ES Llave semiabierta
CN 油管扳手



CrV 6140

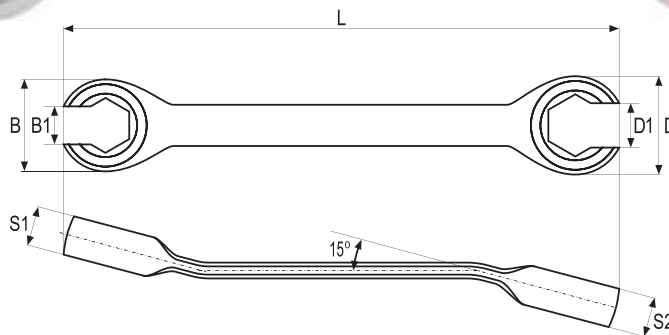

YATO	Ø [mm]	L [mm]	B [mm]	B1 [mm]	D [mm]	D1 [mm]	S1 [mm]	S2 [mm]	PCS
YT-0135	8x10	140	18.7	6.2	21.8	7.2	7.7	8.4	10
YT-0136	11x12	160	21.2	8.1	24.0	9.2	8.5	9.5	10
YT-0137	13x14	175	26.3	9.6	27.3	10.7	9.6	10.5	10
YT-0138	15x17	190	31.2	11.8	31.2	13.0	11.5	10.9	10

YATO	Ø [mm]	L [mm]	B [mm]	B1 [mm]	D [mm]	D1 [mm]	S1 [mm]	S2 [mm]	PCS
YT-01385	17x19	195	29.0	14.5	31.2	15.0	12.4	12.8	10
YT-0139	19x21	230	36.3	14.7	42.1	16.7	12.4	12.8	10
YT-0140	22x24	250	42.7	17.1	44.2	18.6	13.2	13.9	10

- EN Flare nut wrench set
PL Zestaw kluczy oczkowych półotwartych
DE Schraubenschlüssel, halboffen
RU Ключ накладной полуоткрытый
CZ Klíč prstencový polootevřený
HU Csuklós, nyitott
RO Cheie inelară semideschisă
FR Set de clés à tête fendue
IT Set chiavi poligonali semiaperte
ES Llave semiabierta
CN 油管扳手组套

4 PCS CrV 6140



YATO	Ø [mm]	PCS
YT-0143	8x10, 11x12, 13x14, 15x17	25/50

- EN Torx ring spanner set
PL Komplet kluczy oczkowych Torx
DE Torx-Ringschlüsselsatz
RU Набор накладных ключей
CZ Očkové klíče
HU Csillagkulcs készlet
RO Cheie inelare
FR Set de clés à oeil
IT Set chiavi doppie Torx
ES Llaves de anillo Torx
CN 星型扳手组套

4 PCS CrV 6150



YATO	Ø [mm]	PCS
YT-0530	E6xE8, E10xE12, E14xE18, E20xE24	10/60

1

EN Torx type double head flexible wrench
 PL Klucz przegubowy Torx
 DE Torx Doppel-Gelenkschlüssel
 RU Ключ двусторонний шарнирный Torx
 CZ Oboustranný kloubový klíč Torx
 HU Csavarkulcs Torx

RO Cheie Torx cu articulație
 FR Clé articulée Torx
 IT Chiave snodata Torx
 ES Llave articulada Torx
 CN 双摇头杆

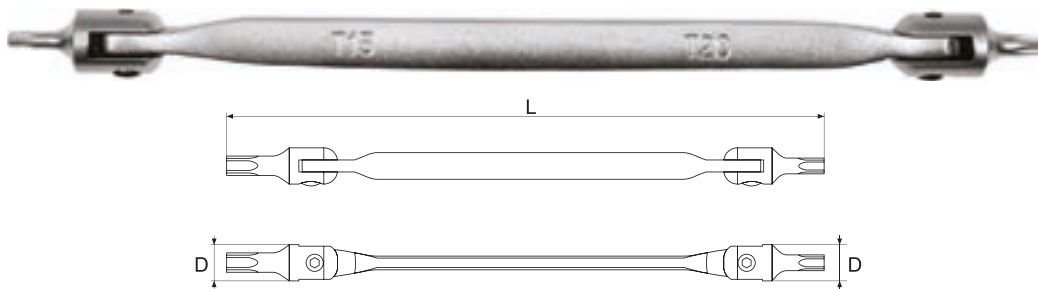

YATO	⊙	L [mm]	D [mm]	📦
YT-05311	T15xT20	202	12.4	25/100
YT-05312	T25xT27	216	13.9	25/100
YT-05313	T30xT40	229	17.8	25/100
YT-05314	T45xT50	243	19.7	10/50
YT-05315	T55xT60	255	21.8	10/50



EN Torx type double head flexible wrench set
 PL Zestaw kluczy Torx z przegubem
 DE Torx Doppel-Gelenkschlüssel-Satz
 RU Набор ключей Torx с шарниром
 CZ Klíče kloubové zástrčné Torx sada
 HU Kétféjű Torx flexibilis szárral készlet
 RO Set chei Torx cu articulație
 FR Clé à double tête de type Torx
 IT Set di chiavi snodate Torx
 ES Juego de llaves articuladas Torx
 CN 双摇头杆

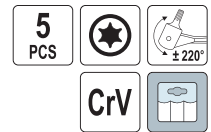

YATO	⊙	📦
YT-05320	T15xT20, T25xT27, T30xT40, T45xT50, T55xT60	20



EN L-type socket wrench
 PL Klucz nasadowy typu „L”
 DE Steckschlüssel gebogen
 RU Ключ торцевой „L” типа
 CZ Nástrčný klíč fajfkový
 HU Kulcs, dugó-pipa
 RO Cheie tubulara cu cot tip „L”
 FR Clé en „L”
 IT Chiave a tubo doppio tipo „L”
 ES Llave de vaso „L”
 CN L 型套筒扳手

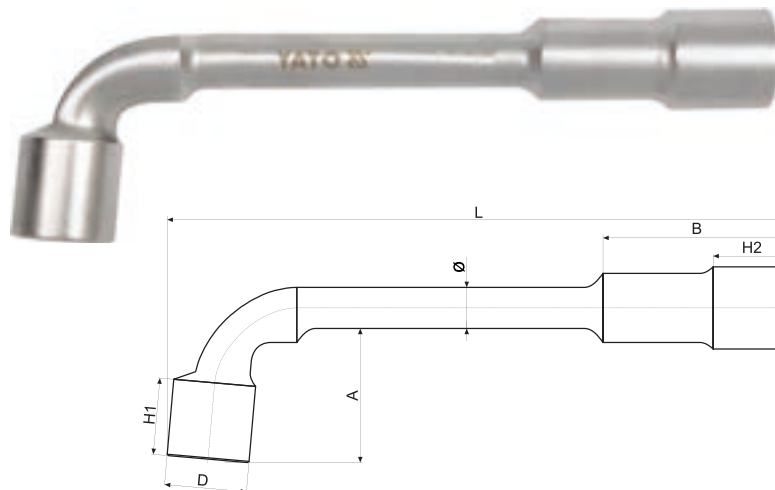

YATO	⊙ [mm]	L [mm]	B [mm]	H1 [mm]	H2 [mm]	A [mm]	D [mm]	Ø [mm]	📦
YT-1627	7	106	27.0	10.1	10.2	21.0	10.7	7	12/60
YT-1628	8	117	29.5	11.9	12.3	18.5	12.2	9	12/60
YT-1629	9	121	31.7	12.8	13.4	19.1	13.2	10	12/60
YT-1630	10	131	35.1	16.9	16.4	23.3	15.0	10	12/60
YT-1631	11	138	36.0	16.8	16.5	24.7	16.3	11	12/60
YT-1632	12	147	42.5	18.2	17.9	17.9	18.0	12	12/60
YT-1633	13	154	44.2	19.1	18.5	30.1	19.3	12	12/60
YT-1634	14	162	47.0	20.3	19.3	30.2	20.8	13	12/60
YT-1635	15	173	48.9	21.6	20.6	31.6	22.3	13	12/60
YT-1636	16	182	55.0	23.1	23.2	37.3	23.6	14	12/60

YATO	⊙ [mm]	L [mm]	B [mm]	H1 [mm]	H2 [mm]	A [mm]	D [mm]	Ø [mm]	📦
YT-1637	17	188	57.0	25.5	25.1	37.9	25.1	14	12/36
YT-1638	18	192	57.1	24.6	25.1	40.1	26.0	14	12/36
YT-1639	19	207	62.3	27.4	26.9	41.6	28.2	16	12/36
YT-1640	20	215	62.4	28.3	27.0	42.4	29.2	16	6/24
YT-1641	21	221	65.0	30.6	30.5	54.0	30.2	16	6/24
YT-1642	22	232	67.5	30.6	30.8	49.1	31.7	16	6/24
YT-1644	24	253	78.2	31.7	32.3	53.5	33.6	17	6/18
YT-1647	27	288	85.3	36.4	36.9	54.7	37.6	20	6/12
YT-1649	30	310	95.0	38.6	38.4	65.3	42.0	22	6/12

EN Ratchet wrench
PL Klucz nasadkowy z grzechotką
DE Gerüstratsche
RU Ключ торцовый с трещоткой
CZ Ráčnový klíč průchozí
HU Kettős racsnis kulcs
RO Cheie tubulara cu clichet
FR Clé à tube à cliquet
IT Chiavi a cricchetto per ponteggi
ES Llave de vaso con carraca
CN 尖尾棘轮扳手

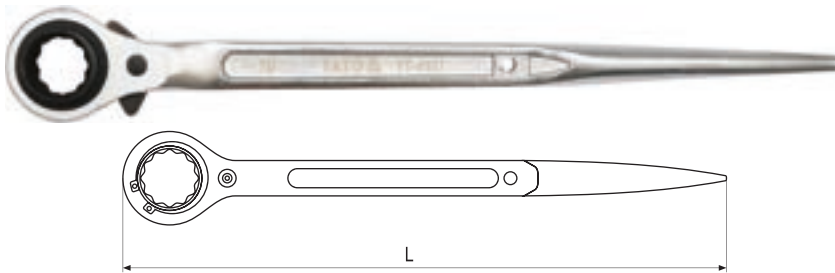

32T

CrV

COLD FORGED
KUTE
NA ZIMNO

YATO	Ø [mm]	L [mm]	
YT-4937	19x22	315	2/40

EN Double ratchet wrench
PL Dwustronny klucz nasadkowy z grzechotką
DE Gerüstratsche
RU Ключ торцовый с трещоткой
CZ Ráčnový klíč průchozí dvoustranný
HU Kettős racsnis kulcs
RO Cheie tubulara dubla cu clichet
FR Clé à oeil à cliquet
IT Chiave a cricco doppio
ES Llave de vaso con carraca
CN 尖尾棘轮扳手

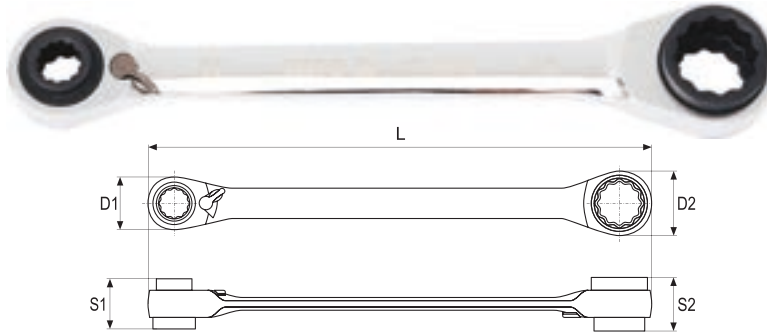

72T

CrV



YATO	Ø [mm]	L [mm]	D1 [mm]	D2 [mm]	S1 [mm]	S2 [mm]	
YT-4945	10x13x17x19	200	29	35	17	22	5/50

EN Socket wrench with handle
PL Klucz nasadowy z rękojeścią
DE Steckschlüssel
RU Ключ торцевой
CZ Nástrčný klíč
HU Kulcs
RO Cheie tubulara
FR Clé à tube
IT Chiave a cricco doppio
ES Llave
CN 六角套筒螺丝批

HRC
44

CrV



YATO	Ø [mm]	D [mm]	L1 [mm]	L2 [mm]	PCS RODR	
YT-1542	6	9.1	125	242	6	120
YT-1543	7	10.9	125	242	6	120
YT-1544	8	12.0	125	242	6	120
YT-1546	10	14.1	125	242	6	120
YT-1549	13	18.0	125	242	6	120

EN T-type deep socket wrench with rotary handle
PL Klucz nasadowy typu „T” z obrotową rękojeścią
DE Steckschlüssel vom Typ „T” mit drehbarem Handgriff
RU Торцовый ключ типа „Т” с вращательной ручкой
CZ Klíč nástrčný typ „T” s otočnou rukojetí
HU „T” típusú dugókulcs, forgatható karral
RO Cheie tubulară de tip „T” cu mâner rotativ
FR Clé à tube en „T”
IT Chiave tipo „T” con manico scorrevole
ES Llave tubular „T” con un mango giratorio
CN T型套筒扳手

CrV
6140

AS-DRIVE



- Ergonomic handle
- Movable handle with position locking system
- Long bar for work in deeply set, difficult to reach places
- Ergonomiczna rękojeść
- Przesuwane pokrętko z blokadą położenia
- Długi trzpień umożliwiający pracę w głębokich wnękach

YATO	Ø [mm]	L1 [mm]	L2 [mm]	Ø [mm]	
YT-1552	8	310	200	10	10/40
YT-1554	10	310	200	10	10/40
YT-1556	12	310	200	10	10/40

YATO	Ø [mm]	L1 [mm]	L2 [mm]	Ø [mm]	
YT-1557	13	310	200	10	10/40
YT-1558	14	310	200	10	10/40
YT-1559	15	310	200	10	10/40

EN T-type adapter with rotary handle
 PL Adapter typu „T” z obrotową rękojeścią
 DE Adapter vom Typ „T” mit drehbarem Handgriff

RO Adaptor tip „T” cu mâner rotativ
 FR Adapteur en „T”
 IT Adattatore tipo „T” con manico scorrevole
 ES Adaptador „T” con un mango giratorio
 CN T型套筒接头

RU Адаптер типа „Т” с вращательной ручкой
 CZ Adaptér typ „T” s otočnou rukojetí
 HU „T” típusú adapter, forgatható karral

1/4"
6.3 mm

3/8"
9.5 mm

1/2"
12.7 mm

CrV
6140

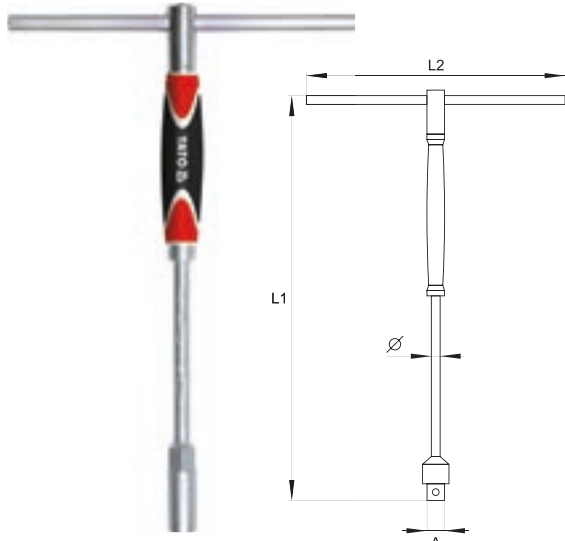

- Ergonomic handle
- Movable handle with position locking system
- Long bar for work in deeply set, difficult to reach places
- Ergonomiczna rękojeść
- Przesuwane pokrętko z blokadą położenia
- Długi trzpień umożliwiający pracę w głębokich wnękach



YATO	Ø H	L1 [mm]	L2 [mm]	Ø [mm]	
YT-1565	1/4" (6.3 mm)	310	200	8	10/40
YT-1566	3/8" (9.5 mm)	310	200	10	10/40
YT-1567	1/2" (12.7 mm)	310	200	10	10/40

EN T-type deep socket wrench
 PL Klucz nasadowy typu „T”
 DE Steckschlüssel vom Typ „T”
 RU Торцовый ключ типа „Т”
 CZ Klíč nástrčný typ „T”
 HU „T” típusú dugókulcs

RO Cheie tubulară de tip „T”
 FR Clé à tube en „T”
 IT Chiave a bussola tipo „T”
 ES Llave tubular „T”
 CN T型套筒扳手

CrV
6140

AS-DRIVE

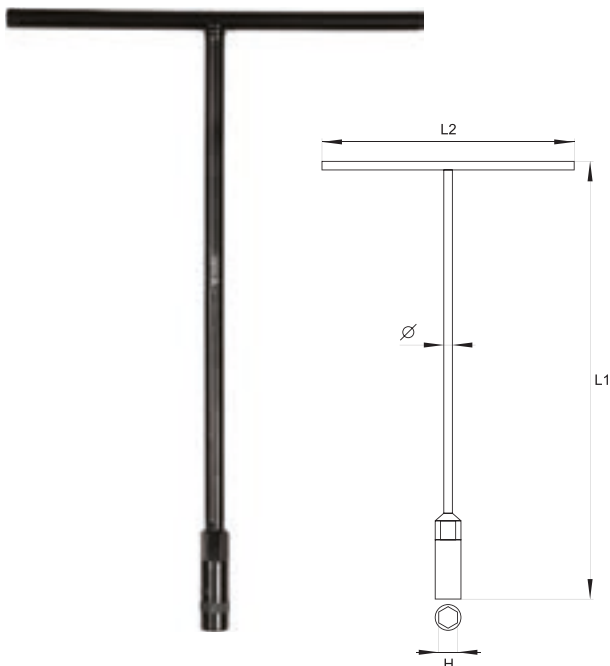

YATO	Ø [mm]	L1 [mm]	L2 [mm]	Ø [mm]	
YT-1571	8	310	200	10	10/40
YT-1573	10	310	200	10	10/40
YT-1575	12	310	200	10	10/40
YT-1576	13	310	200	10	10/40

EN Insulated T-handle wrench
 PL Rękojeść typu „T” izolowana
 DE Steckschlüssel T-griff vollisoliert
 RU Ручка Т-образная изолированная
 CZ Klíč nástrčný typ „T” izolovaný
 HU „T” típusú dugókulcs

RO Manerit tip „T” izolat
 FR Clé à tube en „T” isolée
 IT Chiave a bussola tipo „T” isolati
 ES Llave en T aislada
 CN 绝缘T型套筒扳手

3/8"
9.5 mm

1/2"
12.7 mm

CrV

1000 V



1000 V
 VDE CERTIFICATE
 EN 60900:2012

YATO	Ø H	L1 [mm]	L2 [mm]	Ø [mm]	
YT-21095	3/8" (9.5 mm)	207	160	15.6	4/32
YT-21096	1/2" (12.7 mm)	207	160	19.3	4/32

EN T-type deep socket wrench set
 PL Zestaw kluczy nasadowych typu „T”
 DE Steckschlüsselsatz vom Typ „T”
 RU Набор торцевых ключей типа „Т”
 CZ Sada nástrčných klíčů typ „T”
 HU „T” típusú dugókulcs készlet

RO Set chei tubulare de tip „T”
 FR Ensemble de clé à douille de type „T”
 IT Set di chiavi a bussola a „T”
 ES Juego de llaves tubulares „T”
 CN T型套筒扳手组套

CrV
6140

AS-DRIVE



YATO	Ø [mm]	
YT-15791	8, 10, 13	4/16

EN T-handle swivel socket wrench
 PL Klucz nasadowy z przegubem typu „T”
 DE T-Griff Steckchlüssel mit Gelenk
 RU Ключ торцевой с карданом Т-образный
 CZ Hlavice ohebná na T-rukojeti matny povrch
 HU Csuiklós „T” kulcs adatai
 RO Cheie tubulara cu cruce cardanica tip „T”
 FR Clé à poignée en „T” longue à cardan
 IT Chiave a bussola a „T” con snodo
 ES Llave vaso en „T” con cardan
 CN T型活动套筒扳手



EN T-handle swivel adapter
 PL Klucz z przegubem typu „T”
 DE T-Griff Steckchlüssel mit Gelenk
 RU Вороток Т-образный с карданом
 CZ „T” klič sa kloubem
 HU Csuiklós T-hajtósár
 RO Adaptor tip „T” cu cruce cardanica
 FR Clé à poignée en „T” longue à cardan
 IT Chiave a „T” con snodo
 ES Alargadera a cardan
 CN T型活动套筒扳手

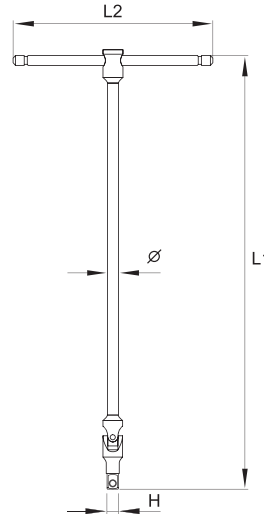

YATO	Ø [mm]	L1 [mm]	L2 [mm]	
YT-15271	6	450	180	10/40
YT-15273	8	450	180	10/40
YT-15275	10	450	180	10/40
YT-15276	11	450	180	10/40
YT-15277	12	450	180	10/40
YT-15278	13	450	180	10/40
YT-15279	14	450	180	10/40
YT-15280	15	450	180	10/40
YT-15281	16	450	180	10/40
YT-15282	17	450	180	10/40
YT-15284	19	450	180	10/40

YATO	Ø H	L1 [mm]	L2 [mm]	
YT-15291	1/4" (6.3 mm)	450	180	10/40
YT-15292	3/8" (9.5 mm)	450	180	10/40
YT-15293	1/2" (12.7 mm)	450	180	10/40

EN Adjustable wrench
 PL Klucz nastawny
 DE Rollgabelschlüssel
 RU Ключ разводной

CZ Nastavitelný klič
 HU Állítható svédkulcs
 RO Cheie reglabilă
 FR Clé à molette

IT Chiave a rullino graduata
 ES Llave ajustable tipo inglesa
 CN 发黑活络扳手



YATO	L [mm]	
YT-2071	150	6/60
YT-2072	200	6/60
YT-2073	250	6/36
YT-2074	300	6/24
YT-2075	375	6/12



DIN 3117 CrV

YATO	L [mm]	
YT-2170	150	6/72
YT-2171	200	6/60
YT-2172	250	6/48
YT-2173	300	6/36



DIN 3117 DROP FORGED KUTE

YATO	L [mm]	Max. jaws range / Maks. rozwarcie szczęk [mm]	
YT-21650	150	19.3	6/60
YT-21651	200	24.0	6/60
YT-21652	250	30.0	6/36
YT-21653	300	36.0	6/24
YT-21654	375	45.0	8/16



1

- EN Insulated adjustable wrench
- PL Klucz nastawny izolowany
- DE Rollgabelschlüssel isoliert
- RU Ключ разводной изолированный
- CZ Izolovaný stavitelný klíč
- HU Állítható svédkulcs
- RO Cheie reglabilă izolată
- FR Clé à molette isolée
- IT Isolati chiave regolabile
- ES Llave ajustable aislante
- CN 双色柄绝缘活络扳手



CrV 1000 V 



1000 V
VDE CERTIFICATE
EN 60900:2012



YATO 	L [mm]	
YT-20940	200	6/48
YT-20941	250	6/36
YT-20942	300	4/24

- EN Flexible hook wrench
- PL Klucz hakowy
- DE Hakenschlüssel
- RU Ключ сегментный шарнирный
- CZ Hákový klíč
- HU Körmös kulcs
- RO Cheie universală cu carlig
- FR Clé à crochet
- IT Chiave a settore
- ES Llave de gancho articulada
- CN 方头钩型扳手

CrV 





YATO 	L [mm]	∅ [mm]	
YT-01670	170	15-35	10/50
YT-01671	210	35-50	10/50
YT-01672	280	50-80	10/50
YT-01673	340	80-120	5/10
YT-01674	470	120-180	5/10

YATO 	L [mm]	∅ [mm]	
YT-01675	170	15-35	10/50
YT-01676	210	35-50	10/50
YT-01677	280	50-80	10/50
YT-01678	340	80-120	5/10
YT-01679	470	120-180	5/10

- EN Sink wrench
- PL Teleskopowy klucz hakowy do armatury
- DE Teleskop-Hakenschlüssel für Armaturen
- RU Ключ для раковины телескопический
- CZ Teleskopický úmyvadlový klíč
- HU Teleszkópos csaptelep kulcs
- RO Cheie telescopică pt. chiuvetă
- FR Clé à siphon télescopique
- IT Chiave telescopica per lavabo
- ES Llave para lavabo telescópica
- CN 水槽扳手



1 1/2" - 2 1/2" 32-63.5 mm 23-41 cm 180° 

YATO 	
YT-22251	6/12

	Memo
--	------

Memo

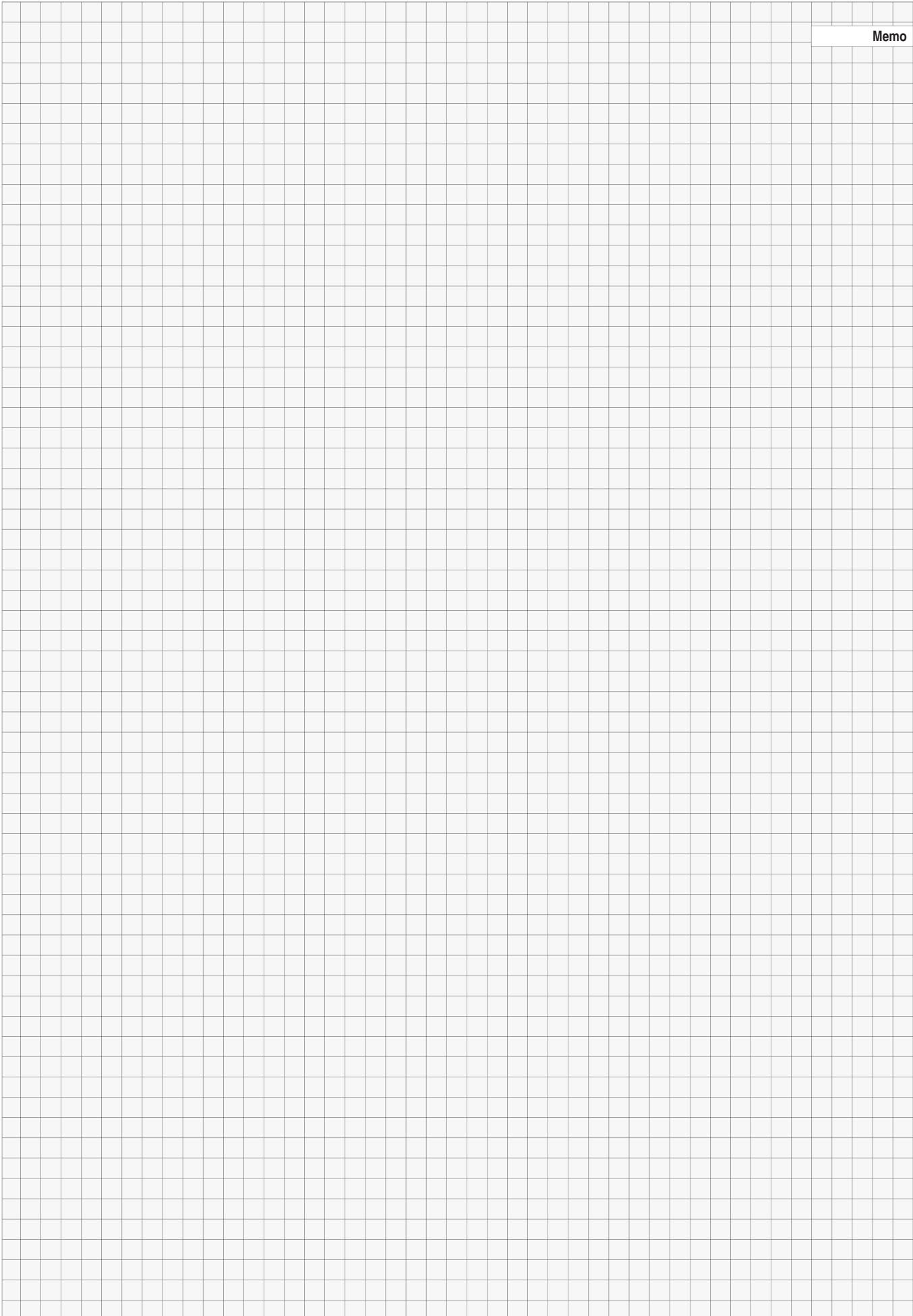

2

Sockets, accessories & sets
Klucze nasadowe,
akcesoria i zestawy



Sockets 1/4"

Klucze nasadowe 1/4"

25



Hexagonal sockets

Klucze nasadowe sześciokątne, krótkie..... 25

Hexagonal deep sockets

Klucze nasadowe sześciokątne, długie..... 25

Accessories 1/4"

Akcesoria 1/4"

25-27



Extension bars

Przedłużki..... 25

Extension bars with wobble

Przedłużki uchylnie..... 26

Flexible extension cords

Przedłużki elastyczne..... 26

Adapters

Redukcje..... 26

Bit adapters

Adaptery do bitów..... 26

Universal joints

Przeguby Cardana..... 26

Spinner handles

Pokręta do nasadek..... 27

Sliding T-bars

Pokręta typu „T”..... 27

Flexible handles

Pokręta łamane..... 27

Ratchet handles 1/4"

Grzechotki 1/4"

27-28



Ratchet handles

Grzechotki..... 27

Flexible ratchet handles

Grzechotki z przegubem..... 27

Composite ratchet handles

Grzechotki powlekane..... 28

Curved ratchet handles

Grzechotki wygięte..... 28

Telescopic ratchet handles

Grzechotki z przedłużonym uchwytem..... 28

Bit and socket drive ratchet handles

Grzechotki do bitów i nasadek..... 28

Rotary head ratchet handles

Grzechotki z obrotową głowicą..... 28

Sockets 3/8"

Klucze nasadowe 3/8"

29



Hexagonal sockets

Klucze nasadowe sześciokątne, krótkie..... 29

Insulated hexagonal sockets

Klucze nasadowe sześciokątne izolowane, krótkie..... 29

Hexagonal deep sockets

Klucze nasadowe sześciokątne, długie..... 29

Accessories 3/8"

Akcesoria 3/8"

29-32



Extension bars

Przedłużki..... 29

Insulated extension bars

Przedłużki izolowane..... 30

Extension bars with wobble

Przedłużki uchylnie..... 30

Adapters

Redukcje..... 30

Bit adapters

Adaptery do bitów..... 30

Universal joints

Przeguby Cardana..... 30

Sliding T-bars

Pokręta typu „T”..... 30

Flexible handles

Pokręta łamane..... 30

Spark plug sockets

Klucze nasadowe do świec..... 31

Ratchet handles 3/8"

Grzechotki 3/8"

32-33



Ratchet handles

Grzechotki..... 32

Flexible ratchet handles

Grzechotki z przegubem..... 32

Composite ratchet handles

Grzechotki powlekane..... 32

Insulated ratchet handles

Grzechotki izolowane..... 33

Curved ratchet handles

Grzechotki wygięte..... 33

Telescopic ratchet handles

Grzechotki z przedłużonym uchwytem..... 33

Sockets 1/2"

Klucze nasadowe 1/2"

33-35



Hexagonal sockets

Klucze nasadowe sześciokątne, krótkie..... 33

Insulated hexagonal sockets

Klucze nasadowe sześciokątne izolowane, krótkie..... 33

Bi-hexagonal sockets

Klucze nasadowe dwunastokątne, krótkie..... 34

Spline sockets

Klucze nasadowe „Spline”..... 34

Hexagonal deep sockets

Klucze nasadowe sześciokątne, długie..... 34

Bi-hexagonal deep sockets

Klucze nasadowe dwunastokątne, długie..... 35

Accessories 1/2"

Akcesoria 1/2"

35-37



Extension bars

Przedłużki..... 35

Insulated extension bars

Przedłużki izolowane..... 35

Extension bars with wobble

Przedłużki uchylnie..... 35

Adapters

Redukcje..... 35

Bit adapters

Adaptery do bitów..... 36

Universal joints

Przeguby Cardana..... 36

Sliding T-bars

Pokręta typu „T”..... 36

Flexible handles

Pokręta łamane..... 36











L-type handles

Pokręta typu „L”..... 36

Spark plug sockets

Klucze nasadowe do świec..... 37



<p>Ratchet handles 1/2" Grzechotki 1/2"</p> <p>..... 37-38 </p>	<p>Tool sets Zestawy narzędziowe</p> <p>..... 54 </p>
<p>Ratchet handles Grzechotki 37</p> <p>Flexible ratchet handles Grzechotki z przegubem 37</p> <p>Composite ratchet handles Grzechotki powlekane 37</p> <p>Insulated ratchet handles Grzechotki izolowane 37</p> <p>Curved ratchet handles Grzechotki wygięte 37</p> <p>Telescopic ratchet handles Grzechotki z przedłużonym uchwytem 38</p> <p>Rotary head ratchet handles Grzechotki z obrotową głowicą 38</p> <p>Step wrenches Klucze sztorcowe 38</p>	<p>Torx sockets & sets Klucze nasadowe „Torx” i zestawy</p> <p>..... 54-55 </p>
<p>Socket sets Zestawy kluczy nasadowych</p> <p>..... 39-52 </p>	<p>Sockets 3/4" Klucze nasadowe 3/4"</p> <p>..... 55 </p>
<p>Socket sets 1/4" Zestawy kluczy nasadowych 1/4" 39</p> <p>Socket sets 3/8" Zestawy kluczy nasadowych 3/8" 40</p> <p>Socket sets 1/2" Zestawy kluczy nasadowych 1/2" 41</p> <p>Socket sets 1/2", 1/4" Zestawy kluczy nasadowych 1/2", 1/4" 42</p> <p>Socket sets 1/2", 3/8", 1/4" Zestawy kluczy nasadowych 1/2", 3/8", 1/4" 46</p>	<p>Accessories 3/4" Akcesoria 3/4"</p> <p>..... 56-57 </p>
<p>Socket sets Zestawy kluczy nasadowych</p> <p>..... 53 </p>	<p>Extension bars Przedłużki 56</p> <p>Adapters Redukcje 56</p> <p>Universal joints Przeguby Cardana 56</p> <p>Sliding T-bars Pokręta typu „T” 56</p> <p>Flexible handles Pokręta łamane 56</p> <p>L-type handles Pokręta typu „L” 57</p>
<p>Socket sets 1/4" Zestawy kluczy nasadowych 1/4" 53</p> <p>Socket sets 1/2" Zestawy kluczy nasadowych 1/2" 53</p> <p>Socket sets 1/2", 3/8" Zestawy kluczy nasadowych 1/2", 3/8" 53</p>	<p>Ratchet handles 3/4" Grzechotki 3/4"</p> <p>..... 57 </p>
<p>Socket sets 1/4" Zestawy kluczy nasadowych 1/4" 53</p> <p>Socket sets 1/2" Zestawy kluczy nasadowych 1/2" 53</p> <p>Socket sets 1/2", 3/8" Zestawy kluczy nasadowych 1/2", 3/8" 53</p>	<p>Socket sets 3/4" Zestawy kluczy nasadowych 3/4"</p> <p>..... 57 </p>
<p>Bit sockets & sets 1/4", 3/8", 1/2" Klucze trzpieniowe i zestawy 1/4", 3/8", 1/2"</p> <p>..... 58-63 </p>	

EN Hexagonal socket
PL Nasadka sześciokątna
DE Sechskantenschlüssel
RU Головка шестигранная короткая
CZ Šestihranný nástavec
HU Dugókulcs hatszög
RO Cheie tubulară hexagonală
FR Douille courte
IT Chiave a bussola esagonale
ES Boquilla hexagonal corta
CN 六角套筒

1/4"
6.3mm
DIN 3121
CrV
50BV30
AS-DRIVE

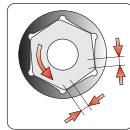

- Drive locks
- Surface finish: chromed, satin / mirror
- Zamki blokujące
- Wykończenie powierzchni: chromowana, satynowa / polerowana

YATO	o A [mm]	D1 [mm]	D2 [mm]	L [mm]	PCS FRONT	
YT-1401	4.0	7.0	12	25	24	240/480
YT-1403	5.0	8.0	12	25	24	240/480
YT-1404	5.5	8.5	12	25	24	240/480
YT-1405	6.0	9.0	12	25	24	240/480
YT-1406	7.0	10.0	12	25	24	240/480
YT-1407	8.0	12.0	11	25	24	240/480
YT-1408	9.0	13.0	12	25	24	240/480
YT-1409	10.0	15.0	12	25	24	240/480
YT-1410	11.0	16.0	14	25	24	240/480
YT-1411	12.0	17.0	15	25	24	240/480
YT-1412	13.0	18.0	16	25	24	240/480

EN Hexagonal deep socket
PL Nasadka sześciokątna długa
DE Sechskantenschlüssel, lange
RU Головка шестигранная длинная
CZ Šestihranný hluboký nástavec
HU Dugókulcs hatszög hosszú
RO Cheie tubulară hexagonală adâncă
FR Douille longue
IT Chiave a bussola esagonale
ES Boquilla hexagonal larga
CN 六角长套筒

1/4"
6.3mm
DIN 3121
CrV
50BV30
AS-DRIVE

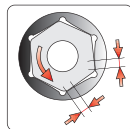
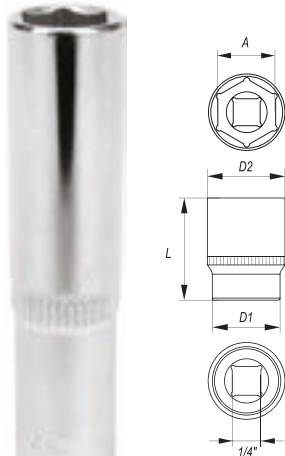

- Drive locks
- Surface finish: chromed, satin / mirror
- Zamki blokujące
- Wykończenie powierzchni: chromowana, satynowa / polerowana

YATO	o A [mm]	D1 [mm]	D2 [mm]	L [mm]	PCS FRONT	
YT-1413	4.0	7.0	12	50	24	240/480
YT-1414	4.5	7.5	12	50	24	240/480
YT-1415	5.0	8.0	12	50	24	240/480
YT-1416	5.5	8.5	12	50	24	240/480
YT-1417	6.0	9.0	12	50	24	240/480
YT-1418	7.0	10.0	12	50	24	240/480
YT-1419	8.0	12.0	12	50	24	240/480
YT-1420	9.0	13.0	12	50	24	240/480
YT-1421	10.0	14.0	13	50	24	240/480
YT-1422	11.0	16.0	14	50	24	120/240
YT-1423	12.0	17.0	15	50	24	120/240
YT-1424	13.0	18.0	16	50	24	120/240

EN Hexagonal socket
PL Nasadka sześciokątna
DE Sechskantenschlüssel
RU Головка шестигранная короткая
CZ Šestihranný nástavec
HU Dugókulcs hatszög
RO Cheie tubulară hexagonală
FR Douille courte
IT Chiave a bussola esagonale
ES Boquilla hexagonal corta
CN 六角套筒

1/4"
6.3mm
CrV
50BV30
AS-DRIVE

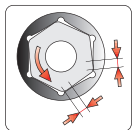

YATO	o A [mm]	D1 [mm]	D2 [mm]	L [mm]	
YT-14120	5.0	8.0	12	25	12/360
YT-14121	5.5	8.5	12	25	12/360
YT-14123	6.0	9.0	12	25	12/360
YT-14124	7.0	10.0	12	25	12/360
YT-14125	8.0	12.0	12	25	6/360
YT-14126	9.0	13.0	12	25	6/360
YT-14127	10.0	15.0	12	25	6/360
YT-14128	12.0	17.0	15	25	6/360
YT-14129	13.0	18.0	16	25	6/360

EN Extension bar
PL Przedłużka
DE Verlängerung
RU Удлинитель для воротка
CZ Prodlužovací přípravek
HU Toldalék
RO Prelungitor
FR Rallonge
IT Prolunga
ES Tubo de prolongación
CN 接杆

1/4"
6.3mm
DIN 3121
CrV
50BV30

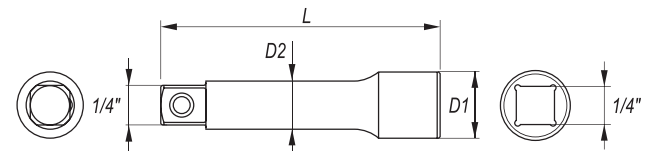

YATO	o	D1 [mm]	D2 [mm]	L [mm]	PCS FRONT	
YT-1429	1/4" (6.3 mm)	12.4	8.3	50.8	30	150/300
YT-1430	1/4" (6.3 mm)	12.4	8.3	76.0	30	150/300
YT-1431	1/4" (6.3 mm)	12.4	8.3	101.6	20	100/200
YT-1432	1/4" (6.3 mm)	12.4	8.3	152.4	20	100/200

EN Extension bar with wobble
 PL Przedłużka uchylna
 DE Gelenkverlängerung
 RU Удлинитель наклонный
 CZ Odchylný prodlužovací přípravek
 HU Csuklós toldalék

RO Prelungitor rabatabil
 FR Rallonge angulaire
 IT Prolunga
 ES Tubo de prolongación desviable
 CN 转向接杆

1/4" 6.3mm
 DIN 3121
 CrV 50BV30

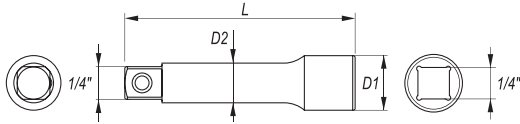

YATO	Ø	D1 [mm]	D2 [mm]	L [mm]	PCS PKG	
YT-1433	1/4" (6.3 mm)	12.4	8.3	50.8	30	150/300
YT-1434	1/4" (6.3 mm)	12.4	8.3	76.0	30	150/300
YT-1435	1/4" (6.3 mm)	12.4	8.3	101.6	20	100/200
YT-1436	1/4" (6.3 mm)	12.4	8.3	152.4	20	100/200

EN Extension bar
 PL Przedłużka elastyczna
 DE Verlängerung

RU Удлинитель для воротка
 CZ Prodlužovací přípravek
 HU Toldalék

RO Prelungitor
 FR Rallonge élastique
 IT Prolunga flessibile

ES Tubo de prolongación
 CN 柔性螺丝批头接杆

1/4" 6.3mm
 CrV 6140

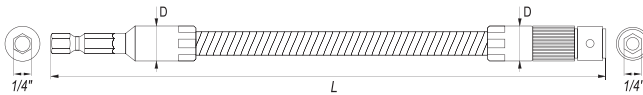

EN Adapter
 PL Redukcja
 DE Reduktion
 RU Переходник
 CZ Redukce
 HU Redukció

RO Reducție
 FR Réduction
 IT Riduttore
 ES Reducción
 CN 转换头

1/4" 6.3mm

DIN 3121

CrV 50BV30

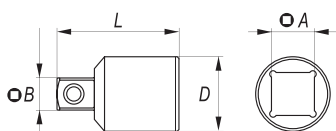

YATO	Ø A	Ø B	D [mm]	L [mm]	PCS PKG	
YT-1438	1/4" (6.3 mm) (F)	3/8" (9.5 mm) (M)	12	25	10	250/500

EN Bit adapter
 PL Adapter do bitów
 DE Bithalter

RU Держатель винтовёртовых наконечников
 CZ Držák na šroubovakové koncovky
 HU Szár a csavarhúzóvégekhez
 RO Capete şurubelniţă
 FR Adaptateur d'embouts
 IT Chiave esagonale a bussola
 ES Mandril para puntas
 CN 旋具头接头

1/4" 6.3mm

CrV 6140

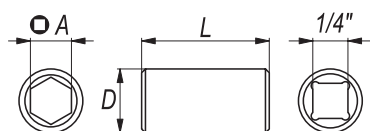

YATO	Ø	Ø A	D [mm]	L [mm]	PCS PKG	
YT-1297	1/4" (6.3 mm)	1/4" (6.3 mm)	11.8	24	10	250/1000

EN Extension bar
 PL Przedłużka elastyczna
 DE Verlängerung
 RU Удлинитель для воротка
 CZ Prodlužovací přípravek
 HU Toldalék

RO Prelungitor
 FR Rallonge élastique
 IT Prolunga flessibile
 ES Tubo de prolongación
 CN 可弯式接杆

1/4" 6.3mm
 CrV 6140

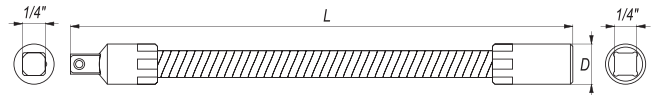

YATO	Ø	Ø	D [mm]	L [mm]	PCS PKG	
YT-1400	1/4" (6.3 mm)	1/4" (6.3 mm)	11.6	150	25	250/500

YATO	Ø	Ø	D [mm]	L [mm]	PCS PKG	
YT-14001	1/4" (6.3 mm)	1/4" (6.3 mm)	11.7	300	100	

EN Bit adapter
 PL Adapter do bitów
 DE Bithalter
 RU Держатель винтовёртовых наконечников
 CZ Držák na šroubovakové koncovky
 HU Szár a csavarhúzóvégekhez
 RO Capete şurubelniţă
 FR Adaptateur d'embouts
 IT Chiave esagonale a bussola
 ES Mandril para puntas
 CN 旋具头接头

1/4" 6.3mm

CrV 6140

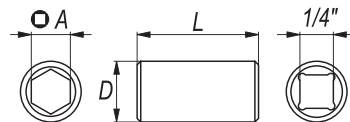

YATO	Ø	Ø A	D [mm]	L [mm]	PCS PKG	
YT-12971	1/4" (6.3 mm)	1/4" (6.3 mm)	11.8	24	5/600	

EN Universal joint
 PL Przegub Cardana
 DE Kardangelen
 RU Карданный шарнир
 CZ Kardanový kloub
 HU Kardán csukló

RO Articulație Cardanică
 FR Cardan
 IT Snodo cardanico
 ES Articulación Cardan
 CN 万向接头

1/4" 6.3mm

DIN 3121

CrV 50BV30

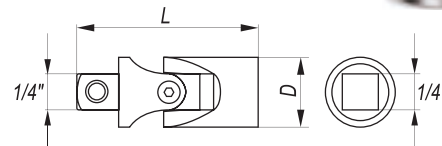

YATO	Ø	D [mm]	L [mm]	PCS PKG	
YT-1437	1/4" (6.3 mm)	14	35	20	120/240

EN Spinner handle
PL Pokrętko do nasadek
DE Drehgriff für Steckschlüssel
RU Ручка с соединением под головки
CZ Nástrčná rukojeť
HU Csavarhúzószáj

RO Maner surubelnita cu antrenor
FR Barre
IT Porta bussola con manico
ES Destornillador con cuadradillo
CN 旋柄

1/4"
6.3mm
CrV
50BV30



YATO	Ø	L [mm]	PCS ROZD	☐
YT-1427	1/4" (6.3 mm)	150	12	48

EN Sliding T-bar
PL Pokrętko typu „T”
DE Handgriff mit Gleitstück
RU Вороток Т-образный
CZ Otočná račka typ „T”
HU „T” alakú hajtókar

RO Măner clupă tipul „T”
FR Barre type „T”
IT Manopola „T” scorrevole
ES Mango tipo „T”
CN 滑行杆

1/4"
6.3mm
DIN
3121
CrV
50BV30

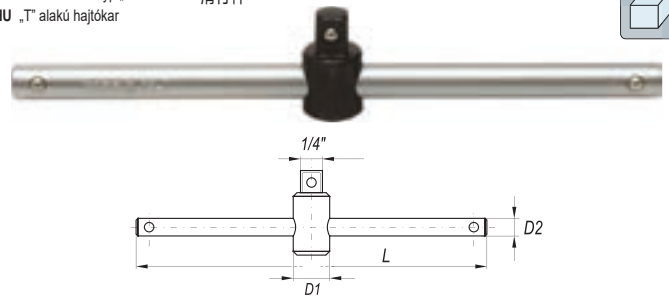

YATO	Ø	D1 [mm]	D2 [mm]	L [mm]	PCS ROZD	☐
YT-1426	1/4" (6.3 mm)	13.3	6.3	152.4	10	100/200

EN Flexible handle
PL Pokrętko lamane
DE Gelenkgriff
RU Вороток шарнирный
CZ Otočná lomená ráčka
HU Hajlított hajtókar

RO Prelungitor cu prindere flexibilă
FR Barre pivotante
IT Manopola a snodo
ES Mango articulado
CN 转向手柄



1/4"
6.3mm
DIN
3121
CrV
50BV30

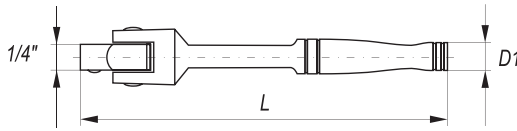

YATO	Ø	D [mm]	L [mm]	PCS ROZD	☐
YT-1425	1/4" (6.3 mm)	13	140	10	100/200

EN Quick release ratchet handle
PL Grzechotka
DE Hebelumschaltknarre
RU Трещотка

CZ Řehtačka
HU Racsnis hajtókar
RO Dispozitiv de prindere cu clichet
FR Clé à cliquet

IT Cricchetto bussola
ES Carraca
CN 快速脱落棘轮扳手

1/4"
6.3mm
DIN
3122
QUICK
RELEASE
SZYBKÓ-
ZLĄCZE
72T



CrV
6140

YATO	Ø	T	L [mm]	PCS ROZD	☐
YT-0307	1/4" (6.3 mm)	72	146	12	24/96

CrV
6140



YATO	Ø	T	L [mm]	PCS ROZD	☐
YT-0310	1/4" (6.3 mm)	72	125	12	36/72

CrV
6140



YATO	Ø	T	L [mm]	PCS ROZD	☐
YT-0313	1/4" (6.3 mm)	72	125	12	24/96

CrV
6135



YATO	Ø	T	L [mm]	PCS ROZD	☐
YT-0316	1/4" (6.3 mm)	72	145	12	24/96

CrV
6140



YATO	Ø	T	L [mm]	PCS ROZD	☐
YT-0322	1/4" (6.3 mm)	72	148	12	48/96

EN Quick release ratchet handle
PL Grzechotka
DE Hebelumschaltknarre
RU Трещотка

CZ Ráčna
HU Racsnis hajtókar
RO Dispozitiv de prindere cu clichet
FR Clé à cliquet

IT Cricchetto bussola
ES Carraca
CN 快速脱落棘轮扳手

1/4"
6.3mm
DIN
3122
QUICK
RELEASE
SZYBKÓ-
ZLĄCZE
72T
CrV
6140

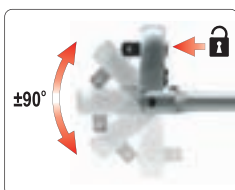

YATO	Ø	T	L [mm]	PCS ROZD	☐
YT-0325	1/4" (6.3 mm)	72	159	12	48/96

EN Quick release ratchet handle
PL Grzechotka powlekana
DE Hebelumschaltknarre
RU Трещотка

CZ Řehtačka
HU Racsnis hajtókar
RO Dispozitiv de prindere cu clichet
FR Clé à cliquet

IT Cricchetto bussola
ES Carraca
CN 快速脱落棘轮扳手

1/4"
6.3mm

DIN
3122

QUICK
RELEASE
SZYBKO-
ZŁĄCZE

72T

CrV
6135



YATO	Ø	T	L [mm]	PCS PIECE	Box
YT-0290	1/4" (6.3 mm)	72	144	12	48/96

YATO	Ø	T	L [mm]	PCS PIECE	Box
YT-0293	1/4" (6.3 mm)	72	144	12	48/96

EN Quick release ratchet handle
PL Grzechotka
DE Hebelumschaltknarre
RU Трещотка
CZ Ráčna
HU Racsnis hajtókar

RO Dispozitiv de prindere cu clichet
FR Clé à cliquet
IT Cricchetto bussola
ES Carraca
CN 快速脱落棘轮扳手

1/4"
6.3mm

QUICK
RELEASE
SZYBKO-
ZŁĄCZE

72T

CrV
6140



EN Quick release ratchet handle
PL Grzechotka
DE Hebelumschaltknarre
RU Трещотка
CZ Ráčna
HU Racsnis hajtókar

RO Dispozitiv de prindere cu clichet
FR Clé à cliquet
IT Cricchetto bussola
ES Carraca
CN 快速脱落棘轮扳手

1/4"
6.3mm

QUICK
RELEASE
SZYBKO-
ZŁĄCZE

72T

CrV
6135



YATO	Ø	T	L [mm]	PCS PIECE	Box
YT-0730	1/4" (6.3 mm)	72	155	12	12/96

YATO	Ø	T	L [mm]	PCS PIECE	Box
YT-0733	1/4" (6.3 mm)	72	155	12	24/96

EN Telescopic ratchet handle
PL Grzechotka z przedłużonym uchwytem
DE Umschaltknarre
RU Трещотка
CZ Ráčna
HU Racsnis hajtókar
RO Antrenor cu clichet
FR Clé à cliquet
IT Cricchetto bussola
ES Carraca telescópico
CN 可伸缩快速脱落棘轮扳手



1/4"
6.3mm

QUICK
RELEASE
SZYBKO-
ZŁĄCZE

72T

CrV
6135



EN Ratchet handle and bit drive
PL Grzechotka do bitów i nasadek
DE Bit- und Steckschlüssel-Umschaltknarre
RU Трещотка для битов и головок
CZ Ráčna kombinovaná pro bity a nástrčné kľíče
HU Bit és dugófej behajtó racsnis hajtókar
RO Antrenor cu clichet pt. bii
FR Clé à cliquet
IT Cricchetto bussola per punte e snodi
ES Carraca para boquillas y puntas
CN 套筒旋具两用棘轮扳手



1/4"
6.3mm

1/4"
6.3mm

DIN
3122

QUICK
RELEASE
SZYBKO-
ZŁĄCZE

72T

CrV
6140



YATO	Ø	T	L [mm]	PCS PIECE	Box
YT-0297	1/4" (6.3 mm)	72	150-200	12	12/48

YATO	Ø	T	L [mm]	PCS PIECE	Box
YT-0331	1/4" (6.3 mm) x 1/4" (6.3 mm)	72	136	12	48

EN Swivel ratchet handle for bits and sockets
PL Grzechotka z obrotową głowicą do bitów i nasadek
DE Umschaltknarre mit Außenvierkantanttrieb
RU Трещотка реверсивная
CZ Ráčna s otočnou hlavou
HU Forgófejes racsnis szár
RO Antrenor cu clichet flexibil
FR Clé à cliquet tête pivotante
IT Cricchetto bussola per punte e snodi
ES Carraca con cabeza giratoria
CN 套筒旋具两用棘轮扳手



1/4"
6.3mm

1/4"
6.3mm

DIN
3122



5°



72T

CrV
6140



EN Flexible ratchet handle, round head
PL Grzechotka z obrotową głowicą
DE Umschaltknarre mit Kugelkopf
RU Трещотка с вращательной головкой
CZ Ráčna s otočnou hlavou
HU Forgófejes racsnis szár
RO Antrenor cu clichet flexibil
FR Clé à cliquet tête pivotante
IT Cricchetto bussola reversibile con ghiera
ES Carraca con cabeza giratoria
CN 旋转头快速脱落棘轮扳手



1/4"
6.3mm

DIN
3122

QUICK
RELEASE
SZYBKO-
ZŁĄCZE

72T

CrV
6140



YATO	Ø	T	L [mm]	PCS PIECE	Box
YT-03311	1/4" (6.3 mm) x 1/4" (6.3 mm)	72	115	10	10/100

YATO	Ø	T	L [mm]	PCS PIECE	Box
YT-0720	1/4" (6.3 mm)	72	145	12	24/96

EN Hexagonal socket
PL Nasadka sześciokątna
DE Sechskantenschlüssel
RU Головка шестигранная короткая
CZ Šestihranný nástavec
HU Dugókulcs hatszög
RO Cheie tubulară hexagonală
FR Douille courte
IT Chiave a bussola esagonale
ES Boquilla hexagonal corta
CN 六角套筒

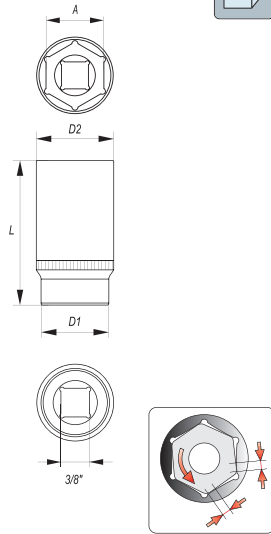

- Drive locks
- Surface finish: chromed, satin / mirror
- Zamki blokujące
- Wykończenie powierzchni: chromowana, satynowa / polerowana

YATO	o A [mm]	D1 [mm]	D2 [mm]	L [mm]	PCS PKCZ	Box
YT-3801	6	10	17	28	24	240/480
YT-3802	7	11	17	28	24	240/480
YT-3803	8	12	17	28	24	240/480
YT-3804	9	13	17	28	24	240/480
YT-3805	10	14	17	28	24	240/480
YT-3806	11	16	17	28	24	240/480
YT-3807	12	18	17	28	24	240/480
YT-3808	13	19	18	28	24	240/480
YT-3809	14	20	19	28	24	240/480
YT-3810	15	21	19	28	12	240/480
YT-3811	16	22	21	28	12	240/480
YT-3812	17	24	22	30	12	120/240
YT-3813	18	25	23	30	12	120/240
YT-3814	19	26	24	30	12	120/240

EN Hexagonal deep socket
PL Nasadka sześciokątna długa
DE Sechskantenschlüssel, lange
RU Головка шестигранная длинная
CZ Šestihranný hluboký nástavec
HU Dugókulcs hatszög hosszú
RO Cheie tubulară hexagonală adâncă
FR Douille longue
IT Chiave a bussola esagonale
ES Boquilla hexagonal larga
CN 六角长套筒

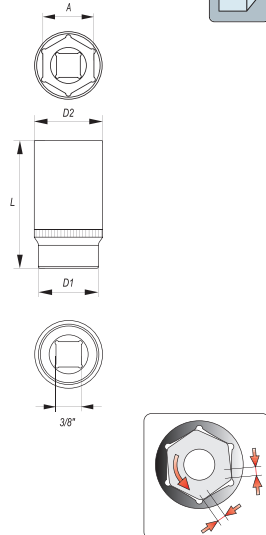
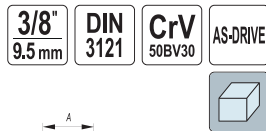

- Drive locks
- Surface finish: chromed, satin / mirror
- Zamki blokujące
- Wykończenie powierzchni: chromowana, satynowa / polerowana

YATO	o A [mm]	D1 [mm]	D2 [mm]	L [mm]	PCS PKCZ	Box
YT-3820	6	10	17	63	24	48/96
YT-3821	7	10	17	63	24	48/96
YT-3822	8	12	17	63	24	48/96
YT-3823	9	13	17	63	24	48/96
YT-3824	10	14	17	63	24	48/96
YT-3825	11	16	17	63	24	48/96
YT-3826	12	18	17	63	24	48/96
YT-3827	13	19	17	63	24	48/96
YT-3828	14	20	19	63	24	48/96
YT-3829	15	21	19	63	12	60/120
YT-3830	16	22	20	63	12	60/120
YT-3831	17	24	23	63	12	60/120
YT-3832	18	25	23	63	12	60/120
YT-3833	19	26	24	63	12	60/120

EN Insulated hexagonal socket
PL Nasadka sześciokątna izolowana
DE Sechskantenschlüssel vollisoliert
RU Головка шестигранная изолированная
CZ Šestihranný nástavec izolovaný
HU Dugókulcs hatszög
RO Cheie tubulară hexagonală izolată
FR Douille courte isolée
IT Chiave a bussola esagonale isolato
ES Boquilla hexagonal corta aislante
CN 绝缘六角套筒

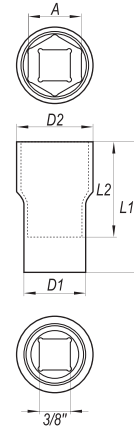
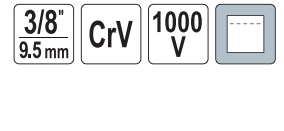

1000 V
VDE CERTIFICATE
EN 60900:2012

YATO	o A [mm]	D1 [mm]	D2 [mm]	L1 [mm]	L2 [mm]	Box
YT-21008	8	18	15.1	45	28	7/126

EN Extension bar
PL Przedłużka
DE Verlängerung
RU Удлинитель для воротка
CZ Prodlužovací přípravek
HU Toldalék
RO Prelungitor
FR Rallonge
IT Prolunga
ES Tubo de prolongación
CN 接杆

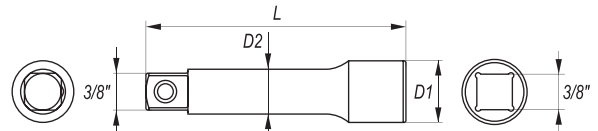

YATO	o	D1 [mm]	D2 [mm]	L [mm]	PCS PKCZ	Box
YT-3842	3/8" (9.5 mm)	18	12.3	42.0	10	100/200
YT-3843	3/8" (9.5 mm)	18	12.3	76.0	10	100/200
YT-3844	3/8" (9.5 mm)	18	12.3	152.4	10	50/100
YT-3845	3/8" (9.5 mm)	18	12.3	254.0	10	50

- EN Insulated extension bar
- PL Przedłużka izolowana
- DE Verlängerung vollisoliert
- RU Удлинитель для воротка
- CZ Prodlužovací přípravek izolovaný
- HU Toldalék
- RO Prelungitor izolat
- FR Rallonge isolée
- IT Prolunga isolato
- ES Tubo de prolongación aislante
- CN 绝缘延长杆

3/8"
9.5 mm **CrV**

1000 V

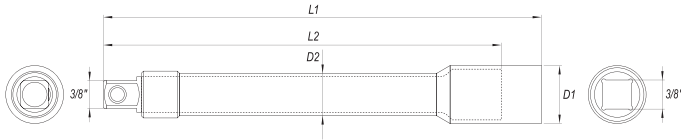

1000 V
VDE CERTIFICATE
EN 60900:2012

YATO	Ø	D1 [mm]	D2 [mm]	L1 [mm]	L2 [mm]	PCS
YT-21055	3/8" (9.5 mm)	23	15.5	125	141	18/72
YT-21056	3/8" (9.5 mm)	23	15.5	250	266	12/48

- EN Adapter
- PL Redukcja
- DE Reduktion
- RU Переходник
- CZ Redukce
- HU Redukció
- RO Reducție
- FR Réduction
- IT Riduttore
- ES Reducción
- CN 转换头

3/8"
9.5 mm **DIN 3121** **CrV**
50B30

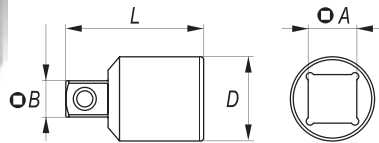

YATO	Ø A	Ø B	D [mm]	L [mm]	PCS
YT-3853	3/8" (9.5 mm) (F)	1/4" (6.3 mm) (M)	17	27	10 250/500
YT-3854	3/8" (9.5 mm) (F)	1/4" (6.3 mm) (M)	17	35	10 100/200

- EN Bit adapter
- PL Adapter do bitów
- DE Bithalter
- RU Держатель винтовёртовых наконечников
- CZ Držák na šroubovakové koncovky
- HU Szár a csavarhúzóvégekhöz
- RO Capete şurubelniță
- FR Adaptateur d'embouts
- IT Chiave esagonale a bussola
- ES Mandril para puntas
- CN 旋具头接头

3/8"
9.5 mm **CrV**
6140

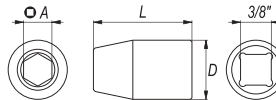

YATO	Ø	Ø A [mm]	D [mm]	L [mm]	PCS
YT-1296	3/8" (9.5 mm)	8	17.9	30	10 250/500

- EN Sliding T-bar
- PL Pokrętko typu „T”
- DE Handgriff mit Gleitstück
- RU Вороток T-образный
- CZ Otočná račká typ „T”
- HU „T” alakú hajtókar
- RO Mâner clipă tipul „T”
- FR Barre type „T”
- IT Manopola „T” scorrevole
- ES Mango tipo „T”
- CN 滑杆

3/8"
9.5 mm **DIN 3121** **CrV**
50B30

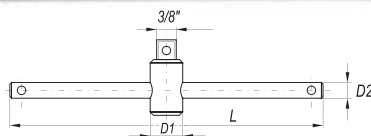

YATO	Ø	D1 [mm]	D2 [mm]	L [mm]	PCS
YT-3840	3/8" (9.5 mm)	20	10.7	198	10 50/100

- EN Extension bar with wobble
- PL Przedłużka uchylna
- DE Gelenkverlängerung
- RU Удлинитель наклонный
- CZ Odchylný prodlužovací přípravek
- HU Csuklós toldalék
- RO Prelungitor rabatabil
- FR Rallonge angulaire
- IT Prolunga
- ES Tubo de prolongación desviable
- CN 转向接杆

3/8"
9.5 mm **DIN 3121**

CrV
50B30

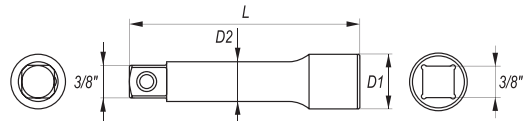

YATO	Ø	D1 [mm]	D2 [mm]	L [mm]	PCS
YT-3847	3/8" (9.5 mm)	18	12.3	76.0	10 100/200
YT-3848	3/8" (9.5 mm)	18	12.3	152.4	10 50/100
YT-3849	3/8" (9.5 mm)	18	12.3	254.0	10 50

- EN Bit adapter
- PL Adapter do bitów
- DE Bithalter
- RU Держатель винтовёртовых наконечников
- CZ Držák na šroubovakové koncovky
- HU Szár a csavarhúzóvégekhöz
- RO Capete şurubelniță
- FR Adaptateur d'embouts
- IT Chiave esagonale a bussola
- ES Mandril para puntas
- CN 旋具头接头

3/8"
9.5 mm **CrV**
6140

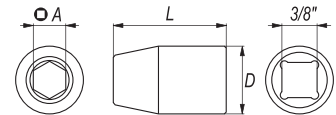

YATO	Ø	Ø A [mm]	D [mm]	L [mm]	PCS
YT-12961	3/8" (9.5 mm)	8	17.9	30	5/300

- EN Universal joint
- PL Przegub Cardana
- DE Kardangelen
- RU Карданный шарнир
- CZ Kardanový kloub
- HU Kárdán csukló
- RO Articulație Cardanică
- FR Cardan
- IT Snodo cardanico
- ES Articulación Cardan
- CN 万向接头

3/8"
9.5 mm **DIN 3121** **CrV**
50B30

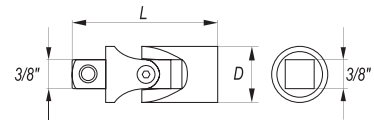

YATO	Ø	D [mm]	L [mm]	PCS
YT-3850	3/8" (9.5 mm)	18	49	10 50/200

- EN Flexible handle
- PL Pokrętko lamane
- DE Gelenkgriff
- RU Вороток шарнирный
- CZ Otočná lomená ráčka
- HU Dugókulcs hatszög hosszú
- RO Prelungitor cu prindere flexibilă
- FR Barre pivotante
- IT Manopola a snodo
- ES Mango articulado
- CN 转向手柄

3/8"
9.5 mm **DIN 3121** **CrV**
50B30

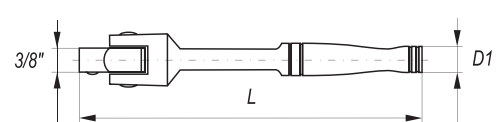

YATO	Ø	D [mm]	L [mm]	PCS
YT-3839	3/8" (9.5 mm)	16	215	8 24/48

- EN Spark plug socket
PL Nasadka do świec
DE Steckschlüssel mit Gummihalterung
RU Головка свечная
CZ Nastavec pro svíčky
HU Gyújtógyertya toldalék
RO Cheie de buji
FR Douille à bougies
IT Chiave a bussola per candele
ES Boquilla de bujías
CN 六角火花塞套筒

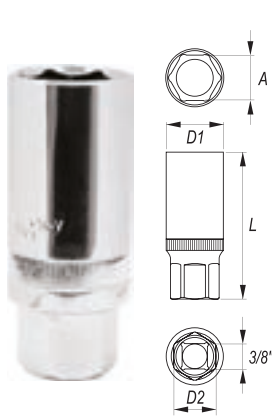

YATO	Ø	A [mm]	D1 [mm]	D2 [mm]	L [mm]	PCS	BOX
YT-3851	3/8" (9.5 mm)	16	22	19	64	10	50/100

- EN Spark plug socket
PL Nasadka do świec
DE Steckschlüssel mit Gummihalterung
RU Головка свечная
CZ Nastavec pro svíčky
HU Gyújtógyertya toldalék
RO Cheie de buji
FR Douille à bougies
IT Chiave a bussola per candele
ES Boquilla de bujías
CN 六角火花塞套筒

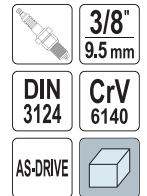
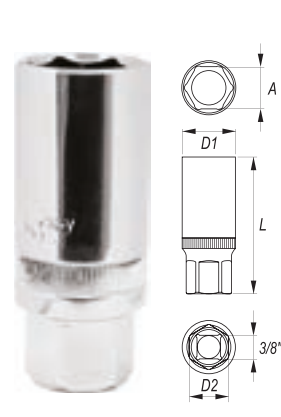

YATO	Ø	A [mm]	D1 [mm]	D2 [mm]	L [mm]	PCS	BOX
YT-3841	3/8" (9.5 mm)	18	25.8	19	63	10	50/100

- EN Spark plug socket
PL Nasadka do świec
DE Steckschlüssel mit Gummihalterung
RU Головка свечная
CZ Nastavec pro svíčky
HU Gyújtógyertya toldalék
RO Cheie de buji
FR Douille à bougies
IT Chiave a bussola per candele
ES Boquilla de bujías
CN 磁性十二角薄壁火花塞套筒

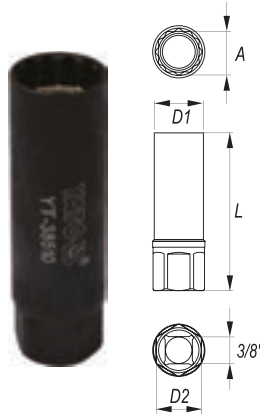

YATO	Ø	A [mm]	D1 [mm]	D2 [mm]	L [mm]	PCS	BOX
YT-38510	3/8" (9.5 mm)	14	18	16	63	25/100	

- EN Spark plug socket
PL Nasadka do świec
DE Steckschlüssel mit Gummihalterung
RU Головка свечная
CZ Nastavec pro svíčky
HU Gyújtógyertya toldalék
RO Cheie de buji
FR Douille à bougies
IT Chiave a bussola per candele
ES Boquilla de bujías
CN 磁性十二角薄壁火花塞套筒

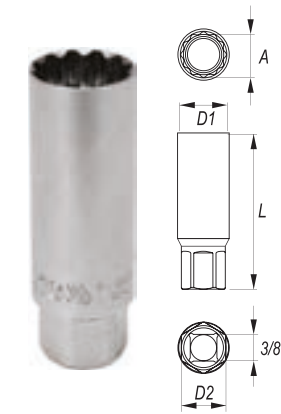

YATO	Ø	A [mm]	D1 [mm]	D2 [mm]	L [mm]	PCS	BOX
YT-38511	3/8" (9.5 mm)	16	20	16	62	25/100	

- EN Spark plug socket
PL Nasadka do świec
DE Steckschlüssel mit Gummihalterung
RU Головка свечная
CZ Nastavec pro svíčky
HU Gyújtógyertya toldalék
RO Cheie de buji
FR Douille à bougies
IT Chiave a bussola per candele
ES Boquilla de bujías
CN 磁性万向十二角火花塞套筒

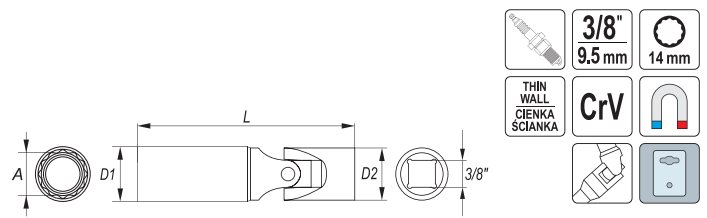

YATO	Ø	A [mm]	D1 [mm]	D2 [mm]	L [mm]	PCS	BOX
YT-38512	3/8" (9.5 mm)	14	20	19	88	25/100	

- EN Spark plug socket
PL Nasadka do świec
DE Steckschlüssel mit Gummihalterung
RU Головка свечная
CZ Nastavec pro svíčky
HU Gyújtógyertya toldalék
RO Cheie de buji
FR Douille à bougies
IT Chiave a bussola per candele
ES Boquilla de bujías
CN 火花塞套筒

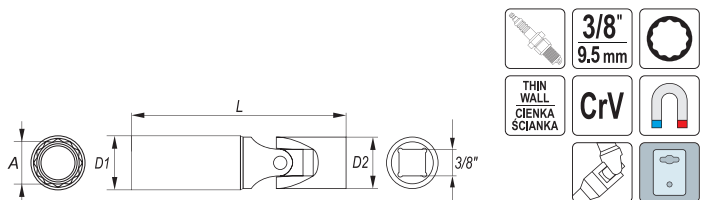

YATO	Ø	A [mm]	D1 [mm]	D2 [mm]	L [mm]	PCS	BOX
YT-38516	3/8" (9.5 mm)	14	19	19	98	25/100	
YT-38517	3/8" (9.5 mm)	16	20	19	98	25/100	

- EN Extra long spark plug socket
PL Nasadka do świec extra długa
DE Zündkerzensteckschlüssel, extra lang
RU Удлиненная насадка для свечи
CZ Násada do svíček extra dlouhá
HU Gyertyakulcs extra hosszú
RO Cheie buji lunga
FR Douille pour bougie d'allumage extra longue
IT Chiave a bussola per candele extra lungo
ES Vaso para bujías extra largo
CN 十二角加长火花塞磁钢款



YATO	A [mm]	PCS	BOX
YT-38521	14	12/48	
YT-38522	16	12/48	

EN Spark plug socket
 PL Klucz do świec z przedłużką
 DE Kerzenschlüssel mit Verlängerungshebel
 RU Ключ к свечам с удлинителем

CZ Klíč na svíčky s prodlužovacím nástavcem
 HU Gyertyakulcs hosszabbítóval
 RO Cheie cu prelungitor pt. buji
 FR Douille à bougies

IT Chiavi per candele a tubo
 ES Llave para las bujías con extensión
 CN 加长带磁方向火星



YATO	A [mm]	
YT-08163	14	15/60
YT-08164	16	15/60
YT-0818	18	10/40

EN Spark plug socket set
 PL Zestaw nasadek do świec
 DE Satz der Zündkerzenaufsätze
 RU Набор головок для свечей накаливания
 CZ Sada nástavců na svíčky
 HU Gyújtógyertya-kulcs készlet
 RO Set chei pt. buji
 FR Ensemble d'embouts pour bougies d'allumage
 IT Set di prese per candele di accensione
 ES Juego de casquillos para bujías
 CN 摇头火花塞组套

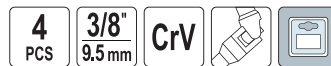

YATO	Ø	
YT-38520	3/8" (9.5 mm)	5/20

3/8" (9.5 mm): 14, 16, 18, 21 mm

EN Quick release ratchet handle
 PL Grzechołka
 DE Hebelumschaltknarre
 RU Трещотка

CZ Řehtačka
 HU Racsnis hajtókar
 RO Dispozitiv de prindere cu clichet
 FR Clé à cliquet

IT Cricchetto bussola
 ES Carraca
 CN 快速脱落棘轮扳手



YATO	Ø	T	L [mm]	PCS PKG	
YT-0308	3/8" (9.5 mm)	72	185	6	24/48



YATO	Ø	T	L [mm]	PCS PKG	
YT-0311	3/8" (9.5 mm)	72	200	6	18/36

YATO	Ø	T	L [mm]	PCS PKG	
YT-0314	3/8" (9.5 mm)	72	170	6	24/48



YATO	Ø	T	L [mm]	PCS PKG	
YT-0317	3/8" (9.5 mm)	72	200	6	24/48

YATO	Ø	T	L [mm]	PCS PKG	
YT-0323	3/8" (9.5 mm)	72	197	6	24/48

EN Quick release ratchet handle
 PL Grzechołka
 DE Hebelumschaltknarre
 RU Трещотка
 CZ Ráčna
 HU Racsnis hajtókar

RO Dispozitiv de prindere cu clichet
 FR Clé à cliquet
 IT Cricchetto bussola
 ES Carraca
 CN 快速脱落棘轮扳手

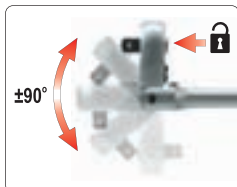

YATO	Ø	T	L [mm]	PCS PKG	
YT-0326	3/8" (9.5 mm)	72	242	6	24/48

EN Quick release ratchet handle
 PL Grzechołka powlekana
 DE Hebelumschaltknarre

RU Трещотка
 CZ Řehtačka
 HU Racsnis hajtókar

RO Dispozitiv de prindere cu clichet
 FR Clé à cliquet
 IT Cricchetto bussola

ES Carraca
 CN 快速脱落棘轮扳手



YATO	Ø	T	L [mm]	PCS PKG	
YT-0291	3/8" (9.5 mm)	72	202	6	24/48

YATO	Ø	T	L [mm]	PCS PKG	
YT-0294	3/8" (9.5 mm)	72	202	6	24/48

- EN Insulated ratchet handle
PL Grzechotka izolowana
DE Hebelumschaltknarre vollisoliert
RU Трещотка диэлектрическая
CZ Ráčna izolovaná
HU Racsnis hajtókar
- RO Antrenor cu clichet izolat
FR Clé à cliquet isolée
IT Cricchetto bussola isolato
ES Carraca aislante
CN 双色柄绝缘双向棘轮扳手



3/8"
9.5 mm CrV 1000 V

1000 V
VDE CERTIFICATE
EN 60900:2012

- EN Quick release ratchet handle
PL Grzechotka
DE Hebelumschaltknarre
RU Трещотка
CZ Ráčna
HU Racsnis hajtókar
- RO Dispozitiv de prindere cu clichet
FR Clé à cliquet
IT Cricchetto bussola
ES Carraca
CN 快速脱落棘轮扳手

3/8"
9.5 mm QUICK RELEASE SZYBKO-ZŁĄCZE 72T CrV 6140

YATO	Ø	T	L [mm]	PCS FRONT
YT-21071	3/8" (9.5 mm)	36	200	6/48

- EN Telescopic ratchet handle
PL Grzechotka z przedłużanym uchwytem
DE Umschaltknarre
RU Трещотка
CZ Ráčna
HU Racsnis hajtókar
RO Antrenor cu clichet
FR Clé à cliquet
IT Cricchetto bussola
ES Carraca telescópico
CN 可伸缩快速脱落棘轮扳手



3/8"
9.5 mm QUICK RELEASE SZYBKO-ZŁĄCZE 72T CrV 6135



YATO	Ø	T	L [mm]	PCS FRONT
YT-0298	3/8" (9.5 mm)	72	215-315	6/24

YATO	Ø	T	L [mm]	PCS FRONT
YT-0731	3/8" (9.5 mm)	72	200	6/48

- EN Hexagonal socket
PL Nasadka sześciokątna
DE Sechskantenschlüssel
RU Головка шестигранная короткая
CZ Šestihranný nástavec
HU Dugúlcus hatszög
RO Cheie tubulară hexagonală
FR Douille courte
IT Chiave a bussola esagonale
ES Boquilla hexagonal corta
CN 六角套筒

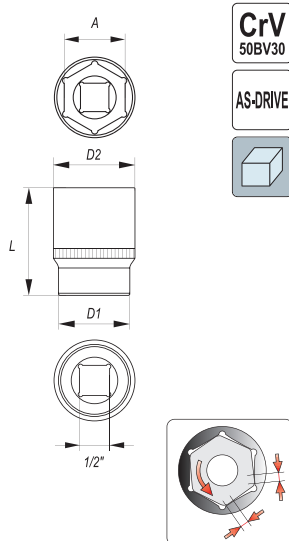

- Drive locks
- Surface finish: chromed, satin / mirror
- Zamki blokujące
- Wykończenie powierzchni: chromowana, satynowa / polerowana

YATO	Ø A [mm]	D1 [mm]	D2 [mm]	L [mm]	PCS FRONT
YT-1201	8	12	22	38	12/240
YT-1202	9	14	22	38	12/240
YT-1203	10	15	22	38	12/240
YT-1204	11	16	22	38	12/240
YT-1205	12	18	22	38	12/240
YT-1206	13	19	22	38	12/240
YT-1207	14	20	22	38	12/240
YT-1208	15	21	22	38	12/240
YT-1209	16	23	22	38	12/240
YT-1210	17	24	23	38	12/240
YT-1211	18	25	23	38	12/240
YT-1212	19	27	24	38	12/240
YT-1213	20	28	24	38	12/240
YT-1214	21	29	24	38	12/240
YT-1215	22	30	26	38	12/240
YT-1216	23	31	28	38	12/60/120
YT-1217	24	32	28	38	12/60/120
YT-1218	27	36	30	42	12/60/120
YT-1219	30	40	34	42	12/60/120
YT-1220	32	42	36	42	6/24/48

- EN Insulated hexagonal socket
PL Nasadka sześciokątna izolowana
DE Sechskantenschlüssel vollisoliert
RU Головка шестигранная изолированная
CZ Šestihranný nástavec izolovaný
HU Dugúlcus hatszög
RO Cheie tubulară hexagonală izolată
FR Douille courte isolée
IT Chiave a bussola esagonale isolata
ES Boquilla hexagonal corta aislante
CN 绝缘六角套筒

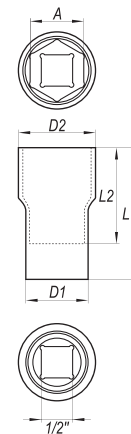

1000 V VDE CERTIFICATE EN 60900:2012

YATO	Ø A [mm]	D1 [mm]	D2 [mm]	L1 [mm]	L2 [mm]	PCS FRONT
YT-21030	10	27	19.5	55	38	12/144
YT-21031	11	27	20.7	55	38	12/144
YT-21032	12	27	22.0	55	38	12/144
YT-21033	13	27	23.2	55	38	12/144
YT-21034	14	27	24.5	55	38	12/144
YT-21036	16	27	27.0	55	38	12/144
YT-21037	17	27	28.5	55	38	12/144
YT-21038	18	27	29.5	55	38	12/144
YT-21039	19	27	30.7	55	38	12/144
YT-21041	21	27	33.2	55	38	10/110
YT-21042	22	27	34.5	55	38	10/110
YT-21044	24	27	37.0	60	38	10/110
YT-21047	27	27	38.8	60	38	6/66
YT-21050	30	27	42.8	60	38	6/66
YT-21052	32	27	44.8	60	38	6/66

EN Bi-hexagonal socket
 PL Nasadka dwunastokątna
 DE Zwölfkant-Steckschlüssel-Einsatz
 RU Головка 12-гранная
 CZ Nástrčný oheč dvanáctihranný
 HU Dugókulcs 12-szögű
 RO Cheie tubulară bihexagonală
 FR Douille courte
 IT Chiave a bussola bi-esagonale
 ES Boquilla de anillo
 CN 十二角套筒



1/2"
12.7mm
DIN 3121
CrV 50BV30
AS-DRIVE

- Drive locks
- Surface finish: chromed, satin / mirror
- Zamki blokujące
- Wykończenie powierzchni: chromowana, satynowa / polerowana

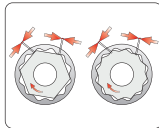

YATO	o A [mm]	D1 [mm]	D2 [mm]	L [mm]	PCS PER SET	
YT-1270	8	12	22	38	12	120/240
YT-1271	9	14	22	38	12	120/240
YT-1272	10	15	22	38	12	120/240
YT-1273	11	16	22	38	12	120/240
YT-1274	12	17	22	38	12	120/240
YT-1275	13	19	22	38	12	120/240
YT-1276	14	20	22	38	12	120/240
YT-1277	15	21	22	38	12	120/240
YT-1278	16	23	22	38	12	120/240
YT-1279	17	24	22	38	12	120/240
YT-1280	18	25	23	38	12	120/240
YT-1281	19	27	24	38	12	120/240
YT-1282	20	28	24	38	12	120/240
YT-1283	21	29	24	38	12	120/240
YT-1284	22	30	26	38	12	120/240
YT-1285	23	31	28	38	12	60/120
YT-1286	24	32	28	38	12	60/120
YT-1289	27	36	30	42	12	60/120
YT-1291	30	40	34	42	6	48/96
YT-1292	32	42	36	42	6	48/96

EN Spline socket
 PL Nasadka Spline
 DE Steckschlüssel Spline
 RU Головка Spline
 CZ Nástrčný klíč profil Spline
 HU Dugókulcs Spline
 RO Cheie tubulară cu stifturi
 FR Douille
 IT Chiave a bussola Spline
 ES Boquilla Spline
 CN 花键型套筒



1/2"
12.7mm
DIN 3121
CrV 50BV30

- Drive locks
- Enables to undo 5 types of screws
- Surface finish: chromed, satin / mirror
- Zamki blokujące
- Możliwość odkręcenia 5 rodzajów śrub
- Wykończenie powierzchni: chromowana, satynowa / polerowana

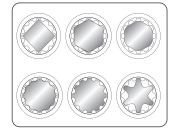

YATO	o A [mm]	D1 [mm]	D2 [mm]	L [mm]	PCS PER SET	
YT-1460	8	13	22	38	12	120/240
YT-1461	9	15	22	38	12	120/240
YT-1462	10	16	22	38	12	120/240
YT-1463	11	17	22	38	12	120/240
YT-1464	12	18	22	38	12	120/240
YT-1465	13	19	22	38	12	120/240
YT-1466	14	20	22	38	12	120/240
YT-1467	15	22	23	38	12	120/240
YT-1468	16	23	22	38	12	120/240
YT-1469	17	25	23	38	12	120/240
YT-1470	18	26	23	38	12	120/240
YT-1471	19	27	24	38	12	120/240
YT-1472	20	28	24	38	12	120/240
YT-1473	21	30	24	38	12	120/240
YT-1474	22	31	26	38	12	120/240
YT-1475	23	32	28	38	12	60/120
YT-1476	24	34	28	38	12	60/120
YT-1478	27	37	30	42	12	60/120
YT-1480	30	41	34	42	6	60/120
YT-1481	32	44	36	42	6	60/120

EN Spline socket
 PL Nasadka Spline
 DE Steckschlüssel Spline
 RU Головка Spline
 CZ Nástrčný klíč profil Spline
 HU Dugókulcs Spline
 RO Cheie tubulară cu stifturi
 FR Douille
 IT Chiave a bussola Spline
 ES Boquilla Spline
 CN 花键型套筒

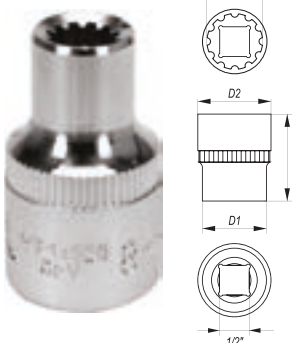

1/2"
12.7mm
CrV 50BV30

- Drive locks
- Surface finish: chromed, satin / mirror
- Zamki blokujące
- Wykończenie powierzchni: chromowana, satynowa / polerowana

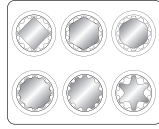

YATO	o A [mm]	D1 [mm]	D2 [mm]	L [mm]	
YT-14820	8	13	22	38	10/200
YT-14821	9	15	22	38	10/200
YT-14822	10	16	22	38	10/200
YT-14824	12	18	22	38	10/200
YT-14825	13	19	22	38	10/200
YT-14826	14	20	22	38	10/200
YT-14827	15	22	22	38	10/200
YT-14828	16	23	22	38	10/200
YT-14829	17	25	23	38	10/200
YT-14830	18	26	23	38	10/200
YT-14831	19	27	24	38	10/200
YT-14833	21	30	24	38	10/160
YT-14834	22	31	26	38	10/160
YT-14836	24	34	28	38	10/160
YT-14838	30	41	34	42	5/60
YT-14839	32	44	36	45	5/60

EN Hexagonal deep socket
 PL Nasadka sześciokątna długa
 DE Sechskantenschlüssel, lange
 RU Головка шестигранная длинная
 CZ Šestihřanný hluboký nástavec
 HU Dugókulcs hatszögű hosszú
 RO Cheie tubulară hexagonală adâncă
 FR Douille longue
 IT Chiave a bussola esagonale
 ES Boquilla hexagonal larga
 CN 六角长套筒

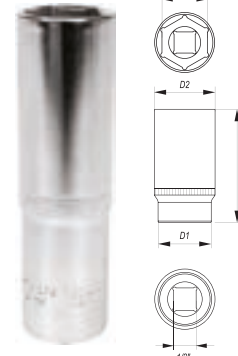

1/2"
12.7mm
DIN 3121
CrV 50BV30
AS-DRIVE

- Drive locks
- Surface finish: chromed, satin / mirror
- Zamki blokujące
- Wykończenie powierzchni: chromowana, satynowa / polerowana

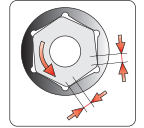

YATO	o A [mm]	D1 [mm]	D2 [mm]	L [mm]	PCS PER SET	
YT-1221	8	13	22	76	12	60/120
YT-1222	9	14	22	76	12	60/120
YT-1223	10	15	22	76	12	60/120
YT-1224	11	17	22	76	12	60/120
YT-1225	12	18	22	76	12	60/120
YT-1226	13	19	22	76	12	60/120
YT-1227	14	20	22	76	12	60/120
YT-1228	15	21	22	76	12	60/120
YT-1229	16	24	22	76	12	60/120
YT-1230	17	24	22	76	12	60/120
YT-1231	18	25	23	76	12	60/120
YT-1232	19	27	24	76	12	60/120
YT-1233	20	28	24	76	12	60/120
YT-1234	21	29	24	76	12	60/120
YT-1235	22	30	26	76	12	60/120
YT-1236	23	31	28	76	12	60/120
YT-1237	24	32	28	76	12	60/120
YT-1238	27	36	30	76	12	36/72
YT-1239	30	40	36	76	12	24/48
YT-1240	32	42	38	76	6	24/48

- EN Bi-hexagonal deep socket
 PL Nasadka dwunastokątna długa
 DE Zwölfkant-Steckschlüssel-Einsatz, lange
 RU Головка 12-гранная длинная
 CZ Dvanáctihřanný hluboký nástavec
 HU Dugókulcs 12-szögű hosszú
 RO Cheie tubulară bihexagonală adâncă
 FR Douille longue
 IT Chiave a bussola bi-esagonale
 ES Boquilla de anillo larga
 CN 十二角长套筒

1/2"
 12.7mm

DIN
 3121

CrV
 50BV30

AS-DRIVE

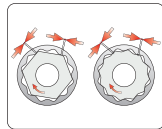
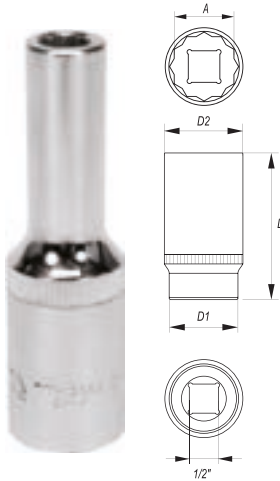

YATO	∅ A [mm]	D1 [mm]	D2 [mm]	L [mm]	PCS PKG	
YT-12930	8	22	14	77	12	60/120
YT-12931	9	22	16	77	12	60/120
YT-12932	10	22	16	77	12	60/120
YT-12933	11	22	18	77	12	60/120
YT-12934	12	22	18	77	12	60/120
YT-12935	13	22	19	77	12	60/120
YT-12936	14	22	19	77	12	60/120
YT-12937	15	21	22	77	12	60/120
YT-12938	16	21	22	77	12	60/120
YT-12939	17	22	24	77	12	60/120
YT-12940	18	22	26	77	12	60/120
YT-12941	19	22	26	77	12	60/120
YT-12942	20	24	28	77	12	60/120
YT-12943	21	24	28	77	12	60/120
YT-12944	22	26	30	77	12	60/120
YT-12945	23	27	32	77	12	60/120
YT-12946	24	28	32	77	12	60/120
YT-12947	27	30	36	77	12	36/72
YT-12948	30	34	40	77	6	24/48
YT-12949	32	36	42	77	6	24/48

- EN Extension bar with wobble
 PL Przedłużka uchylna
 DE Gelenkverlängerung
 RU Удлинитель наклонный
 CZ Odchylný prodlužovací přípravek
 HU Csuklós toldalék
- RO Prelungitor rabatabil
 FR Rallonge angulaire
 IT Prolunga
 ES Tubo de prolongación desviable
 CN 转向接杆

1/2"
 12.7mm

DIN
 3121

CrV
 50BV30

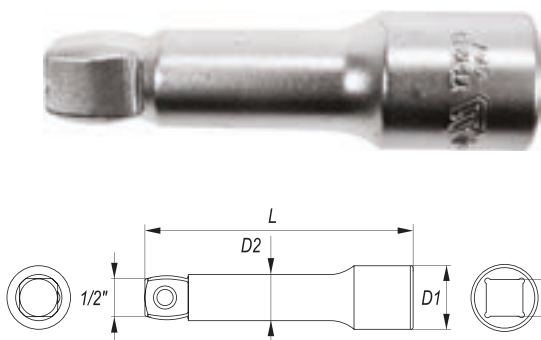

YATO	∅	D1 [mm]	D2 [mm]	L [mm]	PCS PKG	
YT-1249	1/2" (12.7 mm)	24	14.5	76	10	30/120
YT-1250	1/2" (12.7 mm)	24	14.5	127	5	20/80
YT-1251	1/2" (12.7 mm)	24	14.5	254	5	20/40

- EN Extension bar
 PL Przedłużka
 DE Verlängerung
 RU Удлинитель для воротка
 CZ Prodlužovací přípravek
 HU Toldalék
- RO Prelungitor
 FR Rallonge
 IT Prolunga
 ES Tubo de prolongación
 CN 接杆

1/2"
 12.7mm

DIN
 3121

CrV
 50BV30

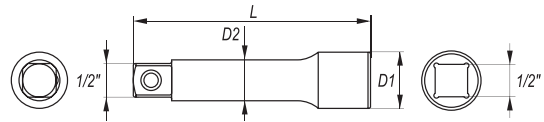

YATO	∅	D1 [mm]	D2 [mm]	L [mm]	PCS PKG	
YT-1246	1/2" (12.7 mm)	24	14.5	76	15	30/120
YT-1247	1/2" (12.7 mm)	24	14.5	127	5	20/80
YT-1248	1/2" (12.7 mm)	24	14.5	254	5	20/40

- EN Insulated extension bar
 PL Przedłużka izolowana
 DE Verlängerung vollisoliert
 RU Удлинитель для воротка
 CZ Prodlužovací přípravek izolovaný
 HU Toldalék
- RO Prelungitor izolat
 FR Rallonge isolée
 IT Prolunga isolato
 ES Tubo de prolongación aislante
 CN 绝缘延长杆

1/2"
 12.7mm

CrV

1000
 V

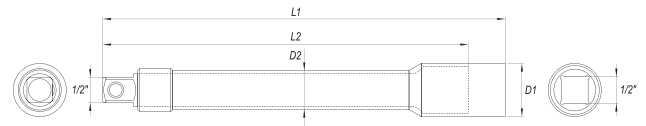

1000 V
 VDE CERTIFICATE
 EN 60900:2012

YATO	∅	D1 [mm]	D2 [mm]	L1 [mm]	L2 [mm]	
YT-21057	1/2" (12.7 mm)	27	19.1	125	141	6/72

- EN Adapter
 PL Redukcja
 DE Reduktion
 RU Переходник
 CZ Redukce
 HU Redukció
 RO Reducție
 FR Réduction
 IT Riduttore
 ES Reducción
 CN 转换头

1/2"
 12.7mm

3/4"
 19mm

DIN
 3121

CrV
 50BV30

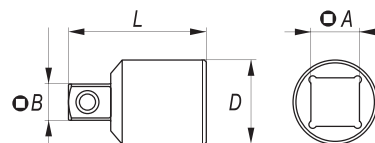
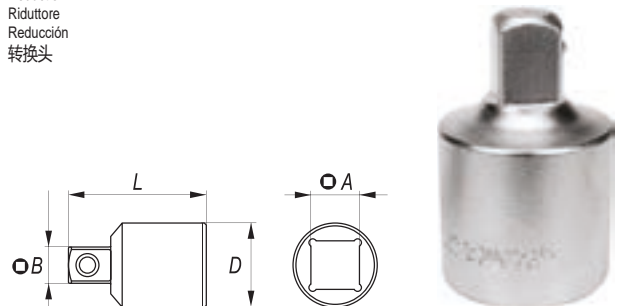

YATO	∅ A	∅ B	D [mm]	L [mm]	PCS PKG	
YT-1255	1/2" (12.7 mm) (F)	3/8" (9.5 mm) (M)	22	34.0	10	100/200
YT-1258	1/2" (12.7 mm) (F)	3/4" (19.0 mm) (M)	27	45.5	10	50/100
YT-1259	3/4" (19.0 mm) (F)	1/2" (12.7 mm) (M)	35	51.0	5	50/100
YT-1356	1/2" (12.7 mm) (F)	3/4" (19.0 mm) (M)	26	48.0	12	48

- EN Bit adapter
- PL Adapter do bitów
- DE Bithalter
- RU Держатель винтовёртовых наконечников
- CZ Držák na šroubovakové koncovky
- HU Szár a csavarhúzóvégekhez
- RO Capete şurubelniţă
- FR Adapteur d'embouts
- IT Chiave esagonale a bussola
- ES Mandril para puntas
- CN 旋具头接头

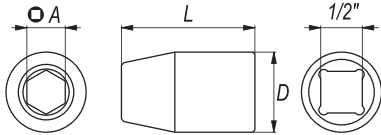

YATO	ø	ø A [mm]	D [mm]	L [mm]	PCS PCKRE	
YT-12951	1/2" (12.7 mm)	8	21.9	38	5/300	

- EN Bit adapter
- PL Adapter do bitów
- DE Bithalter
- RU Держатель винтовёртовых наконечников
- CZ Držák na šroubovakové koncovky
- HU Szár a csavarhúzóvégekhez
- RO Capete şurubelniţă
- FR Adapteur d'embouts
- IT Chiave esagonale a bussola
- ES Mandril para puntas
- CN 旋具头接头

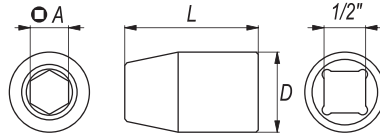

YATO	ø	ø A [mm]	D [mm]	L [mm]	PCS PCKRE	
YT-1295	1/2" (12.7 mm)	8	21.9	38	10/150/300	

- EN Universal joint
- PL Przegub Cardana
- DE Kardangelenk
- RU Карданный шарнир
- CZ Kardanový kloub
- HU Kardán csukló
- RO Articulaţie Cardanică
- FR Cardan
- IT Snodo cardanico
- ES Articulación Cardan
- CN 万向接头

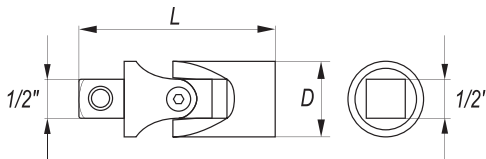

YATO	ø	D [mm]	L [mm]	PCS PCKRE	
YT-1252	1/2" (12.7 mm)	25	69	5/50/100	

- EN Sliding T-bar
- PL Pokrećto typu „T”
- DE Handgriff mit Gleitstück
- RU Вороток Т-образный
- CZ Otočná ráčká typ „T”
- HU „T” alakú hajtókar

- RO Măner clupă tipul „T”
- FR Barre type „T”
- IT Manopola „T” scorrevole
- ES Mango tipo „T”
- CN 滑杆

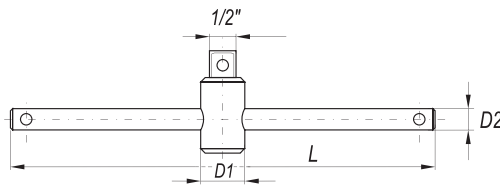

YATO	ø	D1 [mm]	D2 [mm]	L [mm]	PCS PCKRE	
YT-1243	1/2" (12.7 mm)	24	13.5	255	4/24/48	

- EN Flexible handle
- PL Pokrećto lamane
- DE Gelenkgriff
- RU Вороток шарнирный
- CZ Otočná lomená ráčká
- HU Hajlított hajtókar

- RO Prelungitor cu prindere flexibilă
- FR Barre pivotante
- IT Manopola a snodo
- ES Mango articulado
- CN 转向手柄

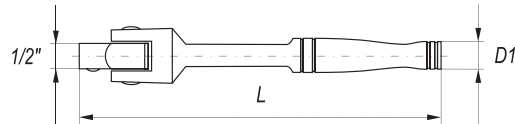
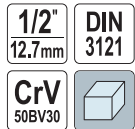

YATO	ø	D [mm]	L [mm]	PCS PCKRE	
YT-1241	1/2" (12.7 mm)	19	360	5/15/30	
YT-1242	1/2" (12.7 mm)	20	457	5/10/20	

- EN L-type handle
- PL Pokrećto typu „L”
- DE Admutterenschlüssel
- RU Вороток тип „L”
- CZ Páka zahnutá
- HU „L” alakú hajtókar

- RO Măner clupă tipul „L”
- FR Barre type „L”
- IT Leva tipo „L”
- ES Mango tipo „L”
- CN L型套筒扳手

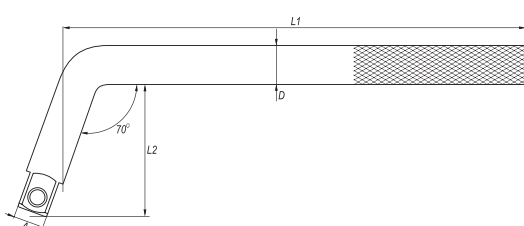

YATO	ø	D [mm]	L1 [mm]	L2 [mm]	PCS PCKRE	
YT-1244	1/2" (12.7 mm)	16	330	62	3/36	

- EN L-type handle
- PL Pokrećto typu „L”
- DE Admutterenschlüssel
- RU Вороток тип „L”
- CZ Páka zahnutá
- HU „L” alakú hajtókar

- RO Măner clupă tipul „L”
- FR Barre type „L”
- IT Leva tipo „L”
- ES Mango tipo „L”
- CN L型扳手

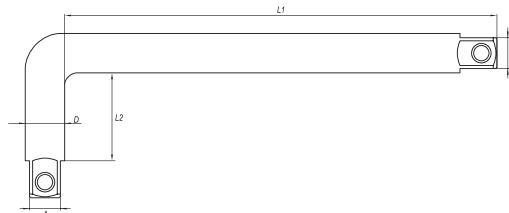

YATO	ø	D [mm]	L1 [mm]	L2 [mm]	PCS PCKRE	
YT-12439	1/2" (12.7 mm)	16	282	55	10/20	
YT-12445	1/2" (12.7 mm)	16	585	190	4/4/12	

EN Spark plug socket
PL Nasadka do świec
DE Steckschlüssel mit Gummihalterung
RU Головка свечная
CZ Nastavec pro svíčky
HU Gyújtógyertya toldalék
RO Cheie de bujii
FR Douille à bougies
IT Chiave a bussola per candele
ES Boquilla de bujías
CN 火花塞套筒

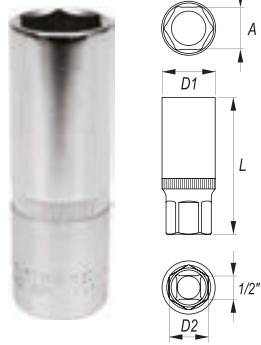

EN Spark plug socket
PL Nasadka do świec
DE Steckschlüssel mit Gummihalterung
RU Головка свечная
CZ Nastavec pro svíčky
HU Gyújtógyertya toldalék
RO Cheie de bujii
FR Douille à bougies
IT Chiave a bussola per candele
ES Boquilla de bujías
CN 火花塞套筒

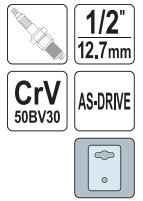
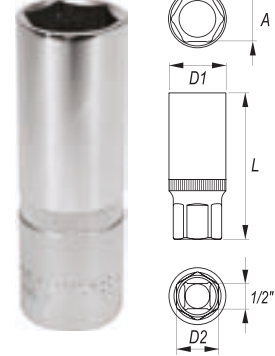

YATO	Ø	A [mm]	D1 [mm]	D2 [mm]	L [mm]	PCS PC/PIE	Box
YT-1253	1/2" (12.7 mm)	16	22	19	64	10	50/100
YT-1254	1/2" (12.7 mm)	21	27.8	24	64	10	50/100

YATO	Ø	A [mm]	D1 [mm]	D2 [mm]	L [mm]	PCS PC/PIE	Box
YT-12531	1/2" (12.7 mm)	16	22.0	19	64	10	10/160
YT-12541	1/2" (12.7 mm)	21	27.8	24	64	10	10/120

EN Quick release ratchet handle
PL Grzechotka
DE Hebelumschaltknarre
RU Трещотка
CZ Rehtačka
HU Racsnis hajtókar

RO Dispozitiv de prindere cu clichet
FR Clé à cliquet
IT Cricchetto bussola
ES Carraca
CN 快速脱落棘轮扳手

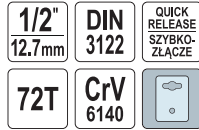

EN Quick release ratchet handle
PL Grzechotka
DE Hebelumschaltknarre
RU Трещотка
CZ Ráčna
HU Racsnis hajtókar
RO Dispozitiv de prindere cu clichet
FR Clé à cliquet
IT Cricchetto bussola
ES Carraca
CN 快速脱落棘轮扳手

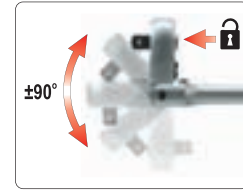

YATO	Ø	T	L [mm]	PCS PC/PIE	Box
YT-0309	1/2" (12.7 mm)	72	278	6	24



YATO	Ø	T	L [mm]	PCS PC/PIE	Box
YT-0312	1/2" (12.7 mm)	72	250	6	12/24

YATO	Ø	T	L [mm]	PCS PC/PIE	Box
YT-0327	1/2" (12.7 mm)	72	290	6	1/24



EN Quick release ratchet handle
PL Grzechotka powlekana
DE Hebelumschaltknarre
RU Трещотка
CZ Rehtačka
HU Racsnis hajtókar

RO Dispozitiv de prindere cu clichet
FR Clé à cliquet
IT Cricchetto bussola
ES Carraca
CN 快速脱落棘轮扳手

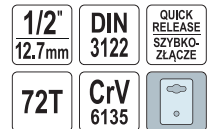

YATO	Ø	T	L [mm]	PCS PC/PIE	Box
YT-0315	1/2" (12.7 mm)	72	250	6	24



YATO	Ø	T	L [mm]	PCS PC/PIE	Box
YT-0318	1/2" (12.7 mm)	72	250	6	24

YATO	Ø	T	L [mm]	PCS PC/PIE	Box
YT-0292	1/2" (12.7 mm)	72	257	6	24



YATO	Ø	T	L [mm]	PCS PC/PIE	Box
YT-0324	1/2" (12.7 mm)	72	265	6	24

YATO	Ø	T	L [mm]	PCS PC/PIE	Box
YT-0295	1/2" (12.7 mm)	72	257	6	24

EN Insulated ratchet handle
PL Grzechotka izolowana
DE Hebelumschaltknarre vollisoliert
RU Трещотка диэлектрическая
CZ Ráčna izolovaná
HU Racsnis hajtókar

RO Antrenor cu clichet izolat
FR Clé à cliquet isolée
IT Cricchetto bussola isolato
ES Carraca aislante
CN 双色柄绝缘双向棘轮扳手

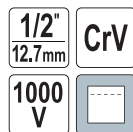

EN Quick release ratchet handle
PL Grzechotka
DE Hebelumschaltknarre
RU Трещотка
CZ Ráčna
HU Racsnis hajtókar

RO Dispozitiv de prindere cu clichet
FR Clé à cliquet
IT Cricchetto bussola
ES Carraca
CN 快速脱落棘轮扳手



1000 V
VDE CERTIFICATE
EN 60900:2012

YATO	Ø	T	L [mm]	PCS PC/PIE	Box
YT-21072	1/2" (12.7 mm)	36	250	6/36	



YATO	Ø	T	L [mm]	PCS PC/PIE	Box
YT-0732	1/2" (12.7 mm)	72	255	6	24

EN Quick release ratchet handle
 PL Grzechotka
 DE Hebelumschaltknarre
 RU Трещотка
 CZ Ráčna
 HU Racsnis hajtókar

RO Dispozitiv de prindere cu clichet
 FR Clé à cliquet
 IT Cricchetto bussola
 ES Carraca
 CN 快速脱落棘轮扳手

1/2"
12.7mm

72T

QUICK RELEASE
SZYBKO-ZŁĄCZE

CrV
6135



YATO	Ø	T	L [mm]	PCS PIECE	Box
YT-0735	1/2" (12.7 mm)	72	255	6	24

EN Flexible ratchet handle, round head
 PL Grzechotka z obrotową głowicą
 DE Umschaltknarre mit Kugelkopf
 RU Трещотка с вращательной головкой
 CZ Ráčna s otočnou hlavou
 HU Forgófejs racsnis szár

RO Antrenor cu clichet flexibil
 FR Clé à cliquet tête pivotante
 IT Cricchetto bussola reversibile con ghiera
 ES Carraca con cabeza giratoria
 CN 旋转头快速脱落棘轮扳手

1/2"
12.7mm

72T

QUICK RELEASE
SZYBKO-ZŁĄCZE

CrV
6140



YATO	Ø	T	L [mm]	PCS PIECE	Box
YT-0722	1/2" (12.7 mm)	72	280	6	30

EN Step wrench
 PL Klucz stopniowy
 DE Stufenschlüssel
 RU Универсальный ступенчатый ключ
 CZ Klíč na radiátorové šroubení
 HU Lépcsős radiátor kulcs

RO Cheie in trepte pt. radiator
 FR Clé de montage étagée
 IT Chiave gradini per radiatori
 ES Llave de radiadores
 CN 六角阶梯扳手

1/2"
12.7 mm

CrV



For YT-03315
 Dla YT-03315

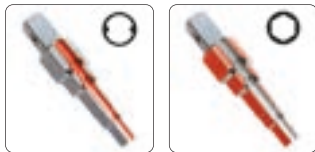

YATO	Ø	Box
YT-03316	1/2" (12.7 mm)	100

EN Step wrench
 PL Klucz stopniowy
 DE Stufenschlüssel
 RU Универсальный ступенчатый ключ
 CZ Klíč na radiátorové šroubení
 HU Lépcsős radiátor kulcs

RO Cheie in trepte pt. radiator
 FR Clé de montage étagée
 IT Chiave gradini per radiatori
 ES Llave de radiadores
 CN 六角阶梯扳手

1/2"
12.7 mm

CrV



For YT-03315
 Dla YT-03315

YATO	Ø	Box
YT-03317	1/2" (12.7 mm)	100

EN Telescopic ratchet handle
 PL Grzechotka z przedłużanym uchwytem
 DE Umschaltknarre
 RU Трещотка
 CZ Ráčna
 HU Racsnis hajtókar
 RO Antrenor cu clichet
 FR Clé à cliquet
 IT Cricchetto bussola
 ES Carraca telescópica
 CN 可伸缩快速脱落棘轮扳手



1/2"
12.7mm

72T

QUICK RELEASE
SZYBKO-ZŁĄCZE

CrV
6135



YATO	Ø	T	L [mm]	PCS PIECE	Box
YT-0299	1/2" (12.7 mm)	72	305-445	6	24

EN Internal ratchet wrench
 PL Grzechotka wewnętrzna
 DE Innenratschenschlüssel
 RU Трещотка внутренняя
 CZ Radiátorový klíč s ráčnou
 HU Lépcsős kulcskészlet racsnival

RO Cheie robinet radiator
 FR Clé de montage étagée
 IT Cricchetto di tipo interno
 ES Llave carraca radiadores
 CN 穿心棘轮扳手

1/2"
12.7 mm

30T

CrV



For YT-03316
 Dla YT-03316

YATO	Ø	Box
YT-03315	1/2" (12.7 mm)	6/24

EN Step wrench with ratchet
 PL Klucz stopniowy z grzechotką
 DE Stufenschlüssel mit Ratsche
 RU Ключ ступенчатый с трещоткой
 CZ Klíč na šroubení s ráčnou
 HU Racsnis lépcsős kulcs

RO Cheie in trepte cu clichet
 FR Clé de montage étagée avec cliquet
 IT Chiave gradini per radiatori con cricchetto
 ES Llave de radiadores con trinquete
 CN 穿心棘轮扳手

1/2"
12.7 mm

30T

CrV



3/8" (9.6 mm), 29/68" (11.6 mm), 1/2" (12.6 mm), 21/32" (16.4 mm), 27/32" (21 mm)

YATO	Ø	Box
YT-03314	1/2" (12.7 mm)	6/24

EN Step wrench
 PL Klucz stopniowy
 DE Stufenschlüssel
 RU Универсальный ступенчатый ключ
 CZ Klíč na radiátorové šroubení
 HU Lépcsős radiátor kulcs
 RO Cheie in trepte pt. radiator
 FR Clé de montage étagée
 IT Chiave a crico
 ES Llave de radiadores
 CN 六角阶梯扳手



1/2"-1 1/8"

CrV



YATO	Box
YT-03318	10/60

EN Socket set
PL Komplet nasadek dlugich
DE Sechskant-Steckschlüssel-Satz
RU Набор насадок
CZ Sada nástrčných klíčů
HU Dugókulcs készlet
RO Trusa de scule
FR Set de douilles longues
IT Serie di chiavi a bussola lunghi
ES Juego de herramientas
CN 套筒组套

8 PCS **1/4"** **6.3mm** **CrV** **50BV30** **AS-DRIVE** 









 1/4" (6.3 mm): 5.5, 6, 7, 8, 9, 10, 12, 13 mm (L=50 mm); CrV 50BV30

YATO 		
YT-14431	1/4" (6.3 mm)	10/20

EN Tool set
PL Zestaw narzędziowy
DE Werkzeug-Set
RU Набор инструмента
CZ Sada nářadí
HU Szerszámkészlet
RO Trusa de scule
FR Coffret d'outillage
IT Set di utensili
ES Juego de herramientas
CN 套筒组套

23 PCS **1/4"** **6.3mm** **CrV** **50BV30** **CrMo** **440**
72T **AS-DRIVE** 









 1/4" (6.3 mm): 4, 5, 6, 7, 8, 9, 10, 12, 13 mm (L=25 mm); CrV 50BV30;
 1/4" (6.3 mm): 4, 5, 6, 7, 8, 9, 10, 12, 13 mm (L=50 mm); CrV 50BV30;
 1/4" (6.3 mm): (50.8, 152.4 mm); CrV 50BV30;
 1/4" (6.3 mm); CrV 50BV30;
 1/4" (6.3 mm); (155 mm); 72T; CrMo 440;
 1/4" (6.3 mm); (150 mm); CrV 50BV30



YATO 		
YT-14451	1/4" (6.3 mm)	10

EN Tool set
PL Zestaw narzędziowy
DE Werkzeug-Set
RU Набор инструмента
CZ Sada nářadí
HU Szerszámkészlet
RO Trusa de scule
FR Coffret d'outillage
IT Set di utensili
ES Juego de herramientas
CN 套筒组套

20 PCS **1/4"** **6.3mm** **CrV** **50BV30** **CrMo** **440**
72T **AS-DRIVE** 









 1/4" (6.3 mm): 3.5, 4, 4.5, 5, 5.5, 6, 7, 8, 9, 10, 11, 12, 13, 14 mm (L=25 mm); CrV 50BV30;
 1/4" (6.3 mm); (51.6, 151.5 mm); CrV 50BV30;
 1/4" (6.3 mm); CrV 50BV30;
 1/4" (6.3 mm); (152.8 mm); CrV 50BV30;
 1/4" (6.3 mm); (155 mm); 72T; CrMo 440;
 1/4" (6.3 mm); (150 mm); CrV 50BV30

YATO 		
YT-14491	1/4" (6.3 mm)	10

EN Tool set
PL Zestaw narzędziowy
DE Werkzeug-Set
RU Набор инструмента
CZ Sada nářadí
HU Szerszámkészlet
RO Trusa de scule
FR Coffret d'outillage
IT Set di utensili
ES Juego de herramientas
CN 套筒组套

25 PCS **1/4"** **6.3mm** **CrV** **50BV30** **CrMo** **440**
CrV **40** **72T** **AS-DRIVE** 



 1/4" (6.3 mm): 3.5, 4, 4.5, 5, 5.5, 6, 7, 8, 9, 10, 11, 12, 13, 14 mm (L=25 mm); CrV 50BV30;
 1/4" (6.3 mm): 8, 10, 11, 12, 13 mm (L=50 mm); CrV 50BV30;
 1/4" (6.3 mm); (50.8, 101.6 mm); CrV 50BV30;
 1/4" (6.3 mm); CrV 50BV30;
 1/4" (6.3 mm); (152.4 mm); CrV 40;
 1/4" (6.3 mm); (155 mm); 72T; CrMo 440;
 1/4" (6.3 mm); (150 mm); CrV 50BV30

YATO 		
YT-14461	1/4" (6.3 mm)	10

EN Tool set
 PL Zestaw narzędziowy
 DE Werkzeug-Set
 RU Набор инструмента

CZ Sada nářadí
 HU Szerszámkészlet
 RO Trusa de scule
 FR Coffret d'outillage

IT Set di utensili
 ES Juego de herramientas
 CN 套筒组套

38
PCS

1/4"
6.3mm

CrV
50BV30

CrV
6150

CrV
40

CrMo
440

S2

72T

AS-DRIVE



- 1/4" (6.3 mm): 3.5, 4, 4.5, 5, 5.5, 6, 7, 8, 9, 10, 11, 12, 13, 14 mm (L=25 mm); CrV 50BV30;
- 1/4" (6.3 mm); (50.8, 101.6 mm); CrV 50BV30;
- 1/4" (6.3 mm); CrV 50BV30;
- 1/4" (6.3 mm); (152.4 mm); CrV 40;
- 1/4" (6.3 mm); (155 mm); 72T; CrMo 440;
- 1/4" (6.3 mm); (150 mm); CrV 50BV30;
- 1/4" (6.3 mm): 4, 5.5, 6.5 mm (L=37 mm); AISI S2 / CrV 6150;
- 1/4" (6.3 mm): PH1, PH2 (L=37 mm); AISI S2 / CrV 6150;
- 1/4" (6.3 mm): PZ1, PZ2 (L=37 mm); AISI S2 / CrV 6150;
- 1/4" (6.3 mm): T10, T15, T20, T25, T30, T40 (L=37 mm); AISI S2 / CrV 6150;
- 1/4" (6.3 mm): 3, 4, 5, 6, 8 mm (L=37 mm); AISI S2 / CrV 6150

YATO	○	
YT-14471	1/4" (6.3 mm)	10

EN Tool set
 PL Zestaw narzędziowy
 DE Werkzeug-Set

RU Набор инструмента
 CZ Sada nářadí
 HU Szerszámkészlet

RO Trusa de scule
 FR Coffret d'outillage
 IT Set di utensili

ES Juego de herramientas
 CN 套筒组套

56
PCS

1/4"
6.3mm

CrV
50BV30

CrV
6150

CrV
40

CrMo
440

S2

72T

AS-DRIVE



- 1/4" (6.3 mm): 4, 4.5, 5, 5.5, 6, 7, 8, 9, 10, 11, 12, 13 mm (L=25 mm); CrV 50BV30;
- 1/4" (6.3 mm): 6, 7, 8, 9, 10, 11, 12, 13 mm (L=50 mm); CrV 50BV30;
- 1/4" (6.3 mm): E4, E5, E6, E7, E8, E10; CrV 6150;
- 1/4" (6.3 mm); (76, 152.4 mm); CrV 50BV30;
- 1/4" (6.3 mm); (150 mm); CrV 50BV30;
- 1/4" (6.3 mm); CrV 50BV30;
- 1/4" (6.3 mm); (152.4 mm); CrV 40;
- 1/4" (6.3 mm); (155 mm); 72T; CrMo 440;
- 1/4" (6.3 mm); (150 mm); CrV 50BV30;
- 1/4" (6.3 mm) (F) x 3/8" (9.5 mm) (M); CrV 50BV30;
- 1/4" (6.3 mm): 4, 5.5, 6.5 mm (L=37 mm); AISI S2 / CrV 6150;
- 1/4" (6.3 mm): PH1, PH2, PH3 (L=37 mm); AISI S2 / CrV 6150;
- 1/4" (6.3 mm): PZ1, PZ2, PZ3 (L=37 mm); AISI S2 / CrV 6150;
- 1/4" (6.3 mm): T8, T10, T15, T20, T25, T30, T40 (L=37 mm); AISI S2 / CrV 6150;
- 1/4" (6.3 mm): 3, 4, 5, 6, 7, 8 mm (L=37 mm); AISI S2 / CrV 6150

YATO	○	
YT-14501	1/4" (6.3 mm)	10

EN Tool set
 PL Zestaw narzędziowy
 DE Werkzeug-Set

RU Набор инструмента
 CZ Sada nářadí
 HU Szerszámkészlet

RO Trusa de scule
 FR Coffret d'outillage
 IT Set di utensili

ES Juego de herramientas
 CN 套筒组套

22
PCS

3/8"
9.5mm

CrV
50BV30

CrV
40

CrMo
440

72T

AS-DRIVE



- 3/8" (9.5 mm): 6, 7, 8, 9, 10, 11, 12, 13, 14, 15, 16 mm (L=28 mm); 17, 18, 19, 20, 21, 22 mm (L=30 mm); CrV 50BV30;
- 3/8" (9.5 mm); (76, 152.4 mm); CrV 50BV30;
- 3/8" (9.5 mm); CrV 50BV30;
- 3/8" (9.5 mm); (198 mm); CrV 40;
- 3/8" (9.5 mm); (200 mm); 72T; CrMo 440

YATO	○	
YT-38561	3/8" (9.5 mm)	10

- EN Socket set
PL Komplet nasadek dlugich
DE Sechskant-Steckschlüssel-Satz
RU Набор насадок
CZ Sada nástrčných klíčů
HU Dugókulcs készlet
RO Trusa de scule
FR Set de douilles longues
IT Serie di chiavi a bussola lunghi
ES Juego de herramientas
CN 套筒组套

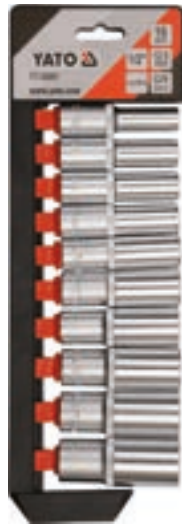

10
PCS
1/2"
12.7mm
CrV
50BV30
AS-DRIVE

1/2" (12.7 mm): 10, 12, 13, 14, 15, 17, 19, 21, 22, 24 mm (L=76 mm); CrV 50BV30

YATO		
YT-38861	1/2" (12.7 mm)	5/10

- EN Socket set
PL Komplet nasadek z akcesoriami
DE Sechskantenschlüssel-Einsatz
RU Набор торцевых головок
CZ Sada nástrčných klíčů a ráčny
HU Dugókulcs készlet racsnis hajtókarral
RO Trusa de scule
FR Set de douilles + accessoires
IT Serie di chiavi a con accessori
ES Juego de boquillas con accesorios
CN 套筒组套



12
PCS
1/2"
12.7mm
CrV
50BV30
CrMo
440
72T
AS-DRIVE

1/2" (12.7 mm): 10, 11, 12, 13, 14, 15, 17, 19, 21, 24 mm (L=38 mm); CrV 50BV30;
1/2" (12.7 mm); (127 mm); CrV 50BV30;
1/2" (12.7 mm); (255 mm); 72T; CrMo 440

YATO		
YT-38821	1/2" (12.7 mm)	5/10

- EN Ratchet handle with socket set
PL Komplet nasadek z grzechotką
DE Sechskant-Steckschlüssel-Satz
RU Набор головок с трещоткой
CZ Sada nástrčných klíčů a ráčny
HU Dugókulcs készlet racsnis hajtókarral
RO Trusa de scule
FR Clé mixte à cliquet + douilles
IT Serie di chiavi con cricchetto
ES Matraca con boquillas
CN 套筒组套



19
PCS
1/2"
12.7mm
CrV
50BV30
CrMo
440
72T
AS-DRIVE

1/2" (12.7 mm): 8, 9, 10, 11, 12, 13, 14, 15, 16, 17, 19, 21, 22, 23, 24 mm (L=38 mm);
27, 30, 32 mm (L=42 mm); CrV 50BV30;
1/2" (12.7 mm); (255 mm); 72T; CrMo 440

YATO		
YT-38681	1/2" (12.7 mm)	3/6

- EN Tool set
PL Zestaw narzędziowy
DE Werkzeug-Set
RU Набор инструмента
CZ Sada nářadí
HU Szerszámkészlet
- RO Trusa de scule
FR Coffret d'outillage
IT Set di utensili
ES Juego de herramientas
CN 套筒组套

12
PCS
1/2"
12.7mm
CrV
50BV30
CrMo
440
72T
AS-DRIVE



1/2" (12.7 mm): 10, 11, 12, 13, 14, 15, 17, 19, 21, 24 mm (L=38 mm); CrV 50BV30;
1/2" (12.7 mm); (127 mm); CrV 50BV30;
1/2" (12.7 mm); (255 mm); 72T; CrMo 440

YATO		
YT-38671	1/2" (12.7 mm)	10

- EN Tool set
PL Zestaw narzędziowy
DE Werkzeug-Set
- RU Набор инструмента
CZ Sada nářadí
HU Szerszámkészlet
- RO Trusa de scule
FR Coffret d'outillage
IT Set di utensili
- ES Juego de herramientas
CN 套筒组套

25
PCS
1/2"
12.7mm
CrV
50BV30
CrV
6140
72T
AS-DRIVE



1/2" (12.7 mm): 10, 11, 12, 13, 14, 15, 16, 17, 18, 19, 20, 21, 22, 23, 24 mm (L=38 mm);
27, 30, 32 mm (L=42 mm); CrV 50BV30;
1/2" (12.7 mm); (127 mm); CrV 50BV30;
1/2" (12.7 mm): 16, 21 mm; CrV 50BV30;
1/2" (12.7 mm); (255 mm); CrV 50BV30;
1/2" (12.7 mm); (255 mm); 72T; CrV 6140;
1/2" (12.7 mm); (317 mm); CrV 50BV30;
1/2" (12.7 mm) (F) x 3/8" (9.5 mm) (M); CrV 50BV30

YATO		
YT-38741	1/2" (12.7 mm)	2

EN Tool set
 PL Zestaw narzędziowy
 DE Werkzeug-Set
 RU Набор инструмента

CZ Sada nářadí
 HU Szerszámkészlet
 RO Trusa de scule
 FR Coffret d'outillage

IT Set di utensili
 ES Juego de herramientas
 CN 套筒组套

72 PCS	1/2" 12.7mm	1/4" 6.3mm	CrV 50BV30	CrV 6150	CrV 6140	72T	AS-DRIVE	
------------------	-----------------------	----------------------	----------------------	--------------------	--------------------	------------	-----------------	--



- 1/2" (12.7 mm): 10, 11, 12, 13, 14, 15, 16, 17, 18, 19, 20, 21, 22, 23, 24 mm (L=38 mm); 27 mm (L=42 mm);
- 1/4" (6.3 mm): 4, 5, 6, 7, 8, 9, 10, 11, 12, 13 mm (L=25 mm); CrV 50BV30;
- 1/2" (12.7 mm): (127, 254 mm), 1/4" (6.3 mm): (152.4 mm); CrV 50BV30;
- 3/8" (9.5 mm) (F) x 1/2" (12.7 mm) (M); CrV 50BV30;
- 1/2" (12.7 mm); CrV 50BV30;
- 1/2" (12.7 mm): 21 mm; CrV 50BV30;
- 1/2" (12.7 mm): (255 mm), 1/4" (6.3 mm): (155 mm); 72T; CrV 6140;
- 1/4" (6.3 mm): (150 mm); CrV 50BV30;
- 1/4" (6.3 mm) x 1/4" (6.3 mm); CrV 6140;
- 1/4" (6.3 mm): 4, 5, 5.5, 6, 7 mm (L=25 mm); CrV 6150;
- 1/4" (6.3 mm): PH0, PH1, PH2, PH3 (L=25 mm); CrV 6150;
- 1/4" (6.3 mm): PZ0, PZ1, PZ2, PZ3 (L=25 mm); CrV 6150;
- 1/4" (6.3 mm): T8, T9, T10, T15, T20, T25, T27, T30, T40 (L=25 mm); CrV 6150;
- 1/4" (6.3 mm): 3, 4, 5, 6, 7, 8 mm (L=25 mm); CrV 6150;
- 1/4" (6.3 mm): S0, S1, S2, S3 (L=25 mm); CrV 6150;
- 1.25, 1.5, 2.5, 3 mm; CrV 6150

YATO		
YT-38782	1/4" (6.3 mm), 1/2" (12.7 mm)	4

EN Tool set
 PL Zestaw narzędziowy
 DE Werkzeug-Set
 RU Набор инструмента
 CZ Sada nářadí
 HU Szerszámkészlet

RO Trusa de scule
 FR Coffret d'outillage
 IT Set di utensili
 ES Juego de herramientas
 CN 套筒组套

77 PCS	1/2" 12.7mm	1/4" 6.3mm	CrV 50BV30	CrV 6150	CrMo 440	S2	72T	AS-DRIVE	
------------------	-----------------------	----------------------	----------------------	--------------------	--------------------	-----------	------------	-----------------	--



- 1/2" (12.7 mm): 10, 11, 12, 13, 14, 15, 17, 19, 22, 24 mm (L=38 mm); 27, 30, 32 mm (L=42 mm);
- 1/4" (6.3 mm): 4, 5, 6, 7, 8, 9, 10, 11, 12 mm (L=25 mm); CrV 50BV30;
- 1/2" (12.7 mm): (127, 254 mm), 1/4" (6.3 mm): (76, 101.6 mm); CrV 50BV30;
- 1/2" (12.7 mm), 1/4" (6.3 mm); CrV 50BV30;
- 1/2" (12.7 mm): 16, 21 mm; CrV 50BV30;
- 1/2" (12.7 mm): (255 mm), 1/4" (6.3 mm): (155 mm); 72T; CrMo 440;
- 1/4" (6.3 mm) x 1/4" (6.3 mm); CrV 50BV30;
- 1/4" (6.3 mm) x 1/4" (6.3 mm); CrV 50BV30;
- 1/4" (6.3 mm): 3, 4, 5.5, 7 mm (L=25 mm); AISI S2;
- 1/4" (6.3 mm): PH0, PH1, PH2, PH3 (L=25 mm); AISI S2;
- 1/4" (6.3 mm): PZ1, PZ2, PZ3 (L=25 mm); AISI S2;
- 1/4" (6.3 mm): T10, T15, T20, T25, T30 (L=25 mm); AISI S2;
- 1/4" (6.3 mm): 2, 3, 4, 5, 6 mm (L=25 mm); AISI S2;
- 7, 8, 9, 10, 11, 12, 13, 14, 15, 17, 19 mm; CrV;
- 8x9, 10x11, 12x13, 14x15 mm; CrV 50BV30;
- 1.5, 2, 2.5, 5, 6, 8, 10 mm; CrV 6150

YATO		
YT-38781	1/4" (6.3 mm), 1/2" (12.7 mm)	2

EN Tool set
PL Zestaw narzędziowy
DE Werkzeug-Set

RU Набор инструмента
CZ Sada nářadí
HU Szerszámkészlet

RO Trusa de scule
FR Coffret d'outillage
IT Set di utensili

ES Juego de herramientas
CN 套筒组套

79 PCS	1/2" 12.7mm	1/4" 6.3mm	CrV 50BV30	CrV 6140	CrV 60
CrMo	SK5	S2	72T	AS-DRIVE	



- 1/2" (12.7 mm): 10, 11, 12, 13, 14, 16, 17, 19, 22, 24, 26 mm (L=38 mm); 27, 30, 32 mm (L=42 mm);
- 1/4" (6.3 mm): 5, 6, 7, 8, 9, 10, 11, 12, 13 mm (L=25 mm); CrV 50BV30;
- 1/2" (12.7 mm): 10, 11, 12, 13, 14, 17, 19 mm (L=76 mm); CrV 50BV30;
- 1/2" (12.7 mm); (125 mm); 1/4" (6.3 mm); (50 mm); CrV 50BV30;
- 1/2" (12.7 mm); CrV 50BV30;
- 1/2" (12.7 mm): 16, 21 mm; CrV 50BV30;
- 1/2" (12.7 mm); (255 mm); 1/4" (6.3 mm); (155 mm); 72T; CrV 6140;
- 1/4" (6.3 mm); (150 mm); CrV 50BV30;
- 1/2" (12.7 mm); (457 mm);
- 6, 7, 8, 9, 10, 11, 12, 13, 14, 16, 17, 19, 22, 24 mm; CrV;
- 2.0x50, 2.4x75 mm; S2;
- 3.0x75, 4.0x100, 6.5x150, 8.0x150 mm; S2;
- PH0x75 mm; S2;
- PH1x75, PH2x100 mm; S2;
- 180 mm;
- 160 mm;
- 160, 200 mm;
- 250 mm;
- 300 g;
- 300 mm;
- 180 mm; CrMo;
- 120 mm; CrV 60;
- SK5;
- 2.5, 3, 4, 5, 6, 8, 10 mm; CrV

YATO		
YT-38911	1/4" (6.3 mm), 1/2" (12.7 mm)	2

EN Tool set
PL Zestaw narzędziowy
DE Werkzeug-Set

RU Набор инструмента
CZ Sada nářadí
HU Szerszámkészlet

RO Trusa de scule
FR Coffret d'outillage
IT Set di utensili

ES Juego de herramientas
CN 套筒组套

82 PCS	1/2" 12.7mm	1/4" 6.3mm	CrV 50BV30	CrV 6150
CrV 40	CrMo 440	S2	72T	AS-DRIVE

















- 1/2" (12.7 mm): 14, 15, 16, 17, 18, 19, 20, 22, 24 mm (L=38 mm); 27, 30, 32 mm (L=42 mm);
- 1/4" (6.3 mm): 4, 4.5, 5, 5.5, 6, 7, 8, 9, 10, 11, 12, 13, 14 mm (L=25 mm); CrV 50BV30;
- 1/2" (12.7 mm); (127, 254 mm); 1/4" (6.3 mm); (50.8, 101.6 mm); CrV 50BV30;
- 3/8" (9.5 mm) (F) x 1/2" (12.7 mm) (M); CrV 50BV30;
- 1/4" (6.3 mm); (150 mm); CrV 50BV30;
- 1/2" (12.7 mm); 1/4" (6.3 mm); CrV 50BV30;
- 1/2" (12.7 mm): 16, 21 mm; CrV 50BV30;
- 1/4" (6.3 mm); (152.4 mm); CrV 40;
- 1/2" (12.7 mm); (255 mm); 1/4" (6.3 mm); (155 mm); 72T; CrMo 440;
- 1/4" (6.3 mm); (150 mm); CrV 50BV30;
- 1/2" (12.7 mm) x 5/16" (7.9 mm); CrV 50BV30;
- 1/4" (6.3 mm) x 1/4" (6.3 mm); CrV 50BV30;
- 5/16" (7.9 mm): 8, 10, 12 mm (L=30 mm); AISI S2;
- 5/16" (7.9 mm): PH3, PH4 (L=30 mm); AISI S2;
- 5/16" (7.9 mm): PZ3, PZ4 (L=30 mm); AISI S2;
- 5/16" (7.9 mm): T40, T45, T50, T55 (L=30 mm); AISI S2;
- 5/16" (7.9 mm): 8, 10, 12, 14 mm (L=30 mm); AISI S2;
- 1/4" (6.3 mm): 4, 5, 5.7 mm (L=37 mm); AISI S2 / CrV 6150;
- 1/4" (6.3 mm): PH1, PH2 (L=37 mm); AISI S2 / CrV 6150;
- 1/4" (6.3 mm): PZ1, PZ2 (L=37 mm); AISI S2 / CrV 6150;
- 1/4" (6.3 mm): T8, T10, T15, T20, T25, T30 (L=37 mm); AISI S2 / CrV 6150;
- 1/4" (6.3 mm): 3, 4, 5, 6 mm (L=37 mm); AISI S2 / CrV 6150;
- 8, 10, 11, 12, 13, 14, 17, 19, 22 mm; CrV

YATO		
YT-12691	1/4" (6.3 mm), 1/2" (12.7 mm)	2

EN Tool set RU Набор инструмента RO Trusa de scule ES Juego de herramientas
 PL Zestaw narzędziowy CZ Sada náradí FR Coffret d'outillage CN 套筒组套
 DE Werkzeug-Set HU Szerszámkészlet IT Set di utensili

94 PCS	1/2" 12.7mm	1/4" 6.3mm
CrV 50BV30	CrV 6150	CrV 40
CrMo 440	S2	72T
AS-DRIVE		



-  1/2" (12.7 mm): 10, 11, 12, 13, 14, 15, 16, 17, 18, 19, 20, 21, 22, 23, 24 mm (L=38 mm); 27, 30, 32 mm (L=42 mm), 1/4" (6.3 mm): 4, 4.5, 5, 5.5, 6, 7, 8, 9, 10, 11, 12, 13, 14 mm (L=25 mm); CrV 50BV30;
-  1/2" (12.7 mm): 14, 15, 17, 19 mm (L=76 mm), 1/4" (6.3 mm): 6, 7, 8, 9, 10, 11, 12, 13 mm (L=50 mm); CrV 50BV30;
-  1/2" (12.7 mm): (127, 254 mm), 1/4" (6.3 mm): (50.8, 101.6 mm); CrV 50BV30;
-  3/8" (9.5 mm) (F) x 1/2" (12.7 mm) (M); CrV 50BV30;
-  1/4" (6.3 mm); (150 mm); CrV 50BV30;
-  1/2" (12.7 mm), 1/4" (6.3 mm); CrV 50BV30;
-  1/2" (12.7 mm): 16, 21 mm; CrV 50BV30;
-  1/4" (6.3 mm); (152.4 mm); CrV 40;
-  1/2" (12.7 mm); (255 mm), 1/4" (6.3 mm); (155 mm); 72T; CrMo 440;
-  1/4" (6.3 mm); (150 mm); CrV 50BV30;
-  1/2" (12.7 mm) x 5/16" (7.9 mm); CrV 50BV30;
-  1/4" (6.3 mm) x 1/4" (6.3 mm); CrV 50BV30;
-  5/16" (7.9 mm): 8, 10, 12 mm (L=30 mm); AISI S2;
-  5/16" (7.9 mm): PH3, PH4 (L=30 mm); AISI S2;
-  5/16" (7.9 mm): PZ3, PZ4 (L=30 mm); AISI S2;
- 5/16" (7.9 mm): T40, T45, T50, T55 (L=30 mm); AISI S2;
- 5/16" (7.9 mm): 8, 10, 12, 14 mm (L=30 mm); AISI S2;
- 1/4" (6.3 mm): 4, 5.5, 7 mm (L=37 mm); AISI S2 / CrV 6150;
- 1/4" (6.3 mm): PH1, PH2 (L=37 mm); AISI S2 / CrV 6150;
- 1/4" (6.3 mm): PZ1, PZ2 (L=37 mm); AISI S2 / CrV 6150;
- 1/4" (6.3 mm): T8, T10, T15, T20, T25, T30 (L=37 mm); AISI S2 / CrV 6150;
- 1/4" (6.3 mm): 3, 4, 5, 6 mm (L=37 mm); AISI S2 / CrV 6150;
- 1.5, 2, 2.5 mm; CrV 6150

EN Tool set
PL Zestaw narzędziowy
DE Werkzeug-Set
RU Набор инструмента
CZ Sada náradí
HU Szerszámkészlet
RO Trusa de scule
FR Coffret d'outillage
IT Set di utensili
ES Juego de herramientas
CN 套筒组套

108
PCS

1/2"
12.7mm

1/4"
6.3mm

CrV
50BV30

CrV
6150

CrV
40

CrMo
440

S2

72T

AS-DRIVE



- 1/2" (12.7 mm): 10, 11, 12, 13, 14, 15, 16, 17, 18, 19, 20, 21, 22, 24 mm (L=38 mm); 27, 30, 32 mm (L=42 mm);
- 1/4" (6.3 mm): 4, 4.5, 5, 5.5, 6, 7, 8, 9, 10, 11, 12, 13, 14 mm (L=25 mm); CrV 50BV30;
- 1/2" (12.7 mm): 14, 15, 17, 19, 22 mm (L=76 mm);
- 1/4" (6.3 mm): 6, 7, 8, 9, 10, 11, 12, 13 mm (L=50 mm); CrV 50BV30;
- 1/2" (12.7 mm): E10, E11, E12, E14, E16, E18, E20, E24, 1/4" (6.3 mm): E4, E5, E6, E7, E8; CrV 50BV30;
- 1/2" (12.7 mm): (127, 254 mm); 1/4" (6.3 mm): (50.8, 101.6 mm); CrV 50BV30;
- 3/8" (9.5 mm) (F) x 1/2" (12.7 mm) (M); CrV 50BV30;
- 1/2" (12.7 mm), 1/4" (6.3 mm); CrV 50BV30;
- 1/2" (12.7 mm): 16, 21 mm; CrV 50BV30;
- 1/4" (6.3 mm): (152.4 mm); CrV 40;
- 1/2" (12.7 mm): (255 mm), 1/4" (6.3 mm): (155 mm); 72T; CrMo 440;
- 1/4" (6.3 mm): (150 mm); CrV 50BV30;
- 1/2" (12.7 mm) x 5/16" (7.9 mm); CrV 50BV30;
- 5/16" (7.9 mm): 8, 10, 12 mm (L=30 mm); AISI S2;
- 5/16" (7.9 mm): PH3, PH4 (L=30 mm); AISI S2;
- 5/16" (7.9 mm): PZ3, PZ4 (L=30 mm); AISI S2;
- 5/16" (7.9 mm): T40, T45, T50, T55, T60 (L=30 mm); AISI S2;
- 5/16" (7.9 mm): 7, 8, 10, 12, 14 mm (L=30 mm); AISI S2;
- 1/4" (6.3 mm): 4, 5.5, 6.5 mm (L=37 mm); AISI S2 / CrV 50BV30;
- 1/4" (6.3 mm): PH1, PH2 (L=37 mm); AISI S2 / CrV 50BV30;
- 1/4" (6.3 mm): PZ1, PZ2 (L=37 mm); AISI S2 / CrV 50BV30;
- 1/4" (6.3 mm): T8, T10, T15, T20, T25, T27, T30 (L=37 mm); AISI S2 / CrV 50BV30;
- 1/4" (6.3 mm): 3, 4, 5, 6 mm (L=37 mm); AISI S2 / CrV 50BV30;
- 1.5, 2, 2.5 mm; CrV 6150

YATO	○	2
YT-38791	1/4" (6.3 mm), 1/2" (12.7 mm)	2

EN Tool set
PL Zestaw narzędziowy
DE Werkzeug-Set
RU Набор инструмента
CZ Sada náradí
HU Szerszámkészlet
RO Trusa de scule
FR Coffret d'outillage
IT Set di utensili
ES Juego de herramientas
CN 套筒组套

109
PCS

1/2"
12.7mm

1/4"
6.3mm

CrV
50BV30

CrV
6150

CrV
6140

CrMo
440

S2

72T

AS-DRIVE



- 1/2" (12.7 mm): 12, 13, 14, 15, 16, 17, 18, 19, 20, 21, 22, 24 mm (L=38 mm); 27, 30, 32 mm (L=42 mm);
- 1/4" (6.3 mm): 4, 4.5, 5, 5.5, 6, 7, 8, 9, 10, 11, 12, 13, 14 mm (L=25 mm); CrV 50BV30;
- 1/2" (12.7 mm): 10, 12, 13, 14, 17, 19 mm (L=76 mm); 1/4" (6.3 mm): 4, 5, 6, 7, 8, 9 mm (L=50 mm); CrV 50BV30;
- 1/2" (12.7 mm): E10, E12, E14, E16, E18, E20, E22, E24; CrV 6150;
- 1/2" (12.7 mm): (254 mm); 1/4" (6.3 mm): (152.4 mm); CrV 50BV30;
- 3/8" (9.5 mm) (F) x 1/2" (12.7 mm) (M), 3/8" (9.5 mm) (F) x 1/4" (6.3 mm) (M); CrV 50BV30;
- 1/2" (12.7 mm), 1/4" (6.3 mm); CrV 50BV30;
- 1/2" (12.7 mm): 16, 21 mm; CrV 50BV30;
- 1/2" (12.7 mm): (255 mm), 1/4" (6.3 mm): (155 mm); 72T; CrMo 440;
- 1/4" (6.3 mm): (150 mm); CrV 50BV30;
- 1/4" (6.3 mm): 4, 5.5, 6.5 mm (L=37 mm); AISI S2 / CrV 6150;
- 1/4" (6.3 mm): PH1, PH2, PH3 (L=37 mm); AISI S2 / CrV 6150;
- 1/4" (6.3 mm): PZ2, PZ3 (L=37 mm); AISI S2 / CrV 6150;
- 1/4" (6.3 mm): T8, T10, T15, T20, T25 (L=37 mm); AISI S2 / CrV 6150;
- 1/4" (6.3 mm): T10, T15, T20, T25, T40 (L=37 mm); AISI S2 / CrV 6150;
- 1/4" (6.3 mm): 3, 4, 5, 6 mm (L=37 mm); AISI S2 / CrV 6150;
- 8, 9, 10, 11, 12, 13, 14, 15, 16, 17, 18, 19 mm; CrV;
- 8x9, 10x11, 12x13, 14x15 mm; CrV 50BV30;
- 8x10, 12x13, 17x19 mm; CrV 6140;
- 3x75, 4x100, 6x150, PH1x75, PH2x100, PH3x150 mm; S2;
- 180 mm;
- 160 mm;
- 300 g

YATO	○	2
YT-38891	1/4" (6.3 mm), 1/2" (12.7 mm)	2

EN Tool set
 PL Zestaw narzędziowy
 DE Werkzeug-Set
 RU Набор инструмента

CZ Sada nářadí
 HU Szerszámkészlet
 RO Trusa de scule
 FR Coffret d'outillage

IT Set di utensili
 ES Juego de herramientas
 CN 套筒组套

122 PCS **1/2"** 12.7mm **1/4"** 6.3mm **CrV** 50BV30 **CrV** 6150 **CrMo** 440 **S2** **72T** **AS-DRIVE**



- 1/2" (12.7 mm): 12, 13, 14, 15, 16, 17, 18, 19, 20, 21, 22, 24 mm (L=38 mm); 27, 30, 32 mm (L=42 mm);
- 1/4" (6.3 mm): 4, 4.5, 5, 5.5, 6, 7, 8, 9, 10, 11, 12, 13, 14 mm (L=25 mm); CrV 50BV30;
- 1/2" (12.7 mm): 10, 12, 13, 14, 17, 19 mm (L=76 mm); 1/4" (6.3 mm): 4, 5, 6, 7, 8, 9 mm (L=50 mm); CrV 50BV30;
- 1/2" (12.7 mm): E10, E12, E14, E16, E18, E20, E22, E24; CrV 6150;
- 1/2" (12.7 mm): (254 mm), 1/4" (6.3 mm): (152.4 mm); CrV 50BV30;
- 3/8" (9.5 mm) (F) x 1/2" (12.7 mm) (M), 3/8" (9.5 mm) (F) x 1/4" (6.3 mm) (M); CrV 50BV30;
- 1/2" (12.7 mm), 1/4" (6.3 mm); CrV 50BV30;
- 1/2" (12.7 mm): 16, 21 mm; CrV 50BV30;
- 1/2" (12.7 mm): (255 mm), 1/4" (6.3 mm): (155 mm); 72T; CrMo 440;
- 1/4" (6.3 mm): (150 mm); CrV 50BV30;
- 1/4" (6.3 mm) x 1/4" (6.3 mm); CrV 50BV30;
- 1/4" (6.3 mm): 3, 4, 5, 6 mm (L=25 mm); AISI S2;
- 1/4" (6.3 mm): PH0, PH1, PH2 (L=25 mm); AISI S2;
- 1/4" (6.3 mm): PZ0, PZ1, PZ2 (L=25 mm); AISI S2;
- 1/4" (6.3 mm): 4, 5.5, 6.5 mm (L=37 mm); AISI S2 / CrV 6150;
- 1/4" (6.3 mm): PH1, PH2, PH3 (L=37 mm); AISI S2 / CrV 6150;
- 1/4" (6.3 mm): PZ2, PZ3 (L=37 mm); AISI S2 / CrV 6150;
- 1/4" (6.3 mm): T8, T10, T15, T20, T25 (L=37 mm); AISI S2 / CrV 6150;
- 1/4" (6.3 mm): T10, T15, T20, T25, T40 (L=37 mm); AISI S2 / CrV 6150;
- 1/4" (6.3 mm): 3, 4, 5, 6 mm (L=37 mm); AISI S2 / CrV 6150;
- 8, 9, 10, 11, 12, 13, 14, 15, 16, 17, 18, 19 mm; CrV;
- 4x100, 6x150, PH2x100, PH3x150 mm; S2;
- 180 mm;
- 160 mm;
- 160 mm;
- 250 mm; CrV;
- 300 g;
- 2, 2.5, 3, 4, 5, 6, 7, 8, 10 mm; CrV 6150

YATO	○	2
YT-38901	1/4" (6.3 mm), 1/2" (12.7 mm)	2

EN Tool set
 PL Zestaw narzędziowy
 DE Werkzeug-Set
 RU Набор инструмента
 CZ Sada nářadí
 HU Szerszámkészlet

RO Trusa de scule
 FR Coffret d'outillage
 IT Set di utensili
 ES Juego de herramientas
 CN 套筒组套

111 PCS **1/2"** 12.7mm **3/8"** 9.5mm **1/4"** 6.3mm **CrV** 50BV30 **CrV** 6150 **CrMo** 440 **S2** **72T** **AS-DRIVE**



- 1/2" (12.7 mm): 14, 15, 16, 17, 18, 19, 20, 21, 22, 23, 24 mm (L=38 mm); 27, 30, 32 mm (L=42 mm);
- 3/8" (9.5 mm): 9, 10, 11, 12, 13, 14, 15, 16 mm (L=28 mm); 17, 18, 19 mm (L=30 mm);
- 1/4" (6.3 mm): 3.5, 4, 4.5, 5, 5.5, 6, 7, 8, 9, 10, 11, 12, 13 mm (L=25 mm); CrV 50BV30;
- 1/2" (12.7 mm): (127, 254 mm), 3/8" (9.5 mm): (76, 152.4 mm), 1/4" (6.3 mm): (50.8, 152.4 mm); CrV 50BV30;
- 3/8" (9.5 mm) (F) x 1/2" (12.7 mm) (M), 1/2" (12.7 mm) (F) x 3/8" (9.5 mm) (M), 3/8" (9.5 mm) (F) x 1/4" (6.3 mm) (M); CrV 50BV30;
- 1/2" (12.7 mm), 3/8" (9.5 mm), 1/4" (6.3 mm); CrV 50BV30;
- 1/2" (12.7 mm): 16, 21 mm, 3/8" (9.5 mm): 16, 21 mm; CrV 50BV30;
- 1/2" (12.7 mm): (255 mm), 3/8" (9.5 mm): (200 mm), 1/4" (6.3 mm): (155 mm); 72T; CrMo 440;
- 1/4" (6.3 mm): (150 mm); CrV 50BV30;
- 1/2" (12.7 mm) x 5/16" (7.9 mm), 3/8" (9.5 mm) x 5/16" (7.9 mm); CrV 50BV30;
- 5/16" (7.9 mm): 6, 6.5, 8 mm (L=30 mm); AISI S2;
- 5/16" (7.9 mm): PH2, PH3 (L=30 mm); AISI S2;
- 5/16" (7.9 mm): PZ2, PZ3 (L=30 mm); AISI S2;
- 5/16" (7.9 mm): T27, T30, T35, T40, T45 (L=30 mm); AISI S2;
- 5/16" (7.9 mm): 5.5, 6, 6.5 mm (L=30 mm); AISI S2;
- 1/4" (6.3 mm): 4, 5.5, 6.5 mm (L=37 mm); AISI S2 / CrV 6150;
- 1/4" (6.3 mm): PH1, PH2 (L=37 mm); AISI S2 / CrV 6150;
- 1/4" (6.3 mm): PZ1, PZ2 (L=37 mm); AISI S2 / CrV 6150;
- 1/4" (6.3 mm): T8, T10, T15, T20, T25 (L=37 mm); AISI S2 / CrV 6150;
- 1/4" (6.3 mm): T10, T15, T20, T25, T40 (L=37 mm); AISI S2 / CrV 6150;
- 1/4" (6.3 mm): 3, 4, 5, 6 mm (L=37 mm); AISI S2 / CrV 6150;
- 8, 9, 10, 11, 12, 13, 14, 15, 16, 17, 18, 19 mm; CrV;
- 1.5, 2, 2.5 mm; CrV 6150

YATO	○	2
YT-38831	1/4" (6.3 mm), 3/8" (9.5 mm), 1/2" (12.7 mm)	2

EN Tool set
 PL Zestaw narzędziowy
 DE Werkzeug-Set
 RU Набор инструмента
 CZ Sada nářadí
 HU Szerszámkészlet

RO Trusa de scule
 FR Coffret d'outillage
 IT Set di utensili
 ES Juego de herramientas
 CN 套筒组套

120 PCS 1/2" 12.7mm 3/8" 9.5mm 1/4" 6.3mm METRIC SAE CrV 50BV30 CrV 6150 CrMo 440 S2 72T AS-DRIVE

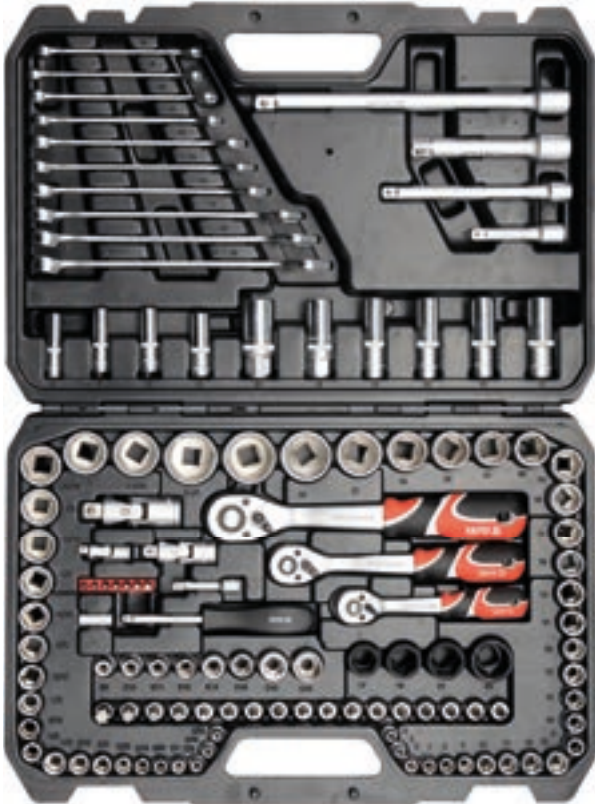

- 1/2" (12.7 mm): 20, 21, 22, 24 mm (L=38 mm); 27, 30, 32 mm (L=42 mm);
- 3/8" (9.5 mm): 9, 10, 11, 12, 13, 14, 15, 16 mm (L=28 mm); 17, 18, 19 mm (L=30 mm);
- 1/4" (6.3 mm): 4, 5, 6, 7, 8, 9, 10, 11, 12, 13 mm (L=25 mm); CrV 50BV30;
- 3/8" (9.5 mm): 13, 14, 15, 17 mm (L=63 mm); 1/4" (6.3 mm): 8, 9, 10, 12 mm (L=50 mm); CrV 50BV30;
- 1/2" (12.7 mm) x 15/16" (23.8 mm), 1/2" (12.7 mm) x 1" (25.4 mm), 1/2" (12.7 mm) x 1-1/16" (27.0 mm),
- 1/2" (12.7 mm) x 1-1/4" (31.8 mm), 3/8" (9.5 mm) x 3/8" (9.5 mm), 3/8" (9.5 mm) x 7/16" (11.1 mm),
- 3/8" (9.5 mm) x 1/2" (12.7 mm), 3/8" (9.5 mm) x 9/16" (14.3 mm), 3/8" (9.5 mm) x 5/8" (15.9 mm),
- 3/8" (9.5 mm) x 11/16" (17.5 mm), 3/8" (9.5 mm) x 3/4" (19.0 mm), 3/8" (9.5 mm) x 13/16" (20.6 mm),
- 3/8" (9.5 mm) x 7/8" (22.2 mm), 1/4" (6.3 mm) x 5/32" (4.0 mm), 1/4" (6.3 mm) x 3/16" (4.8 mm),
- 1/4" (6.3 mm) x 7/32" (5.6 mm), 1/4" (6.3 mm) x 1/4" (6.3 mm), 1/4" (6.3 mm) x 9/32" (7.1 mm),
- 1/4" (6.3 mm) x 5/16" (7.9 mm), 1/4" (6.3 mm) x 11/32" (8.7 mm), 1/4" (6.3 mm) x 3/8" (9.5 mm),
- 1/4" (6.3 mm) x 7/16" (11.1 mm), 1/4" (6.3 mm) x 1/2" (12.7 mm); CrV 50BV30;
- 1/2" (12.7 mm): 17, 19, 21, 23 mm; CrV 50BV30;
- 3/8" (9.5 mm): E8, E10, E11, E12, E14, E16, E18, E20; CrV 6150;
- 1/2" (12.7 mm): (127, 254 mm), 3/8" (9.5 mm): (76, 152.4 mm), 1/4" (6.3 mm): (50.8 mm); CrV 50BV30;
- 1/2" (12.7 mm), 3/8" (9.5 mm), 1/4" (6.3 mm); CrV 50BV30;
- 3/8" (9.5 mm): 16, 21 mm; CrV 50BV30;
- 1/2" (12.7 mm): (255 mm), 3/8" (9.5 mm): (200 mm), 1/4" (6.3 mm): (155 mm); 72T; CrMo 440;
- 1/4" (6.3 mm): (150 mm); CrV 50BV30;
- 1/4" (6.3 mm) x 1/4" (6.3 mm); CrV 50BV30;
- 1/4" (6.3 mm): T10, T15, T20, T25, T27, T30, T40 (L=25 mm); AISI S2;
- 3/8" (9.5 mm): 5.5, 6.5 mm (L=50 mm); AISI S2 / CrV 6150;
- 3/8" (9.5 mm): PH1, PH2 (L=50 mm); AISI S2 / CrV 6150;
- 3/8" (9.5 mm): PZ1, PZ2 (L=50 mm); AISI S2 / CrV 6150;
- 3/8" (9.5 mm): T20, T30, T40, T45, T50, T55, T60 (L=50 mm); AISI S2 / CrV 6150;
- 3/8" (9.5 mm): 3, 4, 5, 6 mm (L=50 mm); AISI S2 / CrV 6150;
- 8, 9, 10, 11, 12, 13, 14, 17, 18, 19 mm; CrV

YATO	O	☐
YT-38801	1/4" (6.3 mm), 3/8" (9.5 mm), 1/2" (12.7 mm)	2

EN Tool set
 PL Zestaw narzędziowy
 DE Werkzeug-Set
 RU Набор инструмента
 CZ Sada nářadí
 HU Szerszámkészlet

RO Trusa de scule
 FR Coffret d'outillage
 IT Set di utensili
 ES Juego de herramientas
 CN 套筒组套

126 PCS 1/2" 12.7mm 3/8" 9.5mm 1/4" 6.3mm CrV 50BV30 CrV 6150 CrV 6140 S2 72T AS-DRIVE



- 1/2" (12.7 mm): 20, 21, 22, 24 mm (L=38 mm); 27, 30, 32 mm (L=42 mm);
- 3/8" (9.5 mm): 9, 10, 11, 12, 13, 14, 15, 16 mm (L=28 mm); 17, 18, 19 mm (L=30 mm);
- 1/4" (6.3 mm): 4, 4.5, 5, 5.5, 6, 7, 8, 9, 10, 11, 12, 13 mm (L=25 mm); CrV 50BV30;
- 3/8" (9.5 mm): 13, 14, 15, 17 mm (L=63 mm); 1/4" (6.3 mm): 8, 9, 10, 12 mm (L=50 mm); CrV 50BV30;
- 3/8" (9.5 mm): E8, E10, E11, E12, E14, E16, E18, E20; CrV 6150;
- 1/2" (12.7 mm): (127, 254 mm), 3/8" (9.5 mm): (76, 152.4 mm), 1/4" (6.3 mm): (50.8 mm); CrV 50BV30;
- 3/8" (9.5 mm) (F) x 1/2" (12.7 mm) (M); CrV 50BV30; 1/2" (12.7 mm), 3/8" (9.5 mm), 1/4" (6.3 mm); CrV 50BV30;
- 3/8" (9.5 mm): 16, 21 mm; CrV 50BV30;
- 1/2" (12.7 mm): (255 mm), 3/8" (9.5 mm): (200 mm), 1/4" (6.3 mm): (155 mm); 72T; CrV 6140;
- 1/4" (6.3 mm): (150 mm); CrV 50BV30;
- 1/2" (12.7 mm) (F) x 3/8" (9.5 mm) (M), 3/8" (9.5 mm) (F) x 1/2" (12.7 mm) (M), 3/8" (9.5 mm) (F) x 1/4" (6.3 mm) (M); CrV 50BV30;
- 1/4" (6.3 mm) x 1/4" (6.3 mm); CrV 6140;
- 1/4" (6.3 mm): 4, 5, 6.5 mm (L=25 mm); AISI S2;
- 1/4" (6.3 mm): PH1, PH3 (L=25 mm); AISI S2;
- 1/4" (6.3 mm): PZ1, PZ2 (L=25 mm); AISI S2;
- 1/4" (6.3 mm): T10, T15, T20, T25, T27, T30, T40 (L=25 mm); AISI S2;
- 1/4" (6.3 mm): 3, 4, 5, 6 mm (L=25 mm); AISI S2;
- 3/8" (9.5 mm): 5.5, 6.5 mm (L=50 mm); AISI S2 / CrV 6150;
- 3/8" (9.5 mm): PH1, PH2 x2 (L=50 mm); AISI S2 / CrV 6150;
- 3/8" (9.5 mm): T20, T30, T40 (L=50 mm); AISI S2 / CrV 6150;
- 3/8" (9.5 mm): T45, T50, T55, T60 (L=50 mm); AISI S2 / CrV 6150;
- 3/8" (9.5 mm): 3, 4, 5, 6, 7 mm (L=50 mm); AISI S2 / CrV 6150;
- 1/2" (12.7 mm): M10 (L=100 mm); AISI S2 / CrV 6150;
- 8, 10, 12, 13, 14, 16, 17, 18, 19 mm; CrV;
- 8x10 mm, 11x12 mm; CrV 6140;
- 6x100 mm, PH2x100 mm; CrV 6150;
- 6-24 V;
- 150 mm;
- 1/2" (12.7 mm), 3/8" (9.5 mm): 63-120 mm; CrV;
- 1.5, 2, 2.5, 3, 4, 5, 6, 8, 10 mm; S2

YATO	O	☐
YT-38875	1/4" (6.3 mm), 3/8" (9.5 mm), 1/2" (12.7 mm)	2

EN Tool set
 PL Zestaw narzędziowy
 DE Werkzeug-Set
 RU Набор инструмента
 CZ Sada nářadí
 HU Szerszámkészlet

RO Trusa de scule
 FR Coffret d'outillage
 IT Set di utensili
 ES Juego de herramientas
 CN 套筒组套

128 PCS 1/2" 12.7mm 3/8" 9.5mm 1/4" 6.3mm CrV 50BV30 CrV 6150 CrMo 440 S2 72T AS-DRIVE



- 1/2" (12.7 mm): 14, 15, 16, 17, 18, 19, 20, 21, 22, 24 mm (L=38 mm); 27, 30, 32 mm (L=42 mm);
- 3/8" (9.5 mm): 10, 11, 12, 13, 14, 15, 16 mm (L=28 mm); 17, 18 mm (L=30 mm);
- 1/4" (6.3 mm): 6, 7, 8, 9, 10, 11, 12, 13 mm (L=25 mm); CrV 50BV30;
- 1/2" (12.7 mm): 17, 18, 19, 22 mm (L=76 mm); 3/8" (9.5 mm): 8, 10, 12, 13, 14, 15 mm (L=63 mm);
- 1/4" (6.3 mm): 6, 7, 8, 10, 12, 13 mm (L=50 mm); CrV 50BV30;
- 1/2" (12.7 mm): 17, 19, 21, 22 mm; CrV 50BV30;
- 3/8" (9.5 mm): E8, E10, E11, E12, E14, E16; CrV 6150;
- 1/2" (12.7 mm): (127, 254 mm); 3/8" (9.5 mm): (152.4, 254 mm);
- 1/4" (6.3 mm): (50.8, 101.6 mm); CrV 50BV30;
- 3/8" (9.5 mm) (F) x 1/2" (12.7 mm) (M); CrV 50BV30;
- 1/2" (12.7 mm), 3/8" (9.5 mm), 1/4" (6.3 mm); CrV 50BV30;
- 1/2" (12.7 mm): 16, 21 mm; CrV 50BV30;
- 3/8" (9.5 mm); (198 mm), 1/4" (6.3 mm); (152.4 mm); CrV 50BV30;
- 1/2" (12.7 mm); (255 mm), 3/8" (9.5 mm); (200 mm), 1/4" (6.3 mm); (155 mm); 72T; CrMo 440;
- 1/4" (6.3 mm); (150 mm); CrV 50BV30;
- 1/2" (12.7 mm); (250 mm); CrV 50BV30;
- 3/8" (9.5 mm) x 5/16" (7.9 mm); CrV 50BV30;
- 1/2" (12.7 mm) x 3/8" (9.5 mm), 3/8" (9.5 mm) x 1/4" (6.3 mm); CrV 50BV30;
- 1/4" (6.3 mm) x 1/4" (6.3 mm); CrV 50BV30;
- 3/8" (9.5 mm): 5.5, 6.5 mm (L=70 mm); AISI S2;
- 3/8" (9.5 mm): PH1, PH2, PH3 (L=70 mm); AISI S2;
- 3/8" (9.5 mm): T20, T30, T40, T45, T50, T55 (L=70 mm); AISI S2;
- 3/8" (9.5 mm): 6, 7, 8, 10, 12 mm (L=70 mm); AISI S2;
- 1/4" (6.3 mm): PZ1, PZ2 (L=25 mm); AISI S2;
- 1/4" (6.3 mm): T8, T10 (L=25 mm); AISI S2;
- 1/4" (6.3 mm): 4, 5.5, 6.5 mm (L=37 mm); AISI S2 / CrV 6150;
- 1/4" (6.3 mm): PH1, PH2 (L=37 mm); AISI S2 / CrV 6150;
- 1/4" (6.3 mm): T8, T10, T15, T20, T25, T30, T40 (L=37 mm); AISI S2 / CrV 6150;
- 1/4" (6.3 mm): 3, 4, 5, 6 mm (L=37 mm); AISI S2 / CrV 6150;
- 8, 10, 12, 13, 14, 15, 16, 17, 18, 19 mm; CrV;
- 1.5, 2, 2.5 mm; CrV 6150

YATO	○	☐
YT-38872	1/4" (6.3 mm), 3/8" (9.5 mm), 1/2" (12.7 mm)	2

EN Tool set
 PL Zestaw narzędziowy
 DE Werkzeug-Set
 RU Набор инструмента
 CZ Sada nářadí
 HU Szerszámkészlet

RO Trusa de scule
 FR Coffret d'outillage
 IT Set di utensili
 ES Juego de herramientas
 CN 套筒组套

129 PCS 1/2" 12.7mm 3/8" 9.5mm 1/4" 6.3mm CrV 50BV30 CrV 6150 CrMo 440 S2 72T AS-DRIVE



- 1/2" (12.7 mm): 12, 13, 14, 15, 16, 17, 18, 19, 20, 21, 22, 24 mm (L=38 mm); 27, 30, 32 mm (L=42 mm);
- 3/8" (9.5 mm): 10, 11, 12, 13, 14, 15, 16 mm (L=28 mm); 17, 18, 19 mm (L=30 mm);
- 1/4" (6.3 mm): 4, 4.5, 5, 5.5, 6, 7, 8, 9, 10, 11, 12, 13, 14 mm (L=25 mm); CrV 50BV30;
- 1/2" (12.7 mm): 10, 12, 13, 14, 17, 19 mm (L=76 mm); 1/4" (6.3 mm): 4, 5, 6, 7, 8, 9 mm (L=50 mm); CrV 50BV30;
- 1/2" (12.7 mm): 17, 19, 21, 23 mm; CrV 50BV30;
- 3/8" (9.5 mm): E8, E10, E11, E12, E14, E16, E18, E20; CrV 6150;
- 1/2" (12.7 mm): (127, 254 mm); 3/8" (9.5 mm): (76, 152.4 mm); 1/4" (6.3 mm): (50.8 mm); CrV 50BV30;
- 1/2" (12.7 mm), 3/8" (9.5 mm), 1/4" (6.3 mm); CrV 50BV30;
- 3/8" (9.5 mm): 16, 21 mm; CrV 50BV30;
- 1/2" (12.7 mm); (255 mm), 3/8" (9.5 mm); (200 mm), 1/4" (6.3 mm); (155 mm); 72T; CrMo 440;
- 1/4" (6.3 mm); (150 mm); CrV 50BV30;
- 3/8" (9.5 mm): 4, 5.5, 6.5 mm (L=50 mm); AISI S2 / CrV 6150;
- 3/8" (9.5 mm): PH1, PH2, PH3 (L=50 mm); AISI S2 / CrV 6150;
- 3/8" (9.5 mm): PZ1, PZ2, PZ3 (L=50 mm); AISI S2 / CrV 6150;
- 3/8" (9.5 mm): T20, T30, T40, T45, T50, T55, T60 (L=50 mm); AISI S2 / CrV 6150;
- 3/8" (9.5 mm): 3, 4, 5, 6, 8, 10 mm (L=50 mm); AISI S2 / CrV 6150;
- 8, 10, 11, 12, 13, 14, 15, 16, 17, 18, 19, 22 mm; CrV;
- 3x75, 4x100, 6x150, PH1x75, PH2x100, PH3x150 mm; S2;
- 160 mm;
- 160 mm;
- 160 mm;
- 1.5, 2, 2.5, 3, 4, 5, 6, 7, 8, 10 mm; CrV 6150

YATO	○	☐
YT-38881	1/4" (6.3 mm), 3/8" (9.5 mm), 1/2" (12.7 mm)	2

EN Tool set RU Набор инструмента RO Trusa de scule ES Juego de herramientas
PL Zestaw narzędziowy CZ Sada náradí FR Coffret d'outillage CN 套筒组套
DE Werkzeug-Set HU Szerszámkészlet IT Set di utensili

150 PCS	1/2" 12,7mm
3/8" 9,5mm	1/4" 6,3mm
METRIC SAE	CrV 50BV30
CrV 6150	CrV 6140
CrMo 440	S2
72T	AS-DRIVE

2

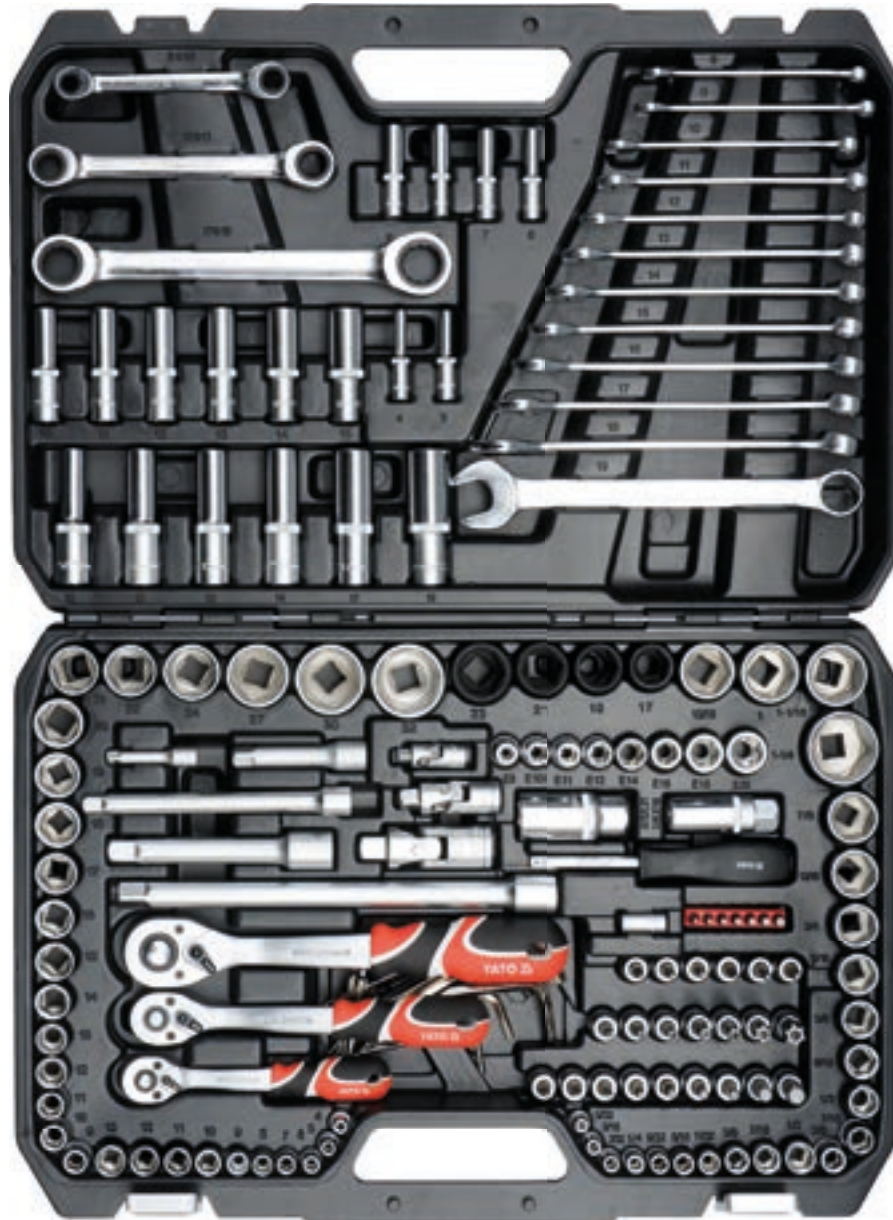













- 1/2" (12.7 mm): 20, 21, 22, 24 mm (L=38 mm); 27, 30, 32 mm (L=42 mm);
- 3/8" (9.5 mm): 9, 10, 11, 12, 13, 14, 15, 16 mm (L=28 mm); 17, 18, 19 mm (L=30 mm);
- 1/4" (6.3 mm): 4, 5, 6, 7, 8, 9, 10, 11, 12, 13 mm (L=25 mm); CrV 50BV30;
- 1/2" (12.7 mm): 10, 12, 13, 14, 17, 19 mm (L=76 mm); 3/8" (9.5 mm): 10, 11, 12, 13, 14, 15 mm (L=63 mm);
- 1/4" (6.3 mm): 4, 5, 6, 7, 8, 9 mm (L=50 mm); CrV 50BV30;
- 1/2" (12.7 mm) x 15/16" (23.8 mm), 1/2" (12.7 mm) x 1" (25.4 mm), 1/2" (12.7 mm) x 1-1/16" (27.0 mm),
- 1/2" (12.7 mm) x 1-1/4" (31.8 mm), 3/8" (9.5 mm) x 3/8" (9.5 mm), 3/8" (9.5 mm) x 7/16" (11.1 mm),
- 3/8" (9.5 mm) x 1/2" (12.7 mm), 3/8" (9.5 mm) x 9/16" (14.3 mm), 3/8" (9.5 mm) x 5/8" (15.9 mm),
- 3/8" (9.5 mm) x 11/16" (17.5 mm), 3/8" (9.5 mm) x 3/4" (19.0 mm), 3/8" (9.5 mm) x 13/16" (20.6 mm),
- 3/8" (9.5 mm) x 7/8" (22.2 mm), 1/4" (6.3 mm) x 5/32" (4.0 mm), 1/4" (6.3 mm) x 3/16" (4.8 mm), 1/4" (6.3 mm) x 7/32" (5.6 mm),
- 1/4" (6.3 mm) x 1/4" (6.3 mm), 1/4" (6.3 mm) x 9/32" (7.1 mm), 1/4" (6.3 mm) x 5/16" (7.9 mm), 1/4" (6.3 mm) x 11/32" (8.7 mm),
- 1/4" (6.3 mm) x 3/8" (9.5 mm), 1/4" (6.3 mm) x 7/16" (11.1 mm), 1/4" (6.3 mm) x 1/2" (12.7 mm); CrV 50BV30;
- 1/2" (12.7 mm): 17, 19, 21, 23 mm; CrV 50BV30;
- 3/8" (9.5 mm): E8, E10, E11, E12, E14, E16, E18, E20; CrV 6150;
- 1/2" (12.7 mm): (127, 254 mm), 3/8" (9.5 mm): (76, 152.4 mm), 1/4" (6.3 mm): (50.8 mm); CrV 50BV30;
- 1/2" (12.7 mm), 3/8" (9.5 mm), 1/4" (6.3 mm); CrV 50BV30;
- 3/8" (9.5 mm): 16, 21 mm; CrV 50BV30;
- 1/2" (12.7 mm): (255 mm), 3/8" (9.5 mm): (200 mm), 1/4" (6.3 mm): (155 mm); 72T; CrMo 440;
- 1/4" (6.3 mm): (150 mm); CrV 50BV30;
- 1/4" (6.3 mm) x 1/4" (6.3 mm); CrV 50BV30;
- 1/4" (6.3 mm): T10, T15, T20, T25, T27, T30, T40 (L=25 mm); AISI S2;
- 3/8" (9.5 mm): 4, 5.5, 6.5 mm (L=50 mm); AISI S2 / CrV 6150;
- 3/8" (9.5 mm): PH1, PH2, PH3 (L=50 mm); AISI S2 / CrV 6150;
- 3/8" (9.5 mm): PZ1, PZ2, PZ3 (L=50 mm); AISI S2 / CrV 6150;
- 3/8" (9.5 mm): T20, T30, T40, T45, T50, T55, T60 (L=50 mm); AISI S2 / CrV 6150;
- 3/8" (9.5 mm): 3, 4, 5, 6, 8, 10 mm (L=50 mm); AISI S2 / CrV 6150;
- 8, 9, 10, 11, 12, 13, 14, 15, 16, 17, 18, 19 mm; CrV;
- 8x10, 12x13, 17x19 mm; CrV 6140;
- 1.5, 2, 2.5, 3, 4, 5, 6, 7, 8, 10 mm; CrV 6150

YATO		
YT-38811	1/4" (6.3 mm), 3/8" (9.5 mm), 1/2" (12.7 mm)	2



EN Tool set
 PL Zestaw narzędziowy
 DE Werkzeug-Set
 RU Набор инструмента
 CZ Sada nářadí
 HU Szerszámkészlet
 RO Trusa de scule
 FR Coffret d'outillage
 IT Set di utensili
 ES Juego de herramientas
 CN 套筒组套



173 PCS	1/2" 12.7mm
3/8" 9.5mm	1/4" 6.3mm
CrV 50BV30	CrV 6150
CrV 40	CrMo 440
S2	72T
AS-DRIVE	

-  1/2" (12.7 mm): 10, 11, 12, 13, 14, 15, 16, 17, 18, 19, 20, 21, 22, 23, 24 mm (L=38 mm); 27, 30, 32 mm (L=42 mm), 3/8" (9.5 mm): 10, 11, 12, 13, 14, 15, 16 mm (L=28 mm); 17, 18, 19 mm (L=30 mm), 1/4" (6.3 mm): 4, 4.5, 5, 5.5, 6, 7, 8, 9, 10, 11, 12, 13, 14 mm (L=25 mm); CrV 50BV30;
-  1/2" (12.7 mm): 16, 17, 18, 19, 22 mm (L=76 mm), 3/8" (9.5 mm): 10, 11, 12, 13, 14, 15 mm (L=63 mm), 1/4" (6.3 mm): 4, 5, 6, 7, 8, 9, 10 mm (L=50 mm); CrV 50BV30;
-  1/2" (12.7 mm): E18, E20, E24, 3/8" (9.5 mm): E10, E11, E12, E14, E16, 1/4" (6.3 mm): E4, E5, E6, E7, E8; CrV 6150;
-  1/2" (12.7 mm): (127, 254 mm), 3/8" (9.5 mm): (152.4 mm), 1/4" (6.3 mm): (50.8, 101.6 mm); CrV 50BV30;
-  3/8" (9.5 mm) (F) x 1/2" (12.7 mm); CrV 50BV30;
-  1/2" (12.7 mm), 3/8" (9.5 mm), 1/4" (6.3 mm); CrV 50BV30;
-  1/2" (12.7 mm): 16, 21 mm, 3/8" (9.5 mm): 18 mm; CrV 50BV30;
-  1/4" (6.3 mm): (152.4 mm); CrV 40;
-  1/2" (12.7 mm); (255 mm), 3/8" (9.5 mm): (200 mm), 1/4" (6.3 mm): (155 mm); 72T; CrMo 440;
-  1/4" (6.3 mm): (150 mm); CrV 50BV30;
-  1/2" (12.7 mm) x 5/16" (7.9 mm), 3/8" (9.5 mm) x 5/16" (7.9 mm); CrV 50BV30;
-  1/4" (6.3 mm) x 1/4" (6.3 mm); CrV 50BV30;

-  5/16" (7.9 mm): 8, 10, 12 mm (L=30 mm); AISI S2;
-  5/16" (7.9 mm): PH3, PH4 (L=30 mm); AISI S2;
-  5/16" (7.9 mm): PZ3, PZ4 (L=30 mm); AISI S2;
-  5/16" (7.9 mm): T40, T45, T50, T55, T60, T70 (L=30 mm); AISI S2;
-  5/16" (7.9 mm): T40, T45, T50, T55, T60, T70 (L=30 mm); AISI S2;
-  5/16" (7.9 mm): 7, 8, 10, 12, 14 mm (L=30 mm); AISI S2;
-  1/4" (6.3 mm): T5, T6, T7 (L=25 mm); AISI S2;
-  1/4" (6.3 mm): T7, T10, T15, T20, T25, T27, T30, T40, T45 (L=25 mm); AISI S2;
-  1/4" (6.3 mm): M5, M6, M8 (L=25 mm); AISI S2;
-  1/4" (6.3 mm): RM5, RM6, RM7, RM8, RM9 (L=25 mm); AISI S2;
-  1/4" (6.3 mm) 4, 5.5, 6.5, 7 mm (L=37 mm); AISI S2 / CrV 6150;
-  1/4" (6.3 mm): PH0, PH1, PH2 (L=37 mm); AISI S2 / CrV 6150;
- 1/4" (6.3 mm) PZ0, PZ1, PZ2 (L=37 mm); AISI S2 / CrV 6150;
- 1/4" (6.3 mm): T8, T9, T10, T15, T20, T25, T27, T30 (L=37 mm); AISI S2 / CrV 6150;
- 1/4" (6.3 mm): T8, T9, T10, T15, T20, T25, T27, T30 (L=37 mm); AISI S2 / CrV 6150;
- 1/4" (6.3 mm): 3, 4, 5, 6 mm (L=37 mm); AISI S2 / CrV 6150;
- 1.25, 1.5, 2, 2.5, 3, 4, 5 mm; CrV 6150

YATO 		
YT-38881	1/4" (6.3 mm), 3/8" (9.5 mm), 1/2" (12.7 mm)	2

EN Tool set
PL Zestaw narzędziowy
DE Werkzeug-Set
RU Набор инструмента
CZ Sada nářadí
HU Szerszámkészlet
RO Trusa de scule
FR Coffret d'outillage
IT Set di utensili
ES Juego de herramientas
CN 套筒组套

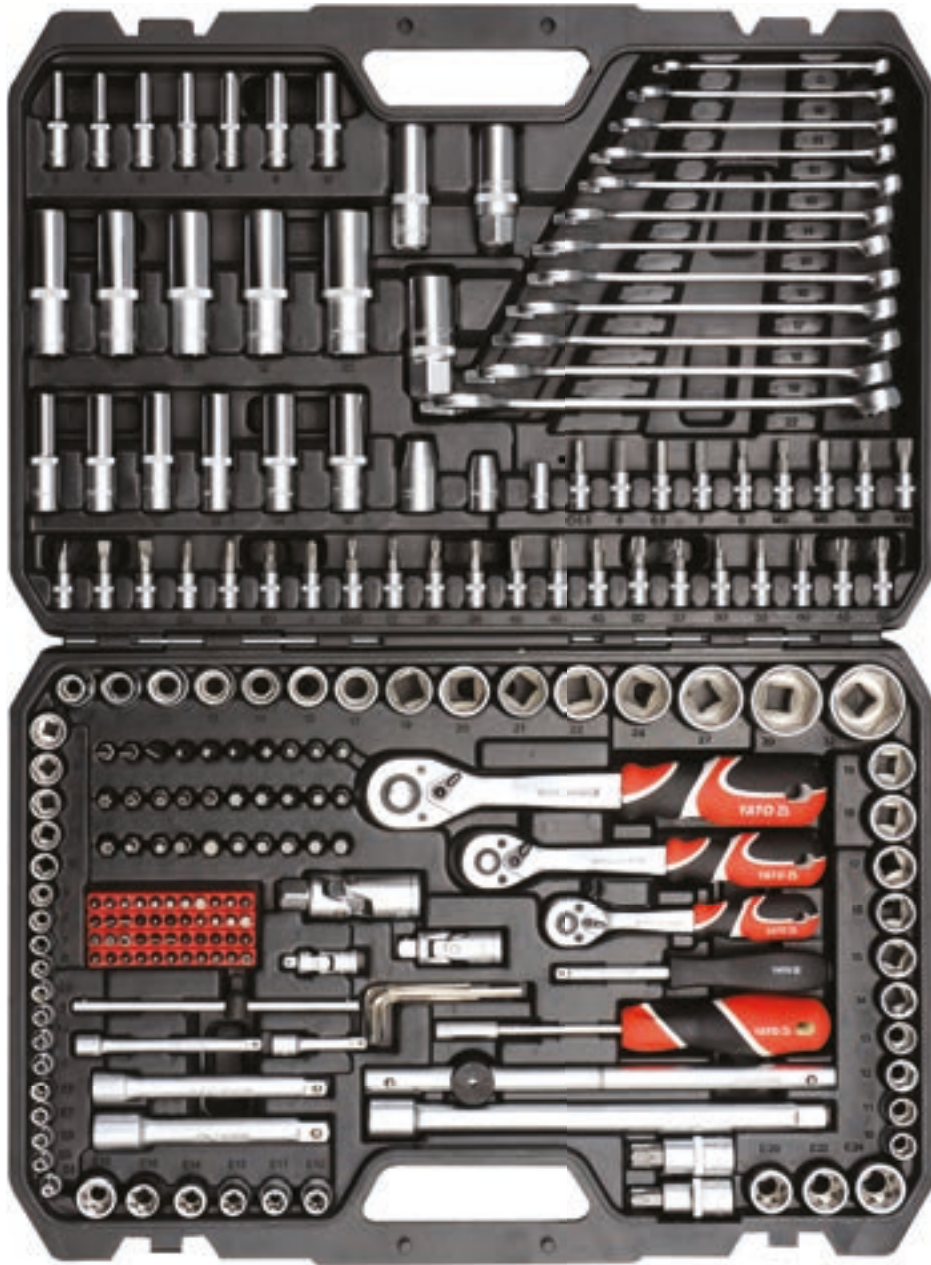

216 PCS	1/2" 12.7mm
3/8" 9.5mm	1/4" 6.3mm
CrV 50BV30	CrV 6150
CrV 40	CrMo 440
S2	72T
AS-DRIVE	

2

- 1/2" (12.7 mm): 10, 11, 12, 13, 14, 15, 17, 19, 20, 21, 22, 24 mm (L=38 mm); 27, 30, 32 mm (L=42 mm);
- 3/8" (9.5 mm): 10, 11, 12, 13, 14, 15, 16 mm (L=28 mm); 17, 18, 19 mm (L=30 mm);
- 1/4" (6.3 mm): 4, 4.5, 5, 5.5, 6, 7, 8, 9, 10, 11, 12, 13, 14 mm (L=25 mm); CrV 50BV30;
- 1/2" (12.7 mm): 16, 17, 18, 19, 22 mm (L=76 mm); 3/8" (9.5 mm): 10, 11, 12, 13, 14, 15 mm (L=63 mm);
- 1/4" (6.3 mm): 4, 5, 6, 7, 8, 9, 10 mm (L=50 mm); CrV 50BV30;
- 1/2" (12.7 mm): E20, E22, E24, 3/8" (9.5 mm): E10, E11, E12, E14, E16, E18, 1/4" (6.3 mm): E4, E5, E6, E7, E8; CrV 50BV30;
- 1/2" (12.7 mm): (127, 254 mm); 3/8" (9.5 mm): (125 mm), 1/4" (6.3 mm): (50.8, 101.6 mm); CrV 50BV30;
- 1/2" (12.7 mm); 3/8" (9.5 mm); 1/4" (6.3 mm); CrV 50BV30;
- 1/2" (12.7 mm): 16, 21 mm; 3/8" (9.5 mm): 18 mm; CrV 50BV30;
- 1/2" (12.7 mm): (255 mm); 1/4" (6.3 mm): (152.4 mm); CrV 40;
- 1/2" (12.7 mm): (255 mm); 3/8" (9.5 mm): (200 mm); 1/4" (6.3 mm): (155 mm); 72T; CrMo 440;
- 1/4" (6.3 mm): (150 mm); CrV 50BV30;
- 1/4" (6.3 mm): (200 mm);
- 1/2" (12.7 mm) x 5/16" (7.9 mm); 3/8" (9.5 mm) x 5/16" (7.9 mm); CrV 50BV30;
- 1/4" (6.3 mm) x 1/4" (6.3 mm); CrV 50BV30;
- 5/16" (7.9 mm): 6, 6.5, 8 mm (L=30 mm); AISI S2;
- 5/16" (7.9 mm): PH3, PH4 (L=30 mm); AISI S2;
- 5/16" (7.9 mm): PZ3, PZ4 (L=30 mm); AISI S2;
- 5/16" (7.9 mm): T25, T27, T30, T35, T40 x2, T45, T50 (L=30 mm); AISI S2;
- 5/16" (7.9 mm): T27, T30, T35, T40, T45, T50 (L=30 mm); AISI S2;
- 5/16" (7.9 mm): 5.5, 6, 6.5, 7, 8 mm (L=30 mm); AISI S2;
- 5/16" (7.9 mm): M5, M6, M8, M10 (L=30 mm); AISI S2;

- 1/4" (6.3 mm): 4, 5.5, 6.5 mm (L=25 mm); AISI S2;
- 1/4" (6.3 mm): PH1, PH2 (L=25 mm); AISI S2;
- 1/4" (6.3 mm): PZ1, PZ2 (L=25 mm); AISI S2;
- 1/4" (6.3 mm): T8, T10, T15, T20, T25 (L=25 mm); AISI S2;
- 1/4" (6.3 mm): T8, T10 x2, T15 x2, T20 x2, T25 x2, T40 (L=25 mm); AISI S2;
- 1/4" (6.3 mm): 3, 4, 5, 6 mm (L=25 mm); AISI S2;
- 1/4" (6.3 mm): 3, 4, 5, 6 mm (L=25 mm); AISI S2;
- 1/4" (6.3 mm): M5, M6, M8 (L=25 mm); AISI S2;
- 1/4" (6.3 mm): S1, S2 (L=25 mm); AISI S2;
- 1/4" (6.3 mm): 1, 2, 3 mm (L=25 mm); AISI S2;
- 1/4" (6.3 mm): 6, 8, 10 mm (L=25 mm); AISI S2;
- 1/4" (6.3 mm): 4, 6, 8 mm (L=25 mm); AISI S2;
- 1/2" (12.7 mm): T55, T60 (L=50 mm); AISI S2 / CrV 50BV30;
- 1/4" (6.3 mm): 6, 6.5, 8 mm (L=37 mm); AISI S2 / CrV 50BV30;
- 1/4" (6.3 mm): PH3, PH4 (L=37 mm); AISI S2 / CrV 50BV30;
- 1/4" (6.3 mm): PZ3, PZ4 (L=37 mm); AISI S2 / CrV 50BV30;
- 1/4" (6.3 mm): T25, T27, T30, T35, T40 x2, T45, T50 (L=37 mm); AISI S2 / CrV 50BV30;
- 1/4" (6.3 mm): T27, T30, T35, T40, T45, T50 (L=37 mm); AISI S2 / CrV 50BV30;
- 1/4" (6.3 mm): 5.5, 6, 6.5, 7, 8 mm (L=37 mm); AISI S2 / CrV 50BV30;
- 1/4" (6.3 mm): M5, M6, M8, M10 (L=37 mm); AISI S2 / CrV 50BV30;
- 8, 10, 11, 12, 13, 14, 15, 16, 17, 18, 19, 22 mm; CrV;
- 1.27, 1.5, 2, 2.5, 3, 4, 5 mm; CrV 6150

YATO		
YT-38841	1/4" (6.3 mm), 3/8" (9.5 mm), 1/2" (12.7 mm)	2

EN Tool set
 PL Zestaw narzędziowy
 DE Werkzeug-Set
 RU Набор инструмента
 CZ Sada nářadí
 HU Szerszámkészlet
 RO Trusa de scule
 FR Coffret d'outillage
 IT Set di utensili
 ES Juego de herramientas
 CN 套筒组套



225 PCS	1/2" 12.7mm
3/8" 9.5mm	1/4" 6.3mm
METRIC SAE	CrV 50BV30
CrV 6150	CrV 6140
CrV 40	CrMo 440
S2	72T
AS-DRIVE	

- 1/2" (12.7 mm): 10, 13, 15, 16, 17, 18, 19, 20, 21, 22, 23, 24 mm (L=38 mm); 27, 30, 32 mm (L=42 mm);
- 3/8" (9.5 mm): 10, 11, 12, 13, 14, 15, 16 mm (L=28 mm); 17, 18, 19 mm (L=30 mm);
- 1/4" (6.3 mm): 3.5, 4, 4.5, 5, 5.5, 6, 7, 8, 9, 10, 11, 12, 13, 14 mm (L=25 mm); CrV 50BV30;
- 1/2" (12.7 mm): 10, 11, 12, 13, 14, 15, 17, 19, 21 mm (L=76 mm);
- 3/8" (9.5 mm): 6, 7, 8, 9, 10 mm (L=63 mm); CrV 50BV30;
- 1/2" (12.7 mm) x 7/16" (11.1 mm), 1/2" (12.7 mm) x 1/2" (12.7 mm), 1/2" (12.7 mm) x 9/16" (14.3 mm),
- 1/2" (12.7 mm) x 5/8" (15.9 mm), 1/2" (12.7 mm) x 11/16" (17.5 mm), 1/2" (12.7 mm) x 3/4" (19.0 mm),
- 1/2" (12.7 mm) x 13/16" (20.6 mm), 1/2" (12.7 mm) x 7/8" (22.2 mm), 1/4" (6.3 mm) x 1/4" (6.3 mm),
- 1/4" (6.3 mm) x 9/32" (7.1 mm), 1/4" (6.3 mm) x 5/16" (7.9 mm), 1/4" (6.3 mm) x 11/32" (8.7 mm),
- 1/4" (6.3 mm) x 3/8" (9.5 mm); CrV 50BV30;
- 1/2" (12.7 mm): 17, 19, 21 mm; CrV 50BV30;
- 1/2" (12.7 mm): E16, E18, E20, E22, E24, 3/8" (9.5 mm): E10, E11, E12, E14,
- 1/4" (6.3 mm): E4, E5, E6, E7, E8; CrV 6150;
- 1/2" (12.7 mm): (127, 254 mm), 3/8" (9.5 mm): (76, 254 mm), 1/4" (6.3 mm): (50.8, 101.6 mm); CrV 50BV30;
- 3/8" (9.5 mm) (F) x 1/2" (12.7 mm) (M), 1/2" (12.7 mm) (F) x 3/8" (9.5 mm) (M); CrV 50BV30;
- 1/2" (12.7 mm), 3/8" (9.5 mm), 1/4" (6.3 mm); CrV 50BV30;
- 1/2" (12.7 mm): 16, 21 mm (L=64 mm); 3/8" (9.5 mm): 18 mm (L=63 mm); CrV 50BV30;
- 1/4" (6.3 mm): (152.4 mm); CrV 40;
- 1/2" (12.7 mm); (255 mm), 3/8" (9.5 mm); (200 mm), 1/4" (6.3 mm); (155 mm); 72T, CrMo 440;
- 1/4" (6.3 mm); (150 mm); CrV 50BV30;
- 1/4" (6.3 mm); (200 mm); CrV 6140;
- 1/2" (12.7 mm) x 5/16" (7.9 mm), 3/8" (9.5 mm) x 5/16" (7.9 mm),
- 3/8" (9.5 mm) x 1/4" (6.3 mm); CrV 50BV30;
- 1/4" (6.3 mm) x 1/4" (6.3 mm); CrV 50BV30;
- 1/4" (6.3 mm) x 3/8" (9.5 mm) (L=50 mm), 1/4" (6.3 mm) x 1/4" (6.3 mm) (L=50 mm),
- 1/4" (6.3 mm) x 1/4" (6.3 mm) (L=25 mm); CrV 50BV30;

- 1/4" (6.3 mm) (L=60 mm);
- 5/16" (7.9 mm): T20, T25, T27, T30, T40, T45, T50, T55 (L=75 mm); AISI S2;
- 5/16" (7.9 mm): 8, 10 mm (L=30 mm); AISI S2;
- 5/16" (7.9 mm): PH3, PH4 (L=30 mm); AISI S2;
- 5/16" (7.9 mm): PZ3, PZ4 (L=30 mm); AISI S2;
- 5/16" (7.9 mm): T40, T45, T50, T55, T60, T70 (L=30 mm); AISI S2;
- 5/16" (7.9 mm): T40, T45, T50, T55, T60, T70 (L=30 mm); AISI S2;
- 5/16" (7.9 mm): 10, 12, 14 mm (L=30 mm); AISI S2;
- 1/4" (6.3 mm): 3, 4, 5.5, 6.5, 7, 8, 9 mm (L=25 mm); AISI S2;
- 1/4" (6.3 mm): PH0, PH1, PH2, PH3 (L=25 mm); AISI S2;
- 1/4" (6.3 mm): PZ0, PZ1, PZ2, PZ3 (L=25 mm); AISI S2;
- 1/4" (6.3 mm): T8, T9, T10, T15, T20, T25, T27, T30 (L=25 mm); AISI S2;
- 1/4" (6.3 mm): T8, T9, T10, T15, T20, T25, T27, T30 (L=25 mm); AISI S2;
- 1/4" (6.3 mm): 3, 4, 5, 6, 7, 8 mm; (L=25 mm); AISI S2;
- 1/4" (6.3 mm): 3, 4, 5, 6, 7, 8 mm (L=25 mm); AISI S2;
- 1/4" (6.3 mm): 4, 5, 6, 7, 8 mm (L=25 mm); AISI S2;
- 1/4" (6.3 mm): 1, 2, 3, 4 (L=25 mm); AISI S2;
- 1/4" (6.3 mm): 6, 8, 10 (L=25 mm); AISI S2;
- 1/4" (6.3 mm): 4, 6, 8, 10 mm (L=25 mm); AISI S2;
- 8, 9, 10, 11, 12, 13, 14, 15, 17, 19, 22 mm; CrV;
- 6x38, PH2X38; S2;
- 180 mm;
- 250 mm; CrV;
- 2, 2.5, 3, 4, 5, 6, 7, 8, 10, 12 mm; CrV 6150

YATO		
YT-38941	1/4" (6.3 mm), 3/8" (9.5 mm), 1/2" (12.7 mm)	2

EN Tool set
PL Zestaw narzędziowy
DE Werkzeug-Set

RU Набор инструмента
CZ Sada nářadí
HU Szerszámkészlet





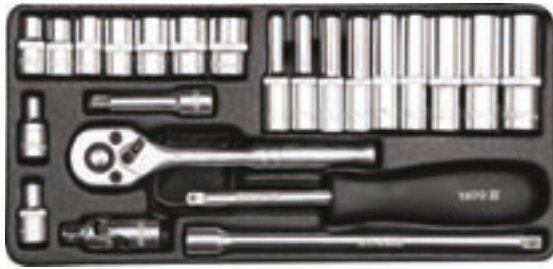

RO Trusa de scule
FR Coffret d'outillage
IT Set di utensili

ES Juego de herramientas
CN 套筒组套

23
PCS
1/4"
6.3mm
CrV
50BV30

CrV
6140
72T
AS-DRIVE

-  1/4" (6.3 mm): 4, 5, 6, 7, 8, 9, 10, 12, 13 mm (L=25 mm); CrV 50BV30;
-  1/4" (6.3 mm): 4, 5, 6, 7, 8, 9, 10, 12, 13 mm (L=50 mm); CrV 50BV30;
-  1/4" (6.3 mm): (50.8, 152.4 mm); CrV 50BV30;
-  1/4" (6.3 mm); CrV 50BV30;
-  1/4" (6.3 mm); (127 mm); 72T; CrV 6140;
-  1/4" (6.3 mm); (150 mm); CrV 50BV30

YATO	○	
YT-14421	1/4" (6.3 mm)	10

EN Go through socket set
PL Zestaw nasadek przelotowych z grzechotką
DE Ratschensteckschlüsselsatz

RU Набор проходных головок с трещоткой
CZ Sada nářadových koncovek s řáčnou
HU Dugókulcs készlet racsnival

RO Set tubulare pt. suruburi lungi
FR Jeu de douilles traversantes avec cliquet
IT Set di bussole con chiave a cricchetto













ES Juego de puntas de paso de trinquete
CN 穿心套筒组套

29
PCS
1/4"
6.3mm

CrV
50BV30
S2
72T

QUICK
RELEASE
SZYBKO-
ZŁĄCZE



-  4.5, 5, 5.5, 6, 7, 8, 9, 10, 11, 12, 13 mm; CrV 50BV30;
-  1/4" (6.3 mm); (L=100 mm); CrV 50BV30;
-  1/4" (6.3 mm); CrV 50BV30;
-  1/4" (6.3 mm); (L=142 mm); 72T; CrV 50BV30;
-  1/4" (6.3 mm); CrV 50BV30;
-  1/4" (6.3 mm); CrV 50BV30;
-  1/4" (6.3 mm) x 1/4" (6.3 mm); CrV 50BV30;
-  1/4" (6.3 mm); CrV 50BV30;
-  (L=50 mm); CrV 50BV30;
-  1/4" (6.3 mm); 4, 5, 7 mm; S2;
-  1/4" (6.3 mm); PH1, PH2; S2;
-  1/4" (6.3 mm); PZ1, PZ2; S2;
-  1/4" (6.3 mm); T10, T15, T20; S2

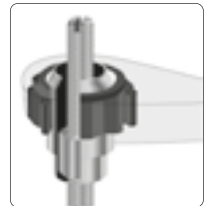

YATO	○	
YT-38650	1/4" (6.3 mm)	20

EN Tool set
PL Zestaw narzędziowy
DE Werkzeug-Set







RU Набор инструмента
CZ Sada nářadí
HU Szerszámkészlet

RO Trusa de scule
FR Coffret d'outillage
IT Set di utensili

ES Juego de herramientas
CN 套筒组套

25
PCS
1/2"
12.7mm
CrV
50BV30
CrV
6140
72T
AS-DRIVE



-  1/2" (12.7 mm): 10, 11, 12, 13, 14, 15, 16, 17, 18, 19, 20, 21, 22, 23, 24 mm (L=38 mm); 27, 30, 32 mm (L=42 mm); CrV 50BV30;
-  1/2" (12.7 mm); (50, 125 mm); CrV 50BV30;
-  1/2" (12.7 mm): 16, 21 mm; CrV 50BV30;
-  1/2" (12.7 mm); (250 mm); CrV 50BV30;
-  1/2" (12.7 mm); (250 mm); 72T; CrV 6140;
-  1/2" (12.7 mm); (317 mm); CrV 50BV30

YATO	○	
YT-12671	1/2" (12.7 mm)	5

EN Go through socket set
PL Zestaw nasadek przelotowych z grzechotką
DE Ratschensteckschlüsselsatz

RU Набор проходных головок с трещоткой
CZ Sada nářadových koncovek s řáčnou
HU Dugókulcs készlet racsnival





RO Set tubulare pt. suruburi lungi
FR Jeu de douilles traversantes avec cliquet
IT Set di bussole con chiave a cricchetto

ES Juego de puntas de paso de trinquete
CN 穿心套筒组套

17
PCS
1/2"
12.7mm
3/8"
9.5mm

CrV
50BV30
72T
QUICK
RELEASE
SZYBKO-
ZŁĄCZE



-  10, 11, 12, 13, 14, 15, 16, 17, 18, 19, 21, 22, 24 mm; CrV 50BV30;
-  (L=195 mm); 72T; CrV 50BV30;
-  (L=76 mm); CrV 50BV30;
-  1/2" (12.7 mm), 3/8" (9.5 mm); CrV 50BV30

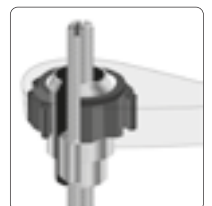

YATO	○	
YT-38653	3/8" (9.5 mm), 1/2" (12.7 mm)	10

EN Tool set
 PL Zestaw narzędziowy
 DE Werkzeug-Set
 RU Набор инструментов
 CZ Sada nářadí
 HU Szerszámkészlet
 RO Trusa de scule
 FR Coffret d'outillage
 IT Set di utensili
 ES Juego de herramientas
 CN 套筒组套



44 PCS 1/4" 6.3mm

CrV S2 SK2

- 6x7, 8x9, 10x11, 12x13, 14x15 mm;
- 1/4" (6.3 mm): 3, 4, 5, 5.5, 6 mm (L=25 mm); AISI S2;
- 1/4" (6.3 mm): PH1, PH2, PH3 (L=25 mm); AISI S2;
- 1/4" (6.3 mm): T8, T10, T15, T20, T25, T27 (L=25 mm); AISI S2;
- 1/4" (6.3 mm): 2, 2.5, 3, 4, 5, 6 mm (L=25 mm); AISI S2;
- 160 mm;
- 160 mm;
- 200 mm;
- 300 g (L=300 mm);
- 3 m x 16 mm;
- 18 mm; SK2;
- 1/4" (6.3 mm); CrV;
- 5x75, 6x100, PH2x100 mm; S2;
- 1.5, 2, 2.5, 3, 4, 5, 6, 8, 10 mm; CrV 6150



YATO	○	
YT-39280	1/4" (6.3 mm)	4

EN Tool set for electricians
 PL Zestaw narzędziowy dla elektryków
 DE Werkzeug-Set für Elektriker
 RU Набор инструментов для электриков
 CZ Sada nářadí pro elektrikáře
 HU Szerszámkészlet villanyszerelők

RO Trusa electrician
 FR Ensemble d'outils pour les électriciens
 IT Set per l'elettricista
 ES Conjunto de herramientas para electricistas
 CN 高档电讯组套



0-500V D.C. 0-500V A.C. 0-5 A D.C. 0-2 MΩ

125-250 V- 50-500 Hz LCD

30 W 230V-50Hz 400 °C TIP

68 PCS 1/4" 6.3mm

CrV 50BV30 CrV 6150

S2 1000 V

- 1/4" (6.3 mm): 4, 4.5, 5, 5.5, 6, 7, 8, 9, 10, 11, 12, 13 mm (L=25 mm); CrV 50BV30;
- 140 mm;
- 190 mm; 3CRB;
- 150 mm;
- 160 mm; 1000 V; CrV;
- 160 mm; 1000 V; CrV;
- 3 m x 16 mm;
- 175 mm;
- 19.5 x 190 mm;
- 1.5 V; 9 LED;
- 9 mm;
- 19 mm x 20 mm;
- 1/4" (6.3 mm); (150 mm); CrV 50BV30;
- 1/4" (6.3 mm) x 1/4" (6.3 mm); CrV 6140;
- 10 g;
- 1.4, 2.0, 2.4 mm; PH00, PH0, PH1; S2;
- 4x100, 5.5x125, PH1x80, PH2x100 mm; 1000V; S2;
- 1/4" (6.3 mm): 3, 4, 5, 5.5, 6 mm (L=25 mm); AISI S2;
- 1/4" (6.3 mm): PH1, PH2, PH3 (L=25 mm); AISI S2;
- 1/4" (6.3 mm): T8, T10, T15, T20, T25, T27 (L=25 mm); AISI S2;
- 1/4" (6.3 mm): 2, 2.5, 3, 4, 5, 6 (L=25 mm); AISI S2;
- 1.5, 2, 2.5, 3, 4, 5, 6, 7, 8, 10 mm; CrV 6150

YATO	○	
YT-39009	1/4" (6.3 mm)	2

EN Torx socket
 PL Nasadka Torx
 DE Torx-Steckschlüssel
 RU Голонка
 CZ Nástavec Torx
 HU Dugókulcs Torx
 RO Cheie tubulară Torx
 FR Douille Torx
 IT Bullone Torx
 ES Boquilla Torx
 CN 星型套筒



1/4" 6.3mm

CrV 50BV30

EN Torx socket
 PL Nasadka Torx
 DE Torx-Steckschlüssel
 RU Голонка
 CZ Nástavec Torx
 HU Dugókulcs Torx
 RO Cheie tubulară Torx
 FR Douille Torx
 IT Bullone Torx
 ES Boquilla Torx
 CN 星型套筒

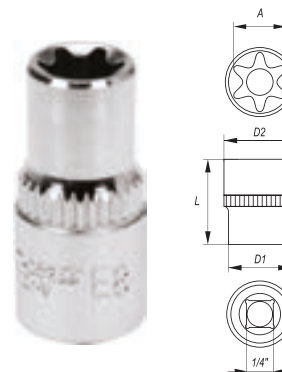

1/4" 6.3mm

DIN 2124

CrV 50BV30

YATO	A	D1 [mm]	D2 [mm]	L [mm]	PCS	
YT-05211	E4	11.9	6.7	25	24	240/480
YT-05212	E5	11.9	7.2	25	24	240/480
YT-05213	E6	11.9	8.3	25	24	240/480
YT-05214	E7	11.9	9.4	25	24	240/480
YT-05215	E8	11.9	10	25	24	240/480

YATO	A	D1 [mm]	D2 [mm]	L [mm]	
YT-05244	E8	11.9	10	25	6/360

EN Torx socket set
PL Klucze nasadowe Torx
DE Torx-Steckschlüsselsatz
RU Набор роторов
CZ Nástrčné klíče
HU Dugókulcsok Torx

RO Trusa tubulara
FR Clés à tube
IT Chiavi a bussola bulloni Torx
ES Llaves de vaso
CN 星型套筒组套

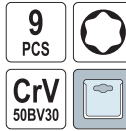

1/4" (6.3 mm): E5, E6, E7, E8, 3/8" (9.5 mm): E10, E12, E14, E16;
1/4" (6.3 mm) (M) x 3/8" (9.5 mm) (F)

YATO	Ø	PCS
YT-0520	1/4" (6.3 mm)	10/40

EN Torx socket
PL Nasadka Torx
DE Torx-Steckschlüssel
RU Голонка
CZ Nástavec Torx
HU Dugókulcs Torx
RO Cheie tubulară Torx
FR Douille Torx
IT Bullone Torx
ES Boquilla Torx
CN 星型套筒

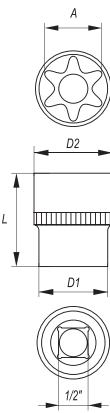

YATO	Ø A	D1 [mm]	D2 [mm]	L [mm]	PCS
YT-05245	E10	21.8	13.1	38	6/180
YT-05246	E11	21.8	13.9	38	6/180
YT-05247	E12	21.8	14.9	38	6/180
YT-05248	E14	21.8	16.3	38	6/180
YT-05249	E16	21.8	18.2	38	6/180
YT-05250	E18	23.8	19.4	38	6/180
YT-05251	E20	21.8	23.9	38	6/180

EN Hexagonal socket
PL Nasadka sześciokątna
DE Sechskantenschlüssel
RU Головка шестигранная короткая
CZ Šestihranný nástavec
HU Dugókulcs hatszög

RO Cheie tubulară hexagonală
FR Douille courte
IT Chiave a bussola esagonale
ES Boquilla hexagonal corta
CN 六角套筒



- Application: industry, car service stations and workshops
- For high loads
- Drive locks
- Surface finish: chromed, satin

- Przeznaczenie: przemysł, serwisy i warsztaty
- Do największych obciążeń
- Zamki blokujące
- Wykończenie powierzchni: chromowana, satynowa

YATO	Ø A [mm]	D1 [mm]	D2 [mm]	L [mm]	PCS
YT-1301	19	30	36	50	12
YT-1302	21	32	36	50	12
YT-1303	22	32	36	50	12
YT-1304	23	34	36	50	12
YT-1305	24	34	36	50	12
YT-1306	25	36	36	50	12
YT-1307	26	37	34	50	12
YT-1308	27	38	34	50	12
YT-1309	28	40	34	50	12
YT-1310	29	40	35	50	12
YT-1311	30	42	36	55	8
YT-1312	32	44	37	55	8
YT-1313	33	46	38	55	8

EN Torx socket
PL Nasadka Torx
DE Torx-Steckschlüssel
RU Голонка
CZ Nástavec Torx
HU Dugókulcs Torx
RO Cheie tubulară Torx
FR Douille Torx
IT Bullone Torx
ES Boquilla Torx
CN 星型套筒

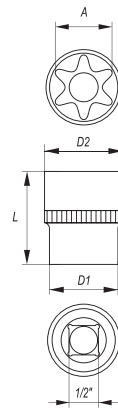

YATO	Ø A	D1 [mm]	D2 [mm]	L [mm]	PCS
YT-05220	E10	21.8	13.1	38	12
YT-05221	E11	21.8	13.9	38	12
YT-05222	E12	21.8	14.9	38	12
YT-05223	E14	21.8	16.3	38	12
YT-05224	E16	21.8	18.2	38	12
YT-05225	E18	23.8	19.4	38	12
YT-05226	E20	21.8	23.9	38	12
YT-05227	E22	23.2	25.7	38	12
YT-05228	E24	23.8	27.8	38	12

EN Torx socket set
PL Klucze nasadowe Torx
DE Torx-Steckschlüsselsatz
RU Набор роторов
CZ Nástrčné klíče
HU Dugókulcsok Torx

RO Trusa tubulara
FR Clés à tube
IT Chiavi a bussola bulloni Torx
ES Llaves de vaso
CN 星型套筒组套



1/2" (12.7 mm): E10, E11, E12, E14, E16, E18, E20, E22, E24

YATO	Ø	PCS
YT-0521	1/2" (12.7 mm)	20

3/4" 19mm DIN 3121 CrV 50BV30 AS-DRIVE

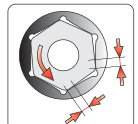
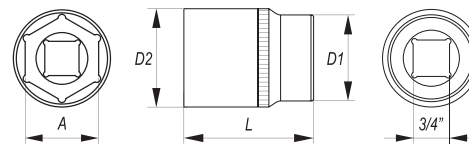

YATO	Ø A [mm]	D1 [mm]	D2 [mm]	L [mm]	PCS
YT-1314	34	47	38	55	8
YT-1315	35	48	42	60	6
YT-1316	36	50	42	60	6
YT-1317	38	52	45	60	6
YT-1318	41	56	45	65	4
YT-1319	42	57	45	65	4
YT-1320	43	58	45	65	4
YT-1322	46	62	48	70	4
YT-1323	48	64	48	70	4
YT-1324	50	68	48	70	4
YT-1326	52	70	48	70	4
YT-1328	55	73	48	75	4
YT-1330	60	80	48	80	4

- EN Extension bar
- PL Przedłużka
- DE Verlängerung
- RU Удлинитель для воротка
- CZ Prodlužovací příravek
- HU Toldalék
- RO Prelungitor
- FR Rallonge
- IT Prolunga
- ES Tubo de prolongación
- CN 接杆



3/4"
19 mm

DIN
3121

CrV
50BV30

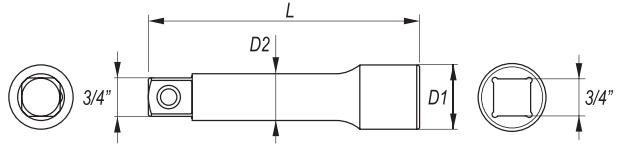

YATO	Ø	D1 [mm]	D2 [mm]	L [mm]	PCS PKBIE	Icon
YT-1340	3/4" (19.0 mm)	36	22	100	6	36
YT-1341	3/4" (19.0 mm)	36	22	200	5	20
YT-1342	3/4" (19.0 mm)	36	22	400	5	10

- EN Adapter
- PL Redukcja
- DE Reduktion
- RU Переходник
- CZ Redukce
- HU Redukció
- RO Reducție
- FR Réduction
- IT Riduttore
- ES Reducción
- CN 转换头

3/4"
19 mm

DIN
3121

CrV
50BV30

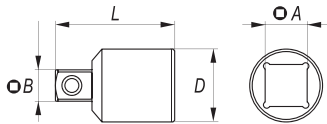

YATO	Ø A	Ø B	D [mm]	L [mm]	PCS PKBIE	Icon
YT-1355	3/4" (19.0 mm) (F)	1/2" (12.7 mm) (M)	36	53	12	48

- EN Universal joint
- PL Przegub Cardana
- DE Kardangelenk
- RU Карданный шарнир
- CZ Kardanový kloub
- HU Kardán csukló
- RO Articulație Cardanică
- FR Cardan
- IT Snodo cardanico
- ES Articulación Cardan
- CN 万向接头

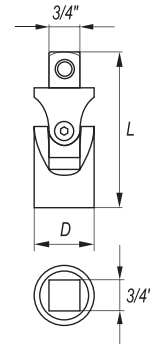

3/4"
19 mm

DIN
3121

CrV
50BV30

YATO	Ø	D [mm]	L [mm]	PCS PKBIE	Icon
YT-1352	3/4" (19.0 mm)	40	106	12	36

- EN Sliding T-bar
- PL Pokrętko typu „T”
- DE Handgriff mit Gleitstück
- RU Вороток Т-образный
- CZ Otočná račká typ „T”
- HU „T” alakú hajtókar
- RO Mâner clupă tipul „T”
- FR Barre type „T”
- IT Manopola „T” scorrevole
- ES Mango tipo „T”
- CN 滑行杆

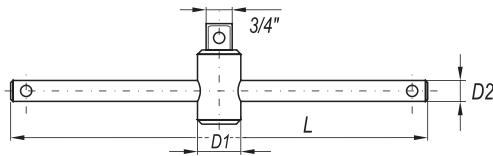

YATO	Ø	D1 [mm]	D2 [mm]	L [mm]	PCS PKBIE	Icon
YT-1350	3/4" (19.0 mm)	37	20	500	5	10

3/4"
19 mm

DIN
3121

CrV
50BV30

- EN Flexible handle
- PL Pokrętko łamane
- DE Gelenkgriff
- RU Вороток шарнирный
- CZ Otočná lomená račká
- HU Hajlított hajtókar
- RO Prelungitor cu prindere flexibilă
- FR Barre pivotante
- IT Manopola a snodo
- ES Mango articulado
- CN 转向手柄

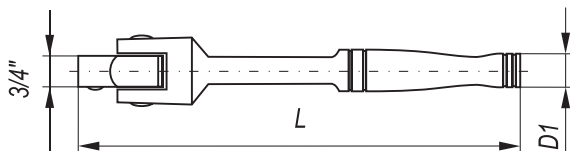

YATO	Ø	D [mm]	L [mm]	PCS PKBIE	Icon
YT-1345	3/4" (19.0 mm)	25	507	5	10

3/4"
19 mm

DIN
3121

CrV
50BV30

EN L-type handle
PL Pokrętko typu „L”
DE Admutternschlüssel
RU Вороток тип „L”
CZ Páka zahnutá
HU „L” alakú hajtókar

RO Mâner clupă tipul „L”
FR Barre type „L”
IT Leva tipo „L”
ES Mango tipo „L”
CN L型扳手

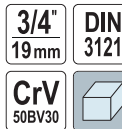

EN L-type handle
PL Pokrętko typu „L”
DE Admutternschlüssel
RU Вороток тип „L”
CZ Páka zahnutá
HU „L” alakú hajtókar

RO Mâner clupă tipul „L”
FR Barre type „L”
IT Leva tipo „L”
ES Mango tipo „L”
CN L型扳手

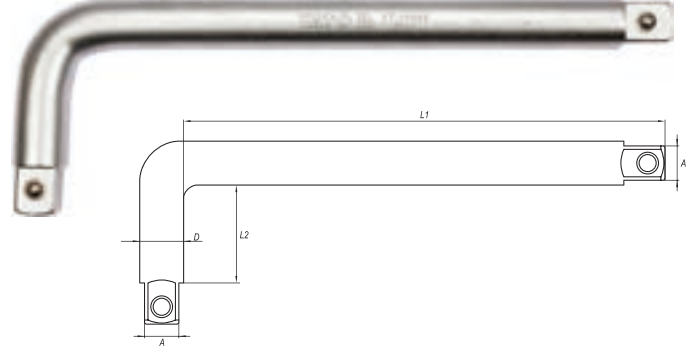
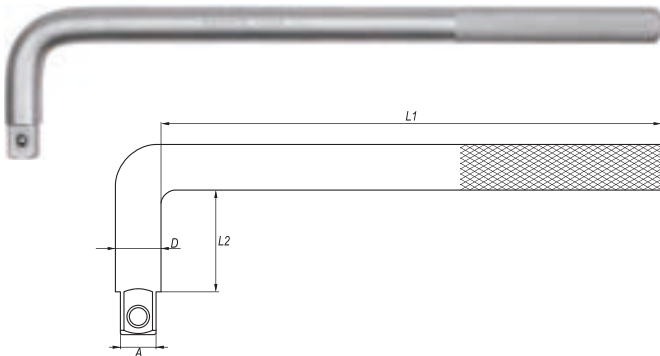
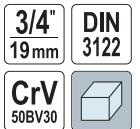

YATO	Ø	D [mm]	L1 [mm]	L2 [mm]	PCS ROUNE	
YT-1347	3/4" (19.0 mm)	25	360	75	5	10
YT-1348	3/4" (19.0 mm)	25	410	75	5	10

YATO	Ø	D [mm]	L1 [mm]	L2 [mm]	
YT-13465	3/4" (19.0 mm)	25	275	75	2/12
YT-13475	3/4" (19.0 mm)	25	373	75	2/8
YT-13490	3/4" (19.0 mm)	25	578	75	2/8

EN Quick release ratchet handle
PL Grzechotka
DE Hebelumschaltknarre
RU Трещотка
CZ Ráčna
HU Racsnis hajtókar
RO Dispozitiv de prindere cu cichet
FR Clé à cliquet
IT Cricchetto bussola
ES Carraca
CN 快速脱落棘轮扳手

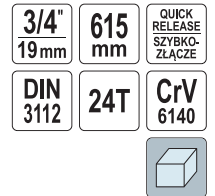

YATO	Ø	T	L [mm]	
YT-1360	3/4" (19.0 mm)	24	615	10

EN Socket set
PL Komplet nasadek z akcesoriami
DE Sechskantenschlüssel-Einsatz
RU Набор торцевых головок
CZ Sada nástrčných klíčů a ráčny
HU Dugókulcs készlet racsnis hajtókarral
RO Trusa de scule
FR Set de douilles + accessoires
IT Serie di chiavi a con accessori
ES Juego de boquillas con accesorios
CN 套筒扳手套



3/4" (19.0 mm): 30, 32, 34 (L=55 mm); 36, 38 (L=60 mm); 41 (L=65 mm); 46, 50 (L=70 mm); 55 (L=75 mm); 60 mm (L=80 mm); CrV 50BV30;
3/4" (19.0 mm): (L=100, 200 mm); CrV 50BV30;
3/4" (19.0 mm): (L=106 mm); CrV 50BV30;
3/4" (19.0 mm): (L=500 mm); CrV 50BV30;
3/4" (19.0 mm): (L=500 mm); 24T; CrV 6140

YATO	Ø	
YT-1334	3/4" (19.0 mm)	1

EN Socket set
PL Komplet nasadek z akcesoriami
DE Sechskantenschlüssel-Einsatz
RU Набор торцевых головок
CZ Sada nástrčných klíčů a ráčny
HU Dugókulcs készlet racsnis hajtókarral
RO Trusa de scule
FR Set de douilles + accessoires
IT Serie di chiavi a con accessori
ES Juego de boquillas con accesorios
CN 套筒扳手套



3/4" (19.0 mm): 19, 21, 22, 24 mm (L=50 mm); 26, 27, 28 mm (L=52 mm); 30, 32 mm (L=53 mm); 33, 34 mm (L=56 mm); 36 mm (L=58 mm); 38 mm (L=60 mm); 41 mm (L=64 mm); 46 mm (L=68 mm); 50 mm (L=72mm); CrV 50BV30;
3/4" (19.0 mm): (L=100, 200 mm); CrV 50BV30;
3/4" (19.0 mm): (L=500 mm); CrV 50BV30;
3/4" (19.0 mm): (L=620 mm); CrV 6140

YATO	Ø	
YT-1335	3/4" (19.0 mm)	1

EN Bit socket
 PL Klucz trzpieniowy
 DE Bit-Stecknuss
 RU Головка торцевая с вставкой
 CZ Hlavice s bitem
 HU Csapkulcs
 RO Chei cu cozi
 FR Douille tournevis
 IT Chiavi a bussola a giravite
 ES Llave de mandril
 CN 星型旋具套筒

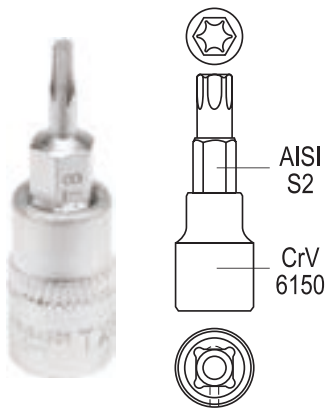

1/4"
6.3mm
AISI S2 **CrV 6150**
HRC 58-62 **DIN 3120**

EN Bit socket
 PL Klucz trzpieniowy
 DE Bit-Stecknuss
 RU Головка торцевая с вставкой
 CZ Hlavice s bitem
 HU Csapkulcs
 RO Chei cu cozi
 FR Douille tournevis
 IT Chiavi a bussola a giravite
 ES Llave de mandril
 CN 六角旋具套筒

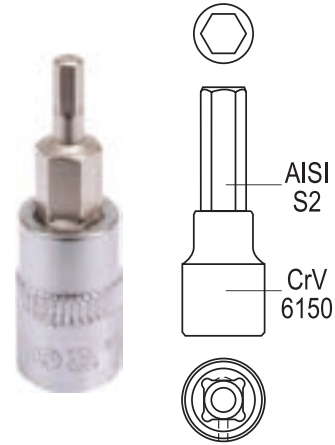

1/4"
6.3mm
AISI S2 **CrV 6150**
HRC 58-62 **DIN 3120**

YATO	Ø	⊕	L [mm]	[Nm]	☐
YT-04301	1/4" (6.3 mm)	T8	37	2.6	150/600
YT-04302	1/4" (6.3 mm)	T10	37	4.6	150/600
YT-04303	1/4" (6.3 mm)	T15	37	7.7	150/600
YT-04304	1/4" (6.3 mm)	T20	37	12.7	150/600
YT-04305	1/4" (6.3 mm)	T25	37	19.0	150/600
YT-04306	1/4" (6.3 mm)	T30	37	37.4	150/600
YT-04307	1/4" (6.3 mm)	T40	37	65.0	150/600

YATO	Ø	⊙ [mm]	L [mm]	[Nm]	☐
YT-04370	1/4" (6.3 mm)	3	37	6.6	150/600
YT-04371	1/4" (6.3 mm)	4	37	16.0	150/600
YT-04372	1/4" (6.3 mm)	5	37	30.0	150/600
YT-04373	1/4" (6.3 mm)	6	37	52.2	150/600
YT-04374	1/4" (6.3 mm)	7	37	78.0	150/600
YT-04375	1/4" (6.3 mm)	8	37	120.0	150/600

EN Bit socket
 PL Klucz trzpieniowy
 DE Bit-Stecknuss
 RU Головка торцевая с вставкой
 CZ Hlavice s bitem
 HU Csapkulcs
 RO Chei cu cozi
 FR Douille tournevis
 IT Chiavi a bussola a giravite
 ES Llave de mandril
 CN 十字旋具套筒

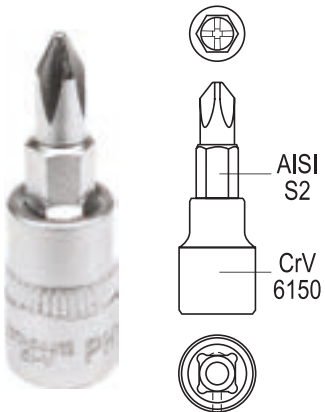

1/4"
6.3mm
AISI S2 **CrV 6150**
HRC 58-62 **DIN 3120**

EN Bit socket
 PL Klucz trzpieniowy
 DE Bit-Stecknuss
 RU Головка торцевая с вставкой
 CZ Hlavice s bitem
 HU Csapkulcs
 RO Chei cu cozi
 FR Douille tournevis
 IT Chiavi a bussola a giravite
 ES Llave de mandril
 CN 十字旋具套筒

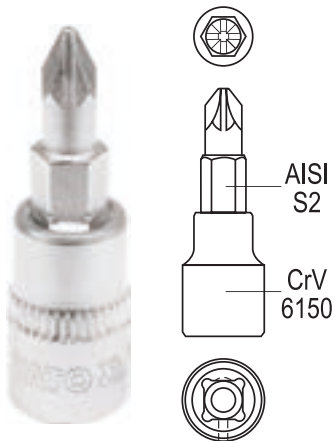

1/4"
6.3mm
AISI S2 **CrV 6150**
HRC 58-62 **DIN 3120**

YATO	Ø	⊕	L [mm]	[Nm]	☐
YT-04411	1/4" (6.3 mm)	PH1	37	3.5	150/600
YT-04412	1/4" (6.3 mm)	PH2	37	8.2	150/600
YT-04413	1/4" (6.3 mm)	PH3	37	19.5	150/600

YATO	Ø	⊕	L [mm]	[Nm]	☐
YT-04417	1/4" (6.3 mm)	PZ1	37	3.5	150/600
YT-04418	1/4" (6.3 mm)	PZ2	37	8.2	150/600

EN Insulated bit socket
 PL Klucz trzpieniowy izolowany
 DE Bit-Stecknuss vollisoliert
 RU Головка торцевая изолированная
 CZ Hlavice s bitem izolovaná
 HU Csapkulcs
 RO Chei cu cozi izolat
 FR Douille tournevis isolée
 IT Chiavi a bussola isolato
 ES Llave de mandril aislante
 CN 绝缘六角旋具套筒



3/8"
9.5mm **CrV**
1000 V

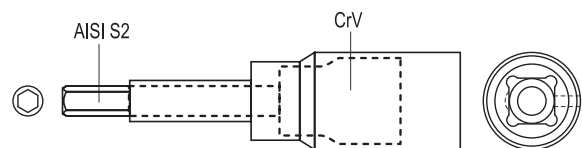

YATO	Ø	⊙ [mm]	L [mm]	[Nm]	☐
YT-21080	3/8" (9.5 mm)	4	75	16	12/144
YT-21081	3/8" (9.5 mm)	5	75	30	12/144
YT-21082	3/8" (9.5 mm)	6	75	52	12/144
YT-21083	3/8" (9.5 mm)	8	75	120	12/144

1000 V
 VDE CERTIFICATE
 EN 60900:2012

EN Bit socket
PL Klucz trzpieniowy
DE Bit-Stecknuss
RU Головка торцевая с вставкой
CZ Hlavice s bitem
HU Csapkulcs
RO Chei cu cozi
FR Douille tournevis
IT Chiavi a bussola a giravite
ES Llave de mandril
CN 六角旋具套筒

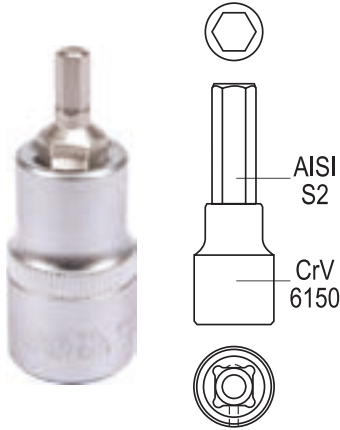

YATO	Ø	◎ [mm]	L [mm]	[Nm]	☐
YT-04381	1/2" (12.7 mm)	5	55	30	40/240
YT-04382	1/2" (12.7 mm)	6	55	52	40/240
YT-04383	1/2" (12.7 mm)	7	55	78	40/240
YT-04384	1/2" (12.7 mm)	8	55	120	40/240
YT-04385	1/2" (12.7 mm)	10	55	220	40/160
YT-04386	1/2" (12.7 mm)	12	55	370	40/160
YT-04387	1/2" (12.7 mm)	14	55	590	40/160
YT-04388	1/2" (12.7 mm)	17	55	1000	40/160

EN Bit socket
PL Klucz trzpieniowy
DE Bit-Stecknuss
RU Головка торцевая с вставкой
CZ Hlavice s bitem
HU Csapkulcs
RO Chei cu cozi
FR Douille tournevis
IT Chiavi a bussola a giravite
ES Llave de mandril
CN 六角旋具套筒

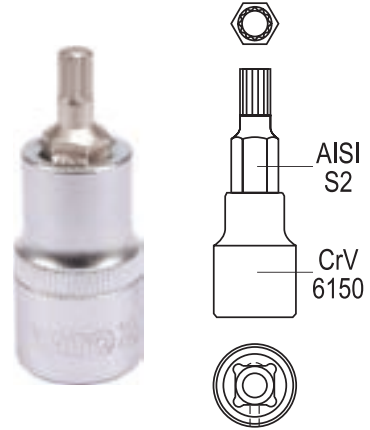
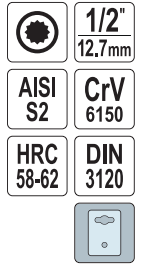

YATO	Ø	◎	L [mm]	[Nm]	☐
YT-04341	1/2" (12.7 mm)	M6	55	30	40/240
YT-04342	1/2" (12.7 mm)	M8	55	52	40/240
YT-04343	1/2" (12.7 mm)	M10	55	120	40/160
YT-04344	1/2" (12.7 mm)	M12	55	220	40/160
YT-04345	1/2" (12.7 mm)	M14	55	370	40/160
YT-04346	1/2" (12.7 mm)	M16	55	590	40/160

EN Bit socket
PL Klucz trzpieniowy
DE Bit-Stecknuss
RU Головка торцевая с вставкой
CZ Hlavice s bitem
HU Csapkulcs
RO Chei cu cozi
FR Douille tournevis
IT Chiavi a bussola a giravite
ES Llave de mandril
CN 星型旋具套筒

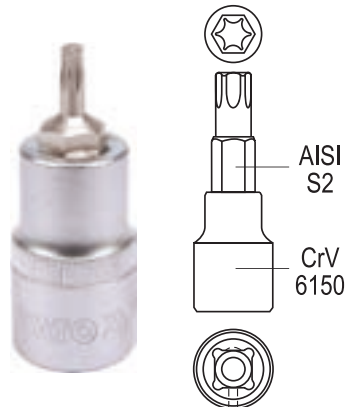
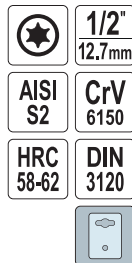

YATO	Ø	◎	L [mm]	[Nm]	☐
YT-04310	1/2" (12.7 mm)	T20	55	12.7	40/240
YT-04311	1/2" (12.7 mm)	T25	55	19.0	40/240
YT-04312	1/2" (12.7 mm)	T27	55	27.0	40/240
YT-04313	1/2" (12.7 mm)	T30	55	37.4	40/240
YT-04314	1/2" (12.7 mm)	T40	55	65.0	40/240
YT-04315	1/2" (12.7 mm)	T45	55	103.5	40/240
YT-04316	1/2" (12.7 mm)	T50	55	159.0	40/240
YT-04317	1/2" (12.7 mm)	T55	55	257.0	40/240
YT-04318	1/2" (12.7 mm)	T60	55	445.0	40/160
YT-04319	1/2" (12.7 mm)	T70	55	700.0	40/160

EN Bit socket
PL Klucz trzpieniowy
DE Bit-Stecknuss
RU Головка торцевая с вставкой
CZ Hlavice s bitem
HU Csapkulcs
RO Chei cu cozi
FR Douille tournevis
IT Chiavi a bussola a giravite
ES Llave de mandril
CN 六角旋具套筒

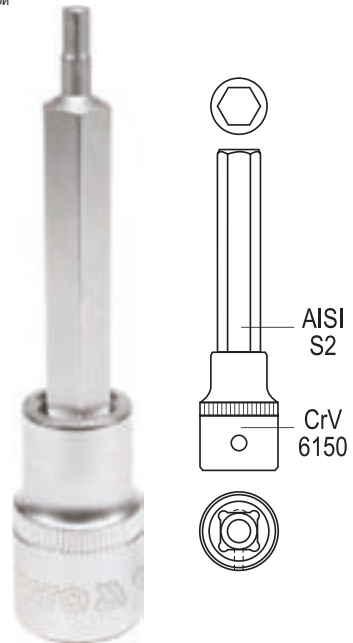
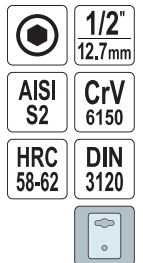

YATO	Ø	◎ [mm]	L [mm]	[Nm]	☐
YT-04390	1/2" (12.7 mm)	4	100	16	20/120
YT-04391	1/2" (12.7 mm)	5	100	30	20/120
YT-04392	1/2" (12.7 mm)	6	100	52	20/120
YT-04393	1/2" (12.7 mm)	7	100	78	20/120
YT-04394	1/2" (12.7 mm)	8	100	120	20/120
YT-04395	1/2" (12.7 mm)	10	100	220	20/120
YT-04396	1/2" (12.7 mm)	12	100	370	20/120
YT-04397	1/2" (12.7 mm)	14	100	590	20/120
YT-04398	1/2" (12.7 mm)	17	100	1000	20/120

- EN Bit socket
- PL Klucz trzpieniowy
- DE Bit-Stecknuss
- RU Головка торцевая с вставкой
- CZ Hlavice s bitem
- HU Csapkulcs
- RO Chei cu cozi
- FR Douille tournevis
- IT Chiavi a bussola a giravite
- ES Llave de mandril
- CN 星型旋具套筒

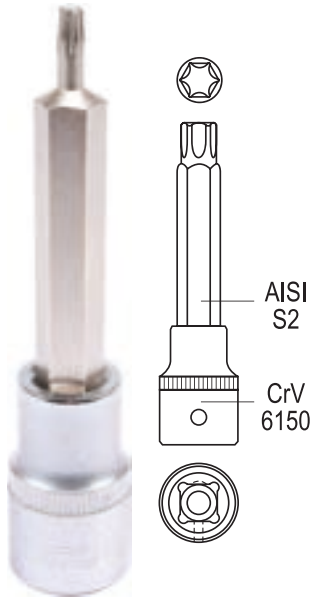

1/2"
12.7mm

AISI S2 **CrV 6150**

HRC 58-62 **DIN 3120**

AISI S2
CrV 6150

- EN Bit socket
- PL Klucz trzpieniowy
- DE Bit-Stecknuss
- RU Головка торцевая с вставкой
- CZ Hlavice s bitem
- HU Csapkulcs
- RO Chei cu cozi
- FR Douille tournevis
- IT Chiavi a bussola a giravite
- ES Llave de mandril
- CN 十二角旋具套筒

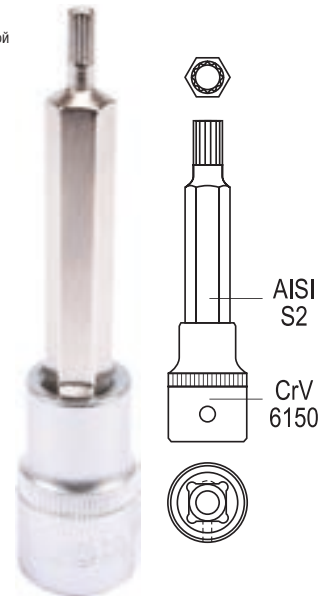

1/2"
12.7mm

AISI S2 **CrV 6150**

HRC 58-62 **DIN 3120**

AISI S2
CrV 6150

YATO	Ø	⊙	L [mm]	[Nm]	
YT-04320	1/2" (12.7 mm)	T20	100	12.7	20/120
YT-04321	1/2" (12.7 mm)	T25	100	19.0	20/120
YT-04322	1/2" (12.7 mm)	T27	100	27.0	20/120
YT-04323	1/2" (12.7 mm)	T30	100	37.4	20/120
YT-04324	1/2" (12.7 mm)	T40	100	65.0	20/120
YT-04325	1/2" (12.7 mm)	T45	100	103.5	20/120
YT-04326	1/2" (12.7 mm)	T50	100	159.0	20/120
YT-04327	1/2" (12.7 mm)	T55	100	257.0	20/120
YT-04328	1/2" (12.7 mm)	T60	100	445.0	20/120
YT-04329	1/2" (12.7 mm)	T70	100	700.0	20/120

YATO	Ø	⊙	L [mm]	[Nm]	
YT-04350	1/2" (12.7 mm)	M5	100	16	20/120
YT-04351	1/2" (12.7 mm)	M6	100	30	20/120
YT-04352	1/2" (12.7 mm)	M8	100	52	20/120
YT-04353	1/2" (12.7 mm)	M10	100	120	20/120
YT-04354	1/2" (12.7 mm)	M12	100	220	20/120
YT-04355	1/2" (12.7 mm)	M14	100	370	20/120
YT-04356	1/2" (12.7 mm)	M16	100	590	20/120
YT-04357	1/2" (12.7 mm)	M17	100	590	20/120

- EN Insulated bit socket
- PL Klucz trzpieniowy izolowany
- DE Bit-Stecknuss vollisoliert
- RU Головка торцевая изолированная
- CZ Hlavice s bitem izolovaná
- HU Csapkulcs
- RO Chei cu cozi izolat
- FR Douille tournevis isolée
- IT Chiavi a bussola isolato
- ES Llave de mandril aislante
- CN 绝缘六角旋具套筒



1/2"
12.7mm

CrV

1000 V

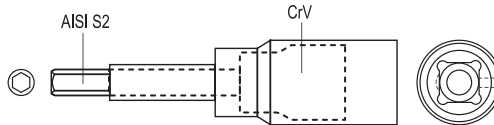

YATO	Ø	⊙ [mm]	L [mm]	[Nm]	
YT-21085	1/2" (12.7 mm)	4	120	16	18/144
YT-21086	1/2" (12.7 mm)	5	120	30	18/144
YT-21087	1/2" (12.7 mm)	6	120	52	18/144
YT-21088	1/2" (12.7 mm)	8	120	120	18/144
YT-21089	1/2" (12.7 mm)	10	120	220	18/144

1000 V
VDE CERTIFICATE
EN 60900:2012

- EN Key wrench ratchet handle
- PL Grzechotka Hex
- DE Ratsche Hex
- RU Трещотка Hex
- CZ Ráčna Hex
- HU Racsnis Hex
- RO Antrenor cu clichet cu bit
- FR Clé à cliquet Hex
- IT Cricchetto Hex
- ES Carraca Hex
- CN 双向棘轮内六角扳手



72T **HRC 42-48**

CrV 50BV30

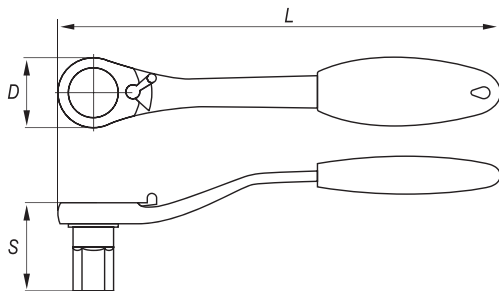

YATO	Ø [mm]	L [mm]	D [mm]	S [mm]	
YT-02390	4	135	18	29	8/160
YT-02391	5	135	18	29	8/160
YT-02392	6	145	23	32	6/120
YT-02393	8	145	23	32	6/120
YT-02394	10	190	31	35	6/60
YT-02395	12	190	31	35	6/60
YT-02396	14	225	36	36	5/40
YT-02397	17	225	36	36	5/40

- EN Universal socket wrench
- PL Klucz z uniwersalną nasadką
- DE Universal-Steckschlüssel
- RU Универсальная торцевая головка с трещоткой
- CZ Univerzální klíč
- HU Univerzális csavarkulcs
- RO Antrenor cu clichet cu tubulara universală
- FR Clé à douille universelle
- IT Chiave con presa universale
- ES Llave de tubo universal
- CN 双向棘轮万能扳手



72T HRC 40
CrV 50BV30

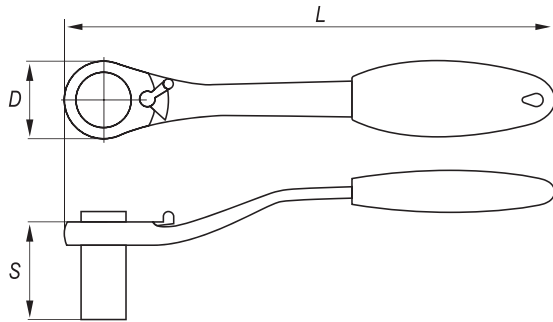

YATO	Ø [mm]	L [mm]	D [mm]	S [mm]	
YT-02400	8-19	225	36	54	5/40

- EN Star bit sockets
- PL Klucze trzpieniowe
- DE Aufsteckschlüssel
- RU Набор головок-вставок
- CZ Čepové klíče
- HU Csapkulcs
- RO Chei cu cozi
- FR Douille tournevis
- IT Chiami a bussola
- ES Llaves de mandril
- CN 星型旋具套筒组套

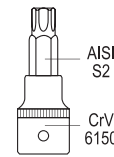

1/4" 6.3mm
3/8" 9.5mm
AISI S2
CrV 6150
DIN 3120
HRC 58-62



12 PCS

12 PCS

- 1/4" (6.3 mm): T8, T10, T15, T20, T25, T27, T30 (L=37 mm);
- 3/8" (9.5 mm): T40, T45, T47, T50, T55 (L=48 mm)

- 1/4" (6.3 mm): T8, T10, T15, T20, T25, T27, T30 (L=37 mm);
- 3/8" (9.5 mm): T40, T45, T47, T50, T55 (L=48 mm)

YATO		
YT-04331	10/40	

YATO		
YT-04332	10/40	



9 PCS

5 PCS

- 1/4" (6.3 mm): 2, 3, 4, 5, 6 mm (L=37 mm);
- 3/8" (9.5 mm): 7, 8, 10, 12 mm (L=48 mm)

- 1/4" (6.3 mm): M5, M6 (L=37 mm);
- 3/8" (9.5 mm): M8, M10, M12 (L=48 mm)

YATO		
YT-04401	6/36	

YATO		
YT-04360	12/48	

- EN Bit sockets
- PL Klucze trzpieniowe
- DE Bit-Stecknuss-Set
- RU Набор головок со вставкой
- CZ Sada nástrčných hlavíc s bitem
- HU Dugókulcs készlet
- RO Chei cu cozi
- FR Douille tournevis
- IT Serie di chiavi a bussola a giravite
- ES Juego de llaves de mandril
- CN 中孔星型旋具套筒组套

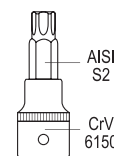



7 PCS
1/4" 6.3mm
AISI S2
CrV 6150
DIN 3120
HRC 58-62

- 1/4" (6.3 mm): T10, T15, T20, T25, T27, T30, T40 (L=35 mm)

YATO		
YT-0461	12/48	



- EN Bit socket set
- PL Zestaw kluczy trzpieniowych
- DE Aufsteckschlüssel-Satz
- RU Набор роловок-вставок
- CZ Čepové klíče
- HU Csapkulcs
- RO Chei cu cozi
- FR Set de douilles tournevis
- IT Chiavi a bussola a vite
- ES Juego de llaves de mandril
- CN 星型套筒批头组套

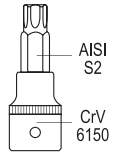

18 PCS		1/2" 12.7mm
1/4" 6.3mm	AISI S2	CrV 6150
DIN 3120	HRC 58-62	





□ 1/2" (12.7 mm): T30, T40, T45, T50, T55, T60 (L=50 mm); T30, T40, T45, T50, T55, T60 (L=100 mm),
1/4" (6.3 mm): T10, T15, T20, T25, T30, T40 (L=37 mm); AISI S2 / CrV 6150



YATO 	
YT-7751	1/4" (6.3 mm), 1/2" (12.7 mm) 10

- EN Bit socket set
- PL Zestaw kluczy trzpieniowych
- DE Aufsteckschlüssel-Satz
- RU Набор роловок-вставок
- CZ Čepové klíče
- HU Csapkulcs
- RO Chei cu cozi
- FR Set de douilles tournevis
- IT Chiavi a bussola a vite
- ES Juego de llaves de mandril
- CN 批头组套





32 PCS		1/2" 12.7mm
S2	CrV	

□ 1/2" (12.7 mm): T20, T25, T27, T30, T40, T45, T50, T55, T60, T70 (L=55 mm);
1/2" (12.7 mm): T20, T25, T27, T30, T40, T45, T50, T55, T60, T70 (L=100 mm);
1/2" (12.7 mm): T40, T45, T50, T55, T60, T70 (L=140 mm); 1/2" (12.7 mm): T40, T45, T50, T55, T60, T70 (L=200 mm); S2 / CrV

YATO 	
YT-7754	1/2" (12.7 mm) 3



- EN Bit socket set
- PL Zestaw kluczy trzpieniowych
- DE Aufsteckschlüssel-Satz
- RU Набор роловок-вставок
- CZ Čepové klíče
- HU Csapkulcs
- RO Chei cu cozi
- FR Set de douilles tournevis
- IT Chiavi a bussola a vite
- ES Juego de llaves de mandril
- CN 六角套筒批头组套

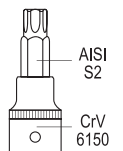

18 PCS		1/2" 12.7mm
1/4" 6.3mm	AISI S2	CrV 6150
DIN 3120	HRC 58-62	



□ 1/2" (12.7 mm): 5, 6, 7, 8, 10, 12 mm (L=50 mm); 5, 6, 7, 8, 10, 12 mm (L=100 mm),
1/4" (6.3 mm): 3, 4, 5, 6, 7, 8 mm (L=37 mm); AISI S2 / CrV 6150

YATO 	
YT-7752	1/4" (6.3 mm), 1/2" (12.7 mm) 10

- EN Bit socket set
- PL Zestaw kluczy trzpieniowych
- DE Aufsteckschlüssel-Satz
- RU Набор ронцовок-вставок
- CZ Čepové klíče
- HU Csapkulcs
- RO Chei cu cozi
- FR Set de douilles tournevis
- IT Chiavi a bussola a vite
- ES Juego de llaves de mandril
- CN 批头组套



30 PCS		1/2" 12.7mm
S2	CrV	

- 1/2" (12.7 mm): 5, 6, 7, 8, 10, 12, 14, 17, 19 mm (L=55 mm);
- 1/2" (12.7 mm): 5, 6, 7, 8, 10, 11, 12, 13 mm (L=100 mm); 1/2" (12.7 mm): 5, 6, 7, 8, 10, 12, 14 mm (L=140 mm);
- 1/2" (12.7 mm): 5, 6, 7, 8, 10, 12 mm (L=200 mm); S2 / CrV

YATO		
YT-77540	1/2" (12.7 mm)	3

- EN Bit socket set
- PL Zestaw kluczy trzpieniowych
- DE Aufsteckschlüssel-Satz
- RU Набор ронцовок-вставок
- CZ Čepové klíče
- HU Csapkulcs
- RO Chei cu cozi
- FR Set de douilles tournevis
- IT Chiavi a bussola a vite
- ES Juego de llaves de mandril
- CN 花型套筒批头组套



12 PCS		1/2" 12.7mm
AISI S2	CrV 6150	DIN 3120
HRC 58-62		

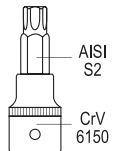

- 1/2" (12.7 mm): M12, M17 (L=50 mm); M6 (L=70 mm); M7, M8 (L=100 mm);
- M8, M10 (L=120 mm); M6, M10, M12 (L=140 mm); M5 (L=180 mm); M6 (L=250 mm); AISI S2 / CrV 6150

YATO		
YT-7753	1/2" (12.7 mm)	10

- EN Bit socket set
- PL Zestaw kluczy trzpieniowych
- DE Aufsteckschlüssel-Satz
- RU Набор ронцовок-вставок
- CZ Čepové klíče
- HU Csapkulcs
- RO Chei cu cozi
- FR Set de douilles tournevis
- IT Chiavi a bussola a vite
- ES Juego de llaves de mandril
- CN 批头组套



26 PCS		1/2" 12.7mm
S2	CrV	

- 1/2" (12.7 mm): M5, M6, M8, M9, M10, M12, M14, M16 (L=55 mm);
- 1/2" (12.7 mm): M5, M6, M8, M9, M10, M12, M14 (L=100 mm);
- 1/2" (12.7 mm): M5, M6, M8, M9, M10, M12, M14 (L=140 mm);
- 1/2" (12.7 mm): M8, M10, M12, M14 (L=200 mm); S2 / CrV

YATO		
YT-77542	1/2" (12.7 mm)	3

3

**Impact sockets,
accessories & sets**
**Udarowe klucze nasadowe,
akcesoria i zestawy**



Impact sockets 1/2" Klucze nasadowe udarowe 1/2"		66-67
--	---	-------

Impact sockets & sets Klucze nasadowe udarowe i zestawy, krótkie	66
Deep impact sockets & sets Klucze nasadowe udarowe i zestawy, długie	66

Impact sockets 1" Udarowe klucze nasadowe 1"		70
--	---	----

Impact sockets Klucze nasadowe udarowe, krótkie	70
Deep impact sockets Klucze nasadowe udarowe, długie	70

Impact accessories 1/2" Akcesoria udarowe 1/2"		67
--	---	----

Impact extension bars Przedłużki udarowe	67
Impact adapters Redukcje udarowe	67
Impact universal joints Przeguby kuliste udarowe	67

Impact accessories 1" Akcesoria udarowe 1"		70
--	---	----

Impact extension bars with adapter Przedłużki udarowe z redukcją	70
--	----

Impact sockets 3/4" Udarowe klucze nasadowe 3/4"		68-69
--	---	-------

Impact sockets & sets Klucze nasadowe udarowe i zestawy, krótkie	68
Deep impact sockets & sets Klucze nasadowe udarowe i zestawy, długie	68

Impact sockets for front hub nuts Nasadki udarowe do piast		71
--	---	----

Impact bit sets & accessories Zestawy bitów udarowych i akcesoria		71-73
---	---	-------

Impact accessories 3/4" Akcesoria udarowe 3/4"		69
--	--	----

Impact extension bars Przedłużki udarowe	69
Impact adapters Redukcje udarowe	69
Impact universal joints Przeguby kuliste udarowe	69

- EN Hexagonal impact socket
 PL Nasadka uderowa sześciokątna
 DE Kraftschrauber-Einsatz
 RU Головка ударная 6-гранная
 CZ Šestihřanný nástavec
 HU Gépi dugókulcs hatszög
- RO Cheie tubulară hexagonală de impact
 FR Douille à choc
 IT Chiave a bussola esagonale per percussione
 ES Boquilla de percusión
 CN 风动套筒

1/2" 12.7mm CrMo SCM440 AS-DRIVE

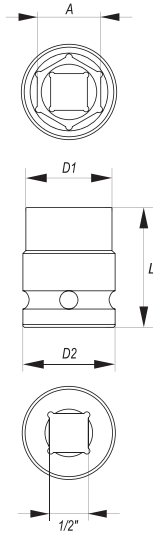

YATO	∅ A [mm]	D1 [mm]	D2 [mm]	L [mm]	PCS BOX	
YT-1000	10	17.5	25	39	60	240
YT-1001	11	18.5	25	39	60	240
YT-1002	12	20.0	25	39	60	240
YT-1003	13	21.0	25	39	60	240
YT-1004	14	22.5	25	39	60	240
YT-1005	15	23.5	30	39	40	160
YT-1006	16	24.0	30	39	40	160
YT-1007	17	26.0	30	39	40	160
YT-1008	18	27.5	30	39	40	160
YT-1009	19	28.0	30	39	40	160
YT-1010	20	30.0	30	39	40	160
YT-1011	21	30.0	30	39	40	160
YT-1012	22	32.0	30	39	30	120
YT-1013	23	32.0	30	39	30	120
YT-1014	24	34.0	30	43	30	120
YT-1015	25	35.0	30	43	30	120
YT-1016	26	38.0	30	43	24	96
YT-1017	27	38.0	30	43	24	96
YT-1018	28	40.0	30	48	24	96
YT-1019	29	41.0	30	48	22	88
YT-1020	30	42.0	30	48	24	96
YT-1022	32	44.0	30	48	20	80

- EN Impact socket set
 PL Zestaw nasadek uderowych
 DE Kraftschrauber-Einsätze
 RU Набор торцевых ударных головок
 CZ Sada nástrčných klíčů pro úderové utahováky
 HU Gépi dugókulcs készlet
 RO Set chei tubulare pt. impact
 FR Douille profonde à choc
 IT Chiave a bussola esagonale per percussione
 ES Juego de boquillas de percusión cortas
 CN 风动套筒组套

10 PCS 1/2" 12.7mm CrMo SCM440 AS-DRIVE



1/2" (12.7 mm): 10, 12, 13, 14, 15, 16, 17, 18, 19, 22 mm (L=39 mm)

YATO	∅	
YT-1025	1/2" (12.7 mm)	20

- EN Hexagonal deep impact socket
 PL Nasadka uderowa sześciokątna długa
 DE Kraftschrauber-Einsatz, lang
 RU Головка ударная 6-гранная глубокая
 CZ Šestihřanný hluboký nástavec
 HU Gépi dugókulcs hatszög hosszú
- RO Cheie tubulară hexagonală de impact adâncă
 FR Douille profonde à choc
 IT Chiave a bussola esagonale per percussione
 ES Boquilla de percusión profunda
 CN 风动套筒

1/2" 12.7mm CrMo SCM440 AS-DRIVE

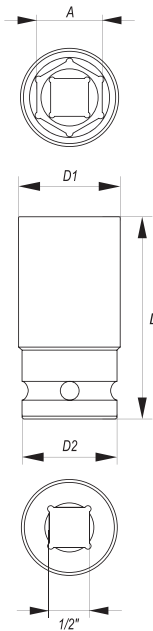

YATO	∅ A [mm]	D1 [mm]	D2 [mm]	L [mm]	PCS BOX	
YT-1030	10	17.5	24	78	30	120
YT-1031	11	18.5	24	78	30	120
YT-1032	12	20.0	24	78	30	120
YT-1033	13	21.0	24	78	30	120
YT-1034	14	22.0	24	78	30	120
YT-1035	15	23.7	24	78	30	120
YT-1036	16	24.0	24	78	30	120
YT-1037	17	26.0	26	78	25	100
YT-1038	18	28.0	28	78	24	96
YT-1039	19	28.0	28	78	24	96
YT-1040	20	30.0	30	78	20	80
YT-1041	21	30.0	30	78	20	80
YT-1042	22	32.0	30	78	18	72
YT-1043	23	32.0	30	78	15	60
YT-1044	24	34.0	30	78	15	60
YT-1045	25	35.0	30	78	15	60
YT-1046	26	38.0	30	78	12	48
YT-1047	27	38.0	30	78	12	48
YT-1048	28	40.0	30	78	12	48
YT-1049	29	41.0	30	78	10	40
YT-1050	30	42.0	30	78	10	40
YT-1052	32	44.0	30	78	10	40

EN Impact socket set
PL Zestaw nasadek udarowych
DE Kraftschrauber-Einsätze
RU Набор торцевых ударных головок

CZ Sada nástrčných klíčů pro úderové utahováky
HU Gépi dugókulcs készlet
RO Set chei tubulare pt. impact
FR Douille profonde à choc

IT Chiave a bussola esagonale per percussione
ES Juego de boquillas de percusión cortas
CN 风动长套筒组套

11 PCS
1/2" 12.7mm
CrMo SCM440
AS-DRIVE



1/2" (12.7 mm): 10, 12, 13, 14, 15, 16, 17, 18, 19, 22, 24 mm (L=78 mm)

YATO	○	
YT-1054	1/2" (12.7 mm)	10

EN Impact socket set
PL Zestaw nasadek udarowych
DE Kraftschrauber-Einsätze
RU Набор торцевых ударных головок

CZ Sada nástrčných klíčů pro úderové utahováky
HU Gépi dugókulcs készlet
RO Set chei tubulare pt. impact
FR Douille profonde à choc

IT Chiave a bussola esagonale per percussione
ES Juego de boquillas de percusión cortas
CN 风动长套筒组套

15 PCS
1/2" 12.7mm
CrMo SCM440
AS-DRIVE



1/2" (12.7 mm): 10, 12, 13, 14, 15, 16, 17, 18, 19, 21, 22, 24, 27, 30, 32 mm (L=78 mm)

YATO	○	
YT-1055	1/2" (12.7 mm)	4

EN Impact extension bar
PL Przedłużka udarowa
DE Verlängerung

RU Удлинитель ударный
CZ Prodluzovací prípravok
HU Toldalék

RO Prelungitor
FR Rallonge
IT Prolunga per percussione

ES Tubo de prolongación
CN 风动接杆

1/2" 12.7mm
CrMo SCM440

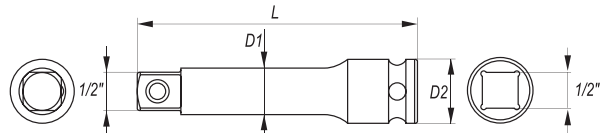

YATO	○	D1 [mm]	D2 [mm]	L [mm]	PCS ROUG	
YT-1060	1/2" (12.7 mm)	17.5	25	75	40	160
YT-1061	1/2" (12.7 mm)	18.5	25	125	28	112
YT-1062	1/2" (12.7 mm)	20.0	25	250	30	60

EN Impact adapter
PL Redukcja udarowa
DE Reduktion
RU Переходник
CZ Redukce
HU Redukció
RO Reducție
FR Réduction
IT Prolunga per percussione
ES Reducción
CN 风动转换头

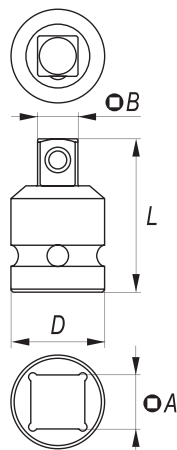

1/2" 12.7mm
CrMo SCM440

YATO	○	○	D [mm]	L [mm]	PCS ROUG	
YT-1067	1/2" (12.7 mm) (F)	3/4" (19.0 mm) (M)	30	48	40	160

EN Impact universal joint
PL Przegub kulisty udarowy
DE Gelenkstück
RU Кардан ударный
CZ Kloub kulový
HU Univerzális csuklós csatlakozó
RO Adaptor
FR Flector rond
IT Prolunga per percussione
ES Articulación redonda
CN 风动万向接头

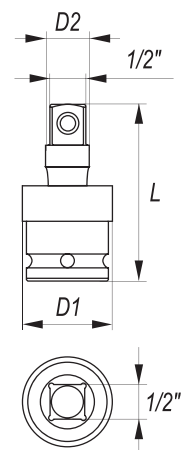

1/2" 12.7mm
CrMo SCM440

YATO	○	D1 [mm]	D2 [mm]	L [mm]	PCS ROUG	
YT-1064	1/2" (12.7 mm)	31	17	63	25	100

EN Hexagonal impact socket
 PL Nasadka uderowa sześciokątna
 DE Kraftschrauber-Einsatz
 RU Головка ударная 6-гранная
 CZ Šestihřanný nástavec
 HU Gépi dugókulcs hatszög

RO Cheie tubulară hexagonală de impact
 FR Douille à choc
 IT Chiave a bussola esagonale per percussione
 ES Boquilla de percusión
 CN 风动套筒

3/4"
19 mm

CrMo
SCM440

AS-DRIVE

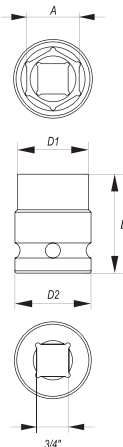

YATO	o A [mm]	D1 [mm]	D2 [mm]	L [mm]	PCS PKG	
YT-1070	19	32	40	50	16	64
YT-1071	21	35	40	50	16	64
YT-1072	22	38	40	50	16	64
YT-1073	23	38	40	50	16	64
YT-1074	24	40	40	50	16	64
YT-1075	25	40	40	50	16	64
YT-1076	26	40	40	50	16	64
YT-1077	27	42	42	53	16	64
YT-1078	28	44	44	53	16	64
YT-1079	29	46	44	53	12	48
YT-1080	30	46	44	53	12	48
YT-1082	32	48	44	56	12	48
YT-1083	33	48	44	56	8	32
YT-1084	34	50	44	56	8	32
YT-1085	35	50	44	56	6	24
YT-1086	36	52	44	56	6	24
YT-1088	38	56	44	57	6	24
YT-1091	41	60	44	57	5	20
YT-1092	42	61	44	57	4	16
YT-1093	43	63	44	57	4	16
YT-1096	46	66	44	62	3	12
YT-1100	50	71	54	72	3	12
YT-1102	52	74	54	72	2	8
YT-1105	55	78	54	74	2	8
YT-1110	60	84	54	74	2	8

EN Impact socket set
 PL Zestaw nasadek uderowych
 DE Kraftschrauber-Einsätze
 RU Набор торцевых ударных головок

CZ Sada nástrčných klíčů pro úderové utahováky
 HU Gépi dugókulcs készlet
 RO Set chei tubulare pt. impact
 FR Douille profonde à choc

IT Chiave a bussola esagonale per percussione
 ES Juego de boquillas de percusión cortas
 CN 风动长套筒组套

8
PCS

3/4"
19 mm

CrMo
SCM440

AS-DRIVE



3/4" (19.0 mm); 22, 24 mm (L=50 mm); 27, 30 mm (L=53 mm); 32, 36 mm (L=55 mm); 38, 41 mm (L=57 mm)

EN Hexagonal deep impact socket
 PL Nasadka uderowa sześciokątna długa
 DE Kraftschrauber-Einsatz, lang
 RU Головка ударная 6-гранная глубокая
 CZ Šestihřanný hluboký nástavec
 HU Gépi dugókulcs hatszög hosszú

RO Cheie tubulară hexagonală de impact adâncă
 FR Douille profonde à choc
 IT Chiave a bussola esagonale per percussione
 ES Boquilla de percusión profunda
 CN 风动长套筒

3/4"
19 mm

CrMo
SCM440

AS-DRIVE

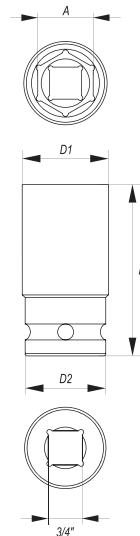

YATO	o A [mm]	D1 [mm]	D2 [mm]	L [mm]	PCS PKG	
YT-1119	19	32	44	90	9	36
YT-1121	21	35	44	90	9	36
YT-1122	22	38	44	90	9	36
YT-1124	24	40	44	90	9	36
YT-1127	27	42	44	90	9	36
YT-1128	28	44	44	90	8	32
YT-1129	29	44	44	90	8	32
YT-1130	30	46	44	90	7	28
YT-1132	32	48	44	90	7	28
YT-1133	33	50	44	90	6	24
YT-1134	34	51	44	90	6	24
YT-1135	35	52	44	90	6	24
YT-1136	36	54	44	90	6	24
YT-1138	38	56	44	90	6	24
YT-1141	41	60	44	90	5	20
YT-1142	42	61	44	90	4	16
YT-1143	43	63	44	90	3	12
YT-1146	46	66	44	90	3	12
YT-1148	48	68	44	90	2	8
YT-1150	50	71	54	90	2	8

YATO	o	
YT-1115	3/4" (19.0 mm)	6

EN Impact socket set
PL Zestaw nasadek udarowych
DE Kraftschrauber-Einsätze
RU Набор торцевых ударных головок
CZ Sada nástrčných klíčů pro úderové utahováky
HU Gépi dugókulcs készlet
RO Set chei tubulare pt. impact
FR Douille profonde à choc
IT Chiave a bussola esagonale per percussione
ES Juego de boquillas de percusión cortas
CN 风动长套筒组套

8 PCS
3/4" 19mm
CrMo SCM440
AS-DRIVE



3/4" (19.0 mm): 22, 24, 27, 30, 32, 36, 38, 41 mm (L=90 mm)

EN Impact extension bar
PL Przedłużka udarowa
DE Verlängerung
RU Удлинитель ударный
CZ Prodlužovací přípravek
HU Toldalék
RO Prolungtor
FR Rallonge
IT Prolunga per percussione
ES Tubo de prolongación
CN 风动接杆

3/4" 19mm

CrMo SCM440

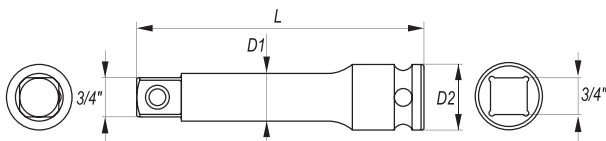

YATO	Ø	D1 [mm]	D2 [mm]	L [mm]	PCS PACKING	
YT-1160	3/4" (19.0 mm)	44	24	100	8	32
YT-1161	3/4" (19.0 mm)	44	24	175	10	20
YT-1162	3/4" (19.0 mm)	44	24	250	8	16
YT-1163	3/4" (19.0 mm)	44	24	330	6	12

EN Impact adapter
PL Redukcja udarowa
DE Reduktion
RU Переходник
CZ Redukce
HU Redukció
RO Reducție
FR Réduction
IT Prolunga per percussione
ES Reducción
CN 风动转换头

3/4" 19mm

CrMo SCM440

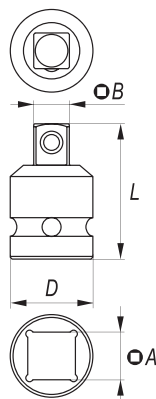

YATO	Ø	Ø	D [mm]	L [mm]	PCS PACKING	
YT-1168	3/4" (19.0 mm) (F)	1" (25.4 mm) (M)	44	63	12	48

YATO	Ø	
YT-1155	3/4" (19.0 mm)	4

EN Impact adapter
PL Redukcja udarowa
DE Reduktion
RU Переходник
CZ Redukce
HU Redukció
RO Reducție
FR Réduction
IT Prolunga per percussione
ES Reducción
CN 转接头

3/4" 19mm

CrV 50BV30

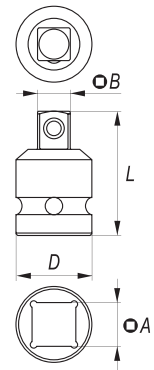

YATO	Ø	Ø	D [mm]	L [mm]	PCS PACKING	
YT-11671	3/4" (19.0 mm) (F)	1/2" (12.7 mm) (M)	44	55	12	48

EN Impact universal joint
PL Przegub kulisty udarowy
DE Gelenkstück
RU Кардан ударный
CZ Kloub kulový
HU Univerzális csuklós csatlakozó
RO Adaptor
FR Flector rond
IT Prolunga per percussione
ES Articulación redonda
CN 风动万向接头

3/4" 19mm

CrMo SCM440

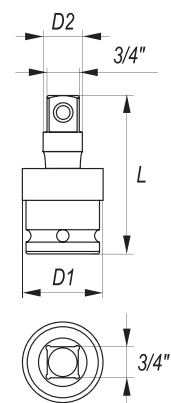

YATO	Ø	D1 [mm]	D2 [mm]	L [mm]	PCS PACKING	
YT-1164	3/4" (19.0 mm)	31	44	102	8	32

EN Hexagonal impact socket
 PL Nasadka uderowa sześciokątna
 DE Kraftschrauber-Einsatz
 RU Головка ударная 6-гранная
 CZ Šestihranný nástavec
 HU Gépi dugókulcs hatszög

RO Cheie tubulară hexagonală de impact
 FR Douille à choc
 IT Chiave a bussola esagonale per percussione
 ES Boquilla de percusión
 CN 风动套筒

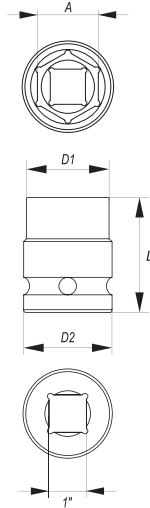
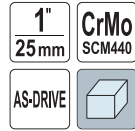

EN Hexagonal deep impact socket
 PL Nasadka uderowa sześciokątna długa
 DE Kraftschrauber-Einsatz, lang
 RU Головка ударная 6-гранная глубокая
 CZ Šestihranný hluboký nástavec
 HU Gépi dugókulcs hatszög hosszú

RO Cheie tubulară hexagonală de impact adâncă
 FR Douille profonde à choc
 IT Chiave a bussola esagonale per percussione
 ES Boquilla de percusión profunda
 CN 风动长套筒

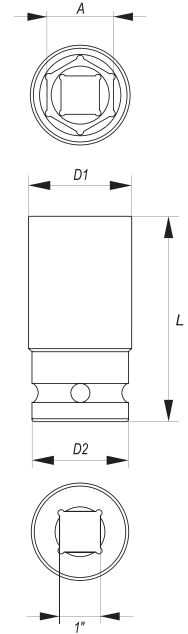

YATO	o A [mm]	D1 [mm]	D2 [mm]	L [mm]	PCS ROB	
YT-1180	24	42	54	59	6	24
YT-1183	27	46	54	59	6	24
YT-1184	28	47	54	59	6	24
YT-1185	29	48	54	60	6	24
YT-1186	30	49	54	60	6	24
YT-1187	32	52	54	61	6	24
YT-1188	33	53	54	61	6	24
YT-1189	34	54	54	61	6	24
YT-1191	36	57	54	65	6	24
YT-1193	38	60	54	65	5	20
YT-1194	41	63	54	65	4	16
YT-1196	46	69	54	73	3	12
YT-1197	48	72	54	73	2	8
YT-1198	50	75	54	73	2	8

YATO	o A [mm]	D1 [mm]	D2 [mm]	L [mm]	PCS ROB	
YT-1175	27	46	54	90	6	24
YT-1176	30	50	54	90	6	24
YT-1177	32	52	54	90	6	24
YT-1178	33	54	54	90	6	24
YT-1179	36	57	54	90	6	24

EN Impact extension bar with adapter
 PL Przedłużka uderowa z redukcją
 DE Verlängerung mit Adapter
 RU Удлинитель с редукцией
 CZ Prodloužení s redukcí
 HU Hosszabbító szár adapterrel

RO Bara extensie cu adaptor
 FR Rallonge avec reduction
 IT Prolunga per percussionecon riduttore
 ES Tubo de prolongación con reductor
 CN 风动转换接头

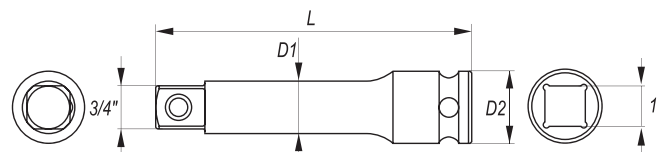
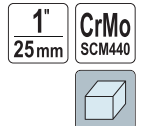

YATO	o A	o B	D1 [mm]	D2 [mm]	L [mm]	PCS ROB	
YT-1169	1" (25.4 mm) (F)	3/4" (19.0 mm) (M)	53	33	250	6	12

EN Hexagonal impact socket
PL Nasadka udarowa sześciokątna
DE Kraftschrauber-Einsatz
RU Головка ударная 6-гранная
CZ Šestihranný nástavec
HU Gépi dugókulcs hatszög
RO Cheie tubulară hexagonală de impact
FR Douille à choc
IT Chiave a bussola esagonale per percussione
ES Boquilla de percusión
CN 风动套筒

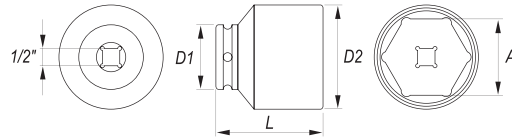

1/2"
12.7mm
FOR FRONT HUB NUTS
DO PIAȘT PRZEDNIŃCH
CrMo
SCM440
AS-DRIVE

YATO	○ A [mm]	D1 [mm]	D2 [mm]	L [mm]	PCS PIEȘTE	
YT-1029	52	44	71	72	3	12

EN Bi-hexagonal impact socket
PL Nasadka udarowa dwunastokątna
DE Zwölfkant-Kraftschrauber-Einsatz
RU Головка ударная 12-гранная
CZ Vanáctíhranný nástavec
HU Gépi dugókulcs 12-szögű
RO Cheie tubulară bihexagonală de impact
FR Douille à choc
IT Chiave a bussola esagonale per percussione
ES Boquilla bihexagonal de percusión
CN 风动套筒

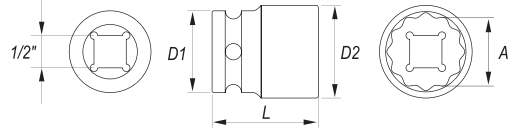

1/2"
12.7mm
FOR FRONT HUB NUTS
DO PIAȘT PRZEDNIŃCH
CrMo
SCM440
AS-DRIVE

YATO	○ A [mm]	D1 [mm]	D2 [mm]	L [mm]	PCS PIEȘTE	
YT-1027	24	30	34	39	10	120

EN Bi-hexagonal impact socket
PL Nasadka udarowa dwunastokątna
DE Zwölfkant-Kraftschrauber-Einsatz
RU Головка ударная 12-гранная
CZ Vanáctíhranný nástavec
HU Gépi dugókulcs 12-szögű
RO Cheie tubulară bihexagonală de impact
FR Douille à choc
IT Chiave a bussola esagonale per percussione
ES Boquilla bihexagonal de percusión
CN 风动套筒

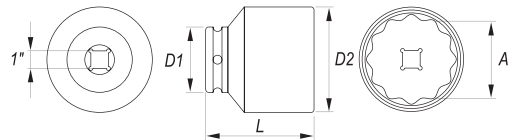

1"
25mm
FOR FRONT HUB NUTS
DO PIAȘT PRZEDNIŃCH
HRC
38-45
CrMo

YATO	○ A [mm]	D1 [mm]	D2 [mm]	L [mm]	
YT-11990	65	54	93	93	4
YT-11995	80	86	112	100	4
YT-11998	85	86	118	102	4

EN Impact bit socket set
PL Zestaw udarowych kluczy trzpieniowych
DE Schlagsteckschlüsselsatz
RU Набор ударных торцовых ключей
CZ Souprava rázových zástrčných klíčů
HU Üthető bit dugókulcs készlet
RO Set chei de șoc cu bolt
FR Jeu de douilles à impact
IT Set di chiavi a bussola per percussione
ES Juego de llaves de mandril de impacto
CN 气动一体批组套



6
PCS

1/2"
12.7mm
CrMo

□ □ □ 1/2" (12.7 mm): M14, M16, M18 (L=43 mm); M14, M16, M18 (L=78 mm)

YATO	○	
YT-10652	1/2" (12.7 mm)	20

EN Impact bit socket set
PL Zestaw udarowych kluczy trzpieniowych
DE Schlagsteckschlüsselsatz
RU Набор ударных торцовых ключей
CZ Souprava rázových zástrčných klíčů
HU Üthető bit dugókulcs készlet
RO Set chei de șoc cu bolt
FR Jeu de douilles à impact
IT Set di chiavi a bussola per percussione
ES Juego de llaves de mandril de impacto
CN 气动一体批组套

9
PCS

1/2"
12.7mm
CrMo



□ □ □ 1/2" (12.7 mm): RM5, RM6, RM7, RM8, RM9, RM10, RM12, RM13, RM14

YATO	○	
YT-10681	1/2" (12.7 mm)	10

EN Impact bit socket set
PL Zestaw udarowych kluczy trzpieniowych
DE Schlagsteckschlüsselsatz
RU Набор ударных торцовых ключей
CZ Souprava rázových zástrčných klíčů
HU Üthető bit dugókulcs készlet

RO Set chei de șoc cu bolt
FR Jeu de douilles à impact
IT Set di chiavi a bussola per percussione
ES Juego de llaves de mandril de impacto
CN 气动一体批组套

9
PCS

1/2"
12.7mm
CrMo

□ □ □ 1/2" (12.7 mm): T20, T25, T30, T40, T45, T50, T55, T60, T70

YATO	○	
YT-10654	1/2" (12.7 mm)	10

EN Impact bit socket set
PL Zestaw udarowych kluczy trzpieniowych
DE Schlagsteckschlüsselsatz
RU Набор ударных торцовых ключей
CZ Souprava rázových zástrčných klíčů
HU Üthető bit dugókulcs készlet

RO Set chei de șoc cu bolt
FR Jeu de douilles à impact
IT Set di chiavi a bussola per percussione
ES Juego de llaves de mandril de impacto
CN 气动一体批组套

9
PCS



1/2"
12.7mm
CrMo



□ □ □ 1/2" (12.7 mm): M4, M5, M6, M8, M9, M10, M12, M14, M16



YATO	○	
YT-10691	1/2" (12.7 mm)	10

EN Impact bit socket set
 PL Zestaw uderowych kluczy trzpieniowych
 DE Schlagsteckschlüsselsatz
 RU Набор ударных торцовых ключей
 CZ Souprava rázových zástrčných klíčů
 HU Üthető dugókulcs - készlet
 RO Set chei de șoc cu bolț
 FR Set de douilles à choc
 IT Set di chiavi a bussola per percussione
 ES Juego de llaves de mandril de impacto
 CN 风动套筒批头组套

8 PCS **1/2"** (12.7mm) **HRC 54**
 





 1/2" (12.7 mm): T30, T40, T45, T50, T55, T60, T70, T80

YATO 		
YT-1065	1/2" (12.7 mm)	15





 1/2" (12.7 mm): 6, 7, 8, 10, 12, 14, 17, 19 mm

YATO 		
YT-1066	1/2" (12.7 mm)	15



 1/2" (12.7 mm): RM5, RM6, RM7, RM8, RM10, RM11, RM12, RM13



YATO 		
YT-1068	1/2" (12.7 mm)	15





 1/2" (12.7 mm): M5, M6, M8, M10, M12, M14, M16, M18



YATO 		
YT-1069	1/2" (12.7 mm)	15

EN Impact bit with holder set
 PL Zestaw uderowych kluczy trzpieniowych z nasadką
 DE Schlagschrauber-Steckschlüsselsatz mit Schutzkappe
 RU Набор ударных ключей с торцевыми головками
 CZ Sada imbusových nástrčných klíčů
 HU Gépi hatlapú dugókulcs készlet
 RO Set biți si adaptor impact
 FR Jeu de clés à choc avec douille
 IT Set di chiavi a brugola con punta
 ES Juego de llaves de vaso de impacto
 CN M型冲击批头组套



9 PCS **1/2"** (12.7mm) **CrMo**
 





 1/2" (12.7 mm): T30, T40, T45, T47, T50, T55, T60, T70;
 (L=35 mm)

YATO 		
YT-10664	1/2" (12.7 mm)	6/36





 1/2" (12.7 mm): 6, 7, 8, 10, 12, 14, 17, 19 mm;
 (L=35 mm)

YATO 		
YT-10662	1/2" (12.7 mm)	6/36



 1/2" (12.7 mm): M6, M8, M9, M10, M12, M14, M16, M18;
 (L=35 mm)

YATO 		
YT-10663	1/2" (12.7 mm)	6/36

EN Spline impact bit set
PL Zestaw bitów udarowych Spline
DE Schlagwerkzeugsatz Spline
RU Набор ударных битов Spline
CZ Souprava bitů pro rázové utahovací Spline
HU Útő bit készlet Spline
RO Set tubulare de impact
FR Set d'embouts à choc
IT Set di chiavi a bussola per percussione Spline
ES Juego de las piezas de percusión Spline
CN 风动花键批头组套

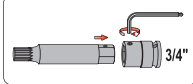
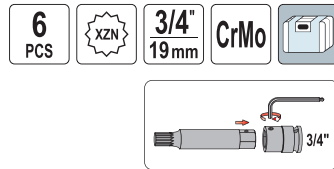

○ 3/4" (19 mm) x 22 mm; (L=107 mm); CrMo;
□ 3/4" (19 mm) x 22 mm; CrMo;

YATO	○	□
YT-1157	3/4" (19.0 mm)	8

EN Impact bit socket set
PL Zestaw udarowych kluczy trzpieniowych
DE Schlagsteckschlüsselsatz
RU Набор ударных торцовых ключей
CZ Souprava rázových zástrčných klíčů
HU Úthető bit dugókulcs készlet

RO Set chei de șoc cu bolt
FR Jeu de douilles à impact
IT Set di chiavi a bussola per percussione
ES Juego de llaves de mandril de impacto
CN 气动一体批组套

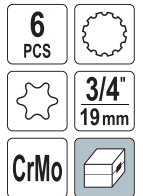

○ 3/4" (19.0 mm): M16, M18;
□ 3/4" (19.0 mm): T70, T80, T90, T100

YATO	○	□
YT-10653	3/4" (19.0 mm)	10

EN Impact bit socket set
PL Zestaw udarowych kluczy trzpieniowych
DE Schlagsteckschlüsselsatz
RU Набор ударных торцовых ключей
CZ Souprava rázových zástrčných klíčů
HU Úthető bit dugókulcs készlet
RO Set chei de șoc cu bolt
FR Jeu de douilles à impact
IT Set di chiavi a bussola per percussione
ES Juego de llaves de mandril de impacto
CN 气动套筒组套

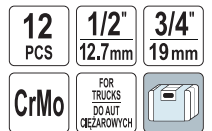

○ 3/4" (19 mm) (F); CrMo;
□ 1/2" (12.7 mm) (M); CrMo;
□ 3/4" (19 mm) (M) (L=200 mm); CrMo;
○ T70, T80, T90, T100 (L=67 mm); CrMo;
○ 14, 17, 19, 21, 22 mm (L=67 mm); CrMo;
□ 3 mm

YATO	○	□
YT-10655	1/2" (12.7 mm), 3/4" (19.0 mm)	5

EN Adaptor set
PL Zestaw redukcji
DE Reduktionsset
RU Редукционный комплект
CZ Redukční sada
HU Adapter készlet

RO Set adaptoare
FR Ensemble de réducteurs pour douilles
DE Kit di riduzioni
ES Set de reductores
CN 气动转换接头组套

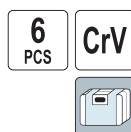

□ 3/8" (9.5 mm) (M) x 1/4" (6.3 mm) (F), 1/4" (6.3 mm) (M) x 3/8" (9.5 mm) (F), 3/8" (9.5 mm) (F) x 1/2" (12.7 mm) (M), 1/2" (12.7 mm) (F) x 3/8" (9.5 mm) (M), 3/4" (19.0 mm) (M) x 1/2" (12.7 mm) (F), 1/2" (12.7 mm) (M) x 3/4" (19.0 mm) (F)

YATO	□	□
YT-10671		20

EN Impact universal joint set
PL Zestaw przegubów udarowych
DE Kraft Kugelgelenk-Satz
RU Кардан шарнирный ударный
CZ Univerzální závěsný konektor
HU Univerzális csuklós csatlakozó
RO Set adaptoare
FR Jeu de joints universels pour douilles pour clés à choc
IT Set di giunti a impatto
ES Junta de impacto universal con encaje
CN 气动方向

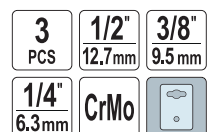

YATO	○	□
YT-10643	1/4" (6.3 mm), 3/8" (9.5 mm), 1/2" (12.7 mm)	10/60

4

**Torque wrenches
& torque multipliers
Klucze dynamometryczne
i wzmacniacze momentu**



Torque wrenches

Klucze dynamometryczne

76-79



Torque angle gauges

Kątomierze do dokręcania śrub

78



Beam torque wrenches

Klucze dynamometryczne wychylne 76

Torque wrenches with metal handle 76

Klucze dynamometryczne z metalową rączką 76

Torque wrenches with plastic handle 76

Klucze dynamometryczne z plastikową rączką 76

Dial torque wrenches 78

Klucze dynamometryczne zegarowe 78

Torque multipliers

Wzmacniacze momentu

78





EN Beam torque wrench RU Ключ динамометрический стрелочный RO Cheie cu dinamometru ES Llave dinamométrica inclin
 PL Klucz dynamometryczny wychylny CZ Dynamometrický klíč FR Clé dynamométrique inclinée CN 扭力扳手
 DE Beam-Typ-Drehmomentschlüssel HU Nyomatékkulcs IT Chiave dinamometrica a quadrante

1/2"
12.7mm

3/4"
19mm

CrV
6140



YATO 	Ø	[Nm]	
YT-07641	1/2" (12.7 mm)	0-300	16
YT-07642	3/4" (19.0 mm)	0-500	9



EN Torque wrench RU Ключ динамометрический RO Cheie cu dinamometru ES Llave dinamométrica
 PL Klucz dynamometryczny CZ Dynamometrický klíč FR Clé dynamométrique CN 传统型可调式扭力扳手
 DE Drehmomentschlüssel HU Nyomatékkulcs IT Chiave dinamometrica

1/2"
12.7mm

3/8"
9.5mm

CrV
6140



YATO 	Ø	[Nm]	L [mm]	
YT-0750	3/8" (9.5 mm)	20-110	342-360	20
YT-0760	1/2" (12.7 mm)	42-210	445-465	12



EN Torque wrench RU Ключ динамометрический RO Cheie cu dinamometru ES Llave dinamométrica
 PL Klucz dynamometryczny CZ Dynamometrický klíč FR Clé dynamométrique CN 扭力扳手
 DE Drehmomentschlüssel HU Nyomatékkulcs IT Chiave dinamometrica

3/8"
9.5mm

+/-
CW 4%
CCW 4%

ALLOY STEEL
STAL
STOPOWA



YATO 	Ø	[Nm]	L [mm]	
YT-07500	3/8" (9.5 mm)	10-60	378-400	12

EN Torque wrench RU Ключ динамометрический RO Cheie cu dinamometru ES Llave dinamométrica
 PL Klucz dynamometryczny CZ Dynamometrický klíč FR Clé dynamométrique CN 扭力扳手
 DE Drehmomentschlüssel HU Nyomatékkulcs IT Chiave dinamometrica

1/4"
6.3mm



1/2"
12.7mm

3/4"
19mm

+/-
4%

ALLOY STEEL
STAL
STOPOWA



YATO 	Ø	[Nm]	L [mm]	
YT-07511	1/4" (6.3 mm)	2.5-20	240-250	16
YT-07611	1/2" (12.7 mm)	10-60	378-400	12
YT-07601	1/2" (12.7 mm)	65-335	518-540	10
YT-07712	3/4" (19.0 mm)	80-400	676-697	4

EN Torque wrench RU Ключ динамометрический RO Cheie cu dinamometru ES Llave dinamométrica
 PL Klucz dynamometryczny CZ Dynamometrický klíč FR Clé dynamométrique CN 传统型可调式扭力扳手
 DE Drehmomentschlüssel HU Nyomatékkulcs IT Chiave dinamometrica



1/2"
12.7mm

SETTINGS WINDOW
OKNO
USTAWIEN

+/-
4%

CrMo
42





YATO 	Ø	[Nm]	L [mm]	
YT-07612	1/2" (12.7 mm)	10-60	415	12
YT-07605	1/2" (12.7 mm)	20-220	481	10

EN Torque wrench RU Ключ динамометрический RO Cheie cu dinamometru ES Llave dinamométrica
 PL Klucz dynamometryczny CZ Dynamometrický klíč FR Clé dynamométrique CN 省力型可调式扭力扳手
 DE Drehmomentschlüssel HU Nyomatékkulcs IT Chiave dinamometrica

1/4"
6.3mm

CrV
6140



YATO 	Ø	[Nm]	L [mm]	
YT-0751	1/4" (6.3 mm)	2-10	268-278	24



EN Torque wrench RU Ключ динамометрический RO Cheie cu dinamometru ES Llave dinamométrica
 PL Klucz dynamometryczny CZ Dynamometrický klíč FR Clé dynamométrique CN 扭力扳手
 DE Drehmomentschlüssel HU Nyomatékkulcs IT Chiave dinamometrica

3/8"
9.5mm

+/-
CW 3%
CCW 3%

CrMo
3042



YATO 	Ø	[Nm]	L [mm]	
YT-07730	3/8" (9.5 mm)	6-30	295-316	12
YT-07731	3/8" (9.5 mm)	10-60	362-385	12



EN Torque wrench RU Ключ динамометрический RO Cheie cu dinamometru ES Llave dinamométrica
 PL Klucz dynamometryczny CZ Dynamometrický klíč FR Clé dynamométrique CN 扭力扳手
 DE Drehmomentschlüssel HU Nyomatékkulcs IT Chiave dinamometrica

1/2"
12.7mm

+/-
CW 3%
CCW 3%

CrMo
3042





YATO 	Ø	[Nm]	L [mm]	
YT-07740	1/2" (12.7 mm)	10-60	360-385	12
YT-07741	1/2" (12.7 mm)	20-100	420-440	12
YT-07742	1/2" (12.7 mm)	25-125	415-440	12
YT-07743	1/2" (12.7 mm)	40-200	445-465	12

EN Torque wrench RU Ключ динамометрический RO Cheie cu dinamometru ES Llave dinamométrica
 PL Klucz dynamometryczny CZ Dynamometrický klíč FR Clé dynamométrique CN 扭力扳手
 DE Drehmomentschlüssel HU Nyomatékkulcs IT Chiave dinamometrica

3/4"
19 mm ≤500 Nm
+/- 3%
CW CCW >500 Nm
+/- 4%
CW CCW **CrMo**
3042 



YATO 	Ø	[Nm]	L [mm]	
YT-07752	3/4" (19.0 mm)	160-800	1030-1050	2
YT-07753	3/4" (19.0 mm)	200-1000	1030-1050	2

EN Torque wrench CZ Dynamometrický klíč IT Chiave dinamometrica
 PL Klucz dynamometryczny HU Nyomatékkulcs ES Llave dinamométrica
 DE Drehmomentschlüssel RO Cheie cu dinamometru CN 扭力扳手
 RU Ключ динамометрический FR Clé dynamométrique

1"
25 mm ≤500 Nm
+/- 3%
CW CCW >500 Nm
+/- 4%
CW CCW **CrMo**
3042 





YATO 	Ø	[Nm]	L [mm]	
YT-07762	1" (25.4 mm)	300-1500	2160-2190	1

EN Torque wrench RU Ключ динамометрический RO Cheie cu dinamometru ES Llave dinamométrica
 PL Klucz dynamometryczny CZ Dynamometrický klíč FR Clé dynamométrique CN 可调式扭力扳手
 DE Drehmomentschlüssel HU Nyomatékkulcs IT Chiave dinamometrica

3/4"
19 mm **1/2"**
12.7 mm **CrV**
6140 





YATO 	Ø	[Nm]	L [mm]	
YT-07761	1/2" (12.7 mm)	40-210	516-534	10
YT-0770	3/4" (19.0 mm)	100-500	845-860	4
YT-0771	3/4" (19.0 mm)	140-980	1215-1230	2

EN Torque wrench RU Ключ динамометрический RO Cheie cu dinamometru ES Llave dinamométrica
 PL Klucz dynamometryczny CZ Dynamometrický klíč FR Clé dynamométrique CN 省力型可调式扭力扳手
 DE Drehmomentschlüssel HU Nyomatékkulcs IT Chiave dinamometrica

3/4"
19 mm **1/2"**
12.7 mm **CrV**
6140 





YATO 	Ø	[Nm]	L [mm]	
YT-0754	1/2" (12.7 mm)	60-340	592-613	10

EN Torque wrench RU Ключ динамометрический RO Cheie cu dinamometru ES Llave dinamométrica
 PL Klucz dynamometryczny CZ Dynamometrický klíč FR Clé dynamométrique CN 扭力扳手
 DE Drehmomentschlüssel HU Nyomatékkulcs IT Chiave dinamometrica

3/4"
19 mm +/-
CW 3%
CCW 5% **HRC**
48-52 **CrV**
6140 



YATO 	Ø	[Nm]	L [mm]	
YT-07711	3/4" (19.0 mm)	150-800	1155-1175	2

EN Dial torque wrench
 PL Zegarowy klucz dynamometryczny
 DE Drehmomentschlüssel mit Skalenmessuhr
 RU Стрелочный динамометрический ключ
 CZ Momentový klíč s kruhovou stupnicí
 HU Mérőtorcsás nyomatékkulcs

RO Cheie dinamometrică cu ceas
 FR Clé dynamométrique avec horloge
 IT Chiave dinamometrica a orologio
 ES Llave dinamométrica con reloj
 CN 扭力扳手

1/4"
6.3mm

3/8"
9.5mm

1/2"
12.7mm

+/-
3%



YATO	Ø	[Nm]	L [mm]	
YT-07830	1/4" (6.3 mm)	0.5-5	335	12
YT-07831	1/4" (6.3 mm)	1-10	335	12
YT-07832	3/8" (9.5 mm)	3-30	335	12

EN Dial torque wrench
 PL Zegarowy klucz dynamometryczny
 DE Drehmomentschlüssel mit Skalenmessuhr
 RU Стрелочный динамометрический ключ
 CZ Momentový klíč s kruhovou stupnicí
 HU Mérőtorcsás nyomatékkulcs

RO Cheie dinamometrică cu ceas
 FR Clé dynamométrique avec horloge
 IT Chiave dinamometrica a orologio
 ES Llave dinamométrica con reloj
 CN 扭力扳手

1/2"
12.7mm

+/-
3%



YATO	Ø	[Nm]	L [mm]	
YT-07835	1/2" (12.7 mm)	20-200	490	10
YT-07836	1/2" (12.7 mm)	30-300	590	10

EN Torque angle gauge
 PL Kątomierz do dokręcania śrub
 DE Winkelmesser zum Anziehen von Schrauben
 RU Угломер для подвёртывания болтов
 CZ Úhloměr k utahování šroubů
 HU Nyomaték szögmérő
 RO Raportor pt. înşurubat şuruburi
 FR Rapporteur à serrer les vis
 IT Goniometro per il serraggio controllo
 ES Calibrador para apretar tornillos
 CN 扭力角度规



1/2"
12.7mm

360°

CrV



YATO		
YT-0593		12/48

EN Torque angle gauge with magnet
 PL Kątomierz z magnesem do klucza dynamometrycznego
 DE Winkelmesser mit Magnet für Drehmomentschlüssel
 RU Транспортёр с магнитом для динамометрического ключа
 CZ Úhloměr s magnetem na momentový klíč
 HU Mágneses szögmérő nyomatékkulcshoz
 RO Cheie dinamometrică cu magnet
 FR Rapporteur avec aimant pour clé dynamométrique
 IT Goniometro con magnete per chiave dinamometrica
 ES Escuadra con imán para llave dinamométrica
 CN 磁性扭力规



1/2"
12.7mm

360°

35 cm

GRADUATION OF 2 DEGREES
POZIŁANKA PO 2 STOPNIE



YATO	Ø	
YT-05934	1/2" (12.7 mm)	10/40

EN Torque multiplier
 PL Mechaniczny wzmacniacz momentu
 DE Drehmomentverstärker
 RU Мультипликатор крутящего момента
 CZ Mechanický posilovač momentu
 HU Nyomaték sokszorozó
 RO Antrenor cu amplificator de forta
 FR Amplificateur de couple mécanique
 IT Moltiplicatore di coppia
 ES Mecanismo de reforzar el momento
 CN 扭力倍增器

1"
25mm

32 mm

33 mm

4200 Nm (max.)

I-1:3.8

II-1:58

CrV



YATO	Ø	Tmax. [Nm]	L [mm]	
YT-0782	1" (25.4 mm)	4200	330	1

EN Torque angle gauge with clamp
 PL Kątomierz z uchwytem do klucza dynamometrycznego
 DE Winkellehre mit Griff für Drehmomentschlüssel
 RU Угломер с держакем моментového ключа
 HU Fogantyús szögmérő nyomatékkulcshoz
 RO Dispozitiv masurat unghiuri cu clema
 FR Clé de serrage angulaire flexible avec pince, carré
 IT Goniometro per chiave dinamometrica
 ES Escuadra para soporte de la llave dinamométrica
 CN 扭力规



1/2"
12.7mm

360°

50 cm

GRADUATION OF 2 DEGREES
POZIŁANKA PO 2 STOPNIE



YATO	Ø	
YT-05933	1/2" (12.7 mm)	6/24

EN Torque multiplier
 PL Mechaniczny wzmacniacz momentu
 DE Drehmomentverstärker
 RU Мультипликатор крутящего момента
 CZ Mechanický posilovač momentu
 HU Nyomaték sokszorozó
 RO Antrenor cu amplificator de forta
 FR Amplificateur de couple mécanique
 IT Moltiplicatore di coppia
 ES Mecanismo de reforzar el momento
 CN 扭力倍增器

1"
25mm

32 mm

33 mm

5800 Nm (max.)

1:66

CrV



YATO	Ø	Tmax. [Nm]	L [mm]	
YT-07822	1" (25.4 mm)	5800	380	1

Memo

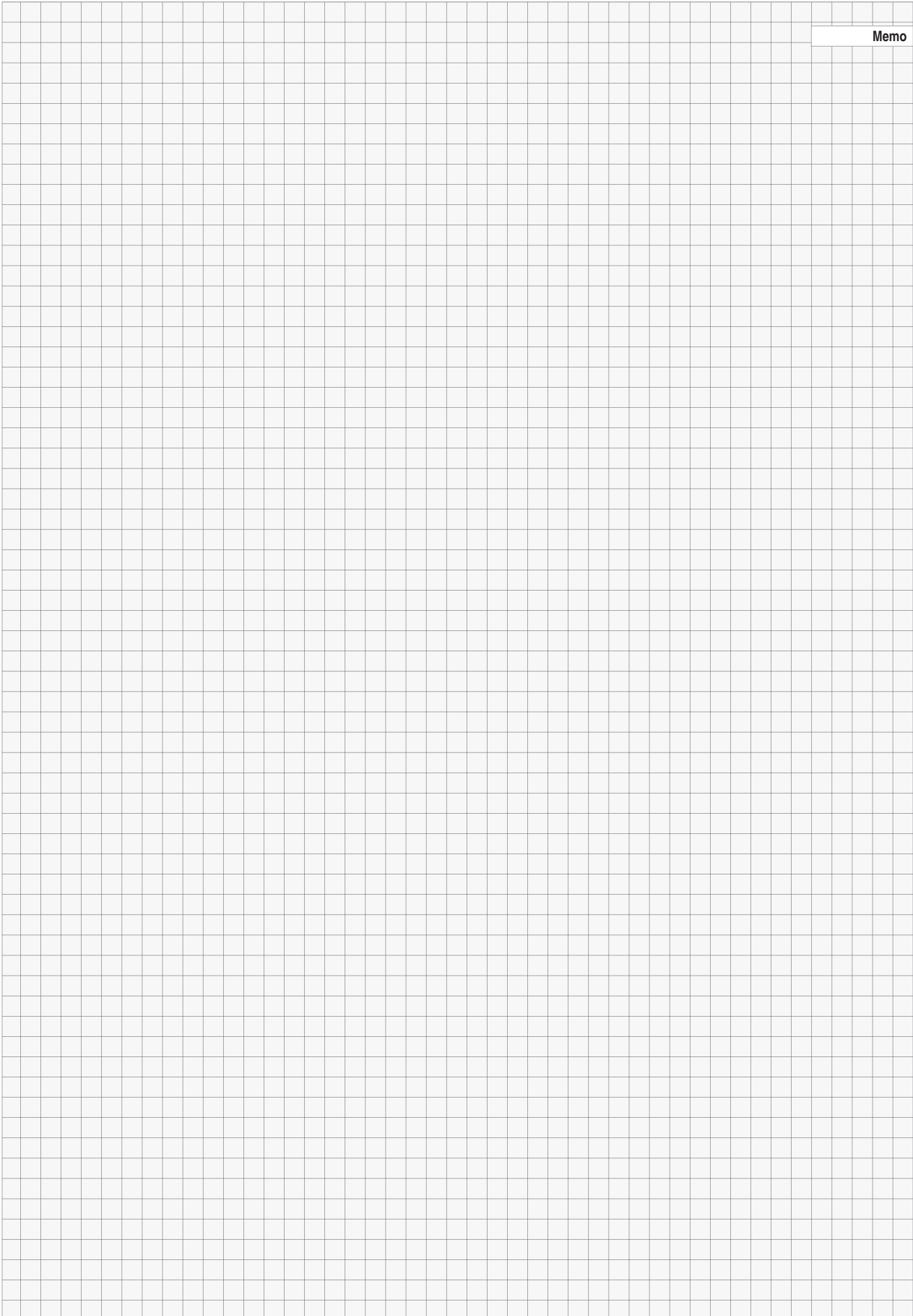

5

**Screwdrivers
& screwdriver bits**
**Wkrętaki i końcówki
wkrętakowe**



Screwdrivers, 3 color handle
Wkrętaki, trójkolorowa rączka

82-85



Slotted screwdrivers

Wkrętaki płaskie

82

Phillips screwdrivers

Wkrętaki krzyżakowe

82

Pozidrive screwdrivers

Wkrętaki „Pozidrive”

82

Torx screwdrivers

Wkrętaki „Torx”

82

Torx Security screwdrivers

Wkrętaki „Torx Security”

82

Go-through screwdrivers

Wkrętaki do pobijania

Screwdriver sets

Komplety wkrętaków

83

Screwdrivers, 3 color handle
Wkrętaki, trójkolorowa rączka

86



Screwdriver sets

Komplety wkrętaków

86

Precision screwdrivers, 3 color handle
Wkrętaki precyzyjne, trójkolorowa rączka

86-87



Precision slotted screwdrivers

Wkrętaki precyzyjne płaskie

86

Precision phillips screwdrivers

Wkrętaki precyzyjne krzyżakowe

86

Precision Torx screwdrivers

Wkrętaki precyzyjne „Torx”

86

Precision screwdriver sets

Zestawy wkrętaków precyzyjnych

86

Insulated screwdrivers
Wkrętaki izolowane

87-88



Insulated slotted screwdrivers

Wkrętaki izolowane płaskie

87

Insulated phillips screwdrivers

Wkrętaki izolowane krzyżakowe

87

Insulated Pozidrive screwdrivers

Wkrętaki izolowane „Pozidrive”

87

Insulated screwdriver sets

Komplety wkrętaków izolowanych

87

Special screwdrivers & impact screwdrivers
Wkrętaki specjalne i udarowe

89-90



Ratchet screwdriver sets

Wkrętaki z grzechotką

89

Impact screwdrivers

Wkrętaki udarowe

90

Screwdriver bits

Kończówki wkrętakowe

90-98



Phillips screwdriver bits

Kończówki wkrętakowe krzyżakowe

90

Torx screwdriver bits

Kończówki wkrętakowe „Torx”

90

YATO NON-SLIP SYSTEM screwdriver bits

Kończówki wkrętakowe „YATO NON-SLIP SYSTEM”

91

Screwdriver bit sets

Zestawy końcówek wkrętakowych

94

Nut setters

Nasadki magnetyczne do wkrętarek

98



Screwdriver bit holders

Uchwyty do końcówek wkrętakowych

98-101



Hex & Torx keys & sets

Klucze imbusowe i zestawy

102-108



T-handle keys & sets

Klucze imbusowe typu „T” i zestawy

102

Hex keys & sets

Klucze imbusowe i zestawy

103

Torx & Torx Security keys & sets

Klucze „Torx”, „Torx Security” i zestawy

107

Plastic covered hex & Torx Security keys

Klucze imbusowe powlekane

108

EN Screwdriver CZ Šroubovák IT Cacciavite
 PL Wkrętak HU Csavarhúzó ES Destornillador
 DE Schraubendreher RO Șurubelniță CN 一字螺丝批
 RU Отвёртка FR Tournevis



5



YATO	⊖ [mm]	L [mm]	PCS PIECE	
YT-25900	2	75	12	96/384
YT-25901	3	75	12	96/384
YT-25902	3	100	12	96/384
YT-25903	3	150	12	60/240
YT-25904	4	100	12	96/384
YT-25905	4	150	12	96/384
YT-25906	4	200	12	96/384
YT-25907	5	75	12	60/240
YT-25908	5	100	12	60/240
YT-25909	5	150	12	60/240
YT-25910	6	38	12	60/240
YT-25911	6	100	12	36/144
YT-25912	6	150	12	36/144
YT-25913	6	200	12	36/144
YT-25914	8	150	6	24/96



YATO	⊕	L [mm]	PCS PIECE	
YT-25920	PH0	75	12	96/384
YT-25921	PH0	100	12	96/384
YT-25922	PH1	38	12	60/240
YT-25923	PH1	75	12	60/240
YT-25924	PH1	100	12	60/240
YT-25925	PH1	150	12	60/240
YT-25926	PH1	200	12	36/144
YT-25927	PH1	300	6	24/96
YT-25928	PH2	38	12	60/240
YT-25929	PH2	100	12	36/144
YT-25930	PH2	150	12	36/144
YT-25931	PH2	200	12	36/144
YT-25932	PH2	300	6	24/96
YT-25933	PH3	150	6	24/96
YT-25934	PH3	200	6	24/96



YATO	⊕	L [mm]	PCS PIECE	
YT-25940	PZ1	75	12	60/240
YT-25941	PZ1	100	12	60/240
YT-25942	PZ2	100	12	36/144
YT-25943	PZ2	150	12	36/144



YATO	⊗	L [mm]	PCS PIECE	
YT-25950	T5	75	12	96/384
YT-25951	T6	75	12	96/384



YATO	⊗	L [mm]	PCS PIECE	
YT-25952	T7	75	12	96/384
YT-25953	T8	75	12	96/384
YT-25954	T9	75	12	96/384
YT-25955	T10	100	12	60/240
YT-25956	T15	100	12	60/240
YT-25957	T20	100	12	60/240
YT-25958	T25	100	12	36/144
YT-25959	T27	100	12	36/144
YT-25960	T30	100	12	36/144
YT-25961	T40	100	6	24/96

EN Go-through screwdriver
PL Wkrętak do pobijania
DE Schlagschrauber
RU Отвёртка-било
CZ Šroubovák s úderným koncem
HU Beütő csavarhúzó
RO Şurubelniţă pt. fixare
FR Tournevis à frapper
IT Cacciaviti per viti con intaglio
ES Destornillador para dar golpes
CN 一字敲击螺丝批



YATO	⊖ [mm]	L [mm]	PCS RO/DE	Box
YT-25985	6	100	6	24/96
YT-25986	6	150	6	24/96
YT-25987	6	200	6	24/96
YT-25988	6	250	6	24/96
YT-25989	8	150	6	24/72
YT-25990	8	200	6	24/72
YT-25991	8	250	6	24/72
YT-25992	8	300	6	24/72

YATO	⊕	L [mm]	PCS RO/DE	Box
YT-25993	PH2	100	6	24/96
YT-25994	PH2	150	6	24/96
YT-25995	PH3	150	6	24/72
YT-25996	PH3	200	6	24/72
YT-25997	PH3	250	6	24/72

EN Screwdriver set
PL Komplet wkrętek
DE Schraubendrehersatz
RU Набор отвёрток
CZ Zámečnické šroubováky
HU Lakatos csavarhúzó
RO Şurubelniţe de lăcătuşerie
FR Set de tournevis
IT Set cacciaviti
ES Juego de destornilladores
CN 敲击螺丝批组套

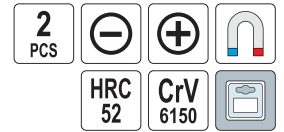

⊖ 6.0 mm (L=150 mm);
⊕ PH2 (L=150 mm)

YATO	Box
YT-25998	6/36

EN Screwdriver set
PL Komplet wkrętek
DE Schraubendrehersatz
RU Набор отвёрток
CZ Zámečnické šroubováky
HU Lakatos csavarhúzó
RO Şurubelniţe de lăcătuşerie
FR Set de tournevis
IT Set cacciaviti
ES Juego de destornilladores
CN 螺丝批组套



⊖ 3.0 mm (L=75 mm), 5.0, 6.0 mm (L=100 mm);
⊕ PH0 (L=75 mm), PH1, PH2 (L=100 mm)

⊖ 2.0, 2.4 mm (L=50 mm), 6.0 mm (L=38 mm), 6.0 mm (L=100 mm);
⊕ PH0, PH1 (L=50 mm), PH2 (L=38 mm), PH2 (L=100 mm)

YATO	Box
YT-25965	6/24

YATO	Box
YT-25980	6/24



⊖ 5.0, 6.0 mm (L=100 mm), 8.0 mm (L=150 mm);
⊕ PH0 (L=75 mm), PH1, PH2 (L=100 mm), PH2 (L=38 mm), PH3 (L=150 mm)

⊖ 3.0, 5.0 mm (L=75 mm), 6.0 mm (L=38 mm), 6.0, 8.0 mm (L=150 mm);
⊕ PH0, PH1 (L=75 mm), PH2 (L=38 mm), PH2 (L=100 mm), PH3 (L=150 mm);
⊖ SQ1, SQ2 (L=100 mm)

YATO	Box
YT-25966	6/12

YATO	Box
YT-25967	6/12

EN Screwdriver set
 PL Komplet wkrętek
 DE Schraubendrehersatz
 RU Набор отвёрток
 CZ Zámečnické šroubováky
 HU Lakatos csavarhőző
 RO Şurubelnițe de lăcătușerie
 FR Set de tournevis
 IT Set cacciaviti
 ES Juego de destornilladores
 CN 螺丝批组套



15
PCS

⊖

⊕

☆

U

HRC
58

S2

- ⊖ 1.5, 2.0 mm (L=50 mm), 5.0 mm (L=75 mm), 6.0 mm (L=38 mm), 6.0 mm (L=100 mm), 6.0 mm (L=125 mm);
- ⊕ PH00, PH0 (L=50 mm), PH1 (L=75 mm), PH2 (L=38 mm), PH2 (L=100 mm);
- ☆ T5, T6, T7, T8 (L=50 mm)

YATO

YT-25981

6/24

EN 6 in 1 interchangeable screwdriver set
 PL Wkrętak z końcówkami dwustronnymi
 DE Umsteckschraubendreher
 RU Отвёртка с двухсторонними насадками
 CZ Šroubovák lancesr z dvoustannou koncovkou
 HU Csavarhőző kétvégű szárral
 RO Şurubelniță cu dublu capăt
 FR Tournevis embouts réversibles
 IT Cacciavite reversibile
 ES Destornillador con punta de dos caras
 CN 螺丝批

⊖

⊕

☆

U

S2



- ⊕ 5.0 mm x PH1, 6.0 mm x PH2;
- 1/4" (6.3 mm) x 5/16" (8 mm)

YATO

YT-25971

12/96

EN Mini pick & hook set
 PL Zestaw haczyków z rękojeścią
 DE Mini Hacken Set
 RU Набор крючков с рукоятками
 CZ Sada háčkových mini páčidel
 HU Mini ár és kampó készlet
 RO Set universal carlige extras garnituri
 FR Set de crochets
 IT Set ganci con maniglia
 ES Juego de palancas de hierro
 CN 迷你拉拔器组套

4
PCS

U

HRC
40



YATO

YT-0843

12/72

EN Screwdriver set
 PL Komplet wkrętek
 DE Schraubendrehersatz
 RU Набор отвёрток
 CZ Zámečnické šroubováky
 HU Lakatos csavarhőző
 RO Şurubelnițe de lăcătușerie
 FR Set de tournevis
 IT Set cacciaviti
 ES Juego de destornilladores
 CN 螺丝批组套



9
PCS

⊖

⊕

U

HRC
58

S2

- ⊖ 3.0, 5.0 mm (L=75 mm), 6.0 mm (L=100 mm), 6.0, 8.0 mm (L=150 mm);
- ⊕ PH0, PH1 (L=75 mm), PH2 (L=100 mm), PH2 (L=150 mm)

YATO

YT-25968

6/12

EN Screwdriver set
 PL Komplet wkrętek
 DE Schraubendrehersatz
 RU Набор отвёрток
 CZ Zámečnické šroubováky
 HU Lakatos csavarhőző
 RO Şurubelnițe de lăcătușerie
 FR Set de tournevis
 IT Set cacciaviti
 ES Juego de destornilladores
 CN 螺丝批组套



18
PCS

⊖

⊕

☆

U

HRC
58

S2

- ⊖ 2.4, 3.0 mm (L=50 mm), 5.0 mm (L=75 mm), 6.0 mm (L=38 mm), 6.0 mm (L=100 mm), 8.0 mm (L=150 mm);
- ⊕ PH00, PH0 (L=50 mm), PH1 (L=75 mm), PH2 (L=38 mm), PH2 (L=100 mm), PH3 (L=150 mm);
- ☆ T5, T6, T7, T8, T9, T10 (L=50 mm)

YATO

YT-25982

6/12

EN Universal hook and pick set
 PL Zestaw haków i skrobaków z rękojeścią
 DE Haken- und Schabersatz mit Griff
 RU Набор крючков и скребков с ручкой
 CZ Sada háků a škrabek s rukojetí
 HU Fogantűs kampó- és kaparókészlet
 RO Set universal carlige extras garnituri
 FR Kit de crochets et de grattoirs avec poignée
 IT Set di ganci e raschietti con impugnatura
 ES Juego de ganchos y raspadores con mango
 CN 发动机清理工具

5
PCS

200
mm

225
mm

23x220
mm

23x245
mm

40Cr



YATO

YT-08422

6/24

EN Universal hook set
PL Zestaw haczyków z rękojeścią
DE Hakenset mit Handgriff
RU Набор крючков с рукояткой
CZ Sada háčků s rukojetí
HU Fogantyús kampó készlet

RO Set universal extractoare garnituri
FR Jeu de crochets avec manche
IT Set di ganci con maniglia
ES Set de ganchos para extracción con mango
CN 油封起子

7
PCS

162
mm

205
mm

40Cr



YATO

YT-08425



6/24

EN Long reach hook and pick tool set
PL Zestaw haków długich z rękojeścią
DE Langhakensatz mit Griff
RU Набор длинных крючков с ручкой
CZ Sada dlouhých háků s rukojetí
HU Fogantyús hosszú kampókészlet

RO Set lung pt. extras garnituri
FR Kit de longs crochets avec poignée
IT Set di ganci lunghi con impugnatura
ES Juego de ganchos largos con mango
CN 油封起子

4
PCS

240
mm

40Cr



YATO

YT-08429



6/72

EN Seal remover and hose pick set
PL Zestaw do demontażu uszczelnień i oringów
DE Demontageset für Dichtungen und O-Ringe
RU Набор для снятия уплотнений и уплотнительных колец
CZ Sada pro demontáž těsnění a těsnících kroužků
HU O-ring és tömítésleszedő készlet

RO Dispozitiv indepartat sigilii si set carlige
FR Kit crochet pour joint torique
IT Kit di strumenti per rimozione di guarnizioni e O-ring
ES Juego de remoción de sellado y juntas tóricas
CN 油封钩

6
PCS

120
mm

150
mm

160
mm

200
mm

210
mm

290
mm

SPECIAL
SHAPE
SPECJALNY
KSZTAŁT



YATO

YT-08432



5

EN Universal hook set
PL Zestaw haczyków z rękojeścią
DE Hakenset mit Handgriff
RU Набор крючков с рукояткой
CZ Sada háčků s rukojetí
HU Fogantyús kampó készlet

RO Set universal extractoare garnituri
FR Jeu de crochets avec manche
IT Set di ganci con maniglia
ES Set de ganchos para extracción con mango
CN 油封起子

9
PCS

162
mm

240
mm

40Cr



YATO

YT-08426



6/12

EN Long reach hook and pick tool set
PL Zestaw haków długich z rękojeścią
DE Langhakensatz mit Griff
RU Набор длинных крючков с ручкой
CZ Sada dlouhých háků s rukojetí
HU Fogantyús hosszú kampókészlet

RO Set lung pt. extras garnituri
FR Kit de longs crochets avec poignée
IT Set di ganci lunghi con impugnatura
ES Juego de ganchos largos con mango
CN 油封起子

6
PCS

240
mm

40Cr



YATO

YT-08428



6/48

EN Hook set for o-ring
PL Zestaw haczyków do uszczelniaczy
DE Dichtungs-Haken-Satz
RU Комплект крючков для герметиков
CZ Sada háčků pro těsnící prstny
HU Kampókészlet tömítésekhez

RO Set carlige pt. o-ring
FR Ensemble de crochet à joint d'étanchéité
IT Set di ganci per sigillanti
ES Set de ganchos para selladores
CN 密封拉拔器

8
PCS

165
mm

225
mm

SPECIAL
SHAPE
SPECJALNY
KSZTAŁT



YATO

YT-08431



48

EN Screwdriver set
 PL Komplet wkrętek
 DE Schraubendrehersatz
 RU Набор отвёрток
 CZ Zámečnické šroubováky
 HU Lakatos csavarhúzó

RO Șurubelnițe de lăcătușerie
 FR Set de tournevis
 IT Set cacciaviti
 ES Juego de destornilladores
 CN 螺丝批组套

6 PCS
 HRC 58-62
 SVC55



⊖ 5.5, 6.5 mm (L=100 mm), 8.0 mm (L=150 mm);
 ⊕ PH1, PH2 (L=100 mm), PH3 (L=150 mm)

YATO
 YT-2668 6/24

EN Screwdriver set
 PL Komplet wkrętek
 DE Schraubendrehersatz
 RU Набор отвёрток
 CZ Zámečnické šroubováky
 HU Lakatos csavarhúzó

RO Șurubelnițe de lăcătușerie
 FR Set de tournevis
 IT Set cacciaviti
 ES Juego de destornilladores
 CN 螺丝批组套

8 PCS
 HRC 58-62
 SVC55



⊖ 4.0, 5.5, 6.5 mm (L=100 mm), 6.5 mm (L=38 mm);
 ⊕ PH0 (L=75 mm), PH1, PH2 (L=100 mm), PH2 (L=38 mm)

YATO
 YT-2670 4/16

EN Precision screwdriver
 PL Wkrętak precyzyjny
 DE Präzisions-Schraubendreher
 RU Отвёртка для точных работ

CZ Šroubovák pro jemnou mechaniku
 HU Műszerész csavarhúzó
 RO Șurubelniță mecanică fină
 FR Tournevis de précision

IT Cacciavite di precisione
 ES Destornillador de precisión
 CN 一字钟表螺丝批

HRC 57-61 S2



YATO	⊖ [mm]	L [mm]	
YT-25802	1.4	50	50/400
YT-25803	1.6	50	50/400
YT-25804	1.8	50	50/400
YT-25805	2.0	50	50/400
YT-25806	2.0	75	50/400
YT-25807	2.4	50	50/400
YT-25808	2.4	75	50/400
YT-25809	3.0	50	50/400
YT-25810	3.0	75	50/400
YT-25811	3.0	100	50/400

YATO	⊕	L [mm]	
YT-25831	PH000	50	50/400
YT-25832	PH000	75	50/400
YT-25833	PH00	50	50/400
YT-25834	PH00	75	50/400
YT-25835	PH0	50	50/400
YT-25836	PH0	75	50/400
YT-25837	PH0	100	50/400
YT-25838	PH1	50	50/400
YT-25839	PH1	100	50/400
YT-25840	PH1	150	50/400

YATO	⊗	L [mm]	
YT-25852	T5	50	50/400
YT-25853	T6	50	50/400
YT-25854	T7	50	50/400
YT-25855	T8	50	50/400
YT-25856	T9	50	50/400
YT-25857	T10	50	50/400

EN Precision screwdriver set
 PL Zestaw wkrętek precyzyjnych
 DE Präzisions-Feinmechanikersatz
 RU Набор прецизионных отвёрток

CZ Šroubovák sada pro jemnou mechaniku
 HU Órás csavarhúzó készlet
 RO Set surubelnite
 FR Set de tournevis de précision

IT Set cacciavite di precisione
 ES Destornilladores precisos
 CN 钟表螺丝批组套

HRC 57-61 S2



6 PCS
 ⊖
 ⊕

⊖ 1.4, 2.0, 2.4 mm (L=50 mm);
 ⊕ PH00, PH0, PH1 (L=50 mm)

YATO
 YT-25861 6/36



6 PCS
 ⊗

⊗ T5, T6, T7, T8, T9, T10 (L=50 mm)

YATO
 YT-25862 6/36



7 PCS
 ⊖
 ⊕
 ⊗

⊖ 2.0, 3.0 mm (L=50 mm);
 ⊕ PH00, PH0 (L=50 mm);
 ⊗ T5, T6, T7 (L=50 mm)

YATO
 YT-25863 6/36

EN Insulated screwdriver set
PL Komplet wkrętek izolowanych
DE Isolierte Schraubendreher
RU Набор изолированных отверток
CZ Izolované šroubováky
HU Szigetelt csavarhúzó készlet
RO Set surubelnita izolata
FR Jeu de tournevis isolés
IT Set cacciaviti isolati
ES Juego de destornilladores aislado
CN 绝缘螺丝批组套

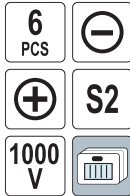

⊖ 1.8, 2.0 mm (L=50 mm), 2.5, 3.0 mm (L=65 mm); S2
⊕ PH00, PH0 (L=65 mm); S2

YATO
YT-28283

6/48

EN Mobile phone repair tools set
PL Zestaw do naprawy telefonów komórkowych
DE Mobiltelefon Reparatur Satz
RU Набор инструмента для ремонта мобильных телефонов
CZ Nástroje na opravu mobilních telefonů
HU Mobiltelefon-javítás szerszámkészlet
RO Set surubelnite service telefoane mobile
FR Outils de réparation de téléphone mobil
IT Set di riparazione del telefono cellulare
ES Herramientas de la reparación del teléfono móvil fijadas
CN 精密批维修套套

⊖ (L=100 mm);
⊖ (L=145 mm);
⊖ 1/4" (6.3 mm); (L=46 mm); S2;
⊖ (L=60 mm);
⊖ (L=85 mm);
⊖ 2.5, 3.0, 3.5, 4.0, 4.5, 5.0, 5.5 mm; PH2 (magnetic); S2;
⊖ 1.0, 1.5, 2.0, 2.5, 3.0, 3.5, 4.0 mm (L=25 mm); S2;
⊖ PH000, PH00, PH0, PH1, PH2 (L=25 mm); S2;
⊖ T2, T3, T4, T5, T6, T7 (L=25 mm); S2;
⊖ T8, T9, T10, T15, T20 (L=25 mm); S2;
⊖ 0.7, 0.9, 1.3, 1.5, 2.0, 2.5, 3.0, 4.0, 4.5, 5.0, 6.0 mm (L=25 mm); S2;
⊖ S0, S1, S2 (L=25 mm); S2;
⊖ 0.8, 1.2, 1.5 mm (L=25 mm); S2;
⊖ 0.6, 2.0, 2.5 mm (L=25 mm); S2;
⊖ 2.0, 3.0 mm (L=25 mm); S2;
⊖ 2.6, 3.0 mm (L=25 mm); S2;
⊖ 0.8 mm (L=25 mm); S2

YATO
YT-25760

25/50

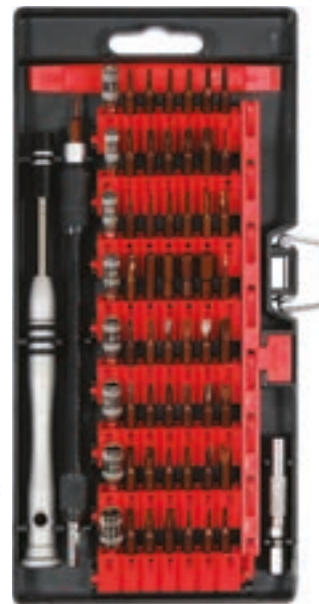

EN Insulated screwdriver
PL Wkrętak izolowany
DE Isolierte Schraubendreher
RU Изолированная отвёртка
CZ Izolovaný šroubovák
HU Szigetelt csavarhúzó
RO Şurubelniţă izolată
FR Tournevis isolé
IT Cacciavite isolato
ES Destornillador aislado
CN 一字绝缘螺丝批



YATO	⊖ [mm]	L [mm]	
YT-28150	2.5	75	12/360
YT-28153	3.0	100	12/360
YT-28174	3.5	100	12/360
YT-2817	4.0	100	12/120
YT-2818	5.5	125	12/120
YT-2819	6.5	150	12/120
YT-2820	8.0	175	12/120



YATO	⊕	L [mm]	
YT-2821	PH0	60	12/120
YT-2822	PH1	80	12/120
YT-2823	PH2	100	12/120
YT-2824	PH3	150	12/120



YATO	⊕	L [mm]	
YT-28245	PZ0	60	12/360
YT-2825	PZ1	80	12/120
YT-2826	PZ2	100	12/120
YT-28263	PZ3	150	12/96

EN Insulated screwdriver set
PL Komplet wkrętek izolowanych
DE Isolierte Schraubendreher
RU Изолированная отвёртка - набор
CZ Izolované šroubováky
HU Szigetelt csavarhúzó
RO Şurubelniţă izolată
FR Set de tournevis isolés
IT Set di cacciavite isolato
ES Juego de destornilladores aislado
CN 绝缘螺丝批组套



5
PCS



⊖ 3.0, 4.0 mm (L=100 mm), 5.5 mm (L=125 mm);
⊕ PH1 (L=80 mm), PH2 (L=100 mm)

YATO
YT-2827

10/40

7
PCS



⊖ 3.0, 4.0 mm (L=100 mm), 5.5 mm (L=125 mm);
⊕ PH1 (L=80 mm), PH2 (L=100 mm);
⊖ PZ1 (L=80 mm), PZ2 (L=100 mm)

YATO
YT-2828

10/40



EN Insulated changeable screwdriver set
 PL Zestaw wkrętek z wymiennymi końcówkami izolowanymi
 DE Isolierte Schraubendrehersatz
 RU Набор изолированных отверток
 CZ Sada izolovaných šroubováků
 HU Szigetelt csavarhúzó készlet
 RO Set surubelnita cu biti izolate
 FR Jeu de tournevis isolés
 IT Set cacciaviti isolati
 ES Juego de destornilladores aislado
 CN 绝缘可换头螺丝批组套

8 PCS

CrV 6150

1000 V



- ⊖ 3.0, 4.0, 5.5 mm (L=100 mm); CrV 6150;
- ⊕ PH1 (L=80 mm), PH2 (L=100 mm); CrV 6150;
- ⊞ Square lock key / Klucz kwadratowy;
- ⊟ Triangle lock key / Klucz trójkątny

1000 V
 VDE CERTIFICATE
 EN 60900:2012

YATO

YT-28294 6/24

EN Insulated changeable screwdriver set
 PL Zestaw wkrętek z wymiennymi końcówkami izolowanymi
 DE Isolierte Schraubendrehersatz
 RU Набор изолированных отверток
 CZ Sada izolovaných šroubováků
 HU Szigetelt csavarhúzó készlet
 RO Set surubelnita cu biti izolate
 FR Jeu de tournevis isolés
 IT Set cacciaviti isolati
 ES Juego de destornilladores aislado
 CN 绝缘可换头螺丝批组套

13 PCS

CrV 6150

1000 V



- ⊖ 3.0, 4.0, 5.5, 6.5 mm (L=100 mm); CrV 6150;
- ⊕ PH1 (L=80 mm), PH2 (L=100 mm); CrV 6150;
- ⊞ PZ1 (L=80 mm), PZ2 (L=100 mm); CrV 6150;
- ⊟ T10, T15, T20 (L=100 mm); CrV 6150;
- ⊞ Torx 3x140 mm; 250 V

1000 V
 VDE CERTIFICATE
 EN 60900:2012

YATO

YT-28295 6/12

EN Insulated changeable screwdriver set
 PL Zestaw wkrętek z wymiennymi końcówkami izolowanymi
 DE Isolierte Schraubendrehersatz
 RU Набор изолированных отверток
 CZ Sada izolovaných šroubováků
 HU Szigetelt csavarhúzó készlet
 RO Set surubelnita cu biti izolate
 FR Jeu de tournevis isolés
 IT Set cacciaviti isolati
 ES Juego de destornilladores aislado
 CN 绝缘可换头螺丝批组套

12 PCS

HRC 54-61

S2 1000 V



- ⊖ 2.0, 2.5, 3.0, 3.5, 4.0, 5.5, 6.5 mm (L=100 mm); S2;
- ⊕ PH0, PH1, PH2 (L=100 mm); S2;
- ⊞ PZ0, PZ1, PZ2 (L=100 mm); S2;
- ⊟ T6, T8, T9, T10, T15, T20, T25, T27, T30 (L=100 mm); S2;
- ⊞ Torx 4x150 mm; 250 V

YATO

YT-28290 24

EN Insulated changeable screwdriver set
 PL Zestaw wkrętek z wymiennymi końcówkami izolowanymi
 DE Isolierte Schraubendrehersatz
 RU Набор изолированных отверток
 CZ Sada izolovaných šroubováků
 HU Szigetelt csavarhúzó készlet

RO Set surubelnita cu biti izolate
 FR Jeu de tournevis isolés
 IT Set cacciaviti isolati
 ES Juego de destornilladores aislado
 CN 绝缘可换头螺丝批组套

50 PCS

HRC 54-61

S2 1000 V



- ⊖ 1, 2, 3, 4 mm (L=100 mm); S2;
- ⊕ 4, 6, 8, 10 mm (L=100 mm); S2;
- ⊞ PZ0, PZ1, PZ2 (L=100 mm); S2;
- ⊟ T6, T8, T9, T10, T15, T20, T25, T27, T30 (L=100 mm); S2;
- ⊞ Torx 4x150 mm; 250 V

YATO

YT-28293 10

EN 22 in 1 interchangeable screwdriver set
PL Wkrętak z końcówkami dwustronnymi
DE Umsteckschraubendreher
RU Отвёртка - двухсторонние насадки
CZ Šroubovák lancer z dvoustannou koncovkou
HU Csavarhúzó kétfélgű szárral

RO Șurubelniță cu dublu capăt
FR Tournevis + embouts 22 en 1
IT Set cacciavite con punte reversibile
ES Destornillador con punta dos caras
CN 螺丝批组套

12
PCS

22in1
22w1



SVCM



- 4 mm x 5.5 mm (L=175/115 mm)
- ⊕ 6.5 mm x PH3 (L=175/115 mm)
- ⊕ PH1 x PH2 (L=175/115 mm)
- ⊕ PZ1 x PZ2 (L=175/115 mm)
- 3 mm x 3 mm (L=175/115 mm)
- 4 mm x 4 mm (L=175/115 mm)
- 5 mm x 5 mm (L=175/115 mm)
- 6 mm x 6 mm (L=175/115 mm)
- ⊗ T10 x T15 (L=175/115 mm)
- ⊗ T20 x T25 (L=175/115 mm)
- ⊗ T30 x T40 (L=175/115 mm)

YATO
YT-2797 6/12

EN Screwdriver set with bits
PL Zestaw - wkrętak z końcówkami
DE Schraubendreher- und Bit-Set
RU Набор - отвёртка с битами
CZ Sada - šroubovák s koncovkami
HU Készlet - csavarhúzó bitfejekkel

RO Set surubelnita cu biti
FR Ensemble tournevis avec embout
IT Set - avvitatrice con punte
ES Juego de atomillador con puntas
CN 螺丝批组套

- 6, 7, 8, 10, 12 mm; CrV;
- ⊕ 1.5 mm x PH000, 2.0 mm x PH00, 2.5 mm x PH0, 3.0 mm x PH1 (L=75 mm);
- 1.5 mm x PH000, 2.0 mm x PH00, 2.5 mm x PH0 (L=115 mm); S2;
- ⊗ T6 x T7, T8 x T9 (L=75 mm); T6 x T7, T8 x T9 (L=115 mm); S2;
- 2 x 3 mm (L=75 mm); S2;
- 5 x 6 mm (L=75 mm); 5 x 6 mm (L=115 mm); S2;
- ⊕ PH1 x PH2, PH2 x PH3 (L=75 mm); PH1 x PH2, PH2 x PH3 (L=115 mm); S2;
- S1 x S2 (L=75 mm); S1 x S3 (L=115 mm); S2;
- 5 x 6 mm (L=75 mm); S2;
- ⊗ T10 x T15 (L=115 mm); S2

EN Precision screwdriver with bits
PL Wkrętak elastyczny z wymiennymi bitami
DE Schraubendreher- und Bit-Satz
RU Отвёртка с прецизионными битами
CZ Šroubovák ráčnový se sadou bitů
HU Órás csavarhúzó-bit készlet
RO Surubelnita + set biti
FR Tournevis élastique

IT Cacciavite flessibile con punte intercambiabili
ES Juego de pizas terminales para destornillador + mango
CN 可弯曲批头组套

31
PCS

215
mm

1/4"
6.3mm



- 1/4" (6.3 mm): 3.0, 3.5, 4.0, 5.0, 5.5, 6.5 mm (L=25 mm);
- ⊕ 1/4" (6.3 mm): PH0, PH1, PH2, PH3 (L=25 mm);
- ⊕ 1/4" (6.3 mm): PZ0, PZ1, PZ2, PZ3 (L=25 mm);
- ⊕ 1/4" (6.3 mm): T10, T15 (L=25 mm);
- 1/4" (6.3 mm): 2, 3, 4, 5, 6 mm (L=25 mm);
- 1/4" (6.3 mm): 5, 6, 7, 8 x2, 9, 10, 11, 12, 13 mm

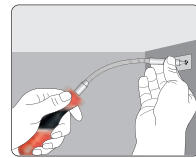

YATO
YT-25972 6/24

EN Ratchet screwdriver with bits
PL Wkrętak z grzechotką i bitami
DE Schraubendreher mit Ratche
RU Отвёртка с трещеткой
CZ Šroubovák z řehačkou
HU Racsnis csavarbehajtó
RO Antrenor cu clichet + set biti
FR Coffret tournevis a cliquet réversible porte-embouts
IT Set di inserti con chiave a cricchetto
ES Juego con destornillador y carraca
CN 螺丝批组套

11
PCS

1/4"
6.3 mm



- 1/4" (6.3 mm): 4, 5, 6 mm; S2;
- ⊕ 1/4" (6.3 mm): PH0, PH1, PH2; S2;
- 1/4" (6.3 mm): S1, S2, S3; S2;
- 1/4" (6.3 mm): S1, S2, S3; S2;

YATO
YT-14390 1/4" (6.3 mm) 25/50



28
PCS

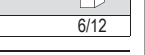
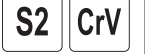

YATO
YT-27940 6/12

EN Ratchet screwdriver set
PL Wkrętak z grzechotką, przegubem i bitami
DE Ratschenschraubendreher-Satz mit Einsätzen
RU Набор головок с трещеткой
CZ Ráčnový kloubový šroubovák s příslušenstvím
HU Dugókulcs és bit készlet csukló

RO Set surubelnita
FR Clé mixte à cliquet + embouts
IT Set do chiavi a cricchetto e inserti
ES Juego con destornillador y carraca
CN 棘轮螺丝批组套

42
PCS

1/4"
6.3mm



- 1/4" (6.3 mm): 5, 6, 7, 8, 9, 10, 11, 12, 13 mm;
- ⊕ 1/4" (6.3 mm) (L=100 mm);
- 1/4" (6.3 mm); CrV 50BV30;
- 3, 4, 5, 6, 7 mm;
- ⊕ PH1 x2, PH2 x2, PH3 x2;
- ⊕ PZ1 x2, PZ2 x2, PZ3 x2;
- ⊗ T10, T15, T20, T25, T27, T30, T40;
- 2, 2.5, 3, 4, 5, 6 mm

YATO
YT-2806 12

EN Impact screwdriver
 PL Wkrętkak udarowy
 DE Schlagschrauber
 RU Отвёртка ударная
 CZ Narazový šroubovák kovový
 HU Kézi ütvecsavarhúzó

RO Şurubelniţă metalică cu percutor
 FR Tournevis à choc
 IT Cacciavite percussione
 ES Destornillador de percusión
 CN 冲击螺丝批组套



7 PCS
 1/2" 12.7 mm
 5/16" 8 mm
 CrV 6150

YATO
 YT-2801 5/20

□ 5/16" (7.9 mm) x 1/2" (12.7 mm);
 ▨ 7, 8 mm (L=35 mm); 8 mm (L=75 mm);
 ⚙ PH2, PH3 (L=35 mm); PH2 (L=75 mm)

EN Impact screwdriver
 PL Wkrętkak udarowy
 DE Schlagschrauber
 RU Отвёртка ударная
 CZ Narazový šroubovák kovový
 HU Kézi ütvecsavarhúzó
 RO Şurubelniţă metalică cu percutor
 FR Tournevis à choc
 IT Cacciavite percussione
 ES Destornillador de percusión
 CN 冲击螺丝批

7 PCS 175 mm 1/2" 12.7 mm 5/16" 8 mm



CrV 6150

□ 5/16" (7.9 mm) x 1/2" (12.7 mm);
 ▨ 7, 8 mm (L=35 mm); 8 mm (L=75 mm);
 ⚙ PH2, PH3 (L=35 mm); PH3 (L=75 mm)

YATO
 YT-28003 8/16

EN Impact screwdriver
 PL Wkrętkak udarowy
 DE Schlagschrauber
 RU Отвёртка ударная
 CZ Narazový šroubovák kovový
 HU Kézi ütvecsavarhúzó

RO Şurubelniţă metalică cu percutor
 FR Tournevis à choc
 IT Cacciavite percussione
 ES Destornillador de percusión
 CN 冲击螺丝批组套

15 PCS 160 mm 1/2" 12.7 mm
 5/16" 8 mm
 CrV 6150
 S2



□ 5/16" (7.9 mm) x 1/2" (12.7 mm);
 ▨ 4, 5, 6, 8, 9 mm (L=35 mm); S2;
 ⚙ PH1, PH2, PH3, PH4 (L=35 mm); S2;
 ○ 4, 5, 6, 8 (L=35 mm); S2

YATO
 YT-28015 16

EN Screwdriver bit set
 PL Zestaw bitów do wkrętek udarowych
 DE Schraubendreherbitsatz
 RU Набор бит крестовых
 CZ Sada bitů
 HU Bitkészlet
 RO Truse bit
 FR Embouts à choc
 IT Set punte cacciavite
 ES Puntas de destornilladora
 CN 冲击批头组套

CrV 6150



YATO	⊕	⊖	L [mm]	⊕ [mm]	pcs / szt.	📦
YT-2810	PH2	-	36	5/16" (7.9 mm)	5	10/100
YT-2811	PH3	-	36	5/16" (7.9 mm)	5	10/100
YT-2812	PH2, PH3	8, 10	36	5/16" (7.9 mm)	4	10/100

EN Impact screwdriver
 PL Wkrętkak udarowy
 DE Schlagschrauber
 RU Отвёртка ударная
 CZ Narazový šroubovák kovový
 HU Kézi ütvecsavarhúzó
 RO Şurubelniţă metalică cu percutor
 FR Tournevis à choc
 IT Cacciavite percussione
 ES Destornillador de percusión
 CN 冲击螺丝批

7 PCS 1/2" 12.7 mm 5/16" 8 mm



CrV 6150

□ 5/16" (7.9 mm) x 1/2" (12.7 mm);
 ▨ 8 mm (L=35 mm); 8 mm (L=75 mm)
 ⚙ PH3 (L=35 mm); PH1, PH2, PH3 (L=75 mm)

YATO
 YT-2802 20

EN Impact screwdriver
 PL Wkrętkak udarowy
 DE Schlagschrauber
 RU Отвёртка ударная
 CZ Narazový šroubovák kovový
 HU Kézi ütvecsavarhúzó
 RO Şurubelniţă metalică cu percutor
 FR Tournevis à choc
 IT Cacciavite percussione
 ES Destornillador de percusión
 CN 冲击螺丝批组套

32 PCS 168 mm 1/2" 12.7 mm
 CrV 6150 S2



1/2" (12.7 mm); 10, 13, 15 mm; CrV 6150;
 ▨ 0.8x5.5, 1.2x6.5, 1.2x8, 1.6x10, 2x12, 2.5x14 mm (L=35 mm); S2;
 ⚙ PH1, PH2, PH3, PH4 (L=35 mm); PH2, PH3 (L=75 mm); S2;
 ⚙ T25, T27, T30, T40, T45, T50, T55 (L=35 mm); S2;
 ○ 4, 5, 6, 7, 8, 10, 12 mm (L=35 mm); S2;
 #3, #4

YATO
 YT-28000 10

EN Screwdriver bit
 PL Końcówka śrubokrętowa
 DE Schraubendreherbit
 RU Бит крестовая
 CZ Šroubováková koncovka
 HU Csavarhúzóvég

RO Capăt pt. şurubelniţă
 FR Douille tournevis
 IT Punta del cacciavite
 ES Punta de destornilladora
 CN 旋具头

AISI S2



YATO	⊕	L [mm]	⊕ [mm]	📦
YT-0404	T25	30	10	10/100
YT-0405	T25	75	10	10/100
YT-04051	T30	30	10	10/100
YT-04052	T30	75	10	10/100
YT-0406	T40	30	10	10/100
YT-0407	T40	75	10	10/100
YT-0408	T45	30	10	10/100
YT-0409	T45	75	10	10/100

EN Screwdriver bit
PL Końcówka śrubokrętowa
DE Schraubendreherbit
RU Бит крестовая

CZ Šroubovaková koncovka
HU Csavarhűzővég
RO Capăt pt. șurubelniță
FR Douille tournevis

IT Punta del cacciavite
ES Punta de destornilladora
CN 旋具头



YATO	+	L [mm]	⊘	📦
YT-0485	PH2	100	1/4" (6.3 mm)	25/100
YT-0486	PH2	150	1/4" (6.3 mm)	25/100
YT-0487	PH2	200	1/4" (6.3 mm)	25/100

EN Screwdriver bit
PL Końcówka śrubokrętowa
DE Schraubendreherbit
RU Бит крестовая

CZ Šroubovaková koncovka
HU Csavarhűzővég
RO Capăt pt. șurubelniță
FR Douille tournevis

IT Punta del cacciavite
ES Punta de destornilladora
CN 旋具头组套

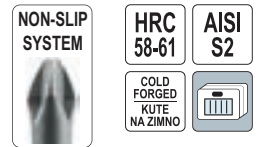

YATO	+	L [mm]	⊘	[Nm]	pcs / szt.	📦
YT-04702	PZ1	25	1/4" (6.3 mm)	6.4	10	25/200
YT-04712	PZ2	25	1/4" (6.3 mm)	19.6	10	25/200
YT-04722	PZ3	25	1/4" (6.3 mm)	45.1	10	25/200

YATO	+	L [mm]	⊘	[Nm]	pcs / szt.	📦
YT-04742	PH1	25	1/4" (6.3 mm)	6.4	10	25/200
YT-04752	PH2	25	1/4" (6.3 mm)	19.6	10	25/200
YT-04762	PH3	25	1/4" (6.3 mm)	45.1	10	25/200

EN Screwdriver bit
PL Końcówka śrubokrętowa
DE Schraubendreherbit

RU Бит крестовая
CZ Šroubovaková koncovka
HU Csavarhűzővég

RO Capăt pt. șurubelniță
FR Douille tournevis
IT Punta del cacciavite

ES Punta de destornilladora
CN 旋具头组套



YATO	+	L [mm]	⊘	[Nm]	pcs / szt.	📦
YT-04772	PH1	50	1/4" (6.3 mm)	6.4	10	25/100
YT-04782	PH2	50	1/4" (6.3 mm)	19.6	10	25/100
YT-04792	PH3	50	1/4" (6.3 mm)	45.1	10	25/100

YATO	+	L [mm]	⊘	[Nm]	pcs / szt.	📦
YT-04812	PH2xPH2	65	1/4" (6.3 mm)	19.6 / 19.6	10	25/100

EN Screwdriver bit set
PL Zestaw końcówek śrubokrętowych
DE Schraubendreherbitsatz
RU Набор битов
CZ Sada bitů
HU Bitkészlet
RO Truse bit
FR Embouts de vissage
IT Set punte cacciavite
ES Puntas de destornilladora
CN 旋具头组套

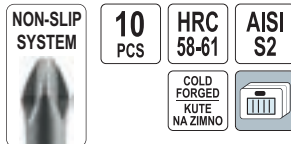

⊘ 5, 6 mm;
⊕ PH1, PH1, PH2, PH2;
⊕ PZ1, PZ1, PZ2, PZ2

YATO	L [mm]	⊘	pcs / szt.	📦
YT-04822	25	1/4" (6.3 mm)	10	25/200

EN Screwdriver bit set
PL Zestaw końcówek śrubokrętowych
DE Schraubendreherbitsatz
RU Набор битов
CZ Sada bitů
HU Bitkészlet
RO Truse bit
FR Embouts de vissage
IT Set punte cacciavite
ES Puntas de destornilladora
CN 旋具头组套

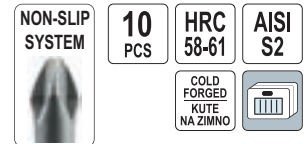

⊘ 5, 6 mm;
⊕ PH1, PH1, PH2, PH2;
⊕ PZ1, PZ1, PZ2, PZ2

YATO	L [mm]	⊘	pcs / szt.	📦
YT-04832	50	1/4" (6.3 mm)	10	25/100

EN Screwdriver bit
 PL Końcówka śrubokrętowa
 DE Schraubendreherbit
 RU Бит крестовая
 CZ Šroubovaková koncovka
 HU Csavarhúzóvég
 RO Capăt pt. șurubelniță
 FR Douille tournevis
 IT Punta del cacciavite
 ES Punta de destornilladora
 CN 十字旋具头

HRC 58-61

AISI S2



YATO	⊕	L [mm]	⊖	[Nm]	pcs / szt.	📦
YT-78130	PH0	25	1/4" (6.3 mm)	2.1	10	20/100
YT-78131	PH1	25	1/4" (6.3 mm)	7.8	10	20/100
YT-78132	PH2	25	1/4" (6.3 mm)	19.6	10	20/100
YT-78133	PH3	25	1/4" (6.3 mm)	45.6	10	20/100

5



YATO	⊕	L [mm]	⊖	[Nm]	pcs / szt.	📦
YT-78134	PZ1	25	1/4" (6.3 mm)	6.4	10	20/100
YT-78135	PZ2	25	1/4" (6.3 mm)	19.6	10	20/100
YT-78136	PZ3	25	1/4" (6.3 mm)	45.1	10	20/100



YATO	⊕	L [mm]	⊖	[Nm]	pcs / szt.	📦
YT-78141	T10	25	1/4" (6.3 mm)	5.9	10	20/100
YT-78142	T15	25	1/4" (6.3 mm)	8.4	10	20/100
YT-78143	T20	25	1/4" (6.3 mm)	14.7	10	20/100
YT-78144	T25	25	1/4" (6.3 mm)	21.6	10	20/100
YT-78145	T27	25	1/4" (6.3 mm)	29.4	10	20/100
YT-78146	T30	25	1/4" (6.3 mm)	45.1	10	20/100
YT-78147	T40	25	1/4" (6.3 mm)	76.5	10	20/100

EN Screwdriver bit
 PL Końcówka śrubokrętowa
 DE Schraubendreherbit
 RU Бит крестовая
 CZ Šroubovaková koncovka
 HU Csavarhúzóvég
 RO Capăt pt. șurubelniță
 FR Douille tournevis
 IT Punta del cacciavite
 ES Punta de destornilladora
 CN 旋具头组套

HRC 58-61

AISI S2



YATO	⊕	L [mm]	⊖	[Nm]	pcs / szt.	📦
YT-78151	PH1	50	1/4" (6.3 mm)	6.4	10	20/100
YT-78152	PH2	50	1/4" (6.3 mm)	19.6	10	20/100
YT-78153	PH3	50	1/4" (6.3 mm)	45.1	10	20/100

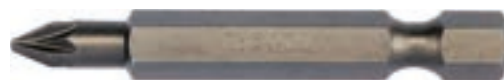

YATO	⊕	L [mm]	⊖	[Nm]	pcs / szt.	📦
YT-78154	PZ1	50	1/4" (6.3 mm)	6.4	10	20/100
YT-78155	PZ2	50	1/4" (6.3 mm)	19.6	10	20/100
YT-78156	PZ3	50	1/4" (6.3 mm)	45.1	10	20/100

EN Screwdriver bit set
 PL Zestaw końcówek śrubokrętowych
 DE Schraubendreherbitsatz
 RU Набор битов
 CZ Sada bitů
 HU Bitkészlet
 RO Truse bit
 FR Embouts de vissage
 IT Set punte cacciavite
 ES Puntas de destornilladora
 CN 旋具头组套



10 PCS

21.8 Nm (max.)

HRC 58-62

AISI S2

COLD FORGED KUTE NA ZIMNO



YATO	⊕	L [mm]	⊖	📦
YT-0470	PZ1	25	1/4" (6.3 mm)	25/200
YT-0471	PZ2	25	1/4" (6.3 mm)	25/200
YT-0472	PZ3	25	1/4" (6.3 mm)	25/200



YATO	⊕	L [mm]	⊖	📦
YT-0477	PH1	50	1/4" (6.3 mm)	25/100
YT-0478	PH2	50	1/4" (6.3 mm)	25/100
YT-0480	PH2	75	1/4" (6.3 mm)	25/100



YATO	⊕	L [mm]	⊖	📦
YT-0474	PH1	25	1/4" (6.3 mm)	25/200
YT-0475	PH2	25	1/4" (6.3 mm)	25/200
YT-0476	PH3	25	1/4" (6.3 mm)	25/200



YATO	⊕	L [mm]	⊖	📦
YT-0481	PH2xPH2	65	1/4" (6.3 mm)	25/100

EN Screwdriver bit set
PL Zestaw końcówek śrubokrętowych
DE Schraubendreherbitsatz
RU Набор битов

CZ Sada bitů
HU Bitkészlet
RO Truse bit
FR Embouts de vissage

IT Set punte cacciavite
ES Puntas de destornilladora
CN 旋具头组套



10
PCS

21.8
Nm
(max.)

HRC
58-62

AISI
S2

COLD
FORGED
KŪTE
NA ZIMNO



□ 1/4" (6.3 mm); 5, 6 mm (L=25 mm); AISI S2;
⊕ 1/4" (6.3 mm); PH1 x2, PH2 x2 (L=25 mm); AISI S2;
⊛ 1/4" (6.3 mm); PZ1 x2, PZ2 x2 (L=25 mm); AISI S2

□ 1/4" (6.3 mm); 5, 6 mm (L=50 mm); AISI S2;
⊕ 1/4" (6.3 mm); PH1 x2, PH2 x2 (L=50 mm); AISI S2;
⊛ 1/4" (6.3 mm); PZ1 x2, PZ2 x2 (L=50 mm); AISI S2

YATO	L [mm]	□	□
YT-0482	25	1/4" (6.3 mm)	25/200

YATO	L [mm]	□	□
YT-0483	25	1/4" (6.3 mm)	25/100

EN Screwdriver bit
PL Końcówka śrubokrętowa
DE Schraubendreherbit

RU Бит крестовая
CZ Šroubovavá koncovka
HU Csavarhűzővég

RO Capăt pt. șurubelniță
FR Douille tournevis
IT Punta del cacciavite

ES Punta de destornilladora
CN 旋具头组套

NON-SLIP
SYSTEM

HRC
58-62

AISI
S2

COLD
FORGED
KŪTE
NA ZIMNO



YATO	⊕	L [mm]	□	pcs / szt.	□
YT-7807	PH1	25	1/4" (6.3 mm)	50	20/40
YT-7808	PH2	25	1/4" (6.3 mm)	50	20/40
YT-7809	PH3	25	1/4" (6.3 mm)	50	20/40



YATO	⊕	L [mm]	□	pcs / szt.	□
YT-7810	PZ1	25	1/4" (6.3 mm)	50	20/40
YT-7811	PZ2	25	1/4" (6.3 mm)	50	20/40
YT-7812	PZ3	25	1/4" (6.3 mm)	50	20/40



YATO	⊕	L [mm]	□	pcs / szt.	□
YT-7848	PH2	50	1/4" (6.3 mm)	50	10/20

EN Screwdriver bit
PL Końcówka śrubokrętowa
DE Schraubendreherbit
RU Бит крестовая
CZ Šroubovavá koncovka
HU Csavarhűzővég
RO Capăt pt. șurubelniță
FR Douille tournevis
IT Punta del cacciavite
ES Punta de destornilladora
CN 旋具头



• With limiter
• Z ogranicznikiem

YATO	L [mm]	□	pcs / szt.	□
YT-7980	25	1/4" (6.3 mm)	20	20/40

EN Screwdriver bit
 PL Końcówka śrubokręta
 DE Schraubendreherbit
 RU Бит крестовая
 CZ Šroubovavková koncovka
 HU Csavarhűzővég
 RO Capăt pt. șurubelniță
 FR Douille tournevis
 IT Punta del cacciavite
 ES Punta de destornilladora
 CN 旋具头组套

2
PCS
1/4"
6.3 mm
S2

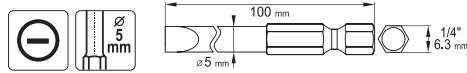

YATO	⊖ [mm]	L [mm]	⊘	📦
YT-0484	4, 5	100	1/4" (6.3 mm)	25/100

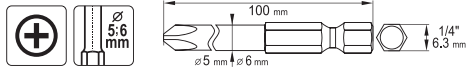

YATO	⊕	L [mm]	⊘	📦
YT-0488	PH1, PH2	100	1/4" (6.3 mm)	25/100

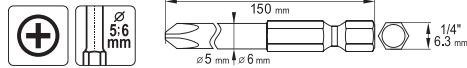

YATO	⊕	L [mm]	⊘	📦
YT-0489	PH1, PH2	150	1/4" (6.3 mm)	25/100

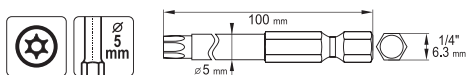

YATO	⊗	L [mm]	⊘	📦
YT-0490	T10, T25	100	1/4" (6.3 mm)	25/100

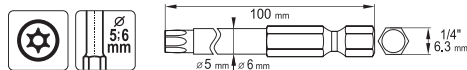

YATO	⊗	L [mm]	⊘	📦
YT-0491	T15, T27	100	1/4" (6.3 mm)	25/100
YT-0492	T20, T30	100	1/4" (6.3 mm)	25/100

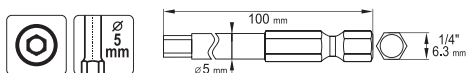

YATO	⊙ [mm]	L [mm]	⊘	📦
YT-0494	3, 5	100	1/4" (6.3 mm)	25/100

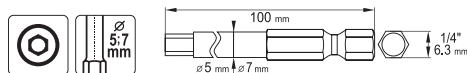

YATO	⊙ [mm]	L [mm]	⊘	📦
YT-0495	4, 6	100	1/4" (6.3 mm)	25/100

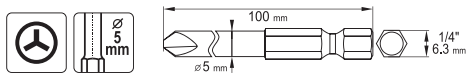

YATO	⊕ [mm]	L [mm]	⊘	📦
YT-0493	0, 1	100	1/4" (6.3 mm)	25/100
YT-0496	1, 3	100	1/4" (6.3 mm)	25/100

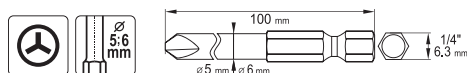

YATO	⊕ [mm]	L [mm]	⊘	📦
YT-0497	2, 4	100	1/4" (6.3 mm)	25/100

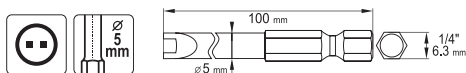

YATO	⊕ [mm]	L [mm]	⊘	📦
YT-0498	4, 8	100	1/4" (6.3 mm)	25/100

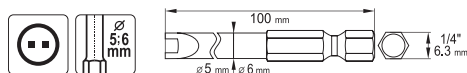

YATO	⊕ [mm]	L [mm]	⊘	📦
YT-0499	6, 10	100	1/4" (6.3 mm)	25/100

EN Screwdriver bit set
PL Zestaw końcówek śrubokrętowych
DE Schraubendreherbitsatz
RU Набор битов
CZ Sada bitů
HU Bitkészlet

RO Truse bit
FR Embouts de vissage
IT Set punte cacciavite
ES Puntas de destornilladora
CN 旋具头组套



3/8" (9.5 mm): T20, T25, T30, T40, T45, T50, T55 (L=30 mm); T20, T25, T30, T40, T45, T50, T55 (L=75 mm); AISI S2;
3/8" (9.5 mm): 4, 5, 6, 7, 8, 10, 12 mm (L=30 mm); 4, 5, 6, 7, 8, 10, 12 mm (L=75 mm); AISI S2;
3/8" (9.5 mm): M5, M6, M8, M10, M12 (L=30 mm); M5, M6, M8, M10, M12 (L=75 mm); AISI S2;
1/2" (12.7 mm) x 3/8" (9.5 mm), 3/8" (9.5 mm) x 3/8" (9.5 mm); CrV 6150

YATO
YT-0400 10

EN Screwdriver bit set
PL Zestaw końcówek śrubokrętowych
DE Schraubendreherbitsatz
RU Набор битов
CZ Sada bitů
HU Bitkészlet

RO Truse bit
FR Embouts de vissage
IT Set punte cacciavite
ES Puntas de destornilladora
CN 星型旋具头

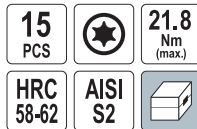

3/8" (9.5 mm): T20, T25, T30, T40, T45, T50, T55 (L=30 mm); T20, T25, T30, T40, T45, T50, T55 (L=75 mm); AISI S2;
1/2" (12.7 mm) x 3/8" (9.5 mm); CrV 6150

YATO
YT-0411 20

EN Screwdriver bit set
PL Zestaw końcówek śrubokrętowych
DE Schraubendreherbitsatz
RU Набор битов
CZ Sada bitů
HU Bitkészlet

RO Truse bit
FR Embouts de vissage
IT Set punte cacciavite
ES Puntas de destornilladora
CN 六角旋具头组套

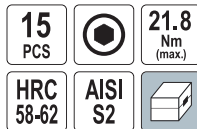

3/8" (9.5 mm): 4, 5, 6, 7, 8, 10, 12 (L=30 mm); 4, 5, 6, 7, 8, 10, 12 (L=75 mm); AISI S2;
1/2" (12.7 mm) x 3/8" (9.5 mm); CrV 6150

YATO
YT-0413 20

EN Screwdriver bit set
PL Zestaw końcówek śrubokrętowych
DE Schraubendreherbitsatz
RU Набор битов
CZ Sada bitů
HU Bitkészlet

RO Truse bit
FR Embouts de vissage
IT Set punte cacciavite
ES Puntas de destornilladora
CN 星型旋具头

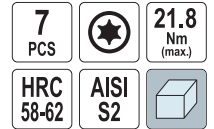

3/8" (9.5 mm): T25, T30, T40, T45, T50, T55 (L=30 mm); AISI S2;
1/2" (12.7 mm) x 3/8" (9.5 mm); CrV 6150

YATO
YT-0410 24/72

EN Screwdriver bit set
PL Zestaw końcówek śrubokrętowych
DE Schraubendreherbitsatz
RU Набор битов
CZ Sada bitů
HU Bitkészlet

RO Truse bit
FR Embouts de vissage
IT Set punte cacciavite
ES Puntas de destornilladora
CN 六角旋具头组套

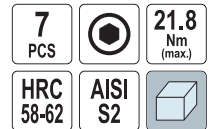

3/8" (9.5 mm): 4, 5, 6, 8, 10, 12 mm (L=30 mm); AISI S2;
1/2" (12.7 mm) x 3/8" (9.5 mm); CrV 6150

YATO
YT-0412 24/72

EN Screwdriver bit set
PL Zestaw końcówek śrubokrętowych
DE Schraubendreherbitsatz
RU Набор битов
CZ Sada bitů
HU Bitkészlet

RO Truse bit
FR Embouts de vissage
IT Set punte cacciavite
ES Puntas de destornilladora
CN 十二角旋具头组套

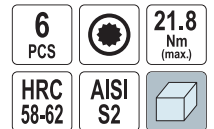

3/8" (9.5 mm): M5, M6, M8, M10, M12 (L=30 mm); AISI S2;
1/2" (12.7 mm) x 3/8" (9.5 mm); CrV 6150

YATO
YT-0414 24/72

EN Screwdriver bit set
 PL Zestaw końcówek śrubokrętowych
 DE Schraubendreherbitsatz
 RU Набор битов
 CZ Sada bitů
 HU Bitkészlet

RO Truse bit
 FR Embouts de vissege
 IT Set punte cacciavite
 ES Puntas de destornilladora
 CN 十二角旋具头组套

11
PCS





21.8
Nm
(max.)

HRC
58-62

AISI
S2



 3/8" (9.5 mm): M5, M6, M8, M10, M12 (L=30 mm); M5, M6, M8, M10, M12 (L=75 mm); AISI S2;
 1/2" (12.7 mm) x 3/8" (9.5 mm); CrV 6150

YATO 

YT-0415  20

EN Screwdriver bit set
 PL Zestaw końcówek śrubokrętowych
 DE Schraubendreherbitsatz
 RU Набор битов
 CZ Sada bitů
 HU Bitkészlet

RO Truse bit
 FR Embouts de vissege
 IT Set punte cacciavite
 ES Puntas de destornilladora
 CN 中孔星型旋具头组套

15
PCS





21.8
Nm
(max.)

HRC
58-62

AISI
S2



 3/8" (9.5 mm): T20, T25, T30, T40, T45, T50, T55 (L=30 mm);
 T20, T25, T30, T40, T45, T50, T55 (L=75 mm); AISI S2;
 1/2" (12.7 mm) x 3/8" (9.5 mm); CrV 6150

YATO 

YT-0417  20

EN Screwdriver bit set
 PL Zestaw końcówek śrubokrętowych
 DE Schraubendreherbitsatz
 RU Набор битов
 CZ Sada bitů
 HU Bitkészlet

RO Truse bit
 FR Embouts de vissege
 IT Set punte cacciavite
 ES Puntas de destornilladora
 CN 花键型旋具头组套

15
PCS





21.8
Nm
(max.)

HRC
58-62

AISI
S2



 3/8" (9.5 mm): M6, M7, M8, M9, M10, M12, M14 (L=30 mm);
 M6, M7, M8, M9, M10, M12, M14 (L=75 mm); AISI S2;
 1/2" (12.7 mm) x 3/8" (9.5 mm); CrV 6150

YATO 

YT-0419  20

EN Screwdriver bit set
 PL Zestaw końcówek śrubokrętowych
 DE Schraubendreherbitsatz
 RU Набор битов
 HU Bitkészlet

RO Truse bit
 FR Embouts de vissege
 IT Set punte cacciavite
 ES Puntas de destornilladora
 CN 中孔星型旋具头组套

7
PCS





21.8
Nm
(max.)

HRC
58-62

AISI
S2



 3/8" (9.5 mm): T25, T30, T40, T45, T50, T55 (L=30 mm); AISI S2;
 1/2" (12.7 mm) x 3/8" (9.5 mm); CrV 6150

YATO 

YT-0416  24/72

EN Screwdriver bit set
 PL Zestaw końcówek śrubokrętowych
 DE Schraubendreherbitsatz
 RU Набор битов
 HU Bitkészlet

RO Truse bit
 FR Embouts de vissege
 IT Set punte cacciavite
 ES Puntas de destornilladora
 CN 花键型旋具头组套

8
PCS



21.8
Nm
(max.)

HRC
58-62

AISI
S2



 3/8" (9.5 mm): M5, M6, M7, M8, M10, M12, M14 (L=30 mm); AISI S2;
 1/2" (12.7 mm) x 3/8" (9.5 mm); CrV 6150

YATO 

YT-0418  24/72

EN Screwdriver bit set
 PL Zestaw końcówek śrubokrętowych
 DE Schraubendreherbitsatz
 RU Набор битов
 HU Bitkészlet

RO Truse bit
 FR Embouts de vissege
 IT Set punte cacciavite
 ES Puntas de destornilladora
 CN 旋具头组套

42
PCS







21.8
Nm
(max.)

HRC
58-62

AISI
S2



 3/8" (9.5 mm): T20, T25, T30, T40, T45, T50, T55, T60, T70 (L=30 mm);
 T20, T25, T30, T40, T45, T50, T55, T60, T70 (L=75 mm); AISI S2;
 3/8" (9.5 mm): M4, M5, M6, M7, M8, M9, M10, M11, M12, M13, M14 (L=30 mm);
 M4, M5, M6, M7, M8, M9, M10, M11, M12, M13, M14 (L=75 mm); AISI S2;
 1/2" (12.7 mm) x 3/8" (9.5 mm), 3/8" (9.5 mm) x 3/8" (9.5 mm); CrV 6150

YATO 

YT-0420  10

EN Screwdriver bit set
PL Zestaw końcówek śrubokrętowych
DE Schraubendreherbitsatz
RU Набор биток

CZ Sada bitů
HU Bitkészlet
RO Truse bit
FR Embouts de vissage

IT Set punte cacciavite
ES Puntas de destornilladora
CN 冲击钻头组套

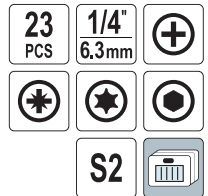

- ✦ 1/4" (6.3 mm): PH0, PH2 x2, PH3 (L=25 mm); PH2 (L=50 mm); S2;
- ✦ 1/4" (6.3 mm): PZ0, PZ2 x2, PZ3 (L=25 mm); PZ2 (L=50 mm); S2;
- ✦ 1/4" (6.3 mm): T20 x2, T25 x2, T30 x2, T40 (L=25 mm); T20, T30 (L=50 mm); S2;
- 1/4" (6.3 mm): 4, 5, 6 mm (L=25 mm); S2;
- 1/4" (6.3 mm): (L=60 mm); CrV

YATO
YT-04621 20

5

EN Screwdriver bit set
PL Zestaw końcówek śrubokrętowych
DE Schraubendreherbitsatz
RU Набор биток

CZ Sada bitů
HU Bitkészlet
RO Truse bit
FR Embouts de vissage

IT Set punte cacciavite
ES Puntas de destornilladora
CN 螺丝批组套

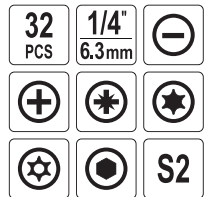

- 1/4" (6.3 mm): 3, 4, 5, 6 mm (L=25 mm); S2;
- ✦ 1/4" (6.3 mm): PH1, PH2 x2, PH3 (L=25 mm); S2;
- ✦ 1/4" (6.3 mm): PZ1, PZ2 x2, PZ3 (L=25 mm); S2;
- ✦ 1/4" (6.3 mm): T10, T15, T20, T25, T27, T30, T40 (L=25 mm); S2;
- ✦ 1/4" (6.3 mm): T10, T15, T20, T25, T27, T30, T40 (L=25 mm); S2;
- 1/4" (6.3 mm): 3, 4, 5, 6 mm (L=25 mm); S2;
- 1/4" (6.3 mm): (L=70 mm); CrV;
- ⊙ 1/4" (6.3 mm): (L=25 mm); S2

YATO
YT-04622 20

EN Screwdriver bit set
PL Zestaw końcówek śrubokrętowych
DE Schraubendreherbitsatz
RU Набор биток

CZ Sada bitů
HU Bitkészlet
RO Truse bit
FR Embouts de vissage

IT Set punte cacciavite
ES Puntas de destornilladora
CN 螺丝批组套

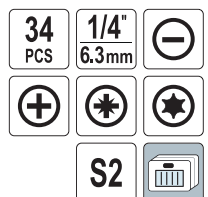

- 1/4" (6.3 mm): 5, 6, 7, 8, 9, 10, 11, 12 mm (L=25 mm);
- 1/4" (6.3 mm): (L=75 mm);
- 1/4" (6.3 mm): 3, 4, 5.5 x2, 6.5 x2 mm (L=25 mm); S2;
- ✦ 1/4" (6.3 mm): PH1 x2, PH2 x2, PH3 x2 (L=25 mm); S2;
- ✦ 1/4" (6.3 mm): PZ1 x2, PZ2 x2, PZ3 x2 (L=25 mm); S2;
- ✦ 1/4" (6.3 mm): T10, T15, T20, T25, T27, T30 (L=25 mm); S2;
- 1/4" (6.3 mm): (L=60 mm); CrV

YATO
YT-04623 20

EN Screwdriver bit set
PL Zestaw końcówek śrubokrętowych
DE Schraubendreherbitsatz
RU Набор биток
CZ Sada bitů
HU Bitkészlet

RO Truse bit
FR Embouts de vissage
IT Set punte cacciavite
ES Puntas de destornilladora
CN 螺丝批组套

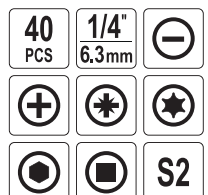

- 1/4" (6.3 mm): 3, 4, 5, 6, 7 mm (L=25 mm); S2;
- ✦ 1/4" (6.3 mm): PH0, PH1, PH2, PH3 (L=25 mm); PH1, PH2 (L=50 mm); S2;
- ✦ 1/4" (6.3 mm): PZ0, PZ1, PZ2, PZ3 (L=25 mm); PZ1, PZ2 (L=50 mm); S2;
- ✦ 1/4" (6.3 mm): T8, T10, T15, T20, T25, T27, T30, T40 (L=25 mm); S2;
- 1/4" (6.3 mm): 2, 2.5, 3, 4, 5, 5.5, 6 x2 mm (L=25 mm); S2;
- 1/4" (6.3 mm): S1, S2, S3 (L=25 mm); S2;
- 1/4" (6.3 mm): 5 mm x PH1, 6 mm x PH2, 6 mm x PH3 (L=65 mm); S2;
- ✦ 1/4" (6.3 mm): PH2 x PH2, PH2 x PH3 (L=65 mm); S2;
- ✦ 1/4" (6.3 mm): PZ1 x PZ1, PZ2 x PZ2, PZ3 x PZ3 (L=65 mm); S2;
- 1/4" (6.3 mm): (L=60 mm); S2

YATO
YT-04620 20

5

EN Screwdriver bit set
 PL Zestaw końcówek śrubokrętowych
 DE Schraubendreherbitsatz
 RU Набор биток

CZ Sada bitů
 HU Bitkészlet
 RO Truse bit
 FR Embouts de vissage

IT Set punte cacciavite
 ES Puntas de destornilladora
 CN 螺丝批组套



- 1/4" (6.3 mm): 4, 5, 6, 7, 8, 9, 10, 11, 12 mm (L=25 mm); CrV;
- 1/4" (6.3 mm); (50 mm); CrV;
- 1/4" (6.3 mm); CrV;
- 1/4" (6.3 mm) x 1/4" (6.3 mm); CrV;
- 1/4" (6.3 mm): 4, 5, 6 mm (L=25 mm); CrV;
- 1/4" (6.3 mm): PH1 x2, PH2 x3, PH3 (L=25 mm); CrV;
- 1/4" (6.3 mm): PZ1 x2, PZ2 x4, PZ3 x2 (L=25 mm); CrV;
- 1/4" (6.3 mm): T10, T15, T20 x2, T25 x2, T27, T30, T40 (L=25 mm); CrV;
- 1/4" (6.3 mm): 4, 5 mm (L=25 mm); CrV

40 PCS 1/4" 6.3mm

Icons: Torx, Phillips, Hex, CrV, Storage

YATO YT-27960 6/24

EN Screwdriver bit set
 PL Zestaw końcówek śrubokrętowych
 DE Schraubendreherbitsatz
 RU Набор биток

CZ Sada bitů
 HU Bitkészlet
 RO Truse bit
 FR Embouts de vissage

IT Set punte cacciavite
 ES Puntas de destornilladora
 CN 螺丝批组套



- 1/4" (6.3 mm): 2, 4, 6.5 mm (L=25 mm); S2;
- 1/4" (6.3 mm): PH0, PH1 x2, PH2 x2, PH3 (L=25 mm); S2;
- 1/4" (6.3 mm): PZ1 x2, PZ2 x2, PZ3 (L=25 mm); S2;
- 1/4" (6.3 mm): T10, T15, T20, T25, T30, T40 (L=25 mm); S2;
- 1/4" (6.3 mm): T8, T9, T10, T15, T20, T25, T27, T30, T40 (L=25 mm); S2;
- 1/4" (6.3 mm): 2, 2.5, 3, 4, 5, 6, 8 mm (L=25 mm); S2;
- 1/4" (6.3 mm): 0, 1, 2, 3 mm (L=25 mm); S2;
- 1/4" (6.3 mm): 1, 2, 3, 4 mm (L=25 mm); S2;
- 1/4" (6.3 mm): 6, 8, 10 mm (L=25 mm); S2;
- 1/4" (6.3 mm): 4, 6, 8, 10 mm (L=25 mm); S2;
- 1/4" (6.3 mm): M5, M6, M8 (L=25 mm); S2;
- 1/4" (6.3 mm): C1, C2, C3 (L=25 mm); S2;
- 1/4" (6.3 mm): (L=70 mm); CrV;
- 1/4" (6.3 mm); CrV

59 PCS 1/4" 6.3mm

Icons: Torx, Phillips, Hex, S2, Storage

YATO YT-04624 20

EN Nut setter
 PL Nasadka magnetyczna do wkrętarek
 DE Magnet-Steckschlüssel mit Adapter

RU Магнитная головка для винтовёрта
 CZ Nástrčný kľúč magnetický do vrtačky
 HU Csavarbehajtó

RO Cheie tubulara cu prindere tip mandrina
 FR Douille tournevis magnétique
 IT Cappuccio magnetico la vite

ES Boquilla magnética de destornilladora
 CN 磁性套筒

48 mm

Icons: Hex, U-shaped, CrV 6150



YATO	ø [mm]	
YT-1501	6	200/600
YT-1502	7	200/600
YT-1503	8	200/600
YT-1505	10	200/600
YT-1507	12	200/600
YT-1508	13	200/600

YATO	ø [mm]	
YT-1511	6	100/200
YT-1512	7	100/200
YT-1513	8	100/200
YT-1515	10	100/200
YT-1517	12	100/200
YT-1518	13	100/200

EN Screwdriver bit holder
 PL Uchwyt do końcówek śrubokrętowych
 DE Bithalter

RU Магнитный держатель
 CZ Držák na šroubovavkovékoncovky
 HU Szár a csavarhúzóvégkehez

RO Capete şurubelniță
 FR Mandrin magnétique
 IT Mandrino portapunta

ES Mandril para puntas
 CN 旋具头磁性接杆

1/4" 6.3mm

Icon: Storage



SS STAINLESS STEEL STAL NIERDZEWNA

YATO	ø	L [mm]	
YT-0465	1/4" (6.3 mm)	60	20/200

YATO	ø	L [mm]	
YT-0466	1/4" (6.3 mm)	60	20/200



YATO	ø	L [mm]	
YT-0467	1/4" (6.3 mm)	80	20/200

YATO	ø	L [mm]	
YT-04671	1/4" (6.3 mm)	120	100

EN Screwdriver bit holder
PL Uchwyt do końcówek śrubokrętowych
DE Bithalter
RU Магнитный держатель
CZ Držák na šroubovákovekoncevky
HU Szár a csavarhúzóvégekekhez
RO Capete șurubelniță
FR Mandrin magnétique
IT Mandrino portapunta
ES Mandril para puntas
CN 旋具头磁性接杆



YATO	1/4" (6.3 mm)	L [mm]	
YT-0468	1/4" (6.3 mm)	60	20/200

EN Swivel bit holder
PL Adapter kątowny do bitów
DE Gelenk-Bit-Adapter
RU Адаптер для бит шарнирный
CZ Držák na bity s jistěním
HU Csuklós bit befogó
RO Bit pivotant
FR Porte embout pivotant
IT Adattatore angolare per punte
ES Adaptador articulado para puntas
CN 万向接杆

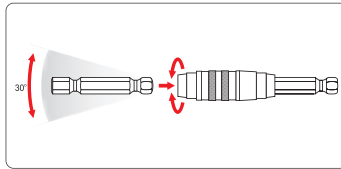

YATO	1/4" (6.3 mm)	
YT-04635	1/4" (6.3 mm)	60/120

EN Keyless chuck snap-out
PL Uchwyt wiertarski bezkluczowy
DE Schnellspan-Bohrfutter
RU Патрон для дрели быстрозажимной
CZ Sklíčadlo
HU Bitbefogású gyorsostómány
RO Mandrina rapida cu coada
FR Adaptador portabrocas
IT Mandrino portapunte autoserrante
ES Mandrin sans clé
CN 夹头

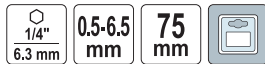

YATO	1/4" (6.3 mm)	
YT-04645	1/4" (6.3 mm)	10/60

EN Screwdriver bit holder set
PL Zestaw uchwytów do bitów
DE Bithalter-Set
RU Набор держателей бит
CZ Sada prodlžovacích úchyťů pro bity
HU Bitbefogó készlet
RO Set prelungitoare biti
FR Jeu de porte-embouts
IT Kit portainseriti
ES Juego de portaherramientas
CN 延长杆组套

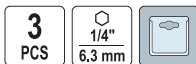

1/4" (6.3 mm): 75, 100, 150 mm

YATO	1/4" (6.3 mm)	
YT-04699	1/4" (6.3 mm)	20/120

EN Adapter
PL Adapter
DE Adapter
RU Адаптер

CZ Adaptér
HU Adapter
RO Adaptor
FR Adaptateur

IT Adattatore
ES Adaptador
CN 转接杆



YATO	1/4" (6.3 mm)	L [mm]	
YT-04626	1/4" (6.3 mm)	65	40/120

EN Screwdriver bit holder
PL Uchwyt do końcówek śrubokrętowych
DE Bithalter
RU Магнитный держатель
CZ Držák na šroubovákovekoncevky
HU Szár a csavarhúzóvégekekhez
RO Capete șurubelniță
FR Mandrin magnétique
IT Mandrino portapunta
ES Mandril para puntas
CN 螺丝批头接杆



YATO	1/4" (6.3 mm)	L [mm]	
YT-04695	1/4" (6.3 mm)	150	100

EN Keyless chuck snap-out
PL Uchwyt wiertarski bezkluczowy
DE Schnellspan-Bohrfutter
RU Патрон для дрели быстрозажимной
CZ Sklíčadlo
HU Bitbefogású gyorsostómány
RO Mandrina rapida cu coada
FR Mandrin sans clé
IT Mandrino portapunte autoserrante
ES Adaptador portabrocas
CN 夹头



YATO	1/4" (6.3 mm)	
YT-04644	1/4" (6.3 mm)	50/150

EN Screwdriver bit holder
PL Uchwyt do końcówek śrubokrętowych
DE Bithalter
RU Магнитный держатель
CZ Držák na šroubovákovekoncevky
HU Szár a csavarhúzóvégekekhez

RO Capete șurubelniță
FR Mandrin magnétique
IT Mandrino portapunta
ES Mandril para puntas
CN 钻套

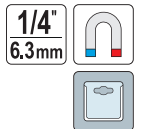

YATO	1/4" (6.3 mm)	L [mm]	
YT-04681	1/4" (6.3 mm)	150	50/100
YT-04682	1/4" (6.3 mm)	200	50/100
YT-04683	1/4" (6.3 mm)	250	50/100
YT-04684	1/4" (6.3 mm)	300	50/100

EN Adapter
PL Adapter
DE Adapter
RU Адаптер

CZ Adaptér
HU Adapter
RO Adaptor
FR Adaptateur

IT Adattatore
ES Adaptador
CN 转接杆



YATO	1/4" (6.3 mm)	L [mm]	
YT-04625	1/4" (6.3 mm)	65	40/120

EN Adapter
PL Adapter
DE Adapter
RU Адаптер

CZ Adaptér
HU Adapter
RO Adaptor
FR Adaptateur

IT Adattatore
ES Adaptador
CN 转接杆



YATO	1/4" (6.3 mm)	L [mm]	
YT-04627	1/4" (6.3 mm)	70	40/120

EN Adapter
PL Adapter
DE Adapter
RU Адаптер

CZ Adaptér
HU Adapter
RO Adaptor
FR Adaptateur

IT Adattatore
ES Adaptador
CN 转接杆

3 PCS	1/4" 6.3 mm	1/4" 6.3 mm	3/8" 9.5 mm
1/2" 12.7 mm	150 mm	CrV	



YATO		L [mm]	
YT-04628	1/4" (6.3 mm)	150	24

EN Adapter
PL Adapter
DE Adapter
RU Адаптер

CZ Adaptér
HU Adapter
RO Adaptor
FR Adaptateur

IT Adattatore
ES Adaptador
CN 转接杆

6 PCS	1/4" 6.3 mm	1/4" 6.3 mm	3/8" 9.5 mm
1/2" 12.7 mm	50 mm	150 mm	CrV



YATO		L [mm]	
YT-04629	1/4" (6.3 mm)	50, 150	24

EN Adapter
PL Adapter
DE Adapter
RU Адаптер

CZ Adaptér
HU Adapter
RO Adaptor
FR Adaptateur

IT Adattatore
ES Adaptador
CN 转接杆

8 PCS	1/4" 6.3 mm	3/8" 9.5 mm	1/2" 12.7 mm
----------	----------------	----------------	-----------------



1/2" (12.7 mm): 50, 72 mm; 3/8" (9.5 mm): 50, 65 mm; 1/4" (6.3 mm): 25, 30, 50, 65 mm

YATO		L [mm]	
YT-04639	1/4" (6.3 mm), 3/8" (9.5 mm), 1/2" (12.7 mm)		20/100

EN Adapter
PL Adapter
DE Adapter
RU Адаптер

CZ Adaptér
HU Adapter
RO Adaptor
FR Adaptateur

IT Adattatore
ES Adaptador
CN 六角柄接杆组套

1/4" 6.3 mm	1/4" 6.3 mm	3/8" 9.5 mm	1/2" 12.7 mm
65 mm	73 mm		

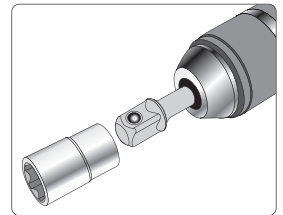

YATO		L [mm]	
YT-04685	1/4" (6.3 mm)		20/100

EN Adapter
PL Adapter
DE Adapter
RU Адаптер

CZ Adaptér
HU Adapter
RO Adaptor
FR Adaptateur

IT Adattatore
ES Adaptador
CN 接杆组套

SDS PLUS	1/4" 6.3 mm	3/8" 9.5 mm
1/2" 12.7 mm	65 mm	

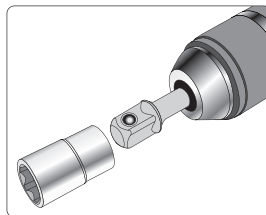

YATO		L [mm]	
YT-04686		20/100	

EN Adapter
PL Adapter
DE Adapter
RU Адаптер

CZ Adaptér
HU Adapter
RO Adaptor
FR Adaptateur

IT Adattatore
ES Adaptador
CN 接杆

1/4" 6.3 mm	SDS PLUS	60 mm

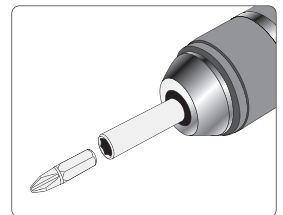

YATO		L [mm]	
YT-04690		60	50/100

EN Extension bar
PL Przedłużka elastyczna
DE Verlängerung

RU Удлинитель для воротка
CZ Prodlužovací přípravek
HU Toldalék

RO Prelungitor
FR Rallonge élastique
IT Prolunga flessibile

ES Tubo de prolongación
CN 可弯式接杆

1/4" 6.3 mm	CrV	6140	
----------------	-----	------	--

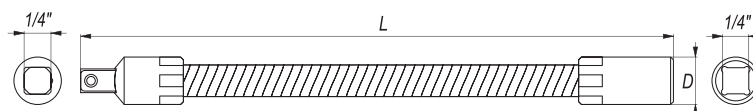

YATO			D [mm]	L [mm]	PCS PKCIE	
YT-1400	1/4" (6.3 mm)	1/4" (6.3 mm)	11.6	150	25	250/500

EN Extension bar
PL Przedłużka elastyczna
DE Verlängerung
RU Удлинитель для воротка
CZ Prodlužovací přípravek
HU Toldalék
RO Prelungitor
FR Rallonge élastique
IT Prolunga flessibile
ES Tubo de prolongación
CN 柔性螺丝批头接杆

1/4"
6.3 mm
CrV
6140

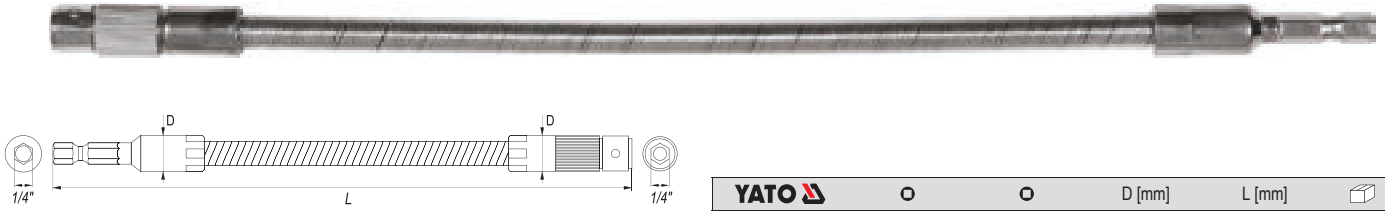

YATO	Hex	Hex	D [mm]	L [mm]	Box
YT-14001	1/4" (6.3 mm)	1/4" (6.3 mm)	11.7	300	100

EN Angled screwdriver bit holder
PL Wkrętak kątowy do końcówek śrubokrętowych
DE Winkelschrauber
RU Г-образный держатель для бит
CZ Šroubovák
HU Csavarhúzó
RO Prelungitor pt. biti, 90 grade
FR Mandrin magnétique
IT Cacciavite ad angolo per punte
ES Porta puntas magnético
CN 直角螺丝批接头

1/4"
6.3 mm
105 mm
90°



YATO	Hex	L [mm]	Box
YT-04630	1/4" (6.3 mm)	105	60/240

EN Angle adapter
PL Adapter kątowy
DE Winkelschrauber
RU Адаптер угловой для бит
CZ Úhel elektrická vrtačka připojení adaptéru
HU Sarokcsavarozó adapter
RO Dispozitiv unghiular de insurubat
FR Renvoi d'angle perceuse visseuse
IT Adattatore
ES Ángulo magnético bit driver adaptador
CN 拐螺丝批接头

1/4"
6.3 mm
1200 min²
105°
12 Nm
SS
STAINLESS STEEL
STAL NERZEWIENNY

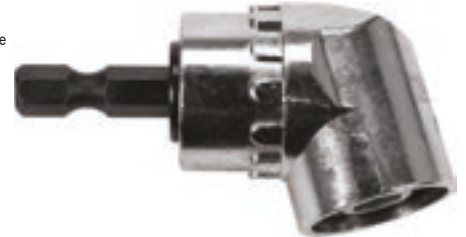

YATO	Hex	L [mm]	Box
YT-04632	1/4" (6.3 mm)	37	100

EN Angle adapter with extension
PL Adapter kątowy z przedłużką
DE Winkelschrauber
RU Адаптер угловой для бит
CZ Úhel elektrická vrtačka připojení adaptéru
HU Sarokcsavarozó adapter
RO Dispozitiv unghiular de insurubat
FR Renvoi d'angle perceuse visseuse
IT Adattatore
ES Ángulo magnético bit driver adaptador
CN 拐批带柔性接杆

1/4"
6.3 mm
400 min²
90°
13 Nm

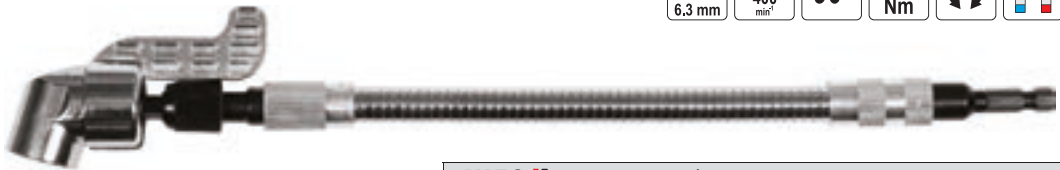

YATO	Hex	L [mm]	Box
YT-04636	1/4" (6.3 mm)	325	10/60

EN Angle adapter
PL Adapter kątowy
DE Winkelschrauber
RU Адаптер угловой для бит
CZ Úhel elektrická vrtačka připojení adaptéru
HU Sarokcsavarozó adapter
RO Dispozitiv unghiular de insurubat
FR Renvoi d'angle perceuse visseuse
IT Adattatore
ES Ángulo magnético bit driver adaptador
CN 带手柄拐螺丝批接头

1/4"
6.3 mm
400 min²
90°



13 Nm



YATO	Hex	L [mm]	Box
YT-04631	1/4" (6.3 mm)	155	50

EN Impact adaptor
PL Adapter udarowy do bitów
DE Schlag-Bit-Adapter
RU Ударный адаптер для бит
CZ Nárazový adaptér pro bity
HU Útvefű adapter bitfejekhez
RO Adaptor impact
FR Adapateur de percussion pour embouts
IT Adattatore a impatto per punte
ES Adaptador de impacto para bites
CN 转接头

1/4"
6.3 mm
1/2"
12.7 mm
50 mm



YATO	Hex	L [mm]	Box
YT-04691	1/4" (6.3 mm)	50	10/60

EN Adapter
PL Adapter
DE Adapter
RU Адаптер
CZ Adaptér
HU Adapter
RO Adaptor
FR Adaptateur
IT Adattatore
ES Adaptador
CN 五坑转换器

220 mm
SDS MAX

SDS PLUS



YATO	L [mm]	Box
YT-41926	220	10/30

EN T-handle key
 PL Klucz typu „T”
 DE T-Griff Stiftschlüssel
 RU Ключ Т-образный с рукояткой

CZ Imbusový klíč s T-rukojetí
 HU Imbuszkulcs T-markolattal
 RO Cheie tip „T”
 FR Clé allen avec en „T”

IT Chiave a „T” per viti con impronta
 ES Llave allen con mango en „T”
 CN T型内六角扳手

S2



5

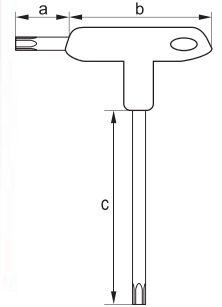
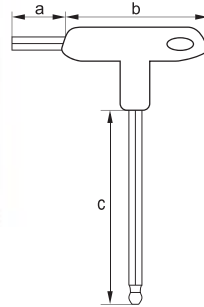
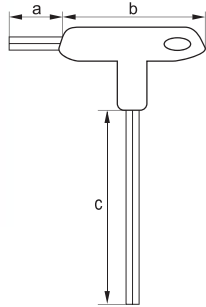

YATO	© [mm]	a [mm]	b [mm]	c [mm]	
YT-05571	2.5	13	76	100	12/240
YT-05572	3.0	13	76	100	12/240
YT-05574	4.0	13	76	140	12/240
YT-05576	5.0	17	92	140	12/144
YT-05577	6.0	17	92	170	12/144
YT-05578	7.0	17	92	170	12/144
YT-05579	8.0	22	102	200	12/96
YT-05581	10.0	22	102	200	12/96

YATO	© [mm]	a [mm]	b [mm]	c [mm]	
YT-05585	2.5	13	76	100	12/240
YT-05586	3.0	13	76	100	12/240
YT-05588	4.0	13	76	140	12/240
YT-05590	5.0	17	92	140	12/144
YT-05591	6.0	17	92	170	12/144
YT-05592	7.0	17	92	170	12/144
YT-05593	8.0	22	102	200	12/96
YT-05594	10.0	22	102	200	12/96

YATO		a [mm]	b [mm]	c [mm]	
YT-05601	T8	13	76	100	12/240
YT-05602	T9	13	76	100	12/240
YT-05603	T10	13	76	100	12/240
YT-05604	T15	13	76	100	12/240
YT-05605	T20	13	76	130	12/240
YT-05606	T25	13	76	130	12/240
YT-05607	T27	17	92	140	12/144
YT-05608	T30	17	92	170	12/144
YT-05609	T40	17	92	170	12/144
YT-05610	T45	22	102	200	12/96
YT-05611	T50	22	102	200	12/96

EN T-handle key
 PL Klucz typu „T”
 DE T-Griff Stiftschlüssel
 RU Ключ Т-образный с рукояткой

CZ Imbusový klíč s T-rukojetí
 HU Imbuszkulcs T-markolattal
 RO Cheie tip „T”
 FR Clé allen avec en „T”

IT Chiave a „T” per viti con impronta
 ES Llave allen con mango en „T”
 CN T型内六角扳手组套

8 PCS



S2

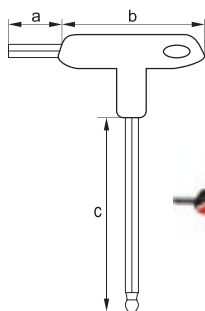
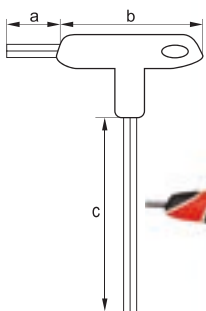
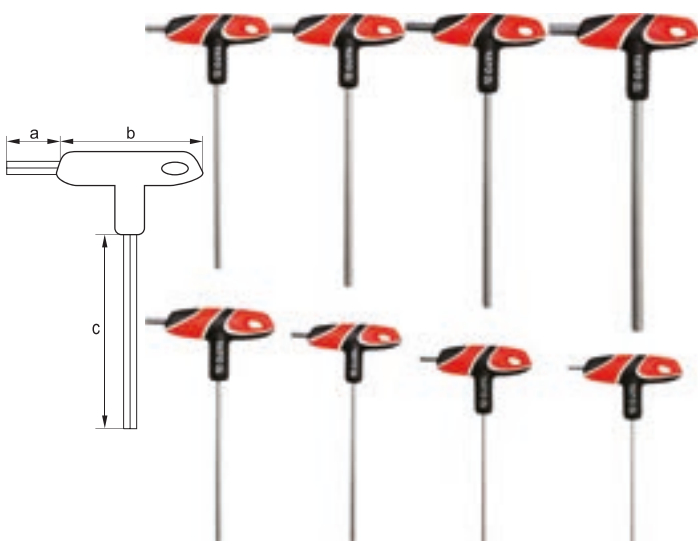

YATO	© [mm]	a [mm]	b [mm]	c [mm]	
YT-05583	2.5, 3, 4, 5, 6, 7, 8, 10	13, 13, 13, 17, 17, 17, 22, 22	76, 76, 76, 92, 92, 92, 102, 102	100, 100, 140, 140, 170, 170, 200, 200	12/24

YATO	© [mm]	a [mm]	b [mm]	c [mm]	
YT-05597	2.5, 3, 4, 5, 6, 7, 8, 10	13, 13, 13, 17, 17, 17, 22, 22	76, 76, 76, 92, 92, 92, 102, 102	100, 100, 140, 140, 170, 170, 200, 200	12/24

EN T-handle key
PL Klucz typu „T”
DE T-Griff Stiftschlüssel
RU Ключ Т-образный с рукояткой
CZ Imbusový klíč s T-rukojetí
HU Imbuskulcs T-markolattal
RO Cheie tip „T”
FR Clé Allen avec en „T”
IT Chiave a „T” per viti con impronta
ES Llave Allen con mango en „T”
CN T型星型内六角扳手组套

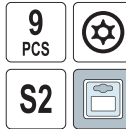
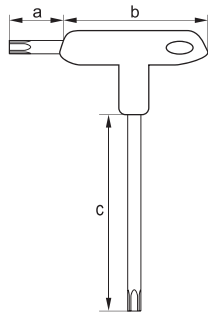

EN Hex and Torx key set
PL Zestaw kluczy trzypieniowych
DE Sechskant und Torx Stiftschlüsselsatz
RU Набор ключей Hex и Torx
CZ Sada klíčů imbusových a Torx
HU Kulcskészlet imbisz és Torx
RO Set de chei imbus și Torx
FR Ensemble clés Hex et Torx
IT Set di chiavi a brugola
ES Juego de llaves hexagonales y Torx
CN 内六角组套



YATO	⊙	a [mm]	b [mm]	c [mm]	📦
YT-05615	T10, T15, T20,	13, 13, 13, 13,	76, 76, 76, 76,	100, 100, 100,	12/24
	T25, T27, T30,	17, 17, 17,	92, 92, 92, 102,	140, 140, 170,	
	T40, T45, T50	22, 22	102	170, 200, 200	

⊙ 1.5, 2, 2.5, 3, 4, 5, 6, 8 mm; 1/16" (1.6 mm), 5/64" (2.0 mm), 3/32" (2.4 mm), 1/8" (3.2 mm), 9/64" (3.6 mm), 5/32" (4.0 mm), 3/16" (4.8 mm), 1/4" (6.3 mm); CrV;
⊙ T6, T7, T8, T9, T10, T15, T20, T25; CrV

YATO	📦
YT-05640	10/40

EN Hex and Torx key set
PL Zestaw kluczy trzypieniowych
DE Sechskant und Torx Stiftschlüsselsatz
RU Набор ключей Hex и Torx
CZ Sada klíčů imbusových a Torx
HU Kulcskészlet imbisz és Torx
RO Set de chei imbus și Torx
FR Ensemble clés Hex et Torx
IT Set di chiavi a brugola
ES Juego de llaves hexagonales y Torx
CN 内六角组套

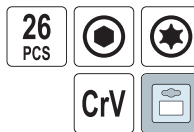

EN Hex key
PL Klucz sześciokątny
DE Sechskant-Stiftschlüssel
RU Шестигранный
CZ Imbusový klíč
HU Imbisz kulcs
RO Cheie imbus
FR Clé Allen
IT Chiave a brugola
ES Llave hexagonal
CN 六角螺丝批

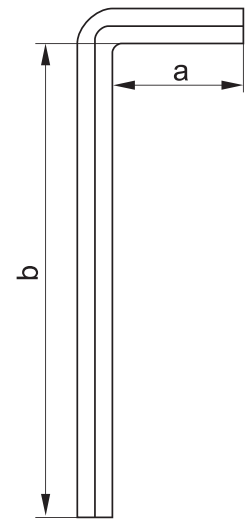

⊙ 1.5, 2, 2.5, 3, 4, 4.5, 5, 5.5, 6 mm; 5/64" (2.0 mm), 3/32" (2.4 mm), 7/64" (2.8 mm), 1/8" (3.2 mm), 9/64" (3.6 mm), 5/32" (4.0 mm), 3/16" (4.8 mm), 7/32" (5.6 mm), 1/4" (6.3 mm); CrV;
⊙ T9, T10, T15, T20, T25, T27, T30, T40; CrV

YATO	📦
YT-05644	6/20

YATO	⊙ [mm]	a [mm]	b [mm]	📦
YT-05430	1.5	14	78	250/2000
YT-05431	2.0	16	83	250/2000
YT-05432	2.5	18	90	250/1500
YT-05433	3.0	20	100	250/1500
YT-05434	4.0	25	105	250/1000
YT-05435	4.5	27	110	50/600
YT-05436	5.0	27	116	100/600
YT-05437	5.5	30	128	100/500
YT-05438	6.0	32	137	100/500
YT-05439	7.0	34	150	100/300
YT-05440	8.0	36	155	50/200
YT-05441	9.0	38	165	25/125
YT-05442	10.0	40	170	25/125
YT-05443	12.0	47	210	25/75
YT-05444	14.0	57	236	25/50
YT-05445	17.0	63	250	15/30
YT-05446	19.0	70	280	10/20

EN Hex key
 PL Klucz sześciokątny
 DE Sechskant-Stiftschlüssel
 RU Шестигранный
 CZ Imbusový klíč
 HU Imbisz kulcs
 RO Cheie imbus
 FR Clé Allen
 IT Chiave a brugola
 ES Llave hexagonal
 CN 六角螺丝批

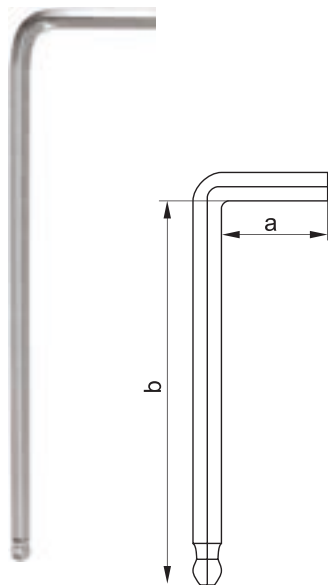

25°
 LONG DEUGI
 CrV

YATO	⊙ [mm]	a [mm]	b [mm]	
YT-05450	1.5	14	78	250/2000
YT-05451	2.0	16	83	250/2000
YT-05452	2.5	18	90	250/2000
YT-05453	3.0	20	100	250/1500
YT-05454	4.0	25	105	250/1000
YT-05455	4.5	27	110	50/650
YT-05456	5.0	27	116	100/600
YT-05457	5.5	30	128	100/500
YT-05458	6.0	32	137	100/500
YT-05459	7.0	34	150	100/300
YT-05460	8.0	36	155	50/200
YT-05461	9.0	38	165	40/160
YT-05462	10.0	40	170	25/125
YT-05463	12.0	47	210	25/75
YT-05464	14.0	57	236	25/50
YT-05465	17.0	63	250	15/30
YT-05466	19.0	70	280	10/20

EN Torx key
 PL Klucz Torx
 DE Torx-Stiftschlüssel
 RU Ключ Torx
 CZ Klíč Torx
 HU Kulcs Torx
 RO Cheie Torx
 FR Clé Torx
 IT Chiave Torx
 ES Llave Torx
 CN 内六角螺丝批

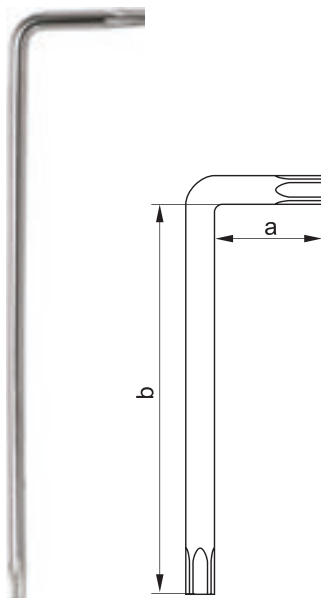

LONG DEUGI
 CrV

YATO	⊙	a [mm]	b [mm]	
YT-05513	T9	16	80	250/2000
YT-05514	T10	17	86	250/2000
YT-05515	T15	17	90	250/2000
YT-05516	T20	19	95	250/1000
YT-05517	T25	20	100	250/1000
YT-05518	T27	21	105	250/1000
YT-05519	T30	24	114	50/600
YT-05520	T40	28	121	50/400
YT-05521	T45	30	132	25/250
YT-05522	T50	32	152	25/200

EN Torx key
 PL Klucz Torx
 DE Torx-Stiftschlüssel
 RU Ключ Torx
 CZ Klíč Torx
 HU Kulcs Torx
 RO Cheie Torx
 FR Clé Torx
 IT Chiave Torx
 ES Llave Torx
 CN 内六角螺丝批

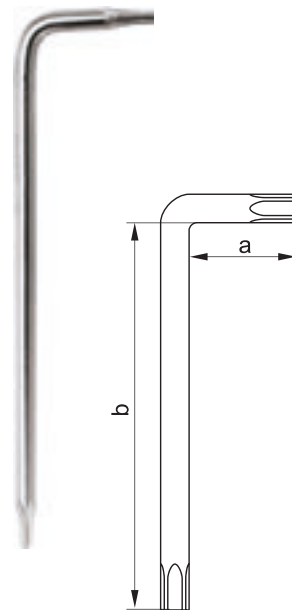

LONG DEUGI
 CrV

YATO	⊙	a [mm]	b [mm]	
YT-05490	T6	16	66	250/2000
YT-05491	T7	16	71	250/2000
YT-05492	T8	16	80	250/2000
YT-05493	T9	16	80	250/2000
YT-05494	T10	17	86	250/2000
YT-05495	T15	17	90	250/2000
YT-05496	T20	19	95	100/1000
YT-05497	T25	20	100	250/1000
YT-05498	T27	21	105	100/1000
YT-05499	T30	24	114	50/600
YT-05501	T40	28	121	50/400
YT-05502	T45	30	132	25/250
YT-05503	T50	32	152	25/200

EN Torx key set
 PL Zestaw kluczy Torx
 DE Torx-Stiftschlüsselsatz
 RU Набор ключей Torx
 CZ Souprava klíčů Torx
 HU Torx kulcskészlet
 RO Set de chei Torx
 FR Set de clés Torx
 IT Set di chiavi a brugola Torx
 ES Juego de llaves Torx
 CN 内六角螺丝批

8 PCS 25° LONG DEUGI

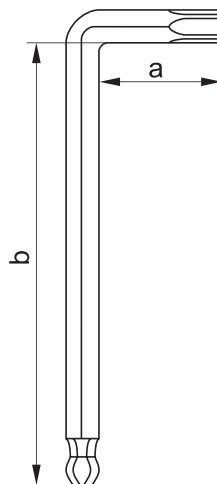

YATO	⊙	a [mm]	b [mm]	
YT-05123	T9, T10, T15, T20, T25, T27, T30, T40	18, 18, 19, 20, 21, 23, 25, 27	85, 90, 95, 100, 107, 115, 123, 132	10/100

EN Hex key set
PL Zestaw kluczy imbusowych
DE Sechskant-Stiftschlüsselsatz
RU Набор шестигранников
CZ Imbusové klíče
HU Imbisz kulcs
RO Chei imbus
FR Set de clés allen
IT Set di chiavi a brugola
ES Juego de llaves hex
CN 内六角扳手组套

12 PCS  SAE CrV 6150 

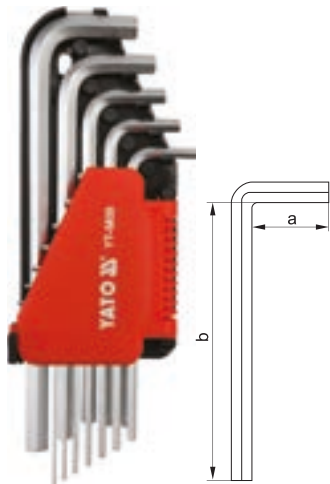

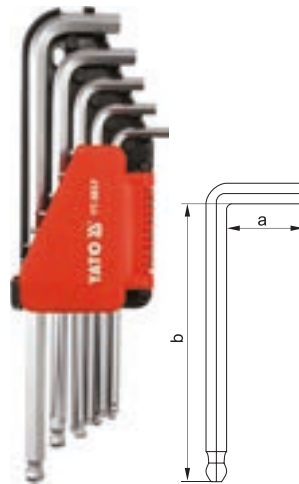

25°  LONG DLUGI

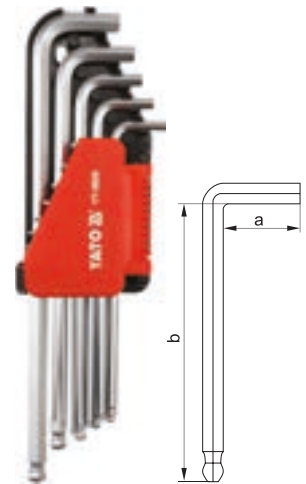

25°  EXTRA LONG EKSTRA DLUGI



YATO	⊙	a [mm]	b [mm]	
YT-5835	1/16" (1.6 mm),			6/36
	5/64" (2.0 mm),			
	3/32" (2.4 mm),			
	7/64" (2.8 mm),		74, 79, 83,	
	1/8" (3.2 mm),	14, 16, 17,	88, 93, 99,	
	9/64" (3.6 mm),	18, 19, 20,	105, 113,	
	5/32" (4.0 mm),	21, 24, 25,	122, 132,	
	3/16" (4.8 mm),	28, 32, 35,	150, 170	
	7/32" (5.6 mm),			
	1/4" (6.3 mm),			
	5/16" (7.9 mm),			
	3/8" (9.5 mm),			

YATO	⊙	a [mm]	b [mm]	
YT-5837	1/16" (1.6 mm),			6/36
	5/64" (2.0 mm),			
	3/32" (2.4 mm),			
	7/64" (2.8 mm),		74, 79, 83,	
	1/8" (3.2 mm),	14, 16, 17,	88, 93, 99,	
	9/64" (3.6 mm),	18, 19, 20,	105, 113,	
	5/32" (4.0 mm),	21, 24, 25,	122, 132,	
	3/16" (4.8 mm),	28, 32, 35,	150, 170	
	7/32" (5.6 mm),			
	1/4" (6.3 mm),			
	5/16" (7.9 mm),			
	3/8" (9.5 mm),			

YATO	⊙	a [mm]	b [mm]	
YT-5838	1/16" (1.6 mm),			6/36
	5/64" (2.0 mm),			
	3/32" (2.4 mm),			
	7/64" (2.8 mm),		91, 100,	
	1/8" (3.2 mm),	14, 16, 17,	110, 116,	
	9/64" (3.6 mm),	18, 19, 20,	123, 130,	
	5/32" (4.0 mm),	21, 24, 25,	132, 150,	
	3/16" (4.8 mm),	28, 32, 35,	165, 185,	
	7/32" (5.6 mm),		200, 233	
	1/4" (6.3 mm),			
	5/16" (7.9 mm),			
	3/8" (9.5 mm),			

EN Hex key set
PL Zestaw kluczy imbusowych
DE Sechskant-Stiftschlüsselsatz
RU Набор шестигранников
CZ Imbusové klíče
HU Imbisz kulcs
RO Chei imbus
FR Set de clés allen
IT Set di chiavi a brugola
ES Juego de llaves hex
CN 内六角扳手组套

 HRC 52-56 CrV 6150 

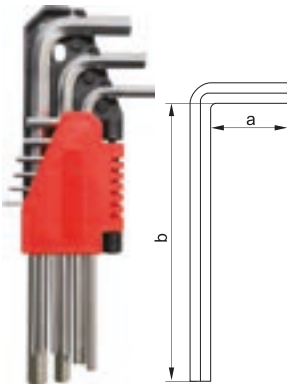

9 PCS

YATO	⊙ [mm]	a [mm]	b [mm]	
YT-0500	1.5, 2, 2.5, 3, 4, 5,	15, 16, 18, 21, 23, 28,	74, 81, 88, 95, 109,	6/36
	6, 8, 10	31, 35, 39	121, 135, 157, 174	

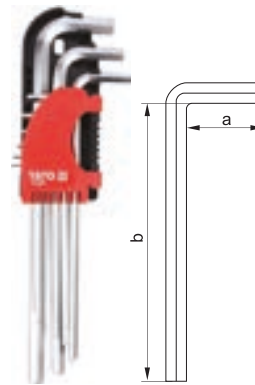

9 PCS

YATO	⊙ [mm]	a [mm]	b [mm]	
YT-0501	1.5, 2, 2.5, 3, 4, 5,	15, 16, 18, 21, 23, 28,	90, 96, 112, 125, 142,	6/36
	6, 8, 10	31, 35, 39	157, 180, 201, 225	

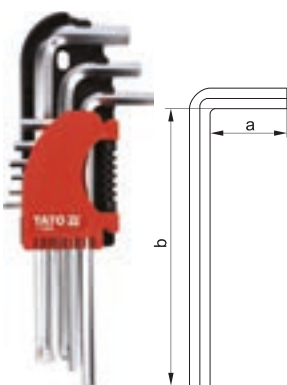

9 PCS

YATO	⊙ [mm]	a [mm]	b [mm]	
YT-0502	2, 2.5, 3, 4, 5, 6, 7,	16, 18, 21, 23, 28, 31,	81, 88, 95, 109, 121,	6/36
	8, 10	33, 35, 39	135, 145, 157, 174	

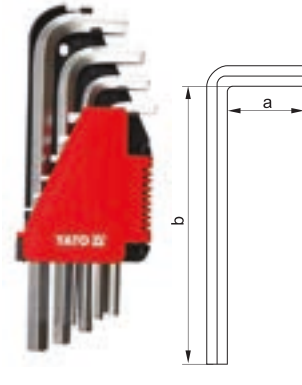

10 PCS

YATO	⊙ [mm]	a [mm]	b [mm]	
YT-0508	2, 2.5, 3, 4, 5, 6, 7, 8,	16, 18, 21, 23, 28, 31,	81, 88, 95, 109, 121,	6/36
	10, 12	33, 35, 39, 42	135, 145, 157, 174,	
			180	

EN Hex key set
 PL Zestaw kluczy imbusowych
 DE Sechskant-Stiftschlüsselsatz
 RU Набор шестигранников

CZ Imbusové klíče
 HU Imbisz kulcs
 RO Chei imbus
 FR Set de clés allen

IT Set di chiavi a brugola
 ES Juego de llaves hex
 CN 内六角扳手组套

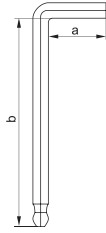

9
PCS

YATO	⊙ [mm]	a [mm]	b [mm]	
YT-0505	1.5, 2, 2.5, 3, 4, 5, 6, 8, 10	15, 16, 18, 21, 23, 28, 31, 35, 39	74, 81, 88, 95, 109, 121, 135, 157, 174	6/36

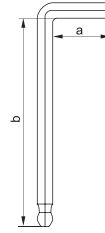

9
PCS

YATO	⊙ [mm]	a [mm]	b [mm]	
YT-0506	1.5, 2, 2.5, 3, 4, 5, 6, 8, 10	15, 16, 18, 21, 23, 28, 31, 35, 39	90, 96, 112, 125, 142, 157, 180, 201, 225	6/36

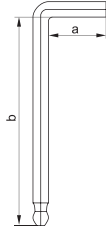

9
PCS

YATO	⊙ [mm]	a [mm]	b [mm]	
YT-0507	2, 2.5, 3, 4, 5, 6, 7, 8, 10	16, 18, 21, 23, 28, 31, 33, 35, 39	81, 88, 95, 109, 121, 135, 145, 157, 174	6/36

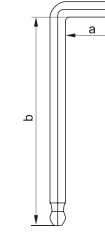

10
PCS

YATO	⊙ [mm]	a [mm]	b [mm]	
YT-0509	2, 2.5, 3, 4, 5, 6, 7, 8, 10, 12	16, 18, 21, 23, 28, 31, 33, 35, 39, 42	81, 88, 95, 109, 121, 135, 145, 157, 174, 180	6/36

EN Hex key set
 PL Zestaw kluczy imbusowych
 DE Sechskant-Stiftschlüsselsatz
 RU Набор шестигранников

CZ Imbusové klíče
 HU Imbisz kulcs
 RO Chei imbus
 FR Set de clés allen

IT Set di chiavi a brugola
 ES Juego de llaves hex
 CN 内六角组套



8
PCS

YATO	⊙ [mm]	a [mm]	b [mm]	
YT-0503	2, 2.5, 3, 4, 5, 6, 8, 10	14, 16, 17, 21, 22, 27, 32, 38	50, 53, 60, 66, 74, 81, 93, 104	12/72

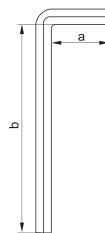

10
PCS

YATO	⊙ [mm]	a [mm]	b [mm]	
YT-0504	1.5, 2, 2.5, 3, 4, 5, 6, 7, 8, 10	12, 14, 16, 17, 21, 22, 27, 31, 32, 38	43, 50, 53, 60, 66, 74, 81, 86, 93, 104	12/72

EN Hex key set
 PL Zestaw kluczy imbusowych
 DE Sechskant-Stiftschlüsselsatz
 RU Набор шестигранников

CZ Imbusové klíče
 HU Imbisz kulcs
 RO Chei imbus
 FR Set de clés Allen
 IT Set di chiavi a brugola
 ES Juego de llaves Hex
 CN 内六角扳手组套

10
PCS

HRC 52-55
CrV 6150

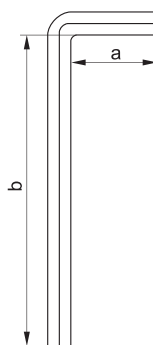

YATO	⊙ [mm]	a [mm]	b [mm]	
YT-0519	3, 4, 5, 5.5, 6, 8, 10, 12, 14, 17	20, 25, 28, 30, 32, 35, 42, 49, 57, 65	125, 140, 160, 170, 180, 200, 220, 250, 285, 320	5



EN TORX key set
PL Zestaw kluczy TORX
DE TORX-Stiftschlüsselsatz
RU Набор ключей TORX

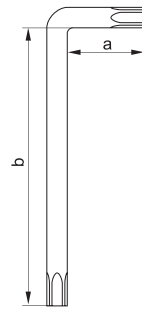
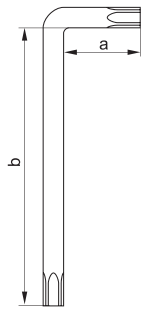

CZ Souprava klíčů TORX
HU Kulcskészlet, TORX
RO Set de chei TORX
FR Set de clés allen

IT Set di chiavi a brugola
ES Juego de llaves TORX
CN 内六角扳手组套

9 PCS  HRC 52-56 CrV 6150 



YATO		a [mm]	b [mm]	
YT-0511	T10, T15, T20, T25, T27, T30, T40, T45, T50	15, 16, 17, 21, 24, 27, 32, 36, 38	72, 79, 86, 94, 107, 122, 133, 155, 174	6/36

YATO		a [mm]	b [mm]	
YT-0512	T10, T15, T20, T25, T27, T30, T40, T45, T50	15, 16, 19, 23, 26, 27, 32, 36, 41	78, 95, 109, 124, 143, 153, 180, 200, 222	6/36



EN Hex key set
PL Zestaw kluczy imbusowych
DE Sechkant-Stiftschlüsselsatz
RU Набор шестигранников

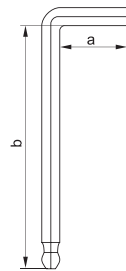
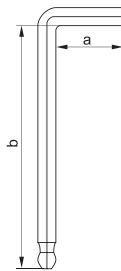

CZ Imbusové klíče
HU Imbisz kulcs
RO Chei imbus
FR Set de clés allen

IT Set di chiavi a brugola
ES Juego de llaves hex
CN 内六角组套

10 PCS  25°  S2



YATO		a [mm]	b [mm]	
YT-0560	1.27, 1.5, 2, 2.5, 3, 4, 5, 6, 8, 10	12, 14, 16, 18, 18, 21, 27, 32, 35, 38	73, 76, 82, 89, 99, 104, 115, 138, 161, 179	12/48

YATO		a [mm]	b [mm]	
YT-0561	1.27, 1.5, 2, 2.5, 3, 4, 5, 6, 8, 10	10, 12, 15, 17, 19, 23, 28, 32, 36, 50	78, 89, 98, 110, 124, 140, 159, 179, 198, 232	12/48

EN TORX key set
PL Zestaw kluczy TORX
DE TORX-Stiftschlüsselsatz
RU Набор ключей TORX

CZ Souprava klíčů TORX
HU Kulcskészlet, TORX
RO Set de chei TORX
FR Set de clés allen



IT Set di chiavi a brugola
ES Juego de llaves TORX
CN 内六角组套

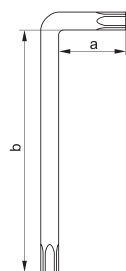
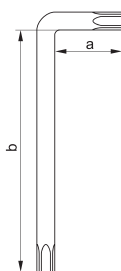

 S2 



7 PCS



9 PCS

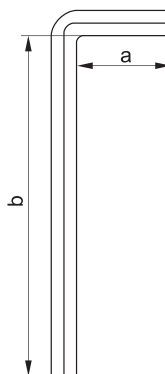

YATO		a [mm]	b [mm]	
YT-0562	T9, T10, T15, T20, T25, T27, T30	18, 19, 19, 19, 22, 24, 26	78, 85, 93, 103, 113, 123, 132	12/48

YATO		a [mm]	b [mm]	
YT-0563	T10, T15, T20, T25, T27, T30, T40, T45, T50	14, 14, 16, 18, 23, 27, 30, 35, 41	87, 97, 108, 123, 137, 158, 177, 197, 216	12/48

- EN Hex key set
- PL Zestaw kluczy imbusowych
- DE Sechskant-Stiftschlüsselsatz
- RU Набор ключи торцовых шестигранных
- CZ Imbusové klíče
- HU Imbisz kulcs
- RO Chei imbus
- FR Set de clés allen
- IT Set di chiavi a brugola
- ES Llaves hexagonales
- CN 内六角扳手组套





9 PCS	
LONG DLUGI	HRC 58-62
S2	

YATO 	◎ [mm]	a [mm]	b [mm]	
YT-05631	1.5, 2, 2.5, 3, 4, 5, 6, 8, 10	14.5, 16, 17.5, 21, 23, 27, 30, 33, 38	78.5, 83, 90.5, 99, 110, 122, 138, 152, 166	10/50

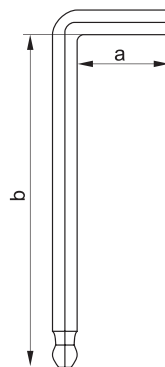
- EN Hex key set
- PL Zestaw kluczy imbusowych
- DE Sechskant-Stiftschlüsselsatz
- RU Набор ключи торцовых шестигранных
- CZ Imbusové klíče
- HU Imbisz kulcs
- RO Chei imbus
- FR Set de clés allen
- IT Set di chiavi a brugola
- ES Llaves hexagonales
- CN 内六角扳手组套





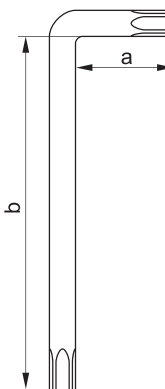

9 PCS	
25° 	LONG DLUGI
HRC 58-62	S2
	

YATO 	◎ [mm]	a [mm]	b [mm]	
YT-05632	1.5, 2, 2.5, 3, 4, 5, 6, 8, 10	14.5, 16, 17.5, 21, 23, 27, 30, 33, 38	78.5, 83, 90.5, 99, 110, 122, 138, 152, 166	10/50

- EN Torx key set
- PL Zestaw kluczy Torx
- DE Torx Schlüsselsatz
- RU Набор ключи Torx
- CZ Souprava klíčů Torx
- HU Kulcskészlet Torx
- RO Set de chei Torx
- FR Set de clés Torx
- IT Set di chiavi a brugola Torx
- ES Juego de llaves Torx
- CN 内六角扳手组套



9 PCS	
LONG DLUGI	HRC 58-62
S2	

YATO 	◎	a [mm]	b [mm]	
YT-05633	T10, T15, T20, T25, T27, T30, T40, T45, T50	15, 17.7, 19.2, 20.75, 23.25, 25.5, 28.2, 34.2, 36.2	83, 90.7, 98.2, 106.75, 113.25, 129.5, 139.2, 149.2, 161.2	10/50

Memo



6

Pliers & pipe wrenches Szczypce i klucze do rur



Pliers, CrV Szczypce, CrV		113
-------------------------------------	---	-----

Combination pliers Szczypce uniwersalne	113
Side cutting pliers Szczypce tnące, boczne	113
Long nose pliers Szczypce wydłużone, proste	113
Bent nose pliers Szczypce wydłużone, wygięte	113

Pliers Szczypce		113-114
---------------------------	---	---------

Combination pliers Szczypce uniwersalne	113
Side cutting pliers Szczypce tnące, boczne	113
Long nose pliers Szczypce wydłużone, proste	113
Bent nose pliers Szczypce wydłużone, wygięte	113
Flat nose pliers Szczypce płaskie	113
Round nose pliers Szczypce okrągłe	113
Wire stripping pliers Szczypce do ściągania izolacji	114
End cutting pliers Szczypce tnące, czołowe	114

Pliers, CrV Szczypce, CrV		114
-------------------------------------	---	-----

Combination pliers Szczypce uniwersalne	114
Side cutting pliers Szczypce tnące, boczne	114

Pliers Szczypce		114
---------------------------	---	-----

Combination pliers Szczypce uniwersalne	114
Side cutting pliers Szczypce tnące, boczne	114

Multifunctional pliers Szczypce wielofunkcyjne		114
--	---	-----

Double joint pliers Szczypce przegubowe		115
---	---	-----

Double joint long nose pliers Szczypce wydłużone proste przegubowe	115
Double joint bent nose pliers Szczypce wydłużone wygięte przegubowe	115

Mini pliers Szczypce „Mini”		115-116
---------------------------------------	---	---------

Combination pliers Szczypce uniwersalne	115
Side cutting pliers Szczypce tnące, boczne	115
Long nose pliers Szczypce wydłużone, proste	115
Bent nose pliers Szczypce wydłużone, wygięte	115
Flat nose pliers Szczypce płaskie	116
Round nose pliers Szczypce okrągłe	116
End cutting pliers Szczypce tnące, czołowe	116

Insulated pliers Szczypce izolowane		116-117
---	---	---------

Combination pliers Szczypce uniwersalne	116
Side cutting pliers Szczypce tnące, boczne	116
Long nose pliers Szczypce wydłużone, proste	116
Wire stripping pliers Szczypce do ściągania izolacji	116
Water pump pliers Szczypce nastawne	116
Insulated flat nose pliers Klucze płaskie izolowane	117

Plastics & cables cutting pliers Szczypce do cięcia plastiku i kabli		117
--	--	-----

Side cutting pliers Szczypce tnące, boczne	117
Long nose pliers Szczypce wydłużone, proste	117

Carpenter's pliers & tower pincers Obcęgi i szczypce		117-118
--	---	---------

Carpenter's pliers Obcęgi	117
Tower pincers Szczypce tynkarskie	118

Heavy duty side cutting pliers Szczypce tnące, boczne		118
---	---	-----

End cutting pliers Szczypce tnące czołowe		118
---	---	-----

Circlip pliers Szczypce Segera		118-120
--	---	---------

Lock grip pliers Szczypce zaciskowe		120-122
---	---	---------



Lock grip pliers	
Szczypce zaciskowe, uniwersalne.....	120
Welding locking pliers	
Szczypce zaciskowe, spawalnicze.....	120
Flat locking pliers	
Szczypce zaciskowe o szerokich szczękach.....	122
C-type welding locking pliers	
Szczypce zaciskowe, klamrowe typu „C”.....	122
Chain locking pliers	
Szczypce zaciskowe z łańcuchem.....	122

Strap wrenches		
Klucze do rur taśmowe		
	125	

Chain pipe wrenches		
Klucze do rur łańcuchowe		
	125	

Profile connection & forming pliers	
Szczypce do łączenia i kształtowania profili	
	122-123

Tweezers		
Pęsety		
	125	

Water pump pliers	
Szczypce nastawne	
	124

Pipe wrenches	
Klucze do rur	
	124-125



EN Combination pliers
PL Szczypce uniwersalne
DE Kombinationszange
RU Плоскогубцы универсальные
HU Kombinálógó

RO Patent universal
FR Pince universelle
IT Pinze universali
ES Alicates universales
CN 钢丝钳

DIN 5746 **HRC 58-62** **HRC 44-50** **CrV 55**



• Application: industry
• Induction hardening
• Przeznaczenie: przemysł
• Hartowane indukcyjnie

YATO 	L [mm]	
YT-1940	160	6/60
YT-1941	180	6/60
YT-1942	200	6/36



EN Long nose pliers
PL Szczypce wydłużone proste
DE Radiozange
RU Тонкогубцы прямые
CZ Prodloužené kleště rovné
HU Rádiófogó, egyenes

RO Clește cu vârf ascuțit
FR Pince prolongée
IT Pinze lunghe diritte
ES Alicates de punta
CN 尖嘴钳

DIN 5746 **HRC 44-50** **HRC 58-62** **CrV 55**



• Application: industry
• Induction hardening
• Przeznaczenie: przemysł
• Hartowane indukcyjnie

YATO 	L [mm]	
YT-1943	160	6/60
YT-1944	200	6/60



EN Combination pliers
PL Szczypce uniwersalne
DE Kombinationszange
RU Плоскогубцы универсальные

CZ Kleště kombinované
HU Kombinálógó
RO Patent universal
FR Pince universelle

IT Pinze universali
ES Alicates universales
CN 钢丝钳

DIN 5746 **NICKEL IRON FINISH**





YATO 	L [mm]	
YT-2006	160	6/60
YT-2007	180	6/60
YT-2008	200	6/36

EN Long nose pliers
PL Szczypce wydłużone proste
DE Radiozange
RU Тонкогубцы прямые
CZ Prodloužené kleště rovné
HU Rádiófogó, egyenes

RO Clește cu vârf ascuțit
FR Pince prolongée
IT Pinze lunghe diritte
ES Alicates de punta
CN 尖嘴钳

DIN 5746 **NICKEL IRON FINISH**



YATO 	L [mm]	
YT-2016	160	6/60
YT-2018	200	6/60

EN Flat nose pliers
PL Szczypce płaskie
DE Flachzange
RU Плоскогубцы удлиненные
CZ Kleště ploché
HU Rádiófogó, egyenes

RO Clește cu vârf ascuțit
FR Pince plate
IT Pinze piatte
ES Alicates de bocas planas
CN 平嘴钳

160 mm **DIN 5745** **NICKEL IRON FINISH**



YATO 	L [mm]	
YT-2029	160	6/60



EN Diagonal side cutting pliers
PL Szczypce tnące boczne
DE Seitenschneider
RU Бокорезы
CZ Řezací kleště boční
HU Oldal csípőfogó

RO Olește tăietor
FR Pince à coupe latérale
IT Pinze taglianti laterali
ES Alicates corte lateral
CN 斜嘴钳

DIN 5746 **HRC 44-50** **HRC 58-62** **CrV 55**



• Application: industry
• Induction hardening
• Przeznaczenie: przemysł
• Hartowane indukcyjnie

YATO 	L [mm]	
YT-1947	160	6/60
YT-1948	190	6/60

EN Bent nose pliers
PL Szczypce wydłużone wygięte
DE Telefonzange
RU Тонкогубцы изогнутые
CZ Prodloužené kleště ohnuté
HU Rádió- és telefonfogó, hajlítógó



RO Clește cu vârf ascuțit îndoit
FR Pince prolongée cambrée
IT Pinze a punta mezzo tonde
ES Alicates de punta curvos
CN 弯嘴钳

DIN 5746 **HRC 44-50** **HRC 58-62** **CrV 55**



• Application: industry
• Induction hardening
• Przeznaczenie: przemysł
• Hartowane indukcyjnie



YATO 	L [mm]	
YT-1945	160	6/60
YT-1946	200	6/60

EN Diagonal side cutting pliers
PL Szczypce tnące boczne
DE Seitenschneider
RU Бокорезы

CZ Řezací kleště boční
HU Oldal csípőfogó
RO Olește tăietor
FR Pince à coupe latérale

IT Pinze taglianti laterali
ES Alicates corte lateral
CN 斜口钳

DIN 5746 **NICKEL IRON FINISH**





YATO 	L [mm]	
YT-2036	160	6/60
YT-2037	180	6/60

EN Bent nose pliers
PL Szczypce wydłużone wygięte
DE Telefonzange
RU Тонкогубцы изогнутые
CZ Prodloužené kleště ohnuté
HU Rádió- és telefonfogó, hajlítógó

RO Clește cu vârf ascuțit îndoit
FR Pince prolongée cambrée
IT Pinze a punta mezzo tonde
ES Alicates de punta curvos
CN 弯嘴钳

DIN 5746 **NICKEL IRON FINISH**



YATO 	L [mm]	
YT-2026	160	6/60
YT-2028	200	6/60

EN Round nose pliers
PL Szczypce okrągłe
DE Rundzange
RU Круглогубцы
CZ Kleště kulaté
HU Kerekcsőrű fogó

RO Patent rotund
FR Pince ronde
IT Pinze tonde
ES Alicates de punta redonda
CN 圆嘴钳

160 mm **DIN 5745** **NICKEL IRON FINISH**



YATO 	L [mm]	
YT-2030	160	6/60

EN Wire stripping pliers
 PL Szczypce do ściągania izolacji
 DE Abisolierzange
 RU Пасатижи для зачистки проводов
 CZ Kleště odizolovací na drát
 HU Blankoló fogó
 RO Decablator
 FR Pince à l'isolation
 IT Pinze spelafili
 ES Pinzas pelacables
 CN 剥线钳



160 mm
 DIN 5745
 NICKEL IRON FINISH

YATO	L [mm]	
YT-2031	160	6/60

EN Combination pliers
 PL Szczypce uniwersalne
 DE Kombinationszange
 RU Плоскогубцы универсальные
 CZ Kleště kombinované
 HU Kombinálfogó



HRC 55-62
 CrV

YATO	L [mm]	
YT-6600	160	6/60
YT-6601	180	6/60
YT-6602	200	6/36

EN Diagonal side cutting pliers
 PL Szczypce tnące boczne
 DE Seitenschneider
 RU Бокорезы
 CZ Řezací kleště boční
 HU Oldal csípőfogó
 RO Olește tăietor
 FR Pince à coupe latérale
 IT Pinze taglianti laterali
 ES Alicates corte lateral
 CN 重型斜嘴钳



180 mm
 HRC 55-62
 CrV

YATO	L [mm]	
YT-6612	180	6/60

EN Diagonal side cutting pliers
 PL Szczypce tnące boczne
 DE Seitenschneider
 RU Бокорезы
 CZ Řezací kleště boční
 HU Oldal csípőfogó



160 mm
 HIGH LEVERAGE ZWIEKSONA SIŁA NACISKU

YATO	L [mm]	
YT-6583	160	6/60

EN Multifunctional pliers
 PL Szczypce wielofunkcyjne
 DE Multifunktionszange
 RU Многофункциональные плоскогубцы
 CZ Multifunkční kleště
 HU Kombinálfogó



205 mm
 HRC 40-50
 HRC 58-62
 CrV

YATO					L [mm]	
YT-20433	1.5	16-14	1-6	18-8	205	5/50

EN End cutting pliers
 PL Szczypce tnące czolowe
 DE Vornscheider
 RU Кусачки торцевые
 CZ Kleště štipací čelní
 HU Homlokcsípő fogó
 RO Cleste retezat
 FR Coupe devant
 IT Pinza a taglio laterale
 ES Cortacables frontales
 CN 顶切钳



DIN 5748
 NICKEL IRON FINISH

YATO	L [mm]	
YT-2066	160	6/60
YT-2067	180	6/60

EN Diagonal side cutting pliers
 PL Szczypce tnące boczne
 DE Seitenschneider
 RU Бокорезы
 CZ Řezací kleště boční
 HU Oldal csípőfogó

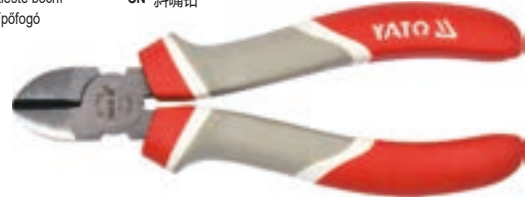

HRC 55-62
 CrV

YATO	L [mm]	
YT-6610	160	6/60
YT-6611	180	6/60

EN Combination pliers
 PL Szczypce uniwersalne
 DE Kombinationszange
 RU Плоскогубцы универсальные
 CZ Kleště kombinované
 HU Kombinálfogó



HIGH LEVERAGE ZWIEKSONA SIŁA NACISKU

YATO	L [mm]	
YT-6581	160	6/60
YT-6582	200	6/36

EN Multifunctional pliers
 PL Szczypce wielofunkcyjne
 DE Multifunktionszange
 RU Многофункциональные плоскогубцы
 CZ Multifunkční kleště
 HU Kombinálfogó



220 mm

HRC 40-50
 HRC 58-62

CrV

YATO					L [mm]	
YT-20430	1.5	16-14	1-6	18-8	220	5/50

EN Multifunctional pliers
 PL Szczypce wielofunkcyjne
 DE Multifunktionszange
 RU Многофункциональные плоскогубцы
 CZ Multifunkční kleště
 HU Kombinálfogó



240 mm

HRC 40-50
 HRC 58-62

CrV



YATO					L [mm]	
YT-20435	1.5	16-14	1-6	18-8	240	5/50

EN Double joint long nose pliers
PL Szczypce wydłużone proste przegubowe
DE Kneifzange verlängert gerade 2 Gelenke
RU Поксогоубцы прямые 2 шарнира
CZ Prodloužené kleště rovné se zdvojeným kloubem
HU Hosszú egyenes 2 csuklós fogó

RO Clește cu falci lungi
FR Pince allongée droite à 2 articulations
IT Pinza lunga dritta con 2 giunti
ES Alicates de pinzas largas rectas 2 articulaciones
CN 尖嘴钳

340 mm HRC 50 CrV 





YATO 	L [mm]	
YT-20400	340	5/50

EN Double joint bent nose pliers
PL Szczypce wydłużone wygięte przegubowe
DE Kneifzange verlängert gebogen 2 Gelenke
RU Поксогоубцы изогнутые 2 шарнира
CZ Prodloužené kleště zahnuté se zdvojeným kloubem
HU Hosszú hajlított 2 csuklós fogó

RO Clește cu falci curbate
FR Pince allongée coudée à 2 articulations
IT Pinza lunga piegata con 2 giunti
ES Alicates de pinzas largas curvadas 2 articulaciones
CN 弯嘴钳

330 mm 45° HRC 50 CrV 



YATO 	L [mm]	
YT-20401	330	5/50





EN Double joint bent nose pliers
PL Szczypce wydłużone wygięte przegubowe
DE Kneifzange verlängert gebogen 2 Gelenke
RU Поксогоубцы изогнутые 2 шарнира
CZ Prodloužené kleště zahnuté se zdvojeným kloubem
HU Hosszú hajlított 2 csuklós fogó

RO Clește cu falci curbate
FR Pince allongée coudée à 2 articulations
IT Pinza lunga piegata con 2 giunti
ES Alicates de pinzas largas curvadas 2 articulaciones
CN 弯嘴钳

330 mm 90° HRC 50 CrV 



YATO 	L [mm]	
YT-20402	330	5/50



EN Combination pliers
PL Szczypce uniwersalne
DE Kombinationszange
RU Поксогоубцы универсальные
CZ Kleště kombinované
HU Kombináltfogó
RO Patent universal
FR Pince universelle
IT Pinze universali
ES Alicates universales
CN 迷你钢丝钳

115 mm NICKEL IRON FINISH 



YATO 	L [mm]	
YT-2080	115	6/120

EN Diagonal side cutting pliers
PL Szczypce tnące boczne
DE Seitenschneider
RU Бокорезы
CZ Rezací kleště boční
HU Oldal csípőfogó
RO Olește tăietor
FR Pince à coupe latérale
IT Pinze taglianti laterali
ES Alicates corte lateral
CN 迷你斜口钳

115 mm NICKEL IRON FINISH 





YATO 	L [mm]	
YT-2081	115	6/120

EN Long nose pliers
PL Szczypce wydłużone proste
DE Radiozange
RU Тонкогубцы прямые
CZ Prodloužené kleště rovné
HU Rádiófogó, egyenes
RO Clește cu vârf ascuțit
FR Pince prolongée
IT Pinze lunghe diritte
ES Alicates de punta
CN 迷你尖嘴钳

115 mm NICKEL IRON FINISH 



YATO 	L [mm]	
YT-2083	115	6/120

EN Bent nose pliers
PL Szczypce wydłużone wygięte
DE Telefonzange
RU Тонкогубцы изогнутые
CZ Prodloužené kleště ohnuté
HU Rádió - és telefonfogó, hajlított
RO Clește cu vârf ascuțit Îndoit
FR Pince prolongée cambrée
IT Pinze a punta mezzo tonda
ES Alicates de punta curvos
CN 迷你弯嘴钳

115 mm NICKEL IRON FINISH 





YATO 	L [mm]	
YT-2084	115	6/120

EN Flat nose pliers
 PL Szczypce płaskie
 DE Flachzange
 RU Плоскогубцы удлиненные
 CZ Kleště ploché
 HU Rádiófogó, egyenes
 RO Clește cu vârf ascuțit
 FR Pince plate
 IT Pinze piatte
 ES Alicates de bocas planas
 CN 迷你平口钳

115 mm NICKEL IRON FINISH 



YATO 	L [mm]	
YT-2085	115	6/120

EN Round nose pliers
 PL Szczypce okrągłe
 DE Rundzange
 RU Круглогубцы
 CZ Kleště kulaté
 HU Kerekcsőrű fogó
 RO Patent rotund
 FR Pince ronde
 IT Pinze tonde
 ES Alicates de punta redonda
 CN 迷你圆嘴钳

115 mm NICKEL IRON FINISH 





YATO 	L [mm]	
YT-2086	115	6/120

EN End cutting pliers
 PL Szczypce tnące czolowe
 DE Vornscheider
 RU Кусачки торцевые
 CZ Kleště štípací čelní
 HU Homlokcsípő fogó
 RO Clește rețezat
 FR Coupe devant
 IT Pinza a taglio laterale
 ES Cortacables frontales
 CN 迷你顶切钳

115 mm NICKEL IRON FINISH 





YATO 	L [mm]	
YT-2082	115	6/120

EN Combination pliers
 PL Szczypce uniwersalne
 DE Kombinationszange
 RU Плоскогубцы универсальные
 CZ Kleště kombinované
 HU Kombináltfogó
 RO Patent universal
 FR Pince universelle
 IT Pinze universali
 ES Alicates universales
 CN 绝缘钢丝钳

CrV 1000 V 



1000 V
 VDE CERTIFICATE
 EN 60900:2012



YATO 	L [mm]	
YT-21151	160	6/36
YT-21152	180	6/36
YT-21153	200	6/36

EN Diagonal side cutting pliers
 PL Szczypce tnące boczne
 DE Seitenschneider
 RU Бокорезы
 CZ Řezací kleště boční
 HU Oldal csípőfogó
 RO Olește tăietor
 FR Pince à coupe latérale
 IT Pinze taglianti laterali
 ES Alicates corte lateral
 CN 绝缘斜嘴钳

CrV 1000 V 



1000 V
 VDE CERTIFICATE
 EN 60900:2012



YATO 	L [mm]	
YT-21158	160	6/36
YT-21159	180	6/36

EN Long nose pliers
 PL Szczypce wydłużone proste
 DE Radiozange
 RU Тонкогубцы прямые
 CZ Prodloužené kleště rovné
 HU Rádiófogó, egyenes
 RO Clește cu vârf ascuțit
 FR Pince prolongée
 IT Pinze lunghe diritte
 ES Alicates de punta
 CN 绝缘尖嘴钳

CrV 1000 V 



1000 V
 VDE CERTIFICATE
 EN 60900:2012



YATO 	L [mm]	
YT-21154	160	6/36
YT-21155	200	6/36

EN Insulated wire stripper
 PL Szczypce do ściągania izolacji, izolowane
 DE Abisolier-Zange, isoliert
 RU Изолированные клещи для снятия изоляции
 CZ Kleště pro stahování izolace, izolované
 HU Szigetelés lehúzó fogó, szigetelt
 RO Decablator VDE
 FR Pince à dénuder isolée
 IT Pinza spelafili isolata
 ES Alicates para quitar aislamiento, aislados
 CN 绝缘剥线钳

CrV 1000 V 



1000 V
 VDE CERTIFICATE
 EN 60900:2012

YATO 	L [mm]	
YT-21160	160	6/36

EN Insulated water pump pliers
 PL Szczypce nastawne hydrauliczne, izolowane
 DE Hydraulik-Rohrzange, isoliert
 RU Изолированные переставные клещи
 CZ Nastavitelné kleště izolované
 HU Vízpumpa fogó szigetelt
 RO Clește papagal VDE
 FR Pince réglable multiprises isolée
 IT Pinza regolabile isolata per idraulici
 ES Alicates hidráulicos ajustables, aislados
 CN 绝缘水泵钳

CrV 1000 V 



1000 V
 VDE CERTIFICATE
 EN 60900:2012



YATO 	L [mm]	
YT-21161	250	6/24

EN Insulated flat nose pliers
PL Szczypce płaskie izolowane
DE Greifzange vollisoliert
RU Плоскогубцы изолированные
CZ Izolované kleště ploché
HU Laposfőgő szigetelt
RO Patent izolat
FR Pince plate isolée
IT Pinza piatta isolata
ES Alicates punta plana aislantes
CN 绝缘塑料圆头线夹

CrV 1000 V 





1000 V
VDE CERTIFICATE
EN 60900:2012

YATO 	L [mm]	
YT-21191	200	6/48

EN Diagonal side cutting pliers
PL Szczypce tnące boczne
DE Seitenschneider
RU Бокорезы
CZ Řezací kleště boční
HU Oldal csípőfogó
RO Olește tăietor
FR Pince à coupe latérale
IT Pinze taglianti laterali
ES Alicates corte lateral
CN 塑料水口钳

 150 mm max ∅ 5.0 mm HRC 56-62 HRC 43-48 CrV 60 





YATO 	L [mm]	
YT-1951	150	6/120

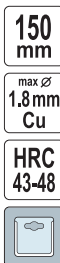

EN Diagonal side cutting pliers
PL Szczypce tnące boczne
DE Seitenschneider
RU Бокорезы
CZ Řezací kleště boční
HU Oldal csípőfogó
RO Olește tăietor
FR Pince à coupe latérale
IT Pinze taglianti laterali
ES Alicates corte lateral
CN 电子斜嘴钳

 150 mm max ∅ 1.0 mm STEEL max ∅ 1.8 mm Cu HRC 56-62 HRC 43-48 CrV 60 





YATO 	L [mm]	
YT-1953	100	6/120

EN Long nose pliers
PL Szczypce wydłużone proste
DE Radiozange
RU Тонкогубцы прямые
CZ Prodloužené kleště rovné
HU Rádiófogó, egyenes
RO Clește cu vârf ascuțit
FR Pince prolongée
IT Pinze lunghe diritte
ES Alicates de punta
CN 电子长嘴钳

 150 mm max ∅ 1.5 mm STEEL max ∅ 2.6 mm Cu HRC 56-62 HRC 43-48 CrV 60 





YATO 	L [mm]	
YT-1956	150	6/120

EN Diagonal side cutting pliers
PL Szczypce tnące boczne
DE Seitenschneider
RU Бокорезы
CZ Řezací kleště boční
HU Oldal csípőfogó
RO Olește tăietor
FR Pince à coupe latérale
IT Pinze taglianti laterali
ES Alicates corte lateral
CN 塑料水口钳

 125 mm max ∅ 3.0 mm HRC 56-62 HRC 43-48 CrV 60 





YATO 	L [mm]	
YT-1950	125	6/120

EN Diagonal side cutting pliers
PL Szczypce tnące boczne
DE Seitenschneider
RU Бокорезы
CZ Řezací kleště boční
HU Oldal csípőfogó
RO Olește tăietor
FR Pince à coupe latérale
IT Pinze taglianti laterali
ES Alicates corte lateral
CN 塑料水口钳

 180 mm max ∅ 6.0 mm HRC 56-62 HRC 43-48 CrV 60 



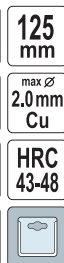

YATO 	L [mm]	
YT-1952	180	6/60

EN Diagonal side cutting pliers
PL Szczypce tnące boczne
DE Seitenschneider
RU Бокорезы
CZ Řezací kleště boční
HU Oldal csípőfogó
RO Olește tăietor
FR Pince à coupe latérale
IT Pinze taglianti laterali
ES Alicates corte lateral
CN 电子斜嘴钳

 125 mm max ∅ 1.2 mm STEEL max ∅ 2.0 mm Cu HRC 56-62 HRC 43-48 CrV 60 





YATO 	L [mm]	
YT-1954	125	6/120

EN Carpenter's pliers
PL Obcegi
DE Kneifzange
RU Клещи строительные
CZ Kleště
HU Harapőfogó
RO Clește cuie
FR Tenailles
IT Tenaglie
ES Tenazas
CN 胡桃钳

DIN 5748 NICKEL IRON FINISH 



YATO 	L [mm]	
YT-2046	160	6/60
YT-2047	180	6/60
YT-2048	200	6/60

EN Tower pincers
 PL Obcegi tynkarskie
 DE Beisszange
 RU Клещи штукатурные
 CZ Kleště štirací čelní
 HU Rabitzfogó
 RO Cleste pt. cuie
 FR Tenaille russe
 IT Tenaglie tronchesi
 ES Tenazas de enlucido
 CN 扎线钳

DIN 5748 **NICKEL IRON FINISH**



YATO	L [mm]	
YT-2058	200	6/60
YT-2060	250	6/36
YT-2061	275	6/36

EN Tower pincers
 PL Obcegi tynkarskie
 DE Beisszange
 RU Клещи штукатурные
 CZ Kleště štirací čelní
 HU Rabitzfogó
 RO Cleste pt. cuie
 FR Tenaille russe
 IT Tenaglie tronchesi
 ES Tenazas de enlucido
 CN 木工铅笔

250 mm **DIN 5746** **HRC 44-50** **HRC 55-62** **CrV 55**



YATO	L [mm]	
YT-1949	250	6/36

EN Heavy duty side cutting pliers
 PL Szczypce tnące boczne
 DE Seitenschneider, Schwer Typ
 RU Бокорезы усиленные
 CZ Řezací kleště boční
 HU Oldal csípőfogó
 RO Olește tăietor
 FR Pince à coupe latérale
 IT Pinze taglianti laterali
 ES Alicates de corte lateral tipo pesado
 CN 重型斜口钳

180 mm **DIN 5749** **NICKEL IRON FINISH**



YATO	L [mm]	
YT-2039	180	6/60

EN Carpenter's pliers
 PL Obcegi
 DE Kneifzange
 RU Клещи строительные
 CZ Kleště
 HU Harapófogó
 RO Cleste cuie
 FR Tenailles
 IT Tenaglie
 ES Tenazas
 CN 胡桃钳

HRC 55-60 **CrV 50**



YATO	L [mm]	Max. cutting capacity in cold rolled steel / Maks. grubość cięcia w stali walcowanej na zimno [mm]	
YT-2050	150	1.5	6/60
YT-2051	175	1.8	6/60
YT-2052	200	2.0	6/48

EN Tower pincers
 PL Obcegi tynkarskie
 DE Beisszange
 RU Клещи штукатурные
 CZ Kleště štirací čelní
 HU Rabitzfogó
 RO Cleste pt. cuie
 FR Tenaille russe
 IT Tenaglie tronchesi
 ES Tenazas de enlucido
 CN 扎线钳

HRC 55-62 **CrV 50**



YATO	L [mm]	Max. cutting capacity in cold rolled steel / Maks. grubość cięcia w stali walcowanej na zimno [mm]	
YT-2055	225	1.8	6/60
YT-2056	250	2.0	6/48
YT-2057	275	2.2	6/24

EN End cutting pliers
 PL Szczypce tnące czolowe
 DE Vornscheider
 RU Кусачки торцевые
 CZ Kleště štirací čelní
 HU Homlokcsípő fogó
 RO Cleste rețezat
 FR Coupe devant
 IT Pinza a taglio laterale
 ES Cortacables frontales
 CN 顶切钳

HRC 55-60 **CrV 50**



YATO	L [mm]	Max. cutting capacity in cold rolled steel / Maks. grubość cięcia w stali walcowanej na zimno [mm]	
YT-2063	175	1.5	6/48
YT-2064	200	1.8	6/48

EN Interior bent nose snap ring pliers
 PL Szczypce Segera do pierścieni zacisków hamulcowych
 DE Bremssattel- Sprengringzange
 RU Клещи зегра для тормозных суппортов
 CZ Kleště na pojsnté kroužky brzdových svorek, segerovky
 HU Seeger-gyűrű fogó
 RO Cleste sigurant interior, indolt
 FR Pince seger pour bagues d'étrier de frein
 IT Pinza per anelli Seeger per freni
 ES Alicates Seeger para anillos de las pinzas de freno
 CN 挡圈钳

90° **190 mm** **55 mm**
BENT WYGIĘTE



YATO	L [mm]	
YT-06561	190	5/20

EN Circlip pliers
 PL Szczypce Segera
 DE Seegeringzange
 RU Съемник стопорных колец
 CZ Kleště Segera
 HU Seegerfogó

RO Clește Seger
 FR Pince pour anneau Seeger
 IT Pinza per anelli Seeger
 ES Alicates Seger
 CN 卡簧钳

5 PCS

160 mm

10-50 mm

23 mm max.	20 mm max.	
28 mm max.	23 mm max.	
30 mm max.	27 mm max.	

YATO	L [mm]	
YT-2130	160	20/60

EN Circlip pliers
PL Szcypce Segeera
DE Seegeringgzange
RU Съёмник стопорных колец
CZ Kleště Segeera
HU Segeerfogó



RO Clește Seger
FR Pince pour anneau Seeger
IT Pinza per anelli Seeger
ES Alicates Seger
CN 直嘴轴用挡圈钳

180
mm

HRC
42-48

CrV
50



YATO 	L [mm]	
YT-2136	180	6/24

EN Circlip pliers
PL Szcypce Segeera
DE Seegeringgzange
RU Съёмник стопорных колец
CZ Kleště Segeera
HU Segeerfogó



RO Clește Seger
FR Pince pour anneau Seeger
IT Pinza per anelli Seeger
ES Alicates Seger
CN 弯嘴轴用挡圈钳

180
mm

HRC
42-48

CrV
50



YATO 	L [mm]	
YT-2138	180	6/24

EN Circlip pliers
PL Szcypce Segeera
DE Seegeringgzange
RU Съёмник стопорных колец
CZ Kleště Segeera
HU Segeerfogó

RO Clește Seger
FR Pince pour anneau Seeger
IT Pinza per anelli Seeger
ES Alicates Seger
CN 直嘴孔用挡圈钳

180
mm

HRC
42-48

CrV
50



YATO 	L [mm]	
YT-2137	180	6/24

EN Circlip pliers
PL Szcypce Segeera
DE Seegeringgzange
RU Съёмник стопорных колец
CZ Kleště Segeera
HU Segeerfogó



RO Clește Seger
FR Pince pour anneau Seeger
IT Pinza per anelli Seeger
ES Alicates Seger
CN 弯嘴孔用挡圈钳

180
mm

HRC
42-48

CrV
50





YATO 	L [mm]	
YT-2139	180	6/24

EN Circlip pliers
PL Szcypce Segeera
DE Seegeringgzange
RU Съёмник стопорных колец
CZ Kleště Segeera
HU Segeerfogó

RO Clește Seger
FR Pince pour anneau Seeger
IT Pinza per anelli Seeger
ES Alicates Seger
CN 直嘴轴用挡圈钳

CrV





YATO 	L [mm]	
YT-2140	150	6/120
YT-2144	200	6/60

EN Circlip pliers
PL Szcypce Segeera
DE Seegeringgzange
RU Съёмник стопорных колец
CZ Kleště Segeera
HU Segeerfogó

RO Clește Seger
FR Pince pour anneau Seeger
IT Pinza per anelli Seeger
ES Alicates Seger
CN 弯嘴轴用挡圈钳

CrV





YATO 	L [mm]	
YT-2141	150	6/120
YT-2145	200	6/60

EN Circlip pliers
PL Szcypce Segeera
DE Seegeringgzange
RU Съёмник стопорных колец
CZ Kleště Segeera
HU Segeerfogó

RO Clește Seger
FR Pince pour anneau Seeger
IT Pinza per anelli Seeger
ES Alicates Seger
CN 直嘴孔用挡圈钳

CrV





YATO 	L [mm]	
YT-2142	150	6/60
YT-2146	200	6/60

EN Circlip pliers
PL Szcypce Segeera
DE Seegeringgzange
RU Съёмник стопорных колец
CZ Kleště Segeera
HU Segeerfogó

RO Clește Seger
FR Pince pour anneau Seeger
IT Pinza per anelli Seeger
ES Alicates Seger
CN 弯嘴孔用挡圈钳

CrV



YATO 	L [mm]	
YT-2143	150	6/120
YT-2147	200	6/60



EN Circlip pliers
PL Szczypce Segera
DE Seegeringgzange
RU Съёмник стопорных колец
CZ Kleště Segera
HU Seegerfogó

RO Clește Seger
FR Pince pour anneau Seeger
IT Pinza per anelli Seeger
ES Alicates Seger
CN 直嘴轴用挡圈钳



CrV
NICKEL IRON FINISH



YATO 	L [mm]	
YT-1988	225	6/60
YT-1992	325	6/48



EN Circlip pliers
PL Szczypce Segera
DE Seegeringgzange
RU Съёмник стопорных колец
HU Seegerfogó

RO Clește Seger
FR Pince pour anneau Seeger
IT Pinza per anelli Seeger
ES Alicates Seger
CN 弯嘴轴用挡圈钳



CrV
NICKEL IRON FINISH



YATO 	L [mm]	
YT-1989	225	6/60
YT-1993	325	6/48



EN Circlip pliers
PL Szczypce Segera
DE Seegeringgzange
RU Съёмник стопорных колец
CZ Kleště Segera
HU Seegerfogó

RO Clește Seger
FR Pince pour anneau Seeger
IT Pinza per anelli Seeger
ES Alicates Morse
CN 直嘴孔用挡圈钳



CrV
NICKEL IRON FINISH



YATO 	L [mm]	
YT-1990	225	6/60
YT-1994	325	6/48



EN Circlip pliers
PL Szczypce Segera
DE Seegeringgzange
RU Съёмник стопорных колец
CZ Kleště Segera
HU Seegerfogó

RO Clește Seger
FR Pince pour anneau Seeger
IT Pinza per anelli Seeger
ES Alicates Morse
CN 弯嘴孔用挡圈钳



CrV
NICKEL IRON FINISH



YATO 	L [mm]	
YT-1991	225	6/60
YT-1995	325	6/48

EN Lock grip pliers
PL Szczypce Morse'a
DE Gripzange
RU Зажим ручной



CZ Kleště Morse'a
HU Morse fogó
RO Clește Morse
FR Pincés de serrage Morse

IT Pinze Morse
ES Alicates Morse
CN 圆口大力钳



WR TYPE
CrV



YATO 	L [mm]	
YT-2151	140	6/48
YT-2152	180	6/36
YT-2153	240	6/36

EN Lock grip pliers
PL Szczypce Morse'a
DE Gripzange
RU Зажим ручной



CZ Kleště Morse'a
HU Morse fogó
RO Clește Morse
FR Pincés de serrage Morse

IT Pinze Morse
ES Alicates Morse
CN 尖嘴大力钳



CD TYPE
CrV



YATO 	L [mm]	
YT-2155	165	6/48
YT-2156	220	6/36

EN Locking pliers
PL Szczypce zaciskowe
DE Klemmzange
RU Клещи давяльные



CZ Kleště samosvorné
HU Patentfogó
RO Clește de strângere
FR Pincés de serrage Morse

IT Pinze Morse
ES Pinzas de tornillo (de apriete)
CN 圆口大力钳



125 mm
CrMo



YATO 	L [mm]	
YT-2449	125	6/24

EN Locking pliers
PL Szczypce zaciskowe
DE Klemmzange
RU Клещи давяльные



CZ Kleště samosvorné
HU Patentfogó
RO Clește de strângere
FR Pincés de serrage Morse

IT Pinze Morse
ES Pinzas de tornillo (de apriete)
CN 直口大力钳



250 mm
CrMo





YATO 	L [mm]	
YT-2453	250	6/24

EN Locking pliers
PL Szczypce zaciskowe
DE Klemmzange
RU Клещи давяльные
CZ Kleště samosvorné
HU Patentfogó

RO Clește de strângere
FR Pinces de serrage Morse
IT Pinze Morse
ES Pinzas de tornillo (de apriete)
CN 圆口大力钳

180 mm
CrMo





YATO  L [mm] 
YT-2450 180 6/24

EN Locking pliers
PL Szczypce zaciskowe
DE Klemmzange
RU Клещи давяльные
CZ Kleště samosvorné
HU Patentfogó

RO Clește de strângere
FR Pinces de serrage Morse
IT Pinze Morse
ES Pinzas de tornillo (de apriete)
CN 尖嘴大力钳

150 mm
CrMo





YATO  L [mm] 
YT-2459 150 6/24

EN Locking pliers
PL Szczypce zaciskowe
DE Klemmzange
RU Клещи давяльные
CZ Kleště samosvorné
HU Patentfogó

RO Clește de strângere
FR Pinces de serrage Morse
IT Pinze Morse
ES Pinzas de tornillo (de apriete)
CN 直口大力钳

180 mm
CrMo



YATO  L [mm] 
YT-2452 180 6/24

EN Locking pliers
PL Szczypce zaciskowe
DE Klemmzange
RU Клещи давяльные
CZ Kleště samosvorné
HU Patentfogó

RO Clește de strângere
FR Pinces de serrage Morse
IT Pinze Morse
ES Pinzas de tornillo (de apriete)
CN 大力钳

250 mm
CrMo



YATO  L [mm] 
YT-2476 250 6/24

EN Locking pliers
PL Szczypce zaciskowe
DE Klemmzange
RU Клещи давяльные
CZ Kleště samosvorné
HU Patentfogó

RO Clește de strângere
FR Pinces de serrage Morse
IT Pinze Morse
ES Pinzas de tornillo (de apriete)
CN 圆口大力钳

250 mm
CrMo



YATO  L [mm] 
YT-2451 250 6/24

EN Locking pliers
PL Szczypce zaciskowe
DE Klemmzange
RU Клещи давяльные
CZ Kleště samosvorné
HU Patentfogó

RO Clește de strângere
FR Pinces de serrage Morse
IT Pinze Morse
ES Pinzas de tornillo (de apriete)
CN 尖嘴大力钳

225 mm
CrMo



YATO  L [mm] 
YT-2460 225 6/24

EN Locking pliers
PL Szczypce zaciskowe
DE Klemmzange
RU Клещи давяльные
CZ Kleště samosvorné
HU Patentfogó

RO Clește de strângere
FR Pinces de serrage Morse
IT Pinze Morse
ES Pinzas de tornillo (de apriete)
CN 大力钳

250 mm
CrMo

0-42 mm



YATO  L [mm] 
YT-2473 250 6/24

EN Sliding arm welding locking pliers
PL Szybkonastawne szczypce spawalnicze
DE Parallel-gripzange
RU Образная струбицина с захватом
CZ Paralelné samosvorné kleště
HU Szorítórúdas önzáró fogó
RO Clește de mană cu prindere tip mghina
FR Pince-étou - serre-joint coulissant
IT Pinze regolabili autobloccanti
ES Pinzas de presión tipo sargento
CN 大力钳

260 mm
0-150 mm

QUICK ADJUSTMENT
SZYBKĄ REGULACJĄ





YATO  L [mm] 
YT-21570 260 2/16

EN Welding locking pliers
 PL Szczypce zaciskowe spawalnicze
 DE Klemmzange zum Schweißen
 RU Клещи давяльные сварочные
 CZ Kleště samosvorné svářečské
 HU Hegesztő fogó

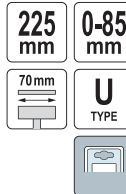
RO Clește de strângere pt. sudură
 FR Pince de serrage pour soudeur
 IT Pinze di bloccaggio per saldatura
 ES Pinzas de tornillo (de apriete) para soldar
 CN 焊接用大力钳





YATO 	L [mm]	
YT-2461	225	6/24

EN Flat locking pliers
 PL Szczypce zaciskowe o szerokich szczękach
 DE Klemmzange mit breiten Backen
 RU Клещи давяльные с широкими губками
 CZ Kleště samosvorné se širokými čelistmi
 HU Lapos fogó

RO Clește de strângere plat / patent
 FR Pince de serrage large
 IT Pinze con ganasce piane e paletta
 ES Pinzas de tornillo (de apriete) con mordazas anchas
 CN 铁皮大力钳



YATO 	L [mm]	
YT-2463	200	6/24

EN C-type welding locking pliers
 PL Szczypce zaciskowe kłamrowe typu „C”
 DE Klemm- und Klammerzange vom Typ „C”
 RU Клещи давяльные типа „C”
 CZ Kleště samosvorné upínací typu „C”
 HU „C” fogó

RO Clește de strângere cu clemă tip „C”
 FR Pince de serrage type „C”
 IT Pinze di bloccaggio tipo „C”
 ES Pinzas de tornillo (de apriete) de grapa tipo „C”
 CN C型大力钳

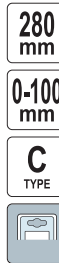



YATO 	L [mm]	
YT-2466	280	6/24

EN C-type welding locking pliers
 PL Szczypce zaciskowe kłamrowe typu „C”
 DE Klemm- und Klammerzange vom Typ „C”
 RU Клещи давяльные типа „C”
 CZ Kleště samosvorné upínací typu „C”
 HU „C” fogó

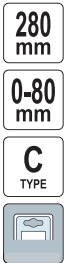
RO Clește de strângere cu clemă tip „C”
 FR Pince de serrage type „C”
 IT Pinze di bloccaggio tipo „C”
 ES Pinzas de tornillo (de apriete) de grapa tipo „C”
 CN C型大力钳



YATO 	L [mm]	
YT-2468	280	6/24

EN Chain locking pliers
 PL Szczypce zaciskowe z łańcuchem
 DE Klemmzange mit Kette
 RU Клещи давяльные с цепью
 CZ Kleště samosvorné s řetězem
 HU Láncos csőfogó

RO Clește de strângere cu lanț
 FR Pince de serrage avec une chaîne
 IT Pinze di bloccaggio con la catena
 ES Pinzas de tornillo (de apriete) con cadena
 CN 链条大力钳

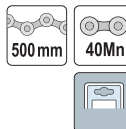



YATO 	L [mm]	
YT-2469	250	6/24

EN Stud crimper
 PL Szczypce do łączenia profili
 DE Profil Verbundzange
 RU Клещи для соединения профилей
 CZ Kleště do spojování profilů
 HU Profilösszekítő fogó

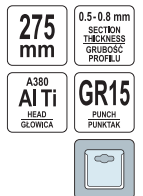
RO Clește sertizat profile rigide
 FR Pince pour assembler des profilés
 IT Alicata para perfis
 ES Alicates para unir perfiles
 CN 龙骨钳



YATO 	L [mm]	
YT-5130	275	6/24

EN Stud crimper
PL Szczypce do łączenia profili
DE Profil Verbundzange
RU Клещи для соединения профилей
CZ Kleště do spojování profilů
HU Profilösszekítő fogó

RO Cleste sertizat profile rigips
FR Pince pour assembler des profilés
IT Alicata para perfis
ES Alicates para unir perfiles
CN 龙骨钳

345 mm
65Mn
0.5-0.8 mm SECTION THICKNESS GRUBOSC PROFILU
PUNCH PUNCTAK



YATO	L [mm]	
YT-5131	345	6/24

EN Stud crimper
PL Szczypce do łączenia profili
DE Profil Verbundzange
RU Клещи для соединения профилей
HU Profilösszekítő fogó

RO Cleste sertizat profile rigips
FR Pince pour assembler des profilés
IT Alicata para perfis
ES Alicates para unir perfiles
CN 龙骨钳

260 mm
ST12
65Mn
0.5-0.8 mm SECTION THICKNESS GRUBOSC PROFILU
PUNCH PUNCTAK

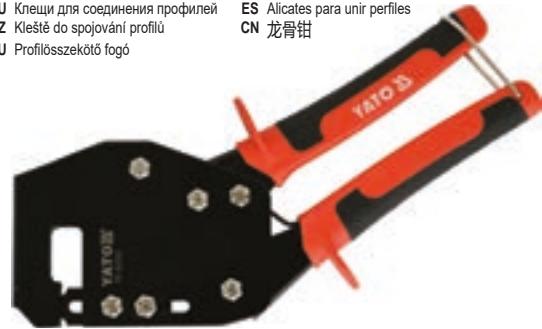

YATO	L [mm]	
YT-51312	260	6/24

EN Stud crimper
PL Szczypce do łączenia profili
DE Profil Verbundzange
RU Клещи для соединения профилей
CZ Kleště do spojování profilů
HU Profilösszekítő fogó

RO Cleste sertizat profile rigips
FR Pince pour assembler des profilés
IT Alicata para perfis
ES Alicates para unir perfiles
CN 新款长柄龙骨钳

280 mm
A380 AlTi
GR15
0.5-0.8 mm SECTION THICKNESS GRUBOSC PROFILU
HEAD GLOWICA
PUNCH PUNCTAK



YATO	L [mm]	
YT-51311	280	6/24

EN Stud crimper
PL Szczypce do łączenia profili
DE Profil Verbundzange
RU Клещи для соединения профилей
CZ Kleště do spojování profilů
HU Profilösszekítő fogó

RO Cleste sertizat profile rigips
FR Pince pour assembler des profilés
IT Alicata para perfis
ES Alicates para unir perfiles
CN 龙骨钳

320 mm
HRC 50
40Cr
PUNCH PUNCTAK



YATO	L [mm]	
YT-51303	320	6/24

EN Punch pliers
PL Szczypce do dziurkowania blach
DE Blech Lochzange
RU Просекатель круглых отверстий
CZ Děrovačí kleště
HU Fogó peremező lyukasztó

RO Cleste pt. perforat
FR Trou pinceuses
IT Pinza per forare lamiera
ES Punzonadora una mano perfiles
CN 打孔钳

240 mm
GR15
3.2 mm
PUNCH PUNCTAK



YATO	L [mm]	
YT-51320	240	5/30

EN Punch kit
PL Ręczny dziurkacz do blach
DE Handlochstanze für Blech
RU Ручной перфоратор для листового металла
CZ Ruční děrovač plechů
HU Kézi fémlemez lyukasztó
RO Set cleste perforat
FR Perforateur à main pour tôle
IT Punzonatrice manuale per lamiera
ES Perforadora manual para chapas
CN 打孔钳

16 PCS
max 1.0mm
max PLATE BLACHA
PUNCH PUNCTAK



Ø 2, 3, 4, 4.5, 5.5, 6, 7 mm

YATO		
YT-18973		12

EN Profile forming pliers
PL Szczypce do kształtowania profili
DE Zange zur Formgebung der Profile
RU Щипцы для формировки профилей

CZ Kleště k tvarování profilů
HU Profilformázó fogó
RO Cleste pt. modelarea profilelor
FR Pince pour former les profiles

IT Pinze per la formazione di profili
ES Pinzas para formar perfiles
CN 龙骨钳

210 mm
PUNCH PUNCTAK



YATO	L [mm]	
YT-5140	210	2/12

YATO	L [mm]	
YT-5141	210	2/12

YATO	L [mm]	
YT-5142	210	2/12

EN Water pump pliers
 PL Szczypce nastawne
 DE Wasserpumpenzange
 RU Клещи переставные
 CZ Nastavitelné kleště
 HU Állítható fogó

RO Cleste papagal
 FR Pince réglable
 IT Pinze regolabili
 ES Alicates de fontanero ajustables
 CN 水泵钳

CrV
 ADJUSTABLE WORK RANGE
 REGULOWANY ZAKRES PRACY
 REINFORCED CONSTRUCTION
 WZMOCNIENIA KONSTRUKCJA



YATO	L [mm]	
YT-2090	250	6/36
YT-2091	300	6/36

EN Water pump pliers
 PL Szczypce nastawne
 DE Wasserpumpenzange
 RU Клещи переставные
 CZ Nastavitelné kleště
 HU Állítható fogó

RO Cleste papagal
 FR Pince réglable
 IT Pinze regolabili
 ES Alicates de fontanero ajustables
 CN 水泵钳

250 mm
 6mm
CrV
 ADJUSTABLE WORK RANGE
 REGULOWANY ZAKRES PRACY
 REINFORCED CONSTRUCTION
 WZMOCNIENIA KONSTRUKCJA



YATO	L [mm]	
YT-20911	250	6/36

EN Pipe wrench
 PL Klucz do rur
 DE Rohrschlüssel
 RU Ключ трубный

CZ Klíč součástí na trubky
 HU Csőkulcs
 RO Cheie reglabila pt. tevi
 FR Clé aux tubes

HRC 55-60
CrMo
AI
 HANDLE SCHWYF



YATO	Size / Rozmiar	L [mm]	Max. pipe diameter / Maks. średnica rury	
YT-2482	14"	350	2" (50 mm)	6/12
YT-2483	18"	450	2.5" (63 mm)	2/10
YT-2484	24"	600	3" (75 mm)	2/6
YT-2485	36"	900	5" (125 mm)	3

EN Pipe wrench
 PL Klucz do rur
 DE Rohrschlüssel
 RU Ключ трубный

CZ Klíč součástí na trubky
 HU Csőkulcs
 RO Cheie reglabila pt. tevi
 CN 铝合金重型管钳

HRC 55-60
AI
 HANDLE SCHWYF



YATO	Size / Rozmiar	L [mm]	Max. pipe diameter / Maks. średnica rury	
YT-2222	12"	300	1" (25 mm)	6/24
YT-2223	14"	350	1.5" (38 mm)	4/16
YT-2224	18"	450	2" (50 mm)	3/12
YT-2225	24"	600	2.5" (63 mm)	3/6

EN Water pump pliers
 PL Szczypce nastawne
 DE Wasserpumpenzange
 RU Клещи переставные
 HU Állítható fogó

RO Cleste papagal
 FR Pince réglable
 IT Pinze regolabili
 ES Alicates de fontanero ajustables
 CN 水泵钳

250 mm
NICKEL IRON FINISH



YATO	L [mm]	
YT-2069	250	6/36

EN Water pump pliers
 PL Szczypce nastawne
 DE Wasserpumpenzange
 RU Клещи переставные
 CZ Nastavitelné kleště
 HU Állítható fogó

RO Cleste papagal
 FR Pince réglable
 IT Pinze regolabili
 ES Alicates de fontanero ajustables
 CN 水泵钳

250 mm
NICKEL IRON FINISH



YATO	L [mm]	
YT-2070	250	6/24

EN Pipe wrench
 PL Klucz do rur
 DE Rohrschlüssel
 RU Ключ трубный

CZ Klíč součástí na trubky
 HU Csőkulcs
 RO Cheie reglabila pt. tevi
 FR Clé aux tubes

HRC 55-60
CrMo



YATO	Size / Rozmiar	L [mm]	Max. pipe diameter / Maks. średnica rury	
YT-2488	10"	250	1" (25 mm)	6/18
YT-2489	12"	300	1.5" (38 mm)	6/12
YT-2490	14"	350	2" (50 mm)	2/10
YT-2491	18"	450	2.5" (63 mm)	3/6
YT-2492	24"	600	3" (75 mm)	2/4
YT-2493	36"	900	5" (125 mm)	1
YT-2494	48"	1200	6" (150 mm)	1

EN Pipe wrench
 PL Klucz do rur
 DE Rohrschlüssel
 RU Ключ трубный

CZ Klíč součástí na trubky
 HU Csőkulcs
 RO Cheie reglabila pt. tevi
 FR Clé aux tubes

HRC 55-60
OFFSET TYPE
ODGIĘTA GŁOWICA



YATO	Size / Rozmiar	L [mm]	Max. pipe diameter / Maks. średnica rury	
YT-2201	10"	250	1" (25 mm)	6/36
YT-2203	14"	350	1.5" (38 mm)	4/16
YT-2204	18"	450	2" (50 mm)	3/12
YT-2205	24"	600	2.5" (63 mm)	3/6
YT-2206	36"	900	4" (100 mm)	2/4

EN Telescopic pipe wrench
PL Szybkonastawny klucz do rur
DE Teleskop-Rohrschlüssel

RU Телескопический трубный гаечный ключ
CZ Teleskopický klíč do trubek
HU Teleszkópos csőfőgő kulcs

RO Cheie pt. tevi telescopica
FR Clé télescopique pour tuyaux
IT Chiave giratubi telescopica

ES Llave telescópica para tubos
CN 管子钳

16" 18"
20" 22"

400-550
mm

HRC
55-60

CrMo



YATO	Size / Rozmiar	L [mm]	Max. pipe diameter / Maks. średnica rury [mm]	
YT-22257	16", 18, 20", 22"	400-550	80	8

EN Auto-adjustable pipe wrench
PL Szybkonastawny klucz do rur
DE Rollgabelschlüssel

RU Ключ разводной
CZ Nastavitelný klíč
HU Állítható svédkulcs

RO Cheie reglabilă
FR Clé à molette
IT Chiave autoregolabile per tubi

ES Llave ajustable
CN 可调式管钳

300
mm

5/8"-1 1/2"
16-38
mm

SELF-
ADJUSTING
SAMO-
NASTAWNY

QUICK
OPENING
SZYBKE
OTWIERANIE

HRC
46-52

HARDENED
JAWS
HARTOWANE
SZCZKI

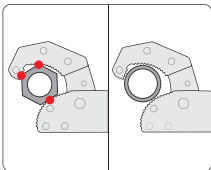

YATO	L [mm]	
YT-22005	300	6/24

EN Telescopic pipe wrench
PL Teleskopowy klucz do rur
DE Teleskop-Rohrschlüssel
RU Телескопический трубный гаечный ключ
CZ Teleskopický klíč do trubek
HU Teleszkópos csőfőgő kulcs

RO Cheie pt. tevi telescopica
FR Clé télescopique pour tuyaux
IT Chiave telescopica per tubi
ES Llave telescópica para tubos
CN 皮带管钳

300
mm

ø8"
20 cm

28x825
mm

NYLON

AI

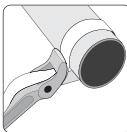

- Chromed pipes
- PVC pipes
- Oil filters
- Rur chromowanych
- Rur PCV
- Filtrów oleju



YATO	L [mm]	Max. pipe diameter / Maks. średnica rury	
YT-22255	300	8" (200 mm)	5/50

EN Strap for pipe wrench
PL Taśma zapasowa do klucza do rur
DE Gurt für Bandschlüssel
RU Ремень для ремешковых ключи
CZ Popruh pro klíče olejových filtrů
HU Szíjas az szíjas csőfőgő

RO Chinga la chei cu chingă
FR Courroie pour clés a courroie
IT Nastro di ricambio per chiave per tubi
ES Correa a llaves de correa
CN 皮带管钳配件

ø8"
20 cm

28x825
mm

NYLON



- Chromed pipes
- PVC pipes
- Oil filters
- Rur chromowanych
- Rur PCV
- Filtrów oleju



For YT-22255
Dla YT-22255

YATO	L [mm]	
YT-22256	50	

EN Chain pipe wrench
PL Klucz łańcuchowy do rur
DE Kettenrohrzange
RU Ключ цепной для труб
CZ Klíč řetězový na trubky
HU Láncos csőfőgő
RO Cheie reglabilă pt. tevi cu lant
FR Clé à chaîne
IT Chiave a catena per tubi
ES Llave de cadena
CN 链条扳手



300
mm

ø4"
10 cm

INDUCTION
HARDENED TEETH
ZĘBY HARTOWANE
INDUCCYJNE

ADJUSTABLE
WORK RANGE
REGULOWANY
ZAKRES PRACY



YATO	L [mm]	Max. pipe diameter / Maks. średnica rury	
YT-22260	300	4" (100 mm)	6/24

EN Tweezer
PL Pęseta
DE Pinzette

RU Пинцет
CZ Pinzeta
HU Csipesz

RO Pensetă
FR Pince
IT Pinza

ES Pinzas
CN 尖头镊子

SS302
STAINLESS STEEL
STAL NIEŻYRNIA

ANTI-
MAGNETIC
ANTI-
MAGNETICZNE

ACID
PROOF
KWASO-
ODPORNOŚĆ



140
mm

HRC
30

YATO	L [mm]	
YT-6903	140	20/240



115
mm

HRC
30

YATO	L [mm]	
YT-6907	115	20/240



140
mm

HRC
40

YATO	L [mm]	
YT-6916	140	20/240

7

Electrician tools Narzędzia dla elektryków



Insulated screwdrivers Wkrętaki izolowane	
.....	128-129

Insulated slotted screwdrivers Wkrętaki izolowane płaskie	128
Insulated phillips screwdrivers Wkrętaki izolowane krzyżakowe	128
Insulated Pozidrive screwdrivers Wkrętaki izolowane „Pozidrive”	128
Insulated screwdriver sets Komplety wkrętaków izolowanych	128

Insulated pliers Szczypce izolowane	
.....	129-130

Combination pliers Szczypce uniwersalne	129
Side cutting pliers Szczypce tnące, boczne	129
Long nose pliers Szczypce wydłużone, proste	129
Wire stripping pliers Szczypce do ściągania izolacji	129
Water pump pliers Szczypce nastawne	130
Insulated flat nose pliers Klucze płaskie izolowane	130

Insulated ring & open end wrenches Klucze oczkowe i płaskie izolowane	
.....	130

Insulated ring wrenches Klucze oczkowe izolowane	130
Insulated open end wrenches Klucze płaskie izolowane	130

Insulated T-handle wrenches Rękojeści typu „T” z zabierakiem izolowane	
.....	131

Insulated adjustable wrenches Klucze nastawne izolowane	
.....	131

Insulated sockets & accessories Klucze nasadowe izolowane i akcesoria	
.....	131-132

Insulated hexagonal sockets 3/8” Klucze nasadowe sześciokątne izolowane, krótkie 3/8”	131
Insulated extension bars 3/8” Przedłużki izolowane 3/8”	131
Insulated ratchet handles 3/8” Grzechotki izolowane 3/8”	131
Insulated hexagonal sockets 1/2” Klucze nasadowe sześciokątne izolowane, krótkie 1/2”	131
Insulated extension bars 1/2” Przedłużki izolowane 1/2”	132
Insulated ratchet handles 1/2” Grzechotki izolowane 1/2”	132

Insulated bit sockets 3/8”, 1/2” Klucze trzpieniowe izolowane 3/8”, 1/2”	
.....	132

Insulated clamps Ściski izolowane	
.....	132

Crimping pliers & sets Szczypce do zaciskania konektorów i zestawy	
.....	132-134

Hydraulic pliers Ręczne praski hydrauliczne	
.....	134

Wire strippers Ściągacze izolacji	
.....	134-136

Electrical cutters Obcinaki elektryczne	
.....	136-137

Cable cutters Nożyce do kabli	
.....	137-139

Electric meters & voltage testers Mierniki elektryczne i próbniki napięcia	
.....	140

Multimeters Mierniki	
.....	141-143

Glue guns Pistolety do klejenia	
.....	144

Soldering tools & accessories Lutownice i akcesoria	
.....	144-149

Tweezers Pęsety	
.....	149

Tapes & sets Taśmy i zestawy	
.....	149-150

Tool sets Zestawy narzędziowe	
.....	150

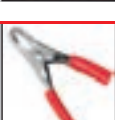
Workshop standardized parts Normalia motoryzacyjne	
.....	151-155

Cable access & accessories Przepychacze przewodów i akcesoria	
.....	155

EN Insulated screwdriver
 PL Wkrętkak izolowany
 DE Isolierte Schraubendreher

RU Изолированная отвёртка
 CZ Izolovaný šroubovák
 HU Szigetelt csavarhúzó

RO Şurubelniţă izolată
 FR Tournevis isolé
 IT Cacciavite isolato

ES Destornillador aislado
 CN 一字绝缘螺丝批

HRC 56-60 S2 1000 V



YATO	⊖ [mm]	L [mm]	📦
YT-28150	2.5	75	12/360
YT-28153	3.0	100	12/360
YT-28174	3.5	100	12/360
YT-2817	4.0	100	12/120
YT-2818	5.5	125	12/120
YT-2819	6.5	150	12/120
YT-2820	8.0	175	12/120

YATO	⊕	L [mm]	📦
YT-2821	PH0	60	12/120
YT-2822	PH1	80	12/120
YT-2823	PH2	100	12/120
YT-2824	PH3	150	12/120

YATO	⊕	L [mm]	📦
YT-28245	PZ0	60	12/360
YT-2825	PZ1	80	12/120
YT-2826	PZ2	100	12/120
YT-28263	PZ3	150	12/96

EN Insulated screwdriver set
 PL Komplet wkrętek izolowanych
 DE Isolierte Schraubendrehersatz

RU Изолированная отвёртка - набор
 CZ Izolované šroubováky
 HU Szigetelt csavarhúzó

RO Şurubelniţă izolată
 FR Set de tournevis isolés
 IT Set di cacciavite isolato

ES Juego de destornilladores aislado
 CN 绝缘螺丝批组套

HRC 56-60 S2 1000 V

7

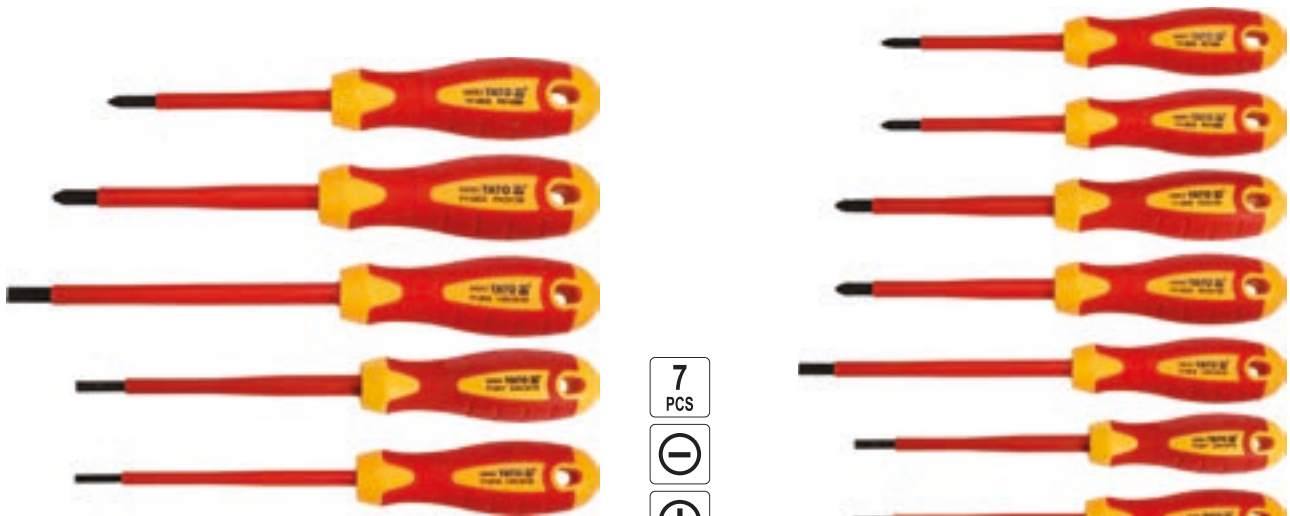

5 PCS



⊖ 3.0, 4.0 mm (L=100 mm), 5.5 mm (L=125 mm);
 ⊕ PH1 (L=80 mm), PH2 (L=100 mm)

7 PCS



⊖ 3.0, 4.0 mm (L=100 mm), 5.5 mm (L=125 mm);
 ⊕ PH1 (L=80 mm), PH2 (L=100 mm);
 ⚙ PZ1 (L=80 mm), PZ2 (L=100 mm)

YATO	📦
YT-2827	10/40

YATO	📦
YT-2828	10/40

EN Insulated changeable screwdriver set
 PL Zestaw wkrętek z wymiennymi końcówkami izolowanymi
 DE Isolierte Schraubendrehersatz
 RU Набор изолированных отверток
 CZ Sada izolovaných šroubováků
 HU Szigetelt csavarhúzó készlet
 RO Set surubelnita cu biti izolate
 FR Jeu de tournevis isolés
 IT Set cacciaviti isolati
 ES Juego de destornilladores aislado
 CN 绝缘可换头螺丝批组套

12 PCS

⊖

⊕ HRC 54-61

S2 1000 V



⊖ 2.0, 2.5, 3.0, 3.5, 4.0, 5.5, 6.5 mm (L=100 mm); S2;
 ⊕ PH0, PH1, PH2 (L=100 mm); S2;
 ⚙ 4x150 mm; 250 V

1000 V
 VDE CERTIFICATE
 EN 60900:2012

YATO	📦
YT-28290	24

EN Insulated changeable screwdriver set
 PL Zestaw wkrętek z wymiennymi końcówkami izolowanymi
 DE Isolierte Schraubendrehersatz
 RU Набор изолированных отверток
 CZ Sada izolovaných šroubováků
 HU Szigetelt csavarhúzó készlet

RO Set surubelnita cu biti izolate
 FR Jeu de tournevis isolés
 IT Set cacciaviti isolati
 ES Juego de destornilladores aislado
 CN 绝缘可换头螺丝批组套

50 PCS

⊖

⊕

⚙

⊕

⊖

⚙

⊕

⊖

HRC 54-61

S2 1000 V



⊖ 2.0, 2.5, 3.0, 3.5, 4.0, 5.5, 6.5 mm (L=100 mm); S2;
 ⊕ PH0, PH1, PH2 (L=100 mm); S2;
 ⚙ PZ0, PZ1, PZ2 (L=100 mm); S2;
 ⚙ T6, T8, T9, T10, T15, T20, T25, T27, T30 (L=100 mm); S2;
 ⚙ 2.5, 3, 4, 5, 6 mm (L=100 mm); S2;
 ⚙ R1, R2 (L=100 mm); S2;

⚙ 1, 2, 3, 4 mm (L=100 mm); S2;
 ⚙ 4, 6, 8, 10 mm (L=100 mm); S2;
 ⚙ 4, 6, 8, 10 mm (L=100 mm); S2;
 ⚙ M4, M5, M6 (L=100 mm); S2;
 ⚙ 4x150 mm; 250 V

1000 V
 VDE CERTIFICATE
 EN 60900:2012

YATO	📦
YT-28293	10

EN Insulated screwdriver set
PL Komplet wkrętek izolowanych
DE Isolierte Schraubendrehersatz
RU Набор изолированных отверток
CZ Izolované šroubováky
HU Szigetelt csavarhúzó készlet
RO Set surubelnita izolata
FR Jeu de tournevis isolés
IT Set cacciaviti isolati
ES Juego de destornilladores aislado
CN 绝缘螺丝批组套



⊖ 1.8, 2.0 mm (L=50 mm), 2.5, 3.0 mm (L=65 mm); S2;
⊕ PH00, PH0 (L=65 mm); S2

YATO		
YT-28283		6/48

EN Insulated changeable screwdriver set
PL Zestaw wkrętków z wymiennymi końcówkami izolowanymi
DE Isolierte Schraubendrehersatz
RU Набор изолированных отверток
CZ Sada izolovaných šroubováků
HU Szigetelt csavarhúzó készlet
RO Set surubelnita cu biti izolate
FR Jeu de tournevis isolés
IT Set cacciaviti isolati
ES Juego de destornilladores aislado
CN 绝缘可换头螺丝批组套

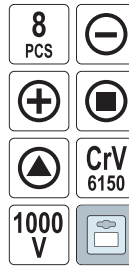

1000 V
VDE CERTIFICATE
EN 60900:2012

⊖ 3.0, 4.0, 5.5 mm (L=100 mm); CrV 6150;
⊕ PH1 (L=80 mm), PH2 (L=100 mm); CrV 6150;
⊗ Square lock key / Klucz kwadratowy;
⊘ Triangle lock key / Klucz trójkątny

YATO		
YT-28294		6/24

EN Insulated changeable screwdriver set
PL Zestaw wkrętków z wymiennymi końcówkami izolowanymi
DE Isolierte Schraubendrehersatz
RU Набор изолированных отверток
CZ Sada izolovaných šroubováků
HU Szigetelt csavarhúzó készlet
RO Set surubelnita cu biti izolate
FR Jeu de tournevis isolés
IT Set cacciaviti isolati
ES Juego de destornilladores aislado
CN 绝缘可换头螺丝批组套

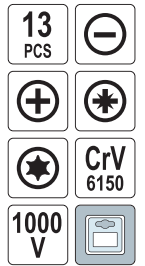

1000 V
VDE CERTIFICATE
EN 60900:2012

⊖ 3.0, 4.0, 5.5, 6.5 mm (L=100 mm); CrV 6150;
⊕ PH1 (L=80 mm), PH2 (L=100 mm); CrV 6150;
⊗ PZ1 (L=80 mm), PZ2 (L=100 mm); CrV 6150;
⊘ T10, T15, T20 (L=100 mm); CrV 6150;
⚡ 3x140 mm; 250 V

YATO		
YT-28295		6/12

EN Combination pliers
PL Szczypce uniwersalne
DE Kombinationszange
RU Плоскогубцы универсальные
CZ Kleště kombinované
HU Kombinálfogó
RO Patent universal
FR Pince universelle
IT Pinze universali
ES Alicates universales
CN 绝缘钢丝钳



1000 V
VDE CERTIFICATE
EN 60900:2012

YATO	L [mm]	
YT-21151	160	6/36
YT-21152	180	6/36
YT-21153	200	6/36

EN Long nose pliers
PL Szczypce wydłużone proste
DE Radiozange
RU Тонкогубцы прямые
CZ Prodloužené kleště rovné
HU Rádiófógó, egyenes
RO Clește cu vârf ascuțit
FR Pince prolongée
IT Pinze lunghe diritte
ES Alicates de punta
CN 绝缘尖嘴钳



1000 V
VDE CERTIFICATE
EN 60900:2012

YATO	L [mm]	
YT-21154	160	6/36
YT-21155	200	6/36

EN Diagonal side cutting pliers
PL Szczypce tnące boczne
DE Seitenschneider
RU Бокорезы
CZ Řezací kleště boční
HU Oldal csípőfogó
RO Olește tăietor
FR Pince à coupe latérale
IT Pinze taglianti laterali
ES Alicates corte lateral
CN 绝缘斜嘴钳



1000 V
VDE CERTIFICATE
EN 60900:2012

YATO	L [mm]	
YT-21158	160	6/36
YT-21159	180	6/36

EN Insulated wire stripper
PL Szczypce do ściągania izolacji, izolowane
DE Abisolier-Zange, isoliert
RU Изолированные клещи для снятия изоляции
CZ Kleště pro stahování izolace, izolované
HU Szigetelés lehúzó fogó, szigetelt
RO Decablator VDE
FR Pince à dénuder isolée
IT Pinza spelafili isolata
ES Alicates para quitar aislamiento, aislados
CN 绝缘剥线钳



1000 V
VDE CERTIFICATE
EN 60900:2012

YATO	L [mm]	
YT-21160	160	6/36

EN Insulated water pump pliers
 PL Szczypce nastawne hydrauliczne, izolowane
 DE Hydraulik-Rohrzange, isoliert
 RU Изолированные переставные клещи
 CZ Nastavitelné kleště izolované
 HU Vízpumpa fogó szigetelt
 RO Clește papagal VDE
 FR Pince réglable multiprises isolée
 IT Pinza regolabile isolata per idraulici
 ES Alicates hidráulicos ajustables, aislados
 CN 绝缘水泵钳

CrV 1000 V



1000 V
 VDE CERTIFICATE
 EN 60900:2012

YATO	L [mm]	
YT-21161	250	6/24

EN Insulated flat nose pliers
 PL Szczypce płaskie izolowane
 DE Greifzange vollisoliert
 RU Плоскогубцы изолированные
 CZ Izolované kleště ploché
 HU Laposfogó szigetelt
 RO Patent izolat
 FR Pince plate isolée
 IT Pinza piatta isolata
 ES Alicates punta plana aislantes
 CN 绝缘塑料圆头线夹

CrV 1000 V



1000 V
 VDE CERTIFICATE
 EN 60900:2012

YATO	L [mm]	
YT-21191	200	6/48

EN Insulated ring wrench
 PL Klucz oczkowy odgięty izolowany
 DE Einring Schlüssel vollisoliert
 RU Ключ накидной односторонний изолированный
 CZ Očkový klíč izolovaný
 HU Hajlítotszárú csillagkulcs
 RO Cheie inelară izolată
 FR Clé polygonale coudée isolée
 IT Chiave poligonale piegato isolato
 ES Llave de estrella acodada aislante
 CN 双色柄绝缘梅花扳手

CrV 1000 V

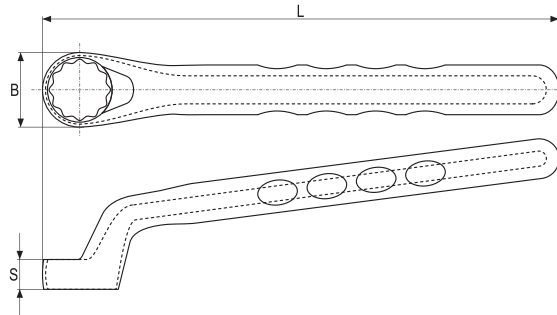

1000 V
 VDE CERTIFICATE
 EN 60900:2012

YATO	Ø [mm]	L [mm]	B [mm]	S [mm]	
YT-20980	6	150	16.0	5.5	6/126
YT-20981	7	150	18.0	5.7	6/126
YT-20982	8	155	19.0	6.1	6/126
YT-20983	9	155	20.0	7.2	6/126
YT-20985	11	170	22.5	7.7	6/90
YT-20986	12	190	22.5	8.5	6/90
YT-20987	13	190	26.5	9.0	6/90
YT-20988	14	205	28.0	9.5	6/90
YT-20989	15	205	29.0	9.5	6/90
YT-20990	16	215	31.0	10.2	6/90

YATO	Ø [mm]	L [mm]	B [mm]	S [mm]	
YT-20991	17	215	32.0	10.7	6/90
YT-20992	18	230	35.0	11.5	6/90
YT-20993	19	230	36.0	12.0	6/90
YT-20994	21	245	39.0	13.0	6/48
YT-20995	22	245	41.0	12.2	6/48
YT-20996	24	265	44.0	13.0	6/48
YT-20997	27	290	48.0	14.5	4/40
YT-20998	30	310	52.0	15.2	4/40
YT-20999	32	310	55.0	16.5	4/40

EN Insulated open end wrench
 PL Klucz płaski izolowany
 DE Doppelmaulschlüssel isoliert
 RU Ключ рожковый односторонний изолированный
 CZ Otevřený klíč izolovaný
 HU Villáskulcs
 ES Llave fija aislata
 CN 双色柄绝缘开口扳手

CrV 1000 V

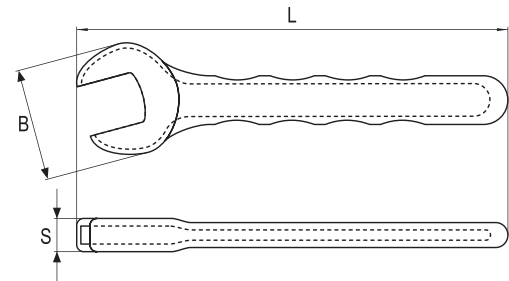

1000 V
 VDE CERTIFICATE
 EN 60900:2012

YATO	Ø [mm]	L [mm]	B [mm]	S [mm]	
YT-20950	6	90	23	7.0	6/108
YT-20951	7	90	25	7.0	6/108
YT-20953	9	100	29	7.5	6/108
YT-20954	10	110	31	8.0	6/108
YT-20955	11	110	34	8.5	6/108
YT-20957	13	135	39	10.5	6/72
YT-20958	14	145	40	10.5	6/72
YT-20959	15	150	42	11.5	6/72
YT-20960	16	160	43	11.5	6/72

YATO	Ø [mm]	L [mm]	B [mm]	S [mm]	
YT-20961	17	160	47	12.5	6/72
YT-20962	18	175	50	13.0	6/72
YT-20963	19	175	53	14.0	6/72
YT-20964	21	195	55	14.0	6/66
YT-20965	22	195	58	14.0	6/66
YT-20966	24	225	62	16.5	6/66
YT-20967	27	250	69	18.0	4/60
YT-20968	30	290	75	19.0	4/48
YT-20969	32	310	79	20.0	4/48

EN Insulated T-handle wrench
PL Rekojęść typu „T” izolowana
DE Steckschlüssel T-griff vollisoliert
RU Ручка Т-образная изолированная
CZ Klíč nástrčný typ „T” izolovaný
HU „T” típusú dugókulcs

RO Manerit tip „T” izolat
FR Clé à tube en „T” isolée
IT Chiave a bussola tipo „T” isolati
ES Llave en T aislada
CN 绝缘T型套筒扳手

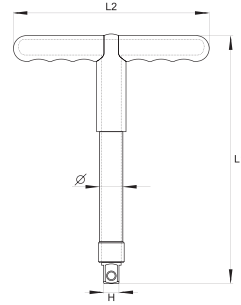

3/8" 1/2"
9.5 mm 12.7 mm
CrV 1000 V

1000 V
VDE CERTIFICATE
EN 60900:2012

EN Insulated adjustable wrench
PL Klucz nastawny izolowany
DE Rollgabelschlüssel isoliert
RU Ключ разводной изолированный
CZ Izolovaný stavitelný klíč
HU Állítható szévkulcs

RO Cheie reglabilă izolată
FR Clé à molette isolée
IT Isolati chiavi regolabile
ES Llave ajustable aislante
CN 双色柄绝缘活络扳手

CrV 1000 V



1000 V
VDE CERTIFICATE
EN 60900:2012

YATO	L [mm]	
YT-20940	200	6/48
YT-20941	250	6/36
YT-20942	300	4/24

EN Insulated extension bar
PL Przedłużka izolowana
DE Verlängerung vollisoliert
RU Удлинитель для воротка
CZ Prodlužovací příravek izolovaný
HU Toldalék

RO Prelungitor izolat
FR Rallonge isolée
IT Prolunga isolato
ES Tubo de prolongación aislante
CN 绝缘延长杆

3/8" 9.5 mm
CrV 1000 V

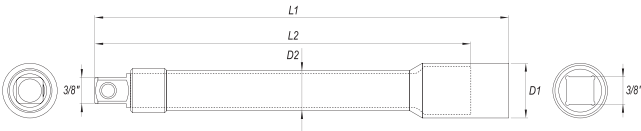

1000 V
VDE CERTIFICATE
EN 60900:2012

YATO	Ø	D1 [mm]	D2 [mm]	L1 [mm]	L2 [mm]	
YT-21055	3/8" (9.5 mm)	23	15.5	125	141	18/72
YT-21056	3/8" (9.5 mm)	23	15.5	250	266	12/48

EN Insulated hexagonal socket
PL Nasadka sześciokątna izolowana
DE Sechskantenschlüssel vollisoliert
RU Головка шестигранная изолированная
CZ Šestihranný nástavec izolovaný
HU Dugókulcs hatszög
RO Cheie tubulară hexagonală izolată
FR Douille courte isolée
IT Chiave a bussola esagonale isolato
ES Boquilla hexagonal corta aislante
CN 绝缘六角套筒

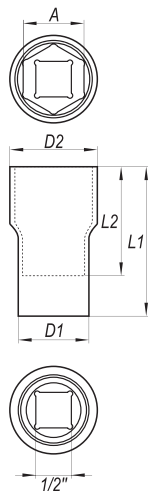

1/2" 12.7 mm
CrV 1000 V

1000 V VDE CERTIFICATE EN 60900:2012

EN Insulated hexagonal socket
PL Nasadka sześciokątna izolowana
DE Sechskantenschlüssel vollisoliert
RU Головка шестигранная изолированная
CZ Šestihranný nástavec izolovaný
HU Dugókulcs hatszög
RO Cheie tubulară hexagonală izolată
FR Douille courte isolée
IT Chiave a bussola esagonale isolato
ES Boquilla hexagonal corta aislante
CN 绝缘六角套筒

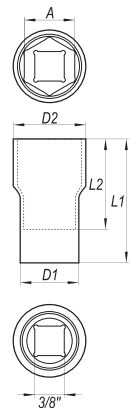

3/8" 9.5 mm
CrV 1000 V

1000 V
VDE CERTIFICATE
EN 60900:2012

YATO	Ø A [mm]	D1 [mm]	D2 [mm]	L1 [mm]	L2 [mm]	
YT-21008	8	18	15.1	45	28	7/126

EN Insulated ratchet handle
PL Grzechotka izolowana
DE Hebelumschaltknarre vollisoliert
RU Трещотка диэлектрическая
CZ Račna izolovaná
HU Racsnis hajtókar

RO Antrenor cu clichet izolat
FR Clé à cliquet isolée
IT Cricchetto bussola isolato
ES Carraca aislante
CN 双色柄绝缘双向棘轮扳手

3/8" 9.5 mm
CrV 1000 V



1000 V
VDE CERTIFICATE
EN 60900:2012

YATO	Ø	T	L [mm]	
YT-21071	3/8" (9.5 mm)	36	200	6/48

YATO	Ø A [mm]	D1 [mm]	D2 [mm]	L1 [mm]	L2 [mm]	
YT-21030	10	27	19.5	55	38	12/144
YT-21031	11	27	20.7	55	38	12/144
YT-21032	12	27	22.0	55	38	12/144
YT-21033	13	27	23.2	55	38	12/144
YT-21034	14	27	24.5	55	38	12/144
YT-21036	16	27	27.0	55	38	12/144
YT-21037	17	27	28.5	55	38	12/144
YT-21038	18	27	29.5	55	38	12/144
YT-21039	19	27	30.7	55	38	12/144
YT-21041	21	27	33.2	55	38	10/110
YT-21042	22	27	34.5	55	38	10/110
YT-21044	24	27	37.0	60	38	10/110
YT-21047	27	27	38.8	60	38	6/66
YT-21050	30	27	42.8	60	38	6/66
YT-21052	32	27	44.8	60	38	6/66

EN Insulated extension bar
 PL Przedłużka izolowana
 DE Verlängerung vollisoliert
 RU Удлинитель для воротка
 CZ Prodlužovací přípravek izolovaný
 HU Toldalék

RO Prelungitor izolat
 FR Rallonge isolée
 IT Prolunga isolato
 ES Tubo de prolongación aislante
 CN 绝缘延长杆

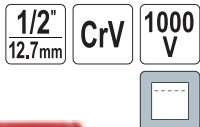

1000 V
 VDE CERTIFICATE
 EN 60900:2012

YATO	Ø	D1 [mm]	D2 [mm]	L1 [mm]	L2 [mm]	Box
YT-21057	1/2" (12.7 mm)	27	19.1	125	141	6/72

EN Insulated ratchet handle
 PL Grzechołka izolowana
 DE Hebelumschaltknarre vollisoliert
 RU Трещотка диэлектрическая
 CZ Ráčna izolovaná
 HU Racsnis hajtókar

RO Antrenor cu clichet izolat
 FR Clé à cliquet isolée
 IT Cricchetto bussola isolato
 ES Carraca aislante
 CN 双色柄绝缘双向棘轮扳手

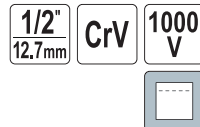

1000 V
 VDE CERTIFICATE
 EN 60900:2012

YATO	Ø	T	L [mm]	Box
YT-21072	1/2" (12.7 mm)	36	250	6/36

EN Insulated bit socket
 PL Klucz trzpieniowy izolowany
 DE Bit-Stecknuss vollisoliert
 RU Головка торцевая изолированная
 CZ Hlávica s bitem izolovaná
 HU Csapkulcs
 RO Chei cu cozi izolat
 FR Douille tournevis isolée
 IT Chiavi a bussola isolato
 ES Llave de mandril aislante
 CN 绝缘六角旋具套筒



1000 V
 VDE CERTIFICATE
 EN 60900:2012

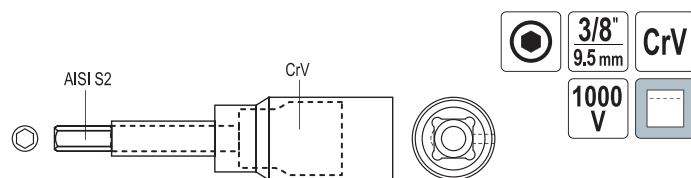

YATO	Ø	◎ [mm]	L [mm]	[Nm]	Box
YT-21080	3/8" (9.5 mm)	4	75	16	12/144
YT-21081	3/8" (9.5 mm)	5	75	30	12/144
YT-21082	3/8" (9.5 mm)	6	75	52	12/144
YT-21083	3/8" (9.5 mm)	8	75	120	12/144

EN Insulated bit socket
 PL Klucz trzpieniowy izolowany
 DE Bit-Stecknuss vollisoliert
 RU Головка торцевая изолированная
 CZ Hlávica s bitem izolovaná
 HU Csapkulcs
 RO Chei cu cozi izolat
 FR Douille tournevis isolée
 IT Chiavi a bussola isolato
 ES Llave de mandril aislante
 CN 绝缘六角旋具套筒



1000 V
 VDE CERTIFICATE
 EN 60900:2012

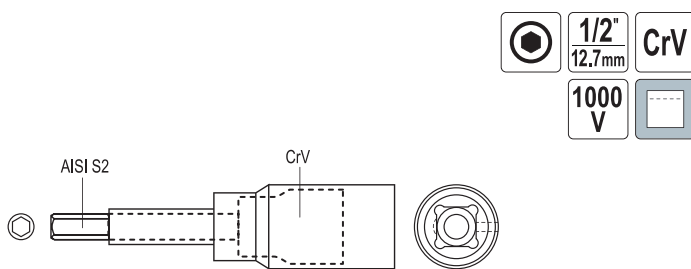

YATO	Ø	◎ [mm]	L [mm]	[Nm]	Box
YT-21085	1/2" (12.7 mm)	4	120	16	18/144
YT-21086	1/2" (12.7 mm)	5	120	30	18/144
YT-21087	1/2" (12.7 mm)	6	120	52	18/144
YT-21088	1/2" (12.7 mm)	8	120	120	18/144
YT-21089	1/2" (12.7 mm)	10	120	220	18/144

EN Insulated spring clamp
 PL Ścisk sprężynowy izolowany
 DE Federklemme vollisoliert
 RU Струбцина изолированная
 CZ Pružňovná svěrka
 HU Rugós szorító

RO Cleste presa pt. lemn izolat
 FR Pince à ressort isolée
 IT Morsetto a molla isolate
 ES Pinza aislante
 CN 绝缘塑料圆头线夹

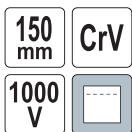

1000 V
 VDE CERTIFICATE
 EN 60900:2012

YATO	Working capacity / Zakres pracy [mm]	L [mm]	Box
YT-21190	2-20	150	5/40

EN Quick interchangeable ratchet crimper set
 PL Zestaw do zaciskania konektorów
 DE Kabelschuhzange
 RU Клещи для опрессовки наконечников
 CZ Kleště pro svěráni zaciskania konektorů
 HU Krimpelő fogó
 RO Clește sertizat conectori
 FR Pince à sertir pour connecteurs
 IT Set pinze i compare a connettori
 ES Pinzas de apretar de conectores
 CN 棘轮压线钳组套

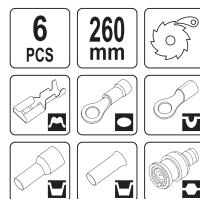
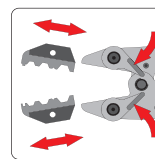

mm²	AWG	mm²	AWG	mm²	AWG	mm²	AWG	Box
0.5-6.0	20-10	0.5-6.0	22-10	1.5-10.0	20-8	0.5-4.0	22-12	RG6, RG58, RG59, RG62

YATO	Box
YT-2245	10

EN Ratchet crimping pliers
PL Szczypce do zaciskania konektorów
DE Kabelschuhzange

RU Инструмент для обжима и зачистки проводов
CZ Kleště pro svěrání zaciskania konektorů
HU Krimpelő fogó

RO Clește sertizat conectori
FR Pince pour serrer les connecteurs
IT Pinze i compare a connettori





ES Pinzas de apretar de conectores
CN 棘轮压线钳



220
mm



230
mm

YATO 	 mm ²	 AWG	
YT-2250	0.5-6	20~10	5/30

YATO 	 mm ²	 AWG	
YT-2300	0.5-6	20~10	5/30

EN Ratchet crimping pliers
PL Szczypce do zaciskania konektorów
DE Kabelschuhzange

RU Инструмент для обжима и зачистки проводов
CZ Kleště pro svěrání zaciskania konektorů
HU Krimpelő fogó







RO Clește sertizat conectori
FR Pince pour serrer les connecteurs
IT Pinze i compare a connettori









ES Pinzas de apretar de conectores
CN 压线钳



180
mm



YATO 	 mm ²	 AWG	 mm ²	 AWG	
YT-2255	0.08-2	28~14	0.12-0.3	26~22	10/60

YATO 	 mm ²	 AWG	 mm ²	 AWG	 mm ²	 AWG	
YT-2256	0.08-2	28~14	0.3-6	22~10	0.12-0.3	26~22	12/72

EN Ratchet crimping pliers
PL Szczypce do zaciskania konektorów
DE Kabelschuhzange

RU Инструмент для обжима и зачистки проводов
CZ Kleště pro svěrání zaciskania konektorů
HU Krimpelő fogó

RO Clește sertizat conectori
FR Pince pour serrer les connecteurs
IT Pinze i compare a connettori





ES Pinzas de apretar de conectores
CN 棘轮压线钳





230
mm



220
mm

YATO 	 mm ²	 AWG	
YT-2296	0.5-6	22~10	5/30

YATO 	 mm ²	 AWG	
YT-2246	0.5-6	22~10	5/30

EN Ratchet crimping pliers
PL Szczypce do zaciskania konektorów
DE Kabelschuhzange
RU Клещи для опрессовки наконечников
CZ Kleště pro svěrání zaciskania konektorů
HU Krimpelő fogó

RO Clește sertizat conectori
FR Pince pour serrer les connecteurs
IT Pinze i compare a connettori
ES Pinzas de apretar de conectores
CN 棘轮压线钳



240
mm

YATO 		
YT-2298	RG6, RG58, RG59, RG62	5/30

EN Ratchet crimping pliers
PL Szczypce do zaciskania konektorów
DE Kabelschuhzange

RU Инструмент для обжима и зачистки проводов
CZ Kleště pro svěrání zaciskania konektorů
HU Krimpelő fogó

RO Clește sertizat conectori
FR Pince pour serrer les connecteurs
IT Pinze i compare a connettori

ES Pinzas de apretar de conectores
CN 棘轮压线钳



220
mm



230
mm

YATO 	 mm ²	 AWG	
YT-2247	1.5-10	20~8	5/30

YATO 	 mm ²	 AWG	
YT-2297	1.5-10	20~8	5/30

EN Ratchet crimping pliers
 PL Szczypce do zaciskania konektorów
 DE Kabelschuhzange
 RU Клещи для опрессовки наконечников
 CZ Kleště pro svěráni zaciskania konektorů
 HU Krimpelő fogó

RO Clește sertizat conectori
 FR Pince pour serrer les connecteurs
 IT Pinze i compare a connettori
 ES Pinzas de apretar de conectores
 CN 棘轮压线钳



YATO			
YT-2299	0.5-4	22-12	5/30

EN Ratchet crimping pliers
 PL Szczypce do zaciskania konektorów
 DE Kabelschuhzange
 RU Клещи для опрессовки наконечников
 CZ Kleště pro svěráni zaciskania konektorů
 HU Krimpelő fogó

RO Clește sertizat conectori
 FR Pince pour serrer les connecteurs
 IT Pinze i compare a connettori
 ES Pinzas de apretar de conectores
 CN 棘轮压线钳

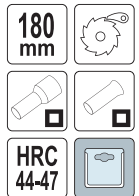

YATO		
YT-2240	0.2-6	6/36

EN Ratchet crimping pliers
 PL Szczypce do zaciskania konektorów
 DE Kabelschuhzange
 RU Клещи для опрессовки наконечников
 CZ Kleště pro svěráni zaciskania konektorů
 HU Krimpelő fogó

RO Clește sertizat conectori
 FR Pince pour serrer les connecteurs
 IT Pinze i compare a connettori
 ES Pinzas de apretar de conectores
 CN 棘轮压线钳

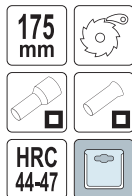

YATO		
YT-2305	0.2-6	6/36

EN Ratchet crimping pliers
 PL Szczypce do zaciskania konektorów
 DE Kabelschuhzange
 RU Клещи для опрессовки наконечников
 CZ Kleště pro svěráni zaciskania konektorů
 HU Krimpelő fogó

RO Clește sertizat conectori
 FR Pince pour serrer les connecteurs
 IT Pinze i compare a connettori
 ES Pinzas de apretar de conectores
 CN 棘轮压线钳

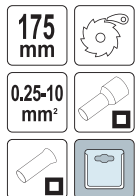

YATO		
YT-23051	0.25-10	10/40

EN Ratchet crimping pliers
 PL Szczypce do zaciskania konektorów
 DE Kabelschuhzange
 RU Клещи для опрессовки наконечников
 CZ Kleště pro svěráni zaciskania konektorů
 HU Krimpelő fogó

RO Clește sertizat conectori
 FR Pince pour serrer les connecteurs
 IT Pinze i compare a connettori
 ES Pinzas de apretar de conectores
 CN 棘轮压线钳



YATO		
YT-22442	RJ45, RJ11, 8P, 6P	10/50

EN Ratchet crimping pliers
 PL Szczypce do zaciskania konektorów
 DE Kabelschuhzange
 RU Клещи для опрессовки наконечников
 CZ Kleště pro svěráni zaciskania konektorů
 HU Krimpelő fogó

RO Clește sertizat conectori
 FR Pince pour serrer les connecteurs
 IT Pinze i compare a connettori
 ES Pinzas de apretar de conectores
 CN 网络压线钳

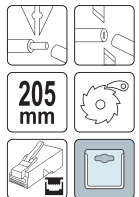

YATO		
YT-22443	RJ45, RJ11, RJ10, 8P, 6P, 4P	10/30

EN Hydraulic pliers
 PL Ręczna praska hydrauliczna
 DE Manuelle Hydraulikpresse
 RU Ручной гидравлический обжимной инструмент
 CZ Ruční hydraulický lis
 HU Kézi hidraulikus prés

RO Presă hidraulică manuală
 FR Pince à sertir
 IT Pressa idraulica manuale
 ES Prensa hidráulica manual
 CN 液压钳



YATO		L [mm]	Force pressure / Siła nacisku [t]	Al [mm²]	Cu [mm²]	
YT-22860	10, 16, 25, 35, 50, 70, 95, 120	415	8	10-95	10-120	4
YT-22861	16, 25, 35, 50, 70, 95, 120, 150, 185, 240	470	12	16-185	16-240	3
YT-22862	16, 25, 35, 50, 70, 95, 120, 150, 185, 240, 300	470	18-20	16-240	16-300	3

EN Pliers for crimping lines
 PL Szczypce do zaciskania lin stalowych
 DE Zangen für Crimp-Linien
 RU Клещи для опрессовки канатов
 CZ Ruční lisovací kleště
 HU Krimpelő fogó

RO Clește pt. sertizat cabluri
 FR Pincés pour lignes de sertissage
 IT Pinze per crimpare cavi metallici
 ES Alicates para líneas de engaste
 CN 多功能压接钳

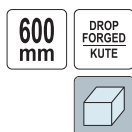

YATO		
YT-22851	4.8, 6.6, 8.7, 9.5, 11.3	6

EN Ratchet crimping pliers
 PL Szczypce do zaciskania konektorów
 DE Kabelschuhzange
 RU Клещи для опрессовки наконечников
 CZ Kleště pro svěráni zaciskania konektorů
 HU Krimpelő fogó

RO Clește sertizat conectori
 FR Pince pour serrer les connecteurs
 IT Pinze i compare a connettori
 ES Pinzas de apretar de conectores
 CN 多功能剥线钳



YATO									
YT-2254	0.5-5	20-10	0.5-5	20-10	0.5-5.5	20-10	0.5-5	20-10	12/48

EN Wire stripper
PL Ściągacz izolacji
DE Abisolierzange
RU Съёмник изоляции
CZ Odizolovací klejte
HU Blankoló fogó

RO Decablator
FR Extracteur d'isolation
IT Pinze per scariare isolamento
ES Extractor de aislado
CN 剥线钳



YATO	mm ²	AWG	mm ²	AWG	mm ²	AWG	
YT-22930	1.5-6	22-10	1.5-6	22-10	0.75-6	22-10	12/48

EN Wire stripper
PL Ściągacz izolacji
DE Abisolierzange
RU Съёмник изоляции
CZ Odizolovací klejte
HU Blankoló fogó

RO Decablator
FR Extracteur d'isolation
IT Pinze per scariare isolamento
ES Extractor de aislado
CN 剥线钳

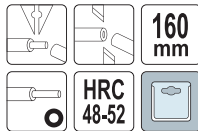

YATO	mm ²	AWG	
YT-2319	0.8-2.6	20-10	10/60

EN Universal wire stripper
PL Uniwersalny ściągacz izolacji
DE Universal Abisolierzange
RU Универсальный съёмник изоляции
CZ Univerzální odizolovací kleště
HU Blankoló fogó
RO Decablator universal
FR Extracteur d'isolation multifonction
IT Pinze per scariare isolamento
ES Extractor de aislado universal
CN 万用剥线钳

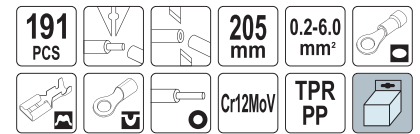

⦿ 0.5 - 1.5 mm² (20 PCS), 1.5 - 2.5 mm² (20 PCS);
⦿ 0.5 - 1.5 mm² (20 PCS), 1.5 - 2.5 mm² (20 PCS);
⦿ 0.5 - 1.5 mm² (20 PCS), 1.5 - 2.5 mm² (20 PCS);
⦿ 0.5 - 1.5 mm² (20 PCS), 1.5 - 2.5 mm² (20 PCS);
⦿ 0.5 - 1.5 mm² (10 PCS), 1.5 - 2.5 mm² (10 PCS);
⦿ 0.5 - 1.5 mm² (10 PCS)

YATO	mm ²	AWG	mm ²	AWG	mm ²	AWG	mm ²	AWG	
YT-23133	0.5-6	22-10	0.5-6	22-10	0.5-6	22-10	0.2-6	24-10	10/20

EN Universal wire stripper & ratchet crimping pliers
PL Uniwersalny ściągacz izolacji i szczytce do zaciskania konektorów
DE Multifunktion Abisolierzange & Kabelschuhklemmzange
RU Инструмент для снятия изоляции и зажима проводов
CZ Kleště odizolovací a konektorové univerzální
HU Blankoló fogó & krimpelő fogó
RO Decablator universal & clește sertizat conectori
FR Extracteur d'isolation multifonction
IT Pinze per scariare isolamento
ES Extractor de aislado multifunción
CN 万用剥线钳

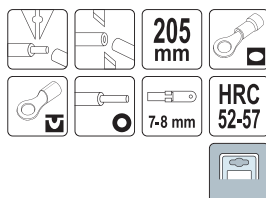

YATO	mm ²	AWG	mm ²	AWG	mm ²	AWG	
YT-2270	0.5-6	22-10	1.5-6	22-10	0.2-6	24-10	5/30

EN Wire stripper
PL Ściągacz izolacji
DE Abisolierzange
RU Съёмник изоляции
CZ Odizolovací klejte
HU Blankoló fogó

RO Decablator
FR Extracteur d'isolation
IT Pinze per scariare isolamento
ES Extractor de aislado
CN 剥线钳

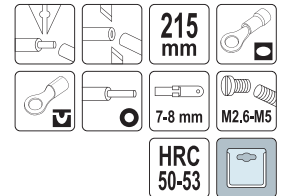

YATO	mm ²	AWG	mm ²	AWG	PCS	
YT-2293	1.25-2.5	8-12	1	8	12	72

EN Wire stripper
PL Ściągacz izolacji
DE Abisolierzange
RU Съёмник изоляции
CZ Odizolovací klejte
HU Blankoló fogó

RO Decablator
FR Extracteur d'isolation
IT Pinze per scariare isolamento
ES Extractor de aislado
CN 剥线钳

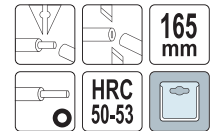

YATO	mm ²	AWG	
YT-2294	0.64-2.6	22-10	12/120

EN Universal wire stripper & ratchet crimping pliers
PL Uniwersalny ściągacz izolacji i szczytce do zaciskania konektorów
DE Multifunktion Abisolierzange & Kabelschuhklemmzange
RU Инструмент для снятия изоляции и зажима проводов
CZ Kleště odizolovací a konektorové univerzální
HU Blankoló fogó & krimpelő fogó
RO Decablator universal & clește sertizat conectori
FR Extracteur d'isolation multifonction
IT Pinze per scariare isolamento
ES Extractor de aislado multifunción
CN 万用剥线钳

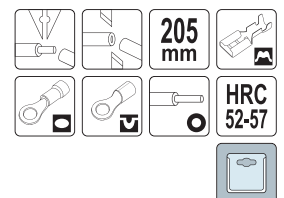

YATO	mm ²	AWG	mm ²	AWG	mm ²	AWG	
YT-2313	0.5-6	22-10	1.5-6	22-10	0.2-6	24-10	5/30

EN Universal wire stripper & ratchet crimping pliers
 PL Uniwersalny ściągacz izolacji i szczytce do zaciskania konektorów
 DE Multifunktion Abisolierzange & Kabelschuhklemmzange
 RU Инструмент для снятия изоляции и зажима проводов
 CZ Kleště odizolovací a konektorové univerzální
 HU Blankoló fogo & krimpelő fogó
 RO Decablator universal & clește sertizat conectori
 FR Extracteur d'isolation multifonction
 IT Pinze per scaricare isolamento
 ES Extractor de aislado multifunción
 CN 剥线钳

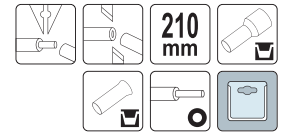

YATO	mm²	AWG	mm²	AWG	
YT-2278	0.5-6	22~10	0.2-6	24~10	10/60

EN Automatic wire stripper
 PL Automatemyczny ściągacz izolacji
 DE Automatische Abisolierzange
 RU Клещи для удаления изоляции
 CZ Automatický stahovač izolace
 HU Automatikus szigeteléslehúzó

RO Clește automat desizolat
 FR Extracteur d'isolation automatique
 IT Pinze per scaricare isolamento
 ES Pelacables automatico
 CN 万用剥线钳

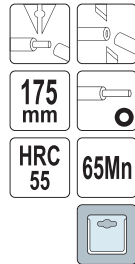

EN Wire stripper
 PL Ściągacz izolacji
 DE Abisolierzange
 RU Съёмник изоляции
 CZ Odizolovací klejte
 HU Blankoló fogo

RO Decablator
 FR Extracteur d'isolation
 IT Pinze per scaricare isolamento
 ES Extractor de aislado
 CN 剥线钳

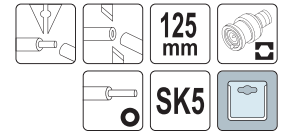

YATO	mm²	AWG	mm²	AWG	
YT-2278	0.5-6	22~10	0.2-6	24~10	10/60

YATO	mm²	AWG	mm²	AWG	
YT-2274	0.5-6	20~10	0.2-6	24~10	10/60



YATO	mm²	AWG	mm²	AWG	
YT-2274	0.5-6	20~10	0.2-6	24~10	10/60

EN Automatic wire stripper
 PL Automatemyczny ściągacz izolacji
 DE Automatische Abisolierzange
 RU Клещи для удаления изоляции
 CZ Automatický stahovač izolace
 HU Automatikus szigeteléslehúzó

RO Clește automat desizolat
 FR Extracteur d'isolation automatique
 IT Pinze per scaricare isolamento
 ES Pelacables automatico
 CN 自动剥线钳



EN Wire stripper
 PL Ściągacz izolacji
 DE Abisolierzange
 RU Съёмник изоляции
 CZ Odizolovací klejte
 HU Blankoló fogo
 RO Decablator
 FR Extracteur d'isolation
 IT Pinze per scaricare isolamento
 ES Extractor de aislado
 CN 万用剥线钳

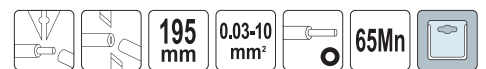

YATO	mm²	AWG	mm²	AWG	
YT-2274	0.5-6	20~10	0.2-6	24~10	10/60

YATO	mm²	AWG	mm²	AWG	
YT-2275	0.5-6	20~10	0.2-6	24~10	10/60

YATO	mm²	AWG	mm²	AWG	
YT-22753	0.03-10	32~8	0.03-10	32~8	10/40

EN Electrical cutter
 PL Obcinak elektryczny
 DE Seitenschneider
 RU Инструмент для обрезки проводов
 CZ Elektrické upichováky
 HU Kábelvágó
 RO Clește tăietor - electrician
 FR Coupeur isolé
 IT Pinza per elettronica
 ES Cortacables eléctricos
 CN 电子斜嘴钳



YATO	mm²	AWG	L [mm]	
YT-2260	0.5-1.5	20~18	125	15/150

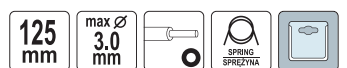



YATO	mm²	AWG	L [mm]	
YT-2261	0.5-1.5	20~18	125	15/150

EN Automatic wire stripper
PL Automacyjny ściągacz izolacji
DE Automatische Abisolierzange
RU Клепци для удаления изоляции
CZ Automatický stahovač izolace
HU Automatikus szigeteléslehúzó

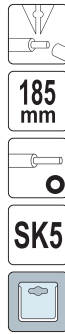
RO Clește automat desizolat
FR Extracteur d'isolation automatique
IT Pinze per scariare isolamento
ES Pelacables automatico
CN 自动剥线钳



YATO 	 mm ²	 AWG	
YT-2316	1-3.2	18-12	8/48

EN Electrical cutter
PL Obcinak elektryczny
DE Seitenschneider
RU Инструмент для обрезки проводов
CZ Elektrické upichováky
HU Kábelvágó
RO Clește tăietor - electrician
FR Coupeur isolé
IT Pinza per elettronica
ES Cortacables eléctricos
CN 电子斜嘴钳



YATO 	 mm ²	 AWG	L [mm]	
YT-2262	0.5-1.5	20-18	125	20/120

EN Electrical cutter
PL Obcinak elektryczny
DE Seitenschneider
RU Инструмент для обрезки проводов
CZ Elektrické upichováky ze stahovadlem
HU Kábelvágó szigeteléslehúzóval
RO Clește tăietor - electrician
FR Coupeur isolé
IT Pinza per elettronica
ES Cortacables eléctricos
CN 电子斜嘴钳

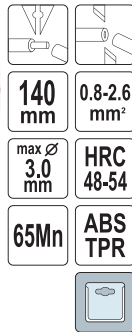

YATO 	 mm ²	 AWG	L [mm]	
YT-22640	0.8-2.6	20-10	140	20/120

EN Electrical cutter
PL Obcinak elektryczny
DE Seitenschneider
RU Инструмент для обрезки проводов
CZ Elektrické upichováky
HU Kábelvágó
RO Clește tăietor - electrician
FR Coupeur isolé
IT Pinza per elettronica
ES Cortacables eléctricos
CN 迷你电子钳

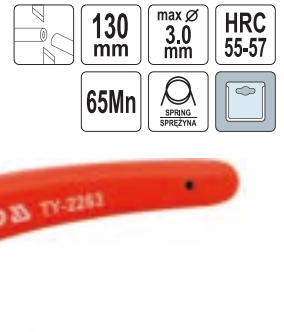

YATO 	 mm ²	 AWG	L [mm]	
YT-2263	0.5-1.5	20-18	130	12/120

EN Cable cutter
PL Szczytce do cięcia przewodów
DE Kabelschere
RU Кабелперезы
CZ Štípačí kleště na kabely
HU Kábelvágó
RO Clește tăiat cabluri
FR Pince à couper les fils
IT Cesovia per cavi elettrici
ES Alicates cortacables
CN 电缆剪



YATO 	max. Ø [mm]	L [mm]	
YT-19682	10.5	200	10/100

EN Cable cutter
PL Szczytce do cięcia przewodów
DE Kabelschere
RU Кабелперезы
CZ Štípačí kleště na kabely
HU Kábelvágó

RO Patent tăietor pt. electrice
FR Pince pour câbles
IT Cesovia per cavi elettrici
ES Alicates cortacables
CN 电缆断线钳



YATO 	max. Ø [mm]	L [mm]	
YT-2279	10.5	170	10/60

EN Universal wire stripper
PL Uniwersalny ściągacz izolacji
DE Universal Abisolierzange
RU Универсальный съёмник изоляции
CZ Univerzální odizolovací klejte
HU Blankoló foga

RO Decablator universal
FR Extracteur d'isolation multifonction
IT Pinze per scariare isolamento
ES Extractor de aislado universal
CN 万用剥线钳



YATO 	 mm ²	 AWG	L [mm]	
YT-19691	1.6-3.2	14-8	170	6/24

EN Multifunctional pliers
PL Szczytce wielofunkcyjne
DE Multifunktionszange
RU Многофункциональные плоскогубцы
CZ Multifunkční kleště
HU Kombinált fogó
RO Patent multifunctionale
FR Pince multifonctionnelle
IT Pinza universale
ES Alicates universales
CN 多功能钢丝钳



YATO 	 mm ²	 AWG	 mm ²	 AWG	L [mm]	
YT-20430	1.5	16-14	1-6	18-8	220	5/50

EN Multifunctional pliers
 PL Szczypce wielofunkcyjne
 DE Multifunktionszange
 RU Многофункциональные плоскогубцы
 CZ Multifunkční kleště
 HU Kombinált fogó
 RO Patent multifunctional
 FR Pince multifonctionnelle
 IT Pinza universale
 ES Alicates universales
 CN 多功能钢丝钳

205 mm

HRC 40-50

HRC 58-62

CrV



YATO	mm ²	AWG	mm ²	AWG	L [mm]	
YT-20433	1.5	16~14	1-6	18~8	205	5/50

EN Cable cutter
 PL Nożyce do kabli
 DE Kabelschere
 RU Кабелперезы

CZ Elektrické upichováky
 HU Kábelvágó
 RO Clește tăietor
 FR Cisailles à câbles

IT Cesioie per cavi
 ES Tijeras para cables
 CN 电缆剪

HRC 50

65Mn



YATO	Max. cutting range / Maks. przekrój cięcia [mm ²]	max. Ø [mm]	L [mm]	
YT-18610	125	12.5	370	20
YT-18611	250	18.0	580	10
YT-18612	500	25.0	770	5

EN Cable stripper
 PL Nożyk do kabli
 DE Kabelmesser

RU Нож кабельный
 CZ Nůž na kabele
 HU Kábelkés

RO Cuițăș pt. cabluri
 FR Couteau aux câbles
 IT Coltellino per cavi

ES Cuchillo
 CN 电缆剥线钳

8-28 mm



YATO	Ø [mm]	
YT-2280	8-28	10/100

EN Insulated electrician scissors
 PL Nożyczki dla elektryków izolowane
 DE Elektrische Schere
 RU Ножницы диэлектрические универсальные
 CZ Elektrikářské nůžky
 HU Villany szerelő olló
 RO Foarfeca electrician izolate
 FR Ciseaux pour electriciens
 IT Forbici per elettricisti
 ES Tijera aislante electricista
 CN 双色柄绝缘电工剪刀

160 mm

CrV

1000 V



1000 V VDE CERTIFICATE EN 60900:2012

YATO	L [mm]	
YT-21200	160	6/48

EN Insulated cable knife
 PL Nóż dla elektryków izolowany
 DE Kabelmesser gerade

RU Нож кабельный изолированный
 CZ Izolovaný nůž
 HU Szerelő kés

RO Cutit pt. cabluri izolat
 FR Couteau d'électricien
 IT Coltello per elettricisti isolato

ES Cuchillo electricista aislante
 CN 双色直刀式绝缘电工刀

65Mn

1000 V



50/180 mm

1000 V VDE CERTIFICATE EN 60900:2012

YATO	L [mm]	
YT-21210	180	6/72

EN Electrician scissors
 PL Nożyczki dla elektryków
 DE Elektrische Schere
 RU Ножницы универсальные
 CZ Elektrikářské nůžky
 HU Univerzális olló
 RO Foarfeca - electrician
 FR Ciseaux pour electriciens
 IT Forbici per elettricisti
 ES Tijeras eléctricos
 CN 不锈钢电工剪

140 mm

HRC 52-56

SS



YATO	L [mm]	
YT-1974	140	12/120

38/155 mm

1000 V VDE CERTIFICATE EN 60900:2012

YATO	L [mm]	
YT-21211	155	6/72

EN Electrician's knife
PL Nóż składany monterski
DE Montagemesser
RU Нож складной
CZ Montážní nůž
HU Szerelőkés
RO Cuijt pt. decablat
FR Couteau d'électricien
IT Coltello
ES Cuchillo de montaje
CN 直刀电工刀

HRC 42-48
3Cr13



85/200
mm



75/190
mm

YATO	L [mm]	
YT-7600	200	6/96

YATO	L [mm]	
YT-7601	190	6/96

EN Cable cutter
PL Szczypce do cięcia przewodów
DE Kabelschere
RU Кабелерезы
CZ Štípači kleště na kabely
HU Kábelvágó
RO Cleste taiat cabluri
FR Pince à couper les fils
IT Cesoia per cavi elettrici
ES Alicata cortacables
CN 电缆剪



HRC 55-60
CrV 50



• Application: for copper and aluminium electric cables

• Przeznaczenie: do cięcia miedzianych i aluminiowych kabli

YATO	max. Ø [mm]	L [mm]	
YT-1966	6	160	6/60
YT-1967	7	210	6/60
YT-1968	8	240	6/48

EN Insulated cable cutter
PL Szczypce do cięcia przewodów izolowane
DE Kabelschere
RU Кабелерезы
CZ Izolované kleště na kabely
HU Kábelvágó
RO Cleste taiat cabluri izolat
FR Pince renforcée isolée
IT Cesoia per cavi isolata
ES Alicata cortacables aislado
CN 双色绝缘电缆剪



250 mm
max Ø 8.0 mm

CrV

1000 V

1000 V
VDE CERTIFICATE
EN 60900:2012

YATO	max. Ø [mm]	L [mm]	
YT-21141	8	250	6/36

EN Heavy duty cable cutter
PL Wzmocnione nożyce do cięcia przewodów
DE Schwere Drahtschere
RU Кабелерезы
CZ Štípači kleště na kabely
HU Kábelvágó
RO Patent tăietor pt. electrice
FR Pince renforcée à couper les fils
IT Cesoia per cavi elettrici
ES Alicata cortacables
CN 电缆剪



240 mm
max Ø 9.0 mm
HRC 55-60

CrV 50



• Application: for copper and aluminium electric cables

• Przeznaczenie: do cięcia miedzianych i aluminiowych kabli

YATO	max. Ø [mm]	L [mm]	
YT-1969	9	240	6/48

EN Ratchet cable cutter
PL Nożyce zapadkowe do kabli
DE Ratschenkabelschneider
RU Кабелерез секторный
CZ Kleště na kabely, rohatka se západkou
HU Racsnis kábelvágó
RO Cleste pt. taiat cablu cu clichet
FR Cisailles à câbles
IT Cricchetto taglia cavo
ES Cortacables de carraca
CN 棘轮电缆剪

Cu/Al
CABLE
KABEL

HRC 50

60Si2Mn



300
mm

max Ø
17.5
mm



380
mm

max Ø
22
mm

YATO	Max. cutting range / Maks. przekrój cięcia [mm ²]	max. Ø [mm]	L [mm]	
YT-18600	240	17.5	300	10

YATO	Max. cutting range / Maks. przekrój cięcia [mm ²]	max. Ø [mm]	L [mm]	
YT-18602	380	22	380	10

EN Voltage tester
 PL Próbnik napięcia
 DE Spannungsprüfer
 RU Тестер напряжения
 CZ Zkoušeč napětí
 HU Fáziskereső

RO Creion de tensiune
 FR Testeur de tension
 IT Cerca fase
 ES Comprobador de corriente
 CN 测电笔

⊖ 190 mm
 125-250 V~



In accordance with polish standard PN-E 08509:1988

Zgodność z polską normą PN-E 08509:1988

YATO	⊖ [mm]	L [mm]	Box
YT-28300	3	190	12/144

EN Voltage tester
 PL Próbnik napięcia
 DE Spannungsprüfer
 RU Тестер напряжения
 CZ Zkoušeč napětí
 HU Fáziskereső

RO Creion de tensiune
 FR Testeur de tension
 IT Cerca fase
 ES Comprobador de corriente
 CN 数显带灯测电笔

⊖ 140 mm 50-500 Hz
 70-250V A.C.
 70-1000V A.C.
 CONTINUITY TEST TEST CIĄGŁOŚCI
 1.5V 9V BATTERY TEST TEST BATERII
 LED LIGHT DIODA
 2x + LR44

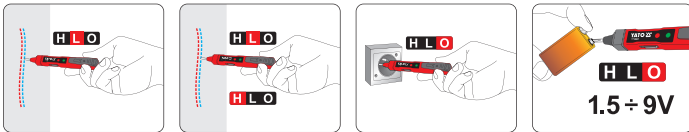

YATO	L [mm]	Box
YT-28631	140	6/120

EN Voltage tester
 PL Próbnik napięcia
 DE Spannungsprüfer
 RU Тестер напряжения
 CZ Zkoušeč napětí
 HU Fáziskereső
 RO Creion de tensiune
 FR Testeur de tension
 IT Cerca fase
 ES Comprobador de corriente
 CN 测电笔



⊖ 150 mm
 90-1000V A.C.
 CONTINUITY TEST TEST CIĄGŁOŚCI
 LED LIGHT DIODA
 LED LIGHTING OSWIETLENIE
 2x AAA

YATO	⊖ [mm]	Box
YT-28312	4.5	12/240

EN Digital voltage tester
 PL Wskaźnik elektryczny
 DE Digitaler-Spannungsprüfer
 RU Тестер напряжения цифровой

CZ Zkoušečka napětí digitální
 HU Digitális voltmérő
 RO Tester digital pt. tensiune electrica
 FR Testeur de tension type tournevis

IT Cerca fase digitale
 ES Indicador eléctrico
 CN 数显测电笔

⊖ 50-500 Hz 12-250V A.C. TEST LCD



130 mm NO BATTERY NEEDED NIE POTRZEBUJE BATERII

YATO	L [mm]	Box
YT-2861	130	20/500



130 mm LED LIGHT DIODA NO BATTERY NEEDED NIE POTRZEBUJE BATERII

YATO	L [mm]	Box
YT-2862	130	20/500



145 mm CONTINUITY TEST TEST CIĄGŁOŚCI LED LIGHT DIODA 3x + LR44

YATO	L [mm]	Box
YT-28630	145	6/120

LED

YATO	⊖ [mm]	L [mm]	Box
YT-2864	3.5	140	6/120

EN Voltage tester
 PL Próbnik napięcia
 DE Spannungsprüfer
 RU Тестер напряжения
 CZ Zkoušeč napětí
 HU Fáziskereső

RO Creion de tensiune
 FR Testeur de tension
 IT Cerca fase
 ES Comprobador de corriente
 CN 测电笔

155 mm 50/60 Hz
 12-1000V A.C.
 CONTINUITY TEST TEST CIĄGŁOŚCI
 SENSITIVITY CZULOSC
 AUTO POWER OFF AUTOMATYCZNE WYŁĄCZANIE
 LED LIGHT DIODA
 LED LIGHTING OSWIETLENIE
 2x AAA



YATO	L [mm]	Box
YT-28313	155	120

EN Digital detector with moisture test
PL Cyfrowy detektor oraz wilgotnościomierz
DE Digitaler Detektor mit Feuchtigkeitstest
RU Цифровой детектор и измеритель влажности
CZ Digitální detektor s testem vlhkosti
HU Digitális detektor nedvségvizsgálattal
RO Detector digital cu test de umiditate
FR Détecteur numérique avec test d'humidité
IT Rivelatore digitale con test di umidità
ES Detector digital con prueba de humedad
CN 墙体探测仪



4 in 1
4 w 1
LCD
6h
5-50%
1.5-33%
max 8 mm
9 V
6F22

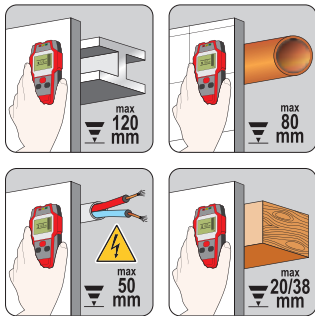

YATO YT-73138 40

EN Stud finder
PL Wykrywacz profili i przewodów
DE Entfernungsmesser
RU Цифровой детектор
CZ Digitální detektor
HU Digitális kereső műszer
RO Detector digital
FR Détecteur de métaux et de câbles électriques
IT Detector digitale
ES Escáner de pared
CN 多功能探测仪



3 in 1
3 w 1
LCD
6h
9 V
6F22

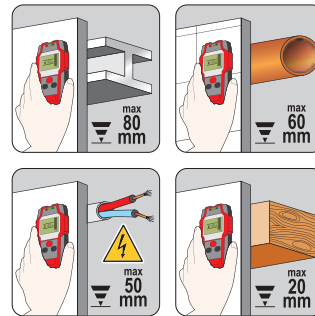

YATO YT-73131 40

EN Infrared thermometer
PL Pirometr
DE Pyrometer
RU Пирометр
CZ Pyrometr
HU Pírométer
RO Termometru cu infrarosu
FR Pyromètre
IT Termometro a infrarossi
ES Pirómetro
CN 红外测温仪



0.10-1 °C
EMISSIVITY
EMISSIVJÓCS
-50
+600
1
-12.4
MAX
MIN
°C
°F
2x
AAA
AUTO POWER OFF
AUTOMATYCZNE
WYŁĄCZANIE

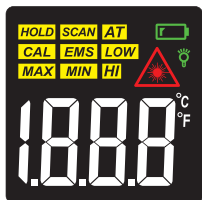

YATO YT-73200 10/60

EN Infrared thermometer
PL Pirometr
DE Pyrometer
RU Пирометр
CZ Pyrometr
HU Pírométer
RO Termometru cu infrarosu
FR Pyromètre
IT Termometro a infrarossi
ES Pirómetro
CN 红外测温仪



0.10-1 °C
EMISSIVITY
EMISSIVJÓCS
-50
+650
1
-12.4
MAX
MIN
°C
°F
x100
MEMORY
PAWIEC
UV
LED
2x
AAA
AUTO POWER OFF
AUTOMATYCZNE
WYŁĄCZANIE

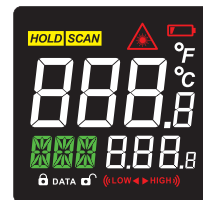

YATO YT-73201 10/60

EN Digital universal multimeter
PL Cyfrowy miernik uniwersalny
DE Digital-Multimeter
RU Универсальный цифровой измеритель
CZ Digitální multimetr univerzální
HU Digitális multiméter
RO Multimetru digital universal
FR Multimètre numérique universel
IT Universale tester digitale
ES Manómetro digital universal
CN 数字万用表



LCD
1999
0-500V
A.C.
0-500V
D.C.
0-5 A
D.C.
0-2
MΩ
5V_{P-P}
hFE
PNP
NPN
9 V
6F22

YATO YT-73080 50

EN Digital universal multimeter
PL Cyfrowy miernik uniwersalny
DE Digital-Multimeter
RU Универсальный цифровой измеритель
CZ Digitální multimetr univerzální
HU Digitális multiméter
RO Multimetru digital universal
FR Multimètre numérique universel
IT Universale tester digitale
ES Manómetro digital universal
CN 数字万用表



LCD
1999
0-600V
A.C.
0-600V
D.C.
0-10 A
D.C.
0-2
MΩ
hFE
PNP
NPN
1.5V 9V
BATTERY TEST
TEST BATERII
DATA HOLD
LED
BACKLIGHT
PODSWETLENIE
2x
AAA

YATO YT-73081 50

EN Digital universal multimeter
 PL Cyfrowy miernik uniwersalny
 DE Digital-Multimeter
 RU Универсальный цифровой измеритель
 CZ Digitální multimetr univerzální
 HU Digitális multiméter
 RO Multimetru digital universal
 FR Multimètre numérique universel
 IT Universale tester digitale
 ES Manómetro digital universal
 CN 数字万用表



TRUE RMS	LCD 6000	0-750V A.C.
0-1000V D.C.	0-10 A A.C.	0-10 A D.C.
0-60 MΩ	0-9,999 mF	0-9,999 MHz
1±99%		
AUTO RANGE AUTO ZAKRES	DATA HOLD	LED BACKLIGHT POSSWIELENIE
AUTO POWER OFF AUTOMATYCZNE WYŁĄCZANIE	2x AAA	

EN Digital universal multimeter
 PL Cyfrowy miernik uniwersalny
 DE Digital-Multimeter
 RU Универсальный цифровой измеритель
 CZ Digitální multimetr univerzální
 HU Digitális multiméter
 RO Multimetru digital universal
 FR Multimètre numérique universel
 IT Universale tester digitale
 ES Manómetro digital universal
 CN 数字万用表



TRUE RMS	LCD 9999	0-750V A.C.
0-999.9V D.C.	0-9.999A A.C.	0-9.999A D.C.
0-9,999 MΩ	0-9,999 mF	0-9,999 MHz
1±99%		
	AUTO RANGE AUTO ZAKRES	DATA HOLD
LED BACKLIGHT POSSWIELENIE	AUTO POWER OFF AUTOMATYCZNE WYŁĄCZANIE	2x AAA

YATO

YT-73096

100

YATO

YT-73089

100

EN Digital universal multimeter
 PL Cyfrowy miernik uniwersalny
 DE Digital-Multimeter
 RU Универсальный цифровой измеритель
 CZ Digitální multimetr univerzální
 HU Digitális multiméter
 RO Multimetru digital universal
 FR Multimètre numérique universel
 IT Universale tester digitale
 ES Manómetro digital universal
 CN 数字万用表



TRUE RMS	LCD 9999	0-600V A.C.
0-600V D.C.	0-10 A A.C.	0-10 A D.C.
0-99 MΩ	0-99 mF	0.01-60 kHz
NCV	V A.C. VFC	1.5V 9V BATTERY TEST TEST BATERII
CONTINUITY TEST TEST CIĄGŁOŚCI	AUTO RANGE AUTO ZAKRES	DATA HOLD
LED BACKLIGHT POSSWIELENIE	FRONT LIGHT LATARKA	AUTO POWER OFF AUTOMATYCZNE WYŁĄCZANIE
	2x AAA	

EN Digital universal multimeter
 PL Cyfrowy miernik uniwersalny
 DE Digital-Multimeter
 RU Универсальный цифровой измеритель
 CZ Digitální multimetr univerzální
 HU Digitális multiméter
 RO Multimetru digital universal
 FR Multimètre numérique universel
 IT Universale tester digitale
 ES Manómetro digital universal
 CN 数字万用表



TRUE RMS	LCD 1999	0-600V A.C.
0-600V D.C.	0-20 A A.C.	0-20 A D.C.
0-20 MΩ	0-20 mF	°C -40 +1000
0-60 MHz	h _{FE} PNP NPN	
	DATA HOLD	LED BACKLIGHT POSSWIELENIE
AUTO POWER OFF AUTOMATYCZNE WYŁĄCZANIE	9 V 6F22	

YATO

YT-73094

40

YATO

YT-73083

20

EN Digital universal multimeter
 PL Cyfrowy miernik uniwersalny
 DE Digital-Multimeter
 RU Универсальный цифровой измеритель
 CZ Digitální multimetr univerzální
 HU Digitális multiméter
 RO Multimetru digital universal
 FR Multimètre numérique universel
 IT Universale tester digitale
 ES Manómetro digital universal
 CN 数字万用表



LCD 1999	0-300V A.C.	0-300V D.C.
0-10 A A.C.	0-10 A D.C.	0-20 MΩ
0-1000 μF	°C -20 +1000	h _{FE} PNP NPN
		AUTO RANGE AUTO ZAKRES
DATA HOLD	MAX HOLD	LED BACKLIGHT POSSWIELENIE
AUTO POWER OFF AUTOMATYCZNE WYŁĄCZANIE	3x AAA	

EN Digital universal multimeter
 PL Cyfrowy miernik uniwersalny
 DE Digital-Multimeter
 RU Универсальный цифровой измеритель
 CZ Digitální multimetr univerzální
 HU Digitális multiméter
 RO Multimetru digital universal
 FR Multimètre numérique universel
 IT Universale tester digitale
 ES Manómetro digital universal
 CN 数字万用表



TRUE RMS	LCD 5999	0-600V A.C.
0-600V D.C.	0-10 A A.C.	0-10 A D.C.
0-60 MΩ	0-60 mF	0-60 MHz
°C -40 +1370	0.1±99%	h _{FE} PNP NPN
		AUTO RANGE AUTO ZAKRES
DATA HOLD	MAX HOLD	MIN HOLD
LED BACKLIGHT POSSWIELENIE	AUTO POWER OFF AUTOMATYCZNE WYŁĄCZANIE	CATCH MOCCOWANIE
	9 V 6F22	

YATO

YT-73084

44

YATO

YT-73085

20

For YT-73090
 Dla YT-73090

EN Digital universal multimeter
PL Cyfrowy miernik uniwersalny
DE Digital-Multimeter
RU Универсальный цифровой измеритель
CZ Digitální multimetr univerzální
HU Digitális multiméter
RO Multimetr digital universal
FR Multimètre numérique universel
IT Universale tester digitale
ES Manómetro digital universal
CN 数字万用表

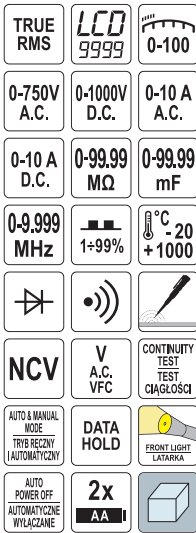

YATO
YT-73097

30

EN Digital universal multimeter
PL Cyfrowy miernik uniwersalny
DE Digital-Multimeter
RU Универсальный цифровой измеритель
CZ Digitální multimetr univerzální
HU Digitális multiméter
RO Multimetr digital universal
FR Multimètre numérique universel
IT Universale tester digitale
ES Manómetro digital universal
CN 数字万用表

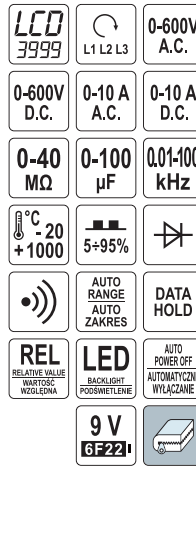

YATO
YT-73086

24

EN Digital universal multimeter
PL Cyfrowy miernik uniwersalny
DE Digital-Multimeter
RU Универсальный цифровой измеритель
CZ Digitální multimetr univerzální
HU Digitális multiméter
RO Multimetr digital universal
FR Multimètre numérique universel
IT Universale tester digitale
ES Manómetro digital universal
CN 数字万用表

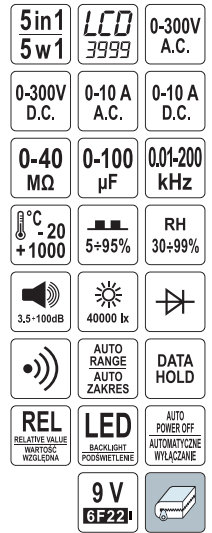

YATO
YT-73087

24

EN Clamp universal multimeter
PL Cęgowy miernik uniwersalny
DE Universal Zangenamperemeter
RU Универсальный цифровой измеритель
CZ Digitální multimetr univerzální
HU Digitális multiméter
RO Multimetr digital universal
FR Pince multimetre universel
IT Universale tester digitale
ES Manómetro digital universal
CN 数字钳形万用表



For YT-73085
Dia YT-73085

YATO
YT-73090

50

EN Digital universal multimeter
PL Cyfrowy miernik uniwersalny
DE Digital-Multimeter
RU Универсальный цифровой измеритель
CZ Digitální multimetr univerzální
HU Digitális multiméter
RO Multimetr digital universal
FR Multimètre numérique universel
IT Universale tester digitale
ES Manómetro digital universal
CN 数字万用表

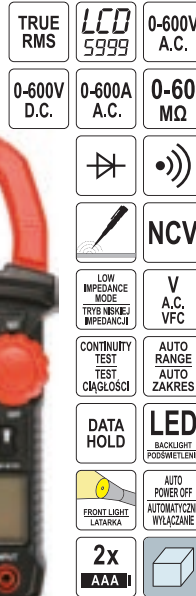

YATO
YT-73092

40

EN Clamp universal multimeter
PL Cęgowy miernik uniwersalny
DE Universal Zangenamperemeter
RU Универсальный цифровой измеритель
CZ Digitální multimetr univerzální
HU Digitális multiméter
RO Multimetr digital universal
FR Pince multimetre universel
IT Universale tester digitale
ES Manómetro digital universal
CN 数字钳形万用表

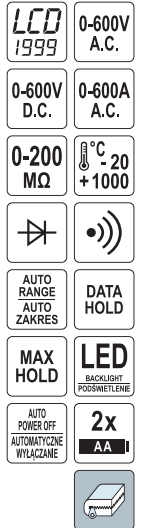

YATO
YT-73091

20

EN Digital universal multimeter
PL Cyfrowy miernik uniwersalny
DE Digital-Multimeter
RU Универсальный цифровой измеритель
CZ Digitální multimetr univerzální
HU Digitális multiméter
RO Multimetr digital universal
FR Multimètre numérique universel
IT Universale tester digitale
ES Manómetro digital universal
CN 数字万用表

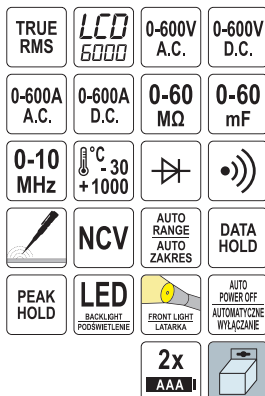

YATO
YT-73093

50

EN Probe set for multimeters
PL Zestaw sond pomiarowych do mierników
DE Sondensatz für Multimeter
RU Набор зонд для тестеров
CZ Měřicí šňůry k multimetru
HU Mérőcszín pár digitális multiméterekhez
RO Set sonde pt. multimetru
FR Jeu de cordons de test multimètre
IT Kit di puntali per misuratori
ES Juego de sondas de medición para medidores
CN 表笔



YATO
YT-73078

50/100

EN Cordless glue gun
 PL Akumulatorowy pistolet do klejenia
 DE Heissklebepistole
 RU Пистолет для клея
 CZ Pistole na lepení
 HU Ragasztópisztoly
 RO Pistol pt. lipit
 FR Pistolet à colle sans-fil
 IT Pistola colla
 ES Pistola de cola
 CN 充电式胶枪



18 V **Li-Ion**
 25 g/min
 3x \varnothing 11 mm \geq 60 min
 2.0 Ah 1h

18V
 Li-Ion

YATO	[V d.c.]	
YT-82854	18	10

EN Electric glue gun
 PL Pistolet do klejenia
 DE Heissklebepistole
 RU Пистолет для клея
 CZ Pistole na lepení
 HU Ragasztópisztoly
 RO Pistol pt. lipit
 FR Électrique pistolet a colle
 IT Pistola colla
 ES Pistola de cola
 CN 热胶枪



230-240V-50Hz 30(450) W
 100-200 °C 3-5 min
 20 g/min \varnothing 11 mm
 1.5 m

YATO	[W]	\varnothing [mm]	[g/min]	
YT-82403	30 (450)	11	20	6

EN Electric glue gun
 PL Pistolet do klejenia
 DE Heissklebepistole
 RU Пистолет для клея
 CZ Pistole na lepení
 HU Ragasztópisztoly
 RO Pistol pt. lipit
 FR Pistolet à colle
 IT Pistola colla
 ES Pistola de cola
 CN 热胶枪



230V~50Hz 35(400) W
 150-200 °C 3-6 min
 15 g/min 2x \varnothing 11 mm

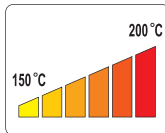

YATO	[W]	\varnothing [mm]	[g/min]	
YT-82401	35 (400)	11	15	12/24

EN Electric glue gun
 PL Pistolet do klejenia
 DE Heissklebepistole
 RU Пистолет для клея
 CZ Pistole na lepení
 HU Ragasztópisztoly
 RO Pistol pt. lipit
 FR Pistolet à colle
 IT Pistola colla
 ES Pistola de cola
 CN 热胶枪



230V~50Hz 20(80) W
 180-200 °C 3-5 min
 15 g/min 3x \varnothing 11 mm

YATO	[W]	\varnothing [mm]	[g/min]	
YT-82402	20 (80)	11	15	12/48

EN Soldering station
 PL Stacja lutownicza
 DE Lötstation
 RU Паяльная станция
 CZ Letovaci stanice
 HU Forrasztópáka állomás
 RO Stație de lipit
 FR Station de soudage
 IT Stazione digitale di saldatura
 ES Estación de soldadura
 CN 焊台

220-240V-50Hz 75 W 200-480 °C +/- 1 °C 900M
 LCD 3 1/2" 89mm LCD BACKLIGHT PODSWIETLENIE ESD SAFE USB BATTERY CHARGER ŁADOWNIKA

- Constant tip temperature control
- Temperature calibration function
- Auto sleep 1-240 min
- Stały odczyt temperatury grzałki
- Funkcja kalibracji temperatury
- Automatyczny tryb czuwania 1-240 min



YATO	[W]	[°C]	
YT-82456	75	200-480	8

EN Hot air soldering station
 PL Stacja lutownicza hot air
 DE Heißluft-Lötstation
 RU Термовоздушная паяльная станция
 CZ Horkovzdušná pájecí stanice
 HU Hot air forrasztóállomás
 RO Stație de lipit cu aer cald
 FR Station de soudage à air chaud
 IT Stazione di saldatura Hot Air
 ES Estación de soldadura hot air
 CN 热风拆焊台

220-240V-50Hz 750 W 100-500 °C +/- 2 °C 120 l/min LED DISPLAY WYŚWIETLACZ ESD SAFE

- Brushless motor fan
- Auto sleep 0-240 min
- Auto power off function
- Built-in position sensor
- Bezszczotkowy wentylator
- Automatyczny tryb czuwania
- Automatische wyłączenie urządzenia
- Czujnik odłożenia grzałki



YATO	[W]	[°C]	
YT-82457	750	100-500	8

EN 2 in 1 hot air soldering station
PL 2 w 1 stacja lutownicza hot air
DE 2 in 1 Heißluft-Lötstation
RU Термовоздушная паяльная станция 2 в 1
CZ Horkovzdušná pájecí stanice 2 v 1
HU 2 az 1-ben hot air forrasztóállomás
RO Stație de lipit, 2 in 1, cu aer cald
FR Station de soudage à air chaud 2 en 1
IT 2 in 1 stazione di saldatura hot air
ES 2 en 1 estación de soldadura hot air
CN 热风拆焊台

220-240V~ 50Hz	750 W	100-480 °C	+/- 2 °C	120 l/min
75 W	200-480 °C	+/- 1 °C	900M	LED DISPLAY WYSWETLACZ
ESD SAFE				

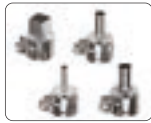

- Constant tip temperature control
- Brushless motor fan
- Auto sleep 0-240 min
- Auto power off function
- Build-in position sensor

- Stały odczyt temperatury grzałki
- Bezszczotkowy wentylator
- Automatyczny tryb czuwania
- Automatyczne wyłączenie urządzenia
- Czujnik odłożenia grzałki



YATO	[W]	[°C]	
YT-82458	75 (lutownica), 750 (dmuchawa hot air)	200-480 (lutownica), 100-480 (dmuchawa hot air)	6

EN Soldering station
PL Stacja lutownicza
DE Lötstation
RU Паяльная станция
CZ Letovací stanice
HU Forrasztópáka állomás
RO Stație de lipit
FR Station de soudage
IT Stazione digitale di saldatura
ES Estación de soldadura
CN 焊台



220-240V~ 50/60Hz	60 W			
90-480 °C	+/- 2 °C	900M	LED DISPLAY WYSWETLACZ	

- Constant tip temperature control
- Auto sleep 10 min
- Stały odczyt temperatury grzałki
- Automatyczny tryb czuwania 10 min

YATO	[W]	[°C]	
YT-82460	60	90-480	16

EN Soldering iron with temperature adjustment
PL Lutownica z regulacją temperatury
DE Temperaturgesteuerter LötKolben
RU Паяльник с терморегулятором
CZ Pájka s regulací teploty
HU Hőszabályozós forrasztó

RO Letcon cu reglaj de temperatura
FR Fer à souder à température réglable
IT Saldatore con temperatura regolabile
ES Soldador con ajuste de temperatura
CN 调温电烙铁



- Constant tip temperature control
- Stały odczyt temperatury grzałki

YATO	[W]	[°C]	
YT-82700	50	200-450	10/100

EN Soldering iron with temperature adjustment
PL Lutownica z regulacją temperatury
DE Temperaturgesteuerter LötKolben
RU Паяльник с терморегулятором
CZ Pájka s regulací teploty
HU Hőszabályozós forrasztó

RO Letcon cu reglaj de temperatura
FR Fer à souder à température réglable
IT Saldatore con temperatura regolabile
ES Soldador con ajuste de temperatura
CN 数显电烙铁



- Constant tip temperature control
- Temperature calibration function
- Stały odczyt temperatury grzałki
- Funkcja kalibracji temperatury

220-240V~ 50Hz	80 W	50-480 °C	+/- 2 °C	900M	LED BACKLIGHT PODSWETLENIE
YATO		[W]	[°C]		
YT-82701		80	50-480	10/50	

EN Soldering iron
PL Lutownica orogowa
DE LötKolben
RU Электропаяльник
CZ Pájka odpragová
HU Forrasztópáka
RO Ciocan de lipit
FR Fer à souder
IT Saldatore a stagno
ES Soldador de resistencia
CN 电烙铁



230V~ 50Hz		2-3 min			
YATO		[W]	[°C]	[mm]	
YT-8271		30	400	Ø3.8x70	16
YT-8272		60	500	Ø6x78	16
YT-8273		80	520	Ø6.8x64	16

EN Soldering station
PL Stacja lutownicza
DE Lötstation
RU Паяльная станция
CZ Letovací stanice
HU Forrasztópáka állomás
RO Stație de lipit
FR Station de soudage
IT Stazione digitale di saldatura
ES Estación de soldadura
CN 焊台

220-240V~ 50Hz	70 W	200-480 °C	+/- 1 °C	900M
YATO		[W]	[°C]	
YT-82459		70	200-480	8



- Constant tip temperature control
- Auto sleep 1-99 min
- Auto power off function 1-99 min
- Stały odczyt temperatury grzałki
- Automatyczny tryb czuwania 1-99 min
- Automatyczne wyłączenie urządzenia 1-99 min

YATO	[W]	[°C]	
YT-82459	70	200-480	8

EN Soldering station
PL Stacja lutownicza
DE Lötstation
RU Паяльная станция
CZ Letovací stanice
HU Forrasztópáka állomás

RO Stație de lipit
FR Station de soudage
IT Stazione digitale di saldatura
ES Estación de soldadura
CN 焊台

110-240V~ 50-60Hz	75 W	90-480 °C	+/- 2 °C	T12	LED DISPLAY WYSWETLACZ	
----------------------	-------------	--------------	-------------	------------	-------------------------------------	--

- Constant tip temperature control
- Temperature calibration function
- Stały odczyt temperatury grzałki
- Funkcja kalibracji temperatury

YATO	[W]	[°C]	
YT-82461	75	90-480	30

EN Transformer soldering gun
PL Lutownica transformatorowa
DE Lötpistole
RU Электрический паяльник
CZ Transformátorová páječka
HU Forrasztópáka

RO Pistol de lipit
FR Pistolet fer à souder électrique
IT Saldatore istantaneo
ES Soldador transformador
CN 电烙铁

220-240V~50Hz
180 W
0-600 °C
S2 20%
WORKING MODE
TRFB PRACTY

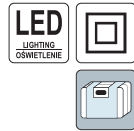

YATO	[W]	[°C]	
YT-8245	180	0-600	10

EN Heat shrink solder sleeve
PL Koszulka termokurczliwa z cyną
DE Wärmeschumpfende Verbinder mit Zinn
RU Термоусадочная гильза с оловом
CZ Smršňovací trubička s cínem
HU Hőre zsugorodó hüvely ónnal
RO Manson pt. lipit cu aer cald
FR Gaine thermorétractable avec étain
IT Guaine termorestringenti con stagno
ES Tubo termorretráctil con estaño
CN 免压热缩中接焊锡端子

30 PCS
0.25 x 0.34 mm²
105 °C

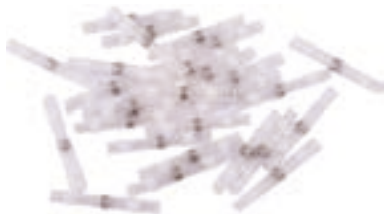

YATO	Cross-sectional area / Przekrój przewodu	
YT-81440	0.25-0.34 mm ² / 26-24 AWG	25/1500

EN Heat shrink solder sleeve
PL Koszulka termokurczliwa z cyną
DE Wärmeschumpfende Verbinder mit Zinn
RU Термоусадочная гильза с оловом
CZ Smršňovací trubička s cínem
HU Hőre zsugorodó hüvely ónnal
RO Manson pt. lipit cu aer cald
FR Gaine thermorétractable avec étain
IT Guaine termorestringenti con stagno
ES Tubo termorretráctil con estaño
CN 免压热缩中接焊锡端子

30 PCS
0.5 x 1.5 mm²
105 °C



YATO	Cross-sectional area / Przekrój przewodu	
YT-81441	0.5-1.5 mm ² / 22-18 AWG	15/900

EN Heat shrink solder sleeve
PL Koszulka termokurczliwa z cyną
DE Wärmeschumpfende Verbinder mit Zinn
RU Термоусадочная гильза с оловом
CZ Smršňovací trubička s cínem
HU Hőre zsugorodó hüvely ónnal
RO Manson pt. lipit cu aer cald
FR Gaine thermorétractable avec étain
IT Guaine termorestringenti con stagno
ES Tubo termorretráctil con estaño
CN 免压热缩中接焊锡端子

30 PCS
1.5 x 2.5 mm²
105 °C



YATO	Cross-sectional area / Przekrój przewodu	
YT-81442	1.5-2.5 mm ² / 16-14 AWG	5/300

EN Transformer soldering gun
PL Lutownica transformatorowa
DE Lötpistole
RU Электрический паяльник
CZ Transformátorová páječka
HU Forrasztópáka

RO Pistol de lipit
FR Pistolet fer à souder électrique
IT Saldatore istantaneo
ES Soldador transformador
CN 电烙铁

230-240V~50Hz
200 W
S2 20%
WORKING MODE
TRFB PRACTY

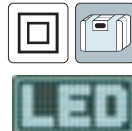

YATO	[W]	[°C]	
YT-82451	200	70-200, 201-350, 351-500	10

EN Heat shrink solder sleeve
PL Koszulka termokurczliwa z cyną
DE Wärmeschumpfende Verbinder mit Zinn
RU Термоусадочная гильза с оловом
CZ Smršňovací trubička s cínem
HU Hőre zsugorodó hüvely ónnal
RO Manson pt. lipit cu aer cald
FR Gaine thermorétractable avec étain
IT Guaine termorestringenti con stagno
ES Tubo termorretráctil con estaño
CN 免压热缩中接焊锡端子

100 PCS
0.25 x 0.34 mm²
105 °C

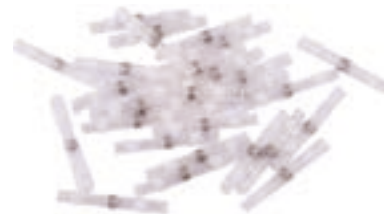

YATO	Cross-sectional area / Przekrój przewodu	
YT-81451	0.25-0.34 mm ² / 26-24 AWG	558

EN Heat shrink solder sleeve
PL Koszulka termokurczliwa z cyną
DE Wärmeschumpfende Verbinder mit Zinn
RU Термоусадочная гильза с оловом
CZ Smršňovací trubička s cínem
HU Hőre zsugorodó hüvely ónnal
RO Manson pt. lipit cu aer cald
FR Gaine thermorétractable avec étain
IT Guaine termorestringenti con stagno
ES Tubo termorretráctil con estaño
CN 免压热缩中接焊锡端子

100 PCS
0.5 x 1.5 mm²
105 °C



YATO	Cross-sectional area / Przekrój przewodu	
YT-81452	0.5-1.5 mm ² / 22-18 AWG	378

EN Heat shrink solder sleeve
PL Koszulka termokurczliwa z cyną
DE Wärmeschumpfende Verbinder mit Zinn
RU Термоусадочная гильза с оловом
CZ Smršňovací trubička s cínem
HU Hőre zsugorodó hüvely ónnal
RO Manson pt. lipit cu aer cald
FR Gaine thermorétractable avec étain
IT Guaine termorestringenti con stagno
ES Tubo termorretráctil con estaño
CN 免压热缩中接焊锡端子

100 PCS
1.5 x 2.5 mm²
105 °C



YATO	Cross-sectional area / Przekrój przewodu	
YT-81453	1.5-2.5 mm ² / 16-14 AWG	130

EN Heat shrink solder sleeve
PL Koszulka termokurczliwa z cyną
DE Wärmeschumpfende Verbinder mit Zinn
RU Термоусадочная гильза с оловом
CZ Smršťovací trubička s cínem
HU Hőre zsugorodó hüvely ónnal
RO Manson pt. lipit cu aer cald
FR Gaine thermorétractable avec étain
IT Guaine termorestringenti con stagno
ES Tubo termorretráctil con estaño
CN 免压热缩中接焊锡端子

20 PCS 4.0 x6.0 mm² 105 °C



YATO	Cross-sectional area / Przekrój przewodu	
YT-81443	4-6 mm ² / 12~10 AWG	5/300

EN Heat shrink solder sleeve set
PL Zestaw koszulek termokurczliwych z cyną
DE Satz wärmeschumpfender Verbinder mit Zinn
RU Комплект термоусадочных гильз с оловом
CZ Sada smršťovacích trubiček s cínem
HU Hőre zsugorodó hüvelykészlet ónnal

RO Set mansoane lipit cu aer cald
FR Jeu de gaines thermorétractables avec étain
IT Set di guaine termorestringenti con stagno
ES Conjunto de tubos termorretráctiles con estaño
CN 免压热缩中接焊锡端子

100 PCS 0.25 x6.0 mm²

105 °C

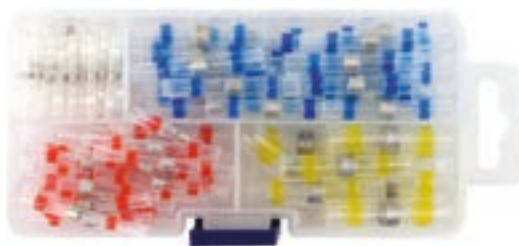

YATO	Cross-sectional area / Przekrój przewodu	
YT-81450	0.25-6 mm ² / 26~10 AWG	150

EN Heat shrink butt connectors set
PL Zestaw zaciskanych koszulek termokurczliwych
DE Satz gewellte Schrumpfhüllen
RU Набор обжимных термоусадочных трубок
CZ Sada upínacích teplem smršťitelných bužírek
HU Szigetelt toldóhüvely készlet
RO Set de conectori termocontractabili
FR Jeu de manchons thermorétractables sertis
IT Set di giunti termorestringenti con stagno
ES Juego de tubos termorretráctiles
CN 防水热缩端子



200 PCS 0.5 x6.0 mm²



□ 0.5-1.5 mm² (90 PCS), 1.5-2.5 mm² (90 PCS), 4.0-6.0 mm² (20 PCS)

YATO	Cross-sectional area / Przekrój przewodu	
YT-81461	0.5-6 mm ² / 20~10 AWG	60

EN Solvent dispenser with pump
PL Butelka z dozownikiem z pompką
DE Flasche mit Dosiereinrichtung mit Pumpe
RU Бутылка с дозатором-насосом
CZ Láhev s dávkovačem a pumpičkou
HU Üveg pumpás adagolóval
RO Distributor de solventi cu pompă
FR Bouteille avec pompe
IT Flacone dosatore a pompa
ES Botella con dispensador y bomba
CN 按压式酒精瓶



100 ml ALCOHOL RESISTANCE ODPORNOŚĆ NA ALKOHOL

ESD SAFE

YATO	[ml]	
YT-82516	100	20/120

EN Heat shrink solder sleeve
PL Koszulka termokurczliwa z cyną
DE Wärmeschumpfende Verbinder mit Zinn
RU Термоусадочная гильза с оловом
CZ Smršťovací trubička s cínem
HU Hőre zsugorodó hüvely ónnal
RO Manson pt. lipit cu aer cald
FR Gaine thermorétractable avec étain
IT Guaine termorestringenti con stagno
ES Tubo termorretráctil con estaño
CN 免压热缩中接焊锡端子

100 PCS 4.0 x6.0 mm² 105 °C



YATO	Cross-sectional area / Przekrój przewodu	
YT-81454	4-6 mm ² / 12~10 AWG	100

EN Heat shrink solder sleeve set
PL Zestaw koszulek termokurczliwych z cyną
DE Satz wärmeschumpfender Verbinder mit Zinn
RU Комплект термоусадочных гильз с оловом
CZ Sada smršťovacích trubiček s cínem
HU Hőre zsugorodó hüvelykészlet ónnal
RO Set mansoane lipit cu aer cald
FR Jeu de gaines thermorétractables avec étain
IT Set di guaine termorestringenti con stagno
ES Kit de capas termorretrácteis com estanho
CN 免压热缩中接焊锡管

220 PCS 0.25 x6.0 mm² 105 °C

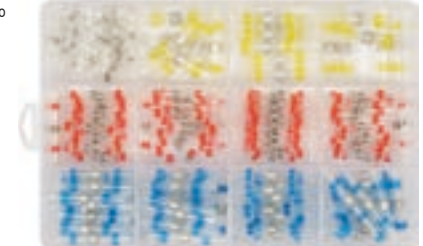

YATO	Cross-sectional area / Przekrój przewodu	
YT-81460	0.25-6 mm ² / 26~10 AWG	60

EN Silicone soldering mat
PL Mata silikonowa do lutowania
DE Silikon-Lötmatte
RU Силиконовый коврик для пайки
CZ Silikonová podložka pro letování
HU Szilikon forrasztóalátét
RO Saltea din silicon pt. lipit
FR Tapis à souder en silicone
IT Tappetino per saldatura in silicone
ES Estera de soldadura de silicona
CN 硅胶垫

max °C 500



YATO	Size / Rozmiar [mm]	
YT-82468	250x350	50
YT-82469	300x400	30

EN Dust blower ball
PL Gruszka do przedmuchiwania
DE Blasebalg
RU Груша для продувки
CZ Hruška pro profukování
HU Porfúvó
RO Pompa suflat praful
FR Poire de gonflage
IT Bulbo soffiatore
ES Pera sopladora
CN 吹尘球

ESD SAFE



YATO		
YT-82512		30/180

EN Solder iron tips set
 PL Zestaw grzyw do lutowania
 DE Lötspitzenset
 RU Набор паяльных жал
 CZ Sada páječích hrotů
 HU Forrasztóhegy készlet
 RO Varfuri pistol de lipit
 FR Jeu de pointes de fer à souder
 IT Set di punte del saldatore
 ES Juego de puntas para soldar
 CN 烙铁头6件套

6 PCS 900M



Tip types: T-1, T-B, T-K, T2.4D, T-2C, T-3C
 Rodzaje grzyw: T-1, T-B, T-K, T2.4D, T-2C, T-3C

YATO	
YT-82525	24/240

EN Solder iron tips set
 PL Zestaw grzyw do lutowania
 DE Lötspitzenset
 RU Набор паяльных жал
 CZ Sada páječích hrotů
 HU Forrasztóhegy készlet
 RO Varfuri pistol de lipit
 FR Jeu de pointes de fer à souder
 IT Set di punte del saldatore
 ES Juego de puntas para soldar
 CN 烙铁头10件套

10 PCS 900M



Tip types: T-1, T-B, T-K, T-1.2D, T2.4D, T-3.2D, T-1C, T-2C, T-3C
 Rodzaje grzyw: T-1, T-B, T-K, T-1.2D, T2.4D, T-3.2D, T-1C, T-2C, T-3C

YATO	
YT-82526	24/240

EN Sponge for soldering station
 PL Gąbka do stacji lutowniczej
 DE Schwamm für Lötstation
 RU Губка для паяльной станции
 CZ Houbička do pájecí stanice
 HU Szivacs forrasztóállomáshoz
 RO Burete pt. statia de lipit
 FR Éponge pour station de soudage
 IT Spugna per stazione di saldatura
 ES Esponja para la estación de soldadura
 CN 烙铁头清洁海绵

3 PCS



YATO	
YT-82467	40/800

EN Solder tip cleaner brass wire
 PL Czyścik do grzyw z mosiężnymi wiórami
 DE Lötspitzen-Reiniger - Messingspäne
 RU Очиститель паяльных жал, латунная стружка
 CZ Čistič hrotů mosazné hobliny
 HU Pákahegy tisztító rézforgács
 RO Burete sarma pt. curatat pistol de lipit
 FR Boule de nettoyage à copeaux de laiton
 IT Pulitore per punte, trucioli in ottone
 ES Alambre de latón para limpieza de puntas de soldadura
 CN 烙铁头除锡球+锡渣盒

BRASS MOSIADZ



YATO	
YT-82510	30/120

EN Hot air nozzles
 PL Zestaw dysz do gorącego powietrza
 DE Heißluftdüsen
 RU Комплект форсунок для горячего воздуха
 CZ Sada horkovzdušných trysek
 HU Forró levegő fúvókakészlet
 RO Duze aer cald
 FR Jeu de buses à air chaud
 IT Set di ugelli per aria calda
 ES Juego de boquillas para aire caliente
 CN 风咀4件套

4 PCS 12 mm 4.4 mm 8.0 mm 10 mm



YATO	
YT-82520	50/300

EN Vacuum pen
 PL Chwytnak próżniowy
 DE Vakuumgreifer
 RU Вакуумный захват
 CZ Vákuové chrapadlo
 HU Vákuumos alkatrészfogó
 RO Aspirator tip pix
 FR Pince à vide
 IT Utensile da presa a vuoto
 ES Pluma de succión de bomba de vacío
 CN 防静电真空吸笔

150 mm 3.0 mm 6.0 mm 10 mm



YATO	L [mm]	
YT-82514	150	12/240

EN Heat resistant tape
 PL Taśma kaptonowa
 DE Kapton-Band
 RU Каптоновая лента
 CZ Kaptonová páska
 HU Kapton szalag
 RO Bandă termorezistentă
 FR Bande kapton
 IT Nastro kapton
 ES Cinta kapton
 CN 防焊高温胶带

300 °C



YATO	W [mm]	L [m]	
YT-82540	5	33	110/440
YT-82541	10	33	64/256
YT-82542	20	33	32/128

EN Solder wick
 PL Taśma rozlutownicza, plecionka miedziana
 DE Lötdocht - Kupfergeflecht
 RU Лента для удаления припоя, медная оплетка
 CZ Odřájecí páska, měděný svazek
 HU Fonott réz kiforrasztó huzal
 RO Sarma pt. lipit
 FR Bande de soudure en cuivre toronné
 IT Nastro dissaldante, treccia rame
 ES Cinta desoldadora trenza de cobre
 CN 吸锡带

COPPER MIEDZ





YATO	W [mm]	L [m]	
YT-82530	1.5	1.5	30/600
YT-82531	2.0	1.5	30/600
YT-82532	3.0	1.5	30/600

EN Desoldering pump CZ Odpájecí sací pumpa IT Pompa aspira stagno
PL Odsysacz do cyny HU Ónszippantó ES Bomba desoldadora
DE Entlötlötpumpe RO Pompa fluidor CN 全铝手动吸锡器
RU Шприц для удаления припоя FR Pompe à étain



YATO 
YT-82742  100/400





YATO 
YT-82743  100/200



YATO 
YT-82744  50/100



EN Tweezer RO Pensetă
PL Pęseta FR Pince
DE Pinzette IT Pinza
RU Пинцет ES Pinzas
CZ Pinzeta CN 尖头镊子
HU Csipesz



YATO 
YT-6903 L [mm]  140 20/240

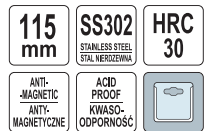

EN Tweezer RO Pensetă
PL Pęseta FR Pince
DE Pinzette IT Pinza
RU Пинцет ES Pinzas
CZ Pinzeta CN 弯头镊子
HU Csipesz

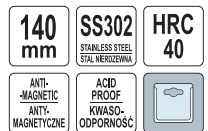

YATO 
YT-6907 L [mm]  115 20/240

EN Tweezer RO Pensetă
PL Pęseta FR Pince
DE Pinzette IT Pinza
RU Пинцет ES Pinzas
CZ Pinzeta CN 防静电镊子
HU Csipesz





YATO 
YT-6916 L [mm]  140 20/240

EN Insulation tape PL Taśma elektroizolacyjna
DE Isolierband RU Изолента
CZ Izolační páska HU Szigetelőszalag
RO Banda izolatoare FR Ruban électrique
IT Nastro isolante ES Cinta aislante
CN 绝缘胶带





- In accordance with standard EN 60454-3-1-1/F-PVC/60/R-Tp
- Dielectric strength: >35 Kv/mm
- Elongation: >125%
- Flame test: Store temperature: 10-40°C
- Using temperature: 5-50°C
- Zgodność z normą EN 60454-3-1-1/F-PVC/60/R-Tp
- Wytrzymałość dielektryczna: >35 Kv/mm
- Wydłużenie: >125%
- Test ogniowy: Temperatura składowania: 10-40°C
- Temperatura użytkowania: 5-50°C

YATO 	W [mm]	L [m]	± [mm]	
YT-8152	12	10	0.13	96/384
YT-8159	15	20	0.13	72/288
YT-8165	19	20	0.13	72/288
YT-8174	25	20	0.19	48/192
YT-8177	50	33	0.19	48

EN Insulation tape PL Taśma elektroizolacyjna
DE Isolierband RU Изолента
CZ Izolační páska HU Szigetelőszalag
RO Banda izolatoare FR Ruban électrique
IT Nastro isolante ES Cinta aislante
CN 红色电工绝缘胶带





- In accordance with standard EN 60454-3-1-1/F-PVC/60/R-Tp
- Dielectric strength: >35 Kv/mm
- Elongation: >125%
- Flame test: Store temperature: 10-40°C
- Using temperature: 5-50°C
- Zgodność z normą EN 60454-3-1-1/F-PVC/60/R-Tp
- Wytrzymałość dielektryczna: >35 Kv/mm
- Wydłużenie: >125%
- Test ogniowy: Temperatura składowania: 10-40°C
- Temperatura użytkowania: 5-50°C

YATO 	W [mm]	L [m]	± [mm]	
YT-81592	15	20	0.13	72/288
YT-8166	19	20	0.13	72/288

EN Insulation tape PL Taśma elektroizolacyjna
DE Isolierband RU Изолента
CZ Izolační páska HU Szigetelőszalag
RO Banda izolatoare FR Ruban électrique
IT Nastro isolante ES Cinta aislante
CN 蓝色电工绝缘胶带



- In accordance with standard EN 60454-3-1-1/F-PVC/60/R-Tp
- Dielectric strength: >35 Kv/mm
- Elongation: >125%
- Flame test: Store temperature: 10-40°C
- Using temperature: 5-50°C
- Zgodność z normą EN 60454-3-1-1/F-PVC/60/R-Tp
- Wytrzymałość dielektryczna: >35 Kv/mm
- Wydłużenie: >125%
- Test ogniowy: Temperatura składowania: 10-40°C
- Temperatura użytkowania: 5-50°C

YATO 	W [mm]	L [m]	± [mm]	
YT-81591	15	20	0.13	72/288
YT-81651	19	20	0.13	72/288

EN Insulation tape
 PL Taśma elektroizolacyjna
 DE Isolierband
 RU Изолента
 CZ Izolační páska
 HU Szigetelőszalag
 RO Banda izolatoare
 FR Ruban électrique
 IT Nastro isolante
 ES Cinta aislante
 CN 黄色电工绝缘胶带



EN Insulation tape
 PL Taśma elektroizolacyjna
 DE Isolierband
 RU Изолента
 CZ Izolační páska
 HU Szigetelőszalag
 RO Banda izolatoare
 FR Ruban électrique
 IT Nastro isolante
 ES Cinta aislante
 CN 黄绿色电工绝缘胶带



EN Insulation tape
 PL Taśma elektroizolacyjna
 DE Isolierband
 RU Изолента
 CZ Izolační páska
 HU Szigetelőszalag
 RO Banda izolatoare
 FR Ruban électrique
 IT Nastro isolante
 ES Cinta aislante
 CN 绿色电工绝缘胶带



- In accordance with standard EN 60454-3-1-1/F-PVC/60/R-Tp
- Dielectric strength: >35 Kv/mm
- Elongation: >125%
- Flame test: Store temperature: 10-40°C
- Using temperature: 5-50°C

- In accordance with standard EN 60454-3-1-1/F-PVC/60/R-Tp
- Dielectric strength: >35 Kv/mm
- Elongation: >125%
- Flame test: Store temperature: 10-40°C
- Using temperature: 5-50°C

- In accordance with standard EN 60454-3-1-1/F-PVC/60/R-Tp
- Dielectric strength: >35 Kv/mm
- Elongation: >125%
- Flame test: Store temperature: 10-40°C
- Using temperature: 5-50°C

- Zgodność z normą EN 60454-3-1-1/F-PVC/60/R-Tp
- Wytrzymałość dielektryczna: >35 Kv/mm
- Wydłużenie: >125%
- Test ogniowy: Temperatura składowania: 10-40°C
- Temperatura użytkowania: 5-50°C

- Zgodność z normą EN 60454-3-1-1/F-PVC/60/R-Tp
- Wytrzymałość dielektryczna: >35 Kv/mm
- Wydłużenie: >125%
- Test ogniowy: Temperatura składowania: 10-40°C
- Temperatura użytkowania: 5-50°C

- Zgodność z normą EN 60454-3-1-1/F-PVC/60/R-Tp
- Wytrzymałość dielektryczna: >35 Kv/mm
- Wydłużenie: >125%
- Test ogniowy: Temperatura składowania: 10-40°C
- Temperatura użytkowania: 5-50°C

YATO	W [mm]	L [m]	+/- [mm]	Icon
YT-81594	15	20	0.13	72/288
YT-81654	19	20	0.13	72/288

YATO	W [mm]	L [m]	+/- [mm]	Icon
YT-81593	15	20	0.13	72/288
YT-81655	19	20	0.13	72/288

YATO	W [mm]	L [m]	+/- [mm]	Icon
YT-81595	15	20	0.13	72/288
YT-81652	19	20	0.13	72/288

EN Insulation tape
 PL Taśma elektroizolacyjna
 DE Isolierband
 RU Изолента
 CZ Izolační páska
 HU Szigetelőszalag

RO Banda izolatoare
 FR Ruban électrique
 IT Nastro isolante
 ES Cinta aislante
 CN 绝缘胶带

10 PCS



- In accordance with standard EN 60454-3-1-1/F-PVC/60/R-Tp
- Dielectric strength: >35 Kv/mm
- Elongation: >125%
- Flame test: Store temperature: 10-40°C
- Using temperature: 5-50°C



- Zgodność z normą EN 60454-3-1-1/F-PVC/60/R-Tp
- Wytrzymałość dielektryczna: >35 Kv/mm
- Wydłużenie: >125%
- Test ogniowy: Temperatura składowania: 10-40°C
- Temperatura użytkowania: 5-50°C

YATO	W [mm]	L [m]	+/- [mm]	Icon
YT-8156	12	10	0.13	10/40
YT-8173	19	20	0.13	6/24

EN Cloth cable wrap tape
 PL Taśma parczana do wiązek kabli
 DE Gewebebänd für Kabelbäume
 RU Лента холщевая для кабельных пучков
 CZ Plátěná páska do kabelových svazků
 HU Polészter kábeltöteg szalag
 RO Banda panza pt. izolat cabluri
 FR Ruban adhésif textile
 IT Nastro di tela per cablaggi
 ES Cinchas para haces de cables
 CN 绒布线束胶带

HOT MELT GLUE KLEJ GORĄCO-TOPLIWY

NONWOVEN FABRIC WŁOKNINA

TEMPERATURE RANGE: -40 to +105



YATO	W [mm]	L [m]	+/- [mm]	Icon
YT-81500	19	15	0.3	10/200
YT-81501	19	25	0.3	10/120

EN Tool set for electricians
 PL Zestaw narzędziowy dla elektryków
 DE Werkzeug-Set für Elektriker
 RU Набор инструментов для электриков
 CZ Sada nářadí pro elektrikáře
 HU Szerszámkészlet villanyszerelők

RO Trusa electrician
 FR Ensemble d'outils pour les électriciens
 IT Set per l'elettricista
 ES Conjunto de herramientas para electricistas
 CN 高档电讯组套



0-500V D.C. 0-500V A.C. 0-5 A D.C. 0-2 MΩ

125-250 V- 50-500 Hz LCD

30 W 230V-50Hz 400 °C TIP

68 PCS 1/4" 6.3mm

CrV 50BV30 CrV 6150

S2 1000 V

- 1/4" (6.3 mm): 4, 4.5, 5, 5.5, 6, 7, 8, 9, 10, 11, 12, 13 mm (L=25 mm); CrV 50BV30;
- 140 mm;
- 190 mm; 3CRB;
- 150 mm;
- 160 mm; 1000 V; CrV;
- 160 mm; 1000 V; CrV;
- 3 m x 16 mm;
- 175 mm;
- 19.5 x 190 mm;
- 1.5 V; 9 LED;
- 9 mm;
- 19 mm x 20 mm;
- 1/4" (6.3 mm); (150 mm); CrV 50BV30;
- 1/4" (6.3 mm) x 1/4" (6.3 mm); CrV 6140;
- 10 g;
- 1.4, 2.0, 2.4 mm; PH00, PH0, PH1; S2;
- 4x100, 5.5x125, PH1x80, PH2x100 mm; 1000V; S2;
- 1/4" (6.3 mm): 3, 4, 5, 5.5, 6 mm (L=25 mm); AISI S2;
- 1/4" (6.3 mm): PH1, PH2, PH3 (L=25 mm); AISI S2;
- 1/4" (6.3 mm): T8, T10, T15, T20, T25, T27 (L=25 mm); AISI S2;
- 1/4" (6.3 mm): 2, 2.5, 3, 4, 5, 6 (L=25 mm); AISI S2;
- 1.5, 2, 2.5, 3, 4, 5, 6, 7, 8, 10 mm; CrV 6150

YATO	Icon
YT-39009	1/4" (6.3 mm) 2

EN Superseal connectors wiring assortment
PL Zestaw złączy elektrycznych hermetycznych
DE Hermetischer Elektrostecker Satz
RU Набор герметичных электрических разъемов
CZ Sada hermetických elektrických svorek
HU Hermetikus elektromos csatlakozókészlet

RO Mufe auto
FR Jeu de connecteurs électriques hermétiques
IT Kit di connettori elettrici a tenuta stagna
ES Set de herméticos conectores eléctricos
CN 低压电源线束快速接头

424
PCS



1-6
PIN

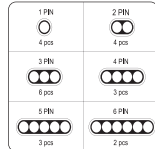

YATO
YT-06869

6/12

EN Back probe kit
PL Zestaw przewodów i końcówek pomiarowych
DE Messleitungen und -endstücke
RU Набор кабелей и измерительных наконечников
CZ Sada měřících vodičů a koncovek
HU Vezeték és mérőfej készlet

RO Trusa de sondă spată
FR Kit de cordons et de fiches de test
IT Set di cavi e terminali di misura
ES Juego de cables y puntas de medición
CN 万用表

20
PCS

0-30V
A.C.

0-30V
D.C.

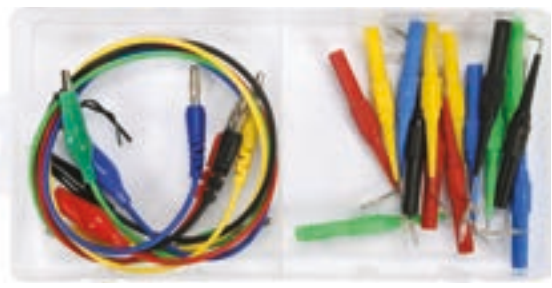

YATO
YT-73079

24

EN Electrical clip assortment
PL Zestaw złączy elektrycznych - krokodylki
DE Krokodil-Klemmen-Kortiment

RU Набор разъемов - крокодил
CZ Terminal alligator krokodil přichytek
HU Krokodil csipesz készlet

RO Sortiment cleme crocodil
FR Assortiment pinces crocodile
IT Set di perni per misure e prove

ES Crocodile clip
CN 夹头组套

28
PCS

MIX



50, 55, 60, 65, 70, 80 mm

EN Terminal assortment
PL Zestaw złączy elektrycznych
DE Kabelschuh-Set
RU Набор электрических клемм
CZ Sada elektrických konektorů
HU Elektromos csatlakozókészlet

RO Set papuci auto
FR Jeu de cosSES de câbles
IT Kit di connettori elettrici
ES Juego de conectores eléctricos
CN 接线端子

160
PCS

MIX



⊘ 04 mm (8 PCS), 04 mm (10 PCS), 05 mm (4 PCS), 05 mm (10 PCS), 06 mm (10 PCS), 08 mm (4 PCS), 010 mm (4 PCS);
□ 0.25-1.5 mm² (12 PCS), 1.5-2.5 mm² (18 PCS), 4-6 mm² (12 PCS);
⊘ 04 mm (10 PCS);
□ 1.5-2.5 mm² (10 PCS);
□ 1.5-2.5 mm² (10 PCS), 4-6 mm² (5 PCS);
□ 1.5-2.5 mm² (10 PCS);
□ 1.5-2.5 mm² (10 PCS), 4-6 mm² (5 PCS);
□ 0.25-1.5 mm² (4 PCS), 1.5-2.5 mm² (4 PCS)

YATO
YT-06891

24

EN Terminal assortment
PL Zestaw złączy elektrycznych
DE Kabelschuh-Set
RU Набор электрических клемм
CZ Sada elektrických konektorů
HU Elektromos csatlakozókészlet

RO Set papuci auto
FR Jeu de cosSES de câbles
IT Kit di connettori elettrici
ES Juego de conectores eléctricos
CN 接线端子

250
PCS

MIX



Connector blue male / Złącze niebieskie męskie: 6.4 mm (1.5-2.5mm; 50 PCS),
Connector blue female / Złącze niebieskie żeńskie: 6.4 mm (1.5-2.5 mm; 50 PCS),
Connector red male / Złącze czerwone męskie: 6.4 mm (0.5-1.5 mm; 50 PCS),
Connector red female / Złącze czerwone żeńskie: 6.4 mm (0.5-1.5 mm; 50 PCS),
Connector tube red / Złącze rurowe czerwone: (0.5-1.5 mm; 25 PCS),
Connector tube blue / Złącze rurowe niebieskie: (0.5-1.5 mm; 25 PCS)

YATO
YT-06891

60

EN Terminal assortment
 PL Zestaw złącz elektrycznych
 DE Kabelschuh-Set
 RU Набор электрических клемм
 CZ Sada elektrických konektorů
 HU Elektromos csatlakozókészlet

RO Set papuci auto
 FR Jeu de cosses de câbles
 IT Kit di connettori elettrici
 ES Juego de conectores eléctricos
 CN 接线端子

240
PCS

MIX



Connector red female / Złącze czerwone żeńskie: 6.4 mm (0.5-1.5 mm; 20 PCS),
 Connector red full female / Złącze czerwone pełne żeńskie: 4.8 mm (0.5-1.5 mm; 20 PCS),
 Connector red male / Złącze czerwone męskie: 4.8 mm (0.5-1.5 mm; 20 PCS),
 Connector red male male / Złącze czerwone męsko-męskie: 6.4 mm (0.5-1.5 mm; 40 PCS),
 Connector blue female / Złącze niebieskie żeńskie: 6.4 mm (1.5-2.5 mm; 20 PCS),
 Connector red full female / Złącze czerwone pełne żeńskie: 6.4 mm (0.5-1.5 mm; 20 PCS),
 Connector blue full female / Złącze niebieskie pełne żeńskie: 6.4 mm (1.5-2.5 mm; 20 PCS),
 Connector blue male male / Złącze niebieskie męsko-męskie: 6.4 mm (1.5-2.5 mm; 40 PCS),
 Connector blue male / Złącze niebieskie męskie: 4.8 mm (1.5-2.4 mm; 20 PCS),
 Connector blue female / Złącze niebieskie żeńskie: 4.8 mm (1.5-2.5 mm; 20 PCS)

YATO

YT-068912

60

EN Terminal assortment
 PL Zestaw złącz elektrycznych
 DE Kabelschuh-Set
 RU Набор электрических клемм
 CZ Sada elektrických konektorů
 HU Elektromos csatlakozókészlet

RO Set papuci auto
 FR Jeu de cosses de câbles
 IT Kit di connettori elettrici
 ES Juego de conectores eléctricos
 CN 接线端子

450
PCS

MIX

BRASS
MOSIADZ



Connector female / Złącze żeńskie: 2.8 mm, 4.8 mm, 6.4 mm (x50 PCS);
 Connector male / Złącze męskie: 2.8 mm, 4.8 mm, 6.4 mm (x50 PCS);
 Connector with hole / Złącze z oczkiem: Ø3.2 mm, Ø5.2 mm, Ø8.2 mm (x50 PCS)

YATO

YT-068683

24

EN Terminal assortment
 PL Zestaw złącz elektrycznych
 DE Kabelschuh-Set
 RU Набор электрических клемм
 CZ Sada elektrických konektorů
 HU Elektromos csatlakozókészlet

RO Set papuci auto
 FR Jeu de cosses de câbles
 IT Kit di connettori elettrici
 ES Juego de conectores eléctricos
 CN 接线端子

600
PCS

MIX



PBDD 1-250, PBDD 2-250, PBDD 5-250, FDFD 5-250, RV 5.5-4, RV 5.5-5, RV 5.5-6 (x100 PCS); E1008 red / czerwone, E1508 red / czerwone, E2508 blue / niebieskie (x50 PCS); TE1008 red / czerwone, TE1508 red / czerwone, TE2510 red / czerwone, MDD 1-250, MDD 2-250 (x20 PCS); MDD 5-250, BV 5.5, FDD 5-250 (x10 PCS); FDFD 1-250, FDFD 2-250, RV 1.25-5, RV 2-5, BV 1.25, BV 2 (x15 PCS); RV 1.25-3, RV 1.25-4, RV 2-3, RV 2-4 (x30 PCS); FDD 1-250, FDD 2-250 (x20 PCS)

YATO

YT-068913

20

EN Terminal assortment
 PL Zestaw złącz elektrycznych
 DE Kabelschuh-Set
 RU Набор электрических клемм
 CZ Sada elektrických konektorů
 HU Elektromos csatlakozókészlet

RO Set papuci auto
 FR Jeu de cosses de câbles
 IT Kit di connettori elettrici
 ES Juego de conectores eléctricos
 CN 接线端子

360
PCS

MIX

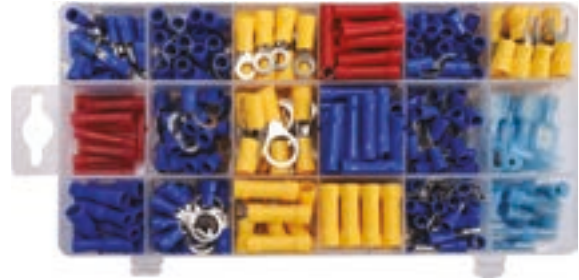
Ø5 mm - 2 mm2 (30 PCS), Ø6 mm - 2 mm2 (20 PCS),
 Ø9.5 mm - 2 mm2 (20 PCS), Ø5 mm - 5.5 mm2 (20 PCS),
 Ø6 mm - 5.5 mm2 (15 PCS), Ø9.5 mm - 5.5 mm2 (15 PCS);
 1.25 mm2 (40 PCS), 2 mm2 (30 PCS), 5.5 mm2 (15 PCS);
 Ø5 mm - 2 mm2 (30 PCS), Ø5 mm - 5.5 mm2 (20 PCS);
 2 mm2 (25 PCS);
 2 mm2 (35 PCS);
 2 mm2 (10 PCS);
 2 mm2 (35 PCS)

YATO

YT-06890

12

EN Terminal assortment
 PL Zestaw złącz elektrycznych
 DE Kabelschuh-Set
 RU Набор электрических клемм
 CZ Sada elektrických konektorů
 HU Elektromos csatlakozókészlet

RO Set papuci auto
 FR Jeu de cosses de câbles
 IT Kit di connettori elettrici
 ES Juego de conectores eléctricos
 CN 接线端子

600
PCS

MIX

BRASS
MOSIADZ



Connector female / Złącze żeńskie: 2.8 mm, 4.8 mm, 6.4 mm (x100 PCS);
 Connector male / Złącze męskie: 2.8 mm, 4.8 mm, 6.4 mm (x100 PCS)

YATO

YT-068684

24

EN Terminal assortment
 PL Zestaw złącz elektrycznych
 DE Kabelschuh-Set
 RU Набор электрических клемм
 CZ Sada elektrických konektorů
 HU Elektromos csatlakozókészlet

RO Set papuci auto
 FR Jeu de cosses de câbles
 IT Kit di connettori elettrici
 ES Juego de conectores eléctricos
 CN 接线端子

750
PCS

MIX

BRASS
MOSIADZ



Connector female / Złącze żeńskie: 2.8 mm, 4.8 mm, 6.4 mm (x100 PCS);
 Connector male / Złącze męskie: 2.8 mm, 4.8 mm, 6.4 mm (x100 PCS);
 Connector with hole / Złącze z oczkiem: Ø3.2 mm, Ø5.2 mm, Ø6.2 mm, Ø8.2 mm, Ø10.5 mm (x30 PCS)

YATO

YT-068685

24

EN Insulated ferrules assortment
PL Zestaw końcówek i konektorów kablowych
DE Kabelschuh- und Verbinder-Set
RU Набор кабельных наконечников и коннекторов
CZ Sada kabelových koncovek a konektorů
HU Végződések és csatlakozókészlet

RO Set conectori
FR Jeu de coses de câbles
IT Set di terminali e connettori per cavi
ES Set de puntas y conectores de cable
CN 欧式接线端子

685
PCS

MIX



0.5 mm (50 PCS), 0.75 mm (50 PCS), 1 mm (100 PCS), 1.5 mm (250 PCS),
2.5 mm (150 PCS), 4 mm (50 PCS), 6 mm (25 PCS), 10 mm (10 PCS)

YATO
YT-06895 5/20

EN Crimp bootlace ferrules assortment
PL Zestaw końcówek kablowych
DE Aderendhülsen Set
RU Набор кабельных наконечников
CZ Sada kabelových koncovek
HU Kábelcsaru készlet

RO Kit cepete sertizat cabluri fara izolare
FR Jeu de coses de câbles
IT Set di terminali
ES Juego casquillos de cable
CN 接线端子

1000
PCS

MIX

BRASS
MOSIADZ



0.5 mm (ferrule length / długość okucia: 6 mm),
0.75 mm (ferrule length / długość okucia: 6 mm),
1 mm (ferrule length / długość okucia: 6 mm),

1.5 mm (ferrule length / długość okucia: 7 mm),
2.5 mm (ferrule length / długość okucia: 7 mm) (x200 PCS)

YATO
YT-06896 100

EN Insulated ferrules assortment
PL Zestaw końcówek i konektorów kablowych
DE Kabelschuh- und Verbinder-Set
RU Набор кабельных наконечников и коннекторов
CZ Sada kabelových koncovek a konektorů
HU Végződések és csatlakozókészlet

RO Set conectori
FR Jeu de coses de câbles
IT Set di terminali e connettori per cavi
ES Set de puntas y conectores de cable
CN 欧式接线端子

1200
PCS

MIX

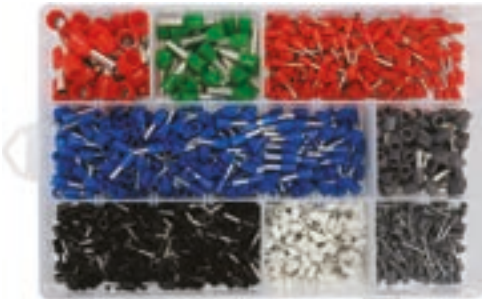

E1012 red / czerwone (25 PCS), E6012 green / zielone (25 PCS), E1008 red / czerwone (200 PCS),
E2508 blue / niebieskie (250 PCS), E4010 grey / szare (50 PCS), E1508 black / czarne (250 PCS),
E0508 white / białe (200 PCS), E7508 grey / szare (200 PCS)

YATO
YT-068914 20

EN Terminal connectors
PL Zestaw szybkozłączy elektrycznych
DE Kabelschuhe schnellkupplung kabelklemme
RU Набор экспресс-клемм
CZ Rychlopřipojky elektrických konektorů
HU Gyors csatlakozó auto

RO Conector rapid pt. auto
FR Connecteur rapide
IT Connettori terminali
ES Conector rapido electrico
CN 连接片组套

50
PCS

MIX

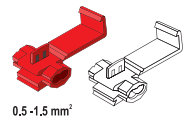

0.5-1.5 mm²

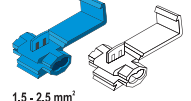

1.5 - 2.5 mm²

0.5-1.5 mm² (25 PCS), 1.5-2.5 mm² (25 PCS)

YATO
YT-06868 5/20

EN Heat-shrink tubing set
PL Zestaw koszulek termokurczliwych
DE Schrumpfschlauch-Set
RU Набор термоусадочных трубок
CZ Sada smršťovacích bužirek
HU Zsugorcso készlet

RO Set tuburi termocontractabile
FR Jeu de gaines thermorétractables
IT Kit guaine termorestringenti
ES Kit de tubos termorretráctiles
CN 热收缩管

100
PCS

MIX

max °C
125

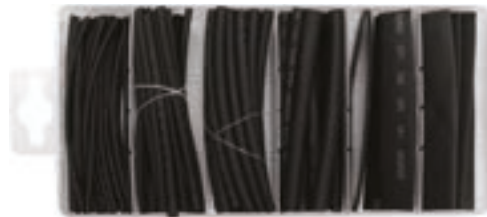

Ø1.5x100 mm (30 PCS), Ø2.5x100 mm (30 PCS), Ø4x100 mm (20 PCS),
Ø6x100 mm (10 PCS), Ø10x100 mm (6 PCS), Ø13x100 mm (4 PCS)

YATO
YT-068661 24

EN Heat-shrink tubing set
PL Zestaw koszulek termokurczliwych
DE Schrumpfschlauch-Set
RU Набор термоусадочных трубок
CZ Sada smršťovacích bužirek
HU Zsugorcso készlet

RO Set tuburi termocontractabile
FR Jeu de gaines thermorétractables
IT Kit guaine termorestringenti
ES Kit de tubos termorretráctiles
CN 热收缩管

100
PCS

MIX

max °C
125



Ø1.5x100 mm (30 PCS), Ø2.5x100 mm (30 PCS), Ø4x100 mm (20 PCS),
Ø6x100 mm (10 PCS), Ø10x100 mm (6 PCS), Ø13x100 mm (4 PCS)

YATO
YT-068667 24

EN Heat-shrink tubing set
PL Zestaw koszulek termokurczliwych
DE Schrumpfschlauch-Set
RU Набор термоусадочных трубок
CZ Sada smršťovacích bužirek
HU Zsugorcso készlet

RO Set tuburi termocontractabile
FR Jeu de gaines thermorétractables
IT Kit guaine termorestringenti
ES Kit de tubos termorretráctiles
CN 热收缩管



127
PCS

MIX

max °C
125

max
600V



Ø2x40 mm, Ø2.5x40 mm, Ø3.5x40 mm, Ø5x40 mm, Ø7x80 mm, Ø10x80 mm, Ø13x85 mm

YATO
YT-06866 5/20

EN Heat-shrink tubing set
 PL Zestaw koszulek termokurczliwych
 DE Schrumpfschlauch-Set
 RU Набор термоусадочных трубок
 CZ Sada smršťovacích bužírek
 HU Zsugorcsó készlet

RO Set tuburi termocontractabile
 FR Jeu de gaines thermorétractables
 IT Kit guaine termorestringenti
 ES Kit de tubos termorretráctiles
 CN 热收缩管

128
PCS
MIX
max°C
125



Ø2.5x8 mm (40 PCS), Ø3.5x80 mm (32 PCS), Ø5x80 mm (24 PCS),
 Ø7x80 mm (16 PCS), Ø10x80 mm (8 PCS), Ø13x80 mm (8 PCS)

YATO
YT-068668 24

EN Heat-shrink tubing set
 PL Zestaw koszulek termokurczliwych
 DE Schrumpfschlauch-Set
 RU Набор термоусадочных трубок
 CZ Sada smršťovacích bužírek
 HU Zsugorcsó készlet

RO Set tuburi termocontractabile
 FR Jeu de gaines thermorétractables
 IT Kit guaine termorestringenti
 ES Kit de tubos termorretráctiles
 CN 热收缩管

171
PCS
MIX
max°C
125



Ø2x30 mm (100 PCS), Ø4x60 mm (10 PCS), Ø4.5x60 mm (10 PCS), Ø5x60 mm (8 PCS), Ø6x60 mm (6 PCS),
 Ø8x90 mm (11 PCS), Ø9x90 mm (11 PCS), Ø12x90 mm (7 PCS), Ø18x90 mm (7 PCS), Ø10x1000 mm (1 PCS)

YATO
YT-06867 24

EN Heat-shrink tubing with glue set
 PL Zestaw koszulek termokurczliwych z klejem
 DE Schrumpfschlauch-Set mit Kleber
 RU Набор термоусадочных трубок с клеем
 CZ Sada smršťovacích bužírek s lepidlem
 HU Ragasztós zsugorcsó készlet

RO Set tub termocontractabil cu lipici
 FR Jeu de gaines thermorétractables avec adhésif
 IT Kit guaine termorestringenti con adesivo
 ES Kit de tubos termorretráctiles adhesivos
 CN 带胶热收缩管

270
PCS
MIX
max°C
125
HERMETIC
HERMETIZĂZINE



Ø1.6x45 mm (70 PCS), Ø2.4x45 mm (80 PCS), Ø3.2x45 mm (80 PCS),
 Ø4.8x90 mm (20 PCS), Ø6.3x90 mm (12 PCS), Ø9.5x90 mm (8 PCS)

YATO
YT-068671 60

EN Heat-shrink tubing with glue set
 PL Zestaw koszulek termokurczliwych z klejem
 DE Schrumpfschlauch-Set mit Kleber
 RU Набор термоусадочных трубок с клеем
 CZ Sada smršťovacích bužírek s lepidlem
 HU Ragasztós zsugorcsó készlet

RO Set tub termocontractabil cu lipici
 FR Jeu de gaines thermorétractables avec adhésif
 IT Kit guaine termorestringenti con adesivo
 ES Kit de tubos termorretráctiles adhesivos
 CN 带胶热收缩管

530
PCS
MIX
max°C
125



Ø1.5x45 mm (80 PCS), Ø2x45 mm (160 PCS), Ø3x45 mm (60 PCS),
 Ø4x45 mm (100 PCS), Ø5x45 mm (30 PCS), 6x45 mm (20 PCS), Ø8x45 mm (20 PCS), Ø10x45 mm (60 PCS)

YATO
YT-068672 60

EN Car fuse assortment
 PL Zestaw bezpieczników
 DE KFZ-Sicherungs-Set
 RU Набор предохранителей
 CZ Sada pojistek
 HU Biztosítékkészlet

RO Set sigurante
 FR Ensemble de fusible
 IT Kit di fusibili lamellari
 ES Conjunto de fusibles
 CN 保险插片

24
PCS
MAXI



20 A, 30 A, 40 A, 50 A, 60 A, 70 A, 80 A, 100 A (x3 PCS)

YATO
YT-83140 24

EN Car fuse assortment
 PL Zestaw bezpieczników
 DE KFZ-Sicherungs-Set
 RU Набор предохранителей
 CZ Sada pojistek
 HU Biztosítékkészlet

RO Set sigurante
 FR Ensemble de fusible
 IT Kit di fusibili lamellari
 ES Conjunto de fusibles
 CN 保险插片

92
PCS
STANDARD
FUSE
PULLER
SCHNÄGEL
BEZPEČENÍKOV



5 A, 10 A, 15 A, 20 A, 25 A, 30 A (x15 PCS); tester 6-24 V

YATO
YT-83142 24

EN Car fuse assortment
 PL Zestaw bezpieczników
 DE KFZ-Sicherungs-Set
 RU Набор предохранителей
 CZ Sada pojistek
 HU Biztosítékkészlet

RO Set sigurante
 FR Ensemble de fusible
 IT Kit di fusibili lamellari
 ES Conjunto de fusibles
 CN 保险插片

97
PCS
STANDARD
FUSE
PULLER
SCHNÄGEL
BEZPEČENÍKOV



3 A, 5 A, 7.5 A, 10 A, 15 A, 20 A, 25 A, 30 A (x12 PCS)

YATO
YT-83141 24

EN Car fuse assortment
 PL Zestaw bezpieczników
 DE KFZ-Sicherungs-Set
 RU Набор предохранителей
 CZ Sada pojistek
 HU Biztosítékkészlet

RO Set sigurante
 FR Ensemble de fusible
 IT Kit di fusibili lamellari
 ES Conjunto de fusibles
 CN 保险插片

100
PCS
MINI



7.5 A (10 PCS), 10 A (20 PCS), 15 A (20 PCS), 20 A (20 PCS), 25 A (20 PCS), 30 A (10 PCS)

YATO
YT-83145 12/60

EN Car fuse assortment
PL Zestaw bezpieczników
DE KFZ-Sicherungs-Set
RU Набор предохранителей
CZ Sada pojistek
HU Biztosítékészlet

RO Set sigurante
FR Ensemble de fusible
IT Kit di fusibili lamellari
ES Conjunto de fusibles
CN 120汽用保险片

120
PCS

MINI



5A, 10A, 15A, 20A, 25A, 30A (x20 PCS)

YATO
YT-83146 12

EN Car fuse assortment
PL Zestaw bezpieczników
DE KFZ-Sicherungs-Set
RU Набор предохранителей
CZ Sada pojistek
HU Biztosítékészlet

RO Set sigurante
FR Ensemble de fusible
IT Kit di fusibili lamellari
ES Conjunto de fusibles
CN 保险插片

121
PCS

MINI



5A, 10A, 15A, 20A, 25A, 30A (x20 PCS)

YATO
YT-83143 24

EN Cable access
PL Przepychacz przewodów
DE Kabel Einziehhilfe

RU Устройство для протяжки кабеля
CZ Pero protahovací
HU Kábelhúzó szalag

RO Dispozitiv de tragere a cablurilor
FR Les baguettes tire fil
IT Dispositivo tiracavi

ES Guía de fibra de vidrio
CN 玻璃纤维杆

14
PCS

10x1
m

BRASS
MOSIADZ

FIBERGLASS
WŁÓKNO
SZKLANE



YATO
YT-23200 12/36

EN Cable access accessories
PL Akcesoria do przepychacza do przewodów
DE Kabel Einziehhilfe Accessoires
RU Устройство для протяжки кабеля - аксессуары
CZ Pero protahovací příslušenství
HU Kábelhúzó szalag kiegészítők

RO Accesorii pt. dispozitiv de tragere a cablurilor
FR Les baguettes tire fil accessoires
IT Accessori per il dispositivo tiracavi
ES Guía de fibra de vidrio accesorios
CN 铜接头



5
PCS

BRASS
MOSIADZ



YATO
YT-23201 24/144

EN Cable access
PL Przepychacz przewodów
DE Kabel Einziehhilfe
RU Устройство для протяжки кабеля
CZ Pero protahovací
HU Kábelhúzó szalag
RO Dispozitiv de tragere a cablurilor
FR Les baguettes tire fil
IT Dispositivo tiracavi
ES Guía de fibra de vidrio
CN 穿线器



3x1.5
mm

STEEL
STAL

ABS

BRAKE
HAMULEC



YATO
YT-25010 L [m] 15.3 6/12

EN Cable access
PL Przepychacz przewodów
DE Kabel Einziehhilfe
RU Устройство для протяжки кабеля
CZ Pero protahovací
HU Kábelhúzó szalag
RO Dispozitiv de tragere a cablurilor
FR Les baguettes tire fil
IT Dispositivo tiracavi
ES Guía de fibra de vidrio
CN 穿线器



30m

∅
4.0
mm

FIBERGLASS
WŁÓKNO
SZKLANE





YATO
YT-25015 L [m] 30 ∅ [mm] 4 10

8

**Hammers, chisels,
punches & axes
Młotki, dłuta,
przecinaki i siekiery**



Machinist hammers Młotki ślusarskie		158
---	---	-----

Ball pein hammers & sets Młotki blacharskie i zestawy		161
---	---	-----

Stoning hammers Młotki kamieniarskie		158
--	---	-----

Chisels, cold chisels & punches Dłuta, przecinaki i przebijaki		161-164
--	---	---------

Hammers with tubular steel handle Młotki z trzonkiem rurowym		159
--	---	-----

Wood chisels & sets Dłuta stolarskie i zestawy	161
Cold chisels Przecinaki	162
Pin punches Wybijaki	162
Punches Punktaki	162
Cold chisel & punch sets Zestawy przecinaków i punktaków	163

Claw hammers Młotki szewskie	159
Roofing hammers Młotki ciesielskie	159
Mason's hammers Młotki murarskie	159
Plasterer's hatchets Toporki tynkarskie	159

Wrecking bars Łomy		164-165
------------------------------	---	---------

Fully drop forged hammers Młotki monolityczne kute		159
--	---	-----

Axes Siekiery		165
-------------------------	---	-----

Claw hammers Młotki szewskie	159
Roofing hammers Młotki ciesielskie	159
Mason's hammers Młotki murarskie	159

Adzes Ciosła		166
------------------------	--	-----

Rubber mallets Młotki gumowe		160
--	---	-----

Forestry tools Narzędzia leśne		166-167
--	---	---------



Dead blow hammers Młotki bezodrzutowe		160
---	---	-----

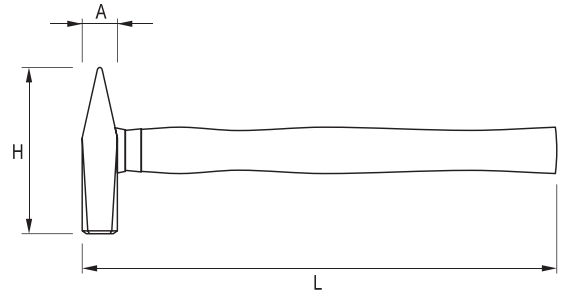

EN Machinist hammer
 PL Młotek ślusarski
 DE Schlosserhammer
 RU Молоток слесарный
 CZ Zámečnické kladívko
 HU Vaskalapács
 RO Ciocan de lăcătușerie
 FR Marteau serrurier
 IT Martello da aggiustatore
 ES Martillo
 CN 钳工锤

DIN 1041 



- High quality wooden handle
- Forged carbon steel head
- Safety protection steel ring
- Drewniany trzonek wysokiej jakości
- Kuty obuch ze stali węglowej
- Klin pierścieniowy zapewniający bezpieczeństwo

YATO 	m [g]	L [mm]	A [mm]	H [mm]	
YT-4491	100	260	15	80	12/120
YT-4492	200	280	20	93	6/60
YT-4493	300	300	21	103	6/60
YT-4494	400	310	23	111	6/48
YT-4495	500	320	26	118	6/36



YATO 	m [g]	L [mm]	A [mm]	H [mm]	
YT-4496	600	330	28	119	6/36
YT-4497	800	350	31	125	6/24
YT-4498	1000	360	35	132	6/24
YT-4499	1500	380	40	143	6/12
YT-4500	2000	400	45	153	6/12

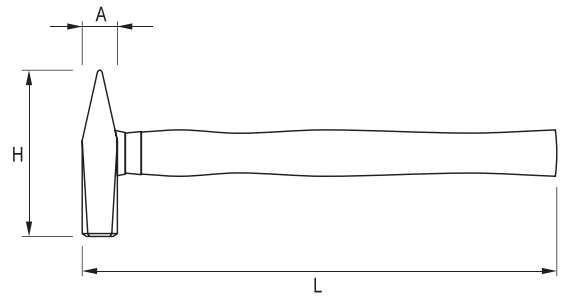

EN Machinist hammer
 PL Młotek ślusarski
 DE Schlosserhammer
 RU Молоток слесарный
 CZ Zámečnické kladívko
 HU Vaskalapács
 RO Ciocan de lăcătușerie
 FR Marteau serrurier
 IT Martello da aggiustatore
 ES Martillo
 CN 钳工锤

DIN 1041 



- High quality wooden handle
- Forged carbon steel head
- Safety protection steel ring
- Drewniany trzonek wysokiej jakości
- Kuty obuch ze stali węglowej
- Klin pierścieniowy zapewniający bezpieczeństwo

YATO 	m [g]	L [mm]	A [mm]	H [mm]	
YT-4501	100	260	15	82	12/120
YT-4502	200	280	19	95	6/60
YT-4503	300	300	23	105	6/60
YT-4504	400	310	25	112	6/48
YT-4505	500	320	27	118	6/36



YATO 	m [g]	L [mm]	A [mm]	H [mm]	
YT-4506	600	330	29	122	6/36
YT-4507	800	350	33	135	6/24
YT-4508	1000	360	36	135	6/24
YT-4509	1500	380	42	145	6/12
YT-4510	2000	400	47	155	6/12

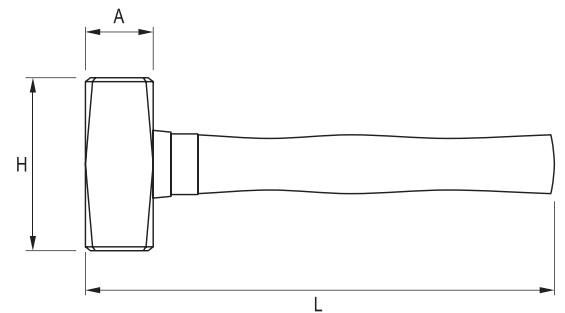

EN Safety stoning hammer
 PL Młotek kamieniarski
 DE Fäustel
 RU Молоток каменщика
 CZ Palička kovová
 HU Kőbőrő kalapács
 RO Ciocan pt. zidarie
 FR Marteau de tailleur de pierres
 IT Martello da aggiustatore
 ES Martillo
 CN 石工锤

DIN 6475 



- High quality wooden handle
- Forged carbon steel head
- Safety protection steel ring
- Drewniany trzonek wysokiej jakości
- Kuty obuch ze stali węglowej
- Klin pierścieniowy zapewniający bezpieczeństwo

YATO 	m [g]	L [mm]	A [mm]	H [mm]	
YT-4550	1000	260	40	95	6/24
YT-4551	1250	260	43	100	6/24

YATO 	m [g]	L [mm]	A [mm]	H [mm]	
YT-4552	1500	280	45	110	6/12
YT-4553	2000	300	50	120	6/12

EN Claw hammer
PL Młotek szewski
DE Schusterhammer
RU Молоток гвоздодёр
CZ Ševcovské kladívko
HU Cipész kalapács
RO Ciocan de cizmărie
FR Marteau de cordonnier
IT Martello calzolaio
ES Martillo sacador
CN 羊角锤



- High quality steel handle
- Forged carbon steel head hardened and tempered
- Stalowy trzonek
- Bijak ze stali węglowej, kuty, ulepszony cieplnie

YATO	m [g]	L [mm]	A [mm]	H [mm]	☐
YT-4560	450	318	30	130	6/24

EN Mason's hammer, type B
PL Młotek murarski berliński
DE Berliner Mauerhammer
RU Молоток каменщика широкий
CZ Zednické kladívko berlinské
HU Kőműves kalapács, berlini típus
RO Ciocan de zidărie tip Berlin
FR Marteau de maçon
IT Martello muratore tipo Berlin
ES Martillo de albañil de Berlín
CN 泥工锤

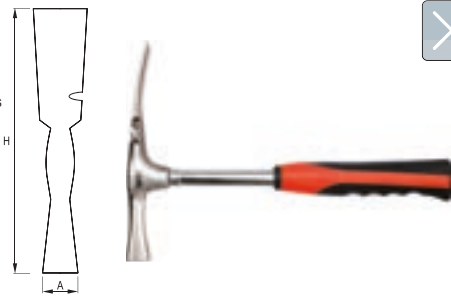

- High quality steel handle
- Forged carbon steel head hardened and tempered
- Stalowy trzonek
- Bijak ze stali węglowej, kuty, ulepszony cieplnie

YATO	m [g]	L [mm]	A [mm]	H [mm]	☐
YT-4562	600	315	24x23	200	6/24

EN Plasterer's hatchet
PL Toperek tynkarski
DE Gipserbeil
RU Топор штукатурный
CZ Omítací sekýrka
HU Kőműves szekerce
RO Toporaş de tencuit
FR Hachette de plâtrier
IT Martello con accetta
ES Hacha enlucido
CN 多用斧



- High quality steel handle
- Forged carbon steel head hardened and tempered
- Stalowy trzonek
- Bijak ze stali węglowej, kuty, ulepszony cieplnie

YATO	m [g]	L [mm]	A [mm]	H [mm]	☐
YT-4564	600	315	25x20	175	6/24

EN Roofing hammer
PL Młotek ciesielski
DE Latthammer Geschmiedet
RU Молоток жестящика
CZ Tesařské kladívko
HU Ácskalapács
RO Ciocan de dulgherie
FR Marteau de charpentier
IT Martello per carpentiere
ES Martillo techumbre
CN 连体羊角锤



- High quality steel handle
- Forged carbon steel head hardened and tempered
- Stalowy trzonek
- Bijak ze stali węglowej, kuty, ulepszony cieplnie

YATO	m [g]	L [mm]	A [mm]	H [mm]	☐
YT-4571	600	331	25x25	165	6/24

EN Roofing hammer
PL Młotek ciesielski
DE Latthammer Geschmiedet
RU Молоток жестящика
CZ Tesařské kladívko
HU Ácskalapács
RO Ciocan de dulgherie
FR Marteau de charpentier
IT Martello per carpentiere
ES Martillo techumbre
CN 独角锤



- High quality steel handle
- Forged carbon steel head hardened and tempered
- Stalowy trzonek
- Bijak ze stali węglowej, kuty, ulepszony cieplnie

YATO	m [g]	L [mm]	A [mm]	H [mm]	☐
YT-4561	600	318	25x25	165	6/24

EN Mason's hammer, type R
PL Młotek murarski reński
DE Mauerhammer Rheinische Form
RU Молоток каменщика узкий
CZ Zednické kladívko renské
HU Kőműves kalapács, rajnai típus
RO Ciocan de zidărie (tip ren)
FR Marteau de maçon
IT Martello muratore tipo rin
ES Martillo de albañil de Rin
CN 泥工锤



- High quality steel handle
- Forged carbon steel head hardened and tempered
- Stalowy trzonek
- Bijak ze stali węglowej, kuty, ulepszony cieplnie

YATO	m [g]	L [mm]	A [mm]	H [mm]	☐
YT-4563	600	315	23x23	170	6/24

EN Claw hammer
PL Młotek szewski
DE Schusterhammer
RU Молоток гвоздодёр
CZ Ševcovské kladívko
HU Cipész kalapács
RO Ciocan de cizmărie
FR Marteau de cordonnier
IT Martello calzolaio
ES Martillo sacador
CN 连体羊角锤



- High quality steel handle
- Forged carbon steel head hardened and tempered
- Stalowy trzonek
- Bijak ze stali węglowej, kuty, ulepszony cieplnie

YATO	m [g]	L [mm]	A [mm]	H [mm]	☐
YT-4570	450	315	30	130	6/24

EN Mason's hammer, type R
PL Młotek murarski reński
DE Mauerhammer Rheinische Form
RU Молоток каменщика узкий
CZ Zednické kladívko renské
HU Kőműves kalapács, rajnai típus
RO Ciocan de zidărie (tip ren)
FR Marteau de maçon
IT Martello muratore tipo rin
ES Martillo de albañil de Rin
CN 连体R型泥工锤

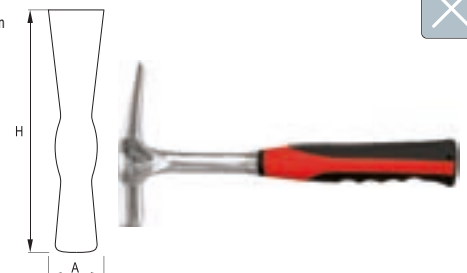

- High quality steel handle
- Forged carbon steel head hardened and tempered
- Stalowy trzonek
- Bijak ze stali węglowej, kuty, ulepszony cieplnie

YATO	m [g]	L [mm]	A [mm]	H [mm]	☐
YT-4573	600	382	25x24	158	6/24

EN Rubber mallet with fibreglass, TPR handle
 PL Młotek gumowy z trzonkiem z włókna szklanego
 DE Gummihammer mit Fiberglasstiel
 RU Киянка резиновая со стеклопластиковой ручкой
 CZ Pevňové kladívko
 HU Gumikalapács
 RO Ciocan de cauciuc
 FR Maillet caoutchouc
 IT Martello mazzuola in gomma
 ES Mazo de goma
 CN 纤维柄橡胶锤



YATO	m [g]	L [mm]	Ø [mm]	H [mm]	
YT-4594	440	340	50	87.5	6/36

EN Rubber mallet with wooden handle
 PL Młotek gumowy z drewnianym trzonkiem
 DE Gummihammer mit Holzstiel
 RU Молоток резиновый
 CZ Pevňové kladívko
 HU Gumikalapács
 RO Ciocan de cauciuc
 FR Maillet caoutchouc
 IT Martello mazzuola in gomma
 ES Mazo de goma
 CN 木柄橡胶锤



YATO	m [g]	L [mm]	Ø [mm]	H [mm]	
YT-4601	340	291	49	79.5	12/48
YT-4602	370	300	50	87.5	6/36
YT-4603	580	341	58	96	6/36
YT-4604	780	341	63	117	6/24
YT-4605	980	345	72	122	6/24

EN Dead blow mallet
 PL Młotek bezodrzutowy
 DE Rückschlagsfreier Schonhammer
 RU Молоток безинерционный
 CZ Palička nárazová plněná celogumová
 HU Visszarúgás mentes gumikalapács
 RO Ciocan cu absorbție
 FR Maillet sans recul
 IT Martello morto colpo
 ES Martillo sin reacción
 CN 防震无回弹橡胶锤

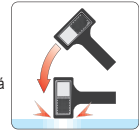

YATO	m [g]	L [mm]	Ø [mm]	H [mm]	
YT-4620	740	300	44.5	100	4/24
YT-4622	900	336	53.5	100	4/24
YT-4623	1300	350	59	118.5	3/12

8

EN Dead blow mallet
 PL Młotek bezodrzutowy
 DE Rückschlagsfreier Schonhammer
 RU Молоток безинерционный
 CZ Palička nárazová plněná celogumová
 HU Visszarúgás mentes gumikalapács
 RO Ciocan cu absorbție
 FR Maillet sans recul
 IT Martello morto colpo
 ES Martillo sin reacción
 CN 防震无回弹橡胶锤



YATO	m [g]	L [mm]	[mm]	
YT-46270	2400	490	70x70x140	2/6
YT-46273	5500	900	105x105x180	2

EN Dead blow mallet
 PL Młotek bezodrzutowy
 DE Rückschlagsfreier Schonhammer
 RU Молоток безинерционный
 CZ Palička nárazová plněná celogumová
 HU Visszarúgás mentes gumikalapács
 RO Ciocan cu absorbție
 FR Maillet sans recul
 IT Martello morto colpo
 ES Martillo sin reacción
 CN 尼龙安装锤



YATO	m [g]	L [mm]	Ø [mm]	H [mm]	
YT-4624	265	318	30	94	10/40
YT-4625	430	350	40	100	6/36
YT-4626	490	348	45	110	6/36

EN Dead blow mallet
 PL Młotek bezodrzutowy
 DE Rückschlagsfreier Schonhammer
 RU Молоток безинерционный
 CZ Palička nárazová plněná celogumová
 HU Visszarúgás mentes gumikalapács
 RO Ciocan cu absorbție
 FR Maillet sans recul
 IT Martello morto colpo
 ES Martillo sin reacción
 CN 防震无回弹橡胶锤



YATO	m [g]	L [mm]	Ø [mm]	H [mm]	
YT-46190	300	225	20	75	6/36
YT-46191	700	330	32	110	6/24

EN PU & nylon heads mallet
 PL Młotek blacharski
 DE Schonhammer mit PU & Nylon-Schlagkopf
 RU Молоток рихтовочный
 CZ Palička klempářská
 HU Vaskalapács
 RO Ciocan tinichigerie cap PU / nylon
 FR Marteau spécial en PU / nylon
 IT Martello per lamiera
 ES Martillo chapista
 CN 木柄安装锤



YATO	m [g]	L [mm]	Ø [mm]	H [mm]	
YT-4630	150	250	22	75	6/48
YT-4631	250	280	28	85	6/36
YT-4632	340	315	35	95	6/36
YT-4633	660	350	45	105	6/24
YT-4634	1340	380	60	132	4/16

EN Aluminum hammer
 PL Młotek aluminiowy
 DE Aluminium-Hammer
 RU Алюминиевый молоток
 CZ Hliníkové kladivo
 HU Alumínium kalapács
 RO Ciocan aluminiu
 FR Marteau en aluminium
 IT Martello in alluminio
 ES Martillo de aluminio
 CN 铝锤



YATO	m [g]	L [mm]	Ø [mm]	H [mm]	
YT-45280	150	280	30	80	6/36
YT-45281	300	300	40	98	6/36
YT-45282	580	320	50	105	6/24

EN Mounting hammer
 PL Młotek montażowy z wymiennymi końcówkami
 DE Montagehammer
 RU Установка молоток
 CZ Montážní kladivo
 HU Szerelő kalapács
 RO Montare ciocan
 FR Marteau de montage
 IT Martello di montaggio con punte intercambiabili
 ES Martillo de montaje
 CN 铝合金多用安装锤

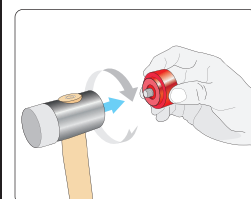

Grey circle	Grey circle	HRC: 65 +/-5
Red circle	Red circle	HRC: 72 +/-5
Blue circle	Blue circle	HRC: 73 +/-5
White circle	White circle	HRC: 80 +/-5
Black circle	Black circle	HRC: 95 +/-5

YATO	
YT-45905	8

EN Auto body fender set
PL Komplet młotków blacharskich
DE Karosserie-Ausbeulsatz
RU Молотки рихтовочные
CZ Souprava klempířských kladívek
HU Bádógos kalapács készlet
RO Set de ciocane de tablă
FR Set pour carrossier
IT Martello per lamiera
ES Juego de mazos de hojalatero
CN 钣金工具组套



7
PCS
DROPPED FORGED KÜTE
HICKORY WOOD DREWNO HIKOROWE

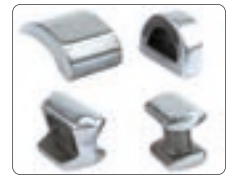

YATO	m [g]	
YT-4590	4900	4

EN Ball pein hammer
PL Młotek blacharski
DE Ausbeulhammer
RU Молоток рихтовочный

CZ Klempířské kladívko
HU Bádógos kalapács
RO Ciocan pt. tabla
FR Marteau à panne ronde

IT Martello per lamiera
ES Martillo de hojalatero
CN 纤维柄圆头锤

FIBERGLASS WŁOKNO SZKLANE



YATO	m [g]	L [mm]	A [mm]	H [mm]	
YT-4515	225	280	26	80	6/36
YT-4516	450	315	34	100	6/24
YT-4518	900	380	40	125	6/12

EN Wood chisel
PL Dłuto stolarskie
DE Stechbeitel
RU Стамеска по дереву
CZ Rezbářské dláto
HU Asztalos véső

RO Dalta de tâmplărie
FR Ciseaux à bois
IT Scalpello per falegname
ES Cincel para madera
CN 木柄木工凿

HRC 56-62
CrV 60



YATO	Size / Rozmiar [mm]	
YT-6241	8	10/60
YT-6242	10	10/60
YT-6243	12	10/60
YT-6244	14	10/60
YT-6245	15	10/60
YT-6246	16	10/60
YT-6247	18	10/60

YATO	Size / Rozmiar [mm]	
YT-6248	20	10/60
YT-6249	22	10/60
YT-6251	25	10/60
YT-6253	28	10/60
YT-6256	35	10/60
YT-6258	38	10/60

EN Chisel set
PL Zestaw dłut stolarskich
DE Stechbeitel Set
RU Набор стамесок
CZ Sada dlát
HU Hidegvágó készlet

RO Set de dălji
FR Set de ciseaux à bois
IT Set scalpelli per falegname
ES Juego de cinceles
CN 木柄木工凿组套

4 PCS
10 mm
16 mm
20 mm
25 mm
HRC 58-60
CrV 60



YATO	Size / Rozmiar [mm]	
YT-6260	10, 16, 20, 25	5/20

EN Ball pein hammer
PL Młotek blacharski
DE Ausbeulhammer
RU Молоток рихтовочный

CZ Klempířské kladívko
HU Bádógos kalapács
RO Ciocan pt. tabla
FR Marteau à panne ronde

IT Martello per lamiera
ES Martillo de hojalatero
CN 胡桃木柄圆头锤

WOODEN HANDLE DREWNIANA REKOWJESC



YATO	m [g]	L [mm]	A [mm]	H [mm]	
YT-4519	225	295	26	80	6/36
YT-4520	450	335	35	100	6/24
YT-4521	680	360	36	115	6/12
YT-4522	900	380	40	125	6/12

EN Half-round wood chisel
PL Dłuto półokrągłe do drewna
DE Meißel für Holz halbrund
RU Полуокруглое зубило по дереву
CZ Půlkulaté dláto do dřeva
HU Félkör alakú fávéső

RO Dalta semirotunda
FR Ciseau à bois semi-circulaire
IT Scalpello semicircolare per legno
ES Cincel semicircular para madera
CN 半圆木凿

#55



YATO	Size / Rozmiar [mm]	
YT-62821	10	12/48
YT-62822	12	12/48
YT-62823	14	12/48
YT-62824	16	12/48
YT-62825	19	12/48
YT-62826	25	12/48
YT-62827	32	12/48
YT-62828	38	12/48

EN Chisel set
PL Zestaw dłut stolarskich
DE Stechbeitel Set
RU Набор стамесок
CZ Sada dlát
HU Hidegvágó készlet

RO Set de dălji
FR Set de ciseaux à bois
IT Set scalpelli per falegname
ES Juego de cinceles
CN 木柄木工凿组套

3 PCS
16 mm
25 mm
32 mm
CrV



YATO	Size / Rozmiar [mm]	
YT-6280	16, 25, 32	10/30

EN Chisel set
 PL Zestaw dłut stolarskich
 DE Stechbeitel Set
 RU Набор стамесок
 CZ Sada dlát
 HU Hidegvágó készlet
 RO Set de dălți
 FR Set de ciseaux à bois
 IT Set scalpelli per falegname
 ES Juego de cinceles
 CN 木锛组套

4 PCS 10 mm 12 mm 16 mm 20 mm CrV



YATO	Size / Rozmiar [mm]	
YT-6281	10, 12, 16, 20	6/24

EN Cold chisel with protection
 PL Przecinak z osłoną
 DE Schlitzmeißel mit Handschutz
 RU Зубило с протектором
 CZ Plochý sekáč (z krytem)
 HU Hidegvágó, lapos (védőfejjel)
 RO Dălță - tăietor plată (cu apărătoare)
 FR Burin
 IT Scalpello con protezione
 ES Cincel plano (con protector)
 CN 石工凿

25x300 mm CrV



YATO	L [mm]	
YT-4700	300	4/24

EN Chisel and punch set
 PL Zestaw przecinaków i punktaków
 DE Trennmeißel- und Durchtreiber-Satz
 RU Зубила и пробойники с протектором
 CZ Sekáče a průbojníky
 HU Véső és lyukasztó készlet
 RO Set dălți de impact
 FR Kit de burins et perçoirs
 IT Scalpelli e bulino
 ES Juego de cinceles de acero templado y punzones
 CN 冲凿组套

6 PCS 180 mm CrV



12, 16, 19 mm;
 Ø 3, 4 mm;
 Ø 3 mm

YATO	L [mm]	
YT-4710	180	10/20

EN Cold chisel
 PL Przecinak płaski
 DE Flach Meißel
 RU Зубило плоское
 CZ Sekáč plochý
 HU Laposvágó

RO Dălta lata
 FR Burin plat
 IT Scalpello piatto
 ES Tajadera en frío
 CN 扁铲

40Cr



YATO	L [mm]	Chisel width / Szerokość przecinaka [mm]	
YT-47020	200	20	10/40
YT-47021	250	22	10/40
YT-47022	300	25	10/40

EN Taper punch
 PL Dobijak stożkowy
 DE Durchtreiber
 RU Пробойник конусный
 CZ Průbojník
 HU Lyukasztó

RO Dorn conic
 FR Matoir
 IT Scalpello a punta
 ES Retacador de cono
 CN 锥形冲子

140 mm CrV 6150



YATO	L [mm]	Taper punch / Średnica wybijaka stożkowego [mm]	
YT-47152	140	2	20/120

EN Cold chisel
 PL Przecinak płaski
 DE Flach meißel
 RU Зубило плоское
 CZ Sekáč plochý
 HU Laposvágó

RO Dălta lata
 FR Burin
 IT Scalpello a punta
 ES Tajadera en frío
 CN 凿子

CrV 6150



YATO	L [mm]	Chisel width / Szerokość przecinaka [mm]	
YT-47147	142	10.0	20/120
YT-47148	152	12.5	20/120
YT-47149	172	16.0	20/120

EN Taper punch
 PL Wybijał równoległy
 DE Durchtreiber
 RU Пробойник конусный
 CZ Průbojník
 HU Lyukasztó

RO Dorn conic
 FR Percuteur
 IT Scalpello a punta
 ES Retacador de cono
 CN 锥形冲子

150 mm CrV 6150



YATO	L [mm]	Pin diameter / Średnica grotu [mm]	
YT-47141	150	1.5	20/120
YT-47142	150	3.0	20/120
YT-47143	150	4.0	20/120
YT-47144	150	5.0	20/120
YT-47145	150	6.0	20/120
YT-47146	150	8.0	20/120

EN Center punch
 PL Punktak
 DE Körner
 RU Пробойник - керн
 CZ Důlčák
 HU Pontozó

RO Punctator
 FR Pointeau
 IT Punzoni
 ES Retacador - punzón centrador
 CN 冲子

CrV 6150

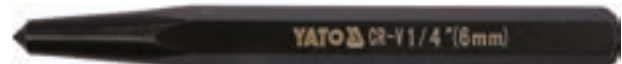



YATO	L [mm]	Center punch / Średnica punktaka [mm]	
YT-47150	100	6	20/120
YT-47151	112	8	20/120

- EN Pin punch set
- PL Zestaw wybijaaków
- DE Splintentreiber Satz
- RU Пробойник булавочный - набор
- CZ Sada vyrážečů
- HU Csapszegkütő készlet
- RO Set de dornuri
- FR Set de perceuteurs
- IT Set scalpelli
- ES Juego de punzones
- CN 销式冲子组套



6 PCS  **150** mm **CrV** 6150 

Ø 1.5, 3.0, 4.0, 5.0, 6.0, 8.0 mm

YATO 	L [mm]	
YT-47121	150	6/24

- EN Chisel set
- PL Zestaw przecinaków
- DE Flachmeisselsatz
- RU Зубила в наборе
- CZ Sekáče
- HU Hídegvágó
- RO Set dalți zidarie
- FR Set de burins
- IT Set scalpelli
- ES Cinceles
- CN 冲凿组套

3 PCS **CrV** 



10x142 mm, 12x152 mm, 16x172 mm

YATO 	
YT-4711	6/24

- EN Chisel and punch set
- PL Zestaw przecinaków i punktaków
- DE Trennmeissel- und Durchtreiber-Satz
- RU Зубила, керны и пробойники в наборе
- CZ Sekáče a průbojníky
- HU Véső és lyukasztó készlet
- RO Set dalți de impact
- FR Set de burins et pointeaux
- IT Set scalpelli
- ES Juego de cinceles de acero templado y punzones
- CN 冲凿组套

6 PCS **CrV** 



10x142, 12x152 mm;
 Ø 3x152, 6x152 mm;
 Ø 2x140 mm;
 Ø 8x115 mm

YATO 	
YT-4712	6/24

- EN Mini cold chisel and punch set
- PL Zestaw wybijaaków i przecinak
- DE Trennmeissel- und Durchtreiber-Satz
- RU Зубила и керны в наборе
- CZ Sekáče a průbojníky
- HU Véső és lyukasztó készlet
- RO Set dalți de impact
- FR Set de burins et perceuteurs mini
- IT Set scalpelli e bulini
- ES Juego de cinceles de acero templado y punzones
- CN 迷你冲凿组套

3 PCS **125** mm **CrV** 



10 mm;
 Ø 3 mm;
 Ø 3 mm

YATO 	
YT-4713	10/60

- EN Chisel and punch set
- PL Zestaw przecinaków i punktaków
- DE Trennmeissel- und Durchtreiber-Satz
- RU Зубила, керны и пробойники в наборе
- CZ Sekáče a průbojníky
- HU Véső és lyukasztó készlet
- RO Set dalți de impact
- FR Set de burins et pointeaux
- IT Set scalpelli
- ES Juego de cinceles de acero templado y punzones
- CN 冲凿组套

12 PCS

CrV





10x140, 12x150, 16x170 mm;
 Ø 1.5x150, Ø 3x150, Ø4x150, Ø5x150, Ø6x150, 8x150 mm;
 Ø 2x140 mm;
 Ø 6x100, Ø 8x110 mm

YATO 	
YT-4714	10/20

- EN Pin punch
- PL Wybijaak
- DE Splintentreiber
- RU Пробойник булавочный
- CZ Vyrážeč
- HU Csapszegkütő
- RO Dorn cilindric
- FR Percuteur
- IT Punzoni
- ES Punzón expulsador
- CN 销式冲子

150 mm **CrV** 60 





YATO 	L [mm]	
YT-4690	150	20/120

- EN Taper punch
- PL Dobijaak stożkowy
- DE Durchtreiber
- RU Пробойник конусный
- CZ Průbojník
- HU Lyukasztó
- RO Dorn conic
- FR Matoir
- IT Punzoni
- ES Retacador de cono
- CN 冲孔器

120 mm **CrV** 60 



YATO 	L [mm]	
YT-4691	120	20/120

EN Center punch
PL Punktak
DE Kömer
RU Пробойник - керн
CZ Důlčák
HU Pontozó

RO Punctator
FR Pointeau
IT Punzoni
ES Retacador- punzón centrador
CN 冲子

120 mm CrV 60



Ø 3.8 mm

YATO	L [mm]	
YT-4692	120	20/120

EN Cape chisel
PL Przcinaak krzyżowy
DE Kreuzmeissel
RU Зубило „лика”
CZ Sekáč křížový
HU Keresztvágó

RO Dalta ascutita
FR Burin
IT Scalpello rettangolare
ES Tajadera rectangular
CN 钎头

130 mm CrV 60



5.5 mm

YATO	L [mm]	
YT-4694	130	20/120

EN Hexagonal wrecking bar
PL Łom sześciokątny
DE Brechstange
RU Лом-гвоздодёр шестигранный
CZ Šestiúhľé páčidlo
HU Hatszögű feszítővas

RO Ranga pt. scos cuie
FR Pied-de-biche manche hexagonal
IT Mazza di ferro
ES Palanca hexagonal
CN 撬棒

DROP FORGED KUTE



YATO	L [mm]	W [mm]	
YT-46800	400	18	6/12
YT-46801	450	18	6/12
YT-46802	600	18	6/12
YT-46803	750	18	6/12
YT-46804	900	18	5/10

EN Profiled wrecking bar
PL Łom profilowany
DE Nageleisen
RU Лом-гвоздодёр
CZ Páčidlo
HU Szögkihúzó

RO Ranga pt. scos cuie
FR Pied-de-biche profilé
IT Mazza di ferro
ES Palanca perfilada
CN 撬棒

DROP FORGED KUTE



YATO	L [mm]	W [mm]	± [mm]	
YT-46810	350	22	13	6/12
YT-46811	450	30	17	6/12
YT-46812	600	30	17	4/8
YT-46813	750	30	17	8
YT-46814	900	30	17	3/6

EN Cold chisel
PL Przcinaak płaski
DE Flach Meissel
RU Зубило плоское
HU Laposvágó

RO Dalta lata
FR Burin plat
IT Scalpello piatto
ES Tajadera en frío
CN 扁铲

130 mm CrV 60



12 mm

YATO	L [mm]	
YT-4693	130	20/120

EN Chisel and punch set
PL Zestaw przcinaaków i punktaków
DE Trennmeissel- und Durchtreiber-Satz
RU Зубила и пробойники с протектором
CZ Sekáče a průbojníky
HU Véső és lyukasztó készlet
RO Set dalți de impact
FR Kit de burins et perçoirs
IT Scalpelli e bulino
ES Juego de cinceles de acero templado y punzones
CN 样冲组套

5 PCS

CrV 60



12x130 mm;
 5.5x130 mm;
 Ø 3.8x150 mm;
 Ø 3.3x120 mm;
 3.8x120 mm

YATO	
YT-4695	6/24

EN Hexagonal wrecking bar
PL Łom sześciokątny
DE Brechstange
RU Лом-гвоздодёр шестигранный
CZ Šestiúhľé páčidlo
HU Hatszögű feszítővas

RO Ranga pt. scos cuie
FR Pied-de-biche manche hexagonal
IT Mazza di ferro
ES Palanca hexagonal
CN 六角撬棒

DROP FORGED KUTE



YATO	L [mm]	W [mm]	
YT-46831	400	16	6/24
YT-46832	600	20	12
YT-46833	800	22	6/12
YT-46834	1000	22	6
YT-46835	1200	25	6
YT-46836	1500	25	6

EN Flat wrecking bar
PL Łom płaski
DE Nageleisen spitze
RU Лом плоский
CZ Páčidlo ploché
HU Lapos feszítővas

RO Ranga plata
FR Pied-de-biche plat
IT Mazza di ferro
ES Palanca plana
CN 撬棒

DROP FORGED KUTE



YATO	L [mm]	W [mm]	± [mm]	
YT-46820	300	35	6	10/30
YT-46821	380	35	6	10/20
YT-46822	450	35	6	10/20
YT-46823	600	35	6	10/20

EN Precision claw bar
PL Lom wąski
DE Brecheisen
RU Лом
CZ Páčidlo
HU Emelőőrúd
RO Rangă
FR Pied de biche
IT Piede di porco
ES Palanca estrecha
CN 撬棒



YATO	L [mm]	W [mm]	→← [mm]	
YT-46750	300	16	13	6/24

EN Pry bar set
PL Zestaw łomów
DE Brechstangensatz
RU Набор ломов
CZ Sada páčidel
HU Feszítővas készlet

RO Set leviere
FR Jeu de barres à clous
IT Set di piedi di porco
ES Juego de palancas
CN 撬棒



YATO	
YT-47303	6

EN Pry bar set
PL Zestaw łomów
DE Brechstangensatz
RU Набор ломов
CZ Sada páčidel
HU Feszítővas készlet

RO Set leviere
FR Jeu de barres à clous
IT Set di piedi di porco
ES Juego de palancas
CN 撬棒



YATO	
YT-47304	6/12

EN Removal tool set
PL Zestaw łomów
DE Brechstangensatz
RU Набор ломов
CZ Sada páčidel
HU Feszítővas készlet
RO Set leviere
FR Jeu de barres à clous
IT Set di piedi di porco
ES Juego de palancas
CN 撬棒组套

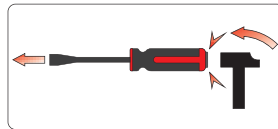

3 PCS

40Cr



205x10x11 mm, 140 g; 310x15x16 mm, 295 g; 400x15x21 mm, 400 g

YATO	
YT-47301	4/16

EN Go-through pry bar set
PL Zestaw łomów
DE Nagelaisensatz
RU Набор ломов
CZ Sada mini páčidel
HU Szóghúzó készlet

RO Set leviere
FR Set de pieds-de-biche
IT Set mazza di ferro
ES Juego de palancas de hierro
CN 穿心撬棒组套



4 PCS



198x6x6 mm, 110 g; 304x10x10 mm, 292 g; 456x10x10 mm, 479 g; 608x12x12 mm, 745 g

YATO	
YT-4730	3/6

EN Axe
PL Siekiera
DE Beil
RU Топор

CZ Sekera
HU Szekecse
RO Secure
FR Hache

IT Ascia
ES Hacha
CN 把斧



YATO	m [g]	L [mm]	DIN	
YT-8001	600	360	5131	24
YT-8002	800	380	5131	20
YT-8003	1000	400	5131	12
YT-8004	1250	710	7294	12
YT-8005	1400	710	7294	12
YT-8006	1600	810	7294	12

EN Axe
PL Siekiera
DE Beil
RU Топор

CZ Sekera
HU Szekecse
RO Secure
FR Hache

IT Ascia
ES Hacha
CN 把斧



YATO	m [g]	L [mm]	
YT-8011	1000	515	6
YT-8012	2000	820	6

EN Adze flat type
 PL Ciosło płaskie
 DE Flachdaxel
 RU Тесло плоское

CZ Sekyřka
 HU Szekerce
 RO Tesla
 FR Hache d'artisans

IT Ascia tipo piatto
 ES Destral de artesanos
 CN 扁斧



EN Long breaking bar with hook
 PL Dźwignia z hakiem do odwracania pni
 DE Fallheber
 RU Рычаг для рубки
 CZ Obraceč kmene
 HU A törzs csonkolója

RO Bara cu carlig pt. ridicat
 FR Tourne-bille métal
 IT Leva giratronchi
 ES Palanca de tala
 CN 翻木器



YATO **YT-80130** 4/24

YATO L [mm] **YT-79901** 830 2/8

EN Lifting tongs
 PL Kleszcze do drewna
 DE Handpackzange
 RU Ручной клещевой захват для бревен
 CZ Souběžné vynášecí kleště na dřevo
 HU Emelőfogó
 RO Cleste pt. ridicare lemn
 FR Pince de levage combinée
 IT Pinza spostatronchi
 ES Madera gancho de elevación
 CN 抓钩



EN Lifting tongs
 PL Kleszcze do drewna
 DE Handpackzange
 RU Ручной клещевой захват для бревен
 CZ Souběžné vynášecí kleště na dřevo
 HU Emelőfogó
 RO Cleste pt. ridicare lemn
 FR Pince de levage combinée
 IT Pinza spostatronchi
 ES Madera gancho de elevación
 CN 抓钩



EN Lifting tongs
 PL Kleszcze do drewna
 DE Handpackzange
 RU Ручной клещевой захват для бревен
 CZ Souběžné vynášecí kleště na dřevo
 HU Emelőfogó
 RO Cleste pt. ridicare lemn
 FR Pince de levage combinée
 IT Pinza spostatronchi
 ES Madera gancho de elevación
 CN 长柄伐木钩



YATO L [mm] **YT-79904** 450 6/24

YATO L [mm] **YT-79905** 330 20

YATO L [mm] **YT-79907** 770 6/12

EN Lifting hook
 PL Hak z uchwytem do drewna
 DE Holz-Hebehaken
 RU Захватный крюк для бревен
 CZ Hák na dřevo
 HU Emelőhorog

RO Carlig pt. ridicare lemn
 FR Pince de levage
 IT Alzatronchi manuale
 ES Madera gancho de elevación
 CN 抓钩



EN Saw trestle
 PL Kozioł do pilowania drewna
 DE Kettensägestütze
 RU Козы металлические для распиловки бревен
 CZ Kozá na řezání dřeva
 HU Fűrészbak

RO Capră de metal pt. tăierea
 FR Chevalet de sciage pour bûches
 IT Cavallo per segare la legna
 ES Caballete de corte para aserrar leña
 CN 锯齿锯架



YATO L [mm] **YT-79910** 265 30

EN Log lifting pick
 PL Hak do wyciągania pni
 DE Handsaprie
 RU Большой зацеп для бревен
 CZ Sapie dřevorubecká - hák na klády
 HU Fa mozgató csákány

RO Țapina usoara din aluminiu
 FR Sappie à main en aluminium avec lame
 IT Piccone spostatronchi
 ES Zapa de aluminio
 CN 铝柄抓钩



YATO L [mm] **YT-79915** 580 12
YT-79916 720 12

YATO **YT-79925** 1

EN Spiked felling wedge
PL Klin do drewna z tworzywa
DE Keil für Holz, Kunststoff
RU Кли́н для дере́ва, пластик
CZ Klín do dřeva, plast
HU Ék fához, műanyag

RO Pana
FR Cale pour bois en plastique
IT Cuneo spaccalegna, materia plastica
ES Cuña para madera, de plástico
CN 楔子



EN Spiked felling wedge set
PL Zestaw klinów
DE Keile-Satz
RU Набор клиньев
CZ Sada klinů
HU Ékkészlet



4
PCS



YATO	Dimensions / Wymiary [mm]	m [g]	
YT-79883	136x65x25	95	50/100
YT-79882	205x72x30	220	20/40
YT-79881	245x85x30	315	20/40
YT-79880	300x85x35	430	20/40

YATO	L [mm]	
YT-79884	136, 205, 245, 300	20

EN Wood splitter (knife)
PL Ręczna luparka do drewna
DE Hand-Holzspalter
RU Механический дровокол
CZ Štěpačka na dřevo
HU Fahasító

RO Despicator de lemn
FR Splitter outil pour fendre le petit bois
IT Spaccalegna manuale
ES Astilladora cortadora de lena manual
CN 劈柴器



355x40
mm



YATO	
YT-79940	4

EN Foot-operated log splitter
PL Nożna luparka do drewna
DE Fuß-Holzspalter
RU Механический дровокол
CZ Štěpačka na dřevo
HU Fahasító

RO Despicator de lemn
FR Splitter outil pour fendre e petit bois
IT Spaccalegna con azionamento a pedale
ES Astilladora cortadora de lena
CN 脚踏劈柴机



max
430x180
mm

1.2t



YATO	
YT-79943	1

9

Clamps, vices & holders
Ściski, imadła i wsporniki



Clamps
Ściski



170-171

Magnetic holders
Wsporniki magnetyczne



173-175

Vices
Imadła



171-173

EN F-clamp
 PL Ścisk stolarski
 DE Schraubzwinge
 RU Струбцина
 CZ Truhlářské upínadlo
 HU Asztalos szorító
 RO Menghină pt. tâmplărie
 FR Presse à serrage pour menuisier

IT Morsetto da falegname
 ES Tornillo de apriete
 CN 塑柄夹



YATO	[mm]	
YT-6401	160x80	10/30
YT-6402	200x80	10/30
YT-6403	250x80	10/30
YT-6404	300x80	10/30
YT-6405	450x80	10/20
YT-6406	600x80	10/20
YT-6407	400x120	10
YT-6408	500x120	10
YT-6409	600x120	10
YT-6410	900x120	5

YATO	[mm]	
YT-64111	250x80	4/24
YT-64112	300x80	4/24
YT-64113	450x80	4/24
YT-6412	300x120	10
YT-6413	400x120	10
YT-6414	500x120	5
YT-6415	600x120	5
YT-6416	900x120	5
YT-6417	1050x120	5

YATO	[mm]	
YT-6440	100x50	12/60
YT-6441	150x50	12/48
YT-6442	200x50	12/48
YT-6443	250x50	12/48
YT-6444	300x50	12/48
YT-6445	200x80	10/20
YT-6446	250x80	10/20
YT-6447	300x80	10/20
YT-6448	500x80	10/20
YT-6449	300x120	10
YT-6450	500x120	10
YT-6451	800x120	6
YT-6452	1000x120	6
YT-6453	1200x120	6
YT-6454	1500x120	6

EN Bar clamp ratchet
 PL Ścisk stolarski zapadkowy
 DE Lenkerklemmung Ratsche
 RU Струбцина быстросфиксируемая
 CZ Svěrka s ráčnou
 HU Bár bilincs racsnis
 RO Presă tip „F” cu clichet
 FR Bar pince à cliquet
 IT Bar morsetto a cricchetto
 ES Barra de mordaza de trinquete
 CN F夹



YATO	[mm]	
YT-63951	200x100	2/12
YT-63952	250x100	2/12
YT-63953	300x100	2/12
YT-63954	400x100	2/6

YATO	[mm]	
YT-63955	500x120	2/4
YT-63956	600x120	2/4
YT-63957	800x120	2/4
YT-63958	1000x120	2

EN Spring clamp
 PL Ścisk sprężynowy
 DE Federklemme
 RU Струбцина с пружинным зажимом
 CZ Pružinová svěrka
 HU Rugós szorító
 RO Cleste presa pt. lemn
 FR Pince à ressort
 IT Morsetto a molla
 ES Pinza de resorte
 CN 弹簧夹



YATO	L [mm]	Max. jaws range / Maks. rozwarcie szczęk [mm]	Max. jaws depth / Maks. głębokość szczęk [mm]	
YT-64270	100	42	44	24/240
YT-64271	150	55	68	12/120
YT-64272	200	79	91	10/100

EN Spring clamp
 PL Ścisk sprężynowy
 DE Federklemme
 RU Струбцина пружинная металлическая
 CZ Pružinová kovová svěrka
 HU Rugós szorító
 RO Cleste presa pt. lemn
 FR Pince à ressort
 IT Morsetto a molla metallo
 ES Pinza de resorte
 CN 弹簧夹



YATO	L [mm]	Max. jaws range / Maks. rozwarcie szczęk [mm]	Max. jaws depth / Maks. głębokość szczęk [mm]	
YT-64275	55	20	20	500/1000
YT-64276	100	25	25	48/96
YT-64277	150	50	50	24/48
YT-64278	230	90	90	8/16

EN Insulated spring clamp
 PL Ścisk sprężynowy izolowany
 DE Federklemme vollisoliert
 RU Струбцина изолированная
 CZ Pružinová svěrka
 HU Rugós szorító
 RO Cleste presa pt. lemn izolat
 FR Pince à ressort isolée
 IT Morsetto a molla isolate
 ES Pinza aislante
 CN 绝缘塑料圆头线夹

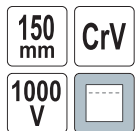

1000 V
 VDE CERTIFICATE
 EN 60900:2012

YATO	Working capacity / Zakres pracy [mm]	L [mm]	
YT-21190	2-20	150	5/40

EN Corner clamp set
PL Zestaw ścisków kątowych sprężynowych
DE Federbelastete Eckklemmen
RU Угловые пружинные зажимы
CZ Pružinové úhlové svorky
HU Rúgós sarokszorító
RO Set de cleme de colț
FR Pincés d'angle à ressort
IT Set di morsetti angolari a molla
ES Abrazaderas de ángulo con muelle
CN 木工夹

4
PCS

90°



YATO
YT-64300

6/24

EN C-Clamp
PL Ścisk typu „C”
DE C-Schraubzwinge
RU Струбцина типа „C”
CZ Svěrka tvaru „C”
HU Pillanászorító
RO Menghina tip „C”
FR Serre-joint
IT Morsetto tipo „C”
ES Tornillo tipo „C”
CN C型夹



YATO	Jaws range / Rozstaw szczęk [mm]	Force pressure / Siła nacisku [kg]	
YT-64250	25	120	100
YT-64251	50	200	50
YT-64252	75	280	30
YT-64253	100	350	30
YT-64254	125	390	18
YT-64255	150	450	12
YT-64256	200	500	10
YT-64257	250	540	5
YT-64258	300	600	5

EN Quick release "C" clamp
PL Ścisk typu "C" z szybkim przesuwem śruby
DE C-Schraubzwinge mit schnellem Vorschub
RU Зажим типа "C" с быстрым перемещением винта
CZ Svorka typu "C" s rychlým posunem šroubu
HU "C" típusú szorító gyors csavareltolással
RO Clema tip "C" cu eliberare rapidă
FR Serre-joint en "C" à vis d'action rapide
IT Morsetto a rilascio rapido di tipo "C"
ES Pinza tipo "C" con desplazamiento rápido de tornillo
CN 快速C型夹

150x85
mm

6
kN

QUICK
ADJUSTMENT
SZYBKĄ
REGULACJĄ



YATO	[mm]	Force pressure / Siła nacisku [kN]	
YT-64263	150x85	6	4/16

EN 3 way "C" clamp
PL Ścisk śrubowy potrójny
DE Dreiwegschraubzwinge
RU Тройной винтовой зажим
CZ Šroubová svorka trojitá
HU Tripla csavaros szorító
RO Clema tip "C" cu 3 prinderi
FR Presse à chant
IT Morsetto a vite triplo
ES Pinza de tornillo triple
CN 三头C字夹

62x62
mm

x3



YATO	[mm]	
YT-64242	62x62	10/60

EN C-Clamp
PL Ścisk typu „C”
DE C-Schraubzwinge
RU Струбцина типа „C”
CZ Svěrka tvaru „C”
HU Pillanászorító
RO Menghina tip „C”
FR Serre-joint
IT Morsetto tipo „C”
ES Tornillo tipo „C”
CN C型夹

DROP
FORGED
KUTE



YATO	Jaws range / Rozstaw szczęk [mm]	Force pressure / Siła nacisku [kg]	
YT-6420	50	1500	6/30
YT-6421	75	1950	6/18
YT-6422	100	2980	6/12
YT-6423	150	3200	6/12
YT-6424	200	3600	6

EN Quick release "C" clamp
PL Ścisk typu "C" z szybkim przesuwem śruby
DE C-Schraubzwinge mit schnellem Vorschub
RU Зажим типа "C" с быстрым перемещением винта
CZ Svorka typu "C" s rychlým posunem šroubu
HU "C" típusú szorító gyors csavareltolással
RO Clema tip "C" cu eliberare rapidă
FR Serre-joint en "C" à vis d'action rapide
IT Morsetto a rilascio rapido di tipo "C"
ES Pinza tipo "C" con desplazamiento rápido de tornillo
CN 快速C型夹

100x50
mm

5
kN

QUICK
ADJUSTMENT
SZYBKĄ
REGULACJĄ



YATO	[mm]	Force pressure / Siła nacisku [kN]	
YT-64262	100x50	5	6/24

EN "C" clamp deep
PL Ścisk typu "C" głęboki
DE C-Schraubzwinge, tief
RU Зажим типа "C" глубокий
CZ Svorka typu "C" hluboká
HU "C" típusú mély szorító
RO Clema tip "C" adanca
FR Serre-joint en "C" à gorge profonde
IT Morsetto profondo di tipo "C"
ES Pinza tipo "C" profunda
CN C型夹



YATO	[mm]	Force pressure / Siła nacisku [kN]	
YT-64190	63x130	3	6/36
YT-64191	76x203	3	6/24
YT-64192	101x304	3	6/12

EN Nylon C-clamp
PL Ścisk typu "C" nylonowy
DE Klemmverschraubung Typ "C" aus Nylon
RU Зажим-струбцина тип "C" нейлоновый
CZ Svorka typu "C" nylonová
HU "C" típusú nylon asztalos szorító
RO Clema plastic tip "C"
FR Pince en "C" en nylon
IT Morsetto di tipo "C" in nylon
ES Sargento tipo "C" de nylon
CN 快速夹

NYLON

QUICK
ADJUSTMENT
SZYBKĄ
REGULACJĄ



YATO	Jaws range / Rozstaw szczęk [mm]	
YT-64183	50	12/72
YT-64184	75	12/48

EN Swivel base bench vice
 PL Imadło ślusarskie obrotowe
 DE Drehbare Schraubstock
 RU Тиски слесарные поворотные
 CZ Zámečnický svěrák otáčivý
 HU Forgatható lakatos satu
 RO Menghină rotativă
 FR Étau rotatif de serrurier
 IT Morsa a cerniera
 ES Tornillo de apriete giratorio
 CN 重型台虎钳



• Anvil and changeable jaws made of hardened steel
 • Kowadzelko i wymienne szczęki z hartowanej stali

YATO	Jaws width / Szerokość szczęk [mm]	m [kg]	
YT-6501	100	7	2
YT-6502	125	10	2
YT-6503	150	15	1
YT-65048	150	19	1
YT-6504	200	21	1
YT-65049	200	29.5	1

EN Swivel base bench vice
 PL Imadło ślusarskie obrotowe
 DE Drehbare Schraubstock
 RU Тиски слесарные поворотные
 CZ Zámečnický svěrák otáčivý
 HU Forgatható lakatos satu
 RO Menghină rotativă
 FR Étau rotatif de serrurier
 IT Morsa a cerniera
 ES Tornillo de apriete giratorio
 CN 多功能台虎钳

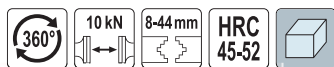

• Anvil and changeable jaws made of hardened steel
 • Kowadzelko i wymienne szczęki z hartowanej stali

YATO	Jaws width / Szerokość szczęk [mm]	Jaws range / Rozstaw szczęk [mm]	m [kg]	
YT-6505	100	100	10	1

EN Swivel base bench vice
 PL Imadło ślusarskie obrotowe
 DE Drehbare Schraubstock
 RU Тиски слесарные поворотные
 CZ Zámečnický svěrák otáčivý
 HU Forgatható lakatos satu
 RO Menghină rotativă
 FR Étau rotatif de serrurier
 IT Morsa a cerniera
 ES Tornillo de apriete giratorio
 CN 多功能台虎钳

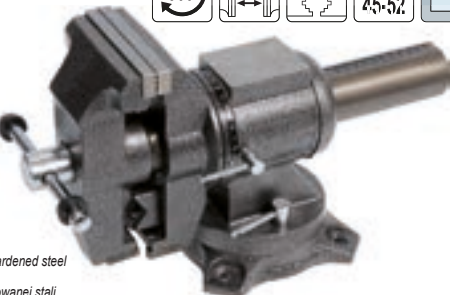
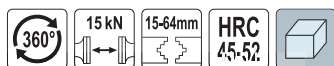

• Anvil and changeable jaws made of hardened steel
 • Kowadzelko i wymienne szczęki z hartowanej stali

YATO	Jaws width / Szerokość szczęk [mm]	Jaws range / Rozstaw szczęk [mm]	m [kg]	
YT-6506	125	125	20	1

EN Hand vice
 PL Imadło ręczne
 DE Handschraubstock
 RU Ручные тиски
 CZ Ruční svěrák
 HU Kézi satu
 RO Menghina manuală
 FR Étau à main
 IT Morsa a mano
 ES Tornillo de banco manual
 CN 手用台钳



YATO	Jaws range / Rozstaw szczęk [mm]	Jaws width / Szerokość szczęk [mm]	
YT-65080	25	25	8/48
YT-65081	27	40	6/36
YT-65082	32	50	4/24

EN Hinged pipe vice
 PL Imadło zaciskowe do rur
 DE Rohrschraubstock
 RU Тиски для труб
 CZ Uprácní svěrák na trubky
 HU Satu, csőszorító
 RO Menghină pt. țevi
 FR Étau de serrage à tuyaux
 IT Morsa stringi tubo
 ES Tornillo de apriete para tubos
 CN 管子台虎钳



YATO	Max. mounting element diameter / Maks. średnica mocowanego elementu [mm]	
YT-6510	60	4
YT-6511	76	2
YT-6512	90	2
YT-6513	110	1

EN Drill vice
 PL Imadło maszynowe
 DE Maschinenschraubstock
 RU Тиски машинные
 CZ Svěrák pod vrtačku
 HU Gépsatu
 RO Menghină universală
 FR Étau de perçage
 IT Morsa per macchina
 ES Tornillo de banco
 CN 平口钳

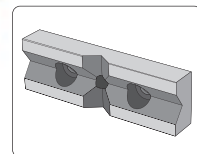

YATO	Jaws width / Szerokość szczęk [mm]	
YT-65071	50	10
YT-65072	100	6
YT-65073	150	2

EN Angle vice
 PL Imadło kątowe
 DE Winkelschraubstock
 RU Угловые тиски
 CZ Úhlový svěrák
 HU Sarokszorító
 RO Menghină pt. colțuri
 FR Étau angulaire
 IT Morsa angolare
 ES Tornillo de banco angular
 CN 木工角夹



YATO	Jaws range / Rozstaw szczęk [mm]	
YT-65136	70	20

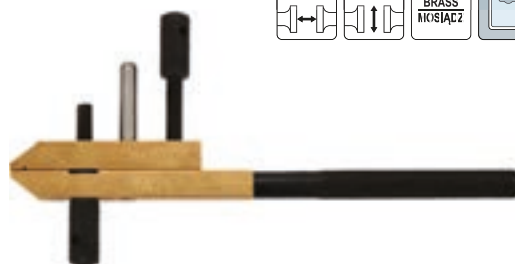
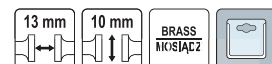

EN Hand vice
 PL Imadło ręczne
 DE Handschraubstock
 RU Ручные тиски
 CZ Ruční svěrák
 HU Kézi satu
 RO Menghina manuală
 FR Étau à main
 IT Morsetto a mano
 ES Tornillo de banco manual
 CN 手用台钳



YATO	Jaws range / Rozstaw szczęk [mm]	Jaws width / Szerokość szczęk [mm]	
YT-65085	13	10	12/48



- EN Soft vice jaws
PL Miękkie szczęki wymienne do imadła
DE Weiche austauschbare Schraubstock-Schutzbacken
RU Мягкие сменные губки для тисков
CZ Měkké čelisti do svěráku
HU Puha csere pófák satuhoz
RO Protecție bacuri înghina
FR Mors de protection souples remplaçables pour étaux
IT Ganasce morbide intercambiabili per morsa
ES Mordazas blandas sustituyibles para el tornillo de banco
CN 磁性钳口保护套

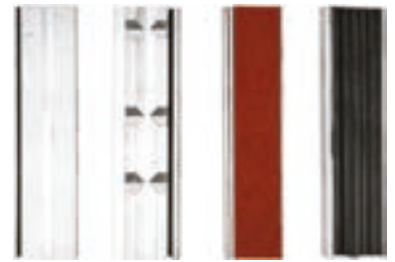

YATO 	Dimensions / Wymiary [mm]	
YT-65000	75x30x10	20/60
YT-65001	100x30x10	20/60
YT-65002	125x30x10	20/60
YT-65003	150x30x10	20/60

- EN Exchangeable vice jaws set
PL Szczęki wymienne do imadła
DE Backen für Schraubstöcke
RU Сменные губки для тисков
CZ Výměnné čelisti do svěráku
HU Satu póf befogó pófák
RO Bacuri de protecție din aluminiu pt. înghina
FR Mâchoires remplaçables pour vices
IT Ganasce intercambiabili per morsa
ES Mordazas sustituyibles para el tornillo de banco
CN 台钳保护夹



YATO 	L [mm]	
YT-65006	100	20
YT-65007	125	20
YT-65008	150	20

- EN Adjustable angle welding magnet
PL Wspornik magnetyczny spawalniczy regulowany
DE Verstellbarer Magnet-Werkstückhalter
RU Регулируемый магнит заварки угла
CZ Pohovací magnetický držák ke svařování
HU Állítható, mágneses, hegesztő támasz

- RO Dispozitiv magnetic reglabil pt. sudura
FR Support magnétique de soudure
IT Supporto della saldatura magnetico
ES Soporte magnético de soldadura, ajustable
CN 焊接磁铁



360°





YATO 	Lifting capacity / Udźwig [kg]	Dimensions / Wymiary [mm]	
YT-0862	2x22.5	85x65x22	6

- EN Magnetic welding holder
PL Kątownik magnetyczny spawalniczy
DE Magnet-Werkstückhalter
RU Магнитная струбцина заварки
CZ Magnetický úhelník ke svařování
HU Mágneses, hegesztő szögvas
RO Dispozitiv magnetic fixare pt. sudura
FR Support magnétique de soudure
IT Angolo magnetico da saldatura
ES Escuadra magnética de soldadura
CN 焊接磁铁



90° 135°



YATO 	Lifting capacity / Udźwig [kg]	Hole diameter / Średnica otworu [mm]	Dimensions / Wymiary [mm]	
YT-0864	22.5	18	102x155x17	6/30
YT-0865	34	46	122x190x25	6/18

- EN Magnetic welding holder
PL Kątownik magnetyczny spawalniczy
DE Magnet-Werkstückhalter
RU Магнитная струбцина заварки
CZ Magnetický úhelník ke svařování
HU Mágneses, hegesztő szögvas
RO Dispozitiv magnetic fixare pt. sudura
FR Support magnétique de soudure
IT Angolo magnetico da saldatura
ES Escuadra magnética de soldadura
CN 焊接磁铁



90° 135°





YATO 	Lifting capacity / Udźwig [kg]	Dimensions / Wymiary [mm]	
YT-0863	11.5	82x120x13	6/48

- EN Magnetic welding holder
PL Kątownik magnetyczny spawalniczy
DE Magnet-Werkstückhalter
RU Магнитная струбцина заварки
CZ Magnetický úhelník ke svařování
HU Mágneses, hegesztő szögvas
RO Dispozitiv magnetic fixare pt. sudura
FR Support magnétique de soudure
IT Triangolo magnetico da saldatura con interruttore
ES Escuadra magnética de soldadura
CN 焊接磁铁



30° 45° 60°
75° 90° 135°





YATO 	Lifting capacity / Udźwig [kg]	Dimensions / Wymiary [mm]	
YT-0866	11.5	64x95x14	6/24
YT-0867	34	111x136x24	6/18

- EN Mini welding magnet holder set
PL Zestaw spawalniczych kątowników magnetycznych mini
DE Mini-Magnetschweißwinkel-Set
RU Набор сварочных магнитных угловых профилей мини
CZ Sada svařovacích magnetických úhelníků mini
HU Mini mágneses hegesztési derékszög készlet
RO Set minimagnet pt. sudura
FR Kit de cornières magnétiques de soudage mini
IT Set di posizionatori magnetici mini per saldatura
ES Juego de escuadras de soldadura magnéticas mini
CN 迷你磁性电焊架



4 PCS 4.5 kg 45°
90° 135°





YATO 	Lifting capacity / Udźwig [kg]	Dimensions / Wymiary [mm]	
YT-08677	4.5	43x72x12	12/36

- EN Welding magnet holder set
PL Zestaw spawalniczych kątowników magnetycznych
DE Magnetschweißwinkel-Set
RU Набор сварочных магнитных угловых профилей
CZ Sada svařovacích magnetických úhelníků
HU Mágneses hegesztési derékszög készlet
RO Set magnet pt. sudura
FR Kit de cornières magnétiques de soudage
IT Set di posizionatori magnetici per saldatura
ES Juego de escuadras de soldadura magnéticas
CN 磁性电焊架



6 PCS 4.5 kg 11.5 kg
45° 90°
135°



YATO 	Lifting capacity / Udźwig [kg]	Dimensions / Wymiary [mm]	
YT-08678	4.5, 11.5	43x72x12, 82x118x14	6/18

- EN Welding magnet holder set
- PL Zestaw spawalniczych kątowników magnetycznych
- DE Magnetschweißwinkel-Set
- RU Набор сварочных магнитных угловых профилей
- CZ Sada svařovacích magnetických úhelníků
- HU Mágneses hegesztési derékszög készlet
- RO Set magneti pt. sudura
- FR Kit de cornières magnétiques de soudage
- IT Set di posizionatori magnetici per saldatura
- ES Juego de escuadras de soldadura magnéticas
- CN 焊接定位器套装



6 PCS		4.5 kg	11.5 kg
30°	45°	60°	75°
90°	135°		

YATO	Lifting capacity / Udźwig [kg]	Dimensions / Wymiary [mm]	
YT-08679	4.5, 11.5	43x72x12, 68x102x14, 82x118x14	10

- EN Magnetic welding holder set
- PL Zestaw magnetycznych uchwytów spawalniczych
- DE Magnetschweißhalter-Set
- RU Комплект магнитных сварочных ручек
- CZ Sada magnetických svařovacích úchytů
- HU Mágneses hegesztő tartó készlet
- RO Set suporti magnetici sudura
- FR Kit positionneur magnétique de soudure
- IT Kit di pinze magnetiche per saldatura
- ES Set de portaelectrodos magnéticos
- CN 焊接磁铁

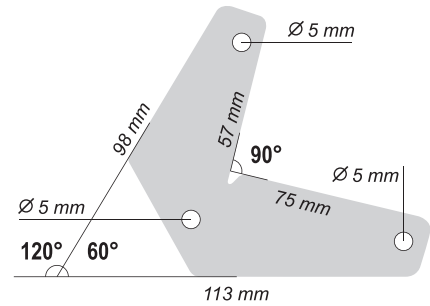

2 PCS		60°
90°	120°	

YATO	Lifting capacity / Udźwig [kg]	Size / Rozmiar [mm]	
YT-08721	10	98x113	6/24

- EN Magnetic welding holder set
- PL Zestaw magnetycznych uchwytów spawalniczych
- DE Magnetschweißhalter-Set
- RU Комплект магнитных сварочных ручек
- CZ Sada magnetických svařovacích úchytů
- HU Mágneses hegesztő tartó készlet
- RO Set suporti magnetici sudura
- FR Kit positionneur magnétique de soudure
- IT Kit di pinze magnetiche per saldatura
- ES Set de portaelectrodos magnéticos
- CN 焊接磁铁

2 PCS		30°
60°	90°	

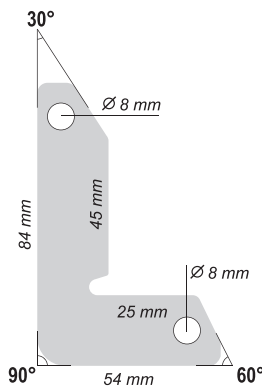
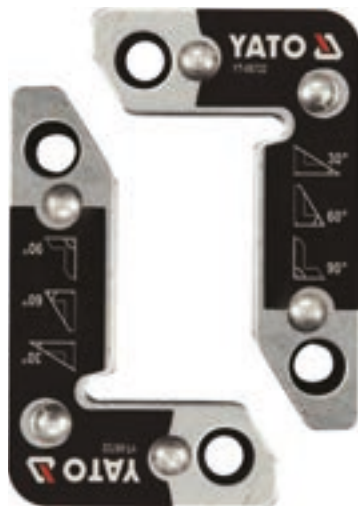

- EN Magnetic welding holder set
- PL Zestaw magnetycznych uchwytów spawalniczych
- DE Magnetschweißhalter-Set
- RU Комплект магнитных сварочных ручек
- CZ Sada magnetických svařovacích úchytů
- HU Mágneses hegesztő tartó készlet
- RO Set suporti magnetici sudura
- FR Kit positionneur magnétique de soudure
- IT Kit di pinze magnetiche per saldatura
- ES Set de portaelectrodos magnéticos
- CN 焊接磁铁

2 PCS		30°
60°	90°	

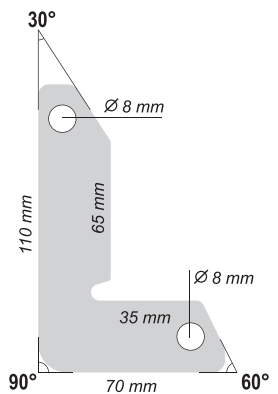









YATO	Lifting capacity / Udźwig [kg]	Size / Rozmiar [mm]	
YT-08723	32	70x110	8/32

YATO	Lifting capacity / Udźwig [kg]	Size / Rozmiar [mm]	
YT-08722	25	54x84	10/40

10

Cutting tools Narzędzia tnące



Drills Wiertła		Arbors for hole saws Uchwyty do otwornic	197
179-190		Hole saw kits Zestawy otwornic	198
Twist drill bits HSS & sets Wiertła do metalu HSS i zestawy	179	Taps & dies Narzędzia do gwintowania	199-203
Double end metal twist drills Wiertła do metalu dwustronne	180	Hand taps & sets Gwintowniki i zestawy	199
Twist drill bits HSS-E Co & sets Wiertła do metalu HSS-E Co i zestawy	180	Circular dies Narzynki	201
Twist drill bits HSS-TiN & sets Wiertła do metalu HSS-TiN i zestawy	181	Step drills Wiertła stopniowe	201
Universal drills & sets Wiertła uniwersalne i zestawy	184	Taper drill sets Zestawy wiertel stożkowych	201
SDS masonry drill bits X-TIP Wiertła do betonu SDS, z grotem krzyżowym	185	Countersinks & sets Pogłębiacze i zestawy	202
SDS masonry drill bits Wiertła do betonu SDS	186	Tap wrenches & die holders Pokręta do gwintowników i narzynek	202
Masonry drill bits with cylindrical shank & sets Wiertła do betonu z uchwytem cylindrycznym i zestawy	187	Thread repair sets & accessories Zestawy do naprawy gwintów i akcesoria	202
Flat wood drill bits & sets Wiertła łopatkowe do drewna i zestawy	187	Plug and forstner cutters & sets Flekowniki-sękówniki do drewna i zestawy	203
Spur wood drill bits Wiertła do drewna spiralne	188	Router bits, rotary rasps & sets Frezy do drewna, metalu i zestawy	204-208
Auger wood drill bits & sets Świdry do drewna i zestawy	188	Diamond tools Narzędzia diamentowe	209-210
Confirmat screw drill bits Wiertła do konfirmatów	189	Diamond blades for cutting construction materials Tarcze diamentowe do cięcia materiałów budowlanych	209
Drills for glass, ceramic tiles & sets Wiertła do szkła, ceramiki, gresu i zestawy	190	Diamond grinding cup wheels Diamentowe talerze szlifierskie do betonu i kamienia	210
Drilling accessories Akcesoria do wiercenia	190	Diamond core drill bits Diamentowe wiertła koronowe	210
Adjustable hand reamers Rozwiertaki nastawne		Tungsten carbide tipped tools Narzędzia z ostrzem z węgliku wolframu	211-212
191		Tungsten carbide saws for wood Tarcze z węglikiem do drewna	211
Spot weld cutter sets Zestawy rozwiertaków do zgrzewów		Tungsten carbide saws for steel & aluminium Tarcze z węglikiem do stali i aluminium	212
191		PVC cutting discs Tarcze do cięcia PCV	212
Tools for dowel joints Narzędzia do połączeń kołkowych		Cutting & grinding discs Tarcze do cięcia i szlifowania	213-215
191-192		Stainless steel cutting discs Tarcze do cięcia stali nierdzewnej	213
Combination edge setters & hole punch pliers Dziurkarko-felcarki		Metal cutting discs Tarcze do cięcia metalu	213
192		Metal grinding discs Tarcze do szlifowania metalu	214
SDS Chisels Przecinaki i dłuta SDS			
193-195			
Hollow drill sets Wiertła koronowe do betonu			
196			
Hole saws Otwornice			
196-198			
Universal hole saws Otwornice uniwersalne	196		
Bi-metal hole saws Otwornice bimetalowe	197		

Stone cutting discs			
Tarcze do cięcia kamienia.....	214	Cup brushes	
Stone grinding discs		Szczotki tarczowe.....	236
Tarcze do szlifowania kamienia.....	214	Electric screwdriver accessories	
Plate discs with hook fastener		Akcesoria do wkrętarek.....	238
Tarcze z rzepem.....	214	Knives & blades	
Cutting & grinding rasp discs		Noże i ostrza.....	239
Tarcze tarnikowe do cięcia i szlifowania.....	215	Squeegees	
		Rakle.....	242
		Scissors	
Shears		Nożyczki.....	242
Nożyce		Marking out tools	
	216-222	Narzędzia traserskie.....	242
		Profile gauges	
		Wzorniki profili.....	244
		Punch sets	
Heavy duty cable cutters		Przebijaki do skóry.....	245
Nożyce do cięcia przewodów.....	216	Cutters	
Tin snips		Obcinaki.....	245
Nożyce do blachy.....	216	Scrapers	
Steel strap cutters		Skrobaki i cykliny.....	248
Nożyce do cięcia taśm stalowych.....	220	Planes	
Bolt cutters		Strugi.....	249
Nożyce do prętów.....	220	Steel files & sets	
Hydraulic cutters & accessories		Pilniki do metalu i zestawy.....	250
Nożyce z silownikiem hydraulicznym i akcesoria.....	221	Chain saw files	
Cable cutters		Pilniki do ostrzenia łańcuchów.....	251
Nożyce do kabli.....	221	Needle file sets	
Multifunctional scissors		Zestawy pilników iglaków.....	252
Nożyce wielofunkcyjne.....	222	Diamond needle files & sets	
		Pilniki iglaki diamentowe i zestawy.....	252
		Diamond whetstones	
Saws & blades		Osełki diamentowe.....	254
Piły i brzeszczoty		Rasps & sets	
	222-232	Tarniki do drewna i zestawy.....	254
		Rasps for plaster	
		Tarniki do gipsu.....	254
Hand saws			
Piły do drewna.....	222	Abrasive products	
Back saws for PVC		Artykuły ściernie	
Piły do PCV.....	222		255-260
Drywall saws			
Piły do płyt gipsowo-kartonowych.....	222	Sand papers	
Bow saws		Papiery ściernie.....	255
Piły kabląkowe.....	223	Waterproof sand papers	
Blades		Papiery ściernie wodoodporne.....	256
Brzeszczoty.....	224	Abrasive clothes	
Hacksaw frames		Płótna ściernie.....	256
Piły do metalu.....	224	Abrasive meshes	
Blades		Siatki ściernie.....	257
Brzeszczoty.....	224	No end abrasive bands	
Jig saw blades		Taśmy ściernie bezkońcowe.....	257
Brzeszczoty do wyrzynarek.....	226	Flap discs	
Accessories for multi-purpose oscillating tools		Ściernice listkowe.....	258
Akcesoria do wielofunkcyjnych narzędzi oscylacyjnych.....	228	Abrasive sheets and discs	
		Arkusze i krążki ściernie.....	259
		Back pads for drywall sander	
Brushes, knives & files		Głowice do szlifierki do gipsu.....	260
Szczotki, noże i pilniki			
	233-255		
Wire brushes & sets			
Szczotki druciane i zestawy.....	233		
Cleaning pads for pipes			
Włókniny do czyszczenia rur.....	234		
Drain cleaning accessories			
Akcesoria do udrażniania kanalizacji.....	234		

EN Twist drill HSS
PL Wiertło do metalu HSS
DE Metallspiralbohrer HSS
RU Сверло по металлу HSS
CZ Vrták na kov HSS
HU Fúrószár fémhez HSS

RO Burghiu pt. metal HSS
FR Foret métal HSS
IT Punta per metallo HSS
ES Broca para metal HSS
CN 轧制麻花钻

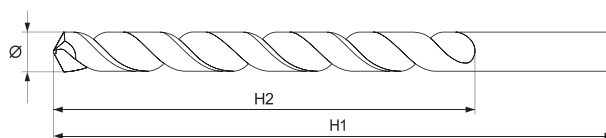
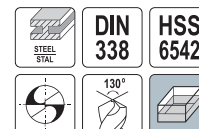

• Application: industry
• For precise drilling in steels, cast steels, non-ferrous metals, plastics

• Przeznaczenie: przemysł
• Do precyzyjnych wierceń w stalach, żeliwach, metalach nieżelaznych, tworzywach sztucznych

YATO	Ø [mm]	H1 [mm]	H2 [mm]	ω [min ⁻¹]	pcs / szt.	
YT-4430	1.0	34	23	3800	10	80/320
YT-4431	1.5	43	20	3800	10	80/320
YT-4432	2.0	49	24	4000	10	80/320
YT-4433	2.5	57	30	3200	10	80/320
YT-4434	2.8	61	33	2800	10	80/320
YT-4435	3.0	61	33	2600	10	80/320
YT-4436	3.2	65	36	2500	10	80/320
YT-4437	3.5	70	39	2300	10	80/320
YT-4438	4.0	75	43	2000	10	80/320
YT-4439	4.2	75	43	1900	10	20/80

YATO	Ø [mm]	H1 [mm]	H2 [mm]	ω [min ⁻¹]	pcs / szt.	
YT-4440	4.5	80	47	1800	10	20/80
YT-4441	4.8	86	52	1600	10	20/80
YT-4442	5.0	86	52	1600	10	20/80
YT-4443	5.2	86	52	1500	10	20/80
YT-4444	5.5	93	57	1500	10	20/80
YT-4445	6.0	93	57	1300	10	20/80
YT-4446	6.5	101	63	1200	10	10/40
YT-4447	7.0	109	69	1100	10	10/40
YT-4448	7.5	109	69	1100	10	10/40
YT-4449	8.0	117	75	1000	10	10/40

YATO	Ø [mm]	H1 [mm]	H2 [mm]	ω [min ⁻¹]	pcs / szt.	
YT-4450	8.5	117	75	900	5	10/40
YT-4451	9.0	125	81	900	5	10/40
YT-4452	9.5	125	81	800	5	10/40
YT-4453	10.0	133	87	800	5	10/40
YT-4454	10.5	133	87	800	3	10/40
YT-4455	11.0	142	94	700	3	10/40
YT-4456	12.0	151	101	700	3	10/40
YT-4457	12.5	151	101	600	3	10/40
YT-4458	13.0	151	101	600	3	10/40

EN Twist drill set
PL Komplet wiertel do metalu
DE Metallspiralbohrersatz

RU Набор сверл по металлу
CZ Souprava vrtáků na kov
HU Fúrószárkészlet fémhez

RO Set de burghie pt. metal
FR Set des forets métal HSS
IT Set punte per metallo

ES Broca para metal
CN 轧制麻花钻组套



10
PCS



19
PCS



YATO	Ø [mm]	
YT-4460	2, 3, 4, 5, 6, 8	15/60

YATO	Ø [mm]	
YT-4461	1, 2, 3, 4, 5, 6, 7, 8, 9, 10	20/40

YATO	Ø [mm]	
YT-4462	1, 1.5, 2, 2.5, 3, 3.5, 4, 4.5, 5, 5.5, 6, 6.5, 7, 7.5, 8, 8.5, 9, 9.5, 10	15/30

EN Twist drill HSS
PL Wiertło do metalu HSS
DE Metallspiralbohrer HSS
RU Сверло по металлу HSS
CZ Vrták na kov HSS
HU Fúrószár fémhez HSS

RO Burghiu pt. metal HSS
FR Foret métal HSS
IT Punta per metallo HSS
ES Broca para metal HSS
CN 磨制麻花钻

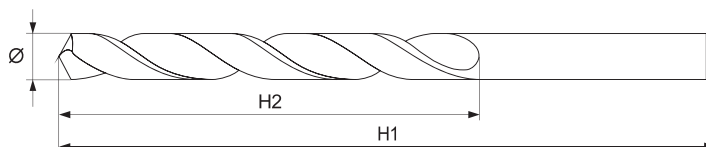

YATO	Ø [mm]	H1 [mm]	H2 [mm]	pcs / szt.	
YT-44200	0.5	22	6	5	100/400
YT-44201	0.8	30	10	5	100/400
YT-44202	1.0	34	11	5	100/400
YT-44203	1.5	40	18	5	100/400
YT-44204	2.0	48	22	5	100/400
YT-44205	2.2	53	28	5	50/400
YT-44206	2.4	56	30	5	100/400
YT-44207	2.5	57	30	5	100/400
YT-44208	2.8	62	30	5	100/400
YT-44209	3.0	61	34	1	100/400
YT-44210	3.1	65	35	1	100/400
YT-44211	3.2	65	35	1	100/400
YT-44212	3.5	70	40	1	100/400
YT-44213	3.8	77	48	1	100/400

YATO	Ø [mm]	H1 [mm]	H2 [mm]	pcs / szt.	
YT-44214	4.0	74	44	1	100/400
YT-44215	4.1	75	44	1	100/400
YT-44216	4.2	75	45	1	100/400
YT-44217	4.5	79	45	1	100/400
YT-44218	4.8	85	51	1	100/400
YT-44219	5.0	86	52	1	100/400
YT-44220	5.2	86	52	1	100/400
YT-44221	5.5	92	56	1	100/400
YT-44222	6.0	93	56	1	100/400
YT-44223	6.5	100	63	1	100/400
YT-44224	7.0	103	64	1	50/300
YT-44225	7.5	108	70	1	50/300
YT-44226	8.0	115	75	1	50/300
YT-44227	8.5	115	73	1	50/300

YATO	Ø [mm]	H1 [mm]	H2 [mm]	pcs / szt.	
YT-44228	9.0	125	81	1	50/300
YT-44229	9.5	125	82	1	50/300
YT-44230	10.0	133	87	1	50/200
YT-44231	10.2	130	85	1	50/200
YT-44232	10.5	132	82	1	50/200
YT-44233	11.0	142	95	1	50/200
YT-44234	11.5	142	95	1	50/150
YT-44235	12.0	150	100	1	50/150
YT-44236	12.5	150	100	1	50/150
YT-44237	13.0	150	100	1	50/150
YT-44238	14.0	160	110	1	25/100
YT-44239	16.0	176	122	1	25/100
YT-44240	20.0	205	140	1	25/50

- EN Double end metal twist drill
- PL Wiertło do metalu dwustronne
- DE Metallbohrer, doppelseitig
- RU Двухстороннее сверло по металлу
- CZ Vrták do kovu dvoustranný
- HU Kétoldalas fém fúrészár
- RO Set burghie metal, capat dublu
- FR Foret pour métal à double extrémité
- IT Punta doppia per metallo
- ES Broca para metal doble
- CN 双头全磨制麻花钻

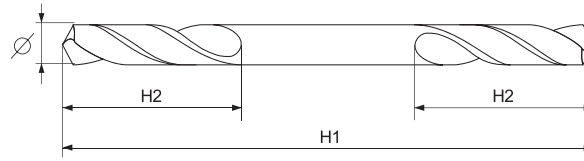

STEEL
STAL

DIN
338

HSS
6542

FULLY
GROUND
WIERTŁO
SZLIFOWANE

135°

YATO	Ø [mm]	H1 [mm]	H2 [mm]	pcs
YT-40010	3.0	46	9.5	100/500
YT-40011	3.2	49	9.5	100/500
YT-40012	3.5	52	13	100/500
YT-40013	4.0	55	13	100/500
YT-40014	4.2	55	13	100/500

YATO	Ø [mm]	H1 [mm]	H2 [mm]	pcs
YT-40015	4.5	58	16	100/500
YT-40016	5.0	62	16	100/500
YT-40017	5.2	62	16	100/500
YT-40018	5.5	66	16	50/500
YT-40019	6.0	66	16	50/500

- EN Double end metal twist drill set
- PL Zestaw dwustronnych wiertł do metalu
- DE Satz von doppelseitigen Bohrern für Metall
- RU Набор двухсторонних сверл по металлу
- CZ Sada oboustranných vrtáků do kovu
- HU Kétoldalas fémfúró szár készlet
- RO Set burghie metal cu cap dublu
- FR Ensemble de forets pour métaux à deux côtés
- IT Set di punte a doppia estremità per metallo
- ES Juego de brocas de doble punta para metal
- CN 双头钻组套



10
PCS

STEEL
STAL

DIN
338

HSS
6542

135°

- EN Twist drill HSS-Cobalt
- PL Wiertło do metalu HSS-Cobalt
- DE Metallschraubbohrer HSS-Cobalt
- RU Сверло по металлу HSS-Cobalt
- CZ Vrták na kov HSS-Cobalt
- HU Fúrészár fémhez HSS-Cobalt
- RO Burghiu pt. metal HSS-Cobalt
- FR Foret métal HSS-Cobalt
- IT Punta per metallo HSS-Cobalt
- ES Broca para metal HSS-Cobalt
- CN 全磨制含钴麻花钻

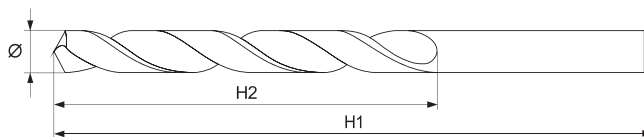

STEEL
STAL

DIN
338

HSS-E
Co

135°

Rm
>900
N/mm²

PN-EN
ISO
4957:2002(U)

- Application: industry
- For precise drilling in hard steels, non-ferrous metals, plastics, stainless steel and acid resistant steel
- Resistant to high temperatures
- Przeznaczenie: przemysł
- Do precyzyjnych wierceń w trudnych materiałach, np. stalach szlachetnych, metalach kolorowych, tworzywach, stalach nierdzewnych i kwasoodpornych
- Odporne na działanie wysokiej temperatury

YATO	Ø [mm]	H1 [mm]	H2 [mm]	pcs / szt.
YT-4020	2.0	49	24	2 125/500
YT-4025	2.5	57	30	2 125/500
YT-4030	3.0	61	33	2 125/500
YT-4032	3.2	65	36	1 100/400
YT-4035	3.5	70	39	1 100/400
YT-4040	4.0	75	43	1 100/400
YT-4042	4.2	75	43	1 100/400
YT-4045	4.5	80	47	1 100/400
YT-4048	4.8	86	52	1 100/400
YT-4050	5.0	86	52	1 100/400
YT-4052	5.2	86	52	1 100/400
YT-4055	5.5	93	57	1 100/400

YATO	Ø [mm]	H1 [mm]	H2 [mm]	pcs / szt.
YT-4060	6.0	93	57	1 100/400
YT-4065	6.5	101	63	1 75/300
YT-4070	7.0	109	69	1 75/300
YT-4075	7.5	109	69	1 75/300
YT-4080	8.0	117	75	1 75/300
YT-4085	8.5	117	75	1 75/300
YT-4090	9.0	125	81	1 75/300
YT-4100	10.0	133	87	1 75/300
YT-4110	11.0	142	94	1 75/300
YT-4120	12.0	151	101	1 75/300
YT-4140	14.0	160	108	1 25/100
YT-4160	16.0	178	120	1 25/100

EN Twist drill set
PL Komplet wiertel do metalu
DE Metallspiralbohrersatz
RU Набор сверл по металлу

CZ Souprava vrtáků na kov
HU Fúrószárkészlet fémhez
RO Set de burghie pt. metal
FR Set des forets métal HSS

IT Set punte per metallo
ES Broca para metal
CN 全磨制合金麻花钻组套



6
PCS

10
PCS

YATO	Ø [mm]	
YT-41602	2, 3, 4, 5, 6, 8	15/60

YATO	Ø [mm]	
YT-41603	1, 2, 3, 4, 5, 6, 7, 8, 9, 10	20/40



19
PCS

25
PCS

YATO	Ø [mm]	
YT-41604	1, 1.5, 2, 2.5, 3, 3.5, 4, 4.5, 5, 5.5, 6, 6.5, 7, 7.5, 8, 8.5, 9, 9.5, 10	15/30

YATO	Ø [mm]	
YT-41605	1, 1.5, 2, 2.5, 3, 3.5, 4, 4.5, 5, 5.5, 6, 6.5, 7, 7.5, 8, 8.5, 9, 9.5, 10, 10.5, 11, 11.5, 12, 12.5, 13	10

EN Twist drill
PL Wierć do metalu
DE Metallspiralbohrer
RU Сверло по металлу
CZ Vrták na kov
HU Fúrószár fémhez

RO Burghiu pt. metal
FR Foret métal
IT Punte per metallo
ES Broca para metal
CN 全磨制麻花钻

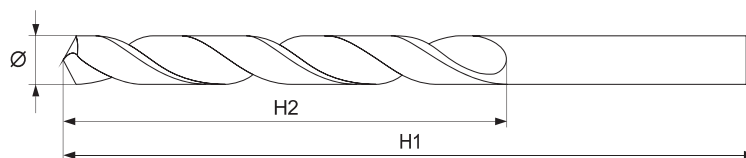

YATO	Ø [mm]	H1 [mm]	H2 [mm]	pcs / szt.	
YT-44630	1.0	34	12	2	50/500
YT-44631	1.5	40	18	2	50/500
YT-44632	2.0	49	24	2	50/500
YT-44633	2.5	57	30	2	50/500
YT-44634	2.8	61	33	2	50/500
YT-44635	3.0	61	33	2	50/500
YT-44637	3.2	65	36	1	50/500
YT-44639	3.5	70	39	1	50/500
YT-44640	4.0	75	43	1	50/500
YT-44642	4.2	75	43	1	50/500

YATO	Ø [mm]	H1 [mm]	H2 [mm]	pcs / szt.	
YT-44643	4.5	80	47	1	50/500
YT-44645	4.8	86	52	1	50/500
YT-44650	5.0	86	52	1	50/500
YT-44652	5.2	86	52	1	50/500
YT-44653	5.5	93	57	1	50/500
YT-44654	6.0	93	57	1	50/500
YT-44655	6.5	101	63	1	50/250
YT-44656	7.0	109	69	1	50/250
YT-44657	7.5	109	69	1	50/250
YT-44658	8.0	117	75	1	50/250

YATO	Ø [mm]	H1 [mm]	H2 [mm]	pcs / szt.	
YT-44659	8.5	117	75	1	50/250
YT-44660	9.0	125	81	1	50/250
YT-44661	9.5	125	81	1	50/250
YT-44662	10.0	133	87	1	50/200
YT-44663	10.5	133	87	1	50/200
YT-44664	11.0	142	94	1	50/200
YT-44666	12.0	151	101	1	50/100
YT-44667	12.5	151	101	1	50/100
YT-44668	13.0	151	101	1	50/100

EN Twist drill set
 PL Komplet wiertel do metalu
 DE Metallspiralbohrersatz
 RU Набор сверл по металлу
 CZ Souprava vrtáků na kov
 HU Fúrószerkészlet fémhez

RO Set de burghie pt. metal
 FR Set de forets métal
 IT Set punte per metallo
 ES Juego de brocas para metal
 CN 轧制麻花钻

190
PCS

HSS
4241

DIN
338

TITANIUM COATED POWŁOKA TYTANOWA

135°



YATO	Ø [mm]	
YT-44677	1, 1.5, 2, 2.5, 3, 3.2, 3.5, 4, 4.2, 4.5, 5, 5.5, 6, 6.5, 7, 7.5, 8, 8.5, 9, 9.5, 10, 10.5, 11, 11.5, 12, 12.5, 13	5

EN Long metal drills
 PL Długie wiertła do metalu
 DE Lange Bohrer für Metall
 RU Длинные сверла по металлу
 CZ Dlouhé vrtáky do kovu
 HU Hosszú fémfúrószerák

RO Burghie lungi pt. metal
 FR Longs forets à métaux
 IT Punte lunghe per metallo
 ES Brocas largas para metal
 CN 加长麻花钻组套

5
PCS

DIN
1869

HSS
4341

FULLY GROUND WIERTEL SZLIFOWANE

118°



YATO	Ø [mm]	
YT-39820	3, 4, 5, 6, 8	20/80

EN Twist drill
 PL Wiertło do metalu
 DE Metallspiralbohrer
 RU Сверло по металлу
 CZ Vrták na kov
 HU Fúrószer fémhez

RO Burghiu pt. metal
 FR Foret métal
 IT Punta per metallo
 ES Broca para metal
 CN 全磨制含钴麻花钻

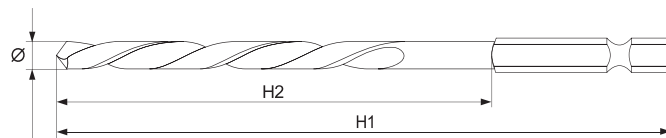

DIN
338

HSS
4241

TITANIUM COATED POWŁOKA TYTANOWA

1/4" 6.3 mm

YATO	Ø [mm]	H1 [mm]	H2 [mm]	pcs / szt.	
YT-44750	1.5	63	18	1	150/600
YT-44751	2.0	72	24	1	150/600
YT-44752	2.5	80	30	1	150/600
YT-44754	3.0	81	33	1	150/600
YT-44755	3.2	85	36	1	150/600
YT-44756	3.5	90	39	1	150/600
YT-44757	4.0	95	43	1	150/600
YT-44758	4.2	95	43	1	100/400

YATO	Ø [mm]	H1 [mm]	H2 [mm]	pcs / szt.	
YT-44759	4.5	100	47	1	150/600
YT-44760	4.8	106	52	1	100/400
YT-44761	5.0	106	52	1	100/400
YT-44763	5.5	113	57	1	100/400
YT-44764	6.0	113	57	1	100/400
YT-44765	6.5	121	63	1	100/400
YT-44766	7.0	109	69	1	100/400
YT-44767	7.5	109	69	1	100/400

YATO	Ø [mm]	H1 [mm]	H2 [mm]	pcs / szt.	
YT-44768	8.0	117	75	1	100/400
YT-44769	8.5	117	75	1	100/400
YT-44770	9.0	125	81	1	50/200
YT-44772	10.0	133	87	1	50/200
YT-44773	11.0	142	94	1	50/200
YT-44774	12.0	151	101	1	50/200
YT-44776	13.0	151	101	1	50/200

EN Twist drill
 PL Wiertło do metalu
 DE Spiralbohrer
 RU Сверло по металлу
 CZ Vrták na kov
 HU Fúrószer fémhez

RO Burghiu pt. metal
 FR Foret hélicoïdal
 IT Punta per metallo
 ES Broca espiral
 CN 整体六角柄全磨钻

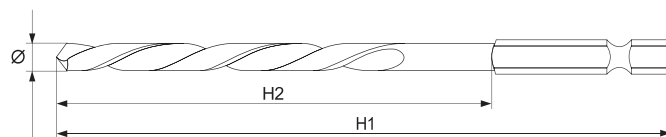

DIN
338

HSS
6542

FULLY GROUND WIERTEL SZLIFOWANE

1/4" 6.3 mm

135°

YATO	Ø [mm]	H1 [mm]	H2 [mm]	pcs / szt.	
YT-44860	1.5	57	26	1	100/500
YT-44861	2.0	57	26	1	100/500
YT-44862	2.5	57	26	1	100/500
YT-44863	3.0	61	31	1	100/500
YT-44864	3.2	65	34	1	100/500
YT-44865	3.5	70	38	1	100/500
YT-44866	4.0	75	43	1	100/500
YT-44867	4.2	75	43	1	50/300
YT-44868	4.5	80	47	1	50/200

YATO	Ø [mm]	H1 [mm]	H2 [mm]	pcs / szt.	
YT-44869	4.8	86	52	1	50/200
YT-44870	5.0	86	52	1	50/200
YT-44871	5.5	93	57	1	50/200
YT-44872	6.0	93	57	1	50/200
YT-44873	6.5	101	63	1	50/200
YT-44874	7.0	109	69	1	50/200
YT-44875	7.5	109	69	1	50/200
YT-44876	8.0	117	75	1	50/200
YT-44877	8.5	117	75	1	50/200

YATO	Ø [mm]	H1 [mm]	H2 [mm]	pcs / szt.	
YT-44878	9.0	125	81	1	50/200
YT-44879	9.5	125	81	1	50/200
YT-44880	10.0	133	87	1	50/200
YT-44881	10.5	133	87	1	50/100
YT-44882	11.0	142	94	1	50/100
YT-44883	12.0	151	101	1	50/100
YT-44884	13.0	151	101	1	50/100

EN Saw drill
 PL Wiertło frezujące do metalu
 DE Metall-Fräsbohrer
 RU Сверло фрезервальное по металлу
 CZ Vrták frézovací
 HU Marófúró fémhez

RO Burghiu freza
 FR Foret de fraisage
 IT Punta per fresatura metalli
 ES Broca de sierra
 CN 整体六角柄锯钻

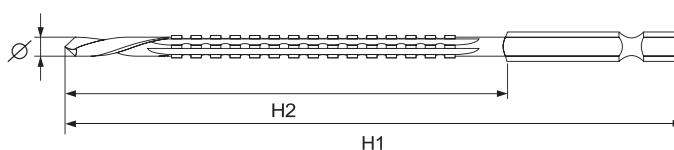

HRC
58-62

HSS
4241

TITANIUM COATED POWŁOKA TYTANOWA

1/4" 6.3 mm

118°

YATO	Ø [mm]	H1 [mm]	H2 [mm]	pcs / szt.	
YT-44820	3.0	70	35	1	150/600
YT-44821	4.0	78	43	1	150/600
YT-44822	5.0	81	46	1	100/400
YT-44823	6.0	89	54	1	100/400

YATO	Ø [mm]	H1 [mm]	H2 [mm]	pcs / szt.	
YT-44824	6.5	89	54	1	100/400
YT-44825	7.0	92	57	1	100/400
YT-44826	8.0	99	64	1	100/400
YT-44827	9.0	102	67	1	50/200

YATO	Ø [mm]	H1 [mm]	H2 [mm]	pcs / szt.	
YT-44828	10.0	105	70	1	50/200
YT-44829	11.0	110	75	1	50/200
YT-44830	12.0	115	80	1	50/200
YT-44831	13.0	120	85	1	50/200

EN Twist drill set
PL Komplet wiertel do metalu
DE Metallspiralbohrersatz
RU Набор сверл по металлу
CZ Souprava vrtáků na kov
HU Fúrószárkészlet fémhez
RO Set de burghie pt. metal
FR Set de forets métal
IT Set punte per metallo
ES Juego de brocas para metal
CN 麻花钻组套

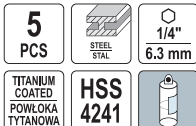

YATO	Ø [mm]	
YT-44700	4, 5, 6, 8, 10	30/60

EN Twist drill set
PL Komplet wiertel do metalu
DE Metallspiralbohrersatz
RU Набор сверл по металлу
CZ Souprava vrtáků na kov
HU Fúrószárkészlet fémhez
RO Set de burghie pt. metal
FR Set de forets métal
IT Set punte per metallo
ES Juego de brocas para metal
CN 麻花钻组套

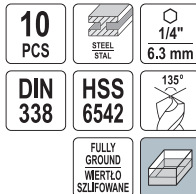

YATO	Ø [mm]	
YT-44888	1.5, 2.0, 2.5, 3.0, 3.5, 4.0, 4.5, 5.0, 5.5, 6.0	10/20

EN Twist drill set
PL Komplet wiertel do metalu
DE Metallspiralbohrersatz
RU Набор сверл по металлу
CZ Souprava vrtáků na kov
HU Fúrószárkészlet fémhez
RO Set de burghie pt. metal
FR Set de forets métal
IT Set punte per metallo
ES Juego de brocas para metal
CN 六角柄宝塔钻铣刀薄板钻组套

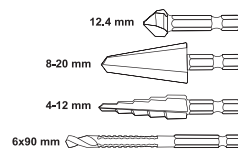
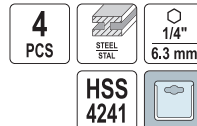

YATO	Ø [mm]	
YT-44705		12/24

EN Twist drill set
PL Komplet wiertel do metalu
DE Metallspiralbohrersatz
RU Набор сверл по металлу

CZ Souprava vrtáků na kov
HU Fúrószárkészlet fémhez
RO Set de burghie pt. metal
FR Set des forets métal HSS

IT Set punte per metallo
ES Broca para metal
CN 全磨制麻花钻



6
PCS

YATO	Ø [mm]	
YT-44673	2, 3, 4, 5, 6, 8	50/100

10
PCS



YATO	Ø [mm]	
YT-44674	1, 2, 3, 4, 5, 6, 7, 8, 9, 10	25/100



19
PCS

YATO	Ø [mm]	
YT-44675	1, 1.5, 2, 2.5, 3, 3.5, 4, 4.5, 5, 5.5, 6, 6.5, 7, 7.5, 8, 8.5, 9, 9.5, 10	6/30



25
PCS

YATO	Ø [mm]	
YT-44676	1, 1.5, 2, 2.5, 3, 3.5, 4, 4.5, 5, 5.5, 6, 6.5, 7, 7.5, 8, 8.5, 9, 9.5, 10, 10.5, 11, 11.5, 12, 12.5, 13	5/20

10

EN Twist drill set
 PL Komplet wiertel do metalu
 DE Metallspiralbohrersatz
 RU Набор сверл по металлу
 CZ Souprava vrtáků na kov
 HU Fúrószárkészlet fémhez
 RO Set de burghie pt. metal
 FR Foret métaux
 IT Set punte per metallo
 ES Broca para metalo
 CN 轧制麻花钻



2
PCS

3
PCS

YATO	Ø [mm]	
YT-44627	26, 28	10

YATO	Ø [mm]	
YT-44626	22, 24, 25	10



4
PCS

5
PCS

YATO	Ø [mm]	
YT-44625	14, 16, 18, 20	10

YATO	Ø [mm]	
YT-44622	10, 11, 12, 13, 15	10

EN Twist drill set
 PL Komplet wiertel do metalu
 DE Metallspiralbohrersatz
 RU Набор сверл по металлу
 CZ Souprava vrtáků na kov
 HU Fúrószárkészlet fémhez
 RO Set de burghie pt. metal
 FR Set de forets métal
 IT Set punte per metallo
 ES Juego de brocas para metal
 CN 轧制麻花钻



YATO	Ø [mm]	
YT-40050	4, 5, 6, 8, 10	24

EN Universal drill
 PL Wiercio uniwersalne
 DE Universalbohrer
 RU Универсальное сверло
 CZ Víceúčelový vrták
 HU Kőzet és többcélú fúró
 RO Burghiu universal cu coada hexagonala
 FR Forets polyvalents
 IT Punta universale
 ES Broca multimaterial
 CN 多功能冲击钻

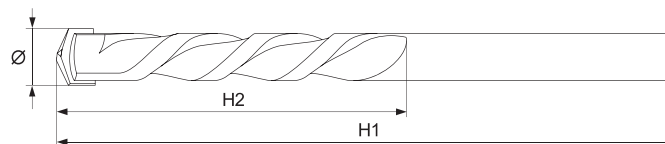
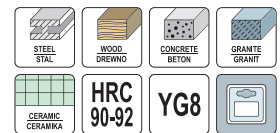

YATO	Ø [mm]	H1 [mm]	H2 [mm]	pcs / szt.	
YT-43940	3	60	35	1	100/600
YT-43941	4	75	40	1	100/600
YT-43942	5	85	50	1	100/600
YT-43943	6	100	60	1	100/400
YT-43960	6	400	240	1	25/100
YT-43944	7	100	60	1	100/400
YT-43945	8	120	70	1	50/400
YT-43962	8	400	240	1	25/100
YT-43946	10	150	90	1	50/200

YATO	Ø [mm]	H1 [mm]	H2 [mm]	pcs / szt.	
YT-43963	10	400	240	1	25/100
YT-43947	12	150	90	1	50/200
YT-43964	12	400	240	1	25/100
YT-43948	14	150	90	1	50/100
YT-43965	14	400	240	1	25/50
YT-43949	16	150	90	1	50/100
YT-43966	16	400	240	1	25/50
YT-43967	18	400	240	1	25
YT-43968	20	400	240	1	25

EN Universal drill
PL Wiertło uniwersalne
DE Universalbohrer
RU Универсальное сверло
CZ Všeúčelový vrták
HU Kőzet és többcéli fúró
RO Burghiu universal cu coada hexagonala
FR Forets polyvalents
IT Punta universale
ES Broca multimatierial
CN 六角柄多功能钻

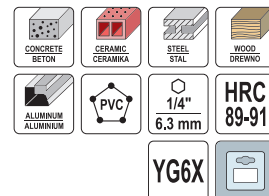
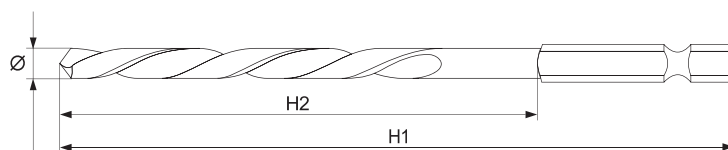

YATO	Ø [mm]	H1 [mm]	H2 [mm]	pcs / szt.	
YT-44780	3	85	30	1	125/250
YT-44781	4	85	30	1	125/250
YT-44782	5	85	30	1	125/250
YT-44783	6	85	30	1	125/250

YATO	Ø [mm]	H1 [mm]	H2 [mm]	pcs / szt.	
YT-44784	7	85	30	1	125/250
YT-44785	8	100	45	1	50/200
YT-44786	10	120	70	1	50/200
YT-44787	12	120	70	1	50/200

EN Universal drills
PL Zestaw wiertel uniwersalnych
DE Universalbohrer-Set
RU Набор универсальных сверл
CZ Sada všeúčelových vrtáků
HU Keményfém többcéli fúró készlet
RO Set burghie universale
FR Jeu de forets universel
IT Set di punte universali
ES Juego de brocas universales
CN 六角柄多功能钻组套

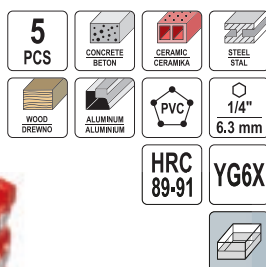

EN Universal drill bit set
PL Zestaw wiertel uniwersalnych
DE Universalbohrer-Set
RU Набор универсальных сверл
CZ Sada všeúčelových vrtáků
HU Keményfém többcéli fúró készlet
RO Set burghie universale
FR Jeu de forets universel
IT Set di punte universali
ES Juego de brocas universales
CN 混合钻组套

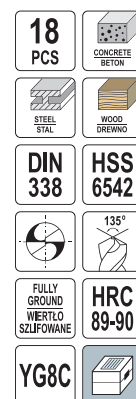

YATO	Ø [mm]	
YT-44789	4, 5, 6, 8, 10	25/100

YATO	Ø [mm]	
YT-43490	3, 4, 5, 6, 8, 10	20

EN Masonry drill bit X-TIP
PL Wiertło do betonu X-TIP
DE Betonspiralbohrer X-TIP
RU Сверло по бетону X-TIP
CZ Vrták na beton X-TIP
HU Fúrószár betonhoz X-TIP
RO Burghiu pt. beton X-TIP
FR Foret béton à pointe en croix
IT Punta per cemento X-TIP
ES Broca para hormigón X-TIP
CN 十字头电锤钻

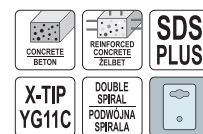
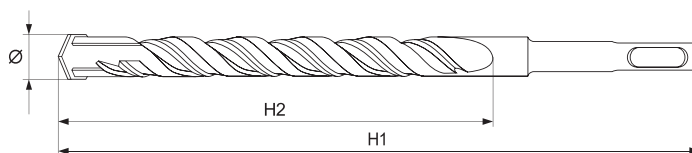

YATO	Ø [mm]	H1 [mm]	H2 [mm]	PCS SZT.	
YT-4200	5	110	45	10	300
YT-4201	6	110	45	10	300
YT-4202	6	160	95	10	200
YT-4203	6	210	135	10	150
YT-4204	8	110	45	10	300
YT-4205	8	160	95	10	200
YT-4206	8	210	140	10	150
YT-4207	8	460	370	10	50
YT-4208	8	600	500	10	50
YT-4209	10	160	95	10	150
YT-4210	10	210	140	10	150
YT-4211	10	300	220	10	100
YT-4212	10	460	370	10	50
YT-4213	10	600	500	10	50
YT-4214	12	160	95	10	150
YT-4215	12	260	185	10	100

YATO	Ø [mm]	H1 [mm]	H2 [mm]	PCS SZT.	
YT-4216	12	460	360	10	50
YT-4217	12	600	490	10	40
YT-4218	14	260	180	10	80
YT-4219	14	460	360	10	40
YT-4220	16	200	125	10	60
YT-4221	16	460	360	10	20
YT-4222	16	600	490	10	20
YT-4223	18	460	360	10	20
YT-4224	18	600	490	10	20
YT-4225	20	460	360	5	20
YT-4226	20	600	490	5	20
YT-4227	22	460	360	5	20
YT-4228	22	600	490	5	20
YT-4229	25	460	360	5	20
YT-4230	25	600	490	5	10

EN Masonry drill bit
 PL Wiertło do betonu
 DE Betonspiralbohrer
 RU Цебно no бетону
 CZ Vrták na beton
 HU Fúrósász betonhoz
 RO Burghiu pt. beton
 FR Foret béton
 IT Punta per cemento
 ES Broca para hormigón
 CN 三尖电锤钻

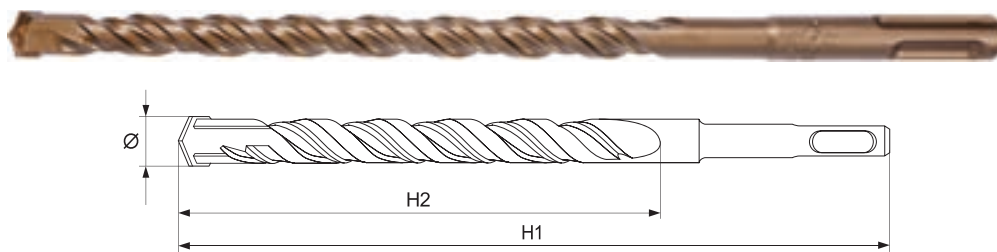

YATO	Ø [mm]	H1 [mm]	H2 [mm]	PCS PER PKG	
YT-4161	5	110	45	10	300
YT-4162	6	110	45	10	300
YT-4163	6	160	95	10	200
YT-4164	6	210	140	10	150
YT-4165	8	110	45	10	300
YT-4166	8	160	90	10	200
YT-4167	8	210	140	10	150
YT-4168	8	460	370	10	50
YT-4169	8	600	500	10	50
YT-4170	10	160	95	10	150
YT-4171	10	210	140	10	150
YT-4172	10	300	220	10	100
YT-4173	10	460	370	10	50
YT-4174	10	600	500	10	50
YT-4175	12	160	85	10	150
YT-4176	12	260	180	10	100

YATO	Ø [mm]	H1 [mm]	H2 [mm]	PCS PER PKG	
YT-4177	12	460	360	10	50
YT-4178	12	600	490	10	40
YT-4179	14	260	180	10	80
YT-4180	14	460	360	10	40
YT-4181	16	200	125	10	60
YT-4182	16	300	220	10	50
YT-4183	16	460	360	10	20
YT-4184	16	600	490	10	20
YT-4185	18	460	360	10	20
YT-4186	18	600	490	10	20
YT-4187	20	460	360	5	20
YT-4188	20	600	490	5	20
YT-4189	22	460	360	5	20
YT-4190	22	600	490	5	20
YT-4191	25	460	360	5	20
YT-4192	25	600	490	5	10

EN Masonry drill bit
 PL Wiertło do betonu
 DE Betonspiralbohrer
 RU Цебно no бетону
 CZ Vrták na beton
 HU Fúrósász betonhoz
 RO Burghiu pt. beton
 FR Foret béton
 IT Punta per cemento
 ES Broca para hormigón
 CN 三尖电锤钻

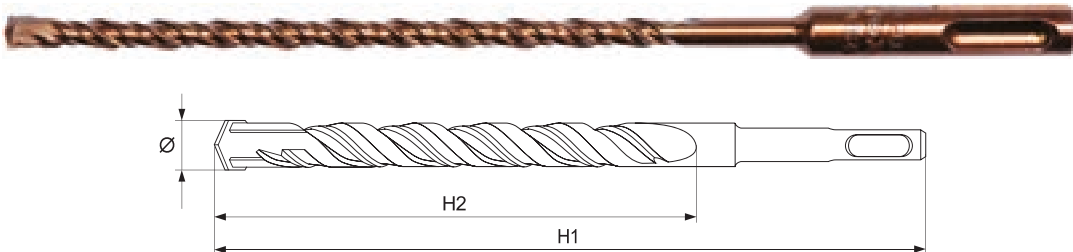

- For windows assembly
- Without necessity of using screw anchors
- Do montażu okien
- Bez użycia kółków rozporowych

YATO	Ø [mm]	H1 [mm]	H2 [mm]	PCS PER PKG	
YT-41641	6.5	200	130	10	10/150
YT-41642	6.5	260	183	10	10/150

EN Masonry drill bit
 PL Wiertło do betonu
 DE Betonspiralbohrer
 RU Цебно no бетону
 CZ Vrták na beton
 HU Fúrósász betonhoz
 RO Burghiu pt. beton
 FR Foret béton
 IT Punta per cemento
 ES Broca para hormigón
 CN 三尖电锤钻

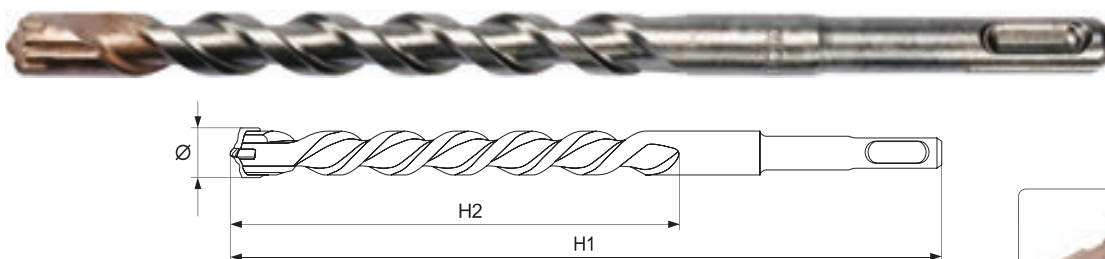

- Resistant for stack in SDS chuck
- DD carbide tip
- Automatic soldering
- Odporne na zakleszczenie w uchwycie SDS
- Widia DD carbide
- Automatische lutowanie



YATO	Ø [mm]	H1 [mm]	H2 [mm]	
YT-41930	5	110	50	40/160
YT-41935	5	160	100	40/160
YT-41931	6	110	50	40/160
YT-41936	6	160	100	40/160
YT-41942	6	210	150	40/160
YT-419503	6	300	250	40/160
YT-41951	6	460	375	30/120
YT-41960	6	600	525	25/100
YT-41932	7	110	50	40/160
YT-41937	7	160	100	40/160
YT-41933	8	110	50	40/160
YT-41938	8	160	100	40/160
YT-41943	8	210	150	40/160
YT-419504	8	300	250	40/160
YT-41952	8	460	375	30/120
YT-41961	8	600	525	20/80
YT-41939	9	160	100	40/160

YATO	Ø [mm]	H1 [mm]	H2 [mm]	
YT-41944	9	210	150	40/160
YT-41934	10	110	50	40/160
YT-41940	10	160	100	40/160
YT-41945	10	210	150	30/120
YT-419505	10	300	250	40/160
YT-41953	10	460	375	30/120
YT-41962	10	600	525	20/80
YT-41941	12	160	100	40/160
YT-41946	12	210	150	30/120
YT-419506	12	300	245	40/160
YT-41954	12	460	375	20/80
YT-41963	12	600	525	15/60
YT-41969	12	1000	930	25
YT-41947	14	210	150	20/80
YT-41955	14	460	375	20/80
YT-41964	14	600	525	15/60
YT-41970	14	1000	930	20

YATO	Ø [mm]	H1 [mm]	H2 [mm]	
YT-41948	16	210	150	20/80
YT-41956	16	460	375	15/60
YT-41965	16	600	525	10/40
YT-41971	16	1000	930	20
YT-41949	18	210	150	20/80
YT-41957	18	460	375	10/40
YT-41966	18	600	525	5/20
YT-41972	18	1000	930	15
YT-41950	22	210	150	20/80
YT-41958	22	460	375	8/32
YT-41967	22	600	525	5/20
YT-41973	22	1000	930	15
YT-41959	25	460	375	8/32
YT-41968	25	600	525	5/20
YT-41974	25	1000	930	15

EN Masonry drill bit
PL Wiertło do betonu
DE Betonspiralbohrer
RU Сверло по бетону
CZ Vrták na beton
HU Fúrószerű betonhoz

RO Burghiu pt. beton
FR Foret béton
IT Punta per cemento
ES Broca para hormigón
CN 建工钻

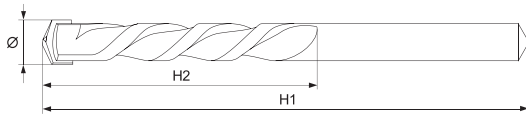
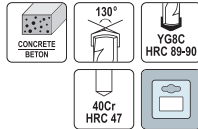

YATO	Ø [mm]	H1 [mm]	H2 [mm]	
YT-4361	4	70	35	100/400
YT-4362	5	90	50	100/400
YT-4363	6	100	60	100/400
YT-4364	6	150	100	100/400
YT-4367	7	100	60	75/300
YT-4369	8	120	80	75/300
YT-4370	8	200	140	50/150

YATO	Ø [mm]	H1 [mm]	H2 [mm]	
YT-4375	10	120	80	75/300
YT-4376	10	200	140	50/150
YT-4379	12	150	100	50/150
YT-4380	12	200	140	50/150
YT-4383	14	180	120	25/100
YT-4385	16	180	120	25/100

EN Masonry drill bit set
PL Komplet wiertel do betonu
DE Betonspiralbohrersatz
RU Свёрла по бетону в наборе
CZ Souprava vrtáků do betonu
HU Fúrószerűkészlet betonhoz
RO Set de burghie pt. beton
FR Set des forets béton
IT Set punte per cemento
ES Brocas para hormigón
CN 建工钻组套

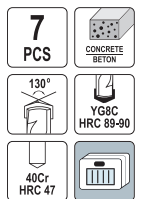

YATO	Ø [mm]	
YT-4390	4, 5, 6, 8, 9, 10, 12	10/80

EN Flat wood drill bit
PL Wiertło łopatkowe do drewna
DE Schaufelbohrer
RU Перовые сверло
CZ Plochý vrták
HU Homlokmarós fúró

RO Burghiu plate
FR Mèche à bois plate
IT Punta per legno piatta
ES Broca de aletas
CN 木工扁钻

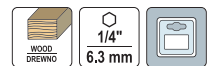
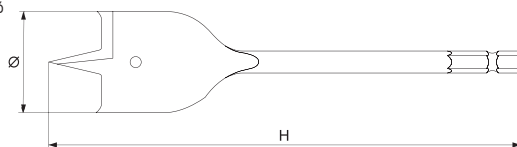

YATO	Ø [mm]	H [mm]	
YT-3236	6	152	50/400
YT-3237	8	152	50/400
YT-3238	10	152	50/300
YT-3239	12	152	50/300
YT-3240	13	152	50/300
YT-3241	14	152	50/300
YT-3242	16	152	50/300

YATO	Ø [mm]	H [mm]	
YT-3243	18	152	50/300
YT-3244	20	152	50/300
YT-3245	22	152	50/300
YT-3246	24	152	50/300
YT-3247	25	152	50/300
YT-3248	26	152	50/300
YT-3249	28	152	50/300

YATO	Ø [mm]	H [mm]	
YT-3250	30	152	50/200
YT-3251	32	152	50/200
YT-3252	34	152	50/200
YT-3253	35	152	50/200
YT-3254	38	152	50/200
YT-3255	40	152	50/200

EN Extension for flat wood drill bits
PL Przedłużka do wiertel łopatkowych, bitów i wiertel
DE Verlängerung für Schaufelbohrer
RU Удлинитель для перовых сверл
CZ Nástavec pro ploché vrtáky
HU Hosszabítló homlokmarós fafúrókhoz
RO Prelungitor pt. burghie plate
FR Rallonge pour mèches à bois
IT Prolunga per punta fresatrice
ES Extensión para brocas de aletas
CN 木工扁钻延长杆

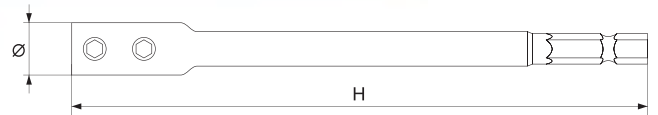
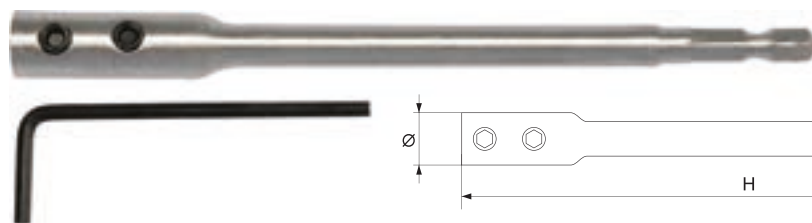

YATO	Ø [mm]	H [mm]	
YT-3256	12.2	150	60/120
YT-3257	13.5	300	30/60

EN Flat wood drill bit set
PL Zestaw wiertel łopatkowych
DE Schaufelbohrersatz
RU Набор перовых сверл
CZ Sada plochých vrtáků
HU Homlokmarós fafúró készlet
RO Set burghie plate
FR Set de mèche à bois
IT Set di punte per legno piatta
ES Juego de brocas de aletas
CN 木工扁钻组套

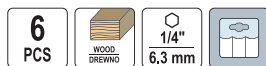

YATO	Ø [mm]	H [mm]	
YT-3258	10, 12, 16, 18, 20, 25	152	25/50

EN Flat wood drill bit set
PL Zestaw wiertel łopatkowych
DE Schaufelbohrersatz
RU Набор перовых сверл
CZ Sada plochých vrtáků
HU Homlokmarós fafúró készlet
RO Set burghie plate
FR Set de mèche à bois
IT Set di punte per legno piatta
ES Juego de brocas de aletas
CN 木工扁钻组套



YATO	Ø [mm]	H [mm]	
YT-3259	12, 16, 18, 20, 22, 25, 28, 32	152	5/20

EN Spur wood drill bit
 PL Wiertło do drewna spiralne
 DE Spiralbohrer für Holz
 RU Спиральное сверло по дереву
 CZ Vrták do dřeva spirálový
 HU Csiga fúrő fához
 RO Burghiu spirală pt. lemn
 FR Mèches hélicoïdales à bois
 IT Punta per legno spirale
 ES Barrena para madera espiral
 CN 木工钻

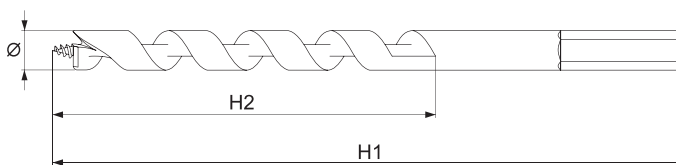
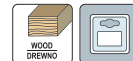

YATO	Ø [mm]	H1 [mm]	H2 [mm]	
YT-4350	3	60	35	30/300
YT-4351	4	75	44	30/300
YT-4352	5	85	52	30/300
YT-4353	6	90	57	30/300

YATO	Ø [mm]	H1 [mm]	H2 [mm]	
YT-4354	7	100	67	30/300
YT-4355	8	110	75	30/300
YT-4356	10	120	77	30/300
YT-4357	12	150	97	15/120

YATO	Ø [mm]	H1 [mm]	H2 [mm]	
YT-4358	13	150	102	15/120
YT-4359	16	160	120	15/120

EN Spur wood drill bit
 PL Wiertło do drewna spiralne
 DE Spiralbohrer für Holz
 RU Спиральное сверло по дереву
 CZ Vrták do dřeva spirálový
 HU Csiga fúrő fához
 RO Burghiu spirală pt. lemn
 FR Mèches hélicoïdales à bois
 IT Punta per legno spirale
 ES Barrena para madera espiral
 CN 木工钻

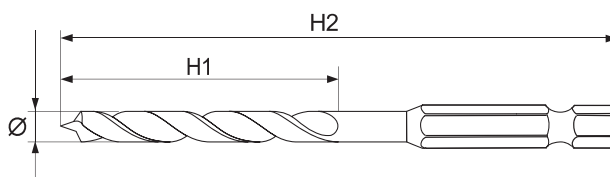
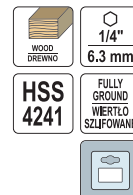

YATO	Ø [mm]	H1 [mm]	H2 [mm]	
YT-33860	3	61	33	125/500
YT-33861	4	75	43	125/500
YT-33862	5	86	52	75/300
YT-33863	6	93	57	75/300

YATO	Ø [mm]	H1 [mm]	H2 [mm]	
YT-33864	7	109	69	75/300
YT-33865	8	117	75	75/300
YT-33866	10	133	87	75/300
YT-33867	12	151	101	75/300

YATO	Ø [mm]	H1 [mm]	H2 [mm]	
YT-33868	13	151	101	50/200
YT-33869	14	160	108	50/200
YT-33870	16	178	120	50/200

EN Spur wood drill set
 PL Zestaw wiertel spiralnych do drewna
 DE Holzspiralbohrer-Set
 RU Набор спиральных сверел по дереву
 CZ Sada spirálových vrtáků do dřeva
 HU Spirál fűrészsár készlet
 RO Set burghie pt. lemn
 FR Jeu de forets à spirale pour bois
 IT Set di punte spirali per legno
 ES Juego de brocas espirales para la madera
 CN 高速钢整体木工钻组套

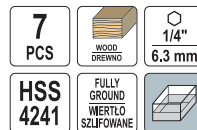

YATO	Ø [mm]	
YT-33873	3, 4, 5, 6, 7, 8, 10	20/80

EN Auger drill bit hex
 PL Wiertło do drewna 4-ostrowe Hex
 DE 4-flöte Schlangenbohrer
 RU Сверло по дереву Hex с 4 режущими кромками
 CZ Vrták do dřeva
 HU Auger fűrészsár bit befogással
 RO Burghiu sfredel
 FR 4 diamètre ébénisterie bois foret
 IT Punta esagonale per legno
 ES Broca espiral de madera Hex
 CN 四槽木工钻

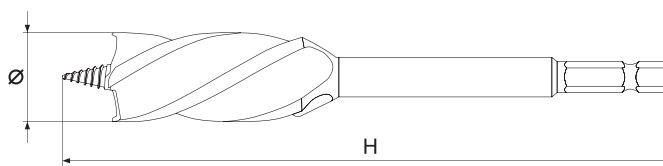

YATO	Ø [mm]	H [mm]	
YT-44680	10	165	100/200
YT-44681	12	165	100/200
YT-44682	14	165	100/200
YT-44683	16	165	100/200

YATO	Ø [mm]	H [mm]	
YT-44684	18	165	75/150
YT-44685	20	165	75/150
YT-44686	22	165	50/100
YT-44687	25	165	50/100

YATO	Ø [mm]	H [mm]	
YT-44688	28	165	50/100
YT-44689	30	165	50/100
YT-44690	32	165	50/100

EN Auger drill bit set
PL Zestaw wiertel do drewna 4-ostrzowych Hex
DE Schlangenbohrer 4-Flöte Set
RU Набор сверл по дереву с 4 режущими кромками
CZ Sada vrtáky do dřeva
HU Auger fűfúrósár bit befogással készlet
RO Set burghiu sfredel
FR Coffret 4 diamètre ébénisterie bois foret
IT Set di punte esagonali per legno
ES Juego de brocas espiral de madera Hex
CN 木工钻



7
PCS

WOOD
DREWNO

1/4"
6,3 mm

HRC
40-45

1/4" (6.3 mm); 16, 18, 20, 22, 25 mm (L=165 mm);
1/4" (6.3 mm); (300 mm);

YATO
YT-44693 10/20

EN Auger wood drill bit
PL Świdrer do drewna
DE Holzbohrer
RU Бур по дереву
CZ Vrták do dřeva hadovité
HU Fafúró
RO Burghiu elicoidal pt. lemn
FR Foret spirale à bois
IT Punta a torciglione per legno
ES Barrena para madera
CN 螺旋木工钻

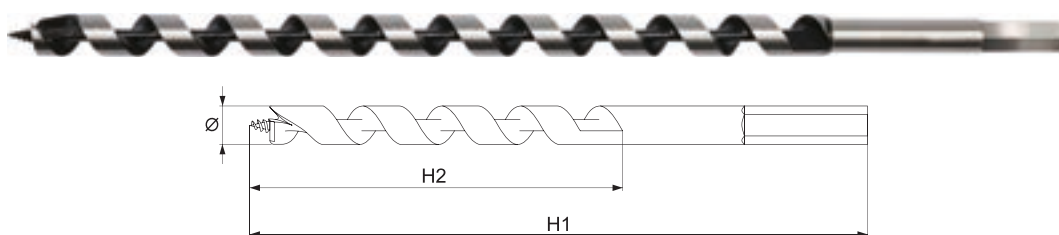

WOOD
DREWNO

13 mm

YATO	Ø [mm]	H1 [mm]	H2 [mm]	
YT-3261	6	230	150	150/300
YT-3262	8	230	150	140/280
YT-3263	8	460	360	60/120
YT-3264	10	230	150	100/200
YT-3265	10	460	360	50/100
YT-3266	12	190	150	75/150
YT-3267	12	460	360	30/60
YT-3268	13	230	150	50/100
YT-3269	13	460	360	30/60
YT-3270	14	191	150	50/100
YT-3271	14	460	360	30/60
YT-3272	16	230	150	50/100
YT-3273	16	460	360	20/40

YATO	Ø [mm]	H1 [mm]	H2 [mm]	
YT-3274	18	230	150	40/80
YT-3275	18	460	360	20/40
YT-3276	20	230	150	30/60
YT-3277	20	460	360	20/40
YT-3278	22	230	150	20/60
YT-3279	22	460	360	15/30
YT-3280	24	230	150	30/60
YT-3281	24	460	360	15/30
YT-3282	25	230	150	20/40
YT-3283	25	460	360	15/30
YT-3284	26	230	150	20/40
YT-3285	26	460	360	10/20
YT-3286	28	230	150	10/20

YATO	Ø [mm]	H1 [mm]	H2 [mm]	
YT-3287	28	460	360	5/20
YT-3288	30	230	150	10/20
YT-3289	30	460	360	5/10
YT-3290	32	230	150	10/20
YT-3291	32	460	360	5/10
YT-3292	35	230	150	10/20
YT-3293	35	460	360	5/10
YT-3294	36	230	150	10/20
YT-3295	36	460	360	5/10
YT-3296	38	230	150	10/20
YT-3297	40	230	360	10/20

EN Auger wood drill bit set
PL Zestaw świdrow do drewna
DE Holzbohrersatz
RU Набор буров по дереву
CZ Sada hadovitých vrtáků do dřeva
HU Fafúró készlet

RO Set de burghie elicoidale pt. lemn
FR Set de forets spirales à bois
IT Set di punte a torciglione
ES Juego de barrenas para madera
CN 螺旋木工钻组套

6
PCS

WOOD
DREWNO



13 mm



13 mm



SDS
PLUS

YATO	Ø [mm]	H [mm]	
YT-3299	10, 12, 14, 16, 18, 20	460	8

YATO	Ø [mm]	H [mm]	
YT-3298	10, 12, 14, 16, 18, 20	230	15

YATO	Ø [mm]	H [mm]	
YT-3300	10, 12, 14, 16, 18, 20	230	20

EN Confirmat screw drill bit
PL Wiertło do konfirmatów
DE Konfirmatbohrer
RU Сверло под конфирмат
CZ Vrták na konfirmáty
HU Konfirmátor csavar előfúró

RO Burghiu tip bit pt. mobilier
FR Foret à vis confirmat
IT Avvitatore per viti di assemblaggio mobili
ES Broca para tornillos confirmat
CN 倒角器木工钻



WOOD
DREWNO



YATO	Ø [mm]	D1 [mm]	D2 [mm]	
YT-33021	4	6	8	25/250
YT-33022	5	7	8	25/250
YT-33023	7	10	8	25/250

EN Drill for ceramic tiles
PL Wiertło do ceramiki i gresu
DE Keramik und Fliesen Bohr

RU Бурильные плитки и керамики
CZ Vrtací tašek a keramických výrobků
HU Fűrő cserép és kerámia

RO Burghiu pt. ceramica si sticla
FR Tuiles de forage et de la céramique
IT Piastrelle e ceramiche trapano

ES Azulejos y cerámicas de perforación
CN 玻璃钻



YATO	Ø [mm]	
YT-3725	4	100/400
YT-3726	6	100/400

EN Diamond tile drill bit
PL Koronka diamentowa
DE Diamantbohrkrone für Winkelschleifer
RU Алмазная коронка
CZ Diamantová korunka
HU Gyémánt koronafűrő
RO Burghiu diamant
FR Trépan diamant
IT Punta a corona diamentata
ES Broca diamante
CN 金刚石电镀薄壁钻

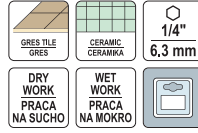

YATO	Ø [mm]	ω [min ⁻¹]	
YT-60401	6	1500	50/200
YT-60402	8	1500	50/200
YT-60403	10	1500	50/200

EN Diamond tile drill bit
PL Koronka diamentowa
DE Diamantbohrkrone für Winkelschleifer
RU Алмазная коронка
CZ Diamantová korunka
HU Gyémánt koronafűrő
RO Burghiu diamant
FR Trépan diamant
IT Punta a corona diamentata
ES Broca diamante
CN 金刚石电镀薄壁钻



YATO	Ø [mm]	ω [min ⁻¹]	
YT-60421	5	600	50/400
YT-60422	6	600	50/400
YT-60423	8	600	50/400
YT-60424	10	600	50/500
YT-60425	12	600	50/200
YT-60426	14	600	50/200
YT-60427	16	600	50/200
YT-60428	20	500	25/100
YT-60429	25	500	25/100
YT-60430	30	500	25/100
YT-60431	40	500	15/60
YT-60432	50	400	15/60
YT-60433	68	400	8/40
YT-60434	80	400	5/25
YT-60435	105	400	4/20
YT-60436	125	400	4/20

YATO	Ø [mm]	
YT-3727	8	100/400
YT-3728	10	50/200

EN Diamond tile drill bit
PL Koronka diamentowa
DE Diamantbohrkrone für Winkelschleifer
RU Алмазная коронка
CZ Diamantová korunka
HU Gyémánt koronafűrő
RO Burghiu diamant
FR Trépan diamant
IT Punta a corona diamentata
ES Broca diamante
CN 金刚石电镀薄壁钻



YATO	Ø [mm]	ω [min ⁻¹]	
YT-60409	6, 8, 10	1500	20/80

EN Dry diamond tile drill bit
PL Koronka diamentowa
DE Diamantbohrkrone für Winkelschleifer
RU Алмазная коронка
CZ Diamantová korunka
HU Gyémánt koronafűrő
RO Burghiu diamant
FR Trépan diamant
IT Punta a corona diamentata
ES Broca diamante
CN 钎焊薄壁钻



YATO	Ø [mm]	ω [min ⁻¹]	
YT-60441	6	12200	100/200
YT-60442	8	12200	100/200
YT-60443	10	12200	100/200
YT-60444	20	12200	100/200
YT-60445	30	12200	50/100
YT-60446	51	12200	40/80
YT-60447	68	12200	50

- EN Adjustable hand reamer
PL Rozwiertak nastawny
DE Verstellbare Reibahle
RU Регулируемая развертка
CZ Nastavitelný výstružník
HU Állítható dörzsár
- RO Alezor reglabil
FR Alesoir à main réglable
IT Alesatore regolabile
ES Escariador ajustable
CN 可调式手用铰刀

HSS
4241



YATO	Working diameter / Średnica robocza [mm²]	L [mm]	Arbor diameter / Średnica trzpienia [mm²]	
YT-28950	7.75-8.5	107	4.5	50/200
YT-28951	8.5-9.25	112	4.5	50/200
YT-28952	9.25-10	116	5.0	50/200
YT-28953	10-10.75	125	5.5	50/200
YT-28954	10.75-11.75	130	6.5	50/200
YT-28955	11.75-12.75	135	7.5	50/150
YT-28956	12.75-13.75	140	7.5	50/150
YT-28957	13.75-15.25	158	8.0	20/60
YT-28958	15.25-17	165	9.0	20/60

YATO	Working diameter / Średnica robocza [mm²]	L [mm]	Arbor diameter / Średnica trzpienia [mm²]	
YT-28959	17-19	175	10.0	20/60
YT-28960	19-21	180	11.5	20/60
YT-28961	21-23	193	13.5	20/60
YT-28962	23-26	210	15.4	4/20
YT-28963	26-29.5	245	17.0	4/20
YT-28964	29.5-33.5	270	19.0	4/20
YT-28965	33.5-38	310	21.0	2/10
YT-28966	38-44	345	24.0	2/10
YT-28967	44-54	400	30.0	5

- EN Straight hole doweling jig kit
PL Uchwyt do wiercenia prostopadłego
DE Bohrschablone zum senkrechten Vorbohren
RU Ручка для перпендикулярного сверления
CZ Rukojeť pro kolmé vrtání
HU Fúrósablón merőleges fúrásoz
- RO Kit pt. gaurit
FR Guide de perçage mobile
IT Mandrino per foratura verticale
ES Soporte para perforación perpendicular
CN 打孔定位器

ABS



YATO	Ø [mm]	
YT-39700	4, 5, 6, 8, 10, 12	40

- EN Spot weld cutter & drill bit set
PL Zestaw rozwiertaków do zgrzewów punktowych
DE Schweißpunktbohrer Set Schweißpunktfräser
RU Набор для высверливания точечной сварки
CZ Sada na odvrtání bodových svárů
HU Hegesztőpont maró készlet
RO Set de freze pt. suduri în puncte
FR Jeu de fraises pour points de soudure
IT Set di alesatori per punti di saldatura
ES Juego de puntos de soldadura de la fresa
CN 电焊钻



9
PCS



YATO		
YT-28920		10/60

- EN Depth collars for drills
PL Ogranicznik głębokości wiercenia
DE Bohrtiefenbegrenzer
RU Ограничитель глубины для сверл
CZ Omezovač hloubky vrtáků
HU Mélységutköző
RO Limitator adancime pt. burghiu
FR Butées de profondeur
IT Arresto di profondità
ES Tope de profundidad para brocas
CN 木工定位器



3
PCS



YATO	Ø [mm]	
YT-44100	6, 8, 10	250/500

- EN Spot weld cutter & drill bit set
PL Zestaw rozwiertaków do zgrzewów punktowych
DE Schweißpunktbohrer Set Schweißpunktfräser
RU Набор для высверливания точечной сварки
CZ Sada na odvrtání bodových svárů
HU Hegesztőpont maró készlet
RO Set de freze pt. suduri în puncte
FR Jeu de fraises pour points de soudure
IT Set di alesatori per punti di saldatura
ES Juego de puntos de soldadura de la fresa
CN 电焊钻



9
PCS



YATO		
YT-28919		10/60

- EN Drill welding points set
PL Zestaw wiertel do zgrzewów punktowych
DE Schweißpunkt-Fräsersatz
RU Набор сверл для точечной сварки
CZ Frézy pro bodové sváry
HU Pont hegesztés lefűró készlet
RO Set burghiu puncte sudura
FR Forets à dépointer les points soudure
IT Set di alesatori per punti di saldatura
ES Juego de brocas para puntos de soldadura
CN 电焊钻



3
PCS

COBALT COATED
POKRYTE
KOBALTEM



YATO	Ø [mm]	
YT-28921	6.5, 8, 10	50

- EN Dowelling centre points
PL Znaczniki do wyznaczenia otworów
DE Holzübel-Markierspitzen
RU Набор кернов для мебельных шкантов
CZ Značící hroty pro kolkování
HU Típlji jelölő
RO Cep pt. centrare
FR Centreurs
IT Set centroneri per spine
ES Centradores
CN 木工顶尖



4
PCS



YATO	Ø [mm]	
YT-44104	6	25/100
YT-44105	8	25/100
YT-44106	10	25/100

EN Dowel kit
 PL Zestaw do połączeń kolkowych
 DE Holzdübeln-Werkzeugsatz
 RU Набор для соединения на шкантах
 CZ Univerzální kolkovací set
 HU Univerzális tipliző szett
 RO Set burghiu + cepi de lemn
 FR Kit d'assemblage bois en mains libres
 IT Set di spinatura in legno
 ES Conjunto de montaje madera
 CN 木工顶尖

17 PCS
 Ø 6.0 mm



6x40 mm (10 PCS);
 6 mm (4 PCS);
 6 mm;
 2.5 mm;
 6x100 mm

YATO	Ø [mm]	
YT-44112	6	4/100

EN Dowel kit
 PL Zestaw do połączeń kolkowych
 DE Holzdübeln-Werkzeugsatz
 RU Набор для соединения на шкантах
 CZ Univerzální kolkovací set
 HU Univerzális tipliző szett
 RO Set burghiu + cepi de lemn
 FR Kit d'assemblage bois en mains libres
 IT Set di spinatura in legno
 ES Conjunto de montaje madera
 CN 木工顶尖

17 PCS
 Ø 8.0 mm



8x40 mm (10 PCS);
 8 mm (4 PCS);
 8 mm;
 2.5 mm;
 8x100 mm

YATO	Ø [mm]	
YT-44111	8	4/100

EN Dowel kit
 PL Zestaw do połączeń kolkowych
 DE Holzdübeln-Werkzeugsatz
 RU Набор для соединения на шкантах
 CZ Univerzální kolkovací set
 HU Univerzális tipliző szett
 RO Set burghiu + cepi de lemn
 FR Kit d'assemblage bois en mains libres
 IT Set di spinatura in legno
 ES Conjunto de montaje madera
 CN 木工顶尖

17 PCS
 Ø 10 mm



10x40 mm (10 PCS);
 10 mm (4 PCS);
 10 mm;
 2.5 mm;
 10x100 mm

YATO	Ø [mm]	
YT-44113	10	4/100

EN Drill gauge and depth stop set
 PL Sprawdzian do średnic i ograniczniki głębokości
 DE Durchmesserlehre und Tiefenanschlag
 RU Измеритель диаметра и ограничители глубины
 CZ Měřidla průměru a hloubkové dorazy
 HU Átmérőellenőrző és mélységátaroló
 RO Set sablon gaurire cu opritor
 FR Jauges de diamètre et butées de profondeur
 IT Calibro per diametri e limitatori di profondità
 ES Calibre de diámetros y limitador de brocas
 CN 钻头量规

10 PCS
 1/16"-1/2"
 1.0-13mm



3, 4, 5, 6, 8, 10, 12 mm;
 1.5 mm

YATO	Ø	
YT-44095	1/16"-1/2" / 1.0-13 mm	20/60

EN Tool drill guide
 PL Szablon do wyznaczania otworów
 DE Schablone zur Markierung von Löchern
 RU Шаблон для разметки отверстий
 CZ Šablona pro značení otvorů
 HU Nyílássablon

RO Instrument ghidare pt. gaurire
 FR Gabarit pour le marquage des trous
 IT Sagoma per fori
 ES Plantilla para determinar perforaciones
 CN 打孔定位工具

250 mm

AI

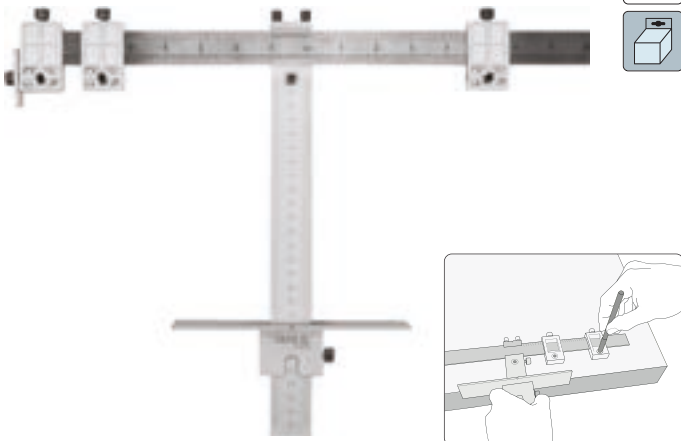

YATO		
YT-44130		20

EN Drill guider with handle
 PL Przyrząd do połączeń kolkowych
 DE Dübel Bohrschablone
 RU Кондуктор для сверления отверстий
 CZ Kolkovací přípravek
 HU Tipliző fúrósablon
 RO Sablon pt. dibluri lemn
 FR Guide de perçage pour assemblage par tourillons
 IT Dima per spinatura legno
 ES Guía de perforación
 CN 摆臂斜孔定位器

6, 8, 10 mm
 AI



YATO	Ø [mm]	
YT-44120	6, 8, 10	10

EN Combination edge setter / hole punch pliers
 PL Dziurkarko-felcarka
 DE Kombinierte Absetzange Lochzange
 RU Дырокол, кромкогиб
 CZ Falcovačka a děrovačka
 HU Lyukasztó peremező fogó

RO Cleste pt. fasonat si gaurit tabla
 FR Pince spéciale perforatrice carrosserie
 IT Combinazione: bordo setter / pinza perforare
 ES Solapadora y ponchadora manual
 CN 折边打孔钳



13 mm
 22 mm
 20 mm
 Ø 5 mm

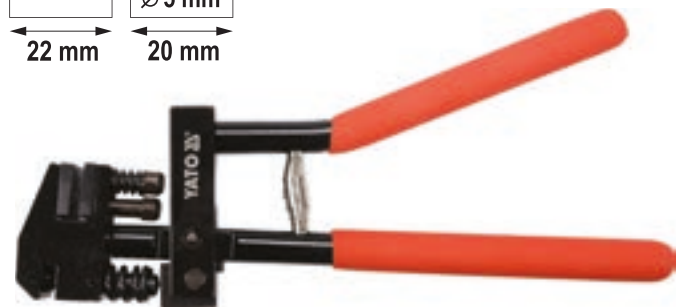



YATO		
YT-21582		10

EN Point chisel SDS Plus RU Зубило SDS Plus RO Punctator SDS Plus ES Cincel puntiagudo SDS Plus
PL Przecinak SDS Plus CZ Sekáč špičák SDS Plus FR Perçoir SDS Plus CN 尖凿
DE Spitzmeißel SDS Plus HU Hegyes véső SDS Plus IT Scalpello a punta SDS Plus

4x14
x250
mm **SDS PLUS** **CrV** 





YATO 	L [mm]	
YT-4720	250	6/48

EN Wood chisel SDS Plus RU Долото столярски SDS Plus RO Daltă de tâmplărie SDS Plus ES Cincel para madera SDS Plus
PL Dłuto do drewna SDS Plus CZ Řezbářské dláto SDS Plus FR Ciseau SDS Plus CN 木工凿
DE Stechbeitel SDS Plus HU Aszталos véső SDS Plus IT Scalpello SDS Plus

 12x180
mm **SDS PLUS** **CrMo** 





YATO 	L [mm]	
YT-4720	180	10/80

EN Flat chisel SDS Plus RU Долото узкое SDS Plus RO Punctator pt. adancit SDS Plus ES Cincel plano estrecho SDS Plus
PL Dłuto wąskie SDS Plus CZ Sekáč plochý SDS Plus FR Ciseau SDS Plus CN 平凿
DE Flachmeißel SDS Plus HU Lapos véső SDS Plus IT Scalpello piatto SDS Plus, punta stretta

20x14
x250
mm **SDS PLUS** **CrV** 





YATO 	L [mm]	
YT-4721	250	6/48

EN Hollow chisel SDS Plus RU Бороздник SDS Plus RO Punctator pt. adancit SDS Plus ES Cincel acanalado SDS Plus
PL Bruzdownik SDS Plus CZ Sekáč drážkovací SDS Plus FR Burin à entailler SDS Plus CN 空心凿
DE Nutenmeißel SDS Plus HU Horonyvéső SDS Plus IT Scalpello per scanalature SDS Plus

22x18
x250
mm **SDS PLUS** **CrV** 





YATO 	L [mm]	
YT-4722	250	6/48

EN Flat chisel SDS Plus RO Punctator tip dalta SDS Plus
PL Dłuto płaskie SDS Plus FR Ciseau SDS Plus
DE Spatmeißel SDS Plus IT Scalpello piatto SDS Plus
RU Долото плоское SDS Plus ES Cincel plano SDS Plus
CZ Sekáč plochý SDS Plus CN 扁凿
HU Széles lapos véső SDS Plus

40x14
x250
mm **SDS PLUS** **CrV** 





YATO 	L [mm]	
YT-4723	250	6/48



EN Flat chisel SDS Plus RO Punctator tip dalta SDS Plus
PL Dłuto płaskie SDS Plus FR Ciseau SDS Plus
DE Spatmeißel SDS Plus IT Scalpello piatto SDS Plus
RU Долото плоское SDS Plus ES Cincel plano SDS Plus
CZ Sekáč plochý SDS Plus CN 扁凿
HU Széles lapos véső SDS Plus

80x250
mm **SDS PLUS** **CrMo** 





YATO 	L [mm]	
YT-47212	250	10/20

EN Groove chisel RO Dalta canal
PL Bruzdownik FR Burin à entailler
DE Nutenmeißel IT Scalpello per scanalature
RU Зубило канавочное ES Cincel acanalado
CZ Sekáč drážkovací CN 五坑蝴蝶凿
HU Horonyvéső

 26x300
mm **SDS MAX** 





YATO 	L [mm]	
YT-4731	300	10/30

EN Groove chisel
 PL Bruzdownik
 DE Nutenmeißel
 RU Зубило канавочное
 CZ Sekáč drážkovací
 HU Horonyvész

RO Dalta canal
 FR Burin a entailleur
 IT Scalpello per scanalature
 ES Cíncel acanalado
 CN 五坑蝴蝶凿





YATO 	L [mm]	
YT-47330	380	10/20

EN Spade chisel
 PL Dłuto szerokie
 DE Spatmeißel
 RU Лопатка
 CZ Sekáč plochý
 HU Széles vész

RO Dalta
 FR Burin plat large
 IT Scalpello largo
 ES Cíncel pala
 CN 五坑扁凿





YATO 	L [mm]	
YT-47336	400	10/20

EN Spade chisel
 PL Dłuto szerokie
 DE Spatmeißel
 RU Лопатка
 CZ Sekáč plochý
 HU Széles vész

RO Dalta
 FR Burin plat large
 IT Scalpello largo
 ES Cíncel pala
 CN 五坑扁凿





YATO 	L [mm]	
YT-47335	300	10/20

EN Spade chisel
 PL Dłuto płaskie
 DE Spatmeißel
 RU Лопатка
 CZ Sekáč plochý
 HU Széles vész

RO Dalta
 FR Burin plat large
 IT Scalpello piatto
 ES Cíncel pala
 CN 五坑扁凿





YATO 	L [mm]	
YT-47341	280	10/40

EN Spade chisel
 PL Dłuto płaskie
 DE Spatmeißel
 RU Лопатка
 CZ Sekáč plochý
 HU Széles vész

RO Dalta
 FR Burin plat large
 IT Scalpello piatto
 ES Cíncel pala
 CN 五坑扁凿





YATO 	L [mm]	
YT-47340	400	10/20

EN Point chisel
 PL Dłuto szpiczak
 DE Spitzmeißel
 RU Зубило пиковое
 CZ Špičák
 HU Hegyes vész

RO Dorn
 FR Burin pointu
 IT Scalpello a punta
 ES Cíncel punta
 CN 五坑尖凿





YATO 	L [mm]	
YT-47345	280	10/40

EN Point chisel
 PL Dłuto szpiczak
 DE Spitzmeißel
 RU Зубило пиковое
 CZ Špičák
 HU Hegyes vész

RO Dorn
 FR Burin pointu
 IT Scalpello a punta
 ES Cíncel punta
 CN 五坑尖凿





YATO 	L [mm]	
YT-47344	400	10/20

EN Bushing tool
 PL Groszkownik
 DE Stockerplatte
 RU Отбойные пластины
 CZ Zdršťovací deska
 HU Szemcsészőlap

RO Placă de tasare
 FR Boucharde
 IT Bocciaarda per martello
 ES Placa de abujardar
 CN 五坑花捶



YATO 	L [mm]	
YT-47348	240	5/10

EN Spade chisel
PL Dłuto szerokie
DE Spatmeißel
RU Широкое долото
CZ Sekáč plochý
HU Széles véső

RO Dalta
FR Burin plat large
IT Scalpello largo
ES Cincel pala
CN 六角扁凿

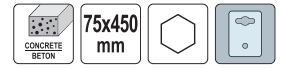

YATO	L [mm]	
YT-47370	450	5/10

EN Spade chisel
PL Dłuto szerokie
DE Spatmeißel
RU Широкое долото
CZ Sekáč plochý
HU Széles véső

RO Dalta
FR Burin plat large
IT Scalpello largo
ES Cincel pala
CN 六角扁凿

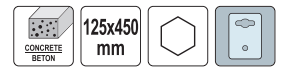

YATO	L [mm]	
YT-47372	450	5

EN Point chisel
PL Dłuto szpiczak
DE Spitzmeißel
RU Зубило пиковое
CZ Špičák
HU Hégyes véső

RO Dorn
FR Burin pointu
IT Scalpello a punta
ES Cincel punta
CN 五坑尖凿

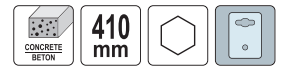

YATO	L [mm]	
YT-47375	410	5/10

EN Spade chisel
PL Dłuto płaskie
DE Spatmeißel
RU Лопатка
CZ Sekáč plochý
HU Széles véső

RO Dalta
FR Burin plat large
IT Scalpello piatto
ES Cincel pala
CN 五坑扁凿

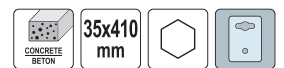

YATO	L [mm]	
YT-47377	410	5/10

EN Point chisel
PL Dłuto samostrzące
DE Spitzmeißel
RU Зубило пиковое
CZ Špičák
HU Hégyes véső

RO Dorn
FR Burin pointu
IT Scalpello a punta autoaffilante
ES Cincel punta
CN 四刃凿子

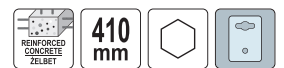

YATO	L [mm]	
YT-47380	410	5/10

EN Adapter
PL Adapter
DE Adapter
RU Адаптер

CZ Adaptér
HU Adapter
RO Adaptor
FR Adaptateur

IT Adattatore
ES Adaptador
CN 五坑转换器

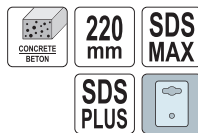

YATO	L [mm]	
YT-41926	220	10/30

EN Ground rod chisel
PL Pobijak do uziomów i gwoździ
DE Erdstab-Treiber-Bit
RU Добойник для гвоздей
CZ Zatloukač uzemňovacích tyčí a hřebíků
HU Rudazatbeütő

RO Ciocan bățut buloane cale ferată
FR Enfonceur de piquet de terre
IT Piantapicchetti per piantare chiodi e picchetti
ES Adaptador de varilla de tierra
CN 电镐圆孔凿



YATO	L [mm]	
YT-47195	250	4/24

EN Plate compactor with hex shank
PL Ubijak do gruntu z uchwytem Hex
DE Stampföse Hex
RU Трамбовочная пластина
CZ Péchovací deska Hex
HU Szerszámtartós tömörítőlap Hex

RO Buciardă Hex
FR Plateau de damage Hex
IT Costipatore Hex per la compattazione di terra
ES Placa de apisonar Hex
CN 六角夯锤

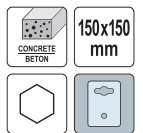

YATO	L [mm]	
YT-47385	150	2

EN Ground rod chisel
PL Pobijak do uziomów i gwoździ
DE Erdstab-Treiber-Bit
RU Добойник для гвоздей
CZ Zatloukač uzemňovacích tyčí a hřebíků
HU Rudazatbeütő

RO Ciocan bățut buloane cale ferată
FR Enfonceur de piquet de terre
IT Piantapicchetti per piantare chiodi e picchetti
ES Adaptador de varilla de tierra
CN 电镐圆孔凿



YATO	L [mm]	
YT-47197	400	4

- EN Hollow drill set
 PL Wiertło koronowe do betonu
 DE Bohrkronen
 RU Свёрла по бетону корончатые
- CZ Korunový vrták na zeď
 HU Koronafúró falhoz
 RO Burghiu cu coronă pt. beton
 FR Trépiéd à mur
- IT Punta a corona per calcestruzzo
 ES Broca widia para muro
 CN 扩孔钻



SDS PLUS

12 mm

YATO	Ø [mm]	Pilot drill diameter / Średnica wiertła pilota [mm]	
YT-4400	65	6	24
YT-4401	65	8	20

YATO	Ø [mm]	Pilot drill diameter / Średnica wiertła pilota [mm]	
YT-4402	65	6	24
YT-4403	65	8	20

- EN Masonry drill bit
 PL Wiertło do betonu
 DE Betonspiralbohrer
 RU Свёрло по бетону
 CZ Vrták na beton
 HU Fúrósár betonhoz
- RO Burghiu pt. beton
 FR Foret béton
 IT Punta per cemento
 ES Broca para hormigón
 CN 四坑开孔器

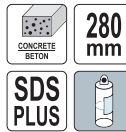

YATO	Ø [mm]	L [mm]	
YT-44033	68	280	2/10
YT-44034	82	280	2/6

- EN Masonry drill bit
 PL Wiertło do betonu
 DE Betonspiralbohrer
 RU Свёрло по бетону
 CZ Vrták na beton
 HU Fúrósár betonhoz
- RO Burghiu pt. beton
 FR Foret béton
 IT Punta per cemento
 ES Broca para hormigón
 CN 四坑开孔器



YATO	Ø [mm]	L [mm]	
YT-44040	68	280	2/10
YT-44041	82	280	2/6

- EN Masonry drill bit
 PL Wiertło do betonu
 DE Betonspiralbohrer
- RU Свёрло по бетону
 CZ Vrták na beton
 HU Fúrósár betonhoz
- RO Burghiu pt. beton
 FR Foret béton
 IT Punta per cemento
- ES Broca para hormigón
 CN 四坑开孔器



YATO	Ø [mm]	L [mm]	
YT-44045	55	600	2/8

- EN Hole saw
 PL Otwornica
 DE Lochsäge
 RU Универсальная коронка
 CZ Vrtací korunka
 HU Koronafúró
 RO Găurător
 FR Scie a trou
 IT Sega a tazza
 ES Sierra de corona universal
 CN TCT开孔器

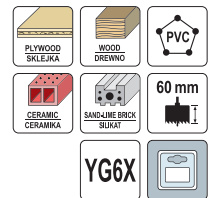

YATO	Ø [mm]	Thread size / Rozmiar gwintu	
YT-43970	16	1/2" (12.5 mm) 20UNF	6/90
YT-43971	19	1/2" (12.5 mm) 20UNF	6/90
YT-43972	22	1/2" (12.5 mm) 20UNF	6/90
YT-43973	25	1/2" (12.5 mm) 20UNF	6/90
YT-43974	32	5/8" (16.0 mm) 18UNF	6/72
YT-43975	38	5/8" (16.0 mm) 18UNF	6/72
YT-43976	51	5/8" (16.0 mm) 18UNF	6/72
YT-43977	60	5/8" (16.0 mm) 18UNF	6/72
YT-43978	64	5/8" (16.0 mm) 18UNF	3/36

YATO	Ø [mm]	Thread size / Rozmiar gwintu	
YT-43979	68	5/8" (16.0 mm) 18UNF	3/36
YT-43980	76	5/8" (16.0 mm) 18UNF	3/36
YT-43981	83	5/8" (16.0 mm) 18UNF	3/36
YT-43982	92	5/8" (16.0 mm) 18UNF	2/36
YT-43983	102	5/8" (16.0 mm) 18UNF	2/36
YT-43984	105	5/8" (16.0 mm) 18UNF	2/36
YT-43985	127	5/8" (16.0 mm) 18UNF	2/20
YT-43986	152	5/8" (16.0 mm) 18UNF	2/20

EN Bi-metal hole saw
PL Otwornica bimetalowa
DE Bimetall-Lochsäge
RU Коронка биметаллическая
CZ Vrtací korunka bimetalová
HU Bi-metál koronafűrő
RO Freză bimetalică
FR Scie-trépan bimétal
IT Sega a tazza bimetallica
ES Sierra de corona bimetálica
CN 双金属孔锯

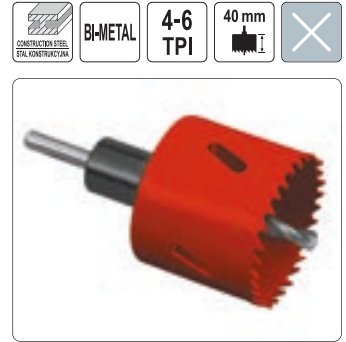

- Application: industry
- To drill holes in stainless steels, cast steels, aluminium, wood, plastics
- Cutting depth: 40 mm
- Przeznaczenie: przemysł
- Do wycinania otworów w stalach nierdzewnych, żelazie, aluminium, drewnie, tworzywach sztucznych
- Głębokość cięcia: 40 mm

YATO	Ø [mm]	Thread size / Rozmiar gwintu	Box	YATO	Ø [mm]	Thread size / Rozmiar gwintu	Box
YT-3303	19	1/2" (12.5 mm) 20UNF	25/100	YT-3329	60	5/8" (16.0 mm) 18UNF	25/50
YT-3304	20	1/2" (12.5 mm) 20UNF	25/100	YT-3330	64	5/8" (16.0 mm) 18UNF	25/50
YT-3306	22	1/2" (12.5 mm) 20UNF	25/100	YT-3332	67	5/8" (16.0 mm) 18UNF	25/50
YT-3308	25	1/2" (12.5 mm) 20UNF	25/100	YT-3333	68	5/8" (16.0 mm) 18UNF	25/50
YT-3311	29	1/2" (12.5 mm) 20UNF	25/100	YT-3334	70	5/8" (16.0 mm) 18UNF	25/50
YT-3313	32	5/8" (16.0 mm) 18UNF	25/100	YT-3336	76	5/8" (16.0 mm) 18UNF	25/50
YT-3315	35	5/8" (16.0 mm) 18UNF	25/100	YT-3338	83	5/8" (16.0 mm) 18UNF	25/50
YT-3317	38	5/8" (16.0 mm) 18UNF	25/100	YT-3343	95	5/8" (16.0 mm) 18UNF	25/50
YT-3318	40	5/8" (16.0 mm) 18UNF	25/100	YT-3345	102	5/8" (16.0 mm) 18UNF	10/20
YT-3321	44	5/8" (16.0 mm) 18UNF	25/100	YT-3346	105	5/8" (16.0 mm) 18UNF	10/20
YT-3322	46	5/8" (16.0 mm) 18UNF	25/100	YT-3349	114	5/8" (16.0 mm) 18UNF	10/20
YT-3323	48	5/8" (16.0 mm) 18UNF	25/100	YT-3350	121	5/8" (16.0 mm) 18UNF	10/20
YT-3324	51	5/8" (16.0 mm) 18UNF	25/100	YT-3351	127	5/8" (16.0 mm) 18UNF	10/20
YT-3327	57	5/8" (16.0 mm) 18UNF	25/50	YT-3353	140	5/8" (16.0 mm) 18UNF	10/20

EN Arbor for hole saw
PL Uchwyt do otwornic
DE Halterung für Lochsägen
RU Держатель универсальных коронок
CZ Šroubový unášec pro vrtací korunky
HU Befogószer a koronafűrőhoz

RO Dispozitiv de antrenare pt. găurători bimetaliți
FR Mandrin aux scies-trépan
IT Alberino per seghe a tazza
ES Adaptador para sierra de corona
CN 孔锯柄轴

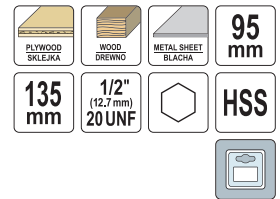

YATO	Ø [mm]	Toolholder type / Rodzaj uchwytu narzędziowego	Thread size / Rozmiar gwintu	Box
YT-43992	6	HEX	1/2" (12.5 mm) 20UNF	20/100

EN Arbor for hole saw
PL Uchwyt do otwornic
DE Halterung für Lochsägen
RU Держатель универсальных коронок
CZ Šroubový unášec pro vrtací korunky
HU Befogószer a koronafűrőhoz

RO Dispozitiv de antrenare pt. găurători bimetaliți
FR Mandrin aux scies-trépan
IT Alberino per seghe a tazza
ES Adaptador para sierra de corona
CN 孔锯柄轴

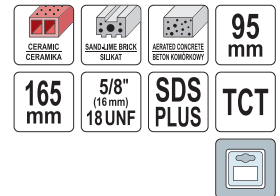

YATO	Ø [mm]	Toolholder type / Rodzaj uchwytu narzędziowego	Thread size / Rozmiar gwintu	Box
YT-43990	8	SDS-Plus	5/8" (16.0 mm) 18UNF	10/90

EN Arbor for hole saw
PL Uchwyt do otwornic
DE Halterung für Lochsägen
RU Держатель универсальных коронок
CZ Šroubový unášec pro vrtací korunky
HU Befogószer a koronafűrőhoz

RO Dispozitiv de antrenare pt. găurători bimetaliți
FR Mandrin aux scies-trépan
IT Alberino per seghe a tazza
ES Adaptador para sierra de corona
CN 孔锯柄轴

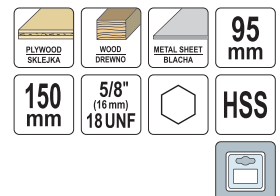

YATO	Ø [mm]	Toolholder type / Rodzaj uchwytu narzędziowego	Thread size / Rozmiar gwintu	Box
YT-43991	6	HEX	5/8" (16.0 mm) 18UNF	10/90

EN Extension bar
PL Przedłużka
DE Verlängerung
RU Удлинитель для воротка
CZ Prodlužovací přípravek
HU Toldalek

RO Prelungitor
FR Rallonge
IT Prolunga
ES Tubo de prolongación
CN 延长接杆



YATO	Toolholder type / Rodzaj uchwytu narzędziowego	H [mm]	Box
YT-43993	sześciokątny, SDS-Plus	300	10/50

EN Pilot drill
PL Wiertło pilot
DE Pilotbohrer
RU Сверло пилот
CZ Středící vrták
HU Kőzpontfűrő

RO Burghiu pilot
FR Foret - pilot
IT Punta pilota
ES Broca piloto
CN 导向钻

2 PCS

PLYWOOD SKLEPKA WOOD DREWING METAL SHEET BLACHA

6 mm HSS



YATO	Ø [mm]	H [mm]	
YT-43994	6	95	50/250

EN Pilot drill
PL Wiertło pilot
DE Pilotbohrer
RU Сверло пилот
CZ Středící vrták
HU Kőzpontfűrő

RO Burghiu pilot
FR Foret - pilot
IT Punta pilota
ES Broca piloto
CN 导向钻

2 PCS

CERAMIC CERAMIKKA SAND-LIME BRICK SILIKAT REINFORCED CONCRETE BETON KÖRNYEK

8 mm TCT



YATO	Ø [mm]	H [mm]	
YT-43995	8	95	50/250

EN Arbor for hole saw
PL Uchwyt do otwornic
DE Halterung für Lochsägen
RU Держатель коронок
CZ Šroubový unášec pro vrtací korunky
HU Befogószer a koronafűrőhoz
RO Burghiu pt. ghidare freză bimetalică
FR Mandrin aux scies-trépan
IT Alberino per seghe a tazza
ES Adaptador para sierra de corona
CN 孔锯柄轴

19-29 mm 1/2" (12.7 mm) 20 UNF

EN Arbor for hole saw
PL Uchwyt do otwornic
DE Halterung für Lochsägen
RU Держатель коронок
CZ Šroubový unášec pro vrtací korunky
HU Befogószer a koronafűrőhoz
RO Burghiu pt. ghidare freză bimetalică
FR Mandrin aux scies-trépan
IT Alberino per seghe a tazza
ES Adaptador para sierra de corona
CN 孔锯柄轴

32-140 mm 5/8" (16 mm) 18 UNF

EN Arbor for hole saw
PL Uchwyt do otwornic
DE Halterung für Lochsägen
RU Держатель коронок
CZ Šroubový unášec pro vrtací korunky
HU Befogószer a koronafűrőhoz
RO Burghiu pt. ghidare freză bimetalică
FR Mandrin aux scies-trépan
IT Alberino per seghe a tazza
ES Adaptador para sierra de corona
CN 孔锯柄轴

32-140 mm 5/8" (16 mm) 18 UNF



YATO	Toolholder type / Rodzaj uchwytu narzędziowego	
YT-3370	sześciokątny	25/100
YT-3373	SDS-Plus	25/100

YATO	Toolholder type / Rodzaj uchwytu narzędziowego	
YT-3371	sześciokątny	25/100

YATO	Toolholder type / Rodzaj uchwytu narzędziowego	
YT-3372	sześciokątny	25/50
YT-3374	SDS-Plus	25/50

EN Pilot drill
PL Wiertło pilot
DE Pilotbohrer
RU Сверло пилот
CZ Středící vrták
HU Kőzpontfűrő
IT Punta pilota

RO Burghiu pilot
FR Foret - pilot
ES Broca piloto
CN 导向钻

HSS



YATO	Ø [mm]	H [mm]	
YT-3376	6	75	25/100

YATO	Ø [mm]	H [mm]	
YT-3377	6	100	25/100

EN Electrician's hole saw kit
PL Zestaw otwornic dla elektryków
DE Lochsägensatz für Elektriker
RU Набор ножек для отверстия для электриков
CZ Sada vrtacích korunek pro elektrikáře
HU Koronafűrő készlet villanyszerelőknék
RO Set freze bimetalice
FR Set de scies trépan aux électriciens
IT Set universale a tazza fresa con strumenti
ES Juego de sierras de marquetería para electricistas
CN 双金属开孔器组套

8 PCS CONSTRUCTION STEEL ÉTEL, KÖRNYEK

4-6 TPI 40 mm

BIMETAL

EN Combination hole saw kit
PL Uniwersalny zestaw otwornic
DE Universal-Lochsägensatz
RU Универсальный набор ножек к отверстиям
CZ Univerzální sada vrtacích korunek
HU Univerzális koronafűrő készlet
RO Set freze bimetalice
FR Set de scies trépan universelles
IT Set universale a tazza fresa con strumenti
ES Juego universal de sierras de marquetería
CN 双金属开孔器组套

15 PCS CONSTRUCTION STEEL ÉTEL, KÖRNYEK

4-6 TPI 40 mm

BIMETAL



YATO	Ø [mm]	
YT-3380	22, 29, 35, 44, 67, 73	10



YATO	Ø [mm]	
YT-3381	19, 22, 25, 32, 35, 38, 44, 51, 57, 64, 76	5

EN Combined drill tap
PL Wiertło-gwintownik
DE Gewindebohrer Bit
RU Сверло метчик
CZ Bitový kombinovaný závitník
HU Fűrő-menetfűrő bit befogású

RO Burghiu tarod Hex
FR Fraise à tarauds combinés
IT Punte madreviti
ES Broca roscadora Hex
CN 六角柄复合丝锥

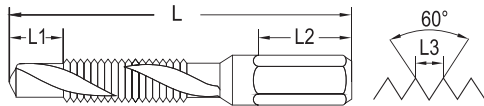
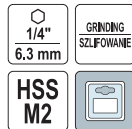

YATO	Size / Rozmiar	L [mm]	L1 [mm]	L2 [mm]	L3 [mm]	
YT-44840	M3	36	5	14	0.5	20/200
YT-44841	M4	39	6	14	0.7	20/200
YT-44842	M5	41	7	14	0.8	20/200
YT-44843	M6	44	8	14	1.0	20/200
YT-44845	M8	51	11	14	1.3	20/200
YT-44847	M10	59	15	14	1.5	20/200

EN Hand tap
PL Gwintownik ręczny
DE Handgewindebohrer
RU Ручной метчик
CZ Závitníky
HU Menetfűrő

RO Tarozi
FR Taraud à main
IT Maschi filettatura a mano
ES Machos de roscar
CN 三件套手用丝锥

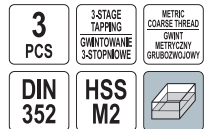

YATO	Size / Rozmiar	Thread pitch / Skok gwintu [mm]	Thread length / Długość gwintu [mm]	L [mm]	Shank diameter / Średnica trzonu [mm]	pcs / szt.	m [g]	
YT-2930	M3	0.5	11	40	3.5	3	25	100/400
YT-2931	M4	0.7	13	45	4.5	3	35	50/200
YT-2932	M5	0.8	16	50	6.0	3	45	60/240
YT-2933	M6	1.0	19	50	6.0	3	45	60/240
YT-2934	M7	1.0	19	50	6.0	3	55	50/200
YT-2935	M8	1.3	22	56	6.0	3	60	50/200
YT-2937	M10	1.5	24	70	7.0	3	85	50/200
YT-2939	M12	1.8	29	75	9.0	3	125	50/200
YT-2940	M14	2.0	30	80	10.5	3	200	20/80
YT-2941	M16	2.0	32	80	11.0	3	235	20/80
YT-2942	M18	2.5	40	95	12.0	3	345	20/80
YT-2943	M20	2.5	40	95	14.0	3	445	20/40

EN Machine tap
PL Gwintownik maszynowy
DE Maschinengewindebohrer
RU Машинный метчик
CZ Strojní závitník
HU Gépi menetfűrő

RO Tarod de mașină
FR Taraud machine
IT Maschi filettatura
ES Macho mecanico
CN 机用丝锥

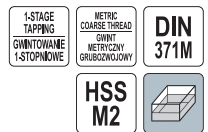

YATO	Size / Rozmiar	Thread pitch / Skok gwintu [mm]	Thread length / Długość gwintu [mm]	L [mm]	Shank diameter / Średnica trzonu [mm]	m [g]	
YT-2950	M3	0.5	11	56	3.5	15	100/400
YT-2951	M4	0.7	13	63	4.5	20	60/240
YT-2952	M5	0.8	16	70	6.0	25	60/240
YT-2953	M6	1.0	19	80	6.0	30	50/200
YT-2954	M7	1.0	19	80	7.1	35	30/120
YT-2955	M8	1.3	22	90	8.0	45	50/200
YT-2956	M10	1.5	24	100	10.0	65	50/200

EN Machine tap
PL Gwintownik maszynowy
DE Maschinengewindebohrer
RU Машинный метчик
CZ Strojní závitník
HU Gépi menetfűrő

RO Tarod de mașină
FR Taraud machine
IT Maschi filettatura
ES Macho mecanico
CN 机用丝锥



YATO	Size / Rozmiar	Thread pitch / Skok gwintu [mm]	Thread length / Długość gwintu [mm]	L [mm]	Shank diameter / Średnica trzonu [mm]	m [g]	
YT-2944	M12	1.8	29	110	9	70	25/100
YT-2945	M14	2.0	30	110	11	110	25/100
YT-2946	M16	2.0	32	110	12	120	25/100





1/4" (6.3 mm)



YATO	Size / Rozmiar	
YT-44849	M3, M4, M5, M6, M8, M10	5/60

EN Tap socket set
 PL Zestaw adapterów do gwintowników
 DE Adaptersatz für Gewindebohrer
 RU Набор адаптеров для метчиков
 CZ Sada hlavic na závitníky
 HU Menetfúró dugókulcs adapter készlet
 RO Set tubulare pt. tarozi
 FR Jeu d'adaptateurs pour tarauds
 IT Set di adattatori per madreviti
 ES Juego de adaptadores para machos de roscar
 CN 丝锥套筒组套





10 PCS
 1/4" 6.3mm
 3/8" 9.5mm



1/4" (6.3 mm): #1, #2, #3, #3.5, #4, #4.5; 3/8" (9.5 mm): #5, #6, #7, #8



YATO 	○	
YT-29280	1/4" (6.3 mm), 3/8" (9.5 mm)	10/40

EN Tap and die set
 PL Zestaw narzynek i gwintowników
 DE Gewindeschneidwerkzeug-Satz
 RU Набор плашек и метчиков
 CZ Souprava závitníků a kruhových závitových čelistí
 HU Menetfúró és menetvágó készlet
 RO Set de tarozi și filiere
 FR Set de filières et tarauds
 IT Set di filiera a maschi
 ES Juego de machos de roscar y cojinetes
 CN 丝锥板牙组套





HSS 



32 PCS
 DIN 223 352

YATO 	Size / Rozmiar	
YT-2975	M3, M4, M5, M6, M8, M10, M12	10



44 PCS
 DIN 223
 DIN 225
 DIN 338
 DIN 352
 DIN 1814

YATO 	Size / Rozmiar	
YT-2978	M3, M4, M5, M6, M8, M10, M12	4



56 PCS
 DIN 223
 DIN 225
 DIN 352
 DIN 1814

YATO 	Size / Rozmiar	
YT-2979	M3, M4, M5, M6, M8, M10, M12, M14, M16, M18, M20	2

EN Tap set
 PL Zestaw gwintowników
 DE Gewindeschneidwerkzeug-Satz
 RU Набор метчиков

CZ Souprava závitníků
 HU Menetfúró készlet
 RO Set de tarozi
 FR Set de tarauds

IT Set di filetture
 ES Juego de machos de roscar
 CN 公制丝锥组套

HSS 







21 PCS
 DIN 352

YATO 	Size / Rozmiar	
YT-2976	M3, M4, M5, M6, M8, M10, M12	20



29 PCS
 DIN 338
 DIN 352
 DIN 1814

YATO 	Size / Rozmiar	
YT-2977	M3, M4, M5, M6, M8, M10, M12	12

EN Circular die CZ Kruhov zvitov elist IT Filiere tonde filettatura
 PL Narzynka HU Menetvg ES Cojinete de roscar
 DE Schneideisen RO Filier CN 圆板牙
 RU Плашка FR Filre



YATO	Size / Rozmiar	Thread pitch / Skok gwintu [mm]	External diameter / rednica zewntrzna [mm]	Thickness / Gruboc [mm]	m [g]	
YT-2961	M4	0.7	20	5	20	125/500
YT-2962	M5	0.8	20	7	20	100/400
YT-2963	M6	1.0	20	7	20	100/400
YT-2964	M7	1.0	25	9	35	100/200
YT-2965	M8	1.3	25	9	35	100/400
YT-2967	M10	1.5	30	11	50	70/280
YT-2969	M12	1.8	38	14	90	60/240
YT-2970	M14	2.0	38	14	95	63/252
YT-2971	M16	2.0	45	18	160	50/200
YT-2973	M20	2.5	45	18	150	50/200
YT-2966	M24	3.0	55	22	300	20/80

EN Step drill RO Burghiu din titan cu gaurire in trepte
 PL Wiertlo stopniowe FR tape de forage
 DE Stufenbohrer IT Punta da trapano graduata
 RU Сверло ступенчатое ES Broca cnica escalonada
 CZ Stupnvit vrtk CN 阶梯钻
 HU Lpcss fr

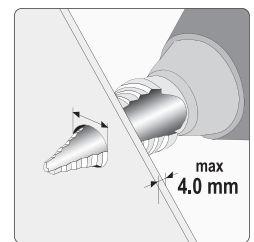

YATO	Steps quantity / Liczba stopni	 [mm]	L [mm]	Working length / Dugoc robocza [mm]	
YT-44743	7	14, 16, 18, 20, 22, 24, 26	70	40	100
YT-44742	8	10, 15, 20, 25, 30, 35, 40, 45	100	75	40
YT-44741	10	4, 6, 8, 10, 12, 14, 16, 18, 20, 22	75	52	25/50
YT-44739	10	6, 10, 13, 16, 19, 22, 25, 29, 32, 35	75	45	10/80
YT-44744	10	6, 12, 13, 14, 15, 16, 17, 18, 19, 20	75	55	20/200
YT-44745	11	10, 11, 12, 13, 14, 15, 16, 17, 18, 19, 20	75	52	20/200
YT-44747	11	20, 21, 22, 23, 24, 25, 26, 27, 28, 29, 30	75	54	12/96
YT-44746	12	10, 20, 21, 22, 23, 24, 25, 26, 27, 28, 29, 30	87	60	12/96
YT-44740	12	6, 8, 11, 14, 17, 20, 23, 26, 29, 32, 35, 38	105	78	10/60

EN Step drill set RO Set burghie in trepte
 PL Zestaw wiertel stopniowych FR tape de forage
 DE Stufenbohrer Set IT Set di punte a gradino
 RU Сверло ступенчатое шуруи ES Juego de brocas cnicas escalonadas
 CZ Stupnvit vrtky sada CN 阶梯钻组套
 HU Lpcss fr készlet

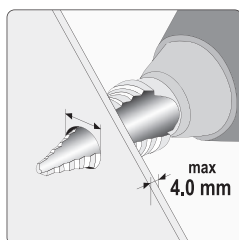

YATO	 [mm]	
YT-44731	3-12 (3, 4, 5, 6, 7, 8, 9, 10, 11, 12 mm), 4-12 (4, 6, 8, 10, 12 mm), 4-20 (4, 6, 8, 10, 12, 14, 16, 18, 20 mm)	40

EN Taper drill set RO Set alezoare in trepte
 PL Zestaw wiertel stokowych FR Set de perceuse taper
 DE Blechshlbohrer-Satz IT Set di punte coniche
 RU Набор конусных сверел ES Conjunto brocas cnicas
 CZ Sada kuelovch vrtk do plechu CN 薄板钻
 HU Rszes lemezfr készlet

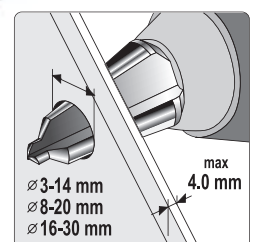

YATO	 [mm]	
YT-44730	3-14, 8-20, 16-30	10/30

- EN Countersink
 PL Pogłębiacz
 DE Kegelsenker
 RU Конусный зенкер
 CZ Kuželový záhlubník
 HU Kúpos sülylesztő
- RO Zencuitor
 FR Fraise conique
 IT Accecatoio
 ES Avellanador cónico
 CN 倒角器

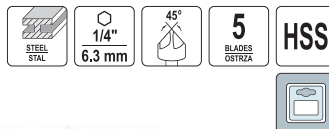

YATO	Ø [mm]	L [mm]	
YT-44721	6.3	40	50/200
YT-44722	8.3	40	50/200
YT-44723	10.4	40	50/200
YT-44724	12.4	40	50/200
YT-44725	16.5	45	25/100
YT-44726	20.5	45	25/100

- EN T-handle tap wrench
 PL Pokrętko typu „T” do gwintowników
 DE Gewinde-Werkzeughalter
 RU Ручьятка типа „Т” к гаечному ключу
 CZ Vratidlo na závitníky typ „T”
 HU Menetfűrő befogó T-nyelű
 RO Port tarod cu maner
 FR Porte-taraud type „T”
 IT Chiave giramaschio tipo „T” per maschi
 ES Llave giramachos „T”
 CN 丝锥扳手



YATO	Size / Rozmiar	L [mm]	
YT-2986	M3-M8	70	20/80
YT-2987	M5-M10	80	20/80
YT-2988	M6-M12	90	20/80

- EN Die handle
 PL Oprawa do narzynek
 DE Schneideisenhalter
 RU Пнашкодержатель
- CZ Závrtová objímka
 HU Menetvágó tartó
 RO Portfilieră
- IT Porta filiere
 ES Portacoinjete
 CN 板牙扳手

DIN 225



YATO	Size / Rozmiar	External diameter / Średnica zewnętrzna [mm]	Thickness / Grubość [mm]	L [mm]	
YT-2980	M3-M4	20	5	200	25/100
YT-2981	M4.5-M6	20	7	200	25/100
YT-2982	M7-M9	25	9	224	25/100
YT-2983	M10-M11	30	11	280	25/50
YT-2984	M12-M14	38	14	315	15/30
YT-2985	M16-M20	45	18	450	10/20

- EN Rethread tool kit set
 PL Zestaw do naprawy gwintów śrub i nakrętek
 DE Gewindereparatursatz für Schrauben und Mutter
 RU Комплект для ремонта резьбы на винтах и гайках
 CZ Sada pro opravu závitů na šroubech a maticích
 HU Csavarok és anyák meneteinek javítására szolgáló készlet

- RO Kit pt. reparat filete
 FR Kit de réparation de filetage
 IT Kit di riparazione delle filettature viti e dadi
 ES Kit de reparación de roscas en tornillos y tuercas
 CN 螺纹修复工具组套

15 PCS



Metric thread file pitches / Pilniki do naprawy gwintów: 0.75, 1.0, 1.25, 1.5, 1.75, 2.0, 2.5, 3.0 mm;
 Rethreader dies / Narzynki: 6x1.00, 8x1.25, 10x1.50, 12x1.25, 12x1.50, 12x1.75 mm;
 Rethreader taps / Gwintowniki: 6x1.00, 8x1.25, 10x1.25, 10x1.50, 12x1.25, 12x1.50, 12x1.75 mm

YATO		
YT-17705		20

- EN Countersink set
 PL Zestaw pogłębiaczy do metalu
 DE Kegelsenker-Satz
 RU Конусный зенкер
 CZ Kuželový záhlubník
 HU Kúpos sülylesztő
 RO Zencuitor
 FR Fraise conique
 IT Set di svasatori per metallo
 ES Avellanador cónico
 CN 倒角器组套



YATO	Ø [mm]	
YT-44729	6.3, 8.3, 10.4, 12.4, 16.5, 20.5	20

- EN Ratchet tap wrench
 PL Grzechołka do gwintownika
 DE Gewinde-Werkzeughalter
 RU Трещетка для метчика
 CZ Ráččnové vratidlo pro závitníky
 HU Racsnis hajtósár menetfűrőhoz
 RO Port tarod
 FR Porte-taraud à cliquet
 IT Chiave giramaschi a cricchetto
 ES Carraca para macho de rosacar
 CN 棘轮丝锥扳手



YATO	Size / Rozmiar	L [mm]	
YT-2989	M3-M10	85	20/80
YT-2997	M3-M10	250	20/80
YT-2990	M5-M12	100	20/80
YT-2991	M5-M12	300	20/40

- EN Tap wrench
 PL Pokrętko do gwintowników
 DE Gewinde-Werkzeughalter
 RU Вороток для метчиков
 CZ Ovládací kolečko na závitník
 HU Hajtósár menetfűrőhoz
- RO Cheie (mâner) pt. tarod
 FR Porte-taraud
 IT Manopola per il maschio
 ES Llave giramachos
 CN 一型丝锥扳手

DIN 1814



YATO	Size / Rozmiar	L [mm]	
YT-2995	M1-M8	125	50/200
YT-2996	M3-M10	180	25/100
YT-2992	M3-M12	200	25/100
YT-2993	M4-M12	280	25/100
YT-2994	M5-M20	375	20/40

- EN Thread repair set
 PL Zestaw do naprawy gwintów
 DE Reparatursatz für Gewinde
 RU Набор для ремонта резьбы
 CZ Souprava na opravu závitů
 HU Meneljavító készlet
 RO Set pt. reparare filete
 FR Set d'helicoils
 IT Kit di riparazione per filettature
 ES Juego para reparar roscas
 CN 螺纹修复工具组套



YATO	Thread size / Rozmiar gwintu	pcs / szt.	
YT-17631	M5x0.8 mm	30	20/40
YT-17632	M6x1.0 mm	30	20/40
YT-17633	M8x1.25 mm	30	20/40
YT-17634	M10x1.5 mm	30	20/40
YT-17635	M12x1.75 mm	30	20/40

EN Thread repair set
PL Zestaw do naprawy gwintów
DE Reparaturersatz für Gewinde
RU Набор для ремонта резьбы
CZ Souprava na opravu závitů
HU Menetjavító készlet
RO Set pt. reparare filete
FR Set d'helicoils
IT Kit di riparazione per filettature

HSS
4341

SS
STAINLESS STEEL
STAL NIERDZEWNA



88
PCS



131
PCS

YATO	Dimensions / Wymiary	
YT-1769	M6x1x10.8 mm, M8x1.25x10.8 mm, M10x1.5x13.5 mm	5/10
YATO	Dimensions / Wymiary	
YT-1763	M5x0.8x6.7 mm, M6x1x10.8 mm, M8x1.25x10.8 mm, M10x1.5x13.5 mm, M12x1.75x16.3 mm	5/10

EN Wire threads
PL Wkłady spiralne do naprawy gwintów
DE Spiraleinlagen für Gewindereparatur
RU Метчики и сверла для ремонта резьбы
CZ Spirálové vložky na opravu závitů
HU Menetjavító betétek
RO Insertii spirală pt. reparare filete
FR Helicoil
IT Inserti a spirale per riparazione
ES Elementos espirales para reparar roscas
CN 不锈钢螺纹套



SS
STAINLESS STEEL
STAL NIERDZEWNA

For YT-1763, YT-1769
Dia YT-1763, YT-1769

YATO	Dimensions / Wymiary	pcs / szt.	
YT-1764	M5x0.8x6.7 mm	20	50/250
YT-1765	M6x1x10.8 mm	20	50/250
YT-1766	M8x1.25x10.8 mm	20	50/200
YATO	Dimensions / Wymiary	pcs / szt.	
YT-1767	M10x1.5x13.5 mm	15	25/100
YT-1768	M12x1.75x16.3 mm	10	25/100

EN Plug & forstener cutter
PL Flekownik-śkownik do drewna
DE Zapfenschneider und Forstnerbohrer für Holz
RU Сверла по дереву: коронка и фреза
CZ Kotočový vykrajovač-sukovník do dřeva
HU Csapmaró-fúró szerszám fához
RO Set burghie reparat lemn
FR Ensemble pour réparation des nœuds dans le bois
IT Punta forstner per legno
ES Broca fresadora para madera
CN 木塞钻和平翼钻组套

2
PCS
WOOD
DREWN
HRC
45-48

EN Plug & forstener cutter set
PL Zestaw flekowników-śkowników do drewna
DE Zapfenschneider und Forstnerbohrer-Set für Holz
RU Набор сверл по дереву: коронки и фрезы
CZ Sada kotočových vykrajovačů-sukovníků do dřeva
HU Csapmaró-fúró szerszámkészlet fához
RO Set burghie reparat lemn
FR Ensemble pour réparation des nœuds dans le bois
IT Set di punte forstner per legno
ES Juego de brocas fresadoras para madera
CN 木塞钻和平翼钻组套

10
PCS
WOOD
DREWN
8,10 mm
10,12 mm
HRC
45-48

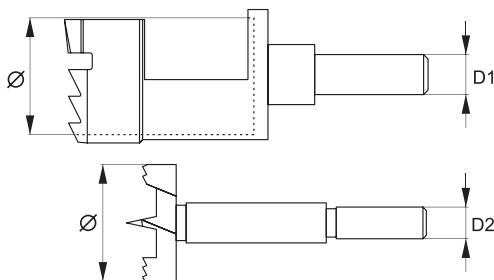

YATO	Ø [mm]	D1 [mm]	D2 [mm]	
YT-33830	15	10	8	10/100
YT-33831	20	12	8	10/100
YT-33832	25	12	8	10/100
YT-33833	30	12	8	10/60
YT-33834	35	12	10	10/60

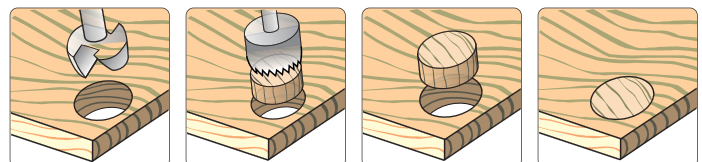

YATO	Ø [mm]	
YT-33837	15, 20, 25, 30, 35	20

EN Rotary file
 PL Tamnik trzpieniowy
 DE Profil-Fräser
 RU Набор фасонных фрез
 CZ Hrotové rašple
 HU Fareszelőkészlet, csapszáras
 RO Raspeluri cu coadă
 FR Fichiers rotary
 IT Fresa a gradino per metallo
 ES Arquivos rotary
 CN 旋转锉



	YATO	Ø [mm]	
STEEL STAL ALUMINIUM ALUMINIUM	YT-61700	4-24	10/120
	YATO	Ø [mm]	
STEEL STAL ALUMINIUM ALUMINIUM	YT-61701	6-15	10/120
	YATO	Ø [mm]	
STEEL STAL ALUMINIUM ALUMINIUM	YT-61702	12	10/120
	YATO	Ø [mm]	
WOOD DREWNG	YT-61703	6-15	10/120



	YATO	Ø [mm]	
WOOD DREWNG	YT-61704	13	10/120
	YATO	Ø [mm]	
WOOD DREWNG	YT-61705	15	10/120
	YATO	Ø [mm]	
WOOD DREWNG	YT-61706	20	10/120
	YATO	Ø [mm]	
WOOD DREWNG	YT-61707	25	10/120

EN Rotary file for metal
 PL Frez trzpieniowy do metalu
 DE Schaftfräser für Metall
 RU Концевая фреза по металлу
 CZ Stopková fréza na kov
 HU Végmaró fémhez
 RO Freza pt. metal
 FR Fraise en bout pour le métal
 IT Fresa a candela per metallo
 ES Fresa de extremo para metal
 CN 硬质合金旋转锉

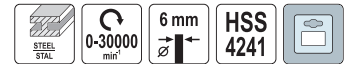

YATO	Ø [mm]	
YT-61714	13	80
YATO	Ø [mm]	
YT-61715	13	80
YATO	Ø [mm]	
YT-61716	13	80



YATO	Ø [mm]	
YT-61717	13	80
YATO	Ø [mm]	
YT-61718	13	80
YATO	Ø [mm]	
YT-61719	6	80

EN Rotary file set
 PL Tamniki trzpieniowe
 DE Profil-Fräser Satz
 RU Набор фрез
 CZ Hrotové rašple
 HU Fareszelőkészlet, csapszáras
 RO Raspeluri cu coadă
 FR Ensemble de fichiers rotary
 IT Set di frese
 ES Rotatorio archivos
 CN 旋转锉

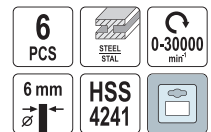

YATO	Ø [mm]	
YT-61711	3-15	12/48

EN Rotary file for metal
PL Frez trzpieniowy do metalu
DE Schafffräser für Metall
RU Концевая фреза по металлу
CZ Stopková fréza na kov
HU Végmaró fémhez
RO Freza pt. metal
FR Fraise en bout pour le métal
IT Fresa a candela per metallo
ES Fresa de extremo para metal
CN 硬质合金旋转锉



56 mm

YATO	Ø [mm]	
YT-61722	10	40/80



56 mm

YATO	Ø [mm]	
YT-61723	10	40/80



58 mm

YATO	Ø [mm]	
YT-61724	10	40/80



45 mm

YATO	Ø [mm]	
YT-61725	10	40/80



58 mm

YATO	Ø [mm]	
YT-61726	10	40/80



50 mm

YATO	Ø [mm]	
YT-61727	10	40/80

EN Rotary file set for metal premium
PL Zestaw frezów trzpieniowych do metalu premium
DE Schafffräser für metall Premium
RU Концевые фрезы по металлу премиум
CZ Stopkové frézy do kovu premium
HU Marószárak fémhez prémium
RO Set freze metal
FR Fraises à mandrin pour métal premium
IT Set di frese con codolo per metalli premium
ES Fresas para metal premium
CN 硬质合金旋转锉

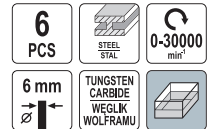

YATO	Ø [mm]	L [mm]	
YT-61729	10	45, 50, 56, 58, 58, 58	20/40

EN Rotary file set
PL Tamiki trzpieniowe
DE Profil-Fräser Satz
RU Набор фрез
CZ Hrotové rašple
HU Fareszelőkészlet, csapszárak
RO Raşpeluri cu coadă
FR Ensemble de fichiers rotary
IT Set di frese
ES Rotatorio archivos
CN 旋转锉

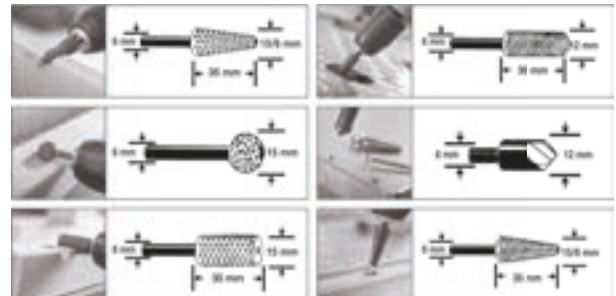

YATO	Ø [mm]	
YT-61712	6-15	10/60

EN Forstner drill bit
PL Wiertło do drewna pod zawiasy
DE Forstnerbohrer
RU Сверло форстнера по дереву
CZ Karbidový vrták na vrtání otvorů pro závěsy
HU Forstner fúrószerő készlet fához
RO Freza pt. lemn
FR Mèche de perceuse à bois
IT Punta per legno per cerniere
ES Broca para bisagras
CN 木工开孔器



YATO	Ø [mm]	
YT-33010	26	10/100
YT-33011	35	10/100

EN Forstner drill bit set
PL Zestaw wiertel do drewna pod zawiasy
DE Forstnerbohrer Set
RU Сверло форстнера по дереву
CZ Sada karbidový vrták na vrtání otvorů pro závěsy
HU Forstner fúrószerő készlet fához
RO Set freze pt. lemn
FR Mèches de perceuse à bois
IT Set di punte per legno per cerniere
ES Juego de brocas para bisagras
CN 木工开孔器组套





YATO	Ø [mm]	
YT-33015	15, 20, 26, 30, 35	20









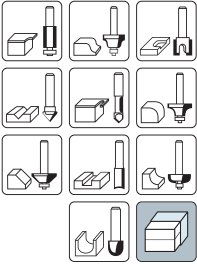



EN Router bit set
 PL Zestaw frezów do drewna
 DE Oberfräsersatz
 RU Набор фрез по дереву
 CZ Souprava frézů do dřeva
 HU Medtjio frezř kompletas
 RO Set de freze pt. lemn
 FR Fraises pour le bois
 IT Set di frese per legno
 ES Juego de frezas para madera
 CN 木工铣刀组套



12 PCS  +/- 0.08 mm

6 mm  YG6X 



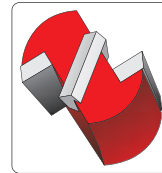

Router bit parameter												
shank diameter / średnica uchwyty [mm]	6.0	6.0	6.0	6.0	6.0	6.0	6.0	6.0	6.0	6.0	6.0	6.0
length / długość [mm]	51.0	49.0	51.0	45.0	48.0	48	50.0	53.0	50.0	52.0	38.0	39.0
router bit diameter / średnica frezu [mm]	6.0	12.0	16.0	12.7	32.0	22.0	25.4	28.6	22.0	12.7	13.0	12.7
cutting edge length / długość krawędzi tnącej [mm]	20.0	20.0	20.0	12.7	12.7	10.5	11.5	16.0	12.0	13.0	9.5	6.35
curvature radius / promień krzywizny [mm]	-	-	-	-	-	12.7	3.175	9.5	6.35	-	-	-
bearing diameter / średnica łożyska [mm]	-	-	-	-	9.0	9.0	9.0	9.0	9.0	9.0	-	-
angle / kąt [°]	-	-	-	10.0	45.0	-	-	-	-	-	90.0	-



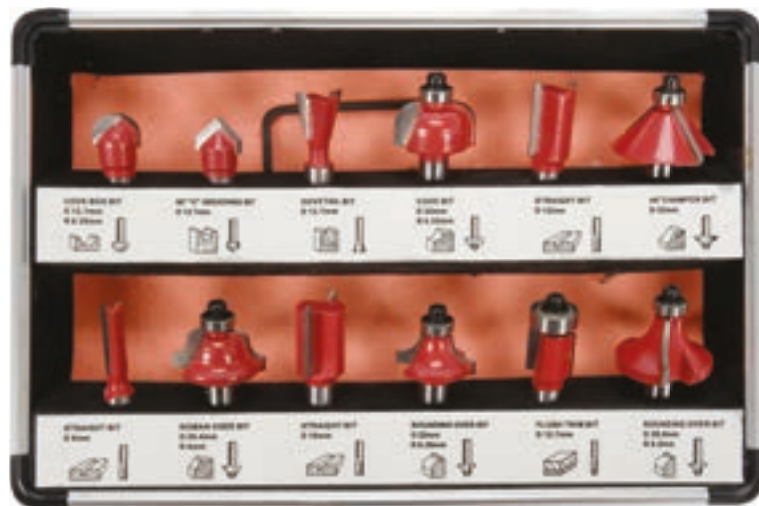

YATO  **YT-68006**  20









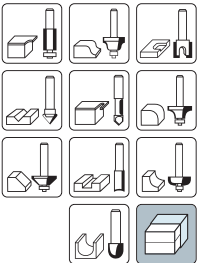



EN Router bit set
 PL Zestaw frezów do drewna
 DE Oberfräsersatz
 RU Набор фрез по дереву
 CZ Souprava frézů do dřeva
 HU Medtjio frezř kompletas
 RO Set de freze pt. lemn
 FR Fraises pour le bois
 IT Set di frese per legno
 ES Juego de frezas para madera
 CN 木工铣刀组套



12 PCS  +/- 0.08 mm

8 mm  YG6X 



Router bit parameter												
shank diameter / średnica uchwyty [mm]	8.0	8.0	8.0	8.0	8.0	8.0	8.0	8.0	8.0	8.0	8.0	8.0
length / długość [mm]	51.0	49.0	51.0	45.0	48.0	48	50.0	53.0	50.0	52.0	38.0	39.0
router bit diameter / średnica frezu [mm]	6.0	12.0	16.0	12.7	32.0	22.0	25.4	28.6	22.0	12.7	13.0	12.7
cutting edge length / długość krawędzi tnącej [mm]	20.0	20.0	20.0	12.7	12.7	10.5	11.5	16.0	12.0	13.0	9.5	6.35
curvature radius / promień krzywizny [mm]	-	-	-	-	-	12.7	3.175	9.5	6.35	-	-	-
bearing diameter / średnica łożyska [mm]	-	-	-	-	9.0	9.0	9.0	9.0	9.0	9.0	-	-
angle / kąt [°]	-	-	-	10.0	45.0	-	-	-	-	-	90.0	-

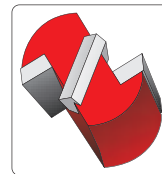

YATO  **YT-68005**  20

EN Router bit set
PL Zestaw frezów do drewna
DE Oberfrärsersatz
RU Набор фрез по дереву
CZ Souprava frézů do dřeva
HU Medjío frezf kompletas
RO Set de freze pt. lemn
FR Fraises pour le bois
IT Set di frese per legno
ES Juego de frezas para madera
CN 木工铣刀组套

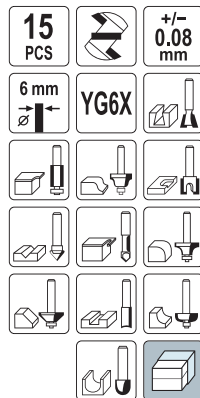

Router bit parameter															
shank diameter / średnica uchwyty [mm]	6.0	6.0	6.0	6.0	6.0	6.0	6.0	6.0	6.0	6.0	6.0	6.0	6.0	6.0	6.0
length / długość [mm]	43.0	49.0	51.0	45.0	48.0	51.0	50.0	53.0	50.0	52.0	38.0	39.0	49.0	60.0	43.0
router bit diameter / średnica frezu [mm]	12.7	12.0	16.0	12.7	32.0	6.0	25.4	28.6	22.0	12.7	12.7	12.7	3.0	6.35	6.35
cutting edge length / długość krawędzi tnącej [mm]	12.7	20.0	20.0	12.7	12.7	20.0	11.5	16.0	12.0	13.0	9.5	6.35	13.0	19.50	6.0
curvature radius / promień krzywizny [mm]	-	-	-	-	-	-	3.175	9.5	6.35	-	-	-	-	-	3.2
bearing diameter / średnica łożyska [mm]	-	-	-	-	9.0	-	9.0	9.0	9.0	9.0	-	-	-	-	-
angle / kąt [°]	-	-	-	10.0	45.0	-	-	-	-	-	90	-	-	-	-

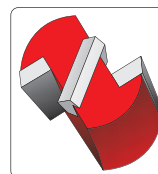

YATO
YT-68007 20

10

EN Router bit set
PL Zestaw frezów do drewna
DE Oberfrärsersatz
RU Набор фрез по дереву
CZ Souprava frézů do dřeva
HU Medjío frezf kompletas
RO Set de freze pt. lemn
FR Fraises pour le bois
IT Set di frese per legno
ES Juego de frezas para madera
CN 木工铣刀组套

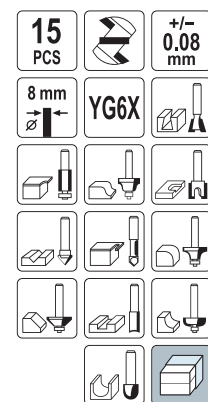
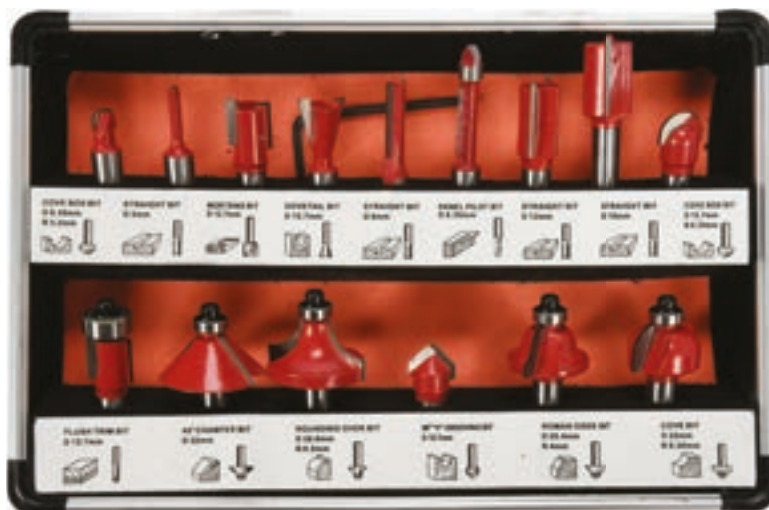

Router bit parameter															
shank diameter / średnica uchwyty [mm]	8.0	8.0	8.0	8.0	8.0	8.0	8.0	8.0	8.0	8.0	8.0	8.0	8.0	8.0	8.0
length / długość [mm]	43.0	49.0	51.0	45.0	48.0	51.0	50.0	53.0	50.0	52.0	38.0	39.0	49.0	60.0	43.0
router bit diameter / średnica frezu [mm]	12.7	12.0	16.0	12.7	32.0	6.0	25.4	28.6	22.0	12.7	12.7	12.7	3.0	6.35	6.35
cutting edge length / długość krawędzi tnącej [mm]	12.7	20.0	20.0	12.7	12.7	20.0	11.5	16.0	12.0	13.0	9.5	6.35	13.0	19.50	6.0
curvature radius / promień krzywizny [mm]	-	-	-	-	-	-	3.175	9.5	6.35	-	-	-	-	-	3.2
bearing diameter / średnica łożyska [mm]	-	-	-	-	9.0	-	9.0	9.0	9.0	9.0	-	-	-	-	-
angle / kąt [°]	-	-	-	10.0	45.0	-	-	-	-	-	90	-	-	-	-

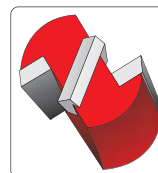

YATO
YT-68002 20

207

EN Router bit set
 PL Zestaw frezów do drewna
 DE Oberfräsersatz
 RU Набор фрез по дереву
 CZ Souprava frézů do dřeva
 HU Medtjio frezř kompletas
 RO Set de freze pt. lemn
 FR Fraises pour le bois
 IT Set di frese per legno
 ES Juego de frezas para madera
 CN 木工铣刀组套

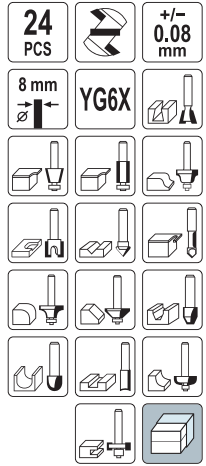

Router bit parameter												
Shank diameter [mm]	8	8	8	8	8	8	8	8	8	8	8	8
Length [mm]	42.0	47.0	47.0	43.5	50.0	51.5	51.0	52.0	58.0	51.5	58.0	56.5
Router bit diameter [mm]	12.7	12.7	9.5	12.7	12.7	9.5	12.7	16.0	6.35	6.35	9.5	12.7
Cutting edge length [mm]	12.7	14.8	11.6	13.0	12.5	20.0	20.0	9.5	19.5	20.0	24.5	25.0
Curvature radius [mm]	-	-	-	-	-	4.75	6.35	-	-	-	-	-
Bearing diameter [mm]	-	-	-	-	-	-	-	12.7	-	-	-	-
Angle [°]	-	15	10	-	45	-	-	15	-	-	-	-
Router bit parameter												
Shank diameter [mm]	8	8	8	8	8	8	8	8	8	8	8	8
Length [mm]	52.0	65.0	51.0	51.5	53.5	57.5	50.5	53.5	52.0	55.0	50.0	54.0
Router bit diameter [mm]	19.0	12.7	19.0	22.0	26.0	32.0	22.0	28.5	27.0	30.0	32.0	32.0
Cutting edge length [mm]	20.4	25.0	9.5	10.0	11.5	16.5	9.72	13.5	12.3	14.0	6.35	12.7
Curvature radius [mm]	-	-	3.2	4.76	6.35	9.5	6.35	9.5	4.0	-	-	-
Bearing diameter [mm]	-	12.7	-	12.7	12.7	12.7	9.5	9.5	9.5	12.7	12.7	12.7
Angle [°]	-	-	-	-	-	-	-	-	-	45	-	-

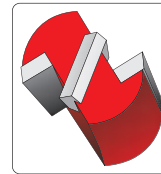

YATO 
 YT-6801

 10

EN Router bit set
 PL Zestaw frezów do drewna
 DE Oberfräsersatz
 RU Набор фрез по дереву
 CZ Souprava frézů do dřeva
 HU Medtjio frezř kompletas
 RO Set de freze pt. lemn
 FR Fraises pour le bois
 IT Set di frese per legno
 ES Juego de frezas para madera
 CN 木工铣刀组套

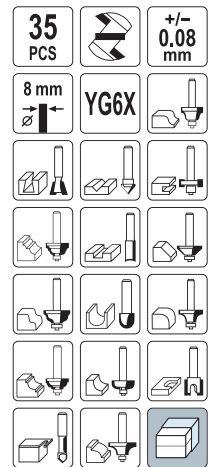

Router bit parameter																																				
Shank diameter [mm]	8	8	8	8	8	8	8	8	8	8	8	8	8	8	8	8	8	8	8	8	8	8	8	8	8	8	8	8	8	8	8	8	8	8	8	
Length [mm]	43.0	38.0	38.0	50.5	42.0	43.5	51.5	49.5	51.5	58.0	58.5	56.5	52.0	58.0	53.5	66.0	53.0	65.0																		
Router bit diameter [mm]	6.35	12.7	12.7	12.7	12.7	12.7	14.3	3.175	6.35	9.5	12.7	12.7	19.0	6.35	9.5	9.5	12.7	12.7																		
Cutting edge length [mm]	6.0	9.5	9.5	18.0	12.7	13.0	12.3	13.0	20.0	24.5	20.3	25.0	20.4	19.5	15.0	26.0	15.0	25.0																		
Curvature radius [mm]	3.175	6.35	-	6.35	-	-	-	-	-	-	-	-	-	-	-	-	-	-																		
Bearing diameter [mm]	-	-	-	-	-	-	-	-	-	-	-	-	-	-	-	9.5	9.5	12.7	12.7																	
Angle [°]	-	-	45	-	-	10	14	-	-	-	-	-	-	-	-	-	-	-																		
Router bit parameter																																				
Shank diameter [mm]	8	8	8	8	8	8	8	8	8	8	8	8	8	8	8	8	8	8	8	8	8	8	8	8	8	8	8	8	8	8	8	8	8	8	8	8
Length [mm]	65.5	55.0	51.0	55.0	50.0	52.5	54.0	55.5	60.0	60.0	56.0	60.0	52.5	58.0	53.5	57.5	61.0	-																		
Router bit diameter [mm]	19.0	30.0	26.0	32.0	32.0	32.0	32.0	32.0	32.0	38.0	32.0	38.0	26.0	38.0	26.0	32.0	38.0	-																		
Cutting edge length [mm]	26.0	14.0	9.7	13.3	6.35	8.0	9.5	15.0	18.5	20.0	16.0	19.0	12.5	17.8	11.5	16.5	20.8																			
Curvature radius [mm]	-	-	6.35	9.5	-	-	-	8.0	4.76	12.7	4.76	6.35	3.175	6.35	6.35	9.5	12.7	-																		
Bearing diameter [mm]	19.0	12.7	12.7	12.7	12.7	12.7	9.5	12.7	9.5	9.5	9.5	9.5	9.5	9.5	9.5	12.7	12.7	-																		
Angle [°]	-	45	-	-	-	-	-	-	-	-	-	-	-	-	-	-	-																			

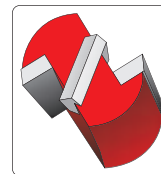

YATO 
 YT-6803

 10

EN Diamond blade
PL Tarcza diamentowa
DE Diamant-Trennscheibe
RU Отрезной алмазный диск
CZ Diamantový kotouč
HU Gyémántkorong
RO Disc cu diamant
FR Disque diamant
IT Disco diamantato
ES Disco de diamante
CN 金刚石切片

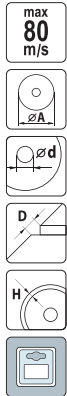

• Application: concrete, brick, tile, masonry, stone, sandstone, refractory materials, limestone

• Przeznaczenie: beton utwardzony, cegła, granit, mur, kamień, piaskowiec, materiały ogniotrwałe, siliakaty

YATO	ØA [mm]	Ød [mm]	max C [min ⁻¹]	D [mm]	H [mm]	
YT-59961	115	22.2	12000	1.8	10	20/200
YT-59962	125	22.2	12000	2.0	10	20/100
YT-59965	230	22.2	6500	2.2	10	25
YT-60003	350	25.4	4400	3.4	10	10
YT-60004	400	25.4	3850	3.6	10	5

EN Diamond blade
PL Tarcza diamentowa
DE Diamant-Trennscheibe
RU Отрезной алмазный диск
CZ Diamantový kotouč
HU Gyémántkorong
RO Disc cu diamant
FR Disque diamant
IT Disco diamantato
ES Disco de diamante
CN 热压X形金刚石锯片

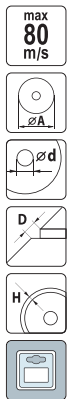

• Application: ceramic, glaze, glass, porcelain, ceramic tiles, composite hardest tiles, roof tiles

• Przeznaczenie: płytki ceramiczne, glazura, płytki kamienne, szkło, porcelana, ceramika, gres, dachówki

YATO	ØA [mm]	Ød [mm]	max C [min ⁻¹]	D [mm]	H [mm]	
YT-59971	115	22.2	12000	1.6	10	20/120
YT-59972	125	22.2	12000	1.6	10	20/100
YT-59975	230	22.2	6500	2.0	10	25

EN Diamond blade
PL Tarcza diamentowa
DE Diamant-Trennscheibe
RU Отрезной алмазный диск
CZ Diamantový kotouč
HU Gyémántkorong

RO Disc cu diamant
FR Disque diamant
IT Disco diamantato
ES Disco de diamante
CN 金刚石切片

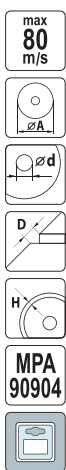

• Application: concrete, brick, calcium-silicate brick, tile, masonry, stone

• Przeznaczenie: beton utwardzony, cegła, cegła siliikatowa, granit, mur, kamień

YATO	ØA [mm]	Ød [mm]	max C [min ⁻¹]	D [mm]	H [mm]	
YT-6002	115	22.2	12000	2.1	8	20/200
YT-6003	125	22.2	11000	2.2	8	20/160
YT-6004	180	22.2	8000	2.5	8	15/60
YT-6005	230	22.2	6500	2.7	8	10/40

EN Diamond blade
PL Tarcza diamentowa
DE Diamant-Trennscheibe
RU Отрезной алмазный диск
CZ Diamantový kotouč
HU Gyémántkorong

RO Disc cu diamant
FR Disque diamant
IT Disco diamantato
ES Disco de diamante
CN 金刚石切片

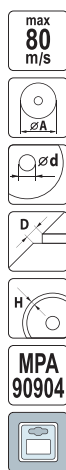

• Application: ceramic, gres, glaze, glass, porcelain

• Przeznaczenie: płytki ceramiczne, gres, glazura, płytki kamienne, szkło, porcelana

YATO	ØA [mm]	Ød [mm]	max C [min ⁻¹]	D [mm]	H [mm]	
YT-6012	115	22.2	12000	2.1	5.3	20/200
YT-6013	125	22.2	11000	2.2	5.3	20/160
YT-6014	180	22.2	8000	2.5	5.3	15/60
YT-6015	230	22.2	6500	2.7	5.3	10/40
YT-6016	180	25.4	8000	2.2	5.3	15/60
YT-6017	200	25.4	8000	2.2	5.3	10/40

EN Diamond blade
PL Tarcza diamentowa
DE Diamant-Trennscheibe
RU Отрезной алмазный диск
CZ Diamantový kotouč
HU Gyémántkorong
RO Disc cu diamant
FR Disque diamant
IT Disco diamantato
ES Disco de diamante
CN 热压湿片

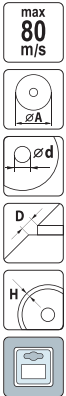

• Application: ceramic, glaze

• Przeznaczenie: płytki ceramiczne, glazura, płytki kamienne

YATO	ØA [mm]	Ød [mm]	max C [min ⁻¹]	D [mm]	H [mm]	
YT-59951	115	22.2	12000	1.6	10	20/200
YT-59952	125	22.2	12000	1.6	10	20/100
YT-59955	230	22.2	6500	2.2	10	25

EN Diamond blade
PL Tarcza diamentowa
DE Diamant-Trennscheibe
RU Отрезной алмазный диск
CZ Diamantový kotouč
HU Gyémántkorong
RO Disc cu diamant
FR Disque diamant
IT Disco diamantato
ES Disco de diamante
CN 热压超薄波纹片

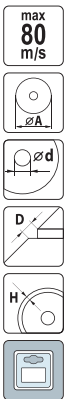

• Application: reinforced concrete, glaze, clinker, brick, limestone

• Przeznaczenie: beton zbrojony, granit, klinkier, siliakaty

YATO	ØA [mm]	Ød [mm]	max C [min ⁻¹]	D [mm]	H [mm]	
YT-59981	115	22.2	12000	1.3	10	20/200
YT-59982	125	22.2	12000	1.3	10	20/100
YT-59985	230	22.2	6500	2.0	10	25

EN Diamond blade
PL Tarcza diamentowa
DE Diamant-Trennscheibe
RU Отрезной алмазный диск
CZ Diamantový kotouč
HU Gyémántkorong

RO Disc cu diamant
FR Disque diamant
IT Disco diamantato
ES Disco de diamante
CN 金刚石切片

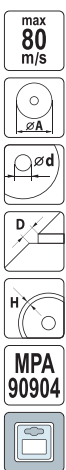

• Application: concrete, reinforced concrete, brick, tile, masonry, stone, sandstone

• Przeznaczenie: beton utwardzony, beton zbrojony, cegła, granit, mur, kamień, piaskowiec

YATO	ØA [mm]	Ød [mm]	max C [min ⁻¹]	D [mm]	H [mm]	
YT-6022	115	22.2	12000	2.4	8	20/200
YT-6023	125	22.2	11000	2.6	8	20/160
YT-6024	180	22.2	8000	2.8	8	15/60
YT-6025	230	22.2	6500	3.1	8	10/40

EN Diamond grinding cup wheel
 PL Tarcza szlifierska diamentowa
 DE Diamant Schleiftopf Schleifteller
 RU Алмазный диск шлифовальный
 CZ Diamantový brusný kotouč
 HU Gyémánt csiszoló kúpos

RO Disc cupa diamentat pt. slefuit
 FR Disque diamant
 IT Disco diamantato
 ES Disco diamante de lijar
 CN 金刚石杯型磨轮



• Application: concrete, clinkier, natural stone, screed
 • Przeznaczenie: beton utwardzony, clinkier, kamień naturalny, jastrych

YATO	ØA [mm]	Ød [mm]	max C [min ⁻¹]	Segment size / Rozmiar segmentu [mm]	
YT-6030	125	22.2	12200	5x7.5	20
YT-6032	125	22.2	12200	4.5x20	20

EN Diamond core bit drilling holes for sockets
 PL Diamentowe wiertło koronowe
 DE Diamant-Bohrkrone
 RU Алмазное сверло корончатое
 CZ Diamantový korunkový vrták
 HU Gyémánt fúrókorona

RO Carota diamentata pt. beton
 FR Trépiéd à mur diamantées
 IT Corona diamentata per calcestruzzo
 ES Broca corona de diamante
 CN 金刚石薄壁钻

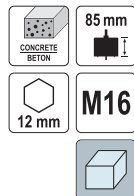

• Application: concrete, calcium-silicate brick, porous ceramics
 • Przeznaczenie: beton utwardzony, cegła silikatowa, ceramika poryzowana

YATO	Ø [mm]	max C [min ⁻¹]	Segment size / Rozmiar segmentu [mm]	
YT-6045	65	1030	3.5x10x24	24
YT-6046	82	850	3.5x10x24	20

EN Diamond grinding cup wheel
 PL Tarcza szlifierska diamentowa
 DE Diamant Schleiftopf Schleifteller
 RU Алмазный диск шлифовальный
 HU Gyémánt csiszoló kúpos

RO Disc cupa diamentat pt. slefuit
 FR Disque diamant
 IT Disco diamantato
 ES Disco diamante de lijar
 CN 金刚石磨轮



• Application: concrete, screed
 • Przeznaczenie: beton, jastrych

YATO	ØA [mm]	Ød [mm]	max C [min ⁻¹]	Segment size / Rozmiar segmentu [mm]	For / Dla	
YT-60322	125	22.2	12200	5x9	YT-82110, YT-82101	30
YT-60323	180	22.2	6600	5x9	YT-82341, YT-82110	10

EN Diamond core bit drilling holes for sockets
 PL Diamentowe wiertło koronowe
 DE Diamant-Bohrkrone
 RU Алмазное сверло корончатое
 CZ Diamantový korunkový vrták
 HU Gyémánt fúrókorona
 RO Carota diamentata pt. beton
 FR Trépiéd à mur diamantées
 IT Corona diamentata per calcestruzzo
 ES Broca corona de diamante
 CN 激光薄壁钻



For YT-81980
 Dla YT-81980

YATO	Ø [mm]	max C [min ⁻¹]	Segment size / Rozmiar segmentu [mm]	
YT-60371	32	1500	4x8x20	10
YT-60372	42	1500	4x8x20	10
YT-60373	52	1500	4x8x24	10
YT-60374	68	1500	4x8x24	8
YT-60375	82	1500	4x8x24	4
YT-60376	102	1500	4x8x24	4
YT-60377	122	1500	4x8x24	4
YT-60378	152	1500	4x8x24	2
YT-60379	182	1500	4x8x24	2

EN TCT circular saw blade for wood
 PL Pila tarczowa do drewna z węglikiem wolframu
 DE Kreissägeblatt HM-Bestückt
 RU Диск пильный с карбидом вольфрама
 CZ Kotoučová pila na dřevo z karbidem wolframu
 HU Wolframkarbidos körfűrész fához
 RO Ferăstrău circular cu dinți din wolfram pt. lemn
 FR Lame de scie circulaire carburée
 IT Lama troncatrice taglio legno
 ES Disco de sierra con carbono de tungsteno
 CN 木工圆锯片

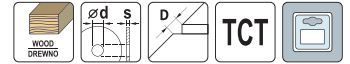

• Application: for cutting wood and plastics

• Przeznaczenie: do cięcia drewna, płyt drewnopochodnych, tworzyw sztucznych

YATO	Ø [mm]	Ød [mm]	max ^C [min ⁻¹]	D [mm]	s [mm]	T	For / Dla	
YT-6050	130	16.0	10000	2.8	2.0	24	-	25/50
YT-6052	140	20.0	10000	2.8	2.0	16	-	25/50
YT-60522	140	20.0	11000	2.8	2.0	30	-	25/50
YT-6053	140	16.0	10000	2.8	2.0	30	-	25/50
YT-60533	150	20.0	10000	2.8	2.0	30	-	25/50
YT-6055	160	20.0	9500	2.8	2.0	18	79254	25/50
YT-6056	160	30.0	9500	2.8	2.0	24	79254	25/50
YT-6057	160	30.0	9500	2.8	2.0	36	-	25/50
YT-60577	160	20.0	9500	2.2	1.5	36	79254	25/50
YT-6058	160	20.0	9500	2.8	2.0	48	79254	25/50
YT-60581	160	20.0	9500	2.2	1.5	60	-	25/50
YT-60590	165	16.0	9500	2.2	1.5	24	YT-82810, YT-82811	25/50
YT-60591	165	16.0	9500	2.2	1.5	36	YT-82810, YT-82811	25/50
YT-60582	170	16.0	9500	3.2	2.2	12	-	25/50
YT-60583	170	16.0	9500	3.2	2.2	40	-	25/50
YT-6060	184	30.0	9000	3.2	2.2	24	YT-82172	25/50
YT-6061	184	30.0	9000	3.2	2.2	40	YT-82172	25/50
YT-6062	184	30.0	9000	3.2	2.2	50	YT-82172	25/50
YT-6063	185	20.0	9000	2.4	1.4	18	YT-82151	10/20
YT-60621	185	20.0	9000	2.2	1.5	24	YT-82151	25/50
YT-60622	185	20.0	9000	2.2	1.5	36	YT-82151	25/50
YT-60633	190	16.0	8500	3.2	2.2	40	YT-82150	10/20
YT-60634	190	20.0	8500	2.2	1.5	24	YT-82150	10/20
YT-60635	190	20.0	8500	2.2	1.5	36	YT-82150	10/20
YT-60636	190	20.0	8500	2.2	1.5	60	-	10/20
YT-60488	190	30.0	8500	3.2	2.2	20	-	10/20
YT-60489	190	30.0	8500	3.2	2.2	40	-	10/20
YT-6065	200	30.0	8000	3.2	2.2	24	-	10/20
YT-60652	200	30.0	8000	3.2	2.2	40	-	10/20
YT-6066	205	18.0	6000	3.2	2.0	24	-	10/20
YT-60665	210	30.0	7500	3.2	2.2	20	-	10/20
YT-6067	210	30.0	8000	3.2	2.2	40	-	10/20
YT-6068	210	30.0	8000	3.2	2.2	60	-	10/20
YT-60682	216	30.0	7500	3.2	2.2	48	-	10/20
YT-60685	235	25.4	7000	2.8	1.8	24	YT-82153	10/20
YT-60686	235	25.4	7000	2.8	1.8	36	YT-82153	10/20
YT-60687	235	25.4	7000	2.8	1.8	60	YT-82153	10/20
YT-6070	250	30.0	6000	3.2	2.2	24	YT-82165	10/20
YT-6071	250	30.0	6000	3.2	2.2	40	YT-82165	10/20
YT-6072	250	30.0	6000	3.2	2.2	60	YT-82165	10/20
YT-60731	255	30.0	6000	30.0	2.0	24	YT-82171, YT-82173, YT-82165	10/20
YT-60732	255	30.0	6000	3.0	2.0	36	YT-82173	10/20
YT-60733	255	30.0	6000	3.0	2.0	60	YT-82173	10/20
YT-6075	300	30.0	6000	3.2	2.2	24	YT-82175	10
YT-6076	300	30.0	5000	3.2	2.2	40	YT-82175	10
YT-6077	300	30.0	5000	3.2	2.2	60	YT-82175	10
YT-6078	300	30.0	5000	3.2	2.2	96	YT-82175	10
YT-60782	305	30.0	5000	3.2	2.2	24	YT-82175	10
YT-60783	305	30.0	5000	3.2	2.2	40	YT-82175	10
YT-60784	305	30.0	5000	3.2	2.2	60	YT-82175	10
YT-60785	305	30.0	5000	3.2	2.2	96	YT-82175	10
YT-60791	315	30.0	4900	3.2	2.2	40	-	10
YT-60792	315	30.0	4500	3.5	2.5	48	-	10
YT-60794	315	30.0	4500	3.5	2.5	80	-	10
YT-60795	315	30.0	4900	3.2	2.2	96	-	10
YT-6080	350	30.0	4500	3.5	2.5	28	-	10
YT-6081	350	30.0	4500	3.5	2.5	40	-	10
YT-6082	350	30.0	4500	3.5	2.5	54	-	10
YT-6083	350	30.0	4500	3.5	2.5	84	-	10
YT-6085	400	30.0	4000	3.8	2.8	32	-	10
YT-6086	400	30.0	4000	3.8	2.8	60	-	10

EN Circular saw blade for wood
 PL Pila tarczowa do drewna
 DE Kreissägeblatt
 RU Диск пильный по дереву
 CZ Kotoučová pila na dřevo
 HU Körfűrész fához
 RO Ferăstrău circular pt. lemn
 FR Lame de scie pour bois
 IT Lama taglio legno
 ES Disco de sierra
 CN 木工尖齿片

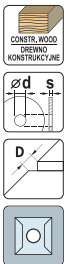

YATO	Ø [mm]	Ød [mm]	max ^C [min ⁻¹]	D [mm]	s [mm]	T	
YT-60871	500	32	3000	4.5	2.9	60	4
YT-60872	500	32	3000	4.5	2.9	80	4

EN TCT circular saw blade for structural wood
 PL Pila tarczowa z węglikiem wolframu do cięcia drewna konstrukcyjnego
 DE Kreissägeblatt HM-Bestuckt von Holzkonstruktionen
 RU Диск пильный твердого сплава для резки строительной конструкционной древесины
 CZ Kotoučová pila s karbidem wolframu k řezání konstrukčního dřeva
 HU Wolfram-karbid szegmens fűrészárca szerkezeti fához
 RO Ferăstrău circular cu dinți din wolfram pt. tăierea lemnului pt. construcții
 FR Lame de scie circulaire carbure pour construction bois
 IT Lama al tungsteno da legno
 ES Disco de sierra con carbono de tungsteno para corte de madera estructural
 CN 木工圆锯片

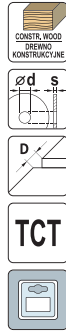

YATO	Ø [mm]	Ød [mm]	max ω [min ⁻¹]	D [mm]	s [mm]	T	
YT-60480	160	20	9500	2.2	1.5	24	25/50
YT-60482	180	20	9000	2.4	1.8	36	20/40
YT-60484	250	30	6000	2.4	1.8	48	10/20

EN TCT circular saw blade for structural wood
 PL Pila tarczowa z węglikiem wolframu do cięcia drewna konstrukcyjnego
 DE Kreissägeblatt HM-Bestuckt von Holzkonstruktionen
 RU Диск пильный твердого сплава для резки строительной конструкционной древесины
 CZ Kotoučová pila s karbidem wolframu k řezání konstrukčního dřeva
 HU Wolfram-karbid szegmens fűrészárca szerkezeti fához
 RO Ferăstrău circular cu dinți din wolfram pt. tăierea lemnului pt. construcții
 FR Lame de scie circulaire carbure pour construction bois
 IT Lama al tungsteno da legno
 ES Disco de sierra con carbono de tungsteno para corte de madera estructural
 CN 锯铁片

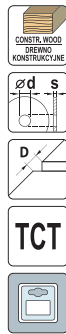

YATO	Ø [mm]	Ød [mm]	max ω [min ⁻¹]	D [mm]	s [mm]	T	
YT-60628	185	20	9000	2.4	1.8	14	25/50

EN Blade for cutting laminate and plywood
 PL Pila tarczowa do cięcia paneli i płyt meblowych
 DE Kreissägeplatte für Laminatböden
 RU Ламинированный режущий диск
 CZ Laminátový řezací kotouč
 HU Körfűrészlap
 RO Disc de tăiere laminat
 FR Disque de coupe en stratifié
 IT Disco da taglio per pannelli e pannelli per mobili
 ES Disco de corte laminado
 CN 普通木工片

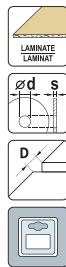

YATO	Ø [mm]	Ød [mm]	max ω [min ⁻¹]	D [mm]	s [mm]	T	
YT-60631	185	20	9000	1.7	1.4	140	25/50

EN TCT circular saw blade for aluminium
 PL Pila tarczowa do aluminium z węglikiem wolframu
 DE Hartmetallbestückt Kreissägeblatt für Aluminium
 RU Диск пильный по алюминию
 CZ Kotoučová pila na hliník s karbidem wolframu
 HU Wolframkarbidos körfűrészlap, alumíniumhoz
 RO Disc circular pt. aluminiu
 FR Lame de scie circulaire pour aluminium
 IT Lama troncatrice alluminio
 ES Disco de sierra con carbono
 CN 圆锯片



- Application: for cutting aluminium profiles, laminates, plexi, corian and other plastics
- Negative angle of teeth
- Przeznaczenie: do cięcia profili aluminiowych, laminatów, pleksi, korianu, tworzyw sztucznych
- Negatywny kąt natarcia zębów

YATO	Ø [mm]	Ød [mm]	max ω [min ⁻¹]	D [mm]	s [mm]	T	
YT-60905	160	20	9500	2.2	1.5	52	25/50
YT-60907	180	20	9000	2.2	1.5	60	20/40
YT-6091	200	30	8000	3.0	2.2	60	10/20
YT-6093	210	30	8000	3.0	2.2	72	10/20
YT-6095	250	30	6000	3.0	2.2	100	10/20
YT-6097	300	30	5000	3.0	2.2	100	10
YT-6099	350	30	4500	3.2	2.5	100	10

EN Metal cutting blade for circular saw
 PL Pila tarczowa do cięcia stali ręczną pilarką tarczową
 DE Kreissägeblatt für Geradschnitte in Edelmetall
 RU Диск циркулярной пилы для стали
 CZ Kruhová pila na řezání kovu
 HU Fűrészárca fém vágáshoz
 RO Panza fierastrau circular pt. debitat metal
 FR Lame scie circulaire
 IT Disco in carburo da taglio dell'acciaio
 ES Sierra circular para cortar metal
 CN 锯铁片

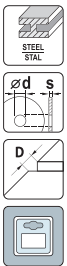

YATO	Ø [mm]	Ød [mm]	max ω [min ⁻¹]	D [mm]	s [mm]	T	
YT-60625	185	20	6000	2.2	1.5	48	25/50

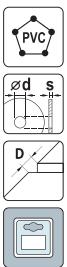

EN PVC cutting blade
 PL Pila tarczowa do cięcia PVC
 DE PVC-Trennscheibe
 RU Режущий диск ПВХ
 CZ PVC řezný disk
 HU Körfűrészárca
 RO Panza de ferastrau circular PVC
 FR Disque de coupe en PVC
 IT Disco da taglio per PVC
 ES Sierra circular CMT para corte PVC
 CN 锯塑料片

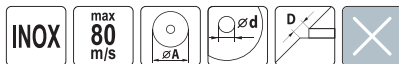

YATO	Ø [mm]	Ød [mm]	max ω [min ⁻¹]	D [mm]	s [mm]	T	
YT-60627	185	20	9000	2.5	1.5	60	25/50

EN Metal cutting disc
PL Tarcza do cięcia metalu
DE Trennscheibe für Metall
RU Диск отрезной по металлу
CZ Kotouč pro řezání kovu
HU Vágókorong fémhez
RO Disc debitat metale
FR Disque à tronçonner pour métal
IT Disco per taglio metallo
ES Disco cortador para metal
CN 金属切割片





YATO 	ØA [mm]	Ød [mm]	D [mm]	max C [min ⁻¹]	pcs / szt.	
YT-6101	115	22	1.2	13200	5	25/200
YT-61025	125	22.23	1.0	12200	5	50/400
YT-6103	125	22	1.2	12200	5	25/200
YT-6104	125	22	2.5	12200	5	25/200
YT-6105	180	22	1.5	8600	5	25/50
YT-6107	230	22	2.0	6500	5	25/50

EN Metal cutting disc
PL Tarcza do cięcia metalu
DE Trennscheibe für Metall
RU Диск отрезной по металлу
CZ Kotouč pro řezání kovu
HU Vágókorong fémhez
RO Disc debitat metale
FR Disque à tronçonner pour métal
IT Disco per taglio metallo
ES Disco cortador para metal
CN 金属切割片





For YT-82180
Dla YT-82180

YATO 	ØA [mm]	Ød [mm]	D [mm]	max C [min ⁻¹]	pcs / szt.	
YT-61132	355	25.4	3.2	4400	25	

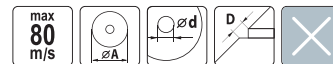
EN Metal cutting disc
PL Tarcza do cięcia metalu
DE Trennscheibe für Metall
RU Диск отрезной по металлу
CZ Kotouč pro řezání kovu
HU Vágókorong fémhez
RO Disc debitat metale
FR Disque à tronçonner pour métal
IT Disco per taglio metallo
ES Disco cortador para metal
CN 金属切割片





YATO 	ØA [mm]	Ød [mm]	D [mm]	max C [min ⁻¹]	pcs / szt.	
YT-5920	115	22	1.2	13200	5	25/200
YT-5923	125	22	1.2	12200	5	25/200
YT-5924	125	22	2.5	12200	5	25/200
YT-6110	125	22	3.2	12200	5	25/200
YT-5925	180	22	1.5	8600	5	25/50
YT-5927	230	22	2.0	6500	5	25/50
YT-6112	230	22	3.2	6500	5	25/50
YT-6113	300	32	3.2	5100	5	25
YT-6136	350	32	3.5	4400	5	25
YT-6137	400	32	4.0	3800	5	25

EN Metal cutting disc
PL Tarcza do cięcia metalu
DE Trennscheibe für Metall
RU Диск отрезной по металлу
CZ Kotouč pro řezání kovu
HU Vágókorong fémhez
RO Disc debitat metale
FR Disque à tronçonner pour métal
IT Disco per taglio metallo
ES Disco cortador para metal
CN 金属切割片



• Depressed center

• Wypukła

YATO 	ØA [mm]	Ød [mm]	D [mm]	max C [min ⁻¹]	pcs / szt.	
YT-6116	125	22	2.5	12200	5	25/200
YT-6120	230	22	3.2	6500	5	25/50

EN Metal grinding disc
 PL Tarcza do szlifowania metalu
 DE Metall-Schleif-scheibe
 RU Круги для шлифования по металлу
 CZ Kotouč pro broušení kovu
 HU Vágókorong fémhez
 RO Disc pt. șlefuit metal
 FR Disque de polissage pour métaux
 IT Disco per rettifica metallo
 ES Disco cortador para metalo
 CN 金属磨片



• Depressed center
 • Wypukła

YATO	ØA [mm]	Ød [mm]	D [mm]	max C [min ⁻¹]	pcs / szt.	
YT-6121	115	22	6.0	13200	5	25/100
YT-6124	125	22	6.0	12200	5	30/120
YT-6126	125	22	8.0	12200	5	25/100
YT-6125	230	22	6.0	6500	5	5/30

EN Metal grinding disc
 PL Tarcza do szlifowania metalu
 DE Metall-Schleif-scheibe
 RU Круги для шлифования по металлу
 CZ Kotouč pro broušení kovu
 HU Vágókorong fémhez
 RO Disc pt. șlefuit metal
 FR Disque de polissage pour métaux
 IT Disco per rettifica metallo
 ES Disco cortador para metalo
 CN 树脂切片

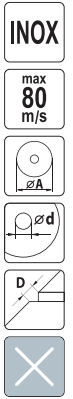

• Depressed center
 • Wypukła

YATO	ØA [mm]	Ød [mm]	D [mm]	max C [min ⁻¹]	pcs / szt.	
YT-5947	125	22	6.8	12200	5	25/100

EN Stone cutting disc
 PL Tarcza do cięcia kamienia
 DE Stein-Trennscheibe
 RU Диск отрезной по камню
 CZ Kotouč pro řezání kamene
 HU Vágókorong kőhöz
 RO Disc pt. tăiat piatră
 FR Disque de coupe pour granit
 IT Disco per taglio pietra
 ES Disco cortador de piedra
 CN 树脂切片



YATO	ØA [mm]	Ød [mm]	D [mm]	max C [min ⁻¹]	pcs / szt.	
YT-5930	115	22	1.5	13200	5	25/200
YT-5932	125	22	1.5	12200	5	25/200
YT-5933	125	22	3.2	12200	5	25/200
YT-5935	230	22	3.2	6500	5	25/50

EN Stone grinding disc
 PL Tarcza do szlifowania kamienia
 DE Stein-Schleifscheibe
 RU Диск для шлифования по камню
 CZ Kotouč pro broušení kamene
 HU Csiszolókorong kőhöz
 RO Disc pt. șlefuit piatră
 FR Disque de polissage pour granit
 IT Disco per rettifica pietra
 ES Disco cortador de piedra
 CN 树脂切片



• Depressed center
 • Wypukła

YATO	ØA [mm]	Ød [mm]	D [mm]	max C [min ⁻¹]	pcs / szt.	
YT-6132	115	22	6.0	13200	5	25/100
YT-6133	125	22	6.8	12200	5	25/100

EN Universal grinding disc
 PL Tarcza szlifująca uniwersalna
 DE Universelle Schleifscheibe
 RU Диск шлифовальный универсальный
 CZ Brusný kotouč univerzální
 HU Univerzális csiszolókorong
 RO Disc de rectificat
 FR Disque de ponçage universel
 IT Disco di molatura
 ES Muela abrasiva universal
 CN 塑基砂盘

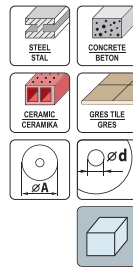

YATO	Grit / Ziarnistość	ØA [mm]	Ød [mm]	max C [min ⁻¹]	
YT-83260	P8	125	22.2	17000	100
YT-83261	P16	125	22.2	17000	100
YT-83262	P24	125	22.2	17000	100
YT-83263	P36	125	22.2	17000	100
YT-83264	P60	125	22.2	17000	100
YT-83265	P80	125	22.2	17000	100
YT-83266	P120	125	22.2	17000	100

EN Rubber disc for angle grinder
 PL Przystawka do szlifierek kątowych
 DE Klett-Gummihaftstützeller mit Gewindeflansch
 RU Диск резиновый с липучкой шлифмашины
 CZ Euro disk do úhelníků ze zipem
 HU Csiszolókorong kőhöz
 RO Suport disc pt. polizor unghiular
 FR Disque caoutchouc avec velcro
 IT Disco con velcro e accessori
 ES Disco de goma para angul con velcro
 CN 抛光垫



YATO	Ø [mm]	max C [min ⁻¹]	
YT-47770	230	6600	25

EN Tapered rasp disc
PL Tarnik skośny
DE Raspelscheibe schräge Oberfläche
RU Диск фреза универсальный по дереву для УШМ
CZ Rotační rašple
HU Rotációs rászpoly
RO Disc raspel
FR Disque râpe
IT Disco raspa obliquo
ES Disco escofina
CN 圆锥锉刀盘



- Grinding, milling
- Wood, cellular concrete, plastics, gypsum, drywall
- Szlifowanie, frezowanie
- Drewno, beton komórkowy, tworzywa sztuczne, gips, płyty gipsowo-kartonowe

YATO	Ø [mm]	Ød [mm]	max C [min ⁻¹]	[#]	
YT-59164	115	22.2	13000	2	10
YT-59165	125	22.2	13000	2	10

EN Tapered rasp disc
PL Tarnik skośny
DE Raspelscheibe schräge Oberfläche
RU Диск фреза универсальный по дереву для УШМ
CZ Rotační rašple
HU Rotációs rászpoly
RO Disc raspel
FR Disque râpe
IT Disco raspa obliquo
ES Disco escofina
CN 圆锥锉刀盘

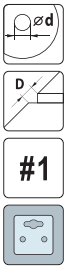

- Grinding, milling
- Wood, cellular concrete, plastics, gypsum, drywall
- Szlifowanie, frezowanie
- Drewno, beton komórkowy, tworzywa sztuczne, gips, płyty gipsowo-kartonowe

YATO	Ø [mm]	Ød [mm]	max C [min ⁻¹]	[#]	
YT-59166	115	22.2	13000	1	10
YT-59167	125	22.2	13000	1	10

EN Tapered rasp disc
PL Tarnik wypukły
DE Raspelscheibe gekröpft
RU Диск фреза универсальный по дереву для УШМ
CZ Rotační rašple
HU Rotációs rászpoly
RO Disc raspel
FR Disque râpe
IT Disco raspa convesso
ES Disco escofina
CN 锯片

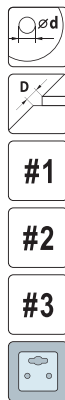

- Grinding, milling
- Wood, cellular concrete, plastics, gypsum, drywall
- Szlifowanie, frezowanie
- Drewno, beton komórkowy, tworzywa sztuczne, gips, płyty gipsowo-kartonowe

YATO	Ø [mm]	Ød [mm]	max C [min ⁻¹]	[#]	
YT-59168	125	22.2	13000	1	10
YT-59169	125	22.2	13000	2	10
YT-59170	125	22.2	13000	3	10

EN Rasp milling cutter
PL Frez tarnikowy
DE Raspelfräs-Scheibe
RU Фреза по дереву для УШМ
CZ Rotační rašple
HU Rotációs rászpoly
RO Disc raspel
FR Fraise râpe
IT Fresa raspa a disco
ES Disco escofina
CN 锯片

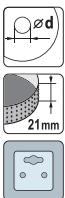

- Milling, ridging
- Wood, cellular concrete, plastics, gypsum, drywall
- Frezowanie, bruzdowanie
- Drewno, beton komórkowy, tworzywa sztuczne, gips, płyty gipsowo-kartonowe

YATO	Ø [mm]	Ød [mm]	max C [min ⁻¹]	[#]	
YT-59175	90	22.2	13000	10	
YT-59176	118	22.2	13000	10	

EN Rasp milling cutter
PL Frez tarnikowy uniwersalny
DE Raspelfräs Universalscheibe
RU Универсальная фреза
CZ Rotační rašple
HU Rotációs rászpoly
RO Disc raspel
FR Fraise râpe
IT Fresa raspa a disco universale
ES Disco escofina
CN 锯片

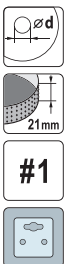

- Milling, grinding, ridging
- Wood, cellular concrete, plastics, gypsum, drywall
- Frezowanie, szlifowanie, bruzdowanie
- Drewno, beton komórkowy, tworzywa sztuczne, gips, płyty gipsowo-kartonowe

YATO	Ø [mm]	Ød [mm]	max C [min ⁻¹]	[#]	
YT-59177	118	22.2	13000	1	10

EN Cable cutter
 PL Szczypce do cięcia przewodów
 DE Kabelschere
 RU Кабелножыцы
 CZ Štípací kleště na kabely
 HU Kábelvágó
 RO Ceste tăiat cabluri
 FR Pince à couper les fils
 IT Cesoia per cavi elettrici
 ES Alicata cortacables
 CN 电缆剪



HRC 55-60 **CrV 50**

* Application: for copper and aluminium electric cables
 * Przeznaczenie: do cięcia miedzianych i aluminiowych kabli

YATO	max. Ø [mm]	L [mm]	
YT-1966	6	160	6/60
YT-1967	7	210	6/60
YT-1968	8	240	6/48

EN Insulated cable cutter
 PL Szczypce do cięcia przewodów izolowane
 DE Kabelschere
 RU Кабелножыцы
 CZ Izolované kleště na kabely
 HU Kábelvágó
 RO Ceste tăiat cabluri izolat
 FR Pince renforcée isolée
 IT Cesoia per cavi isolata
 ES Alicata cortacables aislado
 CN 双色绝缘电缆剪



250 mm **max Ø 8.0 mm**
CrV **1000 V**

1000 V
 VDE CERTIFICATE
 EN 60900:2012

YATO	max. Ø [mm]	L [mm]	
YT-21141	8	250	6/36

EN Heavy duty cable cutter
 PL Wzmocnione nożyce do cięcia przewodów
 DE Schwere Drahtschere
 RU Кабелножыцы
 CZ Štípací kleště na kabely
 HU Kábelvágó
 RO Patent tăietor pt. electrice
 FR Pince renforcée à couper les fils
 IT Cesoia per cavi elettrici
 ES Alicata cortacables
 CN 电缆剪



240 mm **max Ø 9.0 mm** **HRC 55-60**
CrV 50 **DROP FORGED KUTE**

* Application: for copper and aluminium electric cables
 * Przeznaczenie: do cięcia miedzianych i aluminiowych kabli

YATO	max. Ø [mm]	L [mm]	
YT-1969	9	240	6/48

EN Tin snips
 PL Nożyce do cięcia blachy
 DE Blechscherer
 RU Ножницы по металлу

CZ Nůžky na plech
 HU Lemezvágó olló
 RO Foarfece pt. tablă
 FR Cisaille à tôle

IT Cesioie per lamiere
 ES Tijeras para chapas
 CN 航空剪

CrMo **INCREASED CUTTING POWER ZWIĘKSZONA SIŁA CIĘCIA**



DIN 6438 **HRC 60-62**

DIN 6438 **HRC 60-62**

YATO	L [mm]	Cutting length / Długość cięcia [mm]	Cooper / Miedź [mm]	Cold rolled steel / Stal zimnowalcowana [mm]	Steel HRC35 / Stal HRC35 [mm]	SS 304 / Stal Nierdzewna 304 [mm]	
YT-1910	260	35	1.8	1.5	1.0	0.9	6/36

YATO	L [mm]	Cutting length / Długość cięcia [mm]	Cooper / Miedź [mm]	Cold rolled steel / Stal zimnowalcowana [mm]	Steel HRC35 / Stal HRC35 [mm]	SS 304 / Stal Nierdzewna 304 [mm]	
YT-1915	235	30	1.5	1.2	1.0	0.7	6/36



DIN 6438 **HRC 60-62**

HRC 56-62 **HIGH FREQUENCY HARDENING HARTOWANIE IMPULSOWE** **SERRATED EDGES ZĄBKOWANIE KRAWĘDZIE**

YATO	L [mm]	Cutting length / Długość cięcia [mm]	Cooper / Miedź [mm]	Cold rolled steel / Stal zimnowalcowana [mm]	Steel HRC35 / Stal HRC35 [mm]	SS 304 / Stal Nierdzewna 304 [mm]	
YT-1918	260	32	1.8	1.5	1.0	0.9	6/36

YATO	L [mm]	Cutting length / Długość cięcia [mm]	Cooper / Miedź [mm]	Cold rolled steel / Stal zimnowalcowana [mm]	Steel HRC35 / Stal HRC35 [mm]	SS 304 / Stal Nierdzewna 304 [mm]	
YT-1960	250	40	2.0	1.5	1.0	0.8	6/36

EN Tin snips
PL Nożyce do cięcia blachy
DE Blechscherer

RU Ножницы по металлу
CZ Nůžky na plech
HU Lemezvágó olló

RO Foarfece pt. tablă
FR Cisaille à tôle
IT Cesioie per lamiera

ES Tijeras para chapas
CN 台式航空剪



YATO L [mm]	Cutting length / Długość cięcia [mm]	Cooper / Miedź [mm]	Cold rolled steel / Stal zimnowalcowana [mm]	Steel HRC35 / Stal HRC35 [mm]	SS 304 / Stal Nierdzewna 304 [mm]	
YT-1913	225	30	0.78	0.53	0.46	0.36

EN Tin snips
PL Nożyce do cięcia blachy
DE Blechscherer

RU Ножницы по металлу

CZ Nůžky na plech
HU Lemezvágó olló
RO Foarfece pt. tablă
FR Cisaille à tôle

IT Cesioie per lamiera
ES Tijeras para chapas
CN 航空剪



YATO L [mm]	Cutting length / Długość cięcia [mm]	Cooper / Miedź [mm]	Cold rolled steel / Stal zimnowalcowana [mm]	Steel HRC35 / Stal HRC35 [mm]	SS 304 / Stal Nierdzewna 304 [mm]	
YT-1912	260	35	1.8	1.5	1.0	0.9



DIN 6438 HRC 60-62

YATO L [mm]	Cutting length / Długość cięcia [mm]	Cooper / Miedź [mm]	Cold rolled steel / Stal zimnowalcowana [mm]	Steel HRC35 / Stal HRC35 [mm]	SS 304 / Stal Nierdzewna 304 [mm]	
YT-1922	290	75	1.1	0.94	0.7	0.53



HRC 56-62 SERRATED EDGES ZĄBKOWANE KRAWĘDZIE HIGH FREQUENCY HARDENING HARTOWANE IMPULSOWE

YATO L [mm]	Cutting length / Długość cięcia [mm]	Cooper / Miedź [mm]	Cold rolled steel / Stal zimnowalcowana [mm]	Steel HRC35 / Stal HRC35 [mm]	SS 304 / Stal Nierdzewna 304 [mm]	
YT-1962	250	45	2.0	1.5	1.0	0.8

EN Tin snips
PL Nożyce do cięcia blachy
DE Blechscherer

RU Ножницы по металлу

CZ Nůžky na plech
HU Lemezvágó olló
RO Foarfece pt. tablă
FR Cisaille à tôle

IT Cesioie per lamiera
ES Tijeras para chapas
CN 航空剪



DIN 6438 HRC 60-62

YATO L [mm]	Cutting length / Długość cięcia [mm]	Cooper / Miedź [mm]	Cold rolled steel / Stal zimnowalcowana [mm]	Steel HRC35 / Stal HRC35 [mm]	SS 304 / Stal Nierdzewna 304 [mm]	
YT-1911	260	35	1.8	1.5	1.0	0.9



DIN 6438 HRC 60-62

YATO L [mm]	Cutting length / Długość cięcia [mm]	Cooper / Miedź [mm]	Cold rolled steel / Stal zimnowalcowana [mm]	Steel HRC35 / Stal HRC35 [mm]	SS 304 / Stal Nierdzewna 304 [mm]	
YT-1916	235	30	1.5	1.2	1.0	0.7



DIN 6438 HRC 60-62



YATO L [mm]	Cutting length / Długość cięcia [mm]	Cooper / Miedź [mm]	Cold rolled steel / Stal zimnowalcowana [mm]	Steel HRC35 / Stal HRC35 [mm]	SS 304 / Stal Nierdzewna 304 [mm]	
YT-1919	260	32	1.8	1.5	1.0	0.9

HRC 56-62 SERRATED EDGES ZĄBKOWANE KRAWĘDZIE HIGH FREQUENCY HARDENING HARTOWANE IMPULSOWE

YATO L [mm]	Cutting length / Długość cięcia [mm]	Cooper / Miedź [mm]	Cold rolled steel / Stal zimnowalcowana [mm]	Steel HRC35 / Stal HRC35 [mm]	SS 304 / Stal Nierdzewna 304 [mm]	
YT-1961	250	40	2.0	1.5	1.0	0.8



EN Tin snips
 PL Nożyce do cięcia blachy
 DE Blechscherer
 RU Ножницы по металлу
 CZ Nůžky na plech
 HU Lemezvágó olló
 RO Foarfece pt. tablă
 FR Cisaille à tôle
 IT Cesioie per lamiera
 ES Tijeras para chapas
 CN 台式航空剪



YATO  L [mm]	Cutting length / Długość cięcia [mm]	Cooper / Miedź [mm]	Cold rolled steel / Stal zimnowalcowana [mm]	Steel HRC35 / Stal HRC35 [mm]	SS 304 / Stal Nierdzewna 304 [mm]		
YT-1914	225	30	0.78	0.53	0.46	0.36	6/36



EN Tin snips
 PL Nożyce do cięcia blachy
 DE Blechscherer
 RU Ножницы по металлу
 CZ Nůžky na plech
 HU Lemezvágó olló
 RO Foarfece pt. tablă
 FR Cisaille à tôle
 IT Cesioie per lamiera
 ES Tijeras para chapas
 CN 航空剪





YATO  L [mm]	Cutting length / Długość cięcia [mm]	Cooper / Miedź [mm]	Cold rolled steel / Stal zimnowalcowana [mm]	Steel HRC35 / Stal HRC35 [mm]	SS 304 / Stal Nierdzewna 304 [mm]		
YT-1900	260	30	0.94	0.78	0.6	0.45	6/24

EN Tin snips
 PL Nożyce do cięcia blachy
 DE Blechscherer
 RU Ножницы по металлу
 CZ Nůžky na plech
 HU Lemezvágó olló
 RO Foarfece pt. tablă
 FR Cisaille à tôle
 IT Cesioie per lamiera
 ES Tijeras para chapas
 CN 航空剪





YATO  L [mm]	Cutting length / Długość cięcia [mm]	Cooper / Miedź [mm]	Cold rolled steel / Stal zimnowalcowana [mm]	Steel HRC35 / Stal HRC35 [mm]	SS 304 / Stal Nierdzewna 304 [mm]		
YT-1901	260	30	0.94	0.78	0.6	0.45	6/24

YATO  L [mm]	Cutting length / Długość cięcia [mm]	Cooper / Miedź [mm]	Cold rolled steel / Stal zimnowalcowana [mm]	Steel HRC35 / Stal HRC35 [mm]	SS 304 / Stal Nierdzewna 304 [mm]		
YT-1902	300	50	0.94	0.78	0.6	0.45	6/24

EN Tin snips
 PL Nożyce do cięcia blachy
 DE Blechscherer
 RU Ножницы по металлу
 CZ Nůžky na plech
 HU Lemezvágó olló
 RO Foarfece pt. tablă
 FR Cisaille à tôle
 IT Cesioie per lamiera
 ES Tijeras para chapas
 CN 铁皮剪



YATO  L [mm]	Cutting length / Długość cięcia [mm]	Cooper / Miedź [mm]	Cold rolled steel / Stal zimnowalcowana [mm]	Steel HRC35 / Stal HRC35 [mm]	SS 304 / Stal Nierdzewna 304 [mm]		
YT-1970	260	42	2.0	1.4	1.0	1.0	6/36

EN Tin snips
PL Nożyce do cięcia blachy
DE Blechscherer
RU Ножницы по металлу
CZ Nůžky na plech
HU Lemezvágó olló

RO Foarfece pt. tablă
FR Cisaille à tôle
IT Cesiole per lamiera
ES Tijeras para chapas
CN 铁皮剪

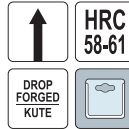

YATO	L [mm]	Cutting length / Długość cięcia [mm]	Cooper / Miedź [mm]	Cold rolled steel / Stal zimnowalcowana [mm]	Steel HRC35 / Stal HRC35 [mm]	SS 304 / Stal Nierdzewna 304 [mm]	
YT-1925	225	52	0.94	0.78	0.6	0.45	6/36

EN Tin snips
PL Nożyce do cięcia blachy
DE Blechscherer
RU Ножницы по металлу
CZ Nůžky na plech
HU Lemezvágó olló

RO Foarfece pt. tablă
FR Cisaille à tôle
IT Cesiole per lamiera
ES Tijeras para chapas
CN 铁皮剪



YATO	L [mm]	Cutting length / Długość cięcia [mm]	Cooper / Miedź [mm]	Cold rolled steel / Stal zimnowalcowana [mm]	Steel HRC35 / Stal HRC35 [mm]	SS 304 / Stal Nierdzewna 304 [mm]	
YT-1924	254	52	0.94	0.78	0.6	0.45	6/36

EN Metal sheet nibbler
PL Nożyce matrycowe do blachy
DE Blechnibbler
RU Ножницы для резки жести
CZ Nůžky na plech
HU Lemezvágó olló
RO Foarfece pt. tablă
FR Grignoteuse a tole
IT Cesiole roditrice per lamiera
ES Tijeras para chapas
CN 法式剪



YATO	L [mm]	
YT-19260	260	6/36

EN Tin snips
PL Nożyce do cięcia blachy
DE Blechscherer
RU Ножницы по металлу
CZ Nůžky na plech
HU Lemezvágó olló

RO Foarfece pt. tablă
FR Cisaille à tôle
IT Cesiole per lamiera
ES Tijeras para chapas
CN 铁皮剪



YATO	L [mm]	Cutting length / Długość cięcia [mm]	Cooper / Miedź [mm]	Cold rolled steel / Stal zimnowalcowana [mm]	Steel HRC35 / Stal HRC35 [mm]	SS 304 / Stal Nierdzewna 304 [mm]	
YT-1920	260	42	1.2	1.0	0.6	0.5	6/36

EN Tin snips
PL Nożyce do cięcia blachy
DE Blechscherer
RU Ножницы по металлу
CZ Nůžky na plech
HU Lemezvágó olló

RO Foarfece pt. tablă
FR Cisaille à tôle
IT Cesiole per lamiera
ES Tijeras para chapas
CN 铁皮剪



S55C

HIGH FREQUENCY
HARDENING
HARTANARE
IMPULSIVE



YATO	L [mm]	Cutting length / Długość cięcia [mm]	Cooper / Miedź [mm]	Cold rolled steel / Stal zimnowalcowana [mm]	Steel HRC35 / Stal HRC35 [mm]	SS 304 / Stal Nierdzewna 304 [mm]	
YT-1963	200	40	1.5	1.0	0.6	0.6	6/36
YT-1964	250	60	1.8	1.2	0.8	0.8	6/24
YT-1965	300	75	2.0	1.4	0.8	0.8	6/12

EN Spare blades for metal sheet nibbler
PL Ostrza zapasowe do nożyc matrycowych
DE Abbrechklingen für Blechnibbler
RU Лезвия для ножиц для резки жести
CZ Ostří náhradní
HU Tartalékpenge
RO Lame de rezervă
FR Lame sécables pour grignoteuse a tole
IT Lame di ricambio per cesiole roditrice per lamiera
ES Cuchillas de recambio
CN 法式剪备用刀片



For YT-19260
Dla YT-19260

YATO		
YT-19261		10/100

- EN Hand notchers
- PL Nożyce dekarские do nacinania blach
- DE Kerbzange
- RU Ножницы V-образные
- CZ Nůžky na plech vystřihování rohů
- HU Lemezvágó olló
- RO Foarfece tabla taiere colturi
- FR Ciseaux à tôle
- IT Cesioie per lamiera
- ES Cizallas para techos
- CN 缺口钳



230 mm
CrV



YATO	L [mm]	
YT-18970	230	6/36

- EN Snap lock punch
- PL Zaciskacz punktowy
- DE Schnappverschluss-Lochtreiber
- RU Плоскогубцы для кровельщиков
- CZ Střešní kleště
- HU Tetőfedő fogó
- RO Clește pt. despiciat
- FR Pincés pour couvreurs
- IT Pinza a crimpare
- ES Punzón de cerradura de resorte
- CN 记号钳



230 mm
CrV



YATO	L [mm]	
YT-18977	230	6/36

- EN Shears for cutting sheet metal
- PL Nożyce krążkowe do cięcia blach
- DE Rollenblechscherer
- RU Дисковые ножницы для резки листового металла
- CZ Kotoučové nůžky na stříhání plechů
- HU Karos lemezvágó olló
- RO Dispozitiv taiat foi de tabla
- FR Cisaille à tôle à molette
- IT Cesioia rotante per lamiera
- ES Cortador rotativo para chapa
- CN 手动钢板剪



1.6 mm
COLD ROLLED STEEL / STAL WILCOWANA NA ZIMNO



YATO	L [mm]	Cold rolled steel / Stal zimnowalcowana [mm]	Stainless steel / Stal nierdzewna [mm]	Aluminium [mm]	
YT-18950	120	1.6	1.2	2.0	1

- EN Steel strap cutter
- PL Nożyce do cięcia taśmy stalowej
- DE Stahlgurtblechscherer
- RU Ножницы для резки стальной ленты
- CZ Nůžky na plech
- HU Lemezvágó olló

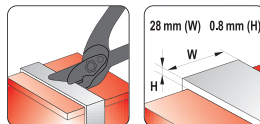

HRC 58-61



YATO	L [mm]	Cutting length / Długość cięcia [mm]	Steel HRC35 / Stal HRC35 [mm]	SS 304 / Stal Nierdzewna 304 [mm]	
YT-1930	305	28	0.8	0.6	6/24

- EN Bolt cutter
- PL Nożyce do drutu
- DE Drahtschere
- RU Болторез
- CZ Nůžky na drát
- HU Drótvágó olló
- RO Clește pt. buloane
- FR Ciseaux à fil
- IT Cesioie tagliafilii
- ES Tijeras para alambre
- CN 断线钳



200 mm max. Ø **3.5 mm** **CrV**

YATO	L [mm]	max. Ø [mm]	
YT-18566	200	3.5	6/48

- EN Bolt cutter
- PL Nożyce do prętów
- DE Drahtschere
- RU Болторез
- CZ Nůžky na tyče
- HU Kábelvágó olló

- RO Foarfece pt. bare
- FR Cisaille pour barres
- IT Cesioie taglia bulloni
- ES Cortavarillas
- CN 断线钳

HRC 56-61 **CrMo**



- EN Bolt cutter
- PL Nożyce do prętów
- DE Drahtschere
- RU Болторез
- CZ Nůžky na tyče
- HU Kábelvágó olló

- RO Foarfece pt. bare
- FR Cisaille pour barres
- IT Cesioie taglia bulloni
- ES Cortavarillas
- CN 断线钳

CrMo



YATO	L [mm]	Size / Rozmiar	max. Ø [mm]	
YT-1851	350	14"	6	6/24
YT-1852	450	18"	7	6/12
YT-1853	600	24"	10	2/12
YT-1854	750	30"	12	6
YT-1855	900	36"	14	4
YT-1856	1050	42"	16	2

YATO	L [mm]	Size / Rozmiar	max. Ø soft / maks. Ø miękki [mm]	max. Ø medium / maks. Ø średnio twardy [mm]	
YT-1843	300	12"	5	4	20
YT-1844	350	14"	7	5	10
YT-1845	450	18"	8	6	10
YT-1846	600	24"	10	8	6
YT-1847	750	30"	13	10	4
YT-1848	900	36"	16	12	3

EN Concrete mesh cutter
PL Nożyce do siatki zbrojarskiej
DE Mattenschneider
RU Ножницы для резки арматурной сетки
CZ Pákové kleště na pletivo
HU Gyékényvágó
RO Cieste pt. fier beton
FR Coupe-trellis
IT Cesoio per reti di rinforzo
ES Cortante para varillas de encofrado
CN 鹰嘴断线钳



800 mm max Ø 11 mm CrV

YATO	L [mm]	
YT-18400	800	5

EN Hydraulic cutter
PL Ręczny obcinak hydrauliczny
DE Manueller Hydraulikscheider
RU Ручной гидравлический резак

CZ Rucni hydraulický odřezávac
HU Kézi hidraulikus betonacélvágó
RO Cutit pt. rețezat tevi
FR Coupe manuelle hydraulique

IT Cesoio idraulica manuale
ES Cortadora hidráulica manual
CN 液压剪

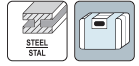

YATO	Cutting diameter / Średnica cięcia [mm]	L [mm]	Force pressure / Siła nacisku [t]	
YT-22870	4-12	320	6	5

YATO	Cutting diameter / Średnica cięcia [mm]	L [mm]	Force pressure / Siła nacisku [t]	
YT-22871	4-16	430	8	5
YT-22872	4-20	515	13	3

EN Heads for hydraulic cutter
PL Noże wymienne do obcinaka hydraulicznego
DE Austauschmesser für Hydraulikscheider
RU Сменные ножи для гидравлического резака
CZ Výměnitelné nože do hydraulického odřezávače
HU Cserékés a hidraulikus betonacélvágóhoz
RO Cutter hidraulic pt. cabluri
FR Lame pour coupe manuelle hydraulique
IT Teste per coltelli idraulici
ES Cuchillas intercambiables para cortadora hidráulica
CN 液压钳钳口配件

2 PCS

EN Hydraulic metal hole puncher
PL Wycinak hydrauliczny otworów w blachach
DE Hydraulischer Blechlocher
RU Инструмент для просечения отверстий гидравлический ручной
CZ Hydraulický vysekávač otvorů v plechu
HU Hidraulikus lemezlyukasztó
RO Perforator hidraulic metalic
FR Emporte-pièce hydraulique à tôle
IT Punzonatrice idraulica per lamiera
ES Cortador hidráulico de agujeros en hojas de chapa
CN 液压开孔器

22-60 mm

6t

max 3mm

360°



EN Hydraulic metal hole puncher
PL Wycinak hydrauliczny otworów w blachach
DE Hydraulischer Blechlocher
RU Инструмент для просечения отверстий гидравлический ручной
CZ Hydraulický vysekávač otvorů v plechu
HU Hidraulikus lemezlyukasztó
RO Perforator hidraulic metalic
FR Emporte-pièce hydraulique à tôle
IT Punzonatrice idraulica per lamiera
ES Cortador hidráulico de agujeros en hojas de chapa
CN 液压开孔器

22-60 mm

6t

max 4mm



YATO	Size / Rozmiar [mm]	For / Dla	
YT-22873	12	YT-22870	10/100
YT-22874	16	YT-22871	10/100
YT-22875	20	YT-22872	10/100



YATO	Cutting diameter / Średnica cięcia [mm]	Force pressure / Siła nacisku [t]	
YT-18900	22-60	6	2



YATO	Cutting diameter / Średnica cięcia [mm]	Force pressure / Siła nacisku [t]	
YT-18907	22-60	6	1

EN Ratchet cable cutter
PL Nożyce zapadkowe do kabli
DE Ratschenkabelschneider

RU Кабелерез секторный
CZ Kleště na kabely, rohatka se západkou
HU Racsnis kábelvágó

RO Cieste pt. taiat cablu cu cichet
FR Cisailles à câbles
IT Cricchetto taglia cavo

ES Cortacables de carraca
CN 棘轮电缆剪

Cu/Al CABLE KABEL HRC 50 60Si2Mn

300 mm

max Ø 17,5 mm



380 mm

max Ø 22 mm



YATO	Max. cutting range / Maks. przekrój cięcia [mm]	max. Ø [mm]	L [mm]	
YT-18600	240	17.5	300	10

YATO	Max. cutting range / Maks. przekrój cięcia [mm]	max. Ø [mm]	L [mm]	
YT-18600	240	17.5	300	10

EN Cable cutter
PL Nożyce do kabli
DE Kabelschere
RU Кабелперезы

CZ Kleště pákové na kabely
HU Kábelvágók
RO Patent tăietor pt. electrice
FR Cisailles a câbles

IT Cesioie per cavi
ES Tijeras para cables
CN 电缆剪

HRC 52-58
CrMo 55



YATO	Max. cutting range / Maks. przekrój cięcia [mm²]	max. Ø [mm]	L [mm]	
YT-18615	150	13.5	450	12
YT-18616	240	17.5	600	10
YT-18617	450	23.5	910	5

EN Cable cutter
PL Nożyce do kabli
DE Kabelschere
RU Кабелперезы

CZ Elektrické upichováky
HU Kábelvágó
RO Clește tăietor
FR Cisailles à câbles

IT Cesioie per cavi
ES Tijeras para cables
CN 电缆剪

HRC 50
65Mn



YATO	Max. cutting range / Maks. przekrój cięcia [mm²]	max. Ø [mm]	L [mm]	
YT-18610	125	12.5	370	20
YT-18611	250	18.0	580	10
YT-18612	500	25.0	770	5

EN Multi-function scissors
PL Nożyce wielofunkcyjne
DE Multifunktionsmesser
RU Ножницы многофункциональные
CZ Víceúčelové nůžky
HU Többfunkciós olló
RO Foarfece multifuncțional
FR Cisailles universelle
IT Cesioie multifunzione
ES Tijeras multifuncionales
CN 不锈钢多用剪

65/200 mm
HRC 50-54



YATO	L [mm]	
YT-1976	200	12/72

EN Multi-function slot angle scissors - professional
PL Nożyce do cięć kątowych (ukośnych)
DE Winkelschere (schräg)
RU Ножницы для резы под углом (по диагонали)
CZ Nůžky pro šikmé stříhání
HU Gérvágó olló
RO Foarfece cu unghi de slot multifuncțional - profesional
FR Cisailles d'angle
IT Forbici per tagli angolari (diagonali)
ES Tijera de inglete
CN 角度剪

245 mm
± 22.5°
+ 45°
90°



YATO	L [mm]	
YT-18960	245	4/24

EN HD multifunctional scissors
PL Nożyce techniczne wielofunkcyjne
DE Multifunktionale technische Schere
RU Технические многофункциональные ножницы
CZ Multifunkční technické nůžky
HU Műszaki olló - multifunkciós
RO Foarfece multifuncționala HD
FR Cisailles polyvalentes
IT Cesioie tecniche multifunzione
ES Tijera técnica multiusos
CN 剪刀

250 mm
SK5



YATO	L [mm]	
YT-18963	250	6/24

EN Hand saw for wood
PL Pila płatnica do drewna
DE Handsäge
RU Пила по дереву

CZ Pila na dřevo platnice
HU Fafűrész, egyenes
RO Ferăstrău pt. lemn
FR Scie

IT Seghetto per legno
ES Serrucho para madera
CN 手板锯

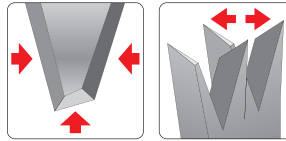

7TPI
1.6 mm
0.9 mm
HRC 50-54
65Mn



YATO	L [mm]	
YT-3101	400	12/48
YT-3102	450	10/40
YT-3103	500	10/40

PTFE



YATO	L [mm]	
YT-3106	400	12/48
YT-3107	450	10/40
YT-3108	500	10/40

EN Hand saw for wood
PL Pila płatnica do drewna
DE Stichsäge
RU Пила для дерева
CZ Pila na dřevo platnice
HU Fafűrész, egyenes

RO Ferăstrău (coadă de vulpe) pt. lemn
FR Scie
IT Seghetto per legno
ES Serrucho para madera
CN 手板锯

7TPI

1.6 mm
0.9 mm

PTFE

65Mn

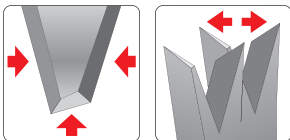

YATO	L [mm]	
YT-31091	400	6/24
YT-31092	450	6/24
YT-31093	500	6/24

EN Back saw for PVC
PL Pila ręczna do PVC
DE Handsäge für PVC
RU Ручная пила для ПВХ
CZ Ruční pila na PVC
HU Kézfűrész PVC-hez

RO Fierastrau cu maner PVC
FR Scie à main pour PVC
IT Segà a mano per PVC
ES Sierra de mano para PVC
CN 锯

PVC
350/440 mm
17 TPI

65Mn



YATO	L [mm]	
YT-31303	440	12/48

EN Japanese saw
PL Pila japońska
DE Japansiche Handsäge

RU Ножовка японского типа
CZ Japonská ruka pila
HU Japán fűrész

RO Ferăstrău de gips-carton
FR Scie japonaise
IT Segà reversibile giapponese

ES Sierra japonesa
CN 双面齿拉锯

320/660 mm
7TPI
12 TPI
SK5



YATO	L [mm]	
YT-31310	660	10/40

EN Drywall saw
PL Pila dwustronna do płyt gipsowo-kartonowych
DE Gipskartonsäge
RU Ножовка по гипсокартону

CZ Pila na sádrokarton
HU Gipszkarton fűrész
RO Kézi gipszkarton fűrész
FR Scie à guichet

IT Sega per pannelli in cartongesso
ES Serrucho para placas de yeso
CN 墙锯



YATO	L [mm]	
YT-31343	315	12/96

EN Saw with adjustable handle
PL Pila z przestawianą rękojmią
DE Säge mit verstellbarem Griff
RU Пила с регулируемой ручкой
CZ Pila s nastavitelnou rukojetí
HU Fűrész állítható markolattal

RO Fierastrau cu maner reglabil
FR Scie à poignée réglable
IT Sega con maniglia regolabile
ES Sierra con mango móvil
CN 调节锯



YATO	L [mm]	
YT-31290	410	6/48

EN Back saw
PL Pila grzbietnica
DE Rücksäge
RU Пила для ступла

CZ Pila hřebenovka
HU Kézifűrész
RO Ferăstrău coadă de vulpe
FR Scie

IT Sega con dorso
ES Serrucho de costilla
CN 夹背锯

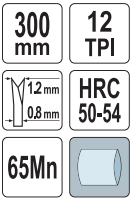

YATO	L [mm]	
YT-3130	300	12/60

EN Compass saw
PL Pila otwornica
DE Stichsäge

RU Выкружная пила
CZ Pila otwornice
HU Lyukfűrész

RO Ferăstrău coadă de șoarece
FR Scie étroite
IT Sega a foretto

ES Serrucho de punta
CN 鸡尾锯



YATO	L [mm]	
YT-3133	300	12/60

EN Wallboard saw
PL Pila do gipsów
DE Gipsäge

RU Ножовка по гипсокартону
CZ Pila na sádro
HU Gipszfűrész

RO Ferăstrău pt. ghips
FR Scie pour plaques de plâtre
IT Sega per cartongesso

ES Serrucho para cartón yeso
CN 墙锯

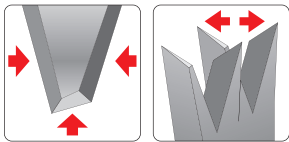

YATO	L [mm]	
YT-3134	300	12/60

EN Plastic miter box with dovetail saw
PL Plastikowa skrzynka uciosowa z pilą
DE Kunststoffschneidladen mit Säge
RU Ступно пластмассовое с пилой
CZ Přípravek na řezání úhlů s pilkou
HU Gérbevágó műanyagláda hód farkú fűrészszel
RO Fierastrau cu dispozitiv de taiat la unghi
FR Boîte à onglets + scie
IT Taglia cornici in plastica con sega
ES Guía de ingletar y sierra
CN 燕尾锯



YATO	L [mm]	
YT-3150	350	10

EN Bow saw
PL Pila kablówka
DE Bügelsäge
RU Лучковая пила
CZ Oblouková pila
HU Keretes fűrész

RO Ferăstrău de curbură
FR Scie à bûches
IT Sega ad arco
ES Sierra de arco
CN 两用弓锯

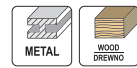

YATO	L [mm]	
YT-3200	300	12/24



YATO	L [mm]	
YT-3201	450	12/24
YT-3202	530	12/24
YT-3203	610	12/24
YT-3204	760	12/24

EN Blade for dry wood
 PL Brzeczczot do drewna suchego
 DE Trockenholzsägeblatt für Handsäge
 RU Лезвие для работы по сухому дереву
 CZ Pilový list na suché dřevo
 HU Fűrészlap száraz fához

RO Lama pt. lemn uscat
 FR lame à bois sec
 IT Lama per il legno secco
 ES Hoja de sierra para madera seca
 CN 干木锯条



EN Blade for wet wood
 PL Brzeczczot do drewna mokrego
 DE Nassholzsägeblatt für Handsäge
 RU Лезвие для работы по влажному дереву
 CZ Pilový list na mokré dřevo
 HU Fűrészlap nedves fához

RO Lama pt. lemn verde
 FR lame à bois humide
 IT Lama per il legno bagnato
 ES Hoja de sierra para madera mojada
 CN 湿木锯条

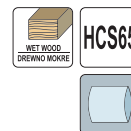

YATO	L [mm]	
YT-3221	450	50/200
YT-3222	530	50/200
YT-3223	610	50/200
YT-3224	760	50/200

YATO	L [mm]	
YT-3230	300	50/200
YT-3231	450	50/200
YT-3232	530	50/200
YT-3233	610	50/200
YT-3234	760	50/200

EN Hacksaw frame
 PL Pila do metalu
 DE Metallbogensäge
 RU Пила по металлу

CZ Pílka na železo
 HU Fémfűrész
 RO Ferăstrău cu cadru metalic
 FR Scie à métal

IT Seghetto per metallo
 ES Sierra de metalo
 CN 锯架

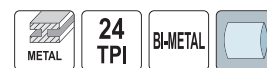

YATO	L [mm]	
YT-3160	300	10

YATO	L [mm]	
YT-3161	300	6/36

YATO	L [mm]	
YT-3163	300	5/20

EN Metal hacksaw
 PL Pila do metalu
 DE Metallsäge
 RU Ножовка по металлу
 CZ Píla na kov
 HU Fémfűrész
 RO Ferăstrău metalic
 FR Scie à métaux
 IT Seghetto per metallo
 ES Sierra para metales
 CN 金属钢锯



YATO	L [mm]	
YT-31612	300	12/36

EN Hacksaw frame blade
 PL Brzeczczot do metalu
 DE Metallsägeblatt
 RU Полотна по металлу

CZ Pilový list na kov
 HU Fémfűrész lap
 RO Panza fierastrau pt. metal
 FR lame à métal

IT Lama per metallo
 ES Hoja de sierra para metalo
 CN 弹性锯条



YATO	L [mm]	W [mm]	TPI	pcs / szt.	
YT-3460	300	12	24	5	10/200



YATO	L [mm]	W [mm]	TPI	pcs / szt.	
YT-3461	300	12	24	2	20/500



YATO	L [mm]	W [mm]	TPI	pcs / szt.	
YT-3462	300	12	24	2	20/500

EN Band saw blade
 PL Brzeczczot do pily taśmowej
 DE Bandsägeblätter
 RU Полотно для ленточной пилы
 CZ Pilový pás na pásovou pílu
 HU Szalagfűrészlap
 RO Panza pt. fierastrau cu banda
 FR lame de scie à ruban
 IT Lama per sega a nastro
 ES Hoja de sierra de cinta
 CN 带锯锯条



For YT-82185
 Dla YT-82185

YATO	L [mm]	± [mm]	TPI	
YT-82189	1140	0.65	14	20

EN Jig saw blades
 PL Brzeczczoty do wyrzynarki
 DE Stichsägeblätter
 RU Полотно для пневматической сабельной пилы
 CZ Pilový list do přímochaře pily
 HU Dekopírlap

RO Set panze pt. fierastrău sabie
 FR lame pour scie sauteuse
 IT lame per seghe pneumatici
 ES Recambio sierra de calar
 CN 锯片



For YT-09955
 Dla YT-09955

YATO	TPI	
YT-09958	24	50/200
YT-09959	32	50/200

EN Sabre saw blade
PL Brzesczczot do pily szablastej
DE Säbelsägeblatt
RU Пильное полотно
CZ Pílový plátek do pily ocasky
HU Szablyafűrészlap
RO Pânză pt. fierăstrău sabie
FR Lames scie sabre
IT Lama per mattoni e mattoni cavi
ES Hoja de sierra sable
CN 硬质合金锯条

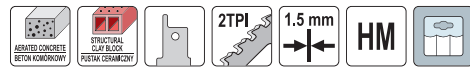

YATO	L [mm]	
YT-33951	300	20/100
YT-33950	455	25/100

EN Sabre saw blade
PL Brzesczczot do pily szablastej
DE Säbelsägeblatt
RU Пильное полотно
CZ Pílový plátek do pily ocasky
HU Szablyafűrészlap
RO Pânză pt. fierăstrău sabie
FR Lames scie sabre
IT Lama per sega a lama oscillante
ES Hoja de sierra sable
CN 碳钢往复锯条

For YT-82280, YT-82814, YT-82904
Dla YT-82280, YT-82814, YT-82904



YATO	L [mm]	+/- [mm]	TPI	
YT-33920	300	1.45	5	50/100

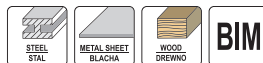

YATO	L [mm]	+/- [mm]	TPI	
YT-33921	150	1.2	4	50/200
YT-33922	150	1.0	6	50/200
YT-33923	150	1.0	8	50/200

YATO	L [mm]	+/- [mm]	TPI	
YT-33930	150	1.0	10	50/200

YATO	L [mm]	+/- [mm]	TPI	
YT-33931	150	1.0	18	50/200
YT-33932	150	1.0	24	50/200



YATO	L [mm]	+/- [mm]	TPI	
YT-33933	225	1.0	10	50/200

YATO	L [mm]	+/- [mm]	TPI	
YT-33934	225	1.0	24	50/200

YATO	L [mm]	+/- [mm]	TPI	
YT-33935	300	1.25	6	50/100

EN Sabre saw blade
PL Brzesczczot do pily szablastej
DE Säbelsägeblatt
RU Пильное полотно
CZ Pílový plátek do pily ocasky
HU Szablyafűrészlap
RO Pânză de ferăstrău sabie
FR Lames scie sabre
IT Lama per sega a lama oscillante
ES Hoja de sierra sable
CN TCT往复锯条

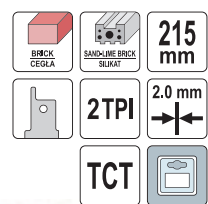

EN Sabre saw blade
PL Brzesczczot do pily szablastej
DE Säbelsägeblatt
RU Пильное полотно
CZ Pílový plátek do pily ocasky
HU Szablyafűrészlap
RO Pânză de ferăstrău sabie
FR Lames scie sabre
IT Lama per sega a lama oscillante
ES Hoja de sierra sable
CN TCT往复锯条

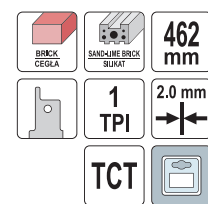

YATO	L [mm]	+/- [mm]	TPI	
YT-33960	215	2.0	2	100/200

YATO	L [mm]	+/- [mm]	TPI	
YT-33961	462	2.0	1	25/50

EN Sabre saw blade
PL Brzesczczot do pily szablastej
DE Säbelsägeblatt
RU Пильное полотно
CZ Pílový plátek do pily ocasky
HU Szablyafűrészlap
RO Pânză pt. fierăstrău sabie
FR Lames scie sabre
IT Lama per sega a lama oscillante
ES Hoja de sierra sable
CN 碳钢往复锯条

For YT-82281, YT-82814, YT-82815, YT-82904
Dla YT-82281, YT-82814, YT-82815, YT-82904

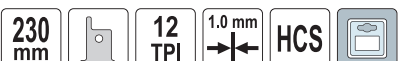

EN Sabre saw blade
PL Brzesczczot do pily szablastej
DE Säbelsägeblatt
RU Пильное полотно
CZ Pílový plátek do pily ocasky
HU Szablyafűrészlap
RO Pânză pt. fierăstrău sabie
FR Lames scie sabre
IT Lama per sega a lama oscillante
ES Hoja de sierra sable
CN 碳钢往复锯条

For YT-82281, YT-82814, YT-82815, YT-82904
Dla YT-82281, YT-82814, YT-82815, YT-82904



- For straight cuts
- Doesn't bend when cuts
- Do cięć na wprost
- Nie wygina się podczas cięcia



- For straight cuts
- Doesn't bend when cuts
- Do cięć na wprost
- Nie wygina się podczas cięcia



YATO	L [mm]	+/- [mm]	TPI	
YT-33970	230	1.0	12	50/200

YATO	L [mm]	+/- [mm]	TPI	
YT-33971	230	1.2	6	50/200

EN Sabre saw blade
 PL Brzeszczot do pily szablastej
 DE Säbelsägeblatt
 RU Пильное полотно
 CZ Pílový plátek do pily ocasky
 HU Szablyafűrészlap

RO Pânză pt. fierăstrău sabie
 FR Lames scie sabre
 IT Lama per sega a lama oscillante
 ES Hoja de sierra sable
 CN 碳钢往复锯条



For YT-82281, YT-82814, YT-82815, YT-82904
 Dla YT-82281, YT-82814, YT-82815, YT-82904

• For plunge and curve cuts

• Do cięć wglębnych i po łuku

YATO	L [mm]	+l- [mm]	TPI	Package
YT-33972	120	1.2	12	50/100

EN Jig saw blades
 PL Brzeszczoty do wyrzynarki
 DE Stichsägeblätter

RU Полотно для электр. станка
 CZ Pílový list do přimočaré pily
 HU Dekopírlap

RO Lama fierastrau pendular
 FR Lames à scie sauteuse
 IT Scalpelli per il seghetto

ES Recambio sierra de calar
 CN 曲线锯条



YATO	L [mm]	Working length / Długość robocza [mm]	+l- [mm]	TPI	Package
YT-3400	100	75	1.27	6	50/250



YATO	L [mm]	Working length / Długość robocza [mm]	+l- [mm]	TPI	Package
YT-3401	100	75	1.3	10	50/250



YATO	L [mm]	Working length / Długość robocza [mm]	+l- [mm]	TPI	Package
YT-3402	100	75	1.2	8	50/250



YATO	L [mm]	Working length / Długość robocza [mm]	+l- [mm]	TPI	Package
YT-3403	100	75	1.3	6	50/250



YATO	L [mm]	Working length / Długość robocza [mm]	+l- [mm]	TPI	Package
YT-3404	100	75	1.3	10	50/250



YATO	L [mm]	Working length / Długość robocza [mm]	+l- [mm]	TPI	Package
YT-3405	100	75	1.3	6	50/250



YATO	L [mm]	Working length / Długość robocza [mm]	+l- [mm]	TPI	Package
YT-3407	75	50	1.0	13	50/250



YATO	L [mm]	Working length / Długość robocza [mm]	+l- [mm]	TPI	Package
YT-3408	115	90	1.3	13-8	50/250



YATO	L [mm]	Working length / Długość robocza [mm]	+l- [mm]	TPI	Package
YT-3409	115	90	1.3	8	50/250



YATO	L [mm]	Working length / Długość robocza [mm]	+l- [mm]	TPI	Package
YT-3410	100	75	1.4	6	50/250

EN Jig saw blades
PL Brzeszczyoty do wyrzynarki
DE Stichsägeblätter
RU Полотно для электр. станка
CZ Pilový list do přímočaré pily
HU Dekopírlap
RO Lama fierastrau pendular
FR Lames à scie sauteuse
IT Scalpelli per il seghetto
ES Recambio sierra de calar
CN 曲线锯条

5
PCS



YATO	L [mm]	Working length / Długość robocza [mm]	+/- [mm]	TPI	Box
YT-3411	100	75	1.0	8	25/250

YATO	L [mm]	Working length / Długość robocza [mm]	+/- [mm]	TPI	Box
YT-3412	75	50	1.0	21	25/250



YATO	L [mm]	Working length / Długość robocza [mm]	+/- [mm]	TPI	Box
YT-3413	75	50	1.0	12	25/250

YATO	L [mm]	Working length / Długość robocza [mm]	+/- [mm]	TPI	Box
YT-3414	75	50	1.0	32	25/250



YATO	L [mm]	Working length / Długość robocza [mm]	+/- [mm]	TPI	Box
YT-3415	100	75	1.0	24-10	25/250

YATO	L [mm]	Working length / Długość robocza [mm]	+/- [mm]	TPI	Box
YT-3416	130	106	1.0	21	25/250



YATO	L [mm]	Working length / Długość robocza [mm]	+/- [mm]	TPI	Box
YT-3417	130	106	1.27	10-5	25/250

YATO	L [mm]	Working length / Długość robocza [mm]	+/- [mm]	TPI	Box
YT-3421	75	50	1.2	25/250	25/250

EN Jig saw blades
PL Brzeszczyoty do wyrzynarki
DE Stichsägeblätter
RU Пилки для лобзика
CZ Pilový list do přímočaré pily
HU Dekopírlap
RO Lama fierastrau pendular
FR Lames à scie sauteuse
IT Scalpelli per il seghetto
ES Recambio sierra de calar
CN 曲线锯条套装

5
PCS

HCS 65Mn HSS BI-METAL



YATO	L [mm]	Working length / Długość robocza [mm]	+/- [mm]	TPI	Box
YT-3445	100, 100, 100, 75, 75	75, 75, 75, 50, 57	1.3, 1.3, 1.27, 1.0, 1.0	10, 6, 10, 32, 12	25/250

EN Half-moon saw blade for oscillating multitool HSS
 PL Brzeszczot okrągły HSS do narzędzia wielofunkcyjnego
 DE Rundes Sägeblatt HSS für Multifunktionswerkzeug
 RU Диское полотно HSS для многофункционального инструмента
 CZ Segmentový pilový list HSS pro multifunkční nářadí
 HU HSS kör keresztmetszetű fűrészlap multifunkciós szerszámhoz
 RO Lamă rotundă HSS pt. unealta multifuncțională
 FR Lame segment HSS pour outil multifonction
 IT Lama di sega circolare per lo strumento multi-funzione HSS
 ES Hoja redonda HSS para herramienta multifuncional
 CN 半圆形摆动锯

88 mm HSS

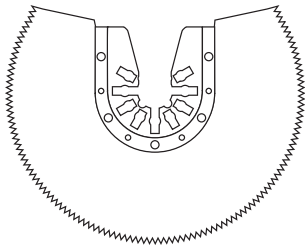

88 mm

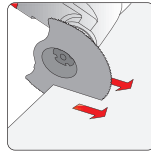

• Application: wood, plastic, soft metal, plaster
 • Zastosowanie: drewno, plastik, miękki metal, gips
 For YT-82220, YT-82223, YT-82818, YT-82900
 Dla YT-82220, YT-82223, YT-82818, YT-82900

YATO
 YT-34680

5/100

EN Half-moon saw blade for oscillating multitool HCS
 PL Brzeszczot okrągły HCS do narzędzia wielofunkcyjnego
 DE Rundes Sägeblatt HCS für Multifunktionswerkzeug
 RU Диское полотно HCS для многофункционального инструмента
 CZ Segmentový pilový list HCS pro multifunkční nářadí
 HU HCS kör keresztmetszetű fűrészlap multifunkciós szerszámhoz
 RO Lamă rotundă HCS pt. unealta multifuncțională
 FR Lame segment HCS pour outil multifonction
 IT Lama di sega circolare per lo strumento multi-funzione HCS
 ES Hoja redonda HCS para herramienta multifuncional
 CN 高碳钢扇型锯片

88 mm HCS

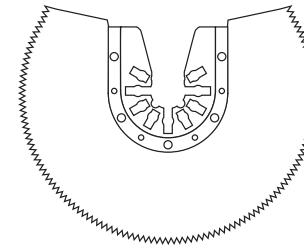

88 mm

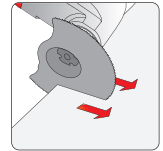

• Application: wood, plastic, soft metal, plaster
 • Zastosowanie: drewno, plastik, miękki metal, gips
 For YT-82220, YT-82223, YT-82818, YT-82900
 Dla YT-82220, YT-82223, YT-82818, YT-82900

YATO
 YT-34681

5/100

EN Brazed carbide d-shape blade for oscillating multitool HM
 PL Brzeszczot okrągły HM do narzędzia wielofunkcyjnego
 DE Rundes Sägeblatt HM für Multifunktionswerkzeug
 RU Диское полотно HM для многофункционального инструмента
 CZ Segmentový pilový list HM pro multifunkční nářadí
 HU HM kör keresztmetszetű fűrészlap multifunkciós szerszámhoz
 RO Lamă rotundă HM pt. unealta multifuncțională
 FR Lame segment HM pour outil multifonction
 IT Lama di sega circolare per lo strumento multi-funzione HM
 ES Hoja redonda HM para herramienta multifuncional
 CN 摆动锯

70 mm HM

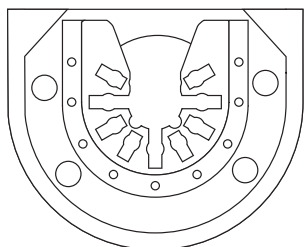

70 mm

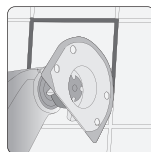

• Application: concrete, ceramic materials, epoxy resin, fibreglass
 • Zastosowanie: beton, materiały ceramiczne, żywica epoksydowa, włókno szklane
 For YT-82220, YT-82223, YT-82818, YT-82900
 Dla YT-82220, YT-82223, YT-82818, YT-82900

YATO
 YT-34682

10/100

EN Half-moon saw blade for oscillating multitool BIM
 PL Brzeszczot półokrągły BIM do narzędzia wielofunkcyjnego
 DE Rundes Sägeblatt BIM für Multifunktionswerkzeug
 RU Диское полотно BIM для многофункционального инструмента
 CZ Segmentový pilový list BIM pro multifunkční nářadí
 HU BIM kör keresztmetszetű fűrészlap multifunkciós szerszámhoz
 RO Lamă rotundă BIM pt. unealta multifuncțională
 FR Lame segment BIM pour outils multifonctions
 IT Lama di sega circolare per lo strumento multi-funzione BIM
 ES Hoja redonda BIM para herramienta multifuncional
 CN 多功能锯片

METAL CONSTRUCTION WOOD 100 mm

BIM TiN

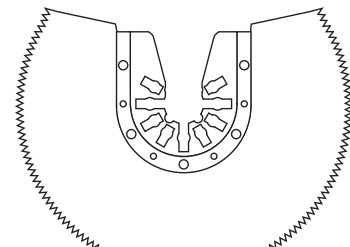

100 mm

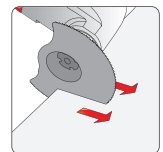

• Application: wood, metal
 • Zastosowanie: drewno, metal
 For YT-82220
 Dla YT-82220

YATO
 YT-34711

10/100

EN Half-moon saw blade for oscillating multitool BIM
 PL Brzeszczot półokrągły BIM do narzędzia wielofunkcyjnego
 DE Rundes Sägeblatt BIM für Multifunktionswerkzeug
 RU Дискоее полотно BIM для многофункционального инструмента
 CZ Segmentový pilový list BIM pro multifunkční nářadí
 HU BIM kör keresztmetszetű fűrészlap multifunkciós szerszámhoz
 RO Lamă rotundă BIM pt. unealta multifuncțională
 FR Lame segment BIM pour outils multifonctions
 IT Lama di sega circolare per lo strumento multi-funzione BIM
 ES Hoja redonda BIM para herramienta multifuncional
 CN 多功能锯片

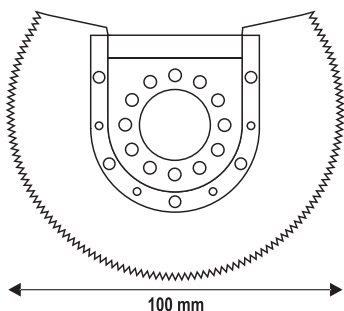

• Application: wood, metal
 • Zastosowanie: drewno, metal

For YT-82223
 Dla YT-82223



EN Plunge cutting saw blade for oscillating multitool BIM
 PL Brzeszczot wglębny BIM do narzędzia wielofunkcyjnego
 DE Tiefenmesser BIM für Multifunktionswerkzeug
 RU Сабельное полотно BIM для многофункционального инструмента
 CZ Pilový list BIM na ponorné fezy pro multifunkční nářadí
 HU BIM merülő fűrészlap multifunkciós szerszámhoz
 RO Lamă de adâncime BIM pt. unealta multifuncțională
 FR Lame scie plongeante BIM pour outils multifonction
 IT Lama per tagli dal pieno BIM
 ES Hoja para cortes profundos BIM para herramienta multifuncional
 CN 锯片

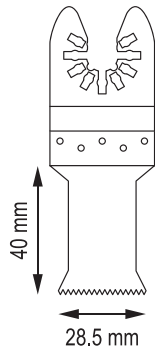
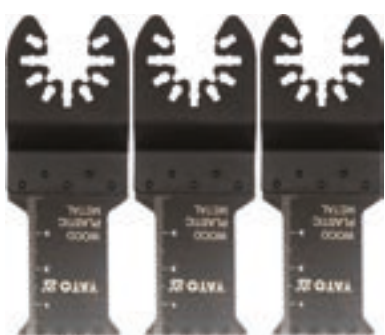
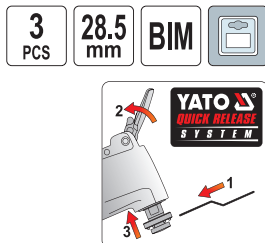

• Application: wood, plastic, metal, plaster, epoxy resin
 • Zastosowanie: drewno, plastik, metal, gips, żywica epoksydowa

For YT-82220, YT-82223, YT-82818, YT-82900
 Dla YT-82220, YT-82223, YT-82818, YT-82900



EN Plunge cutting saw blade for oscillating multitool BIM
 PL Brzeszczot wglębny BIM do narzędzia wielofunkcyjnego
 DE Tiefenmesser BIM für Multifunktionswerkzeug
 RU Сабельное полотно BIM для многофункционального инструмента
 CZ Pilový list BIM na ponorné fezy pro multifunkční nářadí
 HU BIM merülő fűrészlap multifunkciós szerszámhoz
 RO Lamă de adâncime BIM pt. unealta multifuncțională
 FR Lame scie plongeante BIM pour outils multifonction
 IT Lama per tagli dal pieno BIM
 ES Hoja para cortes profundos BIM para herramienta multifuncional
 CN 锯片

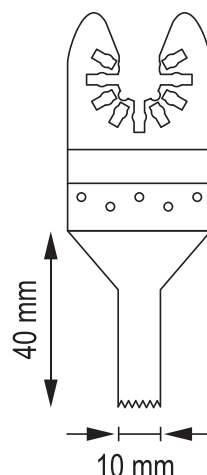
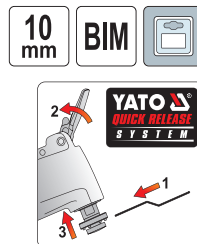

• Application: wood, plastic, metal, plaster, epoxy resin
 • Zastosowanie: drewno, plastik, metal, gips, żywica epoksydowa

For YT-82220, YT-82223, YT-82818, YT-82900
 Dla YT-82220, YT-82223, YT-82818, YT-82900

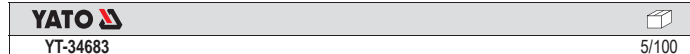

EN Plunge cutting saw blade for oscillating multitool HCS
 PL Brzeszczot wglębny HCS do narzędzia wielofunkcyjnego
 DE Tiefenmesser HCS für Multifunktionswerkzeug
 RU Сабельное полотно HCS для многофункционального инструмента
 CZ Pilový list HCS na ponorné fezy pro multifunkční nářadí
 HU HCS merülő fűrészlap multifunkciós szerszámhoz
 RO Lamă de adâncime HCS pt. unealta multifuncțională
 FR Lame scie plongeante HCS pour outils multifonction
 IT Lama per tagli dal pieno HCS
 ES Hoja para cortes profundos HCS para herramienta multifuncional
 CN 锯片

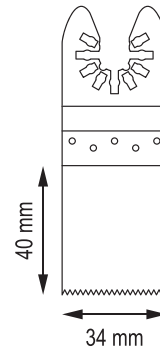
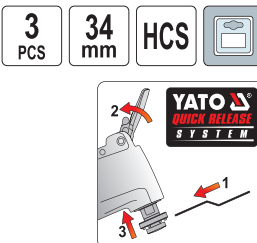

• Application: wood, plastic, plaster
 • Zastosowanie: drewno, plastik, gips

For YT-82220, YT-82223, YT-82818, YT-82900
 Dla YT-82220, YT-82223, YT-82818, YT-82900



EN Plunge cutting saw blade for oscillating multitool BIM
 PL Brzeszczot wglębny BIM do narzędzia wielofunkcyjnego
 DE Tiefenmesser BIM für Multifunktionswerkzeug
 RU Сабельное полотно BIM для многофункционального инструмента
 CZ Pílavý list BIM na ponorné fezy pro multifunkční nářadí
 HU BIM merülő fűrészlap multifunkciós szerszámhoz
 RO Lamă de adâncime BIM pt. unealta multifuncțională
 FR Lame scie plongeante BIM pour outill multifonctions
 IT Lama per tagli dal pieno BIM
 ES Hoja para cortes profundos BIM para herramienta multifuncional
 CN 锯片

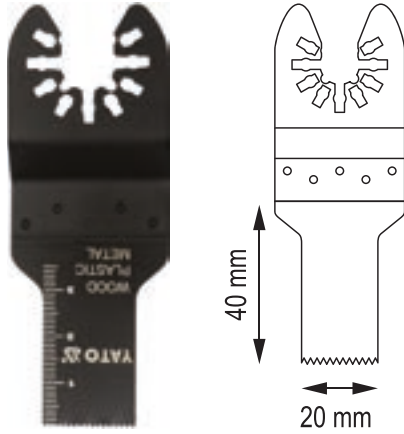
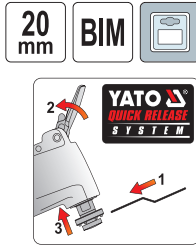

• Application: wood, plastic, metal, plaster, epoxy resin
 • Zastosowanie: drewno, plastik, metal, gips, żywica epoksydowa

For YT-82220, YT-82223, YT-82818, YT-82900
 Dla YT-82220, YT-82223, YT-82818, YT-82900

YATO **YT-34686** 5/100

EN Plunge cutting saw blade for oscillating multitool BIM
 PL Brzeszczot wglębny BIM do narzędzia wielofunkcyjnego
 DE Tiefenmesser BIM für Multifunktionswerkzeug
 RU Сабельное полотно BIM для многофункционального инструмента
 CZ Pílavý list BIM na ponorné fezy pro multifunkční nářadí
 HU BIM merülő fűrészlap multifunkciós szerszámhoz
 RO Lamă de adâncime BIM pt. unealta multifuncțională
 FR Lame plongeante BIM pour outils multifonctions
 IT Lama per tagli dal pieno BIM
 ES Hoja para cortes profundos BIM para herramienta multifuncional
 CN 锯片

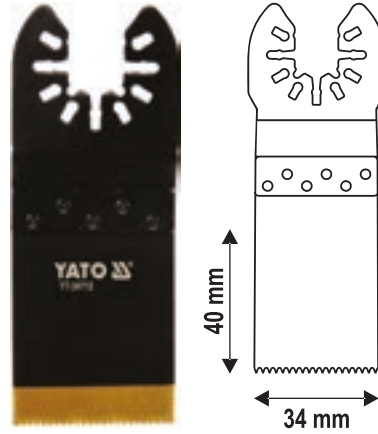
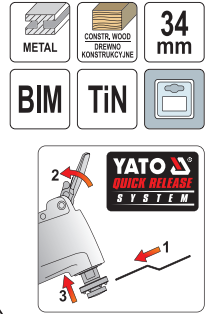

• Application: wood, metal
 • Zastosowanie: drewno, metal

For YT-82220
 Dla YT-82220

YATO **YT-34712** 10/100

EN Plunge cutting saw blade for oscillating multitool HCS
 PL Brzeszczot wglębny HCS do narzędzia wielofunkcyjnego
 DE Tiefenmesser HCS für Multifunktionswerkzeug
 RU Сабельное полотно HCS для многофункционального инструмента
 CZ Pílavý list HCS na ponorné fezy pro multifunkční nářadí
 HU HCS merülő fűrészlap multifunkciós szerszámhoz
 RO Lamă de adâncime HCS pt. unealta multifuncțională
 FR Lame plongeante HCS pour outils multifonctions
 IT Lama per tagli dal pieno HCS
 ES Hoja para cortes profundos HCS para herramienta multifuncional
 CN 锯片

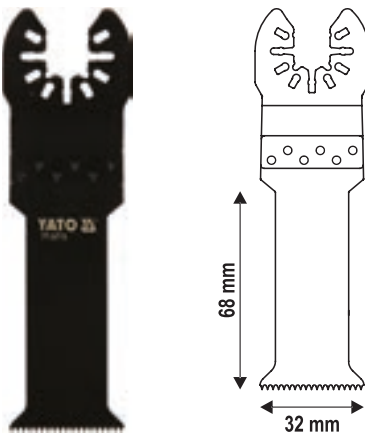
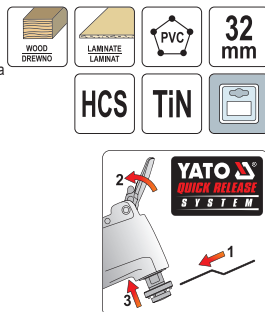

• Application: wood, laminate, plastic
 • Zastosowanie: drewno, laminat, plastik

For YT-82220
 Dla YT-82220

YATO **YT-34710** 10/100

EN Plunge cutting saw blade for oscillating multitool HCS
 PL Brzeszczot wglębny HCS do narzędzia wielofunkcyjnego
 DE Tiefenmesser HCS für Multifunktionswerkzeug
 RU Сабельное полотно HCS для многофункционального инструмента
 CZ Pílavý list HCS na ponorné fezy pro multifunkční nářadí
 HU HCS merülő fűrészlap multifunkciós szerszámhoz
 RO Lamă de adâncime HCS pt. unealta multifuncțională
 FR Lame plongeante HCS pour outils multifonctions
 IT Lama per tagli dal pieno HCS
 ES Hoja para cortes profundos HCS para herramienta multifuncional
 CN 锯片

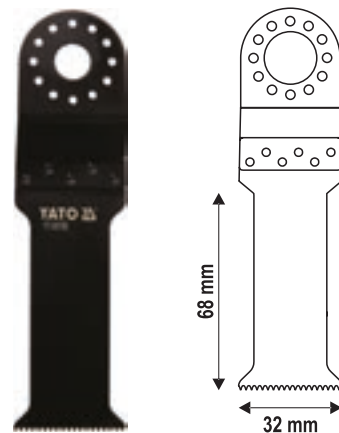

• Application: wood, laminate, plastic
 • Zastosowanie: drewno, laminat, plastik

For YT-82223
 Dla YT-82223

YATO **YT-34700** 10/100

EN Plunge cutting saw blade for oscillating multitool BIM
 PL Brzeszczot wglębny BIM do narzędzia wielofunkcyjnego
 DE Tiefenmesser BIM für Multifunktionswerkzeug
 RU Сабельное полотно BIM для многофункционального инструмента
 CZ Pílový list BIM na ponorné řezy pro multifunkční nářadí
 HU BIM merülő fűrészlap multifunkciós szerszámhoz
 RO Lamă de adâncime BIM pt. unealta multifuncțională
 FR Lame plongeante BIM pour outils multifonctions
 IT Lama per tagli dal pieno BIM
 ES Hoja para cortes profundos BIM para herramienta multifuncional
 CN 锯片

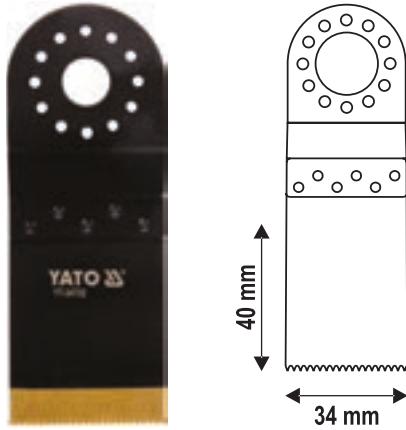
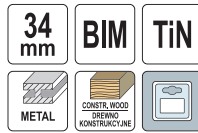

• Application: wood, metal
 • Zastosowanie: drewno, metal

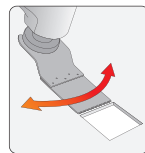

For YT-82223
 Dla YT-82223



EN Plunge cutting saw blade for oscillating multitool BIM
 PL Brzeszczot wglębny BIM do narzędzia wielofunkcyjnego
 DE Tiefenmesser BIM für Multifunktionswerkzeug
 RU Сабельное полотно BIM для многофункционального инструмента
 CZ Pílový list BIM na ponorné řezy pro multifunkční nářadí
 HU BIM merülő fűrészlap multifunkciós szerszámhoz
 RO Lamă de adâncime BIM pt. unealta multifuncțională
 FR Lame plongeante BIM pour outils multifonctions
 IT Lama per tagli dal pieno BIM
 ES Hoja para cortes profundos BIM para herramienta multifuncional
 CN 锯片

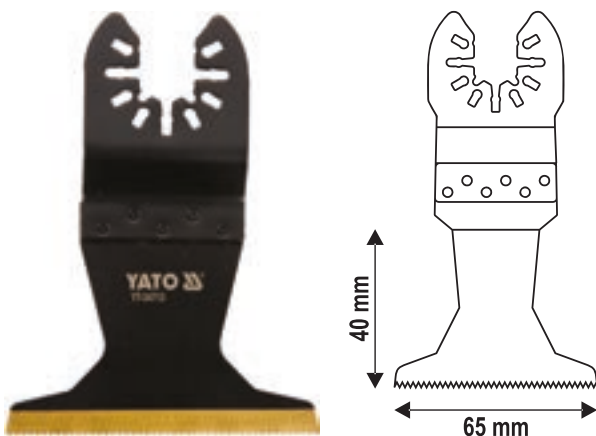

• Application: wood, metal
 • Zastosowanie: drewno, metal

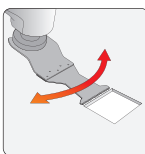

For YT-82220
 Dla YT-82220

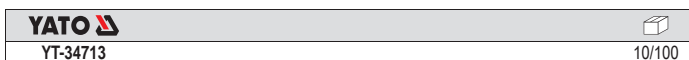

EN Plunge cutting saw blade for oscillating multitool BIM
 PL Brzeszczot wglębny BIM do narzędzia wielofunkcyjnego
 DE Tiefenmesser BIM für Multifunktionswerkzeug
 RU Сабельное полотно BIM для многофункционального инструмента
 CZ Pílový list BIM na ponorné řezy pro multifunkční nářadí
 HU BIM merülő fűrészlap multifunkciós szerszámhoz
 RO Lamă de adâncime BIM pt. unealta multifuncțională
 FR Lame plongeante BIM pour outils multifonctions
 IT Lama per tagli dal pieno BIM
 ES Hoja para cortes profundos BIM para herramienta multifuncional
 CN 锯片

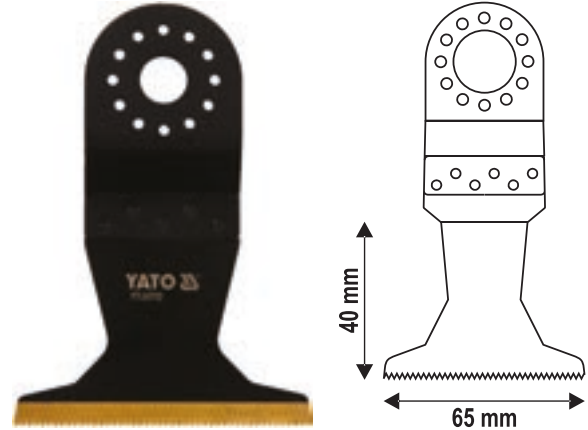
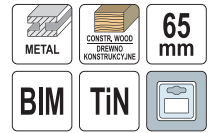

• Application: wood, metal
 • Zastosowanie: drewno, metal



For YT-82223
 Dla YT-82223



EN Brazed carbide triangular rasp for oscillating multitool
 PL Tarnik trójkątny do narzędzia wielofunkcyjnego
 DE Dreieckige Raspel für Multifunktionswerkzeug
 RU Треугольный рашпиль для многофункционального инструмента
 CZ Trojúhelníková brusná deska pro multifunkční nářadí
 HU Háromszög keresztmetszetű reszelő multifunkciós szerszámhoz
 RO Raspel triunghiular pt. unealta multifuncțională
 FR Plateau de ponçage à concretion carbure pour outil multifonction
 IT Raspa in metallo duro forma triangolare multi-funzione
 ES Escofa na triangular para herramienta multifuncional
 CN 锯片

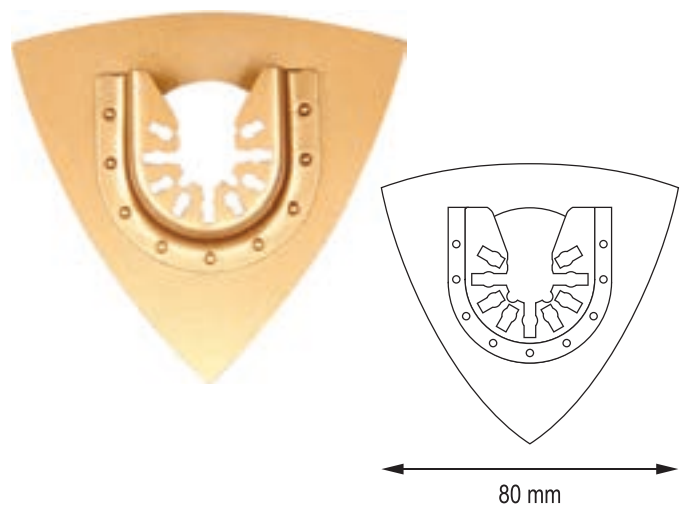
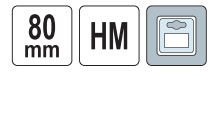

• Application: concrete, ceramic materials
 • Zastosowanie: beton, materiały ceramiczne

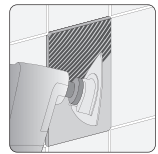

For YT-82220, YT-82223, YT-82818, YT-82900
 Dla YT-82220, YT-82223, YT-82818, YT-82900

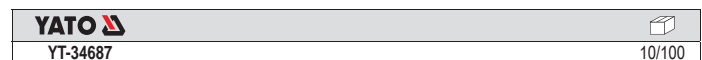

EN Short scraper for oscillating multitool
 PL Skrobak do narzędzia wielofunkcyjnego
 DE Schaber für Multifunktionswerkzeug
 RU Скребок для многофункционального инструмента
 CZ Škrabka pro multifunkční nářadí
 HU Kaparó multifunkciós szerszámhoz
 RO Răzuitor pt. unealta multifuncțională
 FR Spatule pour outil multifonction
 IT Raschietto oscillante multifunzione adatto
 ES Raspador para herramienta multifuncional
 CN 锯片

52 mm HCS

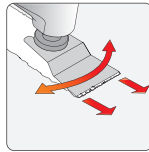
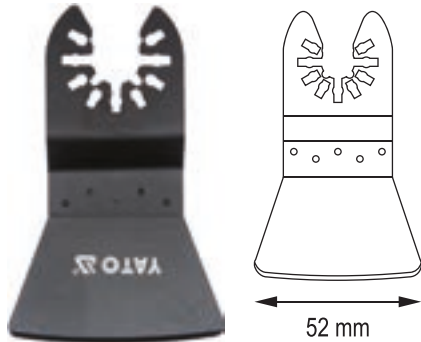

• Application: paint, adhesives, sealing compounds
 • Zastosowanie: farby, kleje, masy uszczelniające

For YT-82220, YT-82223, YT-82818, YT-82900
 Dla YT-82220, YT-82223, YT-82818, YT-82900

YATO
 YT-34688 5/100

EN Triangular eva sanding pad for oscillating multitool
 PL Stopa szlifiarska do narzędzia wielofunkcyjnego
 DE Schleifplatte für Multifunktionswerkzeug
 RU Шлифовальная насадка для многофункционального инструмента
 CZ Brusný nástavec pro multifunkční nářadí
 HU Csiszoló talp multifunkciós szerszámhoz
 RO Picior de sablare pt. unealta multifuncțională
 FR Plateau de ponçage pour outil multifonction
 IT Tasso di smerigliatrice multifunzionale
 ES Pie de rectificación para herramienta multifuncional
 CN 抛光盘

90 mm EVA

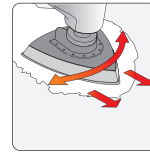
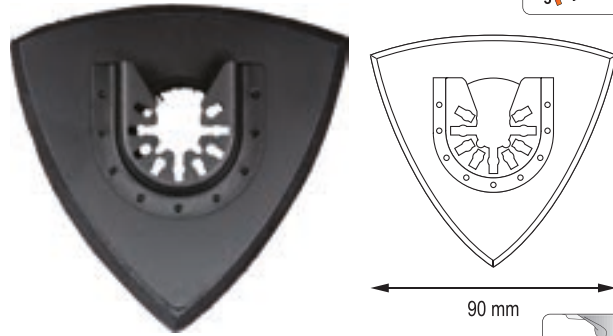

• Application: wood, metal, plaster
 • Zastosowanie: drewno, metal, gips

For YT-82220, YT-82223, YT-82818, YT-82900
 Dla YT-82220, YT-82223, YT-82818, YT-82900

YATO
 YT-34689 5/100

EN Triangular sand paper for oscillating multitool
 PL Papier ścierny do narzędzia wielofunkcyjnego
 DE Schleifpapier für Multifunktionswerkzeug
 RU Шлифовальная бумага
 CZ Brusné plátno pro multifunkční nářadí
 HU Csiszolópapir multifunkciós szerszámhoz
 RO Hârtie abrazivă pt. unealta multifuncțională
 FR Feuilles abrasives pour outil multifonction
 IT Carta abrasiva per utensile multifunzione
 ES Papel de lija para herramienta multifuncional
 CN 抛光拉绒砂盘

10 mm

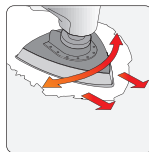
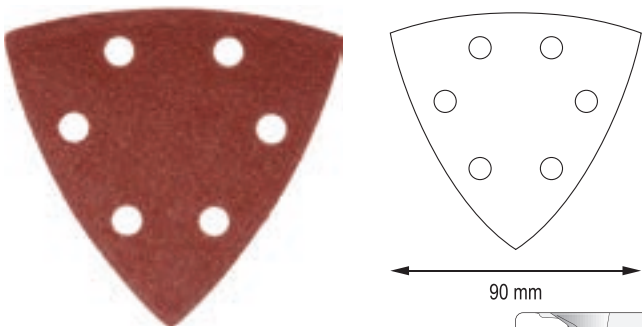

• Application: wood, metal, plaster
 • Zastosowanie: drewno, metal, gips

For YT-82220, YT-82223, YT-82818, YT-82900
 Dla YT-82220, YT-82223, YT-82818, YT-82900

YATO
 YT-34690 10/100

EN Triangular sand paper for oscillating multitool
 PL Papier ścierny do narzędzia wielofunkcyjnego
 DE Schleifpapier für Multifunktionswerkzeug
 RU Шлифовальная бумага
 CZ Brusné plátno pro multifunkční nářadí
 HU Csiszolópapir multifunkciós szerszámhoz
 RO Hârtie abrazivă pt. unealta multifuncțională
 FR Feuilles abrasives pour outil multifonction
 IT Carta abrasiva per utensile multifunzione
 ES Papel de lija para herramienta multifuncional
 CN 抛光拉绒砂盘

20 PCS 80 mm P80
 P120 P240

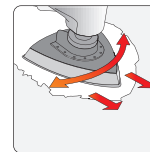
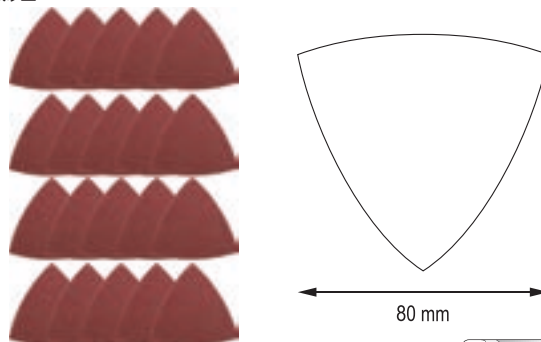
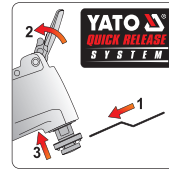

• Application: wood, metal, plaster
 • Zastosowanie: drewno, metal, gips

For YT-82220, YT-82223, YT-82818, YT-82900
 Dla YT-82220, YT-82223, YT-82818, YT-82900
 P80 (10 PCS), P120 (5 PCS), P240 (5 PCS)

YATO
 YT-34693 5/40

EN Accessories set for oscillating multitool
 PL Zestaw akcesoriów do narzędzia wielofunkcyjnego
 DE Zubehörset für Multifunktionswerkzeug
 RU Набор принадлежностей
 CZ Souprava příslušenství pro multifunkční nářadí
 HU Tartozék szett multifunkciós szerszámhoz
 RO Set de accesorii pt. unealta multifuncțională
 FR Set d'accessoires pour outil multifonction
 IT Set di accessori per utensile multifunzione
 ES Juego de accesorios para herramienta multifuncional
 CN 锯片附件



3 PCS HSS HCS BIM

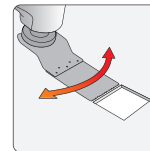
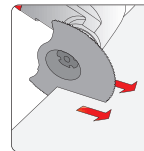
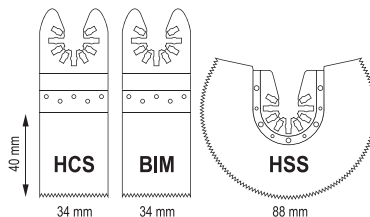
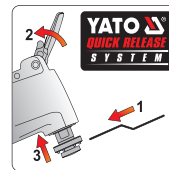

• Application: wood, plastic, metal, plaster, epoxy resin
 • Zastosowanie: drewno, plastik, metal, gips, żywica epoksydowa

For YT-82220, YT-82223, YT-82818, YT-82900
 Dla YT-82220, YT-82223, YT-82818, YT-82900

YATO
 YT-34691 10/100

EN Tube wire brush
PL Szczotka druciana cylindryczna
DE Zylinder-Drahtbürste
RU Щетка-ерш для чистки труб
CZ Kartáč na trubky
HU Tisztító beelső kefe

RO Perie sarma de curatat tevi
FR Brosse cylindrique pour tubes en fil d'acier ondulé
IT Spazzola metallica a cilindro
ES Cepillos en espiral para tubos
CN 试管刷



YATO	Dimensions / Wymiary [mm]	
YT-47695	20x65x200	10/80
YT-47696	26x65x200	10/80

YATO	Dimensions / Wymiary [mm]	
YT-47697	32x65x200	10/80
YT-47698	38x65x200	10/80

EN Steel wire brush
PL Szczotka druciana
DE Stahldrahtbürste

RU Щетка стальная
CZ Drátěný kartáč
HU Drótkefe

RO Perie de sârmă
FR Brosse de fil en laiton
IT Spazzola metallica

ES Cepillo de acero
CN 塑柄钢丝刷



ZINC
PLATED
OCYNKO-
WANA

YATO	Row quantity / Liczba rzędów	
YT-6353	3	12/120
YT-6354	4	12/120
YT-6355	5	12/120
YT-6356	6	12/120

YATO	Row quantity / Liczba rzędów	
YT-6358	4	12/72
YT-6359	5	12/72
YT-6360	6	12/72

EN Steel wire brush
PL Szczotka druciana
DE Stahldrahtbürste
RU Щетка стальная
CZ Drátěný kartáč
HU Drótkefe
RO Perie de sârmă
FR Brosse de fil en laiton
IT Spazzola metallica
ES Cepillo de acero
CN 钢丝刷

STEEL
STAL



STEEL
STAL



YATO	Row quantity / Liczba rzędów	L [mm]	
YT-6330	3	340	12/72

YATO	Row quantity / Liczba rzędów	L [mm]	
YT-6331	3	340	12/72

STEEL
STAL



STEEL
STAL



STEEL
STAL



YATO	Row quantity / Liczba rzędów	L [mm]	
YT-6332	4	260	12/72

YATO	Row quantity / Liczba rzędów	L [mm]	
YT-6333	4	290	12/72

YATO	Row quantity / Liczba rzędów	Size / Rozmiar [mm]	
YT-6334	6	180x65	12/60

SS
STAINLESS STEEL
STAL NIERDZEWNA



SS
STAINLESS STEEL
STAL NIERDZEWNA



SS
STAINLESS STEEL
STAL NIERDZEWNA



YATO	Row quantity / Liczba rzędów	L [mm]	
YT-6335	3	340	12/72

YATO	Row quantity / Liczba rzędów	L [mm]	
YT-6336	3	340	12/72

YATO	Row quantity / Liczba rzędów	L [mm]	
YT-6337	3	180	24/144

SS
STAINLESS STEEL
STAL NIERDZEWNA



SS
STAINLESS STEEL
STAL NIERDZEWNA



SS
STAINLESS STEEL
STAL NIERDZEWNA



YATO	Row quantity / Liczba rzędów	L [mm]	
YT-6338	4	260	12/72

YATO	Row quantity / Liczba rzędów	L [mm]	
YT-6339	4	290	12/72

YATO	Row quantity / Liczba rzędów	L [mm]	
YT-6340	5	180	24/120

BRASS
MOSIĄDZ



BRASS
MOSIĄDZ



BRASS
MOSIĄDZ



YATO	Row quantity / Liczba rzędów	L [mm]	
YT-6341	3	340	12/72

YATO	Row quantity / Liczba rzędów	L [mm]	
YT-6343	3	180	24/144

YATO	Row quantity / Liczba rzędów	L [mm]	
YT-6344	4	260	12/72

BRASS
MOSIĄDZ



BRASS
MOSIĄDZ



NYLON



YATO	Row quantity / Liczba rzędów	L [mm]	
YT-6345	4	290	12/72

YATO	Row quantity / Liczba rzędów	L [mm]	
YT-6346	5	180	24/120

YATO	Row quantity / Liczba rzędów	L [mm]	
YT-6349	5	180	24/120

EN Plastic handle wire brush set
 PL Komplet szczotek druczianych
 DE Bürstensatz
 RU Набор стальных щеток
 CZ Drátěný kartáč
 HU Kefekészlet
 RO Set perii de sarma
 FR Set de brosses de fil en laiton
 IT Set di spazzole metalliche
 ES Juego de cepillos
 CN 刷子组套

3 PCS
 SS STAINLESS STEEL STAL NERDZEWA
 BRASS MOSIADZ
 NYLON



YATO	Row quantity / Liczba rzędów	L [mm]	
YT-6351	3	180	24/144

EN Copper pipe internal brush
 PL Szczotka wewnętrzna do rur miedzianych
 DE Kupferrohr Innenbürste
 RU Щетка для внутренней очистки труб
 CZ Kartáč vnitřní na měděné trubky
 HU Rézcső belső tisztító kefe
 RO Perii de interior pt. tevi de cupru
 FR Brosse aux tubes en cuivre
 IT Spazzola per il rame interno
 ES Cepillo para limpieza de tubos de cobre
 CN 管子刷

SS STAINLESS STEEL STAL NERDZEWA



YATO	Pipe internal diameter / Wewnętrzna średnica rury [mm]	
YT-63701	15	12/240
YT-63702	18	12/240
YT-63703	22	12/240
YT-63704	28	12/240

EN Cleaning pad set for copper pipes
 PL Włóknina do czyszczenia rur miedzianych
 DE Reinigungsvlies-Satz für Kupferrohre
 RU Губка абразивная
 CZ Brusné rouno
 HU Tisztítószivacs
 RO Burete abraziv
 FR Tampons de nettoyage
 IT Fibra abrasiva per la pulizia di tubo di rame
 ES Almohadilla abrasiva
 CN 百洁布

10 PCS
 75x130 mm
 Cu METAL FREE NE ZAWIERA METALU
 DRY WORK PRACA NA SUCHO
 WET WORK PRACA NA MOKRO

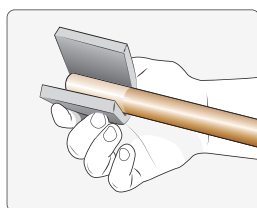

YATO	Size / Rozmiar [mm]	
YT-63740	75x130	50

EN Wire brush set
 PL Zestaw szczotek do gniazd wtryskiwaczy
 DE Bürsten Sortiment
 RU Ерши с наружной резьбой в наборе
 CZ Rougové kartáče válcové
 HU Henger drótkefe
 RO Perii cilindrice pt. curatarea gaurilor
 FR Brosse cylindrique
 IT Vetro di protezione
 ES Cepillos para limpieza interior
 CN 钢丝刷

20 PCS
 150 mm
 1/4" 6.3 mm
 SS STAINLESS STEEL STAL NERDZEWA
 BRASS MOSIADZ
 NYLON



YATO	Ø [mm]	
YT-08195	9, 11, 13, 15, 17, 19	20

EN Copper pipe brush 2 in 1
 PL Szczotka do rur miedzianych 2 w 1
 DE 2 in 1 Kupferrohrbürste für Innen- und Außenreinigung
 RU Щетка для внутренней и внешней зачистки медных труб
 CZ Kartáč vnitřní a vnější na měděné trubky
 HU Rézcső tisztító kefe 2 in 1
 RO Perii pt. tevi de cupru 2 in 1
 FR Brosse aux tubes en cuivre
 IT Spazzola per il tubi di rame 2 in 1
 ES 2 en 1 cepillo para limpieza de tubos de cobre int. y ext
 CN 管子刷

SS STAINLESS STEEL STAL NERDZEWA



YATO	Pipe external & internal diameter / Zewnętrzna i wewnętrzna średnica rury [mm]	
YT-63705	15, 22	50/100

EN Drain auger
 PL Spirala kanalizacyjna
 DE Hand-Rohrreinigungsspirale
 RU Трос для прочистки канализационных труб и каналов
 CZ Spirála na čišťení trubek
 HU Csőtisztító spirál
 RO Sarpe pt. desfundat tevi
 FR Câble de nettoyage de tuyaux pour les mains
 IT Sturafogno a molla spirale
 ES Varilla para limpiar drenajes
 CN 管道疏通器

SS STAINLESS STEEL STAL NERDZEWA



YATO	Ø [mm]	L [m]	
YT-25000	5x1.5	1.5	30/60
YT-25001	5x1.5	3.0	40
YT-25002	6x1.3	3.0	40
YT-25003	6x1.3	5.0	20
YT-25004	9x1.7	5.0	10
YT-25005	9x1.7	10.0	6

- EN Drain auger
PL Spirala kanalizacyjna
DE Hand-Rohrreinigungsspirale
RU Трос для прочистки канализационных труб и каналов
CZ Spirála na čištění trubek
HU Csőtisztító spirál
RO Dedeman cablu pt. desfundat canale
FR Câble de nettoyage de tuyaux pour les mains
IT Sturafogno a molla spirale
ES Varilla para limpiar drenajes
CN 管道疏通器

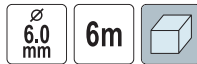

YATO	Ø [mm]	L [m]	
YT-24990	6x1.3	6	12

- EN Drain auger
PL Spirala kanalizacyjna
DE Hand-Rohrreinigungsspirale
RU Трос для прочистки канализационных труб и каналов
CZ Spirála na čištění trubek
HU Csőtisztító spirál
RO Dedeman cablu pt. desfundat canale
FR Câble de nettoyage de tuyaux pour les mains
IT Sturafogno a molla spirale
ES Varilla para limpiar drenajes
CN 管道疏通器



YATO	Ø [mm]	L [m]	
YT-24991	6x1.3	7.6	8

- EN Toilet auger
PL Przetłaczacz do toalet
DE Abflusstamper
RU Средство от засорения унитаза
CZ Čistič toalet
HU Duguláselehárító
RO Dispozitiv pt. desfundat toaleta
FR Ustensile pour déboucher les toilettes
IT Stura WC
ES Sonda destapadora wc
CN 疏通器

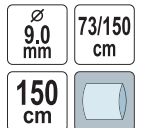

YATO	Ø [mm]	L [cm]	
YT-24983	9	150	6

- EN Drain rod set
PL Zestaw prętów do udrażniania kanalizacji
DE Abflussschnecke-Set
RU Прутья для прочистки канализационных труб
CZ Pruty k čištění kanalizace sada
HU Csőtisztító rúdkészlet
RO Accesorii pt. dispozitiv desfundat revi
FR Tiges pour déboucher les canalisations
IT Kit di barre per lo sturamento della rete fognaria
ES Varillas de alcantarillado, juego
CN 疏通器



YATO	
YT-24980	8

- EN Brush for drain cleaning
PL Szczotka do udrażniania kanalizacji
DE Abflussbürste
RU Щетка для прочистки канализационных труб
CZ Štětka k čištění kanalizace
HU Csőtisztító kefe
RO Perie pt. curățarea scurgerilor
FR Brosse pour déboucher les canalisations
IT Spazzola per lo sturamento della rete fognaria
ES Cepillo de alcantarillado
CN 疏通器刷头



For YT-24980
Dla YT-24980

YATO	Ø [cm]	
YT-24970	10	20/40
YT-24971	20	20/40
YT-24972	25	20/40

- EN Double worm for drain cleaning
PL Końcówka spiralna do udrażniania kanalizacji
DE Doppelschnecke für Abflussreinigung
RU Спиральный наконечник для прочистки канализационных труб
CZ Spirálová koncovka k čištění kanalizace
HU Csőtisztító dupla menetes csavar
RO Cap spiral dublu pt. curățarea scurgerilor
FR Extrémité en spirale pour déboucher les canalisations
IT Testa spirale per lo sturamento della rete fognaria
ES Tubo espiral de drenaje
CN 疏通器绕钩



For YT-24980
Dla YT-24980

YATO	Size / Rozmiar [mm]	
YT-24963	165x7	24/96

- EN Plunger for drain cleaning
- PL Tłok okrągły do udrażniania kanalizacji
- DE Gummi-Saugteller für Abflussreinigung
- RU Кру́пный шток для прочистки канализационных труб
- CZ Kulatý píšť k čištění kanalizace
- HU Csőtisztító gumipumpa
- RO Pompă pt. curățarea scurgerilor
- FR Piston pour déboucher les canalisations
- IT Pistone tondo per lo sturamento della rete fognaria
- ES Embolo redondo de drenaje
- CN 橡胶吸盘



For YT-24980
Dla YT-24980

YATO	Ø [cm]	
YT-24960	10	24/96

- EN Scraper for drain cleaning
- PL Skrobak opadowy do udrażniania kanalizacji
- DE Klappschaber für Abflussreinigung
- RU Прокладной скребок для прочистки канализационных труб
- CZ Odpadová škrabka k čištění kanalizace
- HU Csőtisztító kaparó
- RO Racletă pt. curățarea scurgerilor
- FR Grattoir pour déboucher les canalisations
- IT Raschietto gravitazionale per lo sturamento della rete fognaria
- ES Rasqueta articulada de alcantarillado
- CN 疏通器耙头



For YT-24980
Dla YT-24980

YATO	Size / Rozmiar [mm]	
YT-24965	95x1.5	20/100

- EN Guide wheel for drain cleaning
- PL Kołko prowadzące do udrażniania kanalizacji
- DE Leitrad für Abflussreinigung
- RU Ведущее колесо для прочистки канализационных труб
- CZ Naváděcí kolečko k čištění kanalizace
- HU Csőtisztító vezetőkerék
- RO Roata ghidaj curatarea scurgerilor
- FR Roue de guidage pour déboucher les canalisations
- IT Anello di guida per lo sturamento della rete fognaria
- ES Rueda de guía de drenaje
- CN 疏通器滚轮



For YT-24980
Dla YT-24980

YATO	Ø [mm]	
YT-24966	55	20/60

- EN Cup brush with shaft
- PL Szczotka czelowa z trzpieniem
- DE Stahlraht-Topfbürste
- RU Щетка "чашка" со стержнем
- CZ Čelní kartáč drátěný se stopkou
- HU Homlok drótkefe, nyéllal
- RO Perie frontală pt. bormasina
- FR Brosse coupe avec gouppile
- IT Spazzola a tazza
- ES Cepillo de copa con mandril
- CN 钢丝轮



YATO	Ø [mm]	max. c [min ⁻¹]	
YT-4750	75	4500	12/96



YATO	Ø [mm]	max. c [min ⁻¹]	
YT-4751	75	4500	12/96



YATO	Ø [mm]	max. c [min ⁻¹]	
YT-4752	75	6000	12/72



YATO	Ø [mm]	max. c [min ⁻¹]	
YT-47496	25	4500	20/240



YATO	Ø [mm]	max. c [min ⁻¹]	
YT-47497	50	4500	12/144



YATO	Ø [mm]	max. c [min ⁻¹]	
YT-47511	100	4500	6/36



YATO	Ø [mm]	max. c [min ⁻¹]	
YT-47518	65	12500	10/100



YATO	Ø [mm]	max. c [min ⁻¹]	
YT-47780	25	4500	20/240



YATO	Ø [mm]	max. c [min ⁻¹]	
YT-47782	75	4500	10/120

EN Cup brush with shaft set
PL Szczotki druciane z trzpieniem
DE Drahtbürste mit Einspannschaft
RU Щетки проволочные со стержнем
CZ Drátěný kartáč se stopkou
HU Drótkefe, csapós
RO Perii de sârmă cu tijă
FR Set de brosses coupe avec gouppile
IT Spazzola metallica a disco
ES Cepillos de alambre con espiga
CN 钢丝刷

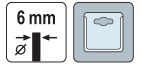

YATO	Ø [mm]	max c [min ⁻¹]	Box
YT-4755	20, 50, 50	6000, 7500, 4500	12/60

EN Circular brush with shaft
PL Szczotka tarczowa z trzpieniem
DE Stahldraht-Scheibenbürste
RU Щетка круговая со стержнем
CZ Okružní kartáč drátěný se stopkou
HU Tarcás drótkefe, nyéllal
RO Perie rotunda pt. bormasina
FR Brosse circulaire avec gouppile
IT Spazzola a disco
ES Cepillo redondo
CN 钢丝轮



YATO	Ø [mm]	max c [min ⁻¹]	Box
YT-4757	100	4500	12/96

YATO	Ø [mm]	max c [min ⁻¹]	Box
YT-4758	100	4500	12/96

YATO	Ø [mm]	max c [min ⁻¹]	Box
YT-4759	75	20000	10/100



YATO	Ø [mm]	max c [min ⁻¹]	Box
YT-47565	50	4500	20/240
YT-47568	75	4500	12/144

YATO	Ø [mm]	max c [min ⁻¹]	Box
YT-47791	75	4500	10/120
YT-47792	100	4500	10/60

YATO	Ø [mm]	max c [min ⁻¹]	Box
YT-47800	50	4500	6/36
YT-47801	75	4500	6/36
YT-47802	100	4500	6/36

EN Cup brush with shaft set
PL Szczotki druciane z trzpieniem
DE Drahtbürste mit Einspannschaft
RU Щетки проволочные со стержнем
CZ Drátěný kartáč se stopkou
HU Drótkefe, csapós
RO Perii de sârmă cu tijă
FR Set de brosses coupe avec gouppile
IT Spazzola metallica a disco
ES Cepillos de alambre con espiga
CN 钢丝刷

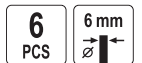

YATO	Ø [mm]	max c [min ⁻¹]	Box
YT-47593	37, 50, 62, 75	4500	6/60

EN Circular brush
PL Szczotka tarczowa z gwintem
DE Stahldraht-Scheibenbürste
RU Щетка круговая
CZ Okružní kartáč drátěný
HU Tarcás drótkefe
RO Perie rotunda pt. bormasina
FR Brosse circulaire avec filet
IT Spazzola conica
ES Cepillo redondo
CN 钢丝轮



YATO	Ø [mm]	max c [min ⁻¹]	Box
YT-4761	100	12500	8/64

YATO	Ø [mm]	max c [min ⁻¹]	Box
YT-4763	100	12500	8/64

YATO	Ø [mm]	max c [min ⁻¹]	Box
YT-4764	125	10000	8/48

YATO	Ø [mm]	max c [min ⁻¹]	Box
YT-47612	125	12500	10/60

EN Cup brush
 PL Szczotka czolowa z gwintem
 DE Stahldraht-Topfbürste
 RU Щетка "чашка"

CZ Čelní kartáč drátěný
 HU Homlok drótkefe
 RO Perie frontală
 FR Brosse coupe avec filet

IT Spazzola conica
 ES Cepillo de copa
 CN 钢丝轮

M14



YATO	Ø [mm]	max. ω [min ⁻¹]	
YT-4766	100	8500	4/32

YATO	Ø [mm]	max. ω [min ⁻¹]	
YT-4767	60	12500	10/80

YATO	Ø [mm]	max. ω [min ⁻¹]	
YT-4768	75	11000	6/36



YATO	Ø [mm]	max. ω [min ⁻¹]	
YT-4769	100	8500	4/16

YATO	Ø [mm]	max. ω [min ⁻¹]	
YT-47691	125	6500	4/16

YATO	Ø [mm]	max. ω [min ⁻¹]	
YT-47658	65	12500	10/80

YATO	Ø [mm]	max. ω [min ⁻¹]	
YT-47785	65	12200	10/80
YT-47787	125	6500	6/24

EN Circular brush
 PL Szczotka tarczowa z gwintem
 DE Stahldraht-Scheibenbürste
 RU Щетка круглая
 CZ Okružní kartáč drátěný
 HU Tarcás drótkefe
 RO Perie rotunda pt. bormasina
 FR Brosse circulaire avec filet
 IT Spazzola conica
 ES Cepillo redondo
 CN 带柄平行刷



YATO	Ø [mm]	max. ω [min ⁻¹]	
YT-47554	150x32	6000	5/40
YT-47555	200x32	4500	5/20

EN Drill powered scrub brushes
 PL Zestaw szczotek na wiertarkę
 DE Bürstensatz für Bohrmaschine
 RU Набор щеток для дрели
 CZ Sada uhliků do vrtáčky
 HU Kefekészlet fúróhoz
 RO Set perii cu prindere
 FR Ensemble de brosses pour perceuse
 IT Set di spazzole per trapano
 ES Juego de cepillos para taladro
 CN 清洁刷

3
PCS

1/4"
6.3 mm



YATO	Ø [mm]	
YT-47553	5, 8, 10	40

238

EN Metal grinding disc
 PL Tarcza do szlifowania metalu
 DE Metall-Schleif-scheibe
 RU Круги для шлифования по металлу
 CZ Kotouč pro broušení kovů
 HU Vágókorong fémhez
 RO Disc pt. slefuit metal
 FR Disque de polissage pour métaux
 IT Disco per rettifica metallo
 ES Disco cortador para metal
 CN 研磨片

M14



YATO	Ø [mm]	max. ω [min ⁻¹]	
YT-47820	125	12500	6/36

EN Drill powered scrub brushes
 PL Zestaw szczotek na wiertarkę
 DE Bürstensatz für Bohrmaschine
 RU Набор щеток для дрели
 CZ Sada uhliků do vrtáčky
 HU Kefekészlet fúróhoz
 RO Set perii cu prindere
 FR Ensemble de brosses pour perceuse
 IT Set di spazzole per trapano
 ES Juego de cepillos para taladro
 CN 清洁刷

5
PCS

1/4"
6.3 mm



YATO	Ø [mm]	
YT-47777	5, 8, 10, 12 (x2)	24

EN Insulated cable knife
PL Nóż dla elektryków izolowany
DE Kabelmesser gerade
RU Нож кабельный изолированный
CZ Izolovaný nůž
HU Szerelőkécs
RO Cutit pt. cabluri izolat
FR Couteau d'électricien
IT Coltello per elettricisti isolato
ES Cuchillo electricista aislante
CN 双色直刃式绝缘电工刀

50/180 mm 65Mn 1000 V 



1000 V
VDE CERTIFICATE
EN 60900:2012

YATO 	L [mm]	
YT-21210	180	6/72

EN Insulated dismantling knife
PL Nóż demontażowy dla elektryków
DE Abmantelungsmesser
RU Нож кабельный изолированный
CZ Zahnutý nůž s vodítkem, izolovaný
HU Szerelőkécs
RO Cutit demontabil izolat
FR Couteau d'électricien
IT Coltello di smontaggio per elettricisti isolati
ES Cuchillo de desmontaje aislante
CN 双色防护式绝缘电工刀

38/155 mm 65Mn 1000 V 



1000 V
VDE CERTIFICATE
EN 60900:2012

YATO 	L [mm]	
YT-21211	155	6/72

EN Electrician's knife
PL Nóż składany monterski
DE Montagmesser
RU Нож складной
CZ Montážní nůž
FR Couteau d'électricien
HU Szerelőkécs
IT Coltello
RO Cutit pt. decablat
ES Cuchillo de montaje
CN 直刃电工刀

HRC 42-48 3Cr13 

85/200 mm







YATO 	L [mm]	
YT-7600	200	6/96

75/190 mm





YATO 	L [mm]	
YT-7601	190	6/96

EN Folding knife with bits
PL Nóż składany z bitami
DE Klappmesser
RU Нож складной
CZ Kapesní nůž
HU Zsebkés
RO Briceag
FR Couteau pince multifonction avec embouts
IT Coltello pieghevole con punte
ES Navaja
CN 折叠刀

   
AI SS 

 3, 4 mm;
 PH1, PH2 mm;
 3, 4 mm;
 T10, T20





YATO 		
YT-76031		6/48

EN Folding knife
PL Nóż składany
DE Klappmesser
RU Нож складной
CZ Kapesní nůž
HU Zsebkés
RO Briceag
FR Couteau pliant
IT Coltello pieghevole
ES Navaja
CN 带登山扣的折叠刀

SS 





AI	YATO 	
	YT-76050	12/72



YATO 	
YT-76051	12/120



YATO 	
YT-76052	6/48



EN Multi knife
PL Narzędzie wielofunkcyjne
DE Klappmesser
RU Нож складной
CZ Kapesní nůž
HU Zsebkés
RO Briceag
FR Couteau pince multifonction
IT Pinza multifunzione
ES Navaja
CN 多功能折叠刀

9 PCS SS 
AI 



YATO 	
YT-76040	12/120

EN Multi knife
PL Narzędzie wielofunkcyjne
DE Klappmesser
RU Нож складной
CZ Kapesní nůž
HU Zsebkés
RO Briceag
FR Couteau pince multifonction
IT Pinza multifunzione
ES Navaja
CN 多功能折叠刀

9 PCS SS 
AI 



YATO 	
YT-76041	12/48

EN Multi knife
 PL Narzędzie wielofunkcyjne
 DE Klappmesser
 RU Нож складной
 CZ Kapesní nůž
 HU Zsebkés
 RO Briceag
 FR Couteau pince multifonction
 IT Pinza multifunzione
 ES Navaja
 CN 多功能折叠刀

9 PCS
 SS STAINLESS STEEL STAL MIERZWIĄNA
 AI



YATO
 YT-76042

12/48

EN Multi knife
 PL Narzędzie wielofunkcyjne
 DE Klappmesser
 RU Нож складной
 CZ Kapesní nůž
 HU Zsebkés
 RO Briceag
 FR Couteau pince multifonction
 IT Pinza multifunzione
 ES Navaja
 CN 多功能折叠刀

9 PCS
 SS STAINLESS STEEL STAL MIERZWIĄNA



YATO
 YT-76043

6/36

EN Cutter knife
 PL Nożyk z ostrzem trapezowym
 DE Cuttermesser
 RU Нож универсальный
 CZ Univerzální nůž s lichoběžníkovou čepelí
 HU Univerzális kés

RO Cuțit cu lamă trapezoidală retractabilă
 FR Cutter à lame trapezoidale
 IT Coltello con lama trapezoidale
 ES Cuchillo con hoja trapezoidal
 CN 折叠实用刀

x5
 SK5



YATO
 YT-7532

Blade size / Rozmiar ostrza [mm]
 61x33x0.5

12/72

EN Cutter knife
 PL Nożyk z ostrzem trapezowym
 DE Cuttermesser
 RU Нож универсальный
 CZ Univerzální nůž s lichoběžníkovou čepelí
 HU Univerzális kés

RO Cuțit cu lamă trapezoidală retractabilă
 FR Cutter à lame trapezoidale
 IT Coltello con lama trapezoidale
 ES Cuchillo con hoja trapezoidal
 CN 折叠实用刀

x5
 SK5



YATO
 YT-7534

Blade size / Rozmiar ostrza [mm]
 61x33x0.5

12/72

EN Cutter knife
 PL Nożyk z ostrzem trapezowym
 DE Cuttermesser
 RU Нож универсальный
 CZ Univerzální nůž s lichoběžníkovou čepelí
 HU Univerzális kés

RO Cuțit cu lamă trapezoidală retractabilă
 FR Cutter à lame trapezoidale
 IT Coltello con lama trapezoidale
 ES Cuchillo con hoja trapezoidal
 CN 折叠实用刀

x3
 SK5



YATO
 YT-7520

Blade size / Rozmiar ostrza [mm]
 61x33x0.5

6/48

EN Cutter knife
 PL Nożyk z ostrzem trapezowym
 DE Cuttermesser
 RU Нож универсальный
 CZ Univerzální nůž s lichoběžníkovou čepelí
 HU Univerzális kés

RO Cuțit cu lamă trapezoidală retractabilă
 FR Cutter à lame trapezoidale
 IT Coltello con lama trapezoidale
 ES Cuchillo con hoja trapezoidal
 CN 折叠实用刀

1+3
 Zn TPR ABS
 SK5
 AUTO RETRACTABLE AUTOMATYCZNIE WYSUNANE
 3 BLADE POSITIONS POZYCJE OSTRZA

 STRAP SIDE CUTTER OBCINAK BOCZNY



YATO
 YT-7501

Blade size / Rozmiar ostrza [mm]
 61x33x0.5

12/72

EN Utility knife
 PL Nożyk z łamanym ostrzem
 DE Abbrechklängen-Messer
 RU Нож строительный
 CZ Nůž ulamovací
 HU Univerzális kés
 RO Cuțit universal (cutter)
 FR Cutter à lame sécable
 IT Taglierino
 ES Cuchillo de papelería
 CN 美工刀

1+2
 ABS TPR
 AUTO LOCK BLOKADA
 METAL SLIDING BAR METALOWA PROWADNICA
 SELF-LOADING BLADES SAMOLADUJĄCE OSTRZA
 SK5



YATO
 YT-75001

Blade size / Rozmiar ostrza [mm]
 9x0.4

12/144

EN Utility knife
 PL Nożyk z łamanym ostrzem
 DE Abbrechklängen-Messer
 RU Нож строительный
 CZ Nůž ulamovací
 HU Univerzális kés
 RO Cuțit universal (cutter)
 FR Cutter à lame sécable
 IT Taglierino
 ES Cuchillo de papelería
 CN 美工刀

AUTO LOCK BLOKADA
 METAL SLIDING BAR METALOWA PROWADNICA
 METAL BODY METALOWY KORPUS
 SK2H



YATO
 YT-75002

Blade size / Rozmiar ostrza [mm]
 9x0.4



10/240

ULTRA SHARP

EN Utility knife
PL Nożyk z łamanym ostrzem
DE Abbrechklingen-Messer
RU Нож строительный
CZ Nůž ulamovací
HU Univerzális kés
RO Cuțit universal (cutter)
FR Cutter à lame sécable
IT Taglierino
ES Cuchillo de papelería
CN 美工刀





ULTRA SHARP

YATO 	Blade size / Rozmiar ostrza [mm]	
YT-75003	9x0.4	10/240

EN Utility knife
PL Nożyk z łamanym ostrzem
DE Abbrechklingen-Messer
RU Нож строительный
CZ Nůž ulamovací
HU Univerzális kés
RO Cuțit universal (cutter)
FR Cutter à lame sécable
IT Taglierino
ES Cuchillo de papelería
CN 美工刀





ULTRA SHARP

YATO 	Blade size / Rozmiar ostrza [mm]	
YT-75124	18x0.5	10/120

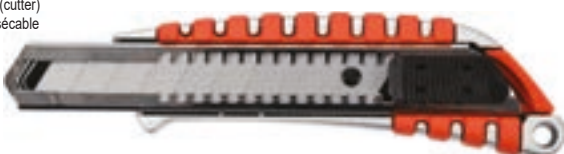

EN Utility knife
PL Nożyk z łamanym ostrzem
DE Abbrechklingen-Messer
RU Нож строительный
CZ Nůž ulamovací
HU Univerzális kés
RO Cuțit universal (cutter)
FR Cutter à lame sécable
IT Taglierino
ES Cuchillo de papelería
CN 美工刀



YATO 	Blade size / Rozmiar ostrza [mm]	
YT-75122	18x0.5	12/144



EN Utility knife
PL Nożyk z łamanym ostrzem
DE Abbrechklingen-Messer
RU Нож строительный
CZ Nůž ulamovací
HU Univerzális kés
RO Cuțit universal (cutter)
FR Cutter à lame sécable
IT Taglierino
ES Cuchillo de papelería
CN 美工刀



YATO 	Blade size / Rozmiar ostrza [mm]	
YT-7506	9x0.4	24/240
YT-7507	18x0.5	12/144

EN Utility knife
PL Nożyk z łamanym ostrzem
DE Abbrechklingen-Messer
RU Нож строительный
CZ Nůž ulamovací
HU Univerzális kés
RO Cuțit universal (cutter)
FR Cutter à lame sécable
IT Taglierino
ES Cuchillo de papelería
CN 美工刀





YATO 	Blade size / Rozmiar ostrza [mm]	
YT-75072	18x0.5	12/144

EN Utility knife
PL Nożyk z łamanym ostrzem
DE Abbrechklingen-Messer
RU Нож строительный
CZ Nůž ulamovací
HU Univerzális kés
RO Cuțit universal (cutter)
FR Cutter à lame sécable
IT Taglierino
ES Cuchillo de papelería
CN 美工刀





ULTRA SHARP

YATO 	Blade size / Rozmiar ostrza [mm]	
YT-75123	18x0.5	10/120



EN Utility knife
PL Nożyk z łamanym ostrzem
DE Abbrechklingen-Messer
RU Нож строительный
CZ Nůž ulamovací
HU Univerzális kés
RO Cuțit universal (cutter)
FR Cutter à lame sécable
IT Taglierino
ES Cuchillo de papelería
CN 美工刀



YATO 	Blade size / Rozmiar ostrza [mm]	
YT-75121	18x0.5	12/144



EN Utility knife
PL Nożyk z łamanym ostrzem
DE Abbrechklingen-Messer
RU Нож строительный
CZ Nůž ulamovací
HU Univerzális kés
RO Cuțit universal (cutter)
FR Cutter à lame sécable
IT Taglierino
ES Cuchillo de papelería
CN 美工刀



YATO 	Blade size / Rozmiar ostrza [mm]	
YT-7511	9x0.4	24/288
YT-7512	18x0.5	12/96

EN Utility knife
PL Nożyk z łamanym ostrzem
DE Abbrechklingen-Messer
RU Нож строительный
CZ Nůž ulamovací
HU Univerzális kés
RO Cuțit universal (cutter)
FR Cutter à lame sécable
IT Taglierino
ES Cuchillo de papelería
CN 美工刀





YATO 	Blade size / Rozmiar ostrza [mm]	
YT-75071	18x0.5	12/144

EN Utility knife
PL Nożyk z łamanym ostrzem
DE Abbrechklingen-Messer
RU Нож строительный
CZ Nůž ulamovací
HU Univerzális kés

RO Cuțit universal (cutter)
FR Cutter à lame sécable
IT Taglierino
ES Cuchillo de papelería
CN 美工刀



YATO 	Blade size / Rozmiar ostrza [mm]	
YT-7504	9x0.4	24/240
YT-7505	18x0.5	24/240

EN Utility knife
 PL Nożyk z lamany ostrzem
 DE Abbrechklingen-Messer
 RU Нож строительный
 CZ Nůž ulamovací
 HU Univerzális kés
 RO Cuiț universal (cutter)
 FR Cutter à lame sécable
 IT Taglierino
 ES Cuchillo de papelería
 CN 美工刀

ABS TPR **max 20 kg** **AUTO LOCK BLOKADA** **METAL SLIDING BAR METALOWA PRÓWADNICA** **SK5**



YATO	Blade size / Rozmiar ostrza [mm]	
YT-75101	25x0.7	12/144

EN Spare blades
 PL Ostrza zapasowe
 DE Abbrechklingen
 RU Лезвия для универсальных ножей
 CZ Lomené ostří náhradní
 HU Törhető tartalékpenge

RO Lame de rezervă rupte
 FR Lame sécables pour le cutter
 IT Lame di ricambio
 ES Filo partido de recambio
 CN 美工刀片

10 PCS **SK2H**



ULTRA SHARP

YATO	Blade size / Rozmiar ostrza [mm]	
YT-75260	9x0.4	10/240
YT-75261	18x0.5	10/120

EN Spare blades
 PL Ostrza zapasowe
 DE Abbrechklingen
 RU Лезвия для универсальных ножей
 CZ Lomené ostří náhradní
 HU Törhető tartalékpenge
 RO Lame de rezervă rupte
 FR Lame sécables pour le cutter
 IT Lame di ricambio
 ES Filo partido de recambio
 CN 美工刀片

10 PCS

SK5



YATO	Blade size / Rozmiar ostrza [mm]	
YT-7528	9x0.4	24/144
YT-7529	18x0.5	24/144
YT-7530	25x0.7	6/48

SK5



YATO	Blade size / Rozmiar ostrza [mm]	
YT-7531	61x33x0.5	24/144

SK2



YATO	Blade size / Rozmiar ostrza [mm]	
YT-7524	9x0.4	24/240
YT-7525	18x0.5	24/144
YT-75262	25x0.7	10/60

SK2



YATO	Blade size / Rozmiar ostrza [mm]	
YT-7527	61x33x0.5	24/144

EN Squeegee with felt for pressing the film
 PL Rakiel do dociskania folii
 DE Folienpressrakel
 RU Рахель для прижатия пленки
 CZ Stěrka pro přitlačení fólie
 HU Fólia kasírozó
 RO Racleta colant
 FR Racloir à feuilles
 IT Raschietto per pellicola
 ES Rasqueta para presionar película
 CN 毛毡刮片



100x73 mm

YATO	Size / Rozmiar [mm]	
YT-52550	100x73	20/200

EN Insulated electrician scissors
 PL Nożyczki dla elektryków izolowane
 DE Elektrische Schere
 RU Ножницы диэлектрические универсальные
 CZ Elektrikářské nůžky
 HU Villanyzerező olló
 RO Foarfeca electrician izolate
 FR Ciseaux pour electriciens
 IT Forbici per elettricisti
 ES Tijera aislante electricista
 CN 双色柄绝缘电工剪刀

160 mm **CrV**
1000 V



1000 V VDE CERTIFICATE EN 60900:2012

YATO	L [mm]	
YT-21200	160	6/48

EN Electrician scissors
 PL Nożyczki dla elektryków
 DE Elektrische Schere
 RU Ножницы универсальные
 CZ Elektrikářské nůžky
 HU Univerzális olló
 RO Foarfecă - electrician
 FR Ciseaux pour electriciens
 IT Forbici per elettricisti
 ES Tijeras eléctricas
 CN 不锈钢电工剪



YATO	L [mm]	
YT-1974	140	12/120

EN Scissors
 PL Nożyczki
 DE Haushaltsschere
 RU Ножницы
 CZ Nůžky
 HU Olló
 RO Foarfecă
 FR Ciseaux
 IT Forbici
 ES Tijeras
 CN 剪刀

SS **STAINLESS STEEL STA. NERZŹENNA**



YATO	L [mm]	
YT-19763	170	12/120
YT-19764	190	12/120
YT-19765	215	12/120
YT-19766	245	12/120
YT-19767	300	12/120

EN Glass oil cutter
 PL Nóż olejowy do szkła
 DE Glasschneider
 RU Стеклорез масляный
 CZ Řezák na sklo
 HU Olajkés üveghez
 RO Diamant pt. taiat sticla cu ulei
 FR Couteau à l'huile pour verre
 IT Taglia vetro con serbatoio olio
 ES Cuchillo de aceite para cristalinación
 CN 玻璃割刀

HRA 92.5-93 **YD05**



YATO	L [mm]	
YT-7560	177	6/120





YATO	L [mm]	
YT-7561	178	6/120

EN Glass cutter with diamond tip
PL Nóż do cięcia szkła z końcówką diamentową
DE Glasschneider mit Diamantspitze
RU Стеклорез с алмазным наконечником
CZ Nůž na sklo s diamentovou koncovkou
HU Üvegágó kés gyémánt fejfel

RO Diamant sticlă
FR Coupe-verre à pointe de diamant
IT Tagliavetro con punta diamentata
ES Cortador de vidrio con punta de diamante
CN 玻璃割刀

175 mm





YATO 	L [mm]	
YT-37390	175	6/240

EN Glass cutter with 3 wheels
PL Nóż do cięcia szkła z trzema kółkami
DE Glasschneider mit drei Rädern
RU Нож для резки гипсокартона с рулеткой
CZ Nůž na sklo se třemi kolečky
HU Üvegágó kés három tárcsával

RO Diamant sticlă cu 3 cutite
FR Coupe-verre à 3 molettes
IT Tagliavetro a 3 ruote
ES Cortador de vidrio con tres ruedas
CN 玻璃割刀

130 mm



YATO 	L [mm]	
YT-37391	130	10/150

EN Drywall board cutting tool with measuring tape
PL Nóż do cięcia płyt gipsowo-kartonowych z miarą zwijaną
DE Gipskartonschneider mit Rollmaß
RU Нож для резки гипсокартона с рулеткой
CZ Nůž na sádkarton se svinovacím metrem
HU Mérőszalagos gipszkartonvágó kés
RO Instrument de tăiat plăci de gips-carton cu bandă de măsurare



5m
19mm



FR Coupeur pour plaque de plâtre avec ruban-mètre intégré
IT Taglierina per cartongesso con metro a nastro
ES Cortador de placa de yeso con cinta métrica
CN 石膏板切割器

YATO 	
YT-31350	30

EN Carving knife set
PL Zestaw nożyków
DE Klingensatz
RU Набор резцов
CZ Sada nožíků
HU Késkészlet
RO Set cutite prelucrare lemn
FR Sculpture ensemble de couteau
IT Set di coltelli
ES Juego de cuchillas
CN 美工刀

14 PCS HRC 60 T10 STEEL HANDLE SCHWYT SOFT GRIP MEKKI UCHWYT 





YATO 	
YT-75140	6/48

EN Carving knife set
PL Zestaw nożyków
DE Klingensatz
RU Набор резцов
CZ Sada nožíků
HU Késkészlet
RO Set cutite prelucrare lemn
FR Sculpture ensemble de couteau
IT Set di coltelli
ES Juego de cuchillas
CN 雕刻刀

16 PCS SK5 



YATO 	
YT-75370	4/24

EN 2-sided glass cutting tool
PL Dwustronny nóż do płytek ceramicznych i szkła
DE Doppelseitiger Fliesen- und Glasschneider
RU Двусторонний резак для керамической плитки и стекла
CZ Oboustranný nůž na keramické dlaždice a sklo
HU Kétoldalú csempé- és üvegágó kés
RO Instrument de tăiat sticlă cu 2 capete
FR Coupeur de carreaux et de verre à double face
IT Taglierina reversibile per piastrelle e vetro
ES Cuchillo doble para baldosas cerámicas y vidrio
CN 玻璃割刀

120 mm

2x 8mm

YG6X



YATO 	L [mm]	
YT-37404	120	6/240

EN Rotary cutter
PL Nóż z okrągłym ostrzem
DE Rollschneider
RU Нож с круглым лезвием
HU Körpengés kés



RO Cutter rotativ
FR Couteau à lame ronde
IT Coltello con lama circolare
ES Cuchillo con filo redondo
CN 割刀

45 mm

ABS TPR

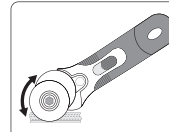
SK5



YATO 	
YT-75360	12/96

EN Double edge trimmer
PL Dwustronny nóż do odcinania oklein
DE Kantentrimmer
RU Двусторонний нож для мебельной пленки
CZ Ořezávací nůž na hrany lamina
HU Kétélű vágó
RO Rindea pt. finisaje



13-25 mm



1-2 SIDED CUTTING EDGE 1-2 STRONIE

SK5



FR Couteau reversible pour bois de placage
IT Doppio coltello
ES Cuchillo de doble filo para cortar chapas de madera
CN 双边刨子



YATO 	
YT-5710	6/48

EN Automatic center punch
PL Punktak automatyczny
DE Automatischer Körner
RU Автоматический кернер
CZ Automatické důlčikem
HU Automatikus központ punci

RO Punctator automat
FR Pointeau automatique
IT Bulino automatico
ES Centro automático punch
CN 自动中心冲

125 mm



YATO 	L [mm]	
YT-47160	125	12/72

EN Scriber for glass, ceramics and metal
PL Rysik do szkła, ceramiki i metalu
DE Reißnadel für Glas, Keramik und Metall
RU Штихель для стекла, керамики и металла
CZ Rýsovací jehla na sklo, keramiku a kov
HU Karctű üveghez, kerámiához és fémhez

RO Ac de trasat pt. sticlă, ceramică și metal
FR Sylet verre, céramique et métal
IT Penna di vetro ceramica metallo
ES Trazador para vidrio, cerámica y metal
CN 划线器

140 mm

YG6X



YATO 	L [mm]	
YT-3740	140	20/300

EN Adjustable automatic center punch
PL Punktak automatyczny regulowany
DE Automatischer Körner mit regelbare Schlagkraft
RU Регулируемое автоматическое кернер
CZ Nastavitelné automatické důlčikem
HU Automatikus központ punci

RO Punctator ajustabil automat
FR Pointeau automatique réglable
IT Bulino automatico regolabile
ES Ajustable centro automático punch
CN 可调中心冲

125 mm

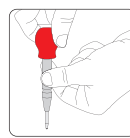

YATO 	L [mm]	
YT-47161	125	12/72

EN Multifunction tool for drawing lines
 PL Przyrząd do trasowania linii równoległych
 DE Markierungswerkzeug für parallele Linien
 RU Устройство для разметки параллельных линий
 CZ Nástroj pro sňmětování rovnolehlých linií
 HU Párhuzamjelölő
 RO Instrument multifuncțional pt. desenarea liniilor
 FR Dispositif de marquage de lignes parallèles
 IT Strumento per disegnare linee parallele
 ES Trazador de arco lineal
 CN 木工划线器

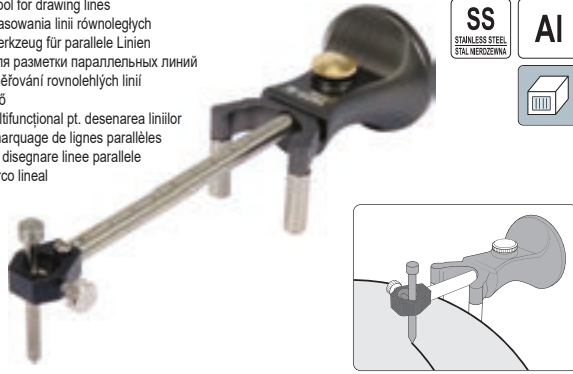

SS
 STAINLESS STEEL
 STAHLMESSINGEN

AI

EN Steel contour gauge
 PL Wzornik do kopiowania kształtów
 DE Profilmuster
 RU Шаблон профилей
 CZ Profilová šablona
 HU Profi Isablon

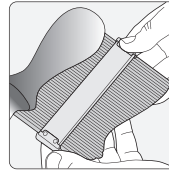

RO Șablon profil
 FR Jauges d'épaisseurs métriques
 IT Sagoma di contorno
 ES Plantilla de perfiles
 CN 仿形规

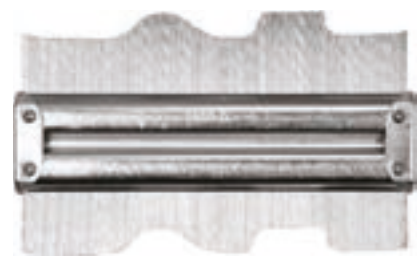

150
 mm

46
 mm

STEEL
 NEEDLES
 STALOWE
 IGLY

mm
inch

YATO		
YT-70730	20	

YATO	L [mm]	
YT-70870	150	12/48

EN Profile gauge
 PL Wzornik profilii
 DE Profilmuster
 RU Шаблон профилей
 CZ Profilová šablona
 HU Profilsablon
 RO Șablon profil

FR Jauges d'épaisseurs métriques
 IT Profilato
 ES Plantilla de perfiles
 CN 轮廓仪



44
 mm

1.5
 mm

YATO	L [mm]	
YT-3735	125	24/72

YATO	L [mm]	
YT-3736	260	10/40

EN Profile gauge
 PL Wzornik profilii
 DE Profilmuster
 RU Шаблон профилей

CZ Profilová šablona
 HU Profilsablon
 RO Șablon profil

IT Profilato
 ES Plantilla de perfiles
 CN 轮廓仪



YATO	L [mm]	
YT-37364	535	9/18

535
 mm

100
 mm

EN Dovetail marker
 PL Szablon do trasowania "jaskółczy ogon"
 DE Schwalbenschwanz-Schablone
 RU Шаблон ласточкин хвост
 CZ Rybinová šablona
 HU Fecskefarag fogazó sablon
 RO Sablon coada de randunica
 FR Gabarit à queue d'aronde
 IT Marcatore a coda di rondine
 ES Plantilla cola de milano
 CN 木工定位器

64x23
x18
 mm

AI

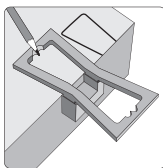

YATO	Dimensions / Wymiary [mm]	
YT-44080	64x23x18	50/200

EN Dovetail marker
 PL Szablon do trasowania "jaskółczy ogon"
 DE Schwalbenschwanz-Schablone
 RU Шаблон ласточкин хвост
 CZ Rybinová šablona
 HU Fecskefarag fogazó sablon
 RO Sablon coada de randunica
 FR Gabarit à queue d'aronde
 IT Marcatore a coda di rondine
 ES Plantilla cola de milano
 CN 木工定位器

64x23
x18
 mm

AI

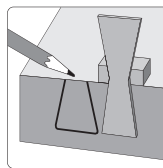

YATO	Dimensions / Wymiary [mm]	
YT-44081	64x23x18	50/200

EN Tine milling template
 PL Szablon frezarski do połączeń na jaskółczy ogon
 DE Zinkenfrässhablone
 RU Шипорезное приспособление для соединения "ласточкин хвост"
 CZ Cinkovací přípravek
 HU Csapoló készülék
 RO Sablon pt. imbinari coada de randunica
 FR Gabarit pour assemblages à queues d'aronde
 IT Dima per fresatura per collegamenti a coda di rondine
 ES Plantilla para juntas cola milano
 CN 开榫机

max
300
 mm

max
8-32
 mm



YATO	Dimensions / Wymiary [mm]	
YT-44085		2

EN Aluminium alloy scribe gauge
 PL Przymiar traserski stolarski
 DE Anreißschablone für Schreiner
 RU Линейка для разметки и стоглярных работ
 CZ Rýsovací a tesafské pravítko
 HU Asztalos sablon
 RO Sablon din aluminiu
 FR Gabarit de pose charpentier
 IT Righello per falegnameria
 ES Regla de carpintería
 CN 木工划线器

60x45
x45
 mm

AI

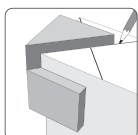

YATO	Dimensions / Wymiary [mm]	
YT-44087	60x45x45	50/200

EN Hinge hole drilling guide locator
 PL Szablon do osadzania zawiasów
 DE Scharnier-Montageschablone
 RU Шаблон для установки петель
 CZ Šablona pro montáž závěsů
 HU Zsanér sablon
 RO Dispozitiv ghidaj gaurile balamale
 FR Gabarit de perçage pour charnières
 IT Dima di traccia per cerniere
 ES Plantilla para bisagras
 CN 定位器

85x40
x22
 mm

ABS



YATO	Dimensions / Wymiary [mm]	
YT-44135	85x40x22	50/200

EN Hinge hole drilling guide locator
 PL Szablon do osadzania zawiasów
 DE Scharnier-Montageschablone
 RU Шаблон для установки петель
 CZ Šablona pro montáž závěsů
 HU Zsanér sablon
 RO Dispozitiv ghidaj gaurile balamale
 FR Gabarit de perçage pour charnières
 IT Dima di traccia per cerniere
 ES Plantilla para bisagras
 CN 定位器

270x55
x3.6
 mm

ABS



YATO	Dimensions / Wymiary [mm]	
YT-44136	270x55x3.6	50/200

EN Leather punch
PL Przebijak do skóry
DE Lederlocher
RU Круглый пробойник для кожи
CZ Průbojník na kůži
HU Bőryukasztó
RO Preducele
FR Perçoirs à cuir
IT Punteruolo per pelle
ES Perforar en piel
CN 皮带冲

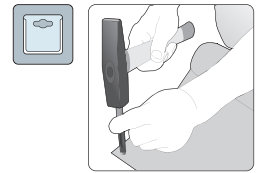

YATO	Ø [mm]	
YT-35850	2	20/100
YT-35851	3	20/100
YT-35852	4	20/100
YT-35853	5	20/100
YT-35854	6	20/100
YT-35855	7	20/100
YT-35856	8	20/100
YT-35857	9	20/100

YATO	Ø [mm]	
YT-35858	10	20/100
YT-35859	11	20/100
YT-35860	12	20/100
YT-35861	13	20/100
YT-35862	14	20/100
YT-35863	15	20/100
YT-35864	16	20/100
YT-35865	17	20/100

YATO	Ø [mm]	
YT-35866	18	20/100
YT-35867	19	20/80
YT-35868	20	20/80
YT-35869	21	20/60
YT-35870	22	20/80
YT-35871	23	10/50
YT-35872	24	20/60
YT-35873	25	20/60

EN Punch set
PL Przebijaki do skóry
DE Lederlocher-set
RU Набор пробойников для кожи
CZ Sada průbojníků na kůži
HU Bőryukasztó készlet
RO Set preducele
FR Kit de perçoirs à cuir
IT Set di punzoni
ES Juego de perforar en piel
CN 皮带冲组套

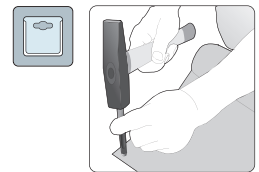

3
PCS

4
PCS

YATO	Ø [mm]	
YT-35881	6, 8, 10	20/120

YATO	Ø [mm]	
YT-35880	2, 3, 4, 5	20/120

EN Punch set
PL Przebijaki do skóry
DE Lederlocher-set
RU Набор пробойников для кожи
CZ Sada průbojníků na kůži
HU Bőryukasztó készlet
RO Set preducele
FR Kit de perçoirs à cuir
IT Set di punzoni
ES Juego de perforar en piel
CN 皮带冲组套



9
PCS



YATO	Ø [mm]	
YT-3590	2, 5, 3, 4, 5, 6, 7, 8, 9, 10	50

EN Punch set
PL Przebijaki do skóry
DE Lederlocher-set
RU Набор пробойников для кожи
CZ Sada průbojníků na kůži
HU Bőryukasztó készlet
RO Set preducele
FR Kit de perçoirs à cuir
IT Set di punzoni
ES Juego de perforar en piel
CN 皮带冲组套



15
PCS



YATO	Ø [mm]	
YT-3591	2, 2.5, 3.2, 4, 4.8, 5.5, 6.4, 8, 9.5, 11.1, 12.7, 14, 15.8, 19, 22	10

EN PVC pipe cutter
PL Obcinak do rur PVC
DE PVC Rohrabscneider
RU Труборез для ПВХ труб
CZ Rezač PVC trubek
HU Csővágó olló PVC csövekhez
RO Clește pt. tăiat țevi din PVC
FR Coupe-tube en PVC
IT Cesovia per tubi in PVC
ES Cortatubos PVC
CN 管子割刀



max Ø 35 mm
PEX
PVC PP PU PE
HRC 54
8Cr13

YATO	max. Ø [mm]	
YT-2230	35	6/48

EN PVC pipe cutter
PL Obcinak do rur PVC
DE PVC Rohrabscneider
RU Труборез для ПВХ труб
CZ Rezač PVC trubek
HU Csővágó olló PVC csövekhez
RO Clește pt. tăiat țevi din PVC
FR Coupe-tube en PVC
IT Cesovia per tubi in PVC
ES Cortatubos PVC
CN 管子割刀



max Ø 42 mm
PEX
PVC PP PU PE
HRC 54
8Cr13
RATCHET SYSTEM ZAPACKOVY
QUICK OPENING SZYBKIE OTWIERANIE

YATO	max. Ø [mm]	
YT-2231	42	6/48

EN PVC pipe cutter
PL Obcinak do rur PVC
DE PVC Rohrabscneider
RU Труборез для ПВХ труб
CZ Rezač PVC trubek
HU Csővágó olló PVC csövekhez
RO Clește pt. tăiat țevi din PVC
FR Coupe-tube en PVC
IT Cesovia per tubi in PVC
ES Cortatubos PVC
CN 管子割刀



max Ø 63 mm
PEX
PVC PP PU PE
HRC 56-58
8Cr13
RATCHET SYSTEM ZAPACKOVY
QUICK OPENING SZYBKIE OTWIERANIE

YATO	max. Ø [mm]	
YT-22312	63	6/24

EN PVC pipe cutter
 PL Obcinak do rur PCV
 DE PVC Rohrschneider
 RU Труборез для ПВХ труб
 CZ Řezač PVC trubek
 HU Csővágó olló PVC csővekhez
 RO Clește pt. tăiat țevi din PVC
 FR Coupeur aux tubes
 IT Taglia tubi PVC
 ES Cortatubos PVC
 CN 管子割刀

PEX
 PVC PP PU PE
 HRC 54
 8Cr13
 AI
 RATCHET SYSTEM SYSTEM ZAPADKOWY
 QUICK OPENING SZYBKE OTWIERANIE

max Ø 51 mm



max Ø 64 mm



YATO	max. Ø [mm]	
YT-2228	51	6/24

YATO	max. Ø [mm]	
YT-2229	64	6/24

EN PVC pipe cutter
 PL Obcinak do rur PVC
 DE PVC Rohrschneider
 RU Труборез для труб из ПВХ
 CZ Řezač PVC trubek
 HU Csővágó olló PVC csővekhez
 RO Clește pt. tăiat țevi din PVC
 FR Coupe-tubes PVC a cliquet
 IT Taglia tubi PVC
 ES Cortatubos para PVC
 CN PVC 管子割刀

PVC PP PU PE
 PTFE
 SK5
 AI

max Ø 36 mm



YATO	max. Ø [mm]	
YT-22270	36	10/50

max Ø 42 mm



max Ø 50 mm



YATO	max. Ø [mm]	
YT-22271	42	10/40

YATO	max. Ø [mm]	
YT-22272	50	10/30

max Ø 63 mm



max Ø 75 mm



YATO	max. Ø [mm]	
YT-22273	63	10/30

YATO	max. Ø [mm]	
YT-22274	75	10/30

EN PVC pipe cutter
 PL Obcinak do rur PVC
 DE PVC Rohrschneider
 RU Труборез для труб из ПВХ
 CZ Řezač PVC trubek
 HU Csővágó olló PVC csővekhez
 RO Clește pt. tăiat țevi din PVC
 FR Coupe-tube en PVC
 IT Cesovia per tubi in PVC
 ES Cortatubos para PVC
 CN PVC 管子割刀

Ø 32 mm
 PVC PP PU PE
 SK5
 AI



YATO	max. Ø [mm]	
YT-22301	32	12/120

EN PVC pipe cutter
 PL Obcinak do rur PVC
 DE PVC Rohrschneider
 RU Труборез для труб из ПВХ
 CZ Řezač PVC trubek
 HU Csővágó olló PVC csővekhez
 RO Clește pt. tăiat țevi din PVC
 FR Coupe-tubes PVC a cliquet
 IT Taglia tubi PVC
 ES Cortatubos para PVC
 CN PVC 管子割刀

PVC PP PU PE
 HRC 54
 8Cr13
 AI

max Ø 42 mm



max Ø 64 mm



YATO	max. Ø [mm]	
YT-22292	42	6/48

YATO	max. Ø [mm]	
YT-22293	64	6/24

EN Pipe cutter
 PL Obcinak do rur
 DE Rohrschneider
 RU Труборез для труб
 CZ Řezač trubek
 HU Csővágó olló csővekhez
 RO Clește pt. tăiat țevi
 FR Coupe-tube
 IT Tagliatubi
 ES Cortatubos
 CN 快速管子割刀

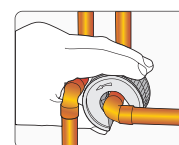

PEX
 PVC PP PU PE
 BEARING STEEL STAL ŁOŻYSKOWA

YATO	Cutting diameter / Średnica cięcia	External diameter / Średnica zewnętrzna [mm]	
YT-22353	19/32" (15 mm)	48	10/50
YT-22354	23/32" (18 mm)	59	10/50
YT-22355	7/8" (22 mm)	56	10/50

EN Exhaust pipe cutting tool
PL Obcinak do rur wydechowych
DE Auspuffrohrsneider
RU Цепной резак выхлопной трубы
CZ Rezačka vyfukového potrubí
HU Kírfűgőcső vágó
RO Instrument de tăiere a țevilor de esapament
FR Coupeur de tuyau d'échappement
IT Tagliatubi di scarico
ES Cortador de tubos de escape
CN 排气管割刀

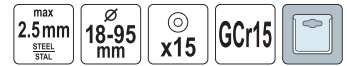

YATO		
YT-06169		12/24

EN Pipe cutter
PL Obcinak do rur
DE Rohrschneider
RU Труборез для труб
CZ Řezač trubek
HU Csővágó olló csövekhez
RO Clește pt. tăiat țevi
FR Coupeurs aux tubes
IT Rullo di taglio per tubi
ES Cortatubos
CN 管子割刀



YATO	Cutting diameter / Średnica cięcia	
YT-22318	1/10" - 7/8" (3-22 mm)	100



QUICK ADJUSTMENT SZYBKA REGULACJA



HRC 56-62



YATO	Cutting diameter / Średnica cięcia [mm]	
YT-22341	3-28	10/60

YATO	Cutting diameter / Średnica cięcia [mm]	
YT-22342	3-28	6/48



YATO	Cutting diameter / Średnica cięcia	
YT-22338	1/10" - 1-1/4" (3-32 mm)	50

YATO	Cutting diameter / Średnica cięcia	
YT-2232	3/8" - 1-5/8" (10-40 mm)	20

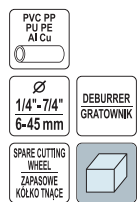

QUICK ADJUSTMENT SZYBKA REGULACJA



HRC 56-62



YATO	Cutting diameter / Średnica cięcia	
YT-2233	1/4" - 1-3/4" (6-45 mm)	25

YATO	Cutting diameter / Średnica cięcia [mm]	
YT-22344	16-54	4/16

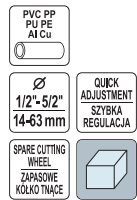

QUICK ADJUSTMENT SZYBKA REGULACJA



YATO	Cutting diameter / Średnica cięcia	
YT-2234	1/2" - 2-1/2" (14-63 mm)	25

YATO	Cutting diameter / Średnica cięcia	
YT-2235	2" - 5" (50-127 mm)	10



DEBURRER GRATOWNIK



YATO	Cutting diameter / Średnica cięcia [mm]	
YT-22332	6-35	5/50

YATO	Cutting diameter / Średnica cięcia [mm]	
YT-22333	3-42	4/32

EN Replacement cutting wheel for pipe cutters
 PL Zapasowe kółko tnące do obcinaka do rur
 DE Ersatzschneidrad für Rohrabsschneider
 RU Запасной режущий диск для труборезов
 CZ Náhradní řezné kolečko na trubky frézy
 HU Tartalék vágókerék cső vágó
 RO Roata de schimb pt. taiere tevi
 FR Molette pour coupe
 IT Ruota di ricambio per tagliatubi
 ES Rueda de corte de repuesto para cortatubos
 CN 管子割刀刀片

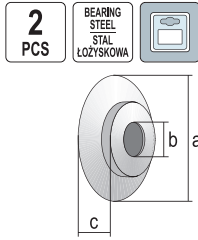

EN Replacement cutting wheel for pipe cutters
 PL Zapasowe kółko tnące do obcinaka do rur
 DE Ersatzschneidrad für Rohrabsschneider
 RU Запасной режущий диск для труборезов
 CZ Náhradní řezné kolečko na trubky frézy
 HU Tartalék vágókerék cső vágó
 RO Roata de schimb pt. taiere tevi
 FR Molette pour coupe
 IT Ruota di ricambio per tagliatubi
 ES Rueda de corte de repuesto para cortatubos
 CN 管子割刀刀片

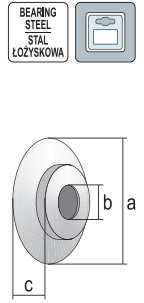

YATO	a [mm]	b [mm]	c [mm]	For / Dla	
YT-22313	18	6.0	4.8	YT-2233	50/300
YT-22314	26	14.0	7.5	YT-2232	6/108
YT-22315	18	6.0	4.8	YT-22338	50/300
YT-22316	27	6.3	5.0	YT-2234	24/288

YATO	a [mm]	b [mm]	c [mm]	For / Dla	
YT-22317	44	10.6	8	YT-2235	12/144

EN Replacement cutting wheel for pipe cutters
 PL Zapasowe kółko tnące do obcinaka do rur
 DE Ersatzschneidrad für Rohrabsschneider
 RU Запасной режущий диск для труборезов
 CZ Náhradní řezné kolečko na trubky frézy
 HU Tartalék vágókerék cső vágó
 RO Roata de schimb pt. taiere tevi
 FR Molette de rechange pour coupe-tube
 IT Ruota di ricambio per tagliatubi
 ES Rueda de corte de repuesto para cortatubos
 CN 管子割刀刀片

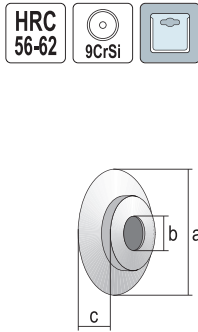

EN Replacement cutting wheel for pipe cutters
 PL Zapasowe kółko tnące do obcinaka do rur
 DE Ersatzschneidrad für Rohrabsschneider
 RU Запасной режущий диск для труборезов
 CZ Náhradní řezné kolečko na trubky frézy
 HU Tartalék vágókerék cső vágó
 RO Roata de schimb pt. taiere tevi
 FR Molette de rechange pour coupe-tube
 IT Ruota di ricambio per tagliatubi
 ES Rueda de corte de repuesto para cortatubos
 CN 管子割刀刀片

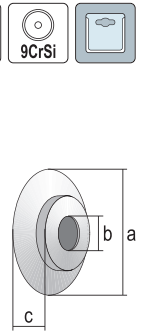

YATO	a [mm]	b [mm]	c [mm]	For / Dla	
YT-22343	18.5	6	4.8	YT-22341, YT-22342	24/144

YATO	a [mm]	b [mm]	c [mm]	For / Dla	
YT-22345	21.5	6	4.9	YT-22344	24/144

EN Window scraper
 PL Skrobak do szyby
 DE Fensterabstreicher
 RU Скребок для стекла

CZ Škrabák na skla
 HU Kaparó üveghez
 RO Răzuitor pt. geamuri
 FR Gratte-givre

IT Collellino con lama trapezoidale
 ES Rascador de cristales
 CN 玻璃刮刀



TELESCOPIC HANDLE
 UCHWYT
 TELESKOPOWY

YATO	L [mm]	
YT-7550	300	10/60

YATO	L [mm]	
YT-7551	390-600	10/60

EN Floor scraper
 PL Skrobak do podłóg
 DE Bodenabstreifer

RU Скребок для полов
 CZ Škrabka na podlahu
 HU Padlókaparó

RO Racleta pt. podea
 FR Racloir à plancher
 IT Raschietto per pavimenti

ES Rascador para suelos
 CN 地板碎刀



350 mm
 Fitting blades: YT-52843
 Pasujące ostrza: YT-52843

YATO	L [mm]	
YT-52840	350	6/12

500 mm
 Fitting blades: YT-52843
 Pasujące ostrza: YT-52843

YATO	L [mm]	
YT-52841	500	2/12

EN Spare blades
 PL Ostrza zapasowe
 DE Ersatzklingen

RU Запасные лезвия
 CZ Náhradní ostří
 HU Pótkések

RO Lame de rezerva
 FR Lames de rechange
 IT Lame di ricambio

ES Cuchillas de repuesto
 CN 刀片



For YT-52840, YT-52841
 Dla YT-52840, YT-52841

YATO		
YT-52843		10

- EN Sliding hammer with scraper
PL Młot bezwładnościowy ze skrobakiem
DE Auswirkungen Schaber
RU Ударный скребок
CZ Škrabka
HU Kaparó eszköz
- RO Ciocan inertial cu răzuitor
FR Impact grattoir
IT Martello inerziale con raschiatore
ES Raspador de impacto
CN 冲击铲刀



YATO	L [mm]	
YT-52850	580-820	6

- EN Scraper
PL Cyklina
DE Ziehklinge
- RU Цикля
CZ Škrabka na parkety
HU Simitógyalu
- RO Răzuitor
FR Grattoir
IT Raschietto per legno
- ES Raspador
CN 油漆刮刀



YATO	L [mm]	Blade length / Długość ostrza [mm]	
YT-75460	260	52	10/60



YATO	L [mm]	Blade length / Długość ostrza [mm]	
YT-75461	290	62	12/48



YATO	L [mm]	Blade length / Długość ostrza [mm]	
YT-75464	200	30	10/50
YT-75465	220	40	10/50
YT-75467	270	65	6/24

- EN Prybar scraper set
PL Zestaw skrobaków ze stali nierdzewnej
DE Edelstahl-Schaber-Set
RU Набор скребок из нержавеющей стали
CZ Sada škrabek z nerezové oceli
HU Kaparókészlet rozsdamentes acélból
RO Set de raclete
FR Ensemble de racleurs en acier inoxydable
IT Set di raschietti in acciaio inox
ES Juego de raspadores de acero inoxidable
CN 铲刀

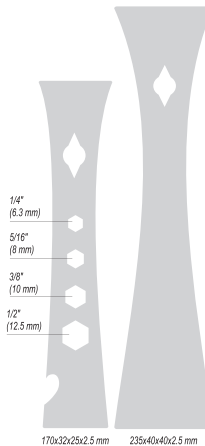

YATO	[mm]	
YT-52860	170x32x25, 235x40x40	12/48

- EN Pry bar scraper set
PL Zestaw łomów i skrobaków
DE Brecheisen Schaber
RU Ломы скребки
CZ Škrabky páčidla
HU Feszítővas kaparó
RO Set leviere
FR Pieds-de-biche et grattoirs
IT Piedi di porco raschietti
ES Palancas raspadores
CN 撬棍

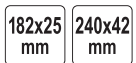

YATO	[mm]	
YT-52863	135x14, 182x25, 240x42	12/48

- EN Cabinet scraper set
PL Zestaw skrobaków ręcznych nierdzewnych
DE Edelstahl-Handschaber-Set
RU Набор ручных нержавеющей скребок
CZ Sada nerezových ručních škrabek
HU Kézi rozsdamentes kaparókészlet
RO Set raclete
FR Ensemble de grattoirs à main en acier inoxydable
IT Set di raschietti manuali inox
ES Juego de raspadores manuales inoxidables
CN 刮板

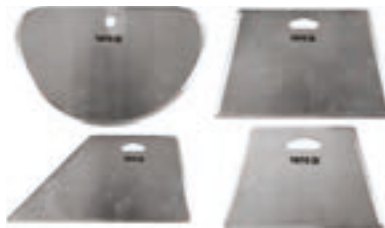

YATO	[mm]	
YT-52788	100x160, 120x80, 160x100, 205x98	20/40

- EN Block plane
PL Metalowy strug do drewna
DE Metallhobel für Holz
RU Металлический рубанок по дереву
CZ Kovový hoblík do dřeva
HU Fémgyalu
RO Rindea
FR Rabot à bois en métal
IT Pialla metallica per legno
ES Cepillo metálico para madera
CN 木工铁刨

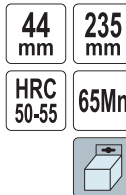

YATO	Blade width / Szerokość ostrza [mm]	L [mm]	
YT-62900	44	235	24

- EN Block plane with two blade
PL Metalowy strug dwuosłzowy
DE Metallhobel mit Doppelreisen
RU Металлический рубанок с обоюдострым лезвием
CZ Kovový hoblík s dvojitým ostrím
HU Kétpengés fémgyalu
RO Rindea cu 2 lame
FR Rabot en métal à deux lames
IT Pialla metallica a due lame
ES Cepillo metálico de doble hoja
CN 墙板刨

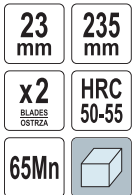

YATO	Blade width / Szerokość ostrza [mm]	L [mm]	
YT-62907	23	235	12/48

EN Steel file
 PL Piłnik do metalu
 DE Werkstatt-Feile
 RU Напильник слесарный
 CZ Zámeňický pilník
 HU Lakatos reszelő
 RO Pliă de lăcătuşerie
 FR Lime à métal
 IT Lime per metallo
 ES Lima para metal
 CN 扁锉

#1 #2 #3 150 mm 200 mm 250 mm 300 mm T12



YATO	#	L [mm]	
YT-62228	1	150	20/80
YT-62229	1	200	20/80
YT-6223	1	250	20/80
YT-62231	1	300	10/40
YT-6180	2	150	20/80
YT-6185	2	200	20/80
YT-6228	2	250	20/80
YT-6190	2	300	10/40
YT-62328	3	150	20/80
YT-62329	3	200	20/80
YT-6233	3	250	20/80
YT-62331	3	300	10/40

YATO	#	L [mm]	
YT-62238	1	150	20/80
YT-62239	1	200	20/80
YT-6224	1	250	20/80
YT-62241	1	300	10/40
YT-6181	2	150	20/80
YT-6186	2	200	20/80
YT-6229	2	250	20/80
YT-6191	2	300	10/40
YT-62243	3	150	20/80
YT-62244	3	200	20/80
YT-62245	3	250	20/80
YT-62246	3	300	10/40



YATO	#	L [mm]	
YT-62248	1	150	20/80
YT-62249	1	200	20/80
YT-6225	1	250	20/80
YT-62251	1	300	10/40
YT-6182	2	150	20/80
YT-6187	2	200	20/80
YT-6230	2	250	20/80
YT-6192	2	300	10/40
YT-62338	3	150	20/80
YT-62339	3	200	20/80
YT-6234	3	250	20/80
YT-62341	3	300	10/40

YATO	#	L [mm]	
YT-62258	1	150	20/80
YT-62259	1	200	20/80
YT-6226	1	250	20/80
YT-62261	1	300	10/40
YT-6183	2	150	20/80
YT-6188	2	200	20/80
YT-6231	2	250	20/80
YT-6193	2	300	10/40
YT-62348	3	150	20/80
YT-62349	3	200	20/80
YT-6235	3	250	20/80
YT-62351	3	300	10/40

YATO	#	L [mm]	
YT-62268	1	150	20/80
YT-62269	1	200	20/80
YT-6227	1	250	20/80
YT-62271	1	300	10/40
YT-6184	2	150	20/80
YT-6189	2	200	20/80
YT-6232	2	250	20/80
YT-6194	2	300	10/40
YT-62358	3	150	20/80
YT-62359	3	200	20/80
YT-6236	3	250	20/80

EN Steel file set
 PL Piłniki do metalu
 DE Werkstatt-Feilen
 RU Набор напильников слесарных
 CZ Zámeňicke pilníky
 HU Lakatos reszelő
 RO Pile de lăcătuşerie
 FR Set de limes à métal
 IT Lime per metallo
 ES Juego de limas para metal
 CN 钢锉组套

#1 #2 #3
 250 mm T12



3 PCS



5 PCS



5 PCS



YATO	#	
YT-6237	2	10/20



YATO	#	
YT-6238	1, 2	5/10

YATO	#	
YT-6239	3	5/10

- EN Flat depth-gauge file
PL Piłnik płaski do szlifowania ograniczników głębokości
DE Flachfeile zum Schleifen von Tiefenanschlägen
RU Плоский напильник для шлифования ограничителей глубины
CZ Plochy pilník k broušení hloubkových dorazů
HU Lapos reszelő mélységátarólok csiszolásához
RO Pila plata pt. ascuțit dintii lant drujba
FR Lime plate pour jauge de profondeur de ponçage
IT Lima piatta per affilatura di fermi di profondità
ES Lima plana para esmerilar topes de profundidad
CN 扁锉





250 mm 15x2 mm BEARING STEEL STAL ŁOŻYSKOWA
PP 

YATO 	L [mm]	
YT-85022	250	200

- EN Round chain saw file set
PL Zestaw pilników okrągłych do ostrzenia łańcuchów
DE Rundfeilensatz zum schärfen von Ketten
RU Набор круглых напильников для заточки цепей
CZ Sada kulatých pilníků k ostření řetězů
HU Kerek reszelőkészlet láncélezéshez
RO Set pile rotunde pt. lant drujba
FR Limes rondes pour affûtage de chaînes
IT Kit di lime tonde per affilatura catene
ES Juego de limas redondas para afilar cadenas
CN 链锯锉



3 PCS 250 mm BEARING STEEL STAL ŁOŻYSKOWA
PP 

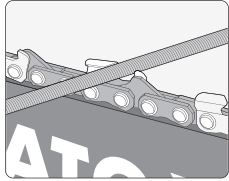

YATO 	Ø [mm]	For / Dla	
YT-85025	4.0	3/8"	4/200
YT-85026	4.5	3/8", 0.325"	4/200
YT-85027	4.8	0.325"	4/200



- EN Chain saw file with guide
PL Prowadnik z pilnikiem do ostrzenia łańcuchów
DE Führungsschiene mit Kettenschärffeile
RU Направляющая с напильником для заточки цепей
CZ Vodítko s pilníkem k ostření řetězů
HU Vezető láncélező reszelővel
RO Pila lant drujba cu ghidaj
FR Guide avec lime pour affûtage de chaîne
IT Guida con lima tonda per affilatura catene
ES Guía con lima para afilar cadenas
CN 链锯锉3件套



3 PCS 250 mm BEARING STEEL STAL ŁOŻYSKOWA
PP 

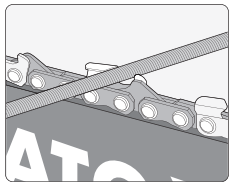

YATO 	Ø [mm]	For / Dla	
YT-85030	4.0	3/8"	4/100
YT-85031	4.5	3/8", 0.325"	4/100
YT-85032	4.8	0.325"	4/100



- EN Chain saw file with guide
PL Prowadnik z pilnikiem do ostrzenia łańcuchów
DE Führungsschiene mit Kettenschärffeile
RU Направляющая с напильником для заточки цепей
CZ Vodítko s pilníkem k ostření řetězů
HU Vezető láncélező reszelővel
RO Pila lant drujba cu ghidaj
FR Guide avec lime pour affûtage de chaîne
IT Guida con lima tonda per affilatura catene
ES Guía con lima para afilar cadenas
CN 链锯锉刀塑柄架



250 mm 30° 35° BEARING STEEL STAL ŁOŻYSKOWA
PP 

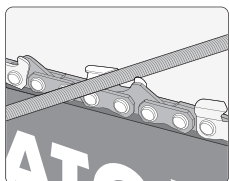

YATO 	Ø [mm]	For / Dla	
YT-85035	4.0	3/8"	200
YT-85036	4.5	3/8", 0.325"	200
YT-85037	4.8	0.325"	200



- EN Chain sharpening set
PL Zestaw do ostrzenia łańcucha
DE Kettenschärfset
RU Набор для заточки цепи
CZ Sada k ostření řetězů
HU Láncélező készlet
RO Set ascuțit lant drujba
FR Kit d'affûtage de chaîne
IT Kit per affilatura catene
ES Set para afilar cadenas
CN 链锯锉刀布袋套装



4 PCS 25° 30° 35° BEARING STEEL STAL ŁOŻYSKOWA
PP 

YATO 	Ø [mm]	For / Dla	
YT-85040	4.0	3/8"	50
YT-85041	4.5	3/8", 0.325"	50
YT-85042	4.8	0.325"	50

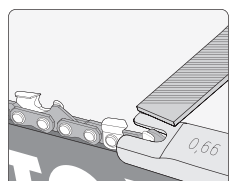
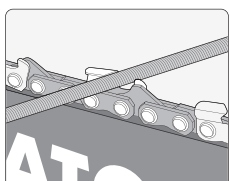

EN Needle file set
 PL Zestaw pilników iglaków
 DE Nadelfeilsatz
 RU Набор напильников надфилей

CZ Sada jehlových pilníků
 HU Tűreszelő készlet
 RO Set pile conice
 FR Set de limes

IT Set di lime e lime ad ago
 ES Juego de limas de aguja
 CN 什锦锉组套

6 PCS GCr15



YATO	Working length / Długość robocza [mm]	[mm]	
YT-6160	65	3x140	50/200

YATO	Working length / Długość robocza [mm]	[mm]	
YT-6160	65	3x140	50/200

YATO	Working length / Długość robocza [mm]	[mm]	
YT-6160	65	3x140	50/200

EN Needle file set
 PL Zestaw pilników iglaków
 DE Nadelfeilsatz
 RU Набор напильников надфилей

CZ Sada jehlových pilníků
 HU Tűreszelő készlet
 RO Set pile conice
 FR Set de limes

IT Set di lime e lime ad ago
 ES Juego de limas de aguja
 CN 什锦锉组套

10 PCS GCr15

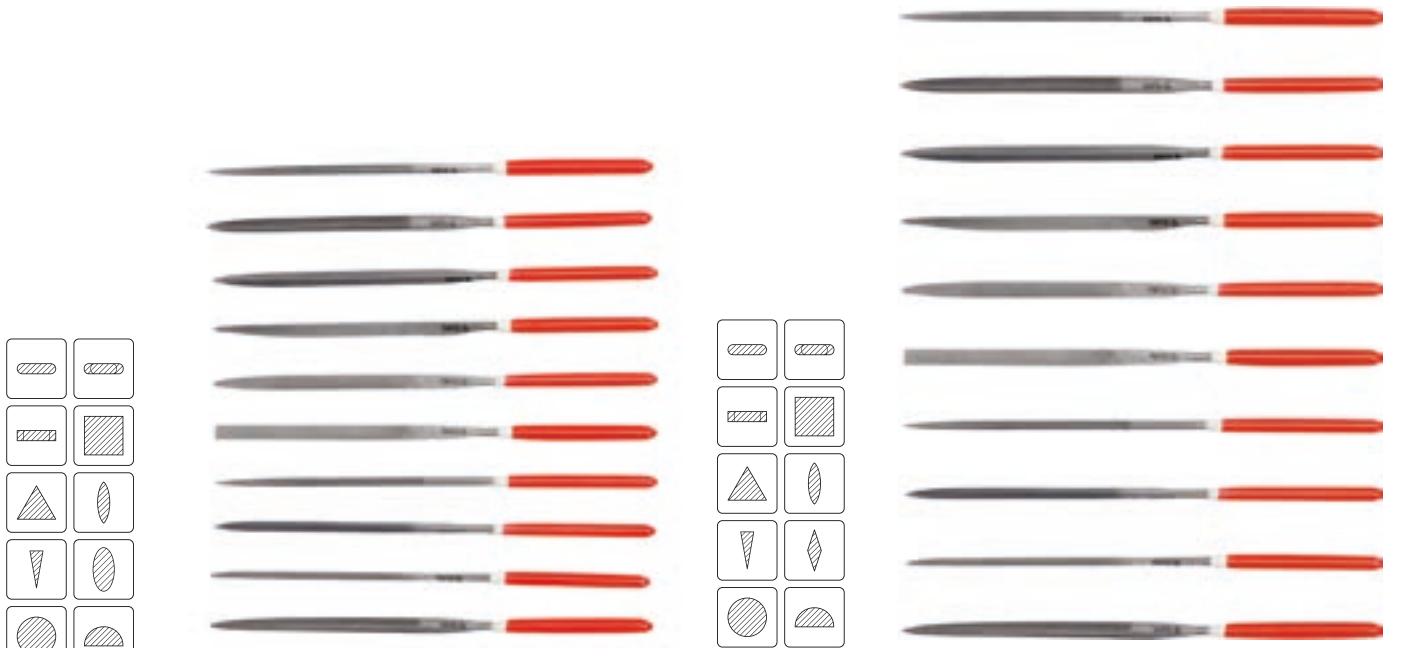

YATO	Working length / Długość robocza [mm]	[mm]	
YT-6163	65	3x140	25/100

YATO	Working length / Długość robocza [mm]	[mm]	
YT-6164	75	4x160	25/100
YT-6165	85	5x180	25/50

EN Diamond needle file
 PL Pilnik iglak diamentowy
 DE Diamant-Nadelfeile
 RU Надфиль алмазный

CZ Diamantový jehlový pilník
 HU Gyémánt tűreszelő
 RO Pila diamantata
 FR Lime diamant

IT Lima ad ago diamantata
 ES Lima de aguja adiamantada
 CN 金刚石平头扁锉

P150



YATO	Grit / Ziarnistość	Coating length / Długość nasypu [mm]	[mm]	
YT-6140	P150	52	3x140	120/1200
YT-6147	P150	50	4x160	80/800
YT-6152	P150	70	5x180	45/450

YATO	Grit / Ziarnistość	Coating length / Długość nasypu [mm]	[mm]	
YT-6140	P150	52	3x140	120/1200
YT-6147	P150	50	4x160	80/800
YT-6152	P150	70	5x180	45/450

YATO	Grit / Ziarnistość	Coating length / Długość nasypu [mm]	[mm]	
YT-6140	P150	52	3x140	120/1200
YT-6147	P150	50	4x160	80/800
YT-6152	P150	70	5x180	45/450

EN Diamond needle file set
PL Zestaw pilników diamentowych iglaków
DE Diamant-Nadelfeileinsatz
RU Набор надфилей алмазных

CZ Sada diamentových jehlových pilníků
HU Gyémánt tűreszelő készlet
RO Set pile diamantate
FR Set de limes diamant

IT Set lime ad ago diamantate
ES Juego de limas de aguja adiamantadas
CN 金刚石整形锉

P150

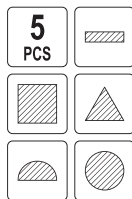
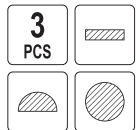

YATO	Grit / Ziarnistość	Coating length / Długość nasypu [mm]	[mm]	
YT-6156	P150	70	5x180	10/100

YATO	Grit / Ziarnistość	Coating length / Długość nasypu [mm]	[mm]	
YT-6156	P150	70	5x180	10/100

EN Diamond needle file set
PL Zestaw pilników diamentowych iglaków
DE Diamant-Nadelfeileinsatz
RU Набор надфилей алмазных

CZ Sada diamentových jehlových pilníků
HU Gyémánt tűreszelő készlet
RO Set pile diamantate
FR Set de limes diamant

IT Set lime ad ago diamantate
ES Juego de limas de aguja adiamantadas
CN 金刚石整形锉

10
PCS

P150

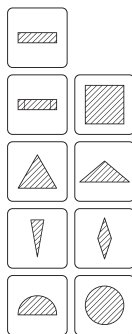
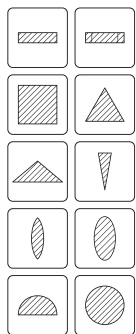

YATO	Grit / Ziarnistość	Coating length / Długość nasypu [mm]	[mm]	
YT-6156	P150	70	5x180	10/100

YATO	Grit / Ziarnistość	Coating length / Długość nasypu [mm]	[mm]	
YT-6156	P150	70	5x180	10/100

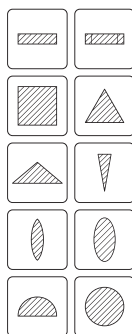
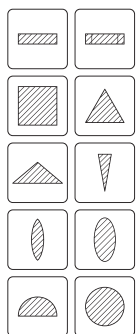

YATO	Grit / Ziarnistość	Coating length / Długość nasypu [mm]	[mm]	
YT-6156	P150	70	5x180	10/100

YATO	Grit / Ziarnistość	Coating length / Długość nasypu [mm]	[mm]	
YT-6156	P150	70	5x180	10/100

- EN Diamond sharpening file
 PL Oseka diamentowa - pilnik
 DE Diamant-Schärfen-Datei
 RU Напильник алмазный
 CZ Diamantový pilník
 HU Gyémánt reszelők
- RO Pila diamentata pt. ascuțit
 FR Fichier de diamant
 IT Pietra diamentata - lima
 ES Archivo de afilado de diamante
 CN 金刚石锉刀



YATO	Grit / Ziarnistość	L [mm]	
YT-76080	G240, G400	250	12/48

- EN Diamond whetstone
 PL Oseka diamentowa - blok
 DE Diamant Schleifstein
 RU Алмазный брусок
 CZ Diamond brousek
 HU Kétoldalas gyémánt fenékö
 RO Piatra abraziva diamentata
 FR Afiloir diamanté
 IT Pietra diamentata
 ES Piedra de afilar diamentada
 CN 金刚石磨刀石



YATO	Grit / Ziarnistość	Coating length / Długość nasypu [mm]	[mm]	
YT-76085	G300	50	4x150	10/60
YT-76086	G400	50	4x150	10/60
YT-76087	G600	50	4x150	10/60

- EN Diamond grinding wheel dresser
 PL Przyrząd diamentowy do wyrównywania tarcz szlifierskich
 DE Diamant-Schleifrad-Dresser
 RU Брусок алмазный для выравнивания абразивных дисков
 CZ Diamantový ohrnovávač brusných kotoučů
 HU Gyémánt kölelhúzó
 RO Diamant pt. rectifi care pietre polizor
 FR Diamant meule roue pierre dresse
 IT Utensile diamentato per levigare le mole
 ES Muelas tocador con diamante plana
 CN 砂轮修正器



YATO	
YT-61395	20/200

- EN Wood rasp
 PL Tarnik do drewna
 DE Holzraspel
 RU Рашпиля для дерева
- CZ Rašple do dřeva
 HU Fareszelő
 RO Raspe
 FR Lime à bois
- IT Lime per legno
 ES Escarpelo para madera
 CN 木工挫 - 半圆



YATO	L [mm]		YATO	L [mm]		YATO	L [mm]	
YT-6220	250	12/72	YT-6219	250	12/72	YT-6221	250	12/72

- EN Wood rasp set
 PL Tarniki do drewna
 DE Holzraspelsatz
 RU Рашпили для дерева
 CZ Sada rašplí do dřeva
 HU Fareszelő készlet
- RO Set raspe
 FR Set de limes à bois
 IT Set di lime per legno
 ES Juego de escarpelos para madera
 CN 木工挫组套

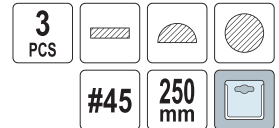

YATO	L [mm]	
YT-6222	250	5/20

- EN Rasp for plaster
 PL Tarnik do gipsu
 DE Gipskartonplatten Rasp
 RU Рашпиля для гипсокартона
 CZ Rašple pro omítky
 HU Reszelt vakolat
 RO Rindea
 FR Râpe pour plâtre
 IT Raspa per gesso
 ES Eliminador de yeso
 CN 挫刨

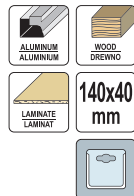

YATO	Working length / Długość robocza [mm]	Working width / Szerokość robocza [mm]	
YT-61678	140	40	15/60

- EN Blade for rasp
 PL Ostrze zapasowe do tarnika
 DE Sägeblatt raspel
 RU Лезвие для рашпиля по гипсокартону
 CZ Čepel do škrabacích
 HU Penge reszelő
 RO Lama pt. rasp
 FR Lame râpe
 IT Lama di ricambio per raspa
 ES Hoja para raspar
 CN 挫刨刀片

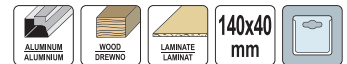

For YT-61678
 Dia YT-61678

YATO	Working length / Długość robocza [mm]	Working width / Szerokość robocza [mm]	
YT-61679	140	40	10/120

EN Rasp for plaster
PL Tarnik do gipsu
DE Gipskartonplatten Rasp
RU Рашиль для гипсокартона
CZ Rašple pro omítky
HU Reszelt vakolat
RO Rindea
FR Râpe pour plâtre
IT Raspa per gesso
ES Eliminador de yeso
CN 锉刨



EN Blade for rasp
PL Ostrze zapasowe do tarnika
DE Sägeblattrespel
RU Лезвие для рашиля по гипсокартону
CZ Čepel do škrabacích
HU Penge reszelő
RO Lama pt. rasp
FR lame râpe
IT Lama di ricambio per raspa
ES Hoja para raspar
CN 锉刨刀片

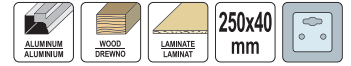

For YT-61680
Dia YT-61680

YATO	Working length / Długość robocza [mm]	Working width / Szerokość robocza [mm]	
YT-61680	250	40	15/60

YATO	Working length / Długość robocza [mm]	Working width / Szerokość robocza [mm]	
YT-61681	250	40	30/120

EN Sand paper
PL Papier ścierny
DE Schleifpapier
RU Наждачная бумага
CZ Smirkový papír
HU Csiszolópapír



- Application: paint, lacquer, filler, wood
- Abrasive: aluminium oxide
- Bond: synthetic resin
- Coating: semi-open
- Zastosowanie: farby, lakiery, szpachle, drewno
- Ścierniwo: tlenek glinu
- Spoiwo: żywica syntetyczna
- Nasyp półotwarty

YATO	Grit / Ziarnistość	[mm]	pcs / szt.	
YT-8350	P40	230x280	50	500
YT-8351	P60	230x280	50	500
YT-8352	P80	230x280	50	500
YT-8353	P100	230x280	50	500
YT-8354	P120	230x280	50	500
YT-8355	P150	230x280	50	500
YT-8356	P180	230x280	50	500
YT-8357	P220	230x280	50	500
YT-8358	P240	230x280	50	500

EN Sand paper
PL Papier ścierny
DE Schleifpapier
RU Наждачная бумага
CZ Smirkový papír
HU Csiszolópapír



- Application: paint, lacquer, filler, wood
- Abrasive: aluminium oxide
- Bond: synthetic resin
- Coating: semi-open
- Zastosowanie: farby, lakiery, szpachle, drewno
- Ścierniwo: tlenek glinu
- Spoiwo: żywica syntetyczna
- Nasyp półotwarty

YATO	Grit / Ziarnistość	Size / Rozmiar	
YT-8441	P60	115 mm x 5 m	12/48
YT-8442	P80	115 mm x 5 m	12/48
YT-8443	P100	115 mm x 5 m	12/48
YT-8444	P120	115 mm x 5 m	12/48
YT-8445	P150	115 mm x 5 m	12/48
YT-8446	P180	115 mm x 5 m	12/48
YT-8447	P240	115 mm x 5 m	12/48
YT-8448	P320	115 mm x 5 m	12/48

EN Sand paper
PL Papier ścierny
DE Schleifpapier
RU Наждачная бумага
CZ Smirkový papír
HU Csiszolópapír



- Application: paint, lacquer, filler, wood
- Abrasive: aluminium oxide
- Bond: synthetic resin
- Coating: semi-open
- Zastosowanie: farby, lakiery, szpachle, drewno
- Ścierniwo: tlenek glinu
- Spoiwo: żywica syntetyczna
- Nasyp półotwarty

YATO	Grit / Ziarnistość	Size / Rozmiar	
YT-8449	P40	93 mm x 5 m	12/48
YT-8450	P60	93 mm x 5 m	12/48
YT-8451	P80	93 mm x 5 m	12/48
YT-8452	P100	93 mm x 5 m	12/48
YT-8453	P120	93 mm x 5 m	12/48
YT-8454	P150	93 mm x 5 m	12/48
YT-8455	P180	93 mm x 5 m	12/48
YT-8456	P240	93 mm x 5 m	12/48

EN Sand paper
PL Papier ścierny
DE Schleifpapier
RU Наждачная бумага
CZ Smirkový papír
HU Csiszolópapír



- Application: paint, lacquer, filler, wood
- Abrasive: aluminium oxide
- Bond: synthetic resin
- Coating: semi-open
- Zastosowanie: farby, lakiery, szpachle, drewno
- Ścierniwo: tlenek glinu
- Spoiwo: żywica syntetyczna
- Nasyp półotwarty

YATO	Grit / Ziarnistość	[mm]	pcs / szt.	
YT-8360	P40	230x280	50	500
YT-8361	P60	230x280	50	500
YT-8362	P80	230x280	50	500
YT-8363	P100	230x280	50	500
YT-8364	P120	230x280	50	500
YT-8365	P150	230x280	50	500
YT-8366	P180	230x280	50	500
YT-8367	P240	230x280	50	500
YT-8368	P320	230x280	50	500

EN Sand paper
 PL Papier ścierny
 DE Schleifpapier
 RU Наждачная бумага
 CZ Smrkový papír
 HU Csiszolópapír

RO Hârtie abrazivă
 FR Papier abrasif
 IT Carta vetrata
 ES Papel de lija
 CN 防水砂纸

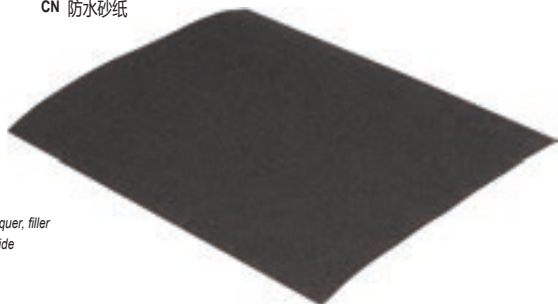

- Application: paint, lacquer, filler
- Abrasive: silicon carbide
- Bond: synthetic resin
- Coating: closed
- Zastosowanie: farby, lakiery, szpachle
- Ścierniwo: węgiel krzemowy
- Spoivo: żywica syntetyczna
- Nasyp pehny

YATO	Grit / Ziarnistość	[mm]	pcs / szt.	
YT-8400	P60	230x280	50	500
YT-8401	P80	230x280	50	500
YT-8402	P100	230x280	50	500
YT-8403	P120	230x280	50	500
YT-8404	P150	230x280	50	500

EN Sand paper
 PL Papier ścierny
 DE Schleifpapier
 RU Наждачная бумага
 CZ Smrkový papír
 HU Csiszolópapír

RO Hârtie abrazivă
 FR Papier abrasif
 IT Carta vetrata
 ES Papel de lija
 CN 防水砂纸



- Application: paint, lacquer, filler
- Abrasive: silicon carbide
- Bond: synthetic resin
- Coating: closed
- Zastosowanie: farby, lakiery, szpachle
- Ścierniwo: węgiel krzemowy
- Spoivo: żywica syntetyczna
- Nasyp pehny

YATO	Grit / Ziarnistość	[mm]	pcs / szt.	
YT-8412	P500	230x280	50	500
YT-8413	P600	230x280	50	500
YT-8414	P800	230x280	50	500
YT-8415	P1000	230x280	50	500
YT-8416	P1200	230x280	50	500
YT-8417	P1500	230x280	50	500
YT-8418	P2000	230x280	50	500

EN Abrasive cloth roll
 PL Płótno ściernie rolka
 DE Schleifgewebe Rolle
 RU Рублон-шлифовальное полотно
 CZ Brusné plátno role
 HU Csiszolóvászon tekercs

RO Rola panza abraziva
 FR Tissu abrasif rouleau
 IT Carta vetrata rotolo
 ES Rollo de pano abrasivo
 CN 砂布



- Application: metal, wood
- Abrasive: aluminium oxide
- Bond: semi-resin
- Coating: closed
- Zastosowanie: metal, drewno
- Ścierniwo: tlenek glinu
- Spoivo: żywica
- Nasyp pehny

YATO	Grit / Ziarnistość	Size / Rozmiar	
YT-83181	P40	150 mm x 30 m	2

EN Sand paper
 PL Papier ścierny
 DE Schleifpapier
 RU Наждачная бумага
 CZ Smrkový papír
 HU Csiszolópapír

RO Hârtie abrazivă
 FR Papier abrasif
 IT Carta vetrata
 ES Papel de lija
 CN 防水砂纸



- Application: paint, lacquer, filler
- Abrasive: silicon carbide
- Bond: synthetic resin
- Coating: closed
- Zastosowanie: farby, lakiery, szpachle
- Ścierniwo: węgiel krzemowy
- Spoivo: żywica syntetyczna
- Nasyp pehny

YATO	Grit / Ziarnistość	[mm]	pcs / szt.	
YT-8405	P180	230x280	50	500
YT-8406	P220	230x280	50	500
YT-8407	P240	230x280	50	500
YT-8408	P280	230x280	50	500
YT-8409	P320	230x280	50	500
YT-8410	P360	230x280	50	500
YT-8411	P400	230x280	50	500

EN Abrasive cloth sheet
 PL Płótno ściernie arkusz
 DE Schleifgewebe Blatt
 RU Шлифовальное полотно
 CZ Brusné plátno
 HU Csiszolóvászon lap

RO Coli panza abraziva
 FR Tissu abrasif
 IT Carta vetrata
 ES Hojas de pano abrasivo
 CN 砂布

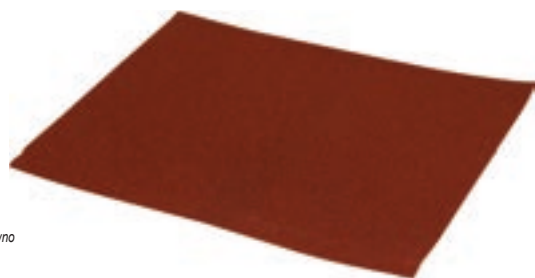

- Application: metal, wood
- Abrasive: aluminium oxide
- Bond: semi-resin
- Coating: closed
- Zastosowanie: metal, drewno
- Ścierniwo: tlenek glinu
- Spoivo: żywica
- Nasyp pehny

YATO	Grit / Ziarnistość	[mm]	pcs / szt.	
YT-83160	P36	230x280	50	250
YT-83161	P40	230x280	50	250
YT-83162	P60	230x280	50	250
YT-83163	P80	230x280	50	250
YT-83164	P100	230x280	50	250
YT-83165	P120	230x280	50	500
YT-83166	P150	230x280	50	500
YT-83167	P180	230x280	50	500
YT-83168	P220	230x280	50	500
YT-83169	P240	230x280	50	500

EN Abrasive cloth roll
 PL Płótno ściernie rolka
 DE Schleifgewebe Rolle
 RU Рублон-шлифовальное полотно
 CZ Brusné plátno role
 HU Csiszolóvászon tekercs

RO Rola panza abraziva
 FR Tissu abrasif rouleau
 IT Carta vetrata rotolo
 ES Rollo de pano abrasivo
 CN 砂布



- Application: metal, wood
- Abrasive: aluminium oxide
- Bond: semi-resin
- Coating: closed
- Zastosowanie: metal, drewno
- Ścierniwo: tlenek glinu
- Spoivo: żywica
- Nasyp pehny

YATO	Grit / Ziarnistość	Size / Rozmiar	
YT-83182	P50	150 mm x 50 m	2
YT-83183	P60	150 mm x 50 m	2
YT-83184	P80	150 mm x 50 m	2
YT-83185	P100	150 mm x 50 m	2
YT-83186	P120	150 mm x 50 m	2
YT-83187	P150	150 mm x 50 m	2
YT-83188	P180	150 mm x 50 m	2

EN Abrasive mesh
PL Siatka ścierna
DE Schleifgitter
RU Абразивная сетка
CZ Brusná síťka
HU Csiszolóháló

RO Plasă abrazivă
FR Disque abrasif à maille
IT Rete abrasiva
ES Malla abrasiva
CN 网状砂纸

3
PCS

28
cm

DELTA

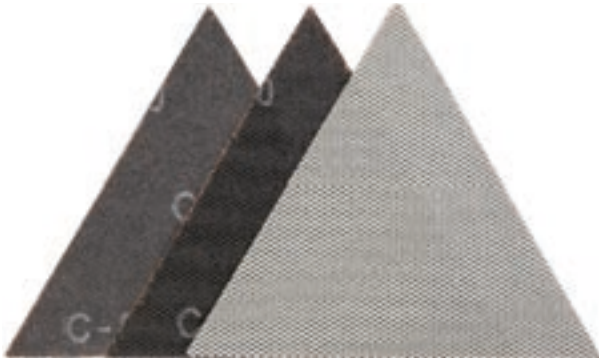



YATO	Grit / Ziarnistość	[mm]	pcs / szt.	
YT-846113	P80	280x280x280	3	100
YT-846133	P120	280x280x280	3	100
YT-846153	P180	280x280x280	3	100

EN Endless sanding belt
PL Taśma ścierna bezkońcowa
DE Schleifband
RU Шлифовальные ленты

CZ Brusný pás
HU Csiszoló szalag
RO Bandă de pânză
FR Bande abrasive sans fin

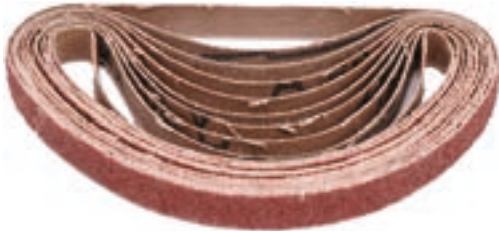
IT Nastro abrasivo senza fine
ES Pano abrasivo cinturón
CN 砂带



- Application: metal, wood
- Abrasive: aluminium oxide
- Bond: semi-resin
- Coating: closed
- Zastosowanie: metal, drewno
- Ścierniwo: tlenek glinu
- Spoiwo: żywica
- Nasyp pełny

YATO	Grit / Ziarnistość	[mm]	pcs / szt.	
YT-09747	P60	20x520	10	50
YT-09748	P80	20x520	10	50
YT-09749	P100	20x520	10	50
YT-09750	P120	20x520	10	50

EN No end abrasive band
PL Pas ścierny bezkońcowy
DE Schleifband
RU Шлифлента бесконечная

CZ Brusný pás
HU Csiszoló szalag
RO Curea abrazivă
FR Bande abrasive sans fin

IT Nastro abrasivo senza fine
ES Banda abrasiva sin fin
CN 砂带



- Application: metal, wood
- Abrasive: aluminium oxide
- Bond: semi-resin
- Coating: closed
- Zastosowanie: metal, drewno
- Ścierniwo: tlenek glinu
- Spoiwo: żywica
- Nasyp pełny

YATO	Grit / Ziarnistość	[mm]	pcs / szt.	
YT-83227	P36	75x533	5	20/60
YT-83228	P40	75x533	5	20/60
YT-83229	P60	75x533	5	20/60
YT-83230	P80	75x533	5	20/60
YT-83231	P100	75x533	5	20/60
YT-83232	P120	75x533	5	20/60
YT-83233	P150	75x533	5	20/60

EN Endless sanding belt
PL Taśma ścierna bezkońcowa
DE Schleifband
RU Шлифовальные ленты
CZ Brusný pás
HU Csiszoló szalag

RO Bandă de pânză
FR Bande abrasive sans fin
IT Nastro abrasivo senza fine
ES Pano abrasivo cinturón
CN 砂带



- Application: metal, wood
- Abrasive: aluminium oxide
- Bond: semi-resin
- Coating: closed
- Zastosowanie: metal, drewno
- Ścierniwo: tlenek glinu
- Spoiwo: żywica
- Nasyp pełny

YATO	Grit / Ziarnistość	[mm]	pcs / szt.	
YT-09743	P60	10x330	10	100
YT-09744	P80	10x330	10	100
YT-09745	P100	10x330	10	100
YT-09746	P120	10x330	10	100

EN No end abrasive band
PL Pas ścierny bezkońcowy
DE Schleifband
RU Шлифлента бесконечная

CZ Brusný pás
HU Csiszoló szalag
RO Curea abrazivă
FR Bande abrasive sans fin

IT Nastro abrasivo senza fine
ES Banda abrasiva sin fin
CN 砂带



- Application: metal, wood
- Abrasive: aluminium oxide
- Bond: semi-resin
- Coating: closed
- Zastosowanie: metal, drewno
- Ścierniwo: tlenek glinu
- Spoiwo: żywica
- Nasyp pełny

YATO	Grit / Ziarnistość	[mm]	pcs / szt.	
YT-83221	P40	75x457	5	20/60
YT-83222	P60	75x457	5	20/60
YT-83223	P80	75x457	5	20/60
YT-83224	P100	75x457	5	20/60
YT-83225	P120	75x457	5	20/60

EN No end abrasive band
PL Pas ścierny bezkońcowy
DE Schleifband
RU Шлифлента бесконечная

CZ Brusný pás
HU Csiszoló szalag
RO Curea abrazivă
FR Bande abrasive sans fin

IT Nastro abrasivo senza fine
ES Banda abrasiva sin fin
CN 砂带



- Application: metal, wood
- Abrasive: aluminium oxide
- Bond: semi-resin
- Coating: closed
- Zastosowanie: metal, drewno
- Ścierniwo: tlenek glinu
- Spoiwo: żywica
- Nasyp pełny

YATO	Grit / Ziarnistość	[mm]	pcs / szt.	
YT-83235	P40	100x610	5	20/60
YT-83236	P60	100x610	5	20/60
YT-83237	P80	100x610	5	20/60
YT-83238	P100	100x610	5	20/60
YT-83239	P120	100x610	5	20/60

EN Flap disc – regular shape
 PL Ściernica listkowa talerzowa płaska
 DE Fächerschleifscheibe gerade
 RU Круг лепестковый тарельчатый
 CZ Lamelový brusný kotouč
 HU Lamellás csiszoló normál
 RO Disc lamelar frontal
 FR Disque à lamelles abrasives plat
 IT Disco abrasivo per metallo
 ES Discos de paño abrasivo
 CN 百叶轮



- Application: metal
- Abrasive: aluminium oxide
- Bond: synthetic resin
- Backing: fibreglass
- Zastosowanie: metal
- Ścierniwo: tlenek glinu
- Spoiwo: żywica syntetyczna
- Podkład: włókno szklane

YATO	Grit / Ziarnistość	Ø [mm]	Mounting hole diameter / Średnica mocowania [mm]	
YT-83271	P36	125	22.4	25/100
YT-83272	P40	125	22.4	25/100
YT-83273	P60	125	22.4	50/200
YT-83274	P80	125	22.4	50/200
YT-83275	P100	125	22.4	50/200
YT-83276	P120	125	22.4	50/200

EN Flap disc – depressed shape
 PL Ściernica listkowa talerzowa wypukła
 DE Fächerschleifscheibe gewölbt
 RU Круг лепестковый тарельчатый - выпуклый
 CZ Lamelový brusný kotouč - vřopuklý
 HU Lamellás csiszoló dombótt
 RO Disc lamelar frontal depresat
 FR Disque à lamelles abrasives bombé
 IT Disco abrasivo a centro depresso
 ES Discos de paño abrasivo centro embudido
 CN 百叶轮



- Application: metal
- Abrasive: aluminium oxide
- Bond: synthetic resin
- Backing: fibreglass
- Zastosowanie: metal
- Ścierniwo: tlenek glinu
- Spoiwo: żywica syntetyczna
- Podkład: włókno szklane

YATO	Grit / Ziarnistość	Ø [mm]	Mounting hole diameter / Średnica mocowania [mm]	
YT-83291	P36	125	22.4	25/100
YT-83292	P40	125	22.4	25/100
YT-83293	P60	125	22.4	50/200
YT-83294	P80	125	22.4	50/200
YT-83295	P100	125	22.4	50/200
YT-83296	P120	125	22.4	50/200

EN Flap wheel with shaft
 PL Ściernica listkowa trzpieniowa
 DE Fächerschleifer mit Schaft
 RU Круг лепестковый со шпинделем
 CZ Lamelový kotouč s hřídelí
 HU Legyező csiszoló csapos
 RO Perie abraziva circulara cu tija
 FR Disque à lamelles abrasives pivot
 IT Ruote lamellari
 ES Rueda laminar en tela abrasiva
 CN 百叶轮



- Application: metal
- Abrasive: aluminium oxide
- Bond: synthetic resin
- Zastosowanie: metal
- Ścierniwo: tlenek glinu
- Spoiwo: żywica syntetyczna

YATO	Grit / Ziarnistość	[mm]	
YT-83351	P40	40x20x6	10/60
YT-83352	P60	40x20x6	10/60
YT-83353	P80	40x20x6	10/60
YT-83354	P100	40x20x6	10/60
YT-83355	P120	40x20x6	10/60
YT-83356	P150	40x20x6	10/60

EN Flap wheel with shaft
 PL Ściernica listkowa trzpieniowa
 DE Fächerschleifer mit Schaft
 RU Круг лепестковый со шпинделем
 CZ Lamelový kotouč s hřídelí
 HU Legyező csiszoló csapos
 RO Perie abraziva circulara cu tija
 FR Disque à lamelles abrasives pivot
 IT Ruote lamellari
 ES Rueda laminar en tela abrasiva
 CN 百叶轮



- Application: metal
- Abrasive: aluminium oxide
- Bond: synthetic resin
- Zastosowanie: metal
- Ścierniwo: tlenek glinu
- Spoiwo: żywica syntetyczna

YATO	Grit / Ziarnistość	[mm]	
YT-83361	P40	60x30x6	10/60
YT-83362	P60	60x30x6	10/60
YT-83363	P80	60x30x6	10/60
YT-83364	P100	60x30x6	10/60
YT-83365	P120	60x30x6	10/60
YT-83366	P150	60x30x6	10/60

EN Flap wheel with shaft
 PL Ściernica listkowa trzpieniowa
 DE Fächerschleifer mit Schaft
 RU Круг лепестковый со шпинделем
 CZ Lamelový kotouč s hřídelí
 HU Legyező csiszoló csapos
 RO Perie abraziva circulara cu tija
 FR Disque à lamelles abrasives pivot
 IT Ruote lamellari
 ES Rueda laminar en tela abrasiva
 CN 百叶轮



- Application: metal
- Abrasive: aluminium oxide
- Bond: synthetic resin
- Zastosowanie: metal
- Ścierniwo: tlenek glinu
- Spoiwo: żywica syntetyczna

YATO	Grit / Ziarnistość	[mm]	
YT-83371	P40	80x30x6	10/60
YT-83372	P60	80x30x6	10/60
YT-83373	P80	80x30x6	10/60
YT-83374	P100	80x30x6	10/60
YT-83375	P120	80x30x6	10/60
YT-83376	P150	80x30x6	10/60

EN Flap wheel with shaft
 PL Ściernica listkowa trzpieniowa
 DE Fächerschleifer mit Schaft
 RU Круг лепестковый со шпинделем
 CZ Lamelový kotouč s hřídelí
 HU Legyező csiszoló csapos
 RO Perie abraziva circulara cu tija
 FR Disque à lamelles abrasives pivot
 IT Ruote lamellari
 ES Rueda laminar en tela abrasiva
 CN 百叶轮



- Application: metal
- Abrasive: aluminium oxide
- Bond: synthetic resin
- Zastosowanie: metal
- Ścierniwo: tlenek glinu
- Spoiwo: żywica syntetyczna

YATO	Grit / Ziarnistość	[mm]	
YT-83381	P40	80x40x6	10/60
YT-83382	P60	80x40x6	10/60
YT-83383	P80	80x40x6	10/60
YT-83384	P100	80x40x6	10/60
YT-83385	P120	80x40x6	10/60
YT-83386	P150	80x40x6	10/60

EN Flap wheel with shaft
PL Ściernica listkowa trzpieniowa
DE Fächerschleifer mit Schaft
RU Круг лепестковый со шпинделем
CZ Lamelový kotouč s hřídelí
HU Legyező csiszoló csapos
RO Perie abraziva circulara cu tija
FR Disque à lamelles abrasives pivot
IT Ruote lamellari
ES Rueda laminar en tela abrasiva
CN 百叶轮



- Application: metal
- Abrasive: aluminium oxide
- Bond: synthetic resin
- Zastosowanie: metal
- Ścierniwo: tlenek glinu
- Spoiwo: żywica syntetyczna

YATO	Grit / Ziarnistość	[mm]	
YT-83390	P60	50x30x6	10/60
YT-83391	P100	50x30x6	10/60
YT-83392	P150	50x30x6	10/60
YT-83393	P200	50x30x6	10/60

EN Flap wheel with shaft
PL Ściernica listkowa trzpieniowa
DE Fächerschleifer mit Schaft
RU Круг лепестковый со шпинделем
CZ Lamelový kotouč s hřídelí
HU Legyező csiszoló csapos
RO Perie abraziva circulara cu tija
FR Disque à lamelles abrasives pivot
IT Ruote lamellari
ES Rueda laminar en tela abrasiva
CN 百叶轮



- Application: metal
- Abrasive: aluminium oxide
- Bond: synthetic resin
- Zastosowanie: metal
- Ścierniwo: tlenek glinu
- Spoiwo: żywica syntetyczna

YATO	Grit / Ziarnistość	[mm]	
YT-83394	P60	60x50x6	10/60
YT-83395	P100	60x50x6	10/60
YT-83396	P150	60x50x6	10/60
YT-83397	P200	60x50x6	10/60

EN Flap wheel with shaft
PL Ściernica listkowa trzpieniowa
DE Fächerschleifer mit Schaft
RU Круг лепестковый со шпинделем
CZ Lamelový kotouč s hřídelí
HU Legyező csiszoló csapos
RO Perie abraziva circulara cu tija
FR Disque à lamelles abrasives pivot
IT Ruote lamellari
ES Rueda laminar en tela abrasiva
CN 百叶轮



- Application: metal
- Abrasive: aluminium oxide
- Bond: synthetic resin
- Zastosowanie: metal
- Ścierniwo: tlenek glinu
- Spoiwo: żywica syntetyczna

YATO	Grit / Ziarnistość	[mm]	
YT-83398	P60	80x50x6	10/60
YT-83399	P100	80x50x6	10/60
YT-83400	P150	80x50x6	10/60
YT-83401	P200	80x50x6	10/60

EN Abrasive mesh
PL Siatka ścierna
DE Schleifgitter
RU Абразивная сетка
CZ Brusná síťka
HU Csiszolóháló
RO Disc abraziv
FR Disque abrasif à maille
IT Rete abrasiva
ES Malla abrasiva
CN 网状砂纸

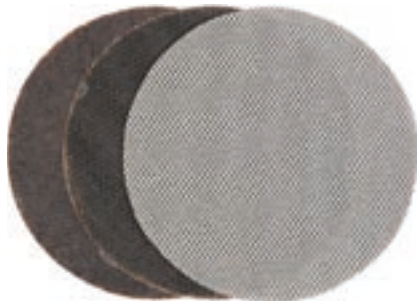

3 PCS **225** mm

YATO	Grit / Ziarnistość	Ø [mm]	pcs / szt.	
YT-845803	P60	225	3	100
YT-845813	P80	225	3	100
YT-845823	P100	225	3	100
YT-845833	P120	225	3	100
YT-845843	P150	225	3	100
YT-845853	P180	225	3	100
YT-845863	P220	225	3	100

EN Abrasive disc
PL Krążek ścierny
DE Schleifblatt
RU Круг шлифовальный
CZ Brusný kotouč
HU Csiszolótárcsa
RO Disc abraziv
FR Disques abrasifs avec velcro
IT Disco abrasivo
ES Juego de discos abrasivos
CN 圆形砂纸



- Application: metal, wood
- Abrasive: aluminium oxide
- Bond: synthetic resin
- Coating: semi-open
- Zastosowanie: metal, drewno
- Ścierniwo: tlenek glinu
- Spoiwo: żywica syntetyczna
- Nasyp półotwarty

YATO	Grit / Ziarnistość	Ø [mm]	
YT-83430	P36	125	50/200
YT-83431	P40	125	50/200
YT-83432	P60	125	50/200
YT-83433	P80	125	50/200
YT-83434	P100	125	50/200
YT-83435	P120	125	50/200
YT-83436	P150	125	50/200
YT-83437	P180	125	50/200
YT-83438	P220	125	50/200

EN Perforated abrasive disc
PL Krążek ścierny perforowany
DE Schleifscheibe, perforiert
RU Перфорированный шлифовальный диск
CZ Brusný kotouč perforovaný
HU Perforált csiszolópapír
RO Disc abraziv cu orificii
FR Disque abrasif perforé
IT Disco abrasivo perforato
ES Muela abrasiva perforada
CN 多孔砂纸



3 PCS **225** mm PERFORATION PERFORACJA

YATO	Grit / Ziarnistość	Ø [mm]	pcs / szt.	
YT-846003	P60	225	3	33
YT-846013	P80	225	3	33
YT-846023	P100	225	3	33
YT-846033	P120	225	3	33
YT-846043	P150	225	3	33
YT-846053	P180	225	3	33
YT-846063	P220	225	3	33

EN Abrasive disc with holes
PL Krążek ścierny z otworami
DE Schleifscheibe mit Löchern
RU Круг шлифовальный перфорированный с липучкой
CZ Brusný kotouč z otvorami
HU Fibertárcsa lyukakkal tépőzáras
RO Disc abraziv cu orificii
FR Disques abrasifs trous avec velcro
IT Disco abrasivo con fori
ES Juego de discos abrasivos con agujeros
CN 圆形带孔砂纸



- Application: metal, wood
- Abrasive: aluminium oxide
- Bond: synthetic resin
- Coating: semi-open
- Zastosowanie: metal, drewno
- Ścierniwo: tlenek glinu
- Spoiwo: żywica syntetyczna
- Nasyp półotwarty

YATO	Grit / Ziarnistość	Ø [mm]	
YT-83451	P40	125	50/200
YT-83452	P60	125	50/200
YT-83453	P80	125	50/200
YT-83454	P100	125	50/200
YT-83455	P120	125	50/200
YT-83456	P150	125	50/200
YT-83457	P180	125	50/200
YT-83458	P220	125	50/200

EN Abrasive disc with holes
 PL Krążek ścierny z otworami
 DE Schleifscheibe mit Löchern
 RU Круг шлифовальный перфорированный с липучкой
 CZ Brusný kotouč z otvorama
 HU Fibertárcsa lyukakkal tépózárás
 RO Disc abraziv cu orificii
 FR Disques abrasifs trous avec velcro
 IT Disco abrasivo con fori
 ES Juego de discos abrasivos con agujeros
 CN 拉绒圆盘砂纸

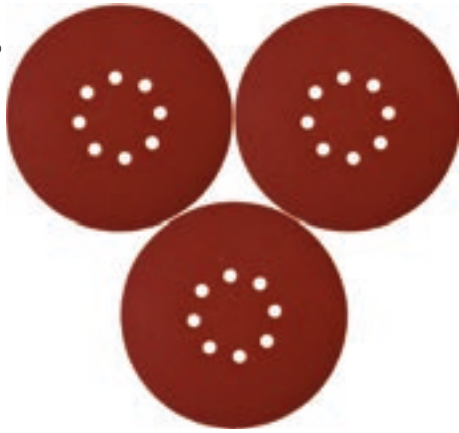

- Application: wood, plaster, paints
- Abrasive: aluminium oxide
- Bond: synthetic resin
- Coating: open
- Zastosowanie: drewno, gips, farby
- Ścierniwo: tlenek glinu
- Spoivo: żywica syntetyczna
- Nasyt półotwarty

For YT-82341
 Dla YT-82341

YATO	Grit / Ziarnistość	Ø [mm]	
YT-83460	P40	180	50/200
YT-83461	P60	180	50/200
YT-83462	P80	180	50/200
YT-83463	P100	180	50/200
YT-83464	P120	180	50/200
YT-83465	P150	180	50/200
YT-83466	P180	180	50/200
YT-83467	P240	180	50/200

EN Abrasive disc with holes
 PL Krążek ścierny z otworami
 DE Schleifscheibe mit Löchern
 RU Круг шлифовальный перфорированный с липучкой
 CZ Brusný kotouč z otvorama
 HU Fibertárcsa lyukakkal tépózárás
 RO Disc abraziv cu orificii
 FR Disques abrasifs trous avec velcro
 IT Disco abrasivo con fori
 ES Juego de discos abrasivos con agujeros
 CN 拉绒圆盘砂纸



- Application: wood, plaster
- Abrasive: aluminium oxide
- Bond: synthetic resin
- Coating: semi-open
- Zastosowanie: drewno, gips
- Ścierniwo: tlenek glinu
- Spoivo: żywica syntetyczna
- Nasyt półotwarty

For YT-82340, YT-82350, 79307
 Dla YT-82340, YT-82350, 79307

YATO	Grit / Ziarnistość	Ø [mm]	
YT-83471	P60	225	60/120
YT-83472	P80	225	60/120
YT-83473	P100	225	60/120
YT-83474	P120	225	60/120
YT-83475	P150	225	60/120
YT-83476	P180	225	60/120
YT-83477	P240	225	60/120

EN Abrasive sheet with holes
 PL Arkusz ścierny z otworami
 DE Schleifblatt mit Löchern
 RU Шлифовальная перфорированная бумага для виброшлифмашинки
 CZ Brusné archy z otvorama
 HU Csiszoló lap lyukakkal
 RO Coale (foi) abrazive cu orificii
 FR Disques abrasifs trous avec velcro
 IT Carta abrasiva con fori
 ES Ojas abrasivas con agujeros
 CN 砂纸



- Application: steel, wood, paints, filler
- Abrasive: aluminium oxide
- Bond: synthetic resin
- Coating: semi-open
- Zastosowanie: stal, drewno, farby, szpachle
- Ścierniwo: tlenek glinu
- Spoivo: żywica syntetyczna
- Nasyt półotwarty

For YT-82230
 Dla YT-82230

YATO	Grit / Ziarnistość	[mm]	
YT-83800	P40	93x187	100/200
YT-83801	P60	93x187	100/200
YT-83802	P80	93x187	100/200
YT-83803	P100	93x187	100/200
YT-83804	P120	93x187	100/200
YT-83805	P150	93x187	100/200
YT-83806	P180	93x187	100/200
YT-83807	P220	93x187	100/200
YT-83808	P240	93x187	100/200

EN Back pad for drywall sander
 PL Wymienna głowica szlifierska dla szlifierki do gipsu
 DE Schleifkopf für Gips-Schleifmaschine abnehmbar
 RU Запасная шлифовальная головка для гипсовой шлифовальной машины
 CZ Náhradní brusná hlavice pro broušení sádry
 HU Cserélhető csiszolófej falcsiszoló géphez
 RO Disc pt. slefuitor pereti
 FR Tête de ponçage de rechange pour ponceuses à plâtre
 IT Testa rotonda sostituibile per smerigliatrice per gesso
 ES Cabeza de rectificadora reemplazable para la rectificadora de yeso
 CN 圆磨盘



For YT-82340, YT-82350
 Fitting sand papers: YT-83470, YT-83471, YT-83472, YT-83473, YT-83474, YT-83475, YT-83476, YT-83477, YT-84600, YT-84601, YT-84602, YT-84603, YT-84604, YT-84605, YT-84606

YATO	Ø [mm]	
YT-82353	225	15/60

EN Triangle back pad for drywall sander
 PL Wymienna trójkątna głowica dla szlifierki do gipsu
 DE Dreieck-Schleifkopf für Gips-Schleifmaschine abnehmbar
 RU Запасная треугольная головка для гипсовой шлифовальной машины
 CZ Vyměnitelná trojúhelníková hlavice pro broušení sádry
 HU Háromszög alakú cserélhető csiszolófej falcsiszoló géphez
 RO Disc triunghiular pt. slefuitor pereti
 FR Tête triangulaire de rechange pour ponceuse à plâtre
 IT Testa triangolare sostituibile per smerigliatrice per gesso
 ES Cabeza triangular reemplazable para la rectificadora de yeso
 CN 三角磨盘



For YT-82350
 Fitting sand papers: YT-84610, YT-84611, YT-84612, YT-84613, YT-84614, YT-84615, YT-84616

YATO	Dimensions / Wymiary [mm]	
YT-82354	280x280x280	20/60

Memo



11

Plumbing tools Narzędzia hydrauliczne



Ratchet die stock sets
Gwintownice ręczne z zestawem głowic

264



Burners & soldering tools
Palniki i lutownice

271-273



Accessories for ratchet die stock
Akcesoria do gwintownic ręcznych

264



Pipe welders
Zgrzewarki do rur

273



Pipe wrenches
Klucze do rur

264-266



Pipe crimping pliers & accessories
Zaciskarki do rur i akcesoria

273-274



Strap wrenches
Klucze do rur taśmowe

265-266

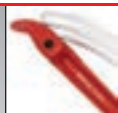

Hinged pipe vices
Imadła zaciskowe do rur

274



Chain pipe wrenches
Klucze do rur łańcuchowe

266



Thread seal strings
Nici do uszczelniania gwintów

275



Water pump pliers
Szcypce nastawne

266-267



Plumbing accessories
Akcesoria hydrauliczne

275



Step wrenches
Klucze sztorcowe

267



Deburrers & accessories
Gratowniki i akcesoria

275



Pipe cutters
Obcinaki do rur

267-270



Pipe brushes
Szczotki do rur

276



Pipe benders
Giętarki do rur

270



Cleaning pads for pipes
Włókniny do czyszczenia rur

276



Hand flaring tools sets
Praski do rozszerzania rur

270



Drain cleaning accessories
Akcesoria do udrażniania kanalizacji

276-277



Calibrators
Kalibratory

271



Tool boxes & tools in PVC trays
Skrzynki narzędziowe i zestawy narzędzi do szuflad

278-279



EN Ratchet die stocks RU Набор нпшек RO Trusa filiere ES Juego de roscar
 PL Gwintownica z zestawem glowic CZ Sada zavitniků FR Taraud manuel CN 管子铰板组套
 DE Rohrgewinde-schneidsatz HU Menetfűr készlet IT Filiera per tubi a mano

9Cr2



5 PCS 3/8" 9.5 mm 1/2" 12.7 mm 3/4" 19 mm 1" 25 mm

7 PCS 1/4" 6.3 mm 3/8" 9.5 mm 1/2" 12.7 mm 3/4" 19 mm 1" 25 mm 1 1/4" 32 mm

YATO	Size / Rozmiar	
YT-29001	3/8" (10.0 mm), 1/2" (12.5 mm), 3/4" (19.0 mm), 1" (25.0 mm)	4

YATO	Size / Rozmiar	
YT-2900	1/4" (6.3 mm), 3/8" (10.0 mm), 1/2" (12.5 mm), 3/4" (19.0 mm), 1" (25.0 mm), 1-1/4" (32.0 mm)	4

EN Spare knives for ratchet die stock
 PL Noże zapasowe do gwintownicy ręcznej
 DE Rohrgewinde-Schneidbacken
 RU Запасные ножи для оправки
 CZ Náhradní nože do ruční závitofezy
 HU Tartalék kések, racsnis csömenetvágóhoz
 RO Cuitit de rezerva pt. filiera
 FR Lame pour taraud à main
 IT Lame di ricambio per filettatrici manuale
 ES Filos de recambio para terraja de mano
 CN 板牙



4 PCS 9Cr2

YATO	Size / Rozmiar	pcs / szt.	
YT-2910	1/4" (6.3 mm)	4	50/200
YT-2911	3/8" (10.0 mm)	4	50/200
YT-2912	1/2" (12.5 mm)	4	50/200
YT-2913	3/4" (19.0 mm)	4	50/200
YT-2914	1" (25.0 mm)	4	50/200

EN Pipe wrench CZ Klíč součásti na trubky IT Chiave per tubi
 PL Klucz do rur HU Csőkulcs ES Llave para tubos
 DE Rohrschlüssel RO Cheie reglabila pt. tevi CN 铝合金管钳
 RU Ключ трубный FR Clé aux tubes

HRC 55-60 CrMo



YATO	Size / Rozmiar	L [mm]	Max. pipe diameter / Maks. średnica rury	
YT-2482	14"	350	2" (50 mm)	6/12
YT-2483	18"	450	2.5" (63 mm)	2/10
YT-2484	24"	600	3" (75 mm)	2/6
YT-2485	36"	900	5" (125 mm)	3

EN Pipe wrench CZ Klíč součásti na trubky IT Chiave per tubi
 PL Klucz do rur HU Csőkulcs ES Llave para tubos
 DE Rohrschlüssel RO Cheie reglabila pt. tevi CN 铝合金重型管钳
 RU Ключ трубный FR Clé aux tubes

HRC 55-60 AI HANDLE USHWYT



YATO	Size / Rozmiar	L [mm]	Max. pipe diameter / Maks. średnica rury	
YT-2222	12"	300	1" (25 mm)	6/24
YT-2223	14"	350	1.5" (38 mm)	4/16
YT-2224	18"	450	2" (50 mm)	3/12
YT-2225	24"	600	2.5" (63 mm)	3/6

EN Spare head for ratchet die stock
 PL Glowica zapasowa do gwintownicy ręcznej
 DE Rohrgewinde-Schneidköpfe
 RU Запасная оправка для нарезания трубной резьбы
 CZ Náhradní hlava pro ruční závitofez
 HU Tartalék fej, racsnis csömenetvágóhoz
 RO Cap de rezerva pt. placa filetat cu clichet
 FR Mandrin porte-taraud
 IT Testina ricambio per filettatrici manuale
 ES Cabezera de recambio para terraja de mano
 CN 板牙头



9Cr2

YATO	Size / Rozmiar	
YT-2916	1/4" (6.3 mm)	10/40
YT-2917	3/8" (10.0 mm)	10/40
YT-2918	1/2" (12.5 mm)	10/40
YT-2919	3/4" (19.0 mm)	10/40
YT-2920	1" (25.0 mm)	10/40
YT-2921	1-1/4" (32.0 mm)	10/20

EN Pipe wrench CZ Klíč součásti na trubky IT Chiave per tubi
 PL Klucz do rur HU Csőkulcs ES Llave para tubos
 DE Rohrschlüssel RO Cheie reglabila pt. tevi CN 加重型管钳
 RU Ключ трубный FR Clé aux tubes

HRC 55-60 CrMo



YATO	Size / Rozmiar	L [mm]	Max. pipe diameter / Maks. średnica rury	
YT-2488	10"	250	1" (25 mm)	6/18
YT-2489	12"	300	1.5" (38 mm)	6/12
YT-2490	14"	350	2" (50 mm)	2/10
YT-2491	18"	450	2.5" (63 mm)	3/6
YT-2492	24"	600	3" (75 mm)	2/4
YT-2493	36"	900	5" (125 mm)	1
YT-2494	48"	1200	6" (150 mm)	1

EN Pipe wrench CZ Klíč součásti na trubky IT Chiave per tubi
 PL Klucz do rur HU Csőkulcs ES Llave para tubos
 DE Rohrschlüssel RO Cheie reglabila pt. tevi CN 偏置式重型管钳
 RU Ключ трубный FR Clé aux tubes

HRC 55-60 OFFSET TYPE ODGIETA GLOWICA



YATO	Size / Rozmiar	L [mm]	Max. pipe diameter / Maks. średnica rury	
YT-2201	10"	250	1" (25 mm)	6/36
YT-2203	14"	350	1.5" (38 mm)	4/16
YT-2204	18"	450	2" (50 mm)	3/12
YT-2205	24"	600	2.5" (63 mm)	3/6
YT-2206	36"	900	4" (100 mm)	2/4

EN Telescopic pipe wrench
PL Teleskopowy klucz do rur
DE Teleskop-Rohrschlüssel

RU Телескопический трубный гаечный ключ
CZ Teleskopický klíč do trubek
HU Teleszkópos csőfogó kulcs

RO Cheie pt. tevi telescopica
FR Clé télescopique pour tuyaux
IT Chiave giratubi telescopica

ES Llave telescópica para tubos
CN 管子钳

16" 18"
20" 22"

400-550
mm

HRC
55-60

CrMo



YATO	Size / Rozmiar	L [mm]	Max. pipe diameter / Maks. średnica rury [mm]	
YT-22257	16", 18", 20", 22"	400-550	80	8

EN Adjustable pipe wrench
PL Klucz nastawny do rur
DE Rohrschlüssel

RU Ключ трубный переставной
CZ Nastavitelný klíč na trubky
HU Állítható csőkulcs

RO Cheie reglabilă pt. țevi
FR Clé serre-tube „suédois”
IT Pinze regolabili per tubi

ES Llave para tubos tipo Inglesa
CN 管钳

90°
1" 25mm
1.5" 38mm
2" 50mm
DIN 5234
CrV 6140



YATO	L [mm]	Max. pipe diameter / Maks. średnica rury	
YT-2210	320	1" (25 mm)	24
YT-2211	420	1-1/2" (38 mm)	18
YT-2212	560	2" (50 mm)	12

EN Adjustable pipe wrench
PL Klucz nastawny do rur
DE Rohrschlüssel

RU Ключ трубный переставной
CZ Nastavitelný klíč na trubky
HU Állítható csőkulcs

RO Cheie reglabilă pt. țevi
FR Clé serre-tube „suédois”
IT Pinze regolabili per tubi

ES Llave para tubos tipo Inglesa
CN 管钳

45°
1" 25mm
1.5" 38mm
2" 50mm
DIN 5234
CrV 6140



YATO	L [mm]	Max. pipe diameter / Maks. średnica rury	
YT-2213	330	1" (25 mm)	24
YT-2214	415	1-1/2" (38 mm)	18
YT-2215	530	2" (50 mm)	12

EN Adjustable pipe wrench
PL Klucz nastawny do rur
DE Rohrschlüssel

RU Ключ трубный
CZ Nastavitelný klíč na trubky
HU Állítható csőkulcs

RO Cheie reglabilă pt. țevi
FR Llave sueca
IT Pinze regolabili per tubi

ES Llave para tubos
CN 弯嘴鹰嘴钳

S
1" 25mm
1.5" 38mm
2" 50mm
3" 76mm
DIN 5234
CrV 6140



YATO	L [mm]	Max. pipe diameter / Maks. średnica rury	
YT-2216	330	1" (25 mm)	24
YT-2217	420	1-1/2" (38 mm)	18
YT-2218	535	2" (50 mm)	12
YT-22183	650	3" (76 mm)	4

EN Auto-adjustable pipe wrench
PL Szybkonastawny klucz do rur
DE Rollgabelschlüssel

RU Ключ разводной
CZ Nastavitelný klíč
HU Állítható svédkulcs

RO Cheie reglabilă
FR Clé à molette
IT Chiave autoregolabile per tubi

ES Llave ajustable
CN 可调式管钳

300 mm
5/8"-1 1/2"
16-38 mm
SELF-ADJUSTING SAMO-NASTAWNY
QUICK OPENING SZYBKIE OTWIERANE
HRC 46-52
HARDENED JAWS HARTOWANE SZCZĘKI



YATO	L [mm]	
YT-22005	300	6/24

EN Pipe wrench - german type
PL Klucz do rur - typ niemiecki
DE Rohrschlüssel - deutsch type
RU Трубный ключ - немецкий тип
CZ Nastavitelný klíč na trubky - němečtina typ
HU Állítható csőkulcs - német típusú

RO Cheie reglabilă pt. țevi - tip german
FR Clé serre-tube type allemand
IT Chiave per tubi - tipo tedesco
ES Llave para tubos tipo alemán
CN 德式管子钳

HRC 47-53

HARDENED JAWS HARTOWANE SZCZĘKI



EN Telescopic pipe wrench
PL Teleskopowy klucz do rur
DE Teleskop-Rohrschlüssel
RU Телескопический трубный гаечный ключ
CZ Teleskopický klíč do trubek
HU Teleszkópos csőfogó kulcs

RO Cheie pt. tevi telescopica
FR Clé télescopique pour tuyaux
IT Chiave telescopica per tubi
ES Llave telescópica para tubos
CN 皮带管钳

300 mm
ø 8" 20 cm

28x825 mm
NYLON

AI

- Chromed pipes
- PVC pipes
- Oil filters
- Rur chromowanych
- Rur PCV
- Filtrów oleju



YATO	L [mm]	Max. pipe diameter / Maks. średnica rury	
YT-22255	300	8" (200 mm)	5/50

YATO	Size / Rozmiar	L [mm]	Max. jaws opening capacity / Maks. zakres rozwarcia szczęk [mm]	Max. pipe diameter / Maks. średnica rury [mm]	
YT-22000	7"	175	45	20	6/60
YT-22001	9"	225	60	30	6/36
YT-22002	10.5"	275	70	35	6/24

EN Strap for pipe wrench
 PL Taśma zapasowa do klucza do rur
 DE Gurt für Bandschlüssel
 RU Ремень для ремешковые ключи
 CZ Popruh pro klíče olejových filtrů
 HU Szíjas az szíjas csőfogó

RO Chinga la chei cu chingă
 FR Courroie pour clés a courroie
 IT Nastro di ricambio per chiave per tubi
 ES Correa a llaves de correa
 CN 皮带管钳配件

∅ 8"
 20 cm
 28x825 mm
 NYLON 

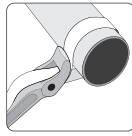



For YT-22255
 Dla YT-22255





YATO 	L [mm]	Max. pipe diameter / Maks. średnica rury	
YT-22256	50	4" (100 mm)	6/24

EN Water pump pliers
 PL Szczypce nastawne
 DE Wasserpumpenzange
 RU Ключи переставные
 CZ Kleště siko
 HU Vízpumpafogó

RO Clește papagal
 FR Pince réglable
 IT Pinze regolabili
 ES Alicates de fontanero ajustables
 CN 水泵钳

CrV 
 ADJUSTABLE WORK RANGE REGULOWANY ZAKRES PRACY
 REINFORCED CONSTRUCTION WZMOCNIONA KONSTRUKCJA 





YATO 	L [mm]	
YT-2090	250	6/36
YT-2091	300	6/36

EN Water pump pliers
 PL Szczypce nastawne
 DE Wasserpumpenzange
 RU Ключи переставные
 CZ Nastavitelné kleště
 HU Állítható fogó

RO Clește papagal
 FR Pince réglable
 IT Pinze regolabili
 ES Alicates de fontanero ajustables
 CN 水泵钳

250 mm 
 NICKEL IRON FINISH 





YATO 	L [mm]	
YT-2069	250	6/36

EN Insulated water pump pliers
 PL Szczypce nastawne hydrauliczne, izolowane
 DE Hydraulik-Rohrzange, isoliert
 RU Изолированные переставные ключи
 CZ Nastavitelné kleště izolované
 HU Vízpumpa fogó szigetelt
 RO Clește papagal VDE
 FR Pince réglable multiprises isolée
 IT Pinza regolabile isolata per idraulici
 ES Alicates hidráulicos ajustables, aislados
 CN 绝缘水泵钳

CrV 
 1000 V 





1000 V
 VDE CERTIFICATE
 EN 60900:2012

YATO 	L [mm]	
YT-21161	250	6/24

EN Chain pipe wrench
 PL Klucz łańcuchowy do rur
 DE Kettenrohrzange
 RU Ключ цепной для труб
 CZ Klíč řetězový na trubky
 HU Láncos csőfogó
 RO Cheie reglabilă pt. tevi cu lant
 FR Clé à chaîne
 IT Chiave a catena per tubi
 ES Llave de cadena
 CN 链条扳手

300 mm 
 ∅ 4" 
 INDUCTION HARDENED TEETH ZĘBY HARTOWANE WYKUCYWIENE 
 ADJUSTABLE WORK RANGE REGULOWANY ZAKRES PRACY 



YATO 	L [mm]	Max. pipe diameter / Maks. średnica rury	
YT-22260	300	4" (100 mm)	6/24

EN Water pump pliers
 PL Szczypce nastawne
 DE Wasserpumpenzange
 RU Ключи переставные
 CZ Nastavitelné kleště
 HU Állítható fogó

RO Clește papagal
 FR Pince réglable
 IT Pinze regolabili
 ES Alicates de fontanero ajustables
 CN 水泵钳



250 mm 
 6mm 
 CrV 
 ADJUSTABLE WORK RANGE REGULOWANY ZAKRES PRACY
 REINFORCED CONSTRUCTION WZMOCNIONA KONSTRUKCJA 



YATO 	L [mm]	
YT-20911	250	6/36

EN Water pump pliers
 PL Szczypce nastawne
 DE Wasserpumpenzange
 RU Ключи переставные
 CZ Nastavitelné kleště
 HU Állítható fogó

RO Clește papagal
 FR Pince réglable
 IT Pinze regolabili
 ES Alicates de fontanero ajustables
 CN 水泵钳

250 mm 
 NICKEL IRON FINISH 



YATO 	L [mm]	
YT-2070	250	6/24

EN Internal ratchet wrench
 PL Grzechotka wewnętrzna
 DE Innenratschenschlüssel
 RU Трещотка внутренняя
 CZ Radiátorový kluč s ráčnou
 HU Lépcsős kulcskészlet racsnal

RO Cheie robinet radiator
 FR Clé de montage étagée
 IT Cricchetto di tipo interno
 ES Llave carraca radiadores
 CN 穿心棘轮扳手

1/2" 
 12.7 mm 
 30T 
 CrV 



For YT-03316
 Dla YT-03316

YATO 		
YT-03315	1/2" (12.7 mm)	6/24

EN Step wrench
PL Klucz stopniowy
DE Stufenschlüssel
RU Универсальный ступенчатый ключ
CZ Klíč na radiátorové šroubení
HU Lépcsős radiátor kulcs

RO Cheie in trepte pt. radiator
FR Clé de montage étagée
IT Chiave gradini per radiatori
ES Llave de radiadores
CN 六角阶梯扳手



For YT-03315
Dia YT-03315

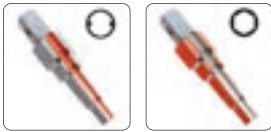

YATO
YT-03316 1/2" (12.7 mm) 100

EN Step wrench
PL Klucz stopniowy
DE Stufenschlüssel
RU Универсальный ступенчатый ключ
CZ Klíč na radiátorové šroubení
HU Lépcsős radiátor kulcs

RO Cheie in trepte pt. radiator
FR Clé de montage étagée
IT Chiave gradini per radiatori
ES Llave de radiadores
CN 六角阶梯扳手



CrV



For YT-03315
Dia YT-03315

YATO
YT-03317 1/2" (12.7 mm) 100

EN Special mixer-tap basin wrench
PL Klucz lamany do instalacji armatury
DE Standhahnmutterschlüssel für Armaturen
RU Сгибющийся гаечный ключ для фитингов
CZ Lámaný klíč pro montáž armatur
HU Derékcsőgő csaptelep kulcs
RO Chei speciale pt. robineti si bazine
FR Clé articulée pour l'installation de ferrure
IT Chiave pieghevole per installazione di rubinetteria
ES Llave articulada para la plomería
CN 水槽扳手



YATO
YT-24780 20/40

EN Nipple extractor set
PL Zestaw do wykrecania nypki
DE Nippelschlüssel-Satz
RU Набор для выкручивания ниппелей
CZ Souprava pro vyšroubování vodovodních redukcí
HU Belső csőkulcs
RO Set extractoare capete filetate rupte ale tevi
FR Jeu de porte-embouts pour dévisser mamelons
IT Set di chavi per rimozione nippi
ES Juego extractor de nipples
CN 内管扳手

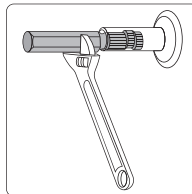
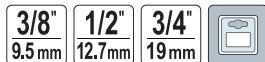

YATO
YT-21793 6/24

EN PVC pipe cutter
PL Obcinak do rur PVC
DE PVC Rohrabhschneider
RU Труборез для ПВХ труб
CZ Rezač PVC trubek
HU Csővágó olló PVC csővekhez
RO Clește pt. tăiat țevi din PVC
FR Coupe-tube en PVC
IT Cesoià per tubi in PVC
ES Cortatubos PVC
CN 管子割刀



YATO
YT-2231 max. Ø [mm] 42 6/48

EN Step wrench with ratchet
PL Klucz stopniowy z grzechotką
DE Stufenschlüssel mit Ratsche
RU Ключ ступенчатый с трещоткой
CZ Klíč na šroubení s ráčnou
HU Racsnis lépcsős kulcs

RO Cheie in trepte cu clichet
FR Clé de montage étagée avec cliquet
IT Chiave gradini per radiatori con cricchetto
ES Llave de radiadores con trinquete
CN 穿心棘轮扳手



CrV



3/8" (9.6 mm), 29/68" (11.6 mm), 1/2" (12.6 mm), 21/32" (16.4 mm), 27/32" (21 mm)

YATO
YT-03314 1/2" (12.7 mm) 6/24

EN Step wrench
PL Klucz stopniowy
DE Stufenschlüssel
RU Универсальный ступенчатый ключ
CZ Klíč na radiátorové šroubení
HU Lépcsős radiátor kulcs
RO Cheie in trepte pt. radiator
FR Clé de montage étagée
IT Chiave a cricco
ES Llave de radiadores
CN 六角阶梯扳手



CrV



YATO
YT-03318 10/60

EN Sink wrench
PL Teleskopowy klucz hakowy do armatury
DE Teleskop-Hakenschlüssel für Armaturen
RU Ключ для раковины телескопический
CZ Teleskopický úhľadový klíč
HU Teleszköpos csaptelepkulcs
RO Cheie telescopică pt. chiuvetă
FR Clé à siphon telescopique
IT Chiave telescopica per lavabo
ES Llave para lavabo telescópica
CN 水槽扳手

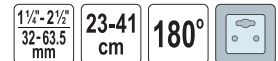

YATO
YT-22251 6/12

EN PVC pipe cutter
PL Obcinak do rur PVC
DE PVC Rohrabhschneider
RU Труборез для ПВХ труб
CZ Rezač PVC trubek
HU Csővágó olló PVC csővekhez

RO Clește pt. tăiat țevi din PVC
FR Coupe-tube en PVC
IT Cesoià per tubi in PVC
ES Cortatubos PVC
CN 管子割刀



YATO
YT-2230 max. Ø [mm] 35 6/48

EN PVC pipe cutter
PL Obcinak do rur PVC
DE PVC Rohrabhschneider
RU Труборез для ПВХ труб
CZ Rezač PVC trubek
HU Csővágó olló PVC csővekhez
RO Clește pt. tăiat țevi din PVC
FR Coupe-tube en PVC
IT Cesoià per tubi in PVC
ES Cortatubos PVC
CN 管子割刀



YATO
YT-22312 max. Ø [mm] 63 6/24

EN PVC pipe cutter
 PL Obcinak do rur PCV
 DE PVC Rohrschneider
 RU Труборез для ПВХ труб
 CZ Řezač PVC trubek
 HU Csővágó olló PVC csővekhez
 RO Clește pt. tăiat țevi din PVC
 FR Coupeur aux tubes
 IT Taglia tubi PVC
 ES Cortatubos PVC
 CN 管子割刀



max Ø
51
mm

max Ø
64
mm

YATO	max. Ø [mm]	
YT-2228	51	6/24

YATO	max. Ø [mm]	
YT-2229	64	6/24

EN PVC pipe cutter
 PL Obcinak do rur PVC
 DE PVC Rohrschneider
 RU Труборез для труб из ПВХ
 CZ Řezač PVC trubek
 HU Csővágó olló PVC csővekhez
 RO Clește pt. tăiat țevi din PVC
 FR Coupe-tubes PVC a cliquet
 IT Taglia tubi PVC
 ES Cortatubos para PVC
 CN PVC 管子割刀



max Ø
36
mm

max Ø
42
mm

max Ø
50
mm



YATO	max. Ø [mm]	
YT-22271	42	10/40

YATO	max. Ø [mm]	
YT-22272	50	10/30

max Ø
63
mm

max Ø
75
mm



YATO	max. Ø [mm]	
YT-22273	63	10/30

YATO	max. Ø [mm]	
YT-22274	75	10/30

EN PVC pipe cutter
 PL Obcinak do rur PVC
 DE PVC Rohrschneider
 RU Труборез для труб из ПВХ
 CZ Řezač PVC trubek
 HU Csővágó olló PVC csővekhez
 RO Clește pt. tăiat țevi din PVC
 FR Coupe-tube en PVC
 IT Cesolia per tubi in PVC
 ES Cortatubos para PVC
 CN PVC 管子割刀



YATO	max. Ø [mm]	
YT-22301	32	12/120

EN PVC pipe cutter
 PL Obcinak do rur PVC
 DE PVC Rohrschneider
 RU Труборез для труб из ПВХ
 CZ Řezač PVC trubek
 HU Csővágó olló PVC csővekhez
 RO Clește pt. tăiat țevi din PVC
 FR Coupe-tubes PVC a cliquet
 IT Taglia tubi PVC
 ES Cortatubos para PVC
 CN PVC 管子割刀



max Ø
42
mm

max Ø
64
mm

YATO	max. Ø [mm]	
YT-22292	42	6/48

YATO	max. Ø [mm]	
YT-22293	64	6/24

EN Pipe cutter
 PL Obcinak do rur
 DE Rohrschneider
 RU Труборез для труб
 CZ Řezač trubek
 HU Csővágó olló csővekhez
 RO Clește pt. tăiat țevi
 FR Coupeurs aux tubes
 IT Tagliatubi
 ES Cortatubos
 CN 快速管子割刀

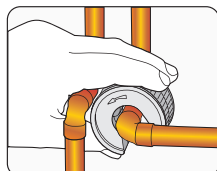

YATO	Cutting diameter / Średnica cięcia	External diameter / Średnica zewnętrzna [mm]	
YT-22353	19/32" (15 mm)	48	10/50
YT-22354	23/32" (18 mm)	59	10/50
YT-22355	7/8" (22 mm)	56	10/50

EN Pipe cutter
PL Obcinak do rur
DE Rohrschneider
RU Труборез для труб
CZ Řezač trubek
HU Csővágó olló csővekhez
RO Clește pt. tăiat țevi
FR Coupeurs aux tubes
IT Rullo di taglio per tubi
ES Cortatubos
CN 管子割刀

PVC PP
PU PE
SS Al Cu
1/10"-7/8"
3-22 mm



YATO
YT-22318

Cutting diameter / Średnica cięcia
1/10" - 7/8" (3-22 mm)

100

PEX
BEARING
STEEL
STAL
ŁOŻYSKOWA



PVC PP
PU PE
SS Al Cu
3-28 mm
QUICK
ADJUSTMENT
SZYBKA
REGULACJA
HRC
56-62
9CrSi



YATO
YT-22341

Cutting diameter / Średnica cięcia [mm]
3-28

10/60

PVC PP
PU PE
SS Al Cu
3-28 mm
QUICK
ADJUSTMENT
SZYBKA
REGULACJA
DEBURRER
GRATOWNIK
HRC
56-62
9CrSi



YATO
YT-22342

Cutting diameter / Średnica cięcia [mm]
3-28

6/48

PVC PP
PU PE
Al Cu
1/10"-5/4"
3-32 mm
QUICK
ADJUSTMENT
SZYBKA
REGULACJA
DEBURRER
GRATOWNIK
SPARE CUTTING
WHEEL
ZAPASOWE
KÓŁKO TNAČE



YATO
YT-22338

Cutting diameter / Średnica cięcia
1/10" - 1-1/4" (3-32 mm)

50

PVC PP
PU PE
SS Al Cu
3/8"-1 5/8"
10-40 mm
QUICK
ADJUSTMENT
SZYBKA
REGULACJA



YATO
YT-2232

Cutting diameter / Średnica cięcia
3/8" - 1-5/8" (10-40 mm)

20

PVC PP
PU PE
Al Cu
1/4"-7/4"
6-45 mm
DEBURRER
GRATOWNIK
SPARE CUTTING
WHEEL
ZAPASOWE
KÓŁKO TNAČE



YATO
YT-2233

Cutting diameter / Średnica cięcia
1/4" - 1-3/4" (6-45 mm)

25

PVC PP
PU PE
SS Al Cu
16-54 mm
QUICK
ADJUSTMENT
SZYBKA
REGULACJA
DEBURRER
GRATOWNIK
HRC
56-62
9CrSi



YATO
YT-22344

Cutting diameter / Średnica cięcia [mm]
16-54

4/16

PVC PP
PU PE
Al Cu
1/2"-5/2"
14-63 mm
QUICK
ADJUSTMENT
SZYBKA
REGULACJA
SPARE CUTTING
WHEEL
ZAPASOWE
KÓŁKO TNAČE



YATO
YT-2234

Cutting diameter / Średnica cięcia
1/2" - 2-1/2" (14-63 mm)

25

PVC PP
PU PE
Al Cu
2"-5"
50-127 mm
QUICK
ADJUSTMENT
SZYBKA
REGULACJA



YATO
YT-2235

Cutting diameter / Średnica cięcia
2" - 5" (50-127 mm)

10

PVC PP
PU PE
Al Cu
6-35 mm
DEBURRER
GRATOWNIK
GCr15
SPARE CUTTING
WHEEL
ZAPASOWE
KÓŁKO TNAČE



YATO
YT-22332

Cutting diameter / Średnica cięcia [mm]
6-35

5/50

PVC PP
PU PE
Al Cu
3-42 mm
DEBURRER
GRATOWNIK
GCr15
SPARE CUTTING
WHEEL
ZAPASOWE
KÓŁKO TNAČE



YATO
YT-22333

Cutting diameter / Średnica cięcia [mm]
3-42

4/32

EN Replacement cutting wheel for pipe cutters
PL Zapasowe kółko tnače do obcinaka do rur
DE Ersatzschneidrad für Rohrschneider
RU Запасной режущий диск для труборезов
CZ Náhradní řezné kolečko na trubky frézy
HU Tartalék vágókerék cső vágó
RO Roata de schimb pt. taiere țevi
FR Molette pour coupe
IT Ruota di ricambio per tagliatubi
ES Rueda de corte de repuesto para cortatubos
CN 管子割刀刀片

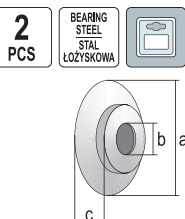

YATO	a [mm]	b [mm]	c [mm]	For / Dla	
YT-22313	18	6.0	4.8	YT-2233	50/300
YT-22314	26	14.0	7.5	YT-2232	6/108
YT-22315	18	6.0	4.8	YT-22338	50/300
YT-22316	27	6.3	5.0	YT-2234	24/288

EN Replacement cutting wheel or pipe cutters
PL Zapasowe kółko tnače do obcinaka do rur
DE Ersatzschneidrad für Rohrschneider
RU Запасной режущий диск для труборезов
CZ Náhradní řezné kolečko na trubky frézy
HU Tartalék vágókerék cső vágó
RO Roata de schimb pt. taiere țevi
FR Molette pour coupe
IT Ruota di ricambio per tagliatubi
ES Rueda de corte de repuesto para cortatubos
CN 管子割刀刀片

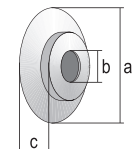

YATO	a [mm]	b [mm]	c [mm]	For / Dla	
YT-22317	44	10.6	8	YT-2235	12/144

EN Replacement cutting wheel for pipe cutters
 PL Zapasowe kółko tnące do obcinaka do rur
 DE Ersatzschneiderrad für Rohrschneider
 RU Зарпасной режущий диск для труборезов
 CZ Náhradní fezné kolečko na trubky frézy
 HU Tartalék vágókerék cső vágó
 RO Roata de schimb pt. taiere tevi
 FR Molette de rechange pour coupe-tube
 IT Ruota di ricambio per tagliatubi
 ES Rueda de corte de repuesto para cortatubos
 CN 管子割刀刀片

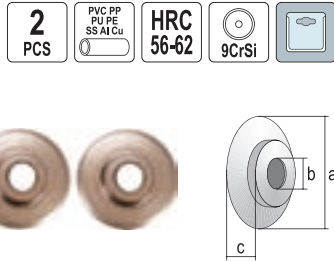

YATO	a [mm]	b [mm]	c [mm]	For / Dla	
YT-22343	18.5	6	4.8	YT-22341, YT-22342	24/144

EN Replacement cutting wheel for pipe cutters
 PL Zapasowe kółko tnące do obcinaka do rur
 DE Ersatzschneiderrad für Rohrschneider
 RU Зарпасной режущий диск для труборезов
 CZ Náhradní fezné kolečko na trubky frézy
 HU Tartalék vágókerék cső vágó
 RO Roata de schimb pt. taiere tevi
 FR Molette de rechange pour coupe-tube
 IT Ruota di ricambio per tagliatubi
 ES Rueda de corte de repuesto para cortatubos
 CN 管子割刀刀片

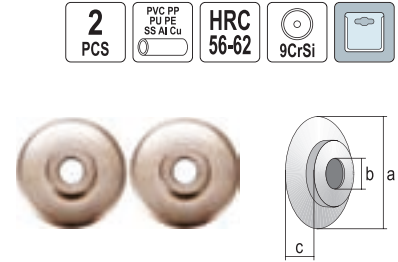

YATO	a [mm]	b [mm]	c [mm]	For / Dla	
YT-22345	21.5	6	4.9	YT-22344	24/144

EN Standard two handed bender
 PL Giętarka do rur
 DE Standard-Zweihand-Bieger
 RU Стандартный двуручный трубогиб
 CZ Dvouruční ohýbačka cu trubek
 HU Kétfézes hajlító
 RO Dispozitiv de indoit teava
 FR Cintreuse à tubes manuelle
 IT Curvatubi manuale
 ES Curvadora de tubo manual
 CN 弯管器

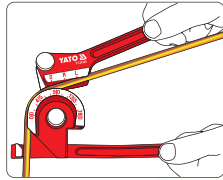

180°



YATO	Pipe diameter / Šrednica rury	
YT-21840	1/4" (6.3 mm), 5/16" (8 mm), 3/8" (10 mm)	20

EN Standard two handed bender
 PL Giętarka do rur
 DE Standard-Zweihand-Bieger
 RU Стандартный двуручный трубогиб
 CZ Dvouruční ohýbačka cu trubek
 HU Kétfézes hajlító
 RO Dispozitiv de indoit teava
 FR Cintreuse à tubes manuelle
 IT Curvatubi manuale
 ES Curvadora de tubo manual
 CN 弯管器

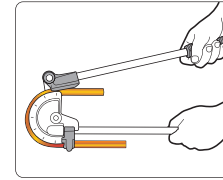

180°



YATO	Pipe diameter / Šrednica rury	
YT-21842	15/32" (12 mm)	20
YT-21844	9/32" (15 mm)	10
YT-21845	5/8" (16 mm)	10
YT-21846	23/32" (18 mm)	10

11

EN Internal pipe bending spring
 PL Sprężyna wewnętrzna do gięcia rur
 DE Innen-Rohrbiegefeder
 RU Пружина внутренняя для изгиба металлопластиковых труб
 CZ Pružina pro ohýbání trubek vnitřní
 HU Belső cső hajlító rugó
 RO Arc indoire pt. tevi flexibile
 FR Ressort à cintrer intérieur
 IT Molla piegatubi interna
 ES Muelle curvatubos interior
 CN 弹簧弯管器

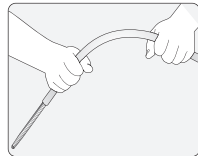

760 mm

PEX

ZINC PLATED OCYNKOWANA

FLAT PROFILE PŁASKI PROFIL



YATO	Pipe internal diameter / Wewnętrzna średnica rury [mm]	
YT-21850	16	25
YT-21851	20	25
YT-21852	25-26	25

EN External pipe bending spring
 PL Sprężyna zewnętrzna do gięcia rur
 DE Außen-Rohrbiegefeder
 RU Пружина наружная для изгиба труб
 CZ Pružina pro ohýbání trubek vnější
 HU Csőhajlító rugó külső
 RO Arc exterior de Indoire a tevii
 FR Ressort à cintrer extérieur pour tube
 IT Molla piegatubi esterna
 ES Muelle curvatubos exterior
 CN 弯管弹簧

600 mm

PEX

ZINC PLATED OCYNKOWANA

FLAT PROFILE PŁASKI PROFIL



YATO	Pipe external diameter / Zewnętrzna średnica rury [mm]	
YT-21855	16	40
YT-21856	20	40
YT-21857	25-26	20

EN Hand flaring tools set
 PL Praska do ręcznego rozszerzania rur
 DE Handpresse zum Aufweiten von Röhren
 RU Пресс для ручного расширения труб
 CZ Přípravek na ruční rozšiřování konců trubek
 HU Kézi csőtágító
 RO Presă manuală pt. lățirea țevilor
 FR Set pour élargir les tubes
 IT Presa per tubi
 ES Prensa para la elongación manual de tubos
 CN 扩孔器组套

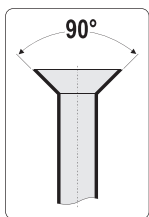
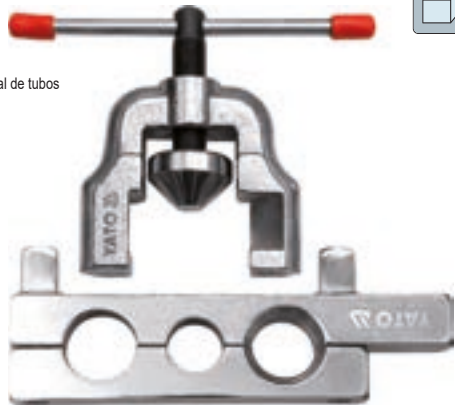

YATO	Pipe diameter / Šrednica rury [mm]	
YT-2182	22, 25, 28	20

EN Hand flaring tools set
 PL Praska do ręcznego rozszerzania rur
 DE Handpresse zum Aufweiten von Röhren
 RU Пресс для ручного расширения труб
 CZ Přípravek na ruční rozšiřování konců trubek
 HU Kézi csőtágító
 RO Presă manuală pt. lățirea țevilor
 FR Set pour élargir les tubes
 IT Presa per tubi
 ES Prensa para la elongación manual de tubos
 CN 扩孔器组套

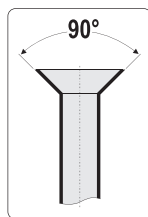

YATO	Pipe diameter / Šrednica rury [mm]	
YT-2180	3, 5, 6, 8, 10, 12, 14, 15, 16, 19	10

- EN Pipe calibration tool with reamer
PL Kalibrator z gratownikiem
DE Kalibrierer und Entgrater für Mehrschichtverbundrohr
RU Калибратор пластиковый с фаскоснимателем
CZ Kalibrátor s odhrotovačem pro trubku
HU Csőkalibráló sorjázóval
RO Calibrator teava cu debavurator
FR Calibreur ébavureur pour tube multicouche
IT Calibratore sbavatore per tubo
ES Desbarbador y calibrador para tubos
CN 三脚内外倒角整圆器

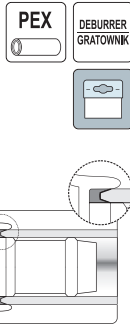

YATO	Pipe external diameter / Zewnętrzna średnica rury [mm]	
YT-22373	16, 20, 25	200
YT-22374	16, 20, 26	200

- EN Pipe calibration tool with reamer
PL Kalibrator z gratownikiem
DE Kalibrierer und Entgrater für Mehrschichtverbundrohr
RU Калибратор пластиковый с фаскоснимателем
CZ Kalibrátor s odhrotovačem pro trubku
HU Csőkalibráló sorjázóval
RO Calibrator teava cu debavurator
FR Calibreur ébavureur pour tube multicouche
IT Calibratore sbavatore per tubo
ES Desbarbador y calibrador para tubos
CN 三脚内外倒角整圆器

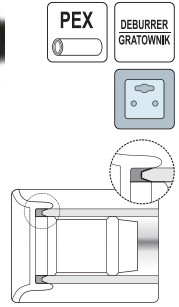

YATO	Pipe external diameter / Zewnętrzna średnica rury [mm]	
YT-22375	16	10/40
YT-22376	20	10/40
YT-22377	25, 26	10/40

- EN Gas torch
PL Palnik gazowy
DE Gasbrenner
RU Газовая горелка
CZ Plynový hořák
HU Gázégő
RO Arzător de gaz
FR Chalumeau à gaz
IT Saldatore bruciatore a gas
ES Soplete de gas
CN 火焰枪



YATO	[kW]	
YT-36700	0.7	10/20

- EN Gas torch
PL Palnik gazowy
DE Gasbrenner
RU Газовая горелка
CZ Plynový hořák
HU Gázégő
RO Arzător de gaz
FR Chalumeau à gaz
IT Saldatore bruciatore a gas
ES Soplete de gas
CN 火焰枪



YATO	[kW]	
YT-36725	0.2	60

- EN Gas torch
PL Palnik gazowy
DE Gasbrenner
RU Газовая горелка
CZ Plynový hořák
HU Gázégő
RO Arzător de gaz
FR Chalumeau à gaz
IT Saldatore bruciatore a gas
ES Soplete de gas
CN 火焰枪

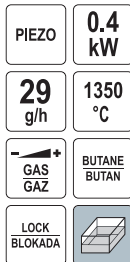

YATO	[kW]	
YT-36726	0.4	10/40

- EN Gas torch
PL Palnik gazowy
DE Gasbrenner
RU Газовая горелка
CZ Plynový hořák
HU Gázégő
RO Arzător de gaz
FR Chalumeau à gaz
IT Saldatore bruciatore a gas
ES Soplete de gas
CN 火焰枪

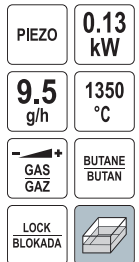

YATO	[kW]	
YT-36727	0.13	10/50

- EN Gas blow torch
PL Palnik gazowy
DE Lötbrenner
RU Газовая горелка
CZ Plynový hořák
HU Gázégő
- RO Arzator pe gaz
FR Chalumeau à gaz
IT Saldatore bruciatore a gas
ES Soplete de gas
CN 喷枪



YATO	[kW]	
YT-36711	1.7	40

- EN Gas soldering lamp
PL Gazowa lampa lutownicza
DE Gaslötlampe
RU Газовая паяльная лампа
CZ Plynová pájecí lampa
HU Gázos forrasztólámpa
- RO Lampă de lipit pe gaz
FR Lampe à souder
IT Lampada per saldare a gas
ES Lampa de gas para soldar
CN 喷灯

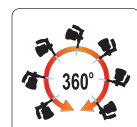

YATO	[kW]	
YT-36720	1.7	12

EN Soldering tool set
 PL Lutownica gazowa z akcesoriami
 DE GaslötKolben Satz
 RU Газовый паяльный набор
 CZ Plynová pajka souprava
 HU Gaz forrasztópaka készletek

RO Set ciocan de lipit cu gaz
 FR Fer à souder à gaz
 IT Saldatore a gas
 ES Soldador a gas con accesorios
 CN 自动点火多功能瓦斯组套

7 PCS PIEZO 30-125 W 30 ml 75 min GAS GAZ BUTANE BUTAN PROPANE BUTANE PROPAN BUTAN LIGHTER GAS GAZ DO ZAPALNIKZEK LOCK BLOKADA CHILDREN PROTECTION ZABEZPECZENIE PRZED DZIECIAMI

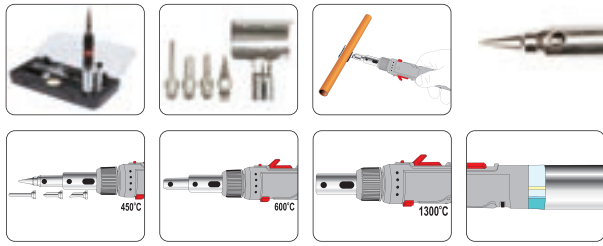

YATO	[W]	
YT-36706	30-125	6

EN Gas blow torch
 PL Palnik gazowy
 DE Lötbrenner
 RU Газовая горелка
 CZ Plynový hořák
 HU Gázégő
 RO Arzător de gaz
 FR Chalumeau à gaz
 IT Saldatore
 bruciatore a gas
 ES Soplete de gas
 CN 火焰枪

PIEZO 1.0 kW 73 g/h GAS GAZ BUTANE BUTAN



YATO	[kW]	
YT-36710	1	10/100

EN Turbo gas torch
 PL Palnik gazowy turbo
 DE Turbo-Handbrenner
 RU Газовая горелка турбо
 CZ Plynový hořák turbo
 HU Kézi gázégő
 RO Arzător cu gaz turbo
 FR Chalumeau à gaz
 IT Saldatore bruciatore a gas
 ES Quemador de gas turbo
 CN 手持式焊枪

PIEZO 2800 °C 2.0 kW 142 g/h 2.59 MPa G1" F GAS GAZ PROPANE PROPAN AUTO START STOP LOCK BLOKADA CONTINUOUS RUN/LOCK BLOKADA PRACY CIĄGŁEJ TURBO NOZZLE DYSZA TURBO

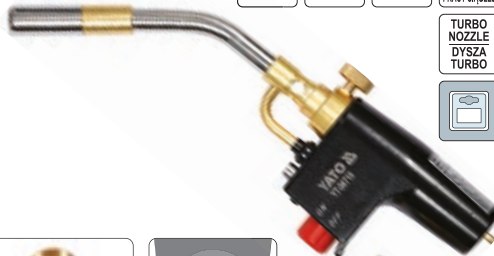

YATO	[kW]	
YT-36715	2	20

EN Blow torch
 PL Lutownica gazowa dekarska
 DE Gas-Dachdeckerlötkolben
 RU Кровельный газовый паяльник
 CZ Pokryvačská plynová pajka
 HU Gázégő tetőfedő munkákhoz
 RO Arzator gaz
 FR Fer à souder couvreur
 IT Cannello saldatore a gas per posa coperture tetti
 ES Soldador a gas de tejás
 CN 焊枪套装

PROPANE BUTANE PROPAN BUTAN Cu TIP GROTT 1.5 m



YATO	[W]	L [mm]	
YT-36701	4	360	20

EN Gas blow torch
 PL Palnik gazowy
 DE Lötbrenner
 RU Газовая горелка
 CZ Plynový hořák
 HU Gázégő
 RO Arzător de gaz
 FR Chalumeau à gaz
 IT Saldatore
 bruciatore a gas
 ES Soplete de gas
 CN 火焰枪

PIEZO 1.28 kW GAS GAZ AIR POWIETRZE LOCK BLOKADA BUTANE BUTAN

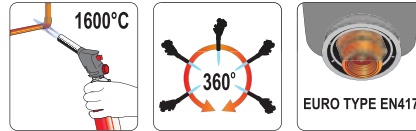

YATO	[kW]	
YT-36709	1.28	6/12

EN Gas blow torch
 PL Palnik gazowy
 DE Lötbrenner
 RU Газовая горелка
 CZ Plynový hořák
 HU Gázégő
 RO Arzător de gaz
 FR Chalumeau à gaz
 IT Saldatore bruciatore a gas
 ES Soplete de gas
 CN 喷枪

PIEZO 2.0 kW 145 g/h GAS GAZ BUTANE BUTAN

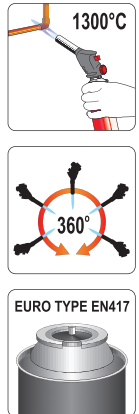

YATO	[kW]	
YT-36712	2	20/80

EN Soldering torch
 PL Palnik do lutowania
 DE Lötbrenner
 RU Горелка для пайки
 CZ Pájecí hořák
 HU Forrasztópaka
 RO Lampa pt. sudura
 FR Torche de soudage
 IT Cannello di brasatura
 ES Soplete de soldadura
 CN 焊枪套装

4 kW 290 g/h 360 mm PROPANE BUTANE PROPAN BUTAN x3 20/40/50 mm 1.5 m



YATO	[kW]	L [mm]	
YT-36730	4	360	20

EN Soldering torch
PL Palnik do lutowania
DE Lötbrenner
RU Горелка для пайки
CZ Pájecí hořák
HU Forrasztópáka

RO Lampa pt. sudura
FR Torche de soudage
IT Cannello di brasatura
ES Soplete de soldadura
CN 焊枪套装

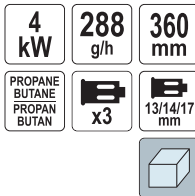

YATO	[kW]	L [mm]	
YT-36731	4	360	20

EN Roofing torch
PL Palnik dekarski
DE Dachdeckerbrenner
RU Горелка кровельная
CZ Pokrývačský hořák
HU Tetőfedő égő
RO Lampa pt. izolatii
FR Outil à souder pour toiture
IT Cannello per posa copertura tetti
ES Antorcha de techo
CN 焊枪套装



YATO	[kW]	L [mm]	
YT-36741	65	900	6

EN PVC plastic pipe welder
PL Zgrzewarka do rur termoplastycznych
DE Schweißgerät für thermoplastische Rohre
RU Аппарат для сварки пластиковых труб
CZ Svářečka na termoplastické trubky
HU Hegesztő berendezés termoplasztikus csövekhez

RO Masina de sudat tevi termoplastice
FR Machine à souder pour tuyaux
IT Polifusore saldatore per tubi
ES Máquina de soldar las tubos termoplasticos
CN 热熔器

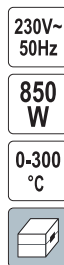

16, 20, 25, 32, 40, 50, 63 mm

YATO	[W]	
YT-82250	850	2

EN Roofing torch
PL Palnik dekarski
DE Dachdeckerbrenner
RU Горелка кровельная
CZ Pokrývačský hořák
HU Tetőfedő égő
RO Lampa pt. izolatii
FR Outil à souder pour toiture
IT Cannello per posa copertura tetti
ES Antorcha de techo
CN 焊枪套装

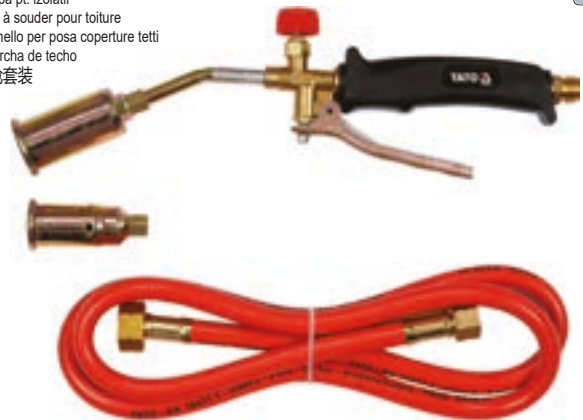

YATO	[kW]	L [mm]	
YT-36740	8	370	10

EN Weed burner
PL Palnik do wypalania chwastów
DE Unkrautbrenner
RU Горелка для выжигания сорняков
CZ Hořák na plevel
HU Gyomégető

RO Arzator pt. buruieni
FR Désherbeur thermique
IT Bruciatore di erbacce
ES Quemador de malezas
CN 除草炬

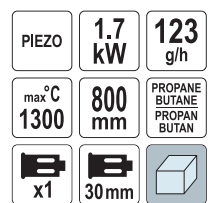

YATO	[kW]	L [mm]	
YT-36742	1.7	800	12

EN Crimping pliers for PEX-AL-PEX pipes
PL Praska do zaciskania złączek PEX-AL-PEX
DE Rohrpresszange PEX-AL-PEX
RU Пресс-клещи для металлопластиковых труб
CZ Lisovací kleště pro trubky PEX-AL-PEX
HU PEX-AL-PEX krimpelő eszköz
RO Clește de serizare pt. țevi PEX-AL-PEX
FR Pince à sertir tuyaux PEX-AL-PEX
IT Crimpatrice per tubi PEX-AL-PEX
ES Crimpadora para tubos PEX-AL-PEX
CN 手动压管钳

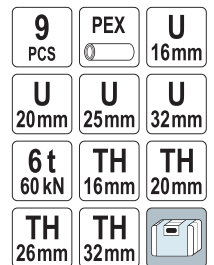

YATO	
YT-21735	2

EN Crimping pliers for PEX-AL-PEX pipes
 PL Praska do zaciskania złączek PEX-AL-PEX
 DE Rohrpresszange PEX-AL-PEX
 RU Пресс-клещи для металлопластиковых труб
 CZ Lisovací kleště pro trubky PEX-AL-PEX
 HU PEX-AL-PEX krimpelő eszköz

RO Clește de sertizare pt. țevi PEX-AL-PEX
 FR Pince à sertir tuyaux PEX-AL-PEX
 IT Crimpatrice per tubi PEX-AL-PEX
 ES Crimpadora para tubos PEX-AL-PEX
 CN 手动压管钳



EN Crimping pliers for PEX-AL-PEX pipes
 PL Praska do zaciskania złączek PEX-AL-PEX
 DE Rohrpresszange PEX-AL-PEX
 RU Пресс-клещи для металлопластиковых труб
 CZ Lisovací kleště pro trubky PEX-AL-PEX
 HU PEX-AL-PEX krimpelő eszköz

RO Clește de sertizare pt. țevi PEX-AL-PEX
 FR Pince à sertir tuyaux PEX-AL-PEX
 IT Crimpatrice per tubi PEX-AL-PEX
 ES Crimpadora para tubos PEX-AL-PEX
 CN 手动压管钳



YATO YT-21750 4

YATO YT-21751 4

EN Spare die for crimping pliers
 PL Matryca zapasowa do zaciskarki
 DE Ersatz Matrize für Presswerkzeug
 RU Вкладыши для пресс-инструмента
 CZ Vyměnné čelisti
 HU Présfogók
 RO Capete de presare pt. inele interschimbabile
 FR Matrices empreinte pour pince
 IT Dies ricambo
 ES Que prensa de troquel para crimpadora
 CN 手动压管钳模具

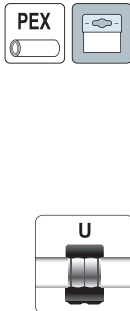

EN Spare die for crimping pliers
 PL Matryca zapasowa do zaciskarki
 DE Ersatz Matrize für Presswerkzeug
 RU Вкладыши для пресс-инструмента
 CZ Vyměnné čelisti
 HU Présfogók
 RO Capete de presare pt. inele interschimbabile
 FR Matrices empreinte pour pince
 IT Dies ricambo
 ES Que prensa de troquel para crimpadora
 CN 手动压管钳模具

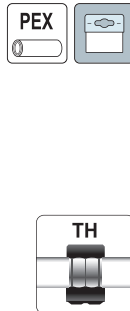

For YT-21735
 Dla YT-21735

For YT-21735
 Dla YT-21735

YATO	[mm]	
YT-21740	16	50
YT-21741	20	50
YT-21742	25	100
YT-21743	32	100

YATO	[mm]	
YT-21744	16	50
YT-21745	20	50
YT-21746	26	50
YT-21747	32	100

EN Spare die for crimping pliers
 PL Matryca zapasowa do zaciskarki
 DE Ersatz Matrize für Presswerkzeug
 RU Вкладыши для пресс-инструмента
 CZ Vyměnné čelisti
 HU Présfogók
 RO Capete de presare pt. inele interschimbabile
 FR Matrices empreinte pour pince
 IT Dies ricambo
 ES Que prensa de troquel para crimpadora
 CN 压模



EN Hinged pipe vice
 PL Imadło zaciskowe do rur
 DE Rohrschraubstock
 RU Тиски для труб
 CZ Uplínací svěrák na trubky
 HU Satu, csőszerítő
 RO Menghină pt. țevi
 FR Étau de serrage à tuyaux
 IT Morsa stringi tubo
 ES Tornillo de apriete para tubos
 CN 管子台虎钳



For YT-21750, YT-21751
 Dla YT-21750, YT-21751

YATO	[mm]	
YT-21755	16	50
YT-21756	20	50
YT-21757	25	50

EN Spare die for crimping pliers
 PL Matryca zapasowa do zaciskarki
 DE Ersatz Matrize für Presswerkzeug
 RU Вкладыши для пресс-инструмента
 CZ Vyměnné čelisti
 HU Présfogók
 RO Capete de presare pt. inele interschimbabile
 FR Matrices empreinte pour pince
 IT Dies ricambo
 ES Que prensa de troquel para crimpadora
 CN 压模



For YT-21750, YT-21751
 Dla YT-21750, YT-21751

YATO	[mm]	
YT-21752	16	50
YT-21753	20	50
YT-21754	26	50

YATO	Max. mounting element diameter / Maks. średnica mocowanego elementu [mm]	
YT-6510	60	4
YT-6511	76	2
YT-6512	90	2
YT-6513	110	1

- EN Thread seal string
PL Nić do uszczelniania gwintów
DE Gewindedichtfaden
RU Уплотнительная нить
CZ Těsnící vlákno na závity
HU Menettömítő zsinór
RO Snur de etansare conducte si filete
FR Tuyau étanchéité cordon
IT Filo sigillafi letti
ES Hilo sellador
CN 螺纹密封线



PIPE DIAMETER / ŚREDNICA RURY	CYCLE NUMBER / LICZBA ZWIĄZKÓW
1/2" (12.5 mm)	6-8
3/4" (19 mm)	7-9
1" (25 mm)	8-12
1 1/2" (38 mm)	10-15
2" (50 mm)	15-25
2 1/2" (63 mm)	20-35
3" (75 mm)	25-35
3 1/2" (88 mm)	30-40
4" (100 mm)	35-45

1.5 MPa (max.)
°C -20 +130
45° READJUSTMENT OF JOINS UP TO 105° (90° ZŁAZKA)
CORD CUTTER NOZ TNACY
50m 110x1/2" EFFICIENCY WYDAJNOŚĆ



YATO L [m] 25/100
YT-29220 50

- EN Thread seal string
PL Nić do uszczelniania gwintów
DE Gewindedichtfaden
RU Уплотнительная нить
CZ Těsnící vlákno na závity
HU Menettömítő zsinór
RO Snur de etansare conducte si filete
FR Tuyau étanchéité cordon
IT Filo sigillafi letti
ES Hilo sellador
CN 螺纹密封线



PIPE DIAMETER / ŚREDNICA RURY	CYCLE NUMBER / LICZBA ZWIĄZKÓW
1/2" (12.5 mm)	6-8
3/4" (19 mm)	7-9
1" (25 mm)	8-12
1 1/2" (38 mm)	10-15
2" (50 mm)	15-25
2 1/2" (63 mm)	20-35
3" (75 mm)	25-35
3 1/2" (88 mm)	30-40
4" (100 mm)	35-45

1.5 MPa (max.)
°C -20 +130
45° READJUSTMENT OF JOINS UP TO 105° (90° ZŁAZKA)
CORD CUTTER NOZ TNACY
150m 330x1/2" EFFICIENCY WYDAJNOŚĆ



YATO L [m] 25/100
YT-29222 150

- EN Water pressure gauge
PL Zestaw do kontroli ciśnienia instalacji wodnej
DE Druckmessgerät für Wasserinstallationen
RU Набор для контроля давления в установках воды
CZ Sada pro kontrolu tlaku vodovodní instalace
HU Víznyomásmérő óra
RO Manometru presiune apa
FR Kit de contrôle de la pression du système sanitaire
IT Set per controllo di pressione nell'impianto idrico
ES Kit para el control de presión en la instalación de agua
CN 水压表

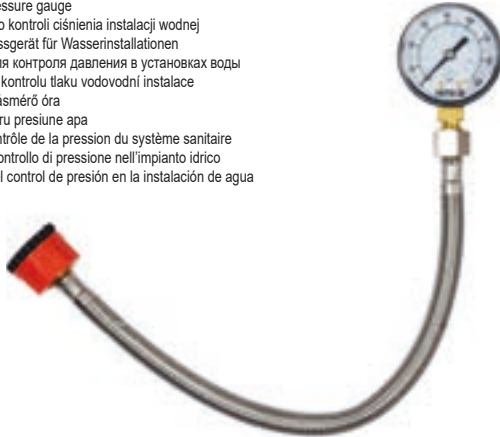

30 cm
0-1.1 MPa
G1/2
G3/4

YATO 10/80
YT-24790

- EN Hand pressure test pump
PL Pompa ręczna do prób ciśnieniowych
DE Handpumpe für Druckproben
RU Ручной насос для опрессовки
CZ Ruční čerpadlo pro tlakové testování
HU Kézi nyomáspróba szivattyú
RO Pompa manuala testat presiunea
FR Pompe manuelle pour tests de pression
IT Pompa manuale per prove di pressione
ES Bomba manual para pruebas de presión
CN 试压泵



490x160 x165 mm
12L
0-5 MPa
G1/2

YATO Tank capacity / Pojemność zbiornika [l] 2
YT-24800 12

- EN External chamfer
PL Gratownik zewnętrzny
DE Außenentgrater
RU Гратосниматель наружный для труб
CZ Přípravek na odstraňování ořepů
HU Külső sorjázó
RO Dispozitiv de teșire extern pt. debavurare
FR Ébavureur externe
IT Sbavatore esterno per tubi
ES Desbarbador de tubo exterior
CN 外圆倒角器



3-19 mm
12 mm
1/4" YG8
6.3 mm

YATO Ø [mm] 10/80
YT-22357 3-19

- EN Universal quick deburrer
PL Gratownik
DE Universal-Schnell-Entgrater
RU Универсальный быстро гратосниматель
CZ Univerzální rychlé odhrotování
HU Univerzális gyors sorjázó
RO Debavurator rapid universal
FR Ébavureur
IT Sbavatore per tubi
ES Desbarbador rápido universal
CN 去毛刺修边器

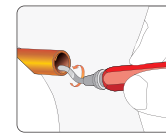

12 mm HSS M2
CHANGEABLE ROTATING BLADE WYMIENNE OSTRZE OBROTOWE



YATO 50/150
YT-22360

- EN Universal quick deburrer
PL Gratownik
DE Universal-Schnell-Entgrater
RU Универсальный быстро гратосниматель
CZ Univerzální odhrotovač
HU Univerzális gyors sorjázó
RO Debavurator rapid universal
FR Ébavureur
IT Sbavatore per tubi
ES Desbarbador rápido universal
CN 去毛刺修边器

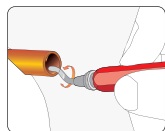

6 PCS HSS M2
CHANGEABLE ROTATING BLADE WYMIENNE OSTRZE OBROTOWE



YATO 50/100
YT-22363

- EN Replacement blade for deburrer
PL Ostrza zapasowe do gratownika
DE Ersatzklinge für Entgrater
RU Лезвие для снятия заусенцев
CZ Náhradní čepel pro odjehlování
HU Tartalék penge sorjázásához
RO Lama rezerva pt. debavurator
FR Set le lames pour ébavureur
IT Set di lame per sbavatore
ES Cuchilla de repuesto para desbarbar
CN 修边器刀片

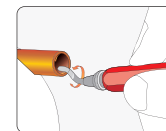

10 PCS HSS M2
UNIVERSAL SHAPE UNIVERZÁLIS KÉSZLET
CHANGEABLE ROTATING BLADE WYMIENNE OSTRZE OBROTOWE

For YT-22360
Dla YT-22360

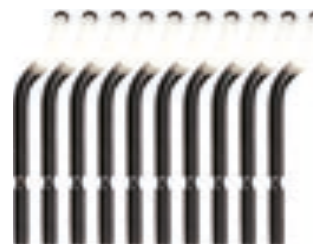

YATO 12/144
YT-22361

- EN Copper pipe internal brush
- PL Szczotka wewnętrzna do rur miedzianych
- DE Kupferrohr Innenbürste
- RU Щетка для внутренней очистки труб
- CZ Kartač vnitřní na měděné trubky
- HU Rézcső belső tisztító kefe
- RO Perii de interior pt. tevi de cupru
- FR Brosse aux tubes en cuivre
- IT Spazzola per il rame interno
- ES Cepillo para limpieza de tubos de cobre
- CN 管子刷



YATO	Pipe internal diameter / Wewnętrzna średnica rury [mm]	
YT-63701	15	12/240
YT-63702	18	12/240
YT-63703	22	12/240
YT-63704	28	12/240

- EN Cleaning pad set for copper pipes
- PL Włókna do czyszczenia rur miedzianych
- DE Reinigungsvlies-Satz für Kupferrohre
- RU Губка абразивная
- CZ Brusné rouno
- HU Tisztítószivacs
- RO Burete abraziv
- FR Tampons de nettoyage
- IT Fibra abrasiva per la pulizia de tubo di rame
- ES Almohadilla abrasiva
- CN 百洁布

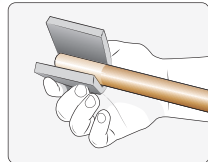

YATO	Size / Rozmiar [mm]	
YT-63740	75x130	50

- EN Drain auger
- PL Spirala kanalizacyjna
- DE Hand-Rohrreinigungsspirale
- RU Трос для прочистки канализационных труб и каналов
- CZ Spirála na čištění trubek
- HU Csőtisztító spirál
- RO Dedeman cablu pt. desfundat canale
- FR Câble de nettoyage de tuyaux pour les mains
- IT Sturafogne a molla spirale
- ES Varilla para limpiar drenajes
- CN 管道疏通器

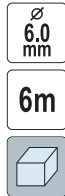

YATO	Ø [mm]	L [m]	
YT-24990	6x1.3	6	12

- EN Drain auger
- PL Spirala kanalizacyjna
- DE Hand-Rohrreinigungsspirale
- RU Трос для прочистки канализационных труб и каналов
- CZ Spirála na čištění trubek
- HU Csőtisztító spirál
- RO Dedeman cablu pt. desfundat canale
- FR Câble de nettoyage de tuyaux pour les mains
- IT Sturafogne a molla spirale
- ES Varilla para limpiar drenajes
- CN 管道疏通器

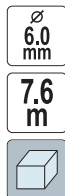

YATO	Ø [mm]	L [m]	
YT-24991	6x1.3	7.6	8

- EN Copper pipe brush 2 in 1
- PL Szczotka do rur miedzianych 2 w 1
- DE 2 in 1 Kupferrohrbürste für Innen- und Außenreinigung
- RU Щетка для внутренней и внешней зачистки медных труб
- CZ Kartač vnitřní a vnější na měděné trubky
- HU Rézcső tisztító kefe 2 in 1
- RO Perii pt. tevi de cupru 2 in 1
- FR Brosse aux tubes en cuivre
- IT Spazzola per il tubi di rame 2 in 1
- ES 2 en 1 cepillo para limpieza de tubos de cobre int. y ext
- CN 管子刷



YATO	Pipe external & internal diameter / Zewnętrzna i wewnętrzna średnica rury [mm]	
YT-63705	15, 22	50/100

- EN Drain auger
- PL Spirala kanalizacyjna
- DE Hand-Rohrreinigungsspirale
- RU Трос для прочистки канализационных труб и каналов
- CZ Spirála na čištění trubek
- HU Csőtisztító spirál
- RO Sarpe pt. desfundat țevi
- FR Câble de nettoyage de tuyaux pour les mains
- IT Sturafogne a molla spirale
- ES Varilla para limpiar drenajes
- CN 管道疏通器

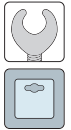

YATO	Ø [mm]	L [m]	
YT-25000	5x1.5	1.5	30/60
YT-25001	5x1.5	3.0	40
YT-25002	6x1.3	3.0	40
YT-25003	6x1.3	5.0	20
YT-25004	9x1.7	5.0	10
YT-25005	9x1.7	10.0	6

- EN Toilet auger
- PL Przetynacz do toalet
- DE Abflusstampfer
- RU Средство от засорения унитаза
- CZ Čistič toalet
- HU Duguláselhárító
- RO Dispozitiv pt. desfundat toaleta
- FR Ustensile pour déboucher les toilettes
- IT Stura WC
- ES Sonda destapadora wc
- CN 疏通器

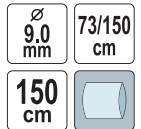

YATO	Ø [mm]	L [cm]	
YT-24983	9	150	6

- EN Drain rod set
PL Zestaw prętów do udrażniania kanalizacji
DE Abflusssreinigungsstangen-Set
RU Прутья для прочистки канализационных труб
CZ Pruty k čištění kanalizace sada
HU Csőtisztító rúdkészlet
RO Accesorii pt. dispozitiv desfundat revi
FR Tiges pour déboucher les canalisations
IT Kit di barre per lo sturamento della rete fognaria
ES Varillas de alcantarillado, juego
CN 疏通器



12 PCS	∅ 20 mm
9.2m	10x93.2 cm
PP	



YATO

YT-24980



8

- EN Brush for drain cleaning
PL Szczotka do udrażniania kanalizacji
DE Abflussbürste
RU Щетка для прочистки канализационных труб
CZ Štětkka k čištění kanalizace
HU Csőtisztító kefe
RO Perie pt. curatarea scurgerilor
FR Brosse pour déboucher les canalisations
IT Spazzola per lo sturamento della rete fognaria
ES Cepillo de alcantarillado
CN 疏通器刷头



For YT-24980
Dla YT-24980

YATO	∅ [cm]	
YT-24970	10	20/40
YT-24971	20	20/40
YT-24972	25	20/40

- EN Plunger for drain cleaning
PL Tłok okrągły do udrażniania kanalizacji
DE Gummi-Saugteller für Abflusreinigung
RU Круглый шток для прочистки канализационных труб
CZ Kulatý pist k čištění kanalizace
HU Csőtisztító gumpumpa
RO Pompă pt. curățarea scurgerilor
FR Piston pour déboucher les canalisations
IT Pistone tondo per lo sturamento della rete fognaria
ES Embolo redondo de drenaje
CN 橡胶吸盘

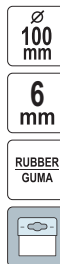

For YT-24980
Dla YT-24980

YATO	∅ [cm]	
YT-24960	10	24/96

- EN Scraper for drain cleaning
PL Skrobak opadowy do udrażniania kanalizacji
DE Klappscher für Abflusreinigung
RU Проходной скребок для прочистки канализационных труб
CZ Odpadová škrabka k čištění kanalizace
HU Csőtisztító kaparó
RO Racleță pt. curățarea scurgerilor
FR Grattoir pour déboucher les canalisations
IT Raschietto gravitazionale per lo sturamento della rete fognaria
ES Rasqueta articulada de alcantarillado
CN 疏通器耙头



For YT-24980
Dla YT-24980

YATO	Size / Rozmiar [mm]	
YT-24965	95x1.5	20/100

- EN Guide wheel for drain cleaning
PL Kółko prowadzące do udrażniania kanalizacji
DE Leitrad für Abflusreinigung
RU Ведущее колесо для прочистки канализационных труб
CZ Naváděcí koleko k čištění kanalizace
HU Csőtisztító vezetőkerék
RO Roata ghidaj curatarea scurgerilor
FR Roue de guidage pour déboucher les canalisations
IT Anello di guida per lo sturamento della rete fognaria
ES Rueda de guía de drenaje
CN 疏通器滚轮



For YT-24980
Dla YT-24980

YATO	∅ [mm]	
YT-24966	55	20/60







EN Tool box
 PL Skrzynka narzędziowa
 DE Werkzeugkasten
 RU Инструментальный ящик

CZ Skříňka na nářadí
 HU Szerszámós láda
 RO Cutie de scule
 FR Boîte à outils

IT Cassetta degli attrezzi
 ES Caja de herramientas
 CN 一抽屉工具组套



YATO 	Drawer quantity / Liczba szuflad	
YT-09108	1	2

YATO 	Drawer quantity / Liczba szuflad	
YT-09107	2	2

EN Tool trolley
 PL Wózek narzędziowy 3-częściowy
 DE Werkzeugkasten
 RU Тележка инструментальная

CZ Vozík na nářadí
 HU Szerszám kocsi
 RO Troler pt. scule
 FR Servante d'atelier

IT Armadio per utensili
 ES Herramienta carro
 CN 拉杆式工具箱



YATO 		
YT-09102		1

YATO 		
YT-09101		1

78
PCS

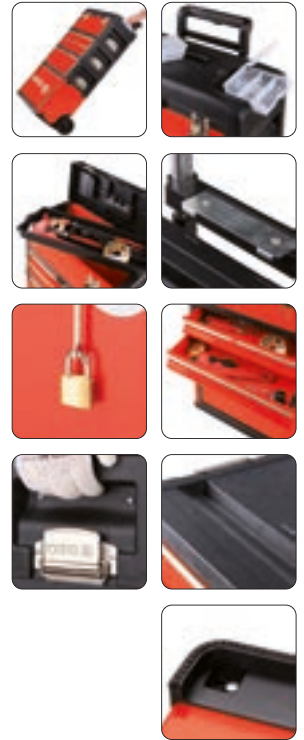

EN Tool trolley
PL Wózek narzędziowy 3-częściowy z narzędziami
DE Werkzeugkasten
RU Тележка инструментальная

CZ Vozík na nářadí
HU Szerszám kocsi
RO Troler cu scule
FR Servante d'atelier

IT Armadio per utensili
ES Herramienta carro
CN 手推式工具箱



Drawer 1 / Szuflada 1

- 1/2" (12.7 mm): 8, 10, 12, 13, 14, 15, 16, 17, 18, 19, 20, 21, 22 mm; CrV 50BV30;
- 1/2" (12.7 mm): (127 mm); CrV 50BV30;
- 1/2" (12.7 mm): (255 mm); 72T; CrV 6140;
- 3x75, 6x100; PH0x75, PH2x100 mm; S2;
- 215 mm;
- 1/4" (6.3 mm): 3.0, 3.5, 4.0, 5.5, 6.5 mm (L=25 mm); S2;
- 1/4" (6.3 mm): PH0, PH1, PH2, PH3 (L=25 mm); S2;
- 1/4" (6.3 mm): PZ0, PZ1, PZ2, PZ3 (L=25 mm); S2;
- 1/4" (6.3 mm): T10, T15 (L=25 mm); S2;
- 1/4" (6.3 mm): 2, 3, 4, 5, 6 mm (L=25 mm); S2;
- 1/4" (6.3 mm): 5, 6, 7, 8 x2, 9, 10, 11, 12, 13 mm



Drawer 2 / Szuflada 2

- 8, 10, 12, 13, 14, 15, 16, 17, 18, 19, 21 mm; CrV;
- 18 mm; SK5;
- 18 mm; SK5;
- 3 m x 16 mm



Drawer 3 / Szuflada 3

- 180 mm;
- 160 mm;
- 200 mm;
- 300 mm; 16-38 mm;
- 2, 2.5, 3, 4, 5, 6, 7, 8, 10, 12 mm; CrV 6150



YATO
YT-09104

1

EN Drawer insert / Tool set for plumbers
PL Wkład do szuflady / Zestaw narzędziowy dla hydraulików
DE Schubladeneinlage / Werkzeug-Set für Klempner
RU Вклад к выдвижному ящику / Набор инструментов для водопроводчик

CZ Vložka do zásuvky / Sada nářadí pro instalatér
HU Fiókbetét / Szerszámkészlet vízvezeték-szerelő
RO Adaos la sertar / Set de instrumente pt. instalator
FR Module plastique pour servante / Un ensemble d'outils pour les plombier

IT Tenone per l'armadio / Tool set per idraulici
ES Accesorio de cajón / Un conjunto de herramientas para fontanero
CN 管道工具组套



4
PCS

CrV CrMo

- 250 mm; CrV;
- 330 mm; CrV 6140;
- 250 mm; CrMo;
- 15 m x 19 mm; PTFE

YATO
YT-55480

5



5
PCS

CrV CrMo

- 250 mm;
- 300 mm;
- 250 mm; CrV;
- 3-32 mm;
- 10 m x 12 mm; PTFE

YATO
YT-55481

5

12

Fastening tools
Narzędzia do łączenia



Hand riveters & accessories
Nitownice ręczne i akcesoria

282-285

**Foam guns**
Pistolety do pianki

290

**Hand riveters**

Nitownice ręczne..... 282

Hand riveting tools

Nitownice ręczne, dźwigniowe..... 283

Hand nut tools

Nitownice do nitonakrętek..... 283

Hand riveters nut column

Nitownice do nitotrzpieni..... 284

Threaded rivet nuts

Nitonakrętki..... 284

Blind rivets

Nity..... 285

Pneumatic riveters

Nitownice pneumatyczne

285

**Caulking guns**

Wyciskacze do mas

291-292

**Steel cable ties**

Opaski metalowe

292

**Cable ties**

Opaski plastikowe

292

**Burners & soldering tools**

Palniki i lutownice

293-300

**Pliers for hollow expansion bolts**

Zaciskarki do kołków typu Molly

285-286

**Glue guns**

Pistolety do klejenia

300

**Screw, plug & nail sets**

Zestawy wkrętów, kołków i gwoździ

286

**Glue sticks**

Wkłady klejowe

301-302

**Staple guns & staples**

Zszywacze i zszywki

287-288

**Jigs & patterns**

Wzorniki i szablony

302-303

**Staple guns**

Zszywacze..... 287

Staple removers

Rozszywacze..... 288

Staples

Zszywki..... 288

Nails

Gwoździe..... 288

Pneumatic staplers & nailers

Zszywacze i gwoździarki pneumatyczne

289-290

**Pneumatic staplers**

Zszywacze pneumatyczne..... 289

Pneumatic nailers

Gwoździarki pneumatyczne..... 289

Screws

Wkręty..... 290

EN Hand riveter
 PL Nitownica ręczna
 DE Hand-Nietzange
 RU Ручной заклепочник
 CZ Ruční nýtovačka
 HU Kézi popszegecshűző

RO Presă de nituit manuală
 FR Riveteuse manuelle
 IT Rivettatrice manuale
 ES Remachadora de mano
 CN 拉铆枪

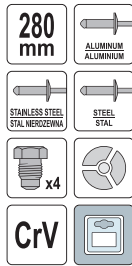

YATO	Ø [mm]	L [mm]	
YT-3600	2.4, 3.2, 4, 4.8	280	6/24

EN Hand riveter
 PL Nitownica ręczna
 DE Hand-Nietzange
 RU Ручной заклепочник
 CZ Ruční nýtovačka
 HU Kézi popszegecshűző

RO Presă de nituit manuală
 FR Riveteuse manuelle
 IT Rivettatrice manuale
 ES Remachadora de mano
 CN 拉铆枪



YATO	Ø [mm]	L [mm]	
YT-36007	2.4, 3.2, 4, 4.8	250	6/24

EN Hand riveter
 PL Nitownica ręczna
 DE Hand-Nietzange
 RU Ручной заклепочник
 CZ Ruční nýtovačka
 HU Kézi popszegecshűző

RO Presă de nituit manuală
 FR Riveteuse manuelle
 IT Rivettatrice manuale
 ES Remachadora de mano
 CN 拉铆枪

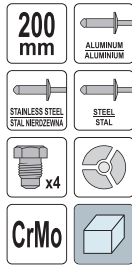

YATO	Ø [mm]	L [mm]	
YT-36012	2.4, 3.2, 4, 4.8	200	30

EN Hand riveter
 PL Nitownica ręczna
 DE Hand-Nietzange
 RU Ручной заклепочник
 CZ Ruční nýtovačka
 HU Kézi popszegecshűző

RO Presă de nituit manuală
 FR Riveteuse manuelle
 IT Rivettatrice manuale
 ES Remachadora de mano
 CN 拉铆枪

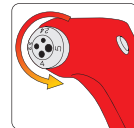

YATO	Ø [mm]	L [mm]	
YT-36011	2.4, 3.2, 4, 4.8	253	12/36

EN Universal hand riveter 3 in 1
 PL Nitownica ręczna uniwersalna 3 w 1
 DE Universal-Handnietzange 3 in 1
 RU Универсальный ручной заклепочник 3 в 1
 CZ Univerzální nýtovací kleště 3 v 1
 HU 3 az 1-ben univerzális kézi popszegecshűző

RO Cleste pop nit universal 3 in 1
 FR Riveteuse manuelle universelle 3 en 1
 IT Rivettatrice manuale universale 3 in 1
 ES Remachadora manual universal 3 en 1
 CN 三合一拉铆枪



YATO	Ø [mm]	Ø	L [mm]	
YT-36013	2.4, 3.2, 4, 4.8	M3, M4, M5, M6	275	8

EN Rivet for plastic rivets kit
 PL Zestaw nitownica do nitów plastikowych
 DE Kunststoff-Nietzangen-Satz
 RU Комплект заклепочница для пластиковых заклепок
 CZ Sada nýtovnice do plastových nýtů
 HU Szegecshűző készlet műanyag szegecsekhez
 RO Set de nituri din plastic + cleste
 FR Ensemble riveteuse pour rivets en plastique
 IT Kit rivettatrice per rivetti in plastica
 ES Juego remachadora para remaches de plástico
 CN 拉铆枪组套



YATO	Ø [mm]	L [mm]	
YT-35970	5, 6.3, 6.6	165	10/30

EN Hand riveter
 PL Nitownica ręczna
 DE Hand-Nietzange
 RU Ручной заклепочник
 CZ Ruční nýtovačka
 HU Kézi popszegecshűző
 RO Presă de nituit manuală
 FR Riveteuse manuelle
 IT Rivettatrice manuale
 ES Remachadora de mano
 CN 手动拉铆枪

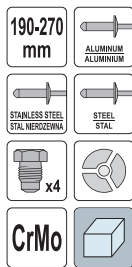

YATO	Ø [mm]	L [mm]	
YT-36070	2.4, 3.2, 4, 4.8	190-270	20

EN Lazy tongue riveter
 PL Nitownica harmonijkowa czolowa
 DE Blindnietzange
 RU Передний складной заклепочник
 CZ Nýtovačka harmoniková čelná
 HU Harmónikás popszegecshűző homlok

RO Presă de nituit armonică - frontală
 FR Pince riveter extensible
 IT Rivettatrice pieghevole anteriore
 ES Remachadora perezoso tong
 CN 重型伸缩拉铆枪



YATO	Ø [mm]	L [mm]	
YT-36060	2.4, 3.2, 4, 4.8, 6.4	250-810	10

EN Hand riveter 3 in 1
PL Nitownica dźwigniowa uniwersalna 3 w 1
DE Universal-Hebelnietzange 3 in 1
RU Заклепочник рычажный 3 в 1
CZ Univerzální pákové nýtovací kleště 3 v 1
HU 3 az 1-ben univerzális popszegecselő
RO Clește popnitruri 3 in 1
FR Riveteuse à levier universelle 3 en 1
IT Rivettatrice a leva universale 3 in 1
ES Remachadora universal de palanca 3 en 1
CN 拉铆枪



YATO	Ø [mm]	Ø	L [mm]	
YT-36091	2.4, 3.2, 4, 4.8, 6.4	M3, M4, M5, M6, M8, M10	260	6

EN Hand riveting tool
PL Nitownica dźwigniowa
DE Blindnietzange
RU Заклепочник рычажный
CZ Nýtovačka páková
HU Popszegecsűző

RO Nituire pârghie
FR Riveteuse à levier
IT Rivettatrice per rivetti a strappo
ES Remachadora de palanca
CN 拉铆枪

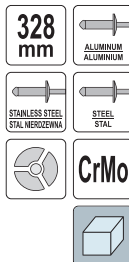
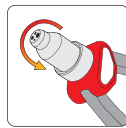

YATO	Ø [mm]	L [mm]	
YT-36092	3.2, 4, 4.8, 6.4	328	12

EN Hand riveting tool
PL Nitownica dźwigniowa
DE Blindnietzange
RU Заклепочник рычажный
CZ Nýtovačka páková
HU Popszegecsűző

RO Nituire pârghie
FR Riveteuse à levier
IT Rivettatrice per rivetti a strappo
ES Remachadora de palanca
CN 双把手拉铆枪

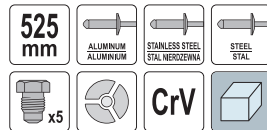

YATO	Ø [mm]	L [mm]	
YT-3610	3.2, 4, 4.8, 6, 6.4	525	12

EN Hand nut tool
PL Nitownica ręczna do nitonakrętek
DE Nietmutterzange
RU Ручной заклепочник для резьбовых заклепок
CZ Nýtovací kleště na matice
HU Emeltyűs popszegecsűző

RO Clește pt. piulițe nituibile
FR Riveteuse manuelle aux écrous
IT Rivettatrice mano rivetto
ES Remachadora de tuercas
CN 手动螺母枪

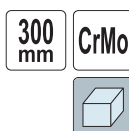

YATO	Ø	L [mm]	
YT-36112	M3, M4, M5, M6, M8	300	20

EN Hand riveting tool
PL Nitownica dźwigniowa
DE Blindnietzange
RU Заклепочник рычажный
HU Popszegecsűző

RO Nituire pârghie
FR Riveteuse à levier
IT Rivettatrice per rivetti a strappo
ES Remachadora de palanca
CN 双把手拉铆枪



YATO	Ø [mm]	L [mm]	
YT-3609	3.2, 4, 4.8, 6, 6.4	330	16

EN Hand riveting tool
PL Nitownica dźwigniowa
DE Blindnietzange
RU Заклепочник рычажный
CZ Nýtovačka páková
HU Popszegecsűző

RO Nituire pârghie
FR Riveteuse à levier
IT Rivettatrice per rivetti a strappo
ES Remachadora de palanca
CN 拉铆枪



YATO	Ø [mm]	L [mm]	
YT-36095	2.4, 3.2, 4, 4.8, 6.4	380	12

EN Hand nut tool
PL Nitownica ręczna do nitonakrętek
DE Nietmutterzange
RU Ручной заклепочник для резьбовых заклепок
CZ Nýtovací kleště na matice
HU Emeltyűs popszegecsűző

RO Clește pt. piulițe nituibile
FR Riveteuse manuelle aux écrous
IT Rivettatrice mano rivetto
ES Remachadora de tuercas
CN 手动螺母枪

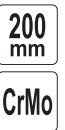

YATO	Ø	L [mm]	
YT-36140	M3, M4, M5, M6	200	20

EN Hand nut tool
PL Nitownica ręczna do nitonakrętek
DE Nietmutterzange
RU Ручной заклепочник для резьбовых заклепок
CZ Nýtovací kleště na matice
HU Emeltyűs popszegecsűző

RO Clește pt. piulițe nituibile
FR Riveteuse manuelle aux écrous
IT Rivettatrice mano rivetto
ES Remachadora de tuercas
CN 双把手螺母枪

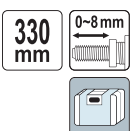

YATO	Ø	L [mm]	
YT-3612	M5, M6, M8, M10, M12	330	5

EN Hand nut tool
 PL Nitownica ręczna do nitonakrętek
 DE Nietmutterzange
 RU Ручной заклепочник для резьбовых заклепок
 CZ Nýtovací kleště na matice
 HU Emeltyűs popszegecshúzó

RO Clește pt. piulite nituibile
 FR Riveteuse manuelle aux écrous
 IT Rivettatrice mano rivetto
 ES Remachadora de tuercas
 CN 柳螺母枪

338 mm

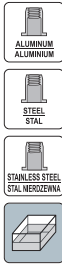

YATO	Ø	L [mm]	
YT-36119	M5, M6, M8, M10, M12	338	6

EN Hand nut tool
 PL Nitownica ręczna do nitonakrętek
 DE Nietmutterzange
 RU Ручной заклепочник для резьбовых заклепок
 CZ Nýtovací kleště na matice
 HU Emeltyűs popszegecshúzó

RO Clește pt. piulite nituibile
 FR Riveteuse manuelle aux écrous
 IT Rivettatrice mano rivetto
 ES Remachadora de tuercas
 CN 手动螺母枪

360 mm



YATO	Ø	L [mm]	
YT-36128	M3, M4, M5, M6, M8, M10, M12	360	6

EN Hand nut tool
 PL Nitownica ręczna do nitonakrętek
 DE Nietmutterzange
 RU Ручной заклепочник для резьбовых заклепок
 CZ Nýtovací kleště na matice
 HU Emeltyűs popszegecshúzó

RO Clește pt. piulite nituibile
 FR Riveteuse manuelle aux écrous
 IT Rivettatrice mano rivetto
 ES Remachadora de tuercas
 CN 柳螺母枪

410 mm



YATO	Ø	L [mm]	
YT-36129	M3, M4, M5, M6, M8, M10, M12	410	5

EN Threaded aluminum rivet nuts
 PL Nitonakrętki aluminiowe
 DE Aluminium blindnietmutter
 RU Алюминиевые резьбовые заклепки
 CZ Nýtovací matice hliník
 HU Szegecsanya alumínium

RO Piulite nituibile
 FR Insert fileté aluminium
 IT Alluminio dadi per rivetti ciechi
 ES Tuercas remachadas aluminio
 CN 柳枪螺母

20 PCS

AI



YATO	Size / Rozmiar	
YT-36451	M3	125/500
YT-36452	M4	100/400

YATO	Size / Rozmiar	
YT-36453	M5	75/300
YT-36454	M6	50/200

EN Hand nut tool
 PL Nitownica ręczna do nitonakrętek
 DE Nietmutterzange
 RU Ручной заклепочник для резьбовых заклепок
 CZ Nýtovací kleště na matice
 HU Emeltyűs popszegecshúzó

RO Clește pt. piulite nituibile
 FR Riveteuse manuelle aux écrous
 IT Rivettatrice mano rivetto
 ES Remachadora de tuercas
 CN 轻便型双手螺母枪

360 mm

CrMo



YATO	Ø	L [mm]	
YT-36127	M3, M4, M5, M6, M8, M10, M12	360	12

EN Hand nut tool
 PL Nitownica ręczna do nitonakrętek
 DE Nietmutterzange
 RU Ручной заклепочник для резьбовых заклепок
 CZ Nýtovací kleště na matice
 HU Emeltyűs popszegecshúzó

RO Clește pt. piulite nituibile
 FR Riveteuse manuelle aux écrous
 IT Rivettatrice mano rivetto
 ES Remachadora de tuercas
 CN 手动柳螺母枪

420 mm

CrMo

0-8 mm



YATO	Ø	L [mm]	
YT-36125	M3, M4, M5, M6, M8, M10, M12	420	5

EN Hand riveter nut column set
 PL Nitownica ręczna do nitotrzpieni z akcesoriami
 DE Nietzange für Blindnietsschrauben mit Zubehör
 RU Заклепочник для резьбовых заклепок с принадлежностями
 CZ Ruční nýtovačka na nýtovací šrouby s příslušenstvím
 HU Kézi szegecsanya húzó tartozékokkal
 RO Set cleste piulite nituibile
 FR Riveteuse manuelle pour boulons à rivet aveugle avec accessoires
 IT Rivettatrice manuale per perni filettati
 ES Remachadora manual para espárragos remachables con accesorios
 CN 柳螺母柱枪

46 PCS

360 mm

AI

CrMo



M4 (10 PCS), M5 (10 PCS), M6 (10 PCS), M8 (10 PCS)

YATO	Ø	L [mm]	
YT-36150	M4, M5, M6, M8	360	10

EN Threaded rivet nuts
 PL Nitonakrętki stalowe
 DE Blindnietmutter
 RU Резьбовые заклепки
 CZ Nýtovací matice
 HU Szegecsanya

RO Nituibile
 FR Insert fileté
 IT Dadi per rivetti ciechi
 ES Tuercas remachadas
 CN 拉柳螺母

20 PCS



YATO	Size / Rozmiar	
YT-36470	M3	125/500
YT-36471	M4	100/400
YT-36472	M5	75/300
YT-36473	M6	50/200

YATO	Size / Rozmiar	
YT-36474	M8	35/140
YT-36475	M10	25/100
YT-36476	M12	15/60

EN Threaded rivet nuts
PL Nitonakrętki
DE Blindnietmutter
RU Резьбовые заклепки
CZ Nýtovací matice
HU Szegecsanya
RO Nituibile
FR Insert fileté
IT Dadi per rivetti ciechi
ES Tuerças remachadas
CN 拉铆螺母



150
PCS

AI

M3x40, M4x35, M5x25, M6x25, M8x15, M10x10 mm



150
PCS

M3x40, M4x35, M5x25, M6x25, M8x15, M10x10 mm



300
PCS

AI

M3x25, M4x25, M5x25, M6x25, M8x25, M10x25, M3x25, M4x25, M5x25, M6x25, M8x25, M10x25 mm



YATO	
YT-36460	24

YATO	
YT-36481	24

YATO	
YT-36480	5/20

EN Plastic blind rivets
PL Nity plastikowe
DE Kunststoffnieten
RU Пластиковые заклепки
CZ Plastové nýty
HU Műanyag szegecsék
RO Nituri din plastic
FR Rivets en plastique
IT Rivetti in plastica
ES Remaches de plástico
CN 塑料铆钉

10
PCS

NYLON



YATO	Size / Rozmiar [mm]	
YT-35981	5.0x15.8	250
YT-35982	5.0x17.2	250
YT-35980	6.3x25.2	250
YT-35983	6.6x17.2	250

EN Pneumatic riveting machine
PL Nitownica pneumatyczna
DE Druckluft Nietzange
RU Пневматический заклепочник
CZ Pneumatická nýtovačka
HU Pneumatikus popszegecsőhúzó
RO Presa pneumatica pt. nituit
FR Riveuse pneumatique
IT Rivettatrice pneumatica
ES Máquina remachadora
CN 气动拉铆枪

0.70
MPa

54
l/min

1/4" 6.3mm
180°

ALUMINIUM
ALUMINIUM

STAINLESS STEEL
STAINLESS STEEL

STEEL
STEEL

x3

x3



$L_{pA} = 83,6 \pm 1,9$ dB; $L_{wA} = 97,4 \pm 2,8$ dB; $a_n = 0,66 \pm 0,21$ m/s²

YATO	Ø [mm]	Max. piston stroke / Maks. skok tłoka siłownika [mm]	F [kg]	F [N]	
YT-36171	2,4, 3,2, 4, 4,8, 5	18	757-1060	7430-10400	10

EN Pneumatic riveting machine
PL Nitownica pneumatyczna
DE Druckluft Nietzange
RU Пневматический заклепочник
CZ Pneumatická nýtovačka
HU Pneumatikus popszegecsőhúzó
RO Presa pneumatica pt. nituit
FR Riveuse pneumatique
IT Rivettatrice pneumatica
ES Máquina remachadora
CN 气动拉铆枪

0.62
MPa

ALUMINIUM
ALUMINIUM

STAINLESS STEEL
STAINLESS STEEL

STEEL
STEEL

x5

STANDARD



• Application: industry

• Przeznaczenie: przemysł

$L_{pA} = 81,2 \pm 3,0$ dB; $L_{wA} = 92,2 \pm 3,0$ dB; $a_n = 0,6 \pm 0,56$ m/s²

YATO	Ø [mm]	Max. piston stroke / Maks. skok tłoka siłownika [mm]	F [kg]	F [N]	
YT-3618	2,4, 3,2, 4, 4,8, 6,4	19	1894	18561	6

EN Pneumatic riveting machine
PL Nitownica pneumatyczna
DE Druckluft Nietzange
RU Пневматический заклепочник
CZ Pneumatická nýtovačka
HU Pneumatikus popszegecsőhúzó
RO Presa pneumatica pt. nituit
FR Riveuse pneumatique
IT Rivettatrice pneumatica
ES Máquina remachadora
CN 气动拉铆枪

0.70
MPa

60
l/min

1/4" 6.3mm
180°

ALUMINIUM
ALUMINIUM

STAINLESS STEEL
STAINLESS STEEL

STEEL
STEEL

x3

x3



$L_{pA} = 87,2 \pm 2,3$ dB; $L_{wA} = 94,5 \pm 3,0$ dB; $a_n = 0,54 \pm 0,15$ m/s²

YATO	Ø [mm]	Max. piston stroke / Maks. skok tłoka siłownika [mm]	F [kg]	F [N]	
YT-36177	4, 4,8, 5, 5,4, 6, 6,4	20	1255	12300	10

EN Pliers for hollow expansion bolts
PL Zaciskarka do kolków „Molly”
DE Maueranker-Einsetzwerkzeug
RU Клещи для дюбелей „Молли”
CZ Kleště kotvící pro Molly hmoždinky
HU Molly fogó üreges bővítőcsavarokhoz
RO Cleste dibluri
FR Pince pour chevilles creux
IT Crimpatrice per pioli „Molly”
ES Alicata para tacos „Molly”
CN 膨胀螺栓钳

175
mm

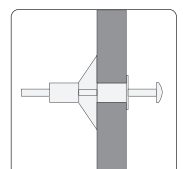

YATO	L [mm]	
YT-51452	175	5/30

EN Pliers for hollow expansion bolts
 PL Zaciskarka do kółków „Molly”
 DE Maueranker-Einsetzwerkzeug
 RU Клещи для дюбелей „Молли”
 CZ Kotvící kleště
 HU Kéretor üreges fémdübel
 RO Cleste dibluri
 FR Pince pour chevilles creux
 IT Crimpatrice per pioli „Molly”
 ES Alicates para tacos „Molly”
 CN 膨胀螺栓钳组套

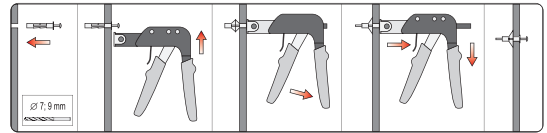

- Ø 7 mm (32 mm) x5;
- Ø 9 mm (37 mm) x5;
- Ø 4 mm (40 mm);
- Ø 5 mm (44 mm)



- Ø 7 mm (32 mm) x35;
- Ø 9 mm (37 mm) x15;
- Ø 9 mm (52 mm) x10;
- Ø 4 mm (40 mm);
- Ø 5 mm (44 mm);
- Ø 5 mm (58 mm)

YATO YT-51450 6/24

YATO YT-51451 3/12

EN Screw & plug set
 PL Zestaw wkrętów i kółków rozporowych
 DE Dübel- und Schrauben Sortiment
 RU Набор крепежа шурупы и дюбеля
 CZ Set šroubů a hmoždínek
 HU Csavar és tipli készlet
 RO Set dibluri + holsuruburi
 FR Set vis et chevilles
 IT Set di viti e tasselli a espansione
 ES Juego de tornillos y tacos
 CN 自攻螺钉膨胀组套



ZINC PLATED
OCYNKOWANA

- 5 x 20 mm (12 PCS), 6 x 25 mm (8 PCS), 8 x 30 mm (6 PCS);
- 3.5 x 25 mm (12 PCS), 4 x 30 mm (8 PCS), 5 x 30 mm (6 PCS)



- 4 x 20 mm (80 PCS), 5 x 25 mm (50 PCS), 6 x 30 mm (60 PCS),
- 7 x 35 mm (30 PCS), 8 x 40 mm (30 PCS), 10 x 45 mm (12 PCS), 12 x 60 mm (4 PCS)

YATO YT-36505 20/60

YATO YT-36502 8/16

EN Hardened knurled nails assortment
 PL Radelkowane gwoździe do betonu
 DE Stahlnägel geriffelt Sortiment
 RU Гвозди оцинкованные для бетона
 CZ Kalený hřebík do betonu
 HU Recézett szeg készlet
 RO Set cuie striate
 FR Assortiment de clous mousés harnes
 IT Chiodi zigrinati per calcestruzzo
 ES Jogo de pregos durados com erradas
 CN 竹节钉组套



ZINC PLATED
OCYNKOWANA



3.5 x 50 mm (66 PCS), 3.5 x 70 mm (40 PCS)

YATO YT-36510 12/24

EN Staple gun
PL Zszywacz tapicerski
DE Tacker
RU Crennep

CZ Čalounická sešivačka
HU Kárpitos tűzőgép
RO Capsator tapiterie
FR Agrafeuse tapissier

IT Cucitrice per tappezzerie
ES Grapadora de tapicero
CN 订书枪

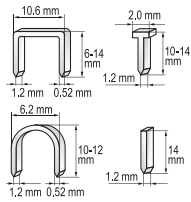

YATO
YT-7000

12/24

EN Staple gun
PL Zszywacz tapicerski
DE Tacker
RU Crennep

CZ Čalounická sešivačka
HU Kárpitos tűzőgép
RO Capsator tapiterie
FR Agrafeuse tapissier

IT Cucitrice per tappezzerie
ES Grapadora de tapicero
CN 订书枪

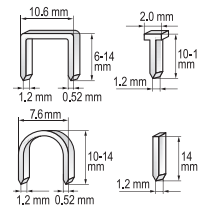

YATO
YT-7001

12/24

EN Staple gun
PL Zszywacz tapicerski
DE Tacker
RU Crennep
CZ Čalounická sešivačka
HU Kárpitos tűzőgép

RO Capsator tapiterie
FR Agrafeuse tapissier
IT Cucitrice per tappezzerie
ES Grapadora de tapicero
CN 订书枪

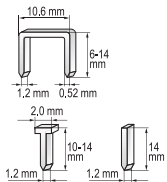
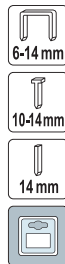

YATO
YT-7003

6/24

EN Staple gun
PL Zszywacz tapicerski
DE Tacker
RU Crennep
CZ Čalounická sešivačka
HU Kárpitos tűzőgép

RO Capsator tapiterie
FR Agrafeuse tapissier
IT Cucitrice per tappezzerie
ES Grapadora de tapicero
CN 订书枪

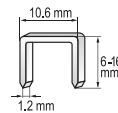

YATO
YT-7005

6/24

EN Staple gun
PL Zszywacz tapicerski
DE Tacker
RU Crennep
CZ Čalounická sešivačka
HU Kárpitos tűzőgép

RO Capsator tapiterie
FR Agrafeuse tapissier
IT Cucitrice per tappezzerie
ES Grapadora de tapicero
CN 订书机

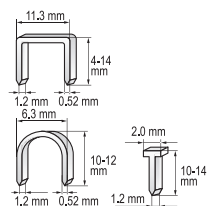
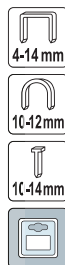

YATO
YT-7002O

6/24

EN Staple gun
PL Zszywacz tapicerski
DE Tacker
RU Crennep
CZ Čalounická sešivačka
HU Kárpitos tűzőgép

RO Capsator tapiterie
FR Agrafeuse tapissier
IT Cucitrice per tappezzerie
ES Grapadora de tapicero
CN 订书枪

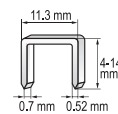

YATO
YT-7007

12/24

EN Staple gun
PL Zszywacz tapicerski
DE Tacker
RU Crennep
CZ Čalounická sešivačka
HU Kárpitos tűzőgép
RO Capsator tapiterie
FR Agrafeuse tapissier
IT Cucitrice per tappezzerie
ES Grapadora de tapicero
CN 订书机

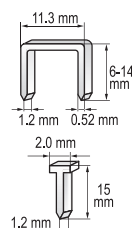

YATO
YT-70021

6/24

- EN Hammer tacker
 PL Zszywacz młotkowy
 DE Hammer Tacker
 RU Молотковый степлер
 CZ Sponkovač klavdivový
 HU Kalapács tűzőgép
- RO Capsator ciocan
 FR Marteau agrafeur
 IT Martello cucitrice
 ES Grapadora de martillo
 CN 钉锤

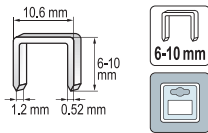

YATO		
YT-7004		10/20

- EN Hog ring pliers
 PL Szczypce do łączenia siatki
 DE Gitterverbindungsange
 RU Клещи для обжима сетки
 CZ Kleště pro spojování pletiva
 HU Drótrögítő kapcsozó fogó
 RO Clește pt. inele
 FR Pince à grillage
 IT Pinza ciappatrice per reti
 ES Grapadora para mallas
 CN 封口钳



YATO	L [mm]	
YT-51470	190	40

- EN Staples
 PL Zszywki
 DE Heftklammern
 RU Скобы
 CZ Sponky
 HU Tűzőkapocs
 RO Capse tapiterie
 FR Agrafes
 IT Punti
 ES Grapas
 CN 码钉

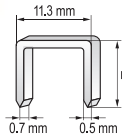
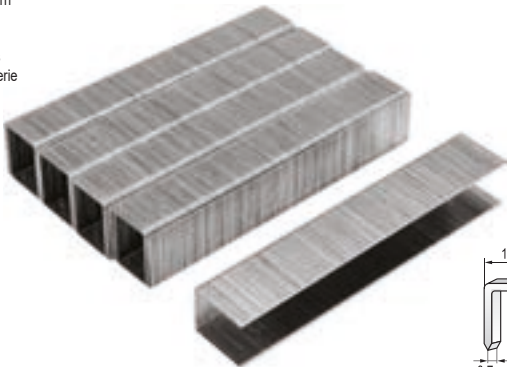

For YT-7007
 Dla YT-7007

YATO	L [mm]	pcs / szt.	
YT-7051	6	1000	60/360
YT-7052	8	1000	60/300
YT-7053	10	1000	60/240
YT-7054	12	1000	50/200
YT-7055	14	1000	40/160

- EN Hog ring staples C-type
 PL Klamry typu "C" do łączenia siatki
 DE C-Typ-Schnallen für Netzverbindungen
 RU Скобы типа "C" для обжима сетки
 CZ Svořky typu "C" pro spojování pletiva
 HU "C" típusú drótfűző kapocs
 RO Capse inele tip "C"
 FR Agrafes en "C" pour pince à grillage
 IT Punti tipo "C" per pinza ciappatrice
 ES Grapas tipo "C" para mallas
 CN 钉



For YT-51470
 Dla YT-51470

YATO		
YT-51471		20

- EN Staple remover
 PL Rozszywacz
 DE Klammern abwender
 RU Скободальитель
 CZ Rozešivač
 HU Kapocskiszedő
- RO Extractor capse
 FR Degrafeuse
 IT Fiocco di rimozione
 ES Quitagrapas
 CN 起钉器



YATO		
YT-7011		25/100

- EN Staples
 PL Zszywki
 DE Heftklammern
 RU Скобы
 CZ Sponky
 HU Tűzőkapocs
 RO Capse tapiterie
 FR Agrafes
 IT Punti
 ES Grapas
 CN 码钉

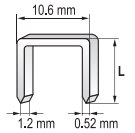
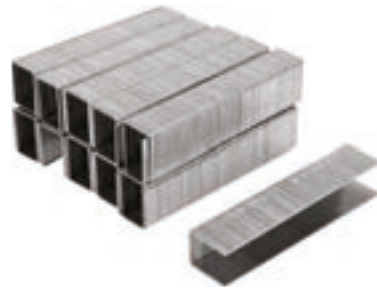

For YT-7000, YT-7001, YT-7003, YT-7005, YT-70020, YT-70021
 Dla YT-7000, YT-7001, YT-7003, YT-7005, YT-70020, YT-70021

YATO	L [mm]	pcs / szt.	
YT-7022	6	1000	50/200
YT-7023	8	1000	50/200
YT-7024	10	1000	50/100
YT-7025	12	1000	50/100
YT-7026	14	1000	50/100

- EN Staples
 PL Zszywki
 DE Heftklammern
 RU Скобы
 CZ Sponky
 HU Tűzőkapocs
 RO Capse tapiterie
 FR Agrafes
 IT Punti
 ES Grapas
 CN 码钉

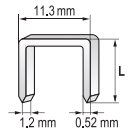

For YT-70020, YT-70021
 Dla YT-70020, YT-70021

YATO	L [mm]	pcs / szt.	
YT-70270	6	1000	50/200
YT-70271	8	1000	50/200
YT-70272	10	1000	50/100
YT-70273	12	1000	50/100
YT-70274	14	1000	50/100

- EN Nails for staple gun
 PL Gwoździe do zszywacza
 DE Nageln für Yato Tacker
 RU Гвозди для степлера
 CZ Hřebíky na sešivačku
 HU Szegek tűzőgéphez
- RO Cuie pt. capsator
 FR Clous pour agrafeuses
 IT Chiodi per cucitrice
 ES Clavos para grapadoras
 CN 直钉

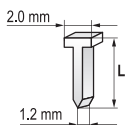

For YT-7000, YT-7001
 Dla YT-7000, YT-7001

YATO	L [mm]	pcs / szt.	
YT-7032	10	1000	50/200
YT-7033	12	1000	50/200
YT-7034	14	1000	50/200

EN Pneumatic stapler
PL Zszywacz pneumatyczny
DE Drucklufthefter
RU Пневматический шпигатель
CZ Pneumatická sešivačka
HU Pneumatikus tűzőgép
RO Capsator pneumatic
FR Agrafeuse pneumatique
IT Cucitrice pneumatica
ES Engrapadora neumática
CN 气动码钉枪

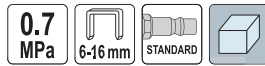

$L_{pa} = 88,0 \pm 2,5$ dB; $L_{wa} = 99,0 \pm 2,5$ dB; $a_n = 3,5 \pm 1,5$ m/s²

YATO 

YT-09201



10

EN Pneumatic stapler
PL Zszywacz pneumatyczny
DE Drucklufthefter
RU Пневматический шпигатель
CZ Pneumatická sešivačka
HU Pneumatikus tűzőgép
RO Capsator pneumatic
FR Agrafeuse pneumatique
IT Cucitrice pneumatica
ES Engrapadora neumática
CN 气动码钉枪

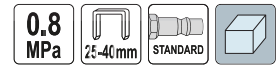

$L_{pa} = 88,6 \pm 2,5$ dB; $L_{wa} = 101,6 \pm 2,5$ dB; $a_n = 2,98 \pm 1,5$ m/s²

YATO 

YT-09202



10

EN Pneumatic stapler
PL Zszywacz pneumatyczny
DE Drucklufthefter
RU Пневматический шпигатель
CZ Pneumatická sešivačka
HU Pneumatikus tűzőgép
RO Capsator pneumatic
FR Agrafeuse pneumatique
IT Cucitrice pneumatica
ES Engrapadora neumática
CN 直钉/码钉二合一钉枪

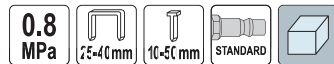

$L_{pa} = 87,8 \pm 2,5$ dB; $L_{wa} = 100,8 \pm 2,5$ dB; $a_n = 2,91 \pm 1,5$ m/s²

YATO 

YT-09203



10

EN Pneumatic roofing coil nailer
PL Gwoździarka bębnowa na gwoździe papowe
DE Pneumatischer Coilnagler für Innenausbau
RU Пневматический нейлер для гвоздей
CZ Pneumatická hřebíkovačka na šindele
HU Pneimatická naglošanas ierice
RO Pistol pneumatic cu bobină pt. bătut cuie pe acoperiș
FR Cloueuse de charpente pneumatique à bandes
IT Chiodatrice pneumatica
ES Clavadora neumática de bobina para tejados
CN 气动屋顶枪

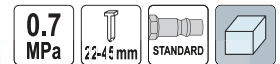

$L_{pa} = 100,3 \pm 2,5$ dB; $L_{wa} = 111,3 \pm 2,5$ dB; $a_n = 11,3 \pm 1,5$ m/s²

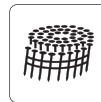

YATO 

YT-09211



3

EN Pneumatic roofing coil nailer
PL Gwoździarka bębnowa na gwoździe papowe
DE Pneumatischer Coilnagler für Innenausbau
RU Пневматический нейлер для гвоздей
CZ Pneumatická hřebíkovačka na šindele
HU Pneimatická naglošanas ierice
RO Pistol pneumatic cu bobină pt. bătut cuie pe acoperiș
FR Cloueuse de charpente pneumatique à bandes
IT Chiodatrice pneumatica
ES Clavadora neumática de bobina para tejados
CN 气动屋顶枪

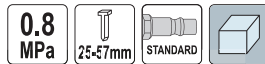

$L_{pa} = 88,6 \pm 2,5$ dB; $L_{wa} = 101,6 \pm 2,5$ dB; $a_n = 3,73 \pm 0,8$ m/s²

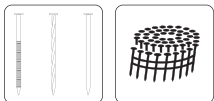

YATO 

YT-09212



3

EN Pneumatic roofing coil nailer
PL Gwoździarka bębnowa na gwoździe papowe
DE Pneumatischer Coilnagler für Innenausbau
RU Пневматический нейлер для гвоздей
CZ Pneumatická hřebíkovačka na šindele
HU Pneimatická naglošanas ierice
RO Pistol pneumatic cu bobină pt. bătut cuie pe acoperiș
FR Cloueuse de charpente pneumatique à bandes
IT Chiodatrice pneumatica
ES Clavadora neumática de bobina para tejados
CN 气动屋顶枪

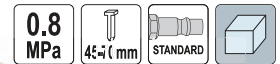

$L_{pa} = 101,7 \pm 2,5$ dB; $L_{wa} = 116,7 \pm 2,5$ dB; $a_n = 4,09 \pm 0,9$ m/s²

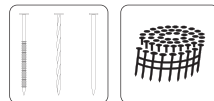

YATO 

YT-09213



3

EN Pneumatic roofing coil nailer
PL Gwoździarka bębnowa na gwoździe papowe
DE Pneumatischer Coilnagler für Innenausbau
RU Пневматический нейлер для гвоздей
CZ Pneumatická hřebíkovačka na šindele
HU Pneimatická naglošanas ierice
RO Pistol pneumatic cu bobină pt. bătut cuie pe acoperiș
FR Cloueuse de charpente pneumatique à bandes
IT Chiodatrice pneumatica
ES Clavadora neumática de bobina para tejados
CN 卷钉枪

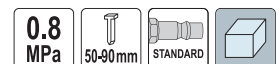

$L_{pa} = 92,3 \pm 2,5$ dB; $L_{wa} = 105,3 \pm 2,5$ dB; $a_n = 5,37 \pm 1,5$ m/s²

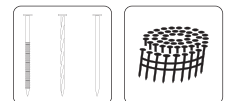

YATO 

YT-09214



2

EN Collated screws for metal
 PL Wkręty na taśmie do metalu
 DE Magazinierete Schrauben für Metall
 RU Саморезы в ленте по металлу
 CZ Šrouby do kovu na pásce
 HU Szalagfáras csavar fémhez

RO Banda suruburi pt. metal
 FR Vis pour métal en bande
 IT Viti per metallo a nastro
 ES Tornillos en tira para metal
 CN 螺丝钉

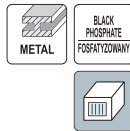

YATO	Ø [mm]	L [mm]	Screw head drive type / Rodzaj nacięcia łba	pcs / szt.	
YT-09440	3.5	25	PH2	1000	10
YT-09442	3.5	35	PH2	1000	10

EN Collated screws for wood
 PL Wkręty na taśmie do drewna
 DE Magazinierete Schrauben für Holz
 RU Саморезы в ленте по дереву
 CZ Šrouby do dřeva na pásce
 HU Szalagfáras csavar fához

RO Banda suruburi pt. lemn
 FR Vis pour bois en bande
 IT Viti per legno a nastro
 ES Tornillos en tira para madera
 CN 螺丝钉

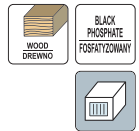

YATO	Ø [mm]	L [mm]	Screw head drive type / Rodzaj nacięcia łba	pcs / szt.	
YT-09460	3.9	35	PH2	1000	10
YT-09461	3.9	45	PH2	1000	8

EN Foam gun
 PL Pistolet do pianki montażowej
 DE Farbspritzpistole

RU Пистолет для нанесения полиуретановой пены
 CZ Pistole na montážní pěnu
 HU Felrakó pisztoly, poliurethán habhoz

RO Pistol pt. spumă
 FR Pistolet mousse expansive

ES Pistola para espuma de montaje de metal
 CN 发泡枪



YATO
YT-6740 10/20

YATO
YT-6741 10/20



YATO
YT-6742 10/20

YATO
YT-6743 20

YATO
YT-6745 20

EN Foam gun
 PL Pistolet do pianki montażowej
 DE Farbspritzpistole

RU Пистолет для нанесения полиуретановой пены
 CZ Pistole na montážní pěnu
 HU Felrakó pisztoly, poliurethán habhoz

RO Pistol pt. spumă
 FR Pistolet mousse expansive
 IT Pistola per schiuma poliuretanică

ES Pistola para espuma de montaje de metal
 CN 发泡枪



PTFE

PTFE

YATO
YT-67421 20

YATO
YT-67441 20

YATO
YT-67433 20

EN Foam gun
 PL Pistolet do pianki montażowej
 DE Schaumpistole
 RU Пистолет для нанесения полиуретановой пены
 CZ Pistole na montážní pěnu
 HU Felrakó pisztoly, poliurethán habhoz
 RO Pistol pt. spumă
 FR Pistolet mousse expansive
 IT Pistola per schiuma poliuretanică
 ES Pistola para espuma de montaje de metal
 CN 发泡枪

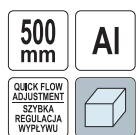

YATO
YT-67460 20

EN Caulking gun
PL Wyciskacz do mas
DE Kartuschenpistole
RU Пистолет для герметика
CZ Protlačovač na hmoty
HU Masszakinyomó
RO Pistol silicon
FR Pistolet à feutrer
IT Pistola per silicone
ES Pistola para masilla
CN 堵缝枪



300 ml

YATO	L [mm]	
YT-6751	225	10/12



300 ml

YATO	L [mm]	
YT-6753	225	6/12



310 ml

YATO	L [mm]	
YT-6754	225	6/12

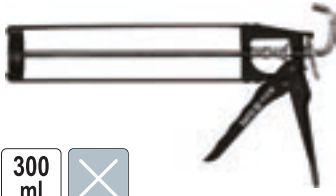

300 ml

YATO	L [mm]	
YT-6750	225	20/24



300 ml

YATO	L [mm]	
YT-6755	225	10/20



300 ml

YATO	L [mm]	
YT-67573	205	10



400 ml

YATO	L [mm]	
YT-67574	245	12

EN Caulking gun
PL Wyciskacz do mas
DE Kartuschenpistole

RU Пистолет для герметика
CZ Ruční vytlačovací pistole
HU Masszakinyomó

RO Pistol silicon
FR Pistolet à feutrer
IT Pistola per silicone

ES Pistola para masilla
CN 堵缝枪



225x60 mm

YATO	L [mm]	
YT-67520	225	12



225x70 mm

YATO	L [mm]	
YT-67560	225	6



225x60 mm

YATO	L [mm]	
YT-67570	225	12

EN Air caulking gun
PL Pneumatyczny wyciskacz do mas
DE Pneumatische Kartuschenpistole
RU Пневматический пистолет для герметика
CZ Pneumatická vytlačovací pistole
HU Pneumatikus extrudáló pisztoly
RO Pistol pneumatic pt. silicon
FR Pistolet à extruder pneumatique
IT Pistola pneumatica per sigillanti
ES Pistola neumática para masilla
CN 气动胶枪



1.0 MPa 380 mm 600 ml AI STANDARD

$L_{pa} = <70$ dB; $L_{ma} = <80$ dB; $a_b = <2,5$ m/s²

YATO	L [mm]	
YT-67470	380	5

EN Sealed nozzle set
PL Końcówki do nakładania silikonu
DE Enden zum Auftragen von Silikon
RU Наконечники для нанесения силикона
CZ Koncovky pro nanášení silikonu
HU Szilikon felhelyező fejek
RO Set duze
FR Embouts d'application du silicone
IT Punte per applicatori di silicone
ES Puntas para aplicar silicona
CN 不锈钢喷嘴

14 PCS SS304 STAINLESS STEEL NERZEWA



YATO	Ø [mm]	
YT-52622	5, 6, 7, 9, 10, 12, 13, 16, 20, 25, 26, 28, 30, 35	50

EN Pressure roller for use in bonding and laminating
PL Walek do silnego dociskania klejonych powierzchni
DE Andruckrolle zum starken Andrücken auf geklebte Oberflächen
RU Ролик для сильного прижима приклеенных поверхностей
CZ Váleček pro silné přitlačení lepených povrchů
HU Henger ragasztott felületek erős lenyomásához
RO Rola pt. lipit si laminat
FR Rouleau à lisser
IT Rullo pressore per superfici difficili da incollare
ES Rodillo para apretar superficies pegadas
CN 地毯滚筒

38x75 mm

320 mm

RUBBER GUMA

AI



YATO	Roller size / Rozmiar wałka [mm]	L [mm]	
YT-44150	38x75	320	6/24

EN Pressure roller for use in bonding and laminating
PL Walek do silnego dociskania klejonych powierzchni
DE Andruckrolle zum starken Andrücken auf geklebte Oberflächen
RU Ролик для сильного прижима приклеенных поверхностей
CZ Váleček pro silné přitlačení lepených povrchů
HU Henger ragasztott felületek erős lenyomásához
RO Rola pt. lipit si laminat
FR Rouleau à lisser
IT Rullo pressore per superfici difficili da incollare
ES Rodillo para apretar superficies pegadas
CN 地毯滚筒

38x75 mm

370 mm

RUBBER GUMA

STEEL STAL



YATO	Roller size / Rozmiar wałka [mm]	L [mm]	
YT-44151	38x75	370	6/24

EN Pressure roller for use in bonding and laminating
PL Walek do silnego dociskania klejonych powierzchni
DE Andruckrolle zum starken Andrücken auf geklebte Oberflächen
RU Ролик для сильного прижима приклеенных поверхностей
CZ Váleček pro silné přitlačení lepených povrchů
HU Henger ragasztott felületek erős lenyomásához
RO Rola pt. lipit si laminat
FR Rouleau à lisser
IT Rullo pressore per superfici difficili da incollare
ES Rodillo para apretar superficies pegadas
CN 地毯滚筒

38x190 mm

450-690 mm

RUBBER GUMA

STEEL STAL



YATO	Roller size / Rozmiar wałka [mm]	L [mm]	
YT-44152	38x190	450-690	6

EN Mortar gun with nozzles kit RO Pistol pt. silicon ES Pistola para calafatear mortero
 PL Wyciskacz do fugowania CZ Pistole vytláčovací FR Seringue mortier CN 堵缝枪
 DE Mörtelspritze HU Kinyomó pisztoly IT Pistola per silicone

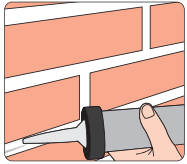

YATO	
YT-67580	10

YATO	
YT-67583	12

EN Stainless steel cable ties RO Legături pt. cabluri oțel
 PL Opaski zaciskowe ze stali nierdzewnej FR Colliers de serrage en acier inoxydable
 DE Edelstahl-Kabelbinder IT Fascette in acciaio inossidabile
 RU Хомуты из нержавеющей стали ES Abrazaderas de acero inoxidable
 CZ Hadicové svorky z nerezové oceli CN 不锈钢扎带
 HU Rozsdamentes acél kábelkötélgő



YATO	Size / Rozmiar [mm]	pcs / szt.	
YT-70560	125x4.6	100	100
YT-70561	200x4.6	100	100
YT-70562	250x4.6	100	50
YT-70563	300x4.6	100	50
YT-70564	350x4.6	100	50
YT-70565	400x4.6	100	50
YT-70566	450x4.6	100	50

YATO	Size / Rozmiar [mm]	pcs / szt.	
YT-70567	500x4.6	100	50
YT-70568	550x4.6	100	50
YT-70569	600x4.6	100	50
YT-70570	650x4.6	100	50
YT-70571	700x4.6	100	50
YT-70580	200x8.0	50	80
YT-70581	250x8.0	50	80

YATO	Size / Rozmiar [mm]	pcs / szt.	
YT-70582	300x8.0	50	60
YT-70583	350x8.0	50	60
YT-70584	400x8.0	50	50
YT-70585	450x8.0	50	50
YT-70586	500x8.0	50	50
YT-70587	550x8.0	50	50
YT-70588	600x8.0	50	50

EN Cable ties RO Set coliere din plastic
 PL Opaski plastikowe FR Attache de câble
 DE Kabelbinder IT Fascette di plastica
 RU Хомуты-стяжки пластмассовые ES Abrazadoras de plástico
 CZ Plastiková páska CN 尼龙扎带
 HU Műanyag pánt



YATO	Size / Rozmiar [mm]	Max. tensile strength / Maks. odporność na zrywanie [kg]	Max. wire bundle diameter / Maks. średnica wiązki kabli [mm]	pcs / szt.	
YT-70630	200x7.6	55	50	50	75/150
YT-70631	300x7.6	55	80	50	50/100
YT-70632	350x7.6	55	90	50	50/100
YT-70633	400x7.6	55	105	50	50/100
YT-70634	430x7.6	55	105	50	50/100

YATO	Size / Rozmiar [mm]	Max. tensile strength / Maks. odporność na zrywanie [kg]	Max. wire bundle diameter / Maks. średnica wiązki kabli [mm]	pcs / szt.	
YT-70635	500x7.6	55	145	50	40/80
YT-70636	450x9.0	80	108	50	30/60
YT-70637	550x9.0	80	160	50	25/50
YT-70638	700x9.0	80	195	50	20/40
YT-70639	760x12.6	114	205	50	10/20

EN Cable ties RO Set coliere din plastic
 PL Opaski plastikowe FR Attache de câble
 DE Kabelbinder IT Fascette di plastica
 RU Хомуты-стяжки пластмассовые ES Abrazadoras de plástico
 CZ Plastiková páska CN 尼龙扎带
 HU Műanyag pánt



YATO	Size / Rozmiar [mm]	Max. tensile strength / Maks. odporność na zrywanie [kg]	Max. wire bundle diameter / Maks. średnica wiązki kabli [mm]	pcs / szt.	
YT-70650	200x7.6	55	50	50	75/150
YT-70651	300x7.6	55	80	50	50/100
YT-70652	350x7.6	55	90	50	50/100
YT-70653	400x7.6	55	105	50	50/100
YT-70654	430x7.6	55	105	50	50/100

YATO	Size / Rozmiar [mm]	Max. tensile strength / Maks. odporność na zrywanie [kg]	Max. wire bundle diameter / Maks. średnica wiązki kabli [mm]	pcs / szt.	
YT-70655	500x7.6	55	145	50	40/80
YT-70656	450x9.0	80	108	50	30/60
YT-70657	550x9.0	80	160	50	25/50
YT-70658	700x9.0	80	195	50	20/40
YT-70659	760x12.6	114	205	50	10/20

EN Gas torch
PL Palnik gazowy
DE Gasbrenner
RU Газовая горелка
CZ Plynový hořák
HU Gázégő
RO Arzător de gaz
FR Chalumeau à gaz
IT Saldatore bruciatore a gas
ES Soplete de gas
CN 火焰枪



PIEZO 0.7 kW
30 ml 60-90 min
GAS GAZ BUTANE BUTAN
LIGHTER GAS GAZ DO ZAPALNICZEK LOCK BLOKADA
CHILDREN PROTECTION ZABEZPECZENIE PRZED DZIECIAMI



YATO	[kW]	
YT-36700	0.7	10/20

EN Gas torch
PL Palnik gazowy
DE Gasbrenner
RU Газовая горелка
CZ Plynový hořák
HU Gázégő
RO Arzător de gaz
FR Chalumeau à gaz
IT Saldatore bruciatore a gas
ES Soplete de gas
CN 火焰枪



PIEZO 0.2 kW
13.1 g/h GAS GAZ
BUTANE BUTAN LIGHTER GAS GAZ DO ZAPALNICZEK
LOCK BLOKADA CHILDREN PROTECTION ZABEZPECZENIE PRZED DZIECIAMI

YATO	[kW]	
YT-36725	0.2	60

EN Gas torch
PL Palnik gazowy
DE Gasbrenner
RU Газовая горелка
CZ Plynový hořák
HU Gázégő
RO Arzător de gaz
FR Chalumeau à gaz
IT Saldatore bruciatore a gas
ES Soplete de gas
CN 火焰枪



PIEZO 0.4 kW
29 g/h 1350 °C
GAS GAZ BUTANE BUTAN
LOCK BLOKADA

YATO	[kW]	
YT-36726	0.4	10/40

EN Gas torch
PL Palnik gazowy
DE Gasbrenner
RU Газовая горелка
CZ Plynový hořák
HU Gázégő
RO Arzător de gaz
FR Chalumeau à gaz
IT Saldatore bruciatore a gas
ES Soplete de gas
CN 火焰枪



PIEZO 0.13 kW
9.5 g/h 1350 °C
GAS GAZ BUTANE BUTAN
LOCK BLOKADA

YATO	[kW]	
YT-36727	0.13	10/50

EN Gas blow torch
PL Palnik gazowy
DE Lötbrenner
RU Газовая горелка
CZ Plynový hořák
HU Gázégő

RO Arzator pe gaz
FR Chalumeau à gaz
IT Saldatore bruciatore a gas
ES Soplete de gas
CN 喷枪



PIEZO 1.7 kW
123 g/h GAS GAZ
BUTANE BUTAN

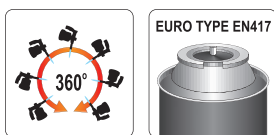

YATO	[kW]	
YT-36711	1.7	40

EN Gas soldering lamp
PL Gazowa lampa lutownicza
DE Gaslötlampe
RU Газовая паяльная лампа
CZ Plynová pájecí lampa
HU Gázos forrasztólámpa

RO Lampă de lipit pe gaz
FR Lampe à souder
IT Lampada per saldare a gas
ES Lampa de gas para soldar
CN 喷灯



PIEZO 1.7 kW
123 g/h GAS GAZ
BUTANE BUTAN

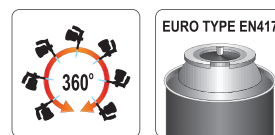

YATO	[kW]	
YT-36720	1.7	12

EN Soldering tool set
PL Lutownica gazowa z akcesoriami
DE Gaslötkolben Satz
RU Газовый паяльный набор
CZ Plynova pajka souprava
HU Gaz forrasztópaka készletek

RO Set ciocan de lipit cu gaz
FR Fer à souder à gaz
IT Saldatore a gas
ES Soldador a gas con accesorios
CN 自动点火多功能瓦斯组套

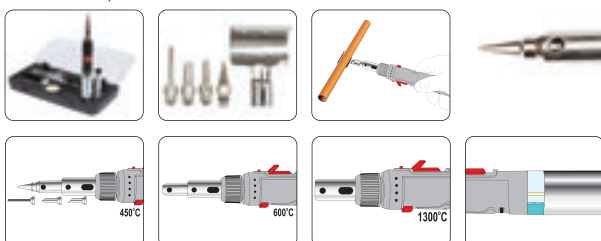

7 PCS PIEZO 30-125 W 30 ml 75 min GAS GAZ BUTANE BUTAN PROPANE BUTANE PROPAN BUTAN LIGHTER GAS GAZ DO ZAPALNICZEK LOCK BLOKADA CHILDREN PROTECTION ZABEZPECZENIE PRZED DZIECIAMI



YATO	[W]	
YT-36706	30-125	6

EN Gas blow torch
 PL Palnik gazowy
 DE Lötbrenner
 RU Газовая горелка
 CZ Plynový hořák
 HU Gázégő
 RO Arzător de gaz
 FR Chalumeau à gaz
 IT Saldatore
 bruciatore a gas
 ES Soplete de gas
 CN 火焰枪

PIEZO 1.0 kW 73 g/h GAS GAZ BUTANE BUTAN



YATO	[kW]	
YT-36710	1	10/100

EN Gas blow torch
 PL Palnik gazowy
 DE Lötbrenner
 RU Газовая горелка
 CZ Plynový hořák
 HU Gázégő
 RO Arzător de gaz
 FR Chalumeau à gaz
 IT Saldatore
 bruciatore a gas
 ES Soplete de gas
 CN 火焰枪

PIEZO 1.28 kW GAS GAZ AIR POWIETRZE LOCK BLOKADA BUTANE BUTAN



YATO	[kW]	
YT-36709	1.28	6/12

EN Turbo gas torch
 PL Palnik gazowy turbo
 DE Turbo-Handbrenner
 RU Газовая горелка турбо
 CZ Plynový hořák turbo
 HU Kézi gázégő
 RO Arzător cu gaz turbo
 FR Chalumeau à gaz
 IT Saldatore bruciatore a gas
 ES Quemador de gas turbo
 CN 手持式焊枪

PIEZO 2800 °C 2.0 kW 142 g/h 2.59 MPa G1" F GAS GAZ

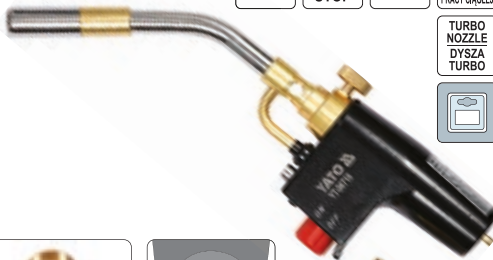

YATO	[kW]	
YT-36715	2	20

EN Gas blow torch
 PL Palnik gazowy
 DE Lötbrenner
 RU Газовая горелка
 CZ Plynový hořák
 HU Gázégő
 RO Arzător de gaz
 FR Chalumeau à gaz
 IT Saldatore bruciatore a gas
 ES Soplete de gas
 CN 喷枪

PIEZO 2.0 kW 145 g/h GAS GAZ BUTANE BUTAN

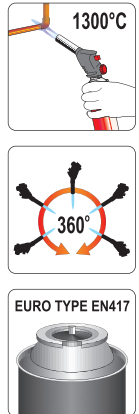

YATO	[kW]	
YT-36712	2	20/80

EN Blow torch
 PL Lutownica gazowa dekarska
 DE Gas-Dachdeckerlötkolben
 RU Кровельный газовый паяльник
 CZ Pokryvačská plynová pájka
 HU Gázégő tetőfedő munkákhoz
 RO Arzator gaz
 FR Fer à souder couvreur
 IT Cannello saldatore a gas per posa coperture tetti
 ES Soldador a gas de tejás
 CN 焊枪套装



PROPANE BUTANE PROPAN BUTAN Cu TP GROT 1.5 m

YATO	[W]	L [mm]	
YT-36701	4	360	20

EN Soldering torch
 PL Palnik do lutowania
 DE Lötbrenner
 RU Горелка для пайки
 CZ Pájecí hořák
 HU Forrasztópáka
 RO Lampa pt. sudura
 FR Torche de soudage
 IT Cannello di brasatura
 ES Soplete de soldadura
 CN 焊枪套装

4 kW 290 g/h



360 mm PROPANE BUTANE PROPAN BUTAN x3 20/40/50 mm 1.5 m

YATO	[kW]	L [mm]	
YT-36730	4	360	20

EN Soldering torch
 PL Palnik do lutowania
 DE Lötbrenner
 RU Горелка для пайки
 CZ Pájecí hořák
 HU Forrasztópáka

RO Lampa pt. sudura
 FR Torche de soudage
 IT Cannello di brasatura
 ES Soplete de soldadura
 CN 焊枪套装

4 kW 288 g/h 360 mm



PROPANE BUTANE PROPAN BUTAN x3 13/14/17 mm

YATO	[kW]	L [mm]	
YT-36731	4	360	20

EN Roofing torch
PL Palnik dekarski
DE Dachdeckerbrenner
RU Горелка кровельная
CZ Pokryvačský hořák
HU Tetőfedő égő

RO Lampa pt. izolatii
FR Outil à souder pour toiture
IT Cannello per posa coperture tetti
ES Antorcha de techo
CN 焊枪套装



8
kW

582
g/h

370
mm

PROPANE
BUTANE
PROPAN
BUTAN

x2

25/30
mm

1.5
m



YATO	[kW]	L [mm]	
YT-36740	8	370	10

EN Weed burner
PL Palnik do wypalania chwastów
DE Unkrautbrenner

RU Горелка для выжигания сорняков
CZ Hořák na plevel
HU Gyomérgető

RO Arzator pt. buruieni
FR Désherbeur thermique
IT Bruciatori di erbacce

ES Quemador de malezas
CN 除草炬



PIEZO

1.7
kW

123
g/h

max °C
1300

800
mm

PROPANE
BUTANE
PROPAN
BUTAN

x1

30mm



YATO	[kW]	L [mm]	
YT-36742	1.7	800	12

EN Heat shrink solder sleeve
PL Koszulka termokurczliwa z cyną
DE Wärmeschrumpfende Verbinder mit Zinn
RU Термоусадочная гильза с оловом
CZ Smršťovací trubička s cínem
HU Hőre zsugorodó hüvely ónnal
RO Manson pt. lipit cu aer cald
FR Gaine thermorétractable avec étain
IT Guaine termorestringenti con stagno
ES Tubo termorretráctil con estaño
CN 免压热缩中接焊锡端子

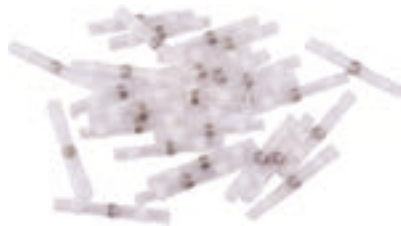

30
PCS

0.25
x0.34
mm²

105
°C

YATO	Cross-sectional area / Przekrój przewodu	
YT-81440	0.25-0.34 mm ² / 26-24 AWG	25/1500

EN Heat shrink solder sleeve
PL Koszulka termokurczliwa z cyną
DE Wärmeschrumpfende Verbinder mit Zinn
RU Термоусадочная гильза с оловом
CZ Smršťovací trubička s cínem
HU Hőre zsugorodó hüvely ónnal
RO Manson pt. lipit cu aer cald
FR Gaine thermorétractable avec étain
IT Guaine termorestringenti con stagno
ES Tubo termorretráctil con estaño
CN 免压热缩中接焊锡端子



30
PCS

0.5
x1.5
mm²

105
°C

YATO	Cross-sectional area / Przekrój przewodu	
YT-81441	0.5-1.5 mm ² / 22-18 AWG	15/900

EN Heat shrink solder sleeve
PL Koszulka termokurczliwa z cyną
DE Wärmeschrumpfende Verbinder mit Zinn
RU Термоусадочная гильза с оловом
CZ Smršťovací trubička s cínem
HU Hőre zsugorodó hüvely ónnal
RO Manson pt. lipit cu aer cald
FR Gaine thermorétractable avec étain
IT Guaine termorestringenti con stagno
ES Tubo termorretráctil con estaño
CN 免压热缩中接焊锡端子

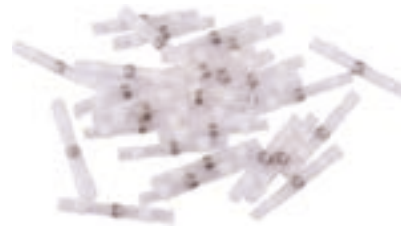

100
PCS

0.25
x0.34
mm²

105
°C

YATO	Cross-sectional area / Przekrój przewodu	
YT-81451	0.25-0.34 mm ² / 26-24 AWG	558

EN Heat shrink solder sleeve
PL Koszulka termokurczliwa z cyną
DE Wärmeschrumpfende Verbinder mit Zinn
RU Термоусадочная гильза с оловом
CZ Smršťovací trubička s cínem
HU Hőre zsugorodó hüvely ónnal
RO Manson pt. lipit cu aer cald
FR Gaine thermorétractable avec étain
IT Guaine termorestringenti con stagno
ES Tubo termorretráctil con estaño
CN 免压热缩中接焊锡端子



100
PCS

0.5
x1.5
mm²

105
°C

YATO	Cross-sectional area / Przekrój przewodu	
YT-81452	0.5-1.5 mm ² / 22-18 AWG	378

EN Heat shrink solder sleeve
 PL Koszulka termokurczliwa z cyną
 DE Wärmeschrumpfende Verbinder mit Zinn
 RU Термоусадочная гильза с оловом
 CZ Smřšťovací trubička s cínem
 HU Hőre zsugorodó hüvely ónnal
 RO Manson pt. lipit cu aer cald
 FR Gaine thermorétractable avec étain
 IT Guaine termorestringenti con stagno
 ES Tubo termorretráctil con estaño
 CN 免压热缩中接焊锡端子

30 PCS 1.5 x2.5 mm² 105 °C



YATO	Cross-sectional area / Przekrój przewodu	
YT-81442	1.5-2.5 mm ² / 16~14 AWG	5/300

EN Heat shrink solder sleeve
 PL Koszulka termokurczliwa z cyną
 DE Wärmeschrumpfende Verbinder mit Zinn
 RU Термоусадочная гильза с оловом
 CZ Smřšťovací trubička s cínem
 HU Hőre zsugorodó hüvely ónnal
 RO Manson pt. lipit cu aer cald
 FR Gaine thermorétractable avec étain
 IT Guaine termorestringenti con stagno
 ES Tubo termorretráctil con estaño
 CN 免压热缩中接焊锡端子

100 PCS 1.5 x2.5 mm² 105 °C



YATO	Cross-sectional area / Przekrój przewodu	
YT-81453	1.5-2.5 mm ² / 16~14 AWG	130

EN Heat shrink solder sleeve
 PL Koszulka termokurczliwa z cyną
 DE Wärmeschrumpfende Verbinder mit Zinn
 RU Термоусадочная гильза с оловом
 CZ Smřšťovací trubička s cínem
 HU Hőre zsugorodó hüvely ónnal
 RO Manson pt. lipit cu aer cald
 FR Gaine thermorétractable avec étain
 IT Guaine termorestringenti con stagno
 ES Tubo termorretráctil con estaño
 CN 免压热缩中接焊锡端子

20 PCS 4.0 x6.0 mm² 105 °C



YATO	Cross-sectional area / Przekrój przewodu	
YT-81443	4-6 mm ² / 12~10 AWG	5/300

EN Heat shrink solder sleeve
 PL Koszulka termokurczliwa z cyną
 DE Wärmeschrumpfende Verbinder mit Zinn
 RU Термоусадочная гильза с оловом
 CZ Smřšťovací trubička s cínem
 HU Hőre zsugorodó hüvely ónnal
 RO Manson pt. lipit cu aer cald
 FR Gaine thermorétractable avec étain
 IT Guaine termorestringenti con stagno
 ES Tubo termorretráctil con estaño
 CN 免压热缩中接焊锡端子

20 PCS 4.0 x6.0 mm² 105 °C



YATO	Cross-sectional area / Przekrój przewodu	
YT-81443	4-6 mm ² / 12~10 AWG	5/300

EN Heat shrink solder sleeve set
 PL Zestaw koszulek termokurczliwych z cyną
 DE Satz wärmeschrumpfender Verbinder mit Zinn
 RU Комплект термоусадочных гильз с оловом
 CZ Sada smřšťovacích trubiček s cínem
 HU Hőre zsugorodó hüvelykészlet ónnal

RO Set mansoane lipit cu aer cald
 FR Jeu de gaines thermorétractables avec étain
 IT Set di guaine termorestringenti con stagno
 ES Conjunto de tubos termorretráctiles con estaño
 CN 免压热缩中接焊锡端子

100 PCS

0.25 x6.0 mm²

105 °C



YATO	Cross-sectional area / Przekrój przewodu	
YT-81450	0.25-6 mm ² / 26~10 AWG	150

EN Heat shrink solder sleeve set
 PL Zestaw koszulek termokurczliwych z cyną
 DE Satz wärmeschrumpfender Verbinder mit Zinn
 RU Комплект термоусадочных гильз с оловом
 CZ Sada smřšťovacích trubiček s cínem
 HU Hőre zsugorodó hüvelykészlet ónnal
 RO Set mansoane lipit cu aer cald
 FR Jeu de gaines thermorétractables avec étain
 IT Set di guaine termorestringenti con stagno
 ES Kit de capas termorretráctiles con estaño
 CN 免压热缩中接焊锡管

220 PCS 0.25 x6.0 mm² 105 °C

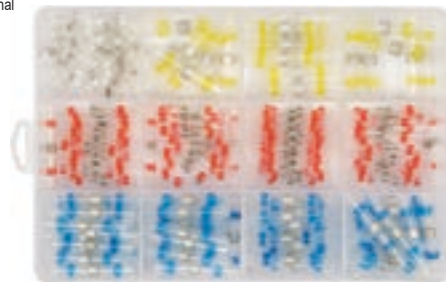

YATO	Cross-sectional area / Przekrój przewodu	
YT-81460	0.25-6 mm ² / 26~10 AWG	60

EN Heat shrink butt connectors set
 PL Zestaw zaciskanych koszulek termokurczliwych
 DE Satz gewellte Schrumpfhüllen
 RU Набор обжимных термоусадочных трубок
 CZ Sada upínacích teplem smřštitelných bužírek
 HU Szigetelt toldóhüvely készlet
 RO Set de conectori termocontractabili
 FR Jeu de manchons thermorétractables sertis
 IT Set di giunti termorestringenti con stagno
 ES Juego de tubos termorretráctiles
 CN 防水热缩端子

200 PCS 0.5 x6.0 mm²



0.5-1.5 mm² (90 PCS), 1.5-2.5 mm² (90 PCS), 4.0-6.0 mm² (20 PCS)

YATO	Cross-sectional area / Przekrój przewodu	
YT-81461	0.5-6 mm ² / 20~10 AWG	60

EN Silicone soldering mat
 PL Mata silikonowa do lutowania
 DE Silikon-Lötmatte
 RU Силиконовый коврик для пайки
 CZ Silikonová podložka pro letování
 HU Szilikon forrasztóalátét
 RO Saltea din silicon pt. lipit
 FR Tapis à souder en silicone
 IT Tappetino per saldatura in silicone
 ES Estera de soldadura de silicona
 CN 硅胶垫

max C 500



YATO	Size / Rozmiar [mm]	
YT-82468	250x350	50
YT-82469	300x400	30

- EN Solvent dispenser with pump
PL Butelka z dozownikiem z pompką
DE Flasche mit Dosiereinrichtung mit Pumpe
RU Бутылка с дозатором-насосом
CZ Láhev s dávkovačem a pumpičkou
HU Üveg pumpás adagolóval
RO Distributor de solvente cu pompă
FR Bouteille avec pompe
IT Fiaccone dosatore a pompa
ES Botella con dispensador y bomba
CN 按压式酒精瓶



100
ml

ALCOHOL
RESISTANCE
ODPORNOŚĆ
NA ALKOHOL

ESD
SAFE





- EN Dust blower ball
PL Gruszka do przedmuchiwania
DE Blasebalg
RU Груша для продувки
CZ Hruška pro profukování
HU Porfúvó
RO Pompa suflat praful
FR Poire de gonflage
IT Bulbo soffiatore
ES Pera sopladora
CN 吹尘球



ESD
SAFE



YATO 	[ml]	
YT-82516	100	20/120

YATO 		
YT-82512		30/180

- EN Solder iron tips set
PL Zestaw grzyw do lutowania
DE Lötspitzenset
RU Набор паяльных жал
CZ Sada pájecích hrotů
HU Forrasztóhegy készlet
RO Varfuri pistol de lipit
FR Jeu de pointes de fer à souder
IT Set di punte del saldatore
ES Juego de puntas para soldar
CN 烙铁头6件套

6
PCS

900M



Tip types: T-1, T-B, T-K, T2.4D, T-2C, T-3C
Rodzaje grzyw: T-1, T-B, T-K, T2.4D, T-2C, T-3C

YATO 		
YT-82525		24/240

- EN Solder iron tips set
PL Zestaw grzyw do lutowania
DE Lötspitzenset
RU Набор паяльных жал
CZ Sada pájecích hrotů
HU Forrasztóhegy készlet
RO Varfuri pistol de lipit
FR Jeu de pointes de fer à souder
IT Set di punte del saldatore
ES Juego de puntas para soldar
CN 烙铁头10件套

10
PCS

900M



Tip types: T-1, T-B, T-K, T-1.2D, T2.4D, T-3.2D, T-1C, T-2C, T-3C
Rodzaje grzyw: T-1, T-B, T-K, T-1.2D, T2.4D, T-3.2D, T-1C, T-2C, T-3C

YATO 		
YT-82526		24/240

- EN Sponge for soldering station
PL Gąbka do stacji lutowniczej
DE Schwamm für Lötstation
RU Губка для паяльной станции
CZ Houbička do pájecí stanice
HU Szivacs forrasztóállomáshoz
RO Burete pt. statia de lipit
FR Éponge pour station de soudage
IT Spugna per stazione di saldatura
ES Esponja para la estación de soldadura
CN 烙铁头清洁海绵

3
PCS



YATO 		
YT-82467		40/800

- EN Hot air nozzles
PL Zestaw dysz do gorącego powietrza
DE Heißluftdüsen
RU Комплект форсунок для горячего воздуха
CZ Sada horkovzdušných trysek
HU Forró levegő fúvókakészlet
RO Duze aer cald
FR Jeu de buses à air chaud
IT Set di ugelli per aria calda
ES Juego de boquillas para aire caliente
CN 风咀4件套

4
PCS

12 mm

4.4 mm

8.0 mm

10 mm



YATO 		
YT-82520		50/300

- EN Solder tip cleaner brass wire
PL Czyścik do grzyw z mosiężnymi wiórami
DE Lötspitzen-Reiniger - Messingspäne
RU Очиститель паяльных жал, латуная стружка
CZ Čistič hrotů mosazné hobliny
HU Pákahegy tisztító rézforgács
RO Burete sarma pt. curatat pistol de lipit
FR Boule de nettoyage à copeaux de laiton
IT Pulitore per punte, trucioli in ottone
ES Alambre de latón para limpieza de puntas de soldadura
CN 烙铁头除锡球+锡渣盒

BRASS
MOSIĄDZ



YATO 		
YT-82510		30/120

- EN Vacuum pen
PL Chwyłak próżniowy
DE Vakuumgreifer
RU Вакуумный захват
CZ Vákuové charpadlo
HU Vákuumos alkatrész fogó
RO Aspirator tip pix
FR Pince à vide
IT Utensile da presa a vuoto
ES Pluma de succión de bomba de vacío
CN 防静电真空吸笔

150
mm

3.0 mm

6.0 mm

10 mm



YATO 	L [mm]	
YT-82514	150	12/240

- EN Heat resistant tape
- PL Taśma kaptonowa
- DE Kapton-Band
- RU Каптоновая лента
- CZ Kaptonová páska
- HU Kapton szalag
- RO Banda termorezistentă
- FR Bande kapton
- IT Nastro kapton
- ES Cinta kapton
- CN 防焊高温胶带



300 °C

YATO	W [mm]	L [m]	
YT-82540	5	33	110/440
YT-82541	10	33	64/256
YT-82542	20	33	32/128

- EN Soldering iron with temperature adjustment
- PL Lutownica z regulacją temperatury
- DE Temperaturgesteuerter LötKolben
- RU Паяльник с терморегулятором
- CZ Pájka s regulací teploty
- HU Hőszabályozós forrasztó

- RO Letcon cu reglaj de temperatura
- FR Fer à souder à température réglable
- IT Saldatore con temperatura regolabile
- ES Soldador con ajuste de temperatura
- CN 数显电烙铁

220-240V~50Hz

80 W

50-480 °C

+/- 2 °C

900M

LCD BACKLIGHT PODSWIETLENIE



- Constant tip temperature control
- Temperature calibration function
- Stały odczyt temperatury grot
- Funkcja kalibracji temperatury

YATO	[W]	[°C]	
YT-82701	80	50-480	10/50

- EN Desoldering pump
- PL Odsysacz do cyny
- DE Entlötlösungspumpe
- RU Шприц для удаления припоя

- CZ Odpájecí sací pumpa
- HU Önszippantó
- RO Pompa fluidor
- FR Pompe à étain

- IT Pompa aspira stagno
- ES Bomba desoldadora
- CN 全铝手动吸锡器

PTFE



YATO	
YT-82742	100/400



YATO	
YT-82743	100/200



YATO	
YT-82744	50/100

- EN Solder wick
- PL Taśma rozlutownicza, plecionka miedziana
- DE Lötdocht - Kupfergeflecht
- RU Лента для удаления припоя, медная оплетка
- CZ Odpájecí páska, měděný svazek
- HU Fonott réz kiforrasztó huzal
- RO Sarma pt. lipit
- FR Bande de soudure en cuivre toronné
- IT Nastro dissaldante, treccia rame
- ES Cinta desoldadora trenza de cobre
- CN 吸锡带



COPPER MIEDZ

- EN Soldering iron with temperature adjustment
- PL Lutownica z regulacją temperatury
- DE Temperaturgesteuerter LötKolben
- RU Паяльник с терморегулятором
- CZ Pájka s regulací teploty
- HU Hőszabályozós forrasztó

- RO Letcon cu reglaj de temperatura
- FR Fer à souder à température réglable
- IT Saldatore con temperatura regolabile
- ES Soldador con ajuste de temperatura
- CN 调温电烙铁

220-240V~50Hz

50 W

200-450 °C

+/- 25 °C

900M



- Constant tip temperature control
- Stały odczyt temperatury grot

YATO	[W]	[°C]	
YT-82700	50	200-450	10/100

- EN Soldering iron
- PL Lutownica orogowa
- DE LötKolben
- RU Электропаяльник
- CZ Pájka odrogová
- HU Forrasztópáka
- RO Ciocan de lipit
- FR Fer à souder
- IT Saldatore a stagno
- ES Soldador de resistencia
- CN 电烙铁

230V~50Hz

2-3 min



YATO	[W]	[°C]	[mm]	
YT-8271	30	400	Ø3.8x70	16
YT-8272	60	500	Ø6x78	16
YT-8273	80	520	Ø6.8x64	16

EN Transformer soldering gun
PL Lutownica transformatorowa
DE Lötstole
RU Электрический паяльник
CZ Transformátorová páječka
HU Forrasztópáka

RO Pistol de lipit
FR Pistolet fer à souder électrique
IT Saldatore istantaneo
ES Soldador transformador
CN 电烙铁



220-240V-50Hz

180 W

0-600 °C

S2 20%
WORKING MODE
TRIP PROTECT

LED
LIGHTING
OSWIETLЕНИЕ

YATO	[W]	[°C]	
YT-8245	180	0-600	10

EN Soldering station
PL Stacja lutownicza
DE Heißeisluft-Lötstation
RU Паяльная станция
CZ Letovací stanice
HU Forrasztópáka állomás
RO Stație de lipit
FR Station de soudage
IT Stazione digitale di saldatura
ES Estación de soldadura
CN 焊台

220-240V-50Hz

75 W

200-480 °C

+/- 1 °C

900M

LCD

3 1/2" 89mm

LCD
BACKLIGHT
POŚWIETLENIE

ESD SAFE

USB
BATTERY CHARGER
ŁADOWNIKA



- Constant tip temperature control
- Temperature calibration function
- Auto sleep 1-240 min
- Stały odczyt temperatury grzałki
- Funkcja kalibracji temperatury
- Automatyczny tryb czuwania 1-240 min



YATO	[W]	[°C]	
YT-82456	75	200-480	8

EN 2 in 1 hot air soldering station
PL 2 w 1 stacja lutownicza hot air
DE 2 in 1 Heißeisluft-Lötstation
RU Термовоздушная паяльная станция 2 в 1
CZ Horkovzdušná pájecí stanice 2 v 1
HU 2 az 1-ben hot air forrasztóállomás
RO Stație de lipit, 2 in 1, cu aer cald
FR Station de soudage à air chaud 2 en 1
IT 2 in 1 stazione di saldatura hot air
ES 2 en 1 estación de soldadura hot air
CN 热风拆焊台

220-240V-50Hz

75 W

100-480 °C

+/- 2 °C

120 l/min

75 W

200-480 °C

+/- 1 °C

900M

LED
DISPLAY
WYŚWIETLACZ

ESD SAFE



- Constant tip temperature control
- Brushless motor fan
- Auto sleep 0-240 min
- Auto power off function
- Build-in position sensor
- Stały odczyt temperatury grzałki
- Bezszczotkowy wentylator
- Automatyczny tryb czuwania
- Automatyczne wyłączenie urządzenia
- Czujnik odłożenia grzałki



YATO	[W]	[°C]	
YT-82458	75 (lutownica), 750 (dmuchawa hot air)	200-480 (lutownica), 100-480 (dmuchawa hot air)	6

EN Transformer soldering gun
PL Lutownica transformatorowa
DE Lötstole
RU Электрический паяльник
CZ Transformátorová páječka
HU Forrasztópáka



RO Pistol de lipit
FR Pistolet fer à souder électrique
IT Saldatore istantaneo
ES Soldador transformador
CN 电烙铁

230-240V-50Hz

200 W

S2 20%
WORKING MODE
TRIP PROTECT

LED
LIGHTING
OSWIETLЕНИЕ

YATO	[W]	[°C]	
YT-82451	200	70-200, 201-350, 351-500	10

EN Hot air soldering station
PL Stacja lutownicza hot air
DE Heißeisluft-Lötstation
RU Термовоздушная паяльная станция
CZ Horkovzdušná pájecí stanice
HU Hot air forrasztóállomás
RO Stație de lipit cu aer cald
FR Station de soudage à air chaud
IT Stazione di saldatura Hot Air
ES Estación de soldadura hot air
CN 热风拆焊台

220-240V-50Hz

750 W

100-500 °C

+/- 2 °C

120 l/min

LED
DISPLAY
WYŚWIETLACZ

ESD SAFE



- Brushless motor fan
- Auto sleep 0-240 min
- Auto power off function
- Build-in position sensor
- Bezszczotkowy wentylator
- Automatyczny tryb czuwania
- Automatyczne wyłączenie urządzenia
- Czujnik odłożenia grzałki



YATO	[W]	[°C]	
YT-82457	750	100-500	8

EN Soldering station
PL Stacja lutownicza
DE Lötstation
RU Паяльная станция
CZ Letovací stanice
HU Forrasztópáka állomás
RO Stație de lipit
FR Station de soudage
IT Stazione digitale di saldatura
ES Estación de soldadura
CN 焊台

220-240V-50Hz

70 W

200-480 °C

+/- 1 °C

900M

LED
DISPLAY
WYŚWIETLACZ

ESD SAFE



- Constant tip temperature control
- Auto sleep 1-99 min
- Auto power off function 1-99 min
- Stały odczyt temperatury grzałki
- Automatyczny tryb czuwania 1-99 min
- Automatyczne wyłączenie urządzenia 1-99 min

YATO	[W]	[°C]	
YT-82459	70	200-480	8

EN Soldering station
 PL Stacja lutownicza
 DE Lötstation
 RU Паяльная станция
 CZ Letovací stanice
 HU Forrasztópáka állomás
 RO Stație de lipit
 FR Station de soudage
 IT Stazione digitale di saldatura
 ES Estación de soldadura
 CN 焊台



220-240V~
50/60Hz

60
W

90-480
°C

+/- 2
°C

900M

LED
DISPLAY
WYSWIETLACZ

- Constant tip temperature control
- Auto sleep 10 min
- Stały odczyt temperatury grota
- Automatyczny tryb czuwania 10 min

YATO	[W]	[°C]	
YT-82460	60	90-480	16

EN Soldering station
 PL Stacja lutownicza
 DE Lötstation
 RU Паяльная станция
 CZ Letovací stanice
 HU Forrasztópáka állomás

RO Stație de lipit
 FR Station de soudage
 IT Stazione digitale di saldatura
 ES Estación de soldadura
 CN 焊台

110-240V~
50-60Hz

75
W

90-480
°C

+/- 2
°C

T12

LED
DISPLAY
WYSWIETLACZ



- Constant tip temperature control
- Temperature calibration function
- Stały odczyt temperatury grota
- Funkcja kalibracji temperatury

YATO	[W]	[°C]	
YT-82461	75	90-480	30

EN Cordless glue gun
 PL Akumulatorowy pistolet do klejenia
 DE Heissklebepistole
 RU Пистолет для клея
 CZ Pistole na lepení
 HU Ragasztópisztoly
 RO Pistol pt. lipit
 FR Pistolet à colle sans-fil
 IT Pistola colla
 ES Pistola de cola
 CN 充电式胶枪



18 V
Li-Ion

25
g/min

3x
≥ 60
min
Ø 11 mm

2.0
Ah

1h

18V
Li-Ion

YATO	[V d.c.]		
YT-82854	18		10

EN Electric glue gun
 PL Pistolet do klejenia
 DE Heissklebepistole
 RU Пистолет для клея
 CZ Pistole na lepení
 HU Ragasztópisztoly
 RO Pistol pt. lipit
 FR Électrique pistolet à colle
 IT Pistola colla
 ES Pistola de cola
 CN 热胶枪



230-240V~
50Hz

30(450)
W

100-200
°C

20
g/min

11
mm

1.5 m

YATO	[W]	Ø [mm]	[g/min]	
YT-82403	30 (450)	11	20	6

EN Electric glue gun
 PL Pistolet do klejenia
 DE Heissklebepistole
 RU Пистолет для клея
 CZ Pistole na lepení
 HU Ragasztópisztoly

RO Pistol pt. lipit
 FR Pistolet à colle
 IT Pistola colla
 ES Pistola de cola
 CN 热胶枪



230V~
50Hz

35(400)
W

150-200
°C

15
g/min

2x
Ø 11 mm

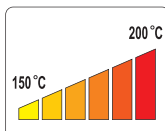

YATO	[W]	Ø [mm]	[g/min]	
YT-82401	35 (400)	11	15	12/24

EN Electric glue gun
 PL Pistolet do klejenia
 DE Heissklebepistole
 RU Пистолет для клея
 CZ Pistole na lepení
 HU Ragasztópisztoly
 RO Pistol pt. lipit
 FR Pistolet à colle
 IT Pistola colla
 ES Pistola de cola
 CN 热胶枪



230V~
50Hz

20(80)
W

180-200
°C

15
g/min

3x
Ø 11 mm

YATO	[W]	Ø [mm]	[g/min]	
YT-82402	20 (80)	11	15	12/48

EN Glue sticks
PL Wkłady klejowe
DE Heissklebpatronen
RU Стержин для горячей склейки
CZ Lepicí vložky
HU Ragasztóbetét
RO Mine cu clei
FR Des bâtons de colle

IT Stick di colla
ES Cartucho de cola
CN 透明热熔胶棒



Ø 11 mm
200 mm



Ø 11 mm
300 mm



YATO 	Ø [mm]	L [mm]	
YT-82430	11	200	20

YATO 	Ø [mm]	L [mm]	
YT-82431	11	300	20

EN Glue sticks
PL Wkłady klejowe
DE Heissklebpatronen
RU Стержин для горячей склейки
CZ Lepicí vložky
HU Ragasztóbetét
RO Mine cu clei
FR Des bâtons de colle
IT Stick di colla
ES Cartucho de cola
CN 褐色热熔胶棒





YATO 	Color / Kolor	Ø [mm]	L [mm]	
YT-82433	czarny	11	200	40/120
YT-82434	czerwony	11	200	40/120
YT-82435	niebieski	11	200	40/120
YT-82436	zielony	11	200	40/120

YATO 	Color / Kolor	Ø [mm]	L [mm]	
YT-82437	żółty	11	200	40/120
YT-82438	biały	11	200	40/120
YT-82439	brazowy	11	200	40/120

EN Glue sticks
PL Wkłady klejowe
DE Heissklebpatronen
RU Стержин для горячей склейки
CZ Lepicí vložky
HU Ragasztóbetét
RO Mine cu clei
FR Des bâtons de colle
IT Stick di colla
ES Cartucho de cola
CN 胶棒





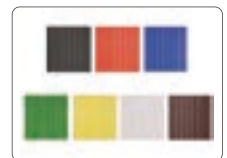

YATO 	Color / Kolor	Ø [mm]	L [mm]	
YT-82440	bezbarny	7.2	200	30/120

YATO 	Color / Kolor	Ø [mm]	L [mm]	
YT-82440	bezbarny	7.2	200	30/120

EN Glue sticks
PL Wkłady klejowe
DE Heissklebpatronen
RU Стержин для горячей склейки
CZ Lepicí vložky
HU Ragasztóbetét
RO Mine cu clei
FR Des bâtons de colle
IT Stick di colla
ES Cartucho de cola
CN 胶棒





YATO 	Color / Kolor	Ø [mm]	L [mm]	
YT-82441	czarny	7.2	100	50/200
YT-82442	czerwony	7.2	100	50/200
YT-82443	niebieski	7.2	100	50/200
YT-82444	zielony	7.2	100	50/200

YATO 	Color / Kolor	Ø [mm]	L [mm]	
YT-82445	żółty	7.2	100	50/200
YT-82446	biały	7.2	100	50/200
YT-82447	brazowy	7.2	100	50/200

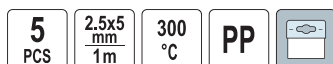

EN Plastic welding rods
PL Wkłady do spawania plastiku
DE Kunststoffschweißdrähte
RU Прутки для сварки пластика
CZ Tyčinky pro svařování plastů
HU Műanyag hegesztő pálcá
RO Batoane plastic pt. lipit
FR Tiges de soudure plastique
IT Bacchette per saldatura del materiale plastico
ES Cartuchos para soldar plástico
CN 塑料焊条



YATO 	Size / Rozmiar [mm]	L [m]	
YT-82303	2.5x5	1	30/120

EN Plastic welding rods
PL Wkłady do spawania plastiku
DE Kunststoffschweißdrähte
RU Прутки для сварки пластика
CZ Tyčinky pro svařování plastů
HU Műanyag hegesztő pálcá
RO Batoane plastic pt. lipit
FR Tiges de soudure plastique
IT Bacchette per saldatura del materiale plastico
ES Cartuchos para soldar plástico
CN 塑料焊条



YATO 	Size / Rozmiar [mm]	L [m]	
YT-82304	2.5x5	1	30/120

EN Plastic welding rods
 PL Wkłady do spawania plastiku
 DE Kunststoffschweißdrähte
 RU Прутки для сварки пластика
 CZ Tyčinky pro svařování plastů
 HU Műanyag hegesztő pálcá
 RO Batoane plastic pt. lipit
 FR Tiges de soudure plastique
 IT Bacchette per saldatura del materiale plastico
 ES Cartuchos para soldar plástico
 CN 塑料焊条

5 PCS 2.5x5 mm 1m 350 °C ABS



YATO	Size / Rozmiar [mm]	L [m]	
YT-82305	2.5x5	1	30/120

EN Plastic welding rods
 PL Wkłady do spawania plastiku
 DE Kunststoffschweißdrähte
 RU Прутки для сварки пластика
 CZ Tyčinky pro svařování plastů
 HU Műanyag hegesztő pálcá
 RO Batoane plastic pt. lipit
 FR Tiges de soudure plastique
 IT Bacchette per saldatura del materiale plastico
 ES Cartuchos para soldar plástico
 CN 塑料焊条

5 PCS 2.5x5 mm 1m 300-400 °C PVC



YATO	Size / Rozmiar [mm]	L [m]	
YT-82306	2.5x5	1	30/120

EN Plastic welding rods
 PL Wkłady do spawania plastiku
 DE Kunststoffschweißdrähte
 RU Прутки для сварки пластика
 CZ Tyčinky pro svařování plastů
 HU Műanyag hegesztő pálcá
 RO Batoane plastic pt. lipit
 FR Tiges de soudure plastique
 IT Bacchette per saldatura del materiale plastico
 ES Cartuchos para soldar plástico
 CN 塑料焊条

5 PCS 2.5x5 mm 1m 300 °C PPR



YATO	Size / Rozmiar [mm]	L [m]	
YT-82307	2.5x5	1	30/120

EN Kitchen worktop jig
 PL Szablon do łączenia blatów
 DE Frässhablone Arbeitsplatte
 RU Шаблон для кухонных столешниц
 CZ Šablona pro spoj kuchyňských desek
 HU Munkalap összemaró sablon
 RO Șablon
 FR Gabarit de profilage pour plans de travail
 IT Sistema di giunzioni per piani da cucina
 ES Plantilla para el fresado de encimeras
 CN 木工模板

1000x390 x53 mm max 700 mm HARDENED LAMINATE LAMINAT UTWARZANY



YATO	Dimensions / Wymiary [mm]	
YT-70890	1000x390x12	5

EN Steel contour gauge
 PL Wzornik do kopiowania kształtów
 DE Profi Imuster
 RU Шаблон профилей
 CZ Profi lová šablona
 HU Profi Isablon
 RO Șablon profil
 FR Jauges d'épaisseurs métriques
 IT Sagoma di contorno
 ES Plantilla de perfiles
 CN 仿形规

150 mm 46 mm STEEL NEEDLES STALOWE IGŁY mm inch

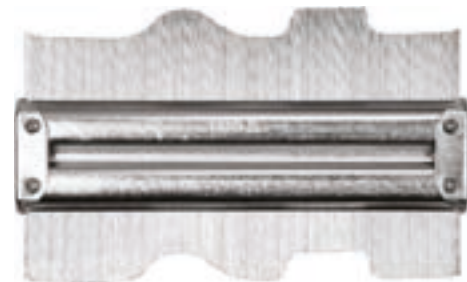
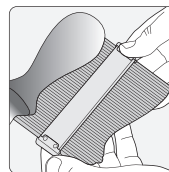

YATO	L [mm]	
YT-70870	150	12/48

EN Profile gauge
 PL Wzornik profilii
 DE Profilmuster
 RU Шаблон профилей

CZ Profilová šablona
 HU Profilsablon
 RO Șablon profil

IT Profilato
 ES Plantilla de perfiles
 CN 轮廓仪

44 mm 1.5 mm



YATO	L [mm]	
YT-3735	125	24/72

YATO	L [mm]	
YT-3736	260	10/40

EN Profile gauge
 PL Wzornik profilii
 DE Profilmuster
 RU Шаблон профилей
 CZ Profilová šablona
 HU Profilsablon

RO Șablon profil
 FR Jauges d'épaisseurs métriques
 IT Profilato
 ES Plantilla de perfiles
 CN 轮廓仪

535 mm 100 mm





YATO	L [mm]	
YT-37364	535	9/18

EN Dovetail marker
PL Szablon do trasowania "jaskółczy ogon"
DE Schwalbenschwanz-Schablone
RU Шаблон ласточкин хвост
CZ Rybinová šablona
HU Fecskefarag fogazó sablon
RO Sablon coada de randunica
FR Gabarit à queue d'aronde
IT Marcatore a coda di rondine
ES Plantilla cola de milano
CN 木工定位器

64x23
x18
mm

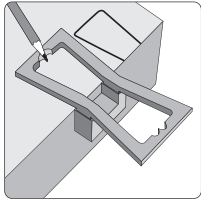
AI





YATO Dimensions / Wymiary [mm] 
YT-44080 64x23x18 50/200

EN Dovetail marker
PL Szablon do trasowania "jaskółczy ogon"
DE Schwalbenschwanz-Schablone
RU Шаблон ласточкин хвост
CZ Rybinová šablona
HU Fecskefarag fogazó sablon
RO Sablon coada de randunica
FR Gabarit à queue d'aronde
IT Marcatore a coda di rondine
ES Plantilla cola de milano
CN 木工定位器

64x23
x18
mm

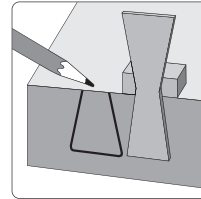
AI



YATO Dimensions / Wymiary [mm] 
YT-44081 64x23x18 50/200

EN Tine milling template
PL Szablon frezarski do połączeń na jaskółczy ogon
DE Zinkenfrässhablone
RU Шлифовое приспособление для соединения "ласточкин хвост"
CZ Cinkovací přípravek
HU Csapoló készülék
RO Sablon pt. imbinari coada de randunica
FR Gabarit pour assemblages à queues d'aronde
IT Dima per fresatura per collegamenti a coda di rondine
ES Plantilla para juntas cola milano
CN 开榫机

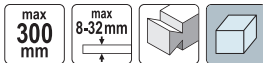



YATO 
YT-44085 2

EN Aluminium alloy scriber gauge
PL Przymiar traserski stolarski
DE Anreißschablone für Schreiner
RU Линейка для разметки и столярных работ
CZ Rýsovací a tesafské pravítko
HU Asztalos sablon
RO Sablon din aluminiu
FR Gabarit de pose charpentier
IT Righello per falegnameria
ES Regla de carpintería
CN 木工划线器

60x45
x45
mm

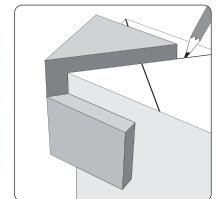
AI



YATO Dimensions / Wymiary [mm] 
YT-44087 60x45x45 50/200

EN Hinge hole drilling guide locator
PL Szablon do osadzania zawiasów
DE Scharnier-Montageschablone
RU Шаблон для установки петель
CZ Šablona pro montáž závěsů
HU Zsanér sablon
RO Dispozitiv ghidaj gaurile balamale
FR Gabarit de perçage pour charnières
IT Dima di traccia per cerniere
ES Plantilla para bisagras
CN 定位器

85x40
x22
mm

ABS



YATO Dimensions / Wymiary [mm] 
YT-44135 85x40x22 50/200

EN Hinge hole drilling guide locator
PL Szablon do osadzania zawiasów
DE Scharnier-Montageschablone
RU Шаблон для установки петель
CZ Šablona pro montáž závěsů
HU Zsanér sablon
RO Dispozitiv ghidaj gaurile balamale
FR Gabarit de perçage pour charnières
IT Dima di traccia per cerniere
ES Plantilla para bisagras
CN 定位器

270x55
x3.6
mm

ABS



YATO Dimensions / Wymiary [mm] 
YT-44136 270x55x3.6 50/200

13

Construction tools
Narzędzia budowlane



Floor laminate cutters & accessories
Gilotyny do cięcia paneli podłogowych i akcesoria



306

Scaffolds
Rusztowania



323

Floor plank cutters
Gilotyny do cięcia wykładzin



306

Shears
Nożyce



323-327

Tile cutting machines & accessories
Przyrządy do cięcia glazury i akcesoria



306-309

Roofwork tools
Narzędzia dekarские



327

Jigs & patterns
Wzorniki i szablony



309-310

Paving tools
Narzędzia brukarskie



328

Scrapers & accessories
Szpachelki i akcesoria



310-312

Floating rules
Łaty



328

Masonry tools
Narzędzia tynkarskie i murarskie



312-317

Knives
Noże



328

Floats
Pace 312
Trowels
Kielnie 315
Plaster scrubbers
Zdzieraki do tynków 315
Mortar guns
Wyciskacze do zapraw 316
Plaster & stucco spray guns
Tynkownice pneumatyczne 316
Finishing work tools
Narzędzia do prac wykończeniowych 316

Electric hoists
Elektryczne wciągarki linowe



329

Extension cords
Przedłużacze elektryczne



329-330

Mixers
Mieszadła



330-331

Painting tools
Narzędzia malarskie



318-319

Suction lifters
Uchwyty do szyb



331-332

Paint brushes
Pędzle 318
Painting bowls
Kuwety malarskie 319
Painting mixers
Mieszadła do farb 319
Painting buckets
Wiadra malarskie 319
Painting sheets
Folie malarskie 319

Pencils & chalks
Ołówki i kredy



332-333

Tools for drywalls
Narzędzia do płyt gipsowo-kartonowych



320-322

Pencils
Ołówki 332
Chalks
Kredy 333

EN Floor laminate cutter
 PL Gilotyina do cięcia paneli podłogowych
 DE Laminat-Schneider
 RU Гильотина для ламината
 CZ Nůžky na laminátové plošoucí podlahy
 HU Laminált padló vágógép
 RO Aparat de tăiat parchet laminat
 FR Guillotine pour couper les panneaux
 IT Ghigliottina per taglio dei pannelli
 ES Guillotina cortapaneles
 CN 密度板切割器

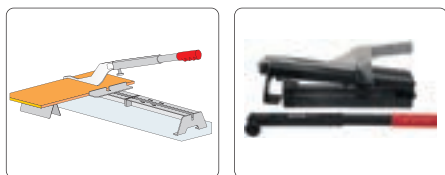

YATO L [mm] 2
 YT-37301

EN Hardwood floor positioning tool
 PL Dociągacz desek podłogowych
 DE Parkettzugeisen
 RU Струби́ца отжим для монтажа ламинатных и паркетных полов
 CZ Nářadí pro montáž podlah - španovák
 HU Behúzóvas profi filc alátéttel
 RO Dispozitiv fixare parchet
 FR Pied de biche
 IT Attrezzo di serraggio per tavole e pannelli
 ES Sujetador de piso profesional
 CN 地板安装器



YATO L [mm] 6
 YT-37317 420

EN Tile cutting machine
 PL Przyrząd do cięcia glazury
 DE Fliesen-schneidmaschine
 RU Плиткорез
 CZ Přístroj na řezání glazury
 HU Csempévágó
 RO Mașină pt. tăiat gresie si faianta
 FR Coupeuse pour la céramique
 IT Ghigliottina per taglio di piastrelle
 ES Cortadora de gres
 CN 瓷砖切割器

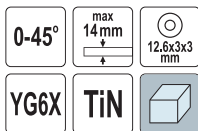

YATO L [mm] 2
 YT-3703 630

EN Floor laminate cutter
 PL Gilotyina do cięcia paneli podłogowych
 DE Laminat-Schneider
 RU Гильотина для ламината
 CZ Nůžky na laminátové plošoucí podlahy
 HU Laminált padló vágógép
 RO Aparat de tăiat parchet laminat
 FR Guillotine pour couper les panneaux
 IT Ghigliottina per taglio dei pannelli
 ES Guillotina cortapaneles
 CN 木地板切割器

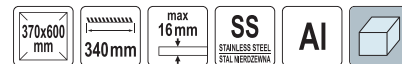

• Application: PVC, laminates, rubber, plastics
 • Zastosowanie: PVC, laminaty, gumy, tworzywa sztuczne



YATO L [mm] 2
 YT-37311 600

EN Floor plank cutter
 PL Gilotyina do cięcia wykładzin z PVC
 DE PVC-Streifenschneider
 RU Гильотина для резки напольных покрытий из ПВХ
 CZ Gilotyina pro řezání podlahových krytín z PVC
 HU PVC padló vágó kés
 RO Cutter parchet
 FR Coupe-bandes PVC
 IT Taglierino per rivestimenti in PVC
 ES Guillotina-cizalla para suelos de PVC
 CN 木地板切割器



• Application: PVC, laminates, rubber, plastics
 • Zastosowanie: PVC, laminaty, gumy, tworzywa sztuczne

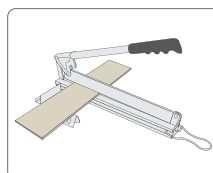

YATO L [mm] 12
 YT-37325

EN Tile cutting wheel
 PL Kółko tnące wymienne
 DE Schneidrad
 RU Ролик для плиткореза
 CZ Výměnné kolečko
 HU Cseregörgő csavarral
 RO Cuijt rolă
 FR Molette coupante avec barre
 IT Lama di ricambio tondo
 ES Recambio de cuchillo redondo
 CN 硬质合金刀片



For YT-3700, YT-3701, YT-3702
 Dla YT-3700, YT-3701, YT-3702

YATO 50/250
 YT-3712

EN Tile cutting wheel
 PL Kółko tnące wymienne
 DE Schneidrad
 RU Ролик для плиткореза
 CZ Výměnné kolečko
 HU Cseregörgő csavarral
 RO Cuijt rolă
 FR Molette coupante avec barre
 IT Lama di ricambio tondo
 ES Recambio de cuchillo redondo
 CN 硬质合金刀片





For YT-3703
 Dla YT-3703

YATO 50/200
 YT-3713

EN Tile cutting machine
PL Przyrząd do cięcia glazury
DE Fliesenschneidmaschine
RU Плиткорез
CZ Přístroj na fezáni glazury
HU Csempévágó

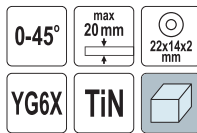
RO Maşină pt. tăiat gresie si faianta
FR Coupeuse pour la céramique
IT Ghigliottina per taglio di piastrelle
ES Cortadora de gres
CN 瓷砖切割器





YATO 	L [mm]	
YT-3705	900	1

EN Tile cutting wheel
PL Kółko tnące wymienne
DE Schneiderrad
RU Ролик для плиткореза
CZ Výměnné kolečko
HU Cserégörgő csavarral

RO Cuţit rolă
FR Molette coupante avec barre
IT Lama di ricambio tondo
ES Recambio de cuchillo redondo
CN 瓷砖切割轮



For YT-3704, YT-3705, YT-3706, YT-3707, YT-3708
Dia YT-3704, YT-3705, YT-3706, YT-3707, YT-3708

YATO 	
YT-3714	50/200

EN Tile cutting machine
PL Przyrząd do cięcia glazury
DE Fliesenschneidmaschine
RU Плиткорез
CZ Přístroj na fezáni glazury
HU Csempévágó

RO Maşină pt. tăiat gresie si faianta
FR Coupeuse pour la céramique
IT Ghigliottina per taglio di piastrelle
ES Cortadora de gres
CN 瓷砖切割器

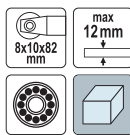

YATO 	L [mm]	
YT-37034	400	4

EN Tile cutting wheel
PL Kółko tnące wymienne
DE Schneiderrad
RU Ролик для плиткореза

CZ Výměnné kolečko
HU Cserégörgő csavarral
RO Cuţit rolă
FR Molette coupante avec barre

IT Lama di ricambio tondo
ES Recambio de cuchillo redondo
CN 划线轮



For YT-37034, YT-37036
Dia YT-37034, YT-37036

EN Tile cutting machine
PL Przyrząd do cięcia glazury
DE Fliesenschneidmaschine
RU Плиткорез
CZ Přístroj na fezáni glazury
HU Csempévágó

RO Maşină pt. tăiat gresie si faianta
FR Coupeuse pour la céramique
IT Ghigliottina per taglio di piastrelle
ES Cortadora de gres
CN 瓷砖切割器





YATO 	L [mm]	
YT-37022	800	2

EN Tile cutting machine
PL Przyrząd do cięcia glazury
DE Fliesenschneidmaschine
RU Плиткорез
CZ Přístroj na fezáni glazury
HU Csempévágó

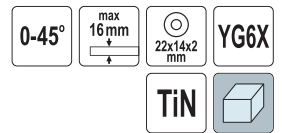
RO Maşină pt. tăiat gresie si faianta
FR Coupeuse pour la céramique
IT Ghigliottina per taglio di piastrelle
ES Cortadora de gres
CN 瓷砖切割器



YATO 	L [mm]	
YT-3707	600	2
YT-3708	800	2

EN Tile cutting wheel
PL Kółko tnące wymienne
DE Schneiderrad
RU Ролик для плиткореза
CZ Výměnné kolečko
HU Cserégörgő csavarral

RO Cuţit rolă
FR Molette coupante avec barre
IT Lama di ricambio tondo
ES Recambio de cuchillo redondo
CN 瓷砖切割轮





For YT-3704, YT-3705, YT-3706, YT-3707, YT-3708
Dia YT-3704, YT-3705, YT-3706, YT-3707, YT-3708



YATO 	
YT-37141	50/200

EN Tile cutting machine
PL Przyrząd do cięcia glazury
DE Fliesenschneidmaschine
RU Плиткорез
CZ Přístroj na fezáni glazury
HU Csempévágó

RO Maşină pt. tăiat gresie si faianta
FR Coupeuse pour la céramique
IT Ghigliottina per taglio di piastrelle
ES Cortadora de gres
CN 瓷砖切割器



YATO 	L [mm]	
YT-37036	600	3

YATO 	
YT-37038	300

EN Tile cutting wheel
PL Kółko tnące wymienne
DE Schneiderrad
RU Ролик для плиткореза
CZ Výměnné kolečko
HU Cserégörgő csavarral

RO Cuţit rolă
FR Molette coupante
IT Lama di ricambio tondo
ES Recambio de cuchillo redondo
CN 硬合金刀片



YATO 	
YT-37150	50/500

EN Tile cutting wheel
PL Kółko tnące wymienne
DE Schneiderrad
RU Ролик для плиткореза
CZ Výměnné kolečko
HU Cserégörgő csavarral

RO Cuţit rolă
FR Molette coupante
IT Lama di ricambio tondo
ES Recambio de cuchillo redondo
CN 硬合金刀片



YATO 	
YT-37150	50/500

EN Tile cutting machine
 PL Przyrząd do cięcia glazury
 DE Fliesenschneidmaschine
 RU Плиткореза
 CZ Přístroj na řezání glazury
 HU Csempevágó

RO Masină pt. tăiat gresie și faianță
 FR Coupeuse pour la céramique
 IT Ghigliottina per taglio di piastrelle
 ES Cortadora de gres
 CN 瓷砖切割器



YATO L [mm]
 YT-37042 600 2

EN Tile cutting machine
 PL Przyrząd do cięcia glazury
 DE Fliesenschneidmaschine
 RU Плиткореза
 CZ Přístroj na řezání glazury
 HU Csempevágó

RO Masină pt. tăiat gresie și faianță
 FR Coupeuse pour la céramique
 IT Ghigliottina per taglio di piastrelle
 ES Cortadora de gres
 CN 瓷砖切割器

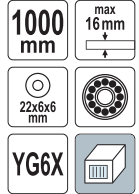

YATO L [mm]
 YT-37052 1000 1

EN Hand cutting system with connectable guide
 PL Przecinarka do płyt ceramicznych
 DE Keramikplattentrenmaschine
 RU Резак для керамической плитки
 CZ Řezačka keramických desek
 HU Csempevágó

RO Sistem de tăiere manuală cu ghidaj conectabil
 FR Coupe carrelage
 IT Troncatrice per pannelli di ceramica
 ES Cortador para placas de cerámica
 CN 薄板切割器



YATO L [mm]
 YT-36980 3200 1

EN Tile cutter with table
 PL Przecinarka do płytek ceramicznych ze stołem
 DE Keramikfliesenschneider mit Tisch
 RU Резак для керамической плитки со столом
 CZ Řezačka keramických dlaždic se stolem
 HU Csempevágó asztal

RO Aparat tăiat gresie, cu masă
 FR Scie à carreaux sur table
 IT Tagliapiastrelle a banco
 ES Cortador para baldosas cerámicas con mesa
 CN 瓷砖切割器



YATO L [mm]
 YT-37040 600 1

EN Tile cutting pliers
 PL Szczypce do cięcia i łamania glazury
 DE Glasurzange
 RU Кусачки для плитки
 CZ Kleště do glazury
 HU Csempefogó
 RO Clește rupt faianță
 FR Pince grès mosaïque
 IT Tenaglia per piastrelle
 ES Tenazas para azulejos
 CN 瓷砖钳



YATO L [mm]
 YT-37160 200 6/36

EN Tile cutting pliers
 PL Szczypce do łamania glazury
 DE Glasurzange
 RU Кусачки для плитки
 CZ Kleště do glazury
 HU Csempefogó
 RO Clește rupt faianță
 FR Pince grès mosaïque
 IT Tenaglia per piastrelle
 ES Tenazas para azulejos
 CN 瓷砖钳

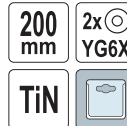

YATO L [mm]
 YT-37161 200 6/36

EN Tile cutting pliers
 PL Szczypce do glazury
 DE Glasurzange
 RU Кусачки для плитки
 CZ Kleště do glazury
 HU Csempefogó
 RO Clește rupt faianță
 FR Pince grès mosaïque
 IT Tenaglia per piastrelle
 ES Tenazas para azulejos
 CN 瓷砖钳



YATO L [mm]
 YT-37164 200 6/60

EN Tile chamfering machine
 PL Prowadnica do fazowania płytek
 DE Führung zum Anfasen von Fliesen
 RU Направляющая для снятия фаски
 CZ Vodítko pro srážení hran dlaždic
 HU Vezetősin átlós csempevágáshoz
 RO Dispozitiv pt. tesit plăci
 FR Dispositif de chanfreinage pour carrelage
 IT Smussatrice per piastrelle
 ES Máquina de biselado de azulejos
 CN 瓷砖倒角器



YATO [mm]
 YT-36984 250x170 50

EN Grout remover
 PL Skrobak do fug
 DE Fugenreiniger
 RU Скребок для швов кладки
 CZ Škrabák na spáry
 HU Fugakihűző
 RO Răzuitoare pt. rosturi
 FR Gratteur pour fugues
 IT Raschietto per fuga piastrelle
 ES Rascador para juntas
 CN 砂浆去除器



YATO
 YT-37170 10/60

- EN Interchangeable brick jointer
PL Przyrząd do wygładzania fug
DE Vorrichtung zum Glätten von Fugen
RU Инструмент для затирки швов
CZ Zařízení na vyhlazení spár
HU Fugasímitó szerzőzám
RO Dispozitiv modelat
rostrurile dintre caramizi
FR Lisseur de joints
IT Attrezzo per levigare
le giunzioni
ES Alisador de juntas
CN 墙缝刀



YATO	
YT-37177	6/24

- EN Glaze bucket
PL Wiadro glazurnicze
DE Fliesenwaschset Rolleneimer
RU Ведро с роликами для затирки швов
CZ Malířské vědro
HU Fugázó vödör
RO Galeata pt. zugravit
FR Seau de peinture
IT Secchio per lavaggio
piastrelle
ES Cubo de pintura
CN 釉桶



YATO	Capacity / Pojemność [l]	
YT-54750	22	42

- EN Steel contour gauge
PL Wzornik do kopiowania kształtów
DE Profilmuster
RU Шаблон профилей
CZ Profilová šablona
HU Profil sablon
RO Şablon profil
FR Jauges d'épaisseurs métriques
IT Sagoma di contorno
ES Plantilla de perfiles
CN 仿形规

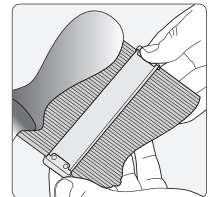
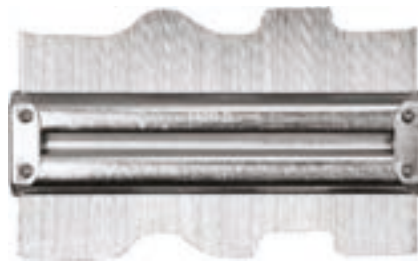

YATO	L [mm]	
YT-70870	150	12/48

- EN Profile gauge
PL Wzornik profili
DE Profilmuster
RU Шаблон профилей
CZ Profilová šablona
HU Profilsablon
RO Şablon profil
FR Jauges d'épaisseurs métriques
IT Profilato
ES Plantilla de perfiles
CN 轮廓仪

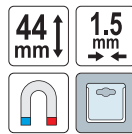

YATO	L [mm]	
YT-3735	125	24/72



YATO	L [mm]	
YT-3736	260	10/40

- EN Profile gauge
PL Wzornik profili
DE Profilmuster
RU Шаблон профилей
CZ Profilová šablona
HU Profilsablon
RO Şablon profil
FR Jauges d'épaisseurs métriques
IT Profilato
ES Plantilla de perfiles
CN 轮廓仪

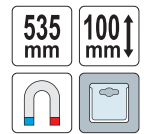

YATO	L [mm]	
YT-37364	535	9/18

- EN Dovetail marker
PL Szablon do trasowania "jaskółczy ogon"
DE Schwalbenschwanz-Schablone
RU Шаблон ласточкин хвост
CZ Rybinová šablona
HU Fecskefarag fogazó sablon
RO Sablon coada de randunica
FR Gabarit à queue d'aronde
IT Marcatore a coda di rondine
ES Plantilla cola de milano
CN 木工定位器

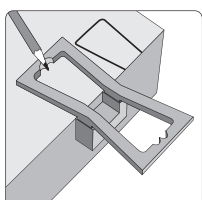

YATO	Dimensions / Wymiary [mm]	
YT-44080	64x23x18	50/200

- EN Dovetail marker
PL Szablon do trasowania "jaskółczy ogon"
DE Schwalbenschwanz-Schablone
RU Шаблон ласточкин хвост
CZ Rybinová šablona
HU Fecskefarag fogazó sablon
RO Sablon coada de randunica
FR Gabarit à queue d'aronde
IT Marcatore a coda di rondine
ES Plantilla cola de milano
CN 木工定位器

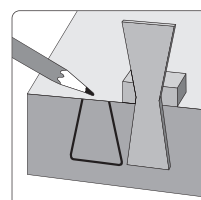

YATO	Dimensions / Wymiary [mm]	
YT-44081	64x23x18	50/200

EN Tine milling template
 PL Szablon frezarski do połączeń na jaskółczy ogon
 DE Zinkenfrässhablone
 RU Шипорезное приспособление для соединения "ласточкин хвост"
 CZ Cinkovací přípravek
 HU Csapóló készülék
 RO Sablon pt. imbinari coada de randunica
 FR Gabarit pour assemblages à queues d'aronde
 IT Dima per fresatura per collegamenti a coda di rondine
 ES Plantilla para juntas cola milano
 CN 开榫机

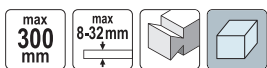

YATO Dimensions / Wymiary [mm]
 YT-44085 2

EN Hinge hole drilling guide locator
 PL Szablon do osadzania zawiasów
 DE Scharnier-Montageschablone
 RU Шаблон для установки петель
 CZ Šablona pro montáž závěsů
 HU Zsanér sablon
 RO Dispozitiv ghidaj gaurile balamale
 FR Gabarit de perçage pour charnières
 IT Dima di traccia per cerniere
 ES Plantilla para bisagras
 CN 定位器



YATO Dimensions / Wymiary [mm]
 YT-44135 85x40x22 50/200

EN Trowel for silicone
 PL Szpachelka do silikonu
 DE Spachtel für Silikon
 RU Шпатель для силикона
 CZ Špachtle na silikon
 HU Spachli szilikonhoz
 RO Spatulă pt. silicon
 FR Spatule à silicone
 IT Spatola per silicone
 ES Espátula para silicona
 CN 橡塑刮板



YATO Dimensions / Wymiary [mm]
 YT-5260 20/300

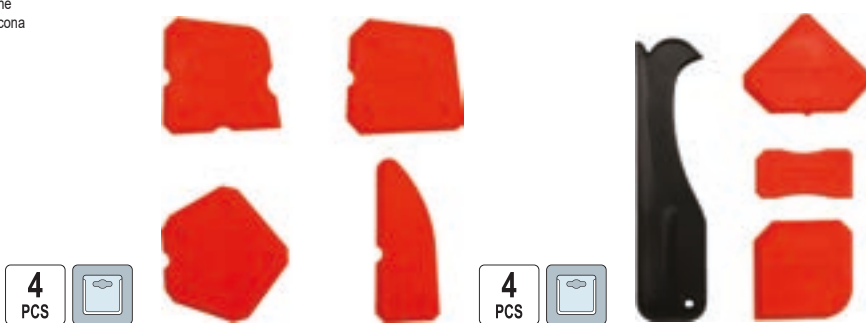

YATO Dimensions / Wymiary [mm]
 YT-5261 20/200



YATO Dimensions / Wymiary [mm]
 YT-5262 20/200

EN Caulking tool set
 PL Zestaw narzędzi do fug silikonowych
 DE Fugenglätter Set
 RU Набор инструментов уплотнительных
 CZ Sada nástrojů pro spoje
 HU Az izületek eszközei
 RO Un set de instrumente pt. rosturi
 FR Ensemble d'outils à cafeutrer
 IT Set di attrezzi per fughe in silicone
 ES Conjunto de herramientas para empalmes
 CN 钢丝刷



YATO Dimensions / Wymiary [mm]
 YT-52621 12/48

EN Aluminium alloy scriber gauge
 PL Przymiar traserski stolarski
 DE Anreißschablone für Schreiner
 RU Линейка для разметки и столярных работ
 CZ Rýsovací a tesafské pravítko
 HU Asztalos sablon
 RO Sablon din aluminiu
 FR Gabarit de pose charpentier
 IT Righello per falegnameria
 ES Regla de carpintería
 CN 木工划线器

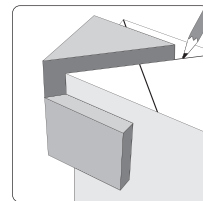
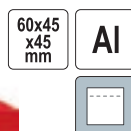

YATO Dimensions / Wymiary [mm]
 YT-44087 60x45x45 50/200

EN Hinge hole drilling guide locator
 PL Szablon do osadzania zawiasów
 DE Scharnier-Montageschablone
 RU Шаблон для установки петель
 CZ Šablona pro montáž závěsů
 HU Zsanér sablon
 RO Dispozitiv ghidaj gaurile balamale
 FR Gabarit de perçage pour charnières
 IT Dima di traccia per cerniere
 ES Plantilla para bisagras
 CN 定位器



YATO Dimensions / Wymiary [mm]
 YT-44136 270x55x3.6 50/200

EN Stucco spatulas set
 PL Szpachelki sztukatorskie
 DE Stukkateureisen
 RU Шпатель штукатурный двухсторонний
 CZ Štukatérský nástroj
 HU Spatulák
 RO Spatula metalica
 FR Spatule à moulures
 IT Set di spatole per stucco
 ES Espátulas
 CN 修正刀

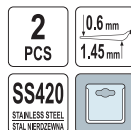

YATO Dimensions / Wymiary [mm]
 YT-52780 6/48

- EN Scraper with bits
PL Szpachelka nierdzewna szlifowana
DE Edelstahlspachtel geschliffen
RU Шпатель из шлифованной нержавеющей стали
CZ Špachtle z broušené nerezové oceli
HU Csiszolt rozsdamentes spakli
RO Racleta cu biti
FR Spatule en acier inoxydable brossé
IT Spatola in acciaio inossidabile rettificato
ES Espátula inox esmerilada
CN 油灰刀

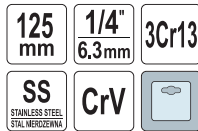

□ 1/4" (6.3 mm): 5, 6 mm (L=25 mm); CrV;
⊕ 1/4" (6.3 mm): PH2 (L=25 mm; 2 PCS); CrV

YATO 	
YT-52760	10/60

- EN Multi-funktion paint scraper
PL Skrobak malarski nierdzewny profilowany
DE Malerschaber rostfrei, profiliert
RU Скребок малярный из нержавеющей стали, профилированный
CZ Profilovaná malířská škrabka z nerezové oceli
HU Profilozott rozsdamentes festékkaparó
RO Racleta vopsea multifunctionala
FR Racleur à peinture profilé en acier inoxydable
IT Raschietto per vernice profilato inossidabile
ES Rasqueta de pintura inoxidable perfilada
CN 油灰刀



YATO 	
YT-52871	12/144



- EN Plastic scraper set
PL Komplet skrobaków - szpachelki
DE Schaber-Spachtel-Satz
RU Набор скребков - шпатели
CZ Sada škrabek - špachtle
HU Kaparókészlet - spatulák
RO Set raclete din plastic
FR Jeu de raclettes et spatules
IT Kit di raschietti - spatole
ES Juego de raspadores - espátulas
CN 塑料油灰刀



YATO 	
YT-52740	6/24

- EN Finishing spatula
PL Szpachla wykończeniowa
DE Flächenspachtel
RU Финишный шпатель
CZ Špachtle fasádní
HU Glett leházó
RO Spatula pt. finisare
FR Spatule de finissage
IT Spatola di finitura
ES Espátula de acabado
CN 刮刀



YATO 	Working width / Szerokość robocza [mm]	
YT-52230	250	4
YT-52231	400	4
YT-52232	600	4
YT-52233	800	2

- EN Multi-funktion paint scraper
PL Skrobak malarski nierdzewny profilowany
DE Malerschaber rostfrei, profiliert
RU Скребок малярный из нержавеющей стали, профилированный
CZ Profilovaná malířská škrabka z nerezové oceli
HU Profilozott rozsdamentes festékkaparó
RO Racleta vopsea multifunctionala
FR Racleur à peinture profilé en acier inoxydable
IT Raschietto per vernice profilato inossidabile
ES Rasqueta de pintura inoxidable perfilada
CN 油灰刀

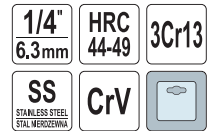



□ 1/4" (6.3 mm): 5, 6 mm (L=25 mm); CrV;
⊕ 1/4" (6.3 mm): PH2 (L=25 mm; 2 PCS); CrV

YATO 	
YT-52870	12/144



- EN Stainless steel putty knife
PL Szpachla nierdzewna
DE Edelstahl-Kleberspachtel
RU Шпатель из нержавеющей стали
CZ Nerezová špachtle
HU Rozsdamentes spakli
RO Spaculă inox pt. chituit
FR Spatule à enduire en inox
IT Spatola in acciaio inox
ES Espátula de acero inoxidable
CN 不锈钢刮刀



YATO 	Working width / Szerokość robocza [mm]	
YT-52245	150	12/120
YT-52246	200	12/120
YT-52247	250	12/120

- EN Finishing spatula
PL Szpachla wykończeniowa
DE Flächenspachtel
RU Финишный шпатель
CZ Špachtle fasádní
HU Glett leházó
RO Spatula pt. finisare
FR Spatule de finissage
IT Spatola di finitura
ES Espátula de acabado
CN 刮刀



YATO 	Working width / Szerokość robocza [mm]	
YT-52220	250	2
YT-52221	400	2
YT-52222	600	2
YT-52223	800	2

- EN Handle adapter for finishing spatula
PL Uchwyt do szpachli wykończeniowej
DE Halter für Fertigschachtelmasse
RU Ручка для финишного шпателя
CZ Držák povrchové špachtle
HU Glett leházó fogantyú
RO Adaptor maner pt. spatula finisare
FR Poignée de spatule de finissage
IT Impugnatura per spatola di finitura
ES Mango para espátula de acabado
CN 刮刀手柄



For YT-52230, YT-52231, YT-52232, YT-52233
Dia YT-52230, YT-52231, YT-52232, YT-52233

YATO 	
YT-52237	4

- EN Replaceable blade for finishing spatula
 PL Ostrze do szpachli
 DE Spachtelklinge
 RU Лезвие для шпателя
 CZ Čepele do špachtle
 HU Glett leghúzó él
- RO Lama de schimb pt. spatula finisare
 FR Lame pour spatule
 IT Lama per spatola
 ES Hoja para espátula
 CN 刮刀刀片

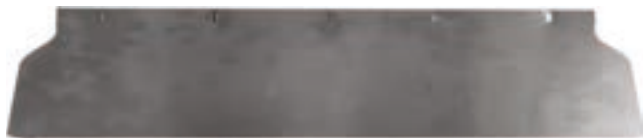

YATO	W [mm]	For / Dla	
YT-52240	250	YT-52230	5
YT-52241	400	YT-52231	5
YT-52242	600	YT-52232	5
YT-52243	800	YT-52233	5

- EN Gypsum container
 PL Pojemnik na gips
 DE Gipsbehälter
 RU Контейнер для гипса
 CZ Nádoba na sádru
 HU Gipsztál
 RO Recipient de gips
 FR Conteneur rond pour préparation de plâtre
 IT Recipiente per gesso
 ES Contenedor para yeso
 CN 石膏桶



- 83 mm
 Ø 130 mm
 0.5 L

YATO		
YT-51881	0.5	20

- EN Smooth float
 PL Paca gładka
 DE Schweizer Glättkelle
 RU Тёрка гладкая
 CZ Hladitko rovné
 HU Glettvás rozsdamentes
- RO Gletiera
 FR Truelle inoxidable
 IT Frattazzo liscio
 ES Llana para enlucido
 CN 不锈钢砌墙刀



- Made of special cold rolled stainless steel sheet with elasticity factor up to 2000 N/mm
- Części robocze ze specjalnej zimnowalcowanej blachy nierdzewnej o sprężystości do 2000 N/mm

YATO	Size / Rozmiar [mm]	
YT-5200	270x130	30

- EN Smooth float
 PL Paca tynkarska
 DE Schweizer Glättkelle
 RU Тёрка гладкая
 CZ Hladitko rovné
 HU Glettvás rozsdamentes
- RO Gletiera
 FR Truelle inoxidable
 IT Frattazzo
 ES Llana para enlucido
 CN 不锈钢砌墙刀



- Made of special cold rolled stainless steel sheet with elasticity factor up to 2000 N/mm
- Części robocze ze specjalnej zimnowalcowanej blachy nierdzewnej o sprężystości do 2000 N/mm

YATO	Size / Rozmiar [mm]	
YT-5207	380x130	10
YT-5209	480x130	10
YT-5210	580x130	10

- EN Gypsum container
 PL Pojemnik na gips
 DE Gipsbehälter
 RU Контейнер для гипса
 CZ Nádoba na sádru
 HU Gipsztál
 RO Recipient de gips
 FR Conteneur rond pour préparation de plâtre
 IT Recipiente per gesso
 ES Contenedor para yeso
 CN 石膏桶

- 50 mm
 Ø 155 mm
 0.5 L



YATO		
YT-51880	0.5	20

- EN Stainless steel scraper set
 PL Szpachelki nierdzewne "japonki"
 DE Aufstreichspachtel
 RU Набор шпателей тип "Японский"
 CZ Špachtle japonsky nerezavějící
 HU Spatula rozsdamentes
 RO Șpacluri japoneze inoxidabile
 FR Racleur en acier inoxydable ensemble
 IT Spatole giapponesi in acciaio inox
 ES Espátulas "japonesas" de acero
 CN 刮刀



YATO		
YT-52790		10/40

- EN Float with teeth
 PL Paca zębata
 DE Zahnkelle
 RU Тёрка с зубами
- CZ Hladitko zuby
 HU Glettvás fogazott
 RO Gletiera zimtata
- IT Frattazzo dentato
 ES Llana dentada
 CN 不锈钢砌墙刀



- Made of special cold rolled stainless steel sheet with elasticity factor up to 2000 N/mm
- Części robocze ze specjalnej zimnowalcowanej blachy nierdzewnej o sprężystości do 2000 N/mm

YATO	Teeth size / Rozmiar zębów [mm]	Size / Rozmiar [mm]	
YT-5202	6x6	275x130	30
YT-5203	8x8	270x130	30
YT-5204	10x10	260x130	30



- EN Sharp ground float
 PL Paca ostra
 DE Steinholzglätter
 RU Стальная острая тёрка
 CZ Hladitko ocelové, špičaté
 HU Aljzatsimító
 RO Gletiera cu varf ascuțit
 FR Truelle acier
 IT Frattazzo acuto
 ES Llana pontiaguda
 CN 砌墙刀



YATO	L [mm]	
YT-5212	500	20

EN Bull float kit
PL Ręczna listwa wibracyjna
DE Handgehaltener Vibrationsstab
RU Ручная виброрейка
CZ Ruční vibrační lišta
HU Kézi betonlehúzó
RO Dispozitiv nivelat sapa
FR Règle à vibrations portative
IT Regola vibrante manuale
ES Regla vibratoria manual
CN 抹子



YATO 	Size / Rozmiar [mm]	
YT-30900	1200x200	1

EN Smooth float
PL Paca wenecka
DE Glättkelle
RU Тёрка венецианская
CZ Hladitko rovné
HU Glettvás rozsdamentes lágy fogantyúval
RO Gletiera
FR Truelle acier
IT Frattazzo
ES Llana puntas redondas
CN 不锈钢砌墙刀



• Made of special cold rolled stainless steel sheet with elasticity factor up to 2000 N/mm
• Części robocze ze specjalnej zimnowalcowanej blachy nierdzewnej o sprężystości do 2000 N/mm

YATO 	Size / Rozmiar [mm]	
YT-5214	200x80	20



EN Float with rubber for grouting
PL Paca z gumą do fugowania
DE Fliesen Fugbrett mit Softgummi
RU Терка с накладкой из губчатой резины
CZ Hladitko s gumou pro správoání
HU Gumis simító fugázáshoz
RO Gletieră din cauciuc pt. umplerea rosturilor
FR Taloge avec gomme de jointeiment
IT Pialletto con gomma per fughe
ES Talocha con goma para juntas
CN 抹泥板



YATO 	Size / Rozmiar [mm]	
YT-51900	250x95	5



EN Float with hydronubber
PL Paca z hydrogumą
DE Fliesenwaschbrett mit Hydro-Schwamm
RU Терка з гидрогумоу
CZ Hladitko s hydrogumou
HU Simító hidrogumival
RO Burete hydronubber
FR Taloge avec hydrogomme
IT Frattazzo con hydrogomma
ES Talocha con hidrorrecubrimiento
CN 抹泥板



YATO 	Size / Rozmiar [mm]	
YT-51909	270x130	10



EN Float with rubber
PL Paca z gumą
DE Fliesenwaschbrett mit Zellgummi Auflage
RU Терка с резиновым покрытием
CZ Hladitko s gumou
HU Gumis simító
RO Gletieră din cauciuc
FR Taloge avec coutchouc
IT Pialletto con gomma
ES Talocha con goma
CN 抹泥板



YATO 	Size / Rozmiar [mm]	
YT-51901	270x130	10



EN Float with sponge SMPX
PL Paca z gąbką SMPX
DE Fliesenwaschbrett mit Schwamm SMPX
RU Терка с губкой SMPX
CZ Hladitko s houbou SMPX
HU Simító szivaccsal SMPX
RO Gletieră din spumă SMPX
FR Taloge avec éponge SMPX
IT Frattazzo con spugna SMPX
ES Talocha con esponja SMPX
CN 抹泥板



YATO 	Size / Rozmiar [mm]	
YT-51902	270x130	10



EN Float with incised sponge SMPX
PL Paca z gąbką nacinaną SMPX
DE Fliesenwaschbrett mit Schwamm SMPX Eingeschnitten
RU Терка с надрезной губкой SMPX
CZ Hladitko s narezávanou houbou SMPX
HU Simító vágott szivaccsal SMPX
RO Gletieră din burete cu model SMPX
FR Taloge avec éponge entaillée SMPX
IT Frattazzo con spugna SMPX scanalata
ES Talocha con esponja renurada SMPX
CN 抹泥板



YATO 	Size / Rozmiar [mm]	
YT-51903	270x130	10



EN Float with thick sponge
 PL Paca z gąbką gęstą
 DE Fliesenwaschbrett mit dichtem Schwamm
 RU Терка с плотной губкой
 CZ Hladitko s hustou houbou
 HU Simitó sűrű szivaccsal
 RO Gletieră din burete dens
 FR Taloge avec éponge épaisse
 IT Frattazzo con spugna densa
 ES Talocha con esponja gruesa
 CN 抹泥板



YATO 	Size / Rozmiar [mm]	
YT-51904	270x130	10



EN Float with gray sponge
 PL Paca z gąbką szarą
 DE Fliesenwaschbrett mit feinem Schwamm grau
 RU Терка с серой губкой
 CZ Hladitko s šedou houbou
 HU Simitó szürke szivaccsal
 RO Gletieră din burete gri
 FR Taloge avec éponge grise
 IT Frattazzo con spugna grigia
 ES Talocha con esponja gris
 CN 抹泥板



YATO 	Size / Rozmiar [mm]	
YT-51906	270x130	10



EN Float with porous sponge
 PL Paca z gąbką porowatą
 DE Fliesenwaschbrett mit porösen Schwamm
 RU Терка с накладкой из микропористой резины
 CZ Hladitko s pórovitou houbou
 HU Simitó porózus szivaccsal
 RO Gletieră din burete poros
 FR Taloge avec éponge poreuse
 IT Frattazzo con spugna porosa
 ES Talocha con esponja porosa
 CN 抹泥板



YATO 	Size / Rozmiar [mm]	
YT-51908	270x130	10

EN Plastic float
 PL Paca plastikowa
 DE Glättkeile PVC
 RU Пластмассовая терка
 CZ Plastové hladitko
 HU Műanyag simító
 RO Gletieră din plastic
 FR Taloge en plastique
 IT Frattazzo in plastica
 ES Talocha en plástico
 CN 抹泥板



YATO 	Size / Rozmiar [mm]	
YT-51911	270x130	20

EN Float with thick and incised sponge
 PL Paca z gąbką gęstą nacinaną
 DE Fliesenwaschbrett mit dichtem Schwamm eingeschnitten
 RU Терка с плотной нарезной губкой
 CZ Hladitko s hustou nařezávanou houbou
 HU Simitó sűrű, vágott szivaccsal
 RO Gletieră din burete dens cu model
 FR Taloge avec éponge entaillée
 IT Frattazzo con spugna densa scanalata
 ES Talocha con esponja gruesa ranurada
 CN 抹泥板



YATO 	Size / Rozmiar [mm]	
YT-51905	270x130	10

EN Float with gray sponge
 PL Paca z gąbką szarą
 DE Fliesenwaschbrett mit feinem Schwamm grau
 RU Терка с серой губкой
 CZ Hladitko s šedou houbou
 HU Simitó szürke szivaccsal
 RO Gletieră din burete gri
 FR Taloge avec éponge grise
 IT Frattazzo con spugna grigia
 ES Talocha con esponja gris
 CN 抹泥板



YATO 	Size / Rozmiar [mm]	
YT-51907	270x130	5

EN Float with felt
 PL Paca z filcem
 DE Filz-Glättbrett
 RU Терка с накладкой из войлока
 CZ Hladitko s filcem
 HU Simitó filccel
 RO Gletieră cu păsă
 FR Taloge avec feutre
 IT Frattazzo con feltro
 ES Talocha con fi eltro
 CN 抹泥板



YATO 	Size / Rozmiar [mm]	
YT-51910	270x130	10

EN Rasp for styrofoam
 PL Tarnik do styropianu
 DE Schiebrett Reibebrett für Styropor
 RU Терка для пенопласта
 CZ Rašple na polystyren
 HU Reszelő polisztrénhez
 RO Pieptene pt. polistiren expandat
 FR Taloge pour mousse de polystyrène
 IT Raspa per polistirolo
 ES Escofina para poliestireno
 CN 多孔砂板



YATO 	Size / Rozmiar [mm]	
YT-51920	375x155	10

EN Abrasive float "Rasp" type
PL Pasa ścierna do styropianu
DE Styropor-Schleifbrett
RU Шлифовальная терка "рашпиль"
CZ Škrabák na porobeton
HU Csiszoló polystirol habhoz
RO Gletiera abraziva
FR Flotteur abrasif à styrofoam
IT Frattazzo abrasivo
ES Lana abrasiva para polietileno
CN 磨砂型砌墙刀



YATO	Size / Rozmiar [mm]	
YT-5218	370x165	20

EN Triangular trowel
PL Kielnia trójkątna
DE Mauerkelle
RU Треугольный мастерок
CZ Lžíce trojúhelníková
HU Kőműves kanál háromszögletű
RO Mistrie triunghi
FR Truelle
IT Cazzuola punta triangolare
ES Paleta triangular
CN 不锈钢砌墙刀



• Made of special cold rolled stainless steel sheet with elasticity factor up to 2000 N/mm
• Części robocze ze specjalnej zimnowalcowanej blachy nierdzewnej o sprężystości do 2000 N/mm

YATO	Size / Rozmiar [mm]	
YT-5234	200x190	10

EN Trapezoid trowel
PL Kielnia trapezowa
DE Stukkateurkelle
RU Трапецидальный мастерок
CZ Lžíce zednická
HU Kőműves kanál rozsdamentes
RO Mistrie
FR Truelle trapézoïdale
IT Cazzuola punta trapezio
ES Paleta trapezoidal
CN 不锈钢砌墙刀



• Made of special cold rolled stainless steel sheet with elasticity factor up to 2000 N/mm
• Części robocze ze specjalnej zimnowalcowanej blachy nierdzewnej o sprężystości do 2000 N/mm

YATO	Dimensions / Wymiary [mm]	
YT-5240	165x80x55	20

EN Stucco sharp trowel
PL Kielnia ostra
DE Putzkelle
RU Кельма заостренная треугольная
CZ Lžíce pokrývačská
HU Gittelő kanál rozsdamentes
RO Mistrie cu cioc ascuțit
FR Truelle
IT Cazzuola punta acuta
ES Paleta pontiaguda
CN 不锈钢砌墙刀



• Made of special cold rolled stainless steel sheet with elasticity factor up to 2000 N/mm
• Części robocze ze specjalnej zimnowalcowanej blachy nierdzewnej o sprężystości do 2000 N/mm

YATO	Size / Rozmiar [mm]	
YT-5245	135x80	20

EN Stripping knife
PL Szpachla fasadowa
DE Flächenspachtel
RU Стальной шпатель
CZ Štěrka fasádní
HU Spatulya fali (rákli)

RO Spaclu inox
FR Spatule inoxydable
IT Spatola per facciata
ES Espátula de fachada
CN 剥皮刀



• Made of special cold rolled stainless steel sheet with elasticity factor up to 2000 N/mm
• Części robocze ze specjalnej zimnowalcowanej blachy nierdzewnej o sprężystości do 2000 N/mm

YATO	L [mm]	
YT-5226	250	20
YT-5228	350	20
YT-5230	500	20

EN Trapezoid trowel
PL Kielnia trapezowa
DE Stukkateurkelle
RU Трапецидальный мастерок
CZ Lžíce zednická
HU Kőműves kanál rozsdamentes
RO Mistrie
FR Truelle trapézoïdale
IT Cazzuola punta trapezio
ES Paleta trapezoidal
CN 不锈钢砌墙刀



• Made of special cold rolled stainless steel sheet with elasticity factor up to 2000 N/mm
• Części robocze ze specjalnej zimnowalcowanej blachy nierdzewnej o sprężystości do 2000 N/mm

YATO	Dimensions / Wymiary [mm]	
YT-5237	120x180x80	10

EN Stucco trowel
PL Kielnia „podkowa”
DE Gipserspachtel
RU Штукатурный мастерок
CZ Lžíce vymazávací
HU Gittelő kanál rozsdamentes
RO Mistrie
FR Truelle en stuc
IT Cazzuola punta tonda
ES Paleta para estucado
CN 不锈钢砌墙刀



• Made of special cold rolled stainless steel sheet with elasticity factor up to 2000 N/mm
• Części robocze ze specjalnej zimnowalcowanej blachy nierdzewnej o sprężystości do 2000 N/mm

YATO	Size / Rozmiar [mm]	
YT-5242	100x130	20
YT-5243	80x110	20

EN Plaster scrubber
PL Zdzierak do tynków
DE Alu-Rabott
RU Треугольный мастерок для каменщиков
CZ Škrabák
HU Vakolat gyalu alu késes
RO Gletiera abraziva
FR Enleveur du badigeon
IT Utensile per grossare
ES Rascador para enlucido
CN 石膏去除器



YATO	Size / Rozmiar [mm]	
YT-52471	248x133	10

EN Scraper for plaster and aerated blocks
 PL Zdzierak wyrównujący
 DE Gipshobel mit Stahlklingen
 RU Рубанок для газобетона
 CZ Vyrovňovací škrabák
 HU Kiegyenlítő dörzsölő
 RO Raspel de nivelare
 FR Lime grosse droit
 IT Raschiatore livellatore
 ES Raspador
 CN 干墙器



EN Scraper with teeth for plaster and aerated blocks
 PL Zdzierak wyrównujący z ząbkami
 DE Gipshobel mit Stahlklingen gezahnt
 RU Рубанок для газобетона зубчатый
 CZ Vyrovňovací škrabák se zoubky
 HU Fogas, kiegyenlítő dörzsölő
 RO Raspel cu dinți
 FR Lime grosse droit avec dents
 IT Raschiatore livellatore dentato
 ES Raspador con dientes
 CN 干墙器



YATO	Size / Rozmiar [mm]	
YT-52472	405x84	10

YATO	Size / Rozmiar [mm]	
YT-52473	405x84	10

EN Plaster scrubber
 PL Zdzierak do tynków
 DE Alu-Rabott
 RU Треугольный мастерок для каменщиков
 CZ Škrabák
 HU Vakolat gyalu alu késes

RO Gletiera abraziva
 FR Enleveur du badigeon
 IT Utensile per sgrossare
 ES Rascador para enlucido
 CN 石膏去除器



YATO	Size / Rozmiar [mm]	
YT-5247	450x90	25

EN Mortar gun with nozzles kit
 PL Wyciskacz do fugowania
 DE Mörtelspritze

RU Пистолет для затирки швов
 CZ Pistole vytláčovací
 HU Kinyomó pisztoly

RO Pistol pt. silicon
 FR Seringue mortier
 IT Pistola per silicone

ES Pistola para calafatear mortero
 CN 堵缝枪

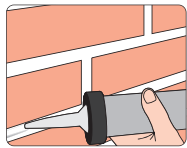

YATO	
YT-67580	10

YATO	
YT-67583	12

EN Plaster / stucco spray gun
 PL Tynkownica pneumatyczna do ścian
 DE Spritzpistole für Mörtel
 RU Пневмоковш для штукатурки стен
 CZ Stříkačká pistole pro maltu
 HU Habarcs szórópisztoly

RO Spray pistol pt. mortar
 FR Pistolet à peinture pour mortier
 IT Intonacatrice pneumatica per pareti
 ES Pistola pulverizadora para mortero
 CN 重型气动便携式墙面水泥砂浆喷枪

0.4-0.8 MPa
 400 l/min
 4.75L
 max 50 m²/h



$L_{pa} = 93,6 \pm 2,5$ dB; $L_{wa} = 104,6 \pm 2,5$ dB; $a_n = <2,5$ m/s²

YATO	
YT-54400	4

EN Spiked soles for work shoes
 PL Podeszwy z kolcami
 DE Sohlen mit Spikes
 RU Подошвы с шипами
 CZ Podesšve s hroty
 HU Szögcs cipőtalp
 RO Talpi cu tepi pt. sapa
 FR Semelles à pointes
 IT Sottoscarpe chiodate
 ES Suelos con clavos
 CN 草地鞋

300 mm
 TTTT 45mm



YATO	L [mm]	
YT-80820	300	20

EN Stamp roller
 PL Walek do wyciskania wzorów w tynku
 DE Musterpresserolle für Putz
 RU Валик для выдавливания рисунков в штукатурке
 CZ Váleček pro vytlačení vzorů na omítkách
 HU Henger minták dombornyomásához a vakolatban
 RO Trafalet cu model
 FR Rouleau texturé pour plâtre
 IT Rullo goffratore per intonaco
 ES Rodillo con relieve para enlucidos
 CN 橡胶压花滚筒



230x70 mm

YATO	Size / Rozmiar [mm]	
YT-51960	230x70	25

EN Stamp roller
 PL Walek do wyciskania wzorów w tynku
 DE Musterpresserolle für Putz
 RU Валик для выдавливания рисунков в штукатурке
 CZ Váleček pro vytlačení vzorů na omítkách
 HU Henger minták dombornyomásához a vakolatban
 RO Trafalet cu model
 FR Rouleau texturé pour plâtre
 IT Rullo goffratore per intonaco
 ES Rodillo con relieve para enlucidos
 CN 橡胶压花滚筒





230x70 mm

YATO	Size / Rozmiar [mm]	
YT-51961	230x70	25

EN Stamp roller
PL Walek do wyciskania wzorów w tynku
DE Musterpressrolle für Putz
RU Валик для выдавливания рисунков в штукатурке
CZ Váleček pro vytlačení vzorů na omítkách
HU Henger minták dombornyomásához a vakolatban
RO Trafalet cu model
FR Rouleau texturé pour plâtre
IT Rullo goffratore per intonaco
ES Rodillo con relieve para enlucidos
CN 橡胶压花滚筒



YATO 	Size / Rozmiar [mm]	
YT-51962	230x70	25



EN Stamp roller
PL Walek do wyciskania wzorów w tynku
DE Musterpressrolle für Putz
RU Валик для выдавливания рисунков в штукатурке
CZ Váleček pro vytlačení vzorů na omítkách
HU Henger minták dombornyomásához a vakolatban
RO Trafalet cu model
FR Rouleau texturé pour plâtre
IT Rullo goffratore per intonaco
ES Rodillo con relieve para enlucidos
CN 橡胶压花滚筒



YATO 	Size / Rozmiar [mm]	
YT-51963	180x70	25



EN Stamp roller
PL Walek do wyciskania wzorów w tynku
DE Musterpressrolle für Putz
RU Валик для выдавливания рисунков в штукатурке
CZ Váleček pro vytlačení vzorů na omítkách
HU Henger minták dombornyomásához a vakolatban
RO Trafalet cu model
FR Rouleau texturé pour plâtre
IT Rullo goffratore per intonaco
ES Rodillo con relieve para enlucidos
CN 橡胶压花滚筒



YATO 	Size / Rozmiar [mm]	
YT-51964	180x70	25



EN Multi-purpose brush
PL Szczotka do tynków dekoracyjnych
DE Bürste für Dekorationsputz
RU Щетка для декоративной штукатурки
CZ Štětka do dekoracních omítek
HU Dekoratív vakolathoz való kefe
RO Perie
FR Brosse multi-fonctions
IT Spazzola per effetti decorativi di intonaco
ES Escoba para enlucidos decorativos
CN 万用刷



YATO 	Size / Rozmiar [mm]	
YT-51970	400x25	50
YT-51971	200x25	50

EN Multi-purpose brush
PL Szczotka do tynków dekoracyjnych
DE Bürste für Dekorationsputz
RU Щетка для декоративной штукатурки
CZ Štětka do dekoracních omítek
HU Dekoratív vakolathoz való kefe
RO Perie
FR Brosse multi-fonctions
IT Spazzola per effetti decorativi di intonaco
ES Escoba para enlucidos decorativos
CN 万用刷





YATO 	Size / Rozmiar [mm]	
YT-51972	135x135	50

EN Multi-purpose brush
PL Szczotka do tynków dekoracyjnych
DE Bürste für Dekorationsputz
RU Щетка для декоративной штукатурки
CZ Štětka do dekoracních omítek
HU Dekoratív vakolathoz való kefe



RO Perie
FR Brosse multi-fonctions
IT Spazzola per effetti decorativi di intonaco
ES Escoba para enlucidos decorativos
CN 万用刷



YATO 	Size / Rozmiar [mm]	
YT-51973	140x235	40

EN Self-adhesive protective film
PL Folia ochronna samoprzylepna
DE Selbstklebende Schutzfolie
RU Самоклеющаяся пленка
CZ Ochranná samolepicí folie
HU Öntapadás védőfólia
RO Folie protectie autoadeziva
FR Film de protection auto-adhésif
IT Pellicola protettiva adesiva
ES Película protectora autoadhesiva
CN 自粘保护膜



YATO 	W [cm]	L [m]	± [µm]	
YT-54300	25	30	45	12
YT-54310	50	30	45	6
YT-54313	50	75	45	6
YT-54320	60	50	45	4

EN Flat paint brush
 PL Pędzel angielski
 DE Flachpinsel
 RU Кисть флейцевая тип Английский
 CZ Štětec anglický
 HU Laposecset

RO Pensulă englezească
 FR Pinceau plat anglais
 IT Pennello piatto
 ES Brocha plana
 CN 平刷



• Application: oil, emulsion, latex and ceramic paints, impregnating paint, varnishe
 • Zastosowanie: farby olejne, emulsyjne, lateksowe i ceramiczne, impregnaty, lakiery

YATO	Brush width / Szerokość pędzla	
YT-54500	1" (25 mm)	12
YT-54501	1.5" (38 mm)	12
YT-54502	2" (50 mm)	12
YT-54503	2.5" (63 mm)	12
YT-54504	3" (76 mm)	12
YT-54505	4" (100 mm)	12

EN Flat paint brush
 PL Pędzel angielski
 DE Flachpinsel
 RU Кисть флейцевая тип Английский
 CZ Štětec anglický
 HU Laposecset

RO Pensulă englezească
 FR Pinceau plat anglais
 IT Pennello piatto
 ES Brocha plana
 CN 平刷



• Application: oil, emulsion, latex and ceramic paints, impregnating paint, varnishe
 • Zastosowanie: farby olejne, emulsyjne, lateksowe i ceramiczne, impregnaty, lakiery

YATO	Brush width / Szerokość pędzla	
YT-54520	1" (25 mm)	12
YT-54521	1.5" (38 mm)	12
YT-54522	2" (50 mm)	12
YT-54523	2.5" (63 mm)	12
YT-54524	3" (76 mm)	12

EN Flat paint brush
 PL Pędzel angielski
 DE Flachpinsel
 RU Кисть флейцевая тип Английский
 CZ Štětec anglický
 HU Laposecset

RO Pensulă englezească
 FR Pinceau plat anglais
 IT Pennello piatto
 ES Brocha plana
 CN 平刷



• Application: oil, emulsion, latex and ceramic paints, impregnating paint, varnishe
 • Zastosowanie: farby olejne, emulsyjne, lateksowe i ceramiczne, impregnaty, lakiery

YATO	Brush width / Szerokość pędzla	
YT-54540	1" (25 mm)	12
YT-54541	1.5" (38 mm)	12
YT-54542	2" (50 mm)	12
YT-54543	2.5" (63 mm)	12
YT-54544	3" (76 mm)	12

EN Flat paint brush
 PL Pędzel angielski
 DE Flachpinsel
 RU Кисть флейцевая тип Английский
 CZ Štětec anglický
 HU Laposecset

RO Pensulă englezească
 FR Pinceau plat anglais
 IT Pennello piatto
 ES Brocha plana
 CN 平刷



• Application: oil, emulsion, latex and ceramic paints, impregnating paint, varnishe
 • Zastosowanie: farby olejne, emulsyjne, lateksowe i ceramiczne, impregnaty, lakiery

YATO	Brush width / Szerokość pędzla	
YT-54550	1" (25 mm)	12
YT-54551	1.5" (38 mm)	12
YT-54552	2" (50 mm)	12
YT-54553	2.5" (63 mm)	12
YT-54554	3" (76 mm)	12

EN Flat paint brush
 PL Pędzel okrągły
 DE Ringpinsel
 RU Кисть круглая
 CZ Kulatý štětec
 HU Marokcset

RO Pensulă rotundă
 FR Pinceau rond
 IT Pennello rotondo
 ES Brocha redonda
 CN 圆刷



• Application: oil, emulsion, latex and ceramic paints, impregnating paint, varnishe
 • Zastosowanie: farby olejne, emulsyjne, lateksowe i ceramiczne, impregnaty, lakiery

YATO	Brush width / Szerokość pędzla	
YT-54560	1" (25 mm)	12
YT-54561	1.5" (38 mm)	12
YT-54562	2" (50 mm)	12
YT-54563	2.5" (63 mm)	12
YT-54564	3" (76 mm)	12

EN Round paint brush
 PL Pędzel pierścieniowy
 DE Ringpinsel
 RU Кисть круглая
 CZ Kulatý štětec
 HU Marokcset

RO Pensula rotundă
 FR Pinceau rond
 IT Pennello circolare
 ES Brocha redonda
 CN 圆刷



• Application: oil, emulsion, latex and ceramic paints, impregnating paint, varnishe
 • Zastosowanie: farby olejne, emulsyjne, lateksowe i ceramiczne, impregnaty, lakiery

YATO	Brush width / Szerokość pędzla [mm]	
YT-54580	35	12
YT-54581	40	12
YT-54582	50	12
YT-54583	60	12

EN Round paint brush
 PL Pędzel okrągły
 DE Ringpinsel
 RU Кисть круглая
 CZ Kulatý štětec
 HU Marokcset

RO Pensula rotundă
 FR Pinceau rond
 IT Pennello rotondo
 ES Brocha redonda
 CN 圆刷



• Application: oil, emulsion, latex and ceramic paints, impregnating paint, varnishe
 • Zastosowanie: farby olejne, emulsyjne, lateksowe i ceramiczne, impregnaty, lakiery

YATO	Brush width / Szerokość pędzla [mm]	
YT-54590	16	12
YT-54591	23	12
YT-54592	29	12
YT-54593	33	12

EN Angled paint brush
 PL Pędzel kątowy
 DE Heizköperpinsel
 RU Кисть радиаторная
 CZ Úhlová štětec
 HU Radiátorecset

RO Pensula pt. calorifere
 FR Pinceau à radiateur
 IT Pennello ad angolo
 ES Brocha angulada de radiadores
 CN 平刷





• Application: oil, emulsion, latex and ceramic paints, impregnating paint, varnishe
 • Zastosowanie: farby olejne, emulsyjne, lateksowe i ceramiczne, impregnaty, lakiery

YATO	Brush width / Szerokość pędzla	
YT-54620	1.5" (38 mm)	12
YT-54621	2" (50 mm)	12
YT-54622	2.5" (63 mm)	12

- EN Wall brush
PL Pędzel tapetowy
DE Flächenstreicher
RU Кисть макловица
CZ Štětec na tapety dřevěný
HU Ecset fa tapétához
RO Bidinea pt. tapet
FR La brosse à peinture rectangulaire
IT Pennello per carta da parati
ES Brocha de empapelar madero
CN 平刷



- Application: oil, emulsion, latex and ceramic paints, impregnating paint, varnishes
• Zastosowanie: farby olejne, emulsyjne, lateksowe i ceramiczne, impregnaty, lakiery

YATO 	Size / Rozmiar [mm]	
YT-54640	110x30	2
YT-54641	140x40	2
YT-54642	150x50	2

- EN Universal painting bowl
PL Uniwersalna kuweta malarska
DE Universal-Küvette
RU Ванночка-ковш для краски
CZ Malířská kyveta
HU Küvette
RO Tava-suport trafalet
FR Cuvette pour peinture à usage universel
IT Vaschetta universale per vernice
ES Cuveta
CN 漆碗



YATO 	
YT-54730	80



- EN Paint mixer
PL Mieszadło do farb ręczne
DE Rührer
RU Мешалка для красок
CZ Míchadlo na hmoty
HU Keverő festékekhez
- RO Mixer vopsea
FR Mélangeur pour peintures
IT Miscelatore manuale per vernici
ES Mezclador para pinturas
CN 油漆搅拌机

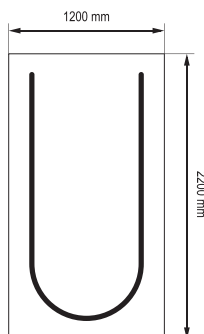
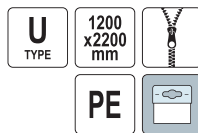

YATO 	
YT-54670	50

- EN Dust protection door type "U"
PL Osłona przeciwpylowa - drzwi foliowe typu "U"
DE Folien-Staubschutztür, U-Form
RU Пылезащитная пленка - пленочная дверь типа "U"
CZ Protiprachový kryt - fóliové dveře typu "U"
HU Porvédelem - "U" típusú fóliajtó
RO Ușă de protecție împotriva prafului tip "U"
FR Pare-poussière - porte en plastique de type "U"
IT Protezione antipolvere - porta in pellicola tipo "U"
ES Puerta de protección antipolvo tipo "U"
CN 塑料装修防尘门





YATO 	Size / Rozmiar [mm]	
YT-67220	1200x2200	12

- EN Ceiling brush
PL Pędzel ławkowiec
DE Malerbürste
RU Макловица
CZ Malířský štětec
HU Kenőkefe
RO Bidinea
FR La brosse à peinture rectangulaire
IT Spazzola per soffitti
ES Brocha
CN 平刷





- Application: oil, emulsion, latex and ceramic paints, impregnating paint, varnishes
• Zastosowanie: farby olejne, emulsyjne, lateksowe i ceramiczne, impregnaty, lakiery

YATO 	Size / Rozmiar [mm]	
YT-54650	170x70	2
YT-54651	180x80	2
YT-54652	190x90	2



- EN Painting bucket
PL Wiadro malarskie
DE Rechteckeimer
RU Ведро малярное
CZ Vědro malířské
HU Festővödör
RO Găleată zidar
FR Seau à peindre
IT Secchio per vernice
ES Cubo para pintar
CN 油漆桶

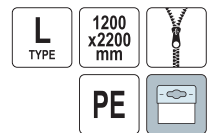

YATO 	V [l]	
YT-54740	6	10
YT-54741	8	10
YT-54742	12	10
YT-54743	15	10
YT-54744	19	10

- EN Dust protection door type "L"
PL Osłona przeciwpylowa - drzwi foliowe typu "L"
DE Folien-Staubschutztür, L-Form
RU Пылезащитная пленка - пленочная дверь типа "L"
CZ Protiprachový kryt - fóliové dveře typu "L"
HU Porvédelem - "L" típusú fóliajtó
RO Ușă de protecție împotriva prafului tip "L"
FR Pare-poussière - porte en plastique de type "L"
IT Protezione antipolvere - porta in pellicola tipo "L"
ES Puerta de protección antipolvo tipo "L"
CN 塑料装修防尘门



YATO 	Size / Rozmiar [mm]	
YT-67221	1200x2200	12

- EN Tile adjuster
- PL Podnośnik do unoszenia płytek
- DE Fliesenheber
- RU Лебедка для поднятия плитки
- CZ Zvedák k zvedání dlaždic
- HU Lapemelő
- RO Presa pt. etrier
- FR Lève panneaux
- IT Sollevatore delle piastrelle
- ES Levantador de baldosas
- CN 瓷砖抬高器

100 mm 

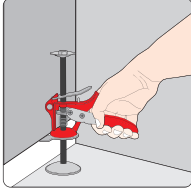

YATO 
YT-37200

 10/60

- EN Transport roller dolly
- PL Wózek, platforma transportowa
- DE Flachtransportwagen
- RU Платформенная тележка для транспортировки
- CZ Vozík přepravní plošina
- HU Platós szállítókosci
- RO Platforma cu roti pt. transport
- FR Chariot à plate-forme
- IT Piattaforma carrello di carico e trasporto
- ES Carro con plataforma de transporte
- CN 木板搬家器

500x300 mm max  200kg MDF 



YATO 
YT-37420

Platform size / Rozmiar platformy [mm]  500x300 6

- EN Transport roller dolly
- PL Wózek do transportu płyt gipsowo-kartonowych
- DE Flachtransportwagen
- RU Тележка для перевозки больших плит
- CZ Vozík přepravní plošina
- HU Platós szállítókosci
- RO Platforma cu roti pt. transport
- FR Chariot à plate-forme
- IT Piattaforma carrello di carico e trasporto
- ES Carro con plataforma de transporte
- CN 木板搬家器

575x300 mm max  200kg PLYWOOD SKLEJKJA 



YATO 
YT-37421

Platform size / Rozmiar platformy [mm]  575x300 6

- EN Drywall tool cart
- PL Wózek do transportu płyt gipsowo-kartonowych
- DE Transportwagen für Gipskartonplatten
- RU Тележка для транспортировки гипсокартона
- CZ Vozík pro přepravu sádro-kartonových desek
- HU Gipskarton szállító kézikocsi
- RO Carucior pt. transport placi gips carton
- FR Chariot pour le transport des plaques de carton-plâtre
- IT Carrello per trasporto pannelli GK
- ES Carro de transporte de placas cartón yeso
- CN 面板运输工具车

1240x640 x1210 mm max  900kg $\varnothing 203$ mm 1x  BRAKE HAMULEC 



YATO 
YT-37430

Dimensions / Wymiary [mm]  1240x640x1210 1

- EN Trolley for transporting large plate
- PL Wózek do transportu dużych płyt
- DE Plattenkarre zum Transport von großflächigen Platten
- RU Тележка для перевозки больших плит
- CZ Vozík pro přepravu velkých panelů
- HU Lapszállító kocsi
- RO Cărucior pt. transportul plăcii mari
- FR Chariot porte plaque et panneau
- IT Carrello porta lastre
- ES Carro manual de transporte para planchas
- CN 移木板车

$\varnothing 125$ mm  



YATO 
YT-37433

 6

- EN Drywall tool cart
- PL Wózek do transportu płyt gipsowo-kartonowych
- DE Transportwagen für Gipskartonplatten
- RU Тележка для транспортировки гипсокартона
- CZ Vozík pro přepravu sádro-kartonových desek
- HU Gipskarton szállító kézikocsi
- RO Carucior pt. transport placi gips carton
- FR Chariot pour le transport des plaques de carton-plâtre
- IT Carrello per trasporto pannelli GK
- ES Carro de transporte de placas cartón yeso
- CN 面板运输工具车

600x90 x1000 mm max  200kg 830 230 mm $\varnothing 260$ mm  



YATO 
YT-37434

Dimensions / Wymiary [mm]  600x90x1000 1

EN Wallboard carrier
PL Uchwyt do noszenia płyt gipsowo-kartonowych
DE Plattenträger mit Tragegriff
RU Приспособление для переноски плит
CZ Držák pro přenášení desek s rukojetí
HU Jellemzők és előnyök
RO Dispositiv pt. transportat plac de gips-carton
FR Porte-plaques a Griffes
IT Impugnatura porta lastre in cartongesso
ES Empunadura porta-placas
CN 石膏板提取器

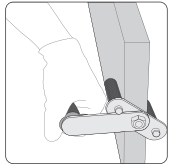

YATO
YT-37440

 2/12

EN Panel carrier
PL Uchwyt do noszenia płyt i desek
DE Tragegriff für Platten und Bretter
RU Ручка для переноски плит и досок
CZ Rukojeť pro přenášení panelů a desek
HU Fogantyú lemezek és deszkák hordozásához
RO Dispozitiv carat plac
FR Porte plaques et panneaux
IT Maniglia per il trasporto pannelli e tavole
ES Soporte para llevar paneles y tableros
CN 石膏板提手



YATO
YT-37441

 20

EN Panel carry
PL Nosidło do płyt gipsowo-kartonowych
DE Plattenträger mit Tragegriff
RU Приспособление для переноски плит
CZ Držák pro přenášení desek s rukojetí
HU Gipskarton hordó
RO Dispozitiv pt. transportat plac de gips-carton
FR Poignée transport de plaque
IT Porta lastre in cartongesso
ES Porta-paneles
CN 石膏板提手

ABS

max  80 kg



YATO
YT-37444

Max. lifting capacity / Maks. udźwig [kg]

 12

EN Drywall board lifter
PL Aluminiowa dźwignia do unoszenia płyt gipsowo-kartonowych
DE Alu-Platteneheber für Gipskartonplatten
RU Педаль подъемная для гипсокартона
CZ Páka pro zdvihacie plošiny
HU Gipskarton emelő
RO Elevator de panieor
FR Levier à panneau
IT Sollevatore in alluminio per lastre
ES Levanta paneles
CN 石膏板起板器

55 mm 

AI



YATO
YT-37450

 10

EN Aluminium try square
PL Kątownik do płyt gipsowo-kartonowych
DE Anschlagwinkel
RU Угольник столярный
CZ Truhlářský úhelník černý
HU Asztalos derékszög, fekete
RO Echer de tâmplărie negru
FR Équerre
IT Squadra per pannelli in gesso
ES Escuadra de aluminio
CN 角尺

90°

1200 mm

+/- 0.03 mm

AI



YATO
YT-70855

L [mm]

 10

EN Edge planing machine for gypsum plate
PL Strug do krawędzi płyt gipsowo-kartonowych
DE Gipskartonhobel
RU Рубанок кромочный для гипсокартона
CZ Sadrokarton hoblak
HU Élgyalu gipszkartonhoz
RO Dispozitiv slefuit, sanfreant gips carton
FR Placo-plâtre raboteuse
IT Pialla per bordi per lastre in cartongesso
ES Cepillo biselador carton yeso
CN 塑料刨边器

9.5-15 mm

x2 BLADES OSTRZA



YATO
YT-76260

 10/60

EN 2 knives for planer set
PL Noże do struga do płyt gipsowo-kartonowych
DE Klingen für Gipskartonhobel
RU Ножи для рубанка для гипсокартона
CZ Nože do hoblíku do sádro-kartonových desek
HU Penge gipszkarton gyaluhoz

RO Set 2 cutite rindea
FR Lame pour cutter de carton plâtre
IT Lame per pialla per pannelli di cartongesso
ES Cuchillas para cepillo de placas cartón-yeso
CN 刀片

2 PCS



For YT-76260
Dla YT-76260

YATO
YT-76261

 75/300

EN Drywall stripper
PL Obcinak dwustronny do płyt gipsowo-kartonowych
DE Streifenschneider
RU Рейсмус-резак для гипсокартона
CZ Řezák na sádrokarton
HU Gipszkarton-vágó
RO Dispozitiv reglabil de taiere a placilor de gips-carton
FR Outil coupe cloison sèche
IT Taglierino reversibile per pannelli in cartongesso
ES Cortador de tiras para tablaroca
CN 石膏板割刀

2x  Ø38 mm

DOUBLE-SIDE DWU-STROMM

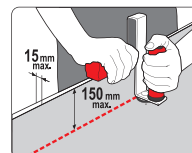

YATO
YT-76266

 6/12

EN Drywall stripper
 PL Obcinak dwustronny do płyt gipsowo-kartonowych
 DE Streifenschnneider
 RU Рейсмус-резак для гипсокартона
 CZ Řezák na sádrokarton
 HU Gipszkarton-vágó
 RO Dispozitiv reglabil de taiere a placilor de gips-carton

FR Outil coupe cloison sèche
 IT Taglierino reversibile per pannelli in cartongesso
 ES Cortador de tiras para tablaroca
 CN 石膏板切割器

DOUBLE-SIDED DWI-STRONNY

 x10

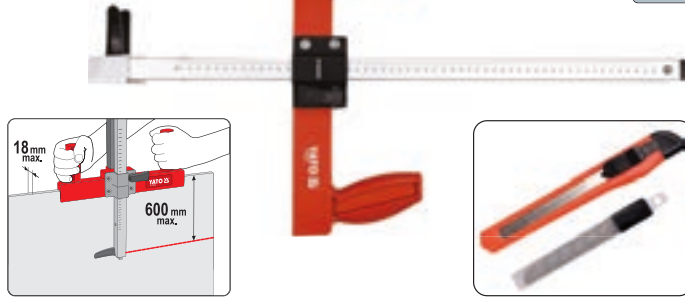
YATO
 YT-76270 1

EN Drywall board cutting tool with measuring tape
 PL Nóż do cięcia płyt gipsowo-kartonowych z miarą zwiżaną
 DE Gipskartonschneider mit Rollmaß
 RU Нож для резки гипсокартона с рулеткой
 CZ Nůž na sádrokarton se svinovacím metrem
 HU Mérőszalagos gipszkartonvágó kés
 RO Instrument de tăiat plăci de gips-carton cu bandă de măsurare
 FR Coupeur pour plaque de plâtre avec ruban-mètre intégré
 IT Taglierina per cartongesso con metro a nastro
 ES Cortador de placa de yeso con cinta métrica
 CN 石膏板切割器

5m 19mm x5 BLADES OSTRZA



YATO
 YT-31350 30

EN Telescopic support bar
 PL Podpora teleskopowa
 DE Baustütze-Schnellspanntüze
 RU Подъемник-распорка для гипсокартона
 CZ Tyč teleskopická rozpěrná
 HU Teleszkópos támasztórúd
 RO Suport sustinere telescopic
 FR Presse extensible
 IT Supporto telescopico
 ES Puntal expansion
 CN 伸缩顶杆

115 60 cm
 max 30 kg



YATO
 YT-64551 6

EN Telescopic support bar
 PL Podpora teleskopowa
 DE Baustütze-Schnellspanntüze
 RU Подъемник-распорка для гипсокартона
 CZ Tyč teleskopická rozpěrná
 HU Teleszkópos támasztórúd
 RO Suport sustinere telescopic
 FR Presse extensible
 IT Supporto telescopico
 ES Puntal expansion
 CN 伸缩顶杆

290 125 cm
 max 30 kg



YATO
 YT-64552 6

EN Pliers for hollow expansion bolts
 PL Zaciskarka do kolków „Molly”
 DE Maueranker-Einsetzwerkzeug
 RU Клеши для дюбелей „Молли”
 CZ Kotvíčci kleště
 HU Kreation üreges fémdűbel
 RO Cleste dibluri
 FR Pince pour chevilles creux
 IT Crimpatrice per pioli „Molly”
 ES Alicata para tacos „Molly”
 CN 膨胀螺栓钳

175 mm

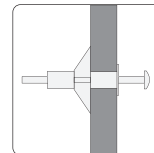
YATO L [mm] 175
 YT-51452 5/30

EN Pliers for hollow expansion bolts
 PL Zaciskarka do kolków „Molly”
 DE Maueranker-Einsetzwerkzeug

RU Клеши для дюбелей „Молли”
 CZ Kotvíčci kleště
 HU Kreation üreges fémdűbel

RO Cleste dibluri
 FR Pince pour chevilles creux
 IT Crimpatrice per pioli „Molly”

ES Alicata para tacos „Molly”
 CN 膨胀螺栓钳组套

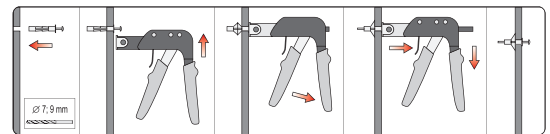

10 PCS

Ø 7 mm (32 mm) x5;
 Ø 9 mm (37 mm) x5;
 Ø 4 mm (40 mm);
 Ø 5 mm (44 mm)

60 PCS



Ø 7 mm (32 mm) x35;
 Ø 9 mm (37 mm) x15;
 Ø 9 mm (52 mm) x10;
 Ø 4 mm (40 mm);
 Ø 5 mm (44 mm);
 Ø 5 mm (58 mm)



YATO
 YT-51450 6/24

YATO
 YT-51451 3/12

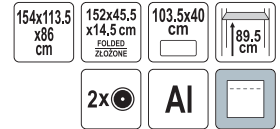
EN Mini folding scaffold
PL Rusztowanie składane
DE Klappgerüst
RU Складные леса
CZ Skládací lešení
HU Összecsukható állvány
RO Mini scelă pliată
FR Échafaudage pliant
IT Ponteggio pieghevole
ES Andamio plegable
CN 迷你脚手架



YATO
YT-30610 1

EN Tin snips
PL Nożyce do cięcia blachy
DE Blechscherer
RU Ножницы по металлу
CZ Nůžky na plech
HU Lemezvágó olló
RO Foarfece pt. tablă
FR Cisaille à tôle
IT Cesiole per lamiera
ES Tijeras para chapas
CN 航空剪



DIN 6438 HRC 60-62

YATO	L [mm]	Cutting length / Długość cięcia [mm]	Cooper / Miedź [mm]	Cold rolled steel / Stal zimnowalcowana [mm]	Steel HRC35 / Stal Nierdzewna 304 [mm]	SS 304 / Stal Nierdzewna 304 [mm]	
YT-1910	260	35	1.8	1.5	1.0	0.9	6/36



DIN 6438 HRC 60-62

YATO	L [mm]	Cutting length / Długość cięcia [mm]	Cooper / Miedź [mm]	Cold rolled steel / Stal zimnowalcowana [mm]	Steel HRC35 / Stal Nierdzewna 304 [mm]	SS 304 / Stal Nierdzewna 304 [mm]	
YT-1915	235	30	1.5	1.2	1.0	0.7	6/36



DIN 6438 HRC 60-62

YATO	L [mm]	Cutting length / Długość cięcia [mm]	Cooper / Miedź [mm]	Cold rolled steel / Stal zimnowalcowana [mm]	Steel HRC35 / Stal Nierdzewna 304 [mm]	SS 304 / Stal Nierdzewna 304 [mm]	
YT-1918	260	32	1.8	1.5	1.0	0.9	6/36



HRC 56-62 HIGH FREQUENCY HARDENING HARTOWANIE IMPULSOWE SERRATED EDGES ZĄBKOWANE KRAWĘDZIE

YATO	L [mm]	Cutting length / Długość cięcia [mm]	Cooper / Miedź [mm]	Cold rolled steel / Stal zimnowalcowana [mm]	Steel HRC35 / Stal Nierdzewna 304 [mm]	SS 304 / Stal Nierdzewna 304 [mm]	
YT-1960	250	40	2.0	1.5	1.0	0.8	6/36

EN Tin snips
PL Nożyce do cięcia blachy
DE Blechscherer
RU Ножницы по металлу
CZ Nůžky na plech
HU Lemezvágó olló
RO Foarfece pt. tablă
FR Cisaille à tôle
IT Cesiole per lamiera
ES Tijeras para chapas
CN 台式航空剪



YATO	L [mm]	Cutting length / Długość cięcia [mm]	Cooper / Miedź [mm]	Cold rolled steel / Stal zimnowalcowana [mm]	Steel HRC35 / Stal Nierdzewna 304 [mm]	SS 304 / Stal Nierdzewna 304 [mm]	
YT-1913	225	30	0.78	0.53	0.46	0.36	6/36

EN Tin snips
 PL Nożyce do cięcia blachy
 DE Blechscherer
 RU Ножницы по металлу

CZ Nůžky na plech
 HU Lemezvágó olló
 RO Foarfece pt. tablă
 FR Cisaille à tôle

IT Cesioie per lamiere
 ES Tijeras para chapas
 CN 航空剪



DIN 6438 **HRC 60-62**

YATO L [mm]	Cutting length / Długość cięcia [mm]	Cooper / Miedź [mm]	Cold rolled steel / Stal zimnowalcowana [mm]	Steel HRC35 / Stal HRC35 [mm]	SS 304 / Stal Nierdzewna 304 [mm]		
YT-1912	260	35	1.8	1.5	1.0	0.9	6/36



DIN 6438 **HRC 60-62**

YATO L [mm]	Cutting length / Długość cięcia [mm]	Cooper / Miedź [mm]	Cold rolled steel / Stal zimnowalcowana [mm]	Steel HRC35 / Stal HRC35 [mm]	SS 304 / Stal Nierdzewna 304 [mm]		
YT-1922	290	75	1.1	0.94	0.7	0.53	6/36



HRC 56-62 **SERRATED EDGES ZABKOWANE KRAWĘDZIE** **HIGH FREQUENCY HARDENING HARTOWANE IMPULSOWE**

YATO L [mm]	Cutting length / Długość cięcia [mm]	Cooper / Miedź [mm]	Cold rolled steel / Stal zimnowalcowana [mm]	Steel HRC35 / Stal HRC35 [mm]	SS 304 / Stal Nierdzewna 304 [mm]		
YT-1962	250	45	2.0	1.5	1.0	0.8	6/36

EN Tin snips
 PL Nożyce do cięcia blachy
 DE Blechscherer
 RU Ножницы по металлу

CZ Nůžky na plech
 HU Lemezvágó olló
 RO Foarfece pt. tablă
 FR Cisaille à tôle

IT Cesioie per lamiere
 ES Tijeras para chapas
 CN 航空剪



DIN 6438 **HRC 60-62**

YATO L [mm]	Cutting length / Długość cięcia [mm]	Cooper / Miedź [mm]	Cold rolled steel / Stal zimnowalcowana [mm]	Steel HRC35 / Stal HRC35 [mm]	SS 304 / Stal Nierdzewna 304 [mm]		
YT-1911	260	35	1.8	1.5	1.0	0.9	6/36



DIN 6438 **HRC 60-62**

YATO L [mm]	Cutting length / Długość cięcia [mm]	Cooper / Miedź [mm]	Cold rolled steel / Stal zimnowalcowana [mm]	Steel HRC35 / Stal HRC35 [mm]	SS 304 / Stal Nierdzewna 304 [mm]		
YT-1916	235	30	1.5	1.2	1.0	0.7	6/36



DIN 6438 **HRC 60-62**

YATO L [mm]	Cutting length / Długość cięcia [mm]	Cooper / Miedź [mm]	Cold rolled steel / Stal zimnowalcowana [mm]	Steel HRC35 / Stal HRC35 [mm]	SS 304 / Stal Nierdzewna 304 [mm]		
YT-1919	260	32	1.8	1.5	1.0	0.9	6/36



HRC 56-62 **SERRATED EDGES ZABKOWANE KRAWĘDZIE** **HIGH FREQUENCY HARDENING HARTOWANE IMPULSOWE**

YATO L [mm]	Cutting length / Długość cięcia [mm]	Cooper / Miedź [mm]	Cold rolled steel / Stal zimnowalcowana [mm]	Steel HRC35 / Stal HRC35 [mm]	SS 304 / Stal Nierdzewna 304 [mm]		
YT-1961	250	40	2.0	1.5	1.0	0.8	6/36

EN Tin snips
 PL Nożyce do cięcia blachy
 DE Blechscherer
 RU Ножницы по металлу

CZ Nůžky na plech
 HU Lemezvágó olló
 RO Foarfece pt. tablă
 FR Cisaille à tôle
 IT Cesioie per lamiere
 ES Tijeras para chapas
 CN 台式航空剪



YATO L [mm]	Cutting length / Długość cięcia [mm]	Cooper / Miedź [mm]	Cold rolled steel / Stal zimnowalcowana [mm]	Steel HRC35 / Stal HRC35 [mm]	SS 304 / Stal Nierdzewna 304 [mm]		
YT-1914	225	30	0.78	0.53	0.46	0.36	6/36

EN Tin snips
PL Nożyce do cięcia blachy
DE Blechscherer
RU Ножницы по металлу

CZ Nůžky na plech
HU Lemezvágó olló
RO Foarfece pt. tablă
FR Cisaille à tôle

IT Cesioie per lamiera
ES Tijeras para chapas
CN 航空剪



HRC
58-61

DROP
FORGED
KÜTE



YATO L [mm]	Cutting length / Długość cięcia [mm]	Cooper / Miedz [mm]	Cold rolled steel / Stal zimnowalcowana [mm]	Steel HRC35 / Stal HRC35 [mm]	SS 304 / Stal Nierdzewna 304 [mm]	
YT-1900	260	30	0.94	0.78	0.6	0.45 6/24

EN Tin snips
PL Nożyce do cięcia blachy
DE Blechscherer
RU Ножницы по металлу

CZ Nůžky na plech
HU Lemezvágó olló
RO Foarfece pt. tablă
FR Cisaille à tôle

IT Cesioie per lamiera
ES Tijeras para chapas
CN 航空剪



HRC
58-61

DROP
FORGED
KÜTE



YATO L [mm]	Cutting length / Długość cięcia [mm]	Cooper / Miedz [mm]	Cold rolled steel / Stal zimnowalcowana [mm]	Steel HRC35 / Stal HRC35 [mm]	SS 304 / Stal Nierdzewna 304 [mm]	
YT-1901	260	30	0.94	0.78	0.6	0.45 6/24

YATO L [mm]	Cutting length / Długość cięcia [mm]	Cooper / Miedz [mm]	Cold rolled steel / Stal zimnowalcowana [mm]	Steel HRC35 / Stal HRC35 [mm]	SS 304 / Stal Nierdzewna 304 [mm]	
YT-1902	300	50	0.94	0.78	0.6	0.45 6/24

EN Tin snips
PL Nożyce do cięcia blachy
DE Blechscherer
RU Ножницы по металлу
CZ Nůžky na plech
HU Lemezvágó olló

RO Foarfece pt. tablă
FR Cisaille à tôle
IT Cesioie per lamiera
ES Tijeras para chapas
CN 铁皮剪

HRC
55-60

S55C

HIGH FREQUENCY
HARDENING
FAKONOVÉ
IMPULSONE



YATO L [mm]	Cutting length / Długość cięcia [mm]	Cooper / Miedz [mm]	Cold rolled steel / Stal zimnowalcowana [mm]	Steel HRC35 / Stal HRC35 [mm]	SS 304 / Stal Nierdzewna 304 [mm]	
YT-1970	260	42	2.0	1.4	1.0	1.0 6/36

EN Tin snips
PL Nożyce do cięcia blachy
DE Blechscherer
RU Ножницы по металлу
CZ Nůžky na plech
HU Lemezvágó olló

RO Foarfece pt. tablă
FR Cisaille à tôle
IT Cesioie per lamiera
ES Tijeras para chapas
CN 铁皮剪



HRC
58-61



DROP
FORGED
KÜTE



EN Tin snips
PL Nożyce do cięcia blachy
DE Blechscherer
RU Ножницы по металлу
CZ Nůžky na plech
HU Lemezvágó olló

RO Foarfece pt. tablă
FR Cisaille à tôle
IT Cesioie per lamiera
ES Tijeras para chapas
CN 铁皮剪



HRC
58-60



YATO L [mm]	Cutting length / Długość cięcia [mm]	Cooper / Miedz [mm]	Cold rolled steel / Stal zimnowalcowana [mm]	Steel HRC35 / Stal HRC35 [mm]	SS 304 / Stal Nierdzewna 304 [mm]	
YT-1925	225	52	0.94	0.78	0.6	0.45 6/36

YATO L [mm]	Cutting length / Długość cięcia [mm]	Cooper / Miedz [mm]	Cold rolled steel / Stal zimnowalcowana [mm]	Steel HRC35 / Stal HRC35 [mm]	SS 304 / Stal Nierdzewna 304 [mm]	
YT-1920	260	42	1.2	1.0	0.6	0.5 6/36

- EN Tin snips
- PL Nożyce do cięcia blachy
- DE Blechscherer
- RU Ножницы по металлу
- CZ Nůžky na plech
- HU Lemezvágó olló
- RO Foarfece pt. tablă
- FR Cisaille à tôle
- IT Cesiole per lamiera
- ES Tijeras para chapas
- CN 铁皮剪

HRC 58-61



YATO L [mm]	Cutting length / Długość cięcia [mm]	Cooper / Miedz [mm]	Cold rolled steel / Stal zimnowalcowana [mm]	Steel HRC35 / Stal HRC35 [mm]	SS 304 / Stal Nierdzewna 304 [mm]	
YT-1924	254	52	0.94	0.78	0.6	0.45 6/36

- EN Tin snips
- PL Nożyce do cięcia blachy
- DE Blechscherer
- RU Ножницы по металлу
- CZ Nůžky na plech
- HU Lemezvágó olló
- RO Foarfece pt. tablă
- FR Cisaille à tôle
- IT Cesiole per lamiera
- ES Tijeras para chapas
- CN 铁皮剪

HRC 55-60

S55C

HIGH FREQUENCY HARDENING HARTOWANIE IMPULSOWE



YATO L [mm]	Cutting length / Długość cięcia [mm]	Cooper / Miedz [mm]	Cold rolled steel / Stal zimnowalcowana [mm]	Steel HRC35 / Stal HRC35 [mm]	SS 304 / Stal Nierdzewna 304 [mm]	
YT-1963	200	40	1.5	1.0	0.6	0.6 6/36
YT-1964	250	60	1.8	1.2	0.8	0.8 6/24
YT-1965	300	75	2.0	1.4	0.8	0.8 6/12

- EN Metal sheet nibbler
- PL Nożyce matrycowe do blachy
- DE Blechnibbler
- RU Ножницы для резки жести
- CZ Nůžky na plech
- HU Lemezvágó olló
- RO Foarfece pt. tablă
- FR Grignoteuse a tole
- IT Cesioia roditrice per lamiera
- ES Tijeras para chapas
- CN 法式剪

260 mm max 1.0mm PLATE BLACHA max 1.2mm Al max 2.0mm PLASTIC PLASTIK

3.0 mm

65Mn

CHANGEABLE BLADES WYMIENNE OSTRZA



YATO L [mm]	
YT-19260	260 6/36

- EN Spare blades for metal sheet nibbler
- PL Ostrza zapasowe do nożyc matrycowych
- DE Abbrechklingen für Blechnibbler
- RU Лезвия для ножиц для резки жести
- CZ Ostrří náhradní
- HU Tartalékpenge
- RO Lame de rezervă
- FR Lame sécables pour grignoteuse a tole
- IT Lame di ricambio per cesioia roditrice per lamiera
- ES Cuchillas de recambio
- CN 法式剪备用刀片

3 PCS

65Mn



For YT-19260
Dla YT-19260

YATO L [mm]	
YT-19261	10/100

- EN Hand notchers
- PL Nożyce dekarzkie do nacinania blach
- DE Kerbzange
- RU Ножницы v-образные
- CZ Koutkové nůžky na stříhání plechů
- HU Lemezvágó olló
- RO Foarfece tabla taiere colturi
- FR Ciseaux à tôle
- IT Cesiole per lamiera
- ES Cizallas para techos
- CN 缺口钳



230 mm

±30°

CrV



YATO L [mm]	
YT-18970	230 6/36

- EN Snap lock punch
- PL Zacziskacz punktowy
- DE Schnappverschluss-Lochtreiber
- RU Плоскогубцы для кровельщиков
- CZ Střešní kleště
- HU Tetőfedő fogó
- RO Clește pt. despicat
- FR Pincas pour couvreurs
- IT Pinza a crimpare
- ES Punzón de cerradura de resorte
- CN 记号钳



230 mm

CrV



YATO L [mm]	
YT-18977	230 6/36

- EN Shears for cutting sheet metal
- PL Nożyce krążkowe do cięcia blach
- DE Rollenblechscherer
- RU Дисковые ножницы для резки листового металла
- CZ Kroužkové nůžky na stříhání plechů
- HU Karos lemezvágó olló
- RO Dispozitiv taiat foi de tabla
- FR Cisaille à tôle à molette
- IT Cesioia rotante per lamiera
- ES Cortador rotativo para chapas
- CN 手动钢板剪



1.6mm COLD ROLLED STEEL STAL ZIMNOWALCOWANA M.2000



YATO L [mm]	Cold rolled steel / Stal zimnowalcowana [mm]	Stainless steel / Stal nierdzewna [mm]	Aluminium [mm]	
YT-18950	120 1.6	1.2	2.0	1

- EN Straight pliers
PL Zaczekacze do gięcia blach
DE Zange zum Blechbiegen
RU Клещи с тупым ножом для жести
CZ Kleště na ohýbání plechu
HU Falcfogó
RO Cleste pt. indoirea tablei
FR Pince à fléchir la tôle
IT Taglie per la lamiera
ES Tenazas para doblar hojalata
CN 钣金钳



45°



90°



180°

YATO	L [mm]	
YT-5416	280	10/20

YATO	L [mm]	
YT-5417	260	10/20

YATO	L [mm]	
YT-5415	280	10/20

- EN Single seam clench
PL Zaciskacz rąbka pojedynczego
DE Klemmvorrichtung für einfachen Falz
RU Зажим одинарного фальца
CZ Svorka pro drážkování s jednoduchým lemem
HU Korczáró fogó
RO Clema pt. falt simplu
FR Pince à joint debout simple
IT Pinza per aggraffatura singola
ES Pinza de primer pliegue para junta alzada
CN 屋顶施工工具

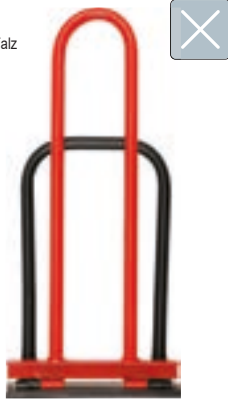

YATO	Pipe diameter / Średnica rurki [mm]	Size / Rozmiar [mm]	
YT-5400	18	480x220	5

- EN Double seam clench
PL Zaciskacz rąbka podwójnego
DE Klemmvorrichtung für doppelten Falz
RU Зажим двойного фальца
CZ Svorka pro drážkování s dvojitým lemem
HU Dupla korczáró fogó
RO Clema pt. falt dublu
FR Pince à double joint debout
IT Pinza per aggraffatura doppia
ES Pinza de segundo pliegue para junta alzada
CN 屋顶施工工具



YATO	Pipe diameter / Średnica rurki [mm]	Size / Rozmiar [mm]	
YT-5402	18	480x220	5

- EN Eaves turner
PL Kantownik okapu
DE Traufenkanter
RU Кромкогиб для карнизной планки
CZ Ohýbač hran okapu
HU Ereszpereszó fogó
RO Cornier streasina
FR Plieuse à larmier
IT Piegatrice per gronda
ES Pinza para doblar bandeja
CN 屋顶施工工具



YATO	Pipe diameter / Średnica rurki [mm]	Size / Rozmiar [mm]	
YT-5404	18	450x200	5

- EN Eaves clench
PL Zaciskacz okapu
DE Traufenklemme
RU Зажим для карнизной планки
CZ Svorka do okapu
HU Ereszszáró fogó
RO Clema pt. streasina
FR Pince à larmier
IT Pinza chiusura gronda
ES Pinza para alero
CN 屋顶施工工具



YATO	Pipe diameter / Średnica rurki [mm]	Size / Rozmiar [mm]	
YT-5405	18	450x200	5

- EN Drainpipe hooks bender
PL Zaginacz haków rynnowych
DE Biegevorrichtung für Rinnenhaken
RU Инструмент для загиба крюков желобов
CZ Ohýbač okapových háků
HU Ereszszatormavas hajlító



YATO	L [mm]	
YT-5410	680	4

- RO Dispozitiv pt. indoit carlige burian
FR Pince à crochets de gouttières
IT Piegaferrì per sostegni grondaia
ES Pinza para soportes de canalón
CN 弯管器

- EN Pipe crimper
PL Szczypce do karbowania rur
DE Rohreinziehzange mit 5 Klingen
RU Ножницы по металлу для гофры
CZ Kleště krepovací
HU Kreppelő kullancsok
RO Cleste gofrare burlane
FR Pince a gauffer 5 lames
IT Pinza per corrugare tubi
ES Crimpadora de tubos
CN 波浪剪

260 mm LOCK BLOKADA



YATO	L [mm]	
YT-22380	260	6/36

- EN Wire tying twister hook
PL Klucz do wiązania drutu zbrojeniowego
DE Rödeldraht-Drillkurbel
RU Крючок для вязки арматуры
CZ Radiovačka
HU Huzalsodró
RO Dispozitiv pt. legat fier beton
FR Lieur
IT Gancio per legare armature
ES Gancho para amarrar alambre
CN 钢筋钩

210 mm



YATO	L [mm]	
YT-54230	210	50/100

- EN Automatic twister hook for wire tying
PL Klucz automatyczny do skręcania drutu
DE Rödeldraht-Drillkurbel
RU Автоматический крюк для вязки арматуры
CZ Spirálový vazáč
HU Huzalsodró készülék
RO Dispozitiv automat pt. legat fier beton
FR Lieur automatique
IT Torcifi lo automatico
ES Gancho para amarrar alambre automatico
CN 自动伸缩钢筋钩

300 mm



YATO	L [mm]	
YT-54233	300	10/30

- EN Paving slab lifter
- PL Chwytyk do płyt chodnikowych
- DE Greifer für Steinplatten
- RU Захват для тротуарной плитки
- CZ Uchopovač dlažebních desky
- HU Járólap fogó
- RO Dispozitiv ridicat placi
- FR Léve-dalle réglable
- IT Maniglia per trasporto piastrelle
- ES Pinzas para transportar losas
- CN 提砖器



GALVANIZED
STEEL
STÁL
CCYNKOVANÁ

YATO	Grip range / Zakres chwytu [mm]	
YT-46500	300-500	5/15
YT-46501	400-600	5/15

- EN Brick tongs
- PL Chwytyk do podnoszenia płyt lub cegieł
- DE Greifer zum Heben von Platten oder Ziegeln
- RU Захват для подъема плит или кирпича
- CZ Nástroj pro přenášení desek a cihel
- HU Csempe- és téglafogó
- RO Clește caramida
- FR Pince de levage pour dalles et briques
- IT Pinza per sollevamento lastre o mattoni
- ES Pinzas para transportar placas o ladrillos
- CN 砖夹



400-670
mm

YATO	Grip range / Zakres chwytu [mm]	
YT-37470	400-670	12

- EN Rectangular floating rule
- PL Lata murarska
- DE Setzlatte 2 Libellen
- RU Правило-уровень
- CZ Lat zednická s libelami
- HU Ólesléc, téglalap keresztmetszetű
- RO Dreptar cu 2 bule
- FR Niveau à bulle
- IT Livella
- ES Nivel de albañil
- CN 刮板

0.057°
1mm/1m
ACCURACY
DOKŁADNOŚĆ

x2



YATO	L [mm]	
YT-3071	1500	10
YT-3072	2000	10
YT-3073	2500	10
YT-3074	3000	10

YATO	L [mm]	
YT-3076	1500	10
YT-3077	2000	10
YT-3078	2500	10
YT-3079	3000	10

- EN Trapezoid floating rule
- PL Lata tynkarska
- DE Abziehlatte mit Trapezprofil
- RU Правило трапециевидное
- CZ Lat malířská
- HU Ólesléc, trapézoid keresztmetszetű
- RO Dreptar trapezoidal
- FR Niveau à bulle
- IT Livella trapezoidale
- ES Nivel de albañil
- CN 梯形刮板



YATO	L [mm]	
YT-3081	1500	10
YT-3082	2000	10
YT-3083	2500	10
YT-3084	3000	10

- EN Toothed comb with variable length
- PL Lata zębata z regulowaną długością
- DE Längenverstellbare Zahnlatte
- RU Зубчатая рейка с регулируемой длиной
- CZ Zubatá lata s nastavitelnou délkou
- HU Állítható hosszúságú fogas léc
- RO Pieptene dintat cu lungime variabilă
- FR Latte dentée réglable en longueur
- IT Livellatrice a cazzuola dentata con lunghezza regolabile
- ES Liana dentada con longitud ajustable
- CN 瓷砖平灰器

20x15
mm

109-150
cm

x1

SS
STAINLESS STEEL
STAL NIERDZEWNA



- EN Knife for roofing paper
- PL Nóż do cięcia papy
- DE Messer zum Schneiden von Pappe
- RU Нож для резки рубероида
- CZ Nůž k řezání lepenky
- HU Kátrányipapírvágó olló
- RO Cutter pt. tăierea cartonului asfaltat
- FR Couteau pour carton
- IT Coltello per tagliare cartone bituminoso
- ES Cuchilla para cortar cartón alquitranado
- CN 多功能刀

90/230
mm

SS
STAINLESS STEEL
STAL NIERDZEWNA



YATO	L [mm]	
YT-7620	230	12/60

- EN Knife for mineral wool
- PL Nóż do cięcia izolacji budowlanych
- DE Messer zum Schneiden von Bauisolierungen
- RU Нож для резки строительной изоляции
- CZ Nůž k řezání stavebních izolačních hmot
- HU Kés épületszigetelés vágásához
- RO Cutter pt. tăierea izolațiilor
- FR Couteau pour isolants
- IT Coltello per tagliare l'isolamento di costruzione
- ES Cuchilla para cortar aislamiento de construcción
- CN 多功能刀

SS
STAINLESS STEEL
STAL NIERDZEWNA

YATO	L [mm]	
YT-7623	500	10/50

YATO	L [mm]	
YT-7624	480	10/50

- EN Thermal knife for polystyrene foam
- PL Nóż termiczny do styropianu
- DE Thermomesser für Styropor
- RU Термонож для пенопласта
- CZ Termický nůž na pěnový polystyrén
- HU Polisztirol vágó hőkés
- RO Cuțit termic pt. stiroplan
- FR Couteau thermique à styrofoam
- IT Coltello termico per polistirolo
- ES Cuchilla térmica para poliestireno
- CN 热切割刀

230V~
50Hz

220
W

70-450
°C

STYROFOAM
STYROPAN

POLYPROPYLENE
POLIPROPILEL

PVC

LED



YATO	[W]	Max. cutting length / Maks. długość cięcia [mm]	
YT-82190	220	220	10

EN Electric hoist
PL Elektryczny wciągnik linowy
DE Elektro-Seilwinde
RU Электрическая канатная лебёдка
HU Elektromos csőrő
RO Troliu electric cu cablu
FR Treuil électrique à corde
IT Verricello elettrico
ES Cabria eléctrica de cuerdas
CN 电动葫芦



$L_{pa} = 52,2 \pm 1,2$ dB; $L_{ma} = 73,6 \pm 2,31$ dB

YATO	[W]	
YT-5901	500	2

EN Electric hoist
PL Elektryczny wciągnik linowy
DE Elektro-Seilwinde
RU Электрическая канатная лебёдка
CZ Elektrický naviják kladkostroj
HU Elektromos csőrő
RO Troliu electric cu cablu
FR Treuil électrique à corde
IT Verricello elettrico
ES Cabria eléctrica de cuerdas
CN 电动葫芦

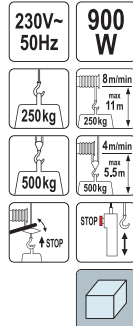

$L_{pa} = 54,0 \pm 0,9$ dB; $L_{ma} = 78,0 \pm 6,57$ dB

YATO	[W]	
YT-5904	900	2

EN Electric hoist
PL Elektryczny wciągnik linowy
DE Elektro-Seilwinde
RU Электрическая канатная лебёдка
CZ Elektrický naviják kladkostroj
HU Elektromos csőrő
RO Troliu electric cu cablu
FR Treuil électrique à corde
IT Verricello elettrico
ES Cabria eléctrica de cuerdas
CN 电动葫芦

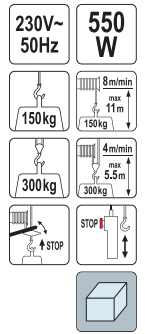

$L_{pa} = 52,2 \pm 0,9$ dB; $L_{ma} = 75,4 \pm 4,8$ dB

YATO	[W]	
YT-5902	550	2

EN Electric hoist
PL Elektryczny wciągnik linowy
DE Elektro-Seilwinde
RU Электрическая канатная лебёдка
CZ Elektrický naviják kladkostroj
HU Elektromos csőrő
RO Troliu electric cu cablu
FR Treuil électrique à corde
IT Verricello elettrico
ES Cabria eléctrica de cuerdas
CN 电动葫芦

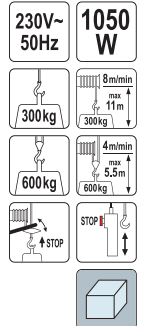

$L_{pa} = 58,9 \pm 1,9$ dB; $L_{ma} = 79,9 \pm 2,79$ dB

YATO	[W]	
YT-5905	1050	2

EN Rubber protection extension cord
PL Przedłużacz w osłonie gumowej
DE Gummiisolierte Verlängerungsschnur
RU Удлинитель с резиновой изоляцией

CZ Prodlužovací kabel s gumovou izolací
HU Gumi szigetelésű hosszabbító
RO Cablu prelungitor cauciu
FR Rallonge électrique

IT Prolunga in gomma
ES Cable de extensión con protección de caucho
CN 电缆延长线



YATO	L [m]	
YT-81021	10	10
YT-81022	20	5
YT-81023	30	5
YT-81024	40	5

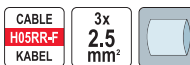

YATO	L [m]	
YT-8100	20	4
YT-8101	30	2
YT-8102	40	2



YATO	L [m]	
YT-8111	5	10
YT-8112	10	10

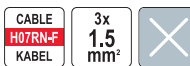

YATO	L [m]	
YT-8116	10	4
YT-81162	20	4

EN Extension cord
PL Przedłużacz elektryczny
DE Verlängerungskabel
RU Удлинитель электрический
CZ Elektrický prodlužovač
HU Elektromos hosszabbító
RO Prelungitor electric
FR Rallonge électrique
IT Prolunga elettrica
ES Extensión eléctrica
CN 电源连接器

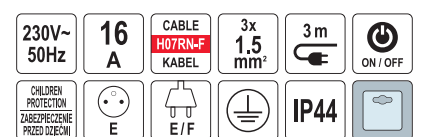

YATO	L [m]		Socket type / Typ gniazda	
YT-81240	3	3	E	10
YT-81241	3	4	E	10
YT-81242	3	5	E	10

EN Cable reel
 PL Przedłużacz zwijany
 DE Kabeltrommel
 RU Удлинитель электрический
 CZ Bubnový prodloužovač
 HU Kábeldob
 RO Prelungitor pe tambur
 FR Rallonge électrique sur tambour enrouleur
 IT Avvolgicavo con bobina
 ES Cable de prolongación de tambor
 CN 电缆卷轴

230V~
50Hz

16
A

CABLE
H05RR-F
KABEL

3x
1,5
mm²

E/F

E

IP44



P_{max} = 1000 W coiled
 P_{max} = 3000 W uncoiled

P_{max} = 1000 W zwinięty
 P_{max} = 3000 W rozwinięty

YATO	L [m]	
YT-81052	20	2
YT-81053	30	2
YT-81054	40	2

EN Cable reel
 PL Przedłużacz zwijany
 DE Kabeltrommel
 RU Удлинитель электрический
 CZ Bubnový prodloužovač
 HU Kábeldob
 RO Prelungitor pe tambur
 FR Rallonge électrique sur tambour enrouleur
 IT Avvolgicavo con bobina
 ES Cable de prolongación de tambor
 CN 电缆延长线

230V~
50Hz

16
A

CABLE
H05RR-F
KABEL

3x
2,5
mm²

E/F

E

IP44



P_{max} = 1200 W coiled
 P_{max} = 3600 W uncoiled

P_{max} = 1200 W zwinięty
 P_{max} = 3600 W rozwinięty

YATO	L [m]	
YT-8106	30	1
YT-8107	40	1
YT-8108	50	1

EN Cable reel
 PL Przedłużacz zwijany
 DE Kabeltrommel
 RU Удлинитель электрический
 CZ Bubnový prodloužovač
 HU Kábeldob
 RO Prelungitor pe tambur
 FR Rallonge électrique sur tambour enrouleur
 IT Avvolgicavo con bobina
 ES Cable de prolongación de tambor
 CN 电缆延长线

~400V
~230V

16
A

CABLE
H07RN-F
KABEL

5x
2,5
mm²

3P+N+E

3P+N+E
2x 2P+E

IP44



~230 V; 2P+E:
 P_{max} = 1200 W coiled
 P_{max} = 3000 W uncoiled

~400 V; 3P+N+E:
 P_{max} = 3000 W coiled
 P_{max} = 9000 W uncoiled~230 V;

2P+E:
 P_{max} = 1200 W zwinięty
 P_{max} = 3000 W rozwinięty

~400 V; 3P+N+E:
 P_{max} = 3000 W zwinięty
 P_{max} = 9000 W rozwinięty

YATO	L [m]	
YT-8120	25	1

EN Spiral bar mixer
 PL Mieszadło spiralne prętowe
 DE Rundstabrührer für Klebrige, geschmeidige Materialien
 RU Краскомешалка
 CZ Spirálové míchadlo drátové
 HU Spirális pálcás keverő

RO Malaxor pt. vopsea
 FR Malaxeur spiral
 IT Mescolatore spirale
 ES Agitador de pala/cinta
 CN 搅拌机



• Application: powder materials, general-purpose adhesives, gypsum surface finishing mixes, epoxy grouts
 • Zastosowanie: materiały sypkie, gotowe zaprawy klejowe, masy szpachlowe, zaprawy do spoinowania

YATO	Ø [mm]	L [mm]	Toolholder type / Rodzaj uchwytu narzędziowego	Max. mixing capacity / Maks. wydajność mieszania [kg]	
YT-5490	85	410	sześciokątny	4-9	30
YT-5491	100	600	sześciokątny	6-16	16
YT-5492	85	450	SDS-Plus	4-9	30
YT-5493	100	600	SDS-Plus	6-16	16

EN Spiral mixer
 PL Mieszadło spiralne
 DE Rondenrührer für dünnflüssige Materialien
 RU Краскомешалка
 CZ Spirálové míchadlo
 HU Spirális keverő

RO Malaxor pt. vopsea
 FR Malaxeur spiral
 IT Mescolatore spirale
 ES Agitador de cinta helicoidal
 CN 搅拌机



• Application: emulsion paints, acrylic paints, lacquers, stains, other liquid materials
 • Zastosowanie: farby emulsyjne, farby akrylowe, lakiery, bejce, inne materiały płynne

YATO	Ø [mm]	L [mm]	Toolholder type / Rodzaj uchwytu narzędziowego	Max. mixing capacity / Maks. wydajność mieszania [kg]	
YT-5494	80	400	sześciokątny	5-10	30
YT-5496	100	600	SDS-Plus	15-30	20

EN Spiral bar mixer
 PL Mieszadło spiralne prętowe
 DE Spiralrührer
 RU Миксер спиральный
 CZ Spirálové míchadlo drátové
 HU Spirális pálcás keverő

RO Malaxor spirala
 FR Malaxeur à spirale
 IT Mescolatore spirale
 ES Agitador de varilla espiral
 CN 搅拌机



• Application: powder materials, general-purpose adhesives, gypsum surface finishing mixes, epoxy grouts
 • Zastosowanie: materiały sypkie, gotowe zaprawy klejowe, masy szpachlowe, zaprawy do spoinowania

YATO	Ø [mm]	L [mm]	Toolholder type / Rodzaj uchwytu narzędziowego	Max. mixing capacity / Maks. wydajność mieszania [kg]	
YT-54895	60	320	sześciokątny	4-9	30

EN Spiral mixer
 PL Mieszadło spiralne
 DE Rondenrührer für dünnflüssige Materialien
 RU Краскомешалка
 CZ Spirálové míchadlo
 HU Spirális keverő

RO Malaxor pt. vopsea
 FR Malaxeur spiral
 IT Mescolatore spirale
 ES Agitador de cinta helicoidal
 CN 搅拌机



• Application: fine-grained paints and adhesives
 • Zastosowanie: farby i kleje drobnociąmiste

YATO	Ø [mm]	L [mm]	Toolholder type / Rodzaj uchwytu narzędziowego	Max. mixing capacity / Maks. wydajność mieszania [kg]	
YT-54952	100	500	sześciokątny	10-20	10
YT-54953	125	600	M14	20-30	10

EN Double spiral mixer
PL Mieszadło spiralne podwójne
DE Doppel-Spiralrührer
RU Миксер спиральный двойной
CZ Spirálové míchadlo dvojité
HU Dupla spirális keverő

RO Malaxor spirala dubla pt. vopsea
FR Malaxeur spiral double
IT Mescolatore a doppia spirale
ES Agitador de cinta helicoidal doble
CN 搅拌器



• Application: general-purpose adhesives, masonry mortars, jointless floors, thin-layer mineral plasters, gypsum surface finishing mixes, isolation masses

• Zastosowanie: zaprawy klejowe, zaprawy murarskie, jastrych, tynki strukturalne, masy szpachlowe, masy izolacyjne

YATO	Ø [mm]	L [mm]	Toolholder type / Rodzaj uchwytu narzędziowego	Max. mixing capacity / Maks. wydajność mieszania [kg]	
YT-5497	70	400	sześcioramienny	5-10	20
YT-5499	100	600	sześcioramienny	10-20	16
YT-5500	120	600	sześcioramienny	15-25	14
YT-5501	100	600	SDS-Plus	10-20	16
YT-5502	120	600	SDS-Plus	15-25	14
YT-5503	120	600	M14	15-25	14
YT-5504	160	600	M14	20-30	8

EN Triple spiral mixer
PL Mieszadło spiralne potrójne
DE Dreifach-Spiralrührer
RU Миксер спиральный тройной
CZ Spirálové míchadlo trojité
HU Tripla spirális keverő

RO Malaxor spirala tripla pt. vopsea
FR Malaxeur spiral triple
IT Mescolatore a triplo spirale
ES Agitador de cinta helicoidal triple
CN 搅拌器



• Application: mortars, concrete, plasters, other semi-fluid materials with sand or gravel filling

• Zastosowanie: zaprawy, beton, tynki, inne półpłynne, lepkie materiały z wypełnieniem piaskowym lub żwirowym

YATO	Ø [mm]	L [mm]	Toolholder type / Rodzaj uchwytu narzędziowego	Max. mixing capacity / Maks. wydajność mieszania [kg]	
YT-5505	100	600	10-20	sześcioramienny	16
YT-5506	120	600	15-25	SDS-Plus	12
YT-5507	120	600	15-25	M14	12
YT-5508	160	600	20-30	M14	8

EN Suction lifter
PL Uchwyt-przyssawka do szyb
DE Glas-Gummissauger
RU Держатель-присоска для стекол
CZ Podtlakový držák na sklo
HU Szélvédő kiemelő
RO Ventuza
FR Ventouse simple pour pare-brise
IT Ventosa per vetro
ES Elevador tipo ventosa
CN 手泵式吸盘



YATO	Ø [mm]	Max. lifting capacity / Maks. udźwąg [kg]	
YT-37220	204	58	10

EN Suction lifter
PL Uchwyt-przyssawka do szyb
DE Glas-Gummissauger
RU Держатель-присоска для стекол
CZ Podtlakový držák na sklo
HU Szélvédő kiemelő
RO Ventuza
FR Ventouse simple pour pare-brise
IT Ventosa per vetro
ES Elevador tipo ventosa
CN 手泵式吸盘



YATO	Ø [mm]	Max. lifting capacity / Maks. udźwąg [kg]	
YT-37223	150	32	24

EN Double spiral mixer
PL Mieszadło spiralne podwójne
DE Doppel-Spiralrührer
RU Миксер спиральный двойной
CZ Spirálové míchadlo dvojité
HU Dupla spirális keverő

RO Malaxor spirala dubla pt. vopsea
FR Malaxeur spiral double
IT Mescolatore a doppia spirale
ES Agitador de cinta helicoidal doble
CN 搅拌器



• Application: general-purpose adhesives, masonry mortars, jointless floors, thin-layer mineral plasters, gypsum surface finishing mixes, isolation masses

• Zastosowanie: zaprawy klejowe, zaprawy murarskie, jastrych, tynki strukturalne, masy szpachlowe, masy izolacyjne

YATO	Ø [mm]	L [mm]	Toolholder type / Rodzaj uchwytu narzędziowego	Max. mixing capacity / Maks. wydajność mieszania [kg]	
YT-55027	100	600	M14	10-20	16
YT-55033	135	600	M14	20-30	10

EN Triple spiral mixer
PL Mieszadło spiralne potrójne
DE Dreifach-Spiralrührer
RU Миксер спиральный тройной
CZ Spirálové míchadlo trojité
HU Tripla spirális keverő

RO Malaxor spirala tripla pt. vopsea
FR Malaxeur spiral triple
IT Mescolatore a triplo spirale
ES Agitador de cinta helicoidal triple
CN 搅拌器



• Application: mortars, concrete, plasters, other semi-fluid materials with sand or gravel filling

• Zastosowanie: zaprawy, beton, tynki, inne półpłynne, lepkie materiały z wypełnieniem piaskowym lub żwirowym

YATO	Ø [mm]	L [mm]	Toolholder type / Rodzaj uchwytu narzędziowego	Max. mixing capacity / Maks. wydajność mieszania [kg]	
YT-55052	120	590	sześcioramienny	15-25	12
YT-55073	135	600	M14	20-30	10

EN Suction lifter
PL Uchwyt-przyssawka do szyb
DE Glas-Gummissauger
RU Держатель-присоска для стекол
CZ Podtlakový držák na sklo
HU Szélvédő kiemelő
RO Ventuza
FR Ventouse simple pour pare-brise
IT Ventosa per vetro
ES Elevador tipo ventosa
CN 手泵式吸盘



YATO	Ø [mm]	Max. lifting capacity / Maks. udźwąg [kg]	
YT-37235	125	60	30

EN Suction lifter
 PL Uchwyt-przysawka do szyb
 DE Glas-Gummissauger
 RU Держатель-присоска для стекол двойная
 CZ Podtlakový držák na sklo
 HU Szélvédő kiemelő
 RO Ventuze
 FR Ventouse double pour pare-brise
 IT Ventosa per vetro
 ES Elevador tipo ventosa
 CN 手泵式吸盘

Ø 125 mm max 120 kg AI



YATO	Ø [mm]	Max. lifting capacity / Maks. udźwig [kg]	
YT-37236	125	120	20

EN Angle suction holder
 PL Uchwyt-przysawka do szyb kątowa
 DE Verstellbarer Winkelsauger für Glas
 RU Угловая присоска для стекла
 CZ Úhlová přísavka na sklo
 HU Derékszögű üvegfogó tappancs
 RO Ventuze pt. colt
 FR Ventouse articulé double pour vitre
 IT Ventosa ad angolo per vetro
 ES Elevador tipo ventosa angular
 CN 角度吸盘

Ø 118 mm 90-270° max 50 kg AI



YATO	Ø [mm]	Max. lifting capacity / Maks. udźwig [kg]	
YT-37214	118	50	10

EN Carpenter's pencil
 PL Ołówek stolarski
 DE Zimmermannsbleistifte
 RU Карандаш столярный
 CZ Tesařská tužka
 HU Asztalos ceruza

RO Creion de tâmplărie
 FR Crayon menuisier
 IT Matita per falegnami
 ES Lapiz de carpintero
 CN 木工铅笔

HB



YATO	L [mm]	W [mm]	
YT-692501	245	15	144/1152

EN Carpenter's pencil set
 PL Zestaw ołówków stolarskich
 DE Bleistiftset für Zimmerleute
 RU Набор столярных карандашей
 CZ Sada tesařských tužek
 HU Asztalos ceruzakészlet

RO Set creioane dulgherie
 FR Jeu de crayons de charpentier
 IT Set di matite da carpiniere
 ES Juego de lapices de carpintero
 CN 木工铅笔

HB



YATO	L [mm]	W [mm]	pcs / szt.	
YT-692603	175	12	3	480
YT-692612	175	12	12	120

EN Carpenters pencils red / blue
 PL Ołówki techniczne czerwony/niebieski
 DE Duo-Marker Bleistift rot / blau

RU Карандаши красный / синий
 CZ Zásuvka červená / modrá tužka
 HU Fiók ceruza piros / kék

RO Creion bicolor, rosu / albastru
 FR Crayon bicolore rouge / bleu
 IT Matite tecniche rosso / blu

EN Suction lifter
 PL Uchwyt-przysawka do szyb
 DE Glas-Gummissauger
 RU Держатель-присоска для стекол тройная
 CZ Podtlakový držák na sklo
 HU Szélvédő kiemelő
 RO Ventuze
 FR Ventouse triple pour pare-brise
 IT Ventosa per vetro
 ES Elevador tipo ventosa
 CN 手泵式吸盘

Ø 125 mm max 190 kg AI



YATO	Ø [mm]	Max. lifting capacity / Maks. udźwig [kg]	
YT-37237	125	190	12

EN Adjustable suction cups
 PL Przyssawki pozycjonujące
 DE Verstellbarer Saugheber
 RU Присоска для стягивания швов двухшассенная
 CZ Polohovací přísavka
 HU Állítható tapadókorong
 RO Ventuza reglabila
 FR Ventouse de manutention
 IT Ventosa regolabile di allineamento
 ES Ventosa de vacío ajustable
 CN 瓷砖拼缝吸盘

Ø 150 mm 440 mm



YATO	Ø [mm]	L [mm]	
YT-37210	150	440	6

EN Carpenter's pencil
 PL Ołówek stolarski
 DE Zimmermannsbleistifte
 RU Карандаш столярный
 CZ Tesařská tužka
 HU Asztalos ceruza

RO Creion de tâmplărie
 FR Crayon menuisier
 IT Matita per falegnami
 ES Lapiz de carpintero
 CN 木工铅笔

144 PCS HB



YATO	L [mm]	W [mm]	pcs / szt.	
YT-6925	245	15	144	8



YATO	L [mm]	W [mm]	pcs / szt.	
YT-6926	245	12	144	8

EN Masonry pencil
 PL Ołówek murarski
 DE Maurerbleistift
 RU Карандаш каменщика
 CZ Tužka zednická
 HU Kőműves keverő

RO Creion
 FR Crayon maçon
 IT Matita per muratori
 ES Lapiz de albañil
 CN 木工铅笔

144 PCS HB



YATO	L [mm]	W [mm]	pcs / szt.	
YT-6927	245	12	144	8

ES Cajón lapiz rojo / azul
 CN 木工铅笔

12 PCS 175 mm 2x4 mm



YATO	
YT-69940	120

EN Automatic carpenters / masonry pencil
PL Ołówek stolarski / murarski automatyczny
DE Tischler- und Maurer-Druckstift
RU Автоматический столярный карандаш / карандаш каменщика

CZ Stolařská / zednická tužka automatická
HU Asztalos / kőműves töltőceruza
RO Creion de tâmplărie / zidărie mecanic
FR Crayon menuisier / maçon automatique

IT Matita per falegnami e carpentieri
ES Lápiz automático de carpintero / albanil
CN 自动木工铅笔

HB

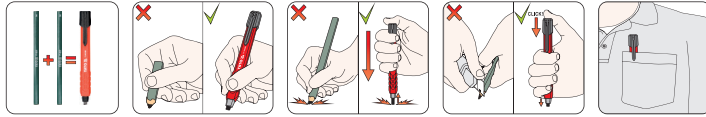

EN Automatic carpenters / masonry pencil with spare leads
PL Ołówek stolarski / murarski automatyczny + dodatkowe grafity
DE Tischler- und Maurer-Druckstift + zusätzliche Bleistiftmine
RU Автоматический столярный карандаш / карандаш каменщика + дополнительный графит
CZ Stolařská / zednická tužka automatická + náhradní tuha
HU Asztalos / kőműves töltőceruza + tartalék grafit
RO Creion de tâmplărie / zidărie mecanic + grafit adițional
FR Crayon menuisier / maçon automatique
IT Matita per falegnami e carpentieri ricaricabile
ES Lápiz automático de carpintero / albanil + mina adicional
CN 自动木工铅笔组套

1+5

HB



YATO **YT-69281** PCS 24 20/1000

EN Lead HB
PL Grafit HB
DE Bleistiftmine HB
RU Графит HB
CZ Tuha HB
HU Grafit HB

RO Grafit HB
FR Mine HB
IT Grafite HB
ES Mina HB
CN 自动木工铅笔笔芯

5 PCS

HB



For YT-69280, YT-69281
Dla YT-69280, YT-69281

YATO **YT-69285** 20/1000

EN Lead HB
PL Grafit HB
DE Bleistiftmine HB
RU Графит HB

CZ Tuha HB
HU Grafit HB
RO Grafit HB
FR Mine HB

5 PCS



HB



For YT-69280, YT-69281
Dla YT-69280, YT-69281

YATO **YT-69287** 20/1000

EN Chalk set
PL Kreda techniczna
DE Signierkreide
RU Мелок для рисования

CZ Barevná křída
HU Színes kréta
RO Creta colorata
FR Craie pour le dessin

IT Gesso tecnico
ES Tiza para dibujar
CN 记号蜡笔



6 COLOURS KOLOR



YATO **YT-69930** 50



YATO **YT-69931** 50

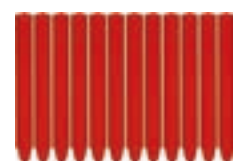

COLOUR KOLOR

YATO **YT-69932** 50

YATO **YT-69280** 50/1000

EN Automatic pencil with leads
PL Ołówek automatyczny z rysikami
DE Automatischer Bleistift mit Griffel
RU Автоматический карандаш со стилусами
CZ Mechanická tužka se stylusy
HU Mechanikus ceruza hegyekkel
RO Creion automat cu mina
FR Automatique crayon avec recharge
IT Matita portamine con mine di ricarica
ES Lápiz mecánico con puntas
CN 木工铅笔



HB



YATO **YT-69290** 10/100

EN Lead H2
PL Grafit H2
DE Bleistiftmine H2
RU Графит H2
CZ Tuha H2
HU Grafit H2

RO Grafit H2
FR Mine H2
IT Grafite H2
ES Mina H2
CN 自动木工铅笔笔芯

5 PCS

H2



For YT-69280, YT-69281
Dla YT-69280, YT-69281

YATO **YT-69286** 20/1000

EN Pensil leads set
PL Zestaw rysików
DE Griffel-Set
RU Набор стилусов
CZ Sada stylusů
HU Hegykészlet
RO Set mine creion
FR Jeu de recharges
IT Set di mine di ricarica
ES Juego de puntas para lápices
CN 铅笔芯

6 PCS

2.8 mm

HB



For YT-69290
Dla YT-69290

YATO **YT-69291** 20/200

12 PCS

120x12 mm



6 COLOURS KOLOR



COLOUR KOLOR

14

Measuring tools Narzędzia miernicze



Electric meters
Mierniki elektryczne

336-337 

Dial indicators
Czujniki zegarowe

344 

Multimeters
Mierniki

337-339 

Electronic measuring tools
Elektroniczne urządzenia pomiarowe

344-348 

Hygrometers
Higrometry

339 

Leveling patches
Łaty niwelacyjne

348 

Measuring tapes
Miary zwijane

339-340 

Levels
Poziomnice

348-349 

Rulers
Przymiary

341 

Feelers
Szczelinomierze

350 

Steel set squares
Ekierki metalowe

341 

Dividers & calipers
Cyrkle i macki

350 

Try squares
Kątowniki stolarskie

342-343 

Protractors
Kątomierze

351 

Vernier calipers
Suwmiarki

343-344 

Screw pitch gauges
Sprawdziany grzebieniowe do gwintów

351 

Micrometers
Mikrometry

344 

EN Digital voltage tester
 PL Wskaźnik elektryczny
 DE Digitaler-Spannungsprüfer
 RU Тестер напряжения цифровой

CZ Zkoušečka napětí digitální
 HU Digitális voltmérő
 RO Tester digital pt. tensiune electrica
 FR Testeur de tension type tournevis

IT Cerca fase digitale
 ES Indicador eléctrico
 CN 数显测电笔



130 mm
 NO BATTERY NEEDED
 NIE POTRZEBUJE BATERII

YATO	L [mm]	
YT-2861	130	20/500



130 mm
 LED LIGHT EMISSION
 NO BATTERY NEEDED
 NIE POTRZEBUJE BATERII

YATO	L [mm]	
YT-2862	130	20/500



145 mm
 CONTINUITY TEST TEST CĂLĂGĂSCOȘII
 LED LIGHT EMISSION
 3x LR41

YATO	L [mm]	
YT-28630	145	6/120

EN Analogue battery tester
 PL Tester akumulatorów analogowy
 DE Analoges Batterieprüfgerät
 RU Аналоговый тестер аккумуляторов
 CZ Analogový tester akumulátorů
 HU Analóg akkuteszter
 RO Tester acumulatori analog
 FR Testeur de charge batterie
 IT Tester analogico per batteria
 ES Tester analógico para acumuladores
 CN 电池测试器

6V
 12V
 CCA 200-1000 A



YATO	
YT-8310	10

EN Digital battery tester
 PL Tester akumulatorów cyfrowy
 DE Digitales Batterieprüfgerät
 RU Цифровой тестер аккумуляторов
 CZ Digitální tester akumulátorů
 HU Digitális akkuteszter
 RO Tester acumulatori digital
 FR Testeur digital de charge batterie
 IT Tester digitale per batteria
 ES Tester digital para acumuladores
 CN 电池测试器

12V
 CCA 150-1400 A
 LED DISPLAY WYSWIETLACZ



YATO	
YT-8311	10

EN Battery tester
 PL Tester akumulatorów
 DE Batterieprüfgerät
 RU Тестер аккумуляторов
 CZ Tester akumulátorů
 HU Akkuteszter
 RO Tester acumulatori
 FR Testeur de batterie
 IT Tester per batteria
 ES Tester para acumuladores
 CN 电池测试器

12V
 BATTERY TEST TEST AKUMULATORA
 ALTERNATOR TEST TEST ALTERNATORA



YATO	
YT-83101	12/72

EN Digital battery analyzer
 PL Elektroniczny tester akumulatorów
 DE Elektronischer Batterietester
 RU Электронный тестер аккумуляторов
 CZ Elektrický tester autobaterií
 HU Elektronikus akkumulátor teszter
 RO Tester acumulatori
 FR Testeur électronique pour accumulateurs
 IT Tester elettronico per batterie
 ES Comprobador electrónico de acumuladores
 CN 电池测试仪

12V
 CCA 200-1200 A
 ALTERNATOR TEST TEST ALTERNATORA
 STARTER TEST TEST ROZRUŠNIKA
 LED DISPLAY WYSWIETLACZ



YATO	
YT-83113	6/48

EN OBD2 multilingual scan tool
 PL Tester diagnostyczny OBD2
 DE OBD2-Diagnosegerät
 RU Диагностический тестер OBD2
 CZ Diagnostický tester OBD2
 HU OBD2 hibakód olvasó teszter
 RO Tester diagnoza auto OBD2
 FR Appareil de diagnostic OBD2
 IT Strumento diagnostico OBD2
 ES Comprobador de diagnóstico OBD2
 CN 多语言汽车读码卡

OBDII DTC
 CAN
 LED DISPLAY WYSWIETLACZ



YATO	
YT-72977	10/60

- EN Injector tester scan tool
PL Elektroniczny tester wtryskiwaczy silników benzynowych
DE Elektronisches Benzin-Einspritzdüsen-Prüfgerät
RU Электронный тестер для инжекторов бензинового двигателя
CZ Elektronický tester trysek benzinového motoru
HU Elektromos teszter benzínmotor befecskendezőhöz
RO Tester scanare injectoare
FR Testeur électronique d'injecteurs de moteurs à essence
IT Tester elettronico per iniettori per motori a benzina
ES Probador electrónico para inyectoros de motores de gasolina
CN 汽车喷油器测试仪



12 V LED DISPLAY WYSWIETLACZ FOR GASOLINE ENGINES DO SILNIKÓW BENZYNOWYCH BATTERY TEST TEST BATERII



YT-72960

8/48

- EN Digital universal multimeter
PL Cyfrowy miernik uniwersalny
DE Digital-Multimeter
RU Универсальный цифровой измеритель
CZ Digitální multimetr univerzální
HU Digitális multiméter
RO Multimetru digital universal
FR Multimètre numérique universel
IT Universale tester digitale
ES Manómetro digital universal
CN 数字万用表



LCD 1999 0-500V A.C. 0-500V D.C. 0-5 A D.C. 0-2 MΩ 5V_{P-P} h_{FE} PNP NPN 9 V 6F22i

- EN Digital universal multimeter
PL Cyfrowy miernik uniwersalny
DE Digital-Multimeter
RU Универсальный цифровой измеритель
CZ Digitální multimetr univerzální
HU Digitális multiméter
RO Multimetru digital universal
FR Multimètre numérique universel
IT Universale tester digitale
ES Manómetro digital universal
CN 数字万用表



LCD 1999 0-600V A.C. 0-600V D.C. 0-10 A D.C. 0-2 MΩ h_{FE} PNP NPN 1.5V 9V BATTERY TEST TEST BATERII DATA HOLD LED BACKLIGHT ПОДСВЕТЛЕНИЕ 2x AAA



YT-73080

50



YT-73081

50

- EN Digital universal multimeter
PL Cyfrowy miernik uniwersalny
DE Digital-Multimeter
RU Универсальный цифровой измеритель
CZ Digitální multimetr univerzální
HU Digitális multiméter
RO Multimetru digital universal
FR Multimètre numérique universel
IT Universale tester digitale
ES Manómetro digital universal
CN 数字万用表



TRUE RMS LCD 6000 0-750V A.C. 0-1000V D.C. 0-10 A A.C. 0-10 A D.C. 0-60 MΩ 0-9.999 mF 0-9.999 MHz 1÷99% AUTO RANGE AUTO ZAKRES DATA HOLD LED BACKLIGHT ПОДСВЕТЛЕНИЕ 2x AAA

- EN Digital universal multimeter
PL Cyfrowy miernik uniwersalny
DE Digital-Multimeter
RU Универсальный цифровой измеритель
CZ Digitální multimetr univerzální
HU Digitális multiméter
RO Multimetru digital universal
FR Multimètre numérique universel
IT Universale tester digitale
ES Manómetro digital universal
CN 数字万用表



TRUE RMS LCD 9999 0-750V A.C. 0-999.9V D.C. 0-9.999A A.C. 0-9.999A D.C. 0-9.999 MΩ 0-9.999 mF 0-9.999 MHz 1÷99% AUTO RANGE AUTO ZAKRES DATA HOLD LED BACKLIGHT ПОДСВЕТЛЕНИЕ 2x AAA



YT-73096

100



YT-73089

100

- EN Digital universal multimeter
PL Cyfrowy miernik uniwersalny
DE Digital-Multimeter
RU Универсальный цифровой измеритель
CZ Digitální multimetr univerzální
HU Digitális multiméter
RO Multimetru digital universal
FR Multimètre numérique universel
IT Universale tester digitale
ES Manómetro digital universal
CN 数字万用表



TRUE RMS LCD 9999 0-600V A.C. 0-600V D.C. 0-10 A A.C. 0-10 A D.C. 0-99 MΩ 0-99 mF 0.01-60 kHz NCV V A.C. VFC 1.5V 9V BATTERY TEST TEST BATERII CONTINUITY TEST TEST CIĄGŁOŚCI AUTO RANGE AUTO ZAKRES DATA HOLD LED BACKLIGHT ПОДСВЕТЛЕНИЕ FRONT LIGHT LATARNA 2x AAA

- EN Digital universal multimeter
PL Cyfrowy miernik uniwersalny
DE Digital-Multimeter
RU Универсальный цифровой измеритель
CZ Digitální multimetr univerzální
HU Digitális multiméter
RO Multimetru digital universal
FR Multimètre numérique universel
IT Universale tester digitale
ES Manómetro digital universal
CN 数字万用表



TRUE RMS LCD 1999 0-600V A.C. 0-600V D.C. 0-20 A A.C. 0-20 A D.C. 0-20 MΩ 0-20 mF °C -40 +1000 0-60 MHz h_{FE} PNP NPN DATA HOLD LED BACKLIGHT ПОДСВЕТЛЕНИЕ 9 V 6F22i



YT-73094

40



YT-73083

20

EN Digital universal multimeter
 PL Cyfrowy miernik uniwersalny
 DE Digital-Multimeter
 RU Универсальный цифровой измеритель
 CZ Digitální multimetr univerzální
 HU Digitális multiméter
 RO Multimetru digital universal
 FR Multimètre numérique universel
 IT Universale tester digitale
 ES Manómetro digital universal
 CN 数字万用表



- LCD 1999
- 0-300V A.C.
- 0-300V D.C.
- 0-10 A A.C.
- 0-10 A D.C.
- 0-20 MΩ
- 0-1000 μF
- °C -20 +1000
- hFE PNP NPN
- DATA HOLD
- MAX HOLD
- LED BACKLIGHT POSSIBILE
- AUTO POWER OFF AUTOMATYCZNE WYŁĄCZANIE
- 3x AAA

EN Digital universal multimeter
 PL Cyfrowy miernik uniwersalny
 DE Digital-Multimeter
 RU Универсальный цифровой измеритель
 CZ Digitální multimetr univerzální
 HU Digitális multiméter
 RO Multimetru digital universal
 FR Multimètre numérique universel
 IT Universale tester digitale
 ES Manómetro digital universal
 CN 数字万用表



- TRUE RMS
- LCD 5999
- 0-600V A.C.
- 0-600V D.C.
- 0-10 A A.C.
- 0-10 A D.C.
- 0-60 MΩ
- 0-60 mF
- 0-60 MHz
- °C -40 +1370
- 0.1+99%
- hFE PNP NPN
- DATA HOLD
- MAX HOLD
- MIN HOLD
- LED BACKLIGHT POSSIBILE
- AUTO POWER OFF AUTOMATYCZNE WYŁĄCZANIE
- CATCH WOODRAME
- 9 V 6F22

For YT-73090
 Dla YT-73090

YATO
 YT-73084 44

YATO
 YT-73085 20

EN Digital universal multimeter
 PL Cyfrowy miernik uniwersalny
 DE Digital-Multimeter
 RU Универсальный цифровой измеритель
 CZ Digitální multimetr univerzální
 HU Digitális multiméter
 RO Multimetru digital universal
 FR Multimètre numérique universel
 IT Universale tester digitale
 ES Manómetro digital universal
 CN 数字万用表



- TRUE RMS
- LCD 9999
- 0-100
- 0-750V A.C.
- 0-1000V D.C.
- 0-10 A A.C.
- 0-10 A D.C.
- 0-99.99 MΩ
- 0-99.99 mF
- 0-9.999 MHz
- 1+99%
- °C -20 +1000
- NCV
- V A.C. VFC
- CONTINUITY TEST TEST CIĄGŁOŚCI
- AUTO & MANUAL MODE TRYB REZYM (AUTOMATYCZNY)
- DATA HOLD
- FRONT LIGHT LATARKA
- AUTO POWER OFF AUTOMATYCZNE WYŁĄCZANIE
- 2x AA

EN Digital universal multimeter
 PL Cyfrowy miernik uniwersalny
 DE Digital-Multimeter
 RU Универсальный цифровой измеритель
 CZ Digitální multimetr univerzální
 HU Digitális multiméter
 RO Multimetru digital universal
 FR Multimètre numérique universel
 IT Universale tester digitale
 ES Manómetro digital universal
 CN 数字万用表



- LCD 3999
- L1 L2 L3
- 0-600V A.C.
- 0-600V D.C.
- 0-10 A A.C.
- 0-10 A D.C.
- 0-40 MΩ
- 0-100 μF
- 0.01-100 kHz
- °C -20 +1000
- 5+95%
- DATA HOLD
- REL RELATIVE VALUE WARTOŚĆ WZGLĘDNA
- LED BACKLIGHT POSSIBILE
- AUTO POWER OFF AUTOMATYCZNE WYŁĄCZANIE
- 9 V 6F22

EN Digital universal multimeter
 PL Cyfrowy miernik uniwersalny
 DE Digital-Multimeter
 RU Универсальный цифровой измеритель
 CZ Digitální multimetr univerzální
 HU Digitális multiméter
 RO Multimetru digital universal
 FR Multimètre numérique universel
 IT Universale tester digitale
 ES Manómetro digital universal
 CN 数字万用表



- 5in1 5w1
- LCD 3999
- 0-300V A.C.
- 0-300V D.C.
- 0-10 A A.C.
- 0-10 A D.C.
- 0-40 MΩ
- 0-100 μF
- 0.01-200 kHz
- °C -20 +1000
- 5+95%
- RH 30+99%
- 3.5-100dB
- 40000 lx
- DATA HOLD
- REL RELATIVE VALUE WARTOŚĆ WZGLĘDNA
- LED BACKLIGHT POSSIBILE
- AUTO POWER OFF AUTOMATYCZNE WYŁĄCZANIE
- 9 V 6F22

YATO
 YT-73097 30

YATO
 YT-73086 24

YATO
 YT-73087 24

EN Clamp universal multimeter
 PL Cęgowy miernik uniwersalny
 DE Universal Zangenamperemeter
 RU Универсальный цифровой измеритель
 CZ Digitální multimetr univerzální
 HU Digitális multiméter
 RO Multimetru digital universal
 FR Pince multimètre universel
 IT Universale tester digitale
 ES Manómetro digital universal
 CN 数字钳形万用表



- 0-600A A.C.

EN Digital universal multimeter
 PL Cyfrowy miernik uniwersalny
 DE Digital-Multimeter
 RU Универсальный цифровой измеритель
 CZ Digitální multimetr univerzální
 HU Digitális multiméter
 RO Multimetru digital universal
 FR Multimètre numérique universel
 IT Universale tester digitale
 ES Manómetro digital universal
 CN 数字万用表



- TRUE RMS
- LCD 5999
- 0-600V A.C.
- 0-600V D.C.
- 0-600A A.C.
- 0-60 MΩ
- NCV
- LOW IMPEDANCE MODE TRYB NISZKIEJ WSPEDZANCJI
- V A.C. VFC
- CONTINUITY TEST TEST CIĄGŁOŚCI
- AUTO RANGE AUTO ZAKRES
- DATA HOLD
- LED BACKLIGHT POSSIBILE
- FRONT LIGHT LATARKA
- AUTO POWER OFF AUTOMATYCZNE WYŁĄCZANIE
- 2x AAA

EN Clamp universal multimeter
 PL Cęgowy miernik uniwersalny
 DE Universal Zangenamperemeter
 RU Универсальный цифровой измеритель
 CZ Digitální multimetr univerzální
 HU Digitális multiméter
 RO Multimetru digital universal
 FR Pince multimètre universel
 IT Universale tester digitale
 ES Manómetro digital universal
 CN 数字钳形万用表



- LCD 1999
- 0-600V A.C.
- 0-600V D.C.
- 0-600A A.C.
- 0-200 MΩ
- °C -20 +1000
- DATA HOLD
- AUTO RANGE AUTO ZAKRES
- DATA HOLD
- MAX HOLD
- LED BACKLIGHT POSSIBILE
- AUTO POWER OFF AUTOMATYCZNE WYŁĄCZANIE
- 2x AA

For YT-73085
 Dla YT-73085

YATO
 YT-73090 50

YATO
 YT-73092 40

YATO
 YT-73091 20

EN Digital universal multimeter
PL Cyfrowy miernik uniwersalny
DE Digital-Multimeter
RU Универсальный цифровой измеритель
CZ Digitální multimetr univerzální
HU Digitális multiméter
RO Multimetru digital universal
FR Multimètre numérique universel
IT Universale tester digitale
ES Manómetro digital universal
CN 数字万用表



TRUE RMS	LCD 6000	0-600V A.C.	0-600V D.C.
0-600A A.C.	0-600A D.C.	0-60 MΩ	0-60 mF
0-10 MHz	°C 30 +1000	⚡	📶
✍️	NCV	AUTO RANGE AUTO ZAKRES	DATA HOLD
PEAK HOLD	LED BACKLIGHT POŚWIETLENIE	FRONT LIGHT LATARKA	AUTO POWER OFF AUTOMATYCZNE WYŁĄCZANIE
	2x AAA		

YATO YT-73093 50

EN Probe set for multimeters
PL Zestaw sond pomiarowych do mierników
DE Sondensatz für Multimeter
RU Набор зонд для тестеров
CZ Měřicí šňůry k multimetru
HU Mérőzsinór pár digitális multiméterekhez
RO Set sonde pt. multimetru
FR Jeu de cordons de test multimètre
IT Kit di puntali per misuratori
ES Juego de sondas de medición para medidores
CN 表笔



600 V
100 cm
CAT. III

YATO YT-73078 50/100

EN Hygrometer
PL Higrometr
DE Hygrometer
RU Гигрометр
CZ Hygrometr
HU Higrométer
RO Higrometru
FR Hygrometre
IT Igrometro
ES Higrómetro
CN 湿度测试仪



6-42%	0.2-2.0%	max 7 mm
LCD	AUTO POWER OFF AUTOMATYCZNE WYŁĄCZANIE	



YATO YT-73140 54/108

EN Hygrometer
PL Higrometr
DE Hygrometer
RU Гигрометр
CZ Hygrometr
HU Higrométer

RO Higrometru
FR Hygrometre
IT Igrometro
ES Higrómetro
CN 湿度测试仪

6-60%	0.2-2.9%
max 10 mm	LCD
AUTO POWER OFF AUTOMATYCZNE WYŁĄCZANIE	



YATO YT-73141 20/40

EN Measuring tape
PL Miara zwijana
DE Rollbandmass
RU Рулетка
CZ Měřicí pásmo
HU Mérőszalag
RO Rulete din pinza
FR Ruban à mesurer
IT Misura di nastro
ES Flexómetro
CN 卷尺

3m 16mm	5m 19mm	AUTOMATIC STOP
	NYLON COATED POWŁOKA NYLONOWA	



YATO	L [m]	W [mm]	
YT-7103	3	16	12/120
YT-7105	5	19	12/120

EN Measuring tape
PL Miara zwijana
DE Rollbandmass
RU Рулетка
CZ Měřicí pásmo
HU Mérőszalag
RO Rulete din pinza
FR Ruban à mesurer
IT Misura di nastro
ES Flexómetro
CN 卷尺

3m 16mm	5m 25mm	8m 25mm
AUTOMATIC STOP		NYLON COATED POWŁOKA NYLONOWA



YATO	L [m]	W [mm]	
YT-7110	3	16	12/120
YT-7111	5	25	12/60
YT-7112	8	25	6/60

EN Measuring tape
PL Miara zwijana
DE Rollbandmass
RU Рулетка
CZ Měřicí pásmo
HU Mérőszalag
RO Rulete din pinza
FR Ruban à mesurer
IT Misura di nastro
ES Flexómetro
CN 卷尺

3m 16mm	5m 19mm	8m 25mm
	NYLON COATED POWŁOKA NYLONOWA	



YATO	L [m]	W [mm]	
YT-7126	3	16	12/120
YT-7127	5	19	12/120
YT-7128	8	25	6/60

EN Measuring tape
 PL Miara zwijana
 DE Rollbandmass
 RU Рулетка
 CZ Měřicí pásmo
 HU Mérőszalag
 RO Rulete din pinza
 FR Ruban à mesurer
 IT Misura di nastro
 ES Flexómetro
 CN 卷尺

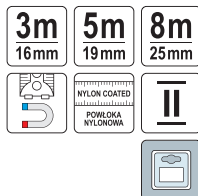

YATO	L [m]	W [mm]	
YT-7129	3	16	12/120
YT-7130	5	19	12/120
YT-7131	8	25	6/60

EN Measuring tape
 PL Miara zwijana
 DE Rollbandmass
 RU Мирная лента
 CZ Měřicí pásmo
 HU Mérőszalag
 RO Rulete din pinza
 FR Metre ruban
 IT Misura di nastro
 ES Flexómetro
 CN 卷尺

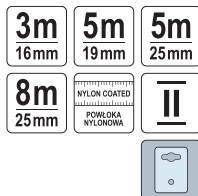

YATO	L [m]	W [mm]	
YT-71070	3	16	12/120
YT-71071	5	19	12/96
YT-71072	5	25	12/72
YT-71073	8	25	6/48

EN Measuring tape
 PL Miara zwijana
 DE Rollbandmass
 RU Мирная лента
 CZ Měřicí pásmo
 HU Mérőszalag
 RO Rulete din pinza
 FR Metre ruban
 IT Misura di nastro
 ES Flexómetro
 CN 卷尺

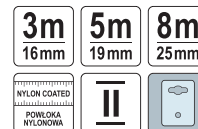

YATO	L [m]	W [mm]	
YT-71075	3	16	12/120
YT-71076	5	19	12/96
YT-71077	8	25	6/48

EN Measuring tape
 PL Miara zwijana
 DE Rollbandmass
 RU Мирная лента
 CZ Měřicí pásmo
 HU Mérőszalag
 RO Rulete din pinza
 FR Metre ruban
 IT Misura di nastro
 ES Flexómetro
 CN 卷尺

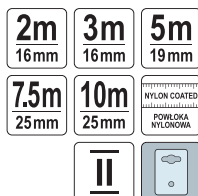

YATO	L [m]	W [mm]	
YT-71150	2	16	12/120
YT-71151	3	16	12/120
YT-71153	5	19	12/96
YT-71155	7.5	25	6/48
YT-71156	10	25	6/36

EN Steel measuring tape
 PL Taśma miernicza stalowa
 DE Rollbandmass
 RU Мерная лента стальная
 CZ Měřicí pásmo ocelové
 HU Acél mérőszalag
 RO Ruleta sticla
 FR Ruban à mesurer acier
 IT Misura di nastro a acciaio
 ES Cinta de medir de acero
 CN 钢卷尺



YATO	L [m]	W [mm]	
YT-71580	20	13	10/40
YT-71581	30	13	10/40
YT-71582	50	13	5/20

EN Fibreglass measuring tape
 PL Taśma miernicza z włókna szklanego
 DE Rollbandmass
 RU Мерная лента фиберглас
 CZ Měřicí pásmo - skleněné vlákno
 HU Mérőszalag - üvegszál
 RO Ruleta fibra sticla
 FR Ruban à mesurer fibre-verre
 IT Misura di nastro in fibra di vetro
 ES Cinta de medir - fibra cristal
 CN 纤维卷尺

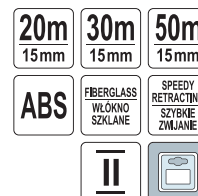

YATO	L [m]	W [mm]	
YT-71570	20	15	10/40
YT-71571	30	15	10/40
YT-71572	50	15	5/20

EN Fibreglass measuring tape
 PL Taśma miernicza z włókna szklanego
 DE Rollbandmass
 RU Мерная лента фиберглас
 CZ Měřicí pásmo - skleněné vlákno
 HU Mérőszalag - üvegszál
 RO Ruleta fibra sticla
 FR Ruban à mesurer fibre-verre
 IT Misura di nastro in fibra di vetro
 ES Cinta de medir - fibra cristal
 CN 纤维卷尺



YATO	L [m]	W [mm]	
YT-71540	30	15	10
YT-71541	50	15	10

EN Diameter and circumference measuring tape
 PL Taśma stalowa do pomiaru średnicy i obwodu
 DE Umfang Bandmass
 RU Циркометр для измерения длины окружности и диаметра
 CZ Cirkometry-měřicí pásky pro obvod a průměr
 HU Circometer szalagos mérés
 RO Banda pt. masurat circumferinte
 FR Ruban à mesurer circomètre
 IT Metro a nastro in acciaio per misurare diametri e circonferenze
 ES Circometer cinta métrica
 CN 圆周尺



YATO	Ø [mm]	Circumference / Obwód [mm]	
YT-71700	20-300	60-950	50
YT-71701	300-700	940-2200	50
YT-71702	700-1100	2190-3460	50

- EN Stainless steel flexible ruler
PL Przymiar stalowy elastyczny
DE Metrisches Gerade Lineal Inox
RU Линейки гибкие, нержавеющей сталь
- CZ Měřítko z nerezové pružinové oceli
HU Acél vonalzó
RO Rigle masura inox
FR Réglet métallique en inox
- IT Righello flessibile in acciaio
ES Regla flexible acero inox
CN 钢直尺



YATO	L [mm]	
YT-70720	150	10/500
YT-70721	300	12/300
YT-70722	500	20/120
YT-70723	600	20/120
YT-70724	1000	20/60

- EN Aluminium ruler
PL Przymiar aluminiowy
DE Alu Zeichen-Massstab
RU Линейка алюминиевая
CZ Měřicí lat hliníková
HU Asztalos vonalzó, alumínium
- RO Riglă tâmplar din aluminiu
FR Règle aluminium
IT Righello di alluminio
ES Regla de aluminio
CN 铝合金直尺



- EN Aluminium ruler
PL Przymiar aluminiowy
DE Alu Zeichen-Massstab
RU Линейка столярная алюминиевая
CZ Meracia lata hliníková
HU Riglă tâmplar din aluminiu
- RO Asztales vonalzó, alumínium
FR Règle aluminium
IT Righello di alluminio
ES Regla de aluminio
CN 铝合金直尺



YATO	L [mm]	
YT-7070	300	25/100
YT-7071	600	10/50

YATO	L [mm]	
YT-70713	500	8/32
YT-70715	1000	8/32

- EN Steel set square
PL Ekiarka metalowa
DE Anschlagwinkeldreieck
RU Угольник для плотника и столяра
CZ Úhelník
HU Fém derékszög
RO Echer tamplarie
FR Équerre de menuisier
IT Squadra metallica
ES Escuadra metálica
CN 铝合金三角尺



- EN Aluminium alloy triangle
PL Kątownik ciesielski do krokwi
DE Anschlagwinkeldreieck
RU Угольник для плотника и столяра
CZ Úhelník na meranie
HU Fém derékszög
RO Echer aluminiu pt. dulgherie
FR Équerre triangle règle
IT Squadra da carpentiere
ES Escuadra metálica
CN 铝合金三角尺



- EN Adjustable quick square
PL Ekiarka metalowa - kątownik
DE Metall-Dreieck - Winkelmesser
RU Металлический угольник
CZ Kovový úhelník
HU Fém vonalzó - derékszög
RO Echer reglabil
FR Équerre de charpentier avec rapporteur d'angle
IT Squadra da disegno metallica
ES Escuadra metálica
CN 金属三角三角板



YATO	L [mm]	
YT-70780	170	6/72
YT-70781	270	6/36

YATO	L [mm]	
YT-70786	180	8/64
YT-70787	300	6/24

YATO	Dimensions / Wymiary [mm]	
YT-70782	175x175x275	6/24

- EN Extension layout tool
PL Kątownik aluminiowy ze stopką - ekiarka
DE Aluminium-Quadrat mit Fuß - Metall-Winkelmess - Winkelmesser
RU Алюминиевый угольник с основанием - металлический угольник - угольник
CZ Hliníkový úhelník s patkou - kovový úhelník - úhelník
HU Talpas alumínium derékszög - fém vonalzó - derékszög
RO Dispozitiv pt. taiat la profil
FR Cornière en aluminium avec pied - équerre en métal - rapporteur
IT Squadra in alluminio con piede - squadra da disegno metallica - squadra
ES Escuadra de aluminio con pie, metálica
CN 铝合金三角尺



YATO	Dimensions / Wymiary [mm]	
YT-70783	165x185x210-290	6/24

- EN Folding builder's square
PL Kątownik budowlany składany
DE Bauwinkel Klappbar
RU Угольник складной строительный
CZ Skládací stavařský úhelník
HU Összecukható derékszög
RO Echer pliabil din aluminiu
FR Équerre pliante
IT Squadra da muratore pieghevole
ES Escuadra plegable construcción
CN 折叠铝合金角尺



YATO	Dimensions / Wymiary [mm]	
YT-70850	840x600x600	6/24
YT-70851	1720x1220x1220	10

EN Aluminium try square
 PL Kątownik do płyt gipsowo-kartonowych
 DE Anschlagwinkel
 RU Угольник столлярный
 CZ Truhlářský úhelník černý
 HU Asztalos derékszög, fekete

RO Echer de tâmplărie neagră
 FR Equerre
 IT Squadra per pannelli in gesso
 ES Escuadra de aluminio
 CN 角尺

90° 1200 mm
 +/- 0.03 mm AI



YATO	L [mm]	
YT-7085	1200	10

EN Try square
 PL Kątownik stalowy
 DE Anschlagwinkel
 RU Угольник столлярный
 CZ Truhlářský úhelník
 HU Asztalos derékszög
 RO Echer de tâmplărie
 FR Equerre
 IT Angolo di acciaio
 ES Escuadra
 CN 不锈钢角尺

SS STAINLESS STEEL STAL NIERDZEWNA



YATO	Size / Rozmiar [mm]	
YT-7083	150x300	25/100
YT-7084	250x500	10/50

EN Combination square
 PL Kątownik ślusarski nierdzewny
 DE Edelstahl-Schlosserwinkel
 RU Угольник слесарный
 CZ Zámečnický úhelník nerezový
 HU Rozsdamentes lakatos derékszög
 RO Echer combinat
 FR Equerre de serrurier en acier inoxydable
 IT Squadra per fabbro in acciaio inox
 ES Escuadra de cerrajero inoxidable
 CN 角尺

150 mm x1 SS STAINLESS STEEL STAL NIERDZEWNA



YATO	L [mm]	
YT-70843	150	6/48

EN Aluminium try square
 PL Kątownik aluminiowy
 DE Alu-Zimmermannswinkel
 RU Угольник столлярный алюминиевый
 CZ Truhlářský úhelník černý
 HU Asztalos derékszög
 RO Echer (unghi drept) de tâmplărie
 FR Règle d'angle
 IT Angolo di alluminio
 ES Escuadra de aluminio
 CN T型尺

mm inch AI



YATO	Size / Rozmiar [mm]	
YT-70791	600x360	6/24
YT-70792	1220x560	6/12

EN Aluminium try square
 PL Kątownik aluminiowy
 DE Anschlagwinkel
 RU Угольник столлярный
 CZ Truhlářský úhelník
 HU Asztalos derékszög
 RO Echer de tâmplărie
 FR Equerre en aluminium
 IT Angolo di alluminio
 ES Escuadra de aluminio
 CN 铝合金角尺

45° 90° AI



YATO	L [mm]	
YT-7080	250	6/36
YT-7081	300	6/36
YT-7082	350	6/36

EN Carpentry square set
 PL Zestaw kątowników stolarskich
 DE Tischlerwinkelsatz
 RU Набор столлярных уголков
 CZ Sada tesařských úhelníků
 HU Asztalos derékszög készlet
 RO Set echere tamplarie
 FR Jeu d'équerres de menuiserie
 IT Set di squadre da carpentiere
 ES Conjunto de escuadras de carpintero
 CN 木工角尺

4 PCS BRASS MOSIADZ SS2Cr13



YATO	L [mm]	
YT-70823	180, 235, 250, 250	4/40

EN Adjustable ruler
 PL Kątownik nastawny do przenoszenia wymiarów
 DE Multifunktionales Messlineal
 RU Разметочный инструмент линейка-шаблон
 CZ Pokosník nastavitelný
 HU Szögmérőfékek
 RO Echer reglabil
 FR Angle mesure
 IT Squadra regolabile tracciatore
 ES Medición del ángulo
 CN 铝合金四折尺

mm inch AI



YATO	Size / Rozmiar [mm]	
YT-70880	250x120	10/50

EN Adjustable angle square
 PL Kątownik nastawny
 DE Einstellbarer Winkel
 RU Регулируемый угольник
 CZ Nastavitelný úhelník
 HU Állítható asztalos derékszög
 RO Echer reglabil
 FR Règle d'angle réglable
 IT Squadra regolabile
 ES Escuadra ajustable
 CN 可调整角度尺

45° 90° 135° 300 mm AI SS STAINLESS STEEL STAL NIERDZEWNA



YATO	L [mm]	
YT-70794	300 (listwa), 160 (stopka)	60

EN Multi-purpose bevel
PL Kątownik wielofunkcyjny
DE Mehrzweck-Winkelhalter
RU Многофункциональный угольник
CZ Multifunkční úhelník
HU Multifunkciós derékszög
RO Vinclu multifunctional cu nivela
FR Règle d'angle multifonction
IT Squadra multifunzionale
ES Escuadra multifunción
CN 组合角尺

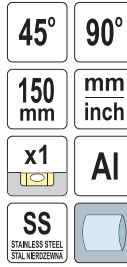

YATO L [mm]
YT-70770 150 12/72

EN Multi-purpose bevel
PL Kątownik wielofunkcyjny
DE Mehrzweck-Winkelhalter
RU Многофункциональный угольник
CZ Multifunkční úhelník
HU Multifunkciós derékszög
RO Vinclu multifunctional cu nivela
FR Règle d'angle multifonction
IT Squadra multifunzionale
ES Escuadra multifunción
CN 组合角尺



YATO L [mm]
YT-70771 300 12/72

EN Multi-purpose bevel with protract
PL Kątownik wielofunkcyjny centrujący
DE Zentrier-Mehrzweck-Winkelhalter
RU Многофункциональный центрирующий угольник
CZ Multifunkční centrovací úhelník
HU Multifunkciós központozó derékszög
RO Vinclu multifunctional cu nivela
FR Règle de centrage multifonctionnel
IT Squadra multifunzionale centrante
ES Escuadra multifunción de centrage
CN 组合角尺

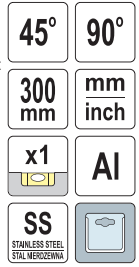

YATO L [mm]
YT-70772 300 12/36

EN 3D aluminium mitre square
PL Kątownik aluminiowy 3D
DE Winkel mit Gehring
RU Угольник алюминиевый 3D
CZ Japonský 3D úhelník
HU Alu derékszög 3D
RO Echer pt. imbinari
FR Japonais en alliage d'aluminium bois règle
IT Squadra in alluminio 3D
ES Japonés regla de aluminio cuadrado diseño
CN 划线尺

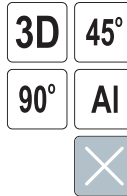

YATO
YT-70797 25/100

EN 3D aluminium mitre square
PL Kątownik przestrzenny
DE Raum-Winkelstahl
RU Пространственный угольник
CZ Posuvný úhelník
HU 3D vonalzó
RO Echer aluminiu 3D
FR Équerre japonaise
IT Squadra tridimensionale
ES Escuadra tridimensional
CN 木工角尺

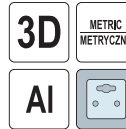

YATO Dimensions / Wymiary [mm]
YT-70825 150x70x215 10/50

EN 3D aluminium mitre square
PL Kątownik aluminiowy 3D
DE Winkel mit Gehring
RU Угольник алюминиевый 3D
CZ Japonský 3D úhelník
HU Alu derékszög 3D
RO Echer pt. imbinari
FR Japonais en alliage d'aluminium bois règle
IT Squadra in alluminio 3D
ES Japonés regla de aluminio cuadrado diseño
CN 铝合金划线尺

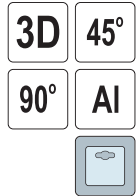

YATO
YT-70796 10/100

EN Vernier caliper
PL Suwmiarka
DE Messschieber
RU Штангенциркуль
CZ Posuvné měřítko
HU Tolómérő

RO Şubler
FR Pied à coulisse
IT Calibro
ES Calibre
CN 钢卷尺

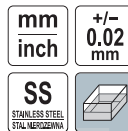

YATO Measuring range / Zakres pomiaru [mm]
YT-7200 0-150 50

EN Digital caliper
PL Suwmiarka elektroniczna
DE Digital Messschieber
RU Штангенциркуль электронный
CZ Posuvné měřítko elektronické
HU Digitális tolómérő

RO Şubler electronic
FR Pied à coulisse électronique
IT Calibro
ES Calibre electrónico
CN 数显卡尺

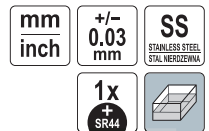

YATO Measuring range / Zakres pomiaru [mm]
YT-7201 0-150 10/50

EN Vernier caliper
PL Suwmiarka
DE Messschieber
RU Штангенциркуль
CZ Posuvné měřítko
HU Tolómérő

RO Şubler
FR Pied à coulisse
IT Calibro
ES Calibre
CN 游标卡尺

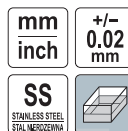

YATO Measuring range / Zakres pomiaru [mm]
YT-72003 0-200 30
YT-72004 0-300 20

EN Vernier caliper
PL Suwmiarka
DE Messschieber
RU Штангенциркуль
HU Tolómérő

RO Şubler
FR Pied à coulisse
IT Calibro
ES Calibre
CN 游标卡尺

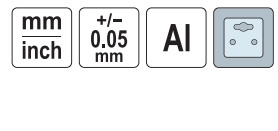

YATO Measuring range / Zakres pomiaru [mm]
YT-70740 0-600 12/24

EN Disc brake vernier caliper
 PL Summiarka do tarcz hamulcowych
 DE Scheibenbremse noniusschieber
 RU Штангенциркуль для тормозных листов
 CZ Digitální posuvné měřtko na brzdové kotouče
 HU Tárcsafék tolómérő
 RO Subler pt. masurat discuri de frana cu display digital
 FR Disque de frein etrier vernier
 IT Calibro a corsoio per dischi del freno
 ES Freno de disco pie de rey
 CN 制动片卡尺

160 mm 0-60 mm +/- 0.01 mm SS STAINLESS STEEL STAL. NIEODZIERZANA



YATO	Measuring range / Zakres pomiaru [mm]	
YT-72090	0-60	50

EN Micrometer
 PL Mikrometr
 DE Mikrometer
 RU Микрометр

CZ Mikrometr
 HU Mikrométer
 RO Micrometru
 FR Micromètre

IT Micrometro
 ES Micrómetro
 CN 外径千分尺

+/- 0.01 mm



YATO	Measuring range / Zakres pomiaru [mm]	
YT-72300	0-25	100
YT-72301	25-50	50
YT-72302	50-75	50
YT-72303	75-100	30

EN Dial indicator
 PL Czujnik zegarowy
 DE Messuhr
 RU Индикатор часового типа
 CZ Analogový senzor
 HU Óramutató érzékelő
 RO Indicator testare cu cadran
 FR Indicateur à cadran
 IT Indicatore a quadrante
 ES Indicador de cuadrante
 CN 百分表

0-10 mm
 +/- 0.01 mm
 55 mm
 8 mm



YATO	Measuring range / Zakres pomiaru [mm]	
YT-72450	0-10	50

EN Electronic dial indicator
 PL Czujnik zegarowy elektroniczny
 DE Elektronische Messuhr
 RU Электронный индикатор часового типа
 CZ Elektronický senzor
 HU Elektromos órá érzékelő
 RO Indicator testare electronic
 FR Indicateur à cadran électrique
 IT Indicatore quadrante elettronico
 ES Indicador de cuadrante electrónico
 CN 数显百分表

0-12.7 mm
 +/- 0.01 mm
 57 mm
 8 mm
 1x LR44



YATO	Measuring range / Zakres pomiaru [mm]	
YT-72450	0-10	50

EN Magnetic indicator stand
 PL Statyw magnetyczny
 DE Magnetständer
 RU Магнитный штатив
 CZ Magnetický stativ
 HU Mágneses állvány
 RO Stand magnetic cu indicator
 FR Trépied magnétique
 IT Supporto magnetico
 ES Soporte magnético
 CN 磁性表座

50x65 x55mm
 BASE / BAZA
 max 70 kg



For YT-72450, YT-72453
 Dla YT-72450, YT-72453

YATO	Measuring range / Zakres pomiaru [mm]	
YT-72460		10

EN Digital detector with moisture test
 PL Cyfrowy detektor oraz wilgotnościomierz
 DE Digitaler Detektor mit Feuchtigkeitstest
 RU Цифровой детектор и измеритель влажности
 CZ Digitální detektor s testem vlhkosti
 HU Digitális detektor nedvességvizsgálattal
 RO Detector digital cu test de umiditate
 FR Détecteur numérique avec test d'humidité
 IT Rivelatore digitale con test di umidità
 ES Detector digital con prueba de humedad
 CN 墙体探测仪

4in1 4w1 LCD
 6h 5-50%
 max 8 mm 1.5-33%
 9 V 6F22!
 AUTO POWER OFF AUTOMATYCZNE WYŁĄCZANIE

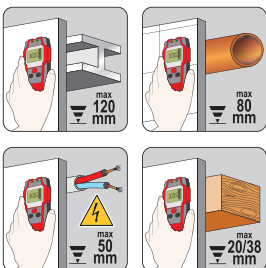

YATO	Measuring range / Zakres pomiaru [mm]	
YT-73138		40

EN Stud finder
 PL Wykrywacz profili i przewodów
 DE Entfernungsmesser
 RU Цифровой детектор
 CZ Digitální detektor
 HU Digitális kereső műszer
 RO Detector digital
 FR Détecteur de métaux et de câbles électriques
 IT Detector digitale
 ES Escáner de pared
 CN 多功能探测仪

3in1 3w1 LCD
 6h
 9 V 6F22!

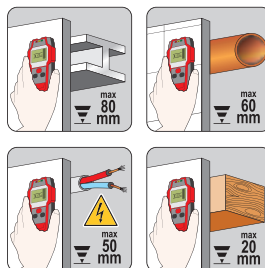

YATO	Measuring range / Zakres pomiaru [mm]	
YT-73131		40

EN Infrared thermometer
PL Pirometr
DE Pyrometer
RU Пирометр
CZ Pyrometr
HU Pirométer
RO Termometru cu infrarosu
FR Pyromètre
IT Termometro a infrarossi
ES Pirómetro
CN 红外测温仪

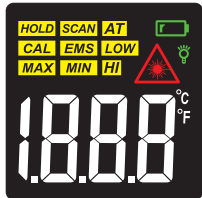
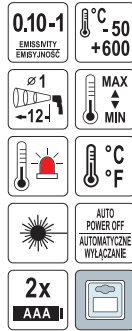

YATO
YT-73200

10/60

EN Infrared thermometer
PL Pirometr
DE Pyrometer
RU Пирометр
CZ Pyrometr
HU Pirométer
RO Termometru cu infrarosu
FR Pyromètre
IT Termometro a infrarossi
ES Pirómetro
CN 红外测温仪

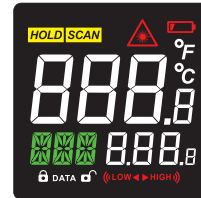
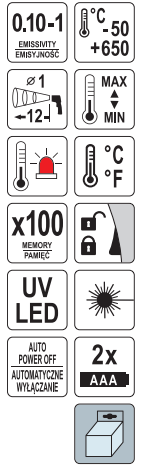

YATO
YT-73201

10/60

EN Laser distance meter with tape measure and cross laser line
PL Dalmierz laserowy z miarą zwiżaną i laserem krzyżowym
DE Laser-Entfernungsmesser mit Maßband und Kreuzlaser
RU Лазерный дальномер с рулеткой и перекрестными лучами
CZ Laserový měřič vzdálenosti
HU Lézeres távolságmérő mérőszalaggal és kereszt lézerekkel
RO Telemetru laser, cu ruleta
FR Télémètre laser avec ruban à mesurer et laser croisé
IT Tracciatore laser con metro a rullo e laser a raggio incrociato
ES Telémetro láser con cinta métrica y láser cruzado
CN 激光卷尺测距仪

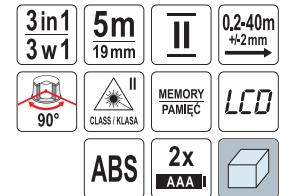

YATO
YT-73122

20

EN Laser distance meter
PL Dalmierz laserowy
DE Laserentfernungsmesser
RU Лазерный дальномер
CZ Laserový měřič vzdálenosti
HU Lézeres távolságmérő
RO Telemetru cu laser
FR Télémètre laser
IT Misuratore di distanza laser
ES Medidores láser de distancias
CN 激光测距仪

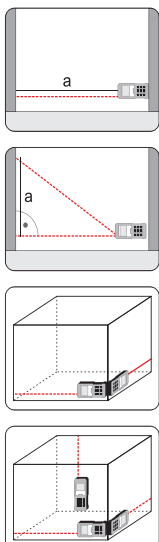

YATO
YT-73126

20

EN Laser distance meter
PL Dalmierz laserowy
DE Laserentfernungsmesser
RU Лазерный дальномер
CZ Laserový měřič vzdálenosti
HU Lézeres távolságmérő
RO Telemetru cu laser
FR Télémètre laser
IT Misuratore di distanza laser
ES Medidores láser de distancias
CN 激光测距仪

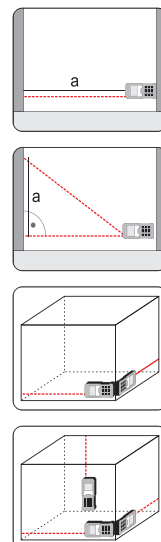

YATO
YT-73127

20

EN Laser distance meter
 PL Dalmierz laserowy
 DE Laserentfernungsmesser
 RU Лазерный дальномер
 CZ Laserový měřič vzdálenosti
 HU Lézeres távolságmérő
 RO Telemetru cu laser
 FR Télémètre laser
 IT Telemetro laser
 ES Medidores láser de distancias
 CN 激光测距仪



5-900m ±1m	905 nm	0-300 ±5 km/h	H	II CLASS / KLASA	2x AAA II	
---------------	-----------	---------------------	---	---------------------	--------------	--

EN Distance measuring wheels
 PL Kolo miernicze
 DE Messrad
 RU Колесо измерительное
 CZ Kolečko pro měření vzdálenosti
 HU Kicsi mérőkerék
 RO Roji de măsură
 FR Roues de mesure
 IT Ruota di misurazione
 ES Ruedas de medición
 CN 测距轮



0.1-9999.9 m	0.5% ACCURACY DOKŁADNOŚĆ	38-92 cm	
160 mm	AI		



YATO
YT-71650 8

EN Distance measuring wheels
 PL Kolo miernicze
 DE Messrad
 RU Колесо измерительное
 CZ Kolečko pro měření vzdálenosti
 HU Kicsi mérőkerék
 RO Roji de măsură
 FR Roues de mesure
 IT Ruota di misurazione
 ES Ruedas de medición
 CN 测距轮



m/ft	0.1-9999.9 m	0.5% ACCURACY DOKŁADNOŚĆ	160 mm
LCD	82-104 cm	AI	ABS



YATO
YT-71655 10

EN 5-point laser level
 PL Laser pięciopunktowy
 DE 5-Punktlaser
 RU Лазерный нивелир
 CZ 5 bodový laser
 HU Keresztugaras és 5 pontos lézer
 RO Nivelă laser în 5 puncte
 FR Niveau laser 5 points
 IT Laser a cinque punte
 ES Nivel laser de 5 puntos - rojo
 CN 五点水平仪

20m	±1.5mm /5m	±3° SELF-REGULATION SAMOREGULACJA	635 nm	30h
1/4" 5/8" (6.3mm) (15.8mm) TRIPOD THREAD GWINT STĄTY/W	°C -15 +40	II CLASS / KLASA	IP54	3x AA II



YATO
YT-30427 12

EN Cross line green laser
 PL Laser krzyżowy zielony
 DE Laser mit grünem Kreuz
 RU Лазерный уровень зеленый крест
 CZ Laser zelený křížový
 HU Zöld keresztlézer
 RO Nivelă cu laser transversală
 FR Niveau laser à croix verte
 IT Livella laser verde a linee incrociate
 ES Láser en cruz verde
 CN 激光水平仪

±3.0mm /10m LASER ACCURACY DOKŁADNOŚĆ LASERA	±4° SELF-REGULATION SAMOREGULACJA	510-530 nm	1/4" (6.3mm) TRIPOD THREAD GWINT STĄTY/W	°C -10 +50
≤1 mW	II CLASS / KLASA	IP54	6V	4x AA II



YATO
YT-30433 30

EN Cross line green laser
PL Laser krzyżowy zielony
DE Laser mit grünem Kreuz
RU Лазерный уровень зеленый крест
CZ Laser zelený křížový
HU Zöld keresztlaser
RO Nivelă cu laser transversală
FR Niveau laser à croix verte
IT Livella laser verde a linee incrociate
ES Láser en cruz verde
CN 激光水平仪

±3.0mm /10m
LASER ACCURACY /DOKŁADNOŚĆ LASERA
±4°
SELF-REGULATING /SAMOREGULACJA
510-530 nm
3.7 V
5200mAh
Li-Ion
1/4"
(6.3 mm)
TRIPOD THREAD /GWIŃT STĄCZYWY

°C -10 +50
≤1 mW
CLASS /KLASA II
IP54



YATO
YT-30434

20

EN Line green laser
PL Laser liniowy zielony
DE Laser mit grüner Linie
RU Лазерный уровень зеленый линейный
CZ Laser zelený liniový
HU Zöld vonallézer
RO Nivelă cu laser
FR Niveau laser à ligne verte
IT Livella laser lineare verde
ES Láser línea verde
CN 投线仪

±3.0mm /10m
LASER ACCURACY /DOKŁADNOŚĆ LASERA
±4°
SELF-REGULATING /SAMOREGULACJA
510-530 nm
1/4"
(6.3 mm)
TRIPOD THREAD /GWIŃT STĄCZYWY

°C -10 +50
≤1 mW
CLASS /KLASA II
IP54

6V
4x AA



YATO
YT-30435

20

EN Line green laser 3D
PL Laser liniowy zielony 3D
DE 3D-Laser mit grüner Linie
RU Лазерный уровень зеленый линейный 3D
CZ Laser zelený liniový 3D
HU Zöld vonallézer 3D
RO Nivelă cu laser 3D
FR Niveau laser 3D à ligne verte
IT Livella laser lineare 3D verde
ES Láser 3D línea verde
CN 投线仪

±3.0mm /10m
LASER ACCURACY /DOKŁADNOŚĆ LASERA
±4°
SELF-REGULATING /SAMOREGULACJA
510-530 nm
3.7 V
5200mAh
Li-Ion
1/4"
(6.3 mm)
TRIPOD THREAD /GWIŃT STĄCZYWY

°C -10 +50
≤1 mW
CLASS /KLASA II
IP54

IP54



YATO
YT-30436

12

EN Tile laser
PL Laser glazurniczy
DE Fliesenlaser
RU Лазерный уровень для плит
CZ Laserová vodováha
HU Csempelézer
RO Nivel laser pt. plăci
FR Laser tuile
IT Livella laser per piastrelle
ES Láser de baldosas
CN 地板仪

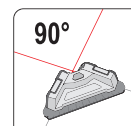

10m
±10mm /10m
x2
ABS
2x AA



YATO
YT-30410

4/16

EN Red glasses for laser
PL Okulary czerwone do pracy z laserem
DE Rote Laserschutzbrille
RU Красные очки для работы с лазером
CZ Červené brýle pro práci s laserem
HU Piros lézerszeműveg
RO Ochelari rosii pt. laser
FR Lunettes d'amélioration laser rouges
IT Occhiali rossi per raggi laser
ES Gafas para visión láser rojas
CN 眼镜



YATO
YT-30460

100

EN Green laser glasses
PL Okulary zielone do pracy z laserem
DE Grüne Laserschutzbrille
RU Зеленые очки для работы с лазером
CZ Zelené brýle pro práci s laserem
HU Zöld lézerszeműveg
RO Ochelari verzi pt. laser
FR Lunettes d'amélioration laser vert
IT Occhiali verdi per raggi laser
ES Gafas para visión láser verde
CN 激光眼镜



YATO
YT-30461

80

EN Red laser target card
PL Płytką pozycjonująca do lasera czerwonego
DE Rote Laser Zielfafel
RU Пластина для красного лазерного нивелира
CZ Čílová deska pro červený laser
HU Céltábla piros lézerhez
RO Card țintă cu laser roșu
FR Plaque de positionnement pour laser rouge
IT Piastra bersaglio rossa per laser
ES Placa de tarjeta para láser rojo
CN 激光靶



YATO
YT-30464

Dimensions / Wymiary [mm]

400

EN Green laser target card
PL Płytką pozycjonująca do lasera zielonego
DE Grüne Laser Zielfafel
RU Пластина для зеленого лазерного нивелира
CZ Čílová deska pro zelený laser
HU Céltábla zöld lézerhez
RO Card țintă laser verde
FR Plaque de positionnement pour laser vert
IT Piastra bersaglio verde per laser
ES Placa de tarjeta para láser verde
CN 激光靶



YATO
YT-30465

Dimensions / Wymiary [mm]

400

EN Aluminium tripod
 PL Statyw aluminiowy
 DE Aluminium-Stativ
 RU Алюминиевый штатив
 CZ Hliníkový stativ
 HU Alumínium állvány
 RO Trepid aluminiu
 FR Trépied en aluminium
 IT Tripode in alluminio
 ES Trípode de aluminio
 CN 三角架

1/4" 5/8"
 (13mm) (15.8mm)
 TRIPOD THREAD
 SWIVEL STATIV



YATO	H [mm]	
YT-30471	150-280	20
YT-30473	320-750	10
YT-30475	460-1200	20
YT-30477	470-1500	20

EN Aluminium tripod
 PL Statyw aluminiowy
 DE Aluminium-Stativ
 RU Алюминиевый штатив
 CZ Hliníkový stativ
 HU Alumínium állvány
 RO Trepid aluminiu
 FR Trépied en aluminium
 IT Tripode in alluminio
 ES Trípode de aluminio
 CN 三角架

1/4" 5/8"
 (13mm) (15.8mm)
 TRIPOD THREAD
 SWIVEL STATIV



YATO	H [mm]	
YT-30479	950-1500	4

EN Laser pole with tripod
 PL Tyczka do lasera ze statywem
 DE Laser Teleskopstange mit Stativ
 RU Штанга-штатив для лазерного уровня
 CZ Tyč se stativem pro laseru
 HU Teleszkóprúd, lézer állvány
 RO Stâlp laser cu trepid
 FR Perche de laser avec trépied
 IT Asta per laser con treppiede
 ES Barra para láser con trípode
 CN 水平仪伸缩杆

max
 370
 cm



YATO	H [mm]	
YT-30500	maks. 3700	4

EN Leveling patch
 PL Łata niwelacyjna teleskopowa
 DE Teleskop-Nivellierlatte
 RU Телескопическая нивелирная рейка
 CZ Teleskopová nivační latka
 HU Teleszkópos szintezőléc
 RO Dispozitiv nivelare
 FR Mire de nivellement télescopique
 IT Stadia telescopica
 ES Varilla de nivelación telescópica
 CN 塔尺



YATO	L [mm]	
YT-30491	1040-3000	12
YT-30492	1200-5000	12

EN Aluminium level
 PL Poziomnica aluminiowa
 DE Wasserwaage
 RU Уровень

CZ Vodováha
 HU Vizmértek
 RO Cumpănă
 FR Niveau à bulle

IT Livella
 ES Nivel
 CN 铝合金水平尺



0.05°
 =
 1mm/m
 ACCURACY
 DOKŁADNOŚĆ

x3
 MAGNIFICATION

ALUMINUM
 HIGH QUALITY
 PROFILE
 ALUMINIUM
 PROFIL WYSOKIEJ
 JAKOŚCI

1.5mm
 PROFILE
 PROFIL

SHOCK-
 PROOF
 ODPORNA
 NA WSTRZĄSY



YATO	L [mm]	
YT-3001	400	20/60
YT-3002	600	20/60
YT-3003	800	10/40
YT-3004	1000	10/40
YT-3005	1200	10/20

EN Aluminium level
PL Poziomnica aluminiowa
DE Wasserwaage
RU Уровень

CZ Vodováha
HU Vízmerék
RO Cumpână
FR Niveau à bulle

IT Livella
ES Nivel
CN 铝合金水平尺

SHOCK-PROOF
ODPORNA
NA WSTRZĄSY



0.057°
= 1mm/m
ACCURACY
DOKŁADNOŚĆ

x3

ALUMINIUM
HIGH QUALITY
PROFILE
ALUMINIOWY
PROFIL WYSOKIEJ
JAKOŚCI

1.5mm
PROFILE
PROFIL



YATO	L [mm]	
YT-3022	600	10/30
YT-3023	800	10/30
YT-3024	1000	30
YT-3025	1200	20
YT-3026	1500	20



0.027°
= 0.5 mm/m
ACCURACY
DOKŁADNOŚĆ

x3

ALUMINIUM
HIGH QUALITY
PROFILE
ALUMINIOWY
PROFIL WYSOKIEJ
JAKOŚCI

YATO	L [mm]	
YT-30071	600	10/40
YT-30072	800	10/30
YT-30073	1000	10/20
YT-30074	1200	10/20



0.027°
= 0.5 mm/m
ACCURACY
DOKŁADNOŚĆ

x2

ALUMINIUM
HIGH QUALITY
PROFILE
ALUMINIOWY
PROFIL WYSOKIEJ
JAKOŚCI

YATO	L [mm]	
YT-30060	400	10/40
YT-30061	600	10/40
YT-30062	800	10/30
YT-30063	1000	10/20
YT-30064	1200	10/20

EN Trapezoidal spirit level
PL Poziomnica trapezowa
DE Trapezförmige Wasserwaage
RU Трапецидальный уровень духа
CZ Vodováha trapezova
HU Vízmerék trapéz

RO Nivelă trapezoidală
FR Trapezes niveau
IT Livella trapezoidale
ES Trapezoides nivel
CN 水平尺

0.027°
= 0.5 mm/m
ACCURACY
DOKŁADNOŚĆ

x2

ALUMINIUM
HIGH QUALITY
PROFILE
ALUMINIOWY
PROFIL WYSOKIEJ
JAKOŚCI

SHOCK-PROOF
ODPORNA
NA WSTRZĄSY



YATO	L [mm]	
YT-30370	250	60

EN Magnetic digital level
PL Poziomnica elektroniczna magnetyczna
DE Elektronische Magnet-Wasserwaage
RU Электронный магнитный спиртовой уровень
CZ Elektronická magnetická vodováha
HU Mágneses elektromos vízmerék
RO Nivelă digitală magnetică
FR Niveau à bulle électronique magnétique
IT Livella magnetica elettronica
ES Magnético nivel electrónico
CN 迷你数显水平尺

AI

LED
DISPLAY
WYŚWIETLACZ



YATO	L [mm]	
YT-30395	150	30

EN Magnetic digital level
PL Poziomnica elektroniczna magnetyczna
DE Elektronische Magnet-Wasserwaage
RU Электронный магнитный спиртовой уровень

CZ Elektronická magnetická vodováha
HU Mágneses elektromos vízmerék
RO Nivelă digitală magnetică
FR Niveau à bulle électronique magnétique

IT Livella elettronica magnetica
ES Magnético nivel electrónico
CN 迷你数显水平尺

x2

AI

LED
DISPLAY
WYŚWIETLACZ



YATO	L [mm]	
YT-30397	400	30

EN Electronic laser level
PL Poziomnica elektroniczna z laserem
DE Elektronische Laser Wasserwaage
RU Уровни электронные лазерные

CZ Úrovňe elektronické laser
HU Elektronikus vízmerék lézeres
RO Nivelurile laser electronice
FR Niveaux laser électronique

IT Livella elettronica con laser
ES Niveles láser electrónica
CN 数显激光水平尺

0.027°
= 0.5 mm/m
ACCURACY
DOKŁADNOŚĆ

x2

±3.0mm
/10m
LASER ACCURACY
DOKŁADNOŚĆ LASERA

0-60
°C

ALUMINIUM
HIGH QUALITY
PROFILE
ALUMINIOWY
PROFIL WYSOKIEJ
JAKOŚCI



YATO	L [mm]	
YT-30400	610	20

EN Feeler
 PL Szczelinomierz
 DE Fühlerlehre
 RU Щупы



CZ Spároměr
 HU Hézagmérő
 RO Lere
 FR Palpeur



IT Spessimetro
 ES Calibre de fisuras
 CN 塞尺



100 mm 10 mm x17 GAUGES LISTRA

200 mm x17 GAUGES LISTRA 12.8 mm



YATO 	L [mm]	W [mm]	± [mm]	
YT-7220	100	10	0.02, 0.03, 0.04, 0.05, 0.06, 0.07, 0.08, 0.09, 0.10, 0.15, 0.20, 0.25, 0.30, 0.40, 0.50, 0.75, 1.0	10/200



YATO 	L [mm]	W [mm]	± [mm]	
YT-7221	200	12.8	0.02, 0.03, 0.04, 0.05, 0.06, 0.07, 0.08, 0.09, 0.10, 0.15, 0.20, 0.25, 0.30, 0.40, 0.50, 0.75, 1.0	10/100



100 mm 10 mm x10 GAUGES LISTRA

200 mm x14 GAUGES LISTRA 12.8 mm

YATO 	L [mm]	W [mm]	± [mm]	
YT-7222	100	10	0.05, 0.06, 0.07, 0.08, 0.09, 0.10, 0.20, 0.30, 0.40, 0.50	10/100

YATO 	L [mm]	W [mm]	± [mm]	
YT-7223	200	12.8	0.05, 0.06, 0.07, 0.08, 0.09, 0.10, 0.15, 0.20, 0.25, 0.30, 0.35, 0.40, 0.45, 0.50	10/100

EN Divider
 PL Cyrkiel z prowadnicą
 DE Bogenspitzzirkel
 RU Циркуль разметочный с подвижной дугой
 CZ Kružidlo s obloukem
 HU Ipari körző
 RO Compas de trasaj
 FR Compas traçoir
 IT Compasso con guida
 ES Compas con fijador
 CN 卡规







EN Spring divider
 PL Cyrkiel ze sprężyną i śrubą
 DE Zirkel mit Stift
 RU Циркуль разметочный с винтом
 CZ Kružidlo s pružinou
 HU Precíziós körző
 RO Compas de trasaj cu reglaj
 FR Compas à ressort
 IT Compasso con molla e vite
 ES Compas de puntas, con muelle
 CN 弹簧卡规

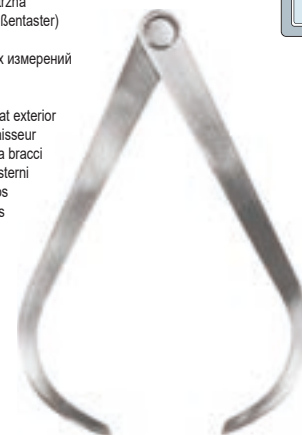



EN Outside caliper
 PL Macka zewnętrzna
 DE Greifzirkel (Außentaster)
 RU Кронциркуль для наружных измерений
 CZ Hmatadlo
 HU Külső jelölő
 RO Calibru masurat exterior
 FR Compas d'épaisseur
 IT Comparatore a bracci tastatori per esterni
 ES Compas planos para exteriores
 CN 外卡规



YATO 	L [mm]	
YT-72100	150	50
YT-72101	200	50
YT-72102	300	50

YATO 	L [mm]	
YT-72106	150	50
YT-72107	200	50
YT-72108	300	50

YATO 	L [mm]	
YT-72115	200	100
YT-72116	300	50

EN Outside caliper with spring
 PL Macka zewnętrzna sprężynowa
 DE Aussenzirkel
 RU Кронциркуль для наружных измерений с винтом
 CZ Obkročné hmatadlo se stavěcím šroubem
 HU Precíziós külső jelölő
 RO Calibru masurat exterior cu reglaj
 FR Compas à ressort d'épaisseur
 IT Comparatore a bracci tastatori per esterni a molla
 ES Compas para exteriores, con muelle
 CN 弹簧外卡规







EN Inside caliper with spring
 PL Macka wewnętrzna sprężynowa
 DE Innenzirkel
 RU Кронциркуль-нутромер для внутренних измерений с винтом
 CZ Hmatadlo vnitorné s pružinou
 HU Precíziós jelölő körző
 RO Calibru masurat interior cu reglaj
 FR Compas à ressort d'intérieur
 IT Comparatore a bracci tastatori per interni a molla
 ES Compas para interiores, con muelle
 CN 弹簧内卡规





EN Inside caliper
 PL Macka wewnętrzna
 DE Lochzirkel
 RU Кронциркуль-нутромер для внутренних измерений
 CZ Hmatadlo
 HU Belső jelölő körző
 RO Calibru masurat interior
 FR Compas d'intérieur
 IT Comparatore a bracci tastatori per interni
 ES Compas planos para interiores
 CN 内卡规



YATO 	L [mm]	
YT-72120	150	50
YT-72121	200	100
YT-72122	250	10/100

YATO 	L [mm]	
YT-72125	150	50
YT-72126	200	10/100
YT-72127	250	100

YATO 	L [mm]	
YT-72130	150	100
YT-72131	250	100
YT-72132	300	100

EN Bevel protractor
PL Kątomierz
DE Winkelmesser
RU Транспортир
CZ Protractor
HU Szögmérő

RO Raportor
FR Rapporteur
IT Rapportatore
ES Transportador
CN 可调量角器

10-170°
5-85° AI



YATO	L [mm]	
YT-70853	380	10/60

EN Protractor
PL Kątomierz
DE Winkelmesser
RU Транспортир

CZ Protractor
HU Szögmérő
RO Raportor
FR Rapporteur

IT Rapportatore
ES Transportador
CN 量角器

+/-
0.1 mm



YATO	Size / Rozmiar [mm]	
YT-72140	120x150	50
YT-72141	150x200	50

EN Digital angle ruler
PL Kątomierz elektroniczny
DE Digitaler Winkelmesser
RU Электронный транспортир
CZ Elektronický úhloměr
HU Elektronikus szögmérő

RO Riglă unghiulară digitală
FR Rapporteur d'angle électronique
IT Rapportatore elettronico
ES Escuadra electrónica
CN 数显角度尺

mm
inch
+/-
0.2°
0-360°
LCD
1x
+
CR2032
MANUAL
LOCKING
RECZNE
BLOKOWANE

AI LCD



YATO	L [mm]	
YT-71003	200	10/50
YT-71004	300	10/40
YT-71005	500	5/20

EN Screw pitch gauges
PL Sprawdzian grzebleniowy do gwintów
DE Gewinde-Messlehre Lehrenblätter
RU Резьбомер

CZ Test hřebefň
HU Menetsablon
RO Set lere filet
FR Manometre pour filetage

IT Pettine per filetti
ES Galga para roscas
CN 螺纹规



METRIC
METRYCZNY
0.25-6.0
mm
60°
x24
BLADES
OSTRZA

WHITWORTH
4-62
55°
x28
BLADES
OSTRZA

METRIC
METRYCZNY
0.25-6.0
mm
60°
WHITWORTH
4-62
55°
x52
BLADES
OSTRZA

YATO	Thread size metric / Rozmiar gwintów metryczne [mm]	
YT-29980	0.25, 0.3, 0.35, 0.4, 0.45, 0.5, 0.6, 0.7, 0.75, 0.8, 0.9, 1, 1.25, 1.5, 1.75, 2, 2.5, 3, 3.5, 4, 4.5, 5, 5.5, 6	30/300

YATO	Thread size Whitworth / Rozmiar gwintów Whitworth	
YT-29982	4, 4.5, 5, 6, 7, 8, 9, 10, 11, 12, 13, 14, 15, 16, 18, 20, 22, 24, 25, 26, 28, 30, 32, 36, 40, 48, 60, 62	30/300

YATO	Thread size metric / Rozmiar gwintów metryczne [mm]	Thread size Whitworth / Rozmiar gwintów Whitworth	
YT-29984	0.25, 0.3, 0.35, 0.4, 0.45, 0.5, 0.6, 0.7, 0.75, 0.8, 0.9, 1, 1.25, 1.5, 1.75, 2, 2.5, 3, 3.5, 4, 4.5, 5, 5.5, 6	4, 4.5, 5, 6, 7, 8, 9, 10, 11, 12, 13, 14, 15, 16, 18, 20, 22, 24, 25, 26, 28, 30, 32, 36, 40, 48, 60, 62	20/200

15

Pneumatic tools

Narzędzia pneumatyczne



Impact wrenches

Klucze udarowe

354-358



Impact wrenches 1/2"

Klucze udarowe 1/2"

354

Impact wrenches 3/4"

Klucze udarowe 3/4"

357

Impact wrenches 1"

Klucze udarowe 1"

357

Other air tools

Inne narzędzia pneumatyczne

358-366



Pneumatic sets

Zestawy pneumatyczne

358

Pneumatic ratchets & sets

Grzechotki pneumatyczne i zestawy

359

Pneumatic grinders & accessories

Szlifierki pneumatyczne i akcesoria

360

Pneumatic cut-off tools & discs

Przecinarki pneumatyczne i tarcze

362

Air body saws

Wyrzynarki pneumatyczne i akcesoria

362

Pneumatic shears

Nożyce pneumatyczne

363

Pneumatic drills

Wiertarki pneumatyczne

363

Pneumatic hammers & accessories

Młotki pneumatyczne i akcesoria

364

Holders for tools

Uchwyty na narzędzia

364

Inflating guns & heads

Pistolety do pompowania i głowice

365

Air brake bleeders

Urządzenia do wymiany płynu hamulcowego

366

Painting equipment & accessories

Narzędzia do malowania i akcesoria

366-369



Spray guns

Pistolety lakiernicze

366

Air vacuum cleaners

Odkurzacze pneumatyczne

366

Cleaning foam guns

Pistolety do wytwarzania piany

367

Blow guns

Pistolety do przedmuchiwania

367

Washing guns

Pistolety do ropowania

368

Sandblasting tools & accessories

Narzędzia do piaskowania i akcesoria

368

Work benches

Stojaki lakiernicze

369

Pneumatic accessories

Akcesoria instalacji pneumatycznej

369-373



Air filters, regulators & lubricators

Filtry, reduktory i smarownice

369

Spiral hoses

Wężę spiralne

370

Reinforced hoses

Wężę zbrojone

370

Couplers

Złącza

372

Air grease guns

Smarownice pneumatyczne

374-375



Pneumatic riveters

Nitownice pneumatyczne

376



Pneumatic staplers & nailers

Zszywacze i gwoździarki pneumatyczne

376-377



Pneumatic staplers

Zszywacze pneumatyczne

376

Pneumatic nailers

Gwoździarki pneumatyczne

377

Screws

Wkręty

377



Air caulking guns

Wyciskacze pneumatyczne

377



EN Impact wrench
 PL Klucz pneumatyczny
 DE Druckluft-Schlagschrauber
 RU Ударный пневматический гайковерт
 CZ Klúč pneumatický
 HU Pneumatikus ütvecsavarozó
 RO Pistol pneumatic
 FR Clé à choc pneumatique
 IT Chiave ad impulsi pneumatica
 ES Llave neumática de percusión
 CN 双锤式气动冲击扳手

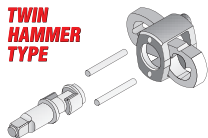

1/2" 12.7mm	TWIN HAMMER TYPE	0.63 MPa
119 l/min	550 Nm	7500 min⁻¹
		



$L_{pa} = 92,0 \pm 3,0$ dB; $L_{wa} = 103,0 \pm 3,0$ dB; $a_n = 5,47 \pm 1,5$ m/s²



YATO 	[Nm]	
YT-09511	550	6

EN Impact wrench
 PL Klucz pneumatyczny
 DE Druckluft-Schlagschrauber
 RU Ударный пневматический гайковерт
 CZ Klúč pneumatický
 HU Pneumatikus ütvecsavarozó
 RO Pistol pneumatic
 FR Clé à choc pneumatique
 IT Chiave ad impulsi pneumatica
 ES Llave neumática de percusión
 CN 气动扳手

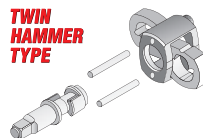

1/2" 12.7mm	TWIN HAMMER TYPE	0.63 MPa
142 l/min	570 Nm	10000 min⁻¹
		



$L_{pa} = 90,7 \pm 3,0$ dB; $L_{wa} = 101,7 \pm 3,0$ dB; $a_n = 3,0 \pm 1,5$ m/s²

YATO 	[Nm]	
YT-09505	570	10

EN Impact wrench
 PL Klucz pneumatyczny
 DE Druckluft-Schlagschrauber
 RU Ударный пневматический гайковерт
 CZ Klúč pneumatický
 HU Pneumatikus ütvecsavarozó
 RO Pistol pneumatic
 FR Clé à choc pneumatique
 IT Chiave ad impulsi pneumatica
 ES Llave neumática de percusión
 CN 气动扳手



1/2" 12.7mm	SINGLE HAMMER TYPE	0.63 MPa	100 l/min
678 Nm	10000 min⁻¹		

15 **ULTRA SHORT BODY**

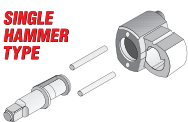

99 mm



$L_{pa} = 97,4 \pm 3,0$ dB; $L_{wa} = 103,0 \pm 3,0$ dB; $a_n = 7,3 \pm 1,21$ m/s²

YATO 	[Nm]	
YT-09512	678	10

EN Impact wrench
 PL Klucz pneumatyczny
 DE Druckluft-Schlagschrauber
 RU Ударный пневматический гайковерт
 CZ Klúč pneumatický
 HU Pneumatikus ütvecsavarozó
 RO Pistol pneumatic
 FR Clé à choc pneumatique
 IT Chiave ad impulsi pneumatica
 ES Llave neumática de percusión
 CN 迷你双锤式气动冲击扳手



1/2" 12.7mm	TWIN HAMMER TYPE	0.63 MPa
165 l/min	680 Nm	10000 min⁻¹
		

SHORT BODY

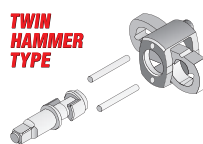
130 mm



$L_{pa} = 94,0 \pm 3,0$ dB; $L_{wa} = 105,0 \pm 3,0$ dB; $a_n = 9,0 \pm 0,4$ m/s²

YATO 	[Nm]	
YT-09513	680	10

EN Impact wrench
PL Klucz pneumatyczny
DE Druckluft-Schlagschrauber
RU Ударный пневматический гайковерт
CZ Klíč pneumatický
HU Pneumatikus ütvecsavarozó
RO Pistol pneumatic
FR Clé à choc pneumatique
IT Chiave ad impulsi pneumatica
ES Llave neumática de percusión
CN 迷你气动扳手

1/2" 12,7mm	SINGLE HAMMER TYPE	0.63 MPa	142 l/min	1200 Nm
10000 min⁻¹	COMPOSITE BODY KOMPÓZITVY KORPUS	STANDARD		

SHORT BODY

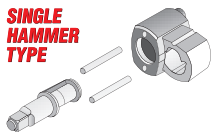

$L_{pA} = 87,0 \pm 1,0$ dB; $L_{wA} = 94,0 \pm 2,0$ dB; $a_h = 9,4 \pm 0,9$ m/s²

YATO	[Nm]	
YT-09515	1200	10

EN Impact wrench
PL Klucz pneumatyczny
DE Druckluft-Schlagschrauber
RU Ударный пневматический гайковерт
CZ Klíč pneumatický
HU Pneumatikus ütvecsavarozó
RO Pistol pneumatic
FR Clé à choc pneumatique
IT Chiave ad impulsi pneumatica
ES Llave neumática de percusión
CN 气动冲击扳手

1/2" 12,7mm	TWIN HAMMER TYPE	0.63 MPa	184 l/min	680 Nm
7000 min⁻¹	COMPOSITE BODY KOMPÓZITVY KORPUS	STANDARD		

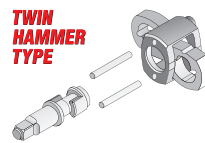

$L_{pA} = 95,0 \pm 3,0$ dB; $L_{wA} = 106,0 \pm 3,0$ dB; $a_h = 9,1 \pm 1,5$ m/s²

YATO	[Nm]	
YT-09524	680	5

EN Impact wrench
PL Klucz pneumatyczny
DE Druckluft-Schlagschrauber
RU Ударный пневматический гайковерт
CZ Klíč pneumatický
HU Pneumatikus ütvecsavarozó
RO Pistol pneumatic
FR Clé à choc pneumatique
IT Chiave ad impulsi pneumatica
ES Llave neumática de percusión
CN 气动冲击扳手

1/2" 12,7mm	TWIN HAMMER TYPE	0,6-0,8 MPa	119 l/min	850 Nm
7000 min⁻¹	STANDARD			

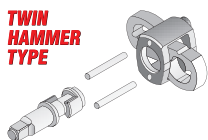

$L_{pA} = 92,0 \pm 3,0$ dB; $L_{wA} = 103,0 \pm 3,0$ dB; $a_h = 5,47 \pm 1,5$ m/s²

YATO	[Nm]	
YT-09525	850	6

EN Impact wrench
PL Klucz pneumatyczny
DE Druckluft-Schlagschrauber
RU Ударный пневматический гайковерт
CZ Klíč pneumatický
HU Pneumatikus ütvecsavarozó
RO Pistol pneumatic
FR Clé à choc pneumatique
IT Chiave ad impulsi pneumatica
ES Llave neumática de percusión
CN 气动扳手

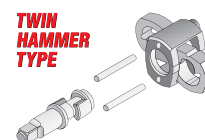

1/2" 12,7mm	TWIN HAMMER TYPE	0.63 MPa	120 l/min	1000 Nm
6000 min⁻¹	STANDARD			





$L_{pA} = 92,0 \pm 3,0$ dB; $L_{wA} = 103,0 \pm 3,0$ dB; $a_h = 5,47 \pm 1,5$ m/s²

YATO	[Nm]	
YT-09528	1000	6

EN Impact wrench
 PL Klucz pneumatyczny
 DE Druckluft-Schlagschrauber
 RU Ударный пневматический гайковерт
 CZ Klúč pneumatický
 HU Pneumatikus ütvecsavarozó
 RO Pistol pneumatic
 FR Clé à choc pneumatique
 IT Chiave ad impulsi pneumatica
 ES Llave neumática de percusión
 CN 双锤式气动冲击扳手

1/2" 12.7mm	TWIN HAMMER TYPE	0.63 MPa	500 l/min
850 Nm	6800 min⁻¹		

EN Impact wrench
 PL Klucz pneumatyczny
 DE Druckluft-Schlagschrauber
 RU Ударный пневматический гайковерт
 CZ Klúč pneumatický
 HU Pneumatikus ütvecsavarozó
 RO Pistol pneumatic
 FR Clé à choc pneumatique
 IT Chiave ad impulsi pneumatica
 ES Llave neumática de percusión
 CN 气动扳手

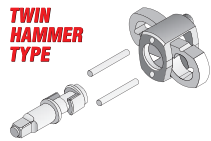

1/2" 12.7mm	TWIN HAMMER TYPE	0.63 MPa	153 l/min	1356 Nm
10000 min⁻¹	COMPOSITE BODY KOMPÓZYTÓVY KORPUS			



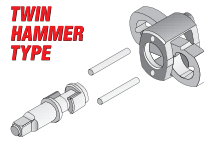

$L_{pa} = 93,1 \pm 3,0$ dB; $L_{wa} = 104,1 \pm 3,0$ dB; $a_n = 6,23 \pm 1,5$ m/s²



$L_{pa} = 93,7 \pm 3,1$ dB; $L_{wa} = 104,7 \pm 3,1$ dB; $a_n = 4,4 \pm 0,4$ m/s²



YATO 	[Nm]	
YT-09531	850	5

YATO 	[Nm]	
YT-0953	1356	10

EN Impact wrench
 PL Klucz pneumatyczny
 DE Druckluft-Schlagschrauber
 RU Ударный пневматический гайковерт
 CZ Klúč pneumatický
 HU Pneumatikus ütvecsavarozó
 RO Pistol pneumatic
 FR Clé à choc pneumatique
 IT Chiave ad impulsi pneumatica
 ES Llave neumática de percusión
 CN 气动扳手

1/2" 12.7mm	TWIN HAMMER TYPE	0.63 MPa	153 l/min	1150 Nm
10000 min⁻¹	COMPOSITE BODY KOMPÓZYTÓVY KORPUS			

EN Impact wrench
 PL Klucz pneumatyczny
 DE Druckluft-Schlagschrauber
 RU Ударный пневматический гайковерт
 CZ Klúč pneumatický
 HU Pneumatikus ütvecsavarozó
 RO Pistol pneumatic
 FR Clé à choc pneumatique
 IT Chiave ad impulsi pneumatica
 ES Llave neumática de percusión
 CN 气动扳手

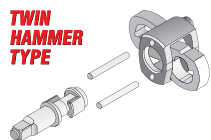

1/2" 12.7mm	TWIN HAMMER TYPE	0.63 MPa	198 l/min	1700 Nm
7000 min⁻¹	COMPOSITE BODY KOMPÓZYTÓVY KORPUS			



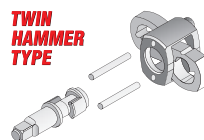

$L_{pa} = 93,7 \pm 3,1$ dB; $L_{wa} = 104,7 \pm 3,1$ dB; $a_n = 4,4 \pm 0,4$ m/s²



$L_{pa} = 92,2 \pm 3,0$ dB; $L_{wa} = 103,2 \pm 3,0$ dB; $a_n = 4,66 \pm 1,5$ m/s²

YATO 	[Nm]	
YT-09540	1150	10

YATO 	[Nm]	
YT-09544	1700	10

EN Impact wrench
PL Klucz pneumatyczny
DE Druckluft-Schlagschrauber
RU Ударный пневматический гайковерт
CZ Klíč pneumatický
HU Pneumatikus ütvecsavarozó
RO Pistol pneumatic
FR Clé à choc pneumatique
IT Chiave ad impulsi pneumatica
ES Llave neumática de percusión
CN 气动扳手

1/2"
12.7mm

TWIN HAMMER TYPE

0.63 MPa

184 l/min

1560 Nm

8000 min⁻¹

COMPOSITE BODY
KOMPÓZITVY KÖRPU

STANDARD

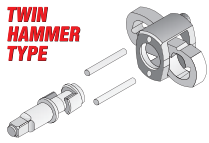

$L_{pa} = 87,0 \pm 1,0$ dB; $L_{wa} = 94,0 \pm 2,0$ dB; $a_n = 9,4 \pm 0,9$ m/s²

YATO	[Nm]	
YT-09545	1560	5

EN Impact wrench
PL Klucz pneumatyczny
DE Druckluft-Schlagschrauber
RU Ударный пневматический гайковерт
CZ Klíč pneumatický
HU Pneumatikus ütvecsavarozó
RO Pistol pneumatic
FR Clé à choc pneumatique
IT Chiave ad impulsi pneumatica
ES Llave neumática de percusión
CN 气动扳手

3/4"
19mm

TWIN HAMMER TYPE

0.63 MPa

198 l/min

1630 Nm

5500 min⁻¹

COMPOSITE BODY
KOMPÓZITVY KÖRPU

G3/8

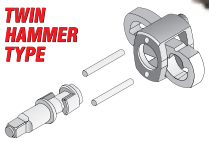

$L_{pa} = 100,6 \pm 3,0$ dB; $L_{wa} = 111,6 \pm 3,0$ dB; $a_n = 10,21 \pm 1,5$ m/s²

YATO	[Nm]	
YT-09571	1630	6

EN Impact wrench
PL Klucz pneumatyczny
DE Druckluft-Schlagschrauber
RU Ударный пневматический гайковерт
CZ Klíč pneumatický
HU Pneumatikus ütvecsavarozó
RO Pistol pneumatic
FR Clé à choc pneumatique
IT Chiave ad impulsi pneumatica
ES Llave neumática de percusión
CN 气动扳手

- Application: automotive service stations, trucks
- Strong, uniform impact
- Przeznaczenie: serwis, samochody ciężarowe
- Silny, jednolity uder

$L_{pa} = 97,2 \pm 2,0$ dB; $L_{wa} = 107,7 \pm 2,8$ dB; $a_n = 23,58 \pm 4,76$ m/s²

EN Impact wrench
PL Klucz pneumatyczny
DE Druckluft-Schlagschrauber
RU Ударный пневматический гайковерт
CZ Klíč pneumatický
HU Pneumatikus ütvecsavarozó
RO Pistol pneumatic
FR Clé à choc pneumatique
IT Chiave ad impulsi pneumatica
ES Llave neumática de percusión
CN 双锤式气动冲击扳手

3/4"
19mm

TWIN HAMMER TYPE

0.63 MPa

660 l/min

1300 Nm

5000 min⁻¹

G3/8

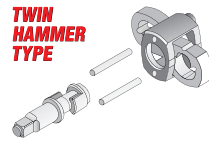

$L_{pa} = 92,0 \pm 3,0$ dB; $L_{wa} = 103,0 \pm 3,0$ dB; $a_n = 5,47 \pm 1,5$ m/s²

YATO	[Nm]	
YT-09564	1300	4

EN Impact wrench
PL Klucz pneumatyczny
DE Druckluft-Schlagschrauber
RU Ударный пневматический гайковерт
CZ Klíč pneumatický
HU Pneumatikus ütvecsavarozó
RO Pistol pneumatic
FR Clé à choc pneumatique
IT Chiave ad impulsi pneumatica
ES Llave neumática de percusión
CN 气动扳手

1"
25mm

PINLESS HAMMER TYPE

0.63 MPa

560 l/min

2600 Nm

4000 min⁻¹

G1/2



- Application: automotive service stations, trucks
- Strong, uniform impact
- Przeznaczenie: serwis, samochody ciężarowe
- Silny, jednolity uder

$L_{pa} = 94,1 \pm 2,8$ dB; $L_{wa} = 104,8 \pm 2,8$ dB; $a_n = 14,53 \pm 1,93$ m/s²

YATO	[Nm]	
YT-0959	2600	1

EN Impact wrench
PL Klucz pneumatyczny
DE Druckluft-Schlagschrauber
RU Ударный пневматический гайковерт
CZ Klíč pneumatický
HU Pneumatikus ütvecsavarozó
RO Pistol pneumatic
FR Clé à choc pneumatique
IT Chiave ad impulsi pneumatica
ES Llave neumática de percusión
CN 气动扳手

- Application: automotive service stations, trucks
- Strong, uniform impact
- Przeznaczenie: serwis, samochody ciężarowe
- Silny, jednolity uder

$L_{pa} = 97,2 \pm 2,0$ dB; $L_{wa} = 107,7 \pm 2,8$ dB; $a_n = 23,58 \pm 4,76$ m/s²

1"
25mm

PINLESS HAMMER TYPE

0.63 MPa

560 l/min

2600 Nm

4000 min⁻¹

G1/2

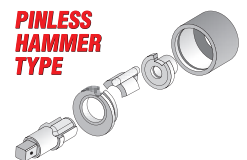

YATO	[Nm]	
YT-0960	2600	1

EN Impact wrench
 PL Klucz pneumatyczny
 DE Druckluft-Schlagschrauber
 RU Ударный пневматический гайковерт
 CZ Klúč pneumatický
 HU Pneumatikus ütvecsavarozó

RO Pistol pneumatic
 FR Clé à choc pneumatique
 IT Chiave ad impulsi pneumatica
 ES Llave neumática de percusión
 CN 气动冲击扳手

1" 25mm	PINLESS HAMMER TYPE	0.6-1.0 MPa	355 l/min	3200 Nm	3500 min ⁻¹	G 1/2	
------------	---------------------------	----------------	--------------	------------	---------------------------	-------	---

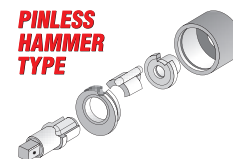

YATO 	[Nm]	
YT-09615	3200	1



$L_{pA} = 97,1 \pm 3,0$ dB; $L_{wA} = 108,1 \pm 3,0$ dB; $a_h = 13,75 \pm 1,5$ m/s²

EN Impact wrench
 PL Klucz pneumatyczny
 DE Druckluft-Schlagschrauber
 RU Ударный пневматический гайковерт
 CZ Klúč pneumatický
 HU Pneumatikus ütvecsavarozó

RO Pistol pneumatic
 FR Clé à choc pneumatique
 IT Chiave ad impulsi pneumatica
 ES Llave neumática de percusión
 CN 气动冲击扳手

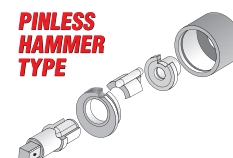
1" 25mm	PINLESS HAMMER TYPE	1.0 MPa	450 l/min	4800 Nm	5000 min ⁻¹	G 1/2	
------------	---------------------------	------------	--------------	------------	---------------------------	-------	---



YATO 	[Nm]	
YT-09618	4800	1



$L_{pA} = 97,0 \pm 3,0$ dB; $L_{wA} = 108,0 \pm 3,0$ dB; $a_h = 12,579 \pm 1,5$ m/s²

EN Impact wrench
 PL Klucz pneumatyczny
 DE Druckluft-Schlagschrauber
 RU Ударный пневматический гайковерт
 CZ Klúč pneumatický
 HU Pneumatikus ütvecsavarozó

RO Pistol pneumatic
 FR Clé à choc pneumatique
 IT Chiave ad impulsi pneumatica
 ES Llave neumática de percusión
 CN 气动冲击扳手

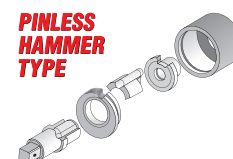
1" 25mm	PINLESS HAMMER TYPE	0.63 MPa (max)	650 l/min	5800 Nm	7000 min ⁻¹	G 1/2	
------------	---------------------------	----------------------	--------------	------------	---------------------------	-------	---





YATO 	[Nm]	
YT-09620	5800	1

$L_{pA} = 84,4 \pm 3,0$ dB; $L_{wA} = 95,4 \pm 3,0$ dB; $a_h = 2,6 \pm 1,5$ m/s²

EN 3 in 1 air combo kit
 PL Zestaw pneumatyczny 3 w 1
 DE 3 in 1 Druckluft-Satz
 RU Пневматический набор 3 в 1
 CZ Pneumatická sada 3 v 1
 HU 3 az 1-ben pneumatikus készlet
 RO Kit aer comprimat 3 in 1
 FR Ensemble pneumatique 3 en 1
 IT Kit di utensili pneumatici 3 in 1
 ES Set neumático 3 en 1
 CN 棘扳手磨三合一工具



1/2" 12.7mm	0.63 MPa	113 l/min	85 Nm	180 min ⁻¹	
15000 min ⁻¹	18000 min ⁻¹	6 mm Ø	STANDARD		



YATO 	[Nm]	
YT-09860	85	10

$L_{pA} = 88,0 \pm 3,0$ dB; $L_{wA} = 99,0 \pm 3,0$ dB; $a_h = 3,95 \pm 1,5$ m/s²

EN Ratchet air wrench
PL Grzechotka pneumatyczna
DE Druckluft-Ratschenschrauber
RU Пневмомрецовка
CZ Pneumatická ráčna
HU Préslevegős behajtó szerszám
RO Antrenor pneumatic
FR Clé à cliquet pneumatique
IT Chiave a cricchetto pneumatica
ES Carraca neumática
CN 气动棘轮扳手

1/4" 6.3mm	0.63 MPa	113 l/min	27 Nm
180 min ⁻¹	360° AIR EXHAUST WYDMUCHY POWIETRZA	SPEED REGULATOR REGULACJA PRĘDKOŚCI	0.5 kg
ULTRALIGHT ULTRALEKKI	COMPOSITE BODY KOMPZYTOWY KORPUS	STANDARD	



ULTRA LIGHT

$L_{pA} = 96.0 \pm 3.0$ dB; $L_{wA} = 107.0 \pm 3.0$ dB; $a_h = 3.1 \pm 1.5$ m/s²

YATO	[Nm]	
YT-09795	27	20

EN Ratchet air wrench
PL Grzechotka pneumatyczna
DE Druckluft-Ratschenschrauber
RU Пневмомрецовка
CZ Pneumatická ráčna
HU Préslevegős behajtó szerszám

RO Antrenor pneumatic
FR Clé à cliquet pneumatique
IT Chiave a cricchetto pneumatica
ES Carraca neumática
CN 气动棘轮扳手

1/2" 12.7mm	0.62 MPa	120 l/min
80 Nm	160 min ⁻¹	STANDARD



$L_{pA} = 87.6 \pm 1.9$ dB; $L_{wA} = 97.7 \pm 2.7$ dB; $a_h = 14.83 \pm 1.96$ m/s²

YATO	[Nm]	
YT-0981	80	20

EN Ratchet wrench kit
PL Zestaw z grzechotką pneumatyczną
DE Druckluft-Ratschenschrauber mit Zubehör
RU Пневмомрецовка в наборе
CZ Klíč ráčnový pneumatický s příslušenstvím
HU Pneumatikus racsniskulcs készlet
RO Cheie pneumatica cu accesorii
FR Clé à cliquet pneumatique
IT Chiave a cricchetto pneumatica
ES Juego con carraca neumática
CN 气动棘轮扳手组套



10, 11, 12, 13, 14, 17, 19 mm;
 1/2" (12.7 mm) (L=75 mm);
 1/2" (12.7 mm);
 6 mm x 1/2" (12.7 mm);
 PH2, PH3, PH4;
 T20, T25, T27, T30, T40;
 4, 5, 6, 7, 8 mm

$L_{pA} = 93.1 \pm 1.9$ dB; $L_{wA} = 104.4 \pm 2.7$ dB; $a_h = 19.98 \pm 2.47$ m/s²

EN Ratchet air wrench
PL Grzechotka pneumatyczna
DE Druckluft-Ratschenschrauber
RU Пневмомрецовка
CZ Pneumatická ráčna
HU Préslevegős behajtó szerszám
RO Antrenor pneumatic
FR Clé à cliquet pneumatique
IT Chiave a cricchetto pneumatica
ES Carraca neumática
CN 气动棘轮扳手

1/2" 12.7mm	0.63 MPa	142 l/min	80 Nm
160 min ⁻¹	360° AIR EXHAUST WYDMUCHY POWIETRZA	SPEED REGULATOR REGULACJA PRĘDKOŚCI	1.4 kg
ULTRALIGHT ULTRALEKKI	COMPOSITE BODY KOMPZYTOWY KORPUS	STANDARD	



ULTRA LIGHT

$L_{pA} = 94.0 \pm 3.0$ dB; $L_{wA} = 105.0 \pm 3.0$ dB; $a_h = 2.6 \pm 1.5$ m/s²

YATO	[Nm]	
YT-09803	80	12

EN Ratchet air wrench
PL Grzechotka pneumatyczna
DE Druckluft-Ratschenschrauber
RU Пневмомрецовка
CZ Pneumatická ráčna
HU Préslevegős behajtó szerszám

RO Antrenor pneumatic
FR Clé à cliquet pneumatique
IT Chiave a cricchetto pneumatica
ES Carraca neumática
CN 气动棘轮扳手

1/2" 12.7mm	0.62 MPa	110 l/min
68 Nm	160 min ⁻¹	STANDARD



$L_{pA} = 93.1 \pm 1.9$ dB; $L_{wA} = 104.4 \pm 2.7$ dB; $a_h = 19.98 \pm 2.47$ m/s²



YATO	[Nm]	
YT-0980	68	20

1/2" 12.7mm	0.62 MPa	110 l/min	68 Nm
160 min ⁻¹	STANDARD	CrV	OIL POT OLIWIARKA

YATO	[Nm]	
YT-0982	68	4

- EN Air grinder
- PL Szlifierka pneumatyczna prosta
- DE Drucklufterhandschleifer
- RU Шлифмашина пневматическая
- CZ Bruska přímá pneumatická
- HU Pneumatikus egyenescsiszoló
- RO Polizor pneumatic
- FR Mini ponceuse pneumatique
- IT Smerigliatrice diritta pneumatica
- ES Lijadora neumática recta
- CN 气动修磨机



0.62 MPa	160 l/min	20000 min ⁻¹
3,6 mm Ø		

$L_{pa} = 100,7 \pm 2,4$ dB; $L_{wa} = 106,2 \pm 3,7$ dB; $a_n = 2,83 \pm 0,93$ m/s²

- EN Air grinder
- PL Szlifierka pneumatyczna prosta
- DE Drucklufterhandschleifer
- RU Шлифмашина пневматическая
- CZ Bruska přímá pneumatická
- HU Pneumatikus egyenescsiszoló
- RO Polizor pneumatic
- FR Mini ponceuse pneumatique
- IT Smerigliatrice diritta pneumatica
- ES Lijadora neumática recta
- CN 气动修磨机





ADJUSTABLE SPEED REGULATOR. REAR AIR EXHAUST CAN BE ROTATED 360°
REGULACJA PRĘDKOŚCI. MOŻLIWOŚĆ USTAWIENIA WYDMUCHU POWIETRZA O 360°

0.63 MPa	113 l/min
25000 min ⁻¹	6.0 mm
	
	



$L_{pa} = 88,0 \pm 3,0$ dB; $L_{wa} = 99,0 \pm 3,0$ dB; $a_n = 2,9 \pm 1,5$ m/s²

YATO 	
YT-09632	20

- EN Pneumatic angle grinder
- PL Szlifierka pneumatyczna kątowa
- DE Ruckluft-Winkelschleifer
- RU Пневматическая угловая шлифовальная машина
- CZ Pneumatické úhlovou brusku
- HU Pneumatikus sarokcsiszoló
- RO Polizor unghiular pneumatic
- FR Pneumatique meuleuse d'angle
- IT Smerigliatrice angolare pneumatica
- ES Amoladora angular neumática
- CN 气动角磨

0.63 MPa	141 l/min	11000 min ⁻¹	125 x 16/22 mm
M10			







$L_{pa} = 87,0 \pm 3,0$ dB; $L_{wa} = 98,0 \pm 3,0$ dB; $a_n = 3,4 \pm 1,5$ m/s²

YATO 	
YT-09675	8

YATO 	
YT-0965	25



- EN Air grinder
- PL Szlifierka pneumatyczna prosta
- DE Drucklufterhandschleifer
- RU Шлифмашина пневматическая
- CZ Bruska přímá pneumatická
- HU Pneumatikus egyenescsiszoló
- RO Polizor pneumatic
- FR Mini ponceuse pneumatique
- IT Smerigliatrice diritta pneumatica
- ES Lijadora neumática recta
- CN 气动刻磨机

0.63 MPa	113 l/min	25000 min ⁻¹	6.0 mm
360° AIR EXHAUST WYDMUCH POWIETRZA	SPEED REGULATOR REGULACJA PRĘDKOŚCI	0.33 kg	
			







ULTRA LIGHT 

$L_{pa} = 97,0 \pm 3,0$ dB; $L_{wa} = 108,0 \pm 3,0$ dB; $a_n = 0,9 \pm 1,5$ m/s²

YATO 	
YT-09633	40

- EN Pneumatic angle grinder
- PL Szlifierka pneumatyczna kątowa
- DE Ruckluft-Winkelschleifer
- RU Пневматическая угловая шлифовальная машина
- CZ Pneumatické úhlovou brusku
- HU Pneumatikus sarokcsiszoló
- RO Polizor unghiular pneumatic
- FR Pneumatique meuleuse d'angle
- IT Smerigliatrice angolare pneumatica
- ES Amoladora angular neumática
- CN 气动刻磨机

0.63 MPa	113 l/min	20000 min ⁻¹	6.0 mm
360° AIR EXHAUST WYDMUCH POWIETRZA	SPEED REGULATOR REGULACJA PRĘDKOŚCI	0.48 kg	
			



ULTRA LIGHT 

$L_{pa} = 92,0 \pm 3,0$ dB; $L_{wa} = 103,0 \pm 3,0$ dB; $a_n = 1,4 \pm 1,5$ m/s²

YATO 	
YT-09676	30

EN Air sander
PL Szlifierka pneumatyczna mimośrodowa
DE Druckluft-Excenterschleifer
RU Шлифмашина эксцентриковая пневматическая
CZ Bruska pneumatická
HU Pneumatikus polírozó
RO Masina de slefuit pneumatica
FR Ponceuse pneumatique
IT Smerigliatrice orbitale pneumatica
ES Lijadora neumática excéntrica
CN 气动抛光机

0.63 MPa	113 l/min	20000 min ⁻¹	50 mm	2.5 mm	SPEED REGULATOR REGULACJA PRĘDKOŚCI
0.65 kg	ULTRA LIGHT ULTRALIGHT	COMPOSITE BODY KOMPZYTOWY KORPUS	STANDARD		



ULTRA LIGHT

$L_{pa} = 87,0 \pm 3,0$ dB; $L_{wa} = 98,0 \pm 3,0$ dB; $a_h = 2,3 \pm 2,5$ m/s²

YATO	YT-09730	20
-------------	----------	----

EN Air sander
PL Szlifierka pneumatyczna mimośrodowa
DE Druckluft-Excenterschleifer
RU Шлифмашина эксцентриковая пневматическая
CZ Bruska pneumatická
HU Pneumatikus polírozó
RO Masina de slefuit pneumatica
FR Ponceuse pneumatique
IT Smerigliatrice orbitale pneumatica
ES Lijadora neumática excéntrica
CN 气动研磨机

0.63 MPa	84 l/min	10500 min ⁻¹	150 mm	VACUUM SYSTEM SYSTEM ODPYLANIA	STANDARD



$L_{pa} = 90,0 \pm 3,0$ dB; $L_{wa} = 101,0 \pm 3,0$ dB; $a_h = 4,4 \pm 2,5$ m/s²

YATO	YT-09740	10
-------------	----------	----

EN Air sander
PL Szlifierka pneumatyczna mimośrodowa
DE Druckluft-Excenterschleifer
RU Шлифмашина эксцентриковая пневматическая
CZ Bruska pneumatická
HU Pneumatikus polírozó
RO Masina de slefuit pneumatica
FR Ponceuse pneumatique
IT Smerigliatrice orbitale pneumatica
ES Lijadora neumática excéntrica
CN 气动磨光机

0.63 MPa	84 l/min	12000 min ⁻¹	150 mm	360° AIR EXHAUST WYDMUCHY POWIETRZA	ULTRA LIGHT ULTRALIGHT
2.5 mm		0.65 kg		STANDARD	



$L_{pa} = 90,0 \pm 3,0$ dB; $L_{wa} = 101,0 \pm 3,0$ dB; $a_h = 4,4 \pm 2,5$ m/s²

YATO	YT-09739	10
-------------	----------	----

EN Air sander
PL Szlifierka pneumatyczna mimośrodowa
DE Druckluft-Excenterschleifer
RU Шлифмашина эксцентриковая пневматическая
CZ Bruska pneumatická
HU Pneumatikus polírozó
RO Masina de slefuit pneumatica
FR Ponceuse pneumatique
IT Smerigliatrice orbitale pneumatica
ES Lijadora neumática excéntrica
CN 气动研磨机

0.63 MPa	128 l/min	12000 min ⁻¹	150 mm	VACUUM SYSTEM SYSTEM ODPYLANIA	M8
5.0 mm				STANDARD	



$L_{pa} = 91,0 \pm 3,0$ dB; $L_{wa} = 105,0 \pm 4,0$ dB; $a_h = 10,3 \pm 1,2$ m/s²

YATO	YT-09738	10
-------------	----------	----

EN Air belt sander
PL Pneumatyczna szlifierka taśmowa
DE Pneumatische Bandschleifer
RU Пневматический шлифовальный
CZ Pneumatická pásová bruska
HU Pneumatikus szalagcsiszoló
RO Polizor pneumatic cu banda
FR Ponceuse à bandes pneumatique
IT Levigatrice a nastro pneumatica
ES Lijadora de banda neumática
CN 气动砂磨机

0.63 MPa	170 l/min	20000 min ⁻¹	EASY BELT REPLACEMENT LISTWA WYMIANA PASA	STANDARD
----------	-----------	-------------------------	---	----------



Includes belts: P60, P80, P120
W zestawie pasy: P60, P80, P120

$L_{pa} = 93,0 \pm 3,0$ dB; $L_{wa} = 104,0 \pm 3,0$ dB; $a_h = 4,8 \pm 1,5$ m/s²

YATO	Abrasive belt size / Rozmiar taśmy ściernej [mm]	10
YT-09741	10x330	10

EN Air belt sander
PL Pneumatyczna szlifierka taśmowa
DE Pneumatische Bandschleifer
RU Пневматический шлифовальный
CZ Pneumatická pásová bruska
HU Pneumatikus szalagcsiszoló
RO Polizor pneumatic cu banda
FR Ponceuse à bandes pneumatique
IT Levigatrice a nastro pneumatica
ES Lijadora de banda neumática
CN 气动砂磨机

0.63 MPa	200 l/min	20000 min ⁻¹	EASY BELT REPLACEMENT LISTWA WYMIANA PASA	STANDARD
----------	-----------	-------------------------	---	----------



Includes belts / W zestawie pasy: P60, P80, P120
W zestawie pasy: P60, P80, P120

$L_{pa} = 93,0 \pm 3,0$ dB; $L_{wa} = 104,0 \pm 3,0$ dB; $a_h = 4,8 \pm 1,5$ m/s²

YATO	Abrasive belt size / Rozmiar taśmy ściernej [mm]	10
YT-09742	20x520	10

EN Endless sanding belt
PL Taśma ścierna bezkońcowa
DE Schleifband
RU Шлифовальные ленты
CZ Brusný pás
HU Csiszoló szalag

RO Bandă de pânză
FR Bande abrasive sans fin
IT Nastro abrasivo senza fine
ES Pano abrasivo cinturón
CN 砂带



- Application: metal, wood
- Abrasive: aluminium oxide
- Bond: synthetic resin
- Coating: closed
- Zastosowanie: metal, drewno
- Ścierniwo: tlenek glinu
- Spoiwo: żywica syntetyczna
- Nasyp pełny

YATO	Grit / Ziarnistość	[mm]	pcs / szt.	
YT-09743	P60	10x330	10	100
YT-09744	P80	10x330	10	100
YT-09745	P100	10x330	10	100
YT-09746	P120	10x330	10	100

EN Endless sanding belt
PL Taśma ścierna bezkońcowa
DE Schleifband
RU Шлифовальные ленты

CZ Brusný pás
HU Csiszoló szalag
RO Bandă de pânză
FR Bande abrasive sans fin

IT Nastro abrasivo senza fine
ES Pano abrasivo cinturón
CN 砂带



- Application: metal, wood
- Abrasive: aluminium oxide
- Bond: synthetic resin
- Coating: closed
- Zastosowanie: metal, drewno
- Ścierniwo: tlenek glinu
- Spoiwo: żywica syntetyczna
- Nasyp pełny

YATO	Grit / Ziarnistość	[mm]	pcs / szt.	
YT-09747	P60	20x520	10	50
YT-09748	P80	20x520	10	50
YT-09749	P100	20x520	10	50
YT-09750	P120	20x520	10	50

EN Air cut-off tool
PL Przecinarka pneumatyczna
DE Druckluft-Schneidmaschine
RU Резак пневматический
CZ Příčná bruska pneumatická
HU Pneumatikus sarokcsiszoló
RO Masina de taiat cu aer comprimat
FR Coupeuse pneumatique
IT Fresa pneumatica
ES Cortadora neumática
CN 气动角磨

0.63 MPa 127 l/min 20000 min⁻¹ 75x9.5 mm STANDARD



L_{pa} = 77.0 ± 3.0 dB; L_{wa} = 88.0 ± 3.0 dB; a_n = 2.38 ± 1.5 m/s²

YATO	
YT-09715	10

EN Air cut-off tool
PL Przecinarka pneumatyczna
DE Druckluft-Schneidmaschine
RU Резак пневматический
CZ Příčná bruska pneumatická
HU Pneumatikus sarokcsiszoló
RO Masina de taiat cu aer comprimat
FR Coupeuse pneumatique
IT Fresa pneumatica
ES Cortadora neumática
CN 气动切割机

0.8 MPa 170 l/min 18000 min⁻¹ 75x9.5 mm 360° AIR EXHAUST TECHNOLOGY
SPEED REGULATOR / REGULACJA PRĘDKOŚCI 0.7 kg ULTRA LIGHT / ULTRALICHTKI COMPOSITE BODY / KOMPACTYWNY KORPUS STANDARD



L_{pa} = 90.0 ± 3.0 dB; L_{wa} = 101.0 ± 3.0 dB; a_n = 1.2 ± 1.5 m/s²

YATO	
YT-09717	20

EN Metal cutting discs
PL Tarcze do cięcia metalu
DE Metall-Trennscheiben
RU Круги отрезные по металлу
CZ Souprava kotoučů pro řezání kovu
HU Vágókorong készlet fémhez

RO Set de pânze de tăiat metal
FR Set de disques pour métal
IT Disco per taglio metallo
ES Juego de discos para cortar metal
CN 金属切割片组套

5 PCS max 80 m/s 18000 min⁻¹ 75x9.5 x2 mm



For YT-0993
Dla YT-0993

YATO	
YT-0994	12/48

EN Air body saw
PL Wyrzynarka pneumatyczna
DE Luft Körper Säge
RU Пила пневматическая сабельная
CZ Pilka pneumatická na plech
HU Pneumatikus kardfűrész
RO Fierastrău pneumatic
FR Scie sabre pneumatique
IT Sega da traforo
ES Sierra neumática
CN 气锯



0.63 MPa 170 l/min 9000 min⁻¹ STANDARD

L_{pa} = 78.0 ± 3.0 dB; L_{wa} = 89.0 ± 3.0 dB; a_n = 23 ± 1.5 m/s²

YATO	
YT-09955	20

EN Jig saw blades
PL Brzeszczoły do wyrzynarki
DE Stichsägeblätter
RU Полотна для пневматической сабельной пилы
CZ Pilový list do přímocaré pily
HU Dekopírlap

RO Set pânze pt. fierăstrău sabie
FR Lame pour scie sauteuse
IT Lame per seghetti pneumatici
ES Recambio sierra de calar
CN 锯片

5 PCS



YATO	TPI	
YT-09958	24	50/200
YT-09959	32	50/200

For YT-09955
Dla YT-09955

EN Air shears pistol type
PL Nożyce pneumatyczne kątowe
DE Pneumatische Schere
RU Пневматические ножницы угловые
CZ Pneumatické nůžky na plech
HU Pneumatikus ollók
RO Foarfeca pneumatica
FR Ciseaux pneumatiques
IT Cesola pneumatica angolare
ES Tijera neumática
CN 气动剪刀



0.63 MPa	141 l/min	1800 min ⁻¹	5.5 mm
max 1.2 mm STEEL STAL	max 1.4 mm Al	STANDARD	



$L_{pa} = 80,0 \pm 3,0$ dB; $L_{wa} = 91,0 \pm 3,0$ dB; $a_n = 6,5 \pm 1,5$ m/s²

YATO

YT-09944



10

EN Air shears
PL Nożyce pneumatyczne proste
DE Pneumatische Schere
RU Пневматические ножницы прямые
CZ Pneumatické nůžky na plech
HU Pneumatikus ollók
RO Foarfeca pneumatica
FR Ciseaux pneumatiques
IT Cesola pneumatica diritta
ES Tijera neumática
CN 气动剪刀

0.63 MPa	141 l/min	2500 min ⁻¹	5.5 mm
max 1.2 mm STEEL STAL	max 1.4 mm Al	STANDARD	



$L_{pa} = 90,0 \pm 3,0$ dB; $L_{wa} = 101,0 \pm 3,0$ dB; $a_n = 4,6 \pm 1,5$ m/s²

YATO

YT-09945



15

EN Reversible air drill
PL Wiertarka pneumatyczna
DE Druckluft-Bohrmaschine mit Stahl-Zahnkranzfutter
RU Пневматическая дрель
CZ Vrtáčka ruční vzduchová
HU Pneumatikus fúró
RO Masina de gaurit pneumatica mandrina
FR Perceuse pneumatique
IT Fresa pneumatica
ES Taladradora neumática
CN 气钻

0.63 MPa	141 l/min	20000 min ⁻¹	max Ø 10 mm
360° AIR EXHAUST WYKŁASKI POWIETRZA	SPEED REGULATOR REGULACJA PRĘDKOŚCI	0.66 kg	ULTRA LIGHT ULTRALEKKI
COMPOSITE BODY KOMPOZYTOWY KORPUS	STANDARD		



ULTRA LIGHT

$L_{pa} = 92,0 \pm 3,0$ dB; $L_{wa} = 103,0 \pm 3,0$ dB; $a_n = 6,2 \pm 1,5$ m/s²

YATO

YT-09695



20

EN Reversible air drill
PL Wiertarka pneumatyczna
DE Druckluft-Bohrmaschine
RU Пневматическая дрель
CZ Vrtáčka ruční vzduchová
HU Pneumatikus fúró
RO Masina de gaurit pneumatica mandrina
FR Perceuse pneumatique
IT Fresa pneumatica
ES Taladradora neumática
CN 正反转气钻

0.63 MPa	198 l/min	700 min ⁻¹	max Ø 10 mm
1.7 kg	STANDARD		



$L_{pa} = 89,7 \pm 3,0$ dB; $L_{wa} = 100,7 \pm 3,0$ dB; $a_n = 0,89 \pm 1,5$ m/s²

YATO

YT-09702



12

EN Reversible air drill
PL Wiertarka pneumatyczna
DE Druckluft-Bohrmaschine
RU Пневматическая дрель
CZ Vrtáčka ruční vzduchová
HU Pneumatikus fúró
RO Masina de gaurit pneumatica mandrina
FR Perceuse pneumatique
IT Fresa pneumatica
ES Taladradora neumática
CN 正反转气钻

0.63 MPa	113 l/min	1800 min ⁻¹	max Ø 10 mm
0.9 kg	ULTRA LIGHT ULTRALEKKI	COMPOSITE BODY KOMPOZYTOWY KORPUS	STANDARD



ULTRA LIGHT

$L_{pa} = 98,0 \pm 3,0$ dB; $L_{wa} = 109,0 \pm 3,0$ dB; $a_n = 2,8 \pm 1,5$ m/s²

YATO

YT-09703



10

EN Air hammer
 PL Młotek pneumatyczny
 DE Druckluft-Schlaghammer
 RU Зубило пневматическое
 CZ Sekáč vzduchový
 HU Pneumatikus vésőkészlet pisztollyal

RO Ciocan pneumatic
 FR Marteau pneumatique
 IT Martello pneumatica
 ES Martillo neumático
 CN 冲击式气铲

0.62 MPa **113 l/min** **T 3200 min¹**



$L_{pA} = 96,3 \pm 1,3$ dB; $L_{wA} = 107,7 \pm 2,5$ dB; $a_n = 2,62 \pm 9,1$ m/s²

YATO	
YT-0990	10

EN Air hammer
 PL Młotek pneumatyczny
 DE Druckluft-Schlaghammer
 RU Зубило пневматическое
 CZ Sekáč vzduchový
 HU Pneumatikus vésőkészlet pisztollyal

RO Ciocan pneumatic
 FR Marteau pneumatique
 IT Martello pneumatica
 ES Martillo neumático
 CN 冲击式气铲

0.63 MPa **113 l/min** **T 4500 min¹**

0.95 kg **COMPOSITE BODY**
 ULTRA LIGHT ULTRALEKKI **KOMPOZITOWY KORPUS**



ULTRA LIGHT

$L_{pA} = 95,0 \pm 3,0$ dB; $L_{wA} = 106,0 \pm 3,0$ dB; $a_n = 20,0 \pm 4,5$ m/s²

YATO	
YT-09904	10

EN Air needle scaler
 PL Pneumatyczny młotek igłowy
 DE Luft-Nadel-Scaler
 RU Пневматический игольчатый отбойник
 CZ Vzduchový jehlový škrabák
 HU Pneumatikus tűs rozsdaleverő pisztollyal
 RO Pistol pneumatic de curăţat cu ace
 FR Dérouilleur décapeur pneumatique
 IT Scrostatore pneumatico ad aghi
 ES Limpiador de agujas neumáticas
 CN 气动除锈器

0.63 MPa **113 l/min** **T 4500 min¹**

x19 NEEDLES ONLY



$L_{pA} = 100,0 \pm 3,0$ dB; $L_{wA} = 111,0 \pm 3,0$ dB; $a_n = 13,0 \pm 1,5$ m/s²

YATO	
YT-09910	8

EN Shank chisel for air hammer
 PL Dłuta do młotka pneumatycznego
 DE Lufthammer Meißel-Set
 RU Комплект зубил для пневматического молотка
 CZ Dláta pro pneumatické kladivo
 HU Véső készlet pneumatikus véső kalapácsolhoz!

RO Set dalti pt. ciocan pneumatic
 FR Ensemble marteau burineur
 IT Set di scalpelli per martelli pneumatici
 ES Juego de martillos para martillos neumáticos
 CN 气动铲刀

4 PCS

120 mm



For YT-0990, 81133
 Dla YT-0990, 81133

YATO	
YT-09901	50

EN Magnetic screwdriver rack
 PL Uchwyt magnetyczny na wkrętaki
 DE Magnetische Halterung für Schraubendreher
 RU Магнитный держатель для отверток
 CZ Magnetický držák šroubováků
 HU Mágneses csavarhúzó tartó

RO Raft magnetic pt. surubelnite
 FR Mandrin magnétique pour tournevis
 IT Supporto magnetico per punte
 ES Soporte magnético para destornilladores
 CN 磁性螺丝刀架

350 mm **x9**

ABS



YATO	L [mm]	
YT-08353	350	6/24

EN Magnetic pliers rack
 PL Uchwyt magnetyczny na narzędzia
 DE Magnetischer Werkzeughalter
 RU Магнитный держатель для инструментов
 CZ Magnetický držák na nářadí
 HU Mágneses szerszámartó

RO Raft magnetic pt. clesti
 FR Fixation magnétique pour outils
 IT Supporto magnetico per attrezzi
 ES Soporte magnético para herramientas
 CN 磁性钳子架

350 mm **x9**

ABS



YATO	L [mm]	
YT-08354	350	6/24

- EN Magnetic holder for tools
PL Uchwyt magnetyczny na narzędzia
DE Magnethalter für Schlagschrauber
RU Магнитный держатель для ударного гайковерта
CZ Magnetický držák náradí
HU Mágneses tartó
RO Suport magnetic pt. scule pneumatice
FR Support magnétique pour outils pneumatiques
IT Fissaggio magnetico per chiave ad impulsi pneumatica
ES Soporte magnético para llave de impacto
CN 磁性喷枪架



max
15 kg



YATO

YT-08707

5/10

- EN Inflating gun
PL Pistolet do pompowania
DE Inflatpistole
RU Пистолет для накачивания
CZ Pistolet na čerpání z manometrem
HU Pumpáló pisztoly nyomásmérővel
RO Pistol cu manometru
FR Pistolet pour gonflage de pneus avec manomètre
IT Pistola per gonfiaggio
ES Pistola de bombeo con manometro
CN 充气枪

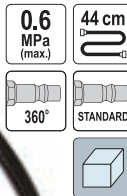

$L_{pa} = 89,0 \pm 2,5$ dB; $L_{wa} = 100,0 \pm 2,5$ dB; $a_h = <2,5$ m/s²

YATO

YT-23701

20

- EN Inflating gun
PL Pistolet do pompowania
DE Inflatpistole
RU Пистолет для накачивания
CZ Pistolet na čerpání z manometrem
HU Pumpáló pisztoly nyomásmérővel
RO Pistol cu manometru
FR Pistolet pour gonflage de pneus avec manomètre
IT Pistola per gonfiaggio
ES Pistola de bombeo con manometro
CN 充气枪

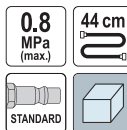

$L_{pa} = 89,0 \pm 2,5$ dB; $L_{wa} = 100,0 \pm 2,5$ dB; $a_h = <2,5$ m/s²

YATO

YT-23703

20

- EN Inflating gun
PL Pistolet do pompowania
DE Inflatpistole
RU Пистолет для накачивания
CZ Pistolet na čerpání z manometrem
HU Pumpáló pisztoly nyomásmérővel
RO Pistol cu manometru
FR Pistolet pour gonflage de pneus avec manomètre
IT Pistola per gonfiaggio
ES Pistola de bombeo con manometro
CN 充气枪



$L_{pa} = 89,0 \pm 2,5$ dB; $L_{wa} = 100,0 \pm 2,5$ dB; $a_h = <2,5$ m/s²

YATO

YT-2370

8/40

- EN Inflating gun
PL Pistolet do pompowania
DE Inflatpistole
RU Пистолет для накачивания
CZ Pistolet na čerpání z manometrem
HU Pumpáló pisztoly nyomásmérővel
RO Pistol cu manometru
FR Pistolet pour gonflage de pneus avec manomètre
IT Pistola per gonfiaggio
ES Pistola de bombeo con manometro
CN 充气枪



$L_{pa} = 89,0 \pm 2,5$ dB; $L_{wa} = 100,0 \pm 2,5$ dB; $a_h = <2,5$ m/s²

YATO

YT-23702

10/40

- EN Inflating head
- PL Glowica do pompowania
- DE Klemmnippel (universal)
- RU Насадка на насос под шланг
- CZ Hlava na čerpání
- HU Pumpafej
- RO Cap pt. pompat
- FR Mandrin de pompe
- IT Testa per il pompaggio
- ES Cabeza de bombeo
- CN 万用接头



YATO	Connector diameter / Średnica króćca [mm]	
YT-2371	6	50/300
YT-2372	8	50/300

- EN Air brake bleeder
- PL Urządzenie pneumatyczne do wymiany płynu hamulcowego
- DE Druckluft-Bremsenentlüfter
- RU Устройство для замены тормозной жидкости
- CZ Sada na odvzdušnění brzdové soustavy a hydraulické spojky
- HU Pneumatikus eszköz a fékfolyadék cseréjére
- RO Aparat de schimb at lichid frână
- FR Purger de frein et d'embrayage pneumatique
- IT Strumento per la sostituzione del liquido freni
- ES Sangrado del freno de aire comprimido
- CN 气动刹车油更换机

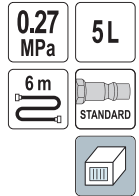

$L_{pA} = \leq 70$ dB; $L_{wA} = \leq 85$ dB; $a_h = \leq 2,5$ m/s²

YATO	
YT-06845	1

- EN Brake and clutch bleeder bleeding vacuum pump kit
- PL Zestaw pneumatyczny do odpowietrzania układu hamulcowego
- DE Pneumatischer Bremsen-Entlüftungs Satz
- RU Пневматический комплект для прокачки тормозной системы
- CZ Pneumatická sada pro odvzdušnění brzdového systému
- HU Pneumatikus fék légtelenítő készlet
- RO Kit pompa de vid pt. aerisire frana si ambreiaj
- FR Kit de purge d'air pour freins
- IT Kit pneumatico per lo spurgo dell'impianto frenante
- ES Kit neumático para purgar el sistema de freno
- CN 刹车油更换机

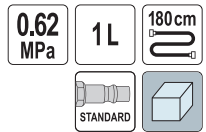

YATO	
YT-06835	20

- EN Spray gun with fluid cup
- PL Pistolet natryskowy
- DE Lackierpistole mit Fließbecher
- RU Пистолет - распылитель с верхним бачком
- CZ Pistole na lakování z nádrží
- HU Festékszóró pisztoly alsó- és felsőtartállyal
- RO Pistol de vopsit cu rezervor inferior
- FR Pistolet à peinture
- IT Pistola vernice
- ES Pistola de barniz
- CN 喷枪

<p>0.3 MPa</p> <p>410 l/min</p> <p>∅ 1.4 mm</p> <p>0.6L</p> <p>HVLP</p>		<p>0.3 MPa</p> <p>410 l/min</p> <p>∅ 1.5 mm</p> <p>0.6L</p> <p>HVLP</p>		<p>0.4 MPa</p> <p>380 l/min</p> <p>∅ 1.8 mm</p> <p>1L</p>		<p>0.3 MPa</p> <p>220 l/min</p> <p>∅ 0.8 mm</p> <p>0.1L</p> <p>HVLP</p>																
<table border="1"> <thead> <tr> <th>YATO</th> <th></th> </tr> </thead> <tbody> <tr> <td>YT-2340</td> <td>20</td> </tr> </tbody> </table>	YATO		YT-2340	20		<table border="1"> <thead> <tr> <th>YATO</th> <th></th> </tr> </thead> <tbody> <tr> <td>YT-2341</td> <td>20</td> </tr> </tbody> </table>	YATO		YT-2341	20		<table border="1"> <thead> <tr> <th>YATO</th> <th></th> </tr> </thead> <tbody> <tr> <td>YT-2346</td> <td>10</td> </tr> </tbody> </table>	YATO		YT-2346	10		<table border="1"> <thead> <tr> <th>YATO</th> <th></th> </tr> </thead> <tbody> <tr> <td>YT-2357</td> <td>20</td> </tr> </tbody> </table>	YATO		YT-2357	20
YATO																						
YT-2340	20																					
YATO																						
YT-2341	20																					
YATO																						
YT-2346	10																					
YATO																						
YT-2357	20																					

- EN Air vacuum cleaner
- PL Odkurzacz pneumatyczny
- DE Druckluftstaubsauger
- RU Пневматический пылесос
- CZ Pneumatický vysavač
- HU Pneumatikus porszívó
- RO Aspirator cu aer comprimat
- FR Aspirateur pneumatique
- IT Aspirapolvere pneumatico
- ES Aspirador neumático
- CN 吹吸尘枪



YATO	
YT-09990	10

$L_{pA} = 83,0 \pm 3,0$ dB; $L_{wA} = 94,0 \pm 3,0$ dB; $a_h = < 2,5$ m/s²

EN Cleaning foam gun
PL Pistolet do wytwarzania piany
DE Schaumpistole
RU Пистолет для образования пены
CZ Pistolet pro vytváření pěny
HU Habpisztoly
RO Pistol pt. spuma
FR Pistolet pour faire de la mousse
IT Pistola per erogazione schiuma
ES Pistola generadora de espuma
CN 发动机清洗枪

0.62 MPa (max)
113 l/min
220 mm
1 L
AI
STANDARD



$L_{pa} = 85,0 \pm 3,0$ dB; $L_{wa} = 96,0 \pm 3,0$ dB; $a_n = <2,5$ m/s²

YATO
YT-23640 10

EN Cleaning foam gun
PL Pistolet do wytwarzania piany
DE Schaumpistole
RU Пистолет для образования пены
CZ Pistolet pro vytváření pěny
HU Habpisztoly
RO Pistol pt. spuma
FR Pistolet pour faire de la mousse
IT Pistola per erogazione schiuma
ES Pistola generadora de espuma
CN 泡沫枪

0.62 MPa
113 l/min
TURBO NOZZLE
DYSZA TURBO
1 L
AI
STANDARD



$L_{pa} = 85,0 \pm 3,0$ dB; $L_{wa} = 96,0 \pm 3,0$ dB; $a_n = <2,5$ m/s²

YATO
YT-23641 10

EN Blow gun with extension
PL Pistolet do przedmuchiwania z przedłużką
DE Gebläsepistole mit Verlängerung
RU Пистолет для продувки с удлинителем
CZ Pistolet na profukování dlouhá
HU Rövid előléfűvő pisztoly
RO Pistol lung pt. suflat
FR Pistolet pour purger
IT Pistola di soffiaggio
ES Pistola de soplado
CN 吹尘枪

0.8 MPa (max)
1/4" 6.3 mm
25 mm
215 mm
AI
STANDARD



$L_{pa} = 91,0$ dB; $L_{wa} = 102,0$ dB; $a_n = <2,5$ m/s²

YATO
YT-2373 20/40

EN Blow gun with extension
PL Pistolet do przedmuchiwania z przedłużką
DE Gebläsepistole mit Verlängerung
RU Пистолет для продувки с удлинителем
CZ Pistolet na profukování dlouhá
HU Rövid előléfűvő pisztoly
RO Pistol lung pt. suflat
FR Pistolet pour purger
IT Pistola di soffiaggio
ES Pistola de soplado
CN 吹尘枪

0.8 MPa (max)
110 mm
BRASS MOSIADZ
PP
STANDARD



$L_{pa} = 89,0$ dB; $L_{wa} = 100,0$ dB; $a_n = <2,5$ m/s²

YATO
YT-2371 20/40

EN Blow gun with extension
PL Pistolet do przedmuchiwania z przedłużką
DE Gebläsepistole mit Verlängerung
RU Пистолет для продувки с удлинителем
CZ Pistolet na profukování dlouhá
HU Rövid előléfűvő pisztoly
RO Pistol lung pt. suflat
FR Pistolet pour purger
IT Pistola di soffiaggio
ES Pistola de soplado
CN 吹尘枪



0.8 MPa (max)
320 mm
PP
BRASS MOSIADZ
STANDARD

$L_{pa} = 89,0$ dB; $L_{wa} = 100,0$ dB; $a_n = <2,5$ m/s²

YATO
YT-2372 30/60

EN Blow gun with extension
PL Pistolet do przedmuchiwania z przedłużką
DE Gebläsepistole mit Verlängerung
RU Пистолет для продувки с удлинителем
CZ Pistolet na profukování dlouhá
HU Rövid előléfűvő pisztoly
RO Pistol lung pt. suflat
FR Pistolet pour purger
IT Pistola di soffiaggio
ES Pistola de soplado
CN 吹尘枪



0.8 MPa (max)
520 mm
PP
BRASS MOSIADZ
STANDARD

$L_{pa} = 89,0$ dB; $L_{wa} = 100,0$ dB; $a_n = <2,5$ m/s²

YATO
YT-2373 30/60

- EN Short air blow gun with turbo
- PL Pistolet do przedmuchiwania krótki turbo
- DE Turbo-Blaspistole, kurz
- RU Короткий турбо пистолет для продувки
- CZ Profukovací pistole krátká turbo
- HU Fúvató pisztoly rövid turbó
- RO Pistol de suflat scurt, functie turbo
- FR Soufflette à air comprimée courte turbo
- IT Pistola per soffiaggio corte turbo
- ES Pistola de soplado, corta turbo
- CN 增压吹尘枪

0.62 MPa 45 mm TURBO NOZZLE DYSZA TURBO STANDARD 



$L_{pA} = 86,0 \pm 3,0$ dB; $L_{wA} = 97,0 \pm 3,0$ dB; $a_h = <2,5$ m/s²

YATO  YT-23722  50

- EN Washing gun
- PL Pistolet do ropowania
- DE Waschpistole
- RU Пистолет для нефтянения
- CZ Pistole na ropování + nádrž
- HU Olajzöpisztoly + tartály
- RO Pistol (dozator) cu rezervor pt. motorină
- FR Pistolet à l'huile
- IT Pistola di lavaggio con nafta
- ES Pistola de petrolear
- CN 喷水枪

0.8 MPa 130 l/min 0.85L AI 



$L_{pA} = 92,0$ dB; $L_{wA} = 103,0$ dB; $a_h = <2,5$ m/s²

YATO  YT-2374  2/12

- EN Gun suitable for sand-blasting
- PL Pistolet do piaskowania ze zbiornikiem
- DE Sandstrahlpistole
- RU Пескоструйный пистолет
- CZ Pískovací pistole se zásobníkem
- HU Homokszóró pisztoly tartállyal
- RO Pistol de sablat
- FR Pistolet de sablage avec réservoir
- IT Pistola sabbiatrice con serbatoio
- ES Pistola para limpieza con chorro de arena con recip
- CN 喷枪

0.8 MPa 160 l/min 1L AI 



$L_{pA} = 91,0$ dB; $L_{wA} = 102,0$ dB; $a_h = 2,03$ m/s²

YATO  YT-2376  20

- EN Long air blow gun with turbo
- PL Pistolet do przedmuchiwania dlugi turbo
- DE Turbo-Blaspistole, lang
- RU Длинный турбо пистолет для продувки
- CZ Profukovací pistole dlouhá turbo
- HU Fúvató pisztoly hosszú turbó
- RO Pistol de suflat lung, functie turbo
- FR Soufflette à air comprimée longue turbo
- IT Pistola per soffiaggio lungo turbo
- ES Pistola de soplado, larga turbo
- CN 长嘴增压吹尘枪

0.62 MPa 110 mm TURBO NOZZLE DYSZA TURBO STANDARD 



$L_{pA} = 86,0 \pm 3,0$ dB; $L_{wA} = 97,0 \pm 3,0$ dB; $a_h = <2,5$ m/s²

YATO  YT-23723  25

- EN Air sand blaster
- PL Pistolet do piaskowania z wężem
- DE Pistole zum Sandstrahlen
- RU Пескоструйный пистолет
- CZ Pískovací pistole s hadicí
- HU Homokszóró pisztoly tömlővel
- RO Pistol de sablat
- FR Pistolet de sablage avec tuyau
- IT Pistola sabbiatrice
- ES Pistola para limpieza con chorro de arena con manguera
- CN 吹气枪



0.8 MPa 160 l/min 1/4" 6.3mm 6.3mm 1m AI 

$L_{pA} = 90,0$ dB; $L_{wA} = 101,0$ dB; $a_h = <2,03$ m/s²



YATO  YT-2375  10

- EN Sandblaster cabinet
- PL Piaskarka kabinowa
- DE Sandstrahlkabine
- RU Пескоструйная камера
- CZ Kabinový pískovací stroj
- HU Homokszóró kabin
- RO Masina de sablat
- FR Cabine de sablage
- IT Sabbiatrice a cabina
- ES Cabina de chorro de arena
- CN 喷砂机

230V~50Hz 0.82 MPa 90L 585x490x490 mm STANDARD 



$L_{pA} = 93,5 \pm 3,0$ dB; $L_{wA} = 95,0 \pm 3,0$ dB; $a_h = <2,5$ m/s²

YATO  YT-55840  1

EN Nozzle for sandblaster cabinet
PL Dysze ceramiczne do piaskarki kabinowej
DE Keramikdüsen für Sandstrahlkabine
RU Керамические насадки для пескоструйной камеры
CZ Keramické trysky pro kabinový pískovací stroj
HU Kerámia fúvókák homokszóró kabinhoz
RO Duze pt. aparat de sablat
FR Buses en céramique pour cabine de sablage
IT Ugelli ceramici per sabbiatrice a cabina
ES Boquillas cerámicas para cabinas de chorro de arena
CN 四件套喷嘴

4
PCS

4, 5,
6, 7
mm



For YT-55840
Dla YT-55840

YATO	Ø [mm]	
YT-55844	4, 5, 6, 7	20/200

EN Protective film for sandblaster cabinet
PL Folie ochronne do piaskarki kabinowej
DE Schutzfolien für Sandstrahlkabine
RU Защитные пленки для пескоструйной камеры
CZ Ochranné fólie pro kabinový pískovací stroj
HU Védőfóliák homokszóró kabinhoz
RO Folie protectie pt. aparat de sablat
FR Film de protection pour cabine de sablage
IT Pellicola protettiva per sabbiatrice a cabina
ES Películas para cabinas de chorro de arena
CN 四片装保护片

4
PCS

410x300
mm



For YT-55840
Dla YT-55840

YATO	[mm]	
YT-55845	410x300	50/100

EN Work bench
PL Stojak lakierniczy rozstawny
DE Lackierständer, verstellbar
RU Раздвижная лакировочная стойка
CZ Stojan lakýrnický rozkládací
HU Kinyitható lakkozó állvány
RO Support extensibil pt. lacuit
FR Support à peindre
IT Supporto pieghevole
ES Montante plegable para barnizar
CN 工作台



max
10 kg
50x55
cm

max
150 kg
100x45
cm



EN Mini filter
PL Filtr
DE Filter
RU Минифильтр
CZ Filtr
HU Szűrő
RO Minifiltru
FR Vidange mini
IT Filtro
ES Filtro
CN 微型过滤器

1.4
MPa
(max.)

8
cm³

1/4"
6.3mm



YATO	
YT-2380	25/50

EN Pressure reducing valve with manometer
PL Reduktor ciśnienia z manometrem
DE Druckminderer mit Manometer
RU Клапан уменьшения давления с манометром
CZ Redukční ventil s manometrem
HU Nyomáscsökkentő szelep nyomásmérővel
RO Valva cu reducatiepresiune + manometru
FR Réducteur avec manomètre
IT Regolatore di pressione con manometro
ES Reductor + manómetro
CN 带表调压减压阀

1.2
MPa
(max.)

1/4"
6.3mm



YATO	
YT-2381	25/50

EN Filter - reductor
PL Filtr - reduktor
DE Druckfilter - Druckminderer
RU Фильтр - редуктор
CZ Filtr derukční ventil
HU Szűrő - nyomásszabályzó
RO Filtru cu reductor
FR Réducteur avec filtre et manomètre
IT Filtro regolatore
ES Reductor + filtro
CN 过滤器

0.93
MPa
(max.)

15
cm³

1/4"
6.3mm

max°C
60



YATO	
YT-2382	25/50

EN Filter - reductor
PL Filtr - reduktor
DE Druckfilter - Druckminderer
RU Фильтр - редуктор
CZ Filtr derukční ventil
HU Szűrő - nyomásszabályzó
RO Filtru cu reductor
FR Réducteur avec filtre et manomètre
IT Filtro regolatore
ES Reductor + filtro
CN 过滤器

0.93
MPa
(max.)

90
cm³

1/2"
12.7mm

max°C
60



YATO	
YT-2383	25/50

EN Air filter regulator and lubricator
 PL Zespól filtrujący, reduktor + smarownica
 DE Druckfilter - Druckminderer + Entöler
 RU Фильтр-редуктор + смазочный прибор
 CZ Redukční ventil s odlučovačem oleje
 HU Levegőelőkészítő
 RO Filtru cu reduktor
 FR Filtre régulateur lubrificateur pour air comprimé
 IT Filtro regolatore lubrificatore
 ES Juego de filtro reductor + engrasador
 CN 气动三联件



0.93 MPa (max.)
 25cm³ FILTER FILTR
 15cm³ LUBRICATOR SMAROWNICA
 1/4" 6.3mm
 max °C 60



EN Air filter regulator and lubricator
 PL Zespól filtrujący, reduktor + smarownica
 DE Druckfilter - Druckminderer + Entöler
 RU Фильтр-редуктор + смазочный прибор
 CZ Redukční ventil s odlučovačem oleje
 HU Levegőelőkészítő
 RO Filtru cu reduktor
 FR Filtre régulateur lubrificateur pour air comprimé
 IT Filtro regolatore lubrificatore
 ES Juego de filtro reductor + engrasador
 CN 气动三联件



0.93 MPa (max.)
 90cm³ FILTER FILTR
 60cm³ LUBRICATOR SMAROWNICA
 1/4" 6.3mm
 max °C 60



YATO
 YT-2385

25

YATO

YT-2384

25/50

EN Air splitter
 PL Rozdzielacz pneumatyczny z regulacją
 DE Druckluftverteiler mit Regelung
 RU Пневмораспределитель с регулированием
 CZ Pneumatický rozdělovač s regulací
 HU Pneumatikus elosztó szabályozóval
 RO Distribuitor aer comprimat
 FR Distributeur pneumatique avec régulation
 IT Distributore pneumatico con regolazione
 ES Distribuidor neumático ajustable
 CN 气路分流器



0.63 MPa
 1.3 MPa (max.)
 x2
 x2
 STANDARD



YATO

YT-2386

5

EN Air hose with quick coupler
 PL Waż techniczny zbrojony z szybkozłączami
 DE Luftschilauch mit Schnellkupplung
 RU Шланг пневматический с быстроразъемным соединением
 CZ Hadice vzduchová s rychlospojkami
 HU Levegőtömítő apa csatlakozóval
 RO Furtun aer comprimat cuplre rapida
 FR Le tuyau d'air avec raccords rapides
 IT Rinforzato tecnico tubo flessibile con rapido
 ES Manguera de aire del con los acopladores rápidos
 CN 气管



2.0 MPa (max.)
 PVC
 STANDARD



EN Spiral tube with quick coupling
 PL Waż spiralny z szybkozłączem
 DE Spiralschlauch mit Schnellkupplung
 RU Шланг спиральный с быстрым соединением
 CZ Spirálová vzduchová hadice
 HU Levegős spiráltömítő gyorscsatlakozóval
 RO Tub spiralat cu, cuplare rapida
 FR Tuyau spirale en polyurethane
 IT Tubo a spirale con rapido
 ES Manguera espiral
 CN 气管



1.2 MPa (max.)
 PU
 STANDARD



YATO	Internal diameter / Średnica wewnętrzna [mm]	External diameter / Średnica zewnętrzna [mm]	L [m]	Icon
YT-24201	5.5	8	5	50
YT-24202	5.5	8	10	25
YT-24203	5.5	8	15	25
YT-24204	6.5	10	5	50
YT-24205	6.5	10	10	20
YT-24206	6.5	10	15	25
YT-24207	8.0	12	5	20
YT-24208	8.0	12	10	25
YT-24209	8.0	12	15	20

YATO	Internal diameter / Średnica wewnętrzna [mm]	L [m]	Icon
YT-24220	8	10	10
YT-24221	8	20	8
YT-24224	10	10	10
YT-24225	10	20	8

EN Hybrid air hose
 PL Przewód pneumatyczny hybrydowy
 DE Hybrid-Druckluftleitung
 RU Пневматический гибридный шланг
 CZ Hybridní pneumatická hadice
 HU Hibrid pneumatikus vezeték
 RO Furtun aer, hibrid
 FR Tuyau pneumatique hybride
 IT Condotto pneumatico ibrido
 ES Conducto neumático híbrido
 CN 橡胶高弹管



2.0 MPa (max.)
 PVC NBR HYBRID
 G 1/4 BSPT



YATO	Internal diameter / Średnica wewnętrzna [mm]	L [m]	Icon
YT-24230	6.5	10	10
YT-24231	6.5	20	5
YT-24232	6.5	30	4

EN Hybrid air hose
PL Przewód pneumatyczny hybrydowy
DE Hybrid-Druckluftleitung
RU Пневматический гибридный шланг
CZ Hybridní pneumatická hadice
HU Hibrid pneumatikus vezeték
RO Furtun aer, hibrid
FR Tuyau pneumatique hybride
IT Condotto pneumatico ibrido
ES Conducto neumático híbrido
CN 橡胶高弹管



YATO	Internal diameter / Średnica wewnętrzna [mm]	L [m]	
YT-24233	8	10	10
YT-24234	8	20	5
YT-24235	8	30	4

EN Hybrid air hose
PL Przewód pneumatyczny hybrydowy
DE Hybrid-Druckluftleitung
RU Пневматический гибридный шланг
CZ Hybridní pneumatická hadice
HU Hibrid pneumatikus vezeték
RO Furtun aer, hibrid
FR Tuyau pneumatique hybride
IT Condotto pneumatico ibrido
ES Conducto neumático híbrido
CN 橡胶高弹管



YATO	Internal diameter / Średnica wewnętrzna [mm]	L [m]	
YT-24236	12.5	10	10
YT-24237	12.5	20	5
YT-24238	12.5	30	4

EN Air hose reel
PL Wąż pneumatyczny na zwijaku
DE Luftschnlauch am Haspel
RU Шланг пневматический на катушке
CZ Naviják se vzduchovou hadicí
HU Levegő tömlő dob es
RO Furtun de aer tumbur
FR Bobine de tuyau d'air et de
IT Tubo pneumatico sull'avvolgitore
ES Carrete de manguera de aire
CN 气动软管卷盘

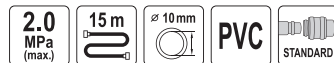

YATO	
YT-24240	2

EN Air hose reel
PL Wąż pneumatyczny na zwijaku
DE Luftschnlauch am Haspel
RU Шланг пневматический на катушке
CZ Naviják se vzduchovou hadicí
HU Levegő tömlő dob es
RO Furtun de aer tumbur
FR Bobine de tuyau d'air et de
IT Tubo pneumatico sull'avvolgitore
ES Carrete de manguera de aire
CN 气动软管卷盘

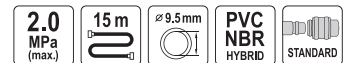

YATO	
YT-24241	2

EN Air hose reel
PL Wąż pneumatyczny na zwijaku
DE Luftschnlauch am Haspel
RU Шланг пневматический на катушке
CZ Naviják se vzduchovou hadicí
HU Levegő tömlő dob es
RO Furtun de aer tumbur
FR Bobine de tuyau d'air et de
IT Tubo pneumatico sull'avvolgitore
ES Carrete de manguera de aire
CN 气管卷管器



YATO	
YT-24242	4

EN Air hose reel
PL Wąż pneumatyczny na zwijaku
DE Luftschnlauch am Haspel
RU Шланг пневматический на катушке
CZ Naviják se vzduchovou hadicí
HU Levegő tömlő dob es
RO Furtun de aer tumbur
FR Bobine de tuyau d'air et de
IT Tubo pneumatico sull'avvolgitore
ES Carrete de manguera de aire
CN 气管卷管器



YATO	
YT-24243	4

EN Air hose reel
 PL Waż pneumatyczny na zwijaku
 DE Luftschnlauch am Haspel
 RU Шланг пневматический на катушке
 CZ Naviják se vzduchovou hadicí
 HU Levegő tömlő dob es
 RO Furtun de aer tumbur
 FR Bobine de tuyau d'air et de
 IT Tubo pneumatico sull'avvolgitore
 ES Carrete de manguera de aire
 CN 英寸卷管器

2.0 MPa (max.) 20 m ∅ 8 mm PVC G 1/4 BSPT

AUTO REWIND AUTOMATYCZNE ZWIJANIE

x4 ANCHORS KOTWY

EASILY MOUNT ŁATWY MONTAŻ



YATO YT-24244 2

EN Air hose reel
 PL Waż pneumatyczny na zwijaku
 DE Luftschnlauch am Haspel
 RU Шланг пневматический на катушке
 CZ Naviják se vzduchovou hadicí
 HU Levegő tömlő dob es
 RO Furtun de aer tumbur
 FR Bobine de tuyau d'air et de
 IT Tubo pneumatico sull'avvolgitore
 ES Carrete de manguera de aire
 CN 英寸卷管器

2.0 MPa (max.) 15 m ∅ 9.5 mm PVC G 1/4 BSPT

AUTO REWIND AUTOMATYCZNE ZWIJANIE

x4 ANCHORS KOTWY

EASILY MOUNT ŁATWY MONTAŻ



YATO YT-24245 1

EN Air hose reel
 PL Waż pneumatyczny na zwijaku
 DE Luftschnlauch am Haspel
 RU Шланг пневматический на катушке
 CZ Naviják se vzduchovou hadicí
 HU Levegő tömlő dob es
 RO Furtun de aer tumbur
 FR Bobine de tuyau d'air et de
 IT Tubo pneumatico sull'avvolgitore
 ES Carrete de manguera de aire
 CN 英寸卷管器

2.0 MPa (max.) 15 m ∅ 12.5 mm PVC G 1/4 BSPT

AUTO REWIND AUTOMATYCZNE ZWIJANIE

x4 ANCHORS KOTWY

EASILY MOUNT ŁATWY MONTAŻ



YATO YT-24246 1

EN Air hose reel
 PL Waż pneumatyczny na zwijaku
 DE Luftschnlauch am Haspel
 RU Шланг пневматический на катушке
 CZ Naviják se vzduchovou hadicí
 HU Levegő tömlő dob es
 RO Furtun de aer tumbur
 FR Bobine de tuyau d'air et de
 IT Tubo pneumatico sull'avvolgitore
 ES Carrete de manguera de aire
 CN 英寸卷管器

2.0 MPa (max.) 15 m ∅ 9.5 mm PVC G 1/4 BSPT

AUTO REWIND AUTOMATYCZNE ZWIJANIE

x4 ANCHORS KOTWY

EASILY MOUNT ŁATWY MONTAŻ



YATO YT-24250 1

EN Quick coupler
 PL Szybkozłącze
 DE Schnellkupplung
 RU Быстрое соединение
 CZ Rychlospojka
 HU Gyorscsatlakozó
 RO Mufa rapida pt. pistol pneumatic
 FR Raccord rapide
 IT Attacco rapido
 ES Conexión de la entrada de aire
 CN 快速接头



YATO	Thread size / Rozmiar gwintu	
YT-2390	G1/4	20/120
YT-2391	G3/8	20/120
YT-2392	G1/2	20/120

YATO	Thread size / Rozmiar gwintu	
YT-2393	G1/4	20/120
YT-2394	G3/8	20/120
YT-2395	G1/2	20/120

YATO	Connector diameter / Średnica króćca [mm]	
YT-2396	6	20/120
YT-2397	8	20/120
YT-2398	10	20/120



YATO	Thread size / Rozmiar gwintu	
YT-2399	G1/4	50/250
YT-2401	G3/8	50/250
YT-2402	G1/2	50/250

YATO	Thread size / Rozmiar gwintu	
YT-2403	G1/4	50/250
YT-2404	G3/8	50/250

YATO	Connector diameter / Średnica króćca [mm]	
YT-2405	6	50/250
YT-2406	8	50/250
YT-2407	10	50/250

EN Quick coupler RU Быстрое соединение RO Mufa rapida pt. pistol pneumatic ES Conexión de la entrada de aire
PL Szybkozłącze CZ Rychlospojka FR Raccord rapide CN 欧式气管接头
DE Schnellkupplung HU Gyorscsatlakozó IT Attacco rapido



YATO **YT-24100** 6/60

YATO **YT-24101** 6/60



YATO **YT-24102** 6/60

YATO **YT-24103** 6/60

EN 2 way quick coupler RO Distribuitoare cuple rapide
PL Szybkozłącze podwójne FR Dérivation type y en cuivre
DE Zwei-wege Schnellkupplung IT Raccordo ottone con vie
RU Двусторонняя быстроразъемные соединения ES Manera 2 manguera de aire pase de acoplamiento rápido
CZ Two-way rychlospojky CN 三通万用插嘴
HU Levegőelosztó kettes gyorscsat

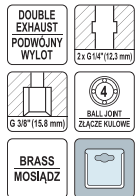

YATO **YT-24091** 25/50

EN Quick coupler CZ Rychlospojka IT Attacco rapido
PL Szybkozłącze HU Gyorscsatlakozó ES Conexión de la entrada de aire
DE Schnellkupplung RO Mufa rapida pt. pistol pneumatic CN 万用插嘴
RU Быстрое соединение FR Raccord rapide

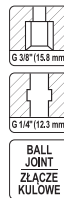
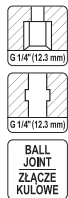

YATO **YT-24092** 50/100

YATO **YT-24093** 50/100



YATO **YT-24094** 50/100

YATO **YT-24095** 50/100



EN Air hose swivel connector RO Conector pivotant pt. furtun de aer
PL Przegub pneumatyczny FR Raccord pneumatique
DE Druckluft Gelenk-Kupplung IT Giunto pneumatico
RU Пневматическое соединение ES Junta neumática
CZ Pneumatický kloub CN 万向接头
HU Pneumatikus forgócsukló



YATO **YT-24130** 20/100

EN Pneumatic grease injector
 PL Towotnica / smarownica pneumatyczna
 DE Druckluft-Fettpresse
 RU Пневматический нагнетатель смазки
 CZ Pneumatiké-čerpadlo maziv
 HU Pneumatikus zsír szivattyú
 RO Pompa de unsoare pneumatice
 FR Pompe a graisse pneumatique
 IT Pneumatica per ingrassaggio
 ES Bomba de engrase neumática lubricar
 CN 注油器



40 MPa (max.)	0.6-0.8 MPa	12L
4 m HOSE WAZ	50:1 RATIO SPREZANIE	
		

$L_{pA} = 97,0 \pm 3,0$ dB; $L_{wA} = 108,0 \pm 3,0$ dB

YATO 		
YT-07067	12	1

EN Pneumatic grease injector
 PL Smarownica pneumatyczna
 DE Druckluft-Fettpresse
 RU Пневматический нагнетатель смазки
 CZ Pneumatiké-čerpadlo maziv
 HU Pneumatikus zsír szivattyú
 RO Pompa de unsoare pneumatice
 FR Pompe a graisse pneumatique
 IT Pneumatica per ingrassaggio
 ES Bomba de engrase neumática lubricar
 CN 注油器



40 MPa (max.)	0.6-0.8 MPa	30L	4 m 
50:1 RATIO SPREZANIE			

$L_{pA} = 97,0 \pm 3,0$ dB; $L_{wA} = 108,0 \pm 3,0$ dB

YATO 		
YT-07068	30	1

EN Pneumatic grease injector
 PL Smarownica pneumatyczna
 DE Druckluft-Fettpresse
 RU Пневматический нагнетатель смазки
 CZ Pneumatiké-čerpadlo maziv
 HU Pneumatikus zsír szivattyú
 RO Pompa de unsoare pneumatice
 FR Pompe a graisse pneumatique
 IT Pneumatica per ingrassaggio
 ES Bomba de engrase neumática lubricar
 CN 注油器







40 MPa (max.)	0.6-0.8 MPa
45L	4 m 
50:1 RATIO SPREZANIE	
	

$L_{pA} = 97,0 \pm 3,0$ dB; $L_{wA} = 108,0 \pm 3,0$ dB

YATO 		
YT-07069	45	1

EN Pneumatic oiling machine
 PL Pneumatyczny napełniacz do oleju
 DE Pneumatischer Oleinfiller
 RU Пневматический наполнитель для масла
 CZ Pneumatiké plnidlo oleje
 HU Pneumatikus olajfeltöltő
 RO Gresor pneumatic
 FR Pompes et de remplissage d'huile pneumatique
 IT Dispositivo di riempimento olio
 ES Dispositivo de llenado de aceite
 CN 齿轮油加油机



0.5 MPa (max.)	20L
2.1 m 	2x 
	

$L_{pA} = 101,2 \pm 3,0$ dB; $L_{wA} = 119,8 \pm 3,0$ dB

YATO 		
YT-07195	20	1

EN Pneumatic oil drain extractor
PL Zlewarko-wysysarka pneumatyczna
DE Druckluft Ölabsauggerät / Ölauffanggerät
RU Маслосборная установка пневматическая
CZ Pneumatická odsávačka vyjetého oleje
HU Pneumatikus fáradtolaj gyűjtő / leszívó
RO Rezervor decantare ulei uzat
FR Récupérateur d'huile par aspiration
IT Aspiratore-recuperatore pneumatico
ES Recuperador de aceite de succión
CN 抽接油机



0.7-0.8 MPa
SUCTION / ODSYŚSIANIE
0.18 MPa
EJECTION / OPRÓZNIANIE
70 L
6
SUCTION PROBES / SONDY ŚRĄC
4x
STANDARD
[Icon]

$L_{pA} = 101,2 \pm 3,0$ dB; $L_{wA} = 119,8 \pm 3,0$ dB

YATO	[Icon]	[Icon]
YT-07191	70	1

EN Air grease gun
PL Smarownica pneumatyczna
DE Druckluft-Fettpresse
RU Шприц для нагнетания густой смазки пневматический
CZ Mazací lis pneumatický
HU Pneumatikus zsírzó
RO Pistol pt. gresat pneumatic
FR Pistolet de graissage pneumatique
IT Pneumatica per ingrassaggio
ES Pistola engrasadora neumática
CN 气动黄油枪



0.63 MPa
IN 0.2-0.8 MPa
OUT 30-40 MPa
400 cm³
28 l/min
STANDARD
[Icon]

$L_{pA} = 93,0 \pm 3,0$ dB; $L_{wA} = 104,0 \pm 3,0$ dB; $a_n = \leq 2,5$ m/s²

YATO	[Icon]	[Icon]
YT-07055		10

EN Pneumatic oil drain extractor
PL Zlewarko-wysysarka pneumatyczna
DE Druckluft Ölabsauggerät / Ölauffanggerät
RU Маслосборная установка пневматическая
CZ Pneumatická odsávačka vyjetého oleje
HU Pneumatikus fáradtolaj gyűjtő / leszívó
RO Rezervor decantare ulei uzat
FR Récupérateur d'huile par aspiration
IT Aspiratore-recuperatore pneumatico
ES Recuperador de aceite de succión
CN 抽接油机



0.7-0.8 MPa
SUCTION / ODSYŚSIANIE
0.18 MPa
EJECTION / OPRÓZNIANIE
90 L
6
SUCTION PROBES / SONDY ŚRĄC
4x
STANDARD
[Icon]

$L_{pA} = 101,2 \pm 3,0$ dB; $L_{wA} = 119,8 \pm 3,0$ dB

YATO	[Icon]	[Icon]
YT-07190	90	1

EN Air grease gun
PL Smarownica pneumatyczna
DE Druckluft-Fettpresse
RU Шприц для нагнетания густой смазки пневматический
CZ Mazací lis pneumatický
HU Pneumatikus zsírzó
RO Pistol pt. gresat pneumatic
FR Pistolet de graissage pneumatique
IT Pneumatica per ingrassaggio
ES Pistola engrasadora neumática
CN 气动黄油枪



0.63 MPa
IN 0.2-0.63 MPa
OUT 6-28 MPa
400 cm³
220 l/min
STANDARD
[Icon]

$L_{pA} = \leq 70,0$ dB; $L_{wA} = \leq 80,0$ dB; $a_n = \leq 2,5$ m/s²

YATO	[Icon]	[Icon]
YT-07057		10

EN Pneumatic riveting machine
 PL Nitownica pneumatyczna
 DE Druckluft Nietzange
 RU Пневматический заклепочник
 CZ Pneumatická nýtovačka
 HU Pneumatikus popszegecsőhúzó
 RO Presa pneumatica pt. nituit
 FR Riveuse pneumatique
 IT Rivettatrice pneumatica
 ES Máquina remachadora
 CN 气动拉铆枪



0.70 MPa

54 l/min

1/4" 6.3mm
180°



$L_{pa} = 83,6 \pm 1,9$ dB; $L_{wa} = 97,4 \pm 2,8$ dB; $a_h = 0,66 \pm 0,21$ m/s²

YATO	Ø [mm]	Max. piston stroke / Maks. skok tłoka silownika [mm]	F [kg]	F [N]	
YT-36171	2,4, 3,2, 4, 4,8, 5	18	757-1060	7430-10400	10

EN Pneumatic riveting machine
 PL Nitownica pneumatyczna
 DE Druckluft Nietzange
 RU Пневматический заклепочник
 CZ Pneumatická nýtovačka
 HU Pneumatikus popszegecsőhúzó
 RO Presa pneumatica pt. nituit
 FR Riveuse pneumatique
 IT Rivettatrice pneumatica
 ES Máquina remachadora
 CN 气动拉铆枪



0.62 MPa



• Application: industry
 • Przeznaczenie: przemysł

$L_{pa} = 81,2 \pm 3,0$ dB; $L_{wa} = 92,2 \pm 3,0$ dB; $a_h = 0,6 \pm 0,56$ m/s²

YATO	Ø [mm]	Max. piston stroke / Maks. skok tłoka silownika [mm]	F [kg]	F [N]	
YT-36171	2,4, 3,2, 4, 4,8, 5	18	757-1060	7430-10400	10

EN Pneumatic stapler
 PL Zszywacz pneumatyczny
 DE Drucklufthefter
 RU Пневматический шпигатель
 CZ Pneumatická sešivačka
 HU Pneumatikus tűzőgép
 RO Capsator pneumatic
 FR Agrafeuse pneumatique
 IT Cucitrice pneumatica
 ES Engrapadora pneumatica
 CN 气动码钉枪



0.8 MPa

25-40mm

STANDARD



$L_{pa} = 88,6 \pm 2,5$ dB; $L_{wa} = 101,6 \pm 2,5$ dB; $a_h = 2,98 \pm 1,5$ m/s²

YATO	
YT-09202	10

EN Pneumatic riveting machine
 PL Nitownica pneumatyczna
 DE Druckluft Nietzange
 RU Пневматический заклепочник
 CZ Pneumatická nýtovačka
 HU Pneumatikus popszegecsőhúzó
 RO Presa pneumatica pt. nituit
 FR Riveuse pneumatique
 IT Rivettatrice pneumatica
 ES Máquina remachadora
 CN 气动拉铆枪



0.70 MPa

60 l/min

1/4" 6.3mm
180°



$L_{pa} = 87,2 \pm 2,3$ dB; $L_{wa} = 94,5 \pm 3,0$ dB; $a_h = 0,54 \pm 0,15$ m/s²

YATO	Ø [mm]	Max. piston stroke / Maks. skok tłoka silownika [mm]	F [kg]	F [N]	
YT-36171	2,4, 3,2, 4, 4,8, 5	18	757-1060	7430-10400	10

EN Pneumatic stapler
 PL Zszywacz pneumatyczny
 DE Drucklufthefter
 RU Пневматический шпигатель
 CZ Pneumatická sešivačka
 HU Pneumatikus tűzőgép
 RO Capsator pneumatic
 FR Agrafeuse pneumatique
 IT Cucitrice pneumatica
 ES Engrapadora pneumatica
 CN 气动码钉枪



0.7 MPa

6-16 mm

STANDARD



$L_{pa} = 88,0 \pm 2,5$ dB; $L_{wa} = 99,0 \pm 2,5$ dB; $a_h = 3,5 \pm 1,5$ m/s²

YATO	
YT-09201	10

EN Pneumatic stapler
 PL Zszywacz pneumatyczny
 DE Drucklufthefter
 RU Пневматический шпигатель
 CZ Pneumatická sešivačka
 HU Pneumatikus tűzőgép
 RO Capsator pneumatic
 FR Agrafeuse pneumatique
 IT Cucitrice pneumatica
 ES Engrapadora pneumatica
 CN 直钉/码钉二合一钉枪



0.8 MPa

25-40mm

10-50mm

STANDARD



$L_{pa} = 87,8 \pm 2,5$ dB; $L_{wa} = 100,8 \pm 2,5$ dB; $a_h = 2,91 \pm 1,5$ m/s²

YATO	
YT-09203	10

EN Pneumatic roofing coil nailer
PL Gwoździarka bębnowa na gwoździe papowe
DE Pneumatischer Coilnagler für Innenausbau
RU Пневматический нейлер для гвоздей
CZ Pneumatická hřebíkovačka na šindele
HU Pneumatiská naglošanas őrce
RO Pistol pneumatic cu bobină
pt. bătut cuie pe acoperiș
FR Cloueuse de charpente
pneumatique à bandes
IT Chiodatrice pneumatica
ES Clavadora neumática
de bobina para tejados
CN 气动屋顶枪

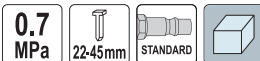

$L_{pa} = 100,3 \pm 2,5$ dB; $L_{wa} = 111,3 \pm 2,5$ dB; $a_n = 11,3 \pm 1,5$ m/s²

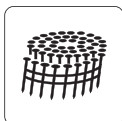

YATO	
YT-09211	3

EN Pneumatic roofing coil nailer
PL Gwoździarka bębnowa na gwoździe papowe
DE Pneumatischer Coilnagler für Innenausbau
RU Пневматический нейлер для гвоздей
CZ Pneumatická hřebíkovačka na šindele
HU Pneumatiská naglošanas őrce
RO Pistol pneumatic cu bobină
pt. bătut cuie pe acoperiș
FR Cloueuse de charpente
pneumatique à bandes
IT Chiodatrice pneumatica
ES Clavadora neumática
de bobina para tejados
CN 气动屋顶枪

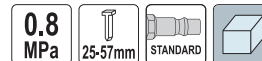

$L_{pa} = 88,6 \pm 2,5$ dB; $L_{wa} = 101,6 \pm 2,5$ dB; $a_n = 3,73 \pm 0,8$ m/s²

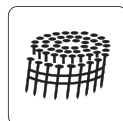
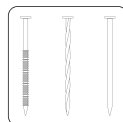

YATO	
YT-09212	3

EN Pneumatic roofing coil nailer
PL Gwoździarka bębnowa na gwoździe papowe
DE Pneumatischer Coilnagler für Innenausbau
RU Пневматический нейлер для гвоздей
CZ Pneumatická hřebíkovačka na šindele
HU Pneumatiská naglošanas őrce
RO Pistol pneumatic cu bobină
pt. bătut cuie pe acoperiș
FR Cloueuse de charpente
pneumatique à bandes
IT Chiodatrice pneumatica
ES Clavadora neumática
de bobina para tejados
CN 气动屋顶枪

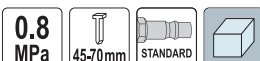

$L_{pa} = 101,7 \pm 2,5$ dB; $L_{wa} = 116,7 \pm 2,5$ dB; $a_n = 4,09 \pm 0,9$ m/s²

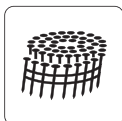
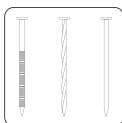

YATO	
YT-09213	3

EN Pneumatic roofing coil nailer
PL Gwoździarka bębnowa na gwoździe papowe
DE Pneumatischer Coilnagler für Innenausbau
RU Пневматический нейлер для гвоздей
CZ Pneumatická hřebíkovačka na šindele
HU Pneumatiská naglošanas őrce
RO Pistol pneumatic cu bobină
pt. bătut cuie pe acoperiș
FR Cloueuse de charpente
pneumatique à bandes
IT Chiodatrice pneumatica
ES Clavadora neumática
de bobina para tejados
CN 气动屋顶枪

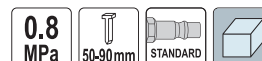

$L_{pa} = 92,3 \pm 2,5$ dB; $L_{wa} = 105,3 \pm 2,5$ dB; $a_n = 5,37 \pm 1,5$ m/s²

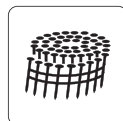
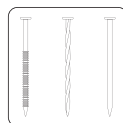

YATO	
YT-09214	2

EN Collated screws for metal
PL Wkręty na taśmie do metalu
DE Magazinierete Schrauben für Metall
RU Саморезы в ленте по металлу
CZ Šrouby do kovu na pásce
HU Szalagláras csavar fémhez

RO Banda suruburi pt. metal
FR Vis pour métal en bande
IT Viti per metallo a nastro
ES Tornillos en tira para metal
CN 螺丝钉

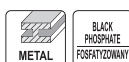

BLACK PHOSPHATE
FOSFATIZOWANY



YATO	Ø [mm]	L [mm]	Screw head drive type / Rodzaj nacięcia łba	pcs / szt.	
YT-09440	3,5	25	PH2	1000	10
YT-09442	3,5	35	PH2	1000	10

EN Collated screws for wood
PL Wkręty na taśmie do drewna
DE Magazinierete Schrauben für Holz
RU Саморезы в ленте по дереву
CZ Šrouby do dřeva na pásce
HU Szalagláras csavar fához

RO Banda suruburi pt. lemn
FR Vis pour bois en bande
IT Viti per legno a nastro
ES Tornillos en tira para madera
CN 螺丝钉



BLACK PHOSPHATE
FOSFATIZOWANY



YATO	Ø [mm]	L [mm]	Screw head drive type / Rodzaj nacięcia łba	pcs / szt.	
YT-09460	3,9	35	PH2	1000	10
YT-09461	3,9	45	PH2	1000	8

EN Air caulking gun
PL Pneumatyczny wyciskacz do mas
DE Pneumatische Kartuschenpistole
RU Пневматический пистолет для герметика
CZ Pneumatická vytlačovací pistole
HU Pneumatikus extrudáló pisztoly
RO Pistol pneumatic pt. silicon
FR Pistolet à extruder pneumatique
IT Pistola pneumatica per sigillanti
ES Pistola neumática para masilla
CN 气动胶枪

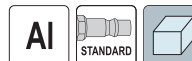

$L_{pa} = <70$ dB; $L_{wa} = <80$ dB; $a_n = <2,5$ m/s²

YATO		L [mm]	
YT-67470		380	5

16

Special automotive tools & equipment
Narzędzia i wyposażenie
warsztatu samochodowego



Furniture & cabinets

Meble i szafki

381-402



Fuel feel pipe pliers

Szczypce motoryzacyjne

432-435



Furniture

Meble 381

Roller cabinets with tools insert 381

Szafki serwisowe z narzędziami 383

Tool cabinets 389

Szafki serwisowe 389

Workbenches 392

Stoły warsztatowe 392

Tools in PVC trays 392

Zestawy narzędzi do szuflad 392

Accessories for tool cabinets & workbenches 398

Akcesoria do szafek i stołów 398

Engine repair tools

Narzędzia do obsługi silnika

436-467



Piston ring compressors

Zaciskacze do pierścieni 436

Honing machines & accessories 436

Honownice i akcesoria 436

Engine repair and diagnostic tools 437

Narzędzia do diagnostyki i naprawy silników 437

Hermetic tool boxes

Walizki narzędziowe hermetyczne

402-403



Brake system tools

Narzędzia do obsługi układu hamulcowego

467-474



Tool boxes

Skrzynki narzędziowe

403-405



Suspension system tools

Narzędzia do obsługi podwozia

474-479



Lubrication system tools

Narzędzia do obsługi układu smarowania

405-413



Spring clamps & accessories

Ściągacze do sprężyn i akcesoria 474

Shock absorber nut sets 475

Zestawy nasadek do amortyzatorów 475

Tire valve stem inserter 475

Przeciągacze do zaworów gumowych 475

Wheel balance pliers 476

Szczypce do wyważania kół 476

Deep thin wall impact sockets 1/2" 476

Udarowe klucze nasadowe 1/2" do felg aluminiowych 476

Wheel wrenches 477

Klucze do kół 477

Impact wrenches 478

Klucze udarowe 478

Tire levers 479

Łyżki do opon 479

Oil filter wrenches & sets

Klucze do filtra oleju i zestawy 405

Oil drain plug sockets 407

Klucze do spustu oleju 407

Grease guns & accessories 408

Smarownice ręczne, pneumatyczne i akcesoria 408

Oil cans 412

Oliwiarki 412

Oil and fuel pumps 413

Pompy do oleju oraz paliwa 413

Pullers

Ściągacze

414-429



Workshop tools

Narzędzia warsztatowe

479-496



Pullers

Ściągacze 414

Roller stud extractor sets 419

Zestawy ściągaczy do szpilek 419

Upholstery removers 428

Ściągacze do tapicerki 428

Inspection tools

Narzędzia inspekcyjne 479

Magnetic pick up tools 479

Chwytki magnetyczne 479

Magnetic trays 480

Tacki magnetyczne 480

Tweezers 481

Pęsety 481

Workshop seats 482

Taborety warsztatowe 482

Workshop creepers 482

Leżanki warsztatowe 482

Workshop mats 482

Maty warsztatowe 482

LED workshop lightning 483

Oświetlenie warsztatowe LED 483

Flashlights 489

Latarki 489

Voltage testers 491

Próbniki napięcia 491

Tapes 491

Taśmy 491

Car window tools

Narzędzia do szyb samochodowych

429



Special pullers

Ściągacze specjalistyczne

429-431







Air condition tools

Narzędzia do klimatyzacji

431



Number & letter stamps Znaczniki cyfrowe i literowe.....	492	Refractometers Refraktometry.....	507	
Thread repair sets & accessories Zestawy do naprawy gwintów i akcesoria.....	492	Workshop cable reels Przedłużacze warsztatowe.....	508	
Pressure gauges Wskaźniki ciśnienia.....	494	Workshop equipment Sprzęt warsztatowy.....	508-512	
Pumps Pompki.....	495	Chain blocks Wciągarki łańcuchowe.....	508	
Compressors Kompresory.....	495	Lever blocks Wciągarki łańcuchowe dźwigniowe.....	508	
Air wedges Poduszki montażowe.....	496	Electric hoists Elektryczne wciągarki linowe.....	508	
Tire racks Stojaki na koła.....	496	Hand pullers Wciągarki linowe, ręczne.....	509	
Funnels, oil drainer & drainer pans Lejki, miski i zlewarki do oleju.....	497-499	Transmission jacks Podnośniki skrzyni biegów.....	510	
Bottle & floor jacks Dźwigniki słupkowe i podnośniki.....	499-501	Parts washers Myjki warsztatowe.....	510	
Vehicle ramps & jack stands Najazdy i podstawki pod samochód.....	501-502	Sandblaster cabinets & accessories Piaskarki kabinowe i akcesoria.....	510	
Porta power kits Rozpieraki hydrauliczne.....	502-503	Shop cranes & shop presses Żurawie i prasy warsztatowe.....	511	
Battery chargers, jump starters, power inverters & battery testers Prostowniki, urządzenia rozruchowe, przetwornice napięcia i testery akumulatorów.....	503-507	Workshop standardized parts Normalia motoryzacyjne.....	513-527	

CREATE YOUR WORKPLACE - STWÓRZ SWOJE MIEJSCE PRACY



YT-08931
High workshop cabinet
Szafka warsztatowa wysoka

YT-08935
Wall cabinet
Szafka podwieszana

YT-08936
Hook panel
Panel perforowany

YT-08938
YT-08939
Worktop
Białe robocze

YT-08934
Workshop cabinet
Szafka warsztatowa

YT-08933
Workshop cabinet
Szafka warsztatowa

EN High workshop cabinet
PL Szafka warsztatowa wysoka
DE Hoher Werkstattschrank
RU Шкаф для мастерской, высокий
CZ Skříňka pro ukládání nástrojů
HU Szekrény szerszámok tárolására
RO Dulap depozitare
FR Armoire de rangement
IT Armadio da officina alto
ES Gabinete de almacenamiento
CN 高柜



660x457
x2000
mm

x3
SHELVES
POCKET

ADJUSTABLE
FEET
REGULOWANE
STOPY

2x 



EN Working cabinet
PL Szafka warsztatowa
DE Werkzeugkasten
RU Портативный ящик для инструментов
CZ Přenosná skříňka na nářadí
HU Hordozható szerszámok láda
RO Dulap pt. scule
FR Servante d'atelier
IT Banco da lavoro armadio
ES Cajonera portátil
CN 工具柜



660x457
x863
mm



4x 

ADJUSTABLE
FEET
REGULOWANE
STOPY

BALL
BEARINGS
ŁOŻYSKA
KULKOWE

2x 



YATO 	Drawer quantity / Liczba szuflad	
YT-08933	4	1

EN Working cabinet
PL Szafka warsztatowa
DE Werkzeugkasten
RU Портативный ящик для инструментов
CZ Přenosná skříňka na nářadí
HU Hordozható szerszámok láda
RO Dulap pt. scule
FR Servante d'atelier
IT Banco da lavoro armadio
ES Cajonera portátil
CN 双门矮柜



660x457
x863
mm

SHELF
POŁKA

ADJUSTABLE
FEET
REGULOWANE
STOPY

2x 



YATO 	
YT-08934	1

YATO 	
YT-08931	1

EN Wall cabinet
 PL Szafka podwieszana
 DE Hängeschrank
 RU Настенный инструментальный шкаф
 CZ Nástěnná skříň
 HU Fali szekrény
 RO Dulap de perete
 FR Armoire murale
 IT Armadio sospeso
 ES Gabinete de pared
 CN 小墙柜

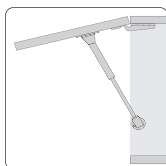

YATO 
 YT-08935



EN Shelf
 PL Półka
 DE Regal
 RU Полка
 CZ Polica
 HU Polc
 RO Raft
 FR Étagère
 IT Scaffale
 ES Estante
 CN 层板



For YT-08931, YT-08934
 Dla YT-08931, YT-08934

YATO 
 YT-08932



EN Worktop
 PL Blat roboczy
 DE Werkstatt Tischplatte
 RU Столешница для мастерской
 CZ Pracovní deska
 HU Munkalap
 RO Blat de lucru
 FR Plan de travail
 IT Piano di lavoro
 ES Encimera
 CN 木质工作台面



YATO 
 YT-08938



EN Worktop
 PL Blat roboczy
 DE Werkstatt Tischplatte
 RU Столешница для мастерской
 CZ Pracovní deska
 HU Munkalap
 RO Blat de lucru
 FR Plan de travail
 IT Piano di lavoro
 ES Encimera
 CN 木质工作台面



YATO 
 YT-08939



EN Strengthening element
 PL Wzmocnienie blatu
 DE Verstärkungselement
 RU Укрепление столешницы
 CZ Podpůrný prvek
 HU Asztali támogatás
 RO Tabla
 FR Support de table
 IT Rinforzo del piano di lavoro
 ES Soporte de mesa
 CN 工作台挂板

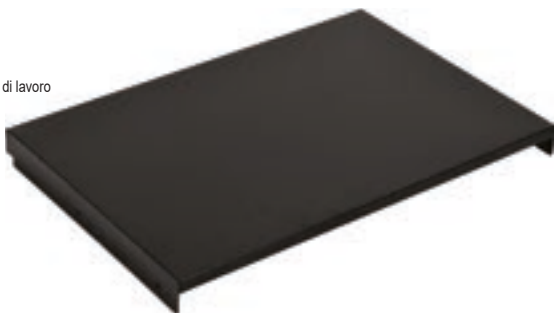

For YT-08939
 Dla YT-08939

YATO 
 YT-08940



EN Hook panel
 PL Panel perforowany
 DE Perforierte Wand
 RU Стенка с перфорацией
 CZ Děrovaná stěna
 HU Perforált fal
 RO Perete perforat
 FR Mur perforé
 IT Pannello forato
 ES Pared perforada
 CN 网孔板

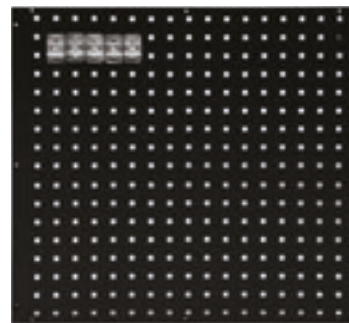
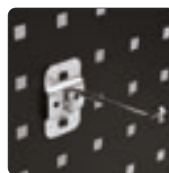

YATO 
 YT-08936



EN Hook panel support
 PL Stelaż do paneli perforowanych
 DE Verstärkungselement Perforierte Wand
 RU Каркас для стенки с перфорацией
 CZ Podpůrný prvek děrovaná stěna
 HU Asztali támogatás perforált fal
 RO Cadru de metal
 FR Panneaux muraux perforés pour le soutien
 IT Telaio per pannelli forati
 ES Paneles de pared perforados de soporte
 CN 工具柜



For YT-08936 x 3
 Dla YT-08936 x 3

YATO 
 YT-08941



EN Hook panel support
 PL Stelaż do paneli perforowanych
 DE Verstärkungselement Perforierte Wand
 RU Каркас для стенки с перфорацией
 CZ Podpůrný prvek děrovaná stěna
 HU Asztali támogatás perforált fal
 RO Cadru de metal
 FR Panneaux muraux perforés pour le soutien
 IT Telaio per pannelli forati
 ES Paneles de pared perforados de soporte
 CN 工具柜



For YT-08936 x 2
 Dla YT-08936 x 2

YATO 
 YT-08942



EN Service tool cabinet with tools
PL Szafka serwisowa z narzędziami
DE Werkstattwagen mit Werkzeug
RU Сервисный шкаф с инструментами
CZ Vozík servisní s nářadím
HU Szerszámkocsi szerszámokkal
RO Dulap echipat cu scule
FR Servante d'atelier complète
IT Armadio da officina con attrezzi
ES Carro taller con herramientas
CN 维修工具柜

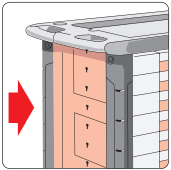

Drawer 1 / Szufiada 1

- 1/2" (12.7 mm): 8, 9, 10, 11, 12, 13, 14, 15, 16, 17, 18, 19, 20, 21, 22, 24 (L=38 mm); 27, 30, 32 mm (L=42 mm); 1/4" (6.3 mm): 4, 4.5, 5, 5.5, 6, 7, 8, 9, 10, 11, 12, 13 (L=25 mm); CrV 50BV30;
- 1/2" (12.7 mm): 10, 13, 14, 15, 17, 19, 21 mm (L=76 mm), 1/4" (6.3 mm): 6, 7, 8, 9, 10, 11, 12, 13 (L=50 mm); CrV 50BV30;
- 1/2" (12.7 mm): E10, E11, E12, E14, E16, 1/4" (6.3 mm): E4, E5, E6, E7, E8; CrV 50BV30;
- 1/2" (12.7 mm): (127, 254 mm), 1/4" (6.3 mm): (50.8, 101.6 mm); CrV 50BV30;
- 1/2" (12.7 mm): CrV 50BV30;
- 1/2" (12.7 mm): 16, 21 mm; CrV 50BV30;
- 1/2" (12.7 mm): (255 mm), 1/4" (6.3 mm): (152.4 mm); CrV 50BV30;
- 1/2" (12.7 mm): (255 mm), 1/4" (6.3 mm): (155 mm); CrV 6140;
- 1/4" (6.3 mm): (150 mm); CrV 50BV30;
- 1/4" (6.3 mm): 4, 5.5, 6.5 mm; AISI S2 / CrV 6150;
- 1/4" (6.3 mm): PH1 (x2), PH2 (x2), PH3; AISI S2 / CrV 6150;
- 1/4" (6.3 mm): PZ1, PZ2, PZ3; AISI S2 / CrV 6150;
- 1/4" (6.3 mm): T8, T10, T15, T20, T25, T30, T40; AISI S2 / CrV 6150;
- 1/4" (6.3 mm): 3, 4, 5, 6, 7, 8 mm; AISI S2 / CrV 6150

Drawer 2 / Szufiada 2

- Ø 3-6 mm (L=52 mm), Ø 6-8 (L=58 mm), Ø 8-11 (L=66 mm), Ø 11-14 (L=75 mm), Ø 14-18 (L=80 mm), Ø 18-25 (L=88 mm);
- 8, 9, 10, 11, 12, 13, 14, 15, 16, 17, 18, 19, 21, 22, 24 mm; CrV;
- 200 mm; CrV;
- T10, T15, T20, T25, T27, T30, T40, T45, T50; CrV 6150;
- 2, 2.5, 3, 4, 5, 6, 7, 8, 10, 12 mm; CrV 6150

Drawer 3 / Szufiada 3

- 6x100 mm; CrV 6150; PH2x100 mm; CrV 6150;
- 6x38, 3x75 mm; S2; PH0x75, PH2x38 mm; S2;
- 180 mm; CrV 50;
- 160 mm; CrV 50;
- 160 mm; CrV 6150;
- 150 mm;
- 180 mm; CrMo;
- 180 mm; CrV 50;
- 180 mm; CrV 50;
- 180 mm; CrV 50;
- 180 mm; CrV 50;
- 1.5, 2, 2.5, 3, 4, 5, 6, 8, 10 mm; CrV 6150



YATO	Drawer quantity / Liczba szuflad	
YT-55308	7	1

EN Service tool cabinet with tools
 PL Szafka serwisowa z narzędziami
 DE Werkstattwagen mit Werkzeug
 RU Сервисный шкаф с инструментами
 CZ Vozík servisní s nářadím
 HU Szerszámokcsi szerszámokkal

RO Dulap echipat cu scule
 FR Servante d'atelier complète
 IT Armadio da officina con attrezzi
 ES Carro taller con herramientas
 CN 维修工具柜

165 PCS	958x766 x465 mm	7x	BALL BEARINGS ŁOŻYSKA KULKOWE	DRAWERS LOCKING BLOKADA SZUFLAD	CENTRAL LOCK BLOKADA CENTRALNA
NON SLIP WORKTOP BLAT ANTY- PCŚLISZĄCY	∅125mm	BRAKE HAMULEC	UNIVERSAL PERFORATION UNIWERSALNA PERFORACJA	DOUBLE WALLS PODWOJNE ŚCIANY	CORNER BUMPERS NAROŻNE CŁECZKI
					3x1

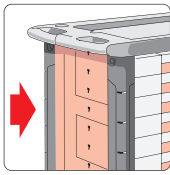

Drawer 1 / Szuflada 1

- 1/2" (12.7 mm), 3/8" (9.5 mm);
- T20, T25, T30, T40, T45, T50, T55 (L=30 mm);
- T20, T25, T30, T40, T45, T50, T55 (L=75 mm); AISI S2;
- 4, 5, 6, 7, 8, 10, 12 mm (L=30 mm); 4, 5, 6, 7, 8, 10, 12 mm (L=75 mm); AISI S2;
- M5, M6, M8, M10, M12 (L=30 mm); M5, M6, M8, M10, M12 (L=75 mm); AISI S2;
- 6, 7, 8, 9, 10, 11, 12, 13, 14, 15, 16, 17, 18, 19, 20, 21 mm; CrV;
- 22, 24, 27, 28, 30, 32 mm; CrV

Drawer 2 / Szuflada 2

- 1/2" (12.7 mm): 10, 11, 12, 13, 14, 15, 16, 17, 18, 19, 20, 21, 22, 23, 24, 27, 30, 32 mm; CrV 50BV30;
- 1/2" (12.7 mm); (127 mm); CrV 50BV30;
- 1/2" (12.7 mm); CrV 50BV30;
- 1/2" (12.7 mm): 16; 21 mm; CrV 50BV30;
- 1/2" (12.7 mm); (255 mm); CrV 50BV30;
- 1/2" (12.7 mm); (255 mm); 72T; CrV 6140;
- 1/4" (6.3 mm): 3.5, 4, 4.5, 5, 5.5, 6, 7, 8, 9, 10, 11, 12, 13, 14 mm; CrV 50BV30;
- 1/4" (6.3 mm): 8, 10, 11, 12, 13 mm; CrV 50BV30;
- 1/4" (6.3 mm); (50.8, 101.6 mm); CrV 6140;
- 1/4" (6.3 mm); CrV 50BV30;
- 1/4" (6.3 mm); (152.4 mm); CrV 50BV30;
- 1/4" (6.3 mm); (155 mm); 72T; CrV 6140;
- 1/4" (6.3 mm); (150 mm); CrV 50BV30;
- 180 mm;
- 160 mm;
- 160 mm long nose;
- 160 mm bent nose

Drawer 3 / Szuflada 3

- 3x75, 5x100, 5x150, 6x38, 6x100, 6x150, 8x150 mm; CrMo;
- PH0x100, PH1x75, PH1x100, PH2x38, PH2x100, PH2x150, PH3x150 mm; CrMo;
- 180, 250 mm;
- 280 mm

Drawer 4 / Szuflada 4

- 3/4" (19.0 mm): 21, 22, 24, 27, 28, 29, 30, 32, 34, 36, 41, 46, 50, 55 mm; CrV 50BV30;
- 3/4" (19.0 mm); (200 mm); CrV 6140;
- 3/4" (19.0 mm); CrV 50BV30;
- 3/4" (19.0 mm); (500 mm); 72T; CrV 6140;
- 3/4" (19.0 mm); (500 mm); CrV 50BV30

Drawer 5 / Szuflada 5

- 1/2" (12.7 mm) x 5/16" (7.9 mm);
- 8 mm (L=35 mm); 8 mm (L=75 mm);
- PH3 (L=35 mm); PH1, PH2, PH3 (L=75 mm);
- 12-38 mm;
- 3" (75 mm);
- 82 mm;
- 200 mm;
- 135 mm;
- 300, 400, 500 mm



13 interchangeable trays with YATO tools
 13 wymiennych modułów z narzędziami YATO

YATO	Drawer quantity / Liczba szuflad	
YT-55293	7	1

EN Service tool cabinet with tools
PL Szafka serwisowa z narzędziami
DE Werkstattwagen mit Werkzeug
RU Сервисный шкаф с инструментами
CZ Vozík servisní s nářadím
HU Szerszámkocsi szerszámokkal

RO Dulap echipat cu scule
FR Servante d'atelier complète
IT Armadio da officina con attrezzi
ES Carro taller con herramientas
CN 维修工具柜

177 PCS	958x766 x465 mm	6x	BALL BEARINGS ŁOŻYSKA KULKOWE	DRAWERS LOCKING BLOKADA SZUFLAD	NON SLIP WORKTOP BLAT ANTY- POŚLIZGOWY
∅125mm	BRAKE HAMULEC	UNIVERSAL PERFORATION UNIWERSALNA PERFORACJA	DOUBLE WALLS PODWOJNE SCIANY	CORNER BUMPERS NAROZNE CDECJNIKI	2x

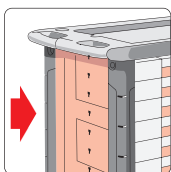

Drawer 1 / Szufiada 1

- 6, 7, 8, 9, 10, 11, 12, 13, 14, 15, 16, 17, 18, 19, 20, 21 mm; CrV;
- 22, 24, 27, 28, 30, 32 mm; CrV;
- 6x7, 8x9, 10x11, 12x13, 14x15, 16x17, 18x19 mm; CrV

Drawer 2 / Szufiada 2

- 3x75, 5x100, 5x150, 6x38, 6x100, 6x150, 8x150 mm; CrMo;
- PH0x100, PH1x75, PH1x100, PH2x38, PH2x100, PH2x150, PH3x150 mm; CrMo;
- 180 mm;
- 160 mm;
- 160 mm long nose;
- 160 mm bent nose

Drawer 3 / Szufiada 3

- 1/2" (12.7 mm): 10, 11, 12, 13, 14, 15, 16, 17, 18, 19, 20, 21, 22, 23, 24, 27, 30, 32 mm; CrV 50BV30;
- 1/2" (12.7 mm): (127 mm); CrV 50BV30;
- 1/2" (12.7 mm); CrV 50BV30;
- 1/2" (12.7 mm): 16; 21 mm; CrV 50BV30;
- 1/2" (12.7 mm); (255 mm); CrV 50BV30;
- 1/2" (12.7 mm); (255 mm); 72T; CrV 6140;
- T20, T25, T30, T40, T45, T50, T55 (L=30 mm); T20, T25, T30, T40, T45, T50, T55 (L=75 mm); AISI S2;
- 4, 5, 6, 7, 8, 10, 12 mm (L=30 mm); 4, 5, 6, 7, 8, 10, 12 mm (L=75 mm); AISI S2;
- M5, M6, M8, M10, M12 (L=30 mm); M5, M6, M8, M10, M12 (L=75 mm); AISI S2;
- 1/2" (12.7 mm), 3/8" (9.5 mm);
- 1/2" (12.7 mm): 8, 9, 10, 11, 12, 13, 14, 15, 16, 17, 18, 19, 20, 21 mm (L=76 mm); CrV 50BV30

Drawer 4 / Szufiada 4

- 300 g (L=300 mm);
- 40 mm (L=350 mm);
- 10x8x142 mm, 12x10x152 mm, 16x13x172 mm;
- 3/8" (9.5 mm): 6, 7, 8, 9, 10, 11, 12, 13, 14, 15, 16, 17, 18, 19, 20, 21, 22 mm; CrV 50BV30;
- 3/8" (9.5 mm): (76, 152.4 mm); CrV 50BV30;
- 3/8" (9.5 mm); CrV 50BV30;
- 3/8" (9.5 mm); (198 mm); CrV 50BV30;
- 3/8" (9.5 mm); (200 mm); 72T; CrV 6140;
- 1/4" (6.3 mm): 3.5, 4, 4.5, 5, 5.5, 6, 7, 8, 9, 10, 11, 12, 13, 14 mm; CrV 50BV30;
- 1/4" (6.3 mm): 8, 10, 11, 12, 13 mm; CrV 50BV30;
- 1/4" (6.3 mm): (50.8, 101.6 mm); CrV 6140;
- 1/4" (6.3 mm); CrV 50BV30;
- 1/4" (6.3 mm); (152.4 mm); CrV 50BV30
- 1/4" (6.3 mm); (155 mm); 72T; CrV 6140;
- 1/4" (6.3 mm); (150 mm); CrV 50BV30



12 interchangeable trays with YATO tools
12 wymiennych modułów z narzędziami YATO

YATO	Drawer quantity / Liczba szuflad	
YT-5530	6	1

EN Service tool cabinet with tools
 PL Szafka serwisowa z narzędziami
 DE Werkstatwagen mit Werkzeug
 RU Сервисный шкаф с инструментами
 CZ Vozík servisní s nářadím
 HU Szerszámkocsi szerszámokkal

RO Dulap echipat cu scule
 FR Servante d'atelier complète
 IT Armadio da officina con attrezzi
 ES Carro taller con herramientas
 CN 维修工具柜

177 PCS	975x765 x 465 mm	6x DRAWERS	BALL BEARINGS ŁOŻYSKA KULKOWE	DRAWERS LOCKING BLOKADA SZUFLAD	NON-SLIP WORKTOP BLAT ANTY- POŚLISZOWY
∅125mm WHEELS	2x BRAKE HAMULEC	UNIVERSAL PERFORATION UNIWERSALNA PERFORACJA	DOUBLE WALLS PODWOJNE ŚCIANY	CORNER BUMPERS NARÓŻNE CDECIENIKI	2x KEYS

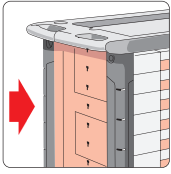

Drawer 1 / Szuflada 1

- 6, 7, 8, 9, 10, 11, 12, 13, 14, 15, 16, 17, 18, 19, 20, 21 mm; CrV;
- 22, 24, 27, 28, 30, 32 mm; CrV;
- 6x7, 8x9, 10x11, 12x13, 14x15, 16x17, 18x19 mm; CrV

Drawer 2 / Szuflada 2

- 3x75, 5x100, 5x150, 6x38, 6x100, 6x150, 8x150 mm; CrMo;
- PH0x100, PH1x75, PH1x100, PH2x38, PH2x100, PH2x150, PH3x150 mm; CrMo;
- 180 mm;
- 160 mm;
- 160 mm long nose;
- 160 mm bent nose

Drawer 3 / Szuflada 3

- 1/2" (12.7 mm): 10, 11, 12, 13, 14, 15, 16, 17, 18, 19, 20, 21, 22, 23, 24, 27, 30, 32 mm; CrV 50BV30;
- 1/2" (12.7 mm); (127 mm); CrV 50BV30;
- 1/2" (12.7 mm); CrV 50BV30;
- 1/2" (12.7 mm): 16, 21 mm; CrV 50BV30;
- 1/2" (12.7 mm); (255 mm); CrV 50BV30;
- 1/2" (12.7 mm); (255 mm); 72T; CrV 6140;
- T20, T25, T30, T40, T45, T50, T55 (L=30 mm); T20, T25, T30, T40, T45, T50, T55 (L=75 mm); AISI S2;
- 4, 5, 6, 7, 8, 10, 12 mm (L=30 mm); 4, 5, 6, 7, 8, 10, 12 mm (L=75 mm); AISI S2;
- M5, M6, M8, M10, M12 (L=30 mm); M5, M6, M8, M10, M12 (L=75 mm); AISI S2;
- 1/2" (12.7 mm), 3/8" (9.5 mm);
- 1/2" (12.7 mm): 8, 9, 10, 11, 12, 13, 14, 15, 16, 17, 18, 19, 20, 21 mm (L=76 mm); CrV 50BV30

Drawer 4 / Szuflada 4

- 300 g (L=300 mm);
- 40 mm (L=350 mm);
- 10x8x142 mm, 12x10x152 mm, 16x13x172 mm;
- 3/8" (9.5 mm): 6, 7, 8, 9, 10, 11, 12, 13, 14, 15, 16, 17, 18, 19, 20, 21, 22 mm; CrV 50BV30;
- 3/8" (9.5 mm); (76, 152.4 mm); CrV 50BV30;
- 3/8" (9.5 mm); CrV 50BV30;
- 3/8" (9.5 mm); (198 mm); CrV 50BV30;
- 3/8" (9.5 mm); (200 mm); 72T; CrV 6140;
- 1/4" (6.3 mm): 3.5, 4, 4.5, 5, 5.5, 6, 7, 8, 9, 10, 11, 12, 13, 14 mm; CrV 50BV30;
- 1/4" (6.3 mm): 8, 10, 11, 12, 13 mm; CrV 50BV30;
- 1/4" (6.3 mm); (50.8, 101.6 mm); CrV 6140;
- 1/4" (6.3 mm); CrV 50BV30;
- 1/4" (6.3 mm); (152.4 mm); CrV 50BV30
- 1/4" (6.3 mm); (155 mm); 72T; CrV 6140;
- 1/4" (6.3 mm); (150 mm); CrV 50BV30

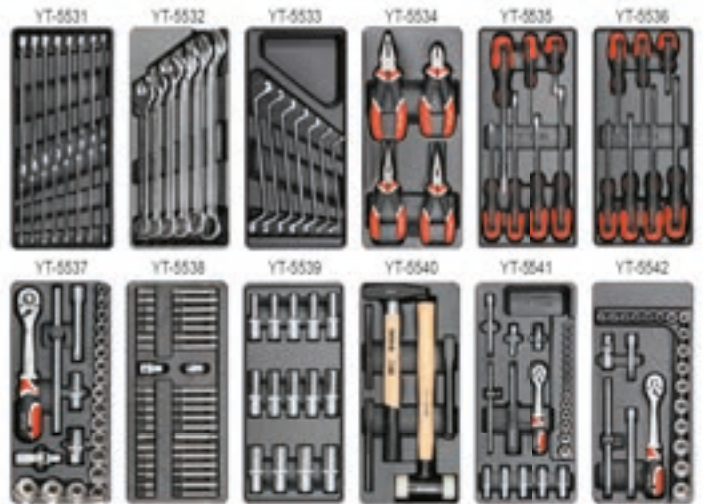

13 interchangeable trays with YATO tools
 13 wymiennych modułów z narzędziami YATO

YATO	Drawer quantity / Liczba szuflad	
YT-55300	6	1

EN Service tool cabinet with tools
PL Szafka serwisowa z narzędziami
DE Werkstattwagen mit Werkzeug
RU Сервисный шкаф с инструментами
CZ Vozík servisní s nářadím
HU Szerszámköcsi szerszámokkal

RO Dulap echipat cu scule
FR Servante d'atelier complète
IT Armadio da officina con attrezzi
ES Carro taller con herramientas
CN 维修工具柜

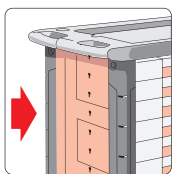

Drawer 1 / Szufiada 1

- 6, 7, 8, 9, 10, 11, 12, 13, 14, 15, 16, 17, 18, 19, 20, 21 mm; CrV;
- 22, 24, 27, 28, 30, 32 mm; CrV;
- 6x7, 8x9, 10x11, 12x13, 14x15, 16x17, 18x19 mm; CrV

Drawer 2 / Szufiada 2

- 3x75, 5x100, 5x150, 6x38, 6x100, 6x150, 8x150 mm; CrMo;
- PH0x100, PH1x75, PH1x100, PH2x38, PH2x100, PH2x150, PH3x150 mm; CrMo;
- 180 mm;
- 160 mm;
- 160 mm long nose;
- 160 mm bent nose

Drawer 3 / Szufiada 3

- 1/2" (12.7 mm): 10, 11, 12, 13, 14, 15, 16, 17, 18, 19, 20, 21, 22, 23, 24, 27, 30, 32 mm; CrV 50BV30;
- 1/2" (12.7 mm); (127 mm); CrV 50BV30;
- 1/2" (12.7 mm); CrV 50BV30;
- 1/2" (12.7 mm): 16, 21 mm; CrV 50BV30;
- 1/2" (12.7 mm); (255 mm); CrV 50BV30;
- 1/2" (12.7 mm); (255 mm); T2T; CrV 6140;
- T20, T25, T30, T40, T45, T50, T55 (L=30 mm); T20, T25, T30, T40, T45, T50, T55 (L=75 mm); AISI S2;
- 4, 5, 6, 7, 8, 10, 12 mm (L=30 mm); 4, 5, 6, 7, 8, 10, 12 mm (L=75 mm); AISI S2;
- M5, M6, M8, M10, M12 (L=30 mm); M5, M6, M8, M10, M12 (L=75 mm); AISI S2;
- 1/2" (12.7 mm), 3/8" (9.5 mm);
- 1/2" (12.7 mm): 8, 9, 10, 11, 12, 13, 14, 15, 16, 17, 18, 19, 20, 21 mm (L=76 mm); CrV 50BV30

Drawer 4 / Szufiada 4

- 300 g (L=300 mm);
- Ø 40 mm (L=350 mm);
- 10x8x142 mm, 12x10x152 mm, 16x13x170 mm;
- 1/4" (6.3 mm): 3.5, 4, 4.5, 5, 5.5, 6, 7, 8, 9, 10, 11, 12, 13, 14 mm; CrV 50BV30;
- 1/4" (6.3 mm): 8, 10, 11, 12, 13 mm; CrV 50BV30;
- 1/4" (6.3 mm); (50.8, 101.6 mm); CrV 6140;
- 1/4" (6.3 mm); CrV 50BV30;
- 1/4" (6.3 mm); (152.4 mm); CrV 50BV30;
- 1/4" (6.3 mm); (155 mm); T2T; CrV 6140;
- 1/4" (6.3 mm); (150 mm); CrV 50BV30;
- 1/2" (12.5 mm): E10, E12, E14, E16, E18, E20;
- 1/4" (6.3 mm): E4, E5, E6, E7, E8;
- 2, 2.5, 3, 4, 5, 6, 7, 8, 10, 12 mm;
- T10, T15, T20, T25, T27, T30, T40, T45, T50

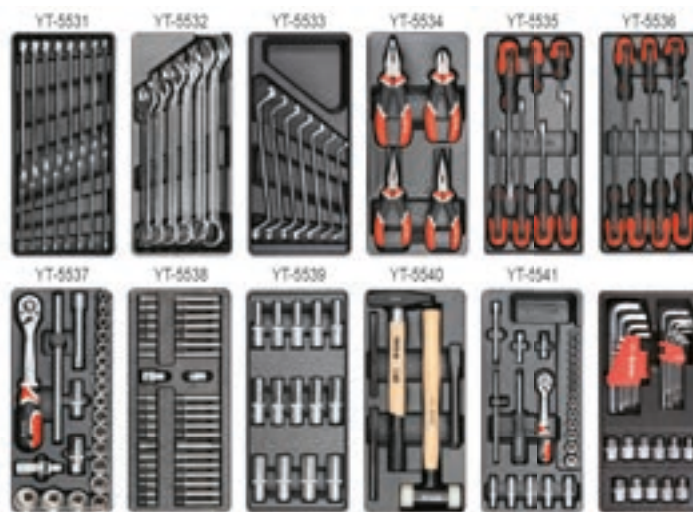

12 interchangeable trays with YATO tools
12 wymiennych modułów z narzędziami YATO

YATO	Drawer quantity / Liczba szuflad	
YT-55307	6	1

EN Service tool cabinet with tools
 PL Szafka serwisowa z narzędziami
 DE Werkstattwagen mit Werkzeug
 RU Сервисный шкаф с инструментами
 CZ Vozík servisní s nářadím
 HU Szerszámkocsi szerszámokkal

RO Dulap echipat cu scule
 FR Servante d'atelier complète
 IT Armadio da officina con attrezzi
 ES Carro taller con herramientas
 CN 维修工具柜

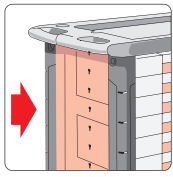

211 PCS	980x770 x465 mm	7x	BALL BEARINGS ŁOŻYSKA KULKOWE
DRAWERS LOCKING BLOKADA SZUFLAD	NON SLIP WORKTOP BLAT ANTI- POŚLIZGOWY	Ø125mm	CORNER BUMPERS NARÓŻNI ODBOJNIKI
E/F/A/E FAMILLEC	UNIVERSAL PERFORATION UNIWERSALNA PERFORACJA	DOUBLE WALLS PODWÓJNE SCIANY	3xT

Drawer 1 / Szufłada 1

- 1/2" (12.7 mm): 8, 9, 10, 11, 12, 13, 14, 15, 16, 17, 18, 19, 20, 21, 22, 24 mm (L=38 mm); 27, 30, 32 mm (L=42 mm), 1/4" (6.3 mm): 4, 4.5, 5, 5.5, 6, 7, 8, 9, 10, 11, 12, 13 mm (L=25 mm); CrV 50BV30;
- 1/2" (12.7 mm): 10, 13, 14, 15, 17, 19, 21 mm (L=76 mm), 1/4" (6.3 mm): 6, 7, 8, 9, 10, 11, 12, 13 mm (L=50 mm); CrV 50BV30;
- 1/2" (12.7 mm): E10, E11, E12, E14, E16, 1/4" (6.3 mm): E4, E5, E6, E7, E8; CrV 50BV30;
- 1/2" (12.7 mm): (127, 254 mm), 1/4" (6.3 mm): (50.8, 101.6 mm); CrV 50BV30;
- 1/2" (12.7 mm); CrV 50BV30;
- 1/2" (12.7 mm): 16, 21 mm; CrV 50BV30;
- 1/2" (12.7 mm): (255 mm), 1/4" (6.3 mm): (152.4 mm); CrV 50BV30;
- 1/2" (12.7 mm): (255 mm), 1/4" (6.3 mm): (155 mm); CrV 6140;
- 1/4" (6.3 mm): (150 mm); CrV 50BV30;
- 1/4" (6.3 mm): 4, 5.5, 6.5 mm; AISI S2 / CrV 6150;
- 1/4" (6.3 mm): PH1 x2, PH2 x2, PH3; AISI S2 / CrV 6150;
- 1/4" (6.3 mm): PZ1, PZ2, PZ3; AISI S2 / CrV 6150;
- 1/4" (6.3 mm): T8, T10, T15, T20, T25, T30, T40; AISI S2 / CrV 6150;
- 1/4" (6.3 mm): 3, 4, 5, 6, 7, 8 mm; AISI S2 / CrV 6150

Drawer 2 / Szufłada 2

- 200 mm; CrV;
- Ø 3-6 mm (L=52 mm), Ø 6-8 mm (L=58 mm), Ø 8-11 mm (L=66 mm), Ø 11-14 mm (L=75 mm), Ø 14-18 mm (L=80 mm), Ø 18-25 mm (L=88 mm);
- 8, 9, 10, 11, 12, 13, 14, 15, 16, 17, 18, 19, 21, 22, 24 mm; CrV;
- T10, T15, T20, T25, T27, T30, T40, T45, T50; CrV 6150;
- 2, 2.5, 3, 4, 5, 6, 7, 8, 10, 12 mm; CrV 6150

Drawer 3 / Szufłada 3

- 6x38, 2x75, 3x75, 4x100, 5x100, 6x100 mm; PH0x100, PH1x100, PH2x38, PH2x150, PH3x150 mm; T7x75, T8x75, T9x75, T10x100, T15x100, T20x100, T25x100, T27x100 mm; S2; 6.0x150 mm; PH2x150 mm; CrV 6150

Drawer 4 / Szufłada 4

- 180 mm;
- 160 mm;
- 200 mm;
- 250 mm;
- 400 g;
- 340 g;
- 12.5x152, 16.0x172 mm; CrV 6150;
- 3x150, 4x150, 5x150, 6x150, 8x150 mm; CrV 6150;
- 8x112 mm; CrV 6150

Drawer 5 / Szufłada 5

- M3x0.5 x3, M4x0.7 x3, M5x0.8 x3, M6x1.0 x3, M7x1.0 x3, M8x1.25 x3, M10x1.5 x3, M12x1.75 x3; HSS M2;
- M3, M4x0.7, M5x0.8, M6x1.0, M7x1.0, M8x1.25, M10x1.5, M12x1.75; HSS M2;
- M7-M9;
- M3-M12;
- #2, 200 mm;
- #2, 200 mm;
- #2, 200 mm;
- LED;
- 3 m x 16 mm;
- 300 mm;
- 0-150 mm

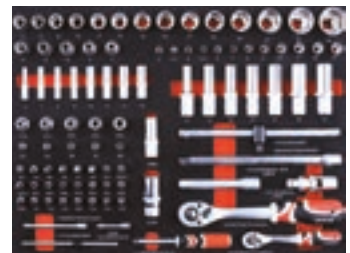

YATO	Drawer quantity / Liczba szuflad	
YT-55290	7	1

CREATE YOUR WORKPLACE - STWÓRZ SWOJE MIEJSCE PRACY

YT-09061



YT-09152



YT-08922



YT-08921



YT-08920

- EN Tool chest
PL Szafka warsztatowa
DE Werkzeugkasten
RU Портативный ящик для инструментов
CZ Přenosná skříňka na nářadí
HU Hordozható szerszámós láda
RO Cabinet pt. scule
FR Servante d'atelier
IT Armadio con cassette per officina
ES Cajonera portátil
CN 工具箱

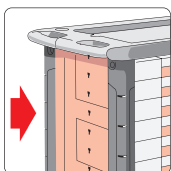
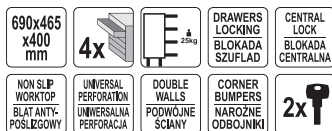

YATO

Drawer quantity / Liczba szuflad



YT-09152

4

1

- EN Roller cabinet
PL Szafka serwisowa
DE Werkstattrollwagen
RU Инструментальный кабинет
CZ Dilenská skříňka
HU Szerszámós kocsi
RO Dulap de scule
FR Servante d'atelier
IT Armadio da officina per attrezzi
ES Armario en ruedas
CN 高档6抽层边柜工具车

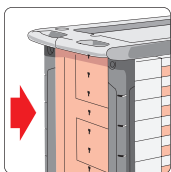
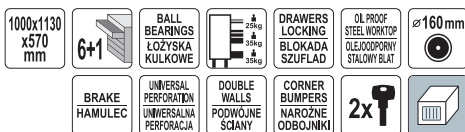

YATO

Drawer quantity / Liczba szuflad



YT-09002

6+1

1

- EN Tool chest
PL Szafka warsztatowa
DE Werkzeugkasten
RU Портативный ящик для инструментов
CZ Přenosná skříňka na nářadí
HU Hordozható szerszámós láda
RO Cabinet pt. scule
FR Servante d'atelier
IT Armadio con cassette per officina
ES Cajonera portátil
CN 工具箱

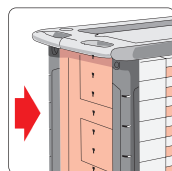
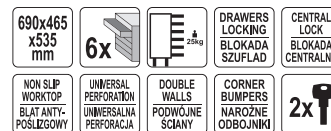

YATO

Drawer quantity / Liczba szuflad



YT-09155

6

1

- EN Roller cabinet
PL Szafka serwisowa
DE Werkstattrollwagen
RU Инструментальный кабинет
CZ Dilenská skříňka
HU Szerszámós kocsi
RO Dulap de scule
FR Servante d'atelier
IT Armadio da officina per attrezzi
ES Armario en ruedas
CN 高档12抽层工具车

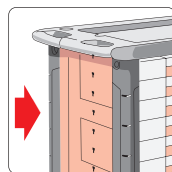

YATO

Drawer quantity / Liczba szuflad







YT-09003



12

1



EN Roller cabinet
 PL Szafka serwisowa
 DE Werkstattrollwagen
 RU Инструментальный кабинет
 CZ Dilenská skříňka
 HU Szerszámokocsi
 RO Dulap de scule
 FR Servante d'atelier
 IT Armadio da officina per attrezzi
 ES Armario en ruedas
 CN 工具车







982x755 x455 mm	 7x	BALL BEARINGS ŁOŻYSKA KULKOWE
	DRAWERS LOCKING BLOKADA SZUFLAD	 01***
NON SLIP WORKTOP BLAT ANTY- POŚLIZGOWY	∅125mm	2x BRAKE HAMULEC
 LED LIGHT DIODA		

YATO 	Drawer quantity / Liczba szuflad	
YT-09004	7	1



EN Roller cabinet
 PL Szafka serwisowa
 DE Werkstattrollwagen
 RU Инструментальный кабинет
 CZ Dilenská skříňka
 HU Szerszámokocsi
 RO Dulap de scule
 FR Servante d'atelier
 IT Armadio da officina per attrezzi
 ES Armario en ruedas
 CN 工具车

977x725 x480 mm	 7x	BALL BEARINGS ŁOŻYSKA KULKOWE	 CENTRAL LOCK BLOKADA CENTRALNA
	OIL PROOF STEEL WORKTOP OLEOODPORNY STALOWY BLAT	∅120mm	2x BRAKE HAMULEC
	CORNER BUMBERS NAROŻNE ODBOJNIKI	2x KEY KŁUCZYK	



EN Roller cabinet
 PL Szafka serwisowa
 DE Werkstattrollwagen
 RU Инструментальный кабинет
 CZ Dilenská skříňka
 HU Szerszámokocsi
 RO Dulap de scule
 FR Servante d'atelier
 IT Armadio da officina per attrezzi
 ES Armario en ruedas
 CN 工具车

1100x990 x480 mm	 7x	 1x	BALL BEARINGS ŁOŻYSKA KULKOWE	
CENTRAL LOCK BLOKADA CENTRALNA		OIL PROOF STEEL WORKTOP OLEOODPORNY STALOWY BLAT	∅120mm	2x BRAKE HAMULEC
UNIVERSAL PERFORATION UNIWERSALNA PERFORACJA	CORNER BUMBERS NAROŻNE ODBOJNIKI	2x KEY KŁUCZYK		



YATO 	Drawer quantity / Liczba szuflad	
YT-09032	7	1



YATO 	Drawer quantity / Liczba szuflad	
YT-09033	7+1	1

EN Roller cabinet
PL Szafka serwisowa
DE Werkstattrollwagen
RU Инструментальный кабинет
CZ Dilenská skříňka
HU Szerszámokocsi
RO Dulap de scule
FR Servante d'atelier
IT Armadio da officina per attrezzi
ES Armario en ruedas
CN 工具车



YATO Drawer quantity / Liczba szuflad
YT-0913 6 1

EN Roller cabinet
PL Szafka serwisowa
DE Werkstattrollwagen
RU Инструментальный кабинет
CZ Dilenská skříňka
HU Szerszámokocsi
RO Dulap de scule
FR Servante d'atelier
IT Armadio da officina per attrezzi
ES Armario en ruedas
CN 工具车

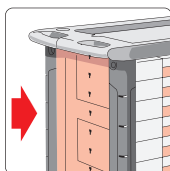
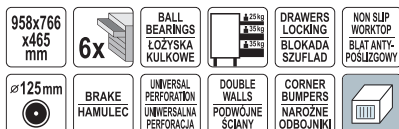

YATO Drawer quantity / Liczba szuflad
YT-0902 6 1

EN Roller cabinet
PL Szafka serwisowa
DE Werkstattrollwagen
RU Инструментальный кабинет
CZ Dilenská skříňka
HU Szerszámokocsi
RO Dulap de scule
FR Servante d'atelier
IT Armadio da officina per attrezzi
ES Armario en ruedas
CN 工具车



YATO Drawer quantity / Liczba szuflad
YT-0914 7 1

EN Roller cabinet
PL Szafka serwisowa
DE Werkstattrollwagen
RU Инструментальный кабинет
CZ Dilenská skříňka
HU Szerszámokocsi
RO Dulap de scule
FR Servante d'atelier
IT Armadio da officina per attrezzi
ES Armario en ruedas
CN 工具车

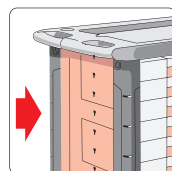

YATO Drawer quantity / Liczba szuflad
YT-55299 6 1

EN Roller cabinet
 PL Szafka serwisowa
 DE Werkstatttrollwagen
 RU Инструментальный кабинет
 CZ Dilenská skříňka
 HU Szerszámos kocsí
 RO Dulap de scule
 FR Servante d'atelier
 IT Armadio da officina per attrezzi
 ES Armario en ruedas
 CN 工具车

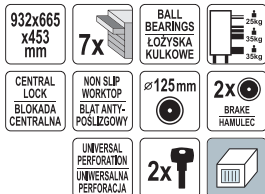

YATO	Drawer quantity / Liczba szuflad	
YT-09000	7	1

EN Shutter cabinet
 PL Szafka wisząca
 DE Werkstatt Hängeschrank
 RU Шкафчик для инструмента настенный
 CZ Zavěsná skříňka
 HU Szerszámtároló
 RO Raft de scule
 FR Placard d'atelier
 IT Scaffale
 ES Armario colgante
 CN 卷帘柜



YATO	Dimensions / Wymiary [mm]	
YT-09061	1500x605x185	1

EN Drawer insert / Combination spanners
 PL Wkład do szuflady / Klucze płasko-oczkowe
 DE Schubladeneinlage / Schrauben- und Ringschlüssel
 RU Вклад к выдвижному ящику / Плоско-закрытый накладной ключ
 CZ Vložka do zásuvky / Klíče ploché-očkové
 HU Fiókbetét / Csillag - villás kulcsok
 RO Adaos la sertar / Chei plane - inelare
 FR Module plastique pour servante clés mixtes
 IT Tenone per l'armadio chiavi
 ES Accesorio de cajón / Llave española de muletilla
 CN 两用扳手托盘组套



22, 24, 27, 28, 30, 32 mm; CrV

YATO		
YT-5532		4

EN Workshop trolley
 PL Wózek warsztatowy
 DE Werkstatt-Servicewagen
 RU Сервисная тележка
 CZ Dilenský policový vozík
 HU Műhelykocsi
 RO Carucior pt. scule
 FR Chariot d'atelier
 IT Carrello da officina
 ES Carro para taller
 CN 3抽屉工具车



YATO	Tray quantity / Liczba pólek	
YT-55210	3	1

EN Workbench
 PL Stół warsztatowy
 DE Werkbank
 RU Бесстак
 CZ Pracovní stůl
 HU Munkapad
 RO Banc de lucru
 FR Table d'atelier
 IT Banco da lavoro
 ES Banco de trabajo
 CN 工作台



YATO	Dimensions / Wymiary [mm]	
YT-08920	1500x780x830	1

EN Drawer insert / Bi-hexagonal ring spanner
 PL Wkład do szuflady / Klucze oczkowe odgięte
 DE Schubladeneinlage / Doppelringschlüssel
 RU Вклад к выдвижному ящику / Ключ накидной изогнутый
 CZ Vložka do zásuvky / Klíče očkové ohnuté
 HU Fiókbetét / Hajlítottszerű csillagkulcs
 RO Adaos la sertar / Chei inelaro-curbată
 FR Module plastique pour servante clés contre-coudées
 IT Tenone per l'armadio chiavi
 ES Accesorio de cajón / Llave de estrella
 CN 双头高颈梅花扳手托盘组套



21x23, 24x27, 25x28, 30x32 mm; CrV

YATO		
YT-5543		8

EN Drawer insert / Combination spanners
PL Wkład do szuflady / Klucze płasko-oczkowe
DE Schubladeneinlage / Schrauben- und Ringschlüssel
RU Вклад к выдвижному ящику / Плоско-закрытый накладной ключ
CZ Vložka do zásuvky / Klíče ploché-očkové
HU Fiókbetét / Csillag - villás kulcsok
RO Adaos la sertar / Chei plane - inelare
FR Module plastique pour servante avec clés mixtes
IT Tenone per l'armadio chiavi
ES Accesorio de cajón / Llave española de muletilla
CN 两用扳手托盘组套

16
PCS CrV

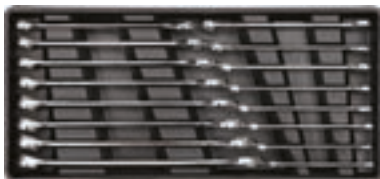

6, 7, 8, 9, 10, 11, 12, 13, 14, 15, 16, 17, 18, 19, 20, 21 mm; CrV

YATO
YT-5531 8

EN Drawer insert / Bi-hexagonal ring spanner
PL Wkład do szuflady / Klucze oczkowe odgięte
DE Schubladeneinlage / Doppelringschlüssel
RU Вклад к выдвижному ящику / Ключ накидной изогнутый
CZ Vložka do zásuvky / Klíče očkové ohnuté
HU Fiókbetét / Hajlítotszárú csillagkulcs
RO Adaos la sertar / Chei inelaro-curbată
FR Module plastique pour servante clés contre-coudées
IT Tenone per l'armadio chiavi
ES Accesorio de cajón / Llave de estrella
CN 双头高颈梅花扳手托盘组套

7
PCS CrV



6x7, 8x9, 10x11, 12x13, 14x15, 16x17, 18x19 mm; CrV

YATO
YT-5533 8

EN Drawer insert / L-type socket wrench
PL Wkład do szuflady / Klucz nasadowy typ „L”
DE Schubladeneinlage / Steckschlüssel gebogen
RU Вклад к выдвижному ящику / Ключ торцевой L-типа
CZ Vložka do zásuvky / Nástrčný klíč fajtkový
HU Fiókbetét / Kulcs, dugó-pipa
RO Adaos la sertar / Cheie tubulara cu cot tip „L”
FR Module plastique pour servante / Clé a douille de type „L”
IT Tenone per l'armadio / Chiave a tubo tipo „L”
ES Accesorio de cajón / Llave de vaso „L”
CN 套筒托盘工具组套

10
PCS CrV



7, 8, 9, 10, 11, 12, 13, 14, 17, 19 mm; CrV

YATO
YT-55456 4

EN Drawer insert / Pliers
PL Wkład do szuflady / Szczypce
DE Schubladeneinlage / Zangen
RU Вклад к выдвижному ящику / Клещи
CZ Vložka do zásuvky / Kleště
HU Fiókbetét / Fogó készlet
RO Adaos la sertar / Clește
FR Module plastique pour servante avec pinces
IT Tenone per l'armadio / Pinze
ES Accesorio de cajón / Pinzas
CN 钳子托盘组套

4
PCS CrV



180 mm; CrV;
160 mm; CrV;
160 mm long nose; CrV;
160 mm bent nose; CrV

YATO
YT-5534 8

EN Drawer insert / Pliers
PL Wkład do szuflady / Szczypce
DE Schubladeneinlage / Zangen
RU Вклад к выдвижному ящику / Клещи
CZ Vložka do zásuvky / Kleště
HU Fiókbetét / Zégerfogó készlet
RO Adaos la sertar / Clește
FR Module plastique pour servante avec pinces
IT Tenone per l'armadio / Pinze
ES Accesorio de cajón / Pinzas
CN 卡簧钳托盘组套

4
PCS CrV



180 mm; external straight; CrV;
180 mm; internal straight; CrV;
180 mm; external bent; CrV;
180 mm; internal bent; CrV

YATO
YT-55443 8

EN Drawer insert / Pliers
PL Wkład do szuflady / Szczypce
DE Schubladeneinlage / Zangen
RU Вклад к выдвижному ящику / Клещи
CZ Vložka do zásuvky / Kleště
HU Fiókbetét / Fogók
RO Adaos la sertar / Clește
FR Module plastique pour servante avec pinces
IT Tenone per l'armadio / Pinze
ES Accesorio de cajón / Pinzas
CN 钳子托盘组套

3
PCS CrMo CrV



180 mm;
250 mm; CrMo;
250 mm; CrV

YATO
YT-55463 8

EN Drawer insert / Pliers
PL Wkład do szuflady / Szczypce
DE Schubladeneinlage / Zangen
RU Вклад к выдвижному ящику / Клещи
CZ Vložka do zásuvky / Kleště
HU Fiókbetét / Fogók
RO Adaos la sertar / Clește
FR Module plastique pour servante avec pinces
IT Tenone per l'armadio / Pinze
ES Accesorio de cajón / Pinzas
CN 大力钳托盘组套

3
PCS CrMo CrV



180 mm; CrMo;
250 mm; CrMo;
280 mm; CrV

YATO
YT-55472 8

EN Drawer insert / Pliers
PL Wkład do szuflady / Szczypce
DE Schubladeneinlage / Zangen
RU Вклад к выдвижному ящику / Клещи
CZ Vložka do zásuvky / Kleště
HU Fiókbetét / Fogók
RO Adaos la sertar / Clește
FR Module plastique pour servante avec pinces
IT Tenone per l'armadio / Pinze
ES Accesorio de cajón / Pinzas
CN 钳子托盘组套

3
PCS CrMo CrV



250 mm; CrV;
125 mm; CrMo;
300 mm; CrV

YATO
YT-55473 8

EN Drawer insert / Tool set for plumbers
 PL Wkład do szuflady / Zestaw narzędziowy dla hydraulików
 DE Schubladeneinlage / Werkzeug-Set für Klempner
 RU Вклад к выдвижному ящику / Набор инструментов для водопроводчик
 CZ Vložka do zásuvky / Sada nářadí pro instalatér
 HU Fiókbetét / Szerszámkészlet vízvezeték-szerelő
 RO Adaos la sertar / Set de instrumente pt. instalator
 FR Module plastique pour servante / Ensemble d'outils pour les plombiers
 IT Tenone per l'armadio / Tool set per idraulici
 ES Accesorio de cajón / Conjunto de herramientas para fontanero
 CN 管道工具组套

4
PCS
CrV
CrMo



250 mm; CrV;
 330 mm; CrV 6140;
 250 mm; CrMo;
 15 m x 19 mm; PTFE



YATO
 YT-55480 5

EN Drawer insert / Tool set for plumbers
 PL Wkład do szuflady / Zestaw narzędziowy dla hydraulików
 DE Schubladeneinlage / Werkzeug-Set für Klempner
 RU Вклад к выдвижному ящику / Набор инструментов для водопроводчик
 CZ Vložka do zásuvky / Sada nářadí pro instalatér
 HU Fiókbetét / Szerszámkészlet vízvezeték-szerelő
 RO Adaos la sertar / Set de instrumente pt. instalator
 FR Module plastique pour servante / Ensemble d'outils pour les plombiers
 IT Tenone per l'armadio / Tool set per idraulici
 ES Accesorio de cajón / Conjunto de herramientas para fontanero
 CN 管道工具组套

5
PCS
CrV
CrMo



250 mm;
 300 mm;
 250 mm; CrV;
 3-32 mm;
 10 m x 12 mm; PTFE



YATO
 YT-55481 5

EN Drawer insert / Pliers and adjustable wrenches
 PL Wkład do szuflady / Szczypce i klucze nastawne
 DE Schubladeneinlage / Zangen und rollgabelschlüssel
 RU Вклад к выдвижному ящику / Клещи и ключ разводной
 CZ Vložka do zásuvky / Kleště, nastavitelný klíč
 HU Fiókbetét / Fogók és állítható svédkulcs
 RO Adaos la sertar / Clește și cheie reglabilă
 FR Module plastique pour servante / Pincés et clé a molette
 IT Tenone per l'armadio / Pinze
 ES Accesorio de cajón / Pinzas y llave ajustable
 CN 活扳手及大力钳托盘组套

4
PCS
CrMo



200 mm;
 250 mm;
 250 mm; CrMo;
 150 mm; CrMo



YATO
 YT-55444 8

EN Drawer insert / Pliers
 PL Wkład do szuflady / Szczypce
 DE Schubladeneinlage / Zangen
 RU Вклад к выдвижному ящику / Клещи
 CZ Vložka do zásuvky / Kleště
 HU Fiókbetét / Fogók
 RO Adaos la sertar / Clește
 FR Module plastique pour servante avec pincés
 IT Tenone per l'armadio / Pinze
 ES Accesorio de cajón / Pinzas
 CN 绝缘钳子托盘组套

4
PCS
CrV



180 mm; 1000V; CrV;
 160 mm; 1000V; CrV;
 160 mm; 1000V; CrV;
 175 mm; 1000V



YATO
 YT-55464 8

EN Drawer insert / Slotted screwdrivers
 PL Wkład do szuflady / Wkrętaki płaskie
 DE Schubladeneinlage / Flachschrauber
 RU Вклад к выдвижному ящику / Плоские отвёртки
 CZ Vložka do zásuvky / Šroubováky ploché
 HU Fiókbetét / Lapos csavarhúzó
 RO Adaos la sertar / Șurubelnițe plane
 FR Module plastique pour servante avec trousseis
 IT Tenone per l'armadio / Set di cacciaviti piatti
 ES Accesorio de cajón / Desarmadores planos
 CN 一字螺丝批托盘组套

7
PCS
CrMo



3x75, 5x100, 5x150, 6x38, 6x100, 6x150, 8x150 mm; CrMo



YATO
 YT-5535 8

EN Drawer insert / Phillips screwdrivers
 PL Wkład do szuflady / Wkrętaki krzyżakowe
 DE Schubladeneinlage / Kreuzschlitzschrauber
 RU Вклад к выдвижному ящику / Крестовидные отвёртки
 CZ Vložka do zásuvky / Šroubováky křížové
 HU Fiókbetét / Kereszt csavarhúzó
 RO Adaos la sertar / Șurubelnițe în cruce
 FR Module plastique pour servante avec trousseis
 IT Tenone per l'armadio / Set di cacciaviti a croce
 ES Accesorio de cajón / Desarmadores de cruz
 CN 十字螺丝批托盘组套

7
PCS
CrMo



PH0x100, PH1x75, PH1x100, PH2x38, PH2x100, PH2x150, PH3x150 mm; CrMo



YATO
 YT-5536 8

EN Drawer insert / Screwdriver set
 PL Wkład do szuflady / Komplet wkrętaków
 DE Schubladeneinlage / Schraubendrehersatz
 RU Вклад к выдвижному ящику / Набор отвёрток
 CZ Vložka do zásuvky / Zámečnické šroubováky
 HU Fiókbetét / Csavarhúzó készlet
 RO Adaos la sertar / Șurubelnițe de lăcătușerie
 FR Module plastique pour servante avec trousseis
 IT Tenone per l'armadio / Set di cacciaviti
 ES Accesorio de cajón / Juego de destornilladores
 CN 螺丝批托盘组套

13
PCS
S2



3x75, 5x75, 4x100, 6x100; PH0x75, PH1x75, PH2x100 mm; S2;
 1.4x50, 2x50, 2.4x50 mm; PH00x50, PH0x50, PH1x50 mm; S2



YATO
 YT-55455 8

EN Drawer insert / Go-through screwdrivers
 PL Wkład do szuflady / Wkrętaki do pobijania
 DE D Schubladeneinlage / Schlagschrauber
 RU Вклад к выдвижному ящику / Отвёртка-било
 CZ Vložka do zásuvky / Šroubovák s úderným koncem
 HU Fiókbetét / Üthető csavarhúzó
 RO Adaos la sertar / Șurubelniță pt. fixare
 FR Module plastique pour servante / Allez - par tournevis
 IT Tenone per l'armadio / Set di cacciaviti
 ES Accesorio de cajón / Destornillador para dar golpes
 CN 敲击螺丝批托盘组套

4
PCS
CrV



6x150, 8x200, PH2x150, PH3x200 mm; CrV



YATO
 YT-55469 8

EN Drawer insert / Screwdriver set
PL Wkład do szuflady / Komplet wkrętek
DE Schubladeneinlage / Schraubendreheratz
RU Вклад к выдвижному ящику / Набор отвёрток
CZ Vložka do zásuvky / Zámečnické šroubováky
HU Fiókbetét / Csavarhúzó készlet
RO Adaos la sertar / Şurubelnițe de lăcătușerie
FR Module plastique pour servante avec trounevis
IT Tenone per l'armadio / Set di cacciaviti
ES Accesorio de cajón / Juego de destornilladores
CN 绝缘螺丝批托盘组套

8
PCS

S2



2.5x75, 4x100, 5.5x125, 6.5x150, PH1x80, PH2x100, PH3x150 mm; 1000V; S2;
4x190 mm; 250V

YATO
YT-55462

8

EN Drawer insert / Socket set
PL Wkład do szuflady / Zestaw kluczy nasadowych
DE Schubladeneinlage / Steckschlüsselsatz
RU Вклад к выдвижному ящику / Торцовые ключи
CZ Vložka do zásuvky / Klíče nástrčné
HU Fiókbetét / Dugókulcsok
RO Adaos la sertar / Duză cheie
FR Module plastique pour servante avec set d'outillages
IT Tenone per l'armadio chiave a bussola
ES Accesorio de cajón / Llaves de cubo
CN 套筒托盘组套

22
PCS

CrV

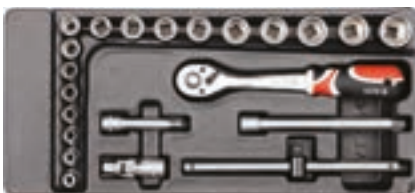

3/8" (9.5 mm); 6, 7, 8, 9, 10, 11, 12, 13, 14, 15, 16, 17, 18, 19, 20, 21, 22 mm; CrV 50BV30;
3/8" (9.5 mm); (76, 152.4 mm); CrV 50BV30;
3/8" (9.5 mm); CrV 50BV30;
3/8" (9.5 mm); (198 mm); CrV 50BV30;
3/8" (9.5 mm); (200 mm); 72T; CrV 6140

YATO
YT-5542

8

EN Drawer insert / Socket set
PL Wkład do szuflady / Zestaw kluczy nasadowych
DE Schubladeneinlage / Steckschlüsselsatz
RU Вклад к выдвижному ящику / Торцовые ключи
CZ Vložka do zásuvky / Klíče nástrčné
HU Fiókbetét / Dugókulcsok
RO Adaos la sertar / Duză cheie
FR Module plastique pour servante avec set d'outillages
IT Tenone per l'armadio chiave a bussola
ES Accesorio de cajón / Llaves de cubo
CN 套筒托盘组套

24
PCS

CrV



1/2" (12.7 mm); 10, 11, 12, 13, 14, 15, 16, 17, 18, 19, 20, 21, 22, 23, 24, 27, 30, 32 mm; CrV 50BV30;
1/2" (12.7 mm); (127 mm); CrV 50BV30;
1/2" (12.7 mm); CrV 50BV30;
1/2" (12.7 mm); 16; 21 mm; CrV 50BV30;
1/2" (12.7 mm); (255 mm); CrV 50BV30;
1/2" (12.7 mm); (255 mm); 72T; CrV 6140

YATO
YT-5537

4

EN Drawer insert / Tool set
PL Wkład do szuflady / Zestaw narzędziowy
DE Schubladeneinlage / Werkzeug-Set
RU Вклад к выдвижному ящику / Набор инструментов
CZ Vložka do zásuvky / Sada nářadí
HU Fiókbetét / Szerszámkészlet
RO Adaos la sertar / Trusa de scule
FR Module plastique pour servante / Coffret d'outillage
IT Tenone per l'armadio / Set di utensili
ES Accesorio de cajón / Juego de herramientas
CN 套筒托盘工具组套

4
PCS

CrV



3/4" (19.0 mm); (200 mm); CrV 6140;
3/4" (19.0 mm); CrV 50BV30;
3/4" (19.0 mm); (500 mm); CrV 50BV30;
3/4" (19.0 mm); (500 mm); 72T; CrV 6140

YATO
YT-55458

4

EN Drawer insert / Socket set
PL Wkład do szuflady / Zestaw kluczy nasadowych
DE Schubladeneinlage / Steckschlüsselsatz
RU Вклад к выдвижному ящику / Торцовые ключи
CZ Vložka do zásuvky / Klíče nástrčné
HU Fiókbetét / Dugókulcsok
RO Adaos la sertar / Duză cheie
FR Module plastique pour servante avec set d'outillages
IT Tenone per l'armadio chiave a bussola
ES Accesorio de cajón / Llaves de cubo
CN 套筒托盘组套

25
PCS

CrV

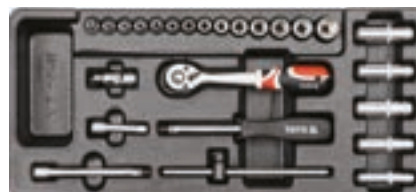

1/4" (6.3 mm); 3.5, 4, 4.5, 5, 5.5, 6, 7, 8, 9, 10, 11, 12, 13, 14 mm; CrV 50BV30;
1/4" (6.3 mm); 8, 10, 11, 12, 13 mm; CrV 50BV30;
1/4" (6.3 mm); (50.8, 101.6 mm); CrV 6140;
1/4" (6.3 mm); CrV 50BV30;
1/4" (6.3 mm); (152.4 mm); CrV 50BV30;
1/4" (6.3 mm); (155 mm); 72T; CrV 6140;
1/4" (6.3 mm); (150 mm); CrV 50BV30

YATO
YT-5541

8

EN Drawer insert / Screwdriver bits
PL Wkład do szuflady / Końcówki śrubokrętowe
DE Schubladeneinlage / Endstücke für Schraubenzieher
RU Вклад к выдвижному ящику / Насадки для отвёрток
CZ Vložka do zásuvky / Šroubovací nástavce
HU Fiókbetét / Csavarhúzó bitek
RO Adaos la sertar / Terminații pt. șurubelnițe
FR Module plastique pour servante avec set d'embouts
IT Tenone per l'armadio chiave punti di avvitamento
ES Accesorio de cajón / Puntas para desarmadores
CN 旋具头托盘组套

40
PCS

S2



T20, T25, T30, T40, T45, T50, T55 (L=30 mm); T20, T25, T30, T40, T45, T50, T55 (L=75 mm); AISI S2;
4, 5, 6, 7, 8, 10, 12 (L=30 mm); 4, 5, 6, 7, 8, 10, 12 (L=75 mm); AISI S2;
M5, M6, M8, M10, M12 (L=30 mm); M5, M6, M8, M10, M12 (L=75 mm); AISI S2;
1/2" (12.7 mm), 3/8" (9.5 mm)

YATO
YT-5538

8

EN Drawer insert / Socket set
 PL Wkład do szuflady / Zestaw kluczy nasadowych
 DE Schubladeneinlage / Steckschlüsselsatz
 RU Вклад к выдвижному ящику / Торцовые ключи
 CZ Vložka do zásuvky / Klíče nástrčné
 HU Fiókbetét / Dugókulcsok
 RO Adaos la sertar / Duză cheie
 FR Module plastique pour servante avec set d'outillage
 IT Tenone per l'armadio chiave a bussola
 ES Accesorio de cajón / Llaves de cubo
 CN 套筒托盘工具组套

14 PCS CrV 50BV30



3/4" (19.0 mm): 19, 21, 22, 24, 27, 28, 30, 32, 34, 36, 41, 46, 50, 55 mm; CrV 50BV30

YATO YT-55457 4

EN Drawer insert / Deep sockets
 PL Wkład do szuflady / Klucze nasadowe długie
 DE Schubladeneinlage / Tiefe Steckschlüssel
 RU Вклад к выдвижному ящику / Торцовые глубокие ключи
 CZ Vložka do zásuvky / Klíče nástrčné hluboké
 HU Fiókbetét / Hosszú dugókulcsok
 RO Adaos la sertar / Prize de curent adânci
 FR Module plastique pour servante avec set de douilles
 IT Tenone per l'armadio chiave a bussola lunghe
 ES Accesorio de cajón / Llaves de cubo profundo
 CN 六角长套筒托盘组套

14 PCS CrV 50BV30



1/2" (12.7 mm): 8, 9, 10, 11, 12, 13, 14, 15, 16, 17, 18, 19, 20, 21 mm (L=76 mm); CrV 50BV30

YATO YT-5539 8

EN Drawer insert / Tool set
 PL Wkład do szuflady / Zestaw narzędziowy
 DE Schubladeneinlage / Werkzeug-Set
 RU Вклад к выдвижному ящику / Набор инструмента
 CZ Vložka do zásuvky / Sada nářadí
 HU Fiókbetét / Szerszámkészlet
 RO Adaos la sertar / Trusa de scule
 FR Module plastique pour servante avec Coffret d'outillage
 IT Tenone per l'armadio / Set di utensili
 ES Accesorio de cajón / Juego de herramientas
 CN 旋具托盘组套

31 PCS CrV S2



1/2" (12.7 mm): E10, E12, E14, E16, E18, E20 (L=38 mm); CrV 50BV30;
 1/2" (12.7 mm): 10 mm; CrV 6150;
 M5, M6, M8, M10, M12 (L=30 mm); AISI S2;
 2, 2.5, 3, 4, 5, 6, 7, 8, 10, 12 mm; CrV 6150;
 T10, T15, T20, T25, T27, T30, T40, T45, T50; CrV 6150

YATO YT-55451 8

EN Drawer insert / Hammers and chisels
 PL Wkład do szuflady / Młotki i przecinaki
 DE Schubladeneinlage / Hämmer und Meißel
 RU Вклад к выдвижному ящику / Молотки и зубила
 CZ Vložka do zásuvky / Kladiva, dláta a sekáče
 HU Fiókbetét / Kalapácsok és hidegvágók
 RO Adaos la sertar / Ciocane și dalți
 FR Module plastique pour servante avec marteaux et burins
 IT Tenone per l'armadio martelli e scalpelli
 ES Accesorio de cajón / Martillos y cinceles
 CN 锤头凿子托盘组套

5 PCS CrV



300 g (L=300 mm);
 40 mm (L=350 mm);
 10x8x142 mm, 12x10x152 mm, 16x13x172 mm; CrV

YATO YT-5540 8

EN Drawer insert / Measuring tools
 PL Wkład do szuflady / Narzędzia miernicze
 DE Schubladeneinlage / Messwerkzeuge
 RU Вклад к выдвижному ящику / Измерительные приборы
 CZ Vložka do zásuvky / Měření
 HU Fiókbetét / Mérészközök
 RO Adaos la sertar / Instrumente de măsură
 FR Module plastique pour servante / Outils de mesure
 IT Tenone per l'armadio / Strumenti di misura
 ES Accesorio de cajón / Instrumentos de medición
 CN 量具托盘组套

5 PCS AI SS ABS



300 mm; AI;
 0-150 mm; SS;
 2 m;
 3m x 16 mm; ABS;
 0.02-1.00 mm

YATO YT-55474 8

EN Drawer insert / Steel file set
 PL Wkład do szuflady / Pilniki do metalu
 DE Schubladeneinlage / Feilensatz
 RU Вклад к выдвижному ящику / Набор напильников
 CZ Vložka do zásuvky / Pilníky na kov
 HU Fiókbetét / LLakatos reszelő készlet
 RO Adaos la sertar / Pile de lăcătuşerie
 FR Module plastique pour servante / Set de limes à métal
 IT Tenone per l'armadio / Set di lime per metallo
 ES Accesorio de cajón / Juego de limas para metal
 CN 锉刀托盘组套

5 PCS T12



#2, 200 mm; T12;
 #2, 200 mm; T12;
 #2, 200 mm; T12;
 #2, 200 mm; T12;
 #2, 200 mm; T12

YATO YT-55453 8

EN Drawer insert / Hand riveter with rivets
PL Wkład do szuflady / Nitownica ręczna z głowicą obrotową
DE Schubladeneinlage / Blindnietzange
RU Вклад к выдвижному ящику / Ручной заклепочник
CZ Vložka do zásuvky / Ruční nýtovačka
HU Fiókbetét / Kézi popszegecshúzó
RO Adaos la sertar / Pclește pt. popnituri
FR Module plastique pour servante / Riveteuse a main
IT Tenone per l'armadio / Rivettatrice manuale girevole
ES Accesorio de cajón / Remachadora de mano
CN 拉铆枪托盘组套

6
PCS CrMo



2.4, 3.2, 4.0, 4.8 mm;
9.6x3.2, 9.6x4.0, 12.7x4.0, 9.6x4.8, 12.7x4.8 mm; Al

YATO
YT-55466 8

EN Drawer insert / Tool set
PL Wkład do szuflady / Zestaw narzędziowy
DE Schubladeneinlage / Werkzeug-Set
RU Вклад к выдвижному ящику / Набор инструмента
CZ Vložka do zásuvky / Sada nářadí
HU Fiókbetét / Szerszámkészlet
RO Adaos la sertar / Trusa de scule
FR Module plastique pour servante / Coffret d'outillage
IT Tenone per l'armadio / Set di utensili
ES Accesorio de cajón / Juego de herramientas
CN 工具托盘组套

6
PCS CrMo CrV



1" (25 mm), L=330 mm; CrV;
250 mm; CrMo;
2.4, 3.2, 4.0, 4.8 mm;
9.6x3.2, 9.6x4.0, 12.7x4.8 mm; Al

YATO
YT-55478 8

EN Drawer insert / Automotive workshop tools
PL Wkład do szuflady / Zestaw narzędzi warsztatowych
DE Schubladeneinlage / Kfz-werkzeuge
RU Вклад к выдвижному ящику / Автомобильные инструменты
CZ Vložka do zásuvky / Auto nářadí
HU Fiókbetét / Autóipari szerszámok
RO Adaos la sertar / Scule auto
FR Module plastique pour servante / Outils de réparation automobile
IT Tenone per l'armadio / Set attrezzi officina
ES Accesorio de cajón / Herramientas de automoción
CN 轮胎修理工具托盘组套

5
PCS CrV



200 mm;
135 mm;
300, 400, 500 mm; CrV

YATO
YT-55477 4

EN Drawer insert / Automotive workshop tools
PL Wkład do szuflady / Zestaw narzędzi warsztatowych
DE Schubladeneinlage / Kfz-werkzeuge
RU Вклад к выдвижному ящику / Автомобильные инструменты
CZ Vložka do zásuvky / Auto nářadí
HU Fiókbetét / Autóipari szerszámok
RO Adaos la sertar / Scule auto
FR Module plastique pour servante / Outils de réparation automobile
IT Tenone per l'armadio / Set attrezzi officina
ES Accesorio de cajón / Herramientas de automoción
CN 轮胎修理工具托盘组套

10
PCS CrV



1/2" (12.7 mm) x 5/16" (7.9 mm); CrV 6150;
8 mm (L=35 mm); 8 mm (L=75 mm); CrV 6150;
PH3 (L=35 mm); PH1, PH2, PH3 (L=75 mm); CrV 6150;
12-38 mm; CrV 6150;
3" (75 mm); CrV;
82 mm; CrV

YATO
YT-55476 4

EN Drawer insert / Tool set
PL Wkład do szuflady / Zestaw narzędziowy
DE Schubladeneinlage / Werkzeug-Set
RU Вклад к выдвижному ящику / Набор инструмента
CZ Vložka do zásuvky / Sada nářadí
HU Fiókbetét / Szerszámkészlet
RO Adaos la sertar / Trusa de scule
FR Module plastique pour servante / Coffret d'outillage
IT Tenone per l'armadio / Set di utensili
ES Accesorio de cajón / Juego de herramientas
CN 工具托盘组套

23
PCS SS 3Cr13 HSS



140 mm; SS;
200 mm; 3Cr13;
19 mm x 20 mm;
4x190 mm; 250 V;
1, 1.5, 2, 2.5, 3, 3.5, 4, 4.5, 5, 5.5, 6, 6.5, 7, 7.5, 8, 8.5, 9, 9.5, 10 mm; HSS 6542

YATO
YT-55471 8

EN Drawer insert / Taps and die set
PL Wkład do szuflady / Zestaw narzynek i gwintowników
DE Schubladeneinlage / Gewindeschneidwerkzeug-Satz
RU Вклад к выдвижному ящику / Набор плашек и метчиков
CZ Vložka do zásuvky / Souprava závitníků a kruhových závitových čelistí
HU Fiókbetét / Menetűró és menetvágó készlet
RO Adaos la sertar / Set de tarozi și fi liere
FR Module plastique pour servante / Pince a riveter avec embouts
IT Tenone per l'armadio / Set di fi liera a maschi
ES Accesorio de cajón / Juego de machos de rosca y cojinetes
CN 丝锥板牙托盘组套

35
PCS HSS M2



M3x0.5 x3, M4x0.7x3, M5x0.8 x3, M6x1.0 x3, M7x1.0 x3, M8x1.25, M10x1.5, M12x1.75; HSS M2;
M3x0.5, M4x0.7, M5x0.8, M6x1.0, M7x1.0, M8x1.25, M10x1.5, M12x1.75; HSS M2;
M7-M9;
M3-M12;
0.5 - 1.75 mm; 27G; 28G

YATO
YT-55465 8

EN Drawer insert
 PL Wkład do szuflady
 DE Schubladeneinlage
 RU Вклад к выдвижному ящику
 CZ Vložka do zásuvky
 HU Fiókbetét

RO Adaos la sertar
 FR Module plastique pour servante
 IT Tenone per l'armadio
 ES Accesorio de cajón
 CN 吸塑盒



For YT-5531
 Dla YT-5531

YATO	
YT-55311	5/30



For YT-5532
 Dla YT-5532

YATO	
YT-55321	5/30



For YT-5533
 Dla YT-5533

YATO	
YT-55331	5/30



For YT-5534
 Dla YT-5534

YATO	
YT-55341	5/30



For YT-5535
 Dla YT-5535

YATO	
YT-55351	5/30



For YT-5536
 Dla YT-5536

YATO	
YT-55361	5/30



For YT-5537
 Dla YT-5537

YATO	
YT-55371	5/30

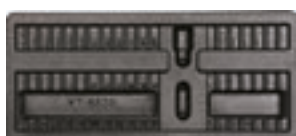

For YT-5538
 Dla YT-5538

YATO	
YT-55381	5/30



For YT-5539
 Dla YT-5539

YATO	
YT-55391	5/30



For YT-5540
 Dla YT-5540

YATO	
YT-55401	5/30



For YT-5541
 Dla YT-5541

YATO	
YT-55411	5/30



For YT-5542
 Dla YT-5542

YATO	
YT-55421	5/30



For YT-55479
 Dla YT-55479

YATO	
YT-55479	5/30

EN Legs for workbench, long
 PL Nogi do stołu warsztatowego, długie
 DE Beine für Werkbank, lange
 RU Ножи для верстака, длинные
 CZ Nohy k pracovnímu stolu, dlouhé
 HU Lábak munkapadhoz
 RO Picioare pt. banc de lucru, lungi
 FR Jambes pour table d'atelier
 IT Gambe del tavolo piedi del banco da lavoro
 ES Patas para banco de trabajo, largas
 CN 工作台长桌腿



2
PCS

140
cm

For YT-08920
 Dla YT-08920

YATO	L [mm]	
YT-08921	1400	2

EN Holders for workshop box
 PL Uchwyty do montażu szafki warsztatowej
 DE Halterungen für die Montage eines Werkstattschranks
 RU Крепеж для рабочего шкафа
 CZ Montážní držáky dílenské skříňky
 HU Műhelyszekrény tartó
 RO Suporturi pt. montarea dulapului de atelier
 FR Porte-placard d'atelier
 IT Staffa di montaggio per armadio portautensili
 ES Elementos de fijación para instalación de cajón de taller
 CN 高档工作台吊柜架



2
PCS

500x100
x350
mm

For YT-08920, YT-09152
 Dla YT-08920, YT-09152

YATO	Dimensions / Wymiary [mm]	
YT-08922	500x100x350	2

EN Connection steel pipes set
PL Rury montażowe
DE Anschluss Stahlrohre Gesetzt
RU Стальная труба монтаж
CZ Ocelové trubky
HU Acélcsővek
RO Tevi din oțel
FR Tuyaux en acier
IT Set di montaggio per tabella utensili
ES Tubos de acero
CN 高档工具柜定位杆

2 PCS 45 cm Ø 28 mm



For YT-09152, YT-09155 + YT-0902, YT-0903, YT-0904
Dia YT-09152, YT-09155 + YT-0902, YT-0903, YT-0904

YATO	L [mm]	Ø [mm]	
YT-09071	450	28	20

EN Compartmented shelf and paper roll holder
PL Półka z uchwytem na papier
DE Werkstattwagenablage mit Papierrollhalter
RU Полка с держателем для бумаги
CZ Police s úchytem na papír
HU Kiegészítő polc és papírrölni tartó funkcióval
RO Compartiment pt. dulap si suport hartie
FR Support rouleau papier
IT Mensola portarotoli carta
ES Estante con sujetapapel
CN 托架



For YT-0902, YT-0903, YT-0904, YT-0905
Dia YT-0902, YT-0903, YT-0904, YT-0905

YATO	Dimensions / Wymiary [mm]	
YT-0907	305x305x145	4

EN Separate board for drawer
PL Przegródka do szafki
DE Trennstegge für Werkstatt-Wagen-Schublade
RU Перегородки для ящика
CZ Přehradka do police
HU Több rekeszes tálcá
RO Sertar separat de masura mica
FR Cloison tiroir court
IT Separatore per armadio
ES Separador para armario
CN 抽屉分隔板

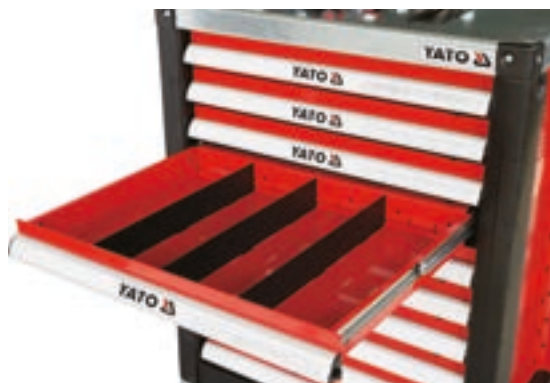

For YT-0902, YT-0903, YT-0904, YT-0905
Dia YT-0902, YT-0903, YT-0904, YT-0905

YATO	Dimensions / Wymiary [mm]	
YT-0910	391x58x4	24
YT-0911	391x128x4	24

EN Double project center backwall
PL Tablica narzędziowa
DE Werkzeugwand
RU Доска инструмент
CZ Držáky na nářadí
HU Szerszámtartó fal akasztókkal
RO Suport perete scule
FR Mur d'outil
IT La tabella utensili
ES Panel de herramientas
CN 高档工具车挂板

2 PCS 652x610 x55 mm



For YT-0902, YT-0903, YT-09031, YT-0904, YT-55290, YT-55292, YT-55293, YT-5530
Dia YT-0902, YT-0903, YT-09031, YT-0904, YT-55290, YT-55292, YT-55293, YT-5530

YATO	Dimensions / Wymiary [mm]	
YT-09072	652x610x55	1

EN Dustbin
PL Pojemnik na odpady
DE Abfalleimer
RU Мусорный ящик
CZ Zásobník na odpad
HU Szemétkosár
RO Lada de gunoi
FR Poubelle
IT Contenitore di rifiuti
ES Cubo de basura
CN 废品箱



For YT-0902, YT-0903, YT-0904, YT-0905
Dia YT-0902, YT-0903, YT-0904, YT-0905

YATO	Dimensions / Wymiary [mm]	
YT-0908	300x300x190	4

EN Magnetic towel holder
 PL Magnetyczny uchwyt na ręczniki
 DE Magnetischer Rollenhalter
 RU Магнитная вешалка для бумаги
 CZ Držáků magnetických papírových ručníků
 HU Mágneses papírtörő állvány

RO Suportji magnetici pt. prosoape
 FR Porte-serviettes en papier magnétique
 IT Portasciugamani magnetico
 ES Magnético de papel toallero
 CN 磁性纸巾挂架



YATO
 YT-08680 24

EN Magnetic shelf
 PL Półka magnetyczna
 DE Magnetische Ablage
 RU Магнитная полка для тележки
 CZ Magnetický regál pro nářadí
 HU Mágneses polc szerszámokcsikhoz

RO Cutie magnetice pt. depozitare
 FR Magnétique plat
 IT Mensola magnetica
 ES Soporte de almacenamiento magnético
 CN 磁性工具箱



YATO
 YT-08681 10

EN Magnetic tool tray set
 PL Zestaw półek magnetycznych
 DE Magnetische Werkzeugablage Set

RU Набор магнитных полок для тележки
 CZ Sada magnetických poliček
 HU Mágneses polc készlet

RO Cutii magnetice pt. depozitare
 FR Magnétique étagères set
 IT Set di ripiani magnetici

ES Juego de estantes magnéticos
 CN 磁性工具盘

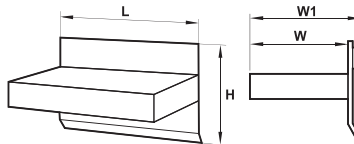

	L (mm)	H (mm)	W (mm)	W1 (mm)
	310	120	115	125
	270	120	115	125
	210	120	115	125
	155	120	115	125

YATO
 YT-08682 6

EN Magnetic hooks set
 PL Zestaw haczyków magnetycznych
 DE Magnetische Haken Set
 RU Набор магнитных крючков для тележки
 CZ Sada magnetických háčků
 HU Mágneses kampók halmozva

RO Set de cârlige magnetice
 FR Ensemble de crochets magnétiques
 IT Set di ganci magnetici
 ES Conjunto de ganchos magnéticos
 CN 磁性挂钩



YATO
 YT-08690 12/48

EN Hook for panel
 PL Haczyki do panelu perforowanego
 DE Haken für perforierte Wände
 RU Гачки для стенки с перфорацией
 CZ Háčky pro stěnu s perforací
 HU Horgok perforált panelhez

RO Cârlige pt. panouri perforate
 FR Crochets pour le mur avec perforation
 IT Ganci per pannelli forati
 ES Ganchos para pared con perforación
 CN 挂钩



For YT-08936
 Dla YT-08936

YATO
 YT-08937 20

EN Service utility key
 PL Klucz do szafek serwisowych
 DE Schallschrank-Schlüssel für Gängige Schränke
 RU Ключ для сервисных шкафов
 CZ Klíč na rozvodné skříně
 HU Kapsolőszekrény kulcs
 RO Cheie universală pt. panoul de comandă
 FR Clés universelles pour armoires de commande
 IT Chiave universale a croce per armadietti
 ES Llaves para armarios de control
 CN 多用阀门钥匙

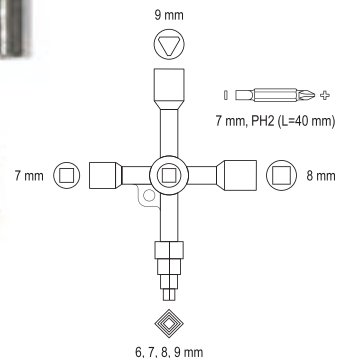
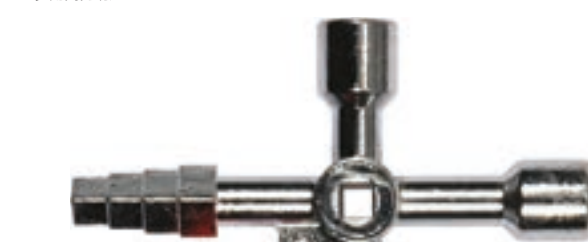

YATO
 YT-66700 20/120







EN Tool box
PL Skrzynka narzędziowa
DE Werkzeugkasten
RU Инструментальный ящик

CS Skříňka na nářadí
HU Szerszámos láda
RO Cutie de scule
FR Boîte à outils

IT Cassetta degli attrezzi
ES Caja de herramientas
ZH 一抽屜工具箱



YATO 	Drawer quantity / Liczba szuflad	
YT-09108	1	2

YATO 	Drawer quantity / Liczba szuflad	
YT-09107	2	2

EN Tool trolley
PL Wózek narzędziowy 3-częściowy
DE Werkzeugkasten
RU Тележка инструментальная

CS Vozík na nářadí
HU Szerszám kocsi
RO Troler pt. scule
FR Servante d'atelier

IT Armadio per utensili
ES Herramienta carro
ZH 拉杆式工具箱



YATO 		
YT-09102		1

YATO 		
YT-09101		1

EN Tool trolley
 PL Wózek narzędziowy 3-częściowy z narzędziami
 DE Werkzeugkasten
 RU Тележка инструментальная

CS Vozík na nářadí
 HU Szerszám kocsi
 RO Troler cu scule
 FR Servante d'atelier

IT Armadio per utensili
 ES Herramienta carro
 ZH 手推式工具箱

78
 PCS



Drawer 1 / Szuflada 1

- 1/2" (12.7 mm): 8, 10, 12, 13, 14, 15, 16, 17, 18, 19, 20, 21, 22 mm; CrV 50BV30;
- 1/2" (12.7 mm): (127 mm); CrV 50BV30;
- 1/2" (12.7 mm): (255 mm); 72T; CrV 6140;
- 3x75, 6x100; PH0x75, PH2x100 mm; S2;
- 215 mm;
- 1/4" (6.3 mm): 3.0, 3.5, 4.0, 5.5, 6.5 mm (L=25 mm); S2;
- 1/4" (6.3 mm): PH0, PH1, PH2, PH3 (L=25 mm); S2;
- 1/4" (6.3 mm): PZ0, PZ1, PZ2, PZ3 (L=25 mm); S2;
- 1/4" (6.3 mm): T10, T15 (L=25 mm); S2;
- 1/4" (6.3 mm): 2, 3, 4, 5, 6 mm (L=25 mm); S2;
- 1/4" (6.3 mm): 5, 6, 7, 8 x2, 9, 10, 11, 12, 13 mm

Drawer 2 / Szuflada 2

- 8, 10, 12, 13, 14, 15, 16, 17, 18, 19, 21 mm; CrV;
- 18 mm; SK5;
- 18 mm; SK5;
- 3 m x 16 mm

Drawer 3 / Szuflada 3

- 180 mm;
- 160 mm;
- 200 mm;
- 300 mm; 16-38 mm;
- 2, 2.5, 3, 4, 5, 6, 7, 8, 10, 12 mm; CrV 6150



YATO
 YT-09104

1

EN Hermetic toolbox
 PL Walizka narzędziowa hermetyczna
 DE Hermetisch Werkzeugkoffer
 RU Герметический инструмент чемодан
 CZ Kufř na nářadí
 HU Szerszámoszláda
 RO Cutie scule ermetica
 FR Boîte à outils hermétique
 IT Valigetta portautensili a tenuta stagna
 ES Caja de herramientas hermetica
 CN 安全箱



EN Hermetic toolbox
 PL Walizka narzędziowa hermetyczna
 DE Hermetisch Werkzeugkoffer
 RU Герметический инструмент чемодан
 CZ Kufř na nářadí
 HU Szerszámoszláda
 RO Cutie scule ermetica
 FR Boîte à outils hermétique
 IT Valigetta portautensili a tenuta stagna
 ES Caja de herramientas hermetica
 CN 安全箱



EN Hermetic toolbox
 PL Walizka narzędziowa hermetyczna
 DE Hermetisch Werkzeugkoffer
 RU Герметический инструмент чемодан
 CZ Kufř na nářadí
 HU Szerszámoszláda
 RO Cutie scule ermetica
 FR Boîte à outils hermétique
 IT Valigetta portautensili a tenuta stagna
 ES Caja de herramientas hermetica
 CN 安全箱



YATO Dimensions / Wymiary [mm]
 YT-08900 232x192x111 12



YATO Dimensions / Wymiary [mm]
 YT-08901 270x246x124 8



YATO Dimensions / Wymiary [mm]
 YT-08902 339x295x152 4

EN Hermetic toolbox
 PL Walizka narzędziowa hermetyczna
 DE Hermetisch Werkzeugkoffer
 RU Герметический инструмент чемодан
 CZ Kufř na nářadí
 HU Szerszámoszláda
 RO Cutie scule ermetica
 FR Boîte à outils hermétique
 IT Valigetta portautensili a tenuta stagna
 ES Caja de herramientas hermetica
 CN 安全箱



EN Hermetic toolbox
 PL Walizka narzędziowa hermetyczna
 DE Hermetisch Werkzeugkoffer
 RU Герметический инструмент чемодан
 CZ Kufř na nářadí
 HU Szerszámoszláda
 RO Cutie scule ermetica
 FR Boîte à outils hermétique
 IT Valigetta portautensili a tenuta stagna
 ES Caja de herramientas hermetica
 CN 安全箱



EN Hermetic toolbox
 PL Walizka narzędziowa hermetyczna
 DE Hermetisch Werkzeugkoffer
 RU Герметический инструмент чемодан
 CZ Kufř na nářadí
 HU Szerszámoszláda
 RO Cutie scule ermetica
 FR Boîte à outils hermétique
 IT Valigetta portautensili a tenuta stagna
 ES Caja de herramientas hermetica
 CN 安全箱



YATO Dimensions / Wymiary [mm]
 YT-08903 406x330x174 2



YATO Dimensions / Wymiary [mm]
 YT-08904 470x357x176 2



YATO Dimensions / Wymiary [mm]
 YT-08906 569x425x215 2

16

EN Hermetic toolbox
PL Walizka narzędziowa hermetyczna
DE Hermetisch Werkzeugkoffer
RU Герметический инструмент чемодан
CZ Kufr na nářadí
HU Szerszámoszláda

RO Cutie scule ermetica
FR Boîte à outils hermétique
IT Valigetta portautensili a tenuta stagna
ES Caja de herramientas hermetica
CN 安全箱



EN Hermetic toolbox
PL Walizka narzędziowa hermetyczna
DE Hermetisch Werkzeugkoffer
RU Герметический инструмент чемодан
CZ Kufr na nářadí
HU Szerszámoszláda
RO Cutie scule ermetica
FR Boîte à outils hermétique
IT Valigetta portautensili a tenuta stagna
ES Caja de herramientas hermetica
CN 安全箱



YATO Dimensions / Wymiary [mm] 1
YT-08905 559x351x229

YATO Dimensions / Wymiary [mm] 2
YT-08907 430x244x341

EN Cantilever tool box
PL Skrzynka narzędziowa
DE Werkzeugkoffer
RU Инструментальный ящик
CZ Nástrojová skřínka
HU Szerszámoszláda

RO Cutie pt. scule
FR Boîte à outils
IT Cassetta degli attrezzi
ES Caja de herramientas
CN 手提工具箱



EN Cantilever tool box
PL Skrzynka narzędziowa
DE Werkzeugkoffer
RU Инструментальный ящик
CZ Nástrojová skřínka
HU Szerszámoszláda

RO Cutie pt. scule
FR Boîte à outils
IT Cassetta degli attrezzi
ES Caja de herramientas
CN 手提工具箱



EN Cantilever tool box
PL Skrzynka narzędziowa
DE Werkzeugkoffer
RU Инструментальный ящик
CZ Nástrojová skřínka
HU Szerszámoszláda

RO Cutie pt. scule
FR Boîte à outils
IT Cassetta degli attrezzi
ES Caja de herramientas
CN 工具箱



YATO Dimensions / Wymiary [mm] 4
YT-0882 360x150x115



YATO Dimensions / Wymiary [mm] 1
YT-0883 428x180x180



YATO Dimensions / Wymiary [mm] 1
YT-0884 460x200x180

EN Cantilever tool box
PL Skrzynka narzędziowa
DE Werkzeugkoffer
RU Инструментальный ящик
HU Szerszámoszláda
RO Cutie pt. scule
FR Boîte à outils
IT Cassetta degli attrezzi
ES Caja de herramientas
CN 工具箱



YATO Dimensions / Wymiary [mm] 1
YT-0885 460x200x225

EN Cantilever tool box
PL Skrzynka narzędziowa
DE Werkzeugkoffer
RU Инструментальный ящик
HU Szerszámoszláda
RO Cutie pt. scule
FR Boîte à outils
IT Cassetta degli attrezzi
ES Caja de herramientas
CN 手提工具箱



YATO Dimensions / Wymiary [mm] 1
YT-0886 510x220x240

EN Cantilever tool box
PL Skrzynka narzędziowa
DE Werkzeugkoffer
RU Инструментальный ящик

CZ Nástrojová skřínka
HU Szerszámoszláda
RO Cutie pt. scule
FR Boîte à outils

IT Cassetta degli attrezzi
ES Caja de herramientas
CN 工具箱



YATO Drawer quantity /
Liczba szuflad 2 Dimensions /
Wymiary [mm] 1
YT-08872 218x255x520



YATO Drawer quantity /
Liczba szuflad 3 Dimensions /
Wymiary [mm] 1
YT-08873 218x300x520



YATO Drawer quantity /
Liczba szuflad 4 Dimensions /
Wymiary [mm] 1
YT-08874 218x360x520

EN Tool box with tools
 PL Skrzynka z narzędziami
 DE Werkzeugkoffer
 RU Инструментальный ящик
 CZ Nástrojová skříňka
 HU Szerszámosláda
 RO Cutie pt. scule
 FR Boîte d'outils
 IT Cassetta degli attrezzi
 ES Caja de herramientas
 CN 工具箱套

62 PCS 1/2" 12.7mm CrV 50BV30 CrV 6150 CrV 6140 72T AS-DRIVE ⊖ ⊕



- 1/2" (12.7 mm): 10, 11, 12, 13, 14, 15, 16, 17, 18, 19, 20, 21, 22, 23, 24 mm (L=38 mm); 27, 30, 32 mm (L=42 mm); CrV 50BV30;
- 1/2" (12.7 mm); (76, 127, 254 mm); CrV 50BV30;
- 1/2" (12.7 mm); CrV 50BV30;
- 1/2" (12.7 mm); 21 mm; CrV 50BV30;
- 1/2" (12.7 mm); (255 mm); CrV 50BV30;
- 1/2" (12.7 mm); 72T; CrV 6140;
- 1/2" (12.7 mm); (450 mm); CrV 50BV30;
- 6, 7, 8, 9, 10, 11, 12, 13, 14, 15, 16, 17, 18, 19, 20, 21, 22, 24 mm; CrV;
- 6x100, 6x150, 8x200 mm; CrV 6150;
- PH2x100, PH3x150, PH3x200 mm; CrV 6150;
- 180 mm; CrV;
- 160 mm; CrV;
- 160 mm; CrV;
- 1.5, 2, 2.5, 3, 4, 5, 6, 8, 10 mm; CrV 6150

YATO	Dimensions / Wymiary [mm]	
YT-3895	475x230x365	1

EN Tool box with tools
 PL Skrzynka z narzędziami
 DE Werkzeugkoffer
 RU Инструментальный ящик
 CZ Nástrojová skříňka
 HU Szerszámosláda

RO Cutie pt. scule
 FR Boîte d'outils
 IT Cassetta degli attrezzi
 ES Caja de herramientas
 CN 工具箱套

80 PCS 1/2" 12.7mm 1/4" 6.3mm CrV 50BV30 CrV 6140 S2 72T AS-DRIVE ⊖ ⊕

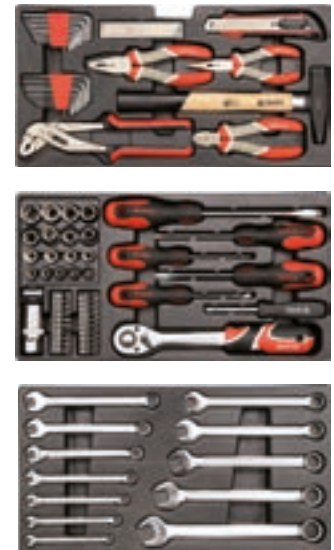

- 1/2" (12.7 mm): 10, 11, 12, 13, 14, 15, 17, 19 mm (L=38 mm);
- 1/4" (6.3 mm): 5, 6, 7, 8, 9, 10, 11, 12, 13 mm (L=25 mm); CrV 50BV30;
- 1/2" (12.7 mm): 21 mm; CrV 50BV30;
- 1/2" (12.7 mm); (255 mm); 72T; CrV 6140;
- 1/4" (6.3 mm); (150 mm); CrV 50BV30;
- 1/4" (6.3 mm) x 1/4" (6.3 mm); CrV 50BV30;
- 1/4" (6.3 mm): 3 x2, 4 x2, 5 x2, 5.5 x2, 6 x2 mm (L=25 mm); AISI S2;
- 1/4" (6.3 mm): PH0, PH1 x2, PH2 x2, PH3 (L=25 mm); AISI S2;
- 1/4" (6.3 mm): PZ0, PZ1 x2, PZ2 (L=25 mm); AISI S2;
- 6, 7, 8, 9, 10, 11, 12, 13, 14, 15, 17, 19 mm; CrV;
- 5x75 mm, 6x100 mm, 8x150 mm, PH1x75 mm, PH2x100 mm; S2;
- 180 mm; CrV;
- 160 mm; CrV;
- 160 mm; CrV;
- 250 mm;
- 300 g;
- 18 mm; SK2;
- 18x0.5 mm; SK2;
- 1.5, 2, 2.5, 3, 4, 5, 5.5, 6 mm; T10, T15, T20, T25, T27, T30, T40; CrV

YATO	Dimensions / Wymiary [mm]	
YT-38951	460x220x245	1

EN Brushless cordless power drill set
PL Zestaw wiertarko-wkrętarka bezszczotkowa z akcesoriami
DE Bürstenloser Bohrschrauber-Satz mit Zubehör
RU Набор дрель-шурупверт без щеток с принадлежностями
CZ Sada bezuhlíkový vrtačko-šroubovák s příslušenstvím
HU Kéfe nélküli fűrés-csavarozó készlet tartozékokkal
RO Set insurubat cu 2 acumulatori, biti, burghie
FR Perceuse visseuse brushless avec accessoires
IT Set di trapano-avvitatore senza spazzole con accessori
ES Juego de taladro / accionador sin cepillos con accesorios
CN 十八伏无刷锂电钻双电池一百二十六件铝箱套装



126 PCS	18V Li-Ion	42 Nm
0-600 min ⁻¹ 0-2000 min ⁻¹	0-10800 min ⁻¹ 0-36000 min ⁻¹	13 mm
2.0 Ah	1h	
1T	BRUSHLESS MOTOR SIŁNIK BEZ SZCZOTKOWY	13 Nm
1/4" 6.3 mm	HSS 4241	5 KLASES OSTREA
45°	HRC 89-91	TiN
YG6X	STEEL STAL	CONCRETE BETON
WOOD DREWNO	ALUMINIUM	PVC

- 1/4" (6.3 mm); 2, 4, 6, 5 mm (L=25 mm); S2;
- ⊕ 1/4" (6.3 mm); PH0, PH1 x2, PH2 x2, PH3 (L=25 mm); S2;
- ⊕ 1/4" (6.3 mm); PZ1 x2, PZ2 x2, PZ3 (L=25 mm); S2;
- ☆ 1/4" (6.3 mm); T10, T15, T20, T25, T30, T40 (L=25 mm); S2;
- ⊕ 1/4" (6.3 mm); T8, T9, T10, T15, T20, T25, T27, T30, T40 (L=25 mm); S2;
- 1/4" (6.3 mm); 2, 2.5, 3, 4, 5, 6, 8 mm (L=25 mm); S2;
- 1/4" (6.3 mm); M5, M6, M8 mm (L=25 mm); S2;
- 1/4" (6.3 mm); 0, 1, 2, 3 mm (L=25 mm); S2;
- ☆ 1/4" (6.3 mm); 1, 2, 3, 4 mm (L=25 mm); S2;
- ⊕ 1/4" (6.3 mm); 6, 8, 10 mm (L=25 mm); S2;
- ⊕ 1/4" (6.3 mm); 4, 6, 8, 10 mm (L=25 mm); S2;
- ⊕ 1/4" (6.3 mm); C1, C2, C3 mm (L=25 mm); S2;
- 1/4" (6.3 mm); (L=70 mm); CrV;
- ⊕ 1/4" (6.3 mm); CrV;
- ⊕ Ø 0-6, 1-8, 2-10, 3-12, 4-14 mm; HSS 4141;
- 200 mm;
- ⊕ Ø 6, 8, 11, 14, 17, 20, 23, 26, 29, 32, 35, 38 mm; Ø 4, 6, 8, 10, 12, 14, 16, 18, 20, 22 mm; HSS 4241;
- ⊕ Ø 6.3, 8.3, 10.4, 12.4 mm (L=40 mm); Ø 16.5, 20.5 mm (L=45 mm); HSS;
- ⊕ Ø 3, 4, 5, 6, 6.5, 7, 8, 9, 10, 11, 12, 13 mm; HRC 58-52; HSS 4241;
- ⊕ Ø 4, 5, 6, 8, 10 mm; HRC 89-91; YG6X;
- ⊕ Ø 1.5, 2, 2.5, 3, 3.2, 3.5, 4, 4.2, 4.5, 4.8, 5, 5.5, 6, 6.5, 7, 7.5, 8, 8.5, 9, 9.5, 10, 10.5, 11, 12, 13 mm; DIN 338; HSS 6542;
- ⊕ M2, M3, M4, M5, M6, M8, M10; HSS M2



L_{pa} = 94,0 ± 3,0 dB; L_{wa} = 95,0 ± 3,0 dB; a_n = 3,0 ± 1,5 / 9,56 ± 1,5 ml^{s2}

YATO	[V d.c.]	
YT-44250	18	2

EN Oil-filter wrench with chain
PL Klucz łańcuchowy do filtrów oleju
DE Rohrzange für Ölfilter
RU Цепной ключ для масляных фильтров
CZ Řetězový klíč pro olejové filtry
HU Olajszűrő-lánckulcs
RO Cheie filtru ulei cu lant
FR Clé à chaîne pour filtre à huile
IT Chiave a catena per filtri d'olio
ES Llave de cadena para filtros de aceite
CN 过滤器链式扳手



1/2"
12.7mm

DOUBLE CHAIN
PODWÓJNY ŁAŃCUCH

CrV

YATO	Ø [mm]	
YT-08253	60-115	5/30
YT-08254	75-170	5/30

EN Self-adjustable oil filters pliers
PL Szczypce samonastawne do filtrów oleju
DE Selbststellende Zangen für Ölfilter
RU Саморегулирующиеся клещи для масляного фильтра
CZ Samonastavovací kleště pro olejové filtry
HU Önbeállító olajszűrő leszedő fogó
RO Cheie ajustabila filtru ulei
FR Pince à filtre à huile auto-ajustable
IT Pinza auto-regolante per filtri d'olio
ES Pinzas autoajustables para filtros de aceite
CN 滤清器扳手



60-120 mm

280 mm

ADJUSTABLE
NASTAWNY

YATO	Ø [mm]	L [mm]	
YT-08231	60-120	280	6/36

EN Oil filter wrench
PL Klucz do filtra oleju
DE Ölfilterschlüssel
RU Ключ к масляному фильтру
CZ Klíč na olejový filtr
HU Olajszűrő-kulcs
RO Cheie pt. filtru de ulei
FR Clé au filtre d'huile
IT Chiave per filtro olio
ES Llave de filtro de apriete
CN 滤清器扳手



1/2"
12.7mm

CrMo

YATO	Ø [mm]	
YT-08235	60-80	20
YT-08236	80-105	20

EN Oil filter wrench
PL Klucz do filtra oleju
DE Ölfilterschlüssel
RU Ключ к масляному фильтру
CZ Klíč na olejový filtr
HU Olajszűrő leszedő
RO Cheie pt. filtru de ulei
FR Clé au filtre d'huile
IT Chiave per filtro olio
ES Llave para el filtro de aceite
CN 滤清器扳手



YATO	Ø [mm]	
YT-0820	60-73	12/48
YT-0821	73-85	12/48
YT-0822	85-95	12/48
YT-0823	95-111	12/48

EN Belt oil wrench
 PL Klucz taśmowy do filtrów oleju
 DE Ölfilterschlüssel mit Riemen
 RU Ключ тросовый для масляных фильтров
 CZ Klíč na olejové filtry
 HU Olajszűrő leszedő

RO Cheie filtru cu banda
 FR Clé au filtre d'huile
 IT Chiave a nastro per filtro olio
 ES Llave de cinta para filtros de aceite
 CN 皮带钳扳手

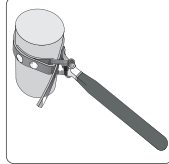

YATO	Ø [mm]	
YT-0824	80-160	6/60
YT-0825	100-200	5/20

EN Oil filter wrench
 PL Klucz do filtra oleju
 DE Ölfilterschlüssel
 RU Съёмник масляных фильтров
 CZ Klíč na filtr oleju fetezouý
 HU Olajszűrő leszedő, 3 kórmós
 RO Cheie pt. filtru de ulei
 FR Clé au filtre d'huile
 IT Chiave per filtro olio
 ES Llave do filtro de cadenta
 CN 两用滤清器扳手

2.5"-4" 63-120 mm	1/2" 12.7 mm	3/8" 9.5 mm	HRC 40-50	CrV	
----------------------	-----------------	----------------	--------------	-----	--



YATO	
YT-0826	12/36

EN Fuel filter socket
 PL Nasadka do filtra paliwa
 DE Aufsatz für Kraftstofffilter
 RU Крышка для топливного фильтра
 CZ Násada do palivového filtru
 RO Cheie pt. filtru combustibil
 FR Douille pour filtre à carburant
 IT Attacco per filtro del carburante
 ES Vaso para filtro de combustible
 CN 燃油过滤器套筒



1/2" 12.7 mm	27 mm
-----------------	-------

CrV

FOR FUEL FILTER DO FILTRA PALIWA

YATO	Ø	
YT-12000	1/2" (12.5 mm)	20/40

EN Haldex filter service tool
 PL Klucz specjalny do filtra haldex
 DE Spezial Schlüssel für Haldex-Filter
 RU Специальный ключ для фильтра haldex
 CZ Speciální klíč do filtru haldex
 HU Speciális kulcs haldex szűrőhöz

RO Instrument service filtru haldex
 FR Clé pour filtre haldex
 IT Chiave filtro olio per frizione haldex
 ES Llave especial para el filtro haldex
 CN 差速器滤芯板

Ø 46 mm	390 mm
CrMo	VAG
HALDEX	



YATO	L [mm]	
YT-05971	390	10/20

EN Cap type oil filter wrench set
 PL Zestaw kluczy nasadowych do filtra oleju
 DE Steckschlüsselsatz für Ölfilter
 RU Набор торцовых ключей к масляному фильтру
 CZ Sada miskovitých klíčů na olejové filtry
 HU Dugkulcs készlet olajszűrőhöz
 RO Set de chei tubulare pt. filtru de ulei
 FR Set d'embouts aux filtres d'huile
 IT Set di chiavi filtro olio
 ES Juego de llaves de tubo para el filtro de aceite
 CN 碗型滤清器扳手组套

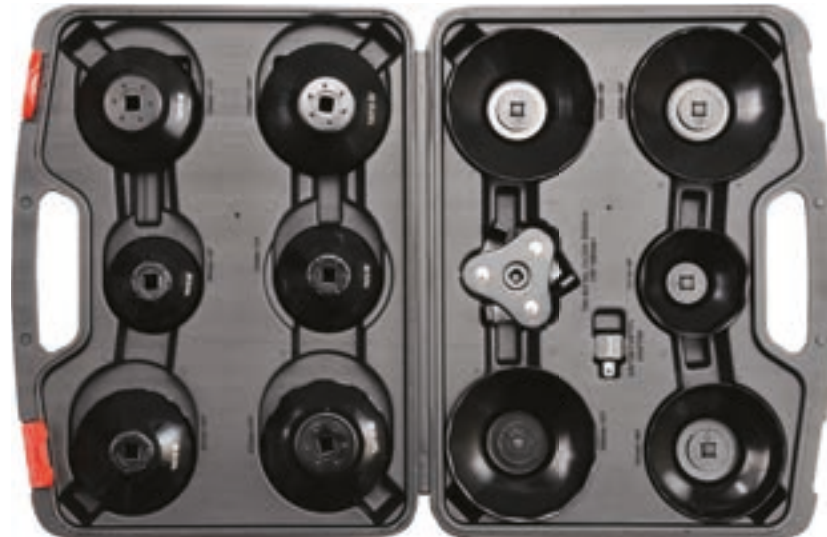

13 PCS	3/8" 9.5 mm
1/2" 12.7 mm	65-120 mm

number	size	layers	grooves	faces	car models
number	rozmiar	warstwy	bruzdy	powierzchnie	modele samochodow
66/6	SW66	1	6		Fiat Punto 1.2, Renault Clio 1.2, Rapid, Twingo
76/8	SW76	1	8		Fiat, Lancia
76/12	SW76	1		12	Fiat, Mercedes, Renault
86/16	SW86	1		16	Volvo
86/18	SW86	1		18	VW Golf, Audi A6 TDI, Peugeot, Citroen
92/10	SW92	1		10	Fiat
93/45	SW93	1	45		VW, Audi TDI
96/18	SW96	1	18		Audi A4, A6 TDI, VQ Passat TDI, Renault Laguna
106/15	SW106	1		15	Fiat Ducato
108/15	SW108	1		15	Volvo
108/18	SW108	1	18		Renault Espace, Laguna, Safrane, Traffic

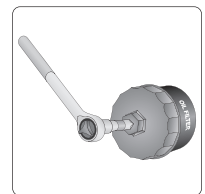

YATO	
YT-0594	5

- EN Cap type oil filter wrench set
PL Zestaw kluczy nasadowych do filtra oleju
DE Steckschlüsselsatz für Ölfilter
RU Набор торцовых ключей к масляному фильтру
CZ Sada miskovitých klíčů na olejové filtry
HU Dugókulcs készlet olajsűrőhöz
RO Set de chei tubulare pt. filtru de ulei
FR Set d'embouts aux filtres d'huile
IT Set di chiavi filtro olio
ES Juego de llaves de tubo para el filtro de aceite
CN 碗型滤清器扳手组套

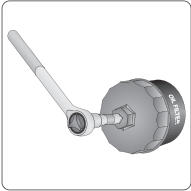

30 PCS 3/8" 9.5 mm

number number	size rozmiar	layers warstwy	grooves bruzdy	faces powierzchnie	car models modele samochodů
66/6	SW66	1	6		Fiat Punto 1.2, Renault Clio 1.2, Rapid, Twingo
65/14	SW65	1		14	Daihatsu, Toyota, Nissan, Fiat
65/67	SW65-67	1		14	Daihatsu, Toyota
68/14	SW68	1		14	Mazda, Ford, Subaru
73/14	SW73	1		14	Toyota, Lexus
74/15	SW74	1		15	Audi, Rover, Chrysler
74/76	SW74-76	2		15	Ford, Opel, VW, Audi, Mercedes
75/77	SW75-77	2		15	VW, Audi, Isuzu, Mercedes
76/12	SW76	1		12	Fiat, Mercedes, Renault
76/14	SW76	1		14	VW, Porsche, Mercedes, BMW, Audi, Opel
76/30	SW76	1	30		Ford
76/8	SW76	1	8		Fiat, Lancia
78/15	SW78	1		15	Nissan, Ford, Toyota
80/15	SW80	1		15	Nissan, Honda, Opel, Mazda
80/82	SW80-82	2		15	Subaru, Toyota, Honda, Nissan
86/16	SW86	1		16	Volvo
86/18	SW86	1		18	VW Golf, Audi A6 TDI, Peugeot, Citroen
90/15	SW90	1		15	Honda, Mitsubishi, Isuzu
92/10	SW92	1		10	Fiat
93/15	SW93	1		15	Mazda, Volvo, Mitsubishi, Nissan, Honda
93/36	SW93	1	36		Ford
93/45	SW93	1	45		VW, Audi TDI
95/15	SW95	1	15		Toyota, Alfa Romeo, Ford
96/18	SW96	1	18		Audi A4, A6 TDI, VQ Passat TDI, Renault Laguna
100/15	SW100	1		15	Isuzu, Mitsubishi
106/15	SW106	1		15	Fiat Ducato
108/15	SW108	1		15	Volvo
108/18	SW108	1	18		Renault Espace, Laguna, Safrane, Traffic

YATO YT-0596 3

- EN Square oil drain plug wrench
PL Klucz do korków spustowych oleju
DE Schlüssel für Ölablassschraube
RU Ключ для маслянивой пробки
CZ Klíč do spouštěcích zátek oleje
HU Olajleeresztő csavar kulcs
- RO Cheie pt. buson ulei
FR Clé pour bouchons de vidange d'huile
IT Chiave per tappo di scarico olio
ES Llave para tapones de descarga de aceite
CN 方形放油塞扳手



8mm 10mm
PEUGEOT RENAULT VOLVO

Peugeot, Renault, Volvo

YATO YT-05995 6/36

- EN Plastic oil plug driver set
PL Komplet kluczy do plastikowych korków oleju
DE Schlüsselsatz für Plastikölstopfen
RU Набор ключей для пластиковых масляных пробок
CZ Sada klíčů na plastové olejové zátky
HU Kulcskészlet műanyag olajleeresztő dugókhöz
RO Set chei filtru ulei
FR Clés universelles pour bouchons de vidange d'huile en matière plastique
IT Set di chiavi per tappi olio in plastica
ES Juego de llaves para tapones de plástico para aceite
CN 塑料油塞扳手组



5 PCS 3/8" 9.5 mm
PLASTIC OIL PLUGS PLASTIKOWE KORKI OLEJU

BMW, Ford, PSA, VAG

YATO YT-05980 3/8" (9.5 mm) 20/40

EN Oil drain plug set
 PL Komplet kluczy do korków oleju
 DE Ölablasschrauben Schlüsselnsatz
 RU Комплект ключей для сливной пробки
 CZ Klíče nástrčné na zátky olejových van motorů
 HU Olajleeresztő kulcs készlet

RO Set bituri pt. bujon ulei
 FR Ensemble de clés de bouchon de vidange d'huile
 IT Set di chiavi a bussola
 ES Juego de llaves para tapones de aceite
 CN 油底壳螺丝组套

6 PCS
 3/8" 9.5 mm
 CrV



- □ 8, 3/8", 10, 12, 1/2", 14 mm;
- □ 3/8" (9.5 mm), 1/2" (12.7 mm)

YATO	○	
YT-05997	3/8" (9.5 mm)	10/40

EN Oil drain plug set
 PL Komplet kluczy do korków oleju
 DE Ölablasschrauben Schlüsselnsatz
 RU Комплект ключей для сливной пробки
 CZ Klíče nástrčné na zátky olejových van motorů
 HU Olajleeresztő kulcs készlet

RO Set bituri pt. bujon ulei
 FR Ensemble de clés de bouchon de vidange d'huile
 IT Set di chiavi a bussola
 ES Juego de llaves para tapones de aceite
 CN 油底壳螺丝组套

18 PCS
 3/8" 9.5 mm
 CrV

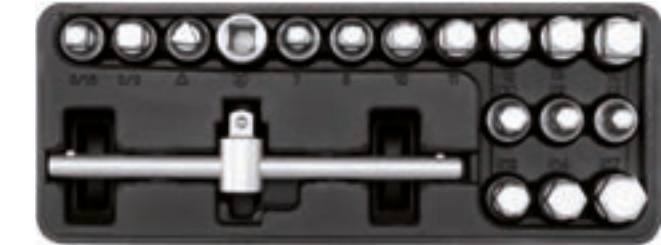

- □ 3/8" (9.5 mm): 7, 8, 10, 11, 12, 13, 14 mm; □ □ 5/16" (7.9 mm), 3/8" (9.5 mm);
- □ 3/8" (9.5 mm): 8, 9, 10, 12, 14, 17 mm; △ □ 3/8" (9.5 mm): 10 mm;
- 3/8" (9.5 mm): 10 mm; □ 3/8" (9.5 mm): 160 mm

YATO	○	
YT-0599	3/8" (9.5 mm)	10

EN Grease gun
 PL Smarownica ręczna
 DE Handhebel-Fettpresse
 RU Шприц для масляной смазки
 CZ Páková maznice
 HU Karos zsírzó

RO Masina de gresat cu furtun rigid
 FR Pistolet de graissage manuel
 IT Lubrificatore manuale
 ES Pistola de engrase
 CN 手动黄油枪

70 MPa (max.)
 31 MPa
 500 cm³
 AI



YATO		
YT-0700		20

EN Oil drain plug set
 PL Komplet kluczy do korków oleju
 DE Ölablasschrauben Schlüsselnsatz
 RU Комплект ключей для сливной пробки
 CZ Klíče nástrčné na zátky olejových van motorů
 HU Olajleeresztő kulcs készlet

RO Set bituri pt. bujon ulei
 FR Ensemble de clés de bouchon de vidange d'huile
 IT Set di chiavi a bussola
 ES Juego de llaves para tapones de aceite
 CN 油底壳螺丝组套

18 PCS
 3/8" 9.5 mm
 CrV 50BV30



- □ 3/8" (9.5 mm): 7, 8, 10, 11, 12, 13, 14 mm;
- □ 5/16" (7.9 mm), 3/8" (9.5 mm);
- □ 3/8" (9.5 mm): 8, 9, 10, 12, 14, 17 mm;
- △ □ 3/8" (9.5 mm): 10 mm;
- □ 3/8" (9.5 mm): M16;
- 3/8" (9.5 mm): 10 mm

YATO	○	
YT-05991	3/8" (9.5 mm)	5/10

EN Oil drain plug set
 PL Komplet kluczy do korków oleju
 DE Ölablasschrauben Schlüsselnsatz
 RU Комплект ключей для сливной пробки
 CZ Klíče nástrčné na zátky olejových van motorů
 HU Olajleeresztő kulcs készlet

RO Set bituri pt. bujon ulei
 FR Ensemble de clés de bouchon de vidange d'huile
 IT Set di chiavi a bussola
 ES Juego de llaves para tapones de aceite
 CN 油底壳螺丝组套

12 PCS
 3/8" 9.5 mm



- □ 3/8" (9.5 mm): 8, 11, 13 mm;
- □ 3/8" (9.5 mm): 8, 9, 10, 12, 14, 17 mm

YATO		
YT-0600		10

EN Grease gun
 PL Smarownica ręczna
 DE Handhebel-Fettpresse
 RU Шприц для масляной смазки
 CZ Páková maznice
 HU Karos zsírzó

RO Masina de gresat cu furtun rigid
 FR Pistolet de graissage manuel
 IT Lubrificatore manuale
 ES Pistola de engrase
 CN 手动黄油枪

70 MPa (max.)
 31 MPa
 120 cm³
 AI



YATO		
YT-0701		30

EN Grease gun
PL Smarownica ręczna
DE Handhebel-Fettpresse
RU Шприц для масляной смазки
CZ Páková maznice
HU Karos zsírzó

RO Masina de gresat cu furtun rigid
FR Pistolet de graissage manuel
IT Lubrificatore manuale
ES Pistola de engrase
CN 手动黄油枪

70 MPa (max)
31 MPa
400 cm³
AI 



YATO  YT-0705  20

EN Grease gun
PL Smarownica ręczna
DE Handhebel-Fettpresse
RU Шприц для масляной смазки
HU Karos zsírzó

RO Masina de gresat cu furtun rigid
FR Pistolet de graissage manuel
IT Lubrificatore manuale
ES Pistola de engrase
CN 大容量黄油枪

70 MPa (max)
31 MPa
600 cm³
AI 



YATO  YT-07044  6

EN Grease gun
PL Smarownica ręczna
DE Handhebel-Fettpresse
RU Шприц для масляной смазки
CZ Páková maznice
HU Karos zsírzó
RO Masina de gresat cu furtun rigid
FR Pistolet de graissage manuel
IT Lubrificatore manuale
ES Pistola de engrase
CN 大容量黄油枪

27-41 MPa
600 cm³
AI 



YATO  YT-07042  6/12

EN Grease gun
PL Smarownica ręczna
DE Handhebel-Fettpresse
RU Шприц для масляной смазки
CZ Páková maznice
HU Karos zsírzó
RO Masina de gresat cu furtun rigid
FR Pistolet de graissage manuel
IT Lubrificatore manuale
ES Pistola de engrase
CN 大容量黄油枪

27-41 MPa
800 cm³
AI 





YATO  YT-07043  4/8

EN Two-way operation grease gun
PL Smarownica ręczna, wzmacniona
DE Handhebel-Fettpresse
RU Шприц для масляной смазки
CZ Páková maznice
HU Karos zsírzó

RO Masina de gresat cu furtun rigid
FR Pistolet de graissage manuel
IT Lubrificatore manuale
ES Pistola de engrase
CN 重型黄油枪

70 MPa (max)
42 MPa
500 cm³
AI 





YATO  YT-0704  12

EN Two-way operation grease gun
PL Smarownica ręczna, wzmacniona
DE Handhebel-Fettpresse
RU Шприц для масляной смазки
CZ Páková maznice
HU Karos zsírzó

RO Masina de gresat cu furtun rigid
FR Pistolet de graissage manuel
IT Lubrificatore manuale
ES Pistola de engrase
CN 重型黄油枪

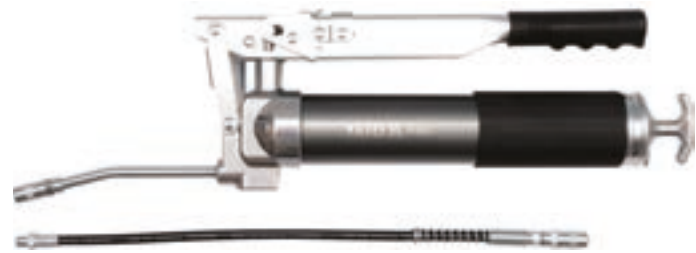
70 MPa (max)
42 MPa
500 cm³
AI 



YATO  YT-07041  10

EN Grease gun
PL Smarownica ręczna
DE Handhebel-Fettpresse
RU Шприц для масляной смазки
CZ Páková maznice
HU Karos zsírzó
RO Masina de gresat cu furtun rigid
FR Pistolet de graissage manuel
IT Lubrificatore manuale
ES Pistola de engrase
CN 黄油枪

55 MPa (max)
24.8 MPa
400 cm³
AI 



YATO  YT-07045  6

EN Grease gun
PL Smarownica ręczna
DE Handhebel-Fettpresse
RU Шприц для масляной смазки
CZ Páková maznice
HU Karos zsírzó
RO Masina de gresat cu furtun rigid
FR Pistolet de graissage manuel
IT Lubrificatore manuale
ES Pistola de engrase
CN 黄油枪

69 MPa (max)
27.6 MPa
400 cm³
AI 



YATO  YT-07046  8

EN Air grease gun
 PL Smarownica pneumatyczna
 DE Druckluft-Fettpresse
 RU Шприц для нагнетания
 густой смазки пневматический
 CZ Mazací lis pneumatický
 HU Pneumatikus zsírózó
 RO Pistol pt. gresat pneumatic
 FR Pistolet de graissage pneumatique
 IT Pneumatica per ingrassaggio
 ES Pistola engrasadora neumática
 CN 气动黄油枪



0.63 MPa
IN 0.2-0.8 MPa
OUT 30-40 MPa
400 cm³
28 l/min
 STANDARD

EN Air grease gun
 PL Smarownica pneumatyczna
 DE Druckluft-Fettpresse
 RU Шприц для нагнетания
 густой смазки пневматический
 CZ Mazací lis pneumatický
 HU Pneumatikus zsírózó
 RO Pistol pt. gresat pneumatic
 FR Pistolet de graissage pneumatique
 IT Pneumatica per ingrassaggio
 ES Pistola engrasadora neumática
 CN 气动黄油枪



0.63 MPa
IN 0.2-0.63 MPa
OUT 6-28 MPa
400 cm³
220 l/min
 STANDARD

$L_{pA} = 93.0 \pm 3.0$ dB; $L_{wA} = 104.0 \pm 3.0$ dB; $a_1 = \leq 2.5$ m/s²

$L_{pA} = \leq 70.0$ dB; $L_{wA} = \leq 80.0$ dB; $a_1 = \leq 2.5$ m/s²

YATO **YT-07055** 10

YATO **YT-07057** 10

EN Extraction & fill pump
 PL Odśysarka ręczna do płynów eksploatacyjnych
 DE Manuelle Absaugvorrichtung für Betriebsflüssigkeiten
 RU Ручной отсос для рабочих жидкостей
 CZ Ruční odsávací zařízení provozních kapalin
 HU Kézi üzemi folyadék elszívó

RO Pompa pt. extras si umplut
 FR Appareil portable de vidange par aspiration
 IT Aspiratore manuale per liquidi
 ES Dispositivo de succión manual
 CN 抽油泵

200 ml
 FOR OPERATIONAL LIQUIDS
 DO PLYNŃW
 EKSPLOATACYJNYCH



YATO **YT-07083** 24

EN Extraction & fill pump
 PL Odśysarka ręczna do płynów eksploatacyjnych
 DE Manuelle Absaugvorrichtung für Betriebsflüssigkeiten
 RU Ручной отсос для рабочих жидкостей
 CZ Ruční odsávací zařízení provozních kapalin
 HU Kézi üzemi folyadék elszívó

RO Pompa pt. extras si umplut
 FR Appareil portable de vidange par aspiration
 IT Aspiratore manuale per liquidi
 ES Dispositivo de succión manual
 CN 抽加油壶

500 ml
 FOR OPERATIONAL LIQUIDS
 DO PLYNŃW
 EKSPLOATACYJNYCH



YATO **YT-07084** 20

EN Oil transfer pump
 PL Pompa transferowa do oleju
 DE Öl-Umfüllpumpe
 RU Шприц для перекачки масел
 CZ Ruční olejová pumpa
 HU Olajpumpa

RO Pompa de ulei de mana
 FR Pompe pour huile
 IT Lubrificatore manuale per travaso olio
 ES Bomba manual de trasvase dual
 CN 输油泵

70 MPa (max.)
31 MPa
500 cm³



YATO **YT-0707** 20

EN Oil drainer
 PL Odśysarka ręczna do oleju
 DE Öl-Absaugpumpe
 RU Ручной шприц для откачки масла
 CZ Ruční odsávacíka oleje
 HU Kézi olajszívató

RO Pompa de ulei
 FR Seringue à huile
 IT Lubrificatore manuale per aspirazione olio
 ES Bomba manual de trasvase
 CN 输油泵

70 MPa (max.)
31 MPa
500 cm³



YATO **YT-0708** 20

EN Multi-use transfer pump
 PL Pompa transferowa do płynów
 DE Übertragungspumpe für Flüssigkeiten
 RU Перекачивающий насос для жидкостей
 CZ Přecherňavací čerpadlo na kapaliny
 HU Átvivő szivattyú folyadékokhoz

RO Pompa de transfer multifunctionala
 FR Pompe de transfert de liquides
 IT Pompa di trasferimento per liquidi
 ES Bomba de transferencia de líquidos
 CN 打气筒

170 ml
 FOR OPERATIONAL LIQUIDS
 DO PLYNŃW
 EKSPLOATACYJNYCH
PUMP FUNCTION FUNKCJA POMPKI
PVC
PP



YATO [ml] **YT-07071** 170 6/24

EN Manual hand pump
 PL Odśysarka ręczna do płynów eksploatacyjnych
 DE Handabsauger für Betriebsflüssigkeiten
 RU Ручной инструмент для всасывания рабочих жидкостей
 CZ Ruční odsávací zařízení provozních kapalin
 HU Kézi szivattyú üzemi folyadékokhoz
 RO Pompa manuala
 FR Pompe d'aspiration manuelle de fluides
 IT Aspiratore manuale per liquidi
 ES Bomba manual para fluidos de trabajo
 CN 抽油泵

1.5L
 FOR OPERATIONAL LIQUIDS
 DO PLYNŃW
 EKSPLOATACYJNYCH





Opel, PSA

YATO **YT-07082** 20

EN Pneumatic grease injector
PL Towotnica / smarownica pneumatyczna
DE Druckluft-Fettpresse
RU Пневматический нагнетатель смазки
CZ Pneumatické čerpadlo maziv
HU Pneumatikus zsír szivattyú
RO Pompa de unsoare pneumatică
FR Pompe a graisse pneumatique
IT Pneumatica per ingrassaggio
ES Bomba de engrase neumática lubricar
CN 注油器



$L_{pA} = 97,0 \pm 3,0$ dB; $L_{wA} = 108,0 \pm 3,0$ dB



YATO 		
YT-07067	12	1

40 MPa (max.)
0.6-0.8 MPa
12L
4m HOSE WAZ
50:1 RATIO SPREZANIE
STANDARD

EN Pneumatic grease injector
PL Smarownica pneumatyczna
DE Druckluft-Fettpresse
RU Пневматический нагнетатель смазки
CZ Pneumatické čerpadlo maziv
HU Pneumatikus zsír szivattyú
RO Pompa de unsoare pneumatică
FR Pompe a graisse pneumatique
IT Pneumatica per ingrassaggio
ES Bomba de engrase neumática lubricar
CN 注油器



$L_{pA} = 97,0 \pm 3,0$ dB; $L_{wA} = 108,0 \pm 3,0$ dB

YATO 		
YT-07068	30	1

40 MPa (max.)
0.6-0.8 MPa
30L
4m HOSE WAZ
50:1 RATIO SPREZANIE
STANDARD

EN Pneumatic grease injector
PL Smarownica pneumatyczna
DE Druckluft-Fettpresse
RU Пневматический нагнетатель смазки
CZ Pneumatické čerpadlo maziv
HU Pneumatikus zsír szivattyú
RO Pompa de unsoare pneumatică
FR Pompe a graisse pneumatique
IT Pneumatica per ingrassaggio
ES Bomba de engrase neumática lubricar
CN 注油器



$L_{pA} = 97,0 \pm 3,0$ dB; $L_{wA} = 108,0 \pm 3,0$ dB

YATO 		
YT-07069	45	1

40 MPa (max.)
0.6-0.8 MPa
45L
4m HOSE WAZ
50:1 RATIO SPREZANIE
STANDARD

EN Grease pump
PL Smarownica ręczna
DE Manuelle fettpumpen
RU Шприц для смазки

CZ Maznice ruční
HU Kézi zsírító pumpa
RO Grăsimă manuală pompă
FR Pistolet de graissage manuel



IT Pompe manuali per grasso
ES Grasa manual de la bomba
CN 黄油泵

1.5m HOSE WAZ



13.8 MPa (max.)



4 kg

YATO 	Grease tank capacity / Pojemność zbiornika smaru [kg]	
YT-07061	4	1



13.8 MPa (max.)



8 kg

YATO 	Grease tank capacity / Pojemność zbiornika smaru [kg]	
YT-07063	8	1



20.5 MPa (max.)

16 kg

YATO 	Grease tank capacity / Pojemność zbiornika smaru [kg]	
YT-07065	16	1

EN Cordless grease gun
 PL Smarownica akumulatorowa
 DE Akku-Fettpresse
 RU Шприц для смазки аккумуляторный
 CZ Akumulátorový mazací lis
 HU Akku zsírzó prés
 RO Pistol de gresat cu acumulator
 FR Pistolet graisseur sans-fil
 IT Lubrificatore a batteria
 ES Lubricador de batería
 CN 无绳黄油枪

18 V
 0.62 MPa
 284 g/min
 76 cm
 3.0 Ah
 LED LIGHTING OSWETLENIE



18V
Li-Ion

$L_{pa} = 76,0 \pm 3,0$ dB; $L_{wa} = 86,0 \pm 3,0$ dB; $a_h = 0,5 \pm 1,5$ m/s²

YATO	[V d.c.]	
YT-07020	18	2

EN Cordless grease gun
 PL Smarownica akumulatorowa
 DE Akku-Fettpresse
 RU Шприц для смазки аккумуляторный
 CZ Akumulátorový mazací lis
 HU Akku zsírzó prés
 RO Pistol de gresat cu acumulator
 FR Pistolet graisseur sans-fil
 IT Lubrificatore a batteria
 ES Lubricador de batería
 CN 无绳黄油枪

18 V
 0.62 MPa
 284 g/min
 76 cm
 LED LIGHTING OSWETLENIE



18V
Li-Ion

$L_{pa} = 76,0 \pm 3,0$ dB; $L_{wa} = 86,0 \pm 3,0$ dB; $a_h = 0,5 \pm 1,5$ m/s²

YATO	[V d.c.]	
YT-07021	18	2

EN Flexible tube for grease gun
 PL Wążek do townitnicy
 DE Schlauch für Fettpresse
 RU Шланг для перекачки масел
 CZ Hadička na maznice na šmir
 HU Tömítő a zsírzóhoz

RO Furtun flexibil pt. pistol de gresat
 FR Flexible pour graisseur
 IT Tubo flessibile per ingrassatore
 ES Manguera para engrasador
 CN 手用黄油枪软管

∅ 3.2mm



YATO	L [mm]	
YT-0709	300	12/144
YT-0710	500	12/144

EN Flexible hose for grease gun
 PL Wążek do townitnicy
 DE Fettpressenschlauch
 RU Шланг для тавотницы
 CZ Hadička do vazeliny
 HU Cső zsírzóhoz

RO Tub flexibil pt. pistol de gresat
 FR Flexible pour graisseur
 IT Tubo flessibile per ingrassatore
 ES Manguera para engrasador
 CN 高压尼龙软管

69 MPa (max)
 440 mm

G26



YATO	L [mm]	
YT-07101	440	9/36

EN Grease gun adaptors set
 PL Zestaw końcówek do smarownic
 DE Mundstücksatz für Fettpressen
 RU Набор наконечников для смазочного шприца
 CZ Sada koncovek pro maznice
 HU Olajózó fejkészlet
 RO Set adaptoare pt. gresoare
 FR Jeu d'accessoires pour pompes à graisse
 IT Kit di nippoli per ingrassatori
 ES Juego de puntas para engrasadores
 CN 黄油嘴配件套装

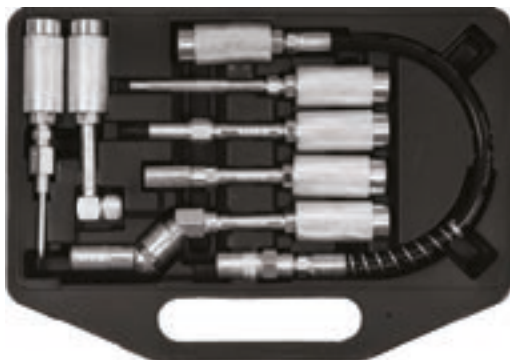

7 PCS
 38 cm
 90°
 180°
 360° UNIVERSAL UNIVERSALNY

EN Grease coupler
 PL Głowica do smarownicy
 DE Fettpressenkopf
 RU Головка для пресс-масленки
 CZ Hlavice do maznice
 HU Olajózó fej
 RO Cupla pt. pistol de gresat
 FR Tête de graisseur
 IT Testa per lubrificatore
 ES Cabezal para engrasador
 CN 高压油嘴头

∅ 15 mm
 G26



YATO	
YT-07110	10

YATO	∅ [mm]	
YT-07102	15	18/72

EN Oiler with a flexible applicator
 PL Oliwiarka z elastycznym aplikatorem
 DE Olkanne mit elastischem Applikator

RU Масленка с гибким аппликатором
 CZ Olejníčka s ohebným aplikátorem
 HU Hajlékony csővű olajózó

RO Gresor cu aplicator flexibil
 FR Burette à huile
 IT Lubrificante con canna flessibile

ES Aceitera con aplicador flexible
 CN 油壺



IMPACT RESISTANT
ODPORNY
NA UDERZENIA



IMPACT RESISTANT
ODPORNY
NA UDERZENIA



IMPACT RESISTANT
ODPORNY
NA UDERZENIA



YATO	V [cm ³]	
YT-0690	220	10/120
YT-0691	270	10/120

YATO	V [cm ³]	
YT-06912	200	10/120

YATO	V [cm ³]	
YT-06913	300	10/120

YATO	V [cm ³]	
YT-06914	500	10/80

EN Precision oiler
PL Oliwiarka precyzyjna
DE Präzisionsöler
RU Прецизионная масленка
CZ Přesná olejníčka
HU Precíz olajozó
RO Gresor de precizie
FR Graisseur de précision
IT Oliatore di precisione
ES Aceitera de precisión
CN 润滑油笔



15 ml
150 mm
AI



YATO V [ml] 15
YT-06977 12/120

EN Engine oil filler set
PL Lejek do wlewania oleju z adapterami
DE Ölfüller-Set
RU Воронка для моторного масла с адаптерами
CZ Sada pro plnění motorového oleje
HU Olajfelöntő adapter
RO Paînă cu adaptor pt. capacul de ulei
FR Adaptateur de remplissage d'huile aide avec entonnoir
IT Imbuto per versare olio con adattatori
ES Automotivo embudo de llenado de aceite
CN 加油漏斗组套



15 PCS
2L
FOR TIGHT SPACES DO CIASNYCH PRZESTRZYM
AI



YATO 4
YT-06919

EN Cordless transfer pump for oil and water
PL Akumulatorowa pompa do oleju i wody
DE Akku-Pumpe
RU Аккумуляторный перекачивающий насос
CZ Akumulátorové čerpadlo
HU Akkus szivattyú
RO Pompa bateriei
FR Pompe à batterie
IT Pompa a batteria per olio e acqua
ES Bomba de batería
CN 无绳水&机油泵

18V Li-Ion
380 W
3/4" 19mm
1800 l/h
22m
9m
3.0 Ah
IPX4
FOR WATER AND OIL DO WODY I OLEJU



18V
Li-Ion

YATO [V d.c.] 18
YT-85290 2

EN Cordless transfer pump for oil and water
PL Akumulatorowa pompa do oleju i wody
DE Akku-Pumpe
RU Аккумуляторный перекачивающий насос
CZ Akumulátorové čerpadlo
HU Akkus szivattyú
RO Pompa bateriei
FR Pompe à batterie
IT Pompa a batteria per olio e acqua
ES Bomba de batería
CN 无绳水&机油泵

18V Li-Ion
380 W
3/4" 19mm
1800 l/h
22m
9m
IPX4
FOR WATER AND OIL DO WODY I OLEJU



18V
Li-Ion

YATO [V d.c.] 18
YT-85291 2

Battery not included
Ohne Akku / Bez akumulatora
Bez baterie / Bez aku
Akkumulátor nélkül
Fără baterie / Sans batterie
Senza batteria / Sin batería
没有电池

EN Oil pump
PL Pompa tłokowa do oleju
DE Öl-Umfüllpumpe
RU Шприц ручной заливной
CZ Ruční olejová pumpa
HU Olajpumpa
RO Pompa de ulei de mana
FR Pompe pour huile
IT Pompa manuale travaso fusti olio
ES Bomba manual para aceite
CN 吸油泵



16-18 l/min
45-90 cm
max 55 min'
0.31 CYCLE CYCLE
AI
FOR OIL DO OLEJU



YATO 10
YT-0712

EN Aluminium rotary oil pump
PL Aluminiowa pompa do oleju
DE Aluminium-Kurbelpumpe
RU Алюминиевый ручной боковой насос
CZ Hliník rotační čerpadlo
HU Alumínium rotációs szivattyú
RO Aluminiu pompă rotativă
FR Pompe manuelle pour huile
IT Pompa a mano per olio
ES Aluminio bomba rotary
CN 手摇油泵

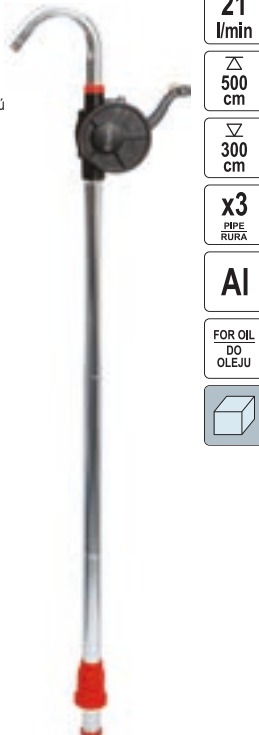

21 l/min
500 cm
300 cm
x3 PIPE RURA
AI
FOR OIL DO OLEJU



YATO 10
YT-07115

EN High value rotary barrel pump
PL Wysokowydajna pompa rotacyjna do paliwa
DE Kurbelpumpe für Benzinfässer
RU Насос топливный ротационный
CZ Čerpadlo palivové rotační
HU Kézi pumpa hordóhoz (forgatható)
RO Pompa rotativa pt. combustibil
FR Pompe rotative à combustible
IT Pompa rotativa travaso gasolio
ES Bomba de combustible rotatoria
CN 手摇泵



100 l/min
100 cm
1.01 CYCLE CYCLE
180µm BRASS FILTER MOSENYI FILTR
2.4m ARTSINK-HOSE HÁZARTYKÉRSZŐR
AI
FOR FUELS AND OIL DO PALIW I OLEJU



YATO 4
YT-0715

EN Two arms jaw puller RU Съёмник для подшипников RO Extractor rulmenti ES Extractor
 PL Ściągacz dwuramienny CZ Stahovák FR Extracteur CN 两爪拉马
 DE Abzieher-2-armig HU Csapágyelhúzó IT Estrattore

CrV 

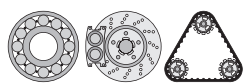

10 mm 4" / 10 cm

YATO 	Height [mm]	Width [mm]	max. Ø [mm]	Weight [t]	Box
YT-2514	10	100	60	1.2	6/60



10 mm 3" / 76 mm

YATO 	Height [mm]	Width [mm]	max. Ø [mm]	Weight [t]	Box
YT-2515	10	75	75	1.1	6/60



12 mm 4" / 10 cm

YATO 	Height [mm]	Width [mm]	max. Ø [mm]	Weight [t]	Box
YT-2516	12	100	100	1.4	12/48



17 mm 6" / 15 cm

YATO 	Height [mm]	Width [mm]	max. Ø [mm]	Weight [t]	Box
YT-2517	17	150	120	6	10/20



22 mm 8" / 20 cm

YATO 	Height [mm]	Width [mm]	max. Ø [mm]	Weight [t]	Box
YT-2518	22	200	180	9	6

EN Three arms jaw puller RU Съёмник для подшипников RO Extractor rulmenti cu trei brate ES Extractor detres patas
 PL Ściągacz trójramienny CZ Stahovák třiramenný FR Extracteur CN 三爪拉马
 DE Abzieher-3-armig HU Csapágyelhúzó IT Estrattore

CrV 

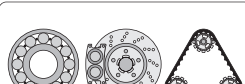

10 mm 3" / 76 mm

YATO 	Height [mm]	Width [mm]	max. Ø [mm]	Weight [t]	Box
YT-2519	10	75	80	1.5	6/60



12 mm 4" / 10 cm

YATO 	Height [mm]	Width [mm]	max. Ø [mm]	Weight [t]	Box
YT-2520	12	100	100	2.5	6/36



17 mm 6" / 15 cm

YATO 	Height [mm]	Width [mm]	max. Ø [mm]	Weight [t]	Box
YT-2521	17	150	130	5	12



22 mm 8" / 20 cm

YATO 	Height [mm]	Width [mm]	max. Ø [mm]	Weight [t]	Box
YT-2522	22	200	180	9	4



22 mm 12" / 30 cm

YATO 	Height [mm]	Width [mm]	max. Ø [mm]	Weight [t]	Box
YT-2523	22	300	180	11	2

EN Three arms jaw puller
PL Ściągacz trójramienny
DE Abzieher-3-armig
RU Съёмник для подшипников

CZ Stahovák tříramenný
HU Csapágylehűző
RO Extractor rulmenti cu trei brate
FR Extracteur

IT Estrattore
ES Extractor detres patas
CN 三爪拉马

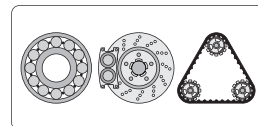

CrV



14 mm 3" 76mm

YATO	Height [mm]	Width [mm]	Ø [mm]	Weight
YT-2511	14	75	50-150	20



15 mm 4" 10cm

YATO	Height [mm]	Width [mm]	Ø [mm]	Weight
YT-2512	15	100	60-200	20



19 mm 6" 15cm

YATO	Height [mm]	Width [mm]	Ø [mm]	Weight
YT-2513	19	150	80-300	10

EN Two leg puller for battery terminals and widescreen wiper arms
PL Ściągacz dwuramienny do klem i ramion wycieraczek
DE Abzieher für Wischerarm und Polklemmen
RU Съёмник стеклоочистителя терминал батареи дворники
CZ Stahovák na svorky akumulátorů a ramen stěračů
HU Akkusaru és ablaktörőkar-lehűző
RO Extractor brat stergator, cleme baterie
FR Extracteur d'essuie glaces et cosse de batterie
IT Estrattore a due griffe per binding post e bracci dei tergicristalli
ES Extractor tirador exterior para brazo del limpiaparabrisas, terminal de batería
CN 电瓶接头拉马



5-30 mm

ADJUSTABLE NASTAWNY



YATO	Ø [mm]	Weight
YT-25145	5-30	48

EN Two leg puller for battery terminals and widescreen wiper arms
PL Ściągacz dwuramienny do klem i ramion wycieraczek
DE Abzieher für Wischerarm und Polklemmen
RU Съёмник стеклоочистителя терминал батареи дворники
CZ Stahovák na svorky akumulátorů a ramen stěračů
HU Akkusaru és ablaktörőkar-lehűző
RO Extractor brat stergator, cleme baterie
FR Extracteur d'essuie glaces et cosse de batterie
IT Estrattore a due griffe per binding post e bracci dei tergicristalli
ES Extractor tirador exterior para brazo del limpiaparabrisas, terminal de batería
CN 电瓶接头拉马



10-40 mm

ADJUSTABLE NASTAWNY



YATO	Ø [mm]	Weight
YT-08462	10-40	6/36

EN Universal puller set
PL Ściągacz do łożysk w miejscach trudno dostępnych
DE Abziehvorrichtung für Lager
RU Съёмник подшипников в труднодоступных местах
CZ Sada na stahování ložisek na obtížně dostupných místech
HU Csapágylehűző
RO Trăgător pt. rulmenti în locuri greu accesibile
FR Extracteur aux roulements
IT Set di estrattori universali
ES Extractor de rodamientos en lugares de difícil acceso
CN 多功能拉拔器

12 PCS

DROP FORGED KÜTE

FOR TIGHT SPACES DO CIĄSIENYCH PRZESTRZENI



- 3 x 250 mm;
- 3 x 200 mm;
- 3 x 100 mm;
- 160 mm;

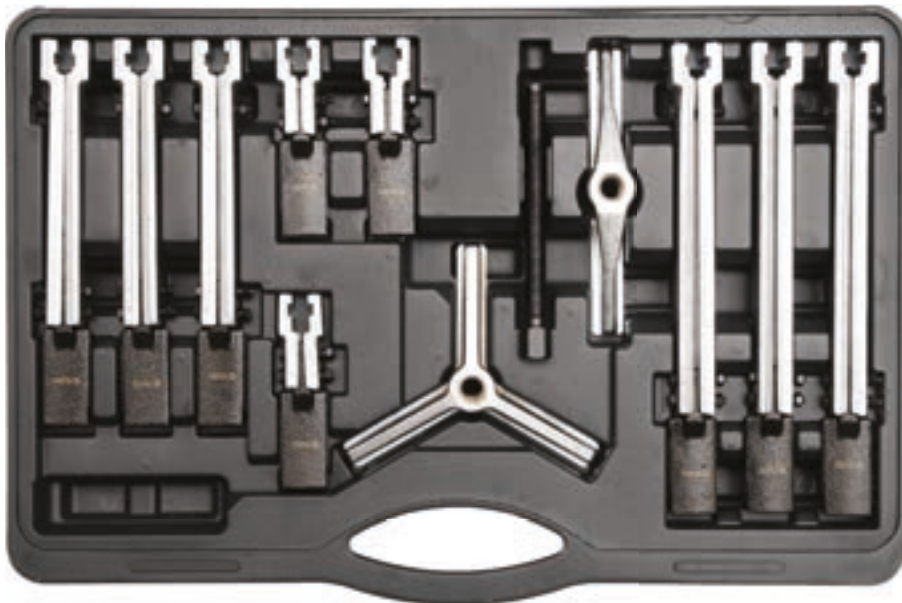
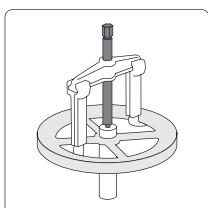
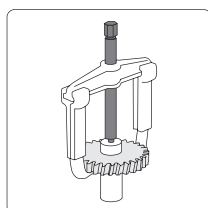

YATO
YT-25105

Weight 2

EN Pilot bearing puller
 PL Ściągacz do łożysk
 DE Abzieher für Innenlager
 RU Съёмник внутренних подшипников
 CZ Stahovák na ložiska vnitřní
 HU Csapágyelhűző
 RO Cleşte interior pt. extras rulmenți
 FR Extracteur intérieur aux roulements
 IT Estrattore cuscinetti
 ES Extractor de cojinetes inter
 CN 轴承拉马

13-38 mm CrV 6150



YATO Ø [mm]
 YT-2510 13-38 20

EN Universal wheel hub puller
 PL Ściągacz uniwersalny do tarczy i bębnow
 DE Scheiben-und Trommelbremsen Abzieher
 RU Универсальный съёмник ступицы и полуоси
 CZ Stahovák na brzdové bubny
 HU Univerzális féktárcsa és fékdob lelhűző
 RO Trusa universală pt. transmisie cardanica
 FR Extracteur universel pour les disques et les tambours
 IT Estrattore a vite universale
 ES Extractor universal de discos y tambores
 CN 万用轮毂拉马

CrV

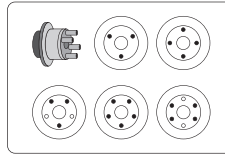

YATO
 YT-0602 6

EN Separator and hydraulic cylinder turnbuckle
 PL Separator i ściągacz z siłownikiem hydraulicznym
 DE Separator und Abziehvorrichtung mit Hydraulikservomotor
 RU Сепаратор и съёмник с сервомотором
 CZ Oddělovač a stahovák s hydraulickým válcem
 HU Csapágyelhűző és körmős csapágyelhűző hidraulikus kézpumpával
 RO Separator și ancoră cu servomotor hidraulic
 FR Séparateur avec actionneur hydraulique
 IT Separatore frizione cilindro idraulico
 ES Separador y tensor de tornillo con cilindro hidráulico
 CN 液压分离器组合

50 kN HYDRAULIC CYLINDER SŁOWNIK HYDRAULICZNY
 HRC 38-45 DROP FORGED KUTE
 CrV

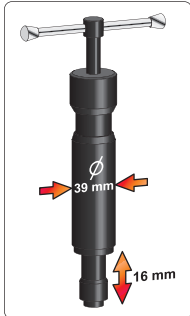

YATO Force pressure / Siła nacisku [kN]
 YT-0609 50 2

EN Twin leg puller with jaw hook
 PL Ściągacz dwuramienny
 DE Doppel Abzieher mit Haken
 RU Съёмник универсальный
 CZ Stahovák dvouřamenný univerzální
 HU Csapágyelhűző készlet
 RO Carlig cu falci pt. extras cu picior dublu
 FR Extracteur universel à deux bras
 IT Estrattore universale a due bracci
 ES Extractor de cuatro patas
 CN 单边两爪拉马

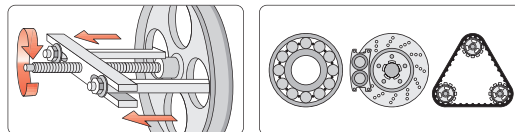

YATO
 YT-0640 10

EN Gear puller set
 PL Ściągacz dwuramienny i separator
 DE Lagerabzieher, Trennmesser
 RU Съёмник универсальный с сепаратором
 CZ Stahovák dvouřamenný
 HU Csapágyelhűző készlet
 RO Set angrenaj pt. extras
 FR Extracteur 2 bras + separateur
 IT Estrattore a due bracci a separatore
 ES Kit de extractor
 CN 齿轮拉拔器

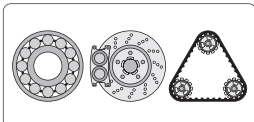
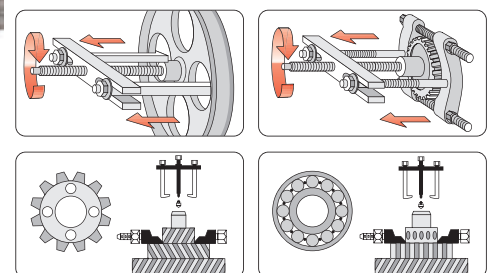

YATO
 YT-0641 4

- EN Gear puller set
- PL Ściągacz dwuramienny i separator
- DE Lagerabzieher, Trennmesser
- RU Съемник универсальный с сепаратором
- CZ Stahovák dvouarmenný
- HU Csapágyelhúzó készlet
- RO Set angrenaj pt. extras
- FR Extracteur 2 bras + separateur
- IT Estrattore a due bracci a separatore
- ES Kit de extractor
- CN 齿轮拉拔器

14 PCS 35-130 mm max 60 mm max 75 mm

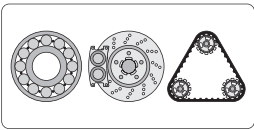
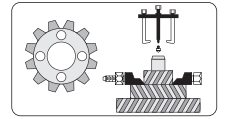
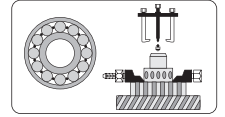
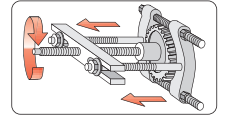
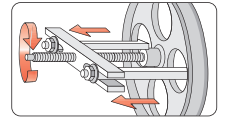
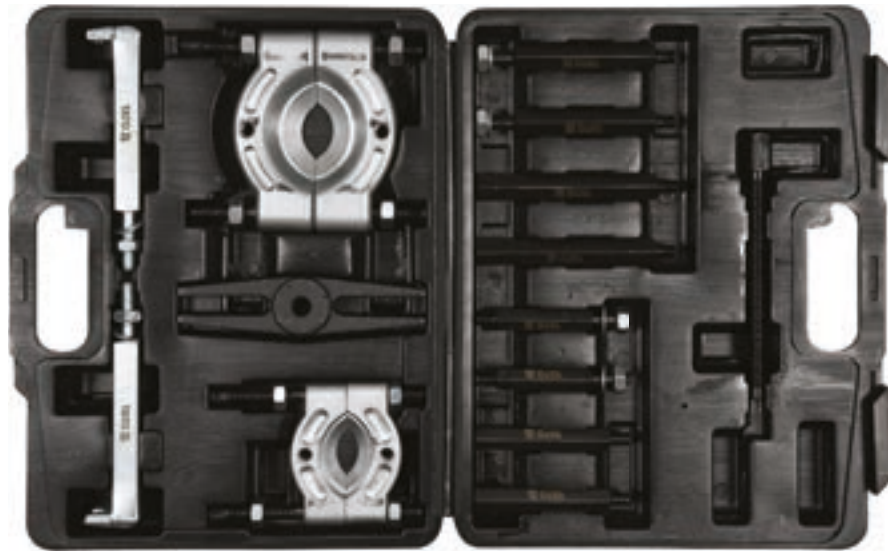

YATO
YT-06412 2

- EN Slide hammer and bearing puller set
- PL Ściągacz bezwładnościowy do łożysk
- DE Träge Abziehvorrichtung für Lager
- RU Набор съемников с обратным молотком
- CZ Rázový stahovák s kluzným kladivem na ložiska
- HU Csúsúzólyos csapágyelhúzó készlet
- RO Set ciocan culisant extractor de rulmenti
- FR Extracteur de roulements à inertie
- IT Set estrattori interni / esterni
- ES Extractor de inercia para cojinetes
- CN 滑锤轴承拉拔器组套

5 PCS

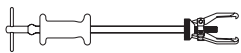
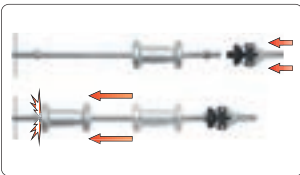
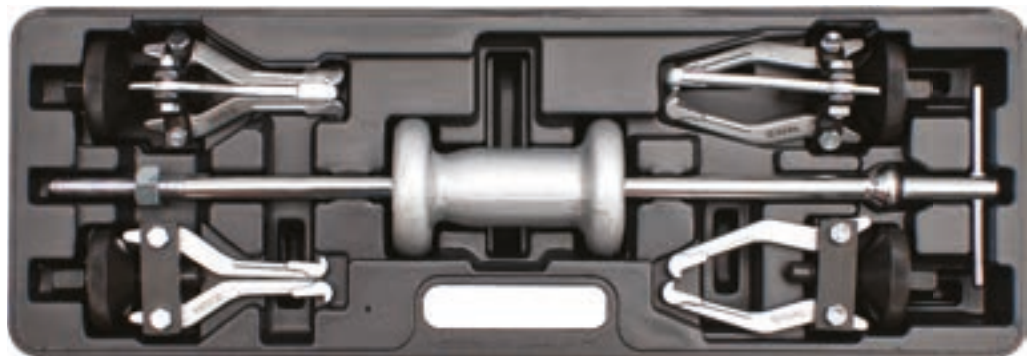

External 3-jaw puller
Ściągacz 3-ramienny zewnętrzny

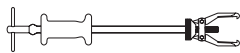

External 2-jaw puller
Ściągacz 2-ramienny zewnętrzny

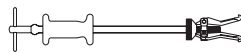

Internal 3-jaw puller
Ściągacz 3-ramienny wewnętrzny

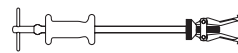

Internal 2-jaw puller
Ściągacz 2-ramienny wewnętrzny

YATO
YT-2540 2

- EN Bearing extractor set
- PL Ściągacz bezwładnościowy do łożysk
- DE Trägheitsabziehvorrichtung für Lager
- RU Инерционный съемник подшипников
- CZ Stahovák kluzného ložiska
- HU Csúsúzó kalapácsos csapágyelhúzó
- RO Set extractor rulment
- FR Extracteur de roulements
- IT Kit estrattori cuscinetti
- ES Extractor de rodamientos por inercia
- CN 内轴承拉马

15 PCS 8-58 mm INTERNAL PULLER ŚCIĄGACZ WEWNĘTRZNY

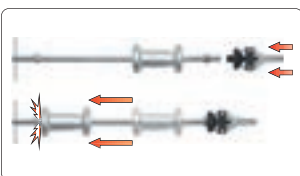
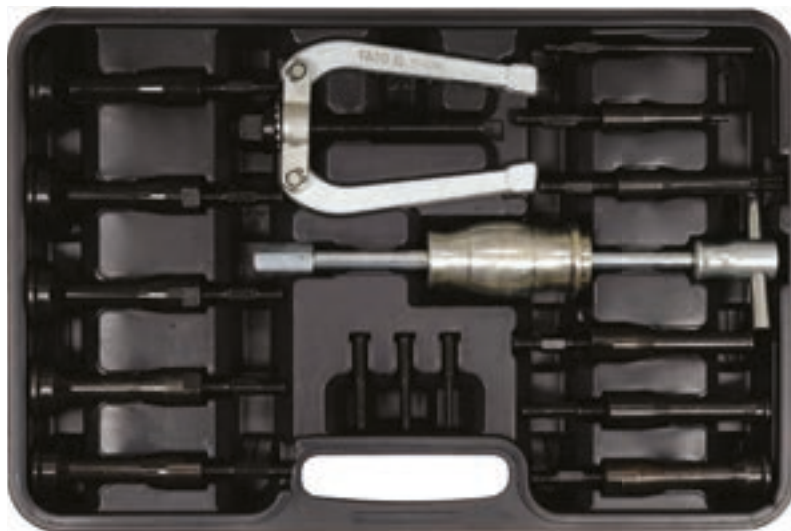

YATO
YT-25390 2

- EN Slide hammer set
- PL Ściągacz bezwładnościowy do piast i łożysk
- DE Träge Abziehvorrichtung für Naben und Lager
- RU Набор съемников с обратным молотком
- CZ Rázový stahovák s kluzným kladivem na náboje a ložiska
- HU Csúszósúlyos kerékagy - és csapágyelhúzó készlet
- RO Set ciocan culisant extractor de rulmenti și bușce
- FR Extracteur de roulements et moyeux à inertie
- IT Set estrattori per cuscinetti inerte
- ES Extractor de inercia para cubos y cojinetes
- CN 滑锤

16
PCS

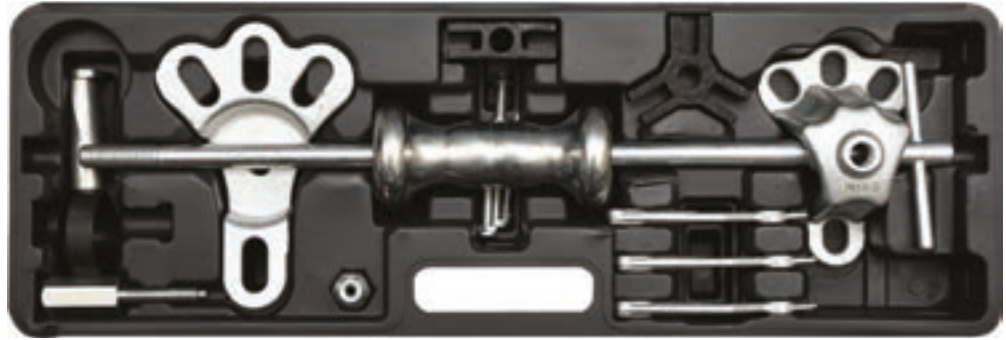
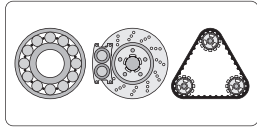

- | | | | | | | | | | | | |
|---|---|-----------------------------------|--|---|---|---|---------------------------------------|-----------------------------|------------------------|----------------|-------------|
| Bar
Trzonek | Hammer
Młot | 2x Axle puller
2x Ściągacz osi | Grip wrench adaptor
Prześciółka do klucza | Nut
Kołnierz | 2-jaw head
Głowica 2-zaczeppowa | 3-jaw head
Głowica 3-zaczeppowa | 3x Nut & bolt
3x Nakrętka i śruba | Attachment
Gniazdo śruby | Leg
Ramię ściągacza | Screw
Śruba | Hook
Hak |
| External 3-jaw puller
Ściągacz 3-ramienny zewnętrzny | External 2-jaw puller
Ściągacz 2-ramienny zewnętrzny | Puller hook
Hak | Dent puller
Ściągacz blacharski | Internal 3-jaw puller
Ściągacz 3-ramienny wewnętrzny | Internal 2-jaw puller
Ściągacz 2-ramienny wewnętrzny | Rear axle puller
Ściągacz tyłnej osi | Grip wrench adaptor
Adapter klucza | | | | |

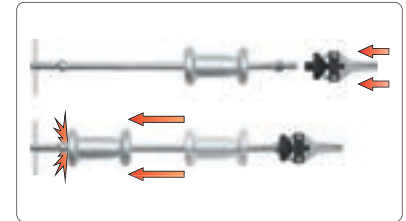

YATO
YT-25391

2

- EN Front wheel bearing adapter set
- PL Ściągacz łożysk piasty przedniej
- DE Radlagerabzieher werkzeugsatz vorderachse
- RU Набор для снятия переднего подшипника переднеприводных автомобилей
- CZ Sada na demontáž ložisek přední nápravy
- HU Csapágyelhúzó adapter készlet első futóműhöz

- RO Set schimbat rulment roata fata
- FR Extracteur de moyeux
- IT Set estrattori per cuscinetti ruota anteriore adattatore universale
- ES Extractor de cojinetes para cubos de rueda delanteros
- CN 轴承拆装套装

23
PCS

FOR FRONT WHEEL BEARINGS DO LOŻYSK PIASTY PRZEDNIEJ



YATO
YT-2541

2

- EN Wheel bearing bushing tool set
- PL Zestaw do obsługi łożysk i tulei
- DE Radlagerwerkzeug-Satz
- RU Набор для обслуживания подшипников и втулок
- CZ Sada pro údržbu ložisek a pouzder
- HU Kerékcsapágy persely szerszámkészlet

- RO Set extractoare rulmenti
- FR Kit d'outils pour l'installation et démontage du roulement
- IT Kit per montaggio / smontaggio dei cuscinetti e manicotti
- ES Juego de herramientas de cojinete de rueda
- CN 轴承安装工具

26
PCS

FOR BEARINGS AND BUSHINGS DO LOŻYSK I TULEI

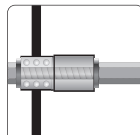

- Ø 10, 12, 14, 16 mm (L=450 mm);
- Yellow / Żółte: 46 x 36 mm, 58 x 48 mm, 70 x 60 mm, 82 x 72 mm, 44 x 34 mm, 56 x 46 mm, 68 x 58 mm, 80 x 70 mm, 54 x 44 mm, 66 x 56 mm, 78 x 68 mm;
- Silver / Srebrne: 52 x 42 mm, 64 x 54 mm, 76 x 66 mm, 50 x 40 mm, 62 x 52 mm, 74 x 64 mm, 48 x 38 mm, 60 x 50 mm, 72 x 62 mm;
- Ø (2 PCS)

YATO
YT-25411

1

- EN Wheel bearing bushing tool set
- PL Zestaw do obsługi łożysk i tulei
- DE Radlagerwerkzeug-Satz
- RU Набор для обслуживания подшипников и втулок
- CZ Sada pro údržbu ložisek a pouzder
- HU Kerékcsapágy persely szerszámkészlet
- RO Set extractoare rulmenti
- FR Kit d'outils pour l'installation et démontage du roulement
- IT Kit per montaggio / smontaggio dei cuscinetti e manicotti
- ES Juego de herramientas de cojinete de rueda
- CN 轴承安装工具

31
PCS

38
mm

FOR BEARINGS AND BUSHINGS DO LOŻYSK I TULEI

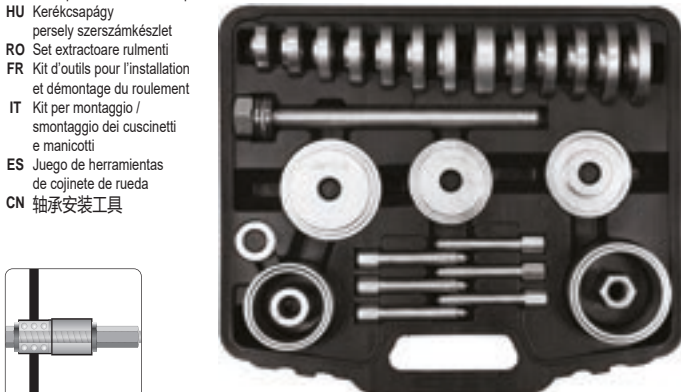

YATO
YT-25412

1

- EN Ball joint separator tool kit
- PL Prasa śrubowa do sworzni i tulei
- DE Schraubenpresse für Bolzen und Buchsen
- RU Винтовой пресс для штифтов и втулок
- CZ Šroubovací lis pro čepy a pouzdra
- HU Gömbcsukló ki-beszerező készlet
- RO Kit extractor articulații cu bilă
- FR Clé à douille universelle
- IT Estrattore per perni e boccole
- ES Prensa de husillo para pernos y casquillos
- CN 球头拆卸组套

9
PCS

22
mm

130
mm

FOR PINS AND BUSHINGS DO SWORZNI I TULEI



Ø 45/51 x 44 mm; Ø 57/63 x 44 mm; Ø 70/76 x 55 mm

YATO
YT-25413

1

EN Small mouth pull clamp
PL Klamra blacharska samozaciskowa
DE Selbstklemmende Blechschele
RU Скрепла самозажимная для жестяных работ
CZ Karosářská svěrka samosvorná k tahání
HU Őnszorító húzóató pofa, egyenes
RO Clemă pt. tablă cu strângere automată
FR Boucle pour tôle auto-serrant
IT Pinza autoserrante per riparazione carrozzeria
ES Abrazadera de tiro para reparación de carrocería
CN 窄型张引夹

5t **125 mm**
42x20mm
AUTO TIGHTEN SAMOZACISKOWA

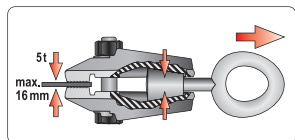

YATO L [mm] 125 12

EN Twist socket set
PL Zestaw wykrętań do śrub
DE Schraubendrehersatz
RU Набор для извлечения обломанных болтов
CZ Sada vyťahováku stržených šroubů
HU Törtcsavar kiszedő készlet

RO Set de chei pt. șuruburi
FR Set d'extracteurs aux vis
IT Set estrattori per dadi
ES Juego de destornilladores
CN 螺栓取出器组套

10 PCS **3/8"** **9.5 mm**
HRC 52-55 CrMo

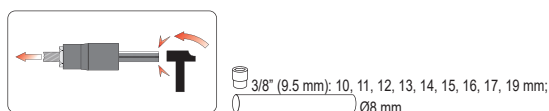

YATO YT-0603 20

EN Twist socket set
PL Zestaw wykrętań do śrub
DE Schraubendrehersatz
RU Набор для извлечения обломанных болтов
CZ Sada vyťahováku stržených šroubů
HU Törtcsavar kiszedő készlet
RO Set de chei pt. șuruburi
FR Set d'extracteurs aux vis
IT Set estrattori per dadi
ES Juego de destornilladores
CN 螺栓取出器组套

6 PCS **1/2"** **12.7 mm** CrMo

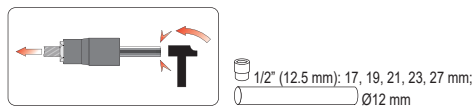

YATO YT-06032 10

EN Box clamp
PL Klamra blacharska samozaciskowa typu „C”
DE Selbstklemmende Blechschele vom Typ „C”
RU Скрепла самозажимная для жестяных работ типа „C”
CZ Karosářská svěrka samosvorná k tahání typ „C”
HU Őnszorító húzóató pofa, öblös
RO Clemă pt. tablă cu strângere automată de tip „C”
FR Boucle pour tôle auto-serrant
IT Pinza autoserrante per riparazione carrozzeria tipo „C”
ES Abrazadera de tiro para reparación de carrocería tipo „C”
CN 宽型张引夹

3t **142 mm**
35x15mm
C TYPE
AUTO TIGHTEN SAMOZACISKOWA

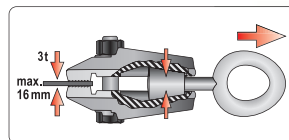

YATO L [mm] 142 10

EN Twist socket set
PL Zestaw wykrętań do śrub
DE Schraubendrehersatz
RU Набор для извлечения обломанных болтов
CZ Sada vyťahováku stržených šroubů
HU Törtcsavar kiszedő készlet

RO Set de chei pt. șuruburi
FR Set d'extracteurs aux vis
IT Set estrattori per dadi
ES Juego de destornilladores
CN 螺栓取出器组套

10 PCS **3/8"** **9.5 mm**

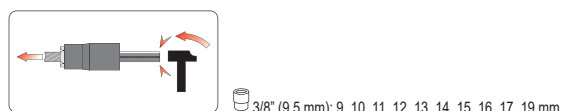

YATO YT-06031 20

EN Screw extractor set & HSS drill bits
PL Wykrętańki do zerwanych śrub i wiertła do metalu HSS
DE Schraubenausdrehersatz & HSS Bohrer
RU Экстракторы и сверла по металлу HSS
CZ Vrtáky do přetržených šroubu & vrtáky na kov HSS
HU Törtcsavar kiszedő készlet + fúrószárak fémhez HSS
RO Capete pt. deșurubat șuruburi rupte & burghie pt. metal HSS
FR Set d'extracteurs aux vis
IT Estrattori di vite HSS
ES Destornillador para tornillos arrancados & HSS brocas
CN 短丝取出器组套

No.	∅ [mm]	M	∅ [mm]
#1	1.4 - 3.6	3 - 6	1.8
#2	2.1 - 4.9	6 - 8	2.6
#3	3.1 - 6.5	8 - 11	3.7
#4	4.8 - 8.8	11 - 14	5.5
#5	6.2 - 11.0	14 - 18	7.0
#6	9.4 - 15.0	18 - 24	10.3



YATO YT-0591 40

EN Universal extractor set
 PL Uniwersalny zestaw do wykręcania
 DE Gewindeausdreh-Satz
 RU Набор экстракторов для болтов и гаек
 CZ Nástrojová sada pro poškozené šrouby a matice
 HU Szerszámkészlet sérült csavarokhoz és anyákhoz
 RO Set universal de extras suruburi
 FR Extracteurs universels de vis et d'écrous
 IT Set universale di cacciaviti
 ES Juego de extractores tornillos rotos
 CN 螺丝, 螺杆, 螺母取出器组套

17 PCS **1/2"** 12.7mm **3/8"** 9.5mm **CrV** 50BV30 **CrMo** 42

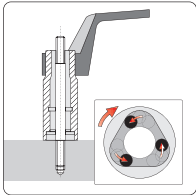

3/8" (9.5 mm): 9, 10, 11, 12, 13, 14, 16 (L=28); 19 mm (L=30); CrMo 42;
 1/2" (12.5 mm): 6, 8 (L=60 mm); 10, 12 mm (L=70 mm); CrV 50BV30;
 M3-M6, M6-M8, M8-M11, M11-M14, M14-M18; CrMo 42

YATO **YT-06033** 10

EN Universal extractor set
 PL Uniwersalny zestaw do wykręcania
 DE Gewindeausdreh-Satz
 RU Набор экстракторов для болтов и гаек
 CZ Nástrojová sada pro poškozené šrouby a matice
 HU Szerszámkészlet sérült csavarokhoz és anyákhoz
 RO Set universal de extras suruburi
 FR Extracteurs universels de vis et d'écrous
 IT Set universale di cacciaviti
 ES Juego de extractores tornillos rotos
 CN 螺丝螺母取出器

26 PCS **3/8"** 9.5mm **CrMo** 35 **CrMo** 42 **HSS** 4341 **HRC** 47-50



1/4", 8 mm, 3/8", 10 mm, 11 mm, 12 mm, 1/2", 13 mm, 14 mm, 16 mm, 17 mm, 11/16", 19 mm; CrMo 42;
 M3-M6, M6-M8, M8-M11, M11-M14, M14-M18, M18-M24; CrMo 35;
 2.4, 3.2, 4.0, 6.4, 7.2, 9.5 mm; HSS 4341;
 1/4" (6.3 mm) x 3/8" (9.5 mm)

YATO **YT-05893** 10

EN Twist socket set
 PL Zestaw wykrętaaków do śrub
 DE Schraubendrehersatz
 RU Набор для извлечения обломанных болтов
 CZ Sada vyťahováku stržených šroubů
 HU Törtcsavar kiszedő készlet
 RO Set de chei pt. șuruburi
 FR Set d'extracteurs aux vis
 IT Set estrattori per dadi
 ES Juego de destornilladores
 CN 螺栓取出器组套

16 PCS **CrMo** 42 **HRC** 47-50 **72T**

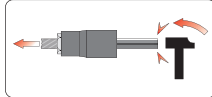

1/4", 8 mm, 3/8", 10 mm, 11 mm, 12 mm, 1/2", 13 mm, 14 mm, 16 mm, 17 mm, 11/16", 19 mm; CrMo 42;
 3/8" (9.5 mm); 72T;
 1/4" (6.3 mm) x 3/8" (9.5 mm);

YATO **YT-05897** 10

EN Universal extractor set
 PL Uniwersalny zestaw do wykręcania
 DE Gewindeausdreh-Satz
 RU Набор инструментов для поврежденных болтов и гаек
 CZ Nástrojová sada pro poškozené šrouby a matice
 HU Szerszámkészlet sérült csavarokhoz és anyákhoz
 RO Set extractoare suruburi si piulite
 FR Etablir extractoare suruburi si piulite
 IT Set universale di cacciaviti
 ES Extractores establecer vis et écrous
 CN 破損螺母取出器

26 PCS **3/8"** 9.5mm **HSS** **CrMo** 42

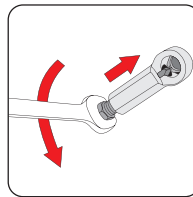

6, 8, 9, 10, 11, 12, 12.6, 13, 14, 16, 17, 18, 19 mm (CrMo 42);
 10-19 mm, 15-29 mm (CrMo 42);
 M3-M5, M4-M6, M5-M8, M6-M10, M8-M14 (CrMo 42);
 2.5, 3.2, 4, 6.4, 7.2 mm (HSS);
 1/4" (6.3 mm), 3/8" (10 mm)

YATO **YT-06037** 10

EN Screw extractor set
 PL Wykrętaaki do zerwanych śrub
 DE Schraubendrehersatz
 RU Набор для извлечения обломанных болтов
 CZ Vrtáky do přetržených šroubů
 HU Törtcsavar kiszedő készlet
 RO Capete pt. desurubat șuruburi rupte
 FR Set d'extracteurs aux vis
 IT Estrattori di viti
 ES Destornillador para tornillos arrancados
 CN 断丝取出器

5 PCS **1/4"** 6.3mm **HSS** 4241



YATO **YT-06035** Ø [mm] 0-6, 1-8, 2-10, 3-12, 4-14 40

EN Twist socket set
 PL Zestaw wykrętaaków do śrub
 DE Schraubendrehersatz
 RU Набор для извлечения обломанных болтов
 CZ Sada vyťahováku stržených šroubů
 HU Törtcsavar kiszedő készlet
 RO Set de chei pt. șuruburi
 FR Set d'extracteurs aux vis
 IT Set estrattori per dadi
 ES Juego de destornilladores
 CN 螺栓取出器组套

5 PCS **3/8"** 9.5mm **CrMo**



3/8" (9.5 mm): 10, 11, 13, 14, 16 mm

YATO **YT-06038** 10/20

EN Screw extractor set
PL Wykrętki do zerwanych śrub
DE Schraubenausdräheratz
RU Набор для извлечения обломанных болтов
CZ Vrtáky do přetržených šroubů
HU Törtcsavar kiszedő készlet
RO Capete pt. deșurubat șuruburi rupte
FR Set d'extracteurs aux vis
IT Estrattori di viti
ES Destornillador para tornillos arrancados
CN 断丝取出器组套



No.	∅ [mm]	L [mm]
#1	3-6	52
#2	6-8	58
#3	8-11	66
#4	11-14	75
#5	14-18	80
#6	18-25	88

6
PCS

YATO
YT-0590 12/48

EN Tap socket set
PL Zestaw adapterów do gwintowników
DE Adaptersatz für Gewindebohrer
RU Набор адаптеров для метчиков
CZ Sada hlavic na závítníky
HU Menetfúró dugókulcs adapter készlet
RO Set tubulare pt. tarozi
FR Jeu d'adaplateurs pour tarauds
IT Set di adattatori per madreviti
ES Juego de adaptadores para machos de rosca
CN 丝锥套筒组套



10
PCS

1/4" 6.3mm 3/8" 9.5mm

1/4" (6.3 mm): #1, #2, #3, #3.5, #4, #4.5; 3/8" (9.5 mm): #5, #6, #7, #8

YATO
YT-29280 1/4" (6.3 mm), 3/8" (9.5 mm) 10/40

EN Bolt extractor set
PL Zestaw wykrętków do szpilek
DE Satz von Ausziehvorrichtungen für Stifte
RU Набор экстракторов для шпилек

CZ Souprava na demontáž závrtných šroubů
HU Csavarkihajító készlet
RO Set de șurubelnțe pt. tije
FR Set d'extracteurs aux épingles

IT Set bussola estrattore per brugola
ES Juego de extractores de alfileres
CN 断丝取出器组套

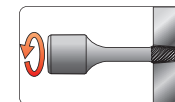

HRC 49-52 8660
HIGH CARBON STEEL
EN: HRC49-52
CN: HRC49-52

6
PCS

3/8" 9.5mm

YATO
YT-0623 ∅ [mm] 2, 3, 4, 6, 8, 10 50

5
PCS

1/2" 12.7mm

YATO
YT-0624 ∅ [mm] 8, 10, 12, 14, 16 20

EN Bolt extractor set
PL Zestaw wykrętków do szpilek
DE Satz von Ausziehvorrichtungen für Stifte
RU Набор экстракторов для шпилек
CZ Souprava na demontáž závrtných šroubů
HU Csavarkihajító készlet

RO Set de șurubelnțe pt. tije
FR Set d'extracteurs aux épingles
IT Set bussola estrattore per brugola
ES Juego de extractores de alfileres
CN 螺絲取出器

10
PCS

CrMo 42

HRC 50-53



3, 4, 5.5, 6, 7, 8, 9, 10, 11 mm; 1/8", 5/32", 3/16", 7/32", 1/4", 9/32", 5/16", 11/32", 3/8", 13/32"

YATO
YT-05890 20

EN Bolt extractor set
PL Zestaw wykrętków do szpilek
DE Satz von Ausziehvorrichtungen für Stifte
RU Набор экстракторов для шпилек
CZ Souprava na demontáž závrtných šroubů
HU Csavarkihajító készlet

RO Set de șurubelnțe pt. tije
FR Set d'extracteurs aux épingles
IT Set bussola estrattore per brugola
ES Juego de extractores de alfileres
CN 断丝取出器组套

25
PCS

3-23 mm

CrV 50 HRC 50-53



3, 4, 5, 5.5, 6, 7, 8, 9, 10, 11, 12, 13, 13.5, 14, 15, 16, 17, 17.5, 18, 19, 20, 21, 21.5, 22, 23 mm

YATO
YT-06034 10

EN Heavy duty nut splitter
PL Zestaw przycinaków do nakrętek
DE Meißelsatz für Schraubenmutter
RU Набор зубил для гаек
CZ Souprava sekáčů na matice
HU Csavaranya-vágó

RO Set retezoatoare capace
FR Set de burins
IT Set estrattore dado
ES Juego de tajaderas para tuercas
CN 螺母破拆组套

4
PCS

HRC 40-45

CrV

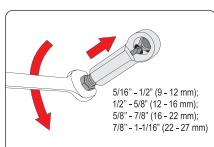

YATO
YT-0585 10

EN Roller stud extractor set
PL Komplet wykrętków do szpilek
DE Stehbolzenlösersatz
RU Набор ключей для снятия штифтов
CZ Sada stahovadel na špendlíky
HU Komplet tűkihívó
RO Set de dispozitive pt. demontat șuruburi rupte
FR Set d'extracteurs de goupilles
IT Estrattori a rulli per viti prigioniere
ES Juego de extractores de agujas
CN 断丝取出器组套

No.	∅ [mm]	D [mm]	L [mm]	A [mm]
#1	6	24	60	21
#2	8			
#3	10	28	70	
#4	12			

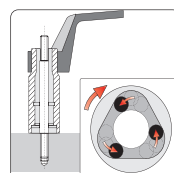
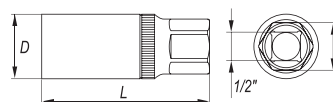

YATO
YT-0620 6/24

EN Stud extractor
 PL Wykręтак do śrub szpilek i nakrętek
 DE Stehbolzenausdreher
 RU Шпильковерт универсальный
 CZ Klíč na povolení závrtných šroubů
 HU Sérültefű csavar kiszedő
 RO Extractor pt. suruburi
 FR Extracteur de goujon, écrou ou boulon arrondis
 IT Stud estratore
 ES Extractor de esparragos
 CN 断头螺丝取出器

1/2"
12.7mm

8.5-19 mm



YATO

YT-06251

10/30

EN Stud extractor
 PL Wykręтак do śrub szpilek i nakrętek
 DE Stehbolzenausdreher
 RU Шпильковерт универсальный
 CZ Klíč na povolení závrtných šroubů
 HU Sérültefű csavar kiszedő
 RO Extractor pt. suruburi
 FR Extracteur de goujon, écrou ou boulon arrondis
 IT Stud estratore
 ES Extractor de esparragos
 CN 断头螺丝取出器

FOR IMPACT TOOLS DO NARZĘDZI UDAROWYCH

6-11 mm

3/8"
9.5 mm

24 mm



HRC 40-45

CrMo



YATO

YT-06255

6/36

EN Stud extractor
 PL Wykręтак do śrub, szpilek i nakrętek
 DE Stehbolzenausdreher
 RU Шпильковерт универсальный
 CZ Klíč na povolení závrtných šroubů
 HU Sérültefű csavar kiszedő
 RO Extractor pt. suruburi
 FR Extracteur de goujon, écrou ou boulon arrondis
 IT Stud estratore
 ES Extractor de esparragos
 CN 断头螺丝取出器

FOR IMPACT TOOLS DO NARZĘDZI UDAROWYCH

6-11 mm

1/2"
12.7 mm

24 mm



HRC 40-45

CrMo



YATO

YT-06256

6/36

EN Nipple extractor set
 PL Zestaw do wykrecania nypeli
 DE Nippelschlüssel-Satz
 RU Набор для выкручивания ниппелей
 CZ Souprava pro vyšroubování vodovodních redukci
 HU Belső csökulcs
 RO Set extractoare capete filetate rupte ale tevii
 FR Jeu de porte-embouts pour dévisser mamelons
 IT Set di chavi per rimozione nippeli
 ES Juego extractor de niples
 CN 内管扳手

3/8"
9.5 mm

1/2"
12.7 mm

3/4"
19 mm

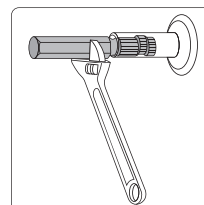

YATO

YT-21793

6/24

EN Tie rod end lifter
 PL Ściągacz do sworzni kulistych
 DE Universal-Kugelgelenk-Abzieher
 RU Съёмник шаровых опор
 CZ Stahovák kulových čepů řízení
 HU Gömbfej kinyomó
 RO Extractor pt. articulatii sferice
 FR Extracteur de rotue
 IT Estrattore per snodi sferici
 ES Extractor de pernos esféricos
 CN 球头拉拔器

100 mm

20-60 mm



YATO

YT-06122

19 [mm]

L [mm] 100

Ø [mm] 20



135 mm



YATO

YT-0612

19 [mm]

L [mm] 135

Ø [mm] 17.5

9/18

EN Tie rod end lifter
 PL Ściągacz do sworzni kulistych
 DE Universal-Kugelgelenk-Abzieher
 RU Струбцина для шаровых опор
 CZ Stahovák kulových čepů řízení
 HU Gömbfej kinyomó
 RO Extractor pt. articulatii sferice
 FR Extracteur de rotue
 IT Estrattore per snodi sferici
 ES Extractor de pernos esféricos
 CN 球头取出器

160 mm

35-80 mm



YATO

YT-06123

19 [mm]

L [mm] 160

Ø [mm] 30



EN Tie rod end lifter
 PL Ściągacz do sworzni kulistych
 DE Universal-Kugelgelenk-Abzieher
 RU Струбцина для шаровых опор
 CZ Stahovák kulových čepů řízení
 HU Gömbfej kinyomó
 RO Extractor pt. articulatii sferice
 FR Extracteur de rotue
 IT Estrattore per snodi sferici
 ES Extractor de pernos esféricos
 CN 球头拉拔器

265 mm

275 mm



YATO

YT-0613

16 [mm]

L [mm] 265

Ø [mm] 17

20

YT-0614

16 [mm]

L [mm] 275

Ø [mm] 20

20

- EN Inner tie rod tool
PL Klucz do drążków kierowniczych
DE Spurstangengelenk Lösewerkzeug
RU Ключ для шарнира рулевой рейки
CZ Přípravek na axiální táhla
HU Csukló szerelő
- RO Cheia de la tija de cravată
FR Clé pour pour rotules de direction
IT Chiave per il tirante
ES Extractor mecanismo de dirección
CN 拉拔器

200
mm

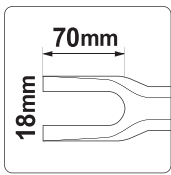

YATO 

L [mm]
200

18/36

- EN Inner tie rod tool
PL Klucz do drążków kierowniczych
DE Spurstangen-Schlüssel
RU Ключ для шарнира рулевой рейки
CZ Přípravek na axiální táhla
HU Axiál csukló szerelő
RO Cheie bielete directie
FR Clé de biellette de direction
IT Chiave per il tirante
ES Extractor rótulas axiales
CN 大机舵扳手

1/2"
12.7mm

∅
35-42
mm



YATO 

YT-06160

25

- EN Inner tie rod tool
PL Klucz do drążków kierowniczych
DE Spurstangen-Schlüssel
RU Ключ для шарнира рулевой рейки
CZ Přípravek na axiální táhla
HU Axiál csukló szerelő
RO Cheie bielete directie
FR Clé de biellette de direction
IT Chiave per il tirante
ES Extractor rótulas axiales
CN 四方滤清扳手

1/2"
12.7mm

∅
27-42
mm

CrMo



YATO 

YT-06162

10/20

- EN Inner tie rod tool
PL Klucz do drążków kierowniczych
DE Spurstangen-Schlüssel
RU Ключ для шарнира рулевой рейки
CZ Přípravek na axiální táhla
HU Axiál csukló szerelő
RO Cheie bielete directie
FR Clé de biellette de direction
IT Chiave per il tirante
ES Extractor rótulas axiales
CN 大机舵扳手

1/2"
12.7mm

∅
30-42
mm

CrMo



YATO 

YT-06163

40

- EN Track rod end remover & installer set
PL Zestaw kluczy do drążków kierowniczych
DE Schlüsselset für Zahnstangenlenkung
RU Набор ключей для рулевых тяг
CZ Sada klíčů pro řízení řízení
HU Kormányrúd telepítő készlet-eltávolító
RO Set montare-demontare bieleta
FR Clé pour rotules de direction
IT Set di chiavi suggerimenti smontaggio tiranti sterzo
ES Herramienta de llaves para barras de dirección
CN 轴接头工具组套

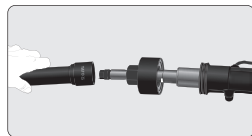

4
PCS

∅
30-45
mm



∅ 30-35mm, 35-40mm, 40-45mm

YATO 

YT-06155

4

- EN Tie rod / ball joint tool kit
PL Ściągacze do drążków
DE Werkzeugsatz für Bremssattel
RU Съемник штанг
CZ Stahováky táhel řízení
HU Rúdlehúzó
RO Ancore pt. tije
FR Set d'extracteurs pour rotules de direction
IT Set tiranti per estrattore
ES Tensores para palancas
CN 汽修工具

6
PCS

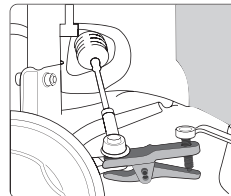

YATO 

YT-06157

5

- EN Tie rod / ball joint tool kit
PL Ściągacze do drążków
DE Werkzeugsatz für Bremssattel
RU Съемник штанг
CZ Stahováky táhel řízení
HU Rúdlehúzó
RO Ancore pt. tije
FR Set d'extracteurs pour rotules de direction
IT Set tiranti per estrattore
ES Tensores para palancas
CN 球头拉拔器组套

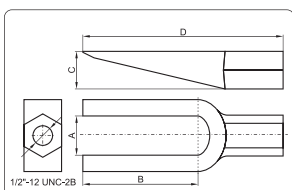
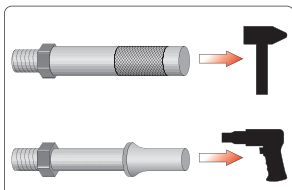

For YT-0990
Dia YT-0990



5
PCS



YATO 

YT-0616

10

EN Seal puller
 PL Ściągacz do uszczeltek
 DE Dichtungs-Abziehwerkzeug
 RU Съёмник прокладок
 CZ Škrabka na těsnění
 HU Tömítésléhvó

RO Ancoră pt. garnituri
 FR Outil pour extraire les joints
 IT Estrattore per guarnizioni
 ES Tensor para juntas
 CN 密封圈拉拔器

max Ø
85 mm

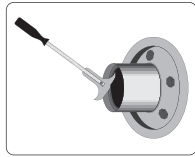

YATO L [mm]
 YT-0642 200 12/48

EN Universal hook and pick set
 PL Zestaw haków i skrobaków z rękojeścią
 DE Haken- und Schabersatz mit Griff
 RU Набор крючков и скребков с ручкой
 CZ Sada háků a škrabek s rukojetí
 HU Fogantyús kampó- és kaparókészlet
 RO Set universal carlige extras garnituri
 FR Kit de crochets et de grattoirs avec poignée
 IT Set di ganci e raschietti con impugnatura
 ES Juego de ganchos y raspadores con mango
 CN 发动机清理工具

5 PCS **200 mm** **225 mm** **23x220 mm**
23x245 mm **40Cr**



YATO
 YT-08422 6/24

EN Universal hook set
 PL Zestaw haczyków z rękojeścią
 DE Hakenset mit Handgriff
 RU Набор крючков с рукояткой
 CZ Sada háků s rukojetí
 HU Fogantyús kampó készlet

RO Set universal extractoare garnituri
 FR Jeu de crochets avec manche
 IT Set di ganci con maniglia
 ES Set de ganchos para extracción con mango
 CN 油封起子

7 PCS **162 mm**
205 mm **40Cr**



YATO
 YT-08425 6/24

EN Universal hook set
 PL Zestaw haczyków z rękojeścią
 DE Hakenset mit Handgriff
 RU Набор крючков с рукояткой
 CZ Sada háků s rukojetí
 HU Fogantyús kampó készlet

RO Set universal extractoare garnituri
 FR Jeu de crochets avec manche
 IT Set di ganci con maniglia
 ES Set de ganchos para extracción con mango
 CN 油封起子

9 PCS **162 mm**
240 mm **40Cr**



YATO
 YT-08426 6/12

EN Long reach hook and pick tool set
 PL Zestaw haków długich z rękojeścią
 DE Langhakensatz mit Griff
 RU Набор длинных крючков с ручкой
 CZ Sada dlouhých háků s rukojetí
 HU Fogantyús hosszú kampókészlet

RO Set lung pt. extras garnituri
 FR Kit de longs crochets avec poignée
 IT Set di ganci lunghi con impugnatura
 ES Juego de ganchos largos con mango
 CN 油封起子

4 PCS **240 mm**
40Cr



YATO
 YT-08429 6/72

EN Long reach hook and pick tool set
 PL Zestaw haków długich z rękojeścią
 DE Langhakensatz mit Griff
 RU Набор длинных крючков с ручкой
 CZ Sada dlouhých háků s rukojetí
 HU Fogantyús hosszú kampókészlet

RO Set lung pt. extras garnituri
 FR Kit de longs crochets avec poignée
 IT Set di ganci lunghi con impugnatura
 ES Juego de ganchos largos con mango
 CN 油封起子

6 PCS **240 mm**
40Cr



YATO
 YT-08428 6/48

EN Seal remover and hose pick set
PL Zestaw do demontażu uszczelniań i oringów
DE Demontageset für Dichtungen und O-Ringe
RU Набор для снятия уплотнений и уплотнительных колец
CZ Sada pro demontáž těsnění a těsnících kroužků
HU O-ring és tömítéskereszt készlet

RO Dispozitiv indepartat sigilii si set carlige
FR Kit crochet pour joint torique
IT Kit di strumenti per rimozione di guarnizioni e O-ring
ES Juego de remoción de sellado y juntas tóricas
CN 油封钩

6
PCS

120
mm

150
mm

160
mm

200
mm

210
mm

290
mm

SPECIAL
SHAPE
SPECJALNY
KSZTAŁT

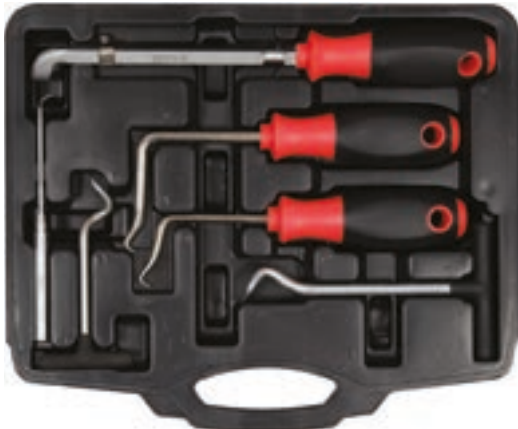

YATO
YT-08432

5

EN Hook set for o-ring
PL Zestaw haczyków do uszczelniaaczy
DE Dichtungs-Haken-Satz
RU Комплект крючков для герметиков
CZ Sada háčků pro těsnící prstěny
HU Kampókészlet tömítésekhez

RO Set carlige pt. o-ring
FR Ensemble de crochet à joint d'étanchéité
IT Set di ganci per sigillanti
ES Set de ganchos para selladores
CN 密封拉拔器

8
PCS

165
mm

225
mm

SPECIAL
SHAPE
SPECJALNY
KSZTAŁT



YATO
YT-08431

48

EN Bearing race and seal driver set
PL Zestaw do osadzania łożysk i uszczelniaaczy
DE Presssatz für Sicherungsringe, Lager etc.
RU Втулка и набор сальниковых уплотнителей для автомобиля
CZ Sada na montáž gufer
HU Csapógy, szimering, persely ki- és beütő készlet
RO Set pt. inlocuit rulment, simering
FR Set de simerings
IT Set di tamponi per cuscinetti e guarnizioni
ES Juego de conductores del anillo y del sello de rodadura
CN 斜型培令套安装器

10
PCS

AI

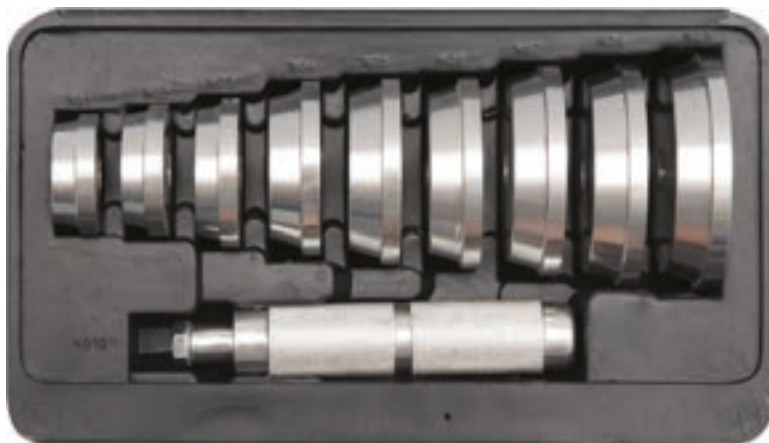
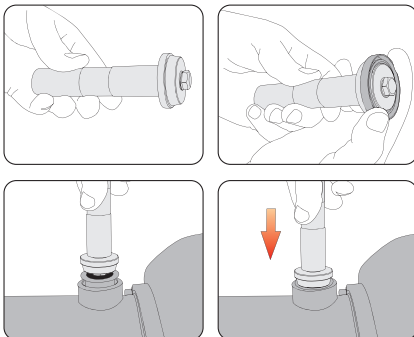

No.	Ø (mm)
01	40
02	44
03	50
04	59
05	63
06	65
07	72
08	76
09	81

YATO
YT-0638

5/10

EN Bearing race and seal driver set
PL Zestaw do osadzania łożysk i uszczelniaaczy
DE Presssatz für Sicherungsringe, Lager etc.
RU Набор для крепления подшипников и уплотнений
CZ Sada pro montáž gufer a ložisek
HU Csapógy, szimering, persely ki- és beütő készlet
RO Set pt. inlocuit rulment, simering
FR Outils montage de roulement
IT Set di tamponi per cuscinetti e guarnizioni
ES Juego de conductores del anillo y del sello de rodadura
CN 斜型培令套安装器

17
PCS

AI



No.	Ø (mm)	No.	Ø (mm)	No.	Ø (mm)
01	10x12	06	18x20	11	30x34
02	12x14	07	20x22	12	32x36
03	14x16	08	22x24	13	35x40
04	15x17	09	25x27	14	38x42
05	16x18	10	28x30		

YATO
YT-25415

10

EN Car radio removal tool set
 PL Zestaw do demontażu radioodbiorników samochodowych
 DE Autoradio Demontage Werkzeugsatz
 RU Набор для разборки авто-ресиверов

CZ Sada k demontáži autorádií
 HU Autórádó kiszereelő készlet
 RO Trusa de scule pt. indepartat radio
 FR Set d'outils pour dépose autoradio

IT Set estrattori per autoradio
 ES Juego para el desmontaje de autorradio
 CN 收音机拆卸组套

52
PCS

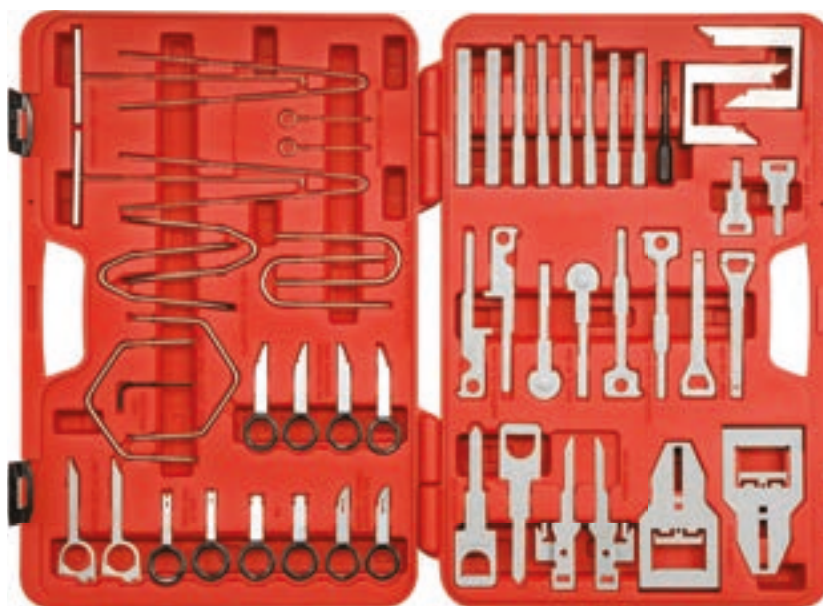

Included: radio removal keys: VW, Audi, Becker, Mercedes (4 PCS); Mercedes, Porsche, Becker (2 PCS); VW (2 PCS); new Becker (2 PCS); new Skoda (2 PCS); Fiat Brava (2 PCS); Mercedes-Benz, BMW (6 PCS); Kenwood II 1998-2001 (2 PCS); Sony II since 2002 (2 PCS); Kenwood III since 2002 (2 PCS); Pioneer, JVC (2 PCS); Sony I until 2001 (2 PCS); Panasonic (2 PCS); Kenwood I until 1998 (2 PCS); Kenwood Mask (2 PCS); new Clarion (2 PCS); old Clarion (2 PCS); Panasonic 2006 (2 PCS); Sony IDIC 2005 (2 PCS); radio removal U-hooks: Ford, VW, Audi, Grundig, Blaupunkt (2 PCS); new Blaupunkt (2 PCS); Opel (2 PCS); special pentagon wrench (BMW); allen hex wrench (BMW, Opel)

W zestawie: klucze do demontażu radia: VW, Audi, Becker, Mercedes (4 szt.); Mercedes, Porsche, Becker (2 szt.); VW (2 szt.); nowy Becker (2 szt.); nowa Skoda (2 szt.); Fiat Brava (2 szt.); Mercedes-Benz, BMW (6 szt.); Kenwood II 1998-2001 (2 szt.); Sony II od 2002 (2 szt.); Kenwood III od 2002 (2 szt.); Pioneer, JVC (2 szt.); Sony I do 2001 (2 szt.); Panasonic (2 szt.); Kenwood I do 1998 (2 szt.); Kenwood Mask (2 szt.); nowy Clarion (2 szt.); stary Clarion (2 szt.); Panasonic 2006 (2 szt.); Sony IDIC 2005 (2 szt.); haki do demontażu radia: Ford, VW, Audi, Grundig, Blaupunkt (2 szt.); nowy Blaupunkt, (2 szt.); Opel (2 szt.); specjalny klucz pięciokątny (BMW); klucz imbusowy (BMW, Opel)

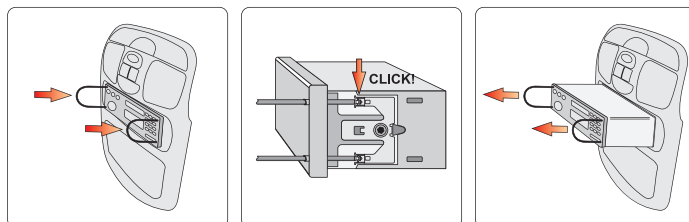

YATO
YT-0838

10

EN Door upholstery remover
 PL Ściągacz do spinek tapicerki
 DE Abziehvorrichtung für Polstererklammern
 RU Съёмник крепежа обивки

CZ Uvolňovač čalounění dveří
 HU Kárpitkiszedő
 RO Dispozitiv de scos agrafe de tapițerie
 FR Arrache agrafes

IT Estrattore per la rimozione di graffette tappezzeria
 ES Extractor de grapas de vestidura
 CN 胶扣起子

SVCM



YATO	Internal width / Szerokość wewnętrzna [mm]	L [mm]	
YT-1370	6	100	12/120

YATO	Internal width / Szerokość wewnętrzna [mm]	L [mm]	
YT-1371	6.2	115	12/120



YATO	Internal width / Szerokość wewnętrzna [mm]	L [mm]	
YT-1372	10	115	12/120

YATO	Internal width / Szerokość wewnętrzna [mm]	L [mm]	
YT-1373	9.5	134	6/96

EN Scratch awl
 PL Szpikulec prosty
 DE Einfache Spicknadel
 RU Прямое шило
 CZ Šídlo rovné
 HU Spékelőtű, egyenes

RO Dorn perforare drept
 FR Brochette droite
 IT Punteruolo piatto
 ES Punzón recto
 CN 锥子



SVCM



YATO	L [mm]	
YT-1374	120	12/120

EN Hook bodkin
 PL Szpikulec hakowy
 DE Hakenspicknadel
 CZ Šídlo háčkové
 HU Spékelőtű, horgos

RO Dorn perforare încoit
 FR Brochette coudée
 IT Gancio punteruolo
 ES Punzón encorvado
 CN 油封拉拔器

90°

SVCM



YATO	L [mm]	
YT-1375	125	12/120

EN Battery cap tool
PL Ściągacz do клем akumulatora
DE Abziehvorrichtung für Akkuklemmen
RU Стяжка для клемм аккумулятора
CZ Stahovák svorek akumulátoru
HU Akkumulátor saru lehűző

RO Extractor pt. clemă acumulator
FR Tournevis plat pour bouchons de batterie
IT Batteria clem estrattore
ES Extractor para los bornes de la batería
CN 扁铲

SVCM



YATO	Working width / Szerokość robocza [mm]	L [mm]	
YT-1378	18.5	100	12/120

EN Glass scraper
PL Skrobak do szyby
DE Scheibenkratzer
RU Шабёр для скла

CZ Škrabka na okna
HU Jégkaparó
RO Răzuitor geamuri
FR Gratteur pour vitres

IT Raschietto per vetro
ES Rascador para os vidrios
CN 刮刀

SVCM



YATO	Working width / Szerokość robocza [mm]	L [mm]	
YT-1379	39	200	6/72

EN Spare blades for glass scraper
PL Ostrze do skrobaka do szyby
DE Abbrechklingen
RU Лезвия для универсальных ножей
CZ Lomené ostří náhradní
HU Törhető tartalékpenge

RO Lame de rezervă rupte
FR Lames pour gratteur pour vitres
IT Lame per raschietto
ES Filo partido de recambio
CN 刮刀刀片配件



10 PCS

SK5



For YT-1379
Dia YT-1379

YATO	Blade size / Rozmiar ostrza [mm]	
YT-13790	19x39	50

EN Flexible spinner handle
PL Pokrętko elastyczne
DE Elastischer Dreher

RU Эластичный вороток
CZ Šroubovák ohebný
HU Hajlékony csavarhúzó

RO Mâner flexibil
FR Barre élastique
IT Chiave flessibile

ES Llave flexible
CN 套筒螺丝批

1/4"
6.3mm

SVCM



YATO	Ø	L [mm]	
YT-1381	1/4" (6.3 mm)	150	6/96

EN Flexible magnetic bit driver
PL Pokrętko elastyczne do bitów
DE Elastischer Dreher für Bits

RU Эластичный вороток для разряда битов
CZ Šroubovák ohebný na bity
HU Hajlékony csavarhúzó, hosszú

RO Mâner flexibil pt. vârf şurubelniţă
FR Barre élastique
IT Chiave flessibile

ES Mango flexible para desarmadores
CN 批头螺丝批



SVCM



YATO	Ø [mm]	L [mm]	
YT-1382	1/4" (6.3 mm)	380	6/72

EN Flexible magnetic pick up tool
PL Ściągacz do spinek tapicerki
DE Abziehvorrichtung für Polstererklammern
RU Съемник крепежа обивки

CZ Uvolňovač čalounění dveří
HU Kárpitkiszedő
RO Dispozitiv de scos agrafe de tapilerie
FR Spatule d'extraction de clips

IT Estrattore per la rimozione di graffette tappezzeria
ES Extractor de grapas de vestidura
CN 胶扣起子



SVCM



YATO	L [mm]	
YT-1385	400	6/72

EN Door upholstery remover
PL Ściągacz do spinek tapicerki
DE Abziehvorrichtung für Polstererklammern
RU Съемник крепежа обивки

CZ Uvolňovač čalounění dveří
HU Kárpitkiszedő
RO Dispozitiv de scos agrafe de tapilerie
FR Spatule d'extraction de clips

IT Estrattore per la rimozione di graffette tappezzeria
ES Extractor de grapas de vestidura
CN 胶扣起子



230 mm

YATO	L [mm]	
YT-0841	230	16/64

200 mm

YATO	L [mm]	
YT-0842	230	25/100

EN Panel removal set
 PL Ściągacze do tapicerki
 DE Abziehvorrichtung für Polsterung
 RU Съемник обивки
 CZ Sada k demontáži čalounění
 HU Kárpitlehúzó

RO Ancore pt. tapiserie
 FR Set d'extracteurs à la tapisserie
 IT Leve in plastica per la tappezzeria
 ES Tensores para las vestiduras
 CN 面板拆卸组套

5
PCS

IMPACT RESISTANT
ODPORNY NA UDERZENIA

NO SCRATCH
BEZ ZARYSOWAN

NYLON

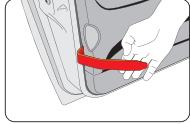
YATO
YT-0836

6/24

EN Panel removal set
 PL Ściągacze do tapicerki
 DE Abziehvorrichtung für Polsterung
 RU Съемник обивки
 CZ Sada k demontáži čalounění
 HU Kárpitlehúzó

RO Ancore pt. tapiserie
 FR Set d'extracteurs à la tapisserie
 IT Leve in plastica per la tappezzeria
 ES Tensores para las vestiduras
 CN 面板拆卸组套

6
PCS

IMPACT RESISTANT
ODPORNY NA UDERZENIA

NO SCRATCH
BEZ ZARYSOWAN

NYLON

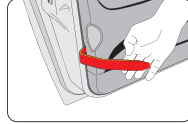
YATO
YT-0837

6/24

EN Panel removal set
 PL Ściągacze do tapicerki
 DE Abziehvorrichtung für Polsterung
 RU Съемник обивки
 CZ Sada k demontáži čalounění
 HU Kárpitlehúzó

RO Ancore pt. tapiserie
 FR Set d'extracteurs à la tapisserie
 IT Leve in plastica per la tappezzeria
 ES Tensores para las vestiduras
 CN 面板拆卸组套

11
PCS

NO SCRATCH
BEZ ZARYSOWAN

NYLON

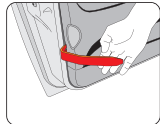
YATO
YT-0844

5/10

EN Panel removal tool kit
 PL Zestaw do obsługi tapicerki
 DE Servicesatz für Polsterung
 RU Набор для обработки обивки
 CZ Sada pro práci s čalouněním
 HU Kárpitleszedő készlet

RO Kit indepartare panouri
 FR Kit d'outils pour démontage de garniture de voiture
 IT Kit di strumenti per tappezzeria interni
 ES Juego de manipulación de tapicería
 CN 汽车面板拆卸工具组套

19
PCS

NO SCRATCH
BEZ ZARYSOWAN

NYLON

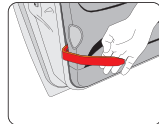
YATO
YT-08442

12

EN Panel removal set
 PL Ściągacze do tapicerki
 DE Abziehvorrichtung für Polsterung
 RU Съемник обивки
 CZ Sada k demontáži čalounění
 HU Kárpitlehúzó

RO Ancore pt. tapiserie
 FR Set d'extracteurs à la tapisserie
 IT Leve in plastica per la tappezzeria
 ES Tensores para las vestiduras
 CN 撬棍

27
PCS

SCRATCH PROOF
ODPORNE NA ZARYSOWANIA

NYLON



YATO
YT-08443

10

EN Scraper set
 PL Zestaw skrobaków do uszczelkek
 DE Dichtungsschaber-Satz
 RU Набор скребков для прокладок
 CZ Sada diátek do těsnění
 HU Tomítás kaparó készlet

RO Set raziuloare
 FR Jeu de racloirs pour joints d'étanchéité
 IT Set di raschietti per la rimozione di guarnizioni
 ES Juego de rascadores para juntas
 CN 铲刀

3
PCS

10x270 mm
25x200 mm
25x310 mm
CrV



YATO
YT-08474

5/20

EN Plastic scraper set
 PL Zestaw skrobaków plastikowych
 DE Satz von Kunst-Stoffschabern
 RU Набор пластмассовых шаберов
 CZ Souprava plastových škrabek
 HU Műanyag vakaró készlet
 RO Set de răzuitoare din plastic
 FR Kit de grattoirs en plastique
 IT Set di raschietto
 ES Juego de rascadores de plástico
 CN 塑料刮刀

4
PCS

265
mm

IMPACT RESISTANT
ODPORNY NA UDERZENIA

NO SCRATCH
BEZ ZARYSOWAN

NYLON



3/4" (19 mm); 7/8" (22 mm); 1" (25 mm); 1 1/2" (37.5 mm)

YATO
YT-0847

L [mm]
265

6/36

EN Plastic chisel set
 PL Przeciniaki z tworzywa
 DE Kunststoff-Meißel-Satz
 RU Съемники пластиковые панелей облицовки
 CZ Plastový klín pro autoklempife
 HU Műanyag véső készlet
 RO Set dalți din plastic
 FR Outils pour le rembourrage de voiture
 IT Scalpelli in plastica
 ES Cinceles plásticos para molduras
 CN 撬棍

6
PCS

NYLON

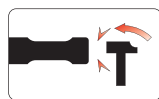
YATO
YT-08477

10/60

EN Lockout wedge set
PL Kliny montażowe
DE Zierleistenkeil mit Loch
RU Клин удаления монтировки
CZ Sada montážních klínů
HU Szerelőék készlet
RO Set pene de montaj
FR Cales de montage
IT Cunei di fissaggio
ES Cuñas plásticas
CN 塑料刹车块

4 PCS
25 mm
100x50 x25 mm



YATO

YT-67370

12/48

EN Lockout wedge set
PL Kliny montażowe
DE Zierleistenkeil mit Loch
RU Клин удаления монтировки
CZ Sada montážních klínů
HU Szerelőék készlet
RO Set pene de montaj
FR Cales de montage
IT Cunei di fissaggio
ES Cuñas plásticas
CN 撬棍

5 PCS
NYLON



YATO

YT-67371

6/24

EN Quick release cut out tool
PL Nóż do wycinania szyb
DE Schneidmesser für Scheiben
RU Нож для вырезания стекол
CZ Nůž na vyřezávání skel
HU Szélvédőkivágó kés
RO Cuițit tăietor de geam
FR Kit de découpe pare-brise
IT Tagliolo per il vetro
ES Cuchilla para cortar cristales
CN 玻璃橡胶刮除器



X3 BLADES
OSTRZA
QUICK RELEASE
SZYBKO-ZŁĄCZE
AI K5

YATO

YT-0659

20/40

EN Spare blades for cut out tool
PL Ostrza zapasowe do noża do wycinania szyb
DE Abbrechklingenn
RU Лезвья для ножей
CZ Ostří náhradní
HU Törhető tartalékpenge
RO Rezerve cutter
FR Lames
IT Lame di ricambio per coltello specialistica per tagliare vetri del auto
ES Filo partido de recambio
CN 玻璃橡胶刮除器刀片

X3 BLADES
OSTRZA
K5



For YT-0659
Dla YT-0659

3/4" (19 mm); 1" (25 mm); 1-1/2" (38 mm)

YATO

YT-06590

10/80

EN Windshield removal set
PL Zestaw do demontażu szyb samochodowych
DE Demontagesatz für Autoscheiben
RU Набор для демонтажа автостекл
CZ Souprava na demontáž autoskel
HU Szélvédőcserélő szett

RO Set pt. demontarea geamurilor de mașină
FR Kit pour démontage de vitres de voiture
IT Set di strumenti di rimozione parabrezza
ES Juego para desmontaje de cristales de coches
CN 风挡玻璃拆卸组套

7 PCS
HRC 38-42



YATO

YT-0845

10

EN Windscreen wiper arm removal tool
PL Ściągacz do ramion wycieraczek
DE Abziehvornrichtung für Scheibenwischerarme
RU Съемник поводков стеклоочистителя
CZ Stahovák na ramínka stěračů
HU Ablaktörökár lehúzó
RO Siguranță pt. brațele ștergătoarelor
FR Bord aux bras d'essuie-glace
IT Estrattore di parabrezza tergicristallo braccio
ES Herramienta para desmontaje de las plumas de los limpiaparabrisas
CN 雨刷臂拆卸工具

ADJUSTABLE
NASTAWNY



YATO

YT-0846

20/120

EN Two leg puller for widescreen wiper arms
PL Ściągacz dwuramienny do ramion i wycieraczek
DE Abzieher für Scheibenwischer
RU Съемник стеклоочистителя батареи
CZ Dvouřiční stahovač pro ramena stěračů
HU Kétkaros húzó az ablaktörők karokhoz
RO Extractor brat ștergator
FR Extracteur d'essuie glaces
IT Estrattore a due griffe per bracci tergicristalli
ES Extractor tirador exterior para brazo del limpiaparabrisas
CN 雨刷臂拉马



max 50 mm
ADJUSTABLE
NASTAWNY

YATO

YT-08461

15/60

EN Two leg puller for battery terminals and widescreen wiper arms
PL Ściągacz dwuramienny do klem i ramion wycieraczek
DE Abzieher für Wischerarm und Polklemmen
RU Съемник стеклоочистителя терминал батареи дворники
CZ Stahovák na svorky akumulátorů a ramen stěračů
HU Akusarú és ablaktörőkár-lehúzó
RO Extractor brat ștergator, cleme baterie
FR Extracteur d'essuie glaces et cosse de batterie
IT Estrattore a due griffe per binding post e bracci dei tergicristalli
ES Extractor tirador exterior para brazo del limpiaparabrisas, terminal de batería
CN 电瓶接头拉马



5-30 mm
ADJUSTABLE
NASTAWNY

YATO

YT-25145

Ø [mm]

5-30

48

- EN Two leg puller for battery terminals and widescreen wiper arms
- PL Ściągacz dwuramienny do klem i ramion wycieraczek
- DE Abzieher für Wischerarm und Polklemmen
- RU Съёмник стеклоочистителя терминал батареи дворники
- CZ Stahováč na svorky akumulátoru a ramen stěračů
- HU Akkusaru és ablaktörökár-lehúzó
- RO Extractor brat stergator, cleme baterie
- FR Extracteur d'essuie glaces et cosse de batterie
- IT Estrattore a due griffe per binding post e bracci dei tergicristalli
- ES Extractor tirador exterior para brazo del limpiaparabrisas, terminal de batería
- CN 电瓶接头拉马



10-40 mm

ADJUSTABLE NASTAWNY



YATO	Ø [mm]	
YT-08462	10-40	6/36

- EN Spring clamp remover VAG
- PL Ściągacz do obejm i sprężyn VAG
- DE Auspuff Federklammer entferner / installer für VAG
- RU Съёмник пружинных, хомутов систем выпуска VAG
- CZ Přípravek na montáž a demontáž svorky výfuku VAG
- HU Kipufogó rugó szerelő VAG
- RO Dispozitiv montat / demontat esapament VAG
- FR Tuyau d'échappement printemps pince outil de suppression pour VAG
- IT Spring clamp rimozione VAG
- ES Abrazadera de resorte herramienta de eliminación-para VAG
- CN 弹簧撑



17 mm

VAG



YATO		
YT-25331		12/24

- EN Puller for ribbed drive pulley
- PL Ściągacz kół pasowych wielorokowych
- DE Riemenscheiben Abzieher Werkzeug Keilriemenscheiben
- RU Универсальный съёмник шкива
- CZ Stavitelný stahovák drážkových řemenic
- HU Bordás szíjtárcsa lehúzó
- RO Tragător de scripele reglabil
- FR Universel extracteur de poulie d'entraînement cannelé
- IT Estrattore puleggia motrice a coste
- ES Extractor de polea acanalada
- CN 皮带轮拉马

40-165 mm

3/8" 9.5 mm

17 mm

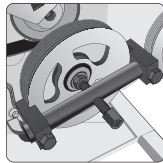

YATO		
YT-25480		10

- EN Ballancer puller and installer
- PL Ściągacz kół pasowych z tłumikiem drgań
- DE Riemenscheibenabzieher mit Schwingungsdämpfer
- RU Съёмник шкива виброгасителя
- CZ Stahováč řemenic s tlumičem vibrací
- HU Ékszíjtárcsa lehúzó készlet
- RO Extractor și instalator de echilibrare
- FR Extracteur de poulie de courroie avec amortisseur de vibrations
- IT Estrattore per puleggia con smorzatore
- ES Extractor de polea de la correa de transmisión con amortiguador de vibraciones
- CN 正时皮带盘拆卸器

23 PCS



YATO		
YT-25483		5

- EN Universal pulley puller
- PL Ściągacz uniwersalny do kół rozrządu
- DE Universal-Riemen-scheiben-Abzieher
- RU Съёмник шкивов универсальный
- CZ Stahováč ozubených kol
- HU Univerzális lehúzó vezérműtengely szíjtárcsa
- RO Extractor universal pt. roata distributie
- FR Extracteur de poulie universel
- IT Estrattore universale per ruote di albero a camme
- ES Extractor de poleas universal
- CN 皮带轮拉马

24 mm

60-90 mm

3 ARMS RAMIENNA

8 SETTINGS USTAWIENIA



YATO		
YT-06340		10

- EN Universal pulley puller
- PL Ściągacz uniwersalny do kół rozrządu
- DE Universal-Riemen-scheiben-Abzieher
- RU Съёмник шкивов универсальный
- CZ Stahováč ozubených kol
- HU Univerzális lehúzó vezérműtengely szíjtárcsa
- RO Extractor universal pt. roata distributie
- FR Extracteur de poulie universel
- IT Estrattore universale per ruote di albero a camme
- ES Extractor de poleas universal
- CN 调节正时拉马

17 mm

50-80 mm

3 ARMS RAMIENNA

6 SETTINGS USTAWIENIA

ADJUSTABLE NASTAWNY

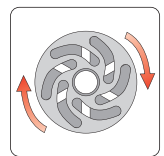

YATO		
YT-06341		10

- EN Camshaft balancer puller
- PL Ściągacz wałka wyrównowazającego
- DE Ausgleichswellen-Abzieher
- RU Съёмник балансирующего вала
- CZ Stahovač hřídele vyvažovače
- HU Kiegyenlítő tengely leszedő
- RO Extractor arbore cu came
- FR Extracteur de roue d'équilibrage
- IT Estrattore per albero di bilanciamento
- ES Extractor del eje de equilibrio
- CN 大众平衡轴拉拔器

3 PCS

VAG

FOR CAMSHAFT BALANCER DO WAŁKA WYRÓWNIWO-WAZAJĄCEGO

FOR GASOLINE ENGINES DO SILNIKÓW BENZYNOWYCH



VAG: Audi: A3 (since 2004), A4 & A5 (since 2008), TT (since 2007); Seat: Alhambra (since 2011), Altea (since 2005), Altea XL & Altea Freerack (since 2007), Exeo (since 2009), Leon (since 2006), Toledo (since 2005); Volkswagen: Eos (since 2006), Golf (since 2004), Passat (since 2006), Passat CC (since 2009), Tiguan (since 2008)

YATO		
YT-06208		10

- EN Camshaft sprocket pulley puller
- PL Ściągacz kół rozrządu
- DE Universal-Abzieher-Satz für Nockenwellenrad
- RU Набор съёмников для шкива распределите
- CZ Stahováč na řemenice vačkové hřídele
- HU Vezérműtengely ékszíjtárcsa lehúzó
- RO Extractor fulli arbore cu camee
- FR Extracteur de poulie d'arbres à came
- IT Estrattore per ruote di albero a camme
- ES Extractor de poleas universal
- CN 凸轮轴链轮拉马

5 PCS

17 mm

VAG



YATO		
YT-06342		8

- EN Fuel tank sender unit spanner
PL Klucz pazurowy do pompy paliwa
DE Tankgeberschlüssel
RU Ключ для крышки топливного насоса
CZ Nastavitelný klíč na šrouby palivových nádrží
HU Üzemanyag jeladó kiséző
RO Cheie reglabila pt. pompa combustibil pe rezervor
FR Outil de démontage de pompe
IT Chiave smontaggio galleggiante serbatoio
ES Llave de tres garras para aforador
CN 油箱盖拆装工具

24 mm 75-160 mm 3 REGULATED WIPES POLISHING PAPER



YATO
YT-06288 20

- EN Transmission line disconnect tool set
PL Zestaw do rozłączania przewodów
DE Werkzeugsatz zum Trennen von Kraftstoffleitungen
RU Набор для рассоединения топливopроводов
CZ Sada na rozpojování palivového potrubí
HU Üzemanyagcső-lebontó készlet
RO Set pt. deconectarea liniilor de combustibil
FR Outil de déconnexion de ligne de transmission de carburant
IT Set per scollegare i tubi di carburante
ES Juego para desconectar conductos de combustible
CN 油管拆卸组套

8 PCS FOR AIR CONDITIONING DO KLIMATYZACJI FOR FUEL LINES DO PRZEWODÓW PALIWA



YATO
YT-0630 20

- EN Conditioning tool set
PL Zestaw nasadek do klimatyzacji
DE Ansatz-Set für Klimaanlage
RU Набор насадок для системы кондиционирования
CZ Sada zásuvek pro klimatizaci
HU Dugókulcs készlet
Klíma berendezéshez
RO Set unelte aer conditionat
FR Ensemble de douille pour la climatisation
IT Kit di attacchi per impianto aria condizionata
ES Juego de vasos para el aire acondicionado
CN 空调修理组套

12 PCS 1/4" 6.3mm CrV



⊕ 1/4" (6.3 mm): SW12, SW15 (L=40 mm); CrV;
⊖ 1/4" (6.3 mm): 2.2, 3.2 mm (L=50 mm); CrV;
⊕ ⊖ 1/4" (6.3 mm);
⊕ ⊖ 1/4" (6.3 mm): TS10, TS15, TS20, TS25, TS27, TS30, TS40 (L=25 mm); CrV

YATO
YT-12007 10/20

- EN Water pump removal tool set
PL Zestaw do demontażu pompy wodnej
DE Demontagesatz für Wasserpumpe
RU Набор для разборки водяного насоса
CZ Sada pro demontáž vodního čerpadla
HU Vízzivattyú leszereb készlet
RO Set demontat pompa de apa
FR Kit de démontage de la pompe à eau
IT Set per rimozione pompa d'acqua
ES Juego para desmontar la bomba de agua
CN 大众水泵拆卸组套

4 PCS



VW: Transporter T5, Tuareg
AXD, AXE, BAC, BLJ, BLK, BPD, BPC, BPE (2003-)

YATO
YT-05390 10

- EN Transmission line disconnect tool set
PL Zestaw do rozłączania przewodów
DE Werkzeugsatz zum Trennen von Kraftstoffleitungen
RU Набор для рассоединения топливopроводов
CZ Sada na rozpojování palivového potrubí
HU Üzemanyagcső-lebontó készlet
RO Set pt. deconectarea liniilor de combustibil
FR Outil de déconnexion de ligne de transmission de carburant
IT Set per scollegare i tubi di carburante
ES Juego para desconectar conductos de combustible
CN 油管拆卸组套

23 PCS FOR AIR CONDITIONING DO KLIMATYZACJI FOR FUEL LINES DO PRZEWODÓW PALIWA



For fuel lines: 5/16" (8 mm), 3/8" (10 mm), 1/2" (12.5 mm), 5/8" (15.9 mm), 3/4" (19 mm), 7/8" (22.2 mm)
For air conditioning: 3/8" (10 mm), 1/2" (12.5 mm), 5/8" (15.9 mm), 3/4" (19 mm)
Do przewodów paliwa: 5/16" (8 mm), 3/8" (10 mm), 1/2" (12.5 mm), 5/8" (15.9 mm), 3/4" (19 mm), 7/8" (22.2 mm)
Do klimatyzacji: 3/8" (10 mm), 1/2" (12.5 mm), 5/8" (15.9 mm), 3/4" (19 mm)

YATO
YT-06301 10

- EN Digital thermometer
PL Termometr elektroniczny z sondą
DE Elektronisches Thermometer mit Sonde
RU Электронный термометр с зондом
CZ Elektronický teploměr se sondou
HU Elektromos hőmérő szondával
RO Termometru digital
FR Thermomètre électronique avec sonde
IT Termometro elettronico con sonda
ES Termómetro electrónico con sonda
CN 电子数显温度计

130 mm +/-1 °C LCD
-50 +300 °C 1x LR44



YATO
YT-72971 130 250



EN Lock-ring pliers
 PL Szczypce rozporowe do pierścieni osadczych
 DE Spreizzange für Schellen
 RU Щипцы распорные для стяжных хомутов
 CZ Kleště na hadicové spony
 HU Seeger fogó

RO Clește pt. desfacerea brățarelor de strângere
 FR Pince tenaille pour les bagues de retenue
 IT Pinza per rondelle elastiche scanalata
 ES Alicates para abrazaderas
 CN C型扣钳

225 mm

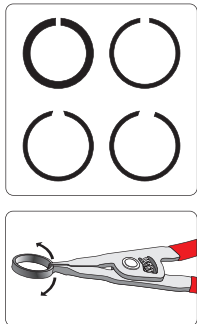
CrV



YATO  L [mm] 
 YT-0607 225 12/72

EN Fuel feel pipe pliers
 PL Szczypce do złączek paliwowych
 DE Zange für Tankverschlüsse
 RU Щипцы для топливных соединений
 CZ Kleště na spojky palivového systému
 HU Üzemanyagvezeték fogó
 RO Clește pt. conectoare de combustibil
 FR Pince tenaille pour connecteurs de carburant
 IT Pinza per tubo carburante
 ES Alicates para enchufes de combustible
 CN 油管钳



AI



YATO  L [mm] 
 YT-0608 10/40

EN Fuel feed pipe remover
 PL Szczypce do złączy przewodów paliwowych
 DE Zange für Kraftstoffleitungen-Anschlüsse
 RU Клеши для разъемов топливных магистралей
 CZ Kleště do spojek palivového potrubí
 HU Üzemanyagvezeték fogó
 RO Extractor conducte de alimentare combustibil
 FR Pince à raccord de carburant
 IT Pinza per raccordi di tubi carburante
 ES Pinzas para conectores de tubos de combustible
 CN 汽车油管钳



235 mm

FOR FUEL LINES DO PRZEWODÓW PALIWA

SPECIAL SHAPE SPECJALNY KSZTAŁT





YATO  
 YT-06082 6/24

EN CV boot clamp pliers
 PL Szczypce do opasek osłony przegubu
 DE Zange für Schellen der Gelenkabdeckung
 RU Щипцы для хомутов крепления кожуа шарнира
 CZ Kleště na spony manžety kloubu
 HU Féltengely bilincs húzó fogó
 RO Clește siguranta burduf planetara
 FR Pince pour collier à recouvrement de joint
 IT Pinza a morsetto per fascette pinzabili
 ES Alicates para abrazadera de protección de la junta
 CN 夹紧钳

235 mm

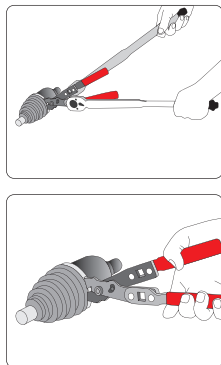
CrV



YATO  L [mm] 
 YT-0606 235 6/36

EN CV boot clamp pliers
 PL Szczypce do opasek osłony przegubu
 DE Zange für Schellen der Gelenkabdeckung
 RU Щипцы для хомутов крепления кожуа шарнира
 CZ Kleště na spony manžety kloubu
 HU Féltengely bilincs húzó fogó
 RO Clește siguranta burduf planetara
 FR Pince pour collier à recouvrement de joint
 IT Pinza a morsetto per fascette pinzabili
 ES Alicates para abrazadera de protección de la junta
 CN 防尘套喉箍夹钳



3/8" 9.5 mm

270 mm

0-40 mm

CrMo



YATO  L [mm] 
 YT-06535 270 5/20

EN CV joint clamp banding tool
 PL Szczypce do opasek przegubów napędowych
 DE Zangen für Schellen der Antriebswellengelenke
 RU Клеши для хомутов сшибов
 CZ Samonastavovací kleště do opasek homokinetických kloubů
 HU Féltengelybilincs lehozó fogó
 RO Clește pt. coliere metalice
 FR Pince pour bandes de joints d'entraînement
 IT Pinza stringi fascette per cuffie giunti omocinetici
 ES Pinzas para abrazaderas de articulaciones de transmisión
 CN 束装钳

max 10 mm

CUT OFF 切割

HARDENED STEEL 硬化鋼



YATO  L [mm] 
 YT-06062 6/36

EN Hose removing pliers
 PL Szczypce do zdejmowania przewodów
 DE Schlauch- und Kabellöszange
 RU Клеши для снятия изоляции
 CZ Kleště na demontáž hadic
 HU Tömölbilincs fogó

RO Clește pt. îndepărtat furtune
 FR Pince pour enlever les fils
 IT Pinza spelacavi universale
 ES Alicates de extracción de mangueras
 CN 油管分离钳

ø5-15mm



YATO  L [mm] 
 YT-0657 6/36

- EN Spark plug puller set VAG
PL Zestaw ściągaczy do cewek zapłonowych VAG
DE Abzieher-Satz Zündspulen VAG
RU Набор съемников для катушек зажигания VAG
CZ Sada stahováků zapalovací cívký
HU Gyújtótekercs lehúzó készlet
RO Set bobina de aprindere tragator
FR Set d'extracteurs des bobines d'allumage
IT Set per la rimozione rapida bobine di accensione nelle auto VAG
ES Extractores bobinas de encendido grupo VAG
CN 四件套火花塞维修工具

4 PCS VAG

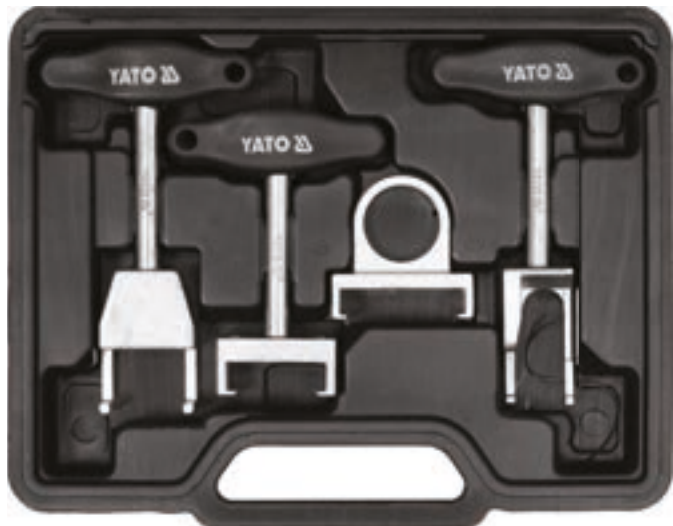

VW, Audi, Skoda, Seat

	Volkswagen FSI Golf / Bora 1998, Polo 2002, Touran 2004, New Beetle 2003, Passat 1997, T4+Audi A2 2001
	Silnik/engines 6 cyl. 24V, 5 cyl. Golf / Bora 1998, Passat / Toureg 1997, Sharan 1996, Phaeton / Toureg 6 cyl. 2003, T5 z 6 cyl. silnikiem 2004
	Volkswagen silnik / engines 2.0 z bezp. wtrysk / direct injection, Touran 2004, Passat 2006, Audi z bezp.wtrysk / direct injection A3 2.0 2004, A6 3.2 2005
	Volkswagen z bezp. wtrysk / direct injection 2.0, Golf / Touran 2004, Passat 2006, Audi z bezp. wtrysk / direct injection, A3 2.0 2004, A6 3.2 2005

YATO YT-06205 10

- EN Hose clamp pliers
PL Szczypce do opasek zaciskowych rozprężnych
DE Zange zum Entspannen der Klemmschellen
RU Щипцы к хомутам зажимным распорным
CZ Kleště na samosvorné hadicové spony
HU Vízcsőbilincs fogó
RO Clește pt. benzile de strângere destindere
FR Pince pour collier de serrage
IT Set pinze per il morsetto
ES Pinzas para las abrazaderas de expansión
CN 管夹钳

215 mm 2 mm + SLOT
LOCK BLOKADA AISI 4130



YATO YT-0646 L [mm] 215 12/72

- EN Hose clamp pliers
PL Szczypce do opasek zaciskowych rozprężnych
DE Zange zum Entspannen der Klemmschellen
RU Щипцы к хомутам зажимным распорным
CZ Kleště na samosvorné hadicové spony
HU Vízcsőbilincs fogó
RO Clește pt. benzile de strângere destindere
FR Pince pour collier de serrage
IT Set pinze per il morsetto
ES Pinzas para las abrazaderas de expansión
CN 管夹钳

230 mm 4mm ø12mm
HRC 40 LOCK BLOKADA



YATO YT-0650 L [mm] 230 6/36

- EN Multi-purpose hose & wire pliers
PL Komplet szczypiec do opasek i przewodów
DE Zangensatz für Schellen und Leitungen
RU Набор щипцов к хомутам и проводам
CZ Souprava kleští na spony a hadice
HU Fogókészlet bilincsekhez és vezetékhez
RO Set clește pt. benzii și conducte
FR Pince pour collier de serrage
IT Set pinze per il morsetto
ES Juego de pinzas para abrazaderas y cables
CN 多功能管夹钳

2 PCS 1/4" 3/4" 217 mm 254 mm

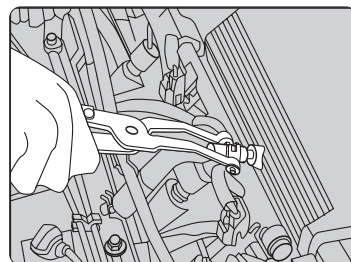

FOR ENGINE AIR PIPE
DO PRZEWODÓW POWIETRZNYCH LISTWY WTRYSKOWEJ

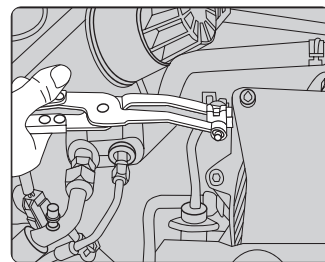

FOR ENGINE INTAKE AIR PIPE
DO PRZEWODÓW GUMOWYCH UKŁADU ZASILANIA

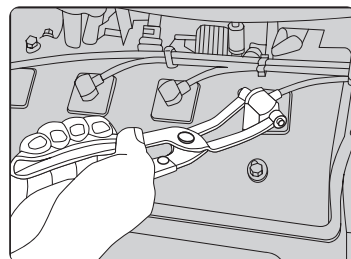

FOR SPARK PLUG LEAD
DO PRZEWODÓW ZAPŁONOWYCH

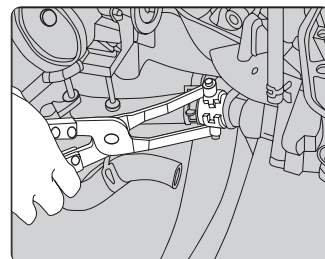

FOR COOLING WATER PIPE
DO PRZEWODÓW GUMOWYCH UKŁADU CHŁODZENIA

YATO YT-0645 L [mm] 217, 254 6/24

- EN Hose clamp pliers
PL Szczypce do opasek zaciskowych rozprężnych
DE Zange zum Entspannen der Klemmschellen
RU Щипцы к хомутам зажимным распорным
CZ Kleště na samosvorné hadicové spony
HU Vízcsőbilincs fogó
RO Clește pt. benzile de strângere destindere
FR Pince pour collier de serrage
IT Set pinze per il morsetto
ES Pinzas para las abrazaderas de expansión
CN 管夹钳

215 mm 4.5 mm V SLOT
LOCK BLOKADA AISI 4130



YATO YT-0647 L [mm] 215 12/72

- EN Hose clamp pliers
PL Szczypce do opasek zaciskowych rozprężnych
DE Zange zum Entspannen der Klemmschellen
RU Щипцы к хомутам зажимным распорным
CZ Kleště na samosvorné hadicové spony
HU Vízcsőbilincs fogó
RO Clește pt. benzile de strângere destindere
FR Pince pour collier de serrage
IT Set pinze per il morsetto
ES Pinzas para las abrazaderas de expansión
CN 弯嘴管夹钳

215 mm 4mm ø12mm
45° HRC 40 LOCK BLOKADA



YATO YT-0651 L [mm] 215 6/36

- EN Exhaust pipe clamp pliers
- PL Szczypce do opasek wydechu
- DE Auspüfischellen-Sicherungszange
- RU Щипцы для пружинных зажимов
- CZ Kleště na spony výfuku
- HU Kipufogóbilincs fogó
- RO Clește pt. coliere teava de esapament
- FR Pince pour collier d'échappement
- IT Set pinze per il morsetto
- ES Pinzas para bridas del tubo de escape
- CN 排气管夹钳



LOCK BLOKADA **300 mm**

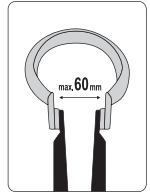

Peugeot, Citroën, Renault, Fiat, Ford

YATO	L [mm]	
YT-0652	300	10/20

- EN Valve stem seal pliers
- PL Szczypce do uszczelniaczy zaworowych, dlugie
- DE Lange Zange für Ventildichtringe
- RU Щипцы для замены масляеьменных колпачков
- CZ Kleště na těsnění ventilů, dlouhé
- HU Szelepszár szimering fogó hosszú

- RO Clește cu picior lung pt. sigilat supape
- FR Pince pour joints de queues de soupapes
- IT Pinza per tenuta anello stelo valvola
- ES Pinzas para juntas de vástago válvula
- CN 气门油封钳



270 mm FOR VALVE STEM SEALS / DO USZCZELNIACZY ZAWOROWYCH

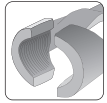

NON-SLIP ANTYPOŚLIZGOWY

YATO	L [mm]	
YT-0648	270	12/60

- EN Pliers for band clips with a cord
- PL Szczypce z linką do opasek zaciskowych
- DE Zange für Rohrschellen mit Seil
- RU Щипцы к зажимным хомутам с тросиком
- CZ Kleště s lankem na samosvorné hadicové spony
- HU Flexibilis bowdenes vízcsőbilincs fogó
- RO Clește pt. cleme de prindere frânghie
- FR Pince pour collier de serrage
- IT Pinza per il montaggio e lo smontaggio delle clips elastiche
- ES Pinzas para bandas de apretadura con cuerda
- CN 延长型弹性管夹钳

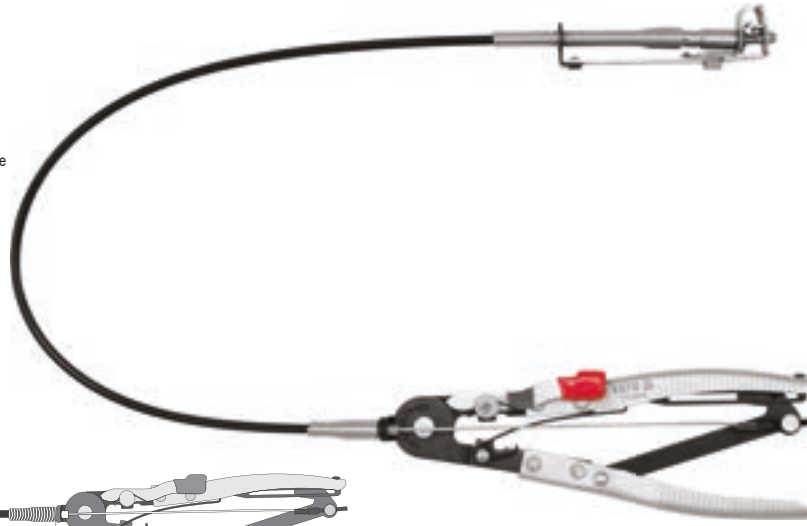

LOCK BLOKADA **CrMo 4140**

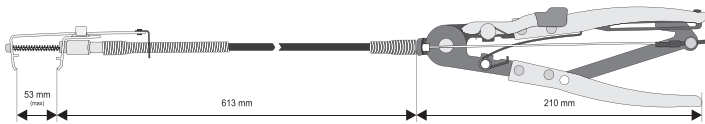

YATO	
YT-0653	12/36

- EN Pliers for band clips with a cord
- PL Szczypce z linką do opasek zaciskowych
- DE Zange für Rohrschellen mit Seil
- RU Щипцы к зажимным хомутам с тросиком
- CZ Kleště s lankem na samosvorné hadicové spony
- HU Flexibilis bowdenes vízcsőbilincs fogó
- RO Clește pt. cleme de prindere frânghie
- FR Pince pour collier de serrage
- IT Pinza per il montaggio e lo smontaggio delle clips elastiche
- ES Pinzas para bandas de apretadura con cuerda
- CN 延长型弹性管夹钳



LOCK BLOKADA **CrMo 4140**

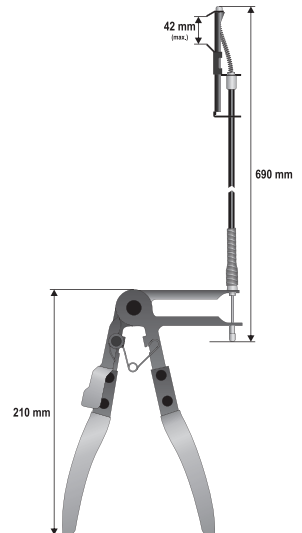



YATO	
YT-0677	25

- EN Hose clip pliers
PL Szczypce do opasek zaciskowych typu CLIC i CLIC-R
DE Schlauchklemmzange
RU Плоскогубцы для зажима шлангов хомуты, CLIC-R
CZ Kleště na hadicové spony
HU Tömlőbilincs fogó
RO Cleste furturn clip
FR Pince pour collier de serrage
IT Pinza per fascetta a CLIC e CLIC-R
ES Alicates abrazaderas
CN 压线钳

170
mm

CLIC
CLIC-R



YATO 	L [mm]	
YT-06475	170	10/60

- EN Tensioner pulley wrench
PL Klucz do rolki napinającej
DE Zahnriemen Spannrollenschlüssel
RU Ключ для регулировки натяжного
CZ Klíč na napínák
HU Bordás szij feszítő
- RO Cheie de pretensionare a centurilor
FR Clé pour rouleau de tension
IT Chiave per il rullo tenditore
ES Llave del tensor de la correa dentada
CN 滑轮定时扳手

32
mm



YATO 		
YT-06273		20/100

- EN Universal pulley holder & fan clutch set
PL Klucz do napinania koła pasowego
DE Schlüssel zum Spannen der Riemenscheibe
RU Ключ для натягивания шкива
CZ Klíč k napínání řemenice
HU Szíjtárcsa feszítő kulcs

- RO Cheie pt. întindere roată de curea
FR Clé universelle pour poulie
IT Blocca puleggia
ES Llave tensora para polea
CN 多形式皮带轮扳手

11
PCS

6-10
mm

8-11
mm

10-12
mm

11-16
mm

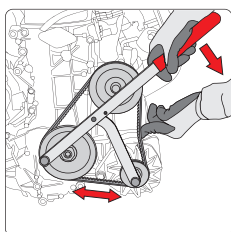

Ø 6-10 mm, Ø 8-11 mm, Ø 10-12 mm, Ø 11-16 mm

YATO 		
YT-0627		8

- EN Serpentine belt tool
PL Zestaw kluczy do napinaczy
DE Spanner-Schlüsselsatz
RU Набор ключей для натяжения ремней ГРМ
CZ Sada klíčů do napínací
HU Ékszij feszítő kulcskészlet
RO Cheie pt. curea serpentina
FR Jeu de clés pour tendeurs
IT Set di chiavi per tenditori
ES Juego de llaves para tensores
CN 惰性皮带扳手调整组



8
PCS

3/8"
9.5 mm

1/2"
12.7 mm

CrV



-  3/8" (9.5 mm): 15, 16, 18 mm; CrV;
 3/8" (9.5 mm): 13, 14, 15 mm; CrV;
590 mm

YATO 		
YT-06278		6/12

- EN Timing belt double pin wrenches tool set for VAG
PL Zestaw do obsługi rolek napinaczy VAG
DE Kit für die Bedienung von VAG-Spannrollen
RU Комплект для обслуживания роликов натяжителя VAG
CZ Sada pro údržbu napínacích kladek VAG
HU VAG feszítőtárgó szervizelő készlet
RO Trusa si chei de curele VAG
FR Kit d'extraction de coussinet VAG
IT Set di attrezzi per rulli tenditori VAG
ES Juego para rodillos tensores VAG
CN 大众奥迪正时皮带双销扳手套装

6
PCS

VAG



YATO 		
YT-06275		5

- EN Stretch fit belt tool kit
PL Zestaw do obsługi pasek elastycznych wielorowkowych
DE Werkzeugsatz für elastische Keilrippenriemen
RU Набор для использования гибких многоканавочных ремней
CZ Sada pro manipulaci s elastickými vícedrážkovými řemeny
HU Készlet több bordás ékszij kezeléséhez
RO Set catarame strangere centura scule
FR Ensemble pour le montage et démontage des courroies élastiques à nervures multiples en V
IT Kit per montaggio / smontaggio delle cinghie elastiche
ES Kit de montaje de correas elásticas ranuradas
CN 正时皮带拆装辅助器

2
PCS

FOR ELASTIC
STRAPS
DO PASKÓW
ELASTYCZNYCH

ASSEMBLY
DISASSEMBLY
MONTAZ
DEMONTAZ



YATO 		
YT-05830		20/80

- EN Piston ring compressor
- PL Zaciskacz do pierścieni
- DE Kolbenring-Spannband
- RU Оправка поршневых колец
- CZ Svěrka na kroužky
- HU Gyűrűbepattintó
- RO Cleşte pt. strâns inele
- FR Compresseur de segments de piston
- IT Morsetto per anelli
- ES Apretador de anillos
- CN 活塞环压缩机



SK5
AISI 301

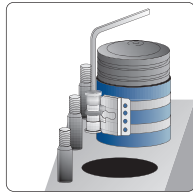

- EN Piston rings pliers
- PL Szczypce do pierścieni tłokowych
- DE Kolbenringe Zange
- RU Клещи для установки поршневых колец
- CZ Kleště na pístní kroužky
- HU Dugattyűgyűrű fogók
- RO Cleşte pt. inelul de piston
- FR Pince pour anneau de piston
- IT Pinze per anelli di pistoni
- ES Alicates de anillo de pistón
- CN 活塞环钳



40-100 mm

YATO	Ø [mm]	H [mm]	
YT-0635	50-125	75	30/60
YT-0636	90-175	100	30/60
YT-0637	90-175	150	20/40

YATO	
YT-06377	5/50

- EN Piston ring tool set
- PL Zestaw do obsługi pierścieni tłokowych
- DE Kolbenring-Wartungssatz
- RU Набор для обслуживания поршневых колец
- CZ Sada pro údržbu pístních kroužků
- HU Dugattyűgyűrű-szerelő készlet
- RO Set unelte pt. inel piston
- FR Kit d'outils d'entretien de segment de piston
- IT Set di attrezzi per fasce elastiche
- ES Kit de ensamblaje de anillos de pistón
- CN 活塞环拆装套装



10 PCS

75 x 50-125 mm, 100 x 60-175 mm, 130 x 60-175 mm

YATO	Ø [mm]	
YT-06373	50-125, 60-175, 60-175	4

- EN Cylinder honing machine
- PL Honownica do cylindrów
- DE Ziehschleifmaschine für Motorenzylinder
- RU Хонинговальный станок
- CZ Valcový honovací stroj
- HU Henger hónoló
- RO Maşină de honuit cilindri
- FR Machine à roder des cylindres
- IT Levigatrice per cilindri
- ES Máquina herramienta para afilar los cilindros
- CN 气缸打磨器



X3 HOMES KAMENJE
ADJUSTABLE TENSION REGULOVANÝ NACISK
FLEXIBLE SHAFT ELASTYČNÝ WALEK

19-63 mm
205 mm
28x6 mm

32-89 mm
230 mm
51x7 mm

51-177 mm
305 mm
76x10 mm

YATO	L [mm]	
YT-05810	205	50/100

YATO	L [mm]	
YT-05811	230	50/100

YATO	L [mm]	
YT-05812	305	5/20

- EN Interchangeable stones for honing machine
- PL Kamienie wymienne do honownicy
- DE Wechselschleifsteine für die Ziehschleifmaschine
- RU Сменный брусок для хонинговального станка
- CZ Výmenné kameny do honovacího stroje
- HU Cserélhető kövek a hónolóhoz
- RO Pietre intersanjabile pt. maşina de honuit
- FR Pierres interchangeable de la machine à roder
- IT Set di pietre di ricambio per levigatrice
- ES Piedras intercambiables a la máquina herramienta para afilar cilindros
- CN 磨石

3 PCS

28x6 mm For YT-1379 Dla YT-1379



51x7 mm For YT-1379 Dla YT-1379



76x10 mm For YT-1379 Dla YT-1379



YATO	
YT-05815	50/200

YATO	
YT-05816	50/200

YATO	
YT-05817	50/100

EN Cylinder hone tool set
PL Zestaw do honowania cylindrów
DE Zylinder-Honwerkzeug-Satz
RU Набор для хонингования цилиндров
CZ Sada pro honování válců
HU Hengerhónoló készlet
RO Kit pt. șlefuit cilindrii
FR Jeu de pierrage de cylindres
IT Set lappatore per cilindri
ES Kit de lapeadores de cilindros
CN 气缸打磨器



7 PCS	∅ 51-177 mm	FLEXIBLE SHAFT ELASTYCZNY WALEK	101x11 mm	102x11 mm
P100	P220	P400		

P100 11x102 mm (3 PCS), P220 11x101 mm (3 PCS), P400 11x101 mm (3 PCS)

YATO 	
YT-05801	10

EN Cylinder hone tool set
PL Zestaw do honowania cylindrów
DE Zylinder-Honwerkzeug-Satz
RU Набор для хонингования цилиндров
CZ Sada pro honování válců
HU Hengerhónoló készlet
RO Kit pt. șlefuit cilindrii
FR Jeu de pierrage de cylindres
IT Set lappatore per cilindri
ES Kit de lapeadores de cilindros
CN 气缸打磨器



7 PCS	∅ 20-50 mm	∅ 25-70 mm	∅ 32-89 mm	∅ 51-177 mm
FLEXIBLE SHAFT ELASTYCZNY WALEK	28x5 mm	50x7 mm	76x10 mm	100x11 mm
P220				

P220 5x28 mm (5 PCS), P220 7x50 mm (3 PCS), P220 10x76 mm (3 PCS), P220 11x100 mm (3 PCS)

YATO 	
YT-05802	10

EN Cylinder hone tool set
PL Zestaw do honowania cylindrów
DE Zylinder-Honwerkzeug-Satz
RU Набор для хонингования цилиндров
CZ Sada pro honování válců
HU Hengerhónoló készlet
RO Kit pt. șlefuit cilindrii
FR Jeu de pierrage de cylindres
IT Set lappatore per cilindri
ES Kit de lapeadores de cilindros
CN 气缸打磨器



14 PCS	∅ 20-50 mm	∅ 25-70 mm	∅ 32-89 mm	FLEXIBLE SHAFT ELASTYCZNY WALEK
28x5 mm	50x7 mm	P220		

P220 5x28 mm (8 PCS), P220 7x50 mm (3 PCS)

YATO 	
YT-05800	10

EN Belt gauge
PL Przyrząd do kontroli naciągu paska rozrządu
DE Werkzeug Spannungsprüfer
RU Прибор для проверки натяжения ремней
CZ Připravek pro kontrolu napnutí rozvodového řemene
HU Méter szíjfeszességét
RO Tester întindere curea de distribuție cu gradatie
FR Controleur de tension de courroie
IT Strumento per il controllo rapido della tensione cinghia distribuzione
ES Medidor para determinar la tensión de la correa
CN 皮带张紧器

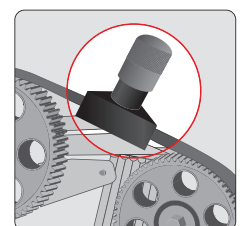

YATO 	
YT-06019	20

- EN Special socket antechamber injection pump
- PL Nasadka do komory wstępnej wtryskowej
- DE Kerbzahn-Einsatz für Vorkammer-Muttern an Dieselmotoren
- RU Сервисный ключ для форкамер
- CZ Klíč pro vstřikovací čerpadla
- HU Dugókulcs befecskendező szivattyúhoz
- RO Tubulara speciala pt. anticamera pompa de injectie motoare
- FR Douille spéciale pipe d'admission
- IT Bussola per precamera
- ES Llave de vaso con dentado exterior para cámara de precombustión
- CN 奔驰火花塞外齿套筒



1/2"
12.7mm

28 mm

MERCEDES

YATO

YT-12005

15/60

- EN VAG high pressure pump pulley remover
- PL Ściągacz pompy wtryskowej VAG
- DE VAG Einspritzpumpenabzieher
- RU Съемник для ТНВД VAG
- CZ Stahovák vstřikovacího čerpadla VAG
- HU VAG befecskendező szivattyú leszedő
- RO Dispozitiv de îndepărtare a fueliei pompei de înaltă presiune VAG
- FR Extracteur de pompe à injection VAG
- IT Estrattore per pompa di iniezione VAG
- ES Extractor de la bomba de inyección VAG
- CN 大众皮带盘扳手



15 mm

VAG

VAG

1.4 I, 1.6 I, 2.0 I TDI

YATO

YT-17527

20

- EN Twin cam locking tool for petrol & diesel engines
- PL Uniwersalna blokada wałków rozrządu
- DE Universelle Blockade der Steuerwellen
- RU Универсальный набор блокировки распределителя
- CZ Univerzální přípravek na zablokování rozvodných hřídelí
- HU Univerzális vezérműtengely rögzítő
- RO Dispozitiv universal blocare distributie
- FR Outil de blocage d'arbre à cames
- IT Universale strumento di bloccaggio a camme
- ES Bloqueo universal de eje de distribución
- CN 凸轮止锁工具



DOHC

FOR DIESEL ENGINES DO SILNIKÓW DZIELA

FOR GASOLINE ENGINES DO SILNIKÓW BENZYNOWYCH

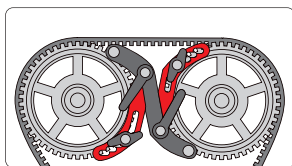

YATO

YT-06008

5

- EN Twin cam locking tool for petrol & diesel engines
- PL Uniwersalna blokada wałków rozrządu
- DE Universelle Blockade der Steuerwellen
- RU Универсальный набор блокировки распределителя
- CZ Univerzální přípravek na zablokování rozvodných hřídelí
- HU Univerzális vezérműtengely rögzítő
- RO Dispozitiv universal blocare distributie
- FR Outil de blocage d'arbre à cames
- IT Universale strumento di bloccaggio a camme
- ES Bloqueo universal de eje de distribución
- CN 双凸齿轮固定器



FOR DIESEL ENGINES DO SILNIKÓW DZIELA

FOR GASOLINE ENGINES DO SILNIKÓW BENZYNOWYCH

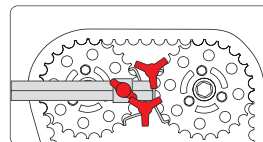

YATO

YT-06011

10/20

- EN Camshaft locking tool
- PL Przyrząd do blokowania kół rozrządu
- DE Nockenwellen-Arretierwerkzeug
- RU Инструмент для блокирования распределительных механизмов
- CZ Přípravek k montáži rozvodových kol
- HU Vezérlés rögzítő szerszám
- RO Arbore cu came
- FR Outil de blocage d'arbre à cames
- IT Set di serrature di temporizzazione
- ES Aparato para bloquear el árbol de levas
- CN 正时皮带固定器

48 mm

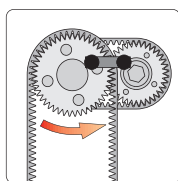

VW: Lupo (since 1999), Polo (since 1995), Caddy (since 1996), Polo Classic (since 1996), Polo Variant (since 1996), New Beetle 1.4 I, Golf 1.4 I, 1.6 I (since 1998), Bora 1.4 I, 1.6 I (since 1999)

YATO

YT-0601

6/36

- EN Diesel engine locking setting kit
- PL Blokada do kół rozrządu
- DE Blockade für Steueräder
- RU Блокировка к колесам распределительных механизмов
- CZ Souprava na fixaci rozvodových kol
- HU Diesel motor rögzítő készlet
- RO Blocadă roților distributje
- FR Outil de blocage d'arbre à cames
- IT Cinghia di distribuzione di bloccaggio
- ES Bloqueo para las poleas del mecanismo de distribución
- CN 正时皮带更换工具

3 PCS

FOR VALVETRAIN DO UKLADU ROZRZĄDU

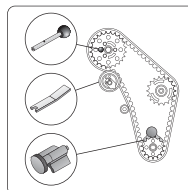

VW: Lupo, Polo, Golf, Bora, Beetle, Caddy, Sharan, Touran, Transporter (1998-2006); Audi: A2, A3, A4, A6; Ford: Galaxy (2000-2006); Seat: Arosa, Ibiza, Cordoba, Leon, Toledo, Alhambra (1999-2005); Skoda: Fabia, Octavia (2000-2006)

3 i 4 cyl 1.2, 1.4, 1.9 TDI PD, 2.0 SDI, 2.0 TDI PD

YATO

YT-0632

10/50

EN Timing locking set
PL Zestaw blokad rozrządu
DE Arretierwerkzeugsatz für Nockenwellen
RU Комплект блокировки газораспределения
CZ Blokovací sada pro opravy rozvodů
HU Vezérlérszögítő készlet

RO Set blocare distributie auto
FR Outils calage distribution moteur
IT Set di bloccaggio distribuzione auto
ES Juego de bloques de distribución
CN 正时皮带固定器组套



Peugeot: 208 1.0/1.2 VTI 2008; Citroen: C3 1.0/1.2 VTI 2012
EBO (ZMZ), EB2 (HMZ)

YATO
YT-06023 5

EN Timing locking set
PL Zestaw blokad rozrządu
DE Arretierwerkzeugsatz für Nockenwellen
RU Комплект блокировки газораспределения
CZ Blokovací sada pro opravy rozvodů
HU Vezérlérszögítő készlet

RO Set blocare distributie auto
FR Outils calage distribution moteur
IT Set di bloccaggio distribuzione auto
ES Juego de bloques de distribución
CN 正时皮带固定器组套



Renault: Twingo, Clio, Kangoo, Megane, Scenic, Laguna, Espace 1.2, 1.4, 1.6, 1.8, 2.0 16V (98-06), 1.5dCi; Nissan: Micra 1.5dCi, Kubistar 1.6 16V (03-06); Opel: Vivaro 2.0 16V (01-06)
Renault: D4F, K4J, K4M, F4P, F4R, F4Rt, F5R740, K9K; Nissan: K9K, K4M; Opel: FR4 720

YATO
YT-06014 10

EN Timing locking set
PL Zestaw blokad rozrządu
DE Arretierwerkzeugsatz für Nockenwellen
RU Комплект блокировки газораспределения

CZ Blokovací sada pro opravy rozvodů
HU Vezérlérszögítő készlet
RO Set blocare distributie auto
FR Outils calage distribution moteur

IT Set di bloccaggio distribuzione auto
ES Juego de bloques de distribución
CN 正时工具组套



- Camshaft locking pin
- Crankshaft locking pin
- 2 camshaft locking clamps
- Trzpień blokujący wałek rozrządu
- Trzpień blokujący wał korbowy
- 2 zaciski blokujące wałki rozrządu

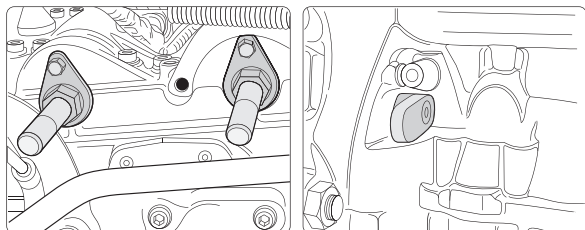

VW, Skoda, Seat 1.2 12V and 1.2 6V (HTP); VW: Polo; Seat: Ibiza, Cordoba; Skoda: Fabia HTP
IAZQ, AWY, BMD, BME (02-07)



YATO
YT-06012 10

EN Timing locking set
PL Zestaw blokad rozrządu
DE Arretierwerkzeugsatz für Nockenwellen
RU Комплект блокировки газораспределения
CZ Blokovací sada pro opravy rozvodů
HU Vezérlérszögítő készlet

RO Set blocare distributie auto
FR Outils calage distribution moteur
IT Set di bloccaggio distribuzione auto
ES Juego de bloques de distribución
CN 正时皮带固定器组套

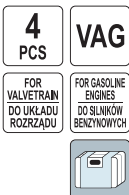

Audi: A3 (03-10); Seat: Altea, Ibiza, Leon; Skoda: Fabia II (07-09), Octavia (04-09), Roomster (06-09), Superb (09-10); VW: Eos (06-09), Golf (03-09), Golf Plus (05-09), Jetta (06-09), Passat (05-09), Polo (02-08), Scirocco (09-10), Tiguan (07-09), Touran (03-09)
1.4 FSI (AXU, BKG, BLN), 1.4 TFSI (BLG, BMY, BWK, CAVA, CAVB, CAVC, CAVD, CAVF, CAXA, CAXC, CDGA), 1.6 FSI (BAG, BLF, BLP, BTS)

YATO
YT-06017 10

EN Timing locking set
PL Zestaw blokad rozrządu
DE Arretierwerkzeugsatz für Nockenwellen
RU Комплект блокировки газораспределения
CZ Blokovací sada pro opravy rozvodů
HU Vezérlérszögítő készlet

RO Set blocare distributie auto
FR Outils calage distribution moteur
IT Set di bloccaggio distribuzione auto
ES Juego de bloques de distribución
CN 正时皮带固定器组套

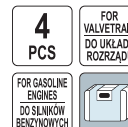

BMW: E30 318iS, E34 520i, E34 525i/525xi, E34 Serie 5, E36 318i/318iS/318ti, Z3 1.9, E36 320i, E36 Serie 3, E36 325i/325is, E36 Z3 2.2i, E36 M3, E36/7 Z3 2.5i, E36 Z3 3.0i, E36/E46 328i, E39 520i, E39 525i, E39 528i, E39 530i, E46 320i/320Ci, E46 325i/325xi, E46 325Ci, E46 325ti, E46 330i/330xi, E46 330Ci, E53 X5 3.0i, E60 530i, E60/E61 520i, E60/E61 525i/525xi, E85 Z4 2.5i, E83 X3 2.5i, E83 X3 3.0i, E85 Z4 2.2i, E85 Z4 3.0i
M42B18, M44B19, M50B20, M50B24, M50B25, M52B21, S50B30US, M54B22, M54B25, M54B30

YATO
YT-06332 10

EN Timing locking set
 PL Zestaw blokad rozrządu
 DE Arretierwerkzeugsatz für Nockenwellen
 RU Комплект блокировки газораспределения
 CZ Blokovači sada pro opravy rozvodů
 HU Vezérlésrögzítő készlet

RO Set blocare distributie auto
 FR Outils calage distribution moteur
 IT Set di bloccaggio distribuzione auto
 ES Juego de bloques de distribución
 CN 正时皮带固定器组套



4
PCS

FOR VALVETRAIN DO UKŁADU ROZRZĄDU

FOR DIESEL ENGINES DO SILNIKÓW DIELSA

FOR GASOLINE ENGINES DO SILNIKÓW BENZYNOWYCH

Dacia: Duster (2010-2014), Logan & Logan MCV (2005-2013), Sandero (2008-2013); Nissan: Kubistar (2003-2009), Primastar (2002-2011); Opel: Vivaro (2002-2011); Renault: Avantime (2000-2003), Clio II (1998-2010), Clio III (2005-2013), Espace III (1998-2003), Espace IV (2002-2010), Kangoo (2001-2008), Kangoo II (2008-2013), Laguna (1998-2001), Laguna II (2001-2007), Laguna III (2007-2013), Megane & Megane Scenic (1999-2003), Megane II (2002-2009), Megane III (2008-2013), Modus (2004-2008), Modus & Grand Modus II (2008-2013), Scenic (1999-2003), Scenic & Grand Scenic II (2002-2009), Scenic & Grand Scenic III (2009-2013), Trafic II (2001-2011), Twingo II (2007-2014), Vel Satis (2000-2010)
 Nissan: K9K, K4M; Opel: FR4 720; Renault: D4F, K4J, K4M, F4P F4R, F4Rt, F5R740, K9K

YATO
YT-06326 4

EN Timing locking set
 PL Zestaw blokad rozrządu
 DE Arretierwerkzeugsatz für Nockenwellen
 RU Комплект блокировки газораспределения
 CZ Blokovači sada pro opravy rozvodů
 HU Vezérlésrögzítő készlet
 RO Set blocare distributie auto
 FR Outils calage distribution moteur
 IT Set di bloccaggio distribuzione auto
 ES Juego de bloques de distribución
 CN 正时皮带固定器组套

RO Set blocare distributie auto
 FR Outils calage distribution moteur
 IT Set di bloccaggio distribuzione auto
 ES Juego de bloques de distribución
 CN 正时皮带固定器组套



5
PCS

FOR VALVETRAIN DO UKŁADU ROZRZĄDU

FOR GASOLINE ENGINES DO SILNIKÓW BENZYNOWYCH

Fiat: 500, Panda, Punto, Grande Punto, Albea, Linea, Bravo, Brava, Palio, Idea, Weekend, Siena, Stilo, Marea (97-10); Lancia: Ypsilon, Musa (96-10)
 1.2 16V: 176B9.000, 182B2.000, 188A5.000; 1.4 16V: 843A1.000, 169A3.000, 192B2.000, 198A1.000, 198A4.000, 199A6.000

YATO
YT-06016 10

EN Timing locking set
 PL Zestaw blokad rozrządu
 DE Arretierwerkzeugsatz für Nockenwellen
 RU Комплект блокировки газораспределения
 CZ Blokovači sada pro opravy rozvodů
 HU Vezérlésrögzítő készlet
 RO Set blocare distributie auto
 FR Outils calage distribution moteur
 IT Set di bloccaggio distribuzione auto
 ES Juego de bloques de distribución
 CN 欧宝发动机正时工具

RO Set blocare distributie auto
 FR Outils calage distribution moteur
 IT Set di bloccaggio distribuzione auto
 ES Juego de bloques de distribución
 CN 欧宝发动机正时工具



5
PCS

FOR VALVETRAIN DO UKŁADU ROZRZĄDU

FOR GASOLINE ENGINES DO SILNIKÓW BENZYNOWYCH

Opel: Agila, Corsa B, Astra G/H, Corsa, Combo C, Meriva, Tigra B
 1.0 12V, 1.0 16V, 1.2 16V, 1.4 16 V (chain); X10XE, Z10XE, Z10XEP, X12XE, Z12XE, Z14XEP

YATO
YT-06002 10

EN Timing locking set
 PL Zestaw blokad rozrządu
 DE Arretierwerkzeugsatz für Nockenwellen
 RU Комплект блокировки газораспределения
 CZ Blokovači sada pro opravy rozvodů
 HU Vezérlésrögzítő készlet

RO Set blocare distributie auto
 FR Outils calage distribution moteur
 IT Set di bloccaggio distribuzione auto
 ES Juego de bloques de distribución
 CN 宝马/雪铁龙发动机正时工具



5
PCS

FOR VALVETRAIN DO UKŁADU ROZRZĄDU

FOR BMW DIESEL ENGINES DO SILNIKÓW DIELSA/BMW

BMW: 520i E60 (04-08), Z4 2.0 E85 (04-08), X3 2.0i E83 (05-08), 118i E87 (04-07), 120i E87 (04-07), 316i E46 (01-05), 316 ti Compact E46 (04-05), 318i E46 (01-07), 318i Compact E46 (01-05), 318i E90 (05-08), 320i E90 (05-08), 116i E81/E87 (03-08), 316i E46/E90 (01-08), 316Ci E46 (01-05), 128i E82 (07-08), 130i E81/E87 (05-08), 135i E82 (07-08), 323i E90/91/92/93 (04-08), 325i/xi E90/91/92/93 (04-08), 328i/xi E90/91/92/93 (04-08), 330i/xi E90/91/92/93 (04-08), 335i/xi E90/91/92/93 (05-08), 523i/Li E60/E61 (04-08), 525 i/Li/xi E60/E61 (04-08), 528i/xi E60/E61 (06-08), 530i/xi E60/E61 (05-08), 535i/xi E60/E61 (06-08), X5 3.0 E70 (06-08), Z4 2.5/3.0 E85/E86 (05-08), 630 E63/E64 (04-08), 730i/Li E65/E66 (04-08), X3 2.5/3.0 E83 (06-08); BMW Mini: R55, R56 Cooper S (06-09), R56 Mini One (07-09); Peugeot: 207, 207 CC, 308 (07-09); Citroën: C4, C4 Picasso (08-09)
 N22/B12: N24-B18A, B20A, B20B; N40/N45/N45T/B16, N51/N52/N52K/N53/N54/N53/N54 (direct injections), N12/N14: EP3 (8FS), EP6 (6FW), EP6DT (5FX), EP6DTS (5FY); OEM: OEM119280, OEM115140, OEM113340, OEM119330

YATO
YT-06004 5

- EN Timing locking set
PL Zestaw blokad rozrządu
DE Arretierwerkzeugsatz für Nockenwellen
RU Комплект блокировки газораспределения
CZ Blokovací sada pro opravy rozvodů
HU Vezérlésrögztű készlet
RO Set blocare distributie auto
FR Outils calage distribution moteur
IT Set di bloccaggio distribuzione auto
ES Juego de bloques de distribución
CN 正时皮带固定器组套



Audi: A3 (since 2013) 1.2/1.4 TSI; Skoda: Citigo 1.0/1.0 Ecofuel/1.0 Green Tech, Octavia (since 2013); Seat: Leon (since 2013), Mii 1.0/1.0 Ecofuel/1.0 Ecomotive; VW: Golf VII (since 2012), Jetta (since 2012), Up 1.0/1.0 BlueMotion/1.0 Ecofuel

1.0 CHYA, CHYB, CPGA, 1.2 TFSI: CJZA, CJZB, 1.4 TFSI: CMBA, CXSA, CHPA, 1.4 TGI: CPWA, 1.4 TSI Multi Fuel CPVA, CZDA, CZDB, CZDC, 1.4 Hybrid CRJA



- EN Timing locking set
PL Zestaw blokad rozrządu
DE Arretierwerkzeugsatz für Nockenwellen
RU Комплект блокировки газораспределения
CZ Blokovací sada pro opravy rozvodů
HU Vezérlésrögztű készlet
RO Set blocare distributie auto
FR Outils calage distribution moteur
IT Set di bloccaggio distribuzione auto
ES Juego de bloques de distribución
CN 正时皮带固定器组套



Fiat: 500, Panda, Punto (10-16)
 312 A2 000, 312 A4 000, 312 A6 000, 199 B6 000 etc.



- EN Timing locking set
PL Zestaw blokad rozrządu
DE Arretierwerkzeugsatz für Nockenwellen
RU Комплект блокировки газораспределения
CZ Blokovací sada pro opravy rozvodů
HU Vezérlésrögztű készlet
RO Set blocare distributie auto
FR Outils calage distribution moteur
IT Set di bloccaggio distribuzione auto
ES Juego de bloques de distribución
CN 正时皮带固定器组套



Opel: Astra, Vectra, Signum, Zafira, 1.9 CDTi (04-06); Fiat: 1.9, 2.4 JTD; 16V, 20V; Alfa Romeo: 147, 156, GT 1.9 JTD 16V, 2.4 JTD 20V
 Opel: Z19DTH, Z19DT; Alfa Romeo: 192 A5.000, 192 B1.000, 937 A4.000, 937 A5.000



- EN Timing locking set
PL Zestaw blokad rozrządu
DE Arretierwerkzeugsatz für Nockenwellen
RU Комплект блокировки газораспределения
CZ Blokovací sada pro opravy rozvodů
HU Vezérlésrögztű készlet
RO Set blocare distributie auto
FR Outils calage distribution moteur
IT Set di bloccaggio distribuzione auto
ES Juego de bloques de distribución
CN 正时皮带固定器组套

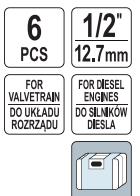

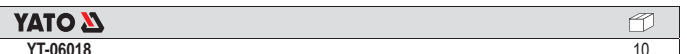

BMW: Serie 1 (E81, E82, E87, E88, F20), Serie 3 (E90, E91, E92, E93, F30), Serie 5 (E60, E61, F10, F11), X1 (E84), X3 (E83, F25)
 2.0 N47, N47S (2007-2010)





- EN Timing locking set
- PL Zestaw blokad rozrządu
- DE Arretierwerkzeugsatz für Nockenwellen
- RU Комплект блокировки газораспределения
- CZ Blokovací sada pro opravy rozvodů
- HU Vezérlésrögztű készlet
- RO Set blocare distributie auto
- FR Outils calage distribution moteur
- IT Set di bloccaggio distribuzione auto
- ES Juego de bloques de distribución
- CN 汽修工具



7 PCS	FOR VALVETRAIN DO UKŁADU ROZRZĄDU
FOR GASOLINE ENGINES DO SILNIKÓW BENZYNOWYCH	

 Opel: Adam, Ampera, Astra J, Corsa D, Meriva B, Mokka, Zafira C Tourer; Chevrolet: Aveo
 1.0 A10 XEP, 1.2 A12 XEL, 1.2 A12 XER, 1.4 A14 XFL, 1.4 A14 XEL, 1.4 A14 XER, 1.4 A14 NEL, 1.4 A14 NET



YATO 	
YT-06009	5

- EN Timing locking set
- PL Zestaw blokad rozrządu
- DE Arretierwerkzeugsatz für Nockenwellen
- RU Комплект блокировки газораспределения
- CZ Blokovací sada pro opravy rozvodů
- HU Vezérlésrögztű készlet
- RO Set blocare distributie auto
- FR Outils calage distribution moteur
- IT Set di bloccaggio distribuzione auto
- ES Juego de bloques de distribución
- CN 引擎正时工具



7 PCS	FOR VALVETRAIN DO UKŁADU ROZRZĄDU
FOR GASOLINE ENGINES DO SILNIKÓW BENZYNOWYCH	

 Opel: Astra G, H, Corsa D, Meriva (06-08), Vectra (06-08), Signum (06-08), Zafira (03-08); Chevrolet: Cruze, Orlando 1.4, 1.6, 1.8; Fiat: Croma; Alfa Romeo: 159
 Opel: 1.6-Z16LEL, Z16LER, Z16LET, Z16XE, Z16XER, 1.8-Z18XER; Chevrolet, Fiat, Alfa Romeo: 939A4.000

YATO 	
YT-06005	10

- EN Timing locking set
- PL Zestaw blokad rozrządu
- DE Arretierwerkzeugsatz für Nockenwellen
- RU Комплект блокировки газораспределения
- CZ Blokovací sada pro opravy rozvodů
- HU Vezérlésrögztű készlet
- RO Set blocare distributie auto
- FR Outils calage distribution moteur
- IT Set di bloccaggio distribuzione auto
- ES Juego de bloques de distribución
- CN 正时皮带固定器组套

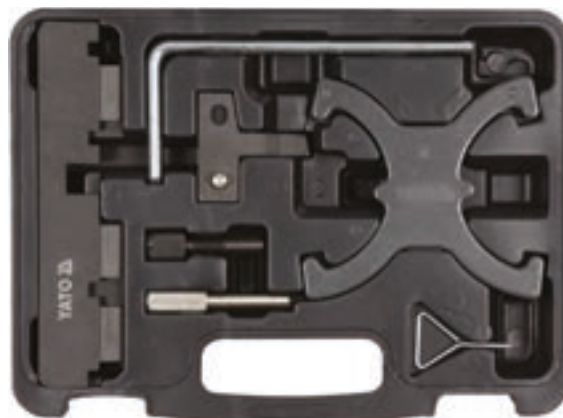

7 PCS	FOR VALVETRAIN DO UKŁADU ROZRZĄDU
FOR GASOLINE ENGINES DO SILNIKÓW BENZYNOWYCH	

 Ford: B-Max (since 2010), C-Max (03-12), Fiesta (since 2013), Galaxy (since 2010), Focus (04-15), Grand C-Max (since 2010), Kuga (since 2013), Mondeo (since 2010), S-Max (since 2010), Tourneo Connect (since 2013), Transit Connect (since 2013); Volvo: S60 Cross Country T4 (11-15), S80 GTDi T3 (10-15), V40 GTDi T4 (12-15), V60 GTDi T4F (11-15), V70 T2/T3/T4 (10-15)



 HXJA, HXJB, HXDA, IQDA, IQDB, PNBA, RHBA, SIDA, 1.6Ti-VCT FFV, PNDA, JTWB, JTWA, JTDB, JTDA, JQDB, JQDA, IQJA, B4164T4, B4164T3, B4164T2, B4164T, JQMA, JQMB, JTMA, XTDA, MUDA, JTJA, JTBA, JTBB, KGBA, JQGA

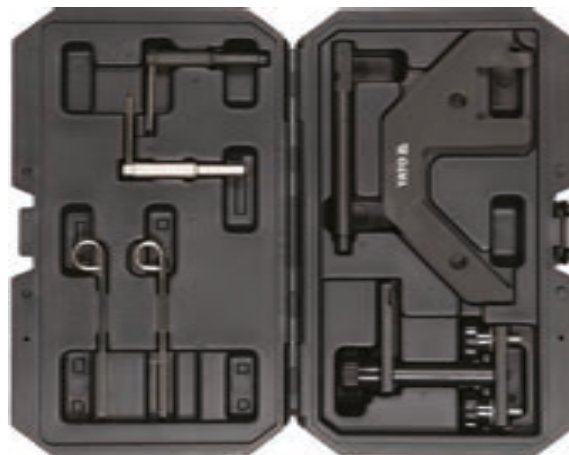

YATO 	
YT-06029	5

- EN Timing locking set
- PL Zestaw blokad rozrządu
- DE Arretierwerkzeugsatz für Nockenwellen
- RU Комплект блокировки газораспределения
- CZ Blokovací sada pro opravy rozvodů
- HU Vezérlésrögztű készlet
- RO Set blocare distributie auto
- FR Outils calage distribution moteur
- IT Set di bloccaggio distribuzione auto
- ES Juego de bloques de distribución
- CN 正时皮带固定器组套



7 PCS	FOR VALVETRAIN DO UKŁADU ROZRZĄDU
FOR DIESEL ENGINES DO SILNIKÓW DIESLA	

 BMW: 2.0 d & 3.0 d: 118d E8 & 120d E87 (2003-2007), 318d/td E46/E90/E91 (2000-2008), 320d E46/E90/E91 (1997-2008), 320cd E46/E90/E91 (1997-2008), 325d E90/91/92/93 (2006-2010), 330d E46/E90/91/92/93 & 330cd E46/E90/91/92/93 & 330cd E46/E90/91/92/93 (1998-2008), 335d E90/91/92 (2006-2010), 520d E39/E60/61 (1999-2010), 525d E39/E60/61 (1999-2010), 525xd E39/E60/61 (1999-2010), 530d E39/E60/61 (1998-2010), 530xd E39/E60/61 (1998-2010), 535d E60/61 (2004-2010), 635d E63/E64 (2004-2010), 730d E38/E65/66 (1998-2008), X3 2.0d E83 (2003-2007), X3 3.0d E83 (2003-2010), X5 3.0d E53/E70 (2000-2010); Land Rover: Freelander 2.0 Td4 (2000-2006); Land Rover/Range Rover: 3.0 Td6 (2002-2006); Opel: Omega B (2001-2003)
 Opel: Y25DT

YATO 	
YT-06333	5

- EN Timing locking set
PL Zestaw blokad rozrządu
DE Arretierwerkzeugsatz für Nockenwellen
RU Комплект блокировки газораспределения
CZ Blokovací sada pro opravy rozvodů
HU Vezérlésrögztű készlet
RO Set blocare distributie auto
FR Outils calage distribution moteur
IT Set di bloccaggio distribuzione auto
ES Juego de bloques de distribución
CN 正时皮带固定器组套





7
PCS

FOR VALVETRAIN DO UKŁADU ROZRZĄDU

FOR DIESEL ENGINES DO SILNIKÓW DIELSA

FOR GASOLINE ENGINES DO SILNIKÓW BENZYNOWYCH



 Opel; Renault; Clio, Espace, Kangoo, Master, Megane, Safrane, Scenic, Spider, R5, R9, R11, R19, R21, R25, Trafic, Twingo
 Opel: DF7, E5F, E6J, E7F, E7J, K7M, F1N, F2N+R, F3N, F3P, F3R, J5R, J5T, J6R, J7R, J7T, DF4, F7P, F7R, F8M, F8Q, F9Q, J6S, G8T, S8U, S9U, S9W; Renault: 1.2, 1.4, 1.6, 1.7, 1.8, 2.0, 2.2, 1.2 16 V, 1.8 16 V, 2.0 16 V, 1.9 D, 1.9 TD, 1.9 dTi, 2.1 D, 2.1 Turbo, 2.2 D, 2.2 TD, 2.5 D, 2.5 TD, 2.8 D, 2.8 Turbo

YATO 

YT-06325



 10

- EN Timing locking set
PL Zestaw blokad rozrządu
DE Arretierwerkzeugsatz für Nockenwellen
RU Комплект блокировки газораспределения
CZ Blokovací sada pro opravy rozvodů
HU Vezérlésrögztű készlet
- RO Set blocare distributie auto
FR Outils calage distribution moteur
IT Set di bloccaggio distribuzione auto
ES Juego de bloques de distribución
CN 正时皮带固定器组套

8
PCS

AI



 Citroen; Berlingo, Dispatch, Relay, Synergie, Santia, Xsara, ZX;
Fiat; Ducato, Ulysse; Ford; Isuzu; Opel; Astra, Calibra, Cavalier, Omega, Sintra, Vectra, Zafira; Peugeot: 205, 305, 306, 309, 406, 605, 806, Boxer, Expert, Partner 1.9 D, Talbot; Rover: 25, 45, 75, 200, 214, 216, 218, 414, 416, BRM; Saab: 900-9000; Volkswagen: Bora, Golf, Lupo, Polo, Passat
 Citroen: Berlingo 1.9 D, Dispatch 1.9 D/TD-FSO 1.9 D, Relay 1.9 D/TD, Synergie 1.9/2.0 T, Santia 1.9/2.0 D/TD/HDI, Xsara 1.9/2.0 D/HDI, ZX 1.9 D/TD, most diesels; Fiat: Ducato 2.0 D, Ulysse 1.8/2.0 Turbo; Ford: most diesels; Isuzu: 1.5/1.7 diesel engines; Opel: Astra G 1.4/1.6/1.8 16V (>1994), 1.7 TD, 2.0 16 V, Calibra 2.5/2.5i/2.6 V6, Cavalier 2.5i V6, Omega B 2.5/2.6/3.0/3.2 V6, Sintra 3.0 V6, Vectra 1.6, 1.8/2.0 16V (>1995), A 2.5i/2.6 V6, Zafira 1.6/1.8 16V; 1.6/1.7 diesel engines, 1.2/1.4/1.6/1.8/2.0 OHC petrol engines; Peugeot: 205 1.6/1.8/1.9 D, 305 1.6/1.8/1.9 D, 306 1.8/1.9 D/TD, 309 1.6/1.9 D-4.5 1.6/1.9D, 406 1.9 D, 605 2.0 D/TD, 806 1.9T D, Boxer 1.9/2.0 D/TD, Expert 1.9 D, Partner 1.9 D, Talbot (Express D, Horizon D-J5 D, Solara); Rover: 25 1.4/1.6/1.8/VVC, 45 1.4/1.6/1.8, 75 1.8, 200 Vi, 214 16V, 216 16V/Cabrio/Coupe, 218 Coupe, 414 16V, 416 16V, BRM 1.8/VV; Volkswagen: Bora 1.9 TDI, Golf 1.9 TDI, Lupo 1.2/1.4/3.0 TDI, Polo 1.4 TDI, Passat 1.9 TDI

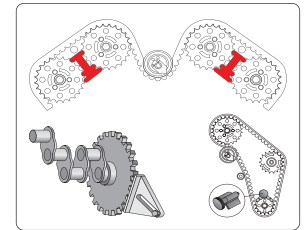

YATO 

YT-0633

 16



- EN Timing locking set
PL Zestaw blokad rozrządu
DE Arretierwerkzeugsatz für Nockenwellen
RU Комплект блокировки газораспределения
CZ Blokovací sada pro opravy rozvodů
HU Vezérlésrögztű készlet
RO Set blocare distributie auto
FR Outils calage distribution moteur
IT Set di bloccaggio distribuzione auto
ES Juego de bloques de distribución
CN 正时皮带固定器组套

8
PCS

FOR VALVETRAIN DO UKŁADU ROZRZĄDU

FOR GASOLINE ENGINES DO SILNIKÓW BENZYNOWYCH



 Ford; Galaxy 2.0, Focus 2.0, Mondeo, S-Max 2.0
 MGDA, TNBA, TNWA, TNWB, TPBA, TPWA, XQDA

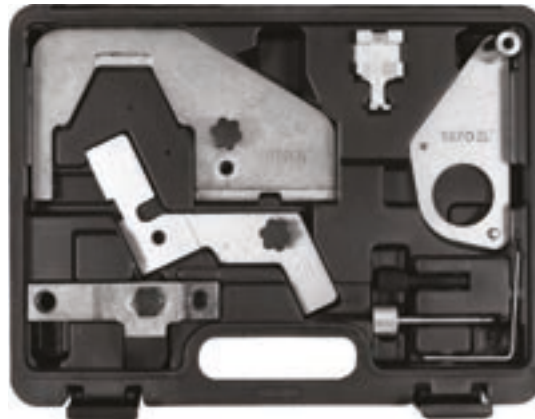

YATO 

YT-06026

 5



- EN Timing locking set
PL Zestaw blokad rozrządu
DE Arretierwerkzeugsatz für Nockenwellen
RU Комплект блокировки газораспределения
CZ Blokovací sada pro opravy rozvodů
HU Vezérlésrögztű készlet
RO Set blocare distributie auto
FR Outils calage distribution moteur
IT Set di bloccaggio distribuzione auto
ES Juego de bloques de distribución
CN 正时皮带固定器组套

8
PCS

FOR VALVETRAIN DO UKŁADU ROZRZĄDU

FOR GASOLINE ENGINES DO SILNIKÓW BENZYNOWYCH



 Ford: B-Max (12-15), C-Max (03-07), C-Max (07-10), C-Max (10-15), Fiesta (08-15), Focus (04-15), Galaxy (10-15), Grand C-Max (10-15), Kuga (13-15), Touneo Connect (13-15), Grand Touneo Connect (13-15), S-Max (10-15), Transit Connect (13-15); Mazda: 5 (CW) (10-15), 6 (GH) (10-13); Volvo: S60 (10-11); S80 (09-14), V40 Cross Country (10-14), V60 (10-14), V70 (09-14), XC60 (09-14)
 1.6: B4164T, B4164T2, B4164T3, HXDA, HXDB, HXJA, HXJB, IQDA, IQDB, IQJA, IQDA, IQDB, JQGA, JQMA, JQMB, JTDA, JTDB, JTJA, JTMA, JTWB, MUDA, PNDA, RVJA, SIDA, U5JA, XTD; 2.0: B4204T6, B4204T7, B4204T7 (MZRDIDS), MGDA, MZR2.0 (LF), R9DA, TNBA, TNBB, TNWA, TPBA, TPWA, ZQDA



YATO 



YT-06028

 5

- EN Timing locking set
- PL Zestaw blokad rozrządu
- DE Arretierwerkzeugsatz für Nockenwellen
- RU Комплект блокировки газораспределения
- CZ Blokovací sada pro opravu rozvodů
- HU Vezérlésrögztető készlet
- RO Set blocare distributie auto
- FR Outils calage distribution moteur
- IT Set di bloccaggio distribuzione auto
- ES Juego de bloques de distribución
- CN 正时皮带固定器组套



8 PCS	+/- 0.01 mm
VAG	FOR VALVETRAIN DO UKŁADU ROZRZĄDU
FOR GASOLINE ENGINES DO SILNIKÓW BENZYNOWYCH	

 VAG: Audi A3 (03-10), Seat Altea, Ibiza, Leon; Skoda Fabia II (07-09), Octavia (04-09), Roomster (06-09), Superb (09-10); VW: Eos (06-09), Golf (03-09), Golf Plus (05-09), Jetta (06-09), Passat (05-09), Polo (02-08), Scirocco (09-10), Tiguan (07-09), Touran (03-09)
 1.4 FSI: AXU, BKG, BLN; 1.4 TFSI: BLG, BMY, BWK, CAVA, CAVB, CAVC, CAVD, CAVF, CAXA, CAXC, CDGA; 1.6 FSI: BAG, BLF, BLP, BTS

YATO 	
YT-06328	5

- EN Timing locking set
- PL Zestaw blokad rozrządu
- DE Arretierwerkzeugsatz für Nockenwellen
- RU Комплект блокировки газораспределения
- CZ Blokovací sada pro opravu rozvodů
- HU Vezérlésrögztető szerszámkészlet
- RO Set blocare distributie auto
- FR Outil de blocage d'arbre à cames
- IT Set di bloccaggio distribuzione auto
- ES Juego de bloques de distribución
- CN 菲亚特正时工具



8 PCS	FOR VALVETRAIN DO UKŁADU ROZRZĄDU
FOR DIESEL ENGINES DO SILNIKÓW DIELA	



 Fiat: Ducato 1.9D / TD, Punto 1.7D / TD, Tempra 1.9TD, Tipo 1.9D
 149B1.000, 160A6.000, 160A7.000, 160D1.000, 176A3.000, 176A5.000, 176B3.000, 230A2.000, 230A3.000, 230A4.000, 280A1.000



YATO 	
YT-06323	5

- EN Timing locking set
- PL Zestaw blokad rozrządu
- DE Arretierwerkzeugsatz für Nockenwellen
- RU Комплект блокировки газораспределения
- CZ Blokovací sada pro opravu rozvodů
- HU Vezérlésrögztető készlet
- RO Set blocare distributie auto
- FR Outils calage distribution moteur
- IT Set di bloccaggio distribuzione auto
- ES Juego de bloques de distribución
- CN 正时皮带固定器组套



9 PCS	FOR VALVETRAIN DO UKŁADU ROZRZĄDU
FOR GASOLINE ENGINES DO SILNIKÓW BENZYNOWYCH	

 BMW: 316i, 316i Compact, 318i, 320i, 323i, 325i, 328i, 330i, 518i, 520i, 523i, 525i, 528i, 728i, 730i
 M52TU, M54, M56, M40, M42, M43, M44, M50, M52

YATO 	
YT-06022	1

- EN Timing locking set
- PL Zestaw blokad rozrządu
- DE Arretierwerkzeugsatz für Nockenwellen
- RU Комплект блокировки газораспределения
- CZ Blokovací sada pro opravy rozvodů
- HU Vezérműrögztető szerszámkészlet
- RO Set blocare distributie auto
- FR Outil de blocage d'arbre à cames
- IT Set di bloccaggio distribuzione auto
- ES Juego de bloqueos de distribución
- CN 雷诺凸轮轴锁止工具





9
PCS

FOR VALVETRAIN
DO UKŁADU
ROZRZĄDU

FOR GASOLINE
ENGINES
DO SILNIKÓW
BENZYNOWYCH



 Citro II, Megane / Scenic, Megane II, Scenic II, Laguna, Laguna II, Espace (since 1998)
 1.8 16 V F4P 720, 722, 760; 2.0 Turbo 16 V F4R 700, 701, 712, 713, 714, 715, 720, 722, 730, 732, 740, 741, 744, 746, 770, 771, 776, 780, 784, 786, 787, 790, 791, 792, 794, 795, 796, 797, 820, 830

YATO 
YT-06327

5

- EN Timing locking set
- PL Zestaw blokad rozrządu
- DE Arretierwerkzeugsatz für Nockenwellen
- RU Набор блокировок к колесам распределительных механизмов
- CZ Blokovací sada pro opravy rozvodů
- HU Vezérműrögztető szerszámkészlet
- RO Set blocare distributie auto
- FR Outil de blocage d'arbre à cames
- IT Set di bloccaggio distribuzione auto
- ES Juego de bloqueos de distribución
- CN 柴油正时工具组套





9
PCS

FOR VALVETRAIN
DO UKŁADU
ROZRZĄDU

FOR DIESEL
ENGINES
DO SILNIKÓW
DIEŚLA



 Nissan: Primastar (2006-), Qashqai (2007-); Renault: Espace/Grand Espace (2006-), Grand Scenic II (2006-), Koleos (2008-), Laguna II (2005-), Laguna III (2007-), Latitude (2010-), Megane II (2006-), Megane III (2009-), Scenic, Trafic (2008-), Vel Satis (2005-)
 Nissan: NV400 (2011-); 2.3 CDTi R9M, X-Trial (2007-); 2.0 DCi M9R; Opel: Movano-B (2010-); 2.3 CDTi, Vivaro (2006-); 2.0 CDTi/ecoFlex; Renault: Grand Scenic III (2009-); 2.0DCi M9R, Master III (2010-); 2.3 DCi M9T

YATO 
YT-06010

5

- EN Timing locking set
- PL Zestaw blokad rozrządu
- DE Arretierwerkzeugsatz für Nockenwellen
- RU Комплект блокировки газораспределения
- CZ Blokovací sada pro opravy rozvodů
- HU Vezérlésrögztető készlet
- RO Set blocare distributie auto
- FR Outils calage distribution moteur
- IT Set di bloccaggio distribuzione auto
- ES Juego de bloqueos de distribución
- CN 宝马迷你专用正时工具

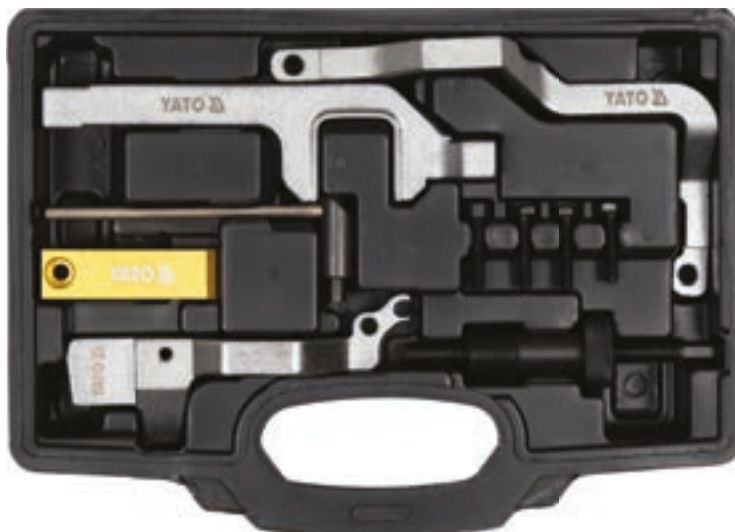

10
PCS

FOR VALVETRAIN
DO UKŁADU
ROZRZĄDU

FOR GASOLINE
ENGINES
DO SILNIKÓW
BENZYNOWYCH



 Citroën: EP3C (8F01), EP6C (5F01), EP3 (8FS), EP6 (5FW), EP6DT (5FX), EP6CDT (5F04); Peugeot: EP3 (8FS), EP6 (5FW), EP6C (5F01), EP6DT (5FX), EP5DTS (5FY), EP3C (8F01), EP6DTX (5FU), EP6DTS (5FY), EP6CDT (5F04), EP6 (5FX), EP6CDTX (5FU); BMW Mini: N12 1.4 Valvetronic (1.4 VTI, 1.5 VTI), N14 1.6 Direkteinspritzer (1.6 THP); BMW: 1.4 VTI, 1.5 VTI, N14 (1.6 THP)

YATO 
YT-06001

5

- EN Timing locking set
- PL Zestaw blokad rozrządu
- DE Arretierwerkzeugsatz für Nockenwellen
- RU Комплект блокировки газораспределения
- CZ Blokovací sada pro opravu rozvodů
- HU Vezérlésrögztítő készlet
- RO Set blocare distributie auto
- FR Outils calage distribution moteur
- IT Set di bloccaggio distribuzione auto
- ES Juego de bloques de distribución
- CN 欧宝/菲亚特/铃木发动机正时工具



12
PCS

FOR VALVETRAIN DO UKŁADU ROZRZĄDU

FOR DIESEL ENGINES DO SILNIKÓW DIESLA



 Ford: 1.3 TDCi; Fiat: Punto 1.3 JTD Multi-Jet (2003-2007), Panda, Idea, Doblo: 1.3 JTD Multi (2003-2009); Suzuki: Ignis, Wagon, Swift: 1.3 CDTi (2003-2010); Opel: Corsa C, Combo C, Astra H, Tigra B, Meriva (2003-2009)

 188A9.000, 169A1.000, 188A8.000, 188A9.000, Z13DT, Z13DTJ

YATO 
YT-06003

5

- EN Timing locking set
- PL Zestaw blokad rozrządu
- DE Arretierwerkzeugsatz für Nockenwellen
- RU Комплект блокировки газораспределения
- CZ Blokovací sada pro opravu rozvodů
- HU Vezérlésrögztítő készlet
- RO Set blocare distributie auto
- FR Outils calage distribution moteur
- IT Set di bloccaggio distribuzione auto
- ES Juego de bloques de distribución
- CN 雷诺·欧宝正时工具



 Renault: Avantime (2005-2007), Clio (2001-2008), Espace (2000-2008), Kangoo (2000-2008), Laguna (1999-2001), Laguna II (2004-2007), Master (2000-2006), Megane (1999-2008), Modus (2004-2008), Scenic (1999-2008), Traffic (2001-2008), Twingo (2007-2008); Nissan: Almera N16 (2002-2006), Interstar (2002-2006), Kubistar (2003-2008), Micra K12 (2003-2008), Note (2006-2008), Primastar (2002-2007), Primera P12 (2003-2007), Qashqai (2008-2009); Opel: Movano (2000-2008), Vivaro (2001-2008)

 1.5 (K9K), 1.9 (F9Q), 2.2 (G9T), 2.5 (G9U)

YATO 
YT-06006

8

- EN Timing locking set
- PL Zestaw blokad rozrządu
- DE Arretierwerkzeugsatz für Nockenwellen
- RU Комплект блокировки газораспределения
- CZ Blokovací sada pro opravu rozvodů
- HU Vezérlésrögztítő készlet
- RO Set blocare distributie auto
- FR Outils calage distribution moteur
- IT Set di bloccaggio distribuzione auto
- ES Juego de bloques de distribución
- CN 福特/马自达正时工具

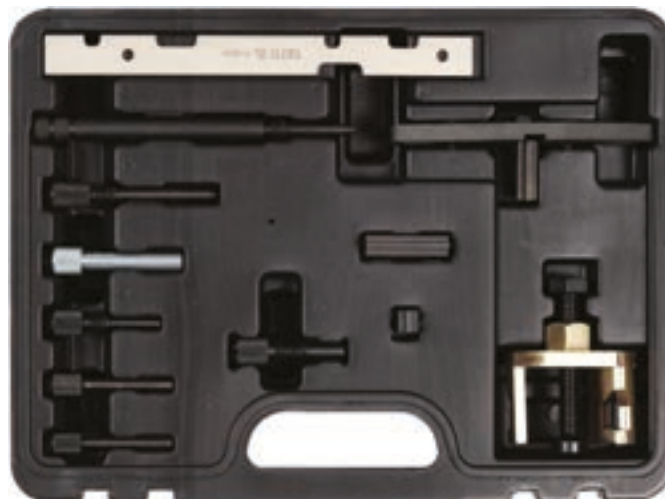

 Ford: Fiesta, Puma, Focus (1998-2008), Focus C-Max, Escort, Orion, Mondeo (1998-2000), Cougar, Courier, Transit, Fusion, Sierra, Sierra, Tourneo (1983-2000), Connect; Mazda: 1.8D (199-1999), 121 (1995-2000), 2 (2002-2007), 3 (2003-), 5 (2005-), 6 (2002-), MX-5 (2005-), MPV (2002-2005), Tribute (2001-2004); Volvo: S40 (2004-2010), V50 (2004-2010), C30 (2006-2010)

 Diesel 1.8 D / TD, 1.8 Di, 1.8 TDCi, 2.5 Di / TD / TDCi / Turbo, 1.25 16 V, 1.4 16 V, 1.6 16 V, 1.8 16 V, 2.0 16 V, 2.3 16 V; C9DC, F9DAVB, FFDA, C9DAVB, BHDAVB, BHPA, HCPA, HCPB, P7PA, P9PA, R2PA, R3PA, RWPA, KKDA, G6DA, G6DB, G6DC, RTN, RTP, RTQ, RFK, RFN, RKD, RTJ, RTK, 4EB, 4EC, 4ED, 4FA, 4FB, 4FC, 4FD, 4GA, 4GB, 4GC, 4GD, 4GE, 4HB, 4HC, 4HA, FUJA, FUJB, FXJA, FXJB, FYJA, L8, Lf, YF, L3

YATO 
YT-06021

4

- EN Timing locking set
- PL Zestaw blokad rozrządu
- DE Arretierwerkzeugsatz für Nockenwellen
- RU Комплект блокировки газораспределения
- CZ Blokovací sada pro opravy rozvodů
- HU Vezérlésrögztű készlet
- RO Set blocare distributie auto
- FR Outils calage distribution moteur
- IT Set di bloccaggio distribuzione auto
- ES Juego de bloques de distribución
- CN 正时皮带固定器组套

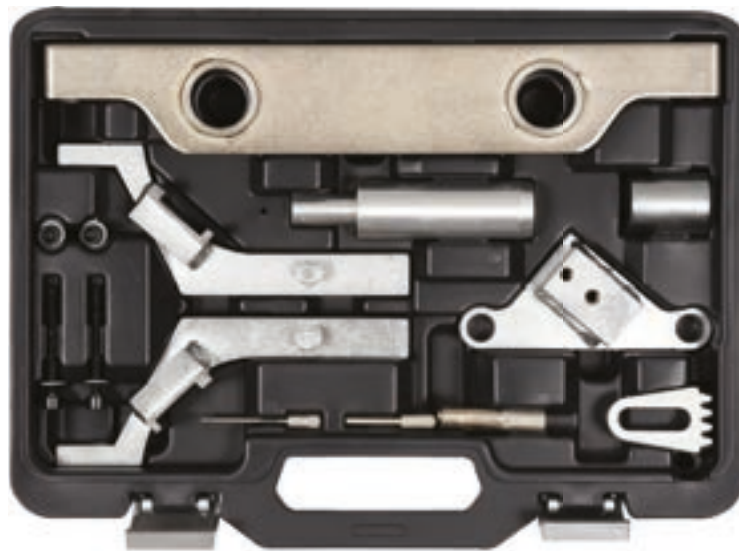



14
PCS

FOR VALVETRAIN DO UKŁADU ROZRZĄDU

FOR GASOLINE ENGINES DO SILNIKÓW BENZYNOWYCH



 Chevrolet: Captiva; Opel: Antara, Astra, Insignia; Saab: 9-5
 2.0: LHU/A20NFT, LTG/A20NHT, LDK/A20NHT; 2.4: LE5, LE9, A24XE, A24XF

YATO 
YT-06027  5

- EN Timing locking set
- PL Zestaw blokad rozrządu
- DE Arretierwerkzeugsatz für Nockenwellen
- RU Комплект блокировки газораспределения
- CZ Blokovací sada pro opravy rozvodů
- HU Vezérlésrögztű készlet
- RO Set blocare distributie auto
- FR Outils calage distribution moteur
- IT Set di bloccaggio distribuzione auto
- ES Juego de bloques de distribución
- CN 正时皮带固定器组套

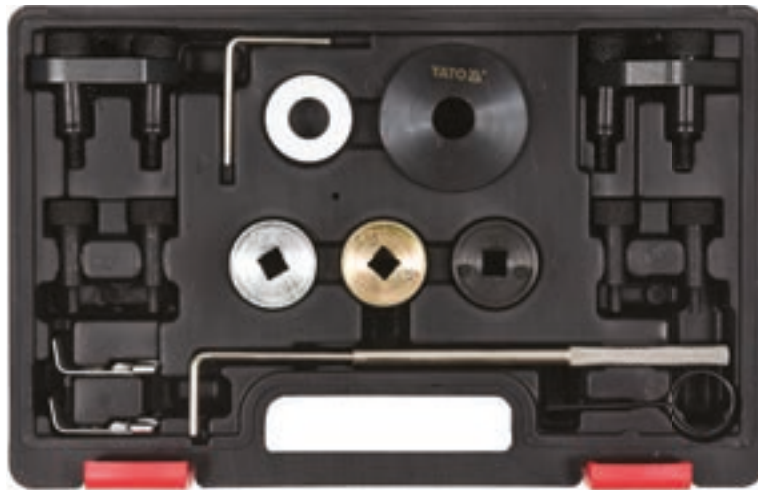



16
PCS



VAG

FOR VALVETRAIN DO UKŁADU ROZRZĄDU

FOR GASOLINE ENGINES DO SILNIKÓW BENZYNOWYCH



 Audi: A3 (8P7), A4 (8K2/8K5), A5 (8T3), Q5, TT (8J3); Seat: Alhambra (710); Skoda: Octavia (1Z3/1Z5), Superb II; VW: Beetle (5C1/5C7), Jetta III+IV, Passat (3C5/CC)
 2006-2014 TSI, TFSI (1.8/2.0): CEAA, CGMA, CCZA, CCZB, CCZC, CCZD, CCUA, CAEB, BYJ, BYE, CDA, CDAB, CDNC, CDZA, CADA, CPSA

YATO 
YT-06024  5

- EN Timing locking set
- PL Zestaw blokad rozrządu
- DE Arretierwerkzeugsatz für Nockenwellen
- RU Комплект блокировки газораспределения
- CZ Blokovací sada pro opravy rozvodů
- HU Vezérlésrögztű készlet
- RO Set blocare distributie auto
- FR Outils calage distribution moteur
- IT Set di bloccaggio distribuzione auto
- ES Juego de bloques de distribución
- CN 欧宝正时工具





29
PCS

FOR VALVETRAIN DO UKŁADU ROZRZĄDU

FOR DIESEL ENGINES DO SILNIKÓW DIELSA

FOR GASOLINE ENGINES DO SILNIKÓW BENZYNOWYCH



 Opel: Agila, Combo C, Corsa, Frontiera, Omega, Sintra, Tigra, Vectra, Zafira
 1.3 CDTI 16V, 1.9 CDTI, 2.0 DTI, 2.2 DTI, 1.0 DTI, 1.0 IZU, 1.2 16V (since 1996); 1.4 16V, 1.6 16V, 1.8 16V, 2.0 16V, 2.2 16V (since 1995)

YATO 
YT-06007  2

- EN Timing locking set
- PL Zestaw blokad rozrządu
- DE Arretierwerkzeugsatz für Nockenwellen
- RU Комплект блокировки газораспределения
- CZ Blokovací sada pro opravu rozvodů
- HU Vezérlésrögztű készlet
- RO Set blocare distributie auto
- FR Outils calage distribution moteur
- IT Set di bloccaggio distribuzione auto
- ES Juego de bloques de distribución
- CN 大众&奥迪正时工具



34
PCS **VAG** 

YATO  4
YT-06015

- EN Wire brush set
- PL Zestaw szczotek do gniazd wtryskiwaczy
- DE Bürsten Sortiment
- RU Ерши с наружной резьбой в наборе
- CZ Rourové kartáče válcové
- HU Henger drótkefe
- RO Perii cilindrice pt. curatarea gaurilor
- FR Brosse cylindrique
- IT Vetro di protezione
- ES Cepillos para limpieza interior
- CN 钢丝刷





20
PCS **150**
mm **1/4"**
6.3mm **SS**
STAINLESS STEEL
STAL NIERDZEWNA
BRASS
MOSIADZ **NYLON** 

YATO  Ø [mm] 4
YT-08195 9, 11, 13, 15, 17, 19 20

- EN Wire brush set
- PL Zestaw szczotek do gniazd wtryskiwaczy
- DE Bürsten Sortiment
- RU Ерши с наружной резьбой в наборе
- CZ Rourové kartáče válcové
- HU Henger drótkefe
- RO Perii cilindrice pt. curatarea gaurilor
- FR Brosse cylindrique
- IT Vetro di protezione
- ES Cepillos para limpieza interior
- CN 钢丝刷组套





38
PCS **150**
mm **1/4"**
6.3mm **SS**
STAINLESS STEEL
STAL NIERDZEWNA
BRASS
MOSIADZ **NYLON** 

YATO  Ø [mm] 4
YT-08196 8, 9, 10, 11, 12, 13, 14, 15, 16, 17, 18, 19 10

- EN Diesel injector puller
- PL Ściągacz bezwładnościowy do wtryskiwaczy
- DE Stoßabziehvorrichtung für Einspritzdüse
- RU Ударный съемник форсунок
- CZ Rázový vytahovač vsřikovačů
- HU Diesel portlasztű kieszedő
- RO Dispozitiv de scoas injectoare
- FR Extracteur à choc d'injecteurs
- IT Martello scorrevole per la rimozione degli iniettori
- ES Tuerca tensora de impacto para inyectores
- CN 柴油喷嘴拔取器



M8 **M12** **M14**
BOSCH
TYPE **LUCAS**
TYPE 

YATO  4
YT-0617 20

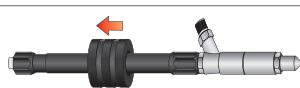

- EN Injector puller
PL Zestaw do demontażu wtryskiwaczy
DE Set zum Abmोलieren von Einspritzdüsen
RU Комплект для снятия форсунок
CZ Souprava pro demontáž vstřikovačů
HU Befecskendező készlet
RO Extractor injectoare
FR Ensemble pour démonter les injecteur
IT Kit per estrazione iniettori
ES Kit de desmontaje de inyectoros
CN 雪铁龙-标致柴油嘴拆装工具

10 PCS HDI BOSCH SIEMENS



YATO
YT-05338 4

- EN Injector puller set CDI
PL Ściągacz do wtrysków CDI
DE Diesel-Injektoren-Auszieher-Satz CDI
RU Съёмник дизельных форсунок CDI
CZ Vytahovák vstřikovačů s úderovým kládívem CDIú
HU Porlasztó kihúzó készlet csúszó kalapáccsal CDI motorhoz
RO Set extractor pt. injectoare cu ciocan inertial pt. motoare CDI
FR Coffret extracteur d'injecteur diesel CDI
IT Estrattore iniettori per Mercedes CDI
ES Juego 8 piezas de extracción de inyectoros en CDI
CN 柴油喷嘴拆卸工具

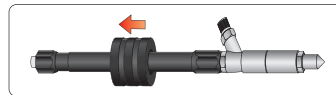

8 PCS

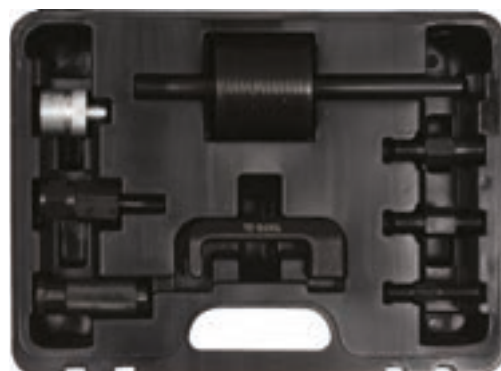

Mercedes: CDI OM611, OM612, OM613

YATO
YT-06176 5

- EN Diesel injector master removal set
PL Zestaw ściągaczy bezwładnościowych do wtryskiwaczy
DE Injektor Auszieher Abzieher Werkzeug Einspritzdüsen
RU Съёмник форсунок с ударным молотком для дизельных двигателей
CZ Souprava na demontáž vstřikovačů s reverzním kládívem
HU Injektor kihúzó készlet, csúszókalapáccsal
RO Set de extractoare inertiiale pt. injectoare
FR Coffret extracteur d'injecteur
IT Set di estrattori ad ineria per iniettori
ES Extractor de inyectoros de inyección
CN 柴油喷嘴维修工具



14 PCS 1/2" 12.7mm

BOSCH DELPHI DENSO SIEMENS

YATO
YT-06174 2

- EN Diesel injector master removal kit
PL Zestaw ściągaczy bezwładnościowych do wtryskiwaczy
DE Injektor Auszieher Abzieher Werkzeug Einspritzdüsen
RU Съёмник форсунок с ударным молотком для дизельных двигателей
CZ Souprava na demontáž vstřikovačů s reverzním kládívem
HU Injektor kihúzó készlet, csúszókalapáccsal
RO Set de extractoare inertiiale pt. injectoare
FR Coffret extracteur d'injecteur
IT Set di estrattori ad ineria per iniettori
ES Extractor de inyectoros de inyección
CN 柴油喷嘴维修工具

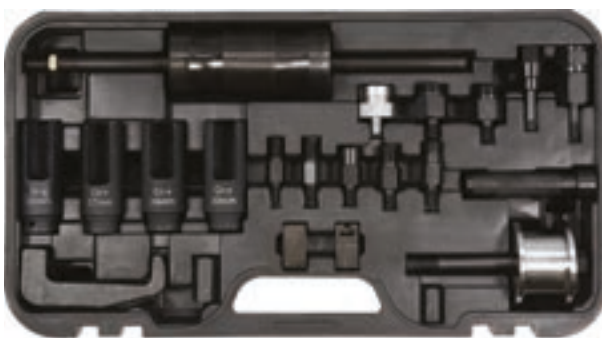

22 PCS 1/2" 12.7mm BOSCH DELPHI DENSO SIEMENS

PUMP DUSE DIESEL INJECTORS PUMP WTRYSKIWACZY 2 HAMMERS "MOLTY"

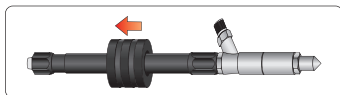

YATO
YT-06175 1

- EN Injector seat cleaning set
PL Zestaw do czyszczenia wtryskiwaczy
DE Einspritzdüsen-Reinigungsset
RU Набор для чистки инжектора
CZ Sada pro čištění trysek
HU Befecskendező fészék tisztító készlet
RO Set de curățare scaun injector
FR Kit de nettoyage pour injecteurs
IT Kit per pulizia iniettori
ES Juego de limpieza para asientos de inyectoros
CN 清洁刷套装



23 PCS 10 mm



20 mm BRASS MOSIADZ



YATO
YT-17622 25

- EN Injector seat and manhole cleaning set
- PL Zestaw do obsługi gniazd wtryskiwaczy
- DE Wartungssatz für Einspritzdüsen
- RU Набор для обслуживания патрубков форсунок
- CZ Sada pro údržbu hnízd vstřikovače
- HU Befecskendő-álműszerelőkészlet
- RO Set curățare scaun injector și gura de vizitare
- FR Kit de montage et démontage d'injecteurs
- IT Set per pulizia sedi iniettori
- ES Juego para casquillos de inyectoros
- CN 喷油嘴底座清理工具

21
PCS 

-  17x17 mm, 17x19 mm;
-  120° 17x17 mm

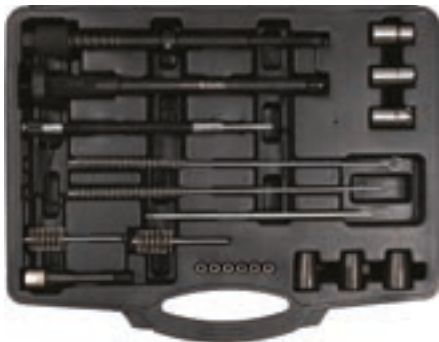
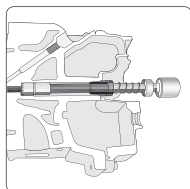

YATO  
YT-17627 4

- EN Diesel injector copper washer remover install tool
- PL Przyrząd do wyciągania podkładek wtryskiwaczy
- DE Ausziehvorrichtung für Einspritzdüsenunterlagen
- RU Инструмент для снятия шайб форсунок
- CZ Nástroj pro demontáž podložek vstřikovačů
- HU Befecskendő alátét eltávolító szerszám
- RO Instrument instalare / extragare injector diesel
- FR Extracteur d'injecteur diesel
- IT Estrattore per rondelle iniettori
- ES Herramienta para quitar arandelas de inyectoros
- CN 柴油喷油嘴垫片拆卸器

 7.5-10 mm **260** mm 







YATO  
YT-17629 10

- EN Glow plug reamer set
- PL Zestaw do czyszczenia gniazd świec żarowych
- DE Reinigungsset für Glühkerzen
- RU Набор для чистки свечей накаливания
- CZ Sada k čištění otvorů zážehových svíček
- HU Gyújtógyertya aljzat tisztítókészlet
- RO Set de curățat și rectificat filete pt. bujii incandescente
- FR Kit de nettoyage des puits de bougie de préchauffage
- IT Kit per pulizia delle bussole delle candele
- ES Set de limpieza de asientos de bujías incandescentes
- CN 热塞铰刀组套

M10 x 1 mm; M12 x 1.25 mm; M12 x 1.25 mm



3
PCS 
CrV 

YATO  
YT-05341 10/20

- EN Glow plug puller set
- PL Zestaw do demontażu uszkodzonej świecy żarowej
- DE Demontagesatz für beschädigte Glühkerzen
- RU Набор для снятия поврежденных свечей накаливания
- CZ Sada pro demontáž poškozené žhavicí svíčky
- HU Izzítógyertya kiszerező készlet
- RO Set extractor bujii incandescente
- FR Kit de démontage d'une bougie de préchauffage défectueuse
- IT Set per rimozione candele danneggiate
- ES Juego de desmontaje de la bujía dañada
- CN 预热塞拆卸器

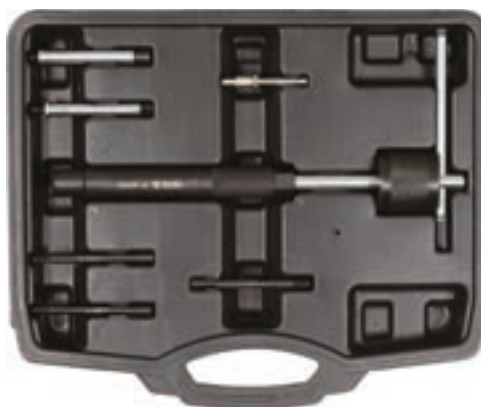
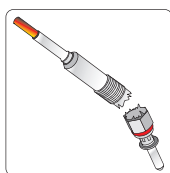

7
PCS 

YATO  
YT-05343 5

- EN Universal extractor broken glow plugs
- PL Zestaw do demontażu urwaných świec żarowych
- DE Glühkerze Entfernung Reparatur
- RU Набор инструментов для демонтажа свечей накаливания
- CZ Přípravek pro odvrtání a opravu závitu žhavicích svíček
- HU Izzítógyertya menesztés készlet
- RO Set extractor bujii reparare filet
- FR Kit extracteur bougie de préchauffage et réparation de filetage
- IT Kit per l'estrazione delle candele rotte
- ES Descripción de juego reparación de rosca
- CN 热塞螺纹修复工具

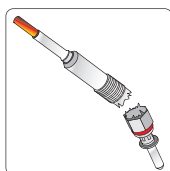

16
PCS
3/8"
9.5 mm
CrV
HSS
4241

YATO  
YT-05342 5

- EN Glow plug heater element removal set
PL Zestaw do demontażu żarnika świecy
DE Set zur Glühfaden-Demontage
RU Комплект для снятия свечей накаливания
CZ Souprava pro odstranění vlákná svíc
HU Gyújtógyertya kiszedő készlet
RO Extractor element incalzitor bujii
FR Kit extracteur de filament de bougie
IT Kit per l'estrazione dei filamenti delle candele
ES Kit de desmontaje de filamento de vela
CN 预热塞



22
PCS

HSS



YATO 
YT-05345

 10

M8 x 1 mm; M10 x 1 mm; M10 x 1.25 mm

- EN Valve grinding set
PL Zestaw docieraków ręcznych do zaworów
DE Handventil-Läppsatz
RU Набор для ручной притирки клапанов
CZ Sada přípravků pro lapování ventilů
HU Manuális szelepcsiszoló készlet
RO Set pt. slefuit supape
FR Kit de rodage soupape
IT Kit di utensili manuali per lappatura valvole
ES Conjunto de reguladores manuales de válvulas
CN 气门研磨棒



2
PCS \varnothing 15-20
mm
 \varnothing 30-36
mm 

YATO 
YT-06187

 40

- EN Overhead valve spring compressor
PL Przyrząd do demontażu zaworów silnikowych
DE Vorrichtung zur Demontage von Motorventilen
RU Устройство для демонтажа клапанов двигателя
CZ Přípravek na demontáž ventilů motoru
HU Szeleplehűző készülék
RO Dispozitiv pt. demontarea supapelor la motoare
FR Outil pour démonter les soupapes de moteur
IT Strumento per la rimozione di valvole motore
ES Instrumento para desmontaje de válvulas de motor
CN 下压式凡尔钳



320 mm OHV  FOR ENGINE VALVES DO ZAWORÓW SILNIKOWYCH

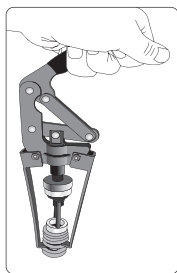

YATO 
YT-0618

 5/25

- EN Overhead valve spring compressor
PL Przyrząd do demontażu zaworów silnikowych
DE Vorrichtung zur Demontage von Motorventilen
RU Устройство для демонтажа клапанов двигателя
CZ Přípravek na demontáž ventilů motoru
HU Szeleplehűző készülék
RO Dispozitiv pt. demontarea supapelor la motoare
FR Outil pour démonter les soupapes de moteur
IT Strumento per la rimozione di valvole motore
ES Instrumento para desmontaje de válvulas de motor
CN 气门弹簧压缩器



YATO 
YT-06184

 10/20

- EN Exhaust pipe expander set
PL Zestaw rozpiereków do rur wydechowych
DE Auspuffrohr-Aufweitungssatz
RU Комплект распорок для выхлопных труб
CZ Sada expandérů do výfuků
HU Kipufogócső tágitó készlet
RO Set largire teava esapament
FR Kit élargisseur de tuyau d'échappement
IT Kit di cilindri per tubi di scarico
ES Kit expansor para tubos de escape
CN 排气管扩孔器

3
PCS \varnothing 17
mm
 \varnothing 19
mm \varnothing 29-42
mm
 \varnothing 38-62
mm \varnothing 54-89
mm 



YATO 
YT-06166

 5

- EN Exhaust pipe cutting tool
PL Obcinak do rur wydechowych
DE Auspuffrohrsneider
RU Цепной резак выхлопной трубы
CZ Rezačka výfukového potrubí
HU Kipufogócső vágó
RO Instrument de tăiere a țevilor de esapament
FR Coupeur de tuyau d'échappement
IT Tagliatubi di scarico
ES Cortador de tubos de escape
CN 排气管割刀

max 2.5 mm STEEL STEEL \varnothing 18-95 mm x15 GCr15 



YATO 
YT-06169

 12/24

EN Oxygen sensor crowfoot wrench
 PL Klucz do sondy lambda
 DE Schlüssel für die Lambdasonde
 RU Ключ для зонда лямбда

CZ Klíč na sondu lambda
 HU Lambda szonda kulcs
 RO Cheie pt. sonda lambda
 FR Clé pour sonde lambda

IT Chiave per sonde lambda
 ES Llave para la sonda lambda
 CN 氧传感器套筒扳手

22 mm

FOR OXYGEN SENSOR DO SONDY LAMBDA



CrMo SCM440

CrV 50BV30



YATO	
YT-1753	15/60

YATO	
YT-1754	6/36

EN Socket and oxygen sensor set
 PL Klucze nasadowe do sondy lambda
 DE Steckschlüssel für Lambdasonde
 RU Торцовые ключи с внутренним многогранником для зонда лямбда

CZ Nástrčné klíče na sondy lambda
 HU Dugókulcs lambda szondához
 RO Prize pt. sonda slambda
 FR Douille pour sonde lambda
 IT Set di riparazione per filetti di sonde lambda
 ES Llaves de cubo para la sonda lambda
 CN 氧传感器套筒扳手组套



3 PCS

22 mm

CrMo SCM440

CrV 50BV30

FOR OXYGEN SENSOR DO SONDY LAMBDA



22 mm; L=50 mm; 6PT; CrMo SCM440;
 22 mm; L=30 mm; 6PT; CrMo SCM440;
 22 mm; L=80 mm; 6PT; CrV 50BV30

EN Oxygen sensor extra-long socket
 PL Klucz do sondy lambda extra dlugi
 DE Lambdasonde-Schlüssel extra lang
 RU Ключ для лямбда-зонда удлиненный

CZ Klíč do lambda sondy extra dlouhý
 HU Lambdaszonda kulcs extra hosszú
 RO Cheie lunga pt. senzorul de oxigen
 FR Clé pour sonde lambda extra longue
 IT Chiave extra lunga per sonda lambda
 ES Llave para sonda lambda extra larga
 CN 加长含氧感应套筒

1/2" 12.7 mm

22 mm

150 mm

CrV

FOR OXYGEN SENSOR DO SONDY LAMBDA



YATO		L [mm]	
YT-17513	1/2" (12.7 mm)	150	10/60

EN Oxygen flexi head wrench
 PL Klucz lamany do sondy lambda
 DE Gelenkschlüssel für Lambdasonde
 RU Двусторонний ключ для лямбда-зонда

CZ Lámaný klíč do lambda sondy
 HU Lambda szonda kulcs
 RO Cheie articulata pt. conducte oxigen
 FR Clé articulée pour sonde lambda
 IT Chiave pieghevole per sonda lambda
 ES Llave articulada para la sonda lambda
 CN 氧传感扳手

22 mm

22 mm

270 mm

CrV

FOR OXYGEN SENSOR DO SONDY LAMBDA



YATO	
YT-17515	6/36

EN Oxygen sensor and fuel injectors wrench set
 PL Zestaw nasadek do sondy lambda i wtryskiwaczy
 DE Steckschlüsselsatz für Lambdasonde und Einspritzdüsen
 RU Набор насадок к лямбда-зондам и форсункам

CZ Sada nástavců na demontáž sondy lambda a vstříkovačů
 HU Dugókészlet lambda szondákhoz és injektorokhoz
 RO Set inelare pt. sonda lambda și injectoare
 FR Douilles pour sonde lambda et injecteurs
 IT Set di attrezzi per sonda lambda e inietture
 ES Juego de boquillas para la sonda lambda y para inyectores
 CN 氧传感器套筒扳手组套



7 PCS

1/2" 12.7 mm

3/8" 9.5 mm

CrMo SCM440

CrV 50BV30

FOR OXYGEN SENSOR DO SONDY LAMBDA

FOR FUEL INJECTORS DO WTRYSKIW PALNIKA



1/2" (12.7 mm) x 29 mm; L=90 mm; 6PT;
 3/8" (9.5 mm) x 22 mm; L=90 mm; 6PT;
 1/2" (12.7 mm) x 27 mm; L=78 mm; 12PT;
 3/8" (9.5 mm) x 27 mm; L=74 mm; 6PT;
 3/8" (9.5 mm) x 22 mm; L=80 mm; 6PT;
 1/2" (12.7 mm) x 22 mm; L=50 mm; 6PT;
 3/8" (9.5 mm) x 22 mm; L=30 mm; 6PT

YATO	
YT-1751	1/2" (12.7 mm), 3/8" (9.5 mm) 5

EN Slotted special socket set
PL Zestaw nasadek otwartych
DE Spezial-Sleckschlüssel-Einsätze, geschlitzt
RU Набор головок разрезных
CZ Sada otevřených hlavic
HU Crowafej speciális vég nyitott
RO Set de chei tubulare pt. injectoare
FR Ensemble de clés creuses avec fenêtre latérale
IT Set di attacchi aperti
ES Conjunto de teclas huecas con ventana lateral
CN 开槽油管扳手

7 PCS 3/8" 9.5mm 1/2" 12.7mm CrV



10, 11, 12, 13, 14, 17, 19 mm

YATO
YT-17508 6/24

EN Drive flex crowfoot socket wrench set tool
PL Zestaw kluczy przegubowych oczkowych otwartych
DE Gelenk-Ringschlüssel-Satz (offen)
RU Набор шарнирных открытых гаечных ключей
CZ Sada otevřených očkových kloubových klíčů
HU Racsnis villáskulcs készlet
RO Set chei tubulare articulate
FR Jeu douilles à joint à anneau
IT Set di chiavi snodate ad anello aperte
ES Juego de llaves articuladas de anillo abiertas
CN 万向扳手

12 PCS 3/8" 9.5mm 8-19 mm

HRC 42-48 CrV



3/8" (9.5 mm): 8, 9, 10, 11, 12, 13, 14, 15, 16, 17, 18, 19 mm; CrV

YATO
YT-38550 3/8" (9.5 mm) 10

EN Diesel injection socket set
PL Zestaw nasadek do wtrysków w silnikach Diesla
DE Aufsätze für Einspritzungen bei Dieselmotoren
RU Набор насадок к форсункам в дизельных двигателях
CZ Sada nástavců na trysky dieselových motorů
HU Szerszámkészlet Dieselmotor befecskendezőkhöz
RO Set de capete pt. injectoare în motoare Diesel
FR Set des douilles pour injecteurs (diesel)
IT Set di custodie per i motori diesel
ES Juego de tapones para las inyecciones en los motores de Diesel
CN 柴油机加注套筒组套



6 PCS 1/2" 12.7mm CrV

AS-DRIVE FOR FUEL INJECTORS DO WTRYSKÓW PALMIA

21x90; 22x78; 22x110; 27x78; 28x78; 28x83 mm

YATO
YT-0622 1/2" (12.7 mm) 10

EN Diesel injector and cutter set
PL Zestaw frezów do gniazd wtryskiwaczy Common Rail
DE Fräasersatz für Buchsen der Einspritzdüsen
RU Комплект фрез для гнезд сопел форсунок
CZ Sada fréz na seda trysek vstřikovačů
HU Marókészlet befecskendező fúvókájának fészékéhez
RO Set de freze pt. socluri de duze injectoare
FR Alimentation d'un injecteur de Common Rail
IT Set di frese per sedi iniettori Common Rail
ES Juego de fresas para el asiento de toberas de inyectores
CN 气门铰刀



7 PCS CrMoV SKD11

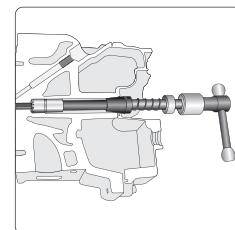

17x17 mm, 17x19 mm, 15x19 mm; CrMoV SKD11;
120° 17x17 mm, 120° 17x21 mm; CrMoV SKD11

YATO
YT-17625 10

EN Tooth socket for injection nozzle
PL Zestaw kluczy czopowych do wtryskiwaczy w samochodach ciężarowych
DE Stiftschlüsselsatz für Einspritzdüse in Lastkraftwagen
RU Набор шиповых ключей к форсункам грузовых автомобилей
CZ Sada klíčů na vstřikovače pro nákladní automobily
HU Csapókulcs készlet tehergépkocsik befecskendezőjéhez
RO Set chei tubulare cu ungere pt. camioane
FR Set de douilles injecteurs
IT Set di chiavi per iniettori camion
ES Juego de llaves de muñon para los inyectores en camiones
CN 卡车喷嘴套筒组套



4 PCS 1/2" 12.7mm

CrMo S45C CrV

FOR FUEL INJECTORS DO WTRYSKÓW PALMIA

1/2" (12.7 mm); L=72 mm; 4T; CrV;
32 mm; M14 x 1.5 mm; L=70 mm, 4T; S45C;
1/2" (12.7 mm); L=120 mm; 3T; CrMo;
32 mm; L=120 mm, 4T; S45C

YATO
YT-1762 1/2" (12.7 mm) 16

EN Socket key-attachments for Bosch VE-pumps
 PL Zestaw nasadek do pomp wtryskowych Bosch VE
 DE Aufsatz-Set für Bosch VE Einspritzpumpen
 RU Набор насадок для инжекторных насосов Bosch VE
 CZ Sada násad pro vstřikovací čerpadla Bosch VE
 HU Dugókulcs készlet Bosch VE befecskendező szivattyúhoz
 RO Set tubulare speciale pt. pompe injectie Bosch
 FR Jeu de douilles Bosch VE pour pompes d'injection
 IT Kit di attacchi per pompe d'iniezione Bosch VE
 ES Set de accesorios para bombas de inyección Bosch VE
 CN 博世泵套筒

3
PCS

1/2"
12.7mm

CrV

FOR
VE PUMPS
DO POMP
TIYPU VE



YATO		
YT-17525	1/2" (12.7 mm)	12/48

EN Camshaft joint sleeve
 PL Nasadka do regulacji faz rozrządu
 DE Aufsatz zur Regelung der Nockenwellenphasenverstellung
 RU Насадка для регулировки фаз газораспределения
 CZ Nástavec pro regulaci časování ventilů
 HU Vezérlésállító dugókulcs
 RO Dispozitiv pt. montat manson axa cu came
 FR Manchon de déphasage d'arbre à cames
 IT Attacco per sincronizzatore albero a camme
 ES Vaso para girar el árbol de levas
 CN 调节气门正时帽

ø3/8"
9.5 mm

VAG



VAG: Audi: A3 & A3 Sportback (12-16), A3 Cabriolet (13-16), A4 (08-15), A4 Quattro (12-15), A5 (09-11), A5 Sportback (09-16), A5 Cabriolet (09-12), A5 Coupe (13-16), Q5 (05-17), TT (15-18); Seat: Alhambra (11-16), Altea, Altea XL & Altea Freetrack (09-16), Exeo (09-16), Leon (09-17), Leon ST (13-17); Skoda: Octavia II (08-13), Octavia III (13-17), Superb II (08-15), Superb III (15-17), Yeti (13-15); VW: Beetle (13-16), CC (12-15), EOS (08-15), Golf V & VI (09-13), Golf VII (12-15), Golf Alltrack (14-17), Jetta VI (11-16), Jetta V (05-11), Passat (11-17), Tiguan (07-15), Touran (14-17)

1.8 TFSI: CDA, CDA, CDAA, CDHA, CDHB, CJEB, CJEE, CJS, CJSB, CJEB, 2.0 TFSI: CNCD, CNCE, CNDC, CDNB, CDNC, CFKA, CPSA

YATO		
YT-06335	3/8" (9.5 mm)	80

EN Camshaft adapter socket set
 PL Zestaw nasadek do regulacji faz rozrządu
 DE Nockenwellen-Adapter-Steckschlüssel-Satz
 RU Набор для регулировки распределительного вала
 CZ Přípravky na nastavení fázi časování rozvodu
 HU Vezérműtengely állító dugókulcs készlet
 RO Set chei adaptoare arbore cu came
 FR Jeu d'adapteurs d'arbre à cames
 IT Set di bussole per sincronizzatore albero a camme
 ES Vasos para girar el árbol de levas
 CN 凸轮轴接头套筒

3
PCS

3/8"
9.5 mm

VAG



Audi: A3 (2011-, 2005-2013), A3 Quattro (2009-2013), A4 (2008, 2009-2015, 2016-), A4 Quattro (2009-2015), A5 (2008-2011), A5 Cabriolet (2009), A5 Coupe (2008), A5 Quattro (2009-2016), A6 2.0 TFSI (2012-2014), Tiguan (2016-), Q3 (2012-2015), Q5 (2008; 2009-2016), TT (2010-2014), TT Quattro (2009-2014); Seat: Alhambra (2011), Altea (2011), Altea XL (2009), Exeo (2009), Freetrack (2011), Leon (2011); Skoda: Octavia (2009-2013), Superb (2009-2015), Yeti 1.8 TSI (2010-2015); VW: Beetle 2.0 TSI (2012-2016), CC 1.8 TSI/2.0 TSI (2012-2016), EOS 2.0 TSI (2010-2016), Golf GTI 1.8 TSI/2.0 TSI (2009-2013), Jetta GLI 2.0 TSI (2008-2014), Passat 1.8 TSI/2.0 TSI (2009-2015), Passat CC 1.8 TSI/2.0 TSI (2009-2012), Scirocco 2.0 TSI (2009-2016), Sharan 1.8 TSI/2.0 TSI (2011-2016), Tiguan 2.0 TSI (2008-2016)

Audi: BYT, BZB, CABA, CABB, CABD, CAEA, CAEB, CAED, CBFA, CCTA, CCZA, CCZC, CDA, CDHA, CDHB, CDNB, CDNC, CESA, CETA, CHJA, CPMA, CPMB, CPSA; Skoda: CCZA; VW: CAWB, CBFA, CCTA, CCZA, CCZB

YATO		
YT-06336	3/8" (9.5 mm)	20

EN Fuel injection test kit
 PL Zestaw diagnostyczny do wtrysku paliwa
 DE Diagnosesatz für Prüfung der Kraftstoffinspritzung
 RU Пневматический набор к тормозным зажимам
 CZ Souprava k diagnostice vstřikování paliva
 HU Diagnosztikai készlet üzemanyag - befecskendezőkhöz
 RO Ansamblu pt. diagnosticarea injectiei combustibilului
 FR Kit de test de débit d'injecteur
 IT Set diagnostico per iniettori la benzina
 ES Juego de herramientas diagnosticas para la inyección de combustible
 CN 燃料注射测试组套

10
PCS

0.7
MPa
(max.)

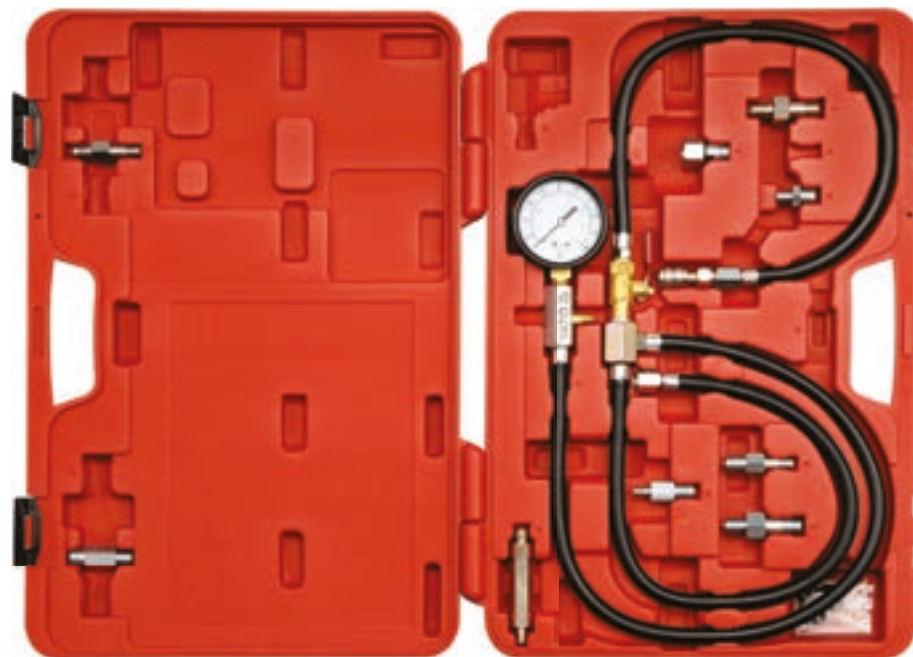

YATO	
YT-0670	10

- EN Fuel pressure tester
- PL Miernik ciśnienia paliwa
- DE Kraftstoffmessgerät
- RU Датчик давления топлива
- CZ Měřič tlaku paliva
- HU Üzemanyagnyomás-mérő
- RO Tester presiune combustibil
- FR Kit de testeur de pression d'injection de carburant
- IT Misuratore della pressione del carburante
- ES Medidor de presión de combustible
- CN 燃油压力表



20 PCS	0-1 MPa	0-140 psi
FOR DIESEL ENGINES DO SILNIKÓW DZIELA	FOR GASOLINE ENGINES DO SILNIKÓW BENZYNOWYCH	

YATO
YT-73025

6

- EN Compression tester
- PL Miernik ciśnienia sprężania
- DE Druckluftmessgerät
- RU Тестер компрессии
- CZ Měřicí přístroj kompresního tlaku
- HU Kompresszió mérő
- RO Aparat de măsurarea presiunii
- FR Testeur de pression adapteur cône
- IT Manometro pressione
- ES Medidor de compresión
- CN 气缸压力表



2.1 MPa	M14 M18
FOR SPARK IGNITION DO ZAPŁONÓW ISKROWYCH	RUBBER ADAPTOR ZŁĄCZE GUMOWE



YATO
YT-73011

10

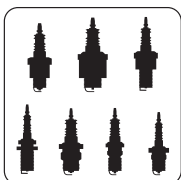

FOR ALL TYPES
DO WSZYSTKICH TYPÓW

- EN Compression pressure gauge in a diesel engine
- PL Miernik ciśnienia sprężania w silnikach diesla
- DE Kompressionsdruckmesser in Dieselmotoren
- RU Измеритель давления компрессии в дизельных двигателях
- CZ Souprava k měření kompresních tlaků v dieselových motorech
- HU Dieselmotorok kompresszióját mérő óra
- RO Manometrul presiunii aerului comprimat pt. motoarele diesel
- FR Testeur de pression cylindrique diesel
- IT Tester di compressione per motori diesel
- ES Medidor de presión de la compresión en los motores diesel
- CN 柴油机压力测试组套



16 PCS	7.0 MPa
FOR DIESEL ENGINES DO SILNIKÓW DZIELA	

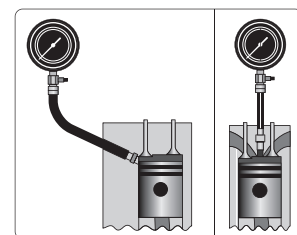

- 70 bar, 500 mm;
- 160 mm;
- M20x1.5: 75 mm; M22x1.5: 73 mm; M24x1.5: 88 mm; M24x2: 63 mm;
- M10x1: 83, 91, 102, 113, 119 mm; M10x1.25: 64, 135 mm; M12x1.25: 47 mm; M22x1.5: 118 mm;
-

YATO
YT-7307

5

- EN Compression pressure gauge in a diesel engine
- PL Miernik ciśnienia sprężania w silnikach diesla
- DE Kompressionsdruckmesser in Dieselmotoren
- RU Измеритель давления компрессии в дизельных двигателях
- CZ Souprava k měření kompresních tlaků v dieselových motorech
- HU Dieselmotorok kompresszióját mérő óra
- RO Manometrul presiunii aerului comprimat pt. motoarele diesel
- FR Testeur de pression cylindrique diesel
- IT Tester di compressione per motori diesel
- ES Medidor de presión de la compresión en los motores diesel
- CN 柴油机压力测试组套



19 PCS	7.0 MPa
FOR DIESEL ENGINES DO SILNIKÓW DZIELA	

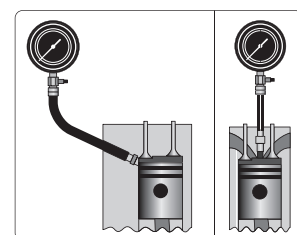

YATO
YT-73072

10

- EN Compression tester
- PL Miernik ciśnienia sprężania
- DE Druckluftmessgerät
- RU Тестер компрессии
- CZ Měřicí přístroj kompresního tlaku
- HU Kompresszió mérő
- RO Aparat de măsurare a presiunii
- FR Testeur de pression adapteur cône
- IT Manometro pressione
- ES Medidor de presión de compresión
- CN 气缸压力表



50 PCS	4.0 MPa
FOR DIESEL ENGINES DO SILNIKÓW DIELSA	FOR GASOLINE ENGINES DO SILNIKÓW BENZYNOWYCH
	

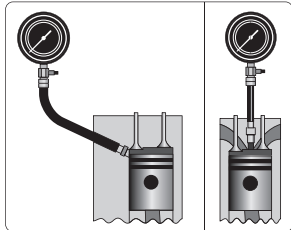



YATO  
YT-73012 4

- EN Compression tester kit
- PL Miernik ciśnienia sprężania - benzyna
- DE Kompressionsmessgerät - Ottomotoren
- RU Измеритель давления сжатия - бензин
- CZ Kompresní tlakoměr - benzin
- HU Benzin kompresszió mérő
- RO Kit tester compresie
- FR Manomètre de compression pour moteur à essence
- IT Tester di compressione per motori a benzina
- ES Medidor de presión de compresión, gasolina
- CN 汽油压力表





8 PCS	0-2 MPa	0-300 psi
FOR GASOLINE ENGINES DO SILNIKÓW BENZYNOWYCH		
		

YATO  
YT-73022 6

- EN Oil combustion spraying pressure meter
- PL Miernik ciśnienia wtrysku paliwa
- DE Kraftstoff-Einspritzdruckmessgerät
- RU Измеритель давления впрыска топлива
- CZ Měřič tlaku vstřikování paliva
- HU Üzemanyag befecskendező nyomásmérő
- RO Kit măsurare presiune injectoare
- FR Manomètre de pression d'injection du carburant
- IT Misuratore della pressione di iniezione del carburante
- ES Medidor de presión de inyección de combustible
- CN 燃油压力表



9 PCS	0-0.7 MPa	0-100 psi
		

YATO  
YT-73024 10

- EN Vacuum & fuel pump tester
- PL Wakuometr - miernik pomiaru ciśnienia i podciśnienia
- DE Vakuummessgerät - Druck- und Unterdruckmessgerät
- RU Вакуумметр - прибор для измерения давления и вакуума
- CZ Vakuové měřidlo - zařízení pro měření tlaku a podtlaku
- HU Nyomásmérő és vákuummérő
- RO Tester pompa combustibil
- FR Vacuomètre - manomètre de mesure de pression et de dépression
- IT Vacuometro - misuratore della pressione-depressione
- ES Vacuómetro: medidor de presión y presión negativa
- CN 真空压力表





9 PCS	0-0.1 MPa	0-14 psi
		

YATO  
YT-73050 10

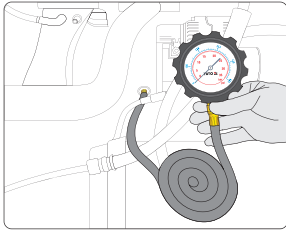
- EN Oil pressure tester
- PL Miernik ciśnienia oleju
- DE Öldruckanzeige
- RU Тестер давления масла с адаптерами
- CZ Tester tlaku oleje
- HU Olajnyomásmérő készlet
- RO Tester presiune ulei
- FR Set de testeurs de pression d'huile
- IT Tester misurazione pressione dell'olio
- ES Manómetro de aceite
- CN 自动波箱压力表





12 PCS	0-35 bar	0-500 psi
185cm 	FOR ALL TYPES OF ENGINES DO WSKYCH TYPOW SILNIKÓW 	

YATO 
YT-73030

10

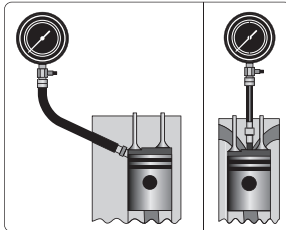
- EN Cylinder leak detector
- PL Zestaw do pomiaru szczelności cylindrów
- DE Zylinder-Druckverlust-Tester
- RU Набор для измерения герметичности цилиндра
- CZ Sada pro měření těsnosti válců
- HU Kompresszióvégnomásmérő készlet
- RO Dispozitiv detectare pierdere presiune cilindrii
- FR Ensemble de mesure d'étanchéité des vérins
- IT Kit per la misura di tenuta cilindri
- ES Kit para medir fugas de cilindros
- CN 汽缸测漏表





4 PCS	7.0 MPa	 STANDARD
FOR GASOLINE ENGINES DO SILNIKÓW BENZYNOWYCH 		

YATO 
YT-73055

5

- EN Common cool gas meter
- PL Zestaw do obsługi systemów klimatyzacji
- DE Bedienungssatz für Klimasysteme
- RU Комплект для эксплуатации систем кондиционирования
- CZ Sada pro obsluhu klimatizačních systémů
- HU Klíma szivárgáskereső készlet
- RO Manometru pt. gaz
- FR Ensemble pour la maintenance des systèmes de climatisation
- IT Kit manutenzione per impianto aria condizionata
- ES Kit de operación de sistemas de aire acondicionado
- CN 冷媒表



6 PCS	0-0.8 MPa	0-3.4 MPa
 3 145cm	R-134a 	

YATO 
YT-72990

6

- EN Ozone generator
- PL Generator ozonu
- DE Ozon-Generator
- RU Генератор озона
- CZ Generátor ozónu
- HU Ózongenerátor
- RO Generator ozon
- FR Générateur d'ozone
- IT Generatore di ozono
- ES Generador de ozono
- CN 臭氧机



110-230V~ 50/60Hz	220 W	10 g/h
 0-90 min		

YATO 
YT-73350

[W]
220

4

EN Compression tester
 PL Miernik ciśnienia sprężania
 DE Druckluftmessgerät
 RU Тестер компрессии

CZ Měřicí přístroj kompresního tlaku
 HU Kompresszió mérő
 RO Aparat de măsurarea presiunii
 FR Testeur de pression adaptateur cône

IT Monometro pressione
 ES Medidor de compresión
 CN 气缸压力表

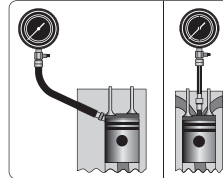
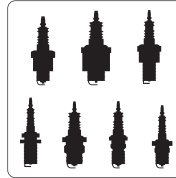

2.1 MPa
 FOR SPARK IGNITION
 DO ZAPŁONU ISKROWEGO

FOR ALL TYPES
 DO WSZYSTKICH TYPÓW



RUBBER CONNECTOR
 ZŁĄCZE GUMOWE



THREADED ADAPTER
 ZŁĄCZE GWINTOWANE



THREADED ADAPTER
 ZŁĄCZE GWINTOWANE

RUBBER CONNECTOR
 ZŁĄCZE GUMOWE



YATO
 YT-7300

24/48

YATO
 YT-7301

12/24

YATO
 YT-7302

6/24

EN Injection nozzle tester
 PL Tester wtryskiwaczy
 DE Einspritz-Tester
 RU Тестер форсунок
 CZ Tester vstřikovačů
 HU Porlasztó vizsgáló teszter
 RO Tester de duze de injectie
 FR Testeur d'injecteur de carburant
 IT Tester per iniettori
 ES Comprobador de inyectoros
 CN 喷油嘴校检器



60 MPa (max.)

600 ml

M12

M14

FOR DIESEL ENGINES
 DO SILNIKÓW DZIELA



YATO
 YT-72963

4

EN Flow meter common rail adapter set
 PL Przelewowy zestaw diagnostyczny do wtryskiwaczy Common Rail
 DE Überlauf-Diagnosesatz für Einspritzdüse Common Rail
 RU Диагностический набор к форсунам Common Rail переливной
 CZ Souprava na diagnostiku vstřikovačů Common Rail průtoková
 HU Diagnosztikai készlet Common Rail injektorokhoz, átfolyós
 RO Set diagnostic preaplin pt. injectoare Common Rail
 FR Kit de test de débit d'injecteur Common Rail
 IT Set controllo portata iniettori Common Rail
 ES Juego diagnóstico de flujo para inyectoros Common Rail
 CN 柴油燃油喷油嘴检测工具

31 PCS

FOR 6 CYLINDERS
 DO 6 CYLINDRÓW

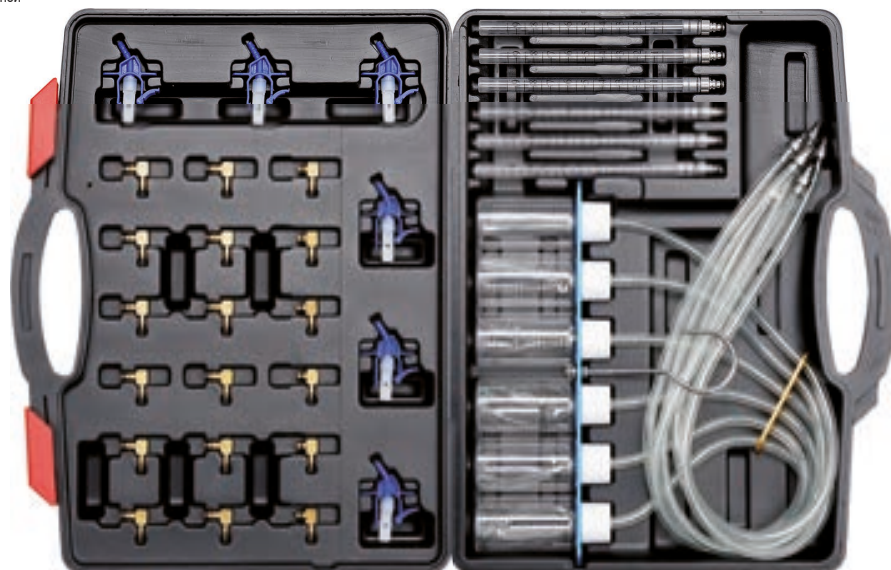

YATO
 YT-7306

5

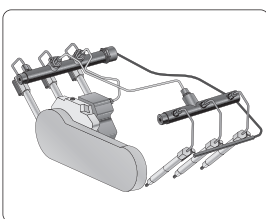

- EN Diesel fuel pump timing set
PL Przyrząd do regulacji pomp wtryskowych
DE Vorrichtung zur Einspritzpumpeneinstellung
RU Инструмент для регулировки ТНВД
CZ Nástroj pro regulaci vstřikovacíh čerpadel
HU Befecskendező szivattyú beállító szerszám
RO Set de distribuție a pompei de combustibil diesel
FR Outil de réglage des pompes d'injection
IT Strumento di regolazione pompa di iniezione
ES Herramienta de ajuste de bombas de inyección
CN 柴油喷射泵校正器



10
PCS

+/-
0.01
mm

For fuel pump: Bosch, Denso, Lukas, Nippon
Dla pomp: Bosch, Denso, Lukas, Nippon

YATO
YT-05337 5

- EN Combined sockets for alternator
PL Zestaw do alternatorów ze sprzęgłem
DE Werkzeugsatz für Lichtmaschine
RU Набор для альтернатора
CZ Souprava na opravu alternátorů
HU Generátor szerszámkészlet
RO Garnitură pt. alternator
FR Set de clés à l'alternateur avec l'embrayage
IT Set di chiavi per smontaggio puleggia e alternatore
ES Enchufes combinados para alternador
CN 发动机拆卸组套

13
PCS

1/2"
12.7mm

CrV

HRC
40-44

S45C

HRC
38-42

8660
HIGH CARBON STEEL
FOR HYDROGEN BLENDED

HRC
53-57

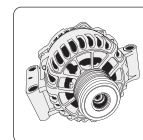

- 1/2" (12.7 mm): M10, HBS, 33T, L=110 mm; CrV; HRC 40-44;
- 1/2" (12.7 mm): T50, HBS, 33T, L=110 mm; CrV; HRC 40-44;
- M8, M10, L=75 mm; 8660; HRC 53-57;
- T40, T50, L=75 mm; 8660; HRC 53-57;
- H8, H10, L=75 mm; 8660; HRC 53-57;
- H15, 33T, L=30 mm; CrV; HRC 40-44;
- H22, 33T, L=30 mm; CrV; HRC 40-44;
- H22, L=30 mm; S45C; HRC 38-42;
- Ø 35 x 30 mm; CrV; HRC 40-44;
- 1/2" (12.7 mm) x 10 mm; CrV; HRC 40-44

YATO
YT-0421 1/2" (12.7 mm) 15

- EN Combined sockets for alternator
PL Zestaw do alternatorów ze sprzęgłem
DE Werkzeugsatz für Lichtmaschine
RU Набор для альтернатора
CZ Souprava na opravu alternátorů
HU Generátor szerszámkészlet
RO Garnitură pt. alternator
FR Set de clés à l'alternateur avec l'embrayage
IT Set di chiavi per smontaggio puleggia e alternatore
ES Enchufes combinados para alternador
CN 发动机拆卸组套

22
PCS

1/2"
12.7mm

3/8"
9.5mm

CrV

HRC
40-44

S45C

HRC
38-42

8660
HIGH CARBON STEEL
FOR HYDROGEN BLENDED

HRC
53-57

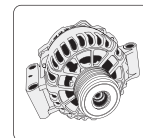

- 1/2" (12.7 mm): M10, HBS, 33T, L=113 mm; CrV; HRC 40-44 / 8660; HRC 53-57;
- 1/2" (12.7 mm): T50, HBS, 33T, L=113 mm; CrV; HRC 40-44 / 8660; HRC 53-57;
- 3/8" (10 mm): M10; HBS, 33T; L=80 mm; CrV; HRC 40-44 / 8660; HRC 53-57;
- 1/2" (12.5 mm): M10; HBS, 33T; L=140 mm; CrV; HRC 40-44;
- M8, M10, L=75 mm; 8660; HRC 53-57;
- T40, T50, L=75 mm; 8660; HRC 53-57;
- H8, H10, L=75 mm; 8660; HRC 53-57;
- M8xH12, L=64 mm; 8660; HRC 53-57;
- H15, 33T, Ø 17 mm, L=30 mm, H15, 33T, Ø 19 mm, L=30 mm, H22, 33T, Ø 19 mm, L=30 mm; CrV; HRC 40-44;
- H17, H22, L=30 mm; S45C; HRC 38-42;
- Ø 35 x 30 mm; S45C; HRC 38-42;
- Ø 38 mm; S45C; HRC 38-42;
- H19x28, H21x28, H22x28; S45C; HRC 38-42;
- 1/2" (12.5 mm) (F) x H10 mm (F); CrV; HRC 40-44

YATO
YT-04211 3/8" (9.5 mm), 1/2" (12.7 mm) 5

- EN Stroboscopic tube
- PL Lampa stroboskopowa
- DE Stroboskoplampe
- RU Стробоскопная лампа
- CZ Stroboskopická lampa
- HU Stroboszkóp lámpa
- RO Lampă stroboscopică
- FR Lampe stroboscopique
- IT Lampada stroboscopica
- ES Tubo estroboscópico
- CN 点火正时灯

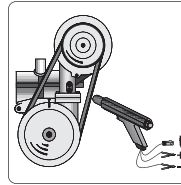

12 V	max 8000 min ⁻¹	XENON	
------	----------------------------	-------	--



0-60°

YATO	
YT-7310	6/12

YATO	
YT-7311	6/12

YATO	
YT-7312	6/12

- EN Universal radiator pressure kit
- PL Zestaw diagnostyczny do chłodnicy
- DE Diagnoseatz für Kühler
- RU Диагностический набор к радиатору
- CZ Souprava k diagnostice chladiče
- HU Diagnosztikai készlet hűtőkhöz
- RO Ansamblu pt. diagnosticarea radiatorului
- FR Set diagnostique pour radiateur de voiture
- IT Set universale tester pressione del radiatore
- ES Juego de herramientas diagnosticas para el radiador
- CN 万用水箱压力测试组套

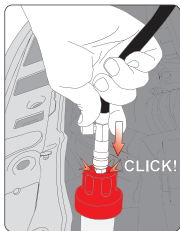

CLICK!

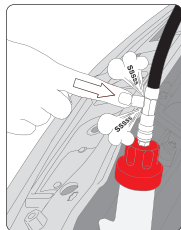
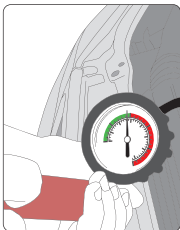

14 PCS
0.25 MPa (max.)
max °C 200

Acura, Alfa Romeo, Audi, BMW, Chrysler, Citroen, Fiat, Ford, General Motors, GEO, Honda, Infiniti, Isuzu, Jaguar, Jeep, Land Rover, Mazda, Mercedes, Mitsubishi, Nissan, Opel, Peugeot, Porsche, Renault, Saab, Subaru, Suzuki, Toyota, Volkswagen, Volvo

YATO	
YT-0672	4

- EN Cooling system vacuum purge and refill kit
- PL Zestaw do próżniowego napełniania układu chłodzenia
- DE Kühlsystem Vakuum Entleer- und Befüll-Set
- RU Комплект для вакуумной заправки системы охлаждения
- CZ Sada pro vakuové plnění chladičoho systému
- HU Vákuumos hűtőrendszer feltöltő
- RO Kit încărcare și aerisire în vid pt. sistem răcire
- FR Kit d'outils de remplissage sous vide de liquide de refroidissement
- IT Kit di riempimento del sistema di raffreddamento sottovuoto
- ES Kit de llenado al vacío del sistema de refrigeración
- CN 防冻液加注器



3 PCS
-1 bar
∅ 15-45 mm

YATO	
YT-72995	10

EN Water tank leak detector
PL Zestaw do diagnostyki i obsługi układu chłodzenia
DE Diagnose- und Wartungssatz für Kühlkreis
RU Комплект для диагностики и обслуживания системы охлаждения
CZ Sada pro diagnostiku a servis chladicího systému
HU Hűtőrendszer diagnosztikai és szerviz készlet
RO Detector scurgeri rezervor apa
FR Kit de diagnostic de système de refroidissement
IT Kit di diagnostica e utilizzo del sistema di raffreddamento
ES Kit de diagnóstico y manejo del sistema de refrigeración
CN 水箱漏测仪

28
PCS

0.25
MPa
(max)

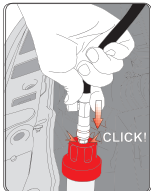

CLICK!

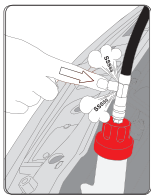
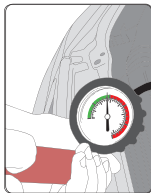

Acura; Alfa Romeo; Audi: A4, A5, A6; Audi VW (1975-1993); BMW: 345, E32, E34, E36, E38, E39, E46, E60, E63, E64, E65, E90; Buick; Cadillac; Chevrolet; Citroen; Chrysler; Daewoo; Dodge; Eagle; Fiat; Ford: C-Max, Focus, Mondeo, USA versions etc.; General Motors; GMC; Honda; Hummer; Hyundai; Infiniti; International; Isuzu; Jaguar; Jeep; Kia; Land Rover; Lexus; Lincoln; Mazda: M3 etc.; Mercedes-Benz: A, C, E, M, S Class (W140, W168, W210, W211, W215, W216, W220, R230), W123, W126, W124, W201, Vito; Mercury; Mini; Mini Cooper; Mitsubishi; Nissan; Oldsmobile; Opel; Peugeot; Pontiac; Porsche; Cayenne etc.; Renault; Saab; Saturn; Ssangyong; Sterling; Subaru; Suzuki; Toyota: Celica, MR2, Previa, RAV4 etc.; Vauxhall; Volvo; VW: Beatele, Golf, Passat (1996, 1997-2002), Sharan (1.8T, 2.8), T4, Vento

YATO
YT-06721

3

EN Hand-held vacuum pump
PL Pompka podciśnieniowa z akcesoriami
DE Unterdruckpumpe mit Zubehör
RU Насос вакуумметрического давления с принадлежностями
CZ Podtlaková-tlaková pumpa s příslušenstvím
HU Vákuum- és ac-pumpa mérő, tartozékokkal

RO Pompa de vidare cu accesorii
FR Pompe à vide avec les accessoires
IT Pompa a pressione con accessori
ES Bomba de subpresión con accesorios
CN 手持式真空泵

16
PCS

-1-0
bar



YATO
YT-0673

10

EN Cooling system vacuum purge and refill kit
PL Zestaw do próżniowego napełniania układu chłodzenia
DE Kühlsystem Vakuum Entleer- und Befüll-Set
RU Комплект для вакуумной заправки системы охлаждения
CZ Sada pro vakuové plnění chladicího systému
HU Vákuumos hűtőrendszer feltöltő
RO Kit încărcare și aerisire în vid pt. sistem răcire
FR Kit d'outils de remplissage sous vide de liquide de refroidissement
IT Kit di riempimento del sistema di raffreddamento sottovuoto
ES Kit de llenado al vacío del sistema de refrigeración
CN 防冻液加注器

6
PCS

-1
bar

30-48
mm



YATO
YT-72996

10

EN Hand-held vacuum pump
PL Pompka ciśnieniowo-podciśnieniowa z akcesoriami
DE Unterdruck-druckpumpe mit Zubehör
RU Насос вакуумметрического давления с принадлежностями
CZ Podtlaková-tlaková pumpa s příslušenstvím
HU Vákuum- és ac-pumpa mérő, tartozékokkal
RO Pompa de vidare cu accesorii
FR Pompe à vide avec les accessoires
IT Pompa a pressione con accessori
ES Bomba de subpresión-presión con accesorios
CN 手持式真空泵

22
PCS

-1-3
bar



YATO
YT-0674

5

EN Flexible line clamp
 PL Komplet zacisków do przewodów z cieczą
 DE Schlauchklemmensatz
 RU Набор зажимов с фиксатором
 CZ Sada hadicových svěrek
 HU Flexibilis cső elszorító készlet
 RO Clema flexibila
 FR Set de pices pour serrer les
 IT Set pinze per chiudere momentaneamente i manicotti
 ES Juego de alicates apretadores para conductos de líquidos
 CN 油管封口钳组套

3 PCS
 NON-CUTTING
 NIETNACE
 NON-CONDUCTIVE
 NEPRZE-WODZĄCE

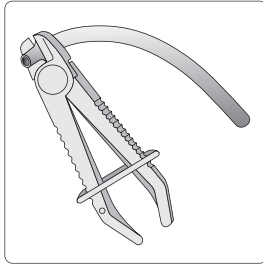

- 1/4"-3/4" (6.3-19 mm) for brake and fuel lines
- 1/2"-5/4" (12.5-32 mm) for flexible hose
- 3/4"-9/4" (19-57 mm) for radiator hose clamp
- 1/4"-3/4" (6.3-19 mm) do przewodów hamulcowych i paliwowych
- 1/2"-5/4" (12.5-32 mm) do przewodów elastycznych
- 3/4"-9/4" (19-57 mm) do przewodu chłodnicy

YATO  **YT-0840**  25/50

EN Flexible line clamp
 PL Komplet zacisków do przewodów z cieczą
 DE Schlauchklemmensatz
 RU Набор зажимов с фиксатором
 CZ Sada hadicových svěrek
 HU Flexibilis cső elszorító készlet
 RO Clema flexibila
 FR Set de pices pour serrer les
 IT Set pinze per chiudere momentaneamente i manicotti
 ES Juego de alicates apretadores para conductos de líquidos
 CN 油管夹

3 PCS
 NON-CUTTING
 NIETNACE
 BENT
 WYGIEŃE
 NON-CONDUCTIVE
 NEPRZE-WODZĄCE

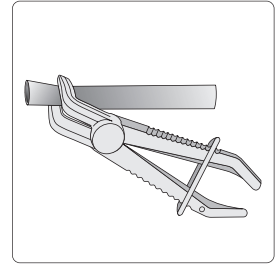

- Max. 13 mm - for brake and fuel lines
- Max. 17 mm - for flexible hose
- Max. 32 mm - for radiator hose clamp
- Max. 13 mm - do przewodów hamulcowych i paliwowych
- Max. 17 mm - do przewodów elastycznych
- Max. 32 mm - do przewodu chłodnicy

YATO  **YT-08403**  5/15

EN Steel line clamp
 PL Zaciski do przewodów metalowych
 DE Klemmen für Leitungen aus Metall
 RU Клеммы для металлических проводов
 CZ Svorky pro kovové vodiče
 HU Csipesz fém vezetékhez
 RO Set pt. blocare conducte de combustibil si conducte de frane
 FR Pince d'arrêt de conduites métalliques
 IT Morsetti per conduttori metallici
 ES Abrazaderas para conductos de metal
 CN 油管夹

4 PCS
 NYLON
 FOR STEEL LINES
 DO PRZEWODÓW METALOWYCH



YATO  **YT-08390**  10/20

EN Steel line clamp
 PL Zaciski do przewodów metalowych
 DE Klemmen für Leitungen aus Metall
 RU Клеммы для металлических проводов
 CZ Svorky pro kovové vodiče
 HU Csipesz fém vezetékhez
 RO Set pt. blocare conducte de combustibil si conducte de frane
 FR Pince d'arrêt de conduites métalliques
 IT Morsetti per conduttori metallici
 ES Abrazaderas para conductos de metal
 CN 油管夹

8 PCS
 NYLON
 FOR STEEL LINES
 DO PRZEWODÓW METALOWYCH



YATO  **YT-08391**  10

- EN Fuel line clamp and stopper kit
PL Zestaw zacisków do przewodów metalowych i elastycznych
DE Satz von Klemmen für flexible Leitungen und Leitungen aus Metall
RU Набор клемм для металлических и гибких проводов
CZ Sada svorek pro kovové a elastické vodiče
HU Csipeszkészlet fém és rugalmas vezetékekhez
RO Cleme pt. conducte combustibil si kit opritor
FR Ensemble de pinces d'arrêt de conduites métalliques et en plastique
IT Morsettiere per conduttori metallici elastici
ES Juego de abrazaderas para conductos de metal y flexibles
CN 燃油管夹

12
PCS

NYLON

FOR STEEL AND FLEXIBLE LINES DO PRZEWODOM METALOWYCH I ELASTYCZNYCH



YATO

YT-08392



5

- EN Spark plug socket
PL Nasadka do świec
DE Steckschlüssel mit Gummihalterung
RU Головка свечная
CZ Nastavec pro svíčky
HU Gyújtógyertya toldalék
RO Cheie de bujii
FR Douille à bougies
IT Chiave a bussola per candele
ES Boquilla de bujías
CN 火花塞套筒

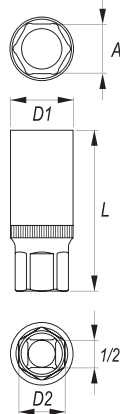

YATO	Ø	A [mm]	D1 [mm]	D2 [mm]	L [mm]	PCS	FIGURE
YT-1253	1/2" (12.7 mm)	16	22	19	64	10	50/100
YT-1254	1/2" (12.7 mm)	21	27.8	24	64	10	50/100

- EN Spark plug socket
PL Nasadka do świec
DE Steckschlüssel mit Gummihalterung
RU Головка свечная
CZ Nastavec pro svíčky
HU Gyújtógyertya toldalék
RO Cheie de bujii
FR Douille à bougies
IT Chiave a bussola per candele
ES Boquilla de bujías
CN 磁性十二角薄壁火花塞套筒

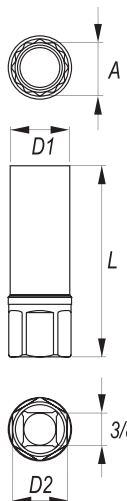

YATO	Ø	A [mm]	D1 [mm]	D2 [mm]	L [mm]	PCS	FIGURE
YT-38510	3/8" (9.5 mm)	14	18	16	63	25/100	

- EN Spark plug socket
PL Nasadka do świec
DE Steckschlüssel mit Gummihalterung
RU Головка свечная
CZ Nastavec pro svíčky
HU Gyújtógyertya toldalék
RO Cheie de bujii
FR Douille à bougies
IT Chiave a bussola per candele
ES Boquilla de bujías
CN 六角火花塞套筒

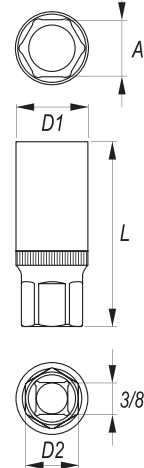

YATO	Ø	A [mm]	D1 [mm]	D2 [mm]	L [mm]	PCS	FIGURE
YT-3851	3/8" (9.5 mm)	16	22	19	64	10	50/100

- EN Spark plug socket
PL Nasadka do świec
DE Steckschlüssel mit Gummihalterung
RU Головка свечная
CZ Nastavec pro svíčky
HU Gyújtógyertya toldalék
RO Cheie de bujii
FR Douille à bougies
IT Chiave a bussola per candele
ES Boquilla de bujías
CN 磁性十二角薄壁火花塞套筒

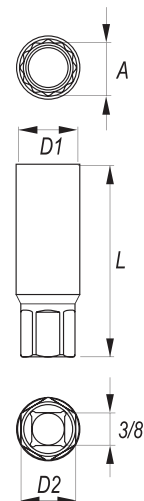

YATO	Ø	A [mm]	D1 [mm]	D2 [mm]	L [mm]	PCS	FIGURE
YT-38511	3/8" (9.5 mm)	16	20	16	62	25/100	

- EN Spark plug socket
- PL Nasadka do świec
- DE Steckschlüssel mit Gummihalterung
- RU Головка свечная
- CZ Nastavec pro svíčky
- HU Gyújtógyertya toldalék
- RO Cheie de bujii
- FR Douille à bougies
- IT Chiave a bussola per candele
- ES Boquilla de bujías
- CN 磁性万向十二角火花塞套筒

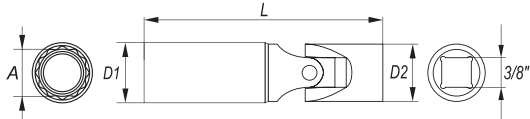
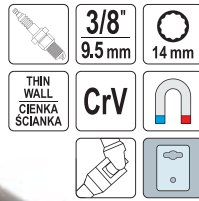

YATO	Ø	A [mm]	D1 [mm]	D2 [mm]	L [mm]	
YT-38512	3/8" (9.5 mm)	14	20	19	88	25/100

- EN Spark plug socket
- PL Nasadka do świec
- DE Steckschlüssel mit Gummihalterung
- RU Головка свечная
- CZ Nastavec pro svíčky
- HU Gyújtógyertya toldalék
- RO Cheie de bujii
- FR Douille à bougies
- IT Chiave a bussola per candele
- ES Boquilla de bujías
- CN 火花塞套筒

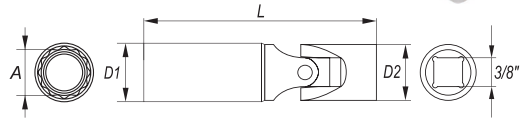
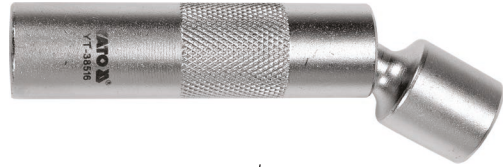

YATO	Ø	A [mm]	D1 [mm]	D2 [mm]	L [mm]	
YT-38516	3/8" (9.5 mm)	14	19	19	98	25/100
YT-38517	3/8" (9.5 mm)	16	20	19	98	25/100

- EN Spark plug socket
- PL Klucz do świec z przedłużką
- DE Kerzenschlüssel mit Verlängerungshebel
- RU Ключ к свечам с удлинителем
- CZ Klíč na svíčky s prodlužovacím nástavcem
- HU Gyertyakulcs hosszabbítóval
- RO Cheie cu prelungitor, pt. bujii
- FR Douille à bougies
- IT Chiavi per candele a tubo
- ES Llave para las bujías con extensión
- CN 加长带磁万向火星



YATO	A [mm]	L [mm]	
YT-0817	16	290	10/40

- EN Extra long spark plug socket
- PL Nasadka do świec extra długa
- DE Zündkerzensteckschlüssel, extra lang
- RU Удлиненная насадка для свечи
- CZ Násada do svíci extra dlouhá
- HU Gyertyakulcs extra hosszú
- RO Cheie bujii lunga
- FR Douille pour bougie d'allumage extra longue
- IT Chiave a bussola per candele extra lungo
- ES Vaso para bujías extra largo
- CN 十二角加长火花塞磁钢款



YATO	A [mm]	
YT-38521	14	12/48
YT-38522	16	12/48

- EN Spark plug socket
- PL Klucz do świec z przedłużką
- DE Kerzenschlüssel mit Verlängerungshebel
- RU Ключ к свечам с удлинителем
- CZ Klíč na svíčky s prodlužovacím nástavcem
- HU Gyertyakulcs hosszabbítóval
- RO Cheie cu prelungitor pt. bujii
- FR Douille à bougies
- IT Chiavi per candele a tubo
- ES Llave para las bujías con extensión
- CN 加长带磁万向火星



YATO	A [mm]	
YT-08163	14	15/60
YT-08164	16	15/60
YT-0818	18	10/40

- EN Spark plug socket set
- PL Zestaw nasadek do świec
- DE Satz der Zündkerzenaufsätze
- RU Набор головок для свечей накаливания
- CZ Sada nástavců na svíčky
- HU Gyújtógyertya-kulcs készlet
- RO Set chei pt. bujii
- FR Ensemble d'embouts pour bougies d'allumage
- IT Set di prese per candele di accensione
- ES Juego de casquillos para bujías
- CN 摇头火花塞组套



3/8" (9.5 mm): 14, 16, 18, 21 mm

YATO	Ø	
YT-38520	3/8" (9.5 mm)	5/20

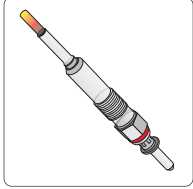

- EN Joined glow plug socket set
PL Zestaw kluczy do świece żarowych
DE Schlüsselsatz für Glühkerzen
RU Набор ключей к калильным свечам
CZ Sada klíčů na žhavicí svíčky
HU Gyertyakulcs készlet
RO Set chei pt. bujii incandescente
FR Set de douilles à bougies
IT Set chiavi a bussola snodate per candelette
ES Juego de llaves para bujías incandescentes
CN 预热火花塞套筒组套



3/8" (9.5 mm): 8, 9, 10, 12, 14, 16 mm



6 PCS
3/8" 9.5 mm
BLOCKING SYSTEM BLOKUJĄCY
CrV 50BV30 

YATO   
YT-0534 3/8" (9.5 mm) 10

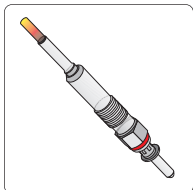

- EN Joined glow plug socket set
PL Zestaw kluczy do świece żarowych
DE Schlüsselsatz für Glühkerzen
RU Набор ключей к калильным свечам
CZ Sada klíčů na žhavicí svíčky
HU Gyertyakulcs készlet
RO Set chei pt. bujii incandescente
FR Set de douilles à bougies
IT Set chiavi a bussola snodate per candelette
ES Juego de llaves para bujías incandescentes
CN 预热火花塞套筒组套



3/8" (9.5 mm): 8, 9, 10, 12, 14, 16 mm



6 PCS
3/8" 9.5 mm
CrV 

YATO   
YT-05339 3/8" (9.5 mm) 10

- EN Torque angle gauge
PL Kątomierz do dokręcania śrub
DE Winkelmesser zum Anziehen von Schrauben
RU Угломер для подвёртывания болтов
CZ Úhloměr k utahování šroubů
HU Nyomaték szögmérő
RO Raportor pt. înşurubat şuruburi
FR Rapporteur à serrer les vis
IT Goniometro per il serraggio controllo
ES Calibrador para apretar tornillos
CN 扭力角度规



1/2" 12.7 mm 360° CrV 

YATO   
YT-0593 12/48

- EN Torque angle gauge with magnet
PL Kątomierz z magnesem do klucza dynamometrycznego
DE Winkelmesser mit Magnet für Drehmomentschlüssel
RU Транспортир с магнитом для динамометрического ключа
CZ Úhloměr s magnetem na momentový klíč
HU Mágneses szögmérő nyomatékkulcshoz
RO Cheie dinamometrica cu magnet
FR Rapporteur avec aimant pour clé dynamométrique
IT Goniometro con magnete per chiave dinamometrica
ES Escuadra con imán para llave dinámométrica
CN 磁性扭力规







1/2" 12.7 mm 360° 35 cm 
GRADUATION OF 2 DEGREES
PODZIAŁKA PO 2 STOPNIEM 

YATO   
YT-05934 1/2" (12.7 mm) 10/40

- EN Torque angle gauge with clamp
PL Kątomierz z uchwytem do klucza dynamometrycznego
DE Winkellehre mit Griff für Drehmomentschlüssel
RU Угломер для динамометрического ключа
CZ Úhloměr s držákem momentového klíče
HU Fogantyús szögmérő nyomatékkulcshoz
RO Dispozitiv masurat unghiului cu clema
FR Clé de serrage angulaire flexible avec pince, carré
IT Goniometro per chiave dinamometrica
ES Escuadra para soporte de la llave dinámométrica
CN 扭力规



1/2" 12.7 mm 360° 50 cm 
GRADUATION OF 2 DEGREES
PODZIAŁKA PO 2 STOPNIEM 

YATO   
YT-05933 1/2" (12.7 mm) 6/24

EN Metal conduit bender
 PL Giętarka do przewodów metalowych
 DE Biegevorrichtung für Metallleitungen
 RU Гибочный станок для проводов из металла

CZ Ohýbačka kovových trubek
 HU Hajlító fémvezetékekhez
 RO Mașina de îndoit (curbat) pt. cabluri metalice
 FR Cintreuse au câble de frein

IT Piegatrice per fili metallici
 ES Dobladora de tubos de metal
 CN 弯管器



125 mm max Ø 6.0 mm

235 mm max Ø 12 mm

YATO	L [mm]	
YT-0813	125	24/96

YATO	L [mm]	
YT-0814	235	6/48

EN Universal clutch adjustment set
 PL Zestaw do centrowania tarczy sprzęgłowej
 DE Universal-set, um die Kupplungsscheibe einstellen
 RU Комплект для центровки дисков сцепления
 CZ Univerzální sada pro nastavení spojky disk
 HU Kuplung központosító készlet
 RO Trusa pt. centrare ambreiaje
 FR Centreur d'embrayage
 IT Set di centraggio frizione
 ES Herramienta alineación embrague
 CN 离合器对孔校正器



9 PCS Ø 11-25 mm

Ø 11, 15, 16.5, 17, 19, 20, 20.5, 25 mm

YATO	
YT-06311	20

EN Universal clutch adjustment set
 PL Zestaw do centrowania tarczy sprzęgłowej
 DE Kupplungs-Zentrier-Werkzeug-Satz
 RU Комплект для центровки дисков сцепления
 CZ Univerzální sada pro nastavení spojky disk
 HU Kuplung központosító készlet
 RO Trusa pt. centrare ambreiaje
 FR Centreur d'embrayage
 IT Set di centraggio frizione
 ES Herramienta alineación embrague
 CN 离合器对孔校正器



2 PCS Ø 15-25 mm Ø 20-27 mm

YATO	
YT-06312	25

EN Universal clutch adjustment set
 PL Zestaw do centrowania tarczy sprzęgłowej
 DE Kupplungs-Zentrier-Werkzeug-Satz
 RU Комплект для центровки дисков сцепления
 CZ Univerzální sada pro nastavení spojky disk
 HU Kuplung központosító készlet
 RO Trusa pt. centrare ambreiaje
 FR Centreur d'embrayage
 IT Set di centraggio frizione
 ES Herramienta alineación embrague
 CN 离合器调整工具



Ø 15-28 mm 3

YATO	
YT-06313	12/24

EN DSG mechatronic unit remover
 PL Przyrząd do demontażu skrzyni biegów DSG
 DE Demontagevorrichtung für DSG-Schaltgetriebe
 RU Инструмент для разборки коробки передач DSG
 CZ Nástroj pro demontáž převodovky DSG
 HU DSG sebességváltó szerelő szerszám
 RO Hit inepartare unitate mecatronica DSG
 FR Outil de démontage de boîte de vitesses type DSG
 IT Leva per sbloccaggio cambio DSG
 ES Herramienta de desmontaje de caja de cambios DGS
 CN 大众奥迪DSG双离合变速箱阀体拆离器



260 mm VAG DSG

YATO	
YT-05333	10/40

EN SAC clutch tool set
PL Zestaw do obsługi sprzęgieł SAC
DE SAC-Kupplungswartungssatz
RU Набор для обслуживания муфт SAC
CZ Servisní sada pro spojky SAC
HU SAC kuplung szerelő készlet
RO Set unelte ambreiaj SAC
FR Kit de service d'embrayage SAC
IT Set di attrezzi per smontaggio e montaggio della frizione SAC
ES Kit de manejo de embragues SAC
CN 离合器拆装工具



YATO

YT-06315



1

EN Tubing pipe bending tool pliers
PL Giełarka do przewodów metalowych
DE Metall-Rohrbieger
RU Гибочный станок для металлических проводов
CZ Ohývačka kovových vodičů
HU Csőhajlító fogó
RO Cleste pt. indoirea conductelor
FR Cintreuse de tuyaux métalliques
IT Piegatrice per fili metallici
ES Dobladora de tubos de metal
CN 弯管器



YATO

YT-08144

L [mm]

255



6/24

EN Brake fluid tester
PL Tester płynu hamulcowego
DE Bremsflüssigkeitstester
RU Тестер тормозной жидкости
CZ Tester stavu brzdové kapaliny
HU Fékfolyadék teszter
RO Tester lichid frana
FR Tester de liquide de frein
IT Tester del fluido frenante
ES Liquido de frenos tester
CN 刹车油检测器

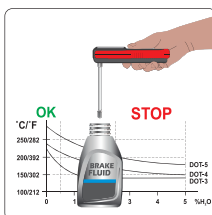

YATO

YT-72981



28/56

EN DSG double clutch tool set
PL Zestaw do wymiany sprzęgła DSG
DE DSG-Kupplungsaustauschsatz
RU Набор для замены сцепления DSG
CZ Sada na výměnu spojky DSG
HU DSG kuplung szerelő készlet
RO Set de instrumente dublu ambreiaj DSG
FR Kit de remplacement embrayage DSG
IT Set di attrezzi per smontaggio e montaggio della frizione DSG
ES Kit para reemplazo de embragues DGS
CN 大众奥迪变速箱拆卸工具



YATO

YT-06316



2

EN Brake line double flaring tool
PL Prasa ręczna do przewodów hamulcowych
DE Handpresse für Bremsleitungen
RU Ручной пресс для развальцовки тормозных труб
CZ Ruční list brzdového vedení
HU Kézi prés fékcsőhöz

RO Instrument de evazare dublă conducte frana
FR Presse à collet pour tuyaux de freins
IT Pressa manuale per tubi freno
ES Prensa manual para cables de freno
CN 铜管扩孔器

6
PCS

Cu

BRASS
MOSIADZ

STEEL
STAL

Al



Ø 4.75, 6.35 mm

YATO

YT-06086



10

EN Brake fluid tester
PL Tester płynu hamulcowego
DE Bremsflüssigkeitstester
RU Тестер тормозной жидкости
CZ Tester stavu brzdové kapaliny
HU Fékfolyadék teszter

RO Tester lichid frana
FR Tester de liquide de frein
IT Tester del fluido frenante
ES Liquido de frenos tester
CN 刹车油检测器

5
LED

1x
AAA



YATO

YT-72982



12/72

EN Brake fluid tester
 PL Tester płynu hamulcowego
 DE Bremsflüssigkeitstester
 RU Тестер тормозной жидкости
 CZ Tester stavu brzdové kapaliny
 HU Fékfolyadék tesztler
 RO Tester lichid frana
 FR Tester de liquide de frein
 IT Tester del fluido frenante
 ES Líquido de frenos tester
 CN 刹车油测试仪



DOT3
DOT4
DOT5.1
180 cm
LCD
LED
FLEXIBLE PROBE
ELASTYCZNA SONDA

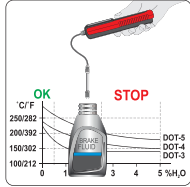

YATO
YT-72985 10/20

EN Brake retainer spring tool
 PL Ściągacz sprężynek szczepek hamulcowych
 DE Montagewerkzeug für Bremsfeder
 RU Съемник для тормозных пружин
 CZ Stahovač pružin brzdových čelistí
 HU Fékrugó szerelő szerszám
 RO Dispozitiv pt. montat arc pe sabot
 FR Extracteur de ressorts freins
 IT Freno scarpa di fissaggio a molla compressori
 ES Herramienta para resorte retenedor de frenos
 CN 鼓式刹车弹簧华司拆装器

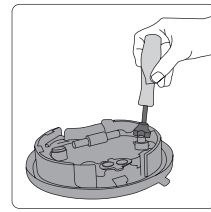

FOR DRUM BRAKES DO HAMULCÓW BĘBNOWYCH



YATO
YT-0685 12/96

EN Brake spring pliers kit
 PL Zestaw do montażu szczepek hamulcowych
 DE Bremsbacken-montage set
 RU Набор инструментов для тормозных пружин
 CZ Sada na montáž brzdových čelistí
 HU Fogókészlet fékrugóhoz

RO Dispozitiv pt. inlocuit garnituri cilindrii receptori
 FR Set pour le montage des mâchoires de freins
 IT Set per montaggio molle freni
 ES Juego para resortes de frenos
 CN 刹车拆卸工具组套

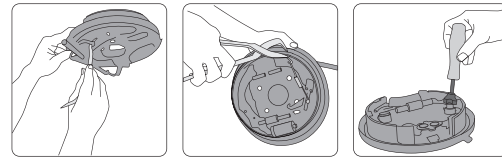

FOR DRUM BRAKES DO HAMULCÓW BĘBNOWYCH

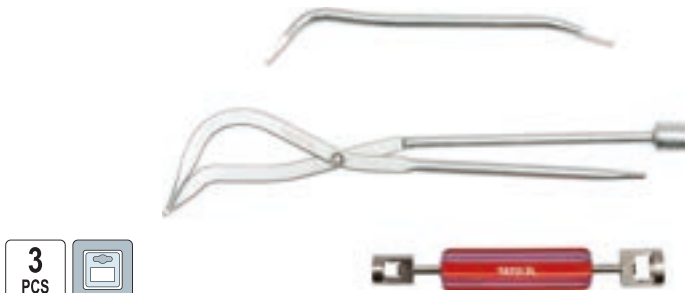

3 PCS

YATO
YT-0684 6/24



8 PCS

YATO
YT-0680 5

EN Universal brake tool set
 PL Zestaw do obsługi układów hamulcowych
 DE Bremsbacken Montageset
 RU Набор для обслуживания тормозной системы
 CZ Sada pro údržbu brzdového systému
 HU Fékrendszer karbantartó készlet
 RO Set universal pt. frane
 FR Kit de maintenance et de montage
 IT Kit di manutenzione dell'impianto frenante
 ES Kit de mantenimiento del sistema de frenos
 CN 制动系统调整工具组套

15 PCS
1/2" 12.7mm
3/8" 9.5mm
CrV

EN Interior bent nose snap ring pliers
 PL Szczytce Segera do pierścieni zacisków hamulcowych
 DE Bremssattel- Sprengringzange
 RU Клещи зегера для тормозных суппортов
 CZ Kleště na pojistné kroužky brzdových svorek, segerovy
 HU Seeger-gyűrű fogó
 RO Cleste sigurante interior, indoit
 FR Pince seger pour bagues d'étrier de frein
 IT Pinza per anelli Seeger per freni
 ES Alicates Seeger para anillos de las pinzas de freno
 CN 挡圈钳

90° 190 mm 55 mm BENT WYGIĘTE



YATO
YT-06561 L [mm] 190 5/20



YATO
YT-06802 4

EN Disc brake spreader
 PL Separator do hamulców tarczowych
 DE Scheibenbremsen Abscheider
 RU Распорка тормозных дисков
 CZ Přípravek na montáž brzdových prasátek
 HU Fékmunkahenger visszanyomó
 RO Separator disc ambreiaj
 FR Séparateur des freins à disque
 IT Separatore per pistoncini freno
 ES Separador de frenos de discos
 CN 棘轮制动卡钳

40-68 mm 116x60 mm 1 2 4 FOR BRAKE CALIPER PISTONS DO ZACISKŮV TLEČKOVÝCH



YATO
YT-06805 20

- EN Disc brake spreader
PL Separator do hamulców tarczowych
DE Scheibenbremsen Abscheider
RU Распорка тормозных дисков
CZ Přípravek na montáž brzdových prásátek
HU Fékmunkahenger visszanyomó
RO Separator disc ambreiaj
FR Séparateur des freins à disque
IT Separatore per pistoncini freno
ES Separador de frenos de discos
CN 快速刹车片撑开器



YATO

YT-0610



6/24

- EN Disc brake piston tool
PL Uniwersalny klucz do wkręcania zacisków hamulcowych
DE Bremskolbenrücksteller universal
RU Ключ для тормозного поршня
CZ Univerzální klíč k montáži brzdových třmenů
HU Féknyereg összesenyomó
RO Dispozitiv pt. impins etrier
FR Clé universelle pour pincés de frein
IT Attrezzo per l'arretamento della pinza dei freni
ES Llave para comprimir pistones del freno de disco
CN 刹车分泵拆装器



CrV



General Motors, Ford, Chrysler, VW, Fiat

YATO

YT-0683



12/96

- EN Brake socket bit set
PL Zestaw nasadek do zacisków hamulcowych
DE Steckschlüssel-Set für Bremssättel
RU Набор насадок для тормозных суппортов
CZ Sada násadek k čištění brzdových třmenů
HU Dugókulcs készlet féknyereg szereléshez
RO Set chei tubulare pt. saboti frana
FR Jeux de douilles pour les étriers de frein
IT Kit di attacchi per pinze di freni
ES Set de vasos para pinzas de freno
CN 刹车制动器套筒组套



YATO

YT-06807



10/20

- EN Brake socket bit set
PL Zestaw nasadek do zacisków hamulcowych
DE Steckschlüssel-Set für Bremssättel
RU Набор насадок для тормозных суппортов
CZ Sada násadek k čištění brzdových třmenů
HU Dugókulcs készlet féknyereg szereléshez
RO Set chei tubulare pt. saboti frana
FR Jeux de douilles pour les étriers de frein
IT Kit di attacchi per pinze di freni
ES Set de vasos para pinzas de freno
CN 刹车制动器套筒组套

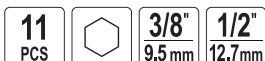

CrV

SPECIAL SHAPE SPECIÁLNY KÉSZTALT



BMW, Mercedes, VAG

1/2" (12.7 mm): 11.5, 15, 20 mm (10 points/wpustów), 22 mm (7 points/wpustów); CrV;

3/8" (9.5 mm): 7, 8, 9 mm; CrV;

3/8" (9.5 mm): 7x72, 7x92, 9x50, 11x100 mm; CrV

YATO

YT-06808



20

- EN Disc brake spreader
PL Separator do hamulców tarczowych
DE Scheibenbremsen Abscheider
RU Распорка тормозных дисков
CZ Přípravek na montáž
HU Fékmunkahenger visszanyomó
RO Separator disc ambreiaj
FR Séparateur des freins à disque
IT Separatore per pistoncini freno
ES Separador de frenos de discos
CN 刹车片分离器

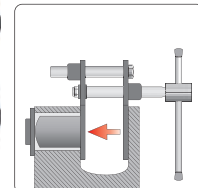

YATO

YT-0610



12/24

- EN Brake caliper piston rewind wind back adaptors
PL Zestaw adapterów regulowanych do zacisków hamulcowych
DE Verstellbarer Adaptersatz für Bremssättel
RU Набор регулируемых адаптеров для тормозных суппортов
CZ Sada nastavitelných adaptérů pro brzdové třmeny
HU Állítható féknyereg adapter készlet
RO Adaptor pt. piston etrier frână
FR Kit adaptateurs ajustables pour étriers de frein
IT Kit di adattatori regolabili per pinze di freni
ES Juego de adaptadores ajustables para pinzas de freno
CN 可调节分泵调整器

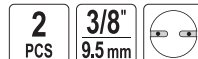

YATO

YT-06809



10/50

- EN Brake socket bit set
PL Zestaw nasadek do zacisków hamulcowych
DE Steckschlüssel-Set für Bremssättel
RU Набор насадок для тормозных суппортов
CZ Sada násadek k čištění brzdových třmenů
HU Dugókulcs készlet féknyereg szereléshez
RO Set chei tubulare pt. saboti frana
FR Jeux de douilles pour les étriers de frein
IT Kit di attacchi per pinze di freni
ES Set de vasos para pinzas de freno
CN 刹车制动器套筒组套

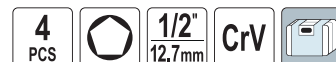

12, 14, 19 mm;
1/2" (12.5 mm): 10 mm; CrV

YATO

YT-06806



20

- EN Brake cliper socket set
PL Zestaw narzędzi do zacisków hamulcowych
DE Bremssattel Werkzeug Satz
RU Набор специальных головок и бит для тормозных суппортов
CZ Sada nářadí pro brzdové čelisti
HU Féknyereg szerelő készlet
RO Set chei etrier de frana
FR Jeu d'outils pour étrier de frein
IT Kit di strumenti per pinze del freno
ES Juego de herramientas para pinzas de freno
CN 刹车卡钳套筒工具组套



CrV

SPECIAL SHAPE SPECIÁLNY KÉSZTALT

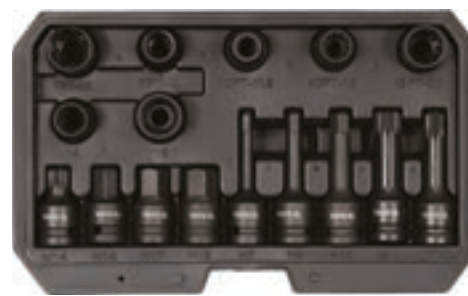

1/2" (12.7 mm): 14, 19 mm (5 points / wpustów); 14, 22 mm (7 points / wpustów); 11.5, 15, 20 mm (10 points / wpustów); CrV;
1/2" (12.7 mm): 14, 17, 19 mm (L=45 mm); 7, 9, 11 mm (L=78 mm); CrMo;
1/2" (12.7 mm): M14; (L=45 mm); M18 (L=78 mm); CrMo;
1/2" (12.7 mm): 14 mm (10 points / wpustów; L=78 mm); CrMo

YATO

YT-06811



5

- EN Disc brake pad & caliper service tool kit
- PL Zestaw ręcznych separatorów do zacisków hamulcowych
- DE Werkzeugsatz von manuellen Separatoren für Bremsklappen
- RU Набор ручных сепараторов для тормозных зажимов
- CZ Ruční sada na montáž kotoučových brzd
- HU Fékmunkahenger prés készlet
- RO Set de separatoare manuale pt. etrier frâna
- FR Set de repousse piston de frein
- IT Kit universale regolazione manuale per pistoni freni
- ES Juego de separadores manuales para abrazaderas de freno
- CN 刹车片分离器组套

11
PCS

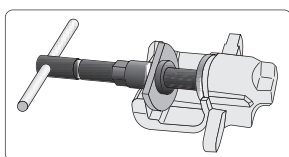
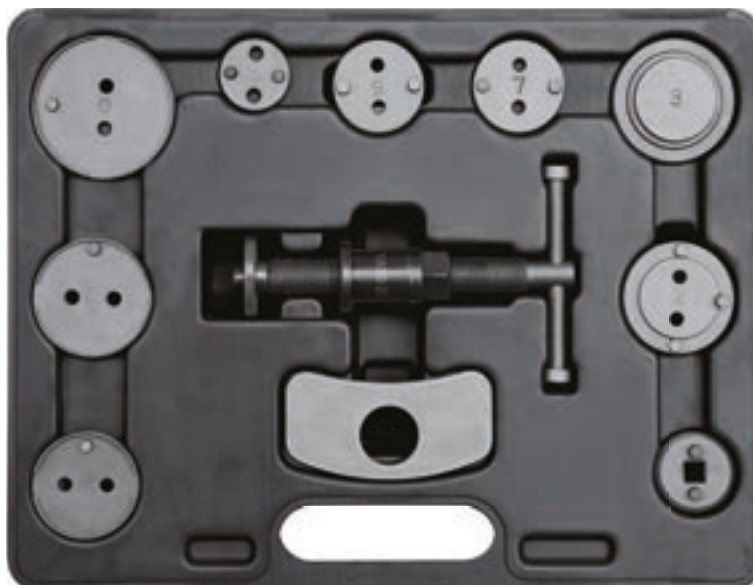

No.	zacisk przedni / front	zacisk tylny / rear
1-1	siłownik	
1	płytki oporowa	
5	adapter z gniazdem	
2	Citroen: XM, Xantia	
3	Alfa Romeo, Audi, Austin, BMW, Honda, Jaguar, MB, Mitsubishi, Nissan, Rover, Toyota, VW	
4		Ford, Mazda, Subaru, Alfa Romeo, Saab
6		Nissan
7		Audi, Ford, Honda, Nissan, Rover, Saab, Subaru, VW
8	General Motors	
9	General Motors	

YATO
YT-0681

5

- EN Disc brake pad & caliper service tool kit
- PL Zestaw ręcznych separatorów do zacisków hamulcowych
- DE Werkzeugsatz von manuellen Separatoren für Bremsklappen
- RU Набор ручных сепараторов для тормозных зажимов
- CZ Ruční sada na montáž kotoučových brzd
- HU Fékmunkahenger prés készlet
- RO Set de separatoare manuale pt. etrier frâna
- FR Set de repousse piston de frein
- IT Kit universale regolazione manuale per pistoni freni
- ES Juego de separadores manuales para abrazaderas de freno
- CN 制动钳活塞工具组套

12
PCS

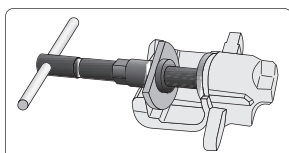
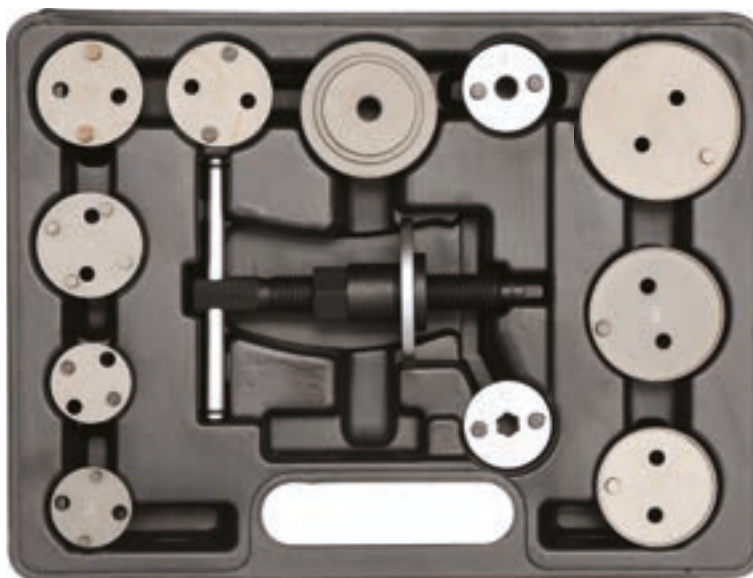

Nr krążka	zacisk przedni / front	zacisk tylny / rear
0	General Motors - zaciski 2 1/2"	
1	adapter do przedniego zacisku	
2	Citroen XM, Xantia	
3	Opel	
4	Ford, Mazda, Saab, Alfa Romeo 164 2.0, Honda, General Motors	
5	Nissan Maxima	
6	Nissan Primera, VW Golf IV	
7	Audi, Rover, Subaru, Ford, Nissan, Peugeot, Toyota, VW	
8	General Motors - zaciski 1 7/8"	
9	General Motors - zaciski 2 1/8"	
11		Adapter do tylnego zacisku

YATO
YT-0611

5

- EN Disk brake pad and caliper
PL Pneumatyczny zestaw do zacisków hamulcowych
DE Pneumatischer Werkzeugsatz für Bremssattelsysteme
RU Пневматический набор к тормозным зажимам
CZ Pneumatická souprava k montáži kotoučových brzd
HU Pneumatikus készlet fék-munkahengerekhez
RO Ansamblu pneumatic pt. cilindre de frana
FR Set pneumatique aux séparateurs de pinces de frein
IT Kit universale regolazione pneumatico per pistoni freni
ES Juego de herramientas neumaticas para apretadores de frenos
CN 盘式制动衬块和制动钳

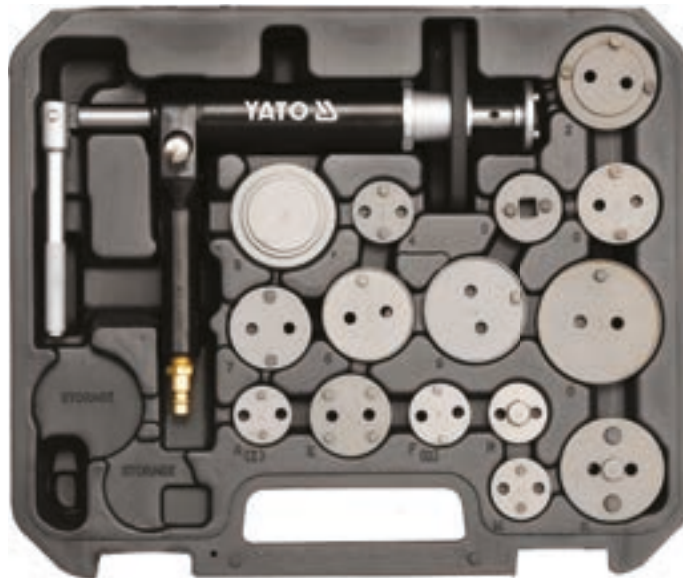

16
PCS

0.75
MPa

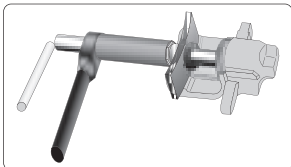
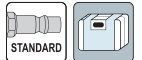

No.	zacisk przedni / front	zacisk tylny / rear
0	General Motors - zaciski 2 1/2" (12.5 mm)	
2		Citroen XM, Xantia
3	Audi, Alfa Romeo, Fiat, Ford Fiesta, Isuzu, Honda Concerto, Jaguar (F/R), BMW, Mercedes - Benz, Mitsubishi Colt, Nissan: Almera, Stanza, Sunny, Rover, Toyota Camry, Volvo, VW: Passat, Golf GTI	
4		Ford, Mazda, Saab, Alfa Romeo 164 2.0, Honda, General Motors
5		adapter z gniazdem 3/8" (10 mm)
6		Nissan Primera, VW Golf IV
7		Audi, Rover, Subaru, Ford, Nissan, Peugeot, Toyota, VW
8	General Motors - zaciski 1 7/8" (47.6 mm)	
9	General Motors - zaciski 2 1/8" (54 mm)	
A		Renault
E		Nissan Maxima
F		Opel
K		Citroen
M		Ford, Cooper
N		Saab, Honda

YATO
YT-0671

5

- EN Disc brake pad & caliper service tool kit
PL Zestaw ręcznych separatorów do zacisków hamulcowych
DE Werkzeugsatz von manuellen Separatoren für Bremssklemmen
RU Набор ручных сепараторов для тормозных зажимов
CZ Ruční sada na montáž kotoučových brzd
HU Fékmunkahenger prés készlet
RO Set de separatoare manuale pt. etrier frâna
FR Set de repousse piston de frein
IT Kit universale regolazione manuale per pistoni freni
ES Juego de separadores manuales para abrazaderas de freno
CN 刹车片分离器组套

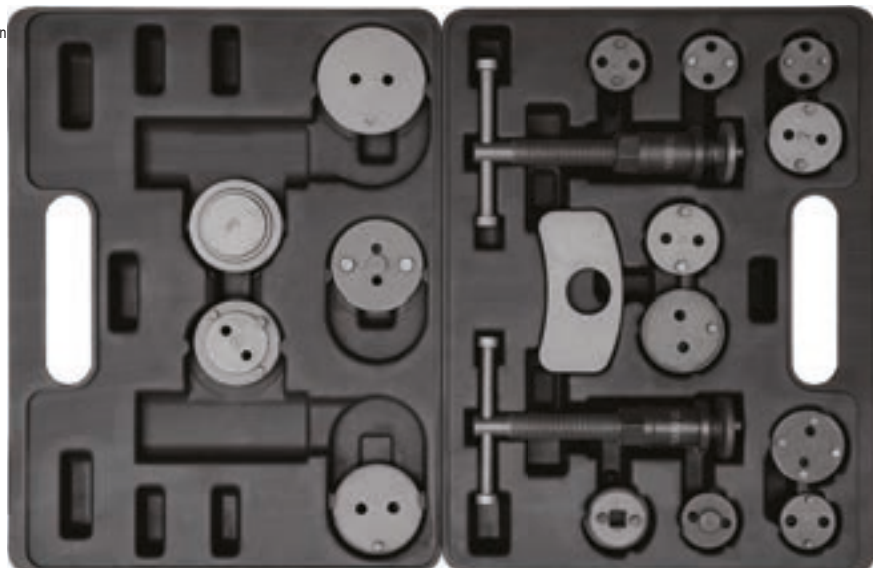

18
PCS

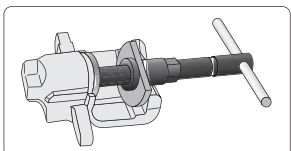
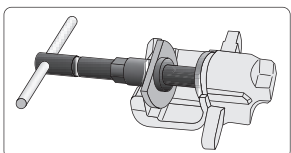

No.	zacisk przedni / front	zacisk tylny / rear
1-1		silowniki z lewym i prawym gwintem
1		plytka oporowa
5	3/8"	adapter z gniazdem
0	2 1/2"	General Motors
2	2 1/64"	Citroen XM, Xantia
3	2 5/32"	Audi, Alfa Romeo, Fiat, Ford Fiesta, Honda, Jaguar, BMW, Mercedes, Mitsubishi Colt, Nissan, Rover, Austin, Toyota Camry, Volvo, VW: Passat, Golf GTI
4	1 1/4"	Jaguar
6	1 21/32"	Ford, Mazda, Saab, Alfa Romeo 164 2.0, Honda, General Motors
7	1 21/32"	Nissan Primera, VW Golf IV
8	1 7/8"	Audi, Rover, Subaru, Ford, Nissan, Peugeot, Toyota, VW
9	2 1/8"	General Motors
E	1 21/32"	General Motors, Cadillac
F	1 1/4"	Nissan Maxima
K	2 1/8"	Opel
M	1 1/4"	Citroen
N	1 1/4"	Ford
A	13/16"	Saab, Honda
		Renault

YATO
YT-0682

5

- EN Disc brake pad & caliper service tool kit
- PL Zestaw ręcznych separatorów do zacisków hamulcowych
- DE Werkzeugsatz von manuellen Separatoren für Bremsklappen
- RU Набор ручных сепараторов для тормозных зажимов
- CZ Ruční sada na montáž kotoučových brzd
- HU Féknyakhengerek prés készlet
- RO Set de separatoare manuale pt. etrieră frână
- FR Set de repousse pistons de frein
- IT Kit universale regolazione manuale per pistoni freni
- ES Juego de separadores manuales para abrazaderas de freno
- CN 碟式分泵刹车调整器组套 35件

35
PCS

3/8"
9.5 mm

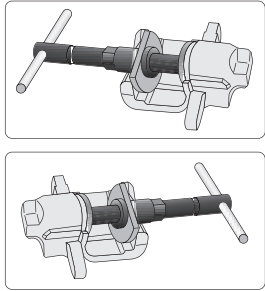

No.	zacisk przedni / front	zacisk tylny / rear
2	2 1/64" (51.0 mm)	Citroen Xantia, Honda Prelude
3	2 5/32" (55.0 mm)	Fiat, Alfa Romeo, Isuzu, Mercedes Benz, BMW, Citroen, Ford, Honda, Jaguar, Nissan, Peugeot, Rover, Toyota, VAG, Volvo
4	1 1/4" (32.0 mm)	Jaguar
5	3/8" (10.0 mm)	Ford, Mazda, Saab, Fiat, Alfa Romeo, General Motors
7	1 21/32" (42.0 mm)	adapter z gniazdem
6	1 21/32" (42.0 mm)	Nissan, VAG, Jaguar S
8	1 7/8" (48.0 mm)	Audi, Rover, Subaru, Ford, Nissan, Peugeot, Toyota, VAG, Saab, Jaguar, GM
9	2 1/8" (54.0 mm)	General Motors, Cadillac
0	2 1/2" (63.5 mm)	General Motors
A	1 1/5" (30.5 mm)	Renault, BMW, Mini
B	1 19/30" (41.5 mm)	Ford, Lincoln, Subaru
C	1 19/30" (41.5 mm)	Mini, Nissan, Opel, Toyota
D	2 1/64" (51.0 mm)	Renault, Citroen
E	1 21/32" (42.0 mm)	Nissan Maxima
F	1 1/4" (32.0 mm)	Opel, Fiat
G	3/8" (10.0 mm)	Peugeot, GM
J	1 22/33" (42.5 mm)	Fiat, Alfa Romeo, Audi, Citroen, Renault, Peugeot, Ford, Nissan, Saab, VAG, Subaru, Volvo
K	2 1/8" (54.0 mm)	Citroen, Opel
K1	2 1/8" (54.0 mm)	Renault, Citroen
K2	1 22/23" (50.0 mm)	Citroen, Renault, Audi
P	1 19/30" (41.5 mm)	VAG, BMW, Ford, Lancia, Proton, Renault, Rover, Citroen
M	1 1/4" (32.0 mm)	Ford, Mini, Nissan
N	1 1/4" (32.0 mm)	Saab, Honda, Alfa Romeo, Ford Mondeo, Lancia, Volkswagen
Z	1 3/16" (30.0 mm)	Ford, Mazda, Mitsubishi, Toyota Corolla
1, 11, 12	płytki oporowa	

YATO

YT-06822

5

- EN Brake disc run out kit
- PL Zestaw do pomiaru bicia tarcz hamulcowych
- DE Set zum Prüfen des Bremsschlags von Bremsscheiben
- RU Набор для измерения биения тормозного диска
- CZ Sada pro měření vibrací brzdových kotoučů
- HU Fékárcsa oldalútés mérő készlet
- RO Set pt. masurat uzura discurilor de frana
- FR Kit de mesure pour disque de frein
- IT Misuratore di spessore del disco del freno
- ES Set para medir el desgaste de los discos de freno
- CN 制动盘跳动检测仪



3
PCS

+/-
0.01 mm

YATO

YT-72970

6

- EN Stud hub cleaner set
- PL Zestaw do czyszczenia piast i szpilek
- DE Reinigungsset für Naben und Bolzen
- RU Набор насадок для чистки болтов ступицы
- CZ Sada na čištění nábojů a šerpů kol
- HU Kerékagy és tű tisztító készlet
- RO Set de curățare butuci de știfturi
- FR Kit de nettoyage pour moyeux et axes
- IT Kit di pulizia dei mozzoli della ruota e spille
- ES Juego de limpieza de bujes
- CN 轮毂抛光盘



14
PCS

1/2"
12.7 mm

FOR IMPACT TOOLS DO NOT USE ON HARDWARE

HEAVY DUTY NYLON WZMOCNIENY NYLON

YATO

YT-25384

10/40

EN Dial indicator
PL Czujnik zegarowy
DE Messuhr
RU Индикатор часового типа
CZ Analogový senzor
HU Óramutató érzékelő
RO Indicator testare cu cadran
FR Indicateur à cadran
IT Indicatore a quadrante
ES Indicador de cuadrante
CN 百分表



0-10 mm
+/- 0.01 mm
55 mm
8 mm
1x + LR44

EN Electronic dial indicator
PL Czujnik zegarowy elektroniczny
DE Elektronische Messuhr
RU Электронный индикатор часового типа
CZ Elektronický senzor
HU Elektromos órá érzékelő
RO Indicator testare electronic
FR Indicateur à cadran électrique
IT Indicatore quadrante elettronico
ES Indicador de cuadrante electrónico
CN 数显百分表



0-12.7 mm
+/- 0.01 mm
57 mm
8 mm
1x + LR44

EN Magnetic indicator stand
PL Statyw magnetyczny
DE Magnetständer
RU Магнитный штатив
CZ Magnetický stativ
HU Mágneses állvány
RO Stand magnetic cu indicator
FR Trépied magnétique
IT Supporto magnetico
ES Soporte magnético
CN 磁性表座



50x65 x55mm
BASE / BAZA
max 70 kg

For YT-72450, YT-72453
Dla YT-72450, YT-72453

YATO	Measuring range / Zakres pomiaru [mm]	
YT-72450	0-10	50

YATO	Measuring range / Zakres pomiaru [mm]	
YT-72453	0-12.7	50

YATO		
YT-72460		10

EN ABS and brake pressure gauge
PL Tester ciśnienia w układzie hamulcowym i ABS
DE Bremsdruck- und ABS-Tester
RU Тестер давления в тормозной системе и ABS
CZ Tester tlaku v brzdovém systému a ABS
HU ABS- és fék nyomásmérő készülék
RO Manometru pt. presiune frane si ABS
FR Testeur de pression de freinage et d'ABS
IT Misuratore pressione del sistema frenante e ABS
ES Probador de presión en el sistema de frenos y ABS
CN ABS刹车压力表

Included: pressure gauges: 0-200 kg/cm², 0-20.6 MPa (2 PCS); adaptors: #1: 7/16, M10x1.5 mm (2 PCS); #2: 7/16, M10x1 mm (2 PCS); #3: 7/16, M7x1 mm (2 PCS); #4: 7/16, M8x1.25 mm (2 PCS); #5: Ø9.34, G3/8, 24T (2 PCS); #6: Ø6.1, G1/4, 28T (2 PCS); #7: Ø10.9, 7/16, 24T (2 PCS); #8: Ø10.9, 7/16, 20T (2 PCS); #9: Ø7.64, 7/16, 24T (2 PCS); #10: M8x1 mm (2 PCS); #11: M10x1 mm (2 PCS); #12: M10x1.25 mm (2 PCS); #13: M6x1 mm (2 PCS); #A: 7/16, M10x1 mm; #B: 7/16, M10x1 mm; #C: Ø9.34, 24T; #D: M12x1 mm; #E: M11x1.5 mm; #F: Ø13, M13x1.5 mm; #G: Ø12.6, 20T; #H: Ø14, 20T; #I: Ø10.9, 24T; #J: Ø14, 18T; #K: M10x1.25; connectors: 90° (2 PCS); 45° (2 PCS); connecting pipe: connecting pipe M8x1.0 mm; angle connecting pipe M4x1.5 mm
W zestawie: manometry: 0-200 kg/cm², 0-20.6 MPa (2 szt.); adaptery: #1: 7/16, M10x1.5 mm (2 szt.); #2: 7/16, M10x1 mm (2 szt.); #3: 7/16, M7x1 mm (2 szt.); #4: 7/16, M8x1.25 mm (2 szt.); #5: Ø9.34, G3/8, 24T (2 szt.); #6: Ø6.1, G1/4, 28T (2 szt.); #7: Ø10.9, 7/16, 24T (2 szt.); #8: Ø10.9, 7/16, 20T (2 szt.); #9: Ø7.64, 7/16, 24T (2 szt.); #10: M8x1 mm (2 szt.); #11: M10x1 mm (2 szt.); #12: M10x1.25 mm (2 szt.); #13: M6x1 mm (2 szt.); #A: 7/16, M10x1 mm; #B: 7/16, M10x1 mm; #C: Ø9.34, 24T; #D: M12x1 mm; #E: M11x1.5 mm; #F: Ø13, M13x1.5 mm; #G: Ø12.6, 20T; #H: Ø14, 20T; #I: Ø10.9, 24T; #J: Ø14, 18T; #K: M10x1.25; złącza: 90° (2 szt.); 45° (2 szt.); rurka łącząca; rurka łącząca M8x1.0 mm; kątowna rurka łącząca M4x1.5 mm



46 PCS
20.6 MPa (max.)
FOR BRAKING SYSTEMS DO UKŁADÓW HAMULCOWYCH

EN Power steering tester kit
PL Zestaw diagnostyczny do wspomagania układu kierowniczego
DE Diagnoseset für Servolenkung
RU Диагностический комплект для гидроусилителя руля
CZ Sada pro diagnostiku systému posilovače řízení
HU Szervő-kormányú nyomásmérő készlet

RO Kit tester servodirectie
FR Kit contrôle direction assistée
IT Kit di diagnostica del servosterzo
ES Kit de diagnóstico para dirección asistida
CN 转向机油压力表

15 PCS
14 MPa (max.)
FOR POWER STEERING SYSTEM DO UKŁADU KIEROWNICZEGO

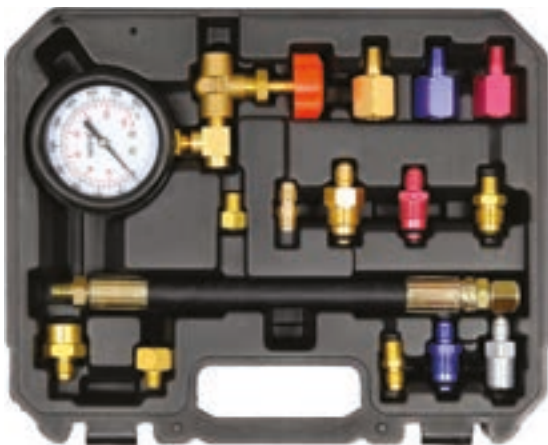

Included: pressure gauge 140 bar / 2000 PSI; flexible hose 250 mm 1/8" NPT x M11 x 1.25; adaptors: 1/8" NPT x M16 x 1.5 (2 PCS), 1/8" NPT x M18 x 1.5, 1/8" NPT x M11 x 1.0, M11 x 1.0 x M11 x 1.25, M11 x 1.25 x M18 x 1.5, M11 x 1.25 x M16 x 1.5 (2 PCS), M16 x 1.5 x M11 x 1.25, 1/8" NPT x M16 x 1.5, M11 x 1.25 x 1/8" NPT, 1/8" NPT x M16 x 1.5, M11 x 1.25 x M16 x 1.5
W zestawie: manometr 140 bar / 2000 PSI; elastyczny węz 250 mm 1/8" NPT x M11 x 1.25; adaptery: 1/8" NPT x M16 x 1.5 (2 PCS), 1/8" NPT x M18 x 1.5, 1/8" NPT x M11 x 1.0, M11 x 1.0 x M11 x 1.25, M11 x 1.25 x M18 x 1.5, M11 x 1.25 x M16 x 1.5 (2 PCS), M16 x 1.5 x M11 x 1.25, 1/8" NPT x M16 x 1.5, M11 x 1.25 x 1/8" NPT, 1/8" NPT x M16 x 1.5, M11 x 1.25 x M16 x 1.5

YATO		
YT-73045		10

YATO		
YT-73040		5

EN Universal hydraulic flaring tool set
PL Prasa hydrauliczna do przewodów hamulcowych i klimatyzacji
DE Hydraulisches Bördelgerät für Bremsleitungen
RU Гидравлический пресс для тормозных проводов и кондиционера
CZ Hydraulický lis pro výrobu brzdového vedení
HU Hidraulikus fék- és légkondicionáló cső peremező készlet

RO Kit hydraulic universal pt. evazare
FR Presse à collet hydraulique pour tuyaux de frein et de climatisation
IT Pressa idraulica per tubi freno e per aria condizionata
ES Kit de abocardador hidráulico para tubos de freno y de aire acondicionado
CN 制动管子扩孔器

14 PCS
Cu
BRASS MOSIĄDZ
AL
STEEL STAL

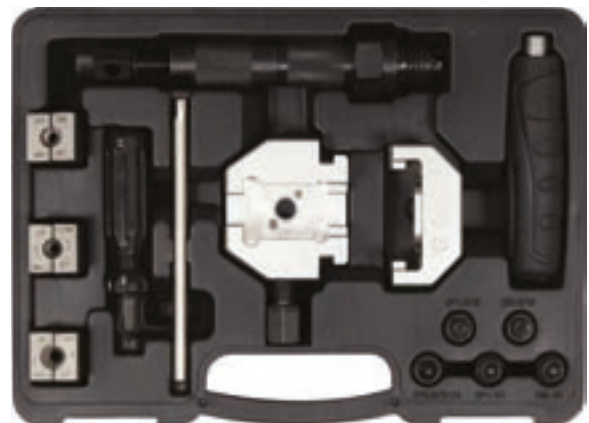

Flare forming tools / Końcówki do spęczania:
OP1: 4.75 mm (3/16"), 5 mm
DIN: 4.75 mm, 5 mm
OP2: 4.75 mm (3/16"), 5 mm, 6.35 mm (1/4")
OP1: 6.35 mm (1/4")
DIN: 6.35 mm

YATO		
YT-06088		5

EN Air brake bleeder
 PL Urządzenie pneumatyczne do wymiany płynu hamulcowego
 DE Druckluft-Bremsenentlüfter
 RU Устройство для замены тормозной жидкости
 CZ Sada na odvzdušnění brzdové soustavy a hydraulické spojky
 HU Pneumatikus eszköz a fékfolyadék cseréjére
 RO Aparat de schimbat lichid frână
 FR Purger de frein et d'embrayage pneumatique
 IT Strumento per la sostituzione del liquido freni
 ES Sangrado del freno de aire comprimido
 CN 气动刹车油更换机



0.27 MPa
 5 L
 6 m
 STANDARD

$L_{pa} = \leq 70$ dB; $L_{wa} = \leq 85$ dB; $a_h = \leq 2,5$ m/s²



YATO	
YT-06845	1

EN Brake and clutch bleeder bleeding vacuum pump kit
 PL Zestaw pneumatyczny do odpowietrzania układu hamulcowego
 DE Pneumatischer Bremsen-Entlüftungs Satz
 RU Пневматический комплект для прокачки тормозной системы
 CZ Pneumatická sada pro odvzdušnění brzdového systému
 HU Pneumatikus fék légtelenítő készlet
 RO Kit pompa de vid pt. aerisire frana si ambreiaj
 FR Kit de purge d'air pour freins
 IT Kit pneumatico per lo spurgo dell'impianto frenante
 ES Kit neumático para purgar el sistema de freno
 CN 刹车油更换机



0.62 MPa
 1 L
 180 cm
 STANDARD

YATO	
YT-06835	20

EN Coil spring clamp
 PL Ściągacz do sprężyn
 DE Federspanner
 RU Съёмник пружин
 CZ Stahovák pružin tlumičů automobilů
 HU Rugóösszehúzó
 RO Presa pt. arcuri
 FR Compresseurs de ressort
 IT Estrattore per smonta molle
 ES Extractor de muelles
 CN 弹簧夹

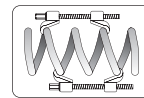
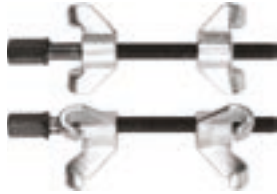

2 PCS
 1/2" 12.7mm
 21 mm

COLD FORGED
 KUTE NA ZIMNO

CrV

YATO	Ø [mm]	L [mm]	
YT-0605	90	200	5/10

YATO	Ø [mm]	L [mm]	
YT-2544	82	370	8

YATO	Ø [mm]	L [mm]	
YT-2546	82	280	8
YT-2547	82	355	8

EN Coil spring compressor
 PL Ściągacz wewnętrzny do sprężyn
 DE Innenabzieher für Federn
 RU Внутренний съёмник для пружин
 CZ Vnitřní stahovák pružin
 HU Belső rugóösszehúzó
 RO Dispozitiv compresat arcuri
 FR Extracteur interne de ressorts
 IT Estrattore interno per molle
 ES Extractor para muelles interior
 CN 弹簧压缩器



20 mm
 145 mm
 300 mm
 DROP FORGED
 KUTE

EN MacPherson spring dumper extractor
 PL Ściągacz do sprężyn MacPhersona
 DE Abziehvorrichtung für Federn von MacPherson
 RU Съёмник пружин подвески Макферсона
 CZ Stahovák pružin McPherson
 HU MacPherson rugó összehúzó
 RO Extractor de arcuri MacPherson
 FR Compresseurs de ressort MacPherson
 IT Estrattore per molle MacPherson
 ES Desmontador para los resortes de MacPherson
 CN 弹簧压缩器



100-250 mm
 max 2900kg
 CrMo SCM415
 3 JOINTS OF TUBE FORMED IN ONCE

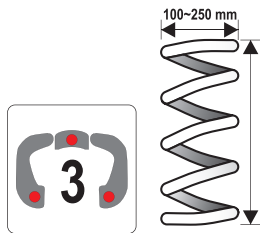

YATO	Ø [mm]	L [mm]	
YT-25472	145	300	6/12

YATO	
YT-2535	2

EN Interchangeable fork spring compressor and removal tool
 PL Ściągacz do sprężyn MacPhersona z wymiennymi uchwyłami
 DE Abziehvorrichtung für MacPherson-Federn mit austauschbaren Halterungen
 RU Стяжка для снятия пружин Макферсона со сменными полукольцами
 CZ Stahovák pružin McPherson s výměnitelnými čelistmi
 HU MacPherson rugó összehúzó cserélhető pófkákkal
 RO Ancoră suspensie MacPherson cu manere interschimbabile
 FR Compresseurs de ressort MacPherson
 IT Smonta ammortizzatori per sospensioni MacPherson
 ES Extractor de resortes MacPherson con mangos intercambiables
 CN 免拆式减震弹簧压缩器

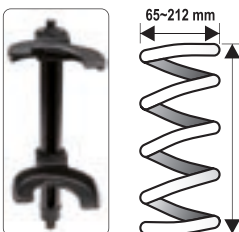

65-212 mm
 300 mm



7 PCS
 65-125 mm
 126-212 mm
 65-212 mm
 max 1500kg

YATO	
YT-2536	1

EN Drive nut set
PL Zestaw nasadek do amortyzatorów
DE Stossdämpfer Nutmutter Einsätze
RU Набор головок для амортизаторов
CZ Sada hlavíc na uložení tlumiče
HU Lengéscsaplítóköszörű szet

RO Set prezoane
FR Set des embouts aux amortisseurs
IT Set di chiavi per aria condizionata
ES Juego de boquillas de amortiguadores
CN 拆装减震器套件组套



5
PCS

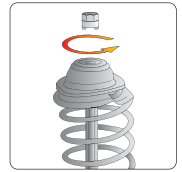

10.5 mm (VW Golf rear), 12.5 mm (VW Golf front), 14.5 mm (VW Polo, Golf, Passat, Audi 80), 14.5 mm (Austin Maestro), 14.0 mm (Mercedes Benz C-Class (W203))

YATO

Size / Rozmiar [mm]

YT-0621

10.5, 12.5, 14.5, 14.5, 14

12/48

EN Turnbuckle for shock absorber's top lid
PL Zestaw kluczy do mocowania amortyzatorów
DE Schlüsselset zum Befestigen der Stoßdämpfer
RU Набор ключей для крепления амортизаторов
CZ Sada klíčů k montáži tlumičů
HU Kulcskészlet lengéscsaplítóköszörű rögzítéséhez
RO Set chei pt. fixare amortizoare
FR Set de clés pour amortisseurs
IT Set chiavi per montare ammortizzatori
ES Juego de llaves para la instalación de amortiguadores
CN 避震器拆卸器



39
PCS

CrV
6140

CrV
50BV30

8660
HARD CARBON STEEL
STYL WYSOKOCIEŃCZĄ

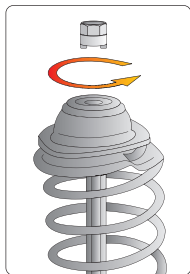

	size / rozmiar	type of car / model samochodu		size / rozmiar	type of car / model samochodu
<p>CrMo SCM415</p>	10.5 x 3.5 mm	VW Golf Rear Axle	<p>CrV 6140</p>	D5	Nissan
	12.5 x 3.5 mm	VW Golf Front Axle		D10	Nissan, Ford
	14.5 x 5 mm	VW Polo, Golf, Passat, Audi 80		8 mm	Mercedes-Benz
	14.5 x 3 mm	Austin Maestro		9 mm	Opel/Vauxhall, Chrysler
	14 x 2.5 mm	Mercedenz Benz W203 (C-class), W209 (CLK)		10 mm	Chrysler, Ford
<p>CrV 50BV30</p>	14 mm	Honda, Nissan	<p>STEEL 8660</p>	11 mm	Japanese Cars
	16 mm	VW, Audi, Seat, Fiat		5 mm	Honda
	17 mm	Ford, VW, Audi, Seat, Fiat		6 mm	Seat, Fiat, Citroen, Peugeot, Ford, Opel, Renault, Japanese Cars, BMW
	18 mm	Ford, VW, Audi, Seat, Rover, Fiat, Opel, Peugeot, Renault, Japanese Cars		7 mm	VW, Audi, Seat, Fiat, Citroen, Peugeot, Mercedes-Benz (W203), Renault
	19 mm	VW, Audi, Seat, Citroen, Fiat, Opel, Peugeot, Toyota		8 mm	Mercedes-Benz
	21 mm	Mercedenz-Benz W203, Chrysler, VW, Audi, Ford, Japanese Cars		3 mm	Mercedes-Benz, Opel, Renault
	22 mm	VW, Audi, Seat, Citroen, Fiat, Opel, Peugeot, Renault, BMW		3.5 mm	Chrysler, Ford, Citroen, Peugeot
	24 mm	Volvo		4 mm	Citroen, Peugeot
	27 mm	VW, Audi, Citroen, Peugeot		M12	Opel/Vauxhall
	<p>CrV 6140</p>	4 mm		Nissan	<p>STEEL 8660</p>
5.2 mm		VW, Audi, Nissan	T60	Ford	
6 mm		VW, Audi, Renault			
6.3 mm		Nissan			
7 mm		VW, Audi, Seat, Fiat			
8 mm		Seat, Fiat			
9 mm		Japanese Cars			
10 mm		Seat, Fiat, Volvo			
12 mm		Seat, Fiat			

YATO

YT-0628

3

EN Tire valve stem inserter
PL Przeciagacz do zaworków gumowych
DE Abziehvorrichtung für Gummiventile
RU Протяжка к резиновым клапанам

CZ Páka k provlékání bezdušových ventilů
HU Szifjesszesség mérő
RO Broșă pt. supapele cauciucate
FR Levier tire-valve

IT Brocca valvola di gomma
ES Brocha de tracción para las válvulas de goma
CN 气门插入工具

290
mm

RUBBER
VALVES
ZAWORY
GUMOWE



YATO

YT-0619

L [mm]

290

12/72

EN Wheel balance pliers
 PL Szczypce do wyważania kół
 DE Auswuchtgewicht-Zange
 RU Клеши для балансировки колес
 CZ Kleště pro vyvažování kol
 HU Centrifúly szerelő szerszám
 RO Cleste pt. cauciuc
 FR Pincés pour le contrepois à agrafe de roue de voiture
 IT Pinze per equilibrio ruota
 ES Tenazas de equilibrar ruedas
 CN 平衡钳

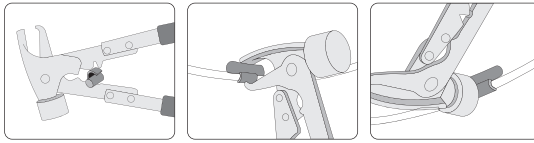

YATO **YT-0643** 12/48

EN Deep thin wall impact sockets
 PL Zestaw nasadek uderowych do felg aluminiowych
 DE Alu-Felgen Kraft-Stecknüsse
 RU Набор головок для алюминиевых дисков
 CZ Sada nástrčných klíčů na alu ráfky
 HU Hosszított dugókulcs készlet, könnyűfém felnikhez
 RO Set chei adanci pt. plite aluminiu
 FR Jeu de douilles profondes à choc
 IT Set di chiavi a bussola per dadi ruota di alluminio
 ES Juego de boquillas de percusión para llantas de aluminio
 CN 风动薄壁长套筒

3 PCS	1/2" 12.7mm	17 19 21 mm	26 29 31 mm
AS-DRIVE	CrMo SCM440		



- For service station and tire workshops
- For maximum impact loads
- Drive locks
- Ultra thin walls and nylon cover for working with alu rims
- Anodised colour finish for fast identification of size
- Dla serwisów i warsztatów oponiarskich
- Do największych obciążeń uderowych i tętniących
- Zamki blokujące
- Ultracienkie ścianki i nylonowe pokrycie do pracy z felgami aluminiowymi
- Anodowane, kolorowe wykończenie dla szybkiej identyfikacji rozmiaru

17, 19, 21 mm

YATO **YT-1056** 1/2" (12.7 mm) 12/24

EN Deep aluminium wheel nut socket set
 PL Zestaw nasadek uderowych długich do felg aluminiowych
 DE Alu-Felgen Kraft-Stecknüsse, lang
 RU Набор длинных ударных насадок для алюминиевых дисков
 CZ Sada dlouhých nárazových zásuvek pro hliníkové disky
 HU Hosszított dugókulcs készlet, könnyűfém felnikhez
 RO Set chei adanci pt. plite aluminiu
 FR Jeu de douilles à chocs longues pour jantes en aluminium
 IT Kit di punte a percussione lunghe per cerchi in lega
 ES Juego de vasos de impacto largos para llantas de aluminio
 CN 加长轮胎保护套筒

6 PCS	1/2" 12.7mm	150 mm
17 19 21 mm	27 29 31 mm	CrMo
AS-DRIVE		



17, 19, 21 mm

YATO **YT-10563** 1/2" (12.7 mm) 10

EN Deep thin wall impact sockets
 PL Zestaw nasadek uderowych do felg aluminiowych
 DE Alu-Felgen Kraft-Stecknüsse
 RU Набор головок для алюминиевых дисков
 CZ Sada nástrčných klíčů na alu ráfky
 HU Hosszított dugókulcs készlet, könnyűfém felnikhez
 RO Diblu de impact cu mufare in interior
 FR Set de douilles profondes à choc
 IT Set di chiavi a bussola per dadi ruota di alluminio
 ES Juego de boquillas de percusión para llantas de aluminio
 CN 风动薄壁长套筒

10 PCS	1/2" 12.7mm	CrMo
AS-DRIVE		



15, 17, 19, 21, 22, 23, 24 mm; 7/8";
 17 mm (Mercedes); 21 mm (Kia, Hyundai)

YATO **YT-10564** 1/2" (12.7 mm) 5

EN Emergency wheel nut remover
 PL Nasadki uderowe do wykręcania śrub zabezpieczających
 DE Schlag-Steckschlüsselsatz für selbstsichernde Schrauben
 RU Ударные головки для снятия предохранительных винтов
 CZ Příkladové násadky k vyjmutí zajišťovacích šroubů
 HU Útve-dugókulcs készlet biztonsági csavarok kihajtásához
 RO Set tubulare speciale pt. prezoane rotunjite
 FR Embouts pour le dévissage par impact des vis de sécurité
 IT Chiavi ad impatto per estrazione viti di sicurezza
 ES Vasos de impacto para desenroscar tornillos de seguridad
 CN 应急螺母组套

4 PCS	1/2" 12.7mm	CrMo



YATO **YT-06030** 1/2" (12.7 mm) 10/20

- EN Steering and suspension indicator
PL Przyrząd do sprawdzania luzów zawieszenia
DE Vorrichtung zur Kontrolle des Aufhängungsspiels
RU Инструмент для проверки люфта подвески
CZ Zařízení pro kontrolu vůle zavěšení
HU Futómű lazulás ellenőrző
RO Indicator de direcție și suspensie
FR Dispositif de contrôle du jeu de la suspension
IT Strumento per il controllo giochi delle sospensioni
ES Equipo para comprobar juegos en la suspensión
CN 底盘间隙测试工具

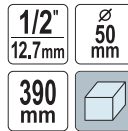

YATO	□	
YT-17490	1/2" (12.7 mm)	20

- EN Folding cross wrench
PL Składany klucz do kół w etui
DE Radmutterenschlüssel
RU Балонный крестовой разборный ключ с чехлом
CZ Skládací křížový klíč na matice
HU Összecsukható kereszt csavarkulcs
RO Cheie cruce pt. șuruburi roți
FR Clé démonte roue en croix démontable
IT Pierevole cress chiave
ES llave para las ruedas de automóviles
CN 可折叠十字扳手

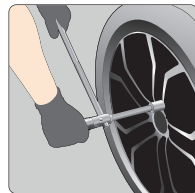

1/2" (12.7 mm): 17, 19, 21, 23 mm

YATO	□	
YT-08035	1/2" (12.7 mm)	10

- EN Tire expander
PL Rozpierek do opon
DE Reifenspreizer
RU Борторасширитель
CZ Roztahovák pneumatik
HU Abroncs leszedő szerző

- RO Dispozitiv întins cauciucuri
FR Écarteur de pneus
IT Divaricatore per pneumatici
ES Esparcidor de neumáticos
CN 扩胎器

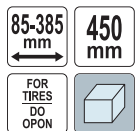

YATO	L [mm]	
YT-08120	450	9

- EN Cross rim wrench
PL Krzyżakowy klucz do kół
DE Kreuzschlüssel
RU Ключ-крест балонный
CZ Klíč na kola křížový
HU Kereszt kerékkulcs

- RO Cheie în cruce pt. roți
FR Clé en croix aux roues
IT Chiavi a croce per auto ruota
ES Llave cruz para ruedas
CN 十字套筒扳手



YATO	Size / Rozmiar [mm]	
YT-0800	17x19x21x22	10
YT-0801	17x19x21x1/2" (12.7 mm)	10
YT-0802	24x27x32x3/4" (19.0 mm)	3

- EN Folding cross wrench
PL Składany klucz do kół
DE Klappbarer Radschlüssel
RU Складной ключ для колес
CZ Skládací klíč na kola
HU Összecsukható kerékkulcs

- RO Cheie in cruce plianta
FR Clé à roue pliante
IT Chiave per ruote pieghevole
ES Llave de rueda plegable
CN 可折叠十字扳手



1/2" (12.7 mm): 17, 19, 21, 23 mm

YATO	□	
YT-08033	1/2" (12.7 mm)	5/10

EN Electric impact wrench
 PL Elektryczny klucz udarowy
 DE Elektro-Schlagschrauber
 RU Электрический гайковерт
 CZ Elektrický rázový utahovák
 HU Elektromos ütvecsavarozó

RO Pistol de impact electric
 FR Clé à choc électrique
 IT Avvitatore elettrico ad impulso
 ES llave de impacto eléctrica
 CN 电动冲击扳手

230V~50Hz	450 W
450 Nm	0-3300 min ⁻¹
0-3300 min ⁻¹	1/4" 6.3 mm
1/2" 12.7 mm	4 m

EN Electric impact wrench
 PL Elektryczny klucz udarowy
 DE Elektro-Schlagschrauber
 RU Электрический гайковерт
 CZ Elektrický rázový utahovák
 HU Elektromos ütvecsavarozó

RO Pistol de impact electric
 FR Clé à choc électrique
 IT Avvitatore elettrico ad impulso
 ES llave de impacto eléctrica
 CN 电动冲击扳手

230V~50Hz	1020 W
600 Nm	2600 min ⁻¹
2700 min ⁻¹	1/4" 6.3 mm
1/2" 12.7 mm	4 m



17, 19, 21, 23 mm

17, 19, 21, 23 mm



$L_{pa} = 96.0 \pm 3.0$ dB; $L_{wa} = 107.0 \pm 3.0$ dB; $a_h = 17.648 \pm 1.5$ m/s²

$L_{pa} = 100.0 \pm 3.0$ dB; $L_{wa} = 111.0 \pm 3.0$ dB; $a_h = 18.9 \pm 1.5$ m/s²

YATO	[W]	
YT-82020	450	4

YATO	[W]	
YT-82021	1020	3

EN Impact tool set
 PL Zestaw narzędzi udarowych
 DE Schlagwerkzeugsatz
 RU Набор инструментов ударных
 CZ Sada příklepových nářadí
 HU Ütvecsavarozó szerszámkészlet
 RO Set pistol impact
 FR Clé à choc avec jeu d'outils
 IT Set di chiavi a percussione
 ES Juego de herramientas de impacto
 CN 锂电冲击扳手套筒组套



21 PCS	18 V Li-Ion	1/2" 12.7 mm	700 Nm	0-2600 min ⁻¹	0-5000 min ⁻¹
3.0 Ah	1.5h			LED CHARGE INDICATOR WSKAZNIK NAŁADZANIWA BATERII	

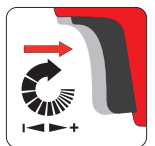

1/2" (12.7 mm): 17, 19, 21 mm (L=87 mm); CrMo;
 1/2" (12.7 mm): 12, 13, 14, 15, 16, 17, 18, 19, 20, 21, 22, 23, 24 mm; CrMo;
 1/2" (12.7 mm); (L=75 mm); CrMo

$L_{pa} = 86.0 \pm 3.0$ dB; $L_{wa} = 97.0 \pm 3.0$ dB; $a_h = 7.58 \pm 1.5$ m/s²

YATO		[V d.c.]	
YT-82807	1/2" (12.7 mm)	18	2

18V
Li-Ion

EN Tire lever
PL Łyzka do opon
DE Reifenmontierhebel
RU Прибор для шиномонтажа
CZ Montážní páka na pneumatiky
HU Gumiabroncs kar
RO Levier pt. roti
FR Cuillère à pneus
IT Leva per pneumatici
ES Desmontable para las llantas
CN 轮胎起子

CrV



YATO	L [mm]		YATO	L [mm]	
YT-0807	300	20	YT-0809	500	5/20
YT-0808	400	20	YT-0810	600	5/20

EN Tire lever
PL Łyzka do opon
DE Reifenmontierhebel
RU Прибор для шиномонтажа
CZ Montážní páka na pneumatiky
HU Gumiabroncs kar
RO Levier pt. roti
FR Cuillère à pneus
IT Leva per pneumatici
ES Desmontable para las llantas
CN 撬棒

380 mm CrMo



YATO	L [mm]	
YT-0811	380	10/50

EN Rectangular telescopic inspection mirror
PL Lusterko inspekcyjne
DE Teleskop Inspektionsspiegel
RU Зеркало инспекционное телескопическое
CZ Zrcátko kontrolní teleskopické
HU Vizsgáló tükör, teleszkópos nyéllel
RO Oglindă telescopica pt. inspectie
FR Miroir d'inspection
IT Telescopio ispezione specchietto
ES Espejo rectangular telescópico de inspección
CN 可伸缩矩形检测镜

50x90 mm 285-770 mm

TELESCOPIC HANDLE UCHWYT TELESKOPOWY



YATO	
YT-0660	12/144

EN LED lighted telescopic inspection mirror
PL Lusterko inspekcyjne z lampką
DE Prüf Spiegel mit Beleuchtung
RU Зеркало досмотровое с подсветкой
CZ Inspekční zrcadélko s lampou
HU Vizsgáló tükör, lámpával
RO Oglindă pt. inspectie cu lampă
FR Miroir d'inspection avec lampe
IT Specchio di ispezione con lampada
ES Espejo de control con lámpara
CN 带灯检测镜

265-920 mm 54 mm SS LED LIGHT DIODA



YATO	
YT-0663	10/100

EN Telescopic magnetic pick up tool
PL Chwytnak teleskopowy z magnesem
DE Teleskop magnet Heber
RU Захват магнитный телескопический
CZ Patka teleskopická magnetická
HU Felszedő mágnes, teleszkópos nyéllel
RO Telescop magnetic
FR Capteur magnétique
IT Telescopio magnete
ES Herramienta levantadora magnética, telescópica
CN 可伸缩拾拾器

2 kg 250-750 mm TELESCOPIC HANDLE UCHWYT TELESKOPOWY



YATO	
YT-0661	12/144

EN Telescopic magnetic pick up tool
PL Chwytnak teleskopowy z magnesem
DE Teleskop magnet Heber
RU Захват магнитный телескопический
CZ Patka teleskopická magnetická
HU Felszedő mágnes, teleszkópos nyéllel
RO Telescop magnetic
FR Capteur magnétique
IT Telescopio magnete
ES Herramienta levantadora magnética, telescópica
CN 带灯可伸缩拾拾器

190-800 mm TELESCOPIC HANDLE UCHWYT TELESKOPOWY LED LIGHT DIODA



YATO	
YT-06611	12/144

EN 3 in 1 pick up tool
PL Zestaw do podnoszenia 3 w 1
DE 3 in 1 Hebeset
RU Подъемный набор 3 в 1
CZ Zvedací sada 3 v 1
HU 3 az 1-ben felszedő készlet
RO Dispozitiv 3 in 1 pt. recuperat
FR Kit de levage 3 en 1
IT Kit per sollevamento 3 in 1
ES Kit de elevación 3 en 1
CN 带灯拾拾器

3 in 1 3 w 1 585 mm FLEXIBLE HANDLE ELASTYCZNY UCHWYT LED LIGHT DIODA 3x LR1130



YATO	
YT-06613	10/60

EN Telescopic magnetic pick up tool
PL Chwytnak teleskopowy z magnesem
DE Teleskop magnet Heber
RU Захват магнитный телескопический
CZ Patka teleskopická magnetická
HU Felszedő mágnes, teleszkópos nyéllel
RO Telescop magnetic
FR Capteur magnétique
IT Telescopio magnete
ES Herramienta levantadora magnética, telescópica
CN 可伸缩磁性拾拾器

590-990 mm 82 mm max 22.5 kg TELESCOPIC HANDLE UCHWYT TELESKOPOWY



YATO	L [mm]	
YT-0860	590-990	6/24

EN Telescopic pick up and mirror set
 PL Zestaw inspekcyjny: lusterko + chwytak
 DE Inspektionsatz: Spiegel + Greifer
 RU Проверочный набор + держатель и зеркальце
 CZ Inspekční souprava: zrcadlo + držák
 HU Teleszkópos ellenőrző készlet
 RO Garnitură de control: oglindă + benă
 FR Kit miroir + grappin
 IT Set per ispezione: specchio + supporto
 ES Juego de inspección: espejo + cuchara de mordazas
 CN 检测镜、拾拾器组套

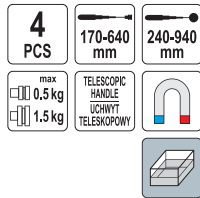

YATO
 YT-0662 10/40

EN Inspection set
 PL Zestaw inspekcyjny
 DE Inspektionsset
 RU Инспекционный набор
 CZ Inspekční sada
 HU Teleszkópos ellenőrző készlet
 RO Set de inspecție
 FR Jeu d'inspection
 IT Strumenti d'ispezione
 ES Juego herramientas inspección
 CN 套磁性伸缩拾器



172-570 mm, 84x53 mm;
 181-779 mm, Ø15 mm;
 129-648 mm, Ø5 mm;
 240-695 mm, Ø50 mm;
 283-880 mm, 84x53 mm

YATO
 YT-06622 48

EN Magnetic parts tray
 PL Miska magnetyczna
 DE Magnetschale
 RU Магнитный поднос
 CZ Miska magnetická
 HU Mágneses tálca
 RO Tava magnetica
 FR Bol magnétique
 IT Ciotola magnetica
 ES Bandeja de accesorios magnética
 CN 磁性工具盘



Ø 110 mm

YATO
 YT-08295 12/48



Ø 150 mm

YATO
 YT-0830 12/48

EN Magnetic parts tray
 PL Miska magnetyczna
 DE Magnetschale
 RU Магнитный поднос
 CZ Miska magnetická
 HU Mágneses tálca
 RO Tava magnetica
 FR Bol magnétique
 IT Ciotola magnetica
 ES Bandeja de accesorios magnética
 CN 磁力盘

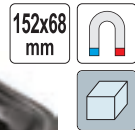

YATO
 YT-08312 48

EN Magnetic parts tray
 PL Miska magnetyczna
 DE Magnetschale
 RU Магнитный поднос
 CZ Miska magnetická
 HU Mágneses tálca
 RO Tava magnetica
 FR Bol magnétique
 IT Ciotola magnetica
 ES Bandeja de accesorios magnética
 CN 磁性工具盘

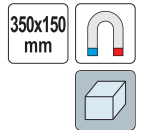

YATO
 YT-0831 6/12

EN Magnetic parts tray
 PL Miska magnetyczna
 DE Magnetschale
 RU Магнитный поднос
 CZ Miska magnetická
 HU Mágneses tálca
 RO Tava magnetica
 FR Bol magnétique
 IT Ciotola magnetica
 ES Bandeja de accesorios magnética
 CN 磁力碗

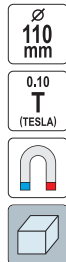

YATO
 YT-08304 24

EN Magnetic parts tray
 PL Miska magnetyczna
 DE Magnetschale
 RU Магнитный поднос
 CZ Miska magnetická
 HU Mágneses tálca
 RO Tava magnetica
 FR Bol magnétique
 IT Ciotola magnetica
 ES Bandeja de accesorios magnética
 CN 磁性工具盘

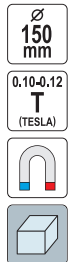

YATO
 YT-08305 20

EN Magnetic parts tray
 PL Miska magnetyczna
 DE Magnetschale
 RU Магнитный поднос
 CZ Miska magnetická
 HU Mágneses tálca
 RO Tava magnetica
 FR Bol magnétique
 IT Ciotola magnetica
 ES Bandeja de accesorios magnética
 CN 磁力碗

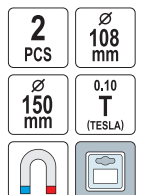

YATO
 YT-08302 6/24

EN Magnetic parts tray
PL Sortownik magnetyczny
DE Magnet-Sortierbox
RU Сортировщик
CZ Magnetický třídící
HU Mágneses rendszerező

RO Tava magnetica pt. piese
FR Rangement compartimenté magnétique
IT Separatore magnetico
ES Clasificador magnético
CN 磁力盘

190x120
x34
mm

PVC



YATO
YT-08320

48

EN Magnetic wristband
PL Opaska magnetyczna
DE Magnetisches Armband
RU Магнитный браслет
CZ Magnetický náramek pro kutily
HU Mágneses karkötő
RO Bratara magnetica pt. scule
FR Bracelet magnétique
IT Braccialeto magnetico
ES Pulsera magnética
CN 磁性腕带



310
mm

HOOK
FASTENER
RZEP

NYLON



YATO
YT-74051

L [mm]
310

50

EN Magnetic screwdriver rack
PL Uchwyt magnetyczny na wkrętaki
DE Magnetische Halterung für Schraubendreher
RU Магнитный держатель для отверток
CZ Magnetický držák šroubováků
HU Mágneses csavarhúzó tartó

RO Raft magnetic pt. surubelnite
FR Mandrin magnétique pour tournevis
IT Supporto magnetico per punte
ES Soporte magnético para destornilladores
CN 磁性螺丝刀架

350
mm

x9

ABS



YATO
YT-08353

L [mm]
350

6/24

EN Magnetic holder for tools
PL Uchwyt magnetyczny na narzędzia
DE Magnethalter für Schlagschrauber
RU Магнитный держатель для ударного гайковерта
CZ Magnetický držák nářadí
HU Mágneses tartó
RO Suport magnetic pt. scule pneumatice
FR Support magnétique pour outils pneumatiques
IT Fissaggio magnetico per chiave ad impulsi pneumatica
ES Soporte magnético para llave de impacto
CN 磁性喷枪架



max
15kg



YATO
YT-08707

5/10



EN Magnetic tool holder
PL Listwa magnetyczna
DE Magnet Werkzeughalter
RU Магнитная рейка
CZ Magnetický držák nářadí
HU Mágneses tartó

RO Suport magnetic
FR Barre et porte outil magnétique
IT Striscia magnetica
ES Bandeja de accesorios magnética
CN 磁性工具架

max
13kg



YATO
YT-0835

4/16

EN Magnetic wristband
PL Opaska magnetyczna
DE Magnetisches Armband
RU Магнитный браслет
CZ Magnetický náramek pro kutily
HU Mágneses karkötő
RO Bratara magnetica pt. scule
FR Bracelet magnétique
IT Braccialeto magnetico
ES Pulsera magnética
CN 磁性腕带



340
mm

2
POCKETS
KIESZENIE

HOOK
FASTENER
RZEP

NYLON



YATO
YT-74050

L [mm]
340

50

EN Magnetic pliers rack
PL Uchwyt magnetyczny na narzędzia
DE Magnetischer Werkzeughalter
RU Магнитный держатель для инструментов
CZ Magnetický držák na nářadí
HU Mágneses szerszámirtartó

RO Raft magnetic pt. clesti
FR Fixation magnétique pour outils
IT Supporto magnetico per attrezzi
ES Soporte magnético para herramientas
CN 磁性钳子架

350
mm

x9

ABS



YATO
YT-08354

L [mm]
350

6/24

EN Tweezer
PL Peseta
DE Pinzette

RU Пинцет
CZ Pinzeta
HU Csipesz

RO Pensetă
FR Pince
IT Pinza

ES Pinzas
CN 尖头镊子

SS302
STAINLESS STEEL
STAL MIECZĄCA

ANTI-MAGNETIC
ANTI-MAGNETYCZNE

ACID PROOF
KWASO-
ODPORNOŚĆ



140
mm

HRC
30

YATO
YT-6903

L [mm]
140

20/240



115
mm

HRC
30

YATO
YT-6907

L [mm]
115

20/240



140
mm

HRC
40

YATO
YT-6916

L [mm]
140

20/240



EN Workshop stool
 PL Taboret warsztatowy
 DE Werkstatt-Sitz
 RU Табурет рабочий
 CZ Dilenský taburet
 HU Műhely zsámoly
 RO Taburet atelier
 FR Tabouret d'atelier
 IT Sgabello da officina
 ES Taburete de taller
 CN 修车凳

450x270 x350 mm
 max 140 kg
 360°
 4x



EN Shop roller seat stool with drawers
 PL Taboret warsztatowy z szufladami
 DE Werkstatthocker mit Schubladen
 RU Табурет для мастерской с выдвижными ящиками
 CZ Stolička do dílny se zásuvkami
 HU Műhelyszék fiókkal
 RO Scaun atelier cu sertare
 FR Tabouret d'atelier avec tiroirs
 IT Sgabello da officina con cassetti
 ES Taburete de taller con cajones
 CN 双抽屉修车凳

530x470 x360 mm
 2x
 max 150 kg
 360°
 4x
 2x BRAKE HAMULEC
 4x



YATO
 YT-08792 1

YATO
 YT-08790 1

EN Shop roller seat stool with tool tray
 PL Taboret warsztatowy z szufladą
 DE Werkstatthocker mit Schublade
 RU Табурет для мастерской с выдвижным ящиком
 CZ Stolička do dílny se zásuvkou
 HU Műhelyszék fiókkal
 RO Scaun atelier cu tava
 FR Tabouret d'atelier avec un tiroir
 IT Sgabello da officina con un cassetto
 ES Taburete de taller con cajón
 CN 轻型修车凳

440x360 x390 mm
 1x
 max 150 kg
 360°
 4x



YATO
 YT-08790 2

EN Adjustable roller stool with drawers
 PL Siedzisko warsztatowe z szufladami
 DE Werkstatt-Sitz mit Schubladen
 RU Сиденье для мастерской с выдвижными ящиками
 CZ Sedátko do dílny se zásuvkami
 HU Műhelyszék fiókkal
 RO Scaun atelier reglabil
 FR Siège d'atelier avec tiroirs
 IT Seggiolino da officina con cassetti
 ES Silla de taller con cajones
 CN 重型方形修车凳

380x380 x450-560 mm
 3x
 max 150 kg
 360°
 4x



YATO
 YT-08795 1

EN Adjustable workshop seat
 PL Siedzisko warsztatowe teleskopowe
 DE Werkstatthocker, teleskopisch
 RU Сиденье для мастерской регулируемое
 CZ Nastavitelné dílenské sedátko
 HU Teleszkópos műhely zsámoly
 RO Scaun atelier reglabil
 FR Tabouret d'atelier telescopique
 IT Sgabello da officina regolabile
 ES Taburete de taller neumático
 CN 修车凳

420x420 x410-550 mm
 max 140 kg
 360°
 4x



YATO
 YT-08793 1

EN Workshop creeper
 PL Leżanka warsztatowa
 DE Werkstatt-Liege
 RU Лежак ремонтный
 CZ Lehátko
 HU Fekpad gurulos
 RO Targa
 FR Chariot de visite
 IT Lettino sdraio sotto vettura
 ES Camilla de taller
 CN 汽车修理躺板

100 cm
 6x



YATO
 YT-0880 1

EN Workshop creeper
 PL Leżanka warsztatowa
 DE Werkstatt-Liege
 RU Лежак ремонтный
 CZ Lehátko
 HU Fekpad gurulos
 RO Targa
 FR Chariot de visite
 IT Lettino sdraio sotto vettura
 ES Camilla de taller
 CN 修车躺板

91 cm
 120 kg
 150 kg
 6x



YATO
 YT-08802 1

EN Kneeling mat
 PL Mata pod kolana
 DE Kniematte
 RU Подставка для колен
 CZ Podložka pod kolena
 HU Térdalát
 RO Covoraș pt. genunchi
 FR Tapis de protection des genoux
 IT Tappetino per ginocchia
 ES Alfombrilla para las rodillas
 CN 跪垫

210x450 mm
 30 mm
 EPE

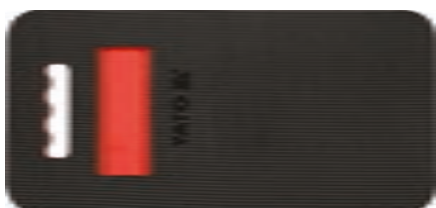

YATO
 YT-08280 40

EN Workshop mat set
 PL Zestaw mat warsztatowych
 DE Werkstattmatten
 RU Пеньные коврики для мастерской
 CZ Pěnové podložky do dílny
 HU Hab garázs szőnyegek
 RO Pres pt. atelier
 FR Jeu de tapis antidérapants
 IT Set di stuoie per officina
 ES Baldosas para taller
 CN 地垫

6 PCS
 60x60 cm
 max 12mm
 EVA



YATO
 YT-08780 6

EN Cordless lamp
PL Akumulatorowa lampa robocza
DE Akku-Lampe
RU Аккумуляторная лампа
CZ Dobjíjecí lampa
HU Újratölthető lámpa
RO Lampa reincarcabila
FR Le projecteur sans-fil
IT Lampada da lavoro a batteria
ES Lámpara recargable a batería
CN 锂电LED工作灯



18 V
Li-Ion
1600 lm
2 LIGHTING MODES TRYBY ŚWIECENIA
180°
METAL FRAME METALOWA RAMKA
TRANSPORT HANDLE UCHWYT TRANSPORTOWY

* 2 lighting modes: 50%, 100%
* 2 tryby świecenia: 50%, 100%

18V
Li-Ion

Battery not included
Obrno Akku / Bez akumulatora
Bez ładowarki / Bez aku
Akumulator nieküll
Fără baterie / Sans batterie
Senza batteria / Sin baterie
没有电池

YATO	[V d.c.]	
YT-82961	18	6

EN LED rechargeable floodlight
PL Reflektor diodowy akumulatorowy
DE Akku-LED-Leuchte
RU Светодиодный аккумуляторный прожектор
CZ LED reflektor dobíjecí
HU LED reflektor újratölthető
RO Reflector cu LED dioda pe acumulatori
FR Projecteur a LED rechargeable
IT Riflettore LED a batteria
ES LED reflector recargable
CN 工作灯

10 W
3.7 V
4400mAh
Li-Ion
800 lm
6000K
5.5h
2.5h
4400 mAh
Micro USB



COB
LED



YATO		
YT-81820		6/12

EN Portable floodlight with speaker
PL Reflektor przenośny z głośnikiem
DE Tragbarer Scheinwerfer mit Lautsprecher
RU Переносной звуковой прожектор
CZ Přenosný reflektor s reproduktorem
HU Hordozható reflektor hangszóróval
RO Projector portabil cu difuzor
FR Projecteur LED portable avec haut-parleur
IT Proiettore portatile con altoparlante
ES Reflector portátil con altavoz
CN 蓝牙音响灯



15W x2
3.7 V
4400mAh
Li-Ion
2000 lm
5/16" 8mm
6 LIGHTING MODES TRYBY ŚWIECENIA
5h
2.5-12h
4400 mAh
IP44
USB BATTERY CHARGER ŁADOWNIKA
COB
LED



Compatible with YT-81809
Kompatybilny z YT-81809

YATO		
YT-81808		24

EN LED rechargeable floodlight
PL Reflektor diodowy akumulatorowy
DE Akku-LED-Leuchte
RU Светодиодный аккумуляторный прожектор
CZ LED reflektor dobíjecí
HU LED reflektor újratölthető

RO Reflector cu LED dioda pe acumulatori
FR Projecteur a LED rechargeable
IT Riflettore LED a batteria
ES LED reflector recargable
CN 工作灯

5W
3.7 V
2000mAh
Li-Ion
300 lm
7000K
5.5h
3.5-4h
5 LIGHTING MODES TRYBY ŚWIECENIA
IP54
USB BATTERY CHARGER ŁADOWNIKA



COB
LED

YATO		
YT-81819		40

EN LED floodlight
PL Reflektor diodowy
DE LED-Leuchte
RU Светодиодный прожектор
CZ LED světlo
HU LED svtelomet
RO Reflector LED
FR Projecteur a LED
IT Riflettore LED
ES LED proyector
CN 手提式工作灯

10 W
6V
680 lm
4x AA
3 LIGHTING MODES TRYBY ŚWIECENIA
PA6



COB
LED



* 3 lighting modes: 100%, 30%, strobe
* 3 tryby świecenia: 100%, 30%, pulsowanie

YATO		
YT-81821		8/16

EN Aluminium tripod
PL Statyw aluminiowy
DE Aluminium-Stativ
RU Алюминиевый штатив
CZ Hliníkový stativ
HU Alumínium állvány
RO Trepied aluminiu
FR Trépied en aluminium
IT Tripode in alluminio
ES Tripode de aluminio
CN 三角架

100
33.5
cm
5/16" 8mm
AI ANTI-SLIP PAIS ANTY-POŚLIZGOWE PODKŁADKI



For YT-81808
Dla YT-81808

YATO	H [mm]	
YT-81809	335-1000	21

EN Rechargeable worklight
 PL Lampa warsztatowa akumulatorowa
 DE Akku-Werkstattleuchte
 RU Аккумуляторная рабочая лампа
 CZ Akumulátorová dílenská lampa
 HU Akkumulátoros műhelylámpa
 RO Lampa de lucru reincarcabila
 FR Kit éclairage mécanicien
 IT Lampada officina a batteria
 ES linterna para taller recargable
 CN 三合一手电筒组套



3 in 1
3 w 1 **XPG**

3.7 V
2200mAh
Li-Ion **4h**

1m **IP54**

USB
CHARGING
LADOWANIE

POWER LED



YATO
YT-08521

10

EN Workshop LED battery lamp
 PL Diodowa lampa warsztatowa akumulatorowa
 DE LED Akku-Werkstattlampe
 RU Светодиодная беспроводная лампа
 CZ Aku pracovní LED svítidla
 HU Akkumulátoros LED szerelőlámpa
 RO Lampa portabila cu acumulator leduri
 FR Lampe d'inspection LED rechargeable
 IT Lampada LED ricaricabile per officina
 ES Lámpara de trabajo LED recargable
 CN 可充电工作灯



CRI 95 **5W**

3.7 V
2600mAh
Li-Ion **400 lm**

4500K **4h**

4h **IP65**

IK07 **x1**
HOOK
HAK

COB LED

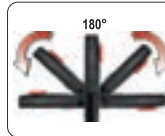

YATO
YT-08509

12

EN Workshop lamp UV
 PL Lampa warsztatowa UV
 DE UV-Werkstattleuchte
 RU УФ лампа для мастерской
 CZ Dilenská lampa UV
 HU UV műhelylámpa
 RO Lampa UV atelier
 FR Lampe d'atelier UV
 IT Lampada da officina UV
 ES Lámpara UV de taller
 CN 工作灯-用于检泄露



5W **UV**

390-405 nm **3.7 V**
2600mAh
Li-Ion **4h**

4.5h

IP65 **IK07**

x1 **USB**
HOOK
HAK CHARGING
LADOWANIE

UV LED

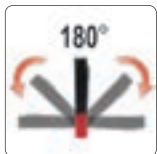

YATO
YT-08500

12

EN Workshop LED battery lamp
 PL Diodowa lampa warsztatowa akumulatorowa
 DE LED Akku-Werkstattlampe
 RU Светодиодная беспроводная лампа
 CZ Aku pracovní LED svítidla
 HU Akkumulátoros LED szerelőlámpa
 RO Lampa portabila cu acumulator leduri
 FR Lampe d'inspection LED rechargeable
 IT Lampada LED ricaricabile per officina
 ES Lámpara de trabajo LED recargable
 CN 可充电工作灯



FRONT LIGHT
LATARKA **1+1 LED**

3.7 V
3600mAh
Li-Ion **180 lm**

230V~50Hz **12V**
BATTERY CHARGER
LADOWNIK BATTERY CHARGER
LADOWNIK

4h **2 LED**
3h

x1 **HOOK**
HAK

COB LED



YATO
YT-08502

10

EN Workshop LED battery lamp
PL Diodowa lampa warsztatowa akumulatorowa
DE LED Akku-Werkstattlampe
RU Светодиодная беспроводная лампа
CZ Aku pracovní LED svítidla
HU Akkumulátoros LED szerelőlámpa
RO Lampa portabila cu acumulator leduri
FR Lampe d'inspection LED rechargeable
IT Lampada LED ricaricabile per officina
ES Lámpara de trabajo LED recargable
CN 可充电工作灯

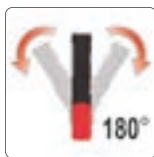

COB
LED



YATO
YT-08558

12

EN Workshop LED battery lamp
PL Diodowa lampa warsztatowa akumulatorowa
DE LED Akku-Werkstattlampe
RU Светодиодная беспроводная лампа
CZ Aku pracovní LED svítidla
HU Akkumulátoros LED szerelőlámpa
RO Lampa portabila cu acumulator leduri
FR Lampe d'inspection LED rechargeable
IT Lampada LED ricaricabile per officina
ES Lámpara de trabajo LED recargable
CN 可充电LED工作灯

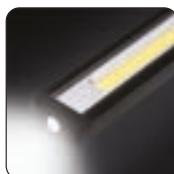
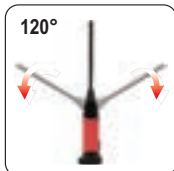

COB
LED



YATO
YT-08518

12

EN Workshop LED battery lamp
PL Diodowa lampa warsztatowa akumulatorowa
DE LED Akku-Werkstattlampe
RU Светодиодная беспроводная лампа
CZ Aku pracovní LED svítidla
HU Akkumulátoros LED szerelőlámpa
RO Lampa portabila cu acumulator leduri
FR Lampe d'inspection LED rechargeable
IT Lampada LED ricaricabile per officina
ES Lámpara de trabajo LED recargable
CN LED工作灯



COB
LED



YATO
YT-08517

6/24

EN Workshop LED battery lamp
PL Diodowa lampa warsztatowa akumulatorowa
DE LED Akku-Werkstattlampe
RU Светодиодная беспроводная лампа
CZ Aku pracovní LED svítidla
HU Akkumulátoros LED szerelőlámpa
RO Lampa portabila cu acumulator leduri
FR Lampe d'inspection LED rechargeable
IT Lampada LED ricaricabile per officina
ES Lámpara de trabajo LED recargable
CN 可充电工作灯

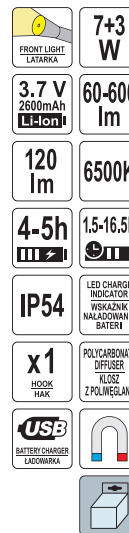

COB
LED



YATO
YT-08519

20

EN Workshop LED battery lamp
 PL Diodowa lampa warsztatowa akumulatorowa
 DE LED Akku-Werkstattlampe
 RU Светодиодная беспроводная лампа
 CZ Aku pracovní LED svítidla
 HU Akkumulátoros LED szerelőlámpa
 RO Lampa portabilă cu acumulator leduri
 FR Lampe d'inspection LED rechargeable
 IT Lampada LED ricaricabile per officina
 ES Lámpara de trabajo LED recargable
 CN LED工作灯



10+4 W	3.7 V 2600mAh Li-Ion
50/500 lm	6500K
4h	2-16h
2m	IP54
IK07	x1 HOOK HAK
USB BATTERY CHARGER KŁOSZKA	

COB
LED



YATO
YT-08527 12

EN Workshop LED battery lamp
 PL Diodowa lampa warsztatowa akumulatorowa
 DE LED Akku-Werkstattlampe
 RU Светодиодная беспроводная лампа
 CZ Aku pracovní LED svítidla
 HU Akkumulátoros LED szerelőlámpa
 RO Lampa portabilă cu acumulator leduri
 FR Lampe d'inspection LED rechargeable
 IT Lampada LED ricaricabile per officina
 ES Lámpara de trabajo LED recargable
 CN LED工作灯



5+1 W	500/250 lm
3.7 V 2600mAh Li-Ion	6500K
120 lm	4h
2.5-7h	IP54
x1 HOOK HAK	USB BATTERY CHARGER KŁOSZKA

COB
LED



YATO
YT-08562 12

EN Workshop LED battery lamp
 PL Diodowa lampa warsztatowa akumulatorowa
 DE LED Akku-Werkstattlampe
 RU Светодиодная беспроводная лампа
 CZ Aku pracovní LED svítidla
 HU Akkumulátoros LED szerelőlámpa
 RO Lampa portabilă cu acumulator leduri
 FR Lampe d'inspection LED rechargeable
 IT Lampada LED ricaricabile per officina
 ES Lámpara de trabajo LED recargable
 CN 可充电工作灯



3.5+3 W	330 lm
3.7 V 2600mAh Li-Ion	4h
6000K	IP54
4h	IK07
x2 HOOKS HAKI	USB BATTERY CHARGER KŁOSZKA

SMD
LED



YATO
YT-085081 12

EN Workshop LED battery lamp
 PL Diodowa lampa warsztatowa akumulatorowa
 DE LED Akku-Werkstattlampe
 RU Светодиодная беспроводная лампа
 CZ Aku pracovní LED svítidla
 HU Akkumulátoros LED szerelőlámpa
 RO Lampa portabilă cu acumulator leduri
 FR Lampe d'inspection LED rechargeable
 IT Lampada LED ricaricabile per officina
 ES Lámpara de trabajo LED recargable
 CN 工作灯



30+7 LED	140 lm
3.7 V 2000mAh Li-Ion	4h
4h	IP54
x2 HOOKS HAKI	USB BATTERY CHARGER KŁOSZKA

LED



YATO
YT-08507 12

EN Workshop LED battery lamp
PL Diodowa lampa warsztatowa akumulatorowa
DE LED Akku-Werkstattlampe
RU Светодиодная беспроводная лампа
CZ Aku pracovní LED svítidla
HU Akkumulátoros LED szerelőlámpa
RO Lampa portabila cu acumulator leduri
FR Lampe d'inspection LED rechargeable
IT Lampada LED ricaricabile per officina
ES Lámpara de trabajo LED recargable
CN 工作灯



FRONT LIGHT
LATAKKA

1+7
LED

250
lm

3.7 V
1800mAh
Li-Ion

3.5-4h
2-15h

x2
HOOKS
HAKI

12V
BATTERY CHARGER
LADONARKA

USB
BATTERY CHARGER
LADONARKA

x2

COB
LED



YATO
YT-08504 10

EN Workshop LED battery lamp
PL Diodowa lampa warsztatowa akumulatorowa
DE LED Akku-Handleuchte
RU Светодиодная беспроводная лампа
CZ Aku pracovní LED svítidla
HU Akkumulátoros LED szerelőlámpa
RO Lampa portabila cu acumulator leduri
FR Lampe d'inspection LED rechargeable
IT Lampada LED ricaricabile per officina
ES Lámpara de trabajo LED recargable
CN 可充电工作灯



FRONT LIGHT
LATAKKA

30+7
LED

3.7 V
1800mAh
Li-Ion

230V-
50Hz
BATTERY CHARGER
LADONARKA

12V
BATTERY CHARGER
LADONARKA

45/100
lm

8000K

4-5h

3.5-15h

x2
HOOKS
HAKI

x2

LED



YATO
YT-085051 10

EN Workshop LED battery lamp
PL Diodowa lampa warsztatowa akumulatorowa
DE LED Akku-Werkstattlampe
RU Светодиодная беспроводная лампа
CZ Aku pracovní LED svítidla
HU Akkumulátoros LED szerelőlámpa
RO Lampa portabila cu acumulator leduri
FR Lampe d'inspection LED rechargeable
IT Lampada LED ricaricabile per officina
ES Lámpara de trabajo LED recargable
CN LED工作灯

FRONT LIGHT
LATAKKA

10+4
W

3.7 V
3200mAh
Li-Ion

1000/170
lm

6500K

4h

1-11h

2m

IP65

IK09

x2
HOOKS
HAKI

USB
BATTERY CHARGER
LADONARKA

x2

COB SMD
LED



YATO
YT-08510 12

EN LED workshop lamp
PL Diodowa lampa warsztatowa
DE LED Werkstattlampe
RU Светодиодный светильник для мастерской
CZ Montážní lampa LED
HU LED szerelőlámpa
RO Lampa cu LED
FR Lampe d'atelier a LED
IT Lampada LED per officina
ES Lámpara de taller LED
CN LED工作灯

60+1
LED

3.7 V
1800mAh
Li-Ion

AC
BATTERY CHARGER
LADONARKA

12V
BATTERY CHARGER
LADONARKA

4h

3h

x1
HOOK
HAKI

LED



LED

YATO
YT-08520 5/20

EN LED workshop lamp
PL Diodowa lampa warsztatowa
DE LED Werkstattlampe
RU Светодиодный светильник для мастерской
CZ Montážní lampa LED
HU LED szerelőlámpa
RO Lampa cu LED
FR Lampe d'atelier a LED
IT Lampada LED per officina
ES Lámpara de taller LED
CN LED工作灯

FRONT LIGHT
LATAKKA

8+1
LED

280
lm

3x
AA

9 LED
4h

3
LIGHTING HOLES
TYPY ŚWIETLENIA

x1
HOOK
HAKI

SMD
LED



YATO
YT-08513 50

EN LED workshop lamp
 PL Diodowa lampka warsztatowa
 DE LED Werkstattlampe
 RU Светодиодный светильник для мастерской
 CZ Montážní lampka LED
 HU LED szerelőlámpa
 RO Lampă cu LED
 FR Lampe d'atelier a LED
 IT Lampada LED per officina
 ES Lámpara de taller LED
 CN 笔式可充电工作灯



8 LED
 80 lm
 3x AAA
 8 LED 20h

SMD LED

YATO YT-08514 12/72

EN LED workshop lamp
 PL Diodowa lampka warsztatowa
 DE LED Werkstattlampe
 RU Светодиодный светильник для мастерской
 CZ Montážní lampka LED
 HU LED szerelőlámpa
 RO Lampă cu LED
 FR Lampe d'atelier a LED
 IT Lampada LED per officina
 ES Lámpara de taller LED
 CN 笔式可充电工作灯



COB LED

YATO YT-08511 20/80

EN LED workshop lamp
 PL Diodowa lampka warsztatowa
 DE LED Werkstattlampe
 RU Светодиодный светильник для мастерской
 CZ Montážní lampka LED
 HU LED szerelőlámpa
 RO Lampă cu LED
 FR Lampe d'atelier a LED
 IT Lampada LED per officina
 ES Lámpara de taller LED
 CN 笔式可充电工作灯



COB LED

YATO YT-08522 12/48

EN Multipurpose lamp
 PL Lampka wielofunkcyjna
 DE Multifunktions-Lampe
 RU Многофункциональная лампа
 CZ Multifunkční lampička
 HU Multifunkciós lámpa
 RO Lampă multifuncțională
 FR Lampe multifonction
 IT Lampada multifunzione
 ES Lámpara multifuncional
 CN 工作灯



3W 3.7 V 700mAh Li-Pol 100 lm 7000K 1.5h
 2-3h IP54 USB BATTERY CHARGER LADOWNIK

COB LED

YATO YT-08516 15/60

EN Workshop LED battery lamp
 PL Diodowa lampka warsztatowa akumulatorowa
 DE LED Akku-Werkstattlampe
 RU Светодиодная беспроводная лампа

CZ Aku pracovní LED svítlna
 HU Akkumulátoros LED szerelőlámpa
 RO Lampă portabilă cu acumulator leduri
 FR Lampe d'inspection LED rechargeable

IT Lampada LED ricaricabile per officina
 ES Lámpara de trabajo LED recargable
 CN 引擎盖检修灯

LED

120 LED 60 LED 120 LED 7.4 V 1800mAh Li-Ion AC BATTERY CHARGER LADOWNIK
 750 lm 4.5-5h 3.5-8h x2 HOOKS HAKI

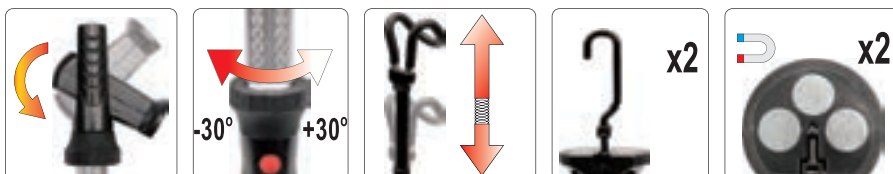

YATO YT-08529 4

EN LED flashlight
PL Latarka LED
DE LED Taschenlampe
RU Светодиодный фонарь
CZ LED svítilna
HU LED zseblámpa
RO Lanterna cu LED
FR Lampe torche LED
IT Torcia LED
ES Linterna LED
CN 手电筒



FRONT LIGHT
LATARKA

2W

200 lm

IPX4

IK07

3x AAA

x1 HOOK HAK

POWER SMD LED

YATO	[W]	[lm]	
YT-08555	2	200 / 70 / 45	50

EN LED flashlight
PL Latarka LED
DE LED Taschenlampe
RU Светодиодный фонарь
CZ LED svítilna
HU LED zseblámpa
RO Lanterna cu LED
FR Lampe torche LED
IT Torcia LED
ES Linterna LED
CN 手电筒



FRONT LIGHT
LATARKA

5W

3.7 V 1500mAh Li-Po

500 lm

3h

2-9h

1500 mAh

IPX4

IK07

x1 HOOK HAK

POWER SMD LED

YATO	[W]	[lm]	
YT-08556	5+1	500 / 200 / 60	50

EN LED flashlight
PL Latarka LED
DE LED Taschenlampe
RU Светодиодный фонарь
CZ LED svítilna
HU LED zseblámpa
RO Lanterna cu LED
FR Lampe torche LED
IT Torcia LED
ES Linterna LED
CN 手电筒



FRONT LIGHT
LATARKA

5W

3.7 V 2000mAh Li-PO

500 lm

4h

2h - 5h 30' - 20'

IP54

IK07

USB BATTERY CHARGER ŁADOWNIKA

COB SMD LED

YATO	[W]	[lm]	
YT-08557	5+0.9	500 / 250 / 90	50

EN LED flashlight
PL Latarka LED
DE LED-Taschenlampe
RU Светодиодный фонарь
CZ LED svítilna
HU LED zseblámpa
RO Lanterna cu LED
FR Lampe torche LED
IT Torcia LED
ES Linterna LED
CN 手电筒



5W

UV

3.7 V 2000mAh Li-Ion

200/300 lm

7000K

5.5h

2-3h

IP54

USB BATTERY CHARGER ŁADOWNIKA

COB LED

YATO	[W]	[lm]	
YT-08580	5	200 / 300	50

EN LED flashlight
PL Latarka LED
DE LED Taschenlampe
RU Светодиодный фонарь
CZ LED svítilna
HU LED zseblámpa
RO Lanterna cu LED
FR Lampe torche LED
IT Torcia LED
ES Linterna LED
CN 手电筒

10 W

XPL

1000 lm

350m

3 LIGHTING MODES TRYBY SWIECENIA

ZOOM

IPX4

6 V 4x CR14

POWER LED



YATO	[W]	[lm]	
YT-08567	10	1000	8/16

EN LED flashlight
PL Latarka LED
DE LED Taschenlampe
RU Светодиодный фонарь
CZ LED svítilna
HU LED zseblámpa
RO Lanterna cu LED
FR Lampe torche LED
IT Torcia LED
ES Linterna LED
CN 手电筒

6W

XPG3

3.7 V 2200mAh Li-Ion

500 lm

200m

3 LIGHTING MODES TRYBY SWIECENIA

ZOOM

IPX7

POWER LED

USB BATTERY CHARGER ŁADOWNIKA



YATO	[W]	[lm]	
YT-08568	6	500	6/24

EN LED flashlight
PL Latarka LED
DE LED Taschenlampe
RU Светодиодный фонарь
CZ LED svítilna
HU LED zseblámpa
RO Lanterna cu LED
FR Lampe torche LED
IT Torcia LED
ES Linterna LED
CN 手电筒

5W

XTE

3.7 V 650mAh Li-Po

350 lm

150m

4 LIGHTING MODES TRYBY SWIECENIA

ZOOM

IPX4

POWER LED

USB BATTERY CHARGER ŁADOWNIKA



YATO	[W]	[lm]	
YT-08569	5	350	12/96

EN LED flashlight
 PL Latarka LED
 DE LED Taschenlampe
 RU Светодиодный фонарь
 CZ LED svítilna
 HU LED zseblámpa
 RO Lanterna cu LED
 FR Lampe torche LED
 IT Torcia LED
 ES Linterna LED
 CN 手电筒

10 W **3.7 V** **900 lm** **200m**
 2200mAh Li-Ion
5 LIGHTING MODES TRYBY SVÍCENÍ
ZOOM **5-6h** **3-7h**
2200 mAh **IP64** **USB** BATTERY CHARGER LADOVNÁKA

- Bottle opener
- Emergency hammer
- Otwieracz do butelek
- Młotek awaryjny do szyb



POWER LED

YATO	[W]	[lm]	
YT-08559	10	900	30

EN LED flashlight
 PL Latarka LED
 DE LED Taschenlampe
 RU Светодиодный фонарь
 CZ LED svítilna
 HU LED zseblámpa
 RO Lanterna cu LED
 FR Lampe torche LED
 IT Torcia LED
 ES Linterna LED
 CN 手电筒

3W **130 lm** **ZOOM**
IP64 **1.5 V** **2x C**



POWER LED

YATO	[W]	[lm]	
YT-08577	3	130	12/48

EN LED flashlight
 PL Latarka LED
 DE LED Taschenlampe
 RU Светодиодный фонарь
 CZ LED svítilna
 HU LED zseblámpa
 RO Lanterna cu LED
 FR Lampe torche LED
 IT Torcia LED
 ES Linterna LED
 CN 手电筒

3W **100 lm** **ZOOM**
IP64 **1x AA**



POWER LED

YATO	[W]	[lm]	
YT-08571	3	100	24/96

EN LED flashlight
 PL Latarka LED
 DE LED Taschenlampe
 RU Светодиодный фонарь
 CZ LED svítilna
 HU LED zseblámpa

RO Lanterna cu LED
 FR Lampe torche LED
 IT Torcia LED
 ES Linterna LED
 CN 手电筒

9 LED **3x AAA**



LED

YATO			
YT-08570			24/192

EN LED headlamp
 PL Latarka czołowa LED
 DE LED Kopflampe
 RU Налобный светодиодный фонарь
 CZ Čelová lampa LED
 HU LED fejlámpa
 RO Lanterna cu LED pt. cap
 FR Lampe frontale LED
 IT Lampada da testa LED
 ES Lámpara LED de cabeza
 CN LED头灯

3W **100 lm** **ZOOM**
3x AAA



POWER LED

YATO	[W]	[lm]	
YT-08590	3	100	50/100

EN LED headlamp
 PL Latarka czołowa LED
 DE LED Kopflampe
 RU Налобный светодиодный фонарь
 CZ Čelová lampa LED
 HU LED fejlámpa
 RO Lanterna cu LED pt. cap
 FR Lampe frontale LED
 IT Lampada da testa LED
 ES Lámpara LED de cabeza
 CN LED头灯

10 W **XM-L2** **450 lm**
ZOOM **3** LIGHTING MODES TRYBY SVÍCENÍ
4x AA



POWER LED

YATO	[W]	[lm]	
YT-08591	10	450	6/24

EN LED headlamp
 PL Latarka czołowa LED
 DE LED Kopflampe
 RU Налобный светодиодный фонарь
 CZ Čelová lampa LED
 HU LED fejlámpa

RO Lanterna cu LED pt. cap
 FR Lampe frontale LED
 IT Lampada da testa LED
 ES Lámpara LED de cabeza
 CN LED头灯

XTE **500 lm** **6** LIGHTING MODES TRYBY SVÍCENÍ **IP44**
3x AAA



POWER SMD LED

YATO	[lm]	
YT-08595	500	12/72

EN LED headlamp
 PL Latarka czołowa LED
 DE LED Kopflampe
 RU Налобный светодиодный фонарь
 CZ Čelová lampa LED
 HU LED fejlámpa
 RO Lanterna cu LED pt. cap
 FR Lampe frontale LED
 IT Lampada da testa LED
 ES Lámpara LED de cabeza
 CN LED头灯

XTE **3.7 V** **500 lm** **6** LIGHTING MODES TRYBY SVÍCENÍ **4-5h** **4.5-9h**
1000mAh Li-Po **IP44** **USB** BATTERY CHARGER LADOVNÁKA



POWER SMD LED

YATO	[lm]	
YT-08596	500	12/72

EN LED headlamp
 PL Latarka czołowa LED
 DE LED Kopflampe
 RU Налобный светодиодный фонарь
 CZ Čelová lampa LED
 HU LED fejlámpa
 RO Lanterna cu LED pt. cap
 FR Lampe frontale LED
 IT Lampada da testa LED
 ES Lámpara LED de cabeza
 CN LED头灯

3.7 V **480 lm** **2-2.5h** **1.5-10h** **1m** **IP54**
1400mAh Li-Po **USB** BATTERY CHARGER LADOVNÁKA



COB LED

YATO	[lm]	
YT-08592	480 (300 lm - P8 100%, 90 lm - P8 30%, 250 lm - COB 100%, 480 lm - P8 + COB)	6/24

EN LED headlamp
PL Latarka czołowa LED
DE LED Kopflampe
RU Напольный светодиодный фонарь
CZ Čelová lampa LED
HU LED fejlámpa
RO Lanterna cu LED pt. cap
FR Lampe frontale LED
IT Lampada da testa LED
ES Lámpara LED de cabeza
CN LED头灯



COB
LED

YATO	[lm]	
YT-08593	500 (400 lm - P8 100%, 120 lm - P8 30%, 200 lm - COB 100%, 500 lm - P8 + COB)	6/24

EN LED headlamp for colour match
PL Lampa czołowa LED do doborzenia kolorów
DE LED-Stirnlampe für Farbanpassung
RU Светодиодный налобный фонарь для подбора цвета
CZ LED čelovka pro barevné sladění
HU LED homloklámpa színválasztáshoz
RO Lanterna cap cu LED pt. potrivirea culorilor
FR Lampe frontale LED adaptation de couleurs
IT Torcia frontale a LED per selezionare colori
ES Lámpara frontal LED para seleccionar colores
CN 头灯-用于对比颜色

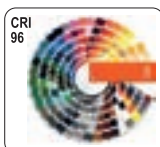

COB
LED

YATO	[lm]	
YT-08490	160	40

EN Automotive circuit tester
PL Wskaźnik elektryczny samochodowy
DE KFZ Prüflampe

RU Пробник напряжения автомобильный
CZ Zkoušečka napětí autoelektrikářská
HU Autóvillamosságí tesztler

RO Tester pt. circuite auto
FR Testeur de tension de voiture
IT Tester elettrico per auto

ES Indicador eléctrico de coche
CN 汽车测电笔



6-24V

YATO		
YT-2865	25/250	

EN Cloth cable wrap tape
PL Taśma parcziana do wiązek kabli
DE Gewebekabel für Kabelbäume
RU Лента хлопцевая для кабельных пучков
CZ Plátěná páska do kabelových svazků
HU Poliészter kábelköteg szalag
RO Banda panza pt. izolat cabluri
FR Ruban adhésif textile
IT Nastro di tela per cablaggi
ES Cinchas para haces de cables
CN 绒布线束胶带

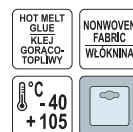

YATO	W [mm]	L [m]	± [mm]	
YT-81500	19	15	0.3	10/200
YT-81501	19	25	0.3	10/120

EN LED headlamp
PL Latarka czołowa LED
DE LED Kopflampe
RU Напольный светодиодный фонарь
CZ Čelová lampa LED
HU LED fejlámpa
RO Lanterna cu LED pt. cap
FR Lampe frontale LED
IT Lampada da testa LED
ES Lámpara LED de cabeza
CN LED头灯



COB
LED

YATO	[lm]	
YT-08594	800 (600 lm - SST40 100%, 250 lm - SST40 30%, 250 lm - COB 100%, 800 lm - SST40 + COB)	6/24

EN Neck lamp
PL Latarka na szyję
DE Halslampe
RU Фонарь на шею
CZ Svítilna na krk
HU Nyaklámpa
RO Lanterna pt. gat
FR Lampe torche tour du cou
IT Torcia da collo
ES Linterna para el cuello
CN 脖子灯

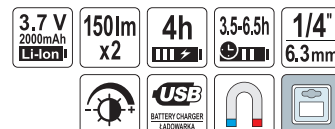

SMD
LED

YATO	[lm]	
YT-08599	150 x2	6/24

EN Number stamps
 PL Znaczniki cyfrowe
 DE Nummernstempel
 RU Клейма цифровые
 CZ Razidla číselná
 HU Számbeütők
 RO Poansoare cu cifre
 FR Chiffres à frapper
 IT Punzoni marcatori
 ES Marcadores de números
 CN 数字冲模



9 PCS
 0-9 NUMBERS NUMBERY
HRC 50-55
1045 CARBON STEEL STAL WEGLOWA

YATO	Digit height / Wysokość cyfr [mm]	pcs / szt.	
YT-6854	6	9	20
YT-6855	8	9	18

EN Letter stamps
 PL Znaczniki literowe
 DE Buchstabenstempel
 RU Клейма буквенные
 CZ Razidla písmenová
 HU Betűbeütők
 RO Poansoare cu litere
 FR Lettres à frapper
 IT Punzoni marcatori
 ES Marcadores de letras
 CN 字母冲模



27 PCS
A-Z|& LETTERS LITERARY
HRC 50-55
1045 CARBON STEEL STAL WEGLOWA

YATO	Letter height / Wysokość liter [mm]	pcs / szt.	
YT-6862	6	27	12
YT-6863	8	27	8

EN Lambda sensor thread chaser
 PL Zestaw do naprawy gwintów sondy lambda
 DE Lambdasonde Gewinde Reparatur-Set
 RU Набор для ремонта сорванной резьбы винтов
 CZ Sada na opravu závitu lambda sondy
 HU Menejavitó készlet lambda szondához
 RO Dispozitiv pt. curatat filet sonda lambda
 FR Set de réparation filetage de sonde lambda
 IT Chiavi a bussola per sonde lambda
 ES Cazador del hilo de rosca para sonda lambda
 CN 火星塞丝攻组套

M12 x1.25
M18 x1.5
HRC 50
 FOR OXYGEN SENSOR DO SONDY LAMBDA



YATO	
YT-1756	12/96

EN Oil pan thread repair set
 PL Zestaw naprawczy korków do miski olejowej
 DE Reparatursatz für Verschlussstopfen von Ölwanne
 RU Набор для ремонта масляных пробок
 CZ Souprava na opravu vypoustěcích šroubů olejových van
 HU Olajteknő-csavar javítókészlet
 RO Set pt. reparare dopuri baie de ulei
 FR Kit réparation de bouchons de carter d'huile
 IT Set per riparazione dei tappi della coppa del olio
 ES Juego de reparación para los tapones del cárter de aceite
 CN 螺纹修复组套



64 PCS
CrMo

M13	M13	13 mm	M17	M17	17 mm
5 pcs	10 pcs	5 pcs	10 pcs	5 pcs	10 pcs
M15	M15	15 mm	M20	M20	20 mm
5 pcs	10 pcs	5 pcs	10 pcs	5 pcs	10 pcs

YATO	
YT-1757	5

EN Oil pan thread repair set
 PL Zestaw naprawczy korków do miski olejowej
 DE Reparatursatz für Verschlussstopfen von Ölwanne
 RU Набор для ремонта масляных пробок
 CZ Souprava na opravu vypoustěcích šroubů olejových van
 HU Olajteknő-csavar javítókészlet
 RO Set pt. reparare dopuri baie de ulei
 FR Carter d'huile fil kit de réparation
 IT Set per riparazione dei tappi della coppa del olio
 ES Juego de reparación para los tapones del cárter de aceite
 CN 螺纹修复组套



7 PCS

YATO	Thread size / Rozmiar gwintu	
YT-17571	M13x1.5 mm	10/40
YT-17572	M15x1.5 mm	10/40
YT-17573	M17x1.5 mm	10/40
YT-17574	M20x1.5 mm	10/40
YT-17575	M22x1.5 mm	10/40

EN Thread repair set
 PL Zestaw do naprawy gwintów
 DE Reparatursatz für Gewinde
 RU Набор для ремонта резьбы
 CZ Souprava na opravu závitu
 HU Menejavitó készlet
 RO Set pt. reparare filete
 FR Set d'helicois
 IT Kit di riparazione per filettature
 ES Juego para reparar roscas
 CN 螺纹修复组套

HSS 4341
SS STAINLESS STEEL STAL WEGLOWA



88 PCS

YATO	Dimensions / Wymiary	
YT-1769	M6x1x10.8 mm, M8x1.25x10.8 mm, M10x1.5x13.5 mm	5/10



131 PCS

YATO	Dimensions / Wymiary	
YT-1763	M5x0.8x6.7 mm, M6x1x10.8 mm, M8x1.25x10.8 mm, M10x1.5x13.5 mm, M12x1.75x16.3 mm	5/10

- EN Wire threads
PL Wkłady spiralne do naprawy gwintów
DE Spiraleinlagen für Gewindereparatur
RU Метчики и сверла для ремонта резьбы
CZ Spirálové vložky na opravu závitů
HU Menetjavító betétek
- RO Insertii spirală pt. reparare filete
FR Helicoil
IT Inserti a spirale per riparazione
ES Elementos espirales para reparar roscas
CN 不锈钢螺套



For YT-1763, YT-1769
Dla YT-1763, YT-1769

YATO	Dimensions / Wymiary	pcs / szt.	
YT-1764	M5x0.8x6.7 mm	20	50/250
YT-1765	M6x1x10.8 mm	20	50/250
YT-1766	M8x1.25x10.8 mm	20	50/200
YT-1767	M10x1.5x13.5 mm	15	25/100
YT-1768	M12x1.75x16.3 mm	10	25/100

- EN Spark plug thread repair set
PL Zestaw naprawczy gwintu świecy zapłonowej
DE Reparatursatz für Zündkerzengewinde
RU Набор для восстановления резьбы свечи зажигания
CZ Sada pro opravu závitů zážehové svíčky
HU Gyújtógyertya menetjavító készlet
RO Set reparat filet bujie
FR Kit de réparation du filetage de bougie d'allumage
IT Kit di riparazione per cavi di candele di accensione
ES Kit de reparación para rosca de bujía de encendido
CN 火花塞螺纹修复工具

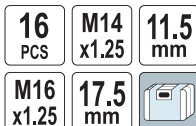

YATO	
YT-17580	20

- EN Brake calliper guide bolt repair tool set
PL Zestaw naprawczy prowadnic zacisków hamulcowych
DE Reparatursatz für Bremssattelführungen
RU Набор для ремонта направляющих тормозного суппорта
CZ Sada pro opravu vodítek brzdových třmenů
HU Féknyereg vezetőpersely szerelő készlet
RO Set de instrumente pt. repararea suruburilor ghidajului etrierului
FR Kit de réparation pour les guides d'étrier de frein
IT Kit di riparazione per guide di scorrimento delle pinze di freni
ES Kit de reparación para guías de mordazas de freno
CN 刹车卡钳螺栓修复工具



Ford, Opel, VAG

YATO	
YT-17588	20

- EN Thread repair set
PL Zestaw do naprawy gwintów
DE Reparatursatz für Gewinde
RU Набор для ремонта резьбы
CZ Souprava na opravu závitů
HU Menetjavító készlet
RO Set pt. reparare filete
FR Set d'helicoils
IT Kit di riparazione per filettature
ES Juego para reparar roscas
CN 螺纹修复工具组套



YATO	Thread size / Rozmiar gwintu	pcs / szt.	
YT-17631	M5x0.8 mm	30	20/40
YT-17632	M6x1.0 mm	30	20/40
YT-17633	M8x1.25 mm	30	20/40
YT-17634	M10x1.5 mm	30	20/40
YT-17635	M12x1.75 mm	30	20/40

- EN Spark plug thread repair set
PL Zestaw naprawczy gwintu świecy zapłonowej
DE Reparatursatz für Zündkerzengewinde
RU Набор для восстановления резьбы свечи зажигания
CZ Sada pro opravu závitů zážehové svíčky
HU Gyújtógyertya menetjavító készlet
RO Set reparat filet bujie
FR Kit de réparation du filetage de bougie d'allumage
IT Kit di riparazione per cavi di candele di accensione
ES Kit de reparación para rosca de bujía de encendido
CN 火花塞螺纹修复工具



YATO	
YT-17581	10

- EN Spark plug thread chaser
PL Zestaw do naprawy gwintów świec
DE Stopfengewinde-Reparaturset
RU Набор для ремонта резьбы свечей
CZ Sada na opravu závitů svíček
HU Gyertyamenet javító készlet
RO Curatorul filet bujie
FR Kit de réparation pour filet de bougies d'allumage
IT Kit per riparazione di filettature di candele
ES Kit de reparación de roscas de bujía
CN 火星塞丝攻组套



YATO	
YT-17697	16/64

EN Glow plug threads repair kit
 PL Zestaw naprawczy gwintów świec żarowych
 DE Reparatursatz für Glühkerzengewinde
 RU Набор для ремонта резьбы свечи накаливания
 CZ Sada pro opravu závitů žhavicích svíček
 HU Izzítógyertyya menetjavító készlet
 RO Set de reparare filete bujii incandescente
 FR Kit de réparation pour les filetages des bougies de préchauffage
 IT Kit di riparazione per filettature di candele di accensione
 ES Kit de reparación para roscas de bujías de calentamiento
 CN 火花塞螺纹修复工具

33
PCS

M8
x1.0

M10
x1.0

M10
x1.25

M12
x1.25



EN Brake thread repair set
 PL Zestaw naprawczy gwintów zacisku hamulcowego
 DE Gewindereparatursatz für Bremssattel
 RU Комплект для ремонта резьбы суппорта тормоза
 CZ Sada na opravu závitů brzdového třmenu
 HU Féknyereg menetjavító készlet
 RO Set reparat cablu de frana
 FR Kit de réparation pour filetages d'étriers de frein
 IT Kit di riparazione per filettature di pinze di freni
 ES Kit de reparación de roscas para pinzas de freno
 CN 刹车螺纹修复工具

16
PCS

M9
x1.25

HSS



Ford, Opel, VAG

YATO
YT-17710

20

YATO
YT-17700

10

EN Rethread tool kit set
 PL Zestaw do naprawy gwintów śrub i nakrętek
 DE Gewindereparatursatz für Schrauben und Mutter
 RU Комплект для ремонта резьбы на винтах и гайках
 CZ Sada pro opravu závitů na šroubech a maticích
 HU Csavarok és anyák meneteinek javítására szolgáló készlet

RO Kit pt. reparat filete
 FR Kit de réparation de filetage
 IT Kit di riparazione delle filettature viti e dadi
 ES Kit de reparación de roscas en tornillos y tuercas
 CN 螺纹修复工具组套

15
PCS

METRIC
METRYCZNY



Metric thread file pitches / Pilniki do naprawy gwintów: 0.75, 1.0, 1.25, 1.5, 1.75, 2.0, 2.5, 3.0 mm;
 Rethreader dies / Narzynki: 6x1.00, 8x1.25, 10x1.25, 10x1.50, 12x1.25, 12x1.50, 12x1.75 mm;
 Rethreader taps / Gwintowniki: 6x1.00, 8x1.25, 10x1.25, 10x1.50, 12x1.25, 12x1.50, 12x1.75 mm

YATO
YT-17705

20

EN Axle spindle rethreading set
 PL Zestaw do naprawy gwintów półosi
 DE Gewindereparatur Set Antriebswelle
 RU Набор для восстановления резьбы оси шруса
 CZ Souprava k opravě závitů hnacích hřídelí
 HU Részcs menetjavító készlet főtengelyekhez

RO Trusa pt. reparat filetele la planetare
 FR Kit réparation filetage cardan
 IT Kit di ripristino di filetti dei semiassi
 ES Kit de herramienta de la reparación
 CN 传动轴螺杆修复组套

8
PCS

5/4"
32mm



M24x1.5; M24x2.0; M22x1.0; M22x1.5; M20x1.25; M20x1.5; 3/4x20 UNEF; 13/16x20 UNEF

YATO
YT-17695

10

EN Injector clamping bolt thread repair kit
 PL Zestaw naprawczy do gwintów śrub mocujących wtryskiwacze
 DE Gewinde-Reparatur Satz für Injektor-Befestigungsschraube
 RU Набор для ремонта резьбы крепежных винтов форсунок
 CZ Sada na opravu závitů upevňovacích šroubů vstřikovače
 HU Menetjavító készlet befecskendezők rögzítőcsavarjaihoz
 RO Kit de reparare a filetelui șurubului de strângere a injectorului
 FR Kit de réparation filetage pour vis de fixation injecteur
 IT Kit per riparazione di filettature delle viti di fissaggio per iniettori
 ES Kit de reparación de roscas de tornillos de fijación de inyectores
 CN 喷油器夹紧螺栓螺纹修复

10
PCS

MERCEDES

M6X1

HSS



YATO
YT-06036

10

EN Pressure gauge
 PL Wskaźnik ciśnienia
 DE Druckanzeige
 RU Манометр
 CZ Tlakometr
 HU Nyomásmérő

RO Indicator de presiune
 FR Manomètre
 IT Manometro
 ES Manómetro
 CN 压力计

0-15
bar

0-220
psi

140
mm

FOR TRUCKS
DO NOT
CHECKEROWYCH



YATO
YT-24301

25/100

EN Foot pump with gauge
PL Pompka nożna z manometrem
DE Fusspumpe
RU Насос ножный с манометром
CZ Nožní pumpa s manometrem
HU Lábpumpa nyomásmérővel
RO Pompă de picior cu manometru
FR Pompe à pied avec manomètre
IT Pompa a pedale con manometro
ES Bomba de pierna con manometro
CN 打气筒



0.7 MPa (max)



EN Foot pump with gauge
PL Pompka nożna z manometrem
DE Fusspumpe
RU Насос ножный с манометром
CZ Nožní pumpa s manometrem
HU Lábpumpa nyomásmérővel
RO Pompă de picior cu manometru
FR Pompe à pied avec manomètre
IT Pompa a pedale con manometro
ES Bomba de pierna con manometro
CN 带压力表双管打气筒



0.7 MPa (max)



YATO
YT-7349

10

YATO
YT-7350

10

EN Hand pump with manometer
PL Pompka słupkowa z manometrem
DE Hand-Luftpumpe mit Manometer
RU Насос ручной с манометром
CZ Pumpa s manometrem
HU Kézi pumpa manométerrel
RO Pompa de mana cu manometru
FR Pompe manuelle avec manomètre
IT Pompa verticale con manometro
ES Bomba de barrote con manometro
CN 直立式打气筒 (機械錶)



0.8 MPa (max)

0-120 psi

65 cm

UNIVERSAL DOUBLE HEAD UNIVERSALNA GŁOWICA PODWÓJNA



YATO
YT-73521

3

EN Rechargeable air compressor
PL Kompressor bezprzewodowy
DE Kabelloser Kompressor
RU Беспроводной компрессор
CZ Bezdrátový kompresor
HU Vezeték nélküli kompresszor
RO Compressor de aer reîncărcabil
FR Compresseur sans-fil
IT Compressore senza fili
ES Compressor inalámbrico
CN 充气泵

120 W

1.0 MPa

25 l/min

11.1V 2200mAh Li-Ion

4h

20min

USB CHARGING LAODWANE

25 cm

LED LIGHTING OSWIETLONE



Setups / Ustawienia: 3-150 psi, 0.2-10.3 bar, 20-995 kPa, 0.2-10.5 kg/cm²

YATO
YT-82950

[V d.c.]

11.1 (3.7 x3)

12

EN Car air compressor
PL Kompressor samochodowy
DE Auto-Kompressor
RU Автомобильный компрессор
CZ Automobilový kompresor
HU Autókompresszor

RO Compressor auto
FR Compresseur de voiture
IT Compressore d'auto
ES Compressor de coche
CN 车用充气泵



120 W

1.0 MPa

12 V

25 l/min

LED

60 cm

3 m



LED



YATO
YT-73470

[W]

120

12

EN Cordless car air compressor
PL Akumulatorowy kompresor samochodowy
DE Akku-Auto-Kompressor
RU Компрессор автомобильный аккумуляторный
CZ Akumulátorový automobilový kompresor
HU Autókompresszor akkumulátoros
RO Compressor auto cu accumulator
FR Compresseur de voiture sans-fil
IT Compressore a batteria per auto
ES Compressor de coche de batería
CN 无绳车载空气压缩机

36 V 2x 18V Li-Ion

8 bar

98 l/min

6 L

3.0 Ah



• Pressure hose
• Tire inflation gun
• Wąż ciśnieniowy
• Pistolet do pompowania kół



18V Li-Ion

L_{pa} = 80.0 ± 3.0 dB; L_{wa} = 90.7 ± 3.0 dB

YATO
YT-23241

[V d.c.]
36 (18 x2)

1

EN Cordless car air compressor
PL Akumulatorowy kompresor samochodowy
DE Akku-Auto-Kompressor
RU Компрессор автомобильный аккумуляторный
CZ Akumulátorový automobilový kompresor
HU Autókompresszor akkumulátoros
RO Compressor auto cu accumulator
FR Compresseur de voiture sans-fil
IT Compressore a batteria per auto
ES Compressor de coche de batería
CN 无绳车载空气压缩机

36 V 2x 18V Li-Ion

8 bar

98 l/min

6 L



• Pressure hose
• Tire inflation gun
• Wąż ciśnieniowy
• Pistolet do pompowania kół



18V Li-Ion

Battery not included
Oline Akku / Bez akumulatora
Bez Gamaresu / Bez aku
Akumulátor neličú
Fără baterie / Sans batterie
Senza batteria / Sin batería
没有电池

L_{pa} = 80.0 ± 3.0 dB; L_{wa} = 90.7 ± 3.0 dB

YATO
YT-23242

[V d.c.]
36 (18 x2)

1

EN Cordless car air compressor
 PL Akumulatorowy kompresor samochodowy
 DE Akku-Auto-Kompressor
 RU Компрессор автомобильный аккумуляторный
 CZ Akumulátorový automobilový kompresor
 HU Autókompresszor akkumulátoros
 RO Compresor auto cu accumulator
 FR Compresseur de voiture sans-fil
 IT Compresore a batteria per auto
 ES Compresor de coche de batería
 CN 无绳车载空气压缩机

18V Li-Ion 12V 11 bar
 3.0 Ah LED LIGHTING ŚWIETLENIE LCD BACKLIGHT POŚWIETLENIE



18V Li-Ion

L_{PA} = 71,2 ± 3,0 dB; L_{WA} = 82,2 ± 3,0 dB

YATO	[V d.c.]	
YT-23247	18	4

EN Cordless car air compressor
 PL Akumulatorowy kompresor samochodowy
 DE Akku-Auto-Kompressor
 RU Компрессор автомобильный аккумуляторный
 CZ Akumulátorový automobilový kompresor
 HU Autókompresszor akkumulátoros
 RO Compresor auto cu accumulator
 FR Compresseur de voiture sans-fil
 IT Compresore a batteria per auto
 ES Compresor de coche de batería
 CN 无绳车载空气压缩机

18V Li-Ion 12V 11 bar
 LED LIGHTING ŚWIETLENIE LCD BACKLIGHT POŚWIETLENIE



18V Li-Ion

L_{PA} = 71,2 ± 3,0 dB; L_{WA} = 82,2 ± 3,0 dB

YATO	[V d.c.]	
YT-23248	18	4

Battery not included
 Ohne Akku / Bez akumulatora
 Без аккумулятора / Bez aku
 Akumulátor není
 Fără baterie / Sans batterie
 Senza batteria / Sin batería
 没有电池

EN Car air compressor
 PL Kompresor samochodowy
 DE Auto-Kompressor
 RU Автомобильный компрессор
 CZ Automobilový kompresor
 HU Autókompresszor

RO Compresor auto
 FR Compresseur de voiture
 IT Compresore d'auto
 ES Compresor de coche
 CN 车用充气泵

180 W 1.0 MPa 12 V
 40 l/min 1m 3m



YATO	[W]	
YT-73460	180	8

EN Car air compressor
 PL Kompresor samochodowy
 DE Auto-Kompressor
 RU Автомобильный компрессор
 CZ Automobilový kompresor
 HU Autókompresszor

RO Compresor auto
 FR Compresseur de voiture
 IT Compresore d'auto
 ES Compresor de coche
 CN 车用充气泵

250 W 1.0 MPa 12 V
 60 l/min 5m 3m



YATO	[W]	
YT-73462	250	4

EN Air wedge
 PL Poduszka montażowa
 DE Luft Keil
 RU Монтажная подушка
 CZ Rozpínací montážní polštář
 HU Emelőpárna
 RO Perna de aer
 FR Coussin élévateur
 IT Cuscino di montaggio
 ES Cojines elevadores
 CN 门窗安装气囊

50 mm TPU



EN Air pump wedge set
 PL Zestaw poduszek montażowych
 DE Montagekissen-Set
 RU Набор монтажных подушек
 CZ Rozpínací polštářky
 HU Szerelőpárna készlet
 RO Set perne de aer
 FR Coussins d'air pour soulever
 IT Set di cuscinetti gonfiabili per montaggio porte e finestre
 ES Juego de bolsas de cuña de aire
 CN 门窗安装气囊

3 PCS 165x150 mm 190x110 mm 270x130 mm
 50 mm TPU



YATO	Size / Rozmiar [mm]	
YT-67380	150x160	24
YT-67381	165x150	48
YT-67382	190x110	48
YT-67383	270x130	48



YATO		
YT-67385		48

EN Tire rack
 PL Stojak na kola
 DE Reifenständer
 RU Стойка для колес
 CZ Stojan na kola
 HU Keréktartó állvány
 RO Raft cauciucuri
 FR Support pour roues
 IT Supporto verticale per pneumatici
 ES Soporte para ruedas
 CN 轮胎架

max 225 mm max 100 kg (4x25)



YATO		
YT-55690		1

EN Oil jug
PL Nalewak warsztatowy
DE Ölkanne
RU Лейка пластиковая с крышкой
CZ Odměrka plastová - konev
HU Olajbetöltő kanna
RO Recipient ulei
FR Broc verseur avec couvercle
IT Serbatoio
ES Jarra con pitorro de aceite
CN 油壶



YATO 	∅ [mm]	∅ [mm]
YT-06980	1	48
YT-06983	3	40
YT-06985	5	16

EN Oil jug
PL Nalewak warsztatowy
DE Ölkanne
RU Лейка пластиковая с крышкой
CZ Odměrka plastová - konev
HU Olajbetöltő kanna
RO Recipient ulei
FR Broc verseur avec couvercle
IT Serbatoio
ES Jarra con pitorro de aceite
CN 油壶

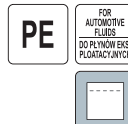

YATO 	∅ [mm]	∅ [mm]
YT-06987	10	8

EN Funnel
PL Lejek
DE Trichter
RU Воронка гибкая
CZ Nálevka
HU Kétrészes tölcser

RO Pálnie
FR Entonnoir
IT Imbuto
ES Embudo
CN 漏斗



YATO 	∅ [mm]	∅ [mm]
YT-0694	135	192

EN Long funnel
PL Lejek długi
DE Trichter
RU Воронка гибкая
CZ Nálevka
HU Kétrészes tölcser
RO Pálnie
FR Entonnoir
IT Imbuto
ES Embudo
CN 漏斗



YATO 	L [mm]	∅ [mm]	∅ [mm]
YT-0693	455	120	48

EN Operating fluids funnel
PL Lejek do płynów eksploatacyjnych
DE Trichter
RU Воронка гибкая
CZ Nálevka
HU Kétrészes tölcser

RO Pálnie
FR Entonnoir
IT Imbuto
ES Embudo
CN 漏斗



YATO 	∅ [mm]	∅ [mm]
YT-0695	100	180

EN Operating fluids funnel
PL Lejek do płynów eksploatacyjnych
DE Trichter
RU Воронка гибкая
CZ Nálevka
HU Kétrészes tölcser

RO Pálnie
FR Entonnoir
IT Imbuto
ES Embudo
CN 漏斗



YATO 	∅ [mm]	∅ [mm]
YT-0696	240	48

EN Fuel and oil funnel
PL Lejek do paliwa i oleju
DE Trichter
RU Воронка гибкая
CZ Nálevka
HU Kétrészes tölcser
RO Pálnie
FR Entonnoir
IT Imbuto
ES Embudo
CN 漏斗



YATO 	∅ [mm]	∅ [mm]
YT-0692	150	30

EN Oil funnel
PL Lejek do oleju
DE Trichter
RU Воронка гибкая
CZ Nálevka
HU Kétrészes tölcser

RO Pálnie
FR Entonnoir
IT Imbuto
ES Embudo
CN 漏斗



YATO 	∅ [mm]	∅ [mm]
YT-0697	280	48

EN Oil funnel with handle
PL Lejek specjalny z uchwytem
DE Spezialtrichter mit Griff
RU Специальная воронка с ручкой
CZ Speciální trychťyř s rukojetí
HU Speciális tölcser fogantyúval
RO Pálnie pt. ulei cu maner
FR Entonnoir spécial avec poignée
IT Imbuto speciale con impugnatura
ES Embudo especial con soporte
CN 漏斗



YATO 	∅ [mm]	∅ [mm]
YT-06972	20, 125	10/20

- EN Pneumatic oiling machine
- PL Pneumatyczny napełniacz do oleju
- DE Pneumatischer Öleinfüller
- RU Пневматический наполнитель для масла
- CZ Pneumatická plnidlo oleje
- HU Pneumatikus olajfeltöltő
- RO Gresor pneumatic
- FR Pompes et de remplissage d'huile pneumatique
- IT Dispositivo di riempimento olio
- ES Dispositivo de llenado de aceite
- CN 齿轮油加油机



0.5 MPa (max.)	20 L
2.1 m	2x
STANDARD	

$L_{pa} = 101,2 \pm 3,0$ dB; $L_{wa} = 119,8 \pm 3,0$ dB

YATO		
YT-0718	20	1

- EN Pneumatic oil drain extractor
- PL Zlewarko-wysysarka pneumatyczna
- DE Druckluft Ölabsauggerät / Ölaufanggerät
- RU Маслосборная установка пневматическая
- CZ Pneumatická odsávačka vyjetého oleje
- HU Pneumatikus fátartolaj gyűjtő / leszívó
- RO Rezervor decantare ulei uzat
- FR Récupérateur d'huile par aspiration
- IT Aspiratore-recuperatore pneumatico
- ES Recuperador de aceite de succión
- CN 抽接油机



0.7-0.8 MPa SUCTION ODSYSANIE
0.18 MPa EJECTION OPRÓZNIANIE
70 L
6 SUCTION PROBES SONDY SSACE
4x
STANDARD

$L_{pa} = 101,2 \pm 3,0$ dB; $L_{wa} = 119,8 \pm 3,0$ dB

YATO		
YT-0719	70	1

- EN Pneumatic oil drain extractor
- PL Zlewarko-wysysarka pneumatyczna
- DE Druckluft Ölabsauggerät / Ölaufanggerät
- RU Маслосборная установка пневматическая
- CZ Pneumatická odsávačka vyjetého oleje
- HU Pneumatikus fátartolaj gyűjtő / leszívó
- RO Rezervor decantare ulei uzat
- FR Récupérateur d'huile par aspiration
- IT Aspiratore-recuperatore pneumatico
- ES Recuperador de aceite de succión
- CN 抽接油机



0.7-0.8 MPa SUCTION ODSYSANIE
0.18 MPa EJECTION OPRÓZNIANIE
90 L
6 SUCTION PROBES SONDY SSACE
4x
STANDARD

$L_{pa} = 101,2 \pm 3,0$ dB; $L_{wa} = 119,8 \pm 3,0$ dB

YATO		
YT-07190	90	1

- EN Manual car oil pump
- PL Odsysarka ręczna do oleju
- DE Manuelle Öl-Absaugpumpe
- RU Ручной насос для откачки масла
- CZ Ruční vakuová odsávačka oleje a kapalín
- HU Kézi pumpás olajleszívó
- RO Pompă de aspirație pt. aspirația uleiului
- FR Pompe à vide pour aspiration d'huile
- IT Aspiratore manuale per olio
- ES Bomba de vacío para aspiración de aceite
- CN 手动抽油机



9 L
3 SUCTION PROBES SONDY SSACE
FOR OIL DO OLEJU

YATO		
YT-07087		4

EN Waste oil storage container
PL Pojemnik zlewowy do oleju
DE Öl-Auffang-Kanister
RU Контейнер отработанного масла
CZ Nádoba na použitý olej
HU Fárdolaj gyűjtő

RO Canistra colectare ulei
FR Bidon de collecte d'huile
IT Contenitore per la raccolta dell'olio
ES Bidón cambio de aceite
CN 积油壶



8L PE



EN Oil drainer
PL Zlewarka do oleju
DE Öleinfüllanlage
RU Устройство для слива масла
CZ Olejová nádrž s odsávacím
HU Fárdolaj leszívó
RO Dispozitiv pt. schimbare ulei
FR Récupérateur d'huile
IT Scolapiatti dell'olio
ES Decantador para aceite
CN 泄油器

75x155 cm PE



YATO	[]	[mm]	[]
YT-06995	8	600x330x110	4

EN Oil drain pan
PL Miska do oleju
DE Ölwanne
RU Миска для масла
CZ Miska na olej
HU Fárdolaj felfogó edény

RO Recipient pt. ulei
FR Bol à l'huile
IT Vaschetta per cambio olio
ES Escudilla para aceite
CN 接油盆



7L PP



YATO	[]	Ø [mm]	[]
YT-0699	7	370	24

EN Oil drain pan
PL Miska do oleju
DE Ölwanne
RU Миска для масла
CZ Miska na olej
HU Fárdolaj felfogó edény

RO Recipient pt. ulei
FR Bol à l'huile
IT Vaschetta per cambio olio
ES Escudilla para aceite
CN 接油盆



PE



YATO	[]	Ø [mm]	[]
YT-0716	10	370	6
YT-0717	15	420	4

EN Farm jack
PL Podnośnik farmerski
DE Bauernhof-Jack
RU Домкрат механический реечный
CZ Zvedák farm jack
HU Hi-jack fogaslécés off-road emelő
RO Cric mecanic tip off-road
FR Vérins mécaniques commerciales
IT Farm jack - sollevatore di auto
ES Elevación mecánicas comerciales
CN 农夫顶

3t 700
130 mm

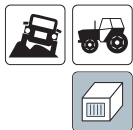

YATO	[]	[]
YT-17260	3	1

EN Farm jack
PL Podnośnik farmerski
DE Bauernhof-Jack
RU Домкрат механический реечный
CZ Zvedák farm jack
HU Hi-jack fogaslécés off-road emelő
RO Cric mecanic tip off-road
FR Vérins mécaniques commerciales
IT Farm jack - sollevatore di auto
ES Elevación mecánicas comerciales
CN 农夫顶

3t 1070
130 mm

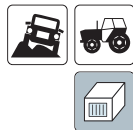

YATO	[]	[]
YT-17261	3	1

EN Farm jack
PL Podnośnik farmerski
DE Bauernhof-Jack
RU Домкрат механический реечный
CZ Zvedák farm jack
HU Hi-jack fogaslécés off-road emelő
RO Cric mecanic tip off-road
FR Vérins mécaniques commerciales
IT Farm jack - sollevatore di auto
ES Elevación mecánicas comerciales
CN 农夫顶

3t 1350
155 mm



YATO	[]	[]
YT-17262	3	1

EN Hydraulic bottle jack
 PL Podnośnik hydrauliczny słupkowy
 DE Hydraulischer Stempelwagenheber
 RU Домкрат гидравлический
 CZ Pístový zvedák hydraulický
 HU Hidraulikus emelő
 RO Cric hidraulic
 FR Cric hydraulique bouteille
 IT Cric idraulico a bottiglia
 ES Gato hidráulico de botella
 CN 立式液压千斤顶

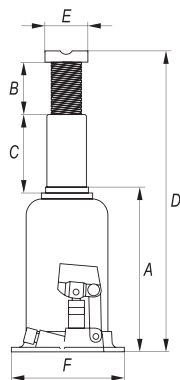

YATO	[t]	A [mm]	B [mm]	C [mm]	D [mm]	E [mm]	F [mm]	
YT-17000	2	181	48	116	345	25	88x92	6
YT-17001	3	194	60	120	374	27	92x100	6
YT-17002	5	216	60	137	413	29	96x110	4
YT-17003	8	230	80	147	457	32	103x118	2
YT-17004	10	230	80	150	460	36	110x123	2
YT-17005	12	230	80	155	465	40	116x134	2
YT-17006	15	230	82	150	462	43	140x134	2
YT-17007	20	242	60	150	452	45	144x150	2
YT-17008	32	285	-	180	465	69	190x152	1
YT-17009	50	300	-	180	480	83	218x176	1

EN Hydraulic bottle jack
 PL Podnośnik hydrauliczny słupkowy
 DE Hydraulischer Stempelwagenheber
 RU Домкрат гидравлический
 CZ Pístový zvedák hydraulický
 HU Hidraulikus emelő
 RO Cric hidraulic
 FR Cric hydraulique bouteille
 IT Cric idraulico a bottiglia
 ES Gato hidráulico de botella
 CN 立式液压千斤顶

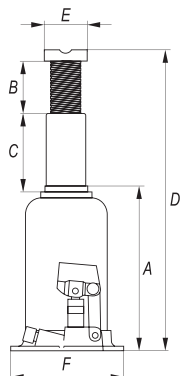

YATO	[t]	A [mm]	B [mm]	C [mm]	D [mm]	E [mm]	F [mm]	
YT-17015	2	172	88	112	372	28	103x105	4
YT-1702	5	218	110	146	474	40	110x112	5
YT-17025	8	220	115	153	488	45	124x127.5	2
YT-1704	10	220	115	148	483	48	124x127.5	3
YT-17045	12	230	115	160	505	45	130x136	2
YT-1706	15	228	113	154	508	56	140x142	2
YT-1707	20	241	115	165	521	60	165x161	2
YT-17075	25	240	110	160	510	65	186x174	1
YT-1709	30	244	108	140	510	65	186x174	1

EN Two-piston hydraulic bottle jack
 PL Podnośnik hydrauliczny słupkowy dwutokowy
 DE Hydraulischer Stempelwagenheber
 RU Домкрат гидравлический
 CZ Pístový zvedák hydraulický
 HU Hidraulikus emelő
 RO Cric hidraulic
 FR Cric hydraulique bouteille
 IT Cric idraulico a bottiglia
 ES Gato hidráulico de botella
 CN 液压双级千斤顶

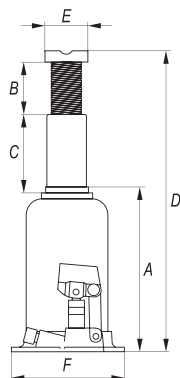

YATO	[t]	A [mm]	B [mm]	C [mm]	D [mm]	E [mm]	F [mm]	
YT-1711	5	230	146	138	500	41	130x136	2
YT-1713	10	128	63	38	223	47	160x165	2

EN Two-piston hydraulic bottle jack
 PL Podnośnik hydrauliczny słupkowy dwutokowy
 DE Hydraulischer Stempelwagenheber
 RU Домкрат гидравлический
 CZ Pístový zvedák hydraulický
 HU Hidraulikus emelő
 RO Cric hidraulic
 FR Cric hydraulique bouteille
 IT Cric idraulico a bottiglia
 ES Gato hidráulico de botella
 CN 液压双级千斤顶

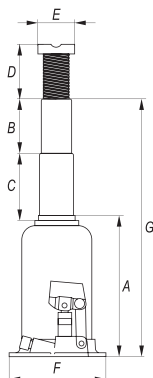

YATO	[t]	A [mm]	B [mm]	C [mm]	D [mm]	E [mm]	F [mm]	G [mm]	
YT-1714	10	208	120	118	78	48	165x161	442	1
YT-1715	12	236	138	128	98	56	186x174.5	498	1

EN Hydraulic floor jack
PL Podnośnik hydrauliczny
DE Hydraulischer Rangierwagenheber
RU Домкрат гидравлический
CZ Pístový zvedák hydraulický
HU Krokodíl emelő

RO Cric tip crocodil
FR Cric hydraulique
IT Sollevatore idraulico
ES Gato hidráulico
CN 卧式液压千斤顶

2t

359
89
mm



YATO 	[t]	
YT-1720	2	1

EN Hydraulic floor jack
PL Podnośnik hydrauliczny
DE Hydraulischer Rangierwagenheber
RU Домкрат гидравлический
CZ Pístový zvedák hydraulický
HU Krokodíl emelő

RO Cric tip crocodil
FR Cric hydraulique
IT Sollevatore idraulico
ES Gato hidráulico
CN 卧式液压千斤顶



2.5t

508
80
mm

QUICK
LIFT
SZYBKE
PODNOŻENIE

LOW
PROFILE
NISKI
PROFIL



YATO 	Max. lifting capacity / Maks. udźwieg [t]	
YT-17207	2.5	1

EN Hydraulic floor jack
PL Podnośnik hydrauliczny
DE Hydraulischer Rangierwagenheber
RU Домкрат гидравлический
CZ Pístový zvedák hydraulický
HU Krokodíl emelő
RO Cric tip crocodil
FR Cric hydraulique
IT Sollevatore idraulico
ES Gato hidráulico
CN 卧式液压千斤顶

RO Cric tip crocodil
FR Cric hydraulique
IT Sollevatore idraulico
ES Gato hidráulico
CN 卧式液压千斤顶

3t

465
130
mm

LOW
PROFILE
NISKI
PROFIL



YATO 	[t]	
YT-17211	3	1

EN Hydraulic floor jack
PL Podnośnik hydrauliczny
DE Hydraulischer Rangierwagenheber
RU Домкрат гидравлический
CZ Pístový zvedák hydraulický
HU Krokodíl emelő
RO Cric tip crocodil
FR Cric hydraulique
IT Sollevatore idraulico
ES Gato hidráulico
CN 卧式液压千斤顶

3t

465
130
mm

DUAL
PUMP
PODWÓJNA
POMPA

QUICK
LIFT
SZYBKE
PODNOŻENIE

LOW
PROFILE
NISKI
PROFIL



YATO 	[t]	
YT-17214	3	1

EN Hydraulic floor jack
PL Podnośnik hydrauliczny
DE Hydraulischer Rangierwagenheber
RU Домкрат гидравлический
HU Krokodíl emelő
RO Cric tip crocodil
FR Cric hydraulique
IT Sollevatore idraulico
ES Gato hidráulico
CN 卧式液压千斤顶

2.5t

465
100
mm

DUAL
PUMP
PODWÓJNA
POMPA

QUICK
LIFT
SZYBKE
PODNOŻENIE

AI



ULTRA LIGHT 

YATO 	[t]	
YT-17205	2.5	1

EN Hydraulic floor jack
PL Podnośnik hydrauliczny
DE Hydraulischer Rangierwagenheber
RU Домкрат гидравлический
HU Krokodíl emelő
RO Cric tip crocodil
FR Cric hydraulique
IT Sollevatore idraulico
ES Gato hidráulico
CN 卧式液压千斤顶

2.5t

455
87
mm



YATO 	[t]	
YT-1721	2.5	1

EN Hydraulic floor jack
PL Podnośnik hydrauliczny
DE Hydraulischer Rangierwagenheber
RU Домкрат гидравлический
CZ Pístový zvedák hydraulický
HU Krokodíl emelő

RO Cric tip crocodil
FR Cric hydraulique
IT Sollevatore idraulico
ES Gato hidráulico
CN 卧式液压千斤顶

3t

500
145
mm



YATO 	[t]	
YT-17213	3	1



EN Vehicle ramp
PL Najazd samochodowy
DE Auffahrrampe
RU Мини эстакада для автомобиля
CZ Nájezd na auto
HU Felhajtó rámpa
RO Rampa auto
FR Rampe pour voiture
IT Rampa per veicoli
ES Rampa para coches
CN 运送顶

1

PC

1000
kg



YATO 	Dimensions / Wymiary [mm]	
YT-55670	815x305x200	10

- EN Jack stand
- PL Podstawa pod samochód
- DE Unterstellböcke
- RU Подставка под автомобиль
- CZ Podstavec pod auto
- HU Gépkocsi alátét
- RO Chituc de metal
- FR Paire de chandeliers
- IT Coppia cavalletti
- ES Apoyos de coche
- CN 汽车安全支架

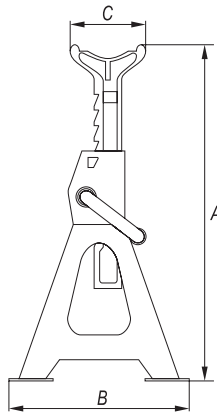

YATO	[t]	A [mm]	B [mm]	C [mm]	pcs / szt.	
YT-17310	2	265-415	190x165	77x40	2	1
YT-17311	3	280-420	182x201	85x29	2	1
YT-17312	6	388-580	258x285	100x29	2	1

- EN Porta power repair kit
- PL Rozpieraek hydrauliczny
- DE Hydraulischer Richt und Ausbeulsatz
- RU Гидравлическая распорная стойка в наборе
- CZ Hydraulický rozpěrák
- HU Hidraulikus bontó

- RO Trusa pompa hidraulica + accesorii
- FR Porta puissance hydraulique
- IT Martinetto idraulico
- ES Gato carrocerro hidráulico
- CN 分离顶

4t



Included: hydraulic cylinder 270x395 mm, expander jaws 0.5T, extensions 115, 170, 250, 470 mm
W zestawie: siłownik 270x395 mm, szczęki rozpieraaka 0.5 t, przedłużki 115, 170, 250, 470 mm

YATO	[t]	
YT-55500	4	1

- EN Accessories for porta power
- PL Pompa do rozpieraaka hydraulicznego
- DE Druckeinheit für hydraulischer Spreizer
- RU Ручной насос для гидравлической распорной стойки
- CZ Pumpa na hydraulický rozpěrák
- HU Szivattyú hidraulikus bontóhoz

- RO Pompa hidraulica
- FR Pompe hydraulique manuelle
- IT Pompa per martinetto idraulico
- ES Bomba hidraulica para gato carrocerro
- CN 分离顶油泵

4t



For YT-55512
Dla YT-55512

YATO	[t]	
YT-55510	4	4

- EN Porta power repair kit
- PL Rozpieraek hydrauliczny
- DE Hydraulischer Richt und Ausbeulsatz
- RU Гидравлическая распорная стойка в наборе
- CZ Hydraulický rozpěrák
- HU Hidraulikus bontó

- RO Trusa pompa hidraulica + accesorii
- FR Porta puissance hydraulique
- IT Martinetto idraulico
- ES Gato carrocerro hidráulico
- CN 分离顶

10t



Included: hydraulic cylinder 355x495 mm, expander jaws 0.5T, extensions 140, 240, 340, 590 mm
W zestawie: siłownik 355x495 mm, szczęki rozpieraaka 0.5 t, przedłużki 140, 240, 340, 590 mm

YATO	[t]	
YT-55503	10	1

- EN Accessories for porta power
- PL Pompa do rozpieraaka hydraulicznego
- DE Druckeinheit für hydraulischer Spreizer
- RU Ручной насос для гидравлической распорной стойки
- CZ Pumpa na hydraulický rozpěrák
- HU Szivattyú hidraulikus bontóhoz

- RO Pompa hidraulica
- FR Pompe hydraulique manuelle
- IT Pompa per martinetto idraulico
- ES Bomba hidraulica para gato carrocerro
- CN 分离顶油泵

10t



For YT-55513
Dla YT-55513

YATO	[t]	
YT-55511	10	2

EN Accessories for porta power
PL Siłownik do rozpięranka hydraulicznego
DE Kraftzylinder für hydraulischer Spreizer
RU Сервомотор для гидравлической распорной стойки
CZ Servomotor na hydraulický rozpěrák
HU Erőátvitel a hidraulikus bontóhoz

RO Accesorii pompa hidraulica
FR Presse hydraulique de la pompe
IT Cilindro per martinetto idraulico
ES Cilindro para gato carroceros
CN 千斤顶

4t



For YT-55510
Dla YT-55510

YATO	[t]	
YT-55512	4	2

EN Accessories for porta power
PL Siłownik do rozpięranka hydraulicznego
DE Kraftzylinder für hydraulischer Spreizer
RU Сервомотор для гидравлической распорной стойки
CZ Servomotor na hydraulický rozpěrák
HU Erőátvitel a hidraulikus bontóhoz

RO Accesorii pompa hidraulica
FR Presse hydraulique de la pompe
IT Cilindro per martinetto idraulico
ES Cilindro para gato carroceros
CN 千斤顶

10t



For YT-55511
Dla YT-55511

YATO	[t]	
YT-55513	10	2

EN Electronic battery charger
PL Prostownik elektroniczny
DE Elektronisches Ladegerät
RU Электронное зарядное устройство

CZ Elektronická nabíječka
HU Elektronikus akkumulátortöltő
RO Redresor electric
FR Chargeur de batterie voiture

IT Avviatore elettronico
ES Rectificador electrónico
CN 蓄电池充电器



220-240V-50Hz	6V 12V	1 4 A	max 200 Ah	WET MOKRY GEL ZELOWY AGM	MICRO- PROCESSOR MIKRO- PROCESOR	
---------------	-----------	------------	------------------	--------------------------------------	---	--

YATO		
YT-8300		8



220-240V-50-60Hz	12 V	4 A	5-120 Ah	WET MOKRY GEL ZELOWY AGM	MICRO- PROCESSOR MIKRO- PROCESOR	
------------------	---------	--------	-------------	--------------------------------------	---	--

YATO		
YT-83031		30



220-240V-50-60Hz	6V 12V	4 A	5-120 Ah	WET MOKRY GEL ZELOWY AGM	MICRO- PROCESSOR MIKRO- PROCESOR	
------------------	-----------	--------	-------------	--------------------------------------	---	--

YATO		
YT-83032		30

EN Electronic battery charger
PL Prostownik elektroniczny
DE Elektronisches Ladegerät
RU Электронное зарядное устройство
CZ Elektronická nabíječka
HU Elektronikus akkumulátortöltő

RO Redresor electric
FR Chargeur de batterie voiture
IT Avviatore elettronico
ES Cargador de batería para coche
CN 电池充电器

220-240V-50-60Hz	6V 12V	1 4 A
------------------	-----------	------------

max 120 Ah	WET MOKRY GEL ZELOWY AGM	MICRO- PROCESSOR MIKRO- PROCESOR
------------------	--------------------------------------	---

LCD	ALTERNATOR TEST TEST ALTERNATORA	STARTER TEST TEST ROZRUSZENKA
-----	---	--

x1 HCCX HF K	
--------------------	--



YATO		
YT-83033		20

EN Electronic battery charger
PL Prostownik elektroniczny
DE Elektronisches Ladegerät
RU Электронное зарядное устройство
CZ Elektronická nabíječka
HU Elektronikus akkumulátortöltő

RO Redresor electric
FR Chargeur de batterie voiture
IT Avviatore elettronico
ES Cargador de batería para coche
CN 电池充电器

220-240V-50Hz	6V 12V	2A 4A
---------------	-----------	----------

max 200 Ah	WET MOKRY GEL ZELOWY AGM / EFB	MICRO- PROCESSOR MIKRO- PROCESOR
------------------	--	---

LCD	
-----	--



YATO		
YT-83000		20

EN Electronic battery charger
 PL Prostownik elektroniczny
 DE Elektronisches Ladegerät
 RU Электронное зарядное устройство
 CZ Elektronická nabíječka
 HU Elektronikus akkumulátortöltő

RO Redresor electric
 FR Chargeur de batterie voiture
 IT Avviatore elettronico
 ES Cargador de batería para coche
 CN 电池充电器

220-240V~
50Hz

6V
12V

2A
8A

max
200
Ah

WET
MOKRY
GEL
ZELOWY
AGM / EFB

MICRO-
PROCESSOR
MICRO-
PROCESSOR

LCD



YATO
YT-83001 20

EN Electronic battery charger
 PL Prostownik elektroniczny
 DE Elektronisches Ladegerät
 RU Электронное зарядное устройство
 CZ Elektronická nabíječka
 HU Elektronikus akkumulátortöltő

RO Redresor electric
 FR Chargeur de batterie voiture
 IT Avviatore elettronico
 ES Cargador de batería para coche
 CN 电池充电器

220-240V~
50Hz

6V
12V

2A
10A

max
200
Ah

WET
MOKRY
GEL
ZELOWY
AGM / EFB

MICRO-
PROCESSOR
MICRO-
PROCESSOR

LCD



YATO
YT-83002 12

EN Electronic battery charger
 PL Prostownik elektroniczny
 DE Elektronisches Ladegerät
 RU Электронное зарядное устройство
 CZ Elektronická nabíječka
 HU Elektronikus akkumulátortöltő
 RO Redresor electric
 FR Chargeur de batterie voiture
 IT Avviatore elettronico
 ES Cargador de batería para coche
 CN 蓄电池充电器



220-240V~
50Hz

12
V

2A
8A
15A

max
200
Ah

WET
MOKRY
GEL
ZELOWY
AGM / EFB

MICRO-
PROCESSOR
MICRO-
PROCESSOR

LCD

YATO
YT-83003 8

EN Electronic battery charger
 PL Prostownik elektroniczny
 DE Elektronisches Ladegerät
 RU Электронное зарядное устройство
 CZ Elektronická nabíječka
 HU Elektronikus akkumulátortöltő
 RO Redresor electric
 FR Chargeur de batterie voiture
 IT Avviatore elettronico
 ES Cargador de batería para coche
 CN 蓄电池充电器



220-240V~
50Hz

6V
12V

8
A

5-200
Ah

WET
MOKRY
GEL
ZELOWY
AGM

MICRO-
PROCESSOR
MICRO-
PROCESSOR

YATO
YT-8301 8

EN Electronic battery charger
 PL Prostownik elektroniczny
 DE Elektronisches Ladegerät
 RU Электронное зарядное устройство
 CZ Elektronická nabíječka
 HU Elektronikus akkumulátortöltő
 RO Redresor electric
 FR Chargeur de batterie voiture
 IT Avviatore elettronico
 ES Cargador de batería para coche
 CN 蓄电池充电器



220-240V~
47-63Hz

12
V

12
A

6-200
Ah

WET
MOKRY

MICRO-
PROCESSOR
MICRO-
PROCESSOR

YATO
YT-8302 8

EN Electronic battery charger
 PL Prostownik elektroniczny
 DE Elektronisches Ladegerät
 RU Электронное зарядное устройство
 CZ Elektronická nabíječka
 HU Elektronikus akkumulátortöltő
 RO Redresor electric
 FR Chargeur de batterie voiture
 IT Avviatore elettronico
 ES Cargador de batería para coche
 CN 蓄电池充电器



220-240V~
47-63Hz

12
V

15
A

6-200
Ah

WET
MOKRY
GEL
ZELOWY
AGM

MICRO-
PROCESSOR
MICRO-
PROCESSOR

YATO
YT-8303 8

EN Battery charger with boost function
 PL Prostownik z funkcją wspomagania ładowania
 DE Ladegerät mit Boost-Funktion
 RU Выпрямитель с функцией поддержки зарядки
 CZ Nabíječka s funkcí boost
 HU Akkumulátortöltő boost funkció
 RO Redresor baterie cu funcție boost
 FR Chargeur de batterie voiture support boost
 IT Caricabatterie con funzione boost
 ES Cargador de baterías con función boost
 CN 充电器启动机



220-240V~
50-60Hz

12
V

15
A

max
300
Ah

WET
MOKRY
GEL
ZELOWY
AGM / EFB / MF

MICRO-
PROCESSOR
MICRO-
PROCESSOR

LED
DISPLAY
WYBIEWLACZ

YATO
YT-83037 8

EN Battery charger with boost function
PL Prostownik z funkcją wspomagania ładowania
DE Ladegerät mit Boost-Funktion
RU Выпрямитель с функцией поддержки зарядки
CZ Nabíječka s funkcií boost
HU Akkumulátortöltő boost funkció
RO Redresor baterie cu funcție boost
FR Chargeur de batterie voiture support boost
IT Caricabatterie con funzione boost
ES Cargador de baterías con función boost
CN 充电器启动机

230V~50Hz 12V 24V 16 A 120-240 Ah WET MOKRY



YATO

YT-8304



2

EN Battery charger with boost function
PL Prostownik z funkcją wspomagania ładowania
DE Ladegerät mit Boost-Funktion
RU Выпрямитель с функцией поддержки зарядки
CZ Nabíječka s funkcií boost
HU Akkumulátortöltő boost funkció
RO Redresor baterie cu funcție boost
FR Chargeur de batterie voiture support boost
IT Caricabatterie con funzione boost
ES Cargador de baterías con función boost
CN 充电器启动机

230V~50Hz 12V 24V 25 A 170-350 Ah WET MOKRY



YATO

YT-8305



2

EN Battery charger with boost function
PL Prostownik z funkcją wspomagania ładowania
DE Ladegerät mit Boost-Funktion
RU Выпрямитель с функцией поддержки зарядки
CZ Nabíječka s funkcií boost
HU Akkumulátortöltő boost funkció

RO Redresor baterie cu funcție boost
FR Chargeur de batterie voiture support boost
IT Caricabatterie con funzione boost
ES Cargador de baterías con función boost
CN 充电器启动机

230V~50Hz 12V 24V

15 A 12 V 75 A BOOST ROZRUCH

10-300 Ah WET MOKRY GEL ZELOWY AGM

MICRO-PROCESSOR MKRRO-PROCESSOR



YATO

YT-83051



2

EN Battery charger with boost function
PL Prostownik z funkcją wspomagania ładowania
DE Ladegerät mit Boost-Funktion
RU Выпрямитель с функцией поддержки зарядки
CZ Nabíječka s funkcií boost
HU Akkumulátortöltő boost funkció

RO Redresor baterie cu funcție boost
FR Chargeur de batterie voiture support boost
IT Caricabatterie con funzione boost
ES Cargador de baterías con función boost
CN 充电器启动机

230V~50Hz 12V 24V

30 A 12 V 145 A BOOST ROZRUCH

50-600 Ah WET MOKRY GEL ZELOWY AGM

MICRO-PROCESSOR MKRRO-PROCESSOR



YATO

YT-83052



2

EN Battery charger with engine start-up supporting function
PL Prostownik z funkcją wspomagania rozruchu
DE Ladegerät mit Starthilfe
RU Выпрямитель с функцией поддержки запуска
CZ Nabíječky s funkcií startovani motoru
HU Akkumulátortöltő indító
RO Redresor cu funcția de pomire de sprijin
FR Chargeur de batterie voiture support demarrage
IT Caricabatterie carrellato con funzione di avviatore rapido
ES Cargador de baterías arrancador
CN 充电器启动机

230V~50Hz

12V 27A START ROZRUCH 300A

24V 25A START ROZRUCH 240A

20-600 Ah

WET MOKRY



YATO

YT-83060



1

EN Battery charger with engine start-up supporting function
PL Prostownik z funkcją wspomagania rozruchu
DE Ladegerät mit Starthilfe
RU Выпрямитель с функцией поддержки запуска
CZ Nabíječky s funkcií startovani motoru
HU Akkumulátortöltő indító
RO Redresor cu funcția de pomire de sprijin
FR Chargeur de batterie voiture support demarrage
IT Caricabatterie carrellato con funzione di avviatore rapido
ES Cargador de baterías arrancador
CN 充电器启动机

230V~50Hz

12V 32A START ROZRUCH 390A

24V 31A START ROZRUCH 360A

20-700 Ah

WET MOKRY



YATO

YT-83061



1

EN Battery charger with engine start-up supporting function
PL Prostownik z funkcją wspomagania rozruchu
DE Ladegerät mit Starthilfe
RU Выпрямитель с функцией поддержки запуска
CZ Nabíječky s funkcií startovani motoru
HU Akkumulátortöltő indító
RO Redresor cu funcția de pomire de sprijin
FR Chargeur de batterie voiture support demarrage
IT Caricabatterie carrellato con funzione di avviatore rapido
ES Cargador de baterías arrancador
CN 充电器启动机

230V~50Hz

12V 38A START ROZRUCH 540A

24V 35A START ROZRUCH 450A

20-800 Ah

WET MOKRY



YATO

YT-83062



1

EN Jump starter power bank
 PL Urządzenie rozruchowe wielofunkcyjne
 DE Multifunktions-Startgerät
 RU Портативное пусковое-зарядное устройство
 CZ Power banka s možností nastartování auta
 HU Indító bikázó starter
 RO Acumulator extern pt. pornire motor si incarcare
 FR Portable demarreur batterie voiture booster
 IT Dispositivo di avviamento multifunzione
 ES Coche portátil salto de arranque
 CN 应急电源

7500 mAh
 2 h
 200 A
 400 A
 5V/2A
 USB
 Li-Po Li

FRONT LIGHT LAMPARCA
 QUICK CHARGING EXTREME LAZIOANIME
 JUMP STARTER ROZRUCH SILNIKA



YATO
 YT-83080 20

EN Jump starter power bank
 PL Urządzenie rozruchowe wielofunkcyjne
 DE Multifunktions-Startgerät
 RU Портативное пусковое-зарядное устройство
 CZ Power banka s možností nastartování auta
 HU Indító bikázó starter
 RO Acumulator extern pt. pornire motor si incarcare
 FR Portable demarreur batterie voiture booster
 IT Dispositivo di avviamento multifunzione
 ES Coche portátil salto de arranque
 CN 应急电源

9000 mAh
 3 h
 200 A
 400 A
 12V
 3.5 A
 5V/2A
 USB
 Li-Po Li

FRONT LIGHT LAMPARCA
 QUICK CHARGING EXTREME LAZIOANIME
 JUMP STARTER ROZRUCH SILNIKA



YATO
 YT-83081 10

EN Jump starter power bank
 PL Urządzenie rozruchowe wielofunkcyjne
 DE Multifunktions-Startgerät
 RU Портативное пусковое-зарядное устройство
 CZ Power banka s možností nastartování auta
 HU Indító bikázó starter
 RO Acumulator extern pt. pornire motor si incarcare
 FR Portable demarreur batterie voiture booster
 IT Dispositivo di avviamento multifunzione
 ES Coche portátil salto de arranque
 CN 应急电源



3.7 V
 12000mAh
 300 A
 500 A
 19V
 3.5 A
 12V
 15V
 4h
 12000mAh
 LCD

FRONT LIGHT LAMPARCA
 JUMP STARTER ROZRUCH SILNIKA



YATO
 YT-83082 10

EN Power inverter
 PL Przetwornica napięcia
 DE Spannungswandler
 RU Автомобильный инвертор
 CZ Měníč napětí
 HU Feszültség átalakító
 RO Convertor de tensiune
 FR Convertisseur de tension
 IT Inverter di corrente
 ES Convertidor de voltaje
 CN 逆变器

500 W
 1000 W
 12V
 220-240V-50 Hz
 THERMAL PROTECTION ZABEZPEČENIE TERMICNE
 LOW VOLTAGE LEVEL SIGNAL STIGNAL NISPOREK PODOLNI NAPICIA

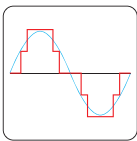

YATO
 YT-81490 12

EN Power inverter
 PL Przetwornica napięcia
 DE Spannungswandler
 RU Автомобильный инвертор
 CZ Měníč napětí
 HU Feszültség átalakító
 RO Convertor de tensiune
 FR Convertisseur de tension
 IT Inverter di corrente
 ES Convertidor de voltaje
 CN 逆变器

800 W
 1600 W
 12V
 220-240V-50 Hz
 THERMAL PROTECTION ZABEZPEČENIE TERMICNE
 LOW VOLTAGE LEVEL SIGNAL STIGNAL NISPOREK PODOLNI NAPICIA

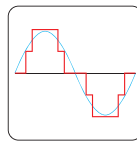

YATO
 YT-81491 12

EN Jumpstart wires
 PL Przewody rozruchowe
 DE Starterkabel
 RU Пусковые провода
 CZ Startovací kabely
 HU Indító kábelek
 RO Cabluri demarare
 FR Câbles de démarrage
 IT Cavi carica batteria
 ES Cables de arranque
 CN 输出线

2.5m



YATO [A] 200 10

EN Jumpstart wires
 PL Przewody rozruchowe
 DE Starterkabel
 RU Пусковые провода
 CZ Startovací kabely
 HU Indító kábelek

RO Cabluri demarare
 FR Câbles de démarrage
 IT Cavi carica batteria
 ES Cables de arranque
 CN 输出线

2.5m



YATO [A] 400 10

EN Jumpstart wires
 PL Przewody rozruchowe
 DE Starterkabel
 RU Пусковые провода
 CZ Startovací kabely
 HU Indító kábelek

RO Cabluri demarare
 FR Câbles de démarrage
 IT Cavi carica batteria
 ES Cables de arranque
 CN 输出线

2.5m



YATO [A] 600 10

EN Analogue battery tester
PL Tester akumulatorów analogowy
DE Analoges Batterieprüfgerät
RU Аналоговый тестер аккумуляторов
CZ Analogový tester akumulátorů
HU Analóg akkuteszter
RO Tester acumulatori analog
FR Testeur de charge batterie
IT Tester analogico per batteria
ES Tester analógico para acumuladores
CN 电池测试仪

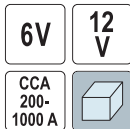

YATO
YT-8310

10

EN Digital battery tester
PL Tester akumulatorów cyfrowy
DE Digitales Batterieprüfgerät
RU Цифровой тестер аккумуляторов
CZ Digitální tester akumulátorů
HU Digitális akkuteszter
RO Tester acumulatori digital
FR Testeur digital de charge batterie
IT Tester digitale per batteria
ES Tester digital para acumuladores
CN 电池测试仪

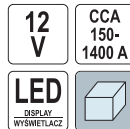

YATO
YT-8311

10

EN Battery tester
PL Tester akumulatorów
DE Batterieprüfgerät
RU Тестер аккумуляторов
CZ Tester akumulátorů
HU Akkuteszter
RO Tester acumulatori
FR Testeur de batterie
IT Tester per batteria
ES Tester para acumuladores
CN 电池测试仪

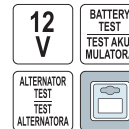

YATO
YT-83101

12/72

EN Digital battery analyzer
PL Elektroniczny tester akumulatorów
DE Elektronischer Batterietester
RU Электронный тестер аккумуляторов
CZ Elektrický tester autobaterií
HU Elektronikus akkumulátor tesztelő
RO Tester acumulatori
FR Testeur électronique pour accumulateurs
IT Tester elettronico per batterie
ES Comprobador electrónico de acumuladores
CN 电池测试仪



YATO
YT-83113

6/48

EN OBD2 multilingual scan tool
PL Tester diagnostyczny OBD2
DE OBD2-Diagnosegerät
RU Диагностический тестер OBD2
CZ Diagnostický tester OBD2
HU OBD2 hibakód olvasó tesztelő
RO Tester diagnoza auto OBD2
FR Appareil de diagnostic OBD2
IT Strumento diagnostico OBD2
ES Comprobador de diagnóstico OBD2
CN 多语言汽车读卡卡



YATO
YT-72977

10/60

EN Injector tester scan tool
PL Elektroniczny tester wtryskiwaczy silników benzynowych
DE Elektronisches Benzin-Einspritzdüsen-Prüfgerät
RU Электронный тестер для инжекторов бензинового двигателя
CZ Elektronický tester trysek benzinového motoru
HU Elektromos tesztelő benzinmotor befecskendezőhöz
RO Tester scanare injectoare
FR Testeur électronique d'injecteurs de moteurs à essence
IT Tester elettronico per iniettori per motori a benzina
ES Probador electrónico para inyectoros de motores de gasolina
CN 汽车喷油器测试仪



YATO
YT-72960

8/48

EN Refractometer
PL Refraktometr
DE Refraktometer
RU Рефрактометр
CZ Refraktometr
HU Fagyálló fokoló
RO Refractometru
FR Réfractomètre
IT Rifrattometro
ES Refractometro
CN 冰点仪



YATO
YT-06722

25

EN Auto retract electric cable reel
 PL Przedłużacz elektryczny na zwijaku automatycznym
 DE Elektro-Kabelaufroller mit automatischem Einzug
 RU Электрический удлинитель на автоматическом барабане
 CZ Elektrický prodlužovací kabel na automatickém navijáku
 HU Elektromos hosszabbító automatikus csévélével
 RO Prelungitor electric retractabil
 FR Câble de rallonge électrique sur enrouleur automatique
 IT Prolunga elettrica con avvolgicavo automatico
 ES Prolongador eléctrico en enrollador automático
 CN 电卷管器



10A ~250V	CABLE H05VV-F KABEL	3G 1.5 mm ²	E
E/F	IP34	AUTO REWIND AUTOMATISCHES ZUHLIAUEN	EASILY MOUNT WITH LATWY MONTAZ
x4 ANCHORS KOTWY			

P_{max} = 2500 W coiled
 P_{max} = 2500 W uncoiled

P_{max} = 2500 W zwinięty
 P_{max} = 2500 W rozwinięty

YATO	L [m]	
YT-81220	10	4
YT-81221	20	2

EN Chain block
 PL Wyciągarka łańcuchowa
 DE Kettenzug Flaschenzug
 RU Таль цепная
 CZ Zvedák řetězový
 HU Láncos csigasor emelő
 RO Scripete cu lant
 FR Treuil à chaîne
 IT Paranco a catena
 ES Cabria de cadena
 CN 三角手拉葫芦



3m

EN Lever block
 PL Wciągnik łańcuchowy
 DE Kettenzug Hebelzug
 RU Таль ручная рычажная
 CZ Kladkostroj díl
 HU Emelő robusztus
 RO Bloc de pârghie
 FR Bloc de levier
 IT Paranco a catena
 ES Bloqe de palanca
 CN 手扳葫芦



1.5m

YATO	Max. load capacity / Maks. obciążenie [kg]	
YT-58950	500	1
YT-58951	1000	1
YT-58953	2000	1
YT-58954	3000	1
YT-58955	5000	1

YATO	Max. lifting capacity / Maks. udźwíg [kg]	
YT-58962	7500	1
YT-58964	1500	1
YT-58966	3000	1
YT-58967	6000	1

EN Electric hoist
 PL Elektryczny wciągnik linowy
 DE Elektro-Seilwinde
 RU Электрическая канатная лебёдка
 CZ Elektrický naviják kladkostroj
 HU Elektromos csőrő

RO Troliu electric cu cablu
 FR Treuil électrique à corde
 IT Verricello elettrico
 ES Cabria eléctrica de cuerdas
 CN 电动葫芦

230V~
50Hz

500
W

125kg

8m/min
max
11m

250kg

4m/min
max
5.5m

STOP



L_{pa} = 52,2 ± 1,2 dB; L_{wa} = 73,6 ± 2,31 dB

YATO	[W]	
YT-5901	500	2

EN Electric hoist
 PL Elektryczny wciągnik linowy
 DE Elektro-Seilwinde
 RU Электрическая канатная лебёдка
 CZ Elektrický naviják kladkostroj
 HU Elektromos csőrő

RO Troliu electric cu cablu
 FR Treuil électrique à corde
 IT Verricello elettrico
 ES Cabria eléctrica de cuerdas
 CN 电动葫芦

230V~
50Hz

550
W

150kg

8m/min
max
11m

300kg

4m/min
max
5.5m

STOP



L_{pa} = 52,2 ± 0,9 dB; L_{wa} = 75,4 ± 4,8 dB

YATO	[W]	
YT-5902	550	2

EN Electric hoist
PL Elektryczny wciągnik linowy
DE Elektro-Seilwinde
RU Электрическая канатная лебедка
CZ Elektrický naviják kladkostroj
HU Elektromos csőrő

RO Troliu electric cu cablu
FR Treuil électrique à corde
IT Verricello elettrico
ES Cabría eléctrica de cuerdas
CN 电动葫芦

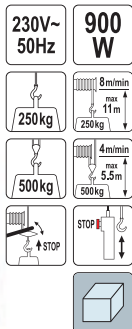

$L_{pa} = 54,0 \pm 0,9$ dB; $L_{wa} = 78,0 \pm 6,57$ dB

YATO	[W]	
YT-5904	900	2

EN Electric hoist
PL Elektryczny wciągnik linowy
DE Elektro-Seilwinde
RU Электрическая канатная лебедка
CZ Elektrický naviják kladkostroj
HU Elektromos csőrő

RO Troliu electric cu cablu
FR Treuil électrique à corde
IT Verricello elettrico
ES Cabría eléctrica de cuerdas
CN 电动葫芦

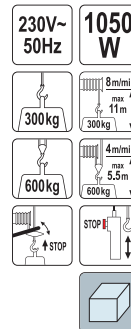

$L_{pa} = 58,9 \pm 1,9$ dB; $L_{wa} = 79,9 \pm 2,79$ dB

YATO	[W]	
YT-5905	1050	2

EN Rope winch
PL Wyciągarka linowa
DE Handseilwinde

RU Канатная лебедка
CZ Lanové vťahovací zařízení
HU Drótköteles csőrő

RO Troliu cu cablu orizontal
FR Treuil à corde
IT Paranco a corda

ES Cabría de cuerdas
CN 绳索拉紧器



YATO	Rope length / Długość liny [m]	Rope diameter / Średnica liny [mm]	
YT-5911	3	5	6

EN Rope winch
PL Wyciągarka linowa
DE Handseilwinde

RU Канатная лебедка
CZ Lanové vťahovací zařízení
HU Drótköteles csőrő

RO Troliu cu cablu orizontal
FR Treuil à corde
IT Paranco a corda

ES Cabría de cuerdas
CN 绳索拉紧器



YATO	Rope length / Długość liny [m]	Rope diameter / Średnica liny [mm]	
YT-5913	3	5	6

EN Rope winch
PL Wyciągarka linowa
DE Handseilwinde

RU Канатная лебедка
CZ Lanové vťahovací zařízení
HU Drótköteles csőrő

RO Troliu cu cablu orizontal
FR Treuil à corde
IT Paranco a corda

ES Cabría de cuerdas
CN 绳索拉紧器



YATO	Rope length / Długość liny [m]	Rope diameter / Średnica liny [mm]	
YT-5914	3	6	3

EN Transmission jack
 PL Podnośnik skrzyni biegów
 DE Hydraulische Getriebeheber
 RU Домкрат для коробки передач
 CZ Pojízdný zvedák motorů a převodovek
 HU Sebességváltó emelő tartó
 RO Cric cutii de viteza
 FR Levage des moteurs et des boîtes de vitesses
 IT Sollevatore scatola del cambio
 ES Motor de transmisión telescópica
 CN 坡道



max **500 kg**
 1900 1100 mm
 PRECISION VALVE
 PRECZYJNY ZAWÓR

EN Transmission jack
 PL Podnośnik skrzyni biegów
 DE Hydraulische Getriebeheber
 RU Домкрат для коробки передач
 CZ Pojízdný zvedák motorů a převodovek
 HU Sebességváltó emelő tartó
 RO Cric cutii de viteza
 FR Levage des moteurs et des boîtes de vitesses
 IT Sollevatore scatola del cambio
 ES Motor de transmisión telescópica
 CN 运送顶



max **500 kg**
 1945 1140 mm
 PRECISION VALVE
 PRECZYJNY ZAWÓR

YATO **YT-55601** 1

YATO **YT-55600** 1

EN Parts washer
 PL Myjka warsztatowa
 DE Teilwaschgerät
 RU Стенд для очистки деталей
 CZ Mycí stůl na součástky
 HU Alkatrészmosó
 RO Cuva pt. spalat piese
 FR Fontaine de nettoyage pièces
 IT Idropulitrice per officina
 ES Lavadora piezas mecánicas
 CN 零件清洗机



230V~
50Hz
 720x480
x260
mm
 80 L
 10
l/min
 FOR SOLVENT
 WATER BASED
 DO PLYNÓW
 NA BAZIE WODY

EN Sandblaster cabinet
 PL Piaskarka kabinowa
 DE Sandstrahlkabine
 RU Пескоструйная камера
 CZ Kabinový pískovací stroj
 HU Homokszóró kabin
 RO Masina de sablat
 FR Cabine de sablage
 IT Sabbiatrice a cabina
 ES Cabina de chorro de arena
 CN 喷砂机



230V~
50Hz
 0.82
MPa
 90 L
 585x490
x490
mm
 STANDARD

$L_{pA} = 93,5 \pm 3,0$ dB; $L_{pA} = 95,0 \pm 3,0$ dB; $a_w = <2,5$ m/s²

YATO **YT-55808** 1

YATO **YT-55840** 1

EN Nozzle for sandblaster cabinet
 PL Dysze ceramiczne do piaskarki kabinowej
 DE Keramikdüsen für Sandstrahlkabine
 RU Керамические насадки для пескоструйной камеры
 CZ Keramické trysky pro kabinový pískovací stroj
 HU Kerámia fúvókák homokszóró kabinhoz
 RO Duze pt. aparat de sablat
 FR Buses en céramique pour cabine de sablage
 IT Ugelli ceramici per sabbiatrice a cabina
 ES Boquillas cerámicas para cabinas de chorro de arena
 CN 四件套喷嘴

4
PCS
 4, 5,
6, 7
mm



For YT-55840
 Dla YT-55840

YATO **YT-55844** Ø [mm] 4, 5, 6, 7 20/200

EN Protective film for sandblaster cabinet
 PL Folie ochronne do piaskarki kabinowej
 DE Schutzfolien für Sandstrahlkabine
 RU Защитные пленки для пескоструйной камеры
 CZ Ochranné fólie pro kabinový pískovací stroj
 HU Védőfóliák homokszóró kabinhoz
 RO Folie protectie pt. aparat de sablat
 FR Film de protection pour cabine de sablage
 IT Pellicola protettiva per sabbiatrice a cabina
 ES Películas para cabinas de chorro de arena
 CN 四片装保护片

4
PCS
 410x300
mm



For YT-55840
 Dla YT-55840

YATO **YT-55845** [mm] 410x300 50/100

EN Shop crane
PL Żuraw warsztatowy
DE Werkstattkran
RU Кран подкатной гидравлический
CZ Hydraulický jeřáb
HU Motorkiemelő zsiráf

RO Girafa pt. scos motor
FR Grue d'atelier
IT Gru idraulica
ES Grúa hidráulica para motores
CN 吊机

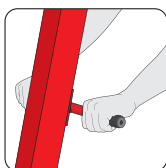

YATO
YT-55556



EN Shop crane
PL Żuraw warsztatowy
DE Werkstattkran
RU Кран подкатной гидравлический
CZ Hydraulický jeřáb
HU Motorkiemelő zsiráf

RO Girafa pt. scos motor
FR Grue d'atelier
IT Gru idraulica
ES Grúa hidráulica para motores
CN 吊机

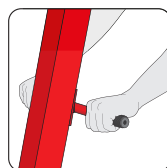
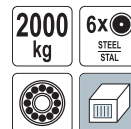

YATO
YT-55557



EN Shop press
PL Prasa hydrauliczna
DE Hydraulische Werkstattpresse
RU Гидравлический пресс
CZ Hydraulický lis
HU Hidraulikus prés

RO Presa hidraulic
FR Presse hydraulique
IT Pressa idraulica
ES Prensa de hidráulica
CN 压力机

12t

695
0
mm

400
mm



YATO
YT-55580



EN Shop press
PL Prasa hydrauliczna
DE Hydraulische Werkstattpresse
RU Гидравлический пресс
CZ Hydraulický lis
HU Hidraulikus prés

RO Presa hidraulic
FR Presse hydraulique
IT Pressa idraulica
ES Prensa de hidráulica
CN 压力机

20t

695
0
mm

490
mm



YATO
YT-55581



EN Shop press
PL Prasa hydrauliczna
DE Hydraulische Werkstattpresse
RU Гидравлический пресс
CZ Hydraulický lis
HU Hidraulikus prés

RO Presa hidraulic
FR Presse hydraulique
IT Pressa idraulica
ES Prensa de hidráulica
CN 压力机

30t

795
0
mm

520
mm



YATO
YT-55582



- EN Engine bar with support arm
- PL Belka z poprzeczką do podwieszania silnika
- DE Motorbrücke mit Tragarm
- RU Балка с перекладиной для подвески двигателя
- CZ Nosník s příčkou pro zavěšení motoru
- HU Motorfelfüggesztő gerenda
- RO Suport ridicare motor
- FR Poutre de support moteur avec barre transversale
- IT Ponte per motori con traversa
- ES Barra de soporte del motor con travesía
- CN 引擎支架

90-160 cm max 320 kg 



YATO  YT-55567  1

- EN Engine suspension beam
- PL Belka do podwieszania silnika
- DE Aufnahmevorrichtung des Motors
- RU Балка для вывешивания двигателя
- CZ Nosník k zavěšení motoru
- HU Motorfelfüggesztő gerenda
- RO Grindă pt. suspendarea motorului
- FR Poutre de suspension de moteur
- IT Fascio sospensione del motore
- ES La viga para suspender el motor
- CN 引擎支架

150 cm max 500 kg 

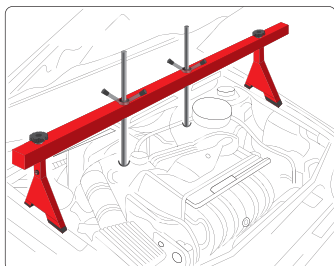

YATO  YT-55568  1

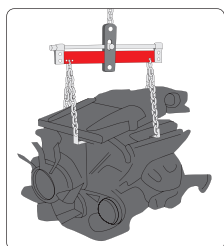

- EN Crane crossbeam
- PL Traversa do żurawia
- DE Traverse zum Kran
- RU Траверса для крана
- CZ Jeřábová traverza
- HU Traverz a zsírát emelőhöz
- RO Traversă pt. macara
- FR Balancier pour grue d'atelier
- IT Traverse per gru
- ES Viga transversal para grua
- CN 平衡器

315 mm max 680 kg 



YATO  YT-55565  1

- EN Engine stand
- PL Stojak do silnika
- DE Motorständer
- RU Стойка для ремонта двигателя
- CZ Stojan na motor
- HU Motorszerelő állvány
- RO Suport pt. motor
- FR Support moteur
- IT Cavalletto per motore
- ES Soporte de motor
- CN 发动机支架

max 450 kg 0-360°  4x STEEL STL 



YATO  YT-55570  1

EN Self locking nuts assortment
PL Zestaw nakrętek metrycznych z zabezpieczeniem
DE Sortiment Mutter metrisch mit Sicherheit
RU Набор гаек самоконтращихся, с нейлоновой вставкой
CZ Šestihranné matice s bezpečností
HU Nuts metrikus menet biztonsági

RO Set piulite autoblocante
FR Hex écrou set avec la sécurité
IT Set di autobloccanti metrica dadi
ES Porcas rosca métrica con a seguridad
CN 螺母组套

146
PCS

MIX

METRIC
METRYCZNY

INTERNAL
SECURITY
WNIEMIERZNE
ZABEZPIECZENIE



M4, M5, M6, M8, M10, M12

YATO
YT-06774

5/20

EN Stainless steel nuts assortment
PL Zestaw nakrętek metrycznych nierdzewnych
DE Sortiment Mutter metrisch rostfrei
RU Набор гаек шестигранных нержавеющей
CZ Nerezové oceli šestihranné matice
HU Nuts metrikus menet rozsdamentes

RO Set piulite inox
FR Hex écrou set inoxydable
IT Set di acciaio inossidabile metrica dadi
ES Rosca métrica tuercas inoxidable
CN 螺母

300
PCS

MIX

METRIC
METRYCZNY

SS
STAINLESS STEEL
STAL NIERDZEWNA

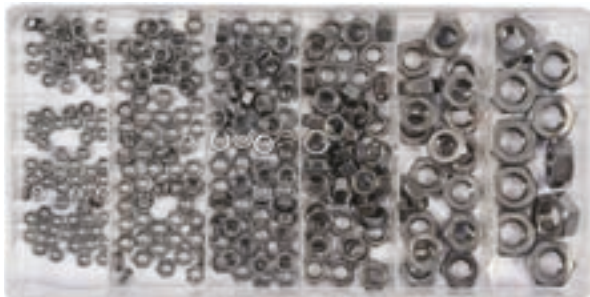

M3, M4, M5, M6, M8, M10

YATO
YT-06773

5/20

EN Metric wing nut assortment
PL Zestaw nakrętek motylkowych
DE Sortiment Flügelmuttern
RU Набор гаек типа «барашек»
CZ Křídlaté matice lisované
HU Szárnyas anya

RO Set piulite fluture
FR Assortiment d'écrous papillon
IT Set di metrica dadi
ES Tuercas con orejas
CN 蝶形螺母组套

150
PCS

MIX

METRIC
METRYCZNY



M4, M5, M6, M8, M10

YATO
YT-06776

25

EN Metric nuts assortment
PL Zestaw nakrętek metrycznych
DE Sortiment Mutter metrisch
RU Набор гаек
CZ Šestihranné matice
HU Nuts metrikus menet

RO Set piulite
FR Hex écrou set
IT Set di metrica dadi
ES Porcas rosca métrica
CN 螺母组套

300
PCS

MIX

METRIC
METRYCZNY



M3, M4, M5, M6, M8, M10

YATO
YT-06772

5/20

EN Hex nut with top assortment
PL Zestaw nakrętek metrycznych kołpakowych
DE Sortiment Mutter metrisch geschlossen
RU Набор гаек копкачковых
CZ Šestihranné matice zavřeno
HU Nuts metrikus menet zárt

RO Set piulite inchise
FR Hex écrou set fermé
IT Set di dadi campana-metrica
ES Rosca métrica tuercas cerrado
CN 螺母

150
PCS

MIX

METRIC
METRYCZNY

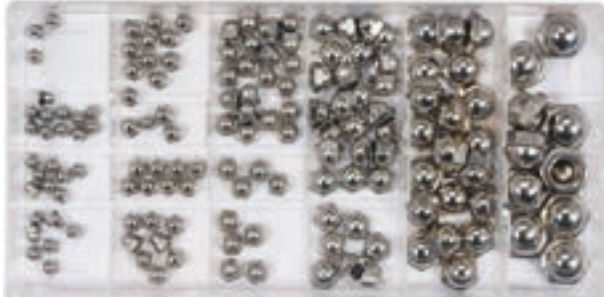

M3, M4, M5, M6, M8, M10

YATO
YT-06775

5/20

EN Aluminium washer set
PL Zestaw podkładek aluminiowych
DE Aluminium Dichting Sortiment
RU Набор алюминиевых шайб
CZ Sada hliníkových podložek
HU Réz alátét készlet

RO Set saibe aluminiu
FR Assortiment de joints en aluminium
IT Set di rondelle in alluminio
ES Juego de cuñas de aluminio
CN 铝垫片

300
PCS

MIX

METRIC
METRYCZNY



5x9x1.0 mm, 8x14x1.5 mm, 12x16x1.0 mm, 14x20x1.5 mm, 18x24x1.5 mm, 22x29x1.5 mm, 6x10x1.0 mm, 9x14x1.0 mm, 12x16x1.5 mm, 14x20x2.0 mm, 20x24.5x1.5 mm, 24x29x1.5 mm, 6x12x1.0 mm, 10x14x1.0 mm, 12x18x1.5 mm, 16x20x1.5 mm, 20x24.5x0.8 mm, 24x32x2.0 mm, 8x12x1.0 mm, 10x14x1.5 mm, 13x18x1.0 mm, 16x22x1.5 mm, 19x26x2.0 mm, 26x34x2.0 mm, 8x14x1.0 mm, 10x16x1.0 mm, 14x18x1.5 mm, 18x22x1.5 mm, 22x27x1.0 mm, 28x36x2.0 mm (x10 PCS)

YATO
YT-06865

5/20

EN Copper crush washer set
 PL Zestaw podkładek miedzianych dmuchanych
 DE Satz geblasener Kupfer-Passplatten
 RU Комплект медных шайб
 CZ Sada foukaných měděných podložek
 HU Réz alátét készlet

RO Set saibe cupru
 FR Jeu de rondelles en cuivre
 IT Set di rondelle di rame soffiante
 ES Conjunto de arandelas de cobre para tapón cárter
 CN 铜环圈

95
PCS

MIX

Cu



8.4x12x1.8 mm (10 PCS), 10.4x15.8x2.0 mm (15 PCS), 12.4x17.8x2.2 mm (15 PCS), 14.4x19.8x2.2 mm (20 PCS), 16.4x21.8x2.0 mm (20 PCS), 18.2x23.8x2.2 mm (10 PCS), 20.2x25.8x2.2 mm (5 PCS)

YATO

YT-068713

24

EN Drain plug gasket assortment
 PL Zestaw podkładek do korków spustowych
 DE Unterlegscheiben-Set für Ablassschrauben
 RU Комплект шайб для сливных пробок
 CZ Sada podložek pro vypouštěcí zátky
 HU Leeresztőcsavar alátétkészlet

RO Set garnituri pt. scurgere
 FR Rondelles de bouchon de vidange
 IT Kit di rondelle per tappi di scarico
 ES Juego de arandelas para tapones de descarga
 CN 油底垫圈

120
PCS

MIX

NYLON

FIBER WŁOKNO

STEEL STAL

AI

Cu

NBR



12x24.7x2 mm, 13.6x24.7x2 mm; Steel+NBR; 13x19x2.3 mm, 16x26x2.3 mm, 18x22x2.3 mm, 19x27x2.3 mm, 24x29x2.3 mm, 14.5x24x2 mm, 13x24x1.5 mm, 12x22x1.5 mm, 14x19.5x1.5 mm; Nylon; 12x22x1.5 mm, 18x28x2 mm, 20x27x1.5 mm, 13x22x2 mm, 14x20x1.5 mm; Fibre / Włókno; 13x18x1.2 mm, 16x22x1.5 mm, 20x26x2.5 mm, 14x20x1.3 mm; Cu; 14x24x2 mm; Al; 12x18x2 mm; Cu crush / Cu dmuchana; 12x20x2mm, 14x21x2.5mm; NBR; (x5 PCS)

YATO

YT-068641

12

EN Copper washer set
 PL Zestaw podkładek miedzianych
 DE Kupfer Dichtring Sortiment
 RU Набор медных колец
 CZ Podložky měděné těsnící
 HU Réz tömítés készlet

RO Saibe din cupru
 FR Patins en cuivre
 IT Set di spessori
 ES Arandelas de cobre
 CN 紫铜垫片

150
PCS

MIX

Cu



5x10x1.0 mm, 6x10x1.0 mm, 7x10x1.0 mm, 8x11x1.0 mm, 10x16x1.0 mm, 10.5x17x1.5 mm, 11x17x1.5 mm, 14x18x1.0 mm, 12x20x1.5 mm, 12.5x20x1.5 mm, 14x20x1.5 mm, 15x20x2.0 mm, 16x22x2.0 mm, 16.5x24x2.0 mm, 17.5x24x2.0 mm (x10 PCS)

YATO

YT-06871

5/20

EN Copper washer set
 PL Zestaw podkładek miedzianych
 DE Kupfer Dichtring Sortiment
 RU Набор медных колец
 CZ Podložky měděné těsnící
 HU Réz tömítés készlet

RO Saibe din cupru
 FR Patins en cuivre
 IT Set di spessori
 ES Arandelas de cobre
 CN 紫铜垫片

220
PCS

MIX

SOFT MATERIAL MIEKKI MATERIAL

Cu



4x8x1 mm, 5x9x1 mm, 6x10x1 mm, 6x12x1 mm (x25 PCS); 8x12x1 mm, 8x14x1 mm, 10x14x1 mm, 10x16x1 mm, 12x16x1.5 mm, 12x18x1.5 mm, 14x18x1.5 mm, 14x20x1.5 mm, 16x20x1.5 mm, 18x24x1.5 mm, 20x26x1.5 mm, 22x27x1.5 mm (x10 PCS)

YATO

YT-068721

24

EN Copper washer set
 PL Zestaw podkładek miedzianych
 DE Kupfer Dichtring Sortiment
 RU Набор медных колец
 CZ Podložky měděné těsnící
 HU Réz tömítés készlet

RO Saibe din cupru
 FR Patins en cuivre
 IT Set di spessori
 ES Arandelas de cobre
 CN 紫铜垫片

300
PCS

MIX

METRIC METRYCZNY

SOFT MATERIAL MIEKKI MATERIAL

Cu



5x9x1.0 mm, 8x14x1.5 mm, 12x16x1.0 mm, 14x20x1.5 mm, 18x24x1.5 mm, 22x29x1.5 mm, 6x10x1.0 mm, 9x14x1.0 mm, 12x16x1.5 mm, 14x20x2.0 mm, 20x24.5x1.5 mm, 24x29x1.5 mm, 6x12x1.0 mm, 10x14x1.0 mm, 12x18x1.5 mm, 16x20x1.5 mm, 20x24.5x0.8 mm, 24x32x2.0 mm, 8x12x1.0 mm, 10x14x1.5 mm, 13x18x1.0 mm, 16x22x1.5 mm, 19x26x2.0 mm, 26x34x2.0 mm, 8x14x1.0 mm, 10x16x1.0 mm, 14x18x1.5 mm, 18x22x1.5 mm, 22x27x1.0 mm, 28x36x2.0 mm (x10 PCS)

YATO

YT-06872

5/20

EN Copper washer set
 PL Zestaw podkładek miedzianych
 DE Kupfer Dichtring Sortiment
 RU Набор медных колец
 CZ Podložky měděné těsnící
 HU Réz tömítés készlet

RO Saibe din cupru
 FR Patins en cuivre
 IT Set di spessori
 ES Arandelas de cobre
 CN 紫铜垫片

580
PCS

MIX

Cu



4x8x1 mm, 4x9x1 mm, 7x10x1 mm, 8x12x1 mm, 6x12x1 mm, 8x14x1 mm, 10x16x1 mm, 11x17x1 mm, 10.5x17x1 mm, 12x16x1 mm (x30 PCS); 8x16x1 mm, 13x18x1 mm, 14x18x1 mm, 12x19x1 mm, 14x20x1 mm, 16x20x1 mm (x20 PCS); 17x21x1 mm, 17x23x1 mm, 18x22x1 mm, 18x24x1 mm (x15 PCS); 19x26x1 mm, 22x26x1 mm, 24x29x1 mm, 20x28x1 mm, 22x29x1 mm, 26x31x1 mm, 24x32x1 mm, 27x32x1 mm, 26x34x1 mm, 30x36x1 mm (x10 PCS)

YATO

YT-068711

20

EN Copper gasket & oil drain plug assortment
PL Zestaw podkładek miedzianych i korków spustowych
DE Ölablasschraube Kupfer Schrauben und O-Ringe
RU Набор медных шайб и сливных пробок поддона двигателя
CZ Sada měděných podložek a zátek pro olejové vypustě
HU Olajlejtéknő csavar és rézaláték készlet
RO Set busoane baie ulei
FR Boulons de carter d'huile & assortiment bagues
IT Set di rondelle in rame a spine
ES Tornillos y juntas para tapon de carter
CN 油封

534
PCS

MIX

Cu



6 mm (50 PCS), 8 mm (50 PCS), 10 mm (50 PCS), 12 mm (50 PCS), 13 mm (50 PCS), 14 mm (50 PCS), 15 mm (50 PCS), 16 mm (50 PCS), 18 mm (50 PCS), 20 mm (50 PCS); M8x1.0 (5 PCS), M10x1.0 (5 PCS), M12x1.5 (5 PCS), M14x1.5 (5 PCS), M16x1.5 (3 PCS), M18x1.5 (3 PCS), M20x1.5 (3 PCS); G1/4 (5 PCS)

YATO
YT-06864 10

EN Oil seal washer assortment
PL Zestaw podkładek metalowo-gumowych
DE Satz Metall- und Gummischeiben
RU Набор металлорезиновых шайб
CZ Sada podložek kov-guma
HU Fém-gumi alátétkészlet

RO Set șaibe simeringuri
FR Jeu de rondelles en métal et en caoutchouc
IT Kit di rondelle in metallo et gomma
ES Juego de arandelas metal goma
CN 橡胶复合垫片

90
PCS

MIX

NBR70

STEEL
STAL



M10x1.9 mm (20 PCS), M12x1.9 mm (20 PCS), M14x1.9 mm (20 PCS), M16x1.9 mm (10 PCS), M18x1.9 mm (5 PCS), M20x1.9 mm (5 PCS), M22x1.9 mm (5 PCS), M24x1.9 mm (5 PCS)

YATO
YT-068581 24

EN Bodywork nuts & screws assortment
PL Zestaw wkrętów i podkładek do karoserii
DE Sortiment Karosseriemuttern mit Schrauben
RU Набор саморезов и металлических клипс для кузовных работ
CZ Tělo matice a šroub kit
HU Karosszéria csavar és anya készlet
RO Set asamblare clema, holsuruburi
FR Assortiment de vis et d'écrous cage

IT Set viti e rondelle al corpo
ES Body kit tornillo
CN 螺丝组套

170
PCS

MIX



M3, M4, M5, M6;
M3x8 mm, M4x16 mm, M5x12 mm, M6x20 mm

YATO
YT-06780 5/20

EN Aluminum gasket and oil drain plug assortment
PL Zestaw podkładek aluminiowych i korków spustowych
DE Alu-Unterlegscheiben- und Ölablassschrauben-Satz
RU Набор алюминиевых подкладок и пробок
CZ Sada hliníkových podložek a vypouštěcích zátek
HU Alumínium aláték és leeresztőcsavar készlet
RO Set garnituri al. si busoane baie ulei
FR Jeu de rondelles et de bouchons de vidange en aluminium
IT Kit di rondelle in alluminio e tappi di scarico
ES Juego de arandelas de aluminio y tapones de descarga
CN 油封

534
PCS

MIX

Al



6 mm (50 PCS), 8 mm (50 PCS), 10 mm (50 PCS), 12 mm (50 PCS), 13 mm (50 PCS), 14 mm (50 PCS), 15 mm (50 PCS), 16 mm (50 PCS), 18 mm (50 PCS), 20 mm (50 PCS); M10 (5 PCS), M12 (5 PCS), M13 (5 PCS), M14 (5 PCS), M15 (5 PCS), M16 (3 PCS), M18 (3 PCS), M20 (3 PCS)

YATO
YT-06862 12

EN Oil seal washer assortment
PL Zestaw podkładek metalowo-gumowych
DE Satz Metall- und Gummischeiben
RU Набор металлорезиновых шайб
CZ Sada podložek kov-guma
HU Fém-gumi alátétkészlet

RO Set șaibe simeringuri
FR Jeu de rondelles en métal et en caoutchouc
IT Kit di rondelle in metallo et gomma
ES Juego de arandelas metal goma
CN 橡胶复合垫片

150
PCS

MIX

NBR70

STEEL
STAL



M6x1.0 mm (10 PCS), M8x1.9 mm (10 PCS), M10x1.9 mm (10 PCS), M12x1.9 mm (20 PCS), M14x1.9 mm (20 PCS), M16x1.9 mm (20 PCS), M18x1.9 mm (20 PCS), M20x1.9 mm (20 PCS), M22x1.9 mm (10 PCS), M24x1.9 mm (10 PCS)

YATO
YT-068582 24

EN Clevis pin assortment
PL Zestaw sworzni z łbem i otworem
DE Bolzen mit Kopf
RU Набор штифтов с отверстиями под шплинт
CZ Čepý s hlavou
HU Csapszeget kit

RO Set bolturi pt. securizare
FR Axe de chape
IT Set di perni con testa e il foro
ES Kit de pasador de horquilla
CN 销柱

60
PCS

5-12
mm

MIX



5x25 mm, 6x25 mm, 6x30 mm, 6x40 mm, 6x45 mm, 6x50 mm, 6x60 mm, 6x65 mm, 8x25 mm, 8x30 mm, 8x40 mm, 8x45 mm, 8x50 mm, 8x60 mm, 8x65 mm, 8x70 mm, 10x25 mm, 10x40 mm, 10x50 mm, 12x40 mm, 12x50 mm

YATO
YT-06786 4/16

EN Grease nipple set
 PL Zestaw smarowniczek
 DE Schmiernippel
 RU Набор масленок
 CZ Sady mazacích hlavíc
 HU Zsírógomb (zsírzófeje) készlet

RO Set gresoare metalice
 FR Set de graisseurs métriques
 IT Set grasso capezzoli
 ES Engrasador
 CN 黄油嘴组套

110
 PCS

METRIC
 METRYCZNY



M6x1 (60 PCS), M6x1 45° (5 PCS), M6x1 90° (5 PCS), M8x1 (10 PCS), M8x1 45° (5 PCS), M8x1 90° (5 PCS), M10x1 (10 PCS), M10x1 45° (5 PCS), M10x1 90° (5 PCS)

YATO
 YT-06888 5/20

EN Spring assortment
 PL Zestaw sprężynek
 DE Schraubenfeder Sortiment
 RU Набор пружиннок оцинкованных
 CZ Sada pružin
 HU Rugó készlet

RO Arcuri tensiune
 FR Assortiment ressorts
 IT Set di molle
 ES Caja surtido de de resortes
 CN 弹簧组套

200
 PCS

MIX



4.0x79.5 mm (12 PCS), 4.5x44.5 mm (8 PCS), 5.0x20.5 mm (10 PCS), 5.5x17.5 mm (10 PCS), 5.5x25.5 mm (10 PCS), 5.5x38.0 mm (10 PCS), 6.5x10.0 mm (10 PCS), 6.5x22.0 mm (10 PCS), 7.0x12.5 mm (10 PCS), 7.0x19.0 mm (10 PCS), 7.0x38.0 mm (10 PCS), 7.0x51.0 mm (12 PCS), 8.0x28.5 mm (8 PCS), 8.0x31.5 mm (10 PCS), 8.0x44.5 mm (12 PCS), 8.5x36.5 mm (10 PCS), 8.5x47.0 mm (12 PCS), 9.0x35.0 mm (8 PCS), 9.5x16.0 mm (6 PCS), 9.5x19.0 mm (12 PCS)

YATO
 YT-06875 5/20

EN Aluminium rivet assortment
 PL Zestaw aluminiowych nitów zrywalnych
 DE Aluminium Blindnieten Sortiment
 RU Набор заклепок
 CZ Sada hliníkové nity
 HU Csöves alumínium szegecs

RO Set popnitr
 FR Rivets tubulaires en aluminium
 IT Set di rivetto alluminio
 ES Remaches tubulares de aluminio
 CN 铆钉

400
 PCS

MIX

AI



2.4, 3.2, 4.0, 4.8 mm

YATO
 YT-36420 5/20

EN Hitch pin assortment set
 PL Zestaw zawleczeek sprężystych
 DE Federsplinte Sortiment
 RU Набор шплинтов с фиксацией
 CZ Pružinové závlačky
 HU Rugós csap

RO Set sigurante securizare
 FR Assortiment goupilles beta
 IT Set di spine elastiche
 ES Pasadores surtido beta
 CN R型销

150
 PCS

6
 SIZES
 ROZMÍRY



2.0x33 mm, 2.0x40 mm, 2.4x31 mm, 2.8x42 mm, 3.5x45 mm, 4.0x75 mm

YATO
 YT-06883 6/24

EN Splint pin assortment
 PL Zestaw zawleczeek prostych
 DE Splinte Sortiment
 RU Набор шплинтов
 CZ Set závlačky
 HU Sasszeg készlet

RO Cuie spintecate mici
 FR Goupilles - goupille fendue
 IT Set di perni
 ES Dividir cotter pinos
 CN 开口销

555
 PCS

MIX



1.6x25 mm, 2.4x25 mm, 2.4x38 mm, 3.2x32 mm, 3.2x50 mm, 4.0x64 mm

YATO
 YT-06873 5/10

EN Splint pin assortment
 PL Zestaw zawleczeek prostych
 DE Splinte Sortiment
 RU Набор шплинтов
 CZ Set závlačky
 HU Sasszeg készlet

RO Cuie spintecate mici
 FR Goupilles - goupille fendue
 IT Set di perni
 ES Dividir cotter pinos
 CN 开口销组套

1000
 PCS

MIX



1.5x25 mm, 2.4x25 mm, 2.4x38 mm, 3.0x32 mm, 3.0x50 mm, 4.0x60 mm

YATO
 YT-06885 12

EN Axle wave washer assortment
PL Zestaw zabezpieczeń osiowych sprężystych
DE Axialer Federschuttsatz
RU Замок осевой пружинный
CZ Sada axiálních pružinových závleček
HU Rugós tengelybiztosító gyűrtű

RO Set saibe axe
FR Jeu de protections axiaux à ressorts
IT Kit di protezioni assiali a molla
ES Juego de sujeciones rápidas elásticas para ejes
CN 轴承夹片

260
PCS
MIX
65Mn

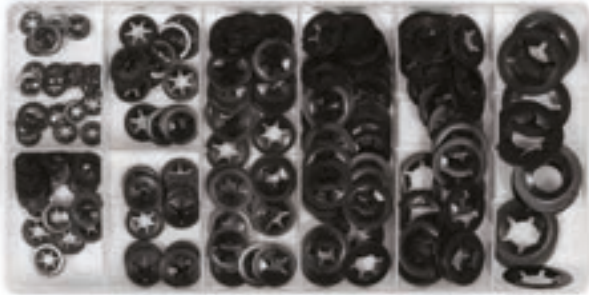

M3x10 mm (30 PCS), M4x11.5 mm (30 PCS), M5x14 mm (40 PCS), M6x16 mm (50 PCS), M8x18 mm (50 PCS), M10x20.5 mm (40 PCS), M12x26 mm (20 PCS)

YATO
YT-06860 24

EN Linch-pins assortment
PL Zestaw zawleczek z kółkiem
DE Klappsplint Sortiment
RU Набор шплинтов с кольцом
CZ Kolik pojistny
HU Rugos biztosítoszeg készlet

RO Set pini pt. securizare
FR Assortiment goupille clip
IT Set di perni dalla ruota
ES Pasador clip
CN 弹性销组套

50
PCS
MIX



Ø 4.5x36 mm, Ø 6.0x45 mm, Ø 8.0x45 mm, Ø 11.0x45 mm

YATO
YT-06787 6/12

EN Hose clamp assortment
PL Zestaw obejm ślimakowych
DE Schlauchschellen Sortiment
RU Набор хомутов
CZ Spony stahovac na hadice sada
HU Tömítőbilincs csőszerelés szett

RO Coliere furtun
FR Colliers de serrage universels
IT Fascetta assortimento
ES Manguera helicoidal instalación de tuberías abrazadera conjunto
CN 喉箍

26
PCS
16-40
mm
MIX



16, 22, 25, 28, 35, 40 mm

YATO
YT-06782 5/20

EN E-ring circlips assortment
PL Zestaw zawleczek typu „E”
DE E-Sicherungsringe Sortiment
RU Набор Э-образных стопорных колец
CZ Otevření pojistný kroužek
HU „E” klip választék készlet

RO Set inele de siguranta tip „E”
FR „E” clip assortment kit
IT Set di spine tipo „E”
ES E-ring anillo de retención variedad
CN 卡簧

300
PCS
1.5-22
mm



1.5 mm, 3 mm, 5 mm, 6 mm, 10 mm, 12 mm, 15 mm, 19 mm, 22 mm

YATO
YT-06884 25

EN Metal tiller tin pin assortment
PL Zestaw zawleczek i sworzni z lbem i otworami
DE Set Splinte und Bolzen mit Kopf und Löchern
RU Набор шплинтов и болтов с головкой и отверстиями
CZ Sada závlaček a šroubů s hlavou a otvory
HU Saszeg és fejes, nyílásos csapszeg készlet

RO Set bolturi cu sigurante
FR Jeu de goupilles et d'axes avec têtes et des trous
IT Kit di copiglie e perni con testa e fori
ES Juego de pasadores y pemos con cabeza y aberturas
CN 八孔销

56
PCS

Ø 8-13
mm

MIX



8x50 mm (5 PCS), 9.5x50 mm (15 PCS), 11x64 mm (5 PCS), 13x50 mm (3 PCS), Pins / Zawleccki: 2x30 mm (5 PCS), 2.5x40 mm (15 PCS), 2.5x40 mm (5 PCS), 3x44 mm (3 PCS)

YATO
YT-06874 20

EN Hose clamp assortment
PL Zestaw obejm skręcanych do przewodów
DE Schlauchschellen-Set
RU Набор винтовых зажимов для кабелей
CZ Sada šroubovaných svorek do hadic
HU Vezetékbilincs készlet

RO Set coliere pt. furtun
FR Jeu de supports à visser pour conducteurs
IT Kit di clip fermacavi
ES Juego de abrazaderas atornillables para cables
CN 喉箍

30
PCS

MIX

Ø 6-16
mm



6-8 mm (7 PCS), 7-9 mm (7 PCS), 8-10 mm (5 PCS), 9-11 mm (5 PCS), 10-12 mm (3 PCS), 14-16 mm (3 PCS)

YATO
YT-06783 24

EN Double ear hose clamp assortment
 PL Zestaw obejm zaciskowych z uszami
 DE 2-Ohr-Schellensatz
 RU Набор хомутов с проушинами
 CZ Dvojité ucho hadicové svorky
 HU Fűles szorítókészlet

RO Set cleme furturn
 FR Jeu de serre-câbles à oreilles
 IT Set di fascette di fissaggio con orecchie
 ES Set de abrazaderas con orejetas
 CN 双耳卡箍套装

175
PCS

MIX



GALVANIZED
STEEL
OCYNKOWANA

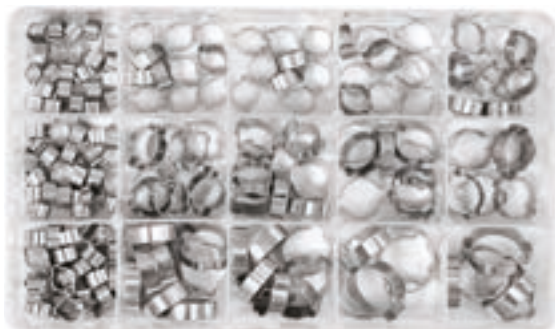

5-7 mm (25 PCS), 7-9 mm (25 PCS), 9-11 mm (25 PCS), 11-13 mm (20 PCS), 13-15 mm (20 PCS), 15-18 mm (20 PCS), 17-20 mm (15 PCS), 20-23 mm (15 PCS), 23-27 mm (10 PCS)

YATO

YT-06784 10

EN External circlip assortment
 PL Zestaw pierścieni Segera zewnętrznych
 DE Aussen-Seegerring Sortiment
 RU Набор стопорных колец
 CZ Sada pojistné kroužky
 HU Külső seeger-gyűrű készlet

RO Set sigurante tip inel alezaj
 FR Set de bagues Seeger
 IT Set di anelli Seeger
 ES Set de anillos Seeger
 CN 外置挡圈

300
PCS



Ø 3, 4, 5, 6, 8, 9, 11, 12, 13, 14, 15, 19, 20, 22, 25, 26, 28, 32 mm

YATO

YT-06880 5/20

EN Feather key assortment
 PL Zestaw klinów do kół pasowych
 DE Keilesset für Riemenscheiben
 RU Комплект клиньев для шкивов
 CZ Sada klinů pro vodící kladky
 HU Szíjtárcsa ékkészlet

RO Set pene
 FR Jeu de cales pour poulies
 IT Set di linguette per pulegge
 ES Juego de cuñas de polea
 CN 平键

60
PCS

MIX



3x3x20 mm (4 PCS), 3x3x25 mm (4 PCS), 8x10x30 mm (5 PCS), 5x5x20 mm (5 PCS), 8x7x30 mm (5 PCS), 5x5x25 mm (5 PCS), 8x7x40 mm (5 PCS), 5x5x30 mm (5 PCS), 6x6x20 mm (5 PCS), 10x8x40 mm (5 PCS), 6x6x30 mm (5 PCS), 6x6x40 mm (5 PCS), 8x12x40 mm (2 PCS)

YATO

YT-06793 24

EN External / internal circlip assortment
 PL Zestaw pierścieni Segera
 DE Seeger-Sicherungsringe
 RU Набор стопорных колец
 CZ Sada vnitřní / vnější kroužky
 HU Seeger gyűrű készlet

RO Set sigurante tip inel alezaj
 FR Set de bagues Seeger
 IT Set di anelli Seeger
 ES Set de anillos Seeger
 CN 卡簧

225
PCS

MIX



Internal / Wewnętrzne: Ø 11, 13, 14, 16, 19, 20 mm; External / Zewnętrzne: Ø 6, 8, 9, 11, 13, 14, 16, 19, 20, 22, 25, 32 mm

YATO

YT-06882 5/20

EN Internal circlip assortment
 PL Zestaw pierścieni Segera wewnętrznych
 DE Innen-Seegerring Sortiment
 RU Набор стопорных колец
 CZ Sada pojistné kroužky
 HU Belső seeger-gyűrű készlet

RO Set sigurante tip inel alezaj
 FR Set de bagues Seeger
 IT Set di anelli Seeger
 ES Set de anillos Seeger
 CN 内置挡圈

300
PCS



Ø 3, 4, 5, 6, 8, 9, 11, 12, 13, 14, 15, 19, 20, 22, 25, 26, 28, 32 mm

YATO

YT-06881 5/20

EN Feather keys assortment
 PL Zestaw klinów półokrągłych
 DE Sortiment Federkeile
 RU Шпонки полукруглые
 CZ Sada klinů polokruhových
 HU Ives hornyok biztosítására

RO Set pene disc pt. imbinari arbore
 FR Aspérule clés assortiment
 IT Set di cunei semicirculari
 ES Surtido de chavetas media luna
 CN 键销组套

80
PCS

MIX



3.0x5.0x13 mm, 3.0x6.5x16 mm, 4.0x5.0x13 mm, 4.0x6.5x16 mm, 4.0x7.5x19 mm, 5.0x7.5x19 mm, 5.0x9.0x22 mm, 6.0x9.0x22 mm

YATO

YT-06790 5/20

EN Steel ball assortment
PL Zestaw kulek stalowych
DE Stahlkugeln-Set
RU Набор стальных шариков
CZ Sada ocelových kuliček
HU Acél golyókészlet

RO Set bile pt. rulmenti
FR Jeu de billes en acier
IT Set di sfere d'acciaio
ES Juego de bolas de acero
CN 轴承钢珠组套

470
PCS

MIX

BEARING
STEEL
STAL
ŁOŻYSKOWA

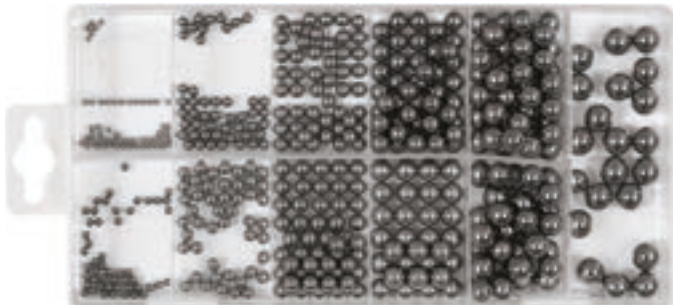

3/32" (2.4 mm, 50 PCS), 1/8" (3.2 mm, 50 PCS), 5/32" (4.0 mm, 50 PCS), 3/16" (4.8 mm, 50 PCS), 7/32" (5.6 mm, 50 PCS), 1/4" (6.3 mm, 50 PCS), 9/32" (7.1 mm, 50 PCS), 5/16" (7.9 mm, 30 PCS), 11/32" (8.7 mm, 50 PCS), 3/8" (9.5 mm, 20 PCS), 13/32" (10.3 mm, 20 PCS)

YATO
YT-06680 5/20

EN Rubber grommet assortment
PL Zestaw przelotek gumowych
DE Gummi-Durchgangs-Tüllen Sortiment
RU Набор резиновых втулок
CZ Gumové průchoďka
HU Gumi grommet készlet

RO Presetupa cauciuc pt. cablu
FR Coffret passe-cloison caoutchouc
IT Gommino angello
ES Caja surtido de pasamuros de goma
CN 垫圈组套

180
PCS

MIX

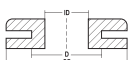

6.3 mm (D=6.3 mm, ID=3.0 mm, OD=8.0 mm; 40 PCS), 7.9 mm (D=7.9 mm, ID=5.0 mm, OD=10.0 mm; 40 PCS), 9.5 mm (D=9.5 mm, ID=6.0 mm, OD=13.0 mm; 40 PCS), 11 mm (D=11.0 mm, ID=9.0 mm, OD=15.0 mm; 25 PCS), 12.7 mm (D=12.7 mm, ID=11.0 mm, OD=15.0 mm; 20 PCS), 15.8 mm (D=15.8 mm, ID=12.0 mm, OD=19.0 mm; 5 PCS), 22 mm (D=22.0 mm, ID=15.0 mm, OD=26.0 mm; 5 PCS), 25.4 mm (D=25.4 mm, ID=17.0 mm, OD=32.0 mm; 5 PCS)

YATO
YT-06878 5/20

EN O-ring assortment
PL Zestaw O-ringów gumowych
DE O-Ring Sortiment
RU Набор резиновых прокладок
CZ Sada gumových o-kroužků
HU O gyűrű készlet

RO Garnituri din cauciuc
FR Set d'o-rings en caoutchouc
IT Set guarnizioni O-ring
ES Kit de junta tórica
CN O型圈组套

225
PCS

HEAT
RESISTANT
TEMPERATURE-
COPIRONE

CHEMICAL
PROOF



3x1 mm (20 PCS), 4x1 mm (20 PCS), 4.5x2 mm (20 PCS), 5x2 mm (20 PCS), 6x2 mm (20 PCS), 6x2.5 mm (20 PCS), 6x3 mm (20 PCS), 7x2 mm (20 PCS), 8x2 mm (20 PCS), 9x2 mm (5 PCS), 10x2 mm (5 PCS), 12x3 mm (5 PCS), 13x3 mm (5 PCS), 14x2.5 mm (5 PCS), 17x2.5 mm (5 PCS), 18x4 mm (5 PCS), 20x2 mm (5 PCS), 22x2 mm (5 PCS)

YATO
YT-06877 5/20

EN Socket head set screw assortment metric
PL Zestaw śrub imbusowych bez łba
DE Sortiment Madenschrauben, metrisch
RU Набор винтов установочных с плоским концом
CZ Šroub stavěcí, plochý konec, bez úpravy
HU Set menetes sasszegekkel

RO Set splituri fi letate
FR Set clavettes de vis
IT Set di viti esagonali senza testa
ES Conjunto de tornillo chavetas
CN 螺钉组套

160
PCS

MIX



3x5 mm, 4x5 mm, 5x6 mm, 6x6 mm, 6x6 mm F, 6x10 mm, 8x10 mm, 8x10 mm F, 8x12 mm, 10x10 mm, 10x10 mm F, 10x12 mm

YATO
YT-06777 5/20

EN Roll pin assortment
PL Zestaw kółków sprężystych
DE Hohlspannstifte Spannstifte Sortiment
RU Набор штифтов с пружиной
CZ Pružné válcové kolíky se štěrbínou
HU Rugalmas hengeres csapok a nyílásba

RO Set splituri elastice
FR Ressorts à rouleaux
IT Perno del rullo assortimento
ES Acero pasador elástico
CN 弹性销

315
PCS

MIX



1.5x5 mm, 1.5x8 mm, 1.5x20 mm, 2x6 mm, 2x12 mm, 2x25 mm, 2.5x16 mm, 2.5x25 mm, 2.5x30 mm, 3x16 mm, 3x25 mm, 3x30 mm, 4x16 mm, 4x25 mm, 4x40 mm, 5x16 mm, 5x25 mm, 5x30 mm, 5.5x16 mm, 5.5x30 mm, 5.5x45 mm, 6x16 mm, 6x30 mm, 6x45 mm, 8x20 mm, 8x40 mm, 8x50 mm, 10x20 mm, 10x40 mm, 10x50 mm

YATO
YT-06785 5/20

EN O-Rings assortment for air conditioning
PL Zestaw O-ringów do klimatyzacji
DE O-Ringe für Klimaanlage
RU Комплект прокладок для кондиционера
CZ Gumový kroužek set klimatizace
HU Gumi gyűrű készlet léghűtőrendszerre

RO Inele pt. aer condiționat
FR Cercle en caoutchouc boîte de kit combinaison
IT O-Ring assortimento per l'aria condizionata
ES Kit círculo caucho combinación caja
CN 氢化丁晴密封圈

225
PCS

MIX



3x1 mm (20 PCS), 4x1 mm (20 PCS), 4.5x2 mm (20 PCS), 5x2 mm (20 PCS), 6x2 mm (20 PCS), 6x2.5 mm (20 PCS), 6x3 mm (20 PCS), 7x2 mm (20 PCS), 8x2 mm (20 PCS), 9x2 mm (5 PCS), 10x2 mm (5 PCS), 12x3 mm (5 PCS), 13x3 mm (5 PCS), 14x2.5 mm (5 PCS), 17x2.5 mm (5 PCS), 18x4 mm (5 PCS), 20x2 mm (5 PCS), 22x2 mm (5 PCS)

YATO
YT-06879 5/20

EN O-Rings assortment for air conditioning
 PL Zestaw O-ringów do klimatyzacji
 DE O-Ringe für Klimaanlage
 RU Комплект прокладок для кондиционера
 CZ Gumový kroužek set klimatizace
 HU Gumi gyűrű készlet légkondicionáló

RO Inele pt. aer condiționat
 FR Cercle en caoutchouc boîte de kit combinaison
 IT O-Ring assortimento per l'aria condizionata
 ES Kit círculo caucho combinación caja
 CN O型圈组套

270
PCS

MIX

HNBR



Ø 5.29x1.78 mm (20 PCS), Ø 6.07x1.78 mm (20 PCS), Ø 6.8x1.9 mm (20 PCS), Ø 7.65x1.78 mm (20 PCS), Ø 7.8x1.9 mm (20 PCS), Ø 8x2 mm (20 PCS), Ø 8.8x1.9 mm (20 PCS), Ø 10.82x1.78 mm (15 PCS), Ø 10.77x2.62 mm (15 PCS), Ø 11x2 mm (15 PCS), Ø 12x2 mm (15 PCS), Ø 13.9x1.8 mm (10 PCS), Ø 13.95x2.62 mm (10 PCS), Ø 10x2 mm (10 PCS), Ø 15x2 mm (10 PCS), Ø 17x2 mm (10 PCS), Ø 17.17x1.78 mm (10 PCS), Ø 17.04x3.53 mm (10 PCS)

YATO
 YT-06879 6/24

EN Electrical clip assortment
 PL Zestaw złącz elektrycznych - krokodylki
 DE Krokodil-Klemmen-Kortiment
 RU Набор разъемов - крокодил
 CZ Terminal alligator krokodil příchytka
 HU Krokodil csipesz készlet

RO Sortiment cleme crocodil
 FR Assortiment pinces crocodile
 IT Set di perni per misure e prove
 ES Crocodile clip
 CN 夹头组套

28
PCS

MIX



50, 55, 60, 65, 70, 80 mm

YATO
 YT-06870 5/20

EN Terminal assortment
 PL Zestaw złącz elektrycznych
 DE Kabelschuh-Set
 RU Набор электрических клемм
 CZ Sada elektrických konektorů
 HU Elektromos csatlakozókészlet

RO Set papuci auto
 FR Jeu de cosSES de câbles
 IT Kit di connettori elettrici
 ES Juego de conectores eléctricos
 CN 接线端子

250
PCS

MIX



Connector blue male / Złącze niebieskie męskie: 6.4 mm (1.5-2.5mm; 50 PCS), Connector blue female / Złącze niebieskie żeńskie: 6.4 mm (1.5-2.5 mm; 50 PCS), Connector red male / Złącze czerwone męskie: 6.4 mm (0.5-1.5 mm; 50 PCS), Connector red female / Złącze czerwone żeńskie: 6.4 mm (0.5-1.5 mm; 50 PCS), Connector tube red / Złącze rurowe czerwone: (0.5-1.5 mm; 25 PCS), Connector tube blue / Złącze rurowe niebieskie: (0.5-1.5 mm; 25 PCS)

YATO
 YT-068911 60

EN O-ring assortment
 PL Zestaw O-ringów gumowych
 DE O-Ring Sortiment
 RU Набор резиновых прокладок
 CZ Sada gumových o-kroužků
 HU O gyűrű készlet

RO Garnituri din cauciuc
 FR Set d'o-rings en caoutchouc
 IT Set guarnizioni O-ring
 ES Kit de junta tórica
 CN O型圈

419
PCS

MIX

NBR

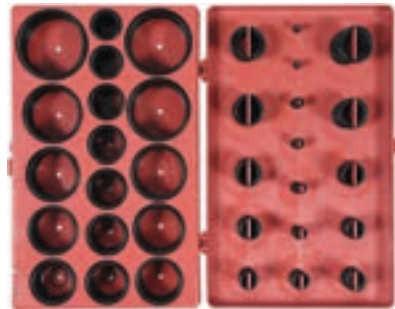

3x1.5 mm, 4.4x2 mm, 5x2 mm, 7x1.5 mm, 10x1.5 mm, 10x2.5 mm, 11x2.5 mm, 13x1.5 mm, 13x2.5 mm, 14x2.5 mm, 16x2.5 mm, 18x2.5 mm, 19x2.5 mm, 21x2.5 mm, 22x2.5 mm, 18x3.5 mm, 20x3.5 mm, 22x3.5 mm, 23.5x3.5 mm, 25x3.5 mm, 26.5x3.5 mm, 28x3.5 mm, 30x3.5 mm, 31x3.5 mm, 33x3.5 mm, 34.5x3.5 mm, 36x3.5 mm, 38x3.5 mm, 41x3.5 mm, 44x3.5 mm, 47x3.5 mm, 50x3.5 mm

YATO
 YT-06876 5/20

EN Terminal assortment
 PL Zestaw złącz elektrycznych
 DE Kabelschuh-Set
 RU Набор электрических клемм
 CZ Sada elektrických konektorů
 HU Elektromos csatlakozókészlet

RO Set papuci auto
 FR Jeu de cosSES de câbles
 IT Kit di connettori elettrici
 ES Juego de conectores eléctricos
 CN 接线端子

160
PCS

MIX



⊙ Ø4 mm (8 PCS), Ø4 mm (10 PCS), Ø5 mm (4 PCS), Ø5 mm (10 PCS), Ø6 mm (10 PCS), Ø8 mm (4 PCS), Ø10 mm (4 PCS);
 □ 0.25-1.5 mm² (12 PCS), 1.5-2.5 mm² (18 PCS), 4-6 mm² (12 PCS);
 ⊗ Ø4 mm (10 PCS);
 ○ 1.5-2.5 mm² (10 PCS);
 ⊞ 1.5-2.5 mm² (10 PCS), 4-6 mm² (5 PCS);
 ⊚ 1.5-2.5 mm² (10 PCS);
 ⊛ 1.5-2.5 mm² (10 PCS), 4-6 mm² (5 PCS);
 ⊜ 0.25-1.5 mm² (4 PCS), 1.5-2.5 mm² (4 PCS)

YATO
 YT-06891 24

EN Terminal assortment
 PL Zestaw złącz elektrycznych
 DE Kabelschuh-Set
 RU Набор электрических клемм
 CZ Sada elektrických konektorů
 HU Elektromos csatlakozókészlet

RO Set papuci auto
 FR Jeu de cosSES de câbles
 IT Kit di connettori elettrici
 ES Juego de conectores eléctricos
 CN 接线端子

240
PCS

MIX



Connector red female / Złącze czerwone żeńskie: 6.4 mm (0.5-1.5 mm; 20 PCS), Connector red full female / Złącze czerwone pełne żeńskie: 4.8 mm (0.5-1.5 mm; 20 PCS), Connector red male / Złącze czerwone męskie: 6.4 mm (0.5-1.5 mm; 40 PCS), Connector blue female / Złącze niebieskie żeńskie: 6.4 mm (1.5-2.5 mm; 20 PCS), Connector red full female / Złącze czerwone pełne żeńskie: 6.4 mm (0.5-1.5 mm; 20 PCS), Connector blue full female / Złącze niebieskie pełne żeńskie: 6.4 mm (1.5-2.5 mm; 20 PCS), Connector blue male male / Złącze niebieskie męsko-męskie: 6.4 mm (1.5-2.5 mm; 40 PCS), Connector blue male / Złącze niebieskie męskie: 4.8 mm (1.5-2.4 mm; 20 PCS), Connector blue female / Złącze niebieskie żeńskie: 4.8 mm (1.5-2.5 mm; 20 PCS)

YATO
 YT-068912 60

EN Terminal assortment
PL Zestaw złączy elektrycznych
DE Kabelschuh-Set
RU Набор электрических клемм
CZ Sada elektrických konektorů
HU Elektromos csatlakozókészlet

RO Set papuci auto
FR Jeu de cosses de câbles
IT Kit di connettori elettrici
ES Juego de conectores eléctricos
CN 接线端子

360
PCS
MIX



⊘ 05 mm - 2 mm2 (30 PCS), ⊘6 mm - 2 mm2 (20 PCS), ⊘9.5 mm - 2 mm2 (20 PCS),
⊘5 mm - 5.5 mm2 (20 PCS), ⊘6 mm - 5.5 mm2 (15 PCS), ⊘9.5 mm - 5.5 mm2 (15 PCS);
1.25 mm2 (40 PCS), 2 mm2 (30 PCS), 5.5 mm2 (15 PCS);
⊘5 mm - 2 mm2 (30 PCS), ⊘5 mm - 5.5 mm2 (20 PCS);
2 mm2 (25 PCS);
2 mm2 (35 PCS);
2 mm2 (10 PCS);
2 mm2 (35 PCS)

YATO
YT-06890 12

EN Terminal assortment
PL Zestaw złączy elektrycznych
DE Kabelschuh-Set
RU Набор электрических клемм
CZ Sada elektrických konektorů
HU Elektromos csatlakozókészlet

RO Set papuci auto
FR Jeu de cosses de câbles
IT Kit di connettori elettrici
ES Juego de conectores eléctricos
CN 接线端子

600
PCS
MIX



Connector female / Złącze żeńskie: 2.8 mm, 4.8 mm, 6.4 mm (x100 PCS); Connector male / Złącze męskie: 2.8 mm, 4.8 mm, 6.4 mm (x100 PCS)

YATO
YT-068684 24

EN Insulated ferrules assortment
PL Zestaw końcówek i konektorów kablowych
DE Kabelschuh- und Verbinder-Set
RU Набор кабельных наконечников и коннекторов
CZ Sada kabelových koncovek a konektorů
HU Végződések és csatlakozókészlet

RO Set conectori
FR Jeu de cosses de câbles
IT Set di terminali e connettori per cavi
ES Set de puntas y conectores de cable
CN 欧式接线端子

685
PCS
MIX



0.5 mm (50 PCS), 0.75 mm (50 PCS), 1 mm (100 PCS), 1.5 mm (250 PCS), 2.5 mm (150 PCS), 4 mm (50 PCS), 6 mm (25 PCS), 10 mm (10 PCS)

YATO
YT-06895 5/20

EN Terminal assortment
PL Zestaw złączy elektrycznych
DE Kabelschuh-Set
RU Набор электрических клемм
CZ Sada elektrických konektorů
HU Elektromos csatlakozókészlet

RO Set papuci auto
FR Jeu de cosses de câbles
IT Kit di connettori elettrici
ES Juego de conectores eléctricos
CN 接线端子

450
PCS
MIX



Connector female / Złącze żeńskie: 2.8 mm, 4.8 mm, 6.4 mm (x50 PCS); Connector male / Złącze męskie: 2.8 mm, 4.8 mm, 6.4 mm (x50 PCS); Connector with hole / Złącze z oczkiem: ⊘3.2 mm, ⊘5.2 mm, ⊘8.2 mm (x50 PCS)

YATO
YT-068683 24

EN Terminal assortment
PL Zestaw złączy elektrycznych
DE Kabelschuh-Set
RU Набор электрических клемм
CZ Sada elektrických konektorů
HU Elektromos csatlakozókészlet

RO Set papuci auto
FR Jeu de cosses de câbles
IT Kit di connettori elettrici
ES Juego de conectores eléctricos
CN 接线端子

600
PCS
MIX



PBDD 1-250, PBDD 2-250, PBDD 5-250, FDFD 5-250, RV 5.5-4, RV 5.5-5, RV 5.5-6 (x10 PCS); E1008 red / czerwone, E1508 red / czerwone, E2508 blue / niebieskie (x50 PCS); TE1008 red / czerwone, TE1508 red / czerwone, TE2510 red / czerwone, MDD 1-250, MDD 2-250 (x20 PCS); MDD 5-250, BV 5.5, FDD 5-250 (x10 PCS); FDFD 1-250, FDFD 2-250, RV 1.25-5, RV 2-5, BV 1.25, BV 2 (x15 PCS); RV 1.25-3, RV 1.25-4, RV 2-3, RV 2-4 (x30 PCS); FDD 1-250, FDD 2-250 (x20 PCS)

YATO
YT-068913 20

EN Terminal assortment
PL Zestaw złączy elektrycznych
DE Kabelschuh-Set
RU Набор электрических клемм
CZ Sada elektrických konektorů
HU Elektromos csatlakozókészlet

RO Set papuci auto
FR Jeu de cosses de câbles
IT Kit di connettori elettrici
ES Juego de conectores eléctricos
CN 接线端子

750
PCS
MIX



Connector female / Złącze żeńskie: 2.8 mm, 4.8 mm, 6.4 mm (x100 PCS); Connector male / Złącze męskie: 2.8 mm, 4.8 mm, 6.4 mm (x100 PCS); Connector with hole / Złącze z oczkiem: ⊘3.2 mm, ⊘5.2 mm, ⊘6.2 mm, ⊘8.2 mm, ⊘10.5 mm (x30 PCS)

YATO
YT-068685 24

- EN Crimp bootlace ferrules assortment
 PL Zestaw końcówek kablowych
 DE Aderendhülsen Set
 RU Набор кабельных наконечников
 CZ Sada kabelových koncovek
 HU Kábelcsatlakozó készlet
- RO Kit cepete sertizat cabluri fara izolare
 FR Jeu de cosses de câbles
 IT Set di terminali
 ES Juego casquillos de cable
 CN 接线端子

1000
PCS

MIX

BRASS
MOŚIADZ



0.5 mm (ferrule length / długość okucia: 6 mm), 0.75 mm (ferrule length / długość okucia: 6 mm), 1 mm (ferrule length / długość okucia: 6 mm), 1.5 mm (ferrule length / długość okucia: 7 mm), 2.5 mm (ferrule length / długość okucia: 7 mm) (x200 PCS)

YATO

YT-06896 100

- EN Insulated ferrules assortment
 PL Zestaw końcówek i konektorów kablowych
 DE Kabelschuh- und Verbinder-Set
 RU Набор кабельных наконечников и коннекторов
 CZ Sada kabelových koncovek a konektorů
 HU Végződés és csatlakozókészlet
- RO Set conectori
 FR Jeu de cosses de câbles
 IT Set di terminali e connettori per cavi
 ES Set de puntas y conectores de cable
 CN 欧式接线端子

1200
PCS

MIX



E1012 red / czerwone (25 PCS), E6012 green / zielone (25 PCS), E1008 red / czerwone (200 PCS), E2508 blue / niebieskie (250 PCS), E4010 grey / szare (50 PCS), E1508 black / czarne (250 PCS), E0508 white / białe (200 PCS), E7508 grey / szare (200 PCS)

YATO

YT-06894 20

- EN Terminal connectors
 PL Zestaw szybkozłączy elektrycznych
 DE Kabelschuhe schnelkupplung kabelklemme
 RU Набор экспресс-клемм
 CZ Rychlopřipojky elektrických konektorů
 HU Gyors csatlakozó auto

- RO Conector rapid pt. auto
 FR Connecteur rapide
 IT Connettori terminali
 ES Conector rapido electrico
 CN 连接片组套

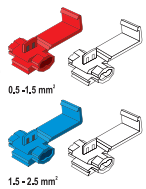

50
PCS

MIX



☞ 0.5-1.5 mm² (25 PCS), 1.5-2.5 mm² (25 PCS)

YATO

YT-06868 5/20

- EN Heat-shrink tubing set
 PL Zestaw koszulek termokurczliwych
 DE Schrumpfschlauch-Set
 RU Набор термоусадочных трубок
 CZ Sada smršťovacích bužirek
 HU Zsugorcső készlet

- RO Set tuburi termocontractabile
 FR Jeu de gaines thermorétractables
 IT Kit guaine termorestringenti
 ES Kit de tubos termorretráctiles
 CN 热收缩管

100
PCS

MIX

max °C
125

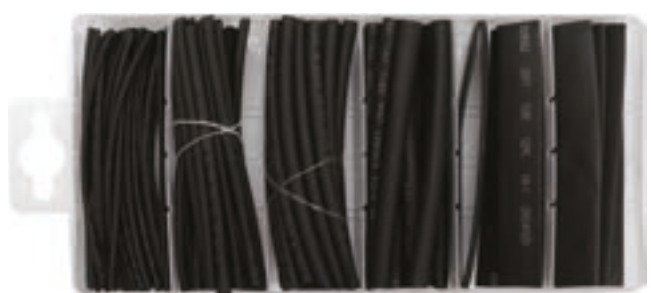

Ø1.5x100 mm (30 PCS), Ø2.5x100 mm (30 PCS), Ø4x100 mm (20 PCS), Ø6x100 mm (10 PCS), Ø10x100 mm (6 PCS), Ø13x100 mm (4 PCS)

YATO

YT-068661 24

- EN Heat-shrink tubing set
 PL Zestaw koszulek termokurczliwych
 DE Schrumpfschlauch-Set
 RU Набор термоусадочных трубок
 CZ Sada smršťovacích bužirek
 HU Zsugorcső készlet

- RO Set tuburi termocontractabile
 FR Jeu de gaines thermorétractables
 IT Kit guaine termorestringenti
 ES Kit de tubos termorretráctiles
 CN 热收缩管

100
PCS

MIX

max °C
125



Ø1.5x100 mm (30 PCS), Ø2.5x100 mm (30 PCS), Ø4x100 mm (20 PCS), Ø6x100 mm (10 PCS), Ø10x100 mm (6 PCS), Ø13x100 mm (4 PCS)

YATO

YT-068667 24

- EN Heat-shrink tubing set
 PL Zestaw koszulek termokurczliwych
 DE Schrumpfschlauch-Set
 RU Набор термоусадочных трубок
 CZ Sada smršťovacích bužirek
 HU Zsugorcső készlet

- RO Set tuburi termocontractabile
 FR Jeu de gaines thermorétractables
 IT Kit guaine termorestringenti
 ES Kit de tubos termorretráctiles
 CN 热收缩管

127
PCS

MIX

max °C
125

max
600V



Ø2x40 mm, Ø2.5x40 mm, Ø3.5x40 mm, Ø5x40 mm, Ø7x80 mm, Ø10x80 mm, Ø13x85 mm

YATO

YT-06866 5/20

EN Heat-shrink tubing set
PL Zestaw koszulek termokurczliwych
DE Schrumpfschlauch-Set
RU Набор термоусадочных трубок
CZ Sada smršťovacích bužírek
HU Zsugorcsó készlet

RO Set tuburi termocontractabile
FR Jeu de gaines thermorétractables
IT Kit guaine termorestringenti
ES Kit de tubos termorretráctiles
CN 热收缩管

128
PCS

MIX

max°C
125



Ø2.5x8 mm (40 PCS), Ø3.5x80 mm (32 PCS), Ø5x80 mm (24 PCS), Ø7x80 mm (16 PCS), Ø10x80 mm (8 PCS), Ø13x80 mm (8 PCS)

YATO
YT-068668 24

EN Heat-shrink tubing with glue set
PL Zestaw koszulek termokurczliwych z klejem
DE Schrumpfschlauch-Set mit Kleber
RU Набор термоусадочных трубок с клеем
CZ Sada smršťovacích bužírek s lepidlem
HU Ragasztós zsugorcsó készlet

RO Set tub termocontractabil cu lipici
FR Jeu de gaines thermorétractables avec adhésif
IT Kit guaine termorestringenti con adesivo
ES Kit de tubos termorretráctiles adhesivos
CN 带胶热缩套管

270
PCS

MIX

max°C
125



Ø1.6x45 mm (70 PCS), Ø2.4x45 mm (80 PCS), Ø3.2x45 mm (80 PCS), Ø4.8x90 mm (20 PCS), Ø6.3x90 mm (12 PCS), Ø9.5x90 mm (8 PCS)

YATO
YT-068671 60

EN Heat shrink solder sleeve
PL Koszulka termokurczliwa z cyną
DE Wärmeschrumpfende Verbinder mit Zinn
RU Термоусадочная гильза с оловом
CZ Smršťovací trubička s cínem
HU Hőre zsugorodó hüvely ónnal
RO Manson pt. lipit cu aer cald
FR Gaine thermorétractable avec étain
IT Guaine termorestringenti con stagno
ES Tubo termorretráctil con estaño
CN 免压热缩中接焊锡端子

30
PCS

0.25
x0.34
mm²

105
°C

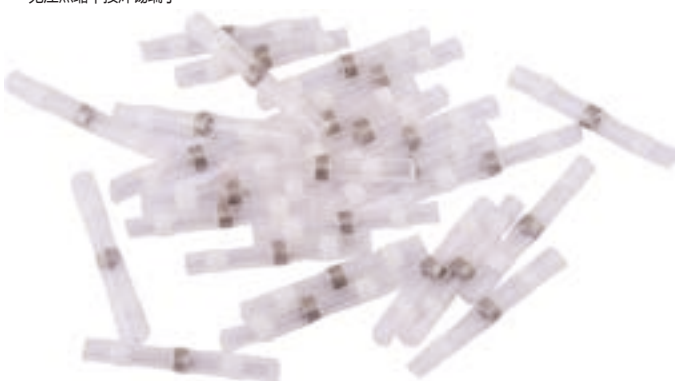

YATO
YT-81440 Cross-sectional area / Przekrój przewodu 0.25-0.34 mm² / 26-24 AWG 25/1500

EN Heat-shrink tubing set
PL Zestaw koszulek termokurczliwych
DE Schrumpfschlauch-Set
RU Набор термоусадочных трубок
CZ Sada smršťovacích bužírek
HU Zsugorcsó készlet

RO Set tuburi termocontractabile
FR Jeu de gaines thermorétractables
IT Kit guaine termorestringenti
ES Kit de tubos termorretráctiles
CN 热收缩管

171
PCS

MIX

max°C
125



Ø2x30 mm (100 PCS), Ø4x60 mm (10 PCS), Ø4.5x60 mm (10 PCS), Ø5x60 mm (8 PCS), Ø6x60 mm (6 PCS), Ø8x90 mm (11 PCS), Ø9x90 mm (11 PCS), Ø12x90 mm (7 PCS), Ø18x90 mm (7 PCS), Ø10x1000 mm (1 PCS)

YATO
YT-06867 24

EN Heat-shrink tubing with glue set
PL Zestaw koszulek termokurczliwych z klejem
DE Schrumpfschlauch-Set mit Kleber
RU Набор термоусадочных трубок с клеем
CZ Sada smršťovacích bužírek s lepidlem
HU Ragasztós zsugorcsó készlet

RO Set tub termocontractabil cu lipici
FR Jeu de gaines thermorétractables avec adhésif
IT Kit guaine termorestringenti con adesivo
ES Kit de tubos termorretráctiles adhesivos
CN 带胶热缩套管

530
PCS

MIX

max°C
125



Ø1.5x45 mm (80 PCS), Ø2x45 mm (160 PCS), Ø3x45 mm (60 PCS), Ø4x45 mm (100 PCS), Ø5x45 mm (30 PCS), 6x45 mm (20 PCS), Ø8x45 mm (20 PCS), Ø10x45 mm (60 PCS)

YATO
YT-068672 60

EN Heat shrink solder sleeve
PL Koszulka termokurczliwa z cyną
DE Wärmeschrumpfende Verbinder mit Zinn
RU Термоусадочная гильза с оловом
CZ Smršťovací trubička s cínem
HU Hőre zsugorodó hüvely ónnal
RO Manson pt. lipit cu aer cald
FR Gaine thermorétractable avec étain
IT Guaine termorestringenti con stagno
ES Tubo termorretráctil con estaño
CN 免压热缩中接焊锡端子

100
PCS

0.25
x0.34
mm²

105
°C



YATO
YT-81451 Cross-sectional area / Przekrój przewodu 0.25-0.34 mm² / 26-24 AWG 558

EN Heat shrink solder sleeve
 PL Koszulka termokurczliwa z cyną
 DE Wärmeschrumpfende Verbinder mit Zinn
 RU Термоусадочная гильза с оловом
 CZ Smršťovací trubička s cínem
 HU Hőre zsugorodó hüvely ónnal
 RO Manson pt. lipit cu aer cald
 FR Gaine thermorétractable avec étain
 IT Guaine termorestringenti con stagno
 ES Tubo termorretráctil con estaño
 CN 免压热缩中接焊锡端子

30 PCS 0.5 x1.5 mm² 105 °C



YATO	Cross-sectional area / Przekrój przewodu	
YT-81441	0.5-1.5 mm ² / 22~18 AWG	15/900

EN Heat shrink solder sleeve
 PL Koszulka termokurczliwa z cyną
 DE Wärmeschrumpfende Verbinder mit Zinn
 RU Термоусадочная гильза с оловом
 CZ Smršťovací trubička s cínem
 HU Hőre zsugorodó hüvely ónnal
 RO Manson pt. lipit cu aer cald
 FR Gaine thermorétractable avec étain
 IT Guaine termorestringenti con stagno
 ES Tubo termorretráctil con estaño
 CN 免压热缩中接焊锡端子

100 PCS 0.5 x1.5 mm² 105 °C



YATO	Cross-sectional area / Przekrój przewodu	
YT-81452	0.5-1.5 mm ² / 22~18 AWG	378

EN Heat shrink solder sleeve
 PL Koszulka termokurczliwa z cyną
 DE Wärmeschrumpfende Verbinder mit Zinn
 RU Термоусадочная гильза с оловом
 CZ Smršťovací trubička s cínem
 HU Hőre zsugorodó hüvely ónnal
 RO Manson pt. lipit cu aer cald
 FR Gaine thermorétractable avec étain
 IT Guaine termorestringenti con stagno
 ES Tubo termorretráctil con estaño
 CN 免压热缩中接焊锡端子

30 PCS 1.5 x2.5 mm² 105 °C



YATO	Cross-sectional area / Przekrój przewodu	
YT-81442	1.5-2.5 mm ² / 16~14 AWG	5/300

EN Heat shrink solder sleeve
 PL Koszulka termokurczliwa z cyną
 DE Wärmeschrumpfende Verbinder mit Zinn
 RU Термоусадочная гильза с оловом
 CZ Smršťovací trubička s cínem
 HU Hőre zsugorodó hüvely ónnal
 RO Manson pt. lipit cu aer cald
 FR Gaine thermorétractable avec étain
 IT Guaine termorestringenti con stagno
 ES Tubo termorretráctil con estaño
 CN 免压热缩中接焊锡端子

100 PCS 1.5 x2.5 mm² 105 °C



YATO	Cross-sectional area / Przekrój przewodu	
YT-81453	1.5-2.5 mm ² / 16~14 AWG	130

EN Heat shrink solder sleeve
 PL Koszulka termokurczliwa z cyną
 DE Wärmeschrumpfende Verbinder mit Zinn
 RU Термоусадочная гильза с оловом
 CZ Smršťovací trubička s cínem
 HU Hőre zsugorodó hüvely ónnal
 RO Manson pt. lipit cu aer cald
 FR Gaine thermorétractable avec étain
 IT Guaine termorestringenti con stagno
 ES Tubo termorretráctil con estaño
 CN 免压热缩中接焊锡端子

20 PCS 4.0 x6.0 mm² 105 °C



YATO	Cross-sectional area / Przekrój przewodu	
YT-81443	4-6 mm ² / 12~10 AWG	5/300

EN Heat shrink solder sleeve
 PL Koszulka termokurczliwa z cyną
 DE Wärmeschrumpfende Verbinder mit Zinn
 RU Термоусадочная гильза с оловом
 CZ Smršťovací trubička s cínem
 HU Hőre zsugorodó hüvely ónnal
 RO Manson pt. lipit cu aer cald
 FR Gaine thermorétractable avec étain
 IT Guaine termorestringenti con stagno
 ES Tubo termorretráctil con estaño
 CN 免压热缩中接焊锡端子

100 PCS 4.0 x6.0 mm² 105 °C



YATO	Cross-sectional area / Przekrój przewodu	
YT-81454	4-6 mm ² / 12~10 AWG	100

EN Heat shrink solder sleeve set
 PL Zestaw koszulek termokurczliwych z cyną
 DE Satz wärmeschrumpfender Verbinder mit Zinn
 RU Комплект термоусадочных гильз с оловом
 CZ Sada smršťovacích trubiček s cínem
 HU Hőre zsugorodó hüvelykészlet ónnal

RO Set mansoane lipit cu aer cald
 FR Jeu de gaines thermorétractables avec étain
 IT Set di guaine termorestringenti con stagno
 ES Conjunto de tubos termorretráctiles con estaño
 CN 免压热缩中接焊锡管子

100 PCS

0.25 x6.0 mm²

105 °C

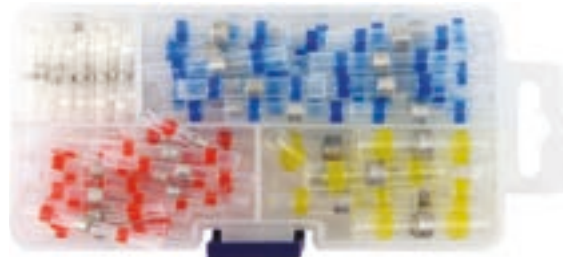

YATO	Cross-sectional area / Przekrój przewodu	
YT-81450	0.25-6 mm ² / 26~10 AWG	150

EN Heat shrink solder sleeve set
 PL Zestaw koszulek termokurczliwych z cyną
 DE Satz wärmeschrumpfender Verbinder mit Zinn
 RU Комплект термоусадочных гильз с оловом
 CZ Sada smršťovacích trubiček s cínem
 HU Hőre zsugorodó hüvelykészlet ónnal
 RO Set mansoane lipit cu aer cald
 FR Jeu de gaines thermorétractables avec étain
 IT Set di guaine termorestringenti con stagno
 ES Kit de capas termorretráctiles con estaño
 CN 免压热缩中接焊锡管

220 PCS

0.25 x6.0 mm²

105 °C

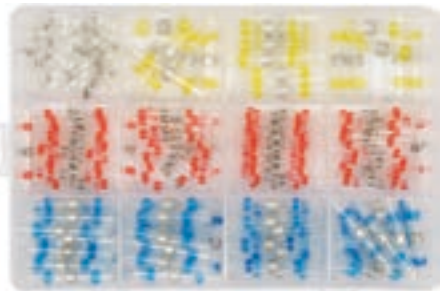

YATO	Cross-sectional area / Przekrój przewodu	
YT-81460	0.25-6 mm ² / 26~10 AWG	60

- EN Heat shrink butt connectors set
PL Zestaw zaciskanych koszulek termokurczliwych
DE Satz gewellte Schrumpfhüllen
RU Набор обжимных термоусадочных трубок
CZ Sada upínacích teplém smršťitelných bužirek
HU Szigetelt toldóhüvely készlet
RO Set de conectori termocontractabili
FR Jeu de manchons thermorétractables sertis
IT Set di giunti termorestringenti con stagno
ES Juego de tubos termocontráctiles
CN 防水热缩端子

200
PCS

0.5
x6.0
mm²



0.5-1.5 mm² (90 PCS), 1.5-2.5 mm² (90 PCS), 4.0-6.0 mm² (20 PCS)

YATO	Cross-sectional area / Przekrój przewodu	
YT-81461	0.5-6 mm ² / 20~10 AWG	60

- EN Back probe kit
PL Zestaw przewodów i końcówek pomiarowych
DE Messleitungen und -endstücke
RU Набор кабелей и измерительных наконечников
CZ Sada měřících vodičů a koncovek
HU Vezeték és mérőfej készlet
- RO Trusa de sondă spată
FR Kit de cordons et de fiches de test
IT Set di cavi e terminali di misura
ES Juego de cables y puntas de medición
CN 万用表

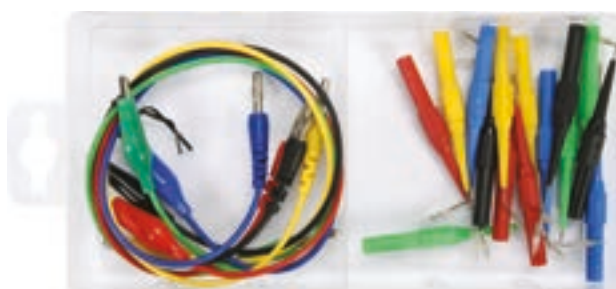

20
PCS

0-30V
A.C.

0-30V
D.C.



YATO		
YT-73079		24

- EN Car fuse assortment
PL Zestaw bezpieczników
DE KFZ-Sicherungs-Set
RU Набор предохранителей
CZ Sada pojistek
HU Biztosítékkészlet
- RO Set sigurante
FR Ensemble de fusible
IT Kit di fusibili lamellari
ES Conjunto de fusibles
CN 保险插片

24
PCS

MAXI



20 A, 30 A, 40 A, 50 A, 60 A, 70 A, 80 A, 100 A (x3 PCS)

YATO		
YT-83140		24

- EN Car fuse assortment
PL Zestaw bezpieczników
DE KFZ-Sicherungs-Set
RU Набор предохранителей
CZ Sada pojistek
HU Biztosítékkészlet
- RO Set sigurante
FR Ensemble de fusible
IT Kit di fusibili lamellari
ES Conjunto de fusibles
CN 保险插片

97
PCS

STANDARD



3 A, 5 A, 7.5 A, 10 A, 15 A, 20 A, 25 A, 30 A (x12 PCS)

YATO		
YT-83141		24

- EN Car fuse assortment
PL Zestaw bezpieczników
DE KFZ-Sicherungs-Set
RU Набор предохранителей
CZ Sada pojistek
HU Biztosítékkészlet
- RO Set sigurante
FR Ensemble de fusible
IT Kit di fusibili lamellari
ES Conjunto de fusibles
CN 保险插片

92
PCS

STANDARD



5 A, 10 A, 15 A, 20 A, 25 A, 30 A (x15 PCS); tester 6-24 V

YATO		
YT-83142		24

- EN Car fuse assortment
PL Zestaw bezpieczników
DE KFZ-Sicherungs-Set
RU Набор предохранителей
CZ Sada pojistek
HU Biztosítékkészlet
- RO Set sigurante
FR Ensemble de fusible
IT Kit di fusibili lamellari
ES Conjunto de fusibles
CN 保险插片

100
PCS

MINI



7.5 A (10 PCS), 10 A (20 PCS), 15 A (20 PCS), 20 A (20 PCS), 25 A (20 PCS), 30 A (10 PCS)

YATO		
YT-83145		12/60

EN Car fuse assortment
 PL Zestaw bezpieczników
 DE KFZ-Sicherungs-Set
 RU Набор предохранителей
 CZ Sada pojistek
 HU Biztosítékkészlet

RO Set sigurante
 FR Ensemble de fusible
 IT Kit di fusibili lamellari
 ES Conjunto de fusibles
 CN 120汽车保险片

120
PCS

MINI



5 A, 10 A, 15 A, 20 A, 25 A, 30 A (x20 PCS)

YATO **YT-83146** 12

EN Car fuse assortment
 PL Zestaw bezpieczników
 DE KFZ-Sicherungs-Set
 RU Набор предохранителей
 CZ Sada pojistek
 HU Biztosítékkészlet

RO Set sigurante
 FR Ensemble de fusible
 IT Kit di fusibili lamellari
 ES Conjunto de fusibles
 CN 120汽车保险片

120
PCS

STANDARD



5 A, 10 A, 15 A, 20 A, 25 A, 30 A (x20 PCS)

YATO **YT-83144** 12

EN Car fuse assortment
 PL Zestaw bezpieczników
 DE KFZ-Sicherungs-Set
 RU Набор предохранителей
 CZ Sada pojistek
 HU Biztosítékkészlet

RO Set sigurante
 FR Ensemble de fusible
 IT Kit di fusibili lamellari
 ES Conjunto de fusibles
 CN 保险插片

121
PCS

MINI



5 A, 10 A, 15 A, 20 A, 25 A, 30 A (x20 PCS)

YATO **YT-83143** 24

EN Glass fuse assortment
 PL Zestaw bezpieczników szklanych
 DE Glas-Sicherungsset
 RU Набор стеклянных предохранителей
 CZ Sada skleněných pojistek
 HU Üvegbiztosíték készlet

RO Set sigurante sticla
 FR Ensemble de fusibles en verre
 IT Set di fusibili in vetro
 ES Set de fusibles de vidrio
 CN 玻璃管保险丝

120
PCS

6x30
mm

GLASS
SZKŁO



5 A, 10 A, 15 A, 20 A, 25 A, 30 A (x20 PCS)

YATO **YT-83130** 5/20

EN Trim clips assortment
 PL Komplet spinek samochodowych
 DE Befestigungs-Clip-Satz
 RU Набор автомобильного крепежа

CZ Sada přichytek čalounění
 HU Kötőelemek szegecsek
 RO Clip de plastic asortat
 FR Ensembles de clips en plastique auto

IT Set di clip per auto
 ES Clip de plástico surtido
 CN 塑料卡扣

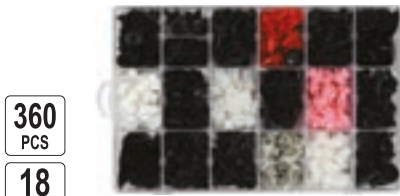

360
PCS

18
TYPES
TYPP

Toyota, Lexus

YATO **YT-06650** 20



300
PCS

6
TYPES
TYPP

Renault

YATO **YT-06651** 20

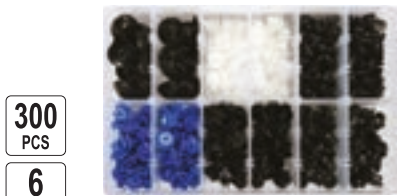

300
PCS

6
TYPES
TYPP

Opel

YATO **YT-06652** 20

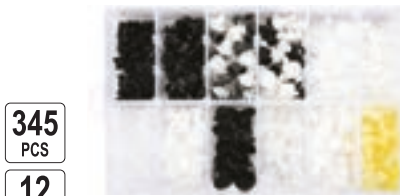

345
PCS

12
TYPES
TYPP

Peugeot

YATO **YT-06653** 20

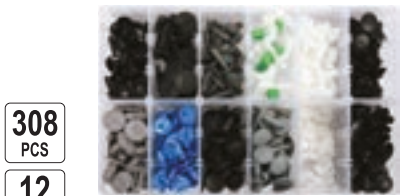

308
PCS

12
TYPES
TYPP

Fiat

YATO **YT-06654** 20

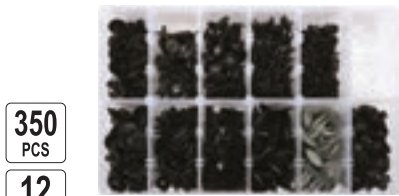

350
PCS

12
TYPES
TYPP

Volvo

YATO **YT-06655** 20

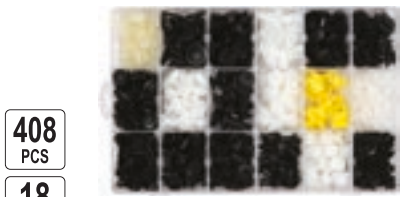

408
PCS

18
TYPES
TYPP

Honda

YATO **YT-06656** 20



408
PCS

18
TYPES
TYPP

Nissan

YATO **YT-06657** 20

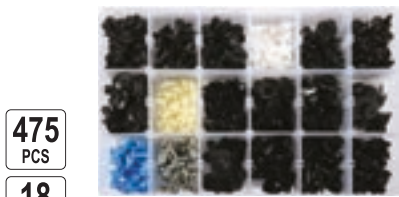

475
PCS

18
TYPES
TYPP

Mazda

YATO **YT-06658** 20

17

Welding equipment & accessories
Narzędzia spawalnicze i akcesoria



Welding helmets & accessories
Przyłbice spawalnicze i akcesoria

530-531



Profile connection & forming pliers
Szczypce do łączenia i kształtowania profili

534-535



Ball peen hammers & sets
Młotki blacharskie i zestawy

531



Spot weld cutter sets
Zestawy rozwiertaków do zgrzewów

535



Dead blow hammers
Młotki bezodrzutowe

532



Combination edge setters & hole punch pliers
Dziurkarko-felcarki

535



Welding workbenches
Stoliki spawalnicze

533



Magnetic holders
Wsporniki magnetyczne

535-537



Lock grip pliers
Szczypce zaciskowe

533-534



Tin snips
Nożyce do blachy

538-541



Welding locking pliers	
Szczypce zaciskowe, spawalnicze.....	533
Flat locking pliers	
Szczypce zaciskowe o szerokich szczękach.....	533
C-type welding locking pliers	
Szczypce zaciskowe, klamrowe typu „C”.....	533
Chain locking pliers	
Szczypce zaciskowe z łańcuchem.....	534

EN Auto-darkening welding helmet
 PL Przyłbica spawalnicza samościemniająca
 DE Schweissmaske, selbstverdunkelnd
 RU Маска сварщика с автозатемнением
 CZ Svářečská kukla samostmívací
 HU Őnmagától sötétedő hegesztőpájsz
 RO Mască de sudură auto-întunecare
 FR Masque de soudage
 IT Oscuramento casco di saldatura
 ES Casco auto-oscurecedor para soldadura
 CN 焊帽



9-13 DARK STATE STAN CIEMNY	SHADE SCIEMIANIE	DIN 4 LIGHT STATE STAN JASNY	1 1 1 1 OPTICAL CLASS KLASA OPTYCZNA	98x43 mm	4 ARC SENSOR CZUJNIKI ŁUKU	1/25000s REACTION TIME CZAS REAKCJI	SENSITIVITY CZUŁOŚĆ	0.1-1.0 s BRIGHTENING ROZJAŚNIANIE	DELAY OPÓZNIENIE
FILTER TEST FILTRA	DIN 16 UV/IR	SOLAR CELL OGNIWO SŁONECZNE	2x CR2450	LOW BATTERY ALARM WSKAZNIK POZIOMU BATERII	4-POINT HEADGEAR WIĘZBA 4-PUNKTOWA	AUTO ON / OFF AUTO WŁ. / WYL.	°C - 5 + 55	MIG/MAG MMA/TIG	GRINDING SZLIFOWANIE
								CUTTING CIĘCIE	

**4 POINT HEADGEAR
WIĘZBA 4 PUNKTOWA**
 Lock into a detent when lifted
 Blokada w pozycji podniesionej

2-point crown strap adjustment
to rise or lower the helmet
2 punktowa regulacja wysokości

3 position slider to
adjust the distance
from eyes to lens
3 pozycje regulacji
odległości od filtra

Regulation at the
occipital area
Regulacja pozycji
potylicznej

Ratchet with soft rubber grip to adjust size without removing the helmet
Regulacji obwodu za pomocą systemu grzechotkowego

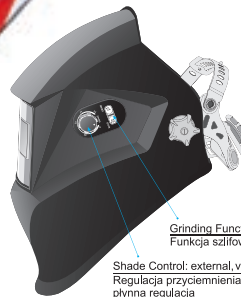
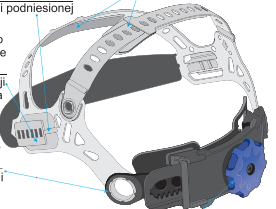

Grinding Function: YES
 Funkcja szlifowania: TAK

Shade Control: external, variable
 Regulacja przyciemnienia: zewnętrzna,
 płynna regulacja

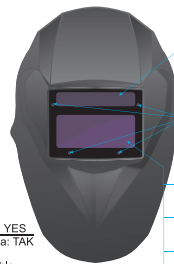

Solar cell filter power
supply during welding
Ogniwo słoneczne
zasilanie filtra
podczas spawania

Arc Sensor: 4
 Liczba czujników
łuku: 4

Viewing Area: 98x43 mm
 Obszar pola widzenia: 98x43 mm

UV/IR Protection
 Ochrona przed promieniowaniem
UV/IR
Automatic power on / off
 Automatyczne włączenie / wyłączenie

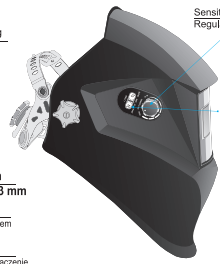

Sensitivity Control
 Regulacja czułości

The rate of dimming
 Szybkość ściemniania
 0.3 - 1.0 ms

- In accordance with standard EN 379
- Optical class: 1/1/1/1
- Cover lens YT-73924 included
- Zgodność z normą EN 379
- Klasa optyczna: 1/1/1/1
- W zestawie szybki ochronne YT-73924

YATO	
YT-73921	6

EN Front cover lens
 PL Szybka ochronna do przyłbicy samościemniającej
 DE Außerschutzglas
 RU Стекло защитное наружное

CZ Přední krycí skličko
 HU Külső védőlemez
 RO Protecția exterioră de plastic
 FR Verres de protection

IT Lente per casco da saldatura
 ES Cubierta de la lente de soldadura
 CN 焊帽镜片

5 PCS	123x98 mm	PC	
----------	--------------	----	--



For YT-73921
 Dla YT-73921

TYPE FC-11 EN 166:2001 B

YATO	
YT-73924	20/160

EN Auto-darkening welding helmet
 PL Przyłbica spawalnicza samościemniająca
 DE Schweissmaske, selbstverdunkelnd
 RU Маска сварщика с автозатемнением
 CZ Svářečská kukla samostmívací
 HU Őnmagától sötétedő hegesztőpájsz
 RO Mască de sudură auto-întunecare
 FR Masque de soudage
 IT Oscuramento casco di saldatura
 ES Casco auto-oscurecedor para soldadura
 CN 焊帽



DIN 5-9/9-13 DARK STATE STAN CIEMNY	SHADE SCIEMIANIE	DIN 4 LIGHT STATE STAN JASNY	1 1 1 2 OPTICAL CLASS KLASA OPTYCZNA	100x50 mm	4 ARC SENSOR CZUJNIKI ŁUKU
1/25000s REACTION TIME CZAS REAKCJI	SENSITIVITY CZUŁOŚĆ	0.1-1.0 s BRIGHTENING ROZJAŚNIANIE	DELAY OPÓZNIENIE	FILTER TEST FILTRA	DIN 16 UV/IR
SOLAR CELL OGNIWO SŁONECZNE	2x CR2032	LOW BATTERY ALARM WSKAZNIK POZIOMU BATERII	3-POINT HEADGEAR WIĘZBA 3-PUNKTOWA	°C - 5 + 55	MIG/MAG MMA/TIG
				GRINDING SZLIFOWANIE	CUTTING CIĘCIE

Grinding function: YES
 Funkcja szlifowania: TAK



3 point headgear
 Więzba 3 punktowa

3 POINT HEADGEAR
 WIĘZBA 3-PUNKTOWA

- In accordance with standard EN 379
- Optical class: 1/1/1/2
- Zgodność z normą EN 379
- Klasa optyczna: 1/1/1/2

YATO	
YT-73925	6

- EN Auto-darkening welding helmet
PL Przyłbica spawalnicza samościemniająca
DE Schweissmaske, selbstverdunkelnd
RU Маска сварщика с автоматическим затемнением
CZ Svářečská kukla samostmívací
HU Őnmagától sötétedő hegesztőorpaiz
RO Mască de sudură auto-întunecare
FR Masque de soudage
IT Oscuramento casco di saldatura
ES Casco auto-oscurecedor para soldadura
CN 焊帽



DIN 5-9/9-13 DARK STATE STAN CIEMNY	SHADE SCIEMIANIANE	DIN 4 LIGHT STATE STAN JASNY	1 1 1 2 OPTICAL CLASS KLASA OPTYCZNA	100x60 mm	4 ARC SENSOR CZUJNIK ŁUKU	1/25000s REACTION TIME CZAS REAKCJI	SENSITIVITY CZUŁOŚĆ	0.1-1.0 s BRIGHTENING ROZJAŚNIANIE	DELAY OPÓZNIENIE
FILTER TEST TEST FILTRA	DIN 16 UV/IR	SOLAR CELL OGNIWO SŁONECZNE	2x + CR2032	LOW BATTERY ALARM WYKAZNIK POZIOMU BATERII	3-POINT HEADGEAR WIĘZBA 3-PUNKTOWA	°C - 5 + 55	MIG/MAG MMA/TIG	GRINDING SZLIFOWANIE	CUTTING CIĘCIE



- In accordance with standard EN 379
- Optical class: 1/1/1/2
- Zgodność z normą EN 379
- Klasa optyczna: 1/1/1/2

YATO	YT-73926	6
-------------	----------	---

- EN Front cover lens
PL Szybka ochronna do przyłbicy samościemniającej
DE Außerschutzglas
RU Стекло защитное наружное
CZ Přední krycí skličko
HU Külső védőlemez
RO Protecția exterioră de plastic
FR Verres de protection
IT Lente per casco da saldatura
ES Cubierta de la lente de soldadura
CN 焊帽镜片

5 PCS	137x120 mm	1.0 mm	PC
----------	---------------	--------	----



For YT-73925, YT-73926, 74484
Dla YT-73925, YT-73926, 74484

TYPE EN 166:2001 F

YATO	Filter size / Rozmiar filtra [mm]	20
YT-73929	137x120	20

- EN Ball pein hammer
PL Młotek blacharski
DE Ausbeulhammer
RU Молоток рихтовочный
- CZ Klempířské kladívko
HU Bádógos kalapács
RO Ciocan pt. tabla
FR Marteau à panne ronde
- IT Martello per lamiera
ES Martillo de hojalatero
CN 纤维柄圆头锤



YATO	m [g]	L [mm]	A [mm]	H [mm]	
YT-4515	225	280	26	80	6/36
YT-4516	450	315	34	100	6/24
YT-4518	900	380	40	125	6/12

- EN Auto body fender set
PL Komplet młotków blacharskich
DE Karosserie-Ausbeulsatz
RU Молотки рихтовочные
CZ Souprava klempířských kladívek
HU Bádógos kalapács készlet
RO Set de ciocane de tablă
FR Set pour carrossier
IT Martello per lamiera
ES Juego de mazos de hojalatero
CN 钣金工具组套

7 PCS	DROP FORGED KÜTE	HICKORY WOOD DREWNIO HIKOROWE
----------	------------------------	--



YATO	m [g]	4
YT-4590	4900	4

- EN Ball pein hammer
PL Młotek blacharski
DE Ausbeulhammer
RU Молоток рихтовочный
- CZ Klempířské kladívko
HU Bádógos kalapács
RO Ciocan pt. tabla
FR Marteau à panne ronde
- IT Martello per lamiera
ES Martillo de hojalatero
CN 胡桃木柄圆头锤



YATO	m [g]	L [mm]	A [mm]	H [mm]	
YT-4519	225	295	26	80	6/36
YT-4520	450	335	35	100	6/24
YT-4521	680	360	36	115	6/12
YT-4522	900	380	40	125	6/12

EN Dead blow mallet
 PL Młotek bezodrzutowy
 DE Rückschlagsfreier Schonhammer
 RU Молоток безинерционный
 CZ Palička nárazová plněná celogumová
 HU Visszarúgás mentes gumikalapács
 RO Ciocan cu absorbție
 FR Maillet sans recul
 IT Martello morto colpo
 ES Martillo sin reacción
 CN 尼龙安装锤

PU

WOODEN HANDLE
 DREHMANNA
 REKOVJESC



YATO	m [g]	L [mm]	Ø [mm]	H [mm]	
YT-4624	265	318	30	94	10/40
YT-4625	430	350	40	100	6/36
YT-4626	490	348	45	110	6/36

EN Dead blow mallet
 PL Młotek bezodrzutowy
 DE Rückschlagsfreier Schonhammer
 RU Молоток безинерционный
 CZ Palička nárazová plněná celogumová
 HU Visszarúgás mentes gumikalapács
 RO Ciocan cu absorbție
 FR Maillet sans recul
 IT Martello morto colpo
 ES Martillo sin reacción
 CN 防震无回弹橡胶锤

PU



YATO	m [g]	L [mm]	Ø [mm]	H [mm]	
YT-4620	740	300	44.5	100	4/24
YT-4622	900	336	53.5	100	4/24
YT-4623	1300	350	59	118.5	3/12

EN Aluminum hammer
 PL Młotek aluminiowy
 DE Aluminium-Hammer
 RU Алюминиевый молоток
 CZ Hliníkové kladivo
 HU Alumínium kalapács
 RO Ciocan aluminiu
 FR Marteau en aluminium
 IT Martello in alluminio
 ES Martillo de aluminio
 CN 铝锤

Al



YATO	m [g]	L [mm]	Ø [mm]	H [mm]	
YT-45280	150	280	30	80	6/36
YT-45281	300	300	40	98	6/36
YT-45282	580	320	50	105	6/24

EN Dead blow mallet
 PL Młotek bezodrzutowy
 DE Rückschlagsfreier Schonhammer
 RU Молоток безинерционный
 CZ Palička nárazová plněná celogumová
 HU Visszarúgás mentes gumikalapács
 RO Ciocan cu absorbție
 FR Maillet sans recul
 IT Martello morto colpo
 ES Martillo sin reacción
 CN 铜头无弹力锤



PVC

BRASS
 MOSIADZ



YATO	m [g]	L [mm]	Ø [mm]	H [mm]	
YT-46190	300	225	20	75	6/36
YT-46191	700	330	32	110	6/24

EN PU & nylon heads mallet
 PL Młotek blacharski
 DE Schonhammer mit PU & Nylon-Schlagkopf
 RU Молоток рихтовочный
 CZ Palička klempířská
 HU Vaskalapács
 RO Ciocan tinichigerie cap PU / nylon
 FR Marteau spécial en PU / nylon
 IT Martello per lamiera
 ES Martillo chapista
 CN 木柄安装锤

PU

NYLON



YATO	m [g]	L [mm]	Ø [mm]	H [mm]	
YT-4630	150	250	22	75	6/48
YT-4631	250	280	28	85	6/36
YT-4632	340	315	35	95	6/36
YT-4633	660	350	45	105	6/24
YT-4634	1340	380	60	132	4/16

EN Mounting hammer
 PL Młotek montażowy z wymiennymi końcówkami
 DE Montagehammer
 RU Установка молоток
 CZ Montážní kladivo
 HU Szerelő kalapács
 RO Montare ciocan
 FR Marteau de montage
 IT Martello di montaggio con punte intercambiabili
 ES Martillo de montaje
 CN 铝合金多用安装锤

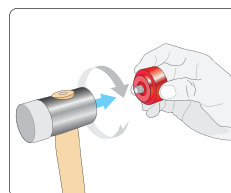

		HRC: 65 +/-5
		HRC: 72 +/-5
		HRC: 73 +/-5
		HRC: 80 +/-5
		HRC: 95 +/-5

8
 PCS

Al



YATO	
YT-45905	8

EN Welding workbench
PL Stolik spawalniczy składany
DE Schweißstisch zusammenklappbar
RU Складной сварочный стол
CZ Svářečský stůlk skládaný
HU Összecsukható hegesztőasztal
RO Banc de lucru pt. sudura
FR Table de soudage pliante
IT Banco per saldatura pieghevole
ES Mesa de soldadura plegable
CN 焊接工作台



66x59
x83
cm

max
150 kg

YATO	Dimensions / Wymiary [mm]	
YT-08950	660x590x830	1

EN Sliding arm welding locking pliers
PL Szybkonastawne szczypce spawalnicze
DE Parallel-gripzange
RU Образная струбина с захватом
CZ Paralelné samosvorné kleště
HU Szorítóúdas önzáró fogó
RO Clește de mana cu prindere tip menghina
FR Pince-étou - serre-joint coulissant
IT Pinze regolabili autobloccanti
ES Pinzas de presión tipo sargento
CN 大力钳

260 mm

0-150 mm

QUICK
ADJUSTMENT
SZYBKĄ
REGULACJĄ



YATO	L [mm]	
YT-21570	260	2/16

EN Welding locking pliers
PL Szczypce zaciskowe spawalnicze
DE Klemmzange zum Schweißen
RU Клещи давяльные сварочные
CZ Kleště samosvorné svářečské
HU Hegesztő fogó

RO Clește de strângere pt. sudură
FR Pinces de serrage pour soudeur
IT Pinze di bloccaggio per saldatura
ES Pinzas de tornillo (de apriete) para soldar
CN 焊接用大力钳

225 mm

0-85 mm

70 mm

U
TYPE



YATO	L [mm]	
YT-2461	225	6/24

EN Flat locking pliers
PL Szczypce zaciskowe o szerokich szczękach
DE Klemmzange mit breiten Backen
RU Клещи давяльные с широкими губками
CZ Kleště samosvorné se širokými čelistmi
HU Lapos fogó

RO Clește de strângere plat / patent
FR Pince de serrage large
IT Pinze con ganasce piane e palette
ES Pinzas de tornillo (de apriete) con mordazas anchas
CN 铁皮大力钳

200 mm

0-50 mm

75 mm



YATO	L [mm]	
YT-2463	200	6/24

EN C-type welding locking pliers
PL Szczypce zaciskowe klamrowe typu „C”
DE Klemm- und Klammerzange vom Typ „C”
RU Клещи давяльные типа „С”

CZ Kleště samosvorné upínací typu „C”
HU „C” fogó
RO Clește de strângere cu clemă tip „C”
FR Pince de serrage type „C”

IT Pinze di bloccaggio tipo „C”
ES Pinzas de tornillo (de apriete) de grapa tipo „C”
CN C型大力钳

280 mm

C
TYPE



0-100 mm

0-80 mm

YATO	L [mm]	
YT-2466	280	6/24

YATO	L [mm]	
YT-2468	280	6/24

EN Chain locking pliers
 PL Szczypce zaciskowe z łańcuchem
 DE Klemmzange mit Kette
 RU Клеши давяльные с цепью
 CZ Kleště samosvorné s řetězem
 HU Láncos csőfogó

RO Clește de strângere cu lanț
 FR Pince de serrage avec une chaîne
 IT Pinze di bloccaggio con la catena
 ES Pinzas de tornillo (de apriete) con cadena
 CN 链条大力钳



YATO	L [mm]	
YT-2469	250	6/24

EN Punch kit
 PL Ręczny dziurkacz do blach
 DE Handlochstanze für Blech
 RU Ручной перфоратор для листового металла
 CZ Ruční děrovač plechů
 HU Kézi fémlemez lyukasztó
 RO Set cleste perforat
 FR Perforateur à main pour tôle
 IT Punzonatrice manuale per lamiera
 ES Perforadora manual para chapas
 CN 打孔钳



Ø 2, 3, 4, 4.5, 5.5, 6, 7 mm

YATO		
YT-18973		12

EN Stud crimper
 PL Szczypce do łączenia profili
 DE Profil Verbundzange
 RU Клеши для соединения профилей
 CZ Kleště do spojování profilů
 HU Profilösszekötő fogó

RO Cleste sertizat profile rigips
 FR Pince pour assembler des profilés
 IT Alicata para perfis
 ES Alicates para unir perfiles
 CN 新款长柄龙骨钳



YATO	L [mm]	
YT-51311	280	6/24

EN Profile forming pliers
 PL Szczypce do kształtowania profili
 DE Zange zur Formgebung der Profile
 RU Щипцы для формовки профилей

CZ Kleště k tvarování profilů
 HU Profilformázó fogó
 RO Cleste pt. modelarea profilelor
 FR Pince pour former les profiles

IT Pinze per la formazione di profili
 ES Pinzas para formar perfiles
 CN 龙骨钳



YATO	L [mm]	
YT-5140	210	2/12
YATO	L [mm]	
YT-5141	210	2/12
YATO	L [mm]	
YT-5142	210	2/12

EN Profile connection pliers
 PL Szczypce do łączenia profili
 DE Zange zum Verbinden der Profile
 RU Щипцы для соединения профилей
 HU Profillegyesítő fogó

RO Cleste pt. imbinarea profilelor
 FR Pince pour sertir les profiles
 IT Pinze per la unione profili
 ES Pinzas para conectar perfiles
 CN 龙骨钳

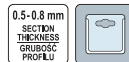

YATO	L [mm]	
YT-5130	275	6/24

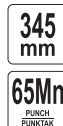

YATO	L [mm]	
YT-5131	345	6/24



YATO	L [mm]	
YT-51312	260	6/24

EN Stud crimper
 PL Szczypce do łączenia profili
 DE Profil Verbundzange
 RU Клеши для соединения профилей
 CZ Kleště do spojování profilů
 HU Profilösszekötő fogó

RO Cleste sertizat profile rigips
 FR Pince pour assembler des profilés
 IT Alicata para perfis
 ES Alicates para unir perfiles
 CN 新款长柄龙骨钳



YATO	L [mm]	
YT-51303	320	6/24

EN Profile forming pliers
 PL Szczypce do kształtowania profili
 DE Zange zur Formgebung der Profile
 RU Щипцы для формовки профилей

CZ Kleště k tvarování profilů
 HU Profilformázó fogó
 RO Cleste pt. modelarea profilelor
 FR Pince pour former les profiles

IT Pinze per la formazione di profili
 ES Pinzas para formar perfiles
 CN 龙骨钳



YATO	L [mm]	
YT-5140	210	2/12
YATO	L [mm]	
YT-5141	210	2/12
YATO	L [mm]	
YT-5142	210	2/12

EN Punch pliers
PL Szczypce do dziurkowania blach
DE Blech Lochzange
RU Прокататель круглых отверстий
CZ Děrovací kleště
HU Fogó peremező lyukasztó

RO Cleste pt. perforat
FR Trou pincés feuilles
IT Pinza per forare lamiera
ES Punzonadora una mano perfiles
CN 打孔钳



YATO	L [mm]	
YT-51320	240	5/30

EN Spot weld cutter & drill bit set
PL Zestaw rozwiertaków do zgrzewów punktowych
DE Schweißpunktbohrer Set Schweißpunktfräser
RU Набор для высверливания точечной сварки
CZ Sada na odvrtání bodových svárů
HU Hegesztőpont maró készlet
RO Set de freze pt. suduri în puncte
FR Jeu de fraises pour points de soudage
IT Set di alesatori per punti di saldatura
ES Juego de puntos de soldadura de la fresa
CN 电焊钻

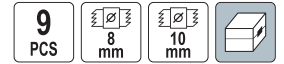

YATO		
YT-28919		10/60

EN Spot weld cutter & drill bit set
PL Zestaw rozwiertaków do zgrzewów punktowych
DE Schweißpunktbohrer Set Schweißpunktfräser
RU Набор для высверливания точечной сварки
CZ Sada na odvrtání bodových svárů
HU Hegesztőpont maró készlet
RO Set de freze pt. suduri în puncte
FR Jeu de fraises pour points de soudage
IT Set di alesatori per punti di saldatura
ES Juego de puntos de soldadura de la fresa
CN 电焊钻

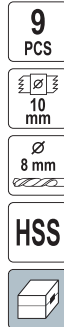

YATO		
YT-28920		10/60

EN Drill welding points set
PL Zestaw wiertel do zgrzewów punktowych
DE Schweißpunkt-Fräsesatz
RU Набор сверл для точечной сварки
CZ Frézy pro bodové sváry
HU Pont hegesztés lefűró készlet
RO Set burghiu puncte sudura
FR Forets à dépointer les points soudure
IT Set di alesatori per punti di saldatura
ES Juego de brocas para puntos de soldadura
CN 电焊钻



YATO	Ø [mm]	
YT-28921	6.5, 8, 10	50

EN Combination edge setter / hole punch pliers
PL Dziurkarko-felcarka
DE Kombinierte Absetzlange Lochzange
RU Дырокол, кромкогиб
CZ Falcovačka a děrovačka
HU Lyukasztó peremező fogó

RO Cleste pt. fasonat si gaurit tabla
FR Pince spéciale perforatrice carrosserie
IT Combinazione: bordo setter / pinza perforare
ES Solapadora y ponchadora manual
CN 折边打孔钳

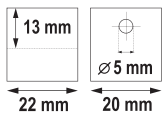

YATO		
YT-21582		10

EN Adjustable angle welding magnet
PL Wspornik magnetyczny spawalniczy regulowany
DE Verstellbarer Magnet-Werkstückhalter
RU Регулируемый магнит заварки угла
CZ Polohovací magnetický držák ke svařování
HU Állítható, mágneses, hegesztő támasz

RO Dispozitiv magnetic reglabil pt. sudura
FR Support magnétique de soudure
IT Supporto della saldatura magnetico
ES Soporte magnético de soldadura, ajustable
CN 焊接磁铁



360°



YATO	Lifting capacity / Udźwig [kg]	Dimensions / Wymiary [mm]	
YT-0862	2x22.5	85x65x22	6

EN Magnetic welding holder
PL Kątownik magnetyczny spawalniczy
DE Magnet-Werkstückhalter
RU Магнитная струбцина заварки
CZ Magnetický uhelník ke svařování
HU Mágneses, hegesztő szögvas
RO Dispozitiv magnetic fixare pt. sudura
FR Support magnétique de soudure
IT Angolo magnetico da saldatura
ES Escuadra magnética de soldadura
CN 焊接磁铁

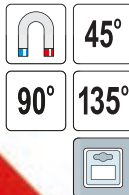

YATO	Lifting capacity / Udźwig [kg]	Dimensions / Wymiary [mm]	
YT-0863	11.5	82x120x13	6/48

EN Magnetic welding holder
PL Kątownik magnetyczny spawalniczy
DE Magnet-Werkstückhalter
RU Магнитная струбцина заварки
CZ Magnetický uhelník ke svařování
HU Mágneses, hegesztő szögvas
RO Dispozitiv magnetic fixare pt. sudura
FR Support magnétique de soudure
IT Angolo magnetico da saldatura
ES Escuadra magnética de soldadura
CN 焊接磁铁

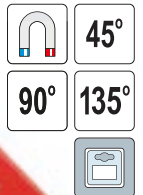

YATO	Lifting capacity / Udźwig [kg]	Hole diameter / Średnica otworu [mm]	Dimensions / Wymiary [mm]	
YT-0864	22.5	18	102x155x17	6/30
YT-0865	34	46	122x190x25	6/18

EN Magnetic welding holder
 PL Kątownik magnetyczny spawalniczy
 DE Magnet-Werkstückhalter
 RU Магнитная струбцина заварки
 CZ Magnetický úhelník ke svařování
 HU Mágneses hegesztő szögvas
 RO Dispozitiv magnetic fixare pt. sudura
 FR Support magnétique de soudure
 IT Triangolo magnetico da saldatura con interruttore
 ES Escuadra magnética de soldadura
 CN 焊接磁铁

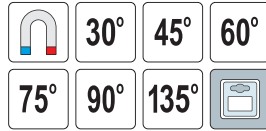

YATO	Lifting capacity / Udźwig [kg]	Dimensions / Wymiary [mm]	
YT-0866	11.5	64x95x14	6/24
YT-0867	34	111x136x24	6/18

EN Welding magnet holder set
 PL Zestaw spawalniczych kątowników magnetycznych
 DE Magnetschweißwinkel-Set
 RU Набор сварочных магнитных угловых профилей
 CZ Sada svařovacích magnetických úhelníků
 HU Mágneses hegesztési derékszög készlet
 RO Set magneti pt. sudura
 FR Kit de cornières magnétiques de soudage
 IT Set di posizionatori magnetici per saldatura
 ES Juego de escuadras de soldadura magnéticas
 CN 磁性电焊架

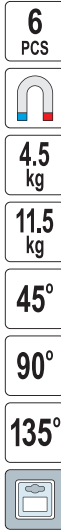

YATO	Lifting capacity / Udźwig [kg]	Dimensions / Wymiary [mm]	
YT-08678	4.5, 11.5	43x72x12, 82x118x14	6/18

EN Mini welding magnet holder set
 PL Zestaw spawalniczych kątowników magnetycznych mini
 DE Mini-Magnetschweißwinkel-Set
 RU Набор сварочных магнитных угловых профилей мини
 CZ Sada svařovacích magnetických úhelníků mini
 HU Mini mágneses hegesztési derékszög készlet
 RO Set minimagnetii pt. sudura
 FR Kit de cornières magnétiques de soudage mini
 IT Set di posizionatori magnetici mini per saldatura
 ES Juego de escuadras de soldadura magnéticas mini
 CN 迷你磁性电焊架



YATO	Lifting capacity / Udźwig [kg]	Dimensions / Wymiary [mm]	
YT-08677	4.5	43x72x12	12/36

EN Welding magnet holder set
 PL Zestaw spawalniczych kątowników magnetycznych
 DE Magnetschweißwinkel-Set
 RU Набор сварочных магнитных угловых профилей
 CZ Sada svařovacích magnetických úhelníků
 HU Mágneses hegesztési derékszög készlet
 RO Set magneti pt. sudura
 FR Kit de cornières magnétiques de soudage
 IT Set di posizionatori magnetici per saldatura
 ES Juego de escuadras de soldadura magnéticas
 CN 焊接定位器套装

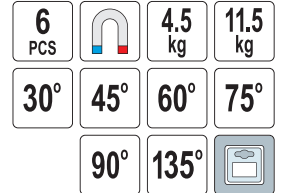

YATO	Lifting capacity / Udźwig [kg]	Dimensions / Wymiary [mm]	
YT-08679	4.5, 11.5	43x72x12, 68x102x14, 82x118x14	10

EN Magnetic welding holder set
 PL Zestaw magnetycznych uchwytów spawalniczych
 DE Magnetschweißhalter-Set
 RU Комплект магнитных сварочных ручек
 CZ Sada magnetických svařovacích úchytů
 HU Mágneses hegesztő tartó készlet
 RO Set suporti magnetici sudura
 FR Kit positionneur magnétique de soudure
 IT Kit di pinze magnetiche per saldatura
 ES Set de portaelectrodos magnéticos
 CN 焊接磁铁

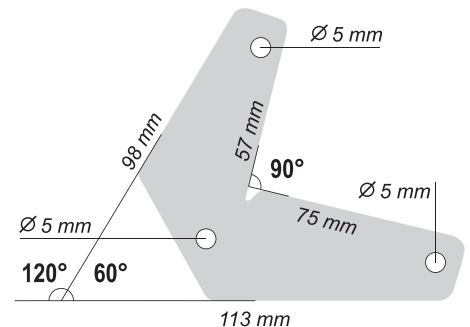

YATO	Lifting capacity / Udźwig [kg]	Size / Rozmiar [mm]	
YT-08721	10	98x113	6/24

EN Magnetic welding holder set
PL Zestaw magnetycznych uchwytów spawalniczych
DE Magnetschweißhalter-Set
RU Комплект магнитных сварочных ручек
CZ Sada magnetických svařovacích úchytů
HU Mágneses hegesztő tartó készlet
RO Set suportri magnetici sudura
FR Kit positionneur magnétique de soudure
IT Kit di pinze magnetiche per saldatura
ES Set de portaelectrodos magnéticos
CN 焊接磁铁

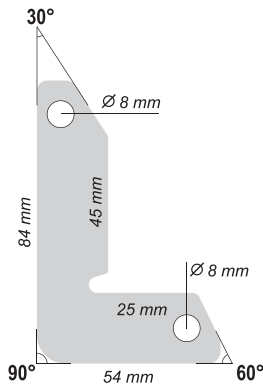
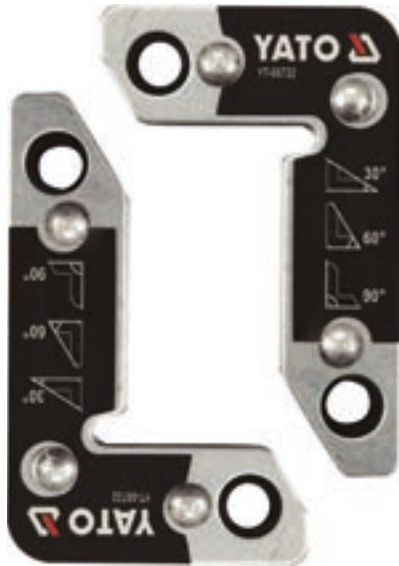
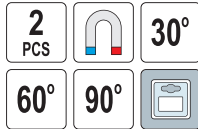

YATO	Lifting capacity / Udźwig [kg]	Size / Rozmiar [mm]	
YT-08722	25	54x84	10/40

EN Magnetic welding holder set
PL Zestaw magnetycznych uchwytów spawalniczych
DE Magnetschweißhalter-Set
RU Комплект магнитных сварочных ручек
CZ Sada magnetických svařovacích úchytů
HU Mágneses hegesztő tartó készlet
RO Set suportri magnetici sudura
FR Kit positionneur magnétique de soudure
IT Kit di pinze magnetiche per saldatura
ES Set de portaelectrodos magnéticos
CN 焊接磁铁

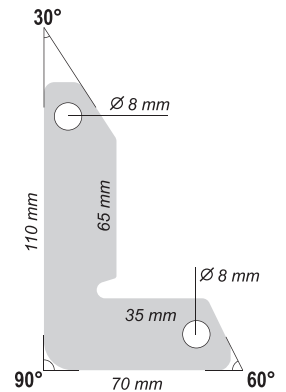
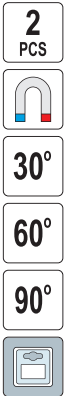

YATO	Lifting capacity / Udźwig [kg]	Size / Rozmiar [mm]	
YT-08723	32	70x110	8/32

EN Magnetic welding ground
PL Spawalniczy zacisk uziemiający
DE Schweißerdungsklemme
RU Сварочный зажим заземляющий
CZ Svařovací svorka zemnicí
HU Földelő csatlakozó hegesztőhöz
RO Suport sudura magnetic
FR Pince de masse pour soudure
IT Morsetti di terra per saldatura
ES Pinza de tierra para soldadura
CN 磁性焊接接地夹



YATO	
YT-08625	6/24

EN MIG torch magnetic holder
PL Podstawa magnetyczna do uchwytu MIG
DE Magnetsockel für MIG-Halter
RU Магнитная подставка для держателя MIG
CZ Magnetický podstavec k držáku MIG
HU Mágneses alátét MIG fogantyúhoz
RO Suport magnetic pt. lampa MIG
FR Base magnétique pour le support MIG
IT Supporto per pistola MIG con base magnetica
ES Base magnética para el soporte MIG
CN 焊枪支架



YATO	
YT-08710	12

EN TIG torch magnetic holder
PL Podstawa magnetyczna do uchwytu TIG
DE Magnetsockel für TIG-Halter
RU Магнитная подставка для держателя TIG
CZ Magnetický podstavec k držáku TIG
HU Mágneses alátét TIG fogantyúhoz
RO Suport magnetic pt. lampa TIG
FR Base magnétique pour le support TIG
IT Supporto per pistola TIG con base magnetica
ES Base magnética para el soporte TIG
CN 氩弧焊焊枪支架

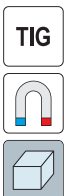

YATO	
YT-08711	12

EN Tin snips
 PL Nożyce do cięcia blachy
 DE Blechscherer
 RU Ножницы по металлу

CZ Nůžky na plech
 HU Lemezvágó olló
 RO Foarfece pt. tablă
 FR Cisaille à tôle

IT Cesiole per lamiera
 ES Tijeras para chapas
 CN 航空剪



DIN 6438 **HRC 60-62**

DIN 6438 **HRC 60-62**

YATO L [mm]	Cutting length / Długość cięcia [mm]	Cooper / Miedź [mm]	Cold rolled steel / Stal zimnowalcowana [mm]	Steel HRC35 / Stal HRC35 [mm]	SS 304 / Stal Nierdzewna 304 [mm]		
YT-1910	260	35	1.8	1.5	1.0	0.9	6/36

YATO L [mm]	Cutting length / Długość cięcia [mm]	Cooper / Miedź [mm]	Cold rolled steel / Stal zimnowalcowana [mm]	Steel HRC35 / Stal HRC35 [mm]	SS 304 / Stal Nierdzewna 304 [mm]		
YT-1915	235	30	1.5	1.2	1.0	0.7	6/36



DIN 6438 **HRC 60-62**

HRC 56-62 **HIGH FREQUENCY HARDENING HARTOWANIE IMPULSOWE** **SERRATED EDGES ZĄBKOWANE KRAWĘDZIE**

YATO L [mm]	Cutting length / Długość cięcia [mm]	Cooper / Miedź [mm]	Cold rolled steel / Stal zimnowalcowana [mm]	Steel HRC35 / Stal HRC35 [mm]	SS 304 / Stal Nierdzewna 304 [mm]		
YT-1918	260	32	1.8	1.5	1.0	0.9	6/36

YATO L [mm]	Cutting length / Długość cięcia [mm]	Cooper / Miedź [mm]	Cold rolled steel / Stal zimnowalcowana [mm]	Steel HRC35 / Stal HRC35 [mm]	SS 304 / Stal Nierdzewna 304 [mm]		
YT-1960	250	40	2.0	1.5	1.0	0.8	6/36

EN Tin snips
 PL Nożyce do cięcia blachy
 DE Blechscherer

RU Ножницы по металлу
 CZ Nůžky na plech
 HU Lemezvágó olló

RO Foarfece pt. tablă
 FR Cisaille à tôle
 IT Cesiole per lamiera

ES Tijeras para chapas
 CN 台式航空剪



YATO L [mm]	Cutting length / Długość cięcia [mm]	Cooper / Miedź [mm]	Cold rolled steel / Stal zimnowalcowana [mm]	Steel HRC35 / Stal HRC35 [mm]	SS 304 / Stal Nierdzewna 304 [mm]		
YT-1913	225	30	0.78	0.53	0.46	0.36	6/36

EN Tin snips
 PL Nożyce do cięcia blachy
 DE Blechscherer
 RU Ножницы по металлу

CZ Nůžky na plech
 HU Lemezvágó olló
 RO Foarfece pt. tablă
 FR Cisaille à tôle

IT Cesiole per lamiera
 ES Tijeras para chapas
 CN 航空剪



DIN 6438 **HRC 60-62**

YATO L [mm]	Cutting length / Długość cięcia [mm]	Cooper / Miedź [mm]	Cold rolled steel / Stal zimnowalcowana [mm]	Steel HRC35 / Stal HRC35 [mm]	SS 304 / Stal Nierdzewna 304 [mm]		
YT-1912	260	35	1.8	1.5	1.0	0.9	6/36



DIN 6438 **HRC 60-62**

HRC 56-62 **SERRATED EDGES ZĄBKOWANE KRAWĘDZIE** **HIGH FREQUENCY HARDENING HARTOWANIE IMPULSOWE**

YATO L [mm]	Cutting length / Długość cięcia [mm]	Cooper / Miedź [mm]	Cold rolled steel / Stal zimnowalcowana [mm]	Steel HRC35 / Stal HRC35 [mm]	SS 304 / Stal Nierdzewna 304 [mm]		
YT-1922	290	75	1.1	0.94	0.7	0.53	6/36

YATO L [mm]	Cutting length / Długość cięcia [mm]	Cooper / Miedź [mm]	Cold rolled steel / Stal zimnowalcowana [mm]	Steel HRC35 / Stal HRC35 [mm]	SS 304 / Stal Nierdzewna 304 [mm]		
YT-1962	250	45	2.0	1.5	1.0	0.8	6/36

EN Tin snips
PL Nożyce do cięcia blachy
DE Blechscherer
RU Ножницы по металлу

CZ Nůžky na plech
HU Lemezvágó olló
RO Foarfece pt. tablă
FR Cisaille à tôle

IT Cesioie per lamiera
ES Tijeras para chapas
CN 航空剪



CrMo

INCREASED CUTTING POWER
ZWIĘKSZONA SIŁA CIĘCIA



DIN 6438 HRC 60-62

YATO L [mm]	Cutting length / Długość cięcia [mm]	Cooper / Miedź [mm]	Cold rolled steel / Stal zimnowalcowana [mm]	Steel HRC35 / Stal HRC35 [mm]	SS 304 / Stal Nierdzewna 304 [mm]		
YT-1911	260	35	1.8	1.5	1.0	0.9	6/36



DIN 6438 HRC 60-62

YATO L [mm]	Cutting length / Długość cięcia [mm]	Cooper / Miedź [mm]	Cold rolled steel / Stal zimnowalcowana [mm]	Steel HRC35 / Stal HRC35 [mm]	SS 304 / Stal Nierdzewna 304 [mm]		
YT-1916	235	30	1.5	1.2	1.0	0.7	6/36



DIN 6438 HRC 60-62

YATO L [mm]	Cutting length / Długość cięcia [mm]	Cooper / Miedź [mm]	Cold rolled steel / Stal zimnowalcowana [mm]	Steel HRC35 / Stal HRC35 [mm]	SS 304 / Stal Nierdzewna 304 [mm]		
YT-1919	260	32	1.8	1.5	1.0	0.9	6/36



HRC 56-62

SERRATED EDGES
ZĄBKOWANE KRAWĘDZIE

HIGH FREQUENCY HARDENING
HARTOWANE IMPULSOWE

YATO L [mm]	Cutting length / Długość cięcia [mm]	Cooper / Miedź [mm]	Cold rolled steel / Stal zimnowalcowana [mm]	Steel HRC35 / Stal HRC35 [mm]	SS 304 / Stal Nierdzewna 304 [mm]		
YT-1961	250	40	2.0	1.5	1.0	0.8	6/36

EN Tin snips
PL Nożyce do cięcia blachy
DE Blechscherer
RU Ножницы по металлу
CZ Nůžky na plech
HU Lemezvágó olló
RO Foarfece pt. tablă
FR Cisaille à tôle
IT Cesioie per lamiera
ES Tijeras para chapas
CN 台式航空剪



90°

HRC 60-62

CrMo

SERRATED EDGES
ZĄBKOWANE KRAWĘDZIE

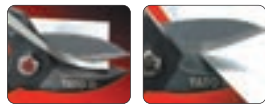

EN Tin snips
PL Nożyce do cięcia blachy
DE Blechscherer
RU Ножницы по металлу
CZ Nůžky na plech
HU Lemezvágó olló

RO Foarfece pt. tablă
FR Cisaille à tôle
IT Cesioie per lamiera
ES Tijeras para chapas
CN 航空剪



HRC 58-61

DROP FORGED KUTE



YATO L [mm]	Cutting length / Długość cięcia [mm]	Cooper / Miedź [mm]	Cold rolled steel / Stal zimnowalcowana [mm]	Steel HRC35 / Stal HRC35 [mm]	SS 304 / Stal Nierdzewna 304 [mm]		
YT-1914	225	30	0.78	0.53	0.46	0.36	6/36



YATO L [mm]	Cutting length / Długość cięcia [mm]	Cooper / Miedź [mm]	Cold rolled steel / Stal zimnowalcowana [mm]	Steel HRC35 / Stal HRC35 [mm]	SS 304 / Stal Nierdzewna 304 [mm]		
YT-1900	260	30	0.94	0.78	0.6	0.45	6/24

EN Tin snips
PL Nożyce do cięcia blachy
DE Blechscherer
RU Ножницы по металлу

CZ Nůžky na plech
HU Lemezvágó olló
RO Foarfece pt. tablă
FR Cisaille à tôle

IT Cesioie per lamiera
ES Tijeras para chapas
CN 航空剪



HRC 58-61

DROP FORGED KUTE



YATO L [mm]	Cutting length / Długość cięcia [mm]	Cooper / Miedź [mm]	Cold rolled steel / Stal zimnowalcowana [mm]	Steel HRC35 / Stal HRC35 [mm]	SS 304 / Stal Nierdzewna 304 [mm]		
YT-1901	260	30	0.94	0.78	0.6	0.45	6/24



YATO L [mm]	Cutting length / Długość cięcia [mm]	Cooper / Miedź [mm]	Cold rolled steel / Stal zimnowalcowana [mm]	Steel HRC35 / Stal HRC35 [mm]	SS 304 / Stal Nierdzewna 304 [mm]		
YT-1902	300	50	0.94	0.78	0.6	0.45	6/24

EN Tin snips
 PL Nożyce do cięcia blachy
 DE Blechscherer
 RU Ножницы по металлу
 CZ Nůžky na plech
 HU Lemezvágó olló
 RO Foarfece pt. tablă
 FR Cisaille à tôle
 IT Cesiole per lamiera
 ES Tijeras para chapas
 CN 铁皮剪



HRC 58-61
 DROP FORGED KUTE

HRC 58-60

YATO L [mm]	Cutting length / Długość cięcia [mm]	Cooper / Miedz [mm]	Cold rolled steel / Stal zimnowalcowana [mm]	Steel HRC35 / Stal HRC35 [mm]	SS 304 / Stal Nierdzewna 304 [mm]	
YT-1925	225	52	0.94	0.78	0.6	0.45 6/36

YATO L [mm]	Cutting length / Długość cięcia [mm]	Cooper / Miedz [mm]	Cold rolled steel / Stal zimnowalcowana [mm]	Steel HRC35 / Stal HRC35 [mm]	SS 304 / Stal Nierdzewna 304 [mm]	
YT-1920	260	42	1.2	1.0	0.6	0.5 6/36

EN Tin snips
 PL Nożyce do cięcia blachy
 DE Blechscherer
 RU Ножницы по металлу
 CZ Nůžky na plech
 HU Lemezvágó olló
 RO Foarfece pt. tablă
 FR Cisaille à tôle
 IT Cesiole per lamiera
 ES Tijeras para chapas
 CN 铁皮剪

HRC 55-60

S55C

HIGH FREQUENCY HARDENING HARTOWANIE IMPULSOWE



YATO L [mm]	Cutting length / Długość cięcia [mm]	Cooper / Miedz [mm]	Cold rolled steel / Stal zimnowalcowana [mm]	Steel HRC35 / Stal HRC35 [mm]	SS 304 / Stal Nierdzewna 304 [mm]	
YT-1963	200	40	1.5	1.0	0.6	0.6 6/36
YT-1964	250	60	1.8	1.2	0.8	0.8 6/24
YT-1965	300	75	2.0	1.4	0.8	0.8 6/12

EN Tin snips
 PL Nożyce do cięcia blachy
 DE Blechscherer
 RU Ножницы по металлу
 CZ Nůžky na plech
 HU Lemezvágó olló
 RO Foarfece pt. tablă
 FR Cisaille à tôle
 IT Cesiole per lamiera
 ES Tijeras para chapas
 CN 铁皮剪

HRC 55-60

S55C

HIGH FREQUENCY HARDENING HARTOWANIE IMPULSOWE



YATO L [mm]	Cutting length / Długość cięcia [mm]	Cooper / Miedz [mm]	Cold rolled steel / Stal zimnowalcowana [mm]	Steel HRC35 / Stal HRC35 [mm]	SS 304 / Stal Nierdzewna 304 [mm]	
YT-1970	260	42	2.0	1.4	1.0	1.0 6/36

EN Spare blades for metal sheet nibbler
 PL Ostrza zapasowe do nożyc matrycowych
 DE Abbrechklingen für Blechnibbler
 RU Лезвия для ножиц для резки жести
 CZ Ostrí náhradní
 HU Tartalékpenge
 RO Lame de rezervă
 FR Lame sécables pour grignoteuse a tole
 IT Lame di ricambio per cesoia roditrice per lamiera
 ES Cuchillas de recambio
 CN 法式剪备用刀片



For YT-19260
 Dla YT-19260

EN Tin snips
 PL Nożyce do cięcia blachy
 DE Blechscherer
 RU Ножницы по металлу
 CZ Nůžky na plech
 HU Lemezvágó olló
 RO Foarfece pt. tablă
 FR Cisaille à tôle
 IT Cesiole per lamiera
 ES Tijeras para chapas
 CN 铁皮剪

HRC 58-61



YATO L [mm]	Cutting length / Długość cięcia [mm]	Cooper / Miedz [mm]	Cold rolled steel / Stal zimnowalcowana [mm]	Steel HRC35 / Stal HRC35 [mm]	SS 304 / Stal Nierdzewna 304 [mm]	
YT-1924	254	52	0.94	0.78	0.6	0.45 6/36

EN Metal sheet nibbler
 PL Nożyce matrycowe do blachy
 DE Blechnibbler
 RU Ножницы для резки жести
 CZ Nůžky na plech
 HU Lemezvágó olló
 RO Foarfece pt. tablă
 FR Grignoteuse a tole
 IT Cesioia roditrice per lamiera
 ES Tijeras para chapas
 CN 法式剪

260 mm

max 1.0 mm
 PLATE BLACHA

max 1.2 mm
 AL

max 2.0 mm
 PLASTIC

3.0 mm

65Mn

CHANGEABLE BLADES WYMIENNE OSTRZA



YATO	L [mm]	
YT-19260	260	6/36

3 PCS

65Mn



YATO	
YT-19261	10/100

- EN Steel strap cutter
PL Nożyce do cięcia taśmy stalowej
DE Stahlgurtblechscherer
RU Ножницы для резки стальной ленты
CZ Nůžky na plech
HU Lemezvágó olló
- RO Foarfece pt. tablă
FR Cisaille à bande acier
IT Cesoia per taglio reggetta in acciaio
ES Tijeras para bandejas de acero
CN 钢带剪

HRC
58-61

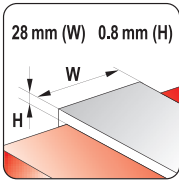
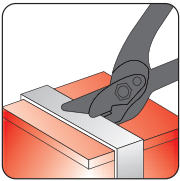

YATO	L [mm]	Cutting length / Długość cięcia [mm]	Steel HRC35 / Stal HRC35 [mm]	SS 304 / Stal Nierdzewna 304 [mm]	
YT-1930	305	28	0.8	0.6	6/24

- EN Hand notchers
PL Nożyce dekarские do nacinania blach
DE Kerbzange
RU Ножницы v-образные
CZ Nůžky na plech vystřihování rohů
HU Lemezvágó olló
RO Foarfece tabla taiere colturi
FR Ciseaux à tôle
IT Cesoia per lamiera
ES Cizallas para techos
CN 缺口钳

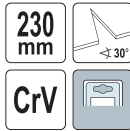

- EN Snap lock punch
PL Zaciskacz punktowy
DE Schnappverschluss-Lochtreiber
RU Плоскогубцы для кровельщиков
CZ Střešní kleště
HU Tetőfedő fogó
RO Clește pt. despicat
FR Pincés pour couvreurs
IT Pinza a cernipare
ES Punzón de cerradura de resorte
CN 记号钳



YATO	L [mm]	
YT-18970	230	6/36



YATO	L [mm]	
YT-18977	230	6/36

- EN Shears for cutting sheet metal
PL Nożyce krawkowe do cięcia blach
DE Rollenblechscherer
RU Дисковые ножницы для резки листового металла
CZ Kotoučové nůžky na střihání plechu
HU Karos lemezvágó olló
RO Dispozitiv taiat foi de tabla
FR Cisaille à tôle à molette
IT Cesoia rotante per lamiera
ES Cortador rotativo para chapa
CN 手动钢板剪



YATO	L [mm]	Cold rolled steel / Stal zimnowalcowana [mm]	Stainless steel / Stal nierdzewna [mm]	Aluminium [mm]	
YT-18950	120	1.6	1.2	2.0	1

- EN Straight pliers
PL Kleszcze do gięcia blach
DE Zange zum Blechbiegen
- RU Клеши с тупым ножом для жести
CZ Kleště na ohybání plechu
HU Falcfogó
- RO Clește pt. indoirea tablei
FR Pince à fléchir la tôle
IT Taglie per la lamiera
- ES Tenazas para doblar hojalata
CN 钣金钳

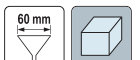

45°

YATO	L [mm]	
YT-5416	280	10/20



90°

YATO	L [mm]	
YT-5417	260	10/20



180°

YATO	L [mm]	
YT-5415	280	10/20

18

**Power & gasoline tools
Elektronarzędzia
i narzędzia spalinowe**



Cordless tools
Narzędzia akumulatorowe

545-566 

Concrete vibrator sets
Wibratory do betonu

574 

Gasoline construction tools
Budowlane narzędzia spalinowe

567 

Paint & mortar mixers
Mieszarki do zapraw i farb

575 

Impact wrenches
Klucze udarowe

567 

Circular saws & accessories
Pilarki tarczowe i akcesoria

575 

Straight grinders
Szlifierki proste

567 

Miter saws
Ukośnice

576-577 

Angle grinders & accessories
Szlifierki kątowe i akcesoria

568-570 

Bench tools
Elektronarzędzia stołowe

577 

Wall chasers
Bruzdownice

570 

Jig saws
Wyrzynarki

577 

Concrete cutters
Przecinarki do betonu

570 

Planers
Strugi

578 

Tile cutters
Przecinarki do ceramiki

571 

Routers
Frezarki

578 

Car polishers
Polerki samochodowe

571 

Belt sanders
Szlifierki taśmowe

578 

Cut-off machines
Przecinarki do metalu

571 

Sabre saws
Piły szablaste

578 

Drilling machines
Wiertarki

571-572 

Orbital sanders
Szlifierki mimośrodowe

579 

Drywall screwdrivers
Wkrętarki do regipsów

572 

Finishing sanders
Szlifierki oscylacyjne

579 

Diamond drills
Wiertnice diamentowe

573 

Burnishing machines
Satyniarki

579 

Rotary hammers
Młotowiertarki

573-574 

Drywall sanders
Szlifierki do gładzi i tynków

579-580 

Demolition hammers
Młoty wyburzeniowe

574 

Painting tools & accessories
Narzędzia do malowania i akcesoria

580-581 





Multi-purpose oscillating tools Wielofunkcyjne narzędzia oscylacyjne	
582	

Vacuum cleaners & accessories Odkurzacze i akcesoria	
582-584	

Wallpaper strippers Parownice do tapet	
584	

Knives Noże	
584	

Hot air guns Opalarki	
585-586	

Blowers Dmuchawy	
586	

Burners & soldering tools Palniki i lutownice	
587-591	

Glue guns Pistolety do klejenia	
591	

Pipe welders Zgrzewarki do rur	
591	

Generators Generatory	
592	

Pumps & accessories Pompy i akcesoria	
592-595	

Pressure washers Myjki ciśnieniowe	
595	

Cordless garden tools & accessories Ogrodowe narzędzia akumulatorowe i akcesoria	
595-599	

Cordless pressure washers Akumulatorowe myjki ciśnieniowe	595
Cordless blowers Dmuchawy akumulatorowe	595
Cordless sprayers Spryskiwacze akumulatorowe	596
Cordless grass trimmers & accessories Akumulatorowe wykasarki i akcesoria	596
Cordless hedge trimmers Akumulatorowe nożyce do żywopłotu	597
Cordless chainsaws Akumulatorowe pilarki łańcuchowe	598
Cordless lawn mowers Kosiarki akumulatorowe	599
Accessories Akcesoria	599

Electric garden tools Ogrodowe narzędzia elektryczne	
599-601	

Electric grass trimmers Wykasarki elektryczne	599
Electric chainsaws Pilarki elektryczne	600
Electric lawn mowers Kosiarki elektryczne	600
Electric tillers Gleboğrafarki elektryczne	600
Electric scarifiers Wertykulatory elektryczne	601
Electric blowers Dmuchawy elektryczne	601
Accessories Akcesoria	601

Gasoline garden tools & accessories Ogrodowe narzędzia spalinowe i akcesoria	
601-610	

Gasoline sprayers Opryskiwacze spalinowe	601
Gasoline earth augers & accessories Wiertnice glebowe i akcesoria	601
Gasoline chainsaws Pilarki spalinowe	602
Gasoline brushcutters Kosy spalinowe	602
Gasoline tillers Gleboğrafarki spalinowe	602
Accessories Akcesoria	603

Electric hoists Elektryczne wciągarki linowe	
610	

EN Cordless precision screwdriver set
PL Precyzyjny wkrętak akumulatorowy z bitami
DE Präzisions-Akkuschrauber mit Bits
RU Прецизионная аккумуляторная отвертка с битами
CZ Přesný aku šroubovák s bity
HU Precíz akkumulátoros csavarozó bifejekkel
RO Set surubelnite electronica
FR Tournevis sans-fil de précision avec embouts
IT Cacciavite a batteria di precisione con punte
ES Atornillador de batería preciso con bits
CN 电动钟表批组套

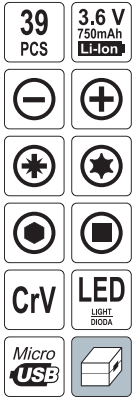

- 2.5, 3.0, 3.5, 4.0, 4.5 mm (L=28 mm); CrV;
- 1.2, 1.6, 2.0, 2.4, 3.0 mm (L=28 mm); CrV;
- PH000, PH00, PH0, PH1 x2 (L=28 mm); CrV;
- PZ0 x2, PZ1 x2 (L=28 mm); CrV;
- T4, T5, T6, T7, T8, T9, T10 (L=28 mm); CrV;
- 1.5, 2.0, 2.5, 3.0, 4.0 mm (L=28 mm); CrV;
- S0, S1, S2, S3 (L=28 mm); CrV;
- 60 mm; CrV;
- 120 mm; CrV

$L_{PA} = 45.6 \pm 3.0$ dB; $L_{WA} = 56.6 \pm 3.0$ dB; $a_n = 0.21 \pm 1.5$ m/s²

YATO	[V d.c.]	
YT-27930	3.6	8

EN Cordless drill/driver
PL Akumulatorowa wiertarko-wkrętarka
DE Akku-Bohrschrauber
RU Аккумуляторная дрель-шуруповерт
CZ Akumulátorový vrtací šroubovák
HU Akkus fúró-csavarozó
RO Mașină de găurit și înșurubat cu acumulator
FR Perceuse-visseuse sans-fil
IT Trapano avvitatore a batteria
ES Taladro atornillador a batería
CN 充电式电钻

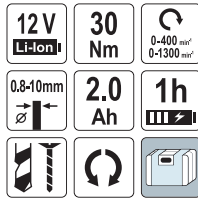

EN Cordless angle grinder
PL Akumulatorowa szlifierka kątowna
DE Akku-Winkelschleifer
RU Аккумуляторная угловая шлифмашина
CZ Akumulátorová úhlová bruska
HU Akkus sarokcsiszoló
RO Polizor unghiular cu acumulator
FR Meuleuse angulaire sans-fil
IT Smerigliatrice angolare a batteria
ES Amoladora angular a batería
CN 充电式角磨

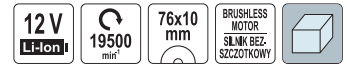

$L_{PA} = 71.50 \pm 5.0$ dB; $L_{WA} = 82.50 \pm 5.0$ dB; $a_n = 2.70 \pm 1.5$ m/s²

YATO	[V d.c.]	
YT-82901	12	5



- Spindle lock for easy blade change
- Blokada wrzeciona dla łatwej wymiany tarczy

$L_{PA} = 68.5 \pm 3.0$ dB; $L_{WA} = 79.5 \pm 3.0$ dB; $a_n = 1.23 \pm 1.5$ m/s²

YATO	[V d.c.]	
YT-82905	12	5

Battery not included
Ohne Akku / Bez akumulatora
Bez Gamaşei / Bez aku
Akumulator nekilj
Fără baterie / Sans batterie
Senza batteria / Sin battery
没有电池

EN Cordless ratchet
 PL Grzechotka akumulatorowa
 DE Akku-Ratsche
 RU Аккумуляторные импульсная трещотка
 CZ Akumulátorová ráčna
 HU Akkus ütvecsavarozó

RO Șurubelniță cu impact cu acumulator
 FR Clé à cliquet sans-fil
 IT Cricchetto a batteria
 ES Llave de carraca a batería
 CN 充电式扳手

12V

3/8"
9.5 mm

45 Nm

2.0 Ah

1h

IMPACT FUNCTION
 FUNKCJA UDARU



3/8" (9.5 mm): 12, 13, 14, 17 mm;
 1/2" (12.7 mm)

$L_{pa} = 78,66 \pm 3,0$ dB; $L_{wa} = 89,66 \pm 3,0$ dB; $a_n = 2,898 \pm 1,5$ m/s²

YATO	[V d.c.]	
YT-82902	12	10

EN Cordless ratchet
 PL Grzechotka akumulatorowa
 DE Akku-Ratsche
 RU Аккумуляторные импульсная трещотка
 CZ Akumulátorová ráčna
 HU Akkus ütvecsavarozó

RO Șurubelniță cu impact cu acumulator
 FR Clé à cliquet sans-fil
 IT Cricchetto a batteria
 ES Llave de carraca a batería
 CN 充电式扳手

12V

1/2"
12.7 mm

80 Nm

0-170 min⁻¹

IMPACT FUNCTION
 FUNKCJA UDARU

BRUSHLESS MOTOR
 SINK BEZ SZCZOTKOWY



Battery not included
 Ohne Akku / Bez akumulatora
 Bez Gamaeou / Bez aku
 Akumulátor nélkül
 Fără baterie / Sans batterie
 Senza batteria / Sin bateria
 没有电池

$L_{pa} = 78,7 \pm 3,0$ dB; $L_{wa} = 89,7 \pm 3,0$ dB; $a_n = 7,373 \pm 1,5$ m/s²

YATO	[V d.c.]	
YT-829021	12	10

EN Cordless polisher
 PL Polerka akumulatorowa
 DE Akku-Polierer
 RU Аккумуляторная полировальная машина
 CZ Akumulátorová leštička
 HU Vezeték nélküli polírozó
 RO Aparat polisat cu acumulator
 FR Polisseuse sans-fil
 IT Lucidatrice a batteria
 ES Pulidora a batería
 CN 充电式抛光机



12V

5/16"
8 mm

0-3000 min⁻¹
0-3300 min⁻¹

80 mm

2.0 Ah

1h



$L_{pa} = 78,6 \pm 3,0$ dB; $L_{wa} = 89,6 \pm 3,0$ dB; $a_n = 4,213 \pm 1,5$ m/s²

YATO	[V d.c.]	
YT-82903	12	5

EN Cordless sabre saw
 PL Akumulatorowa piła szablasta
 DE Akku-Säbelsäge
 RU Аккумуляторная сабельная пила
 CZ Akumulátorová píla oscakač
 HU Akkus szabályfűrész
 RO Ferăstrău sabie cu acumulator
 FR Scie sabre sans-fil
 IT Sega a sciabola a batteria
 ES Sierra sable de batería
 CN 充电式往复锯



12V

0-3000 min⁻¹

2.0 Ah

1h

WOOD
 BREWERY

STEEL
 STEEL

PVC

$L_{pa} = 83,58 \pm 3,0$ dB; $L_{wa} = 94,58 \pm 3,0$ dB; $a_n = 12,86 \pm 1,5 / 10,13 \pm 1,5 / 13,78 \pm 1,5 / 11,92 \pm 1,5$ m/s²

YATO	[V d.c.]	
YT-82904	12	6

EN Battery
 PL Akumulator
 DE Akkumulator
 RU Аккумулятор
 CZ Akumulátor
 HU Akkumulátor

RO Acumulatorul
 FR Batterie
 IT Batteria
 ES Bateria
 CN 锂电池包

12V

2.0 Ah

1h



YATO	[V d.c.]	
YT-82909	12	40

EN Battery
 PL Akumulator
 DE Akkumulator
 RU Аккумулятор
 CZ Akumulátor
 HU Akkumulátor

RO Acumulatorul
 FR Batterie
 IT Batteria
 ES Bateria
 CN 锂电池包

12V

4.0 Ah



YATO	[V d.c.]	
YT-82910	12	20

EN Battery charger
 PL Ładowarka
 DE Ladegerät
 RU Зарядное устройство
 CZ Nabíječka
 HU Akkutöltő

RO Redresor
 FR Chargeur de batterie
 IT Caricabatteria
 ES Rectificador
 CN 充电器

110-240V~
50-60Hz

for: **12V**



YATO	[V d.c.]	
YT-82912	12	20

EN Cordless drill/driver
PL Akumulatorowa wiertarko-wkrętarka
DE Akku-Bohrschrauber
RU Аккумуляторная дрель-шурупверт
CZ Akumulátorový vrtací šroubovák
HU Akkus fűró-csavarozó

RO Mașină de găurit și înșurubat cu acumulator
FR Perceuse-visseuse sans-fil
IT Trapano avvitatore a batteria
ES Taladro atornillador a batería
CN 充电式电钻

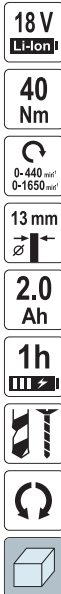

18V
Li-Ion

$L_{pa} = 71,0 \pm 3,0$ dB; $L_{max} = 82,0 \pm 3,0$ dB; $a_n = 3,0 \pm 1,5$ m/s²

YATO	[V d.c.]	
YT-82780	18	5

EN Cordless drill/driver
PL Akumulatorowa wiertarko-wkrętarka
DE Akku-Bohrschrauber
RU Аккумуляторная дрель-шурупверт
CZ Akumulátorový vrtací šroubovák
HU Akkus fűró-csavarozó

RO Mașină de găurit și înșurubat cu acumulator
FR Perceuse-visseuse sans-fil
IT Trapano avvitatore a batteria
ES Taladro atornillador a batería
CN 充电式电钻



18V
Li-Ion

$L_{pa} = 71,0 \pm 3,0$ dB; $L_{max} = 82,0 \pm 3,0$ dB; $a_n = 3,0 \pm 1,5$ m/s²

YATO	[V d.c.]	
YT-82781	18	5

Battery not included
Ohne Akku / Bez akumulátora
Bez Gamapeu / Bez aku
Акумулятор некіл
Fără baterie / Sans batterie
Senza batteria / Sin bateria
没有电池

EN Cordless drill/driver
PL Akumulatorowa wiertarko-wkrętarka
DE Akku-Bohrschrauber
RU Аккумуляторная дрель-шурупверт
CZ Akumulátorový vrtací šroubovák
HU Akkus fűró-csavarozó

RO Mașină de găurit și înșurubat cu acumulator
FR Perceuse-visseuse sans-fil
IT Trapano avvitatore a batteria
ES Taladro atornillador a batería
CN 充电式电钻

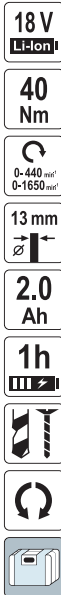

18V
Li-Ion

$L_{pa} = 71,0 \pm 3,0$ dB; $L_{max} = 82,0 \pm 3,0$ dB; $a_n = 3,0 \pm 1,5$ m/s²

YATO	[V d.c.]	
YT-82782	18	4

EN Cordless drill/driver
PL Akumulatorowa wiertarko-wkrętarka
DE Akku-Bohrschrauber
RU Аккумуляторная дрель-шурупверт
CZ Akumulátorový vrtací šroubovák
HU Akkus fűró-csavarozó

RO Mașină de găurit și înșurubat cu acumulator
FR Perceuse-visseuse sans-fil
IT Trapano avvitatore a batteria
ES Taladro atornillador a batería
CN 充电式电钻



18V
Li-Ion

$L_{pa} = 71,0 \pm 3,0$ dB; $L_{max} = 82,0 \pm 3,0$ dB; $a_n = 3,0 \pm 1,5$ m/s²

YATO	[V d.c.]	
YT-82784	18	4

EN Cordless drill/driver
 PL Akumulatorowa wiertarko-wkrętarła
 DE Akku-Bohrschrauber
 RU Аккумуляторная дрель-шурупверт
 CZ Akumulátorový vrtací šroubovák
 HU Akkus fűrés-csavarozó

RO Mașină de găurit și înșurubat cu acumulator
 FR Perceuse-visseuse sans-fil
 IT Trapano avvitatore a batteria
 ES Taladro atornillador a batería
 CN 充电式电钻

18V
Li-Ion

40 Nm

0-440 ^{min}/_{min}
0-1650 ^{min}/_{min}

13 mm

MABUCHI MOTOR SILNIK

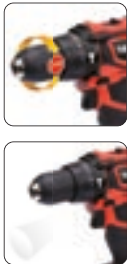

$L_{pA} = 71,0 \pm 3,0$ dB; $L_{wA} = 82,0 \pm 3,0$ dB; $a_n = 3,0 \pm 1,5$ m/s²

YATO	[V d.c.]	
YT-82783	18	5

EN Cordless impact drill/driver
 PL Akumulatorowa wiertarko-wkrętarła udarowa
 DE Akku-Schlagbohrschrauber
 RU Аккумуляторный ударный дрель-шурупверт
 CZ Akumulátorový nárazový šroubovák s příklepem
 HU Akkus ütvefűrés-csavarozó
 RO Mașină de găurit și înșurubat cu percuteje cu acumulator
 FR Perceuse-visseuse percussion sans-fil
 IT Trapano avvitatore a percussione a batteria
 ES Taladro atornillador con percusión a batería
 CN 充电式冲击钻

18V
Li-Ion

40 Nm

0-440 ^{min}/_{min}
0-1650 ^{min}/_{min}

0-7920 ^{min}/_{min}
0-29700 ^{min}/_{min}

13 mm

2.0 Ah

1h



$L_{pA} = 82,0 \pm 3,0$ dB; $L_{wA} = 93,0 \pm 3,0$ dB; $a_n = 3,0 \pm 1,5 / 9,89 \pm 1,5$ m/s²

YATO	[V d.c.]	
YT-82786	18	5

EN Cordless impact drill/driver
 PL Akumulatorowa wiertarko-wkrętarła udarowa
 DE Akku-Schlagbohrschrauber
 RU Аккумуляторный ударный дрель-шурупверт
 CZ Akumulátorový nárazový šroubovák s příklepem
 HU Akkus ütvefűrés-csavarozó
 RO Mașină de găurit și înșurubat cu percuteje cu acumulator
 FR Perceuse-visseuse percussion sans-fil
 IT Trapano avvitatore a percussione a batteria
 ES Taladro atornillador con percusión a batería
 CN 充电式冲击钻

18V
Li-Ion

40 Nm

0-440 ^{min}/_{min}
0-1650 ^{min}/_{min}

0-7920 ^{min}/_{min}
0-29700 ^{min}/_{min}

13 mm

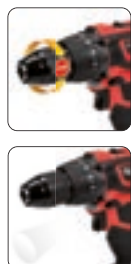

$L_{pA} = 82,0 \pm 3,0$ dB; $L_{wA} = 93,0 \pm 3,0$ dB; $a_n = 3,0 \pm 1,5 / 9,89 \pm 1,5$ m/s²

YATO	[V d.c.]	
YT-82787	18	5

EN Cordless impact drill/driver
 PL Akumulatorowa wiertarko-wkrętarła udarowa
 DE Akku-Schlagbohrschrauber
 RU Аккумуляторный ударный дрель-шурупверт
 CZ Akumulátorový nárazový šroubovák s příklepem
 HU Akkus ütvefűrés-csavarozó
 RO Mașină de găurit și înșurubat cu percuteje cu acumulator
 FR Perceuse-visseuse percussion sans-fil
 IT Trapano avvitatore a percussione a batteria
 ES Taladro atornillador con percusión a batería
 CN 充电式冲击钻

18V
Li-Ion

40 Nm

0-440 ^{min}/_{min}
0-1650 ^{min}/_{min}

0-7920 ^{min}/_{min}
0-29700 ^{min}/_{min}

13 mm

2.0 Ah

1h

MABUCHI MOTOR SILNIK

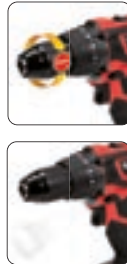

$L_{pA} = 71,0 \pm 3,0$ dB; $L_{wA} = 82,0 \pm 3,0$ dB; $a_n = 3,0 \pm 1,5 / 9,89 \pm 1,5$ m/s²

YATO	[V d.c.]	
YT-82788	18	4

EN Cordless impact drill/driver
PL Akumulatorowa wiertarko-wkrętarka udarowa
DE Akku-Schlagbohrschrauber
RU Аккумуляторный ударный дрель-шурупверт
CZ Akumulátorový nárazový šroubovák s příklepem
HU Akkus ütőfúró-csavarozó
RO Mașină de găurit și înșurubat cu percucie cu acumulator
FR Perceuse-visseuse percussion sans-fil
IT Trapano avvitatore a percussione a batteria
ES Taladro atornillador con percusión a batería
CN 充电式冲击钻

**MABUCHI
MOTOR
SILNIK**



18 V
Li-Ion

40 Nm

0-440 min¹
0-1650 min²

T
0-7920 min¹
0-29700 min²

13 mm
Ø



Battery not included
Ohne Akku / Bez akumulatora
Bez ładowarki / Bez aku
Akumulator nélkül
Fără baterie / Sans batterie
Senza batteria / Sin batería
没有电池

18V
Li-Ion

$L_{pa} = 71,0 \pm 3,0$ dB; $L_{max} = 82,0 \pm 3,0$ dB; $a_n = 3,0 \pm 1,5 / 9,89 \pm 1,5$ m/s²

YATO	[V d.c.]	
YT-82789	18	5

EN Brushless cordless drill/driver
PL Bezszczotkowa wiertarko-wkrętarka akumulatorowa
DE Bürstenloser Akku-Bohrschrauber
RU Бесщеточный аккумуляторный дрель-шурупверт
CZ Bezkartáčový akumulátorový vrtací šroubovák s příklepem
HU Akkus fúró-csavarozó szénkefe nélkül
RO Mașină de găurit și înșurubat cu acumulator fără perii
FR Perceuse-visseuse sans-fil sans charbon
IT Trapano avvitatore senza spazzole a batteria
ES Taladro atornillador a batería sin escobillas
CN 充电式无刷电钻



18 V
Li-Ion

42 Nm

0-600 min¹
0-2000 min²

13 mm
Ø

2.0 Ah

1h



BRUSHLESS MOTOR
SIŁNIK BEZ-SZCZOTKOWY

18V
Li-Ion

$L_{pa} = 74,0 \pm 3,0$ dB; $L_{max} = 85,0 \pm 3,0$ dB; $a_n = 3,0 \pm 1,5$ m/s²

YATO	[V d.c.]	
YT-82794	18	4

EN Brushless cordless drill/driver
PL Bezszczotkowa wiertarko-wkrętarka akumulatorowa
DE Bürstenloser Akku-Bohrschrauber
RU Бесщеточный аккумуляторный дрель-шурупверт
CZ Bezkartáčový akumulátorový vrtací šroubovák s příklepem
HU Akkus fúró-csavarozó szénkefe nélkül
RO Mașină de găurit și înșurubat cu acumulator fără perii
FR Perceuse-visseuse sans-fil sans charbon
IT Trapano avvitatore senza spazzole a batteria
ES Taladro atornillador a batería sin escobillas
CN 充电式无刷电钻

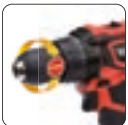

18 V
Li-Ion

42 Nm

0-600 min¹
0-2000 min²

13 mm
Ø



BRUSHLESS MOTOR
SIŁNIK BEZ-SZCZOTKOWY



Battery not included
Ohne Akku / Bez akumulatora
Bez ładowarki / Bez aku
Akumulator nélkül
Fără baterie / Sans batterie
Senza batteria / Sin batería
没有电池

18V
Li-Ion

$L_{pa} = 74,0 \pm 3,0$ dB; $L_{max} = 85,0 \pm 3,0$ dB; $a_n = 3,0 \pm 1,5$ m/s²

YATO	[V d.c.]	
YT-82795	18	5

EN Brushless cordless drill/driver
PL Bezszczotkowa wiertarko-wkrętarka akumulatorowa
DE Bürstenloser Akku-Bohrschrauber
RU Бесщеточный аккумуляторный дрель-шурупверт
CZ Bezkartáčový akumulátorový vrtací šroubovák s příklepem
HU Akkus fúró-csavarozó szénkefe nélkül
RO Mașină de găurit și înșurubat cu acumulator fără perii
FR Perceuse-visseuse sans-fil sans charbon
IT Trapano avvitatore senza spazzole a batteria
ES Taladro atornillador a batería sin escobillas
CN 充电式无刷冲击钻



18 V
Li-Ion

42 Nm

0-600 min¹
0-2000 min²

T
0-10800 min¹
0-36000 min²

13 mm
Ø

2.0 Ah

1h



BRUSHLESS MOTOR
SIŁNIK BEZ-SZCZOTKOWY

18V
Li-Ion

$L_{pa} = 94,0 \pm 3,0$ dB; $L_{max} = 95,0 \pm 3,0$ dB; $a_n = 3,0 \pm 1,5 / 9,6 \pm 1,5$ m/s²

YATO	[V d.c.]	
YT-82796	18	4

EN Brushless cordless drill/driver
 PL Bezszczotkowa wiertarko-wkrętaraka akumulatorowa
 DE Bürstenloser Akku-Bohrschrauber
 RU Бесщеточный аккумуляторный дрель-шуруповерт
 CZ Bezkartáčový akumulátorový vrtací šroubovák s příklepem
 HU Akkus fűró-csavarozó szénkefe nélkül
 RO Mașină de găurit și înșurubat cu acumulator fără perii
 FR Perceuse-visseuse sans-fil sans charbon
 IT Trapano avvitatore senza spazzole a batteria
 ES Taladro atornillador a batería sin escobillas
 CN 充电式无刷冲击钻

18 V Li-Ion	42 Nm	0-600 min ¹ 0-2000 min ²
T 0-10800 min ¹ 0-36000 min ²	13 mm max	BRUSHLESS MOTOR SIŁNIK BEZ-SZCZOTKOWY



Battery not included
 Ohne Akku / Bez akumulatora
 Без аккумулятора / Без аки
 Akumulátor nélkül
 Fără baterie / Sans batterie
 Senza batteria / Sin batería
 没有电池

18V
Li-Ion

$L_{pa} = 94,0 \pm 3,0$ dB; $L_{wa} = 95,0 \pm 3,0$ dB; $a_n = 3,0 \pm 1,5 / 9,6 \pm 1,5$ m/s²

YATO	[V d.c.]	
YT-82797	18	5

EN Brushless cordless drill/driver
 PL Bezszczotkowa wiertarko-wkrętaraka akumulatorowa
 DE Bürstenloser Akku-Bohrschrauber
 RU Бесщеточный аккумуляторный дрель-шуруповерт
 CZ Bezkartáčový akumulátorový vrtací šroubovák s příklepem
 HU Akkus fűró-csavarozó szénkefe nélkül
 RO Mașină de găurit și înșurubat cu acumulator fără perii
 FR Perceuse-visseuse sans-fil sans charbon
 IT Trapano avvitatore senza spazzole a batteria
 ES Taladro atornillador a batería sin escobillas
 CN 充电式无刷电钻

18 V Li-Ion	75 Nm	0-500 min ¹ 0-2100 min ²
T 0-8500 min ¹ 0-29750 min ²	13 mm max	3.0 Ah
1.5h	BRUSHLESS MOTOR SIŁNIK BEZ-SZCZOTKOWY	



18V
Li-Ion

$L_{pa} = 87,0 \pm 5,0$ dB; $L_{wa} = 98,0 \pm 5,0$ dB; $a_n = 6,23 \pm 1,5 / 4,37 \pm 1,5$ m/s²

YATO	[V d.c.]	
YT-82790	18	4

EN Brushless cordless drill/driver
 PL Bezszczotkowa wiertarko-wkrętaraka akumulatorowa
 DE Bürstenloser Akku-Bohrschrauber
 RU Бесщеточный аккумуляторный дрель-шуруповерт
 CZ Bezkartáčový akumulátorový vrtací šroubovák s příklepem
 HU Akkus fűró-csavarozó szénkefe nélkül
 RO Mașină de găurit și înșurubat cu acumulator fără perii
 FR Perceuse-visseuse sans-fil sans charbon
 IT Trapano avvitatore senza spazzole a batteria
 ES Taladro atornillador a batería sin escobillas
 CN 充电式无刷电钻

18 V Li-Ion	75 Nm	0-500 min ¹ 0-2100 min ²
T 0-8500 min ¹ 0-29750 min ²	13 mm max	3.0 Ah
1.5h	BRUSHLESS MOTOR SIŁNIK BEZ-SZCZOTKOWY	



18V
Li-Ion

$L_{pa} = 87,0 \pm 5,0$ dB; $L_{wa} = 98,0 \pm 5,0$ dB; $a_n = 6,23 \pm 1,5 / 4,37 \pm 1,5$ m/s²

YATO	[V d.c.]	
YT-82791	18	3

EN Brushless cordless drill/driver
 PL Bezszczotkowa wiertarko-wkrętaraka akumulatorowa
 DE Bürstenloser Akku-Bohrschrauber
 RU Бесщеточный аккумуляторный дрель-шуруповерт
 CZ Bezkartáčový akumulátorový vrtací šroubovák s příklepem
 HU Akkus fűró-csavarozó szénkefe nélkül
 RO Mașină de găurit și înșurubat cu acumulator fără perii
 FR Perceuse-visseuse sans-fil sans charbon
 IT Trapano avvitatore senza spazzole a batteria
 ES Taladro atornillador a batería sin escobillas
 CN 充电式无刷电钻

18 V Li-Ion	75 Nm	0-500 min ¹ 0-2100 min ²
T 0-8500 min ¹ 0-29750 min ²	13 mm max	3.0 Ah
1.5h	BRUSHLESS MOTOR SIŁNIK BEZ-SZCZOTKOWY	



18V
Li-Ion

$L_{pa} = 87,0 \pm 5,0$ dB; $L_{wa} = 98,0 \pm 5,0$ dB; $a_n = 6,23 \pm 1,5 / 4,37 \pm 1,5$ m/s²

YATO	[V d.c.]	
YT-82792	18	6

Battery not included
 Ohne Akku / Bez akumulatora
 Без аккумулятора / Без аки
 Akumulátor nélkül
 Fără baterie / Sans batterie
 Senza batteria / Sin batería
 没有电池

EN Cordless impact screwdriver
PL Akumulatorowa zakrętkarka udarowa
DE Akku-Schlagschrauber
RU Аккумуляторный ударный винтовёрт
CZ Akumulátorový rázový utahovák
HU Akkus ütvecsavarozó
RO Şurubelniţă cu impact cu acumulator
FR Boulonneuse sans-fil
IT Avvitatore a percussione a batteria
ES Atomillador de impacto a batería
CN 充电式冲击螺丝批

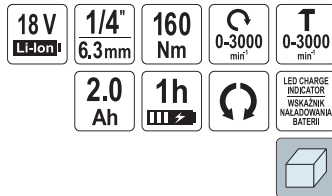

$L_{pa} = 82,0 \pm 3,0$ dB; $L_{wa} = 93,0 \pm 3,0$ dB; $a_n = 8,15 \pm 1,5$ m/s²

18V
Li-Ion

YATO	[V d.c.]	
YT-82800	18	5

EN Cordless impact screwdriver
PL Akumulatorowa zakrętkarka udarowa
DE Akku-Schlagschrauber
RU Аккумуляторный ударный винтовёрт
CZ Akumulátorový rázový utahovák
HU Akkus ütvecsavarozó
RO Şurubelniţă cu impact cu acumulator
FR Boulonneuse sans-fil
IT Avvitatore a percussione a batteria
ES Atomillador de impacto a batería
CN 充电式冲击螺丝批

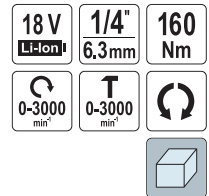

$L_{pa} = 82,0 \pm 3,0$ dB; $L_{wa} = 93,0 \pm 3,0$ dB; $a_n = 8,15 \pm 1,5$ m/s²

18V
Li-Ion

YATO	[V d.c.]	
YT-82801	18	5

Battery not included
Obrne Akku / Bez akumulatora
Bez Gamapeuz / Bez aku
Akumulátor neľoží
Fără baterie / Sans batterie
Senza batteria / Sin batteria
沒有電池

EN Cordless impact screwdriver
PL Akumulatorowa zakrętkarka udarowa
DE Akku-Schlagschrauber
RU Аккумуляторный ударный гайковёрт
CZ Akumulátorový rázový utahovák
HU Akkus ütvecsavarozó
RO Şurubelniţă cu impact cu acumulator
FR Boulonneuse sans-fil
IT Avvitatore a percussione a batteria
ES Atomillador de impacto a batería
CN 充电式无刷冲击扳手



$L_{pa} = 86,0 \pm 3,0$ dB; $L_{wa} = 97,0 \pm 3,0$ dB; $a_n = 7,58 \pm 1,5$ m/s²

18V
Li-Ion

YATO	[V d.c.]	
YT-82802	18	5

EN Cordless impact wrench
PL Akumulatorowy klucz udarowy
DE Akku-DrehSchlagschrauber
RU Аккумуляторный ударный гайковёрт
CZ Akumulátorový rázový utahovák
HU Akkus ütvecsavarozó
RO Şurubelniţă cu impact cu acumulator
FR Boulonneuse sans-fil
IT Chiave a percussione a batteria
ES Atomillador de impacto a batería
CN 充电式冲击扳手



17, 19, 21, 23 mm



$L_{pa} = 84,0 \pm 3,0$ dB; $L_{wa} = 95,0 \pm 3,0$ dB; $a_n = 9,09 \pm 1,5$ m/s²

18V
Li-Ion

YATO	[V d.c.]	
YT-82804	18	4

EN Cordless impact wrench
 PL Akumulatorowy klucz udarowy
 DE Akku-Dreherschlagschrauber
 RU Аккумуляторный ударный гайковёрт
 CZ Akumulátorový rázový utahovák
 HU Akkus ütvecsavarozó
 RO Şurubelniţă cu impact cu acumulator
 FR Boulonneuse sans-fil
 IT Chiave a percussione a batteria
 ES Atornillador de impacto a batería
 CN 充电式冲击扳手

18 V
Li-Ion
1/2"
12,7 mm
300 Nm
0-2200 min⁻¹



Battery not included
 Ohne Akku / Bez akumulatora
 Без батарейки / Bez aku
 Akumulator nélkül
 Fără baterie / Sans batterie
 Senza batteria / Sin batería
 没有电池

17, 19, 21, 23 mm



$L_{pa} = 84,0 \pm 3,0$ dB; $L_{wa} = 95,0 \pm 3,0$ dB; $a_n = 9,09 \pm 1,5$ m/s²

YATO	[V d.c.]	
YT-82805	18	5

EN Cordless impact wrench
 PL Akumulatorowy klucz udarowy
 DE Akku-Dreherschlagschrauber
 RU Аккумуляторный ударный гайковёрт
 CZ Akumulátorový rázový utahovák
 HU Akkus ütvecsavarozó
 RO Şurubelniţă cu impact cu acumulator
 FR Boulonneuse sans-fil
 IT Chiave a percussione a batteria
 ES Atornillador de impacto a batería
 CN 充电式冲击扳手

18 V
Li-Ion
1/2"
12,7 mm
700 Nm
0-2600 min⁻¹
T
0-5000 min⁻¹
3.0 Ah
1.5h
BRUSHLESS MOTOR
SIŁNIK BEZ SZCZOTKOWY



$L_{pa} = 86,0 \pm 3,0$ dB; $L_{wa} = 97,0 \pm 3,0$ dB; $a_n = 7,58 \pm 1,5$ m/s²

YATO	[V d.c.]	
YT-82806	18	3

EN Cordless impact wrench
 PL Akumulatorowy klucz udarowy
 DE Akku-Dreherschlagschrauber
 RU Аккумуляторный ударный гайковёрт
 CZ Akumulátorový rázový utahovák
 HU Akkus ütvecsavarozó
 RO Şurubelniţă cu impact cu acumulator
 FR Boulonneuse sans-fil
 IT Chiave a percussione a batteria
 ES Atornillador de impacto a batería
 CN 充电式冲击扳手

18 V
Li-Ion
1/2"
12,7 mm
700 Nm
0-2600 min⁻¹
T
0-5000 min⁻¹
BRUSHLESS MOTOR
SIŁNIK BEZ SZCZOTKOWY



Battery not included
 Ohne Akku / Bez akumulatora
 Без батарейки / Bez aku
 Akumulator nélkül
 Fără baterie / Sans batterie
 Senza batteria / Sin batería
 没有电池

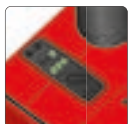

$L_{pa} = 86,0 \pm 3,0$ dB; $L_{wa} = 97,0 \pm 3,0$ dB; $a_n = 7,58 \pm 1,5$ m/s²

YATO	[V d.c.]	
YT-828061	18	6

EN Impact tool set
 PL Zestaw narzędzi udarowych
 DE Schlagwerkzeugsatz
 RU Набор инструментов ударных
 CZ Sada příklepových nářadí
 HU Ütvecsavarozó szerszámkészlet
 RO Set pistol impact
 FR Clé à choc avec jeu d'outils
 IT Set di chiavi a percussione
 ES Juego de herramientas de impacto
 CN 锂电冲击扳手套筒组套

18 V
Li-Ion
21 PCS
18 V
Li-Ion
1/2"
12,7 mm
700 Nm
0-2600 min⁻¹
T
0-5000 min⁻¹
3.0 Ah
1.5h



1/2" (12.7 mm): 17, 19, 21 mm (L=87 mm); CrMo;
 1/2" (12.7 mm): 12, 13, 14, 15, 16, 17, 18, 19, 20, 21, 22, 23, 24 mm; CrMo;
 1/2" (12.7 mm): (L=75 mm); CrMo
 $L_{pa} = 86,0 \pm 3,0$ dB; $L_{wa} = 97,0 \pm 3,0$ dB; $a_n = 7,58 \pm 1,5$ m/s²

YATO	[V d.c.]	
YT-82807	1/2" (12.7 mm)	18

EN Cordless screwdriver
PL Wkręćtak akumulatorowy
DE Akku-Schrauber
RU Аккумуляторный шуруповерт
CZ Uťahovák akumulátorový
HU Akkumulátoros csavarbehajító
RO Șurubelniță cu acumulator
FR Tournevis sans-fil
IT Avvitatore a batteria
ES Herramienta de resistencia para soldar
CN 充电式螺丝批

3.6 V
1300mAh
Li-Ion

3.0 Nm

230 min

WORKING AREA LIGHT
OSWIETLIENIE OBSZARU PRACY

LED CHARGE INDICATOR
WSKAZNIK NAŁADOWANIA BATERII



$L_{pa} = 62,0 \pm 3,0$ dB; $L_{wa} = 73,0 \pm 3,0$ dB; $a_n = 0,39 \pm 1,5$ m/s²

YATO	[V d.c.]	
YT-82760	3.6	20

EN Cordless glue gun
PL Akumulatorowy pistolet do klejenia
DE Heissklebepistole
RU Пистолет для клея
CZ Pistole na lepení
HU Ragasztópisztoly
RO Pistol pt. lipit
FR Pistolet à colle sans-fil
IT Pistola colla
ES Pistola de cola
CN 充电式胶枪

18 V
Li-Ion

25 g/min

3x
Ø 11 mm

≥ 60 min

2.0 Ah

1h



18V
Li-Ion

YATO	[V d.c.]	
YT-82854	18	10

EN Cordless heat gun
PL Opalarka akumulatorowa
DE Akku-Heissluftgebläse
RU Фен технический аккумуляторный
CZ Akumulátorová opalovací pistole
HU Akkus hőlégfúvó
RO Pistol aer cald cu acumulator
FR Décapeur thermique sans-fil
IT Pistola termica a batteria
ES Pistola de calor a batería
CN 热风枪

18 V
Li-Ion

550 °C

100 l/min



Battery not included
Obrona Akku / Bez akumulatora
Eseni Bateria / Bez aku
Akumulator nélkül
Fără baterie / Sans batterie
Senza batteria / Sin batería
没有电池

18V
Li-Ion

YATO	[V d.c.]	
YT-82285	18	10

EN Cordless car air compressor
PL Akumulatorowy kompresor samochodowy
DE Akku-Auto-Kompressor
RU Компрессор автомобильный аккумуляторный
CZ Akumulátorový automobilový kompresor
HU Autókompresszor akkumulátoros
RO Compresor auto cu acumulator
FR Compresseur de voiture sans-fil
IT Compressore a batteria per auto
ES Compresor de coche de batería
CN 无线车载空气压缩机

36 V
2x 18V
Li-Ion

8 bar

98 l/min

6L

3.0 Ah



- Pressure hose
- Tire inflation gun
- Wąż ciśnieniowy
- Pistolet do pompowania kół

18V
Li-Ion

$L_{pa} = 80,0 \pm 3,0$ dB; $L_{wa} = 90,7 \pm 3,0$ dB

YATO	[V d.c.]	
YT-23241	36 (18 x2)	1

EN Cordless car air compressor
PL Akumulatorowy kompresor samochodowy
DE Akku-Auto-Kompressor
RU Компрессор автомобильный аккумуляторный
CZ Akumulátorový automobilový kompresor
HU Autókompresszor akkumulátoros
RO Compresor auto cu acumulator
FR Compresseur de voiture sans-fil
IT Compressore a batteria per auto
ES Compresor de coche de batería
CN 无线车载空气压缩机

36 V
2x 18V
Li-Ion

8 bar

98 l/min

6L



- Pressure hose
- Tire inflation gun
- Wąż ciśnieniowy
- Pistolet do pompowania kół

Battery not included
Obrona Akku / Bez akumulatora
Eseni Bateria / Bez aku
Akumulator nélkül
Fără baterie / Sans batterie
Senza batteria / Sin batería
没有电池

18V
Li-Ion

$L_{pa} = 80,0 \pm 3,0$ dB; $L_{wa} = 90,7 \pm 3,0$ dB

YATO	[V d.c.]	
YT-23242	36 (18 x2)	1

EN Cordless car air compressor
PL Akumulatorowy kompresor samochodowy
DE Akku-Auto-Kompressor
RU Компрессор автомобильный аккумуляторный
CZ Akumulátorový automobilový kompresor
HU Autókompresszor akkumulátoros
RO Compresor auto cu acumulator
FR Compresseur de voiture sans-fil
IT Compressore a batteria per auto
ES Compresor de coche de batería
CN 无线车载空气压缩机

18 V
Li-Ion

12V

11 bar

3.0 Ah

LED LIGHTING
OSWIETLIENIE

LCD BACKLIGHT
POSWIETLENIE



18V
Li-Ion

$L_{pa} = 71,2 \pm 3,0$ dB; $L_{wa} = 82,2 \pm 3,0$ dB

YATO	[V d.c.]	
YT-23247	18	4

- EN Cordless car air compressor
- PL Akumulatorowy kompresor samochodowy
- DE Akku-Auto-Kompressor
- RU Компрессор автомобильный аккумуляторный
- CZ Akumulátorový automobilový kompresor
- HU Autókompresszor akkumulátoros
- RO Compresor auto cu acumulator
- FR Compresseur de voiture sans-fil
- IT Compresore a batteria per auto
- ES Compresor de coche de batería
- CN 无绳车载空气压缩机

18V Li-Ion 12V 11 bar LED LIGHTING OSWIETLЕНИЕ LCD BACKLIGHT PODSWIETLENIE



Battery not included
 Ohne Akku / Bez akumulatora
 Без аккумулятора / Без акумулятора
 Akkumulátor nélkül
 Fără baterie / Sans batterie
 Senza batteria / Sin batería
 没有电池

18V Li-Ion

$L_{pa} = 71,2 \pm 3,0$ dB; $L_{wa} = 82,2 \pm 3,0$ dB

YATO	[V d.c.]	
YT-23248	18	4

- EN Cordless inflator
- PL Pompka akumulatorowa
- DE Akku-Luftpumpe
- RU Аккумуляторный насос
- CZ Čerpadlo baterie
- HU Akkumulátor szivattyú

18V Li-Ion 1.0 MPa 14 l/min 50 cm 2.0 Ah 1h



$L_{pa} = 69,0 \pm 3,0$ dB; $L_{wa} = 80,0 \pm 3,0$ dB; $a_n = 2,346 \pm 1,5$ m/s²

18V Li-Ion

YATO	[V d.c.]	
YT-82894	18	5

- EN Cordless inflator
- PL Pompka akumulatorowa
- DE Akku-Luftpumpe
- RU Аккумуляторный насос
- CZ Čerpadlo baterie
- HU Akkumulátor szivattyú

18V Li-Ion 1.0 MPa 14 l/min 50 cm



Battery not included
 Ohne Akku / Bez akumulatora
 Без аккумулятора / Без акумулятора
 Akkumulátor nélkül
 Fără baterie / Sans batterie
 Senza batteria / Sin batería
 没有电池



$L_{pa} = 69,0 \pm 3,0$ dB; $L_{wa} = 80,0 \pm 3,0$ dB; $a_n = 2,346 \pm 1,5$ m/s²

18V Li-Ion

YATO	[V d.c.]	
YT-82895	18	5

- EN Cordless caulking gun
- PL Akumulatorowy wyciskacz do mas
- DE Akku-Kartuschenpistole
- RU Аккумуляторный пистолет для герметика
- CZ Akumulátorová těsnící pistole
- HU Akkus kinyomó vázas masszákhoz

- RO Pistol pt. etansare
- FR Pistolet a feutrer sans-fil
- IT Pistola applicatrice a batteria
- ES Pistola para masilla a batería
- CN 充电式填缝枪

18V Li-Ion 2000 N 0.5-8 mm/s 225mm 4.0 Ah 2h



18V Li-Ion

$L_{pa} = 80,0 \pm 3,0$ dB; $L_{wa} = 91,0 \pm 3,0$ dB; $a_n = 1,68 \pm 1,5$ m/s²

YATO	[V d.c.]	
YT-82888	18	5

- EN Cordless caulking gun
- PL Akumulatorowy wyciskacz do mas
- DE Akku-Kartuschenpistole
- RU Аккумуляторный пистолет для герметика
- CZ Akumulátorová těsnící pistole
- HU Akkus kinyomó vázas masszákhoz

- RO Pistol pt. etansare
- FR Pistolet a feutrer sans-fil
- IT Pistola applicatrice a batteria
- ES Pistola para masilla a batería
- CN 充电式填缝枪

18V Li-Ion 2000 N 0.5-8 mm/s 225mm



Battery not included
 Ohne Akku / Bez akumulatora
 Без аккумулятора / Без акумулятора
 Akkumulátor nélkül
 Fără baterie / Sans batterie
 Senza batteria / Sin batería
 没有电池

18V Li-Ion

$L_{pa} = 80,0 \pm 3,0$ dB; $L_{wa} = 91,0 \pm 3,0$ dB; $a_n = 1,68 \pm 1,5$ m/s²

YATO	[V d.c.]	
YT-82889	18	5

- EN Cordless grease gun
- PL Smarownica akumulatorowa
- DE Akku-Fettpresse
- RU Шприц для смазки аккумуляторный
- CZ Akumulátorový mazací lis
- HU Akku zsírzó prés
- RO Pistol de grasat cu acumulator
- FR Pistolet graisseur sans-fil
- IT Lubrificatore a batteria
- ES Lubricador de batería
- CN 无绳黄油枪

18V Li-Ion 0.62 MPa 284 g/min 76 cm 3.0 Ah LED LIGHTING OSWIETLЕНИЕ



$L_{pa} = 76,0 \pm 3,0$ dB; $L_{wa} = 86,0 \pm 3,0$ dB; $a_n = 0,5 \pm 1,5$ m/s²

18V Li-Ion

YATO	[V d.c.]	
YT-07020	18	2

EN Cordless grease gun
PL Smarownica akumulatorowa
DE Akku-Fettpresse
RU Шприц для смазки аккумуляторный
CZ Akumulátorový mazací lis
HU Akku zsírzó prés
RO Pistol de gresat cu acumulator
FR Pistolet graisseur sans-fil
IT Lubrificatore a batteria
ES Lubricador de batería
CN 无绳黄油枪

18 V
Li-Ion
0.62 MPa
284 g/min
76 cm
LED LIGHTING OSWIETLIENIE



Battery not included
Ohne Akku / Bez akumulatora
Bez Gamaopu / Bez aku
Akumulátor nélkül
Fără baterie / Sans batterie
Senza batteria / Sin batería
没有电池

18V
Li-Ion

$L_{PA} = 76,0 \pm 3,0$ dB; $L_{WA} = 86,0 \pm 3,0$ dB; $a_h = 0,5 \pm 1,5$ m/s²

YATO	[V d.c.]	
YT-07021	18	2

EN Cordless miter saw
PL Ukośnica akumulatorowa
DE Akku-Paneelsäge
RU Аккумуляторная торцовочная пила
CZ Akumulátorová pokosová píla se základem
HU Akkus sines gérvágó
RO Ferăstrău circular staționar cu acumulator
FR Scie à onglets sans-fil
IT Sega angolare a batteria
ES Ingletadora telescópica a batería
CN 充电式斜切锯

18 V
Li-Ion
3600 min⁻¹
185x30 x1.8 mm
40T
90°/51mm
45°/35mm
CUTTING DEPTH
GŁĘBOKOŚĆ CIĘCIA
90°/203mm
45°/152mm
CUTTING LENGTH
DŁUGOŚĆ CIĘCIA
CLASS / KLASA
4.0 Ah
2h



18V
Li-Ion

Fitting blades: see chapter 10
Pasujące tarcze: patrz rozdział 10
 $L_{PA} = 83,14 \pm 3,0$ dB; $L_{WA} = 96,14 \pm 3,0$ dB

YATO	[V d.c.]	
YT-82816	18	1

EN Cordless miter saw
PL Ukośnica akumulatorowa
DE Akku-Paneelsäge
RU Аккумуляторная торцовочная пила
CZ Akumulátorová pokosová píla se základem
HU Akkus sines gérvágó
RO Ferăstrău circular staționar cu acumulator
FR Scie à onglets sans-fil
IT Sega angolare a batteria
ES Ingletadora telescópica a batería
CN 充电式斜切锯

18 V
Li-Ion
3600 min⁻¹
185x30 x1.8 mm
40T
90°/51mm
45°/35mm
CUTTING DEPTH
GŁĘBOKOŚĆ CIĘCIA
90°/203mm
45°/152mm
CUTTING LENGTH
DŁUGOŚĆ CIĘCIA
CLASS / KLASA



Battery not included
Ohne Akku / Bez akumulatora
Bez Gamaopu / Bez aku
Akumulátor nélkül
Fără baterie / Sans batterie
Senza batteria / Sin batería
没有电池

18V
Li-Ion

Fitting blades: see chapter 10
Pasujące tarcze: patrz rozdział 10
 $L_{PA} = 83,14 \pm 3,0$ dB; $L_{WA} = 96,14 \pm 3,0$ dB

YATO	[V d.c.]	
YT-82817	18	1

EN Cordless spray gun
PL Akumulatorowy pistolet malarski
DE Akkubetriebene Farbspritzpistole
RU Аккумуляторный покрасочный пистолет
CZ Akumulátorová malířská pistole
HU Akkumulátoros festékszórő
RO Pistol de vopsea cu acumulator
FR Pistolet à peinture sans-fil
IT Pistola a batteria per verniciare
ES Pistola para pintar a batería
CN 充电式喷枪

18 V
Li-Ion
2.2 mm
1 l/min
1000 ml
4.0 Ah
2h



18V
Li-Ion

$L_{PA} = 72,1 \pm 3,0$ dB; $L_{WA} = 83,1 \pm 3,0$ dB; $a_h = 0,203 \pm 1,5$ m/s²

YATO	[V d.c.]	
YT-82765	18	4

EN Cordless stirrer
PL Mieszarka akumulatorowa
DE Akku-Rührwerk
RU Аккумуляторная мешалка
CZ Akumulátorové míchadlo
HU Akkus keverőgép
RO Agitator cu acumulator
FR Malaxeur sans-fil
IT Miscelatore a batteria
ES Gíador de batería
CN 充电式搅拌机

18 V
Li-Ion
0-650 min⁻¹
M14
2.0 Ah
1h



18V
Li-Ion

$L_{PA} = 79,0 \pm 3,0$ dB; $L_{WA} = 90,0 \pm 3,0$ dB; $a_h = 4,76 \pm 1,5$ m/s²

YATO	[V d.c.]	
YT-82880	18	2

EN Cordless stirrer
PL Mieszarka akumulatorowa
DE Akku-Rührwerk
RU Аккумуляторная мешалка
CZ Akumulátorové míchadlo
HU Akkus keverőgép
RO Agitator cu acumulator
FR Malaxeur sans-fil
IT Miscelatore a batteria
ES Gíador de batería
CN 充电式搅拌机

18 V
Li-Ion
0-650 min⁻¹
M14



18V
Li-Ion

$L_{PA} = 79,0 \pm 3,0$ dB; $L_{WA} = 90,0 \pm 3,0$ dB; $a_h = 4,76 \pm 1,5$ m/s²

YATO	[V d.c.]	
YT-82881	18	2

EN Cordless circular saw
 PL Akumulatorowa pilarka tarczowa
 DE Akku-Handkreissäge
 RU Аккумуляторная циркулярная пила
 CZ Akumulátorová okružní pila
 HU Akkus körfűrész
 RO Ferăstrău circular cu acumulator
 FR Scie circulaire sans-fil
 IT Sega circolare a batteria
 ES Sierra circular a batería
 CN 充电式电圆锯

18V Li-Ion | 3800 min⁻¹ | 165x16 x2.4 mm | 24T | 54 mm | 90°-54 mm / 45°-40 mm | 2.0 Ah | 1h |



18V Li-Ion

Fitting blades: see chapter 10
 Pasujące tarcze: patrz rozdział 10
 $L_{pA} = 85,0 \pm 3,0$ dB; $L_{wA} = 96,0 \pm 3,0$ dB; $a_h = 5,33 \pm 1,5$ m/s²

YATO	[V d.c.]	
YT-82810	18	2

EN Cordless circular saw
 PL Akumulatorowa pilarka tarczowa
 DE Akku-Handkreissäge
 RU Аккумуляторная циркулярная пила
 CZ Akumulátorová okružní pila
 HU Akkus körfűrész
 RO Ferăstrău circular cu acumulator
 FR Scie circulaire sans-fil
 IT Sega circolare a batteria
 ES Sierra circular a batería
 CN 充电式电圆锯

18V Li-Ion | 4000 min⁻¹ | 184x20 x2.2mm | 24T | 90°-55 mm / 45°-45 mm | BRUSHLESS MOTOR / SILNIK BEZ SZCZOTKOWY | 3.0 Ah | 1.5h |



18V Li-Ion

184 mm

Fitting blades: YT-60625, YT-60631
 Pasujące tarcze: YT-60625, YT-60631
 $L_{pA} = 85,9 \pm 3,0$ dB; $L_{wA} = 96,9 \pm 3,0$ dB; $a_h = 1,031 \pm 1,5$ m/s² / $1,179 \pm 1,5$ m/s²

YATO	[V d.c.]	
YT-82808	18	2

EN Cordless sabre saw
 PL Akumulatorowa pila szablasta
 DE Akku-Säbelsäge
 RU Аккумуляторная шабельная пила
 CZ Akumulátorová pila ocaska
 HU Akkus szablyafűrész
 RO Ferăstrău sabie cu acumulator
 FR Scie sabre sans-fil
 IT Sega a gattuccio a batteria
 ES Sierra sable de batería
 CN 充电式往复锯

18V Li-Ion | 0-3000 min⁻¹ | 80 mm | 10 mm | 2.0 Ah | 1h |



Fitting blades: see chapter 10
 Pasujące brzeszczyty: patrz rozdział 10
 $L_{pA} = 81,0 \pm 3,0$ dB; $L_{wA} = 92,0 \pm 3,0$ dB; $a_h = 7,5 \pm 1,5$ / $8,3 \pm 1,5$ m/s²

YATO	[V d.c.]	
YT-82814	18	4

EN Cordless circular saw
 PL Akumulatorowa pilarka tarczowa
 DE Akku-Handkreissäge
 RU Аккумуляторная циркулярная пила
 CZ Akumulátorová okružní pila
 HU Akkus körfűrész
 RO Ferăstrău circular cu acumulator
 FR Scie circulaire sans-fil
 IT Sega circolare a batteria
 ES Sierra circular a batería
 CN 充电式电圆锯

18V Li-Ion | 3800 min⁻¹ | 165x16 x2.4 mm | 24T | 54 mm | 90°-54 mm / 45°-40 mm |



18V Li-Ion

Fitting blades: see chapter 10
 Pasujące tarcze: patrz rozdział 10
 $L_{pA} = 85,0 \pm 3,0$ dB; $L_{wA} = 96,0 \pm 3,0$ dB; $a_h = 5,33 \pm 1,5$ m/s²

YATO	[V d.c.]	
YT-82811	18	2

EN Cordless circular saw
 PL Akumulatorowa pilarka tarczowa
 DE Akku-Handkreissäge
 RU Аккумуляторная циркулярная пила
 CZ Akumulátorová okružní pila
 HU Akkus körfűrész
 RO Ferăstrău circular cu acumulator
 FR Scie circulaire sans-fil
 IT Sega circolare a batteria
 ES Sierra circular a batería
 CN 充电式电圆锯

18V Li-Ion | 4000 min⁻¹ | 184x20 x2.2mm | 24T | 90°-55 mm / 45°-45 mm | BRUSHLESS MOTOR / SILNIK BEZ SZCZOTKOWY |



18V Li-Ion

184 mm

Fitting blades: YT-60625, YT-60631
 Pasujące tarcze: YT-60625, YT-60631
 $L_{pA} = 85,9 \pm 3,0$ dB; $L_{wA} = 96,9 \pm 3,0$ dB; $a_h = 1,031 \pm 1,5$ m/s² / $1,179 \pm 1,5$ m/s²

YATO	[V d.c.]	
YT-82809	18	4

EN Cordless sabre saw
 PL Akumulatorowa pila szablasta
 DE Akku-Säbelsäge
 RU Аккумуляторная шабельная пила
 CZ Akumulátorová pila ocaska
 HU Akkus szablyafűrész
 RO Ferăstrău sabie cu acumulator
 FR Scie sabre sans-fil
 IT Sega a gattuccio a batteria
 ES Sierra sable de batería
 CN 充电式往复锯

Battery not included
 Ohne Akku / Bez akumulatora
 Bez Gamapeu / Bez aku
 Akkumulátor nélkül
 Fără baterie / Sans batterie
 Senza batteria / Sin batería
 没有电池

18V Li-Ion | 0-3000 min⁻¹ | 80 mm | 10 mm |



Fitting blades: see chapter 10
 Pasujące brzeszczyty: patrz rozdział 10
 $L_{pA} = 81,0 \pm 3,0$ dB; $L_{wA} = 92,0 \pm 3,0$ dB; $a_h = 7,5 \pm 1,5$ / $8,3 \pm 1,5$ m/s²

YATO	[V d.c.]	
YT-82815	18	4

EN Cordless multi-purpose oscillating tool
PL Akumulatorowe wielofunkcyjne narzędzie oscylacyjne
DE Akku-Multifunktionswerkzeug
RU Аккумуляторный многофункциональный инструмент
CZ Akumulátorová multifunkční pila
HU Akkus multifunkcionális vágószerszám
RO Mașină multifuncțională cu acumulator
FR Découpeur-ponceur multifonctions sans-fil
IT Utensile oscillante multifunzione a batteria
ES Multiherramienta a batería
CN 充电式多功能锯



18V
Li-Ion

18V
Li-Ion

8000-8000
min⁻¹

2.0
Ah

1h

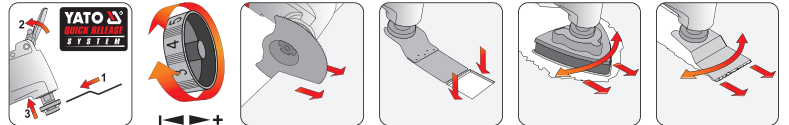
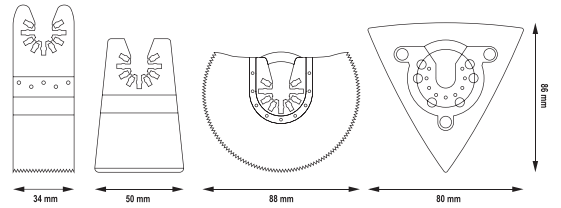

$L_{pa} = 77,0 \pm 3,0$ dB; $L_{wa} = 88,0 \pm 3,0$ dB; $a_n = 4,68 \pm 1,5$ m/s²

YATO	[V d.c.]	
YT-82818	18	4

EN Cordless multi-purpose oscillating tool
PL Akumulatorowe wielofunkcyjne narzędzie oscylacyjne
DE Akku-Multifunktionswerkzeug
RU Аккумуляторный многофункциональный инструмент
CZ Akumulátorová multifunkční pila
HU Akkus multifunkcionális vágószerszám
RO Mașină multifuncțională cu acumulator
FR Découpeur-ponceur multifonctions sans-fil
IT Utensile oscillante multifunzione a batteria
ES Multiherramienta a batería
CN 充电式多功能锯



18V
Li-Ion

Battery not included
Ohne Akku / Bez akumulatora
Bez Gamapeu / Bez aku
Akumulator nélkül
Fără baterie / Sans batterie
Senza batteria / Sin batería
没有电池

18V
Li-Ion

8000-8000
min⁻¹

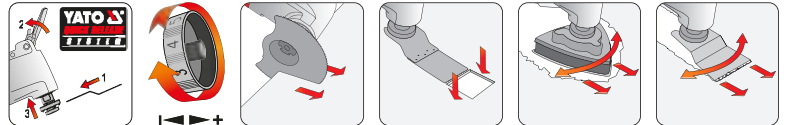
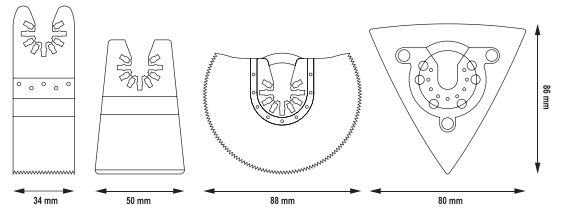

$L_{pa} = 77,0 \pm 3,0$ dB; $L_{wa} = 88,0 \pm 3,0$ dB; $a_n = 4,68 \pm 1,5$ m/s²

YATO	[V d.c.]	
YT-82819	18	4

EN Cordless jig saw
PL Akumulatorowa wyrzynarka
DE Akku-Stichsäge
RU Аккумуляторная лобкобковая пила
CZ Akumulátorová přímočará pila
HU Akkus szűrőfűrész
RO Ferăstrău vertical cu acumulator
FR Scie sauteuse sans-fil
IT Seghetto alternativo a batteria
ES Sierra de calar a batería
CN 充电式曲线锯

18V
Li-Ion

0-2500
min⁻¹

50
mm

5,0
mm

45°

2.0
Ah

1h



$L_{pa} = 76,0 \pm 3,0$ dB; $L_{wa} = 87,0 \pm 3,0$ dB; $a_n = 6,28 \pm 1,5 / 5,78 \pm 1,5$ m/s²

YATO	[V d.c.]	
YT-82822	18	4

EN Cordless jig saw
PL Akumulatorowa wyrzynarka
DE Akku-Stichsäge
RU Аккумуляторная лобкобковая пила
CZ Akumulátorová přímočará pila
HU Akkus szűrőfűrész
RO Ferăstrău vertical cu acumulator
FR Scie sauteuse sans-fil
IT Seghetto alternativo a batteria
ES Sierra de calar a batería
CN 充电式曲线锯

18V
Li-Ion

0-2500
min⁻¹

50
mm

5,0
mm

45°

2.0
Ah

1h



$L_{pa} = 76,0 \pm 3,0$ dB; $L_{wa} = 87,0 \pm 3,0$ dB; $a_n = 6,28 \pm 1,5 / 5,78 \pm 1,5$ m/s²

YATO	[V d.c.]	
YT-82823	18	5

Battery not included
Ohne Akku / Bez akumulatora
Bez Gamapeu / Bez aku
Akumulator nélkül
Fără baterie / Sans batterie
Senza batteria / Sin batería
没有电池

EN Cordless band saw
 PL Akumulatorowa pila taśmowa
 DE Akku-Bandsäge
 RU Аккумуляторная ленточная пила
 CZ Akumulátorová pásová pila
 HU Akkus szalagfűrész
 RO Fierastrau cu banda cu acumulator
 FR Scie à ruban sans-fil
 IT Sega a nastro a batteria
 ES Sierra de cinta a batería
 CN 充电式带锯

18V
 0-120
 14 TPI
 1140x12,7 x0,6 mm
 127 mm
 4.0 Ah



18V
 Li-Ion

$L_{pa} = 82,0 \pm 3,0$ dB; $L_{wa} = 93,0 \pm 3,0$ dB; $a_n = 5,14 \pm 1,5 / 4,65 \pm 1,5$ m/s²

YATO	[V d.c.]	
YT-82187	18	2

EN Cordless angle grinder
 PL Akumulatorowa szlifierka kątowa
 DE Akku-Winkelschleifer
 RU Аккумуляторная угловая шлифмашина
 CZ Akumulátorová úhlová bruska
 HU Akkus sarokcsiszoló
 RO Polizor unghiular cu acumulator
 FR Meuleuse angulaire sans-fil
 IT Smerigliatrice angolare a batteria
 ES Amoladora angular a batería
 CN 充电式角磨

18V
 10000
 125 mm
 M14
 2.0 Ah
 1h



$L_{pa} = 88,0 \pm 3,0$ dB; $L_{wa} = 99,0 \pm 3,0$ dB; $a_n = 4,9 \pm 1,5$ m/s²

YATO	[V d.c.]	
YT-82826	18	4

EN Cordless angle grinder
 PL Akumulatorowa szlifierka kątowa
 DE Akku-Winkelschleifer
 RU Аккумуляторная угловая шлифмашина
 CZ Akumulátorová úhlová bruska
 HU Akkus sarokcsiszoló
 RO Polizor unghiular fara acumulator
 FR Meuleuse angulaire sans-fil
 IT Smerigliatrice angolare a batteria
 ES Amoladora angular a batería
 CN 充电式角磨

18V
 10000
 125 mm
 M14



$L_{pa} = 88,0 \pm 3,0$ dB; $L_{wa} = 99,0 \pm 3,0$ dB; $a_n = 4,9 \pm 1,5$ m/s²

YATO	[V d.c.]	
YT-82827	18	6

EN Cordless band saw
 PL Akumulatorowa pila taśmowa
 DE Akku-Bandsäge
 RU Аккумуляторная ленточная пила
 CZ Akumulátorová pásová pila
 HU Akkus szalagfűrész
 RO Fierastrau cu banda cu acumulator
 FR Scie à ruban sans-fil
 IT Sega a nastro a batteria
 ES Sierra de cinta a batería
 CN 充电式带锯

18V
 0-120
 14 TPI
 1140x12,7 x0,6 mm
 127 mm



18V
 Li-Ion

$L_{pa} = 82,0 \pm 3,0$ dB; $L_{wa} = 93,0 \pm 3,0$ dB; $a_n = 5,14 \pm 1,5 / 4,65 \pm 1,5$ m/s²

YATO	[V d.c.]	
YT-82188	18	2

EN Cordless angle grinder
 PL Akumulatorowa szlifierka kątowa
 DE Akku-Winkelschleifer
 RU Аккумуляторная угловая шлифмашина
 CZ Akumulátorová úhlová bruska
 HU Akkus sarokcsiszoló
 RO Polizor unghiular cu acumulator
 FR Meuleuse angulaire sans-fil
 IT Smerigliatrice angolare a batteria
 ES Amoladora angular a batería
 CN 充电式角磨

18V
 10000
 125 mm
 M14
 3.0 Ah
 1.5h



$L_{pa} = 88,0 \pm 3,0$ dB; $L_{wa} = 99,0 \pm 3,0$ dB; $a_n = 4,9 \pm 1,5$ m/s²

YATO	[V d.c.]	
YT-82828	18	4

EN Cordless angle grinder
 PL Akumulatorowa szlifierka kątowa
 DE Akku-Winkelschleifer
 RU Аккумуляторная угловая шлифмашина
 CZ Akumulátorová úhlová bruska
 HU Akkus sarokcsiszoló
 RO Polizor unghiular cu acumulator
 FR Meuleuse angulaire sans-fil
 IT Smerigliatrice angolare a batteria
 ES Amoladora angular a batería
 CN 充电式角磨

18V
 2000-9000
 125 mm
 M14
 3.0 Ah
 1.5h
 SPEED REGULATOR REGULACJA PREDKOSCI
 SOFT START MIĘKKI START
 BRUSHLESS MOTOR SILNIK BEZ SZCZĘTKOWY



$L_{pa} = 82,6 \pm 3,0$ dB; $L_{wa} = 93,6 \pm 3,0$ dB; $a_n = 6,2 \pm 1,5 / 5,8 \pm 1,5$ m/s²

YATO	[V d.c.]	
YT-82829	18	4

Battery not included
 Ohne Akku / Bez akumulatora
 Bez baterije / Bez aku
 Akkumulátor nélkül
 Fără baterie / Sans batterie
 Senza batteria / Sin batería
 没有电池

EN Cordless angle grinder
PL Akumulatorowa szlifierka kąтова
DE Akku-Winkelschleifer
RU Аккумуляторная угловая шлифмашина
CZ Akumulátorová úhlová bruska
HU Akkus sarokcsiszoló
RO Polizor unghiular cu acumulator
FR Meuleuse angulaire sans-fil
IT Smerigliatrice angolare a batteria
ES Amoladora angular a batería
CN 充电式角磨



18 V Li-Ion	2000-9000 min ⁻¹	125 mm	M14
SPEED REGULATOR REGULACJA PRĘDKOŚCI	SOFT START MIEKKI START	BRUSHLESS MOTOR SIŁNIK BEZ- SZCZOTKOWY	



Battery not included
Ohne Akku / Bez akumulatora
Bez ładowarki / Bez aku
Akumulator nélkül
Fără baterie / Sans batterie
Senza batteria / Sin batería
没有电池

18V
Li-Ion

$L_{PA} = 82,6 \pm 3,0$ dB; $L_{WA} = 93,6 \pm 3,0$ dB; $a_n = 6,2 \pm 1,5 / 5,8 \pm 1,5$ m/s²

YATO	[V d.c.]	
YT-828291	18	6

EN Cordless polisher
PL Polerka akumulatorowa
DE Akku-Polierer
RU Аккумуляторная полировальная машина
CZ Akumulátorová leštička
HU Vezeték nélküli polírozó
RO Aparat de slefuit cu acumulator
FR Polisseuse sans-fil
IT Lucidatrice a batteria
ES Pulidora a batería
CN 充电式抛光机



18 V Li-Ion	2100-5000 min ⁻¹	125 mm	M8	DUAL ACTION RUCH ORBITALNY
	4.0 Ah	SPEED REGULATOR REGULACJA PRĘDKOŚCI	SOFT START MIEKKI START	BRUSHLESS MOTOR SIŁNIK BEZ- SZCZOTKOWY



$L_{PA} = 75,0 \pm 3,0$ dB; $L_{WA} = 86,0 \pm 3,0$ dB; $a_n = 4,56 \pm 1,5$ m/s²

18V
Li-Ion

YATO	[V d.c.]	
YT-82924	18	6

EN Cordless polisher
PL Polerka akumulatorowa
DE Akku-Polierer
RU Аккумуляторная полировальная машина
CZ Akumulátorová leštička
HU Vezeték nélküli polírozó
RO Aparat de slefuit cu acumulator
FR Polisseuse sans-fil
IT Lucidatrice a batteria
ES Pulidora a batería
CN 充电式抛光机



18 V Li-Ion	2100-5000 min ⁻¹	125 mm	M8	DUAL ACTION RUCH ORBITALNY
	15 mm	SPEED REGULATOR REGULACJA PRĘDKOŚCI	SOFT START MIEKKI START	BRUSHLESS MOTOR SIŁNIK BEZ- SZCZOTKOWY



Battery not included
Ohne Akku / Bez akumulatora
Bez ładowarki / Bez aku
Akumulator nélkül
Fără baterie / Sans batterie
Senza batteria / Sin batería
没有电池

18V
Li-Ion

$L_{PA} = 75,0 \pm 3,0$ dB; $L_{WA} = 86,0 \pm 3,0$ dB; $a_n = 4,56 \pm 1,5$ m/s²

YATO	[V d.c.]	
YT-82925	18	6

EN Cordless orbital sander
PL Szlifierka oscylacyjna akumulatorowa
DE Akku-Schwingschleifer
RU Аккумуляторная шлифовальная машина
CZ Akumulátorová bruska
HU Akkumulátoros csiszoló
RO Șlefuitor cu acumulator
FR Ponceuse vibrante sans-fil
IT Levigatrice orbitale a batteria
ES Lijadora orbital inalámbrica
CN 充电式砂光机

18 V Li-Ion	13000 min ⁻¹		2.0 mm	90x187 mm
----------------	----------------------------	--	--------	--------------



Battery not included
Ohne Akku / Bez akumulatora
Bez ładowarki / Bez aku
Akumulator nélkül
Fără baterie / Sans batterie
Senza batteria / Sin batería
没有电池

18V
Li-Ion

Fitting sand papers: see chapter 10
Pasujące papiery ściernie: patrz rozdział 10
 $L_{PA} = 77,8 \pm 3,0$ dB; $L_{WA} = 88,8 \pm 3,0$ dB; $a_n = 5,45 \pm 1,5$ m/s²

YATO	[V d.c.]	
YT-82751	18	4

EN Cordless orbital sander
PL Szlifierka oscylacyjna akumulatorowa
DE Akku-Schwingschleifer
RU Аккумуляторная шлифовальная машина
CZ Akumulátorová bruska
HU Akkumulátoros csiszoló
RO Șlefuitor cu acumulator
FR Ponceuse vibrante sans-fil
IT Levigatrice orbitale a batteria
ES Lijadora orbital inalámbrica
CN 充电式砂光机



18 V Li-Ion	0-12000 min ⁻¹		2.0 mm	125 mm
----------------	------------------------------	--	--------	-----------



Battery not included
Ohne Akku / Bez akumulatora
Bez ładowarki / Bez aku
Akumulator nélkül
Fără baterie / Sans batterie
Senza batteria / Sin batería
没有电池

18V
Li-Ion

Fitting sand papers: see chapter 10
Pasujące papiery ściernie: patrz rozdział 10
 $L_{PA} = 73,7 \pm 3,0$ dB; $L_{WA} = 84,7 \pm 3,0$ dB; $a_n = 7,0 \pm 1,5$ m/s²

YATO	[V d.c.]	
YT-82753	18	4

EN Cordless orbital sander
PL Szlifierka oscylacyjna akumulatorowa
DE Akku-Schwingschleifer
RU Аккумуляторная шлифовальная машина
CZ Akumulátorová bruska
HU Akkumulátoros csiszoló
RO Șlefuitor cu acumulator
FR Ponceuse vibrante sans-fil
IT Levigatrice orbitale a batteria
ES Lijadora orbital inalámbrica
CN 充电式砂光机

18 V Li-Ion	11000 min ⁻¹		2.0 mm	84x184 mm
----------------	----------------------------	--	--------	--------------



Battery not included
Ohne Akku / Bez akumulatora
Bez ładowarki / Bez aku
Akumulator nélkül
Fără baterie / Sans batterie
Senza batteria / Sin batería
没有电池

18V
Li-Ion

$L_{PA} = 69,6 \pm 3,0$ dB; $L_{WA} = 80,6 \pm 3,0$ dB; $a_n = 7,34 \pm 1,5$ m/s²

YATO	[V d.c.]	
YT-82755	18	4

EN Cordless polisher
 PL Polerka akumulatorowa
 DE Akku-Polierer
 RU Аккумуляторная полировальная машина
 CZ Akumulátorová leštička
 HU Vezeték nélküli polírozó
 RO Aparat de slefuit cu acumulator
 FR Polisseuse sans-fil
 IT Lucidatrice a batteria
 ES Pulidora a batería
 CN 充电式抛光机



18 V Li-Ion	1500-5000 min ⁻¹	150 mm	M8	DUAL ACTION RUCH ORBITALNY
16 mm	3.0 Ah	1.5h	SOFT START MIEKKI START	SPEED REGULATOR REGULACJA PRĘDKOŚCI
BRUSHLESS MOTOR SIŁNIK BEZ- SZCZOTKOWY				



18V
Li-Ion

$L_{pa} = 88,0 \pm 3,0$ dB; $L_{wa} = 99,0 \pm 3,0$ dB; $a_n = 15,540 \pm 1,5 / 18,859 \pm 1,5$ m/s²

YATO	[V d.c.]	
YT-82920	18	4

EN Cordless polisher
 PL Polerka akumulatorowa
 DE Akku-Polierer
 RU Аккумуляторная полировальная машина
 CZ Akumulátorová leštička
 HU Vezeték nélküli polírozó
 RO Aparat polisat cu acumulator
 FR Polisseuse sans-fil
 IT Lucidatrice a batteria
 ES Pulidora a batería
 CN 充电式抛光机

18 V Li-Ion	2500 min ⁻¹	254 mm	BRUSHLESS MOTOR SIŁNIK BEZ- SZCZOTKOWY
6.0 mm			



18V
Li-Ion

Battery not included
 Ohne Akku / Bez akumulatora
 Bez Gamapeu / Bez aku
 Akumulátor nélkül
 Fără baterie / Sans batterie
 Senza batteria / Sin bateria
 没有电池

$L_{pa} = 81,0 \pm 3,0$ dB; $L_{wa} = 92,0 \pm 3,0$ dB; $a_n = 7,73 \pm 1,5$ m/s²

YATO	[V d.c.]	
YT-82922	18	4

EN Cordless rotary hammer
 PL Akumulatorowa młotowiertarka
 DE Akku-Bohrhammer
 RU Аккумуляторный перфоратор
 CZ Akumulátorové vrtací kladivo
 HU Akkus fúrókalapács
 RO Ciocan rotopercutor cu acumulator
 FR Marteau-perforateur rotatif sans-fil
 IT Martello rotativo a batteria
 ES Martillo perforador a batería
 CN 充电式电锤

18 V Li-Ion	SDS PLUS	0-1850 min ⁻¹	0-4800 min ⁻¹
2.0 J	18 mm	3.0 Ah	1.5h



18V
Li-Ion

$L_{pa} = 83,0 \pm 3,0 / 91,0 \pm 3,0$ dB; $L_{wa} = 94,0 \pm 3,0 / 102,0 \pm 3,0$ dB; $a_n = 16,9 \pm 1,5 / 15,9 \pm 1,5$ m/s²



YATO	[V d.c.]	
YT-82770	18	3

EN Cordless rotary hammer
 PL Akumulatorowa młotowiertarka
 DE Akku-Bohrhammer
 RU Аккумуляторный перфоратор
 CZ Akumulátorové vrtací kladivo
 HU Akkus fúrókalapács
 RO Ciocan rotopercutor cu acumulator
 FR Marteau-perforateur rotatif sans-fil
 IT Martello rotativo a batteria
 ES Martillo perforador a batería
 CN 充电式电锤

18 V Li-Ion	SDS PLUS	0-1000 min ⁻¹	0-5000 min ⁻¹
2.4 J	24 mm		



18V
Li-Ion

Battery not included
 Ohne Akku / Bez akumulatora
 Bez Gamapeu / Bez aku
 Akumulátor nélkül
 Fără baterie / Sans batterie
 Senza batteria / Sin bateria
 没有电池

$L_{pa} = 89,0 \pm 3,0 / 89,0 \pm 3,0$ dB; $L_{wa} = 100,0 \pm 3,0 / 100,0 \pm 3,0$ dB; $a_n = 13,286 \pm 1,5 / 9,473 \pm 1,5$ m/s²

YATO	[V d.c.]	
YT-82772	18	4

EN Cordless drywall sander
PL Akumulatorowa szlifierka do gipsu
DE Akku-Gipsschleifer
RU Аккумуляторная шлифовальная машина для гипса
CZ Akumulátorová sádrová bruska
HU Akkus falcsiszoló
RO Slefuitor perete cu acumulator
FR Ponceuse murale sans-fil
IT Levigatrice per muro a batteria
ES Lijadora de pared a batería
CN 充电式无刷打磨机

- Vacuum self suction system integrated
- Adapter diameters: 35, 47 mm
- Included 6 pcs sand paper: P60, P80, P120, P150, P180, P240
- Wbudowany system odsysania pyłu
- Średnice adaptera: 35, 47 mm
- W zestawie 6 szt. papieru ściernego: P60, P80, P120, P150, P180, P240



Fitting abrasive discs: see chapter 10
Pasujące krążki ścieme: patrz rozdział 10
 $L_{pA} = 87,0 \pm 3,0$ dB; $L_{wA} = 95,0 \pm 3,0$ dB; $a_s = 3,18 \pm 1,5$ m/s²

YATO	[V d.c.]	
YT-82360	18	2

18V Li-Ion

18 V Li-Ion 600-1200 min

225 mm M6

4.0 Ah BRUSHLESS MOTOR SILNĀK BEZ SZCZOTKOWY

EN Cordless drywall sander
PL Akumulatorowa szlifierka do gipsu
DE Akku-Gipsschleifer
RU Аккумуляторная шлифовальная машина для гипса
CZ Akumulátorová sádrová bruska
HU Akkus falcsiszoló
RO Slefuitor perete cu acumulator
FR Ponceuse murale sans-fil
IT Levigatrice per muro a batteria
ES Lijadora de pared a batería
CN 充电式无刷打磨机

- Vacuum self suction system integrated
- Adapter diameters: 35, 47 mm
- Included 6 pcs sand paper: P60, P80, P120, P150, P180, P240
- Wbudowany system odsysania pyłu
- Średnice adaptera: 35, 47 mm
- W zestawie 6 szt. papieru ściernego: P60, P80, P120, P150, P180, P240



Fitting abrasive discs: see chapter 10
Pasujące krążki ścieme: patrz rozdział 10
 $L_{pA} = 87,0 \pm 3,0$ dB; $L_{wA} = 95,0 \pm 3,0$ dB; $a_s = 3,18 \pm 1,5$ m/s²

YATO	[V d.c.]	
YT-82361	18	2

Battery not included
Ohne Akku / Bez akumulatora
Bez Gamapeu / Bez aku
Akumulator neličūl
Fără baterie / Sans batterie
Senza batteria / Sin batería
没有电池

EN Cordless hybrid air fan
PL Akumulatorowy wentylator hybrydowy
DE Akku-Ventilator
RU Аккумуляторный вентилятор гибридный
CZ Bateriový ventilátor
HU Akkumulátoros ventilátor
RO Ventilator cu acumulator
FR Ventilateur sans-fil
IT Ventilatore ibrido a batteria
ES Ventilador a batería
CN 充电式风扇

18 V Li-Ion 100-240V~50/60Hz

HYBRID HYBRIDOWY 1700 min²

2600 min² 230 mm

360°



Battery not included
Ohne Akku / Bez akumulatora
Bez Gamapeu / Bez aku
Akumulator neličūl
Fără baterie / Sans batterie
Senza batteria / Sin batería
没有电池

YATO	[V d.c.]	
YT-82933	18	2

EN Cordless worksite radio
PL Akumulatorowe radio budowlane
DE Akku-Baustellenradio
RU Аккумуляторное строительное радио
CZ Akumulátorové rádio na stavbu
HU Akkus építkezési rádió
RO Radio pt. atelier cu acumulator
FR Radio d'atelier sans-fil
IT Radio da officina a batteria
ES Radio de obra a batería
CN 蓝牙收音机

18 V Li-Ion 220-240V~50/60Hz 3W

36h x10 FM x10 AM PROGRAMOWANIE

FM 87.5-108 MHz AM 522-1710 kHz

LCD BACKLIGHT PODSWIETLENIE

USB



Battery not included
Ohne Akku / Bez akumulatora
Bez Gamapeu / Bez aku
Akumulator neličūl
Fără baterie / Sans batterie
Senza batteria / Sin batería
没有电池

YATO	[V d.c.]	
YT-82940	18	8

EN Cordless lamp
PL Akumulatorowa lampa robocza
DE Akku-Lampe
RU Аккумуляторная лампа
CZ Dobjíjecí lampa
HU Újratölthető lámpa
RO Lampa reincarcabila
FR Le projecteur sans-fil
IT Lampada da lavoro a batteria
ES Lámpara recargable a batería
CN 锂电LED工作灯

18 V Li-Ion 1600 lm

2 LIGHTING MODES TRYBY SWIECZENIA 180°

METAL FRAME METALOWA RAMKA TRANSPORT HANDLE UCHYTY TRANSPORTOWY



Battery not included
Ohne Akku / Bez akumulatora
Bez Gamapeu / Bez aku
Akumulator neličūl
Fără baterie / Sans batterie
Senza batteria / Sin batería
没有电池

- 2 lighting modes: 50%, 100%
- 2 tryby swiecenia: 50%, 100%

YATO	[V d.c.]	
YT-82961	18	6

EN Cordless vacuum cleaner
 PL Odkurzacz akumulatorowy
 DE Akku-Staubsauger
 RU Аккумуляторный пылесос
 CZ Akumulátorový vysavač
 HU Akkumulátoros porszívó
 RO Aspirator cu acumulator
 FR Aspirateur sans-fil
 IT Aspirapolvere a batteria
 ES Aspirador a batería
 CN 充电式吸尘器

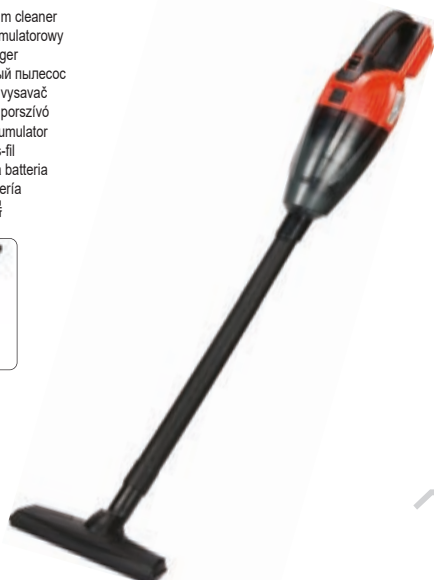

18V
Li-Ion

3.8
kPa

0.5L

BAGLESS
BEZ-
WORKOWY



Battery not included
 Ohne Akku / Bez akumulatora
 Bez Gamapeu / Bez aku
 Akkumulátor nélkül
 Fără baterie / Sans batterie
 Senza batteria / Sin batería
 没有电池

18V
Li-Ion



YATO	[V d.c.]	
YT-85680	18	4

EN Cordless pressure washer
 PL Akumulatorowa myjka ciśnieniowa
 DE Akku-Hochdruckreiniger
 RU Аккумуляторная мойка высокого давления
 CZ Baterový tlakový čistič
 HU Akkumulátoros mosó
 RO Aparat de spalat cu presiune
 FR Nettoyeur à haute pression sans-fil
 IT Idropulitrice a batteria
 ES Limpiadora a vapor a batería
 CN 高压清洗机



18V
Li-Ion

IN (max)
0.5
MPa

OUT
2.3
MPa

6 m

SUCTION
FLUCTUA
FLUKTUA
ZÁSTYSA



Battery not included
 Ohne Akku / Bez akumulatora
 Bez Gamapeu / Bez aku
 Akkumulátor nélkül
 Fără baterie / Sans batterie
 Senza batteria / Sin batería
 没有电池

18V
Li-Ion

YATO	[V d.c.]	
YT-85930	18	6

EN Cordless barrel pump
 PL Akumulatorowa pompa do deszczówki
 DE Akku-Regenfasspumpe
 RU Аккумуляторный насос для дождевой воды
 CZ Akumulátorové čerpadlo na dešťovou vodu
 HU Akkumulátoros esővíz szivattyú
 RO Pompă de butoi fără fir
 FR Pompe à eau de pluie sans-fil
 IT Pompa per acqua piovana a batteria
 ES Bomba de batería para tanques de agua de precipitación
 CN 充电式潜水泵



18V
Li-Ion

2 bar

ø3/4"
19 mm

2000
l/h

21 m

1.5m

max. °C
35

IPX8



Battery not included
 Ohne Akku / Bez akumulatora
 Bez Gamapeu / Bez aku
 Akkumulátor nélkül
 Fără baterie / Sans batterie
 Senza batteria / Sin batería
 没有电池

18V
Li-Ion

YATO	[V d.c.]	
YT-85283	18	4

L_{WA} = <70 dB

EN Cordless leaf vacuum / blower
 PL Akumulatorowy odkurzacz / dmuchawa do liści
 DE Akku-Laubsauger / Laubbläser
 RU Аккумуляторная воздуходувка-пылесос
 CZ Akumulátorový vysavač / odfukovač listů
 HU Akkumulátoros lombszívó / lombfúvó
 RO Sulfanta / aspirator cu acumulator
 FR Aspirateur-souffleur de feuilles sans-fil
 IT Aspiratore / soffiatore per foglie senza fili
 ES Aspiradora / soplador de hojas de batería
 CN 锂电无刷吹吸机



2 in 1
2 w 1

36 V
2x 18V
Li-Ion

6000-12500
mm³

8
m³/min

45 L



- Leaves compress volume function 8:1
- Blowing air speed: 230 km/h
- Funkcja zmniejszania objętości liści 8:1
- Prędkość wydmuchiwanego powietrza: 230 km/h

Battery not included
 Ohne Akku / Bez akumulatora
 Bez Gamapeu / Bez aku
 Akkumulátor nélkül
 Fără baterie / Sans batterie
 Senza batteria / Sin batería
 没有电池

18V
Li-Ion

L_{WA} = 80,5 ± 3,0 dB; L_{WA} = 92,7 ± 3,0 dB; a_n = 2,37 ± 1,5 m/s²

YATO	[V d.c.]	
YT-85175	36 (18 x2)	1

EN Cordless submersible garden pump
 PL Akumulatorowa pompa ogrodowa zatapialna
 DE Akku-Garten-Tauchpumpe
 RU Аккумуляторный садовый насос
 CZ Akumulátorové zahradní čerpadlo
 HU Akkumulátoros kerti merülő szivattyú
 RO Pompă de grădină submersibilă fără fir
 FR Pompe de jardin submersible sans-fil
 IT Pompa sommersa da giardino a batteria
 ES Bomba de batería sumergible para jardín
 CN 充电式潜水泵



18V
Li-Ion

2 bar

ø1"
25 mm

2500
l/h

20 m

1.5m

max. °C
35

IPX8



Battery not included
 Ohne Akku / Bez akumulatora
 Bez Gamapeu / Bez aku
 Akkumulátor nélkül
 Fără baterie / Sans batterie
 Senza batteria / Sin batería
 没有电池

18V
Li-Ion

L_{WA} = <70 dB

YATO	[V d.c.]	
YT-85281	18	4

EN Electric sprayer
 PL Spryskiwacz elektryczny
 DE Elektrische Sprühpistole
 RU Электрический опрыскиватель
 CZ Elektrický ostrihovač
 HU Elektromos festékszóró
 RO Pulverizator electric
 FR Pulvérisateur à main électrique
 IT Spruzzatore elettrico
 ES Rociador eléctrico
 CN 喷壶



3.6 V
2000mAh
Li-Ion

1000 ml

460 ml/min

285 ml/min

2.5h

LED
LIGHTING
OSWIETLIENIE

4-5h

2.5h

LED
LIGHTING
OSWIETLIENIE

LED CHARGE
INDICATOR
WSKAZNIK
NALADOWANIA
BATERII

USB
BATTERY CHARGER
ŁADOWNIK



- Application: watering, washing, disinfection
- Przeznaczenie: podlewanie, mycie, dezynfekcja

L_{WA} = 75,2 ± 3,0 dB; L_{WA} = 86,2 ± 3,0 dB; a_n = 1,137 ± 1,5 m/s²

YATO	[V d.c.]	
YT-86200	3.6	18

EN Cordless transfer pump for oil and water
PL Akumulatorowa pompa do oleju i wody
DE Akku-Pumpe
RU Аккумуляторный перекачивающий насос
HU Akkus szivattyú
RO Pompa baterie
FR Pompe à batterie
IT Pompa a batteria per olio e acqua
ES Bomba de batería
CN 无绳水&机油泵

18 V
Li-Ion
380 W
3/4" 19 mm
1800 l/h
22 m
9 m
3.0 Ah
IPX4
FOR WATER AND OIL DO WODY I OLEJU



18V
Li-Ion

YATO	[V d.c.]	
YT-85290	18	2

EN Cordless backpack sprayer
PL Akumulatorowy opryskiwacz plecakowy
DE Akku-Drucksprüher
RU Аккумуляторный ранцевый опрыскиватель
CZ Aku postřikovač
HU Akkumulátoros hátí permetező
RO Pulverizator cu acumulator
FR Pulvérisateur à batterie
IT Pompa irroratrice a spalla a batteria
ES Pulverizador de mochila a batería
CN 充电式喷雾器

2 in 1
2 w 1
18 V
Li-Ion
12 L
≤ 1.5 l/min
max 7 m



Battery not included
Oltre Akku / Bez akumulatora
Bez baterie / Bez aku
Akumulator nélkül
Fără baterie / Sans batterie
Senza batteria / Sin batería
没有电池

- Water tank
- Sprayer
- Hydronetka
- Opryskiwacz

$L_{PA} = 60.0 \pm 3.0$ dB; $L_{WA} = 70.0 \pm 3.0$ dB; $a_h = 0.74 \pm 1.5$ m/s²

YATO	[V d.c.]	
YT-86211	18	1

EN Cordless grass trimmer
PL Akumulatorowa podkaszarka do trawy
DE Akku-Rasentrimmer
RU Аккумуляторный триммер
CZ Akumulátorová sekačka na trávu
HU Akkus szegélynyíró
RO Trimmere de gazon cu acumulator
FR Débroussailluse sans-fil
IT Tagliabordi a batteria
ES Desbrozadora a batería
CN 充电式打草机

18 V
Li-Ion
7200 min⁻¹
250/300 mm
137 108 cm
2.0 Ah
1 h



18V
Li-Ion

$L_{PA} = 85.0 \pm 3.0$ dB; $L_{WA} = 93.0 \pm 3.0$ dB; $a_h = 2.5 \pm 1.5$ m/s²

YATO	[V d.c.]	
YT-82830	18	2

EN Cordless transfer pump for oil and water
PL Akumulatorowa pompa do oleju i wody
DE Akku-Pumpe
RU Аккумуляторный перекачивающий насос
HU Akkus szivattyú
RO Pompa baterie
FR Pompe à batterie
IT Pompa a batteria per olio e acqua
ES Bomba de batería
CN 无绳水&机油泵

18 V
Li-Ion
380 W
3/4" 19 mm
1800 l/h
22 m
9 m
IPX4
FOR WATER AND OIL DO WODY I OLEJU



18V
Li-Ion

YATO	[V d.c.]	
YT-85291	18	2

Battery not included
Oltre Akku / Bez akumulatora
Bez baterie / Bez aku
Akumulator nélkül
Fără baterie / Sans batterie
Senza batteria / Sin batería
没有电池

EN Battery sprayer with solar panel
PL Opryskiwacz akumulatorowo-solarny
DE Solar-Akku-Sprühergerät
RU Опрыскиватель аккумуляторный на солнечной батарее
CZ Postřikovač bateriovo-solární
HU Akkumulátoros-napelemes permetező
RO Vermorel cu alimentare solara
FR Pulvérisateur à batterie et à dos solaire
IT Pompa irroratrice a batteria e ad energia solare
ES Pulverizador solar a batería
CN 电动太阳能喷雾器

12 V
0.15-0.4 MPa
3.1 l/min
16 L
8.0 Ah
PP
SS
STAINLESS STEEL
STAL NIERDZEWNA



YATO	[V d.c.]	
YT-86220	12	1

EN Cordless grass trimmer
PL Akumulatorowa podkaszarka do trawy
DE Akku-Rasentrimmer
RU Аккумуляторный триммер
CZ Akumulátorová sekačka na trávu
HU Akkus szegélynyíró
RO Trimmere de gazon cu acumulator
FR Débroussailluse sans-fil
IT Tagliabordi a batteria
ES Desbrozadora a batería
CN 充电式打草机

18 V
Li-Ion
7200 min⁻¹
250/300 mm
137 108 cm
2.0 Ah
1 h



18V
Li-Ion

$L_{PA} = 85.0 \pm 3.0$ dB; $L_{WA} = 93.0 \pm 3.0$ dB; $a_h = 2.5 \pm 1.5$ m/s²

YATO	[V d.c.]	
YT-82831	18	2

Battery not included
Oltre Akku / Bez akumulatora
Bez baterie / Bez aku
Akumulator nélkül
Fără baterie / Sans batterie
Senza batteria / Sin batería
没有电池

- EN Cordless grass trimmer
- PL Akumulatorowa podkaszarka do trawy
- DE Akku-Rasentrimmer
- RU Аккумуляторный триммер
- CZ Akumulátorová sekačka na trávu
- HU Akkus szegélynyíró
- RO Trimmere de gazon cu acumulator
- FR Débroussaillouse sans-fil
- IT Tagliabordi a batteria
- ES Desbrozadora a batería
- CN 充电式打草机



18 V Li-Ion	9000 min ⁻¹
240 mm	1.6 mm 3 m
440 170 cm	CUTTING LINE ZYLKA TNACA
PLASTIC BLADE PLASTIKOWE OSTRZE	x20

Battery not included
 Ohne Akku / Bez akumulatora
 Bez Gamapeu / Bez aku
 Akkumulátor nélkül
 Fără baterie / Sans batterie
 Senza batteria / Sin battery
 没有电池

18V
Li-Ion

$L_{pa} = 81,0 \pm 3,0$ dB; $L_{wa} = 88,0 \pm 2,12$ dB; $a_h = \leq 2,5$ m/s²

YATO	[V d.c.]	
YT-85015	18	4

- EN Nylon blades
- PL Nożyki nylonowe
- DE Nylonmesser Set
- RU Сменные ножи для триммера
- CZ Náhradní nože pro vyžinače
- HU Nylon kések
- RO Lame din nailon
- FR Lames en nylon
- IT Piedi di nylon
- ES Cuchillas de nylon
- CN 尼龙打草刀片

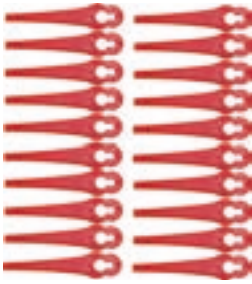

20 PCS	
-----------	--

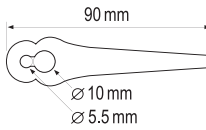

For YT-85015
 Dla YT-85015

YATO	[V d.c.]	
YT-85016	250	

- EN Cordless hedge trimmer
- PL Akumulatorowe nożyce do żywoplotu
- DE Akku-Heckenschere
- RU Аккумуляторный кусторез
- CZ Akumulátorové nůžky na živé ploty
- HU Akkus sövénynyíró
- RO Foarfece de tăiat gard viu cu acumulator
- FR Taille-haies sans-fil
- IT Tagliasiepi a batteria
- ES Cortasetos inalámbrico
- CN 充电式修枝剪

18 V Li-Ion	1050 min ⁻¹	560mm 22"	2.0 Ah	1h
----------------	---------------------------	--------------	-----------	----



18V
Li-Ion

$L_{pa} = 80,0 \pm 3,0$ dB; $L_{wa} = 87,0 \pm 3,0$ dB; $a_h = 3,5 \pm 1,5$ m/s²

YATO	[V d.c.]	
YT-82832	18	2

- EN Cordless brushcutter
- PL Kosa akumulatorowa
- DE Akku-Motorsense
- RU Аккумуляторная коса
- CZ Akumulátorový křovinořez
- HU Akkus fűkasza
- RO Motoacoasa cu acumulator
- FR Débroussaillouse sans-fil
- IT Decespugliatore a batteria
- ES Motoguadaña a batería
- CN 充电式打草机

36 V 2x 18 V Li-Ion	5800 min ⁻¹	255x25,4 mm	340 mm	1.6 mm 3 m	BRUSHLESS MOTOR SZLAK BEZ SZCZOTKOWY
---------------------------	---------------------------	----------------	-----------	---------------	---



Battery not included
 Ohne Akku / Bez akumulatora
 Bez Gamapeu / Bez aku
 Akkumulátor nélkül
 Fără baterie / Sans batterie
 Senza batteria / Sin battery
 没有电池

18V
Li-Ion

$L_{pa} = 79,1 \pm 3,0 / 83,0 \pm 3,0$ dB; $L_{wa} = 88,4 \pm 2,31 / 92,5 \pm 1,92$ dB;
 $a_h = 1,35 \pm 1,5 / 1,11 \pm 1,5$ m/s²

YATO	[V d.c.]	
YT-85010	36 (18 x2)	1

- EN Cordless hedge trimmer
- PL Akumulatorowe nożyce do żywoplotu
- DE Akku-Heckenschere
- RU Аккумуляторный кусторез
- CZ Akumulátorové nůžky na živé ploty
- HU Akkus sövénynyíró
- RO Foarfece de tăiat gard viu cu acumulator
- FR Taille-haies sans-fil
- IT Tagliasiepi a batteria
- ES Cortasetos inalámbrico
- CN 充电式修枝剪

18 V Li-Ion	1050 min ⁻¹	560mm 22"
----------------	---------------------------	--------------



18V
Li-Ion

$L_{pa} = 80,0 \pm 3,0$ dB; $L_{wa} = 87,0 \pm 3,0$ dB; $a_h = 3,5 \pm 1,5$ m/s²

YATO	[V d.c.]	
YT-82833	18	2

EN Cordless hedge trimmer
PL Akumulatorowe nożyce do żywoplotu
DE Akku-Heckenschere
RU Аккумуляторный кусторез
CZ Akumulátorové nůžky na živé ploty
HU Akkus sövénynyíró
RO Foarfece de tăiat gard viu cu acumulator
FR Taille-haies sans-fil
IT Tagliasiepi a batteria
ES Tijera cortasetos a batería
CN 充电式高枝剪

18V
Li-Ion



18V
Li-Ion

2100
min

420
mm

274
207
cm

2.0
Ah

1h

EASY
TRANSPORT
LATVY
TRANSPORT

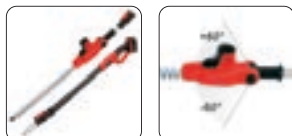

$L_{pA} = 77,3 \pm 3,0$ dB; $L_{wA} = 88,1 \pm 3,0$ dB; $a_h = 1,5 \pm 1,5$ m/s²

YATO	[V d.c.]	
YT-82834	18	2

EN Cordless hedge trimmer
PL Akumulatorowe nożyce do żywoplotu
DE Akku-Heckenschere
RU Аккумуляторный кусторез
CZ Akumulátorové nůžky na živé ploty
HU Akkus sövénynyíró
RO Foarfece de tăiat gard viu cu acumulator
FR Taille-haies sans-fil
IT Tagliasiepi a batteria
ES Tijera cortasetos a batería
CN 充电式高枝剪

18V
Li-Ion



18V
Li-Ion

2100
min

420
mm

274
207
cm

EASY
TRANSPORT
LATVY
TRANSPORT

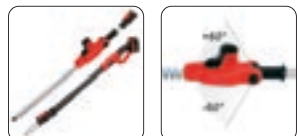

$L_{pA} = 77,3 \pm 3,0$ dB; $L_{wA} = 88,1 \pm 3,0$ dB; $a_h = 1,5 \pm 1,5$ m/s²

YATO	[V d.c.]	
YT-82835	18	2

EN Cordless telescopic pole saw
PL Akumulatorowe okrzęsywarka na wysięgniku
DE Akku-Teleskop-Hochentaster
RU Аккумуляторный телескопический выскорез
CZ Akumulátorová teleskopická vyvrtovací pila
HU Akkus magassági ágévágó távcsöves
RO Ferăstraie cu lanț cu telescopiu cu acumulator
FR Elagueuse sur perche télescopique sans-fil
IT Decespugliatore telescopico a batteria
ES Sierra de pértiga telescópica a batería
CN 充电式高枝锯

18V
Li-Ion



18V
Li-Ion

2500
min

5 m/s

280
200
cm

2.0
Ah

1h

EASY
TRANSPORT
LATVY
TRANSPORT



$L_{pA} = 78,2 \pm 3,0$ dB; $L_{wA} = 91,2 \pm 2,36$ dB; $a_h = 2,109 \pm 1,5$ m/s²

YATO	[V d.c.]	
YT-82836	18	2

EN Cordless telescopic pole saw
PL Akumulatorowe okrzęsywarka na wysięgniku
DE Akku-Teleskop-Hochentaster
RU Аккумуляторный телескопический выскорез
CZ Akumulátorová teleskopická vyvrtovací pila
HU Akkus magassági ágévágó távcsöves
RO Ferăstraie cu lanț cu telescopiu cu acumulator
FR Elagueuse sur perche télescopique sans-fil
IT Decespugliatore telescopico a batteria
ES Sierra de pértiga telescópica a batería
CN 充电式高枝锯

18V
Li-Ion



18V
Li-Ion

2500
min

5 m/s

280
200
cm

2.0
Ah

1h

EASY
TRANSPORT
LATVY
TRANSPORT



$L_{pA} = 78,2 \pm 3,0$ dB; $L_{wA} = 91,2 \pm 2,36$ dB; $a_h = 2,109 \pm 1,5$ m/s²

YATO	[V d.c.]	
YT-82837	18	2

Battery not included
Ohne Akku / Bez akumulatora
Bez Gamapeu / Bez aku
Akumulator nélkül
Fără baterie / Sans batterie
Senza batteria / Sin bateria
没有电池

EN Cordless chainsaw
PL Akumulatorowa pilarka łańcuchowa
DE Akku-Kettensäge
RU Аккумуляторная цепная пила
CZ Akumulátorová řetězová pila
HU Akkus láncfűrész
RO Ferăstrau cu lanț cu acumulator
FR Tronçonneuse sans-fil
IT Motosega a batteria
ES Inalámbrico motosierra
CN 锂电电链锯套装



18V
Li-Ion

2.0
Ah

1h

4.8 m/s

SOFT
GRIP
MIEKKI
UCHWYT



$L_{pA} = 78,0 \pm 3,0$ dB; $L_{wA} = 89,0 \pm 3,0$ dB; $a_h = 3,425 \pm 1,5$ m/s²

YATO	[V d.c.]	
YT-828135	18	4

EN Cordless chainsaw
PL Akumulatorowa pilarka łańcuchowa
DE Akku-Kettensäge
RU Аккумуляторная цепная пила
CZ Akumulátorová řetězová pila
HU Akkus láncfűrész
RO Ferăstrau cu lanț cu acumulator
FR Tronçonneuse sans-fil
IT Motosega a batteria
ES Inalámbrico motosierra
CN 锂电电链锯套装



18V
Li-Ion

2.0
Ah

1h

4.8 m/s

SOFT
GRIP
MIEKKI
UCHWYT



$L_{pA} = 78,0 \pm 3,0$ dB; $L_{wA} = 89,0 \pm 3,0$ dB; $a_h = 3,425 \pm 1,5$ m/s²

YATO	[V d.c.]	
YT-828136	18	4

Battery not included
Ohne Akku / Bez akumulatora
Bez Gamapeu / Bez aku
Akumulator nélkül
Fără baterie / Sans batterie
Senza batteria / Sin bateria
没有电池

EN Cordless chainsaw
 PL Akumulatorowa pilarka łańcuchowa
 DE Akku-Kettensäge
 RU Аккумуляторная цепная пила
 CZ Akumulátorová řetězová pila
 HU Akkus láncfűrész
 RO Ferăstrău cu lanț cu acumulator
 FR Tronçonneuse sans-fil
 IT Motosega a batteria
 ES Inalámbrico motosierra
 CN 锂电电链锯套装

36 V
2x 18 V
Li-Ion

4500
min⁻¹

14"
36 cm

0.375"
9.525 mm

0.655"
1.27 mm

0.17 L

2x
2.0
Ah

1h

AUTOMATIC OIL LUBRICATION SYSTEM SZYBIEŻYŁY OLEJOWANIE (UKŁADOŁY TŁACZĄCY)

QUICK CHAIN TENSION SYSTEM WPRĘCZALNIKOWA



18V
Li-Ion

$L_{PA} = 81,9 \pm 3,0$ dB; $L_{WA} = 92,8 \pm 2,6$ dB; $a_n = 2,57 \pm 1,5 / 4,92 \pm 1,5$ m/s²

YATO	[V d.c.]	
YT-82812	36 (18 x2)	2

EN Cordless chainsaw
 PL Akumulatorowa pilarka łańcuchowa
 DE Akku-Kettensäge
 RU Аккумуляторная цепная пила
 CZ Akumulátorová řetězová pila
 HU Akkus láncfűrész
 RO Ferăstrău cu lanț cu acumulator
 FR Tronçonneuse sans-fil
 IT Motosega a batteria
 ES Inalámbrico motosierra
 CN 锂电电链锯光机

36 V
2x 18 V
Li-Ion

4500
min⁻¹

14"
36 cm

0.375"
9.525 mm

0.655"
1.27 mm

0.17 L

2x
2.0
Ah

1h

AUTOMATIC OIL LUBRICATION SYSTEM SZYBIEŻYŁY OLEJOWANIE (UKŁADOŁY TŁACZĄCY)

QUICK CHAIN TENSION SYSTEM WPRĘCZALNIKOWA



18V
Li-Ion

$L_{PA} = 81,9 \pm 3,0$ dB; $L_{WA} = 92,8 \pm 2,6$ dB; $a_n = 2,57 \pm 1,5 / 4,92 \pm 1,5$ m/s²

YATO	[V d.c.]	
YT-82813	36 (18 x2)	2

Battery not included
 Ohne Akku / Bez akumulatora
 Bez ładowarki / Bez aku
 Akkumulátor nélkül
 Fără baterie / Sans batterie
 Senza batteria / Sin batería
 没有电池

EN Cordless lawn mower
 PL Kosiarka akumulatorowa
 DE Akku-Rasenmäher
 RU Аккумуляторная газонокосилка
 CZ Akumulátorová sekačka na trávu
 HU Fűnyíró akkumulátoros
 RO Masina de tuns iarba cu acumulator
 FR Tondeuse sans-fil
 IT Rasaerba a batteria
 ES Cortacésped de batería
 CN 锂电草坪机套装

36 V
2x 18 V
Li-Ion

3300
min⁻¹

65
20
mm

340
mm

35 L

2x
2.0
Ah

2x
2.0
Ah

1h

LED CHARGE INDICATOR WSKAZNIK NAŁADOWANIA BATERII



18V
Li-Ion

$L_{PA} = 77,9 \pm 3,0$ dB; $L_{WA} = 90,2 \pm 1,85$ dB; $a_n = 0,5 \pm 1,5$ m/s²

YATO	[V d.c.]	
YT-85220	36 (18 x2)	1

EN Cordless lawn mower
 PL Kosiarka akumulatorowa
 DE Akku-Rasenmäher
 RU Аккумуляторная газонокосилка
 CZ Akumulátorová sekačka na trávu
 HU Fűnyíró akkumulátoros
 RO Masina de tuns iarba cu acumulator
 FR Tondeuse sans-fil
 IT Rasaerba a batteria
 ES Cortacésped de batería
 CN 锂电草坪机光机

36 V
2x 18 V
Li-Ion

3300
min⁻¹

65
20
mm

340
mm

35 L

2x
2.0
Ah

2x
2.0
Ah

1h

LED CHARGE INDICATOR WSKAZNIK NAŁADOWANIA BATERII



18V
Li-Ion

$L_{PA} = 77,9 \pm 3,0$ dB; $L_{WA} = 90,2 \pm 1,85$ dB; $a_n = 0,5 \pm 1,5$ m/s²

YATO	[V d.c.]	
YT-85221	36 (18 x2)	1

EN Battery
 PL Akumulator
 DE Akkumulator
 RU Аккумулятор
 CZ Akumulátor
 HU Akkumulátor
 RO Acumulatorul
 FR Batterie
 IT Batteria
 ES Acumulator
 CN 锂电池包

18 V
Li-Ion

LED CHARGE INDICATOR WSKAZNIK NAŁADOWANIA BATERII



18V
Li-Ion

YATO	[V d.c.]	[Ah]	[h]	
YT-82842	18	2	1.0	20
YT-82843	18	3	1.5	20
YT-82844	18	4	2.0	20
YT-82845	18	6	3.0	20

EN Battery charger
 PL Ładowarka
 DE Ladegerät
 RU Зарядное устройство
 CZ Nabíječka
 HU Akkutöltő
 RO Redresor
 FR Chargeur de batterie
 IT Caricabatteria
 ES Rectificador
 CN 充电器

230V~
50Hz

for 18 V
Li-Ion

2.0
Ah

1h

3.0
Ah

1.5h

4.0
Ah

2h

6.0
Ah

3h



18V
Li-Ion

YATO	[V d.c.]	
YT-82848	18	10

EN Battery charger
 PL Ładowarka
 DE Ladegerät
 RU Зарядное устройство
 CZ Nabíječka
 HU Akkutöltő

RO Redresor
 FR Chargeur de batterie
 IT Caricabatteria
 ES Rectificador
 CN 充电器

230V~
50Hz

for 18 V
Li-Ion

2.0
Ah

1h

3.0
Ah

1.5h

4.0
Ah

2h

6.0
Ah

3h



18V
Li-Ion

YATO	[V d.c.]	
YT-82849	18	10

EN Power cutter
PL Przecinarka spalinowa
DE Trennschleifer
RU Бензиновый бензорез
CZ Rozbrušovací pila
HU Beton- és fémdarabolók

RO Motodebitator
FR Découpeuse
IT Troncatrice con motore a combustione interna
ES La cortadora
CN 汽油切割机

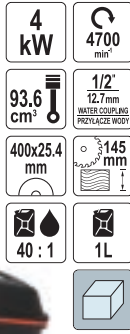

Disc not included
Tarczy nie dołączono

$L_{pa} = 93,35 \pm 2,5 / 107,95 \pm 2,5$ dB; $L_{wa} = 112,33 \pm 2,5 / 115,5 \pm 2,5$ dB;
 $a_n = 6,99 \pm 1,5 / 7,79 \pm 1,5 / 10,26 \pm 1,5 / 9,77 \pm 1,5$ m/s²

YATO	[kW]	
YT-84820	4	1

EN Petrol rotary hammer
PL Spalinowy młot udarowo-obrotowy
DE Benzin Bohr- und Meißelhammer
RU Бензиновый перфоратор
CZ Benzinové kombinované kladivo
HU Benzines forgó bontókalapács
RO Ciocan rotativ cu benzină
FR Marteau rotatif essence
IT Martello combinato perforatore demolitore a benzina
ES Martillo giratorio a gasolina
CN 汽油电锤

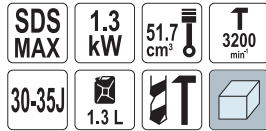

$L_{pa} = 84,0 \pm 3,0$ dB; $L_{wa} = 105,0$ dB; $a_n = 10,76 \pm 1,5 / 18,39 \pm 1,5$ m/s²

YATO	[kW]	[KM]	
YT-82138	1.3	1.74	1

EN Electric impact wrench
PL Elektryczny klucz udarowy
DE Elektro-Schlagschrauber
RU Электрический гайковерт
CZ Elektrický rázový uťahovák
HU Elektromos ütvecsavarozó

RO Pistol de impact electric
FR Clé à choc électrique
IT Avvitatore elettrico ad impulso
ES llave de impacto eléctrica
CN 电动冲击扳手



17, 19, 21, 23 mm



$L_{pa} = 100,0 \pm 3,0$ dB; $L_{wa} = 111,0 \pm 3,0$ dB; $a_n = 18,9 \pm 1,5$ m/s²

YATO	[W]	
YT-82021	1020	3

EN Petrol demolition hammer
PL Spalinowy młot wyburzeniowy
DE Benzin-Abbruchhammer
RU Бензиновый отбойный молоток
CZ Benzinové bourací kladivo
HU Benzines bontókalapács
RO Ciocan demolator cu benzină
FR Marteau piqueur essence
IT Martello demolitore a scoppio
ES Martillo demoleedor a gasolina
CN 汽油电镐

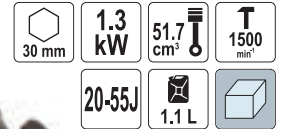

$L_{pa} = 83,0 \pm 3,0$ dB; $L_{wa} = 104,0$ dB; $a_n = 31,87 \pm 1,5 / 31,10 \pm 1,5$ m/s²

YATO	[kW]	[KM]	
YT-82007	1.3	1.74	1

EN Electric impact wrench
PL Elektryczny klucz udarowy
DE Elektro-Schlagschrauber
RU Электрический гайковерт
CZ Elektrický rázový uťahovák
HU Elektromos ütvecsavarozó

RO Pistol de impact electric
FR Clé à choc électrique
IT Avvitatore elettrico ad impulso
ES llave de impacto eléctrica
CN 电动冲击扳手

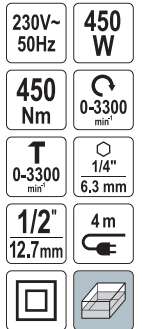

17, 19, 21, 23 mm



$L_{pa} = 96,0 \pm 3,0$ dB; $L_{wa} = 107,0 \pm 3,0$ dB; $a_n = 17,648 \pm 1,5$ m/s²

YATO	[W]	
YT-82020	450	4

EN Straight grinder
PL Szlifierka prosta
DE Geradschleifer
RU Прямая шлифмашина
CZ Příčná bruska
HU Egyenes csiszoló

RO Polizor drept
FR Meuleuse droite
IT Smerigliatrice dritta
ES Amoladora recta
CN 直磨机

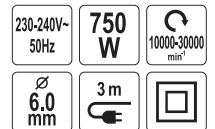

$L_{pa} = 75,0 \pm 3,0$ dB; $L_{wa} = 85,0 \pm 3,0$ dB; $a_n = 2,5 \pm 1,5$ m/s²

YATO	[W]	
YT-82080	750	8

EN Angle grinder
 PL Szlifierka kątowa
 DE Winkelschleifmaschine
 RU Углошлифовальная машина
 CZ Úhlová bruska
 HU Sarokcsiszoló

RO Polizor unghiular
 FR Meuleuse d'angle
 IT Smerigliatrice angolare
 ES Lijadera de angulo
 CN 角磨

230V~50Hz	850 W	12000 min ⁻¹	125 mm
M14	3 m		



$L_{pa} = 87,3 \pm 3,0$ dB; $L_{wa} = 98,3 \pm 3,0$ dB; $a_h = 3,378 \pm 1,5 / 4,746 \pm 1,5$ m/s²

YATO	[W]	
YT-82097	850	6

EN Angle grinder
 PL Szlifierka kątowa
 DE Winkelschleifmaschine
 RU Углошлифовальная машина
 CZ Úhlová bruska
 HU Sarokcsiszoló

RO Polizor unghiular
 FR Meuleuse d'angle
 IT Smerigliatrice angolare
 ES Lijadera de angulo
 CN 角磨

	230-240V-50Hz	1100 W	3000-42000 min ⁻¹
\pm	125 mm	M14	SPEED REGULATOR REGULACIJA PREDKOSCI
	3 m		



Fitting discs: see chapter 10
 Pasujące tarcze: patrz rozdział 10

$L_{pa} = 87,3 \pm 3,0$ dB; $L_{wa} = 95,3 \pm 3,0$ dB; $a_h = 6,743 \pm 1,5$ m/s²

YATO	[W]	
YT-82101	1100	8

EN Angle grinder
 PL Szlifierka kątowa
 DE Winkelschleifmaschine
 RU Углошлифовальная машина
 CZ Úhlová bruska
 HU Sarokcsiszoló

RO Polizor unghiular
 FR Meuleuse d'angle
 IT Smerigliatrice angolare
 ES Lijadera de angulo
 CN 角磨

230-240V-50Hz	1400 W	3000-42000 min ⁻¹
125 mm	M14	3 m



$L_{pa} = 89,3 \pm 3,0$ dB; $L_{wa} = 100,3 \pm 3,0$ dB; $a_h = 6,95 \pm 1,5$ m/s²

YATO	[W]	
YT-82099	1400	6

EN Angle grinder
 PL Szlifierka kątowa
 DE Winkelschleifmaschine
 RU Углошлифовальная машина
 CZ Úhlová bruska
 HU Sarokcsiszoló

RO Polizor unghiular
 FR Meuleuse d'angle
 IT Smerigliatrice angolare
 ES Lijadera de angulo
 CN 角磨

230V~50Hz	1100 W	11000 min ⁻¹	125 mm
M14	2.5 m		



$L_{pa} = 79,0 \pm 3,0$ dB; $L_{wa} = 90,0 \pm 3,0$ dB; $a_h = 3,98 \pm 1,5$ m/s²

YATO	[W]	
YT-82100	1100	6

EN Angle grinder
 PL Szlifierka kątowa
 DE Winkelschleifmaschine
 RU Углошлифовальная машина
 CZ Úhlová bruska
 HU Sarokcsiszoló

RO Polizor unghiular
 FR Meuleuse d'angle
 IT Smerigliatrice angolare
 ES Lijadera de angulo
 CN 角磨

230-240V-50Hz	1400 W	3000-42000 min ⁻¹	125 mm
M14	3 m		



$L_{pa} = 89,3 \pm 3,0$ dB; $L_{wa} = 100,3 \pm 3,0$ dB; $a_h = 6,95 \pm 1,5$ m/s²

YATO	[W]	
YT-82098	1400	6

EN Angle grinder
 PL Szlifierka kątowa
 DE Winkelschleifmaschine
 RU Углошлифовальная машина
 CZ Úhlová bruska
 HU Sarokcsiszoló

RO Polizor unghiular
 FR Meuleuse d'angle
 IT Smerigliatrice angolare
 ES Lijadera de angulo
 CN 角磨

220-240V-50Hz	2000 W	8500 min ⁻¹
180 mm	M14	3 m



$L_{pa} = 92,5 \pm 3,0$ dB; $L_{wa} = 103,5 \pm 3,0$ dB; $a_h = 7,03 \pm 1,5$ m/s²

YATO	[W]	
YT-82104	2000	4

EN Angle grinder
PL Szlifierka kątowa
DE Winkelschleifmaschine
RU Углошлифовальная машина
CZ Úhlová bruska
HU Sarokcsiszoló

RO Polizor unghiular
FR Meuleuse d'angle
IT Smerigliatrice angolare
ES Lijadera de angulo
CN 角磨

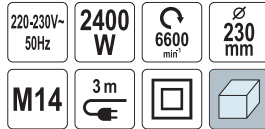

$L_{pa} = 91,9 \pm 3,0$ dB; $L_{wa} = 102,9 \pm 3,0$ dB; $a_s = 7,448 \pm 1,5 / 5,2 \pm 1,5$ m/s²

YATO	[W]	
YT-82105	2400	2

EN Angle grinder
PL Szlifierka kątowa
DE Winkelschleifmaschine
RU Углошлифовальная машина
CZ Úhlová bruska
HU Sarokcsiszoló

RO Polizor unghiular
FR Meuleuse d'angle
IT Smerigliatrice angolare
ES Lijadera de angulo
CN 角磨

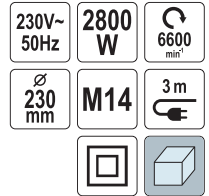

$L_{pa} = 91,8 \pm 3,0$ dB; $L_{wa} = 102,8 \pm 3,0$ dB; $a_s = 4,478 \pm 1,5 / 4,956 \pm 1,5$ m/s²

YATO	[W]	
YT-82110	2800	2

EN Drill stand
PL Statyw do wiertarki
DE Bohrmaschinen-Ständer
RU Штатив для дрели
CZ Stativ do vrtačky
HU Fúróállvány
RO Suport masina de gaurit
FR Support de forage
IT Supporto per trapano
ES Soporte para taladro
CN 电钻支架



YATO	H [mm]	
YT-82970	500	3

EN Drill stand
PL Statyw do wiertarki
DE Bohrmaschinen-Ständer
RU Штатив для дрели
CZ Stativ do vrtačky
HU Fúróállvány
RO Suport masina de gaurit
FR Support de forage
IT Supporto per trapano
ES Soporte para taladro
CN 电钻支架

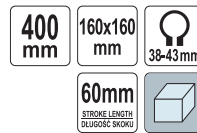

YATO	H [mm]	
YT-82971	400	6

EN Angle grinder stand
PL Statyw do szlifierki kątowej
DE Winkelschleif-Trennständer
RU Стенд для угловой шлифовальной машины
CZ Stojan pro úhlovou brusku
HU Állvány sarokcsiszolóhoz
RO Stativ pt. polizor unghiular
FR Support pour meuleuse d'angle
IT Supporto per smerigliatrice angolare
ES Soporte para lijadera de ángulo
CN 角磨支架



YATO	H [mm]	
YT-82972		4

EN Dust extractor
PL Osłona przeciwpylowa
DE Staubabsaugung
RU Системные принадлежности
CZ Odsavač prachu
HU Tapadó porelszívó adapter
RO Sistem de aspirare a prafului
FR Le dispositif d'aspiration pour de perçage
IT Adattatore aspirazione polvere
ES Sistema de aspiración de polvo
CN 吸尘座



YATO	
YT-82980	40

EN Dust extractor
PL Osłona przeciwpylowa
DE Staubabsaugung
RU Системные принадлежности
CZ Odsavač prachu
HU Tapadó porelszívó adapter
RO Sistem de aspirare a prafului
FR Le dispositif d'aspiration pour de perçage
IT Adattatore aspirazione polvere
ES Sistema de aspiración de polvo
CN 吸尘座



For YT-6045, YT-60374, YT-43979
Dla YT-6045, YT-60374, YT-43979

YATO	
YT-82982	30

EN Dust extractor
 PL Osłona przeciwpylowa
 DE Staubabsaugung
 RU Системные принадлежности
 CZ Odsavač prachu
 HU Tapadó porszívó adapter
 RO Sistem de aspirare a prafului
 FR Le dispositif d'aspiration pour de perçage
 IT Adattatore aspirazione polvere
 ES Sistema de aspiración de polvo
 CN 吸尘座

max Ø 90 mm
 Ø 26-39 mm



For YT-6046, YT-60375, YT-43981
 Dla YT-6046, YT-60375, YT-43981

YATO	
YT-82984	18

EN Dust extractor
 PL Osłona przeciwpylowa
 DE Staubabsaugung
 RU Системные принадлежности
 CZ Odsavač prachu
 HU Tapadó porszívó adapter
 RO Sistem de aspirare a prafului
 FR Le dispositif d'aspiration pour de perçage
 IT Cuffia aspirazione polvere
 ES Sistema de aspiración de polvo
 CN 吸尘座

Ø 125 mm
 Ø 28-36 mm
 32 mm
 M14



For YT-82098, YT-82099, YT-60470
 Dla YT-82098, YT-82099, YT-60470

YATO	
YT-82986	12

EN Dust extractor
 PL Osłona przeciwpylowa
 DE Staubabsaugung
 RU Системные принадлежности
 CZ Odsavač prachu
 HU Tapadó porszívó adapter
 RO Sistem de aspirare a prafului
 FR Le dispositif d'aspiration pour de perçage
 IT Cuffia aspirazione polvere
 ES Sistema de aspiración de polvo
 CN 吸尘座

Ø 125 mm
 Ø 28-36 mm
 max Ø 28 mm
 5-30 mm
 M14



For YT-82098, YT-82099, YT-56961
 Dla YT-82098, YT-82099, YT-56961

YATO	
YT-82988	10

EN Dust extractor
 PL Osłona przeciwpylowa
 DE Staubabsaugung
 RU Системные принадлежности
 CZ Odsavač prachu
 HU Tapadó porszívó adapter
 RO Sistem de aspirare a prafului
 FR Le dispositif d'aspiration pour de perçage
 IT Cuffia aspirazione polvere
 ES Sistema de aspiración de polvo
 CN 吸尘座

Ø 230 mm
 Ø 50-65 mm
 max Ø 60 mm



For YT-82110, YT-59965
 Dla YT-82110, YT-59965

YATO	
YT-82990	4

EN Dust extractor
 PL Osłona przeciwpylowa
 DE Staubabsaugung
 RU Системные принадлежности
 CZ Odsavač prachu
 HU Tapadó porszívó adapter
 RO Sistem de aspirare a prafului
 FR Le dispositif d'aspiration pour de perçage
 IT Cuffia aspirazione polvere
 ES Sistema de aspiración de polvo
 CN 吸尘座

max Ø 125 mm
 Ø 28-36 mm
 max Ø 32 mm



For YT-82094, YT-82097, YT-82100, YT-82101
 Dla YT-82094, YT-82097, YT-82100, YT-82101

YATO	
YT-82992	20

EN Dust extractor
 PL Osłona przeciwpylowa
 DE Staubabsaugung
 RU Системные принадлежности
 CZ Odsavač prachu
 HU Tapadó porszívó adapter
 RO Sistem de aspirare a prafului
 FR Le dispositif d'aspiration pour de perçage
 IT Cuffia aspirazione polvere
 ES Sistema de aspiración de polvo
 CN 吸尘座

Ø 125 mm
 Ø 28-36 mm
 M14



For YT-82098, YT-82101, YT-60470
 Fitting blades: YT-60322, YT-83265

Dla YT-82098, YT-82101, YT-60470
 Pasujące tarcze: YT-60322, YT-83265

YATO	
YT-82994	30

EN Wall chaser
 PL Bruzdownica
 DE Mauernutfräse
 RU Штроборез сетевой
 CZ Drážkovací fréza do zdiva
 HU Falhoronymarógép
 RO Circular manual pt. piatra
 FR Rainureuse à béton
 IT Scanalatrice
 ES Máquina de ranurado de pared
 CN 开槽机



230-240V-50Hz
 1700 W
 10500 min¹
 125x2,0x22,23mm
 max Ø 28mm
 5-30 mm
 M14
 REINFORCED CONCRETE ZELBET
 3 m



For YT-59962
 Dla YT-59962
 $L_{pA} = 93,0 \pm 3,0$ dB; $L_{wA} = 105,0 \pm 3,0$ dB; $a_h = 2,8 \pm 1,5$ m/s²

YATO	[W]	
YT-82015	1700	4

EN Concrete cutter
 PL Przecinakar do betonu
 DE Betonschneider
 RU Электрическая отрезная машина по бетону
 CZ Řezačka betonu
 HU Betonvágó
 RO Drujbă de beton
 FR Decoupeuse beton
 IT Troncatrice per cemento
 ES Cortador de hormigón
 CN 混凝土切割机

220-240V-50/60Hz
 2600 W
 4300 min¹
 355x25,4 mm
 max Ø 125mm
 M10
 REINFORCED CONCRETE ZELBET
 3 m



$L_{pA} = 99,0 \pm 3,0$ dB; $L_{wA} = 110,0 \pm 3,0$ dB; $a_h = 8,22 \pm 1,5$ m/s²

YATO	[W]	
YT-82158	2600	1

EN Electric tile cutter
PL Przecinarka do glazury
DE Fliesenschneider
RU Плиткорез электрический
CZ Elektrická pila na dlažbu
HU Elektromos csempévo gép
RO Aparat electric pt. taiat faianta
FR Scie carrelage
IT Tagliapiastrelle
ES Cortadora de gres
CN 云石机



220-230V-50Hz	1400 W	12000 min ⁻¹
125 mm	125x22.2 x1.6 mm	WET AND DRY, SUCHO I MOKRO
CIRCUIT BREAKER, WYŁĄCZNIK ROZNIĄCOWO-PRĄDOWY	3 m	

$L_{pA} = 102,6 \pm 3,0$ dB; $L_{wA} = 113,6 \pm 3,0$ dB; $a_n = 5,753 \pm 1,5$ m/s²

YATO	[W]	
YT-82159	1400	4

EN Car polisher
PL Polerka samochodowa
DE Autopoliermaschine
RU Полировальная машина
CZ Leštíčka na automobily
HU Gépkocsi polírozógép
RO Masina de lustruit automobile
FR Polisseur de voiture
IT Levigatrice per auto
ES Maquina para pulir coches
CN 偏心抛光机



220-240V-50Hz	720 W	2100-5000 min ⁻¹	150 mm
M8		5 m	

$L_{pA} = 85,0 \pm 3,0$ dB; $L_{wA} = 96,0 \pm 3,0$ dB; $a_n = 5,56 \pm 1,5$ m/s²

YATO	[W]	
YT-82200	720	4

EN Car polisher
PL Polerka samochodowa
DE Autopoliermaschine
RU Полировальная машина
CZ Leštíčka na automobily
HU Gépkocsi polírozógép
RO Masina de lustruit automobile
FR Polisseur de voiture
IT Levigatrice per auto
ES Maquina para pulir coches
CN 磨光器



220-240V-50Hz	1400 W	600-3500 min ⁻¹
180 mm	M14	5 m

$L_{pA} = 89,5 \pm 3,0$ dB; $L_{wA} = 100,5 \pm 3,0$ dB; $a_n = 1,489 \pm 1,5 / 1,785 \pm 1,5$ m/s²

YATO	[W]	
YT-82196	1400	2

EN Grinding wheel cutter for metal
PL Przecinarka ściernicowa do metalu
DE Trennschleifer für Metall
RU Абразивно-отрезной станок по металлу
CZ Rozbrušovací pila na kovy
HU Gyorsdaraboló fémhez
RO Ferăstrău abraziv pt. metal
FR Scie a métaux
IT Trapano a percussione
ES Cortador abrasivo para metales
CN 型材切割机

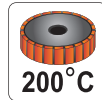

200 °C



230V~50Hz	2450 W	4000 min ⁻¹	355x25.4 mm
0-45°	SOFT START, MIEKLI START	LONG LIFE MOTOR, TRWALY SILNIK	

$L_{pA} = 95,8 \pm 3,0$ dB; $L_{wA} = 108,8 \pm 3,0$ dB

YATO	[W]	
YT-82181	2450	1

EN Band saw
PL Pila taśmowa
DE Bandsäge
RU Ленточная пила
CZ Pásová pila
HU Szalagfűrész
RO Fierastrău cu banda
FR Scie à ruban
IT Sega a nastro
ES Sierra de cinta
CN 带锯



220-240V-50Hz	1100 W
0.7-2.4 m/s	14 TPI
114x12.7 x1.6 mm	127 mm
3 m	

$L_{pA} = 89,0 \pm 3,0$ dB; $L_{wA} = 100,0 \pm 3,0$ dB; $a_n = 6,62 \pm 1,5 / 6,08 \pm 1,5$ m/s²

YATO	[W]	
YT-82185	1100	1

EN Impact drill
PL Wiertarka udarowa
DE Schlagbohrmaschine
RU Ударная дрель
CZ Nárazová vrtačka
HU Kezelési utasítás

RO Masina de gaurit
FR Perceuse à percussion
IT Trapano a percussione
ES Taladradora de percusión
CN 冲击钻



220-240V-50Hz	710 W
0-2800 min ⁻¹	0-44800 min ⁻¹
13 mm	13 mm
3 m	

$L_{pA} = 80,0 \pm 3,0$ dB; $L_{wA} = 91,0 \pm 3,0$ dB; $a_n = 2,95 \pm 1,5 / 8,46 \pm 1,5$ m/s²

YATO	[W]	
YT-82034	710	5

EN Impact drill
PL Wiertarka udarowa
DE Schlagbohrmaschine
RU Ударная дрель
CZ Nárazová vrtačka
HU Kezelési utasítás

RO Masina de gaurit
FR Perceuse à percussion
IT Trapano a percussione
ES Taladradora de percusión
CN 冲击钻



220-240V-50Hz **810 W**

0-2800 min⁻¹ 0-44800 min⁻¹

∅ 25 mm ∅ 13 mm

13 mm

3 m



$L_{pa} = 87,0 \pm 3,0$ dB; $L_{wa} = 98,0 \pm 3,0$ dB; $a_n = 2,29 \pm 1,5 / 8,5 \pm 1,5$ m/s²

YATO	[W]	
YT-82036	810	5

EN Impact drill
PL Wiertarka udarowa
DE Schlagbohrmaschine
RU Ударная дрель
CZ Nárazová vrtačka
HU Kezelési utasítás

RO Masina de gaurit
FR Perceuse à percussion
IT Trapano a percussione
ES Taladradora de percusión
CN 冲击钻



220-240V-50Hz **850 W**

I-0-1100 min⁻¹ II-0-2800 min⁻¹ 0-44800 min⁻¹

∅ 25 mm ∅ 13 mm

13 mm

3 m



$L_{pa} = 89,0 \pm 3,0$ dB; $L_{wa} = 100,0 \pm 3,0$ dB; $a_n = 2,39 \pm 1,5 / 8,78 \pm 1,5$ m/s²

YATO	[W]	
YT-82037	850	5

EN Impact drill
PL Wiertarka udarowa
DE Schlagbohrmaschine
RU Ударная дрель
CZ Nárazová vrtačka
HU Kezelési utasítás

RO Masina de gaurit
FR Perceuse à percussion
IT Trapano a percussione
ES Taladradora de percusión
CN 冲击钻



220-240V-50Hz **1050 W**

I-0-1100 min⁻¹ II-0-2800 min⁻¹ 0-44800 min⁻¹

∅ 25 mm ∅ 13 mm

13 mm

3 m



$L_{pa} = 97,0 \pm 3,0$ dB; $L_{wa} = 108,0 \pm 3,0$ dB; $a_n = 2,85 \pm 1,5 / 10,1 \pm 1,5$ m/s²

YATO	[W]	
YT-82044	1050	5

EN Electric drill/driver
PL Wiertarko-wkrętarzka sieciowa
DE Netz-Bohrschrauber
RU Сетевая дрель-шуруповёрт
CZ Elektrický vrtací šroubovák
HU Hálózati fúró-csavarozó

RO Maşină de găurit şi înşurubat (bormasina) electrica
FR Foret électrique
IT Trapano avvitatore elettrico
ES Taladro atomillador eléctrico
CN 扭力钻



230V~50Hz **300 W**

40 Nm 0-400 min⁻¹ 0-1450 min⁻¹

13 mm

4 m



$L_{pa} = 83,1 \pm 3,0$ dB; $L_{wa} = 94,1 \pm 3,0$ dB; $a_n = 3,32 \pm 1,5$ m/s²

YATO	[W]	
YT-82060	300	6

EN Electric drill/driver
PL Wiertarko-wkrętarzka sieciowa
DE Netz-Bohrschrauber
RU Сетевая дрель-шуруповёрт
CZ Elektrický vrtací šroubovák
HU Hálózati fúró-csavarozó

RO Maşină de găurit şi înşurubat (bormasina) electrica
FR Foret électrique
IT Trapano avvitatore elettrico
ES Taladro atomillador eléctrico
CN 扭力钻



220-240V-50/60Hz **400 W**

85 Nm 0-480 min⁻¹ 0-1800 min⁻¹

13 mm max ∅

4 m



$L_{pa} = 88,0 \pm 5,0$ dB; $L_{wa} = 99,0 \pm 5,0$ dB; $a_n = 6,57 \pm 1,5$ m/s²

YATO	[W]	
YT-82063	400	8

EN Drywall screwdriver
PL Wkrętarzka elektryczna
DE Trockenbauschrauber
RU Сетевая шуруповёрт
CZ Sádrotkartonáfský šroubovák
HU Gipskarton csavarzó

RO Şurubelniţă pt. gips-carton
FR Visseuse spécial plaquiste
IT Avvitatore elettrico
ES Atomilladores para construcción en seco
CN 墙板螺丝刀



230-240V-50Hz **550 W**

0-5500 min⁻¹ 1/4" 6,3 mm

25-55 x 3,5 mm

3 m



$L_{pa} = 81,9 \pm 3,0$ dB; $L_{wa} = 92,9 \pm 3,0$ dB; $a_n = 0,53 \pm 1,5$ m/s²

YATO	[W]	
YT-82071	550	5

EN Diamond drill
PL Wiertnica diamentowa
DE Diamantbohrmaschine
RU Дрель алмазного сверления
CZ Diamantová vrtačka
HU Gyémántfűrőgép

RO Mașină de găurit cu diamant
FR Appareil de forage diamant
IT Perforatrice diamantata
ES Taladradora de diamante
CN 水钻



Fitting core drill bits: see chapter 10
Fitting water tank: YT-86211

Pasujące wiertła koronowe: patrz rozdział 10
Pasująca hydronetka: YT-86211

$L_{pa} = 90,0 \pm 3,0$ dB; $L_{wa} = 103,0 \pm 3,0$ dB; $a_n = 2,90 \pm 1,5$ m/s²

YATO	[W]	
YT-81980	2200	1

EN Rotary hammer
PL Młotowiertarka
DE Bohrhammer
RU Перфоратор
CZ Vrtací kladivo
HU Fúrókalapács

RO Ciocan rotopercutor
FR Marteau perforateur
IT Martello rotativo
ES Martillo perforador
CN 电锤

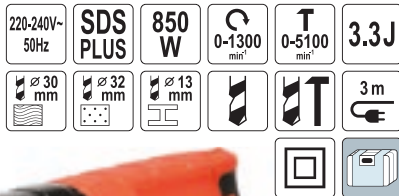

$L_{pa} = 92,3 \pm 3,0$ dB; $L_{wa} = 103,3 \pm 3,0$ dB; $a_n = 11,964 \pm 1,5 / 10,037 \pm 1,5$ m/s²

YATO	[W]	
YT-82122	850	3

EN Rotary hammer
PL Młotowiertarka
DE Bohrhammer
RU Перфоратор
CZ Vrtací kladivo
HU Fúrókalapács

RO Ciocan rotopercutor
FR Marteau perforateur
IT Martello rotativo
ES Martillo perforador
CN 电锤



$L_{pa} = 94,6 \pm 3,0$ dB; $L_{wa} = 105,6 \pm 3,0$ dB; $a_n = 19,167 \pm 1,5 / 13,314 \pm 1,5$ m/s²

YATO	[W]	
YT-82127	1500	2

EN Diamond drill
PL Wiertnica diamentowa
DE Diamantbohrmaschine
RU Дрель алмазного сверления
CZ Diamantová vrtačka
HU Gyémántfűrőgép
FR Appareil de forage diamant
IT Perforatrice diamantata
ES Taladradora de diamante
CN 水钻

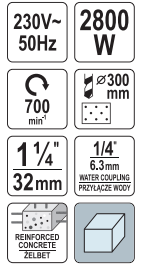

Fitting core drill bits: see chapter 10
Fitting water tank: YT-86211

Pasujące wiertła koronowe: patrz rozdział 10
Pasująca hydronetka: YT-86211

$L_{pa} = 92,4 \pm 3,0$ dB; $L_{wa} = 105,4 \pm 3,0$ dB

YATO	[W]	
YT-81983	2800	1

EN Rotary hammer
PL Młotowiertarka
DE Bohrhammer
RU Перфоратор
CZ Vrtací kladivo
HU Fúrókalapács

RO Ciocan rotopercutor
FR Marteau perforateur
IT Martello rotativo
ES Martillo perforador
CN 电锤



$L_{pa} = 95,0 \pm 3,0$ dB; $L_{wa} = 106,0 \pm 3,0$ dB; $a_n = 14,65 \pm 1,5 / 12,77 \pm 1,5$ m/s²

YATO	[W]	
YT-82123	1100	2

EN Rotary hammer
PL Młotowiertarka
DE Bohrhammer
RU Перфоратор
CZ Vrtací kladivo
HU Fúrókalapács

RO Ciocan rotopercutor
FR Marteau perforateur
IT Martello rotativo
ES Martillo perforador
CN 电锤

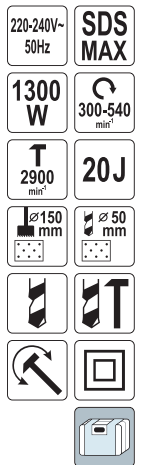

$L_{pa} = 95,0 \pm 3,0$ dB; $L_{wa} = 106,0 \pm 3,0$ dB; $a_n = 20,93 \pm 1,5 / 23,19 \pm 1,5$ m/s²

YATO	[W]	
YT-82131	1300	2

EN Rotary hammer
 PL Miotowiertarka
 DE Bohrhammer
 RU Перфоратор
 CZ Vrtací kladivo
 HU Fúrókalapács

RO Ciocan rotopercutor
 FR Marteau perforateur
 IT Martello rotativo
 ES Martillo perforador
 CN 电锤

230V~50Hz SDS MAX 1600 W 175-350 min⁻¹ 1150-2350 min⁻¹ 25J

∅ 52 mm



$L_{pA} = 96,1 \pm 3,0$ dB; $L_{wA} = 107,1 \pm 3,0$ dB; $a_n = 22,31 \pm 1,5 / 20,91 \pm 1,5$ m/s²

YATO	[W]	
YT-82135	1600	1

EN Demolition hammer
 PL Miot wyburzeniowy
 DE Abbruchhammer
 RU Отбойный молоток
 CZ Bourací kladivo
 HU Bontókalapács
 RO Ciocan demolator
 FR Brise-béton
 IT Martello demolitore
 ES Martillo de demolición
 CN 电镐

230V~50Hz 1600 W 1900 min⁻¹ 65J

T OIL COOLING CHŁODZENIE OLEJEM x2 3 m



- Switch lock for continuous operation
- Blokada włącznika do pracy ciągłej

$L_{pA} = 94,0 \pm 3,0$ dB; $L_{wA} = 105,0 \pm 3,0$ dB; $a_n = 14,59 \pm 1,5$ m/s²

YATO	[W]	
YT-82001	1600	1

EN Concrete vibrator set
 PL Wibrator do betonu (napęd i buława)
 DE Tragbarer Biegewellenrüttler
 RU Вибратор для бетона
 CZ Ponorový vibrátor
 HU Betonvibrátor szett
 RO Vibrator de adancime pt. beton
 FR Vibreur à béton
 IT Vibratore per il calcestruzzo
 ES Vibrador de hormigón eléctrico
 CN 混凝土振动器

230V~50Hz 1200 W 5000 min⁻¹

∅ 35 mm 3.5 m



$L_{pA} = <70$ dB; $L_{wA} = <85$ dB; $a_n = <2,5$ m/s²

YATO	[W]	
YT-82600	1200	1

EN Chiselling hammer
 PL Miot dłutujący
 DE Schlaghammer
 RU Отбойный молоток
 CZ Sekáčí kladivo
 HU Vésókalapács
 RO Ciocan demolator
 FR Marteau-piqueur
 IT Martello demolitore
 ES Martillo de percusión
 CN 电镐

220-240V~50Hz SDS MAX 1150 W 4850 min⁻¹ 15J

T 4.8 kg 2.5 m



$L_{pA} = 83,5 \pm 3,0$ dB; $L_{wA} = 97,5 \pm 2,4$ dB; $a_n = 15,546 \pm 1,5$ m/s²

YATO	[W]	
YT-82133	1150	2

EN Demolition hammer
 PL Miot wyburzeniowy
 DE Abbruchhammer
 RU Отбойный молоток
 CZ Bourací kladivo
 HU Bontókalapács
 RO Ciocan demolator
 FR Brise béton
 IT Martello demolitore
 ES Martillo demoedor
 CN 电镐

230V~50Hz 1600 W 1900 min⁻¹ 70J

T OIL COOLING CHŁODZENIE OLEJEM x2



- Switch lock for continuous operation
- Blokada włącznika do pracy ciągłej

$L_{pA} = 91,3 \pm 3,0$ dB; $L_{wA} = 100,4 \pm 2,42$ dB; $a_n = 14,59 \pm 1,5$ m/s²

YATO	[W]	
YT-82002	1600	1

EN Concrete vibrator set
 PL Wibrator do betonu (napęd i buława)
 DE Tragbarer Biegewellenrüttler
 RU Вибратор для бетона
 CZ Ponorový vibrátor
 HU Betonvibrátor szett

RO Vibrator de adancime pt. beton
 FR Vibreur à béton
 IT Vibratore per il calcestruzzo
 ES Vibrador de hormigón eléctrico
 CN 混凝土振动器

230V~50Hz 2300 W 4000 min⁻¹

∅ 35 mm 4 m



$L_{pA} = <70$ dB; $L_{wA} = <85$ dB; $a_n = <2,5$ m/s²

YATO	[W]	
YT-82601	2300	1

- EN Electric paddle mixer
PL Mieszarka do zapraw
DE Mörtelmischgerät
RU Электрическая мешалка для минометов
CZ Michadlo na maltu
HU Habarcskeverő
RO Malaxor pt. mortar
FR Mélangeur a mortier
IT Trapano miscelatore
ES Mezcladora de mortero
CN 手持式搅拌机

220-240V~ 50/60Hz	1600 W	180-480 ^{min⁻¹} 300-750 ^{min⁻¹}	160 mm
	140L	M14	



$L_{pa} = 87,0 \pm 3,0$ dB; $L_{wa} = 98,0 \pm 3,0$ dB; $a_n = 5,23 \pm 1,5$ m/s²

YATO	[W]	
YT-82607	1600	2

- EN Plunge saw
PL Zagłębiarka
DE Tauchsäge
RU Погружная пила
CZ Ponorná pila
HU Merülőfűrész
RO Ferăstrău circular
FR Scie plongeante
IT Sega circolare a tuffo
ES Sierra circular de incisión
CN 轨道锯

220-230V~ 50Hz	1300 W	2000-5000 min ⁻¹	165x20 x2.4 mm	90°/155mm 45°/138mm CUTTING RANGE CZĘSTOTLIWOŚĆ OBROTOWOŚĆ: 2800	
-------------------	------------------	--------------------------------	-------------------	--	--



$L_{pa} = 89,0 \pm 3,0$ dB; $L_{wa} = 100,0 \pm 3,0$ dB; $a_n = 1,4 \pm 1,5$ m/s²

YATO	[W]	
YT-82168	1300	2

- EN Guide rail for plunge saw
PL Prowadnica do zagłębiarki
DE Führungsschiene für Tauchsäge
RU Направляющая шина для погружной пилы
CZ Vodicí lišta pro ponornou pilu
HU Vezetősín merülőfűrészhez

- RO Sina de ghidare pt. ferăstrău circular
FR Rail de guidage pour scie plongeante
IT Guida per seghe circolari
ES Carril de guía para sierra de incisión
CN 导轨

1400
mm

AI

POSSIBILITY OF
COMBINATION
MOŻLIWOŚĆ
ŁĄCZENIA



For YT-82168
Dla YT-82168

YATO	L [mm]	
YT-82169	1400	5

- EN Circular saw
PL Piłarka elektryczna
DE Handkreissäge
RU Дисковая пила
CZ Ručná kružná pila
HU Kézi körfűrész
RO Fierăstrău circular de mana
FR Scie circulaire
IT Sega circolare
ES Sierra circular
CN 台锯

220-240V~ 50Hz	1500 W	4800 min ⁻¹	185x20 x2.8 mm	24T	65 mm	90°-65 mm 45°-45 mm	3 m	
-------------------	------------------	---------------------------	-------------------	------------	----------	------------------------	-----	--



Fitting blades: see chapter 10
Pasujące tarcze: patrz rozdział 10

$L_{pa} = 95,1 \pm 3,0$ dB; $L_{wa} = 106,1 \pm 3,0$ dB; $a_n = 2,86 \pm 1,5$ m/s²

YATO	[W]	
YT-82152	1500	2

- EN Electric paddle mixer
PL Mieszarka do zapraw
DE Mörtelmischgerät
RU Электрическая мешалка для минометов
CZ Michadlo na maltu
HU Habarcskeverő
RO Malaxor pt. mortar
FR Mélangeur a mortier
IT Trapano miscelatore
ES Mezcladora de mortero
CN 低速钻

220-230V~ 50/60Hz	1200 W	0-1000 min ⁻¹	130 mm
----------------------	------------------	-----------------------------	-----------

3-16mm	40 mm	16 mm	
--------	----------	----------	--

3 m



• Screwdriving: max T40 x 400 mm

• Wkręcanie: maks. T40 x 400 mm

$L_{pa} = 71,63 \pm 3,0$ dB; $L_{wa} = 82,63 \pm 3,0$ dB; $a_n = 3,148 \pm 1,5$ m/s²

YATO	[W]	
YT-82055	1200	4

- EN Circular saw
PL Piłarka elektryczna
DE Handkreissäge
RU Дисковая пила
CZ Ručná kružná pila
HU Kézi körfűrész
RO Ferăstrău circular de mana
FR Tronçonneuse
IT Sega circolare
ES Sierra circular
CN 电圆锯

220-240V~ 50Hz	1500 W	5500 min ⁻¹	185x20 x2.8 mm
-------------------	------------------	---------------------------	-------------------

24T	63 mm	90°-63 mm 45°-44 mm	3 m
------------	----------	------------------------	-----



Fitting blades: see chapter 10
Pasujące tarcze: patrz rozdział 10

$L_{pa} = 95,0 \pm 3,0$ dB; $L_{wa} = 106,0 \pm 3,0$ dB; $a_n = 3,526 \pm 1,5 / 2,905 \pm 1,5$ m/s²

YATO	[W]	
YT-82151	1500	2

- EN Circular saw
PL Piłarka elektryczna
DE Handkreissäge
RU Дисковая пила
CZ Ručná kružná pila
HU Kézi körfűrész
RO Fierăstrău circular de mana
FR Scie circulaire
IT Sega circolare
ES Sierra circular
CN 台锯

220-240V~ 50Hz	2800 W	4800 min ⁻¹	235x25.4 x3.0 mm	24T	85 mm	90°-85 mm 45°-60 mm	HIGH CUTTING RANGE DUŻY ZAKRES CIĘCIA	
-------------------	------------------	---------------------------	---------------------	------------	----------	------------------------	--	--

3 m		
-----	--	--



Fitting blades: see chapter 10
Pasujące tarcze: patrz rozdział 10

$L_{pa} = 99,0 \pm 3,0$ dB; $L_{wa} = 110,0 \pm 3,0$ dB; $a_n = 1,847 \pm 1,5$ m/s²

YATO	[W]	
YT-82154	2800	2

EN Cordless miter saw
 PL Ukośnica akumulatorowa
 DE Akku-Paneelsäge
 RU Аккумуляторная торцовочная пила
 CZ Akumulátorová pokosová pila se základem
 HU Akkus sines gérvágó
 RO Ferăstrău circular staționar cu acumulator
 FR Scie à onglets sans-fil
 IT Sega angolare a batteria
 ES Ingletadora telescópica a batería
 CN 充电式斜切锯

18V Li-Ion	3600 min ¹	185x30 x1.8 mm	40T	90°/51mm 45°/35mm CUTTING DEPTH GLĘBIKOŚĆ CIĘCIA
90°/203mm 45°/152mm CUTTING LENGTH DŁUGOŚĆ CIĘCIA	II CLASS / KLASA	4.0 Ah	2h	

EN Cordless miter saw
 PL Ukośnica akumulatorowa
 DE Akku-Paneelsäge
 RU Аккумуляторная торцовочная пила
 CZ Akumulátorová pokosová pila se základem
 HU Akkus sines gérvágó
 RO Ferăstrău circular staționar cu acumulator
 FR Scie à onglets sans-fil
 IT Sega angolare a batteria
 ES Ingletadora telescópica a batería
 CN 充电式斜切锯

18V Li-Ion	3600 min ¹	185x30 x1.8 mm	40T	90°/51mm 45°/35mm CUTTING DEPTH GLĘBIKOŚĆ CIĘCIA
90°/203mm 45°/152mm CUTTING LENGTH DŁUGOŚĆ CIĘCIA	II CLASS / KLASA			



Fitting blades: see chapter 10
 Pasujące tarcze: patrz rozdział 10
 $L_{pa} = 83,14 \pm 3,0$ dB; $L_{wa} = 96,14 \pm 3,0$ dB

18V
Li-Ion

YATO	[V d.c.]	
YT-82816	18	1

Fitting blades: see chapter 10
 Pasujące tarcze: patrz rozdział 10
 $L_{pa} = 83,14 \pm 3,0$ dB; $L_{wa} = 96,14 \pm 3,0$ dB

18V
Li-Ion

YATO	[V d.c.]	
YT-82817	18	1

EN Miter saw
 PL Ukośnica
 DE Paneelsäge
 RU Панельная пила
 CZ Pokosová pila se základem
 HU Sines gérvágó
 RO Ferăstrău circular staționar
 FR Scie à onglet radiale
 IT Sega angolare taglio leghe
 ES Ingletadora telescópica
 CN 斜切锯

220-240V~ 50Hz	1500 W	4500 min ¹	185x20 x2.8 mm
24T	90°/210mm 45°/145mm CUTTING LENGTH DŁUGOŚĆ CIĘCIA	90°/60mm 45°/38mm CUTTING DEPTH GLĘBIKOŚĆ CIĘCIA	II CLASS / KLASA
3m			

EN Miter saw
 PL Ukośnica
 DE Paneelsäge
 RU Панельная пила
 CZ Pokosová pila se základem
 HU Sines gérvágó
 RO Ferăstrău circular staționar
 FR Scie à onglet radiale
 IT Sega angolare taglio leghe
 ES Ingletadora telescópica
 CN 斜切锯

220-240V~ 50Hz	1800 W	255x25.4 x1.4 mm	36T	
2500 min ¹	90°/5mm 45°/3mm CUTTING DEPTH GLĘBIKOŚĆ CIĘCIA	90°/305mm 45°/210mm CUTTING LENGTH DŁUGOŚĆ CIĘCIA	3800 min ¹	
90°/70mm 45°/40mm CUTTING DEPTH GLĘBIKOŚĆ CIĘCIA	90°/305mm 45°/210mm CUTTING LENGTH DŁUGOŚĆ CIĘCIA	II CLASS / KLASA	3m	



Fitting blades: see chapter 10
 Pasujące tarcze: patrz rozdział 10
 $L_{pa} = 93,6 \pm 3,0$ dB; $L_{wa} = 106,6 \pm 3,0$ dB

YATO	[W]	
YT-82172	1500	1

Fitting blades: see chapter 10
 Pasujące tarcze: patrz rozdział 10
 $L_{pa} = 93,0 \pm 3,0$ dB; $L_{wa} = 105,0 \pm 3,0$ dB

YATO	[W]	
YT-82174	1800	1

EN Miter saw
PL Ukośnica
DE Paneelsäge
RU Панельная пила
CZ Pokosová pila se zákluzem
HU Sínes gérvágó

RO Ferăstrău circular staționar
FR Scie à onglet radiale
IT Sega angolare taglio leghe
ES Ingletadora telescópica
CN 斜切锯



Fitting blades: see chapter 10
Pasujące tarcze: patrz rozdział 10
 $L_{pA} = 94,3 \pm 3,0$ dB; $L_{wA} = 107,3 \pm 3,0$ dB

YATO	[W]	
YT-82173	1800	1

EN Electric table saw
PL Pilarka stolowa do drewna
DE Tischkreissäge für Holz
RU Настольной пила для древесины
CZ Stolní pilka do dřeva
HU Asztali körfűrész fához
RO Ferăstrău circular pt. lemn
FR Scie sur table
IT Sega circolare da banco
ES Máquina cortadora para madera
CN 台锯

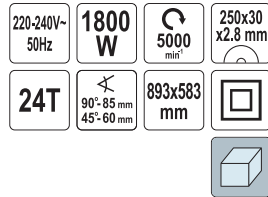

Fitting blades: see chapter 10
Pasujące tarcze: patrz rozdział 10
 $L_{pA} = 91,0 \pm 3,0$ dB; $L_{wA} = 104,0 \pm 3,0$ dB

YATO	[W]	
YT-82165	1800	1

EN Miter saw
PL Ukośnica
DE Paneelsäge
RU Панельная пила
CZ Pokosová pila se zákluzem
HU Sínes gérvágó

RO Ferăstrău circular staționar
FR Scie à onglet radiale
IT Sega angolare taglio leghe
ES Ingletadora telescópica
CN 斜切锯



Fitting blades: see chapter 10
Pasujące tarcze: patrz rozdział 10
 $L_{pA} = 90,7 \pm 3,0$ dB; $L_{wA} = 103,7 \pm 3,0$ dB

YATO	[W]	
YT-82175	1800	1

EN Jig saw
PL Wyrzynarka
DE Stichsäge
RU Электрический лобзик
CZ Přímočará pila
HU Szűrőfűrész
RO Ferăstrău pt. traforaj
FR Scie sauteuse
IT Seghetto alternativo
ES Sierra de calar
CN 曲线锯

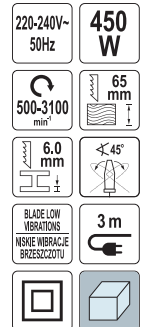

$L_{pA} = 86,0 \pm 3,0$ dB; $L_{wA} = 97,0 \pm 3,0$ dB; $a_n = 8,27 \pm 1,5 / 10,65 \pm 1,5$ m/s²

YATO	[W]	
YT-82274	450	8

EN Jig saw
PL Wyrzynarka
DE Stichsäge
RU Электрический лобзик
CZ Přímočará pila
HU Szűrőfűrész
RO Ferăstrău pt. traforaj
FR Scie sauteuse
IT Seghetto alternativo
ES Sierra de calar
CN 曲线锯

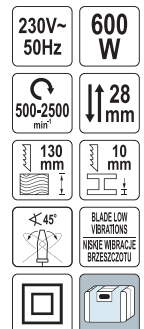

Fitting blades: see chapter 10
Pasujące brzeszczoty: patrz rozdział 10
 $L_{pA} = 90,4 \pm 3,0$ dB; $L_{wA} = 101,4 \pm 3,0$ dB; $a_n = 12,73 \pm 1,5 / 5,41 \pm 1,5$ m/s²

YATO	[W]	
YT-82273	600	4

EN Electric planer
 PL Strug elektryczny
 DE Elektroholbel
 RU Электропобанок
 CZ Elektrický hoblík
 HU Elektromos gyalu

RO Rindea electrica
 FR Rabot électrique
 IT Pialla elettrica
 ES Garlopa electrica
 CN 电刨

230V~50Hz

810 W

16500 min⁻¹

max 11mm

82 mm

0-3 mm

3 m



$L_{pa} = 87,0 \pm 3,0$ dB; $L_{wa} = 98,0 \pm 3,0$ dB; $a_n = 7,68 \pm 1,5$ m/s²

YATO	[W]	
YT-82141	810	6

EN Electric planer
 PL Strug elektryczny
 DE Elektroholbel
 RU Электропобанок
 CZ Elektrický hoblík
 HU Elektro

RO Rindea electrica
 FR Rabot
 IT Pialla elettrica
 ES Garlopa electrica
 CN 电刨

230-240V~50Hz

1300 W

16000 min⁻¹

0-3,5 mm

110 mm

3 m



$L_{pa} = 84,0 \pm 3,0$ dB; $L_{wa} = 95,0 \pm 3,0$ dB; $a_n = 7,11 \pm 1,5$ m/s²

YATO	[W]	
YT-82144	1300	2

EN Router
 PL Frezarka górnorzecionowa
 DE Oberfräse
 RU Вертикальная фрезерная машина
 CZ Horní frézka
 HU Felsőmaró
 RO Maşină de frezat
 FR Défonceuse
 IT Fresatrice verticale
 ES Fresadora de superfi cie
 CN 电木铣



220-240V~50Hz

710 W

13000-33000 min⁻¹

6, 8 mm

SOFT START
MEKKI START

$L_{pa} = 92,0 \pm 3,0$ dB; $L_{wa} = 102,0 \pm 3,0$ dB; $a_n = 2,388 \pm 1,5$ m/s²

YATO	[W]	
YT-82390	710	4

EN Router
 PL Frezarka górnorzecionowa
 DE Oberfräse
 RU Вертикальная фрезерная машина
 CZ Horní frézka
 HU Felsőmaró
 RO Maşină de frezat
 FR Défonceuse
 IT Fresatrice verticale
 ES Fresadora de superfi cie
 CN 电木铣



220-240V~50Hz

2100 W

8000-23500 min⁻¹

8,12 mm

max 55 mm

3 m

Fitting router bits: see chapter 10
 Pasujące frezy: patrz rozdział 10
 $L_{pa} = 94,0 \pm 3,0$ dB; $L_{wa} = 105,0 \pm 3,0$ dB; $a_n = 3,41 \pm 1,5$ m/s²

YATO	[W]	
YT-82380	2100	2

EN Belt sander
 PL Szlifierka taśmowa
 DE Bandschleifer
 RU Ленточная шлифмашина
 CZ Pásová bruska
 HU Szalagcsiszológép

RO Sac rumegus
 FR Ponceuse à bande
 IT Levigatrice a nastro
 ES Máquina de pulir de banda
 CN 砂带机

230-240V~50Hz

1010 W

120-380 m/min.

533x75 mm

3 m



Fitting abrasive bands: see chapter 10
 Pasujące pasy ściernic: patrz rozdział 10
 $L_{pa} = 90,0 \pm 3,0$ dB; $L_{wa} = 101,0 \pm 3,0$ dB; $a_n = 5,1 \pm 1,5$ m/s²

YATO	[W]	
YT-82240	1010	4

EN Sabre saw
 PL Pila szablasta
 DE Stichsäge
 RU Сабельная пила
 CZ Šavlová pila
 HU Szablyafűrész

RO Ferăstrău electric
 FR Scie sabre
 IT Sega a gattuccio
 ES Serra de sabre
 CN 往复锯

230-240V~50Hz

1050 W

0-2500 min⁻¹

28 mm

150 mm

10 mm

3 m



$L_{pa} = 92,2 \pm 3,0$ dB; $L_{wa} = 103,2 \pm 3,0$ dB; $a_n = 25,65 \pm 1,5$ m/s²

YATO	[W]	
YT-82281	1050	4

EN Orbital sander
PL Szlifierka mimośrodowa
DE Exzentrische Schleifmaschine
RU Эксцентриковая шлифовальная машина
CZ Excentrická bruska
HU Excenter csiszoló
RO Polizor cu excentric
FR Ponceuse orbitale
IT Smerigliatrice eccentrica
ES Pulidor excentrico
CN 砂光机



$L_{pA} = 80,0 \pm 3,0$ dB; $L_{wA} = 91,0 \pm 3,0$ dB; $a_n = 3,7 \pm 1,5$ m/s²

YATO	[W]	
YT-82206	350	6

EN Finishing sander
PL Szlifierka oscylacyjna
DE Schwingschleifer
RU Виброшлифмашина
CZ Oscilační bruska
HU Vibrációs csiszológép

RO Polizor oscilant
FR Ponceuse vibrante
IT Levigatrici orbitali
ES Lijadora de oscilación
CN 打磨机

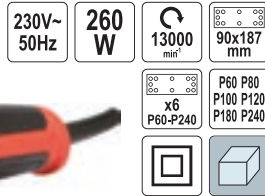

$L_{pA} = 82,0 \pm 3,0$ dB; $L_{wA} = 93,0 \pm 3,0$ dB; $a_n = 5,4 \pm 1,5$ m/s²

YATO	[W]	
YT-82230	260	4

EN Burnishing machine
PL Satyniarka
DE Satiniemaschine
RU Универсальная барабанная шлифмашина
CZ Saténovací bruska
HU Palástcsiszoló
RO Mașină de lustruit
FR Ponceuse à tambour
IT Satinatrice
ES Satinadora
CN 拉丝抛光机

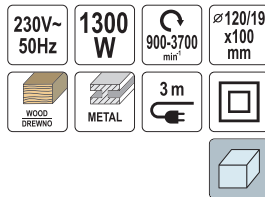

• Included wheel drums: nylon and steel wire
• W zestawie szczotki: nylonowa i druciana

$L_{pA} = 88,0 \pm 3,0$ dB; $L_{wA} = 99,0 \pm 3,0$ dB; $a_n = 8,85 \pm 1,5$ m/s²

YATO	[W]	
YT-81953	1300	2

EN Orbital sander
PL Szlifierka mimośrodowa
DE Exzentrische Schleifmaschine
RU Эксцентриковая шлифовальная машина
CZ Excentrická bruska
HU Excenter csiszoló
RO Polizor cu excentric
FR Ponceuse orbitale
IT Smerigliatrice eccentrica
ES Pulidor excentrico
CN 砂光机

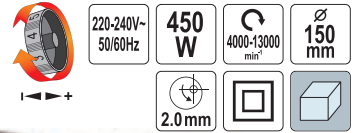

$L_{pA} = 79,0 \pm 3,0$ dB; $L_{wA} = 90,0 \pm 3,0$ dB; $a_n = 12,5 \pm 1,5$ m/s²

YATO	[W]	
YT-82207	450	6

EN Finishing sander
PL Szlifierka oscylacyjna
DE Schwingschleifer
RU Виброшлифмашина
HU Vibrációs csiszológép

RO Polizor oscilant
FR Ponceuse vibrante
IT Levigatrici orbitali
ES Lijadora de oscilación
CN 打磨机

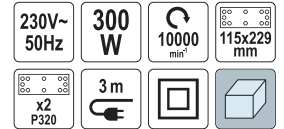

Fitting sand papers: see chapter 10
Pasujące papiery ściernie: patrz rozdział 10
 $L_{pA} = 75,0 \pm 3,0$ dB; $L_{wA} = 86,0 \pm 3,0$ dB; $a_n = 4,83 \pm 1,5$ m/s²

YATO	[W]	
YT-82234	300	4

EN Drywall sander
PL Szlifierka do tynków
DE Wandschleifer
RU Шлифмашина
CZ Bruska muriva
HU Kézi csiszoló fal

RO De perete manual slefuitor
FR Ponceuse à platre filaire
IT Levigatrice per intonaco
ES Lijadora virutex pared manual
CN 多功能打磨机



• Concrete grinding
• Plaster sanding
• Szlifowanie betonu
• Szlifowanie gipsu

Fitting sand papers: see chapter 10
Pasujące papiery ściernie: patrz rozdział 10
 $L_{pA} = 97,0 \pm 3,0$ dB; $L_{wA} = 108,0 \pm 3,0$ dB; $a_n = 8,96 \pm 1,5 / 13,04 \pm 1,5$ m/s²

YATO	[W]	
YT-82341	1300	2

- EN Drywall sander
- PL Szlifierka do tynków
- DE Wandschleifer
- RU Шлифмашина
- CZ Brúška muriva
- HU Kézi csiszoló fal
- RO De perete manual slefuitor
- FR Ponceuse a platre filaire
- IT Levigatrice per intonaco
- ES Lijadora virutex pared manual
- CN 干墙打磨机



230V~50Hz	1220 W	1500-2300 min ²
225 mm	210 215 225 mm	x6 P60-P240
P60 P80 P100 P120 P180 P240		

- Vacuum self suction system integrated
- Wbudowany system odsysania pyłu

Fitting sand papers: see chapter 10
 Pasujące papiery ściernie: patrz rozdział 10
 $L_{pa} = 85,0 \pm 3,0$ dB; $L_{wa} = 96,0 \pm 3,0$ dB; $a_n = 4,83 \pm 1,5$ m/s²

YATO	[W]	
YT-82340	1220	2

- EN Drywall sander
- PL Szlifierka na wysięgniku do ścian
- DE Wandschleifmaschine mit Ausleger
- RU Шлифовальная машина для стен
- CZ Bruska na stěny s ramenem
- HU Hosszúszerű falcsiszoló
- RO Polizor cu brat pt. pereti
- FR Ponceuse pour cloison sèche
- IT Levigatrice telescopica per muri
- ES Pulidor para paredes en un brazo
- CN 干墙打磨机



230-240V~50Hz	710 W
600-1500 min ²	3000-6000 min ²
225 mm	210 215 225 mm
x6 P60 P80 P100 P120 P180 P240	
M6	

- Vacuum self suction system integrated
- Wbudowany system odsysania pyłu

Fitting sand papers: see chapter 10
 Pasujące papiery ściernie: patrz rozdział 10
 $L_{pa} = 88,0 \pm 3,0$ dB; $L_{wa} = 99,0 \pm 3,0$ dB; $a_n = 3,48 \pm 1,5 / 3,51 \pm 1,5$ m/s²

YATO	[W]	
YT-82350	710	2

- EN Drywall sander
- PL Szlifierka na wysięgniku do ścian
- DE Wandschleifmaschine mit Ausleger
- RU Шлифовальная машина для стен
- CZ Bruska na stěny s ramenem
- HU Hosszúszerű falcsiszoló
- RO Polizor cu brat pt. pereti
- FR Ponceuse pour cloison sèche
- IT Levigatrice telescopica per muri
- ES Pulidor para paredes en un brazo
- CN 干墙打磨机



230-240V~50/60Hz	820 W
600-1900 min ²	max 165 cm
215 mm	210 215 225 mm
M6 LED LIGHTING OEWETLENE	
4 m	

- Vacuum self suction system integrated
- Wbudowany system odsysania pyłu

Fitting abrasive discs: see chapter 10
 Pasujące krawężki ściernie: patrz rozdział 10
 $L_{pa} = 86,0 \pm 3,0$ dB; $L_{wa} = 97,0 \pm 3,0$ dB; $a_n = 7,91 \pm 1,5$ m/s²

YATO	[W]	
YT-82355	820	2

- EN Electric spray gun
- PL Elektryczny pistolet malarski
- DE Elektro Farbspritzpistole
- RU Электрический пульверизатор
- CZ Elektrická pistole malářská
- HU Elektromos festekszoro pisztolyé
- RO Pistol de vopsit - electric
- FR Pistolet a peinture électrique
- IT Pistola elettrica per verniciare
- ES Pistola de pintar electric
- CN 电动喷枪



230V~50Hz	500 W
1.8 mm	0.4 l/min
1000 ml	

$L_{pa} = 102,0 \pm 3,0$ dB; $L_{wa} = 113,0 \pm 3,0$ dB; $a_n = 2,12 \pm 1,5$ m/s²

YATO	[W]	
YT-82550	500	4

- EN Electric spray gun
- PL Elektryczny pistolet malarski
- DE Elektro Farbspritzpistole
- RU Электрический пульверизатор
- CZ Elektrická pistole malářská
- HU Elektromos festekszoro pisztolyé
- RO Pistol electric de vopsit
- FR Pistolet a peinture électrique
- IT Pistola elettrica per verniciare
- ES Pistola de pintar electric
- CN 电动喷枪



220-240V~50Hz	600 W
2.6 mm	1.0 l/min
1000 ml	

$L_{pa} = 80,4 \pm 3,0$ dB; $L_{wa} = 91,4 \pm 3,0$ dB; $a_n = 0,67 \pm 1,5$ m/s²

YATO	[W]	
YT-82553	600	6

EN Airless paint sprayer
PL Agregat malarski
DE Farbsprüngerät
RU Краскопульты
CZ Střikací zařízení
HU Festékszóró rendszer
RO Pompa vopsit airless
FR Pistolet à peinture
IT Unità di verniciatura
ES Bomba de piston para spray de pintura airless
CN 高压无气喷涂机



230V~50Hz
480 W
22.7 MPa
AIRLESS REZ-POWIETRZNY
15 m

• For interior paints
• Do farb ściennych

$L_{pA} = 73,9 \pm 3,0$ dB; $L_{wA} = 81,0 \pm 3,0$ dB; $a_p = \leq 2,5$ m/s²

YATO	[W]	
YT-82562	480	1

EN Nozzle
PL Dysza
DE Duese
RU Conno
CZ Třyska
HU Szórófej
RO Duza
FR Buse pour pistolet à peinture
IT Ugello regolabile per verniciatura
ES Boquilla
CN 喷嘴柱



5 PCS
513 515 517 519 521

For YT-82560, YT-82562
Dla YT-82560, YT-82562

YATO		
YT-82563		20

EN Pressure hose for paint
PL Wąż ciśnieniowy do farby
DE Schlauch für Farbe
RU Шланг высокого давления
CZ Střikací hadice
HU Permetező tömlő
RO Furtun de presiune
FR Tuyau de pulvérisation
IT Tubo flessibile di pressione per verniciatura
ES Manguera de rociado
CN 高压输漆管



83 MPa
max °C 65
15 m

For YT-82562
Dla YT-82562

YATO		
YT-82565		5

EN Airless spray gun extension
PL Przedłużka do pistoletu natryskowego
DE Sprühpistole Erweiterung
RU Удлинитель для пистолета-распылителя
CZ Prodlužovák pro postřikovací pistoli
HU Toldósár szórópisztolyhoz
RO Prelungitor pistol airless
FR Extension de pistolet de pulvérisation de peinture
IT Prolunga per pistola a spruzzo
ES Extensión de pistola pulverizadora de pintura
CN 延长杆

3 PCS
300 mm 450 mm 600 mm
AI



YATO	L [mm]	
YT-82567	300, 450, 600	10

EN Airless paint sprayer
PL Agregat malarski
DE Farbsprüngerät
RU Краскопульты
CZ Střikací zařízení
HU Festékszóró rendszer

• For interior paints
• Do farb ściennych



220-240V~50Hz
650 W
1.1 l/min
20.7 MPa
310 mm
AIRLESS REZ-POWIETRZNY
7.5 m

$L_{pA} = 93,3 \pm 3,0$ dB; $L_{wA} = 104,3 \pm 3,0$ dB; $a_p = \leq 2,5$ m/s²

YATO	[W]	
YT-82560	650	1

EN Nozzle
PL Dysza
DE Duese
RU Conno
CZ Třyska
HU Szórófej
RO Duza
FR Buse pour pistolet à peinture
IT Ugello regolabile per verniciatura
ES Boquilla
CN 喷嘴柱



3 PCS
517

For YT-82560, YT-82562
Dla YT-82560, YT-82562

YATO		
YT-82564		20

EN Spray gun
PL Pistolet malarski
DE Sprühpistole
RU Пистолет-распылитель
CZ Střikací pistole
HU Szórópisztoly
RO Pistol de dus
FR Pistolet à peinture
IT Pistola per verniciare
ES Pistola rociadora
CN 无气喷枪+过滤网



22.7 MPa
3 FILTERS

For YT-82560, YT-82562
Dla YT-82560, YT-82562

YATO		
YT-82566		20

EN Airless spray gun extension
PL Przedłużka do pistoletu natryskowego
DE Sprühpistole Erweiterung
RU Удлинитель для пистолета-распылителя
CZ Prodlužovák pro postřikovací pistoli
HU Toldósár szórópisztolyhoz
RO Prelungitor pistol airless
FR Extension de pistolet de pulvérisation de peinture
IT Prolunga per pistola a spruzzo
ES Extensión de pistola pulverizadora de pintura
CN 延长杆

2 PCS
1000 mm 1800 mm
AI



YATO	L [mm]	
YT-82568	1000, 1800	25

EN Multi-purpose oscillating tool
 PL Wielofunkcyjne narzędzie oscylacyjne
 DE Multifunktionales Oszillationswerkzeug
 RU Многофункциональный инструмент
 CZ Multifunkční oscilační nářadí
 HU Multifunkciós rezgő szerszám

RO Unealtă multifuncțională oscilantă
 FR Outil multifonctions oscillant
 IT Oscillante strumento multifunzione
 ES Herramienta oscilatoria multiusos
 CN 多功能锯

230-240V-50Hz **300 W**
 15000-22000 min⁻¹ **2 m**



$L_{PA} = 89,2 \pm 3,0$ dB; $L_{WA} = 100,2 \pm 3,0$ dB; $a_h = 4,464 \pm 1,5$ m/s²

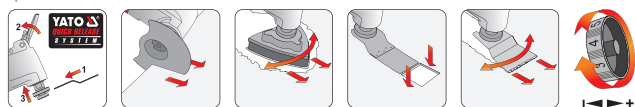

YATO	[W]	
YT-82220	300	4

EN Industrial vacuum cleaner
 PL Odkurzacz przemysłowy
 DE Industriesauger
 RU Пылосос промышленный
 CZ Průmyslový vysavač
 HU Ipari porszívó
 RO Aspirator industrial
 FR Aspirateur eau et poussières
 IT Aspirapolvere industriale
 ES Aspirador industrial
 CN 吸尘器

220-240V-50/60Hz **1400 W**
18 kPa **20 L**
 WET AND DRY SUCHO I MOKRO max 2000 W
IPX4
4.5 m



YATO	[W]	
YT-85700	1400	1

EN Industrial vacuum cleaner
 PL Odkurzacz przemysłowy
 DE Industriesauger
 RU Пылосос промышленный
 CZ Průmyslový vysavač
 HU Ipari porszívó
 RO Aspirator industrial
 FR Aspirateur eau et poussières
 IT Aspirapolvere industriale
 ES Aspirador industrial
 CN 吸尘器

220-240V-50/60Hz **2400 W** **70 L**
18 kPa WET AND DRY SUCHO I MOKRO max 2000 W ADJUSTABLE POWER REGULACJA MOCY
IPX4 **6 m**



YATO	[W]	
YT-85710	2400	1

EN Multi-purpose oscillating tool
 PL Wielofunkcyjne narzędzie oscylacyjne
 DE Multifunktionales Oszillationswerkzeug
 RU Многофункциональный инструмент
 CZ Multifunkční oscilační nářadí
 HU Multifunkciós rezgő szerszám

RO Unealtă multifuncțională oscilantă
 FR Outil multifonctions oscillant
 IT Oscillante strumento multifunzione
 ES Herramienta oscilatoria multiusos
 CN 多功能锯

230-240V-50Hz **500 W**
 8000-16000 min⁻¹



$L_{PA} = 106,4 \pm 3,0$ dB; $L_{WA} = 117,4 \pm 3,0$ dB; $a_h = 12,71 \pm 1,5$ m/s²

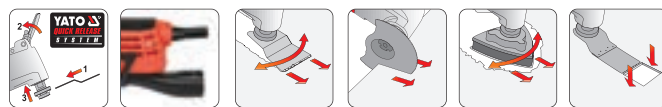

YATO	[W]	
YT-82223	500	5

EN Industrial vacuum cleaner
 PL Odkurzacz przemysłowy
 DE Industriesauger
 RU Пылосос промышленный
 CZ Průmyslový vysavač
 HU Ipari porszívó
 RO Aspirator industrial
 FR Aspirateur eau et poussières
 IT Aspirapolvere industriale
 ES Aspirador industrial
 CN 吸尘器

220-240V-50/60Hz **1400 W**
18 kPa **30 L**
 WET AND DRY SUCHO I MOKRO max 2000 W
IPX4 **4.5 m**



YATO	[W]	
YT-85701	1400	1

EN Industrial vacuum cleaner
 PL Odkurzacz przemysłowy
 DE Industriesauger
 RU Пылосос промышленный
 CZ Průmyslový vysavač
 HU Ipari porszívó
 RO Aspirator industrial
 FR Aspirateur eau et poussières
 IT Aspirapolvere industriale
 ES Aspirador industrial
 CN 多功能吸尘器

220-240V-50/60Hz **1600 W** **30 L**
18 kPa WET AND DRY SUCHO I MOKRO max 2000 W BLOW FUNCTION FUNKCJA Dmuchawy
IPX4 **5 m**



YATO	[W]	
YT-85715	1600	1

EN Industrial vacuum cleaner
PL Odkurzacz przemysłowy
DE Industriesauger
RU Пылесос промышленный
CZ Průmyslový vysavač
HU Ipari porszívó
RO Aspirator industrial
FR Aspirateur eau et poussières
IT Aspirapolvere industriale
ES Aspirador industrial
CN 吸尘器

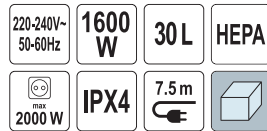

- Self cleaning filter
- HEPA type filter
- Automatischny otrząsacz filtra
- Filtr typu HEPA



YATO	[W]	
YT-85716	1600 / 3600	1

EN Synthetic vacuum bags
PL Worki do odkurzacza syntetyczne
DE Staubsaugerbeutel, synthetisch
RU Синтетические пылесборники
CZ Sáčky do vysavačů syntetické
HU Sztetikus porzsák
RO Sac sintetic pt. aspirator
FR Sac synthétique pour aspirateur
IT Sacchetti sintetici per aspirapolvere
ES Bolsas sintéticas para aspiradoras
CN 合成吸尘器袋



For YT-85710
Dla YT-85710

YATO	
YT-85730	20
YT-85731	20
YT-85733	20
YT-85735	24

EN Synthetic vacuum bag
PL Worek do odkurzacza syntetyczny
DE Staubsaugerbeutel, synthetisch
RU Синтетический мешок для пылесоса
CZ Syntetický sáček do vysavače
HU Sztetikus porzsák
RO Sac sintetic pt. aspirator
FR Sac synthétique pour aspirateur
IT Sacchetto per aspirapolvere sintetico
ES Bolsa sintética para aspiradora
CN 合成吸尘器袋



For YT-85715
Dla YT-85715

YATO	
YT-85741	100

EN Multifunctional vacuum cleaner for pond
PL Odkurzacz wielofunkcyjny do oczka wodnego
DE Multifunktions-Teichsauger
RU Водный пылесос для пруда
CZ Multifunkční vysavač do vodního očka
HU Többfunkciós vízszívó porszívó
RO Aspirator multifuncțional pt. iazuri
FR Aspirateur multifonction pour étangs
IT Aspirapolvere multifunzione per laghetti artificiali
ES Aspiradora multiuso para estanques
CN 水池吸尘器



- Wet and dry floor nozzle (width: 30 cm)
- Round brush (rotating head)
- Crevice nozzle
- Nozzle for cleaning pond
- Long hose (430 cm)
- Drainage hose (200 cm)
- Plastic tubes (4 PCS)
- Pond debris bag
- Cloth filter
- Sponge filter
- Dysza podłogowa do odkurzania na sucho i mokro (szerokość: 30 cm)
- Szczotka okrągła (obracana głowica)
- Dysza szczelinowa
- Dysza do czyszczenia oczka wodnego
- Długi wąż (430 cm)
- Wąż drenażowy (200 cm)
- Rurki z tworzywa sztucznego (4 szt.)
- Torba na zanieczyszczenia
- Filtr materiałowy
- Filtr piankowy



YATO	[W]	
YT-85720	1400	1

EN Synthetic vacuum bag
PL Worek do odkurzacza syntetyczny
DE Staubsaugerbeutel, synthetisch
RU Синтетический мешок для пылесоса
CZ Syntetický sáček do vysavače
HU Sztetikus porzsák
RO Sac sintetic pt. aspirator
FR Sac synthétique pour aspirateur
IT Sacchetto per aspirapolvere sintetico
ES Bolsa sintética para aspiradora
CN 合成吸尘器袋



For YT-85715
Dla YT-85715

YATO	
YT-85740	100

EN Synthetic vacuum bag
PL Worek do odkurzacza syntetyczny
DE Staubsaugerbeutel, synthetisch
RU Синтетический мешок для пылесоса
CZ Syntetický sáček do vysavače
HU Sztetikus porzsák
RO Sac sintetic pt. aspirator
FR Sac synthétique pour aspirateur
IT Sacchetto per aspirapolvere sintetico
ES Bolsa sintética para aspiradora
CN 合成吸尘器袋



For YT-85716
Dla YT-85716

YATO	
YT-85744	100

EN Paper vacuum bags
 PL Worki do odkurzacza papierowe
 DE Staubsaugerbeutel, papier
 RU Бумажные пылесборники
 CZ Sáčky do vysavačů papírové
 HU Papír porzsák
 RO Sac hartie pt aspirator
 FR Sacs en papier pour aspirateur
 IT Sacchetti di carta per aspirapolvere
 ES Bolsas de papel para aspiradoras
 CN 纸质吸尘器袋



For YT-85701
 Dla YT-85701

YATO	
YT-85732	24
YT-85736	24

EN Sponge filter and cloth filter
 PL Filtr piankowy i filtr materiałowy
 DE Schaumstoff- und Gewebefilter
 RU Тканевый фильтр
 CZ Pěnový filtr a látkový filtr
 HU Habszűrő és szövet szűrő
 RO Filtru de burete și filtru de pânză
 FR Filtre en mousse et en tissu
 IT Filtro in schiuma e filtro in tessuto
 ES Filtro de espuma y filtro de tela
 CN 尘袋&过滤海绵套装



For YT-85720
 Dla YT-85720

YATO	
YT-85750	20

EN Vacuum filter
 PL Filtr do odkurzacza
 DE Staubsaugerfilter
 RU Фильтр для пылесоса
 CZ Filtr do vysavače
 HU Porszívó szűrő
 RO Filtru aspirator
 FR Filtre pour aspirateur
 IT Filtro per aspirapolvere
 ES Filtro para aspiradoras
 CN 吸尘器过滤器



For YT-85715
 Dla YT-85715

YATO	
YT-85743	100

EN Wall paper stripper
 PL Parownica do usuwania tapet
 DE Dampftapetenblöser
 RU Паровой аппарат для снятия обоев
 CZ Parní odstraňovač tapet
 HU Tapétaeltávolító
 RO Aparat de dezlipit tapet
 FR Décolleuse à papiers peints
 IT Vaporizzatore per la rimozione di carta da parati
 ES Separador de fondos de pantalla
 CN 剥墙纸机



YATO	[W]	
YT-82320	2000	4

EN Vacuum filter
 PL Filtr do odkurzacza
 DE Staubsaugerfilter
 RU Фильтр для пылесоса
 CZ Filtr do vysavače
 HU Porszívó szűrő
 RO Filtru aspirator
 FR Filtre pour aspirateur
 IT Filtro per aspirapolvere
 ES Filtro para aspiradoras
 CN 吸尘器过滤器



For YT-85700, YT-85701
 Dla YT-85700, YT-85701

YATO	
YT-85738	1
YT-85739	1

EN Vacuum filter
 PL Filtr do odkurzacza
 DE Staubsaugerfilter
 RU Фильтр для пылесоса
 CZ Filtr do vysavače
 HU Porszívó szűrő
 RO Filtru aspirator
 FR Filtre pour aspirateur
 IT Filtro per aspirapolvere
 ES Filtro para aspiradoras
 CN 吸尘器过滤器



HEPA



For YT-85715
 Dla YT-85715

YATO	
YT-85742	100

EN Vacuum filter
 PL Filtr do odkurzacza
 DE Staubsaugerfilter
 RU Фильтр для пылесоса
 CZ Filtr do vysavače
 HU Porszívó szűrő
 RO Filtru aspirator
 FR Filtre pour aspirateur
 IT Filtro per aspirapolvere
 ES Filtro para aspiradoras
 CN 吸尘器过滤器



HEPA



For YT-85716
 Dla YT-85716

YATO	
YT-85745	22

EN Thermal knife for polystyrene foam
 PL Nóż termiczny do styropianu
 DE Thermomesser für Styropor
 RU Термонож для пенопласта
 CZ Termický nůž na pěnový polystyrén
 HU Polisztirol vágó hőkés

RO Cuiț termic pt. stiropian
 FR Couteau thermique à styrofoam
 IT Coltello termico per polistirolo
 ES Cuchilla térmica para poliestireno
 CN 热切割刀

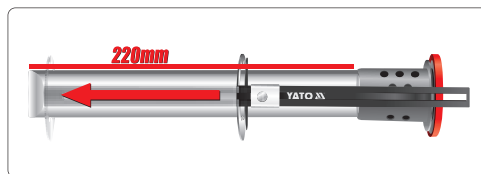
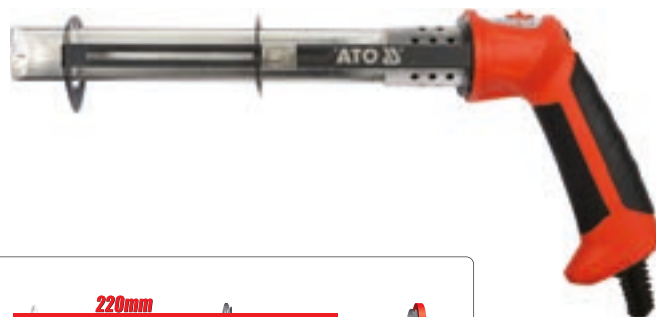

YATO	[W]	Max. cutting length / Maks. długość cięcia [mm]	
YT-82190	220	220	10

EN Cordless heat gun
PL Opalarka akumulatorowa
DE Akku-Heissluftgebläse
RU Фен технический аккумуляторный
CZ Akumulátorová opalovací pistole
HU Akkus hőlégfúvó
RO Pistol aer cald cu acumulator
FR Décapeur thermique sans-fil
IT Pistola termica a batteria
ES Pistola de calor a batería
CN 热风枪



18 V
Li-Ion
550 °C
100 l/min

Battery not included
Ohne Akku / Bez akumulatora
Bez baterije / Bez aku
Akumulator neškil
Fără baterie / Sans batterie
Senza batteria / Sin bateria
没有电池

18V
Li-Ion

YATO	[V d.c.]	
YT-82285	18	10

EN Hot air gun with accessories
PL Opalarka z akcesoriami
DE Heissluftpistole
RU Строительный фен в наборе
CZ Opalovací stroj s příslušenstvím
HU Hőlégfúvó tartozékokkal

RO Fion cu accesorii pt. ars vopseaua
FR Décapeur thermique avec accessoires
IT Pistola termica con accessori
ES Secadora con accesorios
CN 热风枪

230-240V~50Hz
2000 W
550 °C
500 l/min



LED
100 l/min

YATO	[W]	
YT-82291	2000	5

EN Hot air gun with accessories
PL Opalarka z akcesoriami
DE Heissluftpistole
RU Строительный фен в наборе
CZ Opalovací stroj s příslušenstvím
HU Hőlégfúvó tartozékokkal

RO Fion cu accesorii pt. ars vopseaua
FR Décapeur thermique avec accessoires
IT Pistola termica con accessori
ES Secadora con accesorios
CN 热风枪

230-240V~50Hz
2000 W
600 °C
500 l/min



LCD
100 l/min

YATO	[W]	
YT-82293	2000	5

EN Hot air gun
PL Opalarka
DE Heissluftpistole
RU Строительный фен
CZ Opalovací stroj
HU Hőlégfúvó

RO Fion pt. ars vopseaua
FR Décapeur thermique
IT Pistola termica
ES Secadora
CN 热风枪

230-240V~50Hz
2000 W
550 °C
500 l/min



YATO	[W]	
YT-82288	2000	10

EN Hot air gun with accessories
PL Opalarka z akcesoriami
DE Heissluftpistole
RU Строительный фен в наборе
CZ Opalovací stroj s příslušenstvím
HU Hőlégfúvó tartozékokkal

RO Fion cu accesorii pt. ars vopseaua
FR Décapeur thermique avec accessoires
IT Pistola termica con accessori
ES Secadora con accesorios
CN 热风枪

230-240V~50Hz
2000 W
550 °C
500 l/min



LED
100 l/min

YATO	[W]	
YT-82292	2000	5

EN Hot air gun with accessories
PL Opalarka z akcesoriami
DE Heissluftpistole
RU Строительный фен в наборе
CZ Opalovací stroj s příslušenstvím
HU Hőlégfúvó tartozékokkal

RO Fion cu accesorii pt. ars vopseaua
FR Décapeur thermique avec accessoires
IT Pistola termica con accessori
ES Secadora con accesorios
CN 热风枪

220-240V~50Hz
2000 W
450/600 °C
250-500 l/min
1.8 m



YATO	[W]	
YT-82294	2000	5

EN Hot air gun with accessories
 PL Opalarka z akcesoriami
 DE Heissluftpistole
 RU Строительный фен в наборе
 CZ Opaľovací stroj s príslušenstvom
 HU Hőlégfúvó tartozékokkal
 RO Fion cu accesorii pt. ars vopseaua
 FR Décapleur thermique avec accessoires
 IT Pistola termica con accessori
 ES Secadora con accesorios
 CN 热风枪

220-240V-50Hz
2000 W
 50-600 °C
 250-500 l/min
 TEMPERATURE REGULATION
 REGULACJA TEMPERATURY
 1.8 m

EN Hot air gun with accessories
 PL Opalarka z akcesoriami
 DE Heissluftpistole
 RU Строительный фен в наборе
 CZ Opaľovací stroj s príslušenstvom
 HU Hőlégfúvó tartozékokkal
 RO Fion cu accesorii pt. ars vopseaua
 FR Décapleur thermique avec accessoires
 IT Pistola termica con accessori
 ES Secadora con accesorios
 CN 热风枪

220-240V-50Hz
1600 W
 50-650 °C
 250-500 l/min
 LCD
 TEMPERATURE REGULATION
 REGULACJA TEMPERATURY
 1.8 m



YATO [W] 5
 YT-82295 2000

YATO [W] 5
 YT-82296 1500-1600

EN Hot air gun accessories set
 PL Zestaw akcesoriów do opalarki
 DE Heißluftpistolen-Zubehörsatz
 RU Набор принадлежностей для строительного фена
 CZ Sada príslušenství pro horkovzdušnou pistoli
 HU Hőlégfúvó tartozékészlet
 RO Set accesorii pt. pistol aer cald
 FR Accessoires de décapeur thermique
 IT Set di accessori per pistola termica
 ES Juego de accesorios para pistola de aire caliente
 CN 喷嘴五件套



5
 PCS

For YT-82294, YT-82295, YT-82296
 Dla YT-82294, YT-82295, YT-82296

YATO 50
 YT-82301

EN Blower
 PL Dmuchawa
 DE Gebläse
 RU Сетевой вентилятор
 CZ Výtláčny ventilátor
 HU Légfúvó
 RO Sufiantă
 FR Souffleur
 IT Soffiatore
 ES Soplador
 CN 吹吸机



220-240V-50/60Hz
600 W
 6000-16000 min⁻¹
 4 m³/min
 SUCTION FUNCTION
 FUNKCJA ZASYSANIA
 BLOW FUNCTION
 FUNKCJA DMUCHAWY
 2 m



L_{PA} = 82,1 ± 2,5 dB; L_{WA} = 95,0 ± 2,5 dB; ah = 2,994 ± 1,5 m³/s

YATO [W] 4
 YT-85170 600

EN Gas torch
PL Palnik gazowy
DE Gasbrenner
RU Газовая горелка
CZ Plynový hořák
HU Gázégő
RO Arzător de gaz
FR Chalumeau à gaz
IT Saldatore bruciatore a gas
ES Soplete de gas
CN 火焰枪



PIEZO **0.7 kW**
30 ml 60-90 min
GAS GAZ BUTANE BUTAN
LIGHTER GAS GAZ DO ZAPALNICZEK LOCK BLOKADA
CHILDREN PROTECTION ZABEZPECZENIE PRZED DZIECIAMI



YATO [kW] 0.7 10/20

EN Gas torch
PL Palnik gazowy
DE Gasbrenner
RU Газовая горелка
CZ Plynový hořák
HU Gázégő
RO Arzător de gaz
FR Chalumeau à gaz
IT Saldatore bruciatore a gas
ES Soplete de gas
CN 火焰枪



PIEZO **0.2 kW**
13.1 g/h GAS GAZ
BUTANE BUTAN LIGHTER GAS GAZ DO ZAPALNICZEK
LOCK BLOKADA CHILDREN PROTECTION ZABEZPECZENIE PRZED DZIECIAMI

YATO [kW] 0.2 60

EN Gas torch
PL Palnik gazowy
DE Gasbrenner
RU Газовая горелка
CZ Plynový hořák
HU Gázégő
RO Arzător de gaz
FR Chalumeau à gaz
IT Saldatore bruciatore a gas
ES Soplete de gas
CN 火焰枪



PIEZO **0.4 kW**
29 g/h 1350 °C
GAS GAZ BUTANE BUTAN
LOCK BLOKADA

YATO [kW] 0.4 10/40

EN Gas torch
PL Palnik gazowy
DE Gasbrenner
RU Газовая горелка
CZ Plynový hořák
HU Gázégő
RO Arzător de gaz
FR Chalumeau à gaz
IT Saldatore bruciatore a gas
ES Soplete de gas
CN 火焰枪



PIEZO **0.13 kW**
9.5 g/h 1350 °C
GAS GAZ BUTANE BUTAN
LOCK BLOKADA

YATO [kW] 0.13 10/50

EN Gas blow torch
PL Palnik gazowy
DE Lötbrenner
RU Газовая горелка
CZ Plynový hořák
HU Gázégő

RO Arzător pe gaz
FR Chalumeau à gaz
IT Saldatore bruciatore a gas
ES Soplete de gas
CN 喷枪



PIEZO **1.7 kW**
123 g/h GAS GAZ
BUTANE BUTAN

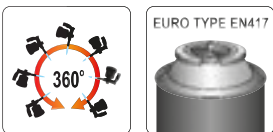

YATO [kW] 1.7 40

EN Gas soldering lamp
PL Gazowa lampa lutownicza
DE Gaslötlampe
RU Газовая паяльная лампа
CZ Plynová pájecí lampa
HU Gázos forrasztólámpa

RO Lampă de lipit pe gaz
FR Lampe à souder
IT Lampada per saldare a gas
ES Lampa de gas para soldar
CN 喷灯



PIEZO **1.7 kW**
123 g/h GAS GAZ
BUTANE BUTAN

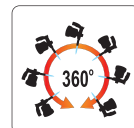

YATO [kW] 1.7 12

EN Soldering tool set
PL Lutownica gazowa z akcesoriami
DE Gaslötkolben Satz
RU Газовый паяльный набор
CZ Plynová rajka souprava
HU Gaz forrasztópaka készletek

RO Set ciocan de lipit cu gaz
FR Fer à souder à gaz
IT Saldatore a gas
ES Soldador a gas con accesorios
CN 自动点火多功能瓦斯组套

7 PCS PIEZO 30-125 W 30 ml 75 min GAS GAZ BUTANE BUTAN PROPANE BUTANE PROPAN BUTAN LIGHTER GAS GAZ DO ZAPALNICZEK LOCK BLOKADA CHILDREN PROTECTION ZABEZPECZENIE PRZED DZIECIAMI

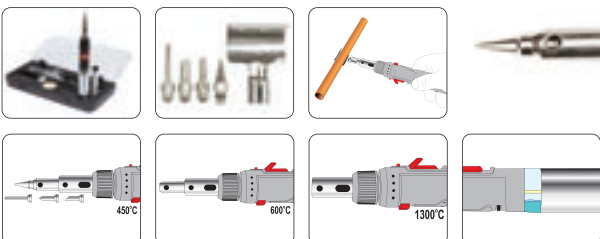

YATO [W] 30-125 6

EN Gas blow torch
 PL Palnik gazowy
 DE Lötbrenner
 RU Газовая горелка
 CZ Plynový hořák
 HU Gázégő
 RO Arzător de gaz
 FR Chalumeau à gaz
 IT Saldatore
 bruciatore a gas
 ES Soplete de gas
 CN 火焰枪

PIEZO 1.0 kW 73 g/h GAS GAZ BUTANE BUTAN



1000°C 360° EURO TYPE EN417

YATO	[kW]	
YT-36710	1	10/100

EN Gas blow torch
 PL Palnik gazowy
 DE Lötbrenner
 RU Газовая горелка
 CZ Plynový hořák
 HU Gázégő
 RO Arzător de gaz
 FR Chalumeau à gaz
 IT Saldatore
 bruciatore a gas
 ES Soplete de gas
 CN 火焰枪

PIEZO 1.28 kW GAS GAZ AIR POWETRZE LOCK BLOKADA BUTANE BUTAN



1600°C 360° EURO TYPE EN417

YATO	[kW]	
YT-36709	1.28	6/12

EN Turbo gas torch
 PL Palnik gazowy turbo
 DE Turbo-Handbrenner
 RU Газовая горелка турбо
 CZ Plynový hořák turbo
 HU Kézi gázégő
 RO Arzător cu gaz turbo
 FR Chalumeau à gaz
 IT Saldatore bruciatore a gas
 ES Quemador de gas turbo
 CN 手持式焊枪

PIEZO 2800 °C 2.0 kW 142 g/h 2.59 MPa G1" F GAS GAZ



360° G1" M x G7/16" F EURO TYPE EN417

YATO	[kW]	
YT-36715	2	20

EN Gas blow torch
 PL Palnik gazowy
 DE Lötbrenner
 RU Газовая горелка
 CZ Plynový hořák
 HU Gázégő
 RO Arzător de gaz
 FR Chalumeau à gaz
 IT Saldatore bruciatore a gas
 ES Soplete de gas
 CN 喷枪

PIEZO 2.0 kW 145 g/h GAS GAZ BUTANE BUTAN



1300°C 360° EURO TYPE EN417

YATO	[kW]	
YT-36712	2	20/80

EN Blow torch
 PL Lutownica gazowa dekarska
 DE Gas-Dachdeckerlötkolben
 RU Кровельный газовый паяльник
 CZ Pokryvačská plynová pájka
 HU Gázégő tetőfedő munkákhoz
 RO Arzator gaz
 FR Fer à souder couvreur
 IT Cannello saldatore a gas per posa coperture tetti
 ES Soldador a gas de tejás
 CN 焊枪套装



PROPANE BUTANE PROPAN BUTAN Cu TP GROT 1.5 m

YATO	[W]	L [mm]	
YT-36701	4	360	20

EN Soldering torch
 PL Palnik do lutowania
 DE Lötbrenner
 RU Горелка для пайки
 CZ Pájecí hořák
 HU Forrasztópáka
 RO Lampa pt. sudura
 FR Torche de soudage
 IT Cannello di brasatura
 ES Soplete de soldadura
 CN 焊枪套装



4 kW 290 g/h 360 mm PROPANE BUTANE PROPAN BUTAN x3 20/40/50 mm 1.5 m

YATO	[kW]	L [mm]	
YT-36730	4	360	20

EN Soldering torch
 PL Palnik do lutowania
 DE Lötbrenner
 RU Горелка для пайки
 CZ Pájecí hořák
 HU Forrasztópáka

RO Lampa pt. sudura
 FR Torche de soudage
 IT Cannello di brasatura
 ES Soplete de soldadura
 CN 焊枪套装

4 kW 288 g/h 360 mm PROPANE BUTANE PROPAN BUTAN x3 13/14/17 mm



YATO	[kW]	L [mm]	
YT-36731	4	360	20

EN Roofing torch
PL Palnik dekarski
DE Dachdeckerbrenner
RU Горелка кровельная
CZ Pokrývačský hořák
HU Tetőfedő égő

RO Lampa pt. izolatii
FR Outil à souder pour toiture
IT Cannello per posa coperture tetti
ES Antorcha de techo
CN 焊枪套装

8
kW
582
g/h
370
mm

PROPANE
BUTANE
PROPAN
BUTAN

x2

25/30
mm

1.5
m



YATO	[kW]	L [mm]	
YT-36740	8	370	10

EN Roofing torch
PL Palnik dekarski
DE Dachdeckerbrenner
RU Горелка кровельная
CZ Pokrývačský hořák
HU Tetőfedő égő

RO Lampa pt. izolatii
FR Outil à souder pour toiture
IT Cannello per posa coperture tetti
ES Antorcha de techo
CN 焊枪套装

PIEZO
65
kW
4640
g/h
900
mm
0.25
MPa
5
m
x1
60
mm

PROPANE
BUTANE
PROPAN
BUTAN

x1

60
mm

5
m



YATO	[kW]	L [mm]	
YT-36741	65	900	6

EN Weed burner
PL Palnik do wypalania chwastów
DE Unkrautbrenner

RU Горелка для выжигания сорняков
CZ Hořák na pleveľ
HU Gyomégető

RO Arzator pt. buruieni
FR Désherbeur thermique
IT Bruciatori di erbacce

ES Quemador de malezas
CN 除草炬

PIEZO
1.7
kW
123
g/h
max °C
1300
800
mm
PROPANE
BUTANE
PROPAN
BUTAN
x1
30
mm

EURO TYPE EN417

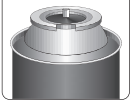

YATO	[kW]	L [mm]	
YT-36742	1.7	800	12

EN Soldering iron with temperature adjustment
PL Lutownica z regulacją temperatury
DE Temperaturgesteuerter LötKolben
RU Паяльник с терморегулятором
CZ Pájka s regulací teploty
HU Hőszabályozós forrasztó

RO Letcon cu reglaj de temperatura
FR Fer à souder à température réglée
IT Saldatore con temperatura regolabile
ES Soldador con ajuste de temperatura
CN 调温电烙铁

220-240V~
50Hz
50
W
200-450
°C
+/- 25
°C
900M
mm

• Constant tip temperature control

• Stały odczyt temperatury grzałki



YATO	[W]	[°C]	
YT-82700	50	200-450	10/100

EN Soldering iron with temperature adjustment
PL Lutownica z regulacją temperatury
DE Temperaturgesteuerter LötKolben
RU Паяльник с терморегулятором
CZ Pájka s regulací teploty
HU Hőszabályozós forrasztó

RO Letcon cu reglaj de temperatura
FR Fer à souder à température réglée
IT Saldatore con temperatura regolabile
ES Soldador con ajuste de temperatura
CN 数显电烙铁

220-240V~
50Hz
80
W
50-480
°C
+/- 2
°C
900M
mm
LCD
BACKLIGHT
PODSWIECZENIE

• Constant tip temperature control

• Temperature calibration function

• Stały odczyt temperatury grzałki

• Funkcja kalibracji temperatury



YATO	[W]	[°C]	
YT-82701	80	50-480	10/50

EN Soldering iron
PL Lutownica oporowa
DE LötKolben
RU Электропаяльник
CZ Pájka odporová
HU Forrasztópáka
RO Ciocan de lipit
FR Fer à souder
IT Saldatore a stagno
ES Soldador de resistencia
CN 电烙铁



230V~
50Hz
2-3
min

YATO	[W]	[°C]	[mm]	
YT-8271	30	400	Ø3.8x70	16
YT-8272	60	500	Ø6x78	16
YT-8273	80	520	Ø6.8x64	16

EN Transformer soldering gun
 PL Lutownica transformatorowa
 DE Lötstole
 RU Электрический паяльник
 CZ Transformátorová páječka
 HU Forrasztópáka

RO Pistol de lipit
 FR Pistolet fer à souder électrique
 IT Saldatore istantaneo
 ES Soldador transformador
 CN 电烙铁

220-240V~50Hz **180 W**
 0-600 °C **S2 20%**
LED
 LIGHTING OSWIEPLENIE



LED
 LIGHTING OSWIEPLENIE

YATO	[W]	[°C]	
YT-8245	180	0-600	10

EN Soldering station
 PL Stacja lutownicza
 DE Heiluft-Llstation
 RU Паяльная станция
 CZ Letovaci stanice
 HU Forrasztpka lloms
 RO Staie de lipit
 FR Station de soudage
 IT Stazione digitale di saldatura
 ES Estacin de soldadura
 CN 焊台

220-240V~50Hz **75 W** 200-480 °C **+/- 1 °C** **900M**
LCD **3 1/2"** **LCD** **ESD SAFE** **USB**
 BACKLIGHT PODSWIEPLENIE BATTERY CHARGER LADOWNIKA

- Constant tip temperature control
- Temperature calibration function
- Auto sleep 1-240 min
- Stly odczyt temperatury grota
- Funkcja kalibracji temperatury
- Automatyny tryb czuwania 1-240 min



YATO	[W]	[°C]	
YT-82456	75	200-480	8

EN 2 in 1 hot air soldering station
 PL 2 w 1 stacja lutownicza hot air
 DE 2 in 1 Heiluft-Llstation
 RU Термовоздушная паяльная станция 2 в 1
 CZ Horkovzdun pjeci stanice 2 v 1
 HU 2 az 1-ben hot air forrasztlloms
 RO Staie de lipit, 2 in 1, cu aer cald
 FR Station de soudage  air chaud 2 en 1
 IT 2 in 1 stazione di saldatura hot air
 ES 2 en 1 estacin de soldadura hot air
 CN 热风拆焊台

220-240V~50Hz **750 W** 100-480 °C **+/- 2 °C** **120 l/min**
75 W 200-480 °C **+/- 1 °C** **900M** **LED**
 DISPLAY WYWETLACZ **ESD SAFE**



- Constant tip temperature control
- Brushless motor fan
- Auto sleep 0-240 min
- Auto power off function
- Build-in position sensor
- Stly odczyt temperatury grota
- Bezszczlkowy wentylator
- Automatyny tryb czuwania
- Automatyne wyczenie urzdzenia
- Czujnik odloenia grzlki



YATO	[W]	[°C]	
YT-82458	75 (lutownica), 750 (dmuchawa hot air)	200-480 (lutownica), 100-480 (dmuchawa hot air)	6

EN Transformer soldering gun
 PL Lutownica transformatorowa
 DE Ltpistole
 RU Электрический паяльник
 CZ Transformátorová páječka
 HU Forrasztpka

RO Pistol de lipit
 FR Pistolet fer à souder électrique
 IT Saldatore istantaneo
 ES Soldador transformador
 CN 电烙铁

230-240V~50Hz **200 W**
S2 20% **LED**
 LIGHTING OSWIEPLENIE



LED
 LIGHTING OSWIEPLENIE

YATO	[W]	[°C]	
YT-82451	200	70-200, 201-350, 351-500	10

EN Hot air soldering station
 PL Stacja lutownicza hot air
 DE Heiluft-Llstation
 RU Термовоздушная паяльная станция
 CZ Horkovzdun pjeci stanice
 HU Hot air forrasztlloms
 RO Staie de lipit cu aer cald
 FR Station de soudage  air chaud
 IT Stazione di saldatura Hot Air
 ES Estacin de soldadura hot air
 CN 热风拆焊台

220-240V~50Hz **750 W** 100-500 °C **+/- 2 °C**
120 l/min **LED** **ESD SAFE**
 DISPLAY WYWETLACZ

- Brushless motor fan
- Auto sleep 0-240 min
- Auto power off function
- Build-in position sensor
- Bezszczlkowy wentylator
- Automatyny tryb czuwania
- Automatyczne wyczenie urzdzenia
- Czujnik odloenia grzlki



YATO	[W]	[°C]	
YT-82457	750	100-500	8

EN Soldering station
 PL Stacja lutownicza
 DE Llstation
 RU Паяльная станция
 CZ Letovaci stanice
 HU Forrasztpka lloms
 RO Staie de lipit
 FR Station de soudage
 IT Stazione digitale di saldatura
 ES Estacin de soldadura
 CN 焊台

220-240V~50Hz **70 W** 200-480 °C **+/- 1 °C** **900M**
LED **ESD SAFE**



- Constant tip temperature control
- Auto sleep 1-99 min
- Auto power off function 1-99 min
- Stly odczyt temperatury grota
- Automatyny tryb czuwania 1-99 min
- Automatyczne wyczenie urzdzenia 1-99 min

YATO	[W]	[°C]	
YT-82459	70	200-480	8

EN Soldering station
PL Stacja lutownicza
DE Lötstation
RU Паяльная станция
CZ Letovací stanice
HU Forrasztópáka állomás
RO Stație de lipit
FR Station de soudage
IT Stazione digitale di saldatura
ES Estación de soldadura
CN 焊台



220-240V~
50/60Hz
60 W
90-480 °C
+/- 2 °C
900M
LED
DISPLAY
WYSWIETLACZ

- Constant tip temperature control
- Auto sleep 10 min
- Stały odczyt temperatury grota
- Automatyczny tryb czuwania 10 min

YATO	[W]	[°C]	
YT-82460	60	90-480	16

EN Electric glue gun
PL Pistolet do klejenia
DE Heissklebepistole
RU Пистолет для клея
CZ Pistole na lepení
HU Ragasztópisztoly
RO Pistol pt. lipit
FR Electrique pistolet a colle
IT Pistola colla
ES Pistola de cola
CN 热胶枪



230-240V~
50Hz
30(450) W
100-200 °C
3-5 min
20 g/min
11 mm
1.5 m
LED

YATO	[W]	Ø [mm]	[g/min]	
YT-82403	30 (450)	11	20	6

EN Electric glue gun
PL Pistolet do klejenia
DE Heissklebepistole
RU Пистолет для клея
CZ Pistole na lepení
HU Ragasztópisztoly
RO Pistol pt. lipit
FR Pistolet à colle
IT Pistola colla
ES Pistola de cola
CN 热胶枪



230V~
50Hz
20(80) W
180-200 °C
3-5 min
15 g/min
3x
Ø 11 mm
LED

YATO	[W]	Ø [mm]	[g/min]	
YT-82402	20 (80)	11	15	12/48

EN Soldering station
PL Stacja lutownicza
DE Lötstation
RU Паяльная станция
CZ Letovací stanice
HU Forrasztópáka állomás

RO Stație de lipit
FR Station de soudage
IT Stazione digitale di saldatura
ES Estación de soldadura
CN 焊台

110-240V~
50-60Hz
75 W
90-480 °C
+/- 2 °C
T12
LED
DISPLAY
WYSWIETLACZ



- Constant tip temperature control
- Temperature calibration function
- Stały odczyt temperatury grota
- Funkcja kalibracji temperatury

YATO	[W]	[°C]	
YT-82461	75	90-480	30

EN Electric glue gun
PL Pistolet do klejenia
DE Heissklebepistole
RU Пистолет для клея
CZ Pistole na lepení
HU Ragasztópisztoly

RO Pistol pt. lipit
FR Pistolet à colle
IT Pistola colla
ES Pistola de cola
CN 热胶枪

230V~
50Hz
35(400) W
150-200 °C
3-6 min
15 g/min
2x
Ø 11 mm
LED

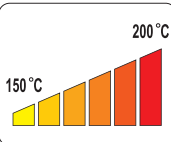

YATO	[W]	Ø [mm]	[g/min]	
YT-82401	35 (400)	11	15	12/24

EN PVC plastic pipe welder
PL Zgrzewarka do rur termoplastycznych
DE Schweissgerät für thermoplastische Rohre
RU Аппарат для сварки пластиковых труб
CZ Svářečka na termoplastické trubky
HU Hegesztő berendezés termoplasztikus csövekhez

RO Masina de sudat tevi termoplastice
FR Machine à souder pour tuyaux
IT Polifusore saldatore per tubi
ES Maquina de soldar las tubos termoplasticos
CN 热熔器

230V~
50Hz
850 W
0-300 °C
LED



16, 20, 25, 32, 40, 50, 63 mm

YATO	[W]	
YT-82250	850	2

EN Gasoline generator
PL Generator prądowórczy
DE Stromgenerator
RU Генератор тока
CZ Generátor vytvářející proud
HU Áramfejlesztő generátorhoz

RO Generator de curent
FR Groupe électrogène
IT Generatore di corrente
ES Generador de corriente
CN 发电机

max 2200 W
2x 230V-50Hz
196 cm³
No Pb
3.6 L
0.6 L



L_{pa} = 72,7 ± 2,03 dB; L_{wa} = 92,2 ± 2,03 dB

YATO
YT-85451 1

EN Gasoline generator
PL Generator prądowórczy
DE Stromgenerator
RU Генератор тока
CZ Generátor vytvářející proud
HU Áramfejlesztő generátorhoz

RO Generator de curent
FR Groupe électrogène
IT Generatore di corrente
ES Generador de corriente
CN 发电机

max 2700 W
2x 230V-50Hz
196 cm³
No Pb
3.6 L
0.6 L



L_{pa} = 73,6 ± 2,0 dB; L_{wa} = 93,2 ± 2,0 dB

YATO
YT-85453 1

EN Gasoline generator
PL Generator prądowórczy
DE Stromgenerator
RU Генератор тока
CZ Generátor vytvářející proud
HU Áramfejlesztő generátorhoz

RO Generator de curent
FR Groupe électrogène
IT Generatore di corrente
ES Generador de corriente
CN 发电机

max 5500 W
3x 230V-50Hz
380V 1x
389 cm³
No Pb
25 L
1.1 L



L_{pa} = 75,0 ± 2,62 dB; L_{wa} = 93,7 ± 2,62 dB

YATO
YT-85460 1

EN Inverter generator
PL Generator prądowórczy inwerterowy
DE Stromgenerator
RU Генератор тока
CZ Generátor vytvářející proud
HU Áramfejlesztő generátorhoz

RO Generator de curent
FR Générateur à essence
IT Generatore di corrente
ES Generador de corriente
CN 逆变发电机

max 880 W
230V-50Hz
42.7 cm³
No Pb
3.5 L
50 : 1
ULTRA SILENT
BARDZO CICHY



ULTRA LIGHT
8.5 kg

L_{pa} = 70,46 ± 0 dB; L_{wa} = 90,46 ± 0 dB

YATO
YT-85481 1

EN Gasoline water pump
PL Pompa spalinowa
DE Pumpe mit verbrennungsmotor
RU Бензоначос
CZ Čerpadlo se spalovacím motorem
HU Robbanómotoros szivattyú
RO Pompa cu motor cu ardere internă
FR Pompe à eau à essence
IT Motopompa
ES Bomba de combustion
CN 汽油抽水泵

4.0 kW
3600 min⁻¹
208 cm³
50 mm 2"
Q max 500 l/min
Q max 30 m³/h
25 m
8 m
3.6 L



L_{pa} = 82,1 ± 3,0 dB; L_{wa} = 95,4 ± 3,0 dB

YATO
YT-85401 1

EN Gasoline water pump
PL Pompa spalinowa
DE Pumpe mit verbrennungsmotor
RU Бензоначос
CZ Čerpadlo se spalovacím motorem
HU Robbanómotoros szivattyú
RO Pompa cu motor cu ardere internă
FR Pompe à eau à essence
IT Motopompa
ES Bomba de combustion
CN 汽油抽水泵

4.0 kW
3600 min⁻¹
208 cm³
80 mm 3"
Q max 800 l/min
Q max 50 m³/h
20 m
8 m
3.6 L



L_{pa} = 81,9 ± 3,0 dB; L_{wa} = 95,0 ± 3,0 dB

YATO
YT-85402 1

EN Gasoline water pump
PL Pompa spalinowa
DE Pumpe mit verbrennungsmotor
RU Бензоначос
CZ Čerpadlo se spalovacím motorem
HU Robbanómotoros szivattyú
RO Pompa cu motor cu ardere internă
FR Pompe à eau à essence
IT Motopompa
ES Bomba de combustion
CN 汽油抽水泵

4.0 kW
3600 min⁻¹
208 cm³
100 mm 4"
Q max 1300 l/min
Q max 78 m³/h
20 m
8 m
3.6 L



L_{pa} = 81,9 ± 3,0 dB; L_{wa} = 94,9 ± 3,0 dB

YATO
YT-85403 1

EN Submersible pump for dirty water and wastewater
PL Pompa zatapialna do wody brudnej i ścieków
DE Tauchpumpe für Schmutzwasser
RU Погружной насос для грязной воды
CZ Ponorné čerpadlo pro odpadní vody
HU Bűvárszivattyú szennyvíz
RO Pompă submersibilă pt. apă uzată
FR Pompe submersible pour eaux usees
IT Pompa sommersa per acque reflue
ES Bomba sumergible para aguas residuales
CN 污水切割泵

230V~
50Hz

400 W

Q max
12000
l/h



Δ	Q [l/h]
3	12000
4	9000
5	6000
6	3000
7	1500
7.5	500

YATO	[W]	[l/h]	H max. [m]	
YT-85349	400	12000	7.5	1

EN Dirty water submersible pump
PL Pompa zatapialna do wody brudnej
DE Tauchpumpe für Schmutzwasser
RU Погружной насос для грязной воды
CZ Ponorné čerpadlo pro špinavú vodu
HU Bűvárszivattyú
RO Pompă submersibilă pt. apă murdara
FR Pompe submersible pour eaux polluées
IT Pompa sommersa per acque reflue
ES Bomba sumergible para agua sucia
CN 清污两用潜水泵

220-240V~
50Hz

400 W

Q max
11000
l/h



Δ	Q [l/h]
0	11000
1	10500
2	10000
3	9500
4	9000
5	8000
6	7000
7	6000
8	5000
9	4000
10	3000
11	2000
12	1000

YATO	[W]	[l/h]	H max. [m]	
YT-85330	400	11000	5.8	4

EN Dirty water submersible pump
PL Pompa zatapialna do wody brudnej
DE Tauchpumpe für Schmutzwasser
RU Погружной насос для грязной воды
CZ Ponorné čerpadlo pro špinavú vodu
HU Bűvárszivattyú
RO Pompă submersibilă pt. apă murdara
FR Pompe submersible pour eaux polluées
IT Pompa sommersa per acque reflue
ES Bomba sumergible para agua sucia
CN 清污两用潜水泵

220-240V~
50Hz

900 W

Q max
18000
l/h



Δ	Q [l/h]
0	18000
1	17000
2	16000
3	15000
4	14000
5	12000
6	11000
7	10000
8	8000
9	7000
10	6000
11	5000
12	4000
13	3000
14	2000
15	1000

YATO	[W]	[l/h]	H max. [m]	
YT-85333	900	18000	8.9	4

EN Submersible pump for dirty water and wastewater
PL Pompa zatapialna do wody brudnej i ścieków
DE Tauchpumpe für Schmutzwasser
RU Погружной насос для грязной воды
CZ Ponorné čerpadlo pro odpadní vody
HU Bűvárszivattyú szennyvíz
RO Pompă submersibilă pt. apă uzată
FR Pompe submersible pour eaux usees
IT Pompa sommersa per acque reflue
ES Bomba sumergible para aguas residuales
CN 污水切割泵

230V~
50Hz

750 W

Q max
16000
l/h



Δ	Q [l/h]
0	16000
1	15000
2	14000
3	13500
4	12500
5	11500
6	11000
7	10500
8	9500
9	8000
10	5500
11	3500
12	2000
13	500

YATO	[W]	[l/h]	H max. [m]	
YT-85350	750	16000	13	1

EN Deep well pump
PL Pompa głębinowa
DE Tiefbrunnenpumpe
RU Глубинный насос
CZ Čerpadlo do vrtaných studní
HU Bűvárszivattyú
RO Pompă submersibilă
FR Pompe de puits profond
IT Pompa sommergibile
ES Bomba agua sumergible
CN 深井泵

230V~
50Hz

370 W

Q max
5400
l/min

20 m



YATO	[W]	[l/h]	
YT-85300	370	5400	1

EN Deep well pump
PL Pompa głębinowa
DE Tiefbrunnenpumpe
RU Глубинный насос
CZ Čerpadlo do vrtaných studní
HU Bűvárszivattyú
RO Pompă submersibilă
FR Pompe de puits profond
IT Pompa sommergibile
ES Bomba agua sumergible
CN 深井泵

230V~
50Hz

550 W

Q max
6000
l/h

20 m



YATO	[W]	[l/h]	
YT-85301	550	6000	1

EN Dirty water submersible pump
 PL Pompa zatapiałna do wody brudnej
 DE Tauchpumpe für Schmutzwasser
 RU Погружной насос для грязной воды
 CZ Ponorné čerpadlo pro špinavú vodu
 HU Bűvárszivattyú
 RO Pompă submersibilă pt. apă murdara
 FR Pompe submersible pour eaux polluées
 IT Pompa sommersa per acque reflue
 ES Bomba sumergible para aguas sucias
 CN 不锈钢潜水泵 (内置式开关)



230V~
50Hz
750 W
Q max
11000 l/h

Δ	Q [l/h]
0	11000
1	10500
2	10000
3	9500
4	9000
5	8500
6	8000
7	7500
8	7000
9	6500
10	6000
11	5000
12	4000
13	3000
14	2000
15	1000

YATO	[W]	[l/h]	H max. [m]	
YT-85341	750	11000	8.5	3

EN Brass straight connection
 PL Króciec mosiężny do pomp
 DE Messingstutzen für Pumpen
 RU Латунный патрубок для насосов
 CZ Mosazná prípojka pro čerpadla
 HU Sárgaréz csatlakozó szivattyúkhöz
 RO Conector alama
 FR Raccord de pompe en laiton
 IT Raccordo in ottone per pompe
 ES Conector de latón para bombas
 CN 铜接头



1"
25mm
BRASS
MOSIADZ

YATO	
YT-85395	10/80

EN Nylon head jet pump
 PL Pompa ogrodowa z głowicą nylonową
 DE Gartenpumpe
 RU Огородный насос
 CZ Zahradní čerpadlo
 HU Kerti szivattyúhoz

RO Pompa de apa
 FR Bomba de jardin con cabeza nylon
 IT Pompa da giardino
 ES Pompe a eau de surface
 CN 花园泵 (含电子压力开关)



230V~
50Hz
600 W
Q max
3100 l/h

L_{PA} = 69,43 ± 1,49 dB; L_{WA} = 82,35 ± 1,49 dB

YATO	[W]	[l/h]	H max. [m]	
YT-85360	600	3100	35	1

EN Dirty water submersible pump
 PL Pompa zatapiałna do wody brudnej
 DE Tauchpumpe für Schmutzwasser
 RU Погружной насос для грязной воды
 CZ Ponorné čerpadlo pro špinavú vodu
 HU Bűvárszivattyú
 RO Pompă submersibilă pt. apă murdara
 FR Pompe submersible pour eaux polluées
 IT Pompa sommersa per acque reflue
 ES Bomba sumergible para aguas sucias
 CN 不锈钢潜水泵 (浮球开关)



230V~
50Hz
1100 W
Q max
17000 l/h

Δ	Q [l/h]
0	17000
1	16500
2	16000
3	15000
4	14000
5	13000
6	12000
7	11000
8	10000
9	9000
10	8000
11	7000
12	6000
13	5000
14	4000
15	3000
16	2000
17	1000

YATO	[W]	[l/h]	H max. [m]	
YT-85343	1100	17000	10	3

EN Drill pump
 PL Pompa na wiertarkę
 DE Bohrerpumpe
 RU Насос для дрели
 CZ Čerpadlo na vrtačku
 HU Szivattyú fúróra
 RO Pompa de foraj
 FR Pompe pour perceuse
 IT Pompa per trapano
 ES Bomba para taladradora
 CN 手转泵



Q max
2.4 m³/h
3.0m
3400 min⁻¹(max.)
8 mm
STANDARD

YATO	
YT-89000	6/60

EN Hydrophore
 PL Hydrofor
 DE Hauswasserwerk
 RU Гидрофор
 CZ Vodárna domáci
 HU Hydrovor



230V~
50Hz
1200 W
1" 25mm
4000 l/min
Δ 50m
▽ 9m
max °C 35
19L
IPX4
INOX

L_{PA} = 69,43 ± 1,49 dB; L_{WA} = 82,35 ± 1,49 dB

YATO	[W]	[l/h]	H max. [m]	
YT-85370	1200	4000	50	1

EN Cordless submersible garden pump
PL Akumulatorowa pompa ogrodowa zatapialna
DE Akku-Garten-Tauchpumpe
RU Аккумуляторный садовый насос
CZ Akumulátorové zahradní čerpadlo
HU Akkumulátoros kerti merülő szivattyú
RO Pompă de grădină submersibilă fără fir
FR Pompe à jardin submersible sans fil
IT Pompa sommersa da giardino a batteria
ES Bomba de batería sumergible para jardín
CN 充电式潜水泵



18 V
Li-Ion
2 bar
25 mm
2500 l/h
20 m
1.5 m
max °C 35
IPX8

Battery not included
Obrno Akku / Bez akumulatora
Esz Gamapeu / Bez aku
Akkumulátor nélkül
Fără baterie / Sans batterie
Senza batteria / Sin batería
没有电池

18V
Li-Ion

$L_{wa} < 70$ dB

YATO	[V d.c.]	
YT-85281	18	4

EN Cordless barrel pump
PL Akumulatorowa pompa do deszczówki
DE Akku-Regenfasspumpe
RU Аккумуляторный насос для дождевой воды
CZ Akumulátorové čerpadlo na dešťovou vodu
HU Akkumulátoros esővíz szivattyú
RO Pompă de butoi fără fir
FR Pompe à eau de pluie sans fil
IT Pompa per acqua piovana a batteria
ES Bomba de batería para tanques de agua de precipitación
CN 充电式潜水泵



18 V
Li-Ion
2 bar
3/4" 19 mm
2000 l/h
21 m
1.5 m
max °C 35
IPX8

Battery not included
Obrno Akku / Bez akumulatora
Esz Gamapeu / Bez aku
Akkumulátor nélkül
Fără baterie / Sans batterie
Senza batteria / Sin batería
没有电池

18V
Li-Ion

$L_{wa} < 70$ dB

YATO	[V d.c.]	
YT-85283	18	4

EN High pressure washer
PL Myjka ciśnieniowa
DE Hochdruckereiniger
RU Мойка высокого давления
CZ Tlakový mycí stroj
HU Vízsztóró
RO Instrument cu presiune pt. spălat
FR Nettoyeur haute pression
IT Idropulitrice
ES Lavadora de presión
CN 高压清洗机



230-240V~
50Hz
1400 W
10.5 MPa (max.)
7.0 MPa
5 l/min
IPX5

$L_{pa} = 88,43 \pm 3,0$ dB; $L_{wa} = 95,23 \pm 3,0$ dB; $a_n = \leq 2,5$ m/s²

YATO	[W]	
YT-85910	1400	1

EN High pressure washer
PL Myjka ciśnieniowa
DE Hochdruckereiniger
RU Мойка высокого давления
CZ Tlakový mycí stroj
HU Vízsztóró
RO Instrument cu presiune pt. spălat
FR Nettoyeur haute pression
IT Idropulitrice
ES Lavadora de presión
CN 高压清洗机



220-240V~
50Hz
2000 W
15 MPa (max.)
10 MPa
6 l/min
IPX5

$L_{pa} = 85,8 \pm 3,0$ dB; $L_{wa} = 95,39 \pm 3,0$ dB; $a_n = 2,64$ m/s²

YATO	[W]	
YT-85915	2000	1

EN Cordless pressure washer
PL Akumulatorowa myjka ciśnieniowa
DE Akku-Hochdruckereiniger
RU Аккумуляторная мойка высокого давления
CZ Bateriový tlakový čistič
HU Akkumulátoros mosó
RO Aparat de spălat cu presiune
FR Nettoyeur à haute pression sans-fil
IT Idropulitrice a batteria
ES Limpiadora a vapor a batería
CN 高压清洗机



18 V
Li-Ion
IN (max.) 0.5 MPa
OUT 2.3 MPa
6 m
SLICKA FUNKCIA ZASYSANIA

Battery not included
Obrno Akku / Bez akumulatora
Esz Gamapeu / Bez aku
Akkumulátor nélkül
Fără baterie / Sans batterie
Senza batteria / Sin batería
没有电池

18V
Li-Ion

YATO	[V d.c.]	
YT-85930	18	6

EN Cordless leaf vacuum / blower
PL Akumulatorowy odkurzacz / dmuchawa do liści
DE Akku-Laubsauger / Laubbläser
RU Аккумуляторная воздуходувка-пылесос
CZ Akumulátorový vysavač / odľukovač listí
HU Akkumulátoros lombszívó / lombfúvó
RO Sulfanta / aspirator cu acumulator
FR Aspirateur-souffleur de feuilles sans-fil
IT Aspiratore / soffiatore per foglie senza fili
ES Aspiradora / soplador de hojas de batería
CN 锂电无刷吹吸机

- Leaves compress volume function 8:1
- Blowing air speed: 230 km/h
- Funkcja zmniejszania objętości liści 8:1
- Prędkość wydmuchiwanego powietrza: 230 km/h



2 in 1
2 w 1
36 V
2x 18V
Li-Ion
6000-12500 min⁻¹
8 m³/min
45 L

Battery not included
Obrno Akku / Bez akumulatora
Esz Gamapeu / Bez aku
Akkumulátor nélkül
Fără baterie / Sans batterie
Senza batteria / Sin batería
没有电池

18V
Li-Ion

$L_{pa} = 80,5 \pm 3,0$ dB; $L_{wa} = 92,7 \pm 3,0$ dB; $a_n = 2,37 \pm 1,5$ m/s²

YATO	[V d.c.]	
YT-85175	36 (18 x 2)	1

EN Electric sprayer
 PL Spryskiwacz elektryczny
 DE Elektrische Sprühpistole
 RU Электрический опрыскиватель
 CZ Elektrický ostřikovač
 HU Elektromos festékszóró
 RO Pulverizator electric
 FR Pulvérisateur à main électrique
 IT Spruzzatore elettrico
 ES Rociador eléctrico
 CN 喷壶



3.6 V 2000mAh Li-Ion	1000 ml	460 ml/min
285 ml/min		
4-5h	2.5h	LED LIGHTING OSWETLENIE
LED CHARGE INDICATOR WSKAZNIK NAŁADZOWANIA BATERII	USB BATTERY CHARGER ŁADOWNIKA	

• Application: watering, washing, disinfection
 • Przeznaczenie: podlewanie, mycie, dezynfekcja

$L_{PA} = 75,2 \pm 3,0$ dB; $L_{WA} = 86,2 \pm 3,0$ dB; $a_h = 1,137 \pm 1,5$ m/s²

YATO	[V d.c.]	
YT-86200	3.6	18

EN Cordless backpack sprayer
 PL Akumulatorowy opryskiwacz plecakowy
 DE Akku-Drucksprüher
 RU Аккумуляторный ранцевый опрыскиватель
 CZ Aku postřikovač
 HU Akkumulátoros hátí permetező
 RO Pulverizator cu acumulator
 FR Pulvérisateur à batterie
 IT Pompa irroratrice a spalla a batteria
 ES Pulverizador de mochila a batería
 CN 充电式喷雾器



2in1 2w1	18 V Li-Ion	12 L
≤1.5 l/min	max 7m	

• Water tank
 • Sprayer
 • Hydronetka
 • Opryskiwacz

Battery not included
 Ohne Akku / Bez akumulatora
 Bez Gamapeu / Bez aku
 Akkumulátor nélkül
 Fără baterie / Sans batterie
 Senza batteria / Sin batería
 没有电池

$L_{PA} = 60,0 \pm 3,0$ dB; $L_{WA} = 70,0 \pm 3,0$ dB; $a_h = 0,74 \pm 1,5$ m/s²

YATO	[V d.c.]	
YT-86211	18	1

EN Battery sprayer with solar panel
 PL Opryskiwacz akumulatorowo-solarny
 DE Solar-Akku-Sprüngerät
 RU Опрыскиватель аккумуляторный на солнечной батарее
 CZ Postřikovač bateriovo-solární
 HU Akkumulátoros-napelemes permetező
 RO Vermorel cu alimentare solara
 FR Pulvérisateur à batterie et à dos solaire
 IT Pompa irroratrice a batteria e ad energia solare
 ES Pulverizador solar a batería
 CN 电动太阳能喷雾器



12 V	
0.15-0.4 MPa	3.1 l/min
16 L	8.0 Ah
PP	SS STAINLESS STEEL SPAL NIEROZŻYWA

YATO	[V d.c.]	
YT-86220	12	1

EN Cordless telescopic pole saw
 PL Akumulatorowe okrzesywarka na wysięgniku
 DE Akku-Teleskop-Hochentaster
 RU Аккумуляторный телескопический высоторез
 CZ Akumulátorová teleskopická vyvrtovací pila
 HU Akkus magassági ágvágó távcsöves
 RO Ferăstraie cu lanț cu telescopiu cu acumulator
 FR Elagueuse sur perche télescopique sans-fil
 IT Decescpugliatore telescopico a batteria
 ES Sierra de pértiga telescópica a batería
 CN 充电式高枝锯

18V Li-Ion



18 V Li-Ion	2500 min ⁻¹
5 m/s	
8" 20 cm	
280 200 cm	2.0 Ah
1h	EASY TRANSPORT LATWY TRANSPORT

$L_{PA} = 78,2 \pm 3,0$ dB; $L_{WA} = 91,2 \pm 2,36$ dB; $a_h = 2,109 \pm 1,5$ m/s²

YATO	[V d.c.]	
YT-82836	18	2

EN Cordless telescopic pole saw
 PL Akumulatorowe okrzesywarka na wysięgniku
 DE Akku-Teleskop-Hochentaster
 RU Аккумуляторный телескопический высоторез
 CZ Akumulátorová teleskopická vyvrtovací pila
 HU Akkus magassági ágvágó távcsöves
 RO Ferăstraie cu lanț cu telescopiu cu acumulator
 FR Elagueuse sur perche télescopique sans-fil
 IT Decescpugliatore telescopico a batteria
 ES Sierra de pértiga telescópica a batería
 CN 充电式高枝锯

18V Li-Ion

Battery not included
 Ohne Akku / Bez akumulatora
 Bez Gamapeu / Bez aku
 Akkumulátor nélkül
 Fără baterie / Sans batterie
 Senza batteria / Sin batería
 没有电池

$L_{PA} = 78,2 \pm 3,0$ dB; $L_{WA} = 91,2 \pm 2,36$ dB; $a_h = 2,109 \pm 1,5$ m/s²

YATO	[V d.c.]	
YT-82837	18	2

EN Cordless grass trimmer
 PL Akumulatorowa podkaszarka do trawy
 DE Akku-Rasentrimmer
 RU Аккумуляторный триммер
 CZ Akumulátorová sekačka na trávu
 HU Akkus szegélynyíró
 RO Trimmer de gazon cu acumulator
 FR Débroussailluse sans-fil
 IT Tagliabordi a batteria
 ES Desbrozadora a batería
 CN 充电式打草机

18V Li-Ion



18 V Li-Ion	7200 min ⁻¹
250/300 mm	137 108 cm
2.0 Ah	1h

$L_{PA} = 85,0 \pm 3,0$ dB; $L_{WA} = 93,0 \pm 3,0$ dB; $a_h = 2,5 \pm 1,5$ m/s²

YATO	[V d.c.]	
YT-82830	18	2

- EN Cordless grass trimmer
PL Akumulatorowa podkaszarka do trawy
DE Akku-Rasentrimmer
RU Аккумуляторный триммер
CZ Akumulátorová sekačka na trávu
HU Akkus szegélynyíró
RO Trimmer de gazon cu acumulator
FR Débroussaillouse sans-fil
IT Tagliabordi a batteria
ES Desbrozadora a batería
CN 充电式打草机



Battery not included
Ohne Akku / Bez akumulatora
Esz Gámapau / Bez aku
Akumulator nélkül
Fără baterie / Sans batterie
Senza batteria / Sin batería
没有电池

18V
Li-Ion

$L_{PA} = 85,0 \pm 3,0$ dB; $L_{WA} = 93,0 \pm 3,0$ dB; $a_n = 2,5 \pm 1,5$ m/s²

YATO	[V d.c.]	
YT-82831	18	2

- EN Nylon blades
PL Nożyki nylonowe
DE Nylonmesser Set
RU Сменные ножи для триммера
CZ Náhradní nože pro vyžínáče
HU Nylon kések
RO Lame din nylon
FR Lames en nylon
IT Piedi di nylon
ES Cuchillas de nylon
CN 尼龙打草刀片

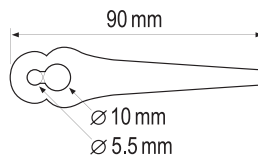
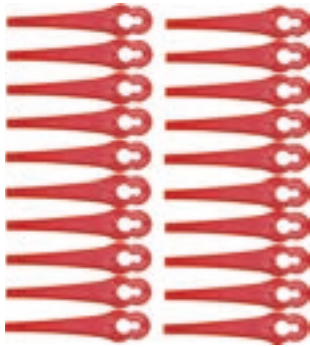

For YT-85015
Dla YT-85015

YATO	
YT-85016	250

- EN Cordless hedge trimmer
PL Akumulatorowe nożyce do żywoplotu
DE Akku-Heckenschere
RU Аккумуляторный кусторез
CZ Akumulátorové nůžky na živé ploty
HU Akkus sövénynyíró
RO Foarfece de tăiat gard viu cu acumulator
FR Taille-haies sans-fil
IT Tagliasiepi a batteria
ES Cortasetos inalámbrico
CN 充电式修枝剪

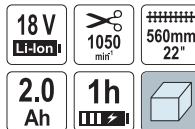

18V
Li-Ion

$L_{PA} = 80,0 \pm 3,0$ dB; $L_{WA} = 87,0 \pm 3,0$ dB; $a_n = 3,5 \pm 1,5$ m/s²

YATO	[V d.c.]	
YT-82832	18	2

- EN Cordless grass trimmer
PL Akumulatorowa podkaszarka do trawy
DE Akku-Rasentrimmer
RU Аккумуляторный триммер
CZ Akumulátorová sekačka na trávu
HU Akkus szegélynyíró
RO Trimmer de gazon cu acumulator
FR Débroussaillouse sans-fil
IT Tagliabordi a batteria
ES Desbrozadora a batería
CN 充电式打草机

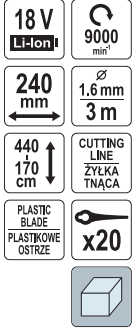

Battery not included
Ohne Akku / Bez akumulatora
Esz Gámapau / Bez aku
Akumulator nélkül
Fără baterie / Sans batterie
Senza batteria / Sin batería
没有电池

18V
Li-Ion

$L_{PA} = 81,0 \pm 3,0$ dB; $L_{WA} = 88,0 \pm 2,12$ dB; $a_n = \leq 2,5$ m/s²

YATO	[V d.c.]	
YT-85015	18	4

- EN Cordless brushcutter
PL Kosa akumulatorowa
DE Akku-Motorsense
RU Аккумуляторная коса
CZ Akumulátorový křovinořez
HU Akkus fűkasza
RO Molocoasa cu acumulator
FR Débroussaillouse sans-fil
IT Decespugliatore a batteria
ES Motoguadaña a batería
CN 充电式打草机



Battery not included
Ohne Akku / Bez akumulatora
Esz Gámapau / Bez aku
Akumulator nélkül
Fără baterie / Sans batterie
Senza batteria / Sin batería
没有电池

18V
Li-Ion

$L_{PA} = 79,1 \pm 3,0$ / $83,0 \pm 3,0$ dB; $L_{WA} = 88,4 \pm 2,31$ / $92,5 \pm 1,92$ dB;
 $a_n = 1,35 \pm 1,5$ / $1,11 \pm 1,5$ m/s²

YATO	[V d.c.]	
YT-85010	36 (18 x2)	1

- EN Cordless hedge trimmer
PL Akumulatorowe nożyce do żywoplotu
DE Akku-Heckenschere
RU Аккумуляторный кусторез
CZ Akumulátorové nůžky na živé ploty
HU Akkus sövénynyíró
RO Foarfece de tăiat gard viu cu acumulator
FR Taille-haies sans-fil
IT Tagliasiepi a batteria
ES Cortasetos inalámbrico
CN 充电式修枝剪

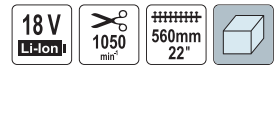

18V
Li-Ion

$L_{PA} = 80,0 \pm 3,0$ dB; $L_{WA} = 87,0 \pm 3,0$ dB; $a_n = 3,5 \pm 1,5$ m/s²

YATO	[V d.c.]	
YT-82833	18	2

EN Cordless hedge trimmer
 PL Akumulatorowe nożyce do żywoplotu
 DE Akku-Heckenschere
 RU Аккумуляторный кусторез
 CZ Akumulátorové nůžky na živé ploty
 HU Akkus sövénynyíró
 RO Foarfece de tăiat gard viu cu acumulator
 FR Taille-haies sans-fil
 IT Tagliasiepi a batteria
 ES Tijera cortasetos a batería
 CN 充电式高枝剪

18V
Li-Ion

2100
mm²

420
mm

274
207
cm

2.0
Ah

1h

EASY
TRANSPORT
LATVY
TRANSPORT



18V
Li-Ion

$L_{pa} = 77,3 \pm 3,0$ dB; $L_{wa} = 88,1 \pm 3,0$ dB; $a_n = 1,5 \pm 1,5$ m/s²

YATO	[V d.c.]	
YT-82834	18	2

EN Cordless hedge trimmer
 PL Akumulatorowe nożyce do żywoplotu
 DE Akku-Heckenschere
 RU Аккумуляторный кусторез
 CZ Akumulátorové nůžky na živé ploty
 HU Akkus sövénynyíró
 RO Foarfece de tăiat gard viu cu acumulator
 FR Taille-haies sans-fil
 IT Tagliasiepi a batteria
 ES Tijera cortasetos a batería
 CN 充电式高枝剪

18V
Li-Ion

2100
mm²

420
mm

274
207
cm

EASY
TRANSPORT
LATVY
TRANSPORT



18V
Li-Ion

$L_{pa} = 77,3 \pm 3,0$ dB; $L_{wa} = 88,1 \pm 3,0$ dB; $a_n = 1,5 \pm 1,5$ m/s²

YATO	[V d.c.]	
YT-82835	18	2

Battery not included
 Ohne Akku / Bez akumulatora
 Bez Gamapeu / Bez aku
 Akumulator năkăi
 Fără baterie / Sans batterie
 Senza batteria / Sin bateria
 沒有電池

EN Cordless chainsaw
 PL Akumulatorowa pilarka łańcuchowa
 DE Akku-Kettensäge
 RU Аккумуляторная цепная пила
 CZ Akumulátorová řetězová pila
 HU Akkus láncfűrész
 RO Ferăstrău cu lanț cu acumulator
 FR Tronçonneuse sans-fil
 IT Motosega a batteria
 ES Inalámbrico motosierra
 CN 锂电电链锯套装

18V
Li-Ion

2.0
Ah

1h

4"
10 cm

0,043"
1,1 mm

4,8 m/s

SOFT
GRIP
MIEKKI
UCHWYT



18V
Li-Ion

$L_{pa} = 78,0 \pm 3,0$ dB; $L_{wa} = 89,0 \pm 3,0$ dB; $a_n = 3,425 \pm 1,5$ m/s²

YATO	[V d.c.]	
YT-828135	18	4

EN Cordless chainsaw
 PL Akumulatorowa pilarka łańcuchowa
 DE Akku-Kettensäge
 RU Аккумуляторная цепная пила
 CZ Akumulátorová řetězová pila
 HU Akkus láncfűrész
 RO Ferăstrău cu lanț cu acumulator
 FR Tronçonneuse sans-fil
 IT Motosega a batteria
 ES Inalámbrico motosierra
 CN 锂电电链锯套装

18V
Li-Ion

4"
10 cm

0,043"
1,1 mm

4,8 m/s

SOFT
GRIP
MIEKKI
UCHWYT



18V
Li-Ion

$L_{pa} = 78,0 \pm 3,0$ dB; $L_{wa} = 89,0 \pm 3,0$ dB; $a_n = 3,425 \pm 1,5$ m/s²

YATO	[V d.c.]	
YT-828136	18	4

Battery not included
 Ohne Akku / Bez akumulatora
 Bez Gamapeu / Bez aku
 Akumulator năkăi
 Fără baterie / Sans batterie
 Senza batteria / Sin bateria
 沒有電池

EN Cordless chainsaw
 PL Akumulatorowa pilarka łańcuchowa
 DE Akku-Kettensäge
 RU Аккумуляторная цепная пила
 CZ Akumulátorová řetězová pila
 HU Akkus láncfűrész
 RO Ferăstrău cu lanț cu acumulator
 FR Tronçonneuse sans-fil
 IT Motosega a batteria
 ES Inalámbrico motosierra
 CN 锂电电链锯套装

36V
2x 18V
Li-Ion

4500
mm²

14"
36 cm

0,375"
9,525 mm

0,050"
1,27 mm

0.17 L

2x
2.0
Ah

1h

AUTOMATIC OIL
LUBRICATION
AUTOMATYCZNE
SMAROWANIE
UKŁADU TŁACZEGO

QUICK CHAIN
TENSION SYSTEM
SYSTEM SZPIKOWEGO
NAPĘCIA ŁAŃCUCHA



18V
Li-Ion

$L_{pa} = 81,9 \pm 3,0$ dB; $L_{wa} = 92,8 \pm 2,6$ dB; $a_n = 2,57 \pm 1,5 / 4,92 \pm 1,5$ m/s²

YATO	[V d.c.]	
YT-82812	36 (18 x2)	2

EN Cordless chainsaw
 PL Akumulatorowa pilarka łańcuchowa
 DE Akku-Kettensäge
 RU Аккумуляторная цепная пила
 CZ Akumulátorová řetězová pila
 HU Akkus láncfűrész
 RO Ferăstrău cu lanț cu acumulator
 FR Tronçonneuse sans-fil
 IT Motosega a batteria
 ES Inalámbrico motosierra
 CN 锂电电链锯光机

36V
2x 18V
Li-Ion

4500
mm²

14"
36 cm

0,375"
9,525 mm

0,050"
1,27 mm

0.17 L

AUTOMATIC OIL
LUBRICATION
AUTOMATYCZNE
SMAROWANIE
UKŁADU TŁACZEGO

QUICK CHAIN
TENSION SYSTEM
SYSTEM SZPIKOWEGO
NAPĘCIA ŁAŃCUCHA



18V
Li-Ion

$L_{pa} = 81,9 \pm 3,0$ dB; $L_{wa} = 92,8 \pm 2,6$ dB; $a_n = 2,57 \pm 1,5 / 4,92 \pm 1,5$ m/s²

YATO	[V d.c.]	
YT-82813	36 (18 x2)	2

Battery not included
 Ohne Akku / Bez akumulatora
 Bez Gamapeu / Bez aku
 Akumulator năkăi
 Fără baterie / Sans batterie
 Senza batteria / Sin bateria
 沒有電池

EN Cordless lawn mower
PL Kosiarka akumulatorowa
DE Akku-Rasenmäher
RU Аккумуляторная газонокосилка
CZ Akumulátorová sekačka na trávu
HU Fűnyíró akkumulátoros
RO Masina de tuns iarba cu acumulator
FR Tondeuse sans-fil
IT Rasaerba a batteria
ES Cortacésped de batería
CN 锂电草坪机套装



18V
Li-Ion

$L_{pA} = 77,9 \pm 3,0$ dB; $L_{wA} = 90,2 \pm 1,85$ dB; $a_n = 0,5 \pm 1,5$ m/s²

YATO	[V d.c.]	
YT-85220	36 (18 x2)	1

EN Cordless lawn mower
PL Kosiarka akumulatorowa
DE Akku-Rasenmäher
RU Аккумуляторная газонокосилка
CZ Akumulátorová sekačka na trávu
HU Fűnyíró akkumulátoros
RO Masina de tuns iarba cu acumulator
FR Tondeuse sans-fil
IT Rasaerba a batteria
ES Cortacésped de batería
CN 锂电草坪机光机

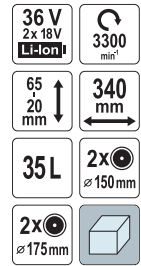

18V
Li-Ion

Battery not included
Obrze Akku / Bez akumulatora
Bez Gamapeu / Bez aku
Akkumulátor nélkül
Fără baterie / Sans batterie
Senza batteria / Sin batería
没有电池

$L_{pA} = 77,9 \pm 3,0$ dB; $L_{wA} = 90,2 \pm 1,85$ dB; $a_n = 0,5 \pm 1,5$ m/s²

YATO	[V d.c.]	
YT-85221	36 (18 x2)	1

EN Battery
PL Akumulator
DE Akkumulator
RU Аккумулятор
CZ Akumulátor
HU Akkumulátor
RO Acumulatorul
FR Batterie
IT Batteria
ES Acumulador
CN 锂电池包



18V
Li-Ion



YATO	[V d.c.]	[Ah]	[h]	
YT-82842	18	2	1.0	20
YT-82843	18	3	1.5	20
YT-82844	18	4	2.0	20
YT-82845	18	6	3.0	20

EN Battery charger
PL Ładowarka
DE Ladegerät
RU Зарядное устройство
CZ Nabíječka
HU Akkutöltő
RO Redresor
FR Chargeur de batterie
IT Caricabatteria
ES Rectificador
CN 充电器

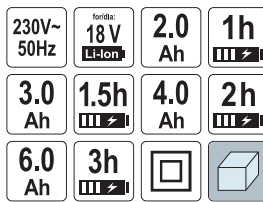

18V
Li-Ion



YATO	[V d.c.]	
YT-82848	18	10

EN Battery charger
PL Ładowarka
DE Ladegerät
RU Зарядное устройство
CZ Nabíječka
HU Akkutöltő
RO Redresor
FR Chargeur de batterie
IT Caricabatteria
ES Rectificador
CN 充电器

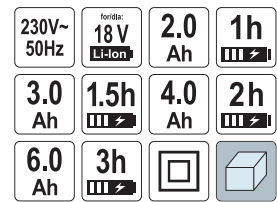

18V
Li-Ion



YATO	[V d.c.]	
YT-82849	18	10

EN Electric grass trimmer
PL Podkaszarka elektryczna
DE Elektro-Rasentrimmer
RU Электрический триммер
CZ Elektrická sekačka
HU Elektromos fűnyíró
RO Cositoare electrică
FR Coupe-herbe
IT Decespugliatore elettrico
ES Segadora eléctrica
CN 打草机



$L_{pA} = 70,21 \pm 0,88$ dB; $L_{wA} = 90,18 \pm 0,88$ dB; $a_n = 1,853 \pm 1,5 / 2,835 \pm 1,5$ m/s²

YATO	[W]	
YT-85230	250	12

EN Electric grass trimmer
PL Podkaszarka elektryczna
DE Elektro-Rasentrimmer
RU Электрический триммер
CZ Elektrická sekačka
HU Elektromos fűnyíró
RO Cositoare electrică
FR Coupe-herbe
IT Decespugliatore elettrico
ES Segadora eléctrica
CN 打草机

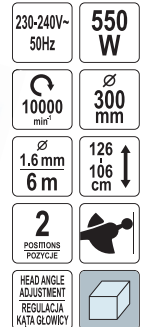

$L_{pA} = 73,45 \pm 1,52$ dB; $L_{wA} = 93,17 \pm 1,52$ dB; $a_n = 4,556 \pm 1,5 / 4,306 \pm 1,5$ m/s²

YATO	[W]	
YT-85234	550	4

EN Electric chainsaw 2 in 1
 PL Elektryczna pilarka łańcuchowa 2 w 1
 DE 2 in 1 elektrische Kettensäge
 RU Электрическая цепная пила 2 в 1
 CZ Elektrická řetězová pila 2 v 1
 HU 2 az 1-ben elektromos láncfűrész
 RO Ferăstrău electric cu lanț 2 in 1
 FR Tronçonneuse électrique 2 en 1
 IT Motosega elettrica 2 in 1
 ES 2 en 1 sierra de cadena eléctrica
 CN 2合1电链锯

2 in 1 2 w 1	230-240V~ 50Hz	750 W	10" 25 cm	
		12 m/s	170 110 cm	
40	0.043" 1.1 mm		SOFT GRIP MIEKKI UCHWYT	



• Chainsaw
 • Pole chainsaw

• Pila łańcuchowa
 • Okrzeszywarka

$L_{pa} = 89,5 \pm 3,0$ dB; $L_{wa} = 102,7 \pm 2,47$ dB; $a_n = 2,67 \pm 1,5 / 3,32 \pm 1,5$ m/s²

YATO	[W]	
YT-84877	750	1

EN Electric chainsaw
 PL Elektryczna pilarka łańcuchowa
 DE Elektrische Kettensäge
 RU Электрическая цепная пила
 CZ Elektrická řetězová pila
 HU Elektromos láncfűrész
 RO Ferăstrău electric cu lanț
 FR Tronçonneuse électrique
 IT Motosega elettrica
 ES Sierra de cadena eléctrica
 CN 电链锯

230-240V~ 50Hz	2000 W	7000 min ⁻¹	16" 40 cm	
		13 m/s	0.11 L	
0.05" 1.3 mm		SOFT GRIP MIEKKI UCHWYT		



$L_{pa} = 90,2 \pm 3,0$ dB; $L_{wa} = 103,2 \pm 3,0$ dB; $a_n = 8,393 \pm 1,5 / 6,002 \pm 1,5$ m/s²

YATO	[W]	
YT-84870	2000	2

EN Electric lawn mower
 PL Kosiarka elektryczna
 DE Elektrischer grasmäher
 RU Электрокосилка
 CZ Elektrická sekačka
 HU Elektromos fűnyíró-gép
 RO Cositoare electrica pt. iarba
 FR Tondeuse à gazon électrique
 IT Rasaerba elettrico
 ES Contracesped
 CN 电动草坪机

230V~ 50/60Hz	1300 W	3400 min ⁻¹	330 mm	60 40 20 mm	30 L	140 mm	
------------------	---------------	----------------------------------	------------------	---	-------------	------------------	--



$L_{pa} = 82,3 \pm 3,0$ dB; $L_{wa} = 93,1 \pm 1,91$ dB; $a_n = 2,72 \pm 1,5$ m/s²

YATO	[W]	
YT-85200	1300	1

EN Electric lawn mower
 PL Kosiarka elektryczna
 DE Elektrischer grasmäher
 RU Электрокосилка
 CZ Elektrická sekačka
 HU Elektromos fűnyíró-gép
 RO Cositoare electrica pt. iarba
 FR Tondeuse à gazon électrique
 IT Rasaerba elettrico
 ES Contracesped
 CN 电动草坪机

230V~ 50/60Hz	1800 W	3300 min ⁻¹	380 mm	60 40 50 20 30 mm	50 L	160 mm	
------------------	---------------	----------------------------------	------------------	---	-------------	------------------	--



$L_{pa} = 82,8 \pm 3,0$ dB; $L_{wa} = 93,7 \pm 2,4$ dB; $a_n = 3,15 \pm 1,5$ m/s²

YATO	[W]	
YT-85205	1800	1

EN Electric lawn mower
 PL Kosiarka elektryczna
 DE Elektrischer grasmäher
 RU Электрокосилка
 CZ Elektrická sekačka
 HU Elektromos fűnyíró-gép
 RO Cositoare electrica pt. iarba
 FR Tondeuse à gazon électrique
 IT Rasaerba elettrico
 ES Contracesped
 CN 电动草坪机

230V~ 50/60Hz	2000 W	3300 min ⁻¹	430 mm	60 70 40 50 20 30 mm	50 L	160 mm	
------------------	---------------	----------------------------------	------------------	--	-------------	------------------	--



$L_{pa} = 83,6 \pm 3,0$ dB; $L_{wa} = 94,6 \pm 1,8$ dB; $a_n = 3,45 \pm 1,5$ m/s²

YATO	[W]	
YT-85208	2000	1

EN Electric tiller
 PL Głębogryzarka elektryczna
 DE Elektro-Bodenhacke
 RU Электрический культиватор
 CZ Elektrický kultivátor
 HU Elektromos kapálógép
 RO Motosapa electrica
 FR Motobineuse électrique
 IT Motozappatrice elettrica
 ES Cultivador rotativo eléctrico
 CN 松土机

230-240V~ 50Hz	1500 W	220 mm	450 mm	205 mm	
-------------------	---------------	------------------	------------------	------------------	--



$L_{pa} = 80,4 \pm 3,0$ dB; $L_{wa} = 91,57 \pm 1,28$ dB; $a_n = 0,968 \pm 1,5 / 0,947 \pm 1,5$ m/s²

YATO	[W]	
YT-84850	1500	1

EN Electric scarifier
PL Wertykulator elektryczny
DE Elektrischer Vertikutierer
RU Электрический скарификатор
CZ Elektrický vertikutátor
HU Elektromos gypeszellőztető
RO Scarificator electric
FR Scarificateur électrique
IT Scarificatore elettrico
ES Escarificador eléctrico
CN 电动松土机

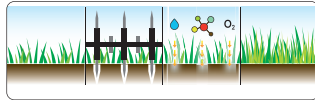

$L_{pA} = 90,2 \pm 3,0$ dB; $L_{wA} = 105,17 \pm 3,0$ dB; $a_n = 1,679 \pm 1,5$ m/s²

230-240V~
50Hz
1800 W
3500 min⁻¹
max
12mm
380 mm
45 L
INTERCHANGEABLE
ROLLERS
WYMIENNE
WALKI
x16
x24

EN Leaf vacuum / blower
PL Odkurzacz / dmuchawa do liści
DE Laubsauger / Laubbläser
RU Воздуходувка-пылесос
CZ Vysavač / odfukovač listí
HU Lombszívó / lombfúvó
RO Sulfanta / aspirator
FR Aspirateur-souffleur de feuilles
IT Aspiratore / soffiatore per foglie
ES Aspiradora / soplador de hojas
CN 电动吹吸机



$L_{pA} = 90,2 \pm 3,0$ dB; $L_{wA} = 102,4 \pm 3,0$ dB; $a_n = 4,27 \pm 1,5$ m/s²



3 in 1
3 w 1
220-240V~
50Hz
3500 W
9000-15000 min⁻¹
13.2 m³/min
270 km/h
35 L

- Vacuuming
- Blowing
- Shredding
- Odkurzanie
- Dmucanie
- Rozdrabnianie

YATO	[W]	
YT-84840	1800	1

YATO	[W]	
YT-85180	3500	1

EN Blade for lawn mower
PL Ostrze do kosiarki
DE Mähmesser
RU Нож для косилки
CZ Nůž do sekačky
HU Fűnyíró kés

RO Lama pt. masina tuns iarba
FR Lame de tondeuse
IT Lama per tosaerba
ES Cuchillas de segadoras
CN 电动割草机刀片

5.5 mm
9.5 mm
320 mm



For YT-85200
Dla YT-85200

YATO	L [mm]	
YT-85160	320	80

EN Blade for lawn mower
PL Ostrze do kosiarki
DE Mähmesser
RU Нож для косилки
CZ Nůž do sekačky
HU Fűnyíró kés

RO Lama pt. masina tuns iarba
FR Lame de tondeuse
IT Lama per tosaerba
ES Cuchillas de segadoras
CN 电动割草机刀片

5.5 mm
9.5 mm
380 mm



For YT-85205
Dla YT-85205

YATO	L [mm]	
YT-85161	380	50

EN Blade for lawn mower
PL Ostrze do kosiarki
DE Mähmesser
RU Нож для косилки
CZ Nůž do sekačky
HU Fűnyíró kés

RO Lama pt. masina tuns iarba
FR Lame de tondeuse
IT Lama per tosaerba
ES Cuchillas de segadoras
CN 电动割草机刀片

5.5 mm
9.5 mm
430 mm



For YT-85208
Dla YT-85208

YATO	L [mm]	
YT-85162	430	50

EN Gasoline backpack sprayer
PL Opryskiwacz plecakowy spalinowy
DE Benzin Motorsprüher
RU Опрыскиватель бензиновый
CZ Motorový rosič
HU Benzines permetező
RO Pulverizatoare pe benzina
FR Pulvérisateur a essence
IT Pompa irroratrice a spalla a motore
ES Pulverizador de gasolina
CN 汽油喷雾器

2.13 kW
2.9 KM
41.5 cm³
20 L
17 m³/min
12 m



$L_{pA} = 99,0 \pm 3,0$ dB; $L_{wA} = 111,0 \pm 3,0$ dB; $a_n = 0,8 \pm 1,5 / 0,9 \pm 1,5$ m/s²

YATO	[kW]	[KM]	
YT-86240	2.13	2.9	1

EN Gasoline earth auger
PL Wiertnica spalinowa
DE Benzin Erdlochbohrer
RU Бензобур
CZ Zemní vrtačí stroj benzínový
HU Benzines talajfúró
RO Motoburghiu de pamant
FR Tarière à moteur
IT Mototrivella a scoppio
ES Ahoyadora
CN 地钻

- Tool-free drill exchange
- Balanced and easy to operate
- Beznarzędziowa wymiana wiertel
- Dobrze wyważona i łatwa w obsłudze

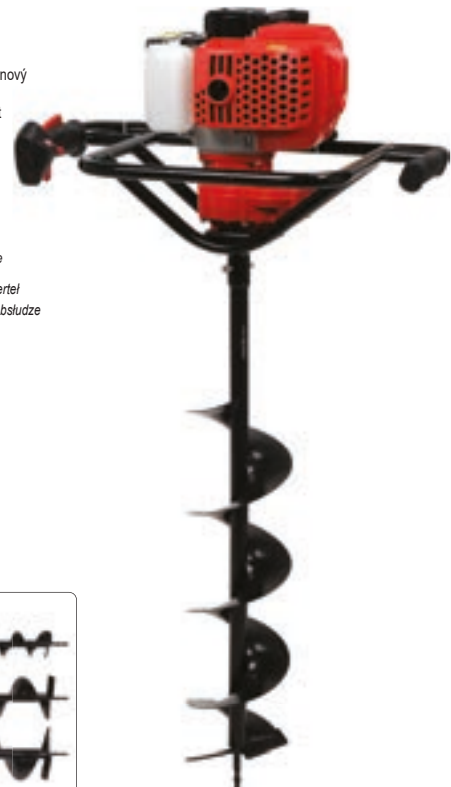
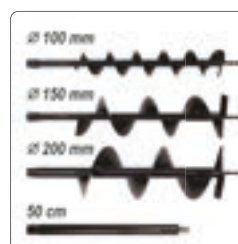

$L_{pA} = 103,8 \pm 3,0$ dB; $L_{wA} = 107,54 \pm 3,0$ dB; $a_n = 12,469 \pm 1,5$ m/s²

YATO	[kW]	[KM]	
YT-84660	1.4	1.9	1

EN Soil drill bit
 PL Wiertło glebowe
 DE Erdbohrer
 RU Шнек для бензобура
 CZ Půdní vrták
 HU Talajfúró szár
 RO Burghiu pt. pamant
 FR Foret pour tarière
 IT Punta per trivella
 ES Broca ahoyadora
 CN 地钻钻头



YATO	Ø [mm]	L [mm]	
YT-84670	100	785	1
YT-84671	150	785	1
YT-84672	200	785	1

EN Soil drill bit extension
 PL Przedłużka do wiertła glebowego
 DE Verlängerung für Erdbohrer
 RU Удлинитель шнека для бензобура
 CZ Nástavec pro půdní vrták
 HU Talajfúró szár hosszabbító
 RO Extensie burghiu pt. pamant
 FR Extension pour foret de sol
 IT Prolunga per trivella per terreno
 ES Extensión de broca ahoyadora
 CN 接杆

50
cm



YATO	L [mm]	
YT-84675	500	20

EN Gasoline chainsaw
 PL Pilarka spalinowa
 DE Motorsägen
 RU Бензопила
 CZ Motorová pila
 HU Benzin láncfűrész
 RO Drujba pe benzina
 FR Tronçonneuses
 IT Motosega a benzina
 ES Motosierra de gasolina
 CN 油锯



1.3 kW	1.7 KM	37.2 cm ³	8000 min ⁻¹	14" 36 cm	0.17 L
40 : 1	38" 9.62 mm	0.05" 1.3 mm		ANTI-VIBRATION SYSTEM ANTI-WIBRACYJNY	

YATO	[kW]	[KM]	L [mm]	
YT-84895	1.3	1.7	330	1

$L_{pa} = 93,35 \pm 1,08$ dB; $L_{wa} = 112,33 \pm 1,08$ dB; $a_h = 5,600 \pm 1,5 / 4,884 \pm 1,5$ m/s²

EN Gasoline chainsaw
 PL Pilarka spalinowa
 DE Motorsägen
 RU Бензопила
 CZ Motorová pila
 HU Benzin láncfűrész
 RO Drujba pe benzina
 FR Tronçonneuses
 IT Motosega a benzina
 ES Motosierra de gasolina
 CN 油锯



1.8 kW	2.4 KM	45.1 cm ³	8500 min ⁻¹	16" 40 cm	0.24 L
40 : 1	38" 9.62 mm	0.05" 1.3 mm		ANTI-VIBRATION SYSTEM ANTI-WIBRACYJNY	

YATO	[kW]	[KM]	L [mm]	
YT-84901	1.8	2.4	360	1

$L_{pa} = 89,69 \pm 1,37$ dB; $L_{wa} = 109,19 \pm 1,37$ dB; $a_h = 5,650 \pm 1,5 / 6,027 \pm 1,5$ m/s²

EN Gasoline chainsaw
 PL Pilarka spalinowa
 DE Motorsägen
 RU Бензопила
 CZ Motorová pila
 HU Benzin láncfűrész
 RO Drujba pe benzina
 FR Tronçonneuses
 IT Motosega a benzina
 ES Motosierra de gasolina
 CN 油锯



2.5 kW	3.4 KM	56.5 cm ³	8500 min ⁻¹	20" 50 cm	0.24 L
40 : 1	38" 9.62 mm	0.05" 1.3 mm		ANTI-VIBRATION SYSTEM ANTI-WIBRACYJNY	

YATO	[kW]	[KM]	L [mm]	
YT-84910	2.5	3.4	480	1

$L_{pa} = 94,59 \pm 1,34$ dB; $L_{wa} = 113,46 \pm 1,34$ dB; $a_h = 7,234 \pm 1,5 / 9,528 \pm 1,5$ m/s²

EN Brushcutter
 PL Kosa spalinowa
 DE Motorsense
 RU Бензокоса
 CZ Motorový křovinořez
 HU Motoros fűkasza
 RO Motocoasa
 FR Débroussailluse
 IT Decespugliatore a benzina
 ES Motoguadaña de gasolina
 CN 割草机



1.25 kW	1.7 KM	42.7 cm ³	430 mm	255x25.4 mm	0.85 L
40 : 1		ANTI-VIBRATION SYSTEM ANTI-WIBRACYJNY	EASY START LATWY POZRUCH	EASY TRANSPORT LATWY TRANSPORT	



$L_{pa} = 96,3 \pm 3,0$ dB; $L_{wa} = 110,3 \pm 3,0$ dB; $a_h = 3,992 \pm 1,5 / 10,403 \pm 1,5$ m/s²

YATO	[kW]	[KM]	
YT-85003	1.25	1.7	1

EN Gasoline tiller
 PL Glebogryzarka spalinowa
 DE Motorhackmaschine
 RU Бензиновый культиватор
 CZ Motorový kultivátor
 HU Benzines kapálógép
 RO Motosapa
 FR Motobineuses avec moteur à combustion
 IT Motozappa a benzina
 ES Motobinadora
 CN 汽油旋耕机



3.6 kW	173 cm ³	170 mm	600 mm	X6 BLADES OSTRZA	270 mm	150 mm	1.5 L	0.6 L	
--------	---------------------	--------	--------	------------------	--------	--------	-------	-------	--

$L_{pa} = 77,9 \pm 0,199$ dB; $L_{wa} = 92,58 \pm 0,199$ dB; $a_h = 3,10 \pm 1,5 / 3,02 \pm 1,5$ m/s²

YATO	[kW]	[KM]	
YT-84860	3.6	4.08	1

EN Trimmer head
PL Głowica żyłkowa
DE Trimmerkopf
RU Головка с леской
CZ Strunová hlava
HU Damil fej
RO Cap cu cablu
FR Tête de coupe
IT Testina di taglio a filo
ES Cabezal de hilo
CN 铝制打草头



For YT-85001, YT-85003, YT-85010
Dla YT-85001, YT-85003, YT-85010



EN Trimmer head
PL Głowica żyłkowa
DE Trimmerkopf
RU Головка с леской
CZ Strunová hlava
HU Damil fej

RO Cap cu cablu
FR Tête de coupe
IT Testina di taglio a filo
ES Cabezal de hilo
CN 铝制打草头

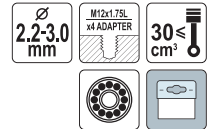

For YT-85001, YT-85003, YT-85010
Dla YT-85001, YT-85003, YT-85010



EN Trimmer head
PL Głowica żyłkowa
DE Trimmerkopf
RU Головка с леской
CZ Strunová hlava
HU Damil fej
RO Cap cu cablu
FR Tête de coupe
IT Testina di taglio a filo
ES Cabezal de hilo
CN 铝制打草头

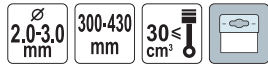
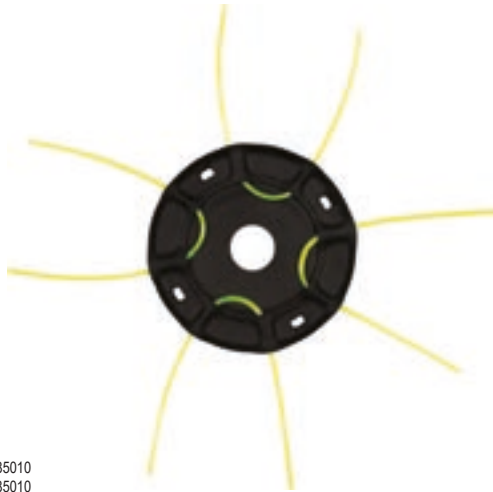

For YT-85001, YT-85003, YT-85010
Dla YT-85001, YT-85003, YT-85010



EN TCT blade for brushcutters
PL Tarcza tnąca do kosy spalinowej
DE Sägeblatt für Motorsensen
RU Режущий диск для косы
CZ Pílový kotouč do křovinořezy
HU Fűkasza vágókorong
RO Disc pt. motocoasa
FR Lame disque pour débroussaillouse
IT Disco da taglio per decespugliatore
ES Disco de corte para desbrozadora
CN 多孔割草片



For YT-85001, YT-85003, YT-85010
Dla YT-85001, YT-85003, YT-85010

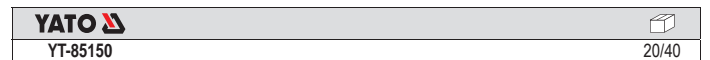

EN 3-tooth brushcutter blade
PL Tarcza tnąca trójzębna
DE 3-Zahn Dickichtmesser
RU Нож трехлопастной
CZ Žací nůž 3-zubý
HU 3 fogú vágókés
RO Lama taiera cu 3 dinti pt. motocoasa
FR Lame 3 dents pour débroussaillouse
IT Disco per decespugliatore a 3 denti
ES Cuchilla de 3 puntas para desbrozadora
CN 三齿割草片

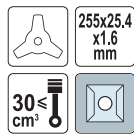

For YT-85001, YT-85003, YT-85010
Dla YT-85001, YT-85003, YT-85010

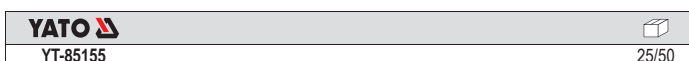

EN Brushcutter wire brush
PL Szczotka druciana do kosy
DE Drahtbürste für Motorsense
RU Щетка для мотокосяки
CZ Drátěný kartáč na křovinořez
HU Drótkefelátácsa fűkaszához
RO Perie circulara cu toroane
FR Brosse métallique pour débroussaillouse
IT Spazzola metallica per decespugliatore
ES Cepillo de alambre para desbrozadora
CN 除草盘



YATO	Ø [mm]	Ød [mm]	max C [min ⁻¹]	
YT-85141	150	25.4	10000	30
YT-85142	200	25.4	10000	20

EN Chainsaw guide bar
 PL Prowadnica do pilarek
 DE Kettensägeführung
 RU Шина для бензопил
 CZ Vodicí lišta k řetězové pile
 HU Lánvezető

RO Lama de ghidai pt. ferastrau
 FR Guide de tronçonneuse
 IT Barra per motosega
 ES Barra guía motosierra
 CN 导板

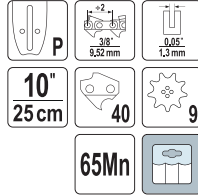

For YT-84948, YT-84960
 Dla YT-84948, YT-84960

YATO	L	
YT-84925	10" (250 mm)	20

EN Chainsaw guide bar
 PL Prowadnica do pilarek
 DE Kettensägeführung
 RU Шина для бензопил
 CZ Vodicí lišta k řetězové pile
 HU Lánvezető

RO Lama de ghidai pt. ferastrau
 FR Guide de tronçonneuse
 IT Barra per motosega
 ES Barra guía motosierra
 CN 导板

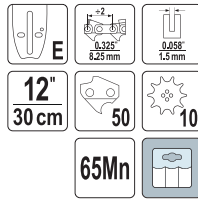

For YT-849395, YT-84963
 Dla YT-849395, YT-84963

YATO	L	
YT-84928	12" (300 mm)	20

EN Chainsaw guide bar
 PL Prowadnica do pilarek
 DE Kettensägeführung
 RU Шина для бензопил
 CZ Vodicí lišta k řetězové pile
 HU Lánvezető

RO Lama de ghidai pt. ferastrau
 FR Guide de tronçonneuse
 IT Barra per motosega
 ES Barra guía motosierra
 CN 导板

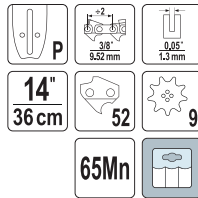

For YT-84951, YT-84960
 Dla YT-84951, YT-84960

YATO	L	
YT-84931	14" (360 mm)	20

EN Chainsaw guide bar
 PL Prowadnica do pilarek
 DE Kettensägeführung
 RU Шина для бензопил
 CZ Vodicí lišta k řetězové pile
 HU Lánvezető

RO Lama de ghidai pt. ferastrau
 FR Guide de tronçonneuse
 IT Barra per motosega
 ES Barra guía motosierra
 CN 导板

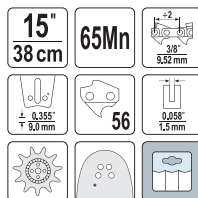

For YT-84961
 Dla YT-84961

YATO	L	
YT-84932	15" (380 mm)	20

EN Chainsaw guide bar
 PL Prowadnica do pilarek
 DE Kettensägeführung
 RU Шина для бензопил
 CZ Vodicí lišta k řetězové pile
 HU Lánvezető

RO Lama de ghidai pt. ferastrau
 FR Guide de tronçonneuse
 IT Barra per motosega
 ES Barra guía motosierra
 CN 导板

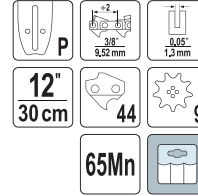

For YT-84949, YT-84960
 Dla YT-84949, YT-84960

YATO	L	
YT-84927	12" (300 mm)	20

EN Chainsaw guide bar
 PL Prowadnica do pilarek
 DE Kettensägeführung
 RU Шина для бензопил
 CZ Vodicí lišta k řetězové pile
 HU Lánvezető

RO Lama de ghidai pt. ferastrau
 FR Guide de tronçonneuse
 IT Barra per motosega
 ES Barra guía motosierra
 CN 导板

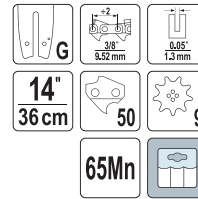

For YT-84950, YT-84960
 Dla YT-84950, YT-84960

YATO	L	
YT-84930	14" (360 mm)	20

Alpina, Oleo-Mac, Stihl

EN Chainsaw guide bar
 PL Prowadnica do pilarek
 DE Kettensägeführung
 RU Шина для бензопил
 CZ Vodicí lišta k řetězové pile
 HU Lánvezető

RO Lama de ghidai pt. ferastrau
 FR Guide de tronçonneuse
 IT Barra per motosega
 ES Barra guía motosierra
 CN 导板

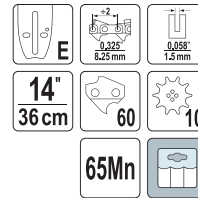

For YT-84940, YT-84963
 Dla YT-84940, YT-84963

YATO	L	
YT-84931	14" (360 mm)	20

EN Chainsaw guide bar
 PL Prowadnica do pilarek
 DE Kettensägeführung
 RU Шина для бензопил
 CZ Vodicí lišta k řetězové pile
 HU Lánvezető

RO Lama de ghidai pt. ferastrau
 FR Guide de tronçonneuse
 IT Barra per motosega
 ES Barra guía motosierra
 CN 导板

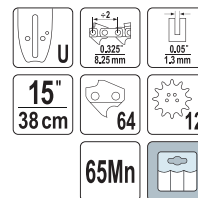

For YT-84905, YT-84945, YT-84962
 Dla YT-84905, YT-84945, YT-84962

YATO	L	
YT-84933	15" (380 mm)	20

Dolmar, Husqvarna, Jonsered, Makita, Oleo-Mac, Partner, Solo

EN Chainsaw guide bar
PL Prowadnica do pilarek
DE Kettensägeführung
RU Шина для бензопилы
CZ Vodicí lišta k řetězové pile
HU Lánvezető

RO Lama de ghidai pt. ferastrau
FR Guide de tronçonneuse
IT Barra per motosega
ES Barra guía motosierra
CN 导板

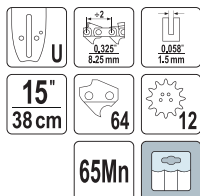

For YT-84900, YT-84941, YT-84963
Dia YT-84900, YT-84941, YT-84963

Dolmar, Homelite, Husqvarna, Jonsered, Makita, NAC, Oleo-Mac, Partner

YATO	L	
YT-84934	15" (380 mm)	20

EN Chainsaw guide bar
PL Prowadnica do pilarek
DE Kettensägeführung
RU Шина для бензопилы
CZ Vodicí lišta k řetězové pile
HU Lánvezető

RO Lama de ghidai pt. ferastrau
FR Guide de tronçonneuse
IT Barra per motosega
ES Barra guía motosierra
CN 导板

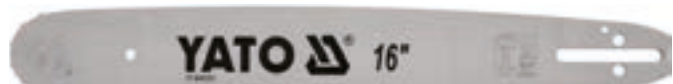
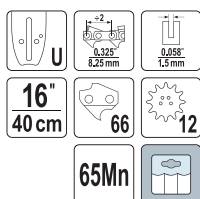

For YT-84942, YT-84963
Dia YT-84942, YT-84963

YATO	L	
YT-849351	16" (400 mm)	20

EN Chainsaw guide bar
PL Prowadnica do pilarek
DE Kettensägeführung
RU Шина для бензопилы
CZ Vodicí lišta k řetězové pile
HU Lánvezető

RO Lama de ghidai pt. ferastrau
FR Guide de tronçonneuse
IT Barra per motosega
ES Barra guía motosierra
CN 导板

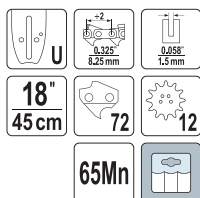

For YT-84900, YT-84943, YT-84963
Dia YT-84900, YT-84943, YT-84963

Dolmar, Homelite, Husqvarna, Jonsered, Makita, NAC, Oleo-Mac, Partner, Solo

YATO	L	
YT-84936	18" (450 mm)	20

EN Chain regulating plate
PL Płytkę regulującą napięcie łańcucha
DE Einstellplatte für Kettenspannung
RU Пластина натяжитель цепи
CZ Destička pro nastavení napnutí řetězu
HU Lánfeszesség szabályozó lemez
RO Placă de reglare a lanțului
FR Plaque de réglage de la tension de la chaîne
IT Piastra tendicatena
ES Placa reguladora del apriete de cadena
CN 链条张力调节片



For guide bars A041/P
Do prowadnic A041/P

YATO	L	
YT-84939		400

EN Chainsaw guide bar
PL Prowadnica do pilarek
DE Kettensägeführung
RU Шина для бензопилы
CZ Vodicí lišta k řetězové pile
HU Lánvezető

RO Lama de ghidai pt. ferastrau
FR Guide de tronçonneuse
IT Barra per motosega
ES Barra guía motosierra
CN 导板

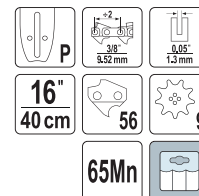

For YT-84953, YT-84960
Dia YT-84953, YT-84960

Al-Ko, Alpina, Echo, Hitachi, Homelite, Husqvarna, Jonsered, Makita, McCulloch, Oleo-Mac, Partner, Ryobi

YATO	L	
YT-84935	16" (400 mm)	20

EN Chainsaw guide bar
PL Prowadnica do pilarek
DE Kettensägeführung
RU Шина для бензопилы
CZ Vodicí lišta k řetězové pile
HU Lánvezető

RO Lama de ghidai pt. ferastrau
FR Guide de tronçonneuse
IT Barra per motosega
ES Barra guía motosierra
CN 导板

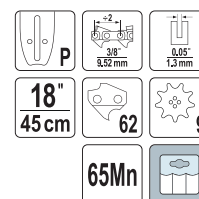

For YT-84956, YT-84960
Dia YT-84956, YT-84960

YATO	L	
YT-849355	18" (450 mm)	20

EN Chainsaw guide bar
PL Prowadnica do pilarek
DE Kettensägeführung
RU Шина для бензопилы
CZ Vodicí lišta k řetězové pile
HU Lánvezető

RO Lama de ghidai pt. ferastrau
FR Guide de tronçonneuse
IT Barra per motosega
ES Barra guía motosierra
CN 导板

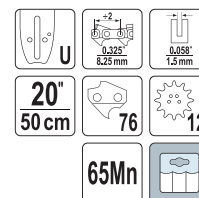

For YT-84944, YT-84963
Dia YT-84944, YT-84963

YATO	L	
YT-84937	20" (500 mm)	20

EN Chain for chainsaw
PL Łańcuch tnący do pilarek
DE Kette für Kettensägen
RU Цепь для бензопилы
CZ Řetěz pro řetězové pily
HU Lánclánzfűrész

RO Lanț pt. drijba
FR Chaîne de tronçonneuse
IT Catena motosega
ES Cadena de motosierra
CN 链条

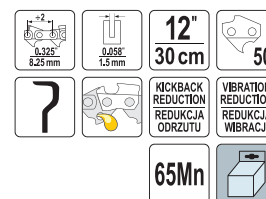

For YT-84928
Dia YT-84928

YATO	L	
YT-849395	12" (300 mm)	50

EN Chain for chainsaw
 PL Łańcuch łańcuch do pilarek
 DE Kette für Kettensägen
 RU Цепь для бензопилы
 CZ Řetěz pro řetězové pily
 HU Láncláncfűrés

RO Lant pt. drujba
 FR Chaîne de tronçonneuse
 IT Catena motosega
 ES Cadena de motosierra
 CN 链条

13"
33 cm

56

65Mn



For YT-84900
 Dla YT-84900

YATO	L	
YT-84940	13" (330 mm)	50

EN Chain for chainsaw
 PL Łańcuch łańcuch do pilarek
 DE Kette für Kettensägen
 RU Цепь для бензопилы
 CZ Řetěz pro řetězové pily
 HU Láncláncfűrés

RO Lant pt. drujba
 FR Chaîne de tronçonneuse
 IT Catena motosega
 ES Cadena de motosierra
 CN 链条

15"
38 cm

64

65Mn



For YT-84900, YT-84934
 Dla YT-84900, YT-84934

YATO	L	
YT-84941	15" (380 mm)	50

EN Chain for chainsaw
 PL Łańcuch łańcuch do pilarek
 DE Kette für Kettensägen
 RU Цепь для бензопилы
 CZ Řetěz pro řetězové pily
 HU Láncláncfűrés

RO Lant pt. drujba
 FR Chaîne de tronçonneuse
 IT Catena motosega
 ES Cadena de motosierra
 CN 链条

16"
40 cm

66

65Mn



For YT-84900
 Dla YT-84900

YATO	L	
YT-84942	16" (400 mm)	50

EN Chain for chainsaw
 PL Łańcuch łańcuch do pilarek
 DE Kette für Kettensägen
 RU Цепь для бензопилы
 CZ Řetěz pro řetězové pily
 HU Láncláncfűrés

RO Lant pt. drujba
 FR Chaîne de tronçonneuse
 IT Catena motosega
 ES Cadena de motosierra
 CN 链条

18"
45 cm

72

65Mn



For YT-84900, YT-84936
 Dla YT-84900, YT-84936

YATO	L	
YT-84943	18" (450 mm)	50

EN Chain for chainsaw
 PL Łańcuch łańcuch do pilarek
 DE Kette für Kettensägen
 RU Цепь для бензопилы
 CZ Řetěz pro řetězové pily
 HU Láncláncfűrés

RO Lant pt. drujba
 FR Chaîne de tronçonneuse
 IT Catena motosega
 ES Cadena de motosierra
 CN 链条

20"
50 cm

76

65Mn



For YT-84900
 Dla YT-84900

YATO	L	
YT-84944	20" (500 mm)	50

EN Chain for chainsaw
 PL Łańcuch łańcuch do pilarek
 DE Kette für Kettensägen
 RU Цепь для бензопилы
 CZ Řetěz pro řetězové pily
 HU Láncláncfűrés

RO Lant pt. drujba
 FR Chaîne de tronçonneuse
 IT Catena motosega
 ES Cadena de motosierra
 CN 链条

15"
38 cm

64

65Mn



For YT-84905, YT-84933
 Dla YT-84905, YT-84933

YATO	L	
YT-84945	15" (380 mm)	50

EN Chain for chainsaw
 PL Łańcuch łańcuch do pilarek
 DE Kette für Kettensägen
 RU Цепь для бензопилы
 CZ Řetěz pro řetězové pily
 HU Láncláncfűrés

RO Lant pt. drujba
 FR Chaîne de tronçonneuse
 IT Catena motosega
 ES Cadena de motosierra
 CN 链条

10"
25 cm

40

65Mn



For YT-84925
 Dla YT-84925

YATO	L	
YT-84948	10" (250 mm)	50

EN Chain for chainsaw
 PL Łańcuch łańcuch do pilarek
 DE Kette für Kettensägen
 RU Цепь для бензопилы
 CZ Řetěz pro řetězové pily
 HU Láncláncfűrés

RO Lant pt. drujba
 FR Chaîne de tronçonneuse
 IT Catena motosega
 ES Cadena de motosierra
 CN 链条

12"
30 cm

44

65Mn



For YT-84927
 Dla YT-84927

YATO	L	
YT-84949	12" (300 mm)	50

EN Chain for chainsaw
 PL Łańcuch łańcuch do pilarek
 DE Kette für Kettensägen
 RU Цепь для бензопилы
 CZ Řetěz pro řetězové pily
 HU Láncláncfűrés

RO Lant pt. drujba
 FR Chaîne de tronçonneuse
 IT Catena motosega
 ES Cadena de motosierra
 CN 链条

14"
36 cm

50

65Mn



For YT-84931
 Dla YT-84931

YATO	L	
YT-84950	14" (360 mm)	50

EN Chain for chainsaw
 PL Łańcuch łańcuch do pilarek
 DE Kette für Kettensägen
 RU Цепь для бензопилы
 CZ Řetěz pro řetězové pily
 HU Láncláncfűrés

RO Lant pt. drujba
 FR Chaîne de tronçonneuse
 IT Catena motosega
 ES Cadena de motosierra
 CN 链条

14"
36 cm

52

65Mn



For YT-84931
 Dla YT-84931

YATO	L	
YT-84951	14" (360 mm)	50

EN Chain for chainsaw
PL Łańcuch łańcuch do pilarek
DE Kette für Kettensägen
RU Цепь для бензопилы
CZ Řetěz pro řetězové pily
HU Láncláncfűrészt

RO Lant pt. drijba
FR Chaîne de tronçonneuse
IT Catena motosega
ES Cadena de motosierra
CN 链条



For YT-84935
Dla YT-84935

Al-Ko, Alpina, Dolmar, Echo, Hitachi, Homelite, Husqvarna, Jonsered, Makita, McCulloch, Oleo-Mac, Partner, Ryobi

YATO	L	
YT-84953	16" (400 mm)	50

EN Chain for chainsaw
PL Łańcuch łańcuch do pilarek
DE Kette für Kettensägen
RU Цепь для бензопилы
CZ Řetěz pro řetězové pily
HU Láncláncfűrészt

RO Lant pt. drijba
FR Chaîne de tronçonneuse
IT Catena motosega
ES Cadena de motosierra
CN 链条

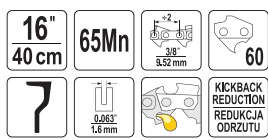

For YT-84935
Dla YT-84935

Stihl

YATO	L	
YT-84955	16" (400 mm)	50

EN Chain for chainsaw
PL Łańcuch łańcuch do pilarek
DE Kette für Kettensägen
RU Цепь для бензопилы
CZ Řetěz pro řetězové pily
HU Láncláncfűrészt

RO Lant pt. drijba
FR Chaîne de tronçonneuse
IT Catena motosega
ES Cadena de motosierra
CN 链条卷

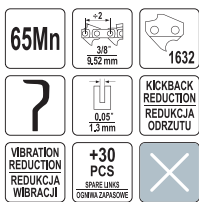

For YT-84930, YT-84931, YT-84935
Dla YT-84930, YT-84931, YT-84935

Alpina, Dolmar, Husqvarna, McCulloch, Oleo-Mac, Partner

YATO		
YT-84960		1

EN Chain for chainsaw
PL Łańcuch łańcuch do pilarek
DE Kette für Kettensägen
RU Цепь для бензопилы
CZ Řetěz pro řetězové pily
HU Láncláncfűrészt

RO Lant pt. drijba
FR Chaîne de tronçonneuse
IT Catena motosega
ES Cadena de motosierra
CN 链条卷

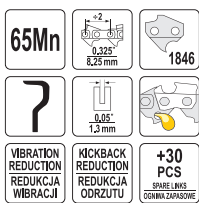

For YT-84905, YT-84933
Dla YT-84905, YT-84933

Dolmar, Husqvarna, Jonsered, Makita, Oleo-Mac, Partner

YATO		
YT-84962		1

EN Spare link for chainsaw
PL Zestaw ogniw do łańcucha do pil
DE Ersatzglied für Kettensägen
RU Запасная цепь
CZ Náhradní řetězové pily
HU Cseré lánclánc

RO Nituri lant drijba
FR Lien de rechange ogniv tronçonneuse
IT Set di maglie di catena
ES Repuesto para sierra de cadena
CN 连接片

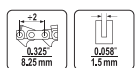

For YT-84940, YT-84941, YT-84942,
YT-84943, YT-84944, YT-84963
Dla YT-84940, YT-84941, YT-84942,
YT-84943, YT-84944, YT-84963

YATO		
YT-84975		100

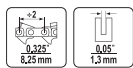

For YT-84945, YT-84962
Dla YT-84945, YT-84962

YATO		
YT-84976		100

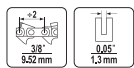

For YT-84950, YT-84951, YT-84953, YT-84954, YT-84960
Dla YT-84950, YT-84951, YT-84953, YT-84954, YT-84960

YATO		
YT-84977		100

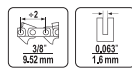

For YT-84955
Dla YT-84955

YATO		
YT-84978		100

EN Chain for chainsaw
PL Łańcuch łańcuch do pilarek
DE Kette für Kettensägen
RU Цепь для бензопилы
CZ Řetěz pro řetězové pily
HU Láncláncfűrészt

RO Lant pt. drijba
FR Chaîne de tronçonneuse
IT Catena motosega
ES Cadena de motosierra
CN 链条



For YT-84935
Dla YT-84935

Al-Ko, Alpina, Dolmar, Hitachi, Homelite, Husqvarna, Jonsered, Makita, Oleo-Mac, Partner, Ryobi

YATO	L	
YT-84954	16" (400 mm)	50

EN Chain for chainsaw
PL Łańcuch łańcuch do pilarek
DE Kette für Kettensägen
RU Цепь для бензопилы
CZ Řetěz pro řetězové pily
HU Láncláncfűrészt

RO Lant pt. drijba
FR Chaîne de tronçonneuse
IT Catena motosega
ES Cadena de motosierra
CN 链条



For YT-84935
Dla YT-84935

YATO	L	
YT-84956	18" (450 mm)	50

EN Chain for chainsaw
PL Łańcuch łańcuch do pilarek
DE Kette für Kettensägen
RU Цепь для бензопилы
CZ Řetěz pro řetězové pily
HU Láncláncfűrészt

RO Lant pt. drijba
FR Chaîne de tronçonneuse
IT Catena motosega
ES Cadena de motosierra
CN 链条卷

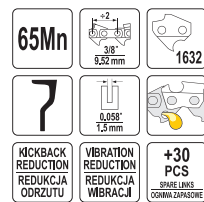

For YT-84932
Dla YT-84932

Alpina, Dolmar, Echo, Husqvarna, Jonsered, Makita, Oleo-Mac, Partner

YATO		
YT-84961		1

EN Chain for chainsaw
PL Łańcuch łańcuch do pilarek
DE Kette für Kettensägen
RU Цепь для бензопилы
CZ Řetěz pro řetězové pily
HU Láncláncfűrészt

RO Lant pt. drijba
FR Chaîne de tronçonneuse
IT Catena motosega
ES Cadena de motosierra
CN 链条卷



For YT-84900, YT-84934, YT-84936
Dla YT-84900, YT-84934, YT-84936

Dolmar, Husqvarna, Jonsered, Makita, NAC, Oleo-Mac, Partner

YATO		
YT-84963		1

EN Chainsaw chain spinner
 PL Nitownica do łańcuchów do pilarek
 DE Sägeketten-Vernietgerät
 RU Станок для клепания цепей
 CZ Nýtovačka pilových řetězů
 HU Szegecselő készülék fűrészlánchoz

RO Masina de nituit lanturi si de spart lanturi
 FR Riveteuse d'établi pour chaînes de tronçonneuses
 IT Imbutitore per motoseghe
 ES Remachadora banco cadenas de motosierra
 CN 接链器

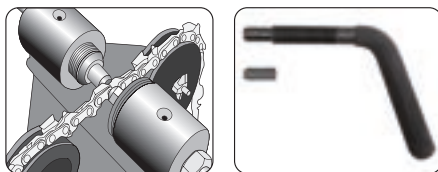
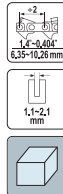

YATO
 YT-84970 4

EN Chainsaw chain breaker
 PL Rozkuwarka do łańcuchów do pilarek
 DE Sägeketten-Entnietgerät
 RU Станок для расклевки цепей
 CZ Roznýtovačka pilových řetězů
 HU Szegecskinnyó fűrészlánchoz
 RO Masina spart lant drijba
 FR Dériveteuse pour chaîne de tronçonneuse
 IT Spezzacatena per motoseghe
 ES Rompe cadenas de motosierra
 CN 截链器

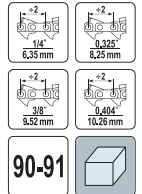

YATO
 YT-84971 4

EN Chain sharpener
 PL Ostrzałka do łańcuchów
 DE Kettenschärfgerät
 RU Заточка для цепей
 CZ Bruska řetězů
 HU Lánccélező
 RO Masina ascutit lant drijba
 FR Affûteuse de chaîne
 IT Affilatrice per catene
 ES Afilador para cadenas
 CN 电动磨链机



$L_{pA} = 63,5 \pm 3,0$ dB; $L_{wA} = 76,5 \pm 3,0$ dB



YATO
 YT-84990 4

EN Replacement wheel for chainsaw sharpening tool
 PL Kamień do ostrzałki łańcuchów
 DE Schleifscheibe für Kettenschärfgerät
 RU Камень для заточки цепей
 CZ Kámen do brusky pilových řetězů
 HU Lánccélező kő
 RO Roata schimb pt. aparat ascutit lant drijba
 FR Pierre à affûter les chaînes
 IT Mola affilacatene
 ES Sierra para afiladora de cadenas
 CN 磨轮



For YT-84990
 Dla YT-84990

YATO
 YT-84991 100

EN Flat depth-gauge file
PL Płaski pilnik do szlifowania ograniczników głębokości
DE Flachfeile zum Schleifen von Tiefenanschlägen
RU Плоский напильник для шлифования ограничителей глубины
CZ Plochy pilník k broušení hloubkových dorazů
HU Lapos reszelő mélységátarólok csiszolásához

RO Pila plata pt. ascuțit dinti lant drujba
FR Lime plate pour jauge de profondeur de ponçage
IT Lima piatta per affilatura di fermi di profondità
ES Lima plana para esmerlar topes de profundidad
CN 扁挫

250
mm

15x2
mm

BEARING
STEEL
STAL
ŁOŻYSKOWA

PP



YATO	L [mm]	
YT-85022	250	200

EN Round chain saw file set
PL Zestaw pilników okrągłych do ostrzenia łańcuchów
DE Rundfeileinsatz zum Schärfen von Ketten
RU Набор круглых напильников для заточки цепи
CZ Sada kulatých pilníků k ostění řetězu
HU Kerek reszelőkészlet láncélezéshez
RO Set pile rotunde pt. lant drujba
FR Limes rondes pour affûtage de chaînes
IT Kit di lime tonde per affilatura catene
ES Juego de limas redondas para afilar cadenas
CN 鏈鋸挫



3
PCS

250
mm

BEARING
STEEL
STAL
ŁOŻYSKOWA

PP



YATO	Ø [mm]	For / Dla	
YT-85025	4.0	3/8"	4/200
YT-85026	4.5	3/8", 0.325"	4/200
YT-85027	4.8	0.325"	4/200

EN Chain saw file with guide
PL Prowadnik z pilnikiem do ostrzenia łańcuchów
DE Führungsschiene mit Kettenschärfleile
RU Направляющая с напильником для заточки цепи
CZ Vodítko s pilníkem k ostění řetězu
HU Vezető láncélező reszelővel
RO Pila lant drujba cu ghidaj
FR Guide avec lime pour affûtage de chaîne
IT Guida con lima tonda per affilatura catene
ES Guía con lima para afilar cadenas
CN 鏈鋸挫3件套

3
PCS

250
mm

BEARING
STEEL
STAL
ŁOŻYSKOWA

PP

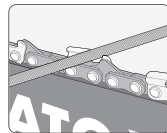

EN Chain saw file with guide
PL Prowadnik z pilnikiem do ostrzenia łańcuchów
DE Führungsschiene mit Kettenschärfleile
RU Направляющая с напильником для заточки цепи
CZ Vodítko s pilníkem k ostění řetězu
HU Vezető láncélező reszelővel
RO Pila lant drujba cu ghidaj
FR Guide avec lime pour affûtage de chaîne
IT Guida con lima tonda per affilatura catene
ES Guía con lima para afilar cadenas
CN 鏈鋸挫刀架

250
mm

30°

35°

BEARING
STEEL
STAL
ŁOŻYSKOWA

PP

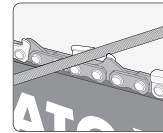

YATO	Ø [mm]	For / Dla	
YT-85030	4.0	3/8"	4/100
YT-85031	4.5	3/8", 0.325"	4/100
YT-85032	4.8	0.325"	4/100

YATO	Ø [mm]	For / Dla	
YT-85035	4.0	3/8"	200
YT-85036	4.5	3/8", 0.325"	200
YT-85037	4.8	0.325"	200

EN Chain sharpening set
PL Zestaw do ostrzenia łańcucha
DE Kettenschärfset
RU Набор для заточки цепи

CZ Sada k ostění řetězu
HU Láncélező készlet
RO Set ascuțit lant drujba
FR Kit d'affûtage de chaîne

IT Kit per affilatura catene
ES Set para afilar cadenas
CN 鏈鋸挫刀布袋套裝

4
PCS

25°

30°

35°

BEARING
STEEL
STAL
ŁOŻYSKOWA

PP

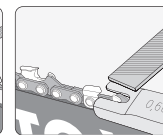
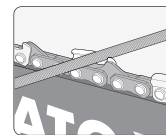

YATO	Ø [mm]	For / Dla	
YT-85040	4.0	3/8"	50
YT-85041	4.5	3/8", 0.325"	50
YT-85042	4.8	0.325"	50

EN Guide for round chain saw file
PL Prowadnik do pilnika okrągłego do łańcuchów
DE Rundfeilen-Führungsschiene zum Schärfen von Ketten
RU Направляющая для круглого напильника для цепи

CZ Vodítko ke kulatému pilníku do řetězu
HU Vezető kerek láncreszelőhöz
RO Ghidaj pt. pila rotunda lant drujba
FR Guide de limes rondes pour chaînes

IT Guida per lima tonda per catene
ES Guía para lima redonda para cadenas
CN 鏈鋸挫架

190
mm



25° 30° 35°

10° 25° 30° 35°

YATO	Ø [mm]	For / Dla	
YT-85044	4.0	3/8" / YT-85025	200
YT-85045	4.5	3/8", 0.325" / YT-85026	200
YT-85046	4.8	0.325" / YT-85027	200

YATO	Ø [mm]	For / Dla	
YT-85047	4.0	3/8" / YT-85025	200
YT-85048	4.5	3/8", 0.325" / YT-85026	200
YT-85049	4.8	0.325" / YT-85027	200

EN Guide for depth-gauge
 PL Przymiar do szlifowania ograniczników głębokości
 DE Schleiflehre für das Schleifen von Tiefenanschlägen
 RU Измеритель для шлифования ограничителей глубины

CZ Měřítka k broušení hloubkových dorazů
 HU Csiszolásablón mélység szabályozóhoz
 RO Ghidaj pt. ascuțit dinți lant drujba
 FR Jauge de profondeur de ponçage

IT Indicatore per affilatura di fermi di profondità
 ES Medida para esmerilar topes de profundidad
 CN 链条打磨深度尺



0.65 mm 10° 30° 35°

0.65 mm 0.75 mm 35°

YATO	L [mm]	For / Dla	
YT-85051	150	YT-85022	200

YATO	L [mm]	For / Dla	
YT-85052	170	YT-85022	200

EN Handle for round chain sharpening file
 PL Rękojeść do piłnika okrągłego
 DE Griff für Rundfeile

RU Рукотка для круглого напильника
 CZ Rukojeť do kulatého pílníku
 HU Markolat kerek reszelőhöz

RO Maner pt. pila rotunda de ascuțit lant
 FR Poignée de lime ronde
 IT Impugnatura per lima tonda

ES Mango de lima redonda
 CN 塑料手柄



YATO	Ø [mm]	For / Dla	
YT-85060	4.0	3/8" / YT-85025	500
YT-85061	4.5	3/8", 0.325" / YT-85026	500
YT-85062	4.8	0.325" / YT-85027	500

YATO	Ø [mm]	For / Dla	
YT-85065	4.0	3/8" / YT-85025	200
YT-85066	4.5	3/8", 0.325" / YT-85026	200
YT-85067	4.8	0.325" / YT-85027	200

EN Logger filing vice
 PL Imadło do mocowania prowadnicy
 DE Schraubstock zur Befestigung der Führungsschiene
 RU Тиски для крепления направляющей
 CZ Svěrák k uchopení vodičí lišty
 HU Vezetőirgáztól satu
 RO Presa pt. nituit lant drujba
 FR Etaou pour maintenir le guide
 IT Morsa per fissaggio della guida
 ES Tornillo de banco para fijar la guía
 CN 导板支架

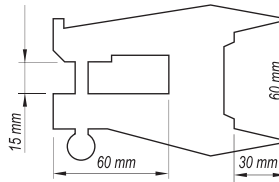

YATO	
YT-85075	2/60

EN Electric hoist
 PL Elektryczny wciągnik linowy
 DE Elektro-Seilwinde
 RU Электрическая канатная лебедка
 CZ Elektrický naviják kladkostroj
 HU Elektromos csőrő
 RO Troliu electric cu cablu
 FR Treuil électrique à corde
 IT Verricello elettrico
 ES Cabria eléctrica de cuerdas
 CN 电动葫芦



230V~50Hz 500 W

125kg 8min max 11m

250kg 4min max 5.5m

STOP

$L_{PA} = 52,2 \pm 1,2$ dB; $L_{WA} = 73,6 \pm 2,31$ dB

YATO	[W]	
YT-5901	500	2

EN Electric hoist
 PL Elektryczny wciągnik linowy
 DE Elektro-Seilwinde
 RU Электрическая канатная лебедка
 CZ Elektrický naviják kladkostroj
 HU Elektromos csőrő
 RO Troliu electric cu cablu
 FR Treuil électrique à corde
 IT Verricello elettrico
 ES Cabria eléctrica de cuerdas
 CN 电动葫芦



230V~50Hz 900 W

250kg 8min max 11m

500kg 4min max 5.5m

STOP

$L_{PA} = 54,0 \pm 0,9$ dB; $L_{WA} = 78,0 \pm 6,57$ dB

YATO	[W]	
YT-5904	900	2

EN Electric hoist
 PL Elektryczny wciągnik linowy
 DE Elektro-Seilwinde
 RU Электрическая канатная лебедка
 CZ Elektrický naviják kladkostroj
 HU Elektromos csőrő
 RO Troliu electric cu cablu
 FR Treuil électrique à corde
 IT Verricello elettrico
 ES Cabria eléctrica de cuerdas
 CN 电动葫芦



230V~50Hz 550 W

150kg 8min max 11m

300kg 4min max 5.5m

STOP

$L_{PA} = 52,2 \pm 0,9$ dB; $L_{WA} = 75,4 \pm 4,8$ dB

YATO	[W]	
YT-5902	550	2

EN Electric hoist
 PL Elektryczny wciągnik linowy
 DE Elektro-Seilwinde
 RU Электрическая канатная лебедка
 CZ Elektrický naviják kladkostroj
 HU Elektromos csőrő
 RO Troliu electric cu cablu
 FR Treuil électrique à corde
 IT Verricello elettrico
 ES Cabria eléctrica de cuerdas
 CN 电动葫芦



230V~50Hz 1050 W

300kg 8min max 11m

600kg 4min max 5.5m

STOP

$L_{PA} = 58,9 \pm 1,9$ dB; $L_{WA} = 79,9 \pm 2,79$ dB

YATO	[W]	
YT-5905	1050	2

Memo

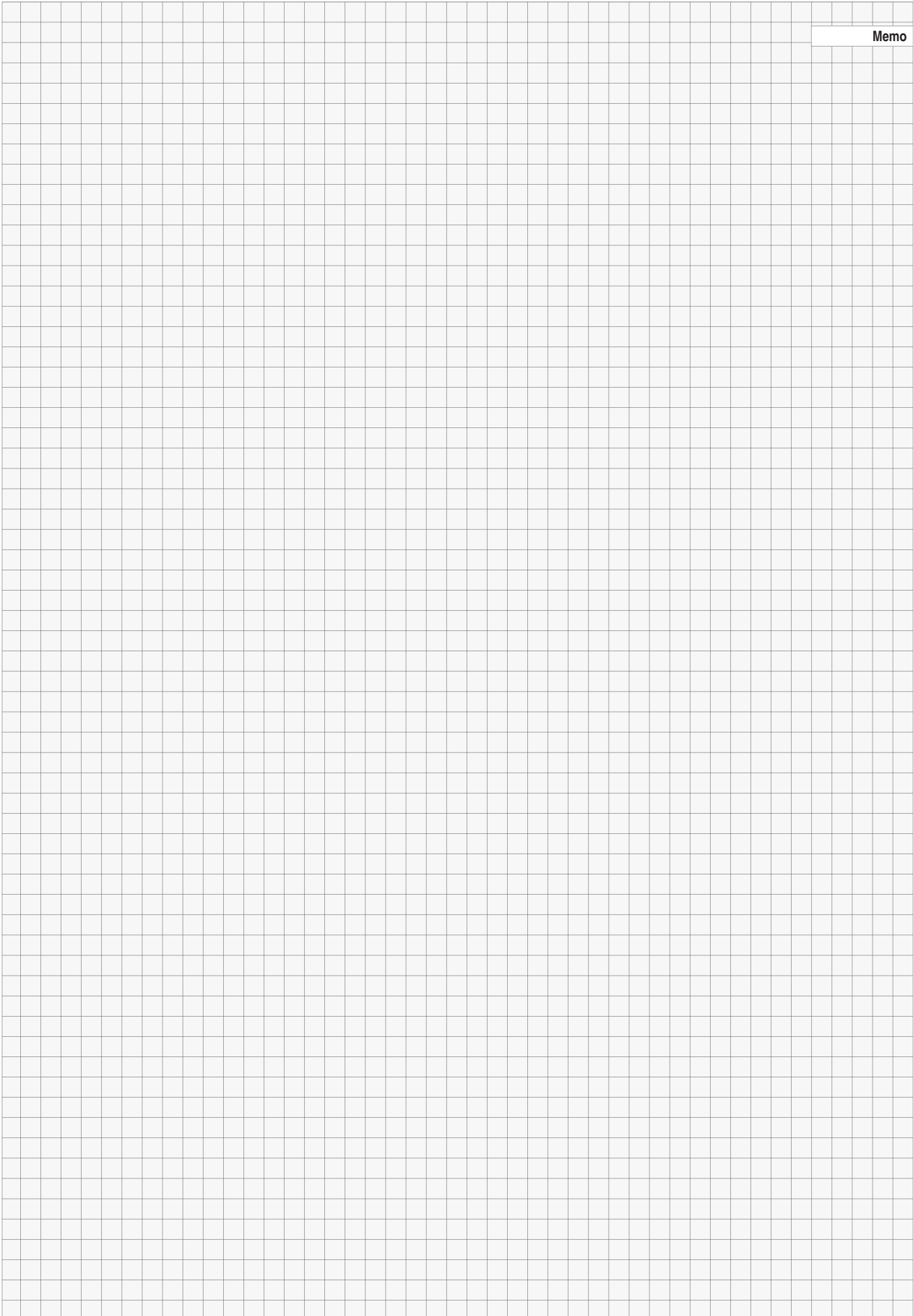

19

Accessories Akcesoria



Tool belts
Pasy na narzędzia

614-615



Tool boxes
Skrzynki narzędziowe

618-621



Tool pockets
Kieszenie na narzędzia

615-616



Floor conveyors
Transport poziomy

622



Tool bags
Torby narzędziowe

616-618



Tool lanyards
Linki do narzędzi

622



EN Tool belt
 PL Pas narzędziowy
 DE Werkzeuggürtel
 RU Инструмент пояса
 CZ Opasek s nářadím
 HU Szerszám öv

RO Centura scule
 FR Ceinture à outils
 IT Cintura porta utensilii
 ES Cinturón para herramientas
 CN 工具袋

600D
 POLYESTER
 POLYESTER



- Tool belt
- 4 large pockets
- 2 hammer holders
- 6 small pockets
- Pas narzędziowy
- 4 duże kieszenie
- 2 uchwyty na młotki
- 6 kieszonek

EN Tool belt
 PL Pas narzędziowy
 DE Werkzeuggürtel
 RU Инструмент пояса
 CZ Opasek s nářadím
 HU Szerszám öv



RO Centura scule
 FR Ceinture à outils
 IT Cintura porta utensilii
 ES Cinturón para herramientas
 CN 工具袋

600D
 POLYESTER
 POLYESTER



- Tool belt
- 4 big patch pockets
- Measuring tape holder
- 10 small pockets
- Pas narzędziowy
- 4 duże nakładane kieszenie
- Uchwyt na taśmę mierniczą
- 10 kieszonek

YATO  **YT-74001**  10

YATO  **YT-74002**  10

EN Tooling belt with harness
 PL Pas narzędziowy na szelkach
 DE Werkzeuggurt mit Hosenträger
 RU Инструментальный пояс с ляжками
 CZ Opasek na nářadí
 HU Szerszám öv

RO Curea port scule
 FR Ceinture à outils avec harnais
 IT Cintura portautensilii con bretelle
 ES Cinturón para herramientas con arnés
 CN 背带式组合工具袋

600D
 POLYESTER
 POLYESTER

DETACHABLE
 HARNESS
 ODPINANA
 UPRZĄŻ



- Harness
- Tool bags
- Hammer holder
- Nails pouch
- Szelki (uprząż)
- Sakwy
- Uchwyt na młotek
- Torba na gwoździe

EN Tooling belt with harness
 PL Pas narzędziowy na szelkach
 DE Werkzeuggurt mit Hosenträger
 RU Инструментальный пояс с ляжками
 CZ Opasek na nářadí
 HU Szerszám öv

RO Curea port scule
 FR Ceinture à outils avec harnais
 IT Cintura portautensilii con bretelle
 ES Cinturón para herramientas con arnés
 CN 背带式组合工具袋

600D
 POLYESTER
 POLYESTER

DETACHABLE
 HARNESS
 ODPINANA
 UPRZĄŻ



- Harness
- Tool bag
- 2 drill holsters
- Hammer holder
- Nails pouch
- Szelki (uprząż)
- Sakwa
- 2 kabury na elektronarzędzia
- Uchwyt na młotek
- Torba na gwoździe

YATO  **YT-74070**  10

YATO  **YT-74071**  8

EN Heavy duty nail & tool pouch
PL Pas z kieszeniami na gwoździe i narzędzia
DE Werkzeuggürtel mit Nägelund Schraubentaschen
RU Ремень с сумками для гвоздей и инструментов

CZ Pás na nářadí pěťikapsový
HU Szeg és szerszámtartó öv
RO Centura port scule
FR Ceinture porte-outils clous

IT Cintura con le tasche per chiodi e utensili
ES Cinturón porta herramientas y accesorios varios
CN 重型工具袋

21
POCKETS
KIESZENIE

130
cm

HEAVY DUTY
NYLON
WZMOCNIONY
NYLON



YATO
YT-7400

10

EN Pouch belt
PL Pas na kieszenie na narzędzia
DE Gürtel für Werkzeugtaschen

RU Пояс для карманов для инструмента
CZ Opasek na monterské kapsáře
HU Öv erszényhez

RO Curea cu buzunar
FR Ceinture porte-outils
IT Cintura con le tasche porta utensili

ES Cinturón para bolsas de herramientas
CN 工具腰帶

90-120
cm

HEAVY DUTY
NYLON
WZMOCNIONY
NYLON



YATO
YT-7409

50/100

EN 8-pocket tool bag
PL 8-kieszeniowa torba na narzędzia
DE Gürtelwerkzeugtasche mit 8 Fächern
RU Сумка - 8 карманов для инструмента
CZ Kapsář na nářadí 8-kapsový
HU Szerszámtartó erszény, 8 zsebbel
RO Geantă pt. scule 8 buzunare
FR Pochette à outils
IT Borsa porta attrezzi con 8 tasche
ES Bolso para herramientas de 8 bolsillos
CN 工具包

8
POCKETS
KIESZENIE

HEAVY DUTY
NYLON
WZMOCNIONY
NYLON



YATO
YT-7410

20/40

EN Universal cordless drill holder
PL Kieszeń na wiertarkę akumulatorową
DE Gürteltasche für Akkuschauber
RU Карман для аккумуляторной дрели
CZ Kapsář za opasek na akuvrtáčku
HU Univerzális tartóerszény akkus csavabehajtóhoz
RO Suport universal pt. bormasina
FR Pochette à perceuse sans-fil
IT Fondina per trapano a batteria
ES Bolsa porta taladradora de acumulador
CN 电钻通用挂袋

HEAVY DUTY
NYLON
WZMOCNIONY
NYLON



YATO
YT-7413

10/40

EN Tool pouch
PL Kabura na wkrętarke lub wiertarkę
DE Werkzeugbeutel
RU Инструмент мешок
CZ Opaskové pouzdro
HU Szerszám pisztolytáska
RO Suport masina de gaurit pt. centura
FR Pochette d'outil
IT Fondina per trapani a batteria
ES Herramientas de bolsillo
CN 电钻通用挂袋

600D
PCLYESTER
PCLYESTER



YATO
YT-74141

60

EN Universal cordless drill holder
PL Kieszeń na wiertarkę akumulatorową
DE Gürteltasche für Akkuschauber
RU Карман для аккумуляторной дрели
CZ Kapsář za opasek na akuvrtáčku
HU Univerzális tartóerszény akkus csavabehajtóhoz
RO Suport universal pt. bormasina
FR Pochette à perceuse sans-fil
IT Fondina per trapano a batteria
ES Bolsa porta taladradora de acumulador
CN 电钻通用挂袋

HEAVY DUTY
NYLON
WZMOCNIONY
NYLON



YATO
YT-7414

48/96

EN Nail and tool pouch
 PL Kieszka na gwoździe i narzędzia
 DE Gürtelwerkzeughasche
 RU Карман для гвоздей и инструментов
 CZ Kapsák na nářadí
 HU Szeg és szerszámtartó erszény
 RO Buzunar pt. scule si cuie
 FR Pochette à outils et clous
 IT Tasche per chiodi e utensili
 ES Bolsa porta herramientas y accesorios varios
 CN 钉子袋



HEAVY DUTY
 NYLON
 WZMOCNIONY
 NYLON 



YATO 

YT-7416

 20/40

EN Nail and tool pouch
 PL Kieszka na gwoździe i narzędzia
 DE Gürtelwerkzeughasche
 RU Карман для гвоздей и инструментов
 CZ Kapsák na nářadí
 HU Szeg és szerszámtartó erszény
 RO Buzunar pt. scule si cuie
 FR Pochette à outils et clous
 IT Tasche per chiodi e utensili
 ES Bolsa porta herramientas y accesorios varios
 CN 钉子袋



HEAVY DUTY
 NYLON
 WZMOCNIONY
 NYLON 



YATO 

YT-7417

 39/156

EN Pouch for nails and tools
 PL Sakwa na gwoździe i narzędzia
 DE Werkzeugtasche
 RU Сумка для инструментов
 CZ Univerzální kapsa na nářadí
 HU Impregnált bőr szerszám-szögtáska
 RO Geanta cu buzunare pt. cuie si scule
 FR Multi-poche sac pour outil
 IT Borsa per chiodi e attrezzi
 ES Bolsillo para uñas y herramientas
 CN 工具袋

8
 POCKETS
 KIESZENIE 

600D
 POLYESTER
 POLYESTER 



YATO 

YT-74172

 24

EN Nail pocket + hammer loop
 PL Kieszka z uchwytem na młotek
 DE Hammer und Nägel-Gürteltasche
 RU Карман-держатель для молотка
 CZ Kapsák za opasek na kladivo
 HU Szeg tartó erszény kalapácsolóval
 RO Suport pt. ciocan
 FR Pochette à outils + porte-marteau
 IT Tasca porta martello
 ES Bolsa con el soporte para martillo
 CN 锤头钉子袋

HEAVY DUTY
 NYLON
 WZMOCNIONY
 NYLON 



YATO 

YT-7419

 40/80

EN Mobile phone pouch
 PL Kieszka na telefon komórkowy
 DE Handy-Gürteltasche
 RU Карман для мобильного телефона
 CZ Pouzdro za opasek na mobilni telefon
 HU Mobil telefon tartó
 RO Suport pt. telefon
 FR Pochette à téléphone portable
 IT Tasca porta cellulare
 ES Bolsa de teléfono móvil
 CN 手机袋

HEAVY DUTY
 NYLON
 WZMOCNIONY
 NYLON 



YATO 

YT-7420

 27/54

EN Tool bag
 PL Torba na narzędzia
 DE Werkzeugtasche
 RU Сумка для инструмента
 CZ Taška montérská
 HU Szerszámos táska
 RO Geanta pt. scule
 FR Sac à outils
 IT Borsa per attrezzi
 ES Bolso de herramientas
 CN 工具包

600D
 POLYESTER
 POLYESTER 

17
 POCKETS
 KIESZENIE 

RUBBER
 BOTTOM
 GUMOWE
 DNO 



YATO 

YT-74360

 8

EN Tool bag
 PL Torba na narzędzia
 DE Werkzeugtasche
 RU Сумка для инструмента
 CZ Taška montérská
 HU Szerszámos táska
 RO Geanta pt. scule
 FR Sac à outils
 IT Borsa per attrezzi
 ES Bolso de herramientas
 CN 工具包

600D
 POLYESTER
 POLYESTER 

15
 POCKETS
 KIESZENIE 

RUBBER
 BOTTOM
 GUMOWE
 DNO 



YATO 

YT-74361

 6

EN Tool bag
 PL Torba na narzędzia
 DE Werkzeugtasche
 RU Сумка для инструмента
 CZ Taška montérská
 HU Szerszámos táska
 RO Geanta pt. scule
 FR Sac à outils
 IT Borsa per attrezzi
 ES Bolso de herramientas
 CN 工具包

600D
 POLYESTER
 POLYESTER 

41
 POCKETS
 KIESZENIE 



YATO 

YT-74351

 4

EN Tool bag
PL Torba na narzędzia
DE Werkzeugtasche
RU Сумка для инструмента

CZ Taška montérská
HU Szerszámás táská
RO Geanta pt. scule
FR Sac à outils

IT Borsa per attrezzi
ES Bolso de herramientas
CN 工具包

HEAVY DUTY
NYLON
WZMOCONNY
NYLON



50
POCKETS
MIESZENIE

STEEL
EDGES
STALOWE
KRAWĘDZIE

EASY OPEN
ŁATWE
OTWIERANIE

EASY CLOSE
ŁATWE
ZAMYKANIE

16
POCKETS
MIESZENIE

YATO
YT-7430

12

YATO
YT-7433

12

EN Open tote tool bag
PL Pojemnik na narzędzia
DE Werkzeugtrage
RU Контейнер для инструментов

CZ Přepravka na nářadí
HU Szerszám tartó csövazás
RO Geanta de otel pt. portbagaj
FR Panier porte-outils

IT Borsa portautensili
ES Maletín de herramientas
CN 工具包

600D
POLYESTER
POLIESTER



16
POCKETS
MIESZENIE

9
POCKETS
MIESZENIE

YATO
YT-74370

6

YATO
YT-74371

6



17
POCKETS
MIESZENIE

11
POCKETS
MIESZENIE

YATO
YT-74372

6

YATO
YT-74373

6

- EN Steel tube tool carrier
- PL Walizka narzędziowa
- DE Werkzeugkoffer
- RU Семодан для инструмента
- CZ Taška na nářadí
- HU Szerszámtartó csővázas
- RO Geanta de otel pt. portbagaj
- FR Sac à outils
- IT Valigetta per attrezzi
- ES Maletín de herramientas
- CN 钢管柄工具包

31
POCKETS
REZERVNE

HEAVY DUTY
NYLON
WZMOCNIONY
NYLON





- EN Foldable chair with bag
- PL Torba narzędziowa z krzeselkiem
- DE Werkzeugtasche mit Klappstuhl
- RU Стул складной с сумкой для инструмента
- CZ Taška na nářadí se stojánkem
- HU Őszecsukható szék tartózsébbel
- RO Scaun rabatabil cu geanta
- FR Sac à outils + tabouret
- IT Sedia pieghevole per borsa attrezzi
- ES Bolso de herramientas con silla plegable
- CN 带包折叠椅



22
POCKETS
REZERVNE

max  **90 kg**

HEAVY DUTY
NYLON
WZMOCNIONY
NYLON



YATO  
YT-7435 4

YATO  
YT-7446 10

- EN System organizer
- PL Organizer systemowy
- DE System-Sortimentskasten
- RU Системный органайзер
- CZ Systémový ortganizér
- HU Csavartartó doboz
- RO Modul organizator
- FR Organisateur outils système
- IT Portautensili modulari
- ES Organizador modular
- CN 工具箱

257x180
x66
mm



YATO  
YT-09177 6

- EN System organizer
- PL Organizer systemowy
- DE System-Sortimentskasten
- RU Системный органайзер
- HU Rendszer szervező
- RO Modul organizator
- FR Organisateur outils système
- IT Portautensili modulari
- ES Organizador modular
- CN 工具箱

263x363
x77
mm

M





YATO  
YT-09182 1

- EN System organizer
- PL Organizer systemowy
- DE System-Sortimentskasten
- RU Системный органайзер
- CZ Systémový ortganizér
- HU Csavartartó doboz
- RO Modul organizator
- FR Organisateur outils système
- IT Portautensili modulari
- ES Organizador modular
- CN 工具箱

452x296
x79
mm





YATO  
YT-09178 1

- EN System organizer
- PL Organizer systemowy
- DE System-Sortimentskasten
- RU Системный органайзер
- HU Csavartartó doboz
- RO Modul organizator
- FR Organisateur outils système
- IT Portautensili modulari
- ES Organizador modular
- CN 工具箱

452x358
x110
mm



YATO  
YT-09179 1

EN System organizer
PL Organizator systemowy
DE System-Sortimentskasten
RU Системный органайзер
CZ Systémový organizér
HU Csavartartó doboz

RO Modul organizator
FR Organisateur outils système
IT Portautensilii modulare
ES Organizador modular
CN 工具箱

531x379
x77
mm



YATO
YT-09181



EN System organizer
PL Organizator systemowy
DE System-Sortimentskasten
RU Системный органайзер
HU Csavartartó doboz

RO Modul organizator
FR Organisateur outils système
IT Portautensilii modulare
ES Organizador modular
CN 工具箱

585x387
x131
mm



YATO
YT-09180



EN System tote tray
PL Pojemnik systemowy
DE System-Container
RU Системный контейнер
CZ Systémový box
HU Rendszer tároló

RO Modul lada scule
FR Boîte à outils système
IT Contenitore portautensili modulare
ES Recipiente modular
CN 工具箱

576x359
x237
mm



YATO
YT-09168



EN Power tool box
PL Skrzynka na elektronarzędzia
DE Kasten für Elektrowerkzeuge
RU Ящик для электроинструментов
CZ Box na elektronářadí
HU Szerszámosláda elektromos szerszámokhoz

RO Cutie pt. scule electrice
FR Boîte à outils électriques
IT Cassetta porta attrezzi elettrici
ES Caja para herramientas eléctricas
CN 电动工具箱

450x322
x126
mm



YATO
YT-09170



EN Toolbox
PL Skrzynka narzędziowa
DE Werkzeugkoffer
RU Ящик для инструментов
CZ Skříňka na nářadí
HU Szerszámosláda

RO Modul cutie scule
FR Boîte à outils
IT Cassetta degli attrezzi
ES Caja de herramientas
CN 工具箱

450x260
x240
mm



YATO
YT-09183



EN Toolbox
PL Skrzynka narzędziowa
DE Werkzeugkoffer
RU Ящик для инструментов
CZ Skříňka na nářadí
HU Szerszámosláda

RO Modul cutie scule
FR Boîte à outils
IT Cassetta degli attrezzi
ES Caja de herramientas
CN 工具箱

650x270
x272
mm



YATO
YT-09184



EN System tool box with organizers
 PL Skrzynia z organizerami
 DE Box mit Organizern
 RU Ящик с организерами
 CZ Box s organizéry
 HU Láda szervezőkkel
 RO Cutie scule modulara cu organizator
 FR Boîte de rangement
 IT Cassa portautensili con organizer
 ES Caja con organizador
 CN 工具箱



241x450
x321
mm 

EN System tool box
 PL Skrzynia systemowa
 DE System-Werkzeugkoffer
 RU Системный ящик
 HU Rendszer láda

RO Modul cutie scule
 FR Caisse à outils système
 IT Cassa portautensili modulare
 ES Caja modular
 CN 工具箱

585x385
x190
mm 



YATO  
 YT-09163 1

YATO  
 YT-09169 1

EN System tool box
 PL Skrzynia systemowa
 DE Systembox
 RU Системный ящик
 CZ Systémový box
 HU Rendszerláda

RO Cutie scule modulara
 FR Boîte système
 IT Cassa portautensili modulare
 ES Caja modular
 CN 工具箱

241x450
x321
mm 







EN System tool box
 PL Skrzynia systemowa
 DE System-Werkzeugkoffer
 RU Системный ящик
 HU Rendszer láda

RO Modul cutie scule
 FR Caisse à outils système
 IT Cassa portautensili modulare
 ES Caja modular
 CN 工具箱

585x385
x320
mm 



YATO  
 YT-09164 1

YATO  
 YT-09167 1

EN System tool box on wheels
 PL Skrzynia systemowa na kołach
 DE Systembox auf Rädern
 RU Системный ящик на колесиках
 CZ Systémový box na kolečkách
 HU Kerekos rendszerláda
 RO Troller scule
 FR Boîte système sur roulettes
 IT Cassa portautensili modulare con ruote
 ES Caja modular con ruedas
 CN 工具箱

347x450
x381
mm

975
685
mm 



2x 



EN System tool box on wheels
 PL Skrzynia systemowa na kołach
 DE System-Werkzeugkoffer auf Rädern
 RU Системный ящик на колесиках
 CZ Systémový skříň na kolech
 HU Kerekos rendszer láda
 RO Sistem modular cutie pt. scule cu roti
 FR Caisse à outils roulante système
 IT Cassa portautensili modulare con ruote
 ES Caja modular con ruedas
 CN 工具箱



585x425
x410
mm



2x 



YATO  
 YT-09165 1

YATO  
 YT-09166 1

EN Tool box set
PL Zestaw skrzynek
DE Werkzeugkoffer-Set
RU Набор ящиков
CZ Sada skříněk
HU Ládakészlet
RO Troler pt. scule
FR Jeu de caisses
IT Set di cassette portautensili
ES Juego de cajas
CN 工具箱



2
PCS

585x425
x645
mm

2x  

EN Tool box set
PL Zestaw skrzynek
DE Boxenset
RU Комплект ящиков
CZ Sada skříněk
HU Ládakészlet
RO Set cutii scule tip troller
FR Jeu de boîtes
IT Set di cassette portautensili
ES Conjunto de cajas
CN 工具箱



3
PCS

421x450
x323
mm



YATO 

YT-09162



1

YATO 

YT-09175



1

EN Tool box set
PL Zestaw skrzynek
DE Werkzeugkoffer-Set
RU Набор ящиков
CZ Sada skříněk
HU Ládakészlet
RO Troler pt. scule
FR Jeu de caisses
IT Set di cassette portautensili
ES Juego de cajas
CN 工具箱



3
PCS

585x425
x810
mm

2x  

EN Tool box set
PL Zestaw skrzynek
DE Boxenset
RU Комплект ящиков
CZ Sada skříněk
HU Ládakészlet
RO Set cutii scule tip troller
FR Jeu de boîtes
IT Set di cassette portautensili
ES Conjunto de cajas
CN 工具箱



4
PCS

722x450
x380
mm



YATO 

YT-09161



1

YATO 

YT-09174



1

EN Tool box with wheels
PL Skrzynia na kółkach
DE Kasten auf Rädern
RU Ящик на колесиках
CZ Skřínka na kolečkách
HU Kerekés számszámoló
RO Cutie scule cu roti
FR Caisse à outils roulante
IT Cassa portautensili con ruote
ES Caja con ruedas
CN 工具箱



793x385
x322
mm

2x  

EN Two-parts tool box with wheels
PL Skrzynia dwupoziomowa na kółkach
DE Werkzeugkoffer mit zwei Etagen auf Rädern
RU Двухуровневый ящик на колесиках
CZ Dvoúpatrová skřínka na kolečkách
HU Kétszintes kerekés láda
RO Troler cu doua cutii scule
FR Caisse double à outils roulante
IT Cassetta portautensili a due livelli con ruote
ES Caja dos niveles con ruedas
CN 工具箱



495x350
x710
mm

2x  

YATO 

YT-09185



1

YATO 

YT-09160



1

EN Lifting and moving straps
 PL Pasy do przenoszenia mebli
 DE Gürtel zum Bewegen von Heben
 RU Ремни для переноски мебели
 CZ Pohyblivé pásy pro zvedání nábytku
 HU Emelő mozgó pántok
 RO Curele pt. mutat obiecte
 FR Sangles de levage et de déplacement
 IT Cinghie per trasporto di mobili
 ES Cinturones para llevar muebles
 CN 双人手抬带

2 PCS **8x280** cm **PP**



EN Lifting and moving straps
 PL Pasy do przenoszenia mebli
 DE Gürtel zum Bewegen von Heben
 RU Ремни для переноски мебели
 CZ Pohyblivé pásy pro zvedání nábytku
 HU Emelő mozgó pántok
 RO Curele pt. mutat obiecte
 FR Sangles de levage et de déplacement
 IT Cinghie per trasporto di mobili
 ES Cinturones para llevar muebles
 CN 双人搬运带

3 PCS **5x370** cm **PP**

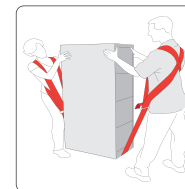

YATO

YT-74260

18/36

YATO

YT-74261

10/20

EN Lifting and moving straps
 PL Pasy do przenoszenia mebli
 DE Gürtel zum Bewegen von Heben
 RU Ремни для переноски мебели
 CZ Pohyblivé pásy pro zvedání nábytku
 HU Emelő mozgó pántok
 RO Curele pt. mutat obiecte
 FR Sangles de levage et de déplacement
 IT Cinghie per trasporto di mobili
 ES Cinturones para llevar muebles
 CN 双人搬运带

4 PCS **8x280** cm **PP**

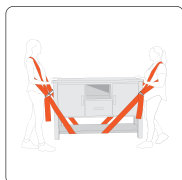

YATO

YT-74262

8/16

EN Lifting and moving straps
 PL Pasy do przenoszenia ładunku
 DE Gürtel zum Bewegen von Heben
 RU Такелажный ремень для переноски грузов
 CZ Pásy pro ruční přenášení nákladu
 HU Emelő mozgó pánt
 RO Curele pt. mutat obiecte
 FR Sangles de levage et de déplacement
 IT Cinghia per trasporto di carico
 ES Cinta de levantamiento e movimiento
 CN 环保手提带

8x180 cm **PP**

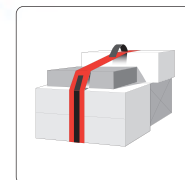

YATO

YT-74263

25/100

EN Furniture transport roller set
 PL Zestaw rolek do transportu mebli
 DE Möbel-Transportroller-Set
 RU Набор для перемещения мебели
 CZ Sada na stěhování nábytku
 HU Bútor szállító készlet
 RO Set transport si ridicat mobila
 FR Paire de roues et de pousoir de transporteur mobile
 IT Set di rulli per trasporto di mobili
 ES Muebles transporte conjunto
 CN 搬运器

5 PCS **max 300kg**



YATO

YT-37490

6

EN Lanyard with safety breakaway buckles
 PL Linka zabezpieczająca narzędzia
 DE Sicherungsleine für Werkzeuge
 RU Тросик для предохранения инструментов
 CZ Zabezpečovací lanko k nářadí
 HU Szerszámrogzító kötél
 RO Cablu siguranta extensibil
 FR Cordon de sécurité de l'outil
 IT Cavo di ancoraggio per utensile
 ES Cable de seguridad para herramientas
 CN 弹簧安全绳

52-170 cm



YATO

Ø [mm]

Max. lifting capacity / Maks. udźwig [kg]

YATO	Ø [mm]	Max. lifting capacity / Maks. udźwig [kg]	
YT-74008	1.0	2	24/144
YT-74009	1.5	3	24/144

Memo

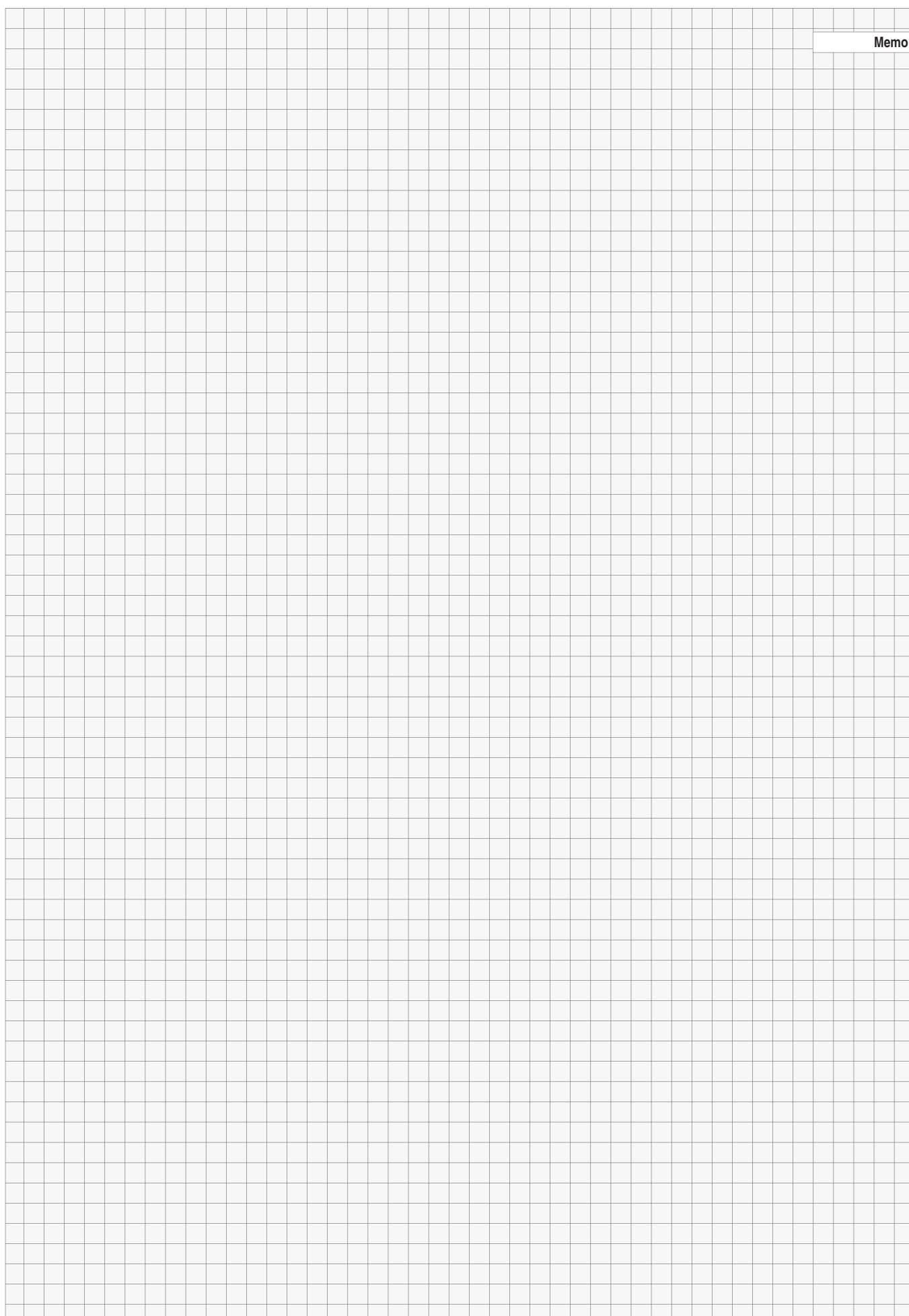

20

Health & safety articles
Artykuły BHP



Safety glasses
Okulary ochronne

626-627



Ear plugs
Zatyczki do uszu

635-636



Corrective protection glasses
Okulary ochronne korekcyjne

627



Hearing protectors
Nauszniki przeciwhałasowe

636-637

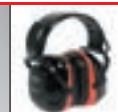

Safety goggles
Gogle ochronne

627-628



Safety helmets & accessories
Kaski ochronne i akcesoria

637



Magnifiers
Lupy

628



Working shoes
Buty robocze

638-640



Working gloves
Rękawice robocze

628-630



Safety sandals

Sandały robocze

638

Low-cut safety shoes

Półbuty robocze

638

Middle-cut safety shoes

Trzewiki robocze

639

Safety boots

Buty ochronne wysokie

640

Safety rain boots

Kalosze robocze

640

Working aprons
Fartuchy robocze

631



Working clothes
Odzież robocza

641-648



Safety support belts
Pasy antyprzeciążeniowe

631



Working jackets

Bluzy i kurtki robocze

641

Working trousers

Spodnie robocze

643

Work bib pants

Spodnie robocze ogrodniczki

646

Rainsuits

Komplety przeciwdeszczowe

648

Safety harness & accessories
Szelki bezpieczeństwa i akcesoria

631-632

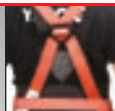

Knee pads
Nakolanniki

632



Disposable dust masks
Półmaski filtrujące

633-635



EN Safety glasses
 PL Okulary ochronne
 DE Schutzbrille
 RU Очки защитные открытые
 CZ Ochranné brýle
 HU Védőszemüveg
 RO Ochelari pt. protectie
 FR Lunettes de protection
 IT Occhiali protettivi
 ES Gafas protectoras
 CN 防护眼镜

PC

1
OPTICAL CLASS
KLASA OPTYCZNA



YATO 

YT-7360

12/240

1
OPTICAL CLASS
KLASA OPTYCZNA



YATO 

YT-7361

12/240

1
OPTICAL CLASS
KLASA OPTYCZNA



YATO 

YT-7363

12/240

1
OPTICAL CLASS
KLASA OPTYCZNA



YATO 

YT-7365

12/240

1
OPTICAL CLASS
KLASA OPTYCZNA



YATO 

YT-7367

12/240

1
OPTICAL CLASS
KLASA OPTYCZNA



YATO 

YT-7369

12/240

1
OPTICAL CLASS
KLASA OPTYCZNA



YATO 

YT-7371

12/240

1
OPTICAL CLASS
KLASA OPTYCZNA



YATO 

YT-73631

12/300

1
OPTICAL CLASS
KLASA OPTYCZNA



YATO 

YT-73761

12/300

1
OPTICAL CLASS
KLASA OPTYCZNA



YATO 

YT-7362

12/240

1
OPTICAL CLASS
KLASA OPTYCZNA



YATO 

YT-7364

12/240

1
OPTICAL CLASS
KLASA OPTYCZNA



YATO 

YT-7366

12/240

1
OPTICAL CLASS
KLASA OPTYCZNA



YATO 

YT-7368

12/240

1
OPTICAL CLASS
KLASA OPTYCZNA



YATO 

YT-7376

12/240

1
OPTICAL CLASS
KLASA OPTYCZNA



YATO 

YT-73641

12/300

1
OPTICAL CLASS
KLASA OPTYCZNA



YATO 

YT-73760

12/300

1
OPTICAL CLASS
KLASA OPTYCZNA



YATO 

YT-73602

12/240

1
OPTICAL CLASS
KLASA OPTYCZNA



YATO 

YT-73632

10/100

2
OPTICAL CLASS
KLASA OPTYCZNA



YATO 

YT-73634

10/100

EN Safety glasses
PL Okulary ochronne
DE Schutzbrille
RU Очки защитные
CZ Ochranné brýle
HU Védőszemüveg

RO Ochelari pt. protectie
FR Lunettes de protection
IT Occhiali protettivi
ES Gafas protectoras
CN 劳保眼镜



TYPE 92218SR EN 166:2001 F

YATO
YT-73700 12/240

EN Safety glasses
PL Okulary ochronne
DE Schutzbrille
RU Очки защитные
CZ Ochranné brýle
HU Védőszemüveg

RO Ochelari pt. protectie
FR Lunettes de protection
IT Occhiali protettivi
ES Gafas protectoras
CN 劳保眼镜



TYPE 92281 EN 166:2001 F

YATO
YT-73603 12/240

EN Safety glasses
PL Okulary ochronne
DE Schutzbrille
RU Очки защитные
CZ Ochranné brýle
HU Védőszemüveg

RO Ochelari pt. protectie
FR Lunettes de protection
IT Occhiali protettivi
ES Gafas protectoras
CN 劳保眼镜



TYPE 92218SR EN 166:2001 F

YATO
YT-73701 12/240

EN Safety glasses
PL Okulary ochronne
DE Schutzbrille
RU Очки защитные
CZ Ochranné brýle
HU Védőszemüveg
RO Ochelari pt. protectie
FR Lunettes de protection
IT Occhiali protettivi
ES Gafas protectoras
CN 劳保眼镜



TYPE 90960FA-RX EN 166:2001 FT

YATO
YT-73621 12/300

EN Safety glasses
PL Okulary ochronne
DE Schutzbrille
RU Очки защитные
CZ Ochranné brýle
HU Védőszemüveg
RO Ochelari pt. protectie
FR Lunettes de protection
IT Occhiali protettivi
ES Gafas protectoras
CN 劳保眼镜

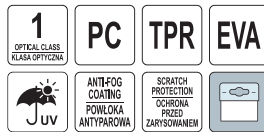

TYPE 90960FA-RX EN 166:2001 FT

YATO
YT-73702 12/300

EN Safety glasses
PL Okulary ochronne
DE Schutzbrille
RU Очки защитные
CZ Ochranné brýle
HU Védőszemüveg
RO Ochelari pt. protectie
FR Lunettes de protection
IT Occhiali protettivi
ES Gafas protectoras
CN 劳保眼镜

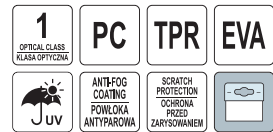

TYPE 90960FA-RX EN 166:2001 FT

YATO
YT-73703 12/300

EN Corrective protection glasses
PL Okulary ochronne korekcyjne
DE Schutzbrille

RU Очки защитные открытые
CZ Ochranné brýle
HU Védőszemüveg

RO Ochelari pt. protectie
FR Lunettes de sécurité
IT Occhiali da vista di protezione

ES Gafas protectoras
CN 雙光老花眼鏡



TYPE 9844BI 166:2001 F

YATO	Correction / Korekcja	
YT-73611	+1.0 D	12/300
YT-73612	+1.5 D	12/300
YT-73613	+2.0 D	12/300
YT-73614	+2.5 D	12/300
YT-73615	+3.0 D	12/300

EN Safety goggles with strap
PL Gogle ochronne z paskiem
DE Schutzbrille
RU Очки защитные
CZ Ochranné brýle
HU Védőszemüveg
RO Ochelari pt. protectie
FR Lunettes de protection
IT Occhiali protettivi con cinghia
ES Gafas protectoras
CN 劳保眼镜



TYPE 92275 EN 166:2001 F

YATO
YT-73765 12/240

EN Safety goggles with strap
PL Gogle ochronne z paskiem
DE Schutzbrille
RU Очки защитные
CZ Ochranné brýle
HU Védőszemüveg
RO Ochelari pt. protectie
FR Lunettes de protection
IT Occhiali protettivi con cinghia
ES Gafas protectoras
CN 劳保眼镜



TYPE 92275 EN 166:2001 F

YATO
YT-73766 12/240

EN Safety goggles
PL Gogle ochronne
DE Schutzbrille
RU Очки защитные
CZ Ochranné brýle
HU Védőszemüveg

RO Ochelari pt. protectie
FR Lunettes de protection
IT Occhiali protettivi
ES Gafas protectoras
CN 劳保眼镜



TYPE 2876 EN 166:2001 F

YATO
YT-73777 12/120

EN Safety goggles
PL Gogle ochronne
DE Schutzbrille
RU Очки защитные
CZ Ochranné brýle
HU Védőszemüveg

RO Ochelari pt. protectie
FR Lunettes de protection
IT Occhiali protettivi
ES Gafas protectoras
CN 防护眼镜

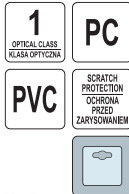

TYPE SG90A EN 166:2001 F

YATO	
YT-7380	20/200

EN Safety goggles with indirect ventilation
PL Gogle ochronne z wywietrznikami
DE Schutzbrille mit Lüftung
RU Защищенные защитные очки с вентиляцией
CZ Ochranné brýle s ventilací
HU Védőszemüveg szellőzőnyílásokkal
RO Ochelari protectie cu ventilatie
FR Lunettes de sécurité avec aération
IT Occhiali di protezione con valvole di aerazione
CN 防护眼镜



TYPE SG90B-1 EN 166:2001 B

YATO	
YT-73810	20/200

EN Safety goggles
PL Gogle ochronne
DE Schutzbrille
RU Очки защитные
CZ Ochranné brýle
HU Védőszemüveg

RO Ochelari pt. protectie
FR Lunettes de protection
IT Occhiali protettivi
ES Gafas protectoras
CN 劳保眼镜



TYPE SG-60 EN 166:2001 B

YATO	
YT-7382	10/100

EN Safety goggles
PL Gogle ochronne
DE Schutzbrille
RU Очки защитные
HU Védőszemüveg
RO Ochelari pt. protectie
FR Lunettes de protection
IT Occhiali protettivi
ES Gafas protectoras
CN 劳保眼镜

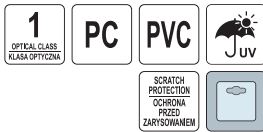

TYPE B421 EN 166:2001 B

YATO	
YT-73830	10/100

EN Safety goggles with indirect ventilation
PL Gogle ochronne z wywietrznikami
DE Schutzbrille mit Lüftung
RU Защищенные защитные очки с вентиляцией
CZ Ochranné brýle s ventilací
HU Védőszemüveg szellőzőnyílásokkal
RO Ochelari protectie cu ventilatie
FR Lunettes de sécurité avec aération
IT Occhiali protettivi a mascherina
ES Gafas de seguridad con ventilación
CN 防护眼镜



TYPE KM2101 EN 166:2001 F

YATO	
YT-73831	10/100

EN Safety goggles with indirect ventilation
PL Gogle ochronne z wywietrznikami
DE Schutzbrille mit Lüftung
RU Очки защитные с вентиляцией
CZ Ochranné brýle s ventilací
HU Védőszemüveg szellőzőnyílásokkal
RO Ochelari protectie cu ventilatie
FR Lunettes de sécurité avec aération
IT Occhiali protettivi a mascherina
ES Gafas de seguridad con ventilación
CN 防护眼镜



TYPE KM2101 EN 166:2001 F

YATO	
YT-73832	10/100

EN Magnifier with LED light
PL Lupa z oświetleniem mocowane na głowie
DE Stirnlupe mit Beleuchtung
RU Лупы с подсветкой с креплением на голову
CZ Lupa s osvětlením upevněné na hlavě
HU Fejre rögzíthető nagyító lámpával
RO Ochelari cu lupa si LED
FR Loupes à fixer à la tête avec éclairage
IT Lenti d'ingrandimento da testa con luce
ES Lupa para cabeza con luz
CN 头戴式放大镜



Battery not included
Baterii nie dołączono



YATO	
YT-73840	60

EN Magnifier with LED light
PL Lupa z oświetleniem mocowane na głowie
DE Stirnlupe mit Beleuchtung
RU Лупы с подсветкой с креплением на голову
CZ Lupa s osvětlením upevněné na hlavě
HU Fejre rögzíthető nagyító lámpával
RO Ochelari cu lupa si LED
FR Loupes à fixer à la tête avec éclairage
IT Lenti d'ingrandimento da testa con luce
ES Lupa para cabeza con luz
CN 头戴式放大镜



Battery not included
Baterii nie dołączono



YATO	
YT-73842	40

EN Working gloves
PL Rękawice robocze
DE Arbeitshandschuhe
RU Рабочие перчатки
CZ Pracovní rukavice
HU Védőkesztyű
RO Mănuși de lucru
FR Gants de travail
IT Guanti da lavoro
ES Guantes de piel
CN 防护手套



YATO	Size / Rozmiar	
YT-74754	8	12/144
YT-74755	9	12/144
YT-74756	10	12/144

EN Working gloves
PL Rękawice robocze
DE Arbeitshandschuhe
RU Рабочие перчатки
CZ Pracovní rukavice
HU Védőkesztyű
RO Mănuși de lucru
FR Gants de travail
IT Guanti da lavoro
ES Guantes de piel
CN 防护手套

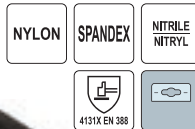

YATO	Size / Rozmiar	
YT-74757	8	12/120
YT-74758	9	12/120
YT-74759	10	12/120

EN Working gloves
PL Rękawice robocze
DE Arbeitshandschuhe
RU Рабочие перчатки
CZ Pracovní rukavice
HU Védőkesztyű
RO Mănuși de lucru
FR Gants de travail
IT Guanti da lavoro
ES Guantes de piel
CN 防护手套



YATO	Size / Rozmiar	
YT-74751	8	12/144
YT-74752	9	12/144
YT-74753	10	12/144

EN Working gloves
PL Rękawice robocze
DE Arbeitshandschuhe
RU Рабочие перчатки
CZ Pracovní rukavice
HU Védőkesztyű

RO Mănuși de lucru
FR Gants de travail
IT Guanti da lavoro
ES Guantes de piel
CN 防护手套

NYLON

PU



4131X EN 388



YATO

Size / Rozmiar



YT-74699	9	50/100
YT-7470	10	50/100

EN Working gloves
PL Rękawice robocze
DE Arbeitshandschuhe
RU Рабочие перчатки
CZ Pracovní rukavice
HU Védőkesztyű

RO Mănuși de lucru
FR Gants de travail
IT Guanti da lavoro
ES Guantes de piel
CN 劳保手套

NYLON

PU



3131X EN 388



YATO

Size / Rozmiar



YT-74719	9	50/100
YT-7472	10	50/100

EN Working gloves
PL Rękawice robocze
DE Arbeitshandschuhe
RU Рабочие перчатки
CZ Pracovní rukavice
HU Védőkesztyű

RO Mănuși de lucru
FR Gants de travail
IT Guanti da lavoro
ES Guantes de piel
CN 防护手套

NYLON

PU



4131X EN 388



YATO

Size / Rozmiar



YT-74728	8	50/100
YT-74729	9	50/100
YT-7473	10	50/100

EN Working gloves
PL Rękawice robocze
DE Arbeitshandschuhe
RU Рабочие перчатки
CZ Pracovní rukavice
HU Védőkesztyű

RO Mănuși de lucru
FR Gants de travail
IT Guanti da lavoro
ES Guantes de piel
CN 防护手套

NYLON

NITRILE
NITRYL



3121X EN 388



YATO

Size / Rozmiar



YT-74739	9	50/100
YT-7474	10	10/100

EN Working gloves
PL Rękawice robocze
DE Arbeitshandschuhe
RU Рабочие перчатки
CZ Pracovní rukavice
HU Védőkesztyű

RO Mănuși de lucru
FR Gants de travail
IT Guanti da lavoro
ES Guantes de piel
CN 劳保手套

PE

NITRILE
NITRYL



4121X EN 388



YATO

Size / Rozmiar



YT-7480	9	12/120
YT-7481	10	12/120

EN Working gloves
PL Rękawice robocze
DE Arbeitshandschuhe
RU Рабочие перчатки
CZ Pracovní rukavice
HU Védőkesztyű

RO Mănuși de lucru
FR Gants de travail
IT Guanti da lavoro
ES Guantes de piel
CN 防护手套

HPPE

PU



4X43B EN 388



YATO

Size / Rozmiar



YT-74771	9	12/120
YT-74772	10	12/120

EN Assembly gloves
PL Rękawice ochronne
DE Schutzhandschuhe
RU Защитные перчатки
CZ Ochranné rukavice
HU Védőkesztyű

RO Manusi pt. lucru
FR Gants de protection
IT Guanti di protezione
ES Guantes de protección
CN 防护手套



COTTON
BAWELNA



2122X EN 388



YATO

Size / Rozmiar



YT-74639	8	10/120
YT-746391	9	10/120
YT-74640	10	10/120

EN Assembly gloves
PL Rękawice ochronne
DE Schutzhandschuhe
RU Защитные перчатки
CZ Ochranné rukavice
HU Védőkesztyű

RO Manusi pt. lucru
FR Gants de protection
IT Guanti di protezione
ES Guantes de protección
CN 防护手套



COTTON
BAWELNA



2122X EN 388



YATO

Size / Rozmiar



YT-746418	8	10/120
YT-746419	9	10/120
YT-74642	10	10/120

EN Assembly gloves
PL Rękawice ochronne
DE Schutzhandschuhe
RU Защитные перчатки
CZ Ochranné rukavice
HU Védőkesztyű

RO Manusi pt. lucru
FR Gants de protection
IT Guanti di protezione
ES Guantes de protección
CN 防护手套

10
SIZE / ROZMIAR



2122X EN 388



YATO

Size / Rozmiar



YT-74645	10	10/120
----------	----	--------

EN Assembly gloves
PL Rękawice ochronne
DE Schutzhandschuhe
RU Защитные перчатки
CZ Ochranné rukavice
HU Védőkesztyű

RO Manusi pt. lucru
FR Gants de protection
IT Guanti di protezione
ES Guantes de protección
CN 防护手套

10
SIZE / ROZMIAR



2122X EN 388



YATO

Size / Rozmiar



YT-74647	10	10/120
----------	----	--------

EN Assembly gloves
PL Rękawice ochronne
DE Schutzhandschuhe
RU Защитные перчатки
CZ Ochranné rukavice
HU Védőkesztyű

RO Manusi pt. lucru
FR Gants de protection
IT Guanti di protezione
ES Guantes de protección
CN 劳保手套

10
SIZE / ROZMIAR



2122X EN 388



YATO

Size / Rozmiar



YT-74650	10	10/120
----------	----	--------

EN Assembly gloves
PL Rękawice ochronne
DE Arbeitshandschuhe
RU Защитные перчатки
CZ Ochranné rukavice
HU Védőkesztyű

RO Manusi pt. lucru
FR Gants de protection
IT Guanti di protezione
ES Guantes de protección
CN 防护手套

10
SIZE / ROZMIAR



SYNTHETIC
LEATHER
SZTUCZNA
SKÓRA



YATO

Size / Rozmiar





YT-74670	10	10/120
----------	----	--------

EN Fingerless assembly gloves
PL Rękawice ochronne bez palców
DE Fingerlose Arbeitshandschuhe
RU Защитные перчатки без пальцев
CZ Ochranné rukavice bez prstů
HU Ujjvég nélküli védőkesztyű

RO Mănuși de lucru
FR Gants de protection sans doigts
IT Guanti di protezione senza dita
ES Guantes de protección sin dedos
CN 手套





YATO 	Size / Rozmiar	
YT-74658	8	12/72
YT-74659	9	12/72
YT-74660	10	12/72

EN Fingerless assembly gloves
PL Rękawice ochronne bez palców
DE Fingerlose Arbeitshandschuhe
RU Защитные перчатки без пальцев
CZ Ochranné rukavice bez prstů
HU Ujjvég nélküli védőkesztyű

RO Mănuși de lucru
FR Gants de protection sans doigts
IT Guanti di protezione senza dita
ES Guantes de protección sin dedos
CN 手套





YATO 	Size / Rozmiar	
YT-74661	9	12/72
YT-74662	10	12/72

EN Working gloves
PL Rękawice robocze
DE Arbeitshandschuhe
RU Рабочие перчатки
CZ Pracovní rukavice
HU Védőkesztyű



RO Mănuși de lucru
FR Gants de travail
IT Guanti da lavoro
ES Guantes de piel
CN 防护手套



YATO 	Size / Rozmiar	
YT-74651	8	12/120
YT-74652	9	12/120
YT-74653	10	12/120



EN Working gloves
PL Rękawice robocze
DE Arbeitshandschuhe
RU Рабочие перчатки
CZ Pracovní rukavice
HU Védőkesztyű
RO Mănuși de lucru
FR Gants de travail
IT Guanti da lavoro
ES Guantes de piel
CN 防护手套



YATO 	Size / Rozmiar	
YT-74654	8	12/120
YT-74655	9	12/120
YT-74656	10	12/120



EN Working gloves
PL Rękawice robocze
DE Arbeitshandschuhe
RU Рабочие перчатки
CZ Pracovní rukavice
HU Védőkesztyű
RO Mănuși de lucru
FR Gants de travail
IT Guanti da lavoro
ES Guantes de piel
CN 防护手套



YATO 	Size / Rozmiar	
YT-746628	8	12/72
YT-74663	9	12/72
YT-74664	10	12/72



EN Working gloves
PL Rękawice robocze
DE Arbeitshandschuhe
RU Рабочие перчатки
CZ Pracovní rukavice
HU Védőkesztyű
RO Mănuși de lucru
FR Gants de travail
IT Guanti da lavoro
ES Guantes de piel
CN 防护手套



YATO 	Size / Rozmiar	
YT-746648	8	12/72
YT-74665	9	12/72
YT-74666	10	12/72

EN Working gloves
PL Rękawice robocze
DE Arbeitshandschuhe
RU Рабочие перчатки
CZ Pracovní rukavice
HU Védőkesztyű
RO Mănuși de lucru
FR Gants de travail
IT Guanti da lavoro
ES Guantes de piel
CN 防护手套



YATO 	Size / Rozmiar	
YT-74667	9	12/72
YT-74668	10	12/72

EN Welding gloves
PL Rękawice spawalnicze
DE Schweißhandschuhe
RU Сварочные перчатки
CZ Svářečské rukavice
HU Hegesztőkesztyű

RO Manusi pt. sudura
FR Gants de soudure
IT Guanti per saldatura
ES Guantes de soldador
CN 焊接手套



YATO 	Size / Rozmiar	
YT-74820	10	12/120

EN Welding gloves
PL Rękawice spawalnicze
DE Schweißhandschuhe
RU Сварочные перчатки
CZ Svářečské rukavice
HU Hegesztőkesztyű

RO Manusi pt. sudura
FR Gants de soudure
IT Guanti per saldatura
ES Guantes de soldador
CN 焊接手套





YATO 	Size / Rozmiar	
YT-74822	10	12/72

EN Welding gloves
PL Rękawice spawalnicze
DE Schweißhandschuhe
RU Сварочные перчатки
CZ Svářečské rukavice
HU Hegesztőkesztyű

RO Manusi pt. sudura
FR Gants de soudure
IT Guanti per saldatura
ES Guantes de soldador
CN 焊接手套



YATO 	Size / Rozmiar	
YT-74824	10	12/72

EN Tool apron
PL Fartuch roboczy
DE Werkzeugschürze
RU Фартук для инструментов
CZ Zástěra na nářadí
HU Kertész kötény
RO Șort pt. scule
FR Outil tablier
IT Grembiule da lavoro
ES Delantal para herramientas
CN 围裙



6
PCS





YATO  
YT-74060 60

EN Elastic adjustable safety support belt
PL Pas antyprzeciążeniowy elastyczny
DE Elastische Industriegurt
RU Эластичный поддерживающий пояс с подтяжками
CZ Elastický opasek
HU Rugalmas deréktámasztó öv
RO Cureau de siguranță elastică ajustabilă
FR Élastique de sécurité retour ceinture de soutien
IT Cintura elastica di sovraccarico con bretelle staccabili
ES Cinturón de soporte elástico ajustable
CN 护腰带



ELASTIC
ELASTYCZNY
DETACHABLE
SUSPENSERS
ODPIRANE
SZELKI





YATO  
YT-742401 Size / Rozmiar XL 50

EN High visibility elastic adjustable safety support belt
PL Pas antyprzeciążeniowy elastyczny odblaskowy
DE Elastische reflektierende Industriegurt
RU Эластичный поддерживающий пояс с высокой видимостью
CZ Reflexní elastický opasek
HU Hivis rugalmas deréktámasztó öv
RO Cureau de siguranță elastică reglabilă cu vizibilitate ridicată
FR Élastique salut-vis de sécurité retour ceinture de soutien
IT Cintura di sovraccarico ad alta visibilità
ES Cinturón de soporte elástico ajustable de alta visibilidad
CN 护腰带

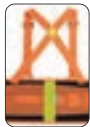

HOOK
FASTENER
RZEP
HIGH
VISIBILITY
DOBRA
WIDOCZNOŚĆ





YATO  
YT-74241 XL 50
YT-742411 XXL 50

EN High visibility elastic adjustable safety support belt
PL Pas antyprzeciążeniowy elastyczny odblaskowy
DE Elastische reflektierende Industriegurt
RU Эластичный поддерживающий пояс с высокой видимостью
CZ Reflexní elastický opasek
HU Hivis rugalmas deréktámasztó öv
RO Cureau de siguranță elastică reglabilă cu vizibilitate ridicată
FR Élastique salut-vis de sécurité retour ceinture de soutien
IT Cintura di sovraccarico ad alta visibilità
ES Cinturón de soporte elástico ajustable de alta visibilidad
CN 护腰带



HOOK
FASTENER
RZEP
HIGH
VISIBILITY
DOBRA
WIDOCZNOŚĆ



YATO  
YT-74242 XL 50
YT-742421 XXL 50

EN Safety harness for working at height
PL Szelki bezpieczeństwa z pasem biodrowym
DE Sicherheitsgurt für Arbeiten in Höhe
RU Страхочная привязь для работы на высоте
CZ Celotělový úvazek
HU Biztonsági heveder
RO Centura de siguranță tip ham
FR Arnés de seguridad
IT Imbracatura di sicurezza con cosciale
ES Harnais de sécurité
CN 高空作业安全带



x4
TOOL LOOP
PĘTLA NARZĘDZIOWA
max
100 kg
EVA
PADDING
WYSOČKÓŁKA
AI

YATO  
YT-74218 5

EN Harness and lanyard set
PL Zestaw szelki i amortyzator
DE Auffanggurt mit Abseilgerät Set
RU Комплект для работ на высоте
CZ Sada šle a tlumič
HU Teljes testheveder és energiaelnyelő kántár szett
RO Set ham si franghie sustinere
FR Kit harnais de protection anti-chutes et amortisseur
IT Set di imbracatura di sicurezza e ammortizzatore
ES Arnés y amortiguador, juego
CN 安全绳



100%
POLYESTER
POLYESTER



YATO  
YT-74235 10

EN Safety harness for working at height
PL Szelki bezpieczeństwa z pasem biodrowym
DE Sicherheitsgurt für Arbeiten in Höhe
RU Страхочная привязь для работы на высоте
CZ Celotělový úvazek
HU Biztonsági heveder
RO Centura de siguranță tip ham
FR Arnés de seguridad
IT Imbracatura di sicurezza con cosciale
ES Harnais de sécurité
CN 高空作业安全带



100%
POLYESTER
POLYESTER

YATO  
YT-74220 10

EN Safety harness for working at height
PL Szelki bezpieczeństwa
DE Sicherheitsgurt für Arbeiten in Höhe
RU Страхочная привязь для работы на высоте
CZ Celotělový úvazek
HU Biztonsági heveder
RO Centura de siguranță tip ham
FR Arnés de seguridad
IT Imbracatura di sicurezza
ES Harnais de sécurité
CN 高空作业安全带



100%
POLYESTER
POLYESTER

YATO  
YT-74221 20

EN Single shock absorber with rope
 PL Amortyzator z linką
 DE Abseilgerät mit Seil
 RU Амортизатор с тросиком
 CZ Tlumič s lanem
 HU Energiaelnyelő kántár kötéllel
 RO Franghie cu amortizor pt. socuri
 FR Amortisseur avec câble d'attache
 IT Ammortizzatore con cordino
 ES Amortiguador con cable
 CN 安全绳

100%
 POLYESTER



YATO
 YT-74236

12

EN Shock absorber
 PL Amortyzator bezpieczeństwa
 DE Verbindungsmittel mit Bandfalldämpfer
 RU Строп с амортизатором
 CZ Tlumič pádu s karabinou
 HU Energiaelnyelő hevederszalag
 RO Disipator de energie, cu cordon
 FR Cordes de sécurité avec amortisseur de chute
 IT Ammortizzatore di sicurezza
 ES Amortiguador de caída
 CN 安全绳

100%
 POLYESTER



YATO
 YT-74227

15

EN Shock absorber
 PL Amortyzator bezpieczeństwa
 DE Verbindungsmittel mit Bandfalldämpfer
 RU Строп с амортизатором
 CZ Tlumič pádu s karabinou
 HU Energiaelnyelő hevederszalag
 RO Disipator de energie, cu cordon
 FR Cordes de sécurité avec amortisseur de chute
 IT Ammortizzatore di sicurezza
 ES Amortiguador de caída
 CN 高空作业挂绳

1.8 m
 45 mm
 max 100 kg

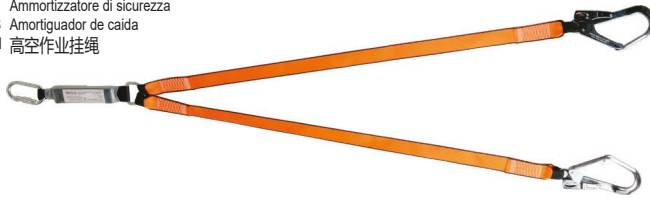

YATO
 YT-74225

10

EN Stranded hooks
 PL Linka pomocnicza z karabińczykami
 DE Hilfsseil mit Karabinerhaken
 RU Вспомогательный тросик с карабинами
 CZ Pomocné lano s karabinami
 HU Segédkötél karabinerekkel
 RO Franghie de sustinere
 FR Câble de secours avec mousquetons
 IT Cordino con moschettoni
 ES Cable auxiliar con mosquetones
 CN 安全绳

100%
 POLYESTER



YATO
 YT-74231

15

EN Steel carabiner snap hook with locking screw
 PL Karabińczyk, zatrzasknik do szelek bezpieczeństwa z nakrętką blokującą
 DE Karabiner Snap Haken Clip mit Schraube Lock
 RU Карабин стальной
 CZ Carabiná
 HU Karabiner
 RO Carabiná
 FR Mousqueton
 IT Moschettone
 ES Mosquetón
 CN 弹簧钩

16 mm
 SELF CLOSING
 AUTOMATYCZNE ZAMYKANIE
 MANUAL LOCKING
 RĘCZNE BLOKOWANIE



YATO
 YT-74229

20

EN Snap hook
 PL Karabińczyk stalowy
 DE Stahlkarabinerhaken
 RU Стальной карабин
 CZ Ocelová karabina
 HU Acél karabiner
 RO Carabina
 FR Mousqueton en acier
 IT Moschettone in acciaio
 ES Mosquetón de acero
 CN 大钩

52 mm
 SELF CLOSING
 AUTOMATYCZNE ZAMYKANIE



YATO
 YT-74230

30

EN Knee pads
 PL Nakolanniki
 DE Knieeschützer
 RU Наколенники
 CZ Chrániče kolien
 HU Térdvédő
 RO Genunchiere
 FR Genouillères
 IT Protettore per ginocchio
 ES Rodilleras
 CN 护膝

600D
 POLYESTER
 PE
 NBR



YATO
 YT-74612

20

EN Gel knee pads
 PL Nakolanniki żelowe
 DE Gel Knieeschoner
 RU Гелевые наколенники
 CZ Nákolenníky gelové
 HU Térdvédő zselés
 RO Genunchiere cu protectie de silicon
 FR Genouillères à coussinets de gel
 IT Protettore per ginocchio
 ES Protectores de gel para rodillas
 CN 护膝

600D
 POLYESTER
 EVA
 PVC
 GEL
 SUPPORT
 OCHRONA



YATO
 YT-7460

12

EN Gel knee pads
 PL Nakolanniki żelowe
 DE Gel Knieeschoner
 RU Гелевые наколенники
 CZ Nákolenníky gelové
 HU Térdvédő zselés
 RO Genunchiere cu protectie de silicon
 FR Genouillères à coussinets de gel
 IT Protettore per ginocchio
 ES Protectores de gel para rodillas
 CN 护膝

600D
 POLYESTER
 EVA
 PVC
 GEL
 SUPPORT
 OCHRONA



YATO
 YT-7461

12

EN Disposable dust masks
PL Półmaski filtrujące jednorazowe
DE Atemschutzmaske
RU Респиратор противопылевой одноразовый
CZ Protiprašná maska
HU Eldobható porvédőmaszk
RO Masca praf
FR Demi-masques de filtration
IT Maschera filtra polvere
ES Mascarilla desechable para protección contra polvo
CN 折叠口罩



EN 149:2001 + A1

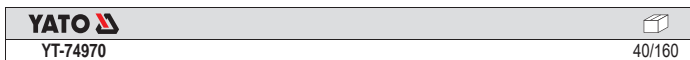

EN Disposable dust masks
PL Półmaski filtrujące jednorazowe
DE Atemschutzmaske
RU Респиратор противопылевой одноразовый
CZ Protiprašná maska
HU Eldobható porvédőmaszk
RO Masca praf
FR Demi-masques de filtration
IT Maschera filtra polvere
ES Mascarilla desechable para protección contra polvo
CN 折叠口罩



EN 149:2001 + A1



EN Disposable dust masks with valve
PL Półmaski filtrujące jednorazowe z zaworem
DE Atemschutzmaske mit Ventil
RU Респиратор противопылевой одноразовый с клапаном
CZ Protiprašná maska s ventilem
HU Eldobható porvédőmaszk, szelepes
RO Masca praf cu valva
FR Demi-masques de filtration
IT Maschera respiratoria con valvola di espirazione
ES Mascarilla desechable para protección contra polvo
CN 带阀防尘面罩



EN 149:2001 + A1



EN Disposable dust masks
PL Półmaski filtrujące jednorazowe
DE Atemschutzmaske
RU Респиратор противопылевой одноразовый
CZ Protiprašná maska
HU Eldobható porvédőmaszk
RO Masca praf
FR Demi-masques de filtration
IT Maschera filtra polvere
ES Mascarilla desechable para protección contra polvo
CN 折叠口罩



EN 149:2001 + A1



EN Disposable dust masks with valve
PL Półmaski filtrujące jednorazowe z zaworem
DE Atemschutzmaske mit Ventil
RU Респиратор противопылевой одноразовый с клапаном
CZ Protiprašná maska s ventilem
HU Eldobható porvédőmaszk, szelepes
RO Masca praf cu valva
FR Demi-masques de filtration
IT Maschera respiratoria con valvola di espirazione
ES Mascarilla desechable para protección contra polvo
CN 带阀防尘面罩



EN 149:2001 + A1



EN Disposable dust masks with valve
PL Półmaski filtrujące jednorazowe z zaworem
DE Atemschutzmaske mit Ventil
RU Респиратор противопылевой одноразовый с клапаном
CZ Protiprašná maska s ventilem
HU Eldobható porvédőmaszk, szelepes
RO Masca praf cu valva
FR Demi-masques de filtration
IT Maschera respiratoria con valvola di espirazione
ES Mascarilla desechable para protección contra polvo
CN 带阀防尘面罩



EN 149:2001 + A1



EN Disposable dust masks
 PL Półmaski filtrujące jednorazowe
 DE Atemschutzmaske
 RU Респиратор противопылевой одноразовый
 CZ Protiprašná maska
 HU Eldobható porvédőmaszk
 RO Masca praf
 FR Demi-masques de filtration
 IT Maschera filtra polvere
 ES Mascara de polvo desechable para protección contra polvo
 CN 折叠口罩

2
PCS **FFP1** 



EN 149:2001 + A1

YATO  **YT-74852**  50

EN Disposable dust masks
 PL Półmaski filtrujące jednorazowe
 DE Atemschutzmaske
 RU Респиратор противопылевой одноразовый
 CZ Protiprašná maska
 HU Eldobható porvédőmaszk
 RO Masca praf
 FR Demi-masques de filtration
 IT Maschera filtra polvere
 ES Mascara de polvo desechable para protección contra polvo
 CN 折叠口罩

3
PCS **FFP1** 



EN 149:2001 + A1



YATO  **YT-7485**  25/50

EN Disposable dust mask with valve
 PL Półmaska filtrująca jednorazowa z zaworem
 DE Atemschutzmaske mit Ventil
 RU Респиратор противопылевой одноразовый с клапаном
 CZ Protiprašná maska s ventilem
 HU Eldobható porvédőmaszk, szelepes
 RO Masca praf cu valva
 FR Demi-masques de filtration
 IT Maschera respiratoria con valvola di espirazione
 ES Mascara de polvo desechable para protección contra polvo
 CN 带阀防尘面罩

FFP1 



EN 149:2001 + A1



YATO  **YT-74862**  50

EN Disposable dust masks with valve
 PL Półmaski filtrujące jednorazowe z zaworem
 DE Atemschutzmaske mit Ventil
 RU Респиратор противопылевой одноразовый с клапаном
 CZ Protiprašná maska s ventilem
 HU Eldobható porvédőmaszk, szelepes
 RO Masca praf cu valva
 FR Demi-masques de filtration
 IT Maschera respiratoria con valvola di espirazione
 ES Mascara de polvo desechable para protección contra polvo
 CN 带阀防尘面罩

3
PCS **FFP1** 



EN 149:2001 + A1



YATO  **YT-7486**  25/50

EN Disposable dust masks
 PL Półmaski filtrujące jednorazowe
 DE Atemschutzmaske
 RU Респиратор противопылевой одноразовый
 CZ Protiprašná maska
 HU Eldobható porvédőmaszk
 RO Masca praf
 FR Demi-masques de filtration
 IT Maschera filtra polvere
 ES Mascara de polvo desechable para protección contra polvo
 CN 折叠口罩

3
PCS **FFP1** 



EN 149:2001 + A1

YATO  **YT-74870**  50

EN Disposable dust masks with valve
 PL Półmaski filtrujące jednorazowe z zaworem
 DE Atemschutzmaske mit Ventil
 RU Респиратор противопылевой одноразовый с клапаном
 CZ Protiprašná maska s ventilem
 HU Eldobható porvédőmaszk, szelepes
 RO Masca praf cu valva
 FR Demi-masques de filtration
 IT Maschera respiratoria con valvola di espirazione
 ES Mascara de polvo desechable para protección contra polvo
 CN 带阀防尘面罩

3
PCS **FFP1** 



EN 149:2001 + A1

YATO  **YT-7488**  50/50

EN Disposable dust masks with valve
PL Półmaski filtrujące jednorazowe z zaworem
DE Atemschutzmaske mit Ventil
RU Респиратор противопылевой одноразовый с клапаном
CZ Protiprášná maska s ventilem
HU Eldobható porvédőmaszk, szelepes
RO Masca praf cu valva
FR Demi-masques de filtration
IT Maschera respiratoria con valvola di espirazione
ES Mascarilla desechable para protección contra polvo
CN 带阀防尘面罩



3
PCS
FFP2

EN 149:2001 + A1

YATO 
YT-74917  50

EN Disposable dust masks with valve
PL Półmaski filtrujące jednorazowe z zaworem
DE Atemschutzmaske mit Ventil
RU Респиратор противопылевой одноразовый с клапаном
CZ Protiprášná maska s ventilem
HU Eldobható porvédőmaszk, szelepes
RO Masca praf cu valva
FR Demi-masques de filtration
IT Maschera respiratoria con valvola di espirazione
ES Mascarilla desechable para protección contra polvo
CN 带阀防尘面罩



3
PCS
FFP2

EN 149:2001 + A1

YATO 
YT-7492  15/50

EN Disposable dust masks
PL Półmaski filtrujące jednorazowe
DE Atemschutzmaske
RU Респиратор противопылевой одноразовый
CZ Protiprášná maska
HU Eldobható porvédőmaszk
RO Masca praf
FR Demi-masques de filtration
IT Maschera filtra polvere
ES Mascarilla desechable para protección contra polvo
CN 折叠口罩



2
PCS
FFP2

EN 149:2001 + A1

YATO 
YT-74919  50

EN Disposable dust mask with valve
PL Półmaska filtrująca jednorazowa z zaworem
DE Atemschutzmaske mit Ventil
RU Респиратор противопылевой одноразовый с клапаном
CZ Protiprášná maska s ventilem
HU Eldobható porvédőmaszk, szelepes
RO Masca praf cu valva
FR Demi-masques de filtration
IT Maschera respiratoria con valvola di espirazione
ES Mascarilla desechable para protección contra polvo
CN 带阀防尘面罩



FFP2



EN 149:2001 + A1

YATO 
YT-74949  50

EN Ear plugs
PL Zatyczki do uszu
DE Ohrstöpsel
RU беруши
CZ Zátkové chrániče sluchu
HU Fül dugó
RO Antifoane interne
FR Bouchons anti-bruit
IT Tappi per orecchie
ES Tapones para los oídos
CN 耳塞

 x5 **SNR 38dB** 





YATO  Ø [mm] Pairs / Pary 
YT-7451 7-12 5 25/500

EN Ear plugs
PL Zatyczki do uszu
DE Ohrstöpsel
RU беруши
CZ Zátkové chrániče sluchu
HU Fül dugó
RO Antifoane interne
FR Bouchons anti-bruit
IT Tappi per orecchie
ES Tapones para los oídos
CN 耳塞

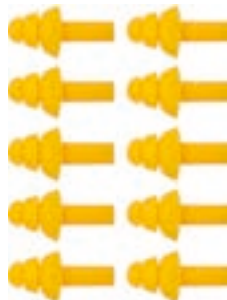
 x5 **SNR 32dB** 





YATO  Ø [mm] Pairs / Pary 
YT-7455 8-12 5 25/500

EN Ear plugs
PL Zatyczki do uszu
DE Ohrstöpsel
RU беруши
CZ Zátkové chrániče sluchu
HU Fül dugó
RO Antifoane interne
FR Bouchons anti-bruit
IT Tappi per orecchie
ES Tapones para los oídos
CN 耳塞

 x5 **SNR 31dB** 





YATO  Ø [mm] Pairs / Pary 
YT-74551 7-12 5 40/800

EN Ear plugs
PL Zatyczki do uszu
DE Ohrstöpsel
RU беруши
CZ Zátkové chrániče sluchu
HU Fül dugó
RO Antifoane interne
FR Bouchons anti-bruit
IT Tappi per orecchie
ES Tapones para los oídos
CN 耳塞

 x200 **SNR 38dB** 





YATO  Ø [mm] Pairs / Pary 
YT-74510 7-12 200 20

EN Ear plugs
PL Zatyczki do uszu
DE Ohrstöpsel
RU беруши
CZ Zátkové chrániče sluchu
HU Fül dugó
RO Antifoane interne
FR Bouchons anti-bruit
IT Tappi per orecchie
ES Tapones para los oídos
CN 耳塞

 x50 **SNR 28dB** 



YATO  Ø [mm] Pairs / Pary 
YT-7456 8-12 50 20

EN Ear plugs
 PL Zatyczki do uszu na pałką
 DE Ohrstöpsel
 RU Бериши
 CZ Zátkové chrániče sluchu
 HU Fül dugó
 RO Antifoane interne
 FR Bouchons anti-bruit
 IT Tappi per orecchie
 ES Tapones para los oídos
 CN 耳塞



SNR 29dB



YATO
 YT-7458

 25/500

EN Hearing protectors
 PL Nauszniki przeciwhałasowe
 DE Gehörschutz
 RU Средства защиты слуха
 CZ Chrániče sluchu
 HU Fültok
 RO Antifoane
 FR Casque anti-bruit
 IT Cuffie antirumore
 ES Protectores auditivos
 CN 耳罩



SNR 28dB



YATO
 YT-74624

 20

EN Hearing protectors
 PL Nauszniki przeciwhałasowe
 DE Gehörschutz
 RU Средства защиты слуха
 CZ Chrániče sluchu
 HU Fültok
 RO Antifoane
 FR Casque anti-bruit
 IT Cuffie antirumore
 ES Protectores auditivos
 CN 耳罩



SNR 26dB



YATO
 YT-7462

 40

EN Hearing protectors
 PL Nauszniki przeciwhałasowe
 DE Gehörschutz
 RU Средства защиты слуха
 CZ Chrániče sluchu
 HU Fültok
 RO Antifoane
 FR Casque anti-bruit
 IT Cuffie antirumore
 ES Protectores auditivos
 CN 耳罩



SNR 25dB



YATO
 YT-7463

 20

EN Hearing protectors
 PL Nauszniki przeciwhałasowe
 DE Gehörschutz
 RU Средства защиты слуха
 CZ Chrániče sluchu
 HU Fültok
 RO Antifoane
 FR Casque anti-bruit
 IT Cuffie antirumore
 ES Protectores auditivos
 CN 耳罩



SNR 27dB



YATO
 YT-74621

 60

EN Hearing protectors
 PL Nauszniki przeciwhałasowe
 DE Gehörschutz
 RU Средства защиты слуха
 CZ Chrániče sluchu
 HU Fültok
 RO Antifoane
 FR Casque anti-bruit
 IT Cuffie antirumore
 ES Protectores auditivos
 CN 耳罩



SNR 32dB



YATO
 YT-74633

 24

EN Combined eye & ear protection muffs
 PL Nauszniki zintegrowane z okularami
 DE Kapselgehörschutz mit Brille integriert
 RU Противошумные наушники с очками
 CZ Chrániče uší integrované s brýlemi
 HU Szemüveggel integrált fülvédő
 RO Set ochelari protectie + antifoane
 FR Protège-oreilles combiné aux lunettes
 IT Cuffie antirumore con occhiali integrati
 ES Orejeras de seguridad con gafas
 CN 二合一护眼耳防护套

SNR 23.9dB

ABS

PC

1
 OPTICAL CLASS
 KLASA OPTYCZNA



Juv
 SCRATCH PROTECTION
 OCHRONA PRZED ZARYSOWANIEM



EN Combined eye & ear protection muffs
 PL Nauszniki zintegrowane z okularami
 DE Kapselgehörschutz mit Brille integriert
 RU Противошумные наушники с очками
 CZ Chrániče uší integrované s brýlemi
 HU Szemüveggel integrált fülvédő
 RO Set ochelari protectie + antifoane
 FR Protège-oreilles combiné aux lunettes
 IT Cuffie antirumore con occhiali integrati
 ES Orejeras de seguridad con gafas
 CN 二合一护眼耳防护套

SNR 23.9dB

ABS

PC

1
 OPTICAL CLASS
 KLASA OPTYCZNA



Juv
 SCRATCH PROTECTION
 OCHRONA PRZED ZARYSOWANIEM

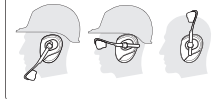

YATO
 YT-74635

 24

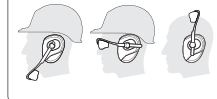

YATO
 YT-74636

 24

EN Electronic earmuffs
PL Nauszniki przeciwhałasowe elektroniczne
DE Elektronischer Gehörschutz
RU Электронные противошумные наушники
CZ Elektronické protihlukové chrániče sluchu
HU Elektronikus fültok
RO Casti electronice
FR Casque antibruit électronique
IT Cuffie protettive elettroniche
ES Casco antiruido electrónico
CN 电子耳罩



SNR
28dB

3.5h

30h

BUILT-IN MICROPHONES
WBUDOWANE MIKROFONY

VOLUME
GŁOSNOŚĆ

SMART EAR PROTECTION
INTELEGENNA OCHRONA SŁUCHU

LOW BATTERY ALARM
WSKAZNIK POZIOMU BATERII

AUX
∅ 3,5 mm

AUTO POWER OFF
AUTOMATYCZNE WYŁĄCZANIE

USB
BATTERY CHARGER
ŁADOWNIKA

EN Electronic earmuffs
PL Nauszniki przeciwhałasowe elektroniczne
DE Elektronischer Gehörschutz
RU Электронные противошумные наушники
CZ Elektronické protihlukové chrániče sluchu
HU Elektronikus fültok
RO Casti electronice
FR Casque antibruit électronique
IT Cuffie protettive elettroniche
ES Casco antiruido electrónico
CN 电子耳罩



SNR
29dB

3.5h

30h

BUILT-IN MICROPHONES
WBUDOWANE MIKROFONY

WIRELESS TECHNOLOGY
TECHNOLOGIA BEZPRZEWODOWA

LOW BATTERY ALARM
WSKAZNIK POZIOMU BATERII

AUX
∅ 3,5 mm

AUTO POWER OFF
AUTOMATYCZNE WYŁĄCZANIE

USB
BATTERY CHARGER
ŁADOWNIKA

YATO
YT-74625 20

YATO
YT-74626 20

EN Replacement grey lens
PL Szkiełka wymienne szare
DE Wechselläser grau
RU Сменные стекла, серые
CZ Výměnná skla šedá
HU Szürke pótlencse
RO Lentile gri rezerva
FR Verres gris interchangeables
IT Lenti per occhiali grigi
ES Lentes reemplazables, color gris
CN 镜片

1
OPTICAL CLASS
KLASA OPTYCZNA

PC

Juv

SCRATCH PROTECTION
OCZYSZCZENIE PRZED ZARYSOWANIEM



For YT-74635, YT-74636
Dla YT-74635, YT-74636

YATO
YT-74637 30/600

EN Replacement transparent lens
PL Szkiełka wymienne bezbarwne
DE Wechselläser klar
RU Сменные стекла, бесцветные
CZ Výměnná skla bezbarvá
HU Színezetlen pótlencse
RO Lentile transparente rezerva
FR Verres transparentes interchangeables
IT Lenti per occhiali trasparenti
ES Lentes reemplazables, transparentes
CN 镜片

1
OPTICAL CLASS
KLASA OPTYCZNA

PC

Juv

SCRATCH PROTECTION
OCZYSZCZENIE PRZED ZARYSOWANIEM



For YT-74635, YT-74636
Dla YT-74635, YT-74636

YATO
YT-74638 30/600

EN Safety helmet
PL Kask ochronny
DE Schutzhelm
RU Каска защитная
CZ Ochranná přilba
HU Védősisak
RO Cască de protecție
FR Casque de sécurité
IT Casco di protezione
ES Casco de protección
CN 安全帽



ABS

YATO	Color / Kolor	
YT-73970	pomarańczowy	30
YT-73971	żółty	30
YT-73972	biały	30
YT-73973	czerwony	30
YT-73974	niebieski	30
YT-73975	zielony	30

EN Hearing protectors
PL Nauszniki przeciwhałasowe
DE Gehörschutz
RU Средства защиты слуха
CZ Chrániče sluchu
HU Fültok
RO Antifoane
FR Casque anti-bruit
IT Cuffie antrumore
ES Protectores auditivos
CN 耳罩



SNR
28dB

YATO
YT-74624 20

- EN Safety sandals
- PL Sandały robocze
- DE Arbeitshalschuhe
- RU Полуботинки рабочие
- CZ Pracovní polobotky
- HU Munkavédelmi félcipő
- RO Bocanci de lucru
- FR Sandale de sécurité
- IT Sandalo da lavoro
- ES Zapato de trabajo
- CN 劳保鞋



- Composite toe cap
- PU overcup
- Insole & mesh coated EVA
- Shock absorber
- Kompozytowy nosek
- Podeszwa z poliuretanu z noskiem
- Wkładka i wyściółka z materiału EVA
- Amortyzator drgań

SEGURA

YATO	Size / Rozmiar	
YT-80460	36	10
YT-80461	37	10
YT-80462	38	10
YT-80463	39	10
YT-80464	40	10
YT-80465	41	10
YT-80466	42	10
YT-80467	43	10
YT-80468	44	10
YT-80469	45	10
YT-80470	46	10
YT-80471	47	10

- EN Low-cut safety shoes
- PL Półbuty robocze
- DE Arbeitshalschuhe
- RU Полуботинки рабочие
- CZ Pracovní polobotky
- HU Munkavédelmi félcipő
- RO Bocanci de lucru
- FR Chaussure de sécurité
- IT Scarpe da lavoro
- ES Zapato de trabajo
- CN 劳保鞋



- Steel toe cap
- PU overcup
- Insole & mesh coated EVA
- Shock absorber
- Stalowy nosek
- Podeszwa z poliuretanu z noskiem
- Wkładka i wyściółka z materiału EVA
- Amortyzator drgań

PUNO

YATO	Size / Rozmiar	
YT-80521	39	10
YT-80522	40	10
YT-80523	41	10
YT-80524	42	10
YT-80525	43	10
YT-80526	44	10
YT-80527	45	10
YT-80528	46	10
YT-80529	47	10

- EN Low-cut safety shoes
- PL Półbuty robocze
- DE Arbeitshalschuhe
- RU Полуботинки рабочие
- CZ Pracovní polobotky
- HU Munkavédelmi félcipő
- RO Bocanci de lucru
- FR Chaussure de sécurité
- IT Scarpe da lavoro
- ES Zapato de trabajo
- CN 劳保鞋



- Steel toe cap
- PU overcup
- Insole & mesh coated EVA
- Shock absorber
- Stalowy nosek
- Podeszwa z poliuretanu z noskiem
- Wkładka i wyściółka z materiału EVA
- Amortyzator drgań

PARENA

YATO	Size / Rozmiar	
YT-80572	39	10
YT-80573	40	10
YT-80574	41	10
YT-80575	42	10
YT-80576	43	10
YT-80577	44	10
YT-80578	45	10
YT-80579	46	10
YT-80580	47	10

- EN Low-cut safety shoes
- PL Półbuty robocze
- DE Arbeitshalschuhe
- RU Полуботинки рабочие
- CZ Pracovní polobotky
- HU Munkavédelmi félcipő
- RO Bocanci de lucru
- FR Chaussure de sécurité
- IT Scarpe da lavoro
- ES Zapato de trabajo
- CN 劳保鞋



- Steel toe cap
- PU overcup
- Insole & mesh coated EVA
- Shock absorber
- Stalowy nosek
- Podeszwa z poliuretanu z noskiem
- Wkładka i wyściółka z materiału EVA
- Amortyzator drgań

PIURA

YATO	Size / Rozmiar	
YT-80552	39	10
YT-80553	40	10
YT-80554	41	10
YT-80555	42	10
YT-80556	43	10
YT-80557	44	10
YT-80558	45	10
YT-80559	46	10
YT-80560	47	10

- EN Low-cut safety shoes
- PL Półbuty robocze
- DE Arbeitshalschuhe
- RU Полуботинки рабочие
- CZ Pracovní polobotky
- HU Munkavédelmi félcipő
- RO Bocanci de lucru
- FR Chaussure de sécurité
- IT Scarpe da lavoro
- ES Zapato de trabajo
- CN 劳保鞋

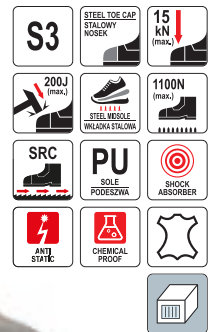

- Steel toe cap
- PU overcup
- Insole & mesh coated EVA
- Shock absorber
- Stalowy nosek
- Podeszwa z poliuretanu z noskiem
- Wkładka i wyściółka z materiału EVA
- Amortyzator drgań

PUEBLE

YATO	Size / Rozmiar	
YT-80583	39	10
YT-80584	40	10
YT-80585	41	10
YT-80586	42	10
YT-80587	43	10
YT-80588	44	10
YT-80589	45	10
YT-80590	46	10
YT-80591	47	10

EN Sport safety shoes
PL Buty ochronne sportowe
DE Sportschutzhuhe
RU Спортивная защитная обувь
CZ Sportovní ochranné boty
HU Sport védőcipő
RO Pantof sport de lucru
FR Chaussures de sécurité sport
IT Scarpe antinfortunistiche sportive
ES Calzado de seguridad deportivo
CN 安全鞋



- Steel toe cap
- Puncture-resistant flexible composite midsole
- Comfortable EVA foam insole

- Stalowy nosek
- Elastyczna wkładka antyprzebiociva z tworzywa sztucznego
- Komfortowa wkładka wewnętrzna z pianki EVA



PACS

YATO	Size / Rozmiar	Box
YT-80629	36	10
YT-80630	37	10
YT-80631	38	10
YT-80632	39	10
YT-80633	40	10
YT-80634	41	10

YATO	Size / Rozmiar	Box
YT-80635	42	10
YT-80636	43	10
YT-80637	44	10
YT-80638	45	10
YT-80639	46	10
YT-80640	47	10

EN Low-cut safety shoes
PL Półbuty robocze
DE Arbeitshalbschuhe
RU Полуботинки рабочие
CZ Pracovní polobotky
HU Munkavédelmi félcipő
RO Bocanci de lucru
FR Chaussure de sécurité
IT Scarpe da lavoro
ES Zapato de trabajo
CN 劳保鞋



- Composite toe cap
- Puncture-resistant flexible composite midsole

- Kompozycyjny nosek
- Elastyczna wkładka antyprzebiociva z tworzywa sztucznego



PERA

YATO	Size / Rozmiar	Box
YT-80488	39	10
YT-80489	40	10
YT-80490	41	10
YT-80491	42	10
YT-80492	43	10

YATO	Size / Rozmiar	Box
YT-80493	44	10
YT-80494	45	10
YT-80495	46	10
YT-80496	47	10

EN Sport safety shoes
PL Buty ochronne sportowe
DE Sportschutzhuhe
RU Спортивная защитная обувь
CZ Sportovní ochranné boty
HU Sport védőcipő
RO Pantof sport de lucru
FR Chaussures de sécurité sport
IT Scarpe antinfortunistiche sportive
ES Calzado de seguridad deportivo
CN 安全鞋



- Steel toe cap
- Puncture-resistant flexible composite midsole
- Comfortable EVA foam insole
- Stalowy nosek
- Elastyczna wkładka antyprzebiociva z tworzywa sztucznego
- Komfortowa wkładka wewnętrzna z pianki EVA



PUBS

YATO	Size / Rozmiar	Box
YT-80620	39	10
YT-80621	40	10
YT-80622	41	10
YT-80623	42	10
YT-80624	43	10

YATO	Size / Rozmiar	Box
YT-80625	44	10
YT-80626	45	10
YT-80627	46	10
YT-80628	47	10

EN Sport safety shoes
PL Buty ochronne sportowe
DE Sportschutzhuhe
RU Спортивная защитная обувь
CZ Sportovní ochranné boty
HU Sport védőcipő
RO Pantof sport de lucru
FR Chaussures de sécurité sport
IT Scarpe antinfortunistiche sportive
ES Calzado de seguridad deportivo
CN 防护运动鞋



- Composite toe cap
- Puncture-resistant flexible composite midsole
- Kompozycyjny nosek
- Elastyczna wkładka antyprzebiociva z tworzywa sztucznego



PARAD

YATO	Size / Rozmiar	Box
YT-80497	39	10
YT-80498	40	10
YT-80499	41	10
YT-80500	42	10
YT-80501	43	10

YATO	Size / Rozmiar	Box
YT-80502	44	10
YT-80503	45	10
YT-80504	46	10
YT-80505	47	10

EN Sport safety shoes
PL Buty ochronne sportowe
DE Sportschutzhuhe
RU Спортивная защитная обувь
CZ Sportovní ochranné boty
HU Sport védőcipő
RO Pantof sport de lucru
FR Chaussures de sécurité sport
IT Scarpe antinfortunistiche sportive
ES Calzado de seguridad deportivo
CN 防护运动鞋



- Composite toe cap
- Puncture-resistant flexible composite midsole
- Kompozycyjny nosek
- Elastyczna wkładka antyprzebiociva z tworzywa sztucznego



POMPA

YATO	Size / Rozmiar	Box
YT-80506	36	10
YT-80507	37	10
YT-80508	38	10
YT-80509	39	10
YT-80510	40	10
YT-80511	41	10

YATO	Size / Rozmiar	Box
YT-80512	42	10
YT-80513	43	10
YT-80514	44	10
YT-80515	45	10
YT-80516	46	10
YT-80517	47	10

EN Middle-cut safety shoes
PL Trzewiki robocze
DE Arbeitsschnürschuhe
RU Ботинки рабочие
CZ Pracovní boty šněrovací
HU Munkavédelmi bakancs
RO Pantof de lucru
FR Chaussure de sécurité
IT Scarpe da lavoro
ES Calzado de trabajo
CN 劳保鞋



- Steel toe cap
- PU overcup
- Insole & mesh coated EVA
- Shock absorber
- Stalowy nosek
- Podeszwa z poliuretanu z noskiem
- Wkładka i wyściółka z materiału EVA
- Amortyzator drgań



TRAT

YATO	Size / Rozmiar	Box
YT-80733	39	10
YT-80734	40	10
YT-80735	41	10
YT-80736	42	10
YT-80737	43	10

YATO	Size / Rozmiar	Box
YT-80738	44	10
YT-80739	45	10
YT-80740	46	10
YT-80741	47	10

EN Middle-cut safety shoes
 PL Trzewiki robocze
 DE Arbeitsschnürschuhe
 RU Ботинки рабочие
 CZ Pracovní boty šněrovací
 HU Munkavédelmi bakancs
 RO Pantof de lucru
 FR Chaussure de sécurité
 IT Scarpe da lavoro
 ES Calzado de trabajo
 CN 劳保鞋



- Steel toe cap
- PU overcup
- Insole & mesh coated EVA
- Shock absorber
- Stalowy nosek
- Podeszwa z poliuretanu z noskiem
- Wkładka i wyściółka z materiału EVA
- Amortyzator drgań

TEZU

YATO	Size / Rozmiar	
YT-80841	39	10
YT-80842	40	10
YT-80843	41	10
YT-80844	42	10
YT-80845	43	10
YT-80846	44	10
YT-80847	45	10
YT-80848	46	10
YT-80849	47	10

EN Middle-cut safety shoes
 PL Trzewiki robocze
 DE Arbeitsschnürschuhe
 RU Ботинки рабочие
 CZ Pracovní boty šněrovací
 HU Munkavédelmi bakancs
 RO Pantof de lucru
 FR Chaussure de sécurité
 IT Scarpe da lavoro
 ES Calzado de trabajo
 CN 劳保鞋



- Steel toe cap
- PU overcup
- Insole & mesh coated EVA
- Shock absorber
- Stalowy nosek
- Podeszwa z poliuretanu z noskiem
- Wkładka i wyściółka z materiału EVA
- Amortyzator drgań

TOLU

YATO	Size / Rozmiar	
YT-80794	39	10
YT-80795	40	10
YT-80796	41	10
YT-80797	42	10
YT-80798	43	10
YT-80799	44	10
YT-80800	45	10
YT-80801	46	10
YT-80802	47	10

EN Middle-cut safety shoes
 PL Trzewiki robocze
 DE Arbeitsschnürschuhe
 RU Ботинки рабочие
 CZ Pracovní boty šněrovací
 HU Munkavédelmi bakancs
 RO Pantof de lucru
 FR Chaussure de sécurité
 IT Scarpe da lavoro
 ES Calzado de trabajo
 CN 劳保鞋



- Steel toe cap
- PU overcup
- Insole & mesh coated EVA
- Shock absorber
- Stalowy nosek
- Podeszwa z poliuretanu z noskiem
- Wkładka i wyściółka z materiału EVA
- Amortyzator drgań

TWER

YATO	Size / Rozmiar	
YT-80783	39	10
YT-80784	40	10
YT-80785	41	10
YT-80786	42	10
YT-80787	43	10
YT-80788	44	10
YT-80789	45	10
YT-80790	46	10
YT-80791	47	10

EN Safety boots
 PL Buty ochronne wysokie
 DE Schutzstiefel
 RU Защитные ботинки выше щиколотки
 CZ Vysoké ochranné boty
 HU Magas védőcipő
 RO Bocanci de lucru inalti
 FR Chaussures de sécurité hautes
 IT Scarpe antinfortunistiche alte
 ES Botas de seguridad
 CN 高防护靴



- Steel toe cap
- Puncture-resistant steel midsole
- Stalowy nosek
- Stalowa wkładka antyprzebiwająca

GORA

YATO	Size / Rozmiar	
YT-80701	39	5
YT-80702	40	5
YT-80703	41	5
YT-80704	42	5
YT-80705	43	5
YT-80706	44	5
YT-80707	45	5
YT-80708	46	5
YT-80709	47	5

EN Safety rain boots
 PL Kalosze z metalowym podnoskiem
 DE Gummistiefel mit Metall-Zehenschutzkappe
 RU Резиновые сапоги с металлическим подноском
 CZ Holinky s kovovou špičkou
 HU Fém orrmerevítő s gumicsizma
 RO Cizme de protecție din cauciuc pt. ploaie
 FR Bottes en caoutchouc de sécurité
 IT Stivali di gomma con puntale in metallo
 ES Botas de goma con punta metálica
 CN 安全雨鞋



- Steel toe cap
- Knee high PVC boots
- Cleated PVC outsole
- Shock absorber
- Stalowy nosek
- Cholewka z PVC do kolana
- Wyrzeźbiona podeszwa z PVC
- Amortyzator drgań

YATO	Size / Rozmiar	
YT-80881	39	8
YT-80882	40	8
YT-80883	41	8
YT-80884	42	8
YT-80885	43	8
YT-80886	44	8
YT-80887	45	8
YT-80888	46	8

EN Softshell jacket
PL Kurtka softshell
DE Softshelljacke
RU Softshell kypitka
CZ Softshellová bunda
HU Softshell dzseki
RO Jacheta softshell
FR Veste softshell
IT Giacca softshell
ES Chaqueta softshell
CN 冲锋衣



96% polyester, 4% spandex
96% poliester, 4% spandex

YATO	Size / Rozmiar	
YT-79550	S (EU) / 34 (US)	10
YT-79551	M (EU) / 36 (US)	10
YT-79552	L (EU) / 38 (US)	10
YT-79553	XL (EU) / 40 (US)	10
YT-79554	XXL (EU) / 42 (US)	10
YT-79555	XXXL (EU) / 44 (US)	10

EN Softshell jacket
PL Kurtka softshell
DE Softshelljacke
RU Softshell kypitka
CZ Softshellová bunda
HU Softshell dzseki
RO Jacheta softshell
FR Veste softshell
IT Giacca softshell
ES Chaqueta softshell
CN 冲锋衣

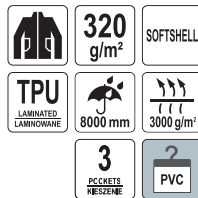

96% polyester, 4% spandex
96% poliester, 4% spandex

YATO	Size / Rozmiar	
YT-79530	S (EU) / 34 (US)	10
YT-79531	M (EU) / 36 (US)	10
YT-79532	L (EU) / 38 (US)	10
YT-79533	XL (EU) / 40 (US)	10
YT-79534	XXL (EU) / 42 (US)	10
YT-79535	XXXL (EU) / 44 (US)	10

EN Softshell jacket
PL Kurtka softshell
DE Softshelljacke
RU Softshell kypitka
CZ Softshellová bunda
HU Softshell dzseki
RO Jacheta softshell
FR Veste softshell
IT Giacca softshell
ES Chaqueta softshell
CN 冲锋衣

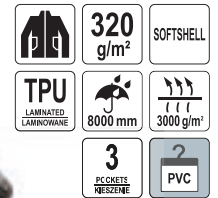

96% polyester, 4% spandex
96% poliester, 4% spandex

YATO	Size / Rozmiar	
YT-79560	S (EU) / 34 (US)	10
YT-79561	M (EU) / 36 (US)	10
YT-79562	L (EU) / 38 (US)	10
YT-79563	XL (EU) / 40 (US)	10
YT-79564	XXL (EU) / 42 (US)	10
YT-79565	XXXL (EU) / 44 (US)	10

EN Softshell jacket
PL Kurtka softshell
DE Softshelljacke
RU Softshell kypitka
CZ Softshellová bunda
HU Softshell dzseki
RO Jacheta softshell
FR Veste softshell
IT Giacca softshell
ES Chaqueta softshell
CN 冲锋衣

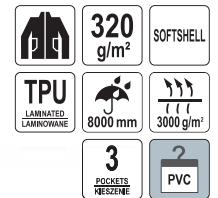

96% polyester, 4% spandex
96% poliester, 4% spandex

YATO	Size / Rozmiar	
YT-79540	S (EU) / 34 (US)	10
YT-79541	M (EU) / 36 (US)	10
YT-79542	L (EU) / 38 (US)	10
YT-79543	XL (EU) / 40 (US)	10
YT-79544	XXL (EU) / 42 (US)	10
YT-79545	XXXL (EU) / 44 (US)	10

EN Fleece jacket
 PL Bluza polarowa
 DE Fleecejacke
 RU Флисовая кофта
 CZ Fleeceová bunda
 HU Fleece dzseki
 RO Bluză polar
 FR Veste polaire
 IT Felpa in pile
 ES Chaqueta polar
 CN 摇粒绒夹克

420
g/m²
3
POCKETS
KESZENE



100% polyester
 100% poliester

YATO	Size / Rozmiar	
YT-79520	S (EU) / 34 (US)	10
YT-79521	M (EU) / 36 (US)	10
YT-79522	L (EU) / 38 (US)	10
YT-79523	XL (EU) / 40 (US)	10
YT-79524	XXL (EU) / 42 (US)	10
YT-79525	XXXL (EU) / 44 (US)	10

EN Working jacket
 PL Bluza robocza
 DE Arbeitsjacke
 RU Рабочая рубашка
 CZ Pracovní blůza
 HU Munkaruha felső
 RO Bluză de lucru
 FR Blouson de travail
 IT Felpa da lavoro
 ES Blusa de trabajo
 CN 工作服

270
g/m²
4
POCKETS
KESZENE **2**
PVC



65% polyester, 35% cotton
 65% poliester, 35% baweina

DAN

YATO	Size / Rozmiar	
YT-80280	S (EU) / 34 (US)	10
YT-80281	M (EU) / 36 (US)	10
YT-80282	L (EU) / 38 (US)	10
YT-80283	XL (EU) / 40 (US)	10
YT-80284	XXL (EU) / 42 (US)	10

EN Reflective waterproof winter safety jacket
 PL Kurtka robocza ocieplana, wodoodporna, odblokowa
 DE Warme wasserbeständige Jacke mit Reflektionsstreifen
 RU Утепленная водонепроницаемая светоотражающая куртка
 CZ Oteplená voděodolná reflexní bunda
 HU Vízálló bélelet fényvisszaverő kabát
 RO Jacheta impermeabilă reflectorizantă pt. iarnă
 FR Veste imperméable réfléchissante isolée
 IT Giacca imbottita, impermeabile, ad alta visibilità
 ES Chaqueta acolchada impermeable reflectante
 CN 荧光棉夹克

440
g/m²
PU
COATING
POWLOKA
5000
mm
 3
POCKETS
KESZENE



100% polyester
 100% poliester

YATO	Size / Rozmiar	
YT-80950	S (EU) / 34 (US)	10
YT-80951	M (EU) / 36 (US)	10
YT-80952	L (EU) / 38 (US)	10
YT-80953	XL (EU) / 40 (US)	10
YT-80954	XXL (EU) / 42 (US)	10

EN Working jacket
 PL Bluza robocza
 DE Arbeitsjacke
 RU Рабочая рубашка
 CZ Pracovní blůza
 HU Munkaruha felső
 RO Bluză de lucru
 FR Blouson de travail
 IT Felpa da lavoro
 ES Blusa de trabajo
 CN 工作服

275
g/m²
8
POCKETS
KESZENE **2**
PVC



65% polyester, 35% cotton
 65% poliester, 35% baweina

DUERO

YATO	Size / Rozmiar	
YT-8020	S (EU) / 34 (US)	20
YT-8021	M (EU) / 36 (US)	10
YT-8022	L (EU) / 38 (US)	10
YT-8023	XL (EU) / 40 (US)	20
YT-8024	XXL (EU) / 42 (US)	10

EN Working jacket
 PL Bluza robocza
 DE Arbeitsjacke
 RU Рабочая рубашка
 CZ Pracovní blůza
 HU Munkaruha felső
 RO Bluză de lucru
 FR Blouson de travail
 IT Felpa da lavoro
 ES Blusa de trabajo
 CN 劳保夹克

267
g/m²
8
POCKETS
KESZENE **2**
PVC



65% polyester, 35% cotton
 65% poliester, 35% baweina

YATO	Size / Rozmiar	
YT-80140	S	10
YT-80141	M	10
YT-80142	L	10
YT-80143	L/XL	10
YT-80144	XL	10
YT-80145	XXL	10

EN Work jacket
 PL Bluza robocza
 DE Arbeitsjacke
 RU Рабочая рубашка
 CZ Pracovní blůza
 HU Munkaruha felső
 RO Bluză de lucru
 FR Blouson de travail
 IT Felpa da lavoro
 ES Blusa de trabajo
 CN 劳保夹克

300
g/m²
7
POCKETS
KESZENE **2**
PVC



100% brushed cotton
 100% szczotkowana baweina

COMFY

YATO	Size / Rozmiar	
YT-79230	S	10
YT-79231	M	10
YT-79232	L	10
YT-79233	L/XL	10
YT-79234	XL	10
YT-79235	XXL	10

EN Working jacket
PL Bluza robocza
DE Arbeitsjacke
RU Рабочая рубашка
CZ Pracovní blůza
HU Munkaruha felső
RO Bluză de lucru
FR Blouson de travail
IT Felpa da lavoro
ES Blusa de trabajo
CN 劳保夹克



270
g/m²

8
POCKETS
MÉSZENE

2
PVC

100% polyester
100% poliester

YATO	Size / Rozmiar	
YT-80158	S	10
YT-80159	M	10
YT-80160	L	10
YT-80161	L/XL	10
YT-80162	XL	10
YT-80163	XXL	10

EN Working jacket
PL Bluza robocza
DE Arbeitsjacke
RU Рабочая рубашка
CZ Pracovní blůza
HU Munkaruha felső
RO Bluză de lucru
FR Blouson de travail
IT Felpa da lavoro
ES Blusa de trabajo
CN 劳保夹克



267
g/m²

8
POCKETS
MÉSZENE

2
PVC

65% polyester, 35% cotton
65% poliester, 35% bawelna

YATO	Size / Rozmiar	
YT-80176	S	10
YT-80177	M	10
YT-80178	L	10
YT-80179	L/XL	10
YT-80180	XL	10
YT-80181	XXL	10

EN Working jacket
PL Bluza robocza
DE Arbeitsjacke
RU Рабочая рубашка
CZ Pracovní blůza
HU Munkaruha felső
RO Bluză de lucru
FR Blouson de travail
IT Felpa da lavoro
ES Blusa de trabajo
CN 劳保夹克



245
g/m²

5
POCKETS
MÉSZENE

2
PVC

65% polyester, 35% cotton
65% poliester, 35% bawelna

YATO	Size / Rozmiar	
YT-80395	S	10
YT-80396	M	10
YT-80397	L	10
YT-80398	L/XL	10
YT-80399	XL	10
YT-80400	XXL	10

EN Working jacket
PL Bluza robocza
DE Arbeitsjacke
RU Рабочая рубашка
CZ Pracovní blůza
HU Munkaruha felső
RO Bluză de lucru
FR Blouson de travail
IT Felpa da lavoro
ES Blusa de trabajo
CN 劳保夹克



190
g/m²

8
POCKETS
MÉSZENE

2
PVC

65% polyester, 35% cotton
65% poliester, 35% bawelna

YATO	Size / Rozmiar	
YT-80900	S	10
YT-80901	M	10
YT-80902	L	10
YT-80903	L/XL	10
YT-80904	XL	10
YT-80905	XXL	10

EN Working shorts
PL Spodnie robocze krótkie
DE Kurze Arbeitshose
RU Рабочие шорты
CZ Pracovní šortky
HU Munkaruha rövid nadrág
RO Pantaloni scurți de lucru
FR Pantalon de travail court
IT Pantaloni da lavoro corti
ES Pantalónes cortos de trabajo
CN 工装短裤

245
g/m²

7
POCKETS
MÉSZENE

2
PVC



65% polyester, 35% cotton
65% poliester, 35% bawelna

YATO	Size / Rozmiar	
YT-80924	S	10
YT-80925	M	10
YT-80926	L	10
YT-80927	L/XL	10
YT-80928	XL	10
YT-80929	XXL	10

EN Working shorts
PL Spodnie robocze krótkie
DE Kurze Arbeitshose
RU Рабочие шорты
CZ Pracovní šortky
HU Munkaruha rövid nadrág
RO Pantaloni scurți de lucru
FR Pantalon de travail court
IT Pantaloni da lavoro corti
ES Pantalónes cortos de trabajo
CN 工装短裤

245
g/m²

10
POCKETS
MÉSZENE

2
PVC



100% cotton
100% bawelna

YATO	Size / Rozmiar	
YT-80930	S	10
YT-80931	M	10
YT-80932	L	10
YT-80933	L/XL	10
YT-80934	XL	10
YT-80935	XXL	10

EN Working shorts
PL Spodnie robocze krótkie
DE Kurze Arbeitshose
RU Рабочие шорты
CZ Pracovní šortky
HU Munkaruha rövid nadrág
RO Pantaloni scurți de lucru
FR Pantalon de travail court
IT Pantaloni da lavoro corti
ES Pantalónes cortos de trabajo
CN 工装短裤

245
g/m²

10
POCKETS
MÉSZENE

2
PVC



100% cotton
100% bawelna

YATO	Size / Rozmiar	
YT-80936	S	10
YT-80937	M	10
YT-80938	L	10
YT-80939	L/XL	10
YT-80940	XL	10
YT-80941	XXL	10

EN Softshell trousers
 PL Spodnie softshell
 DE Softshellhose
 RU Брюки софтшелл
 CZ Kalhoty softshell
 HU Softshell nadrág
 RO Pantaloni softshell
 FR Pantalon softshell
 IT Pantaloni softshell
 ES Pantalones softshell
 CN 冲锋裤



220
g/m²

SOFTSHELL 8000 mm

5
POCKETS
KIESZENIE

96% polyester, 4% spandex
 96% poliester, 4% spandex



YATO	Size / Rozmiar	
YT-79420	S	10
YT-79421	M	10
YT-79422	L	10
YT-79423	XL	10
YT-79424	XXL	10
YT-79425	XXXL	10

EN Softshell trousers
 PL Spodnie softshell
 DE Softshellhose
 RU Брюки софтшелл
 CZ Kalhoty softshell
 HU Softshell nadrág
 RO Pantaloni softshell
 FR Pantalon softshell
 IT Pantaloni softshell
 ES Pantalones softshell
 CN 冲锋裤



260
g/m²

SOFTSHELL 8000 mm

7
POCKETS
KIESZENIE

96% polyester, 4% spandex
 96% poliester, 4% spandex



YATO	Size / Rozmiar	
YT-79430	S	10
YT-79431	M	10
YT-79432	L	10
YT-79433	XL	10
YT-79434	XXL	10
YT-79435	XXXL	10

EN Working trousers
 PL Spodnie robocze
 DE Arbeitshose
 RU Рабочие брюки
 CZ Pracovní kalhoty
 HU Munkaruha nadrág
 RO Pantaloni de lucru
 FR Pantalon de travail
 IT Pantalone da lavoro
 ES Pantalón de trabajo
 CN 工作服



325
g/m²

SPANDEX **17**
POCKETS
KIESZENIE



71% cotton, 25.5% polyester, 2% viscose, 1.5% spandex
 71% bawełna, 25.5% poliester, 2% wiskoza, 1.5% spandex

YATO	Size / Rozmiar	
YT-79070	S	10
YT-79071	M	10
YT-79072	L	10
YT-79073	L/XL	10
YT-79074	XL	10
YT-79075	XXL	10

EN Working trousers
 PL Spodnie robocze
 DE Arbeitshose
 RU Рабочие брюки
 CZ Pracovní kalhoty
 HU Munkaruha nadrág
 RO Pantaloni de lucru
 FR Pantalon de travail
 IT Pantalone da lavoro
 ES Pantalón de trabajo
 CN 工作服



300
g/m²

SPANDEX **14**
POCKETS
KIESZENIE

97% cotton, 3% spandex
 97% bawełna, 3% spandex



YATO	Size / Rozmiar	
YT-79360	S	10
YT-79361	M	10
YT-79362	L	10
YT-79363	L/XL	10
YT-79364	XL	10
YT-79365	XXL	10

REBAR

EN Stretch work trousers
 PL Spodnie z elastanem
 DE Hose mit Elasthan
 RU Брюки с эластаном
 CZ Kalhoty s elastanem
 HU Elasztános nadrág
 RO Pantaloni de lucru elastici
 FR Pantalon élasthane
 IT Pantaloni con elastan
 ES Pantalones con elastano
 CN 冲锋裤



240
g/m²

STRETCH
STRECCZ **9**
POCKETS
KIESZENIE



64% polyester, 34% cotton, 2% elastane
 64% poliester, 34% bawełna, 2% elastan

YATO	Size / Rozmiar	
YT-79440	S	10
YT-79441	M	10
YT-79442	L	10
YT-79443	XL	10
YT-79444	XXL	10
YT-79445	XXXL	10

EN Working trousers
 PL Spodnie robocze
 DE Arbeitshose
 RU Рабочие брюки
 CZ Pracovní kalhoty
 HU Munkaruha nadrág
 RO Pantaloni de lucru
 FR Pantalon de travail
 IT Pantalone da lavoro
 ES Pantalón de trabajo
 CN 工作服



275
g/m²

9
POCKETS
KIESZENIE

65% polyester, 35% cotton
 65% poliester, 35% bawełna

YATO	Size / Rozmiar	
YT-8025	S (EU) / 34 (US)	10
YT-8026	M (EU) / 36 (US)	10
YT-8027	L (EU) / 38 (US)	20
YT-8028	XL (EU) / 40 (US)	10
YT-8029	XXL (EU) / 42 (US)	10

DUERO

EN Working trousers
PL Spodnie robocze
DE Arbeitshose
RU Рабочие брюки
CZ Pracovní kalhoty
HU Munkaruha nadrág
RO Pantaloni de lucru
FR Pantalon de travail
IT Pantalone da lavoro
ES Pantalón de trabajo
CN 工作服



270
g/m²

5
POCKETS
KIESZENIE

2
PVC



65% polyester, 35% cotton
65% poliester, 35% bawełna

DAW

YATO	Size / Rozmiar	
YT-80285	S (EU) / 34 (US)	10
YT-80286	M (EU) / 36 (US)	10
YT-80287	L (EU) / 38 (US)	10
YT-80288	XL (EU) / 40 (US)	10
YT-80289	XXL (EU) / 42 (US)	10

EN Working trousers
PL Spodnie robocze
DE Arbeitshose
RU Рабочие брюки
CZ Pracovní kalhoty
HU Munkaruha nadrág
RO Pantaloni de lucru
FR Pantalon de travail
IT Pantalone da lavoro
ES Pantalón de trabajo
CN 工作服



267
g/m²

9
POCKETS
KIESZENIE

2
PVC



65% polyester, 35% cotton
65% poliester, 35% bawełna

YATO	Size / Rozmiar	
YT-80146	S	10
YT-80147	M	10
YT-80148	L	10
YT-80149	L/XL	10
YT-80150	XL	10
YT-80151	XXL	10

EN Working trousers
PL Spodnie robocze
DE Arbeitshose
RU Рабочие брюки
CZ Pracovní kalhoty
HU Munkaruha nadrág
RO Pantaloni de lucru
FR Pantalon de travail
IT Pantalone da lavoro
ES Pantalón de trabajo
CN 工作服



300
g/m²

7
POCKETS
KIESZENIE

2
PVC

100% brushed cotton
100% szczotkowana bawełna



COMFY

YATO	Size / Rozmiar	
YT-79240	S	10
YT-79241	M	10
YT-79242	L	10
YT-79243	L/XL	10
YT-79244	XL	10
YT-79245	XXL	10

EN Working trousers
PL Spodnie robocze
DE Arbeitshose
RU Рабочие брюки
CZ Pracovní kalhoty
HU Munkaruha nadrág
RO Pantaloni de lucru
FR Pantalon de travail
IT Pantalone da lavoro
ES Pantalón de trabajo
CN 工作服



270
g/m²

9
POCKETS
KIESZENIE

2
PVC

100% cotton
100% bawełna



YATO	Size / Rozmiar	
YT-80164	S	10
YT-80165	M	10
YT-80166	L	10
YT-80167	L/XL	10
YT-80168	XL	10
YT-80169	XXL	10

EN Working trousers
PL Spodnie robocze
DE Arbeitshose
RU Рабочие брюки
CZ Pracovní kalhoty
HU Munkaruha nadrág
RO Pantaloni de lucru
FR Pantalon de travail
IT Pantalone da lavoro
ES Pantalón de trabajo
CN 工作服



267
g/m²

9
POCKETS
KIESZENIE

2
PVC

65% polyester, 35% cotton
65% poliester, 35% bawełna



YATO	Size / Rozmiar	
YT-80182	S	10
YT-80183	M	10
YT-80184	L	10
YT-80185	L/XL	10
YT-80186	XL	10
YT-80187	XXL	10

EN Working trousers
PL Spodnie robocze
DE Arbeitshose
RU Рабочие брюки
CZ Pracovní kalhoty
HU Munkaruha nadrág
RO Pantaloni de lucru
FR Pantalon de travail
IT Pantalone da lavoro
ES Pantalón de trabajo
CN 工作服



245
g/m²

5
POCKETS
KIESZENIE

2
PVC

65% polyester, 35% cotton
65% poliester, 35% bawełna

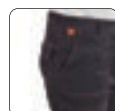

YATO	Size / Rozmiar	
YT-80401	S	10
YT-80402	M	10
YT-80403	L	10
YT-80404	L/XL	10
YT-80405	XL	10
YT-80406	XXL	10

- EN Reflective winter trousers with padding
- PL Spodnie robocze ocieplane, odblaskowe
- DE Warme Warnschutzhose mit Reflektionsstreifen
- RU Утепленные рабочие светоотражающие брюки
- CZ Oteplené pracovní kalhoty reflexní
- HU Bélelt fényvisszaverő munkanadrág
- RO Pantaloni impermeabili reflectorizanti pt. iarnă
- FR Pantaloni de travail isolant et réfléchissant
- IT Pantaloni da lavoro imbottiti, ad alta visibilità
- ES Pantalones acolchados de trabajo, reflectantes
- CN 荧光棉长裤



400
g/m²

PU
COATING
POWLOKA

5000 mm

5000 g/m²

6
POCKETS
KIESZENIE

100% polyester
100% poliester



YATO	Size / Rozmiar	
YT-80955	S (EU) / 34 (US)	10
YT-80956	M (EU) / 36 (US)	10
YT-80957	L (EU) / 38 (US)	10
YT-80958	XL (EU) / 40 (US)	10
YT-80959	XXL (EU) / 42 (US)	10

- EN Working trousers
- PL Spodnie robocze
- DE Arbeitshose
- RU Рабочие брюки
- CZ Pracovní kalhoty
- HU Munkaruha nadrág
- RO Pantaloni de lucru
- FR Pantalon de travail
- IT Pantalone da lavoro
- ES Pantalón de trabajo
- CN 工作服



190
g/m²

9
POCKETS
KIESZENIE

2
PVC



65% polyester, 35% cotton
65% poliester, 35% bawełna

YATO	Size / Rozmiar	
YT-80906	S	10
YT-80907	M	10
YT-80908	L	10
YT-80909	L/XL	10
YT-80910	XL	10
YT-80911	XXL	10

- EN Work bib pants
- PL Spodnie robocze ogrodniczki
- DE Arbeitslatzhose
- RU Рабочий полукombineзон
- CZ Pracovní kalhoty lačlové
- HU Kertész nadrág
- RO Pantaloni de lucru grădină
- FR Salopette de travail
- IT Salopette da lavoro
- ES Pantalón de trabajo tipo jardinero
- CN 工作服



275
g/m²

11
POCKETS
KIESZENIE

2
PVC

65% polyester, 35% cotton
65% poliester, 35% bawełna

DUERO

YATO	Size / Rozmiar	
YT-8030	S (EU) / 34 (US)	10
YT-8031	M (EU) / 36 (US)	10
YT-8032	L (EU) / 38 (US)	10
YT-8033	XL (EU) / 40 (US)	10
YT-8034	XXL (EU) / 42 (US)	10

- EN Work bib pants
- PL Spodnie robocze ogrodniczki
- DE Arbeitslatzhose
- RU Рабочий полукombineзон
- CZ Pracovní kalhoty lačlové
- HU Kertész nadrág
- RO Pantaloni de lucru grădină
- FR Salopette de travail
- IT Salopette da lavoro
- ES Pantalón de trabajo tipo jardinero
- CN 背带裤



270
g/m²

7
POCKETS
KIESZENIE

2
PVC



65% polyester, 35% cotton
65% poliester, 35% bawełna



DAN

YATO	Size / Rozmiar	
YT-80290	S (EU) / 34 (US)	10
YT-80291	M (EU) / 36 (US)	10
YT-80292	L (EU) / 38 (US)	10
YT-80293	XL (EU) / 40 (US)	10
YT-80294	XXL (EU) / 42 (US)	10

EN Work bib pants
PL Spodnie robocze ogrodniczki
DE Arbeitslatzhose
RU Рабочий полукombineзон
CZ Pracovní kalhoty lačlové
HU Kertész nadrág
RO Pantaloni de lucru grădină
FR Salopette de travail
IT Salopette da lavoro
ES Pantalón de trabajo tipo jardinero
CN 背带裤



65% polyester, 35% cotton
65% poliester, 35% bawełna



YATO 	Size / Rozmiar	
YT-80152	S	10
YT-80153	M	10
YT-80154	L	10
YT-80155	L/XL	10
YT-80156	XL	10
YT-80157	XXL	10

EN Work bib pants
PL Spodnie robocze ogrodniczki
DE Arbeitslatzhose
RU Рабочий полукombineзон
CZ Pracovní kalhoty lačlové
HU Kertész nadrág
RO Pantaloni de lucru grădină
FR Salopette de travail
IT Salopette da lavoro
ES Pantalón de trabajo tipo jardinero
CN 背带裤



100% brushed cotton
100% szczotkowana bawełna



COMFY

YATO 	Size / Rozmiar	
YT-79250	S	10
YT-79251	M	10
YT-79252	L	10
YT-79253	L/XL	10
YT-79254	XL	10
YT-79255	XXL	10

EN Work bib pants
PL Spodnie robocze ogrodniczki
DE Arbeitslatzhose
RU Рабочий полукombineзон
CZ Pracovní kalhoty lačlové
HU Kertész nadrág
RO Pantaloni de lucru grădină
FR Salopette de travail
IT Salopette da lavoro
ES Pantalón de trabajo tipo jardinero
CN 背带裤





100% cotton
100% bawełna

YATO 	Size / Rozmiar	
YT-80170	S	10
YT-80171	M	10
YT-80172	L	10
YT-80173	L/XL	10
YT-80174	XL	10
YT-80175	XXL	10

EN Work bib pants
PL Spodnie robocze ogrodniczki
DE Arbeitslatzhose
RU Рабочий полукombineзон
CZ Pracovní kalhoty lačlové
HU Kertész nadrág
RO Pantaloni de lucru grădină
FR Salopette de travail
IT Salopette da lavoro
ES Pantalón de trabajo tipo jardinero
CN 背带裤



65% polyester, 35% cotton
65% poliester, 35% bawełna

YATO 	Size / Rozmiar	
YT-80188	S	10
YT-80189	M	10
YT-80190	L	10
YT-80191	L/XL	10
YT-80192	XL	10
YT-80193	XXL	10

EN Work bib pants
 PL Spodnie robocze ogrodniczki
 DE Arbeitslatzhose
 RU Рабочий полукombineзон
 CZ Pracovní kalhoty lačlové
 HU Kertész nadrág
 RO Pantaloni de lucru grădină
 FR Salopette de travail
 IT Salopette da lavoro
 ES Pantalón de trabajo tipo jardinero
 CN 背带裤



245
g/m²

7
POCKETS
KIESZENÉ

2
PVC



65% polyester, 35% cotton
 65% poliester, 35% bawełna

YATO	Size / Rozmiar	
YT-80407	S	10
YT-80408	M	10
YT-80409	L	10
YT-80410	L/XL	10
YT-80411	XL	10
YT-80412	XXL	10

EN Reflective winter bib pants with padding
 PL Spodnie robocze ogrodniczki ocieplane, odblaskowe
 DE Warme Wamuschutzhose mit Hosenträger und Reflektionsstreifen
 RU Утепленные брюки на bretелях с увеличенной видимостью
 CZ Oteplené kalhoty na šlích se zvýšenou viditelností
 HU Növelt láthatóságú bélelt vállpántos nadrág
 RO Pantaloni impermeabili reflectorizanti pt. iarnă
 FR Pantalon isolant à bretelles avec augmentation de la visibilité
 IT Pantaloni con pettorale imbottiti, alla visibilità aumentata
 ES Pantalones acolchados de tirantes, visibilidad elevada
 CN 荧光棉背带裤



400
g/m²

PU
COATING
POWŁOKA

5000 mm

7
POCKETS
KIESZENÉ



100% polyester
 100% poliester

YATO	Size / Rozmiar	
YT-80960	S (EU) / 34 (US)	10
YT-80961	M (EU) / 36 (US)	10
YT-80962	L (EU) / 38 (US)	10
YT-80963	XL (EU) / 40 (US)	10
YT-80964	XXL (EU) / 42 (US)	10

EN Work bib pants
 PL Spodnie robocze ogrodniczki
 DE Arbeitslatzhose
 RU Рабочий полукombineзон
 CZ Pracovní kalhoty lačlové
 HU Kertész nadrág
 RO Pantaloni de lucru grădină
 FR Salopette de travail
 IT Salopette da lavoro
 ES Pantalón de trabajo tipo jardinero
 CN 背带裤



190
g/m²

13
POCKETS
KIESZENÉ

2
PVC

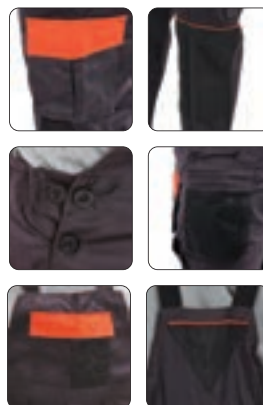

65% polyester, 35% cotton
 65% poliester, 35% bawełna

YATO	Size / Rozmiar	
YT-80912	S	10
YT-80913	M	10
YT-80914	L	10
YT-80915	L/XL	10
YT-80916	XL	10
YT-80917	XXL	10

EN Rainsuit
 PL Komplet przeciwdeszczowy
 DE Regenschutz-Set
 RU Противодождевой набор
 CZ Průdešťová sada
 HU Esővédő szett
 RO Costum impermeabil
 FR Kit anti pluie
 IT Tuta impermeabile
 ES Juego impermeable
 CN 男式雨衣套装



200
g/m²

PU
COATING
POWŁOKA

3
POCKETS
KIESZENÉ

2
PVC

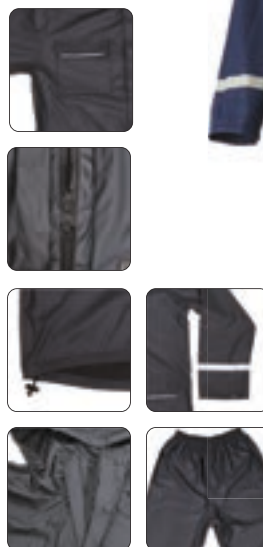

100% polyester
 100% poliester

YATO	Size / Rozmiar	
YT-79710	S	10
YT-79711	M	10
YT-79712	L	10
YT-79713	XL	10
YT-79714	XXL	10
YT-79715	XXXL	10

Memo



21

Electric products Artykuły elektryczne



Ceiling & wall lamps
Oprawy sufitowe i ścienne

652



Flashlights
Latarki

661-665



Floodlights & accessories
Naświetlacze i akcesoria

653-655



Infrared heaters & accessories
Promienniki podczerwieni i akcesoria

665-666



Solar lamps
Oprawy solarne

655



Travel adapters
Adaptory podróżne

666



Workshop lightning
Oświetlenie warsztatowe

656-660



Extension cords
Przedłużacze elektryczne

666-667



EN Wall lamp
 PL Lampa naścienna
 DE Wandleuchte
 RU Светильник настенный
 CZ Nástěnné svítidlo
 HU Fali lámpa

RO Lampă de perete
 FR Applique
 IT Lampada da parete
 ES Lámpara de pared
 CN 防潮灯

220-240V~
50/60Hz

12
W

840
lm

3000K

120°

IP20



YATO	[W]	[lm]	[mm]	
YT-81844	12	840	290x95	10

EN Wall lamp
 PL Lampa naścienna
 DE Wandleuchte
 RU Светильник настенный
 CZ Nástěnné svítidlo
 HU Fali lámpa

RO Lampă de perete
 FR Applique
 IT Lampada da parete
 ES Lámpara de pared
 CN 防潮灯

220-240V~
50/60Hz

18
W

1260
lm

3000K

120°

IP20



YATO	[W]	[lm]	[mm]	
YT-81846	18	1260	330x105	10

EN Wall lamp
 PL Lampa naścienna
 DE Wandleuchte
 RU Светильник настенный
 CZ Nástěnné svítidlo
 HU Fali lámpa

RO Lampă de perete
 FR Applique
 IT Lampada da parete
 ES Lámpara de pared
 CN 防潮灯

220-240V~
50/60Hz

24
W

1680
lm

3000K

120°

IP20



YATO	[W]	[lm]	[mm]	
YT-81848	24	1680	385x115	5

EN Wall lamp
 PL Lampa naścienna
 DE Wandleuchte
 RU Светильник настенный
 CZ Nástěnné svítidlo
 HU Fali lámpa
 RO Lampă de perete
 FR Applique
 IT Lampada da parete
 ES Lámpara de pared
 CN 户外壁灯



220-240V~
50Hz

GU10
max. 35W

IP44

Outdoor lamp
 Lampa zewnętrzna

YATO	
YT-81900	20

EN Wall lamp
 PL Lampa naścienna
 DE Wandleuchte
 RU Светильник настенный
 CZ Nástěnné svítidlo
 HU Fali lámpa
 RO Lampă de perete
 FR Applique
 IT Lampada da parete
 ES Lámpara de pared
 CN 户外壁灯



220-240V~
50Hz

GU10
max. 35W

IP44

Outdoor lamp
 Lampa zewnętrzna

YATO	
YT-81901	20

EN Wall lamp
 PL Lampa naścienna
 DE Wandleuchte
 RU Светильник настенный
 CZ Nástěnné svítidlo
 HU Fali lámpa
 RO Lampă de perete
 FR Applique
 IT Lampada da parete
 ES Lámpara de pared
 CN 户外壁灯



220-240V~
50Hz

GU10
max. 2x35W

IP44

Outdoor lamp
 Lampa zewnętrzna

YATO	
YT-81902	12

EN Wall lamp
 PL Lampa naścienna
 DE Wandleuchte
 RU Светильник настенный
 CZ Nástěnné svítidlo
 HU Fali lámpa
 RO Lampă de perete
 FR Applique
 IT Lampada da parete
 ES Lámpara de pared
 CN 户外壁灯



220-240V~
50Hz

GU10
max. 2x35W

IP44

Outdoor lamp
 Lampa zewnętrzna

YATO	
YT-81903	12

EN Wall lamp
 PL Lampa naścienna
 DE Wandleuchte
 RU Светильник настенный
 CZ Nástěnné svítidlo
 HU Fali lámpa
 RO Lampă de perete
 FR Applique
 IT Lampada da parete
 ES Lámpara de pared
 CN 户外壁灯



220-240V~
50Hz

GU10
max. 2x35W

IP44

Outdoor lamp
 Lampa zewnętrzna

YATO	
YT-81904	12

EN Garden light with spike
 PL Reflektor ogrodowy ze szpikulcem
 DE Gartenleuchte mit Erdspiess
 RU Светильник садовый
 CZ Zahradní svítidlo
 HU Kerti túske fényvető
 RO Lampa gradina cu pivot
 FR Lampe de jardin
 IT Lampada da giardino con punta
 ES Reflector de jardín
 CN 地插灯



220-240V~
50Hz

GU10
max. 35W

AI

IP54



Outdoor lamp
 Lampa zewnętrzna

YATO	
YT-81775	8

EN LED floodlight
PL Reflektor diodowy
DE LED-Leuchte
RU Светодиодный прожектор
CZ LED reflektor
HU Diódás reflektor
RO Reflector diodă
FR Projecteur a LED
IT Riflettore LED
ES Reflector de diodos
CN LED投光灯

230V~
50/60Hz

10 W

950 lm

6500K

30000 h

IP65

SMD
LED



YATO
YT-818221

20

EN LED floodlight
PL Reflektor diodowy
DE LED-Leuchte
RU Светодиодный прожектор
CZ LED reflektor
HU Diódás reflektor
RO Reflector diodă
FR Projecteur a LED
IT Riflettore LED
ES Reflector de diodos
CN LED投光灯

230V~
50/60Hz

20 W

1900 lm

6500K

30000 h

IP65

SMD
LED



YATO
YT-818231

16

EN LED floodlight
PL Reflektor diodowy
DE LED-Leuchte
RU Светодиодный прожектор
CZ LED reflektor
HU Diódás reflektor
RO Reflector diodă
FR Projecteur a LED
IT Riflettore LED
ES Reflector de diodos
CN LED投光灯

230V~
50/60Hz

30 W

2850 lm

6500K

30000 h

IP65

SMD
LED



YATO
YT-818241

10

EN LED lamp
PL Reflektor diodowy
DE Diodescheinwerfer
RU Светодиодный прожектор
CZ LED reflektor
HU Diódás reflektor
RO Reflector diodă
FR Projecteur a LED
IT Riflettore LED
ES Reflector de diodos
CN LED投光灯

230V~
50/60Hz

50 W

4750 lm

6500K

30000 h

IP65

SMD
LED



YATO
YT-818251

8

EN LED lamp
PL Reflektor diodowy
DE Diodescheinwerfer
RU Светодиодный прожектор
CZ LED reflektor
HU Diódás reflektor
RO Reflector diodă
FR Projecteur a LED
IT Riflettore LED
ES Reflector de diodos
CN 手提式投光灯

230V~
50/60Hz

30 W

2850 lm

6500K

30000 h

IP65

CABLE
H05RN-F
KABEL

1.5 m

SMD
LED



YATO
YT-818381

10

EN LED lamp
PL Reflektor diodowy
DE Diodescheinwerfer
RU Светодиодный прожектор
CZ LED reflektor
HU Diódás reflektor
RO Reflector diodă
FR Projecteur a LED
IT Riflettore LED
ES Reflector de diodos
CN 手提式投光灯

230V~
50/60Hz

50 W

4750 lm

6500K

30000 h

IP65

CABLE
H05RN-F
KABEL

1.5 m

SMD
LED



YATO
YT-818391

8

EN Hybrid floodlight
PL Reflektor
DE siesciowo-akumulatorowy
RU Аккумуляторно-сетевой прожектор
CZ Sítovo-bateriový reflektor
HU Hálózati-akkumulátoros reflektor
RO Proiecteur hibrid
FR Projecteur LED avec trépied
IT Faro LED a batteria
ES Lámpara reflector de pie con cable y batería
CN 三脚架工作灯

SMD
LED

CRI 70

7.4 V
4000mAh
Li-Ion

5000 lm

6h

1.5h

1.8 m

0.96 m

CABLE
H05RN-F
KABEL

2x
0.75 mm²

5m



YATO
YT-81811

2

EN LED floodlight with tripod
PL Reflektor diodowy na stojaku
DE LED-Stativ-Leuchte
RU Светодиодный прожектор на стойке
CZ LED reflektor na stojanu
HU Alványos diodás reflektor
RO Reflector diodă pe stativ
FR Projecteur a LED sur un trépied
IT Riflettore LED sul cavalletto
ES Reflector de diodos con trípode
CN 带支架投光灯

230V~
50/60Hz

20W
x2

1900lm
x2

6500K

30000 h

1.2 m

0.6 m

IP65

CABLE
H05RN-F
KABEL

2m

SMD
LED

E A G



YATO
YT-818151

4

EN LED floodlight with tripod
PL Reflektor diodowy na stojaku
DE LED-Stativ-Leuchte
RU Светодиодный прожектор на стойке
CZ LED reflektor na stojanu
HU Alványos diodás reflektor
RO Reflector diodă pe stativ
FR Projecteur a LED sur un trépied
IT Riflettore LED sul cavalletto
ES Reflector de diodos con trípode
CN 带支架投光灯

230V~
50/60Hz

30W
x2

2850lm
x2

6500K

30000 h

1.2 m

0.6 m

IP65

CABLE
H05RN-F
KABEL

2m

SMD
LED

E A G



YATO
YT-818171

4

EN Workshop LED lamp
 PL Diodowa lampa warsztatowa
 DE LED Arbeitsleuchte
 RU Светодиодная лампа для мастерской
 CZ LED pracovní lampa
 HU LED szerelőlámpa
 RO Lampa cu LED pt. atelier
 FR Lanterne d'atelier LED
 IT Lampada da lavoro LED
 ES Lámpara de trabajo LED
 CN 工作灯

SMD
LED

220-240V~
50Hz

50 W

3800 lm

3000 W

5000K

CRI 80

360°

30000 h

IP44

1.5 m



YATO

YT-08495 4

EN Workshop LED lamp
 PL Diodowa lampa warsztatowa
 DE LED Arbeitsleuchte
 RU Светодиодная лампа для мастерской
 CZ LED pracovní lampa
 HU LED szerelőlámpa
 RO Lampa cu LED pt. atelier
 FR Lanterne d'atelier LED
 IT Lampada da lavoro LED
 ES Lámpara de trabajo LED
 CN 工作灯

SMD
LED

220-240V~
50Hz

100 W

7500 lm

3000 W

5000K

CRI 80

360°

30000 h

IP44

1.5 m



YATO

YT-08496 4

EN Cordless lamp
 PL Akumulatorowa lampa robocza
 DE Akku-Lampe
 RU Аккумуляторная лампа
 CZ Dobjíjecí lampa
 HU Újratölthető lámpa
 RO Lampa reincarcabila
 FR Le projecteur sans-fil
 IT Lampada da lavoro a batteria
 ES Lámpara recargable a batería
 CN 锂电LED工作灯

18 V
Li-Ion

1600 lm

2 LIGHTING MODES TRYBY SWIĘCZENIA

180°

METAL FRAME NIETALOWA RAMKA

TRANSPORT HANDLE UCHWYT TRANSPORTOWY



• 2 lighting modes: 50%, 100%
 • 2 tryby świecenia: 50%, 100%

18V
Li-Ion

Battery not included
 Ohne Akku / Bez akumulatora
 Bez baterii / Bez aku
 Akkumulátor nélkül
 Fără baterie / Senza batterie
 Senza batteria / Sin batería
 没有电池

YATO

YT-82961 [V d.c.] 18 6

EN LED rechargeable floodlight
 PL Reflektor diodowy akumulatorowy
 DE Akku-LED-Leuchte
 RU Светодиодный аккумуляторный прожектор
 CZ LED reflektor dobíjecí
 HU LED reflektor újratölthető

RO Reflector cu LED dioda pe acumulatori
 FR Projecteur a LED rechargeable
 IT Riflettore LED a batteria
 ES LED reflector recargable
 CN 工作灯

5W

3.7 V
2000mAh
Li-Ion

300 lm

7000K

5.5h

3.5-4h

5 LIGHTING MODES TRYBY SWIĘCZENIA

IP54

USB BATTERY CHARGER LADOWNIKA



YATO

YT-81819 40

EN LED rechargeable floodlight
 PL Reflektor diodowy akumulatorowy
 DE Akku-LED-Leuchte
 RU Светодиодный аккумуляторный прожектор
 CZ LED reflektor dobíjecí
 HU LED reflektor újratölthető
 RO Reflector cu LED dioda pe acumulatori
 FR Projecteur a LED rechargeable
 IT Riflettore LED a batteria
 ES LED reflector recargable
 CN 工作灯

10 W

3.7 V
4400mAh
Li-Ion

800 lm

6000K

5.5h

2.5h

4400 mAh

Micro USB



YATO

YT-81820 6/12

EN LED floodlight
 PL Reflektor diodowy
 DE LED-Leuchte
 RU Светодиодный прожектор
 CZ LED světlo
 HU LED svétlo
 RO Reflector LED
 FR Projecteur a LED
 IT Riflettore LED
 ES LED projector
 CN 手提式工作灯

10 W

6V

680 lm

4x AA

3 LIGHTING MODES TRYBY SWIĘCZENIA

PA6



• 3 lighting modes: 100%, 30%, strobe
 • 3 tryby świecenia: 100%, 30%, pulsowanie

YATO

YT-81821 8/16

EN Portable floodlight with speaker
PL Reflektor przenośny z głośnikiem
DE Tragbarer Scheinwerfer mit Lautsprecher
RU Переносной звуковой прожектор
CZ Přenosný reflektor s reproduktorem
HU Hordozható reflektor hangszóróval
RO Projector portabil cu difuzor
FR Projecteur LED portable avec haut-parleur
IT Proiettore portatile con altoparlante
ES Reflector portátil con altavoz
CN 蓝牙音响灯

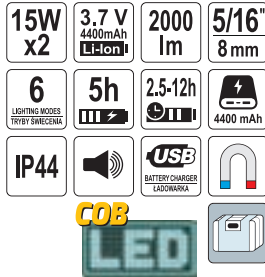

Compatible with YT-81809
Kompatybilny z YT-81809

YATO	
YT-81808	24

EN Solar LED floodlight with motion detector
PL Reflektor solarny LED z czujnikiem ruchu
DE Solar-Diodenscheinwerfer mit Bewegungsmelder
RU Настенный светильник на солнечной батарее с датчиком движения
CZ LED solární reflektor se snímačem pohybu
HU Napelemes reflektor LED mozgásérzékelővel
RO Lampă solară cu senzor
FR LED projecteur solaire avec détecteur de mouvement
IT Lampada solare a LED con sensore di movimento
ES LED solar reflector con sensor de movimiento
CN 带感应太阳能投光灯



YATO	
YT-81860	12

EN Solar LED wall lamp
PL Lampka ścienna solarna LED
DE LED Solar-Wandleuchte
RU Настенный светильник
CZ LED solární světla
HU Fali lámpa napelemes LED
RO Lampă solară pt. perete
FR Lampe solaire LED
IT Lampada da parete LED solare
ES Luz de pared de LED solar
CN 太阳能感应壁灯

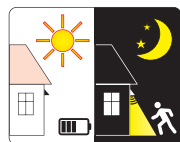

YATO	
YT-81856	12/48

EN Aluminium tripod
PL Statyw aluminiowy
DE Aluminium-Stativ
RU Алюминиевый штатив
CZ Hliníkový statív
HU Alumínium állvány
RO Trepid aluminium
FR Trépied en aluminium
IT Tripode in alluminio
ES Tripode de aluminio
CN 三角架

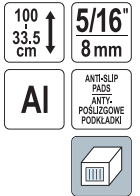

For YT-81808
Dla YT-81808

YATO	H [mm]
YT-81809	335-1000
	21

EN Solar LED wall lamp
PL Lampka ścienna solarna LED
DE LED Solar-Wandleuchte
RU Настенный светильник
CZ LED solární světla
HU Fali lámpa napelemes LED
RO Lampă solară pt. perete
FR Lampe solaire LED
IT Lampada da parete LED solare
ES Luz de pared de LED solar
CN 太阳能感应壁灯

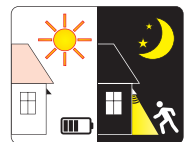

YATO	
YT-81855	12/48

EN Solar LED floodlight with spike
PL Reflektor solarny LED ze szpiculcem
DE Solar-Diodenscheinwerfer mit Spitze
RU Настенный светильник на солнечной батарее со шпайком
CZ LED solární reflektor s hrotem
HU Napelemes reflektor LED tűskével
RO Lampă solară cu vârf
FR LED projecteur solaire avec avec pique
IT Lampada solare a LED con punta
ES LED solar reflector con pincho
CN 带感应太阳能地插灯

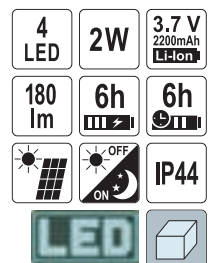

YATO	
YT-81880	20

EN Rechargeable worklight
 PL Lampa warsztatowa akumulatorowa
 DE Akku-Werkstattleuchte
 RU Аккумуляторная рабочая лампа
 CZ Akumulátorová dílenská lampa
 HU Akkumulátoros műhelylámpa
 RO Lampa de lucru reincarcabila
 FR Kit éclairage mécanicien
 IT Lampada officina a batteria
 ES Linterna para taller recargable
 CN 三合一手电筒组套



3 in 1
3 w 1

XPG

3.7 V
2200mAh
Li-Ion

4h

1m

IP54

USB
CHARGING
LADOWANIE

POWER LED



YATO
YT-08521

10

EN Workshop LED battery lamp
 PL Diodowa lampa warsztatowa akumulatorowa
 DE LED Akku-Werkstattlampe
 RU Светодиодная беспроводная лампа
 CZ Aku pracovní LED svítidla
 HU Akkumulátoros LED szerelőlámpa
 RO Lampa portabila cu acumulator leduri
 FR Lampe d'inspection LED rechargeable
 IT Lampada LED ricaricabile per officina
 ES Lámpara de trabajo LED recargable
 CN 可充电工作灯



CRI 95

5W

3.7 V
2600mAh
Li-Ion

400 lm

4500K

4h

4h

IP65

IK07

x1
HOOK
HAK

COB LED

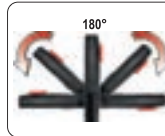

YATO
YT-08509

12

EN Workshop lamp UV
 PL Lampa warsztatowa UV
 DE UV-Werkstattleuchte
 RU УФ лампа для мастерской
 CZ Dílenská lampa UV
 HU UV műhelylámpa
 RO Lampa UV atelier
 FR Lampe d'atelier UV
 IT Lampada da officina UV
 ES Lámpara UV de taller
 CN 工作灯-用于检泄露



5W

UV

390-405 nm

3.7 V
2600mAh
Li-Ion

4h

4.5h

IP65

IK07

x1
HOOK
HAK

USB
CHARGING
LADOWANIE

UV LED

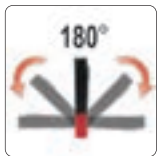

YATO
YT-08500

12

EN Workshop LED battery lamp
 PL Diodowa lampa warsztatowa akumulatorowa
 DE LED Akku-Werkstattlampe
 RU Светодиодная беспроводная лампа
 CZ Aku pracovní LED svítidla
 HU Akkumulátoros LED szerelőlámpa
 RO Lampa portabila cu acumulator leduri
 FR Lampe d'inspection LED rechargeable
 IT Lampada LED ricaricabile per officina
 ES Lámpara de trabajo LED recargable
 CN 可充电工作灯



FRONT LIGHT
LATARKA

1+1 LED

3.7 V
3600mAh
Li-Ion

180 lm

230V~50Hz
BATTERY CHARGER
LADOWNIKA

12V
BATTERY CHARGER
LADOWNIK

4h

2 LED
3h

x1
HOOK
HAK

COB LED



YATO
YT-08502

10

EN Workshop LED battery lamp
PL Diodowa lampa warsztatowa akumulatorowa
DE LED Akku-Werkstattlampe
RU Светодиодная беспроводная лампа
CZ Aku pracovní LED svítidla
HU Akkumulátoros LED szerelőlámpa
RO Lampa portabilă cu acumulator leduri
FR Lampe d'inspection LED rechargeable
IT Lampada LED ricaricabile per officina
ES Lámpara de trabajo LED recargable
CN 可充电工作灯



FRONT LIGHT
LATAKWA

CRI 80

6+1 W

3.7 V
2600mAh
Li-Ion

600/250 lm

4h

1.5-10h

IP54

IK07

x1
HOOK
HAK

USB
BATTERY CHARGER
ŁADOWNIK

x2

COB
LED



YATO
YT-08558 12

EN Workshop LED battery lamp
PL Diodowa lampa warsztatowa akumulatorowa
DE LED Akku-Werkstattlampe
RU Светодиодная беспроводная лампа
CZ Aku pracovní LED svítidla
HU Akkumulátoros LED szerelőlámpa
RO Lampa portabilă cu acumulator leduri
FR Lampe d'inspection LED rechargeable
IT Lampada LED ricaricabile per officina
ES Lámpara de trabajo LED recargable
CN LED工作灯

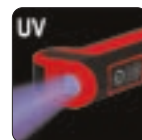

FRONT LIGHT
LATAKWA

5+1 W

3.7 V
2200mAh
Li-Ion

UV

500/250 lm
40 lm

6500K

3h

1.5-11h

2200 mAh

IK07

x1
HOOK
HAK

USB
BATTERY CHARGER
ŁADOWNIK

COB
LED



YATO
YT-08517 6/24

EN Workshop LED battery lamp
PL Diodowa lampa warsztatowa akumulatorowa
DE LED Akku-Werkstattlampe
RU Светодиодная беспроводная лампа
CZ Aku pracovní LED svítidla
HU Akkumulátoros LED szerelőlámpa
RO Lampa portabilă cu acumulator leduri
FR Lampe d'inspection LED rechargeable
IT Lampada LED ricaricabile per officina
ES Lámpara de trabajo LED recargable
CN 可充电LED工作灯

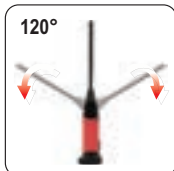

FRONT LIGHT
LATAKWA

5+3 W

3.7 V
2600mAh
Li-Ion

600/260 lm

6500K

4h

2.5-5.5h

POLYCARBONATE DIFFUSER
KŁOSZ Z POLIWĘGLANU

USB
BATTERY CHARGER
ŁADOWNIK

x1

COB
LED



YATO
YT-08518 12

EN Workshop LED battery lamp
PL Diodowa lampa warsztatowa akumulatorowa
DE LED Akku-Werkstattlampe
RU Светодиодная беспроводная лампа
CZ Aku pracovní LED svítidla
HU Akkumulátoros LED szerelőlámpa
RO Lampa portabilă cu acumulator leduri
FR Lampe d'inspection LED rechargeable
IT Lampada LED ricaricabile per officina
ES Lámpara de trabajo LED recargable
CN 可充电工作灯



FRONT LIGHT
LATAKWA

7+3 W

3.7 V
2600mAh
Li-Ion

60-600 lm

120 lm

6500K

4-5h

1.5-16.5h

IP54

LED CHARGE INDICATOR
WSKAZNIK NAŁADOWANIA BATERII

x1
HOOK
HAK

USB
BATTERY CHARGER
ŁADOWNIK

POLYCARBONATE DIFFUSER
KŁOSZ Z POLIWĘGLANU

COB
LED

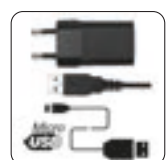

YATO
YT-08519 20

EN Workshop LED battery lamp
 PL Diodowa lampa warsztatowa akumulatorowa
 DE LED Akku-Werkstattlampe
 RU Светодиодная беспроводная лампа
 CZ Aku pracovní LED svítidla
 HU Akkumulátoros LED szerelőlámpa
 RO Lampa portabilă cu acumulator leduri
 FR Lampe d'inspection LED rechargeable
 IT Lampada LED ricaricabile per officina
 ES Lámpara de trabajo LED recargable
 CN LED工作灯



10+4 W	3.7 V 2600mAh Li-Ion
50/500 lm	6500K
4h	2-16h
2m	IP54
IK07	x1 HOOK HAK
USB BATTERY CHARGER ŁĄCZOWNIKA	USB BATTERY CHARGER ŁĄCZOWNIKA

COB
LED



YATO
YT-08527 12

EN Workshop LED battery lamp
 PL Diodowa lampa warsztatowa akumulatorowa
 DE LED Akku-Werkstattlampe
 RU Светодиодная беспроводная лампа
 CZ Aku pracovní LED svítidla
 HU Akkumulátoros LED szerelőlámpa
 RO Lampa portabilă cu acumulator leduri
 FR Lampe d'inspection LED rechargeable
 IT Lampada LED ricaricabile per officina
 ES Lámpara de trabajo LED recargable
 CN LED工作灯



5+1 W	500/250 lm
3.7 V 2600mAh Li-Ion	6500K
120 lm	4h
2.5-7h	IP54
x1 HOOK HAK	USB BATTERY CHARGER ŁĄCZOWNIKA

COB
LED



YATO
YT-08562 12

EN Workshop LED battery lamp
 PL Diodowa lampa warsztatowa akumulatorowa
 DE LED Akku-Werkstattlampe
 RU Светодиодная беспроводная лампа
 CZ Aku pracovní LED svítidla
 HU Akkumulátoros LED szerelőlámpa
 RO Lampa portabilă cu acumulator leduri
 FR Lampe d'inspection LED rechargeable
 IT Lampada LED ricaricabile per officina
 ES Lámpara de trabajo LED recargable
 CN 可充电工作灯



3.5+3 W	330 lm
3.7 V 2600mAh Li-Ion	4h
6000K	IP54
4h	IK07
x2 HOOKS HAKI	USB BATTERY CHARGER ŁĄCZOWNIKA

SMD
LED



YATO
YT-085081 12

EN Workshop LED battery lamp
 PL Diodowa lampa warsztatowa akumulatorowa
 DE LED Akku-Werkstattlampe
 RU Светодиодная беспроводная лампа
 CZ Aku pracovní LED svítidla
 HU Akkumulátoros LED szerelőlámpa
 RO Lampa portabilă cu acumulator leduri
 FR Lampe d'inspection LED rechargeable
 IT Lampada LED ricaricabile per officina
 ES Lámpara de trabajo LED recargable
 CN 工作灯



30+7 LED	140 lm
3.7 V 2000mAh Li-Ion	4h
4h	x2 HOOKS HAKI
USB BATTERY CHARGER ŁĄCZOWNIKA	USB BATTERY CHARGER ŁĄCZOWNIKA

LED



YATO
YT-08507 12

EN Workshop LED battery lamp
PL Diodowa lampa warsztatowa akumulatorowa
DE LED Akku-Werkstattlampe
RU Светодиодная беспроводная лампа
CZ Aku pracovní LED svítidla
HU Akkumulátoros LED szerelőlámpa
RO Lampa portabila cu acumulator leduri
FR Lampe d'inspection LED rechargeable
IT Lampada LED ricaricabile per officina
ES Lámpara de trabajo LED recargable
CN 工作灯



COB
LED



YATO
YT-08504 10

EN Workshop LED battery lamp
PL Diodowa lampa warsztatowa akumulatorowa
DE LED Akku-Handleuchte
RU Светодиодная беспроводная лампа
CZ Aku pracovní LED svítidla
HU Akkumulátoros LED szerelőlámpa
RO Lampa portabila cu acumulator leduri
FR Lampe d'inspection LED rechargeable
IT Lampada LED ricaricabile per officina
ES Lámpara de trabajo LED recargable
CN 可充电工作灯

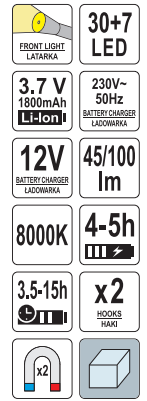

LED



YATO
YT-085051 10

EN Workshop LED battery lamp
PL Diodowa lampa warsztatowa akumulatorowa
DE LED Akku-Werkstattlampe
RU Светодиодная беспроводная лампа
CZ Aku pracovní LED svítidla
HU Akkumulátoros LED szerelőlámpa
RO Lampa portabila cu acumulator leduri
FR Lampe d'inspection LED rechargeable
IT Lampada LED ricaricabile per officina
ES Lámpara de trabajo LED recargable
CN LED工作灯



COB SMD
LED

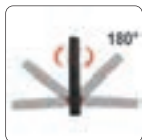

YATO
YT-08510 12

EN LED workshop lamp
PL Diodowa lampa warsztatowa
DE LED Werkstattlampe
RU Светодиодный светильник для мастерской
CZ Montážní lampa LED
HU LED szerelőlámpa
RO Lampa cu LED
FR Lampe d'atelier a LED
IT Lampada LED per officina
ES Lámpara de taller LED
CN LED工作灯



LED



YATO
YT-08520 5/20

EN LED workshop lamp
PL Diodowa lampa warsztatowa
DE LED Werkstattlampe
RU Светодиодный светильник для мастерской
CZ Montážní lampa LED
HU LED szerelőlámpa
RO Lampa cu LED
FR Lampe d'atelier a LED
IT Lampada LED per officina
ES Lámpara de taller LED
CN LED工作灯

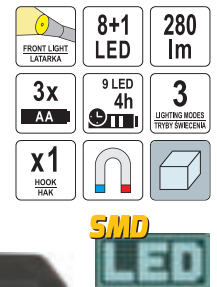

YATO
YT-08513 50

EN LED workshop lamp
 PL Diodowa lampa warsztatowa
 DE LED Werkstattlampe
 RU Светодиодный светильник для мастерской
 CZ Montážní lampa LED
 HU LED szerelőlámpa
 RO Lampa cu LED
 FR Lampe d'atelier a LED
 IT Lampada LED per officina
 ES Lámpara de taller LED
 CN 笔式可充电工作灯



8 LED
 80 lm
 3x AAA
 8 LED 20h

SMD LED

YATO
 YT-08514 12/72

EN LED workshop lamp
 PL Diodowa lampa warsztatowa
 DE LED Werkstattlampe
 RU Светодиодный светильник для мастерской
 CZ Montážní lampa LED
 HU LED szerelőlámpa
 RO Lampa cu LED
 FR Lampe d'atelier a LED
 IT Lampada LED per officina
 ES Lámpara de taller LED
 CN 笔式可充电工作灯



3W
 200 lm
 RED FLASH Czerwone Miganie
 IP44
 3x AAA

COB LED

YATO
 YT-08511 20/80

EN LED workshop lamp
 PL Diodowa lampa warsztatowa
 DE LED Werkstattlampe
 RU Светодиодный светильник для мастерской
 CZ Montážní lampa LED
 HU LED szerelőlámpa
 RO Lampa cu LED
 FR Lampe d'atelier a LED
 IT Lampada LED per officina
 ES Lámpara de taller LED
 CN 笔式可充电工作灯



3W
 400 lm
 RED FLASH Czerwone Miganie
 IP44
 3x AA

COB LED

YATO
 YT-08522 12/48

EN Multipurpose lamp
 PL Lampka wielofunkcyjna
 DE Multifunktions-Lampe
 RU Многофункциональная лампа
 CZ Multifunkční lampička
 HU Multifunkciós lámpa
 RO Lampa multifunctională
 FR Lampe multifonction
 IT Lampada multifunzione
 ES Lámpara multifuncional
 CN 工作灯



3W
 3.7 V 700mAh Li-Pol
 100 lm
 7000K
 1.5h
 2-3h
 IP54

COB LED

YATO
 YT-08516 15/60

EN Workshop LED battery lamp
 PL Diodowa lampa warsztatowa akumulatorowa
 DE LED Akku-Werkstattlampe
 RU Светодиодная беспроводная лампа

CZ Aku pracovní LED svítlna
 HU Akkumulátoros LED szerelőlámpa
 RO Lampa portabila cu acumulator leduri
 FR Lampe d'inspection LED rechargeable

IT Lampada LED ricaricabile per officina
 ES Lámpara de trabajo LED recargable
 CN 引擎盖检修灯

LED
 120 LED
 60 LED
 120 LED
 7.4 V 1800mAh Li-Ion
 AC BATTERY CHARGER LADOWARKA
 12V BATTERY CHARGER LADOWARKA
 750 lm
 4.5-5h
 3.5-8h
 x2 HOOKS TAKI

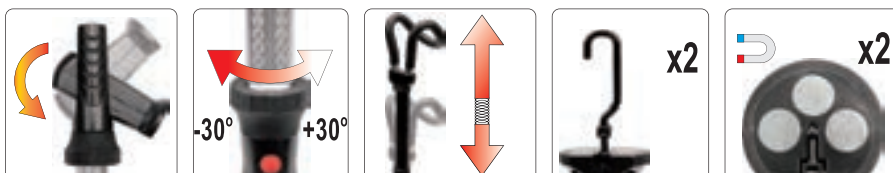

YATO
 YT-08529 4

EN UV LED flashlight and glasses set
PL Zestaw latarka UV LED i okulary
DE UV LED Taschenlampe mit UV Schutzbrille
RU Комплект для проверки утечек хладагента - УФ фонарь с очками
CZ UV LED svítilna + brýle
HU UV LED zseblámpa + szemüveg
RO Set lanterna UV LED si ochelari
FR UV LED lampe de poche avec lunettes
IT Lampada UV LED con occhiali
ES UV LED linterna con gafas para
CN 手电筒

51
LED
UV
395
nm
3x
AAA



UV
LED

YATO

YT-08581

40

EN UV LED flashlight and glasses set
PL Zestaw latarka UV LED i okulary
DE UV LED-Taschenlampe mit UV Schutzbrille
RU Комплект для проверки утечек хладагента - УФ фонарь с очками
CZ UV LED svítilna + brýle
HU UV LED zseblámpa + szemüveg
RO Set lanterna UV LED si ochelari
FR UV LED lampe de poche avec lunettes
IT Lampada UV LED con occhiali
ES UV LED linterna con gafas para
CN 紫外线手电筒和防护眼镜

100
LED
UV
395
nm
6x
AA



UV
LED

YATO

YT-08582

12

EN UV LED flashlight and glasses set
PL Zestaw latarka UV LED i okulary
DE UV LED-Taschenlampe mit UV Schutzbrille
RU Комплект для проверки утечек хладагента - УФ фонарь с очками
CZ UV LED svítilna + brýle
HU UV LED zseblámpa + szemüveg
RO Set lanterna UV LED si ochelari
FR UV LED lampe de poche avec lunettes
IT Lampada UV LED con occhiali
ES UV LED linterna con gafas para
CN 紫外线手电筒和防护眼镜

1W
UV
395
nm
3.7 V
1500mAh
Li-Ion
6-8h
3.5-4h
ZOOM
Micro
USB



UV
LED

YATO

YT-08587

12

EN UV LED flashlight and glasses set
PL Zestaw latarka UV LED i okulary
DE UV LED-Taschenlampe mit UV Schutzbrille
RU Комплект для проверки утечек хладагента - УФ фонарь с очками
CZ UV LED svítilna + brýle
HU UV LED zseblámpa + szemüveg
RO Set lanterna UV LED si ochelari
FR UV LED lampe de poche avec lunettes
IT Lampada UV LED con occhiali
ES UV LED linterna con gafas para
CN 紫外线手电筒和防护眼镜

3W
UV
395
nm
3.7 V
1500mAh
Li-Ion
6-8h
3.5-4h
FLASH
MIGANIE
Micro
USB



UV
LED

YATO

YT-08588

12

EN LED flashlight
PL Latarka LED
DE LED Taschenlampe
RU Светодиодный фонарь
CZ LED svítilna
HU LED zseblámpa
RO Lanterna cu LED
FR Lampe torche LED
IT Torcia LED
ES Linterna LED
CN 手电筒

FRONT LIGHT
LATARKA
2W
200
lm
IPX4
IK07
3x
AAA
x1
HOOK
HAK
x2

POWER SMD
LED



YATO

[W]

[lm]

50

YT-08555

2

200 / 70 / 45

EN LED flashlight
PL Latarka LED
DE LED Taschenlampe
RU Светодиодный фонарь
CZ LED svítilna
HU LED zseblámpa
RO Lanterna cu LED
FR Lampe torche LED
IT Torcia LED
ES Linterna LED
CN 手电筒

FRONT LIGHT
LATARKA
5W
3.7 V
1500mAh
Li-Po
500
lm
3h
2-9h
1500 mAh
IPX4
IK07
x1
HOOK
HAK
x2
USB
BATTERY CHARGER
LADOWNIKA

POWER SMD
LED



YATO

[W]

[lm]

50

YT-08556

5+1

500 / 200 / 60

EN LED flashlight
 PL Latarka LED
 DE LED Taschenlampe
 RU Светодиодный фонарь
 CZ LED svítilna
 HU LED zseblámpa
 RO Lanterna cu LED
 FR Lampe torche LED
 IT Torcia LED
 ES linterna LED
 CN 手电筒



FRONT LIGHT
LATARKA

5W

3.7 V
2000mAh
Li-Po

500 lm

4h **2h** **5h**
30' - 20'

IP54 **IK07**

USB
BATTERY CHARGER
LADOWNARKA

COB SMD
LED



YATO	[W]	[lm]	
YT-08557	5+0.9	500 / 250 / 90	50

EN LED flashlight
 PL Latarka LED
 DE LED-Taschenlampe
 RU Светодиодный фонарь
 CZ LED svítilna
 HU LED zseblámpa
 RO Lanterna cu LED
 FR Lampe torche LED
 IT Torcia LED
 ES linterna LED
 CN 手电筒



5W **UV**

3.7 V
2000mAh
Li-Ion

200/300 lm

7000K **5.5h**

2-3h

IP54

USB
BATTERY CHARGER
LADOWNARKA

COB
LED



YATO	[W]	[lm]	
YT-08580	5	200 / 300	50

EN LED flashlight
 PL Latarka LED
 DE LED Taschenlampe
 RU Светодиодный фонарь
 CZ LED svítilna
 HU LED zseblámpa

RO Lanterna cu LED
 FR Lampe torche LED
 IT Torcia LED
 ES linterna LED
 CN 手电筒

10 W **XPL** **1000 lm** **350m**

3 LIGHTING MODES
TRYBY SWIECENIA

ZOOM **IPX4** **6 V**
4x
CR14

POWER
LED



YATO	[W]	[lm]	
YT-08567	10	1000	8/16

EN LED flashlight
 PL Latarka LED
 DE LED Taschenlampe
 RU Светодиодный фонарь
 CZ LED svítilna
 HU LED zseblámpa

RO Lanterna cu LED
 FR Lampe torche LED
 IT Torcia LED
 ES linterna LED
 CN 手电筒

6W **XPG3** **3.7 V**
2200mAh
Li-Ion

500 lm

200m **3** LIGHTING MODES
TRYBY SWIECENIA

ZOOM **IPX7** **USB**
BATTERY CHARGER
LADOWNARKA

POWER
LED



YATO	[W]	[lm]	
YT-08568	6	500	6/24

EN LED flashlight
 PL Latarka LED
 DE LED Taschenlampe
 RU Светодиодный фонарь
 CZ LED svítilna
 HU LED zseblámpa

RO Lanterna cu LED
 FR Lampe torche LED
 IT Torcia LED
 ES linterna LED
 CN USB充电手电筒

5W **XTE** **3.7 V**
650mAh
Li-Po

350 lm **150m** **4** LIGHTING MODES
TRYBY SWIECENIA

ZOOM **IPX4** **USB**
BATTERY CHARGER
LADOWNARKA

POWER
LED



YATO	[W]	[lm]	
YT-08569	5	350	12/96

EN LED flashlight
 PL Latarka LED
 DE LED Taschenlampe
 RU Светодиодный фонарь
 CZ LED svítilna
 HU LED zseblámpa
 RO Lanterna cu LED
 FR Lampe torche LED
 IT Torcia LED
 ES linterna LED
 CN 手电筒

10 W **3.7 V**
2200mAh
Li-Ion

900 lm **200m**

5 LIGHTING MODES
TRYBY SWIECENIA

ZOOM **5-6h** **3-7h**

2200 mAh **IP64** **USB**
BATTERY CHARGER
LADOWNARKA

POWER
LED



YATO	[W]	[lm]	
YT-08559	10	900	30

- Bottle opener
- Emergency hammer
- Otwieracz do butelek
- Młotek awaryjny do szyb

EN LED flashlight
 PL Latarka LED
 DE LED Taschenlampe
 RU Светодиодный фонарь
 CZ LED svítilna
 HU LED zseblámpa
 RO Lanterna cu LED
 FR Lampe torche LED
 IT Torcia LED
 ES linterna LED
 CN 手电筒



POWER
LED

3W **130 lm** **ZOOM** **IP64**

1.5 V
2x
C

YATO	[W]	[lm]	
YT-08577	3	130	12/48



EN LED flashlight
PL Latarka LED
DE LED Taschenlampe
RU Светодиодный фонарь
CZ LED svítilna
HU LED zseblámpa

RO Lanterna cu LED
FR Lampe torche LED
IT Torcia LED
ES linterna LED
CN 手电筒

3W
100 lm
ZOOM
IP64
1x AA



POWER LED

YATO 	[W]	[lm]	
YT-08571	3	100	24/96



EN LED flashlight
PL Latarka LED
DE LED Taschenlampe
RU Светодиодный фонарь
CZ LED svítilna
HU LED zseblámpa

RO Lanterna cu LED
FR Lampe torche LED
IT Torcia LED
ES linterna LED
CN 手电筒

9 LED
3x AAA



LED

YATO 	
YT-08570	24/192

EN Spotlight
PL Latarka szperacz
DE Suchscheinwerfer
RU Прожекторный фонарь
CZ Ruční svítilna
HU Keresőlámpa

RO Lanterna
FR Projecteur de recherche
IT Proiettore portatile ricaricabile
ES Reflector linterna
CN 多功能探照灯

3.7 V
3000mAh
Li-Ion
380/200 lm
500m
6 LIGHTING MODES
TRIPLE SWITCHING
6h
4h
x1 HOOK HAKK
Micro USB



POWER LED

YATO 	[lm]	
YT-08547	380/200	24

EN Spotlight
PL Latarka szperacz
DE Suchscheinwerfer
RU Прожекторный фонарь
CZ Ruční svítilna
HU Keresőlámpa

RO Lanterna
FR Projecteur de recherche
IT Proiettore portatile ricaricabile
ES Reflector linterna
CN 多功能探照灯

XPG
3.7 V
4400mAh
Li-Ion
530 lm
500m
11 LIGHTING MODES
TRIPLE SWITCHING
5h
3h
4400 mAh
IP54
x1 HOOK HAKK
USB BATTERY CHARGER
LADONARKA



POWER LED

YATO 	[lm]	
YT-08579	530/170	10

EN Spotlight
PL Latarka szperacz
DE Suchscheinwerfer
RU Прожекторный фонарь
CZ Ruční svítilna
HU Keresőlámpa
RO Lanterna
FR Projecteur de recherche
IT Proiettore portatile ricaricabile
ES Reflector linterna
CN 手枪灯

10 W
900 lm
200m
FLASH MIGNANE
IP68
4x AA



POWER LED

YATO 	[W]	[lm]	
YT-08550	10	900/450	10/20

EN Spotlight
PL Latarka szperacz
DE Suchscheinwerfer
RU Прожекторный фонарь
CZ Ruční svítilna
HU Keresőlámpa
RO Lanterna
FR Projecteur de recherche
IT Proiettore portatile ricaricabile
ES Reflector linterna
CN 手枪灯

15 W
3.7 V
4400mAh
Li-Ion
1200 lm
250m
FLASH MIGNANE
6h
5-6h
4400 mAh
IP68
USB BATTERY CHARGER
LADONARKA



POWER LED

YATO 	[W]	[lm]	
YT-08551	15	1200/600	10/20

EN LED headlamp
 PL Latarka czołowa LED
 DE LED Kopflampe
 RU Налобный светодиодный фонарь
 CZ Čelová lampa LED
 HU LED fejlámpa
 RO Lanterna cu LED pt. cap
 FR Lampe frontale LED
 IT Lampada da testa LED
 ES Lámpara LED de cabeza
 CN LED头灯



3W **100 lm**
 ZOOM
 3x AAA

POWER LED

YATO	[W]	[lm]	
YT-08590	3	100	50/100

EN LED headlamp
 PL Latarka czołowa LED
 DE LED Kopflampe
 RU Налобный светодиодный фонарь
 CZ Čelová lampa LED
 HU LED fejlámpa
 RO Lanterna cu LED pt. cap
 FR Lampe frontale LED
 IT Lampada da testa LED
 ES Lámpara LED de cabeza
 CN LED头灯



10 W **XM-L2**
450 lm
 ZOOM
 3 LIGHTING MODES TRYBY SWIECENIA
 4x AA

POWER LED

YATO	[W]	[lm]	
YT-08591	10	450	6/24

EN LED headlamp
 PL Latarka czołowa LED
 DE LED Kopflampe
 RU Налобный светодиодный фонарь
 CZ Čelová lampa LED
 HU LED fejlámpa

RO Lanterna cu LED pt. cap
 FR Lampe frontale LED
 IT Lampada da testa LED
 ES Lámpara LED de cabeza
 CN LED头灯

XTE **500 lm** **6** LIGHTING MODES TRYBY SWIECENIA
IP44 **3x AAA**



POWER SMD LED

YATO	[lm]	
YT-08595	500	12/72

EN LED headlamp
 PL Latarka czołowa LED
 DE LED Kopflampe
 RU Налобный светодиодный фонарь
 CZ Čelová lampa LED
 HU LED fejlámpa
 RO Lanterna cu LED pt. cap
 FR Lampe frontale LED
 IT Lampada da testa LED
 ES Lámpara LED de cabeza
 CN LED头灯

XTE **3.7 V 1000mAh Li-Po** **500 lm** **6** LIGHTING MODES TRYBY SWIECENIA
4-5h **4.5-9h** **IP44** **USB** BATTERY CHARGER ŁADOWNIK



POWER SMD LED

YATO	[lm]	
YT-08596	500	12/72

EN LED headlamp
 PL Latarka czołowa LED
 DE LED Kopflampe
 RU Налобный светодиодный фонарь
 CZ Čelová lampa LED
 HU LED fejlámpa

RO Lanterna cu LED pt. cap
 FR Lampe frontale LED
 IT Lampada da testa LED
 ES Lámpara LED de cabeza
 CN LED头灯

3.7 V 1400mAh Li-Po **480 lm**
2-2.5h **15-10h**
1m **IP54**
USB BATTERY CHARGER ŁADOWNIK



COB LED

YATO	[lm]	
YT-08592	480 (300 lm - P8 100%, 90 lm - P8 30%, 250 lm - COB 100%, 480 lm - P8 + COB)	6/24

EN LED headlamp
 PL Latarka czołowa LED
 DE LED Kopflampe
 RU Налобный светодиодный фонарь
 CZ Čelová lampa LED
 HU LED fejlámpa

RO Lanterna cu LED pt. cap
 FR Lampe frontale LED
 IT Lampada da testa LED
 ES Lámpara LED de cabeza
 CN LED头灯

3.7 V 1000mAh Li-Po **3x AAA**
500 lm **2-2.5h**
1h 20min - 10h **1m**
IP54 **USB** BATTERY CHARGER ŁADOWNIK



COB LED

YATO	[lm]	
YT-08593	500 (400 lm - P8 100%, 120 lm - P8 30%, 200 lm - COB 100%, 500 lm - P8 + COB)	6/24

EN LED headlamp
 PL Latarka czołowa LED
 DE LED Kopflampe
 RU Налобный светодиодный фонарь
 CZ Čelová lampa LED
 HU LED fejlámpa

RO Lanterna cu LED pt. cap
 FR Lampe frontale LED
 IT Lampada da testa LED
 ES Lámpara LED de cabeza
 CN LED头灯

3.7 V 2200mAh Li-Po **800 lm** **4h**
1.5-5h **1m**
IP54 **USB** BATTERY CHARGER ŁADOWNIK



COB LED

YATO	[lm]	
YT-08594	800 (600 lm - SST40 100%, 250 lm - SST40 30%, 250 lm - COB 100%, 800 lm - SST40 + COB)	6/24

EN LED headlamp for colour match
 PL Lampa czołowa LED do doborzenia kolorów
 DE LED-Stirnleuchte für Farbanpassung
 RU Светодиодный налобный фонарь для подбора цвета
 CZ LED čelovka pro barevné sladění
 HU LED homloklámpa színválasztáshoz
 RO Lanterna cap cu LED pentru potrivirea culorilor
 FR Lampe frontale LED adaptation de couleurs
 IT Torcia frontale a LED per selezionare colori
 ES Lámpara frontal LED para seleccionar colores
 CN 头灯-用于比对颜色

CRI 96 **3.7 V 1500mAh Li-Ion** **160 lm** **2700K 4500K 6500K** **3h** **3h**
IP65 **IK07** **USB** CHARGING ŁADOWNIK



COB LED

YATO	[lm]	
YT-08490	160	40

EN Neck lamp
PL Lataka na szyję
DE Halslampe
RU Фонарь на шею
CZ Svítilna na krk
HU Nyaklámpa
RO Lanterna pt. gat
FR Lampe torche tour du cou
IT Torcia da collo
ES Linterna para el cuello
CN 脖子灯

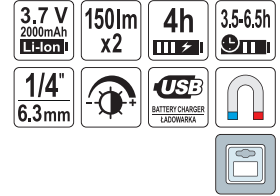

YATO	[lm]	
YT-08599	150 x2	6/24

EN Infrared heater
PL Promiennik podczerwieni
DE Infrarotstrahler
RU Инфракрасный обогреватель
CZ Infrazářič
HU Infravörös melegítő
RO Incalzitör cu infrarosu
FR Illuminateur infrarouge
IT Irradiatore a raggi infrarossi
ES Radiador infrarrojo
CN 取暖器

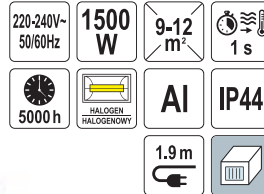

YATO	[W]	
YT-99500	1500	1

EN Infrared heater
PL Promiennik podczerwieni
DE Infrarotstrahler
RU Инфракрасный обогреватель
CZ Infrazářič
HU Infravörös melegítő
RO Incalzitör cu infrarosu
FR Illuminateur infrarouge
IT Irradiatore a raggi infrarossi
ES Radiador infrarrojo
CN 取暖器



YATO	[W]	
YT-99501	1500	1

EN Infrared heater
PL Promiennik podczerwieni
DE Infrarotstrahler
RU Инфракрасный обогреватель
CZ Infrazářič
HU Infravörös melegítő
RO Incalzitör cu infrarosu
FR Illuminateur infrarouge
IT Irradiatore a raggi infrarossi
ES Radiador infrarrojo
CN 取暖器

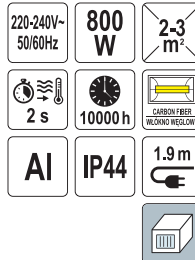

YATO	[W]	
YT-99520	800	4

EN Infrared heater
PL Promiennik podczerwieni
DE Infrarotstrahler
RU Инфракрасный обогреватель
CZ Infrazářič
HU Infravörös melegítő
RO Incalzitör cu infrarosu
FR Illuminateur infrarouge
IT Irradiatore a raggi infrarossi
ES Radiador infrarrojo
CN 取暖器



Compatible with YT-99570, YT-99571
Kompatybilny z YT-99570, YT-99571

YATO	[W]	
YT-99530	2000	1

EN Infrared heater
PL Promiennik podczerwieni
DE Infrarotstrahler
RU Инфракрасный обогреватель
CZ Infrazářič
HU Infravörös melegítő
RO Incalzitör cu infrarosu
FR Illuminateur infrarouge
IT Irradiatore a raggi infrarossi
ES Radiador infrarrojo
CN 取暖器



Compatible with YT-99570, YT-99571
Kompatybilny z YT-99570, YT-99571

YATO	[W]	
YT-99531	2000	6

EN Infrared heater
PL Promiennik podczerwieni
DE Infrarotstrahler
RU Инфракрасный обогреватель
CZ Infrazářič
HU Infravörös melegítő
RO Incalzitör cu infrarosu
FR Illuminateur infrarouge
IT Irradiatore a raggi infrarossi
ES Radiador infrarrojo
CN 取暖器

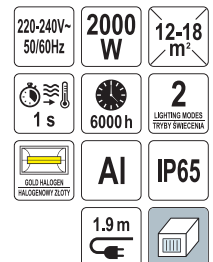

Compatible with YT-99570, YT-99571
Kompatybilny z YT-99570, YT-99571

YATO	[W]	
YT-99532	2000	6

EN Infrared heater
 PL Promiennik podczerwieni
 DE Infrarotstrahler
 RU Инфракрасный обогреватель
 CZ Infrazářič
 HU Infravörös melegítő
 RO Incalzitor cu infrarosu
 FR Illuminateur infrarouge
 IT Irradiatore a raggi infrarossi
 ES Radiador infrarrojo
 CN 取暖器

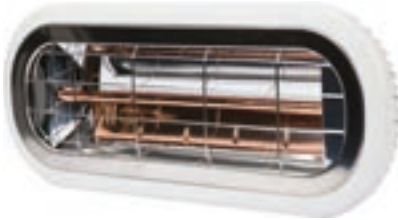

Compatible with YT-99570, YT-99571
 Kompatybilny z YT-99570, YT-99571

YATO	[W]	
YT-99536	2000	4

EN Stand for infrared heater
 PL Statyw do promienników podczerwieni
 DE Infrarotstrahlgerstell
 RU Подставка для инфракрасных обогревателей
 CZ Stojan pro infrazářiče
 HU Állvány infravörös melegítőhöz
 RO Stand pt. incalzitor cu infrarosu
 FR Trépied pour illuminateur infrarouge
 IT Treppiede per irradiatore a raggi infrarossi
 ES Trípode para radiadores infrarrojos
 CN 支架

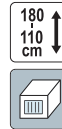

For YT-99530, YT-99531, YT-99532, YT-99536
 Dla YT-99530, YT-99531, YT-99532, YT-99536

YATO	H [mm]	
YT-99570	1100-1800	6

EN Stand for infrared heater
 PL Statyw do promienników podczerwieni
 DE Infrarotstrahlgerstell
 RU Подставка для инфракрасных обогревателей
 CZ Stojan pro infrazářiče
 HU Állvány infravörös melegítőhöz
 RO Stand pt. incalzitor cu infrarosu
 FR Trépied pour illuminateur infrarouge
 IT Treppiede per irradiatore a raggi infrarossi
 ES Trípode para radiadores infrarrojos
 CN 支架



For YT-99530, YT-99531, YT-99532, YT-99536
 Dla YT-99530, YT-99531, YT-99532, YT-99536

YATO	H [mm]	
YT-99571	1100-2100	1

EN Universal travel adapter with USB
 PL Uniwersalny adapter podróżny z USB
 DE Universal-Reisestecker mit USB
 RU Универсальный дорожный адаптер-переходник с USB
 CZ Univerzální cestovní adaptér s USB
 HU Univerzális utazó adapter USB-vel
 RO Adaptor universal de călătorie cu USB
 FR Adaptateur de voyage universel avec USB
 IT Adattatore universale da viaggio con USB
 ES Adaptador universal de viaje con USB
 CN 旅行转换插头

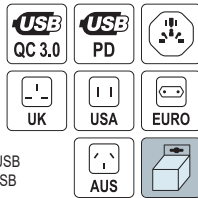

YATO	
YT-81300	50

EN Universal travel adapter with USB
 PL Uniwersalny adapter podróżny z USB
 DE Universal-Reisestecker mit USB
 RU Универсальный дорожный адаптер-переходник с USB
 CZ Univerzální cestovní adaptér s USB
 HU Univerzális utazó adapter USB-vel
 RO Adaptor universal de călătorie cu USB
 FR Adaptateur de voyage universel avec USB
 IT Adattatore universale da viaggio con USB
 ES Adaptador universal de viaje con USB
 CN 旅行转换插头

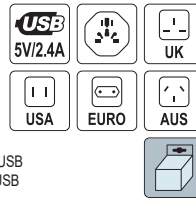

YATO	
YT-81301	50

EN Universal travel adapter
 PL Uniwersalny adapter podróżny
 DE Universal-Reisestecker
 RU Универсальный дорожный адаптер-переходник
 CZ Univerzální cestovní adaptér
 HU Univerzális utazó adapter
 RO Adaptor universal de călătorie
 FR Adaptateur de voyage universel
 IT Adattatore universale da viaggio
 ES Adaptador universal de viaje
 CN 旅行转换插头

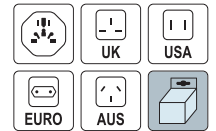

YATO	
YT-81302	50

EN Rubber protection extension cord
 PL Przedłużacz w osłonie gumowej
 DE Gummiisolierte Verlängerungsschnur
 RU Удлинитель с резиновой изоляцией
 CZ Prodlužovací kabel s gumovou izolací
 HU Gumi szigetelésű hosszabbító
 RO Cablu prelungitor cauciu
 FR Rallonge électrique
 IT Prolunga in gomma
 ES Cable de extensión con protección de caucho
 CN 电缆延长线

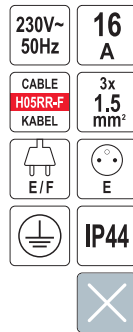

YATO	L [m]	
YT-81021	10	10
YT-81022	20	5
YT-81023	30	5
YT-81024	40	5

EN Rubber protection extension cord
 PL Przedłużacz w osłonie gumowej
 DE Gummiisolierte Verlängerungsschnur
 RU Удлинитель с резиновой изоляцией
 CZ Prodlužovací kabel s gumovou izolací
 HU Gumi szigetelésű hosszabbító
 RO Cablu prelungitor cauciu
 FR Rallonge électrique
 IT Prolunga in gomma
 ES Cable de extensión con protección de caucho
 CN 电缆延长线

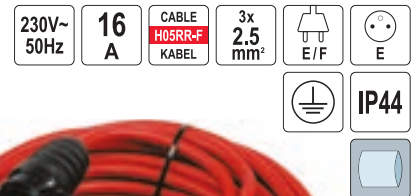

YATO	L [m]	
YT-8100	20	4
YT-8101	30	2
YT-8102	40	2

EN Rubber protection extension cord
PL Przedłużacz w osłonie gumowej
DE Gummiisolierte Verlängerungsschnur
RU Удлинитель с резиновой изоляцией
CZ Prodlužovací kabel s gumovou izolací
HU Gumi szigetelésű hosszabbító
RO Cablu prelungitor cauciu
FR Rallonge électrique
IT Prolunga in gomma
ES Cable de extensión con protección de caucho
CN 电缆延长线



YATO	L [m]	
YT-8111	5	10
YT-8112	10	10

EN Rubber protection extension cord
PL Przedłużacz w osłonie gumowej
DE Gummiisolierte Verlängerungsschnur
RU Удлинитель с резиновой изоляцией
CZ Prodlužovací kabel s gumovou izolací
HU Gumi szigetelésű hosszabbító
RO Cablu prelungitor cauciu
FR Rallonge électrique
IT Prolunga in gomma
ES Cable de extensión con protección de caucho
CN 电缆延长线

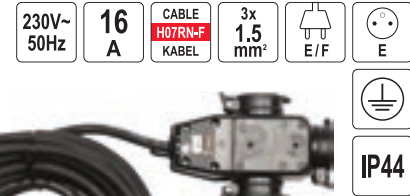

YATO	L [m]	
YT-8116	10	4
YT-81162	20	4

EN Extension cord
PL Przedłużacz elektryczny
DE Verlängerungskabel
RU Удлинитель электрический
CZ Elektrický prodlužovač
HU Elektromos hosszabbító
RO Prelungitor electric
FR Rallonge électrique
IT Prolunga elettrica
ES Extensión eléctrica
CN 电源连接器

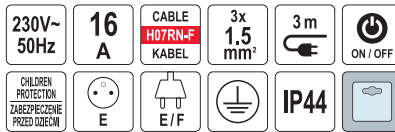

YATO	L [m]		Socket type / Typ gniazda	
YT-81240	3	3	E	10
YT-81241	3	4	E	10
YT-81242	3	5	E	10

EN Auto retract electric cable reel
PL Przedłużacz elektryczny na zwijaku automatycznym
DE Elektro-Kabelaufroller mit automatischem Einzug
RU Электрический удлинитель на автоматическом барабане
CZ Elektrický prodlužovací kabel na automatickém navijáku
HU Elektromos hosszabbító automatikus csévével
RO Prelungitor electric retractabil
FR Câble de rallonge électrique sur enrouleur automatique
IT Prolunga elettrica con avvolgicavo automatico
ES Prolongador eléctrico en enrollador automático
CN 电缆卷管器

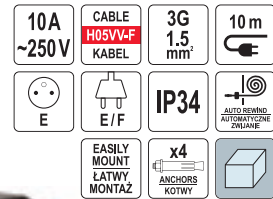

YATO	L [m]	
YT-81220	10	4

EN Cable reel
PL Przedłużacz zwijany
DE Kabeltrommel
RU Удлинитель электрический
CZ Bubnový prodlužovač
HU Kábeldob
RO Prelungitor pe tambur
FR Rallonge électrique sur tambour enrouleur
IT Avvolgicavo con bobina
ES Cable de prolongación de tambor
CN 电缆卷轴

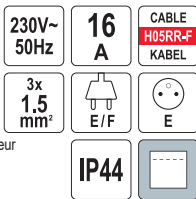

$P_{max} = 1000$ W coiled
 $P_{max} = 3000$ W uncoiled
 $P_{max} = 1000$ W zwinięty
 $P_{max} = 3000$ W rozwinięty

YATO	L [m]	
YT-81053	20	2
YT-81052	30	2
YT-81054	40	2

EN Cable reel
PL Przedłużacz zwijany
DE Kabeltrommel
RU Удлинитель электрический
CZ Bubnový prodlužovač
HU Kábeldob
RO Prelungitor pe tambur
FR Rallonge électrique sur tambour enrouleur
IT Avvolgicavo con bobina
ES Cable de prolongación de tambor
CN 电缆延长线

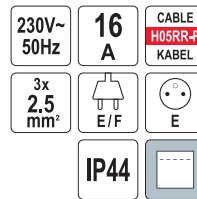

$P_{max} = 1200$ W coiled
 $P_{max} = 3600$ W uncoiled
 $P_{max} = 1200$ W zwinięty
 $P_{max} = 3600$ W rozwinięty

YATO	L [m]	
YT-8106	30	1
YT-8107	40	1
YT-8108	50	1

EN Cable reel
PL Przedłużacz zwijany
DE Kabeltrommel
RU Удлинитель электрический
CZ Bubnový prodlužovač
HU Kábeldob
RO Prelungitor pe tambur
FR Rallonge électrique sur tambour enrouleur
IT Avvolgicavo con bobina
ES Cable de prolongación de tambor
CN 电缆延长线

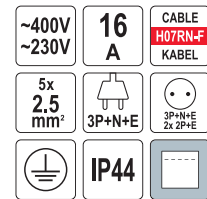

~230 V; 2P+E:
 $P_{max} = 1200$ W coiled
 $P_{max} = 3000$ W uncoiled
~400 V; 3P+N+E:
 $P_{max} = 3000$ W coiled
 $P_{max} = 9000$ W uncoiled

YATO	L [m]	
YT-8120	25	1

22

Garden tools
Narzędzia ogrodnicze





Watering program Program wodny	
.....	670-677

Hose connectors, male connectors, couplings, hose menders Złącza, nypły, łączniki, rozgałęziacze, reparatory	670
Hose nozzles (sprinklers) & sets Zraszacze i zestawy	672
Garden hose holders Stojaki na węże ogrodowe	675
Pumps & accessories Pompy i akcesoria	675

Pruners & shears Sekatory i nożyce ogrodowe	
.....	677-682

Pruners Sekatory	677
Lopping shears Sekatory do gałęzi	680
Leverage tree pruners Sekatory gąsienicowe	681
Hedge shears Nożyce do żywopłotu	682
Grass shears Nożyce do trawy	682

Bow saws & blades Piły kabłąkowe i brzeszczoty	
.....	682

Axes Siekiry	
.....	682

Hand tools Narzędzia ręczne	
.....	682-685

Small garden tools Małe narzędzia ogrodowe	682
Big garden tools Duże narzędzia ogrodowe	685
Accessories Akcesoria	685

Cordless garden tools & accessories Ogrodowe narzędzia akumulatorowe i akcesoria	
.....	686-689

Cordless pressure washers Akumulatorowe myjki ciśnieniowe	686
Cordless blowers Dmuchawy akumulatorowe	686
Cordless sprayers Spryskiwacze akumulatorowe	686
Cordless grass trimmers & accessories Akumulatorowe wykasarki i akcesoria	686
Cordless hedge trimmers Akumulatorowe nożyce do żywopłotu	687
Cordless chainsaws Akumulatorowe pilarki łańcuchowe	688
Cordless lawn mowers Kosiarki akumulatorowe	689
Accessories Akcesoria	689

Electric garden tools Ogrodowe narzędzia elektryczne	
.....	690-691

Electric grass trimmers Wykasarki elektryczne	690
Electric chainsaws Pilarki elektryczne	690
Electric lawn mowers Kosiarki elektryczne	690
Electric tillers Gleboğrafzarki elektryczne	690
Electric scarifiers Wertykulatory elektryczne	691
Electric blowers Dmuchawy elektryczne	691
Accessories Akcesoria	691

Gasoline garden tools & accessories Ogrodowe narzędzia spalinowe i akcesoria	
.....	691-699

Gasoline sprayers Opryskiwacze spalinowe	691
Gasoline earth augers & accessories Wiertnice glebowe i akcesoria	691
Gasoline chainsaws Pilarki spalinowe	692
Gasoline brushcutters Kosy spalinowe	692
Gasoline tillers Gleboğrafzarki spalinowe	692
Accessories Akcesoria	693

EN Hose connector
 PL Złącze standard
 DE Universal Schnellschlauchkupplung
 RU Соединитель
 CZ Rychlospojka
 HU Fitting
 RO Mufă pt. pistol
 FR Raccord standard
 IT Connettore standard
 ES Junta estandar
 CN 通水接头



Ø1/2"
 12.7mm
 ABS

YATO  
 YT-99801 12/120

EN Waterstop hose connector
 PL Złącze stop
 DE Universal Schnellschlauchkupplung mit Wasserstop
 RU Соединитель с автостопом
 CZ Rychlospojka
 HU Fitting
 RO Mufă pt. pistol
 FR Raccord stop
 IT Connettore stop
 ES Junta estandar
 CN 止水接头



Ø1/2"
 12.7mm
 ABS
 STOP

YATO  
 YT-99803 12/120

EN Hose connector
 PL Złącze standard
 DE Universal Schnellschlauchkupplung
 RU Соединитель
 CZ Rychlospojka
 HU Fitting
 RO Mufă pt. pistol
 FR Raccord standard
 IT Connettore standard
 ES Junta estandar
 CN 通水接头



Ø3/4"
 19mm
 ABS

YATO  
 YT-99802 12/120

EN Waterstop hose connector
 PL Złącze stop
 DE Universal Schnellschlauchkupplung mit Wasserstop
 RU Соединитель с автостопом
 CZ Rychlospojka
 HU Fitting
 RO Mufă pt. pistol
 FR Raccord stop
 IT Connettore stop
 ES Junta estandar
 CN 止水接头



Ø3/4"
 19mm
 ABS
 STOP

YATO  
 YT-99804 12/120

EN Hose mender
 PL Reparatör do węzła
 DE Schlauchreparatur, Schlauchverbinder
 RU Соединитель шлангов
 CZ Opravka
 HU Gyorstoldó
 RO Mufă înădire
 FR Réparateur de tuyau
 IT Tubo reparatore
 ES Reparador para manguera
 CN 修补接头



Ø1/2"
 12.7mm
 ABS

YATO  
 YT-99810 12/120

EN Hose mender
 PL Reparatör do węzła
 DE Schlauchreparatur, Schlauchverbinder
 RU Соединитель шлангов
 CZ Opravka
 HU Gyorstoldó
 RO Mufă înădire
 FR Réparateur de tuyau
 IT Tubo reparatore
 ES Reparador para manguera
 CN 修补接头





Ø3/4"
 19mm
 ABS

YATO  
 YT-99811 12/120

EN Hose reducer
 PL Reduktor do węzła
 DE Schlauchdruckminderer
 RU Редуктор
 CZ Redukce
 HU Szűkítő
 RO Reductor
 FR Réducteur
 IT Regolatore
 ES Reductor
 CN 修补转换接头



Ø1/2"
 12.7mm
 Ø3/4"
 19mm
 ABS

YATO  
 YT-8979 24/240

EN Snap-in tap adaptor
 PL Przyłącze do kranu
 DE Wasserhahnanschluss für Gartenschlauch
 RU Адаптер внутренний
 CZ Šroubení
 HU Tömlővég csaphoz
 RO Mufă pt. robinet cu filet interior
 FR Raccord
 IT Collegamento al rubinetto
 ES Tubuladura de grifo
 CN 铁箍接头



G1/2 ABS

YATO  
 YT-8970 24/240

EN Snap-in tap adaptor
 PL Przyłącze do kranu
 DE Wasserhahnanschluss für Gartenschlauch
 RU Адаптер внутренний
 CZ Šroubení
 HU Tömlővég csaphoz
 RO Mufă pt. robinet cu filet interior
 FR Raccord
 IT Collegamento al rubinetto
 ES Tubuladura de grifo
 CN 母接头



(F)
 G3/4
 ABS

YATO  
 YT-8971 12/120

EN Snap-in tap adaptor
 PL Przyłącze do kranu
 DE Wasserhahnanschluss für Gartenschlauch
 RU Адаптер внутренний
 CZ Šroubení
 HU Tömlővég csaphoz
 RO Mufă pt. robinet cu filet interior
 FR Raccord
 IT Collegamento al rubinetto
 ES Tubuladura de grifo
 CN 母接头



(F)
 G3/4
 ABS

YATO  
 YT-99812 12/120

EN Snap-in tap adaptor
 PL Przyłącze do kranu
 DE Wasserhahnanschluss für Gartenschlauch
 RU Адаптер внутренний
 CZ Šroubení
 HU Tömlővég csaphoz
 RO Mufă pt. robinet cu filet interior
 FR Raccord
 IT Collegamento al rubinetto
 ES Tubuladura de grifo
 CN 母接头



(F)
 G1
 ABS

YATO  
 YT-8972 12/120

EN Snap-in tap adaptor
 PL Przyłącze do kranu
 DE Wasserhahnanschluss für Gartenschlauch
 RU Адаптер внутренний
 CZ Šroubení
 HU Tömlővég csaphoz
 RO Mufă pt. robinet cu filet interior
 FR Raccord
 IT Collegamento al rubinetto
 ES Tubuladura de grifo
 CN 母接头



(F)
 G1
 ABS

YATO  
 YT-99813 12/120

EN Snap-in tap adaptor
PL Przyłącze do kranu
DE Wasserhahnanschluss für Gartenschlauch
RU Адаптер внутренний
CZ Šroubení
HU Tömlovég csaphoz
RO Mufa pt. robinet cu filet interior
FR Raccord
IT Collegamento al rubinetto
ES Tubuladura de grifo
CN 转换接头



(F)
G1/2
(F)
G3/4
ABS

YATO
YT-8973

12/120

EN Snap-in tap adaptor
PL Przyłącze do kranu
DE Wasserhahnanschluss für Gartenschlauch
RU Адаптер внутренний
CZ Šroubení
HU Tömlovég csaphoz
RO Mufa pt. robinet cu filet interior
FR Raccord
IT Collegamento al rubinetto
ES Tubuladura de grifo
CN 接头



(F)
G1/2
(F)
G3/4
ABS

YATO
YT-99814

12/120

EN Snap-in tap adaptor
PL Przyłącze do kranu
DE Wasserhahnanschluss für Gartenschlauch
RU Адаптер внутренний
CZ Šroubení
HU Tömlovég csaphoz
RO Mufa pt. robinet cu filet interior
FR Raccord
IT Collegamento al rubinetto
ES Tubuladura de grifo
CN 转换接头



(F)
G3/4
(F)
G1
ABS

YATO
YT-8974

12/120

EN Snap-in tap adaptor
PL Przyłącze do kranu
DE Wasserhahnanschluss für Gartenschlauch
RU Адаптер внутренний
CZ Šroubení
HU Tömlovég csaphoz
RO Mufa pt. robinet cu filet interior
FR Raccord
IT Collegamento al rubinetto
ES Tubuladura de grifo
CN 接头



(F)
G3/4
(F)
G1
ABS

YATO
YT-99815

12/120

EN Snap-in tap adaptor
PL Przyłącze do kranu
DE Wasserhahnanschluss für Gartenschlauch
RU Адаптер внутренний
CZ Šroubení
HU Tömlovég csaphoz
RO Mufa pt. robinet cu filet interior
FR Raccord
IT Collegamento al rubinetto
ES Tubuladura de grifo
CN 公接头



(M)
G3/4
ABS

YATO
YT-8975

24/240

EN 2 way coupling
PL Złącze typu „I”
DE Schlauchkupplung
RU Соединитель шлангов
CZ Spojka
HU „I” típusú csőtoldó idom
RO Prelungitor furtun apă
FR Connecteur type „I”
IT Connettore tipo „I”
ES Junta tipo „I”
CN 水管接头



ABS

YATO
YT-8976

24/240

EN 3 way coupling
PL Rozdzielacz typu „Y”
DE Drei wege Kupplung
RU Тройник для шлангов
CZ Y-kus
HU „Y” típusú elágazás
RO Distributor 3 căi
FR Dérivation type „Y”
IT Connettore tipo „Y”
ES Distribuidor tipo „Y”
CN 水管接头



ABS

YATO
YT-8977

24/240

EN Y-switch coupling with swivel
PL Rozdzielacz z zaworami
DE 2-Wege Ventil
RU Распределитель внешний
CZ Rozbočovač s uzavíracími ventily
HU Y-elágazó, 2 db külső menetes elzáróval
RO Racord iny cu robinet
FR Dérivation type „Y”
IT Distributore con valvole
ES Distribuidor tipo „Y”
CN 双通水管转换接头



ø1/2"
12.7mm
(M)
G3/4
ABS

YATO
YT-8978

24/240

EN One way tap adaptor
PL Zawór ogrodowy
DE Garten-Ventil
RU Вентиль
CZ Ventil
HU Szelep
RO Robinet
FR Raccord régulateur
IT Valvola giardino
ES Válvula
CN 接头



ø3/4"
19mm
BRASS
MOSIADZ
AI
ABS

YATO
YT-9940

12/48

EN Y-switch coupling with swivel
PL Rozdzielacz z zaworami
DE 2-Wege Ventil
RU Распределитель внешний
CZ Rozbočovač s uzavíracími ventily
HU Y-elágazó, 2 db külső menetes elzáróval
RO Racord iny cu robinet
FR Soupape double
IT Distributore con valvole
ES Distribuidor tipo „Y”
CN 两用转换接头



(F)
G3/4
(F)
G1
ABS

YATO
YT-99848

12/48

EN Y-switch coupling with swivel
PL Rozdzielacz z zaworami
DE 2-Wege Ventil
RU Распределитель внешний
CZ Rozbočovač s uzavíracími ventily
HU Y-elágazó, 2 db külső menetes elzáróval
RO Racord iny cu robinet
FR Soupape double
IT Distributore con valvole
ES Distribuidor tipo „Y”
CN 两用转换接头



ø3/4"
19mm
BRASS
MOSIADZ
AI
ABS

YATO
YT-9941

12/48

EN Adjustable spray nozzle
 PL Zraszacz prosty regulowany
 DE Spritze
 RU Распылитель поливочный
 CZ Postřikovač
 HU Szórófej

RO Stropitor apă
 FR Pistolet d'arrosage droit et réglé
 IT Semplice sprinkler regolabile
 ES Rociador
 CN 调节式水枪



EN Adjustable spray gun
 PL Pistolet zraszający regulowany
 DE Regelbare Sprühpistole
 RU Регулируемый оросительный пистолет
 CZ Kropící pistole regulovatelná
 HU Öntöző pisztoly állítható sugarú
 RO Pistolet de irigare ajustabil
 FR Pistolet d'arrosage réglé
 IT Pistola a spruzzo regolabile
 ES Pistola rociadora ajustable
 CN 调节式水枪



YATO
 YT-99830

12/120

YATO
 YT-8965

12/48

EN Adjustable spray gun
 PL Pistolet zraszający regulowany
 DE Regelbare Sprühpistole
 RU Регулируемый оросительный пистолет
 CZ Kropící pistole regulovatelná
 HU Öntöző pisztoly állítható sugarú
 RO Pistolet de irigare ajustabil
 FR Pistolet d'arrosage réglé
 IT Pistola a spruzzo regolabile
 ES Pistola rociadora ajustable
 CN 调节式水枪

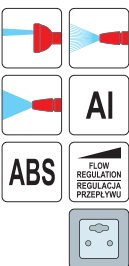

EN Adjustable spray gun
 PL Pistolet zraszający regulowany
 DE Regelbare Sprühpistole
 RU Регулируемый оросительный пистолет
 CZ Kropící pistole regulovatelná
 HU Öntöző pisztoly állítható sugarú
 RO Pistolet de irigare ajustabil
 FR Pistolet d'arrosage réglé
 IT Pistola a spruzzo regolabile
 ES Pistola rociadora ajustable
 CN 铝合金调节式水枪



YATO
 YT-8955

12/48

YATO
 YT-8966

12/48

EN Adjustable spray gun
 PL Pistolet zraszający regulowany
 DE Regelbare Sprühpistole
 RU Регулируемый оросительный пистолет
 CZ Kropící pistole regulovatelná
 HU Öntöző pisztoly állítható sugarú
 RO Pistolet de irigare ajustabil
 FR Pistolet d'arrosage réglé
 IT Pistola a spruzzo regolabile
 ES Pistola rociadora ajustable
 CN 调节式水枪



EN Adjustable spray gun
 PL Pistolet zraszający regulowany
 DE Regelbare Sprühpistole
 RU Регулируемый оросительный пистолет
 CZ Kropící pistole regulovatelná
 HU Öntöző pisztoly állítható sugarú
 RO Pistolet de irigare ajustabil
 FR Pistolet d'arrosage réglé
 IT Pistola a spruzzo regolabile
 ES Pistola rociadora ajustable
 CN 铝合金调节式水枪

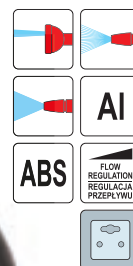

YATO
 YT-8956

12/48

YATO
 YT-8957

12/48

EN Adjustable spray gun
 PL Pistolet zraszający regulowany
 DE Regelbare Sprühpistole
 RU Регулируемый оросительный пистолет
 CZ Kropící pistole regulovatelná
 HU Öntöző pisztoly állítható sugarú
 RO Pistolet de irigare ajustabil
 FR Pistolet d'arrosage réglé
 IT Pistola a spruzzo regolabile
 ES Pistola rociadora ajustable
 CN 调节式水枪



EN Multifunction sprinkling gun
 PL Wielofunkcyjny pistolet zraszający
 DE Multifunktions-Spritzpistole
 RU Многофункциональный оросительный пистолет
 CZ Multifunkční postřikovač pistole
 HU Többfunkciós öntöző pisztoly
 RO Pistol multifuncțional pt. pulverizare
 FR Pistolet d'arrosage multifonctions
 IT Multifunzione pistola a spruzzo
 ES Pistola para regar multifuncional
 CN 六用途调节式水枪

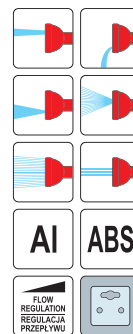

YATO
 YT-8967

12

YATO
 YT-8958

12/48

EN Multifunction sprinkling gun
PL Wielofunkcyjny pistolet zraszający
DE Multifunktions-Spritzpistole
RU Многофункциональный оросительный пистолет
CZ Multifunkční postřikovací pistole
HU Többfunkciós öntöző pisztoly
RO Pistol multifuncțional pt. pulverizare
FR Pistolet d'arrosage multifonctions
IT Multifunzione pistola a spruzzo
ES Pistola para regar multifuncional
CN 六用途调节式水枪

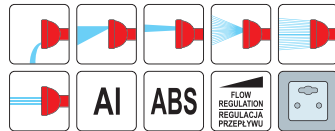

YATO
YT-8964

12/48

EN Multifunction sprinkling gun
PL Wielofunkcyjny pistolet zraszający
DE Multifunktions-Spritzpistole
RU Многофункциональный оросительный пистолет
CZ Multifunkční postřikovací pistole
HU Többfunkciós öntöző pisztoly
RO Pistol multifuncțional pt. pulverizare
FR Pistolet d'arrosage multifonctions
IT Multifunzione pistola a spruzzo
ES Pistola para regar multifuncional
CN 六用途调节式水枪

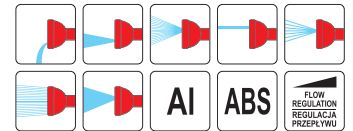

YATO
YT-8963

12/48

EN Multifunction sprinkling gun
PL Wielofunkcyjny pistolet zraszający
DE Multifunktions-Spritzpistole
RU Многофункциональный оросительный пистолет
CZ Multifunkční postřikovací pistole
HU Többfunkciós öntöző pisztoly
RO Pistol multifuncțional pt. pulverizare
FR Pistolet d'arrosage multifonctions
IT Multifunzione pistola a spruzzo
ES Pistola para regar multifuncional
CN 六用途调节式水枪

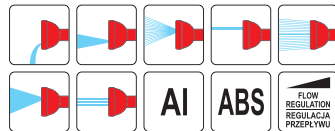

YATO
YT-8959

12/48

EN Multifunction sprinkling gun
PL Wielofunkcyjny pistolet zraszający
DE Multifunktions-Spritzpistole
RU Многофункциональный оросительный пистолет
CZ Multifunkční postřikovací pistole
HU Többfunkciós öntöző pisztoly
RO Pistol multifuncțional pt. pulverizare
FR Pistolet d'arrosage multifonctions
IT Multifunzione pistola a spruzzo
ES Pistola para regar multifuncional
CN 六用途调节式水枪

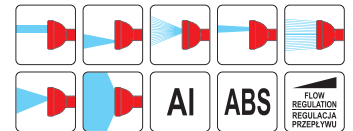

YATO
YT-8960

12/48

EN Multifunction sprinkling gun
PL Wielofunkcyjny pistolet zraszający
DE Multifunktions-Spritzpistole
RU Многофункциональный оросительный пистолет
CZ Multifunkční postřikovací pistole
HU Többfunkciós öntöző pisztoly
RO Pistol multifuncțional pt. pulverizare
FR Pistolet d'arrosage multifonctions
IT Multifunzione pistola a spruzzo
ES Pistola para regar multifuncional
CN 六用途调节式水枪

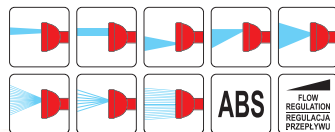

YATO
YT-9984

12/48

EN Multifunction sprinkling gun
PL Wielofunkcyjny pistolet zraszający
DE Multifunktions-Spritzpistole
RU Многофункциональный оросительный пистолет
CZ Multifunkční postřikovací pistole
HU Többfunkciós öntöző pisztoly
RO Pistol multifuncțional pt. pulverizare
FR Pistolet d'arrosage multifonctions
IT Multifunzione pistola a spruzzo
ES Pistola para regar multifuncional
CN 六用途调节式水枪

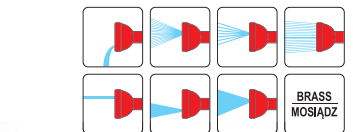

YATO
YT-8968

12

EN Basic hose set with straight nozzle
 PL Zestaw złączek ze zraszaczem prostym
 DE Bewässerungs Spritz und Anschlusset
 RU Набор поливочный
 CZ Sada postřikovač a spojky
 HU Készlet gyorskapocsos csaphoz
 RO Ștut furtun apă cu accesorii pt. robinet
 FR Set d'arrosage raccord
 IT Set raccordi con sprinkler semplice
 ES Juego de rociar tubuladura de grifo
 CN 花园浇水软管



Ø 1/2" (F)
 12.7mm G1/2
 (F) G3/4 ABS
 SOFT COATED MIEKKA POWŁOKA
 FLOW REGULATION REGULACJA PRZEPŁYWU



EN Basic hose set with straight nozzle
 PL Zestaw złączek ze zraszaczem prostym
 DE Bewässerungs Spritz und Anschlusset
 RU Набор поливочный
 CZ Sada postřikovač a spojky
 HU Készlet gyorskapocsos csaphoz
 RO Ștut furtun apă cu accesorii pt. robinet
 FR Set d'arrosage raccord
 IT Set raccordi con sprinkler semplice
 ES Juego de rociar tubuladura de grifo
 CN 花园浇水软管



Ø 1/2" (F)
 12.7mm G3/4
 (F) G1 ABS
 SOFT COATED MIEKKA POWŁOKA
 FLOW REGULATION REGULACJA PRZEPŁYWU



YATO
 YT-99831

48

YATO
 YT-99832

48

EN Impulse sprinkler
 PL Zraszacz impulsowy
 DE Impulssprenger
 RU Распылитель импульсный на пике
 CZ Postřikovač
 HU Impulzus szórófej
 RO Stropitor apă
 FR Arroseur impulsion sur piquet
 IT Sprinkler impulso
 ES Rociador
 CN 脉冲洒水器



max 24 m RANGE ZASIEG
 ABS
 ZINC ALLOY STOP CYNKU



EN Impulse sprinkler
 PL Zraszacz impulsowy
 DE Impulssprenger
 RU Распылитель импульсный на пике
 CZ Postřikovač
 HU Impulzus szórófej
 RO Stropitor apă
 FR Arroseur impulsion sur piquet
 IT Sprinkler impulso
 ES Rociador
 CN 脉冲洒水器



max 24 m RANGE ZASIEG
 ZINC ALLOY STOP CYNKU



EN 3-arms revolving sprinkler
 PL Zraszacz 3-ramienny
 DE 3-Arm Kreis-Regner
 RU Трехсторонний распылитель
 CZ Rozprašovac třiramenný
 HU Forgó locsoló leszúrató
 RO Aspersol cu 3 brate
 FR Arroseur sur piquet 3 branches
 IT Tre braccio sprinkler
 ES Rociador 3-brazos
 CN 三叉插针洒水器



max 12 m RANGE ZASIEG
 ABS
 ZINC ALLOY STOP CYNKU



YATO
 YT-8985

48

YATO
 YT-8986

48

YATO
 YT-8987

48

EN Tripod impulse sprinkler
 PL Zraszacz impulsowy na statywie
 DE Impulssprenger
 RU Распылитель импульсный на подставке
 CZ Postřikovač
 HU Impulzus szórófej
 RO Stropitor apă
 FR Arroseur impulsion lance
 IT Sprinkler impulso su un treppiede
 ES Rociador
 CN 洒水器



AI ABS



EN 8 pattern sprinkler
 PL Zraszacz 8-funkcyjny
 DE 8-Flächenregner
 RU Распылитель 8-позиционный на подставке
 CZ Postřikovač
 HU 8 funkciós szórófej
 RO Stropitor apă cu 8 duze
 FR Turbine d'arrosage 8 fonctionnes
 IT Sprinkler 8-funzioni
 ES Rociador 8-funciones de tierra
 CN 洒水器

ABS
 FLOW REGULATION REGULACJA PRZEPŁYWU



YATO
 YT-8984

12

YATO
 YT-8991

48

EN Aluminium tube oscillating sprinkler
PL Zraszacz oscylacyjny z rurką aluminiową
DE Rechteckregner
RU Распылитель осциллирующий
CZ Obdélníkový zavlažovač
HU Oszcillációs szórófejt

RO Aspersor oscilant
FR Arroseur oscillant aluminium
IT Oscillante sprinkler con tubo di alluminio
ES Aspersor oscilante con tubo de aluminio
CN 摇摆洒水器

17
HOLES
OTWORY

AI

ABS



YATO
YT-8993

6

EN Aluminium tube oscillating sprinkler
PL Zraszacz oscylacyjny z rurką aluminiową
DE Rechteckregner
RU Распылитель осциллирующий
CZ Obdélníkový zavlažovač
HU Oszcillációs szórófejt

RO Aspersor oscilant
FR Arroseur oscillant aluminium
IT Oscillante sprinkler con tubo di alluminio
ES Aspersor oscilante con tubo de aluminio
CN 摇摆洒水器

17
HOLES
OTWORY

AI

ABS



YATO
YT-99845

6

EN Hose holder
PL Stojak do węża ogrodowego
DE Gartenschlauchträger
RU Барабан для намотки поливочного шланга
CZ Stojan navlečel na zahradní hadici
HU Utartódob locsolótömlőhöz
RO Suport pt. furtun
FR Dévidoir portable de tuyau
IT Carrello avvolgitubo
ES Estante para manguera de jardín
CN 卷线盘



20 m
ø 3/4" (19 mm)

30 m
ø 1/2" (12.7 mm)

PP



YATO
YT-99850

2

EN Hose cart
PL Wózek do węża ogrodowego
DE Gartenschlauchwagen
RU Барабан для намотки поливочного шланга
CZ Stojan navlečel na zahradní hadici
HU Utartódob locsolótömlőhöz
RO Suport pt. furtun
FR Dévidoir sur roues
IT Carrello avvolgitubo
ES Carretilla para manguera de jardín
CN 卷线盘



20 m
ø 3/4" (19 mm)

50 m
ø 1/2" (12.7 mm)

PP



YATO
YT-99852

2

EN Submersible pump for dirty water and wastewater
PL Pompa zatapialna do wody brudnej i ścieków
DE Tauchpumpe für Schmutzwasser
RU Погружной насос для грязной воды
CZ Ponorné čerpadlo pro odpadní vody
HU Búvárszivattyú szennyvíz
RO Pompă submersibilă pt. apă uzată
FR Pompe submersible pour eaux usees
IT Pompa sommersa per acque reflue
ES Bomba sumergible para aguas residuales
CN 污水切割泵



230V~
50Hz

400 W

Q max
12000 l/h



Δ	Q [l/h]
3	12000
4	9000
5	6000
6	3000
7	1500
7.5	500

YATO
YT-85349

[W]

[l/h]

H max. [m]

1

EN Submersible pump for dirty water and wastewater
PL Pompa zatapialna do wody brudnej i ścieków
DE Tauchpumpe für Schmutzwasser
RU Погружной насос для грязной воды
CZ Ponorné čerpadlo pro odpadní vody
HU Búvárszivattyú szennyvíz
RO Pompă submersibilă pt. apă uzată
FR Pompe submersible pour eaux usees
IT Pompa sommersa per acque reflue
ES Bomba sumergible para aguas residuales
CN 污水切割泵



230V~
50Hz

750 W

Q max
16000 l/h

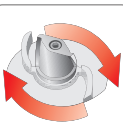

Δ	Q [l/h]
0	16000
1	15000
2	14000
3	13500
4	12500
5	11500
6	11000
7	10500
8	9500
9	8000
10	5500
11	3500
12	2000
13	500

YATO
YT-85350

[W]

[l/h]

H max. [m]

13

1

EN Dirty water submersible pump
PL Pompa zatapialna do wody brudnej
DE Tauchpumpe für Schmutzwasser
RU Погружной насос для грязной воды
CZ Ponorné čerpadlo pro špinavou vodu
HU Búvárszivattyú
RO Pompă submersibilă pt. apă murdara
FR Pompe submersible pour eaux polluées
IT Pompa sommersa per acque reflue
ES Bomba sumergible para agua sucia
CN 清污两用潜水泵



220-240V~
50Hz

400 W

Q max
11000 l/h



Δ	Q [l/h]
0	11000
1	10500
2	10000
3	9500
4	9000
5	8000
6	7000
7	6000
8	5000
9	4000
10	3000
11	2000
12	1000

YATO
YT-85330

[W]

[l/h]

H max. [m]

5.8

4

EN Dirty water submersible pump
PL Pompa zatapialna do wody brudnej
DE Tauchpumpe für Schmutzwasser
RU Погружной насос для грязной воды
CZ Ponorné čerpadlo pro špinavou vodu
HU Búvárszivattyú
RO Pompă submersibilă pt. apă murdara
FR Pompe submersible pour eaux polluées
IT Pompa sommersa per acque reflue
ES Bomba sumergible para agua sucia
CN 清污两用潜水泵



220-240V~
50Hz

900 W

Q max
18000 l/h



Δ	Q [l/h]
0	18000
1	17000
2	16000
3	15000
4	14000
5	12000
6	11000
7	10000
8	8000
9	7000
10	6000
11	5000
12	4000
13	3000
14	2000
15	100

YATO
YT-85333

[W]

[l/h]

H max. [m]

8.9

4

EN Deep well pump
 PL Pompa głębinowa
 DE Tiefbrunnenpumpe
 RU Глубинный насос
 CZ Čerpadlo do vrtaných studní
 HU Búvárszivattyú
 RO Pompă submersibilă
 FR Pompe de puits profond
 IT Pompa sommergibile
 ES Bomba agua sumergible
 CN 深井泵



230V~
50Hz

370
W

Q max
5400
l/min

20 m

EN Deep well pump
 PL Pompa głębinowa
 DE Tiefbrunnenpumpe
 RU Глубинный насос
 CZ Čerpadlo do vrtaných studní
 HU Búvárszivattyú
 RO Pompă submersibilă
 FR Pompe de puits profond
 IT Pompa sommergibile
 ES Bomba agua sumergible
 CN 深井泵



230V~
50Hz

550
W

Q max
6000
l/h

20 m



YATO	[W]	[l/h]	
YT-85300	370	5400	1

YATO	[W]	[l/h]	
YT-85301	550	6000	1

EN Dirty water submersible pump
 PL Pompa zatapiałna do wody brudnej
 DE Tauchpumpe für Schmutzwasser
 RU Погружной насос для грязной воды
 CZ Ponorné čerpadlo pro špinavú vodu
 HU Búvárszivattyú
 RO Pompă submersibilă pt. apă murdara
 FR Pompe submersible pour eaux polluées
 IT Pompa sommersa per acque reflue
 ES Bomba sumergible para aguas sucias
 CN 不锈钢潜水泵 (内置式开关)



230V~
50Hz

750
W

Q max
11000
l/h

EN Dirty water submersible pump
 PL Pompa zatapiałna do wody brudnej
 DE Tauchpumpe für Schmutzwasser
 RU Погружной насос для грязной воды
 CZ Ponorné čerpadlo pro špinavú vodu
 HU Búvárszivattyú
 RO Pompă submersibilă pt. apă murdara
 FR Pompe submersible pour eaux polluées
 IT Pompa sommersa per acque reflue
 ES Bomba sumergible para aguas sucias
 CN 不锈钢潜水泵 (浮球开关)



230V~
50Hz

1100
W

Q max
17000
l/h

Δ	Q [l/h]
0	11000
1	10500
2	10000
3	9500
4	9000
5	8500
6	8000
7	7500
8	7000
9	6500
10	6000
11	5000
12	4000
13	3000
14	2000
15	1000

Δ	Q [l/h]
0	17000
1	16500
2	16000
3	15000
4	14000
5	13000
6	12000
7	11000
8	10000
9	9000
10	8000
11	7000
12	6000
13	5000
14	4000
15	3000
16	2000
17	1000

YATO	[W]	[l/h]	H max. [m]	
YT-85341	750	11000	8.5	3

YATO	[W]	[l/h]	H max. [m]	
YT-85343	1100	17000	10	3

EN Brass straight connection
 PL Króciec mosiężny do pomp
 DE Messingstutzen für Pumpen
 RU Латунный патрубок для насосов
 CZ Mosazná prípojka pro čerpadla
 HU Sárgaréz csatlakozó szivattyúkhöz
 RO Conector alama
 FR Raccord de pompe en laiton
 IT Raccordo in ottone per pompe
 ES Conector de latón para bombas
 CN 铜接头



1"
25mm

BRASS
MOSIADZ

EN Drill pump
 PL Pompka na wiertarkę
 DE Bohrerpumpe
 RU Насос для дрели
 CZ Čerpadlo na vrtačku
 HU Szivattyú fúróra
 RO Pompa de foraj
 FR Pompe pour perceuse
 IT Pompa per trapano
 ES Bomba para taladradora
 CN 手转泵



Q max
2.4
m³/h

3.0m

3400
min⁻¹(max.)

8 mm

STANDARD

YATO	
YT-85395	10/80

YATO	
YT-89000	6/60

EN Nylon head jet pump
PL Pompa ogrodowa z głowicą nylonową
DE Gartenpumpe
RU Огородный насос
CZ Zahradní čerpadlo
HU Kerti szivattyúhoz

RO Pompa de apa
FR Bomba de jardin con cabeza nylon
IT Pompa da giardino
ES Pompe a eau de surface
CN 花园泵 (含电子压力开关)

230V~
50Hz
600
W
Q max
3100
l/h



$L_{PA} = 69,43 \pm 1,49$ dB; $L_{WA} = 82,35 \pm 1,49$ dB

YATO	[W]	[l/h]	H max. [m]	
YT-85360	600	3100	35	1

EN Hydrophore
PL Hydrofor
DE Hauswasserwerk
RU Гидрофор
CZ Vodárna domácí
HU Hydrovor

RO Hidrofor
FR Groupe de surpression
IT Idroforo
ES Grupo de presión
CN 花园泵

230V~
50Hz
1200
W
1"
25mm
4000
l/min
50m
max°C
35
19L
IPX4
INOX



$L_{PA} = 69,43 \pm 1,49$ dB; $L_{WA} = 82,35 \pm 1,49$ dB

YATO	[W]	[l/h]	H max. [m]	
YT-85370	1200	4000	50	1

EN Cordless submersible garden pump
PL Akumulatorowa pompa ogrodowa zasilana
DE Akku-Garten-Tauchpumpe
RU Аккумуляторный садовый насос
CZ Akumulátorové zahradní čerpadlo
HU Akkumulátoros kerti merülő szivattyú
RO Pompă de grădină submersibilă fără fir
FR Pompe de jardin submersible sans-fil
IT Pompa per acqua piovana a batteria
ES Bomba de batería sumergible para jardín
CN 充电式潜水泵

18V
Li-Ion
2
bar
1"
25mm
2500
l/h
20m
1.5m
max°C
35
IPX8



Battery not included
Oltre Akku / Bez akumulatora
Bez bateriepu / Bez aku
Akkumulátor nélkül
Fără baterie / Sans batterie
Senza batteria / Sin batería
没有电池

$L_{WA} = <70$ dB

YATO	[V d.c.]	
YT-85281	18	4

EN Cordless barrel pump
PL Akumulatorowa pompa do deszczówki
DE Akku-Regenfasspumpe
RU Аккумуляторный насос для дождевой воды
CZ Akumulátorové čerpadlo na dešťovou vodu
HU Akkumulátoros esővíz szivattyú
RO Pompă de butoi fără fir
FR Pompe à eau de pluie sans-fil
IT Pompa per acqua piovana a batteria
ES Bomba de batería para tanques de agua de precipitación
CN 充电式潜水泵

18V
Li-Ion
2
bar
3/4"
19mm
2000
l/h
21m
1.5m
max°C
35
IPX8



Battery not included
Oltre Akku / Bez akumulatora
Bez bateriepu / Bez aku
Akkumulátor nélkül
Fără baterie / Sans batterie
Senza batteria / Sin batería
没有电池

$L_{WA} = <70$ dB

YATO	[V d.c.]	
YT-85283	18	4

EN Bypass pruner
PL Sekator uniwersalny
DE Gartenschere
RU Секатор
CZ Zahradní nůžky
HU Metszőolló

RO Foarfece pt. pomi
FR Sécateur traditionnel
IT Forbici da potatura universale
ES Tijera de poda
CN 剪枝剪

205
mm
15mm



YATO	L [mm]	
YT-8800	205	12/72

EN Bypass pruner
PL Sekator uniwersalny
DE Gartenschere
RU Секатор
CZ Zahradní nůžky
HU Metszőolló

RO Foarfece pt. pomi
FR Sécateur traditionnel
IT Forbici da potatura universale
ES Tijera de poda
CN 剪枝剪

220
mm
25mm
PTFE



YATO	L [mm]	
YT-8801	220	12/72

EN Anvil pruner
PL Sekator kowadełkowy
DE Amboss-Gartenschere
RU Секатор с наковальней
CZ Kovadlinkové zahradní nůžky
HU Metszőolló

RO Foarfece nicovala
FR Sécateur à enclume
IT Forbici a incudine
ES Tijera de poda de yunque
CN 剪枝剪

200
mm
19mm
PTFE



YATO	L [mm]	
YT-8802	200	12/72

EN Bypass pruner
PL Sekator uniwersalny
DE Gartenschere
RU Секатор
CZ Zahradní nůžky
HU Metszőolló

RO Foarfece pt. pomi
FR Sécateur traditionnel
IT Forbici da potatura universale
ES Tijera de poda
CN 剪枝剪

180
mm
13mm
PTFE



YATO	L [mm]	
YT-8805	180	12/72

EN Ratchet by-pass pruner
PL Sekator z grzechotką
DE Gartenschere
RU Секатор
CZ Nožnice zahradnicke
HU Metszőolló

RO Foarfece pt. pomi
FR Sécateur à cliquet
IT Cesioie con cricchetto
ES Podadera con carraca
CN 棘轮剪枝剪



YATO L [mm]
YT-8807 200 12/72

EN Ratchet by-pass pruner
PL Sekator z grzechotką
DE Gartenschere
RU Секатор
CZ Nožnice zahradnicke
HU Metszőolló

RO Foarfece pt. pomi
FR Sécateur à cliquet
IT Cesioie con cricchetto
ES Podadera con carraca
CN 棘轮剪枝剪



YATO L [mm]
YT-8808 200 12/72

EN Anvil pruner
PL Sekator kowadełkowy
DE Amboss-Gartenschere
RU Секатор с наковальней
CZ Kovadlinkové zahradní nůžky
HU Metszőolló

RO Foarfece nicovala
FR Sécateur à enclume
IT Forbici a incudine
ES Tijera de poda de yunque
CN 剪枝剪



YATO L [mm]
YT-8809 210 12/72

EN Bypass pruner
PL Sekator uniwersalny
DE Gartenschere
RU Секатор
CZ Zahradní nůžky
HU Metszőolló

RO Foarfece pt. pomi
FR Sécateur traditionnel
IT Forbici da potatura universale
ES Tijera de poda
CN 剪枝剪



YATO L [mm]
YT-8811 190 12/72

EN Bypass pruner
PL Sekator uniwersalny
DE Gartenschere
RU Секатор
CZ Zahradní nůžky
HU Metszőolló

RO Foarfece pt. pomi
FR Sécateur traditionnel
IT Forbici da potatura universale
ES Tijera de poda
CN 剪枝剪



YATO L [mm]
YT-8845 200 12/72

EN Bypass pruner
PL Sekator uniwersalny
DE Gartenschere
RU Секатор
CZ Zahradní nůžky
HU Metszőolló

RO Foarfece pt. pomi
FR Sécateur traditionnel
IT Forbici da potatura universale
ES Tijera de poda
CN 剪枝剪



YATO L [mm]
YT-8790 200 12/60

EN Fruit and flower shears
PL Sekator do obcinania zawiązków
DE Blumen- und Rebschere
RU Секатор
CZ Nožnice zahradnicke
HU Metszőolló

RO Foarfece pt. pomi
FR Sécateur
IT Cesioia taglio gemme
ES Podadera para cortar germenos
CN 剪枝剪



YATO L [mm]
YT-8791 200 12/60

EN Fruit and flower shears
PL Sekator do obcinania zawiązków
DE Blumen- und Rebschere
RU Секатор
CZ Nožnice zahradnicke
HU Metszőolló

RO Foarfece pt. pomi
FR Sécateur
IT Cesioia taglio gemme
ES Podadera para cortar germenos
CN 花枝剪



YATO L [mm]
YT-8815 180 12/72

EN Fruit and flower shears
PL Sekator do obcinania zawiązków
DE Blumen- und Rebschere
RU Секатор
CZ Nožnice zahradnicke
HU Metszőolló

RO Foarfece pt. pomi
FR Sécateur
IT Cesioia taglio gemme
ES Podadera para cortar germenos
CN 花枝剪



YATO L [mm]
YT-8816 190 12/72

EN Fruit and flower shears
PL Sekator do obcinania zawiązków
DE Blumen- und Rebschere
RU Секатор
CZ Nožnice zahradnicke
HU Metszőolló

RO Foarfece pt. pomi
FR Sécateur
IT Cesioia taglio gemme
ES Podadera para cortar germenos
CN 花枝剪



YATO L [mm]
YT-8817 190 12/72

EN Grafting tool
PL Sekator do szczepień
DE Gartenschere zum Pfropfen
RU Секатор для прививки
CZ Roubovací nůžky
HU Oltó olló
RO Instrument pt. altoit
FR Sécateur de greffage
IT Forbici da innesto
ES Tijera injertadora
CN 嫁接剪



YATO

YT-88505



20

EN Bypass pruner
PL Sekator uniwersalny
DE Gartenschere
RU Секатор
CZ Zahradní nůžky
HU Metszőolló

RO Foarfece pt. pomi
FR Sécateur traditionnel
IT Forbici da potatura universale
ES Tijera de poda
CN 剪枝剪



208 mm

SK5

PTFE

PP



YATO

YT-88180

L [mm]

208



12/48

EN Anvil pruner
PL Sekator kowadełkowy
DE Amboss-Gartenschere
RU Секатор с наковальной
CZ Kovadlinkové zahradní nůžky
HU Metszőolló

RO Foarfece nicovală
FR Sécateur à enclume
IT Forbici a incudine
ES Tijera de poda de yunque
CN 剪枝剪



208 mm

SK5

PTFE

PP



YATO

YT-88182

L [mm]

208



12/48

EN Bypass pruner
PL Sekator uniwersalny
DE Gartenschere
RU Секатор
CZ Zahradní nůžky
HU Metszőolló

RO Foarfece pt. pomi
FR Sécateur traditionnel
IT Forbici da potatura universale
ES Tijera de poda
CN 剪枝剪



205 mm

SK5

PTFE

AI



YATO

YT-88183

L [mm]

205



12/48

EN Bypass pruner
PL Sekator uniwersalny
DE Gartenschere
RU Секатор
CZ Zahradní nůžky
HU Metszőolló

RO Foarfece pt. pomi
FR Sécateur traditionnel
IT Forbici da potatura universale
ES Tijera de poda
CN 剪枝剪



220 mm

SK5

PTFE

PP

ADJUSTABLE RANGE
REGULOWANY ROZSTAW



YATO

YT-88185

L [mm]

220



12/48

EN Bypass pruner
PL Sekator uniwersalny
DE Gartenschere
RU Секатор
CZ Zahradní nůžky
HU Metszőolló

RO Foarfece pt. pomi
FR Sécateur traditionnel
IT Forbici da potatura universale
ES Tijera de poda
CN 剪枝剪



220 mm

SK5

PTFE

AI

ADJUSTABLE RANGE
REGULOWANY ROZSTAW



YATO

YT-88186

L [mm]

220



12/48

EN Bypass pruner
PL Sekator uniwersalny
DE Gartenschere
RU Секатор
CZ Zahradní nůžky
HU Metszőolló

RO Foarfece pt. pomi
FR Sécateur traditionnel
IT Forbici da potatura universale
ES Tijera de poda
CN 剪枝剪



208 mm

SK5

PTFE

PP

ADJUSTABLE RANGE
REGULOWANY ROZSTAW



YATO

YT-88190

L [mm]

208



12/48

EN Anvil pruner
PL Sekator kowadełkowy
DE Amboss-Gartenschere
RU Секатор с наковальной
CZ Kovadlinkové zahradní nůžky
HU Metszőolló

RO Foarfece nicovală
FR Sécateur à enclume
IT Forbici a incudine
ES Tijera de poda de yunque
CN 剪枝剪



208 mm

SK5

PTFE

PP

ADJUSTABLE RANGE
REGULOWANY ROZSTAW



YATO

YT-88191

L [mm]

208





12/48

EN Bypass pruner
 PL Sekator uniwersalny
 DE Gartenschere
 RU Секатор
 CZ Zahradní nůžky
 HU Metszőolló

RO Foarfece pt. pomi
 FR Sécateur traditionnel
 IT Forbici da potatura universale
 ES Tijera de poda
 CN 剪枝剪



  **180 mm**

 **SS**
STAINLESS STEEL
ETAL MEGECERNA

 **AI**
HANDLE
UCHWYT

 **LOCK**
BLOKADA



YATO 	L [mm]	
YT-8843	180	5/60

EN By-pass pruner
 PL Sekator uniwersalny
 DE Rebenschere
 RU Секатор
 CZ Nožnice zahradnicke
 HU Metszőolló

RO Foarfece pt. pomi
 FR Sécateur traditionnel
 IT Cesoia universale
 ES Podadera universal
 CN 剪枝剪

  **200 mm**

 **SK5**

 **AI**
HANDLE
UCHWYT





YATO 	L [mm]	
YT-8849	200	12/72

EN Anvil lopping shears
 PL Sekator kowadełkowy do gałęzi
 DE Amboss Astschere
 RU Сучкорез
 CZ Nožnice zahradnicke
 HU Ágvágó fix

RO Foarfece curbata pt. taiat crengi
 FR Coupe-branches à éclume
 IT Cesoia anvil tagliarami
 ES Podadera para ramas, de bigornia
 CN 高枝剪

  **25 mm**

 **635 mm**





YATO 	L [mm]	
YT-8832	635	12

EN Anvil lopping shears
 PL Sekator kowadełkowy do gałęzi
 DE Amboss Astschere
 RU Сучкорез
 CZ Nožnice zahradnicke
 HU Ágvágó fix



RO Foarfece curbata pt. taiat crengi
 FR Coupe-branches à éclume
 IT Cesoia anvil tagliarami
 ES Podadera para ramas, de bigornia
 CN 高枝剪

  **35 mm**

 **PTFE**









YATO 	L [mm]	
YT-8834	700	12

EN By-pass lopping shears
 PL Sekator do gałęzi
 DE Astschere
 RU Сучкорез
 CZ Nožnice zahradnicke
 HU Ágvágó fix

RO Foarfece curbata pt. taiat crengi
 FR Coupe-branches à lame franche
 IT Cesoia tagliarami
 ES Podadera para ramas
 CN 高枝剪

  **705 mm**



  **25 mm**

 **PTFE**



EN By-pass lopping shears
 PL Sekator do gałęzi
 DE Astschere
 RU Сучкорез
 CZ Nožnice zahradnicke
 HU Ágvágó fix

RO Foarfece curbata pt. taiat crengi
 FR Coupe-branches à lame franche
 IT Cesoia tagliarami
 ES Podadera para ramas
 CN 高枝剪

  **25 mm**

 **625 mm**









YATO 	L [mm]	
YT-8831	625	12

EN By-pass lopping shears
 PL Sekator do gałęzi
 DE Astschere
 RU Сучкорез
 CZ Nožnice zahradnicke
 HU Ágvágó fix

RO Foarfece curbata pt. taiat crengi
 FR Coupe-branches à lame franche
 IT Cesoia tagliarami
 ES Podadera para ramas
 CN 高枝剪

  **780 mm**

  **44 mm**

 **PTFE**







YATO 	L [mm]	
YT-8835	780	12

EN Anvil lopping shears
PL Sekator kowadełkowy do gałęzi
DE Amboss Astschere
RU Сучкорез
CZ Nožnice zahradnicke
HU Ágvágó fix

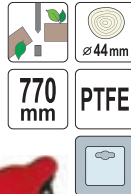
RO Foarfeca curbata pt. taiat crengi
FR Coupe-branches à éclume
IT Cesoia anvil tagliarami
ES Podadera para ramas, de bigornia
CN 高枝剪





YATO 	L [mm]	
YT-8836	770	12

EN Telescopic by-pass lopping shears
PL Sekator teleskopowy do gałęzi
DE Astschere
RU Секатор с телескопическими ручками
CZ Nožnice zahradnicke
HU Ágvágó teleszkópos

RO Foarfeca curbata pt. taiat crengi
FR Coupe-branches télescopique
IT Cesoie tagliarami telescopica
ES Podadera telescópica para ramas
CN 可伸缩高枝剪





YATO 	L [mm]	
YT-8838	630-960	6/12

EN Telescopic by-pass lopping shears
PL Sekator teleskopowy do gałęzi
DE Astschere
RU Секатор с телескопическими ручками
CZ Nožnice zahradnicke
HU Ágvágó teleszkópos

RO Foarfeca curbata pt. taiat crengi
FR Coupe-branches télescopique
IT Cesoie tagliarami telescopica
ES Podadera telescópica para ramas
CN 可伸缩高枝剪





YATO 	L [mm]	
YT-8839	650-900	6

EN Telescopic by-pass lopping shears
PL Sekator teleskopowy do gałęzi
DE Astschere
RU Секатор с телескопическими ручками
CZ Nožnice zahradnicke
HU Ágvágó teleszkópos

RO Foarfeca curbata pt. taiat crengi
FR Coupe-branches télescopique
IT Cesoie tagliarami telescopica
ES Podadera telescópica para ramas
CN 可伸缩高枝剪





YATO 	L [mm]	
YT-8840	640-885	12

EN Telescopic by-pass lopping shears
PL Sekator teleskopowy do gałęzi
DE Astschere
RU Секатор с телескопическими ручками
CZ Nožnice zahradnicke
HU Ágvágó teleszkópos

RO Foarfeca curbata pt. taiat crengi
FR Coupe-branches télescopique
IT Cesoie tagliarami telescopica
ES Podadera telescópica para ramas
CN 可伸缩高枝剪





YATO 	L [mm]	
YT-8841	690-930	6

EN Telescopic by-pass lopping shears
PL Sekator teleskopowy do gałęzi
DE Astschere
RU Секатор с телескопическими ручками
CZ Nožnice zahradnicke
HU Ágvágó teleszkópos



RO Foarfeca curbata pt. taiat crengi
FR Coupe-branches télescopique
IT Cesoie tagliarami telescopica
ES Podadera telescópica para ramas
CN 可伸缩高枝剪

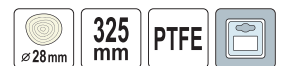

YATO 	L [mm]	
YT-8842	660-910	12

EN Leverage tree pruner
PL Sekator gąsienicowy z piłą
DE Baumsäge mit astschere
RU Сучкорез штанговый с пилой
CZ Sřířnač na větve s pilovým listem
RO Kóteles ágvágó
RU Fierastraun pt. pomu cu prelungitor
FR Système de scie à poulie
IT Taglio pista con sega
ES Podadera de palanca con sierra
CN 高枝锯



YATO 	L [mm]	
YT-8876	325	12

EN Hedge shears
 PL Nożyce do żywoplotu
 DE Heckenschere
 RU Кусторезы
 CZ Nožnice na živý plot
 HU Sívényvágó olló

RO Foarfeca pt. gard viu
 FR Cisaille à haie
 IT Cesioie per le siepe
 ES Tijeras para seto vivo
 CN 整篱剪





YATO 	L [mm]	
YT-8821	520	24

EN Hedge shears
 PL Nożyce do żywoplotu
 DE Heckenschere
 RU Кусторезы
 CZ Nožnice na živý plot
 HU Sívényvágó olló

RO Foarfeca pt. gard viu
 FR Cisaille à haie
 IT Cesioie per le siepe
 ES Tijeras para seto vivo
 CN 整篱剪





YATO 	L [mm]	
YT-8822	550	12

EN Hedge shears
 PL Nożyce do żywoplotu
 DE Heckenschere
 RU Кусторезы
 CZ Nožnice na živý plot
 HU Sívényvágó olló

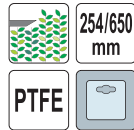
RO Foarfeca pt. gard viu
 FR Cisaille à haie
 IT Cesioie per le siepe
 ES Tijeras para seto vivo
 CN 整篱剪





YATO 	L [mm]	
YT-8823	650	12

EN Telescopic hedge shears
 PL Teleskopowe nożyce do żywoplotu
 DE Heckenschere
 RU Кусторезы с телескопическими ручками
 CZ Nožnice na živý plot
 HU Sívényvágó olló

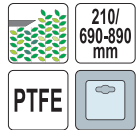
RO Foarfeca pt. gard viu
 FR Cisaille télescopique à haie
 IT Cesioie telescopiche per siepe
 ES Tijeras para seto vivo
 CN 可伸缩整篱剪



YATO 	L [mm]	
YT-8824	690-890	6

EN Grass shears
 PL Nożyce do trawy wielopozycyjne
 DE Handgrassschere
 RU Ножницы для стрижки травы
 CZ Nožnice na trávu
 HU Forgatható fűvágó olló
 RO Foarfeca pt. gazon
 FR Cisaille à gazon
 IT Cesioie per erba multifunzione
 ES Tijeras de cesped
 CN 草剪

RO Foarfeca pt. gazon
 FR Cisaille à gazon
 IT Cesioie per erba multifunzione
 ES Tijeras de cesped
 CN 草剪

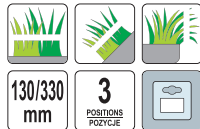



YATO 	L [mm]	
YT-8851	330	12/60

EN Grass shears
 PL Nożyce do trawy wielopozycyjne
 DE Handgrassschere
 RU Ножницы для стрижки травы
 CZ Nožnice na trávu
 HU Forgatható fűvágó olló
 RO Foarfeca pt. gazon
 FR Cisaille à gazon
 IT Cesioie per erba multifunzione
 ES Tijeras de cesped
 CN 草剪

RO Foarfeca pt. gazon
 FR Cisaille à gazon
 IT Cesioie per erba multifunzione
 ES Tijeras de cesped
 CN 草剪



YATO 	L [mm]	
YT-8852	310	6/24

EN Grass shears
 PL Nożyce do trawy wielopozycyjne
 DE Handgrassschere
 RU Ножницы для стрижки травы
 CZ Nožnice na trávu
 HU Forgatható fűvágó olló
 RO Foarfeca pt. gazon
 FR Cisaille à gazon
 IT Cesioie per erba multifunzione
 ES Tijeras de cesped
 CN 草剪

RO Foarfeca pt. gazon
 FR Cisaille à gazon
 IT Cesioie per erba multifunzione
 ES Tijeras de cesped
 CN 草剪

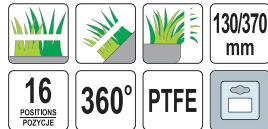



YATO 	L [mm]	
YT-8853	370	6/72

EN Grass shears
 PL Nożyce do trawy wielopozycyjne
 DE Handgrassschere
 RU Ножницы для стрижки травы
 CZ Nožnice na trávu
 HU Forgatható fűvágó olló
 RO Foarfeca pt. gazon
 FR Cisaille à gazon
 IT Cesioie per erba multifunzione
 ES Tijeras de cesped
 CN 草剪

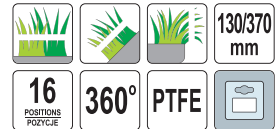
RO Foarfeca pt. gazon
 FR Cisaille à gazon
 IT Cesioie per erba multifunzione
 ES Tijeras de cesped
 CN 草剪



YATO 	L [mm]	
YT-8854	370	6/72

EN Bow saw
PL Piła kabląkowa
DE Bügelsäge
RU Лучковая пила по дереву
CZ Oblouková pila
HU Keretes fűrész

RO Ferăstrău de curbură
FR Scie à bûches
IT Sega ad arco
ES Sierra de arco
CN 弓锯



YATO	L [mm]	
YT-3200	300	12/24

EN Bow saw
PL Piła kabląkowa
DE Bügelsäge
RU Лучковая пила
CZ Oblouková pila
HU Keretes fűrész

RO Ferăstrău de curbură
FR Scie à bûches
IT Sega ad arco
ES Sierra de arco
CN 弓锯



YATO	L [mm]	
YT-3201	450	12/24
YT-3202	530	12/24
YT-3203	610	12/24
YT-3204	760	12/24

EN Blade for dry wood
PL Brzeszczot do drewna suchego
DE Trockenholzsägeblatt für Handsäge
RU Лезвие для работы по сухому дереву
CZ Pilový list na suché dřevo
HU Fűrészlap száraz fához

RO Lama pt. lemn uscat
FR lame à bois sec
IT Lama per il legno secco
ES Hoja de sierra para madera seca
CN 干木锯条



YATO	L [mm]	
YT-3221	450	50/200
YT-3222	530	50/200
YT-3223	610	50/200
YT-3224	760	50/200

EN Blade for wet wood
PL Brzeszczot do drewna mokrego
DE Nassholzsägeblatt für Handsäge
RU Лезвие для работы по влажному дереву
CZ Pilový list na mokré dřevo
HU Fűrészlap nedves fához

RO Lama pt. lemn verde
FR lame à bois humide
IT Lama per il legno bagnato
ES Hoja de sierra para madera mojada
CN 湿木锯条



YATO	L [mm]	
YT-3230	300	50/200
YT-3231	450	50/200
YT-3232	530	50/200
YT-3233	610	50/200
YT-3234	760	50/200

EN Axe
PL Siekiera
DE Beil
RU Топор

CZ Sekerka
HU Szekeerce
RO Secure
FR Hache

IT Ascia
ES Hacha
CN 把斧



YATO	m [g]	L [mm]	DIN	
YT-8001	600	360	5131	24
YT-8002	800	380	5131	20
YT-8003	1000	400	5131	12
YT-8004	1250	710	7294	12
YT-8005	1400	710	7294	12
YT-8006	1600	810	7294	12

EN Axe
PL Siekiera
DE Beil
RU Топор

CZ Sekerka
HU Szekeerce
RO Secure
FR Hache

IT Ascia
ES Hacha
CN 把斧



YATO	m [g]	L [mm]	
YT-8011	1000	515	6
YT-8012	2000	820	6

EN Transplanter
PL Lopatka
DE Blumenkelle
RU Совок посадочный
CZ Lopatka
HU Ásó
RO Mini-lopata gradinarit
FR Transplantoir
IT Spatoia
ES Paleta estrecha
CN 移植器



YATO	L [mm]	
YT-8865	350	10/60

EN Rake
PL Grabki
DE Blumenrechen
RU Грабли
CZ Hračičky
HU Gereblye
RO Mini grebla
FR Râteau
IT Rastrelli
ES Rastrillo
CN 园艺耙

325 mm



YATO L [mm]
YT-8866 325 10/60

EN Hoe and cultivator
PL Motyczka z pazurkami
DE Kleinhacke
RU Рыхлитель комбинированный
CZ Motyčka s kultivátorem
HU Kerti villás kapa
RO Cultivator cu sapaliga
FR Serfolette
IT Zappa con artigli
ES Escarificador y azadilla
CN 园艺锄

310 mm



YATO L [mm]
YT-8867 310 10/60

EN Cultivator
PL Pazurki
DE Grubber
RU Рыхлитель
CZ Kultivátor
HU Kultivátor
RO Cultivator
FR Griffes piocheuse
IT Artigli
ES Escarifi cador
CN 园艺耙

420 mm



YATO L [mm]
YT-8868 420 10/60

EN Garden rake
PL Grabki wachlarzowe
DE Landschaftsbesen
RU Грабли веерные
CZ Hračičky
HU Kerti gereblye
RO Grebla de gradina
FR Râteau
IT Rastrelli ventilatore
ES Rastrillo de abanico de hojalata
CN 园艺耙

400 mm



YATO L [mm]
YT-8869 400 10/60

EN Transplanter
PL Łopatka
DE Blumenkelle
RU Совок посадочный
CZ Lopatka
HU Ásó
RO Mini-lopată gradinarit
FR Transplantoir
IT Spatola
ES Paleta estrecha
CN 园艺铲

360 mm



YATO L [mm]
YT-8870 360 10/60

EN Transplanter
PL Łopatka
DE Blumenkelle
RU Совок посадочный
CZ Lopatka
HU Ásó
RO Mini-lopată gradinarit
FR Transplantoir
IT Spatola
ES Paleta estrecha
CN 移植器

340 mm



YATO L [mm]
YT-8885 340 12/72

EN Transplanter
PL Łopatka
DE Blumenkelle
RU Совок посадочный
CZ Lopatka
HU Ásó
RO Mini-lopată gradinarit
FR Transplantoir
IT Spatola
ES Paleta estrecha
CN 园艺铲

340 mm



CHROME PLATED CHROMO-WANE



YATO L [mm]
YT-8886 340 12/72

EN Hoe
PL Motyczka
DE Garten Handhacke
RU Мотыжка
CZ Motyčka
HU Kerti kapa
RO Sapaliga
FR Binette
IT Zappetta
ES Azadilla
CN 园艺锄

280 mm



CHROME PLATED CHROMO-WANE



YATO L [mm]
YT-8889 280 12/72

EN Cultivator
PL Pazurki
DE Grubber
RU Рыхлитель
CZ Kultivátor
HU Kultivátor
RO Cultivator
FR Griffes piocheuse
IT Artigli
ES Escarifi cador
CN 园艺耙

270 mm



CHROME PLATED CHROMO-WANE



YATO L [mm]
YT-8890 270 12/72

EN Rolling tiller
PL Spulchniacz
DE Rollpflüger
RU Рыхлитель дисковый
CZ Kypřič púdy
HU Görgös talajlazító
RO Maruntitor pt. pamant
FR Émietteur
IT Coltivatore
ES Escarifi cador
CN 松土器

370 mm



CHROME PLATED CHROMO-WANE



YATO L [mm]
YT-8891 370 12/72

EN Hoe and cultivator
PL Motyczka z pazurkami
DE Kleinhacke
RU Рыхлитель комбинированный
CZ Motyčka s kultivátorem
HU Kerti villás kapa
RO Cultivator cu sapaliga
FR Serfolette
IT Zappa con artigli
ES Escarificador y azadilla
CN 园艺锄

320 mm



CHROME PLATED CHROMO-WANE



YATO L [mm]
YT-8892 320 12/72

EN Dibble
PL Pikownik ogrodniczy
DE Pflanzer
RU Конус посадочный
CZ Zahradnický přepichovač
HU Kerti palántázó
RO Chitonag pt. grădină
FR Plantoir
IT Foraterra
ES Picadeor de jardín
CN 挖洞器

280 mm



SS STAINLESS STEEL MERCEZWA



YATO L [mm]
YT-8894 280 10/60

EN Sharp spade
PL Szpadel ostry
DE Scharfer Spaten
RU Штыковая лопата
CZ Rýč špičatý
HU Hegyes ásó
RO Hârlet ascuțit
FR Bêche à bord pointu
IT Vanga affilata
ES Pala puntiaguda
CN 铁锹



120 cm
HRC 40-48
1050 Mn

EN Flat spade
PL Szpadel prosty
DE Rodespaten
RU Заступ
CZ Rýč rovný
HU Egyenes ásó
RO Hârlet cu coadă
FR Bêche
IT Vanga dritta
ES Pala recta
CN 铁锹



120 cm
HRC 40-48
1050 Mn

EN Coal shovel
PL Lopata węglowa
DE Kohlenschaufel
RU Лопата для угля
CZ Lopata na uhlí
HU Szénlapát
RO Lopata pt. carbune
FR Pelle à charbon
IT Pala per carbone
ES Pala para carbón
CN 铁锹



120 cm
HRC 40-48
1050 Mn

YATO L [cm] 6
YT-86804 120 6

YATO L [cm] 6
YT-86800 120 6

YATO L [cm] 6
YT-86801 120 6

EN Sand shovel
PL Lopata piaskowa
DE Sandschaufel
RU Лопата для песка
CZ Lopata na písek
HU Homoklapát
RO Lopată pt. nisip
FR Pelle à sable
IT Pala per sabbia
ES Pala para arena
CN 铁锹



120 cm
HRC 40-48
1050 Mn

EN Digging fork
PL Widły
DE Grabegabel
RU Вилы
CZ Zahradnické vidlice
HU Vasvilla
RO Furcă pt. grădinărit
FR Fourche à bêcher
IT Forchetta
ES Horca
CN 铁叉



120 cm

EN Digging fork
PL Widły
DE Grabegabel
RU Вилы
CZ Zahradnické vidlice
HU Vasvilla
RO Furcă pt. grădinărit
FR Fourche à bêcher
IT Forchetta
ES Horca
CN 铁叉



120 cm

YATO L [cm] 6
YT-86808 120 6

YATO L [cm] 6
YT-86805 120 6

YATO L [cm] 6
YT-86809 120 6

EN Weed puller
PL Wyrrywacz chwastów
DE Unkrautentferner
RU Приспособление для вырывания сорняков
CZ Vytrhávač plevelu
HU Gyomkihúzó

RO Dispozitiv de scos burieni
FR Extracteur de mauvaises herbes
IT Estrattore di erbacce
ES Extractor de maleza
CN 移苗器

995 mm
AI
PP



YATO L [mm] 6
YT-86840 995 6

EN Multiple holder
PL Wieszak na narzędzia
DE Werkzeughalter
RU Подвеска для инструмента
CZ Věšák na nářadí
HU Szerszámakasztó

RO Suport multiplu
FR Porte-outils
IT Portautensili
ES Colgador para herramientas
CN 塑料挂架

18-32 mm
x5 HOLDERS
320 g
ABS TPR



YATO 40
YT-87650 40

EN Cordless pressure washer
 PL Akumulatorowa myjka ciśnieniowa
 DE Akku-Hochdruckreiniger
 RU Аккумуляторная мойка
 высокого давления
 CZ Bateriaový tlakový čistič
 HU Akkumulátoros mosó
 RO Aparat de spalat cu presiune
 FR Nettoyeur à haute pression sans-fil
 IT Idropulitrice a batteria
 ES Limpiadora a vapor a batería
 CN 高压清洗机



18 V
Li-Ion
IN (max.)
0.5 MPa
OUT
2.3 MPa
6 m
SUCTION
FUNCTION
FUNKCJA
ZASYSANIA

Battery not included
 Ohne Akku / Bez akumulatora
 Bez Gamapeu / Bez aku
 Akkumulátor nélkül
 Fără baterie / Sans batterie
 Senza batteria / Sin batería
 沒有電池

18V
Li-Ion

YATO	[V d.c.]	
YT-85930	18	6

EN Cordless leaf vacuum / blower
 PL Akumulatorowy odkurzacz / dmuchawa do liści
 DE Akku-Laubsauger / Laubbläser
 RU Аккумуляторная воздуходувка-пылесос
 CZ Akumulatorový vysavač / odfukovač listí
 HU Akkumulátoros lombszívó / lombfúvó
 RO Sulfanta / aspirator cu acumulator
 FR Aspirateur-souffleur de feuilles sans-fil
 IT Aspiratore / soffiatore per foglie senza fili
 ES Aspiradora / soplador de hojas de batería
 CN 锂电无刷吹吸机

- Leaves compress volume function 8:1
- Blowing air speed: 230 km/h
- Funkcja zmniejszania objętości liści 8:1
- Prędkość wydmuchiwanego powietrza: 230 km/h



2in1
2w1
36 V
2x 18V
Li-Ion
6000-12500
min²
8
m³/min
45 L

Battery not included
 Ohne Akku / Bez akumulatora
 Bez Gamapeu / Bez aku
 Akkumulátor nélkül
 Fără baterie / Sans batterie
 Senza batteria / Sin batería
 沒有電池

18V
Li-Ion

$L_{pA} = 80,5 \pm 3,0$ dB; $L_{wA} = 92,7 \pm 3,0$ dB; $a_n = 2,37 \pm 1,5$ m/s²

YATO	[V d.c.]	
YT-85175	36 (18 x2)	1

EN Electric sprayer
 PL Spryskiwacz elektryczny
 DE Elektrische Sprühpistole
 RU Электрический опрыскиватель
 CZ Elektrický ostřikovač
 HU Elektromos festékszóró
 RO Pulverizator electric
 FR Pulvérisateur à main électrique
 IT Spruzzatore elettrico
 ES Rociador eléctrico
 CN 喷雾器



3.6 V
2000mAh
Li-Ion
1000 ml
460 ml/min
285 ml/min
4-5h
2.5h
LED
LIGHTING
OSWIETLIENIE
LED CHARGE
INDICATOR
WSKAZNIK
NALADOWNIA
BATERII
USB
BATTERY CHARGER
ŁADOWNIA

- Application: watering, washing, disinfection
- Przeznaczenie: podlewanie, mycie, dezynfekcja

$L_{pA} = 75,2 \pm 3,0$ dB; $L_{wA} = 86,2 \pm 3,0$ dB; $a_n = 1,137 \pm 1,5$ m/s²

YATO	[V d.c.]	
YT-86200	3.6	18

EN Cordless backpack sprayer
 PL Akumulatorowy opryskiwacz plecakowy
 DE Akku-Drucksprüher
 RU Аккумуляторный ранцевый опрыскиватель
 CZ Aku postřikovač
 HU Akkumulátoros hátí permetező
 RO Pulverizator cu acumulator
 FR Pulvérisateur à batterie
 IT Pompa irroratrice a spalla a batteria
 ES Pulverizador de mochila a batería
 CN 充电式喷雾器



2in1
2w1
18 V
Li-Ion
12 L
≤1.5 l/min
max
7m

- Water tank
- Sprayer
- Hydronetka
- Opryskiwacz

Battery not included
 Ohne Akku / Bez akumulatora
 Bez Gamapeu / Bez aku
 Akkumulátor nélkül
 Fără baterie / Sans batterie
 Senza batteria / Sin batería
 沒有電池

18V
Li-Ion

$L_{pA} = 60,0 \pm 3,0$ dB; $L_{wA} = 70,0 \pm 3,0$ dB; $a_n = 0,74 \pm 1,5$ m/s²

YATO	[V d.c.]	
YT-86211	18	1

EN Battery sprayer with solar panel
 PL Opryskiwacz akumulatorowo-solarny
 DE Solar-Akku-Sprüngerät
 RU Опрыскиватель аккумуляторный
 на солнечной батарее
 CZ Postřikovač bateriový-solární
 HU Akkumulátoros-napelemes permetező
 RO Vermorel cu alimentare solara
 FR Pulvérisateur à batterie et à dos solaire
 IT Pompa irroratrice a batteria
 e ad energia solare
 ES Pulverizador solar a batería
 CN 电动太阳能喷雾器



12 V
0.15-0.4 MPa
3.1 l/min
16 L
8.0 Ah
PP
SS
STAINLESS STEEL
STAL MIERZWIĄ

YATO	[V d.c.]	
YT-86220	12	1

EN Cordless telescopic pole saw
 PL Akumulatorowe okrzyszarka na wysięgniku
 DE Akku-Teleskop-Hochentaster
 RU Аккумуляторный телескопический высотерез
 CZ Akumulatorová teleskopická vyvětvovací pila
 HU Akkus magassági ágvágó távcsőves
 RO Ferăstraie cu lanț cu telescopic cu acumulator
 FR Elagueuse sur perche télescopique sans-fil
 IT Decespugliatore telescopico a batteria
 ES Sierra de pértiga telescópica a batería
 CN 充电式高枝锯

18V
Li-Ion



18 V
Li-Ion
2500 min²
8" / 20 cm
5 m/s
280 / 200 cm
2.0 Ah
1h
EASY
TRANSPORT
ŁATWY
TRANSPORT

$L_{pA} = 78,2 \pm 3,0$ dB; $L_{wA} = 91,2 \pm 2,36$ dB; $a_n = 2,109 \pm 1,5$ m/s²

YATO	[V d.c.]	
YT-82836	18	2

EN Cordless telescopic pole saw
PL Akumulatorowe okrzesywarka na wysięgniku
DE Akku-Teleskop-Hochentaster
RU Аккумуляторный телескопический высоторез
CZ Akumulátorová teleskopická vyvrtovací pila
HU Akkus magassági ágvágó távcsoves
RO Ferăstrăie cu lanț cu telescopiu cu acumulator
FR Elagueuse sur perche télescopique sans-fil
IT Decespugliatore telescopico a batteria
ES Sierra de pértiga telescópica a batería
CN 充电式高枝锯

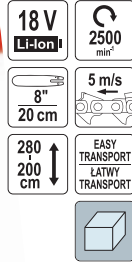

18V
Li-Ion

Battery not included
Ohne Akku / Bez akumulatora
Bez baterije / Bez aku
Акумулятор не в комплекті
Fără baterie / Sans batterie
Senza batteria / Sin batería
没有电池



$L_{pa} = 78,2 \pm 3,0$ dB; $L_{wa} = 91,2 \pm 2,36$ dB; $a_n = 2,109 \pm 1,5$ m/s²

YATO	[V d.c.]	
YT-82837	18	2

EN Cordless grass trimmer
PL Akumulatorowa podkaszarka do trawy
DE Akku-Rasentrimmer
RU Аккумуляторный триммер
CZ Akumulátorová sekačka na trávu
HU Akkus szegélynyíró
RO Trimmer de gazon cu acumulator
FR Débroussailluse sans-fil
IT Tagliabordi a batteria
ES Desbrozadora a batería
CN 充电式打草机

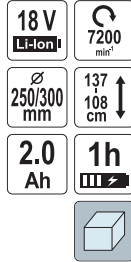

18V
Li-Ion

$L_{pa} = 85,0 \pm 3,0$ dB; $L_{wa} = 93,0 \pm 3,0$ dB; $a_n = 2,5 \pm 1,5$ m/s²

YATO	[V d.c.]	
YT-82830	18	2

EN Cordless grass trimmer
PL Akumulatorowa podkaszarka do trawy
DE Akku-Rasentrimmer
RU Аккумуляторный триммер
CZ Akumulátorová sekačka na trávu
HU Akkus szegélynyíró
RO Trimmer de gazon cu acumulator
FR Débroussailluse sans-fil
IT Tagliabordi a batteria
ES Desbrozadora a batería
CN 充电式打草机



18V
Li-Ion

Battery not included
Ohne Akku / Bez akumulatora
Bez baterije / Bez aku
Акумулятор не в комплекті
Fără baterie / Sans batterie
Senza batteria / Sin batería
没有电池



$L_{pa} = 85,0 \pm 3,0$ dB; $L_{wa} = 93,0 \pm 3,0$ dB; $a_n = 2,5 \pm 1,5$ m/s²

YATO	[V d.c.]	
YT-82831	18	2

EN Cordless grass trimmer
PL Akumulatorowa podkaszarka do trawy
DE Akku-Rasentrimmer
RU Аккумуляторный триммер
CZ Akumulátorová sekačka na trávu
HU Akkus szegélynyíró
RO Trimmer de gazon cu acumulator
FR Débroussailluse sans-fil
IT Tagliabordi a batteria
ES Desbrozadora a batería
CN 充电式打草机

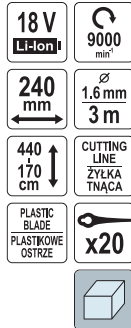

18V
Li-Ion

Battery not included
Ohne Akku / Bez akumulatora
Bez baterije / Bez aku
Акумулятор не в комплекті
Fără baterie / Sans batterie
Senza batteria / Sin batería
没有电池

$L_{pa} = 81,0 \pm 3,0$ dB; $L_{wa} = 88,0 \pm 2,12$ dB; $a_n = \leq 2,5$ m/s²

YATO	[V d.c.]	
YT-85015	18	4

EN Nylon blades
PL Nożyki nylonowe
DE Nylonmesser Set
RU Сменные ножи для триммера
CZ Náhradní nože pro vyžinače
HU Nylon kések
RO Lame din nylon
FR Lames en nylon
IT Piedi di nylon
ES Cuchillas de nylon
CN 尼龙打草刀片

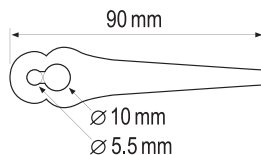
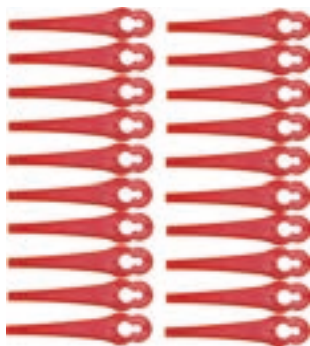

For YT-85015
Dla YT-85015

YATO		
YT-85016		250

EN Cordless brushcutter
PL Kosa akumulatorowa
DE Akku-Motorsense
RU Аккумуляторная коса
CZ Akumulátorový křovinořez
HU Akkus fűkasza
RO Motocoasa cu acumulator
FR Débroussailluse sans-fil
IT Decespugliatore a batteria
ES Motoguadaña a batería
CN 充电式打草机

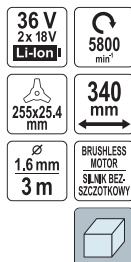

18V
Li-Ion

$L_{pa} = 79,1 \pm 3,0$ / $83,0 \pm 3,0$ dB; $L_{wa} = 88,4 \pm 2,31$ / $92,5 \pm 1,92$ dB; $a_n = 1,35 \pm 1,5$ / $1,11 \pm 1,5$ m/s²

YATO	[V d.c.]	
YT-85010	36 (18 x2)	1

EN Cordless hedge trimmer
 PL Akumulatorowe nożyce do żywoplotu
 DE Akku-Heckenschere
 RU Аккумуляторный кусторез
 CZ Akumulátorové nůžky na živé ploty
 HU Akkus sövénynyíró
 RO Foarfece de tăiat gard viu cu acumulator
 FR Taille-haies sans-fil
 IT Tagliasiepi a batteria
 ES Cortasetos inalámbrico
 CN 充电式修枝剪

18V
Li-Ion

1050
mm²

560mm
22"

2.0
Ah

1h



18V
Li-Ion

$L_{pA} = 80,0 \pm 3,0$ dB; $L_{wA} = 87,0 \pm 3,0$ dB; $a_n = 3,5 \pm 1,5$ m/s²

YATO	[V d.c.]	
YT-82832	18	2

EN Cordless hedge trimmer
 PL Akumulatorowe nożyce do żywoplotu
 DE Akku-Heckenschere
 RU Аккумуляторный кусторез
 CZ Akumulátorové nůžky na živé ploty
 HU Akkus sövénynyíró
 RO Foarfece de tăiat gard viu cu acumulator
 FR Taille-haies sans-fil
 IT Tagliasiepi a batteria
 ES Cortasetos inalámbrico
 CN 充电式修枝剪

18V
Li-Ion

1050
mm²

560mm
22"



18V
Li-Ion

$L_{pA} = 80,0 \pm 3,0$ dB; $L_{wA} = 87,0 \pm 3,0$ dB; $a_n = 3,5 \pm 1,5$ m/s²

YATO	[V d.c.]	
YT-82833	18	2

Battery not included
 Ohne Akku / Bez akumulatora
 Без аккумулятора / Bez aku
 Akkumulátor nélkül
 Fără baterie / Sans batterie
 Senza batteria / Sin battery
 没有电池

EN Cordless hedge trimmer
 PL Akumulatorowe nożyce do żywoplotu
 DE Akku-Heckenschere
 RU Аккумуляторный кусторез
 CZ Akumulátorové nůžky na živé ploty
 HU Akkus sövénynyíró
 RO Foarfece de tăiat gard viu cu acumulator
 FR Taille-haies sans-fil
 IT Tagliasiepi a batteria
 ES Tijera cortasetos a batería
 CN 充电式高枝剪

18V
Li-Ion

2100
mm²

420
mm

274
207
cm

2.0
Ah

1h

EASY
TRANSPORT
LATVY
TRANSPORT



18V
Li-Ion

$L_{pA} = 77,3 \pm 3,0$ dB; $L_{wA} = 88,1 \pm 3,0$ dB; $a_n = 1,5 \pm 1,5$ m/s²

YATO	[V d.c.]	
YT-82834	18	2

EN Cordless hedge trimmer
 PL Akumulatorowe nożyce do żywoplotu
 DE Akku-Heckenschere
 RU Аккумуляторный кусторез
 CZ Akumulátorové nůžky na živé ploty
 HU Akkus sövénynyíró
 RO Foarfece de tăiat gard viu cu acumulator
 FR Taille-haies sans-fil
 IT Tagliasiepi a batteria
 ES Tijera cortasetos a batería
 CN 充电式高枝剪

18V
Li-Ion

2100
mm²

420
mm

274
207
cm

EASY
TRANSPORT
LATVY
TRANSPORT



18V
Li-Ion

$L_{pA} = 77,3 \pm 3,0$ dB; $L_{wA} = 88,1 \pm 3,0$ dB; $a_n = 1,5 \pm 1,5$ m/s²

YATO	[V d.c.]	
YT-82835	18	2

Battery not included
 Ohne Akku / Bez akumulatora
 Без аккумулятора / Bez aku
 Akkumulátor nélkül
 Fără baterie / Sans batterie
 Senza batteria / Sin battery
 没有电池

EN Cordless chainsaw
 PL Akumulatorowa pilarka łańcuchowa
 DE Akku-Kettensäge
 RU Аккумуляторная цепная пила
 CZ Akumulátorová řetězová píla
 HU Akkus láncfűrész
 RO Ferăstrau cu lanț cu acumulator
 FR Tronçonneuse sans-fil
 IT Motosega a batteria
 ES Inalámbrico motosierra
 CN 锂电电链锯套装

18V
Li-Ion

2.0
Ah

1h

4"
10 cm

0.043"
1.1 mm

4.8 m/s

SOFT
GRIP
MIEKKI
UCHWYT



18V
Li-Ion

$L_{pA} = 78,0 \pm 3,0$ dB; $L_{wA} = 89,0 \pm 3,0$ dB; $a_n = 3,425 \pm 1,5$ m/s²

YATO	[V d.c.]	
YT-828135	18	4

EN Cordless chainsaw
 PL Akumulatorowa pilarka łańcuchowa
 DE Akku-Kettensäge
 RU Аккумуляторная цепная пила
 CZ Akumulátorová řetězová píla
 HU Akkus láncfűrész
 RO Ferăstrau cu lanț cu acumulator
 FR Tronçonneuse sans-fil
 IT Motosega a batteria
 ES Inalámbrico motosierra
 CN 锂电电链锯套装

18V
Li-Ion

2.0
Ah

1h

4"
10 cm

0.043"
1.1 mm

4.8 m/s

SOFT
GRIP
MIEKKI
UCHWYT



18V
Li-Ion

$L_{pA} = 78,0 \pm 3,0$ dB; $L_{wA} = 89,0 \pm 3,0$ dB; $a_n = 3,425 \pm 1,5$ m/s²

YATO	[V d.c.]	
YT-828136	18	4

Battery not included
 Ohne Akku / Bez akumulatora
 Без аккумулятора / Bez aku
 Akkumulátor nélkül
 Fără baterie / Sans batterie
 Senza batteria / Sin battery
 没有电池

EN Cordless chainsaw
PL Akumulatorowa piła łańcuchowa
DE Akku-Kettensäge
RU Аккумуляторная цепная пила
CZ Akumulátorová řetězová pila
HU Akkus láncfűrész
RO Ferăstrău cu lanț cu acumulator
FR Tronçonneuse sans-fil
IT Motosega a batteria
ES Inalámbrico motosierra
CN 锂电电链锯套装

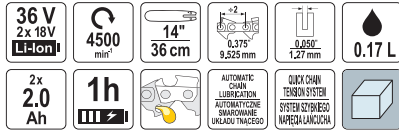

18V
Li-Ion

$L_{pA} = 81,9 \pm 3,0$ dB; $L_{wA} = 92,8 \pm 2,6$ dB; $a_n = 2,57 \pm 1,5 / 4,92 \pm 1,5$ m/s²

YATO	[V d.c.]	
YT-82812	36 (18 x2)	2

EN Cordless chainsaw
PL Akumulatorowa piła łańcuchowa
DE Akku-Kettensäge
RU Аккумуляторная цепная пила
CZ Akumulátorová řetězová pila
HU Akkus láncfűrész
RO Ferăstrău cu lanț cu acumulator
FR Tronçonneuse sans-fil
IT Motosega a batteria
ES Inalámbrico motosierra
CN 锂电电链锯光机

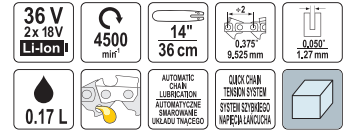

18V
Li-Ion

$L_{pA} = 81,9 \pm 3,0$ dB; $L_{wA} = 92,8 \pm 2,6$ dB; $a_n = 2,57 \pm 1,5 / 4,92 \pm 1,5$ m/s²

YATO	[V d.c.]	
YT-82813	36 (18 x2)	2

Battery not included
Omot Akku / Bez akumulátora
Esz Gámapau / Bez aku
Akumulátor nélkül
Fără baterie / Sans batterie
Senza batteria / Sin batería
没有电池

EN Cordless lawn mower
PL Kosiarka akumulatorowa
DE Akku-Rasenmäher
RU Аккумуляторная газонокосилка
CZ Akumulátorová sekačka na trávu
HU Fűnyíró akkumulátoros
RO Masina de tuns iarba cu acumulator
FR Tondeuse sans-fil
IT Rasaerba a batteria
ES Cortacésped de batería
CN 锂电草坪机套装



18V
Li-Ion

$L_{pA} = 77,9 \pm 3,0$ dB; $L_{wA} = 90,2 \pm 1,85$ dB; $a_n = 0,5 \pm 1,5$ m/s²

YATO	[V d.c.]	
YT-85220	36 (18 x2)	1



EN Cordless lawn mower
PL Kosiarka akumulatorowa
DE Akku-Rasenmäher
RU Аккумуляторная газонокосилка
CZ Akumulátorová sekačka na trávu
HU Fűnyíró akkumulátoros
RO Masina de tuns iarba cu acumulator
FR Tondeuse sans-fil
IT Rasaerba a batteria
ES Cortacésped de batería
CN 锂电草坪机光机



18V
Li-Ion

$L_{pA} = 77,9 \pm 3,0$ dB; $L_{wA} = 90,2 \pm 1,85$ dB; $a_n = 0,5 \pm 1,5$ m/s²

YATO	[V d.c.]	
YT-85221	36 (18 x2)	1

Battery not included
Omot Akku / Bez akumulátora
Esz Gámapau / Bez aku
Akumulátor nélkül
Fără baterie / Sans batterie
Senza batteria / Sin batería
没有电池

EN Battery
PL Akumulator
DE Akkumulator
RU Аккумулятор
CZ Akumulátor
HU Akkumulátor
RO Acumulatorul
FR Batterie
IT Batteria
ES Acumulador
CN 锂电池包



18V
Li-Ion



YATO	[V d.c.]	[Ah]	[h]	
YT-82842	18	2	1.0	20
YT-82843	18	3	1.5	20
YT-82844	18	4	2.0	20
YT-82845	18	6	3.0	20

EN Battery charger
PL Ładowarka
DE Ladegerät
RU Зарядное устройство
CZ Nabíječka
HU Akkutöltő
RO Redresor
FR Chargeur de batterie
IT Caricabatteria
ES Rectificador
CN 充电器

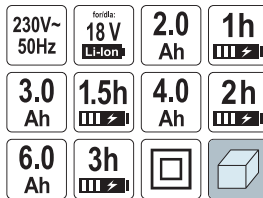

18V
Li-Ion



YATO	[V d.c.]	
YT-82848	18	10

EN Battery charger
PL Ładowarka
DE Ladegerät
RU Зарядное устройство
CZ Nabíječka
HU Akkutöltő
RO Redresor
FR Chargeur de batterie
IT Caricabatteria
ES Rectificador
CN 充电器

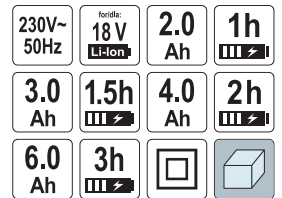

18V
Li-Ion



YATO	[V d.c.]	
YT-82849	18	10

EN Electric grass trimmer
 PL Podkaszarka elektryczna
 DE Elektro-Rasentrimmer
 RU Электрический триммер
 CZ Elektrická sekačka
 HU Elektromos fűnyíró
 RO Cositoare electrică
 FR Coupe-herbe
 IT Decespugliatore elettrico
 ES Segadora eléctrica
 CN 打草机



230-240V~50Hz	250 W
12500 min ⁻¹	∅ 220 mm
1.2 mm	6 m

$L_{pA} = 70,21 \pm 0,88$ dB; $L_{wA} = 90,18 \pm 0,88$ dB; $a_n = 1,853 \pm 1,5 / 2,835 \pm 1,5$ m/s²

YATO	[W]	
YT-85230	250	12

EN Electric grass trimmer
 PL Podkaszarka elektryczna
 DE Elektro-Rasentrimmer
 RU Электрический триммер
 CZ Elektrická sekačka
 HU Elektromos fűnyíró
 RO Cositoare electrică
 FR Coupe-herbe
 IT Decespugliatore elettrico
 ES Segadora eléctrica
 CN 打草机



230-240V~50Hz	550 W
10000 min ⁻¹	∅ 300 mm
1.6 mm	126 106 cm
2 POSITIONS / POZYCJE	
HEAD ANGLE ADJUSTMENT / REGULACJA KĄTA GŁOWICY	

$L_{pA} = 73,45 \pm 1,52$ dB; $L_{wA} = 93,17 \pm 1,52$ dB; $a_n = 4,556 \pm 1,5 / 4,306 \pm 1,5$ m/s²

YATO	[W]	
YT-85234	550	4

EN Electric chainsaw 2 in 1
 PL Elektryczna piła łańcuchowa 2 w 1
 DE 2 in 1 elektrische Kettensäge
 RU Электрическая цепная пила 2 в 1
 CZ Elektrická řetězová pila 2 v 1
 HU 2 az 1-ben elektromos láncfűrész
 RO Ferăstrău electric cu lanț 2 in 1
 FR Tronçonneuse électrique 2 en 1
 IT Motosega elettrica 2 in 1
 ES 2 en 1 sierra de cadena eléctrica
 CN 2合1电链锯

2 in 1 / 2 w 1	230-240V~50Hz	750 W	10" / 25 cm	40
12 m/s	170 110 cm	0.045" / 1.1 mm	12 m/s	0.11 L
SOFT GRIP / MIEKKI LC+WT1				



$L_{pA} = 89,5 \pm 3,0$ dB; $L_{wA} = 102,7 \pm 2,47$ dB; $a_n = 2,67 \pm 1,5 / 3,32 \pm 1,5$ m/s²

YATO	[W]	
YT-84877	750	1

EN Electric chainsaw
 PL Elektryczna piła łańcuchowa
 DE Elektrische Kettensäge
 RU Электрическая цепная пила
 CZ Elektrická řetězová pila
 HU Elektromos láncfűrész
 RO Ferăstrău electric cu lanț
 FR Tronçonneuse électrique
 IT Motosega elettrica
 ES Sierra de cadena eléctrica
 CN 电链锯

230-240V~50Hz	2000 W	7000 min ⁻¹	16" / 40 cm	40
13 m/s	170 110 cm	0.045" / 1.1 mm	13 m/s	0.11 L
SOFT GRIP / MIEKKI LC+WT1				



$L_{pA} = 90,2 \pm 3,0$ dB; $L_{wA} = 103,2 \pm 3,0$ dB; $a_n = 8,393 \pm 1,5 / 6,002 \pm 1,5$ m/s²

YATO	[W]	
YT-84870	2000	2

EN Electric lawn mower
 PL Kosiarka elektryczna
 DE Elektrischer grasmäher
 RU Электрокосилка
 CZ Elektrická sekačka
 HU Elektromos fűnyíró-gép
 RO Cositoare electrica pt. iarba
 FR Tondeuse à gazon électrique
 IT Rasaerba elettrico
 ES Contracesped
 CN 电动草坪机



230V~50/60Hz	1300 W
3400 min ⁻¹	∅ 330 mm
60 40 20 mm	30 L
∅ 140 mm	

$L_{pA} = 82,3 \pm 3,0$ dB; $L_{wA} = 93,1 \pm 1,91$ dB; $a_n = 2,72 \pm 1,5$ m/s²

YATO	[W]	
YT-85200	1300	1

EN Electric lawn mower
 PL Kosiarka elektryczna
 DE Elektrischer grasmäher
 RU Электрокосилка
 CZ Elektrická sekačka
 HU Elektromos fűnyíró-gép
 RO Cositoare electrica pt. iarba
 FR Tondeuse à gazon électrique
 IT Rasaerba elettrico
 ES Contracesped
 CN 电动草坪机



230V~50/60Hz	1800 W
3300 min ⁻¹	∅ 380 mm
60 70 40 50 20 30 mm	50 L
∅ 160 mm / ∅ 200 mm	

$L_{pA} = 82,8 \pm 3,0$ dB; $L_{wA} = 93,7 \pm 2,4$ dB; $a_n = 3,15 \pm 1,5$ m/s²

YATO	[W]	
YT-85205	1800	1

EN Electric lawn mower
 PL Kosiarka elektryczna
 DE Elektrischer grasmäher
 RU Электрокосилка
 CZ Elektrická sekačka
 HU Elektromos fűnyíró-gép
 RO Cositoare electrica pt. iarba
 FR Tondeuse à gazon électrique
 IT Rasaerba elettrico
 ES Contracesped
 CN 电动草坪机



230V~50/60Hz	2000 W
3300 min ⁻¹	∅ 430 mm
60 70 40 50 20 30 mm	50 L
∅ 160 mm / ∅ 240 mm	

$L_{pA} = 83,6 \pm 3,0$ dB; $L_{wA} = 94,6 \pm 1,8$ dB; $a_n = 3,45 \pm 1,5$ m/s²

YATO	[W]	
YT-85208	2000	1

EN Electric tiller
 PL Głębogryzarka elektryczna
 DE Elektro-Bodenhacke
 RU Электрический культиватор
 CZ Elektrický kultivátor
 HU Elektromos kapálógép
 RO Motosapa electrica
 FR Motobineuse électrique
 IT Motozappatrice elettrica
 ES Cultivador rotativo eléctrico
 CN 松土机



230-240V~50Hz	1500 W
220 mm	450 mm
∅ 205 mm	

$L_{pA} = 80,4 \pm 3,0$ dB; $L_{wA} = 91,57 \pm 1,28$ dB; $a_n = 0,968 \pm 1,5 / 0,947 \pm 1,5$ m/s²

YATO	[W]	
YT-84850	1500	1

EN Electric scarifier
PL Wertykulator elektryczny
DE Elektrischer Vertikutierer
RU Электрический скарификатор
CZ Elektrický vertikutátor
HU Elektromos gyepszellőztető
RO Scarificator electric
FR Scarificateur électrique
IT Scarificatore elettrico
ES Escarificador eléctrico
CN 电动松土机

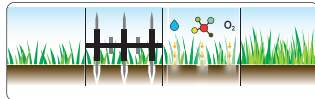

$L_{PA} = 90,2 \pm 3,0$ dB; $L_{WA} = 105,17 \pm 3,0$ dB; $a_n = 1,679 \pm 1,5$ m/s²

YATO	[W]	
YT-84840	1800	1

EN Leaf vacuum / blower
PL Odkurzacz / dmuchawa do liści
DE Laubsauger / Laubbläser
RU Воздуходувка-пылесос
CZ Vysavač / odfukovač listí
HU Lombszívó / lombfúvó
RO Sufianta / aspirator
FR Aspirateur-souffleur de feuilles
IT Aspiratore / soffiatore per foglie
ES Aspiradora / soplador de hojas
CN 电动吹吸机



$L_{PA} = 90,2 \pm 3,0$ dB; $L_{WA} = 102,4 \pm 3,0$ dB; $a_n = 4,27 \pm 1,5$ m/s²

YATO	[W]	
YT-85180	3500	1

EN Blade for lawn mower
PL Ostrze do kosiarki
DE Mähmesser
RU Нож для косилки
CZ Nůž do sekačky
HU Fűnyíró kés

RO Lama pt. masina tuns iarba
FR Lame de tondeuse
IT Lama per tosaerba
ES Cuchillas de segadoras
CN 电动割草机刀片

5.5 mm

9.5 mm

320 mm



For YT-85200
Dla YT-85200

YATO	L [mm]	
YT-85160	320	80

EN Blade for lawn mower
PL Ostrze do kosiarki
DE Mähmesser
RU Нож для косилки
CZ Nůž do sekačky
HU Fűnyíró kés

RO Lama pt. masina tuns iarba
FR Lame de tondeuse
IT Lama per tosaerba
ES Cuchillas de segadoras
CN 电动割草机刀片

5.5 mm

9.5 mm

380 mm



For YT-85205
Dla YT-85205

YATO	L [mm]	
YT-85161	380	50

EN Blade for lawn mower
PL Ostrze do kosiarki
DE Mähmesser
RU Нож для косилки
CZ Nůž do sekačky
HU Fűnyíró kés

RO Lama pt. masina tuns iarba
FR Lame de tondeuse
IT Lama per tosaerba
ES Cuchillas de segadoras
CN 电动割草机刀片

5.5 mm

9.5 mm

430 mm



For YT-85208
Dla YT-85208

YATO	L [mm]	
YT-85162	430	50

EN Gasoline backpack sprayer
PL Opryskiwacz plecakowy spalinowy
DE Benzin Motorsprüher
RU Опрыскиватель бензиновый
CZ Motorový rosič
HU Benzines permetező
RO Pulverizatoare pe benzina
FR Pulvérisateur à essence
IT Pompa irroratrice a spalla a motore
ES Pulverizador de gasolina
CN 汽油喷雾器

2.13 kW

2.9 KM

41.5 cm³

20 L

17 m³/min

12 mm



$L_{PA} = 99,0 \pm 3,0$ dB; $L_{WA} = 111,0 \pm 3,0$ dB; $a_n = 0,8 \pm 1,5 / 0,9 \pm 1,5$ m/s²

YATO	[kW]	[KM]	
YT-86240	2.13	2.9	1

EN Gasoline earth auger
PL Wiertnica spalinowa
DE Benzin Erdlochbohrer
RU Бензобур
CZ Zemní vrtací stroj benzínový
HU Benzines talajfúró
RO Motoburghiu de pamant
FR Tarière à moteur
IT Mototrivella a scoppio
ES Ahoyadora
CN 地钻

1.4 kW

51.2 cm³

320 min⁻¹ (max.)

40 : 1

ANTI-VIBRATION SYSTEM ANTY-WIBRACYJNY

50 cm

100 mm

150 mm

200 mm



• Tool-free drill exchange
• Balanced and easy to operate
• Beznarzędziowa wymiana wiertel
• Dobrze wyważona i łatwa w obsłudze

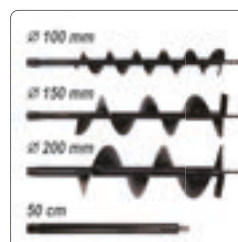

$L_{PA} = 103,8 \pm 3,0$ dB; $L_{WA} = 107,54 \pm 3,0$ dB; $a_n = 12,469 \pm 1,5$ m/s²

YATO	[kW]	[KM]	
YT-84660	1.4	1.9	1

EN Soil drill bit
 PL Wiertło glebowe
 DE Erdböhler
 RU Шнек для бензобура
 CZ Půdní vrták
 HU Talajfúró szár
 RO Burghiu pt. pamant
 FR Foret pour tarière
 IT Punta per trivella
 ES Broca ahoyadora
 CN 地钻钻头



YATO	Ø [mm]	L [mm]	
YT-84670	100	785	1
YT-84671	150	785	1
YT-84672	200	785	1

EN Soil drill bit extension
 PL Przedłużka do wiertła glebowego
 DE Verlängerung für Erdböhler
 RU Удлинитель шнека для бензобура
 CZ Nástavec pro půdní vrták
 HU Talajfúró szár hosszabbító
 RO Extensie burghiu pt. pamant
 FR Extension pour foret de sol
 IT Prolunga per trivella per terreno
 ES Extensión de broca ahoyadora
 CN 接杆

50
cm



YATO	L [mm]	
YT-84675	500	20

EN Gasoline chainsaw
 PL Pilarka spalinowa
 DE Motorsägen
 RU Бензопила
 CZ Motorová pila
 HU Benzin láncfűrész
 RO Drujba pe benzina
 FR Tronçonneuses
 IT Motosega a benzina
 ES Motosierra de gasolina
 CN 油锯



1.3 kW	1.7 KM	37.2 cm ³	8000 min ⁻¹	14" 36 cm	0.17 L
40 : 1	3/8" 9.52 mm	0.05" 1.3 mm		ANTI-VIBRATION SYSTEM ANTY-WIBRACYJNY	

L_{pa} = 93,35 ± 1,08 dB; L_{wa} = 112,33 ± 1,08 dB; a_h = 5,600 ± 1,5 / 4,884 ± 1,5 m/s²

YATO	[kW]	[KM]	L [mm]	
YT-84895	1.3	1.7	330	1

EN Gasoline chainsaw
 PL Pilarka spalinowa
 DE Motorsägen
 RU Бензопила
 CZ Motorová pila
 HU Benzin láncfűrész
 RO Drujba pe benzina
 FR Tronçonneuses
 IT Motosega a benzina
 ES Motosierra de gasolina
 CN 油锯



1.8 kW	2.4 KM	45.1 cm ³	8500 min ⁻¹	16" 40 cm	0.24 L
40 : 1	3/8" 9.52 mm	0.05" 1.3 mm		ANTI-VIBRATION SYSTEM ANTY-WIBRACYJNY	

L_{pa} = 89,69 ± 1,37 dB; L_{wa} = 109,19 ± 1,37 dB; a_h = 5,650 ± 1,5 / 6,027 ± 1,5 m/s²

YATO	[kW]	[KM]	L [mm]	
YT-84901	1.8	2.4	360	1

EN Gasoline chainsaw
 PL Pilarka spalinowa
 DE Motorsägen
 RU Бензопила
 CZ Motorová pila
 HU Benzin láncfűrész
 RO Drujba pe benzina
 FR Tronçonneuses
 IT Motosega a benzina
 ES Motosierra de gasolina
 CN 油锯



2.5 kW	3.4 KM	56.5 cm ³	8500 min ⁻¹	20" 50 cm	0.24 L
40 : 1	3/8" 9.52 mm	0.05" 1.3 mm		ANTI-VIBRATION SYSTEM ANTY-WIBRACYJNY	

L_{pa} = 94,59 ± 1,34 dB; L_{wa} = 113,46 ± 1,34 dB; a_h = 7,234 ± 1,5 / 9,528 ± 1,5 m/s²

YATO	[kW]	[KM]	L [mm]	
YT-84910	2.5	3.4	480	1

EN Brushcutter
 PL Kosa spalinowa
 DE Motorsense
 RU Бензокоса
 CZ Motorový křovinořez
 HU Motoros fűkasza
 RO Motocoasa
 FR Débroussaileuse
 IT Decespugliatore a benzina
 ES Motoguadaña de gasolina
 CN 割草机



1.25 kW	1.7 KM	42.7 cm ³	Ø 430 mm	255x25.4 mm	0.85 L
40 : 1				ANTI-VIBRATION SYSTEM ANTY-WIBRACYJNY	
EASY START LATWY PROZRUCH	EASY TRANSPORT LATWY TRANSPORT				



L_{pa} = 96,3 ± 3,0 dB; L_{wa} = 110,3 ± 3,0 dB; a_h = 3,992 ± 1,5 / 10,403 ± 1,5 m/s²

YATO	[kW]	[KM]	
YT-85003	1.25	1.7	1

EN Gasoline tiller
 PL Glebogryzarka spalinowa
 DE Motorhackmaschine
 RU Бензиновый культиватор
 CZ Motorový kultivátor
 HU Benzines kapálógép
 RO Motosapa
 FR Motobineuses avec moteur à combustion
 IT Motozappa a benzina
 ES Motobinadora
 CN 汽油旋耕机



3.6 kW	173 cm ³	170 mm	600 mm	x6 BLADES OSTRZA	270 mm	Ø 150 mm	1.5 L	0.6 L
				ANTI-VIBRATION SYSTEM ANTY-WIBRACYJNY				

L_{pa} = 77,9 ± 0,199 dB; L_{wa} = 92,58 ± 0,199 dB; a_h = 3,10 ± 1,5 / 3,02 ± 1,5 m/s²

YATO	[kW]	[KM]	
YT-84860	3.6	4.08	1

EN Trimmer head
PL Głowica żyłkowa
DE Trimmerkopf
RU Головка с леской
CZ Strunová hlava
HU Damil fej
RO Cap cu cablu
FR Tête de coupe
IT Testina di taglio a filo
ES Cabezal de hilo
CN 铝制打草头

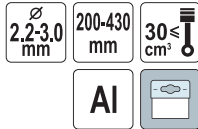

For YT-85001, YT-85003, YT-85010
Dla YT-85001, YT-85003, YT-85010

YATO	
YT-85111	25/50

EN Trimmer head
PL Głowica żyłkowa
DE Trimmerkopf
RU Головка с леской
CZ Strunová hlava
HU Damil fej

RO Cap cu cablu
FR Tête de coupe
IT Testina di taglio a filo
ES Cabezal de hilo
CN 铝制打草头



For YT-85001, YT-85003, YT-85010
Dla YT-85001, YT-85003, YT-85010

YATO	
YT-85121	32

EN Trimmer head
PL Głowica żyłkowa
DE Trimmerkopf
RU Головка с леской
CZ Strunová hlava
HU Damil fej
RO Cap cu cablu
FR Tête de coupe
IT Testina di taglio a filo
ES Cabezal de hilo
CN 铝制打草头

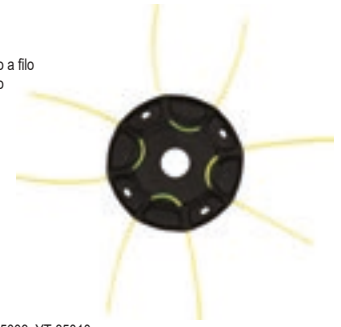

For YT-85001, YT-85003, YT-85010
Dla YT-85001, YT-85003, YT-85010

YATO	
YT-85135	25/100

EN TCT blade for brushcutters
PL Tarcza tnąca do kosy spalinoowej
DE Sägeblatt für Motorsensen
RU Режущий диск для косы
CZ Pilyový kotouč do křovinořezy
HU Fűkasza vágókorong
RO Disc pt. motocoasa
FR Lame disque pour débroussaillouse
IT Disco da taglio per decespugliatore
ES Disco de corte para desbrozadora
CN 多孔割草片

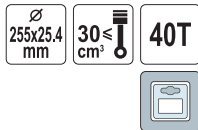

For YT-85001, YT-85003, YT-85010
Dla YT-85001, YT-85003, YT-85010

YATO	
YT-85150	20/40

EN 3-tooth brushcutter blade
PL Tarcza tnąca trójzębna
DE 3-Zahn Dickichtmesser
RU Нож трехлопастной
CZ Žací nůž 3-zubý
HU 3 fogú vágókés
RO Lama taieri cu 3 dinti pt. motocoasa
FR Lame 3 dents pour débroussaillouse
IT Disco per decespugliatore a 3 denti
ES Cuchilla de 3 puntas para desbrozadora
CN 三齿割草片

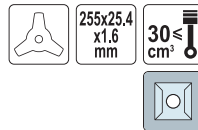

For YT-85001, YT-85003, YT-85010
Dla YT-85001, YT-85003, YT-85010

YATO	
YT-85155	25/50

EN Brushcutter wire brush
PL Szczotka druciana do kosy
DE Drahtbürste für Motorsense
RU Щетка для мотокосы
CZ Drátěný kartáč na křovinořez
HU Drótkefetárcsa fűkaszához
RO Perie circulara cu toroane
FR Brosse métallique pour débroussaillouse
IT Spazzola metallica per decespugliatore
ES Cepillo de alambre para desbrozadora
CN 除草盘



YATO	Ø [mm]	Ød [mm]	max. C [min ⁻¹]	
YT-85141	150	25.4	10000	30
YT-85142	200	25.4	10000	20

EN Chainsaw guide bar
PL Prowadnica do pilarek
DE Kettensägeführung
RU Шина для бензопил
CZ Vodicí lišta k řetězové pile
HU Lánvezető

RO Lama de ghidai pt. ferastrau
FR Guide de tronçonneuse
IT Barra per motosega
ES Barra guía motosierra
CN 导轨

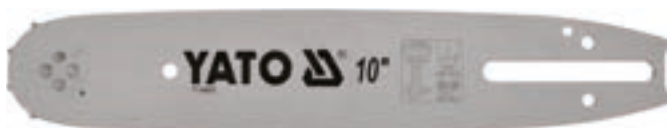
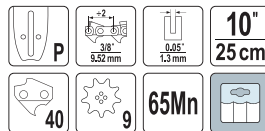

For YT-84948, YT-84960
Dla YT-84948, YT-84960

YATO	L	
YT-84925	10" (250 mm)	20

EN Chainsaw guide bar
PL Prowadnica do pilarek
DE Kettensägeführung
RU Шина для бензопил
CZ Vodicí lišta k řetězové pile
HU Lánvezető

RO Lama de ghidai pt. ferastrau
FR Guide de tronçonneuse
IT Barra per motosega
ES Barra guía motosierra
CN 导轨

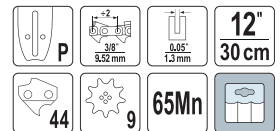

For YT-84949, YT-84960
Dla YT-84949, YT-84960

YATO	L	
YT-84927	12" (300 mm)	20

EN Chainsaw guide bar
PL Prowadnica do pilarek
DE Kettensägeführung
RU Шина для бензопил
CZ Vodicí lišta k řetězové pile
HU Lánvezető

RO Lama de ghidai pt. ferastrau
FR Guide de tronçonneuse
IT Barra per motosega
ES Barra guía motosierra
CN 导轨

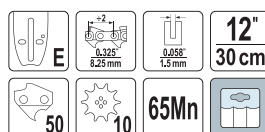

For YT-849395, YT-84963
Dla YT-849395, YT-84963

YATO	L	
YT-84928	12" (300 mm)	20

EN Chainsaw guide bar
PL Prowadnica do pilarek
DE Kettensägeführung
RU Шина для бензопил
CZ Vodicí lišta k řetězové pile
HU Lánvezető

RO Lama de ghidai pt. ferastrau
FR Guide de tronçonneuse
IT Barra per motosega
ES Barra guía motosierra
CN 导轨

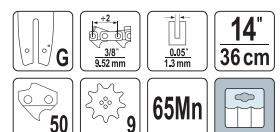

For YT-84950, YT-84960
Dla YT-84950, YT-84960

YATO	L	
YT-84930	14" (360 mm)	20

Alpina, Oleo-Mac, Stihl

EN Chainsaw guide bar
 PL Prowadnica do pilarek
 DE Kettensägeführung
 RU Шина для бензопил
 CZ Vodící lišta k řetězové pile
 HU Láncevezető

RO Lama de ghidai pt. ferastrau
 FR Guide de tronçonneuse
 IT Barra per motosega
 ES Barra guía motosierra
 CN 导板

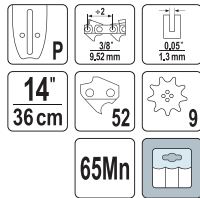

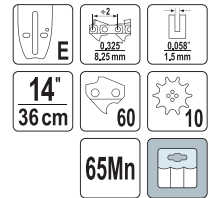

EN Chainsaw guide bar
 PL Prowadnica do pilarek
 DE Kettensägeführung
 RU Шина для бензопил
 CZ Vodící lišta k řetězové pile
 HU Láncevezető

RO Lama de ghidai pt. ferastrau
 FR Guide de tronçonneuse
 IT Barra per motosega
 ES Barra guía motosierra
 CN 导板





For YT-84951, YT-84960
 Dla YT-84951, YT-84960

 Al-Ko, Alpina, Dolmar, Einhell, Hitachi, Homelite, Husqvarna, Jonsered, Makita, McCulloch, Oleo-Mac, Partner, Ryobi, Skil

YATO 	L	
YT-84931	14" (360 mm)	20

For YT-84940, YT-84963
 Dla YT-84940, YT-84963

YATO 	L	
YT-849311	14" (360 mm)	20

EN Chainsaw guide bar
 PL Prowadnica do pilarek
 DE Kettensägeführung
 RU Шина для бензопил
 CZ Vodící lišta k řetězové pile
 HU Láncevezető

RO Lama de ghidai pt. ferastrau
 FR Guide de tronçonneuse
 IT Barra per motosega
 ES Barra guía motosierra
 CN 导板

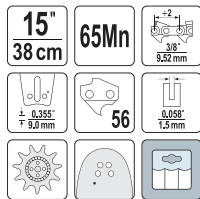

EN Chainsaw guide bar
 PL Prowadnica do pilarek
 DE Kettensägeführung
 RU Шина для бензопил
 CZ Vodící lišta k řetězové pile
 HU Láncevezető

RO Lama de ghidai pt. ferastrau
 FR Guide de tronçonneuse
 IT Barra per motosega
 ES Barra guía motosierra
 CN 导板

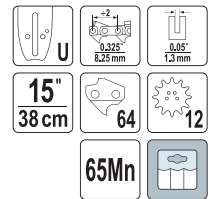



For YT-84961
 Dla YT-84961

 Alpina, Dolmar, Dolpima, Echo, Husqvarna, Jonsered, Makita, Partner, Solo

YATO 	L	
YT-84932	15" (380 mm)	20

For YT-84905, YT-84945, YT-84962
 Dla YT-84905, YT-84945, YT-84962

 Dolmar, Husqvarna, Jonsered, Makita, Oleo-Mac, Partner, Solo

YATO 	L	
YT-84933	15" (380 mm)	20

EN Chainsaw guide bar
 PL Prowadnica do pilarek
 DE Kettensägeführung
 RU Шина для бензопил
 CZ Vodící lišta k řetězové pile
 HU Láncevezető

RO Lama de ghidai pt. ferastrau
 FR Guide de tronçonneuse
 IT Barra per motosega
 ES Barra guía motosierra
 CN 导板

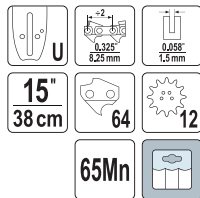

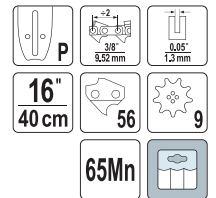

EN Chainsaw guide bar
 PL Prowadnica do pilarek
 DE Kettensägeführung
 RU Шина для бензопил
 CZ Vodící lišta k řetězové pile
 HU Láncevezető

RO Lama de ghidai pt. ferastrau
 FR Guide de tronçonneuse
 IT Barra per motosega
 ES Barra guía motosierra
 CN 导板





For YT-84900, YT-84941, YT-84963
 Dla YT-84900, YT-84941, YT-84963

 Dolmar, Homelite, Husqvarna, Jonsered, Makita, NAC, Oleo-Mac, Partner

YATO 	L	
YT-84934	15" (380 mm)	20

For YT-84953, YT-84960
 Dla YT-84953, YT-84960

 Al-Ko, Alpina, Echo, Hitachi, Homelite, Husqvarna, Jonsered, Makita, McCulloch, Oleo-Mac, Partner, Ryobi

YATO 	L	
YT-84935	16" (400 mm)	20

EN Chainsaw guide bar
 PL Prowadnica do pilarek
 DE Kettensägeführung
 RU Шина для бензопил
 CZ Vodící lišta k řetězové pile
 HU Láncevezető

RO Lama de ghidai pt. ferastrau
 FR Guide de tronçonneuse
 IT Barra per motosega
 ES Barra guía motosierra
 CN 导板

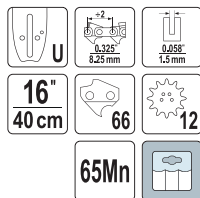

EN Chainsaw guide bar
 PL Prowadnica do pilarek
 DE Kettensägeführung
 RU Шина для бензопил
 CZ Vodící lišta k řetězové pile
 HU Láncevezető

RO Lama de ghidai pt. ferastrau
 FR Guide de tronçonneuse
 IT Barra per motosega
 ES Barra guía motosierra
 CN 导板

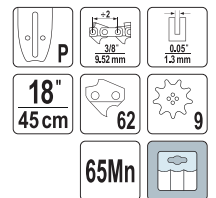

For YT-84942, YT-84963
 Dla YT-84942, YT-84963

YATO 	L	
YT-849351	16" (400 mm)	20

For YT-84956, YT-84960
 Dla YT-84956, YT-84960

YATO 	L	
YT-849355	18" (450 mm)	20

EN Chainsaw guide bar
PL Prowadnica do pilarek
DE Kettensägeführung
RU Шина для бензопилы
CZ Vodicí lišta k řetězové pile
HU Lánvezető

RO Lama de ghidai pt. ferastrau
FR Guide de tronçonneuse
IT Barra per motosega
ES Barra guía motosierra
CN 导板

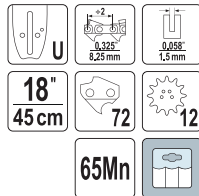

For YT-84900, YT-84943, YT-84963
Dla YT-84900, YT-84943, YT-84963

Dolmar, Homelite, Husqvarna, Jonsered, Makita, NAC, Oleo-Mac, Partner, Solo

YATO	L	
YT-84936	18" (450 mm)	20

EN Chain regulating plate
PL Płytką regulująca naciąg łańcucha
DE Einstellplatte für Kettenspannung
RU Пластина натяжитель цепи
CZ Destička pro nastavení napnutí řetězu
HU Lánfeszesség szabályozó lemez
RO Placă de reglare a lanțului
FR Plaque de réglage de la tension de la chaîne
IT Piastra tendicatena
ES Placa reguladora del apriete de cadena
CN 链条张力调节片



For guide bars A041/P
Do prowadnic A041/P

YATO	L	
YT-84939		400

EN Chain for chainsaw
PL Łańcuch tnący do pilarek
DE Kette für Kettensägen
RU Цепь для бензопилы
CZ Řetěz pro řetězové pily
HU Lánclánfűrész

RO Lant pt. drujba
FR Chaîne de tronçonneuse
IT Catena motosega
ES Cadena de motosierra
CN 链条



For YT-84900
Dla YT-84900

Alpina, Dolmar, Echo, Homelite, Husqvarna, Jonsered, Makita

YATO	L	
YT-84940	13" (330 mm)	50

EN Chain for chainsaw
PL Łańcuch tnący do pilarek
DE Kette für Kettensägen
RU Цепь для бензопилы
CZ Řetěz pro řetězové pily
HU Lánclánfűrész

RO Lant pt. drujba
FR Chaîne de tronçonneuse
IT Catena motosega
ES Cadena de motosierra
CN 链条

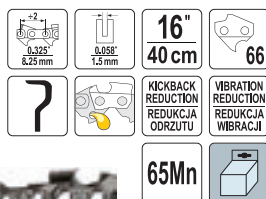

For YT-84900
Dla YT-84900

Dolmar, Husqvarna, Jonsered, Makita, NAC, Oleo-Mac, Partner

YATO	L	
YT-84942	16" (400 mm)	50

EN Chain for chainsaw
PL Łańcuch tnący do pilarek
DE Kette für Kettensägen
RU Цепь для бензопилы
CZ Řetěz pro řetězové pily
HU Lánclánfűrész

RO Lant pt. drujba
FR Chaîne de tronçonneuse
IT Catena motosega
ES Cadena de motosierra
CN 链条

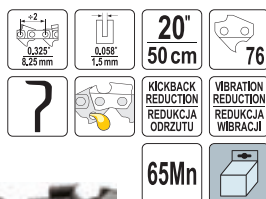

For YT-84900
Dla YT-84900

Dolmar, Husqvarna, Jonsered, Makita, NAC, Oleo-Mac, Partner

YATO	L	
YT-84944	20" (500 mm)	50

EN Chainsaw guide bar
PL Prowadnica do pilarek
DE Kettensägeführung
RU Шина для бензопилы
CZ Vodicí lišta k řetězové pile
HU Lánvezető

RO Lama de ghidai pt. ferastrau
FR Guide de tronçonneuse
IT Barra per motosega
ES Barra guía motosierra
CN 导板

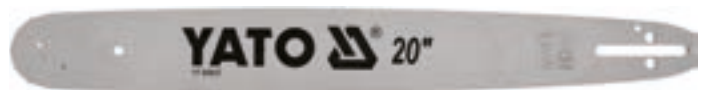
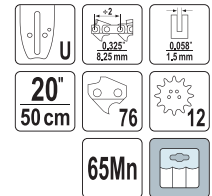

For YT-84944, YT-84963
Dla YT-84944, YT-84963

YATO	L	
YT-84937	20" (500 mm)	20

EN Chain for chainsaw
PL Łańcuch tnący do pilarek
DE Kette für Kettensägen
RU Цепь для бензопилы
CZ Řetěz pro řetězové pily
HU Lánclánfűrész

RO Lant pt. drujba
FR Chaîne de tronçonneuse
IT Catena motosega
ES Cadena de motosierra
CN 链条



For YT-84928
Dla YT-84928

YATO	L	
YT-849395	12" (300 mm)	50

EN Chain for chainsaw
PL Łańcuch tnący do pilarek
DE Kette für Kettensägen
RU Цепь для бензопилы
CZ Řetěz pro řetězové pily
HU Lánclánfűrész

RO Lant pt. drujba
FR Chaîne de tronçonneuse
IT Catena motosega
ES Cadena de motosierra
CN 链条

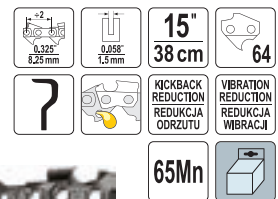

For YT-84900, YT-84934
Dla YT-84900, YT-84934

Dolmar, Husqvarna, Jonsered, Makita, NAC, Oleo-Mac, Partner

YATO	L	
YT-84941	15" (380 mm)	50

EN Chain for chainsaw
PL Łańcuch tnący do pilarek
DE Kette für Kettensägen
RU Цепь для бензопилы
CZ Řetěz pro řetězové pily
HU Lánclánfűrész

RO Lant pt. drujba
FR Chaîne de tronçonneuse
IT Catena motosega
ES Cadena de motosierra
CN 链条

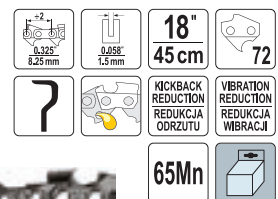

For YT-84900, YT-84936
Dla YT-84900, YT-84936

Dolmar, Husqvarna, Jonsered, Makita, NAC, Oleo-Mac, Partner

YATO	L	
YT-84943	18" (450 mm)	50

EN Chain for chainsaw
PL Łańcuch tnący do pilarek
DE Kette für Kettensägen
RU Цепь для бензопилы
CZ Řetěz pro řetězové pily
HU Lánclánfűrész

RO Lant pt. drujba
FR Chaîne de tronçonneuse
IT Catena motosega
ES Cadena de motosierra
CN 链条

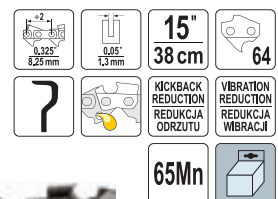

For YT-84905, YT-84933
Dla YT-84905, YT-84933

Dolmar, Husqvarna, Jonsered, Makita, Oleo-Mac, Partner

YATO	L	
YT-84945	15" (380 mm)	50

EN Chain for chainsaw
 PL Łańcuch łańcuch do pilarek
 DE Kette für Kettensägen
 RU Цепь для бензопилы
 CZ Řetěz pro řetězové pily
 HU Láncláncfűrész

RO Lant pt. drujba
 FR Chaîne de tronçonneuse
 IT Catena motosega
 ES Cadena de motosierra
 CN 链条



65Mn

For YT-84925
 Dla YT-84925

YATO	L	
YT-84948	10" (250 mm)	50

EN Chain for chainsaw
 PL Łańcuch łańcuch do pilarek
 DE Kette für Kettensägen
 RU Цепь для бензопилы
 CZ Řetěz pro řetězové pily
 HU Láncláncfűrész

RO Lant pt. drujba
 FR Chaîne de tronçonneuse
 IT Catena motosega
 ES Cadena de motosierra
 CN 链条



65Mn

Alpina, Dolmar, Husqvarna, McCulloch, Oleo-Mac, Partner, Stihl

YATO	L	
YT-84950	14" (360 mm)	50

EN Chain for chainsaw
 PL Łańcuch łańcuch do pilarek
 DE Kette für Kettensägen
 RU Цепь для бензопилы
 CZ Řetěz pro řetězové pily
 HU Láncláncfűrész

RO Lant pt. drujba
 FR Chaîne de tronçonneuse
 IT Catena motosega
 ES Cadena de motosierra
 CN 链条



65Mn

For YT-84935 Al-Ko, Alpina, Dolmar, Echo, Hitachi, Homelite, Husqvarna, Jonsered, Makita, McCulloch, Oleo-Mac, Partner, Ryobi

YATO	L	
YT-84953	16" (400 mm)	50

EN Chain for chainsaw
 PL Łańcuch łańcuch do pilarek
 DE Kette für Kettensägen
 RU Цепь для бензопилы
 CZ Řetěz pro řetězové pily
 HU Láncláncfűrész

RO Lant pt. drujba
 FR Chaîne de tronçonneuse
 IT Catena motosega
 ES Cadena de motosierra
 CN 链条



65Mn

For YT-84935 Stihl

YATO	L	
YT-84955	16" (400 mm)	50

EN Chain for chainsaw
 PL Łańcuch łańcuch do pilarek
 DE Kette für Kettensägen
 RU Цепь для бензопилы
 CZ Řetěz pro řetězové pily
 HU Láncláncfűrész

RO Lant pt. drujba
 FR Chaîne de tronçonneuse
 IT Catena motosega
 ES Cadena de motosierra
 CN 链条



65Mn

For YT-84930, YT-84931, YT-84935
 Dla YT-84930, YT-84931, YT-84935

Alpina, Dolmar, Husqvarna, McCulloch, Oleo-Mac, Partner

YATO	L	
YT-84960		1

EN Chain for chainsaw
 PL Łańcuch łańcuch do pilarek
 DE Kette für Kettensägen
 RU Цепь для бензопилы
 CZ Řetěz pro řetězové pily
 HU Láncláncfűrész

RO Lant pt. drujba
 FR Chaîne de tronçonneuse
 IT Catena motosega
 ES Cadena de motosierra
 CN 链条



65Mn

For YT-84927
 Dla YT-84927

YATO	L	
YT-84949	12" (300 mm)	50

EN Chain for chainsaw
 PL Łańcuch łańcuch do pilarek
 DE Kette für Kettensägen
 RU Цепь для бензопилы
 CZ Řetěz pro řetězové pily
 HU Láncláncfűrész

RO Lant pt. drujba
 FR Chaîne de tronçonneuse
 IT Catena motosega
 ES Cadena de motosierra
 CN 链条



65Mn

For YT-84931 Al-Ko, Alpina, Dolmar, Echo, Hitachi, Homelite, Husqvarna, Jonsered, Makita, McCulloch, Oleo-Mac, Partner, Ryobi

YATO	L	
YT-84951	14" (360 mm)	50

EN Chain for chainsaw
 PL Łańcuch łańcuch do pilarek
 DE Kette für Kettensägen
 RU Цепь для бензопилы
 CZ Řetěz pro řetězové pily
 HU Láncláncfűrész

RO Lant pt. drujba
 FR Chaîne de tronçonneuse
 IT Catena motosega
 ES Cadena de motosierra
 CN 链条



65Mn

For YT-84935 Al-Ko, Alpina, Dolmar, Hitachi, Homelite, Husqvarna, Jonsered, Makita, Oleo-Mac, Partner, Ryobi

YATO	L	
YT-84954	16" (400 mm)	50

EN Chain for chainsaw
 PL Łańcuch łańcuch do pilarek
 DE Kette für Kettensägen
 RU Цепь для бензопилы
 CZ Řetěz pro řetězové pily
 HU Láncláncfűrész

RO Lant pt. drujba
 FR Chaîne de tronçonneuse
 IT Catena motosega
 ES Cadena de motosierra
 CN 链条



65Mn

For YT-84935
 Dla YT-84935

YATO	L	
YT-84956	18" (450 mm)	50

EN Chain for chainsaw
 PL Łańcuch łańcuch do pilarek
 DE Kette für Kettensägen
 RU Цепь для бензопилы
 CZ Řetěz pro řetězové pily
 HU Láncláncfűrész

RO Lant pt. drujba
 FR Chaîne de tronçonneuse
 IT Catena motosega
 ES Cadena de motosierra
 CN 链条



65Mn

For YT-84932 Alpina, Dolmar, Echo, Husqvarna, Jonsered, Makita, Oleo-Mac, Partner

YATO	L	
YT-84961		1

EN Chain for chainsaw
PL Łańcuch tnący do pilarek
DE Kette für Kettensägen
RU Цепь для бензопилы
CZ Řetěz pro řetězové pily
HU Láncláncfűrész
RO Lant pt. druþba
FR Chaîne de tronçonneuse
IT Catena motosega
ES Cadena de motosierra
CN 链条卷

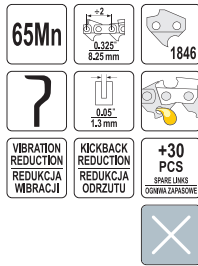

For YT-84905, YT-84933
Dla YT-84905, YT-84933

Dolmar, Husqvarna, Jonsered, Makita, Oleo-Mac, Partner



EN Chain for chainsaw
PL Łańcuch tnący do pilarek
DE Kette für Kettensägen
RU Цепь для бензопилы
CZ Řetěz pro řetězové pily
HU Láncláncfűrész
RO Lant pt. druþba
FR Chaîne de tronçonneuse
IT Catena motosega
ES Cadena de motosierra
CN 链条卷

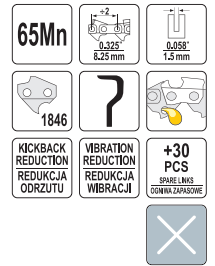

For YT-84900, YT-84934, YT-84936
Dla YT-84900, YT-84934, YT-84936

Dolmar, Husqvarna, Jonsered, Makita, NAC, Oleo-Mac, Partner



EN Spare link for chainsaw
PL Zestaw ogniw do łańcucha do pił
DE Ersatzglied für Kettensäge
RU Запасная цепь
CZ Náhradní řetěz řetězů
HU Csere lánc
RO Nituri lant druþba
FR Lien de rechange pour tronçonneuse
IT Set di maglie di catena
ES Repuesto para sierra de cadena
CN 连接片

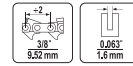
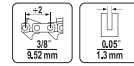
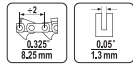
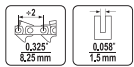

For YT-84940, YT-84941, YT-84942, YT-84943, YT-84944, YT-84963

Dla YT-84940, YT-84941, YT-84942, YT-84943, YT-84944, YT-84963

For YT-84945, YT-84962
Dla YT-84945, YT-84962

For YT-84950, YT-84951, YT-84953, YT-84954, YT-84960
Dla YT-84950, YT-84951, YT-84953, YT-84954, YT-84960

For YT-84955
Dla YT-84955

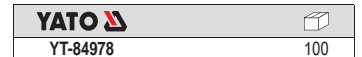
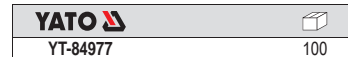
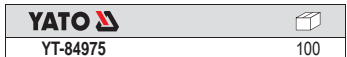

EN Chainsaw chain spinner
PL Nitownica do łańcuchów do pilarek
DE Sägeketten-Vermietgerät
RU Станок для клепания цепей
CZ Nýtovačka pilových řetězů
HU Szegescsélő készülék fűrészlánchoz
RO Masina de nituit lanturi si de spart lanturi
FR Riveteuse d'établi pour chaînes de tronçonneuses
IT Imbutitore per motoseghe
ES Remachadora banco cadenas de motosierra
CN 接链器

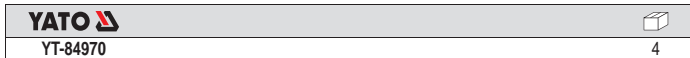
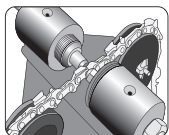

EN Chainsaw chain breaker
PL Rozkwiarka do łańcuchów do pilarek
DE Sägeketten-Entnietergerät
RU Станок для расклевки цепей
CZ Roznýtovačka pilových řetězů
HU Szegescskinyomó fűrészláncokhoz
RO Masina spart lant druþba
FR Dériveteuse pour chaîne de tronçonneuse
IT Spezzacatena per motoseghe
ES Rompe cadenas de motosierra
CN 截链器

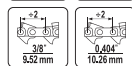
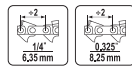

EN Chain sharpener
PL Ostrzałka do łańcuchów
DE Kettenschärfgerät
RU Заточка для цепей
CZ Bruska řetězů
HU Lánccélező
RO Masina ascutit lant druþba
FR Affûteuse de chaîne
IT Affilatrice per catene
ES Afilador para cadenas
CN 电动磨链机

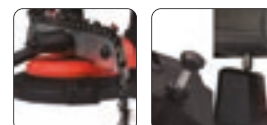
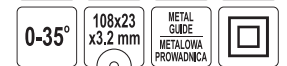

$L_{pA} = 63,5 \pm 3,0$ dB; $L_{wA} = 76,5 \pm 3,0$ dB

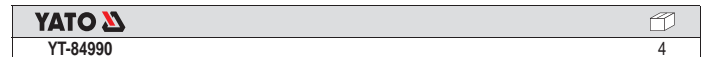

EN Replacement wheel for chainsaw sharpening tool
PL Kamień do ostrzałki łańcuchów
DE Schleifscheibe für Kettenschärfgerät
RU Камень для заточки цепей
CZ Kámen do brusky pilových řetězů
HU Lánccélező kő
RO Roata schimb pt. aparat ascutit lant druþba
FR Pierre à aiguiser les chaînes
IT Mola affilacatene
ES Sierra para afiladora de cadenas
CN 磨轮



For YT-84990
Dla YT-84990



EN Flat depth-gauge file
 PL Pilnik płaski do szlifowania ograniczników głębokości
 DE Flachfeile zum Schleifen von Tiefenschlägen
 RU Плоский напильник для шлифования ограничителей глубины
 CZ Plochy pilník k broušení hloubkových dorazů
 HU Lapos reszelő mélységhatárolók csiszolásához

RO Pila plata pt. ascuțit dinti lant drijba
 FR Lime plate pour jauge de profondeur de ponçage
 IT Lima piatta per affilatura di fermi di profondità
 ES Lima plana para esmerilar topes de profundidad
 CN 扁锉

250 mm 15x2 mm BEARING STEEL STAL ŁOŻYSKOWA PP



YATO	L [mm]	
YT-85022	250	200

EN Round chain saw file set
 PL Zestaw pilników okrągłych do ostrzenia łańcuchów
 DE Rundfeileinsatz zum schärfen von Ketten
 RU Набор круглых напильников для заточки цепей
 CZ Sada kulatých pilníků k ostření řetězu
 HU Kerek reszelőkészlet láncélezéshez
 RO Set pile rotunde pt. lant drijba
 FR Limes rondes pour affûtage de chaînes
 IT Kit di lime tonde per affilatura catene
 ES Juego de limas redondas para afilar cadenas
 CN 链锯锉



3 PCS 250 mm BEARING STEEL STAL ŁOŻYSKOWA PP

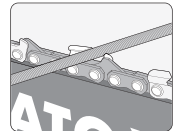

YATO	Ø [mm]	For / Dla	
YT-85025	4.0	3/8"	4/200
YT-85026	4.5	3/8", 0.325"	4/200
YT-85027	4.8	0.325"	4/200

EN Chain saw file with guide
 PL Prowadnik z pilnikiem do ostrzenia łańcuchów
 DE Führungsschiene mit Kettenschärfefeile
 RU Направляющая с напильником для заточки цепей
 CZ Vodítko s pilníkem k ostření řetězu
 HU Vezető láncélező reszelővel
 RO Pila lant drijba cu ghidaj
 FR Guide avec lime pour affûtage de chaîne
 IT Guida con lima tonda per affilatura catene
 ES Guía con lima para afilar cadenas
 CN 链锯锉刀塑柄架

3 PCS 250 mm BEARING STEEL STAL ŁOŻYSKOWA PP

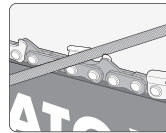

EN Chain saw file with guide
 PL Prowadnik z pilnikiem do ostrzenia łańcuchów
 DE Führungsschiene mit Kettenschärfefeile
 RU Направляющая с напильником для заточки цепей
 CZ Vodítko s pilníkem k ostření řetězu
 HU Vezető láncélező reszelővel
 RO Pila lant drijba cu ghidaj
 FR Guide avec lime pour affûtage de chaîne
 IT Guida con lima tonda per affilatura catene
 ES Guía con lima para afilar cadenas
 CN 链锯锉刀塑柄架

250 mm 30° 35° BEARING STEEL STAL ŁOŻYSKOWA PP

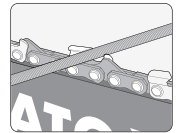

YATO	Ø [mm]	For / Dla	
YT-85035	4.0	3/8"	200
YT-85036	4.5	3/8", 0.325"	200
YT-85037	4.8	0.325"	200

YATO	Ø [mm]	For / Dla	
YT-85030	4.0	3/8"	4/100
YT-85031	4.5	3/8", 0.325"	4/100
YT-85032	4.8	0.325"	4/100

EN Chain sharpening set
 PL Zestaw do ostrzenia łańcucha
 DE Kettenschärfset
 RU Набор для заточки цепи



CZ Sada k ostření řetězu
 HU Láncélező készlet
 RO Set ascuțit lant drijba
 FR Kit d'affûtage de chaîne

4 PCS 25° 30° 35° BEARING STEEL STAL ŁOŻYSKOWA PP

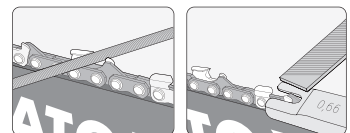

YATO	Ø [mm]	For / Dla	
YT-85040	4.0	3/8"	50
YT-85041	4.5	3/8", 0.325"	50
YT-85042	4.8	0.325"	50

EN Guide for round chain saw file
PL Prowadnik do pilnika okrągłego do łańcuchów
DE Rundfeilen-Führungsschiene zum Schärfen von Ketten
RU Направляющая для круглого напильника для цепей

CZ Vodítko ke kulatému pilníku do řetězů
HU Vezető kerek láncreszelőhöz
RO Ghidaj pt. pila rotunda lant drijba
FR Guide de limes rondes pour chaînes

IT Guida per lima tonda per catene
ES Guía para lima redonda para cadenas
CN 链锯链条架

190 mm



25° 30° 35°

10° 25° 30° 35°

YATO	Ø [mm]	For / Dla	
YT-85044	4.0	3/8" / YT-85025	200
YT-85045	4.5	3/8", 0.325" / YT-85026	200
YT-85046	4.8	0.325" / YT-85027	200

YATO	Ø [mm]	For / Dla	
YT-85047	4.0	3/8" / YT-85025	200
YT-85048	4.5	3/8", 0.325" / YT-85026	200
YT-85049	4.8	0.325" / YT-85027	200

EN Guide for depth-gauge
PL Przymiar do szlifowania ograniczników głębokości
DE Schleiflehre für das Schleifen von Tiefenanschlägen
RU Измеритель для шлифования ограничителей глубины

CZ Měřítko k broušení hloubkových dorazů
HU Csiszolásablron mélység szabályozóhoz
RO Ghidaj pt. ascutit dinti lant drijba
FR Jauge de profondeur de ponçage

IT Indicatore per affilatura di fermi di profondità
ES Medida para esmerilar topes de profundidad
CN 链条打磨深度尺



0.65 mm 10° 30° 35°

0.65 mm 0.75 mm 35°

YATO	L [mm]	For / Dla	
YT-85051	150	YT-85022	200

YATO	L [mm]	For / Dla	
YT-85052	170	YT-85022	200

EN Handle for round chain sharpening file
PL Rękojść do pilnika okrągłego
DE Griff für Rundfeile

RU Рукотка для круглого напильника
CZ Rukojeť do kulatého pilníku
HU Markolat kerek reszelőhöz

RO Maner pt. pila rotunda de ascutit lant
FR Poignée de lime ronde
IT Impugnatura per lima tonda

ES Mango de lima redonda
CN 塑料手柄

PP



YATO	Ø [mm]	For / Dla	
YT-85060	4.0	3/8" / YT-85025	500
YT-85061	4.5	3/8", 0.325" / YT-85026	500
YT-85062	4.8	0.325" / YT-85027	500

YATO	Ø [mm]	For / Dla	
YT-85065	4.0	3/8" / YT-85025	200
YT-85066	4.5	3/8", 0.325" / YT-85026	200
YT-85067	4.8	0.325" / YT-85027	200

EN Logger filing vice
PL Imadło do mocowania prowadnicy
DE Schraubstock zur Befestigung der Führungsschiene
RU Тиски для крепления направляющей
CZ Svěrák k uchopení vodící lišty
HU Vezetőörgztő satu
RO Presa pt. nituit lant drijba
FR Étau pour maintenir le guide
IT Morsa per fissaggio della guida
ES Tornillo de banco para fijar la guía
CN 导板支架

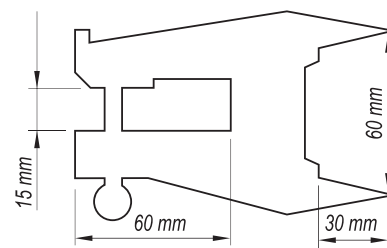

YATO
YT-85075

2/60

YATO	page/strona	YATO	page/strona	YATO	page/strona	YATO	page/strona	YATO	page/strona	YATO	page/strona	YATO	page/strona	YATO	page/strona	YATO	page/strona
YT-00760	8	YT-02372	13	YT-0356	8	YT-04323	60	YT-04691	101	YT-05313	16	YT-05591	102	YT-0603	419	YT-0637	436
YT-00761	8	YT-02373	13	YT-0357	8	YT-04324	60	YT-04695	99	YT-05314	16	YT-05592	102	YT-06030	476	YT-06373	436
YT-00762	8	YT-02374	13	YT-0358	8	YT-04325	60	YT-04699	99	YT-05315	16	YT-05593	102	YT-06031	419	YT-06377	436
YT-00763	8	YT-02375	13	YT-0359	8	YT-04326	60	YT-0470	92	YT-05320	16	YT-05594	102	YT-06032	419	YT-0638	425
YT-00764	8	YT-02376	13	YT-0360	8	YT-04327	60	YT-04702	91	YT-05333	466	YT-05597	102	YT-06033	420	YT-0640	416
YT-00765	8	YT-02377	13	YT-0362	8	YT-04328	60	YT-0471	92	YT-05337	459	YT-0560	107	YT-06034	421	YT-0641	416
YT-00766	8	YT-02378	13	YT-0363	8	YT-04329	60	YT-04712	91	YT-05338	449	YT-05601	102	YT-06035	420	YT-06412	417
YT-00767	8	YT-02379	13	YT-0365	8	YT-04331	61	YT-0472	92	YT-05339	465	YT-05602	102	YT-06036	494	YT-0642	424
YT-00768	8	YT-02380	13	YT-0367	11	YT-04332	61	YT-04722	91	YT-0534	465	YT-05603	102	YT-06037	420	YT-0643	476
YT-00769	8	YT-02381	13	YT-0368	11	YT-04341	59	YT-0474	92	YT-05341	450	YT-05604	102	YT-06038	420	YT-0645	433
YT-0135	15	YT-02382	13	YT-0369	11	YT-04342	59	YT-04742	91	YT-05342	450	YT-05605	102	YT-0605	474	YT-0646	433
YT-0136	15	YT-02383	13	YT-0370	11	YT-04343	59	YT-0475	92	YT-05343	450	YT-05606	102	YT-0606	432	YT-0647	433
YT-0137	15	YT-02384	13	YT-0371	11	YT-04344	59	YT-04752	91	YT-05345	451	YT-05607	102	YT-06062	432	YT-06475	435
YT-0138	15	YT-02385	13	YT-0372	11	YT-04345	59	YT-0476	92	YT-05390	431	YT-05608	102	YT-0607	432	YT-0648	434
YT-01385	15	YT-02386	13	YT-0373	11	YT-04346	59	YT-04762	91	YT-05430	103	YT-05609	102	YT-0608	432	YT-0650	433
YT-0139	15	YT-02387	13	YT-0374	11	YT-04350	60	YT-0477	92	YT-05431	103	YT-0561	107	YT-06082	432	YT-0651	433
YT-0140	15	YT-02388	13	YT-0375	11	YT-04351	60	YT-04772	91	YT-05432	103	YT-05610	102	YT-06086	467	YT-0652	434
YT-0143	15	YT-02390	60	YT-0376	11	YT-04352	60	YT-0478	92	YT-05433	103	YT-05611	102	YT-06088	473	YT-0653	434
YT-01670	20	YT-02391	60	YT-0377	11	YT-04353	60	YT-04782	91	YT-05434	103	YT-05615	103	YT-0609	416	YT-06535	432
YT-01671	20	YT-02392	60	YT-0378	11	YT-04354	60	YT-04792	91	YT-05435	103	YT-0562	107	YT-0610	469	YT-06561	118, 468
YT-01672	20	YT-02393	60	YT-0380	11	YT-04355	60	YT-0480	92	YT-05436	103	YT-0563	107	YT-06101	469	YT-0657	432
YT-01673	20	YT-02394	60	YT-0381	11	YT-04356	60	YT-0481	92	YT-05437	103	YT-05631	108	YT-0611	470	YT-0659	429
YT-01674	20	YT-02395	60	YT-0383	12	YT-04357	60	YT-04812	91	YT-05438	103	YT-05632	108	YT-0612	422	YT-06590	429
YT-01675	20	YT-02396	60	YT-0384	12	YT-04360	61	YT-0482	93	YT-05439	103	YT-05633	108	YT-06122	422	YT-0660	479
YT-01676	20	YT-02397	60	YT-0385	12	YT-04370	58	YT-04822	91	YT-05440	103	YT-05640	103	YT-06123	422	YT-0661	479
YT-01677	20	YT-02400	61	YT-0386	12	YT-04371	58	YT-0483	93	YT-05441	103	YT-05644	103	YT-0613	422	YT-06611	479
YT-01678	20	YT-0290	28	YT-0387	12	YT-04372	58	YT-04832	91	YT-05442	103	YT-05800	437	YT-0614	422	YT-06613	479
YT-01679	20	YT-0291	32	YT-0388	12	YT-04373	58	YT-0484	94	YT-05443	103	YT-05801	437	YT-0615	423	YT-0662	480
YT-0170	15	YT-0292	37	YT-0389	12	YT-04374	58	YT-0485	91	YT-05444	103	YT-05802	437	YT-06155	423	YT-06622	480
YT-0171	15	YT-0293	28	YT-0390	12	YT-04375	58	YT-0486	91	YT-05445	103	YT-05810	436	YT-06157	423	YT-0663	479
YT-0172	15	YT-0294	32	YT-0391	12	YT-04381	59	YT-0487	91	YT-05446	103	YT-05811	436	YT-0616	423	YT-06650	526
YT-0173	15	YT-0295	37	YT-0392	12	YT-04382	59	YT-0488	94	YT-05450	104	YT-05812	436	YT-06160	423	YT-06651	526
YT-0175	15	YT-0297	28	YT-0394	12	YT-04383	59	YT-0489	94	YT-05451	104	YT-05815	436	YT-06162	423	YT-06652	526
YT-01851	10	YT-0298	33	YT-03950	12	YT-04384	59	YT-0490	94	YT-05452	104	YT-05816	436	YT-06163	423	YT-06653	526
YT-01852	10	YT-0299	38	YT-03951	12	YT-04385	59	YT-0491	94	YT-05453	104	YT-05817	436	YT-06166	451	YT-06654	526
YT-01853	10	YT-0307	27	YT-03952	12	YT-04386	59	YT-0492	94	YT-05454	104	YT-05830	435	YT-06169	247, 451	YT-06655	526
YT-01854	10	YT-0308	32	YT-03953	12	YT-04387	59	YT-0493	94	YT-05455	104	YT-0585	421	YT-0617	448	YT-06656	526
YT-01855	10	YT-0309	37	YT-03954	12	YT-04388	59	YT-0494	94	YT-05456	104	YT-05890	421	YT-06174	449	YT-06657	526
YT-01856	10	YT-0310	27	YT-03955	12	YT-04390	59	YT-0495	94	YT-05457	104	YT-05893	420	YT-06175	449	YT-06658	526
YT-01857	10	YT-0311	32	YT-03956	12	YT-04391	59	YT-0496	94	YT-05458	104	YT-05897	420	YT-06176	449	YT-06659	527
YT-01858	10	YT-0312	37	YT-0396	13	YT-04392	59	YT-0497	94	YT-05459	104	YT-0590	421	YT-0618	451	YT-06660	527
YT-01859	10	YT-0313	27	YT-0398	13	YT-04393	59	YT-0498	94	YT-05460	104	YT-0591	419	YT-06184	451	YT-06661	527
YT-01860	10	YT-0314	32	YT-0400	95	YT-04394	59	YT-0499	94	YT-05461	104	YT-0593	78, 465	YT-06187	451	YT-06662	527
YT-01861	10	YT-0315	37	YT-0404	90	YT-04395	59	YT-0500	105	YT-05462	104	YT-05933	78, 465	YT-0619	475	YT-06663	527
YT-01862	10	YT-0316	27	YT-0405	90	YT-04396	59	YT-0501	105	YT-05463	104	YT-05934	78, 465	YT-0620	421	YT-06664	527
YT-01863	10	YT-0317	32	YT-04051	90	YT-04397	59	YT-0502	105	YT-05464	104	YT-0594	406	YT-06205	433	YT-06680	519
YT-01864	10	YT-0318	37	YT-04052	90	YT-04398	59	YT-0503	106	YT-05465	104	YT-0596	407	YT-06208	430	YT-0670	454
YT-01865	11	YT-0322	27	YT-0406	90	YT-04401	61	YT-0504	106	YT-05466	104	YT-05971	406	YT-0621	475	YT-0671	471
YT-01870	11	YT-0323	32	YT-0407	90	YT-04411	58	YT-0505	106	YT-05490	104	YT-05980	407	YT-0622	453	YT-0672	460
YT-01871	11	YT-0324	37	YT-0408	90	YT-04412	58	YT-0506	106	YT-05491	104	YT-0599	408	YT-0623	421	YT-06721	461
YT-01872	11	YT-0325	27	YT-0409	90	YT-04413	58	YT-0507	106	YT-05492	104	YT-05991	408	YT-0624	421	YT-06722	507
YT-01873	11	YT-0326	32	YT-0410	95	YT-04417	58	YT-0508	105	YT-05493	104	YT-05995	407	YT-06251	422	YT-0673	461
YT-01874	11	YT-0327	37	YT-0411	95	YT-04418	58	YT-0509	106	YT-05494	104	YT-05997	408	YT-06255	422	YT-0674	461
YT-01875	11	YT-0331	28	YT-0412	95	YT-0461	61	YT-0511	107	YT-05495	104	YT-0600	408	YT-06256	422	YT-0677	434
YT-01876	11	YT-03311	28	YT-0413	95	YT-04620	97	YT-0512	107	YT-05496	104	YT-06001	445	YT-0627	435	YT-06772	513
YT-01877	11	YT-03314	38, 267	YT-0414	95	YT-04621	97	YT-05123	104	YT-05497	104	YT-06002	440	YT-06273	435	YT-06773	513
YT-01878	11	YT-03315	38, 266	YT-0415	96	YT-04622	97	YT-0519	106	YT-05498	104	YT-06003	446	YT-06275	435	YT-06774	513
YT-01879	11	YT-03316	38, 267	YT-0416	96	YT-04623	97	YT-0520	55	YT-05499	104	YT-06004	440	YT-06278	435	YT-06775	513
YT-01880	11	YT-03317	38, 267	YT-0417	96	YT-04624	98	YT-0521	55	YT-05501	104	YT-06005	442	YT-0628	475	YT-06776	513
YT-01881	11	YT-03318	38, 267	YT-0418	96	YT-04625	99	YT-05211	54	YT-05502	104	YT-06006	446	YT-06288	431	YT-06777	519
YT-0189	9	YT-0332	11	YT-0419	96	YT-04626	99	YT-05212	54	YT-05503	104	YT-06007	447	YT-0630	431	YT-06780	515
YT-01906	9	YT-0333	11	YT-0420	96	YT-04627	99	YT-05213	54	YT-05513	104	YT-06008	438	YT-06301	431	YT-06782	517
YT-01907	9	YT-0334	11	YT-0421	459	YT-04628	100	YT-05214	54	YT-05514	104	YT-06009	442	YT-06311	466	YT-06783	517
YT-01908	9	YT-0335	8	YT-04211	459	YT-04629	100	YT-05215	54	YT-05515	104	YT-0601	438	YT-06312	466	YT-06784	518
YT-01909	9	YT-0336	8	YT-04301	58	YT-04630	101	YT-05220	55	YT-05516	104	YT-06010	445	YT-06313	466	YT-06785	519
YT-0191	9	YT-0337	8	YT-04302	58	YT-04631	101	YT-05221	55	YT-05517	104	YT-06011	438	YT-06315	467	YT-06786	515
YT-0192	9	YT-0338	8	YT-04303	58	YT-04632	101	YT-05222	55	YT-05518	104	YT-06012	439	YT-06316	467	YT-06787	517
YT-0193	9	YT-0339	8	YT-04304	58	YT-04635	99	YT-05223	55	YT-05519	104	YT-06013	441	YT-0632	438	YT-06790	518
YT-0194	9	YT-0340	8	YT-043													

YATO	page/strona	YATO	page/strona	YATO	page/strona	YATO	page/strona	YATO	page/strona	YATO	page/strona	YATO	page/strona	YATO	page/strona
YT-0685	468	YT-07063	411	YT-08195	234, 448	YT-08559	490, 662	YT-09002	389	YT-09717	362	YT-1060	67	YT-1185	70
YT-068581	515	YT-07065	411	YT-08196	448	YT-08562	486, 658	YT-09003	389	YT-09730	361	YT-1061	67	YT-1186	70
YT-068582	515	YT-07067	374, 411	YT-0820	405	YT-08567	489, 662	YT-09004	390	YT-09738	361	YT-1062	67	YT-1187	70
YT-06860	517	YT-07068	374, 411	YT-0821	405	YT-08568	489, 662	YT-0900	391	YT-09739	361	YT-1064	67	YT-1188	70
YT-06862	515	YT-07069	374, 411	YT-0822	405	YT-08569	489, 662	YT-09032	390	YT-09740	361	YT-10643	73	YT-1189	70
YT-06864	515	YT-0707	410	YT-0823	405	YT-08570	490, 663	YT-09033	390	YT-09741	361	YT-1065	72	YT-1191	70
YT-068641	514	YT-07071	410	YT-08231	405	YT-08571	490, 663	YT-09061	392	YT-09742	361	YT-10652	71	YT-1193	70
YT-06865	513	YT-0708	410	YT-08235	405	YT-08577	490, 662	YT-0907	399	YT-09743	257, 362	YT-10653	73	YT-1194	70
YT-06866	153, 522	YT-07082	410	YT-08236	405	YT-08579	663	YT-09071	399	YT-09744	257, 362	YT-10654	71	YT-1196	70
YT-068661	153, 522	YT-07083	410	YT-0824	406	YT-08580	489, 662	YT-09072	399	YT-09745	257, 362	YT-10655	73	YT-1197	70
YT-068667	153, 522	YT-07084	410	YT-0825	406	YT-08581	661	YT-0908	399	YT-09746	257, 362	YT-1066	72	YT-1198	70
YT-068668	154, 523	YT-07087	498	YT-08253	405	YT-08582	661	YT-0910	399	YT-09747	257, 362	YT-10662	72	YT-11990	71
YT-06867	154, 523	YT-0709	412	YT-08254	405	YT-08587	661	YT-09101	278, 401	YT-09748	257, 362	YT-10663	72	YT-11995	71
YT-068671	154, 523	YT-0710	412	YT-0826	406	YT-08588	661	YT-09102	278, 401	YT-09749	257, 362	YT-10664	72	YT-11998	71
YT-068672	154, 523	YT-07101	412	YT-08280	482	YT-08590	490, 664	YT-09104	279, 402	YT-09750	257, 362	YT-1067	67	YT-12000	406
YT-06868	153, 522	YT-07102	412	YT-08295	480	YT-08591	490, 664	YT-09107	278, 401	YT-09795	359	YT-10671	73	YT-12005	438
YT-068683	152, 521	YT-07110	412	YT-0830	480	YT-08592	490, 664	YT-09108	278, 401	YT-0980	359	YT-1068	72	YT-12007	431
YT-068684	152, 521	YT-07115	413	YT-08302	480	YT-08593	491, 664	YT-0911	399	YT-09803	359	YT-10681	71	YT-1201	33
YT-068685	152, 521	YT-0712	413	YT-08304	480	YT-08594	491, 664	YT-0913	391	YT-0981	359	YT-1069	72	YT-1202	33
YT-06869	151, 525	YT-0715	413	YT-08305	480	YT-08595	490, 664	YT-0914	391	YT-0982	359	YT-10691	71	YT-1203	33
YT-06870	151, 520	YT-0716	499	YT-0831	480	YT-08596	490, 664	YT-09152	389	YT-09860	358	YT-1070	68	YT-1204	33
YT-06871	514	YT-0717	499	YT-08312	480	YT-08599	491, 665	YT-09155	389	YT-0990	364	YT-1071	68	YT-1205	33
YT-068711	514	YT-0718	499	YT-08320	481	YT-0860	479	YT-09160	621	YT-09901	364	YT-1072	68	YT-1206	33
YT-068713	514	YT-07190	375, 498	YT-0835	481	YT-0862	173, 535	YT-09161	621	YT-09904	364	YT-1073	68	YT-1207	33
YT-06872	514	YT-07191	375, 498	YT-08353	364, 481	YT-08625	175, 537	YT-09162	621	YT-09910	364	YT-1074	68	YT-1208	33
YT-068721	514	YT-07195	374, 498	YT-08354	364, 481	YT-0863	173, 535	YT-09163	620	YT-0994	362	YT-1075	68	YT-1209	33
YT-06873	516	YT-0720	28	YT-0836	428	YT-0864	173, 535	YT-09164	620	YT-09944	363	YT-1076	68	YT-1210	33
YT-06874	517	YT-0722	38	YT-0837	428	YT-0865	173, 535	YT-09165	620	YT-09945	363	YT-1077	68	YT-1211	33
YT-06875	516	YT-0730	28	YT-0838	426	YT-0866	173, 536	YT-09166	620	YT-09955	362	YT-1078	68	YT-1212	33
YT-06876	520	YT-0731	33	YT-08390	462	YT-0867	173, 536	YT-09167	620	YT-09958	224, 362	YT-1079	68	YT-1213	33
YT-06877	519	YT-0732	37	YT-08391	462	YT-08677	173, 536	YT-09168	619	YT-09959	224, 362	YT-1080	68	YT-1214	33
YT-06878	519	YT-0733	28	YT-08392	463	YT-08678	173, 536	YT-09169	619	YT-09990	366	YT-1082	68	YT-1215	33
YT-06879	520	YT-0735	38	YT-0840	462	YT-08679	174, 536	YT-09170	620	YT-1000	66	YT-1083	68	YT-1216	33
YT-068791	519	YT-0750	76	YT-08403	462	YT-08680	400	YT-09174	621	YT-1001	66	YT-1084	68	YT-1217	33
YT-06880	518	YT-07500	76	YT-0841	427	YT-08681	400	YT-09175	621	YT-1002	66	YT-1085	68	YT-1218	33
YT-06881	518	YT-0751	76	YT-0842	427	YT-08682	400	YT-09177	618	YT-1003	66	YT-1086	68	YT-1219	33
YT-06882	518	YT-07511	76	YT-08422	84, 424	YT-08690	400	YT-09178	618	YT-1004	66	YT-1088	68	YT-1220	33
YT-06883	516	YT-0754	77	YT-08425	85, 424	YT-08707	365, 481	YT-09179	618	YT-1005	66	YT-1091	68	YT-1221	34
YT-06884	517	YT-0760	76	YT-08426	85, 424	YT-08710	175, 537	YT-09180	619	YT-1006	66	YT-1092	68	YT-1222	34
YT-06885	516	YT-07601	76	YT-08428	85, 424	YT-08711	175, 537	YT-09181	619	YT-1007	66	YT-1093	68	YT-1223	34
YT-06888	516	YT-07605	76	YT-08429	85, 424	YT-08721	174, 536	YT-09182	618	YT-1008	66	YT-1096	68	YT-1224	34
YT-06890	152, 521	YT-0761	77	YT-0843	84	YT-08722	174, 537	YT-09183	619	YT-1009	66	YT-1100	68	YT-1225	34
YT-06891	151, 520	YT-07611	76	YT-08431	85, 425	YT-08723	174, 537	YT-09184	619	YT-1010	66	YT-1102	68	YT-1226	34
YT-068911	151, 520	YT-07612	76	YT-08432	85, 425	YT-08780	482	YT-09185	621	YT-1011	66	YT-1105	68	YT-1227	34
YT-068912	152, 520	YT-07641	76	YT-0844	428	YT-08790	482	YT-09201	289, 376	YT-1012	66	YT-1110	68	YT-1228	34
YT-068913	152, 521	YT-07642	76	YT-08442	428	YT-08791	482	YT-09202	289, 376	YT-1013	66	YT-1115	68	YT-1229	34
YT-068914	153, 522	YT-0770	77	YT-08443	428	YT-08792	482	YT-09203	289, 376	YT-1014	66	YT-1119	68	YT-1230	34
YT-06895	153, 521	YT-0771	77	YT-0845	429	YT-08793	482	YT-09211	289, 377	YT-1015	66	YT-1121	68	YT-1231	34
YT-06896	153, 522	YT-07711	77	YT-0846	429	YT-08795	482	YT-09212	289, 377	YT-1016	66	YT-1122	68	YT-1232	34
YT-0690	412	YT-07712	76	YT-08461	429	YT-0880	482	YT-09213	289, 377	YT-1017	66	YT-1124	68	YT-1233	34
YT-0691	412	YT-07730	76	YT-08462	415, 430	YT-08802	482	YT-09214	289, 377	YT-1018	66	YT-1127	68	YT-1234	34
YT-06912	412	YT-07731	76	YT-0847	428	YT-0882	403	YT-09440	290, 377	YT-1019	66	YT-1128	68	YT-1235	34
YT-06913	412	YT-07740	76	YT-08474	428	YT-0883	403	YT-09442	290, 377	YT-1020	66	YT-1129	68	YT-1236	34
YT-06914	412	YT-07741	76	YT-08477	428	YT-0884	403	YT-09460	290, 377	YT-1022	66	YT-1130	68	YT-1237	34
YT-06919	413	YT-07742	76	YT-08490	491, 664	YT-0885	403	YT-09461	290, 377	YT-1025	66	YT-1132	68	YT-1238	34
YT-0692	497	YT-07743	76	YT-08495	654	YT-0886	403	YT-09505	354	YT-1027	71	YT-1133	68	YT-1239	34
YT-0693	497	YT-07752	77	YT-08496	654	YT-08872	403	YT-09511	354	YT-1029	71	YT-1134	68	YT-1240	34
YT-0694	497	YT-07753	77	YT-08500	484, 656	YT-08873	403	YT-09512	354	YT-1030	66	YT-1135	68	YT-1241	36
YT-0695	497	YT-07762	77	YT-08502	484, 656	YT-08874	403	YT-09513	354	YT-1031	66	YT-1136	68	YT-1242	36
YT-0696	497	YT-0782	78	YT-08504	487, 659	YT-08900	402	YT-09515	355	YT-1032	66	YT-1138	68	YT-1243	36
YT-0697	497	YT-07822	78	YT-085051	487, 659	YT-08901	402	YT-09524	355	YT-1033	66	YT-1141	68	YT-12439	36
YT-06972	497	YT-07830	78	YT-08507	486, 658	YT-08902	402	YT-09525	355	YT-1034	66	YT-1142	68	YT-1244	36
YT-06977	413	YT-07831	78	YT-085081	486, 658	YT-08903	402	YT-09528	355	YT-1035	66	YT-1143	68	YT-12445	36
YT-06980	497	YT-07832	78	YT-08509	484, 656	YT-08904	402	YT-0953	356	YT-1036	66	YT-1146	68	YT-1246	35
YT-06983	497	YT-07835	78	YT-08510	487, 659	YT-08905	403	YT-09531	356	YT-1037	66	YT-1148	68	YT-1247	35
YT-06985	497	YT-07836	78	YT-08511	488, 660	YT-08906	403	YT-09540	356	YT-1038	66	YT-1150	68	YT-1248	35
YT-06987	497	YT-0800	477	YT-08513	487, 659	YT-08907	402	YT-09544	356	YT-1039	66	YT-1155	69	YT-1249	35
YT-0699	499	YT-0801	477	YT-08514	488, 660	YT-08920	392	YT-09545	357	YT-1040	66	YT-1157	73	YT-1250	35
YT-06995	499	YT-0802	477	YT-08516	488, 660	YT-08921	398	YT-09564	357	YT-1041	66	YT-1160	69	YT-1251	35
YT-0700	408	YT-08033	477	YT-08517	485, 657	YT-08922	398	YT-09571	357	YT-1042	66	YT-1161	69	YT-1252	36
YT-0701	408	YT-08035	477	YT-08518	485, 657	YT-08931	381	YT-0959	357	YT-1043	66	YT-1162	69	YT-1253	37, 463
YT-07020	412, 554	YT-0807	479	YT-08519	485, 657	YT-08932	382	YT-0960	357	YT-1044	66	YT-1163	69	YT-12531	37
YT-07021	412, 555	YT-0808	479	YT-08520	487, 659	YT-08933	381	YT-09615	358	YT-1045	66				

YATO	page/strona	YATO	page/strona	YATO	page/strona	YATO	page/strona	YATO	page/strona	YATO	page/strona	YATO	page/strona	YATO	page/strona	YATO	page/strona
YT-1370	426	YT-1478	34	YT-1621	14	YT-17207	501	YT-1901	218, 325, 539	YT-2050	118	YT-21050	33, 131	YT-21844	270	YT-2245	132
YT-1371	426	YT-1480	34	YT-1622	14	YT-1721	501	YT-1902	218, 325, 539	YT-2051	118	YT-21052	33, 131	YT-21845	270	YT-2246	133
YT-1372	426	YT-1481	34	YT-1627	16	YT-17211	501	YT-1910	216, 323, 538	YT-2052	118	YT-21055	30, 131	YT-21846	270	YT-2247	133
YT-1373	426	YT-14820	34	YT-1628	16	YT-17213	501	YT-1911	217, 324, 539	YT-2055	118	YT-21056	30, 131	YT-21850	270	YT-2250	133
YT-1374	426	YT-14821	34	YT-1629	16	YT-17214	501	YT-1912	217, 324, 538	YT-2056	118	YT-21057	35, 132	YT-21851	270	YT-2254	134
YT-1375	426	YT-14822	34	YT-1630	16	YT-17260	499	YT-1913	217, 323, 538	YT-2057	118	YT-21071	33, 131	YT-21852	270	YT-2255	133
YT-1378	427	YT-14824	34	YT-1631	16	YT-17261	499	YT-1914	218, 324, 539	YT-2058	118	YT-21072	37, 132	YT-21855	270	YT-2256	133
YT-1379	427	YT-14825	34	YT-1632	16	YT-17262	499	YT-1915	216, 323, 538	YT-2060	118	YT-21080	58, 132	YT-21856	270	YT-2260	136
YT-13790	427	YT-14826	34	YT-1633	16	YT-17310	502	YT-1916	217, 324, 539	YT-2061	118	YT-21081	58, 132	YT-21857	270	YT-2261	136
YT-1381	427	YT-14827	34	YT-1634	16	YT-17311	502	YT-1918	216, 323, 538	YT-2063	118	YT-21082	58, 132	YT-22000	265	YT-2262	137
YT-1382	427	YT-14828	34	YT-1635	16	YT-17312	502	YT-1919	217, 324, 539	YT-2064	118	YT-21083	58, 132	YT-22001	265	YT-2263	137
YT-1385	427	YT-14829	34	YT-1636	16	YT-17490	477	YT-1920	219, 325, 540	YT-2066	114	YT-21085	60, 132	YT-22002	265	YT-22640	137
YT-1400	26, 100	YT-14830	34	YT-1637	16	YT-17508	453	YT-1922	217, 324, 538	YT-2067	114	YT-21086	60, 132	YT-22005	125, 265	YT-2268	136
YT-14001	26, 101	YT-14831	34	YT-1638	16	YT-1751	452	YT-1924	219, 326, 540	YT-2069	124, 266	YT-21087	60, 132	YT-2201	124, 264	YT-2270	135
YT-1401	25	YT-14833	34	YT-1639	16	YT-17513	452	YT-1925	219, 325, 540	YT-2070	124, 266	YT-21088	60, 132	YT-2203	124, 264	YT-2274	136
YT-1403	25	YT-14834	34	YT-1640	16	YT-17515	452	YT-19260	219, 326, 540	YT-2071	19	YT-21089	60, 132	YT-2204	124, 264	YT-2275	136
YT-1404	25	YT-14836	34	YT-1641	16	YT-1752	452	YT-19261	219, 326, 540	YT-2072	19	YT-21095	18, 131	YT-2205	124, 264	YT-22753	136
YT-1405	25	YT-14838	34	YT-1642	16	YT-17525	454	YT-1930	220, 541	YT-2073	19	YT-21096	18, 131	YT-2206	124, 264	YT-2278	136
YT-1406	25	YT-14839	34	YT-1644	16	YT-17527	438	YT-1940	113	YT-2074	19	YT-21141	139, 216	YT-2210	265	YT-2279	137
YT-1407	25	YT-1501	98	YT-1647	16	YT-1753	452	YT-1941	113	YT-2075	19	YT-21151	116, 129	YT-2211	265	YT-2280	138
YT-1408	25	YT-1502	98	YT-1649	16	YT-1754	452	YT-1942	113	YT-2080	115	YT-21152	116, 129	YT-2212	265	YT-22851	134
YT-1409	25	YT-1503	98	YT-1651	10	YT-1756	492	YT-1943	113	YT-2081	115	YT-21153	116, 129	YT-2213	265	YT-22860	134
YT-1410	25	YT-1505	98	YT-1652	10	YT-1757	492	YT-1944	113	YT-2082	116	YT-21154	116, 129	YT-2214	265	YT-22861	134
YT-1411	25	YT-1507	98	YT-1653	10	YT-17571	492	YT-1945	113	YT-2083	115	YT-21155	116, 129	YT-2215	265	YT-22862	134
YT-1412	25	YT-1508	98	YT-1654	10	YT-17572	492	YT-1946	113	YT-2084	115	YT-21158	116, 129	YT-2216	265	YT-22870	221
YT-14120	25	YT-1511	98	YT-1655	10	YT-17573	492	YT-1947	113	YT-2085	116	YT-21159	116, 129	YT-2217	265	YT-22871	221
YT-14121	25	YT-1512	98	YT-1656	10	YT-17574	492	YT-1948	113	YT-2086	116	YT-21160	116, 129	YT-2218	265	YT-22872	221
YT-14123	25	YT-1513	98	YT-1657	10	YT-17575	492	YT-1949	118	YT-2090	124, 266	YT-21161	116, 130, 266	YT-22183	265	YT-22873	221
YT-14124	25	YT-1515	98	YT-1658	10	YT-17580	493	YT-1950	117	YT-2091	124, 266	YT-21190	132, 170	YT-2222	124, 264	YT-22874	221
YT-14125	25	YT-1517	98	YT-1659	10	YT-17581	493	YT-1951	117	YT-20911	124, 266	YT-21191	117, 130	YT-2223	124, 264	YT-22875	221
YT-14126	25	YT-1518	98	YT-1660	10	YT-17588	493	YT-1952	117	YT-20940	20, 131	YT-21200	138, 242	YT-2224	124, 264	YT-2293	135
YT-14127	25	YT-15271	19	YT-1661	10	YT-1762	453	YT-1953	117	YT-20941	20, 131	YT-21210	138, 239	YT-2225	124, 264	YT-22930	135
YT-14128	25	YT-15273	19	YT-1662	10	YT-17622	449	YT-1954	117	YT-20942	20, 131	YT-21211	138, 239	YT-22251	20, 267	YT-2294	135
YT-14129	25	YT-15275	19	YT-1663	10	YT-17625	453	YT-1956	117	YT-20950	14, 130	YT-2130	118	YT-22255	125, 265	YT-2296	133
YT-1413	25	YT-15276	19	YT-1664	10	YT-17627	450	YT-1960	216, 323, 538	YT-20951	14, 130	YT-2136	119	YT-22256	125, 266	YT-2297	133
YT-1414	25	YT-15277	19	YT-1665	10	YT-17629	450	YT-1961	217, 324, 539	YT-20953	14, 130	YT-2137	119	YT-22257	125, 265	YT-2298	133
YT-1415	25	YT-15278	19	YT-1666	10	YT-1763	203, 492	YT-1962	217, 324, 538	YT-20954	14, 130	YT-2138	119	YT-22260	125, 266	YT-2299	134
YT-1416	25	YT-15279	19	YT-1667	10	YT-17631	202, 493	YT-1963	219, 326, 540	YT-20955	14, 130	YT-2139	119	YT-22270	246, 268	YT-2300	133
YT-1417	25	YT-15280	19	YT-1669	10	YT-17632	202, 493	YT-1964	219, 326, 540	YT-20957	14, 130	YT-2140	119	YT-22271	246, 268	YT-2305	134
YT-1418	25	YT-15281	19	YT-1670	10	YT-17633	202, 493	YT-1965	219, 326, 540	YT-20958	14, 130	YT-2141	119	YT-22272	246, 268	YT-23051	134
YT-1419	25	YT-15282	19	YT-1671	10	YT-17634	202, 493	YT-1966	139, 216	YT-20959	14, 130	YT-2142	119	YT-22273	246, 268	YT-2313	135
YT-1420	25	YT-15284	19	YT-1672	10	YT-17635	202, 493	YT-1967	139, 216	YT-20960	14, 130	YT-2143	119	YT-22274	246, 268	YT-23133	135
YT-1421	25	YT-15291	19	YT-1673	10	YT-1764	203, 493	YT-1968	139, 216	YT-20961	14, 130	YT-2144	119	YT-2228	246, 268	YT-2316	137
YT-1422	25	YT-15292	19	YT-1674	10	YT-1765	203, 493	YT-19682	137	YT-20962	14, 130	YT-2145	119	YT-2229	246, 268	YT-2319	135
YT-1423	25	YT-15293	19	YT-1675	10	YT-1766	203, 493	YT-1969	139, 216	YT-20963	14, 130	YT-2146	119	YT-22292	246, 268	YT-23200	155
YT-1424	25	YT-1542	17	YT-1676	10	YT-1767	203, 493	YT-19691	137	YT-20964	14, 130	YT-2147	119	YT-22293	246, 268	YT-23201	155
YT-1425	27	YT-1543	17	YT-1677	10	YT-1768	203, 493	YT-1970	218, 325, 540	YT-20965	14, 130	YT-2151	120	YT-2230	245, 267	YT-23241	495, 553
YT-1426	27	YT-1544	17	YT-1678	10	YT-1769	203, 492	YT-1974	138, 242	YT-20966	14, 130	YT-2152	120	YT-22301	246, 268	YT-23242	495, 553
YT-1427	27	YT-1546	17	YT-1679	10	YT-17695	494	YT-1976	222	YT-20967	14, 130	YT-2153	120	YT-2231	245, 267	YT-23247	496, 553
YT-1429	25	YT-1549	17	YT-1680	10	YT-17697	493	YT-19763	242	YT-20968	14, 130	YT-2155	120	YT-22312	245, 267	YT-23248	496, 554
YT-1430	25	YT-1552	17	YT-1681	10	YT-17700	494	YT-19764	242	YT-20969	14, 130	YT-2156	120	YT-22313	248, 269	YT-2340	366
YT-1431	25	YT-1554	17	YT-1682	10	YT-17705	202, 494	YT-19765	242	YT-20980	13, 130	YT-21570	121, 533	YT-22314	248, 269	YT-2341	366
YT-1432	25	YT-1556	17	YT-1683	10	YT-17710	494	YT-19766	242	YT-20981	13, 130	YT-21582	192, 535	YT-22315	248, 269	YT-2346	366
YT-1433	26	YT-1557	17	YT-1684	10	YT-18400	221	YT-19767	242	YT-20982	13, 130	YT-21650	19	YT-22316	248, 269	YT-2357	366
YT-1434	26	YT-1558	17	YT-1685	10	YT-1843	220	YT-1988	120	YT-20983	13, 130	YT-21651	19	YT-22317	248, 269	YT-23640	367
YT-1435	26	YT-1559	17	YT-1686	10	YT-1844	220	YT-1989	120	YT-20985	13, 130	YT-21652	19	YT-22318	247, 269	YT-23641	367
YT-1436	26	YT-1565	18	YT-1687	10	YT-1845	220	YT-1990	120	YT-20986	13, 130	YT-21653	19	YT-2232	247, 269	YT-2370	365
YT-1437	26	YT-1566	18	YT-1688	10	YT-1846	220	YT-1991	120	YT-20987	13, 130	YT-21654	19	YT-2233	247, 269	YT-23701	365
YT-1438	26	YT-1567	18	YT-1690	10	YT-1847	220	YT-1992	120	YT-20988	13, 130	YT-2170	19	YT-22332	247, 269	YT-23702	365
YT-14390	89	YT-1571	18	YT-17000	500	YT-1848	220	YT-1993	120	YT-20989	13, 130	YT-2171	19	YT-22333	247, 269	YT-23703	365
YT-14421	53	YT-1573	18	YT-17001	500	YT-1851	220	YT-1994	120	YT-20990	13, 130	YT-2172	19	YT-22338	247, 269	YT-2371	366
YT-14431	39	YT-1575	18	YT-17002	500	YT-1852	220	YT-1995	120	YT-20991	13, 130	YT-2173	19	YT-2234	247, 269	YT-2372	366
YT-14451	39	YT-1576	18	YT-17003	500	YT-1853	220	YT-2006	113	YT-20992	13, 130	YT-21735	273	YT-22341	247, 269	YT-23722	368
YT-14461	39	YT-15791	18	YT-17004	500	YT-1854	220										

YATO	page/strona	YATO	page/strona	YATO	page/strona	YATO	page/strona	YATO	page/strona	YATO	page/strona	YATO	page/strona	YATO	page/strona	YATO	page/strona
YT-2396	372	YT-24970	235, 277	YT-25903	82	YT-28174	87, 128	YT-2953	199	YT-3071	328	YT-3272	189	YT-33866	188	YT-35868	245
YT-2397	372	YT-24971	235, 277	YT-25904	82	YT-2818	87, 128	YT-2954	199	YT-3072	328	YT-3273	189	YT-33867	188	YT-35869	245
YT-2398	372	YT-24972	235, 277	YT-25905	82	YT-2819	87, 128	YT-2955	199	YT-3073	328	YT-3274	189	YT-33868	188	YT-35870	245
YT-2399	372	YT-24980	235, 277	YT-25906	82	YT-2820	87, 128	YT-2956	199	YT-3074	328	YT-3275	189	YT-33869	188	YT-35871	245
YT-2401	372	YT-24983	235, 276	YT-25907	82	YT-2821	87, 128	YT-2961	201	YT-3076	328	YT-3276	189	YT-33870	188	YT-35872	245
YT-2402	372	YT-24990	235, 276	YT-25908	82	YT-2822	87, 128	YT-2962	201	YT-3077	328	YT-3277	189	YT-33873	188	YT-35873	245
YT-2403	372	YT-24991	235, 276	YT-25909	82	YT-2823	87, 128	YT-2963	201	YT-3078	328	YT-3278	189	YT-33920	225	YT-35880	245
YT-2404	372	YT-25000	234, 276	YT-25910	82	YT-2824	87, 128	YT-2964	201	YT-3079	328	YT-3279	189	YT-33921	225	YT-35881	245
YT-2405	372	YT-25001	234, 276	YT-25911	82	YT-28245	87, 128	YT-2965	201	YT-3081	328	YT-3280	189	YT-33922	225	YT-3590	245
YT-2406	372	YT-25002	234, 276	YT-25912	82	YT-2825	87, 128	YT-2966	201	YT-3082	328	YT-3281	189	YT-33923	225	YT-3591	245
YT-2407	372	YT-25003	234, 276	YT-25913	82	YT-2826	87, 128	YT-2967	201	YT-3083	328	YT-3282	189	YT-33930	225	YT-35970	282
YT-24091	373	YT-25004	234, 276	YT-25914	82	YT-28263	87, 128	YT-2969	201	YT-3084	328	YT-3283	189	YT-33931	225	YT-35980	285
YT-24092	373	YT-25005	234, 276	YT-25920	82	YT-2827	87, 128	YT-2970	201	YT-30900	313	YT-3284	189	YT-33932	225	YT-35981	285
YT-24093	373	YT-25010	155	YT-25921	82	YT-2828	87, 128	YT-2971	201	YT-3101	222	YT-3285	189	YT-33933	225	YT-35982	285
YT-24094	373	YT-25015	155	YT-25922	82	YT-28283	87, 129	YT-2973	201	YT-3102	222	YT-3286	189	YT-33934	225	YT-35983	285
YT-24095	373	YT-2510	416	YT-25923	82	YT-28290	88, 128	YT-2975	200	YT-3103	222	YT-3287	189	YT-33935	225	YT-3600	282
YT-24100	373	YT-25105	415	YT-25924	82	YT-28293	88, 128	YT-2976	200	YT-3106	222	YT-3288	189	YT-33950	225	YT-36007	282
YT-24101	373	YT-2511	415	YT-25925	82	YT-28294	88, 129	YT-2977	200	YT-3107	222	YT-3289	189	YT-33951	225	YT-36011	282
YT-24102	373	YT-2512	415	YT-25926	82	YT-28295	88, 129	YT-2978	200	YT-3108	222	YT-3290	189	YT-33960	225	YT-36012	282
YT-24103	373	YT-2513	415	YT-25927	82	YT-28300	140	YT-2979	200	YT-31091	222	YT-3291	189	YT-33961	225	YT-36013	282
YT-24130	373	YT-2514	414	YT-25928	82	YT-28312	140	YT-2980	202	YT-31092	222	YT-3292	189	YT-33970	225	YT-36060	282
YT-24201	370	YT-25145	415, 429	YT-25929	82	YT-28313	140	YT-2981	202	YT-31093	222	YT-3293	189	YT-33971	225	YT-36070	282
YT-24202	370	YT-2515	414	YT-25930	82	YT-2861	140, 336	YT-2982	202	YT-31290	223	YT-3294	189	YT-33972	226	YT-3609	283
YT-24203	370	YT-2516	414	YT-25931	82	YT-2862	140, 336	YT-2983	202	YT-3130	223	YT-3295	189	YT-3400	226	YT-36091	283
YT-24204	370	YT-2517	414	YT-25932	82	YT-28630	140, 336	YT-2984	202	YT-31303	223	YT-3296	189	YT-3401	226	YT-36092	283
YT-24205	370	YT-2518	414	YT-25933	82	YT-28631	140	YT-2985	202	YT-31310	222	YT-3297	189	YT-3402	226	YT-36095	283
YT-24206	370	YT-2519	414	YT-25934	82	YT-2864	140	YT-2986	202	YT-3133	223	YT-3298	189	YT-3403	226	YT-3610	283
YT-24207	370	YT-2520	414	YT-25940	82	YT-2865	491	YT-2987	202	YT-3134	223	YT-3299	189	YT-3404	226	YT-36112	283
YT-24208	370	YT-2521	414	YT-25941	82	YT-2866	491	YT-2988	202	YT-31343	223	YT-3300	189	YT-3405	226	YT-36119	284
YT-24209	370	YT-2522	414	YT-25942	82	YT-28919	191, 535	YT-2989	202	YT-31350	243, 322	YT-33010	205	YT-3407	226	YT-3612	283
YT-24220	370	YT-2523	414	YT-25943	82	YT-28920	191, 535	YT-2990	202	YT-3150	223	YT-33011	205	YT-3408	226	YT-36125	284
YT-24221	370	YT-25331	430	YT-25950	82	YT-28921	191, 535	YT-2991	202	YT-3160	224	YT-33015	205	YT-3409	226	YT-36127	284
YT-24224	370	YT-2535	474	YT-25951	82	YT-28950	191	YT-2992	202	YT-3161	224	YT-33021	189	YT-3410	226	YT-36128	284
YT-24225	370	YT-2536	474	YT-25952	82	YT-28951	191	YT-2993	202	YT-31612	224	YT-33022	189	YT-3411	227	YT-36129	284
YT-24230	370	YT-25384	472	YT-25953	82	YT-28952	191	YT-2994	202	YT-3163	224	YT-33023	189	YT-3412	227	YT-36140	283
YT-24231	370	YT-25390	417	YT-25954	82	YT-28953	191	YT-2995	202	YT-3200	223, 683	YT-3303	197	YT-3413	227	YT-36150	284
YT-24232	370	YT-25391	418	YT-25955	82	YT-28954	191	YT-2996	202	YT-3201	223, 683	YT-3304	197	YT-3414	227	YT-36171	285, 376
YT-24233	371	YT-2540	417	YT-25956	82	YT-28955	191	YT-2997	202	YT-3202	223, 683	YT-3306	197	YT-3415	227	YT-36177	285, 376
YT-24234	371	YT-2541	418	YT-25957	82	YT-28956	191	YT-29980	351	YT-3203	223, 683	YT-3308	197	YT-3416	227	YT-3618	285, 376
YT-24235	371	YT-25411	418	YT-25958	82	YT-28957	191	YT-29982	351	YT-3204	223, 683	YT-3311	197	YT-3417	227	YT-36420	516
YT-24236	371	YT-25412	418	YT-25959	82	YT-28958	191	YT-29984	351	YT-3221	224, 683	YT-3313	197	YT-3421	227	YT-36451	284
YT-24237	371	YT-25413	418	YT-25960	82	YT-28959	191	YT-3001	348	YT-3222	224, 683	YT-3315	197	YT-3445	227	YT-36452	284
YT-24238	371	YT-25415	425	YT-25961	82	YT-28960	191	YT-3002	348	YT-3223	224, 683	YT-3317	197	YT-3460	224	YT-36453	284
YT-24240	371	YT-2542	419	YT-25965	83	YT-28961	191	YT-3003	348	YT-3224	224, 683	YT-3318	197	YT-3461	224	YT-36454	284
YT-24241	371	YT-2543	419	YT-25966	83	YT-28962	191	YT-3004	348	YT-3230	224, 683	YT-3321	197	YT-3462	224	YT-36460	285
YT-24242	371	YT-2544	474	YT-25967	83	YT-28963	191	YT-3005	348	YT-3231	224, 683	YT-3322	197	YT-34680	228	YT-36470	284
YT-24243	371	YT-2546	474	YT-25968	84	YT-28964	191	YT-30060	349	YT-3232	224, 683	YT-3323	197	YT-34681	228	YT-36471	284
YT-24244	372	YT-2547	474	YT-25971	84	YT-28965	191	YT-30061	349	YT-3233	224, 683	YT-3324	197	YT-34682	228	YT-36472	284
YT-24245	372	YT-25472	474	YT-25972	89	YT-28966	191	YT-30062	349	YT-3234	224, 683	YT-3327	197	YT-34683	229	YT-36473	284
YT-24246	372	YT-25480	430	YT-25980	83	YT-28967	191	YT-30063	349	YT-3236	187	YT-3329	197	YT-34684	229	YT-36474	284
YT-24250	372	YT-25483	430	YT-25981	84	YT-2900	264	YT-30064	349	YT-3237	187	YT-3330	197	YT-34685	229	YT-36475	284
YT-24301	494	YT-25760	87	YT-25982	84	YT-29001	264	YT-30071	349	YT-3238	187	YT-3332	197	YT-34686	230	YT-36476	284
YT-2449	120	YT-25802	86	YT-25985	83	YT-2910	264	YT-30072	349	YT-3239	187	YT-3333	197	YT-34687	231	YT-36480	285
YT-2450	121	YT-25803	86	YT-25986	83	YT-2911	264	YT-30073	349	YT-3240	187	YT-3334	197	YT-34688	232	YT-36481	285
YT-2451	121	YT-25804	86	YT-25987	83	YT-2912	264	YT-30074	349	YT-3241	187	YT-3336	197	YT-34689	232	YT-36502	286
YT-2452	121	YT-25805	86	YT-25988	83	YT-2913	264	YT-3022	349	YT-3242	187	YT-3338	197	YT-34690	232	YT-36505	286
YT-2453	120	YT-25806	86	YT-25989	83	YT-2914	264	YT-3023	349	YT-3243	187	YT-3343	197	YT-34691	232	YT-36510	286
YT-2459	121	YT-25807	86	YT-25990	83	YT-2916	264	YT-3024	349	YT-3244	187	YT-3345	197	YT-34693	232	YT-36700	271, 293, 587
YT-2460	121	YT-25808	86	YT-25991	83	YT-2917	264	YT-3025	349	YT-3245	187	YT-3346	197	YT-34700	230	YT-36701	272, 294, 588
YT-2461	122, 533	YT-25809	86	YT-25992	83	YT-2918	264	YT-3026	349	YT-3246	187	YT-3349	197	YT-34701	229	YT-36706	272, 293, 587
YT-2463	122, 533	YT-25810	86	YT-25993	83	YT-2919	264	YT-30370	349	YT-3247	187	YT-3350	197	YT-34702	231	YT-36709	272, 294, 588
YT-2466	122, 533	YT-25811	86	YT-25994	83	YT-2920	264	YT-30395	349	YT-3248	187	YT-3351	197	YT-34703	231	YT-36710	272, 294, 588
YT-2468	122, 533	YT-25831	86	YT-25995	83	YT-2921	264	YT-30397	349	YT-3249	187	YT-3353	197	YT-34710	230	YT-36711	271, 293, 587
YT-2469	122, 534	YT-25832	86	YT-25996	83	YT-29220	275	YT-30400	349	YT-3250	187	YT-3370	198	YT-34711	228	YT-36712	272, 294, 588
YT-2473	121	YT-25833	86	YT-25997	83	YT-29222	275	YT-30410	347	YT-3251	187	YT-3371	198	YT-34712	230	YT-36715	272, 294, 588
YT-2476	121	YT-25834	86	YT-25998	8												

YATO	page/strona	YATO	page/strona	YATO	page/strona	YATO	page/strona	YATO	page/strona	YATO	page/strona	YATO	page/strona	YATO	page/strona	YATO	page/strona
YT-37052	308	YT-3849	30	YT-4163	186	YT-4202	185	YT-43982	196	YT-4433	179	YT-44724	202	YT-44878	182	YT-46813	164
YT-3707	307	YT-3850	30	YT-4164	186	YT-4203	185	YT-43983	196	YT-4434	179	YT-44725	202	YT-44879	182	YT-46814	164
YT-3708	307	YT-3851	31, 463	YT-41641	186	YT-4204	185	YT-43984	196	YT-4435	179	YT-44726	202	YT-44880	182	YT-46820	164
YT-3712	306	YT-38510	31, 463	YT-41642	186	YT-4205	185	YT-43985	196	YT-4436	179	YT-44729	202	YT-44881	182	YT-46821	164
YT-3713	306	YT-38511	31, 463	YT-4165	186	YT-4206	185	YT-43986	196	YT-4437	179	YT-44730	201	YT-44882	182	YT-46822	164
YT-3714	307	YT-38512	31, 464	YT-4166	186	YT-4207	185	YT-43990	197	YT-4438	179	YT-44731	201	YT-44883	182	YT-46823	164
YT-37141	307	YT-38516	31, 464	YT-4167	186	YT-4208	185	YT-43991	197	YT-4439	179	YT-44739	201	YT-44884	182	YT-46831	164
YT-37150	307	YT-38517	31, 464	YT-4168	186	YT-4209	185	YT-43992	197	YT-4440	179	YT-44740	201	YT-44888	183	YT-46832	164
YT-37160	308	YT-38520	32, 464	YT-4169	186	YT-4210	185	YT-43993	197	YT-4441	179	YT-44741	201	YT-4491	158	YT-46833	164
YT-37161	308	YT-38521	31, 464	YT-4170	186	YT-4211	185	YT-43994	198	YT-4442	179	YT-44742	201	YT-4492	158	YT-46834	164
YT-37164	308	YT-38522	31, 464	YT-4171	186	YT-4212	185	YT-43995	198	YT-4443	179	YT-44743	201	YT-4493	158	YT-46835	164
YT-37170	308	YT-3853	30	YT-4172	186	YT-4213	185	YT-4400	196	YT-4444	179	YT-44744	201	YT-4494	158	YT-46836	164
YT-37177	309	YT-3854	30	YT-4173	186	YT-4214	185	YT-4401	196	YT-4445	179	YT-44745	201	YT-4495	158	YT-4690	163
YT-37200	320	YT-38550	453	YT-4174	186	YT-4215	185	YT-4402	196	YT-4446	179	YT-44746	201	YT-4496	158	YT-4691	163
YT-37210	332	YT-38561	40	YT-4175	186	YT-4216	185	YT-4403	196	YT-4447	179	YT-44747	201	YT-4497	158	YT-4692	164
YT-37214	332	YT-38650	53	YT-4176	186	YT-4217	185	YT-44033	196	YT-4448	179	YT-44750	182	YT-4498	158	YT-4693	164
YT-37220	331	YT-38653	53	YT-4177	186	YT-4218	185	YT-44034	196	YT-4449	179	YT-44751	182	YT-4499	158	YT-4694	164
YT-37223	331	YT-38671	41	YT-4178	186	YT-4219	185	YT-44040	196	YT-4450	179	YT-44752	182	YT-4500	158	YT-4695	164
YT-37235	331	YT-38681	41	YT-4179	186	YT-4220	185	YT-44041	196	YT-4451	179	YT-44754	182	YT-4501	158	YT-4700	162
YT-37236	332	YT-38741	41	YT-4180	186	YT-4221	185	YT-44045	196	YT-4452	179	YT-44755	182	YT-4502	158	YT-47020	162
YT-37237	332	YT-38781	42	YT-4181	186	YT-4222	185	YT-44080	244, 303, 309	YT-4453	179	YT-44756	182	YT-4503	158	YT-47021	162
YT-3725	190	YT-38782	42	YT-4182	186	YT-4223	185	YT-44081	244, 303, 309	YT-4454	179	YT-44757	182	YT-4504	158	YT-47022	162
YT-3726	190	YT-38791	45	YT-4183	186	YT-4224	185	YT-44085	244, 303, 310	YT-4455	179	YT-44758	182	YT-4505	158	YT-4710	162
YT-3727	190	YT-38801	47	YT-4184	186	YT-4225	185	YT-44087	244, 303, 310	YT-4456	179	YT-44759	182	YT-4506	158	YT-4711	163
YT-3728	190	YT-38811	49	YT-4185	186	YT-4226	185	YT-44095	192	YT-4457	179	YT-44760	182	YT-4507	158	YT-4712	163
YT-37301	306	YT-38821	41	YT-4186	186	YT-4227	185	YT-44100	191	YT-4458	179	YT-44761	182	YT-4508	158	YT-47121	163
YT-37311	306	YT-38831	46	YT-4187	186	YT-4228	185	YT-44104	191	YT-4460	179	YT-44763	182	YT-4509	158	YT-4713	163
YT-37317	306	YT-38841	51	YT-4188	186	YT-4229	185	YT-44105	191	YT-4461	179	YT-44764	182	YT-4510	158	YT-4714	163
YT-37325	306	YT-38861	41	YT-4189	186	YT-4230	185	YT-44106	191	YT-4462	179	YT-44765	182	YT-4515	161, 531	YT-47141	162
YT-3735	244, 302, 309	YT-38872	48	YT-4190	186	YT-43490	185	YT-44111	192	YT-44622	184	YT-44766	182	YT-4516	161, 531	YT-47142	162
YT-3736	244, 302, 309	YT-38875	47	YT-4191	186	YT-4350	188	YT-44112	192	YT-44625	184	YT-44767	182	YT-4518	161, 531	YT-47143	162
YT-37364	244, 302, 309	YT-38881	48	YT-4192	186	YT-4351	188	YT-44113	192	YT-44626	184	YT-44768	182	YT-4519	161, 531	YT-47144	162
YT-37390	243	YT-38891	45	YT-41926	101, 195	YT-4352	188	YT-44120	192	YT-44627	184	YT-44769	182	YT-4520	161, 531	YT-47145	162
YT-37391	243	YT-38901	46	YT-41930	186	YT-4353	188	YT-44130	192	YT-44630	181	YT-44770	182	YT-4521	161, 531	YT-47146	162
YT-3740	243	YT-38911	43	YT-41931	186	YT-4354	188	YT-44135	244, 303, 310	YT-44631	181	YT-44772	182	YT-4522	161, 531	YT-47147	162
YT-37404	243	YT-38941	52	YT-41932	186	YT-4355	188	YT-44136	244, 303, 310	YT-44632	181	YT-44773	182	YT-45280	160, 532	YT-47148	162
YT-37420	320	YT-3895	404	YT-41933	186	YT-4356	188	YT-44150	291	YT-44633	181	YT-44774	182	YT-45281	160, 532	YT-47149	162
YT-37421	320	YT-38951	404	YT-41934	186	YT-4357	188	YT-44151	291	YT-44634	181	YT-44776	182	YT-45282	160, 532	YT-47150	162
YT-37430	320	YT-39009	54, 150	YT-41935	186	YT-4358	188	YT-44152	291	YT-44635	181	YT-44780	185	YT-4550	158	YT-47151	162
YT-37433	320	YT-39280	54	YT-41936	186	YT-4359	188	YT-44200	179	YT-44637	181	YT-44781	185	YT-4551	158	YT-47152	162
YT-37434	320	YT-39700	191	YT-41937	186	YT-4361	187	YT-44201	179	YT-44639	181	YT-44782	185	YT-4552	158	YT-47160	243
YT-37440	321	YT-39820	182	YT-41938	186	YT-4362	187	YT-44202	179	YT-44640	181	YT-44783	185	YT-4553	158	YT-47161	243
YT-37441	321	YT-40010	180	YT-41939	186	YT-4363	187	YT-44203	179	YT-44642	181	YT-44784	185	YT-4560	159	YT-47195	195
YT-37444	321	YT-40011	180	YT-41940	186	YT-4364	187	YT-44204	179	YT-44643	181	YT-44785	185	YT-4561	159	YT-47197	195
YT-37450	321	YT-40012	180	YT-41941	186	YT-4367	187	YT-44205	179	YT-44645	181	YT-44786	185	YT-4562	159	YT-4720	193
YT-37470	328	YT-40013	180	YT-41942	186	YT-4369	187	YT-44206	179	YT-44650	181	YT-44787	185	YT-4563	159	YT-47200	193
YT-37490	622	YT-40014	180	YT-41943	186	YT-4370	187	YT-44207	179	YT-44652	181	YT-44789	185	YT-4564	159	YT-4721	193
YT-3801	29	YT-40015	180	YT-41944	186	YT-4375	187	YT-44208	179	YT-44653	181	YT-44820	182	YT-4570	159	YT-47212	193
YT-3802	29	YT-40016	180	YT-41945	186	YT-4376	187	YT-44209	179	YT-44654	181	YT-44821	182	YT-4571	159	YT-4722	193
YT-3803	29	YT-40017	180	YT-41946	186	YT-4379	187	YT-44210	179	YT-44655	181	YT-44822	182	YT-4573	159	YT-4723	193
YT-3804	29	YT-40018	180	YT-41947	186	YT-4380	187	YT-44211	179	YT-44656	181	YT-44823	182	YT-4590	161, 531	YT-4730	165
YT-3805	29	YT-40019	180	YT-41948	186	YT-4383	187	YT-44212	179	YT-44657	181	YT-44824	182	YT-45905	160, 532	YT-47301	165
YT-3806	29	YT-40025	180	YT-41949	186	YT-4385	187	YT-44213	179	YT-44658	181	YT-44825	182	YT-4594	160	YT-47303	165
YT-3807	29	YT-40050	184	YT-41950	186	YT-4390	187	YT-44214	179	YT-44659	181	YT-44826	182	YT-4601	160	YT-47304	165
YT-3808	29	YT-4020	180	YT-419503	186	YT-43940	184	YT-44215	179	YT-44660	181	YT-44827	182	YT-4602	160	YT-47330	194
YT-3809	29	YT-4025	180	YT-419504	186	YT-43941	184	YT-44216	179	YT-44661	181	YT-44828	182	YT-4603	160	YT-47331	193
YT-3810	29	YT-4030	180	YT-419505	186	YT-43942	184	YT-44217	179	YT-44662	181	YT-44829	182	YT-4604	160	YT-47335	194
YT-3811	29	YT-4032	180	YT-419506	186	YT-43943	184	YT-44218	179	YT-44663	181	YT-44830	182	YT-4605	160	YT-47336	194
YT-3812	29	YT-4035	180	YT-41951	186	YT-43944	184	YT-44219	179	YT-44664	181	YT-44831	182	YT-46190	160, 532	YT-47340	194
YT-3813	29	YT-4040	180	YT-41952	186	YT-43945	184	YT-44220	179	YT-44666	181	YT-44840	199	YT-46191	160, 532	YT-47341	194
YT-3814	29	YT-4042	180	YT-41953	186	YT-43946	184	YT-44221	179	YT-44667	181	YT-44841	199	YT-4620	160, 532	YT-47344	194
YT-3820	29	YT-4045	180	YT-41954	186	YT-43947	184	YT-44222	179	YT-44668	181	YT-44842	199	YT-4622	160, 532	YT-47345	194
YT-3821	29	YT-4048	180	YT-41955	186	YT-43948	184	YT-44223	179	YT-44673	183	YT-44843	199	YT-4623	160, 532	YT-47348	194
YT-3822	29	YT-4050	180	YT-41956	186	YT-43949	184	YT-44224	179	YT-44674	183	YT-44845	199	YT-4624	160, 532	YT-47370	195
YT-3823	29	YT-4052	180	YT-41957	186	YT-43960	184	YT-44225	179	YT-44675	183	YT-44847	199	YT-4625	160, 532	YT-47372	195
YT-3824	29	YT-4055	180	YT-41958	186	YT-43962	184	YT-44226	179								

YATO	page/strona	YATO	page/strona	YATO	page/strona	YATO	page/strona	YATO	page/strona	YATO	page/strona	YATO	page/strona	YATO	page/strona	YATO	page/strona
YT-4759	237	YT-5204	312	YT-54543	318	YT-55381	398	YT-59170	215	YT-60480	212	YT-6112	213	YT-62258	250	YT-63703	234, 276
YT-47593	237	YT-5207	312	YT-54544	318	YT-5539	396	YT-59175	215	YT-60482	212	YT-6113	213	YT-62259	250	YT-63704	234, 276
YT-4761	237	YT-5209	312	YT-54550	318	YT-55391	398	YT-59176	215	YT-60484	212	YT-61132	213	YT-6226	250	YT-63705	234, 276
YT-47612	237	YT-5210	312	YT-54551	318	YT-5540	396	YT-59177	215	YT-60488	211	YT-6116	213	YT-62261	250	YT-63740	234, 276
YT-4763	237	YT-5212	312	YT-54552	318	YT-55401	398	YT-5920	213	YT-60489	211	YT-6120	213	YT-62268	250	YT-63951	170
YT-4764	237	YT-5214	313	YT-54553	318	YT-5541	395	YT-5923	213	YT-6050	211	YT-6121	214	YT-62269	250	YT-63952	170
YT-47658	238	YT-5218	315	YT-54554	318	YT-55411	398	YT-5924	213	YT-6052	211	YT-6124	214	YT-6227	250	YT-63953	170
YT-4766	238	YT-5220	311	YT-54560	318	YT-5542	395	YT-5925	213	YT-60522	211	YT-6125	214	YT-62271	250	YT-63954	170
YT-4767	238	YT-52221	311	YT-54561	318	YT-55421	398	YT-5927	213	YT-6053	211	YT-6126	214	YT-6228	250	YT-63955	170
YT-4768	238	YT-52222	311	YT-54562	318	YT-5543	392	YT-5930	214	YT-60533	211	YT-6132	214	YT-6229	250	YT-63956	170
YT-4769	238	YT-52223	311	YT-54563	318	YT-55443	393	YT-5932	214	YT-6055	211	YT-6133	214	YT-6230	250	YT-63957	170
YT-47691	238	YT-52230	311	YT-54564	318	YT-55444	394	YT-5933	214	YT-6056	211	YT-6136	213	YT-6231	250	YT-63958	170
YT-47695	233	YT-52231	311	YT-54580	318	YT-55451	396	YT-5935	214	YT-6057	211	YT-6137	213	YT-6232	250	YT-6401	170
YT-47696	233	YT-52232	311	YT-54581	318	YT-55453	396	YT-5947	214	YT-60577	211	YT-61395	254	YT-62328	250	YT-6402	170
YT-47697	233	YT-52233	311	YT-54582	318	YT-55455	394	YT-59951	209	YT-6058	211	YT-6140	252	YT-62329	250	YT-6403	170
YT-47698	233	YT-52237	311	YT-54583	318	YT-55456	393	YT-59952	209	YT-60581	211	YT-6147	252	YT-6233	250	YT-6404	170
YT-4770	214	YT-52240	312	YT-54590	318	YT-55457	396	YT-59955	209	YT-60582	211	YT-6152	252	YT-62331	250	YT-6405	170
YT-47777	238	YT-52241	312	YT-54591	318	YT-55458	395	YT-59961	209	YT-60583	211	YT-6156	253	YT-62338	250	YT-6406	170
YT-47780	236	YT-52242	312	YT-54592	318	YT-55462	395	YT-59962	209	YT-60590	211	YT-6160	252	YT-62339	250	YT-6407	170
YT-47782	236	YT-52243	312	YT-54593	318	YT-55463	393	YT-59965	209	YT-60591	211	YT-6163	252	YT-6234	250	YT-6408	170
YT-47785	238	YT-52245	311	YT-54620	318	YT-55464	394	YT-59971	209	YT-6060	211	YT-6164	252	YT-62341	250	YT-6409	170
YT-47787	238	YT-52246	311	YT-54621	318	YT-55465	397	YT-59972	209	YT-6061	211	YT-6165	252	YT-62348	250	YT-6410	170
YT-47791	237	YT-52247	311	YT-54622	318	YT-55466	397	YT-59975	209	YT-6062	211	YT-61678	254	YT-62349	250	YT-64111	170
YT-47792	237	YT-5226	315	YT-54640	319	YT-55469	394	YT-59981	209	YT-60621	211	YT-61679	254	YT-6235	250	YT-64112	170
YT-47800	237	YT-5228	315	YT-54641	319	YT-55471	397	YT-59982	209	YT-60622	211	YT-61680	255	YT-62351	250	YT-64113	170
YT-47801	237	YT-5230	315	YT-54642	319	YT-55472	393	YT-59985	209	YT-60625	212	YT-61681	255	YT-62358	250	YT-6412	170
YT-47802	237	YT-5234	315	YT-54650	319	YT-55473	393	YT-60003	209	YT-60627	212	YT-61700	204	YT-62359	250	YT-6413	170
YT-47820	238	YT-5237	315	YT-54651	319	YT-55474	396	YT-60004	209	YT-60628	212	YT-61701	204	YT-6236	250	YT-6414	170
YT-4901	9	YT-5240	315	YT-54652	319	YT-55476	397	YT-6002	209	YT-6063	211	YT-61702	204	YT-6237	250	YT-6415	170
YT-4902	9	YT-5242	315	YT-54670	319	YT-55477	397	YT-6003	209	YT-60631	212	YT-61703	204	YT-6238	250	YT-6416	170
YT-4903	9	YT-5243	315	YT-54730	319	YT-55478	397	YT-6004	209	YT-60633	211	YT-61704	204	YT-6239	250	YT-6417	170
YT-4904	9	YT-5245	315	YT-54740	319	YT-55479	398	YT-6005	209	YT-60634	211	YT-61705	204	YT-6241	161	YT-6418	171
YT-4905	9	YT-5247	316	YT-54741	319	YT-55480	279, 394	YT-6012	209	YT-60635	211	YT-61706	204	YT-6242	161	YT-64184	171
YT-4906	9	YT-52471	315	YT-54742	319	YT-55481	279, 394	YT-6013	209	YT-60636	211	YT-61707	204	YT-6243	161	YT-64190	171
YT-4907	9	YT-52472	316	YT-54743	319	YT-55500	502	YT-6014	209	YT-6065	211	YT-61711	204	YT-6244	161	YT-64191	171
YT-4908	9	YT-52473	316	YT-54744	319	YT-55503	502	YT-6015	209	YT-60652	211	YT-61712	205	YT-6245	161	YT-64192	171
YT-4909	9	YT-52550	242	YT-54750	309	YT-55510	502	YT-6016	209	YT-6066	211	YT-61714	204	YT-6246	161	YT-6420	171
YT-4910	9	YT-5260	310	YT-54895	330	YT-55511	502	YT-6017	209	YT-60665	211	YT-61715	204	YT-6247	161	YT-6421	171
YT-4911	9	YT-5261	310	YT-5490	330	YT-55512	503	YT-6022	209	YT-6067	211	YT-61716	204	YT-6248	161	YT-6422	171
YT-4912	9	YT-5262	310	YT-5491	330	YT-55513	503	YT-6023	209	YT-6068	211	YT-61717	204	YT-6249	161	YT-6423	171
YT-4937	17	YT-52621	310	YT-5492	330	YT-5555	369	YT-6024	209	YT-60682	211	YT-61718	204	YT-6251	161	YT-6424	171
YT-4945	17	YT-52622	291	YT-5493	330	YT-55556	511	YT-6025	209	YT-60685	211	YT-61719	204	YT-6253	161	YT-64242	171
YT-5038	12	YT-52740	311	YT-5494	330	YT-55557	511	YT-6030	210	YT-60686	211	YT-61722	205	YT-6256	161	YT-64250	171
YT-5130	122, 534	YT-52760	311	YT-54952	330	YT-55565	512	YT-6032	210	YT-60687	211	YT-61723	205	YT-6258	161	YT-64251	171
YT-51303	123, 534	YT-52780	310	YT-54953	330	YT-55567	512	YT-60322	210	YT-6070	211	YT-61724	205	YT-6260	161	YT-64252	171
YT-5131	123, 534	YT-52788	249	YT-5496	330	YT-55568	512	YT-60323	210	YT-6071	211	YT-61725	205	YT-6280	161	YT-64253	171
YT-51311	123, 534	YT-52790	312	YT-5497	331	YT-55570	512	YT-60371	210	YT-6072	211	YT-61726	205	YT-6281	162	YT-64254	171
YT-51312	123, 534	YT-52840	248	YT-5499	331	YT-55580	511	YT-60372	210	YT-60731	211	YT-61727	205	YT-62821	161	YT-64255	171
YT-51320	123, 535	YT-52841	248	YT-5500	331	YT-55581	511	YT-60373	210	YT-60732	211	YT-61729	205	YT-62822	161	YT-64256	171
YT-5140	123, 534	YT-52843	248	YT-5501	331	YT-55582	511	YT-60374	210	YT-60733	211	YT-6180	250	YT-62823	161	YT-64257	171
YT-5141	123, 534	YT-52850	249	YT-5502	331	YT-55600	510	YT-60375	210	YT-6075	211	YT-6181	250	YT-62824	161	YT-64258	171
YT-5142	123, 534	YT-52860	249	YT-55027	331	YT-55601	510	YT-60376	210	YT-6076	211	YT-6182	250	YT-62825	161	YT-64262	171
YT-51450	286, 322	YT-52863	249	YT-5503	331	YT-55670	501	YT-60377	210	YT-6077	211	YT-6183	250	YT-62826	161	YT-64263	171
YT-51451	286, 322	YT-52870	311	YT-55033	331	YT-55690	496	YT-60378	210	YT-6078	211	YT-6184	250	YT-62827	161	YT-64270	170
YT-51452	285, 322	YT-52871	311	YT-5504	331	YT-55808	510	YT-60379	210	YT-60782	211	YT-6185	250	YT-62828	161	YT-64271	170
YT-51470	288	YT-5400	327	YT-5505	331	YT-55840	368, 510	YT-60401	190	YT-60783	211	YT-6186	250	YT-62900	249	YT-64272	170
YT-51471	288	YT-5402	327	YT-55052	331	YT-55844	369, 510	YT-60402	190	YT-60784	211	YT-6187	250	YT-62907	249	YT-64275	170
YT-51880	312	YT-5404	327	YT-5506	331	YT-55845	369, 510	YT-60403	190	YT-60785	211	YT-6188	250	YT-6330	233	YT-64276	170
YT-51881	312	YT-5405	327	YT-5507	331	YT-5710	243	YT-60409	190	YT-60791	211	YT-6189	250	YT-6331	233	YT-64277	170
YT-51900	313	YT-5410	327	YT-55073	331	YT-5835	105	YT-60421	190	YT-60792	211	YT-6190	250	YT-6332	233	YT-64278	170
YT-51901	313	YT-5415	327, 541	YT-5508	331	YT-5837	105	YT-60422	190	YT-60794	211	YT-6191	250	YT-6333	233	YT-64300	171
YT-51902	313	YT-5416	327, 541	YT-55210	392	YT-5838	105	YT-60423	190	YT-60795	211	YT-6192	250	YT-6334	233	YT-6440	170
YT-51903	313	YT-5417	327, 541	YT-55290	388	YT-58950	508	YT-60424	190	YT-6080	211	YT-6193	250	YT-6335	233	YT-6441	170
YT-51904	314	YT-54230	327	YT-55293	384	YT-58951	508	YT-60425	190	YT-6081	211	YT-6194	250	YT-6336	233	YT-6442	170
YT-51905	314	YT-54233	327	YT-55299	391	YT-58953	508	YT-60426	190	YT-6082	211	YT-6219	254	YT-6337	233	YT-6443	170
YT-51906	314	YT-54300	317	YT-5530	385	YT-58954	508	YT-60427	190	YT-6083	211	YT-6220	254	YT-6338	233	YT-6444	170
YT-51907	314	YT-54310	317														

YATO	page/strona	YATO	page/strona	YATO	page/strona	YATO	page/strona	YATO	page/strona	YATO	page/strona	YATO	page/strona	YATO	page/strona	YATO	page/strona
YT-80158	643	YT-80460	638	YT-80626	639	YT-80915	648	YT-81595	150	YT-82181	571	YT-82532	148, 298	YT-82837	565, 596, 687	YT-83165	256
YT-80159	643	YT-80461	638	YT-80627	639	YT-80916	648	YT-8165	149	YT-82185	571	YT-82540	148, 298	YT-82842	566, 599, 689	YT-83166	256
YT-80160	643	YT-80462	638	YT-80628	639	YT-80917	648	YT-81651	149	YT-82187	558	YT-82541	148, 298	YT-82843	566, 599, 689	YT-83167	256
YT-80161	643	YT-80463	638	YT-80629	639	YT-80924	643	YT-81652	150	YT-82188	558	YT-82542	148, 298	YT-82844	566, 599, 689	YT-83168	256
YT-80162	643	YT-80464	638	YT-80630	639	YT-80925	643	YT-81654	150	YT-82189	224	YT-82550	580	YT-82845	566, 599, 689	YT-83169	256
YT-80163	643	YT-80465	638	YT-80631	639	YT-80926	643	YT-81655	150	YT-82190	328, 584	YT-82553	580	YT-82846	566, 599, 689	YT-83170	256
YT-80164	645	YT-80466	638	YT-80632	639	YT-80927	643	YT-8166	149	YT-82196	571	YT-82560	581	YT-82847	566, 599, 689	YT-83171	256
YT-80165	645	YT-80467	638	YT-80633	639	YT-80928	643	YT-8173	150	YT-82200	571	YT-82562	581	YT-82848	566, 599, 689	YT-83172	256
YT-80166	645	YT-80468	638	YT-80634	639	YT-80929	643	YT-8174	149	YT-82206	579	YT-82563	581	YT-82849	566, 599, 689	YT-83173	256
YT-80167	645	YT-80469	638	YT-80635	639	YT-80930	643	YT-8177	149	YT-82207	579	YT-82564	581	YT-82850	566, 599, 689	YT-83174	256
YT-80168	645	YT-80470	638	YT-80636	639	YT-80931	643	YT-81775	652	YT-82220	582	YT-82565	581	YT-82851	566, 599, 689	YT-83175	256
YT-80169	645	YT-80471	638	YT-80637	639	YT-80932	643	YT-81808	483, 655	YT-82223	582	YT-82566	581	YT-82852	566, 599, 689	YT-83176	256
YT-80170	647	YT-80488	639	YT-80638	639	YT-80933	643	YT-81809	483, 655	YT-82230	579	YT-82567	581	YT-82853	566, 599, 689	YT-83177	256
YT-80171	647	YT-80489	639	YT-80639	639	YT-80934	643	YT-81811	653	YT-82234	579	YT-82568	581	YT-82854	566, 599, 689	YT-83178	256
YT-80172	647	YT-80490	639	YT-80640	639	YT-80935	643	YT-818151	653	YT-82240	578	YT-82569	581	YT-82855	566, 599, 689	YT-83179	256
YT-80173	647	YT-80491	639	YT-80701	640	YT-80936	643	YT-818171	653	YT-82250	273, 591	YT-82570	581	YT-82856	566, 599, 689	YT-83180	256
YT-80174	647	YT-80492	639	YT-80702	640	YT-80937	643	YT-81819	483, 654	YT-82273	577	YT-82571	581	YT-82857	566, 599, 689	YT-83181	256
YT-80175	647	YT-80493	639	YT-80703	640	YT-80938	643	YT-81820	483, 654	YT-82274	577	YT-82572	145, 298, 589	YT-82858	566, 599, 689	YT-83182	256
YT-80176	643	YT-80494	639	YT-80704	640	YT-80939	643	YT-81821	483, 654	YT-82281	578	YT-82573	145, 298, 589	YT-82859	566, 599, 689	YT-83183	256
YT-80177	643	YT-80495	639	YT-80705	640	YT-80940	643	YT-818221	653	YT-82285	553, 585	YT-82574	145, 298, 589	YT-82860	566, 599, 689	YT-83184	256
YT-80178	643	YT-80496	639	YT-80706	640	YT-80941	643	YT-818231	653	YT-82288	585	YT-82575	145, 298, 589	YT-82861	566, 599, 689	YT-83185	256
YT-80179	643	YT-80497	639	YT-80707	640	YT-80950	642	YT-818241	653	YT-82291	585	YT-82576	145, 298, 589	YT-82862	566, 599, 689	YT-83186	256
YT-80180	643	YT-80498	639	YT-80708	640	YT-80951	642	YT-818251	653	YT-82292	585	YT-82577	149, 298	YT-82863	566, 599, 689	YT-83187	256
YT-80181	643	YT-80499	639	YT-80709	640	YT-80952	642	YT-818381	653	YT-82293	585	YT-82578	149, 298	YT-82864	566, 599, 689	YT-83188	256
YT-80182	645	YT-80500	639	YT-80733	639	YT-80953	642	YT-818391	653	YT-82294	585	YT-82579	149, 298	YT-82865	566, 599, 689	YT-83189	256
YT-80183	645	YT-80501	639	YT-80734	639	YT-80954	642	YT-81844	652	YT-82295	586	YT-82580	559	YT-82866	566, 599, 689	YT-83190	256
YT-80184	645	YT-80502	639	YT-80735	639	YT-80955	646	YT-81846	652	YT-82296	586	YT-82581	559	YT-82867	566, 599, 689	YT-83191	256
YT-80185	645	YT-80503	639	YT-80736	639	YT-80956	646	YT-81848	652	YT-82301	586	YT-82582	559	YT-82868	566, 599, 689	YT-83192	256
YT-80186	645	YT-80504	639	YT-80737	639	YT-80957	646	YT-81855	655	YT-82303	301	YT-82583	559	YT-82869	566, 599, 689	YT-83193	256
YT-80187	645	YT-80505	639	YT-80738	639	YT-80958	646	YT-81856	655	YT-82304	301	YT-82584	559	YT-82870	566, 599, 689	YT-83194	256
YT-80188	647	YT-80506	639	YT-80739	639	YT-80959	646	YT-81860	655	YT-82305	302	YT-82585	560	YT-82871	569	YT-83195	256
YT-80189	647	YT-80507	639	YT-80740	639	YT-80960	648	YT-81880	655	YT-82306	302	YT-82586	560	YT-82872	569	YT-83196	256
YT-80190	647	YT-80508	639	YT-80741	639	YT-80961	648	YT-81900	652	YT-82307	302	YT-82587	560	YT-82873	569	YT-83197	256
YT-80191	647	YT-80509	639	YT-80783	640	YT-80962	648	YT-81901	652	YT-82320	584	YT-82588	560	YT-82874	569	YT-83198	256
YT-80192	647	YT-80510	639	YT-80784	640	YT-80963	648	YT-81902	652	YT-82340	580	YT-82589	560	YT-82875	569	YT-83199	256
YT-80193	647	YT-80511	639	YT-80785	640	YT-80964	648	YT-81903	652	YT-82341	579	YT-82590	560	YT-82876	569	YT-83200	256
YT-8020	642	YT-80512	639	YT-80786	640	YT-8100	329, 666	YT-81904	652	YT-82350	580	YT-82591	560	YT-82877	569	YT-83201	256
YT-8021	642	YT-80513	639	YT-80787	640	YT-8101	329, 666	YT-81953	579	YT-82353	260	YT-82592	560	YT-82878	569	YT-83202	256
YT-8022	642	YT-80514	639	YT-80788	640	YT-8102	329, 666	YT-81980	573	YT-82354	260	YT-82593	560	YT-82879	569	YT-83203	256
YT-8023	642	YT-80515	639	YT-80789	640	YT-81021	329, 666	YT-81983	573	YT-82355	260	YT-82594	560	YT-82880	569	YT-83204	256
YT-8024	642	YT-80516	639	YT-80790	640	YT-81022	329, 666	YT-82001	574	YT-82360	561	YT-82595	560	YT-82881	569	YT-83205	256
YT-8025	644	YT-80517	639	YT-80791	640	YT-81023	329, 666	YT-82002	574	YT-82361	561	YT-82596	560	YT-82882	569	YT-83206	256
YT-8026	644	YT-80521	638	YT-80794	640	YT-81024	329, 666	YT-82007	567	YT-82380	578	YT-82597	560	YT-82883	569	YT-83207	256
YT-8027	644	YT-80522	638	YT-80795	640	YT-81052	330, 667	YT-82015	570	YT-82390	578	YT-82598	560	YT-82884	569	YT-83208	256
YT-8028	644	YT-80523	638	YT-80796	640	YT-81053	330, 667	YT-82020	478, 567	YT-82401	144, 300, 591	YT-82599	560	YT-82885	569	YT-83209	256
YT-80280	642	YT-80524	638	YT-80797	640	YT-81054	330, 667	YT-82021	478, 567	YT-82402	144, 300, 591	YT-82600	560	YT-82886	569	YT-83210	256
YT-80281	642	YT-80525	638	YT-80798	640	YT-8106	330, 667	YT-82034	571	YT-82403	144, 300, 591	YT-82601	560	YT-82887	569	YT-83211	256
YT-80282	642	YT-80526	638	YT-80799	640	YT-8107	330, 667	YT-82036	572	YT-82430	301	YT-82602	560	YT-82888	569	YT-83212	256
YT-80283	642	YT-80527	638	YT-80800	640	YT-8108	330, 667	YT-82037	572	YT-82431	301	YT-82603	560	YT-82889	569	YT-83213	256
YT-80284	642	YT-80528	638	YT-80801	640	YT-8111	329, 667	YT-82044	572	YT-82433	301	YT-82604	560	YT-82890	569	YT-83214	256
YT-80285	645	YT-80529	638	YT-80802	640	YT-8112	329, 667	YT-82055	575	YT-82434	301	YT-82605	560	YT-82891	569	YT-83215	256
YT-80286	645	YT-80552	638	YT-80820	316	YT-8116	329, 667	YT-82060	572	YT-82435	301	YT-82606	560	YT-82892	569	YT-83216	256
YT-80287	645	YT-80553	638	YT-80841	640	YT-81162	329, 667	YT-82063	572	YT-82436	301	YT-82607	560	YT-82893	569	YT-83217	256
YT-80288	645	YT-80554	638	YT-80842	640	YT-8120	330, 667	YT-82071	572	YT-82437	301	YT-82608	560	YT-82894	569	YT-83218	256
YT-80289	645	YT-80555	638	YT-80843	640	YT-81220	508, 667	YT-82080	567	YT-82438	301	YT-82609	560	YT-82895	569	YT-83219	256
YT-8029	644	YT-80556	638	YT-80844	640	YT-81221	508	YT-82097	568	YT-82439	301	YT-82610	560	YT-82896	569	YT-83220	256
YT-80290	646	YT-80557	638	YT-80845	640	YT-81240	329, 667	YT-82098	568	YT-82440	301	YT-82611	560	YT-82897	569	YT-83221	256
YT-80291	646	YT-80558	638	YT-80846	640	YT-81241	329, 667	YT-82099	568	YT-82441	301	YT-82612	560	YT-82898	569	YT-83222	256
YT-80292	646	YT-80559	638	YT-80847	640	YT-81242	329, 667	YT-82100	568	YT-82442	301	YT-82613	560	YT-82899	569	YT-83223	256
YT-80293	646	YT-80560	638	YT-80848	640	YT-81300	666	YT-82101	568	YT-82443	301	YT-82614	560	YT-82900	569	YT-83224	256
YT-80294	646	YT-80572	638	YT-80849	640	YT-81301	666	YT-82104	568	YT-82444	301	YT-82615	560	YT-82901	569	YT-83225	256
YT-8030	646	YT-80573	638	YT-80881	640	YT-81302	666	YT-82105	569	YT-82445	301	YT-82616	560	YT-82902	569	YT-83226	256
YT-8031	646	YT-80574	638	YT-80882	640	YT-81440	146,										

Memo





REG-992
Display rack for REG-707 for pipe wrenches YATO /
Ekspozytor do REG-707 na klucze do rur YATO



REG-994
Display rack for REG-707 for YATO bits /
Ekspozytor do REG-707 na nasadki YATO



REG-994P
Display rack with the lid for REG-707 for YATO bits /
Ekspozytor z pokrywą do REG-707 na nasadki YATO



REG-998
Display rack for REG-707 for YATO hammers /
Ekspozytor do REG-707 na młotki YATO



REG-993
Display rack for REG-707 for YATO pneumatic tools /
Ekspozytor do REG-707 na narzędzia pneumatyczne YATO



REG-951
Display for carpentry clamps /
Ekspozytor na ściski stolarskie



REG-804
Tag for YATO shoes / Zawieszka na buty YATO



REG-991
Display rack for REG-707 for YATO disc saws /
Ekspozytor do REG-707 na piły tarczowe YATO



REG-952
Display for the disc for disc cutters /
Ekspozytor na tarcze do szlifierek kątowych



REG-761
Hook for axes / Wieszak na siekiery



REG-930
Display for YATO buck saws /
Ekspozytor na piły kabłąkowe YATO



REG-868
Hook 30 cm for trowels / Hak 30 cm na kielnie



REG-144
Pendant for wall mounted faucet FALA /
Zawieszka na baterię ścienną FALA



REG-145
Pendant for deck mounted faucet FALA /
Zawieszka na baterię stojącą FALA



REG-909
Display stand for FLO garden tools /
Ekspozytor na narzędzia ogrodowe FLO



REG-911
Pallet display for garden tools /
Ekspozytor paletowy na narzędzia ogrodnicze



REG-799
Display stand VOREL /
Display ekspozycyjny VOREL



REG-902
Standing display for YATO sockets /
Ekspozytor stojący na nasadki YATO



REG-807
Display box for STHOR drill bits /
Ekspozytor skrzynka na wiertła STHOR



REG-604
Wall-stand display rack YATO /
Ekspozytor stojąco-wiszący YATO



REG-605
Waterfall display rack YATO /
Ekspozytor kaskadowy YATO



REG-705
Advertising wobler YATO /
Wobler reklamowy YATO



REG-803
YATO wrench tester /
Tester kluczy YATO



REG-711
Rack shelf for REG-707 YATO /
Półka do REG-707 YATO



REG-992
Display rack for REG-707 for pipe wrenches YATO /
Ekspozytor do REG-707 na klucze do rur YATO



REG-994
Display rack for REG-707 for YATO bits /
Ekspozytor do REG-707 na nasadki YATO



REG-994P
Display rack with the lid for REG-707 for YATO bits /
Ekspozytor z pokrywą do REG-707 na nasadki YATO



REG-998
Display rack for REG-707 for YATO hammers /
Ekspozytor do REG-707 na młotki YATO



REG-993
Display rack for REG-707 for YATO pneumatic tools /
Ekspozytor do REG-707 na narzędzia pneumatyczne YATO



REG-951
Display for carpentry clamps /
Ekspozytor na ściski stolarskie



REG-804
Tag for YATO shoes / Zawieszka na buty YATO



REG-991
Display rack for REG-707 for YATO disc saws /
Ekspozytor do REG-707 na piły tarczowe YATO



REG-952
Display for the disc cutters /
Ekspozytor na tarcze do szlifierek kątowych



REG-761
Hook for axes / Wieszak na siekiery



REG-930
Display for YATO buck saws /
Ekspozytor na piły kabłąkowe YATO



REG-868
Hook 30 cm for trowels / Hak 30 cm na kielnie



REG-144
Pendant for wall mounted faucet FALA /
Zawieszka na baterię ścienną FALA



REG-145
Pendant for deck mounted faucet FALA /
Zawieszka na baterię stojącą FALA



REG-909
Display stand for FLO garden tools /
Ekspozytor na narzędzia ogrodowe FLO



REG-911
Pallet display for garden tools /
Ekspozytor paletowy na narzędzia ogrodnicze



REG-799
Display stand VOREL /
Display ekspozycyjny VOREL



REG-902
Standing display for YATO sockets /
Ekspozytor stojący na nasadki YATO



REG-807
Display box for STHOR drill bits /
Ekspozytor skrzynka na wiertła STHOR



REG-604
Wall-stand display rack YATO /
Ekspozytor stojąco-wiszący YATO



REG-605
Waterfall display rack YATO /
Ekspozytor kaskadowy YATO

REG-705
Advertising wobler YATO /
Wobler reklamowy YATO

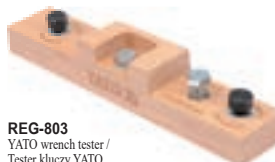

REG-803
YATO wrench tester /
Tester kluczy YATO



REG-711
Rack shelf for REG-707 YATO /
Półka do REG-707 YATO

PL

I. TOYA S.A. informuje, iż: 1) niniejszy katalog nie stanowi oferty w rozumieniu prawa cywilnego; 2) prezentowane w niniejszym katalogu artykuły mogą w rzeczywistości odbiegać od wskazanego na zdjęciach wzoru, w szczególności jeżeli chodzi o cechy zewnętrzne, tj. wielkość, kolor, sposób opakowania, liczbę przedmiotów w opakowaniu; 3) nie ponosi odpowiedzialności za drobne różnice w sposobie pakowania czy właściwościach artykułów pozostających bez wpływu na jego przeznaczony cel lub sposób użytkowania; 4) nie ponosi odpowiedzialności wynikającej z jakichkolwiek niedokładności lub nieścisłości, co do informacji zawartych w przedmiotowym katalogu; 5) nie ponosi odpowiedzialności za ewentualną szkodę powstałą w wyniku otrzymania towaru o innych właściwościach niż prezentowany na zdjęciach.

II. Pomimo najlepszych starań poczynionych przez TOYA S.A. nie może ona zagwarantować, iż informacje zawarte w niniejszym katalogu w pełni odpowiadają rzeczywistości.

III. Wszelkie decyzje podjęte na podstawie informacji zawartych w przedmiotowym katalogu podejmowane są na własne ryzyko osoby, która korzysta z tych informacji.

GB

I. TOYA S.A. informs that: 1) the present catalogue does not constitute an offer as construed in the civil law; 2) the goods presented in the present catalogue may in fact differ from the models shown in the pictures, particularly as far as external properties are concerned, namely size, colour, packaging, number of items in the package; 3) the company will not be held responsible for small differences in packaging or properties of the goods, which do not affect the purpose or the exploitation of the tools; 4) the company will not be held responsible for any inaccuracies or imprecision regarding the information presented in the catalogue; 5) the company will not be held responsible for any damage caused by goods whose properties differ from those of the tools presented in the photographs.

II. In spite of all the efforts made by TOYA S.A., the company cannot guarantee the information contained in the present catalogue fully correspond to the reality.

III. Any decisions made on the basis of the information contained in the present catalogue will be made at the risk of the person who makes them using the aforementioned information.

D

I. TOYA S.A. informiert, dass: 1) der vorliegende Katalog kein Angebot im zivilrechtlichen Sinne darstellt; 2) die im vorliegenden Katalog präsentierten Artikel in der Realität von den auf den Musterfotos gezeigten abweichen können, und zwar besonders dann, wenn es um äußere Eigenschaften geht, wie z.B. Größe, Farbe, Art der Verpackung, Anzahl der Gegenstände in der Verpackung; 3) sie keine Verantwortung für geringfügige Unterschiede bei der Verpackungsart oder den Eigenschaften der Artikel übernimmt, die ohne Auswirkungen auf seinen Bestimmungszweck oder die Art der Nutzung bleiben; 4) sie keine Verantwortung für irgendwelche Oberflächlichkeiten und Ungenauigkeiten bzgl. der im Sachkatalog enthaltene Informationen übernimmt; 5) sie keine Verantwortung für eventuelle Schäden, die im Ergebnis des Erhalts der Ware mit anderen als auf den Fotos dargestellten Eigenschaften entstanden sind, übernimmt.

II. Trotz großer Bemühungen seitens TOYA S.A. kann die Firma nicht garantieren, dass die im vorliegenden Katalog enthaltenen Informationen voll der Realität entsprechen.

III. Sämtliche Entscheidungen, die auf der Grundlage der im Sachkatalog enthaltenen Informationen getroffen wurden, gehen auf das Risiko der Person, die diese Informationen benutzt.

RUS

I. TOYA S.A. заявляет: 1) настоящий каталог не является торговым предложением с точки зрения гражданского законодательства; 2) изделия, представленные в настоящем каталоге, могут отличаться от образцов на снимках, особенно внешним видом, то есть размером, цветом, способом упаковки, количеством предметов в упаковке; 3) производитель не отвечает за мелкие отличия в способе упаковки или свойствах изделий, которые не влияют на предназначение или способ пользования изделиями; 4) производитель не отвечает за мелкие неточности в сведениях из предметного каталога; 5) производитель не отвечает за ущерб, нанесенный вследствие поставки товара, отличающегося параметрами от указанного на снимках.

II. Несмотря на все усилия в данном направлении, компания TOYA S.A. не гарантирует, что информация, метящаяся в настоящем каталоге, полностью отвечает действительности.

III. Риск, связанный с любыми решениями, принятыми на основании информации из предметного каталога, берут на себя лица, пользующиеся указанной информацией.

CZ

I. TOYA S.A. informuje že: 1) tento katalog nepředstavuje nabídku ve smyslu občanského práva; 2) výrobky prezentované v tomto katalogu se mohou ve skutečnosti lišit od modelů uvedených na obrázcích, zejména co se týká vnějších znaků, tj. velikosti, barvy, způsobu balení, počtu předmětů v balení; 3) nenese odpovědnost za drobné rozdíly ve způsobu balení nebo ve vlastnostech výrobků, které nemají zásadní vliv na jejich určený účel nebo způsob používání; 4) nenese odpovědnost vyplývající z jakýchkoli nepřesností co do informací uvedených v předmětném katalogu; 5) nenese odpovědnost za případné škody vzniklé v důsledku obdržení zboží s jinými vlastnostmi, než je uvedeno na obrázcích.

II. Navzdory mimořádnému úsilí vynaloženému firmou TOYA S.A. tato nemůže garantovat, zda informace uvedené v tomto katalogu zcela odpovídají skutečnosti.

III. Veškerá rozhodnutí přijatá na základě informací uvedených v předmětném katalogu jsou přijímána na vlastní riziko osoby, která tyto informace využívá.

H

I. A TOYA S.A. tájékoztatja, hogy: 1) a jelen katalógus a polgári jog szerint nem kereskedelmi ajánlat; 2) a jelen katalógusban bemutatott árucikkek a valóságban eltérhetnek a képeken látható mintáktól, különösen a külső tulajdonságok, mint a méret, szín, csomagolási mód, a csomagban lévő tárgyak száma tekintetében; 3) nem vállal felelősséget a csomagolás módjában vagy az árucikkek olyan tulajdonságaiban történt változtatásokért, amelyek nem befolyásolják lényeges módon annak rendeltetését vagy a felhasználás módját; 4) nem vállal felelősséget a jelen katalógusban lévő információk pontatlanságáért; 5) nem vállal felelősséget azokért az esetleges károkért, amik az áruknak a fényképeken látható tulajdonságoktól eltérő tulajdonságokkal történő leszállításából erednek.

II. A TOYA S.A. minden igyekezete ellenére nem tudja garantálni, hogy a jelen katalógusban található információk teljes egészében megfelelnek a valóságnak.

III. A tárgyi katalógusban található információk alapján meghozott bármilyen döntés annak a személynek a rizikója, aki ezeket az információkat felhasználja.

RO

I. TOYA S.A. informează că: 1) prezentul catalog nu constituie ofertă în înțelesul dreptului civil; 2) articolele prezentate în prezentul catalog se pot diferi față de mostrele din fotografiile, în special aspectul exterior, adică mărimea, culoarea, modul de ambalare, cantitatea obiectelor în ambalaj; 3) nu-și asumă răspunderea referitor la mici diferențe la modul de ambalare sau la articolele al căror proprietăți nu au influență referitor la destinația sau modul lor de utilizare; 4) nu-și asumă răspunderea referitor la orice inexactitate sau imprecizie, datorită informațiilor cuprinse în catalogul respectiv; 5) nu-și asumă răspunderea referitor la o eventuală pagubă ca urmare primirii marfei cu alte proprietăți decât cele prezentate pe fotografii.

II. Cu toate strădanile TOYA S.A., firma nu poate garanta că, informațiile din prezentul catalog corespund realității.

III. Orice decizie preluată în baza informațiilor cuprinse în catalogul respectiv, sunt preluate pe riscul și răspunderea persoanei care a făcut folos de aceste informații.

E

I. TOYA S.A. comunica lo siguiente: 1) el presente catálogo no constituye una oferta, en el sentido que la noción adquiere en la ley civil; 2) los artículos presentados en el presente catálogo pueden en realidad diferir de los modelos indicados en las fotografías, especialmente en cuanto a sus propiedades externas, es decir el tamaño, el color, el empaque o la cantidad de los objetos en el empaque; 3) la empresa no se hace responsable por pequeñas diferencias en cuanto al empaque o las propiedades de los artículos, siempre y cuando estas diferencias no afectan el propósito o el modo de operación de las herramientas; 4) la empresa no se hace responsable por ninguna imprecisión en cuanto a la información presentada en el presente catálogo; 5) la empresa no se hace responsable por ningún daño que surja del hecho de que los artículos recibidos difieran de los artículos presentados en las fotografías en cuanto a sus propiedades.

II. A pesar de los mejores intentos de parte TOYA S.A. la empresa no puede garantizar que la información presentada en el presente catálogo corresponda completamente a la realidad.

III. Todas las decisiones tomadas en base a la información presentada en el presente son responsabilidad de la persona que recurra a la dicha información.



MANUFACTURER / PRODUCENT

TOYA S.A.
ul. Sołtysowicka 13-15
51-168 Wrocław
Poland
☎ (+48 71) 32 46 200
fax: (+48 71) 32 46 370
sales@yato.pl (domestic)
export@yato.pl (export)
import@yato.pl (import)

ODDZIAŁ WARSZAWSKI
Teren ProLogis Park Nadarzyn
al. Kasztanowa 160
05-831 Młochów k. Warszawa
Poland
☎ (+48 22) 73 82 800
☎ (+48 22) 73 82 828
sales@yato.pl (domestic)
export@yato.pl (export)

TOYA ROMANIA S.A.
Șos. Stefănești, 8-8A
Stefăneștii De Jos, Ilfov
România
☎ (+40 031) 710 8692
office@yato.ro

YATO TOOLS (SHANGHAI) CO., LTD.
No. 1, Lane 1300,
East Kangqiao Road
Shanghai, China 201315
☎ (+86 21) 681 829 50
fax: (+86 21) 681 829 51
yato@yato-sh.com

YATO TOOLS (JIAXING) CO., LTD.
No.1033 Yan Hu Road,
Baibu Town, Haiyan County,
Jiaxing City, Zhejiang Province, China
☎ (+86 21) 681 829 50
yato@yato-sh.com

YOUR TRUSTED SUPPLIER: / TWÓJ ZAUFANY DOSTAWCA:



www.yato.com

GET ACQUAINTED WITH OUR WIDE OFFER:
ZOBACZ NASZĄ BOGATĄ OFERTĘ;

