

# iHome

AUTOVAC  
ECLIPSE PRO



For support content and the latest digital copy of this manual, scan the QR code above or visit [iHomeclean.com](http://iHomeclean.com)

**Owner's Guide**  
Model iHRV11



# TABLE OF CONTENTS

1	Safety
2	In The Box
3	Product Overview
4	Dustbin Overview
5	Auto Empty Base Overview
6	AUTOVAC Indicators
7	Auto Base Indicators
8 - 10	Setting Up The Auto Empty Base
11	Setting Up The AUTOVAC
12	Using the iHome Clean App
13	Using Your AUTOVAC
14	Using The Remote
15 - 17	Using Powermop Scrub
18	Main Brush Maintenance
19	Maintaining the Dustbin, Filters and Mop
20	Side Brush and Sensor Maintenance
21	Auto Empty Base Maintenance
22	AUTOVAC Eclipse Pro Troubleshoot
23	Auto Empty Base Troubleshoot

## Questions? Contact Customer Service

Web/Email: [iHomeclean.com](http://iHomeclean.com)

Phone: 877-370-4580

**Before using this product, please read the following safety instructions and follow all safety precautions. Any operation inconsistent with this instruction manual may cause damage to this product.**

**WARNING - To reduce the risk of fire, electric shock, or injury:**

- Do not use products in environments with open flames or fragile objects.
- Do not allow human hair, clothes, fingers and other parts to approach the opening and operate parts of the product.
- Do not allow the Eclipse Pro to pick up objects such as stones and waste paper that may clog product.
- Do not allow the Eclipse Pro to pick up flammable substances such as oil, printer toner and photocopier toner.
- Do not allow the Eclipse Pro to pick up any burning articles, such as cigarettes, matches, ashes and other articles that may cause fire.
- Do not place objects near the suction port. Do not use the product when the suction port is blocked. Clean up the garbage dust, wool, hair, etc to ensure smooth air circulation at the suction port.
- Use the power cord carefully to avoid damage. Do not use the power cord to drag or pull the product and the charging base. Do not use the power cord as a handle.
- Only authorized technicians can disassemble this product. Users are not recommended to disassemble this product by themselves. Doing so will void warranty.
- Only use the included power adapter. Third part adapters may damage the Eclipse Pro.
- Do not touch wires, sockets or power adapters when your hands are wet.
- Do not place this product near cigarette butts, lighters and other materials with smoldering fire.
- Please clean Dustbin and brushes regularly.
- Do not place any object, pets or people on top of the Eclipse Pro.
- This product is an indoor household product. Do not use outdoors.
- Do not use this product in wet environment i.e, bathroom.
- Before using this product, please clear the floor of all objects other than furniture as some small objects may obstruct, get caught in, or damage the Eclipse Pro.
- Please use and store Eclipse Pro in room temperature environments only.

## FCC Information

**1:** This device complies with Part 15 of the FCC Rules. Operation is subject to the following two conditions: (1) This device may not cause harmful interference, and (2) This device must accept any interference received, including interference that may cause undesired operation.

**2:** Changes or modifications not expressly approved by the party responsible for compliance could void the user's authority to operate the equipment.

**NOTE:** This equipment has been tested and found to comply with the limits for a Class B digital device, pursuant to Part 15 of the FCC Rules. These limits are designed to provide reasonable protection against harmful interference in a residential installation. This equipment generates uses and can radiate radio frequency energy and, if not installed and used in accordance with the instructions, may cause harmful interference to radio communications. However, there is no guarantee that interference will not occur in a particular installation. If this equipment does cause harmful interference to radio or television reception, which can be determined by turning the equipment off and on, the user is encouraged to try to correct the interference by one or more of the following measures: Reorient or relocate the receiving antenna. Increase the separation between the equipment and receiver. Connect the equipment into an outlet on a circuit different from that to which the receiver is connected. Consult the dealer or an experienced radio/TV technician for help.

1: Auto Empty Base

2: Powermop Scrub Attachment

3: Autovac Eclipse Pro

4: Extra Dust Bag

5: Power Cable

6: Remote

7: Extra HEPA Filter

8: Extra Mop Pad

9: Cleaning Tool

10: Extra Side Brush

11: Parking Plate



## Questions? Contact Customer Service

Web/Email: [iHomeclean.com](http://iHomeclean.com)

Phone: 877-370-4580

## FRONT

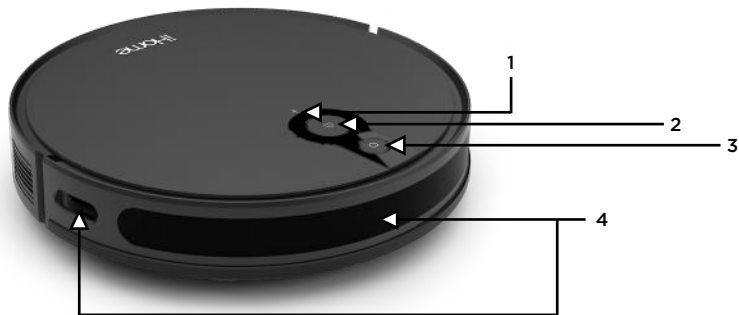

## BOTTOM

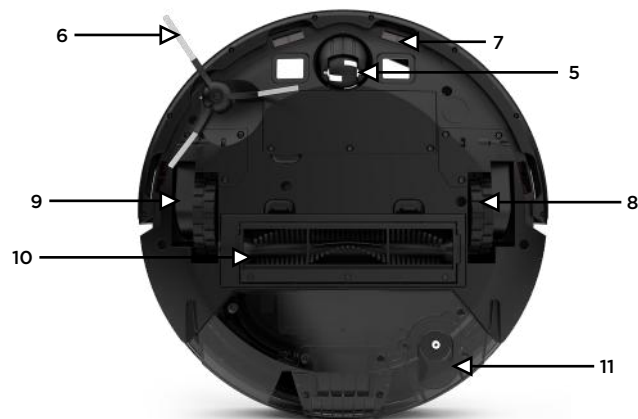

## BACK

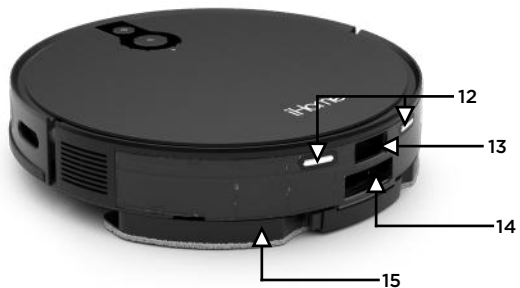

- 1: WiFi Indicator
- 2: Home Button
- 3: Power Button

- 4: Infrared Sensors
- 5: Omnidirectional Wheel
- 6: Side Brush

- 7: Detection Sensors
- 8: Right Wheel
- 9: Left Wheel

- 10: Main Brush
- 11: 2-IN-1 Dustbin/Mop Tank
- 12: Charging Contacts

- 13: Bin Release Button
- 14: Dust Collection Port
- 15: Powermop Scrub Attachment

- 1: Water Fill Cap
- 2: Filter Door Latch
- 3: Bin Release Button

- 4: Dust Collection Port
- 5: Screen Filter
- 6: HEPA Filter

- 7: Charging Contacts
- 8: Washable Mop Pad
- 9: Powermop Scrub Attachment

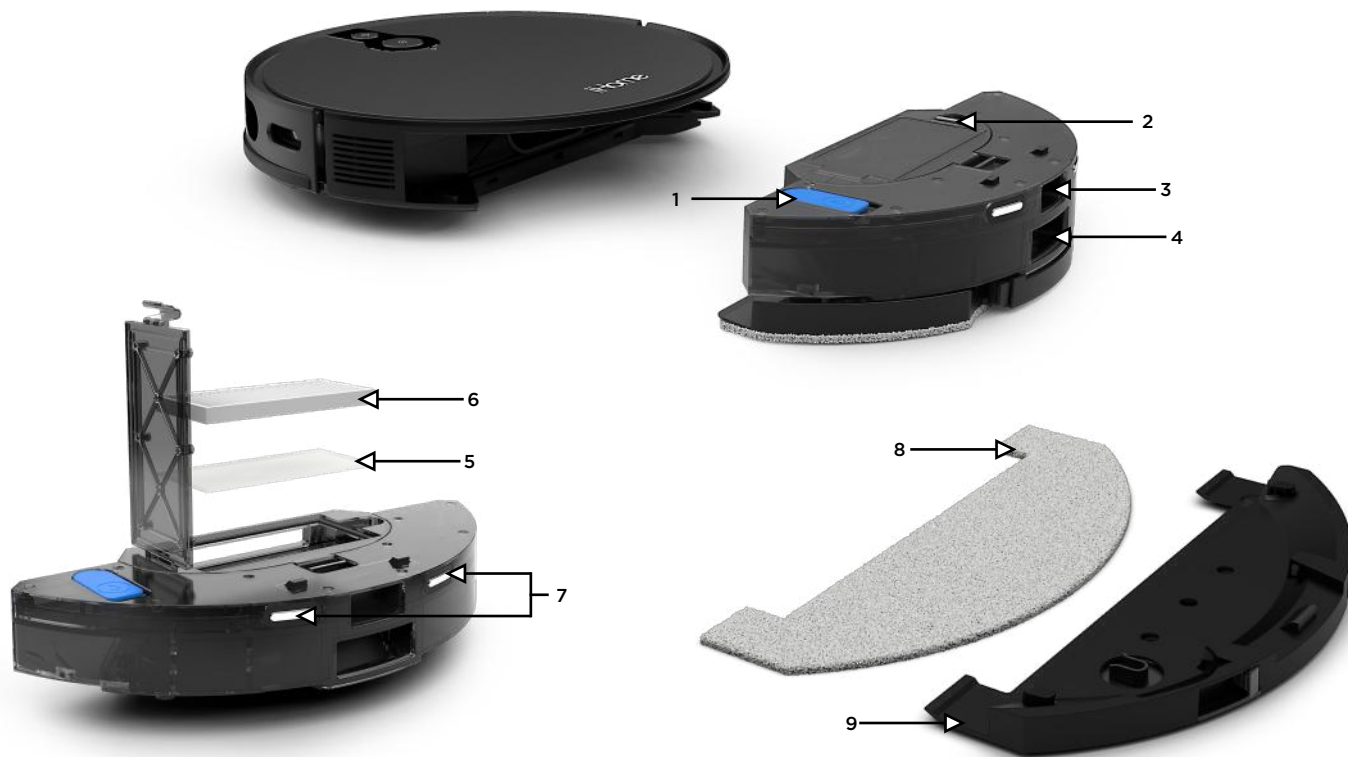

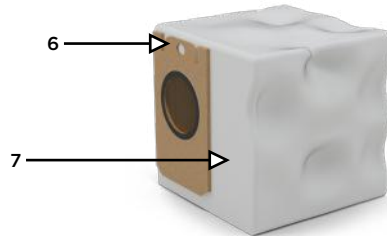
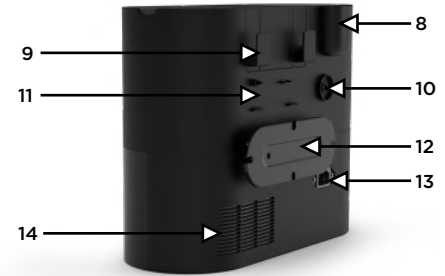
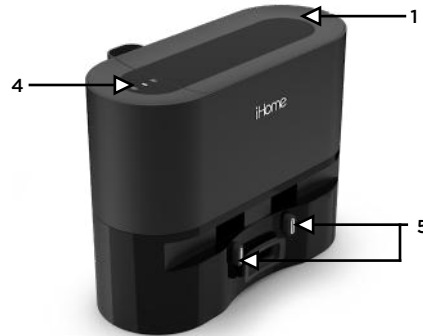

**NOTE:** One dustbag is already pre-installed in the Auto Empty Base. Dustbag may appear to be “deflated”. This is normal. The Dustbag handle must be fully lowered as shown in order for debris to enter properly.

- |                        |                            |                       |                              |                     |
|------------------------|----------------------------|-----------------------|------------------------------|---------------------|
| 1: Cover               | 4: LED Display Panel       | 7: Dust Bag           | 10: Extra Side Brush Storage | 13: Power Interface |
| 2: Dust Collector Port | 5: Charging Contact Points | 8: Remote Storage     | 11: Cleaning Tool Storage    | 14: Air Outlet      |
| 3: Parking Plate       | 6: Dust Bag Handle         | 9: Extra HEPA Storage | 12: Power Cord Organizer     |                     |

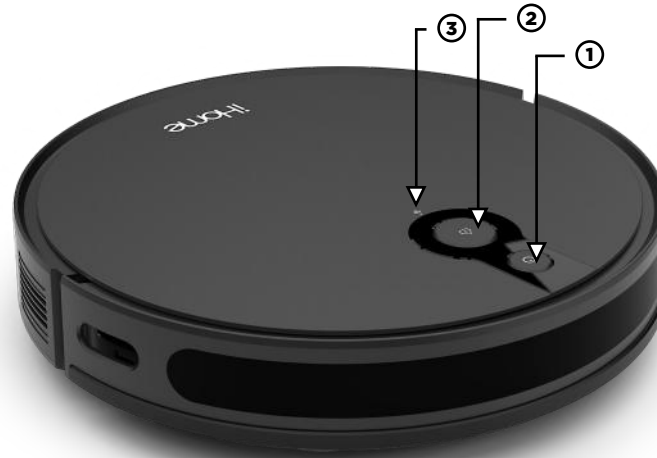

## ① POWER BUTTON

- Hold to turn on/off.
- Press to start/pause cleaning.

## ② HOME BUTTON

- Press to return to Auto Empty Base for recharging.

## ③ WIFI INDICATOR

## POWER/HOME LED STATES

- Flashing blue light: Powering on/configuring network/upgrading firmware.
- Solid blue light: Powered on/normal working state.
- Flashing yellow light: Low battery/recharging.
- Flashing green light: Charging.
- Solid green light: Fully charged.
- Flashing red light: Error state.
- Light off: Off/sleeping.

## WIFI INDICATOR STATES

- Flashing white light: Network configuration mode.
- Solid white light: Wifi connected.
- Light off: Wifi disconnected / Network configuration failure.



## ① DUST BAG STATUS



- Light off: Functioning Normally.
- Solid white light: Dust bag is full/dust duct is blocked.
- Flashing red light: Dust bag is not installed/dust bag is not installed correctly.

## ② ROBOT CHARGING STATUS



- Flashing green light: Charging
- Solid green light: Fully charged/standby.

## ③ DUST COLLECTION STATUS



- Light off: Standby.
- Solid white light: Collecting dust.
- Flashing red light: Fan overheating/fan error/cover not closed properly.



# SETTING UP YOUR AUTOVAC

---

The following pages outline the complete setup process. For your convenience we created a step-by-step video to help guide you through setup. Please scan the QR code to access the video and other support content.





## ABOUT YOUR AUTO EMPTY BASE

The Auto Empty Base is designed to automatically empty and charge the iHome AUTOVAC. Ensure that there is a clear space in front and both sides so that your AUTOVAC can return to Base to re-charge and empty. **We strongly recommend placement on a hard surface to ensure smooth parking.** Avoid placement on edges of carpet as that may become an obstacle for parking. Placement on low pile carpet can be attempted if necessary.

## PARKING PLATE ASSEMBLY

① Assemble the parking plate as shown in the picture.



② Please place the assembled parking plate on the horizontal ground.



- ③ Conveniently store parts and remote control as shown.



1: Remote. 2: Extra HEPA Filter 3: Cleaning Tool.  
4: Extra Side Brush. 5: Cord Wrap.

- ④ Plug the power cable into the back panel of the Auto Empty base. Wind extra cable slack around the cord management system.



- ⑤ Position the Auto Empty Base on the Parking Plate as shown. The four guide tabs on the parking plate will help align placement.



- ⑥ Plug the power cable into a functioning wall outlet.



**NOTE:** The Auto Empty Base must always remain connected to power. Avoid using a power source that may inadvertently be switched off (e.g. power strip, outlet controlled by a light switch, GFCI).



## STEP 1

Position the Eclipse Pro on the floor near your Auto Empty Base. To turn on Press and Hold the Power button until the indicator turns blue.



## STEP 2

Press the Home button to pair Eclipse Pro to your Auto Empty Base. Eclipse Pro will navigate and dock to the base for charging. **Allow Eclipse Pro to fully charge (up to 5 hours) before first use.** The indicators on your robot will turn solid green when fully charged.



**NOTE:** Dust collection may activate during initial docking. Do not be alarmed. Dust collection frequency can be adjusted later in the iHome Clean App.

## UNDERSTANDING YOUR ECLIPSE PRO

Your iHome Autovac is designed to automatically and methodically clean your home. Eclipse uses multiple sensors to clean your home efficiently, row by row. Cleaning history is available to view in the iHome Clean app. Once cleaning is finished the Eclipse Pro will automatically return to the Auto Empty Base to charge and automatically empty the contents of the dustbin.

## DOWNLOAD THE IHOME CLEAN APP

- Search “iHome Clean” in the App Store or use the QR code below:

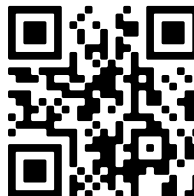

**NOTE: Connecting Eclipse to Wi-Fi is not required but highly recommended. Using the iHome Clean app, you can follow the steps to connect your Eclipse to Wi-Fi . The app will let you manage Eclipse from anywhere, set cleaning schedules, view cleaning history, access support and more!**

---

The iHome Clean app provides an easy step by step guide to get your Eclipse Pro connected to Wi-Fi. Here is a checklist of what you'll need before getting started:

- An iPhone (iOS 10 or later) OR Android (4.4 or later).
- Make sure that your phone is connected to your desired Wi-Fi Network. This will be the network that your Autovac Eclipse Pro connects to.
- Your Wi-Fi network must be a 2.4Ghz network (5Ghz networks are not supported).
- Download and launch the iHome Clean app from the app store. Create a user account.
- Follow the steps in the app to add the Eclipse Pro.

For your convenience we've created a video to walk through the App Setup process. Scan the QR code below to watch.



Before starting your first cleaning cycle please clear the floor of all objects other than furniture as some small objects may obstruct, get caught in, or damage the iHome Autovac Eclipse Pro.

## FIRST CLEANING

Simply press the Power button on your Eclipse Pro to begin an Auto-Clean cycle of your home. Eclipse Pro will start cleaning and will continue until it has covered the entire cleaning area. Once cleaning is finished, the Eclipse Pro will automatically return back to the Auto Empty Base to empty the dustbin.

## CLEANING MODES

**Auto Clean** - The Eclipse Pro will automatically clean your floor until it has covered the entire surface. Once cleaning is finished the Eclipse Pro will automatically return back to the Auto Empty Base to empty the dustbin and re-charge

**Powermop Scrub** - Fill the water tank and connect the Powermop Scrub attachment. Eclipse will automatically mop and vacuum your floor area. If you prefer mopping only, use the iHome Clean App to turn off vacuum suction during a Powermop cycle.

**Manual Control** - Using the navigational D-Pad on the remote control (or in the iHome Clean App) you can manually control where the Eclipse Pro goes to clean.

**Spot Clean** - The Eclipse Pro will deep clean a specific spot. First, use the manual navigation control to guide your Eclipse Pro to the desired location. Then, choose Spot Clean mode for a deep clean.

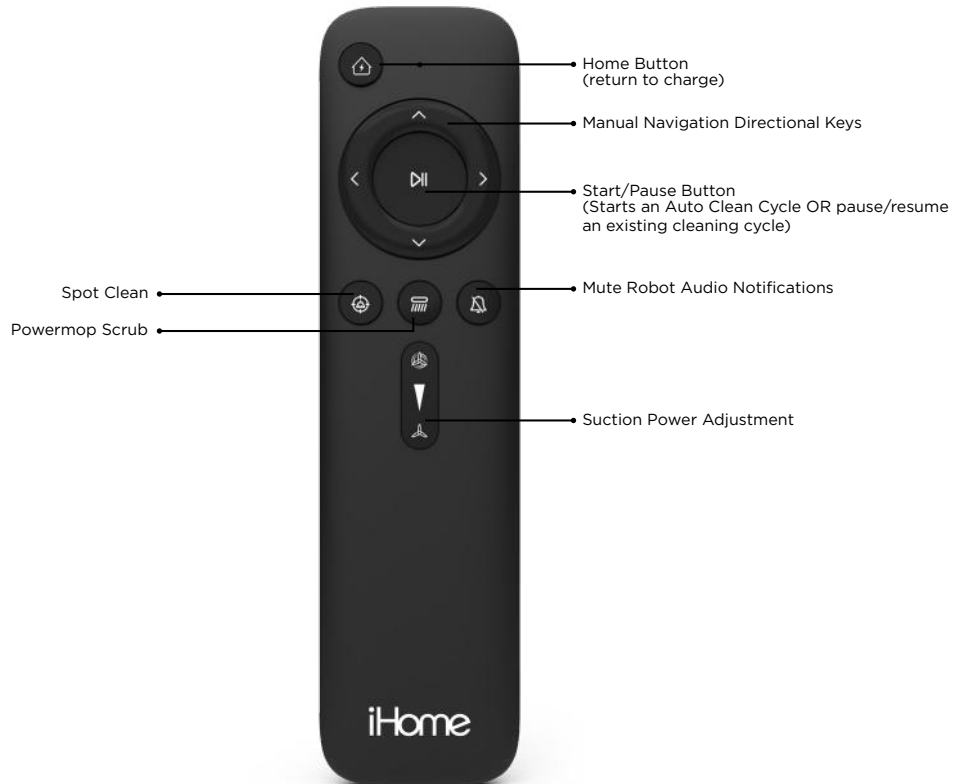
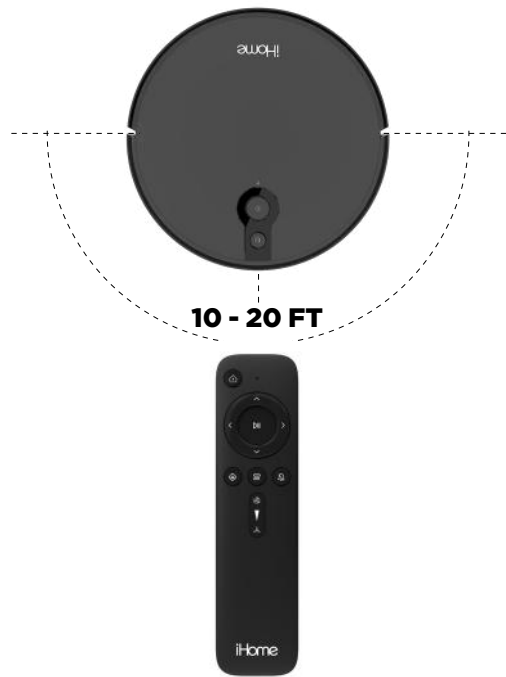

**NOTE:**

- 1: It is recommended to point the remote to the front of the Eclipse Pro for best results.
- 2: The remote control range is 10 - 20 feet.



Your Autovac comes equipped with a Powermop Scrub mopping attachment that connects to the 2-in-1 Dustbin/Water Tank. Follow the steps below to initiate wet mopping with your Autovac.

---

- 1 Place the mop pad onto the mop attachment and secure it to the Velcro strips. Slip corners of the mop pad over the plastic tabs at the rear of the mop attachment.



- 2 Slide mop attachment onto dustbin as shown in figure below until you hear a click confirming that it is locked in place.



- ③ Remove the dustbin from the Eclipse Pro with the mop attachment still installed.



- ④ Open the water fill cap on the dustbin and fill with water, then close the cap. Please ensure that the mop attachment is connected before filling water.



- 5 Install the dustbin with the mop attachment still installed into the Eclipse Pro according to the figure below.



- 6 Activate Powermop Scrub mode in the app or using the remote control.



Your Eclipse Pro is designed to be used regularly. As with most floor care devices, regular use may cause build-up around brushes, in debris compartments and near filters. We recommend performing regular maintenance, as outlined in the following pages, to keep your Autovac Eclipse Pro running at optimal performance.

- 1: Pinch the left and right tabs on the main brush cover. Lift and remove the cover.
- 2: Remove the main brush and clean with the included cleaning tool as seen in the figure below.
- 3: Replace the main brush and snap the cover back into place.

**NOTE:** It is recommended to replace the main brush every 6-12 months depending on use.

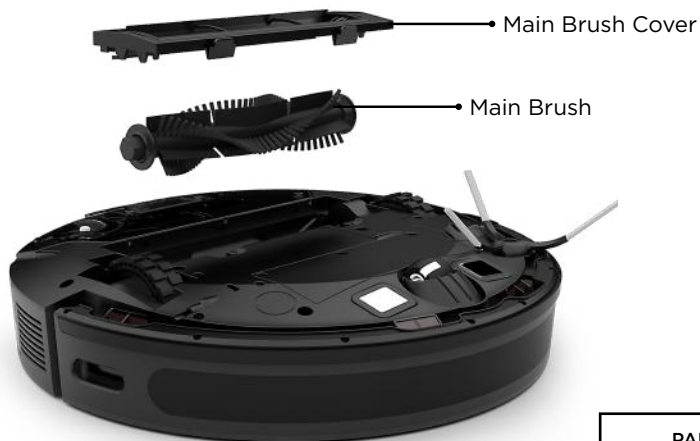

## MAINTENANCE SCHEDULE

PART	CARE FREQUENCY	REPLACEMENT FREQUENCY
Main Brush	Once a month	Replace every 6-12 months
Side Brushes	Once a month	Replace every 6-12 months
HEPA Filter	Every 2 Weeks	Replace every 3 months
Main Filter	Every 2 Weeks	Replace twice a year.

- ① Press the dustbin release button and remove the dustbin.



- ② Clean the inside of the dustbin thoroughly with a dry cloth.



- ③ Remove the primary filter and HEPA filter, wipe down the surface with a dry cloth or use the cleaning tool. Rinse the primary filter with water and let dry completely before using.

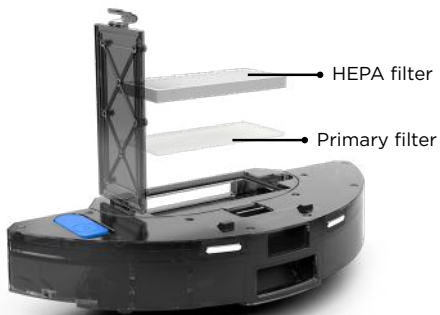

- ④ Remove the mop pad to wash (machine washable).

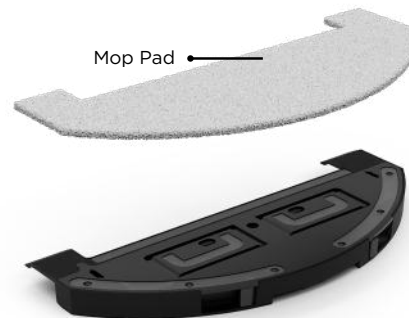

1: Use a Philips screwdriver to unscrew the side brush screw and remove the side brush.

2: Remove dirt and debris and reinstall using Philips screwdriver.



**NOTE:** It is recommended to replace the side brush every 6-12 months depending on use.

---

### Questions? Contact Customer Service

Web/Email: [iHomeclean.com](http://iHomeclean.com)

Phone: 877-370-4580

## AUTO EMPTY BASE DUST BAG

The Auto Empty Base will indicate when the dust bag is full on the smart LED display panel (Dust bag indicator will be white). Discard dust bag once full and replace dust bag with a new one.

**NOTE:** Extend the dust bag handle to seal the debris hole.



## REPLACING THE DUST BAG



Open Cover



Pull up the dust bag from handle



Discard the old dust bag



Replace with new dust bag & fully lower cardboard handle



Close Cover

## CLEANING THE DUCT

If the Eclipse Pro dustbin is not emptying sufficiently or the  is solid white it may indicate that the duct is blocked. Refer to the image: Unplug and turn over the Auto Empty Base. Remove the duct cover with a philips screwdriver and clean out any dirt or debris.





## PROBLEM

## SOLUTION

Unable to power on	Please charge before use. This is commonly caused due to low battery.
Unable to start cleaning	Please charge before use. This is commonly caused due to low battery.
Unable to return to Auto Empty Base	<ul style="list-style-type: none"> <li>• There are too many obstacles near the Auto Empty Base. Please make sure there is a clear area 2 FT of space on either side and 5 FT in front of the Auto Empty Base.</li> <li>• The Eclipse Pro is out of range of the Auto Empty Base. Move the Eclipse Pro closer to the Auto Empty Base to re-establish connection.</li> </ul>
Abnormal behavior	Power down and restart.
Abnormal noise during cleaning	Main brush, side brush or left/right wheel may be obstructed, Check underneath the Eclipse Pro to make sure it is clear from any obstruction. If there is an obstruction clear it and restart the Eclipse Pro.
Decrease in cleaning ability or dust falling out from dustbin.	<ul style="list-style-type: none"> <li>• The dustbin is full, please empty the dustbin.</li> <li>• Check and clean the HEPA filter.</li> <li>• Check that the brush is clear from obstruction.</li> </ul>
Unable to connect to Wi-Fi	Wi-Fi signal is not good , please check that there is a strong Wi-Fi connection while paring. Make sure the network is 2.4G and not 5G or dual band.
Eclipse Pro is not returning to the Auto Empty Base after spot cleaning or after moving it far from the Auto Empty Base.	After spot cleaning or moving the Eclipse Pro far from the Auto Empty Base the Eclipse Pro will re-generate the map. If the Eclipse Pro is far from the Auto Empty Base it may not be able to locate it. Please manually dock the Eclipse Pro to the Auto Empty Base to recharge.
Unable to charge after docking	Make sure there is no obstruction or heavy dust on both the Eclipse Pro and Auto Empty Base charging contacts.
Scheduled cleaning not working	Please confirm that the Eclipse Pro is connected to your Wi-Fi network.If the Eclipse Pro is not connected to the network you cannot synchronize the scheduled cleaning task.



INDICATOR	DEFINITION	SOLUTION
 <p data-bbox="148 323 269 339">Flashing Red</p>	<ul data-bbox="384 208 703 274" style="list-style-type: none"> <li>• Fan error</li> <li>• Overheating</li> <li>• The cover is not closed properly</li> </ul>	<ol data-bbox="826 208 1485 295" style="list-style-type: none"> <li>1. Frequent dust collection leads to fan overheating protection or fan malfunction. It is recommended to try to collect dust after 30 minutes;</li> <li>2. Ensure that the cover of the Auto Empty Base is completely closed and that the AutoVac Eclipse Pro is properly docked and charging.</li> </ol>
 <p data-bbox="148 585 269 601">Flashing Red</p>	<ul data-bbox="384 476 727 519" style="list-style-type: none"> <li>• The dust bag is not installed</li> <li>• The dust bag not installed properly</li> </ul>	<ol data-bbox="826 476 1445 563" style="list-style-type: none"> <li>1. Ensure that the dust bag is properly installed and fully lower the cardboard handle(see figure page 21).</li> <li>2. Check whether the dust bag is installed, if not, please install the dust bag.</li> </ol>

**Questions? Contact Customer Service**

Web/Email: [iHomeclean.com](http://iHomeclean.com)

Phone: 877-370-4580