

UK Price List

May 2026



BISLEY



Contents

BeSmart®

BeSmart	6
LockerWall	8
Deco	12
Primary+	16

Lockers

LateralFile Lockers	20
Essentials Lockers	28
Primary Lockers	32
CLK Lockers	44
General Locking	48

Zoning

Arches	52
Outline	60
Kubbi	76
Planters	80

Storage Systems

LateralFile	86
Essentials	100
Pren	114
Bridge	122

Classics

Glide	130
MultiDrawer	136
Office Filing	142
Plan & Card Filing	150

Desking

Height-Adjustable Desks	158
Fixed Desk	166
Home Desks	176

Desk Storage

Note Pedestals	184
Buddy	188
Caddy	192
Platform & Mosaic	196

Seating & Booths

Thomas Montgomery	
Task	202
Meeting	206
Soft Seating	210
Quarters	214

Home

Fern	222
Rowan	228
Bridge Home	234
Sideboards	238
BOB	242

Shelving

Gallery	250
Place	254
Economy Shelving	258

Finishes	262
----------	-----

Brochure Library	274
------------------	-----

Memberships and Accreditations	278
--------------------------------	-----

Terms and Conditions	280
----------------------	-----

BeSmart	06
LockerWall	08
Deco	12
Primary*	16

BeSmart®

Smarter Locking Solutions, Powered by Bisley.

BeSmart is Bisley's consultancy-led smart locker service, designed to help organisations of all sizes adopt secure, flexible, and future-ready storage systems.

Combining our manufacturing expertise with global lock technology partners, we deliver tailored solutions — from enterprise-level hardwired systems to straightforward offline lockers — that fit your workflows, your people, and your sector.

BeSmart®

BeSmart is Bisley's consultancy-led smart locker service. We help organisations of every size adopt secure, flexible and future-ready storage systems from enterprise hardwired solutions to simple offline locks, all integrated into our market-leading locker ranges.

Our Smart Locking Categories

Hardwired - real-time control and enterprise integration.

Networked - connected, scalable, centrally managed.

Batteryless NFC - mobile-first, no wiring or batteries.

Offline - simple, robust, cost-effective day-use locking.

Our Global Technology Partners

We collaborate with trusted global lock partners to deliver solutions tailored to every project - all under the BeSmart umbrella.



BeSmart Locker Portfolio

Explore our three core locker ranges to find the right solution for your space, usage, and aesthetic.

Range	Type	Design Focus	Ideal For
LockerWall	Modular locker system	Fully modular and architectural with built-in options for seating, planters, tech integration and zoning. Designed to become part of the workspace itself.	Agile workspaces, enterprise fitouts, campuses, smart zoning
Deco	Smart, refined steel locker	Soft curves, powder-coated body, and double-skinned doors for acoustic control and added safety. A design-led take on personal storage.	Corporate offices, front-of-house areas, hybrid workplaces, A&D-led interiors, postal lockers
Primary*	Smart steel locker	Durable and cost-effective with a clean, minimalist design. 5-column door configuration options, simplifying the specifying process.	Educational settings, events, cloakrooms, rental lockers, back-of-house storage

Where BeSmart Works

BeSmart supports a wide range of sectors, including:

Workplace - hybrid, agile, and enterprise environments.

Education - schools, colleges, and universities.

Healthcare - dispensing, secure personal storage.

Hospitality & Leisure - luggage storage and changing areas.

Retail & Venues - event-day lockers and click-and-collect.

Warehouse - asset management fulfilment.

Why Choose BeSmart

Consultancy-led - we match the correct lock technology to your needs.

Fully compatible - all Bisley lockers pair with any BeSmart lock type.

Flexible & scalable - from small installations to global estates.

Integrated - works with existing access control systems (HID, MIFARE, Paxton, SSO).

Supported - UK-based technical support, training, and renewal management.

The BeSmart Customer Journey

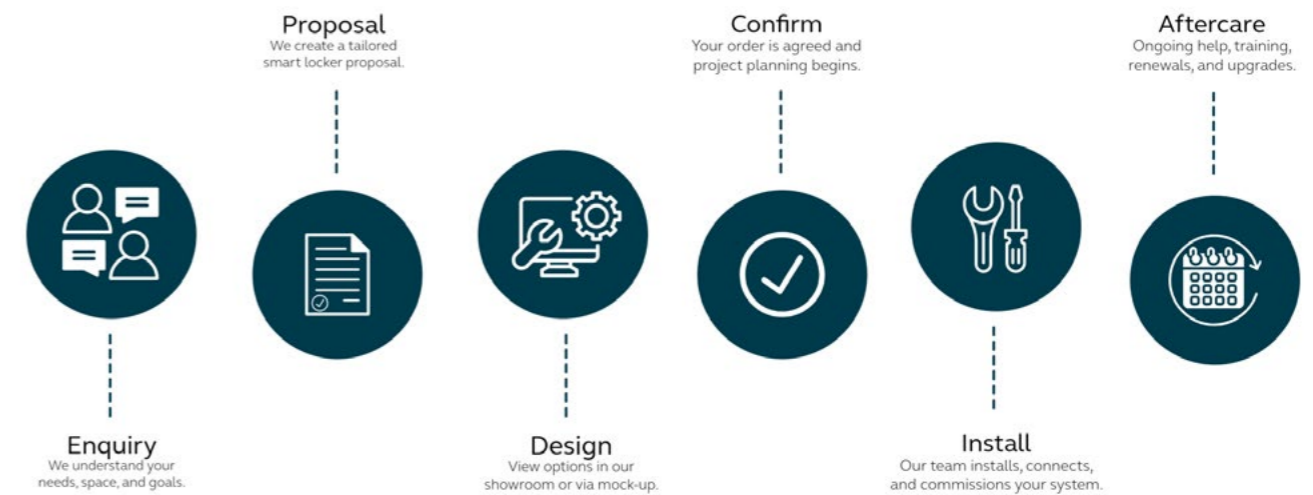

LockerWall

LockerWall, fully integrated with our comprehensive BeSmart service, is our smart storage system that delivers dependable security without dominating space or sacrificing style.

Integrating seamlessly into your environment, LockerWall is available in a wide range of material and colour finishes, including wood and steel. And utilising the latest smart locking software, personal storage and facility management has never been simpler and safer.

There is a growing demand for intelligent locker systems, and with the integration of BeSmart, LockerWall has been expertly created with functionality, security and style in mind, tailored precisely to each project requirement. Available across a range of sectors, our professional, consultative approach ensures that each solution is customised to suit your environment – from a corporate office to educational institutions, healthcare facility, or a leisure space.

Backed by decades of experience and expertise, Bisley works with you to build a data-driven LockerWall that not only transforms your space but also streamlines how users interact with their environment.

Create an efficient, sleek system that integrates seamlessly into your design.





LockerWall represents the modular, architectural arm of the BeSmart portfolio, designed to transform storage from a standalone necessity into a fully integrated part of the interior landscape. As a core BeSmart solution, LockerWall combines large-scale configurability with smart, centrally managed locking to support dynamic, high-traffic environments.

Built as an adaptable system rather than a fixed product, LockerWall enables zones, neighbourhoods and circulation spaces to work harder - offering storage, wayfinding, division and placing in a single cohesive installation. With extensive material choices and the ability to accommodate diverse smart locking workflows, LockerWall becomes the foundation for data-driven, user-centred environments across corporate, education, public and leisure sectors.



 For more specification information click here



Deco

Deco is our premium steel locker range, offered as part of the dedicated product offering from BeSmart, our consultancy-led smart locker service. With its sleek, modern design featuring radiused edges, Deco elevates spaces with a soft, curved aesthetic that sets it apart from traditional steel lockers.

Designed as a freestanding solution, Deco offers flexible column options and the ability to position the control terminal on the front or side of the locker bank, maximising door capacity. Ideal for a wide range of use cases across various sectors, such as retail, healthcare, hospitality, education, and more, Deco combines style, security, and practicality. Enhanced with the latest smart locking technology, Deco simplifies storage management, providing secure, efficient solutions tailored to the needs of today's dynamic environments.

With its double-skinned design, Deco is entirely secure and fully customisable, we can supply your chosen lockers in any size, configuration, and colour you need. We have all the expertise and knowledge on-hand to bring you a tailored design service, creating a truly unique and flexible storage solution.

Deco – secure, intelligent steel storage.

Deco forms the refined, design-led element of the BeSmart® portfolio, offering a premium steel locker solution that pairs elegant detailing with intelligent functionality. As part of BeSmart, Deco becomes a fully connected storage system, combining its soft, curved aesthetic with seamless digital management to support modern, hybrid environments.

Engineered for both visual impact and practical performance, Deco integrates effortlessly into front-of-house, workplace and hospitality settings, providing a sophisticated approach to personal storage. With flexible configurations and full colour customisation, Deco allows BeSmart schemes to be tailored precisely to each project, delivering intuitive user journeys and a refined architectural presence within any space.





Primary⁺

Durable. Versatile. Now smart.

Primary⁺ is the smart-enabled evolution of our trusted Primary locker – a robust, steel-bodied range designed to deliver reliable performance in busy, demanding environments. Built for strength, simplicity and long-term durability, Primary⁺ retains the clean lines and practical design of the original Primary model but introduces integrated smart lock compatibility as part of the Bisley BeSmart family.

With a choice of one to five doors per column and three standard sizes, Primary⁺ gives you the flexibility to configure locker banks to suit your space, usage, and flow of people. Choose from ventilated or unventilated doors, depending on your needs, helping your belongings stay fresh throughout the day, while a steel body – available in a wide range of paint finishes – ensures the lockers are as visually adaptable as they are tough.

Fully compatible with our full suite of BeSmart locks – including hardwired and wireless options – it's the ideal entry point into connected storage for high-volume, fast-paced settings. From schools and universities to hybrid workplaces, gyms, events, and temporary installations, Primary⁺ is designed for projects where you need dependable, cost-effective smart storage without compromising on functionality.

 For more specification information click here





LateralFile Lockers

LateralFile lockers are a secure personal storage solution for the agile workplace. Its superior design, high-quality hand-finish and versatility make it a first choice for architects, designers and end users. LateralFile lockers are ideal for a mobile workforce, with a range of locking and internal options to choose from.



10-Year Warranty

 For more specification information click here

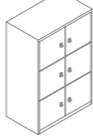

LateralFile Lockers H: 845mm (33.3") W: 800mm (31.5") D: 470mm (18.5")

Product Code	Description	Price	
L0824SABX2SXP	Four 381mm (15") doors	£1,150	
L0824SABXDXP	Two 762mm (30") doors	£1,090	
L0824SABXSPXP	Two 381mm (15") doors & two 381mm (15") locker drawers	£1,313	

LateralFile Lockers H: 1225mm (48.2") W: 800mm (31.5") D: 470mm (18.5")

Product Code	Description	Price	
L0836SABX3SXP	Six 381mm (15") doors	£1,515	
L0836SABXSDXP	Two 381mm (15") doors & two 762mm (30") doors	£1,440	
L0836SABX2SPXP	Four 381mm (15") doors & two 381mm (15") locker drawers	£1,675	

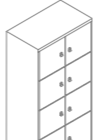
LateralFile Lockers H: 1605mm (63.2") W: 800mm (31.5") D: 470mm (18.5")

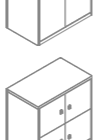
Product Code	Description	Price	
L0848SABX4SXP	Eight 381mm (15") doors	£1,930	
L0848SABX2SDXP	Four 381mm (15") doors & two 762mm (30") doors	£1,835	
L0848SABX3SPXP	Six 381mm (15") doors & two 381mm (15") locker drawers	£2,090	

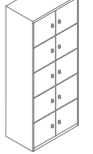
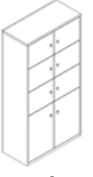
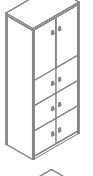
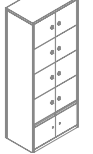

LateralFile Lockers H: 1985mm (78.1") W: 800mm (31.5") D: 470mm (18.5")

Product Code	Description	Price	
L0861SABX5SXP	Ten 381mm (15") doors	£2,238	
L0861SABX3SDXP	Six 381mm (15") doors & two 762mm (30") doors	£2,126	
L0861SABXD3SXP	Two 762mm (30") doors & six 381mm (15") doors	£2,126	
L0861SABX4SPXP	Eight 381mm (15") doors & two 381mm (15") locker drawers	£2,400	



LateralFile Lockers - Additional Shelves

Product Code	Description	Price	
SL04LHPS	Left handed shelf for 800mm (31.5") locker	£44	 SL04LHPS
SL04RHPS	Right handed shelf for 800mm (31.5") locker	£44	



LateralFile Lockers H: 845mm (33.3") W: 1000mm (39.4") D: 470mm (18.5")

Product Code	Description	Price	
L1024SABX2SXP	Four 381mm (15") doors	£1,189	
L1024SABXDXP	Two 762mm (30") doors	£1,127	
L1024SABXSPXP	Two 381mm (15") doors & two 381mm (15") locker drawers	£1,358	





LateralFile Lockers H: 1225mm (48.2") W: 1000mm (39.4") D: 470mm (18.5")

Product Code	Description	Price	
L1036SABX3SXP	Six 381mm (15") doors	£1,582	
L1036SABXSDXP	Two 381mm (15") doors & two 762mm (30") doors	£1,503	
L1036SABX2SPXP	Four 381mm (15") doors & two 381mm (15") locker drawers	£1,753	

LateralFile Lockers H: 1605mm (63.2") W: 1000mm (39.4") D: 470mm (18.5")

Product Code	Description	Price	
L1048SABX4SXP	Eight 381mm (15") doors	£1,995	
L1048SABX2SDXP	Four 381mm (15") doors & two 762mm (30") doors	£1,895	
L1048SABX3SPXP	Six 381mm (15") doors & two 381mm (15") locker drawers	£2,162	

LateralFile Lockers H: 1985mm (78.1") W: 1000mm (39.4") D: 470mm (18.5")

Product Code	Description	Price	
L1061SABX5SXP	Ten 381mm (15") doors	£2,318	
L1061SABX3SDXP	Six 381mm (15") doors & two 762mm (30") doors	£2,202	
L1061SABXD3SXP	Two 762mm (30") doors & six 381mm (15") doors	£2,202	
L1061SABX4SPXP	Eight 381mm (15") doors & two 381mm (15") locker drawers	£2,488	

LateralFile Locker - Additional Shelves

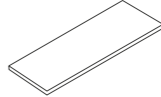
Product Code	Description	Price	
SL05LHPS	Left handed shelf for 1000mm (39.4") locker	£54	SL05RHPS
SL05RHPS	Right handed shelf for 1000mm (39.4") locker	£54	

Alternative Locking Options

Description	Price (per lock)
For M3 locks change characters of the code from 'AB' to 'M3'	£58
For M2 locks change characters of the code from 'AB' to 'M2'	£58
For E4 locks change characters of the code from 'AB' to 'E4'	£150
For RFID Public locks change characters of the code from 'AB' to 'RF1'	£192

Power Options

Description	Price (per compartment)
To add UK USB power inside locker compartments change characters of the code from 'XP' to '4P'	£58
To add EU USB power inside locker compartments change characters of the code from 'XP' to '5P'	£58
To add US USB power inside locker compartments change characters of the code from 'NP' to '6P'	£58

Please note USB power socket comprises of x1 A and x1 C ports.

Additional Accessories

Description	Price (per compartment)
To add postal slots change 9th character of the code from 'X' to 'M'	£13
For MFC doors change 6th character of the code from 'S' to 'W'	-

Finish Options

Please note: Wood grain direction on doors will always be vertical.

Please note: Multiple door finishes are available in both wood and steel on the same lockers. Please refer to the LateralFile locker configurator on thebisleygroup.com to customise.

Business card holders are supplied as standard.

For all finishes options, please refer to page 262.





Essentials Lockers

This range offers the secure, personal storage a mobile workforce needs to feel at ease, wherever they're working. You can choose from a range of colours, heights and widths – so you get the best configuration for your working environment.

Personal storage lockers for front-of-house applications, all with an individual lock and barrel key for security. Name slot holders come as standard.

5-Year Warranty

 For more specification information click here

Product Code	Description	Height	Price	
YELD0807	Two 267mm (10.5") & two 305mm (12") doors	693mm (27.3")	£1,061	
YELD0810	Four 267mm (10.5") & two 305mm (12") doors	1000mm (39.4")	£1,201	
YELD0811	Two 305mm (12") & four 343mm (13.5") doors	1149mm (45.2")	£1,304	
YELD0812	Eight 267mm (10.5") doors	1270mm (50")	£1,445	
YELD0813	Six 267mm (10.5") & two 305mm (12") doors	1300mm (51.2")	£1,463	
YELD0819	Ten 343mm (13.5") doors	1947mm (76.7")	£1,739	

Product Code	Description	Height	Price	
YELD1007	Two 267mm (10.5") & two 305mm (12") doors	693mm (27.3")	£1,090	
YELD1010	Four 267mm (10.5") & two 305mm (12") doors	1000mm (39.4")	£1,232	
YELD1011	Two 305mm (12") & four 343mm (13.5") doors	1149mm (45.2")	£1,334	
YELD1012	Eight 267mm (10.5") doors	1270mm (50")	£1,511	
YELD1013	Six 267mm (10.5") & two 305mm (12") doors	1300mm (51.2")	£1,531	
YELD1019	Ten 343mm (13.5") doors	1947mm (76.7")	£1,820	





Primary Lockers

Robust, versatile and hard-wearing - lockers crafted for the workplace.

Primary Lockers by Bisley span a wide range of sizes and configurations, allowing you to stow your personal belongings, workwear or equipment as required. With perfect sized compartments to suit every need; whether you're storing uniform and bulky items, or separating your clothes from dirty overalls. Designed for durability, these lockers are aimed at fulfilling tough 'back-of-house' storage requirements, however, the neat and minimalist design means they will look great in changing rooms and customer-facing cloakrooms too.

This straightforward locker range is easy to specify. Featuring a smart grey carcass and a selection of door colours, there's also a selection of optional upgrades, such as benching, feet, sloping tops, and a choice of locking options.

Available in single columns or nests of up to two nests of up to four lockers, Primary Lockers work around your space and capacity.

Primary Lockers: Built to last.

5-Year Warranty

 For more specification information click here

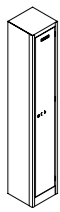

PEDS1830301
NEST 1



PEDD1830301
NEST 2

Everyday Lockers - 1 Door

H: 1800mm (70.9")

Product Code	Description	Nest	Width	Depth	Price
PEDS1830301	One door locker	1	300mm (11.8")	300mm (11.8")	£254
PEDD1830301	One door locker	2	600mm (23.6")	300mm (11.8")	£450
PEDS1830381	One door locker	1	300mm (11.8")	380mm (15")	£278
PEDD1830381	One door locker	2	600mm (23.6")	380mm (15")	£482
PEDS1830451	One door locker	1	300mm (11.8")	450mm (17.7")	£296
PEDD1830451	One door locker	2	600mm (23.6")	450mm (17.7")	£514
PEDS1838381	One door locker	1	380mm (15")	380mm (15")	£298
PEDD1838381	One door locker	2	760mm (29.9")	380mm (15")	£531
PEDS1838511	One door locker	1	380mm (15")	510mm (20.1")	£333
PEDD1838511	One door locker	2	760mm (29.9")	510mm (20.1")	£590
PEDS1845451	One door locker	1	450mm (17.7")	450mm (17.7")	£336
PEDD1845451	One door locker	2	900mm (35.4")	450mm (17.7")	£605
PEDS1845511	One door locker	1	450mm (17.7")	510mm (20.1")	£355
PEDD1845511	One door locker	2	900mm (35.4")	510mm (20.1")	£635
PEDS1860451	One door locker	1	600mm (23.6)	450mm (17.7")	£381
PEDD1860451	One door locker	2	1200mm (47.2")	450mm (17.7")	£691



PEDS1830302
NEST 1

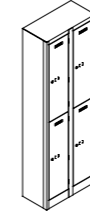

PEDD1830302
NEST 2

2 Door

H: 1800mm (70.9")

Product Code	Description	Nest	Width	Depth	Price
PEDS1830302	Two door locker	1	300mm (11.8")	300mm (11.8")	£288
PEDD1830302	Two door locker	2	600mm (23.6")	300mm (11.8")	£515
PEDS1830382	Two door locker	1	300mm (11.8")	380mm (15")	£311
PEDD1830382	Two door locker	2	600mm (23.6")	380mm (15")	£555
PEDS1830452	Two door locker	1	300mm (11.8")	450mm (17.7")	£331
PEDD1830452	Two door locker	2	600mm (23.6")	450mm (17.7")	£586
PEDS1838382	Two door locker	1	380mm (15")	380mm (15")	£335
PEDD1838382	Two door locker	2	760mm (29.9")	380mm (15")	£605
PEDS1838512	Two door locker	1	380mm (15")	510mm (20.1")	£374
PEDD1838512	Two door locker	2	760mm (29.9")	510mm (20.1")	£669
PEDS1845452	Two door locker	1	450mm (17.7")	450mm (17.7")	£378
PEDD1845452	Two door locker	2	900mm (35.4")	450mm (17.7")	£685
PEDS1845512	Two door locker	1	450mm (17.7")	510mm (20.1")	£396
PEDD1845512	Two door locker	2	900mm (35.4")	510mm (20.1")	£717
PEDS1860452	Two door locker	1	600mm (23.6)	450mm (17.7")	£427
PEDD1860452	Two door locker	2	1200mm (47.2")	450mm (17.7")	£782

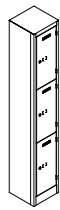

PEDS1830303
NEST 1



PEDD1830303
NEST 2

3 Door

H: 1800mm (70.9")

Product Code	Description	Nest	Width	Depth	Price
PEDS1830303	Three door locker	1	300mm (11.8")	300mm (11.8")	£323
PEDD1830303	Three door locker	2	600mm (23.6")	300mm (11.8")	£584
PEDS1830383	Three door locker	1	300mm (11.8")	380mm (15")	£348
PEDD1830383	Three door locker	2	600mm (23.6")	380mm (15")	£624
PEDS1830453	Three door locker	1	300mm (11.8")	450mm (17.7")	£367
PEDD1830453	Three door locker	2	600mm (23.6")	450mm (17.7")	£661
PEDS1838383	Three door locker	1	380mm (15")	380mm (15")	£372
PEDD1838383	Three door locker	2	760mm (29.9")	380mm (15")	£677
PEDS1838513	Three door locker	1	380mm (15")	510mm (20.1")	£413
PEDD1838513	Three door locker	2	760mm (29.9")	510mm (20.1")	£751
PEDS1845453	Three door locker	1	450mm (17.7")	450mm (17.7")	£420
PEDD1845453	Three door locker	2	900mm (35.4")	450mm (17.7")	£767
PEDS1845513	Three door locker	1	450mm (17.7")	510mm (20.1")	£439
PEDD1845513	Three door locker	2	900mm (35.4")	510mm (20.1")	£804
PEDS1860453	Three door locker	1	600mm (23.6)	450mm (17.7")	£472
PEDD1860453	Three door locker	2	1200mm (47.2")	450mm (17.7")	£872



PEDS1830304
NEST 1



PEDD1830304
NEST 2

4 Door

H: 1800mm (70.9")

Product Code	Description	Nest	Width	Depth	Price
PEDS1830304	Four door locker	1	300mm (11.8")	300mm (11.8")	£357
PEDD1830304	Four door locker	2	600mm (23.6")	300mm (11.8")	£650
PEDS1830384	Four door locker	1	300mm (11.8")	380mm (15")	£382
PEDD1830384	Four door locker	2	600mm (23.6")	380mm (15")	£695
PEDS1830454	Four door locker	1	300mm (11.8")	450mm (17.7")	£404
PEDD1830454	Four door locker	2	600mm (23.6")	450mm (17.7")	£732
PEDS1838384	Four door locker	1	380mm (15")	380mm (15")	£408
PEDD1838384	Four door locker	2	760mm (29.9")	380mm (15")	£752
PEDS1838514	Four door locker	1	380mm (15")	510mm (20.1")	£454
PEDD1838514	Four door locker	2	760mm (29.9")	510mm (20.1")	£698
PEDS1845454	Four door locker	1	450mm (17.7")	450mm (17.7")	£460
PEDD1845454	Four door locker	2	900mm (35.4")	450mm (17.7")	£849
PEDS1845514	Four door locker	1	450mm (17.7")	510mm (20.1")	£481
PEDD1845514	Four door locker	2	900mm (35.4")	510mm (20.1")	£889
PEDS1860454	Four door locker	1	600mm (23.6)	450mm (17.7")	£515
PEDD1860454	Four door locker	2	1200mm (47.2")	450mm (17.7")	£963

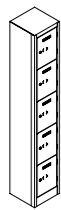

PEDS1830305
NEST 1



PEDD1830305
NEST 2

5 Door H: 1800mm (70.9")

Product Code	Description	Nest	Width	Depth	Price
PEDS1830305	Five door locker	1	300mm (11.8")	300mm (11.8")	£389
PEDD1830305	Five door locker	2	600mm (23.6")	300mm (11.8")	£716
PEDS1830385	Five door locker	1	300mm (11.8")	380mm (15")	£414
PEDD1830385	Five door locker	2	600mm (23.6")	380mm (15")	£761
PEDS1830455	Five door locker	1	300mm (11.8")	450mm (17.7")	£439
PEDD1830455	Five door locker	2	600mm (23.6")	450mm (17.7")	£806
PEDS1838385	Five door locker	1	380mm (15")	380mm (15")	£447
PEDD1838385	Five door locker	2	760mm (29.9")	380mm (15")	£827
PEDS1838515	Five door locker	1	380mm (15")	510mm (20.1")	£494
PEDD1838515	Five door locker	2	760mm (29.9")	510mm (20.1")	£909
PEDS1845455	Five door locker	1	450mm (17.7")	450mm (17.7")	£501
PEDD1845455	Five door locker	2	900mm (35.4")	450mm (17.7")	£929
PEDS1845515	Five door locker	1	450mm (17.7")	510mm (20.1")	£525
PEDD1845515	Five door locker	2	900mm (35.4")	510mm (20.1")	£971
PEDS1860455	Five door locker	1	600mm (23.6")	450mm (17.7")	£560
PEDD1860455	Five door locker	2	1200mm (47.2")	450mm (17.7")	£1,055



PEDS1830306
NEST 1



PEDD1830306
NEST 2

6 Door H: 1800mm (70.9")

Product Code	Description	Nest	Width	Depth	Price
PEDS1830306	Six door locker	1	300mm (11.8")	300mm (11.8")	£423
PEDD1830306	Six door locker	2	600mm (23.6")	300mm (11.8")	£782
PEDS1830386	Six door locker	1	300mm (11.8")	380mm (15")	£450
PEDD1830386	Six door locker	2	600mm (23.6")	380mm (15")	£832
PEDS1830456	Six door locker	1	300mm (11.8")	450mm (17.7")	£476
PEDD1830456	Six door locker	2	600mm (23.6")	450mm (17.7")	£877
PEDS1838386	Six door locker	1	380mm (15")	380mm (15")	£481
PEDD1838386	Six door locker	2	760mm (29.9")	380mm (15")	£898
PEDS1838516	Six door locker	1	380mm (15")	510mm (20.1")	£533
PEDD1838516	Six door locker	2	760mm (29.9")	510mm (20.1")	£990
PEDS1845456	Six door locker	1	450mm (17.7")	450mm (17.7")	£539
PEDD1845456	Six door locker	2	900mm (35.4")	450mm (17.7")	£1,013
PEDS1845516	Six door locker	1	450mm (17.7")	510mm (20.1")	£564
PEDD1845516	Six door locker	2	900mm (35.4")	510mm (20.1")	£1,056
PEDS1860456	Six door locker	1	600mm (23.6")	450mm (17.7")	£608
PEDD1860456	Six door locker	2	1200mm (47.2")	450mm (17.7")	£1,144

Workwear Lockers - 1 Door

H: 1800mm (70.9") W: 450mm (17.7")

Product Code	Description	Depth	Price
PCOS1845451	Combi locker (includes one full width shelf, three half width shelves and open hanging space with coat hook)	450mm (17.7")	£447
PPOS1845601	Police locker (includes one shelf and one coat rail)	600mm (23.6")	£455
PCDS1845601	Clean & dirty locker (includes one shelf with central partition and coat rail either side)	600mm (23.6")	£487

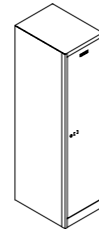

PPOS1845601

Workwear Lockers - 2 Door

H: 1800mm (70.9") W: 450mm (17.7")

Product Code	Description	Depth	Price
P2PS1845454	Two person locker (includes two full width compartments and two vertical compartments with coat hook in each)	450mm (17.7")	£649
PTWS1845602	Twin locker (each locker includes one shelf with coat rail below)	600mm (23.6")	£584



PTWS1845602

Locker Stand with Bench

H: 350mm (13.8")

Product Code	Description	Width	Depth	Price
PLB354538	For use with 380mm D lockers only	450mm (17.7")	680mm (26.8")	£403
PLB354545	For use with 450mm D lockers only	450mm (17.7")	750mm (29.5")	£476
PLB354551	For use with 510mm D lockers only	450mm (17.7")	810mm (31.9")	£482
PLB356030	For use with 300mm D lockers only	600mm (23.6")	600mm (23.6")	£555
PLB356038	For use with 380mm D lockers only	600mm (23.6")	680mm (26.8")	£562
PLB356045	For use with 450mm D lockers only	600mm (23.6")	750mm (29.5")	£573
PLB356060	For use with 600mm D lockers only	600mm (23.6")	900mm (35.4")	£582
PLB357638	For use with 380mm D lockers only	760mm (29.9")	680mm (26.8")	£613
PLB357660	For use with 600mm D lockers only	760mm (29.9")	900mm (35.4")	£719
PLB357651	For use with 510mm D lockers only	760mm (29.9")	810mm (31.9")	£625
PLB359030	For use with 300mm D lockers only	900mm (35.4")	600mm (23.6")	£637
PLB359045	For use with 450mm D lockers only	900mm (35.4")	750mm (29.5")	£648
PLB359038	For use with 380mm D lockers only	900mm (35.4")	680mm (26.8")	£656
PLB359051	For use with 510mm D lockers only	900mm (35.4")	810mm (31.9")	£723
PLB359060	For use with 600mm D lockers only	900mm (35.4")	900mm (35.4")	£663
PLB351045	For use with 450mm D lockers only	1000mm (39.4")	750mm (29.5")	£708
PLB351138	For use with 380mm D lockers only	1140mm (44.9")	680mm (26.8")	£669
PLB351160	For use with 600mm D lockers only	1140mm (44.9")	900mm (35.4")	£726
PLB351151	For use with 510mm D lockers only	1140mm (44.9")	810mm (31.9)	£705
PLB351230	For use with 300mm D lockers only	1200mm (47.2")	600mm (23.6")	£717
PLB351238	For use with 380mm D lockers only	1200mm (47.2")	680mm (26.8")	£728
PLB351245	For use with 450mm D lockers only	1200mm (47.2")	750mm (29.5")	£734
PLB351260	For use with 600mm D lockers only	1200mm (47.2")	900mm (35.4")	£749

Locker Stands

H: 150mm (6")

Product Code	Description	Price
PLS154538	W: 450mm (17.7") D: 380mm (15")	£315
PLS154545	W: 450mm (17.7") D: 450mm (17.7")	£332
PLS154551	W: 450mm (17.7") D: 510mm (20.1")	£333
PLS154560	W: 450mm (17.7") D: 600mm (23.6")	£335
PLS156030	W: 600mm (23.6") D: 300mm (11.8")	£335
PLS156038	W: 600mm (23.6") D: 380mm (15")	£336
PLS156045	W: 600mm (23.6") D: 450mm (17.7")	£338
PLS156060	W: 600mm (23.6") D: 600mm (23.6")	£339
PLS157638	W: 760mm (29.9") D: 380mm (15")	£331
PLS157651	W: 760mm (29.9") D: 510mm (20.1")	£348
PLS157660	W: 760mm (29.9") D: 600mm (23.6")	£353
PLS159030	W: 900mm (35.4") D: 300mm (11.8")	£338
PLS159038	W: 900mm (35.4") D: 380mm (15")	£339
PLS159045	W: 900mm (35.4") D: 450mm (17.7")	£342
PLS159051	W: 900mm (35.4") D: 510mm (20.1")	£355
PLS159060	W: 900mm (35.4") D: 600mm (23.6")	£345
PLS151045	W: 1000mm (39.4") D: 450mm (17.7")	£352
PLS151138	W: 1140mm (44.9") D: 380mm (15")	£364
PLS151151	W: 1140mm (44.9") D: 510mm (20.1")	£369
PLS151160	W: 1140mm (44.9") D: 600mm (23.6")	£375
PLS151230	W: 1200mm (47.2") D: 300mm (11.8")	£375
PLS151238	W: 1200mm (47.2") D: 380mm (15")	£377
PLS151245	W: 1200mm (47.2") D: 450mm (17.7")	£378
PLS151260	W: 1200mm (47.2") D: 600mm (23.6")	£381

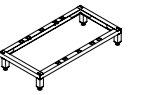

PLS154538

Levelling Feet

Product Code	Description	Price
PLAF	Adjustable levelling foot kit (includes four feet and four brackets) - suitable for single locker columns. For nests one set of PLAF per column required	£25

Free-standing Bench

H: 470mm (18.5") D: 300mm (11.8")

Product Code	Description	Price
PFB471030	W: 1000mm (39.4")	£504
PFB471230	W: 1200mm (47.2")	£623
PFB471530	W: 1500mm (59.1")	£671

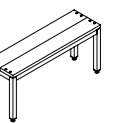

PFB471030

Single-sided Cloakroom Benches

D: 300mm (11.9")

Product Code	Description	Height	Width	Price
PCB181230	Single-sided cloakroom benches with nine hooks	1800mm (70.9")	1200mm (47.2")	£966
PCB181530	Single-sided cloakroom benches with twelve hooks	1800mm (70.9")	1500mm (59.1")	£1,025
PCJ131230	Single-sided cloakroom benches with nine hooks	1370mm (53.9")	1200mm (47.2")	£924
PCJ131530	Single-sided cloakroom benches with twelve hooks	1370mm (53.9")	1500mm (59.1")	£980

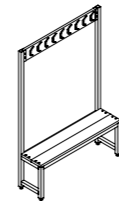

PCB181230

Double-sided Cloakroom Benches

D: 600mm (23.6")

Product Code	Description	Height	Width	Price
PCD181260	Double-sided cloakroom benches with eighteen hooks	1800mm (70.9")	1200mm (47.2")	£1,314
PCD181560	Double-sided cloakroom benches with twenty-four hooks	1800mm (70.9")	1500mm (59.1")	£1,426
PCDJ131260	Double-sided cloakroom benches with eighteen hooks	1370mm (53.9")	1200mm (47.2")	£1,272
PCDJ131560	Double-sided cloakroom benches with twenty-four hooks	1370mm (53.9")	1500mm (59.1")	£1,389

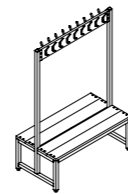

PCD181260

Sloping Tops

H: 150mm (6")

PS4538	PS4545	PS4560	PS6030	PS6038
W: 450mm (17.7")	W: 450mm (17.7")	W: 450mm (17.7")	W: 600mm (23.6")	W: 600mm (23.6")
D: 380mm (15")	D: 450mm (17.7")	D: 600mm (23.6")	D: 300mm (11.8")	D: 380mm (15")
£72	£75	£80	£77	£87
PS6045	PS6060	PS6738	PS7638	PS7651
W: 600mm (23.6")	W: 600mm (23.6")	W: 675mm (26.6")	W: 760mm (30")	W: 760mm (30")
D: 450mm (17.7")	D: 600mm (23.6")	D: 380mm (15")	D: 380mm (15")	D: 510mm (20.1")
£99	£105	£93	£102	£109
PS9030	PS9038	PS9045	PS9051	PS9060
W: 900mm (35.4")	W: 900mm (35.4")	W: 900mm (35.4")	W: 900mm (35.4")	W: 900mm (35.4")
D: 300mm (11.8")	D: 380mm (15")	D: 450mm (17.7")	D: 510mm (20.1")	D: 600mm (23.6")
£137	£150	£162	£172	£183
PS1045	PS1138	PS1151	PS1160	PS1230
W: 1000mm (39.4")	W: 1140mm (44.9")	W: 1140mm (44.9")	W: 1140mm (44.9")	W: 1200mm (47.2")
D: 450mm (17.7")	D: 380mm (15")	D: 510mm (20.1")	D: 600mm (23.6")	D: 300mm (11.8")
£175	£178	£188	£197	£172
PS1238	PS1245	PS1260		
W: 1200mm (47.2")	W: 1200mm (47.2")	W: 1200mm (47.2")		
D: 380mm (15")	D: 450mm (17.7")	D: 600mm (23.6")		
£188	£205	£212		

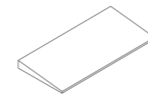

PS9030

Alternative Locking Options

Description	Price (per lock)
To add Hasp locks add 'H' to the end of the code	£13
To add Rotary Combination locks add 'R' to the end of the code	£24
To add Pound Coin Return locks add 'C' to the end of the code	£52
To add Euro Coin Return locks add 'U' to the end of the code	£52
To add M3 locks add 'M3' to the end of the code	£58
To add M2 locks add 'M2' to the end of the code	£58
To add E4 locks add 'E' to the end of the code	£150

All Primary Lockers are available in galvanised steel.
For galvanised steel please add Suffix 'G' to the end of the code, for example:
PEDS1825456 becomes PEDS1825456G

If you are specifying a locker with an alternative locking option and in galvanised steel, please put the suffix for the lock before suffix 'G'.

Benches, stands and sloping tops are also available in galvanised steel using suffix 'G'.

Galvanised steel = +20% surcharge

Please note: Primary Lockers in galvanised steel still require a paint finish to be specified.

For all finishes options, please refer to page 262.





CLK Lockers

Made from steel with concealed hinges, clean lines, and a welded construction, our CLK locker is a strong yet subtle addition to your home or office. It's a smart, personal storage solution for any work environment, or a fun alternative for staying organised at home.

With an authentic, robust design, our CLK lockers are perfect for creating neat banks of personal storage. Maximise your space by placing multiple lockers side by side – they offer great stability and a neat installation when ganged together. Each compartment has a built-in label holder and separate key lock for keeping your items secure.

5-Year Warranty

 For more specification information click here

Product Code	Description	Height	Price	
CLK121C	One door cube, 305mm (12") deep	529mm (21")	£147	
CLK181C	One door cube, 457mm (18") deep	529mm (21")	£170	
CLK121	One door locker, 305mm (12") deep	1802mm (70.9")	£207	
CLK122	Two door locker, 305mm (12") deep	1802mm (70.9")	£264	
CLK124	Four door locker, 305mm (12") deep	1802mm (70.9")	£322	
CLK126	Six door locker, 305mm (12") deep	1802mm (70.9")	£386	
CLK181	One door locker, 457mm (18") deep	1802mm (70.9")	£252	
CLK182	Two door locker, 457mm (18") deep	1802mm (70.9")	£298	
CLK184	Four door locker, 457mm (18") deep	1802mm (70.9")	£348	
CLK186	Six door locker, 457mm (18") deep	1802mm (70.9")	£420	

Alternative Locking Options

BLLP1	Hasp lock, supplied separately as retrofitted option	N/A	£13
Description			Price (per lock)
To add Hasp locks add 'P' to the end of the code			£13
For 'Same lock number' on key locking add 'X' to the end of the code			-

For other locking options, please speak to your Bisley representative.

Optional extras:

Sloping tops are available for larger orders of CLK lockers. Please contact your Bisley representative for more information.

For all finishes options, please refer to page 262.



General Locking

Description	Price
Coin return lock	£52
Plastic locker combination lock - three x-digit dials	£24
Latch lock - for use with 6-7mm hasp padlock (not supplied)	£13
Mechanical combination lock - four x-digit dials	£58
Digital combination lock	£150
Programming & managers key - E4	£277
RFID lock	£192
Programming & managers key - RF1	£277

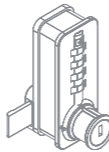
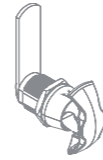
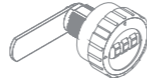
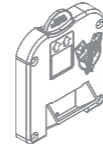

Description	Feature	Benefits
Coin return lock (5 Year Warranty)	<ul style="list-style-type: none"> - Wet area tested - High-quality brass pin tumbler barrel - High strength nickel silver key - Coin return tray as standard - Escutcheon available - Comprehensive range of coins or tokens - Industry standard footprint 	<ul style="list-style-type: none"> - For primary use in personal lockers sited in wet or dry area "open access" environments, this coinlock can be specified to operate with a comprehensive range of coins or tokens and encourages the user to return their key and therefore release the locker for use by others.
Plastic locker combination lock (5 Year Warranty)	<ul style="list-style-type: none"> - Compact three digit mechanical combination lock with simple code change and code finding functions. - Three-wheeled programmable combination lock, code find capability by using a shim - Low cost option 	<ul style="list-style-type: none"> - It has industry standard panel piercing size and is suitable for panel widths of up to 12mm (0.5") - Body size: 44mm (1.7") diameter - 20mm (0.8") body, fitted with cam 7240853 locked at 9:00, cranked away 90° clockwise movement
Latch lock (5 Year Warranty)	<ul style="list-style-type: none"> - Latch Lock for many applications - Uses 6-7mm (0.2") hasp pad lock - Handle turns freely with pad lock in place - Cam cannot be turned with pad lock in place - Push in handle to engage cam motion - 90° engaged movement - Optional cam specification - Chrome finish - Attractive size - Padlock not included 	<ul style="list-style-type: none"> - Locker Latch Lock - REF: 4428-702 - Low cost option - Please note: this lock does not include pad lock - Commonly used on locker units - person can bring own padlock to secure unit
Mechanical combination lock (2 Year Warranty)	<ul style="list-style-type: none"> - Automatic 0000 scramble feature to hide user's code once opened - Management key override - Established product and comprehensive applications available (cams, bolts, locking rods, sliding doors). European sourced - Available in horizontal and vertical orientations 	<ul style="list-style-type: none"> - Simple installation - Customisable settings - Programming & Managers key starter pack (must be specified with every order)
E4 Digital combination lock (3 Year Warranty)	<ul style="list-style-type: none"> - Keypad operation - Brushed nickel finish - Visible and audible indicators 	
RFID lock (3 Year Warranty)	<ul style="list-style-type: none"> - Brushed nickel finish - Visible and audible indicators - Manage with electronic keys or mobile device 	<ul style="list-style-type: none"> - Simple installation - Customisable settings - Programming & Managers key starter pack (must be specified with every order)



Arches

Introducing Arches - the ultimate workplace solution where zoning, flexibility, collaboration, and productivity can flourish.

With its sleek assortment of mobile screens and desks, Arches empowers you to tailor your environment to suit the task at hand. Flexible and moveable, Arches is mounted on sturdy, high-quality castors enabling easy mobility as needed. From quiet focussed individual workspaces to large, dynamic breakout areas where the Arches collection can be configured to include everyone, the range promotes inclusivity and wellness.

The Arches frames can be painted in a colour that suits you; ranging from muted, sophisticated neutrals to bright pops of colour that is sure to provide the centre point for your workspace. Arches' frames are also available in a sustainable, solid ash wood option, bringing with it a natural look and feel. The panels are covered in durable, high-quality fabric, suitable for a variety of commercial environments.

Arches also incorporates technology with a useful, integrated media unit, enabling you to showcase your latest marketing project or to host an informal presentation or workshop session. Unleash your creativity with endless possibilities and fluid spaces that inspire. And with the addition of practical yet thoughtful accessories like whiteboards, canopies, and planters, Arches promotes engagement and sparks innovation among every team member.

Arches - transforming spaces, inspiring possibilities.

 For more specification information click here

Arches Aluminium Frames

H: 1835mm (72.2") W: 1235mm (48.6") D: 550mm (21.7")

Product Code	Description
ARAF1812FAB	Fabric - aluminium frame with four fabric panels.

Band 1	Band 2	Band 3	Band 4
£2,100	£2,231	£2,361	£2,491



ARAF1812FAB

H: 1835mm (72.2") W: 1235mm (48.6") D: 550mm (21.7")

Product Code	Description
ARAF1812PET	PET - aluminium frame with one PET pinboard and three fabric panels.

Band 1	Band 2	Band 3	Band 4
£2,100	£2,193	£2,285	£2,378

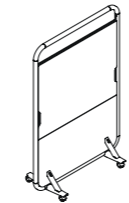

ARAF1812PET

H: 1835mm (72.2") W: 1235mm (48.6") D: 550mm (21.7")

Product Code	Description
ARAF1812COR	Cork - aluminium frame with one cork board and three fabric panels.

Band 1	Band 2	Band 3	Band 4
£2,100	£2,193	£2,285	£2,378

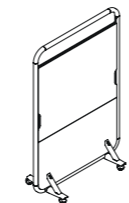

ARAF1812COR

H: 1835mm (72.2") W: 1235mm (48.6") D: 550mm (21.7")

Product Code	Description
ARAF1812GLA	Glass - aluminium frame with one coloured glass writing board and three fabric panels.

Band 1	Band 2	Band 3	Band 4
£3,001	£3,094	£3,185	£3,278

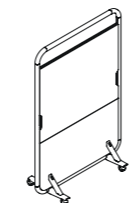

ARAF1812GLA

H: 1835mm (72.2") W: 1235mm (48.6") D: 550mm (21.7")

Product Code	Description
ARAF1812PLA	Planter - aluminium frame with three hanging planters and two bottom fabric panels.

Band 1	Band 2	Band 3	Band 4
£1,801	£1,856	£1,910	£1,964

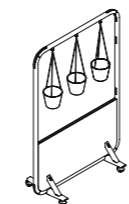

ARAF1812PLA

H: 1835mm (72.2") W: 1235mm (48.6") D: 550mm (21.7")

Product Code	Description	Price
ARAF1812MED	Media - aluminium frame with four laminated panels, including VESA standard TV mounting kit. Mains powered. Please note rechargeable battery version available on request.	£2,363

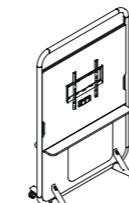

ARAF1812MED

Arches Wood Frames

H: 1835mm (72.2") W: 1235mm (48.8") D: 550mm (21.7")

Product Code	Description
ARWF1812FAB	Fabric - solid ash wood frame with four fabric panels.

Band 1	Band 2	Band 3	Band 4
£3,150	£3,281	£3,411	£3,541

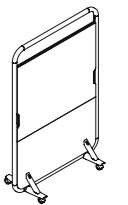

ARWF1812FAB

H: 1835mm (72.2") W: 1235mm (48.6") D: 550mm (21.7")

Product Code	Description
ARWF1812PET	PET - solid ash wood frame with one PET pinboard and three fabric panels.

Band 1	Band 2	Band 3	Band 4
£3,150	£3,243	£3,335	£3,428

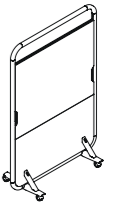

ARWF1812PET

H: 1835mm (72.2") W: 1235mm (48.6") D: 550mm (21.7")

Product Code	Description
ARWF1812COR	Cork - solid ash wood frame with one cork board and three fabric panels.

Band 1	Band 2	Band 3	Band 4
£3,150	£3,243	£3,335	£3,428

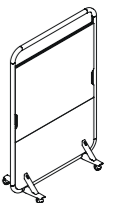

ARWF1812COR

H: 1835mm (72.2") W: 1235mm (49.2") D: 550mm (21.7")

Product Code	Description
ARWF1812GLA	Glass - solid ash wood frame with one coloured glass writing board and three fabric panels.

Band 1	Band 2	Band 3	Band 4
£4,051	£4,144	£4,235	£4,328

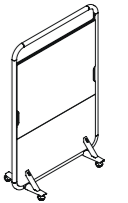

ARWF1812GLA

H: 1835mm (72.2") W: 1235mm (48.6") D: 550mm (21.7")

Product Code	Description
ARWF1812PLA	Planter - solid ash wood frame with three hanging planters and two bottom fabric panels.

Band 1	Band 2	Band 3	Band 4
£2,851	£2,906	£2,960	£3,014

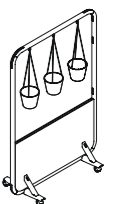

ARWF1812PLA

H: 1835mm (72.2") W: 1235mm (48.6") D: 550mm (21.7")

Product Code	Description	Price
ARWF1812MED	Media - solid ash wood frame with four laminated panels, including VESA standard TV mounting kit. Mains powered. Please note rechargeable battery version available on request.	£3,413

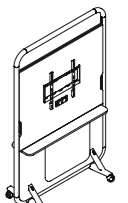

ARWF1812MED

Arches Canopy

W: 1230mm (48.4") T: 15.8mm (0.62")

Product Code	Description
AR6512CPY/AR5012CPY	Arches canopy - set of 2, length 500mm (19.7") and 650mm (25.6")

Band 1	Band 2	Band 3	Band 4
£1,050	£1,142	£1,232	£1,323

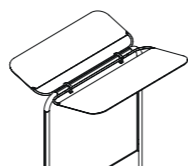

AR6512CPY/AR5012CPY

Arches Benches

H: 450mm (17.7") W: 1000mm (39.4") D: 500mm (19.7")

Product Code	Description
ARCHBENCHL	Arches bench with solid ash wood leg

Band 1	Band 2	Band 3	Band 4
£1,186	£1,271	£1,355	£1,440

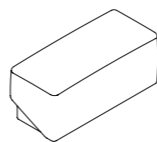

ARCHBENCHLS

Product Code	Description
ARCHBENCHS	Arches bench with ply slab leg

Band 1	Band 2	Band 3	Band 4
£886	£971	£1,056	£1,140

Arches Stools

H: 450mm (17.7") W: 500mm (19.7") D: 500mm (19.7")

Product Code	Description
ARCHSTOOLL	Arches stool with solid ash wood leg

Band 1	Band 2	Band 3	Band 4
£886	£937	£987	£1,039

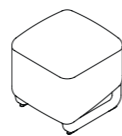

ARCHSTOOLL

Product Code	Description
ARCHSTOOLS	Arches stool with ply slab leg

Band 1	Band 2	Band 3	Band 4
£586	£637	£687	£739



Ply slab leg



Solid wood leg

Arches Tables

L:1050mm (41.3") W: 850mm (33.5") H: 1060mm (41.7")

Product Code	Description	Price
ARPD1608PS	Arches desk poseur with chamfered ply top	£1,336

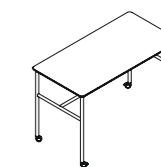

ARMD1608PS

Product Code	Description	Price
ARMD1608PS	Arches desk poseur with MFC top	£1,126

L:1050mm (41.3") W: 650mm (25.6") H: 1060mm (41.7")

Product Code	Description	Price
ARPD1006PS	Arches desk poseur with chamfered ply top	£1,081

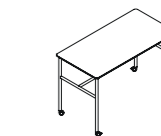

ARPD1006PS

Product Code	Description	Price
ARMD1006PS	Arches desk poseur with MFC top	£991

L:1050mm (41.3") W: 1050mm (41.3") H: 1060mm (41.7")

Product Code	Description	Price
ARPD1010PS	Arches desk poseur with chamfered ply top	£1,186

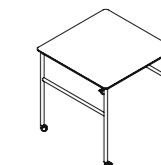

ARMD1010PS

Product Code	Description	Price
ARMD1010PS	Arches desk poseur with MFC top	£1,036

L:1050mm (41.3") W: 650mm (25.6") H: 715mm (28.1")

Product Code	Description	Price
ARPD1006SD	Arches desk seated with chamfered ply top	£826

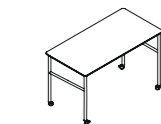

ARMD1006SD

Product Code	Description	Price
ARMD1006SD	Arches desk seated with MFC top	£661

For all finishes options, please refer to page 262.

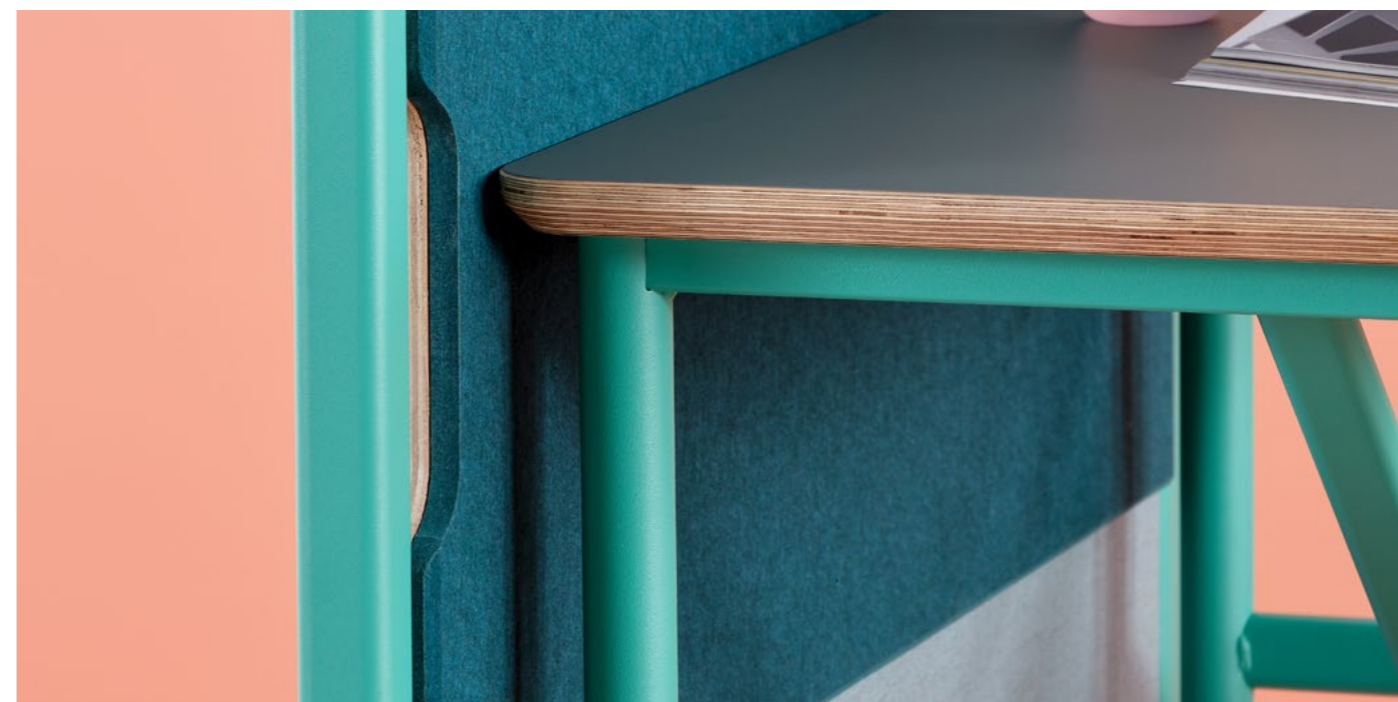





Outline

Step away from traditional desking and display with Outline by Bisley - the beautiful office frame that lets you fill in the details.

Office spaces are becoming more flexible, collaborative, and agile. Workspaces must adapt and accommodate both hybrid workers and in-person employees, supporting various workstyles while keeping personal belongings safe and secure.

Crafted from hand-welded steel for a seamless finish, Outline allows you to shape your environment for a sleek, minimalist, and modern look, so you can focus and stay on top of your workload in style and comfort.

10-Year Warranty

 For more specification information click here

Floor Standing Frames - Two Tier Floor Standing

H: 753mm (29.6") D: 400mm (15.7")

Product Code	Description	Width	Price
OF08402	Floor standing frame	800mm (31.5")	£1,296
OF10402	Floor standing frame	1000mm (39.4")	£1,418



OF08402

Floor Standing Frames - Two Tier Floor Standing

H: 812mm (32") D: 470mm (18.5")

Product Code	Description	Width	Price
OF08472	Floor standing frame	800mm (31.5")	£1,307
OF10472	Floor standing frame	1000mm (39.4")	£1,464



OF10472

Floor Standing Frames - Three Tier Floor Standing

H: 1133mm (44.6") D: 400mm (15.7")

Product Code	Description	Width	Price
OF08403	Floor standing frame	800mm (31.5")	£1,554
OF10403	Floor standing frame	1000mm (39.4")	£1,697



OF08403

Floor Standing Frames - Three Tier Floor Standing

H: 1199mm (47.2") D: 470mm (18.5")

Product Code	Description	Width	Price
OF08473	Floor standing frame	800mm (31.5")	£1,574
OF10473	Floor standing frame	1000mm (39.4")	£1,769



OF10473

Floor Standing Frames - Four Tier Floor Standing

H: 1512mm (59.5") D: 400mm (15.7")

Product Code	Description	Width	Price
OFS40404*	Floor standing frame	400mm (15.7")	£1,035



OFS40404

OF08404	Floor standing frame	800mm (31.5")	£1,675
OF10404	Floor standing frame	1000mm (39.4")	£1,809

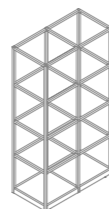

OF08404

Floor Standing Frames - Four Tier Floor Standing

H: 1585mm (62.4") D: 470mm (18.5")

Product Code	Description	Width	Price
OF08474	Floor standing frame	800mm (31.5")	£1,693
OF10474	Floor standing frame	1000mm (39.4")	£1,907

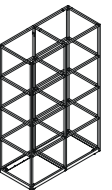

OF08474

Floor Standing Frames - Five Tier Floor Standing

H: 1891mm (74.5") D: 400mm (15.7")

Product Code	Description	Width	Price
OFS40405*	Floor standing frame	400mm (15.7")	£929



OFS40405

OF08405	Floor standing frame	800mm (31.5")	£1,778
OF10405	Floor standing frame	1000mm (39.4")	£1,987

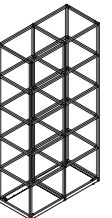

OF08405

Floor Standing Frames - Five Tier Floor Standing

H: 1968mm (77.5") D: 470mm (18.5")

Product Code	Description	Width	Price
OF08475	Floor standing frame	800mm (31.5")	£1,924
OF10475	Floor standing frame	1000mm (39.4")	£2,170

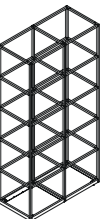

OF08475

*Please note: Single frames allow for 90 degree angles to be made from a run of floor standing frames. Only shelf accessories are compatible with these frames

Be Storage with Frames - One Tier

H: 1133mm (44.6") D: 400mm (15.7")

Product Code	Description	Width	Price	
OBC08401	Be cupboard with frame	800mm (31.5")	£1,902	 OBC08401
OBC10401	Be cupboard with frame	1000mm (39.4")	£2,062	
OBO08401	Be open unit with frame	800mm (31.5")	£1,557	 OBOC08401
OBO10401	Be open unit with frame	1000mm (39.4")	£1,713	

Be Storage with Frames - Two Tier

H: 1512mm (59.5") D: 400mm (15.7")

Product Code	Description	Width	Price	
OBC08402	Be cupboard with frame	800mm (31.5")	£2,106	 OBC10402
OBC10402	Be cupboard with frame	1000mm (39.4")	£2,320	
OBO08402	Be open unit with frame	800mm (31.5")	£1,759	 OBO10402
OBO10402	Be open unit with frame	1000mm (39.4")	£1,950	

Be Storage with Frames - Three Tier

H: 1891mm (74.4") D: 400mm (15.7")

Product Code	Description	Width	Price	
OBC08403	Be cupboard with frame	800mm (31.5")	£2,314	 OBO08403
OBC10403	Be cupboard with frame	1000mm (39.4")	£2,515	
OBO08403	Be open unit with frame	800mm (31.5")	£1,999	 OBO10403
OBO10403	Be open unit with frame	1000mm (39.4")	£2,229	

LateralFile Storage with Frames - One Tier

H: 1239mm (48.8") D: 470mm (18.5")

Product Code	Description	Width	Price	
OLC08471	LateralFile cupboard with frame	800mm (31.5")	£1,475	 OLC08471
OLC10471	LateralFile cupboard with frame	1000mm (39.4")	£1,623	
OLL08471AB	LateralFile four door locker with AB locks and frame	800mm (31.5")	£1,752	 OLL08471
OLL10471AB	LateralFile four door locker with AB locks and frame	1000mm (39.4")	£1,899	

LateralFile Storage with Frames - Two Tier

H: 1625mm (64") D: 470mm (18.5")

Product Code	Description	Width	Price	
OLC08472	LateralFile cupboard with frame	800mm (31.5")	£1,657	 OLC10472
OLC10472	LateralFile cupboard with frame	1000mm (39.4")	£1,816	
OLL08472AB	LateralFile four door locker with AB locks and frame	800mm (31.5")	£1,934	 OLL10472AB
OLL10472AB	LateralFile four door locker with AB locks and frame	1000mm (39.4")	£2,047	

LateralFile Storage with Frames - Three Tier

H: 2011mm (79.2") D: 470mm (18.5")

Product Code	Description	Width	Price	
OLC08473	LateralFile cupboard with frame	800mm (31.5")	£1,900	 OLC10473
OLC10473	LateralFile cupboard with frame	1000mm (39.4")	£2,088	
OLL08473AB	LateralFile four door locker with AB locks and frame	800mm (31.5")	£2,178	 OLL10473AB
OLL10473AB	LateralFile four door locker with AB locks and frame	1000mm (39.4")	£2,270	

Outline Storage with Frames - One Tier

H: 1133mm (44.6") D: 400mm (15.7")

Product Code	Description	Width	Price
OW08401	MFC cupboard with Outline frame	800mm (31.5")	£1,338
OW10401	MFC cupboard with Outline frame	1000mm (39.4")	£1,455



OW08401

Outline Storage with Frames - Two Tier

H: 1512mm (59.5") D: 400mm (15.7")

Product Code	Description	Width	Price
OW08402	MFC cupboard with Outline frame	800mm (31.5")	£1,550
OW10402	MFC cupboard with Outline frame	1000mm (39.4")	£1,700

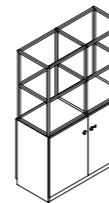

OW10402

Outline Storage with Frames - Three Tier

H: 1891mm (74.4") D: 400mm (15.7")

Product Code	Description	Width	Price
OW08403	MFC cupboard with Outline frame	800mm (31.5")	£1,770
OW10403	MFC cupboard with Outline frame	1000mm (39.4")	£1,953



OW10403

Outline Accessories - Wooden Locking Cube

H: 329mm (13") D: 396mm (15.6")

Product Code	Description	Width	Price
OL0804Z1AB	MFC locker cube with AB lock, compatible with 800mm wide x 400mm deep zone one frames	368mm (14.5")	£383
OL1004Z1AB	MFC locker cube, with AB lock compatible with 1000mm wide x 400mm deep zone one frames	468mm (18.4")	£402

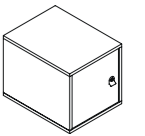

OL0804Z1AB

Outline Accessories - Wooden Locking Cube

H: 357mm (14") D: 396mm (15.6")

Product Code	Description	Width	Price
OL0804Z2AB	MFC locker cube with AB lock, compatible with 800mm wide x 400mm deep zone two frames	368mm (14.5")	£383
OL1004Z2AB	MFC locker cube with AB lock, compatible with 1000mm wide x 400mm deep zone two frames	468mm (18.4")	£402

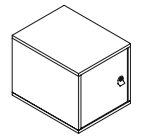

OL0804Z2AB

Outline Accessories - Wooden Locking Cube

H: 364mm (14.3") D: 466mm (18.3")

Product Code	Description	Width	Price
OL0847AB	MFC locker cube with AB lock, compatible with 800mm wide x 470mm deep frames	368mm (14.5")	£406
OL1047AB	MFC locker cube with AB lock, compatible with 1000mm wide x 470mm deep frames	468mm (18.4")	£425

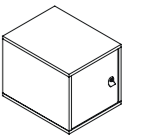

OL0847AB

Outline Accessories - Wooden Open Cube with Back Panel

H: 329mm (13") D: 396mm (15.6")

Product Code	Description	Width	Price
OB0804Z1	MFC open cube with back, compatible with 800mm wide x 400mm deep zone one frames	368mm (14.5")	£260
OB1004Z1	MFC open cube with back, compatible with 1000mm wide x 400mm deep zone one frames	468mm (18.4")	£273

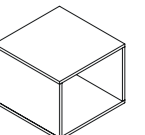

OB0804Z1

Outline Accessories - Wooden Open Cube with Back Panel

H: 357mm (14") D: 396mm (15.6")

Product Code	Description	Width	Price
OB0804Z2	MFC open cube with back, compatible with 800mm wide x 400mm deep zone two frames	368mm (14.5")	£260
OB1004Z2	MFC open cube with back, compatible with 1000mm wide x 400mm deep zone two frames	468mm (18.4")	£273

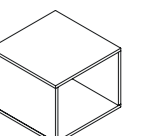

OB0804Z2

Outline Accessories - Wooden Open Cube with Back Panel

H: 357mm (14") D: 396mm (15.6")

Product Code	Description	Width	Price
OB0847	MFC open cube with back, compatible with 800mm wide x 470mm deep frames	368mm (14.5")	£266
OB1047	MFC open cube with back, compatible with 1000mm wide x 470mm deep frames	468mm (18.4")	£289



Outline Accessories - Wooden Cube with Moss Panel

H: 329mm (13") D: 400mm (15.7")

Product Code	Description	Width	Price
OM0804Z1	MFC moss backed cube, compatible with 800mm wide x 400mm deep zone one frames	368mm (14.5")	£531
OM1004Z1	MFC moss backed cube, compatible with 1000mm wide x 400mm deep zone one frames	468mm (18.4")	£636

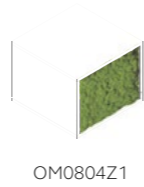

Outline Accessories - Wooden Cube with Moss Panel

H: 357mm (14") D: 400mm (15.7")

Product Code	Description	Width	Price
OM0804Z2	MFC moss backed cube, compatible with 800mm wide x 400mm deep zone two frames	368mm (14.5")	£531
OM1004Z2	MFC moss backed cube, compatible with 1000mm wide x 400mm deep zone two frames	468mm (18.4")	£636



Outline Accessories - Wooden Cube with Moss Panel

H: 364mm (14.3") D: 470mm (18.5")

Product Code	Description	Width	Price
OM0847	MFC moss backed cube, compatible with 800mm wide x 470mm deep frames	368mm (14.5")	£640
OM1047	MFC moss backed cube, compatible with 1000mm wide x 470mm deep frames	468mm (18.4")	£745



Outline Accessories - Wooden Pass Through Cube

H: 329mm (13") D: 396mm (15.6")

Product Code	Description	Width	Price
OP0804Z1	MFC pass through cube, compatible with 800mm wide x 400mm deep zone one frames	368mm (14.5")	£237
OP1004Z1	MFC pass through cube, compatible with 1000mm wide x 400mm deep zone one frames	468mm (18.4")	£248

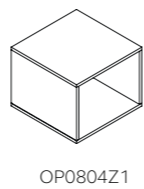

Outline Accessories - Wooden Pass Through Cube

H: 357mm (14") D: 396mm (15.6")

Product Code	Description	Width	Price
OP0804Z2	MFC pass through cube, compatible with 800mm wide x 400mm deep zone two frames	368mm (14.5")	£237
OP1004Z2	MFC pass through cube, compatible with 1000mm wide x 400mm deep zone two frames	468mm (18.4")	£248

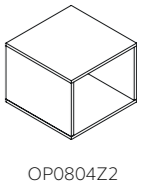

Outline Accessories - Wooden Pass Through Cube

H: 364mm (14.3") D: 466mm (18.3")

Product Code	Description	Width	Price
OP0847	MFC pass through cube, compatible with 800mm wide x 470mm deep frames	368mm (14.5")	£242
OP1047	MFC pass through cube, compatible with 1000mm wide x 470mm deep frames	468mm (18.4")	£262

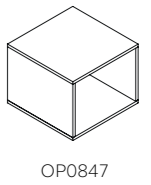

Outline Accessories - Wooden and Steel Shelves

D: 358mm (14.1")

Product Code	Description	Width	Price
OBWS04	18mm (0.7") MFC shelf compatible with 800mm wide x 400mm deep frames	367mm (14.5")	£53
OBWS05	18mm (0.7") MFC shelf compatible with 1000mm wide x 400mm deep frames	467mm (18.4")	£58
OBSS04	15mm (0.6") steel shelf compatible with 800mm wide x 400mm deep frames	367mm (14.5")	£53
OBSS05	15mm (0.6") steel shelf compatible with 1000mm wide x 400mm deep frames	467mm (18.4")	£58
OBWS04S	18mm (0.7") MFC shelf compatible with 400mm wide x 400mm deep single frames	367mm (14.5")	£53
OBSS04S	15mm (0.6") steel shelf compatible with 400mm wide x 400mm deep single frames	467mm (18.4")	£58

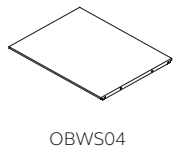

Outline Accessories - Wooden and Steel Shelves

D: 428mm (16.9")

Product Code	Description	Width	Price
OLWS04	18mm (0.7") MFC shelf compatible with 800mm wide x 470mm deep frames	367mm (14.5")	£57
OLWS05	18mm (0.7") MFC shelf compatible with 1000mm wide x 470mm deep frames	467mm (18.4")	£62
OLSS04	15mm (0.6") steel shelf compatible with 800mm wide x 470mm deep frames	367mm (14.5")	£57
OLSS05	15mm (0.6") steel shelf compatible with 1000mm wide x 470mm deep frames	467mm (18.4")	£62



Outline Accessories - Fabric Panels

H: 328mm (12.9") D: 18mm (0.7")

Product Code	Description	Width	Price
OF0804Z1	Fabric back panel compatible with 800mm wide x 400mm deep zone one frames	366mm (14.4")	£252
OF1004Z1	Fabric back panel compatible with 1000mm wide x 400mm deep zone one frames	466mm (18.3")	£303

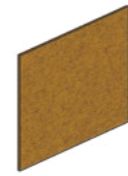

OF0804Z1

Outline Accessories - Fabric Panels

H: 356mm (14") D: 18mm (0.7")

Product Code	Description	Width	Price
OF0804Z2	Fabric back panel compatible with 800mm wide x 400mm deep zone two frames	368mm (14.5")	£252
OF1004Z2	Fabric back panel compatible with 1000mm wide x 400mm deep zone two frames	468mm (18.4")	£303

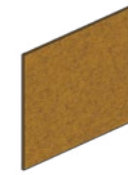

OF0804Z2

Outline Accessories - Fabric Panels

H: 361mm (14.2") D: 18mm (0.7")

Product Code	Description	Width	Price
OF0847	Fabric back panel compatible with 800mm wide x 470mm deep frames	368mm (14.5")	£252
OF1047	Fabric back panel compatible with 1000mm wide x 470mm deep frames	468mm (18.4")	£303

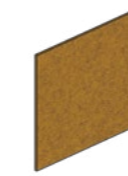

OF0847

Outline Planter

H: 123mm (4.8") D: 490mm (19.3")

Product Code	Description	Height	Width	Depth	Price
OP0804S	Steel planter compatible with 800mm wide x 400mm deep frames	123mm (4.8")	368mm (14.5")	396mm (15.6")	£179
OP1004S	Steel planter compatible with 1000mm wide x 400mm deep	123mm (4.8")	468mm (18.4")	396mm (15.6")	£197
OP0847S	Steel planter compatible with 800mm wide x 470mm deep frames	123mm (4.8")	368mm (14.5")	466mm (18.3")	£207
OP1047S	Steel planter compatible with 1000mm wide x 470mm deep frames	123mm (4.8")	468mm (18.4")	466mm (18.3")	£216



OP0804S

Outline Accessories - Hanging Whiteboards

H: 780mm (30.7") D: 39mm (1.5")

Product Code	Description	Width	Price
OBW40804	Small whiteboard (4 squares) compatible with 800mm wide x 400mm deep frames	796mm (31.3")	£155
OBW41004	Small whiteboard (4 squares) compatible with 1000mm wide x 400mm deep frames	996mm (39.2")	£182

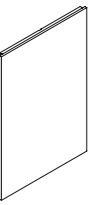

OBW40804

Outline Accessories - Hanging Whiteboards

H: 1158mm (45.6") D: 39mm (1.5")

Product Code	Description	Width	Price
OBW60804	Large whiteboard (6 squares) compatible with 800mm wide x 400mm deep frames	796mm (31.3")	£195
OBW61004	Large whiteboard (6 squares) compatible with 1000mm wide x 400mm deep frames	996mm (39.2")	£210

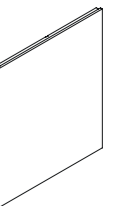

OBW60804

Outline Accessories - Hanging Whiteboards

H: 793mm (31.2") D: 39mm (1.5")

Product Code	Description	Width	Price
OLW40847	Small whiteboard (4 squares) compatible with 800mm wide x 470mm deep frames	796mm (31.3")	£166
OLW41047	Small whiteboard (4 squares) compatible with 1000mm wide x 470mm deep frames	996mm (39.2")	£194

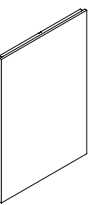

OLW41047

Outline Accessories - Hanging Whiteboards

H: 1178mm (46.4") D: 39mm (1.5")

Product Code	Description	Width	Price
OLW60847	Large whiteboard (6 squares) compatible with 800mm wide x 470mm deep frames	796mm (31.3")	£186
OLW61047	Large whiteboard (6 squares) compatible with 1000mm wide x 470mm deep frames	996mm (39.2")	£204

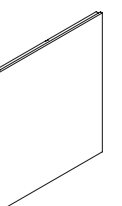

OLW60847

Outline Accessories - Retrofit Frames - One Tier

H: 406mm (16") D: 470mm (18.5")

Product Code	Description	Width	Price
OR08471	Retrofitting one tier Outline frame, compatible with 800mm wide x 470mm deep LateralFile units	800mm (31.5")	£645
OR10471	Retrofitting one tier Outline frame, compatible with 1000mm wide x 470mm deep LateralFile units	1000mm (39.4")	£672

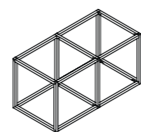

OR08471

Outline Accessories - Retrofit Frames - Two Tier

H: 792mm (31.2") D: 470mm (18.5")

Product Code	Description	Width	Price
OR08472	Retrofitting two tier Outline frame, compatible 800mm wide x 470mm deep LateralFile units	800mm (31.5")	£810
OR10472	Retrofitting two tier Outline frame, compatible 1000mm wide x 470mm deep LateralFile units	1000mm (39.4")	£853

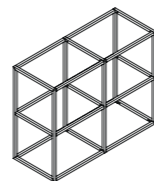

OR10472

Outline Accessories - Retrofit Frames - Three Tier

H: 1179mm (46.4") D: 470mm (18.5")

Product Code	Description	Width	Price
OR08473	Retrofitting three tier Outline frame, compatible 800mm wide x 470mm deep LateralFile units	800mm (31.5")	£1,070
OR10473	Retrofitting three tier Outline frame, compatible 1000mm wide x 470mm deep LateralFile units	1000mm (39.4")	£1,136

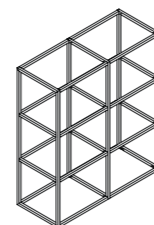

OR10473

For alternative locking options, please speak to your Bisley representative.

400mm (15.7") storage with frame (Be storage)

Please note: A steel finish is required for the carcass and frame. Additional steel or wood finishes are required for the base shelves, closures and back panel.

400mm (15.7") storage with frame (Outline storage)

Please note: A wood finish is required for the carcass and closures. A steel finish is required for the frame. Either a wood or steel finish is required for the base shelves, and an additional handle finish is also required.

470mm (18.5") storage with frame

Please note: A steel finish is required for the carcass and frame. An additional steel or wood finish is required for the base shelves.

Additional materials:

Fabric back panels are available in Camira Blazer.

Outline storage round wood handles are available in either light, medium or dark wood finishes.

For all finishes options, please refer to page 262.

Zone information

Our 400mm deep frames are split into two 'zones'. The frame dimensions vary slightly from ZONE 1 and ZONE 2.

Each of the accessories, apart from MFC shelves and planters, have two versions, one to fit each zone.

Please note: All Outline frames are supplied empty, except for the two base shelves. We recommend adding shelves and/or accessories to your frames.

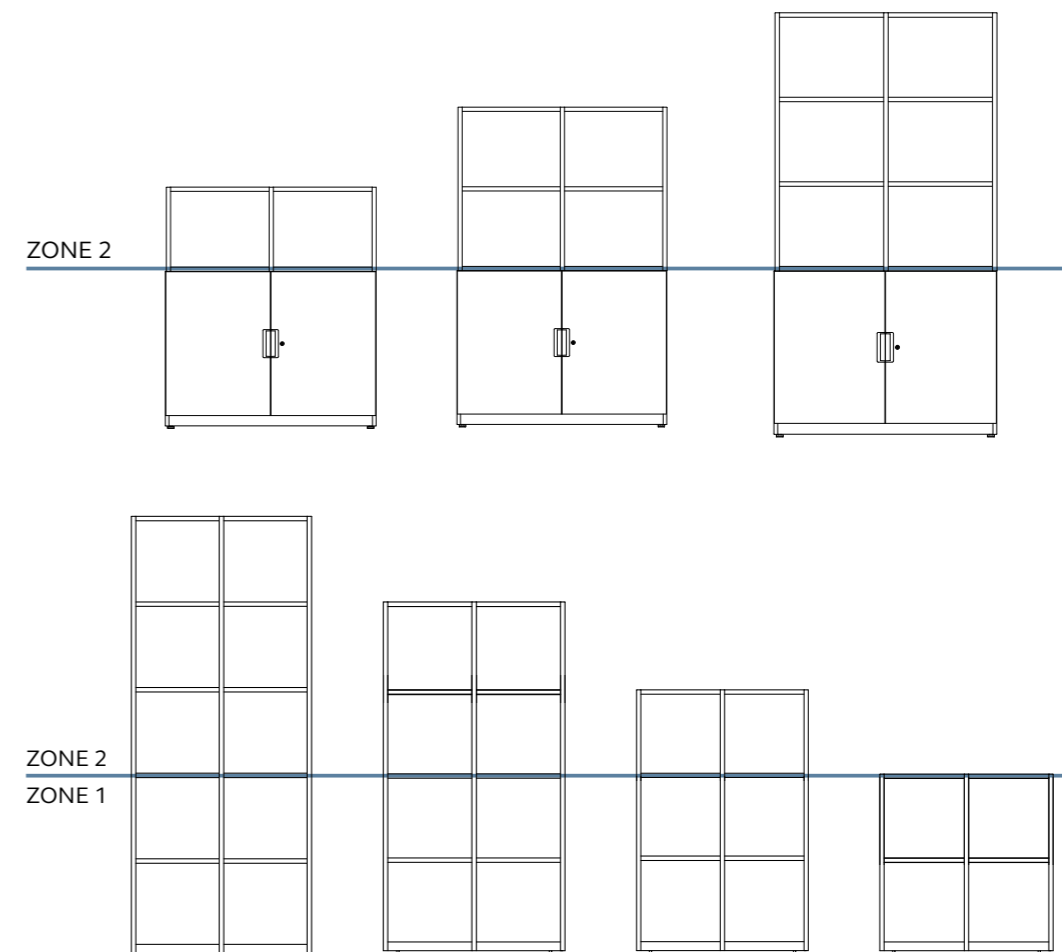



Kubbi

Kubbi is your perfect stowage solution for the workplace.

Lock away your personal belongings for the day in one of Kubbi's cosy compartments. Tailored to suit you with a variety of cube combinations, including open display cube compartments, Kubbi gives you the room to build and tailor your workspace.

With storage at the heart, Kubbi connects your space and can be used as a stylish and useful room divider, all without building any walls. Dual facing, Kubbi can act as a standalone piece, or you can choose to create larger configurations by connecting several units together.

5-Year Warranty



Kubbi Configuration A

H: 1638mm (64.5") D: 440mm (17.3")

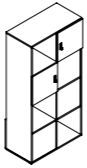
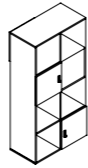
Product Code	Description	Width	Price	Front	Rear
KU16084A1	Four single doors with M3 locks, three pass through, one open with back panel.	800mm (31.4")	£1,155		
KU16084A2	Four single doors with AB locks, three pass through, one open with back panel.	800mm (31.4")	£928		

Kubbi Configuration B

H: 1638mm (64.5") D: 440mm (17.3")

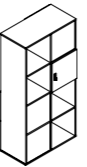
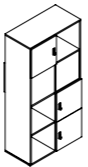
Product Code	Description	Width	Price	Front	Rear
KU16084B1	Four single doors with M3 locks, three pass through, one open with back panel.	800mm (31.4")	£1,155		
KU16084B2	Four single doors with AB locks, three pass through, one open with back panel.	800mm (31.4")	£928		

Kubbi Configuration C

H: 1638mm (64.5") D: 440mm (17.3")

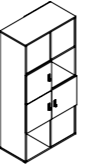
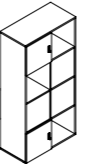
Product Code	Description	Width	Price	Front	Rear
KU16084C1	Five single doors with M3 locks, two pass through, one open with back panel.	800mm (31.4")	£1,319		
KU16084C2	Five single doors with AB locks, two pass through, one open with back panel.	800mm (31.4")	£1,035		

Kubbi Configuration D

H: 1638mm (64.5") D: 440mm (17.3")

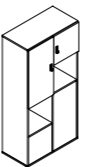
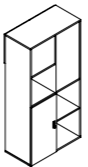
Product Code	Description	Width	Price	Front	Rear
KU16084D1	One single door with M3 lock, two double doors with M3 locks, two pass through, one open with back panel.	800mm (31.4")	£992		
KU16084D2	One single door with AB lock, two double doors with AB locks, two pass through, one open with back panel.	800mm (31.4")	£822		

Kubbi Configuration E

H: 1638mm (64.5") D: 440mm (17.3")

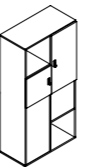
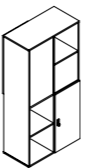
Product Code	Description	Width	Price	Front	Rear
KU16084E1	One single door with M3 lock, two double doors with M3 locks, two pass through, one open with back panel.	800mm (31.4")	£992		
KU16084E2	One single door with AB lock, two double doors with AB locks, two pass through, one open with back panel.	800mm (31.4")	£822		

Kubbi codes ending in '1' = M3 locks
Kubbi codes ending in '2' = AB locks

For all finishes options, please refer to page 262.





Planters

- Our beautiful, planter range can be incorporated into a collection of our product ranges, including LateralFile, Outline, Bridge, and Pren. Add a touch of biophilia to your space to really boost employee well-being and introduce calmness and tranquillity.

Biophilia is something that many businesses have embraced with open arms. Some spaces are even taking it to the next level by planting full sized trees in the lobby or reception, while greenery is appearing in lights, fixtures, and furniture throughout the office.

 [For more specification information click here](#)

Slatted Planter H: 940mm (37") W: 1015mm (40") D: 490mm (19.3")

Product Code	Description	Price
AMR8A	Static slatted planter	£1,229
AMR8B	Mobile slatted planter	£1,284
RECPL0910	Static slatted planter with three recycling bins	£1,633



AMR8A

Mobile Frame Planter H: 1145mm (45.1") W: 970mm (38.2") D: 415mm (16.3")

Product Code	Description	Price
AMR10	Mobile planter with locking castors	£1,147



All planters come with one watertight liner*

Please note: All planter liners have an internal depth of 113mm (4.4").

*Mobile Frame Planter comes with two liners.

For all finishes options, please refer to page 262.



Product shown: AMR8C

Please note: All planter liners have an internal depth of 113mm (4.4")



Product shown: AMR10



LateralFile



Incredibly versatile, with a superior, minimalist design and a seamless finish, LateralFile is a true furniture systems approach to storage, enabling an entire floor plan to be specified with one product range.

Its wide variety of options can meet the needs of even the most challenging filing and storage requirements. The LateralFile range is stylish and high-quality, with a seam-free design and soft-close double-skin doors. With a strong reputation and a timeless aesthetic appeal, LateralFile is first choice for architects, designers and end users around the world.

10-Year Warranty

 For more specification information click here

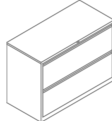

LateralFile Drawers W: 800mm (31.5") D: 470mm (18.5")

Product Code	Description	Height	Price	
08C20.2HQ	Two 305mm (12") drawers including file bars and counterbalance	693mm (27.3")	£1,269	
08C30.3HQ	Three 305mm (12") drawers including file bars and counterbalance	997mm (39.2")	£1,658	
08C40.4H	Four 305mm (12") drawers including file bars	1301mm (51.2")	£1,947	

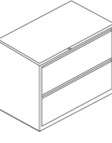
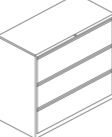
LateralFile Drawers W: 900mm (35.4") D: 470mm (18.5")

Product Code	Description	Height	Price	
09C20.2HQ	Two 305mm (12") drawers including file bars and counterbalance	693mm (27.3")	£1,384	
09C30.3HQ	Three 305mm (12") drawers including file bars and counterbalance	997mm (39.2")	£1,792	

LateralFile Drawers W: 1000mm (39.4") D: 470mm (18.5")

Product Code	Description	Height	Price	
10C20.2HQ	Two 305mm (12") drawers including file bars and counterbalance	693mm (27.3")	£1,384	
10C30.3HQ	Three 305mm (12") drawers including file bars and counterbalance	997mm (39.2")	£1,793	
10C40.4H	Four 305mm (12") drawers including file bars	1301mm (51.2")	£2,140	

LateralFile Two Door Cupboards W: 800mm (31.5") D: 470mm (18.5")

08D20	08DD21*	08D24	08D30	08D32	08D34	
H: 693mm (27.3") £938	H: 718mm (28.3") £1,125	H: 845mm (33.3") £1,023	H: 997mm (39.2") £1,112	H: 1073mm (42.2") £1,158	H: 1149mm (45.2") £1,204	
08D36	08D40	08D43	08D48	08D50	08D54	
H: 1225mm (48.2") £1,248	H: 1301mm (51.2") £1,294	H: 1415mm (55.3") £1,383	H: 1605mm (63.2") £1,417	H: 1643mm (64.7") £1,437	H: 1795mm (70.7") £1,537	
08D60	08D61	08D64				
H: 1947mm (76.6") £1,629	H: 1985mm (78.1") £1,701	H: 2099mm (82.6") £1,769				





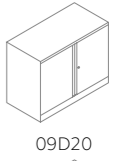
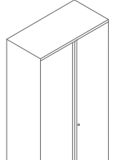

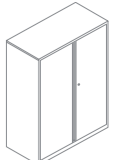
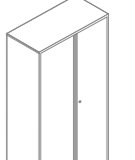

*Height is adjustable up to 8mm (0.3") in total

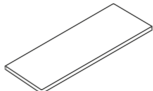
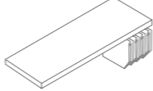
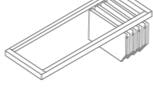
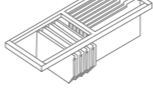
LateralFile Two Door Cupboards W: 900mm (35.4") D: 470mm (18.5")

09D20	09D30	09D32	09D34	09D36	09D60	
H: 693mm (27.3") £1,007	H: 997mm (39.2") £1,173	H: 1073mm (42.2") £1,200	H: 1149mm (45.2") £1,231	H: 1225mm (48.2") £1,275	H: 1947mm (76.6") £1,731	
09D64						
H: 2099mm (82.6") £1,860						

LateralFile Two Door Cupboards W: 1000mm (39.4") D: 470mm (18.5")

10D20	10D24	10D30	10D32	10D34	10D36	
H: 693mm (27.3") £1,007	H: 845mm (33.3") £1,089	H: 997mm (39.2") £1,173	H: 1073mm (42.2") £1,200	H: 1149mm (45.2") £1,231	H: 1225mm (48.2") £1,275	
10D40	10D43	10D48	10D50	10D54	10D60	
H: 1301mm (51.2") £1,322	H: 1415mm (55.3") £1,437	H: 1605mm (63.2") £1,495	H: 1643mm (64.7") £1,566	H: 1795mm (70.7") £1,654	H: 1947mm (76.6") £1,731	
10D61	10D64					
H: 1985mm (78.1") £1,779	H: 2099mm (82.6") £1,860					

Product Code	Description	Width	Price	
IC08BSPS:T5	Basic shelf – 27.5mm (1.1") thick	800mm (31.5")	£66	
IC09BSPS:T5	-	900mm (35.4")	£71	
IC10BSPS:T5	-	1000mm (39.4")	£71	
IC08BSUPS	Basic shelf with undershelf filing	800mm (31.5")	£84	
IC09BSUPS	-	900mm (35.4")	£96	
IC10BSUPS	-	1000mm (39.4")	£96	
IC08LRPS	Lateral rail	800mm (31.5")	£67	
IC09LRPS	-	900mm (35.4")	£71	
IC10LRPS	-	1000mm (39.4")	£71	
IC08RFPS	Roll-out filing frame	800mm (31.5")	£213	
IC09RFPS	-	900mm (35.4")	£227	
IC10RFPS	-	1000mm (39.4")	£227	
ICCRPS	Cross rails (pair) for front to back suspension	N/A	£41	
IACB08PS	Counterbalance	800mm (31.5")	£93	
IACB09PS	-	900mm (35.4")	£115	
IACB10PS	-	1000mm (39.4")	£137	
IC08NBSPS*	Narrow basic shelf – 25mm (1") thick	800mm (31.5")	£66	
IC09NBSPS*	-	900mm (35.4")	£71	
IC10NBSPS*	-	1000mm (39.4")	£71	
IC08CRPS	Shelf with coat rail front to back	800mm (31.5")	£112	
IC09CRPS	-	900mm (35.4")	£124	
IC10CRPS	-	1000mm (39.4")	£124	
CAPCHP4PS	Captive coat hangers (pack of 4)	N/A	£49	
IC08SSPDPS:T5	Slotted shelf – 27.5mm (1") for plastic dividers	800mm (31.5")	£95	
IC09SSPDPS:T5	-	900mm (35.4")	£108	
IC10SSPDPS:T5	-	1000mm (39.4")	£108	
IC08SSUPDPS:T5	Slotted shelf with undershelf filing – 27.5mm (1") for plastic dividers	800mm (31.5")	£117	
IC09SSUPDPS:T5	-	900mm (35.4")	£129	
IC10SSUPDPS:T5	-	1000mm (39.4")	£129	
IC08NSSPDPS*	Narrow slotted shelf – 25mm (1") for plastic dividers	800mm (31.5")	£105	
IC09NSSPDPS*	-	900mm (35.4")	£108	
IC10NSSPDPS*	-	1000mm (39.4")	£108	
SHDV64P5PS	Plastic shelf dividers (pack of 5)	N/A	£69	
MSDIV431P2	Steel shelf dividers (clip on design) (pack of 2)	N/A	£78	
PGNHLESET	Plastic pigeon hole set (includes dividers and intershelves - for use with slotted shelves only)	N/A	£186	
	(slotted shelf not included)			



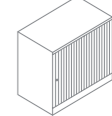
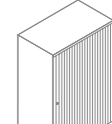

*Please note: For use behind flipper only

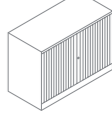
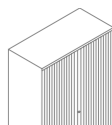
08T20.*	08DT21.*†	08T24.*	08T30.*	08T32.*	08T34.*	
H: 693mm (27.3")	H: 718mm (28.3")	H: 845mm (33.3")	H: 997mm (39.2")	H: 1073mm (42.2")	H: 1149mm (45.2")	
£860	£955	£955	£1,034	£1,118	£1,200	
08T36.*	08T40.*	08T43.*				
H: 1225mm (48.2")	H: 1301mm (51.2")	H: 1415mm (55.3")	£1,200	£1,200	£1,357	

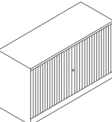
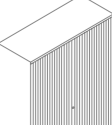
†Height is adjustable up to 8mm (0.3") in total

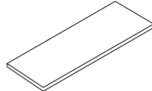
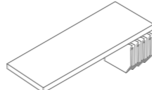
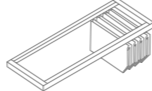
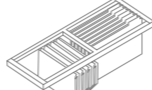
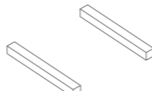
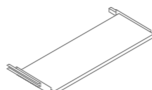
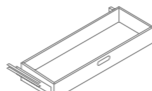
10T20.*	10T24.*	10T30.*	10T32.*	10T34.*	10T36.*	
H: 693mm (27.3")	H: 845mm (33.3")	H: 997mm (39.2")	H: 1073mm (42.2")	H: 1149mm (45.2")	H: 1225mm (48.2")	
£1,007	£1,112	£1,212	£1,317	£1,415	£1,415	
10T40.*	10T43.*	10T50.*	10T54.*	10T60.*	10T64.*	
H: 1301mm (51.2")	H: 1415mm (55.3")	H: 1643mm (64.7")	H: 1795mm (70.7")	H: 1947mm (76.6")	H: 2099mm (82.6")	
£1,415	£1,654	£1,682	£1,759	£1,884	£1,957	

12T20.*	12T24.*	12T30.*	12T34.*	12T40.*	12T50.*	
H: 693mm (27.3")	H: 845mm (33.3")	H: 997mm (39.2")	H: 1149mm (45.2")	H: 1315mm (51.8")	H: 1643mm (64.7")	
£1,112	£1,221	£1,331	£1,560	£1,560	£1,826	
12T54.*	12T60.*	12T64.*				
H: 1795mm (70.7")	H: 1947mm (76.6")	H: 2099mm (82.6")	£1,950	£2,069	£2,193	

Product Code	Description	Width	Price	
IT08BSPS:T5	Basic shelf – 27.5mm (1.1") thick	800mm (31.5")	£70	
IT10BSPS:T5	-	1000mm (39.4")	£75	
IT12BSPS:T5	-	1200mm (47.2")	£91	
IT08BSUPS	Basic shelf with undershelf filing	800mm (31.5")	£91	
IT10BSUPS	-	1000mm (39.4")	£101	
IT12BSUPS	-	1200mm (47.2")	£118	
IT08LRPS	Lateral rail	800mm (31.5")	£70	
IT10LRPS	-	1000mm (39.4")	£75	
IT12LRPS	-	1200mm (47.2")	£78	
IT08RFPS	Roll-out filing frame	800mm (31.5")	£213	
IT10RFPS	-	1000mm (39.4")	£227	
IT12RFPS	-	1200mm (47.2")	£252	
ITCRPS	Cross rails (pair) for front to back suspension	N/A	£45	
ITCRPBPS	Piggy back cross rails (pair)	N/A	£46	
IT08RSPS	Roll-out reference shelf (tambours only)	800mm (31.5")	£261	
IT10RSPS	-	1000mm (39.4")	£276	
IT12RSPS	-	1200mm (47.2")	£285	
IT08RDPS	Roll-out 4" drawer	800mm (31.5")	£227	
IT10RDPS	-	1000mm (35.4")	£246	
IT12RDPS	-	1200mm (47.2")	£256	
IAD4P3PS	Dividers for roll-out 4" drawer (pack of 3)	800mm (31.5")	£45	
IACB08PS	Counterbalance	1000mm (39.4")	£93	
IACB10PS	-	1200mm (47.2")	£137	
IACB12PS	-	800mm (31.5")	£137	
IT08NBSPS	Narrow basic shelf – 25mm (1") thick	1000mm (39.4")	£70	
IT10NBSPS	-	800mm (31.5")	£75	
IT08CRPS	Shelf with coat rail front to back	1000mm (39.4")	£119	
IT10CRPS	-	1200mm (47.2")	£132	
IT12CRPS	-	N/A	£152	
CAPCHP4PS	Captive coat hangers (pack of 4)		£49	
IT08SSPDPS:T5	Slotted shelf – 27.5mm (1") for plastic dividers	800mm (31.5")	£100	
IT10SSPDPS:T5	-	1000mm (39.4")	£115	
IT12SSPDPS:T5	-	1200mm (47.2")	£128	
IT08SSUPDPS:T5	Slotted shelf with undershelf filing – 27.5mm (1") for plastic dividers	800mm (31.5")	£124	
IT10SSUPDPS:T5	-	1000mm (39.4")	£136	
IT12SSUPDPS:T5	-	1200mm (47.2")	£164	
SHDV64P5PS	Plastic shelf dividers (pack of 5)	N/A	£69	
MSDIV431P2	Steel shelf dividers (clip on design)	N/A	£78	
PGNHLESET	Plastic pigeon hole set (includes dividers and intershelves - for use with slotted shelves only) (slotted shelf not included)	N/A	£186	

Product Code	Description	Height	Price	
08C32B.2HQ	381mm (15") flipper, 2x 305mm (12") drawers inc file bars and counterbalance	1073mm (42.2")	£1,606	
08C34ET.2HQ	419.1mm (16.5") flipper, tie bar, two 305mm (12") drawers inc file bars and counterbalance	1149mm (45.2")	£1,710	
08C502CT.3H	Two 305mm (12") flippers, tie bar, three 305mm (12") drawers inc file bars	1643mm (64.7")	£2,176	
08C50WT.3H	609.6mm (24") doors, tie bar, three 305mm (12") drawers inc file bars	1643mm (64.7")	£2,183	
08C542BT.3H	Two 318mm (15") flippers, tie bar, three 305mm (12") drawers inc file bars	1795mm (70.7")	£2,262	

Product Code	Description	Height	Price	
10C32B.2HQ	381mm (15") flipper, two 305mm (12") drawers inc file bars and counterbalance	1073mm (42.2")	£1,689	
10C34L.3HQ	152.4mm (6") drawer, three 305mm (12") drawers inc file bars and counterbalance	1149mm (45.2")	£2,156	
10C34ET.2HQ	419.1mm (16.5") flipper, tie bar, two 305mm (12") drawers inc file bars and counterbalance	1149mm (45.2")	£1,820	

W: 1000mm (39.4") D: 470mm (18.5")

Product Code	Description	Height	Price	
10C502CT.3H	Two 305mm (12") flippers, tie bar, three 305mm (12") drawers inc file bars	1643mm (64.7")	£2,303	
10C50WT.3H	609.6mm (24") doors, tie bar, three 305mm (12") drawers inc file bars	1643mm (64.7")	£2,314	
10C542BT.3H	Two 381mm (15") flippers, tie bar, three 305mm (12") drawers inc file bars	1795mm (70.7")	£2,385	
10C54ST.3H	762mm (30") doors, tie bar, three 305mm (12") drawers inc file bars	1795mm (70.7")	£2,365	
10C60WT.4H	609.6mm (24") doors, tie bar, four 305mm (12") drawers inc file bars	1947mm (76.6")	£2,753	
10C60XT.3H	914.4mm (36") doors, tie bar, three 305mm (12") drawers inc file bars	1947mm (76.6")	£2,523	

LateralFile Specialist - Bookcase Units

D: 300mm (11.8")

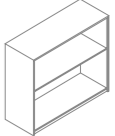
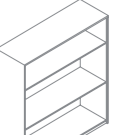
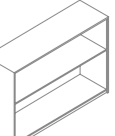
Product Code	Description	Width	Height	Price	
08BK20	One shelf	800mm (31.5")	693mm (27.3")	£574	
08BK30	Two shelves	800mm (31.5")	997mm (39.2")	£744	
08BK34	Two shelves	800mm (31.5")	1149mm (45.2")	£835	
09BK20	One shelf	900mm (35.4")	693mm (27.3")	£646	
09BK30	Two shelves	900mm (35.4")	997mm (39.2")	£785	
09BK34	Two shelves	900mm (35.4")	1149mm (45.2")	£853	
10BK20	One shelf	1000mm (39.4")	693mm (27.3")	£774	
10BK30	Two shelves	1000mm (39.4")	997mm (39.2")	£812	
10BK34	Two shelves	1000mm (39.4")	1149mm (45.2")	£853	

LateralFile Specialist - Magazine Units

D: 470mm (18.5")

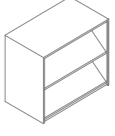
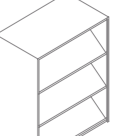
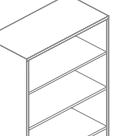
Product Code	Description	Width	Height	Price	
08MU20	Two fixed Sloping Shelves	800mm (31.5")	693mm (27.3")	£835	
08MU30	Three fixed Sloping Shelves	800mm (31.5")	997mm (39.2")	£1,085	
08MU40	Four fixed Sloping Shelves	800mm (31.5")	1301mm (51.2")	£1,231	
09MU20	Two fixed Sloping Shelves	900mm (35.4")	693mm (27.3")	£941	
09MU30	Three fixed Sloping Shelves	900mm (35.4")	997mm (39.2")	£1,183	
09MU40	Four fixed Sloping Shelves	900mm (35.4")	1301mm (51.2")	£1,396	
10MU20	Two fixed Sloping Shelves	1000mm (39.4")	693mm (27.3")	£941	
10MU30	Three fixed Sloping Shelves	1000mm (39.4")	997mm (39.2")	£1,183	
10MU40	Four fixed Sloping Shelves	1000mm (39.4")	1301mm (51.2")	£1,396	

LateralFile Specialist - Magazine Seated Units

H: 514mm (21.3") D: 470mm (18.5")

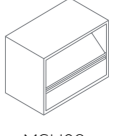
Product Code	Description	Width	Price	
MSU08	One fixed sloping shelf, 190.5mm (7.5") drawer	800mm (31.5")	£1,064	
MSU10	One fixed sloping shelf, 190.5mm (7.5") drawer	1000mm (39.4")	£1,120	

LateralFile Specialist - Magazine Unit Seat Pads (Suitable for 470mm (18.5") Deep Units)

H: 38mm (1.5")

Product Code	Description	Width	Price
SPAD8047*XXXXX	Seat pad	800mm (31.5")	£303
SPAD1047*XXXXX	Seat pad	1000mm (39.4")	£303

LateralFile Specialist - RecycleSpace (Top Access) W: 800mm (31.5") D: 470mm (18.5")

Product Code	Description	Height	Price
RCY3B08D30	Three bin cupboard (includes a shelf & three bins)	997mm (39.2")	£1,804
RCY3B08D33	Three bin cupboard (includes a shelf & three bins)	1111mm (43.7")	£1,836
RCY3B08D34	Three bin cupboard (includes a shelf & three bins)	1149mm (45.2")	£1,846

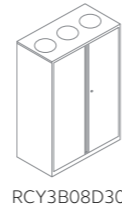

LateralFile Specialist - RecycleSpace (Top Access) W: 900mm (35.4") D: 470mm (18.5")

Product Code	Description	Height	Price
RCY3B09D30	Three bin cupboard (includes a shelf & three bins)	997mm (39.2")	£1,837
RCY3B09D33	Three bin cupboard (includes a shelf & three bins)	1111mm (43.7")	£1,883
RCY3B09D34	Three bin cupboard (includes a shelf & three bins)	1149mm (45.2")	£1,917

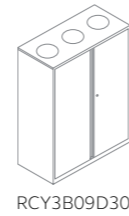

LateralFile Specialist - RecycleSpace (Top Access) W: 1000mm (39.4") D: 470mm (18.5")

Product Code	Description	Height	Price
RCY3B10D30	Three bin cupboard (includes a shelf & three bins)	997mm (39.2")	£1,837
RCY3B10D33	Three bin cupboard (includes a shelf & three bins)	1111mm (43.7")	£1,883
RCY3B10D34	Three bin cupboard (includes a shelf & three bins)	1149mm (45.2")	£1,917

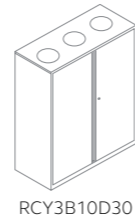

LateralFile Specialist - RecycleSpace (Front Access) W: 800mm (31.5") D: 470mm (18.5")

Product Code	Description	Height	Price
FRCY3B08D30	Three bin cupboard (includes three bins)	997mm (39.2")	£1,887
FRCY3B08D33	Three bin cupboard (includes a shelf & three bins)	1111mm (43.7")	£1,916
FRCY3B08D34	Three bin cupboard (includes a shelf & three bins)	1149mm (45.2")	£1,929

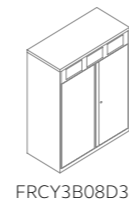

LateralFile Specialist - RecycleSpace (Front Access) W: 900mm (35.4") D: 470mm (18.5")

Product Code	Description	Height	Price
FRCY3B09D30	Three bin cupboard (includes three bins)	997mm (39.2")	£2,026
FRCY3B09D33	Three bin cupboard (includes a shelf & three bins)	1111mm (43.7")	£2,067
FRCY3B09D34	Three bin cupboard (includes a shelf & three bins)	1149mm (45.2")	£2,099

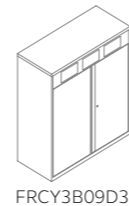

LateralFile Specialist - RecycleSpace (Front Access) W: 1000mm (39.4") D: 470mm (18.5")

Product Code	Description	Height	Price
FRCY3B10D30	Three bin cupboard (includes three bins)	997mm (39.2")	£2,026
FRCY3B10D33	Three bin cupboard (includes a shelf & three bins)	1111mm (43.7")	£2,067
FRCY3B10D34	Three bin cupboard (includes a shelf & three bins)	1149mm (45.2")	£2,099

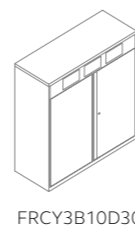

LateralFile Specialist - Coat Cupboards (with rail and shelf) D: 600mm (23.6")

Product Code	Description	Width	Price
V08CTCPD54	H: 1795mm (70.7") W: 800mm (31.5")	800mm (31.5")	£2,287
V09CTCPD54	H: 1795mm (70.7") W: 900mm (35.4")	900mm (35.4")	£2,461
V10CTCPD54	H: 1795mm (70.7") W: 1000mm (39.4")	1000mm (39.4")	£2,461
V08CTCPD60	H: 1947mm (76.6") W: 800mm (31.5")	800mm (31.5")	£2,423
V09CTCPD60	H: 1947mm (76.6") W: 900mm (35.4")	900mm (35.4")	£2,582
V10CTCPD60	H: 1947mm (76.6") W: 1000mm (39.4")	1000mm (39.4")	£2,582
O8CTCPD54	H: 1795mm (70.7") W: 800mm (31.5")	800mm (31.5")	£2,174
O9CTCPD54	H: 1795mm (70.7") W: 900mm (35.4")	900mm (35.4")	£2,346
10CTCPD54	H: 1795mm (70.7") W: 1000mm (39.4")	1000mm (39.4")	£2,346
O8CTCPD60	H: 1947mm (76.6") W: 800mm (31.5")	800mm (31.5")	£2,309
O9CTCPD60	H: 1947mm (76.6") W: 900mm (35.4")	900mm (35.4")	£2,469
10CTCPD60	H: 1947mm (76.6") W: 1000mm (39.4")	1000mm (39.4")	£2,469

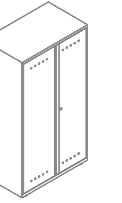
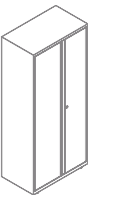

Please note: Coat Cupboard codes beginning with a 'V' = Ventilated doors

LateralFile Specialist - Coat Cupboards

D: 600mm (23.6")

Product Code	Description	Width	Price
CTCSH086PS	Basic shelf for coat cupboards	800mm (31.5")	£100
CTCSH096PS	Basic shelf for coat cupboards	900mm (35.4")	£100
CTCSH106PS	Basic shelf for coat cupboards	1000mm (39.4")	£100
BICC08CRSTSPS	Coat rail with shelf	800mm (31.5")	£163
BICC09CRSTSPS	Coat rail with shelf	900mm (35.4")	£163
BICC10CRSTSPS	Coat rail with shelf	1000mm (39.4")	£163
CAPCHP4PS	Captive coat hangers (pack of 4)	N/A	£49

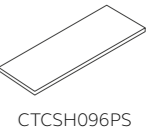

Range Addition Storage Planter H: 113mm (4.4")

Product Code	Description	Height	Width	Price
RP08M	Planter units for 470mm (18.5") deep units	113mm (4.4")	800mm (31.5")	£469
RP10M	Planter units for 470mm (18.5") deep units	113mm (4.4")	1000mm (39.4")	£528

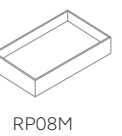

Additional information

Levelling feet

Adjustable levelling feet are fitted as standard to all LateralFile units. Height is adjustable up to 24mm (1") in total. With the exception of 718mm (28.3") high two door cupboards and tambours, which are fitted with adjustable levelling feet that are adjustable up to 8mm (0.3") and are fitted with one fixed shelf with centre partition on the bottom half of the unit.

Internal specification

Two door cupboards are supplied empty except for 718mm high cupboards which are supplied with one fixed shelf.

LateralFile bookcase and magazine unit shelves will match the carcass finish.

Please note: 600mm (23.6") deep coat cupboards will be assembled using SystemFile carcass.

All internals are supplied in black, except plastic shelf dividers & pigeon hole sets supplied in translucent plastic.

All drawer units have slotted bases and open backs and will include file bars as standard.

Safety warning

It is recommended that all cabinets below 1300mm (51.2") high should be fitted with a counterbalance, if any pull out elements are fitted. Pull out elements should only be fitted in the lower half of the cabinets.

For all finishes options, please refer to page 262.





Essentials

Affordable, high-quality and long-lasting, Essentials makes specifying your workspace refreshingly straightforward.

From drawers and cupboards, to tambour doors, Essentials is available in a range of popular sizes and specific finishes that look great in any environment.

5-Year Warranty

 For more specification information click here

Essentials Drawer Units (Drawers have full back and sides)

W: 800mm (31.5") D: 470mm (18.5")

Product Code	Description	Height	Price	
YESFDH0807	Drawer unit with one 305mm (12") drawer & one 343mm (13.5") drawer	718mm (28.3")	£1,140	

W: 800mm (31.5") D: 470mm (18.5")

Product Code	Description	Height	Price	
YESF0807	Two 305mm (12") drawers	693mm (27.3")	£1,100	
YESF0810	Three 305mm (12") drawers	1000mm (39.4")	£1,253	
YESF0812	One 267mm (10.5") drawer & three 305mm (12") drawers	1270mm (50")	£1,617	
YESF0813	Four 305mm (12") drawers	1300mm (51.2")	£1,626	

W: 1000mm (39.4") D: 470mm (18.5")

Product Code	Description	Height	Price	
YESF1007	Two 305mm (12") drawers	693mm (27.3")	£1,125	
YESF1010	Three 305mm (12") drawers	1000mm (39.4")	£1,415	
YESF1012	One 267mm (10.5") drawer & three 305mm (12") drawers	1270mm (50")	£1,678	
YESF1013	Four 305mm (12") drawers	1300mm (51.2")	£1,692	

W: 1000mm (39.4") D: 470mm (18.5")

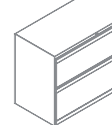
Product Code	Description	Height	Price	
YESFDH1007	Drawer unit with one 305mm (12") drawer & one 343mm (13.5") drawer	718mm (28.3")	£1,155	

YESFDH1007

Essentials Two Door Cupboards

W: 800mm (31.5") D: 470mm (18.5")

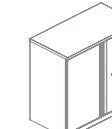
Product Code	Description	Height	Price	
YECB0807/1S	Cupboard with one fixed shelf	693mm (27.3")	£522	
YECBDH0807/1S	Cupboard with one fixed shelf with partition	718mm (28.3")	£522	

YECB0807/1S

W: 800mm (31.5") D: 470mm (18.5")

Product Code	Description	Height	Price	
YECB0810	Empty cupboard	1000mm (39.4")	£477	
YECB0810/1S	Including one shelf	1000mm (39.4")	£527	
YECB0811	Empty cupboard	1070mm (42.1")	£490	
YECB0811/1S	Including one shelf	1070mm (42.1")	£536	
YECB0812	Empty cupboard	1270mm (50")	£508	
YECB0812/2S	Including two shelves	1270mm (50")	£601	
YECB0815	Empty cupboard	1570mm (61.8")	£535	
YECB0815/3S	Including three shelves	1570mm (61.8")	£677	
YECB0819	Empty cupboard	1970mm (77.5")	£637	
YECB0819/4S	Including four shelves	1970mm (77.5")	£827	

YECB0810

YECB0819

W: 914mm (36") D: 470mm (18.5")

Product Code	Description	Height	Price	
YECB0910	Empty cupboard	1000mm (39.4")	£499	
YECB0910/1S	Including one shelf	1000mm (39.4")	£549	
YECB0911	Empty cupboard	1070mm (42.1")	£517	
YECB0911/1S	Including one shelf	1070mm (42.1")	£565	
YECB0912	Empty cupboard	1270mm (50")	£545	
YECB0912/2S	Including two shelves	1270mm (50")	£639	
YECB0915	Empty cupboard	1570mm (61.8")	£591	
YECB0915/3S	Including three shelves	1570mm (61.8")	£731	
YECB0919	Empty cupboard	1970mm (77.5")	£756	
YECB0919/4S	Including four shelves	1970mm (77.5")	£944	

YECB0910

YECB0919

W: 1000mm (39.4") D: 470mm (18.5")

Product Code	Description	Height	Price
YECB1007/1S	Tambour including one shelf	693mm (27.3")	£538
YECBDH1007/1S	Tambour including one fixed shelf with partition	718mm (28.3")	£538

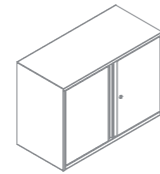

YECB1007/1S

W: 1000mm (39.4") D: 470mm (18.5")

Product Code	Description	Height	Price
YECB1010	Empty cupboard	1000mm (39.4")	£499
YECB1010/1S	Including one shelf	1000mm (39.4")	£549
YECB1011	Empty cupboard	1070mm (42.1")	£517
YECB1011/1S	Including one shelf	1070mm (42.1")	£565
YECB1012	Empty cupboard	1270mm (50")	£545
YECB1012/2S	Including two shelves	1270mm (50")	£639
YECB1015	Empty cupboard	1570mm (61.8")	£591
YECB1015/3S	Including three shelves	1570mm (61.8")	£731
YECB1019	Empty cupboard	1970mm (77.5")	£756
YECB1019/4S	Including four shelves	1970mm (77.5")	£944

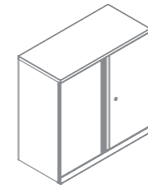

YECB1010

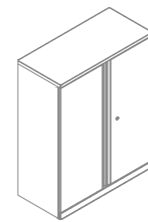

YECB1015

Internal Options - Two Door Cupboards only

Product Code	Description	Width	Price
YECBUS08	800mm (31.5") wide shelf with under shelf A4 filing	794mm (31.3")	£49
YECBUS09	914mm (36") wide shelf with under shelf A4 filing	908mm (35.8")	£49
YECBUS10	1000mm (39.4") wide shelf with under shelf A4 filing	994mm (39.1")	£49

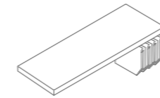

YECBUS08

Essentials Open Front Units

W: 914mm (36") D: 470mm (18.5")

Product Code	Description	Height	Price
YECBOF0910/1S	Open unit with no doors including one shelf	1000mm (39.4")	£506
YECBOF0911/1S	Open unit with no doors including one shelf	1070mm (42.2")	£523
YECBOF0912/2S	Open unit with no doors including two shelves	1270mm (50")	£594
YECBOF0915/3S	Open unit with no doors including three shelves	1570mm (61.8")	£647
YECBOF0919/4S	Open unit with no doors including four shelves	1970mm (77.5")	£857

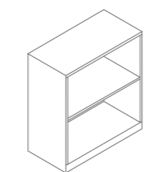

YECBOF0910/1S

Essentials Tambour Units

W: 800mm (31.5") D: 470mm (18.5")

Product Code	Description	Height	Price
YETB0807/1S	Tambour including one shelf	693mm (27.3")	£686
YETBDH0807/1S	Tambour including one fixed shelf with partition	718mm (28.3")	£686

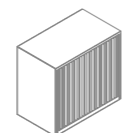

YETB0807/1S

W: 800mm (31.5") D: 470mm (18.5")

Product Code	Description	Height	Price
YETB0810.*	Empty tambour	1000mm (39.4")	£668
YETB0810/1S.*	Tambour including one shelf	1000mm (39.4")	£717
YETB0811.*	Empty tambour	1070mm (42.1")	£698
YETB0811/1S.*	Tambour including one shelf	1070mm (42.1")	£746
YETB0812.*	Empty tambour	1270mm (50")	£735
YETB0812/2S.*	Tambour including two shelves	1270mm (50")	£831
YETB0815.*	Empty tambour	1570mm (61.8")	£813
YETB0815/3S.*	Tambour including three shelves	1570mm (61.8")	£955
YETB0819.*	Empty tambour	1970mm (77.5")	£921
YETB0819/4S.*	Tambour including four shelves	1970mm (77.5")	£1,111

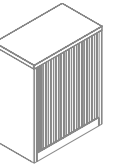

YETB0810/1S

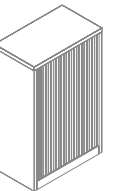

YETB0812

W: 1000mm (39.4") D: 470mm (18.5")

Product Code	Description	Height	Price
YETB1007/1S.*	Tambour including one shelf	693mm (27.3")	£765
YETBDH1007/1S.*	Tambour including one fixed shelf with partition	718mm (28.3")	£765

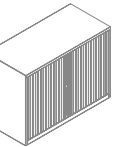

YETB1007/1S

W: 1000mm (39.4") D: 470mm (18.5")

Product Code	Description	Height	Price
YETB1010.*	Empty tambour	1000mm (39.4")	£754
YETB1010/1S.*	Tambour including one shelf	1000mm (39.4")	£803
YETB1011.*	Empty tambour	1070mm (42.1")	£792
YETB1011/1S.*	Tambour including one shelf	1070mm (42.1")	£840
YETB1012.*	Empty tambour	1270mm (50")	£837
YETB1012/2S.*	Tambour including two shelves	1270mm (50")	£933
YETB1015.*	Empty tambour	1570mm (61.8")	£944
YETB1015/3S.*	Tambour including three shelves	1570mm (61.8")	£1,087
YETB1019.*	Empty tambour	1970mm (77.5")	£1,028
YETB1019/4S.*	Tambour including four shelves	1970mm (77.5")	£1,216
YETB1022.*	Empty tambour	2270mm (89.4")	£1,579
YETB1022/5S.*	Tambour including five shelves	2270mm (89.4")	£1,815

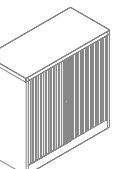

YETB1010*

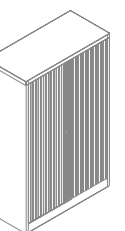

YETB1015*

*Add digits for shutter colour. See page 270 for finish options.

Internal Options - Tambours only

Product Code	Description	Width	Price
YETBUS08	800mm (31.5") wide shelf with under shelf A4 filing	731mm (28.8")	£49
YETBUS10	1000mm (39.4") wide shelf with under shelf A4 filing	908mm (35.8")	£49
MSDIV395P2	Steel shelf dividers (clip on design) (set of 2)	50mm (2")	£76

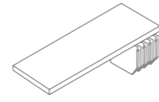

YETBUS08

Essentials Alternative Internal Options

Please note: For 914mm (36") wide Two Door Cupboards and 1000mm (39.4") wide Tambours only

Product Code	Description	Width	Price
BUS1	Adjustable under shelf lateral filing (single pack)	908mm (35.8")	£101
BUR	Adjustable lateral filing rail (single pack) (max size A4) (range 190 – 330mm (7.5 – 11.8"))	905mm (35.6")	£50
ROSFF	Roll-out suspension filing frame (single pack) (fools-cap side to side or two rows of foolscap or A4 front to back)	828mm (32.6")	£172
ROSH	Roll-out shelf (single pack)	800mm (31.5")	£151
RODWR4	Roll-out drawer (single pack) 102mm (4") deep	821mm (32.3")	£217
BDD3P5	Drawer dividers (set of 5)	392mm (15.4")	£47
BSSPDP1:33	Slotted shelf (single pack) for plastic dividers Plastic shelf dividers - for use with slotted shelf only	908mm (35.8")	£69
SHDV85P5PS	(shelf not included)	N/A	£71
PGNHLESET	Plastic pigeon hole set (includes dividers and inter-shelves) for use with slotted shelves only (slotted shelf not included)	859mm (33.8")	£186
BWS	Wardrobe shelf and back to front coat rail (single pack)	908mm (35.8")	£84
BWP	Wardrobe pack for 1970mm (77.6") cupboard and 1970mm (77.6") & 2270mm (89.4") tambour	908mm (35.8")	£377



BUR

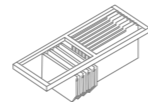

ROSFF

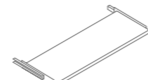

ROSH



BDD3P5



BSSPDP1:33



PGNHLESET



BWS

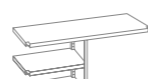

BWP

Sliding Door Cupboard

W:1200mm (47.2") D: 430mm (16.9")

Product Code	Description	Height	Price
CSD0812431	Sliding door cupboard with one shelf	839mm (33")	£677
CSD1112432	Sliding door cupboard with two shelves	1181mm (46.5")	£790
CSD1612433	Sliding door cupboard with three shelves	1637mm (64.4")	£905
CSD1912434	Sliding door cupboard with four shelves	1980mm (78")	£1,018
CSD1243SHELF	Sliding door cupboard shelf	N/A	£41

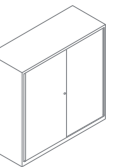

CSD1112432

A4 EuroTambour

W:600mm (23.6") D: 430mm (16.9")

Product Code	Description	Height	Price
ET406/19.*	A4 tambour	1980mm (78")	£900
ET406/19/4S.*	A4 tambour with four shelves	1980mm (78")	£1,061
ET406/19/WS.*	Tambour with wardrobe shelf	1980mm (78")	£991
ET406SHPS	600mm shelf with undershelf filing	27mm (1.1")	£41

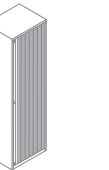

ET406/19.*

W:800mm (31.5") D: 430mm (16.9")

Product Code	Description	Height	Price
ET408/06.*	A4 tambour	695mm (27.4")	£630
ET408/06/1S.*	A4 tambour with one shelf	695mm (27.4")	£668
ET408/10.*	A4 tambour	1030mm (40.6")	£662
ET408/10/2S.*	A4 tambour with two shelves	1030mm (40.6")	£742
ET408/11.*	A4 tambour	1181mm (46.5")	£686
ET408/11/2S.*	A4 tambour with two shelves	1181mm (46.5")	£763
ET408/13.*	A4 tambour	1330mm (52.4")	£701
ET408/13/3S.*	A4 tambour with three shelves	1330mm (52.4")	£819
ET408/17.*	A4 tambour	1637mm (64.4")	£838
ET408/17/3S.*	A4 tambour with three shelves	1637mm (64.4")	£958
ET408/19.*	A4 tambour	1980mm (78")	£900
ET408/19/4S.*	A4 tambour with four shelves	1980mm (78")	£1,060
ET408/TB.*	A4 tambour top box	495mm (19.5")	£571

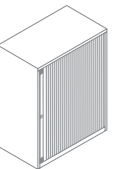

ET408/10.*

W:1000mm (39.4") D: 430mm (16.9")

Product Code	Description	Height	Price
ET410/06.*	A4 tambour	695mm (27.4")	£701
ET410/06/1S.*	A4 tambour with one shelf	695mm (27.4")	£746
ET410/10.*	A4 tambour	1030mm (40.6")	£734
ET410/10/2S.*	A4 tambour with two shelves	1030mm (40.6")	£822
ET410/11.*	A4 tambour	1181mm (46.5")	£775
ET410/11/2S.*	A4 tambour with two shelves	1181mm (46.5")	£863
ET410/13.*	A4 tambour	1330mm (52.4")	£822
ET410/13/3S.*	A4 tambour with three shelves	1330mm (52.4")	£952
ET410/17.*	A4 tambour	1637mm (64.4")	£929
ET410/17/3S.*	A4 tambour with three shelves	1637mm (64.4")	£1,074
ET410/19.*	A4 tambour	1980mm (78")	£1,004
ET410/19/4S.*	A4 tambour with four shelves	1980mm (78")	£1,179
ET410/TB.*	A4 tambour top box	495mm (19.5")	£651

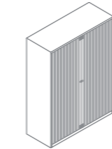

ET410/17/3S.*

W:1200mm (47.2") D: 430mm (16.9")

Product Code	Description	Height	Price
ET412/06.*	1200mm wide A4 tambour	695mm (27.4")	£806
ET412/06/1S.*	1200mm wide A4 tambour with one shelf	695mm (27.4")	£856
ET412/10.*	1200mm wide A4 tambour	1030mm (40.6")	£834
ET412/10/2S.*	1200mm wide A4 tambour with two shelves	1030mm (40.6")	£936
ET412/11.*	1200mm wide A4 tambour	1181mm (46.5")	£891
ET412/11/2S.*	1200mm wide A4 tambour with two shelves	1181mm (46.5")	£993
ET412/13.*	1200mm wide A4 tambour	1330mm (52.4")	£949
ET412/13/3S.*	1200mm wide A4 tambour with three shelves	1330mm (52.4")	£1,101
ET412/17.*	1200mm wide A4 tambour	1637mm (64.4")	£1,057
ET412/17/3S.*	1200mm wide A4 tambour with three shelves	1637mm (64.4")	£1,210
ET412/19.*	1200mm wide A4 tambour	1980mm (78")	£1,131
ET412/19/4S.*	1200mm wide A4 tambour with four shelves	1980mm (78")	£1,335
ET412/19/WP.*	1200mm wide tambour with Wardrobe Pack	1980mm (78")	£1,342
ET412/TB.*	1200mm wide A4 tambour top box	495mm (19.5")	£770
ET41219WPPS	Wardrobe pack for ET412/19 tambour	N/A	£435

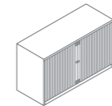

ET412/06.*

EuroTambour Internal Options

Product Code	Description	Width	Price
ET408SHPS	Shelf with undershelf filing	800mm (31.5")	£41
ET410SHPS	-	1000mm (39.4")	£46
ET412SHPS	-	1200mm (47.2")	£52
ET408SSHMDPS	Slotted shelf	800mm (31.5")	£57
ET410SSHMDPS	-	1000mm (39.4")	£65
ET412SSHMDPS	-	1200mm (47.2")	£71
ET408LRPS	Lateral rail	800mm (31.5")	£46
ET410LRPS	-	1000mm (39.4")	£46
ET412LRPS	-	1200mm (47.2")	£52
ET4SHDVCLIPONP3	Clip-on shelf divider (3 pack) Roll-out filing frame for A4 & foolscap suspension pockets	N/A	£62
ET408RFPS	-	800mm (31.5")	£155
ET410RFPS	-	1000mm (39.4")	£163
ET412RFPS	-	1200mm (47.2")	£188
ET408RSPS	Roll-out shelf	800mm (31.5")	£135
ET410RSPS	-	1000mm (39.4")	£145
ET412RSPS	-	1200mm (47.2")	£164
ET408RD4PS	Roll-out 100mm (4") drawer	800mm (31.5")	£198
ET410RD4PS	-	1000mm (39.4")	£204
ET412RD4PS	-	1200mm (47.2")	£222
ET4DW4DP3PS	4" drawer dividers (3 pack)	N/A	£47
TWSHDVP4PS	Steel shelf dividers (clip on design)	N/A	£71
TWISP6PS	Plastic intershelves (pack of 6)	N/A	£76
ETCRP1PS	Cross rails	N/A	£28

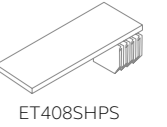

ET408SHPS

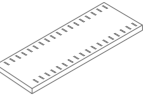

ET408SSHMDPS

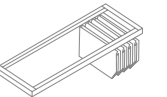

ET408LRPS

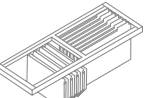

ET408RFPS

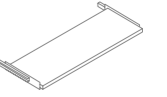

ET408RSPS

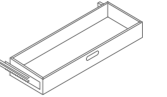

ET408RD4PS

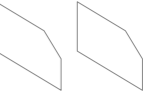

TWSHDVP4PS

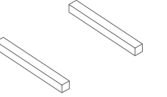

ETCRP1PS

A shutter finish must be specified for tambour units:

Finish	Suffix
Palette one	
Light Grey	1/LG**
Dark Grey	9
Black	5
White	EW
Palette two*	
Silver	SL
Beech	BC**

*+5% surcharge

**EuroTambour only

Additional information

Levelling feet

Adjustable levelling feet are fitted as standard to all Essentials units*. Height is adjustable up to 24mm (1") in total.

Exception to 718mm (28.3") high two door cupboards, tambours and drawers which are fitted with adjustable levelling feet that are adjustable up to 8mm (0.3") and are fitted with one fixed shelf** with centre partition on bottom half of the unit.

*Not including Essentials stationery cupboard

**Not including drawer unit

Internals

All internals are supplied in black except plastic shelf dividers and pigeonhole sets supplied in translucent plastic.

Internal specification

Essentials desk high tambours and cupboards come as standard with one specific shelf and will not support any Essentials Internals.

All Essentials drawer units have full back and side and will include file bars and cross rails.

Please note, 693mm (27.3") high cupboards and tambours will have LateralFile shelf clips.

All internals are supplied in black except plastic shelf dividers & pigeon hole sets supplied in translucent plastic).

Card holders are fitted as standard to Essentials lockers.

For all finishes options please refer to page 262.



Range Extensions

Applied tops for 470mm (18.5") deep units

Product Code	Description	Width	Price	
SLTP08	Sloping top with 20mm (0.8") front edge, 100mm (3.9") at rear	800mm (31.5")	£152	
SLTP09	Sloping top with 20mm (0.8") front edge, 100mm(3.9") at rear	900mm (35.4")	£161	
SLTP10	Sloping top with 20mm (0.8") front edge, 100mm (3.9") at rear	1000mm (39.4")	£161	
SLTP12	Sloping top with 20mm (0.8") front edge, 100mm (3.9") at rear	1200mm (47.2")	£166	
RDH08M	Half dome top with 20mm (0.8") front edge, 100mm (3.9") at rear	800mm (31.5")	£375	
RDH09M	Half dome top with 20mm (0.8") front edge, 100mm (3.9") at rear	900mm (35.4")	£395	
RDH10M	Half dome top with 20mm (0.8") front edge, 100mm (3.9") at rear	1000mm (39.4")	£395	
RDH12M	Half dome top with 20mm (0.8") front edge, 100mm (3.9") at rear	1200mm (47.2")	£405	
RDF08M	Full dome top with 20mm (0.8") at front and rear edges, 100mm (3.9") at centre	800mm (31.5")	£557	
RDF09M	Full dome top with 20mm (0.8") at front and rear edges, 100mm (3.9") at centre	900mm (35.4")	£583	
RDF10M	Full dome top with 20mm (0.8") at front and rear edges, 100mm (3.9") at centre	1000mm (39.4")	£583	
RDF12M	Full dome top with 20mm (0.8") at front and rear edges, 100mm (3.9") at centre	1200mm (47.2")	£609	
RP08M	Planter comes with one full width plastic liner, height 113mm (4.5")	800mm (31.5")	£469	
RP10M	Planter comes with one full width plastic liner, height 113mm (4.5")	1000mm (39.4")	£528	

Infill Panels

Applied tops for 470mm (18.5") deep units

Product Code	Description	Width	Price
IFPA06020	680mm (26.8") steel with double strength magnetic strips for self-alignment	60mm (2.4")	£78
IFPA10020	-	100mm (3.9")	£84
IFPA13020	-	130mm (5.1")	£91
IFPA06024	832mm (32.7") steel with double strength magnetic strips for self-alignment	60mm (2.4")	£86
IFPA10024	-	100mm (3.9")	£92
IFPA13024	-	130mm (5.1")	£97
IFPA06030	984mm (38.7") steel with double strength magnetic strips for self-alignment	60mm (2.4")	£95
IFPA10030	-	100mm (3.9")	£100
IFPA13030	-	130mm (5.1")	£105
IFPA06034	1136mm (44.7") steel with double strength magnetic strips for self-alignment	60mm (2.4")	£108
IFPA10034	-	100mm (3.9")	£114
IFPA13034	-	130mm (5.1")	£120
IFPA06040	1288mm (50.7") steel with double strength magnetic strips for self-alignment	60mm (2.4")	£115
IFPA10040	-	100mm (3.9")	£121
IFPA13040	-	130mm (5.1")	£126

Accessories - Seat Pads

H: 38mm (1.5")

Product Code	Description	Price
SPAD8047*XXXXXX	Seat pad 802mm (31.6") wide, 472mm (18.6") deep	POA
SPAD9047*XXXXXX	Seat pad 902mm (35.5") wide, 472mm (18.6") deep	POA
SPAD1047*XXXXXX	Seat pad 1002mm (39.4") wide, 472mm (18.6") deep	POA
SPAD1147*XXXXXX	Seat pad 1102mm (43.4") wide, 472mm (18.6") deep	POA
SPAD1247*XXXXXX	Seat pad 1202mm (47.3") wide, 472mm (18.6") deep	POA
SPAD3056*XXXXXX	Seat pad 302mm (11.9") wide, 567mm (22.3") deep	POA
SPAD4256*XXXXXX	Seat pad 422mm (16.6") wide, 567mm (22.3") deep	POA
SPAD4277*XXXXXX	Seat pad 422mm (16.6") wide, 777mm (30.6") deep	POA
SPAD4249*XXXXXX	Seat pad 422mm (16.6") wide, 490mm (19.3") deep	POA

* XXXXX digits refer to fabric choices. Seat pads are available in a selection of fabrics please see page 271.

Decorative Tops

H: 18mm (0.7")

Product Code	Description	Price
DT0800047018	Decorative top 800mm (31.5") wide, 470mm (18.5") deep	£78
DT1000047018	Decorative top 1000mm (39.5") wide, 470mm (18.5") deep	£100
DT1600047018	Decorative top 1,600mm (63") wide, 470mm (18.5") deep	£141
DT2000047018	Decorative top 2,000mm (79") wide, 470mm (18.5") deep	£173
DT080049018	Decorative top 800mm (31.5") wide, 490mm (19.3") deep	£86
DT090049018	Decorative top 900mm (35.4") wide, 490mm (19.3") deep	£93
DT100049018	Decorative top 1000mm (39.5") wide, 490mm (19.3") deep	£119

Inches are to the nearest half inch. Other widths and depths available. Please contact your Bisley representative for more information.

For all finishes options, please refer to page 262.



Pren

A collection of freestanding lockers, wardrobes, and cupboards that make specifying your entire storage system refreshingly simple.

With purpose beyond storage, Pren's freestanding units act as zone dividers throughout the office, creating defined neighbourhoods wherever you need. And with contrafacing units available at different heights, you can accessorise them with planter tops for the added benefits of mood-boosting biophilia, or create an extended, standing height workbench with a sleek oversailing top.

Spanning classic, warm wood-effect tones and solid colour finishes, Pren is available in a variety of laminates, matching LockerWall's broad palette, creating symmetry for your storage.

5-Year Warranty

 For more specification information click here

Pren - Two Door Cupboards

W: 800mm (31.5") D: 500mm (19.7")

Product Code	Description	Height	Price
SC0807S020AB	Two door cupboard with one shelf, key lock	715mm (28.2")	£585
SC0810S020AB	Two door cupboard with two shelves, key lock	1018mm (40.1")	£696
SC0812S020AB	Two door cupboard with two shelves, key lock	1210mm (47.6")	£733
SC0815S020AB	Two door cupboard with three shelves, key lock	1590mm (62.6")	£860
SC0819S020AB	Two door cupboard with four shelves, key lock	1970mm (77.6")	£983

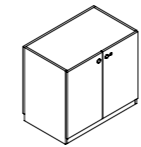

SC0807S020NL

W: 1000mm (39.4") D: 500mm (19.7")

Product Code	Description	Height	Price
SC1010S020AB	Two door cupboard with two shelves, key lock	1018mm (40.1")	£755
SC1012S020AB	Two door cupboard with two shelves, key lock	1210mm (47.6")	£802
SC1015S020AB	Two door cupboard with three shelves, key lock	1590mm (62.6")	£942
SC1019S020AB	Two door cupboard with four shelves, key lock	1970mm (77.6")	£1,058

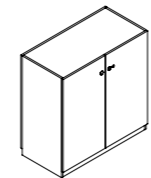

SC1010S020NL

Pren Cupboard - Internal Options

Product Code	Description	Width	Price
SCSHELF08	Black steel shelf with A4 undershelf filing	800mm (31.5")	£71
SCSHELF10	Black steel shelf with A4 undershelf filing	1000mm (39.4")	£86

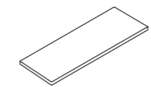

SCSHELF08

Pren - Wardrobe Units

W: 800mm (31.5") D: 500mm (19.7")

Product Code	Description	Height	Price
SW0810S020AB	Wardrobe with one coat rail, key lock	1018mm (40.1")	£597
SW0812S020AB	Wardrobe with one coat rail, key lock	1210mm (47.6")	£637
SW0815S020AB	Wardrobe with one coat rail & one fixed MFC shelf, key lock	1590mm (62.6")	£770
SW0819S020AB	Wardrobe with one coat rail & two fixed MFC shelves, key lock	1970mm (77.6")	£858

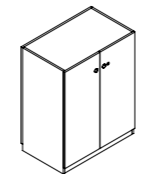

SW0810S020NL

Pren - Wardrobe Units

W: 1000mm (39.4") D: 500mm (19.7")

Product Code	Description	Height	Price
SW1010S020AB	Wardrobe with one coat rail, key lock	1018mm (40.1")	£648
SW1012S020AB	Wardrobe with one coat rail, key lock	1210mm (47.6")	£693
SW1015S020AB	Wardrobe with one coat rail & one fixed MFC shelf, key lock	1590mm (62.6")	£846
SW1019S020AB	Wardrobe with one coat rail & two fixed MFC shelves, key lock	1970mm (77.6")	£944

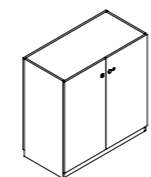

SW1010S020NL

Pren Lockers - Single Lockers

H: 1018mm (40.1") W: 400mm (15.7") D: 500mm (19.7")

Product Code	Description	Price
SL0410S010AB	One door locker with coat rail, AB lock	£430
SL0410S020AB	Two door locker, AB lock	£524
SL0410S021AB	Two door & one drawer locker, AB lock	£671

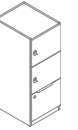
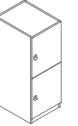
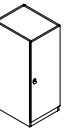

Pren Lockers - Single Lockers

H: 1970mm (77.6") W: 400mm (15.7") D: 500mm (19.7")

Product Code	Description	Price
SL0419S010AB	One door locker with coat rail & two fixed shelves, AB lock	£599



SL0419S020AB	Two door locker with coat rail, AB lock	£642
--------------	---	------

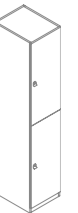

SL0419S030AB	Three door locker, AB lock	£705
--------------	----------------------------	------

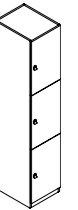

SL0419S040AB	Four door locker, AB lock	£775
--------------	---------------------------	------

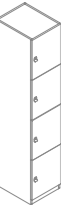

SL0419S041AB	Four door & one drawer locker, AB lock	£980
--------------	--	------

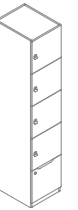

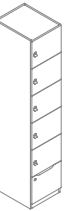

SL0419S051AB	Five door & one drawer locker, AB lock	£1,027
--------------	--	--------





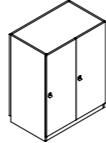

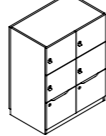

Pren Lockers - Double Lockers

H: 1018mm (40.1") W: 800mm (31.5") D: 500mm (19.7")

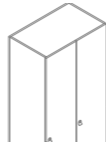
Product Code	Description	Price	
SL0810S020AB	Two one door locker with coat rail, AB lock	£642	
SL0810S040AB	Two two door locker with, AB lock	£819	
SL0810S042AB	Two two door & two drawer locker, AB lock	£1,163	

Pren Lockers - Double Lockers

H: 1970mm (77.6") W: 800mm (31.5") D: 500mm (19.7")

Product Code	Description	Price	
SL0819S020AB	Two one door locker with coat rail & two fixed shelves, AB lock	£874	
SL0819S040AB	Two two door locker with coat rail, AB lock	£1,014	
SL0819S060AB	Two three door locker, AB lock	£1,221	
SL0819S080AB	Two four door locker, AB lock	£1,313	
SL0819S082AB	Two four door & two drawer locker, AB lock	£1,771	
SL0819S102AB	Two five door & two drawer locker, AB lock	£1,884	

Pren Locker Internal Options

Product Code	Description	Width	Price	
SLSHELF04	MFC locker shelf for single 400w units	362mm (14.3")	£44	
SLSHELF08	MFC locker shelf for double 800w units	371mm (14.6")	£58	SLSHELF08

Pren Accessories - MFC Decorative Top

H: 18mm (0.7") D: 500mm (19.7")

DT0400050018	DT0800050018	DT1000050018	DT1200050018	DT1600050018	DT2000050018	
W: 400mm (15.7")	W: 800mm (31.5")	W: 1000mm (39.4")	W: 1200mm (47.2")	W: 1600mm (63")	W: 2000mm (78.7")	
£37	£53	£61	£70	£87	£102	
DT2400050018						
W: 2400mm (94.5")						
£118						DT1600050018

H: 18mm (0.7") D: 1000mm (39.4")

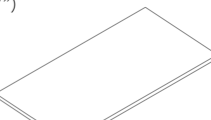
DT0400100018	DT0800100018	DT1000100018	DT1200100018	DT1600100018	DT2000100018	
W: 400mm (15.7")	W: 800mm (31.5")	W: 1000mm (39.4")	W: 1200mm (47.2")	W: 1600mm (63")	W: 2000mm (78.7")	
£58	£90	£102	£118	£147	£177	
DT2400100018						
W: 2400mm (94.5")						
£207						DT1600100018

Pren - Planter

H: 145mm (5.7") D: 500mm (19.7")

Product Code	Description	Width	Price	
LWPB0400	Planter c/w watertight liner	400mm (15.7")	£320	
LWPB0800	Planter c/w watertight liner	800mm (31.5")	£433	LWPB0800
LWPB1000	Planter c/w watertight liner	1000mm (39.4")	£478	
LWPB1200	Planter c/w watertight liner	1200mm (47.2")	£501	

Additional Locking Options

Description	Price (per lock)
For no locks change characters of the code from 'AB' to 'NL'	-
For M3 locks change characters of the code from 'AB' to 'M3'	£58
For M2 locks change characters of the code from 'AB' to 'M2'	£58
For E4 locks change characters of the code from 'AB' to 'E4'	£150
For RFID Public locks change characters of the code from 'AB' to 'RF1'	£192

Pren handles are offered in light, medium and dark wood.
For all finishes options, please refer to page 262.



Bridge

Bridge is the modern credenza that effortlessly combines storage and display in one beautiful, seamless system.

Inspired by the traditional credenza, but reimagined for a contemporary setting, Bridge connects flexible spaces with ease. Your day should flow gracefully and with Bridge, enjoy multiple functions in a myriad of spaces.

At the heart of its design is storage, providing the perfect place to stow all your workplace essentials. Bridge's elegant yet stylish nature gives you flexible options, includes spacious compartments for your valuables and technology, why not add an oversailing top for a clean and sleek finish?

Available in a breadth of steel and wood finishes, customise Bridge to suit your personal style, with this credenza's clean lines and modern finish. Enjoyed as a gorgeous focal point for a specific space or a complementary addition to your existing décor, Bridge is adaptable, allowing you create exactly what you have in mind.

Prefer to specify your own Bridge unit from scratch? You can build your own unique configuration selecting from the bases, legs, modules and finishing touches shown below. Please contact your Bisley Representative for support when creating your own Bridge.

5-Year Warranty



 For more specification information click here



Possible Bridge Configurations

Inspired by the traditional meeting room credenza for the contemporary office, see below our most popular credenza options.

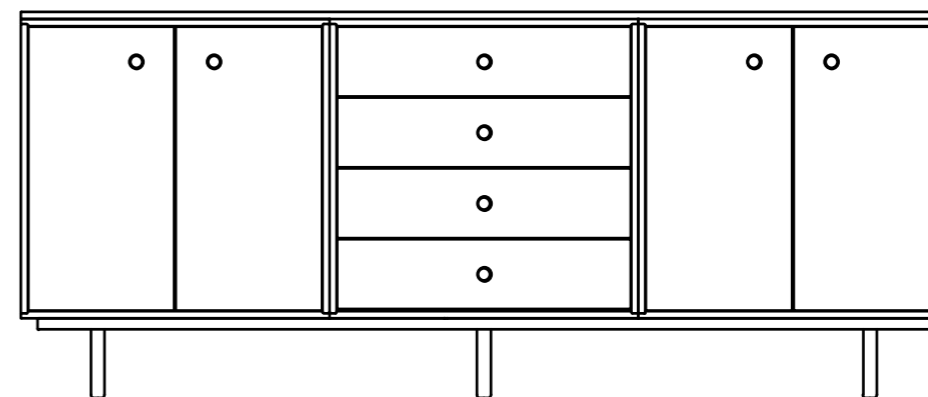

Codes required:
 1x BRB24IN
 1x BRLWD
 2x BMM0808FCDRW
 1x BMM0808DRWRW

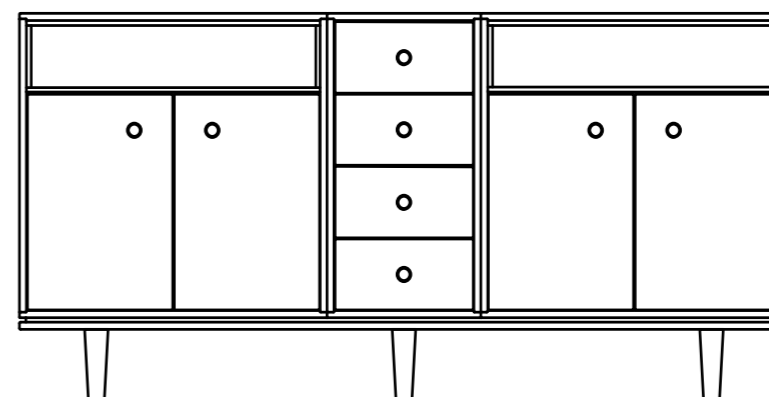

Codes required:
 1x BRB20FW
 1x BRLSF
 2x BMM0808SCDRW
 1x BMM0408DRWRW

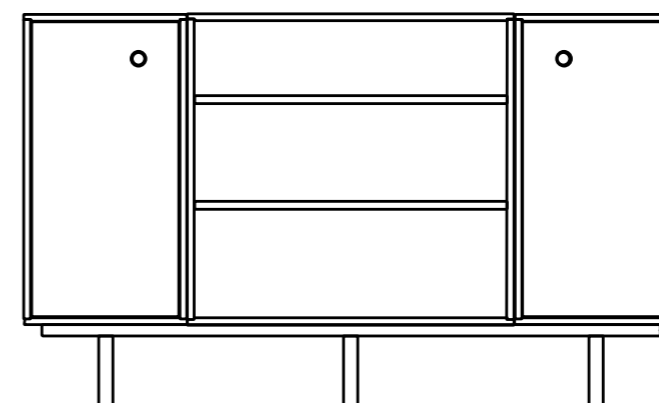

Codes required:
 1x BRB16IN
 1x BRLWD
 1x BMM0408RFDRW
 1x BMM0408LFDRW
 1x BRM0808OBP

Originally crafted as a credenza system, Bridge is adaptable for a variety of functions – from welcome spaces to sleek room division, the possibilities are endless.

Here are some examples that we've created.

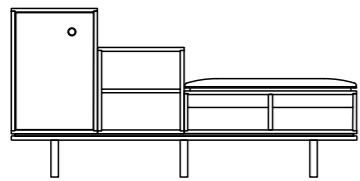
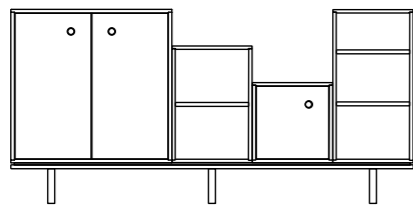
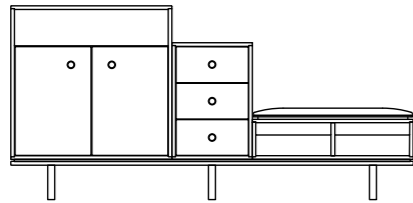
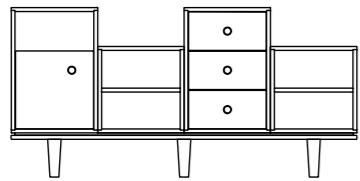
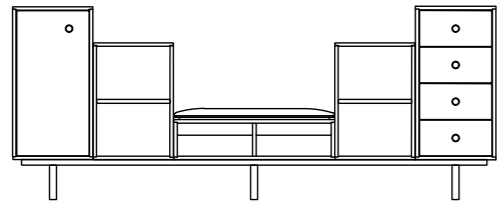
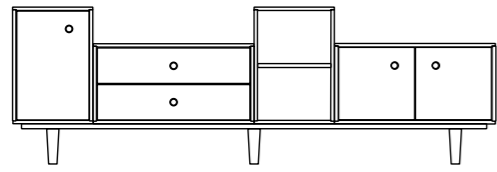

Glide	130
MultiDrawer	136
Office Filing	144
Plan & Card Filing	150

Classics

Add a design icon to your home or office. Bisley has always been known for quality that you can trust.

And that's in no small part due to our original iconic designs, which continue to be as beautiful as they are useful. Today, we combine a spirit of innovation with a collective knowledge that can only come from experience.

From our MultiDrawer design classic to the original plan filer, our classic products are practical, stylish, and ideal for office or home use.



Glide

This innovative unit combines clean, unbroken lines with thoughtful details that ensure the sliding doors really do glide.

Our high-quality, sliding door storage system is an ideal, spacesaving solution for open-plan work environments. You can choose bespoke timber tops, backs and end-cladding, and we can provide a comprehensive range of optional internal fittings, including roll-out filing frames and drawers. Door options include plain, perforated and acoustic dampening - which better absorbs noise from the hustle and bustle of a busy office. Glide particularly complements our LateralFile products, but fits well with all of our ranges.

10-Year Warranty

 For more specification information click here

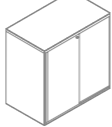
Product Code	Description	Height	Price	
BG20821SDSBST	Plain doors	743mm (29.2")	£1,554	 BG20821SDSBST
BG20821PDSBST	Perforated doors	743mm (29.2")	£1,603	
BG20821ADSBST	Acoustic doors	743mm (29.2")	£1,652	
BG20823SDSBST	Plain doors	807mm (31.8")	£2,065	 BG20823PDSBST
BG20823PDSBST	Perforated doors	807mm (31.8")	£2,127	
BG20823ADSBST	Acoustic doors	807mm (31.8")	£2,193	
BG20834SDSBST	Plain doors	1149mm (45.2")	£1,705	 BG20834ADSBST
BG20834PDSBST	Perforated doors	1149mm (45.2")	£1,756	
BG20834ADSBST	Acoustic doors	1149mm (45.2")	£1,810	
BG20846SDSBST	Plain doors	1529mm (60.2")	£1,951	 BG20846ADSBST
BG20846PDSBST	Perforated doors	1529mm (60.2")	£2,010	
BG20846ADSBST	Acoustic doors	1529mm (60.2")	£2,071	

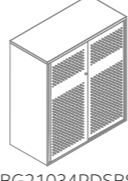
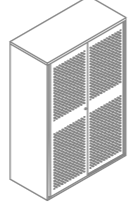
Product Code	Description	Height	Price	
BG21021SDSBST	Plain doors	743mm (29.2")	£1,652	 BG21021SDSBST
BG21021PDSBST	Perforated doors	743mm (29.2")	£1,701	
BG21021ADSBST	Acoustic doors	743mm (29.2")	£1,753	
BG21023SDSBST	Plain doors	807mm (31.8")	£1,652	 BG21023PDSBST
BG21023PDSBST	Perforated doors	807mm (31.8")	£1,701	
BG21023ADSBST	Acoustic doors	807mm (31.8")	£1,753	
BG21034SDSBST	Plain doors	1149mm (45.2")	£1,817	 BG21034PDSBST
BG21034PDSBST	Perforated doors	1149mm (45.2")	£1,872	
BG21034ADSBST	Acoustic doors	1149mm (45.2")	£1,928	
BG21046SDSBST	Plain doors	1529mm (60.2")	£2,085	 BG21046ADSBST
BG21046PDSBST	Perforated doors	1529mm (60.2")	£2,148	
BG21046ADSBST	Acoustic doors	1529mm (60.2")	£2,212	

Product Code	Description	Height	Price	
BG21221SDSBST	Plain doors	743mm (29.2")	£1,754	 BG21221PDSBST
BG21221PDSBST	Perforated doors	743mm (29.2")	£1,808	
BG21221ADSBST	Acoustic doors	743mm (29.2")	£1,862	
BG21223SDSBST	Plain doors	807mm (31.8")	£1,754	 BG21221PDSBST
BG21223PDSBST	Perforated doors	807mm (31.8")	£1,808	
BG21223ADSBST	Acoustic doors	807mm (31.8")	£1,862	
BG21234SDSBST	Plain doors	1149mm (45.2")	£1,923	 BG21221PDSBST
BG21234PDSBST	Perforated doors	1149mm (45.2")	£1,981	
BG21234ADSBST	Acoustic doors	1149mm (45.2")	£2,041	
BG21246SDSBST	Plain doors	1529mm (60.2")	£2,216	 BG21221PDSBST
BG21246PDSBST	Perforated doors	1529mm (60.2")	£2,283	
BG21246ADSBST	Acoustic doors	1529mm (60.2")	£2,352	

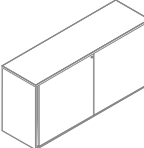
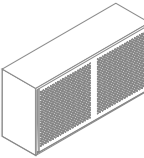
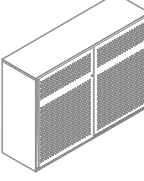
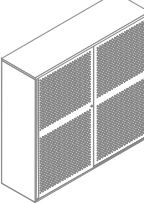
Product Code	Description	Height	Price	
BG21621SDSBST	Plain doors	743mm (29.2")	£2,519	 BG21621SDSBST
BG21621PDSBST	Perforated doors	743mm (29.2")	£2,596	
BG21621ADSBST	Acoustic doors	743mm (29.2")	£2,674	
BG21623SDSBST	Plain doors	807mm (31.8")	£2,519	 BG21623PDSBST
BG21623PDSBST	Perforated doors	807mm (31.8")	£2,596	
BG21623ADSBST	Acoustic doors	807mm (31.8")	£2,674	
BG21634SDSBST	Plain doors	1149mm (45.2")	£2,761	 BG21634PDSBST
BG21634PDSBST	Perforated doors	1149mm (45.2")	£2,808	
BG21634ADSBST	Acoustic doors	1149mm (45.2")	£2,860	
BG21646SDSBST	Plain doors	1529mm (60.2")	£3,202	 BG21646ADSBST
BG21646PDSBST	Perforated doors	1529mm (60.2")	£3,299	
BG21646ADSBST	Acoustic doors	1529mm (60.2")	£3,398	

W: 2000mm (78.4") D: 470mm (18.5")

Product Code	Description	Height	Price	
BG22021SDSBST	Plain doors	743mm (29.2")	£2,724	 BG22021SDSBST
BG22021PDSBST	Perforated doors	743mm (29.2")	£2,806	
BG22021ADSBST	Acoustic doors	743mm (29.2")	£2,891	
BG22023SDSBST	Plain doors	807mm (31.8")	£2,724	 BG22023PDSBST
BG22023PDSBST	Perforated doors	807mm (31.8")	£2,806	
BG22023ADSBST	Acoustic doors	807mm (31.8")	£2,891	
BG22034SDSBST	Plain doors	1149mm (45.2")	£2,993	 BG22034PDSBST
BG22034PDSBST	Perforated doors	1149mm (45.2")	£3,083	
BG22034ADSBST	Acoustic doors	1149mm (45.2")	£3,177	
BG22046SDSBST	Plain doors	1529mm (60.2")	£3,462	 BG22046ADSBST
BG22046PDSBST	Perforated doors	1529mm (60.2")	£3,567	
BG22046ADSBST	Acoustic doors	1529mm (60.2")	£3,675	

W: 2400mm (94.5") D: 470mm (18.5")

Product Code	Description	Height	Price	
BG22421SDSBST	Plain doors	743mm (29.2")	£2,926	 BG22421SDSBST
BG22421PDSBST	Perforated doors	743mm (29.2")	£3,015	
BG22421ADSBST	Acoustic doors	743mm (29.2")	£3,105	
BG22423SDSBST	Plain doors	807mm (31.8")	£2,926	 BG22423PDSBST
BG22423PDSBST	Perforated doors	807mm (31.8")	£3,015	
BG22423ADSBST	Acoustic doors	807mm (31.8")	£3,105	
BG22434SDSBST	Plain doors	1149mm (45.2")	£3,209	 BG22434PDSBST
BG22434PDSBST	Perforated doors	1149mm (45.2")	£3,307	
BG22434ADSBST	Acoustic doors	1149mm (45.2")	£3,406	
BG22446SDSBST	Plain doors	1529mm (60.2")	£3,728	 BG22446ADSBST
BG22446PDSBST	Perforated doors	1529mm (60.2")	£3,840	
BG22446ADSBST	Acoustic doors	1529mm (60.2")	£3,956	

Glide Internal Options

Product Code	Description	Width	Price
G2IC08SSUPS	Slotted shelf with undershelf filing	800mm (31.5")	£60
G2IC10SSUPS	Slotted shelf with undershelf filing	1000mm (39.4")	£68
G2IC12SSUPS	Slotted shelf with undershelf filing	1200mm (47.2")	£72
G2IC08RFPS	Roll-out filing frame - to be used in 1600mm (63") wide units only	800mm (31.5")	£163
G2IC10RFPS	Roll-out filing frame - to be used in 2000mm (78.7") wide units only	1000mm (39.4")	£174
G2IC12RFPS	Roll-out filing frame includes one cross rail - to be used in 2400mm (94.5") wide units only	1200mm (47.2")	£198
G2DB08	Drawer base (includes three drawer dividers) to fit into roll-out filing frame	800mm (31.5")	£121
G2DB10	Drawer base (includes three drawer dividers) to fit into roll-out filing frame	1000mm (39.4")	£135
G2DB12	Drawer base (includes three drawer dividers) to fit into roll-out filing frame	1200mm (47.2")	£161
G2DBDVP3PS	Drawer base divider (pack of 3)	N/A	£41
G2IC21A408SSUPS	Shelf to allow two rows of A4 filing for 734mm (29.2") high unit	800mm (31.5")	£82
G2IC21A410SSUPS	Shelf to allow two rows of A4 filing for 734mm (29.2") high unit	1000mm (39.4")	£87
G2IC21A412SSUPS	Shelf to allow two rows of A4 filing for 734mm (29.2") high unit	1200mm (47.2")	£95
DSB4	Drop-in storage bin to fit into roll-out filing frame	N/A	£108
TWSHDVP4PS	Steel shelf dividers (clip on design) (pack of 4)	50mm (2")	£71
TWISP6PS	Plastic intershelves - (pack of 6) to make pigeon hole arrangement	50mm (2")	£76

Assembly:

Glide units 1600mm (63") wide and over will require on-site assembly.

Filing capabilities

Roll out filing frames are only compatible with Glide units 1600mm (63") wide and above.

Safety

Pull out elements should only be fitted in the lower half of the cabinet.

For all finishes options, please refer to page 262.





MultiDrawers

The MultiDrawer by Bisley is a design classic that's as versatile as it is iconic.

Compact, robust and available in a broad range of colours, it fits in any setting, from home offices to industrial workshops and everything in between.

Originally designed in 1958 and awarded the Design Guild Mark in 2017, the MultiDrawer can be used to organise all sorts of things in the home, office or workshop. Available in different drawer heights with the option of multi compartment insert trays for small items. There are three ranges of A4 MultiDrawers as well as an A3 range.

5-Year Warranty

 [For more specification information click here](#)

MultiDrawer 12 Series H: 325mm (12.7") W: 279mm (11") D: 380mm (15")

Product Code	Description	Price	
H123NL	MultiDrawer (3 drawer)	£134	
H125NL	MultiDrawer (5 drawer)	£150	



MultiDrawer 29 Series H: 590mm (23.2") W: 279mm (11") D: 380mm (15")

Product Code	Description	Price	
H298BNL	MultiDrawer (2+3+3 drawers)	£217	
H296NL	MultiDrawer (6 drawer)	£208	
H2910NL	MultiDrawer (10 drawer)	£224	

MultiDrawer 39 Series H: 860mm (33.8") W: 279mm (11") D: 380mm (15")

Product Code	Description	Price	
H399NL	MultiDrawer (9 drawer)	£293	
H3915NL	MultiDrawer (15 drawer)	£317	

MultiDrawer A3 Series W: 349mm (13.7") D: 432mm (17")

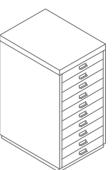
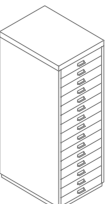
Product Code	Description	Height	Price	
112	BA3/6 non-locking (6 drawer)	670mm (26.5")	£363	
114	BA3/9 non-locking (9 drawer)	940mm (37")	£461	
116	BA3/10 non-locking (10 drawer)	670mm (26.5")	£381	
118	BA3/15 non-locking (15 drawer)	940mm (37")	£494	

MultiDrawer Internal Compartment Trays

Product Code	Description	Height	Price
223P5	A4, 4 compartment tray (pack of 5)	22mm (1")	£92
222P5	A4, 9 compartment tray (pack of 5)	22mm (1")	£92
221P5	A4, 35 compartment tray (pack of 5)	22mm (1")	£92
227P5	A4, 4 compartment tray (pack of 5)	51mm (2")	£92
226P5	A4, 9 compartment tray (pack of 5)	51mm (2")	£92
225P5	A4, 16 compartment tray (pack of 5)	51mm (2")	£92
224P5	A4, 24 compartment tray (pack of 5)	51mm (2")	£92
PIT580P5	A4, pen tray (pack of 5)	51mm (2")	£95
PIT451P5	A3, 12 compartment tray (pack of 5)	83mm (3.25")	£135

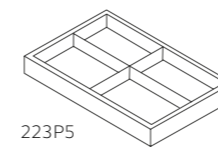

223P5

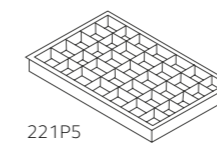

221P5

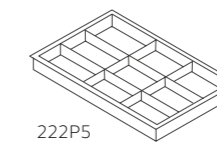

222P5

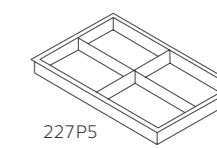

227P5

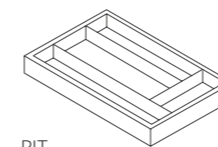

PIT

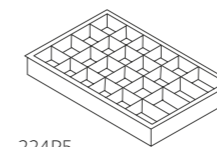

224P5

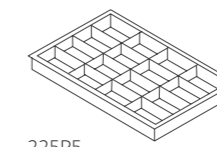

225P5

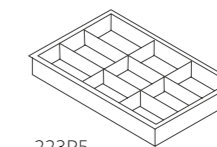

223P5

Product Code	Description	Factory Fitted	Price
CB5	Castor base for 29 & 39 series	-	£84
MDSP	Standard plinth for 29 & 39 series black (118mm high)	Suffix/SPB	£36
MDSP*	Standard plinth for 29 & 39 series matching colour (118mm high)	Suffix/SPM	£36
MDHP	High plinth for 29 & 39 series black (146mm high)	-	£58
MDHP*	High plinth for 29 & 39 series matching colour (146mm high)	-	£58
MDFC	Floor channels for 29 & 39 series only, black only available	Suffix/FC	£12
CB3	Castor base for A3 series	-	£89
MDSPA3*	Standard plinth for A3 series matching colour (118mm high)	Suffix/SPM	£36
MDHPA3	High plinth for A3 series black (146mm high)	-	£72
MDHPA3*	High plinth for A3 series matching colour (146mm high)	-	£72
MDFCA3	Floor channel for A3 series matching colour	Suffix/FCA3	£12

* Please confirm colour when ordering.

MultiSling H: 410mm (16.1") W: 286mm (11.3") D: 379mm (14.9")

Product Code	Description	Price
MSLING	Under desk MultiDrawer fixing kit and tray for 12 series Multidrawer	£84

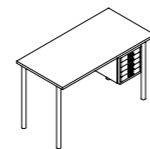

MSLING

MultiDrawer not included, must be purchased separately. Compatible with the Mosaic hanging accessory pack. See page 196.

MultiTray H: 50mm (2") W: 280mm (11") D: 380mm (15")

Product Code	Description	Price
MTTRAY	A4 mobile steel task tray	£65

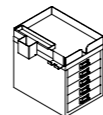

MTTRAY

Please note: There are no locking options available for MultiDrawer.

12, 29 and 39 Series MultiDrawers are compatible with the MultiDesk.

For all finishes options, please refer to page 262.





Office Filing

Bisley's office filing products are durable, robust, and stylish.

Sturdy yet stylish, stout, and strong, our office filing products give you a timeless Bisley design. Store items neatly and securely in our robust steel filing cabinets, whether you keep them next to your desk or tuck them away tidily in a corner. Featuring elegant chrome handles and a trim plinth base, with A4 or foolscap suspension filing, these are available in a variety of fronts and finishes. Our classic designs make a beautiful addition to any office.

For warranty please see specification notes page.



5-7-Year Warranty

 For more specification information click here

Premium

BS Filing Cabinets - Foolscap

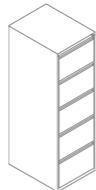

W: 470mm (18.5") D: 622mm (24.5")

Product Code	Description	Height	Price	
1623	(BS2E) Two drawer cabinet	711mm (28")	£405	
1633	(BS3E) Three drawer cabinet	1016mm (40")	£481	
1643	(BS4E) Four drawer cabinet	1321mm (52")	£543	
Please note: For classic handles suppress the last digit #3				
1653	(BS5E) Five drawer cabinet (use flat label files)	1511mm (59.5")	£1,150	
Suffix 0	Security bar (factory fitted)	N/A	£58	
PFBBSPSP1	File bar (single pack)	N/A	£13	
PFBBSPSP10	File bar (pack of 10)	N/A	£74	

Security bar cannot be fitted to five drawer cabinet.
Filing cabinets are designed for suspension filing only.

A4 BS Filing Cabinets

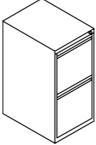
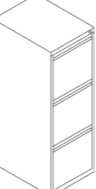
W: 413mm (16.3") D: 622mm (24.5")

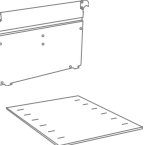

Product Code	Description	Height	Price	
3623	(A4BS2E) Two drawer cabinet	711mm (28")	£405	
3633	(A4BS3E) Three drawer cabinet	1016mm (40")	£481	
3643	(A4BS4E) Four drawer cabinet	1321mm (52")	£543	
Suffix 0	Security bar (factory fitted)	N/A	£58	

Drop in Base & Compressor Plate Matrix - BS A4 2, 3, 4 Drawers

Product Code	Description	Price	
BSA4BASEP2D	Drop in base complete with two compressor plates	£41	
BSA4BASE	Drop in base only	£20	
BSA4DIVP2	Compressor plates only (pack of 2)	£28	

F-Series Cabinets

W: 470mm (18.5") D: 470mm (18.5")

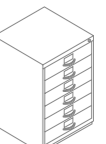
Product Code	Description	Height	Price	
Flush	Classic			
0503	050 One filing & three storage drawers - 1F3E/1F3	711mm (28")	£669	
0463	046 Two filing drawers - 2FE/2F	711mm (28")	£639	
0493	049 Six storage drawers - F6E/F6	711mm (28")	£849	
PIT522P5	Five compartment plastic insert tray fits storage drawers (pack of 5)		£172	
CB1	Castor base for all units (please specify if factory fitted)	N/A	£101	

Contract Double Filers

W: 800mm (31.5") D: 622mm (24.5")

Product Code	Description	Height	Price	
CDF2	Two drawer double filer	713mm (28.1")	£794	
CDF3	Three drawer double filer	1016mm (40")	£944	
CDF4	Four drawer double filer	1321mm (52")	£1,056	

Suffix

To change to a matching colour plinth	P
To add a counterweight	Q

Drawer front style





All BS and F series filing cabinets are available with two handle choices.

Please note all F series cabinets are listed with both classic and flush front handle options. BS filing cabinets are listed with flush front handles as standard. To order a classic front handle, please remove the '3' at the end of the relevant code listed. For example: 1643 becomes 164.

Double Filers W: 800mm (31.5") D: 622mm (24.5")

Product Code	Description	Height	Price	
DF2	Two drawer double filer	713mm (28.1")	£697	
DF3	Three drawer double filer	1016mm (40")	£827	
DF4	Four drawer double filer	1321mm (52")	£923	
DF6	Six drawer double filer	1321mm (52")	£1,381	



PFA Home Filer W: 413mm (16.2") D: 400mm (15.7")

Product Code	Description	Height	Price	
PFAM1S1F	One stationery drawer, one filing drawer, mobile	529mm (20.8")	£203	
PFAM3S	Three stationery drawers, mobile	529mm (20.8")	£226	
PFA4S	Four stationery drawers	672mm (26.5")	£313	
PFA3	Two stationery drawers, one filing drawer	672mm (26.5")	£280	
PFA2	Two filing drawers	672mm (26.5")	£239	

Standard

Standard office filing and stationery cupboards are only available in a selected finishes

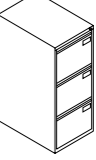
AOC Filing Cabinets W: 470mm (18.5") D: 622mm (24.5")

Product Code	Description	Height	Price	
AOC2E	Two drawer cabinet (flush handle, separate label holder)	711mm (28")	£361	
AOC3E	Three drawer cabinet (flush handle, separate label holder)	1016mm (40")	£412	
AOC4E	Four drawer cabinet (flush handle, separate label holder)	1321mm (52")	£460	

Drop in Base & Compressor Plate Matrix - Contract Footscap 2,3,4 Drawer Base

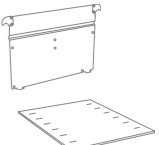

Product Code	Description	Price	
CONFBASEP2D	Drop in base complete with two compressor plates	£41	
CONFBASE	Drop in base only	£20	
CONFDIVP2	Compressor plates only (pack of 2)	£28	

IPCC Filing Cabinets W: 413mm (16.3") D: 622mm (24.5")

Product Code	Description	Height	Price	
IPCCA12E	Two drawer cabinet A4	711mm (28")	£327	
IPCCA13E	Three drawer cabinet A4	1016mm (40")	£377	
IPCCA14E	Four drawer cabinet A4	1321mm (52")	£433	

PSF Filing Cabinets W: 470mm (18.5") D: 622mm (24.5")

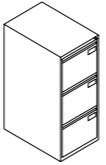
Product Code	Description	Height	Price	
PSF2E	Two drawer cabinet A4	711mm (28")	£352	

PSF3E	Three drawer cabinet A4	1016mm (40")	£402	
PSF4E	Four drawer cabinet A4	1321mm (52")	£451	

Drop in Base & Compressor Plate Matrix - BS Foolscap 5 Drawers

Product Code	Description	Price
BSF5DBASEP2D	Drop in base complete with two compressor plates	£41
BSFBASE	Drop in base only	£20
BS5DDIVP2	Compressor plates only (pack of 2)	£28

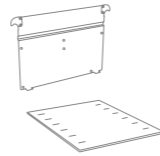

Drop in Base & Compressor Plate Matrix - BS Foolscap 2, 3, 4 Drawers

Product Code	Description	Price
BSFBASEP2D	Drop in base complete with two compressor plates	£41
BSFBASE	Drop in base only	£20
BSFDIVP2	Compressor plates only (pack of 2)	£28

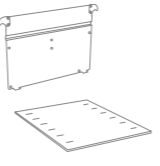

Stationery Cupboards

D: 400mm (15.7")

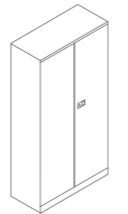
Product Code	Description	Height	Width	Price	
E402A01E	Stationery cupboard with one grey filing shelf	1000mm (39.5")	914mm (36")	£396	
E722A03E	Stationery cupboard with three grey filing shelves	1806mm (71")	914mm (36")	£533	
E782A04E	Stationery cupboard with four grey filing shelves	1950mm (76.8")	914mm (36")	£566	
E782AWPE	Stationery cupboard with wardrobe pack	1950mm (76.8")	914mm (36")	£641	
ECO10084022	Stationery cupboard with two black filing shelves	1000mm (39.4")	800mm (31.5")	£360	

ECO19084024	Stationery cupboard with four black filing shelves	1950mm (76.8")	800mm (31.5")	£489	
ECO19124024	Stationery cupboard with four black filing shelves	1950mm (76.8")	1200mm (47.2")	£603	

Internals

Product Code	Description	Price	Height
ECO800SHELF	Stationery cupboard shelf	£37	800mm (31.5")
ECO1200SHELF	Stationery cupboard shelf	£41	1200mm (47.2")
E198P1:45	Additional dual purpose shelf - grey	£38	N/A



ECO800SHELF

Castor Base

Product Code	Description	Price	Height
CB1	Castor base for all units (please specify if factory fitted)	£101	N/A

Additional information

All filing cabinets are designed for suspension filing only. Please note: Additional drop in bases are available for BS and AOC to add strength to allow storage on the base of the unit.

All filing cabinets have a 5-year warranty with the exception of the BS filing cabinets which have a 7-year warranty.

Standard - AOC, IPCC, PSF, BS five drawer and Stationery cupboards are only available in the follow: Traffic White, Chalk, Coffee/Cream, Light Grey, Goose Grey and Black. *BS five drawer is not available in traffic white.

Premium - BS, F-series, double, contract double and PFA home filers are available in our full palette.

Stationery cupboards are designed to accommodate a dual-purpose shelf with undershelf filing.





Plan & Card Filing

Some items need their own unique kind of storage. Our high-quality units organise and help protect specialist items.

Sturdy and secure, the Plan File provides reliable storage and complete protection for large format documents. With a subtle, elegant design that fits seamlessly in any workspace our Plan File, Card Filing and Index Cabinets are favoured by architects and designers, due to their sleek finish and ability to house everything from media through to smaller items. They are also ideal for organising documents such as drawings, prints, plans, samples and contact cards.

5-10-Year Warranty

 For more specification information click here

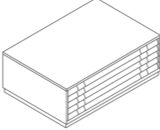
Product Code	Description	Height	Price	
460	FCB 41 – Five drawer intermediate section only	406mm (16")	£2,831	
463	FCB 40 – Five drawer unit complete with top and plinth	508mm (20")	£3,448	
461/462	FCB 33 – Ten drawer unit complete with top and plinth	914mm (36")	£6,270	
PFD	Plan file dividers (pack of 2)	N/A	£40	

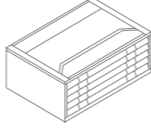
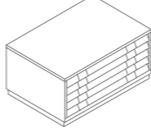
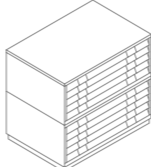
Product Code	Description	Height	Price	
470	FCB 44 – Five drawer unit intermediate section only	406mm (16")	£2,287	
473	FCB 43 – Five drawer unit complete with top and plinth	508mm (20")	£2,778	
471/472	FCB 42 – Ten drawer unit complete with top and plinth	914mm (36")	£5,063	
PFD	Plan file dividers (pack of 2)	N/A	£40	

Plinth

All Plan Files are fitted with a black plinth as standard. For a factory fitted plinth in matching colour, please add suffix 'P' to the relevant code listed. For example: 460 becomes 460P

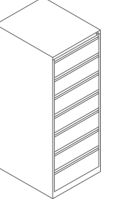
Product Code	Description	Height	Price	
B64	BCF64 – Card filing cabinet (9)*, 413mm (16.2") wide	1321mm (52")	£3,212	
Available in Goose Grey AV4 only.				
B85	BCF85 – Card filing cabinet (7)*, 518mm (20.3") wide	1321mm (52")	£2,834	
Available in Goose Grey AV4 only.				
B96	BCF96 – Card filing cabinet (6)*, 568mm (22.3") wide	1321mm (52")	£2,757	
Available in Light Grey AV7 only.				
8346P10	Compressor plates for B64 (pack of 10)	N/A	£110	
8347P10	Compressor plates for B85 (pack of 10)	N/A	£110	
8348P10	Compressor plates for B96 (pack of 10)	N/A	£130	

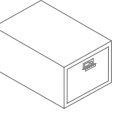
Product Code	Description	Height	Price	
Imperial	Metric			
130L	A5HS	FCB15 – Card index cabinet (1)*, 271mm (10.7") wide	206mm (8")	£307
132L	A6HD	FCB24 – Card index cabinet (2)*, 434mm (17") wide	159mm (6.2")	£538
138P10		Compressor plates (pack of 10) 5x3 (A7)	N/A	£98
1381P10		Compressor plates (pack of 10) 6x4 (A6)	N/A	£98
1382P10		Compressor plates (pack of 10) 8x5 (A5)	N/A	£98

Available in Goose Grey AV4 only.

*Number of drawers.

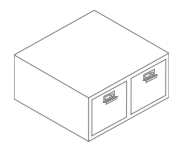





Height-Adjustable Desks

Our selection of height-adjustable desks and accessories combine ergonomic comfort with genuine flexibility, meaning you can work in style. Arguably the most important consideration when choosing how to work, we have the knowledge and expertise to advise on whether your preference is to work while seated, standing, or a combination of the two.

Why not add an extra touch of luxury and indulgence to your sit stand desk with the addition of a PerfectSense desktop. Micro-scratch resistant and robust, we provide comfort and quality, without compromising style.

5-Year Warranty

 For more specification information click here

Bisley Cube H: 625-1275mm (24.6-50.2") D: 800mm (27.6")

Product Code	Description	Width	Price
JOYM12800UK*	Electric height-adjustable desk with 1200mm wide MFC top	1200mm (47.2")	£1,108
JOYM14800UK*	Electric height-adjustable desk with 1400mm wide MFC top	1400mm (55.1")	£1,160
JOYM16800UK*	Electric height-adjustable desk with 1600mm wide MFC top	1600mm (63")	£1,211
JOYM18800UK*	Electric height-adjustable desk with 1800mm wide MFC top	1800mm (70.9")	£1,263
JOYP12800UK*	Electric height-adjustable desk with 1200mm wide PerfectSense plywood top	1200mm (47.2")	£1,563
JOYP14800UK*	Electric height-adjustable desk with 1400mm wide PerfectSense plywood top	1400mm (55.1")	£1,699
JOYP16800UK*	Electric height-adjustable desk with 1600mm wide PerfectSense plywood top	1600mm (63")	£1,836
JOYP18800UK*	Electric height-adjustable desk with 1800mm wide PerfectSense plywood top	1800mm (70.9")	£1,972

* Add letter R for rectangular, S for scallop, C for cut-out desktop

Bisley Cyl H: 625-1275mm (24.6-50.2") D: 800mm (27.6")

Product Code	Description	Width	Price
RINM12700UK *	Electric height-adjustable desk with 1200mm wide MFC top	1200mm (47.2")	£1,080
RINM14700UK *	Electric height-adjustable desk with 1400mm wide MFC top	1400mm (55.1")	£1,131
RINM16700UK *	Electric height-adjustable desk with 1600mm wide MFC top	1600mm (63")	£1,183
RINM18700UK *	Electric height-adjustable desk with 1800mm wide MFC top	1800mm (70.9")	£1,234
RINP12700UK *	Electric height-adjustable desk with 1200mm wide PerfectSense plywood top	1200mm (47.2")	£1,535
RINP14700UK *	Electric height-adjustable desk with 1400mm wide PerfectSense plywood top	1400mm (55.1")	£1,636
RINP16700UK *	Electric height-adjustable desk with 1600mm wide PerfectSense plywood top	1600mm (63")	£1,739
RINP18700UK *	Electric height-adjustable desk with 1800mm wide PerfectSense plywood top	1800mm (70.9")	£1,841

* Add letter R for rectangular, S for scallop, C for cut-out desktop

Bisley Duo H: 625-1275mm (24.6-50.2") D: 1650mm (31.5")

Product Code	Description	Width	Price
MODM12800UK *	Electric twin height-adjustable desks with 1200mm wide MFC tops	1200mm (47.2")	£1,875
MODM14800UK *	Electric twin height-adjustable desks with 1400mm wide MFC tops	1400mm (55.1")	£1,988
MODM16800UK *	Electric twin height-adjustable desks with 1600mm wide MFC tops	1600mm (63")	£2,102
MODM18800UK *	Electric twin height-adjustable desks with 1800mm wide MFC tops	1800mm (70.9")	£2,216
MODP12800UK *	Electric twin height-adjustable desks with 1200mm wide PerfectSense plywood tops	1200mm (47.2")	£3,068
MODP14800UK *	Electric twin height-adjustable desks with 1400mm wide PerfectSense plywood tops	1400mm (55.1")	£3,238
MODP16800UK *	Electric twin height-adjustable desks with 1600mm wide PerfectSense plywood tops	1600mm (63")	£3,408
MODP18800UK *	Electric twin height-adjustable desks with 1800mm wide PerfectSense plywood tops	1800mm (70.9")	£3,579

* Add letter R for rectangular, S for scallop, C for cut-out desktop

Structures

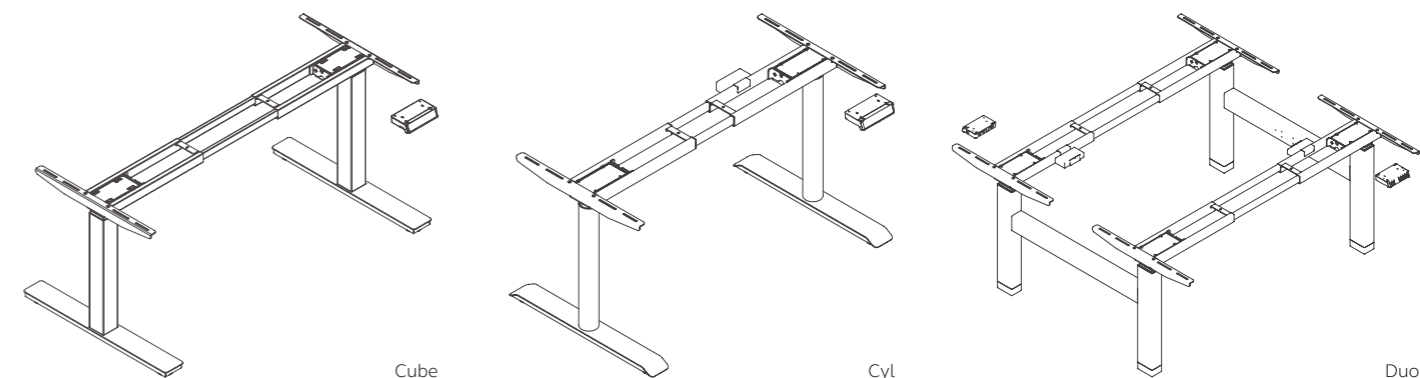
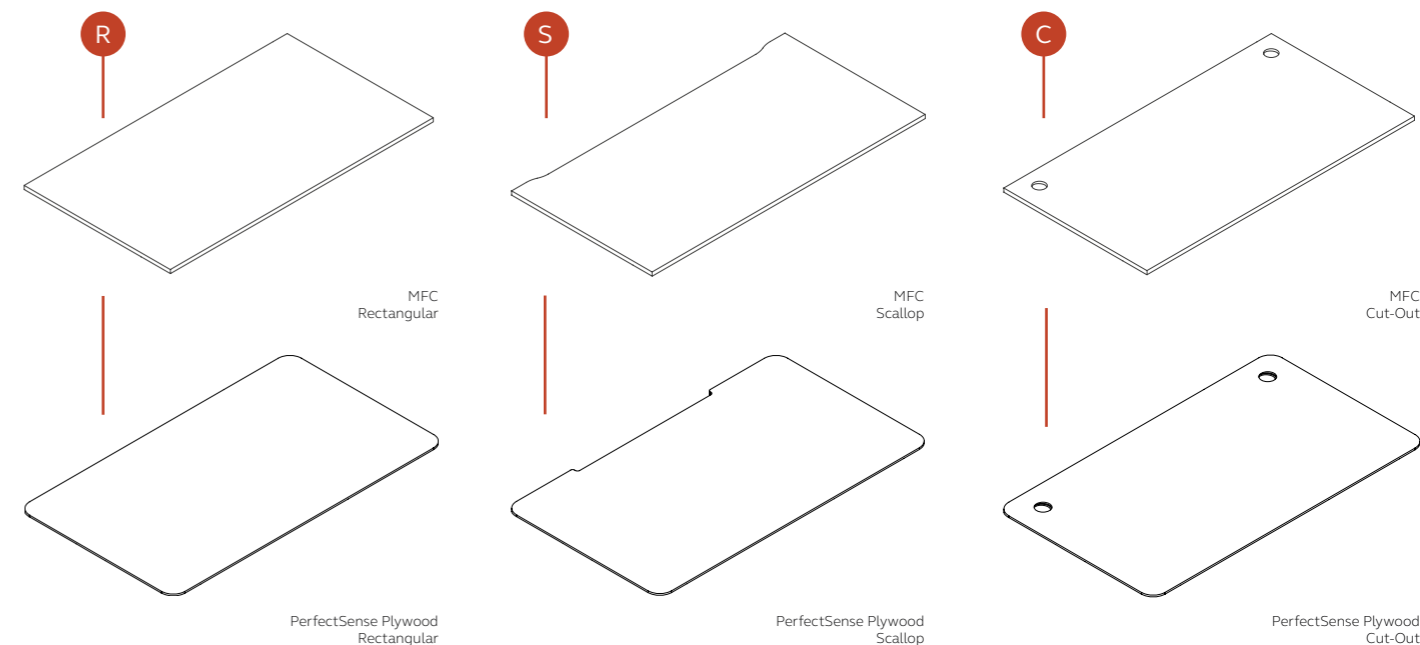

Table Tops



Accessories

Product Code	Description	Price
CSSINGLE	Cable spine for height-adjustable desk – single desk - floor to tray	£115
CSDUOT	Cable spine for height-adjustable desk – duo desk - central tray to top tray	£103
CSDUOC	Cable spine for height-adjustable duo desk - floor to central tray	£103
CTSINGLE	Cable tray for height-adjustable desk – single desk	£109
CTDUO	Cable tray for height-adjustable desk – duo desk	£109
CTTILT	Tilttable cable tray	£143
MODFLEXDUO	Modesty panel - flex duo	£398

Modesty Panel

H: 375mm (14.8")

Product Code	Description	Width	Price
MPSP12	Perforated steel modesty panel for 1200mm wide desk	1078mm (42.4")	£77
MPSP14	Perforated steel modesty panel for 1400mm wide desk	1278mm (50.3")	£82
MPSP16	Perforated steel modesty panel for 1600mm wide desk	1478mm (58.2")	£92
MPSP18	Perforated steel modesty panel for 1800mm wide desk	1678mm (66.1")	£98

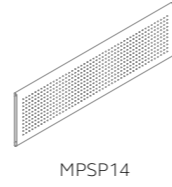

Mounted Screens for Single Desks - Air

H: 380mm (15") D:27mm (1.1")

Product Code	Description	Band 1	Band 2	Band 3	Band 4
ASDMSCRN10	Desk screen 1000mm (39.4") wide	£156	£218	£230	£278
ASDMSCRN12	Desk screen 1200mm (47.2") wide	£163	£228	£241	£291
ASDMSCRN14	Desk screen 1400mm (55.1") wide	£174	£244	£258	£310
ASDMSCRN16	Desk screen 1600mm (63") wide	£183	£256	£256	£270
ASDMSCRN18	Desk screen 1800mm (70.9") wide	£326	£206	£288	£304

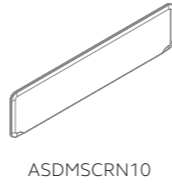

Mounted Screens for Bench Desks - Air

H: 628mm (15") D:27mm (1.1")

Product Code	Description	Band 1	Band 2	Band 3	Band 4
ABDMSCRN10	Desk screen 1000mm (39.4") wide	£220	£308	£325	£341
ABDMSCRN12	Desk screen 1200mm (47.2") wide	£225	£315	£333	£349
ABDMSCRN14	Desk screen 1400mm (55.1") wide	£251	£352	£372	£390
ABDMSCRN16	Desk screen 1600mm (63") wide	£307	£430	£455	£476
ABDMSCRN18	Desk screen 1800mm (70.9") wide	£322	£450	£476	£498

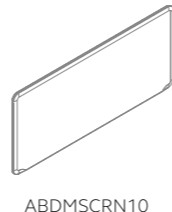

Mounted Screens for Single Desks - Cirrus

H: 380mm (15") D:27mm (1.1")

Product Code	Description	Price
CSDMSCRN10	Desk screen 1000mm (39.4") wide	£293
CSDMSCRN12	Desk screen 1200mm (47.2") wide	£299
CSDMSCRN14	Desk screen 1400mm (55.1") wide	£313
CSDMSCRN16	Desk screen 1600mm (63") wide	£355
CSDMSCRN18	Desk screen 1800mm (70.9") wide	£510

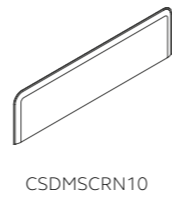

Mounted Screens for Bench Desks - Cirrus

H: 628mm (15") D:27mm (1.1")

Product Code	Description	Price
CBDMSCRN10	Desk screen 1000mm (39.4") wide	£472
CBDMSCRN12	Desk screen 1200mm (47.2") wide	£511
CBDMSCRN14	Desk screen 1400mm (55.1") wide	£562
CBDMSCRN16	Desk screen 1600mm (63") wide	£623
CBDMSCRN18	Desk screen 1800mm (70.9") wide	£747

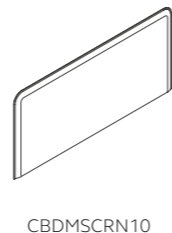

Brackets for Screens - Air and Cirrus

H: 240mm (15") D:50 mm (1.1")

Product Code	Description	Width	Price
BISBKT01	Brackets for single desk (pack of 2)	20mm	£58
BISBKT03	Brackets for double desk (pack of 2)	40mm	£57

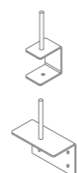

References Sequence

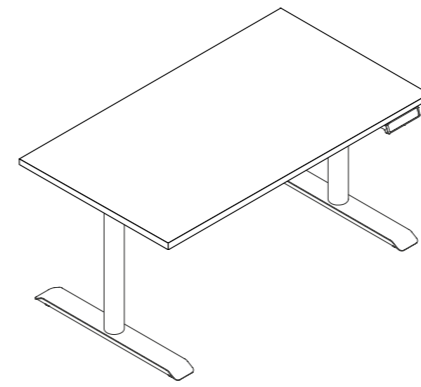

JOYM14800UKR

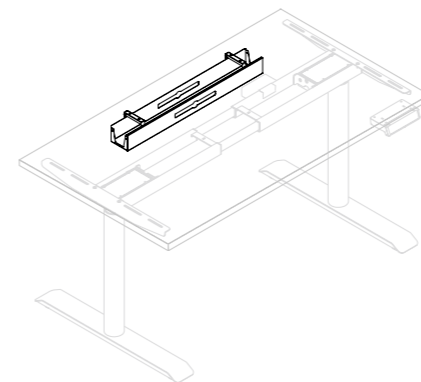

JOYM14800UKR + CTSINGLE or CTTILT

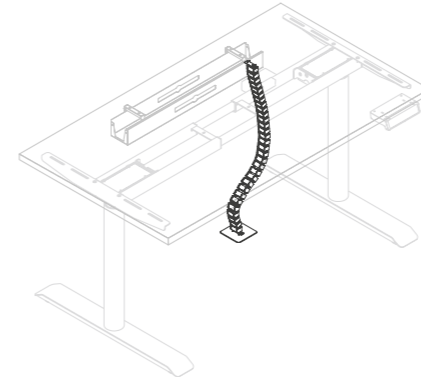

JOYM14800UKR + CTSINGLE or CTTILT + CSSINGLE

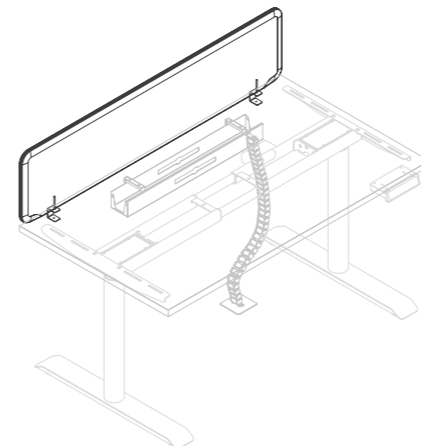

JOYM14800UKR + CTSINGLE or CTTILT + CSSINGLE + SBKT-BISBKT-01 + ABDMSCRN14

1

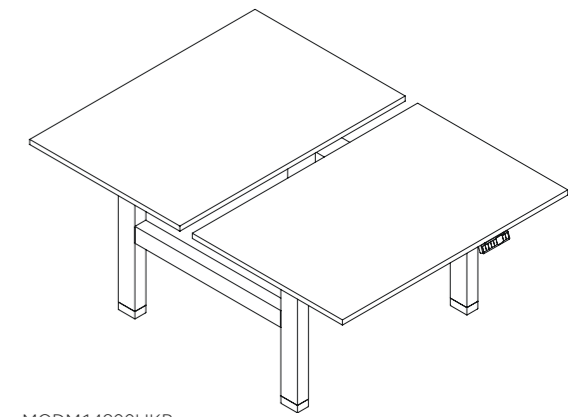

MODM14800UKR

2

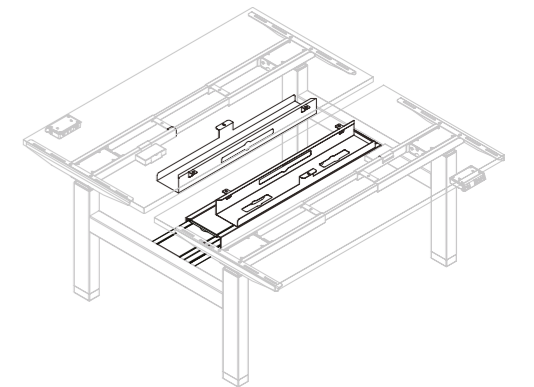

MODM14800UKR + CTSINGLE or CTTILT + CTDUO

3

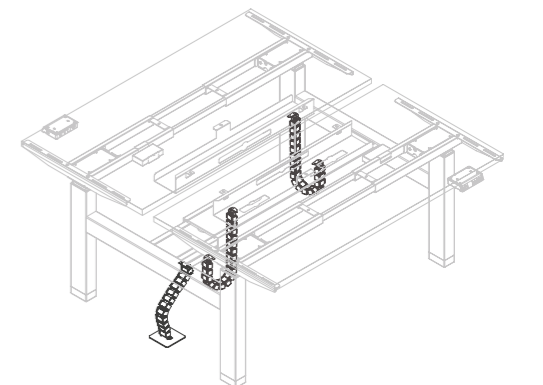

MODM14800UKR + CTSINGLE or CTTILT + CSUOC + 2xCTDUOT

4

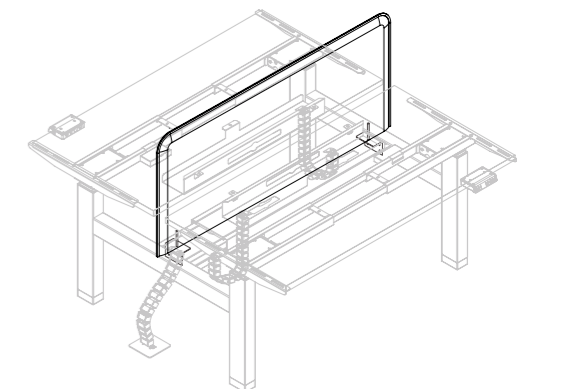

MODM14800UKR + CTSINGLE or CTTILT + CSUOC + 2xCTDUOT + SBKT-BISBKT-03 + CSDMSCRN14

Additional information

Leg finish



Maximum Lifting Capacity

Bisley Cube - 120kg
Bisley Cyl - 120kg
Bisley Duo - 120kg per desk

Noise Rating

All Bisley height-adjustable desks have a noise rating of less than 45db

Warranty

Bisley Cube - 5 years
Bisley Cyl - 5 years
Bisley Duo - 5 years

Controller

Bisley Cube and Bisley Cyl are fitted with bluetooth, high resolution LCD display controller.
Bisley Duo is fitted with a premium analogue handset.



Fixed Desk - Align

Presenting Align by Bisley, our versatile new range of office desks that are designed for flexibility, functionality, and ultimate comfort for a smoother workday.

Proudly made in the UK, Align is a collection of office desks that are an essential addition to the workplace. High-quality and available in various sizes, configurations, and finishes, Align is available in three leg style options: goalpost, A-frame, or solid oak. Depending on your preference and aesthetic, Align adapts effortlessly to suit all office requirements – from single desks to eight-person benches, making collaborative working simple and scalable.

Align can also be combined with our popular office desk storage solutions—Buddy, Caddy and Note Pedestals—to truly maximise and enhance your floor space.

The Align range includes additional accessories to elevate productivity and ergonomic comfort, such as discreet cable ports, acoustic screens, monitor arms, and modesty panels. Every detail has been carefully considered and designed, providing a comprehensive solution that covers all your office needs in one streamlined package.

5-Year Warranty



Product Code	Description	Width	Depth	Price
SGP12081 *	Goalpost frame with MFC desktop - single	1200mm (47.2")	800mm (31.5")	£503
SGP14081 *	Goalpost frame with MFC desktop - single	1400mm (55.1")	800mm (31.5")	£519
SGP16081 *	Goalpost frame with MFC desktop - single	1600mm (63")	800mm (31.5")	£536
SGP18081 *	Goalpost frame with MFC desktop - single	1800mm (70.9")	800mm (31.5")	£553
SGP12082 *	Goalpost frame with MFC desktop - 2 person	1200mm (47.2")	1600mm (63")	£845
SGP14082 *	Goalpost frame with MFC desktop - 2 person	1400mm (55.1")	1600mm (63")	£878
SGP16082 *	Goalpost frame with MFC desktop - 2 person	1600mm (63")	1600mm (63")	£910
SGP18082 *	Goalpost frame with MFC desktop - 2 person	1800mm (70.9")	1600mm (63")	£942
SGP12084 *	Goalpost frame with MFC desktop - 4 person	2400mm (94.5")	1600mm (63")	£1,499
SGP14084 *	Goalpost frame with MFC desktop - 4 person	2800mm (110.2")	1600mm (63")	£1,564
SGP16084 *	Goalpost frame with MFC desktop - 4 person	3200mm (126")	1600mm (63")	£1,628
SGP18084 *	Goalpost frame with MFC desktop - 4 person	3600mm (141.7")	1600mm (63")	£1,692
SGP12086 *	Goalpost frame with MFC desktop - 6 person	3600mm (141.7")	1600mm (63")	£2,152
SGP14086 *	Goalpost frame with MFC desktop - 6 person	4200mm (165.4")	1600mm (63")	£2,251
SGP16086 *	Goalpost frame with MFC desktop - 6 person	4800mm (189")	1600mm (63")	£2,345
SGP18086 *	Goalpost frame with MFC desktop - 6 person	5400mm (212.6")	1600mm (63")	£2,444
SGP12088 *	Goalpost frame with MFC desktop - 8 person	4800mm (189")	1600mm (63")	£2,806
SGP14088 *	Goalpost frame with MFC desktop - 8 person	5600mm (220.5")	1600mm (63")	£2,936
SGP16088 *	Goalpost frame with MFC desktop - 8 person	6400mm (252")	1600mm (63")	£3,064
SGP18088 *	Goalpost frame with MFC desktop - 8 person	7200mm (283.5")	1600mm (63")	£3,194

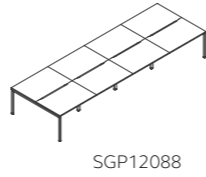
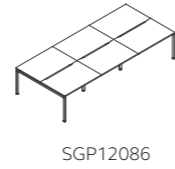

* Add letter R for rectangular, S for scallop, C for cut-out desktop

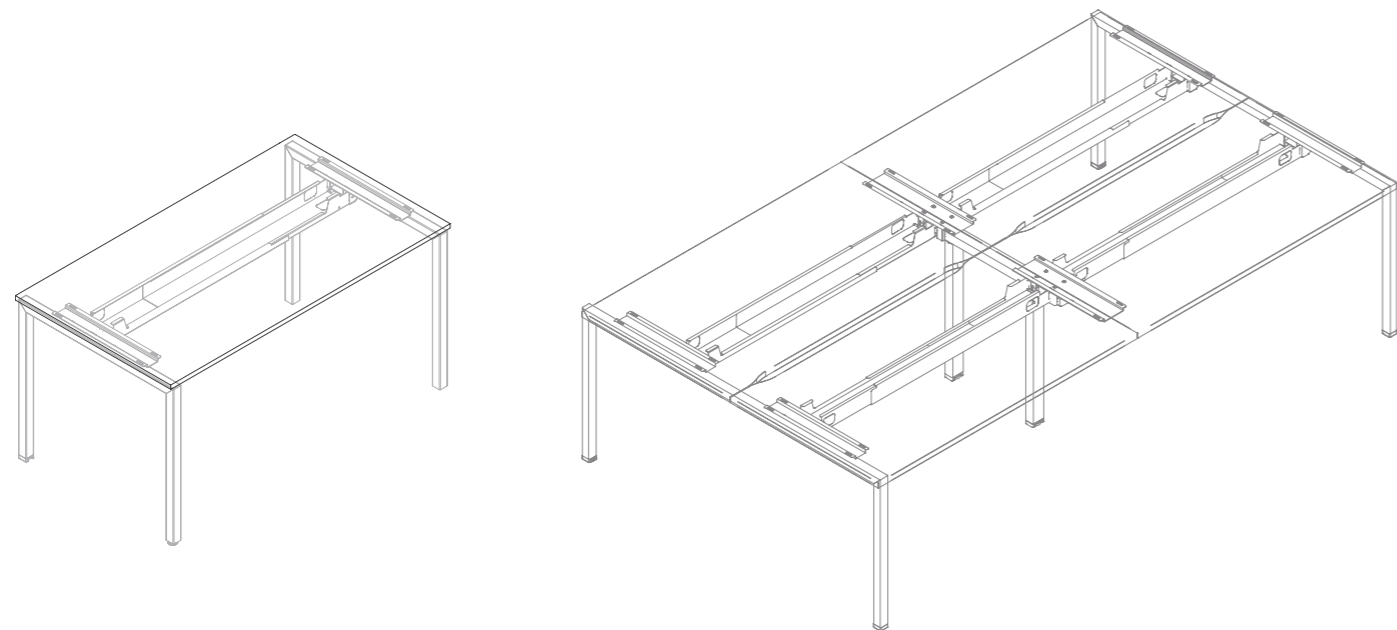



Product Code	Description	Width	Depth	Price
SAF12081 *	A-frame with MFC desktop - single	1200mm (47.2")	800mm (31.5")	£499
SAF14081 *	A-frame with MFC desktop - single	1400mm (55.1")	800mm (31.5")	£515
SAF16081 *	A-frame with MFC desktop - single	1600mm (63")	800mm (31.5")	£531
SAF18081 *	A-frame with MFC desktop - single	1800mm (70.9")	800mm (31.5")	£546
SAF12082 *	A-frame with MFC desktop - 2 person	1200mm (47.2")	1600mm (63")	£893
SAF14082 *	A-frame with MFC desktop - 2 person	1400mm (55.1")	1600mm (63")	£926
SAF16082 *	A-frame with MFC desktop - 2 person	1600mm (63")	1600mm (63")	£958
SAF18082 *	A-frame with MFC desktop - 2 person	1800mm (70.9")	1600mm (63")	£991
SAF12084 *	A-frame with MFC desktop - 4 person	2400mm (94.5")	1600mm (63")	£1,547
SAF14084 *	A-frame with MFC desktop - 4 person	2800mm (110.2")	1600mm (63")	£1,613
SAF16084 *	A-frame with MFC desktop - 4 person	3200mm (126")	1600mm (63")	£1,676
SAF18084 *	A-frame with MFC desktop - 4 person	3600mm (141.7")	1600mm (63")	£1,741
SAF12086 *	A-frame with MFC desktop - 6 person	3600mm (141.7")	1600mm (63")	£2,201
SAF14086 *	A-frame with MFC desktop - 6 person	4200mm (165.4")	1600mm (63")	£2,299
SAF16086 *	A-frame with MFC desktop - 6 person	4800mm (189")	1600mm (63")	£2,394
SAF18086 *	A-frame with MFC desktop - 6 person	5400mm (212.6")	1600mm (63")	£2,492
SAF12088 *	A-frame with MFC desktop - 8 person	4800mm (189")	1600mm (63")	£2,854
SAF14088 *	A-frame with MFC desktop - 8 person	5600mm (220.5")	1600mm (63")	£2,986
SAF16088 *	A-frame with MFC desktop - 8 person	6400mm (252")	1600mm (63")	£3,112
SAF18088 *	A-frame with MFC desktop - 8 person	7200mm (283.5")	1600mm (63")	£3,243

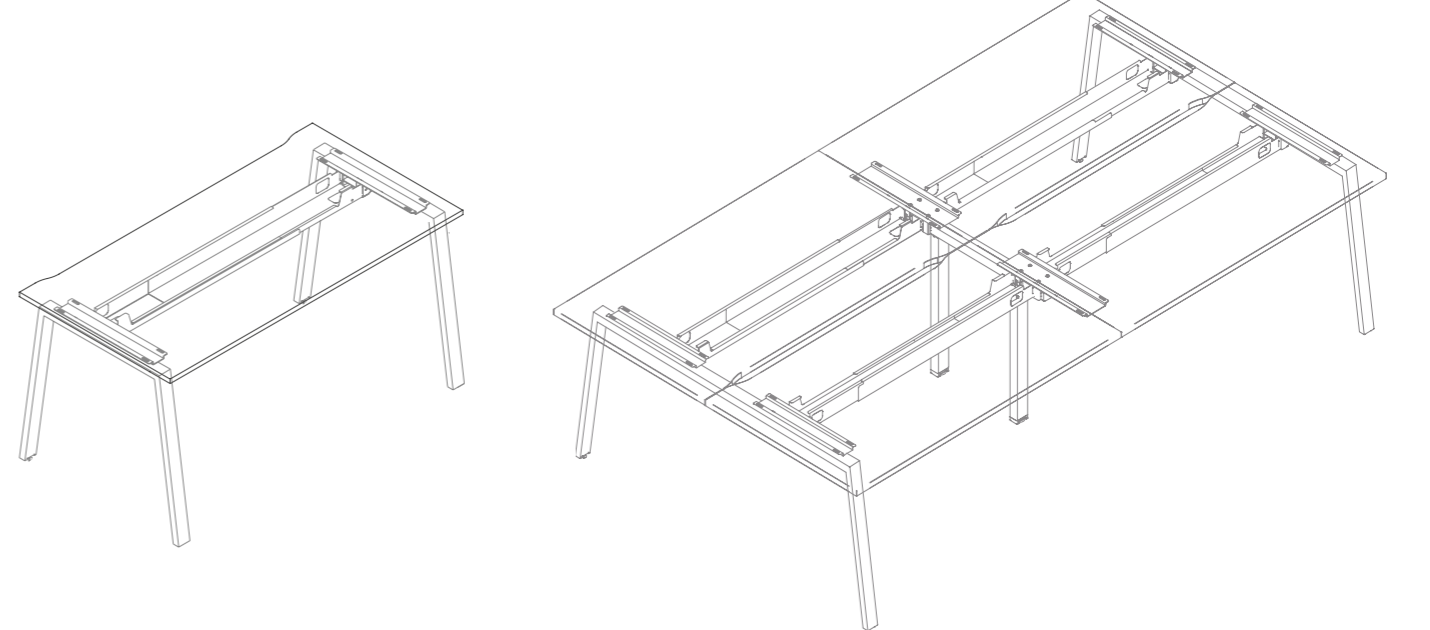

* Add letter R for rectangular, S for scallop, C for cut-out desktop



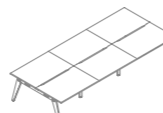
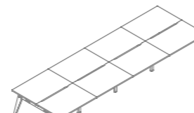

Product Code	Description	Width	Depth	Price	
SWL12081 *	Solid oak with MFC desktop - single	1200mm (47.2")	800mm (31.5")	£895	 SWL12081 *
SWL14081 *	Solid oak with MFC desktop - single	1400mm (55.1")	800mm (31.5")	£912	
SWL16081 *	Solid oak with MFC desktop - single	1600mm (63")	800mm (31.5")	£928	
SWL18081 *	Solid oak with MFC desktop - single	1800mm (70.9")	800mm (31.5")	£944	
SWL12082 *	Solid oak with MFC desktop - 2 person	1200mm (47.2")	1600mm (63")	£1,271	 SWL12082 *
SWL14082 *	Solid oak with MFC desktop - 2 person	1400mm (55.1")	1600mm (63")	£1,304	
SWL16082 *	Solid oak with MFC desktop - 2 person	1600mm (63")	1600mm (63")	£1,335	
SWL18082 *	Solid oak with MFC desktop - 2 person	1800mm (70.9")	1600mm (63")	£1,369	
SWL12084 *	Solid oak with MFC desktop - 4 person	2400mm (94.5")	1600mm (63")	£1,925	 SWL12084 *
SWL14084 *	Solid oak with MFC desktop - 4 person	2800mm (110.2")	1600mm (63")	£1,990	
SWL16084 *	Solid oak with MFC desktop - 4 person	3200mm (126")	1600mm (63")	£2,054	
SWL18084 *	Solid oak with MFC desktop - 4 person	3600mm (141.7")	1600mm (63")	£2,119	
SWL12086 *	Solid oak with MFC desktop - 6 person	3600mm (141.7")	1600mm (63")	£2,579	 SWL12086 *
SWL14086 *	Solid oak with MFC desktop - 6 person	4200mm (165.4")	1600mm (63")	£2,676	
SWL16086 *	Solid oak with MFC desktop - 6 person	4800mm (189")	1600mm (63")	£2,772	
SWL18086 *	Solid oak with MFC desktop - 6 person	5400mm (212.6")	1600mm (63")	£2,870	
SWL12088 *	Solid oak with MFC desktop - 8 person	4800mm (189")	1600mm (63")	£3,232	 SWL12088 *
SWL14088 *	Solid oak with MFC desktop - 8 person	5600mm (220.5")	1600mm (63")	£3,364	
SWL16088 *	Solid oak with MFC desktop - 8 person	6400mm (252")	1600mm (63")	£3,490	
SWL18088 *	Solid oak with MFC desktop - 8 person	7200mm (283.5")	1600mm (63")	£3,621	

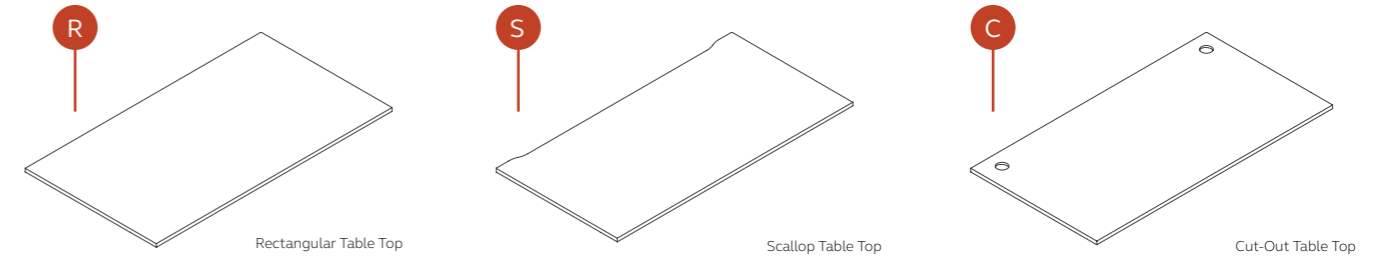
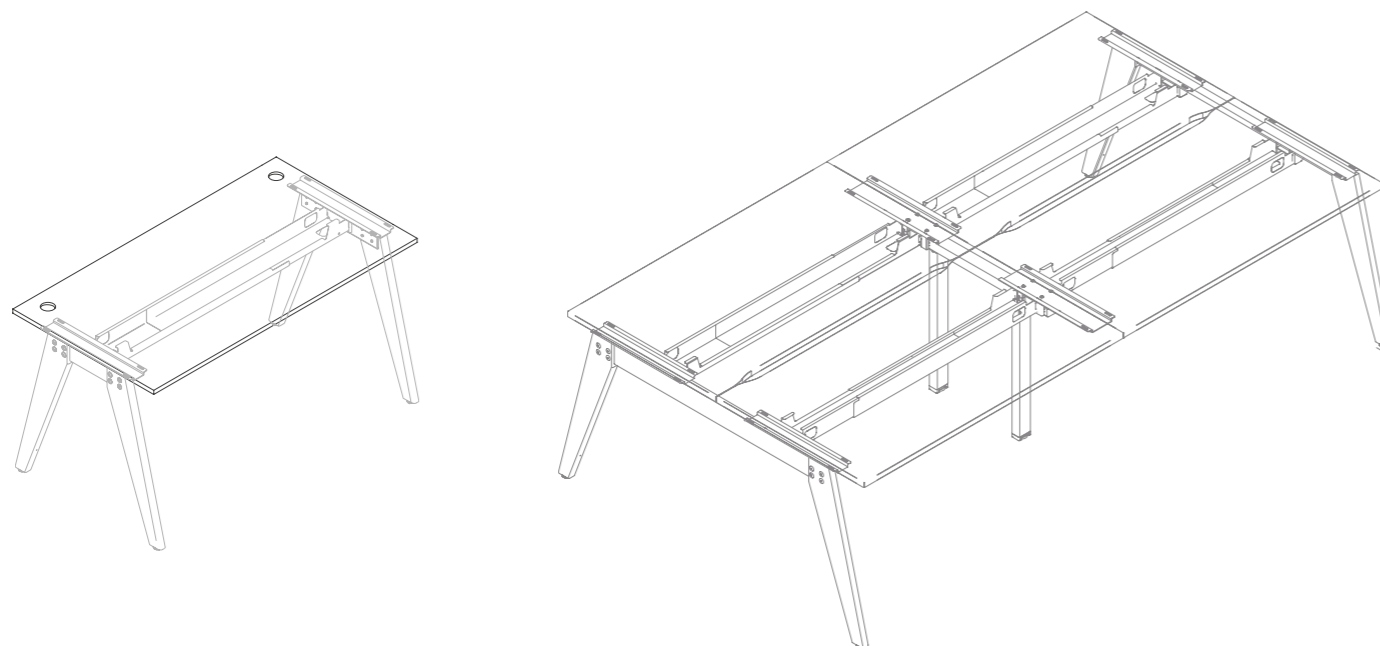
* Add letter R for rectangular, S for scallop, C for cut-out desktop

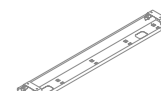

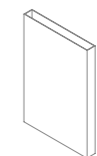
Product Code	Description	Width	Price	
BISTRAY10	Cable tray - Bench desk 1000mm wide	752mm (29.6")	£50	 BISTRAY14
BISTRAY12	Cable tray - Bench desk 1200mm wide	952mm (37.5")	£52	
BISTRAY14	Cable tray - Bench desk 1400mm wide	1152mm (45.4")	£55	
BISTRAY16	Cable tray - Bench desk 1600mm wide	1352mm (53.2")	£58	
BISTRAY18	Cable tray - Bench desk 1800mm wide	1552mm (61.1")	£61	
SANCAP	Cable tray end cap - Pack of 2		£52	

Product Code	Description	Price	
CRINTERLEG	Mass cable riser for intermediate leg	£80	
CRSOCK	Cable riser sock c/w base weight	£42	

Product Code	Description	Width	Price	
MPSP12	Perforated steel modesty panel for 1200mm wide desk	1078mm (42.4")	£77	 MPSP14
MPSP14	Perforated steel modesty panel for 1400mm wide desk	1278mm (50.3")	£82	
MPSP16	Perforated steel modesty panel for 1600mm wide desk	1478mm (58.2")	£92	
MPSP18	Perforated steel modesty panel for 1800mm wide desk	1678mm (66.1")	£98	

Mounted Screens for Single and Bench Desks - Air

H: 380mm (15") D: 27mm (1.1")

Product Code	Description	Band 1	Band 2	Band 3	Band 4
ASDMSCRN10	Desk screen 1000mm (39.4") wide	£156	£218	£230	£278
ASDMSCRN12	Desk screen 1200mm (47.2") wide	£163	£228	£241	£291
ASDMSCRN14	Desk screen 1400mm (55.1") wide	£174	£244	£258	£310
ASDMSCRN16	Desk screen 1600mm (63") wide	£183	£256	£270	£326
ASDMSCRN18	Desk screen 1800mm (70.9") wide	£206	£288	£304	£367

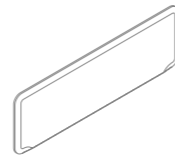

ASDMSCRN14

Mounted Screens for Single and Bench Desks - Cirrus

H: 380mm (15") D: 27mm (1.1")

Product Code	Description	Price
CSDMSCRN10	Desk screen 1000mm (39.4") wide	£293
CSDMSCRN12	Desk screen 1200mm (47.2") wide	£299
CSDMSCRN14	Desk screen 1400mm (55.1") wide	£313
CSDMSCRN16	Desk screen 1600mm (63") wide	£355
CSDMSCRN18	Desk screen 1800mm (70.9") wide	£510

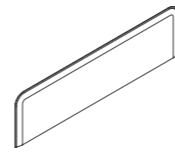

CSDMSCRN14

Brackets for Screens - Air and Cirrus

H: 240mm (15") D: 50 mm (1.1")

BISBKT01	Brackets for single desk (pack of 2)	£58
BISBKT02	Brackets for double desk (pack of 2)	£57

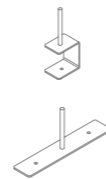

Additional information

Leg finish



Warranty

Goalpost - 5 years
A frame - 5 years
Timber - 5 years

Mounted Screens for Single Desks - Aero

H: 380mm (15") D: 27mm (1.1")

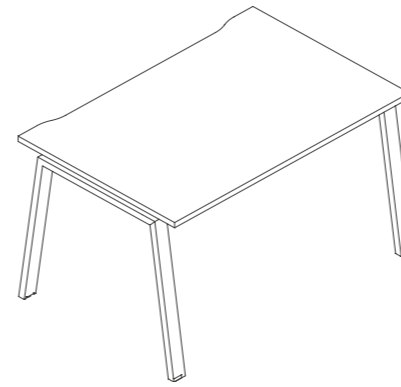

SAF14081S

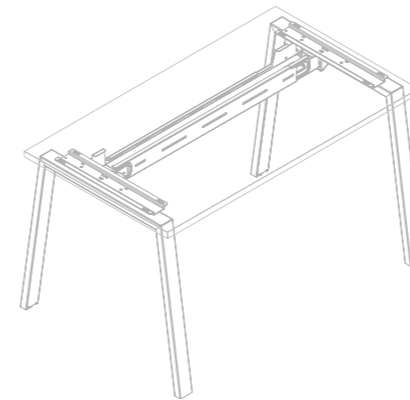

SAF14081R - Central Beam Supports Cable Management



SAF14081S + CR SOCK

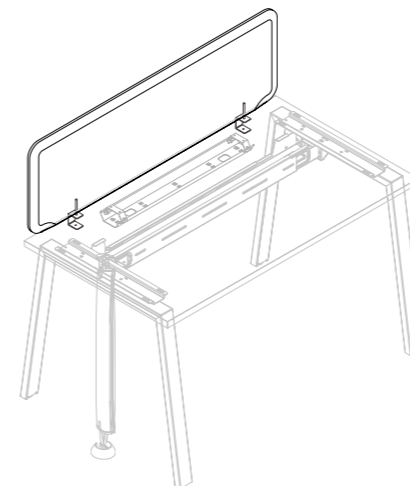

SAF14081S + CR SOCK + SBKT-BISBKT-01 + ABDMSCRN18

1

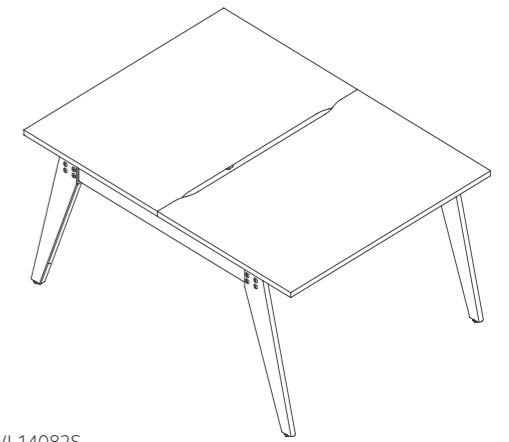

SWL14082S

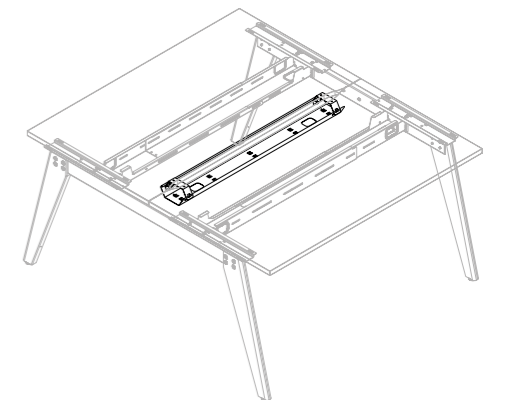

SWL14082S + BISTRAY16

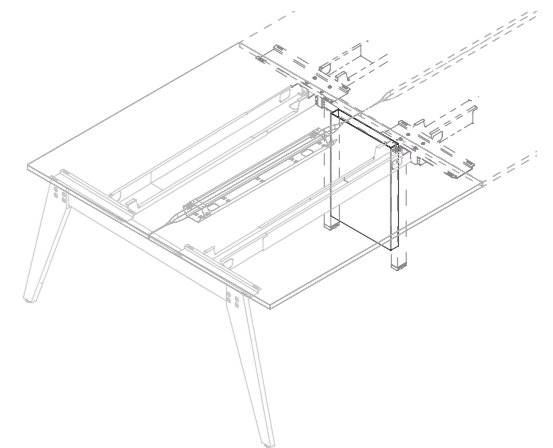

SWL14082S + BISTRAY16 + CRINTERLEG





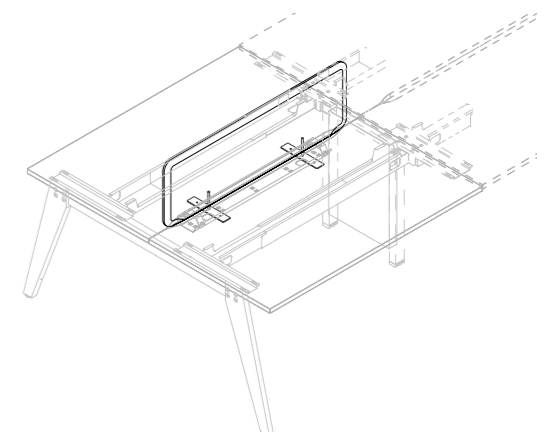

2

3

4

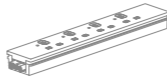
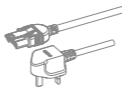
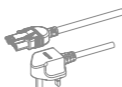
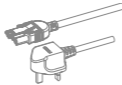

SWL14082S + BISTRAY16 + CRINTERLEG + SBKT-BISBKT-02 + ABDMSCRN18

OSL101W1W	White body/white face on desk 1 x power module (240v) + 1 x A (27w) + 1 x C (30w) USB	£161	
OSL101W2W	White body/white face on desk 2 x power module (240v)	£161	
OSL101B1B	Black body/black face on desk 1 x power module (240v) + 1 x A (27w) + 1 x C (30w) USB	£96	
OSL101B2B	Black body/black face on desk 2 x power module (240v)	£96	
OSL200WW1W	80mm cable port only white body/white face in desk 1 x power module (240v) + 1 x A (27w) + 1 x C (30w) USB	£155	
OSL200BB1B	80mm cable port only black body/black face in desk 1 x power module (240v) + 1 x A (27w) + 1 x C (30w) USB	£155	
NEX3001B	Black body only below desk 4 x power module (240v)	£50	
NEX100311B-01	1m mains starter cable UK	£17	
NEX100312B-01	2m mains starter cable UK	£26	
NEX100313B-01	3m mains starter cable UK	£34	





Home Desks

Our selection of desking and accompanying accessories combine ergonomic comfort with genuine flexibility, meaning you can work in style without compromising your personal well-being.

5-Year Warranty

 [For more specification information click here](#)



MultiDesk Top H: 25mm (1") D: 600mm (23.6")

Product Code	Description	Width	Price	
MDTP105060025	Desktop in plywood	1050mm (41.3")	£454	 MDTP105060025
MDTP140060025	Desktop in plywood	1400mm (55.1")	£624	
MDTM105060025	Desktop in MFC	1050mm (41.3")	£159	
MDTM140060025	Desktop in MFC	1400mm (55.1")	£205	

MultiDrawer and high plinth not included, must be purchased separately. See MultiDrawer - 29 Series section below.

MultiDesk Legs H: 710mm (28")

Product Code	Description	Price	
MDWLEG	Wooden leg in oak	£94	  MDWLEG MDHLEG
MDHLEG	Hairpin leg, steel	£54	

MultiDrawer 29 series H: 590mm (23.2") W: 279mm (11") D: 380mm (15")

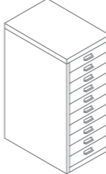
Product Code	Description	Price	
H298BNL	MultiDrawer (2+3+3 drawers)	£217	 H2910NL
H296NL	MultiDrawer (6 drawer)	£208	
H2910NL	MultiDrawer (10 drawer)	£224	
MDHP	High plinth for 29 & 39 series black (146mm high)	£58	

*High plinth supplied in black as standard.

Please note High plinth + 29 series MultiDrawer = H: 710mm (28")

Poise Desk H: 740mm (29.1") W: 1400mm (55.1") D: 600mm (23.6")

Product Code	Description	Price	
POD1406W	Poise desk with suspended steel sling, one plywood shelf, oak legs	£938	 POD1406W

Poise Laptop Table H: 656mm (25.8") W: 400mm (15.7") D: 400mm (15.7")

Product Code	Description	Price	
POL6540	Poise laptop table	£376	 POL6540



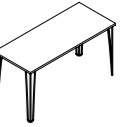

Pebble Desk H: 740mm (29.1") W: 1050mm (41.3") D: 600mm (23.6")

Product Code	Description	Price	
SPPHL1050	Pebble desk with PerfectSense laminated plywood top and steel hairpin legs	£638	 SPPHL1050

Outline - Outline Desk W: 1000mm (39.4") D: 500mm (19.7")

Product Code	Description	Height	Price	
OULD1007	Outline desk with steel frame and MFC top	740mm (29.1")	£398	  
OULD1011	Outline desk with back panel, steel frame and MFC top	1120mm (44.1")	£450	
OULD1018	Outline desk with MFC display shelves and steel frame	1880mm (74")	£654	

Outline - Outline Storage W: 510mm (20.1") D: 400mm (15.7")

Product Code	Description	Height	Price	
OUC0507	Steel frame and one internal MFC shelf	740mm (29.1")	£455	   
OUC0511	Single steel frame, one internal and one external MFC shelf	1120mm (44.1")	£512	
OUC0514	Double steel frame, one internal and two external MFC shelves	1500mm (59.1")	£569	
OUC0518	Triple steel frame, one internal and three external MFC shelves	1880mm (74")	£625	

Additional information

Assembly for all desks is required on site.

Hideaway Desks

Hideaway Wall Desk

Maximise functionality in style, wherever you are.

We understand that multi-functional spaces need clever, thoughtful furniture solutions. When space is at a premium, the Hideaway Wall Desk allows you to work when needed and then discreetly fold your whole set-up away when you're finished.



Hideaway Wall Desk

Hideaway Swing Desk

Seamlessly move back and forth between work and home, without ever changing location.

Transform your space from a sleek and stylish sideboard into a working, functional desk in one subtle move. With a luxurious finish suitable for a variety of settings, our Hideaway Swing Desk moves out at 90 degrees to form a desk so you can work, rest and store throughout the day. And, when you're finished, Hideaway Swing Desk transforms back into a beautiful sideboard, perfect for kitchen, dining and living room spaces.



Hideaway Swing Desk

5-Year Warranty

Hideaway Wall Desk

H: 400mm (15.7") W: 800mm (31.5") D: 230mm (9.1")

Product Code	Description	Price
HIS0804UK	Wall mounted desk with perforated steel back panel, light and USB	£625

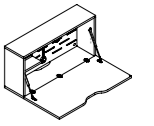

HIS0804UK

Compatible with the Mosaic hanging accessory pack. See page 196.

Hideaway Swing Desk

H: 743mm (29.3") W: 1240mm (48.8") D: 554mm (21.8")

Product Code	Description	Price
HID1255LNP	Hideaway Swing Desk left-hand with no power	£1,591
HID1255RNP	Hideaway Swing Desk right-hand with no power	£1,591

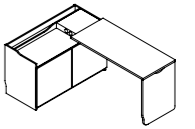

HID1255LNP

Power Options

Description	Price
To add UK USB power suffix code 'UK'	£1,988
To add EU USB power suffix code 'EU'	£1,988

Please note both left-hand and right-hand Hideaway Swing desk options are listed in the price list.

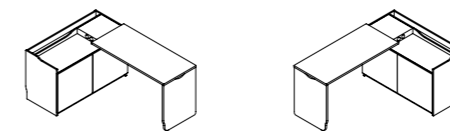

Left-hand

Right-hand

Hideaway Wall and Desk

Power options for Hideaway Wall Desk

The Hideaway Wall desk is listed with UK USB power as standard. For alternative USB power options, please replace 'UK' with the below relevant suffix. For EU USB replace 'UK' with 'EU' For example HIS0804UK becomes HIS0804EU For alternative USB power options please speak to your Bisley representative.

Power options for Hideaway Desk (Price on application)

All Hideaway Swing Desk codes are listed with no power. For power options please swap 'NP' in the listed code for the below relevant suffix. UK USB power = 'UK' EU USB power = 'EU' For example, code HID1255RNP becomes HID1255RUK

Please note: Both pin plug and USB power will be available.

Additional information

The power box within the Hideaway Swing Desk will be Anthracite Grey.

 For more specification information click here



Note Pedestals

Our Note pedestals provide secure and convenient storage, and are the classic way to keep desks clutter-free.

They can be used as additional under desk drawer space, or pull-out storage that extends your work surface.

Featuring a seamed carcass, which complements our LateralFile and Essentials ranges, Note pedestals are available as static or mobile, and come with a personal storage drawer and drop-in pen tray.





5-Year Warranty

 For more specification information click here



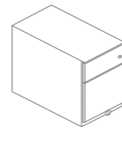

Note - Mobile W: 300mm (11.8") D: 565mm (22.2")

Product Code	Description	Height	Price	
NW359M7SF	One stationery drawer & one filing drawer with 5th castor	495mm (19.5")	£290	
NW359M7SSS	Three stationery drawers	495mm (19.5")	£301	
NW35AM7IIF	Two intermediate drawers & one filing drawer with 5th castor	565mm (22.2")	£301	
NW352M7FF	Two filing drawers including counterweight	645mm (25.3")	£350	
NW352M7SSF	Two stationery drawers & one filing drawer with 5th castor	645mm (25.3")	£301	

Note - Mobile W: 420mm (16.5") D: 565mm (22.2")

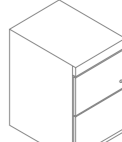
Product Code	Description	Height	Price	
NWA59M7SF	One stationery drawer & one filing drawer with 5th castor	495mm (19.5")	£290	
NWA59M7SSS	Three stationery drawers	495mm (19.5")	£301	
NWA5AM7IIF	Two intermediate drawers & one filing drawer with 5th castor	565mm (22.2")	£301	
NWA52M7FF	Two filing drawers including counterweight	645mm (25.3")	£393	
NWA52M7SSF	Two stationery drawers & one filing drawer with 5th castor NWA52M7SSF*	645mm (25.3")	£301	

Note Pedestals - Freestanding/Desk supporting H: 698mm (28") W: 420mm (16.5")

Product Code	Description	Depth	Price	
NWA53G7FF	Two filing drawers	565mm (22.2")	£405	
NWA53G7SSF	Two stationery drawers & one filing drawer	565mm (22.2")	£320	
NWA73G7FF	Two filing drawers	775mm (30.5")	£496	
NWA73G7SSF	Two stationery drawers & one filing drawer	775mm (30.5")	£427	

Pedestal Accessories

Product Code	Description	Width	Depth	Height	Price
SPAD3056*XXXXX	Seat pad	302mm (11.9")	567mm (22.3")	38mm (1.5")	POA
SPAD4256*XXXXX	-	422mm (16.6")	567mm (22.3")	38mm (1.5")	POA
1*	6mm (0.2") over-sailing decorative steel top (add 6mm (0.2") to overall height)	300mm (11.8")/420mm (16.5")	567mm (22.3")/775mm (30.5")	6mm (0.2")	£33

A4 Drop-in Pen Tray

Product Code	Description	Price
DIP	Drop-in pen tray can be either specified as factory fitted (suffix pedestal item U) or ordered separately. U – factory fitted, DIP – drop in pen tray (A4)	£28

All Note pedestals listed are without a decorative top. To add a decorative steel top to any Note pedestal, replace '7' with '1' within the code. For example: NWA52M7SSF becomes NWA52M1SSF

Please note: A decorative top will add 6mm (0.2") to the pedestal height.

For all finishes options, please refer to page 262.



Buddy

An alternative to the versatile freestanding Note pedestal and Caddy, Buddy is a single-person desk-attached locker, the perfect addition to your working day!

The compact and space efficient design allows you to stay connected with your work, while maintaining a clutter-free desk. With your office Buddy, you can feel reassured that not only are your belongings stowed within a safe personal workspace, but that they are always within reach, for maximum productivity.

5-Year Warranty

 For more specification information click here

Buddy (No lock) W: 270mm (10.6") H: 470mm (18.5") D:426mm (16.8")

Product Code	Description	Price	
BU2747NLS	Steel front and no lock	£330	
BU2747NLW	Wood front and no lock	£330	

BU2747NLS

Buddy (AB lock) W: 270mm (10.6") H: 470mm (18.5") D:426mm (16.8")

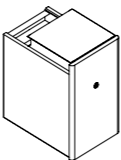
Product Code	Description	Price	
BU2747ABS	Steel front and AB lock	£354	
BU2747ABW	Wood front and AB lock	£354	

BU2747ABS

Buddy (M3 lock) W: 270mm (10.6") H: 470mm (18.5") D:426mm (16.8")

Product Code	Description	Price	
BU2747M3S	Steel front and M3 lock	£412	
BU2747M3W	Wood front and M3 lock	£412	

BU2747M3S

Buddy (E4 lock) W: 270mm (10.6") H: 470mm (18.5") D:426mm (16.8")

Product Code	Description	Price	
BU2747E4S	Steel front and E4 lock	£502	
BU2747E4W	Wood front and E4 lock	£502	

BU2747E4S

Buddy (RFID lock) W: 270mm (10.6") H: 470mm (18.5") D:426mm (16.8")

Product Code	Description	Price	
BU2747RFS	Steel front and RFID lock	£545	
BU2747RFW	Wood front and RFID lock	£545	

BU2747RFS

Power Options

Description	Price
To add UK USB power suffix code 'UK'	£58
To add EU USB power suffix code 'EU'	£58
To add US USB power suffix code 'US'	£58

Please note USB power socket comprises of x1 A and x1 C ports.

Additional information
Fixing brackets are not included.

For all finishes options, please refer to page 262.





Caddy

Personal storage at its very best – the Caddy.

Mobile, secure, and multifunctional, Caddies perform throughout the workplace; under your desk, against a wall or can be used to subtly divide open offices.

Mounted on castors, Caddy doesn't have to live in one space, it can be taken to wherever it is needed most, using the 360 degree drag handle. And, adding a seat pad makes it an ideal perch place for impromptu meetings or collaboration.

Our large choice of colours, finishes and fabrics make the Caddy an attractive and flexible addition to any vibrant, agile workspace.

5-Year Warranty

 For more specification information click here

Caddy H: 563mm (22.2") D: 490mm (19.3")

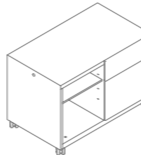
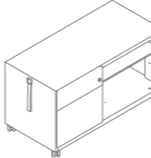
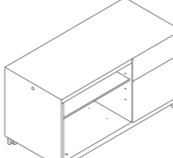
Product Code	Description	Width	Price	
CADM08LH	Left-hand configuration, one stationery drawer, one filing drawer	800mm (31.5")	£909	
CADM08RH	Right-hand configuration, one stationery drawer, one filing drawer	800mm (31.5")	£909	
CADM09LH	Left-hand configuration, one stationery drawer, one filing drawer	900mm (35.4")	£928	
CADM09RH	Right-hand configuration, one stationery drawer, one filing drawer	900mm (35.4")	£928	
CADM10LH	Left-hand configuration, one stationery drawer, one filing drawer	1000mm (39.4")	£944	
CADM10RH	Right-hand configuration, one stationery drawer, one filing drawer	1000mm (39.4")	£944	

Accessories - Seat pad H: 38mm (1.5") W: 422mm (16.6") D: 490mm (19.3")

Product Code	Description	Price
SPAD4249*XXXXX	Seat pad	POA

Accessories - Decorative top H: 18mm (0.7") D: 490mm (19.3")

Product Code	Description	Width	Price
DT080049018	Decorative top	800mm (31.5")	£91
DT090049018	-	900mm (35.4")	£98
DT100049018	-	1000mm (39.5")	£125



Left-hand

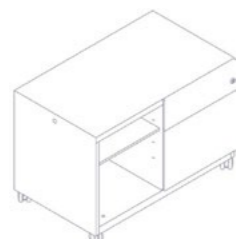

Right-hand

For all finishes options, please refer to page 262.

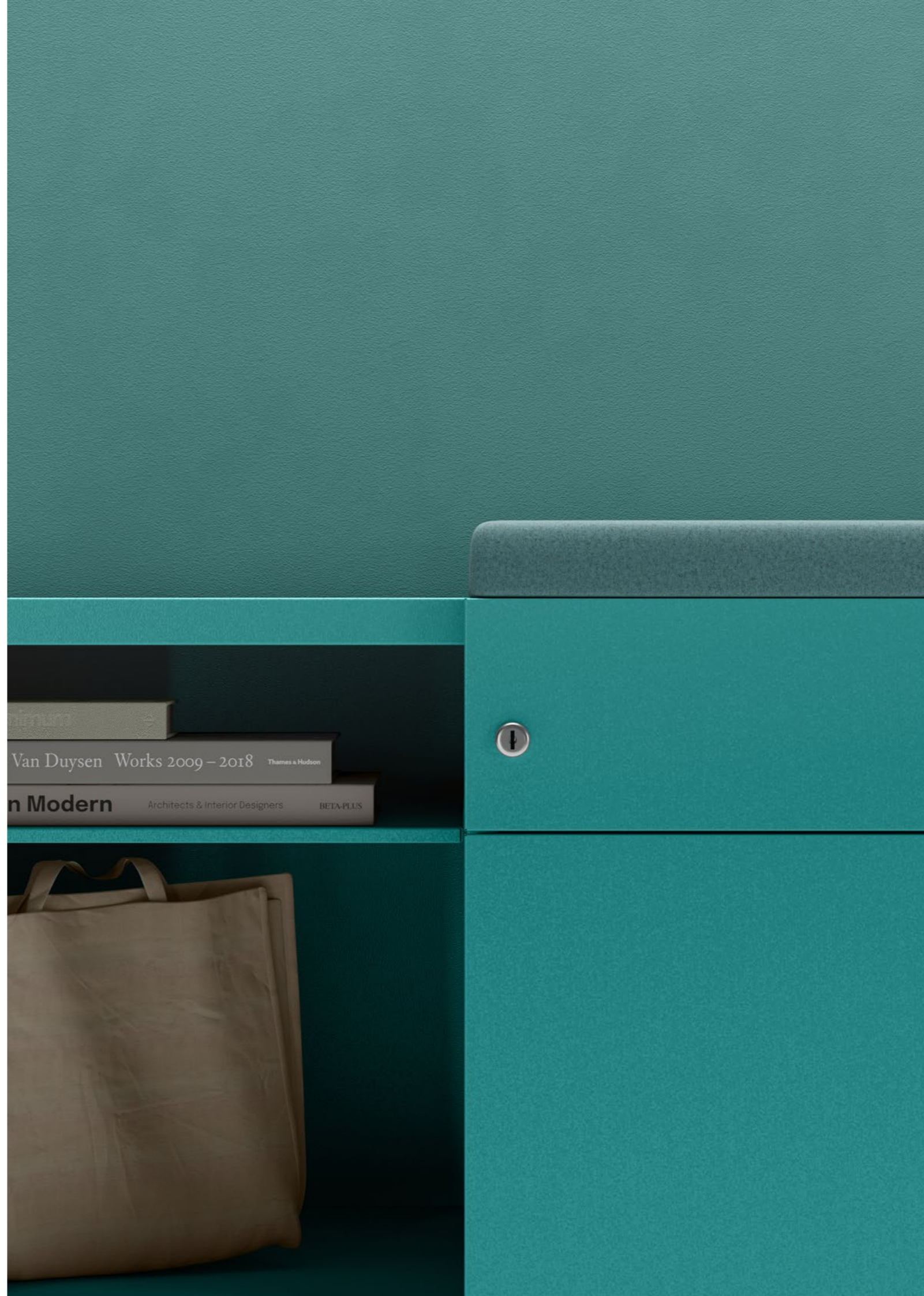



Platform & Mosaic

Platform

Elevate your working day with a Platform. With many of us working longer or more flexible hours, it's vital to make sure your monitor is at the correct and comfortable height. Available in a variety of widths to suit different screens and needs, Platform's minimalist design ensures that your display is always lifted.

Mosaic

We know that organisation can be difficult in an active and agile workspace. Organise your work materials meticulously around you with our Mosaic range. Handy hooks and trays come in a variety of different sizes that can work together with your other work tools.

2-Year Warranty

 [For more specification information click here](#)

Platform H: 111mm (4.4") D: 235mm (9.3")

Product Code	Description	Width	Price	
PL500	Steel monitor stand, with fabric top and steel tray	500mm (19.7")	£195	 PL500
PL750	Steel monitor stand, with fabric top and steel tray	750mm (29.5")	£217	

Fabric is Camira Blazer Silcoates (Dark Grey) as standard

Mosaic - Desk Accessories H: 103mm (4.1") W: 367mm (14.4")

Product Code	Description	Depth	Price	
MOSMALL	Set of six steel storage trays	144mm (5.7")	£84	 MOSMALL
MOLARGE	Set of eight steel storage trays	267mm (10.5")	£103	

Mosaic - Hanging Accessories

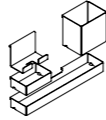
Product Code	Description	Price	
MOHANG	Set of four hook on accessories compatible with Hideaway Wall Desk, Platform & MultiTask	£84	 MOHANG

Platform fabric top is available in Camira Silcoates Grey only.

Please note: The base tray for the Mosaic desk accessories are only available in Anthracite Grey. Please specify the two accent colours for additional items from the paint palette.

For all finishes options, please refer to page 262.





Task

Roe

Designed to provide comfort and wellness while working, Roe is the stylish task chair that supports you.

With a sleek, minimalist frame, an elegant high back, and a synchro mechanism sliding seat, Roe is elevated on castors, allowing you to smoothly navigate around your workstation. Quickly grab a file from your under-desk storage or move to sit next to your office buddy for a quick catch up with Roe. Available in a classic black or white frame with a mesh back, Roe readily complements the office décor while continuously supporting your posture.

Eske

A task chair that provides everything you need for a comfortable and productive day at work, Eske is all you need.

A timeless, durable, and multifunctional chair, Eske is the perfect support for the modern-day office. Available in two different base options, elevated on castors for ease of movement, and choose from either a mesh or upholstered back, Eske can be easily adjusted allows you to work, collaborate, and meet without compromising your well-being.

Roe Mesh back task chair

H: 1030mm (40.6") to 1135mm (44.7") W: 540mm (21.3") D: 660mm (26")

Product Code	Description	Band 1	Band 2	Band 3	Band 4
ROEMESHBLK	Mesh back chair with 5-star swivel nylon base with castors in black	£641	£647	£653	£659
ROEMESHWBC	Mesh back chair with 5-star swivel nylon base with castors in white	£680	£686	£692	£698

Eske Mesh back task chair

H: 840mm (33.1") to 960mm (37.8") W: 700mm (27.6") D: 700mm (27.6")

Product Code	Description	Band 1	Band 2	Band 3	Band 4
ESMESHFRAME	Mesh back chair with cantilever frame base	£476	£483	£490	£497
ESMESH5STARC	Mesh back chair with 5-star swivel base with castors	£531	£538	£545	£552

Eske Upholstered back task chair

H: 840mm (33.1") to 960mm (37.8") W: 700mm (27.6") D: 700mm (27.6")

Product Code	Description	Band 1	Band 2	Band 3	Band 4
ESUPHFRAME	Upholstered back chair with cantilever frame base	£504	£519	£533	£547
ESUPH5STARC	Upholstered back chair with 5-star swivel base with castors	£560	£574	£588	£602



Eske

[For more specification information click here](#)



Meeting

Moy

The Moy range provides style and relaxation, thoughtfully designed to complement your day.

Elegantly crafted with its smooth, curved seat, Moy is a sleek addition to your workstation, meeting area or your cosy home office. With a plush, foam upholstery finish, a selection of swivel or static base options, Moy may be discreet, but it provides all the comfort you need for a smooth day.

Nore

A tub chair that oozes elegance and sophistication, Nore provides ultimate comfort without compromising style.

Fully upholstered in a range of gorgeous, durable fabrics, a smooth, swivel centre, and a selection of bases depending on your preference, Nore envelops you, providing a cosy feel that supports you during the next meeting or catch up.

Moy

 For more specification information click here



Moy Static chair

H: 830mm (32.7") W: 510mm (20.1") D: 550mm (21.7")

Product Code	Description	Band 1	Band 2	Band 3	Band 4
MOYSTATSLED	Static chair with black sled frame	£346	£366	£385	£404
MOYSTATWOOD	Static chair with 4-leg wooden base	£607	£626	£645	£664

Moy Swivel chair

H: 830mm (32.7") W: 510mm (20.1") D: 550mm (21.7")

Product Code	Description	Band 1	Band 2	Band 3	Band 4
MOYSWIVNYL	Swivel chair with black nylon pyramid base	£368	£387	£406	£425
MOYSWIVWOOD	Swivel chair with 4-star wooden pyramid base	£689	£708	£728	£747

Nore

H: 611mm (24") W: 516mm (20.3") D: 745mm (29.3")

Product Code	Description	Band 1	Band 2	Band 3	Band 4
NOREUPFRAME	Upholstered tub chair with black frame base	£623	£648	£674	£700
NOREUPWOOD	Upholstered tub chair with wooden frame base	£815	£841	£867	£892
NOREUP4STAR	Upholstered tub chair with 4-star pyramid swivel base	£861	£887	£913	£938

Nore



Soft Seating

Allua

Add a touch of elegance and luxury to your space with Allua, our opulent seating collection that provides a welcoming area for the next meeting or catch up.

With beautiful, high-quality upholstery detailing, a tasteful moulded foam shell, and comfortable sprung foam seat, the Allua range is sleek and sophisticated. Choose the best back option for your chair, depending on its intended setting and take advantage of the coordinating footstool for that added home comfort.

Available in a range of beautiful, high-quality fabrics and a choice of legs, create a gorgeous setting that welcomes you back time after time.

 For more specification information click here

Allua - Low back chair

H: 860mm (33.9") W: 730mm (28.7") D: 790mm (31.1")

Product Code	Description	Band 1	Band 2	Band 3	Band 4
ALBTUBE	Low back chair with black tube legs	£1,832	£1,885	£1,938	£1,992
ALBSWIVEL	Low back chair with black swivel base	£1,901	£1,954	£2,008	£2,061
ALBWOOD	Low back chair with wooden base	£2,016	£2,069	£2,122	£2,176

Allua - High back chair

H: 1060mm (41.7") W: 730mm (28.7") D: 790mm (31.1")

Product Code	Description	Band 1	Band 2	Band 3	Band 4
AHBTUBE	High back chair with black tube legs	£1,997	£2,072	£2,146	£2,221
AHBSWIVEL	High back chair with black swivel base	£2,066	£2,141	£2,216	£2,290
AHBWOOD	High back chair with wooden base	£2,181	£2,256	£2,330	£2,405



Quarters

Providing a quiet haven away from the hustle and bustle of a busy workspace, Bisley's Quarters booths offer a secluded, peaceful space for individual focused work, a private place to take a call, or a cosy, meeting space where collaboration can thrive.

Available in a range of sizes from a single to six-person booths, Quarters features high-quality sound dampening panels, so that you can work in a tranquil haven while still feeling connected to the hubbub of the bustling office. Host an intimate team meeting within our four-person booth and let your creativity shine!

Offering an inclusive, light space where you can store your belongings is vital for peace of mind and personal well-being. Featuring subtle exterior storage, Quarters allows you to access and return your belongings with ease, enabling you to focus on your day.

5-Year Warranty



 For more specification information click here

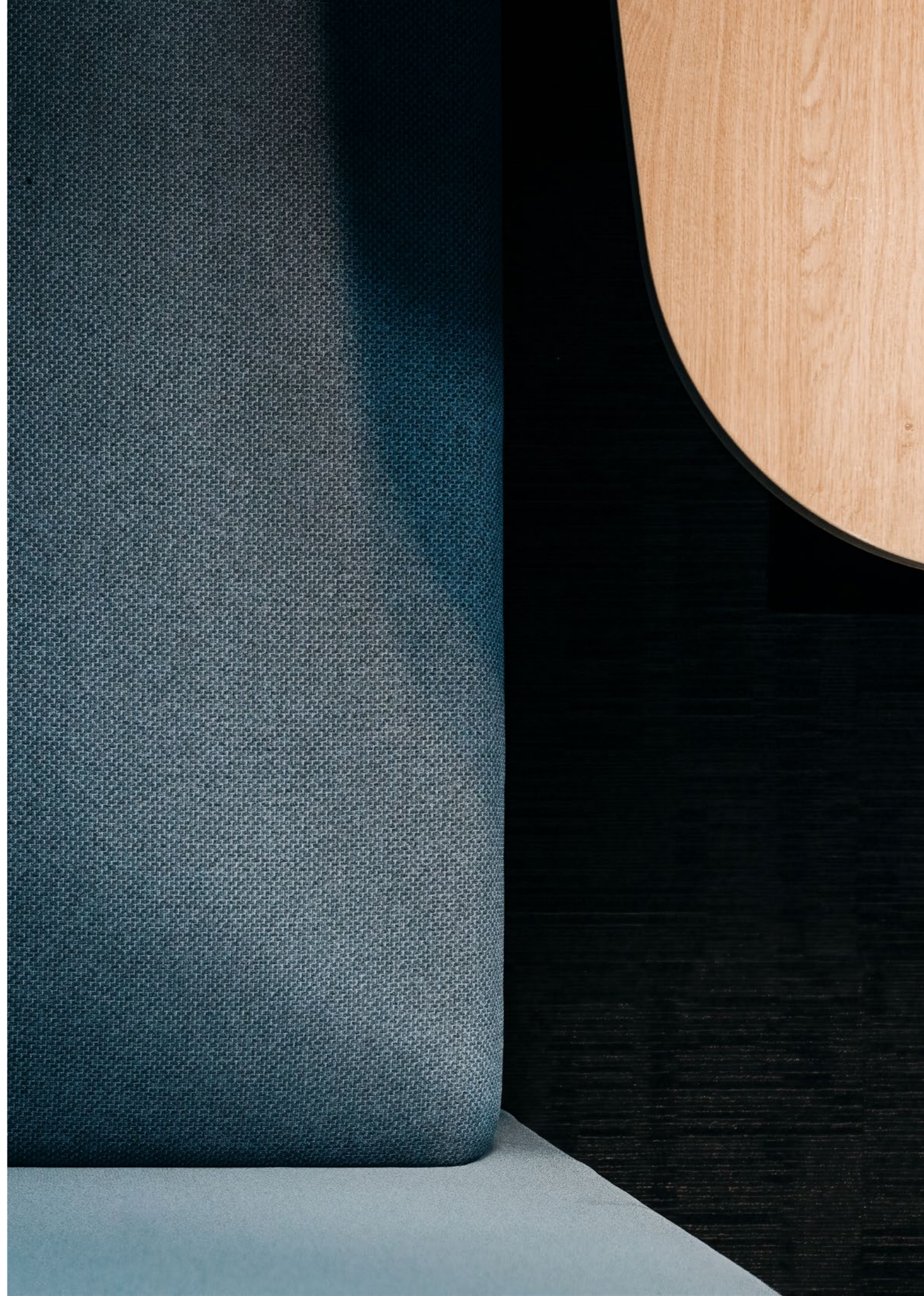



Whiteboard with hand-drawn diagrams and the word "Better".

Diagram 1: A box containing three small circles with arrows pointing to the right.

Diagram 2: A box containing three small circles with arrows pointing to the right, and a larger box to its right with an arrow pointing from the first box to it.

Diagram 3: A hand holding a pen, with a speech bubble above it containing the text "Idea".

Text: "Better"

Modular shelving unit with a green plant, a pen holder, and a book titled "Belong".

Book title: "Belong"

Fern

Fern – the sleek and stylish steel locker collection.

Our Fern family was crafted to enhance the cosy nooks in your home, allowing you to maximise your space without compromising style and charm.

With chic and contemporary features, our original Fern cabinets and our newly revamped Fern Peek collection, balance modern design with a classic retro feel. Elegantly designed to effortlessly complement your décor, choose your favourite Fern - from our best-selling Midi to the brand-new Stendi Peek.

Available in a selection of gorgeous hues to reflect your personality, enjoy Fern in a bright jewel-like colour or a muted, calming neutral. Style each piece your way, whether on its own or the full collection, to create a modern, industrial feel.

Each member of the Fern family is lovingly hand crafted in the UK. Made with high-quality, sustainable steel and reed-effect doors for Fern Peek's pieces, the collection is sure to last you a lifetime. All members, big or small, are delivered with care, fully-assembled, and ready to move in.

5-Year Warranty



 For more specification information click here

Fern Lockers H: 1800mm (70.9") W: 380mm (15") D: 510mm (20.1")

Product Code	Description	Price
FLSS51	Fern locker with three fixed shelves	£468
FLSS51LH	Fern locker with three fixed shelves left-hand opening	£468
FLSC51	Fern locker with clothes rail and one fixed shelf	£483
FLSC51LH	Fern locker with clothes rail and one fixed shelf left-hand opening	£483



FLSS51

Fern Maxi H: 1800mm (70.9") W: 700mm (27.6") D: 510mm (20.1")

Product Code	Description	Price
FLDW51	Fern Maxi double wardrobe with clothes rail and one fixed shelf	£643
FLDW51	Fern Maxi with three fixed shelves	£819
FPDW51	Fern Maxi Peek with three fixed shelves	£1,007

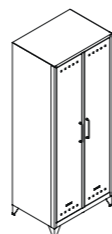

FLDW51

Fern Middle H: 1100mm (43.3") W: 800mm (31.5") D: 400mm (15.7")

Product Code	Description	Price
FLDL04	Fern Middle double locker with two fixed shelves	£530
FPDL04	Fern Middle Peek double locker with two fixed shelves	£771

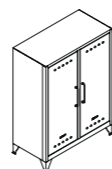

FLDL04

Fern Cabby H: 725mm (28.5") W: 1140mm (44.9") D: 400mm (15.7")

Product Code	Description	Price
FLTV04	Fern Cabby with one fixed shelf and cable management in back panel	£467
FPTV04	Fern Cabby Peek with one fixed shelf and cable management in back panel	£701

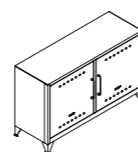

FLTV04

Fern Stendi H: 900mm (35.4") W: 1200mm (42.7") D: 400mm (15.7")

Product Code	Description	Price
FLS1204	Fern Stendi with two doors and open shelving	£657
FPS1204	Fern Stendi Peek with two doors and open shelving	£788

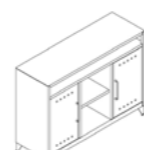

FLS1204

Fern Mini H: 725mm (28.5") W: 380mm (15") D: 400mm (15.7")

Product Code	Description	Price
FLBS04LH	Fern Mini with one fixed shelf, left-hand open	£336
FLBS04RH	Fern Mini with one fixed shelf, right-hand open	£336

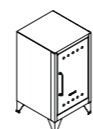

FLBS04LH

For all finishes options, please refer to page 262.





THE BOTANY GARDENERS
joshua weissman
CURATE





Rowan

Timeless versatility for you.

Our Rowan family was developed with modern Scandi elegance in mind, with sleek clean-cut lines and gorgeous wood details. Providing a true home from home, this capsule collection balances character and charm with simplicity and function.

5-Year Warranty

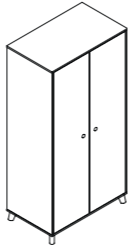
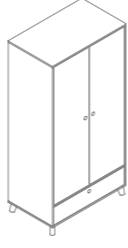

 [For more specification information click here](#)

Rowan Maxi H: 2000mm (78.7") W: 1004mm (39.5") D: 604mm (23.8")

Product Code	Description	Price	
ROS2DHP	Rowan Maxi storage cupboard with hanging rail, steel doors, and hairpin legs	£1,098	
ROS2DWL	Rowan Maxi storage cupboard with hanging rail, steel doors, and wooden legs	£1,128	
ROW2DHP	Rowan Maxi storage cupboard with hanging rail, wooden doors, and hairpin legs	£1,098	
ROW2DWL	Rowan Maxi storage cupboard with hanging rail, wooden doors, and wooden legs	£1,128	
ROS2D1DWHP	Rowan Maxi storage cupboard with hanging rail, one drawer, steel doors, and hairpin legs	£1,209	
ROS2D1DWL	Rowan Maxi storage cupboard with hanging rail, one drawer, steel doors, and wooden legs	£1,239	
ROW2D1DWHP	Rowan Maxi storage cupboard with hanging rail, one drawer, wooden doors, and hairpin legs	£1,209	
ROW2D1DWL	Rowan Maxi storage cupboard with hanging rail, one drawer, wooden doors, and wooden legs	£1,239	

*Assembly required

Rowan Midi H: 990mm (39") W: 804mm (31.7") D: 514mm (20.2")

Product Code	Description	Price	
RO3DRHP	Rowan Midi storage cabinet with three drawers and hairpin legs	£945	
RO3DRWL	Rowan Midi storage cabinet with three drawers and wooden legs	£976	
RO4DRHP	Rowan Midi storage cabinet with four drawers and hairpin legs	£1,057	
RO4DRWL	Rowan Midi storage cabinet with four drawers and wooden legs	£1,087	

Rowan Medi H: 500mm (19.7") W: 1204mm (47.4") D: 414mm (16.3")

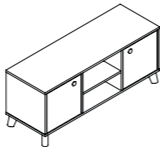
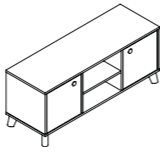
Product Code	Description	Price	
ROTV2DHP	Rowan Medi media unit with two cupboards and one shelf with hairpin legs	£710	
ROTV2DWL	Rowan Medi media unit with two cupboards and one shelf with wooden legs	£743	
ROTV4DRHP	Rowan Medi media unit with four drawers and one shelf with hairpin legs	£885	
ROTV4DRWL	Rowan Medi media unit with four drawers and one shelf with wooden legs	£915	

Rowan Mini H: 500mm (19.7") W: 402mm (15.8") D: 344mm (13.5")

Product Code	Description	Price	
ROBED1DRHP	Rowan Mini cabinet with one shelf and hairpin legs	£476	
ROBED1DRWL	Rowan Mini cabinet with one shelf and wooden legs	£507	







Bridge Home

We understand your workday needs to flow, no matter where you are.

Inspired by the traditional office, but re-imagined for the contemporary home and office, Bridge connects flexible spaces and work styles bringing together stowage and display in one seamless system.

5-Year Warranty

 [For more specification information click here](#)

Product Code	Description	Height	Price	
BHM0804CRWIW	Cupboard with wooden fronts	601mm (23.7")	£667	 BRH0804CRWIS
BHM0804CRWIS	Cupboard with steel fronts	601mm (23.7")	£794	
BHM0804CRWISF	Cupboard with single frame steel topper	981mm (38.6")	£1,210	
BHM0804DRWIW	Two drawers with wooden fronts	601mm (23.7")	£812	 BRH0806CRWISF
BHM0804DRWIS	Two drawers with steel fronts	601mm (23.7")	£961	
BHM0804DRWISF	Two drawers with single frame steel topper	981mm (38.6")	£1,370	
BHM0806CRWIW	Cupboard with wooden fronts	783mm (30.8")	£691	 BRH0808DRWIW
BHM0806CRWIS	Cupboard with steel fronts	783mm (30.8")	£818	
BHM0806CRWISF	Cupboard with single frame steel topper	1163mm (45.8")	£1,228	
BHM0806DRWIW	Three drawers with wooden fronts	783mm (30.8")	£953	 BRH0808DRWIS
BHM0806DRWIS	Three drawers with steel fronts	783mm (30.8")	£1,132	
BHM0806DRWISF	Three drawers with single frame steel topper	1163mm (45.8")	£1,540	
BHM0808CRWIW	Cupboard with wooden fronts	964mm (38")	£781	 BRH0808DRWISF
BHM0808CRWIS	Cupboard with steel fronts	964mm (38")	£921	
BHM0808CRWISF	Cupboard with single frame steel topper	1344mm (52.9")	£1,330	
BHM0808DRWIW	Four drawers with wooden fronts	964mm (38")	£1,140	
BHM0808DRWIS	Four drawers with steel fronts	964mm (38")	£1,355	
BHM0808DRWISF	Four drawers with single frame steel topper	1344mm (52.9")	£1,764	

Additional information

Please note: When specifying Bridge Home products, please consider the following:

Bridge Home products are available with a laminated carcass only. Closure fronts are available in either laminated or steel.

The back panel will always match the selected finish of the front closures.

Please note: The frame finish will match the closure finish.

All Bridge Home products will have a steel inset black base and oak wood legs.

For all finishes options, please refer to page 262.

Handle finishes

All Bridge Home products have an oak round wood handle.

Round wooden handle

Assembly

Assembly for fitting legs and Bridge Home products to the base will be required on-site.





Sideboards

Charming on the outside but perfectly practical on the inside, our range of beautiful sideboards can store anything, from toys and trinkets to blankets and books.

5-Year Warranty

 For more specification information click here

Poise Sideboard

H: 621mm (24.4") W: 1000mm (39.4") D: 450mm (17.7")

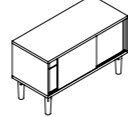
Product Code	Description	Price	
POS1007W	Poise sideboard plywood carcass with wooden legs and steel sliding doors	£966	 POS1007W

MultiSideboard

H: 752mm (29.6") W: 1000mm (39.4") D: 450mm (17.7")

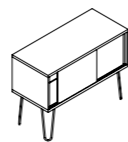
Product Code	Description	Price	
MS1007H	Steel sliding doors, one steel shelf and steel hairpin legs	£534	 MS1007H

Finn Sideboard

H:969mm(38.1") D:400mm (15.7")

Product Code	Description	Width	Price	
FN0810CB	2 door sideboard	800mm (31.5")	£954	 FN0810CB
FN0810DW	2 door, 1 drawer sideboard	800mm (31.5")	£1,063	
FN1410SB	2 door wide cupboard	1400mm (55.1")	£1,325	

Additional information

Assembly

The Poise Sideboard and MultiSideboard will require legs to be attached on-site.

For all finishes, options please refer to page 262..





BOB

Think it. Click it. Love it.

BOB® by Bisley is the beautifully hand-crafted, magnetic, display unit that lets you click, twist and re-think storage at home. Combining high-quality, smooth plywood with exposed edges and a selection of durable, steel accessories, BOB is a welcome addition to a living room, hallway, or an open plan space where subtle room division is needed.

The vision of award-winning designer Paul Kelly, in collaboration with Bisley's unrivalled storage expertise, BOB transcends the way we think about storage. Secured using a self-adjusting, technology-friendly magnetic system, BOB is strong enough to click and hold everything together, yet light enough to move with a simple twist.



Originally crafted to store a music devotee's vinyl collection, BOB is both timeless and adaptable. With its smooth sliding doors and additional shelves, showcase your treasures or cleverly conceal bulky toys with BOB's customisable features.

If you can think it, BOB can help you create it.

2-Year Warranty

 For more specification information click here





BOB Range W: 400mm (15.8") H:800mm (31.5") D:380mm (13")

Product Code	Description	Price	
BOBDOCBS	Double unit, open with back panel, two shelves	£503	
BOBDODR	Double unit, three drawers	£1,338	

W: 800mm (31.5") H:400mm (15.8") D:380mm (13")

Product Code	Description	Price	
BOBDOSD	Double unit, sliding door	£600	

W: 400mm (15.8") H:400mm (15.8") D:380mm (13")

Product Code	Description	Price	
BOBSIOB	Single unit, pass through (no shelf positions)	£303	
BOBSICB	Single unit, open with back panel	£323	
BOBSICBS	Single unit, open with back panel and shelf	£334	
BOBSICD	Single unit, push-to-open door and shelf	£432	

BOB Kits

Product Code	Description	Price	
BOBSMALL1	One single, pass-through One single, open with back panel One double, sliding door (dividers available as an accessory)	£1,131	

Product Code	Description	Price	
BOBSMALL2	One double, open with back panel and two shelves One single, open with back panel One single, push-to-open cupboard door shelf	£1,227	

BOB Kits

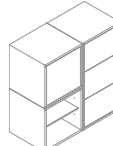
Product Code	Description	Price	
BOBSMALL3	One double, three drawer unit One single, push-to-open cupboard door and shelf One single, open with back panel and shelf	£2,097	

Product Code	Description	Price	
BOBSMALL4	One single, push to open cupboard door and shelf Two singles, open with back panel and shelf One single, open with back panel	£1,385	

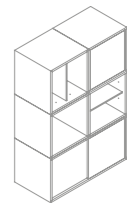
Product Code	Description	Price	
BOBMEDIUM1	Two singles, open with back panel and shelf One single, push-to-open cupboard door with shelf One single, pass-through One double, sliding door	£1,990	

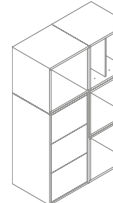
Product Code	Description	Price	
BOBMEDIUM2	One double, three drawers Two singles, pass-through One single, open with back panel and shelf One single, open with back panel	£2,561	

Product Code	Description	Price	
BOBMEDIUM3	One single, pass-through One single, open with back panel and shelf One double, sliding door One double, open with back panel and two shelves	£1,731	

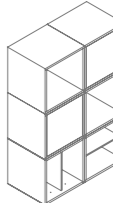
Product Code	Description	Price	
BOBMEDIUM4	Two singles, open with back panel and shelf Two singles, push-to-open cupboard door and shelf One single, pass-through unit One single, open with back panel	£2,115	

Product Code	Description	Price
BOBLARGE1	Five singles, pass-through One single, push-to-open cupboard door with shelf Three singles, open with back panel and shelf	£2,919

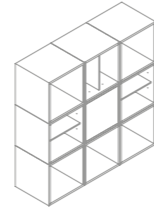

Product Code	Description	Price
BOBLARGE2	One double, three drawers One double, open with back panel and two shelves Two singles, push-to-open cupboard door with shelf units Two singles, pass-through One single, open with back panels and shelf	£3,625

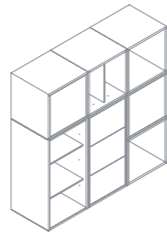

Product Code	Description	Price
BOBLARGE3	One double, three drawers One double, sliding door Two singles, pass-through Two singles, open with back panel and shelf One single, open with back panel	£3,489



BOB Accessories - Shelf

Product Code	Description	Width	Depth	Price
BOBSHELF	Compatible with all units except sliding door unit	366mm (14.4")	330mm (13")	£44
BOBSHELFSM	Compatible with sliding door unit	366mm (14.4")	310mm (12.2")	£44

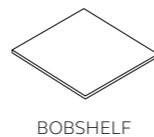

Plinth

Product Code	Description	Width	Depth	Price
BOB08PLINTH	Steel plinth with adjustable feet	780mm (30.7")	56mm (2.2")	£212
BOB12PLINTH	Steel plinth with adjustable feet	1180mm (46.4")	56mm (2.2")	£268

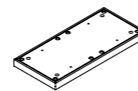

BOB08PLINTH

Steel Liners

Product Code	Description	Width	Depth	Price
BOBFSL	Full steel liner	361mm (14.2")	352mm (13.8")	£110
BOBHSL	Half steel liner	361mm (14.2")	171mm (6.7")	£103

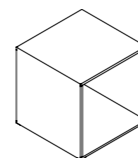

BOBFSL



BOB steel liners are available in from our paint palette.
BOB steel plinth is available in white only.

For all finishes options, please refer to page 262.

Safety guidance:

- Take care when lifting and stacking units.
- Use with caution, product contains strong magnets.
- Make sure your BOB is used on a flat surface.
- Only sit on single units with a back panel.
- Do not stack any higher than 1600mm (63") high (four single BOB units high).
- Do not exceed the maximum weight load capacity of the drawers and shelves (8kg).
- Do not stack your three-drawer unit on top of any other BOB units.
- Do not sit on double or pass-through units.
- Do not lift double units alone.
- Do not use excessive amounts of liquid to clean your BOB.

Gallery

Gallery is a collection of customisable wall-mounted accessories engineered to help make the most of your available space. Used as an extension of your surface area, Gallery frees you of clutter and ensures that treasured items are close to hand and neatly organised within the colourful panels and pots.

5-Year Warranty

 For more specification information click here



Gallery Hanging Panel with Single Shelf H: 467mm (18.4") W:660mm (26") D:165mm (6.5")

Product Code	Description	Price	
SAMOSAICSW	Small Gallery hanging panel with single oak shelf	£176	SAMOSAICSW

Gallery Magazine Shelf H: 467mm (18.4") W:660mm (26") D:160mm (6.3")

Product Code	Description	Price	
SAMAGSW	Gallery wall mounted magazine shelf	£150	SAMAGSW

Gallery Whiteboard H: 467mm (18.4") W:660mm (26")

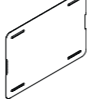
Product Code	Description	Price	
SAWHITEBSW	Wall mounted, small Gallery magnetic whiteboard	£215	SAWHITEBSW

Gallery Shelf H: 200mm (7.9") W: 660mm (26") D: 160mm (6.3")

Product Code	Description	Price	
SASHELFSW	Extendable wall shelf	£157	SASHELFSW

Planter Shelf H: 200mm (7.9") W: 660mm (26") D: 150mm (5.9")

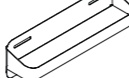
Product Code	Description	Price	
SAPLANTSW	Planter with MFC shelf wrapped in steel - potted plants only, no liner	£204	SAPLANTSW

Gallery Extension Hooks H:110mm (4.3") W:410mm (16.1") D:160mm (6.3")

Product Code	Description	Price	
QBEXHOOKPK2	Gallery extension hook	£27	QBEXHOOKPK2

Additional information
Wall brackets included. Suitable screws/plugs for fixing brackets to the wall not included.

For all finishes options, please refer to page 262.

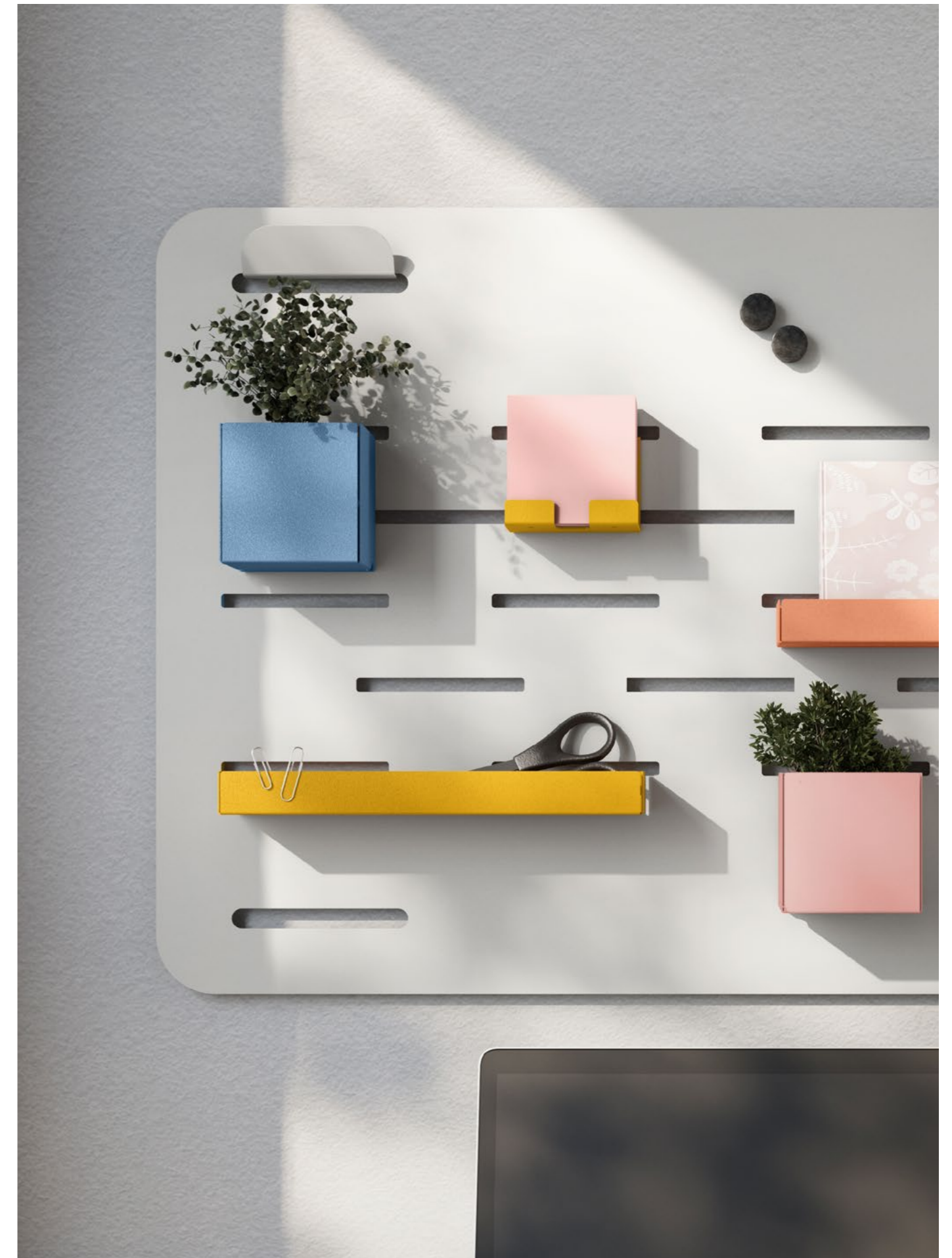



Place

With a soft curved, bevelled frame and slimline folded shelves the Place collection has a distinct, playful, and modern silhouette that will look right at home in your office, kitchen or hallway.

5-Year Warranty

 For more specification information click here

Place Single Shelf H:175mm (6.9") W:570mm (22.4") D:175mm (6.9")

Product Code	Description	Price	
PS1SF	Place single shelf	£124	 PS1SF

Place Double Shelf H:400mm (15.7") W:570mm (22.4") D:175mm (6.9")

Product Code	Description	Price	
PS2DF	Place double shelf	£160	 PS2DF

Place Offset Shelf H:400mm (15.7") W:570mm (22.4") D:175mm (6.9")

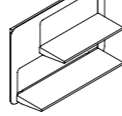
Product Code	Description	Price	
PS2OS	Asymmetrical double height steel frame shelf	£160	 PS2OS

Place Triple Shelf H:570mm (22.4") W:696mm (27.4") D:175mm (6.9")

Product Code	Description	Price	
PS3TS	Triple height steel shelves	£197	 PS3TS

Place Cork Board H:570mm (22.4") W:570mm (22.4") D:175mm (6.9")

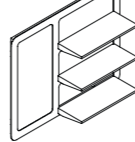
Product Code	Description	Price	
PS3PB	Triple height shelf frame with cork pin board	£292	 PS3PB

Additional information
Suitable screws/plugs for fixing brackets to the wall not included.

For all finishes options please refer to page 262





Economy Shelving

Our economy shelving is a cost-effective, contemporary solution that is available in starter kits, with add-on units to increase storage capacity. It can cope with a load of up to 90kg per shelf, making the economy shelving collection a robust and reliable choice for both the home and at work.

5-Year Warranty

 [For more specification information click here](#)

Product Code	Description	Width	Depth	Price
0818ESSTK30	Starter kit – two frames*, one cross bracing kit	832mm (32.8")	300mm (11.8")	£216
0818ESEXK30	Extension kit – one frame*	800mm (31.4")	300mm (11.8")	£124
08SH30P1PS	Shelf***	770mm (30.2")	292mm (11.5")	£39
0818ESSTK36	Starter kit – two frames*, one cross bracing kit	832mm (32.8")	360mm (14.2")	£216
0818ESEXK36	Extension kit – one frame*	800mm (31.4")	360mm (14.2")	£124
08SH36P1PS	Shelf***	770mm (30.2")	352mm (13.9")	£41
0818ESSTK40	Starter kit – two frames*, one cross bracing kit	832mm (32.8")	400mm (15.7")	£216
0818ESEXK40	Extension kit – one frame*	800mm (31.4")	400mm (15.7")	£124
08SH40P1PS	Shelf***	770mm (30.2")	392mm (15.5")	£49
0818ESSTK46	Starter kit – two frames*, one cross bracing kit	832mm (32.8")	460mm (18.1")	£216
0818ESEXK46	Extension kit – one frame*	800mm (31.4")	460mm (18.1")	£124
08SH46P1PS	Shelf***	770mm (30.2")	452mm (17.9")	£54



0818ESSTK30

Product Code	Description	Width	Depth	Price
0822ESSTK30	Starter kit – two frames*, one cross bracing kit	832mm (32.8")	300mm (11.8")	£254
0822ESEXK30	Extension kit – one frame*	800mm (31.4")	300mm (11.8")	£139
08SH30P1PS	Shelf***	770mm (30.2")	292mm (11.6")	£39
0822ESSTK36	Starter kit – two frames*, one cross bracing kit	832mm (32.8")	360mm (14.2")	£254
0822ESEXK36	Extension kit – one frame*	800mm (31.4")	360mm (14.2")	£139
08SH36P1PS	Shelf***	770mm (30.2")	352mm (13.9")	£41
0822ESSTK40	Starter kit – two frames*, one cross bracing kit	832mm (32.8")	400mm (15.7")	£254
0822ESEXK40	Extension kit – one frame*	800mm (31.4")	400mm (15.7")	£139
08SH40P1PS	Shelf***	770mm (30.2")	392mm (15.5")	£49
0822ESSTK46	Starter kit – two frames*, one cross bracing kit	832mm (32.8")	460mm (18.1")	£254
0822ESEXK46	Extension kit	800mm (31.4")	460mm (18.1")	£139
08SH46P1PS	Shelf***	770mm (30.2")	452mm (17.9")	£54
08ESEBK	Extra bracing kit, required for every second shelving bay**	800mm (31.4")	N/A	£39

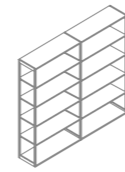

0822ESSTK36

Product Code	Description	Width	Depth	Price
1018ESSTK30	Starter kit – two frames*, one cross bracing kit	1032mm (40.6")	300mm (11.8")	£216
1018ESEXK30	Extension kit – one frame*	1000mm (39.4")	300mm (11.8")	£124
10SH30P1PS	Shelf***	970mm (38.2")	292mm (11.6")	£41
1018ESSTK36	Starter kit – two frames*, one cross bracing kit	1032mm (40.6")	360mm (14.2")	£216
1018ESEXK36	Extension kit – one frame*	1000mm (39.4")	360mm (14.2")	£124
10SH36P1PS	Shelf***	970mm (38.2")	352mm (13.9")	£50
1018ESSTK40	Starter kit – two frames*, one cross bracing kit	1032mm (40.6")	400mm (15.7")	£216
1018ESEXK40	Extension kit – one frame*	1000mm (39.4")	400mm (15.7")	£124
10SH40P1PS	Shelf***	970mm (38.2")	392mm (15.5")	£57
1018ESSTK46	Starter kit – two frames*, one cross bracing kit	1032mm (40.6")	460mm (18.1")	£216
1018ESEXK46	Extension kit – one frame*	1000mm (39.4")	460mm (18.1")	£124
10SH46P1PS	Shelf***	970mm (38.2")	452mm (17.9")	£62

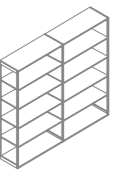

1018ESSTK40

Product Code	Description	Width	Depth	Price
1022ESSTK30	Starter kit – two frames*, one cross bracing kit	1032mm (40.6")	300mm (11.8")	£254
1022ESEXK30	Extension kit – one frame*	1000mm (39.4")	300mm (11.8")	£139
10SH30P1PS	Shelf***	970mm (38.2")	292mm (11.6")	£41
1022ESSTK36	Starter kit – two frames*, one cross bracing kit	1032mm (40.6")	360mm (14.2")	£254
1022ESEXK36	Extension kit – one frame*	1000mm (39.4")	360mm (14.2")	£139
10SH36P1PS	Shelf***	970mm (38.2")	352mm (13.9")	£50
1022ESSTK40	Starter kit – two frames*, one cross bracing kit	1032mm (40.6")	400mm (15.7")	£254
1022ESEXK40	Extension kit – one frame*	1000mm (39.4")	400mm (15.7")	£139
10SH40P1PS	Shelf***	970mm (38.2")	392mm (15.5")	£57
1022ESSTK46	Starter kit – two frames*, one cross bracing kit	1032mm (40.6")	460mm (18.1")	£254
1022ESEXK46	Extension kit – one frame*	1000mm (39.4")	460mm (18.1")	£139
10SH46P1PS	Shelf***	970mm (38.2")	452mm (17.9")	£62
10ESEBK	Extra bracing kit, required for every second shelving bay**	1000mm (39.4")	N/A	£39



1022ESSTK46

* Frame = one upright and two end plates.

** A cross bracing kit needs to be supplied for every second extended bay.

*** We recommend having six shelves per bay.

All Economy Shelving are available in the steel paint finish 'Light Grey Smooth' AT4 only.

For all finishes options, please refer to page 262.

Additional information:

Please note that a frame is comprised of one upright and two plates.

Extension kits and shelves need to be ordered separately using the codes listed.

Palette one

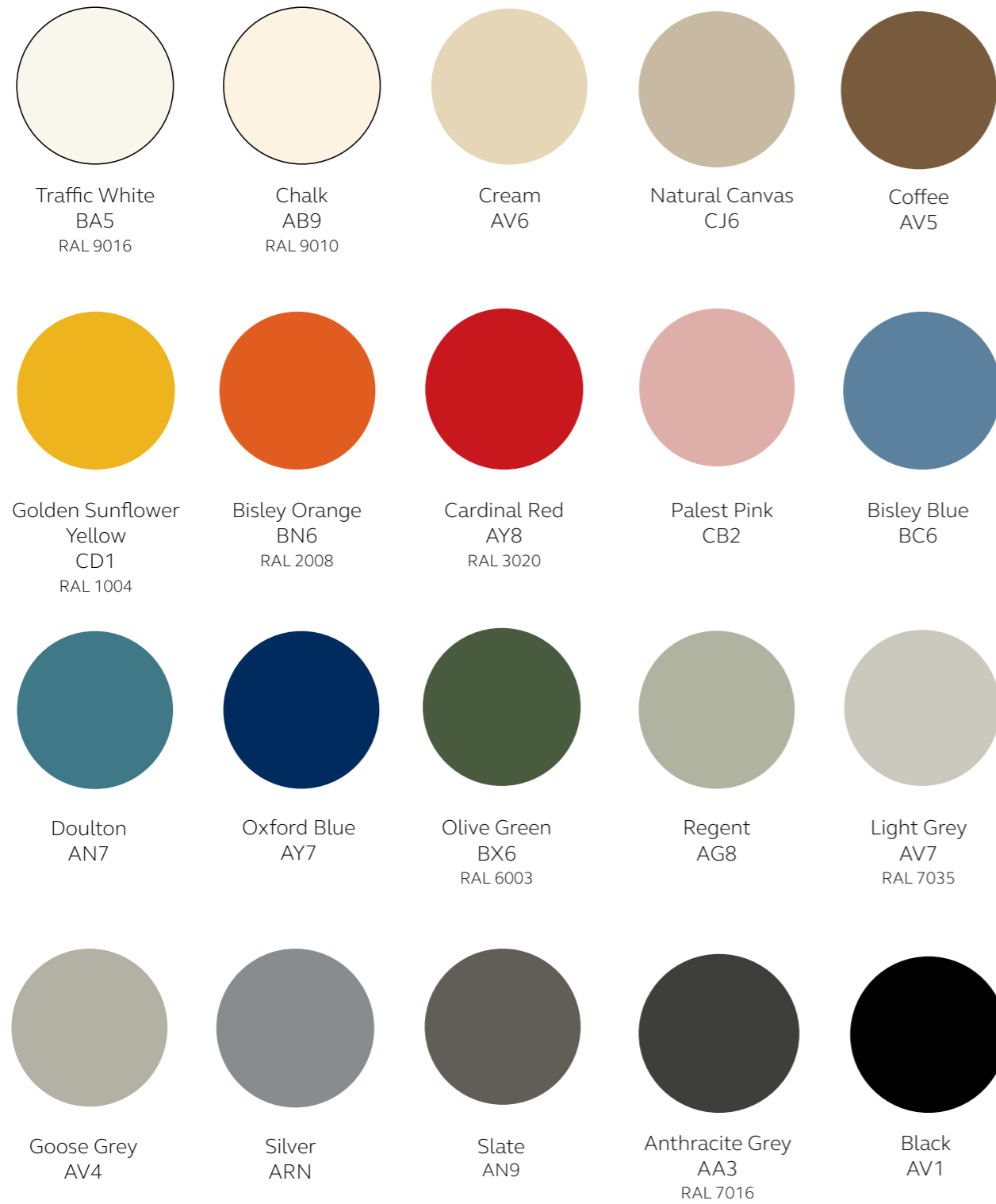

Palette two

A 5% surcharge may apply, with the exception of the Outline, Glide, Bridge and LaterfalFile ranges.

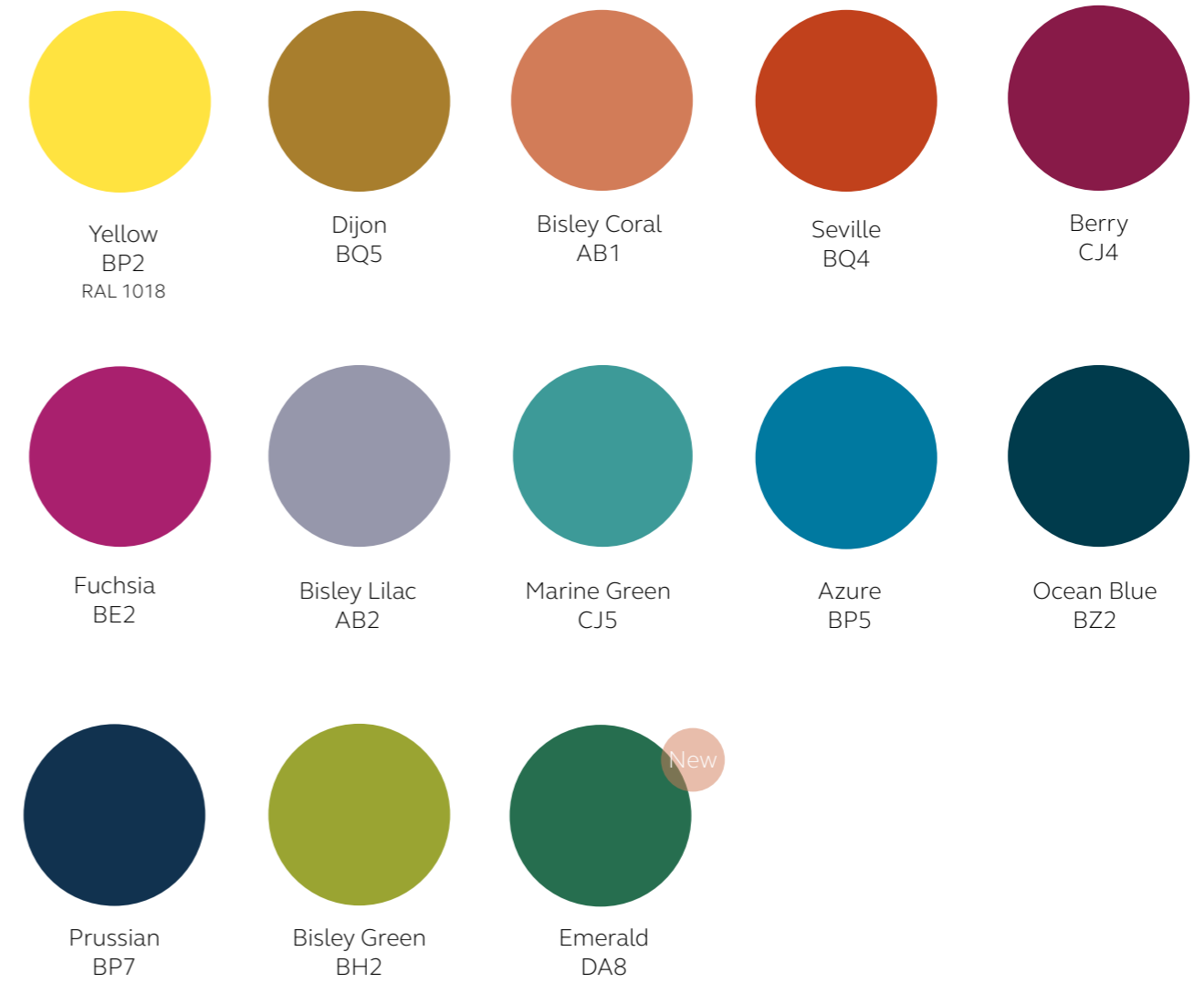

Please note: All finishes are textured, except for Silver.
For dual finish options please speak to your Bisley representative.

Standard - AOC, IPCC, PSF, BS five drawer and Stationery cupboards are only available in the below finishes.
Traffic White, Chalk, Coffee/Cream. Light Grey, Goose Grey and Black.
*BS five drawer is not available in traffic white.

Premium - BS, F-series, double, contract double and PFA home filers are available in our full palette.

Wood palette one

Below are a selection of our 18mm MFC finishes.

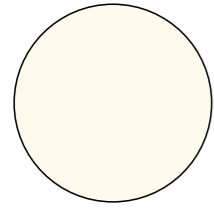

Platinum White
562
W980 ST7



Light Grey
554
U708 ST9

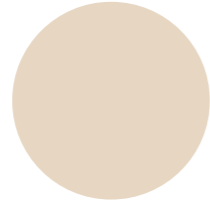

Sand Beige
899
U156 ST9



Pearl Grey
634
U763 ST9

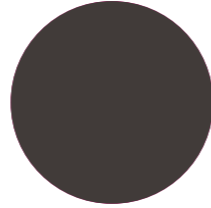

Graphite Grey
521
U961 ST7

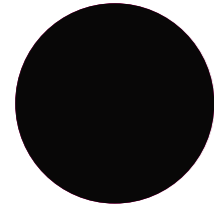

Black
574
U999 ST7

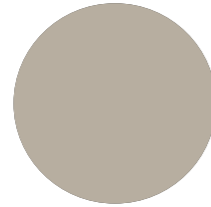

Pebble Grey
630
U201 ST9

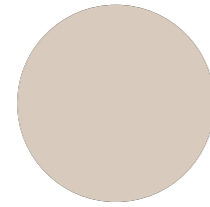

Cashmere Grey
741
U702 ST9

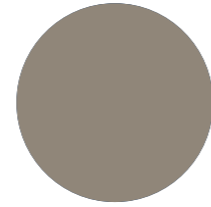

Stone Grey
557
U727 ST9

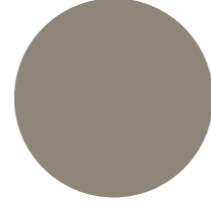

Dark Taupe
795
U740 ST9

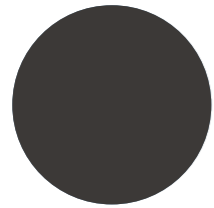

Soft Black
621
U899 ST9

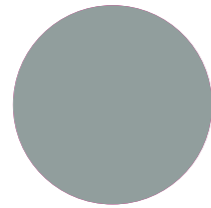

Fjord Green
638
U636 ST9

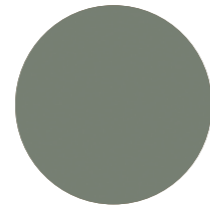

Reed Green
050
U604 ST9

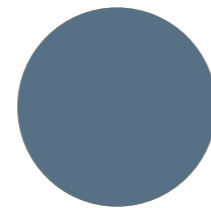

Misty Blue
057
U502 ST9



Carbon Grey
635
U968 ST9

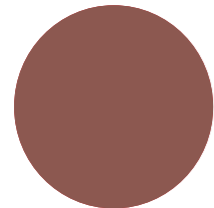

Rusty Red
058
U335 ST9

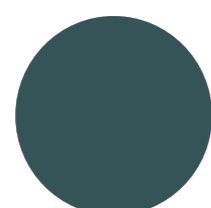

Petrol
641
244 SU



Verade Oak
002
305 SU



Oregon
642
5529 SN



Maple
014
375 PE

Wood palette two

*A 10% surcharge applies.

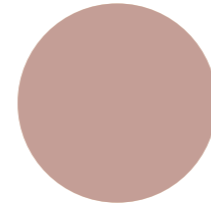

Antique Rose
200
U325 ST9

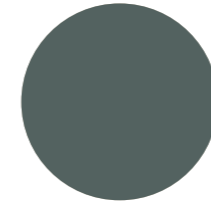

Stone Green
047
U665 ST9

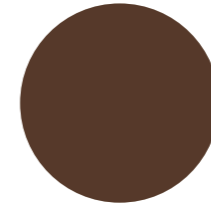

Dark Brown
059
U818 ST9

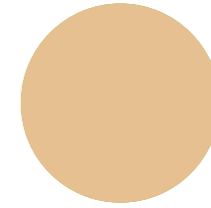

Sand Yellow
056
U125 ST9



Natural Kendal Oak
018
H3170 ST12



Lincoln Walnut
998
H1714 ST19



Grey Beige Spree
796
H1357 ST10



Sevilla Ash
060
H1223 ST19



Parona Walnut
036
H1715 ST12



Anthracite Finline
Metallic
032
H3190 ST19

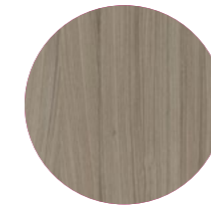

Shorewood
529
H3090 ST19

Wood palette three

*A 20% surcharge applies.



White Halifax Oak
751
H1176 ST37



Brown Orleans Oak
061
H1379 ST36



Marone Casella Oak
062
H1369 ST40

Desktop palette one - 25mm MFC

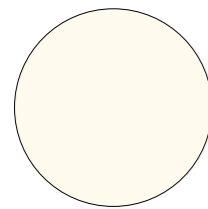

Platinum White
562
W980ST7

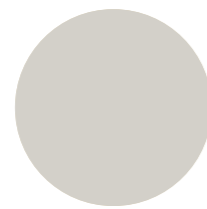

Light Grey
554
U708ST9

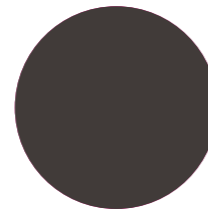

Graphite Grey
521
U961ST7

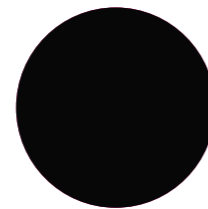

Black
574
U999ST7

Desktop palette two - 25mm MFC

A 10% surcharge applies.



Natural Kendall Oak
018
H3170ST12



Lincoln Walnut
998
H1714ST19



Verade Oak
002
305SU



Maple
014
375PE

Desktop - PerfectSense

PerfectSense laminated plywood is only available on Pebble and Height-Adjustable desking.

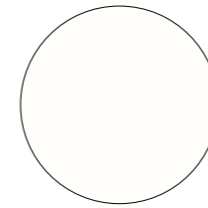

Alpine White
614
W1100PM

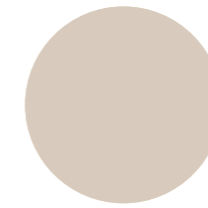

Cashmere Grey
736
U702PM

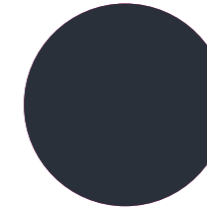

Indigo Blue
746
U599PM

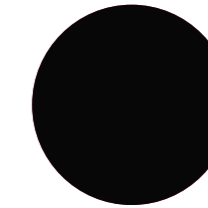

Black
732
U999PM

12mm CGL

Price on Application

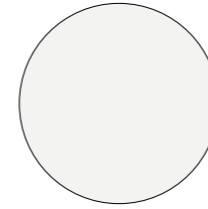

Royal White
042
U11209 SD

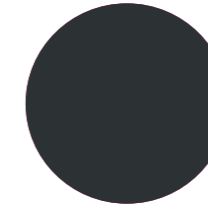

Volcanic Black
037
U12000 SD

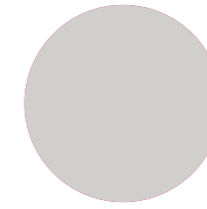

Light Grey
978
U12188 SD

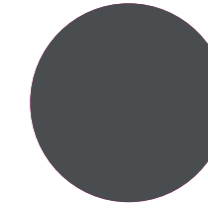

Slate Grey
035
U12231 SD

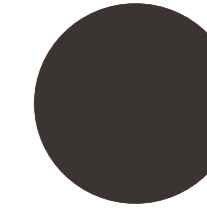

Be Rooted
105
U16058 SD

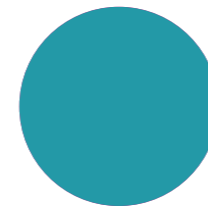

Java
249
U18008 SD

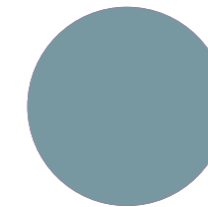

Pacific
329
U18079 SD



Lindberg Oak
910
R20021 RU/RT



Natural Chalet Oak
691
R20038 VV



Mountain Ash
979
R34033 RU/RT

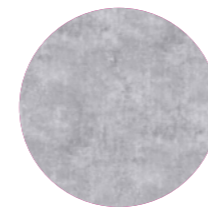

Bellato Grey
330
F76044 SD

Tambour Shutter palette one

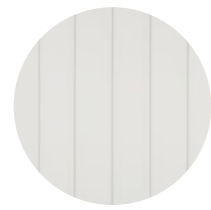

Extra white (EW)

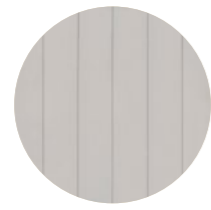

Light grey (1)/(LG)*



Cream (2)



Dark grey (9)



Black (5)

Tambour Shutter palette two

A 5% surcharge applies.



Beech (BC)*



Silver (SL)

* Eurotambours only.

Please note: The swatches are an approximate match, we recommend ordering a sample for an accurate colour match. Please contact your Bisley representative or sales@bisley.com for more information.

For further finishes please [click here](#).

Bridge and Pren handles

Round wood handles are available in three finishes:



Light
847



Medium
807



Dark
808



Fabric Matrix

Supplier	Range	Band	Desk screens		Arches		Thomas Montgomery		
			Air	Seat pads	Panels and Seating	Canopy	Soft Seating	Task	Meeting
Camira	Cara	1	●		●	●		●	●
Camira	Carlow	1	●		●			●	●
Camira	Citadel	1			●			●	●
Camira	Fiji	1			●			●	●
Camira	Phoenix	1			●	●		●	●
Camira	Target	1			●			●	●
Camira	Advantage	1			●	●	●	●	●
Camira	Era	1			●	●		●	●
Camira	Gravity	1			●			●	●
Camira	Lucia	1			●	●		●	●
Camira	Manhattan	1			●			●	●
Camira	Rivet	1			●	●		●	●
Camira	Sonus	1			●			●	●
Camira	Sprint	1			●			●	●
Camira	Xtreme	1		●	●	●	●	●	●
Gabriel	Event	1			●	●	●	●	●
Gabriel	Fighter	1			●			●	●
Gabriel	Twist	1			●	●		●	●
Gabriel	Step	1			●	●		●	●
Gabriel	Gaja	1			●	●	●	●	●
Gabriel	Felicity	1			●	●		●	●
Gabriel	Twist Melange	1			●	●		●	●
Trimproof	Just Colour	1			●		●	●	●
Camira	Aspect	2	●		●	●	●	●	●
Camira	Lucia CS	2			●	●	●	●	●
Camira	Main Line Plus	2	●		●	●	●	●	●
Camira	Main Line Flax	2	●	●	●	●	●	●	●
Camira	Manila	2			●	●	●	●	●
Camira	Quest	2			●	●	●	●	●
Camira	Replay	2			●	●	●	●	●
Camira	Urban	2			●	●	●	●	●
Camira	Vita	2			●	●	●	●	●
Camira	X2	2	●		●	●	●	●	●
Gabriel	Frame	2			●	●	●	●	●
Gabriel	Step Melange	2			●	●	●	●	●
Gabriel	Focus	2			●	●	●	●	●
Gabriel	Flex	2			●	●	●	●	●
Camira	Blazer Lite	3	●	●	●	●	●	●	●
Camira	Halycon Cedar	3			●	●	●	●	●
Camira	Main Line Twist	3			●	●	●	●	●
Camira	Nexus	3			●	●	●	●	●
Camira	Oceanic	3			●	●	●	●	●
Camira	Patina	3			●	●	●	●	●
Gabriel	Capture	3			●	●	●	●	●
Gabriel	Europost	3			●	●	●	●	●
Gabriel	Mood	3			●	●	●	●	●
Gabriel	Focus Melange	3			●	●	●	●	●

Supplier	Range	Band	Desk screens		Arches		Thomas Montgomery		
			Air	Seat pads	Panels and seating	Canopy	Soft Seating	Task	Meeting
Camira	Aquarius	4			●	●	●	●	●
Camira	Blazer	4	●	●	●	●	●	●	●
Camira	Halycon Aspen	4			●	●	●	●	●
Camira	Halycon Blossom	4			●	●	●	●	●
Camira	Hemp	4	●		●	●	●	●	●
Camira	Hi-Tech	4			●	●	●	●	●
Camira	Oxygen	4			●	●	●	●	●
Camira	Regent	4			●	●	●	●	●
Camira	Silk	4			●	●	●	●	●
Camira	Sumi	4			●	●	●	●	●
Camira	Synergy	4	●	●	●	●	●	●	●
Camira	Synergy 170	4			●	●	●	●	●
Camira	Track	4			●	●	●	●	●

Additional Information

The Cirrus screen is only available in the following Blazer Lite foam backed fabric; Hope, Wish, Angel, Tender, Mood, Retreat, Solace, Daydream, Devoted, Happy, Harmony, Haven, Balance, Buddha, Cuddle, Dainty, True.

Quarters are available across all fabric bands. Please contact your bisley representative for more information.



Brochure Library



Everything Bisley

Life may be unpredictable, but you can always count on Bisley.

When it comes to creating work environments, Bisley is the name people turn to for quality they can trust. For over ninety years, we've been creating innovative products that meet the evolving needs of our working world. Since we launched the iconic MultiDrawer in 1958, we have pioneered innovative furniture solutions that meet the challenges of the times and stay relevant, decade after decade.

Whether you're in the office or at home, we provide unique, innovative furniture that doesn't compromise on style—so that you can thrive anywhere.

Bisley. Made for you. Made for life.

[View Everything Bisley.](#)

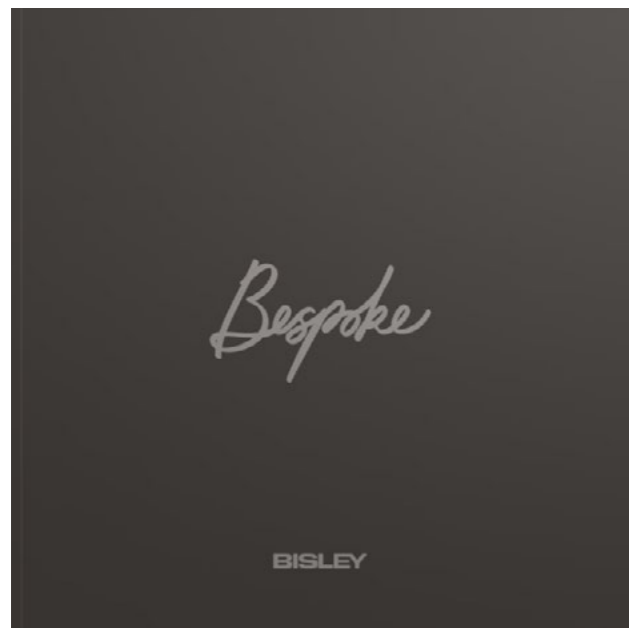

Bisley Bespoke

Manufacturing excellence that's engineered around you.

People always come first at Bisley. Whether you're a customer, dealer, architect, or designer, you benefit from a service that's engineered entirely around you and your needs.

We regularly accommodate bespoke requirements; from having existing Bisley products finished in your brand colours, to building completely new solutions to fulfil your specific needs. We're able to design, manufacture, and deliver entirely bespoke products.

[View Bespoke](#)



The Sustainability Report

As a responsible manufacturer, we are committed to creating a more sustainable environment for all. We're dedicated to reducing our environmental footprint, as well as supporting the health and well-being of our people, and raising awareness in our local communities, encapsulating all the UN's SDGs into our company operations.

At Bisley, we strive to improve our environmental performance, becoming an industry leader and creating a more sustainable company, while also achieving net zero targets and ensuring intergenerational environmental equity.

[View Sustainability Report](#)



Hotels

Helping you to provide the perfect stay.

With over 90 years' experience in the furniture industry, our products are designed with your guests in mind. Luxurious, classic, and distinct, our high-quality furniture provides a comfortable yet stylish stay.

[View Hotels.](#)



Memberships & Accreditations

EPD - 16 Environmental Product Declarations covering a large proportion of our steel and wood storage product portfolio, including the following products:

LateralFile Range (including lockers, drawer units, two-door cupboards, combination units, and tambours)
Essentials Range (As above without combination units)
Be Range
Note Pedestals
Bite
Monobloc and CLK
LockerWall
Living by Bisley
Glide
Caddy
Outline
Pren

HPD - 12 Health Product Declarations self-prepared using HPD Collaborative Builder Tool, including the following products:

LateralFile Range (including lockers, drawer units, two-door cupboards, combination units, and tambours)
Essentials Range (As above without combination units)
Note Pedestals
Bite
Monobloc and CLK
Lockerwall
Living by Bisley
Glide
Caddy

Memberships

OPI
Made In Britain - Certificate
Confederation of British Metalforming - CBM Membership Certificate
Achilles
SafeContractor
Builder's Profile

Accreditations & Certificates

Achilles Audit Certificate 2021 to 2022
Achilles Building Confidence Membership Certificate 2020 to 2021
Achilles SSIP Certificate
Once For All Health and Safety SSIP
SSIP Alcumus - SafeContractor
Constructionline Gold Status Certificate
Constructionline Social Value
ISO 14001 Certificate (Shown on MiB)
ISO 27001 Certificate (Shown on MiB)
ISO 45001 Certificate
ISO 9001 Certificate (Shown on MiB)
Manufacturing Guild Mark Certificate
TUV Nord Certificate
British Gas 100% - Renewable Energy certificate
FISP Membership Certificate Bisley 2020
FSC Chain of Custody - NQA-COC-006268
Constructionline Social Value
Cyber Essentials

Awards

Manufacturing Guild Mark 2015 - present

Mixology - Storage Product of the Year 2019 - BOB

ICONIC Best of Best Award 2020 for BOB

FX Design Award - Public, Leisure or Office Product - Buddy 2020

Mixology North - Storage Product of the Year 2021 - Belong Collection

Designer Awards - Commercial Product of the Year 2021 - Be

Mixology Manufacturer of the Year Award 2021

Insider Made in Wales Award - Manufacturer of the Year Award 2021

Mixology North - Manufacturer of the year.

Ideal Home Awards with Rowan

Outstanding Contribution to Manufacturing award at Insider Made in Wales

We have been awarded Design Guild Marks for:
MultiDrawer (2017)
BOB (2019)
Buddy (2022)
Hideaway Wall Desk (2023)
Hideaway Swing Desk (2023)

Terms & Conditions

Guarantee

All Bisley products are guaranteed to cover all defects in materials and workmanship. For details of specific guarantee periods against each product check for up to date information on our website www.bisley.com

Conditions

1. The guarantee is only valid with the customer's original invoice or proof of purchase (indicating the date of purchase, product type and dealer's name).
2. The guarantee does not cover damage resulting from misuse, neglect, or accidents and applies when the product is used during normal office hours. Where the product is used for periods which exceed normal office hours (maximum 45 hours per week), the guarantee is valid for eighteen months.
3. Failure due to fair wear and tear is specifically excluded.
4. This guarantee is not transferable and can only be exercised by the original purchaser and is only applicable to the UK Mainland.

Dealer advice

1. Please ensure that your customer has proof of purchase. This will be required for guarantee claims.
2. If the furniture requires in-guarantee repair, please contact Bisley Service Department and request a Service Form.
3. If the furniture requires repair out of guarantee, please contact Bisley Service Department and request a quotation.

Replacement keys

To order replacement keys please contact: Lowe and Fletcher – tel. 0121 505 0400, with details of your product type, the three digits from the relevant lock barrel and the purchase date.

Minimum order value to dealer warehouse

UK Mainland: £250
Northern Ireland and Scottish Highlands: £1500
Above order values excl. VAT.

Direct delivery to end user site – UK mainland

FOC delivery for orders over £6,600 (excl. VAT) in normal working hours (6am-5pm) Monday to Friday on 45ft articulated vehicle.

Any requirements outside above times and vehicle size are subject to a separate quotation – please contact Bisley to discuss your needs.

Order cancellation / delivery deferment

Any request to cancel an order placed to be made in writing. Cancellation costs will be advised based on the following:

1. Order acknowledged, parts ordered, not in production: costs to be agreed by a Director
2. Standard product scheduled for assembly: order value less 25%
3. Special product scheduled for production and all products made awaiting dispatch: full order value

Any request to defer delivery from original request to be made in writing. Costs may be incurred and will be advised at time of enquiry.

Returns

Goods incorrectly ordered or no longer required will not be taken back for credit.

In special circumstances and solely on the basis of "Goodwill", goods may be taken back within a 28 day period from delivery date. This does not apply to specially manufactured products, which will not be taken back.

All goods returned will be subject to a fee of 75% of

their original purchase price. A credit will be issued after a satisfactory inspection of the returned goods.

Conditions of sale

1. The ownership of the goods will only be transferred to the purchaser when the purchaser has paid all that is owing to F. C. Brown (Steel Equipment) Ltd in respect of all goods supplied. Where goods are lost, damaged or destroyed after delivery and ownership has yet to pass the purchaser will indemnify F. C. Brown (Steel Equipment) Ltd against any loss incurred provided such loss, damage or destruction does not result from the negligence of F. C. Brown (Steel Equipment) Ltd.
2. Payment Terms: Nett monthly.
3. All goods are invoiced at prices ruling at date of purchase order.
4. This price list cancels and replaces all previous price lists.
5. We reserve the right to alter models and prices without prior notice.
6. We reserve the right to offset any amount that may be due to the purchaser against their sales ledger account with F.C. Brown (Steel Equipment) Ltd.

Newport - HQ
Caswell Way
Reevesland Ind. Est
Newport
South Wales
NP19 4PW

BISLEY

London Showroom
32 Dallington Street
London
EC1V 0BB

Manchester Showroom
Calico
55 Mosley Street
Manchester
M2 3HQ

thebisleygroup.com