



EQUIPMENT
VERTICAL LINE

2025

TCORX
VERTICAL LINE

CARDIO	3	PLX3800 - BICEPS CURL	37	PRX3000	78
TAPIS ROULANT - TREADMILLS		PLX4400 - TRICEPS PRESS	38	FWX6950	79
TRX3500 TFT	4	PLX4800 - HORIZONTAL LEG PRESS	39	FWX7000	80
TRX3500	5	PLX4600 - LEG EXTENSION	40	LTX3000	81
TRX 2500 TFT	6	PLX4300 - PRONE LEG CURL	41	LTX2000	82
TRX2500	7	PLX4700 - MULTI HIP	42	HSX3000	83
TRX2000	8	PLX3700 - ABDUCTOR	43	LPX5000	84
POWER MAG	9	PLX3600 - ADDUCTOR	44	LPX3000	85
ELLITTICHE - ELLIPTICALS		PLX5000 - PECTORAL FLY/REAR DELTOID	45	RACKS & LADDERS 86	
ERX3500	10	PLX5200 - LAT MACHINE/PULLEY	46	WLX3800	87
ERX3000	11	PLX5600 - SEATED LEG CURL/LEG EXTENSION	47	WLX3600	88
BIKES		PLX5400 - ABDUCTOR/ADDUCTOR	48	WLX3400	89
BRXR3000	12	AKTIV LINE PLATE LOADED		WLX3200	90
BRX3000	13	FWX5800 - CHEST PRESS	49	WLX3000	91
SRX9000	14	FWX5400 - SHOULDER PRESS	50	WLX2800	92
SRX8500	15	FWX5600 - PULL DOWN	51	LDX5000	93
TX-POWER KEO	16	FWX5200 - ROW	52	LDX3000	94
TX-POWER SPD	17	WBX4000 - LINEAR LEG PRESS	53	SPALLIERA SVEDESE 1 CAMPATA	
SRX3500	18	FWX6000 - LEG PRESS	54	SINGLE WOODEN WALL BAR	96
VOGATORE - ROWER		FWX6200 - HACK SQUAT	55	SPALLIERA SVEDESE 2 CAMPATE	
RWX3000	19	FWX4800 - LEG EXTENSION	56	DUAL WOODEN WALL BAR	96
CROSSTRAINING & FUNCTIONAL CARDIO		FWX5000 - STANDING LEG CURL	57	BENCHES 97	
RACE CROSS PRO	20	FWX4600 - GLUTEUS	58	FUNCTIONAL	
RACE CROSS	21	FWX4400 - HIP THRUST	59	WBX1000	98
RWX AIRMAG 7000	22	WBX3000 - CALF RAISE	60	BACK & GLUTEUS	
SKX AIRMAG 7000	23	ALL IN ONE		WBX3300	99
BRX AIRMAG 7000	24	ASX9000	61	WBX250	100
RWX AIR 5000	25	ASX8000	62	WBX240	101
SKX AIR 5000	26	ASX7000	63	WEIGHTS	
BRX AIR 5000	27	ASX6000	64	WBX950	102
BRX AIR CROSS PRO	28	ASX5000	65	WBX700	103
BRX AIR CROSS	29	ASX4500	66	WBX400	104
STRENGTH 30		ASX4000	67	WBX200	105
AKTIV LINE PIN LOADED		ASX3000	68	WBX100	106
PLX4100 - CHEST PRESS	31	ASX2000	69	GRAVITY	
PLX4200 - SHOULDER PRESS	32	STATIONS - BACK - LEGS		GBX3000	107
PLX4500 - LAT MACHINE	33	MSX3000	70		
PLX4000 - SEATED ROW	34	CSX6000	71		
PLX3900 - PULLEY	35	CSX2000	72		
PLX4900 - ASSISTED PULL UP/CHIN UP/DIP	36	CSX5500	73		
		CSX3500	74		
		CSX2500	75		
		PRX5000	76		
		PRX3500	77		





CARDIO

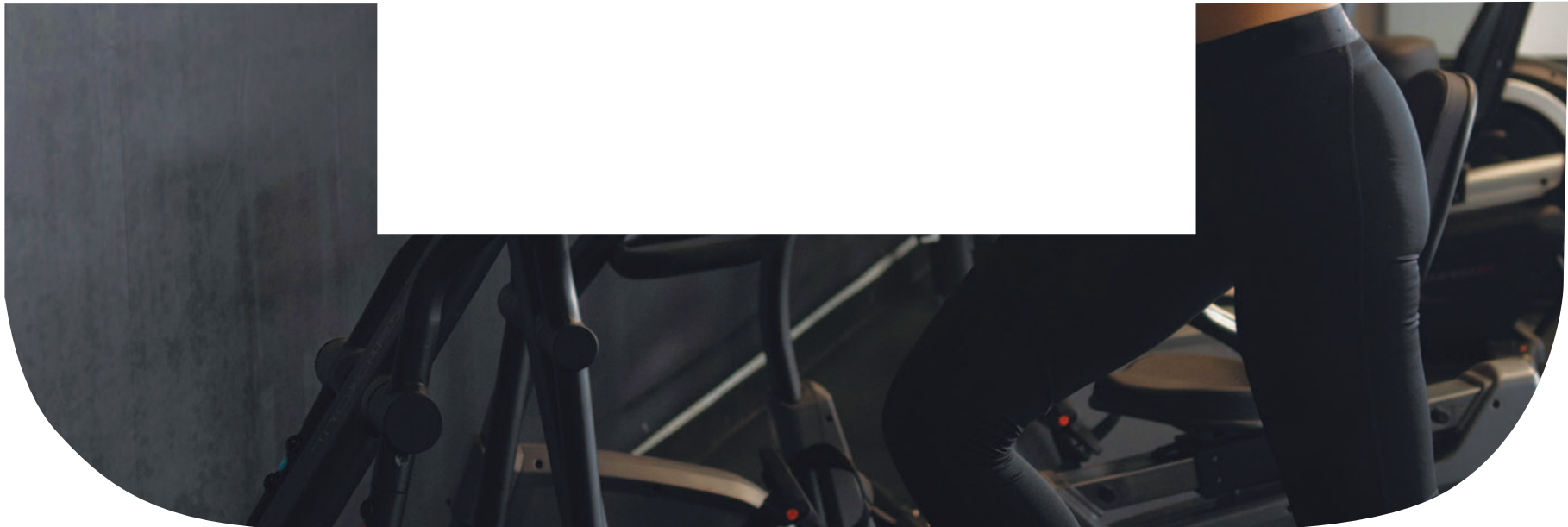

TRX3500 TFT

cod. TRX-3500TFT

App ready 3.0

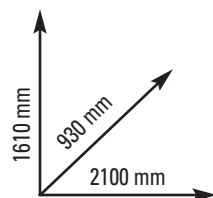
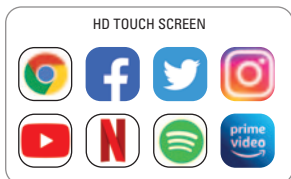

CARDIO - TREADMILLS

MOTORE 4,5/7 (Peak) HP AC
VELOCITÀ 0,8 - 24,0 Km/h con incremento di 0,1 km/h
PIANO DI CORSA 600 x 1640 mm - spessore nastro 2,0 mm
CONSOLE 15,6" TFT HD touch screen. App pre-installate: Chrome, Facebook, Twitter, Instagram, Youtube, Netflix*, Spotify*, Prime Video*.
* Abbonamento non incluso. Informazioni: velocità, inclinazione, tempo, distanza, calorie, pulse.
PROGRAMMI Quick start/Real mode (6) / Target mode(3)/Training mode(5)
CLASSE D'UTILIZZO PROFESSIONALE (EN20957-1 / EN957-6 classe S)

MOTOR 4,5/7 (Peak) HP AC
SPEED 0,8 - 24,0 Km/h 0,1 km/h increasing
RUNNING BOARD 600 x 1640 mm - belt thickness 2,0 mm
CONSOLE 15,6" TFT HD touch screen. App pre-installed: Chrome, Facebook, Twitter, Instagram, Youtube, Netflix*, Spotify*, Prime Video*. * Subscription not included. Functions: speed, incline, time, distance, calories, pulse
PROGRAMS Quick start/Real mode (6) / Target mode(3)/Training mode(5)
COMMERCIAL USE (EN20957-1 / EN957-6 class S)

- Inclinazione: elettrica 15% su 15 livelli
 - Rilevazione cardio: hand pulse. Ricevitore wireless per fascia cardio integrato. Fascia cardio TOORX inclusa
 - Peso max utilizzatore: 160 kg
 - Dotazioni multimediali: ingresso per lettore MP3 e casse acustiche - Wireless station per ricarica smartphone e tablet, se supportato dai dispositivi. Ingresso USB. Supporto per smartphone/tablet. APP READY 3.0 - Sistema Bluetooth intelligente integrato. Compatibile con Zwift App e Kinomap fitness App (abbonamenti non inclusi).
 - Dimensioni prodotto: 2100x930x1610 mm
 - Peso: 145 kg
-
- Incline: 15% with 15-level incline
 - Heart rate: hand pulse. Built-in wireless pulse receiver. TOORX chest belt included
 - Max userweight: 160 kg
 - Multimedia equipment: Audio input for MP3 player and loudspeakers - Wireless charging station for smartphone and tablet if supported by your device. USB door. Smartphone/tablet holder. APP READY 3.0 - Built-in Bluetooth intelligent system. Compatible with Zwift App and Kinomap fitness App (subscription not included).
 - Set up size 2100x930 x1610 mm
 - Weight: 145 kg



TRX3500

cod. TRX-3500

App ready 3.0

COMPATIBILE CON
COMPATIBLE WITH

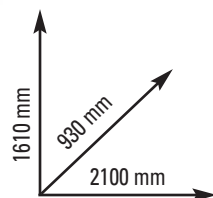

CARDIO - TREADMILLS

MOTORE 4,5/7 (Peak) HP AC
VELOCITÀ 0,8 - 24,0 Km/h con incremento di 0,1 km/h
PIANO DI CORSA 600 x 1640 mm - spessore nastro 2,0 mm
CONSOLE 7 display LED bianchi + 1 display con grafico a LED blu.
Informazioni: tempo, inclinazione, velocità, step, calorie, distanza, pulse, pace, MET's, temperatura
PROGRAMMI HRC, Custom, Manual, Hill, Fat Burn, Target, Cardio, Strength, Fit Test
CLASSE D'UTILIZZO PROFESSIONALE (EN20957-1 / EN957-6 classe S)

MOTOR 4,5/7 (Peak) HP AC
SPEED 0,8 - 24,0 Km/h 0,1 km/h increasing
RUNNING BOARD 600 x 1640 mm - belt thickness 2,0 mm
CONSOLE 7 white LED displays + 1 LED blue display with diagram.
Functions: time, incline, speed, steps, calorie, distance, pulse, pace, MET's, temperature
PROGRAMS HRC, Custom, Manual, Hill, Fat Burn, Target, Cardio, Strength, Fit Test
COMMERCIAL USE (EN20957-1 / EN957-6 class S)

- Inclinazione: elettrica 15% su 15 livelli
- Rilevazione cardio: hand pulse. Ricevitore wireless per fascia cardio integrato. Fascia cardio TOORX inclusa
- Peso max utilizzatore: 160 kg
- Dotazioni multimediali: ingresso per lettore MP3 e casse acustiche - Ingresso USB. Supporto per smartphone/tablet. APP READY 3.0 - Sistema Bluetooth intelligente integrato. Compatibile con Zwift App e Kinomap fitness App (abbonamenti non inclusi).
- Dimensioni prodotto: 2100x930x1610 mm
- Peso: 145 kg

- Incline: 15% with 15-level incline
- Heart rate: hand pulse. Built-in wireless pulse receiver. TOORX chest belt included
- Max userweight: 160 kg
- Multimedia equipment: Audio input for MP3 player and loudspeakers - USB door. Smartphone/tablet holder. APP READY 3.0 - Built-in Bluetooth intelligent system. Compatible with Zwift App and Kinomap fitness App (subscription not included).
- Set up size 2100x930x1610 mm
- Weight: 145 kg



TRX2500 TFT

cod. TRX-2500TFT

App ready 3.0

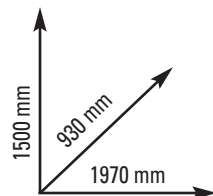
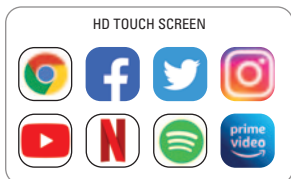

CARDIO - TREADMILLS

MOTORE 4,5/7 (Peak) HP AC
VELOCITÀ 1 - 22,0 Km/h con incremento di 0,1 km/h
PIANO DI CORSA 570 x 1530 mm - spessore nastro 1,8 mm
CONSOLE 15,6" TFT HD touch screen. App pre-installate: Chrome, Facebook, Twitter, Instagram, Youtube, Netflix*, Spotify*, Prime Video*.
* Abbonamento non incluso. Informazioni: velocità, inclinazione, tempo, distanza, calorie, pulse
PROGRAMMI Quick start/Real mode (6) / Target mode(3)/Training mode(5)
CLASSE D'UTILIZZO PROFESSIONALE (EN20957-1 / EN957-6 classe S)

MOTOR 4,5/7 (Peak) HP AC
SPEED 1 - 22,0 Km/h 0,1 km/h increasing
RUNNING BOARD 570 x 1530 mm - belt thickness 1,8 mm
CONSOLE 15,6" TFT HD touch screen. App pre-installed: Chrome, Facebook, Twitter, Instagram, Youtube, Netflix*, Spotify*, Prime Video*.
* Subscription not included. Functions: speed, incline, time, distance, calories, pulse
PROGRAMS Quick start/Real mode (6) / Target mode(3)/Training mode(5)
COMMERCIAL USE (EN20957-1 / EN957-6 class S)

- Inclinazione: elettrica 15% su 15 livelli
- Rilevazione cardio: hand pulse. Ricevitore wireless per fascia cardio integrato. Fascia cardio TOORX inclusa
- Peso max utilizzatore: 150 kg
- Dotazioni multimediali: ingresso per lettore MP3 e casse acustiche - Wireless station per ricarica smartphone e tablet, se supportato dai dispositivi. Ingresso USB. Supporto per smartphone/tablet. APP READY 3.0 - Sistema Bluetooth intelligente integrato. Compatibile con Zwift App e Kinomap fitness App (abbonamenti non inclusi).
- Dimensioni prodotto: 1970x930x1500 mm
- Peso: 134 kg

- Incline: 15% with 15-level incline
- Heart rate: hand pulse. Built-in wireless pulse receiver. TOORX chest belt included
- Max userweight: 150 kg
- Multimedia equipment: Audio input for MP3 player and loudspeakers - Wireless charging station for smartphone and tablet if supported by your device. USB door. Smartphone/tablet holder. APP READY 3.0 - Built-in Bluetooth intelligent system. Compatible with Zwift App and Kinomap fitness App (subscription not included).
- Set up size 1970x930x1500 mm
- Weight: 134 kg



TRX2500

cod. TRX-2500

App ready 3.0

COMPATIBILE CON
COMPATIBLE WITH

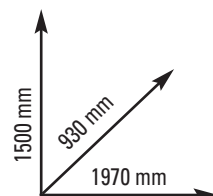

CARDIO - TREADMILLS

MOTORE 4,5/7 (Peak) HP AC
VELOCITÀ 1 - 22,0 Km/h con incremento di 0,1 km/h
PIANO DI CORSA 570 x 1530 mm - spessore nastro 1,8 mm
CONSOLE 6 display LED bianchi + 1 display con grafico a LED blu.
Informazioni: tempo, inclinazione, velocità, calorie, distanza, pulse
PROGRAMMI HRC, Custom, Manual, Hill, Fat, Burn, Target, Cardio,
Strength, Fit Test
CLASSE D'UTILIZZO PROFESSIONALE (EN20957-1 / EN957-6 classe S)

MOTOR 4,5/7 (Peak) HP AC
SPEED 1 - 22,0 Km/h 0,1 km/h increasing
RUNNING BOARD 570 x 1530 mm - belt thickness 1,8 mm
CONSOLE 6 white LED displays + 1 LED blue display with diagram.
Functions: time, incline, speed, calorie, distance, pulse
PROGRAMS HRC, Custom, Manual, Hill, Fat, Burn, Target, Cardio,
Strength, Fit Test
COMMERCIAL USE (EN20957-1 / EN957-6 class S)

- Inclinazione: elettrica 15% su 15 livelli
- Rilevazione cardio: hand pulse. Ricevitore wireless per fascia cardio integrato. Fascia cardio TOORX inclusa
- Peso max utilizzatore: 150 kg
- Dotazioni multimediali: MP3 Bluetooth integrato e casse acustiche. Ingresso USB. Supporto per smartphone/tablet.
- APP READY 3.0 - Sistema Bluetooth intelligente integrato. Compatibile con Zwift App e Kinomap fitness App (abbonamenti non inclusi).
- Dimensioni prodotto: 1970x930x1500 mm
- Peso: 134 kg

- Incline: 15% with 15-level incline
- Heart rate: hand pulse. Built-in wireless pulse receiver. TOORX chest belt included
- Max userweight: 150 kg
- Multimedia equipment: MP3 Bluetooth player and stereo loudspeakers. USB door. Smartphone/tablet holder. APP READY 3.0 - Built-in Bluetooth intelligent system. Compatible with Zwift App and Kinomap fitness App (subscription not included).
- Set up size 1970x930x1500 mm
- Weight: 134 kg



TRX2000

cod. TRX-2000

App ready 3.0

COMPATIBILE CON
COMPATIBLE WITH

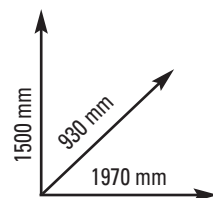

CARDIO - TREADMILLS

MOTORE 4,5/7 (Peak) HP DC BRUSHLESS
VELOCITÀ 1 - 22,0 Km/h con incremento di 0,1 km/h
PIANO DI CORSA 570 x 1530 mm - spessore nastro 1,8 mm
CONSOLE 6 display LED bianchi + 1 display con grafico a LED blu.
Informazioni: tempo, inclinazione, velocità, calorie, distanza, pulse
PROGRAMMI HRC, Custom, Manual, Hill, Fat, Burn, Target, Cardio, Strength, Fit Test
CLASSE D'UTILIZZO PROFESSIONALE (EN20957-1 / EN957-6 classe S)

MOTOR 4,5/7 (Peak) HP DC BRUSHLESS
SPEED 1 - 22,0 Km/h 0,1 km/h increasing
RUNNING BOARD 570 x 1530 mm - belt thickness 1,8 mm
CONSOLE 6 white LED displays + 1 LED blue display with diagram.
Functions: time, incline, speed, calorie, distance, pulse
PROGRAMS HRC, Custom, Manual, Hill, Fat, Burn, Target, Cardio, Strength, Fit Test
COMMERCIAL USE (EN20957-1 / EN957-6 class S)

- Inclinazione: elettrica 15% su 15 livelli
- Rilevazione cardio: hand pulse. Ricevitore wireless per fascia cardio integrato. Fascia cardio TOORX inclusa
- Peso max utilizzatore: 150 kg
- Dotazioni multimediali: MP3 Bluetooth integrato e casse acustiche. Ingresso USB. Supporto per smartphone/tablet.
- APP READY 3.0 - Sistema Bluetooth intelligente integrato. Compatibile con Zwift App e Kinomap fitness App (abbonamenti non inclusi).
- Dimensioni prodotto: 1970x930x1500 mm
- Peso: 134 kg

- Incline: 15% with 15-level incline
- Heart rate: hand pulse. Built-in wireless pulse receiver. TOORX chest belt included
- Max userweight: 150 kg
- Multimedia equipment: MP3 Bluetooth player and stereo loudspeakers. USB door. Smartphone/tablet holder. APP READY 3.0 - Built-in Bluetooth intelligent system. Compatible with Zwift App and Kinomap fitness App (subscription not included).
- Set up size 1970x930x1500 mm
- Weight: 134 kg



POWER MAG

cod. POWER-MAG

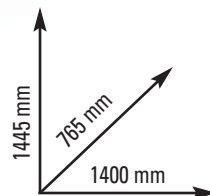

CARDIO - TREADMILLS

MASSA VOLANICA 20 kg con doppio volano
SISTEMA DI FRENAGGIO magnetico su 8 posizioni
PIANO DI CORSA 460x1250 mm
CONSOLE LCD display. Informazioni: tempo, distanza, velocità, recovery, pulsazioni, calorie
CLASSE D'UTILIZZO PROFESSIONALE (EN20957-1 / EN957-6 classe S)

FLYWHEEL SYSTEM 20 kg with double flywheel
BRAKING SYSTEM magnetic with 8-level resistance adjuster
RUNNING BOARD 460x1250 mm
CONSOLE LCD display. Functions: time, distance, speed, recovery, pulse, calories
COMMERCIAL USE (EN20957-1 / EN957-6 class S)

- Inclinazione: manuale su 3 livelli
- Rilevazione cardio: Ricevitore wireless per fascia cardio integrato
- Peso max utilizzatore: 180 kg
- Dotazione: porta borraccia.
- Dimensioni prodotto: 1400x765x1445 mm
- Dimensioni chiuso: 765x670x1450 mm
- Peso: 75 kg

- Incline: manual with 3-level adjuster
- Heart rate: built-in wireless pulse receiver
- Max userweight: 180 kg
- Equipment: bottle holder
- Set up size 1400x765x1445 mm
- Folded size: 765x670x1450 mm
- Weight: 75 kg



ERX3500

cod. ERX-3500

App ready

COMPATIBILE CON
COMPATIBLE WITH

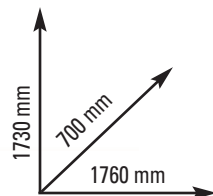

CARDIO - ELLIPTICALS

SISTEMA DI FRENAGGIO Ergometro - magnetico ad induzione e regolazione elettronica dello sforzo su 32 livelli
POGGIAPIEDI extra large per una posizione di allenamento ottimale e confortevole
LUNGHEZZA PASSO 510 mm

CONSOLE display LCD - white backlight . Inclinazione regolabile micrometrica. Informazioni: tempo, velocità, distanza, calorie, pulsazioni, RPM, watt, programma in uso
PROGRAMMI 1 libero, 12 predefiniti, recovery, race, 4 user, 4 HRC, Watt
CLASSE D'UTILIZZO PROFESSIONALE (EN20957-1 / EN957-9 classe S)

BRAKING SYSTEM Ergometer with induction magnetic braking system with 32-level electronic resistance adjuster

PLATFORMS extra large for a comfortable training position

STRIDE LENGTH 510 mm

CONSOLE LCD display - white backlight. Micrometric adjustable incline. Functions: time, speed, distance, calories, pulse, RPM, watt, current working program

PROGRAMS 1 manual, 12 pre-set, recovery, race, 4 user, 4 HRC, Watt
COMMERCIAL USE (EN20957-1 / EN957-9 class S)

- Rilevazione cardio: hand pulse. Ricevitore wireless per fascia cardio integrato
- Peso max utilizzatore: 160 kg
- Dotazioni multimediali: App Ready: sistema Bluetooth intelligente integrato che include iConsole+ App. Compatibile con Kinomap fitness App (abbonamento non incluso). Supporto per smartphone e tablet
- Dimensioni prodotto: 1760x700x1730 mm
- Peso: 89 kg

- Heart rate: hand pulse. Built-in wireless pulse receiver.
- Max userweight: 160 kg
- Multimedia equipment: App Ready: Built-in Bluetooth intelligent system which includes iConsole+ App. Compatible with Kinomap fitness App (subscription not included). Smartphone/tablet holder
- Set up size 1760x700x1730 mm
- Weight: 89 kg



ERX3000

cod. ERX-3000

App ready

COMPATIBILE CON
COMPATIBLE WITH

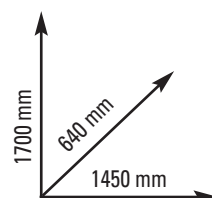

CARDIO - ELLIPTICALS

SISTEMA DI FRENAGGIO Ergometro - magnetico ad induzione e regolazione elettronica dello sforzo su 32 livelli
POGGIAPIEDI regolabile su 3 posizioni. Extra large per una posizione di allenamento ottimale e confortevole
LUNGHEZZA PASSO 400 mm
CONSOLE display LCD - white backlight. Inclinazione regolabile micrometrica. Informazioni: tempo, velocità, distanza, calorie, pulsazioni, RPM, watt, programma in uso
PROGRAMMI 1 libero, 12 predefiniti, recovery, race, 4 user, 4 HRC, Watt
CLASSE D'UTILIZZO PROFESSIONALE (EN20957-1 / EN957-9 classe S)

BRAKING SYSTEM Ergometer with induction magnetic braking system with 32-level electronic resistance adjuster
PLATFORMS 3-level adjustment. Extra large for a comfortable training position
STRIDE LENGTH 400 mm
CONSOLE LCD display - white backlight. Micrometric adjustable incline. Functions: time, speed, distance, calories, pulse, RPM, watt, current working program
PROGRAMS 1 manual, 12 pre-set, recovery, race, 4 user, 4 HRC, Watt
COMMERCIAL USE (EN20957-1 / EN957-9 class S)

- Rilevazione cardio: hand pulse. Ricevitore wireless per fascia cardio integrato
- Peso max utilizzatore: 160 kg
- Dotazioni multimediali: App Ready: sistema Bluetooth intelligente integrato che include iConsole+ App. Compatibile con Kinomap fitness App (abbonamento non incluso). Supporto per smartphone e tablet
- Dimensioni prodotto: 1450x640x1700 mm
- Peso: 65 kg

- Heart rate: hand pulse. Built-in wireless pulse receiver.
- Max userweight: 160 kg
- Multimedia equipment: App Ready: Built-in Bluetooth intelligent system which includes iConsole+ App. Compatible with Kinomap fitness App (subscription not included). Smartphone/tablet holder
- Set up size 1450x640x1700 mm
- Weight: 65 kg



BRXR3000

cod. BRX-R3000

App ready

COMPATIBILE CON
COMPATIBLE WITH

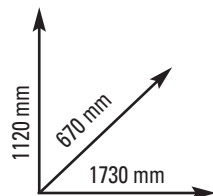

CARDIO - BIKES

SISTEMA DI FRENAGGIO Ergometro - magnetico ad induzione e regolazione elettronica dello sforzo su 32 livelli

SEDILE regolazione orizzontale. Ampio schienale avvolgente per una posizione di allenamento ottimale e confortevole

PEDALI extra large ed ergonomici per un comfort ottimale

CONSOLE display LCD - white backlight. Inclinazione regolabile micrometrica. Informazioni: tempo, velocità, distanza, calorie, pulsazioni, RPM, watt, programma in uso

PROGRAMMI 1 libero, 12 predefiniti, recovery, race, 4 user, 4 HRC, Watt

CLASSE D'UTILIZZO PROFESSIONALE (EN20957-1 / EN957-5 classe S)

BRAKING SYSTEM Ergometer with induction magnetic braking system with 32-level electronic resistance adjuster

SEAT horizontal seat adjustment with ergonomic backrest for a comfortable training position

PEDALS extra large and ergonomic for a great comfort

CONSOLE LCD display - white backlight. Micrometric adjustable incline.

Functions: time, speed, distance, calories, pulse, RPM, watt, current working program

PROGRAMS 1 manual, 12 pre-set, recovery, race, 4 user, 4 HRC, Watt

COMMERCIAL USE (EN20957-1 / EN957-5 class S)

- Rilevazione cardio: hand pulse. Ricevitore wireless per fascia cardio integrato
- Peso max utilizzatore: 160 kg
- Dotazioni multimediali: App Ready: sistema Bluetooth intelligente integrato che include iConsole+ App. Compatibile con Kinomap fitness App (abbonamento non incluso). Supporto per smartphone e tablet
- Dimensioni prodotto: 1730x670x1120 mm
- Accesso facilitato
- Peso: 64 kg

- Heart rate: hand pulse. Built-in wireless pulse receiver.
- Max userweight: 160 kg
- Multimedia equipment: App Ready: Built-in Bluetooth intelligent system which includes iConsole+ App. Compatible with Kinomap fitness App (subscription not included). Smartphone/tablet holder
- Set up size 1730x670x1120 mm
- Easy access
- Weight: 64 kg



BRX3000

cod. BRX-3000

App ready

COMPATIBILE CON
COMPATIBLE WITH

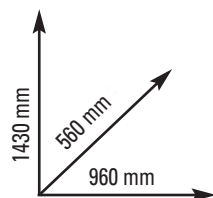

CARDIO - BIKES

SISTEMA DI FRENAGGIO Ergometro - magnetico ad induzione e regolazione elettronica dello sforzo su 32 livelli

SELLA ampia e confortevole con regolazione verticale e orizzontale

PEDALI extra large per una posizione di allenamento ottimale e confortevole

CONSOLE display LCD - white backlight . Inclinazione regolabile

micrometrica. Informazioni: tempo, velocità, distanza, calorie, pulsazioni,

RPM, watt, programma in uso

PROGRAMMI 1 libero, 12 predefiniti, recovery, race, 4 user, 4 HRC, Watt

CLASSE D'UTILIZZO PROFESSIONALE (EN20957-1 / EN957-5 classe S)

BRAKING SYSTEM Ergometer with induction magnetic braking system with 32-level electronic resistance adjuster

SEAT vertical and horizontal adjustment for a comfortable training position

PEDALS extra large for a comfortable training position

CONSOLE LCD display - white backlight. Micrometric adjustable incline.

Functions: time, speed, distance, calories, pulse, RPM, watt, current

working program

PROGRAMS 1 manual, 12 pre-set, recovery, race, 4 user, 4 HRC, Watt

COMMERCIAL USE (EN20957-1 / EN957-5 class S)

- Rilevazione cardio: hand pulse. Ricevitore wireless per fascia cardio integrato
- Peso max utilizzatore: 160 kg
- Dotazioni multimediali: App Ready: sistema Bluetooth intelligente integrato che include iConsole+ App. Compatibile con Kinomap fitness App (abbonamento non incluso). Supporto per smartphone e tablet
- Dimensioni prodotto: 960x560x1430 mm
- Accesso facilitato
- Peso: 58 kg

- Heart rate: hand pulse. Built-in wireless pulse receiver.
- Max userweight: 160 kg
- Multimedia equipment: App Ready: Built-in Bluetooth intelligent system which includes iConsole+ App. Compatible with Kinomap fitness App (subscription not included). Smartphone/tablet holder
- Set up size 960x560x1430 mm
- Easy access
- Weight: 58 kg



SRX9000

cod. SRX-9000

COMPUTER E FASCIA CARDIO OPTIONAL
COMPUTER AND CHEST BELT OPTIONAL



POWER METER PEDALS
KEO SYSTEM OPTIONAL
COD. PMP-KEO



POWER METER PEDALS
SPD SYSTEM OPTIONAL
COD. PMP-SPD

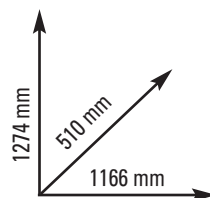

CARDIO - BIKES

SISTEMA DI FRENAGGIO a tampone con feltri in cuoio. Dotato di leva di sicurezza per il bloccaggio rapido del volano.

SISTEMA DI TRASMISSIONE a cinghia

SELLA racing con regolazione verticale e regolazione orizzontale micrometrica

PEDALI a sgancio rapido spd. Pedivella 3 pezzi

CLASSE D'UTILIZZO PROFESSIONALE (EN20957-1 / EN957-5 classe S)

BRAKING SYSTEM long life leather brake pad. Brake button for emergency stop

DRIVE TRAIN belt drive system

SEAT racing saddle with vertical adjustment and micrometrical horizontal adjustment

PEDALS quick cleat retention system spd. Crank: 3 pieces

COMMERCIAL USE (EN20957-1 / EN957-5 class S)

- Manubrio regolazione verticale e regolazione orizzontale micrometrica - con doppio porta borraccia
- Peso max utilizzatore: 150 kg
- Dimensioni prodotto: 1166x510x1274 mm
- Peso: 56 kg

- Handlebar vertical adjustment and micrometrical horizontal adjustment - with double bottle holder
- Max user weight: 150 kg
- Set up size: 1166x510x1274 mm
- Weight: 56 kg

COMPUTER E FASCIA CARDIO **OPTIONAL**
COMPUTER AND CHEST BELT **OPTIONAL**

Informazioni: velocità, distanza, RPM, calorie, pulsazioni, tempo, watt. Dati personali preimpostabili. Fascia cardio con canali di trasmissione BLE, ANT+. Indicatore batteria scarica.

Functions. speed, distance, RPM, calories, pulse, time, watt. Pre-settable data. Chest belt with BLE, ANT+ transmission channel. Low battery indicator



SRX8500

cod. SRX-8500

COMPUTER E FASCIA CARDIO OPTIONAL
COMPUTER AND CHEST BELT OPTIONAL



POWER METER PEDALS
KEO SYSTEM OPTIONAL
COD. PMP-KEO



POWER METER PEDALS
SPD SYSTEM OPTIONAL
COD. PMP-SPD

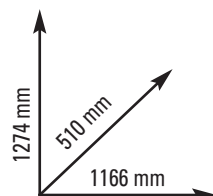

SISTEMA DI FRENAGGIO a tampone con feltri in cuoio. Dotato di leva di sicurezza per il bloccaggio rapido del volano.

SISTEMA DI TRASMISSIONE a catena

SELLA racing con regolazione verticale e regolazione orizzontale micrometrica

PEDALI a sgancio rapido spd. Pedivella 3 pezzi

CLASSE D'UTILIZZO PROFESSIONALE (EN20957-1 / EN957-5 classe S)

BRAKING SYSTEM long life leather brake pad. Brake button for emergency stop

DRIVE TRAIN chain drive system

SEAT racing saddle with vertical adjustment and micrometrical horizontal adjustment

PEDALS quick cleat retention system spd. Crank: 3 pieces

COMMERCIAL USE (EN20957-1 / EN957-5 class S)

- Manubrio regolazione verticale e regolazione orizzontale micrometrica - con doppio porta borraccia
- Peso max utilizzatore: 150 kg
- Dimensioni prodotto: 1166x510x1274 mm
- Peso: 56 kg

- Handlebar vertical adjustment and micrometrical horizontal adjustment - with double bottle holder
- Max user weight: 150 kg
- Set up size: 1166x510x1274 mm
- Weight: 56 kg

COMPUTER E FASCIA CARDIO **OPTIONAL**
COMPUTER AND CHEST BELT **OPTIONAL**

Informazioni: velocità, distanza, RPM, calorie, pulsazioni, tempo, watt. Dati personali preimpostabili. Fascia cardio con canali di trasmissione BLE, ANT+. Indicatore batteria scarica.

Functions. speed, distance, RPM, calories, pulse, time, watt. Pre-settable data. Chest belt with BLE, ANT+ transmission channel. Low battery indicator



TX-POWER

POWER METER PEDALS KEO SYSTEM

COD. PMP-KEO



CORPO IN ALLUMINIO PRESSOFUSO (Die-Cast), garantisce alta resistenza e longevità

ASSE DEL PEDALE in Cr-Mo (cromo-molibdeno) con lavorazione CNC

CUSCINETTO: con Boccola LSL (Light Self-Lubricating) e Sigillato

ATTACCO (compatibile KEO) in materiale termoplastico, rinforzato con fibra di vetro e tensione regolabile

PROTOCOLLI DI COLLEGAMENTO: ANT+ / BLE 4.0. Consente il collegamento con tutti i devices compatibili con questi protocolli

APPLICAZIONE DI SUPPORTO: Ride for Life, tramite la quale è possibile operare lo "ZERO RESET" del pedale per garantire una perfetta calibrazione

PESO: 218g compreso di batteria

BATTERIA: CR2032, 3V

DURATA BATTERIA: Approssimativamente 100 ore

RESISTENZA ALL'ACQUA: IPX7

MISURA: 97.8mm x 92mm x 42.2mm

DIE-CAST ALUMINIUM BODY, ensuring high strength and longevity

PEDAL AXLE: CNC-machined Cr-Mo (chrome-molybdenum)

BEARING: with LSL bushing (Light Self-Lubricating) and Sealed

KEO CLEATS compatible. Made of thermoplastic material, reinforced with glass fibre and adjustable tension

CONNECTION PROTOCOLS: ANT+ / BLE 4.0. Allows connection with all devices compatible with these protocols

SUPPORTING APPLICATION: Ride for Life, through which you can perform the "ZERO RESET" of the pedal to ensure a perfect calibration

WEIGHT: 218g including battery

BATTERY: CR2032, 3V

BATTERY LIFE: Approx. 100 hours

WATER RESISTANCE: IPX7

DIMENSIONS: 97.8mm x 92mm x 42.2mm

- Misurazione Potenza Totale
- Misurazione media pedale destro e sinistro
- Misurazione indipendente pedale destro e sinistro
- Cadenza (RPM)
- Accuratezza misurazione watt +/- 2.0%
- Compatibilità nativa con ZWIFT
- ANT+ & BLE
- Calibrazione Pre-Attività (Zero Offset)
- Tacchette Keo System comprese
- APP user friendly
- Codice EAN: 8029975809748

- Total Power Measurement
- Average measurement Left and right pedal
- Independent measurement right and left pedal
- Cadence (RPM)
- Watt measurement accuracy +/- 2.0%
- Native compatibility with ZWIFT
- ANT+ & BLE
- Pre-Activity Calibration (Zero Offset)
- Keo System cleats included
- User friendly APP
- EAN code: 8029975809748

SET TX-POWER KEO

COD. PMP-KEO-COMP

Il set comprende una coppia di power meter pedals KEO system e un ciclocomputer d'allenamento per indoor cycling, capace di rilevare tutti i dati emessi dai pedali. Fascia cardio inclusa.

Codice EAN: 8029975810119

The set includes a pair of KEO system power meter pedals and a training computer for indoor cycling, capable of detecting all the data emitted by the pedals. Heart rate monitor included.

EAN code: 8029975810119



TX-POWER

POWER METER PEDALS SPD SYSTEM

COD. PMP-SPD



CORPO IN ALLUMINIO 6061

ASSE DEL PEDALE in Cr-Mo (cromo-molibdeno) con lavorazione CNC

CUSCINETTO: con Boccola LSL (Light Self-Lubricating) e Sigillato

ATTACCO (compatibile SPD) in materiale termoplastico, rinforzato con fibra di vetro e tensione regolabile

PROTOCOLLI DI COLLEGAMENTO: ANT+ / BLE 4.0. Consente il collegamento con tutti i devices compatibili con questi protocolli

APPLICAZIONE DI SUPPORTO: Ride for Life, tramite la quale è possibile operare lo "ZERO RESET" del pedale per garantire una perfetta calibrazione

PESO: 212g compreso di batteria

BATTERIA: CR2032, 3V

DURATA BATTERIA: Approssimativamente 100 ore

RESISTENZA ALL'ACQUA: IPX7

MISURA: 99.15mm x 57.60mm x 40.15mm

ALUMINIUM BODY: 6061

PEDAL AXLE: CNC-machined Cr-Mo (chrome-molybdenum)

BEARING: with LSL (Light Self-Lubricating) bushing and Sealed

LINKAGE (SPD compatible) made of thermoplastic material, reinforced with glass fibre and adjustable tension

CONNECTION PROTOCOLS: ANT+ / BLE 4.0. Allows connection with all devices compatible with these protocols

SUPPORTING APPLICATION: Ride for Life, through which you can perform the "ZERO RESET" of the pedal to ensure a perfect calibration

WEIGHT: 212g including battery

BATTERY: CR2032, 3V

BATTERY LIFE: Approx. 100 hours

WATER RESISTANCE: IPX7

MEASUREMENT: 99.15mm x 57.60mm x 40.15mm

- Misurazione Potenza Totale
- Misurazione media pedale destro e sinistro
- Misurazione indipendente pedale destro e sinistro
- Cadenza (RPM)
- Accuratezza misurazione watt +/- 2.0%
- Compatibilità nativa con ZWIFT
- ANT+ & BLE
- Calibrazione Pre-Attività (Zero Offset)
- Tacchette SPD comprese
- APP user friendly
- Codice EAN: 8029975809755

- Total power measurement
- Average measurement Left and right pedal
- Independent measurement right and left pedal
- Cadence (RPM)
- Watt measurement accuracy +/- 2.0%
- Native compatibility with ZWIFT
- ANT+ & BLE
- Pre-Activity Calibration (Zero Offset) SPD cleats included
- User friendly AP
- EAN code: 8029975809755

SET TX-POWER SPD

COD. PMP-SPD-COMP

Il set comprende una coppia di power meter pedals SPD system e un ciclocomputer d'allenamento per indoor cycling, capace di rilevare tutti i dati emessi dai pedali. Fascia cardio inclusa.

Codice EAN: 8029975810126

The set includes a pair of SPD system power meter pedals and a training computer for indoor cycling, capable of detecting all the data emitted by the pedals. Heart rate monitor included.

EAN code: 8029975810126



SRX3500

cod. SRX-3500

App ready 3.0

COMPATIBILE CON
COMPATIBLE WITH



Kinomap

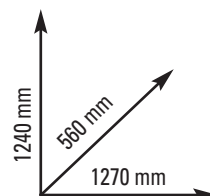

CARDIO - BIKES

SISTEMA DI FRENAGGIO magnetico con regolazione elettronica dello sforzo su 32 livelli
 SISTEMA DI TRASMISSIONE a cinghia con scatto libero
 SELLA racing con regolazione verticale e orizzontale micrometrica
 PEDALI a sgancio rapido SPD. Pedivella 3 pezzi
 CONSOLE con display LCD retro illuminato multicolor - supporto per smartphone e tablet in dotazione con inclinazione regolabile micrometrica. Informazioni: distanza, tempo, calorie, pulse, velocità, odometro, RPM
 PROGRAMMI 12 predefiniti, 4 HRC, Watt (max 500 Watt)
 CLASSE D'UTILIZZO PROFESSIONALE (EN20957-1 / EN957-10 classe S)

BRAKING SYSTEM magnetic with 32-level electronic resistance adjuster
 DRIVE TRAIN belt drive system - free wheel
 SEAT racing saddle with micrometric vertical and horizontal adjustment
 PEDALS quick cleat retention system SPD. Crank: 3 pieces
 CONSOLE multicolor LCD display - smartphone/tablet holder included with micrometric adjustable incline.
 Functions: distance, time, calories, pulse, speed, odometer, RPM
 PROGRAMS 12 pre-set , 4 HRC,Watt (max 500Watt)
 COMMERCIAL USE (EN20957-1 / EN957-10 class S)

- Manubrio regolazione verticale e orizzontale micrometrica
- Rilevazione cardio: hand pulse. Ricevitore wireless per fascia cardio integrato. Fascia cardio inclusa.
- Peso max utilizzatore: 150 kg
- Dotazioni multimediali: App Ready 3.0: include iConsole+ Training App. Compatibile con Zwift App e Kinomap fitness App (abbonamenti non inclusi)
- Dimensioni prodotto: 1270x560x1240 mm
- Peso: 58 kg
- Handlebar micrometric vertical and horizontal adjustment
- Heart rate: hand pulse. Built-in wireless pulse receiver. Chest belt included.
- Max userweight: 150 kg
- Multimedia equipment: App Ready 3.0: includes iConsole+ Training App. Compatible with Zwift App and Kinomap fitness App (subscription not included)
- Set up size 1270x560x1240 mm
- Weight: 58 kg



RWX3000

cod. RWX-3000

App ready

COMPATIBILE CON
COMPATIBLE WITH

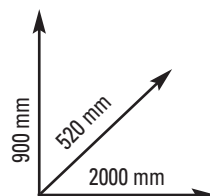

CARDIO - ROWER

SISTEMA DI FRENAGGIO idraulico progettato per simulare la dinamica di una barca in movimento sull'acqua
REGOLAZIONE SFORZO su 6 livelli dipendente dal livello dell'acqua
SEDILE a rulli con cuscinetti a sfera su binario in alluminio
POGGIAPIEDI ergonomici con lunghezza regolabile
CONSOLE display LCD - supporto per smartphone e tablet in dotazione - inclinazione regolabile. Informazioni: numero vogate/min e totali, calorie, tempo, tempo/ 500M, DRAG FORCE, SPM, distanza, pulse
PROGRAMMI quick start, standard, target (interval/ single), custom, race
CLASSE D'UTILIZZO PROFESSIONALE (EN20957-1 / EN957-7 classe S)

BRAKING SYSTEM hidraulic studied to simulate the dynamic of a boat moving onto the water

RESISTANCE ADJUSTMENT 6-level depending on the water level

SEAT with roller bearings sliding on aluminum rail

PEDALS ergonomic with length adjuster

CONSOLE LCD display - smartphone/tablet holder included -

adjustable incline. Functions: strokes/min and total, calories, time,

time/500m, DRAG FORCE, SPM, distance, pulse

PROGRAMS quick start, standard, target (interval/ single), custom, race

COMMERCIAL USE (EN20957-1 / EN957-7 class S)

- Rilevazione cardio: ricevitore wireless per fascia cardio integrato
- Peso max utilizzatore: 160 kg
- Dotazioni multimediali: App ready: sistema Bluetooth intelligente integrato. Supporto per smartphone
- Dimensioni prodotto: 2000x520x900 mm
- Peso: 39 kg

- Heart rate: built-in wireless pulse receiver.
- Max userweight: 160 kg
- Multimedia equipment: App Ready: built-in Bluetooth intelligent system. Compatible with Kinomap fitness App (subscription not included). Smartphone/tablet holder
- Set up size 2000x520x900 mm
- Weight: 39 kg



RACE CROSS PRO

cod. RACE-CROSS-PRO

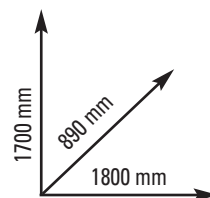

SISTEMA DI FRENAGGIO magnetico su 6 posizioni
PIANO DI CORSA 450 x 1620 mm. Scorrimento su cuscinetti a sfera
CONSOLE 9 display LCD. Informazioni: tempo, distanza, velocità, calorie, pulsazioni, Watt, pace. Inclinazione regolabile
PROGRAMMI interval 20-10, interval 10-20, interval custom, target time, target distance, target calorie, target HR
CLASSE D'UTILIZZO PROFESSIONALE (EN20957-1 / EN957-6 classe S)

BRAKING SYSTEM magnetic with 6-level of resistance adjustment
RUNNING BOARD 450 x 1620 mm. Sliding on ball bearing
CONSOLE 9 LCD displays. Functions: time, distance, speed, calories, pulse, Watt, pace. Adjustable incline
PROGRAMS interval 20-10, interval 10-20, interval custom, target time, target distance, target calorie, target HR
COMMERCIAL USE (EN20957-1 / EN957-6 class S)

- Rilevazione cardio: ricevitore wireless per fascia cardio integrato. Fascia cardio inclusa
- Manubrio multipresa. Maniglie di spinta con inclinazione regolabile
- Peso max utilizzatore: 180 kg
- Dotazioni: porta borraccia
- Dimensioni prodotto: 1800x890x1700 mm
- Peso: 162 kg

- Heart rate: built-in wireless pulse receiver. Chest belt included
- Multiple handles. Push handles with adjustable incline
- Max userweight: 180 kg
- Equipment: bottle holder
- Set up size 1800x890x1700 mm
- Weight: 162 kg



RACE CROSS

cod. RACE-CROSS

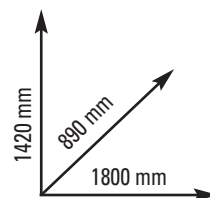

PIANO DI CORSA 450x 1620 mm. Scorrimento su cuscinetti a sfera
CONSOLE 9 display LCD. Informazioni: tempo, distanza, velocità, calorie, pulsazioni, Watt, pace. Inclinazione regolabile
PROGRAMMI interval 20-10, interval 10-20, interval custom, target time, target distance, target calorie, target HR
CLASSE D'UTILIZZO PROFESSIONALE (EN20957-1 / EN957-6 classe S)

RUNNING BOARD 450 x 1620 mm. Sliding on ball bearing
CONSOLE 9 LCD displays. Functions: time, distance, speed, calories, pulse, Watt, pace. Adjustable incline
PROGRAMS interval 20-10, interval 10-20, interval custom, target time, target distance, target calorie, target HR
COMMERCIAL USE (EN20957-1 / EN957-6 class S)

- Rilevazione cardio: ricevitore wireless per fascia cardio integrato. Fascia cardio inclusa
- Peso max utilizzatore: 180 kg
- Dotazioni: porta borraccia
- Dimensioni prodotto: 1800x890x1420 mm
- Peso: 155 kg
- Heart rate: built-in wireless pulse receiver. Chest belt included
- Max userweight: 180 kg
- Equipment: bottle holder
- Set up size 1800x890x1420 mm
- Weight: 155 kg



RWX AIRMAG 7000

cod. RWX-AIRMAG-7000

App ready



COMPATIBILE CON
COMPATIBLE WITH

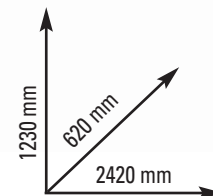

SISTEMA DI FRENAGGIO ad aria e magnetico per un movimento estremamente fluido e scorrevole e un allenamento diversificato
 REGOLAZIONE SFORZO ad aria dal livello 1 al livello 10, ad aria+magnetico dal livello 11 al livello 16
 SEDILE a rulli con cuscinetti a sfera su binario in alluminio
 POGGIPIEDI ergonomici con lunghezza regolabile
 CONSOLE display LCD - inclinazione regolabile
 Informazioni: numero vogate/min, calorie, tempo, distanza, distanza/30 min, distanza/vogata, level, tempo/500 mt, data, pulsazioni, memory
 PROGRAMMI quick start, time, distance, calories, 3 interval
 CLASSE D'UTILIZZO PROFESSIONALE (EN20957-1 / EN957-7 classe S)
 BRAKING SYSTEM the air and magnetic resistance system grants a real smooth feeling and a more diverse workout
 RESISTANCE ADJUSTMENT air resistance from level 1-10, air+magnetic resistance from level 11-16
 SEAT with roller bearings sliding on aluminum rail
 PEDALS ergonomic with length adjuster
 CONSOLE LCD display - adjustable incline
 Functions: strokes/min, calories, time, distance, distance/30 min, paddle width, level, time/500m, date, pulse, memory
 PROGRAMS quick start, time, distance, calories, 3 interval
 COMMERCIAL USE (EN20957-1 / EN957-7 class S)

- Trasmissione a catena
- Rilevazione cardio: ricevitore wireless per fascia cardio integrato
- Peso max utilizzatore: 150 kg
- Dotazioni: supporto per smartphone e tablet.
- App Ready FTMS: sistema Bluetooth intelligente integrato che consente di usufruire di app specifiche per l'allenamento. Compatibile con Kinomap e tutte le app che utilizzano il protocollo Bluetooth® FTMS (EXR, HOLOFIT...).
- Abbonamenti non inclusi.
- Dimensioni prodotto: 2420x620x1230 mm
- Peso: 52 kg
- Drive train chain
- Heart rate: built-in wireless pulse receiver
- Max userweight: 150 kg
- Equipment: smartphone/tablet holder. App Ready FTMS: Built-in Bluetooth intelligent system which enables your machine to fully interact with the most motivating Apps specifically suitable for training. Compatible with Kinomap and all the Apps that use the Bluetooth® FTMS protocol (EXR, HOLOFIT...).
- Subscriptions not included.
- Set up size 2420x620x1230 mm
- Weight: 52 kg



SKX AIRMAG 7000

cod. SKX-AIRMAG-7000

App ready



COMPATIBILE CON
COMPATIBLE WITH



Kinomap



cod. SKX-AIRMAG-7000 +
cod. PED-SKX-SKI-CROSS

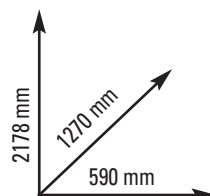

SISTEMA DI FRENAGGIO ad aria e magnetico per un movimento estremamente fluido e scorrevole e un allenamento diversificato
REGOLAZIONE SFORZO ad aria dal livello 1 al livello 10, ad aria+magnetico dal livello 11 al livello 16

PEDANA per utilizzo autoportante optional
CONSOLE display LCD - inclinazione regolabile
Informazioni: numero vogate/min, calorie, tempo, distanza, distanza/30 min, distanza/vogata, level, tempo/500 mt, data, pulsazioni, memory
PROGRAMMI quick start, time, distance, calories, 3 interval
CLASSE D'UTILIZZO PROFESSIONALE (EN20957-1 / EN957-7 classe S)

BRAKING SYSTEM the air and magnetic resistance system grants a real smooth feeling and a more diverse workout

RESISTANCE ADJUSTMENT air resistance from level 1-10, air+magnetic resistance from level 11-16

PLATFORM kit for standalone use - optional

CONSOLE LCD display - adjustable incline
Functions: strokes/min, calories, time, distance, distance/30 min, paddle width, level, time/500m, date, pulse, memory

PROGRAMS quick start, time, distance, calories, 3 interval
COMMERCIAL USE (EN20957-1 / EN957-7 class S)

- Rilevazione cardio: ricevitore wireless per fascia cardio integrato
- Dotazioni: sistema di cavi in Dyneema con rivestimento ultra resistente. Maniglie ergonomiche con sistema di rotazione di 180°. L'utilizzo dello Ski Trainer richiede il fissaggio a muro o ad una gabbia tramite specifiche staffe. Supporto per smartphone e tablet. App Ready FTMS: sistema Bluetooth intelligente integrato che consente di usufruire di app specifiche per l'allenamento. Compatibile con Kinomap e tutte le app che utilizzano il protocollo Bluetooth® FTMS. Abbonamenti non inclusi.
- Dimensioni prodotto: 590x1270x2178 mm
- Peso: 43,6 kg

- Heart rate: built-in wireless pulse receiver
- Equipment: heavy-duty cables system made in Dyneema with high resistance coating. Ergonomic handles with non-sweat surface and 180° rotating system. Fixing to the wall or to rigs through specific brackets is required. Smartphone/ tablet holder. App Ready FTMS: Built-in Bluetooth intelligent system which enables your machine to fully interact with the most motivating Apps specifically suitable for training. Compatible with Kinomap and all the Apps that use the Bluetooth® FTMS protocol. Subscriptions not included.
- Set up size 590x1270x2178 mm
- Weight: 43,6 kg



BRX AIRMAG 7000

cod. BRX-AIRMAG-7000

App ready



COMPATIBILE CON
COMPATIBLE WITH

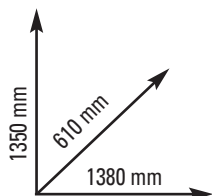
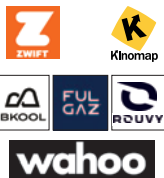

SISTEMA DI FRENAGGIO ad aria e magnetico per un movimento estremamente fluido e scorrevole e un allenamento diversificato
REGOLAZIONE SFORZO ad aria dal livello 1 al livello 10, ad aria+magnetico dal livello 11 al livello 32

SELLA regolazione verticale micrometrica

CONSOLE display LCD - supporto per smartphone e tablet in dotazione.
Informazioni console: RPM, pulsazioni, distanza, distanza/30 min, level, Cycle, velocità, Watts, Watts AVG, tempo, tempo/1km, tempo AVG, data, calorie/hr, memory

PROGRAMMI quick start, time, distance, calories, 3 interval
CLASSE D'UTILIZZO PROFESSIONALE (EN20957-1 / EN957-5 classe S)

BRAKING SYSTEM the air and magnetic resistance system grants a real smooth feeling and a more diverse workout

RESISTANCE ADJUSTMENT air resistance from level 1-10, air+magnetic resistance from level 11-32

SEAT micrometrical vertical adjustment

CONSOLE LCD display - smartphone/ tablet holder included.

Functions: RPM, pulse, distance, distance/30 min, level, cycle, speed, Watts, Watts AVG, time, time/1km, time AVG, date, Calories/hr, memory

PROGRAMS quick start, time, distance, calories, 3 interval

COMMERCIAL USE (EN20957-1 / EN957-5 class S)

- Manubrio: regolazione micrometrica verticale e orizzontale
- Trasmissione a cinghia
- Rilevazione cardio: ricevitore wireless per fascia cardio integrato
- Peso max utilizzatore: 135 kg
- Dotazioni: porta borraccia. Supporto per smartphone e tablet.
- App Ready FTMS: sistema Bluetooth intelligente integrato che consente di usufruire di app specifiche per l'allenamento. Compatibile con Kinomap, Zwift App e tutte le app che utilizzano il protocollo Bluetooth® FTMS (BKool, Rouvy, Wahoo, Fulgaz...). Abbonamenti non inclusi.
- Dimensioni prodotto: 1380x610x1350 mm
- Peso: 42,4 kg

- Handlebar: micrometrical vertical and horizontal adjustment
- Rubber belt
- Heart rate: built-in wireless pulse receiver
- Max userweight: 135 kg
- Equipment: bottle holder. Smartphone/ tablet holder. App Ready FTMS: Built-in Bluetooth intelligent system which enables your machine to fully interact with the most motivating Apps specifically suitable for training. Compatible with Kinomap, Zwift App and all the Apps that use the Bluetooth® FTMS protocol (BKool, Rouvy, Wahoo, Fulgaz...). Subscriptions not included.
- Set up size: 1380x610x1350 mm
- Weight: 42,4 kg



RWX AIR 5000

cod. RWX-AIR-5000

App ready



COMPATIBILE CON
COMPATIBLE WITH

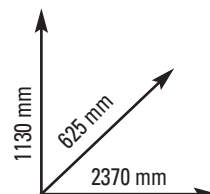

SISTEMA DI FRENAGGIO ad aria per un movimento estremamente fluido e scorrevole
 REGOLAZIONE SFORZO su 10 livelli
 SEDILE a rulli con cuscinetti a sfera su binario in alluminio
 POGGIAPIEDI ergonomici con lunghezza regolabile
 CONSOLE display LCD retro-illuminato blue backlight - inclinazione regolabile. Informazioni: numero vogate/min, calorie, tempo, distanza, distanza/vogata, tempo/500 mt, pulsazioni
 PROGRAMMI game, time, distanza, calorie, 3 interval (serie selezionabili da 1 a 99), user
 CLASSE D'UTILIZZO PROFESSIONALE (EN20957-1 / EN957-7 classe S)

BRAKING SYSTEM the air resistance system grants a real smooth feeling
 RESISTANCE ADJUSTMENT 10-level
 SEAT with roller bearings sliding on aluminum rail
 PEDALS ergonomic with length adjuster
 CONSOLE LCD display blue backlight - adjustable incline
 Functions: strokes/min, calories, time, distance, paddle width, time/500m, pulse
 PROGRAMS game, time, distance, calories, 3 interval (1-99 cycles), user
 COMMERCIAL USE (EN20957-1 / EN957-7 class S)

- Trasmissione a catena
- Rilevazione cardio: ricevitore wireless per fascia cardio integrato
- Peso max utilizzatore: 150 kg
- Dotazioni: supporto per smartphone e tablet. App Ready FTMS: sistema Bluetooth intelligente integrato che consente di usufruire di app specifiche per l'allenamento. Compatibile con Kinomap e tutte le app che utilizzano il protocollo Bluetooth® FTMS (EXR, HOLOFIT...). Abbonamenti non inclusi.
- Dimensioni prodotto: 2370x625x1130 mm
- Peso: 52 kg

- Drive train chain
- Heart rate: built-in wireless pulse receiver
- Max userweight: 150 kg
- Equipment: smartphone/tablet holder. App Ready FTMS: Built-in Bluetooth intelligent system which enables your machine to fully interact with the most motivating Apps specifically suitable for training. Compatible with Kinomap and all the Apps that use the Bluetooth® FTMS protocol (EXR, HOLOFIT...). Subscriptions not included.
- Set up size 2370x625x1130 mm
- Weight: 52 kg



SKX AIR 5000

SKX-AIR-5000

App ready



COMPATIBILE CON
COMPATIBLE WITH



Kinomap



cod. SKX-AIR-5000 +
cod. PED-SKX-AIR-5000

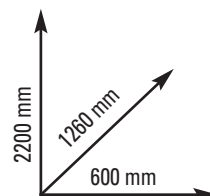

SISTEMA DI FRENAGGIO ad aria per un movimento estremamente fluido e scorrevole
 REGOLAZIONE SFORZO su 10 livelli
 PEDANA per utilizzo autoportante optional
 CONSOLE display LCD retro-illuminato blu backlight - inclinazione regolabile.
 Informazioni console: media vogate, tempo/500 m, AVG, tempo/500m, pulsazioni, distanza, Watt AVG
 PROGRAMMI quick start, tempo / distanza / calorie (countdown), game, 3 interval (serie selezionabili da 1 a 99)
 CLASSE D'UTILIZZO PROFESSIONALE (EN20957-1 / EN957-7 classe S)
 BRAKING SYSTEM the air resistance system grants a real smooth feeling
 RESISTANCE ADJUSTMENT 10-level
 PLATFORM kit for standalone use - optional
 CONSOLE display blue backlight - adjustable incline.
 Functions: strokes rate, time /500m AVG, time /500m, pulse, distance, Watt AVG
 PROGRAMS quick start, time/ distance / calories (countdown), game, 3 interval (1-99 cycles)
 COMMERCIAL USE (EN20957-1 / EN957-7 class S)

- Rilevazione cardio: ricevitore wireless per fascia cardio integrato
- Dotazioni: sistema di cavi in Dyneema con rivestimento ultra resistente. Maniglie ergonomiche con sistema di rotazione di 180°. L'utilizzo dello Ski Trainer richiede il fissaggio a muro o ad una gabbia tramite specifiche staffe. Supporto per smartphone e tablet. App Ready FTMS: sistema Bluetooth intelligente integrato che consente di usufruire di app specifiche per l'allenamento. Compatibile con Kinomap e tutte le app che utilizzano il protocollo Bluetooth® FTMS. Abbonamenti non inclusi.
- Dimensioni prodotto: 600x1260x2200 mm
- Peso: 40 kg
- Heart rate: built-in wireless pulse receiver
- Equipment: heavy-duty cables system made in Dyneema with high resistance coating. Ergonomic handles with non-sweat surface and 180° rotating system. Fixing to the wall or to rigs through specific brackets is required. Smartphone/ tablet holder. App Ready FTMS: Built-in Bluetooth intelligent system which enables your machine to fully interact with the most motivating Apps specifically suitable for training. Compatible with Kinomap and all the Apps that use the Bluetooth® FTMS protocol. Subscriptions not included.
- Set up size 600x1260x2200 mm
- Weight: 40 kg



BRX AIR 5000

cod. BRX-AIR-5000

App ready

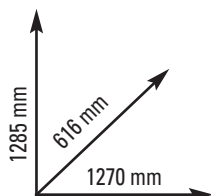
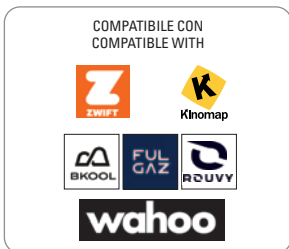

SISTEMA DI FRENAGGIO ad aria per un movimento estremamente fluido e scorrevole
 REGOLAZIONE SFORZO su 10 livelli
 SELLA regolazione verticale e orizzontale micrometrica
 CONSOLE display LCD retro-illuminato blue backlight
 Informazioni console: RPM, pulsazioni, distanza, Level, Cycle, velocità, Watts, Watts AVG, tempo, tempo/1km, Calorie/hr
 PROGRAMMI game, time, distanza, calorie, 3 interval (serie selezionabili da 1 a 99), user
 CLASSE D'UTILIZZO PROFESSIONALE (EN20957-1 / EN957-5 classe S)

BRAKING SYSTEM the air resistance system grants a real smooth feeling
 RESISTANCE ADJUSTMENT 10-level
 SEAT micrometrical vertical and horizontal adjustment
 CONSOLE LCD display blue backlight
 Functions: RPM, Pulse, Distance, Level, Cycle, Speed, Watts, Watts AVG, Time, Time/1km, Calories/hr
 PROGRAMS game, time, distance, calories, 3 interval (1-99 cycles), user
 COMMERCIAL USE (EN20957-1 / EN957-5 class S)

- Trasmissione a cinghia
- Rilevazione cardio: ricevitore wireless per fascia cardio integrato
- Peso max utilizzatore: 150 kg
- Dotazioni: porta borraccia. Supporto per smartphone e tablet. App Ready, FTMS: sistema Bluetooth intelligente integrato che consente di usufruire di app specifiche per l'allenamento. Compatible con Kinomap, Zwift App e tutte le app che utilizzano il protocollo Bluetooth® FTMS (BKool, Rouvy, Wahoo, Fulgaz...). Abbonamenti non inclusi.
- Dimensioni prodotto: 1270x616x1285 mm
- Peso: 45 kg
- Rubber belt
- Heart rate: built-in wireless pulse receiver.
- Max userweight: 150 kg
- Equipment: bottle holder. Smartphone/ tablet holder. App Ready FTMS: Built-in Bluetooth intelligent system which enables your machine to fully interact with the most motivating Apps specifically suitable for training. Compatible with Kinomap, Zwift App and all the Apps that use the Bluetooth® FTMS protocol (BKool, Rouvy, Wahoo, Fulgaz...). Subscriptions not included.
- Set up size: 1270x616x1285 mm
- Weight: 45 kg



BRX AIR CROSS PRO

cod. BRX-AIRCROSS-PRO

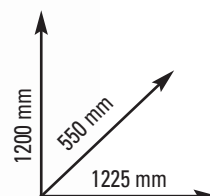

SISTEMA DI FRENAGGIO ad aria con 10 pale radiali
REGOLAZIONE SFORZO dipendente dalla resistenza dell'aria
SELLA regolazione verticale su 5 livelli e regolazione orizzontale su 9 livelli
CONSOLE display LCD retro-illuminato blue backlight - supporto per smartphone e tablet in dotazione.
Informazioni console: RPM, velocità, tempo, distanza, calorie, watt, pulsazioni
PROGRAMMI programma Manuale, programmi Target :tempo, distanza, calorie, pulsazioni. 3 programmi a Intervalli: 10/20, 20/10, Custom
CLASSE D'UTILIZZO PROFESSIONALE (EN20957-1 / EN957-5 classe S)

BRAKING SYSTEM air resistance system with 10 radial blades
RESISTANCE ADJUSTMENT dependent on the air resistance
SEAT vertical adjustment on 5-level and horizontal adjustment on 9-level
CONSOLE LCD display blue backlight - smartphone/ tablet holder included.
Functions: RPM, speed, time, distance, calories, watt, pulse
PROGRAMS Manual, Target programs: time, calories, distance, pulse, 3 Interval programs: 10/20, 20/10, Custom
COMMERCIAL USE (EN20957-1 / EN957-5 class S)

- Trasmissione a cinghia
- Rilevazione cardio: ricevitore wireless per fascia cardio integrato
- Peso max utilizzatore: 150 kg
- Dotazioni: porta borraccia
- Dimensioni prodotto: 1225x550x1200 mm
- Peso: 72 kg

- Drive train belt
- Heart rate: built-in wireless pulse receiver.
- Max userweight: 150 kg
- Equipment: bottle holder
- Set up size: 1225x550x1200 mm
- Weight: 72 kg



BRX AIR CROSS

cod. BRX-AIR-CROSS

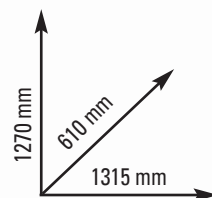

SISTEMA DI FRENAGGIO ad aria con 7 pale radiali
REGOLAZIONE SFORZO dipendente dalla resistenza dell'aria
SEDILE regolazione verticale e regolazione orizzontale micrometrica
POGGIAPIEDI extra large/3 pezzi
CONSOLE display LCD - supporto per smartphone e tablet in dotazione.
Informazioni console: tempo, distanza, calorie, velocità, RPM, pulsazioni, watt
PROGRAMMI Programma Manuale, Programmi Target: Tempo, Distanza, Calorie, Pulsazioni, 3 Programmi a Intervalli: 10/20, 20/10, Custom
CLASSE D'UTILIZZO PROFESSIONALE (EN20957-1 / EN957-5 classe S)

BRAKING SYSTEM air resistance system with 7 radial blades
RESISTANCE ADJUSTMENT dependent on the air resistance
SEAT vertical adjustment and horizontal micrometric adjustment
PEDALS extra large/3 pieces
CONSOLE LCD display - smartphone/ tablet holder included. Functions: time, distance, calories, speed, pulse, RPM, pulsazioni, watt
PROGRAMS Manual, Target programs: Time, Calories, Distance, Pulse, 3 Interval programs: 10/20, 20/10, Custom
COMMERCIAL USE (EN20957-1 / EN957-5 class S)

- Trasmissione a cinghia e a catena
- Rilevazione cardio: ricevitore wireless per fascia cardio integrato
- Peso max utilizzatore: 150 kg
- Dotazioni: porta borraccia
- Dimensioni prodotto: 1315x610x1270 mm
- Peso: 53,5 kg

- Drive train chain and belt
- Heart rate: built-in wireless pulse receiver.
- Max userweight: 150 kg
- Equipment: bottle holder
- Set up size 1315x610x1270 mm
- Weight: 53,5 kg





STRENGTH

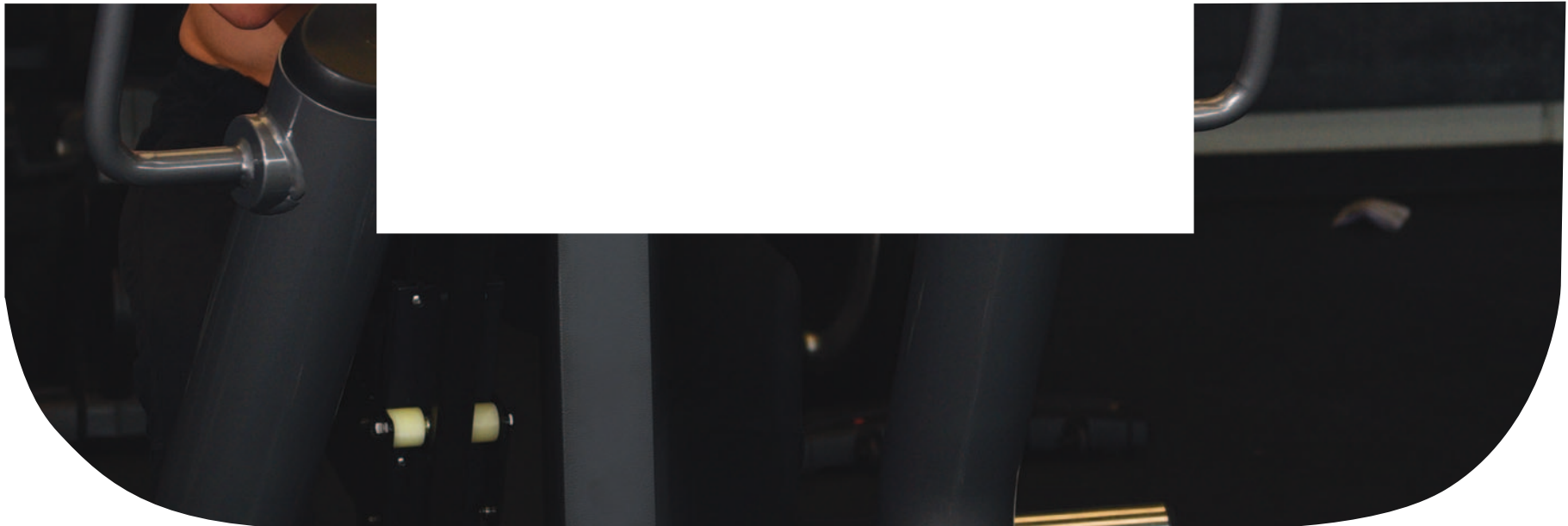

PLX4100

cod. PLX-4100

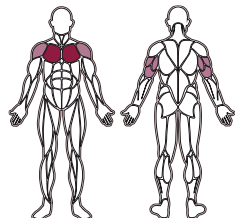

MUSCOLI COINVOLTI MUSCLE GROUPS

- Pettorali - Pectorals
- Tricipiti - Triceps
- Deltoide anteriore - Anterior deltoid

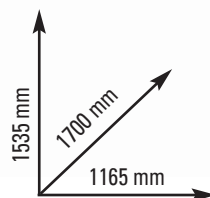

STRENGTH - AKTIV LINE - PIN LOADED

SISTEMA DI SPINTA a telaio fisso
 PACCO PESI 100 kg in acciaio. Carter di protezione integrale
 REGOLAZIONI: altezza sedile su 5 livelli
 DIMENSIONI PRODOTTO: 1165x1700x1535 mm
 PESO MAX UTILIZZATORE 150 Kg
 PESO: 208 kg
 CLASSE D'UTILIZZO PROFESSIONALE (EN20957-1 / EN957-2 classe S)

FIXED FRAME system
 WEIGHT STACK steel 100 kg weight stack with full protection cage
 ADJUSTMENTS: seat height on 5-level
 SET UP SIZE 1165x1700x1535 mm
 MAX USER WEIGHT 150 Kg
 WEIGHT: 208 kg
 COMMERCIAL USE (EN20957-1 / EN957-2 class S)

- Struttura tubolare in acciaio a sezione ovale piatta 50x120 mm - spessore 2,5 mm
- Verniciatura doppia a polveri epossidiche, antigraffio. Trattamento dei tubolari con sabbiatura e fosfatazione
- Sistema di carrucole/pullegge realizzate in NYLON - cuscinetti POWER GRADE
- Sistema di cavi in acciaio ø 5 mm
- Cuscini in schiuma ad alta densità con rivestimento in PU
- Dotazione/ note: porta borraccia/ salvietta incluso
- Structure oval flat steel tubing 50x120 mm - thickness 2,5 mm
- Painting double heavy duty powder coating painting, scratch-resistant. Tubing treatment with sandblasting and phosphating process.
- Pulley system made of NYLON - POWER GRADE bearings
- Cables system steel woven cables ø 5 mm
- High-density foam cushions with PU upholstery
- Equipment/notes: bottle / towel holder included



SHOULDER PRESS

PLX4200

cod. PLX-4200

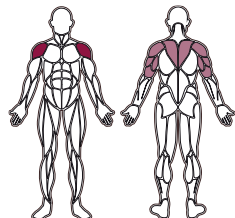

MUSCOLI COINVOLTI MUSCLE GROUPS

- Deltoido anteriore - Anterior deltoid
- Deltoido posteriore - Posterior deltoid
- Tricipiti - Triceps
- Trapezi - Trapezius

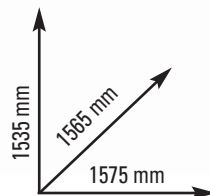

STRENGTH - AKTIV LINE - PIN LOADED

SISTEMA DI SPINTA a leveraggi indipendenti
PACCO PESI 80 kg in acciaio. Carter di protezione integrale
REGOLAZIONI: altezza sedile su 5 livelli
DIMENSIONI PRODOTTO: 1575x1565x1535 mm
PESO MAX UTILIZZATORE 150 Kg
PESO: 201 kg
CLASSE D'UTILIZZO PROFESSIONALE (EN20957-1 / EN957-2 classe S)

INDEPENDENT CONVERGING PUSH leverage system
WEIGHT STACK steel 80 kg weight stack with full protection cage
ADJUSTMENTS: seat height on 5-level
SET UP SIZE 1575x1565x1535 mm
MAX USER WEIGHT 150 Kg
WEIGHT: 201 kg
COMMERCIAL USE (EN20957-1 / EN957-2 class S)

- Struttura tubolare in acciaio a sezione ovale piatta 50x120 mm - spessore 2,5 mm
- Verniciatura doppia a polveri epossidiche, antigraffio. Trattamento dei tubolari con sabbiatura e fosfatazione
- Sistema di carrucole/pulegge realizzate in NYLON - cuscinetti POWER GRADE
- Sistema di cavi in acciaio ø 5 mm
- Cuscini in schiuma ad alta densità con rivestimento in PU
- Dotazione/ note: porta borraccia/ salvietta incluso

- Structure oval flat steel tubing 50x120 mm - thickness 2,5 mm
- Painting double heavy duty powder coating painting, scratch-resistant. Tubing treatment with sandblasting and phosphating process.
- Pulley system made of NYLON - POWER GRADE bearings
- Cables system steel woven cables ø 5 mm
- High-density foam cushions with PU upholstery
- Equipment/notes: bottle / towel holder included



PLX4500

cod. PLX-4500

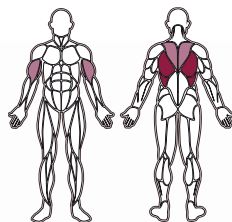

MUSCOLI COINVOLTI
MUSCLE GROUPS

- Gran dorsale - Latissimus dorsi
- Bicipiti - Biceps
- Romboidi - Rhomboids
- Trapezio inferiore - Lower trapezius

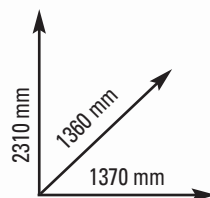

STRENGTH - AKTIV LINE - PIN LOADED

SISTEMA DI TIRO a vettore singolo
 PACCO PESI 120 kg in acciaio. Carter di protezione integrale
 REGOLAZIONI: altezza sedile su 5 livelli
 DIMENSIONI PRODOTTO: 1370x1360x2310 mm
 PESO MAX UTILIZZATORE 150 Kg
 PESO: 207 kg
 CLASSE D'UTILIZZO PROFESSIONALE (EN20957-1 / EN957-2 classe S)

SINGLE VECTOR PUSH system
 WEIGHT STACK steel 120 kg weight stack with full protection cage
 ADJUSTMENTS: seat height on 5-level
 SET UP SIZE 1370x1360x2310 mm
 MAX USER WEIGHT 150 Kg
 WEIGHT: 207 kg
 COMMERCIAL USE (EN20957-1 / EN957-2 class S)

- Struttura tubolare in acciaio a sezione ovale piatta 50x120 mm - spessore 2,5 mm
- Verniciatura doppia a polveri epossidiche, antigraffio.
- Trattamento dei tubolari con sabbiatura e fosfatazione
- Sistema di carrucole/pulegge realizzate in NYLON - cuscinetti POWER GRADE
- Sistema di cavi in acciaio ø 5 mm
- Cuscini in schiuma ad alta densità con rivestimento in PU
- Dotazione/ note: porta borraccia/ salvietta incluso
- Structure oval flat steel tubing 50x120 mm - thickness 2,5 mm
- Painting double heavy duty powder coating painting, scratch-resistant.
- Tubing treatment with sandblasting and phosphating process.
- Pulley system made of NYLON - POWER GRADE bearings
- Cables system steel woven cables ø 5 mm
- High-density foam cushions with PU upholstery
- Equipment/notes: bottle / towel holder included



PLX4000

cod. PLX-4000

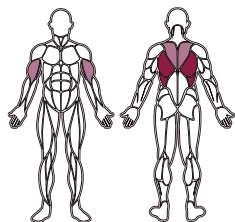
MUSCOLI COINVOLTI
MUSCLE GROUPS

- Gran dorsale - Latissimus dorsi
- Bicipiti - Biceps
- Romboidi - Rhomboids
- Trapezio inferiore - Lower trapezius

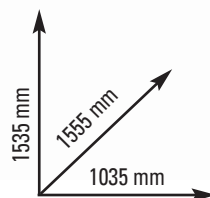

STRENGTH - AKTIV LINE - PIN LOADED

SISTEMA DI SPINTA a telaio fisso
 PACCO PESI 100 kg in acciaio. Carter di protezione integrale
 REGOLAZIONI: altezza sedile su 5 livelli. Profondità schienale su 8 livelli
 DIMENSIONI PRODOTTO: 1035x1555x1535 mm
 PESO MAX UTILIZZATORE 150 Kg
 PESO: 215 kg
 CLASSE D'UTILIZZO PROFESSIONALE (EN20957-1 / EN957-2 classe S)

FIXED FRAME system
 WEIGHT STACK steel 100 kg weight stack with full protection cage
 ADJUSTMENTS: seat height on 5-level. Backrest width on 8-level
 SET UP SIZE 1035x1555x1535 mm
 MAX USER WEIGHT 150 Kg
 WEIGHT: 215 kg
 COMMERCIAL USE (EN20957-1 / EN957-2 class S)

- Struttura tubolare in acciaio a sezione ovale piatta 50x120 mm - spessore 2,5 mm
- Verniciatura doppia a polveri epossidiche, antigraffio. Trattamento dei tubolari con sabbiatura e fosfatazione
- Sistema di carrucole/pullegge realizzate in NYLON - cuscinetti POWER GRADE
- Sistema di cavi in acciaio ø 5 mm
- Cuscini in schiuma ad alta densità con rivestimento in PU
- Dotazione/ note: porta borraccia/ salvietta incluso

- Structure oval flat steel tubing 50x120 mm - thickness 2,5 mm
- Painting double heavy duty powder coating painting, scratch-resistant. Tubing treatment with sandblasting and phosphating process.
- Pulley system made of NYLON - POWER GRADE bearings
- Cables system steel woven cables ø 5 mm
- High-density foam cushions with PU upholstery
- Equipment/notes: bottle / towel holder included



PULLEY

PLX3900

cod. PLX-3900

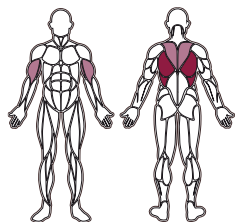

MUSCOLI COINVOLTI MUSCLE GROUPS

- Gran dorsale - Latissimus dorsi
- Bicipiti - Biceps
- Romboidi - Rhomboids
- Trapezio inferiore - Lower trapezius

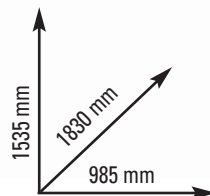

STRENGTH - AKTIV LINE - PIN LOADED

SISTEMA DI SPINTA a vettore singolo
PACCO PESI 120 kg in acciaio. Carter di protezione integrale
DIMENSIONI PRODOTTO: 985x1830x1535 mm
PESO MAX UTILIZZATORE 150 Kg
PESO: 193 kg
CLASSE D'UTILIZZO PROFESSIONALE (EN20957-1 / EN957-2 classe S)

SINGLE VECTOR system
WEIGHT STACK steel 120 kg weight stack with full protection cage
SET UP SIZE 985x1830x1535 mm
MAX USER WEIGHT 150 Kg
WEIGHT: 193 kg
COMMERCIAL USE (EN20957-1 / EN957-2 class S)

- Struttura tubolare in acciaio a sezione ovale piatta 50x120 mm - spessore 2,5 mm
- Verniciatura doppia a polveri epossidiche, antigraffio.
Trattamento dei tubolari con sabbatura e fosfatazione
- Sistema di carrucole/pulegge realizzate in NYLON - cuscinetti POWER GRADE
- Sistema di cavi in acciaio ø 5 mm
- Cuscini in schiuma ad alta densità con rivestimento in PU
- Dotazione/ note: porta borraccia/ salvietta incluso

- Structure oval flat steel tubing 50x120 mm - thickness 2,5 mm
- Painting double heavy duty powder coating painting, scratch-resistant.
Tubing treatment with sandblasting and phosphating process.
- Pulley system made of NYLON - POWER GRADE bearings
- Cables system steel woven cables ø 5 mm
- High-density foam cushions with PU upholstery
- Equipment/notes: bottle / towel holder included



PLX4900

cod. PLX-4900

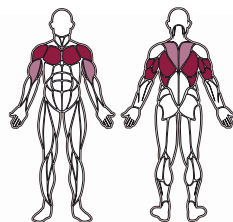

MUSCOLI COINVOLTI MUSCLE GROUPS

- Gran dorsale - Latissimus dorsi
- Pettorali - Pectorals
- Deltoidi anteriori - Anterior deltoids
- Tricipiti - Triceps
- Bicipiti - Biceps
- Romboidi - Rhomboids
- Trapezio inferiore - Lower trapezius

PACCO PESI 120 kg in acciaio. Carter di protezione integrale
 DIMENSIONI PRODOTTO: 1455x1275x2335 mm
 PESO MAX UTILIZZATORE 150 Kg
 PESO: 258 kg
 CLASSE D'UTILIZZO PROFESSIONALE (EN20957-1 / EN957-2 classe S)

WEIGHT STACK steel 120 kg weight stack with full protection cage
 SET UP SIZE 1455x1275x2335 mm
 MAX USER WEIGHT 150 Kg
 WEIGHT: 258 kg
 COMMERCIAL USE (EN20957-1 / EN957-2 class S)

- Struttura tubolare in acciaio a sezione ovale piatta 50x120 mm - spessore 2,5 mm
- Verniciatura doppia a polveri epossidiche, antigraffio.
- Trattamento dei tubolari con sabbiatura e fosfatazione
- Sistema di carrucole/pulegge realizzate in NYLON - cuscinetti POWER GRADE
- Sistema di cavi in acciaio ø 5 mm
- Cuscini in schiuma ad alta densità con rivestimento in PU
- Dotazione/ note: porta borraccia/ salvietta incluso

- Structure oval flat steel tubing 50x120 mm - thickness 2,5 mm
- Painting double heavy duty powder coating painting, scratch-resistant.
- Tubing treatment with sandblasting and phosphating process.
- Pulley system made of NYLON - POWER GRADE bearings
- Cables system steel woven cables ø 5 mm
- High-density foam cushions with PU upholstery
- Equipment/notes: bottle / towel holder included

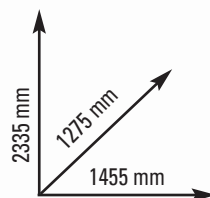

BICEPS CURL

PLX3800

cod. PLX-3800

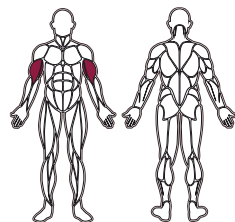

MUSCOLI COINVOLTI MUSCLE GROUPS

■ Bicipiti - Biceps

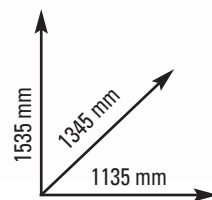

STRENGTH - AKTIV LINE - PIN LOADED

SISTEMA DI TIRO a leveraggio singolo
PACCO PESI 80 kg in acciaio. Carter di protezione integrale
REGOLAZIONI: altezza sedile su 5 livelli
DIMENSIONI PRODOTTO: 1135x1345x1535 mm
PESO MAX UTILIZZATORE 150 Kg
PESO: 180 kg
CLASSE D'UTILIZZO PROFESSIONALE (EN20957-1 / EN957-2 classe S)

SINGLE PUSH LEVERAGE system
WEIGHT STACK steel 80 kg weight stack with full protection cage
ADJUSTMENTS: seat height on 5-level
SET UP SIZE 1135x1345x1535 mm
MAX USER WEIGHT 150 Kg
WEIGHT: 180 kg
COMMERCIAL USE (EN20957-1 / EN957-2 class S)

- Struttura tubolare in acciaio a sezione ovale piatta 50x120 mm - spessore 2,5 mm
- Verniciatura doppia a polveri epossidiche, antigraffio. Trattamento dei tubolari con sabbatura e fosfatazione
- Sistema di carrucole/pulegge realizzate in NYLON - cuscinetti POWER GRADE
- Sistema di cavi in acciaio ø 5 mm
- Cuscini in schiuma ad alta densità con rivestimento in PU
- Dotazione/ note: porta borraccia/ salvietta incluso

- Structure oval flat steel tubing 50x120 mm - thickness 2,5 mm
- Painting double heavy duty powder coating painting, scratch-resistant. Tubing treatment with sandblasting and phosphating process.
- Pulley system made of NYLON - POWER GRADE bearings
- Cables system steel woven cables ø 5 mm
- High-density foam cushions with PU upholstery
- Equipment/notes: bottle / towel holder included



TRICEPS PRESS

PLX4400

cod. PLX-4400

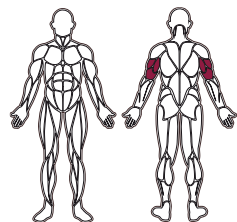

MUSCOLI COINVOLTI MUSCLE GROUPS

■ Tricipiti - Triceps

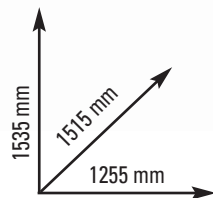

STRENGTH - AKTIV LINE - PIN LOADED

SISTEMA DI SPINTA a telaio fisso
PACCO PESI 80 kg in acciaio. Carter di protezione integrale
REGOLAZIONI: altezza sedile su 5 livelli
DIMENSIONI PRODOTTO: 1255x1515x1535 mm
PESO MAX UTILIZZATORE 150 Kg
PESO: 214 kg
CLASSE D'UTILIZZO PROFESSIONALE (EN20957-1 / EN957-2 classe S)

FIXED FRAME system
WEIGHT STACK steel 80 kg weight stack with full protection cage
ADJUSTMENTS: seat height on 5-level
SET UP SIZE 1255x1515x1535 mm
MAX USER WEIGHT 150 Kg
WEIGHT: 214 kg
COMMERCIAL USE (EN20957-1 / EN957-2 class S)

- Struttura tubolare in acciaio a sezione ovale piatta 50x120 mm - spessore 2,5 mm
- Verniciatura doppia a polveri epossidiche, antigraffio. Trattamento dei tubolari con sabbiatura e fosfatazione
- Sistema di carrucole/pulegge realizzate in NYLON - cuscinetti POWER GRADE
- Sistema di cavi in acciaio ø 5 mm
- Cuscini in schiuma ad alta densità con rivestimento in PU
- Dotazione/ note: porta borraccia/ salvietta incluso

- Structure oval flat steel tubing 50x120 mm - thickness 2,5 mm
- Painting double heavy duty powder coating painting, scratch-resistant. Tubing treatment with sandblasting and phosphating process.
- Pulley system made of NYLON - POWER GRADE bearings
- Cables system steel woven cables ø 5 mm
- High-density foam cushions with PU upholstery
- Equipment/notes: bottle / towel holder included

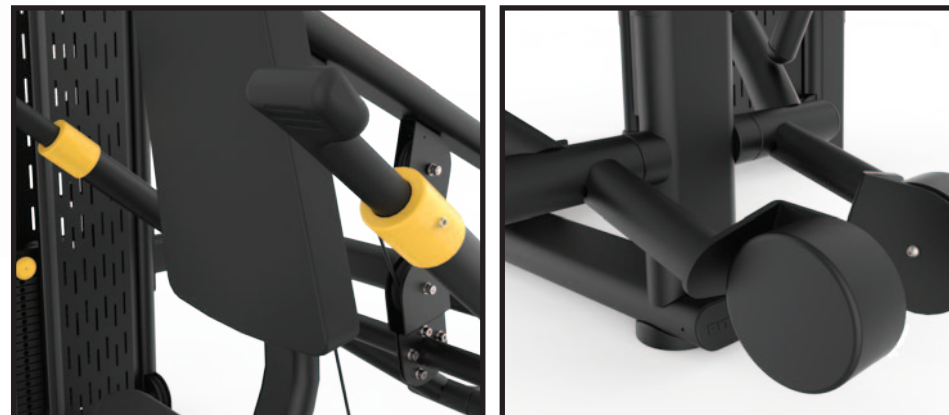

HORIZONTAL LEG PRESS

PLX4800

cod. PLX-4800

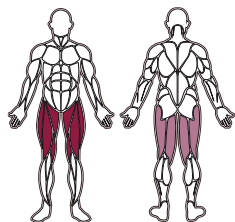

MUSCOLI COINVOLTI MUSCLE GROUPS

- Quadricipiti - Quadriceps
- Ischiocrurali - Hamstrings

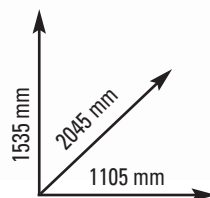

STRENGTH - AKTIV LINE - PIN LOADED

SISTEMA DI SPINTA a pedana
PACCO PESI 130 kg in acciaio. Carter di protezione integrale
REGOLAZIONI: pedana su 4 livelli
DIMENSIONI PRODOTTO: 1105x2045x1535 mm
PESO MAX UTILIZZATORE 150 Kg
PESO: 241 kg
CLASSE D'UTILIZZO PROFESSIONALE (EN20957-1 / EN957-2 classe S)

PLATFORM PUSH system
WEIGHT STACK steel 130 kg weight stack with full protection cage
ADJUSTMENTS: platform on 4-level
SET UP SIZE 1105x2045x1535 mm
MAX USER WEIGHT 150 Kg
WEIGHT: 241 kg
COMMERCIAL USE (EN20957-1 / EN957-2 class S)

- Struttura tubolare in acciaio a sezione ovale piatta 50x120 mm - spessore 2,5 mm
- Verniciatura doppia a polveri epossidiche, antigraffio. Trattamento dei tubolari con sabbatura e fosfatazione
- Sistema di carrucole/pullegge realizzate in NYLON - cuscinetti POWER GRADE
- Sistema di cavi in acciaio ø 5 mm
- Cuscini in schiuma ad alta densità con rivestimento in PU
- Dotazione/ note: porta borraccia/ salvietta incluso

- Structure oval flat steel tubing 50x120 mm - thickness 2,5 mm
- Painting double heavy duty powder coating painting, scratch-resistant. Tubing treatment with sandblasting and phosphating process.
- Pulley system made of NYLON - POWER GRADE bearings
- Cables system steel woven cables ø 5 mm
- High-density foam cushions with PU upholstery
- Equipment/notes: bottle / towel holder included



LEG EXTENSION

PLX4600

cod. PLX-4600

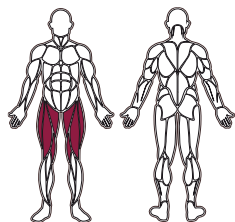

MUSCOLI COINVOLTI MUSCLE GROUPS

■ Quadricipiti - Quadriceps

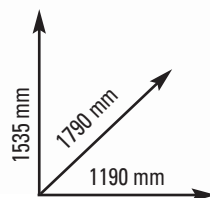

STRENGTH - AKTIV LINE - PIN LOADED

SISTEMA DI SPINTA a leveraggio singolo
PACCO PESI 120 kg in acciaio. Carter di protezione integrale
REGOLAZIONI: bracci su 4 livelli. Profondità schienale su 10 livelli.
Altezza rulli gambe su 4 livelli
DIMENSIONI PRODOTTO: 1190x1790x1535 mm
PESO MAX UTILIZZATORE 150 Kg
PESO: 224 kg
CLASSE D'UTILIZZO PROFESSIONALE (EN20957-1 / EN957-2 classe S)

SINGLE PUSH leverage system
WEIGHT STACK steel 120 kg weight stack with full protection cage
ADJUSTMENTS: moving arms on 4-level. Backrest width on 10-level.
Leg rollers height on 4-level
SET UP SIZE 1190x1790x1535 mm
MAX USER WEIGHT 150 Kg
WEIGHT: 224 kg
COMMERCIAL USE (EN20957-1 / EN957-2 class S)

- Struttura tubolare in acciaio a sezione ovale piatta 50x120 mm - spessore 2,5 mm
- Verniciatura doppia a polveri epossidiche, antigraffio.
- Trattamento dei tubolari con sabbatura e fosfatazione
- Sistema di carrucole/pullegge realizzate in NYLON - cuscinetti POWER GRADE
- Sistema di cavi in acciaio ø 5 mm
- Cuscini in schiuma ad alta densità con rivestimento in PU
- Dotazione/ note: porta borraccia/ salvietta incluso

- Structure oval flat steel tubing 50x120 mm - thickness 2,5 mm
- Painting double heavy duty powder coating painting, scratch-resistant.
- Tubing treatment with sandblasting and phosphating process.
- Pulley system made of NYLON - POWER GRADE bearings
- Cables system steel woven cables ø 5 mm
- High-density foam cushions with PU upholstery
- Equipment/notes: bottle / towel holder included



PRONE LEG CURL

PLX4300

cod. PLX-4300

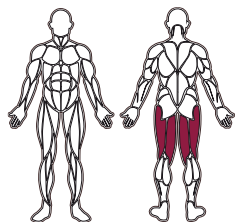

MUSCOLI COINVOLTI MUSCLE GROUPS

■ Ischiocrurali - Hamstrings

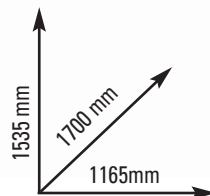

STRENGTH - AKTIV LINE - PIN LOADED

SISTEMA DI SPINTA a leveraggio singolo
PACCO PESI 80 kg in acciaio. Carter di protezione integrale
REGOLAZIONI: bracci su 4 livelli. Altezza rulli gambe su 4 livelli
DIMENSIONI PRODOTTO: 1165x1700x1535 mm
PESO MAX UTILIZZATORE 150 Kg
PESO: 205 kg
CLASSE D'UTILIZZO PROFESSIONALE (EN20957-1 / EN957-2 classe S)

SINGLE PUSH leverage system
WEIGHT STACK steel 80 kg weight stack with full protection cage
ADJUSTMENTS: moving arms on 4-level. Leg rollers height on 4-level
SET UP SIZE 1165x1700x1535 mm
MAX USER WEIGHT 150 Kg
WEIGHT: 205 kg
COMMERCIAL USE (EN20957-1 / EN957-2 class S)

- Struttura tubolare in acciaio a sezione ovale piatta 50x120 mm - spessore 2,5 mm
- Verniciatura doppia a polveri epossidiche, antigraffio. Trattamento dei tubolari con sabbiatura e fosfatazione
- Sistema di carrucole/pullegge realizzate in NYLON - cuscinetti POWER GRADE
- Sistema di cavi in acciaio ø 5 mm
- Cuscini in schiuma ad alta densità con rivestimento in PU
- Dotazione/ note: porta borraccia/ salvietta incluso

- Structure oval flat steel tubing 50x120 mm - thickness 2,5 mm
- Painting double heavy duty powder coating painting, scratch-resistant. Tubing treatment with sandblasting and phosphating process.
- Pulley system made of NYLON - POWER GRADE bearings
- Cables system steel woven cables ø 5 mm
- High-density foam cushions with PU upholstery
- Equipment/notes: bottle / towel holder included



MULTI HIP

PLX4700

cod. PLX-4700

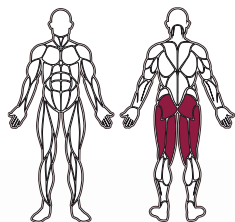

MUSCOLI COINVOLTI MUSCLE GROUPS

- Glutei - Gluteus
- Ischiocrurali - Hamstrings

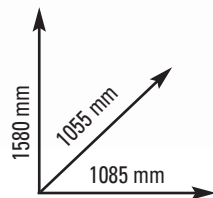

STRENGTH - AKTIV LINE - PIN LOADED

SISTEMA DI TIRO ad avvolgimento
PACCO PESI 80 kg in acciaio. Carter di protezione integrale
REGOLAZIONI: bracci su 8 livelli. Altezza rulli gambe su 13 livelli
DIMENSIONI PRODOTTO: 1085x1055x1580 mm
PESO MAX UTILIZZATORE 150 Kg
PESO: 210 kg
CLASSE D'UTILIZZO PROFESSIONALE (EN20957-1 / EN957-2 classe S)

WINDING PULL system
WEIGHT STACK steel 80 kg weight stack with full protection cage
ADJUSTMENTS: moving arms on 8-level. Leg rollers height on 13-level
SET UP SIZE 1085x1055x1580 mm
MAX USER WEIGHT 150 Kg
WEIGHT: 210 kg
COMMERCIAL USE (EN20957-1 / EN957-2 class S)

- Struttura tubolare in acciaio a sezione ovale piatta 50x120 mm - spessore 2,5 mm
- Verniciatura doppia a polveri epossidiche, antigraffio. Trattamento dei tubolari con sabbatura e fosfatazione
- Sistema di carrucole/pullegge realizzate in NYLON - cuscinetti POWER GRADE
- Sistema di cavi in acciaio ø 5 mm
- Cuscini in schiuma ad alta densità con rivestimento in PU
- Dotazione/ note: porta borraccia/ salvietta incluso
- Structure oval flat steel tubing 50x120 mm - thickness 2,5 mm
- Painting double heavy duty powder coating painting, scratch-resistant. Tubing treatment with sandblasting and phosphating process.
- Pulley system made of NYLON - POWER GRADE bearings
- Cables system steel woven cables ø 5 mm
- High-density foam cushions with PU upholstery
- Equipment/notes: bottle / towel holder included



ABDUCTOR

PLX3700

cod. PLX-3700

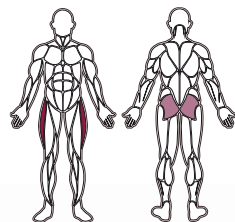

MUSCOLI COINVOLTI MUSCLE GROUPS

- Abduttori - Abductors
- Glutei - Gluteus

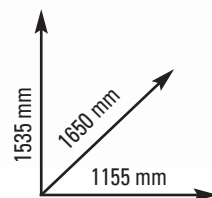

STRENGTH - AKTIV LINE - PIN LOADED

SISTEMA DI SPINTA a leveraggi indipendenti
PACCO PESI 80 kg in acciaio. Carter di protezione integrale
REGOLAZIONI: bracci su 7 livelli
DIMENSIONI PRODOTTO: 1155x1650x1535 mm
PESO MAX UTILIZZATORE 150 Kg
PESO: 200 kg
CLASSE D'UTILIZZO PROFESSIONALE (EN20957-1 / EN957-2 classe S)

INDEPENDENT CONVERGING PUSH leverage system
WEIGHT STACK steel 80 kg weight stack with full protection cage
ADJUSTMENTS: moving arms on 7-level
SET UP SIZE 1155x1650x1535 mm
MAX USER WEIGHT 150 Kg
WEIGHT: 200 kg
COMMERCIAL USE (EN20957-1 / EN957-2 class S)

- Struttura tubolare in acciaio a sezione ovale piatta 50x120 mm - spessore 2,5 mm
- Verniciatura doppia a polveri epossidiche, antigraffio. Trattamento dei tubolari con sabbiatura e fosfatazione
- Sistema di carrucole/pullegge realizzate in NYLON - cuscinetti POWER GRADE
- Sistema di cavi in acciaio ø 5 mm
- Cuscini in schiuma ad alta densità con rivestimento in PU
- Dotazione/ note: porta borraccia/ salvietta incluso

- Structure oval flat steel tubing 50x120 mm - thickness 2,5 mm
- Painting double heavy duty powder coating painting, scratch-resistant. Tubing treatment with sandblasting and phosphating process.
- Pulley system made of NYLON - POWER GRADE bearings
- Cables system steel woven cables ø 5 mm
- High-density foam cushions with PU upholstery
- Equipment/notes: bottle / towel holder included



ADDUCTOR

PLX3600

cod. PLX-3600

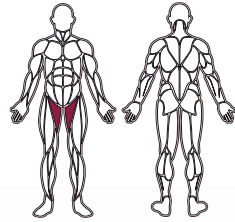

MUSCOLI COINVOLTI MUSCLE GROUPS

■ Adduttori - Adductors

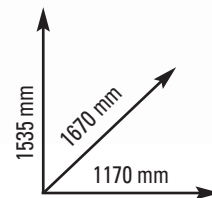

STRENGTH - AKTIV LINE - PIN LOADED

SISTEMA DI SPINTA a leveraggi indipendenti
PACCO PESI 80 kg in acciaio. Carter di protezione integrale
REGOLAZIONI: bracci su 7 livelli
DIMENSIONI PRODOTTO: 1170x1670x1535 mm
PESO MAX UTILIZZATORE 150 Kg
PESO: 200 kg
CLASSE D'UTILIZZO PROFESSIONALE (EN20957-1 / EN957-2 classe S)

INDEPENDENT PUSH leverage system
WEIGHT STACK steel 80 kg weight stack with full protection cage
ADJUSTMENTS: moving arms on 7-level
SET UP SIZE 1170x1670x1535 mm
MAX USER WEIGHT 150 Kg
WEIGHT: 200 kg
COMMERCIAL USE (EN20957-1 / EN957-2 class S)

- Struttura tubolare in acciaio a sezione ovale piatta 50x120 mm - spessore 2,5 mm
- Verniciatura doppia a polveri epossidiche, antigraffio. Trattamento dei tubolari con sabbiatura e fosfatazione
- Sistema di carrucole/pullegge realizzate in NYLON - cuscinetti POWER GRADE
- Sistema di cavi in acciaio ø 5 mm
- Cuscini in schiuma ad alta densità con rivestimento in PU
- Dotazione/ note: porta borraccia/ salvietta incluso

- Structure oval flat steel tubing 50x120 mm - thickness 2,5 mm
- Painting double heavy duty powder coating painting, scratch-resistant. Tubing treatment with sandblasting and phosphating process.
- Pulley system made of NYLON - POWER GRADE bearings
- Cables system steel woven cables ø 5 mm
- High-density foam cushions with PU upholstery
- Equipment/notes: bottle / towel holder included



PLX5000

cod. PLX-5000

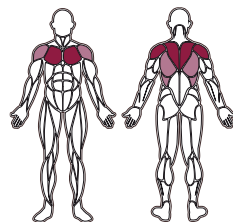

MUSCOLI COINVOLTI MUSCLE GROUPS

- Pettorali - Pectorals
- Deltoidi posteriori - Posterior deltoids
- Trapezi - Trapezius
- Gran dorsale - Latissimus dorsi
- Sottospinato - Infraspinatus

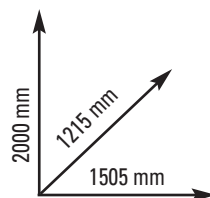

SISTEMA DI SPINTA a leveraggi indipendenti
 PACCO PESI 80 kg in acciaio. Carter di protezione integrale
 REGOLAZIONI: bracci su 6 livelli. Altezza sedile su 5 livelli
 DIMENSIONI PRODOTTO: 1505x1215x2000 mm
 PESO MAX UTILIZZATORE 150 Kg
 PESO: 213 kg
 CLASSE D'UTILIZZO PROFESSIONALE (EN20957-1 / EN957-2 classe S)

INDEPENDENT CONVERGING PUSH leverage system
 WEIGHT STACK steel 80 kg weight stack with full protection cage
 ADJUSTMENTS: moving arms on 6-level. Seat height on 5-level
 SET UP SIZE 1505x1215x2000 mm
 MAX USER WEIGHT 150 Kg
 WEIGHT: 213 kg
 COMMERCIAL USE (EN20957-1 / EN957-2 class S)

- Struttura tubolare in acciaio a sezione ovale piatta 50x120 mm - spessore 2,5 mm
- Verniciatura doppia a polveri epossidiche, antigraffio.
- Trattamento dei tubolari con sabbiatura e fosfatazione
- Sistema di carrucole/pulegge realizzate in NYLON - cuscinetti POWER GRADE
- Sistema di cavi in acciaio ø 5 mm
- Cuscini in schiuma ad alta densità con rivestimento in PU
- Dotazione/ note: porta borraccia/ salvietta incluso

- Structure oval flat steel tubing 50x120 mm - thickness 2,5 mm
- Painting double heavy duty powder coating painting, scratch-resistant.
- Tubing treatment with sandblasting and phosphating process.
- Pulley system made of NYLON - POWER GRADE bearings
- Cables system steel woven cables ø 5 mm
- High-density foam cushions with PU upholstery
- Equipment/notes: bottle / towel holder included



PLX5200

cod. PLX-5200

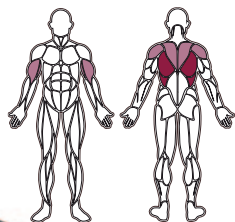

MUSCOLI COINVOLTI MUSCLE GROUPS

- Gran dorsale - Latissimus dorsi
- Bicipiti - Biceps
- Romboidi - Rhomboids
- Trapezio inferiore - Lower trapezius
- Deltoidi posteriori - Posterior deltoids

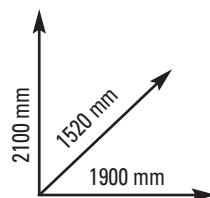

SISTEMA DI TIRO a vettore singolo
 PACCO PESI 100 kg in acciaio. Carter di protezione integrale
 REGOLAZIONI: altezza rulli leg press su 4 livelli
 DIMENSIONI PRODOTTO: 1900x1520x2100 mm
 PESO MAX UTILIZZATORE 150 Kg
 PESO: 230 kg
 CLASSE D'UTILIZZO PROFESSIONALE (EN20957-1 / EN957-2 classe S)

SINGLE VECTOR PUSH system
 WEIGHT STACK steel 100 kg weight stack with full protection cage
 ADJUSTMENTS: leg press rollers height on 4-level
 SET UP SIZE 1900x1520x2100 mm
 MAX USER WEIGHT 150 Kg
 WEIGHT: 230 kg
 COMMERCIAL USE (EN20957-1 / EN957-2 class S)

- Struttura tubolare in acciaio a sezione ovale piatta 50x120 mm - spessore 2,5 mm
- Verniciatura doppia a polveri epossidiche, antigraffio. Trattamento dei tubolari con sabbiatura e fosfatazione
- Sistema di carrucole/pullegge realizzate in NYLON - cuscinetti POWER GRADE
- Sistema di cavi in acciaio ø 5 mm
- Cuscini in schiuma ad alta densità con rivestimento in PU
- Dotazione/ note: porta borraccia/ salvietta incluso

- Structure oval flat steel tubing 50x120 mm - thickness 2,5 mm
- Painting double heavy duty powder coating painting, scratch-resistant. Tubing treatment with sandblasting and phosphating process.
- Pulley system made of NYLON - POWER GRADE bearings
- Cables system steel woven cables ø 5 mm
- High-density foam cushions with PU upholstery
- Equipment/notes: bottle / towel holder included



SEATED LEG CURL/LEG EXTENSION - DUAL FUNCTION

PLX5600

cod. PLX-5600

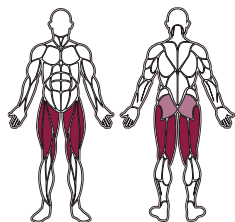

MUSCOLI COINVOLTI MUSCLE GROUPS

- Quadricipiti - Quadriceps
- Femorali - Femorals
- Glutei - Gluteus

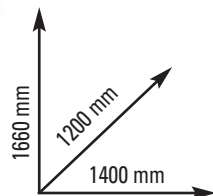

STRENGTH - AKTIV LINE - PIN LOADED

SISTEMA DI SPINTA a leveraggio singolo
PACCO PESI 100 kg in acciaio. Carter di protezione integrale
REGOLAZIONI: bracci su 6 livelli. Profondità schienale su 5 livelli.
Altezza rulli leg press su 4 livelli
DIMENSIONI PRODOTTO: 1400x1200x1660 mm
PESO MAX UTILIZZATORE 150 Kg
PESO: 245 kg
CLASSE D'UTILIZZO PROFESSIONALE (EN20957-1 / EN957-2 classe S)

SINGLE PUSH LEVERAGE system
WEIGHT STACK steel 100 kg weight stack with full protection cage
ADJUSTMENTS: moving arms on 6-level. Backrest width on 5-level.
Leg press rollers height on 4-level
SET UP SIZE 1400x1200x1660 mm
MAX USER WEIGHT 150 Kg
WEIGHT: 245 kg
COMMERCIAL USE (EN20957-1 / EN957-2 class S)

- Struttura tubolare in acciaio a sezione ovale piatta 50x120 mm - spessore 2,5 mm
- Verniciatura doppia a polveri epossidiche, antigraffio. Trattamento dei tubolari con sabbatura e fosfatazione
- Sistema di carrucole/pulegge realizzate in NYLON - cuscinetti POWER GRADE
- Sistema di cavi in acciaio ø 5 mm
- Cuscini in schiuma ad alta densità con rivestimento in PU
- Dotazione/ note: porta borraccia/ salvietta incluso

- Structure oval flat steel tubing 50x120 mm - thickness 2,5 mm
- Painting double heavy duty powder coating painting, scratch-resistant. Tubing treatment with sandblasting and phosphating process.
- Pulley system made of NYLON - POWER GRADE bearings
- Cables system steel woven cables ø 5 mm
- High-density foam cushions with PU upholstery
- Equipment/notes: bottle / towel holder included

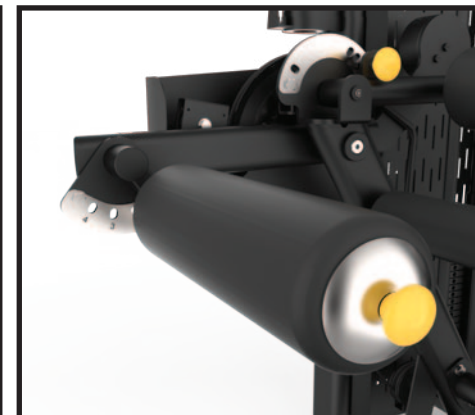

PLX5400

cod. PLX-5400

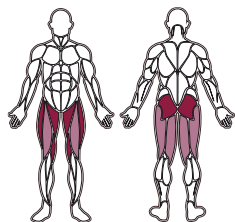

MUSCOLI COINVOLTI MUSCLE GROUPS

- Glutei - Gluteus
- Adduttori - Adductors
- Abduttori - Abductors
- Quadricipiti - Quadriceps
- Femorali - Femorals

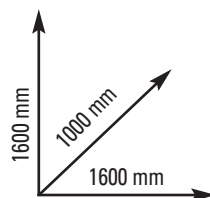

SISTEMA DI SPINTA a leveraggi indipendenti
 PACCO PESI 80 kg in acciaio. Carter di protezione integrale
 REGOLAZIONI: bracci su 6 livelli
 DIMENSIONI PRODOTTO: 1600x1000x1600 mm
 PESO MAX UTILIZZATORE 150 Kg
 PESO: 215 kg
 CLASSE D'UTILIZZO PROFESSIONALE (EN20957-1 / EN957-2 classe S)

INDEPENDENT PUSH leverage system
 WEIGHT STACK steel 80 kg weight stack with full protection cage
 ADJUSTMENTS: moving arms on 6-level
 SET UP SIZE 1600x1000x1600 mm
 MAX USER WEIGHT 150 Kg
 WEIGHT: 215 kg
 COMMERCIAL USE (EN20957-1 / EN957-2 class S)

- Struttura tubolare in acciaio a sezione ovale piatta 50x120 mm - spessore 2,5 mm
- Verniciatura doppia a polveri epossidiche, antigraffio. Trattamento dei tubolari con sabbiatura e fosfatazione
- Sistema di carrucole/pulegge realizzate in NYLON - cuscinetti POWER GRADE
- Sistema di cavi in acciaio ø 5 mm
- Cuscini in schiuma ad alta densità con rivestimento in PU
- Dotazione/ note: porta borraccia/ salvietta incluso

- Structure oval flat steel tubing 50x120 mm - thickness 2,5 mm
- Painting double heavy duty powder coating painting, scratch-resistant. Tubing treatment with sandblasting and phosphating process.
- Pulley system made of NYLON - POWER GRADE bearings
- Cables system steel woven cables ø 5 mm
- High-density foam cushions with PU upholstery
- Equipment/notes: bottle / towel holder included



FWX5800

cod. FWX-5800

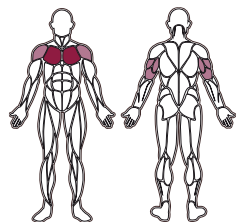
**MUSCOLI COINVOLTI**
MUSCLE GROUPS

- Pettorali - Pectorals
- Tricipiti - Triceps
- Deltoide anteriore - Anterior deltoid

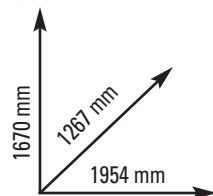

SISTEMA DI SPINTA a leveraggi convergenti
 DIMENSIONI PRODOTTO: 1954x1267x1670 mm
 PESO MAX UTILIZZATORE 150 Kg
 PESO MAX CARICABILE 200 Kg
 PESO: 132 kg
 CLASSE D'UTILIZZO PROFESSIONALE
 (EN ISO 20957-1 / EN ISO 20957-2 classe S)

CONVERGENT PUSH leverage system
 SET UP SIZE 1954x1267x1670 mm
 MAX USER WEIGHT 150 Kg
 MAX LOADABLE WEIGHT 200 Kg
 WEIGHT: 132 kg
 COMMERCIAL USE (EN ISO 20957-1 / EN ISO 20957-2 class S)

- Struttura tubolare in acciaio rinforzato a sezione ovale piatta 50x110 mm - spessore 3 mm. Bracci di movimento in acciaio rinforzato a sezione circolare \varnothing 89 mm - spessore 3 mm
- Verniciatura doppia a polveri epossidiche, antigraffio. Trattamento dei tubolari con sabbiatura e fosfatazione
- Sistema di cuscinetti POWER GRADE per garantire uno scorrimento preciso e progressivo
- Cuscini in schiuma ad alta densità che si adattano alla forma del corpo dell'utilizzatore garantendo sostegno e un comfort ottimale
- Structure oval flat heavy-duty steel tubing 50x110 mm - thickness 3 mm. Movement arms made of round heavy-duty steel tubing \varnothing 89 mm - thickness 3 mm
- Painting double heavy duty powder coating painting, scratch-resistant. Tubing treatment with sandblasting and phosphating process.
- Pulleys system POWER GRADE bearings for a smooth and precise action
- High-density foam cushions anatomically adaptable to the body shape



FWX5400

cod. FWX-5400

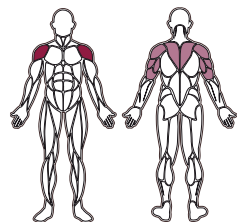
MUSCOLI COINVOLTI
MUSCLE GROUPS

- Deltoide anteriore - Anterior deltoid
- Deltoidi posteriori - Posterior deltoids
- Tricipiti - Triceps
- Trapezi - Trapezius

SISTEMA DI SPINTA a leveraggi convergenti
 DIMENSIONI PRODOTTO: 1945x1345x1705 mm
 PESO MAX UTILIZZATORE 150 Kg
 PESO MAX CARICABILE 200 Kg
 PESO: 132 kg
 CLASSE D'UTILIZZO PROFESSIONALE
 (EN ISO 20957-1 / EN ISO 20957-2 classe S)

CONVERGENT PUSH leverage system
 SET UP SIZE 1945x1345x1705 mm
 MAX USER WEIGHT 150 Kg
 MAX LOADABLE WEIGHT 200 Kg
 WEIGHT: 132 kg
 COMMERCIAL USE (EN ISO 20957-1 / EN ISO 20957-2 class S)

- Struttura tubolare in acciaio rinforzato a sezione ovale piatta 50x110 mm - spessore 3 mm. Bracci di movimento in acciaio rinforzato a sezione circolare \varnothing 89 mm - spessore 3 mm
- Verniciatura doppia a polveri epossidiche, antigraffio. Trattamento dei tubolari con sabbatura e fosfatazione
- Sistema di cuscinetti POWER GRADE per garantire uno scorrimento preciso e progressivo
- Cuscini in schiuma ad alta densità che si adattano alla forma del corpo dell'utilizzatore garantendo sostegno e un comfort ottimale

- Structure oval flat heavy-duty steel tubing 50x110 mm - thickness 3 mm. Movement arms made of round heavy-duty steel tubing \varnothing 89 mm - thickness 3 mm
- Painting double heavy duty powder coating painting, scratch-resistant. Tubing treatment with sandblasting and phosphating process.
- Pulleys system POWER GRADE bearings for a smooth and precise action
- High-density foam cushions anatomically adaptable to the body shape

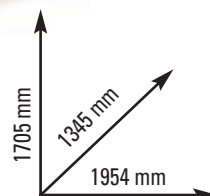

PULL DOWN

FWX5600

cod. FWX-5600

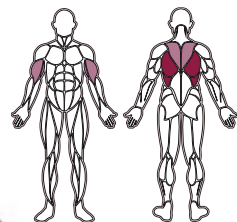

MUSCOLI COINVOLTI MUSCLE GROUPS

- Gran dorsale - Latissimus dorsi
- Bicipiti - Biceps
- Romboidi - Rhomboids
- Trapezio inferiore - Lower trapezius

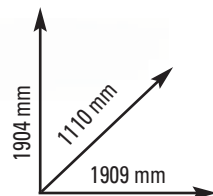

STRENGTH - **AKTIV LINE** - PLATE LOADED

SISTEMA DI SPINTA a leveraggi divergenti
DIMENSIONI PRODOTTO: 1909x1110x1904 mm
PESO MAX UTILIZZATORE 150 Kg
PESO MAX CARICABILE 200 Kg
PESO: 119 kg
CLASSE D'UTILIZZO PROFESSIONALE
(EN ISO 20957-1 / EN ISO 20957-2 classe S)

DIVERGENT PUSH leverage system
SET UP SIZE 1909x1110x1904 mm
MAX USER WEIGHT 150 Kg
MAX LOADABLE WEIGHT 200 Kg
WEIGHT: 119 kg
COMMERCIAL USE (EN ISO 20957-1 / EN ISO 20957-2 class S)

- Struttura tubolare in acciaio rinforzato a sezione ovale piatta 50x110 mm - spessore 3 mm. Bracci di movimento in acciaio rinforzato a sezione circolare \varnothing 89 mm - spessore 3 mm
- Verniciatura doppia a polveri epossidiche, antigraffio. Trattamento dei tubolari con sabbiatura e fosfatazione
- Sistema di cuscinetti POWER GRADE per garantire uno scorrimento preciso e progressivo
- Cuscini in schiuma ad alta densità che si adattano alla forma del corpo dell'utilizzatore garantendo sostegno e un comfort ottimale

- Structure oval flat heavy-duty steel tubing 50x110 mm - thickness 3 mm. Movement arms made of round heavy-duty steel tubing \varnothing 89 mm - thickness 3 mm
- Painting double heavy duty powder coating painting, scratch-resistant. Tubing treatment with sandblasting and phosphating process.
- Pulleys system POWER GRADE bearings for a smooth and precise action
- High-density foam cushions anatomically adaptable to the body shape



FWX5200

cod. FWX-5200

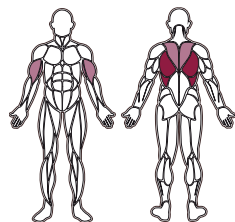

MUSCOLI COINVOLTI MUSCLE GROUPS

- Gran dorsale - Latissimus dorsi
- Bicipiti - Biceps
- Romboidi - Rhomboids
- Trapezio inferiore - Lower trapezius

STRENGTH - AKTIV LINE - PLATE LOADED

SISTEMA DI SPINTA a leveraggi divergenti
 DIMENSIONI PRODOTTO: 1580x1318x1314 mm
 PESO MAX UTILIZZATORE 150 Kg
 PESO MAX CARICABILE 200 Kg
 PESO: 121 kg
 CLASSE D'UTILIZZO PROFESSIONALE
 (EN ISO 20957-1 / EN ISO 20957-2 classe S)

DIVERGENT PUSH leverage system
 SET UP SIZE 1580x1318x1314 mm
 MAX USER WEIGHT 150 Kg
 MAX LOADABLE WEIGHT 200 Kg
 WEIGHT: 121 kg
 COMMERCIAL USE (EN ISO 20957-1 / EN ISO 20957-2 class S)

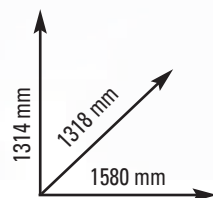

- Struttura tubolare in acciaio rinforzato a sezione ovale piatta 50x110 mm - spessore 3 mm. Bracci di movimento in acciaio rinforzato a sezione circolare \varnothing 89 mm - spessore 3 mm
- Verniciatura doppia a polveri epossidiche, antigraffio. Trattamento dei tubolari con sabbiatura e fosfatazione
- Sistema di cuscinetti POWER GRADE per garantire uno scorrimento preciso e progressivo
- Cuscini in schiuma ad alta densità che si adattano alla forma del corpo dell'utilizzatore garantendo sostegno e un comfort ottimale
- Structure oval flat heavy-duty steel tubing 50x110 mm - thickness 3 mm. Movement arms made of round heavy-duty steel tubing \varnothing 89 mm - thickness 3 mm
- Painting double heavy duty powder coating painting, scratch-resistant. Tubing treatment with sandblasting and phosphating process.
- Pulleys system POWER GRADE bearings for a smooth and precise action
- High-density foam cushions anatomically adaptable to the body shape

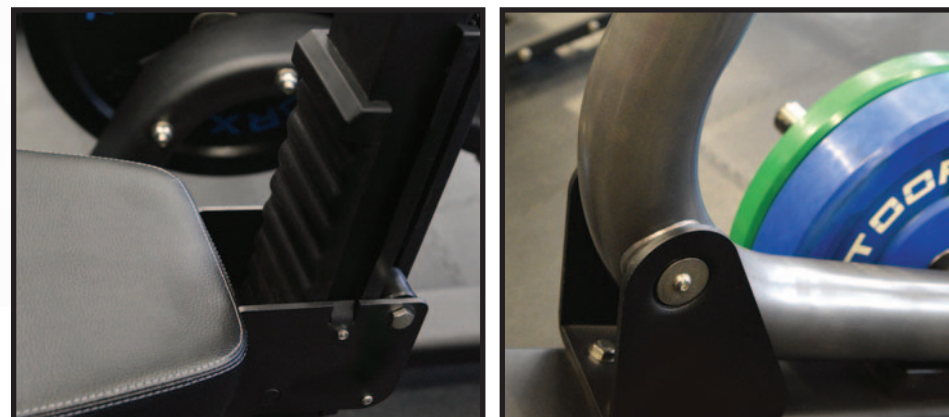

WBX4000

cod. WBX-4000

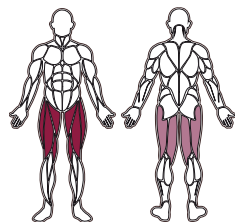

MUSCOLI COINVOLTI
MUSCLE GROUPS

- Quadricipiti - Quadriceps
- Ischiocrurali - Hamstrings

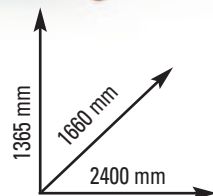

SISTEMA DI SPINTA a pedana montata su carrello
 DIMENSIONI PRODOTTO: 2400x1660x1365 mm
 PESO MAX UTILIZZATORE 150 Kg
 PESO MAX CARICABILE 350 Kg
 PESO: 165 kg
 CLASSE D'UTILIZZO PROFESSIONALE (EN20957-1 / EN957-2 classe S)

PLATFORM PUSH system mounted on carriage
 SET UP SIZE 2400x1660x1365 mm
 MAX USER WEIGHT 150 Kg
 MAX LOADABLE WEIGHT 350 Kg
 WEIGHT: 165 kg
 COMMERCIAL USE (EN20957-1 / EN957-2 class S)

- Struttura tubolare in acciaio rinforzato a sezione ovale piatta 114x65 mm - spessore 3 mm
- Verniciatura doppia a polveri epossidiche, antigraffio. Trattamento dei tubolari con sabbatura e fosfatazione
- Sistema di cuscinetti POWER GRADE per garantire uno scorrimento preciso e progressivo
- Cuscini in schiuma ad alta densità che si adattano alla forma del corpo dell'utilizzatore garantendo sostegno e un comfort ottimale
- Structure flat oval heavyduty steel tubing 114x65 mm - thickness 3 mm
- Painting double heavy duty powder coating painting, scratch-resistant. Tubing treatment with sandblasting and phosphating process.
- Pulleys system POWER GRADE bearings for a smooth and precise action
- High-density foam cushions anatomically adaptable to the body shape



FWX6000

cod. FWX-6000

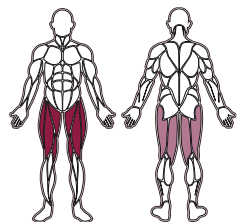

MUSCOLI COINVOLTI MUSCLE GROUPS

- Quadricipiti - Quadriceps
- Ischiocrurali - Hamstrings

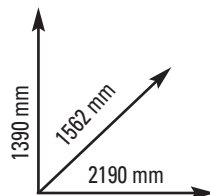

SISTEMA DI SPINTA a pedana a pantografo
 DIMENSIONI PRODOTTO: 2190x1562x1390 mm
 PESO MAX UTILIZZATORE 150 Kg
 PESO MAX CARICABILE 350 Kg
 PESO: 214 kg
 CLASSE D'UTILIZZO PROFESSIONALE
 (EN ISO 20957-1 / EN ISO 20957-2 classe S)

PANTOGRAPH PLATFORM PUSH system
 SET UP SIZE 2190x1562x1390 mm
 MAX USER WEIGHT 150 Kg
 MAX LOADABLE WEIGHT 350 Kg
 WEIGHT: 214 kg
 COMMERCIAL USE (EN ISO 20957-1 / EN ISO 20957-2 class S)

- Struttura tubolare in acciaio rinforzato a sezione ovale piatta 50x110 mm - spessore 3 mm
- Verniciatura doppia a polveri epossidiche, antigraffio. Trattamento dei tubolari con sabbiatura e fosfatazione
- Sistema di cuscinetti POWER GRADE per garantire uno scorrimento preciso e progressivo
- Cuscini in schiuma ad alta densità che si adattano alla forma del corpo dell'utilizzatore garantendo sostegno e un comfort ottimale
- Structure oval flat heavy-duty steel tubing 50x110 mm - thickness 3 mm
- Painting double heavy duty powder coating painting, scratch-resistant. Tubing treatment with sandblasting and phosphating process.
- Pulleys system POWER GRADE bearings for a smooth and precise action
- High-density foam cushions anatomically adaptable to the body shape

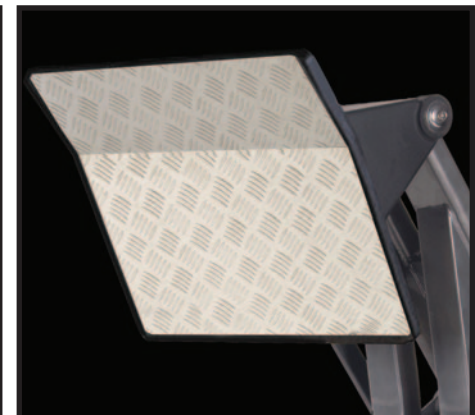

HACK SQUAT

FWX6200

cod. FWX-6200

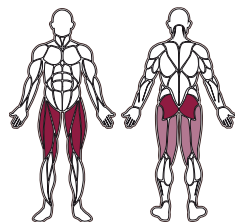

MUSCOLI COINVOLTI MUSCLE GROUPS

- Quadricipiti - Quadriceps
- Glutei - Gluteus
- Ischiocrurali - Hamstrings

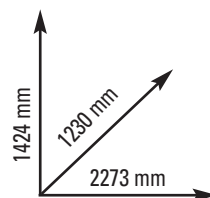

STRENGTH - AKTIV LINE - PLATE LOADED

SISTEMA DI SPINTA a pedana fissa
DIMENSIONI PRODOTTO: 2273x1230x1424 mm
PESO MAX UTILIZZATORE 150 Kg
PESO MAX CARICABILE 250 Kg
PESO: 192 kg
CLASSE D'UTILIZZO PROFESSIONALE
(EN ISO 20957-1 / EN ISO 20957-2 classe S)

FIXED PLATFORM PUSH system
SET UP SIZE 2273x1230x1424 mm
MAX USER WEIGHT 150 Kg
MAX LOADABLE WEIGHT 250 Kg
WEIGHT: 192 kg
COMMERCIAL USE (EN ISO 20957-1 / EN ISO 20957-2 class S)

- Struttura tubolare in acciaio rinforzato a sezione ovale piatta 50x110 mm - spessore 3 mm
- Verniciatura doppia a polveri epossidiche, antigraffio. Trattamento dei tubolari con sabbatura e fosfatazione
- Sistema di cuscinetti POWER GRADE per garantire uno scorrimento preciso e progressivo
- Cuscini in schiuma ad alta densità che si adattano alla forma del corpo dell'utilizzatore garantendo sostegno e un comfort ottimale
- Pedana di spinta: inclinazione di 20°

- Structure oval flat heavy-duty steel tubing 50x110 mm - thickness 3 mm
- Painting double heavy duty powder coating painting, scratch-resistant. Tubing treatment with sandblasting and phosphating process
- Pulleys system POWER GRADE bearings for a smooth and precise action
- High-density foam cushions anatomically adaptable to the body shape
- Footplate: 20° incline



FWX4800

cod. FWX-4800

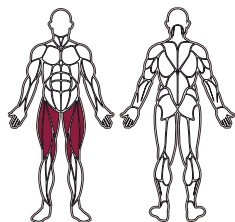

**MUSCOLI COINVOLTI
MUSCLE GROUPS**

■ Quadricipiti - Quadriceps

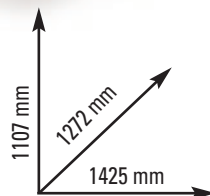

SISTEMA DI SPINTA a leveraggio singolo
 DIMENSIONI PRODOTTO: 1425x1272x1107 mm
 PESO MAX UTILIZZATORE 150 Kg
 PESO MAX CARICABILE 150 Kg
 PESO: 95 kg
 CLASSE D'UTILIZZO PROFESSIONALE
 (EN ISO 20957-1 / EN ISO 20957-2 classe S)

SINGLE PUSH leverage system
 SET UP SIZE 1425x1272x1107 mm
 MAX USER WEIGHT 150 Kg
 MAX LOADABLE WEIGHT 150 Kg
 WEIGHT: 95 kg
 COMMERCIAL USE (EN ISO 20957-1 / EN ISO 20957-2 class S)

- Struttura tubolare in acciaio rinforzato a sezione ovale piatta 50x110 mm - spessore 3 mm. Bracci di movimento in acciaio rinforzato a sezione circolare \varnothing 89 mm - spessore 3 mm
- Verniciatura doppia a polveri epossidiche, antigraffio. Trattamento dei tubolari con sabbiatura e fosfatazione
- Sistema di cuscinetti POWER GRADE per garantire uno scorrimento preciso e progressivo
- Cuscini in schiuma ad alta densità che si adattano alla forma del corpo dell'utilizzatore garantendo sostegno e un comfort ottimale
- Structure oval flat heavy-duty steel tubing 50x110 mm - thickness 3 mm. Movement arms made of round heavy-duty steel tubing \varnothing 89 mm - thickness 3 mm
- Painting double heavy duty powder coating painting, scratch-resistant. Tubing treatment with sandblasting and phosphating process
- Pulleys system POWER GRADE bearings for a smooth and precise action
- High-density foam cushions anatomically adaptable to the body shape



STANDING LEG CURL

FWX5000

cod. FWX-5000

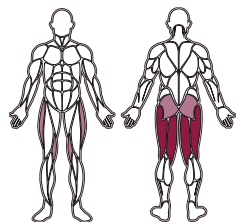

MUSCOLI COINVOLTI MUSCLE GROUPS

- Femorali - Femorals
- Glutei - Gluteus
- Adduttori - Adductors
- Abduttori - Abductors

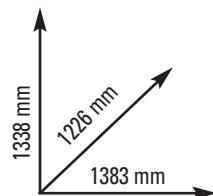

STRENGTH - AKTIV LINE - PLATE LOADED

SISTEMA DI SPINTA a leveraggio singolo
DIMENSIONI PRODOTTO: 1383x1226x1338 mm
PESO MAX UTILIZZATORE 150 Kg
PESO MAX CARICABILE 150 Kg
PESO: 120 kg
CLASSE D'UTILIZZO PROFESSIONALE
(EN ISO 20957-1 / EN ISO 20957-2 classe S)

SINGLE PUSH leverage system
SET UP SIZE 1383x1226x1338 mm
MAX USER WEIGHT 150 Kg
MAX LOADABLE WEIGHT 150 Kg
WEIGHT: 120 kg
COMMERCIAL USE (EN ISO 20957-1 / EN ISO 20957-2 class S)

- Struttura tubolare in acciaio rinforzato a sezione ovale piatta 50x110 mm - spessore 3 mm. Bracci di movimento in acciaio rinforzato a sezione circolare \varnothing 89 mm - spessore 3 mm
- Verniciatura doppia a polveri epossidiche, antigraffio. Trattamento dei tubolari con sabbiatura e fosfatazione
- Sistema di cuscinetti POWER GRADE per garantire uno scorrimento preciso e progressivo
- Cuscini in schiuma ad alta densità che si adattano alla forma del corpo dell'utilizzatore garantendo sostegno e un comfort ottimale

- Structure oval flat heavy-duty steel tubing 50x110 mm - thickness 3 mm. Movement arms made of round heavy-duty steel tubing \varnothing 89 mm - thickness 3 mm
- Painting double heavy duty powder coating painting, scratch-resistant. Tubing treatment with sandblasting and phosphating process
- Pulleys system POWER GRADE bearings for a smooth and precise action
- High-density foam cushions anatomically adaptable to the body shape



FWX4600

cod. FWX-4600

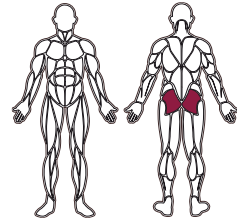

**MUSCOLI COINVOLTI
MUSCLE GROUPS**

■ Glutei - Gluteus

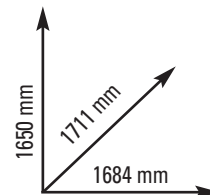

STRENGTH - AKTIV LINE - PLATE LOADED

SISTEMA DI SPINTA a leveraggio singolo
 DIMENSIONI PRODOTTO: 1684x1711x1650 mm
 PESO MAX UTILIZZATORE 150 Kg
 PESO MAX CARICABILE 200 Kg
 PESO: 134 kg
 CLASSE D'UTILIZZO PROFESSIONALE
 (EN ISO 20957-1 / EN ISO 20957-2 classe S)

SINGLE PUSH leverage system
 SET UP SIZE 1684x1711x1650 mm
 MAX USER WEIGHT 150 Kg
 MAX LOADABLE WEIGHT 200 Kg
 WEIGHT: 134 kg
 COMMERCIAL USE (EN ISO 20957-1 / EN ISO 20957-2 class S)

- Struttura tubolare in acciaio rinforzato a sezione ovale piatta 50x110 mm - spessore 3 mm. Bracci di movimento in acciaio rinforzato a sezione circolare ø 89 mm - spessore 3 mm
- Verniciatura doppia a polveri epossidiche, antigraffio. Trattamento dei tubolari con sabbiatura e fosfatazione
- Sistema di cuscinetti POWER GRADE per garantire uno scorrimento preciso e progressivo
- Cuscini in schiuma ad alta densità che si adattano alla forma del corpo dell'utilizzatore garantendo sostegno e un comfort ottimale
- Structure oval flat heavy-duty steel tubing 50x110 mm - thickness 3 mm. Movement arms made of round heavy-duty steel tubing ø 89 mm - thickness 3 mm
- Painting double heavy duty powder coating painting, scratch-resistant. Tubing treatment with sandblasting and phosphating process
- Pulleys system POWER GRADE bearings for a smooth and precise action
- High-density foam cushions anatomically adaptable to the body shape



HIP THRUST

FWX4400

cod. FWX-4400

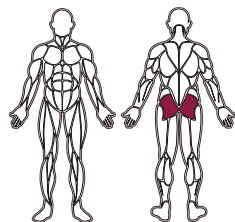

MUSCOLI COINVOLTI MUSCLE GROUPS

■ Glutei - Gluteus

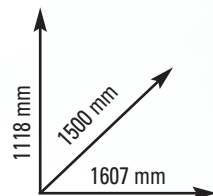

STRENGTH - AKTIV LINE - PLATE LOADED

SISTEMA DI SPINTA a pedana fissa
DIMENSIONI PRODOTTO: 1607x1500x1118 mm
PESO MAX UTILIZZATORE 150 Kg
PESO MAX CARICABILE 250 Kg
PESO: 110 kg
CLASSE D'UTILIZZO PROFESSIONALE
(EN ISO 20957-1 / EN ISO 20957-2 classe S)

FIXED PLATFORM PUSH system
SET UP SIZE 1607x1500x1118 mm
MAX USER WEIGHT 150 Kg
MAX LOADABLE WEIGHT 250 Kg
WEIGHT: 110 kg
COMMERCIAL USE (EN ISO 20957-1 / EN ISO 20957-2 class S)

- Struttura tubolare in acciaio rinforzato a sezione ovale piatta 50x110 mm - spessore 3 mm
- Verniciatura doppia a polveri epossidiche, antigraffio. Trattamento dei tubolari con sabbatura e fosfatazione
- Sistema di cuscinetti POWER GRADE per garantire uno scorrimento preciso e progressivo
- Cuscini in schiuma ad alta densità che si adattano alla forma del corpo dell'utilizzatore garantendo sostegno e un comfort ottimale

- Structure oval flat heavy-duty steel tubing 50x110 mm - thickness 3 mm
- Painting double heavy duty powder coating painting, scratch-resistant. Tubing treatment with sandblasting and phosphating process
- Pulleys system POWER GRADE bearings for a smooth and precise action
- High-density foam cushions anatomically adaptable to the body shape



CALF RAISE

WBX3000

cod. WBX-B3000

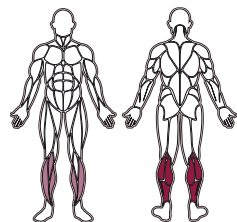

MUSCOLI COINVOLTI MUSCLE GROUPS

- Polpacci - Calves
- Tibiali - Tibialis

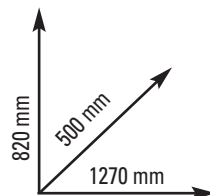

STRENGTH - **AKTIV LINE** - PLATE LOADED

SISTEMA DI SPINTA a leveraggio singolo
DIMENSIONI PRODOTTO: 1270x500x820 mm
PESO MAX UTILIZZATORE 150 Kg
PESO MAX CARICABILE 120 Kg
PESO: 40 kg
CLASSE D'UTILIZZO PROFESSIONALE (EN20957-1 / EN957-2 classe S)

SINGLE PUSH leverage system
SET UP SIZE 1270x500x820 mm
MAX USER WEIGHT 150 Kg
MAX LOADABLE WEIGHT 120 Kg
WEIGHT: 40 kg
COMMERCIAL USE (EN20957-1 / EN957-2 class S)

- Struttura tubolare in acciaio rinforzato a sezione ovale piatta 100x50 mm - spessore 3 mm
- Verniciatura doppia a polveri epossidiche, antigraffio. Trattamento dei tubolari con sabbatura e fosfatazione
- Sistema di cuscinetti POWER GRADE per garantire uno scorrimento preciso e progressivo
- Cuscini in schiuma ad alta densità che si adattano alla forma del corpo dell'utilizzatore garantendo sostegno e un comfort ottimale

- Structure flat oval heavyduty steel tubing 100x50 mm - thickness 3 mm
- Painting double heavy duty powder coating painting, scratch-resistant. Tubing treatment with sandblasting and phosphating process
- Pulleys system POWER GRADE bearings for a smooth and precise action
- High-density foam cushions anatomically adaptable to the body shape

cod. WBX-3000

Disponibile anche con finitura silver
Also available with silver finishing



ALL IN ONE

ASX9000

cod. ASX-9000

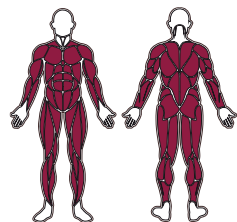

MUSCOLI COINVOLTI MUSCLE GROUPS

■ Full body



TABELLA COMPARATIVA
COMPARATIVE CHART

STRENGTH - ALL IN ONE

PULLEY regolabile su 31 livelli (194 mm-1594 mm)
PACCO PESI in acciaio 2x80kg
DIMENSIONI PRODOTTO: 2090x1654x2104 mm
PESO MASSIMO UTILIZZATORE 120 Kg
PESO: 408 Kg (incluso pacco pesi)
CLASSE D'UTILIZZO PROFESSIONALE (EN20957-1 / EN957-2 classe S)

PULLEYS adjustable on 31 levels (194 mm-1594 mm)
WEIGHT STACK steel weight stack 2x80 kg
SET UP SIZE: 2090x1654x2104 mm
MAX USER WEIGHT: 120 KG
WEIGHT: 408 Kg (include weight plates)
COMMERCIAL USE (EN20957-1 / EN957-2 class S)

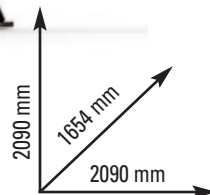
- Struttura tubolare a sezione quadrata 50x50 mm - spessore 2,5
- Ratio: 1:2 pulley; 1:1 smith bar; 1:2 lat pull down; 1:2 seated rowing
- Bilanciere: 2090mm, scorrimento su cuscinetti a sfera lineari; 2 sicurezze con gancio regolabile, regolabili su 10 posizioni (299mm-1760 mm). Diametro porta dischi da 50 mm.
- DOTAZIONI/NOTE 2-IN-1 dual pulley, 3D smith machine. Lat pulldown/seated rowing/chin-up bar. Attachments: bilanciere, barra tricipiti, barra bicipiti, 2 maniglie trazioni, 2 maniglie trazioni extra long, corda doppia tricipiti, cavigliera

- Structure section square tubing 50x50 mm - thickness 2,5
- Ratio: 1:2 pulley; 1:1 smith bar; 1:2 lat pull down; 1:2 seated rowing
- Barbell: 2090 mm, linear bearing; 2 safety systems with hook to avoid barbell falling, vertically adjustable on 10 levels (299mm-1760 mm). Weight plate holder diameter suitable for ø50 mm weight plates.
- EQUIPMENT/NOTES 2-IN-1 dual pulley, 3D smith machine. Lat pulldown/seated rowing/chin-up bar. Attachments: straight bar, triceps bar, straight short bar, 2 Y-handles, 2 Y-handles extra long, rope, ankle strap

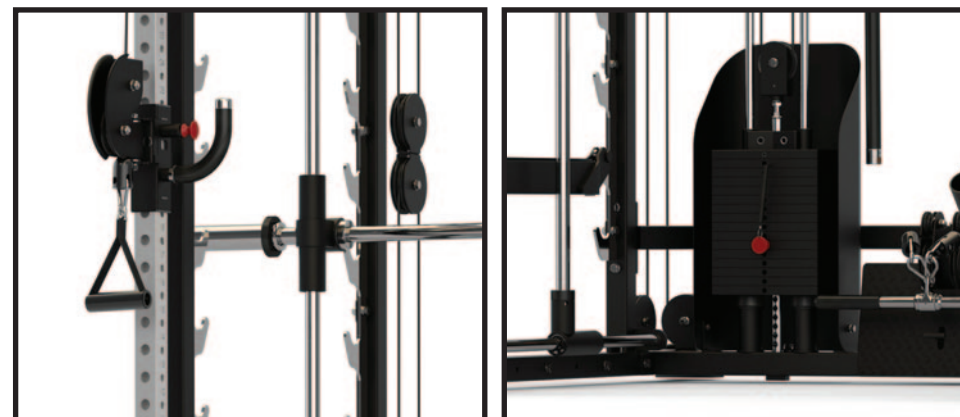

ALL IN ONE

ASX8000

cod. ASX-8000

OPTIONAL



D-HANDLEASX8-WLX38
Parallele
Dip handle



LR-FOOTPLATEASX-8
Pedana per low row
Low row foot plate



LPDASX-8
Lat pull down
Lat pull down



LAT-SEATASX8
Lat seat
Lat seat



LMPBASX-8
Seduta lat machine/pulley
Lat machine/pulley seat

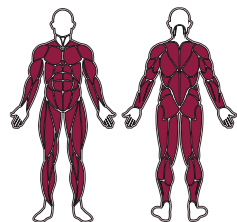

MUSCOLI COINVOLTI MUSCLE GROUPS

■ Full body



TABELLA COMPARATIVA
COMPARATIVE CHART

STRENGTH - ALL IN ONE

PULLEY regolabile 312-1862 mm su 31 livelli interasse 50mm
PACCO PESI in acciaio 2x90kg
DIMENSIONI PRODOTTO: 1514X1996X2200 mm
PESO MASSIMO UTILIZZATORE 160 Kg
PESO: 470 kg
CLASSE D'UTILIZZO PROFESSIONALE (EN20957-1 / EN957-2 / EN957-4 classe S)

PULLEYS adjustable on 31 levels (312-1862 mm), distance 50mm
WEIGHT STACK 2 x 90 kg steel weight stack
SET UP SIZE 1514X1996X2200 mm
MAX USER WEIGHT 160 Kg
WEIGHT: 470 kg
COMMERCIAL USE (EN20957-1 / EN957-2 / EN957-4 class S)

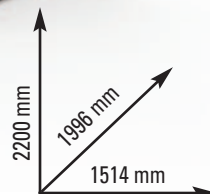
- Struttura tubolare a sezione quadrata 75x75 mm - spessore 3 mm
- Ratio: 1:1 / smith bar - 2:1 / dual pulley - 2:1 / lat pull down
- Bilanciere: 1996 mm, scorrimento su cuscinetto lineare ultra fluido per guida bilanciere Smith, 2 sicurezze con gancio, regolabile verticalmente su 11 livelli (537-1837 mm), passo 130 mm, altezza minima 407 mm da terra (su ganci di sicurezza). Diametro porta dischi da 50 mm.
- DOTAZIONI/NOTE ultra smooth plastic pulley, 2 J-hooks, coppia fermi di sicurezza bilanciere, barra trazioni multi-presa, porta bilanciere, 4 porta dischi ø50 mm, 6 ferma dischi a molla ø49 mm. Attachments: cavigliera, corda doppia tricipiti, catena, 2 maniglie trazioni, maniglia doppia, barra tricipiti, bilanciere e bilanciere CURL, pedana per low row (opzionale)

- Structure section square tube 75x75 mm - thickness 3 mm
- Ratio: 1:1 / smith bar - 2:1 / dual pulley - 2:1 / lat pull down
- Barbell: 1996mm, ultra smooth linear bearing for smith bar guiding, 2 safety systems with hook to avoid barbell falling, vertically adjustable on 11 levels (537-1837mm), distance 130 mm, Lowest height 407 mm from ground up (on safety hooks). Weight plate holder diameter suitable for ø50 mm weight plates.
- EQUIPMENT/NOTES ultra smooth plastic pulley, 2 J-hooks, 2 safety spotter arms, multi-grip chin-up bar, barbell storage, 4 weight plates holders for ø50 mm plates, 6 olympic spring clip ø49 mm. Attachments: ankle strap, tricep rope, chain, 2 Y- handles, V-bar, short straight bar, straight bar and curved bar, non-slip metal footplate(option)

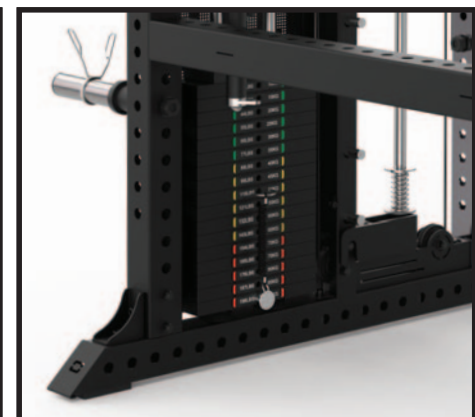

ASX7000

cod. ASX-7000

OPTIONAL



COD. LEG-PRESSASX
Vertical leg press



COD. M-BARASX
Multifunctional bar



COD. MLIFTASX-4.5-6
Monolift



COD. LAT-SEATASX-4.5-6
Lat seat



COD. W-HOLDERASX
Perno porta pesi
Weight plates holder



COD. LPDASX-4.5-6
Lat pull down



COD. J-ARMSASX6000
Jammer arms



COD. SW-HOLDERASX-7
Set 6 perni porta pesi
6 pcs weight plates holders



COD. D-HANDLEASX-7
Parallele
Dip handle



COD. W-HOLDER-SMASX-7
Set 2 perni porta pesi per smith bar
Set of 2 weight plates holders for smith bar



COD. LMASX-7
Landmine
Landmine



COD. SB-FSASX-7
Supporti bilanciere e fermi di sicurezza
J-cups and safety spotter arms



COD. LR-FOOTPLATEASX-7
Pedana per low row
Low row foot plate

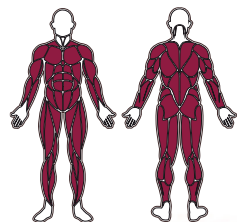

**MUSCOLI COINVOLTI
MUSCLE GROUPS**

■ Full body



TABELLA COMPARATIVA
COMPARATIVE CHART

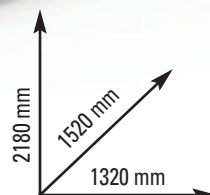

PULLEY regolabile 300-1875 mm su 50 livelli interasse 25-50 mm
PACCO PESI in acciaio 2x90kg
DIMENSIONI PRODOTTO: 1320x1520x2180 mm
PESO MASSIMO UTILIZZATORE 160 Kg
PESO: 382.8 kg
CLASSE D'UTILIZZO PROFESSIONALE (EN20957-1 / EN957-2 / EN957-4 classe S)

PULLEYS adjustable on 50 levels (300-1875 mm) distance 25-50 mm
WEIGHT STACK steel weight stack 2x90 kg
SET UP SIZE 1320x1520x2180 mm
PESO MASSIMO UTILIZZATORE 160 Kg
WEIGHT: 382.8 kg
COMMERCIAL USE (EN20957-1 / EN957-2 / EN957-4 class S)

- Struttura tubolare a sezione rettangolare 50x70 mm - spessore 2,5 e ovale 50x100 – spessore 2,5 mm
- Ratio: 1:2 / smith bar - 1:2 / fly handle - 1:2 / lat pull down - 1:2 / seated rowing
- Bilanciere: 1282 mm, scorrimento su cuscinetti a sfera lineari, 2 sicurezze con gancio regolabile, regolabili su 11 posizioni (455-1750 mm), passo 130 mm. Diametro porta dischi da 50 mm. Sistema brevettato di aggancio bilanciere guidato ai pacchi peso.
- DOTAZIONI/NOTE 3-IN-1 dual pulley, smith machine, rack. Barra trazioni, 8 ferma dischi a molla ø49 mm. Attachments: cavigliera, corda doppia tricipiti, catena, 2 maniglie trazioni, maniglia doppia, barra tricipiti, bilanciere e bilanciere CURL

- Structure section rectangular tubing 50x70 mm - thickness 2,5 and oval 50x100 – thickness 2,5 mm
- Ratio: 1:2 / smith bar - 1:2 / fly handle - 1:2 / lat pull down - 1:2 / seated rowing
- Barbell: 1282 mm, linear bearings sliding, 2 safety systems with hook to avoid barbell falling, vertically adjustable on 11 levels (455-1750 mm), distance 130 mm. Weight plate holder diameter suitable for ø50 mm weight plates. Patented system to link the barbell to the weight stacks.
- EQUIPMENT/NOTES 3-IN-1 dual pulley, smith machine, rack. Chin-up bar, 8 olympic spring clips ø49 mm. Attachments : ankle strap, rope, chain, 2 D- handles, V-bar, short straight bar, straight bar and curved bar



ASX6000

cod. ASX-6000

OPTIONAL



COD. J-ARMSASX6000
Jammer arms



COD. LAT-SEATASX-4.5-6
Lat seat



COD. LEG-PRESSASX
Leg press



COD. W-HOLDERASX
Perno porta pesi
Weight plates holder



COD. M-BARASX
Multifunctional bar



COD. LPDASX-4.5-6
Lat pull down



COD. MLIFTASX-4.5-6
Monolift



COD. BELT-SQUATASX6000
Belt squat / T bar machine

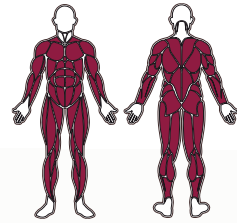

**MUSCOLI COINVOLTI
MUSCLE GROUPS**

■ Full body

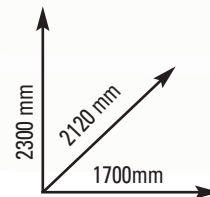

PULLEY regolabile 372-1947 mm su 22 livelli interasse 75 mm
PACCO PESI in acciaio 2x90kg
J-CUP/SAFETY SPOTTER ARMS Extra strong spessore 5 mm con protezione UHMW (Ultra High Molecular Weight). Regolabile 432-1982 mm su 31 livelli interasse 50 mm
DIMENSIONI PRODOTTO: 1700x2120x2300 mm
PESO MASSIMO UTILIZZATORE 160 Kg
PESO: 415.7 kg
CLASSE D'UTILIZZO PROFESSIONALE (EN20957-1 / EN957-2 / EN957-4 classe S)

PULLEYS adjustable on 22 levels (372-1947 mm) distance 75 mm
WEIGHT STACK steel weight stack 2x90 kg
J-CUP/SAFETY SPOTTER ARMS Extra strong - 5 mm thickness with UHMW (Ultra High Molecular Weight) protection pads, adjustable on 31 levels (432-1982 mm) distance 50 mm
SET UP SIZE 1700x2120x2300 mm
PESO MASSIMO UTILIZZATORE 160 Kg
WEIGHT: 415.7 kg
COMMERCIAL USE (EN20957-1 / EN957-2 / EN957-4 class S)

- Struttura tubolare a sezione rettangolare 50x70 mm - spessore 2,5 e 50x100 - spessore 3 mm.
- Ratio: 1:2 / fly handle - 1:2 / lat pull down - 1:2 / seated rowing
- Bilanciere: 1993 mm, scorrimento su cuscinetti a sfera lineari, 2 sicurezze con gancio regolabile, regolabili su 14 posizioni (538-2020 mm), passo 130 mm. Diametro porta dischi da 50 mm
- DOTAZIONI/NOTE 3-IN-1 dual pulley, smith machine, rack, 2 J-hook, coppia fermi di sicurezza bilanciere, barra trazioni, parallele, porta bilanciere, 6 porta dischi ø50 mm, 8 ferma dischi a molla ø49 mm. Attachments: cavigliera, corda doppia tricipiti, catena, landmine, 2 maniglie trazioni, pedana per low row, maniglia doppia, barra tricipiti, bilanciere e bilanciere CURL

- Structure section rectangular tubing 50x70 mm - thickness 2,5 and 50x100 - thickness 3 mm
- Ratio: 1:2 / fly handle - 1:2 / lat pull down - 1:2 / seated rowing
- Barbell: 1993 mm, linear bearings sliding, 2 safety systems with hook to avoid barbell falling, vertically adjustable on 14 levels (538-2020mm), distance 130 mm. Weight plate holder diameter suitable for ø50 mm weight plates
- EQUIPMENT/NOTES 3-IN-1 dual pulley, smith machine, rack, 2 J-hooks, 2 safety spotter arms, chin-up bar, dip up bar, barbell storage, 6 weight plates holders for ø50 mm plates, 8 olympic spring clips ø49 mm. Attachments: ankle strap, rope, chain, landmine, non-slip metal footplate, 2 Y- handles, V-bar, short straight bar, straight bar and curved bar



TABELLA COMPARATIVA
COMPARATIVE CHART

ALL IN ONE

ASX5000

cod. ASX-5000

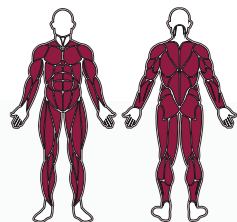

**MUSCOLI COINVOLTI
MUSCLE GROUPS**

■ Full body

OPTIONAL



COD. J-ARMSASX2-4-5
Jammer arms



COD. LAT-SEATASX2-4-5
Lat seat



COD. LEG-PRESSASX
Leg press



COD. W-HOLDERASX
Perno porta pesi
Weight plates holder



COD. M-BARASX
Multifunctional bar



COD. LPDASX-2-4-5
Lat pull down

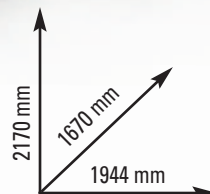

STRENGTH - ALL IN ONE

PULLEY regolabile 266x1841 mm su 22 livelli interasse 75 mm
PACCO PESI in acciaio 2x90kg
J-CUP/SAFETY SPOTTER ARMS Extra strong spessore 5 mm con protezione UHMW (Ultra High Molecular Weight). Regolabile 316-1816 mm su 31 livelli interasse 50 mm
DIMENSIONI PRODOTTO: 1944x1670x2170 mm
PESO MASSIMO UTILIZZATORE 135 Kg
PESO: 391.5 kg
CLASSE D'UTILIZZO PROFESSIONALE (EN20957-1 / EN957-2 / EN957-4 classe S)

PULLEYS adjustable on 22 levels (266x1841 mm) distance 75 mm
WEIGHT STACK steel weight stack 2x90 kg
J-CUP/SAFETY SPOTTER ARMS Extra strong - 5 mm thickness with UHMW (Ultra High Molecular Weight) protection pads, adjustable on 31 levels (316-1816 mm) distance 50 mm
SET UP SIZE 1944x1670x2170 mm
PESO MASSIMO UTILIZZATORE 135 Kg
WEIGHT: 391.5 kg
COMMERCIAL USE (EN20957-1 / EN957-2 / EN957-4 class S)

- Struttura tubolare a sezione rettangolare 50x70 mm - spessore 2,5 mm/2 mm e quadrata 50x50 mm - spessore 2 mm
- Ratio: 1:1 / smith bar - 1:2 / fly handle - 1:2 / lat pull down - 1:2 / seated rowing
- Bilanciere: 1944mm, scorrimento su cuscinetti a sfera lineari, 2 sicurezze con gancio regolabile, regolabili su 11 posizioni (539 - 1861 mm), passo 150 mm. Diametro porta dischi da 50 mm. Sistema brevettato di aggancio bilanciere guidato ai pacchi peso
- DOTAZIONI/NOTE 3-IN-1 dual pulley, smith machine, rack, 2 J-hook, coppia fermi di sicurezza bilanciere con rulli gambe in foam, barra trazioni multi presa, parallele, porta bilanciere, 4 porta dischi ø50 mm, 4 ferma dischi a molla ø49 mm, 2 ferma dischi a molla ø47 mm. Attachments : cavigliera, corda doppia tricipiti, catena, landmine, 2 maniglie trazioni con catena regolabile, maniglia doppia, barra tricipiti, bilanciere e bilanciere CURL, pedana per low row.

- Structure section rectangular tubing 50x70 mm - thickness 2,5 mm/2 mm and square tubing 50x50 mm - thickness 2 mm
- Ratio: 1:1 / smith bar - 1:2 / fly handle - 1:2 / lat pull down - 1:2 / seated rowing
- Barbell: 1944mm, linear bearings sliding, 2 safety systems with hook to avoid barbell falling, vertically adjustable on 11 levels (539 - 1861 mm), distance 150 mm. Weight plate holder diameter suitable for ø50 mm weight plates. Patented system to link the barbell to the weight stacks
- EQUIPMENT/NOTES 3-IN-1 dual pulley, smith machine, rack, 2 J-hook, set leg holder foam, multi-grip chin-up bar, dip up bar, barbell storage, 4 weight plates holders for ø50 mm plates, 4 olympic spring clips ø49 mm, 2 spring clips ø47 mm. Attachments : ankle strap, rope, chain, landmine, 2 Y- handles with adjustable chain, V-bar, short straight bar, straight bar and curved bar, non-slip metal footplate.



TABELLA COMPARATIVA
COMPARATIVE CHART

ALL IN ONE

ASX4500

cod. ASX-4500

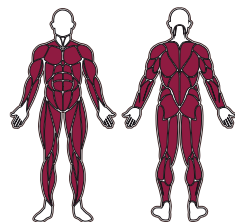

MUSCOLI COINVOLTI
MUSCLE GROUPS

■ Full body

OPTIONAL



COD. J-ARMSASX4500
Jammer arms



COD. LAT-SEATASX-4.5-6
Lat seat



COD. LEG-PRESSASX
Leg press



COD. W-HOLDERASX
Perno porta pesi
Weight plates holder



COD. M-BARASX
Multifunctional bar



COD. LPDASX-4.5-6
Lat pull down



COD. MLIFTASX-4.5-6
Monolift



COD. LP-SUPPORTASX4500
Supporto leg press
Leg press support

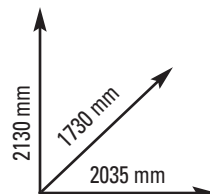

STRENGTH - ALL IN ONE

PULLEY regolabile 321-1822 mm su 31 livelli interasse 50 mm
PACCO PESI in acciaio 2x90kg
J-CUP/SAFETY SPOTTER ARMS Extra strong spessore 5 mm con protezione UHMW (Ultra High Molecular Weight). Regolabile 321-1822 mm su 31 livelli interasse 50 mm
DIMENSIONI PRODOTTO: 2035x1730x2130 mm
PESO MASSIMO UTILIZZATORE 135 Kg
PESO: 363.2 kg
CLASSE D'UTILIZZO PROFESSIONALE (EN20957-1 / EN957-2 / EN957-4 classe S)

PULLEYS adjustable on 31 levels (321-1822 mm) distance 50 mm
WEIGHT STACK steel weight stack 2x90 kg
J-CUP/SAFETY SPOTTER ARMS Extra strong - 5 mm thickness with UHMW (Ultra High Molecular Weight) protection pads, adjustable on 31 levels (321-1822 mm) distance 50 mm
SET UP SIZE 2035x1730x2130 mm
PESO MASSIMO UTILIZZATORE 135 Kg
WEIGHT: 363.2 kg
COMMERCIAL USE (EN20957-1 / EN957-2 / EN957-4 class S)

- Struttura a sezione rettangolare 50x70 mm - spessore 2,5 mm
- Ratio: 1:1 & 1:2 / fly handle - 1:1 & 1:2 / lat pull down - 1:1 & 1:2 / seated rowing
- Bilanciere: 2037 mm, scorrimento su cuscinetti a sfera lineari, 2 sicurezze con gancio regolabile, regolabili su 11 posizioni (353-1822 mm), passo 130 mm. Diametro porta dischi da 50 mm
- DOTAZIONI/NOTE 3-IN-1 dual pulley, smith machine, rack. 2 J-hook, coppia fermi di sicurezza bilanciere, barra trazioni, parallele, porta bilanciere, 6 porta dischi ø50 mm e 25 mm, 8 ferma dischi a molla ø49 mm. Attachments: cavigliera, corda doppia tricipiti, catena, landmine, 2 maniglie trazioni, pedana per low row, maniglia doppia, barra tricipiti, bilanciere e bilanciere CURL.

- Structure rectangular tubing 50x70 mm - thickness 2,5 mm
- Ratio: 1:1 & 1:2 / fly handle - 1:1 & 1:2 / lat pull down - 1:1 & 1:2 / seated rowing
- Barbell: 2037 mm, linear bearings sliding, 2 safety systems with hook to avoid barbell falling, vertically adjustable on 11 levels (353-1822 mm), distance 130 mm. Weight plate holder diameter suitable for ø50 mm weight plates
- EQUIPMENT/NOTES 3-IN-1 dual pulley, smith machine, rack. 2 J-hooks, 2 safety spotter arms, chin-up bar, dip up bar, barbell storage, 6 weight plates holders for ø50 mm and 25 mm plates, 8 olympic spring clips ø49 mm. Attachments : ankle strap, rope, chain, landmine, non-slip metal footplate, 2 Y- handles, V-bar, short straight bar, straight bar and curved bar.



TABELLA COMPARATIVA
COMPARATIVE CHART

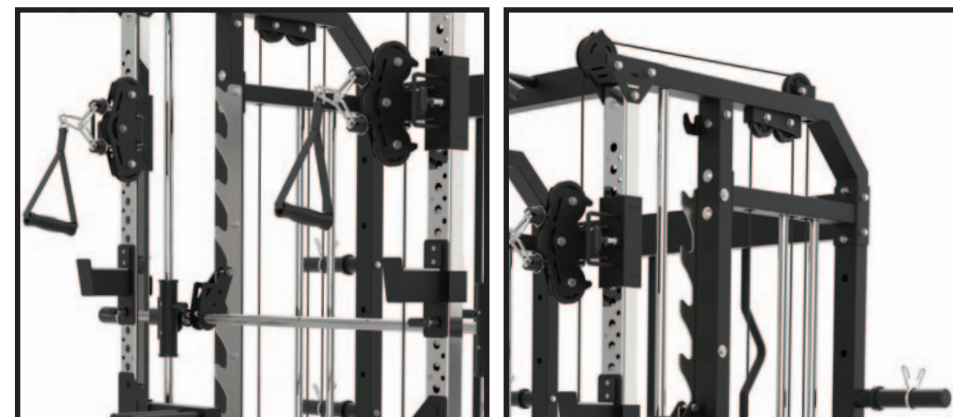

ALL IN ONE

ASX4000

cod. ASX-4000

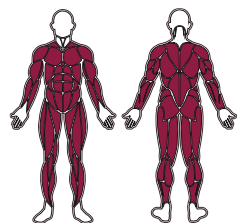

**MUSCOLI COINVOLTI
MUSCLE GROUPS**

■ Full body

OPTIONAL



COD. J-ARMSASX2-4-5
Jammer arms



COD. LAT-SEATASX2-4-5
Lat seat



COD. LEG-PRESSASX
Leg press



COD. W-HOLDERASX
Perno porta pesi
Weight plates holder



COD. M-BARASX
Multifunctional bar



COD. LPDASX2-4-5
Lat pull down

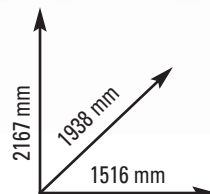

STRENGTH - ALL IN ONE

PULLEY regolabile 264-1839 mm su 22 livelli interasse 75 mm
PACCO PESI in acciaio 2x90kg
J-CUP/SAFETY SPOTTER ARMS Extra strong spessore 5 mm con protezione UHMW (Ultra High Molecular Weight). Regolabile 314-1814 mm su 31 livelli interasse 50 mm
DIMENSIONI PRODOTTO: 1516x1938x2167 mm
PESO MASSIMO UTILIZZATORE 150 Kg
PESO: 369.5 kg
CLASSE D'UTILIZZO PROFESSIONALE (EN20957-1 / EN957-2 / EN957-4 classe S)

PULLEYS adjustable on 22 levels (264-1839 mm) distance 75 mm
WEIGHT STACK steel weight stack 2x90 kg
J-CUP/SAFETY SPOTTER ARMS Extra strong - 5 mm thickness with UHMW (Ultra High Molecular Weight) protection pads, adjustable on 31 levels (314-1814 mm) distance 50 mm
SET UP SIZE 1516x1938x2167 mm
PESO MASSIMO UTILIZZATORE 150 Kg
WEIGHT: 369.5 kg
COMMERCIAL USE (EN20957-1 / EN957-2 / EN957-4 class S)

- Struttura tubolare a sezione rettangolare 50x70 mm - spessore 2,5 mm/2 mm e quadrata 50x50 mm - spessore 3 mm
- Ratio: 1:2 / fly handle - 1:2 / lat pull down - 1:2 / seated rowing
- Bilanciere: 1936 mm, scorrimento su cuscinetti a sfera, 2 sicurezze con gancio regolabile, regolabili su 12 posizioni (622 - 1832 mm), passo 110 mm. Diametro porta dischi da 50 mm
- DOTAZIONI/NOTE 3-IN-1 dual pulley, smith machine, rack. 2 J-hook, coppia fermi di sicurezza bilanciere con rulli gambe in foam, barra trazioni, parallele, porta bilanciere, 6 porta dischi ø50 mm, 8 ferma dischi a molla ø49 mm. Attachments: cavigliera, corda, landmine, 2 maniglie trazioni regolabili, barra tricipiti, barra tricipiti dritta, bilanciere e bilanciere CURL.

- Structure section rectangular tubing 50x70 mm - thickness 2,5 mm/2 mm and square tubing 50x50 mm - thickness 3 mm
- Ratio: 1:2 / fly handle - 1:2 / lat pull down - 1:2 / seated rowing
- Barbell: 1936 mm, linear bearings sliding, 2 safety systems with hook to avoid barbell falling, vertically adjustable on 12 levels (622 - 1832 mm), distance 110 mm. Weight plate holder diameter suitable for ø50 mm weight plates
- EQUIPMENT/NOTES 3-IN-1 dual pulley, smith machine, rack. 2 J-hooks, 2 safety spotter arms with 1 set leg holder foam, chin-up bar, dip up bar, barbell storage, 6 weight plates holders for ø50 mm plates, 8 olympic spring clips ø49 mm. Attachments: ankle strap, rope, landmine, 2 adjustable Y- handles, V-bar, short straight bar, straight bar and curved bar.



TABELLA COMPARATIVA
COMPARATIVE CHART

ALL IN ONE

ASX3000

cod. ASX-3000

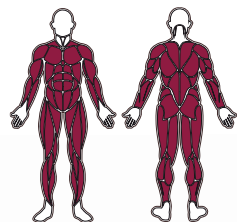

MUSCOLI COINVOLTI MUSCLE GROUPS

■ Full body



TABELLA COMPARATIVA
COMPARATIVE CHART

STRENGTH - ALL IN ONE

J-CUP/SAFETY SPOTTER ARMS Extra strong spessore 5 mm con protezione UHMW (Ultra High Molecular Weight). Regolabile 429-1869 mm su 17 livelli interasse 50 mm
DIMENSIONI PRODOTTO: 1610x1650x2310 mm
DIMENSIONE CHIUSO: 820x1650x2310 mm
PESO MASSIMO UTILIZZATORE 150 Kg
PESO: 171.7 kg
CLASSE D'UTILIZZO PROFESSIONALE (EN20957-1 / EN957-2 / EN957-4 classe S)

J-CUP/SAFETY SPOTTER ARMSExtra strong - 5 mm thickness with UHMW (Ultra High Molecular Weight) protection pads, adjustable on 17 levels (429-1869 mm) distance 50 mm
SET UP SIZE 1610x1650x2310 mm
FOLDED SIZE 820x1650x2310 mm
PESO MASSIMO UTILIZZATORE 150 Kg
WEIGHT: 171.7 kg
COMMERCIAL USE (EN20957-1 / EN957-2 / EN957-4 class S)

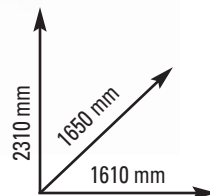
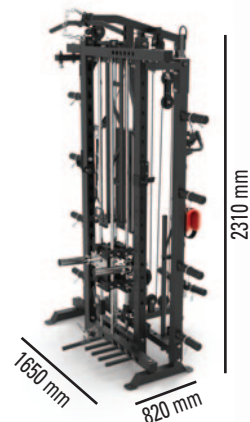
- Struttura tubolare a sezione quadrata 50x50 mm e 60x60 mm - spessore 2 mm
- Ratio: 1:2 / fly handle - 1:2 / lat pull down - 1:2 / seated rowing
- Bilanciere: 1743mm, scorrimento su cuscinetti a sfera, 2 sicurezze con gancio regolabile, regolabili su 16 posizioni (455 - 1805 mm), passo 90 mm. Diametro porta dischi da 50 mm.
- DOTAZIONI/NOTE 4-IN-1 dual pulley&row, lat machine, smith machine, rack. Pieghevole salva-spazio. Manubri, 2 J-hook, porta bilanciere, barra trazioni multi presa, 4 ganci per fasce elastiche, 8 porta dischi ø50 mm e 25 mm, 12 ferma dischi a molla ø49 mm, 4 ferma dischi a molla ø47 mm. Attachments: cavigliera, corda, catena, landmine, 2 maniglie trazioni regolabili, barra lat pull-down, barra row, barra tricipiti dritta.

- Structure square tubing 50x50 mm e 60x60 mm - thickness 2 mm
- Ratio: 1:2 / fly handle - 1:2 / lat pull down - 1:2 / seated rowing
- Barbell: 1743mm, linear bearings sliding, 2 safety systems with hook to avoid barbell falling, vertically adjustable on 16 levels (455 - 1805 mm), distance 90 mm. Weight plate holder diameter suitable for ø50 mm weight plates
- EQUIPMENT/NOTES 4-IN-1 dual pulley&row, lat machine, smith machine, rack. Foldable save-space. Dumbbell bar, 2 J-hooks, barbell storage, multi-grip chin-up bar, 4 pegs for resistance band, 8 weight plates holders for ø50 mm and ø25 mm plates, 12 olympic spring clips ø49 mm and 4 spring clips ø25 mm. Attachments : ankle strap, rope, chain, landmine, 2 adjustable Y- handles, lat pull-down bar, row bar, short straight bar.



ALL IN ONE

ASX2000

cod. ASX-2000

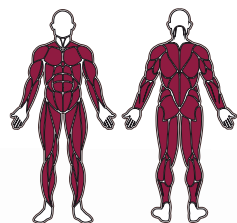

MUSCOLI COINVOLTI
MUSCLE GROUPS

■ Full body

OPTIONAL



COD. J-ARMSASX2-4-5
Jammer arms



COD. LAT-SEATASX2-4-5
Lat seat



COD. M-BARASX
Multifunctional bar



COD. LPDASX2-4-5
Lat pull down



TABELLA COMPARATIVA
COMPARATIVE CHART

STRENGTH - ALL IN ONE

PULLEY regolabile 339-1839 mm su 21 livelli interasse 75 mm
J-CUP/SAFETY SPOTTER ARMS Extra strong spessore 5 mm con protezione UHMW (Ultra High Molecular Weight). Regolabile 314-1814 mm su 31 livelli interasse 50 mm
DIMENSIONI PRODOTTO: 1990x1500x2200 mm
PESO MASSIMO UTILIZZATORE 135 Kg
PESO: 139.5 kg
CLASSE D'UTILIZZO PROFESSIONALE (EN20957-1 / EN957-2 / EN957-4 classe S)

PULLEYS adjustable on 21 levels (339-1839 mm) distance 75 mm
J-CUP/SAFETY SPOTTER ARMS Extra strong - 5 mm thickness with UHMW (Ultra High Molecular Weight) protection pads, adjustable on 31 levels (314-1814 mm) distance 50 mm
SET UP SIZE 1990x1500x2200 mm
PESO MASSIMO UTILIZZATORE 135 Kg
WEIGHT: 139.5 kg
COMMERCIAL USE (EN20957-1 / EN957-2 / EN957-4 class S)

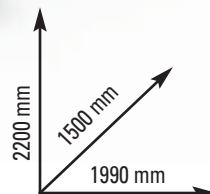
- Struttura tubolare a sezione rettangolare 50x70 mm - spessore 2 mm e quadrata 50x50 mm - spessore 2 mm
- Ratio: 1:2 / fly handle - 1:2 / lat pull down - 1:2 / seated rowing
- Bilanciere: 1980mm, scorrimento su cuscinetti a sfera, 2 sicurezze con gancio regolabile, regolabili su 12 posizioni (523 - 1733 mm), passo 110 mm. Diametro porta dischi da 50 mm e da 25 mm
- DOTAZIONI/NOTE 3-IN-1 dual pulley, smith machine, rack. 2 J-hook, coppia fermi di sicurezza bilanciere con rulli gambe in foam, barra trazioni, parallele, porta bilanciere, 4 porta dischi ø50 mm e 25 mm, 10 ferma dischi a molla ø49 mm, 10 ferma dischi a molla ø47 mm. Attachments : cavigliera, landmine, 2 maniglie trazioni, bilanciere curl.

- Structure section rectangular tubing 50x70 mm - thickness 2 mm and square tubing 50x50 mm thickness 2 mm
- Ratio: 1:2 / fly handle - 1:2 / lat pull down - 1:2 / seated rowing
- Barbell: 1980mm, linear bearings sliding, 2 safety systems with hook to avoid barbell falling, vertically adjustable on 12 levels (523 - 1733 mm), distance 110 mm. Weight plate holder diameter suitable for ø50 mm and 25 mm weight plates
- EQUIPMENT/NOTES 3-IN-1 dual pulley, smith machine, rack. 2 J-hooks, 2 safety spotter arms with 1 set leg holder foam, chin-up bar, dip up bar, barbell storage, 4 weight plates holders for ø50 mm and 25 mm plates, 10 olympic spring clips ø49 mm, 10 spring clips ø47 mm. Attachments : ankle strap, landmine, 2 Y-handles, curved bar.



MSX3000

cod. MSX-3000

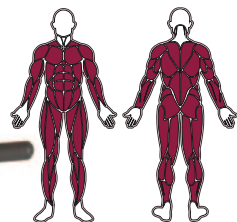

MUSCOLI COINVOLTI MUSCLE GROUPS

■ Full body



LEG PRESS MSX3000 **OPTIONAL**

cod. LEG-PRESSMSX-3000



Dimensioni prodotto: 1355 x 1881 x 1220 mm
Peso del prodotto 95 Kg
Set up size: 1355 x 1881 x 1220 mm
Weight 95 Kg

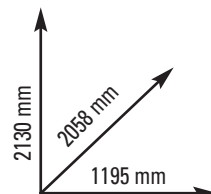

PACCO PESI in acciaio 90 kg con carter di protezione integrale
FUNZIONI arm rowing, lat pull down, leg lift, chest press, biceps, triceps, cable cross, hand side lift, latissimus, deltoid, pectorals
DIMENSIONI PRODOTTO: 1195x2058x2130 mm
PESO MAX UTILIZZATORE 150 Kg
PESO: 220 kg
CLASSE D'UTILIZZO PROFESSIONALE (EN20957-1 / EN957-2 / EN957-4 classe S)

WEIGHT STACK 90 kg steel weight stacks with full protection cage
FUNCTIONS arm rowing, lat pull down, leg lift, chest press, biceps, triceps, cable cross, hand side lift, latissimus, deltoid, pectorals
SET UP SIZE 1195x2058x2130 mm
MAX USER WEIGHT 150 Kg
WEIGHT: 220 kg
COMMERCIAL USE (EN20957-1 / EN957-2 / EN957-4 class S)

- Struttura tubolare in acciaio a sezione ovale 50x100 mm
- Verniciatura doppia a polveri epossidiche, antigraffio.
- Sistema di carrucole con cuscinetti a sfera HIGH PERFORMANCE.
- Cavi in acciaio rivestiti in PU ø 4.8 mm
- Dotazione: 2 maniglie per trazioni, barra latissimus, barra tricipiti, braccia con cavo libero

- Structure oval heavyduty steel tubing 50x100 mm
- Painting double heavy duty powder coating painting, scratch-resistant.
- Pulleys system with HIGH PERFORMANCE ball bearings. Woven cables system ø 4.8 mm - PU coated
- Equipment: 2 pulling handles, latissimus bar, triceps bar, fly arms



CABLE CROSSOVER

CSX6000

cod. CSX-6000

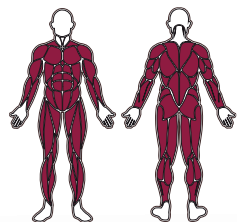

MUSCOLI COINVOLTI MUSCLE GROUPS

■ Full body

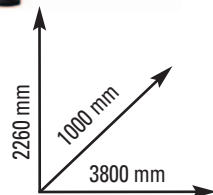

STRENGTH - STATIONS - BACK - LEGS

PACCO PESI 2x70 kg in acciaio. Carter di protezione integrale. Pacco pesi 2x30 kg **OPTIONAL** disponibile 2x cod. W-STACKCSX2-6
DOTAZIONE: 2 coppie maniglie pulley, 2 corde doppie per tricipiti, 2 barre tricipiti dritte
DIMENSIONI PRODOTTO: 3800x1000x2260 mm
PESO MAX UTILIZZATORE 150 Kg
PESO: 324 kg
CLASSE D'UTILIZZO PROFESSIONALE (EN20957-1 / EN957-2 classe S)

WEIGHT STACK steel 2x70 kg weight stack with full protection cage. 2x30 kg **OPTIONAL** weight stack available 2x cod. W-STACKCSX2-6
EQUIPMENT: 4 pulley handles, 2 triceps ropes, 2 streight triceps bars
SET UP SIZE: 3800x1000x2260 mm
MAX USER WEIGHT 150 Kg
WEIGHT: 324 kg
COMMERCIAL USE (EN20957-1 / EN957-2 class S)

- Struttura tubolare in acciaio rinforzato a sezione ovale piatta 50x100 mm - spessore 2,5 mm.
- Verniciatura doppia a polveri epossidiche, antigraffio.
- Sistema di carrucole/pullegge con cuscinetti POWER GRADE per garantire uno scorrimento preciso e progressivo. Cavi in acciaio rivestiti in poliuretano
- Structure oval flat heavy-duty steel tubing 50x100 mm - thickness 2,5 mm.
- Painting double heavy duty powder coating painting, scratch-resistant
- Pulley system POWER GRADE bearings for a smooth and precise action. Cables system steel woven cables with polyurethane coating



SINGLE PULLEY

CSX2000

cod. CSX-2000

OPTIONAL

cod. CROSS-BARCSX2000

cross bar di collegamento da utilizzare tra 2 single pulley CSX2000 per comporre la cable crossover CSX6000
Dimensioni 960x1000x226 mm

connection cross bar to be used among 2 single pulleys CSX2000 to create the cable crossover CSX6000
Dimensions 960x1000x226 mm

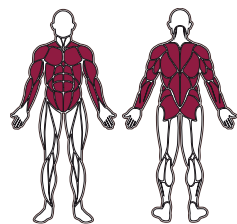

MUSCOLI COINVOLTI MUSCLE GROUPS

- Upper body
- Glutei

CONFIGURAZIONE CABLE CROSSOVER CABLE CROSSOVER CONFIGURATION



2 x cod. CSX2000 +
1 x cod. CROSS-
BARCSX2000

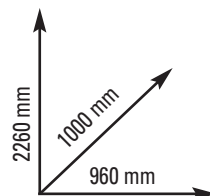

STRENGTH - STATIONS - BACK - LEGS

PACCO PESI 70 kg in acciaio. Carter di protezione integrale. Pacco pesi 30 kg **OPTIONAL** disponibile cod. W-STACKCSX2-6
DOTAZIONE: coppia maniglie pulley, corda doppia per tricipiti, barra tricipiti dritta
DIMENSIONI PRODOTTO: 960x1000x2260 mm
PESO MAX UTILIZZATORE 150 Kg
PESO: 154 kg
CLASSE D'UTILIZZO PROFESSIONALE (EN20957-1 / EN957-2 classe S)

WEIGHT STACK steel 70 kg weight stack with full protection cage. 30 kg **OPTIONAL** weight stack available cod. W-STACKCSX2-6
EQUIPMENT: pulley handles, triceps rope, streight triceps bar
SET UP SIZE: 960x1000x2260 mm
MAX USER WEIGHT 150 Kg
WEIGHT: 154 kg
COMMERCIAL USE (EN20957-1 / EN957-2 class S)

- Struttura tubolare in acciaio rinforzato a sezione ovale piatta 50x100 mm - spessore 2,5 mm.
- Verniciatura doppia a polveri epossidiche, antigraffio.
- Sistema di carrucole/pulegge con cuscinetti POWER GRADE per garantire uno scorrimento preciso e progressivo. Cavi in acciaio rivestiti in poliuretano

- Structure oval flat heavy-duty steel tubing 50x100 mm - thickness 2,5 mm.
- Painting double heavy duty powder coating painting, scratch-resistant
- Pulley system POWER GRADE bearings for a smooth and precise action. Cables system steel woven cables with polyurethane coating



DUAL PULLEY

CSX5500

cod. CSX-5500

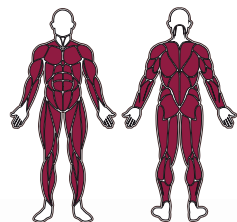

MUSCOLI COINVOLTI MUSCLE GROUPS

■ Full body

STRENGTH - STATIONS - BACK - LEGS

PACCO PESI 2 x 90 kg
DOTAZIONE coppia maniglie pulley, cavigliera, bilanciere, bilanciere curvo, barra tricipiti
DIMENSIONI PRODOTTO: 1314x2945x2147 mm
PESO: 373,5 kg
CLASSE D'UTILIZZO PROFESSIONALE (EN20957-1 / EN957-2 classe S)

WEIGHT STACK 2 x 90 kg
EQUIPMENT: ankle strap 2 x D handles; straight bar, curved bar and triceps bar
SET UP SIZE: 1314x2945x2147 mm
WEIGHT: 373,5 kg
COMMERCIAL USE (EN20957-1 / EN957-2 class S)

- Struttura tubolare in acciaio rinforzato a sezione ovale piatta 50x100 mm - spessore 2,5 mm, a sezione rettangolare 50x100 mm e 75x100 mm - spessore 3 mm
- Verniciatura doppia a polveri epossidiche, antigraffio
- Sistema di carrucole/pulegge con cuscinetti POWER GRADE per garantire uno scorrimento preciso e progressivo. Cavi in acciaio rivestiti in poliuretano

- Structure oval flat heavy-duty steel tubing 50x100 mm - thickness 2,5 mm and rectangular 50x100 mm and 75x100 mm - thickness 3 mm.
- Painting double heavy duty powder coating painting, scratch-resistant
- Pulley system POWER GRADE bearings for a smooth and precise action. Cables system steel woven cables with polyurethane coating

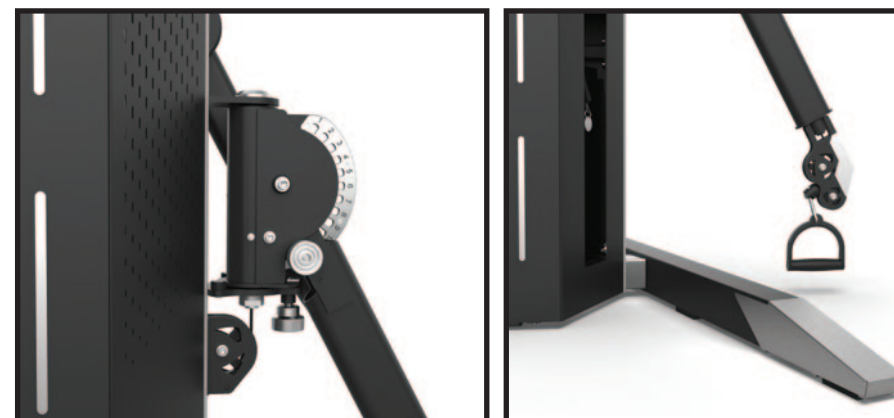

DUAL PULLEY

CSX3500

cod. CSX-3500

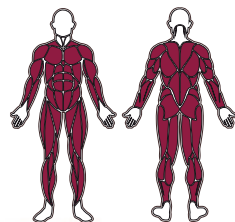

MUSCOLI COINVOLTI MUSCLE GROUPS

■ Full body

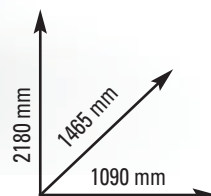

STRENGTH - STATIONS - BACK - LEGS

PACCO PESI 2 x 90 kg
DOTAZIONE coppia maniglie pulley, corda doppia, cavigliera, bilanciere, bilanciere curvo
DIMENSIONI PRODOTTO: 1090x1465x2180 mm
PESO MAX UTILIZZATORE 135 Kg
PESO: 320 kg
CLASSE D'UTILIZZO PROFESSIONALE (EN20957-1 / EN957-2 classe S)

STEEL WEIGHT STACK 2 x 90kg
EQUIPMENT ankle strap, 2 x D handles, straight bar and curved bar, rope
SET UP SIZE 1090x1465x2180 mm
MAX USER WEIGHT 135 Kg
WEIGHT: 320 kg
COMMERCIAL USE (EN20957-1 / EN957-2 class S)

- Struttura tubolare in acciaio rinforzato a sezione ovale piatta 40x80 e 50x100 mm - spessore 2 mm e sezione quadrata 50x50 mm - spessore 2 mm
- Verniciatura doppia a polveri epossidiche, antigraffio.
- Sistema di carrucole montate su cuscinetti HIGH PERFORMANCE. Cavi in acciaio rivestiti in PU ø 4.8 mm

- Structure oval flat heavy-duty steel tubing 40x80 mm and 50x100 mm - thickness 2 mm and squared 50x50 mm - thickness 2 mm
- Painting double heavy duty powder coating painting, scratch-resistant.
- Pulleys system with HIGH PERFORMANCE ball bearings. Woven cables system ø 4.8 mm - PU coated

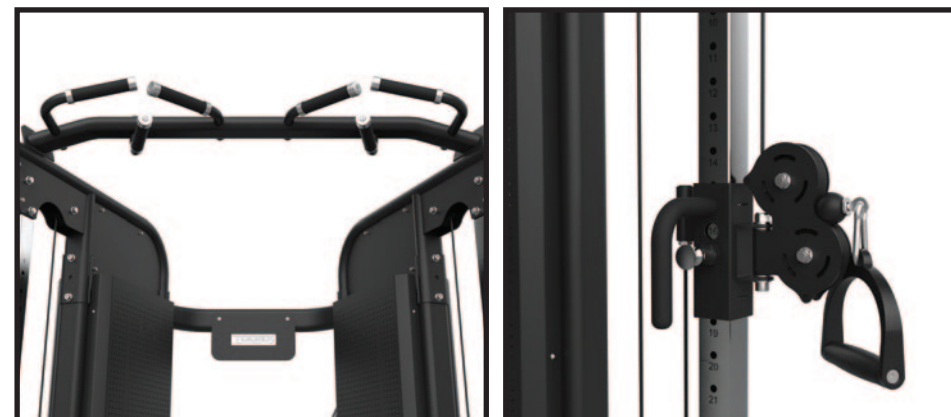

DUAL PULLEY

CSX2500

cod. CSX-2500

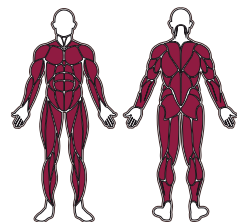

MUSCOLI COINVOLTI
MUSCLE GROUPS

■ Full body

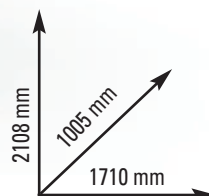

STRENGTH - STATIONS - BACK - LEGS

PACCO PESI 2 x 60 kg.
Pacco pesi 2x30 kg **OPTIONAL** disponibile cod. W-STACKCSX-2.5
DOTAZIONE coppia maniglie pulley, corda doppia, cavigliera, bilanciere
DIMENSIONI PRODOTTO: 1710x1005x2108 mm
PESO MAX UTILIZZATORE 135 Kg
PESO: 207 kg
CLASSE D'UTILIZZO PROFESSIONALE (EN20957-1 / EN957-2 classe S)

STEEL WEIGHT STACK 2 x 60 kg
2x30 kg **OPTIONAL** weight stack available cod. W-STACKCSX-2.5
EQUIPMENT ankle strap; 2 x D handles; straight bar; rope
SET UP SIZE 1710x1005x2108 mm
MAX USER WEIGHT 135 Kg
WEIGHT: 207 kg
COMMERCIAL USE (EN20957-1 / EN957-2 class S)

- Struttura tubolare in acciaio rinforzato a sezione quadrata 50x50 mm - spessore 2 mm e sezione rettangolare 50x80 mm - spessore 2 mm.
- Verniciatura doppia a polveri epossidiche, antigraffio.
- Sistema di carrucole montate su cuscinetti HIGH PERFORMANCE.
Cavi in acciaio rivestiti in PU ø 4.8 mm

- Structure squared heavy-duty steel tubing 50x5 mm - thickness 2 mm and rectangular 50x80 mm - thickness 2 mm.
- Painting double heavy duty powder coating painting, scratch-resistant.
- Pulleys system with HIGH PERFORMANCE ball bearings. Woven cables system ø 4.8 mm - PU coated



PRX5000

cod. PRX-5000

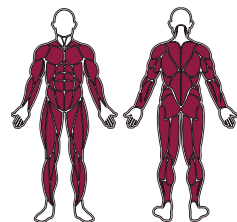

MUSCOLI COINVOLTI MUSCLE GROUPS

■ Full body



STAND AUTOPORTANTE PER PRX5000
STAND FRAME FOR STANDALONE USE
OPTIONAL

cod. STAND-PRX-5000



STAND AUTOPORTANTE
- Dimensione: 1390x106x1690 mm.
- Peso 73 Kg

STAND FRAME FOR STANDALONE USE
- Dimensions 1390x1060x1690mm.
-Weight 73 Kg

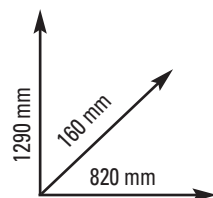

SISTEMA DI RESISTENZA MAGNETICA: max 50 kg selezionabili su 20 livelli
CONSOLE superficie a specchio con 5 display LED. Informazioni del computer: tempo, calorie, 8 programmi predefiniti, mode, selezione peso, conta pull per singolo braccio, scala intensità movimento
DIMENSIONI PRODOTTO: (braccia non in uso) 820x160x1290 mm*
* da fissare a 56 cm da terra
PESO: 69 kg
CLASSE D'UTILIZZO PROFESSIONALE (EN20957-1 / EN957-2 classe S)

MAGNETIC RESISTANCE SYSTEM: max 50 kg selectable on 20-level
CONSOLE mirror surface with 5 LED windows. Functions: time, calories, 8 pre-set programs, mode, weight selection, pull counter of each swing arm, movement intensity scale
SET UP SIZE (arms not in use) 820x160x1290 mm*
*to be fixed at 56 cm from the ground
WEIGHT: 69 kg
COMMERCIAL USE (EN20957-1 / EN957-2 class S)

- Struttura facile da montare e fissare al muro SUPER SLIM 16 cm di profondità
- Verniciatura doppia a polveri epossidiche, antigraffio.
- Sistema di carrucole montate su cuscinetti HIGH PERFORMANCE. Cavi in acciaio rivestiti in PU ø 4.8 mm
- Dotazione: coppia maniglie pulley. Casse acustiche Bluetooth. Regolazione delle braccia con selettori quick-adjust. Salvaspazio. Pre-assemblato.

- Structure easy assembly and wall mounting SUPER SLIM 16 cm deep
- Painting double heavy duty powder coating painting, scratch-resistant.
- Pulleys system with HIGH PERFORMANCE ball bearings. Woven cables system ø 4.8 mm - PU coated
- Equipment: pulley handles. Bluetooth speakers. Arms adjustment with quickadjust selectors. Space saving. Pre-assembled.



PRX3500

cod. PRX-3500

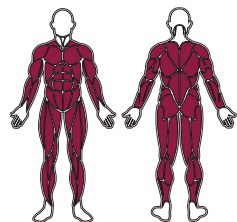

MUSCOLI COINVOLTI
MUSCLE GROUPS

■ Full body

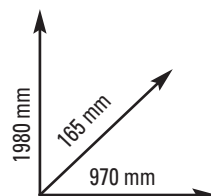

STRENGTH - STATIONS - BACK - LEGS

PACCO PESI in acciaio 2x50 kg selezionabili su 20 livelli.
Carter di protezione integrale con superficie a specchio
DIMENSIONI PRODOTTO: 970x165x1980 mm
PESO: 172 kg
CLASSE D'UTILIZZO PROFESSIONALE (EN20957-1 / EN957-2 classe S)

STEEL WEIGHT STACK 2x50kg selectable on 20-level each.
Full protection cage with mirror surface
SET UP SIZE: 970x165x1980 mm
WEIGHT: 172 kg
COMMERCIAL USE (EN20957-1 / EN957-2 class S)

- Struttura facile da montare e fissare al muro SUPER SLIM 16,5 cm di profondità
- Verniciatura doppia a polveri epossidiche, antigraffio.
- Sistema di carrucole in alluminio anodizzato montate su cuscinetti a sfera HIGH PERFORMANCE. Cavi in acciaio rivestiti in PU ø 4.8 mm
- Dotazione: coppia maniglie pulley

- Structure easy assembly and wall mounting SUPER SLIM 16,5 cm deep
- Painting double heavy duty powder coating painting, scratch-resistant.
- Pulleys system aluminium pulleys with ball bearings HIGH PERFORMANCE. Woven cables system ø 4.8 mm - PU coated
- Equipment: 2 pulley handles



PRX3000

cod. PRX-3000

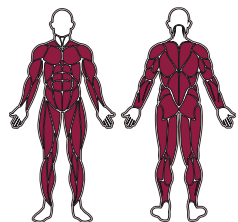

MUSCOLI COINVOLTI MUSCLE GROUPS

■ Full body

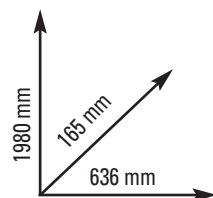

STRENGTH - STATIONS - BACK - LEGS

PACCO PESI in acciaio 50 kg selezionabile su 20 livelli.
Carter di protezione integrale con superficie a specchio
DIMENSIONI PRODOTTO: 636x165x1980 mm
PESO: 103 kg
CLASSE D'UTILIZZO PROFESSIONALE (EN20957-1 / EN957-2 classe S)

STEEL WEIGHT STACK 50kg selectable on 20-level.
Full protection cage with mirror surface
SET UP SIZE: 636x165x1980 mm
WEIGHT: 103 kg
COMMERCIAL USE (EN20957-1 / EN957-2 class S)

- Struttura facile da montare e fissare al muro SUPER SLIM 16,5 cm di profondità
- Verniciatura doppia a polveri epossidiche, antigraffio.
- Sistema di carrucole in alluminio anodizzato montate su cuscinetti a sfera HIGH PERFORMANCE. Cavi in acciaio rivestiti in PU \varnothing 4.8 mm
- Dotazione: coppia maniglie pulley

- Structure easy assembly and wall mounting SUPER SLIM 16,5 cm deep
- Painting double heavy duty powder coating painting, scratch-resistant.
- Pulleys system aluminium pulleys with ball bearings HIGH PERFORMANCE. Woven cables system \varnothing 4.8 mm - PU coated
- Equipment: 2 pulley handles



FWX6950

cod. FWX-6950

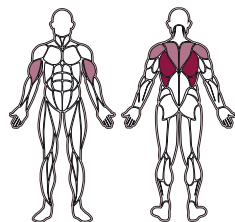

MUSCOLI COINVOLTI MUSCLE GROUPS

- Gran dorsale - Latissimus dorsi
- Bicipiti - Biceps
- Trapezio - Trapezius
- Deltoide posteriore - Posterior deltoid

DIMENSIONI PRODOTTO: 1800x1000x1160 mm
PESO MAX UTILIZZATORE: 120 Kg
PESO MAX CARICABILE: 300 kg
PESO: 60kg
CLASSE D'UTILIZZO PROFESSIONALE (EN ISO 20957-1 / EN ISO 20957-2 class S)

SET UP SIZE 1800x1000x1160 mm
MAX USER WEIGHT: 120 Kg
MAX LOADABLE WEIGHT: 300 kg
WEIGHT: 60 kg
COMMERCIAL USE (EN ISO 20957-1 / EN ISO 20957-2 class S)

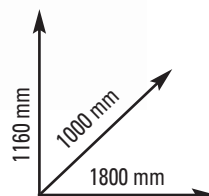

- Struttura tubolare in acciaio rinforzato a sezione rettangolare 50x100x3 mm
- Cuscini in schiuma ad alta densità con rivestimento in cotone riciclato
- Structure tubing section reinforced-steel rectangular tube 50x100x3 mm
- High-density foam cushions with recycled cotton upholstery



T BAR

FWX7000

cod. FWX-7000

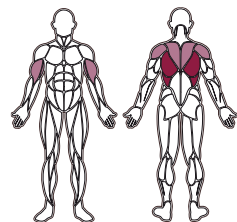

MUSCOLI COINVOLTI MUSCLE GROUPS

- Gran dorsale - Latissimus dorsi
- Bicipiti - Biceps
- Trapezio - Trapezius
- Deltoide posteriore - Posterior deltoid

STRENGTH - STATIONS - BACK - LEGS

DIMENSIONI PRODOTTO: 1875x931,5x349 mm
PESO MAX UTILIZZATORE: 120 Kg
PESO MAX CARICABILE: 200 kg
PESO: 38kg
CLASSE D'UTILIZZO PROFESSIONALE (EN ISO 20957-1 classe S)

SET UP SIZE 1875x931,5x349 mm
MAX USER WEIGHT: 120 Kg
MAX LOADABLE WEIGHT: 200 kg
WEIGHT: 38 kg
COMMERCIAL USE (EN ISO 20957-1 class S)

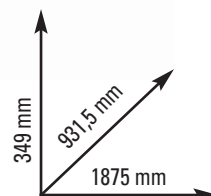

- Struttura tubolare in acciaio rinforzato a sezione quadrata 50x50x2 mm, rettangolare 75x50x2 mm e rotonda \varnothing 50x3 mm
- Verniciatura doppia a polveri epossidiche, antigraffio. Trattamento dei tubolari con sabbiatura e fosfatazione
- Structure tubing section reinforced-steel squared tube 50x50x2 mm, rectangular 75x50x2 mm and round \varnothing 50x3 mm
- Verniciatura doppia a polveri epossidiche, antigraffio. Trattamento dei tubolari con sabbiatura e fosfatazione



LTX3000

cod. LTX-3000

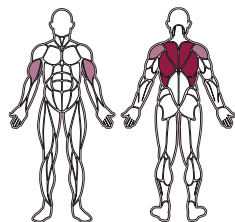

MUSCOLI COINVOLTI MUSCLE GROUPS

- Gran dorsale - Latissimus dorsi
- Romboidi - Rhomboids
- Trapezio inferiore - Lower trapezius
- Bicipiti - Biceps
- Deltoide posteriore - Posterior deltoid

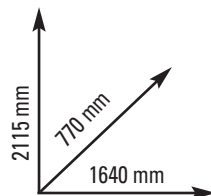

PACCO PESI IN ACCIAIO 90 kg con carter di protezione laterale in microrete
LAT MACHINE a pulley basso
DIMENSIONI PRODOTTO: 1640x770x2115 mm
PESO MAX UTILIZZATORE 100 Kg
PESO: 140 kg
CLASSE D'UTILIZZO PROFESSIONALE (EN20957-1 / EN957-2 classe S)

STEEL WEIGHT STACK 90 kg with micro-mesh lateral protection cage
LAT MACHINE with low pulley
SET UP SIZE 1640x770x2115 mm
MAX USER WEIGHT 100 Kg
WEIGHT: 140 kg
COMMERCIAL USE (EN20957-1 / EN957-2 class S)

- Struttura in acciaio rinforzato a sezione rettangolare 50x70x2mm e quadrata 50x50x2mm
- Sistema di carrucole e pulegge con cuscinetti a sfera.
- Sistema di cavi in acciaio intrecciati rivestiti in poliuretano.
- Dotazione: barra tricipiti, lat bar

- Structure reinforced-steel rectangular tube 70x50x2 mm and square tube 50x50x2mm
- Pulleys system with ball bearings. Cables system steel woven cables with polyuretane coating
- Equipment: triceps bar, lat bar



LTX2000

cod. LTX-2000

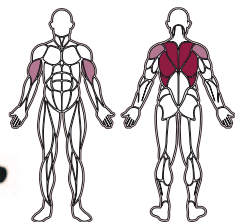

MUSCOLI COINVOLTI MUSCLE GROUPS

- Gran dorsale - Latissimus dorsi
- Romboidi - Rhomboids
- Trapezio inferiore - Lower trapezius
- Bicipiti - Biceps
- Deltoide posteriore - Posterior deltoid



Dischi peso non inclusi.
Weight plates not included.

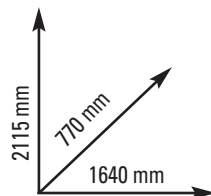

CARICAMENTO A DISCHI con foro \varnothing 25 mm e \varnothing 50 mm
LAT MACHINE a pulley basso
DIMENSIONI PRODOTTO: 1640x770x2115 mm
PESO MAX UTILIZZATORE 100 Kg
PESO: 57 kg
CLASSE D'UTILIZZO PROFESSIONALE (EN20957-1 / EN957-2 classe S)

FOR WEIGHT PLATES with 25 mm and 50 mm diameter hole
LAT MACHINE with low pulley
SET UP SIZE 1640x770x2115 mm
MAX USER WEIGHT 100 Kg
WEIGHT: 57 kg
COMMERCIAL USE (EN20957-1 / EN957-2 class S)

- Struttura in acciaio rinforzato a sezione rettangolare 50x70x2mm e quadrata 50x50x2mm
- Sistema di carrucole e pulegge con cuscinetti a sfera. Sistema di cavi in acciaio intrecciati rivestiti in poliuretano.
- Dotazione: barra tricipiti, lat bar, adattatore per utilizzo dischi in ghisa con foro \varnothing 50 mm
- Structure reinforced-steel rectangular tube 70x50x2 mm and square tube 50x50x2mm
- Pulleys system with ball bearings. Cables system steel woven cables with polyuretane coating
- Equipment: triceps bar, lat bar, adapter for cast iron weight plates with 50 mm diameter hole

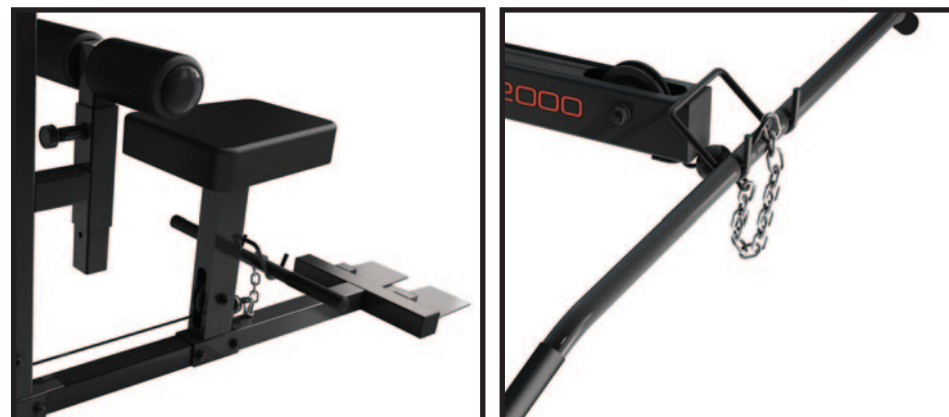

HSX3000

cod. HSX-3000

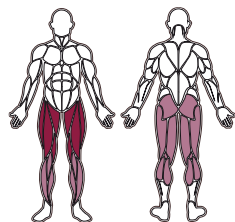

MUSCOLI COINVOLTI MUSCLE GROUPS

- Quadricipiti - Quadriceps
- Glutei - Gluteus
- Ischiocrurali - Hamstrings
- Polpacci - Calves

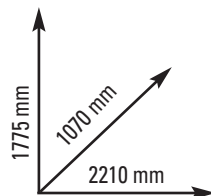

DIMENSIONI PRODOTTO: 2210x1070x1775 mm
 PESO MAX UTILIZZATORE 150 Kg
 PESO MAX CARICABILE 350 Kg
 PESO: 140.7 kg
 CLASSE D'UTILIZZO PROFESSIONALE (EN20957-1 / EN957-2 classe S)

SET UP SIZE 2210x1070x1775 mm
 MAX USER WEIGHT 150 Kg
 PESO MAX CARICABILE 350 Kg
 WEIGHT: 140.7 kg
 COMMERCIAL USE (EN20957-1 / EN957-2 class S)

- Struttura in acciaio rinforzato a sezione rettangolare 70x50x2,5 mm, 50x100x2,5 mm e quadrata 50x50x3 mm, 50x50x2,5mm, 50x50x2 mm
- Dotazione/ note: 2-IN-1 leg press, hack squat. Maniglie con funzione fermi di sicurezza su entrambe le posizioni di allenamento, 2 ganci per fasce elastiche, piedini in gomma anti scivolo, sistema di carico dischi ø25 e ø50 mm di facile accesso sotto al carrello, 4 ferma dischi a molla ø 25 mm, 2 ferma dischi a molla ø 49 mm.

- Structure reinforced-steel rectangular tube 70x50x2,5 mm, 50x100x2,5 mm and square tube 50x50x3 mm, 50x50x2,5mm, 50x50x2 mm
- Equipment/notes: 2-IN-1 leg press, hack squat. Hold down handles on both training positions, 2 pegs for resistance band, anti-slip rubber feet, easy-access under-carriage plate load system suitable for ø25 and ø50 mm weight plates, 4 spring clip ø 25 mm and 2 olympic spring clip ø 49 mm.



LPX5000

cod. LPX-5000

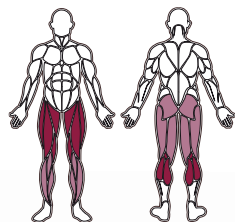

MUSCOLI COINVOLTI MUSCLE GROUPS

- Quadricipiti - Quadriceps
- Polpacci - Calves
- Glutei - Gluteus
- Ischiocrurali - Hamstrings

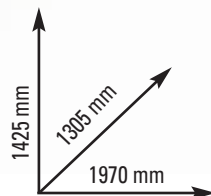

REGOLAZIONI: inclinazione schienale su 3 livelli, inclinazione pedana su 3 livelli, altezza posizione calf su 3 livelli. 4 posizioni blocco di sicurezza, 3 posizioni start/stop
 DIMENSIONI PRODOTTO: 1970x1305x1425 mm
 PESO MAX UTILIZZATORE 160 Kg
 PESO MAX CARICABILE 340 Kg
 PESO: 102.5 kg
 CLASSE D'UTILIZZO PROFESSIONALE (EN20957-1 / EN957-2 classe S)

ADJUSTMENTS: backrest angle on 3-level, footplate angle on 3-level, calf block height on 3-level. 4 lockout safety positions, 3 start/stop positions
 SET UP SIZE 1970x1305x1425 mm
 MAX USER WEIGHT 160 Kg
 PESO MAX CARICABILE 340 Kg
 WEIGHT: 102.5 kg
 COMMERCIAL USE (EN20957-1 / EN957-2 class S)

- Struttura in acciaio rinforzato a sezione rettangolare 70x50x2,5 mm, 40x80x2,5 mm, 50x80x2,5 mm e rotonda ø50x3 mm
- Dotazione: piedini in gomma anti scivolo, sistema di carico dischi ø50 mm e 25 mm, 2 ferma dischi a molla ø25 spring clip, 2 ferma dischi a molla ø 49 mm.

- Structure reinforced-steel rectangular tube 70x50x2,5 mm, 40x80x2,5 mm, 50x80x2,5 mm and round tube ø50x3 mm
- Equipment: anti-slip rubber feet, plate load system suitable for ø25 mm and ø50 mm weight plates, 2 spring clip ø25, 2 olympic spring clip ø 49 mm.



LPX3000

cod. LPX-3000

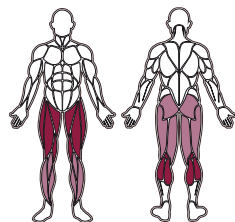

MUSCOLI COINVOLTI MUSCLE GROUPS

- Quadricipiti - Quadriceps
- Polpacci - Calves
- Glutei - Gluteus
- Ischiocrurali - Hamstrings

REGOLAZIONI: inclinazione schienale su 3 livelli, inclinazione pedana su 3 livelli, altezza posizione calf su 3 livelli
 DIMENSIONI PRODOTTO: 1651x1298x1460 mm
 PESO MAX UTILIZZATORE 135 Kg
 PESO MAX CARICABILE 295 Kg
 PESO: 82 kg
 CLASSE D'UTILIZZO PROFESSIONALE (EN20957-1 / EN957-2 classe S)

ADJUSTMENTS: backrest angle on 3-level, footplate angle on 3-level, calf block height on 3-level
 SET UP SIZE 1651x1298x1460 mm
 MAX USER WEIGHT 135 Kg
 PESO MAX CARICABILE 295 Kg
 WEIGHT: 82 kg
 COMMERCIAL USE (EN20957-1 / EN957-2 class S)

- Struttura in acciaio rinforzato a sezione rettangolare 70x50x2 mm, quadrata 60x60x2 mm, 45x45x2 mm rotonda ø50x3 mm
- Dotazione: 4 ganci per fasce elastiche, piedini in gomma anti scivolo, sistema di carico dischi ø50 mm e 25 mm, 2 ferma dischi a molla ø25 spring clip, 2 ferma dischi a molla ø 49 mm.

- Structure reinforced-steel rectangular tube 70x50x2 mm, square tube 60x60x2 mm, 45x45x2 mm and round tube ø50x3 mm
- Equipment: 4 pegs for resistance band, anti-slip rubber feet, plate load system suitable for ø25 mm and ø50 mm weight plates, 2 spring clip ø25, 2 olympic spring clip ø 49 mm.

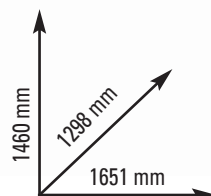



RACKS & LADDERS



POWER RACK

WLX3800

cod. WLX-3800



cod. D-HANDLEASX8-WLX38

PARALLELE
DIP HANDLE
OPTIONAL



cod. KIT-SMTWLX-3800

KIT SMITH MACHINE
SMITH MACHINE KIT
OPTIONAL

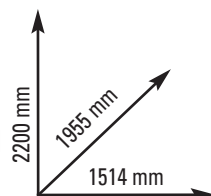

RACKS & LADDERS

BILANCIERI Altezza j-cup regolabile (362-1712 mm) su 26 livelli. Interasse 50 mm J-cup spessore 5 mm con protezione UHMW
DIMENSIONI PRODOTTO: 1514X1955X2200 mm
PESO MAX STRUTTURA 350 Kg
PESO MAX UTILIZZATORE 160 Kg
PESO: 130,6 kg
CLASSE D'UTILIZZO PROFESSIONALE (EN20957-1 / EN957-4 classe S)

BARBELLS J-cup height adjustable (362-1712 mm) su 26 livelli. Distance 50 mm J-cup 5 mm thickness with UHMW protection pads
SET UP SIZE: 1514X1955X2200 mm
MAX STRUCTURE WEIGHT 350 kg
MAX USER WEIGHT 160 kg
WEIGHT: 130,6 kg
COMMERCIAL USE (EN20957-1 / EN957-4 class S)

- Struttura tubolare a sezione quadrata 75x75 mm - spessore 3 mm
- Verniciatura doppia a polveri epossidiche, antigraffio
- Dotazioni/notes: 2 J-hooks, coppia fermi di sicurezza bilanciere, barra trazioni multi-presa, porta bilanciere, 4 porta dischi ø50 mm, 6 ferma dischi a molla ø49 mm.

- Structure section square tube 75x75 mm - thickness 3 mm
- Painting double heavy duty powder coating painting, scratch-resistant
- Equipment/notes: 2 J-hooks, 2 safety spotter arms, multi-grip chin-up bar, barbell storage, 4 weight plates holders for ø50 mm plates, 6 olympic spring clip ø49 mm.

KIT SMITH MACHINE PER WLX-3800 OPTIONAL

- Peso massimo caricabile 250 Kg.
- Peso 74 kg.
- Bilanciere: 1996 mm, scorrimento su cuscinetto lineare ultra fluido per guida bilanciere Smith, 2 sicurezze con gancio. Diametro porta dischi da 50 mm.
- Peso massimo utilizzatore: 160 Kg
- Dotazioni/notes: smith bar, 2 glide rods, 28 hooks stop

SMITH MACHINE KIT FOR WLX-3800 OPTIONAL

- Max loadable weight 250 Kg.
- Weight 74 kg.
- Barbells: 1996mm, ultra smooth linear bearing for smith bar guiding, 2 safety systems with hook to avoid barbell falling. Weight plate holder diameter suitable for ø50 mm weight plates.
- Max user weight: 160 Kg
- Equipment/notes: smith bar, 2 glide rods, 28 hooks stop

POWER RACK

WLX3600

cod. WLX-3600

TRALICCIO TRAZIONI
MULTIPRESA

TRUSS WITH MULTIPLE HANDLES

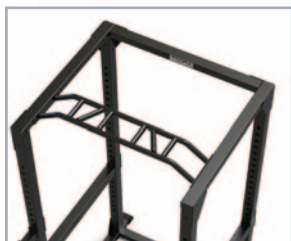

cod. LAT-ATTWLX-3600

OPTIONAL
LAT/ PULLDOWN/
SEATED ROW MACHINE

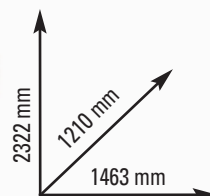

RACKS & LADDERS

BILANCIERI Altezza j-cup regolabile (450-1890 mm) su 25 livelli.
Interasse 60 mm J-cup spessore 6 mm con protezione UHMW
DIMENSIONI PRODOTTO: 1463x1210x2322 mm
PESO MAX STRUTTURA 300 Kg
PESO: 132 kg
CLASSE D'UTILIZZO PROFESSIONALE (EN20957-1 / EN957-4 classe S)

BARBELLS J-cup height adjustable (450-1890 mm) on 25 levels.
Distance 60 mm J-cup 6 mm thickness with UHMW protection pads
SET UP SIZE 1463x1210x2322 mm
MAX STRUCTURE WEIGHT 300 kg
WEIGHT: 132 kg
COMMERCIAL USE (EN20957-1 / EN957-4 class S)

- Struttura tubolare in acciaio rinforzato a sezione 75x75 mm - spessore 3 mm
- Verniciatura doppia a polveri epossidiche, antigraffio .
- Dotazione: 2 j-cups, 2 safety bars, traliccio trazioni

- Structure square heavyduty steel tubing 75x75 mm - thickness 3 mm
- Painting double heavy duty powder coating painting, scratch-resistant
- Equipment: 2 j-cups, 2 safety bars, truss with multiple-handle.

LAT/ PULLDOWN/ SEATED ROW MACHINE **OPTIONAL**.

- Peso max caricabile 160 kg.
- Caricamento a dischi con foro \varnothing 25 mm e \varnothing 50 mm.
- Sistema di carrucole /puleggie con cuscinetti a sfera.
- Dotazioni/note: lat bar, barra tricipiti, poggia piedi per seated row, adattatore per utilizzo dischi in ghisa con foro \varnothing 50 mm inclusi.

- Max loadable weight 160 Kg.
- For weight plates with 25 mm and 50 mm diameter hole.
- Pulleys system with ball bearings.
- Equipment/note: lat bar, triceps bar, foot supports for seated row, adapter for weight plates with 50 mm diameter hole included.



HALF RACK

WLX3400

cod. WLX-3400

TRALICCIO TRAZIONI
MULTIPRESA

TRUSS WITH MULTIPLE HANDLES



RACKS & LADDERS

BILANCIERI Altezza j-cup/safety spotter arm regolabile (450-1890 mm) su 25 livelli. Interasse 60 mm j-cup/spotter arm spessore 6 mm con protezione UHMW
DIMENSIONI PRODOTTO: 1400x1308x2321 mm
PESO MAX STRUTTURA 300 Kg
PESO: 105 kg
CLASSE D'UTILIZZO PROFESSIONALE (EN20957-1 / EN957-4 classe S)

BARBELLS j-cup/ safety spotter arm height adjustable (450-1890 mm) on 25 levels. Distance 60 mm j-cup/safety spotter arm 6 mm thickness with UHMW protection pads
SET UP SIZE 1400x1308x2321 mm
MAX STRUCTURE WEIGHT 300 kg
WEIGHT: 105 kg
COMMERCIAL USE (EN20957-1 / EN957-4 class S)

- Struttura tubolare in acciaio rinforzato a sezione 75x75 mm - spessore 3 mm
- Verniciatura doppia a polveri epossidiche, antigraffio .
- Dotazione: 2 j-cups, 2 safety spotter arms, 8 barre porta pesi, 2 porta bilancieri, 8 barre in acciaio per fasce elastiche, 4 ganci per elastici, traliccio trazione
- Structure square heavyduty steel tubing 75x75 mm - thickness 3 mm
- Painting double heavy duty powder coating painting, scratch-resistant
- Equipment: 2 j-cups, 2 safety spotter arms, 8 weight plates holders, 2 barbell holders, 8 steel bars for resistance bands, 4 hooks for resistance bands, truss with multiplehandle



SQUAT STAND

WLX3200

cod. WLX-3200

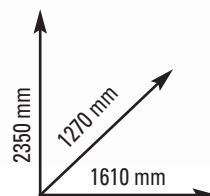

RACKS & LADDERS

BILANCIERI altezza j-cup/ safety spotter arm regolabile (450-1890 mm) su 25 livelli. Interasse 60 mm j-cup/spotter arm spessore 8 mm con protezione UHMW
DIMENSIONI PRODOTTO: 1610x1270x2350 mm
PESO MAX STRUTTURA 300 kg
PESO: 85 kg
CLASSE D'UTILIZZO PROFESSIONALE (EN20957-1 / EN957-4 classe S)

BARBELLS j-cup/ safety spotter arm height adjustable (450-1890 mm) on 25 levels. Distance 60 mm j-cup/safety spotter arm 8 mm thickness with UHMW protection pads
SET UP SIZE 1610x1270x2350 mm
MAX STRUCTURE WEIGHT 300 kg
WEIGHT: 85 kg
COMMERCIAL USE (EN20957-1 / EN957-4 class S)

- Struttura tubolare in acciaio rinforzato a sezione quadrata 60x60 mm e rettangolare 50x70 mm - spessore 3 mm
- Verniciatura doppia a polveri epossidiche, antigraffio.
- Dotazione: 2 j-cups, 2 safety spotter arms, 2 barre porta pesi, 6 barre in acciaio per fasce elastiche, barra trazioni

- Structure square heavyduty steel tubing 60x60 mm and rectangular 50x70 mm - thickness 3 mm
- Painting double heavy duty powder coating painting, scratch-resistant.
- Equipment: 2 j-cups, 2 safety spotter arms, 2 weight plates holders, 6 steel bars for resistance bands, chin-up bar



WLX3000

cod. WLX-3000

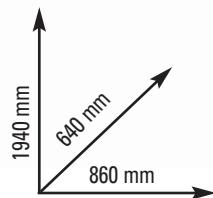

RACKS & LADDERS

BILANCIERI altezza j-cup/ safety spotter arm regolabile (450-1890 mm) su 25 livelli. Interasse 60mm j-cup/spotter arm spessore 8 mm con protezione UHMW
DIMENSIONI PRODOTTO: 860x640x1940 mm
PESO MAX STRUTTURA 300 kg
PESO: 58 kg
CLASSE D'UTILIZZO PROFESSIONALE (EN20957-1 / EN957-4 classe S)

BARBELLS j-cup/ safety spotter arm height adjustable (450-1890 mm) on 25 levels. Distance 60 mm j-cup/ safety spotter arm 8 mm thickness with UHMW protection pads
SET UP SIZE 860x640x1940 mm
MAX STRUCTURE WEIGHT 300 kg
WEIGHT: 58 kg
COMMERCIAL USE (EN20957-1 / EN957-4 class S)

- Struttura tubolare in acciaio rinforzato a sezione quadrata 60x60 mm e rettangolare 50x70 mm - spessore 3 mm
- Verniciatura doppia a polveri epossidiche, antigraffio.
- Dotazione: 2 j-cups, 2 safety spotter arms, 2 barre porta pesi, 4 ruote di trasporto

- Structure square heavyduty steel tubing 60x60 mm and rectangular 50x70 mm - thickness 3 mm
- Painting double heavy duty powder coating painting, scratch-resistant.
- Equipment: 2 j-cups, 2 safety spotter arms, 2 weight plates holders, 4 moving wheels



WLX2800

cod. WLX-2800



SALVASPAZIO
SPACE SAVING
1355x90x2300 mm

ACCESSORIO **OPTIONAL**
COPPIA FERMI
DI SICUREZZA BILANCIERE

ACCESSORY **OPTIONAL**
SAFETY SPOTTER ARMS

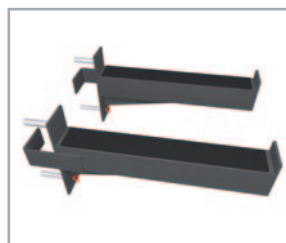

cod. AG75-FS

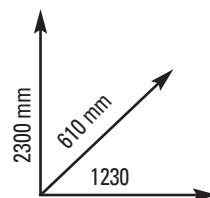

BILANCIERI regolabile 450-1850 su 25 livelli. Interasse 50/100mm.
J-cup spessore 6 mm con protezione UHMW
DIMENSIONI PRODOTTO: 1230x610x2300 mm
DIMENSIONI PRODOTTO CHIUSO: 1355x90x2300 mm
PESO MAX STRUTTURA 300 kg
PESO: 61 kg
CLASSE D'UTILIZZO PROFESSIONALE (EN20957-1 / EN957-4 classe S)

BARBELLS adjustable on 25 levels (450-1850 mm) distance 50/100 mm.
J-cup 6 mm thickness with UHMW protection pads
SET UP SIZE 1230x610x2300 mm
FOLDED SIZE 1355x90x2300 mm
MAX STRUCTURE WEIGHT 300 kg
WEIGHT: 61 kg
COMMERCIAL USE (EN20957-1 / EN957-4 class S)

- Struttura tubolare a sezione quadrata 75x75 mm - spessore 3 mm
- Verniciatura doppia a polveri epossidiche, antigraffio.
- Dotazione: J-cups inclusi

- Structure squared tubing 75x75 mm - thickness 3 mm
- Painting double heavy duty powder coating painting, scratch-resistant.
- Equipment: j-cup included

ACCESSORIO **OPTIONAL**

- Coppia fermi di sicurezza bilanciere AG75-FS.
- Spessore 8 mm.
- Dotati di protezioni e pin di sicurezza \varnothing 16 mm

- Safety spotter arms AG75-FS.
- Thickness 8 mm.
- Protection pads and \varnothing 16 mm safety pin included

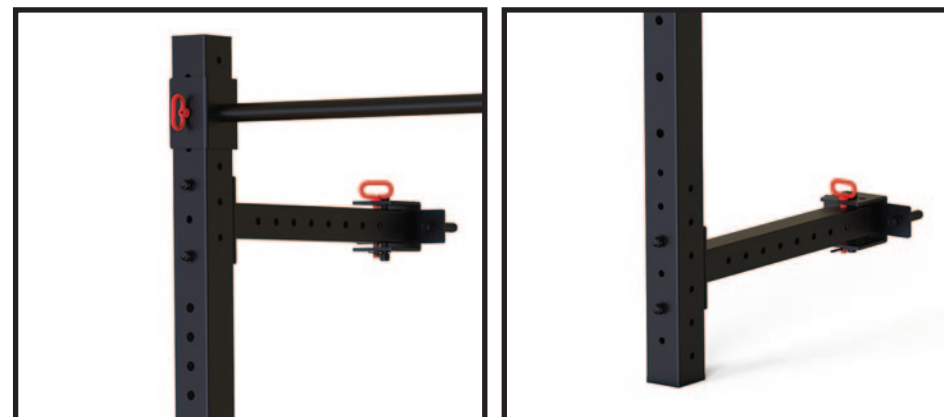

LDX5000

cod. LDX-5000

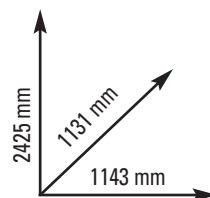

MODULO PIOLI configurazione rack: n°5 pioli 1050xø32.
 Dimensione 1050x60x872 mm. Fissaggio con bulloni
 TRALICCIO TRAZIONI: con sei impugnature antiscivolo. Altezza da terra
 2230 mm - larghezza 1080 mm - ø36 e ø 30 mm
 DIMENSIONI PRODOTTO: 1143x1131x2425 mm
 PESO MAX UTILIZZATORE 120 Kg
 PESO: 73 kg
 CLASSE D'UTILIZZO PROFESSIONALE (EN20957-1 / EN957-4 classe S)

BARS MODULE with rack configuration: n°5 bars 1050xø32.
 Dimensions 1050x60x872 mm. Fixing with bolts
 TRUSS: with 6 non-slip handles. 2230 mm from the ground up - width 1080
 mm - ø36 and ø 30 mm
 SET UP SIZE 1143x1131x2425 mm
 MAX USER WEIGHT 120 Kg
 WEIGHT: 73 kg
 COMMERCIAL USE (EN20957-1 / EN957-4 class S)

- Struttura tubolare in acciaio rinforzato a sezione quadrata 75x75x3 mm
- J-HOOK extra strong spessore 6 mm con protezione UHMW (Ultra High Molecular Weight)
- Staffe fissaggio a muro: n°2 lunghezza 512 mm
- Dotazione: 2 j-cups, traliccio trazioni

- Structure reinforced steel square tube 75x75x3 mm square tube 50x50x2mm
- J-HOOK extra strong 6 mm thickness with UHMW(Ultra High MolecularWeight)
- Wall brackets: n° 2 length 512 mm.
- Equipment: 2 j-cups, truss





COD. ALDX5-MPS

COD. ALDX5-MPS
 MODULO PIOLI CONFIGURAZIONE
 SPALLIERA :n°6 pioli 1050xø32 mm.
 Dimensione 1240x75x1125 mm.
 Fissaggio con bulloni inclusi
**BARS MODULE WITH LADDER
 CONFIGURATION: n°6 bars 1050xø32 mm.
 Dimensions 1240x75x1125 mm.
 Fixing with bolts included**



COD. ALDX5-SU

COD. ALDX5-SU
 STEP PLYO: superficie pedana 600x500 mm. Pin di sicurezza ø16 mm. Sistema di fissaggio a sgancio rapido con pin di connessione ø16 mm.
STEP PLYO: platform surface 600x500 mm. Safety pin ø16 mm. Quick release fixing system with ø16 mm pin.



COD. ALDX5-B

COD. ALDX5-B
 BERSAGLIO: dimensione disco ø400 mm. Staffe spessore 6 mm
TARGET: disc dimensions ø400 mm. 6 mm thick brackets



COD: AG75-P

COD: AG75-P
 PARALLELE: dimensioni 887x600x358 mm. Pin di sicurezza ø16 mm. Sistema di fissaggio a sgancio rapido con pin di connessione ø16 mm.
DIP HORNS: dimensions 887x600x358 mm. Safety pin ø16 mm. Quick release fixing system with ø16 mm pin.

COD. AG75-FS
 COPPIA FERMI DI SICUREZZA BILANCIERE: spessore 8 mm. Superficie d'appoggio 500 mm. Dotati di protezioni e pin di sicurezza ø16 mm. Sistema di fissaggio a sgancio rapido con pin di connessione ø16 mm.
SAFETY SPOTTER ARMS: thickness 8 mm. Surface length 500 mm. Protection pads and ø16 mm safety pin included. Quick release fixing system with ø16 mm pin.

COD. AGU-LD
 LANDMINE DOPPIO: snodo cardanico con doppia sede per bilancieri ø50 mm. Lunghezza 250 mm
LANDMINE DOUBLE: carina joint with dual slot for ø50 mm barbells. Length 250 mm

COD. AGU-GC
 GANCIO CORDA: progettato per battle rope, fune da arrampicata e sacco boxe
ROPE RING: designed for battle rope, climbing rope and boxing bag

COD. ALDX5-SM
 COPPIA STAFFE A MURO addizionale per fissaggio esclusivamente a parete
ADDITIONAL WALL BRACKETS for fixing to the wall only

COD. PANCA-LDX3-5
 PANCA: Dimensione 1346x666x857 mm (in posizione piana). Dimensione schienale 1230x300x50mm. Regolazione inclinazione su 3 livelli. Dimensione sedile 187x200x50 mm. Sedile removibile. 4 modalità di utilizzo: panca piana, panca addominali, panca inclinata e panca declinata. Sistema di fissaggio a sgancio rapido con 2 ganci. Rulli bloccaggio caviglie inclusi.
BENCH: dimensions 1346x666x857 mm (flat position). Backrest dimensions 1230x300x50mm. Adjustable incline on 3 levels. Saddle dimensions 187x200x50 mm. Removable saddle. 4 modes of use: flat bench, abdominal bench, inclined bench and declined bench. Quick release fixing system with 2 hooks. Roller ankle cushions included



COD. AG75-FS



COD. AGU-LD



COD. AGU-GC



COD. ALDX5-SM



COD. PANCA-LDX3-5



LDX3000

cod. LDX-3000

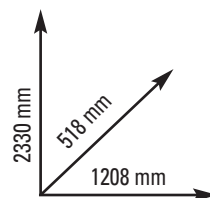

MODULO PIOLI: n°10 pioli a sezione ovale 40x32 mm. Lunghezza 710 mm.
 Distanza pioli 220 mm. Distanza primo piolo da terra 160 mm.
 TRALICCIO TRAZIONI: con sei impugnature antiscivolo.
 Altezza da terra 2260 mm - larghezza 1208 mm - ø 32 mm
 DIMENSIONI PRODOTTO: 1208x518x2330 mm
 PESO MAX UTILIZZATORE 100 Kg
 PESO: 28,5 kg
 CLASSE D'UTILIZZO PROFESSIONALE (EN20957-1 / EN957-4 classe S)

BARS MODULE: n°10 wooden bars with oval section 40x32 mm. Width 710 mm.
 Distances among bars 220 mm. 160 mm from the ground to the first lower bar
 TRUSS: with 6 non-slip handles. 2260 mm from the ground up -
 width 1208 mm - ø 32 mm
 SET UP SIZE 1208x518x2330 mm
 MAX USER WEIGHT 100 Kg
 WEIGHT: 28,5 kg
 COMMERCIAL USE (EN20957-1 / EN957-4 class S)

- Struttura montanti: in acciaio a sezione ovale 80x40x2mm
- Staffe fissaggio a muro: n°4 lunghezza 108 mm
- Dotazione: traliccio trazionii

- Uprights structure: reinforced steel oval tube 80x40x2mm
- Wall brackets: n°4 width 108 mm
- Equipment: truss





» COD. CFSLDX3000
 COPPIA FERMI DI SICUREZZA BILANCIERE: spessore 4 mm. Lunghezza superficie d'appoggio 500 mm. Dotati di protezioni e pin di sicurezza ø16 mm. Sistema di fissaggio a sgancio rapido con pin di connessione ø16 mm.
 SAFETY SPOTTER ARMS: thickness 4 mm. Surface length 500 mm. Protection pads and ø16 mm safety pin included. Quick release fixing system with ø16 mm pin.



» COD. DIP-STATIONLDX3000
 DIP STATION: Dimensione 797x724x570 mm. Cuscini spessore 60 mm. 2 pin di sicurezza ø16 mm. Sistema di fissaggio a sgancio rapido con 2 ganci. 2 appoggi bilancieri alti integrati per allenamento squat.
 DIP STATION: dimensions 797x724x570 mm. Cushions thickness 60 mm. 2 ø16 mm safety pins. Quick release fixing system with 2 hooks. 2 upper barbel holders for squat training.



» COD. PANCA-LDX3-5
 PANCA: Dimensione 1346x666x857 mm (in posizione piana). Dimensione schienale 1230x300x50mm. Regolazione inclinazione su 3 livelli. Dimensione sedile 187x200x50mm. Sedile removibile.
 4 modalità di utilizzo: panca piana, panca addominali, panca inclinata e panca declinata. Sistema di fissaggio a sgancio rapido con 2 ganci. Rulli bloccaggio caviglie inclusi.
 BENCH: dimensions 1346x666x857 mm (flat position). Backrest dimensions 1230x300x50mm. Incline adjustment on 3-level. Saddle dimensions 187x200x50mm. Removable saddle.
 4 modes of use: flat bench, abdominal bench, inclined bench and declined bench. Quick release fixing system with 2 hooks. Roller ankle cushions included.

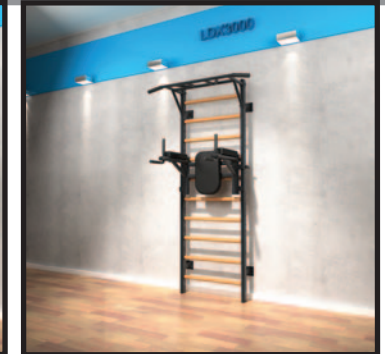

SPALLIERE SVEDESI - SWEDISH LADDERS

SPALLIERA SVEDESE 1 CAMPATA
 SINGLE WOODEN WALL BAR

cod. AHF-158



- SPALLIERA SVEDESE ad una campata realizzata con legno massello di faggio europeo.
- LEVIGATO E VERNICIATO con protettivo trasparente
- PIOLI ø 38mm
- DIMENSIONE PRODOTTO 90x250 cm

- SINGLE WOODEN WALL BAR made of solid beechwood
- VARNISHED well finished and polished
- RUNGS ø 38mm
- PRODUCT DIMENSIONS 90x250 cm

SPALLIERA SVEDESE 2 CAMPATE
 DUAL WOODEN WALL BAR

cod. AHF-159



- SPALLIERA SVEDESE a doppia campata realizzata con legno massello di faggio europeo.
- LEVIGATO E VERNICIATO con protettivo trasparente
- PIOLI ø 38mm
- DIMENSIONE PRODOTTO 180x250 cm

- DUAL WOODEN WALL BAR made of solid beechwood
- VARNISHED well finished and polished
- RUNGS ø 38mm
- PRODUCT DIMENSIONS 180x250 cm

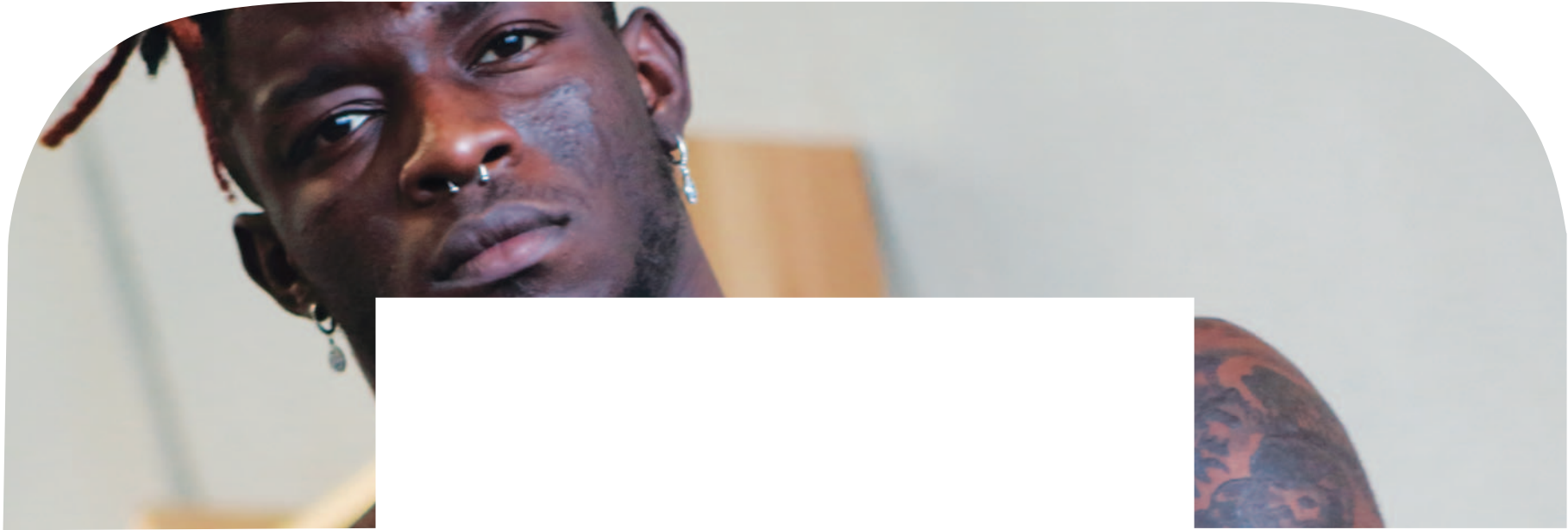

BENCHES



WBX1000

cod. WBX-1000

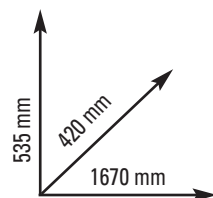

BENCHES - FUNCTIONAL

INCLINAZIONE SCHIENALE regolabile su 8 livelli (0-85°)
DIMENSIONI PRODOTTO: 1670x420x535 mm
PESO MAX UTILIZZATORE 150 Kg
PESO MAX CARICABILE: 250 kg
PESO: 70 kg
CLASSE D'UTILIZZO PROFESSIONALE (EN20957-1 classe S)

BACKREST INCLINE 8-level adjustment (0-85°)
SET UP SIZE 1670x420x535mm
MAX USER WEIGHT 150 Kg
MAX LOADABLE WEIGHT: 250 kg
WEIGHT: 70 kg
COMMERCIAL USE (EN20957-1 class S)

- Cuscineria spessore 55 mm
- Dotazioni: 4 ruote e maniglia di trasporto, 2 ganci per battle rope, 4 ganci per elastici, 2 piedini stabilizzanti retrattili, landmine
- Capacità di stoccaggio: 3 coppie di manubri, 6 kettlebell, 1 palla, piccoli accessori

- Saddlery 55 mm thickness
- Equipment: 4 moving wheels, moving handle, 2 hooks for battle rope, 4 hooks for elastic bands, 2 retractable stabilizing levers, landmine
- Storage capacity: 3 pairs of dumbbells, 6 kettlebells, 1 ball, small accessories



WBX3300

cod. WBX-3300

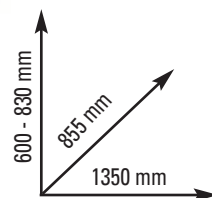

BENCHES - BACK AND GLUTEUS

ALTEZZA SCHIENALE regolabile su 10 livelli (min. 600, max. 830 mm)
DIMENSIONI PRODOTTO: 1350x855x600/830 mm
PESO MAX UTILIZZATORE: 120 Kg
PESO MAX CARICABILE: 200 kg
PESO: 41 kg
CLASSE D'UTILIZZO PROFESSIONALE (EN20957-1/ EN957-4 classe S)

BACKREST HEIGHT 10-level adjustment (min. 600, max. 830 mm)
SET UP SIZE 1350x855x600/830 mm
MAX USER WEIGHT: 120 Kg
MAX LOADABLE WEIGHT: 200 kg
WEIGHT: 41 kg
COMMERCIAL USE (EN20957-1 / EN957-4 class S)

- Struttura tubolare in acciaio rinforzato a sezione quadrata 75x75x3 mm e rettangolare 75x50x3 mm
- Cuscineria spessore 70 mm - con imbottitura sagomata. Ideale per esercizi di tirata orizzontale con bilanciere dritto e offset
- Structure tubing section reinforced-steel squared tube 75x75x3 mm and rectangular 75x50x3 mm
- Saddlery 70 mm thickness - with shaped padding. Ideal for horizontal pull exercises with straight or offset barbell



WBX250

cod. WBX-250

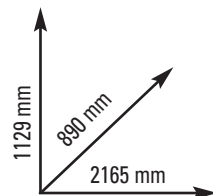

BENCHES - BACK AND GLUTEUS

CARRELLO regolazione orizzontale su 7 livelli
APPOGGI ADDOMINALI/LOMBARI imbottitura ad alta densità e rivestimento in eco pelle
DIMENSIONI PRODOTTO: 2165x890x1129 mm
PESO MAX UTILIZZATORE 150 Kg
PESO: 50 kg
CLASSE D'UTILIZZO PROFESSIONALE (EN20957-1 classe S)

CARRIAGE horizontal adjustment on 7 levels
ABDOMINAL/ LUMBAR SUPPORTS heavy duty padding with ecoleather coating
SET UP SIZE 2165x890x1129 mm
MAX USER WEIGHT 150 Kg
WEIGHT: 50 kg
COMMERCIAL USE (EN20957-1 class S)

- Struttura tubolare in acciaio rinforzato a sezione rettangolare 70x50x3 mm
- Dimensione appoggi addominali/lombari 220x270x 60 mm x 2
- Dotazione/ note: panca allenamento crosstraining. Rulli extra large in foam ad alta densità con rivestimento in ecopelle. Ruote di trasporto incluse

- Structure tubing section reinforced-steel rectangular tube 70x50x3 mm
- Abdominal/ lumbar supports size 220x270x 60 mm x 2
- Equipment/notes: crosstraining bench. Extra large rollers - high density foam with ecoleather coating. Moving wheels included



WBX240

cod. WBX-240

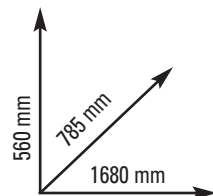

BENCHES - BACK AND GLUTEUS

CUSCINO 600x310x160 mm con rivestimento in ecopelle.
Regolabile in altezza su 2 livelli
PEDANA antiscivolo
DIMENSIONI PRODOTTO: 1680x785x560 mm
PESO MAX UTILIZZATORE 120 Kg
PESO: 56 kg
CLASSE D'UTILIZZO PROFESSIONALE (EN20957-1 classe S)

BACKREST 600x310x160 mm with eco-leather coating.
Height adjustment on 2-level
PLATFORM non-slip
SET UP SIZE 1680x785x560 mm
MAX USER WEIGHT 120 Kg
WEIGHT: 56 kg
COMMERCIAL USE (EN20957-1 class S)

- Struttura tubolare in acciaio rinforzato a sezione rettangolare 100x50x2 mm
- Supporti bilancieri con protezione UHMW
- Dotazione: 2 maniglie di sollevamento, 2 ruote per il trasporto, 8 ganci per fasce elastiche

- Structure tubing section reinforced steel rectangular tube 100x50x 2mm
- Barbell holders with UHMW protection pads
- Equipment: 2 carry handles, 2 moving wheels, 8 hooks for resistance bands



WBX950

cod. WBX-950

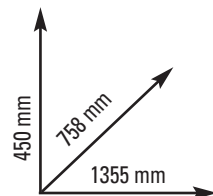

BENCHES - WEIGHTS

INCLINAZIONE SEDILE regolabile su 3 livelli: 0°, 15°, 30°
INCLINAZIONE SCHIENALE regolabile su 9 livelli: 0°, 20°, 30°, 40°, 50°, 60°, 70°, 80°, 90°
CUSCINERIA spessore 70 mm
DIMENSIONI PRODOTTO: 1355x758x450 mm
PESO MAX UTILIZZATORE 160 kg
PESO MAX CARICABILE 390 kg
PESO: 35,6 kg
CLASSE D'UTILIZZO PROFESSIONALE (EN20957-1 classe S)

SADDLE INCLINE 3-level adjustment (0°, 15°, 30°)
BACKREST INCLINE 9 adjustment (0°, 20°, 30°, 40°, 50°, 60°, 70°, 80°, 90°)
CUSHIONS thickness 70 mm
SET UP SIZE 1355x758x450 mm
MAX USER WEIGHT 160 kg
MAX LOADABLE WEIGHT 390 kg
WEIGHT: 35,6 kg
COMMERCIAL USE (EN20957-1 class S)

- Struttura in acciaio rinforzato a sezione quadrata 75x75x2,5 mm
- Verniciatura doppia a polveri epossidiche, antigraffio
- Dotazioni: maniglia e ruote di trasporto
- Structure reinforced-steel squared tube 75x75x2,5 mm
- Painting double heavy duty powder coating painting, scratch-resistant
- Equipment: carry handle and moving wheels

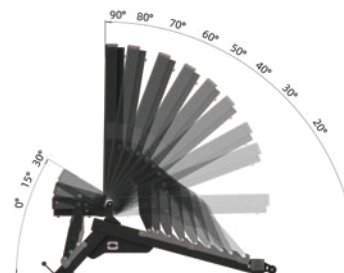

WBX700

cod. WBX-700

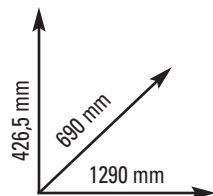

BENCHES - WEIGHTS

INCLINAZIONE SEDILE regolabile su 2 livelli (0-25°)
INCLINAZIONE SCHIENALE regolabile su 7 livelli (-15 a 85°)
CUSCINERIA spessore 65 mm
DIMENSIONI PRODOTTO: 1290x690x426,5 mm
PESO MAX UTILIZZATORE 160 kg
PESO MAX CARICABILE 320 kg
PESO: 33,6 kg
CLASSE D'UTILIZZO PROFESSIONALE (EN20957-1 classe S)

SADDLE INCLINE 2-level adjustment (0-25°)
BACKREST INCLINE 7-level adjustment (-15 to 85°)
CUSHIONS thickness 65 mm
SET UP SIZE 1290x690x426,5 mm
MAX USER WEIGHT 160 kg
MAX LOADABLE WEIGHT 320 kg
WEIGHT: 33,6 kg
COMMERCIAL USE (EN20957-1 class S)

- Struttura in acciaio rinforzato a sezione rettangolare 70x50x2,5 mm
- Verniciatura doppia a polveri epossidiche, antigraffio.
- Dotazioni: maniglia e ruote di trasporto
- Structure reinforced-steel rectangular tube 70x50x2,5 mm
- Painting double heavy duty powder coating painting, scratch-resistant.
- Equipment: carry handle and moving wheels

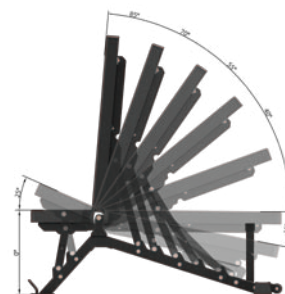

WBX400

cod. WBX-400

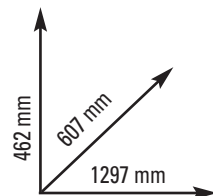

BENCHES - WEIGHTS

INCLINAZIONE SEDILE regolabile su 2 livelli (0-17°)
INCLINAZIONE SCHIENALE regolabile su 8 livelli (-17-85°)
DIMENSIONI PRODOTTO: 1297x607x462 mm
PESO MAX CARICABILE 240 kg
PESO MAX UTILIZZATORE 160 Kg
PESO: 26 kg
CLASSE D'UTILIZZO PROFESSIONALE (EN20957-1 classe S)

SADDLE INCLINE 2-level adjustment (0-17°)
BACKREST INCLINE 8-level adjustment (-17-85°)
SET UP SIZE 1297x607x462 mm
MAX LOADABLE WEIGHT 240 kg
MAX USER WEIGHT 160 Kg
WEIGHT: 26 kg
COMMERCIAL USE (EN20957-1 class S)

- Struttura tubolare in acciaio rinforzato a sezione rettangolare 70x50x2 mm e 60x40x2 mm
- Cuscineria spessore 65 mm
- Structure tubing section reinforced-steel rectangular tube 70x50x2 mm and 60x40x2 mm
- Saddlery 65 mm thickness

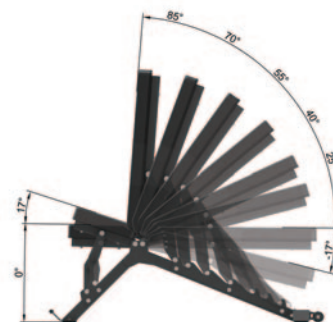

WBX200

cod. WBX-200

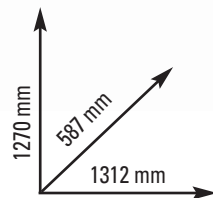

BENCHES - WEIGHTS

INCLINAZIONE SEDILE regolabile su 4 livelli (0-22,5°)
INCLINAZIONE SCHIENALE regolabile su 6 livelli (0-85°)
DIMENSIONI PRODOTTO: 1312 x 587 x 470/1270* mm
* schienale in posizione piana/ 85°
PESO MAX CARICABILE 200 kg
PESO MAX UTILIZZATORE 120 Kg
PESO: 31 kg
CLASSE D'UTILIZZO PROFESSIONALE (EN20957-1 classe S)

SADDLE INCLINE 4-level adjustment (0-22,5°)
BACKREST INCLINE 6-level adjustment (0-85°)
SET UP SIZE 1312 x 587 x 470/1270* mm. * flat/85° backrest position
MAX LOADABLE WEIGHT 200 kg
MAX USER WEIGHT 120 Kg
WEIGHT: 31 kg
COMMERCIAL USE (EN20957-1 class S)

- Struttura tubolare in acciaio rinforzato a sezione rettangolare 70x50x2 mm
- Cuscineria spessore: 60 mm
- Dimensione sedile: 310x360x60 mm
- Dimensione schienale: 940x310x60 mm
- Dotazione/ note: panca piana/ inclinabile. Maniglia e ruote di trasporto incluse.
- Structure tubing section reinforced-steel rectangular tube 70x50x2 mm
- Saddlery: 60 mm thickness
- Saddle dimension: 310x360x60 mm
- Backrest dimension: 940x310x60 mm
- Equipment/notes: flat/incline bench. Handle and moving wheels included



WBX100

cod. WBX-100

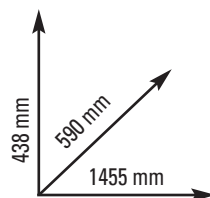

BENCHES - WEIGHTS

DIMENSIONI PRODOTTO: 1455x590x438 mm
PESO MAX CARICABILE 200 kg
PESO MAX UTILIZZATORE 120 Kg
PESO: 19 kg
CLASSE D'UTILIZZO PROFESSIONALE (EN20957-1 classe S)

SET UP SIZE 1455x590x438 mm
MAX LOADABLE WEIGHT 200 kg
MAX USER WEIGHT 120 Kg
WEIGHT: 19 kg
COMMERCIAL USE (EN20957-1 class S)

- Struttura tubolare in acciaio rinforzato a sezione quadrata 75x75x2 mm
- Cuscineria spessore: 60 mm
- Dimensione sedile: 1200x310x60 mm
- Dotazione/ note: panca piana. Maniglia e ruote di trasporto incluse
- Structure tubing section reinforced-steel square tube 75x75x2 mm
- Saddlery: 60 mm thickness
- Saddle dimension: 1200x310x60 mm
- Equipment/notes: fla bench. Handle and moving wheels included



GBX3000

cod. GBX-3000

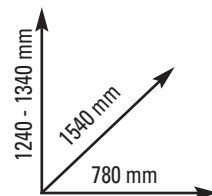

BENCHES - GRAVITY

REGOLABILE per altezza utente da 147 a 198 cm. Rotazione schienale su 5 livelli predefiniti (5° - 25° - 50° - 75° - 90°) + rotazione libera
DIMENSIONI PRODOTTO: 780x1540x1550/2250mm
SISTEMA DI INCLINAZIONE PRESS&LOCK che consente di bloccare lo schienale a qualunque livello di rotazione
PESO MAX UTILIZZATORE: 150 kg
PESO: 34 kg
CLASSE D'UTILIZZO PROFESSIONALE (EN20957-1 classe S)

ADJUSTABLE for user height from 147 to 198 cm.
Backrest rotation 5 preset levels (5° - 25° - 50° - 75° - 90°) + free rotation
SET UP SIZE: 780x1540x1550/2250mm
PRESS&LOCK INCLINE SYSTEM which allows to lock the backrest position in whatever rotation level
MAX USER WEIGHT: 150 kg
WEIGHT: 34 kg
COMMERCIAL USE (EN20957-1 classe S)

- Utilizzo: allungamento e rilassamento muscoli della schiena
- Sistema di sicurezza: barra di sicurezza centrale con blocca caviglie regolabile
- Schienale confort multi-wave spessore 60 mm
- Richiudibile salvaspazio. 500x780x2060 mm
- Impugnature laterali ergonomiche anti scivolo
- Use: stretching and relaxing back muscles
- Safety system: central safety bar with adjustable ankle boots
- Comfortable multi-wave backrest 60 mm thick
- Space saving foldable. 500x780x2060 mm
- Lateral ergonomic non-slip handles





contact@toorxvertical.it
www.toorxvertical.it

TOORX® è un marchio di proprietà di / *is a brand of*

Garlando S.p.A.

Via Regione Piemonte, 32 - Zona Ind. D1
15068 Pozzolo Formigaro (AL) - Italy
Tel. +39.0143.318500
Fax +39.0143.318585