



Hella marine



LIGHTING YOUR LIFESTYLE

WORLD LEADING MARINE LIGHTING

PRODUCT CATALOGUE



Photo Credit: Haines Hunter

Cover Image Credit: Riviera 46 Sports Motor Yacht

A full-page background image showing a sunset over a large body of water. The sky is filled with vibrant orange, pink, and purple hues, with scattered clouds. In the distance, a coastal town with buildings and a few boats is visible on the horizon. The water in the foreground is calm, reflecting the colors of the sky.

Take us on your next adventure

At Hella marine, we strive to be the beacon of innovation and reliability in the marine lighting industry, setting new standards for performance, safety, and environmental responsibility.

Guided by our unwavering commitment to excellence, we are the first choice of boat builders, marine enthusiasts, and commercial operators worldwide. Through cutting-edge technology, we illuminate the seas with energy-efficient, durable, and aesthetically pleasing lighting solutions that enhance safety and optimize your marine experience.



APELO LIGHTING

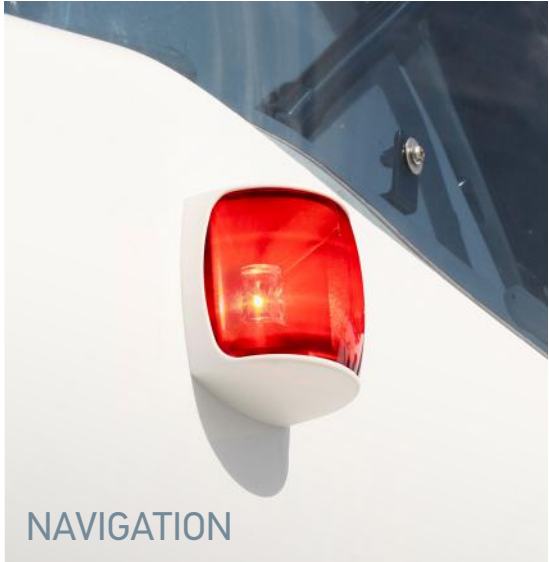

NAVIGATION



LIGHT BARS



WORK LAMPS



COURTESY



INTERIOR / EXTERIOR

Contents

Hella marine

Lighting Excellence Assured	6
Design, Manufacture, Test	7

Apelo Ecosystem

Apelo Light Controller & App	8
Apelo EuroLED 75 RGB/W Downlight	11
Apelo RGB Step Lamp	11

Apelo Underwater Lights

Synchronised Vibrant Colour	12
A1 Polymer 1800 Lumen	14
A2 Aluminium 3000 Lumen	15
A2 Bronze 3000 Lumen	16
A1 & A2 Mounting Accessories	16
A3 Bronze 6000 Lumen	17

Sea Hawk Light Bars

Choosing the Right Light	18
Sea Hawk-470 Edge Light	20
Sea Hawk-470	21
Sea Hawk-350	21

Work Lamps

Define How You Work	22
Work Lamps	24
Deck Lamps	26
Round	27
High Output	28
Search Lamps	30

Navigation Lights

Setting the Standard	32
IMO COLREG 72	34
NaviLED Compact	36
NaviLED Deck Mount	37
NaviLED Tri-Colour	37
NaviLED Pro	38
NaviLED 360	40

Interior Lights

Lighting Your Lifestyle	42
Down Lights	44
Strip Lamps	47
Utility / Engine Room	48
Chart / Reading Lamps	50

Courtesy Lights

Create Your Style	52
Step Lighting	53
Oblong	53
Round	54
Strip Lighting	55
Livewell Lamps	56
Multi-flash Signal Lamps	57

Trailer Lighting & Accessories

Submersible Trailer Lamps	59
Fans	59
Battery Master Switches	60
Voltage Sensitive Relay	61
2 Group Dimmer	62
Switches	63
Plugs & Sockets	64

Quick Reference

Technical Advantages	65
----------------------	----

Warranty

Standing Behind our Product	66
-----------------------------	----

HELLA MARINE

LIGHTING EXCELLENCE ASSURED

Hella marine is a leading brand of high performance lighting products that excel in harsh environments. The product range is manufactured in various global locations, with the majority coming from our world class facility in New Zealand.

With a rich heritage spanning over a century, and more than 3 decades of experience with LEDs, Hella marine has always been consistently committed to the design and manufacturing of high-quality lighting products. The company has witnessed a significant expansion over the past five decades, owed to the adoption of modern production methods and substantial investments in pioneering lighting technology.

In light of New Zealand's prolific maritime history and world-class yacht manufacturing prowess, HELLA New Zealand was designated as the global headquarters for Hella marine in 2004. The NaviLED lamp series elevated our status as pioneers in marine navigation lighting.

One of our earliest accomplishments includes being the first company globally to secure the European 'BSH*' compliance for a navigation light using LEDs, in the form of the NaviLED PRO series. This approach to ongoing design and development has positioned us as a trusted partner globally.

* Bundesamt für Seeschifffahrt und Hydrographie



HELLA TODAY

With Faurecia's successful bid and acquisition of HELLA globally, Forvia was born. The newly named Forvia is now the 7th largest Automotive supplier in the world. One vision, speaking with one voice, working as one team.



150,000
employees



40 Countries



300 distribution,
manufacturing,
R&D sites



Product available
in over 70 countries



Our in-house product development team of skilled specialists and engineers are authorities in electronic and optical design.

Utilizing cutting-edge materials we create innovative products that are not only reliable but also energy-efficient: embodying excellence through performance and sustainability by integrating the latest LED technology.

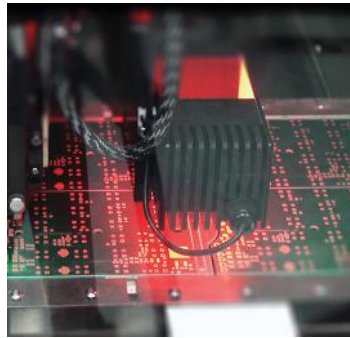

Our manufacturing premises are a testament to modern engineering with highly automated production capabilities.

Our electronics plant is equipped with the most recent automated, precision Surface Mount Technology (SMT) assembly systems, achieving self-sufficiency in Printed Circuit Board Assemblies (PCBAs) production in 2013. The plant places 53,000 LEDs daily, or 12.8 million LEDs per annum.



On-site testing facilities subject our products to cycles of extreme temperatures, intense UV light, chemical exposure, humidity, and salt-laden, corrosive conditions. Impact and vibration testing ensures that they perform under extreme stresses.

Our purpose built light tunnel ensures we meet all standards, and can guarantee quoted light output in all conditions.

EMC testing guarantees our products won't interfere with any sensitive radio or navigation equipment.



LONG TERM SUSTAINABILITY

As a global company committed to sustainability and environmental protection, HELLA continues to accelerate its efforts against climate change and send a clear signal for climate protection. By 2025, all production sites worldwide are to manufacture in a CO₂-neutral manner. Carbon neutrality is to be achieved through direct energy savings, the purchase of green electricity, aiming for a consistently climate-neutral supply chain by 2050 at the latest, and to supply customers worldwide with CO₂-neutral products.

Hella marine is committed to playing an active role in protecting the environment, preventing pollution, minimizing waste, and avoiding adverse environmental impacts of our activities and products. We will achieve this by creating innovative, long lasting, energy efficient products, and applying operational excellence throughout the organization to ensure long term sustainability. Our Auckland, New Zealand factory today uses 100 per cent renewable energy, and 95 per cent of waste material generated during the moulding process is recycled. Hella marine invests in fully electric BEV and hybrid HEV vehicles in its fleet, and this number increases year on year.

SYNCHRONISED VIBRANT COLOUR

Apelo Light Controller

Transform your space into a stunning visual display, with unified control of all Apelo RGB/W Underwater, Interior, Flood, and Courtesy lamps; plus a selection of universal RGB products.

Effortlessly group and intelligently network multiple sets of lights and controllers wirelessly over Bluetooth® Mesh. Show your true colours with fully synchronised, completely customisable lighting throughout your vessel.



Customisable Lighting

Easily create custom RGB/W lighting and animations, or switch between preset modes, combining convenience and creativity in every use.



Bluetooth® Mesh Communication

Minimal wiring required for controller integration – the units communicate wirelessly over robust peer-to-peer Bluetooth® Mesh networking.



Effortless Control

Seamlessly move between a multi-pole switch and the intuitive Apelo App to control your lighting.



Synchronised Lighting

Synchronise light colours and groups throughout your vessel. Settings are distributed between and stored on connected controllers, so a constant Smartphone connection isn't required.



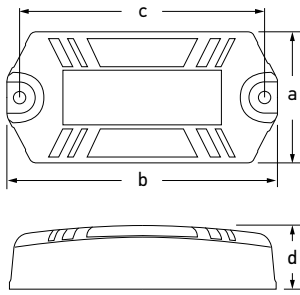

Dimensions:
a = 63mm (2.5")
b = 129mm (5.1")
c = 117mm (4.6")
d = 30mm (1.2")

Apelo Light Controller

Elevate your lighting experience with the Hella marine Apelo Light Controller. Vibrant, dynamic, synchronised colours will transform your space into a stunning visual display.

Download the Apelo App and pair Apelo RGB Step lamps, Apelo EuroLED 75 RGB/W Downlights, and Apelo Underwater Lights to enhance your lighting experience. The Apelo Light Controller App lets you personalise your lighting configuration with ease.

Customisable Lighting

Personalise your lighting with the Apelo Light Controller App and unlock endless colour possibilities. Easily create custom lighting or switch between preset modes, combining convenience and creativity in every use.

Effortless Control

Seamlessly move between a multi-pole switch and the intuitive Apelo App to control your lighting. Bluetooth mesh technology allows seamless integration of multiple devices without having to connect them together.

Mesh Communication

No wiring required for controller integration – the units communicate wirelessly. Once paired, instructions are seamlessly transmitted between controllers via over-the-air communication.

Description	Part Number
Apelo Light Controller	5XA 285 814-001
<i>Packaging</i>	<i>Retail Carton for Single Pack</i>
Operating Voltage	Multivolt™ 12 / 24V DC Nominal
Power Handling	150W (13A @ 12V DC / 6.5A @ 24V DC) (3A Per channel)
Power Consumption	1W
Connectivity	iOS / Android App over Bluetooth 13A Max High Side 3A Max Low Side Direct Switch Control to toggle functions (1 switch can control multiple devices)
Communication	Bluetooth Low Energy (BLE) Mesh
Protection	IP67 (Completely sealed)
Cable	140mm tinned marine cable
Base Material	V0 Rated Plastic
Compliance	FC CE UK B I



12V
24V



Scan or Click
for more info

Apelo Light Controller App

Pair the Apelo App with the Apelo Light Controller for infinite creativity and control of all compatible connected RGB/W lighting. Use the intuitive Apelo App to easily manage multiple controllers and light groups, access built-in presets, and express yourself with vivid colours and vibrant custom lighting sequences throughout your craft.

No Phone? No Worries...

Directly wired Switch control allows for simple cycling through colour modes; press and hold, and the lights will dim or brighten. Switch control can be used alongside the Apelo Light Controller and Apelo App.

Control more than just RGB

Apelo Light Controller is also able to manage single colour, dual colour, dual function, and dual intensity lights such as EuroLED 75/95, dual intensity Sea Hawk XLR floodlights, and Sea Hawk Light bars.



iPhone and App Store are registered trademarks of Apple Inc. Google Play is a registered trademark of Google Inc.

APELO CONTROLLER BRINGS IT ALL TOGETHER

Control

Connect Apelo Light Controllers to any combination of compatible Apelo RGB and RGB/W Underwater, Interior, Flood, and Courtesy lamps for individual and/or synchronised control. Easily adjust a single light or trigger a colour pattern throughout an entire grouping.

Group

Use the intuitive Apelo App to easily group multiple lights and manage multiple controllers (individually, or groups containing multiple controllers and lights), to create areas of unique colours and functions throughout your vessel. All without additional wiring.

Create

Make it as simple or as advanced as you like: from basic coloured mood and safety lighting, to a multi-colour, animating entertainment area synced with underwater lights, while also preserving the captain's night vision with red downlighting at the controls.

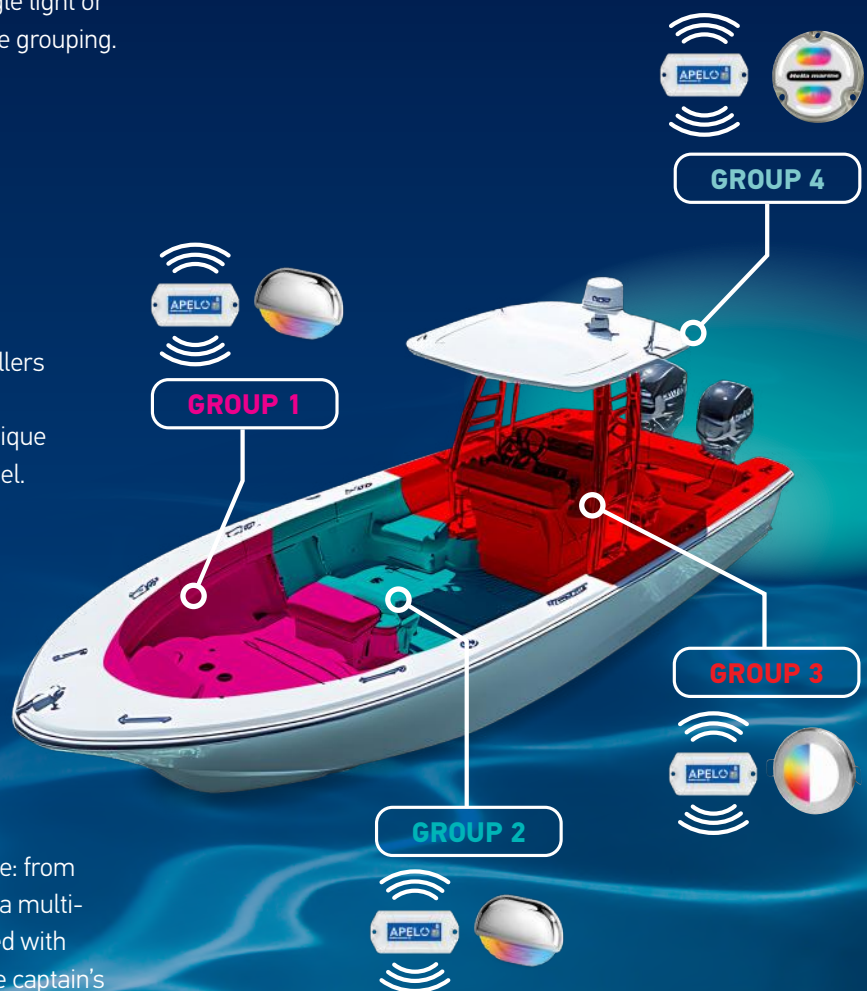

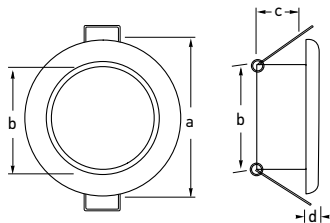

Dimensions:

- a = Ø75mm (3.0") Dia
- b = Ø54mm (2.2") Dia hole with spring clips
Ø50mm (2.0") Dia hole for screw mount
- c = 21mm (0.9")
- d = 7.4mm (0.3")

*May be Spring or Screw mounted.
When screw mounting, remove springs and ensure mounting hole is only 50mm, versus 54mm for Spring mount.

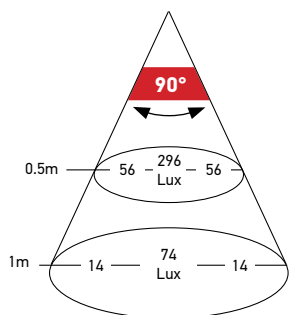

EuroLED 75 RGB/W

Apelo EuroLED 75 RGB/W Downlight

A downlight with no compromise to form or function, the Apelo EuroLED 75 RGB/W delivers full spectrum colour, plus bright, even, broad illumination of 150 Lumens from dedicated White LED's. Whether you're setting the mood with vivid colours, or preserving your sensitive night vision with illuminating red, the Apelo EuroLED 75 RGB/W is a powerfully flexible lighting solution. Single and dual colour models also available.



Function	Trim	Part Number
RGB/W	White	2JA 017 884-001
RGB/W	Stainless	2JA 017 884-011
<i>Packaging</i> Retail carton for single pack. PN shown in table above. Trade Carton Pack 20pc multiple, replace final PN digit '1' with '7'. DT Trade Carton Pack 18pc multiple, replace last 3 PN digits with '-207' (White Plastic) and '-217' (Stainless Steel)		
Mounting	Recessed*	
Cap Material	White plastic, polished 316 stainless steel	
Lens Material	PC	
Operating Voltage	12V DC only (9-16V)	
Lumen Light Output	150 lumen measured output (White)	
Power Consumption	3W RGB / 0.25A @ 12V DC 3W White / 0.25A @ 12V DC	
Connectivity	Flexible 6 wire connection. Apelo Light Controller compatible	
Protection	IP6K7 & IP6K9K (Completely sealed): Suitable for submersion in operation and high pressure water jet cleaning	
Cable length	120mm tinned marine cable	
Connector (DT Models)	4 Pin + 2 Pin DT Connector	
Compliance	CE UK CA	



Scan or Click for more info

Apelo RGB Step Lamp

Apelo RGB Step lamps offer a vibrant way to highlight and accent your steps and gangways. Dynamic, synchronised colours will transform your space into a stunning visual display. Apelo RGB Step Lamps use a simple, 4-wire connection for power and control. Labour saving installation via a 25mm hole. Available with chrome, white or stainless steel trim.

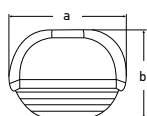
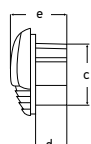

Dimensions:

- a = 45mm (1.77")
- b = 31.5mm (1.24")
- c = 25.4mm (1.00")
- d = 14mm (0.55")
- e = 22.7mm (0.89")

Function	Trim	Part Number
RGB	White	2JA 958 126-531
RGB	Chrome	2JA 958 126-541
RGB	Stainless	2JA 958 126-551
<i>Packaging</i> Retail carton for single pack. PN shown in table above. Trade Carton Pack 54pc multiple, replace final PN digit '1' with '7'. DT Trade Carton Pack 54pc multiple, replace final 3 PN digits with '-507' (White Plastic), '-517' (Chrome), and '-527' (Stainless Steel)		
Mounting	Recessed	
Lens Material	UV resistant enhanced impact acrylic	
Cap Material	White plastic, chrome plated plastic, polished 316 stainless steel	
Operating Voltage	Multivolt™ 12 / 24V DC Nominal	
Power Consumption	1W / 0.03A (30 mA) MAX	
Connectivity	Simple 4 wire connection. Apelo Light Controller compatible	
Protection	IP67 (Completely sealed)	
Cable length	100mm tinned marine cable	
Connector (DT Models)	4 pin DT Connector	
Compliance	CE UK CA	



Scan or Click for more info

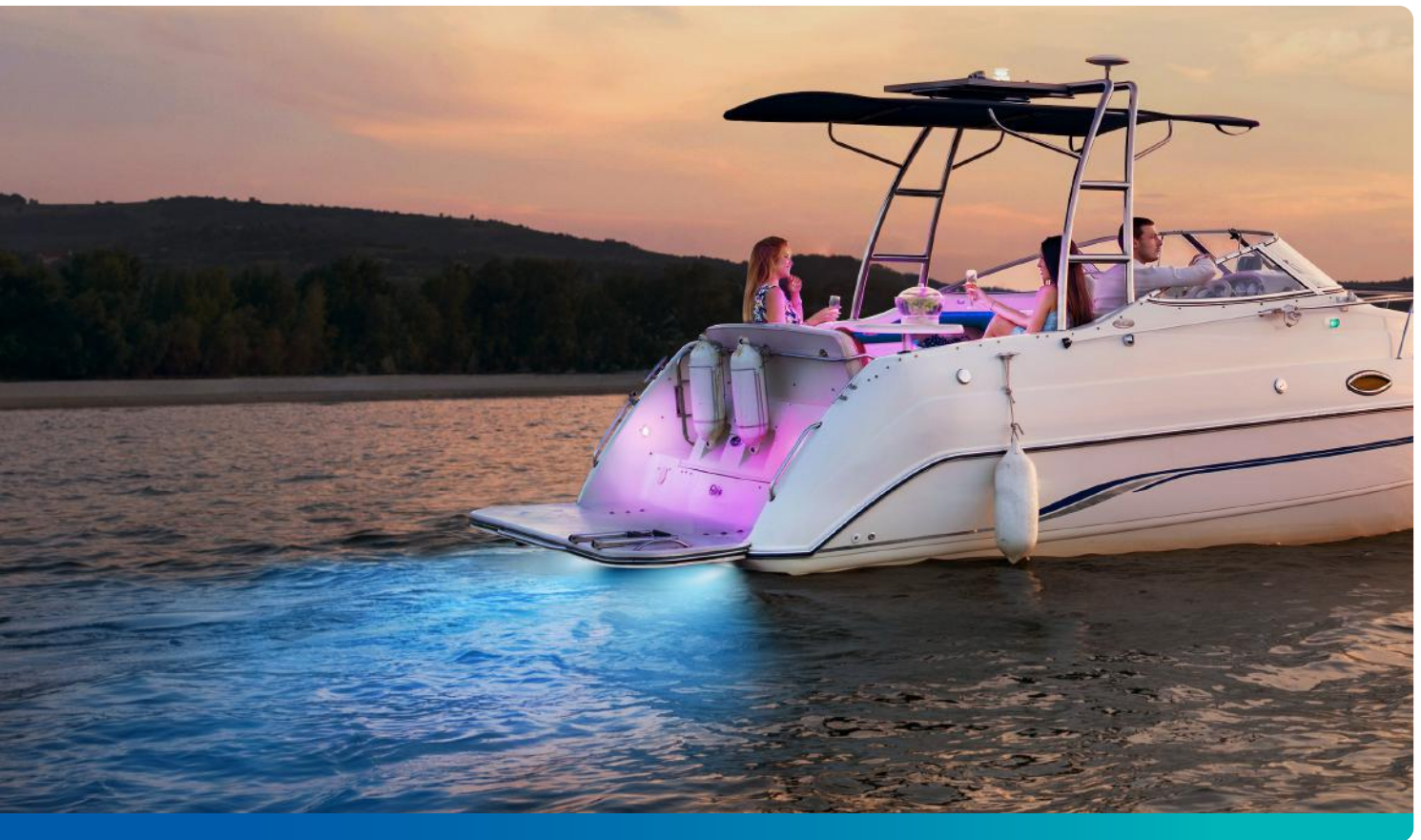

APELO

Underwater Lights

Synchronised Vibrant Colour

As the sun sets, Apelo Underwater Lights come alive. Rich vibrant colour emblazes your transom, setting the scene for the night ahead. Whether entertaining, or attracting the next trophy catch, Apelo has it all.

Choose either vibrant blue or intense white transom lighting, or take control and set the stage with stunning full spectrum RGB colour at your fingertips.

Distinctive glowing signatures of Apelo's innovative Edge Light elegantly illuminates the border of the lamp front. The Edge Light functions in or out of the water and highlights the stern of the boat even when it's on the trailer.

Apelo Underwater Lights are made in New Zealand.



Advanced materials

Apelo A1 uses a thermal polymer housing, a material completely resistant to corrosion and suitable for any hull material. Hella marine has employed thermal polymers for decades and built-up substantial experience. Thermal polymer draws heat away from the internal electronics to support the brightest polymer underwater lamps on the market.

Electronic protection

Inside every Apelo lamp are intelligent drive circuits that sense their environment to regulate the power and control the heat inside. Apelo is as happy running out of the water as in it. We call this dry running protected.

Sealing confidence

Robotic gluing delivers an incredible sealing accuracy of the glue mix and pinpoint placement batch after batch with near infinite repeatability. For confidence, Apelo is certified to IP68 and IP69.



OPTICAL INTELLIGENCE FOR SUPERIOR BRIGHTNESS

Expert optical design delivers more light with a wide horizontal spread and a narrow vertical distribution for high lux levels where it counts instead of sending light too high or too low where it becomes invisible.

For the lumen rating on offer, Apelo competes with lamps offering higher lumen ratings using less energy to achieve the same intensity levels.

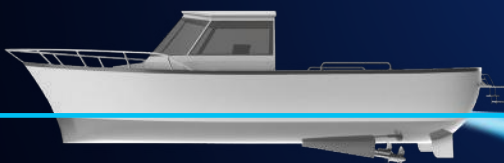

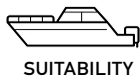

SUITABILITY

- FIBREGLASS
- TIMBER
- STEEL
- COMPOSITE
- ALUMINIUM



Apelo A1 Underwater Light Polymer 1800 Lumen

The Apelo A1 is the most powerful light in its class, delivering vibrant blue or intense white, or full spectrum RGB* colour experiences. All Apelo models use intelligent optical design to get impressive illumination levels that outshines the competition.

The A1 RGB* light gives you complete control to choose any colour you wish, with Apelo's optical intelligence creating an even distribution of colour across the transom.

A completely sealed, corrosion resistant, thermal polymer housing ensures ongoing protection against the harshest environments. The A1 is suitable for mounting to any hull material. All Apelo models are equipped with an advanced thermal management system to allow operation in or out of the water.



White / Blue



RGB

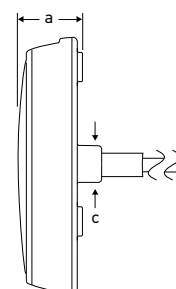
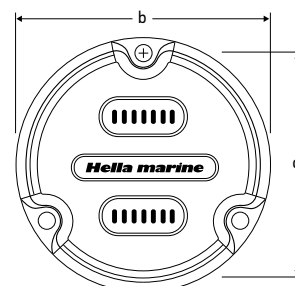

Dimensions:
a = 25.5mm (1.01")
b = 95mm (3.74")
c = 15.5mm (0.61") (Cable Hole)
d = 83.5mm (3.29") (PCD)

Light Colour	White Lens	Charcoal Lens
White / Blue	2LT 016 145-011	2LT 016 145-001
RGB	2LT 016 146-011	2LT 016 146-001

*Packaging Retail carton for single pack. PN shown in table above
Trade Carton Pack 4pc multiple, replace final PN digit '1' with '2'*

Lumen	1800 (White)	
Lens Material	Grilamid® plastic, impact and UV resistant	
Housing Material	Corrosion proof thermal polymer	
Colour Temperature	5000K (White)	
Cable	2.5m / 8.2ft, tinned marine cable	
Operating Voltage	Multivolt™ 9-32V DC, 12 / 24V DC Nominal	
Power Consumption†	Blue / White	20W (1.7A @ 12V / 0.9A @ 24V)
	RGB	15W (1.25A @ 12V / 0.7A @ 24V)
Protection	IP68 / IP69K	
Weight (incl. cable)	White / Blue	250g
	RGB	300g
Compliance	EN55015 / CISPR 15, IEC60533, IEC61547, ICES-005, CE, RCM, UKCA	

*Connect Apelo RGB lights to an RGB lighting controller for unlimited colour selection (Not supplied).
† Allow up to 200% of power consumption to account for momentary peak.



Scan or Click
for more info

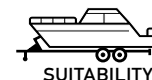

ALUMINIUM

Apelo A2 Underwater Light Aluminium 3000 Lumen

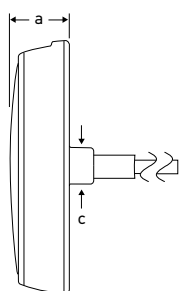
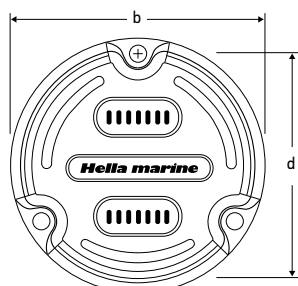

Dimensions:

a = 23.5mm (0.92")
b = 95mm (3.74")
c = 15.5mm (0.61") (Cable Hole)
d = 83.5mm (3.29") (PCD)

Boasting an incredibly bright 3000 lumen light output, the Apelo A2 offers not only more light, but more features. The Apelo A2 is available in either a vibrant blue or intense white combination, or full spectrum RGB*. The additional stylish Edge Light illuminates your transom with distinctive glowing signatures bordering the lamp front. 'Fish mode' strobe function on the A2 Blue / White version is a sure fire way to attract attention, including from your next big catch.

Apelo A2's corrosion resistant, hard anodised, aluminium housing ensures even greater ongoing protection against the harshest environments. All Apelo Underwater Lights are completely sealed for total peace of mind. The A2's aluminium housing is tailored specifically for aluminium hulls which are not permanently submerged in salt water.

Light Colour	Charcoal Lens
White / Blue	2LT 016 147-001
RGB	2LT 016 148-001

*Packaging Retail carton for single pack. PN shown in table above
Trade Carton Pack 4pc multiple, replace final PN digit '1' with '2'*

Lumen	3000 (White)
Lens Material	Grilamid® plastic, impact and UV resistant
Housing Material	Hard Anodised Aluminium
Colour Temperature	5000K (White)
Cable	2.5m / 8.2ft, tinned marine cable
Operating Voltage	Multivolt™ 9-32V DC, 12 / 24V DC Nominal
Power Consumption†	Blue / White 30W (2.5A @ 12V / 1.3A @ 24V) RGB 30W (2.5A @ 12V / 1.3A @ 24V) Edge Light <2W (<0.2A @ 12V / <0.1A @ 24V)
Protection	IP68 / IP69K
Weight (incl. cable)	White / Blue 310g RGB 360g
Compliance	EN55015 / CISPR 15, IEC60533, IEC61547, ICES-005, CE, RCM, UKCA

*Connect Apelo RGB lights to an RGB lighting controller for unlimited colour selection (Not supplied).
† Allow up to 200% of power consumption to account for momentary peak.



White / Blue



RGB



Scan or Click for more info



Edge Light Technology

Apelo A2 and A3 models showcase Edge Light, distinctive glowing signatures of elegant illumination bordering the lamp front.



Lightspeed™ Recommended

Hella marine recommends Lightspeed™ by PropSpeed®, a foul-release coating to protect Apelo Underwater Lights and maintain their underwater brilliance. Lightspeed™ is tested to provide no decrease in light intensity, no colour shift and no other adverse performance decreases.



Optical Intelligence

Apelo's precision optical distribution system projects light with spectacular effect. An asymmetrical, wide 90° horizontal spread and shallow 24° vertical beam height, means the light is able to efficiently spread further through the water.



Dry Running Protected

Advanced thermal management ensuring ongoing protection and no damage by operation out of the water.

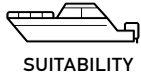

SUITABILITY

- FIBREGLASS
- TIMBER
- STEEL
- COMPOSITE



Apelo A2 Underwater Light Bronze

3000 Lumen

The A2 Bronze stands out with its corrosion resistance properties, in addition to the Apelo A2 features of vibrant blue or intense white, or full spectrum RGB* colour experiences, signature Edge Light, and strobe function.

A marine grade bronze housing delivers the ultimate in protection from harsh conditions, while offering superior durability and thermal management properties.

All the features and power of the A2 model in a no-compromise package makes this the preferred choice for permanent submersion. Suitable for fibreglass, timber, steel, and composite hulls (not aluminium).



White / Blue



RGB



Scan or Click for more info

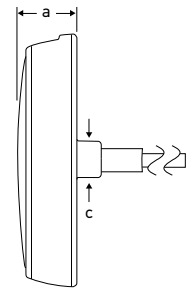
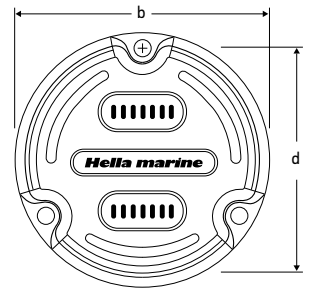

Dimensions:

- a = 23.5mm (0.92")
- b = 95mm (3.74")
- c = 15.5mm (0.61") (Cable Hole)
- d = 83.5mm (3.29") (PCD)

Light Colour	White Lens	
White / Blue	2LT 016 147-101	
RGB	2LT 016 148-101	
<i>Packaging Retail carton for single pack. PN shown in table above</i>		
<i>Trade Carton Pack 4pc multiple, replace final PN digit '1' with '2'</i>		
Lumen	3000 (White)	
Lens Material	Grilamid® plastic, impact and UV resistant	
Housing Material	Marine grade bronze	
Colour Temperature	5000K (White)	
Cable	2.5m / 8.2ft, tinned marine cable	
Operating Voltage	Multivolt™ 9-32V DC, 12 / 24V DC Nominal	
Power Consumption†	Blue / White	30W (2.5A @ 12V / 1.3A @ 24V)
	RGB	30W (2.5A @ 12V / 1.3A @ 24V)
	Edge Light	<2W (<0.2A @ 12V / <0.1A @ 24V)
Protection	IP68 / IP69K	
Weight (incl. cable)	White / Blue 600g	RGB 650g
Compliance	EN55015 / CISPR 15, IEC60533, IEC61547, ICES-005, CE, RCM, UKCA	

*Connect Apelo RGBW lights to an RGBW lighting controller for unlimited colour selection (Not supplied).
 † Allow up to 200% of power consumption to account for momentary peak.

Apelo Surface Mount Spacer

Underwater Light Mounting Accessory

The APELO surface mount spacer offers positioning flexibility and optimum cabling routing when mounting your APELO underwater lights. Rather than drilling holes into the transom, cable can be routed through the side to an above water position or somewhere that internal access is far more favourable.

The spacer features a 5 degree surface to allow for fine tuning the lighting direction: useful if you prefer the light to be directed out towards the side, or to avoid an obstruction, such as an outboard motor or trim tab, from blocking some of the light. This angle can also be used to offset a transom angle. Compatible with all APELO A1 and A2 models.

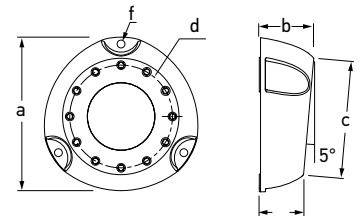

Dimensions:

- a = Ø125mm (4.93") Dia
- b = 45mm (1.78")
- c = Ø95mm (3.75") Dia
- d = Ø83.5mm (3.39") PCD
- e = 35mm (1.38")
- f = Ø5.5mm (0.22")

Description	Part Number
Surface Mount Spacer Underwater Light Mounting Accessory	8HG 280 801-001
<i>Packaging Trade Carton for Single Pack</i>	

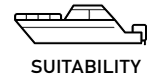

- FIBREGLASS
- TIMBER
- STEEL
- COMPOSITE

Apelo A3 Underwater Light Bronze

6000 Lumen

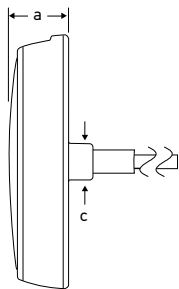
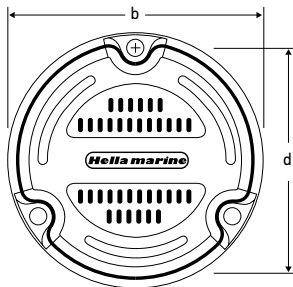

Dimensions:

- a = 23.5mm (0.92")
- b = 130mm (5.12")
- c = 15.5mm (0.61")
- d = 117.5mm (4.63") (PCD)

The ultimate in the Apelo Underwater Light range, and supercharged with 6000 lumen light output, and a larger overall size than the Apelo A2 Bronze. The A3 model has an improved formula with double the light output, maximizing the vibrant blue or intense white, or full spectrum RGB/W* colour. The blue or white model retains the strobe functionality, while the RGB/W version includes dedicated white light emitting LEDs, adding brighter and more intense white light to your RGB underwater lighting. Both versions have Edge Light.

With the addition of Nickel-silver to the extremely corrosion resistant housing, the Apelo A3 is perfect for permanently submerged installations on larger boats and ships. Suitable for fibreglass, timber, steel, and composite hulls. Only mount on aluminium hulled vessels with a suitable isolation spacer.

Light Colour	White Lens
White / Blue	2LT 016 830-001
RGB/W	2LT 016 831-001
Packaging	Retail Carton for Single Pack
Lumen	6000 (White)
Lens Material	Grilamid® plastic, impact and UV resistant
Housing Material	Marine grade bronze
Colour Temperature	5000K (White)
Cable	2.5m / 8.2ft, tinned marine cable
Operating Voltage	Multivolt™ 9-32V DC, 12 / 24V DC Nominal
Power Consumption†	Blue / White 70W (5.9A @ 12V / 2.9A @ 24V) RGB/W 70W (5.9A @ 12V / 2.9A @ 24V) Edge Light <5W (0.37A @ 12V / 0.2A @ 24V)
Protection	IP68 / IP69K
Weight (incl. cable)	White / Blue 1020g RGBW 1080g
Compliance	EN55015 / CISPR 15, IEC60533, IEC61547, ICES-005, CE, RCM, UKCA



White / Blue



RGB/W

*Connect Apelo RGB/W lights to an RGB/W lighting controller for unlimited colour selection (Not supplied).
† Allow up to 200% of power consumption to account for momentary peak.



Scan or Click for more info





Sea Hawk Light Bars

Sleek, Powerful & Ultra Durable

When outstanding light intensity and proven reliability is needed to safely get you home, the Sea Hawk Light Bars are the preferred choice.

These light bars are meticulously crafted using premium materials and construction techniques, guaranteeing their durability and appearance over an extended period of use.

Offering a range of beam patterns tailored to enhance night-time operations. Whether your priority is achieving the best distance-to-power ratio or achieving the widest light spread, you'll discover a Sea Hawk Light Bar that perfectly aligns with your specific requirements.

Choosing the Right Light Pattern

A selection of Lux diagrams on page 19 show the distance the beam will travel down to 1lux, as well as the width of the beam at any given distance. You can generally consider half or a quarter of this distance as the usable range at which you need to see objects at night. As a general rule, we can classify this purpose into two main categories: close-range and long-range.



Close Range Lighting

When you need to illuminate the local area, you can rely on the 'Spread' or 'Diffuse Flood' light bars. These light bars resemble traditional work lights in a 'bar' form, making them versatile for mounting options. You can opt for the conventional hard top mount for forward-facing illumination or choose to mount on the rear or sides to replace smaller-style work lamps.

Long Range lighting

The Sea Hawk long range light bar family offers exceptional distance patterns called Spot or Pencil. These are typically unsuitable for immediate area illumination, so it is important to ensure you get the right pattern to suit your use case. These lights are typically used in front facing situations, mounted onto the hard top.

The Work Lamps section on page 22 also provides valuable insights for selecting the appropriate work lamp.

Sea Hawk-470 Diffuse Flood: Serves as an excellent immediate area floodlight. It is also a highly effective replacement for fluorescent lighting due to its wide and smooth light distribution.

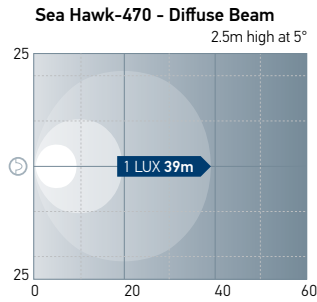

Sea Hawk-470 Pencil Beam with Edge light: Offers an impressive 1lux distance of 330 metres, a remarkable feat considering its low power consumption. This provides a substantial safety margin for detecting objects directly ahead, especially when navigating at high speeds in low-light conditions.

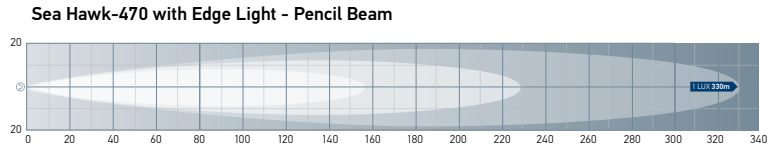

Sea Hawk-470 Spot Beam: This versatile light strikes a balance between wide and narrow illumination with its 30x30 degree beam. While it still provides a good reach, its beam width makes it particularly handy for slower navigation, through channels trying to pinpoint channel markers.

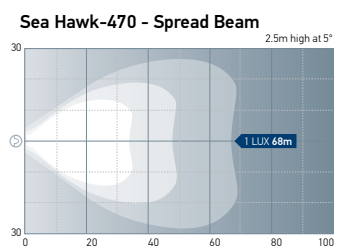
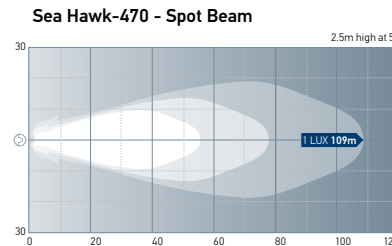

Sea Hawk-470 Spread Beam: Maintains the beam height at 30 degrees, but doubles the width to 60 degrees. The result is less centre punch, but much higher visibility to the sides. Great for operations such as manoeuvring through tight marina berths.

Sea Hawk-350 Spot Beam: A highly popular lamp that offers amazing distance for its compact size, the beam maintains width at medium distances making it a great all purpose choice.

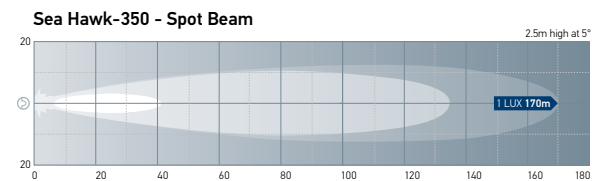

MOUNTING LOCATION FOR SUPERIOR PERFORMANCE

Often overlooked, the mounting location is crucial to the application. Often times 'distance' beam light bars are mounted right at the lip of the hardtop, which causes reflections when turned on. These reflections draw the eyes to the bow and minimise the advantage of having the lights.

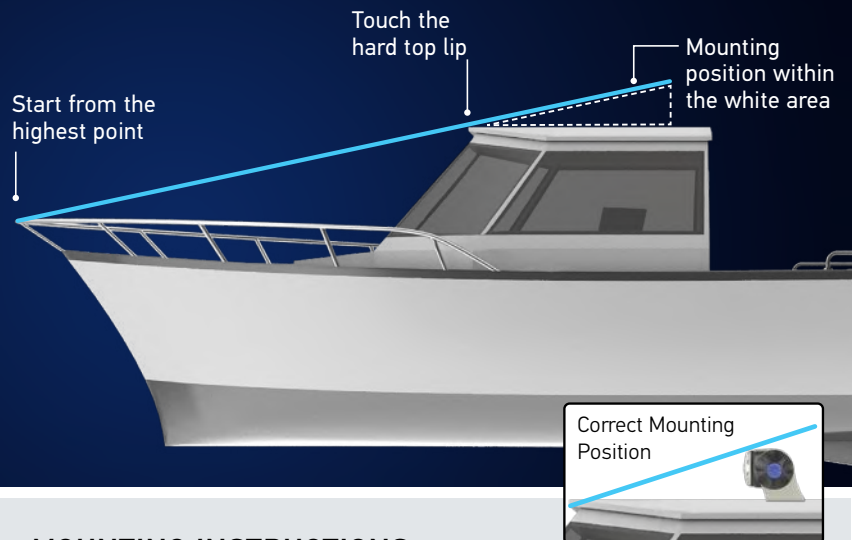

MOUNTING INSTRUCTIONS:

- Make a string line off the highest point of the bow rail.
- Take this line over the roof, and lower it until it just touches the hard top lip.
- Note the height of the string as it moves further back on to the roof.
- This dotted triangle shown is the location for the light bar.
- Since light moves in straight lines, it is now impossible for the light to reflect and reduce visibility.



Sea Hawk-470 Pencil Beam with Edge Light

The Sea Hawk-470 Pencil Beam with Edge Light combines long distance light performance capable of picking out even the most distant objects, and a striking Edge Light using light pipe technology.

Edge Light has been integrated into this powerful long distance light bar to give a distinctive glowing signature whilst also providing gentle ambient lighting. The Edge Light is available in both blue or white to give your vessel a unique appearance.

The unique corrosion proof housing provides exceptional durability and long-term reliability. The heavy duty Grilamid® lens offers an unbeatable combination of properties including toughness against impact, long term UV stability. Grilamid® will not lose its lustre or embrittle over time and will remain clear for the life of the product.



2LT 958 140-501



2LT 958 140-521



2LT 958 140-511



2LT 958 140-531

Description	Black Housing	White Housing
White Edge Light	2LT 958 140-501	2LT 958 140-511
Blue Edge Light	2LT 958 140-521	2LT 958 140-531
Packaging	Trade Carton for Single Pack	
Voltage	Multivolt™ 12 / 24V DC	
Maximum Power Consumption	Pencil Beam: 36W (2.7A @ 12V / 1.4A @ 24V) Edge Light: 4W (300mA @ 12V / 150mA @ 24V)	
Maximum Luminous Intensity	113,000 candela	
Light Performance	1 Lux @ 330m	
Beam Angle	8° x 4°	
Protection	Reverse polarity and transient spike protection IP6K7 (Protection against dust and temporary water immersion) IP6K9K (Protection against dust and high-pressure/steam jet cleaning)	
Cable	2.5m of tinned multi-core marine cable	
Housing Material	Corrosion proof thermal polymer	
Lens Material	Grilamid® plastic, impact and UV resistant	
Compliance	CE, ECE R10, RCM, UKCA	



Note: Dimensions as Sea Hawk-470 on the opposite page

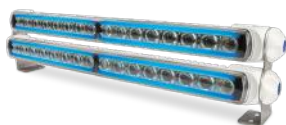
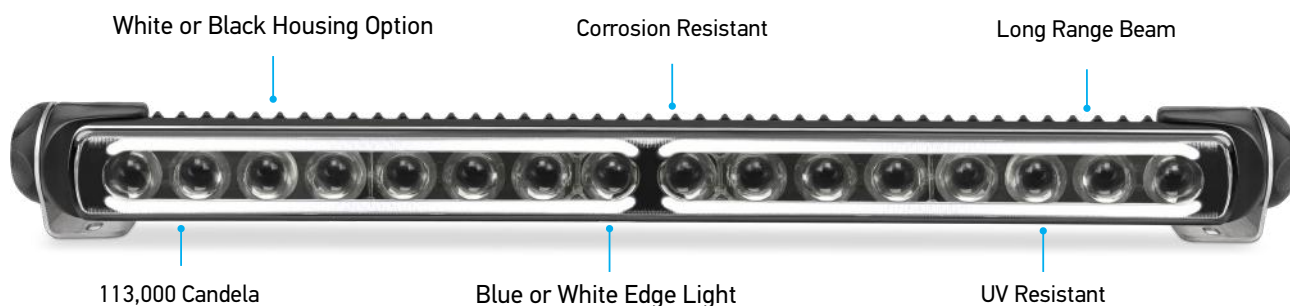

ACCESSORIES Double Mounting Bracket

Optional double bracket enables multiple lamps to be stacked to increase the light output or spread of light.

Description	Part Number
Double Bracket	8HG 958 128-811

Sea Hawk-470 Light Bars

The sleek and powerful Sea Hawk-470 range features multiple lens options. Multivolt™ circuitry operating between 9 to 33V can be used with 12V or 24V DC supply.

A thermally conductive polymer housing, and the toughness of a UV, chemical and impact resistant Grilamid® lens, the Sea Hawk-470 is the natural choice when durability and long term reliability is needed.

Lens Type	Black Housing	White Housing
Spread	2LT 958 130-601	2LT 958 130-611
Spot	2LT 958 130-631	2LT 958 130-641
Diffused	2LT 958 130-501	2LT 958 130-511
Combi	2LT 958 130-441	2LT 958 130-451
Packaging	Trade Carton for Single Pack	

Voltage	Multivolt™ 12 / 24V DC
Power Consumption	36W (High) 4W (Low)
Lumen	3600 (Diffused), 2800 (Spot/Spread)
Cable	2.5m of tinned multi-core marine cable
Housing Material	Corrosion proof thermal polymer
Lens Material	Grilamid® plastic, impact and UV resistant
Compliance	CE, ECE R10, RCM, UKCA

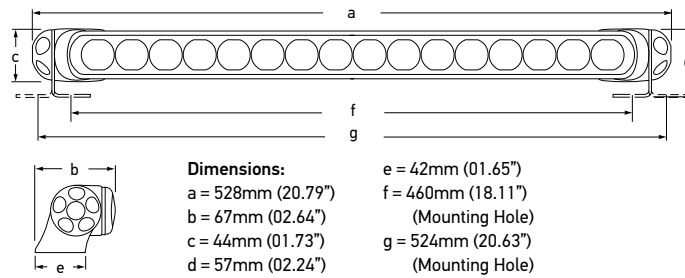

Spread Lens



Spot Lens



Diffused Lens



Combi Lens
Spot with spread on the sides



Sea Hawk-350 Light Bars

The Sea Hawk-350 floodlights generate over 2200 lumens of crisp, white light to illuminate the hardest to see places. Advanced electronics ensure constant and reliable light output and lamp protection even under severe voltage fluctuations and low battery voltages.

Lens Type	Black Housing	White Housing
Spread	2LT 958 040-701	2LT 958 040-711
Spot	2LT 958 040-651	2LT 958 040-661
Packaging	Trade Carton for Single Pack	

Voltage	Multivolt™ 12 / 24V DC
Power Consumption	25W (High) 5W (Low)
Lumen	2200 (High)
Cable	2.5m of tinned multi-core marine cable
Housing Material	Corrosion proof thermal polymer
Lens Material	Grilamid® plastic, impact and UV resistant
Compliance	CE, ECE R10, RCM, UKCA

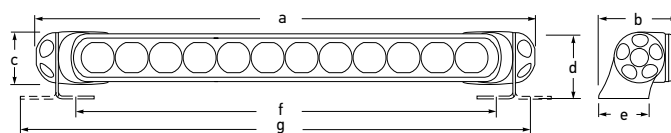

Spot Lens



Spread Lens



Work Lamps

Define How You Work

Hella marine's extensive range of work lamps are designed to meet the needs of marine enthusiasts, professionals, and adventurers alike.

We have a wide range of beam patterns that significantly enhance nighttime operations. Whether you're seeking compact, low-power draw solutions or the largest, most robust lamps designed for extreme environments, we have you covered. Professional sports fisherman, commercial operators, and ocean racers all recognize the 'non-glare' night vision preservation advantages of red lighting.

Choosing the right lamp - Lux Level

The crucial element to selecting the right work lamp is to first determine the tasks required beneath this lighting. Low level ambient lighting for walkways might only require 25 lux, but where high accuracy work in the cockpit could be upwards of 3-500 lux. When considering lux calculations, it's essential to note that these values are cumulative, meaning that two lights with 100 lux each would result in a combined total of 200 lux.

Area to be Lit

Measure the length and width of the area you require to be lit, but taking note of the area within the area where the work might be required. This will guide you as to whether the lux ratings are required right out to the edge of the area, or more in the middle.

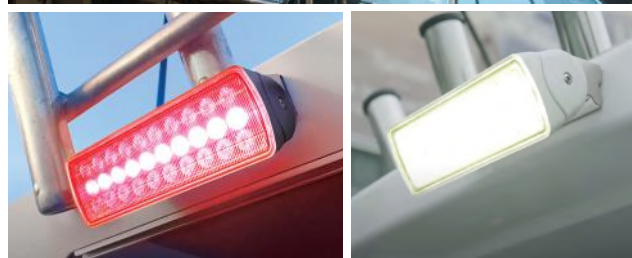
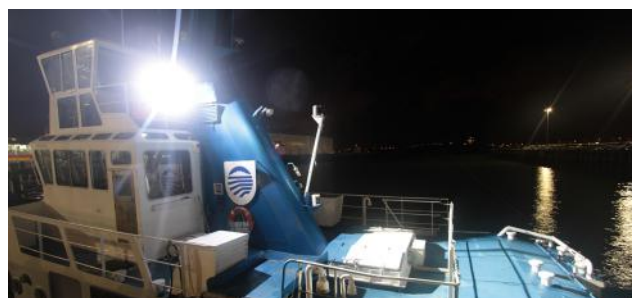

Red lighting is perfect for preserving your night vision.

Lux Charts

Lighting lux charts give an idea as to how much lux each light will offer over what distance and width. Once you have all of the information, the lux charts should make a lot more sense. Feel free to reach out to your local agent if you need further assistance.



Lighting Examples

Sea Hawk-XL Dual Colour LED Floodlights are ideal when changing between white light and coloured light is desired. Red is perfect for preserving your night vision, blue is popular to show off white gel coat.

Sea Hawk-XLR LED Floodlights offer big lighting performance in a small size. The Spread pattern is perfect for lighting up cockpits of any size, while the Spot beam can be mounted much higher on a mast or spreader to light up a deck from directly above. Both lamps have a dual intensity mode for when only ambient lighting is required, or very low power draw is necessary.

FMS Deck Lamps are a great solution where only vertical mounting surfaces exist, and space is tight. Alternatively, these can mount upside down and out of the way in a corner, meaning head clearance is not impaired. These innovative lamps direct the light out and down at 45 degrees with no requirement for a bracket. Their spread beam pattern gives great coverage over a wide area.

Mounting

The next consideration when selecting a work lamp is to assess the mounting environment. Various lamps provide different bracket options, that can be configured for upright or pendant mounting, offering maximum flexibility. Additionally, for more compact Sea Hawk lamps, there is the option of a recessed mount version if it aligns better with your specific application.

The specific mounting location will also dictate the height above the area to be lit, and this will affect the lux levels at the ground. If the mounting platform is high by necessity, then a narrow beam or spot lamp might be the most suitable, as this would 'throw' the light to where it needs to be.

Dual Light Sources

One aspect that is frequently overlooked is the presence of objects that can obstruct the light, and more commonly, these objects are people. In such situations, having two lower-powered light sources positioned at opposite ends of the illuminated area proves far more practical than relying on a single source. This arrangement allows the light beams to intersect, significantly minimizing the potential for shadows to form.

Sea Hawk-XL Dual Colour - Spread

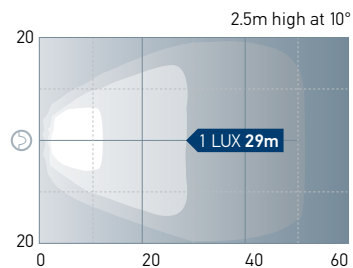

Sea Hawk-XLR - Spread

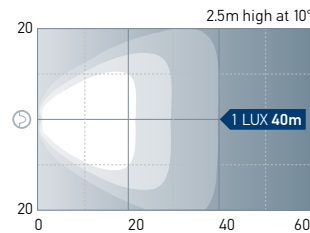

Sea Hawk-XLR - Spot

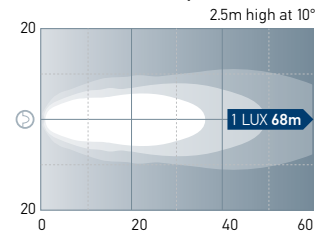

FMS1200

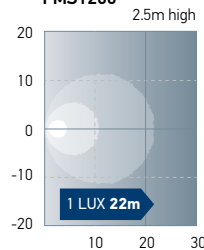

FMS2500

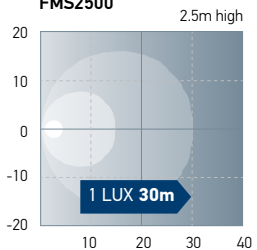



Sea Hawk-XL Dual Colour LED Floodlights Spread Beam

Professional sports fisherman, commercial operators, and ocean racers all recognise the 'non-glare' night vision preservation advantages of red lighting. Two rows of bright white light is ideal when working, docking or landing the big one while the third row of secondary colour adds versatility. Red is perfect for preserving your night vision, blue is popular when a point of difference is needed.

A heavy duty Grilamid® lens provides exceptional impact resistance. The unique ceramic thermal polymer housing distributes heat away from internal components and avoids potential corrosion issues associated with metal housings.

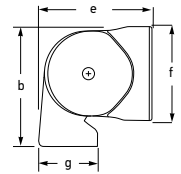
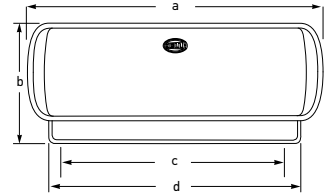

LED Colours	Housing Colour	Part Number
White / Red	Black Housing	2LT 980 950-041
White / Red	White Housing	2LT 980 950-051
White / Blue	Black Housing	2LT 980 950-061
White / Blue	White Housing	2LT 980 950-071

*Packaging Retail blister for single pack. PN shown in table above
Trade Carton Pack 18pc multiple, replace final PN digit '1' with '7'*

Housing Material	Corrosion proof thermal polymer
Lens Material	Grilamid® plastic, impact and UV resistant
Bracket Material	316 Stainless Steel
Lumen	750 lumen
Colour Temperature	5000K (White)
Operating Voltage	Multivolt™ 12 / 24V DC
Power Consumption	12W - White LEDs, 4W - Blue LEDs, 2W - Red LEDs
Cable	2.5m tinned marine cable
Protection	IP67 (Completely sealed)
Compliance	CE, RCM, UKCA

Dimensions

a = 170mm / 6.69" e = 58mm / 2.28"
 b = 68mm / 2.68" f = 55mm / 2.17"
 c = 120mm / 4.72" g = 30mm / 1.18"
 d = 154mm / 6.06"

Note: Dimensions for Sea Hawk-XL Dual Colour and Sea Hawk-XLR.



Beam Pattern Dual Colour - Spread

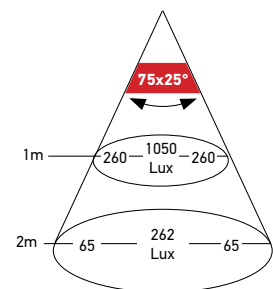
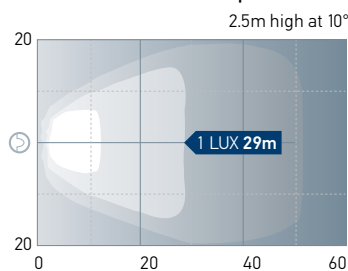

Sea Hawk Dual Colour

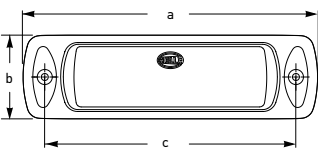

Dimensions

- a = 175mm / 6.90"
- b = 49mm / 1.93"
- c = 150mm / 5.91"
- d = 35mm / 1.38"
- e = 42mm / 1.65"
- f = 12mm / 0.47"

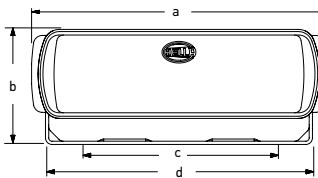
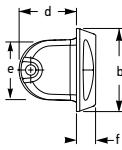

Dimensions

- a = 136mm (5.35")
- b = 53mm (2.08")
- c = 90mm (3.54")
- d = 123mm (4.85")
- e = 52mm (2.04")
- f = 42.0mm (1.66")
- g = 25mm (0.99")

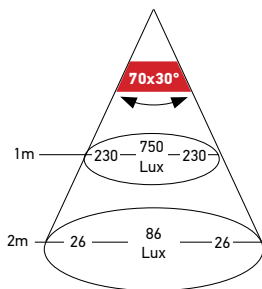
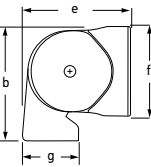

Sea Hawk-R Recess & Bracket Mount Spread

Sea Hawk-R LED Floodlights

Recessed / Bracket Mount

Sea Hawk-R housings are 'Non-metal', precision injection moulded from thermally conductive ceramic polymer that is highly resistant to degradation, even under harsh UV. Effectively transferring heat away from internal electronics to external surfaces for reliable long-term operation.

The Sea Hawk-R offers 550 lumens for only 7W of consumption. The engineered optical system illuminates with a wide, close-range spread over cockpits, foredecks or working areas on commercial and recreational vessels. Mounting options include a Stainless Steel bracket for mounting upright or as a pendant, or mount it recessed where desired.



Recess Mount

Lens Type	Black Housing	White Housing
Spread	2LT 980 577-001	2LT 980 577-011

Bracket Mount

Light Colour	Black Housing	White Housing
White	2LT 980 573-011	2LT 980 573-021

*Packaging Retail blister for single pack. PN shown in table above
Trade Carton Pack 18pc multiple, replace final PN digit '1' with '7'*

Housing Material	Corrosion proof thermal polymer
Lens Material	Grilamid® plastic, impact and UV resistant
Bracket (0573 Series)	316 stainless steel
Lumen	550 lumen
Colour Temperature	5000K (White)
Operating Voltage	Multivolt™ 12 / 24V DC
Power Consumption	7W (0.58A @ 12V / 0.29A @ 24V)
Cable	Recess: 500mm tinned marine cable Bracket: 2.5m tinned marine cable
Protection	IP67 (Completely Sealed)
Compliance	CE, RCM, UKCA



Sea Hawk-XLR LED Floodlights

1500 lumens of crisp, white, darkness-busting illumination with the proven Sea Hawk-XLR. Housings are precision injection moulded from thermally conductive ceramic polymer. This advanced material draws heat from internal electronics for reliable long-term operation and eliminates the need for an aluminium housing in this class of floodlight, removing corrosion risks in the harsh marine environment.

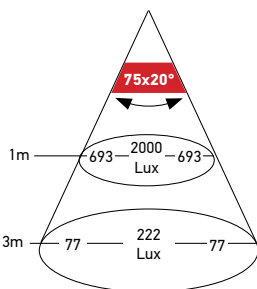

Sea Hawk-XLR

Note: Dimensions same as Sea Hawk-XL
Dual Colour.

Lens Type	Black Housing	White Housing
Spread	2LT 980 740-001	2LT 980 740-011
Spot	2LT 980 740-201	2LT 980 740-211

*Packaging Retail blister for single pack. PN shown in table above
Trade Carton Pack 18pc multiple, replace final PN digit '1' with '7'*

Housing Material	Corrosion proof thermal polymer
Lens Material	Grilamid® plastic, impact and UV resistant
Bracket Material	316 Stainless Steel
Lumen	1500 lumen
Colour Temperature	5000K
Operating Voltage	Multivolt™ 12 / 24V DC
Power Consumption	18W (High) 2W (Low)
Cable	2.5m tinned marine cable
Protection	IP67 (Completely Sealed)
Compliance	CE, RCM, UKCA





FMS Deck Lamps

Hella marine introduces the low profile and powerful FMS LED deck lamps. These surface mount scene lamps are purpose designed to integrate discretely into tight spaces and exterior recesses, yet throw a huge amount of light wherever they are installed. With a protrusion of only 38mm, the FMS lamps are sleek and unobtrusive during the day, but make themselves very well-known at night!

Two light intensities are offered: the FMS1200 with 1200 lumens; and the FMS2500 with an even more powerful 2500 lumens. Both lamps offer even, close-range illumination directly underneath the lamp. The light is projected downwards at a fixed angle of 45 degrees, no brackets to adjust.

Energy efficient, completely sealed, shock and vibration resistant lighting. Advanced electronics provide consistent illumination and circuit protection across a range of inputs from 12/24V DC for an ultra-long service life.



Lamp Type	Black Housing	White Housing
FMS1200	1GB 996 098-001	1GB 996 098-501
FMS2500	1GB 996 098-011	1GB 996 098-511
Packaging	Trade carton for single pack	

Housing Material	Die-cast aluminium, CoroSafe coating
Mounting	Surface mount
Lumen	FMS1200: 1200 lumen FMS2500: 2500 lumen
Colour Temperature	6500K
Operating Voltage	Multivolt™ 12 / 24V DC
Power Consumption	FMS1200: 14W (1.17A @ 12V DC / 0.58A @ 24V DC) FMS2500: 28W (2.33A @ 12V DC / 1.17A @ 24V DC)
Cable	500mm of twin core cable
Protection	IP6K9K, IP6K8
Compliance	ECE R10, RCM, ADR / GGVSEB, UKCA

FMS1200 Light Distribution

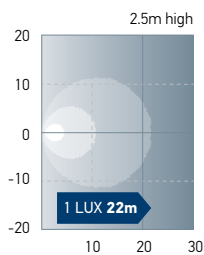

FMS2500 Light Distribution

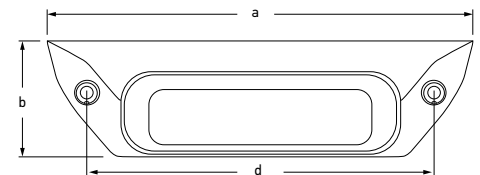
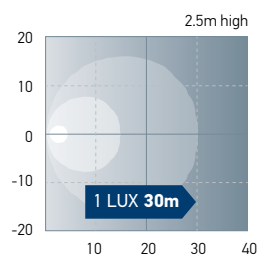

Dimensions

- a = 243mm (9.57")
- b = 66mm (2.59")
- c = 38mm (1.49")
- d = 134mm (5.27")

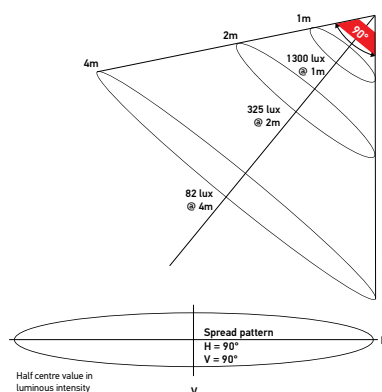
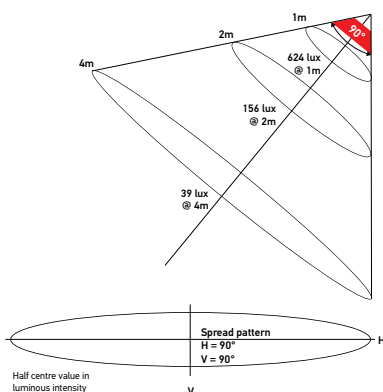
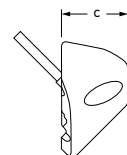



Module 70-S & Module 70 Gen 5

The updated Module 70-S offers an impressive 1850 lumen of crisp white light illumination, while the Module 70 Gen 5 steps this up to offer 3500 lumen, or over 1.8x the light output in the same size housing. A single or pair of 1850 lumen Module 70-S lamps is more than enough to light up your average cockpit, but these could be replaced by a single Module 70 Gen 5, or a pair if significant lighting in a larger area is needed.

12/24V
MULTI
VOLT™

CORROSION
RESISTANT

IP6K9K
COMPLETELY
SEALED

UV
RESISTANT

HD
MOUNT

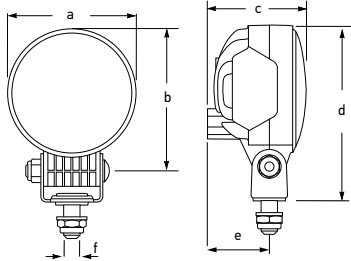

Dimensions
a = 83mm (3.3")
b = 91mm (3.6")
c = 64mm (2.6")
d = 114mm (4.5")
e = 40mm (1.6")
f = M10mm (0.4")

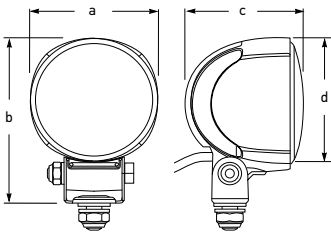

Dimensions
a = 83mm (3.27")
b = 110mm (4.33")
c = 74mm (2.91")
d = 83mm (3.27")

Module 70-S

Lens Type	Black Housing
Close Range	1G0 996 776-431
Long Range	1G0 996 776-441
Packaging	Trade carton for single pack

Module 70 Gen 5

Lens Type	Black Housing	White Housing
Close Range	1G0 996 476-211	1G0 996 476-191
Long Range	1G0 996 476-221	1G0 996 476-201
Packaging	Retail blister for single pack	

	Module 70-S	Module 70 Gen 5
Housing Material	Housing: Advanced Thermal Polymer Cover lens: Plastic Bracket: Stainless Steel	Aluminium, CoroSafe coating. Glass lens Bracket: Stainless Steel
Lumen	1850 lumen	3500 lumen
Colour Temperature	6500K	
Operating Voltage	Multivolt™ 12 / 24V DC	
Power Consumption	17W (1.29A @ 12V DC / 0.61A @ 24V DC)	29W (2.4A @ 12V DC / 1.2A @ 24V DC)
Cable/Connector	DT connector, 2-pin. Cable not included*	1m tinned marine cable
Protection	IP 6K7, IP6K9K (Completely sealed)	

*Module 70-S requires 8KB 958 757-501 cable with DT Connector (shown below) or equivalent.



8KB 958 757-501
2m cable with DT Connector



1G0 996 776-431
M70-S Close Range
1G0 996 776-441
M70-S Long Range



1G0 996 476-211
M70 Gen 5 Close Range
1G0 996 476-221
M70 Gen 5 Long Range



1G0 996 476-191
M70 Gen 5 Close Range
1G0 996 476-201
M70 Gen 5 Long Range

Module 70-S Close Range 2.5m high at -10°

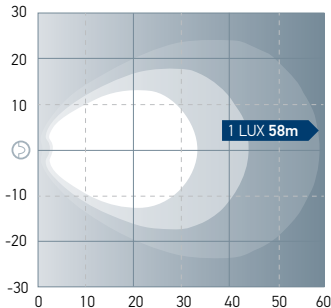

Module 70-S Long Range 2.5m high at -4°

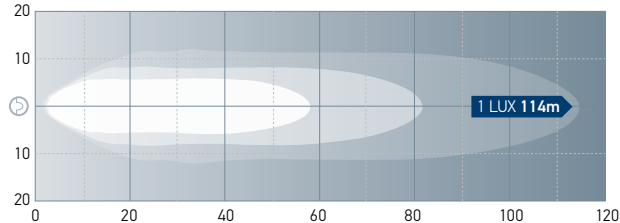

Module 70 Gen 5 Close Range 2.5m high at -3°

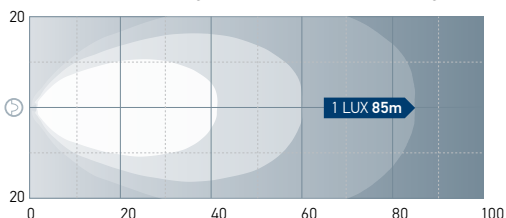

Module 70 Gen 5 Long Range 2.5m high at -3°

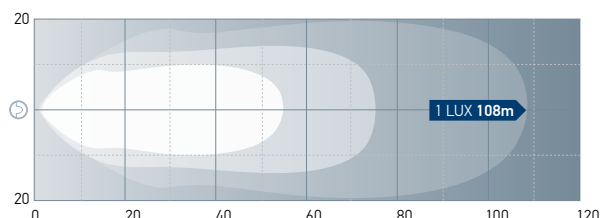



RokLUME 280N Gen. 2 Floodlight

The next Generation of RokLUME 280 floodlights build on their expertise in heavy duty marine applications. High quality materials offer superior impact, shock, vibration, UV and corrosion resistance. NanoSafe coating provides extra layers of non-stick corrosion protection. RokLUME Gen 2 features increased 5000 lumen output. Advanced optics and updated beam patterns generate even illumination and avoid bright spots, dark patches or stray light rays that serve no useful purpose. Each lamp is fully sealed against dust and water ingress, making these work lights suitable for the harshest environments and ensuring an ultra long service life.

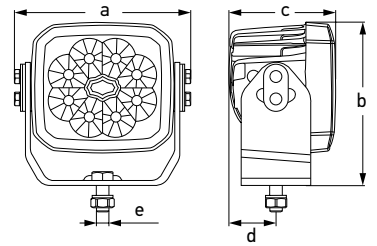

Dimensions:

a = 142mm (5.6")
 b = 131mm (5.2")
 c = 86mm (3.4")
 d = 38mm (1.50")
 e = 10mm (0.39")



Close Range



Long Range

Lens Type	Part Number
Close Range	1GA 995 706-501
Long Range	1GA 995 706-511
Packaging	Trade Carton for single pack
Housing Material	Die-cast aluminium with NanoSafe non-stick coating
Bracket Material	Heavy Duty Stainless Steel
Lumen	5000 lumen
Colour Temperature	5000K
Power Consumption	46W (3.85A @ 12V DC) / 45W (1.86A @ 24V DC). 50W Max
Operating Voltage	Multi-voltage (9-32V)
Cable	DT socket (counter plug supplied)
Protection	IP6K8 & IP6K9K – (Protection against dust, prolonged water immersion and high-pressure/steam)
Compliance	CE, ECE R10, RCM, UKCA



RokLUME 380 Heavy Duty 24V Floodlight

RokLUME 380 floodlights offer incredible performance and durability in the harshest conditions for hard working vessels. With 7500 lumen of light output in either close or long range beam options, the RokLUME 380 is suitable for a wide variety of installations. Purpose designed for commercial marine applications, the impact resistant, hard-coated polycarbonate lens and premium corrosion-resistant aluminium housing ensure a long life. The heavy duty stainless steel bracket features Nord-Lock washers and a rubber damping system to limit movement on high vibration vessels. The advanced optic systems provide powerful forward facing lighting.

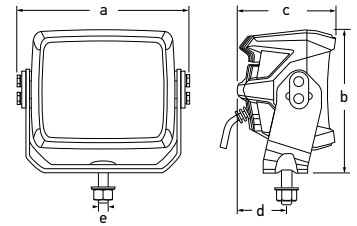

Dimensions:

a = 179mm (7.05")
 b = 148mm (5.80")
 c = 102mm (4.01")
 d = 51mm (2.0")
 e = 10mm (0.39")



Long Range

Lens Type	Part Number
Close Range	1GA 996 197-601
Long Range	1GA 996 197-611
Packaging	Trade Carton for single pack
Housing Material	Premium aluminium with NanoSafe non-stick coating
Bracket Material	Heavy Duty Stainless Steel
Lumen	7500 lumen
Colour Temperature	5000K
Power Consumption	84W
Operating Voltage	20V-32V DC (Nominal 24V)
Cable	2.0m double insulated silicone supply cable with bare ends
Protection	Reverse polarity and voltage spike protection IP6K8 & IP6K9K - (Protection against dust and high-pressure/steam jet cleaning)
Compliance	CE, ECE R10, RCM, CISPR 25 CLASS 4, UKCA



RokLUME 380
Heavy Duty Floodlights

WATCH THE VIDEO

HypaLUME Floodlighting



A quantum technology leap for commercial vessels, HypaLUME is Hella marine's most powerful floodlight. Designed for applications where high output lighting in extreme environments are required. Comprehensive sealing and anti-corrosion measures have been taken to ensure the lamps withstand the toughest conditions. The premium aluminium housing is corrosion resistant with a non-stick and easy to clean surface coating.

A heavy duty Grilamid® lens offers unbeatable toughness against impacts and vibration while providing long term UV stability and resistance to commonly used chemicals for the life of the product. The HypaLUME is designed to operate over an extreme temperature range from -40°C to +50°C. The advanced thermal management draws heat away from the LEDs to maintain a long service life.

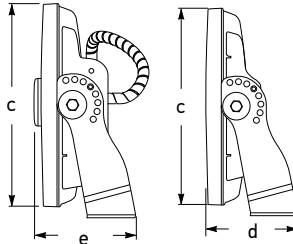
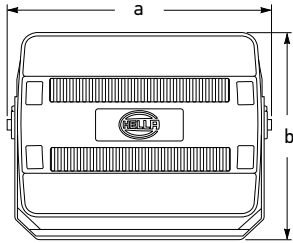

AC

DC

Dimensions

110 / 230V AC	24 / 48V DC
a = 520mm (20.47")	a = 520mm (20.47")
b = 380mm (15.9")	b = 380mm (15.9")
c = 359mm (14.13")	c = 359mm (14.13")
e = 180mm (7.08")	d = 166mm (6.54")

110 / 230V AC LED Floodlights

Lens Type	Part Number
Close Range	1GJ 958 334-011
Long Range	1GJ 958 334-021
Extra Wide	1GJ 958 334-031
<i>Packaging</i>	<i>Trade Carton for single pack</i>
Operating Voltage	100 to 240V AC
Power Consumption	300W
Lumen	28000 lumen
Connection	Wieland RST Mini - 16A
Cable	Supplied with 2.0m of easy plug-in sheathed cable
Protection	IP66 and IP67 (Protection against dust and high pressure water jets and temporary water immersion) Over-temperature protection
Compliance	CE, RCM, FCC, AS/NZS 60598.2.5, UKCA



Close Range Lens



Long Range Lens



Extra Wide Lens

24 / 48V DC LED Floodlights

Lens Type	Part Number
Close Range	1GJ 011 872-501
Long Range	1GJ 011 872-511
Extra Wide	1GJ 011 872-521
<i>Packaging</i>	<i>Trade Carton for single pack</i>
Operating Voltage	22 to 52V DC
Power Consumption	260W
Lumen	25000 lumen
Connection	4 Pin Deutsch plug
Cable	Supplied with 1.8m of easy plug-in sheathed cable
Protection	IP6K9K (Fully sealed against dust and high-pressure / steam jet cleaning) Advanced thermal management. Reverse polarity, transient spike and over voltage protection
Compliance	CE, RCM, FCC, ISO 13766, ECE R10, UKCA



Wieland RST Mini Connection



DT connection



Extra Wide 1GJ 958 334-031

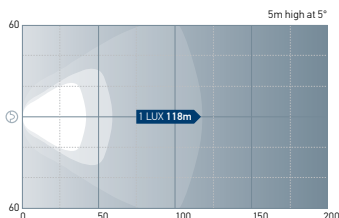

Close Range 1GJ 958 334-011

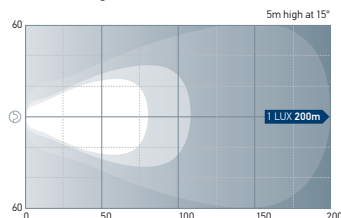

Long Range 1GJ 958 334-021

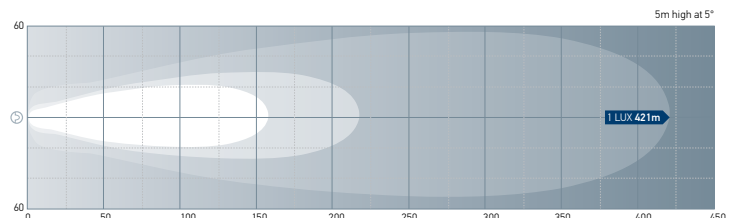



LED Hand Held Search Light

Hella marine hand held search lights are vital tools for night sailing and essential for spotting looming obstacles from a safe distance, or dependable light in an emergency. Integrated trigger switch and handle allows for Morse code signalling.

Rugged construction and a CoroSafe coating system is specifically designed for the harsh marine environments. Multivolt™ technology ensures reliable illumination and lamp protection even under severe voltage fluctuations and low battery conditions. Advanced electronics provide reverse polarity, spike and over-voltage protection for long life and reliable operation.

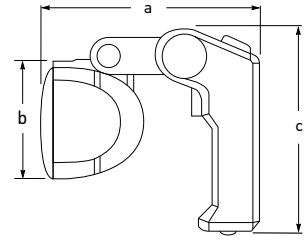

Dimensions
a = 160mm (6.30")
b = 83mm (3.30")
c = 145mm (5.71")

Lens Type	Black Housing
Long Range	1H0 996 476-502
Packaging	Retail blister for single pack
Housing Material	Die-cast aluminium, CoroSafe coating
Lumen	3500 lumen
Operating Voltage	Multivolt™ 12 / 24V DC
Cable	Spiral cable with cigarette plug (3.5m)
Power Consumption	29W (2.42 @ 12V DC / 1.21A @ 24V DC)
Protection	IP6K9K, IP6K8 (Completely sealed)

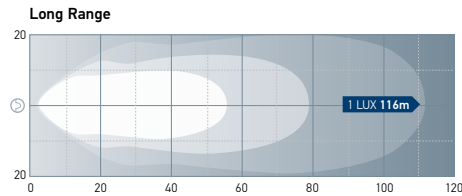

Accessory	
Deck Mount Base	8HG 998 519-001

Ultra Beam Search

Cabin Controlled Search Light

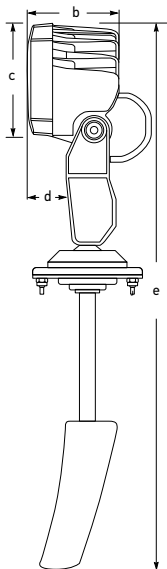
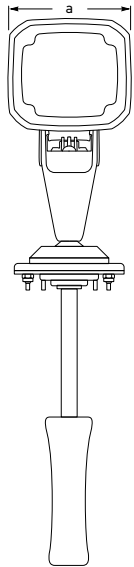

Dimensions

- a = 115mm (4.53")
- b = 86mm (3.39")
- c = 129mm (5.1")
- d = 38mm (1.5")
- e = 502mm (19.8")

The Ultra Beam search light is a through-roof mountable lamp, giving beam direction control from inside the cabin. The lamp features a powerful light output of 4400 lumen in a search light pattern for illumination distance of 310m @ 1 Lux. The proven mounting system offers operation in any direction from the comfort of the cabin or wheelhouse with 360° of rotation and 30° of vertical adjustment.

The unique corrosion proof housing provides exceptional durability and long-term reliability through unmatched corrosion resistance. Quality materials like the impact resistant polycarbonate lens and the premium aluminium housing ensure a long lifetime, and a maintenance-free lighting product.

This LED search light uses the same footprint and mounting situation as the Halogen series 1H3 998.502-02x. An upgrade is easily possible.

Lens Type	Part Number
Spot illumination	1GA 995 606-091
Packaging	Trade Carton for single pack
Installation	Designed for installations through cabin roofs
Lens Material	High impact PC lens
Colour Temperature	6500K
Light Output	4400 Lumen
Operating Voltage	Multivolt™ 12 / 24V DC
Power Consumption	50W (2.1A @ 12V / 4.2A @ 24V)
Cable	350mm of cable, grommet sealed, O-ring included
Protection	Lamp: IP6K9K (Protection against dust and high-pressure/steam jet cleaning) Handle: IPx4 (Protection from splashing water from any direction)
Compliance	CE, RCM, ECE R10, UKCA



Ultra Beam Search

2.5m high - 3 degrees

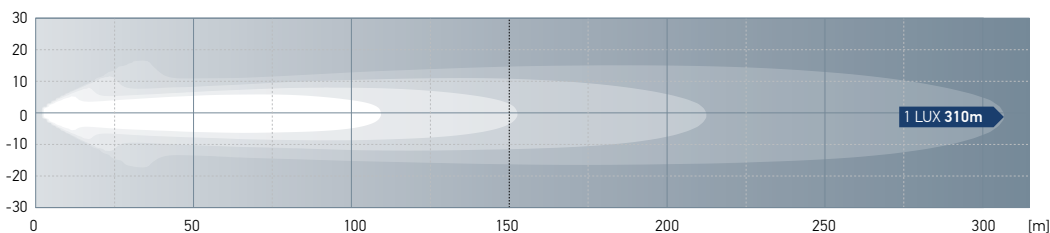



NaviLED Navigation Lights

Setting The Standard

Hella marine's NaviLED range are the leaders in the marine Navigation signal lighting industry, having established an enviable reputation for superior light control and reliability.

Proven on the harshest waters worldwide, Hella marine LED Navigation Lamps provide power saving, highly visible and ultra durable lighting.

Navigation Lamps, often overlooked, are an essential component for any boat. Various rules dictate which lights are necessary for different types of vessels. For detailed information, refer to our Navigation Lamp Guide on page 34.

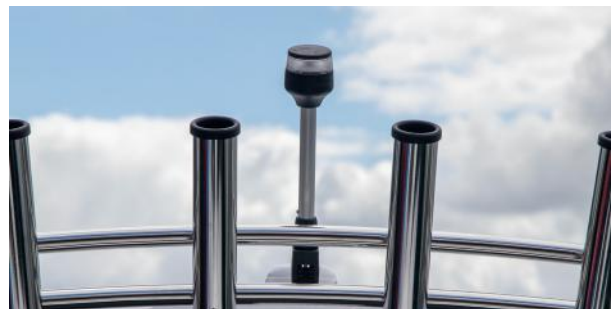

NaviLED, Superior Performance

Advanced LED optics deliver optimal horizontal and vertical light distribution according to international standards. Cut-off angles are ultra precise, clearly indicating a vessel's movement and heading.

Each Hella marine LED lamp is a completely sealed opto-electronic device. Proven design, precision engineering, and the use of high impact acrylic materials ensures superior resistance to water, impact, UV and general wear and tear.

All our Navigation Lamps feature extra thick lenses. Taking ultra durable lighting to a new level, Hella marine specifies Grilamid®, a high performance polyamide as a standard or optional lens choice. Grilamid® is a revolutionary transparent plastic with an exceptionally high impact strength and resistance to UV and chemical damage.

Multivolt™ circuitry provides a uniform level of intensity for reliable and safe illumination across a range of DC inputs such as 9-33 volts. Multivolt™ LED lamps can be connected to 12 or 24 volt systems without modification, providing full light performance and automatic compensation for low battery voltages and voltage drop over long cables and connections. Multivolt™ LED lamps are also reverse polarity and spike protected for enhanced durability even under severe voltage fluctuations.

We design our products to suppress electromagnetic interference, complying with the emission and immunity limits prescribed in international standards. This protects the radio, communication, navigation and other electrical equipment onboard from possible interference with our products.

Photometric Testing

NaviLED lamps are photometrically verified in our facility by a sophisticated goniometer to ensure compliance with the intensity and cut-off requirements of international navigation lamp standards.

After passing photometric testing and where required, a unique serial number is laser engraved onto the lens. This serial number is referenced to individual test reports which are electronically archived by Hella marine, ensuring international navigation lamp standards are consistently met.



Navigation Lamp Approvals

Hella marine navigation lamps comply with the International Regulations for Prevention of Collisions at Sea (IMO COLREG 72). Refer to our Navigation Lamp Guide on page 34.

This IMO compliance, together with supplementary national or regional requirements, is listed with each navigation lamp series throughout the catalogue.

Approval types:



Complies with IMO (International Maritime Organization) requirements under the International Regulations for the Prevention of Collisions at Sea. (IMO COLREG 72). IMO COLREG 72 forms the international basis for legal navigation lighting on vessels.



Complies with USCG (United States Coast Guard) requirements. Lamps carry a marking for minimum visible distance in nautical miles, e.g. USCG 2NM.



Approved under the Wheelmark Marine Equipment Directive (MED) 96/98/EC last modified by directive 2008/67/EC for use throughout Europe in all EC member states for both pleasure and commercial vessels.



Complies with ABYC (American Boat and Yacht Council) Navigation Lamp Standard C-5.



Suitable for vessels compliant with RCD (Recreational Crafts and Personal Watercraft Directive) 2013/53/EU. RCD promotes a single set of EU safety and technical requirements for new recreational vessels less than 24m in length within the European Community.



Approved for placement on UK ships. Carries the UK conformity mark for marine equipment, the 'Red Ensign'. Required from 1st January 2023.

Certifying bodies:



Approved by the German BSH (Bundesamt für Seeschifffahrt und Hydrographie) and carry BSH type approval numbers. BSH was formerly called DHI (Deutsches Hydrographisches Institut).



Approved by the Italian RINA (Registro Italiano Navale) authority.

IMO COLREG 72 Lights and Visibility - Powerboats

IMO COLREG requirements for navigation lighting on powerboats less than 50m (164ft) LOA (Length Overall).

Note - Sailboats under motor adopt the rules for Powerboats.

Powerboats up to 7m (23ft).
Not capable of more than 7 knots

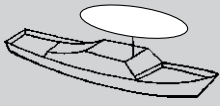

- 1x All Round White

Powerboats up to 12m (39ft)
Where Separate Masthead and Stern cannot be mounted

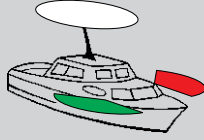

- 1x Port lamp (2NM)
- 1x Starboard lamp (2NM)
- OR
- 1x Bi-Colour lamp (2NM)
- 1x All Round White lamp (2NM)

Powerboats up to 12m (39ft)

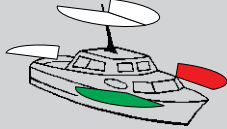

- 1x Port lamp (2NM)
- 1x Starboard lamp (2NM)
- OR
- 1x Bi-Colour lamp (2NM)
- 1x Masthead lamp (2NM)
- 1x Stern lamp (2NM)

Powerboats more than 12m (39ft), but less than 20m (65ft)

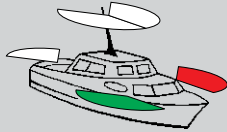

- 1x Port lamp (2NM)
- 1x Starboard lamp (2NM)
- OR
- 1x Bi-Colour lamp (2NM)
- 1x Masthead lamp (3NM)
- 1x Stern lamp (2NM)

Powerboats more than 20m (65ft), but less than 50m (164ft)

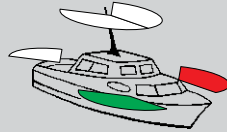

- 1x Port lamp (2NM)
- 1x Starboard lamp (2NM)
- 1x Masthead lamp (5NM)
- 1x Stern lamp (2NM)

The following images depict **ADDITIONAL** lighting requirements for specific activities:

A vessel less than 50m (164ft) engaged in trawling

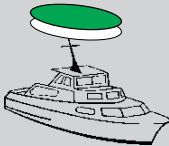

- 1x All Round Green lamp (2NM)
 - 1x All Round White lamp (2NM)
- Mounted above one another

A vessel less than 50m (164ft) engaged in fishing, other than trawling

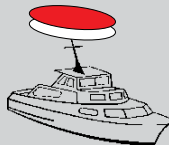

- 1x All Round Red lamp (2NM)
 - 1x All Round White lamp (2NM)
- Mounted above one another

Powerboats towing with a tow length of less than 200m

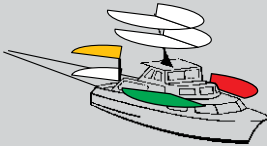

- 1x Towing lamp (2NM)
Mounted above Stern lamp
- 2x Masthead lamps in a vertical line.
(When the tow length exceeds 200m, 3x Masthead lamps in a vertical line)

A vessel engaged in diving operations

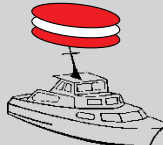

- 1x All Round Red lamp (2NM)
 - 1x All Round White lamp (2NM)
 - 1x All Round Red lamp (2NM)
- Mounted above one another

A vessel engaged in pilotage duty

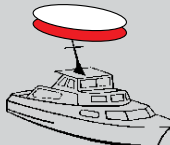

- 1x All Round White lamp (2NM)
 - 1x All Round Red lamp (2NM)
- Mounted above one another

IMO COLREG 72 Lights and Visibility - Sailboats

IMO COLREG requirements for navigation lighting on sailboats less than 50m (164ft) LOA (Length Overall).

Note - Sailboats under motor adopt the rules for Powerboats.

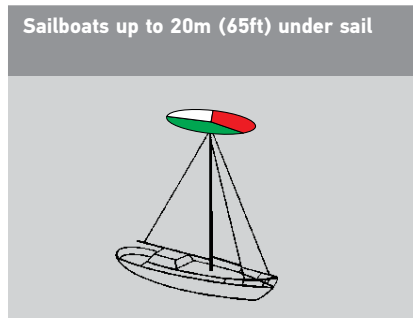

- 1x Tri-Colour lamp (2NM)

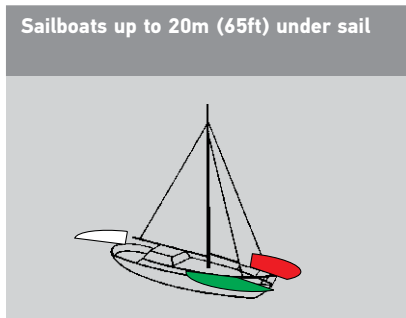

- 1x Port lamp (2NM)
- 1x Starboard lamp (2NM)
- OR
- 1x Bi-Colour lamp (2NM)
- 1x Stern lamp (2NM)

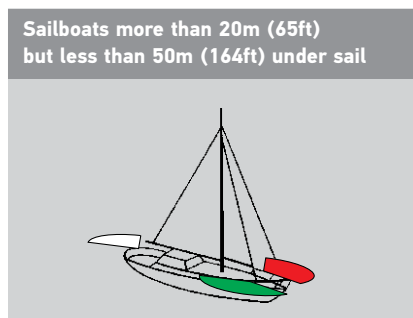

- 1x Port lamp (2NM)
- 1x Starboard lamp (2NM)
- 1x Stern lamp (2NM)

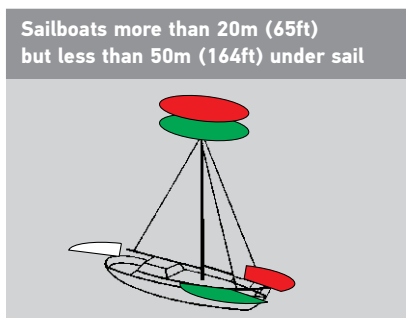

- 1x All Round Red lamp (2NM)
- 1x All Round Green lamp (2NM)
- 1x Port lamp (2NM)
- 1x Starboard lamp (2NM)
- 1x Stern lamp (2NM)

IMO COLREG requirements for navigation lighting on sailboats and powerboats less than 50m (164ft) LOA (Length Overall) at anchor.

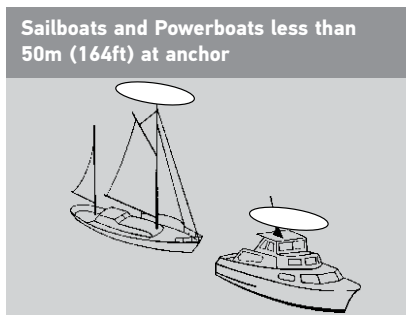

- 1x All Round White lamp (2NM)

The following images depict ADDITIONAL lighting requirements for specific activities:

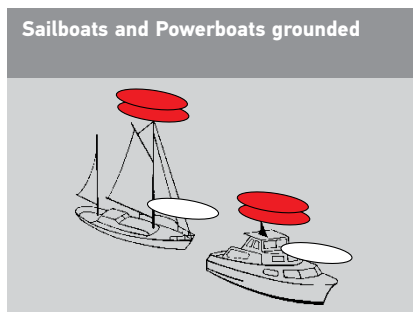

- 1x All Round White lamp (2NM)
- 2x All Round Red lamp (2NM)
Mounted above one another

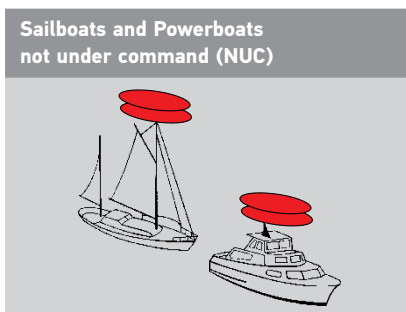

- 2x All Round Red lamp (2NM)
Mounted above one another

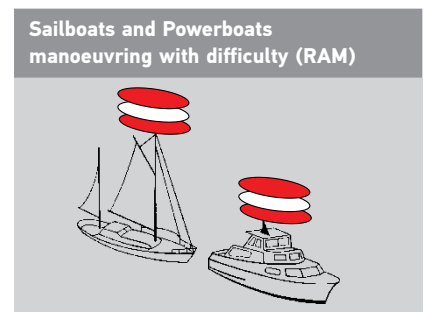

- 1x All Round Red lamp (2NM)
- 1x All Round White lamp (2NM)
- 1x All Round Red lamp (2NM)
Mounted above one another



NaviLED Compact 2NM

Hella marine NaviLED products are the leaders in the marine navigation signal lighting industry, having established an enviable reputation for superior light control and reliability. NaviLED Compact Port, Starboard and Stern lamps, with their 2NM visibility, cover vessel requirements up to 50m.

Designed with components that suppress possible interference, both emission as well as susceptibility to emissions, to the limits prescribed in international standards. This prevents possible interference with radio, communication, navigation and other electrical equipment on board.

Hella marine lamps are rated at IP67 and completely sealed. UV from the sun, corrosive salt air and constant vibration: these lamps are impervious to the marine environment.

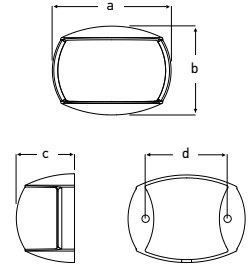

Dimensions

a = 71mm (2.80")
 b = 53mm (2.09")
 c = 33mm (1.30")
 d = 50mm (1.97")



Single Lamps

Lamp Type	Lens	Cable	Black Shroud	White Shroud
Port	Colour	120mm	2LT 980 520-001	2LT 980 520-011
Port	Clear	120mm	2LT 980 520-101	2LT 980 520-111
Port	Colour	2.5m	2LT 980 520-031	2LT 980 520-041
Port	Clear	2.5m	2LT 980 520-131	2LT 980 520-161
Starboard	Colour	120mm	2LT 980 520-201	2LT 980 520-211
Starboard	Clear	120mm	2LT 980 520-301	2LT 980 520-311
Starboard	Colour	2.5m	2LT 980 520-231	2LT 980 520-241
Starboard	Clear	2.5m	2LT 980 520-331	2LT 980 520-361
Stern	Clear	120mm	2LT 980 520-501	2LT 980 520-511
Stern	Clear	2.5m	2LT 980 520-531	2LT 980 520-541

Packaging Retail carton for single pack. PN shown in table above
 Trade Carton Pack 10pc multiple, replace final PN digit '1' with '7'

Port & Starboard Pairs

Lamp Type	Lens	Cable	Black Shroud	White Shroud
Port & Starboard	Colour	120mm	2LT 980 520-801	2LT 980 520-811
Port & Starboard	Clear	120mm	2LT 980 520-901	2LT 980 520-911

Packaging Retail blister for single pack. PN shown in table above
 Trade Carton Pack 10pc multiple, replace final PN digit '1' with '7'



Housing Material	UV Resistant ASA polymer
Lens Material	Enhanced impact, UV resistant acrylic
Minimum Visible Distance	2NM (Yachts and Powerboats)
Operating Voltage	Multivolt™ 12 / 24V DC
Voltage Protection	Spike protected to +500 volts Reverse polarity protected to -700 volts
Power Consumption	Port / Starboard <2W combined - Stern <2W
Cable	Tinned marine cable
Protection	IP67 (Completely Sealed)
Compliance	IMO COLREG 72, USCG, ABYC C-5, RCM, Maritime NZ, CE, RINA, UKCA

NaviLED Deck Mount 2NM Pair

NaviLED Deck Mount Port and Starboard lamps, with their 2NM visibility, cover vessel requirements up to 50m. Ultra low power consumption from the highly efficient LED light source, these lamps also provide exacting light intensity across a wide range of voltage inputs from 9V DC to 32V DC.

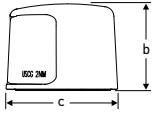
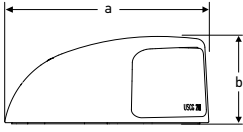

Dimensions:

a = 90mm (3.54")
b = 38.5mm (1.52")
c = 50mm (1.97")

Lamp with Coloured Lens	Black Housing	White Housing
Port & Starboard (2NM)	2LT 980 620-801	2LT 980 620-811
Lamp with Clear Lens	Black Housing	White Housing
Port & Starboard (2NM)	2LT 980 620-901	2LT 980 620-911
<i>Packaging Retail blister for 1 pair of lamps. PN shown in table above Trade Carton Pack 5pc multiple, replace final PN digit '1' with '7'</i>		
Housing Material	UV Resistant ASA polymer	
Lens Material	Enhanced impact, UV resistant acrylic	
Minimum Visible Distance	2NM (Yachts and Powerboats)	
Operating Voltage	Multivolt™ 12 / 24V DC	
Voltage Protection	Spike protected to +500 volts Reverse polarity protected to -700 volts	
Power Consumption	Port / Starboard <2W combined.	
Cable	500mm of tinned marine cable	
Protection	IP67 (Completely Sealed)	
Compliance	IMO COLREG 72, USCG, ABYC A-16, RINA, Maritime NZ, CE, UKCA	



NaviLED Tri-Colour 2NM

NaviLED Tri-Colour includes a 2NM rated Port, Starboard, Stern and separate Anchor function for sailing vessels under sail. Designed with components that suppress possible interference, both emission as well as susceptibility to emissions, to the limits prescribed in international standards. This prevents possible interference with radio, communication, navigation and other electrical equipment on board. Hella marine lamps are rated at IP67 and completely sealed. UV from the sun, corrosive salt air and constant vibration, these lamps are impervious to the marine environment.

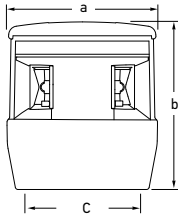

Side profile

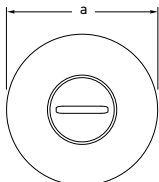

Top profile

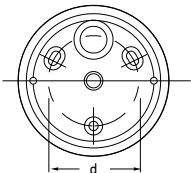

Mounting Layout

Dimensions

a = 85mm (3.35")
b = 95mm (3.74")
c = 75mm (2.95")
d = Ø50.8mm (2")

Tri Colour Lamp with Anchor

Visibility	Black Base
2NM	2LT 980 650-001
<i>Packaging Retail blister for single pack. PN shown in table above Trade Carton Pack 10pc multiple, replace final PN digit '1' with '7'</i>	
Housing Material	UV resistant, high impact nylon
Lens Material	Grilamid® plastic, impact and UV resistant
Mounting Shaft	316 Stainless Steel
Minimum Visible Distance	2 NM (Yacht)
Operating Voltage	Multivolt™ 12 / 24V DC
Voltage Protection	Spike protected to +500 volts Reverse polarity protected to -700 volts
Power Consumption	Port, Starboard and Stern - <3.5W combined All Round White / Anchor - <1.5W
Cable	400mm of tinned marine cable
Protection	IP67 (Completely Sealed)
Compliance	BSH, IMO COLREG 72, USCG, ABYC A-16, RCM, Maritime NZ, CE, UKCA



NaviLED Trio Windex Adaptor Nut Part Number: 9NM 958 988-402

Machined 316 stainless steel adaptor nut to install a Windex directly onto the LED Tri Colour mounting shaft. M12 (Mounting Shaft) to 5/16UNC. Female to female.





NaviLED PRO

Hella marine NaviLED products are the leaders in the marine navigation signal lighting industry, having established an enviable reputation for superior light control and reliability.

NaviLED PRO Port, Starboard, and Stern lamps 2NM are now compliant with the new ABYC C-5 standards update, and cover vessel requirements up to 50m (164ft) LOA, while the 3NM versions cover vessel sizes greater than 50m (164ft) LOA.

Designed with components that suppress possible interference, both emission as well as susceptibility to emissions, to the limits prescribed in international standards. This prevents possible interference with radio, communication, navigation and other electrical equipment on board.

Hella marine lamps are rated at IP67 and completely sealed. UV from the sun, corrosive salt air and constant vibration, these lamps are impervious to the marine environment.

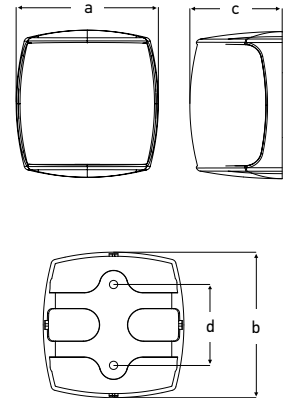

Dimensions

a = 87mm (3.43")
 b = 90mm (3.54")
 c = 57mm (2.25")
 d = 50mm (1.97")



Lamp Type	Visibility	Black Shroud	White Shroud
Port	2NM	2LT 017 460-001	2LT 017 460-011
Port	3NM	2LT 017 460-101	2LT 017 460-111
Starboard	2NM	2LT 017 461-001	2LT 017 461-011
Starboard	3NM	2LT 017 461-101	2LT 017 461-111
Stern	2NM	2LT 017 462-001	2LT 017 462-011
Stern	3NM	2LT 017 462-101	2LT 017 462-111

Packaging Retail sleeve for single pack. PN shown in table above
 Trade Carton Pack 10pc multiple, replace final PN digit '1' with '7'

Visibility	2NM / 3NM Powerboat and Yacht
Lens Material	High impact and UV resistant acrylic
Operating Voltage	Multivolt™ 9–33V DC for 12 / 24V DC applications
Voltage Protection	Spike protected to +500 volts Reverse polarity protected to -500 volts
Power Consumption	<2W (0.17A @ 12V / 0.09A @ 24V DC)
Cable	2.5m of tinned marine cable
Protection	IP67 (Completely Sealed)
Compliance	ABYC C-5, Wheelmark (MED), Red Ensign, UKCA, Maritime NZ, CE, RCM

NaviLED PRO Deck Mount Adaptor

The NaviLED PRO Deck Mount Adaptor allows the NaviLED PRO lamps to be mounted on a horizontal surface. MoQ: 2pc



Black Housing	White Housing
8HG 241 287-802	8HG 241 287-812

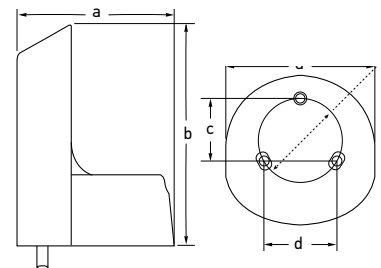

Dimensions

a = 90mm (3.54")
 b = 128mm (5.0")
 c = 38mm (1.5")
 d = 44mm (1.73")
 e = 50.8mm (2.0")

NavILED PRO Masthead

NavILED PRO Masthead lamps 3NM are now compliant with the new ABYC C-5 standards update, and cover vessel requirements up to 20m (65ft) LOA, while the 5NM versions cover vessel sizes 20–50m (66–164ft) LOA.

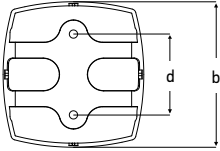
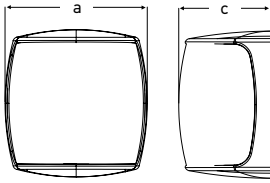

Dimensions

a = 87mm (3.43")
b = 90mm (3.54")
c = 57mm (2.25")
d = 50mm (1.97")

All Hella marine products are designed with components that suppress possible interference, both emission as well as susceptibility to emissions, to the limits prescribed in international standards. This prevents possible interference with radio, communication, navigation and other electrical equipment on board.

Hella marine lamps are rated at IP67 and completely sealed. UV from the sun, corrosive salt air and constant vibration, these lamps are impervious to the marine environment.

Lamp Type	Visibility	Black Shroud	White Shroud
Masthead	3NM	2LT 959 940-201	2LT 959 940-211
Masthead	5NM	2LT 959 940-401	2LT 959 940-411

Packaging Retail sleeve for single pack. PN shown in table above
Trade Carton Pack 10pc multiple, replace final PN digit '1' with '7'

Visibility	3NM / 5NM Powerboat
Lens Material	Grilamid® plastic, impact and UV resistant
Operating Voltage	Multivolt™ 12 / 24V DC
Voltage Protection	Spike protected to +500 volts Reverse polarity protected to -700 volts
Power Consumption	3NM <2.5W (0.2A @ 12V / 0.1A @ 24V) 5NM 4W (0.33A @ 12V / 0.17A @ 24V)
Cable	2.5m of tinned marine cable
Protection	IP67 (Completely Sealed)
Compliance	Wheelmark (MED)*, Red Ensign*, IMO COLREG 72, USCG, ABYC C-5, Maritime NZ, CE, RCM, UKCA

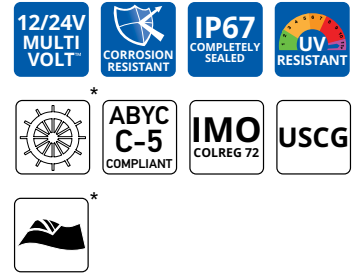

*Wheelmark (MED) and Red Ensign applicable to 5NM only.

NavILED PRO Bi-Colour 2NM

NavILED PRO Bi-Colour lamps are now compliant with the new ABYC C-5 standards update, and cover vessel requirements up to 20m (65ft) LOA. Designed with components that suppress possible interference, both emission as well as susceptibility to emissions, to the limits prescribed in international standards. This prevents possible interference with radio, communication, navigation and other electrical equipment on board.

Hella marine lamps are rated at IP67 and completely sealed. UV from the sun, corrosive salt air and constant vibration, these lamps are impervious to the marine environment.

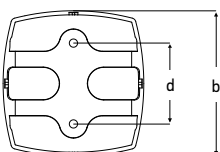
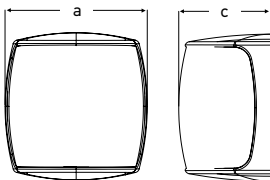

Dimensions

a = 87mm (3.43")
b = 90mm (3.54")
c = 57mm (2.25")
d = 50mm (1.97")

Lamp Type	Visibility	Black Shroud	White Shroud
Bi-Colour	2NM	2LT 959 941-001	2LT 959 941-011

Packaging Retail sleeve for single pack. PN shown in table above
Trade Carton Pack 10pc multiple, replace final PN digit '1' with '7'

Visibility	2NM Powerboat and Yacht
Lens Material	High impact and UV resistant acrylic
Operating Voltage	Multivolt™ 9-33V DC (12 / 24V DC Nominal)
Voltage Protection	Spike protected to +500 volts Reverse polarity protected to -700 volts
Power Consumption	Less than 2W (0.14A @ 12V / 0.08A @ 24V)
Cable	2.5m of tinned marine cable
Protection	IP67 (Completely Sealed)
Compliance	Wheelmark (MED), IMO COLREG 72, USCG, ABYC C-5, Maritime NZ, CE, Red Ensign, CE, RCM, UKCA

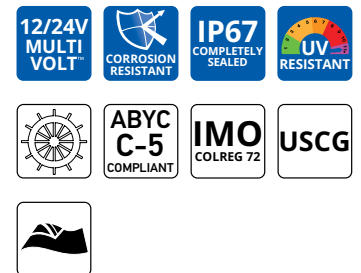

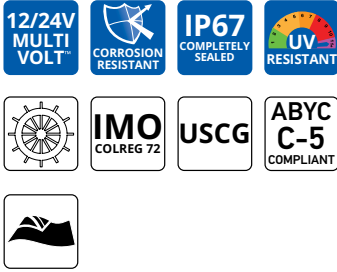

NaviLED 360 Compact

All Round White Navigation Lamp

With a compact mounting footprint and a variety of mounting options, NaviLED 360 Compact lamps feature single LED efficiency, advanced Multivolt™ electronics and precision optics for reliable and highly visible all round lighting. They are designed with components that suppress possible interference with radio, communication, navigation and other electrical equipment on board.

Ultra low power consumption from the highly efficient LED light source, these lamps also provide exacting light intensity across a wide range of voltage inputs from 12–24V DC.



Anchor Lamps with Compact Surface Mount Base

Height	Visibility	Black Base	White Base
56mm (2.2")	2NM	2LT 980 960-001	2LT 980 960-011

Packaging Retail blister for single pack. PN shown in table above
Trade Carton Pack 20pc multiple, replace final PN digit '1' with '7'

Fixed Pole Anchor Lamps

Overall Length	Visibility	Black Base	White Base
167mm (6")	2NM	2LT 980 960-201	2LT 980 960-211
205mm (8")	2NM	2LT 980 960-231	2LT 980 960-241

Packaging Retail blister for single pack. PN shown in table above
Trade Carton Pack 20pc multiple, replace final PN digit '1' with '7'

Fold Down Anchor Lamps

Overall Length	Visibility	Black Base	White Base
205mm (8")	2NM	2LT 980 960-281	2LT 980 960-291
315mm (12")	2NM	2LT 980 960-301	2LT 980 960-311
510mm (20")	2NM	2LT 980 960-321	2LT 980 960-331
605mm (24")	2NM	2LT 980 960-341	2LT 980 960-351
865mm (34")	2NM	2LT 980 960-361	2LT 980 960-371
1015mm (40")	2NM	2LT 980 960-461	2LT 980 960-471

Packaging Retail blister or hangsell for single pack. PN shown in table above
Trade Carton Pack 20pc multiple, replace final PN digit '1' with '7'

Plug-in Pole Anchor Lamps

Overall Length	Visibility	Black Base	White Base
610mm (24")	2NM	2LT 980 960-401	2LT 980 960-411
1080mm (42")	2NM	2LT 980 960-421	
1380mm (54")	2NM	2LT 980 960-441	

Packaging Retail blister or hangsell for single pack. PN shown in table above
Trade Carton Pack 20pc multiple, replace final PN digit '1' with '7'

Housing Material	Corrosion, UV and impact resistant plastic
Lens Material	Grilamid® plastic, impact and UV resistant
Minimum Visible Distance	2NM
Operating Voltage	Multivolt™ 12 / 24V DC
Power Consumption	1W
Cable	2 core tinned marine cable
Protection	IP67 (Completely sealed)
Compliance	IMO COLREG 72, Wheelmark (MED), USCG, ABYC C-5, Maritime NZ, CE, Red Ensign, UKCA, RCM

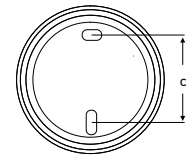
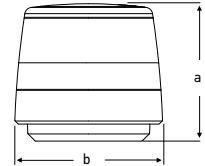

Dimensions
a = 56mm (2.20")
b = 60mm (2.36")
c = 33mm (1.30")
(mounting holes)

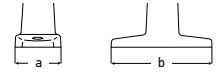

Dimensions
a = 34mm (1.34")
b = 75mm (2.95")

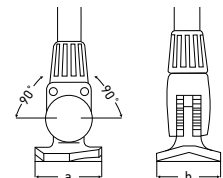

Dimensions
a = 56mm (2.2")
b = 52mm (2.05")

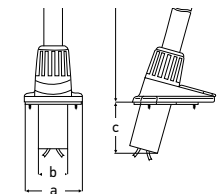

Dimensions
a = 58mm (2.29")
b = Ø30mm (1.19")
c = 54mm (2.13")

NaviLED 360 PRO 2NM

All Round White, Green and Red

NaviLED 360 PRO 2NM Series All Round Navigation Lamps have a low profile surface mount design, and are available in White, Green and Red.

All Hella marine products are designed with components that suppress possible interference, both emission as well as susceptibility to emissions, to the limits prescribed in international standards. This prevents possible interference with radio, communication, navigation and other electrical equipment on board.

Hella marine lamps are rated at IP67 and completely sealed. UV from the sun, corrosive salt air and constant vibration, these lamps are impervious to the marine environment.

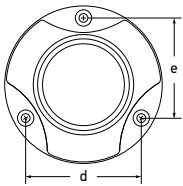
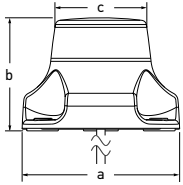

Dimensions

- a = 90mm (3.54")
- b = 68mm (2.68")
- c = 53mm (2.09")
- d = 66mm (2.60")
(mounting holes)
- e = 57mm (2.24")
(mounting holes)

Anchor and All Round Lamps with Wide Base

Light Colour	Visibility	Black Base	White Base
White	2NM	2LT 980 910-121	2LT 980 910-131
Red	2NM	2LT 980 910-521	2LT 980 910-531
Green	2NM	2LT 980 910-321	2LT 980 910-331

Packaging Retail blister for single pack. PN shown in table above
Trade Carton Pack 10pc multiple, replace final PN digit '1' with '7'

Housing Material	Corrosion, UV and impact resistant plastic
Lens Material	Grilamid® plastic, impact and UV resistant
Minimum Visible Distance	2NM
Operating Voltage	Multivolt™ 12 / 24V DC
Power Consumption	1.5W
Cable	1.4m of tinned marine cable
Protection	IP67 (Completely sealed)
Compliance	IMO COLREG 72, Wheelmark (MED), USCG, ABYC C-5, Maritime NZ, CE, Red Ensign, UKCA, RCM





Interior Lighting

Lighting Your Lifestyle

Designing or retrofitting your vessels lighting plays an important part of creating your perfect lifestyle / workspace environment.

Hella marine's interior lighting range presents a versatile selection of luminaires designed to meet various applications. Every product in this range benefits from our three decades of expertise in LED technology, assuring you that you're choosing a lamp crafted by industry experts.

Choosing the perfect lighting solution demands thoughtful deliberation. Continue reading to uncover how Hella marine lights can genuinely transform your experience.

Light Output

While lumens, measured in lumen, are often heavily promoted for modern downlights, they usually provide a poor indication of whether a light will meet your requirements. While total lumens do matter to some extent, there are more crucial factors to consider.

Beam Angle/Lux @ Distance

For any given lumen count, a change to the beam angle will produce a higher lux, but over a smaller area. Narrow angle lamps are best when used to highlight a specific object with high intensity, or when the lamp is mounted up high. Wide beam angle lights are used for general purpose lighting to spread the light as wide as possible, and or where height is restricted and/or the lights need to spread as soon as possible.



Colour Temperature or 'CCT'

This is the measure of how 'Warm' or 'Cool' the light appears. Measured on a scale of Kelvin, similar to temperature, hence the association. Warmer tones, in the 2700K to 3000K range, replicate traditional halogen filament lighting and suit where the atmosphere is designed to be cosy and inviting: Saloons and Cabins. Cooler tone, in 4500K – 5500K range, would typically be where work is taking place, or where people need to be alert: Galleys, heads, and cockpits.

Colour Rendering Index or 'CRI'

LED lighting is significantly more efficient than traditional lighting sources, and a core reason for that is due to the fact that LEDs don't produce light on all spectrums. Isolated frequencies are produced that appear white to various degrees (see CCT above), but in doing so, can cause colours to appear washed out. Quality LED luminaires, like the Hella marine interior range, will select LED chips that replicate more of the frequencies across the colour spectrum, which in turn means that the reflected light will produce more vibrant colours, and appear similar to sunlight.

Materials / Sealing

Hella marine interior lamps are all fully sealed, allowing for these lamps to be fitted to any interior or exterior space. Being sealed is only the start, as our lamps are impervious to UV and offer mainly polymer construction. Where metal trims are required, these are typically 316 Stainless Steel, which retains its look after many years with only the occasional wipe down.



Original cabin lighting.



EuroLED 75 lighting upgrade.

Electro Magnetic Interference (EMI)

All active electronic devices, including LED products, create some degree of EMI. The danger comes when this interference occurs in the frequency range between 156 MHz and 165 MHz, used by marine VHF and AIS systems. This can potentially compromise communication, with major operational consequences posing a serious safety risk.



However, by utilizing LED products that are purposefully engineered to mitigate EMI, owners can pro-actively steer clear of potential issues. As a result, regional and international regulatory authorities have established precise standards for LED lighting utilized on boats, particularly in the context of maritime navigation and radio communications equipment.

In the interest of safety, boat owners should prioritize the verification of both exterior and interior LED lamps to ensure they adhere to maritime EMI standards. In cases where they do not meet these standards, upgrading to high-quality models that do can be a straightforward retrofit process. Moreover, such an upgrade offers additional advantages, including increased durability, brighter illumination, and an extended lifespan that these products provide.



EuroLED 75 Down Lights Spring / Screw Mount

The EuroLED 75 uses a highly efficient optical system that produces a very wide and even illumination that is specifically designed to reduce individual light source glare, which can lead to discomfort and eye strain.

A high colour rendering index of 85+ ensures object and surface colours are replicated naturally. EuroLED 75 is available in warm (2700K) or neutral (5000k) White light which will beautifully enhance the materials chosen for your vessel. Additional dual colour option available with Red LEDs to allow a low light mode for navigation at night. Screw or spring mount options and using a standard 50mm / 2" cutout make new or refit installation a breeze.

Completely sealed so can be used for interior and exterior, wet or dry locations. These lamps are impervious to the marine environment and can be fitted throughout the vessel, maintaining a consistent appearance.

For even more colour options, also see the Apelo RGB/W EuroLED 75 downlights (Page 11) for use with the Apelo Lighting Controller (Page 8) for total colour control.



Round Lamps - Dual Colour

Light Colour	Voltage	Mounting	White Plastic Trim	Stainless Steel Trim
Red / White	12V	Screw	2JA 015 247-011	2JA 015 247-021
Red / White	12V	Spring	2JA 015 247-511	2JA 015 247-521
Red / Warm White	12V	Spring	2JA 015 247-611	2JA 015 247-621

Round Lamps - Single Colour

Light Colour	Voltage	Mounting	White Plastic Trim	Stainless Steel Trim
White	12V	Screw	2JA 958 110-011	2JA 958 110-021
White	24V	Screw	2JA 958 110-111	2JA 958 110-121
Warm White	12V	Screw	2JA 958 109-011	2JA 958 109-021
Warm White	24V	Screw	2JA 958 109-111	2JA 958 109-121
White	12V	Spring	2JA 958 110-511	2JA 958 110-521
White	24V	Spring	2JA 958 110-611	2JA 958 110-621
Warm White	12V	Spring	2JA 958 109-511	2JA 958 109-521
Warm White	24V	Spring	2JA 958 109-611	2JA 958 109-621

Packaging Retail blister for single pack. PN shown in table above
Screw Mount Trade Carton Pack 20pc multiple /
Spring Mount Trade Carton Pack 18pc multiple,
replace final PN digit '1' with '7'

Trim material	UV resistant plastic or 316 Polished Stainless Steel
Lumen	190 lumen
Beam Angle	80°
CRI	85
Operating Voltage	12V DC or 24V DC voltage options
Power Consumption	<3W (<0.19A @ 12V DC / <0.1A @ 24V DC)
Colour Temperature	5000K (White), 2700K (Warm White)
Dimming	Via PWM or Voltage Resistive dimmer
Cable	120mm tinned marine cable
Protection	IP6K7 & IP6K9K (Completely sealed)
Compliance	CE, RCM, EN60945:2002, UKCA

EuroLED 75 - Round

Screw Mount

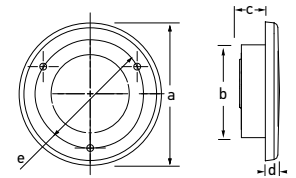

Spring Mount

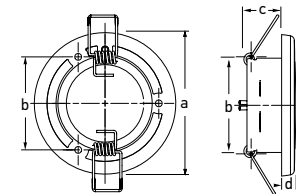

Round

a	75mm (2.95")
b	50mm (1.96") Screw
b	54mm (2.12") Spring
c	16mm (0.63) Screw
c	21mm (0.82") Spring
d	7mm (0.29")
e	57mm (2.24")

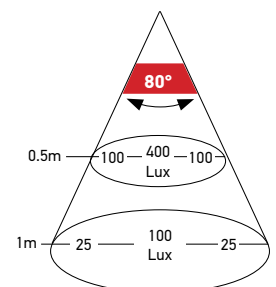

EuroLED 75



WATCH
THE VIDEO



EuroLED 95 Down Lights

Spring / Screw Mount



Spring Mount, Stainless Trim

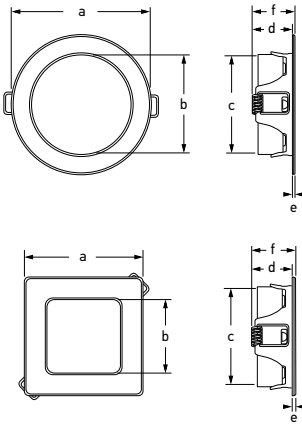

	Round	Square
a	95mm (3.7")	78mm (3.1")
b	68mm (2.7")	48mm (1.9")
c	72mm (2.83")	72mm (2.83")
d	27.3mm (1.07")	26.4mm (1.04")
e	2mm (0.08")	2.5mm (0.1")
f	30mm (1.2")	29mm (1.14")

Screw Mount, White/Stainless Trim

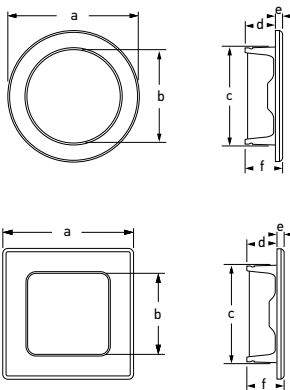

	Round (White/SS)	Square (White/SS)
a	97mm / 95mm 3.8" / 3.74"	80mm / 79mm 3.15" / 3.11"
b	68mm / 2.7"	48mm / 1.85"
c	72mm / 2.83"	72mm / 2.83"
d	22.2mm / 0.9"	22.2mm / 0.9"
e	5.5mm / 4.9mm 0.22" / 0.19"	5.5mm / 5.1mm 0.22" / 0.20"
f	27.7mm / 27.1mm 1.09" / 1.07"	27.7mm / 27.3mm 1.09" / 1.07"

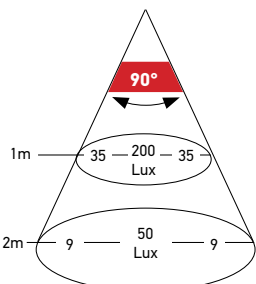

EuroLED 95

The low-profile stainless-steel trim, available in both square and round, is highly polished to super yacht standards, but without the super yacht price tag. EuroLED 95 down lights are readily dimmable and offer spring and screw mounting options designed for easy installation.

A high colour rendering index of >80 ensures object and surface colours are replicated naturally. The optional dual colour lamp enhances the offering. Choose to combine White with either Red, which enhances night-time visibility and functionality, or Blue, which creates a feeling of calm and adds 'wow-factor' to white gel coats. Low EMC noise ensures that these lamps won't interfere with radio communications.

Round Lamps - Spring Mount

Light Colour	Mounting	Stainless Steel Trim
White / Red	Spring	2JA 958 340-101
Warm White / Red	Spring	2JA 958 340-121
White / Blue	Spring	2JA 958 340-111
White	Spring	2JA 958 340-011
Warm White	Spring	2JA 958 340-021

Square Lamps - Spring Mount

Light Colour	Mounting	Stainless Steel Trim
White	Spring	2JA 958 340-511
Warm White	Spring	2JA 958 340-521
White / Red	Spring	2JA 958 340-601
White / Blue	Spring	2JA 958 340-611

Round Lamps - Screw Mount

Light Colour	Mounting	White Trim	Stainless Steel Trim
White / Red	Screw	2JA 958 340-061	2JA 958 340-161
Warm White / Red	Screw	2JA 958 340-071	2JA 958 340-171
White / Blue	Screw	2JA 958 340-081	2JA 958 340-181

Square Lamps - Screw Mount

Light Colour	Mounting	White Trim	Stainless Steel Trim
White / Red	Screw	2JA 958 340-561	2JA 958 340-661
White / Blue	Screw	2JA 958 340-581	2JA 958 340-681

Packaging Retail blister for single pack. PN shown in table above
Trade Carton Pack 12pc multiple, replace final PN digit '1' with '7'

Trim Material	UV resistant plastic or 316 Polished Stainless Steel
Lumen	420 lumen
Beam Angle	90°
CRI	>80
Operating Voltage	Multivolt™ 12 / 24V DC
Power Consumption	<6W (0.5A @ 12V / 0.25A @ 24V)
Colour Temperature	5000K (White), 2700K (Warm White)
Dimming	Via PWM
Cable	120mm tinned marine cable
Protection	IP67 & IP6K9K (Completely sealed)
Compliance	CE, RCM, EN60945:2002, UKCA



Dual Colour



Single Colour



Single Colour

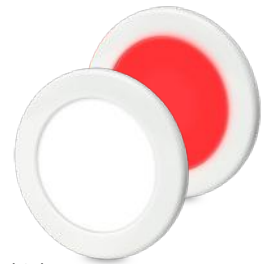

Dual Colour



EuroLED 130 Lamps

Dual Colour EuroLED 130 Lamps with Touch Switch

Light Colour	White shroud	Black Trim
White / Red	2JA 959 950-121	2JA 959 950-111
White / Blue	2JA 959 951-121	2JA 959 951-111

Single Colour EuroLED 130 Lamps with Touch Switch

Light Colour	White shroud	Black Trim
White	2JA 959 950-521	2JA 959 950-511

Single Colour EuroLED 130 Lamps without Switch

Light Colour	White shroud	Black Trim
White	2JA 959 820-521	2JA 959 820-511

*Packaging Retail blister for single pack. PN shown in table above
Trade Carton Pack 12pc multiple, replace final PN digit '1' with '7'*

Lens material	UV resistant enhanced impact acrylic
Trim material	Heavy duty nylon
Colour Temperature	5000K (White)
Operating Voltage	Multivolt™ 9-33V DC
Power Consumption	4.0W (0.33A @ 12V / 0.16A @ 24V)
Cable	2.5m of tinned marine cable
Protection	IP6K6 IP6K7 (Completely Sealed)
Compliance	ISO 8846 (Ignition Protection)

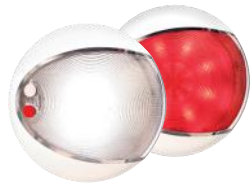

EuroLED 130 Spacer Rings
Black 8HG 959 952-002
White 8HG 959 952-012



EuroLED 130 Shroud
Black 9HD 959 027-002
White 9HD 959 027-012

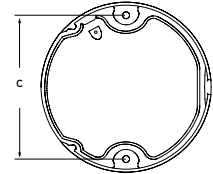
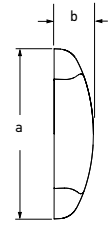

Dimensions:
a = 129.5mm (5.10")
b = 29.5mm (1.16")
c = 110mm (4.33")

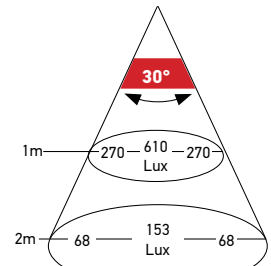

EuroLED 130



EuroLED 150 Lamps

Dual Colour EuroLED 150 Lamps with Touch Switch

Light Colour	White Plastic Trim	Stainless Steel Trim
White / Red	2JA 980 630-001	2JA 980 630-011
Warm White / Red	2JA 980 630-101	2JA 980 630-111
White / Blue	2JA 980 630-201	2JA 980 630-211

Single Colour EuroLED 150 Lamps with Touch Switch

Light Colour	White Plastic Trim	Stainless Steel Trim
White	2JA 980 630-501	2JA 980 630-511

Single Colour EuroLED 150 Lamps without Switch

Light Colour	White Plastic Trim	Stainless Steel Trim
White	2JA 980 631-501	2JA 980 631-511

*Packaging Retail blister for single pack. PN shown in table above
Trade Carton Pack 10pc multiple, replace final PN digit '1' with '7'*

Lens material	UV resistant enhanced impact acrylic
Trim material	UV resistant plastic or 316 Polished Stainless Steel
Colour Temperature	5000K (White) 3000K (Warm White)
Operating Voltage	Multivolt™ 9-33V DC
Power Consumption	4.0W (0.33A @ 12V / 0.16A @ 24V)
Cable	500mm of tinned marine cable
Protection	IP67 (Completely Sealed)

Note - A white spacer ring is included with each EuroLED 150

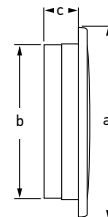
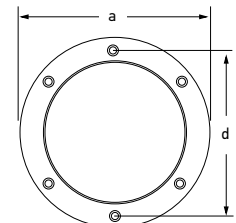
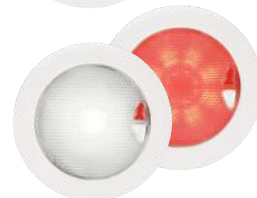
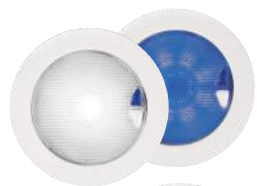

Dimensions:
a = 150mm (5.90")
b = 124mm (4.88")
c = 20mm (0.79")
d = 135mm (5.31")

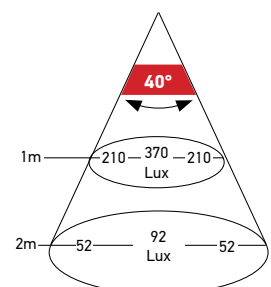

EuroLED 150

Surface Mount Strip Lamps



Offering exceptional light output, these low-profile lamps are an ideal replacement for bulky fluorescent lighting. Producing 250 lumen (White) and offering a leading CRI rating of 85, these LEDs will enhance the appearance of your vessel and provide bright and accurate illumination. With a choice of light temperatures between 5000K White and 2700K Warm White. Bright white LEDs are best for enhanced brightness in areas like galleys and the helm, while the warm white LEDs create a cosy atmosphere, bringing out the best in wooden furniture. Dual Colour options are Red, for enhanced night vision, or Blue for the wow factor.

The sealed switch system prevents moisture and other contaminants from affecting electronics. Fastenings at each end of the lamp body are covered by Snap-On end caps for a clean and modern appearance.



Surface mount strip lamps (with switch)

Light Colour	12V	24V
White	2JA 958 123-001	2JA 958 123-401
White / Red	2JA 958 121-001	
White / Blue	2JA 958 121-011	
Warm White	2JA 958 123-101	
Warm White / Red	2JA 958 121-101	

Surface mount strip lamps (without switch)

Light Colour	12V	24V
White	2JA 958 124-001	2JA 958 124-401
Warm White	2JA 958 124-101	2JA 958 124-501

Packaging Retail blister for single pack. PN shown in table above
Trade Carton Pack 20pc multiple, replace final PN digit '1' with '7'

Lens Material	UV resistant enhanced impact acrylic
Colour Temperature	5000K (White), 2700K (Warm White)
CRI	85
Power Consumption	<3.0W (<0.25A @ 12V / <0.16A @ 24V)
Operating Voltage	12V DC or 24V DC
Dimming	Hella marine Dimmer 5XA 998 572-001 (Not recommended for 2JA 958 121-xxx Dual colour lamp series)
Cable	500mm of tinned marine cable
Protection	IP67 (Completely Sealed)
Installation	Surface Mount
Compliance	CE, RCM, UKCA

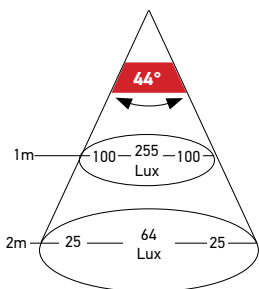

Surface Mount Strip Lamp

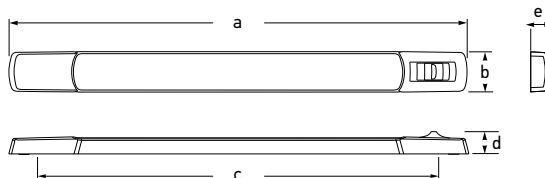

Dimensions:
 a = 283mm (11.14")
 b = 25mm (1.0")
 c = 265mm (10.43")
 d = 14mm (0.55") Switch Cap
 e = 11mm (0.43") Plain Cap



Strip Lamp Accessories

Accessory	Part Number
45° Mounting Bracket White	8HG 958 000-011
45° Mounting Bracket Charcoal	8HG 958 000-021





DuraLED 12

The DuraLED 12 lamps are surface mounted and feature a unique installation system where the fastening load is taken up by a heavy-duty nylon bush to eliminate possible stress on the lamp housing. Purposely designed for engine rooms, storage lockers, lazarettes and applications where reliability must not be compromised.



Low EMC noise ensures that these lamps won't interfere with radio communications. Completely sealed to ISO 8846 and have protection against ignition of surrounding flammable gases. This means they can be used in high risk areas, interior and exterior, wet or dry locations. These lamps are impervious to the marine environment and can be fitted throughout the vessel, maintaining a consistent appearance.

Light Colour	Switch	Non Switch
White	2JA 980 704-001	2JA 959 700-101
Packaging	Trade Carton for single pack	
Installation	Surface mount with robust bush mount	
Lens material	UV resistant enhanced impact acrylic	
Shroud Material	Heavy duty nylon	
Colour Temperature	5000K (White)	
Power Consumption	<2.5W (<0.20A @ 12V / <0.10A @ 24V)	
Voltage Protection	Spike protected to +500 volts Reverse polarity protected to -700 volts	
Operating Voltage	Multivolt™ 12 / 24V DC	
Cable	500mm of tinned marine cable	
Protection	IP67 (Completely Sealed)	
Compliance	CE, ISO 8846 (Ignition protection), RCM, UKCA, ECE R10	

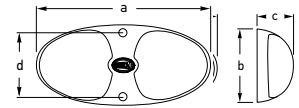

Dimensions
a = 140mm (5.51")
b = 65mm (2.56")
c = 32mm (1.26")
d = 47mm (1.85")

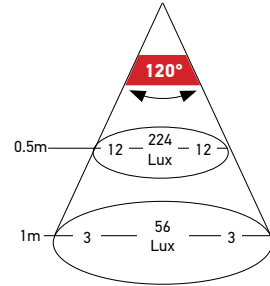

5000 K - 12 LED



DuraLED 20 / 36

DuraLED lamps provide powerful white light, a safe, energy efficient and reliable alternative to incandescent and fluorescent lighting.



Low EMC noise ensures that these lamps won't interfere with radio communications. Completely sealed to ISO 8846 and have protection against ignition of surrounding flammable gases. This means they can be used in high risk areas, interior and exterior, wet or dry locations. These lamps are impervious to the marine environment and can be fitted throughout the vessel, maintaining a consistent appearance.

Light Colour	20 / Spread lens	36 / Spread lens
White	2JA 980 608-001	2JA 959 037-521
Packaging	Trade Carton for single pack	
Installation	Surface mount with robust bush mount	
Lens material	UV resistant enhanced impact acrylic	
Colour Temperature	6500K (White) DuraLED 20 5000K (White) DuraLED 36	
Operating Voltage	Multivolt 9-33V DC	
Voltage Protection	Spike protected to +500 volts Reverse polarity protected to -700 volts	
Power Consumption	20 LED <4W (<0.33A @ 12V / <0.17A @ 24V) 36 LED <7W (<0.51A @ 12V / <0.28A @ 24V)	
Cable	2.5m of tinned marine cable	
Protection	IP67 (Completely Sealed)	
Compliance	CE, ISO 8846 (Ignition protection), RCM, UKCA	

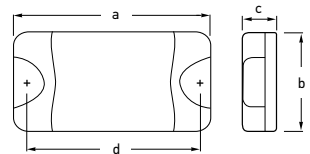

Dimensions
a = 177mm (6.97")
b = 100mm (3.94")
c = 30mm (1.18")
d = 148mm (5.83")

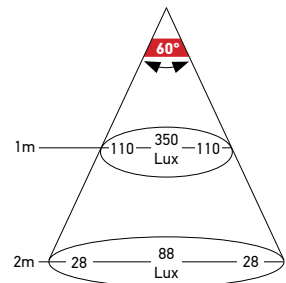

6500 K - 20 LED

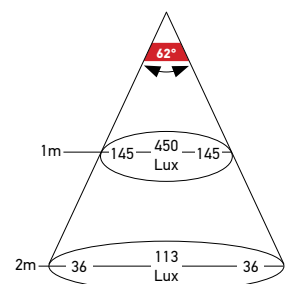

5000 K - 36 LED

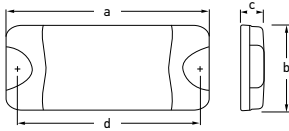

Dimensions:
a = 222mm (8.74")
b = 96mm (3.78")
c = 25mm (0.98")
d = 193mm (7.60")

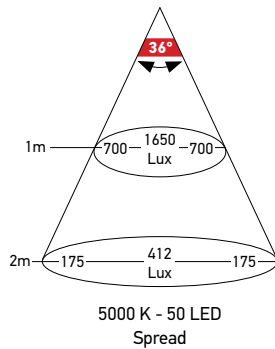
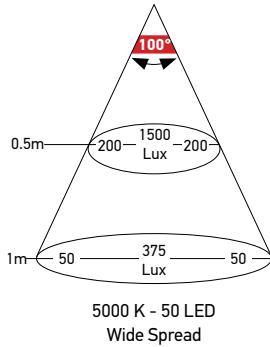

DuraLED 50 Low Profile (LP)

Purposely designed for engine rooms, storage lockers, lazarettes and heavy-duty applications where reliability must not be compromised. Advanced lens and optic engineering ensures an extremely wide spread of light without glare or harsh point sources.

Product reliability is second to none, proven worldwide in thousands of highly demanding applications. Each lamp is completely sealed, impact resistant and shock resistant, ensuring an ultra long service life. Low EMC noise ensures that these lamps won't interfere with radio communications.

The DuraLED 50 lamps are completely sealed to ISO 8846 and have protection against ignition of surrounding flammable gases. This means they can be used in high-risk areas, interior and exterior, wet or dry locations.

Light Colour	Spread lens	Wide Spread lens
White	2JA 980 629-001	2JA 980 629-501
Blue	2JA 980 629-111	
<i>Packaging</i>	<i>Trade Carton for single pack</i>	

Installation	Surface mount with robust bush mount
Lens material	UV resistant enhanced impact acrylic
Colour Temperature	5000K (White)
Operating Voltage	Multivolt 9-33V DC
Voltage Protection	Spike protected to +500 volts Reverse polarity protected to -700 volts
Power Consumption	<12W (<1.0A @ 12V / <0.5A @ 24V)
Cable	2.5m of tinned marine cable
Protection	IP67 (Completely Sealed)
Compliance	CE, ISO 8846 (Ignition protection), RCM, UKCA



DuraLED 50 Red / White

DuraLED lamps provide powerful White or Red light, a safe, energy efficient and reliable alternative to incandescent and fluorescent lighting. The secondary red LED colour also adds increased functionality by enhancing night time visibility.

Each lamp is completely sealed, impact resistant and shock resistant, ensuring an ultra long service life.

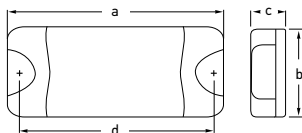

Dimensions:
a = 222mm (8.66")
b = 96mm (3.78")
c = 31mm (1.22")
d = 193mm (7.60")

Light Colour	Spread lens
White / Red	2JA 980 604-061
<i>Packaging</i>	<i>Trade Carton for single pack</i>

Installation	Surface mount with robust bush mount
Lens material	UV resistant enhanced impact acrylic
Colour Temperature	5000K (White) and Red
Operating Voltage	Multivolt 9-33V DC
Voltage Protection	Spike protected to +500 volts, Reverse polarity protected to -700 volts
Power Consumption	<10W (<0.80A @ 12V / <0.39A @ 24V)
Cable	0.5m of tinned marine cable
Protection	IP67 (Completely Sealed)
Compliance	CE, ISO 8846 (Ignition protection), RCM, UKCA





LED Flexi Chart / Reading Lamps

LED Chart/Reading lamps offer energy efficient lighting for a variety of interior applications, including chart table and navigation area lighting, berth lighting and adjustable reading lights.

A UV and Impact resistant plastic housing, and a coated steel or 316 Stainless arm makes these lamps extraordinarily robust.

Low EMC noise ensures that these lamps won't interfere with radio communications.

The chart lamps are rated IP53 and are suitable for areas that may be exposed to rain or similar wet environments.



Dual colour LED chart table lamps feature a rotary dial for on / off and red / white light control and dimming.

Light Colour	150mm Shaft	400mm Shaft
White / Red	2JA 343 720-522	2JA 343 720-622
White	2JA 346 720-022	2JA 346 720-122
Red		2JA 343 720-152

*Packaging Retail blister for single pack. PN shown in table above
Trade Carton Pack 12pc multiple, replace final PN digit '1' with '7'*

Housing Description	UV and impact resistant plastic
Arm material	Single colour - Coated steel arm Dual colour red / white - 316 stainless arm
Operating Voltage	Multivolt™ 12 / 24V DC
Power Consumption	<2W (<0.16A @ 12V / <0.08A @ 24V)
Cable	120mm of cable
Protection	IP53
Compliance	CE, ECE R10

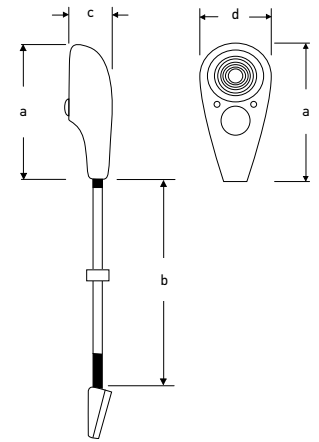

Dimensions:

a = 104mm (4.09")
 b = 150mm (5.91")
 400mm (15.75")
 c = 36mm (1.42")
 d = 46mm (1.81")

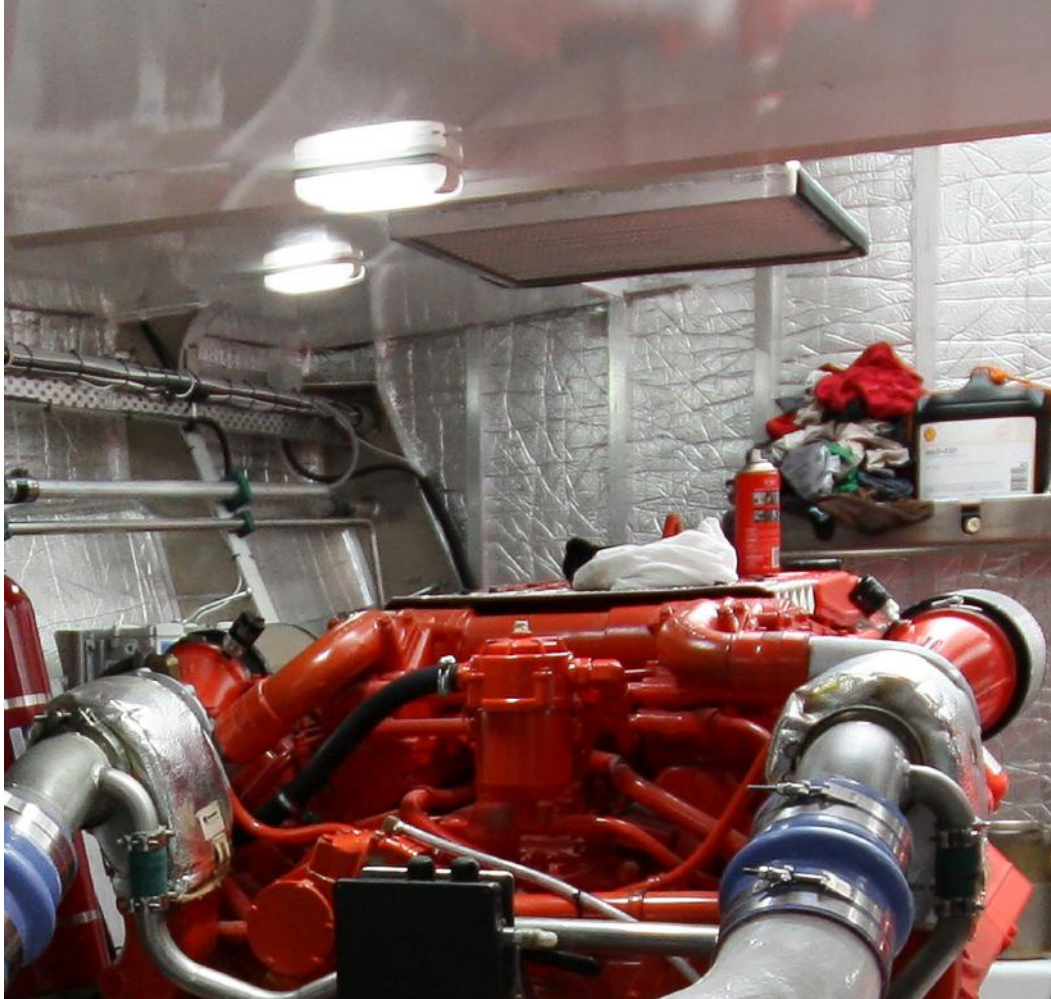

DuraLED

for Maximum Reliability

Purpose designed for engine rooms and heavy duty applications.
Wide, even, glare-free illumination below decks and low vertical spaces.

Safety assured, even under severe voltage fluctuations, and ISO Ignition Protected for certified installation near flammable gas sources.

**For uncompromising reliability and safety,
choose DuraLED.**



COMPACT, ENERGY EFFICIENT, RELIABLE & ULTRA DURABLE



Courtesy Lighting

Create Your Style

Hella marine courtesy lamp series offer subtle ambient lighting to highlight specific areas in your vessel. Available in a range of attractive colourways, or with a highly polished stainless steel clip on cover.

These lights are great to use during both day and night and are often installed in transom walkthroughs, gangways, inside smaller lockers, under gunnels or around the perimeter of the walk around. Other applications may include stairs, toe kicks, and storage areas.

Colour options are available to match interior lighting colour temperatures of either cool or warm white, or alternatively a red or blue option are available for utility or to create more interesting looks. For even more colour options, also see the new Apelo RGB Step Lamps (Page 11) for use with the Apelo Lighting Controller (Page 8) for total colour control.

Each lamp is completely sealed, highly shock, impact and vibration resistant making them suitable for the demanding marine environment. Lamps can be installed on a vessel's interior or exterior, and operate in wet or dry conditions.

Hella marine courtesy lamps are reverse polarity protected, and Multivolt™ electronics ensure constant light output across a wide variety of voltage inputs from 9-32V DC, for nominal 12V or 24V DC systems.

The Hella marine courtesy lamp range is made in New Zealand and supported by a 5 year warranty for complete peace of mind.



Surface and flush mount models for unobtrusive safety lighting

Easy Fit Step Lamps

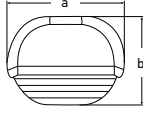
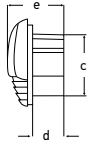

Dimensions:

- a = 45mm (1.77")
- b = 31.5mm (1.24")
- c = 25.4mm (1.00")
- d = 14mm (0.55")
- e = 22.7mm (0.89")

Light Colour	Chrome Plated Trim	White Plastic Trim	Stainless Steel Trim
White	2JA 958 126-001	2JA 958 126-011	2JA 958 126-031
Warm White	2JA 958 126-401	2JA 958 126-411	2JA 958 126-431
Blue	2JA 958 126-101	2JA 958 126-111	2JA 958 126-131
Red	2JA 958 126-201	2JA 958 126-211	2JA 958 126-231

Packaging Retail blister for single pack. PN shown in table above
Trade Carton Pack 20pc multiple, replace final PN digit '1' with '7'

Lens Material	UV resistant enhanced impact acrylic
Cap Material	White plastic, chrome plated plastic, polished 316 stainless steel
Operating Voltage	Multivolt™ 12 / 24V DC
Power Consumption	0.5W (<0.04A @ 12V / <0.02A @ 24V)
Cable	100mm of tinned marine cable
Protection	IP67 (Completely Sealed)
Compliance	CE, RCM, UKCA



For even more colour options, also see the Apelo RGB Step Lamps (Page 11) for use with the Apelo Lighting Controller (Page 8) for total colour control.

Surface Mount Oblong Courtesy Lamps

Light Colour	Stainless Steel Trim	White Body (Bulk)
White	2XT 980 869-301	2XT 980 869-317
Warm White	2XT 980 869-401	
Blue	2XT 980 869-601	2XT 980 869-617
Red	2XT 980 869-501	2XT 980-869-517

Packaging Retail blister for single pack, Trade Carton Pack 24pc multiple, replace final PN digit '1' with '7' (Stainless Only).
White Body available as Bulk Pack Only, as shown

Lens Material	Impact resistant acrylic
Cap Material	316 stainless steel
Operating Voltage	Multivolt™ 12 / 24V DC
Power Consumption	0.5W (<0.04A @ 12V / <0.02A @ 24V)
Cable	120mm of tinned marine cable
Protection	IP67 (Completely Sealed)
Compliance	CE, RCM, UKCA

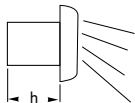
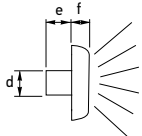
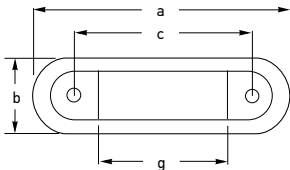

Dimensions:

- a = 84 mm / 3.31"
- b = 29 mm / 1.14"
- c = 58 mm / 2.28"
- d = ø10 mm / 0.39"
- e = 10 mm / 0.39"
- f = 9 mm / 0.35"
- g = 44 mm / 1.74"

Flush Mount Oblong Step Lamps

Light Colour	Stainless Trim	Satin Stainless Trim
White	2XT 959 680-811	2XT 959 680-851
Warm White	2XT 959 680-411	2XT 959 680-431
Blue	2XT 959 680-611	2XT 959 680-631
Red	2XT 959 680-711	2XT 959 680-731

Accessory	Part Number
Polished 316 Stainless Steel Trim	9AR 998 019-001
Satin 316 Stainless Steel Trim	9AR 959 685-061
Black Plastic Trim	9AB 959 686-002

Packaging Retail blister for single pack. PN shown in table above
Trade Carton Pack 24pc multiple, replace final PN digit '1' with '7'

Lens Material	Impact resistant acrylic
Cap Material	316 Stainless Steel
Operating Voltage	Multivolt™ 12 / 24V DC
Power Consumption	0.5W (<0.04A @ 12V / <0.02A @ 24V)
Cable	120mm of tinned marine cable
Protection	IP67 (Completely Sealed)
Compliance	CE, RCM, UKCA





Round Lamps

White Light Round Lamps*



Trim Finish	12V	24V
Stainless steel trim	2XT 980 500-521	2XT 980 501-521
White plastic trim	2XT 980 500-541	2XT 980 501-541

*Includes a surface mounting spacer ring and stainless steel screws.

Blue Light Round Lamps



Trim Finish	12V	24V
Stainless steel trim	2XT 980 502-221	2XT 980 503-221
White plastic trim	2XT 980 502-241	2XT 980 503-241

Lens Material	UV resistant enhanced impact acrylic
Trim Material	UV resistant plastic. 316 stainless steel
Dimming	Via PWM or Voltage Resistive Dimmer
Operating Voltage	12V DC or 24V DC
Power Consumption	<0.5W (<0.04A @ 12V / <0.02A @ 24V)
Cable	120mm of tinned marine cable
Protection	IP67 (Completely Sealed)
Mounting	Stainless steel screws included

Warm White Light Round Lamps*



Trim Finish	12V	24V
Stainless steel trim	2XT 980 500-721	2XT 980 501-721
White plastic trim	2XT 980 500-741	2XT 980 501-741

*Includes a surface mounting spacer ring and stainless steel screws.

Red Light Round Lamps



Trim Finish	12V	24V
Stainless steel trim	2XT 980 507-221	2XT 980 508-221
White plastic trim	2XT 980 507-241	2XT 980 508-241

*Packaging Retail blister for single pack. PN shown in table above
Trade Carton Pack 24pc multiple, replace final PN digit '1'
with '7'*

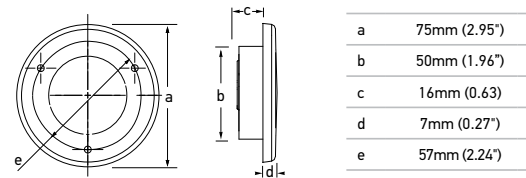

Courtesy Strip Lamps



A shallow 10mm profile, completely sealed housings and class leading efficiency for illumination duties from interior downlighting to cockpit enhancing courtesy lighting.

These strip lamps provide a soft and uniform courtesy light pattern in white, warm white, blue or red. The range is ideal for interior or exterior applications including storage lockers, under cabinetry, under gunnels and more. Surface mount installation with fastenings in each end of the lamp body are covered by snap-on end caps for a clean and modern appearance.

Surface Mount Courtesy

Light Colour	12V	24V
White	2JA 980 881-012	2JA 980 881-112
Warm White	2JA 980 881-212	2JA 980 881-312
Blue	2JA 980 881-402	2JA 980 881-502
Red	2JA 980 881-602	2JA 980 881-702

Packaging Retail blister for single pack. PN shown in table above
Trade Carton Pack 20pc multiple, replace final PN digit '2' with '7'

Lens Material	UV resistant enhanced impact acrylic
Colour Temperature	5000K (White), 2700K (Warm White)
Operating Voltage	12V DC or 24V DC
Power Consumption	White 1.5W (0.15A @ 12V / 0.06A @ 24V)
Cable	500mm of tinned marine cable
Protection	IP67 (Completely Sealed)

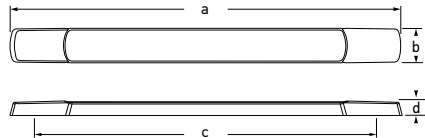
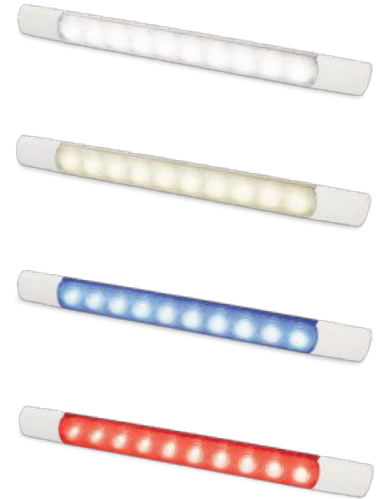

Dimensions:

a = 283mm (11.14")
b = 25mm (1.0")
c = 265mm (10.43")
d = 11mm (0.43")

Strip Lamp Accessories

Accessory	Part Number
45° Mounting Bracket White	8HG 958 000-011
45° Mounting Bracket Charcoal	8HG 958 000-021





LED Livewell / Courtesy Lamps

Livewell lamps are designed for installation into live bait tanks with a wall thickness up to 26mm. Supplied with a plastic nut and rubber gaskets for a watertight seal, installation is swift and secure into often inaccessible locations.

Often used as courtesy lamps due to their low power consumption and rugged construction. Fit these at ground level for a unique look in your vessel.



Lamp Colour	Part Number
White	2JA 998 543-051
Blue	2JA 998 543-031
Amber	2JA 998 543-001
Red	2JA 998 543-021

*Packaging Retail blister for single pack. PN shown in table above
Trade Carton Pack 50pc multiple, replace final PN digit '1' with '7'*

Housing Description	Heavy duty polycarbonate
Operating Voltage	12V DC
Power Consumption	0.5W (<0.04A @ 12V)
Cable	120mm of cable
Protection	IP67 - Completely sealed
Mounting	Single hole. Rubber gaskets included

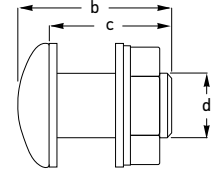
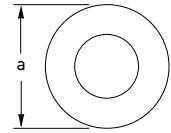

Dimensions
a = 50mm / 1.97"
b = 49mm / 1.93"
c = 40mm / 1.57"
d = 26mm / 1.02"



LED Multi-flash Signal Lamps



Multi-purpose signal lamps with robust housings, 10 programmable flash modes and the ability to be synchronised to flash alternately or in unison.

Each lamp is a completely sealed unit. Proven design, precision engineering and the use of high impact acrylic materials ensure superior resistance to water, impact, UV and wear and tear.

Advanced Multivolt™ circuitry provides reliable illumination across a range of DC inputs from 9-33 volts, even during low battery voltages, and voltage drop over long cable runs.

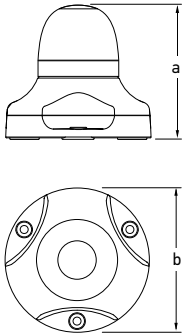

Dimensions
a = 83mm / 3.27"
b = ø90mm / 3.54"

LED 360° Multi-flash Signal Lamp

Lamp Colour	Part Number
White	2XD 980 911-002
Green	2XD 980 911-202
Red	2XD 980 911-402
Amber	2XD 980 911-602
Blue	2XD 980 911-702
<i>Packaging</i>	<i>Trade Carton for single pack</i>
Housing Description	Corrosion, UV and impact resistant plastic
Lens Material	Ultra heavy duty Grilamid® lens
Operating Voltage	Multivolt™ 9-33V DC
Voltage Protection	Spike protected to +500 volts
Power Consumption	5W (<0.42A @ 12V / <0.021A @ 24V) (Continuously on) Less in flash modes
Cable	2.5m of cable
Protection	IP67 - Completely sealed
Compliance	RCM, ECE R10



DuraLED Multi-flash Signal Lamps

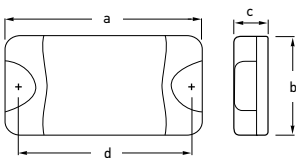

Dimensions
a = 177mm (6.97")
b = 100mm (3.94")
c = 30mm (1.18")
d = 148mm (5.83")

Lamp Colour	Part Number
Red	2XD 959 037-012
Amber	2XD 959 037-112
Blue	2XD 959 037-612
Green	2XD 959 037-812
<i>Packaging</i>	<i>Trade Carton for single pack</i>
Housing Description	Corrosion, UV and impact resistant plastic
Lens Material	Heavy duty acrylic lens
Operating Voltage	Multivolt™ 9-33V DC
Voltage Protection	Spike protected to +500 volts
Power Consumption	<9W (<0.75A @ 12V / <0.375A @ 24V) (Continuously on) Less in flash modes
Cable	2.5m of cable
Protection	IP67 - Completely sealed
Compliance	RCM, ECE R10





TRAILER LIGHTING & ACCESSORIES



Submersible LED Trailer Lamps

Sold as a pair, the submersible trailer lamps are ADR Compliant and include the complete combination of functions required for on-road driving. Each lamp is completely sealed against dust and moisture ingress.

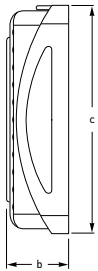
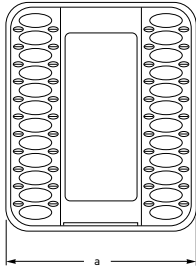

Dimensions

a = 80mm / 3.15"
b = 26mm / 1.03"
c = 96mm / 3.78"

- Stop/Brake
- Rear position/Park
- Rear indicator lamps
- Number plate (Only on 1 side)
- 18cm² red reflector.

Trailer Kit Contents	Part Number
Trailer Pack Pair, 0.5m Cable	2VB 980 720-811
Trailer Pack Pair, 9m Cable	2VB 980 720-821

Packaging Retail blister for single pack

Lens Material	Grilamid® plastic, impact and UV resistant
Mounting	Horizontal or vertical
Operating Voltage	Multivolt™ 12 / 24V DC
Power Consumption	Stop: 2W / Rear direction indicator: 2W Rear position 1W / Number plate: 1W
Voltage Protection	Spike, Over Voltage and Reverse Polarity
Cable	0.5m or 9m multi-core cable
Compliance	ADR compliant*

*Not available in all markets.



Stop



Rear Direction Indicator



Rear Position/Number Plate

Two Speed Hella marine Turbo Fans

Hella Turbo Fans offer ventilation into areas that may not have suitable airflow.

- Quiet operation
- 150mm diameter fan blade with guard
- High air moving capacity with low power consumption
- Two speed switch in front of the blade guard

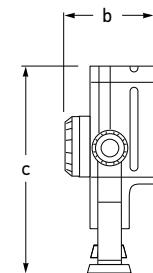
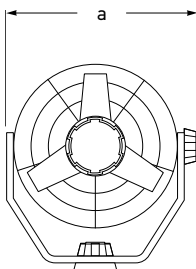

Dimensions

a = 188mm / 7.41"
b = 95mm / 3.75"
c = 195mm / 7.67"

Voltage	Housing Colour	Part Number
12V	Black Housing	8EV 003 361-002
12V	White Housing	8EV 003 361-022
24V	Black Housing	8EV 003 361-012

Packaging Retail Carton for single pack

Material Description	Impact resistant plastic
Switch	Integrated 2 stage rotary
Output	Speed 1: 70 litre / sec. Speed 2: 95 litre / sec.
Power Consumption	6.5W



Battery Master Switches

275 Amp Battery Master Switch

Contour Lock system with removable plates allows the switch to be a stand alone unit or locked together with other switches. The control knob cannot be removed whilst in an ON or OFF position, however, it can be removed by switching to an anti-clockwise 45° position. Suitable for surface or recess mounting by cutting a 52mm diameter hole.



Part Number

6EK 998 540-001

Housing Material	Impact resistant plastic. Tin plated studs.	
Termination Stud Size	2 x 10mm (3/4")	
Operation	ON / OFF	
Protection	IP56	
Max. Load 12 / 24V DC	Continuous	275 Amps
	Intermittent	455 Amps (5 minutes)
	Cranking	1250 Amps (10 seconds)
Max. Voltage	48V DC	

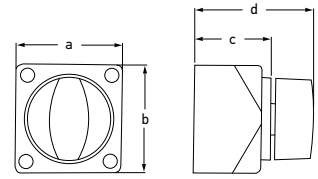

Dimensions

a = 68mm / 2.72"
b = 68mm / 2.72"
c = 48mm / 1.90"
d = 75mm / 2.93"

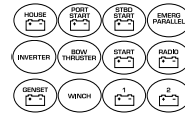

600 Amp Battery Master Switch

Contour Lock system with removable plates allows the switch to be a stand alone unit or locked together with other switches. The control knob cannot be removed whilst in an ON or OFF position, however, it can be removed by switching to an anti-clockwise 45° position. Suitable for surface or recess mounting by cutting a 85mm diameter hole.



Part Number

6EK 998 540-061

Housing Material	Impact resistant plastic. Tin plated studs.	
Termination Stud Size	2 x 12mm (1/2")	
Operation	ON / OFF	
Protection	IP56	
Max. Load 12 / 24V DC	Continuous	600 Amps
	Intermittent	800 Amps (5 minutes)
	Cranking	2500 Amps (10 seconds)
Max. Voltage	48V DC	

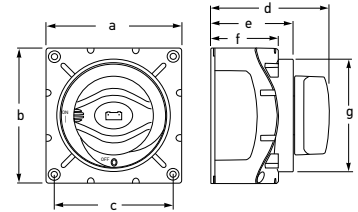

Dimensions

a = 102mm / 4.02" e = 62mm / 2.45"
b = 102mm / 4.02" f = 51mm / 2.01"
c = 89mm / 3.51" g = 85mm / 3.35"
d = 90mm / 3.55"

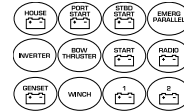

350 Amp Battery Selector Switch

Contour Lock system with removable plates for connection from all sides. This allows the switch to be a stand alone unit or locked together with battery distribution modules. Necessary for on board systems fed from 2 or more batteries and whose supply comes from more than 1 generator. Rotary switch in 4 switch positions of battery 1-2-Both-OFF. Switch can also be pad locked. Suitable for surface or recess mounting by cutting an 85mm diameter hole.



Part Number

6EB 998 540-201

Housing Material	Impact resistant plastic. Tin plated studs.	
Termination Stud Size	3 x 10mm (3/4")	
Operation	1-2-Both-OFF	
Protection	IP56	
Max. Load 12 / 24V DC	Continuous	350 Amps - B1 or B2
	Continuous	500 Amps - B1 and B2
	Intermittent	500 Amps (5 minutes)
	Cranking	1500 Amps (10 seconds)
Max. Voltage	48V DC	

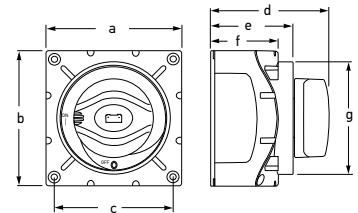

Dimensions

a = 102mm / 4.02" e = 62mm / 2.45"
b = 102mm / 4.02" f = 51mm / 2.01"
c = 89mm / 3.51" g = 85mm / 3.35"
d = 90mm / 3.55"

Battery Master Switches

These heavy duty battery switches are perfect for 100/150A depending on the model. They offer a removable key, which can be removed in the OFF position, when the current is interrupted. This ensures that loads cannot be applied accidentally. Positive or negative cable can be switched as required.

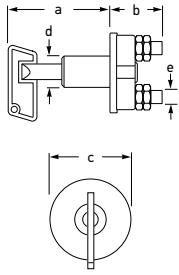

Dimensions

a = 66mm / 2.60"
 b = 40mm / 2.58"
 c = 57mm / 2.25"
 d = 22mm / 0.87"
 e = 10mm / 0.40"

150 Amp Battery Master Switch

Part Number	Spare Key Number
6EK 002 843-051	9SL 706 729-011
Housing Material	Impact resistant plastic
Cable Connection	2 screw terminals, M10
Protection	IPX4
Max load - Continuous	150A
Max load - 10s	500A (Compliant with VDA 72750)

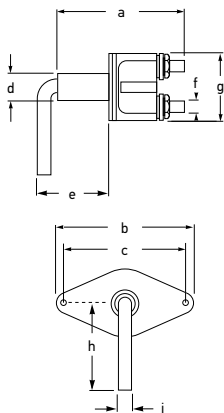

Dimensions

e = 62mm / 2.45"
 a = 109mm / 4.30" f = 10mm / 0.40"
 b = 120mm / 4.73" g = 58mm / 2.29"
 c = 100mm / 4.94" h = 75mm / 2.96"
 d = 22mm / 0.87" i = 10mm / 0.40"

100 Amp Battery Master Switch

Part Number	Spare Key Number
6EK 001 559-001	9SL 042 991-001
Housing Material	Steel key and mounting plate
Cable Connection	2 screw terminals, M10
Protection	IPX4
Max load - Continuous	100A
Max load - 10s	2500A (Compliant with VDA 72750)



Voltage Sensitive Relay*

"Dual battery charging made easy", the Voltage Sensitive Relay (VSR) allows two batteries to be charged at the same time.

When the engine is started and the start battery reaches 13.7 volts, the VSR engages, allowing two battery banks (start and auxiliary) to be charged simultaneously.

When the voltage drops below 12.8 volts (e.g. the engine is stopped), the VSR disengages, separating the batteries. This system eliminates the possibility of draining the start battery and protects sensitive electronic equipment powered from the auxiliary battery from harmful engine start up spikes.

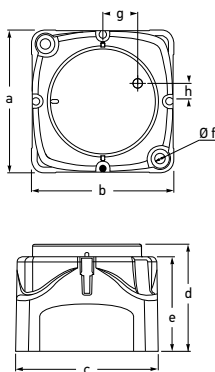

Dimensions

a = 68mm / 2.68"
 b = 68mm / 2.68"
 c = 68mm / 2.68"
 d = 51mm / 2.01"
 e = 45mm / 1.78"
 f = Ø5.20mm / 0.20"
 g = 17mm / 0.67"
 h = 9mm / 3.36"

Part Number	
4RD 980 830-001	
Housing Material	Impact resistant plastic. Copper studs.
Termination Stud Size	2 x 6mm (1/4")
Protection	IP56
Voltage	12V DC
Max. Load 12 DC	140 Amps
Dimensions	68 x 68 x 50mm (W x D x H)

*Not available in all markets



2 Group Light Dimmer

The 2 Group LED Dimmer provides precise dimming control for one or two separate light groups, via PWM technology. Please check the specific lamp suitability to this type of dimming.

The dimmers low voltage protection also protects against deep battery discharge. Lights will turn off automatically when battery voltage is lower than 9V on a 12V system or lower than 18V on a 24V system.

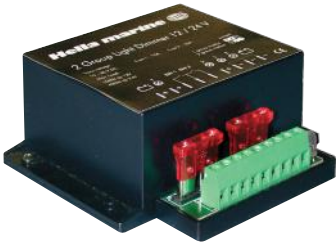

Part Number

5XA 998 572-001

Max. Load	200W at 12V and 400W at 24V
Max. Load Per Group	100W at 12V and 200W at 24V
Input Voltage Range	8 – 30V DC
System Voltage	12V or 24V DC
Number of Groups	2
Switches Per Group	Unlimited
Switch Type	Momentary normally open
Weight	140 grams
Protection	Overload, Temperature, Low voltage
Fuse	2 x 10A
PWM Frequency	400Hz

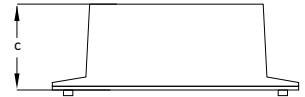
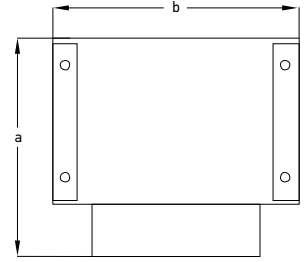

Dimensions

a = 89mm / 3.51"
 b = 99mm / 3.90"
 c = 41mm / 1.62"

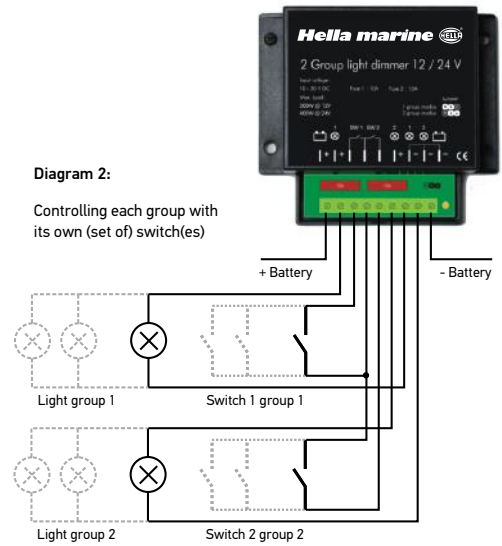
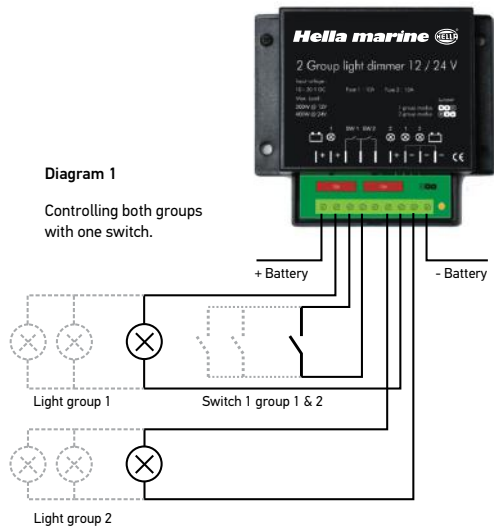

Stainless Steel LED Switches

Attractive stainless steel switches featuring an appealing ring of LED light. Manufactured from 304 stainless steel, these through panel mount switches are IP67 rated when installed and ideal for switching lighting or installing into custom switch panels.

The light rings may be wired to show power to a system or signal circuit activation. The range also includes matching stainless steel warning buzzers with LED light rings.

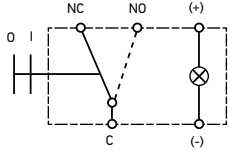
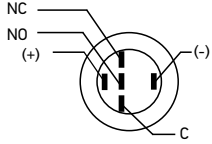

Switch

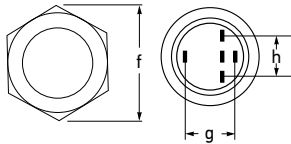
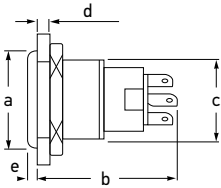

Dimensions

- a = 22mm / 0.87"
- b = 37mm / 1.46"
- c = M19x1 / 0.75"
- d = 10mm / 0.40" Max
- e = 2mm / 0.08"
- f = 25mm / 0.99"
- g = 12mm / 0.48"
- h = 10mm / 0.40"

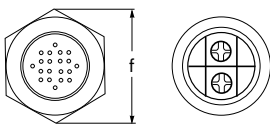
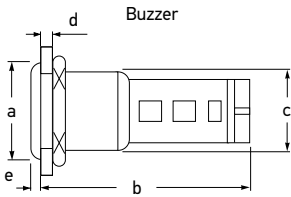

Dimensions

- a = 22mm / 0.87"
- b = 53.6mm / 2.12"
- c = M19x1 / 0.75"
- d = 10mm / 0.40" Max
- e = 2mm / 0.08"
- f = 25mm / 0.99"

Latching Switches with LED Ring

Light Colour	Voltage	Operation	Part Number
Red	12V DC	On / Off	8HG 958 455-001
Blue	12V DC	On / Off	8HG 958 455-011
Red	24V DC	On / Off	8HG 958 455-101
Blue	24V DC	On / Off	8HG 958 455-111



Momentary Switches with LED Ring

Light Colour	Voltage	Operation	Part Number
Red	12V DC	Momentary	8HG 958 455-201
Blue	12V DC	Momentary	8HG 958 455-211
Red	24V DC	Momentary	8HG 958 455-301
Blue	24V DC	Momentary	8HG 958 455-311



Buzzers with LED Ring

Light Colour	Voltage	Operation	Part Number
Red	12V DC	Buzzer	8HG 958 456-001
Red	24V DC	Buzzer	8HG 958 456-101



Body Material	304 Stainless Steel
Contact Material	Silver Alloy
Terminal Type	5 Pin (2.8 x 0.5mm) switches 2 screws for buzzer
Panel Thickness	1 – 10mm
Operating Temp	-20°C – +55°C
Insulation Resistance	≥1000mΩ
Contact Resistance	≤50mΩ
Max. Switch Rating	5A
Protection	IP67 for switches (Front only) IP40 for buzzer (Front only)
Buzzer sound intensity	>80dB (0.1m)

Accessory	Part Number
Marine Switch Pigtail Loom	8KB 990 258-021



8JB 950 987-001



8JB 950 988-001



Metal Plug & Socket suitable for cable up to 6.5mm diameter.

Water Resistant Plugs and Sockets

Add power to where you need it in exposed places of the vessel. Perfect for plugging in fishing reels. Cap supplied to cover when not in use.

Description	Pin	Material	Part Number
Socket	2 Pin	Chrome Brass	8JB 950 987-001
Plug	2 Pin	Chrome Brass	8JB 950 988-001

Plug Socket Type	Chrome Brass
Material Description	Chrome brass housings Brass contacts
Maximum Load	10A @ 12V
Installation	Screw terminals

Quick Reference Technical Advantages



Multivolt™

Can be connected to either 12 or 24 volt DC electrical systems.



Heavy Duty Grilamid® Lens

A revolutionary transparent plastic with exceptionally high impact strength and resistance to UV and chemical damage.



IP67 - Completely Sealed

Preventing moisture from corroding electronics is vital for long term durability. Hella marine products are completely sealed for interior or exterior use, wet or dry.



Corrosion Resistant

For the ultimate in longevity under salt water conditions.



IP6K9K - Completely Sealed

Protection from dust and high-pressure/steam jet cleaning.



Dual Colour

Dual colour lamps offering a selection of White light, paired with either night vision preserving red light, or a cool blue aesthetic.



Outstanding UV Resistance

Advanced UV resistant polymers that will not yellow or deteriorate in the harshest marine conditions.



Heavy Duty Mount

Designed for heavy duty mounting.



CE

The Conformité Européene (CE) Mark is defined as the European Union's (EU) mandatory conformity marking for regulating the goods sold within the European Economic Area (EEA) since 1985.



Edge Light

Use your lights more. Edge light enhances utility by having a low power operating mode for ambient lighting requirements. This lighting won't affect batteries but creates a visual difference when anchored or cruising.



Hella marine Warranty

Standing behind our product

All HELLA LED based lighting products, supplied by Hella marine, carry a Five-Year Warranty from end user purchase covering faults in materials, components or workmanship, and provided that the product is installed in accordance with our mounting instructions and by suitable qualified personnel with the exceptions as stated below:

- NaviLED TRIO Tri Colour LED navigation lamps carry a 7-Year Warranty.
- Apelo Underwater Lights carry a 3-year Warranty.
- Bulb-based lamps and products in the accessories section come with a 1-year manufacturer's warranty

This warranty is in addition to and does not preclude any other rights or remedies available to the consumer under any local legislation related to the provision of goods or services.

In the unlikely event that you should experience a confirmed warranty with a HELLA product, we will at our discretion, either repair or replace the product or refund the purchase price.

Warranty services may be obtained by returning the product within the warranty period to the HELLA Dealer where the product was originally purchased.

This warranty does not cover:

1. Claim/s as a result of normal wear and tear or of any modifications and / or alterations to the product in any shape or form.
2. Claim/s as a result of non-compliance of the assembly, service and operating instructions and/or any unfit or improper use and /or wrong or negligent treatment, and /or normal wear and tear, contamination, results from accidents, insufficient or excessive electrical supply, subject to undue environmental conditions, accident or improper application.
3. Any expenses incurred in the process of making the claim.





WORLD LEADING MARINE LIGHTING

Excellence Assured



Hella marine 

APELO LIGHT CONTROLLER

DISCOVER A WORLD OF COLOUR



974 980.100-291 APAC/ME/SA V6



Wirelessly group, manage, and sync Apelo RGB lighting for vibrant colour displays, using the Apelo Controller & App.



iPhone and App Store are registered trademarks of Apple Inc.
Google Play is a registered trademark of Google Inc.



Hella marine Asia Pacific
HELLA New Zealand Ltd
81-83 Ben Lomond Crescent
Pakuranga 2010,
Auckland, New Zealand
Phone +64 9 577-0366
info@hellamarine.com

Hella marine Australia
HELLA Australia Pty Ltd
15D Chifley Drive
Moorabbin Airport, Victoria 3194 Australia
Phone 1800 061 729
hellaorders@hella.com
custservice@hella.com

Hella marine Europe
HELLA GmbH & Co. KGaA
Rixbecker Str. 75
59552 Lippstadt
Germany
Phone +49 29 41 38 66 44
info@hella.com



See the Apelo Ecosystem



www.hellamarine.com