



# **B** WORK STANDS



**PERTH**  
(08) 9459 8600  
**KALGOORLIE**  
(08) 9021 8300

**ADELAIDE**  
(08) 8231 1513  
**NEWMAN**  
(08) 9175 1164

**DARWIN**  
(08) 8963 5621  
**MT ISA**  
(07) 4743 6458

✉ sales@bendtechgroup.com.au  
🌐 [bendtechgroup.com.au](http://bendtechgroup.com.au)

2-10 Kewdale Road, Welshpool WA 6106





## **BEND-TECH GROUP**

**Bend-tech Group** delivers a tailored design, engineering and fabrication service which empowers our customers towards operational safety, efficiency, and excellence. Intelligent systems and processes propel our consultative approach towards problem solving, it is imperative we create comfort and certainty. Service that takes control of problems and accountability puts solutions in motion, we have learned through a deep understanding of our customers that this is what they need.

Being global providers of designed and engineered products, services and solutions has allowed us to develop cross-industrial expertise that has galvanised our internal processes and put us at the forefront of technology and innovation. Our people are what we believe sets us apart, our culture of learning, understanding and excellence means the whole organisation progresses in synchronicity. Our team makes an impact internally, as well as throughout all our customer interactions.

Over 30 years of delivering intelligent design, custom-certified products and services has taken us across many industries and into many countries. We have provided our industry leading solutions across the Mining, Defence, Fabrication, Marine, Rail and Oil and Gas industries globally.

**3** | **BUILT BETTER  
BY BEND-TECH**



**WORK STANDS**

**INDEX**

<b>WORK STANDS 1 - 15 TONNES</b>	<b>///</b>	<b>3 - 6</b>
<b>WORK STANDS 16 - 30 TONNES</b>	<b>///</b>	<b>7 - 8</b>
<b>WORK STANDS 31 - 60 TONNES</b>	<b>///</b>	<b>9 - 10</b>
<b>WORK STANDS 80+ TONNES</b>	<b>///</b>	<b>11 - 13</b>

## WORK STANDS 1 - 15 TONNE

**GENERAL PURPOSE WORK  
STAND 3 TONNE 500MM (H)**  
Part No. 5412026



**CONSTRUCTION**

- Heavy-duty steel
- SWL: 3 Tonne
- Fully engineered and certified

**GENERAL PURPOSE WORK  
STAND 10 TONNE 1020MM (H)**  
Part No. 5414124

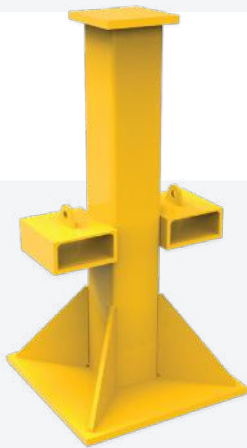

**CONSTRUCTION**

- Heavy-duty steel
- SWL: 10 Tonne
- Height: 1020mm
- Length: 500mm
- Width: 500mm
- Engineered and certified

**GENERAL PURPOSE WORK  
STAND 10 TONNE 500MM (H)**  
Part No. 5414004



**CONSTRUCTION**

- Heavy-duty steel
- SWL: 10 Tonne
- Height: 500mm
- Fully engineered and certified

**GENERAL PURPOSE WORK  
STAND 10 TONNE 1700MM (H)**  
Part No. 5413031

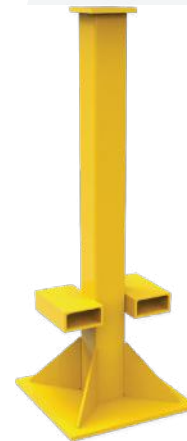

**CONSTRUCTION**

- Heavy-duty steel
- SWL: 10 Tonne
- Height: 1700mm
- Length: 600mm
- Width: 600mm
- Engineered and certified

**WORK STANDS**  
**1 - 15 TONNE**

**GENERAL PURPOSE WORK STAND 10 TONNE 2400MM (H)**

Part No. 5414068



**CONSTRUCTION**

- Heavy-duty steel
- SWL: 10 Tonne
- Height: 2400mm
- Fully engineered and certified

**GENERAL PURPOSE WORK STAND 10 TONNE 3000MM (H)**

Part No. 5412204



**CONSTRUCTION**

- Heavy-duty steel
- SWL: 10 Tonne
- Height: 3000mm
- Fully engineered and certified

**GENERAL PURPOSE WORK STAND 10 TONNE SQUARE TOP**

Part No. 5000004



**CONSTRUCTION**

- Heavy-duty steel
- SWL: 10 Tonne
- Height: 1020mm
- Length: 500mm
- Width: 500mm
- Engineered and certified

**GENERAL PURPOSE WORK STAND 10 TONNE**

Part No. 5501658



**CONSTRUCTION**

- Heavy-duty steel
- WLL: 10 Tonne
- Height: 1000mm
- Length: 2000mm
- Width: 2300mm
- Engineered and certified

## WORK STANDS 1 - 15 TONNE

### WORK STAND WITH RETRACTABLE WHEELS 10 TONNE 2400MM (H)

Part No. 5501592



#### CONSTRUCTION

- Heavy-duty steel
- WLL: 10 Tonne
- Fitted with forklift slots
- Fitted with retractable wheels
- Fully engineered and certified

### GENERAL PURPOSE WORK STAND 10 TONNE 3300MM (H)

Part No. 5504681

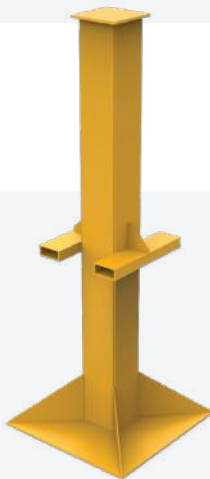

#### CONSTRUCTION

- Heavy-duty steel
- WLL: 10 Tonne
- Length: 1000mm
- Width: 1150mm
- Fully engineered and certified

### STEEL SUPPORT STAND ON WHEELS

Part No. 5501714



#### CONSTRUCTION

- Heavy-duty steel
- WLL: 500kg
- Height: 740mm
- Length: 600mm
- Width: 720mm
- Fully engineered and certified

### WATER PUMP DRIVE STAND

Part No. 5502871

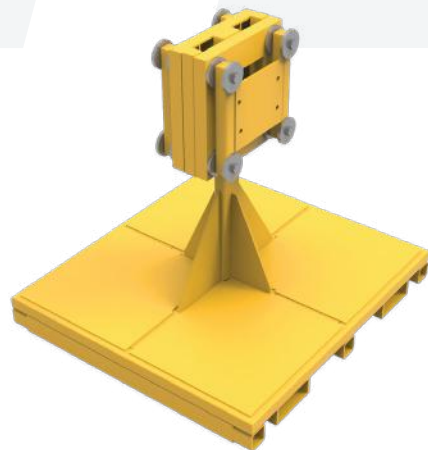

#### CONSTRUCTION

- Heavy-duty steel
- WLL: 1.5 Tonne
- Height: 1105mm
- Length: 1100mm
- Width: 1200mm
- Painted in company or site colours upon request

**WORK STANDS**  
**1 - 15 TONNE**

**GENERAL PURPOSE WORK  
STAND 10 TONNE 2400MM (H)**

Part No. 5502846

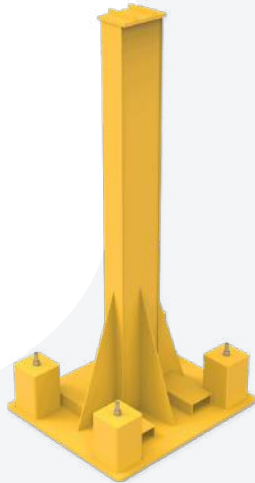

**CONSTRUCTION**

- Heavy-duty steel
- WLL: 10 Tonne
- Length: 1000mm
- Width: 1150mm
- Fitted with forklift slots

**GENERAL PURPOSE WORK  
STAND 15 TONNE 730MM (H)**

Part No. 5401121



**CONSTRUCTION**

- Heavy-duty steel
- SWL: 15 Tonne
- Height: 730mm
- Forklift friendly for plate loading
- Fully engineered and certified

**GENERAL PURPOSE  
ADJUSTABLE STAND 10 TONNE**

Part No. 5503166



**CONSTRUCTION**

- Heavy-duty steel
- WLL: 10 Tonne
- Pin-lock adjusting system
- 100mm increments
- Lifting lugs on top section to remove manual handling risks

## WORK STANDS

# 16 - 30 TONNE

### GENERAL PURPOSE WORK STAND 20 TONNE 800MM (H)

Part No. 5401137



#### CONSTRUCTION

- Heavy-duty steel
- WLL: 20 Tonne
- Height: 800mm
- Fully engineered and certified

### GENERAL PURPOSE WORK STAND 25 TONNE 400MM (H)

Part No. 5000006

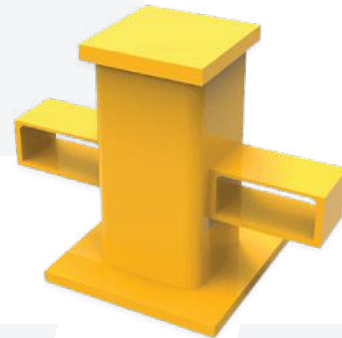

#### CONSTRUCTION

- Heavy-duty steel
- SWL: 25 Tonne
- Height: 400mm
- Fully engineered and certified

### GENERAL PURPOSE WORK STAND 25 TONNE 600MM (H)

Part No. 5401116

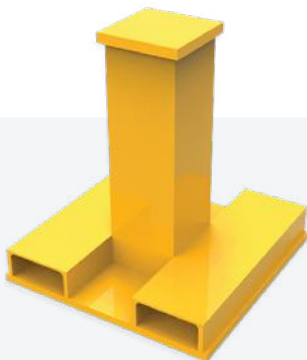

#### CONSTRUCTION

- Heavy-duty steel
- WLL: 25 Tonne
- Height: 600mm
- Fully engineered and certified

### GENERAL SUPPORT WORK STAND 30 TONNE 655MM (H)

Part No. 5501038



#### CONSTRUCTION

- Heavy-duty steel
- SWL: 30 Tonne
- Fully engineered and certified

## WORK STANDS 16 - 30 TONNE

### GENERAL PURPOSE WORK STAND 30 TONNE 270MM (H)

Part No. 5412032

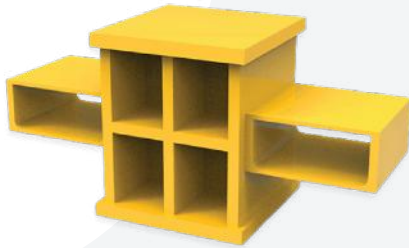

#### CONSTRUCTION

- Heavy-duty steel
- SWL: 30 Tonne
- Height: 270mm
- Fully engineered and certified

### GENERAL PURPOSE WORK STAND 30 TONNE 2000MM (H)

Part No. 5410135



#### CONSTRUCTION

- Heavy-duty steel
- SWL: 30 Tonne
- Length: 1400mm
- Width: 1400mm
- Fully engineered and certified

### GENERAL SUPPORT WORK STAND 16 TONNE 458MM (H)

Part No. 5001963

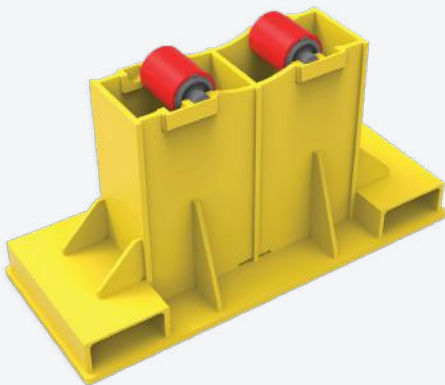

#### CONSTRUCTION

- Heavy-duty steel
- WLL: 25 Tonne
- Length: 900mm
- Width: 375mm
- Fully engineered and certified

## WORK STANDS

# 31 - 60 TONNE

**GENERAL PURPOSE WORK STAND 45 TONNE 305MM (H)**  
Part No. 5401153

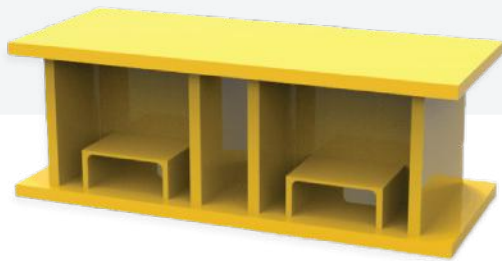

**CONSTRUCTION**

- Heavy-duty steel
- WLL: 45 Tonne
- Height: 305mm
- Fully engineered and certified

**GENERAL PURPOSE WORK STAND 45 TONNE 680MM (H)**  
Part No. 5413077



**CONSTRUCTION**

- Heavy-duty steel
- WLL: 45 Tonne
- Height: 680mm
- Fully engineered and certified

**GENERAL SUPPORT STAND 50 TONNE 670MM (H)**  
Part No. 5511038



**CONSTRUCTION**

- Heavy-duty steel
- WLL: 50 Tonne
- Fully engineered and certified

**GENERAL SUPPORT STAND 50 TONNE 600MM (H)**  
Part No. 5500988



**CONSTRUCTION**

- Heavy-duty steel
- WLL: 50 Tonne
- Height: 600mm

# WORK STANDS 31 - 60 TONNE

## GENERAL PURPOSE WORK STAND 60 TONNE 1160MM (H)

Part No. 5412029



### CONSTRUCTION

- Heavy-duty steel
- WLL: 60 Tonne
- Height: 1160mm
- Fully engineered and certified

## GENERAL PURPOSE WORK STAND 60 TONNE 500MM (H)

Part No. 5503149

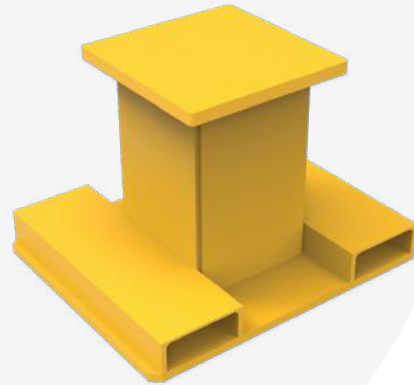

### CONSTRUCTION

- Heavy-duty steel
- WLL: 60 Tonne
- Height: 500mm
- Fully engineered and certified

## 50T WORK STAND 1600MM

Part No. 5504698



### CONSTRUCTION

- Heavy-duty steel
- WLL: 50 Tonne
- Length: 700mm
- Width: 700mm
- Height: 1600mm
- Engineered and certified

## 50T WORK STAND 1700MM

Part No. 5504697



### CONSTRUCTION

- Heavy-duty steel
- WLL: 50 Tonne
- Length: 700mm
- Width: 700mm
- Height: 1700mm
- Engineered and certified

## WORK STANDS 80+ TONNE

### GENERAL PURPOSE WORK STAND 80 TONNE 300MM (H)

Part No. 5000009

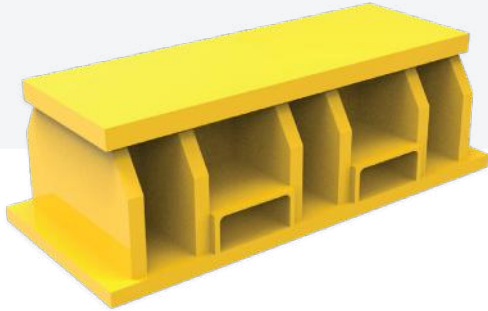

#### CONSTRUCTION

- Heavy-duty steel
- SWL: 80 Tonne
- Length: 900mm
- Fully engineered and certified

### GENERAL PURPOSE STAND 80 TONNE 650MM (H)

Part No. 5502989



#### CONSTRUCTION

- Heavy-duty steel
- WLL: 80 Tonne
- Length: 720mm
- Fully engineered and certified

### GENERAL PURPOSE WORK STAND 80 TONNE 1200MM (H)

Part No. 5001749



#### CONSTRUCTION

- Heavy-duty steel
- SWL: 80 Tonne
- Length: 780mm
- Fully engineered and certified

### GENERAL PURPOSE WORK STAND 90 TONNE 1200MM (H)

Part No. 5412079



#### CONSTRUCTION

- Heavy-duty steel
- SWL: 90 Tonne
- Height: 1200mm
- Fully engineered and certified

# WORK STANDS 80+ TONNE

## GENERAL PURPOSE WORK STAND 100 TONNE SQUARE TOP

Part No. 5512169



### CONSTRUCTION

- Heavy-duty steel
- SWL: 100 Tonne
- Height: 1200mm
- Fully engineered and certified

## GENERAL PURPOSE WORK STAND 100 TONNE ROUND TOP

Part No. 5401192



### CONSTRUCTION

- Heavy-duty steel
- WLL: 100 Tonne
- Length: 1200mm
- Fully engineered and certified

## GENERAL PURPOSE STAND 120 TONNE 970MM (H)

Part No. 5503835

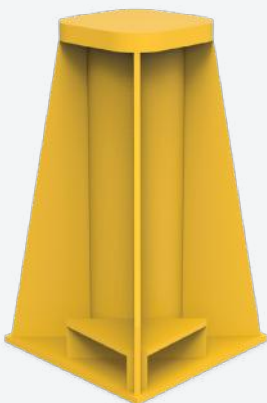

### CONSTRUCTION

- Heavy-duty steel
- WLL: 120 Tonne
- Length: 560mm
- Fully engineered and certified

## GENERAL PURPOSE WORK STAND 270 TONNE

Part No. 5001988



### CONSTRUCTION

- Heavy-duty steel
- WLL: 270 Tonne
- Fully engineered and certified

## WORK STANDS 80+ TONNE

### WORK STAND WITH CURVED TOP 90 TONNE

Part No. 5506270

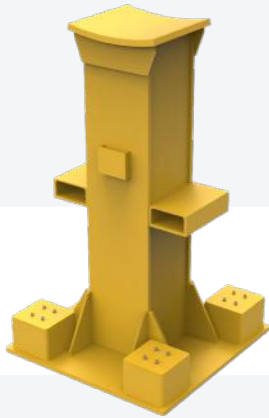

#### CONSTRUCTION

- Heavy-duty steel
- WLL: 90 Tonne
- Length: 830mm
- Curved top
- Spring loaded castor wheels
- Fully engineered and certified

### PRIMARY CRUSHER MANTLE STORAGE STAND

Part No. 5505283



#### CONSTRUCTION

- Extremely heavy-duty steel
- WLL: 110 Tonne
- Length: 4840mm
- Height: 2253mm
- Width: 4840mm
- Fully engineered and certified

**B** BIGGER THAN BUSINESS

# TAKE NOTE

A large grid area for taking notes, consisting of a 30x30 grid of small squares. The grid is light gray and occupies the central portion of the page. There are large, faint, light gray circular shapes in the background behind the grid.

# TAKE NOTE



## EXPERIENCE OUR CONSULTING, DESIGN AND ENGINEERING SERVICE

Projects and the associated challenges often require custom solutions which our CDEC system facilitates. Consultation, Design, Engineering and Construction is our holistic approach to solution development, making maintenance on-site safe, efficient, and easy.



### CONSULTATION

We come to you and visit your site to get a hands-on feel for your project. The aim of our consultation is to listen to and understand your requirements. If the project requires it, our 3D scanning capabilities will streamline measurement and data capture. This approach allows us to discuss your problem on-site, possible solutions, and the benefits we can offer.



### DESIGN

After the consultation we go back to our design team to begin the development of your custom solution. Our team produce designs in CAD Design complete with all drafting documentation ensuring an advanced manufacturing process.



### ENGINEERING

Once the design is approved, we begin the engineering process. This ensures that the right material grade is used for your project to guarantee structural and functional integrity. We provide full certification that includes WLL, load ratings, integrity reports as well as certification plates and identifications. We design and engineer all our solutions to ensure full compliance with Australian standards.

Our engineering department includes 9 draftsman and 14 engineers. We are experienced in the design and development of complex mechanical engineering analysis and solutions.



### CONSTRUCTION AND FABRICATION

Our industry leading 10000 sq/m facility in Welshpool, Western Australia is armed with highly qualified consulting, drafting, engineering and fabrication personnel dedicated to manufacturing precision, engineered high performance industrial solutions.

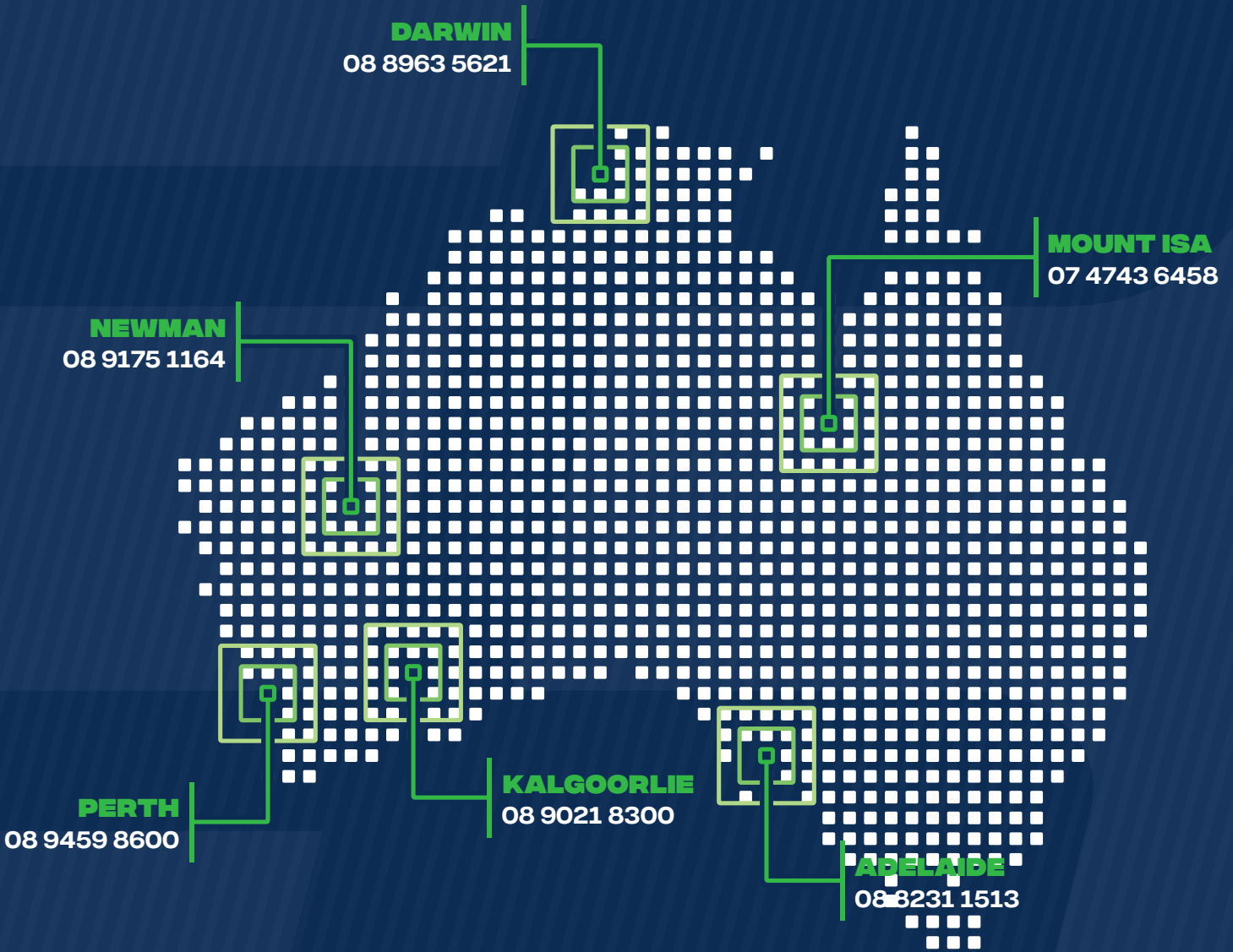

 [sales@bendtechgroup.com.au](mailto:sales@bendtechgroup.com.au)

 [www.bendtechgroup.com.au](http://www.bendtechgroup.com.au)

