



**MARCO
INDUSTRIES™**

Roofing Ventilation & Accessories

PRODUCT CATALOG



KEEPING YOUR ROOF AND EVERYTHING UNDERNEATH SAFE

Marco Industries has demonstrated its value-based commitment to its customers, from the products we offer to the service we provide. Put simply, it drives everything we do.

We take seriously our brand promise to customers, which is, value through the roof. By focusing on value-added solutions and services we've been able to grow the breadth of our product offering to an industry leading level.

Our product catalog contains the Marco Weather-Tite Roof System™, a comprehensive line of quality products offering easy installation, remarkable building ventilation resulting in lower energy costs and outstanding warranties. From superior material characteristics to overall product quality, convenient installation and packaging, the Weather-Tite Roof System™ focuses on the business solutions our customers' seek.

Our dedication to customer service and product excellence has resulted in Marco being awarded Rural Builders Gold Key awards year-after-year, plus multiple Top 10 Product Awards.

Your business is valued at Marco. Thank you for joining us on our continuous journey to develop and deliver value-added products and services for the Roofing Industry.

Sincerely,

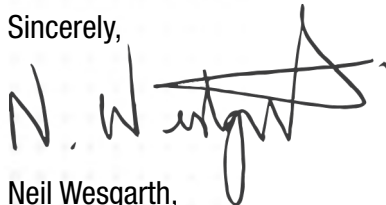

Neil Wesgarth,
President

Investing in Quality

For more than 30 years, we have made the best ventilation and accessories for all roofs. This competitive advantage allows us to use specially formulated polyester in our ventilation products - manufactured from recycled material - to prevent moisture absorption and to help keep dust, dirt, and bugs out of your attic. Marco's ventilation line offers several options when it comes to ridge vents or static vents. Our full and innovative line offers venting solutions that are environmentally friendly while offering superior performance and easy installation.

Tested Tough

We invest heavily in testing to ensure our products are safe, reliable and consistently high quality. Our ongoing partnership with one of the nation's leading materials and product qualification testing labs augments Marco's own internal quality control measures and performance testing. Accredited by A2LA/ISO 17025 and others, the lab tests Marco against competitive products to validate performance, durability, quality and additional important measures. This data is not only used by our engineers in product development, it provides third-party confirmation of our products' superior performance. Which is why Marco products always come with a little something extra: peace of mind.

Perfectly Positioned to Deliver

Our corporate headquarters and almost 220,000 square feet of made in the USA manufacturing and warehousing are centrally located in Tulsa, Oklahoma. From here, and through several distribution facilities across North America, we deliver Marco quality coast to coast.



ROOFING VENTILATION PRODUCTS

METAL

LP2 Ridge Vent
pages 6-7



Flexpro Ridge Vent
Profile Venting Material
pages 8-11



Flex-O-Vent
Universal Venting Material
pages 12-13



Closure Foam
pages 14-15

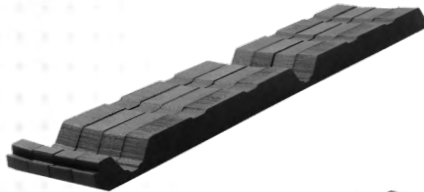

Anglekut Beveled Closure System
pages 16-17



Metal Gooseneck Vent
pages 18-19

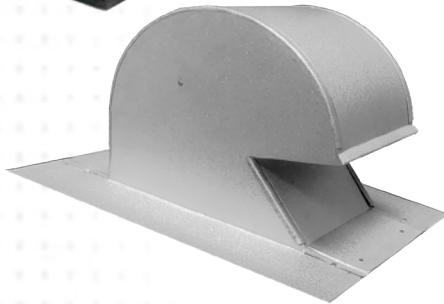

Standing Seam Vent
pages 20-21



SHINGLE

Python Weather-Tite Roll Ridge Vent
pages 22-23



SHINGLE

Weather Tite Python Pro 4ft. Ridge Vent
pages 24-25



PythonPro 4ft. Ridge Vent
pages 26-27



45 Intake Vent
page 28-29



Shingle Gooseneck
pages 30-31



Shingle Off-Ridge Vent
pages 32-33



Round Duct Exhaust Vent
page 35



50 Square Vent
pages 36-37



Weather-Tite 60 Square Vent
pages 38-39



SHINGLE

65 Slant Back Vent
pages 40 - 41

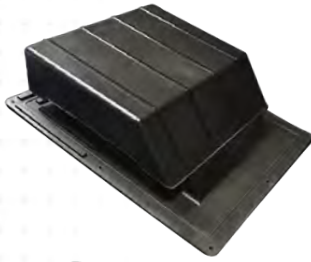

Low Profile Dryer Vent
pages 42 - 43



Combo Bathroom Exhaust Vent
pages 44 - 45



FLASHING

Valley Cap
pages 46 - 47



Bathroom Pipe Flashing
pages 48



Metal Roof Multi-Flash Sealing Vent Adapter
pages 49

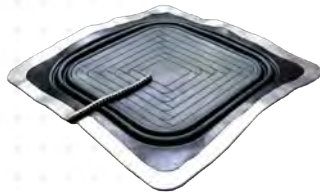

Universal RoofBoots
pages 50 - 51



Master-Flex
page 52 - 53



Box Gutter Expansion Joint
page 54

ACCESSORIES

Universal Foam
page 55



X-Seal Expandable Foam Tape
page 56 - 57



RE2 Polyethylene Foam Spacer System
page 58 - 59



Mastix Butyl Tape
page 60 - 61



Weather-Tite Metal Roof Sealant
page 62 - 63



MarcoFlex Weather-Tite Gunnable Butyl
page 64



Alto8000 Snow Guard
page 65



Yeti Guard
page 66

UNDERLAYMENT

Hydrashell Underlayment
page 68 - 83



FASTENERS

Fastener Program Quickgrip, Quickdrill, Cantech Paint
page 84 - 91



MCLIPS

Hidden clips that fasten standing seam roof panels together
page 92 - 95



1.800.800.8590 / Marcoindustries.com





Roofing Ventilation & Accessories



LP2™ LOW PROFILE RIDGE VENT

ECO-FRIENDLY INVISIBLE RIDGE VENT

It fits in almost all major metal roofing pitches and profiles because of its unique shape.



Features:

- ▶ Custom-cut vent strip includes Python polyester vent material inserts for optimum fit and ventilation.
- ▶ Superior net-free ventilation reduces condensation.
- ▶ One-person installation.
- ▶ M63 Marco proprietary adhesive, superior hold.
- ▶ Reduces utility costs.

EXPAND YOUR ROOFING SYSTEM PERFORMANCE
PREVENT LEAKS • PROTECT PROPERTY • ASSURE VENTILATION

INSTALLATION INSTRUCTIONS

VALUE DRIVES EVERYTHING WE DO

Value drives everything we do. That's why we developed a comprehensive line of ventilation products that offer easy installation, remarkable building ventilation, lower utility costs, extended roof deck life, extreme durability, and outstanding warranties. Get more quality, more performance, and more value...from Marco Industries.™

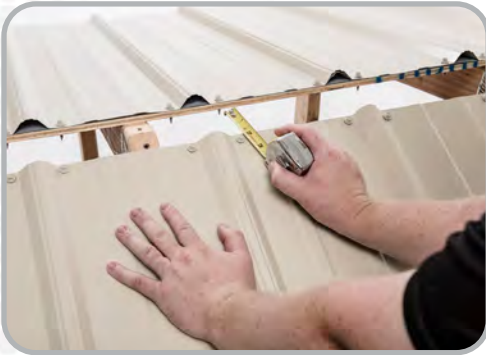

Step 1:

Allow a 2" slot at the ridge of the metal roof for ventilation. apply the LP2 ridge vent to metal roof by removing the backing paper.



Step 2:

Align LP2 1/2"-1" up-slope from the edge of the ridge cap. Place onto metal roof with adhesive side down. Be sure LP2 Ridge Vent is in place the first time, the adhesive makes it hard to move.



Step 3:

To attach consecutive LP2 Vents, butt fit pieces together, sealing with Marco's Weather-Tite Metal Roof Sealant. Place ridge cap over LP2. Secure with Marco QuickGrip/QuickDrill fasteners through metal roof ridge locations, using screw bed locations to avoid penetrating the LP2 insert material.

Specs*

Overall

Net Free Area: Varies with profile based on 17 square inches per linear foot of ventilation material

Dimensions: Varies with profile

Air Permeability: >760 cubic feet per minute

Cold Cracking: -25° F

Tear & Tensile Strength:

Machine 25 ppi / Counter 25 ppi

Compressive Strength: 1.8 psi at 75%

Rain: No leakage

Closure Material

Nominal Density-Skin/Skin (BS ISO 7214 1998): 24 kg/m³

Compression Stress-Strain (BS ISO 7214 1998)

10% compression: 34 kPa

25% compression: 53 kPa

40% compression: 85 kPa

50% compression: 118 kPa

Shore Hardness 00 Scale, 10 mm Cell/ Cell Thickness (ISO 868 1985): 50 00

Thermal Conductivity — Mean Temp of 10° C (ISO 8302 1991): 0.0392 W/m.K

Flammability — Automotive (FMVSS.302-Burn Rate):

Pass 12 mm & thicker <100mm/min

Flammability — Horizontal Burn Rate (ISO 7214 1998): 5 mm thick, 2.1 mm/sec and 13 mm thick, 1.5 mm/sec

Python Material

Net Free Area: Varies with profile based on 17 square inches per linear foot of ventilation material

Dimensions: Varies with profile

Cold Cracking: -25° F

Compressive Strength: 1.8 psi at 75%

Rain: No leakage

Air Permeability: (ASTM D737)

760 cubic feet per minute

Tear & Tensile Strength: (Tear: ASTM D1294-86, Tensile: ASTM D2261-83)

Machine 25 ppi / Counter 25 ppi

Self-Ignition Temperature: (ASTM D1929) 963° F



1.800.800.8590 / Marcoindustries.com





FlexPro

PROFILE-CUT VENTING MATERIAL

Save on energy costs while protecting your building from moisture, pests and dust with FlexPro™ exclusively from Marco.

Ridge Vent



Features:

- ▶ Effective rib-cut profile fits most metal roofs.
- ▶ High density ensures quick, full material recovery after installation.
- ▶ Eliminates condensation and prevents moisture, pest and dust from entering the structure.
- ▶ Easy, one-person installation.
- ▶ Reduces utility bills through added attic ventilation.
- ▶ 2 beads of M63 Marco proprietary adhesive for superior hold.
- ▶ Available in box or roll quantities.
- ▶ A profile-cut strip or roll designed to fit most roof panels.
- ▶ Green Product.

EXPAND YOUR ROOFING SYSTEM PERFORMANCE
PREVENT LEAKS • PROTECT PROPERTY • ASSURE VENTILATION

INSTALLATION INSTRUCTIONS

VALUE DRIVES EVERYTHING WE DO

Value drives everything we do. That's why we developed a comprehensive line of ventilation products that offer easy installation, remarkable building ventilation, lower utility costs, extended roof deck life, extreme durability, and outstanding warranties. Get more quality, more performance, and more value...from Marco Industries.™

EASY INSTALL

See our installation online at marcoindustries.com

To install FlexPro, simply peel and stick the product to the metal roof, careful to match the custom-cut contours to roof ridges. Next put the ridge cap in place and fasten down-slope from the FlexPro product (shown below):

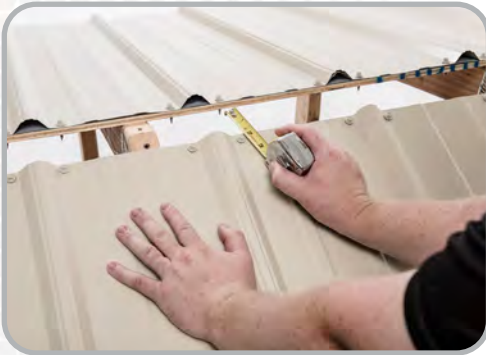

Step 1:

Flexpro comes in various panel configurations, roll and stick package options. apply the Flexpro ridge vent to metal roof by removing the backing paper.

Step 2:

Align the FlexPro Ridge Vent 1/2"-1" up-slope from the edge of the ridge cap. Place onto metal roof with adhesive side down. Note that the adhesive is strong and once put in place it will be hard to move. Be sure the FlexPro Ridge Vent is in place the first time.

Step 3:

When attaching consecutive FlexPro Vents, butt fit the pieces together. Marco Weather-Tite Metal Roof Sealant can be used to seal the butt joint. Place ridge cap over FlexPro. Secure in place with Marco QuickGrip/QuickDrill fasteners; fasten through the metal roof ridge locations, avoiding penetrating the FlexPro material, using a min. 3300 rpm screw gun.

SPECS:

Net Free Area: FlexPro Panel Fit - 1-1/8" free-standing product, NFA 26 sq. in.*

Available in: 3' stick, 20' and 50' rolls

Air Permeability: >800 cubic feet per minute

Tear Strength: 3.5 ppi

Tensile Strength: 16 psi – Elongation 175%

Compressive Strength: 1.8 psi at 75%

ASTM Testing: D1929, D737

*Effective Net Free Area varies based on product height, panel profile, and installation methods.

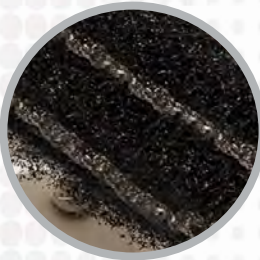

Marco's proprietary M63 continuous double-bead adhesive is key to quick, easy FlexPro installation.



1.800.800.8590 / Marcoindustries.com





Roofing Ventilation & Accessories

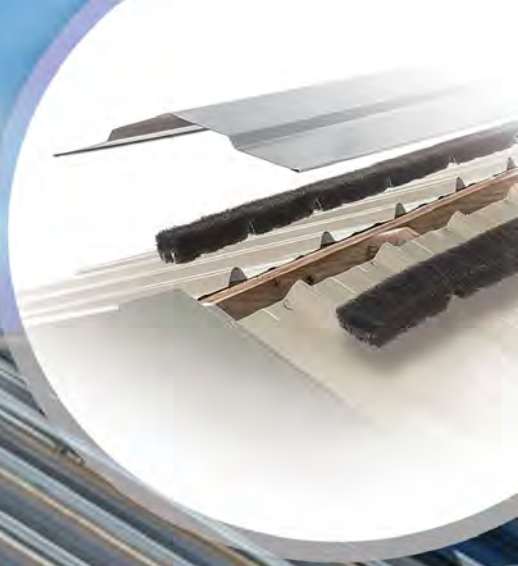

FlexPro Ridge Vent

PROFILE-CUT VENTING MATERIAL

Save on energy costs while protecting your building from moisture, pests and dust with FlexPro,™ exclusively from Marco.

**NEW 3" INCH
WIDTH AVAILABLE**



Features:

- ▶ Effective rib-cut profile fits most metal roofs.
- ▶ High density ensures quick, full material recovery after installation
- ▶ Eliminates condensation and prevents moisture, pest and dust from entering the structure.
- ▶ Easy, one-person installation.
- ▶ Reduces utility bills through added attic ventilation.
- ▶ 2 beads of M63 Marco proprietary adhesive for superior hold.
- ▶ Available in box or roll quantities.
- ▶ A profile-cut strip or roll designed to fit most roof panels.
- ▶ Green Product.

EXPAND YOUR ROOFING SYSTEM PERFORMANCE
PREVENT LEAKS • PROTECT PROPERTY • ASSURE VENTILATION

INSTALLATION INSTRUCTIONS

VALUE DRIVES EVERYTHING WE DO

Value drives everything we do. That's why we developed a comprehensive line of ventilation products that offer easy installation, remarkable building ventilation, lower utility costs, extended roof deck life, extreme durability, and outstanding warranties. Get more quality, more performance, and more value...from Marco Industries.™

EASY INSTALL

See our installation online at marcoindustries.com

To install FlexPro, simply peel and stick the product to the metal roof, careful to match the custom-cut contours to roof ridges. Next put the ridge cap in place and fasten down-slope from the FlexPro product (shown below):

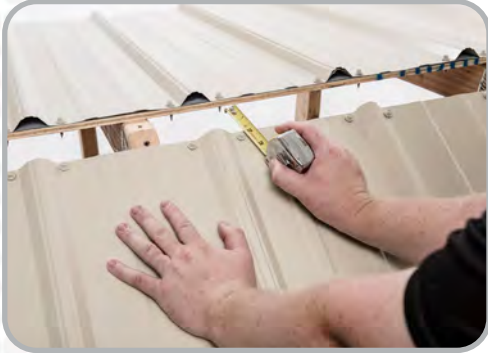

Step 1:

Flexpro comes in various panel configurations, roll and stick package options. apply the Flexpro ridge vent to metal roof by removing the backing paper.

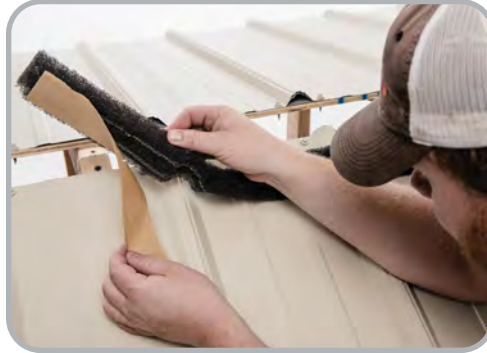

Step 2:

Align the FlexPro Ridge Vent 1/2"-1" up-slope from the edge of the ridge cap. Place onto metal roof with adhesive side down. Note that the adhesive is strong and once put in place it will be hard to move. Be sure the FlexPro Ridge Vent is in place the first time.

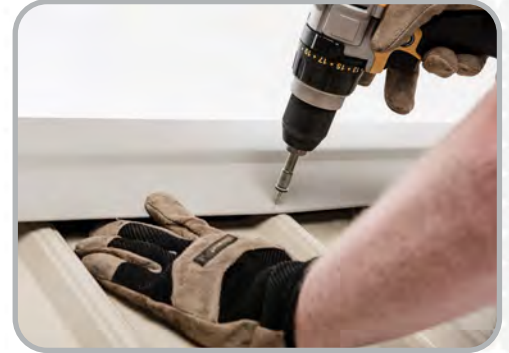

Step 3:

When attaching consecutive FlexPro Vents, butt fit the pieces together. Marco Weather-Tite Metal Roof Sealant can be used to seal the butt joint. Place ridge cap over FlexPro. Secure in place with Marco QuickGrip/QuickDrill fasteners; fasten through the metal roof ridge locations, avoiding penetrating the FlexPro material, using a min. 3300 rpm screw gun.

SPECS:

Net Free Area: FlexPro Panel Fit - 3" free-standing product, NFA 26 sq. in.*

Available in: 3' stick, 20' and 50' rolls

Air Permeability: >800 cubic feet per minute

Tear Strength: 3.5 ppi

Tensile Strength: 16 psi – Elongation 175%

Compressive Strength: 1.8 psi at 75%

ASTM Testing: D1929, D737

*Effective Net Free Area varies based on product height, panel profile, and installation methods.

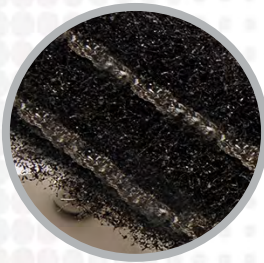

Marco's proprietary M63 continuous double-bead adhesive is key to quick, easy FlexPro installation.



1.800.800.8590 / Marcoindustries.com





Roofing Ventilation & Accessories



Flex-O-Vent



PROTECTS & LAST LIKE NO OTHER

Flex-O-Vent is a long-term air flow solution, that lowers utility costs, complies with building codes, and decreases the damage that improper ventilation can do to buildings.



Features:

- ▶ Won't absorb moisture, which can freeze and block all ventilation
- ▶ M63 Marco proprietary adhesive for superior hold
- ▶ Prevents moisture, pest and dust from entering the structure
- ▶ Easy, one-person installation.
- ▶ ASTM testing: D1929, D737
- ▶ Most economical polyester-based ventilation product.
- ▶ Available in 10' and 20' rolls and multiple packaging options
- ▶ 40-year limited warranty
- ▶ Green Product

EXPAND YOUR ROOFING SYSTEM PERFORMANCE
PREVENT LEAKS • PROTECT PROPERTY • ASSURE VENTILATION

INSTALLATION INSTRUCTIONS

VALUE DRIVES EVERYTHING WE DO

Value drives everything we do. That's why we developed a comprehensive line of ventilation products that offer easy installation, remarkable building ventilation, lower utility costs, extended roof deck life, extreme durability, and outstanding warranties. Get more quality, more performance, and more value...from Marco Industries.™

EASY INSTALL

See our installation online at marcoindustries.com

With Flex-O-Vent, one size fits most panels. Installation is a simple three-step process easily handled by one installer. Flex-O-Vent comes in easy-to-handle 10-foot rolls (mirroring most ridge cap lengths) or larger 20-foot rolls if you prefer. It is easily cut with scissors or utility knife and a double bead of M63 adhesive holds Flex-O-Vent securely in place until the ridge cap is installed.

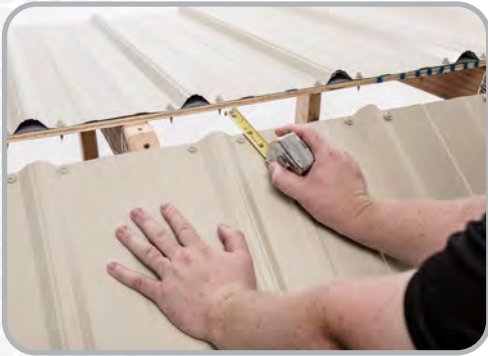

Step 1:

Make sure panel is free of dust and debris. If not pre-cut, cut 2" slot at ridge. Measure and mark where the ridge cap will sit on the panel.



Step 2:

Start from the end of the ridge, rolling out Flex-O-Vent along the length of the ridge (both sides), making sure the vent sits "up-slope" from the edge of the ridge cap.



Step 3:

Apply ridge cap, compressing material between the ridge cap and major rib. Fasten at the major rib using a screw gun set to at least 2700 rpm.

SPECS:

Net Free Area: FOV - 1" free-standing product, NFA 23 sq. in.*

1-1/2" x 3" x 10': Rib heights up to 1-1/4"

1-1/2" x 2" x 10': Rib heights up to 1-1/4"

1" x 3" x 10': Rib heights up to 3/4"

1" x 2" x 10': Rib heights up to 3/4"

Air Permeability: >760 cubic feet per minute

Cold Cracking: -55° C (-130° F)

Compression Strength: 1.8 psi at 75%

Tensile Strength: 16 psi – Elongation 175%

Tear Strength: 3.5 ppi

Abrasion: No Damage

*Effective Net Free Area varies based on product height, panel profile, and installation methods

Marco's proprietary M63 continuous double-bead adhesive is key to quick, easy Flex-O-Vent installation.



FV
FLEX-O-VENT



1.800.800.8590 / Marcoindustries.com

MARCO INDUSTRIES
Roofing Ventilation & Accessories



Roofing Ventilation & Accessories

Closure Foam

DESIGNED TO STAY PUT

Marco's M63 industrial adhesive eliminates blow away problems with an adhesive bead applied to either the flat or the ribbed side of Closure-Foam.



CLOSURE FOAM™

Features:

- ▶ Full bead (once installed) of adhesive applied.
- ▶ Thickness variety.
- ▶ Adheres in subfreezing temperatures and on wet surfaces.
- ▶ Profiles for every application.
- ▶ No excess scrap for easier cleanup.
- ▶ Eliminate gaps and ensure a snug end-to-end fit.
- ▶ Better UV resistance/longer lasting than competition
- ▶ 40-year limited warranty
- ▶ Economically priced without sacrificing quality.

EXPAND YOUR ROOFING SYSTEM PERFORMANCE
PREVENT LEAKS • PROTECT PROPERTY • ASSURE VENTILATION

INSTALLATION INSTRUCTIONS

VALUE DRIVES EVERYTHING WE DO

Value drives everything we do. That's why we developed a comprehensive line of ventilation products that offer easy installation, remarkable building ventilation, lower utility costs, extended roof deck life, extreme durability, and outstanding warranties. Get more quality, more performance, and more value...from Marco Industries.™

EASY INSTALL

See our installation online at marcoindustries.com

Closure-Foam can be installed by a single person in just three easy steps shown below.



Step 1:

Ensure the self-adhesive closure configuration fits the roof panel used.

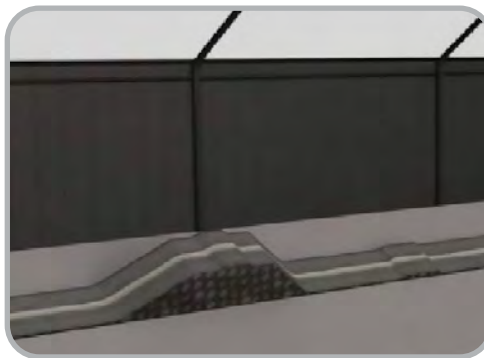

Step 2:

The inside Closure fits the underside of the panel.

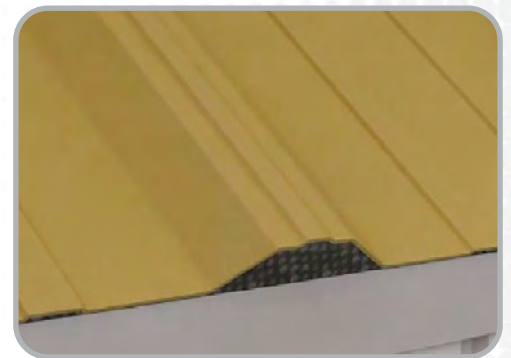

Step 3:

Place the roof panel over pre-cut closure configuration for a snug fit. Attach panel over closure with fasteners.

SPECS:

Nominal Density-Skin/Skin (BS ISO 7214 1998): 24 kg/m³

Cell Size, Typical Diameter: 0.3mm

Shore Hardness 00 Scale, 10 mm cell/cell thickness (ISO 868 1985): 50 00

Recommended Operating Temp. Range: +100° C/-70° C (+212° F/-97° F)

Thermal Conductivity – Mean Temp of 10° C/ 50° F (ISO 8302 1991): 0.0392 W/m.K

Flammability – Automotive (FMVSS.302-Burn Rate): Pass 12 mm & thicker <100mm/min

Flammability – Horizontal Burn Rate (ISO 7214 1998): 5 mm thick, 2.1 mm/sec & 13 mm thick, 1.5 mm/sec

Compression Stress-Strain (BS ISO 7214 1998)

10% Compression: 34 kPa

25% Compression: 53 kPa

40% Compression: 85 kPa

50% Compression: 118 kPa

Durometer (50): Shore 00

Water: 5% lbs/ft³

Compression Set: 25% comp, 22hr, 23° C/73° F

1/2 hr recovery (25 mm cell-cell): 27% set

24 hr recovery (25 mm cell-cell): 19% set

Tensile Strength (ISO 7214 1998): 320 kPa

Tensile Elongation: 130%

Tear Strength (BS EN ISO 8067 1995): 495 N/m



CLOSURE-FOAM™



1.800.800.8590 / Marcoindustries.com



AngleKut™ Beveled Closure System

A SUPERIOR BEVELED CLOSURE

That effectively seals metal roof panels, preventing water from entering the roof's hips and valleys



Features:

- ▶ Can be made at any angle, it will fit any metal roof profile.
- ▶ Made from crosslink polyethylene foam the same as M-Cell closures.
- ▶ Closures doesn't bleed, dry out, or dissolve with weather and UV exposure.
- ▶ 1-1/2" thick foam increases the strength of the beveled closure.
- ▶ Closures are an easy replacement for caulking and polyuethane strips.
- ▶ Anglekut Easy Order Form.

EXPAND YOUR ROOFING SYSTEM PERFORMANCE
PREVENT LEAKS • PROTECT PROPERTY • ASSURE VENTILATION

VALUE DRIVES EVERYTHING WE DO

Value drives everything we do. That's why we developed a comprehensive line of ventilation products that offer easy installation, remarkable building ventilation, lower utility costs, extended roof deck life, extreme durability, and outstanding warranties. Get more quality, more performance, and more value...from Marco Industries™

ANGLEKUT™ Easy Order Form

It's fast and easy to order Angle-Kut. Just call 1-800-800-8590 and we'll walk you through each step in minutes!

Date _____ Customer P.O.# _____ Job # _____

Complete the following information for each separate closure configuration and beveled angle:

- 1. Panel Name: _____
- 2. Application: End Wall _____ Hip _____ Valley _____
- 3. Cut-back Angle: _____
- 4. Roof Slope (Rise/Run) _____ / _____
- 5. A. Number of Panels - Inside: Left Hand _____ Right Hand _____
 Outside: Left Hand _____ Right Hand _____

OR

- 6. A. Number of Panels - Inside: Left Hand _____ Right Hand _____
 Outside: Left Hand _____ Right Hand _____

Key to Order Entry Information:

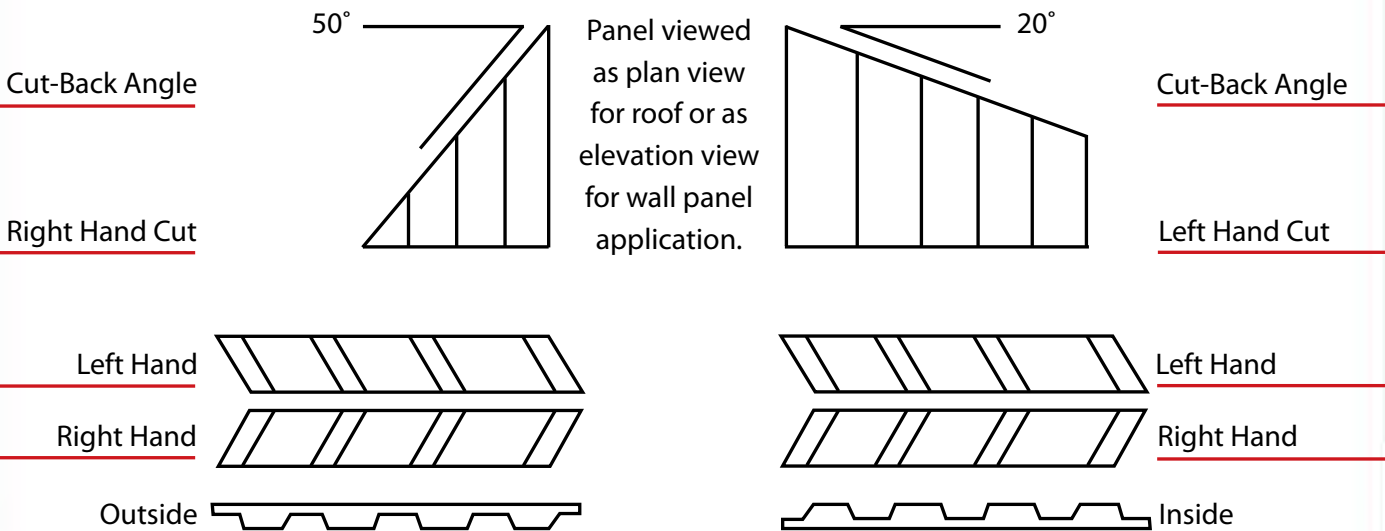

Metal Roofing Gooseneck Vent

EXCELLENT VENTILATION

Built with durability, reliability
and passed the Standard TAS
100 Wind-Driven Rain Test



X Not to be Used as a Laundry Vent.

Features:

- ▶ Built in water-tight damper duct that is fast to open and close.
- ▶ Suitable for metal roofs.
- ▶ Keeps rodents and birds out.
- ▶ Promotes superior airflow and makes it ideal for kitchen or bathroom exhausts.
- ▶ Marco's Metal Gooseneck Vent is made with rugged 26 gauge galvalume metal.
- ▶ Suitable for any roof pitch from 3/12 to 12/12.
- ▶ High Quality & Durability - Reduces customer call-backs.

EXPAND YOUR ROOFING SYSTEM PERFORMANCE
PREVENT LEAKS • PROTECT PROPERTY • ASSURE VENTILATION

INSTALLATION INSTRUCTIONS

VALUE DRIVES EVERYTHING WE DO

Value drives everything we do. That's why we developed a comprehensive line of ventilation products that offer easy installation, remarkable building ventilation, lower utility costs, extended roof deck life, extreme durability, and outstanding warranties. Get more quality, more performance, and more value...from Marco Industries.™

EASY INSTALL

See our installation online at marcoindustries.com

- 1 Location of vent: It is recommended to position the vent on roof deck directly above location of the exhaust tube or opening in roof deck.
2. Position and Secure: Fasten vent over sub roofing membrane with 1 ¼" galv. Roofing nails or pan head screws through the vent flanges at provided holes spaced no more than 4" apart.
3. Seal flanges to sub roofing membrane as recommended by membrane manufacturer.
4. Cut metal roof panel to fit tightly around body of vent and test fit before applying sealant. Once satisfied with the way the panel fits around the vent, remove panel in preparation for final install.
5. Apply a liberal amount of tripolymer sealant or other approved metal roof sealant on flanges around body of the vent in a manner as to insure a complete bond of sealant to the underside of the roof panel. It is preferable to use a sealant with a color that matches the panel color.
6. Cut tile to fit around vent and install per tile manufacturer recommendations.
6. Install precut metal roof panel and press into the sealant so that the panel and sealant create a complete bond. There will be some ooze out of sealant at the body of the vent. Tool in the sealant at the body of the vent to cover the edge of the panel cut out. You may need to add some sealant to accomplish this task. It is important to be consistent with this tooling process for a neat and aesthetically pleasing finish.

Note: Some metal roof mechanics may want to use an alternative attachment method such as mechanical fasteners or cleating the panel. These methods are acceptable as long as proper sealing is incorporated in the process.

**Metal
Gooseneck
Vent**



SPECS:

Dimensions: Width 16 1/2" x Height 9 1/2"

Material: 26 - gauge galvalume

Codes & Standards: FL Building Code, patents pending

Roof Pitch: Conforms to any pitch from 3/12" to 12/12"

Color: Galvalume and other colors available

Sizes: 4", 6" and 10"



Not to be Used as a Laundry Vent.



1.800.800.8590 / Marcoindustries.com





Roofing Ventilation & Accessories



STANDING SEAM VENT

SUPERIOR VENTILATION

The SSV is the only vent tested and proven to deliver 18 square inches of Net Free Area per linear foot. The added exclusive non-woven material won't break down over time and is reliable, and built to last. The pre-applied butyl tape makes installation quick and easy—so you can install the next SSV without missing a beat.

EXPAND YOUR ROOFING SYSTEM PERFORMANCE
PREVENT LEAKS • PROTECT PROPERTY • ASSURE VENTILATION

INSTALLATION INSTRUCTIONS

VALUE DRIVES EVERYTHING WE DO

Value drives everything we do. That's why we developed a comprehensive line of ventilation products that offer easy installation, remarkable building ventilation, lower utility costs, extended roof deck life, extreme durability, and outstanding warranties. Get more quality, more performance, and more value...from Marco Industries.™

EASY INSTALL

See our installation online at marcoindustries.com



STEP 1: Snap a chalk line about one-eighth to one-sixteenth of an inch above the position where the ridge cap will be installed.



STEP 2: Peel away the backing from the butyl tape. Allow the over-stuffed foam to expand so it completely fills the gap between the top of the rib and the SSV. Align the SSV along the chalk line.



STEP 3: Secure the SSV using type 410 fasteners, ensuring at least one-half inch of penetration into the decking. Space the fasteners no more than three inches apart.



STEP 4: Apply sealant at the points where the SSV meets the panel ribs.



STEP 5: Install the open hem ridge cap by locking both bottom sides over the top and side of the SSV. Secure and finish installing the ridge cap by following the steel manufacturer's installation instructions and detail.



SPECS:

Height: 1", 1.5", 1.75", 2"

Length: Custom cut

Testing: Passed TAS-100(A)

Python Weather-Tite™ Rolled Ridge Vent

**KEEPING YOUR ATTIC
COOL, DRY & VENTILATED**

The Rolled Ridge Vent is economical, quick to install and will keep out insects, dust and moisture, extending the life of your roof.

**NAILS
INCLUDED**

**LIMITED
LIFETIME
WARRANTY**

Features:

- ▶ Resists damage from ice, hail, and other weather. No warping and less loosening problems
- ▶ Installer friendly, its light flexible and comes in 20' and 50' rolls
- ▶ No waste. Cut and use what you need
- ▶ Effectively Blocks - Insects, bats, birds, and wind borne debris, dust and dirt
- ▶ No clogs, deterioration, or dirt and snow snow trapping
- ▶ Prevents mold and mildew
- ▶ Reduces air conditioning maintenance costs
- ▶ Eliminates damaging ice dams in winter
- ▶ Extend shingle and roof deck life

EXPAND YOUR ROOFING SYSTEM PERFORMANCE
PREVENT LEAKS • PROTECT PROPERTY • ASSURE VENTILATION

INSTALLATION INSTRUCTIONS

VALUE DRIVES EVERYTHING WE DO

Value drives everything we do. That's why we developed a comprehensive line of ventilation products that offer easy installation, remarkable building ventilation, lower utility costs, extended roof deck life, extreme durability, and outstanding warranties. Get more quality, more performance, and more value...from Marco Industries.™

EASY INSTALL

See our installation online at marcoindustries.com

1. Use on a minimum 3/8" (10 mm) plywood or OSB decking.
2. Cut a 2" (51 mm) slot along the ridge, 1" (25.4 mm) on each side. Leave uncut (closed) sheathing area of 6" (152 mm) at each end of the ridge. Cut through sheathing only, avoiding roof trusses. (In houses with a ridgeboard, cut 3 1/2" (89 mm) slot, 1 3/4" on each side.
3. Where short ridges (dormers, ridge intersections) are used, mark and cut the slot and make sure that the end of the opening stops at least 12" (305 mm) from the ridge intersection.
4. Uncoil Python Single Layer Vent along the entire length of the ridge, covering uncut 6" (152mm) sheathing area on both ends. Shorter lengths can be joined by caulking and butting the end.
5. Install cap shingles directly over Python Single Layer Vent. Use included 1 3/4" (44.4mm) coil nails. Python Single Layer Vent has a 3/4" (19.1mm) nominal thickness. Be sure not to crush or compress the vent during installation.

SPECS:

Net Free Venting Area: 3/4" thick: 17.5 sq. in. per lineal foot of ridge

Ridge Vent Roll Sizes: 3/4" x 8" x 20', 3/4" x 10.5" x 20' 3/4" x 11.75" x 20', 3/4" x 10.5" x 50', 3/4" x 11.75" x 50'

Material: Highly durable and high performing non-woven, non-wicking modified polyester. Made with over 90% recycled plastic and 30% post-consumer content

Codes & Standards: FBC, and CSA approvals

Color: Dark Grey

Nails: Coil of 1 3/4" Nails (Nails included)

Roof Pitch: Conforms to any pitch from 2/12 to 20/12

Pack Unit of Measurement: 1 per bag

Air Permeability: (ASTM D737) 760 cubic/minute

Tear Strength: ASTM D1294-86

Tensile Strength: ASTM D2261-83, Machine 25 ppi / Counter 25 ppi

Cold Crack Resistance: (GLIT C115) -25°F

Snow Infiltration: (CRL 5704) Zero

Self-Ignition Temperature: (ASTM D1929) 963°F

Weathering: UV stable, polyester composite

Maintenance: Properly installed, maintenance free



1.800.800.8590 / Marcoindustries.com



Weather-Tite™ PythonPro 4 ft. Stick

SUPERIOR ATTIC VENTILATION

Our top-performing shingle over ridge vent. Provides maximum airflow in all wind conditions and Weather-Tite protection from the elements.



**NAILS
INCLUDED**



Features:

- ▶ Meets or exceeds the industry's toughest standards for ventilation performance.
- ▶ Built-in self-closing end caps, no additional parts or labor required.
- ▶ Prevents mold and mildew.
- ▶ Includes 30 - 3" roofing nails attached to each piece for installation.
- ▶ Extends shingle and roof deck life.
- ▶ Suitable for any pitch from 3/12 to 16/12.
- ▶ 18 Square Inches of Net Free Venting Area per lineal foot.
- ▶ Eliminates damaging ice dams in winter.

EXPAND YOUR ROOFING SYSTEM PERFORMANCE
PREVENT LEAKS • PROTECT PROPERTY • ASSURE VENTILATION

INSTALLATION INSTRUCTIONS

VALUE DRIVES EVERYTHING WE DO

Value drives everything we do. That's why we developed a comprehensive line of ventilation products that offer easy installation, remarkable building ventilation, lower utility costs, extended roof deck life, extreme durability, and outstanding warranties. Get more quality, more performance, and more value...from Marco Industries.™

EASY INSTALL

See our installation online at marcoindustries.com

1. Remove ridge cap shingles from the entire length of the ridge. NOTE: Skip step 1 for new construction.
2. Snap chalk line on both sides of the ridges and no more than ¾" from the peak.
3. Cut along both chalk lines. Remove roof sheathing. NOTE: Slots should not be cut any closer than within 12" of the gable end, hip, or intersecting ridge.
4. It is recommended that the vent be installed the entire length of the ridge to ensure blending with the roof line. Position the first piece at one end of the ridge. Using 3" nails, for ¾" roof penetration or penetration through the deck, whichever is less, anchor vent through preformed nail holes.
5. Nail each additional section in the same manner until the entire ridge is covered. A chalk line may be utilized to ensure vent alignment. Cut the last piece to length and install with original uncut end to the outside.
6. Install a new ridge cap using 3" roofing nails, for ¾" deck penetration or penetration through the deck, whichever is less. Nail the ridge caps through the vent along the nail line to secure the vent. Shingle may need to be trimmed.
7. Ridge-to-ridge application requires a mitre-cut to maintain continuous ridge line appearance.
8. Ridge-to-roof application requires a mitre-cut to maintain continuous ridge line appearance.

IMPORTANT INSTALLATION NOTES:

- Python Pro Ridge Vent must always be installed with soffit vents of equal or slightly greater area.
- When installing Python Pro Ridge Vents, all other vent openings (except soffits) should be closed off.
- The slot cut in the roof ridge should only be cut no closer than 12" from any junction point, such as intersecting roofing ridge, chimney, gable, or other obstruction.
- Install the vent over the entire length of the ridge.
- Do not overdrive fasteners.

SPECS:

Net Free Area: 18 Square Inches of NFVA per lineal ft

Dimensions: Width 14" x Length 48"

Roof Pitch: Conforms to any pitch from 3/12 to 16/12

Color: Black

Nails: Bag of 30 - 3" nails

Pack Unit of Measurement: 10 per carton

Installer: Shingle nail lines for easy installation

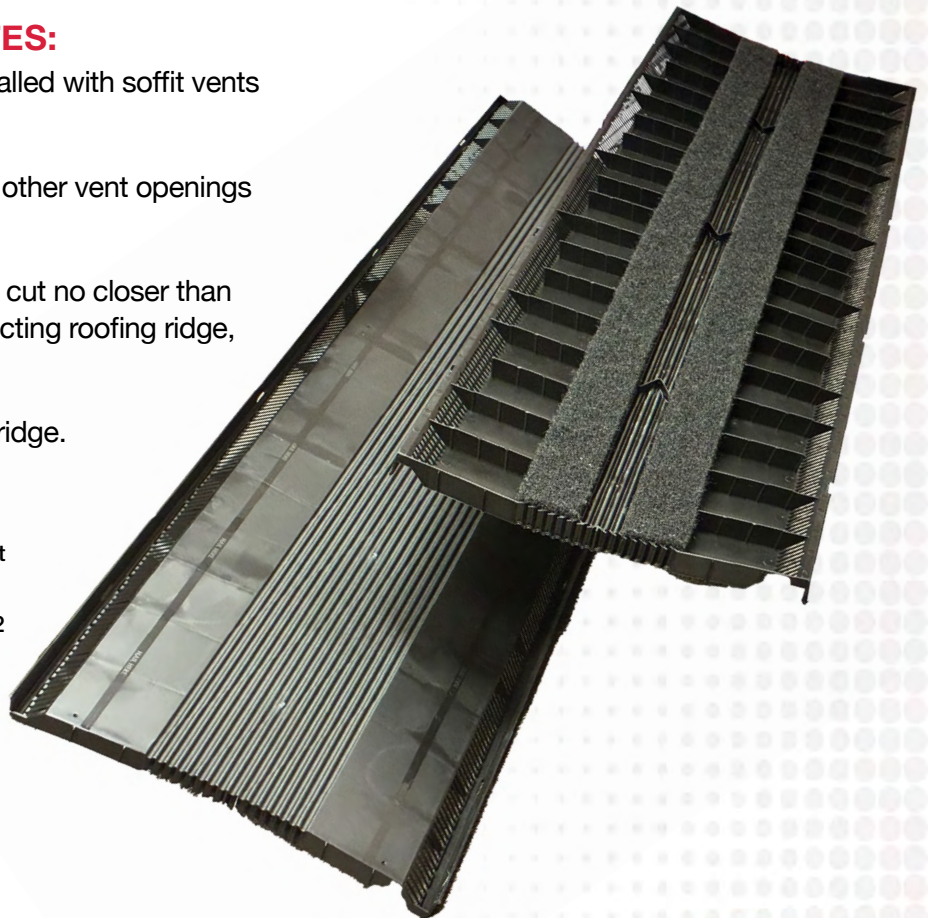

1.800.800.8590 / Marcoindustries.com





Roofing Ventilation & Accessories

Python Pro™ 4 ft. Ridge Vent

SUPERIOR ATTIC VENTILATION

Our top-performing shingle over ridge vent. Provides maximum airflow in all wind conditions.

**NAILS
INCLUDED**

Features:

- ▶ Meets or exceeds the industry's toughest standards for ventilation performance.
- ▶ Built-in self-closing end caps, no additional parts or labor required.
- ▶ Prevents mold and mildew.
- ▶ Includes 30 - 3" roofing nails attached to each piece for installation.
- ▶ Extends shingle and roof deck life.
- ▶ Suitable for any pitch from 3/12 to 16/12.
- ▶ 18 Square Inches of Net Free Venting Area per lineal foot.
- ▶ Eliminates damaging ice dams in winter.

EXPAND YOUR ROOFING SYSTEM PERFORMANCE
PREVENT LEAKS • PROTECT PROPERTY • ASSURE VENTILATION

INSTALLATION INSTRUCTIONS

VALUE DRIVES EVERYTHING WE DO

Value drives everything we do. That's why we developed a comprehensive line of ventilation products that offer easy installation, remarkable building ventilation, lower utility costs, extended roof deck life, extreme durability, and outstanding warranties. Get more quality, more performance, and more value...from Marco Industries.™

EASY INSTALL

See our installation online at marcoindustries.com

1. Using a chalk line, mark 1" on both sides of the ridge (1" beyond ridge pole) as a guide for cutting a slot in the decking.
2. Cut a slot in the roof ridge using a circular saw with the blade set at a depth to cut through the roof decking only—avoid cutting trusses and rafters.
3. Center the FlexFit™ 3-IN-1 Ridge Vent over the slot that has been cut in the ridge, ensuring that the Ridge Vent support pegs sit flat on the roof. To ensure proper alignment along the ridge, run a chalk line down both sides of the ridge.
4. Using roofing nails provided, install the vent starting from the outer edge moving inward. Properly secure by using the 12" nail holes.
5. As you install more pieces of the Ridge Vent, ensure that each piece is joined together using the male/female connectors.
6. Cut the final piece to a length long enough so that it is flush with the edge of the roof. Ensure that the self-closed end cap is facing out to prevent weather infiltration. Interlocking feature will not be used on the final piece.
7. Install the cap shingles using the nails provided in the "shingle nail line" area for cap shingle installation as indicated on the FlexFit™ 3-IN-1 Ridge Vent. Visit MarcoIndustries.com for 10" and 9" Cap Shingle Installation.

IMPORTANT INSTALLATION NOTES:

- Python Pro Ridge Vent must always be installed with soffit vents of equal or slightly greater area.
- When installing Python Pro Ridge Vents, all other vent openings (except soffits) should be closed off.
- The slot cut in the roof ridge should only be cut no closer than 12" from any junction point, such as intersecting roofing ridge, chimney, gable, or other obstruction.
- Install the vent over the entire length of the ridge.
- Do not overdrive fasteners.

SPECS:

Net Free Area: 84 Square Inches of NFVA

Dimensions: Width 15-1/2" x Length 48"

Material: No break polypropylene

Roof Pitch: Conforms to any pitch from 3/12 to 16/12

Color: Black

Nails: Bag of 30 - 3" nails

Pack Unit of Measurement: 10 per carton

Construction Details: Closed external baffles with self closing end caps

Installer Detail: Shingle nail lines for easy installation

Nail Holes: Reinforced to prevent deformation and crushing

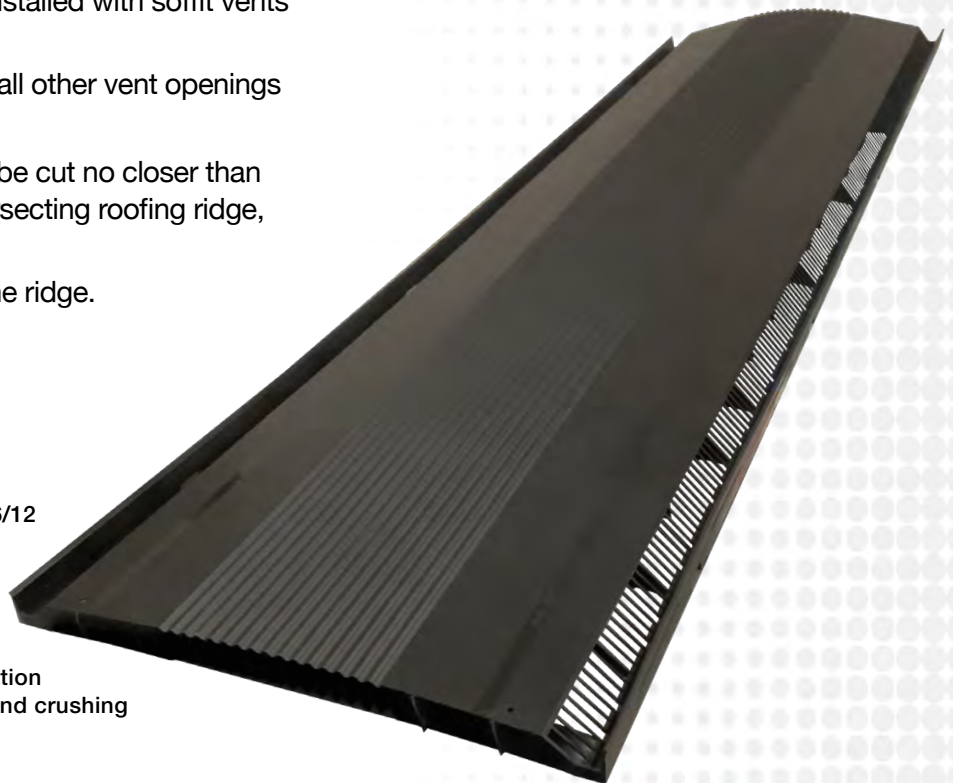

PROUDLY MADE IN NORTH AMERICA



1-800-800-8590 / Marcoindustries.com



Roofing Ventilation & Accessories

45 Intake Vent



INNOVATION IN VENTILATION

The 45 Intake Vent is made of high impact virgin polypropylene with heat stabilizers and UV inhibitors throughout the vent.



Features:

- ▶ Offers 45 Square Inches of Net Free Area per piece
- ▶ Closed External Baffle
- ▶ Molded Nail Holes for Easy Installation
- ▶ Bag of 30 - 3" Roofing Nails attached to each piece of 451V
- ▶ Molded in Nail Line Indicators for Easy Installation
- ▶ Patented Design with Internal and External Baffles

EXPAND YOUR ROOFING SYSTEM PERFORMANCE
PREVENT LEAKS • PROTECT PROPERTY • ASSURE VENTILATION

INSTALLATION INSTRUCTIONS

VALUE DRIVES EVERYTHING WE DO

Value drives everything we do. That's why we developed a comprehensive line of ventilation products that offer easy installation, remarkable building ventilation, lower utility costs, extended roof deck life, extreme durability, and outstanding warranties. Get more quality, more performance, and more value...from Marco Industries.™

INSTALLATION

See our installation online at marcoindustries.com

All requirements specified in the International Residential Code (IRC) and the International Building Code (IBC) must be satisfied and manufacturer's installation instructions followed, unless otherwise specified by this product evaluation.

Roof Deck: The roof deck must be minimum nominal 7/16" thick OSB wood structural panels.

Attachment of Vent to Roof Deck: The vent is secured to a minimum 7/6" OSB roof deck and has a 1-1/2" by 46" hole cut out. The base of the vent (flashing) is fastened to the roof deck using minimum 11-gauge x 2-1/2" long galvanized smooth shank nails with a minimum 3/8" diameter head. Refer to manufacturer's instructions for fastener locations. The fasteners are not required to penetrate the roof framing. Fasteners must be long enough to penetrate completely through the roof deck.

Note: Keep the manufacturer's installation instructions available on the job site during the installation. Use corrosion resistant fasteners as specified in the IRC and the IBC.

SPECS:

Net Free Area: 45 square inches
Width: 11 3/4"
Length: 48"
Vent Weight: 1 1/8
Material: No Break Polypropylene
Color: Black

LIMITATIONS:

Roof Slope: The roof vent may be installed on roofs with a minimum slope of 3:12 and any slope up to a maximum slope of 16:12.
Design Pressure: -75 psf

CODE & STANDARDS:

U.S. Pat. No. 11,746,531
 Texas Department of Insurance RV-131
 Florida Building Code PENDING
 Miami-Dade County NOA No.24-0313.04
 Screened & Filtered version are also available.



Note: *It is the contractors' responsibility to use the appropriate roofing underlayment for the region of install.



1-800-800-8590 / Marcoindustries.com





Roofing Ventilation & Accessories

Shingle Gooseneck Vent

OUTSTANDING PERFORMANCE

The only Gooseneck
Vent of its kind to pass
the Standard TAS
100 Wind-Driven
Rain Test



Features:

- ▶ High Quality & Durability - Reduces customer call-backs.
- ▶ Promotes superior airflow and makes it ideal for kitchen or bathroom exhausts.
- ▶ Suitable for any roof pitch from 3/12 to 12/12.
- ▶ Internal baffle offers a third line of defense against wind-driven rain.
- ▶ Interior louver panel captures any moisture directing it to vent pan away from the attic.
- ▶ Keeps insects and critters out.
- ▶ High Quality & Durability - Reduces customer call-backs.

EXPAND YOUR ROOFING SYSTEM PERFORMANCE
PREVENT LEAKS • PROTECT PROPERTY • ASSURE VENTILATION

INSTALLATION INSTRUCTIONS

VALUE DRIVES EVERYTHING WE DO

Value drives everything we do. That's why we developed a comprehensive line of ventilation products that offer easy installation, remarkable building ventilation, lower utility costs, extended roof deck life, extreme durability, and outstanding warranties. Get more quality, more performance, and more value...from Marco Industries.™

EASY INSTALL

See our installation online at marcoindustries.com

1. When installing vents on an existing shingle roof: remove shingles immediately around sides and top of opening to provide space to install vent as per instructions below.
2. Shingle courses should be installed close to the deck opening so that the front flange of the vent completely covers exposed section of shingle.
3. Position the vent to cover the last course of shingles at the sides and bottom of the opening. Center the vent over the opening in the deck. Apply an industry approved sealant under front flange of vent.
4. Fasten side and top flanges securely with minimum 1.25" standard roofing nails spaced 4" on center and 1.5" from outer edge of flange.
5. Apply roof cement on side and top flanges. Completely cover flanges 2" beyond flange onto underlayment with 1/4" thick bed of plastic roof cement or equal.
6. Install shingles, cut to fit so flanges are completely covered. Press into place to ensure a complete bond of cement to the shingles. Fasten shingles with nails as per shingle manufacturer's instructions.

*Tip: Pre-cut shingles to fit prior to applying roof cement.
Then remove cut pieces, apply roof cement, and install shingles per above.*

SPECS:

Dimensions: Width 19-3/16" x Height 7 1/2"

Material: 26 - gauge galvalume

Codes & Standards: FL Building Code

Roof Pitch: Conforms to any pitch from 3/12 to 12/12

Color: Black, Weather Wood, Galvalume

Patents: Pending

Sizes: 4", 6" and 10"

Vent Hood: Mini louvers in lower portion of hood block water.

Interior Louver Panel: Acts as second water barrier.

Internal Baffle: Placed at the top of the vent pan, the internal baffle is the third line of defense against water intrusion.



X Not to be Used as a Laundry Vent.



1.800.800.8590 / Marcoindustries.com





Shingle Off-Ridge Vent

BUILT TO LAST

Eliminating water infiltration while providing 100 square inch Net Free Venting Area per 4' unit.



Features:

- ▶ Zero water entry at 110 MPH wind-driven rain.
- ▶ No additional external baffle is needed in the front of vent, saving time and money.
- ▶ Reduces air conditioning maintenance and utility costs.
- ▶ High Quality & Durability - Reduces customer call-backs.
- ▶ Suitable for any roof pitch from 3/12 to 12/12.
- ▶ Keeps insects and critters out.

EXPAND YOUR ROOFING SYSTEM PERFORMANCE
PREVENT LEAKS • PROTECT PROPERTY • ASSURE VENTILATION

INSTALLATION INSTRUCTIONS

VALUE DRIVES EVERYTHING WE DO

Value drives everything we do. That's why we developed a comprehensive line of ventilation products that offer easy installation, remarkable building ventilation, lower utility costs, extended roof deck life, extreme durability, and outstanding warranties. Get more quality, more performance, and more value...from Marco Industries.™

EASY INSTALL

See our installation online at marcoindustries.com

1. Space vent openings evenly across ridge. The opening size should be a minimum of a 2½" by 46" cut between two sets of rafters. Note: Do not cut into rafters.
2. If shingle have previously been installed on the roof, remove the shingles around sides and top of opening to provide space to install vent as per instructions.
3. Shingle courses should be installed close to deck opening so that the front flange of the vent completely covers unexposed section of shingle.
4. Position the vent to cover the last course of shingles, leaving the proper exposed section of shingle at the side flanges of vent. Center vent over the opening of the deck. Apply approved sealant under front flange of vent.
5. Fasten side and top flanges securely with minimum 1¼" standard roofing nails. Space nails approximately 4" on the center and approximately 1½" from outer edge of flange.
6. Secure the bottom flange with provided wood screws. Space screws evenly no more than 18" apart. A 4 ft. vent will require a minimum of 2 screws.
7. Apply roof cement on side and top flanges. Completely cover flanges 2" beyond flange onto underlayment with ¼" thick bed of plastic roof cement.
8. Cut shingles to fit so flanges are completely covered. Press shingles into place to ensure they are bonded to the cement. Fasten shingles with nails per shingle manufacturer's instructions.



SPECS:

Dimensions: Width 23 1/2" - x Height 3 1/4"

Material: 26 - gauge galvalume

Codes & Standards: FL Building Code

Roof Pitch: Conforms to any pitch from 3/12" to 12/12"

Color: Black, Weatherwood, Galvalume

Patents: Pending

Nominal Lengths: 4'

Screws: 1 3/4" Wood Type for Bottom Flange (not included)

Vent Hood: Mini louvers in lower portion of hood block water.

Interior Louver Panel: Mini louvers in opposite direction to louvers on lower portion of hood as second water barrier

Internal Baffle: Placed at the top of the vent pan, the internal baffle is the third line of defense against water intrusion.



1.800.800.8590 / Marcoindustries.com



YOU CAN'T STOP THE STORMS... BUT YOU CAN STOP THE LEAKS

Keep your attic cool and dry with Marco's never-seen-before Weather-Tite technology!



The upward-facing baffles on the front of the vent prevent wind-driven rain from entering.



If water does enter the vent, our proprietary Weather-Tite non-woven material acts as a barrier between the upward-facing baffles and interior baffles.

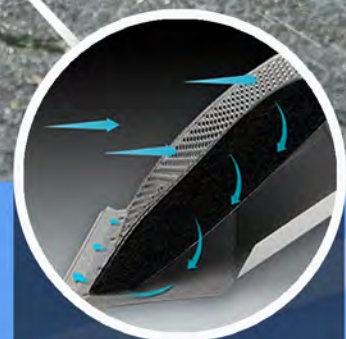

If the wind is extra strong and water somehow gets past the non-woven barrier, the water will be caught in the interior drip pan and will run out the front – keeping your attic dry!



1-800-800-8590 / Marcoindustries.com



ROUND DUCT EXHAUST VENT

A HIGH-EFFICIENCY EXHAUST VENT

This easy-to-install exhaust vent is designed for pitched roofs and compatible with 3" to 4" ducting. It is not suitable for use as a dryer vent. The unit includes a built-in backdraft damper to stop outside air from entering the home, along with a bird screen to prevent birds and other small animals from accessing the ductwork.

(Collar not included.)



Steel 3"-4" Round Duct Exhaust Vent Dimensions and Specifications

Base: 9-1/4" x 11"

Gauge: 26 Gauge galvanized steel.

Vent Height: 4-1/2"

Finish: Black, high-performance polyester powder-coat for corrosion & UV resistance.

Vent Width: 5-5/16"

Vent Length: 8-1/4"



1-800-800-8590 / Marcoindustries.com

MARCO INDUSTRIES™
Roofing Ventilation & Accessories

50 Square Vent

EXCEPTIONAL PERFORMANCE

The only static vent on the market with a turned down baffle.

This creates wind turbulence and keeps wind-driven rain, insects, vermin and debris out of the attic.



Features:

- ▶ A square vent made with no-break polypropylene material that provides 50 square inches of NFA (Net Free Area) per vent.
- ▶ The turned down baffle is made possible with living hinge technology, meaning the baffle is molded and then folded into place during vent assembly.
- ▶ Can be installed over standard size holes on re-roofs and its low profile design makes it more discreet and enhances curb appeal.

EXPAND YOUR ROOFING SYSTEM PERFORMANCE
PREVENT LEAKS • PROTECT PROPERTY • ASSURE VENTILATION

INSTALLATION INSTRUCTIONS

VALUE DRIVES EVERYTHING WE DO

Value drives everything we do. That's why we developed our Steep Slope Ventilation Division. This comprehensive line of products offer easy installation, remarkable building ventilation, lower utility costs, extended shingle and roof deck life, extreme durability, and outstanding warranties. Get more quality, more performance, and more value... from Marco Industries™

EASY INSTALL

See our installation online at marcoindustries.com

1. Locate the roof vents toward the rear or side of the house spaced evenly over the width of the roof.
2. Mark the location of all roof vents before cutting holes. Cut the hole in the roof deck to closely match the hole in the vent. Center the holes between the rafters down two feet (24") from the peak of the roof. When installed as an intake vent, position vent at two feet (24") from the eave or edge of the roof. Ensure that attic insulation does not block intake vent.
3. Install shingles until the bottom of the hole is covered. Cut the excess shingles away. Apply an approved sealant around the edge of the hole.
4. The top of the vent has an arrow at the top of the flashing to install facing the ridge. Ensure that the vents are installed to the up-arrow position.
5. Secure the vent base with a minimum of 6 galvanized nails. Nails should be a minimum of 1 1/4" long and should penetrate the vent, shingle, and decking. Secure a nail in each corner of the vent flashing and along the middle of each side of the vent.
6. For proper sealing, use a plastic-friendly roofing sealant. All nails should receive a dab of sealant.
7. Install shingles around the vent ensuring that the shingles butt up against the throat of the vent.
8. Pre-cut the top shingle to fit around the top side of the vent throat and nail in place. Install shingles as normal.

SPECS:

Net Free Area: 50 square inch per vent

Material: No break polypropylene

Codes & Standards: CSA

Roof Pitch: Conforms to any pitch from 3/12 to 12/12

Color: Black, Brown, Weather Wood

Patents: Pending

Height: 4.45 inches

Flashing Size: 17.75" x 17.75"

Hood Dimensions: 13" x 13"



Weather-Tite™ 60 Square Vent

EXCEPTIONAL PERFORMANCE

The only static vent on the market with a turned down baffle.

This creates wind turbulence and keeps wind-driven rain, insects, vermin and debris out of the attic.



Features:

- ▶ A square vent made with no-break polypropylene material that provides 60 square inches of NFA (Net Free Area) per vent.
- ▶ The turned down baffle is made possible with living hinge technology, meaning the baffle is molded and then folded into place during vent assembly.
- ▶ Can be installed over standard size holes on re-roofs and it's low profile design makes it more discreet and enhances curb appeal.

EXPAND YOUR ROOFING SYSTEM PERFORMANCE
PREVENT LEAKS • PROTECT PROPERTY • ASSURE VENTILATION

INSTALLATION INSTRUCTIONS

VALUE DRIVES EVERYTHING WE DO

Value drives everything we do. That's why we developed our Steep Slope Ventilation Division. This comprehensive line of products offer easy installation, remarkable building ventilation, lower utility costs, extended shingle and roof deck life, extreme durability, and outstanding warranties. Get more quality, more performance, and more value... from Marco Industries™

EASY INSTALL

See our installation online at marcoindustries.com

1. Locate the roof vents toward the rear or side of the house spaced evenly over the width of the roof.
2. Mark the location of all roof vents before cutting holes. Cut the hole in the roof deck to closely match the hole in the vent. Center the holes between the rafters down two feet (24") from the peak of the roof. When installed as an intake vent, position vent at two feet (24") from the eave or edge of the roof. Ensure that attic insulation does not block intake vent.
3. Install shingles until the bottom of the hole is covered. Cut the excess shingles away. Apply an approved sealant around the edge of the hole.
4. The top of the vent has an arrow at the top of the flashing to install facing the ridge. Ensure that the vents are installed to the up-arrow position.
5. Secure the vent base with a minimum of 6 galvanized nails. Nails should be a minimum of 1 1/4" long and should penetrate the vent, shingle, and decking. Secure a nail in each corner of the vent flashing and along the middle of each side of the vent.
6. For proper sealing, use a plastic-friendly roofing sealant. All nails should receive a dab of sealant.
7. Install shingles around the vent ensuring that the shingles butt up against the throat of the vent.
8. Pre-cut the top shingle to fit around the top side of the vent throat and nail in place. Install shingles as normal.

SPECS:

Net Free Area: 60 square inch per vent

Material: No break polypropylene

Codes & Standards: CSA, CCMC

Roof Pitch: Conforms to any pitch from 3/12 to 12/12

Color: Black, Brown, Weather Wood

Patents: Pending

Height: 4.45 inches

Flashing Size: 17.75" x 17.75"

Hood Dimensions: 13" x 13"





Roofing Ventilation & Accessories

65 SLANT BACK VENT

STAYS SOLID. BUILT TO LAST.

A compact, square-top static roof vent that's built for the long-term protection of asphalt shingle roof systems.

Engineered for durability, installer confidence, and dependable ventilation performance. The 65 slant back incorporates structural ribs that enhance rigidity and strength, reinforcing structural integrity and providing peace of mind.

Features:

- ▶ **Structural Ribbed Hood Design**
Engineered ribs enhance rigidity and and reinforce durability.
- ▶ **Built for Strength & Reliability**
Rigid construction holds shape during installation and maintains durability over time.
- ▶ **Installer-Friendly Design**
Delivered fully assembled and ready to install. Fastens securely to the roof deck beneath shingles using standard roofing practices.
- ▶ **Compact Footprint & Clean Roofline Appearance**
Square-top profile supports efficient placement and a clean finished look after installation.
- ▶ **Ventilation & Weather Management**
Supports balanced attic airflow to help reduce heat and moisture buildup. Watershedding geometry helps manage wind-driven rain while maintaining reliable performance. Provides 65 sq. in. net free area (NFA).



EXPAND YOUR ROOFING SYSTEM PERFORMANCE
PREVENT LEAKS • PROTECT PROPERTY • ASSURE VENTILATION

INSTALLATION INSTRUCTIONS

VALUE DRIVES EVERYTHING WE DO

Value drives everything we do. That's why we developed a comprehensive line of ventilation products that offer easy installation, remarkable building ventilation, lower utility costs, extended roof deck life, extreme durability, and outstanding warranties. Get more quality, more performance, and more value...from Marco Industries.™

EASY INSTALL

See our installation online at marcoindustries.com

1. Identify the roof vent locations toward the rear or sides of the home. Space vents evenly across the width of the roof.
2. Before cutting any openings, mark all vent locations. Holes should be centered between rafters and positioned 24 inches down from the roof peak. When installing the vent as an intake, place it 24 inches up from the eave or roof edge. Make sure attic insulation does not obstruct the intake opening.
3. Cut an opening measuring 11 inches high by 10 inches wide. Do not cut the roof opening larger than the vent's bottom opening.
4. Install shingles up to the point where they cover the lower edge of the opening, then trim away excess material. Since shingles are part of a porous roofing system, apply an approved sealant around the perimeter of the opening.
5. The top of the Slant Back Vent is angled. Be sure the vent is installed with the slanted peak facing upward.
6. Attach the vent base using at least eight galvanized nails. Nails must be a minimum of 1¼ inches long and penetrate the vent, shingles, and roof decking. Place one nail in each corner of the flashing and one centered along each side.
7. For watertight seal, use a roofing sealant that is safe for plastic materials. Apply a small amount of sealant over each nail head.
8. Shingle up and around the vent ensuring that the shingles butt up against the throat of the vent.
8. Continue shingling up and around the vent, ensuring the shingles fit snugly against the vent throat.
9. Cut the top shingle to match the slope of the vent, secure it in place, and continue shingling normally to finish the installation.

SPECS:

Dimensions: 16.5" x 19.5"

Construction Details: High Wind Deflector prevents wind driven rain from entering vent.

Durability: Holds shape and maintains performance due to structural reinforcement. Corrosion-resistant and built for long-term exposure.

Codes & Standards: TDI (pending)

Roof Pitch: Conforms to any pitch from 3/12 to 12/12

Color: Black, Brown, Weatherwood

Material: UV-stabilized, high-impact engineered resin

Net Free Venting Area: 65 sq. in. per vent



TDI (pending)



1.800.800.8590 / Marcoindustries.com

MARCO INDUSTRIES
Roofing Ventilation & Accessories



Roofing Ventilation & Accessories

LOW PROFILE Dryer Vent

PROTECT YOUR ROOF

and everything underneath
by removing hot, moist air
and lint buildup from your
dryer to the outdoors.



Features:

- ▶ Removeable Cap for Easy Cleaning
- ▶ 110MPH Wind Driven Rain Tested
- ▶ Eliminate Call Backs From Leaks
- ▶ Dryer Vent Collar Included
- ▶ Easy to Install
- ▶ Keeps out insects, critters and rain

EXPAND YOUR ROOFING SYSTEM PERFORMANCE
PREVENT LEAKS • PROTECT PROPERTY • ASSURE VENTILATION

INSTALLATION INSTRUCTIONS

LOCATION OF DRYER VENT

1. It is recommended to position dryer vent on roof deck directly above location of the dryer or as close as possible for most efficient exhaust of lint.
2. Once location is determined cut hole in roof deck (5"x5" hole or 5" round).
3. Insert the collar into hole and fasten to roof deck with at least 4 nails.
4. Apply roof cement on the side and top flanges of the collar. Completely cover flanges and approximately 2" beyond flanges onto underlayment with 1/4" thick bed of plastic roof cement.
5. Attach dryer duct to collar on attic side of roof deck.

POSITION AND SECURE

1. Place vent so that inner collar attaches to the dryer ducting in the attic.
2. Install shingles so that the bottom flange on vent covers over the unexposed portion of the shingle.
3. Apply an industry approved sealant under the front flange of the vent.
4. Using the holes provided on the flanges, fasten side and top flanges securely with minimum 1.25" standard roofing nails.

SHINGLE INSTALLATION

1. Apply roof cement on the side and top flanges. Completely cover flanges and approximately 2" beyond flanges onto the underlayment with 1/4" thick bed of plastic roof cement.
2. Install shingles, cut to fit so flanges are completely covered. Press into place to ensure a complete bond of cement to shingles. Fasten shingles with nails as per shingle manufacturer's instructions. However, do not place any nails within 3" of the body of the vent.



Specs

Dimensions: 11.75" long x 6.25" wide x 7.25" high (body) 18.25" long x 13" wide (flange)

Material: 26ga galvalume steel

Codes & Standards: FL Building Code,

Color: Black, Galvalume, Weatherwood

Nails: Coil of 13/4" Nails

Roof Pitch: Conforms to any pitch from 3/12

Patents: Pending

Included in Box: One dryer vent and collar per box

Features: Removable hood panel for cleaning interior front baffles that divert wind driven rain



**PATENT
PENDING**

NOTES

- Installers may want to pre-cut shingles to fit prior to applying roof cement. Once the shingles have been pre-cut remove cut pieces, apply roof cement, and install shingles as described above.
- It is highly recommended that the dryer duct be attached to the collar and the vent attached to the cover for the most efficient exhaust lint. However, some re-roof situations may not accommodate the use of the collar, using the collar is optional where duct is exiting through the roof deck.

Combo Bathroom Dryer Exhaust Vent



**Seamless,
Leak-Free Body**

**Exhausts the Bathroom Fan
or Dryer Through the Roof**

**Attaches to 4"
or 5" Inch Duct**

CSA Pending

**Flapper and
Attached Collar**

**Available With
and Without Collar**

EXPAND YOUR ROOFING SYSTEM PERFORMANCE
PREVENT LEAKS • PROTECT PROPERTY • ASSURE VENTILATION

INSTALLATION INSTRUCTIONS

LOCATION OF COMBO BATHROOM DRYER EXHAUST VENT

1. Installed on a sloped, shingled roof to exhaust bathroom fans or dryers by the means of a roof opening.
2. Includes internal damper to reduce back-draft and an exterior grill to prevent the infiltration and nesting of birds, vermin and insects.
3. Once location is determined cut hole in roof deck (5"x5" hole or 5" round).
4. Insert the collar into hole and fasten to roof deck with at least 4 nails.

POSITION AND SECURE

1. Shingle up until the first full course of shingles covers the bottom of the hole.
2. Cut the excess shingles away and install the roof vent using the predrilled nail holes.
3. The top of the roof vent has a molded-in peak. Ensure that the vent is installed in the proper orientation.
4. Do not use roofing tar to seal the vent to the shingles. The wide flange and molded-in water guards will force the water down the roof over the shingles.
5. Use of roofing tar will void any warranty on the Combo Exhaust Vent.
6. Continue installing shingles, overlapping the flange on the vent.
7. Cut the shingles around the top of the vent to match its shape.

ADDING VENTILATION TO FINISHED ROOFS

1. Determine how much additional ventilation is required and the best location for the holes.
2. Inspect the attic to determine the location of rafters and any other obstructions.
3. Mark the holes in the appropriate hole locations on the top of the shingles.
4. Using a sharp knife, cutaway the shingles.
5. Drill a pilot hole and cut through the sheathing using a keyhole saw or electric reciprocating saw.
6. Inspect the hole for size and location and compensate if necessary. If the hole must be modified, ensure that any change will not enlarge the hole beyond the maximum recommended size.
7. Carefully remove the roofing nails within three inches of the hole.
8. Cut the shingles at the top of the hole to accommodate the molded peak of the roof vent.

PART #	DESCRIPTION
CBDEVCBK	Combo Bath/Dryer Exhaust Vent c/w 3"/4" collar, Black
CBDEVCBN	Combo Bath/Dryer Exhaust Vent c/w 3"/4" collar, Brown
CBDEVFBK	Combo Bath/Dryer Exhaust Vent, Flat, Black
CBDEVFBN	Combo Bath/Dryer Exhaust Vent, Flat, Brown

SPECS:

Dimensions: 11.75" long x 6.25" wide x 7.25" high (body) 18.25" long x 13" wide (flange)

Codes & Standards: FL Building Code, Miami-Dade

Color: Black, Brown

Roof Pitch: Conforms to any pitch from 2/12

Included in Box: 12 per Master Carton

Features: One Seamless Unit for Bathroom and Dryer Exhaust



1-800-800-8590 / Marcoindustries.com





Roofing Ventilation & Accessories

Valley Cap™

DESIGNED TO PREVENT LEAKS

Where primary and secondary roofs intersect with valleys.



Advanced Ozone Resistance tested to...	EPDM 70 hour @ 500 pphm
High Temperature Resistance tested to...	Intermittent: +135°C (+275°F) • Continuous: +100°C (+212°F)
Low Temperature Resistance tested to...	-55°C (-67°F)
Compression Set Maximum...	25%

Features:

- ▶ Eliminates bulge and maintains straight ridge line.
- ▶ Adaptable base designed to fit most roof pitches and valley conditions.
- ▶ One piece construction allows for easy on-site installation.

Available in Two Sizes		
Opening	12-1/4" (311mm)	16-1/2" (419mm)
Inner Depth	3" (76mm)	
Overall Height	1-1/4" (31mm)	
Base	11-3/4" x 20-1/8" x 11-3/4" (298x511x298mm)	



1-800-800-8590 / Marcoindustries.com



AG INSTALLATION

1. Prepare the W Valley trim. Make mirror images of each W Valley panel, notching 1" from the outside across the center valley peak, leaving a 1" offset.
2. Take about 9"-10" of the reverse hook, which catches water if it splashes back up under the other side. The points of the center valley peak are critical in terms of alignment. When these are overlapped, the two points will be lined up in the center of the ridge of secondary ridge line.
3. Lay the Valley Cap right over the top securing it with roof sealant and fasteners. Once in place, water will be channeled away from valley and will not get beneath the roof substrate.



STANDING SEAM INSTALLATION

Typically, the difference between a AG Panel Roof and a Standing Seem Snap-Lock Panel Roof are the clips that must be installed on the W Valley.

1. When using a Valley Cap, you must use a separate clip. (That's because you will not be able to place the cleat over the top of the Valley Cap, but you can run this clip over the top of the Valley Cap).
2. When the panel comes in, it hooks over the metal clips and forms a complete water shed, from panel, to Valley Cap into the W Valley.



SECONDARY RIDGE LINES

When a roof has a secondary ridge line that is parallel to the primary ridge line, it may be difficult to install a Ridge Cap since it will be impeded by the secondary roof. A common construction method is to divide the Ridge Cap, fan it out, and press it under the roof panels, which can result in a big bubble beneath the panels that is above the Ridge Cap. The best way to remedy this issue is to install a Valley Cap.

Secondary Ridge Line Installation

1. Place the Valley Cap atop and between both valleys of the roof.
2. Notch the Ridge Cap to accommodate the Valley Cap.
3. Ensure that the Primary Ridge Line is perfectly straight.
4. Place the Secondary Ridge Cap over the Valley Cap.



DETERMINING WHICH VALLEY CAP SIZE TO USE

There are two sizes of valley caps, a 12 1/4" and 16 1/2" throat. To determine which size you need, start at the ridge line of the the secondary ridge, measure out 4", then measure from the center of the valley straight across, 4" out. If that measurement is 12 1/4" or less, you will use the 12 1/4" throat. If that measurement is more than 12 1/4", you will use the larger Valley Cap which has a 16 1/2" throat.



SPECS:

- Advance Ozone Resistance tested to: EPDM 70 hours @ 500 pphm
- High Temperature Resistance tested to: Intermittent: +135C (+275F)
Continuous: +100C (+212F)
- Low Temperature Resistance tested to: -55C (-67F)
- Compression Set Maximum: 25%

Available in Two Sizes		
Opening	12-1/4" (311mm)	16-1/2" (419mm)
Inner Depth	3" (76mm)	
Overall Height	1-1/4" (31mm)	
Base	11-3/4" x 20-1/8" x 11-3/4" (298x511x298mm)	



Bathroom Pipe Flashing

PROTECT YOUR HOME TODAY

The Bathroom Roof Top
Pipe Flashing that
works as a barrier and
a path for water to
flow down and off
your roof effectively.



Features:

- ▶ Slides over pipe - for pitch to 45 degrees.
- ▶ Non-fading and non-cracking, rigid black thermoplastic base.
- ▶ Non-fading, sealing collar
- ▶ Rated 180°F continuous heat.
- ▶ Do not use petroleum-based products on plastic bases or rubber collars.
- ▶ Approved for Type B installations.

Installation:

Installed over a 3 inch to 4 inch plumbing vent stack to seal the roof opening. Press fit application, no sealant needed. The flashing will be secured to the roof and shingled around as part of the roofing application. Features a rigid plastic base.

EXPAND YOUR ROOFING SYSTEM PERFORMANCE
PREVENT LEAKS • PROTECT PROPERTY • ASSURE VENTILATION

Metal Roof Multi-Flash Sealing Vent Adapter

Weather Protection Made of EPDM
These ashings are compounded specifically for maximum resistance to weathering due to ozone and ultraviolet light.

Ribbed Canals
The ribbed canals allow for maximum flexibility, without affecting performance.

Standard or Retrofit Application
Turn the standard application into a retrofit by cutting down the center and adding the stainless steel gripper.

Sleeve Flexibility
Sleeve flexibility absorbs vibration and movement caused by expansion/contraction.

Stainless Steel Gripper & Aluminum
Termination strips for retro applications included.

Adaptable Base
The base is designed to mold to most panel configurations and roof pitches regardless of pipe location.

Applications:

- Turbine Vents • Roof Exhaust Fans
- Metal Roof Vents • Roof Caps
- Goose Neck Air Vent

Available in Three EPDM Colors:
• Black • Gray • Dark Gray

For Roof Vents With A:
Pre-installed metal base for the metal roofing industry.

Roof Vent Sealing Adapter Multi-Flash Flashing Details	
A-Top Opening	Closed
B-Overall Height	1/4" (6mm)
C-Base	24" (609mm)

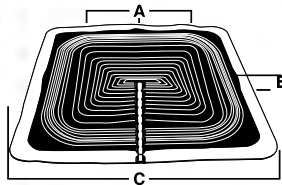

Advanced Ozone Resistance tested to...	EPDM 70 hour @ 500 pphm
High Temperature Resistance • Intermittent	+135°C (+275°F)
Tested to • Continuous	+100°C (+212°F)
Low Temperature Resistance tested to...	-55°C (-67°F)
Compression Set Maximum...	25%

*Complete specification data and testing methods are available upon request.



Roofing Ventilation & Accessories

RoofBoots™

GET A SUPERIOR SEAL, IN A FLASH

Get the roof flashing you need quickly, and rest easy knowing you're getting industry-leading warranties and Weather-Tite performance.



ROOFBOOTS™



Features:

- ▶ Easy, on-site customization for superior fit
- ▶ Sleeve flexibility absorbs vibration and pipe movement caused by expansion/contraction.
- ▶ Maximum resistance to ozone weathering
- ▶ Available in black or grey EPDM, red or grey silicone, or colors upon request
- ▶ The first ICC-listed flashing in the metal building industry with a 35-year warranty (available on black EPDM only)
- ▶ Square or circular flexible sleeve

EXPAND YOUR ROOFING SYSTEM PERFORMANCE
PREVENT LEAKS • PROTECT PROPERTY • ASSURE VENTILATION

VALUE DRIVES EVERYTHING WE DO

Value drives everything we do. That's why we developed a comprehensive line of ventilation products that offer easy installation, remarkable building ventilation, lower utility costs, extended roof deck life, extreme durability, and outstanding warranties. Get more quality, more performance, and more value...from Marco Industries.™

UNIVERSAL ROOFBOOT FLEXIBLE SLEEVE



- Easy, on-site customization for superior fit
- Sleeve flexibility absorbs vibration and pipe movement caused by expansion/contraction
- Maximum resistance to ozone weathering
- Available in black or grey EPDM, red or grey silicone, or colors upon request
- The proven choice with a 20-year warranty

Specs

Ozone Resistance: 70 hrs @ 500pphm (EPDM and RS)

High Temp. Resistance:

Intermittent: +135°C/+275°F (EPDM), +260°C/+500°F (RS)

Continuous: +100°C/+212°F (EPDM), +225°C/+437°F (RS)

Low Temp. Resistance: -55°C/-67°F (EPDM), -74°C/-101°F (RS)

Compression Set: 25% (EPDM), 50% (RS)

*RS = Red Silicone

	PIPE RANGE	BASE
MINI	0" - 3/4"	4" (101 mm)
#1	1/4" - 2 1/2"	3 1/4" (82 mm)
#2	1 3/4" - 3"	6 1/4" (158 mm)
#3	1/4" - 5"	7 3/4" (234 mm)
#4	3" - 6 1/4"	9 1/4" (234 mm)
#5	4 1/4" - 7 3/4"	10 1/2" (266 mm)
#6	5" - 9"	13" (330 mm)
#7	6" - 11"	14" 1/2" (368 mm)
#8	7" - 13"	16" 1/2" (412 mm)
#9	9" - 19"	25" 1/4" (641 mm)

RoofBoots Colors

Our Universal and Standard RoofBoots are available in black or grey EPDM, red or grey silicone, or these custom colors upon request. *Call for availability.



STANDARD ROOFBOOT SQUARE FLEXIBLE SLEEVE



- Easy, on-site customization for superior fit
- Sleeve flexibility absorbs vibration and pipe movement caused by expansion/contraction
- Maximum resistance to ozone weathering
- The first icc-listed flashing in the metal building industry with a 35 - Year Warranty (Available on black EPDM only)
- Available in black or grey EPDM, red or grey silicone, or colors upon request
- Standard 20-year warranty. 35-year warranty available

Specs

Ozone Resistance: 70 hrs @ 500pphm (EPDM and RS)

High Temp. Resistance:

Intermittent: +135°C/+275°F (EPDM), +260°C/+500°F (RS)

Continuous: +100°C/+212°F (EPDM), +225°C/+437°F (RS)

Low Temp. Resistance: -55°C/-67°F (EPDM), -74°C/-101°F (RS)

Compression Set: 25% (EPDM), 50% (RS)

*RS = Red Silicone

	PIPE RANGE	BASE
MINI	1/8" - 3/4"	2 1/4" (57 mm)
#1	1/4" - 2 3/4"	4 1/2" (114mm)
#2	7/8" - 4"	6" (152 mm)
#3	1/4" - 5 3/4"	8" (203 mm)
#4	2 3/4" - 7"	10" (254 mm)
#5	4" - 8 1/4"	11" (279 mm)
#6	4 3/4" - 10"	12" (279 mm)
#7	5 1/2" - 11 1/2"	14" (355 mm)
#8	6 3/4" - 13 1/2"	17" (431 mm)
#9	9 1/2" - 20 1/2"	25" (635 mm)
MAXI	12" - 28 1/2"	34" (863 mm)

Master-Flex

SELF-ADHESIVE FLASHING TAPE

Master-Flex Master Flash® was created to seal roof seams and areas that are tough to waterproof, such as around chimneys, dormer windows, and adjoining walls.



STICKY ROLL FLAT

STICKY ROLL WAVE

Features:

- ▶ 4 different sizes (Width x Length):
200mm x 5metres · 300mm x 5metres.
450mm x 5metres · 600mm x 5metres.
- ▶ Completely self-supporting and stable.
- ▶ Soft, lightweight and easy to layout.
- ▶ Available in 5 colours: black, graphite, light grey, terracotta red and chocolate brown.
- ▶ Can be applied to various surfaces, i.e. metal, plastic or ceramic.
- ▶ Extends shingle and roof deck life.
- ▶ Environmentally friendly - can replace lead in any kind of roof covering applications.
- ▶ Obtainable in two types: Flat for Standard applications and Wave for increased shaping capabilities where more stretch is needed.

EXPAND YOUR ROOFING SYSTEM PERFORMANCE
PREVENT LEAKS • PROTECT PROPERTY • ASSURE VENTILATION

INSTALLATION INSTRUCTIONS

VALUE DRIVES EVERYTHING WE DO

Value drives everything we do. That's why we developed our Steep Slope Ventilation Division. This comprehensive line of products offer easy installation, remarkable building ventilation, lower utility costs, extended shingle and roof deck life, extreme durability, and outstanding warranties. Get more quality, more performance, and more value... from Marco Industries™

MASTER-FLEX MASTER FLASH®

- Specifically for: Abutments, Step Flashings, Chimneys and more!
- Easy to form in valleys and peaks by hand or steel roller.
- Made of EPDM rubber reinforced with stretchable aluminum mesh core for better profiling and shaping on roof tiles or metal roofs with peaks and valleys.
- Environmentally friendly can replace lead in any kind of roof covering applications

STORAGE AND APPLICATION

- Obtainable in two types Flat for standard applications and Wave with increased shaping capabilities for applications where more stretch is needed
- To ensure proper adhesion surfaces must be clean of dust and grime.
- Sticky Roll should be applied at temperatures above 5 °C.
- After applying flashing to the surface press firmly with roller or rubber mallet.
- Do not store Sticky Roll in open sunlight as it can negatively affect butyl adhesive properties. The product should be stored in its original packaging until use.

SPECS

PARAMETER	UNIT	VALUE
Visible Flaws	-	No
Length	M	5 or 10 (0% to +5%)
Width	M	from 0,15 to 0,60 (from 0,5% to +1%)
Straightness	mm	≤50/10
Thickness w/o Butyl Layer	mm	1,5 (± 5%)
Grammage w/o Butyl Layer	kg/mm ²	1,690 (± 5%)
Fire Resistance	Class	E
Watertightness	10k Pa Method B	Watertight
Tensile Strength Longitudinal • Traverse	N/50mm N/50mm	≥200 ≥350
Elongation Longitudinal • Traverse	% %	≥50 ≥29
Static Load	kg	≥20
Impact Durability	mm	≥500

PARAMETER	UNIT	VALUE
Hail Resistance Soft Base • Hard Base	m/s	≥33 ≥22
Tearing Resistance Longitudinal • Traverse	N	≥80 ≥140
Peel-Off Resistance Longitudinal • Traverse	N/50mm	≥1,2 ≥1,1
Shear Resistance Longitudinal Overlap Traverse Overlap	N/50mm	≥60 ≥45
Dimensional Stability Longitudinal • Traverse	%	0,0
Low Temperature Bending	°C	≤40
UV Resistance	1000h	Requirement met
Artificial Aging in High Temperature	8h 100 °C	Requirement met



Box Gutter Expansion Joint

Product Details

- 9" (228mm) width
- 059 mm thick
- 12', 33', and 50' lengths available
- Made of grey ozone resistant EPDM
- 20-year warranty

Applications

- Transition Walls
- Parapet Walls
- Stepped Roofs
- Corrugated Metal Roofs
- Roof Penetrations
- Expansion Joint
- Skylights

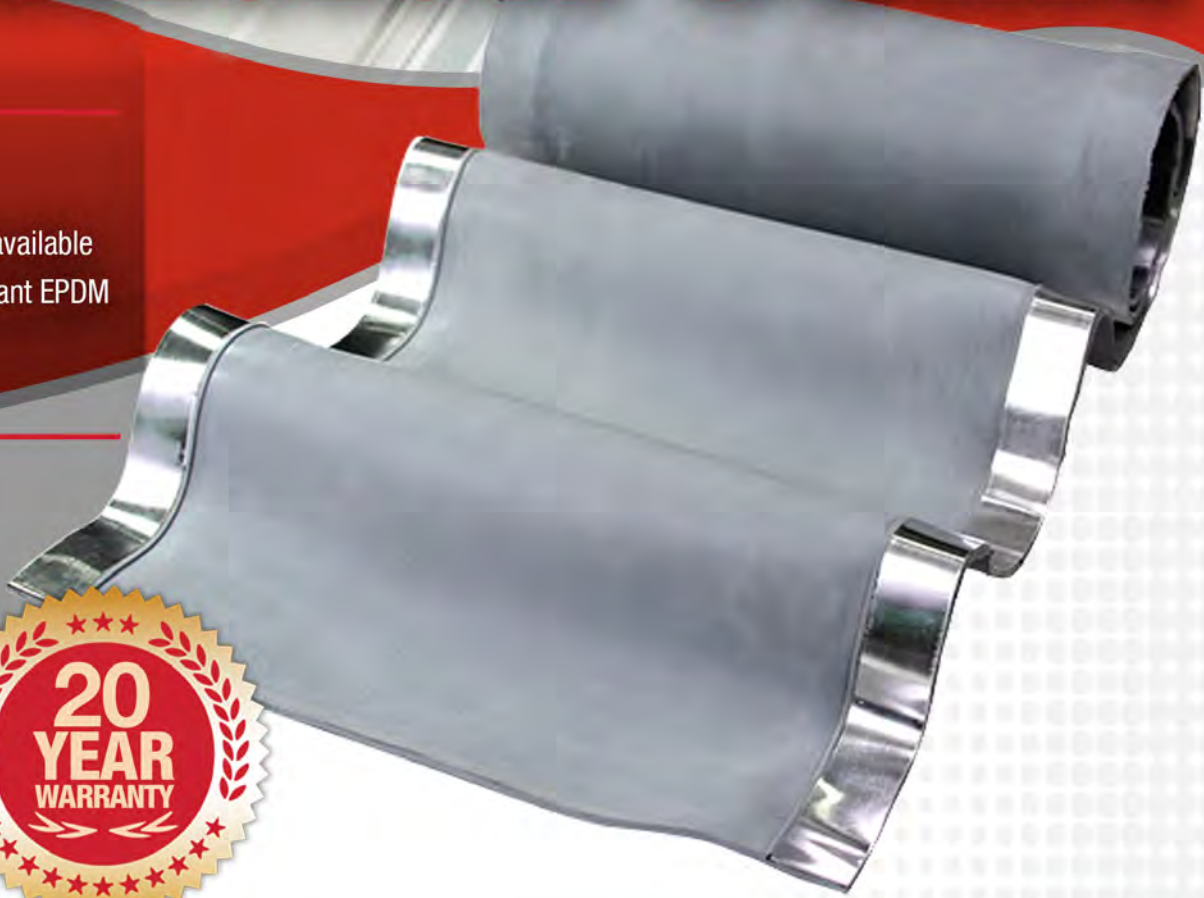

Box Gutter Expansion Joint

Compound	Part No.	Flashing Details
Grey EPDM	MFBGE912	9" wide 12' long (9" x 12')
Grey EPDM	MFBGE933	9" wide 33' long (9" x 33')
Grey EPDM	MFBGE950	9" wide 50' long (9" x 50')

Universal Foam



A VERSATILE SOLUTION

- ▶ Designed to fit a wide range of panel configurations and sizes.
- ▶ 25 feet per roll, providing ample material for multiple uses.
- ▶ Adhesive included on one side of foam for easy application.
- ▶ Flexible polyurethane foam, semi-close cell.

PART NUMBER	DESCRIPTION	ROLL PER BAG	BAGS PER PALLET
12-112-25P	1 1/2" x 1 1/2" x 25' W/PSA	20 per bag	10 bags per pallet
10-100-25P	1" x 1" x 25' W/PSA	20 per bag	14 bags per pallet
11-200-25P	1 1/2" x 2" x 25' W/PSA	20 per bag	6 bags per pallet

X-SEAL™ Expandable Foam Tape

CREATE A BREATHABLE EXPANDABLE SEAL

A hermetic seal that allows the absorption of moisture and when conditions permit, the slow release of moisture through evaporation.



Features:

- ▶ Follows, flexes, expands, compresses to fit.
- ▶ Expands from 1/4" to 1".
- ▶ Highly resistant to bugs and vermin.
- ▶ Universally adaptable to most roof panels, including hips and valleys.
- ▶ Expands from 3/8" to 1 1/2".
- ▶ Maintains seal in heat and cold.
- ▶ Holds the exterior out and the interior in, yet allows vapors to move through.
- ▶ Will not leech out or stain.
- ▶ A economical alternative to conventional sealants.

EXPAND YOUR ROOFING SYSTEM PERFORMANCE
PREVENT LEAKS • PROTECT PROPERTY • ASSURE VENTILATION

INSTALLATION INSTRUCTIONS

VALUE DRIVES EVERYTHING WE DO

Value drives everything we do. That's why we developed a comprehensive line of ventilation products that offer easy installation, remarkable building ventilation, lower utility costs, extended roof deck life, extreme durability, and outstanding warranties. Get more quality, more performance, and more value...from Marco Industries.™



Before Expansion



Expansion



X-Seal Roll

X-Seal's versatility makes it perfect for sealing gaps in so many construction projects, between similar and dissimilar materials:

- Joints and seams in metal construction
- Around doors and windows
- For control joints, expansion joints and isolation joints in concrete construction
- Civil and underground construction (highway and airport runways)
- Log and prefabricated homes

Specs

Color: Base foam is black, other colors available

Density: 10 lbs./cu Ft. (150kg/m3)

Flammability: UL 94 HF1, Self-extinguishing, DIN 4102, B1 compression at 50%, B2 compressed Temperature Stability

Range: -40° F to 212° F Manufacturer's Lab: -40°C to 120° C

Weather Resistancy: Excellent

Compression Set: Maximum 2%

Tensile Strength: 21.8 psi

Thermal Conductivity: 12,106 BTU (hr.) (ft2) (*F/ft)

EASY INSTALL

See our installation online at marcoindustries.com

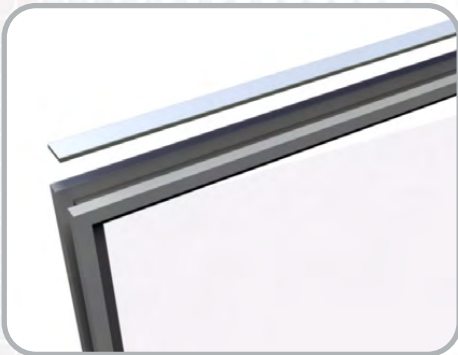

Step 1:

Cut the desired length of X-Seal.

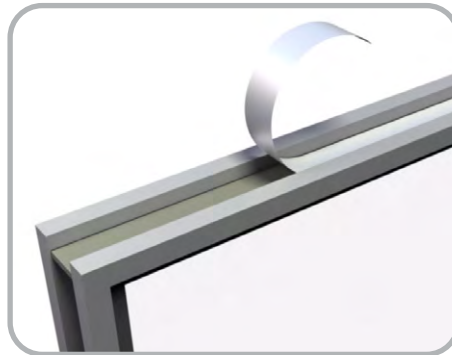

Step 2:

Place X-Seal into the gap opening—even one with irregular hips and valleys—and remove the protective release paper.



Step 3:

X-Seal slowly expand up to 1" to completely fill and seal the gap.



Roofing Ventilation & Accessories

RE2™ Polyethylene Foam Spacer System

SOLVING A COMMON RE-ROOFING PROBLEM

RE2 acts as a spacer between the old shingles and the new metal roof, providing air flow and ventilation.



NAILS INCLUDED

Features:

- ▶ Cost comparable to wood, increases profitability.
- ▶ Eliminate tear-off.
- ▶ Will not decay, corrode or crease metal.
- ▶ RE2 is Sold in two 150-foot, easy-to-handle rolls.
- ▶ No more warped wood furring.
- ▶ Roll it across the old shingled roof, tack it down and install the metal roof on top.
- ▶ Easy to handle and install. Increased installation efficiency.
- ▶ Does not require heavy tools.
- ▶ One box of RE2 is equivalent to 40 furring strips.

EXPAND YOUR ROOFING SYSTEM PERFORMANCE
PREVENT LEAKS • PROTECT PROPERTY • ASSURE VENTILATION

INSTALLATION INSTRUCTIONS

VALUE DRIVES EVERYTHING WE DO

Value drives everything we do. That's why we developed a comprehensive line of ventilation products that offer easy installation, remarkable building ventilation, lower utility costs, extended roof deck life, extreme durability, and outstanding warranties. Get more quality, more performance, and more value...from Marco Industries™

EASY INSTALL

See our installation online at marcoindustries.com



Step 1:

Unroll across existing shingle roof.



Step 2:

Tack with staple gun or nails.

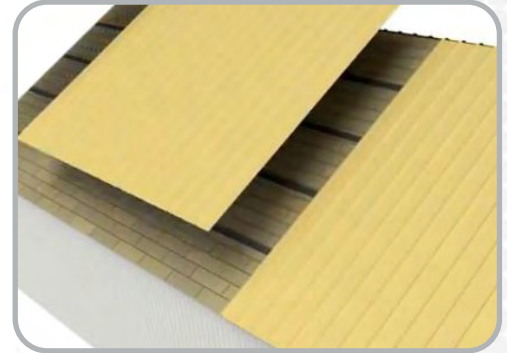

Step 3:

Install the metal roof on top.

Compressive Strength - Vertical direction (psi) (astm d3575-00) 3.8

Surface resistivity (anti-static grade) (EIA std. 541, Section 4.3) $1.0 \times 10^9 - 1.0 \times 10^{12}$ thermal

Compression Set (%) (ASTM d3575-00) >30

Tensile strength (psi) (ASTM d3575-00, suffix t (md / cmd), 58, 30

Elongation (ASTM d3575-00, suffix t (md / cmd), 86, 60

Tear resistance (lb/in) (ASTM d3575-00, suffix g (md / cmd), 11, 17

Density range (lb/ft²) (ASTM d3575-00) 1.5-1.9

Water absorption (lb/ft²) (ASTM d3575-00, suffix l) >0.1

Thermal stability (ASTM d3575-00, suffix s) >5%

Contact corrosivity (alum. Plate) (Method 3005 fed std. 101) None

Static decay (anti-static grade) (EIA std. 541, Appendix f) >2 sec.

conductivity k-value (btu-in / hr-ft²-°f) (ASTM c518-91) 0.35-0.42

Thermal resistance r-value (hr-ft²-°f / btu) (ASTM c518-91) 1.30-1.60



Mastix Butyl Tape

STAYING POWER

Choose the sealant that will stick around before and after installation.



MASTIX

Features:

- ▶ Trimmable joint and end lap sealing tape.
- ▶ Non-staining, permanently flexible.
- ▶ Seals around windows, doors, roof vents, and more.
- ▶ Keeps even hot metal roofing panels in place—no melting or oozing.
- ▶ High quality adhesive.
- ▶ Adhesive prevents the product roll from “telescoping.”
- ▶ Superior adhesive which is end-to-end fit.
- ▶ Joins metal to metal roofing panels.
- ▶ Made in North America

EXPAND YOUR ROOFING SYSTEM PERFORMANCE
PREVENT LEAKS • PROTECT PROPERTY • ASSURE VENTILATION

INSTALLATION INSTRUCTIONS

VALUE DRIVES EVERYTHING WE DO

Value drives everything we do. That's why we developed a comprehensive line of ventilation products that offer easy installation, remarkable building ventilation, lower utility costs, extended roof deck life, extreme durability, and outstanding warranties. Get more quality, more performance, and more value...from Marco Industries.™

EASY INSTALL

See our installation online at marcoindustries.com

Mastix requires no tools for installation. It comes in an easy-to-handle roll and the adhesive is quickly exposed with a simple peel-back.



Step 1:

Roll Mastix Butyl tape out on through-fastened and standing seam panels, removing the release paper to expose adhesive.



Step 2:

Position panel over Mastix.



Step 3:

When positioned, press panel down on Mastix and fasten in place with Quik-Drill™ or QuikGrip™ fasteners.

SPECS:

3/32" x 3/8" x 45': 16 rolls/carton, 30 carton/pallet

3/32" x 1/2" x 45': 16 rolls/carton, 30 carton/pallet

3/32" x 3/4" x 45': 16 rolls/carton, 30 carton/pallet

3/32" x 1" x 45': 12 rolls/carton, 30 carton/pallet

Chemical Name: Isobutylene

Chemical Family: Butyl Mixture

Health Hazard: 0-Minimal

Flammability Hazard: 0-Minimal

Reactivity Hazard: 0-Minimal

Volatile (WL)%: 0

Solubility in Water: Insoluble

Specific Gravity: (H2O=1) 1.59-1.64

Evaporation Rate: Not Applicable

Appearance: Soft, pliable gum

Color: Q-126 (off-white to gray), Q126BB (black), Q-126-10 (off-white to gray)

Odor: None



1.800.800.8590 / Marcoindustries.com





Weather-Tite™ Metal Roof Sealant



**SPECIFICALLY FORMULATED TO OUT PERFORM
ALL OTHER SEALANT TECHNOLOGIES.**

Features:

- ▶ Waterproof seal against water, wind, dust, dirt or other filtrations.
- ▶ Adheres to almost any common building substrate or material.
- ▶ Extrudes in extreme weather conditions (down to 0° F) and is UV-resistant.
- ▶ 18 month shelf life.
- ▶ Chemically curing <1% VOC
- ▶ Tack-free in 40 minutes
- ▶ 14 standard colors

EXPAND YOUR ROOFING SYSTEM PERFORMANCE
PREVENT LEAKS • PROTECT PROPERTY • ASSURE VENTILATION

INSTALLATION INSTRUCTIONS

VALUE DRIVES EVERYTHING WE DO

Value drives everything we do. That's why we developed our Steep Slope Ventilation Division. This comprehensive line of products offer easy installation, remarkable building ventilation, lower utility costs, extended shingle and roof deck life, extreme durability, and outstanding warranties. Get more quality, more performance, and more value... from Marco Industries™

EASY INSTALL

See our installation online at marcoindustries.com

Marco's Weather-Tite Metal Roof Sealant comes in a variety of colors and goes on easily. If touch-ups are necessary, it may be painted (excluding translucent) with a water-based paint after one hour of application.



Step 1:



Step 2:



Step 3:

SPECS:

Water Clean-Up: Yes

Non-Toxic: Yes

Non-Flammable: Yes

VOC-Compliant: <1% VOC

Cold Weather Extrusion: 0° F

Waterproof: Yes

Tensile Strength: 225 psi

Conforms to ASTM C920: Yes

Tack-Free: Tack-Free in 1 Hour @ 77° F / 50% RH\

Gap Filling: 1"

Service Temperature: -75° to 300° F for short periods of time

UV Rating: Conforms to ASTM G26

Elongation: 275%

Cartridge: Plastic – 10.1 oz.

Warranty: Limited

Hazardous Ingredients: None

SAMPLE COLORS:



White



Bright White



Tan



Sandstone



Cocoa Bean



Bronze



Pebble Gray



Gray



Charcoal



Black



Forest Green



Red



Ultra Clear



Translucent





Roofing Ventilation & Accessories



MarcoFlex™

WEATHER-TITE™ • GUNNABLE BUTYL

A NON-SKINNING / NON-HARDENING BUTYL SEALANT THAT PROVIDES EXCELLENT ADHESION



MarcoFlex is a versatile, ever-flexible sealant suitable for metal roofing, architectural panels, lap joints, flashing and many other applications.

Features:

- ▶ Excellent Chemical Resistance
- ▶ Permanently Flexible
- ▶ Non-Corrosive to Metals
- ▶ Excellent Adhesion to Oily Metal Surfaces and Other Materials
- ▶ Low Shrinkage
- ▶ Ideal for use as Seam Sealant in Roll Forming Applications
- ▶ Safe for use on Kynar 500, Zinalume, Galvalume, Aluminum, and most other Metals

Technical Information:

PROPERTIES	VALUE-RESULT	TEST METHOD
Weight:	12-13 lbs./gal.	ASTM D71-72
Color:	Light Gray	Internal Lab
Order:	Light Solvent	Internal Lab
Solids Content:	90% +/- 2%	ASTM C771-74
Vaper Transfer:	<1 gram/day	ASTM D96
Flashpoint:	>102f - non-red label	ASTM D93-79
Slump:	Max 3/16" @ 210f	ASTM D2202
Water Absorption:	None	GSTM 21
Weathering:	None at 1000 hrs.	UV Light / Sunlamp
Service Temps:	-40°F/-40°C to 249°F/120°C	
Storage Temps:	0°F/-18°C to 100°F/38°C	*store in clean, dry area
Shelf Life:	18 months	

EXPAND YOUR ROOFING SYSTEM PERFORMANCE

PREVENT LEAKS • PROTECT PROPERTY • ASSURE VENTILATION



Roofing Ventilation & Accessories

ALTO8000 SNOW GUARD



A RUGGED SNOW GUARD

Made of 16-gauge stainless steel, protect your home's sidewalks and driveways to designed to prevent large amounts of snow from sliding off all at once, protecting people and property below. Enjoy years of maintenance-free protection.



- Easy Installation
- Powder-Coated Finish
- 28 Standard Colours
- Can Be Mechanically Fastened With Metal-To-Wood Fasteners
- Made In Canada



800.800.8590
marconindustries.com

28 STANDARD COLOURS



ITEM #	DESCRIPTION	QUANTITY
ASGBK01	Black	20 pcs/ctn, 2000 pcs/skid
ASGWT04	Bone White	20 pcs/ctn, 2000 pcs/skid
ASGRD07	Bright Red	20 pcs/ctn, 2000 pcs/skid
ASGWT01	Bright White	20 pcs/ctn, 2000 pcs/skid
ASGRD04	Burgundy	20 pcs/ctn, 2000 pcs/skid
ASGGY09	Charcoal	20 pcs/ctn, 2000 pcs/skid
ASGBN60	Coffee Brown	20 pcs/ctn, 2000 pcs/skid
ASGBN07	Dark Brown	20 pcs/ctn, 2000 pcs/skid
ASGGN25	Dark Green	20 pcs/ctn, 2000 pcs/skid
ASGRD05	Dark Red	20 pcs/ctn, 2000 pcs/skid
ASGBL60	Heron Blue	20 pcs/ctn, 2000 pcs/skid
ASGWT06	Ivory	20 pcs/ctn, 2000 pcs/skid
ASGBN08	Metro Brown	20 pcs/ctn, 2000 pcs/skid
ASGTN55	Pebble Khaki	20 pcs/ctn, 2000 pcs/skid
ASGGY05	Regent Grey	20 pcs/ctn, 2000 pcs/skid
ASGBL03	Slate Blue	20 pcs/ctn, 2000 pcs/skid
ASGGY15	Stone Grey	20 pcs/ctn, 2000 pcs/skid
ASGTN05	Tan	20 pcs/ctn, 2000 pcs/skid
ASGRD49	Tertacotta	20 pcs/ctn, 2000 pcs/skid
ASGRD06	Tile Red	20 pcs/ctn, 2000 pcs/skid
ASGWT05	White White	20 pcs/ctn, 2000 pcs/skid
ASGBK04	Jet Black (Tex)	20 pcs/ctn, 2000 pcs/skid
ASGBN03	Chocolate Brn (Tex)	20 pcs/ctn, 2000 pcs/skid
ASGGY36	Deep Grey (Tex)	20 pcs/ctn, 2000 pcs/skid
ASGGN56	Chrome Green (Tex)	20 pcs/ctn, 2000 pcs/skid
ASGGY51	Graphite Grey (Tex)	20 pcs/ctn, 2000 pcs/skid
ASGBN52	Sepia Brown (Tex)	20 pcs/ctn, 2000 pcs/skid
ASGXXX	Oxide Red (Tex)	20 pcs/ctn, 2000 pcs/skid



Roofing Ventilation & Accessories

Yeti Guard

ELIMINATE MOVEMENT OF SNOW AND ICE WITH YETI GUARD.

A practical, low-cost and aesthetically pleasing solution to the problem of sliding snow and ice off of metal roofing. Featuring a low profile, the forward mounted 3" x 5" snow guard is virtually invisible, UV resistant, and fits most roof panels without rib straddling



YETI GUARD

Features:

- ▶ Highest quality polycarbonate material provides optimal strength
- ▶ UV Resistant
- ▶ Reinforced struts for additional holding power
- ▶ 1.5" based will fit 95+% of roof panels



EXPAND YOUR ROOFING SYSTEM PERFORMANCE
PREVENT LEAKS • PROTECT PROPERTY • ASSURE VENTILATION

YETI GUARD INSTALLATION INSTRUCTIONS

VALUE DRIVES EVERYTHING WE DO

That's why we developed a comprehensive line of ventilation products that offer easy installation, remarkable building ventilation, lower utility costs, extended roof deck life, extreme durability, and outstanding warranties. Get more quality, more performance, and more value...from Marco Industries.™

EASY INSTALL

See our installation online at marcoindustries.com

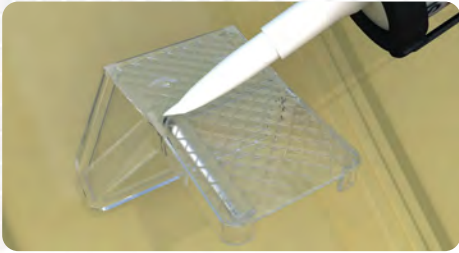

STEP 1:

After cleaning the area, apply adhesive to the back base of the Yeti Guard.



STEP 2:

Screw and tightern two bolts, through the Yeti Guard and the roof metal.



STEP 3:

Install and stagger the Yeti Guards on the metal roof.



YETI GUARD

SPECS:

Dimensions: 3" x 5" 1.5" base

Material: UV stable, Lexan polycarbonate, Thermal Stability

Snow Load: Mechanically fastened (#14 QG) holds over 3400 lbs.

Snow Load: Adhesively attached (SB-190) holds over 1300 lbs.

Color: Clear Color

Eco-Impact: Recyclable, eco-friendly

YOU MAY ALSO NEED:

Surebound Sealant: Sealant for surfaces

Weather-Tite: Metal roof sealant

QuikGrip: Metal and wood fasteners



Roofing Ventilation & Accessories

HydraShell™ Max

SUPERIOR SYNTHETIC PROTECTIVE UNDERLAYMENT

When you need a high strength light weight synthetic roof underlayment, HydraShell™ Max is the choice for you. water resistance, a wrinkle-free surface, and resistance to UV-breakdown.



Features:

- ▶ 25 times stronger than Type 15 felt and 12 times stronger than type 30 felt.
- ▶ Requires fewer fasteners and provides a tough, durable deck cover.
- ▶ Stays flexible in cold weather
- ▶ It installs quickly, easier and with less risk. It's lighter and stronger with a larger covering area.
- ▶ Cool gray surface to reduce heat build-up.
- ▶ Won't wrinkle or absorb water.
- ▶ 30 year limited warranty applies to Max. Contact Marco for more details.
- ▶ Designed for use under all types of roofing materials; including: asphalt shingles, synthetic shingles, cedar shakes, and metal

EXPAND YOUR ROOFING SYSTEM PERFORMANCE
PREVENT LEAKS • PROTECT PROPERTY • ASSURE VENTILATION

MAX UNDERLAYMENT

VALUE DRIVES EVERYTHING WE DO

Value drives everything we do. That's why we developed a comprehensive line of ventilation products that offer easy installation, remarkable building ventilation, lower utility costs, extended roof deck life, extreme durability, and outstanding warranties. Get more quality, more performance, and more value...from Marco Industries™



SPECS:

Roll Dimensions: 40"/300"
 Permeability: 0.1 perms
 Water Transmission: Pass
 Tear Strength: 33lbs MD/24 lbs CD
 Tensile Strength: 95 lbs MD/85 lbs CD
 Burst Strength: 160 psi
 Elongation: 20%
 Weight Per Square: 1.96 lbs
 Nominal Thickness: 6.2 mils
 Temp. Range (Internal): -70° F to 240° F



You May Also Need:

Roof Boots™ / Weather-Tite™ Metal Roof Sealant

EASY INSTALL

See our installation instructions online at MarcoIndustries.com. HydraShell Max is lighter than felt so its easier to handle. It offers more coverage per roll, and is pre-printed with a nailing pattern for easier installation.



STEP 1:

Lay out horizontally on the eave, printed side up, with 3" horizontal laps and 6" vertical laps.



STEP 2:

Fasten with 1" diameter plastic cap roofing nails or cap staples according to the pre-printed nail pattern.

1.800.800.8590 / Marcoindustries.com



HydraShell™ Supreme

DESIGNED TO USE ON STEEPER SLOPE ROOFS

HydraShell™ Supreme has a non-woven walking surface and specially formulated low slip bottom side coating offering a safer installation process.

Features:

- ▶ 20 times stronger than #30 felt. and 12 times stronger than type 30 felt.
- ▶ Less weight per roll. Each 10 square roll weighs less than 26 lbs.
- ▶ Stays flexible in cold weather.
- ▶ It installs quickly, easier and with less risk. It's lighter and stronger with a larger covering area.
- ▶ Cool gray surface to reduce heat build-up.
- ▶ 90-day UV exposure rating.
- ▶ Nonwoven walking surface and specially formulated, low-slip, bottom-side coating.
- ▶ Superior lay-flat properties: won't wrinkle or absorb water.
- ▶ Class A fire rating.

EXPAND YOUR ROOFING SYSTEM PERFORMANCE
PREVENT LEAKS • PROTECT PROPERTY • ASSURE VENTILATION

SUPREME UNDERLAYMENT

VALUE DRIVES EVERYTHING WE DO

Value drives everything we do. That's why we developed a comprehensive line of ventilation products that offer easy installation, remarkable building ventilation, lower utility costs, extended roof deck life, extreme durability, and outstanding warranties. Get more quality, more performance, and more value...from Marco Industries.™



SPECS:

Roll Dimensions: 40"/300"

Permeability: 0.1 perms

Water Transmission (ASTM D4869): Pass

Tear Strength: 38 lbs MD/37 lbs CD

Tensile Strength: 120 lbs MD/115 lbs CD

Burst Strength: 160 psi

Elongation: 20%

Weight Per Square (ASTM D5261): 2.46 lbs

Nominal Thickness (ASTM D1777): 7.5 mils

Temp. Range (Internal): -70° F to 240° F



You May Also Need:

Roof Boots™ / Weather-Tite™ Metal Roof Sealant

EASY INSTALL

See our installation instructions online at MarcoIndustries.com. HydraShell Supreme is lighter than felt so its easier to handle. It comes 10 squares to a roll, offering more coverage per roll, and is pre-printed with a nailing pattern for easier installation.



STEP 1:

Lay out horizontally on the eave, printed side up, with 3" horizontal laps and 6" vertical laps.



STEP 2:

Fasten with 1" diameter plastic cap roofing nails or cap staples according to the pre-printed nail pattern.

1.800.800.8590 / Marcoindustries.com



Roofing Ventilation & Accessories

HydraShell™ Premium

SUPERIOR SYNTHETIC PROTECTIVE UNDERLAYMENT

Premium offers superior strength and durability, dynamic steep-slope traction for a variety of weather conditions, water resistance, a wrinkle-free surface, and resistance to UV-breakdown.

Features:

- ▶ **STRONGER:** than Type 15 or 30 felt and easier to handle during installation.
- ▶ **LIGHTER:** Up to four times lighter than competitive products, making it easier to handle during all installation stages.
- ▶ **RATED FOR:** commercial & residential applications using plastic caps & roofing nails (3/8" head) for a variety of roofing materials.
- ▶ **SIMPLER TO APPLY:** installs quickly, easier and with less risk. It's lighter and stronger with a larger covering area.
- ▶ **WON'T BUCKLE, WARP OR CRACK:** superior lay-flat properties and water resistance keeps Premium from warping, wrinkling, and cracking in cold weather.
- ▶ **WARRANTY:** Lifetime limited warranty applies to Premium. Contact Marco for more details.
- ▶ **SAFER:** skid-resistant polymer coating and proprietary Fiber Claw™ walking surface offers dynamic traction.
- ▶ **Exposure:** 180-day UV exposure rating.

EXPAND YOUR ROOFING SYSTEM PERFORMANCE
PREVENT LEAKS • PROTECT PROPERTY • ASSURE VENTILATION

PREMIUM UNDERLAYMENT

VALUE DRIVES EVERYTHING WE DO

Value drives everything we do. That's why we developed a comprehensive line of ventilation products that offer easy installation, remarkable building ventilation, lower utility costs, extended roof deck life, extreme durability, and outstanding warranties. Get more quality, more performance, and more value...from Marco Industries.™

PROPERTY	STANDARD	UOM
Thermal Stability	ASTM D 882	MD 41/CD 37
Tear Resistance	ASTM D 4533	MD 41/CD 37
Rupture Resistance	ASTM D 3462-02 (LBF)	87
Beach Puncture	ICC AC-08	Pass
Long Term Sag	ICC AC-08	Pass
Liquid Water Transmission	ASTM D 4869-02	Pass
Ultra Violet Aging	ICC-ES AC 188	Pass
Accerlerated Aging	ICC-ES AC 188	Pass

SPECS:

Roll size: 48"x 250' (1.22m x 76.20m)
 ASTM D 226, Type 1 & 2: Standard Specification for Asphalt-Saturated Organic Felt Used in Roofing and Waterproofing.

CSA A123.3 Type I & II: Asphalt Saturated Organic Roofing Felt
 ASTM E 108 – Class A: Standard Test Methods for Fire Tests of Roof Coverings

CSA A 220.1: Acceptance Criteria for Concrete Roof Tile



LIFETIME
LIMITED WARRANTY



EASY INSTALL

See our installation instructions online at MarcoIndustries.com. HydraShell Premium is lighter than felt so its easier to handle. It offers more coverage per roll, and is pre-printed with a nailing pattern for easier installation.



STEP 1:
 Lay out horizontally on the eave, printed side up, with 3" horizontal laps and 6" vertical laps.

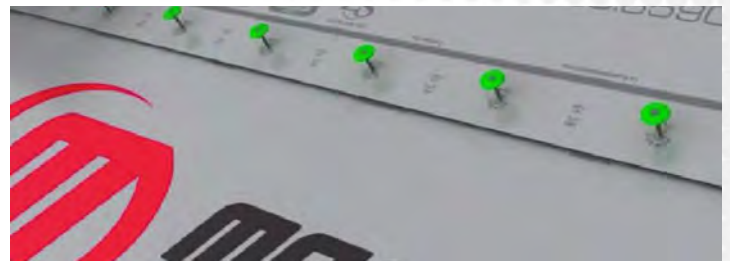

STEP 2:
 Fasten with 1" diameter plastic cap roofing nails or cap staples according to the pre-printed nail pattern.

1.800.800.8590 / Marcoindustries.com

HydraShell™ Supreme SA

**THE BEST CHOICE IN
HIGH-TEMP, EASY TO HANDLE,
SELF-ADHERING UNDERLAYMENT.**

Supreme SA helps to protect a building's deck or internal structure against leaks caused by ice and water damming and wind-driven rain.

Features:

- ▶ Split-back release film peels offer easy installation.
- ▶ Exceptionally durable high tensile/tear strengths.
- ▶ Adheres to a variety of substrates.
- ▶ Polymer-modified asphalt gives excellent pliability.
- ▶ Cool gray surface to reduce heat build-up.
- ▶ 90-day UV exposure rating.
- ▶ Helps to protect structures against leaks caused by ice and water damming and wind-driven rain.
- ▶ Provides superior leak protection for all areas of a standard roof.
- ▶ 30-year limited warranty.

EXPAND YOUR ROOFING SYSTEM PERFORMANCE
PREVENT LEAKS • PROTECT PROPERTY • ASSURE VENTILATION

SUPREME SA UNDERLAYMENT

VALUE DRIVES EVERYTHING WE DO

Value drives everything we do. That's why we developed a comprehensive line of ventilation products that offer easy installation, remarkable building ventilation, lower utility costs, extended roof deck life, extreme durability, and outstanding warranties. Get more quality, more performance, and more value...from Marco Industries.™



SPECS:

Roll Dimensions: 36"/67'
 Roll Weight: 55lbs
 Area Per Carton: 201 ft²
 Cartons Per Pallet: 25
 Permeability(ASTM E96): .067 perms
 Nail Sealability(D1970): Pass
 Adhesion To Plywood @ 75° F (D903): >12 lbs/ft
 Adhesion To Plywood @ 40° F (D903): >2 lbs/ft
 Mill Thickness (ASTM D5147): .44
 Flexibility at -20° F (D1970): Pass
 High Temperature Rating: 240° F
 ASTM D 1970 | ASTM D4869 | CSA A 123.22



You May Also Need:

Roof Boots™ / Weather-Tite™ Metal Roof Sealant

EASY INSTALL

See our installation instructions online at MarcoIndustries.com. HydraShell Supreme SA features a split-back release film that peels off for easy installation. The clean, easy-to-handle, self-adhering application makes installation quick and efficient.



STEP 1:

Tack/secure the end of the roll with a nail.
 Unroll the membrane 3-6 feet.



STEP 2:

Carefully remove the upper release liner, align the membrane and continue to peel the release liner from the membrane in place with **heavy hand or roller pressure**.



STEP 3:

When finished with the desired length, repeat the process at the starting point by removing the remaining poly release film and pressing the membrane in place with heavy hand or roller pressure. Slide laps (horizontal laps) must be a minimum of 3" and end laps a minimum of 6".

1.800.800.8590 / Marcoindustries.com



Roofing Ventilation & Accessories

HYDRASHELL™ AIRX-30

with Sahara Technologies

BREATHABLE SYNTHETIC ROOF UNDERLAYMENT

HydraShell AIRX-30 is a premium multi-layered structure with a slip-resistant textured top surface combined with our advanced breathable Moisture Release Technology (MRT). MRT actively assists in drawing trapped moisture from within the roof system and releasing it to the outside air.

Features & Benefits

- ▶ All temp. All weather performance; remains flexible and easy to install in freezing or extremely hot conditions (-40°F to 240°F)
- ▶ Minimizes stretching around fasteners with no blow-offs!
- ▶ Meets the performance requirements of CAN/CSA A220.1 and CAN/CSA A123.3 synthetic underlayment.
- ▶ Meets ASTM D226 Type I and II and ASTM D4869 Types II & IV.
- ▶ Class A Fire Rating - ASTM E108
- ▶ Moisture Release Technology
- ▶ Excellent water resistance
- ▶ High strength to weight ratio
- ▶ Minimizes stretching around fasteners with no blow-offs!
- ▶ Limited Lifetime Warranty

EXPAND YOUR ROOFING SYSTEM PERFORMANCE
PREVENT LEAKS • PROTECT PROPERTY • ASSURE VENTILATION



HydraShell AIRX-30

Using AIRX-30™ breathable underlayment allows roof decks that have been exposed to rain or snow during construction to dry after the primary roof has been installed. Breathability is key to preventing mold, mildew and possible structural damage. Specifying AIRX-30™ breathable underlayment gives you the competitive edge by providing your clients the confidence and security they are looking for to compliment their premium lifetime warranty roofing system. AIRX-30's textured slip-resistant walking surface provides superior steep-slope walkability, productivity, comfort and increased safety for roofers. AIRX-30™ is designed for use under asphalt shingles, concrete and clay tiles, all metal panels, synthetic shingles and primed cedar shakes. AIRX-30™ meets all the code requirements including ASTM D226, ASTM D4869 and AC 188 as required by ICC-ES.

Test/Standard*	Typical Value
Tensile Strength ASTM D5034	MD 85 lbs (38.5kg) CD 70 lbs (31.7 kg)
Tear Strength ASTM D4533	MD 32 lbs (14.5 kg) CD 25 lbs (11.3 kg)
Liquid Water Transmission ASTM D4869	Pass
Fire Rating ASTM E108	Class A
Puncture Resistance ASTM D751	150 Psi
Permeability (MVTR) ASTM E96	8 Perms
UV Exposure Period ASTM G154	6 Months
Temperature Range	-40° F to 240° F



Roll/Pallet Specs

Length per roll: 250' / 76.2 m
 Width per roll: 48" / 1.2 m
 Weight per roll: 28 lbs / 12.7 kg
 Roll size: 10 sq / 93 m²
 Rolls per pallet: 25
 Weight per pallet: 1230

*Test data is based on average taken over several production runs and should not be considered or interpreted as minimum or maximum values. Values are typical data and not limiting specifications. All values \pm 10 %. This product is manufactured in accordance with national standards which allow for non-critical variances in weights and measures.
 †When correctly installed as per installation instructions. All product installation instructions are available to download or view from our website.

**Switch to AIRX-30
and start saving on
labor, time & money.
Contact us today!**



Roofing Ventilation & Accessories



HYDRASHELL™ MAX-GRIP

A DURABLE UNDERLAYMENT WITH MAXIMUM SURFACE GRIP

MAX-GRIP is a high-performance, self-adhesive roofing underlayment, designed for superior protection against ice and water intrusion.

Engineered with a granulated surface that provides enhanced traction and a firm, confident feel underfoot. The under surface is an easily detachable silicon based release film covering a highly adhesive layer of asphalt.

Features & Benefits

- ▶ **Conforms to** CSA A123.22-08 and ASTM D1970.
- ▶ **Excellent** adhesion to multiple substrates.
- ▶ **Product performance** tear and puncture resistant, rot resistant.
- ▶ **Moisture** vapour barrier.
- ▶ **Size Structor** good dimensional stability.
- ▶ **High** flexibility.
- ▶ **Split** release film for easy application.
- ▶ **Standards** complies with the standards of ASTM D1970 and CSA A123.22-08.
- ▶ **Protects Against** ice and water intrusion that may damage the roofing system.

EXPAND YOUR ROOFING SYSTEM PERFORMANCE
PREVENT LEAKS • PROTECT PROPERTY • ASSURE VENTILATION



HYDRASHELL™ MAX-GRIP

HydraShell Max-Grip

MAX-GRIP is a self-adhesive roofing underlayment constructed of a glass mat carrier coated with our popular blend of SBS polymers, premium asphalt, and additives that gives the membrane the perfect combination of durability and flexibility. **MAX-GRIP** top surface is a sanded layer, and the under surface is an easily detachable siliconbased release film covering a highly adhesive layer of asphalt. **MAX-GRIP** is used as an underlayment on high-sloped roof decks to protect against ice and water intrusion that may damage the roofing system. The sheet is highly effective against possible ridge build-up of ice dams on rakes, eaves, and valleys of steep roofs.

PHYSICAL PROPERTIES

Dimensions	36" x 65'
Nominal Thickness	1.1 mm 43 mils
Nominal Weight	25 kg 55 lbs
No. on Pallet	30 Rolls

Top Surface	Sand
Bottom Surface	Split Release Film
Gross Coverage	18 m ² (197 sqft)
UV Exposure	17m ² (179 sqft)

TEST STANDARDS

TEST PROPERTY	REQUIREMENTS	TEST METHOD
Maximum Load (L, T)	4.4 KN / m	ASTM D2523
Elongation at Break (L, T)	10%	ASTM D2523
Adhesion to Plywood at 4°C, min	0.92 kg/30.5 cm	ASTM D903
Adhesion to Plywood at 23°C, min	5.44 kg/30.5 cm	ASTM D903
Thermal Stability	3 mm	ASTM D1204
Flexibility Temperature	-29 °C	ASTM D1970
Tear Resistance (L, T)	89 N	ASTM D4073
Waterproof Integrity of Lap Seam	Pass	ASTM D1970
Sealability Around Nail	Pass	ASTM D7349
Moisture Vapour Permeance, max	5.7 ng/Pa.S.M ²	ASTM E96
Slip Resistance	Pass	ASTM D1970



Roll/Pallet Specs

Length per roll: 65'
 Width per roll: 36"
 Weight per roll: 55 lbs
 Roll size: 36" x 65'
 Rolls per pallet: 30
 Weight per pallet: 1650 lbs

This Technical Data is the average result of tests, measurements, and trials carried out by MARCO's own laboratory in accordance to international standards such as ASTM, BS, and UEAtc. acceptable deviation according to UEAtc. Nothing contained within the technical tables is represented by a warranty or guarantee for which MARCO can be held legally responsible.

Switch to MAX-GRIP
and experience better
roofing safety with
your underlayment.
Contact us today!

1-800-800-8590 / marcoindustries.com





Roofing Ventilation & Accessories

HYDRASHELL™ WEATHER-TITE HT HT



EXPERIENCE SUPERIOR DURABILITY AND PROTECTION IN ALL WEATHER CONDITIONS

Weather-Tite HT is specifically formulated for high-temperature roofing applications, making it the perfect underlayment for metal roofs, asphalt shingles, and other steep-slope roofing systems. It is particularly effective in regions with high solar exposure or where metal roofing is preferred.

DOUBLE SIDED ADHESIVE LAP SEAL

Features & Benefits

- ▶ **Conforms to:** CSA A123.22-08 and ASTM D1970.
- ▶ **Superior Adhesion** exceptional bitumen-to-bitumen adhesion for watertight seams.
- ▶ **Product performance:** tear and puncture resistant, rot resistant.
- ▶ **High-Temperature Resistance:** Capable withstanding temperatures up to 125°C (257°F) ideal for metal roofing systems.
- ▶ **Split release film** for easy application.
- ▶ **Slip-Resistant Surface:** The anti-slip film provides a safer working surface, even in challenging conditions.
- ▶ **UV Resistant Surface:** Enhanced UV-resistant formulation allows for prolonged exposure to sunlight for up to 12 months without degradation.
- ▶ **Weather-Tite HT Lap Seal:** Engineered over-lap seal, that ensures a superior leak proof seal that will protect the life of your roof.

EXPAND YOUR ROOFING SYSTEM PERFORMANCE
PREVENT LEAKS • PROTECT PROPERTY • ASSURE VENTILATION

HydraShell Weather-Tite HT

Weather-Tite HT is a premium-grade, high-temperature self-adhering roofing underlayment engineered for superior durability and performance. Designed to withstand extreme conditions, this underlayment provides robust protection beneath metal roofs and asphalt shingles. The advanced anti-slip top surface ensures safe and efficient application, while the bottom layer features a high-tack, asphalt-based adhesive with a split-release liner for easy installation.

PHYSICAL PROPERTIES

Dimensions	0.915x20m 36" x 65'
Nominal Thickness	1.2 mm 48 mils
Nominal Weight	26.5 kg 58 lbs
No. on Pallet	30 Rolls

Top Surface	Anti-Slip
Bottom Surface	Split Release Film
Gross Coverage	18.3 m ² 197 sqft
UV Exposure	12 months

TEST STANDARDS

TEST PROPERTY	REQUIREMENTS	TEST METHOD
Compound Stability	> 125°C (257°F)	ASTM D36
Maximum Load (L, T)	4.4 KN / m	ASTM D2523
Elongation at Break (L, T)	10%	ASTM D2523
Adhesion to Plywood at 4°C, min	0.92 kg/30.5 cm	ASTM D903
Adhesion to Plywood at 23°C, min	5.44 kg/30.5 cm	ASTM D903
Thermal Stability	3 mm	ASTM D1204
Flexibility Temperature	-29° C (20°F)	ASTM D1970
Tear Resistance (L, T)	89 N	ASTM D4073
Waterproof Integrity of Lap Seam	Pass	ASTM D1970
Sealability Around Nail	Pass	ASTM D7349
Moisture Vapour Permeance, max	5.7 ng/Pa.S.M ²	ASTM E96
Slip Resistance	Pass	ASTM D1970

Roll/Pallet Specs

Length per roll: 65'
 Width per roll: 36"
 Weight per roll: 55 lbs
 Roll size: 36" x 65'
 Rolls per pallet: 30
 Weight per pallet: 1650 lbs

This Technical Data is the average result of tests, measurements, and trials carried out by MARCO's own laboratory in accordance to international standards such as ASTM, BS, and UEAtc. acceptable deviation according to UEAtc. Nothing contained within the technical tables is represented by a warranty or guarantee for which MARCO can be held legally responsible.

Switch to **Weather-Tite HT
 and experience superior
 durability in extreme weather
 conditions and robust
 protection for your roof.
 Contact us today!**

PROUDLY MADE IN NORTH AMERICA



1-800-800-8590 / marcoindustries.com

Smart Starter

DOUBLE SIDED - SELF ADHESIVE TAPE

PRODUCT DESCRIPTION

Smart Start Tape is a high-performance, SBS-modified double-sided self adhesive tape engineered to enhance the initial stages of roofing installation. Specifically designed for application around the eaves, **Smart Start Tape** provides a superior alternative to traditional starter shingles by creating a secure base that ensures watertight integrity from the outset. This product effectively establishes a durable bond for subsequent ice and water shields.

FEATURES AND BENEFITS

- ▶ **Double-Sided Adhesive:** Extra-tacky adhesive on both sides ensures a robust and reliable seal between the underlayment and shingle, preventing water infiltration.
- ▶ **High Flexibility:** The SBS-modified composition allows for easy application around corners and irregular surfaces, accommodating various roof designs.
- ▶ **Dimensional Stability:** Engineered to maintain its shape and effectiveness under thermal stress, ensuring consistent performance.
- ▶ **Puncture Resistance:** Resilient construction resists damage during installation and protects the roof system over time.

APPLICATIONS

Smart Start Tape is an ideal solution for roofing professionals seeking an efficient and reliable alternative to traditional starter shingles. It is particularly well-suited for use in environments where a secure and watertight bond is critical from the start of the installation process.

EXPAND YOUR ROOFING SYSTEM PERFORMANCE
PREVENT LEAKS • PROTECT PROPERTY • ASSURE VENTILATION

SMART START TEST STANDARDS

PHYSICAL PROPERTIES

Dimensions	0.22x20m • 8.5" x 65'
Nominal Thickness	1.2 mm • 48 mils
Nominal Weight	9 kg • 20 lbs
Tapes / Box	Tapes

Boxes / Pallet	24
Top Surface	Release Film
Bottom Surface	Release Film
Gross Coverage	4.4 M2 • 47.4 SQFT

TEST STANDARDS

TEST PROPERTY	REQUIREMENT	TEST METHOD
Compound Stability	> 115°C (240°F)	ASTM D36
Maximum Load (L, T)	4.4 KN / m	ASTM D2523
Elongation at Break (L, T)	10%	ASTM D2523
Adhesion to Plywood at 4°C, min	0.92 kg/30.5cm	ASTM D903
Adhesion to Plywood at 23°C, min	5.44 kg/30.5cm	ASTM D903
Thermal Stability	3 mm	ASTM D1204
Flexibility Temperature	-29°C (-20°F)	ASTM D1970
Tear Resistance (L, T)	89 N	ASTM D4073
Waterproof Integrity of Lap Seam	Pass	ASTM D1970
Sealability Around Nail	Pass	ASTM D7349
Moisture Vapour Permeance, max	5.7 ng/Pa.S.M ²	ASTM E96
Slip Resistance	Pass	ASTM D1970

This Technical Data is the average result of test, measurements, and trials carried out in accordance to international standards such as ASTM, BS, and UEAtc. acceptable deviation according to UEAtc.



MARCO CANADA FASTENER PROGRAM

QUICKGRIP™

QUICKDRILL™

CANTECH PAINT



Roofing Ventilation & Accessories

Proven Performance. Huge Selection. Marco Quality.

Value drives everything we do. That's why our exclusive Weather-Tite™ System offers everything you need for superior metal cladding installation, right down to the fasteners that hold it all together. Like all our products, Marco fasteners live up to our industry-leading focus on quality and performance. Independent lab testing confirms Marco fasteners stand up to salt spray longer than other leading fasteners, giving you peace of mind for years to come. Get the quality, performance and value you need all from one source: Marco.



Get The Colour You Want, With The Performance You Need.

Marco offers 26 standard in stock colours. All with a premium paint finish that bends and bounces back under stress without the cracking, flaking, or chipping you can get with powder coating. . If you want superior performance and a wide variety of durable colours to match, don't settle for anything less.

Colour samples available upon request.



Marco



Powder Coat

Typical powder coating paint processes can end up cracking, flaking, chipping, and disintegrating under pressure.

QuikGrip Metal2Wood

Our Metal2Wood fastener is designed to attach steel roofing and siding used in post frame and residential metal applications. A high-hex washer head provides driving stability, Hi-Lo and Standard threads deliver superior holding strength, and the Type 17 point makes installation quick. High-quality zinc plating provides extended corrosion resistance while a bonded seal washer creates a truly Weather-Tite seal – even when driven at an angle.

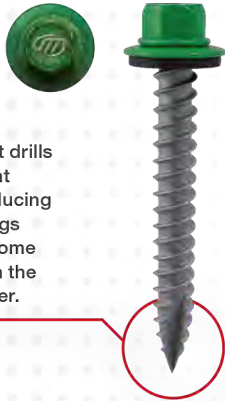

Type 17 point drills with no "point walking," reducing metal shavings that can become embedded in the rubber washer.

Size	Head	Carton Qty	Weight per thous.
10 x 1"	1/4" HWH	3000	7.6lbs
10 x 1-1/2"	1/4" HWH	2500	9.87lbs
10 x 2"	1/4" HWH	2000	12.52lbs
10 x 2-1/2"	1/4" HWH	1500	14.79lbs
10 x 3"	1/4" HWH	1000	17.15lbs

WASHER SIZES
OD
12mm Bonded Washer

Point Diameter	Major Diameter	Minor Diameter	Head Across Flat
26° Type 17	0.188 / 0.194	0.128 / 0.133	0.244/0.250

Point Diameter	Nominal Tensile	Minimum Torsional	Nominal Shear
26° Type 17	2100lbs	68 in-lbs	1265lbs

PULL OUT STRENGTH (LBS ULT)

SUBSTRATES											
Plywood			OSB	Southern Pine		Spruce Pine Fir		Oak	Hemlock Fir		
3/4"	5/8"	1/2"	7/16"	1"	1-1/2"	1"	1-1/2"	1"	1"	1-1/2"	
583	406	430	168	732	1132	580	794	1008	522	900	

PULL OVER STRENGTH (LBS ULT)

MATERIAL			
Designation	AZ55 Galvalume		
Nom. Gauge	29	26	24
Thickness	0.015	0.019	0.024
#10 x .472	345	472	621

QuikGrip Metal2Wood XD

Ideal for wood and light gauge metal with a pre-drilled hole. Our full range of carbon steel self-tapping screws deliver Marco quality proven in installations coast-to-coast.

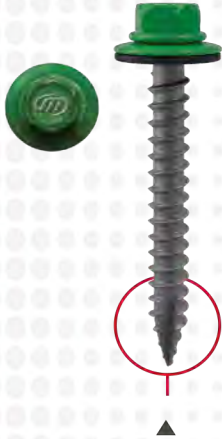

Metal2Wood XD is available
in type 17 point.

Size	Head	Carton Qty	Weight per thous.
14 x 1-1/4"	3/8" HWH	2000	19.16lbs
14 x 1-1/2"	3/8" HWH	2000	21.67lbs
14 x 2"	3/8" HWH	1500	26.2lbs

WASHER SIZES

OD

15mm Bonded Washer

Point Diameter	Major Diameter	Minor Diameter	Head Across Flat
40° Type 17	0.248 / 0.254	0.178 / 0.185	0.367 / 0.375

Point Diameter	Nominal Tensile	Minimum Torsional	Nominal Shear
40° Type 17	3150lbs	125 in-lbs	2150lbs

PULL OUT STRENGTH (LBS ULT)

SUBSTRATES										
Plywood*			OSB*	Yellow Pine		Hemlock	Spruce	HRS Prime Only		
3/4"	5/8"	1/2"	7/16"	1"	1-1/2"	1"	1-1/2"	16/0.065	14/0.070	12/0.106
644	461	402	183	764	1175	586	1064	935	1422	1769

*Full Penetration

PULL OVER STRENGTH (LBS ULT)

MATERIAL				
Designation	AZ55 Galvalume			
Nom. Gauge	29	26	24	22
Thickness	0.015	0.019	0.024	0.032
#14 x .590"	565	671	1014	122

QuikGrip Metal2Wood ClipScrews

Marco QuickGrip Metal2Wood ClipScrews are the ideal choice to attach standing-seam roof clips to plywood. Our full range of carbon steel self-tapping screws deliver Marco quality proven in installations coast-to-coast.



Size	Head	Carton Qty	Weight per thous.
10 x 1"	#2 Phillips Square Pancake	3000	7.25lbs
10 x 1-1/2"	#2 Phillips Square Pancake	2500	9.48lbs
10 x 2	#2 Phillips Square Pancake	2000	12.23lbs

Point Diameter	Major Diameter	Minor Diameter	Head Across Flat
26° Type 17	0.188 / 0.194	0.126 / 0.133	0.440 / 0.460

Point Diameter	Nominal Tensile	Minimum Torsional	Nominal Shear
26° Type 17	1700lbs	68 in-lbs	1175lbs

PULL OUT STRENGTH (LBS ULT)

SUBSTRATES										
Plywood*			OSB*	Southern Pine		Spruce Pine Fir		Oak	Hemlock Fir	
3/4"	5/8"	1/2"	7/16"	1"	1-1/2"	1"	1-1/2"	1"	1"	1-1/2"
584	485	363	199	687	1008	527	748	877	709	1037

*Full Penetration

QuikGrip UltraLo Metal2Wood ClipScrews

QuickGrip UltraLo Metal2Wood ClipScrews offer a 45% lower-than-standard head height, making them the low-profile choice for securing slotted, snap-lock roof panels to plywood, OSB, or wood purlins. The UltraLo addresses common installation problems such as dimpling and canning.



Size	Head	Carton Qty	Weight per thous.
10 x 1"	#2 Phillips Square Pancake	5000	5.71lbs
10 x 1-1/2"	#2 Phillips Square Pancake	2000	7.82lbs
10 x 2"	#2 Phillips Square Pancake	1500	10.47lbs

Point Diameter	Major Diameter	Minor Diameter	Head Across Flat
26° Type 17	0.188 / 0.194	0.126 / 0.133	0.430 / 0.450

Point Diameter	Nominal Tensile	Minimum Torsional	Nominal Shear
26° Type 17	1700lbs	68 in-lbs	1175lbs

PULL OUT STRENGTH (LBS ULT)

SUBSTRATES										
Plywood*			OSB*	Southern Pine		Spruce Pine Fir		Oak	Hemlock Fir	
3/4"	5/8"	1/2"	7/16"	1"	1-1/2"	1"	1-1/2"	1"	1"	1-1/2"
584	485	363	199	687	1008	527	748	877	709	1037

*Full Penetration

QUIKDRILL

Reliable Self-Drilling Performance. Superior Marco Value. Value drives everything we do. That's why our exclusive Weather-Tite™ System includes a full line of dependable QuikDrill™ Metal-To-Metal self-drilling fasteners for attaching metal roofs, sidewalls, and other metal panels with superior Marco performance.

QuikDrill Metal2Metal ClipScrews

Marco QuikDrill screws are to attach standing-seam roof clips to steel purlins or frames. The special low profile design features pancake heads and a deep thread that pulls the fastener tighter and resists pullouts better.



Size	Head	Carton Qty	Weight per thous.
10 x 1"	#2 Phillips Square Pancake	5000	7.38lbs
10 x 1-1/2"	#2 Phillips Square Pancake	2500	10.03lbs
10 x 2"	#2 Phillips Square Pancake	2000	12.45lbs

Point Diameter	Drill Point	Major Diameter	Minor Diameter	Head Diameter
#10	#3	0.188 / 0.194	0.126 / 0.133	0.440 / 0.460

Point Diameter	Nominal Tensile	Minimum Torsional	Nominal Shear
#10	1550lbs	61 in-lbs	1050lbs

PULL OVER STRENGTH (LBS ULT)

MATERIAL				
Designation	HRS PRIMED ONLY			
Nom. Gauge	12	14	16	
Thickness	0.105	0.075	0.060	
#10	1271	1032	723	

Installation Tips

Always choose the appropriate fastener for the thickness and type of material to be drilled for any given application. To ensure optimum fastening performance, a 1900 to 2500 RPM screw gun rated 6 amps or more and fitted with a properly adjusted depth-locating nosepiece should be used. Sufficient pressure must be applied while screw gun is perpendicular to the working area. Overdriving fasteners can lead to leaks and other problems.



A lobe socket grips the fastener on 6 sides to prevent paint chipping which leads to rust. The nosepiece of the drill needs to be set to the correct height for proper washer installation.

CORRECT



INCORRECT



Drive fastener level to metal surface.

QuikDrill Metal2Metal

These self-drilling screws are ideal for light-to-medium gauge metal-to-metal applications. Our QuikDrill Metal2Metal drill points are designed to penetrate a wide variety of metal thicknesses. QuikDrill #3 points utilize a chisel flute that speeds up drilling time and eliminates point walking.



Size	Head	Carton Qty	Weight per thous.
12 x 1"	5/16" HWH	2500	12.21lbs
12 x 1-1/2"	5/16" HWH	2000	15.85lbs
12 x 2"	5/16" HWH	1500	19.15lbs
14 x 7/8"	5/16" HWH	2500	13.00lbs

WASHER SIZE	WASHER SIZE	DRILLING CAPACITY
#12 OD	#14 Stich OD	#12
15mm Bonded Washer	14mm Bonded Washer	0.035"-0.21"

Point Diameter	Drill Point	Major Diameter	Minor Diameter	Head Across Flat	Washer Face Diameter
#12	#3	0.209 / 0.215	0.157 / 0.165	0.305 / 0.310	0.440 / 0.460
#14 Stich	#1	0.240 / 0.246	0.185 / 0.192	0.305 / 0.312	0.398 / 0.432

PULL OUT STRENGTH (LBS ULT)

MATERIAL								
Designation	HRS Primed Only				G-90 Galvanized			
Nom. Gauge	16	14	12	22	18	16	14	12
Thickness	0.065	0.070	0.106	0.031	0.047	0.060	0.072	0.101
#12	805	1128	1495	256	455	619	785	1446

PULL OVER STRENGTH (LBS ULT)

MATERIAL				
Designation	AZ55 Galvalume			
Nom. Gauge	26	24	22	20
Thickness	0.019	0.024	0.032	0.038
#12 with 15mm washer	644	904	1144	1400

Get The Colour You Want, With The Performance You Need.

"Our state of the art, premium paint system finish is all you want for your fastener needs, utilizing the latest coating technology for superior paint adhesion and appearance". Don't settle for typical powder coating or other paint processes that can crack, flake and chip under stress.

Marco's premium paint makes it the most durable paint coating technology in the fastener industry, offering unsurpassed durability and weather resistance.

▶ Marco offers 20 standard in stock colours to meet commonly used colour palettes in the industry. Note: Colours are an approximation, color calibration should be made from actual samples.



M-Clips™

Hidden clips that fasten standing seam roof panels together

A standing seam roof is only as reliable as the clips that hold it all together.

Which is why Marco offers two types of clips made from premium steel, 18- 26-gauge, that will not fail under extreme heat, ice, rain or wind. We've ensured that the utmost quality is in your hands—our clips are completely free of burrs, preventing rust and other corrosion problems. Our clips are also inspected during the production process to guarantee all dimensions will match factory panel specifications.

As opposed to “thru-fastened” roofs, standing seam roofs are made of spring joints that fasten panels together along their edges. Because standing seam roofs are designed to float and the fasteners are concealed, they do not leak. Our clips function in much the same way—they are hidden, fastened to the roof while the panel is pressed down onto the clip, locking it in place. Simple, effective and absolutely reliable.

Whatever your standing seam roof requires—fixed mechanical seam clips, snap lock clips, or ClipScrews—we have you covered with the M-Clips roof clip system. Our Weather-Tite system keeps everything out of sight.

Our statistical process control system maintains all dimensions and met tolerances to ensure the utmost precision and quality. While our competitors' lower grade steel clips may have burrs that cause leaks and rust, our M-Clips™ are made from premium grade steel that are free of burrs. Be sure your project is Weather-Tite™ with Marco's M-Clips.



m-clips™

Mechanical Seam

Our fixed mechanical seam clips keep everything in place—with a slider assembly that can stand up to extreme wind stress. The slider assemblies for panels over 40' allow for thermal expansion between the panels during intense hot or cold temperatures. Heavy duty to withstand all types of environments, including excessive heat, ice and wind.

MANUFACTURER PANEL NAME	CLIP NAME	STANDARD	ALTERNATE	GAUGES
Englert - A1300 Mechanical Seam Standard	1-5/8" Fixed Clip	MRC-107	MRC-128 - Slider Assembly	24
Englert - A1301 Mechanical Seam Special	1-1/8" Fixed Clip	MRC-105	MRC-205 - Slider Assembly	24
Englert - S2500 Mechanical Seam	2-1/8" Fixed Clip - N	MRC-108	MRC-129 - Slider Assembly	24 / 22
ESE - 1" Mechanical Seam	1-1/8" Fixed Clip	MRC-105	MRC-205 - Slider Assembly	24
ESE - 1-1/2" Mechanical Seam	1-5/8" Fixed Clip	MRC-107	MRC-128 - Slider Assembly	24
Knudson - KR-24 2" Mechanical Seam	2-1/8" Fixed Clip - N	MRC-108	MRC-129 - Slider Assembly	24 / 22
Metal Forming - 1" Mechanical Lock	1-1/8" Fixed Clip	MRC-105	MRC-205 - Slider Assembly	24
Metal Forming - 1.5" Mechanical Lock / Quadra Pro - TM	1-5/8" Fixed Clip	MRC-107	MRC-128 - Slider Assembly	24
Metal Forming - 2" Mechanical Lock / Quadra Pro - TM	2-1/8" Fixed Clip	MRC-145	MRC-146 - Slider Assembly	24 / 22
New Tech - SS100 Mechanical Seam	1-1/8" Fixed Clip	MRC-105	MRC-205 - Slider Assembly	24
New Tech - SS150 1.5" Mechanical Seam	1-5/8" Fixed Clip	MRC-107	MRC-128 - Slider Assembly	24
New Tech - SS200P - 2" Mechanical Seam	2-1/8" Fixed Clip - M	MRC-108	MRC-129 - Slider Assembly	24 / 22
Roll Former - VS-150 1" Mechanical Seam	1-1/8" Fixed Clip	MRC-105	MRC-205 - Slider Assembly	24
Roll Former - VS-150 1-1/2" Mechanical Seam	1-5/8" Fixed Clip	MRC-107	MRC-128 - Slider Assembly	-
Roll Former - VS-150 1-1/2" Mechanical Seam Plus 50 Profile	1-5/8" Fixed Clip	MRC-107	MRC-128 - Slider Assembly	24

*Contact Marco for more options.



SLIDER ASSEMBLY

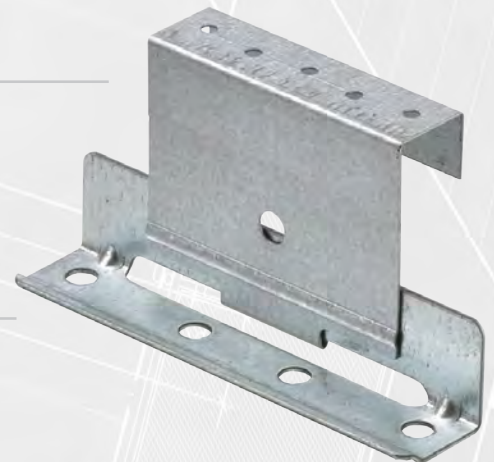

Snap Lock

Our hard-working snap lock clips make attaching roof panels a snap. Use Marco screws to secure and simply snap your roof into place. Heavy-duty to withstand all types of environments, including excessive heat, ice and wind.

MANUFACTURER PANEL NAME	CLIP NAME	STANDARD	ALTERNATE
Englert - A1500 Snap Lock	1-1/2" Snap Lock Clip	MRC-112	MRC-115 - Heavy Duty 3-1/2" Base
Englert - S2000 Snap Lock	1-3/4" Snap Lock Clip	MRC-100	MRC-113 - Heavy Duty 3-1/2" Base
Metal Forming - 1" Snap Seam / Quadra Pro - TM	1" Snap Lock Clip - Heavy Duty	MRC-130	-
Metal Forming - 1.5" Snap Seam / Quadra Pro - TM	1-1/2" Snap Lock Clip	MRC-112	MRC-115 - Heavy Duty 3-1/2" Base
Metal Forming - 1.75" Snap Seam / Quadra Pro - TM	1-3/4" Snap Lock Clip	MRC-101	MRC-114 Heavy Duty 3-1/2" Base
New Tech - SS675 - 1-3/4" Snap Lock	1-3/4" Snap Lock Clip	MRC-101	MRC-114 - Heavy Duty 3-1/2" Base
Zimmerman - SL-1750 1-3/4" Snap Lock	1-3/4" Snap Lock Clip	MRC-101	Heavy Duty 3-1/2" Base

*Contact Marco for more options.

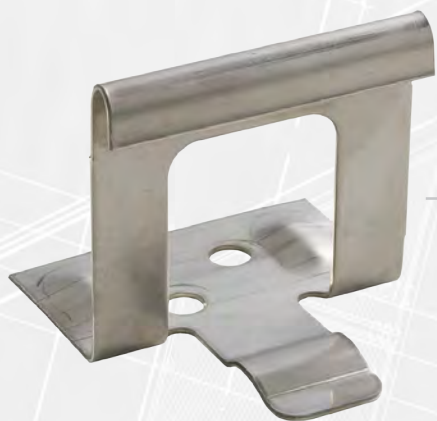

STANDARD

HEAVY DUTY

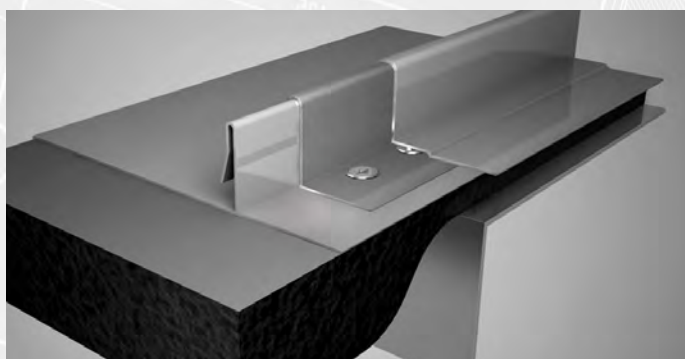

**M - CLIP
INSTALLATION**

ClipScrews & UltraLo Screws

Like all other Marco products, our clip screws are made of heavy-duty alloys that stand up to tough rooftop conditions. Both our ClipScrews and UltraLo models fasten smoothly and securely to prevent canning on roof panels—a hallmark of poor product quality.



ClipScrews

Standard clip screws have regular profile heads. When those regular clip screws don't fasten tight, it can cause dimpled roof panels and result in serious loose panel problems. Problem solved with Marco's low profile ClipScrews – available in both QuikGrip™ and QuikDrill™.

QuikGrip™ and QuikDrill™ ClipScrews™ have a deep thread that pulls the fastener tighter and resists pullout better. And with the 17pt special thread design, you'll get an even quicker drill or grip on 24 and 26 ga. metal.

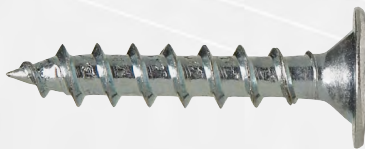

ULTRA LO

For a low profile clip screw that causes absolutely no canning or telescoping – which can add a “wavy” appearance to your standing seam roof – choose Marco's UltraLo ClipScrews.

UltraLo's head is 45% lower than a standard clip screw. It is also designed with an aggressive double lead thread for faster installation. Available in a regular #2 Phillips Square Wafer head and 36° point, this heavy-duty clip screw is made to last.

To make sure that your standing seam roof is truly Weather-Tite, make sure to ventilate the ridgecap with LP2 – a durable, non-woven, and non-wicking custom profile ridge vent that is flame and tear resistant.

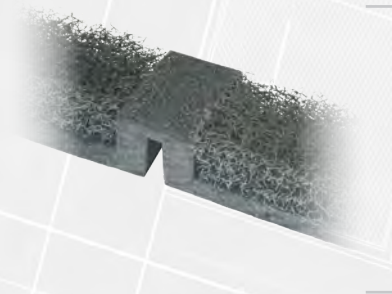

Custom contours fit any pitch, all major metal roof profiles, for either ridge cap application or roof-to-wall applications. LP2™ creates a low-profile look and a seal that helps keep out moisture. Python™ is a single-layer, non-fabric-covered ridge vent re-cycled material made from silicone-coated fibers that prohibit clogging. This strong, durable, modified polyester allows the greatest air flow in and out of the attic. The special cut contours plus a 2" Marco closure create an incredible WEATHER TITE™ seal to help keep out moisture, insects, dust, and plant materials.

M-Clips™ represent yet another Marco Industries technological development in bringing you innovative, higher quality, and more economical products for the building industry.



800.800.8590 - marcoindustries.com

