



# SASH + DOOR HARDWARE

The essential  
products that trade  
professionals rely  
on every day.



Tel: 01752 651330 / [www.sdhardware.co.uk](http://www.sdhardware.co.uk)

## Screws

### Timber Construction Screws

Premium Woodscrews	9
Multi-Purpose Woodscrews	19
Woodscrews	21
Mirror & Decorative Screws	27
Screw Caps & Covers	27
Decking & Timber Screws	29
Coach Screws	34

### Dry-Lining & Collated Screws

Drywall Screws	36
Cement Board Screws	37
Collated Drywall Screws	38
Collated Screws	39

### Metal Construction Screws

Self-Drilling Screws	43
Fibre Cement Board Screws	43
Slash Point Screws	43
Wing-Tip Self-Drilling Screws	44
Washers, Caps & Sheet Fixings	45
Metal Framing Screws	46
Self-Tapping Screws	47
Machine Screws	49

### Window Fabrication Screws

Specialist Window Screws	51
Screws for Reinforced Frames	52
Screws for Unreinforced Frames	53

## Fasteners & Fixings

### Engineering Fasteners

Carriage Bolts	55
Exterior Carriage Bolts	56
Bolts & Threaded Bar	57
Set Screws	58
Nuts & Washers	59
Rivets & Riveters	66

### Stainless Steel Fasteners

Carriage Bolts	62
Socket Screws	63
Set Screws	64
Threaded Bar	64
Nuts & Washers	65

### Hanging & Utility Fixings

Hooks & Picture Hangers	66
Cups Hooks, Screw Eyes & Hooks	67

Storage Hooks & Tool Clips	68
Clips & Pins	68

### Electrical Fittings & Fixings

Cable Ties & Clips	69
--------------------	----

### Plumbing Fittings & Fixings

Sanitary Fixings	70
Pipe Fittings	71
Pipe Clips	73
Hose & Jubilee Clips	74
Jubilee Packs, Kits & Dispensers	77
Jubilee Tools	78

### Assorted Trays

Mixed Trays	79
-------------	----

## Masonry & Cavity Fixings

### Cavity Fixings

Corefix	84
Zip-Fix	85
Stella-Fix	86
Spring Toggles	87
Metal Cavity Anchors	87
Speed Plugs	87
Hammer-In Fixings	88

### Masonry & Insulation Fixings

Plastic, Nylon & Metal Plugs	88
Express Nails	90
Wirehangers	90
Ceiling Anchor & Bracket	90
Vertical Flange Clips	90
Metal Insulations Fixings	91
Plastic Insulation Fixings	91
Discs & Covers	91

### Concrete & Masonry Fixings

Zamac Nail In Anchors	92
Nylon Fixings	92
Masonry Screws	93
Concrete Screws	94
Masonry Bolts	96
Through Bolts	98
Drop-In Anchors	98
Shield Anchors	99
Chemical Anchor Studs	100

### Chemical Resin & Accessories

Chemical Resin	101
Accessories	102



## Nails

### Collated Nails & Fuel Cells

FirmaHold Clipped Head Nails	105
FirmaHold Brad Nails	106
FirmaHold Fuel Cells	107
Paslode Fuel Cells	108
Paslode Nails & Brad Nails	108
Paslode Twisted Shank Nails	108
Staples & Staplers	109

### Loose Nails

Bright & Galvanised Loose Nails	111
Sherardised Loose Nails	113
Copper & Aluminium Loose Nails	113
Stainless Steel Loose Nails	114
Masonry Nails	114
Upholstery Nails & Cut Tacks	114
Polymer Headed Nails & Pins	115

## Powertool Accessories

### Drilling

SDS Plus & Max Hammer Bits	117
Rebar Cutters	118
Masonry Drill Bits	119
Tile & Glass Drill Bits	119
Wood Auger & Flat Bits	120
HSS Drill Bits	122
Step Drills & Countersinks	124
Drill Sets	126

### Cutting

Holesaws & Accessories	128
Dry Diamond Core Bits	130
Diamond Blades	131
Circular Saw Blades	133
Jigsaw Blades	134

Reciprocating Saw Blades	135
Multi-Tool Blades	137

### Abrasives

Hand Sanding	139
Powertool Sanding	140
Powertool Wire Brushes	141
Flap Discs	142

### Chucks, Driver Bits & Adaptors

Chucks, Keys & Adaptors	143
Driver Bits	144
Adaptors & Socket Drivers	147

### Mixing

Mixing Paddles	149
----------------	-----

## Hand Tools

### Striking & Demolition

Hammers & Axes	151
Mallets, Chisels & Bolsters	153
Pry Bars	154

### Bricklaying & Plastering

Trowels & Aluminium Hawk	155
Brick Jointers	157
Plasterers Jab Saw	157
Grouting Float	157

### Sawing & Cutting

Hand, Jab & Tenon Saws	158
Rasp Planes	159
Knives & Blades	159
Scissors	160
Cable & Wire Cutters/Strippers	160
Pipe Shears & Snips	162

### Pliers, Cutters & Wrenches

Cutters & Pliers	162
Wrenches	162
Bolt Croppers	163

### Spanners & Chisels

Spanner Sets	164
Chisels	164

### Screwdrivers & Hex Keys

Screwdriver Sets	165
Bradawl	166
Hex Key Sets	167

### Files & Rasps

File & Rasp Sets	168
------------------	-----

### Clamping

Bar Clamps	169
F & G Clamps	169
Spring Clamps	169

### Levelling, Measuring & Marking

Spirit Levels	170
Measuring Tapes & Wheels	172
Squares & Rulers	173
Chalk, Brick Lines & Ropes	174
Stationery & Levelling Tools	175

### Riveters & Staplers

Riveters & Staplers	176
---------------------	-----

### Preparation & Finishing

Wire Brushes	177
Glass & Tile Scraper	177
Applicator Guns	178



## Adhesives & Chemicals

### Tapes

General Purpose	181
Building	182
Plumbing & Electrical	183
Safety & Hazard	183

### Adhesives, Sealants & Fillers

Contact Adhesives & Superglue	184
Admixtures	184
Wood Adhesives	185
Grip & Fill	185
Adhesive Sealants	186
Sealants & Sealant Remover	187
Acrylic Sealants & Applicator Guns	188
Foams & Applicator Guns	189
Fillers	190

### Metolux

Decor & Wood Fillers	191
Metoset Liquid Mortar	191

### Briwax Woodcare

Finishing Wax & Spray	192
Wax & Sticks	192

### Lubricants & Greases

Multi-Purpose Lubricant	193
Silicone Lubricant	193
Copper Anti-Seize	193
Cutting & Tapping Lubricant	193
Chain Lubricant	193
Graphite Lock Lubricant	193

### Greases & Oils

Lithium Greases	194
2 Stroke & 4 Stroke	195
Chainsaw	195

### Cleaning & Maintenance Sprays

Oil & Grease Remover	196
Adhesive Residue Remover	196
Label Remover	196
Welder's Anti-Spatter	196
Air & Gas Leak Detector	196
Cordless Nail Gun Remover	196

### Paints

Galvanising & Metal Paint	197
Finishing Paint	197
Very High Temperature Paint	197
Primer	197
Stain Concealing Paint	197
Survey & Spot Marker	197

### Barrettine

Barrettine Wood Treatment	198
---------------------------	-----

### Cleaners

Exterior Multi-Purpose	202
Brick, Masonry & Patio	202
Path, Patio & Driveway Sealer	202
Wood / PVCU / Glass	203
Cleaner & Degreaser	203
Grout Cleaner	203
Calcium, Lime & Rust Remover	203



## Site Protection & PPE

### Hand Cleaners, Sanitisers

Hand Cleaners & Sanitisers	205
----------------------------	-----

### Wipes, Rags & Cloths

Wipes	206
Rolls, Rags & Cloths	206

### Site Protection & Refuse

Protective Board	207
Protective Films	208
Dust Sheets	208
Plastic Sheets	208
Tarpaulin & Tie Downs	209
Ratchet Straps & Bungee Cords	210
Lifting Slings	210
Barrier Fencing	211
A Frames Safety Signs	211
Sandbags & Rubble Sacks	211

### First Aid

Workplace First Aid Kits	212
Eyecare & Burn Kits	212
Car & Van First Aid Kit	212
Accident Book	212
Plasters	212

### PPE

Ear Protection	213
Knee Pads	213
Eye Protection	214
Face Shield	216
Safety Masks	217
Gloves	218
Shoe Covers	218
Coveralls	221

### Hi-Vis Clothing

Hi-Visibility Vest	222
--------------------	-----



## Building Hardware

### Builder's Metalwork

Masonry Hangers	225
Timber Hangers	226
Restraints	227
Wall Starter Kits	228
Truss Clips	228
Angle Brackets	228
Flat Connector Plates	228
Herringbone Joist Struts	228
Nail Plates	228
Universal Framing Anchors	228
Timber Connectors	229
Helical Bars	229
Brick Reinforcement Coils	229
Fixing Bands	229
Water Bar	229
Drywall Brackets	229
Cramps & Ties	230

### Building Supplies

Damp Proof Membrane	231
Builders Tape	231
Spacers	232
Roof-line & Above	234
Weeps & Drill Vents	234
Underfloor Ventilation	235
Through-Wall Ventilation	235
Internal Grille Vents	236
Loft Doors & Access Panels	236

## Security & Ironmongery

### Ironmongery

Door & Cabinet Hinges	238
Specialist Hinges	243
Fire Door Hinges & Accessories	245
Door Locks	250
Door Latches & Catches	253
Door Bolts	254
Door & Window Security	255
Furniture Fixings	256
Door Stops & Hooks	258
Hanging Rails & Accessories	259
Storage & Shelving	260

### Security

Padlocks	261
Key Storage & Accessories	262
Chains & Cables	262
Squire	263

## Gate & Fence Hardware

### Gate Hardware

Exterior Gate & Door Hinges	272
Bolts	276
Latches & Catches	280
Hasps & Staples	283
Locks & Handles	285
Gate Kits	287

### Field Gate Hardware

Field Gate Hinge Sets	288
Field Gate Hooks & Eyes	290
Throw-Over Loops	291
Field Gate Wheels	291
Field Gate Catches	292

### Fence Hardware

Fence Post Supports	293
Fencing Accessories	295
Chains and Accessories	297

## Recess Style

- 

**Pozi / Cross Recess**

Standard recess for woodscrews, chipboard screws etc.
- 

**Phillips Recess**

Standard recess for self-drilling, drywall and window screws.
- 

**Combi Recess**

A combination of a traditional slotted recess with a more common pozi recess.
- 











**TX Drive Recess**

High performance recess on C2 Clamp-Fix and TIMCO concrete/masonry screws.
- 

**Square Recess/  
Robertson Drive**

Recess on square drive pan self-drilling and solo screws.

## Head Types

- |   |  |
|---|--|
| <ul style="list-style-type: none"> <li style="border-bottom: 1px solid #ccc; padding: 10px 0;"> <div style="display: flex; align-items: center;">  <div> <p><b>Countersunk</b></p> <p>Designed for countersinking into timber for a flush or recessed finish. May have ribs to assist countersinking.</p> </div> </div> </li> <li style="border-bottom: 1px solid #ccc; padding: 10px 0;"> <div style="display: flex; align-items: center;">  <div> <p><b>Double Countersunk</b></p> <p>Improved design on the countersunk head to give additional head strength and assist countersinking.</p> </div> </div> </li> <li style="border-bottom: 1px solid #ccc; padding: 10px 0;"> <div style="display: flex; align-items: center;">  <div> <p><b>Double Countersunk with Ribs</b></p> <p>Ribs under head to assist with countersinking.</p> </div> </div> </li> <li style="border-bottom: 1px solid #ccc; padding: 10px 0;"> <div style="display: flex; align-items: center;">  <div> <p><b>Shallow Pan Countersunk</b></p> <p>A special head design, to assist with clamping and countersinking.</p> </div> </div> </li> <li style="border-bottom: 1px solid #ccc; padding: 10px 0;"> <div style="display: flex; align-items: center;">  <div> <p><b>Wafer / Flange / Pancake</b></p> <p>Low profile head with a flat underside for applications where a large clamping area and an obstructive head is required.</p> </div> </div> </li> </ul> | <ul style="list-style-type: none"> <li style="border-bottom: 1px solid #ccc; padding: 10px 0;"> <div style="display: flex; align-items: center;">  <div> <p><b>Pan / Round</b></p> <p>Head with a flat underside. Designed for application fixing against metal surfaces.</p> </div> </div> </li> <li style="border-bottom: 1px solid #ccc; padding: 10px 0;"> <div style="display: flex; align-items: center;">  <div> <p><b>Hexagon</b></p> <p>Positive drive hex head with an integral washer to increase clamping effectiveness.</p> </div> </div> </li> <li style="border-bottom: 1px solid #ccc; padding: 10px 0;"> <div style="display: flex; align-items: center;">  <div> <p><b>Bugle</b></p> <p>A curved surface under the head to prevent damage or tearing to the plasterboard paper.</p> </div> </div> </li> <li style="border-bottom: 1px solid #ccc; padding: 10px 0;"> <div style="display: flex; align-items: center;">  <div> <p><b>Socket Button</b></p> <p>Designed for a raised finish with a flat underside to aid clamping.</p> </div> </div> </li> <li style="border-bottom: 1px solid #ccc; padding: 10px 0;"> <div style="display: flex; align-items: center;">  <div> <p><b>Socket Cap</b></p> <p>An industry standard, requiring a hex key to loosen or tighten.</p> </div> </div> </li> </ul> |
|---|--|

## Thread Types

- 

**Self Tapping Thread**

A common thread design, mainly used in steel applications (1-5mm).
- 

**Twin Thread**

Also known as twin lead threads, they are designed to give a fast insertion time in soft material.
- 

**Coarse Thread** (up to 16 TPI)

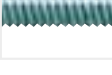
Also known as spaced threads, they are normally used for all timber applications.
- 

**Fine Thread** (over 16 TPI)

Also known as metric threads, they are only used in steel applications. Fine threads are for use with thicker steels. (5 - 12mm thickness).
- 

**Serrated Thread**

Reduces the torque required to install the fastener as well as assisting with the speed of insertion.
- 

**Hi-Lo Thread**

Used in soft timbers, plastics and thin sheet sections. Hi-Lo threads have superior holding power compared to a low TPI coarse thread in these types of material.

## Point Styles

- 

**AB Point**

For use in pre-drilled sheet material applications.
- 

**Needle / Gimlet and Super Sharp Point (SS)**

Designed for piercing timber, MDF, plastic and light gauge metal up to 0.6mm without pre-drilling.
- 

**B POINT**

For use in pre-drilled shallow holes.
- 

**Self Drill Point**

For drilling into metals without the need for pre-drilling.
- 

**C2 Slash**

Twin cut for rapid "pick up" and reduced splitting.
- 

**Type 17 Point**

Also known as slash point, they are used for fixing timber without the need to pre-drill. The cutting edge helps reduce splitting of the timber.

## Gauge / Diameter

The gauge of the screw is determined by the size of the outside thread diameter.

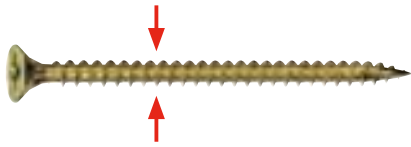

Gauge	Metric (mm)
0g	1.5
1g	1.9
2g	2.25
3g	2.5
4g	3.0
5g	3.3
6g	3.5
7g	3.9
8g	4.2
9g	4.5
10g	4.8
12g	5.5
13g	6.1
14g	6.3
15g	6.5
16g	6.8
18g	7.5
20g	8.1
24g	9.4

## Thread Length

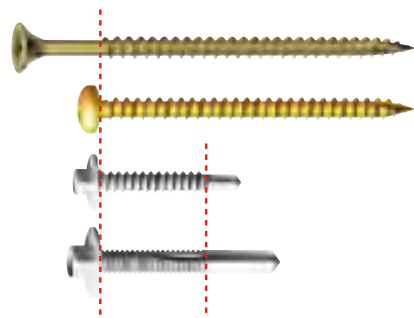

## Threads Per Inch (TPI)

The TPI is the number of thread crests that can be counted within 1" (25.4mm). The closer the thread the faster the insertion time but lower the holding power.

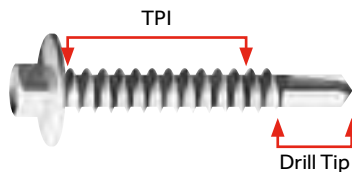

## Measuring Length

Screws with the following head types are measured from the top of the countersunk to the point of the screw:

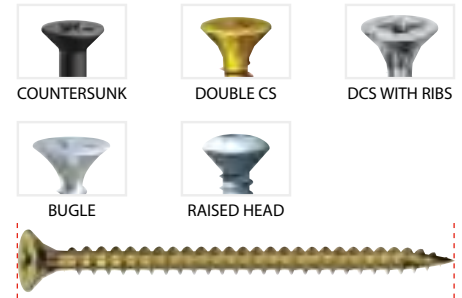

Screws with the following head types are measured from the underside of the head to the point of the screw:

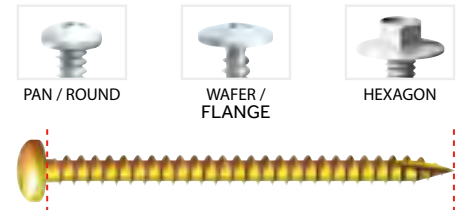

## Metric/Imperial Size Comparison Chart

Listed beside the common imperial sizes are the metric equivalents. Also listed are common 'even' approximate metric equivalents in brackets.

Imperial (inch)	Metric (mm)	Imperial (inch)	Metric (mm)	Imperial (inch)	Metric (mm)	Imperial (inch)	Metric (mm)
1/64"	0.40	27/64"	10.72	27/32"	21.43	3-1/2"	88.90 (90.0)
1/32"	0.79	7/16"	11.11	55/64"	21.83	3-3/4"	95.25 (95.0)
3/64"	1.19	29/64"	11.51	7/8"	22.23 (22.0)	4"	101.60 (100)
1/16"	1.59	15/32"	11.91	57/64"	22.62	4-1/2"	114.30 (115)
5/64"	1.98	31/64"	12.30	29/32"	23.02	5"	127.00 (125)
3/32"	2.38	1/2"	12.70 (13.0)	59/64"	23.42	5-1/2"	139.70 (140)
7/64"	2.78	17/32"	13.49	15/16"	23.81	6"	152.40 (150)
1/8"	3.17 (3.0)	35/64"	13.89	61/64"	24.21	6-1/2"	165.10 (165)
9/64"	3.5	9/16"	14.29 (14.0)	31/32"	24.61	7"	177.80 (175)
5/32"	3.97 (4.0)	37/64"	14.68	63/64"	25.00	7-1/2"	190.50 (190)
11/64"	4.5	19/32"	15.08	1"	25.40 (25.0)	8"	203.20 (200)
3/16"	4.76 (5.0)	39/64"	15.48	1-1/16"	26.99	8-1/2"	215.90 (215)
13/64"	5.16	5/8"	15.88 (16.0)	1-3/32"	27.78	9"	228.60 (230)
7/32"	5.5	41/64"	16.27	1-1/8"	28.58 (28.0)	9-1/2"	241.30 (240)
15/64"	5.95	21/32"	16.67	1-5/32"	29.37	10"	254.00 (250/255)
1/4"	6.35 (6.0)	43/64"	17.06	1-3/16"	30.16 (30.0)	11"	279.40 (280)
17/64"	6.75	11/16"	17.46	1-7/32"	30.96	12"	304.80 (305)
9/32"	7.14	45/64"	17.86	1-1/4"	31.75 (32.0)	13"	330.20 (330)
19/64"	7.54	23/32"	18.26	1-1/2"	38.10 (38.0)	14"	355.60 (350/355)
5/16"	7.94 (8.0)	47/64"	18.65	1-3/4"	45.45 (45.0)	15"	381.00 (380)
21/64"	8.33	3/4"	19.05 (19.0)	2"	50.80 (50.0)	16"	406.40 (400/405)
11/32"	8.73	49/64"	19.45	2-1/4"	57.15 (57.0)	18"	457.20 (455/460)
23/64"	9.13	25/32"	19.84	2-1/2"	63.50 (65.0)		
3/8"	9.52 (10.0)	51/64"	20.24	2-3/4"	69.85 (70.0)		
25/64"	9.92	13/16"	20.64	3"	76.20 (75.0)		
13/32"	10.32	53/64"	21.03	3-1/4"	82.55 (82.0)		

## Plating Guide

**Bright** - Polished only.

**Zinc (CR3)** - A bright Zinc electrolytic plating with a clear toxin free finish. Complies with restrictions of hazardous substances in electrical/electronic equipment (ROHS) directive (2002/95/EC).

**FirmaGalv** - An electro-galvanic plating.

**Black Phos.** - An immersed black phosphate plating for corrosion resistance and lubrication.

**Nickel** - An electroplated, high lustre, corrosion resistant finish.

**FirmaGalv+** - Similar to the electro-galvanic plating on FirmaGalv. This plating provides better corrosion resistance.

**Black** - A zinc electrolytic plating with a black passivation after treatment to enhance corrosion resistance.

**Sherardised** - A dry galvanised, zinc bonded plating.

**Galv.** - An post-manufacturing electro-galvanic plating applied to the product.

**Yellow** - Zinc electrolytic plating and yellow passivated after treatment for enhanced corrosion.

**Exterior** - A superior organic finish which is environmentally friendly and offers excellent resistance to corrosion in outdoor applications. Exterior includes; nano technology, silver, green and brown finishes.

**Mart. SS + Rusp.** - A magnetic, martensitic stainless steel with moderate heat resistance, with silver ruspert plating.

**Pre Galv.** - An pre-manufacturing electro-galvanic plating applied to the product.

**Hot Dipped** - A galvanised zinc plating which gives excellent corrosion resistance.

**A2 SS** - A non-magnetic austenitic steel suitable for many day to day external or corrosive applications offering an excellent resistance to corrosion.

**A4 SS** - Very similar to the A2 SS but more suitable for extremely corrosive applications, including coastal environments.

## Corrosion Ratings



Clean, dry & low humidity environments



Occasionally damp/wet, rural and sheltered areas



Urban & industrial areas with a low salt atmosphere



Urban & industrial areas with a moderate salt atmosphere



Industrial & coastal areas with an aggressive salt atmosphere





# Screws

## Timber Construction Screws

Premium Woodscrews	9
Multi-Purpose Woodscrews	19
Woodscrews	21
Mirror & Decorative Screws	27
Screw Caps & Covers	27
Decking & Timber Screws	29
Coach Screws	34

## Dry-Lining & Collated Screws

Drywall Screws	36
Cement Board Screws	37
Collated Drywall Screws	38
Collated Screws	39

## Metal Construction Screws

Self-Drilling Screws	43
Fibre Cement Board Screws	43
Slash Point Screws	43
Wing-Tip Self-Drilling Screws	44
Washers, Caps & Sheet Fixings	45
Metal Framing Screws	46
Self-Tapping Screws	47
Machine Screws	49

## Window Fabrication Screws

Specialist Window Screws	51
Screws for Reinforced Frames	52
Screws for Unreinforced Frames	53



# C2

## STRONG-FIX PREMIUM SCREW

### FOR ALL ROUND FINISHING STRENGTH



EXTREME  
PULL-OUT  
RESISTANCE



DESIGNED FOR  
SUPERIOR  
HOLD



PRECISION  
PZ DRIVE  
PREVENTS  
"CAM-OUT"

**43%**  
QUICKER\*

**52%**  
LESS TORQUE\*

THE  
**C2**

### TWIN-CUT

1<sup>ST</sup> CUT FOR  
RAPID "PICK-  
UP" AND QUICK  
INSERTION TIME

2<sup>ND</sup> CUT HELPS  
PREVENT WOOD  
SPLITTING WHEN  
SCREWING CLOSE  
TO THE EDGE

\*Compared against a standard woodscrew



### Precision PZ Drive Recess

prevents  
'cam-out', giving  
a precise and  
positive drive  
control on  
every screw.

### Double Countersunk with Ribs

helps improve  
countersinking, giving a  
smooth and flush finish  
whilst also preventing  
splitting and substrate  
damage.

### Helix Shank

helps remove  
debris and  
improve  
clamping.

(From 100mm  
and above only)



### Unique Synthetic Lubrication

reduces insertion torque and  
increases rust protection up  
to 20x longer than a standard  
zinc plating.

### Dual Angle Thread

gives an ultimate performance  
and an exceptionally high pull out  
resistance. (Partially threaded from 80mm)



C2 Strong-Fix Premium  
Screws carry the CE mark  
in compliance with the  
Construction Products  
Regulations  
(Eurocode 5 EN1995-1-1)





## C2 Strong-Fix Premium Screw

Yellow



POZI

EN 14592:2008

CORROSION RATING



Occasionally damp/wet, rural and sheltered areas



HARD & SOFT WOODS



MAN MADE BOARDS



THIN METAL



PLASTIC

Using the most modern manufacturing methods and design techniques, the C2 is a revolutionary high performance multi-purpose screw.

Designed to give ultimate performance in a multitude of materials, the patented twin-cut point gives a consistent and rapid pick-up and reduces timber splitting.

**NEW Industry Pack Available Now!**



Product Code	Size (mm)	Driver Bit Size	Pack Qty (pcs)	Carton Qty (packs)	Pallet Qty (packs)
<b>INDUSTRY PACK (1,000 PCS)</b>					
40030C2IND	4.0 x 30	PZ2	1,000	12	288
40040C2IND	4.0 x 40	PZ2	1,000	12	288
40050C2IND	4.0 x 50	PZ2	1,000	6	144
40060C2IND	4.0 x 60	PZ2	1,000	6	144
40080C2IND	4.0 x 80	PZ2	1,000	6	144
50050C2IND	5.0 x 50	PZ2	1,000	6	144
50060C2IND	5.0 x 60	PZ2	1,000	3	81
50070C2IND	5.0 x 70	PZ2	1,000	3	81
50080C2IND	5.0 x 80	PZ2	1,000	3	81
50100C2IND	5.0 x 100	PZ2	1,000	3	81

TYPE - CC2 SUB TYPE - CC201



C2 Strong-Fix Premium Screw Boxes

Product Code	Size (mm)	Driver Bit Size	Pack Qty (pcs)	Carton Qty (packs)	Pallet Qty (packs)
<b>BOX</b>					
35012C2	3.5 x 12	PZ2	200	140	5040
35016C2	3.5 x 16	PZ2	200	140	5040
35020C2	3.5 x 20	PZ2	200	75	2700
35025C2	3.5 x 25	PZ2	200	75	2700
35030C2	3.5 x 30	PZ2	200	75	1800
35040C2	3.5 x 40	PZ2	200	50	1200
35050C2	3.5 x 50	PZ2	200	35	840
40025C2	4.0 x 25	PZ2	200	75	1800
40030C2	4.0 x 30	PZ2	200	75	1800
40035C2	4.0 x 35	PZ2	200	50	1200
40040C2	4.0 x 40	PZ2	200	50	1200
40045C2	4.0 x 45	PZ2	200	35	840
40050C2	4.0 x 50	PZ2	200	35	840
40060C2	4.0 x 60	PZ2	200	15	540
40070C2	4.0 x 70	PZ2	200	15	540
40080C2	4.0 x 80	PZ2	200	16	384
45030C2	4.5 x 30	PZ2	200	50	1200
45040C2	4.5 x 40	PZ2	200	35	840
45050C2	4.5 x 50	PZ2	200	15	540
45060C2	4.5 x 60	PZ2	200	15	540
45070C2	4.5 x 70	PZ2	200	16	384
45080C2	4.5 x 80	PZ2	200	16	384
50030C2	5.0 x 30	PZ2	200	50	1200
50040C2	5.0 x 40	PZ2	200	35	840
50045C2	5.0 x 45	PZ2	200	15	540
50050C2	5.0 x 50	PZ2	200	15	540
50060C2	5.0 x 60	PZ2	200	16	384
50070C2	5.0 x 70	PZ2	200	16	384
50075C2	5.0 x 75	PZ2	200	16	384
50080C2	5.0 x 80	PZ2	200	16	384
50090C2	5.0 x 90	PZ2	100	15	540
50100C2	5.0 x 100	PZ2	100	15	540
50120C2	5.0 x 120	PZ2	100	15	540
60050C2	6.0 x 50	PZ3	200	16	384
60060C2	6.0 x 60	PZ3	200	16	384
60070C2	6.0 x 70	PZ3	200	12	288
60080C2	6.0 x 80	PZ3	200	12	288
60090C2	6.0 x 90	PZ3	100	15	540
60100C2	6.0 x 100	PZ3	100	15	540
60120C2	6.0 x 120	PZ3	100	16	384
60130C2	6.0 x 130	PZ3	100	12	288
60150C2	6.0 x 150	PZ3	100	12	288
60180C2	6.0 x 180	PZ3	100	8	192
60200C2	6.0 x 200	PZ3	100	8	192

TYPE - CC2 SUB TYPE - CC201

NOTE: Partially threaded from 80mm. Helix from 100mm and above. Twin cut tip on 3.5 gauge from 20mm.

C2 Strong-Fix Premium Screw Tubs



x3 PZ 38mm Power Bit Included

**NEW SIZES**

Product Code	Size (mm)	Driver Bit Size	Pack Qty (pcs)	Carton Qty (packs)	Pallet Qty (packs)
<b>TUB (C2 IMPACT POWER BIT INCLUDED)</b>					
35025C2TUB	3.5 x 25	PZ2	2,000	4	180
35030C2TUB	3.5 x 30	PZ2	1,800	4	180
40025C2TUB	4.0 x 25	PZ2	1,700	4	180
40030C2TUB	4.0 x 30	PZ2	1,500	4	180
40040C2TUB	4.0 x 40	PZ2	1,200	4	180
40050C2TUB	4.0 x 50	PZ2	800	4	180
40060C2TUB	4.0 x 60	PZ2	600	4	180
40070C2TUB	4.0 x 70	PZ2	500	4	180
45040C2TUB	4.5 x 40	PZ2	1,000	4	180
45050C2TUB	4.5 x 50	PZ2	700	4	180
45080C2TUB	4.5 x 80	PZ2	375	4	180
50040C2TUB	5.0 x 40	PZ2	800	4	180
50050C2TUB	5.0 x 50	PZ2	600	4	180
50060C2TUB	5.0 x 60	PZ2	400	4	180
50070C2TUB	5.0 x 70	PZ2	375	4	180
50080C2TUB	5.0 x 80	PZ2	350	4	180
50090C2TUB	5.0 x 90	PZ2	325	4	180
50100C2TUB	5.0 x 100	PZ2	300	4	180
60100C2TUB	6.0 x 100	PZ3	225	4	180

TYPE - CCT SUB TYPE - CCT01

**NEW Large Tub Available Now!**



Includes x3 PZ2 38mm Power Bit

Product Code	Size (mm)	Driver Bit Size	Pack Qty (pcs)	Pallet Qty (packs)
<b>TUB</b>				
50050C2LT	5.0 x 50	PZ2	1,600	64
50070C2LT	5.0 x 70	PZ2	1,200	64
50080C2LT	5.0 x 80	PZ2	1,000	64
50100C2LT	5.0 x 100	PZ2	800	64

TYPE - CC2 SUB TYPE - CC201

## C2 Strong-Fix Premium Screw - Mixed Packs

NEW



**Grab Pack**

A selection of popular C2 Strong-Fix screw sizes in a handy and reusable storage pack with clip-shut lid.

Product Code	Size (mm)	Driver Bit Size	Pack Qty (pcs)	Carton Qty (packs)	Pallet Qty (packs)
<b>GRAB PACK (600 PCS)</b>					
C2GPACK	-	-	600	5	150
	4.0 x 30	PZ2	140		
	4.0 x 40	PZ2	100		
	4.0 x 50	PZ2	70		
	4.0 x 60	PZ2	60		
	5.0 x 40	PZ2	80		
	5.0 x 50	PZ2	55		
	5.0 x 60	PZ2	45		
	5.0 x 70	PZ2	30		
	5.0 x 80	PZ2	20		
	38mm Power Bits	PZ2	3		

TYPE - CC2 SUB TYPE - CC201



**Trade Case**

The C2 trade case contains 9 of the most popular sizes in a robust portable case.

Product Code	Size (mm)	Driver Bit Size	Pack Qty (pcs)	Carton Qty (packs)
<b>MIXED TRADE CASE (1,800 PCS)</b>				
C2SC	-	-	1,798	10
	3.5 x 16	PZ2	480	
	3.5 x 25	PZ2	350	
	4.0 x 30	PZ2	250	
	4.0 x 40	PZ2	350	
	4.0 x 50	PZ2	100	
	5.0 x 60	PZ2	65	
	5.0 x 70	PZ2	55	
	5.0 x 80	PZ2	100	
	5.0 x 100	PZ2	45	
	38mm Power Bits	PZ2	3	

TYPE - CC2 SUB TYPE - CC201

NOTE: Partially threaded from 80mm. Helix from 100mm and above. Twin cut tip on 3.5 gauge from 20mm.



# C2

## CLAMP-FIX PREMIUM SCREW

### ADVANCED CLAMPING PERFORMANCE



STOPS THE  
TIMBER  
JACKING  
APART



DESIGNED  
FOR  
SUPERIOR  
HOLD



PRECISION  
TX DRIVE  
PREVENTS  
"CAM-OUT"

**43%**  
QUICKER\*

**52%**  
LESS TORQUE\*

### THE C2 TWIN-CUT

1<sup>ST</sup> CUT FOR  
RAPID "PICK-UP"  
AND QUICK  
INSERTION TIME

2<sup>ND</sup> CUT HELPS  
PREVENT WOOD  
SPLITTING WHEN  
SCREWING CLOSE  
TO THE EDGE

\*Compared against a standard woodscrew



#### Precision TX Drive Recess

prevents  
'cam-out', giving  
a precise and  
positive drive  
control on  
every screw.

#### Double Countersunk with Ribs

helps improve  
countersinking, giving a  
smooth and flush finish  
whilst also preventing  
splitting and substrate  
damage.

#### Partially Threaded Shank with Helix



stops the timber from  
jacking apart, whilst  
helping remove debris  
Partially threaded from 40mm  
Helix shank on 100mm & above

#### Unique Synthetic Lubrication

reduces insertion torque and  
increases rust protection up  
to 20x longer than a standard  
zinc plating.

#### Dual Angle Thread

gives an ultimate performance  
and an exceptionally high pull out  
resistance.



C2 Clamp-Fix Premium  
Screws carry the CE mark  
in compliance with the  
Construction Products  
Regulations  
(Eurocode 5 EN1995-1-1)



## C2 Clamp-Fix Premium Screw

Yellow



TX DRIVE



EN 14592:2008

CORROSION RATING



Occasionally damp/wet, rural and sheltered areas



HARD & SOFT WOODS



MAN MADE BOARDS



THIN METAL



PLASTIC

A premium multi-material screw featuring the award winning C2 twin-cut technology. The dual angle partial thread and high torque TX drive ensures maximum clamping strength on every fixing.

Designed to prevent the timber from 'jacking' apart when fastening timber to timber. Ideal for applications such as timber studwork, panelling, roof and decking framework.

### Advanced Clamping Performance

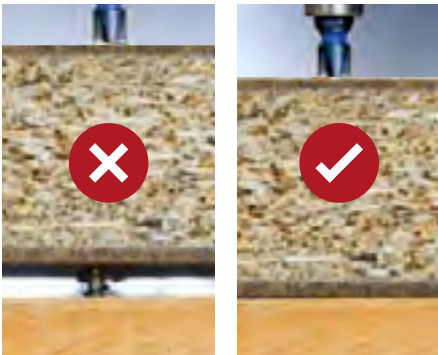

Prevents the timber 'jacking' apart

### C2 Clamp-Fix Premium Screw Boxes



Product Code	Size (mm)	Max. CFT (mm)	Driver Bit Size	Pack Qty (pcs)	Carton Qty (packs)	Pallet Qty (packs)
--------------	-----------	---------------	-----------------	----------------	--------------------	--------------------

BOX						
40025C2C	4.0 x 25	0	TX20	200	75	1,800
40030C2C	4.0 x 30	0	TX20	200	75	1,800
40035C2C	4.0 x 35	0	TX20	200	50	1,200
40040C2C	4.0 x 40	10	TX20	200	50	1,200
40045C2C	4.0 x 45	15	TX20	200	35	840
40050C2C	4.0 x 50	20	TX20	200	35	840
40060C2C	4.0 x 60	20	TX20	200	15	540
40070C2C	4.0 x 70	30	TX20	200	15	540
40080C2C	4.0 x 80	30	TX20	200	16	384
45070C2C	4.5 x 70	30	TX25	200	16	384
45080C2C	4.5 x 80	30	TX25	200	16	384
50030C2C	5.0 x 30	0	TX25	200	50	1,200
50040C2C	5.0 x 40	10	TX25	200	35	840
50050C2C	5.0 x 50	20	TX25	200	15	540
50060C2C	5.0 x 60	20	TX25	200	16	384
50070C2C	5.0 x 70	30	TX25	200	16	384
50075C2C	5.0 x 75	35	TX25	200	16	384
50080C2C	5.0 x 80	30	TX25	200	16	384
50090C2C	5.0 x 90	30	TX25	100	15	540
50100C2C	5.0 x 100	40	TX25	100	15	540
60050C2C	6.0 x 50	20	TX30	200	16	384
60060C2C	6.0 x 60	20	TX30	200	16	384
60070C2C	6.0 x 70	30	TX30	200	12	288
60080C2C	6.0 x 80	30	TX30	200	12	288
60090C2C	6.0 x 90	30	TX30	100	15	540
60100C2C	6.0 x 100	30	TX30	100	15	540
60120C2C	6.0 x 120	50	TX30	100	16	384
60130C2C	6.0 x 130	60	TX30	100	16	384
60150C2C	6.0 x 150	80	TX30	100	12	324
60180C2C	6.0 x 180	110	TX30	100	8	216
60200C2C	6.0 x 200	130	TX30	100	8	216
80080C2C	8.0 x 80	40	TX40	100	16	384
80100C2C	8.0 x 100	20	TX40	100	12	288
80120C2C	8.0 x 120	40	TX40	50	12	288
80150C2C	8.0 x 150	70	TX40	50	12	288
80200C2C	8.0 x 200	120	TX40	50	8	216
80225C2C	8.0 x 225	145	TX40	50	8	216
80250C2C	8.0 x 250	170	TX40	50	9	216
80275C2C	8.0 x 275	195	TX40	25	9	216
80300C2C	8.0 x 300	220	TX40	25	9	216
80360C2C	8.0 x 360	280	TX40	25	9	270
80420C2C	8.0 x 420	340	TX40	25	9	270

TYPE - CF2 | SUB TYPE - CF201 CFT = CLAMPING FIXTURE THICKNESS

NOTE: Partially threaded from 40mm and above. Helix shank from 100mm and above.

### C2 Clamp-Fix Premium Screw Tubs



#### C2 Impact Power Bit Included

Designed to handle the most demanding impact driving applications with optimum durability and unbeatable break resistance.



**x3 TX 38mm Power Bit Included**

Product Code	Size (mm)	Max. CFT (mm)	Driver Bit Size	Pack Qty (pcs)	Carton Qty (packs)	Pallet Qty (packs)
--------------	-----------	---------------	-----------------	----------------	--------------------	--------------------

TUB (DRIVER BIT INCLUDED)						
40040C2CTUB	4.0 x 40	10	TX20	1,200	20	180
40050C2CTUB	4.0 x 50	20	TX20	800	20	180
50050C2CTUB	5.0 x 50	20	TX25	600	20	180
50070C2CTUB	5.0 x 70	30	TX25	375	20	180
50080C2CTUB	5.0 x 80	30	TX25	350	20	180
50100C2CTUB	5.0 x 100	40	TX25	300	20	180

TYPE - CFT | SUB TYPE - CFT01 CFT = CLAMPING FIXTURE THICKNESS

NOTE: Partially threaded from 40mm and above. Helix shank from 100mm and above.

# C2

## EXTERIOR STRONG-FIX PREMIUM SCREW

DESIGNED FOR OUTDOOR APPLICATIONS

*Ideal for: Ironmongery | Decking | Fencing*

**EXTREME PULL-OUT RESISTANCE**

**DESIGNED FOR SUPERIOR HOLD**

**PRECISION PZ DRIVE PREVENTS "CAM-OUT"**

# C2

## DECK-FIX PREMIUM SCREW

DESIGNED FOR DECKING PLATFORMS & EXTERNAL TIMBER CONSTRUCTION

**DESIGNED FOR SUPERIOR CLAMPING WITH HELIX TO STOP TIMBER JACKING**

**REDUCED IMPACT RESISTANT HEAD FOR A CLEAN FINISH**

**PRECISION TX DRIVE PREVENTS "CAM-OUT"**

**Exterior**



All the features and superior performance of the C2 screw complete with an organic plating for optimal corrosion resistance when used in the harshest of environments. Silver colour to match commonly used ironmongery. Ideal for many general external applications.

- Ribs under head for improved countersinking
- Special plating to give 1,000 hours salt spray resistance
- Multi-layer coating consisting of organic top coat barrier and a zinc base layer
- Dual angle thread gives an ultimate performance and an exceptionally high pull-out resistance
- Patented twin cut technology for rapid "pick-up" and reduces timber splitting

NOTE: Partially threaded from 80mm. Twin cut tip on 3.5 gauge from 20mm. Helix from 100mm and above.



Urban & industrial areas with a low salt atmosphere



**NEW**



Product Code	Size (mm)	Driver Bit Size	Pack Qty (pcs)	Carton Qty (packs)	Pallet Qty (packs)
--------------	-----------	-----------------	----------------	--------------------	--------------------

**TUB (C2 IMPACT POWER BIT INCLUDED)**

40030C2S	4.0 x 30	PZ2	400	12	360
40040C2S	4.0 x 40	PZ2	350	12	360
40050C2S	4.0 x 50	PZ2	300	12	360
40060C2S	4.0 x 60	PZ2	200	12	360
40070C2S	4.0 x 70	PZ2	170	12	360
50040C2S	5.0 x 40	PZ2	200	12	360
50050C2S	5.0 x 50	PZ2	180	12	360
50060C2S	5.0 x 60	PZ2	150	12	360
50070C2S	5.0 x 70	PZ2	120	12	360
50080C2S	5.0 x 80	PZ2	110	12	360
50100C2S	5.0 x 100	PZ2	80	12	360
60040C2S	6.0 x 40	PZ3	150	12	360
60050C2S	6.0 x 50	PZ3	120	12	360
60070C2S	6.0 x 70	PZ3	90	12	360
60100C2S	6.0 x 100	PZ3	60	12	360

TYPE - CC2 SUB TYPE - CC204

Product Code	Size (mm)	Driver Bit Size	Pack Qty (pcs)	Carton Qty (packs)	Pallet Qty (packs)
--------------	-----------	-----------------	----------------	--------------------	--------------------

**GRAB PACK (600 PCS)**

C2SGPACK	-	-	600	5	150
	4.0 x 30	PZ2	140		
	4.0 x 40	PZ2	100		
	4.0 x 50	PZ2	70		
	4.0 x 60	PZ2	60		
	5.0 x 40	PZ2	80		
	5.0 x 50	PZ2	55		
	5.0 x 60	PZ2	45		
	5.0 x 70	PZ2	30		
	5.0 x 80	PZ2	20		

Impact 38mm Driver Bits PZ2 3 SUB TYPE - CC204

**Exterior**



**CORROSION RATING**



Urban & industrial areas with a low salt atmosphere



**NEW SIZE**

Product Code	Size (mm)	Driver Bit Size	Pack Qty (pcs)	Carton Qty (packs)	Pallet Qty (packs)
--------------	-----------	-----------------	----------------	--------------------	--------------------

**BOX (DRIVER BIT INCLUDED)**

50C2D250BX	4.5 x 50	TX20	250	15	540
65C2D250BX	4.5 x 65	TX20	250	18	432
75C2D250BX	4.5 x 75	TX20	250	18	432
85C2D250BX	4.5 x 85	TX20	250	18	432

**TUB (DRIVER BIT INCLUDED)**

50C2D250	4.5 x 50	TX20	250	4	288
65C2D250	4.5 x 65	TX20	250	4	288
65C2D1000	4.5 x 65	TX20	1,000	1	72
75C2D250	4.5 x 75	TX20	250	4	216

**TIMBAG**

50C2DB	4.5 x 50	TX20	175	5	500
65C2DB	4.5 x 65	TX20	145	5	500
75C2DB	4.5 x 75	TX20	120	5	500

TYPE - IDD / IDD / BAG SUB TYPE - IDD04 / BAG01

Product Code	Size (mm)	Driver Bit Size	Pack Qty (pcs)	Carton Qty (packs)	Pallet Qty (packs)
--------------	-----------	-----------------	----------------	--------------------	--------------------

**INDUSTRY PACK (1,000 PCS)**

65C2DIND	4.5 x 65	TX20	1,000	3	81
----------	----------	------	-------	---	----

TYPE - IDD SUB TYPE - IDD04

A premium decking screw using the C2 twin-cut technology.

- Strengthened head to prevent shearing when installed with an impact tool
- Ribs under the head for improved countersinking
- Helix shank for removing debris and to improve clamping
- Coated with a patented multi-layer corrosion resistant plating to withstand 1,000 hours salt spray
- Patented twin cut technology for rapid "pick-up" and reduces timber splitting

**NEW Industry Pack Available Now!**







**C2**  
**FLOOR-FIX**  
**PREMIUM SCREW**

**DESIGNED FOR FIXING FLOORBOARDS TO JOISTS**

*Ideal for: Hardwood | Softwood | Man-Made Board*



**DESIGNED FOR SUPERIOR HOLD**



**STOPS THE BOARDS JACKING**



**PRECISION TX DRIVE PREVENTS "CAM-OUT"**



**C2**  
**TONGUE-FIX**  
**PREMIUM SCREW**

**DESIGNED FOR FIXING TONGUE & GROOVE FLOORBOARDS & PANNELLING**

*Ideal for: Hardwood | Chipboard | Softwood*



**DESIGNED FOR SUPERIOR HOLD**



**HIDDEN FIXING SYSTEM**



**PRECISION TX DRIVE PREVENTS "CAM-OUT"**

Yellow

Yellow

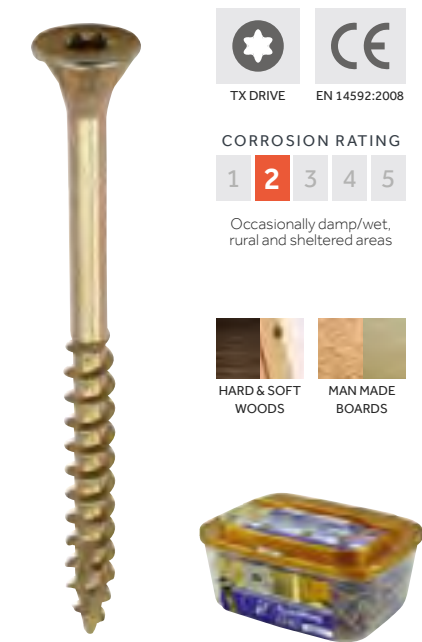

Product Code	Size (mm)	Driver Bit Size	Pack Qty (pcs)	Carton Qty (packs)	Pallet Qty (packs)
42055C2MDF	4.2 x 55	TX20	250	12	360
TYPE - CC2		SUB TYPE - CC203			

Designed for use in man-made boards such as MDF and chipboard. The C2 twin-cut tip gives rapid pick up and reduces the likelihood of splitting, whilst the steep head design with finishing teeth and self-countersinking ribs ensure a flush finish.

- Specifically designed dual action head - finishing teeth and self-countersinking ribs ensures a flush finish
- Plain shank for pulling the two substrates together without manual clamping
- Coated with a high-molecular polymer lubricant that reduces the insertion torque by up to 52% and increases rust protection up to 20 times longer than a standard zinc plating
- Dual angle thread gives an ultimate performance and an exceptionally high pull-out resistance
- Patented twin cut technology for rapid "pick-up" and reduces timber splitting

**TUB (C2 IMPACT POWER BIT INCLUDED)**



Product Code	Size (mm)	Driver Bit Size	Pack Qty (pcs)	Carton Qty (packs)	Pallet Qty (packs)
35045C2TG	3.5 x 45	TX10	350	20	600
TYPE - CC2		SUB TYPE - CC202			

**TUB (C2 IMPACT POWER BIT INCLUDED)**

Specially designed for attaching tongue and groove floorboards and panelling. Provides a secure hidden fixture without causing damage, allowing a flush fit with the next board.

- Reduced head for concealed countersinking
- Plain shank for pulling the two substrates together without manual clamping
- Coated with a high-molecular polymer lubricant that reduces the insertion torque by up to 52% and increases rust protection up to 20 times longer than a standard zinc plating
- Dual angle thread gives an ultimate performance and an exceptionally high pull-out resistance
- Patented twin cut technology for rapid "pick-up" and reduces timber splitting

# VELOCITY

## Premium Multi-Use Screw

### FOR ALL ROUND DRIVE & CLAMPING PERFORMANCE

The unique patented TIMCO Velocity screw has been specifically designed to give rapid installation into many different materials whilst achieving exceptional pull out resistance.

The Velocity screw is designed and manufactured using the most advanced technology giving the user a consistent and reliable product that can be used in a variety of applications.

For: Wood | Man-Made Board | Thin Metal | Plastic



**Dual Angle Thread**  
Designed For Superior Hold



**Partially Threaded**  
Stops The Timber Jacking



**Rapid Drive Twist Cut**  
Enhances Drive Performance



Pozi



TX Drive

#### Corrosion Rating

**2**

Occasionally damp/wet, rural and sheltered areas.

Available in: **Yellow**



### Double countersunk with Ribs

Helps improve countersinking, giving a smooth and flush finish whilst also preventing splitting and substrate damage.

### Superior corrosion Resistance

Special plating to give over 504 hours salt spray resistance in accordance to BS EN 9227:2012.

### Partially threaded from 40mm

To assist clamping of material.

### Anti-friction lubrication

Lubricated with XXS5 to enhance screw insertion time and reduce driving torque.

### Dual angle thread

Designed for superior hold

### Twist cut thread

To give rapid drive & performance.

### Single slash tip from 25mm

Helps prevent the timber splitting when screwing close to the edge, whilst also helping to reduce torque.

## Velocity Premium Multi-Use Screw - Pozi

Yellow



POZI



EN 14592:2008

CORROSION RATING



Occasionally damp/wet, rural and sheltered areas



HARD & SOFT WOODS



MAN MADE BOARDS



THIN METAL



PLASTIC

Product Code	Size (mm)	Thread Length (mm)	Driver Bit Size	Pack Qty (pcs)	Carton Qty (packs)	Pallet Qty (packs)
--------------	-----------	--------------------	-----------------	----------------	--------------------	--------------------

BOX

30016VY	3.0 x 16	16	PZ1	200	140	5,040
30020VY	3.0 x 20	20	PZ1	200	140	5,040
30030VY	3.0 x 30	30	PZ1	200	75	2,700
30040VY	3.0 x 40	40	PZ1	200	50	1,200
35012VY	3.5 x 12	12	PZ2	200	140	5,040
35016VY	3.5 x 16	16	PZ2	200	140	5,040
35020VY	3.5 x 20	20	PZ2	200	75	2,700
35025VY	3.5 x 25	25	PZ2	200	75	2,700
35030VY	3.5 x 30	30	PZ2	200	75	1,800
35035VY	3.5 x 35	35	PZ2	200	50	1,200
35040VY	3.5 x 40	30	PZ2	200	50	1,200
35045VY	3.5 x 45	30	PZ2	200	35	840
35050VY	3.5 x 50	30	PZ2	200	35	840
40016VY	4.0 x 16	16	PZ2	200	75	2,700
40020VY	4.0 x 20	20	PZ2	200	75	2,700
40025VY	4.0 x 25	25	PZ2	200	75	1,800
40030VY	4.0 x 30	30	PZ2	200	75	1,800
40035VY	4.0 x 35	35	PZ2	200	50	1,200
40040VY	4.0 x 40	30	PZ2	200	50	1,200
40045VY	4.0 x 45	30	PZ2	200	35	840
40050VY	4.0 x 50	30	PZ2	200	35	840
40060VY	4.0 x 60	40	PZ2	200	15	540
40070VY	4.0 x 70	40	PZ2	200	15	540
40080VY	4.0 x 80	50	PZ2	200	16	384
45030VY	4.5 x 30	30	PZ2	200	50	1,200
45040VY	4.5 x 40	30	PZ2	200	35	840
45050VY	4.5 x 50	30	PZ2	200	15	540
45060VY	4.5 x 60	40	PZ2	200	15	540
45070VY	4.5 x 70	40	PZ2	200	16	384
45080VY	4.5 x 80	50	PZ2	200	16	384
50030VY	5.0 x 30	30	PZ2	200	50	1,056
50040VY	5.0 x 40	30	PZ2	200	35	840
50045VY	5.0 x 45	30	PZ2	200	15	540
50050VY	5.0 x 50	30	PZ2	200	15	540
50060VY	5.0 x 60	40	PZ2	200	16	384
50070VY	5.0 x 70	40	PZ2	200	16	384
50075VY	5.0 x 75	40	PZ2	200	16	384
50080VY	5.0 x 80	50	PZ2	200	16	384
50090VY	5.0 x 90	60	PZ2	100	15	540
50100VY	5.0 x 100	60	PZ2	100	15	540
60040VY	6.0 x 40	30	PZ3	200	15	540
60045VY	6.0 x 45	30	PZ3	200	15	540
60050VY	6.0 x 50	30	PZ3	200	16	384
60060VY	6.0 x 60	40	PZ3	200	16	384
60070VY	6.0 x 70	40	PZ3	200	12	288
60080VY	6.0 x 80	50	PZ3	200	12	288
60090VY	6.0 x 90	60	PZ3	100	15	540
60100VY	6.0 x 100	70	PZ3	100	15	540
60120VY	6.0 x 120	70	PZ3	100	16	384
60130VY	6.0 x 130	70	PZ3	100	12	384
60150VY	6.0 x 150	70	PZ3	100	12	324
60180VY	6.0 x 180	70	PZ3	100	8	192
60200VY	6.0 x 200	70	PZ3	100	8	192

TYPE - VEL

SUB TYPE - VEL01

Product Code	Size (mm)	TL (mm)	Driver Bit Size	Pack Qty (pcs)	Carton Qty (packs)	Pallet Qty (packs)
--------------	-----------	---------	-----------------	----------------	--------------------	--------------------

TUB (DRIVER BIT INCLUDED)

40030VYTUB	4.0 x 30	30	PZ2	1,500	4	180
40040VYTUB	4.0 x 40	30	PZ2	1,200	4	180
40050VYTUB	4.0 x 50	30	PZ2	800	4	180
50040VYTUB	5.0 x 40	30	PZ2	800	4	180
50050VYTUB	5.0 x 50	30	PZ2	600	4	180
50060VYTUB	5.0 x 60	40	PZ2	400	4	180
50070VYTUB	5.0 x 70	40	PZ2	375	4	180
50080VYTUB	5.0 x 80	50	PZ2	350	4	180
50090VYTUB	5.0 x 90	60	PZ2	325	4	180
50100VYTUB	5.0 x 100	60	PZ2	300	4	180

TYPE - VEL | SUB TYPE - VEL01

TL = THREAD LENGTH

NEW Industry Pack Available Now!



Product Code	Size (mm)	Driver Bit Size	Pack Qty (pcs)	Carton Qty (packs)	Pallet Qty (packs)
--------------	-----------	-----------------	----------------	--------------------	--------------------

INDUSTRY PACK (1,000 PCS)

40030VYIND	4.0 x 30	PZ2	1,000	12	288
40040VYIND	4.0 x 40	PZ2	1,000	12	288
40050VYIND	4.0 x 50	PZ2	1,000	6	144
50040VYIND	5.0 x 40	PZ2	1,000	6	144
50050VYIND	5.0 x 50	PZ2	1,000	6	144
50060VYIND	5.0 x 60	PZ2	1,000	3	81
50070VYIND	5.0 x 70	PZ2	1,000	3	81
50080VYIND	5.0 x 80	PZ2	1,000	3	81
50090VYIND	5.0 x 90	PZ2	1,000	3	81
50100VYIND	5.0 x 100	PZ2	1,000	3	81

TYPE - VEL

SUB TYPE - VEL01

## Velocity Screw Grab Pack

A selection of popular velocity screw sizes in a handy and reusable storage pack with clip-shut lid.



NEW

Product Code	Size (mm)	Driver Bit Size	Pack Qty (pcs)	Carton Qty (packs)	Pallet Qty (packs)
--------------	-----------	-----------------	----------------	--------------------	--------------------

GRAB PACK (600 PCS)

VEYGPAC	-	-	600	5	150
	4.0 x 30	PZ2	140		
	4.0 x 40	PZ2	100		
	4.0 x 50	PZ2	70		
	4.0 x 60	PZ2	60		
	5.0 x 40	PZ2	80		
	5.0 x 50	PZ2	55		
	5.0 x 60	PZ2	45		
	5.0 x 70	PZ2	30		
	5.0 x 80	PZ2	20		
	25mm Driver Bits	PZ2	1		

TYPE - VEL

SUB TYPE - VEL01



# CLASSIC/C<sup>®</sup> //

## MULTI-PURPOSE SCREWS

### Exceptional Reliability & Strength

The TIMCO Multi-Purpose Classic Screw enables the user to rely on one product for a variety of applications.

Specifically designed as a multi-purpose product, the 25° sharp point, special thread design, lubrication and corrosion resistant plating ensures the screw will consistently perform efficiently in hardwood, chipboard, MDF, plastic and thin sheet metal, while offering exceptional holding power.



Pozi

#### Corrosion Rating

**2**

Occasionally damp/wet, rural and sheltered areas.

Available in:

Yellow

Black

A2 Stainless

Nickel

A4 Stainless

Countersunk  
Head



Pan  
Head



Reduced  
Head (Hinge)



#### Double Countersunk

Reduces the likelihood of head shear and assists completion of countersinking.

#### Fully Threaded up to and including 75mm

Partially threaded thereafter. (with 70mm thread length)

#### Molecular Lubrication

Patented lubrication, designed to enhance screw insertion time and provides greater resistance to corrosion.

#### 40° Deep Single Thread

To provide a secure fixing with high pull-out resistance.

#### Surface Hardened

Up to 750 HV to prevent torque shearing under load and a core hardness of up to 450 HV for improved ductility.

#### Type 17 Single Slash

\*Single slash on 25mm

To reduce torque and the likelihood of the timber splitting when the screw is inserted close to the edge.



## Classic Multi-Purpose Screw - Double Countersunk

Yellow



POZI



EN 14592:2008

CORROSION RATING



Occasionally damp/wet, rural and sheltered areas



HARD & SOFT WOODS



MAN MADE BOARDS



THIN METAL



PLASTIC

Product Code	Size (mm)	Driver Bit Size	Pack Qty (pcs)	Carton Qty (packs)	Pallet Qty (packs)
<b>BOX</b>					
30012CLAF	3.0 x 12	PZ1	200	140	5,040
30016CLAF	3.0 x 16	PZ1	200	140	5,040
30020CLAF	3.0 x 20	PZ1	200	140	5,040
30025CLAF	3.0 x 25	PZ1	200	75	2,700
30030CLAF	3.0 x 30	PZ1	200	75	2,700
30035CLAF	3.0 x 35	PZ1	200	50	1,200
30040CLAF	3.0 x 40	PZ1	200	50	1,200
35012CLAF	3.5 x 12	PZ2	200	140	5,040
35016CLAF	3.5 x 16	PZ2	200	140	5,040
35020CLAF	3.5 x 20	PZ2	200	75	2,700
35025CLAF	3.5 x 25	PZ2	200	75	2,700
35030CLAF	3.5 x 30	PZ2	200	75	1,800
35035CLAF	3.5 x 35	PZ2	200	50	1,200
35040CLAF	3.5 x 40	PZ2	200	50	1,200
35045CLAF	3.5 x 45	PZ2	200	35	840
35050CLAF	3.5 x 50	PZ2	200	35	840
40012CLAF	4.0 x 12	PZ2	200	140	5,040
40016CLAF	4.0 x 16	PZ2	200	75	2,700
40020CLAF	4.0 x 20	PZ2	200	75	2,700
40025CLAF	4.0 x 25	PZ2	200	75	1,800
40030CLAF	4.0 x 30	PZ2	200	75	1,800

TYPE - CLA SUB TYPE - CLA01

NOTE: Partially threaded from 80mm. Single slash from 25mm.

Product Code	Size (mm)	Driver Bit Size	Pack Qty (pcs)	Carton Qty (packs)	Pallet Qty (packs)
<b>BOX</b>					
40035CLAF	4.0 x 35	PZ2	200	50	1,200
40040CLAF	4.0 x 40	PZ2	200	50	1,200
40045CLAF	4.0 x 45	PZ2	200	35	840
40050CLAF	4.0 x 50	PZ2	200	35	840
40055CLAF	4.0 x 55	PZ2	200	15	540
40060CLAF	4.0 x 60	PZ2	200	15	540
40070CLAF	4.0 x 70	PZ2	200	15	540
40080CLAF	4.0 x 80	PZ2	200	16	384
45016CLAF	4.5 x 16	PZ2	200	75	1,800
45020CLAF	4.5 x 20	PZ2	200	75	1,800
45025CLAF	4.5 x 25	PZ2	200	50	1,200
45030CLAF	4.5 x 30	PZ2	200	50	1,200
45035CLAF	4.5 x 35	PZ2	200	35	840
45040CLAF	4.5 x 40	PZ2	200	35	840
45045CLAF	4.5 x 45	PZ2	200	35	840
45050CLAF	4.5 x 50	PZ2	200	15	540
45055CLAF	4.5 x 55	PZ2	200	15	540
45060CLAF	4.5 x 60	PZ2	200	15	540
45070CLAF	4.5 x 70	PZ2	200	16	384
45080CLAF	4.5 x 80	PZ2	200	16	384
50020CLAF	5.0 x 20	PZ2	200	50	1,200
50025CLAF	5.0 x 25	PZ2	200	50	1,200
50030CLAF	5.0 x 30	PZ2	200	50	1,200
50035CLAF	5.0 x 35	PZ2	200	35	840
50040CLAF	5.0 x 40	PZ2	200	35	840
50045CLAF	5.0 x 45	PZ2	200	15	540
50050CLAF	5.0 x 50	PZ2	200	15	540
50055CLAF	5.0 x 55	PZ2	200	15	540
50060CLAF	5.0 x 60	PZ2	200	16	384
50070CLAF	5.0 x 70	PZ2	200	16	384
50075CLAF	5.0 x 75	PZ2	200	16	384
50080CLAF	5.0 x 80	PZ2	200	16	384
50090CLAF	5.0 x 90	PZ2	100	15	540
50100CLAF	5.0 x 100	PZ2	100	15	540
50120CLAF	5.0 x 120	PZ2	100	15	540
60040CLAF	6.0 x 40	PZ3	200	15	540
60045CLAF	6.0 x 45	PZ3	200	15	540
60050CLAF	6.0 x 50	PZ3	200	16	384
60060CLAF	6.0 x 60	PZ3	200	16	384
60070CLAF	6.0 x 70	PZ3	200	12	288
60080CLAF	6.0 x 80	PZ3	200	12	288
60090CLAF	6.0 x 90	PZ3	100	15	540
60100CLAF	6.0 x 100	PZ3	100	15	540
60120CLAF	6.0 x 120	PZ3	100	16	384
60130CLAF	6.0 x 130	PZ3	100	12	288
60150CLAF	6.0 x 150	PZ3	100	12	288
60180CLAF	6.0 x 180	PZ3	100	8	192
60200CLAF	6.0 x 200	PZ3	100	8	192

TYPE - CLA SUB TYPE - CLA01

NOTE: Partially threaded from 80mm. Single slash from 25mm.

## Classic Multi-Purpose Screw - Pan Head

Yellow



POZI



EN 14592:2008

CORROSION RATING



Occasionally damp/wet, rural and sheltered areas



HARD & SOFT WOODS



MAN MADE BOARDS



THIN METAL



PLASTIC

Product Code	Size (mm)	Driver Bit Size	Pack Qty (pcs)	Carton Qty (packs)	Pallet Qty (packs)
<b>BOX</b>					
35012CLAP	3.5 x 12	PZ2	200	140	5,040
35016CLAP	3.5 x 16	PZ2	200	75	2,700
35020CLAP	3.5 x 20	PZ2	200	75	2,700
35025CLAP	3.5 x 25	PZ2	200	75	1,800
40016CLAP	4.0 x 16	PZ2	200	75	2,700
40020CLAP	4.0 x 20	PZ2	200	75	1,800
40025CLAP	4.0 x 25	PZ2	200	75	1,800
40030CLAP	4.0 x 30	PZ2	200	50	1,200
40035CLAP	4.0 x 35	PZ2	200	50	1,200
40040CLAP	4.0 x 40	PZ2	200	35	840
40050CLAP	4.0 x 50	PZ2	200	35	840
50030CLAP	5.0 x 30	PZ2	200	35	840
50050CLAP	5.0 x 50	PZ2	200	15	540

TYPE - CLA SUB TYPE - CLA01

NOTE: Partially threaded from 80mm. Single slash from 25mm.

## Classic Multi-Purpose Screw Mixed Tray

The Classic screw mixed tray contains 12 of the most popular sizes.



Product Code	Size (mm)	Driver Bit Size	Pack Qty (pcs)	Carton Qty (packs)	Pallet Qty (packs)
<b>MIXED TRAY (895 PCS)</b>					
CLASSICTRAY	-	-	895	6	108
	3.5 x 16	PZ2	200		
	3.5 x 25	PZ2	100		
	3.5 x 30	PZ2	100		
	4.0 x 20	PZ2	100		
	4.0 x 25	PZ2	60		
	4.0 x 30	PZ2	50		
	4.0 x 40	PZ2	70		
	4.0 x 50	PZ2	60		
	4.0 x 60	PZ2	50		
	5.0 x 40	PZ2	30		
	5.0 x 50	PZ2	40		
	5.0 x 60	PZ2	35		

TYPE - CLA SUB TYPE - CLA01

## Classic Multi-Purpose Screw - Double Countersunk

A2 Stainless Steel



CORROSION RATING



Urban & industrial areas with a moderate salt atmosphere



HARD & SOFT WOODS MAN MADE BOARDS

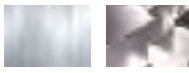

THIN METAL PLASTIC

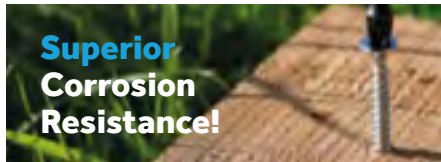

Please note a pilot hole is recommended for all stainless steel screws.

Product Code	Size (mm)	Driver Bit Size	Pack Qty (pcs)	Carton Qty (packs)
<b>TIMPAC</b>				
35030CHSSP	3.5 x 30	PZ2	30	10
40025CHSSP	4.0 x 25	PZ2	25	10
40030CHSSP	4.0 x 30	PZ2	20	10
40040CHSSP	4.0 x 40	PZ2	15	10
40050CHSSP	4.0 x 50	PZ2	14	10
50030CHSSP	5.0 x 30	PZ2	10	10
50040CHSSP	5.0 x 40	PZ2	10	10
50050CHSSP	5.0 x 50	PZ2	10	10
50060CHSSP	5.0 x 60	PZ2	8	10
50070CHSSP	5.0 x 70	PZ2	7	10
50080CHSSP	5.0 x 80	PZ2	6	10
50100CHSSP	5.0 x 100	PZ2	4	10

TYPE - PAK SUB TYPE - PAK01

NOTE: Partially threaded from 80mm. Single slash from 25mm.

Product Code	Size (mm)	Driver Bit Size	Pack Qty (pcs)	Carton Qty (packs)	Pallet Qty (packs)
<b>BOX</b>					
30012CLASS	3.0 x 12	PZ1	200	140	5,040
30016CLASS	3.0 x 16	PZ1	200	140	5,040
30020CLASS	3.0 x 20	PZ1	200	140	5,040
30025CLASS	3.0 x 25	PZ1	200	75	2,700
35012CLASS	3.5 x 12	PZ2	200	140	5,040
35016CLASS	3.5 x 16	PZ2	200	140	5,040
35020CLASS	3.5 x 20	PZ2	200	75	2,700
35025CLASS	3.5 x 25	PZ2	200	75	2,700
35030CLASS	3.5 x 30	PZ2	200	75	1,800
35035CLASS	3.5 x 35	PZ2	200	50	1,200
35040CLASS	3.5 x 40	PZ2	200	35	840
35050CLASS	3.5 x 50	PZ2	200	35	840
40016CLASS	4.0 x 16	PZ2	200	75	2,700
40020CLASS	4.0 x 20	PZ2	200	75	2,700
40025CLASS	4.0 x 25	PZ2	200	75	1,800
40030CLASS	4.0 x 30	PZ2	200	75	1,800
40035CLASS	4.0 x 35	PZ2	200	50	1,200
40040CLASS	4.0 x 40	PZ2	200	50	1,200
40045CLASS	4.0 x 45	PZ2	200	35	840
40050CLASS	4.0 x 50	PZ2	200	35	840
40060CLASS	4.0 x 60	PZ2	200	15	540
40070CLASS	4.0 x 70	PZ2	200	15	540
45025CLASS	4.5 x 25	PZ2	200	50	1,200
45030CLASS	4.5 x 30	PZ2	200	50	1,200
45040CLASS	4.5 x 40	PZ2	200	35	840
45050CLASS	4.5 x 50	PZ2	200	15	540
45060CLASS	4.5 x 60	PZ2	200	15	540
50025CLASS	5.0 x 25	PZ2	200	50	1,200
50030CLASS	5.0 x 30	PZ2	200	35	1,200
50035CLASS	5.0 x 35	PZ2	200	35	840
50040CLASS	5.0 x 40	PZ2	200	35	840
50050CLASS	5.0 x 50	PZ2	200	15	540
50060CLASS	5.0 x 60	PZ2	200	16	384
50070CLASS	5.0 x 70	PZ2	200	16	384
50080CLASS	5.0 x 80	PZ2	200	16	384
50090CLASS	5.0 x 90	PZ2	100	15	540
50100CLASS	5.0 x 100	PZ2	100	15	540
60040CLASS	6.0 x 40	PZ3	200	15	540
60050CLASS	6.0 x 50	PZ3	200	16	384
60060CLASS	6.0 x 60	PZ3	200	16	384
60070CLASS	6.0 x 70	PZ3	200	12	288
60080CLASS	6.0 x 80	PZ3	200	12	288
60100CLASS	6.0 x 100	PZ3	100	15	540
60130CLASS	6.0 x 130	PZ3	100	12	384
60150CLASS	6.0 x 150	PZ3	100	12	288

TYPE - CSS SUB TYPE - CSS01

NOTE: Partially threaded from 80mm. Single slash from 25mm.

## Classic Multi-Purpose Screw - Pan Head

A2 Stainless Steel



CORROSION RATING



Urban & industrial areas with a moderate salt atmosphere



HARD & SOFT WOODS MAN MADE BOARDS

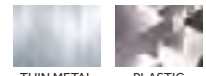

THIN METAL PLASTIC

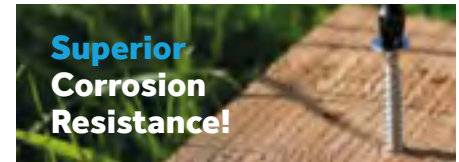

Please note a pilot hole is recommended for all stainless steel screws.

Product Code	Size (mm)	Driver Bit Size	Pack Qty (pcs)	Carton Qty (packs)	Pallet Qty (packs)
<b>BOX</b>					
35016CLAPSS	3.5 x 16	PZ2	200	75	2,700
35020CLAPSS	3.5 x 20	PZ2	200	75	1,800
35025CLAPSS	3.5 x 25	PZ2	200	75	1,800
35030CLAPSS	3.5 x 30	PZ2	200	50	1,800
40020CLAPSS	4.0 x 20	PZ2	200	75	1,800
40025CLAPSS	4.0 x 25	PZ2	200	75	1,800
40030CLAPSS	4.0 x 30	PZ2	200	50	1,200
40040CLAPSS	4.0 x 40	PZ2	200	50	1,200
40050CLAPSS	4.0 x 50	PZ2	200	15	540
50025CLAPSS	5.0 x 25	PZ2	200	50	1,200
50030CLAPSS	5.0 x 30	PZ2	200	35	840
50040CLAPSS	5.0 x 40	PZ2	200	35	840
50050CLAPSS	5.0 x 50	PZ2	200	15	540
60040CLAPSS	6.0 x 40	PZ3	200	15	540
60050CLAPSS	6.0 x 50	PZ3	200	16	384

TYPE - CSS SUB TYPE - CSS01

NOTE: Partially threaded from 80mm. Single slash from 25mm.



### Mixed Tray

The Classic stainless steel screw mixed tray contains 12 of the most popular sizes.

Product Code	Size (mm)	Driver Bit Size	Screw Qty (pcs)	Pack Qty (pcs)	Pallet Qty (packs)
<b>MIXED TRAY (895 PCS)</b>					
STSTTRAY	-	-	-	6	108
	3.5 x 16	PZ2	200		
	3.5 x 25	PZ2	100		
	3.5 x 30	PZ2	100		
	4.0 x 20	PZ2	100		
	4.0 x 25	PZ2	60		
	4.0 x 30	PZ2	50		
	4.0 x 40	PZ2	70		
	4.0 x 50	PZ2	60		
	4.0 x 60	PZ2	50		
	5.0 x 40	PZ2	30		
	5.0 x 50	PZ2	40		
	5.0 x 60	PZ2	35		

TYPE - CSS SUB TYPE - CSS01

## Collated Screws

Available in:

A2 Stainless Steel

Page 39

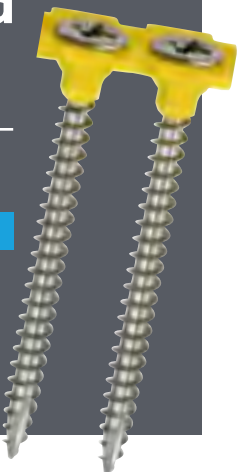



## Classic Multi-Purpose Screw - Double Countersunk

A4 Stainless Steel



POZI



EN 14592:2008

CORROSION RATING



Industrial and coastal areas with an aggressive salt atmosphere



HARD & SOFT WOODS



MAN MADE BOARDS



THIN METAL



PLASTIC

**Ultimate Corrosion Resistance!**

**PERFECT FOR MARINE APPLICATIONS**

Product Code	Size (mm)	Driver Bit Size	Pack Qty (pcs)	Carton Qty (packs)	Pallet Qty (packs)
<b>BOX</b>					
30016CLA4	3.0 x 16	PZ1	200	140	5,040
35020CLA4	3.5 x 20	PZ2	200	75	2,700
35025CLA4	3.5 x 25	PZ2	200	75	2,700
35030CLA4	3.5 x 30	PZ2	200	75	1,800
40025CLA4	4.0 x 25	PZ2	200	75	1,800
40030CLA4	4.0 x 30	PZ2	200	75	1,800
40035CLA4	4.0 x 35	PZ2	200	50	1,200
40040CLA4	4.0 x 40	PZ2	200	50	1,200
40050CLA4	4.0 x 50	PZ2	200	35	840
40060CLA4	4.0 x 60	PZ2	200	15	540
40070CLA4	4.0 x 70	PZ2	200	15	540
50030CLA4	5.0 x 30	PZ2	200	50	1,200
50040CLA4	5.0 x 40	PZ2	200	35	840
50050CLA4	5.0 x 50	PZ2	200	15	540
50060CLA4	5.0 x 60	PZ2	200	16	384
50070CLA4	5.0 x 70	PZ2	200	16	384
50080CLA4	5.0 x 80	PZ2	200	16	384
50100CLA4	5.0 x 100	PZ2	100	15	540
60080CLA4	6.0 x 80	PZ3	200	12	288
60100CLA4	6.0 x 100	PZ3	100	15	540
60130CLA4	6.0 x 130	PZ3	100	16	288
60150CLA4	6.0 x 150	PZ3	100	12	288
TYPE - CCS			SUB TYPE - CCS01		

NOTE: Partially threaded from 80mm. Single slash from 25mm.

## Classic Multi-Purpose Screw - Double Countersunk

Exterior (Black Organic)



POZI



EN 14592:2008

CORROSION RATING



Urban & industrial areas with a moderate salt atmosphere



HARD & SOFT WOODS



MAN MADE BOARDS



THIN METAL



PLASTIC

**Superior Corrosion Resistance!**

**NEW PACK TYPE**

Product Code	Size (mm)	Driver Bit Size	Pack Qty (pcs)	Carton Qty (packs)	Pallet Qty (packs)
<b>BOX</b>					
35016CLAB	3.5 x 16	PZ2	200	140	5,040
35025CLAB	3.5 x 25	PZ2	200	75	2,700
40025CLAB	4.0 x 25	PZ2	200	75	1,800
40030CLAB	4.0 x 30	PZ2	200	75	1,800
40040CLAB	4.0 x 40	PZ2	200	50	1,200
50030CLAB	5.0 x 30	PZ2	200	35	840
50040CLAB	5.0 x 40	PZ2	200	15	540
TYPE - CLA			SUB TYPE - CLA04		
<b>TIMPAC</b>					
40030CHBP	4.0 x 30	PZ2	25	10	-
TYPE - PAK			SUB TYPE - PAK02		

NOTE: Single slash from 25mm. No single slash on TIMPAC screws.

## Classic Hinge Screw



Yellow

Nickel



POZI



EN 14592:2008

CORROSION RATING



Occasionally damp/wet, rural and sheltered areas

Reduced 5mm head for specific use in continuous/piano hinges.

Product Code	Size (mm)	Driver Bit Size	Pack Qty (pcs)	Carton Qty (packs)	Pallet Qty (packs)
<b>BOX</b>					
<b>Yellow</b>					
30012CLAH	3.0 x 12	PZ1	200	140	5,040
30016CLAH	3.0 x 16	PZ1	200	140	5,040
30020CLAH	3.0 x 20	PZ1	200	140	5,040
30025CLAH	3.0 x 25	PZ1	200	75	2,700
TYPE - CLA			SUB TYPE - CLA01		
<b>BOX</b>					
<b>Nickel</b>					
30012CLAHN	3.0 x 12	PZ1	200	140	5,040
30016CLAHN	3.0 x 16	PZ1	200	140	5,040
30020CLAHN	3.0 x 20	PZ1	200	140	5,040
TYPE - CLA			SUB TYPE - CLA03		

# Solo Woodscrews

**Ideal for:**  
Softwood  
Chipboard  
Plastic  
and some  
hardwoods

## For general applications

An economic single thread woodscrew designed to be consistently reliable in softwood, chipboard, plastic and some hardwoods.

The Solo range is an ideal fixing for today's tradesman when fixing into low density substrates.



Pozi



Square

### Corrosion Rating

**1**

Clean, dry &  
low humidity  
environments

Available in:

Yellow

Zinc

Double  
Countersunk



Pan  
Head



### Double Countersunk

Reduces the likelihood of head shear and assists completion of countersinking.

### Fully Threaded up to and including 75mm

Partially threaded thereafter. (with 70mm thread length)

### Wax Lubricated

To enhance screw insertion time, reduced driving torque and resistance to corrosion.

### 40° Deep Single Thread

To provide a secure fixing with high pull-out resistance.

### 25° Sharp Point

Sharp point and single lead for a fast start and improved thread acceptance.



## Solo - Double Countersunk

Yellow



POZI EN 14592:2008

### CORROSION RATING



Clean, dry & low humidity environments



SOFTWOOD CHIPBOARD

### NEW SIZE

Product Code	Size (mm)	Driver Bit Size	Pack Qty (pcs)	Carton Qty (packs)	Pallet Qty (packs)
<b>BOX</b>					
30012SOLOC	3.0 x 12	PZ1	200	140	5,040
30015SOLOC	3.0 x 15	PZ1	200	140	5,040
30017SOLOC	3.0 x 17	PZ1	200	140	5,040
30020SOLOC	3.0 x 20	PZ1	200	140	5,040
30025SOLOC	3.0 x 25	PZ1	200	75	2,700
30030SOLOC	3.0 x 30	PZ1	200	75	2,700
35012SOLOC	3.5 x 12	PZ2	200	140	5,040
35015SOLOC	3.5 x 15	PZ2	200	140	5,040
35017SOLOC	3.5 x 17	PZ2	200	140	5,040
35020SOLOC	3.5 x 20	PZ2	200	75	2,700
35025SOLOC	3.5 x 25	PZ2	200	75	2,700
35030SOLOC	3.5 x 30	PZ2	200	75	1,800
35035SOLOC	3.5 x 35	PZ2	200	50	1,200
35040SOLOC	3.5 x 40	PZ2	200	50	1,200
35050SOLOC	3.5 x 50	PZ2	200	35	840
40015SOLOC	4.0 x 15	PZ2	200	75	2,700
40017SOLOC	4.0 x 17	PZ2	200	75	2,700
40020SOLOC	4.0 x 20	PZ2	200	75	2,700
40025SOLOC	4.0 x 25	PZ2	200	75	1,800
40030SOLOC	4.0 x 30	PZ2	200	75	1,800
40035SOLOC	4.0 x 35	PZ2	200	50	1,200
40040SOLOC	4.0 x 40	PZ2	200	50	1,200
40045SOLOC	4.0 x 45	PZ2	200	35	840
40050SOLOC	4.0 x 50	PZ2	200	35	840
40060SOLOC	4.0 x 60	PZ2	200	15	540
40070SOLOC	4.0 x 70	PZ2	200	15	540
40080SOLOC	4.0 x 80	PZ2	200	15	540
45020SOLOC	4.5 x 20	PZ2	200	75	1,800
45030SOLOC	4.5 x 30	PZ2	200	50	1,200
45035SOLOC	4.5 x 35	PZ2	200	35	840
45040SOLOC	4.5 x 40	PZ2	200	35	840
45045SOLOC	4.5 x 45	PZ2	200	35	840
45050SOLOC	4.5 x 50	PZ2	200	15	540
45060SOLOC	4.5 x 60	PZ2	200	15	540
45070SOLOC	4.5 x 70	PZ2	200	16	384

Product Code	Size (mm)	Driver Bit Size	Pack Qty (pcs)	Carton Qty (packs)	Pallet Qty (packs)
<b>BOX</b>					
45080SOLOC	4.5 x 80	PZ2	200	16	384
50025SOLOC	5.0 x 25	PZ2	200	50	1,200
50030SOLOC	5.0 x 30	PZ2	200	50	1,200
50035SOLOC	5.0 x 35	PZ2	200	35	840
50040SOLOC	5.0 x 40	PZ2	200	35	840
50045SOLOC	5.0 x 45	PZ2	200	15	540
50050SOLOC	5.0 x 50	PZ2	200	15	540
50060SOLOC	5.0 x 60	PZ2	200	16	384
50070SOLOC	5.0 x 70	PZ2	200	16	384
50075SOLOC	5.0 x 75	PZ2	200	16	384
50080SOLOC	5.0 x 80	PZ2	200	16	384
50090SOLOC	5.0 x 90	PZ2	100	15	540
50100SOLOC	5.0 x 100	PZ2	100	15	540
50120SOLOC	5.0 x 120	PZ2	100	15	540
60040SOLOC	6.0 x 40	PZ3	200	15	540
60050SOLOC	6.0 x 50	PZ3	200	16	384
60060SOLOC	6.0 x 60	PZ3	200	16	384
60070SOLOC	6.0 x 70	PZ3	200	12	288
60080SOLOC	6.0 x 80	PZ3	200	12	288
60090SOLOC	6.0 x 90	PZ3	100	15	540
60100SOLOC	6.0 x 100	PZ3	100	15	540
60120SOLOC	6.0 x 120	PZ3	100	16	384
60130SOLOC	6.0 x 130	PZ3	100	12	384
60150SOLOC	6.0 x 150	PZ3	100	12	324
60180SOLOC	6.0 x 180	PZ3	100	8	216
60200SOLOC	6.0 x 200	PZ3	100	8	192

TYPE - SOC SUB TYPE - SOC01

Product Code	Size (mm)	Driver Bit Size	Pack Qty (pcs)	Carton Qty (packs)	Pallet Qty (packs)
<b>TUB</b>					
40040STUBY	4.0 x 40	PZ2	1,000	4	20
40050STUBY	4.0 x 50	PZ2	800	4	20
50050STUBY	5.0 x 50	PZ2	525	4	20
50060STUBY	5.0 x 60	PZ2	400	4	20
50070STUBY	5.0 x 70	PZ2	375	4	20
50080STUBY	5.0 x 80	PZ2	325	4	20
50100STUBY	5.0 x 100	PZ2	250	4	20

TYPE - SOC SUB TYPE - SOC01

Product Code	Size (mm)	Driver Bit Size	Pack Qty (pcs)	Carton Qty (packs)	Pallet Qty (packs)
<b>TIMBAG</b>					
35015CHYB	3.5 x 15	PZ2	750	5	870
35030CHYB	3.5 x 30	PZ2	500	5	870
40025CHYB	4.0 x 25	PZ2	470	5	870
40030CHYB	4.0 x 30	PZ2	430	5	870
40035CHYB	4.0 x 35	PZ2	380	5	600
40040CHYB	4.0 x 40	PZ2	350	5	600
40050CHYB	4.0 x 50	PZ2	280	5	600
40060CHYB	4.0 x 60	PZ2	230	5	600
50040CHYB	5.0 x 40	PZ2	220	5	600
50050CHYB	5.0 x 50	PZ2	180	5	600
50060CHYB	5.0 x 60	PZ2	160	5	600
50070CHYB	5.0 x 70	PZ2	140	5	600
50080CHYB	5.0 x 80	PZ2	120	5	600
50100CHYB	5.0 x 100	PZ2	90	5	600
60080CHYB	6.0 x 80	PZ3	90	5	600
60120CHYB	6.0 x 120	PZ3	50	5	600
60150CHYB	6.0 x 150	PZ3	35	5	600

TYPE - BAG SUB TYPE - BAG01

Product Code	Size (mm)	Driver Bit Size	Pack Qty (pcs)	Carton Qty (packs)	Pallet Qty (packs)
<b>TIMPAC</b>					
35015CHYP	3.5 x 15	PZ2	45	10	-
35030CHYP	3.5 x 30	PZ2	35	10	-
40025CHYP	4.0 x 25	PZ2	30	10	-
40030CHYP	4.0 x 30	PZ2	25	10	-
40035CHYP	4.0 x 35	PZ2	22	10	-
40040CHYP	4.0 x 40	PZ2	20	10	-
40050CHYP	4.0 x 50	PZ2	16	10	-
40060CHYP	4.0 x 60	PZ2	12	10	-
50040CHYP	5.0 x 40	PZ2	10	10	-
50050CHYP	5.0 x 50	PZ2	12	10	-
50060CHYP	5.0 x 60	PZ2	10	10	-
50070CHYP	5.0 x 70	PZ2	8	10	-
50080CHYP	5.0 x 80	PZ2	6	10	-
50100CHYP	5.0 x 100	PZ2	4	10	-
60080CHYP	6.0 x 80	PZ3	4	10	-
60120CHYP	6.0 x 120	PZ3	2	10	-
60150CHYP	6.0 x 150	PZ3	2	10	-

TYPE - PAK SUB TYPE - PAK02

### NEW Industry Pack Available Now!



Product Code	Size (mm)	Driver Bit Size	Pack Qty (pcs)	Carton Qty (packs)	Pallet Qty (packs)
<b>INDUSTRY PACK (1,000 PCS)</b>					
40030SOLOIND	4.0 x 30	PZ2	1,000	12	288
40040SOLOIND	4.0 x 40	PZ2	1,000	12	288
40050SOLOIND	4.0 x 50	PZ2	1,000	6	144
40060SOLOIND	4.0 x 60	PZ2	1,000	6	144
40080SOLOIND	4.0 x 80	PZ2	1,000	6	144
50050SOLOIND	5.0 x 50	PZ2	1,000	6	144
50060SOLOIND	5.0 x 60	PZ2	1,000	3	81
50070SOLOIND	5.0 x 70	PZ2	1,000	3	81
50080SOLOIND	5.0 x 80	PZ2	1,000	3	81
50100SOLOIND	5.0 x 100	PZ2	1,000	3	81

TYPE - SOC SUB TYPE - SOC04

## Solo Screw Mixed Packs

### Mixed Pack



The Solo woodscrew mixed pack contains 9 of the most popular sizes in 200 & 100 quantities.

Product Code	Size (mm)	Driver Bit Size	Screw Qty (pcs)	Pack Qty (pcs)	Carton Qty (packs)
<b>MIXED PACK (1,140 PCS)</b>					
SOLOMP	-	-	-	1,400	10
	3.5 x 25	PZ2	200		
	4.0 x 30	PZ2	200		
	4.0 x 40	PZ2	200		
	4.0 x 50	PZ2	200		
	5.0 x 50	PZ2	200		
	5.0 x 60	PZ2	100		
	5.0 x 70	PZ2	100		
	5.0 x 80	PZ2	100		
	5.0 x 100	PZ2	100		

TYPE - SOC SUB TYPE - SOC01



The Solo woodscrew mixed tray contains 9 of the most popular sizes.

### Grab Pack

Product Code	Size (mm)	Driver Bit Size	Pack Qty (pcs)	Carton Qty (packs)	Pallet Qty (packs)
<b>GRAB PACK (1,200 PCS)</b>					
TRAY1200	-	-	1,200	5	135
	3.5 x 16	PZ2	150		
	3.5 x 20	PZ2	130		
	3.5 x 25	PZ2	220		
	4.0 x 30	PZ2	350		
	4.0 x 40	PZ2	120		
	4.0 x 50	PZ2	80		
	5.0 x 50	PZ2	65		
	5.0 x 60	PZ2	55		
	5.0 x 80	PZ2	30		

TYPE - SOC SUB TYPE - SOC01



## Solo - Double Countersunk

Zinc



CORROSION RATING



Clean, dry & low humidity environments



SOFTWOOD CHIPBOARD



Product Code	Size (mm)	Driver Bit Size	Pack Qty (pcs)	Carton Qty (packs)	Pallet Qty (packs)
<b>BOX</b>					
30012SOLOZ	3.0 x 12	PZ1	200	140	5,040
30015SOLOZ	3.0 x 15	PZ1	200	140	5,040
30020SOLOZ	3.0 x 20	PZ1	200	140	5,040
30025SOLOZ	3.0 x 25	PZ1	200	75	2,700
35015SOLOZ	3.5 x 15	PZ2	200	140	5,040
35020SOLOZ	3.5 x 20	PZ2	200	75	2,700
35025SOLOZ	3.5 x 25	PZ2	200	75	2,700
35030SOLOZ	3.5 x 30	PZ2	200	75	1,800
35035SOLOZ	3.5 x 35	PZ2	200	50	1,200
35040SOLOZ	3.5 x 40	PZ2	200	50	1,200
35050SOLOZ	3.5 x 50	PZ2	200	35	840
40015SOLOZ	4.0 x 15	PZ2	200	75	2,700
40020SOLOZ	4.0 x 20	PZ2	200	75	2,700
40025SOLOZ	4.0 x 25	PZ2	200	75	1,800
40030SOLOZ	4.0 x 30	PZ2	200	75	1,800
40035SOLOZ	4.0 x 35	PZ2	200	50	1,200
40040SOLOZ	4.0 x 40	PZ2	200	50	1,200
40045SOLOZ	4.0 x 45	PZ2	200	35	840
40050SOLOZ	4.0 x 50	PZ2	200	35	840
40060SOLOZ	4.0 x 60	PZ2	200	15	540
40070SOLOZ	4.0 x 70	PZ2	200	15	540
40080SOLOZ	4.0 x 80	PZ2	200	15	540
45025SOLOZ	4.5 x 25	PZ2	200	35	1,200
45030SOLOZ	4.5 x 30	PZ2	200	50	1,200
45035SOLOZ	4.5 x 35	PZ2	200	50	840
45040SOLOZ	4.5 x 40	PZ2	200	35	840
45050SOLOZ	4.5 x 50	PZ2	200	15	540
45060SOLOZ	4.5 x 60	PZ2	200	15	540
45070SOLOZ	4.5 x 70	PZ2	200	16	384
45080SOLOZ	4.5 x 80	PZ2	200	16	384

Product Code	Size (mm)	Driver Bit Size	Pack Qty (pcs)	Carton Qty (packs)	Pallet Qty (packs)
<b>BOX</b>					
50025SOLOZ	5.0 x 25	PZ2	200	50	1,200
50030SOLOZ	5.0 x 30	PZ2	200	50	1,200
50035SOLOZ	5.0 x 35	PZ2	200	35	840
50040SOLOZ	5.0 x 40	PZ2	200	35	840
50045SOLOZ	5.0 x 45	PZ2	200	15	540
50050SOLOZ	5.0 x 50	PZ2	200	15	540
50060SOLOZ	5.0 x 60	PZ2	200	16	384
50070SOLOZ	5.0 x 70	PZ2	200	16	384
50080SOLOZ	5.0 x 80	PZ2	200	16	384
50090SOLOZ	5.0 x 90	PZ2	100	15	540
50100SOLOZ	5.0 x 100	PZ2	100	15	540
50120SOLOZ	5.0 x 120	PZ2	100	15	540
60040SOLOZ	6.0 x 40	PZ3	200	15	540
60050SOLOZ	6.0 x 50	PZ3	200	16	384
60060SOLOZ	6.0 x 60	PZ3	200	16	384
60070SOLOZ	6.0 x 70	PZ3	200	12	288
60080SOLOZ	6.0 x 80	PZ3	200	12	288
60100SOLOZ	6.0 x 100	PZ3	100	15	540
60120SOLOZ	6.0 x 120	PZ3	100	16	384
60150SOLOZ	6.0 x 150	PZ3	100	12	324
60200SOLOZ	6.0 x 200	PZ3	100	8	192
TYPE - SOC			SUB TYPE - SOC02		
<b>TUB (DRIVER BIT INCLUDED)</b>					
40030STUBZ	4.0 x 30	PZ2	1,250	4	20
TYPE - SOC			SUB TYPE - SOC02		

## Solo Square Recess



A single thread woodscrew mainly used in various types of timber and man-made boards or into masonry with the use of a plastic plug.

## Solo - Double Countersunk

Zinc

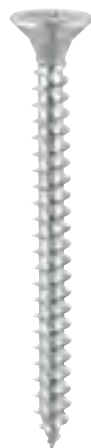

CORROSION RATING



Clean, dry & low humidity environments



SOFTWOOD CHIPBOARD

Product Code	Size (mm)	Driver Bit Size	Pack Qty (pcs)	Carton Qty (packs)	Pallet Qty (packs)
<b>BOX</b>					
40020SQSZ	4.0 x 20	SQ2	200	75	2,700
40025SQSZ	4.0 x 25	SQ2	200	75	2,700
40040SQSZ	4.0 x 40	SQ2	200	50	1,200
50040SQSZ	5.0 x 40	SQ2	200	35	840
50050SQSZ	5.0 x 50	SQ2	200	15	540
50080SQSZ	5.0 x 80	SQ2	200	16	384
TYPE - SOC			SUB TYPE - SOC02		

## Solo - Pan Head

Zinc



CORROSION RATING



Clean, dry & low humidity environments



SOFTWOOD CHIPBOARD

Product Code	Size (mm)	Driver Bit Size	Pack Qty (pcs)	Carton Qty (packs)	Pallet Qty (packs)
<b>BOX</b>					
40020SQPSZ	4.0 x 20	SQ2	200	75	2,700
40025SQPSZ	4.0 x 25	SQ2	200	75	1,800
40040SQPSZ	4.0 x 40	SQ2	200	35	840
50040SQPSZ	5.0 x 40	SQ2	200	15	540
TYPE - SOC			SUB TYPE - SOC02		

# Twin-Threaded Woodscrews

**Ideal for:**  
Softwood & masonry with a plastic plug

## For general applications

A traditional woodscrew designed to give rapid installation into softwoods.

This fixing is also ideal for use with a plastic plug when fixing into masonry.



Pozi

### Corrosion Rating

**1**

Clean, dry & low humidity environments

Available in:

Zinc

Double Countersunk



Round Head



### Double Countersunk

Reduces the likelihood of head shear and assists completion of countersinking.

### Partially Threaded

1-1/4" twin thread woodscrews and above are part threaded.

### 60° Twin Thread

60° Twin-Threads with parallel shank for faster insertion and greater pull out resistance.

### Surface Hardened

Up to 750 HV to prevent torque shearing under load and a core hardness of up to 450 HV for improved ductility.

### 25° Sharp Point

Sharp point and single threading for a fast start and improved thread acceptance.



## Twin-Threaded - Double Countersunk

Zinc



POZI



EN 14592:2008

CORROSION RATING



Clean, dry & low humidity environments



SOFTWOOD

A traditional twin-thread woodscrew with single lead start for a fast

installation. Mainly used in soft timber applications or masonry with a plastic plug.

Note: Partially threaded from 1¼"

Product Code	Size (imp.)	Driver Bit Size	Pack Qty (pcs)	Carton Qty (packs)	Pallet Qty (packs)
--------------	-------------	-----------------	----------------	--------------------	--------------------

**BOX**

00412CWZ	4 x ½	PZ1	200	140	5,040
00458CWZ	4 x ¾	PZ1	200	140	5,040
00434CWZ	4 x ¾	PZ1	200	140	5,040
00041CWZ	4 x 1	PZ1	200	75	2,700
00558CWZ	5 x ¾	PZ2	200	140	5,040
00534CWZ	5 x ¾	PZ2	200	140	5,040
00612CWZ	6 x ½	PZ2	200	140	5,040
00658CWZ	6 x ¾	PZ2	200	140	5,040
00634CWZ	6 x ¾	PZ2	200	75	2,700
00061CWZ	6 x 1	PZ2	200	75	2,700
06114CWZ	6 x 1 ¼	PZ2	200	50	1,200
06112CWZ	6 x 1 ½	PZ2	200	50	1,200
06134CWZ	6 x 1 ¾	PZ2	200	35	840
00062CWZ	6 x 2	PZ2	200	35	840
00758CWZ	7 x ¾	PZ2	200	75	2,700
00734CWZ	7 x ¾	PZ2	200	75	1,800
00071CWZ	7 x 1	PZ2	200	75	1,800
07114CWZ	7 x 1 ¼	PZ2	200	50	1,200
07112CWZ	7 x 1 ½	PZ2	200	35	840
00812CWZ	8 x ½	PZ2	200	140	5,040
00858CWZ	8 x ¾	PZ2	200	75	2,700
00834CWZ	8 x ¾	PZ2	200	75	2,700
00081CWZ	8 x 1	PZ2	200	75	1,800
08114CWZ	8 x 1 ¼	PZ2	200	50	1,200
08112CWZ	8 x 1 ½	PZ2	200	50	1,200
08134CWZ	8 x 1 ¾	PZ2	200	35	840
00082CWZ	8 x 2	PZ2	200	35	540
08214CWZ	8 x 2 ¼	PZ2	200	15	540
08212CWZ	8 x 2 ½	PZ2	200	16	384
00083CWZ	8 x 3	PZ2	200	16	384
00083CWZ100	8 x 3	PZ2	100	50	1,200
01034CWZ	10 x ¾	PZ2	200	50	1,200
00101CWZ	10 x 1	PZ2	200	50	1,200
10114CWZ	10 x 1 ¼	PZ2	200	50	1,200
10112CWZ	10 x 1 ½	PZ2	200	35	840
10134CWZ	10 x 1 ¾	PZ2	200	15	540
00102CWZ	10 x 2	PZ2	200	15	540
10214CWZ	10 x 2 ¼	PZ2	200	16	384
10212CWZ	10 x 2 ½	PZ2	200	16	384
00103CWZ	10 x 3	PZ2	200	16	384
00103CWZ100	10 x 3	PZ2	100	15	540
10312CWZ	10 x 3 ½	PZ2	100	15	540
00104CWZ	10 x 4	PZ2	100	15	540
00121CWZ	12 x 1	PZ3	200	35	840
12114CWZ	12 x 1 ¼	PZ3	200	35	840
12112CWZ	12 x 1 ½	PZ3	200	15	540
00122CWZ	12 x 2	PZ3	200	16	384
12212CWZ	12 x 2 ½	PZ3	200	16	384
00123CWZ	12 x 3	PZ3	200	12	288
00123CWZ100	12 x 3	PZ3	100	15	540
12312CWZ	12 x 3 ½	PZ3	100	15	540
00124CWZ	12 x 4	PZ3	100	15	540

TYPE - WOO

SUB TYPE - WOO01



Product Code	Size (imp.)	Driver Bit Size	Pack Qty (pcs)	Carton Qty (packs)	Pallet Qty (packs)
--------------	-------------	-----------------	----------------	--------------------	--------------------

**TIMBAG**

00658CWZB	6 x ¾	PZ2	700	5	870
00634CWZB	6 x ¾	PZ2	620	5	870
00061CWZB	6 x 1	PZ2	500	5	870
00834CWZB	8 x ¾	PZ2	540	5	870
00081CWZB	8 x 1	PZ2	470	5	870
08114CWZB	8 x 1 ¼	PZ2	390	5	600
08112CWZB	8 x 1 ½	PZ2	350	5	600
00082CWZB	8 x 2	PZ2	270	5	600
08212CWZB	8 x 2 ½	PZ2	200	5	600
00083CWZB	8 x 3	PZ2	180	5	600
10112CWZB	10 x 1 ½	PZ2	250	5	600
00102CWZB	10 x 2	PZ2	190	5	600
10212CWZB	10 x 2 ½	PZ2	160	5	600
00103CWZB	10 x 3	PZ2	140	5	600
00104CWZB	10 x 4	PZ2	90	5	600

TYPE - BAG

SUB TYPE - BAG02

**TIMPAC**

00658CWZP	6 x ¾	PZ2	45	10	-
00634CWZP	6 x ¾	PZ2	40	10	-
00061CWZP	6 x 1	PZ2	35	10	-
00834CWZP	8 x ¾	PZ2	35	10	-
00081CWZP	8 x 1	PZ2	30	10	-
08114CWZP	8 x 1 ¼	PZ2	25	10	-
08112CWZP	8 x 1 ½	PZ2	20	10	-
00082CWZP	8 x 2	PZ2	16	10	-
08212CWZP	8 x 2 ½	PZ2	12	10	-
00083CWZP	8 x 3	PZ2	10	10	-
10112CWZP	10 x 1 ½	PZ2	15	10	-
00102CWZP	10 x 2	PZ2	12	10	-
10212CWZP	10 x 2 ½	PZ2	10	10	-
00103CWZP	10 x 3	PZ2	8	10	-
00104CWZP	10 x 4	PZ2	6	10	-

TYPE - PAK

SUB TYPE - PAK02

## Mixed Tray



A traditional twin-thread woodscrew with single lead start for a fast installation. Mainly used in soft timber applications or masonry with a plastic plug.

Product Code	Size (imp.)	Driver Bit Size	Pack Qty (pcs)	Carton Qty (pcs)	Pallet Qty (pcs)
--------------	-------------	-----------------	----------------	------------------	------------------

**MIXED TRAY (1,140 PCS)**

WOODTRAY	6 x ½	PZ2	180	6	108
	6 x ¾	PZ2	190		
	6 x ¾	PZ2	130		
	6 x 1	PZ2	100		
	6 x 1 ¼	PZ2	110		
	8 x ¾	PZ2	100		
	8 x 1 ¼	PZ2	85		
	8 x 1 ½	PZ2	65		
	8 x 1	PZ2	60		
	8 x 2	PZ2	50		
	10 x 2	PZ2	35		
	10 x 2 ½	PZ2	35		

TYPE - WOO

SUB TYPE - WOO01

## Twin-Threaded - Roundhead

Zinc



POZI



EN 14592:2008

CORROSION RATING



Clean, dry & low humidity environments



SOFTWOOD

Roundhead zinc and clear woodscrew used for clamping to flat surfaces or to achieve a high aesthetic appearance.

Note: Partially threaded from 1¼"

Product Code	Size (imp.)	Driver Bit Size	Pack Qty (pcs)	Carton Qty (packs)	Pallet Qty (packs)
--------------	-------------	-----------------	----------------	--------------------	--------------------

**BOX**

00412CRWZ	4 x ½	PZ1	200	140	5,040
00458CRWZ	4 x ¾	PZ1	200	140	5,040
00612CRWZ	6 x ½	PZ2	200	140	5,040
00658CRWZ	6 x ¾	PZ2	200	75	2,700
00634CRWZ	6 x ¾	PZ2	200	75	1,800
00061CRWZ	6 x 1	PZ2	200	75	1,800
06114CRWZ	6 x 1 ¼	PZ2	200	50	1,200
00812CRWZ	8 x ½	PZ2	200	75	2,700
00858CRWZ	8 x ¾	PZ2	200	75	2,700
00834CRWZ	8 x ¾	PZ2	200	50	1,200
00081CRWZ	8 x 1	PZ2	200	50	1,200
08114CRWZ	8 x 1 ¼	PZ2	200	50	1,200
08112CRWZ	8 x 1 ½	PZ2	200	35	840
00082CRWZ	8 x 2	PZ2	200	35	540
00101CRWZ	10 x 1	PZ2	200	50	1,200
10114CRWZ	10 x 1 ¼	PZ2	200	35	840
10112CRWZ	10 x 1 ½	PZ2	200	35	840
00102CRWZ	10 x 2	PZ2	200	15	540
10212CRWZ	10 x 2 ½	PZ2	200	16	384
00103CRWZ	10 x 3	PZ2	200	16	384
00122CRWZ	12 x 2	PZ3	200	16	384

TYPE - WOO

SUB TYPE - WOO01



## Twin-Threaded Screws & Plugs

A traditional twin-thread woodscrew with single lead start for a fast installation. Mainly used in soft timber applications or masonry with a plastic plug.

Note: Partially threaded from 1 1/4"



## Red Plugs & Twin-Threaded Screws



Premium red plastic plugs made from high density polyethylene material (HDPE) to fit screw diameter 3.5, 4.2, 4.8mm.

Note: It may be beneficial to reduce drill diameter in soft materials.



Product Code	Contents	Size	Pack Qty (pcs)	Carton Qty (packs)
<b>TUB</b>				
778159	-	-	-	20
	Woodscrews	8 x 1 1/4"	500	
	Red Plastic Plugs	5.5 x 34	500	
	Masonry Drill Bit	5.5 x 85	1	
	Impact Driver Bits	PZ2 x 25	5	

TYPE - PLU SUB TYPE - PLU01

## Brown Plugs & Twin-Threaded Screws



Premium brown premium plastic plugs made from high density polyethylene material (HDPE) to fit screw diameter 4.8, 5.5, 6.3mm.

Note: It may be beneficial to reduce drill diameter in soft materials.

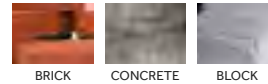

Product Code	Contents	Size	Pack Qty (pcs)	Carton Qty (packs)
<b>TUB</b>				
778254	-	-	-	20
	Woodscrews	10 x 2"	400	
	Brown Plastic Plugs	7.0 x 42	400	
	Masonry Drill Bit	7.0 x 100	1	
	Impact Driver Bits	PZ2 x 25	5	

TYPE - PLU SUB TYPE - PLU01

## Rainwater Screws

Specially designed for the fitting of brackets and clips during installation of PVCu rainwater systems.

When fixing into brick, a brown (6mm) or red (5mm) plug is needed.

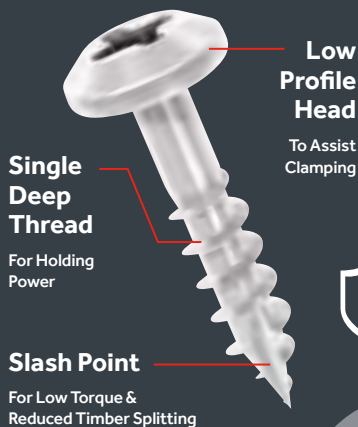

**Superior Corrosion Resistance**

Salt Spray Tested Up To 1,000 Hours

**For Fixing:**  
Gutters • Downpipes • Rainwater Systems

## Rainwater Screws

Exterior (Black or White Organic)



CORROSION RATING



1 2 3 4 5

Urban & industrial areas with a low salt atmosphere



Product Code	Size (mm)	Driver Bit Size	Pack Qty (pcs)	Carton Qty (packs)	Pallet Qty (packs)
<b>TUB (DRIVER BIT INCLUDED)</b>					
<b>Black Organic</b>					
40040CLARB	4.0 x 40	PZ2	300	12	360
50025CLARB	5.0 x 25	PZ2	400	12	360
60040CLARB	6.0 x 40	PZ3	200	12	360
<b>White Organic</b>					
40040CLARW	4.0 x 40	PZ2	300	12	360
50025CLARW	5.0 x 25	PZ2	400	12	360
60040CLARW	6.0 x 40	PZ3	200	12	360

TYPE - RWS SUB TYPE - RWS01

## Blackjax



### Blackjax

Black Organic



CORROSION RATING



Urban & industrial areas with a low salt atmosphere



SOFTWOOD

A twin-threaded wood screw with a black organic finish designed to be used with black ironmongery.

Note: Partially threaded from 1¼"

Product Code	Size (imp.)	Driver Bit Size	Pack Qty (pcs)	Carton Qty (packs)	Pallet Qty (packs)
<b>BOX</b>					
00658BJC	6 x ¾	PZ2	200	75	2,700
00634BJC	6 x ¾	PZ2	200	75	1,800
00061BJC	6 x 1	PZ2	200	75	1,800
00858BJC	8 x ¾	PZ2	200	75	2,700
00834BJC	8 x ¾	PZ2	200	50	1,200
00081BJC	8 x 1	PZ2	200	35	840
08114BJC	8 x 1¼	PZ2	200	35	840
08112BJC	8 x 1½	PZ2	200	35	840
00082BJC	8 x 2	PZ2	200	15	540
00101BJC	10 x 1	PZ2	200	35	840
10114BJC	10 x 1¼	PZ2	200	35	840
10112BJC	10 x 1½	PZ2	200	15	540
00102BJC	10 x 2	PZ2	200	15	540
TYPE - WOO			SUB TYPE - WOO02		
<b>TIMPAC</b>					
00061BJCP	6 x 1	PZ2	20	10	-
00081BJCP	8 x 1	PZ2	15	10	-
08112BJCP	8 x 1½	PZ2	10	10	-
10112BJCP	10 x 1½	PZ2	8	10	-
TYPE - PAK			SUB TYPE - PAK03		

## Carcass Screw



### Carcass Screw

Black Phosphate



CORROSION RATING



Clean, dry & low humidity environments



SOFTWOOD

Designed for use in the construction of furniture carcasses.

Product Code	Size (mm)	Driver Bit Size	Pack Qty (pcs)	Carton Qty (packs)	Pallet Qty (packs)
<b>BOX</b>					
40033CARC	4.0 x 33	PZ2	500	16	384
40045CARC	4.0 x 45	PZ2	500	16	384
TYPE - CAR			SUB TYPE - CAR01		

## Solid Brass Screws



### Solid Brass Screws

Made from Solid Brass



Countersunk

Roundhead

Raised Head

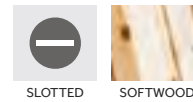

SLOTTED

SOFTWOOD

CORROSION RATING



Industrial and coastal areas with an aggressive salt atmosphere

A range of traditional polished solid brass slotted woodscrews. Ideal for applications where a traditional cosmetic finish is required or for use in corrosive environment.

Product Code	Head Type	Size (imp.)	Pack Qty (pcs)	Carton Qty (packs)	Pallet Qty (packs)
<b>BOX</b>					
00238CBS	Countersunk	2 x ¾	200	140	5,040
00412CBS	Countersunk	4 x ½	200	140	5,040
00458CBS	Countersunk	4 x ¾	200	140	5,040
00434CBS	Countersunk	4 x ¾	200	140	5,040
00612CBS	Countersunk	6 x ½	200	140	5,040
00634CBS	Countersunk	6 x ¾	200	75	2,700
00061CBS	Countersunk	6 x 1	200	75	2,700
06112CBS	Countersunk	6 x 1½	200	50	1,200
00071CBS	Countersunk	7 x 1	200	75	1,800
00834CBS	Countersunk	8 x ¾	200	75	2,700
00081CBS	Countersunk	8 x 1	200	75	1,800
08114CBS	Countersunk	8 x 1¼	200	75	1,800
08112CBS	Countersunk	8 x 1½	200	50	1,200
00082CBS	Countersunk	8 x 2	200	15	540
10114CBS	Countersunk	10 x 1¼	200	50	1,200
10112CBS	Countersunk	10 x 1½	200	15	840
00102CBS	Countersunk	10 x 2	100	15	840
10212CBS	Countersunk	10 x 2½	100	15	540
12212CBS	Countersunk	12 x 2½	100	15	540
00412RBS	Roundhead	4 x ½	200	140	540
00634RBS	Roundhead	6 x ¾	200	75	5,040
00061RBS	Roundhead	6 x 1	200	75	2,700
06112RBS	Roundhead	6 x 1½	200	50	1,800
00834RBS	Roundhead	8 x ¾	200	75	1,200
00081RBS	Roundhead	8 x 1	200	50	2,700
08112RBS	Roundhead	8 x 1½	200	35	1,200
00061RRBS	Raised Head	6 x 1	200	75	1,800
00082RRBS	Raised Head	8 x 2	200	15	540
TYPE - WOB			SUB TYPE - WOB01		

# Mirror & Decorative Screws & Accessories



## Mirror Screw

For hanging a mirror where an aesthetic finish is required. Solid head with rubber washer to protect the mirror from cracking. Includes screws with a slotted recess.

### Dome Head

Chrome



### Flat Head

Chrome



Product Code	Head Type	Finish	Screw Size (imp.)	Pack Qty (pcs)	Carton Qty (packs)
<b>BOX</b>					
00834CMIR200	Dome	Chrome	8 x ¾	200	10
00081CMIR200	Dome	Chrome	8 x 1	200	10
08112CMIR200	Dome	Chrome	8 x 1½	200	10
00082CMIR200	Dome	Chrome	8 x 2	200	10
TYPE - MIR				SUB TYPE - MIR01	
<b>TIMPAC</b>					
08114CMIRP	Dome	Chrome	8 x 1¼	10	10
08112CMIRP	Dome	Chrome	8 x 1½	8	10
08114FCMIRP	Flat	Chrome	8 x 1¼	10	10
08112FCMIRP	Flat	Chrome	8 x 1½	8	10
TYPE - PAK				SUB TYPE - PAK06	

## Screw Cup



A surface screw cup designed to allow the head of the screw to sit proud giving a decorative finish.

		Electro Brass	Nickel			
Product Code	Finish	To Fit Screw Ø (mm)	To Fit Screw G (imp.)	Pack Qty (pcs)	Carton Qty (packs)	
<b>TIMBAG</b>						
8BCUPB	Electro Brass	4.0	8	800	5	
8NCUPB	Nickel	4.0	8	800	5	
TYPE - BAG				SUB TYPE - BAG03		
<b>TIMPAC</b>						
6BCUPP	Electro Brass	3.5	6	60	10	
8BCUPP	Electro Brass	4.0	8	55	10	
10BCUPP	Electro Brass	5.0	10	50	10	
6NCUPP	Nickel	3.5	6	60	10	
8NCUPP	Nickel	4.0	8	55	10	
10NCUPP	Nickel	5.0	10	50	10	
TYPE - PAK				SUB TYPE - PAK07 G - GAUGE		

## Brass Threaded Screw Cap

Made from Solid Brass



A range of two piece solid brass screw caps, available in 5 finishes and 4 sizes. Used for mirrors, signs, plaques or acrylic poster holders



Product Code	Finish	Ø (mm)	To Fit Screw Ø. (mm)	To Fit Screw Gauge (imp.)	Pack Qty (pcs)	Carton Qty (packs)
<b>TIMPAC</b>						
TSC12PCP	Polished Chrome	12	3.5	6	4	5
TSC14PCP	Polished Chrome	14	4.0	8	4	5
TSC16PCP	Polished Chrome	16	5.0	10	4	5
TSC18PCP	Polished Chrome	18	6.0	12	4	5
TSC12SCP	Satin Chrome	12	3.5	6	4	5
TSC14SCP	Satin Chrome	14	4.0	8	4	5
TSC16SCP	Satin Chrome	16	5.0	10	4	5
TSC18SCP	Satin Chrome	18	6.0	12	4	5
TSC12PBP	Polished Brass	12	3.5	6	4	5
TSC14PBP	Polished Brass	14	4.0	8	4	5
TSC16PBP	Polished Brass	16	5.0	10	4	5
TSC18PBP	Polished Brass	18	6.0	12	4	5
TSC12SBP	Satin Brass	12	3.5	6	4	5
TSC14SBP	Satin Brass	14	4.0	8	4	5
TSC16SBP	Satin Brass	16	5.0	10	4	5
TSC18SBP	Satin Brass	18	6.0	12	4	5
TSC12SNP	Satin Nickel	12	3.5	6	4	5
TSC14SNP	Satin Nickel	14	4.0	8	4	5
TSC16SNP	Satin Nickel	16	5.0	10	4	5
TSC18SNP	Satin Nickel	18	6.0	12	4	5
TYPE - PAK				SUB TYPE - PAK07		
<b>BULK BOX</b>						
TSC14PC	Polished Chrome	14	4.0	8	40	18
TSC16PC	Polished Chrome	16	5.0	10	40	15
TSC14SC	Satin Chrome	14	4.0	8	40	18
TSC16SC	Satin Chrome	16	5.0	10	40	15
TYPE - BSC				SUB TYPE - BSC01		

## Knurled Brass Inset Screw Cup

Made from Solid Brass



Solid brass screw cups for a highly professional and flush finish. Commonly used with brass countersunk screws for decorative finish or for panels where frequent removal and replacement may be required.

Drill hole Ø size provided is a guide only and may vary in woods with varying hardness. We recommend cups are covered before gently tapping into place to avoid damage to both brass and timber.



Product Code	To Fit Screw Ø (mm)	To Fit Screw G (imp.)	Drill Hole Ø (mm)	Pack Qty (pcs)	Carton Qty (packs)
<b>TIMPAC</b>					
725221	3.5	6	8	8	10
725584	4.0 - 4.5	8	8.5	8	10
725174	4.8 - 5.0	10	11	8	10
725569	5.5 - 6.0	12	12	8	10
TYPE - PAK				SUB TYPE - PAK07 G - GAUGE	



# Screw Caps & Covers



## Hinged Screw Cap



For cosmetic use to conceal screws. Hinged to aid cap retention during and after installation.

White

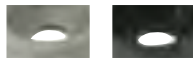

Grey Dark Grey

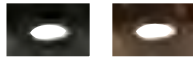

Black Brown



Blue Yellow

Product Code	Colour	To Fit Screw Ø (mm)	To Fit Screw G (imp.)	Pack Qty (pcs)	Carton Qty (packs)
<b>TIMPAC</b>					
SHCCWHITEP	White	3.0 - 4.5	4 - 9	100	10
SHCCGREYP	Grey	3.0 - 4.5	4 - 9	100	10
SHCCDGREYP	Dark Grey	3.0 - 4.5	4 - 9	100	10
SHCCBLACKP	Black	3.0 - 4.5	4 - 9	100	10
SHCCBROWNP	Brown	3.0 - 4.5	4 - 9	100	10
SHCCBLUEP	Blue	3.0 - 4.5	4 - 9	100	10
SHCCYELLOWP	Yellow	3.0 - 4.5	4 - 9	100	10
LHCCWHITEP	White	5.0 - 6.0	10 - 12	50	10
LHCCGREYP	Grey	5.0 - 6.0	10 - 12	50	10
LHCCDGREYP	Dark Grey	5.0 - 6.0	10 - 12	50	10
LHCCBLACKP	Black	5.0 - 6.0	10 - 12	50	10
LHCCBROWNP	Brown	5.0 - 6.0	10 - 12	50	10

TYPE - PAK

SUB TYPE - PAK07

## Two Piece Screw Cap



White

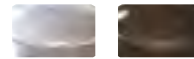

Chrome Brown

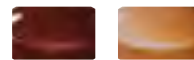

Clay Oak



Cream Grey



Anthracite Black

Two piece clip on caps with retaining washers, to provide a protective and decorative finish.



Product Code	Finish	To Fit Screw Ø (mm)	To Fit Screw G (Imp.)	Pack Qty (pcs)	Carton Qty (packs)
<b>TIMPAC</b>					
WHITEPLAST	White	3.5 - 4.2	6 - 8	100	15
CHROMEPLAST	Chrome	3.5 - 4.2	6 - 8	100	15
BROWNPLAST	Brown	3.5 - 4.2	6 - 8	100	15
CBROWNPLAST	Clay Brown	3.5 - 4.2	6 - 8	100	15
OAKPLAST	Oak	3.5 - 4.2	6 - 8	100	15
CREAMPLAST	Cream	3.5 - 4.2	6 - 8	100	15
GREYPLAST	Grey	3.5 - 4.2	6 - 8	100	15
ANTHPLAST	Anthracite	3.5 - 4.2	6 - 8	100	15
BLACKPLAST	Black	3.5 - 4.2	6 - 8	100	15

TYPE - PLA

SUB TYPE - PLA01

## Self-Adhesive Cover Cap



Provides a discreet, flush and water tight covering. Ideal for screw heads, unused pre-drilled holes and general repairs to damaged surfaces.

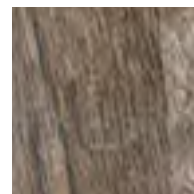
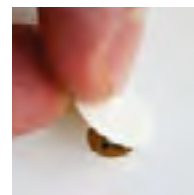

Product Code	Colour	Ø (mm)	Pack Qty (pcs)	Carton Qty (packs)
<b>PACK</b>				
COVERWM13	White Matt	13	112	200
COVERWM18	White Matt	18	105	200
COVERWG13	White Gloss	13	112	200
COVERIV13	Ivory	13	112	200
COVERBG13	Beige	13	112	200
COVERAL13	Aluminium	13	112	200
COVERGR13	Grey	13	112	200
COVEROA13	Oak	13	112	200
COVEROO13	Odessa Oak	13	112	200
COVERBE13	Beech	13	112	200
COVERMA13	Maple	13	112	200
COVERDR13	Driftwood	13	112	200
COVERMH13	Mahogany	13	112	200
COVERAH13	African Hardwood	13	112	200
COVERDW13	Dijon Walnut	13	112	200
COVERNW13	Natural Walnut	13	112	200
COVERWO13	Winchester Oak	13	112	200
COVERAG13	Anthracite Grey	13	112	200
COVERBL13	Black	13	112	200

TYPE - PLA

SUB TYPE - PLA03

<b>TRADE PACK</b>				
752493	White Gloss	13	1,008	100
752030	White Matt	13	1,008	100
752645	Black	13	1,008	100

TYPE - PLA

SUB TYPE - PLA03

Premium Decking Screws



**DECK-FIX  
PREMIUM SCREW**

DESIGNED FOR DECKING  
PLATFORMS & EXTERNAL  
TIMBER CONSTRUCTION



DESIGNED FOR SUPERIOR CLAMPING WITH HELIX TO STOP TIMBER JACKING



REDUCED IMPACT RESISTANT HEAD FOR A CLEAN FINISH



PRECISION TX DRIVE RECESS

**NEW SIZE**

Product Code	Size (mm)	Pack Qty (pcs)	Carton Qty (packs)	Pallet Qty (packs)
--------------	-----------	----------------	--------------------	--------------------

**BOX (DRIVER BIT INCLUDED)**

50C2D250BX	4.5 x 50	250	15	540
65C2D250BX	4.5 x 65	250	18	432
75C2D250BX	4.5 x 75	250	18	432
85C2D250BX	4.5 x 85	250	18	432

**TUB (DRIVER BIT INCLUDED)**

50C2D250	4.5 x 50	250	4	288
65C2D250	4.5 x 65	250	4	288
65C2D1000	4.5 x 65	1,000	1	72
75C2D250	4.5 x 75	250	4	216

**TIMBAG**

50C2DB	4.5 x 50	175	5	500
65C2DB	4.5 x 65	145	5	500
75C2DB	4.5 x 75	120	5	500

TYPE - IDD / IDD / BAG SUB TYPE - IDD04 / BAG01

**NEW Industry Pack Available Now!**

Product Code	Size (mm)	Pack Qty (pcs)	Carton Qty (packs)	Pallet Qty (packs)
--------------	-----------	----------------	--------------------	--------------------

**INDUSTRY PACK (1,000 PCS)**

65C2DIND	4.5 x 65	1,000	3	81
----------	----------	-------	---	----

TYPE - IDD SUB TYPE - IDD04

**Impact Resistant Head**

strengthened head to prevent shearing when installed with an impact tool.

**Ribs Under Head** for improved countersinking.

**Helix** for removing debris and improving clamping.

**Patented Multi-Layer** coated with a patented multi-layer corrosion resistant plating to withstand 1000hrs salt spray.



**1<sup>ST</sup> CUT FOR RAPID "PICK-UP" AND QUICK INSERTION TIME**

**2<sup>ND</sup> CUT HELPS PREVENT WOOD SPLITTING WHEN SCREWING CLOSE TO THE EDGE**

**C2 Cylinder Head Decking Screws**

Exterior (Green Organic)



Urban & industrial areas with a low salt atmosphere

A premium decking screw with a reduced cylindrical head to give a concealed finish and patented C2 twin-cut technology.

Product Code	Size (mm)	Driver Bit Size	Pack Qty (pcs)	Carton Qty (packs)	Pallet Qty (packs)
433209	4.5 x 60	TX15	250	8	288

**TUB (DRIVER BIT INCLUDED)**

TYPE - IDD SUB TYPE - IDD04

**A2 Stainless Steel**



Urban & industrial areas with a moderate salt atmosphere

reduced cylindrical head to give a concealed finish and single slash for low torque and reduced timber splitting.



**Superior Corrosion Resistance!**

Product Code	Size (mm)	Driver Bit Size	Pack Qty (pcs)	Carton Qty (packs)	Pallet Qty (packs)
433187	4.5 x 60	TX15	250	4	315

**TUB (DRIVER BIT INCLUDED)**

TYPE - IDD SUB TYPE - IDD02

# Decking Screws



## Decking Screw - Double Countersunk NEW

Exterior (Green Organic)



**Long Lasting Corrosion Resistance!**

CORROSION RATING  
1 2 **3** 4 5

Urban & industrial areas with a low salt atmosphere

An economic but highly effective softwood decking screw. Plated to withstand up to 500 hours in a salt spray test and is designed to give a rapid installation and a secure fixing.

**NEW SIZE AVAILABLE IN TUB**

Product Code	Size (mm)	Driver Bit Size	Pack Qty (pcs)	Carton Qty (packs)	Pallet Qty (packs)
<b>BOX</b>					
50TDECK	4.5 x 50	PZ2	200	15	540
60TDECK	4.5 x 60	PZ2	200	15	540
70TDECK	4.5 x 70	PZ2	200	16	384
80TDECK	4.5 x 80	PZ2	200	16	384
<b>TUB (DRIVER BIT INCLUDED)</b>					
50TDECK2000	4.5 x 50	PZ2	2,000	2	72
60TDECK1500	4.5 x 60	PZ2	1,500	2	72

TYPE - IDD SUB TYPE - IDDD01

**NEW Industry Pack Available Now!**

Product Code	Size (mm)	Driver Bit Size	Pack Qty (pcs)	Carton Qty (packs)	Pallet Qty (packs)
<b>INDUSTRY PACK (1,000 PCS)</b>					
60TDECKIND	4.5 x 60	PZ2	1,000	6	144

TYPE - IDD SUB TYPE - IDDD01



## Decking Screw - Double Countersunk NEW

A2 Stainless Steel



**Superior Corrosion Resistance!**

CORROSION RATING  
1 2 3 **4** 5

Urban & industrial areas with a moderate salt atmosphere

An economic but highly effective softwood decking screw.

Manufactured from A2 Stainless Steel. Offering superior corrosion resistance making it ideal for multiple external applications, especially for the construction of decking platforms. Stainless steel must be used where there is a corrosive environment and/or the base material has inherent corrosive characteristics e.g. Green Oak.

Product Code	Size (mm)	Driver Bit Size	Pack Qty (pcs)	Carton Qty (packs)	Pallet Qty (packs)
<b>TUB</b>					
50TDECKSS	4.5 x 50	PZ2	250	8	288
65TDECKSS	4.5 x 65	PZ2	250	8	288

TYPE - IDD SUB TYPE - IDDD02



# Collated Decking Screws



## C2 Deck-Fix Collated Decking Screw



Exterior (Green Organic)



A premium decking screw using the C2 twin-cut technology.

See page 31 for more information about the C2 Deck-Fix.

CORROSION RATING  
1 2 **3** 4 5

Urban & industrial areas with a low salt atmosphere

Product Code	Size (mm)	Pack Qty (pcs)	Carton Qty (packs)	Pallet Qty (packs)
<b>BOX</b>				
65C2DCOLL	4.5 x 65	500	10	240

TYPE - COL SUB TYPE - COL08

**C2**  
**DECK-FIX**  
**PREMIUM SCREW**

DESIGNED FOR DECKING PLATFORMS & EXTERNAL TIMBER CONSTRUCTION



# Timber Framing & Landscaping Screws

Previously  
**IN-DEX™**

**Ideal for:**  
Decking Frames • Sleepers  
Fencing & Stairs • Roofing  
Pergolas • Gazebos

## Designed for outdoor applications

Designed as an alternative to the traditional coach screw mainly used for timber to timber applications. Coated with a patented multi-layer corrosion resistant plating, this screw is ideal for outdoor applications.



DESIGNED FOR SUPERIOR CLAMPING



STOPS TIMBER JACKING



NO PILOT HOLE REQUIRED\*



**LONGER LASTING CORROSION RESISTANCE #**

Available in:

A4 Stainless Steel

A2 Stainless Steel

Exterior



Hex Head



Wafer Head



### Hex/Wafer Head

8mm hex head countersunk with a fixed washer or wafer head with TX30/TX40 recess

### Patented Molecular Lubrication

Patented lubrication, designed to enhance screw insertion time and provides greater resistance to corrosion

### Helix

To remove debris and improve clamping.

### 50° Deep Single Thread

To provide secure fixing with high pull-out resistance

### Type 17 Slash

Slash point tip helps prevent the timber splitting when screwing close to the edge, whilst also helping to reduce torque.

### 25° Sharp Point

Sharp point and single threading for a fast start, easy penetration and improved thread acceptance.

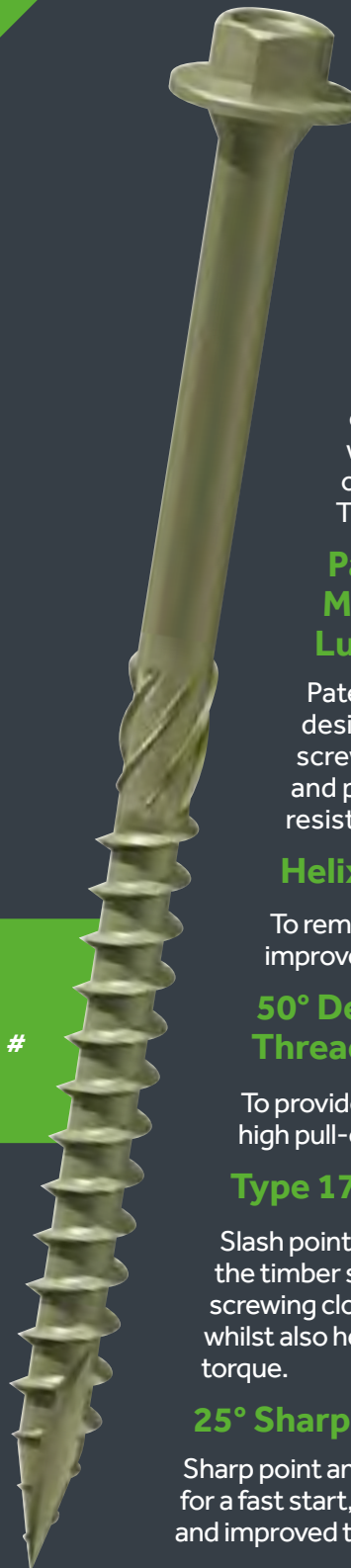

\* pilot hole may be required into certain hardwoods. # compared to standard zinc & clear plating

## Timber Screw - Hex Head

NEW

Exterior		A4 Stainless Steel
Silver Organic	Green Organic	



Exterior				
1	2	3	4	5

Urban & industrial areas with a low salt atmosphere

A4 Stainless Steel				
1	2	3	4	5

Urban & industrial areas with a moderate salt atmosphere

**Ultimate Corrosion Resistance!**

Please note a pilot hole is recommended for all stainless steel screws



Product Code	Size (mm)	Socket Size (mm)	Pack Qty (pcs)	Carton Qty (packs)	Pallet Qty (packs)
--------------	-----------	------------------	----------------	--------------------	--------------------

A4 Stainless Steel					
TUBE					
50INDEXSST	6.7 x 50	8.0	25	40	960
75INDEXSST	6.7 x 75	8.0	25	40	960
100INDEXSST	6.7 x 100	8.0	25	40	960
125INDEXSST	6.7 x 125	8.0	25	40	960
150INDEXSST	6.7 x 150	8.0	25	30	720
200INDEXSST	6.7 x 200	8.0	25	15	540
250INDEXSST	6.7 x 250	8.0	25	18	432
300INDEXSST	6.7 x 300	8.0	25	12	288

TIMPAC					
75INDEXSSTP	6.7 x 75	8.0	8	10	-
100INDEXSSTP	6.7 x 100	8.0	6	10	-
150INDEXSSTP	6.7 x 150	8.0	4	10	-

Exterior (Silver Organic)					
BAG					
875INH	8.0 x 75	10.0	10	25	1,000
8100INH	8.0 x 100	10.0	10	25	1,000
8150INH	8.0 x 150	10.0	10	25	1,000
8200INH	8.0 x 200	10.0	10	25	1,000
10100INH	10.0 x 100	13.0	10	25	1,000
10150INH	10.0 x 150	13.0	10	25	1,000
10200INH	10.0 x 200	13.0	10	25	1,000

PACK (SOCKET DRIVER INCLUDED)					
640INI	6.0 x 40	8.0	10	10	1,200
660INI	6.0 x 60	8.0	10	10	1,200
680INI	6.0 x 80	8.0	10	10	1,200
6100INI	6.0 x 100	8.0	10	10	1,200
840INI	8.0 x 40	10.0	10	10	1,200
860INI	8.0 x 60	10.0	10	10	1,200
875INI	8.0 x 75	10.0	10	10	1,200
8100INI	8.0 x 100	10.0	10	5	600
8120INI	8.0 x 120	10.0	10	5	600
8150INI	8.0 x 150	10.0	10	5	600
8200INI	8.0 x 200	10.0	10	5	600
1060INI	10.0 x 60	13.0	10	5	600
1080INI	10.0 x 80	13.0	10	5	600
10100INI	10.0 x 100	13.0	10	5	600
10130INI	10.0 x 130	13.0	10	5	600
10150INI	10.0 x 150	13.0	10	5	600
10160INI	10.0 x 160	13.0	10	5	600
10200INI	10.0 x 200	13.0	10	5	600

GRAB PACK (165 PCS)					
INDGPACK	-	-	165	5	150
	6.7 x 75	8.0	30		
	6.7 x 87	8.0	45		
	6.7 x 100	8.0	35		
	6.7 x 125	8.0	35		
	6.7 x 150	8.0	20		
	8mm Socket Driver	-	1		

Product Code	Size (mm)	Socket Size (mm)	Pack Qty (pcs)	Carton Qty (packs)	Pallet Qty (packs)
--------------	-----------	------------------	----------------	--------------------	--------------------

Exterior (Green Organic)					
BOX					
60IN	6.7 x 60	8.0	50	35	840
75IN	6.7 x 75	8.0	50	35	840
87IN	6.7 x 87	8.0	50	35	840
100IN	6.7 x 100	8.0	50	15	540
125IN	6.7 x 125	8.0	50	15	540
150IN	6.7 x 150	8.0	50	18	432
175IN	6.7 x 175	8.0	50	18	432
200IN	6.7 x 200	8.0	50	12	288
225IN	6.7 x 225	8.0	50	9	216
250IN	6.7 x 250	8.0	50	9	216

TIMBAG					
100INDEXTB	6.7 x 100	8.0	50	5	600
150INDEXTB	6.7 x 150	8.0	30	5	600
200INDEXTB	6.7 x 200	8.0	20	5	600

TIMPAC					
100INDEXP	6.7 x 100	8.0	6	10	-
150INDEXP	6.7 x 150	8.0	4	10	-

### NEW Tub Available Now!



Designed as an alternative to the traditional coach screw mainly used for timber to timber applications. Coated with a patented multi-layer corrosion resistant plating to withstand 1,000 hours salt spray test, this screw is ideal for external applications.

Product Code	Size (mm)	Socket Size (mm)	Pack Qty (pcs)	Pallet Qty (packs)
--------------	-----------	------------------	----------------	--------------------

Exterior (Green Organic)				
LARGE TUB (SOCKET DRIVER INCLUDED)				
87INLT	6.7 x 87	8.0	400	64
100INLT	6.7 x 100	8.0	300	64
150INLT	6.7 x 150	8.0	250	64

### NEW Grab Pack Available Now!



A selection of popular exterior hex head landscaping screw sizes in a handy and reusable storage pack with clip-shut lid.

Product Code	Size (mm)	Socket Size (mm)	Pack Qty (pcs)	Carton Qty (packs)	Pallet Qty (packs)
--------------	-----------	------------------	----------------	--------------------	--------------------

Exterior (Green Organic)					
GRAB PACK (165 PCS)					
INDGPACK	-	-	165	5	150
	6.7 x 75	8.0	30		
	6.7 x 87	8.0	45		
	6.7 x 100	8.0	35		
	6.7 x 125	8.0	35		
	6.7 x 150	8.0	20		
	8mm Socket Driver	-	1		

## Timber Screw - Wafer Head

Exterior (GO)	A2 Stainless Steel
---------------	--------------------



CORROSION RATINGS

Exterior (GO)				
1	2	3	4	5

Urban & industrial areas with a low salt atmosphere

A2 Stainless Steel				
1	2	3	4	5

Urban & industrial areas with a moderate salt atmosphere

Product Code	Size (mm)	Driver Bit Size	Pack Qty (pcs)	Carton Qty (packs)	Pallet Qty (packs)
--------------	-----------	-----------------	----------------	--------------------	--------------------

Exterior (Green Organic)					
BOX (DRIVER BIT INCLUDED)					
60INW	6.7 x 60	TX30	50	35	840
75INW	6.7 x 75	TX30	50	35	840
95INW	6.7 x 95	TX30	50	15	540
125INW	6.7 x 125	TX30	50	15	540
150INW	6.7 x 150	TX30	50	18	432
175INW	6.7 x 175	TX30	50	18	432
200INW	8.0 x 200	TX40	50	8	192
225INW	8.0 x 225	TX40	50	6	144
250INW	8.0 x 250	TX40	50	6	144
275INW	8.0 x 275	TX40	25	9	216
300INW	8.0 x 300	TX40	25	9	216
350INW	8.0 x 350	TX40	25	9	270
400INW	8.0 x 400	TX40	25	9	270

Exterior (Green Organic)					
TIMBAG (DRIVER BIT INCLUDED)					
95INDEXWB	6.7 x 95	TX30	50	5	600
125INDEXWB	6.7 x 125	TX30	30	5	600
150INDEXWB	6.7 x 150	TX30	20	5	600

TIMPAC					
95INDEXWP	6.7 x 95	TX30	6	10	-
125INDEXWP	6.7 x 125	TX30	5	10	-
150INDEXWP	6.7 x 150	TX30	4	10	-

A2 Stainless Steel					
TUBE (DRIVER BIT INCLUDED)					
80INDEXWSST	8.0 x 80	TX40	20	40	960
100INDEXWSST	8.0 x 100	TX40	20	40	960
125INDEXWSST	8.0 x 125	TX40	20	33	660
150INDEXWSST	8.0 x 150	TX40	20	24	480

# Exterior Coach Screws & Carriage Bolt



## Exterior Coach Screw

Exterior (Green Organic)



HEX



EN 14592:2008

CORROSION RATING



Urban & industrial areas with a low salt atmosphere

A traditional way of fastening timber with an added advantage of a corrosion resistant plating for external applications.

Coated with a patented multi-layer corrosion resistant plating to

withstand 500 hours salt spray making it ideal for external applications.

Manufactured to DIN571.

Product Code	Size (mm)	Socket Size (mm)	Pack Qty (pcs)	Carton Qty (packs)
<b>BAG</b>				
650INCSB	6.0 x 50	10.0	10	70
675INCSB	6.0 x 75	10.0	10	70
850INCSB	8.0 x 50	13.0	10	70
875INCSB	8.0 x 75	13.0	10	50
TYPE - IND			SUB TYPE - IND03	

## Exterior Carriage Bolt

Exterior (Green Organic)



DOMED



EN 14592:2008

CORROSION RATING



Urban & industrial areas with a low salt atmosphere

A domed head bolt with a square anti spin shoulder mainly used for clamping timber or attaching ironmongery to timber.

Coated with a patented multi-layer corrosion resistant plating to

withstand 500 hours salt spray making it ideal for external applications.

Manufactured to DIN 603, DIN 934 and DIN 125-A.

Product Code	Size (mm)	Socket Size (mm)	Pack Qty (pcs)	Carton Qty (packs)	Pallet Qty (packs)
<b>BAG</b>					
10100INCB	M10 x 100	17.0	10	10	1000
10150INCB	M10 x 150	17.0	10	6	600
10160INCB	M10 x 160	17.0	10	6	600
10200INCB	M10 x 200	17.0	10	6	600
10220INCB	M10 x 220	17.0	10	5	500
TYPE - IND			SUB TYPE - IND04		

Exterior (Silver Organic)



DOMED



EN 14592:2008

CORROSION RATING



Urban & industrial areas with a low salt atmosphere

A domed head bolt with a square anti spin shoulder mainly used for clamping timber or attaching ironmongery to timber.

Coated with a patented multi-layer corrosion resistant plating to

withstand 1,000 hours salt spray test making it ideal for external applications.

Supplied with hex nuts and form A washers.

Product Code	Size (mm)	Socket Size (mm)	Pack Qty (pcs)	Carton Qty (packs)	Pallet Qty (packs)
<b>BAG</b>					
0640CBI	M6 x 40	10.0	10	5	600
0650CBI	M6 x 50	10.0	10	5	600
0675CBI	M6 x 75	10.0	10	5	600
06100CBI	M6 x 100	10.0	10	5	600
0850CBI	M8 x 50	13.0	10	5	600
0875CBI	M8 x 75	13.0	10	5	600
08100CBI	M8 x 100	13.0	10	5	600
08110CBI	M8 x 110	13.0	10	5	600
08130CBI	M8 x 130	13.0	10	5	400
08150CBI	M8 x 150	13.0	10	5	400
1075CBI	M10 x 75	17.0	10	5	600
10100CBI	M10 x 100	17.0	10	5	600
10120CBI	M10 x 120	17.0	10	5	400
10130CBI	M10 x 130	17.0	10	5	400
10150CBI	M10 x 150	17.0	10	5	400
10180CBI	M10 x 180	17.0	10	5	400
1275CBI	M12 x 75	19.0	10	5	600
12100CBI	M12 x 100	19.0	10	5	400
12130CBI	M12 x 130	19.0	10	5	400
TYPE - CAB			SUB TYPE - CAB03		

## Coach Screws

Platings available:

Zinc

Page  
**35**



## Full Range of Carriage Bolts

Platings available:

Zinc

Exterior

HDG

Page  
**55**





# Advanced Coach Screws

**Ideal for:**  
 Framing • Landscaping  
 Fencing • Stairs • Roofing  
 Gazebos • Pergolas • Sleepers

## 3x FASTER



THAN A STANDARD COACH SCREW



DESIGNED FOR SUPERIOR CLAMPING



NO PILOT HOLE REQUIRED\*



STOPS TIMBER JACKING



**Hex Flange Head**

Hexagon head with fixed washer for excellent clamping

**Partially Threaded**

Partially threaded to assist clamping of materials

**50° Deep Single Thread**

To provide secure fixing with high pull-out resistance

**Single Slash**

To reduce torque and the likelihood of the timber splitting when the screw is inserted close to the edge

**25° Sharp Point**

Sharp point and single threading for a fast start, easy penetration and improved thread acceptance.

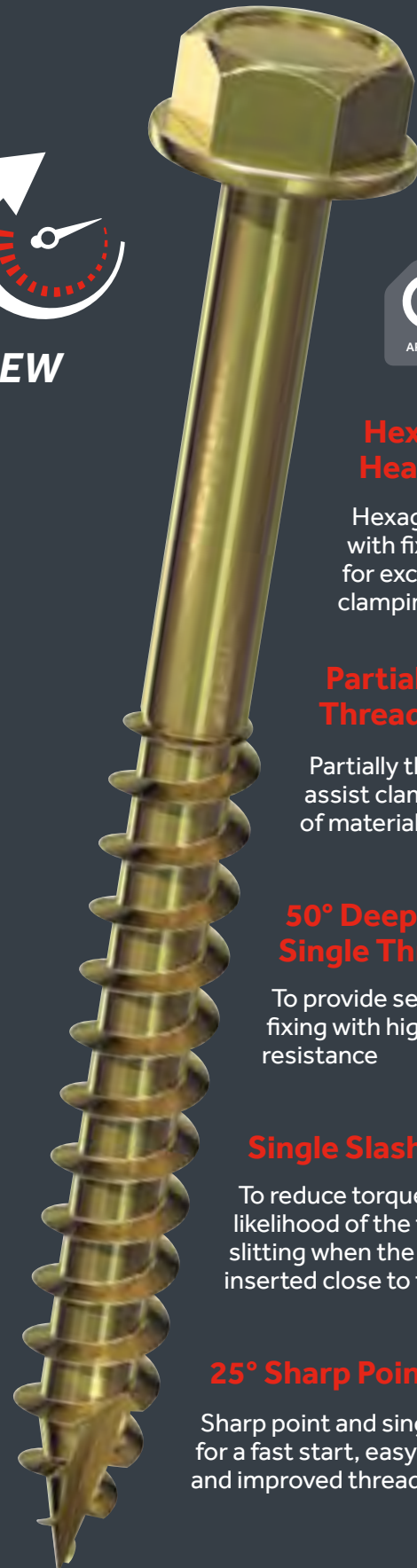

### Yellow

Product Code	Size (mm)	Socket Size (mm)	Fixed Washer Ø (mm)	Pack Qty (pcs)	Carton Qty (packs)	Pallet Qty (packs)
<b>BOX (SOCKET DRIVER INCLUDED)</b>						
625SCSY	6.0 x 25	8	12.6	100	18	648
640SCSY	6.0 x 40	8	12.6	100	12	432
650SCSY	6.0 x 50	8	12.6	100	10	360
660SCSY	6.0 x 60	8	12.6	100	10	360
670SCSY	6.0 x 70	8	12.6	100	10	360
680SCSY	6.0 x 80	8	12.6	100	10	360
6100SCSY	6.0 x 100	8	12.6	100	10	360
840SCSY	8.0 x 40	10	14.6	50	12	432
850SCSY	8.0 x 50	10	14.6	50	12	432
860SCSY	8.0 x 60	10	14.6	50	10	360
870SCSY	8.0 x 70	10	14.6	50	10	360
880SCSY	8.0 x 80	10	14.6	50	10	360
8100SCSY	8.0 x 100	10	14.6	50	10	360
8120SCSY	8.0 x 120	10	14.6	50	8	288
1040SCSY	10.0 x 40	13	17.5	50	10	360
1050SCSY	10.0 x 50	13	17.5	50	10	360
1060SCSY	10.0 x 60	13	17.5	50	10	360
1070SCSY	10.0 x 70	13	17.5	50	10	360
1080SCSY	10.0 x 80	13	17.5	50	10	360
10100SCSY	10.0 x 100	13	17.5	50	8	288
10130SCSY	10.0 x 130	13	17.5	50	8	288
10160SCSY	10.0 x 160	13	17.5	50	6	216
1280SCSY	12.0 x 80	16	22.0	25	10	360
12100SCSY	12.0 x 100	16	22.0	25	10	360
12130SCSY	12.0 x 130	16	22.0	25	8	288
12160SCSY	12.0 x 160	16	22.0	25	6	216
TYPE - SOC				SUB TYPE - SOC03		
<b>TIMPAC</b>						
640SCSYP	6.0 x 40	8	12.6	12	10	-
650SCSYP	6.0 x 50	8	12.6	12	10	-
670SCSYP	6.0 x 70	8	12.6	10	10	-
680SCSYP	6.0 x 80	8	12.6	10	10	-
6100SCSYP	6.0 x 100	8	12.6	8	10	-
8100SCSYP	8.0 x 100	10	14.6	4	10	-
8120SCSYP	8.0 x 120	10	14.6	4	10	-
10100SCSYP	10.0 x 100	13	17.5	2	10	-
TYPE - PAK				SUB TYPE - PAK08		

# Coach Screws



## Coach Screw

Zinc



HEX



EN 14592:2008

CORROSION RATING

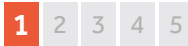

Clean, dry & low humidity environments

A traditional heavy duty woodscrew mainly used for timber to timber applications, attaching ironmongery to timber or for use with a nylon plug into masonry. Pilot holes may be required into certain hard woods.

NOTE: Thread length is 2/3 of the overall length screw.  
E.g. 100mm = 60mm thread.

## Exterior Coach Screws

Page 33



Product Code	Size (mm)	Socket Size (mm)	Pack Qty (pcs)	Carton Qty (packs)	Pallet Qty (packs)
<b>BOX</b>					
0625CSC	6.0 x 25	10	250	12	432
0630CSC	6.0 x 30	10	200	12	540
0640CSC	6.0 x 40	10	200	12	432
0650CSC	6.0 x 50	10	200	8	240
0660CSC	6.0 x 60	10	200	8	240
0670CSC	6.0 x 70	10	200	8	240
0675CSC	6.0 x 75	10	100	12	432
0680CSC	6.0 x 80	10	100	12	432
06100CSC	6.0 x 100	10	200	6	180
0830CSC	8.0 x 30	13	200	8	240
0840CSC	8.0 x 40	13	200	8	240
0850CSC	8.0 x 50	13	100	12	432
0860CSC	8.0 x 60	13	100	8	240
0865CSC	8.0 x 65	13	100	8	240
0870CSC	8.0 x 70	13	100	8	240
0875CSC	8.0 x 75	13	100	8	240
0880CSC	8.0 x 80	13	100	8	240
0890CSC	8.0 x 90	13	50	12	432
08100CSC	8.0 x 100	13	50	12	432
08120CSC	8.0 x 120	13	50	12	432
08150CSC	8.0 x 150	13	50	8	240
1040CSC	10.0 x 40	17	100	8	240
1050CSC	10.0 x 50	17	100	8	240
1060CSC	10.0 x 60	17	100	6	180
1070CSC	10.0 x 70	17	100	6	180
1075CSC	10.0 x 75	17	100	6	180
1080CSC	10.0 x 80	17	50	8	240
10100CSC	10.0 x 100	17	50	8	240
10120CSC	10.0 x 120	17	50	8	240
10130CSC	10.0 x 130	17	50	8	240
10150CSC	10.0 x 150	17	25	12	432
10160CSC	10.0 x 160	17	25	12	432
10200CSC	10.0 x 200	17	20	12	432
1250CSC	12.0 x 50	19	100	6	180
1275CSC	12.0 x 75	19	50	8	240
1280CSC	12.0 x 80	19	25	12	432
12100CSC	12.0 x 100	19	25	12	432
12150CSC	12.0 x 150	19	25	8	240
TYPE - COA			SUB TYPE - COA01		

Product Code	Size (mm)	Socket Size (mm)	Pack Qty (pcs)	Carton Qty (packs)	Pallet Qty (packs)
<b>TIMBAG</b>					
0650CSCB	6.0 x 50	10	120	5	600
0670CSCB	6.0 x 70	10	100	5	600
06100CSCB	6.0 x 100	10	70	5	600
0850CSCB	8.0 x 50	13	75	5	600
0860CSCB	8.0 x 60	13	65	5	600
0880CSCB	8.0 x 80	13	48	5	600
08100CSCB	8.0 x 100	13	40	5	600
1050CSCB	10.0 x 50	17	45	5	600
1080CSCB	10.0 x 80	17	30	5	600
10100CSCB	10.0 x 100	17	28	5	600
10120CSCB	10.0 x 120	17	24	5	600
10130CSCB	10.0 x 130	17	23	5	600
10150CSCB	10.0 x 150	17	18	5	600
1280CSCB	12.0 x 80	19	25	5	600
12100CSCB	12.0 x 100	19	20	5	600
12150CSCB	12.0 x 150	19	12	5	600
TYPE - BAG			SUB TYPE - BAG06		
<b>TIMPAC</b>					
0650CSCP	6.0 x 50	10	10	5	-
0670CSCP	6.0 x 70	10	10	5	-
0680CSCP	6.0 x 80	10	10	5	-
06100CSCP	6.0 x 100	10	10	5	-
0850CSCP	8.0 x 50	13	5	5	-
0860CSCP	8.0 x 60	13	5	5	-
0880CSCP	8.0 x 80	13	5	5	-
08100CSCP	8.0 x 100	13	5	5	-
1050CSCP	10.0 x 50	17	4	5	-
1080CSCP	10.0 x 80	17	4	5	-
10100CSCP	10.0 x 100	17	2	5	-
10150CSCP	10.0 x 150	17	2	5	-
1275CSCP	12.0 x 75	19	2	5	-
TYPE - PAK			SUB TYPE - PAK12		

## Coach Screw With Nylon Plug

Zinc

Nylon



HEX

A traditional heavy duty woodscrew with a nylon plug for masonry applications.

Product Code	Screw Size (mm)	Plug Size (mm)	Socket Size (mm)	Pack Qty (pcs)	Carton Qty (packs)	Pallet Qty (packs)
<b>TIMBAG</b>						
0660CSCNB	6.0 x 60	10 x 50	10	40	5	600
0680CSCNB	6.0 x 80	10 x 50	10	30	5	600
08100CSCNB	8.0 x 100	12 x 60	13	12	5	600
TYPE - BAG			SUB TYPE - BAG06			
<b>TIMPAC</b>						
0660CSCNP	6.0 x 60	10 x 50	10	2	5	-
0680CSCNP	6.0 x 80	10 x 50	10	2	5	-
08100CSCNP	8.0 x 100	12 x 60	13	2	5	-
TYPE - PAK			SUB TYPE - PAK12			

## Nylon Plug

Nylon



Product Code	Size (mm)	To Fit Screw Ø (mm)	Pack Qty (pcs)	Carton Qty (packs)	Pallet Qty (packs)
<b>TIMBAG</b>					
06NLPB	6.0 x 30	3.5 - 5.0	200	5	870
08NLPB	8.0 x 40	5.0 - 6.0	100	5	870
10NLPB	10.0 x 50	6.0 - 8.0	70	5	600
TYPE - BAG			SUB TYPE - BAG07		
<b>TIMPAC</b>					
06NLPP	6.0 x 30	3.5 - 5.0	20	10	-
08NLPP	8.0 x 40	5.0 - 6.0	10	10	-
10NLPP	10.0 x 50	6.0 - 8.0	5	10	-
12NLPP	12.0 x 60	8.0 - 10.0	2	10	-
14NLPP	14.0 x 75	10.0 - 12.0	2	10	-
TYPE - PAK			SUB TYPE - PAK13		

Nylon plug for use with coach screws into masonry.

# Drywall Screws



## Coarse Thread Screw

### Black Phosphate



CORROSION RATING  
**1** 2 3 4 5  
 Clean, dry & low humidity environments



Used to secure plasterboard to timber stud work.  
 Note: Partially threaded from 60mm.

Product Code	Size (mm)	Driver Bit Size	Pack Qty (pcs)	Carton Qty (packs)	Pallet Qty (packs)
<b>BOX (DRIVER BIT INCLUDED)</b>					
00025DRYC	3.5 x 25	PH2	1,000	16	384
00032DRYC	3.5 x 32	PH2	1,000	12	324
00035DRYC	3.5 x 35	PH2	1,000	12	288
00038DRYC	3.5 x 38	PH2	1,000	12	288
00042DRYC	3.5 x 42	PH2	1,000	9	216
00045DRYC	3.5 x 45	PH2	1,000	8	192
00050DRYC	3.5 x 50	PH2	1,000	6	144
00055DRYC	3.5 x 55	PH2	500	12	288
00060DRYC	3.5 x 60	PH2	500	12	288
00065DRYC	4.2 x 65	PH2	500	8	192
00075DRYC	4.2 x 75	PH2	500	8	192
00100DRYC	4.8 x 100	PH2	500	6	144
TYPE - DRY			SUB TYPE - DRY02		

Product Code	Size (mm)	Driver Bit Size	Pack Qty (pcs)	Carton Qty (packs)	Pallet Qty (packs)
<b>BOX OF 200</b>					
00025DRYCS	3.5 x 25	PH2	200	75	1,800
00032DRYCS	3.5 x 32	PH2	200	50	1,200
00038DRYCS	3.5 x 38	PH2	200	35	840
00042DRYCS	3.5 x 42	PH2	200	35	840
00050DRYCS	3.5 x 50	PH2	200	35	840
00075DRYCS	4.2 x 75	PH2	200	16	384
TYPE - DRY			SUB TYPE - DRY02		

Product Code	Size (mm)	Driver Bit Size	Pack Qty (pcs)	Carton Qty (packs)	Pallet Qty (packs)
<b>TUB (DRIVER BIT INCLUDED)</b>					
00032DRYCT	3.5 x 32	PH2	2,000	20	-
00038DRYCT	3.5 x 38	PH2	1,500	20	-
TYPE - DRY			SUB TYPE - DRY02		

Product Code	Size (mm)	Driver Bit Size	Pack Qty (pcs)	Carton Qty (packs)	Pallet Qty (packs)
<b>TIMBAG</b>					
00032DRYCB	3.5 x 32	PH2	400	5	600
00038DRYCB	3.5 x 38	PH2	350	5	600
00050DRYCB	3.5 x 50	PH2	250	5	600
TYPE - BAG			SUB TYPE - BAG08		

### Yellow



Product Code	Size (mm)	Driver Bit Size	Pack Qty (pcs)	Carton Qty (packs)	Pallet Qty (packs)
<b>BOX (DRIVER BIT INCLUDED)</b>					
00125DRYCY	4.8 x 125	PH2	100	18	432
00150DRYCY	4.8 x 150	PH2	100	18	432
TYPE - DRY			SUB TYPE - DRY02		

## Fine Thread Screw

### Black Phosphate



CORROSION RATING  
**1** 2 3 4 5  
 Clean, dry & low humidity environments



Used to secure plasterboard to wall/ceiling track systems with a max of 0.6mm thickness.  
 Note: Partially threaded from 60mm.

Product Code	Size (mm)	Driver Bit Size	Pack Qty (pcs)	Carton Qty (packs)	Pallet Qty (packs)
<b>BOX (DRIVER BIT INCLUDED)</b>					
00025DRY	3.5 x 25	PH2	1,000	16	384
00032DRY	3.5 x 32	PH2	1,000	12	324
00035DRY	3.5 x 35	PH2	1,000	12	288
00038DRY	3.5 x 38	PH2	1,000	12	288
00042DRY	3.5 x 42	PH2	1,000	9	216
00045DRY	3.5 x 45	PH2	1,000	8	192
00050DRY	3.5 x 50	PH2	1,000	6	144
00055DRY	3.5 x 55	PH2	500	12	288
00060DRY	3.5 x 60	PH2	500	12	288
00065DRY	4.2 x 65	PH2	500	8	192
00075DRY	4.2 x 75	PH2	500	8	192
00090DRY	4.8 x 90	PH2	500	6	144
00100DRY	4.8 x 100	PH2	500	6	144
TYPE - DRY			SUB TYPE - DRY01		

Product Code	Size (mm)	Driver Bit Size	Pack Qty (pcs)	Carton Qty (packs)	Pallet Qty (packs)
<b>BOX OF 200</b>					
00025DRYS	3.5 x 25	PH2	200	75	1,800
00032DRYS	3.5 x 32	PH2	200	50	1,200
00038DRYS	3.5 x 38	PH2	200	35	840
00042DRYS	3.5 x 42	PH2	200	35	840
00045DRYS	3.5 x 45	PH2	200	35	840
00050DRYS	3.5 x 50	PH2	200	35	840
00060DRYS	3.5 x 60	PH2	200	15	540
00065DRYS	4.2 x 65	PH2	200	16	384
00075DRYS	4.2 x 75	PH2	200	16	384
00100DRYS	4.8 x 100	PH2	200	16	384
TYPE - DRS			SUB TYPE - DRS01		

Product Code	Size (mm)	Driver Bit Size	Pack Qty (pcs)	Carton Qty (packs)	Pallet Qty (packs)
<b>TUB (DRIVER BIT INCLUDED)</b>					
00032DRYT	3.5 x 32	PH2	2,000	20	-
00038DRYT	3.5 x 38	PH2	1,500	20	-
TYPE - DRY			SUB TYPE - DRY01		

Product Code	Size (mm)	Driver Bit Size	Pack Qty (pcs)	Carton Qty (packs)	Pallet Qty (packs)
<b>TIMBAG</b>					
00032DRYB	3.5 x 32	PH2	400	5	600
00038DRYB	3.5 x 38	PH2	350	5	600
00042DRYB	3.5 x 42	PH2	320	5	600
00050DRYB	3.5 x 50	PH2	250	5	600
00060DRYB	3.5 x 60	PH2	200	5	600
00075DRYB	4.2 x 75	PH2	130	5	600
00090DRYB	4.8 x 90	PH2	70	5	600
TYPE - BAG			SUB TYPE - BAG09		

### Zinc



CORROSION RATING  
**1** 2 3 4 5  
 Clean, dry & low humidity environments

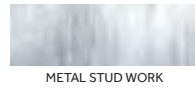

Used to secure plasterboard to wall/ceiling track systems with a max of 0.6mm thickness.  
 Note: Partially threaded from 60mm.

Product Code	Size (mm)	Driver Bit Size	Pack Qty (pcs)	Carton Qty (packs)	Pallet Qty (packs)
<b>BOX (DRIVER BIT INCLUDED)</b>					
00025DRYZ	3.5 x 25	PH2	1,000	16	384
00032DRYZ	3.5 x 32	PH2	1,000	12	324
00035DRYZ	3.5 x 35	PH2	1,000	12	288
00038DRYZ	3.5 x 38	PH2	1,000	12	288
00042DRYZ	3.5 x 42	PH2	1,000	9	216
00045DRYZ	3.5 x 45	PH2	1,000	8	192
00050DRYZ	3.5 x 50	PH2	1,000	6	144
00055DRYZ	3.5 x 55	PH2	500	12	288
00060DRYZ	3.5 x 60	PH2	500	12	288
00065DRYZ	4.2 x 65	PH2	500	8	192
00075DRYZ	4.2 x 75	PH2	500	8	192
00090DRYZ	4.8 x 90	PH2	500	6	144
00100DRYZ	4.8 x 100	PH2	500	6	144
00125DRYZ	4.8 x 125	PH2	100	18	432
00150DRYZ	4.8 x 150	PH2	100	18	432
TYPE - DRY			SUB TYPE - DRY01		



# Drywall Bracket



# Drywall Screws

## Dense Board Screw

Black Phosphate



CORROSION RATING  
**1** 2 3 4 5

Clean, dry & low humidity environments

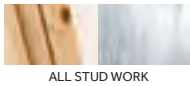

ALL STUD WORK

Designed for attaching dense board to timber stud work. The super sharp point and high low thread is specifically designed for an excellent fixing into timber.

Product Code	Size (mm)	Driver Bit Size	Pack Qty (pcs)	Carton Qty (packs)	Pallet Qty (packs)
<b>BOX (DRIVER BIT INCLUDED)</b>					
00030DRYD	3.9 x 30	PH2	1,000	16	384
00045DRYD	3.9 x 45	PH2	1,000	8	192
00055DRYD	3.9 x 55	PH2	1,000	6	144
TYPE - DRY			SUB TYPE - DRY03		

## Reverse Thread Screw

Black Phosphate



CORROSION RATING  
**1** 2 3 4 5

Clean, dry & low humidity environments



METAL STUD WORK

The reverse thread is designed to assist countersinking in dense board or hard boards.

Product Code	Size (mm)	Driver Bit Size	Pack Qty (pcs)	Carton Qty (packs)	Pallet Qty (packs)
<b>BOX (DRIVER BIT INCLUDED)</b>					
00042DRYR	3.9 x 42	PH2	1,000	9	216
TYPE - DRY			SUB TYPE - DRY04		

## Self-Drilling Screw

Zinc



CORROSION RATING  
**1** 2 3 4 5

Clean, dry & low humidity environments

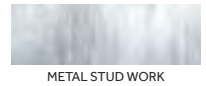

METAL STUD WORK

Self-drilling point to aid fixing plasterboard to wall /ceiling track systems with a max. of 2.0mm thickness. Note: 4.2 diameter screws drill 3.0mm and 4.8 diameter screws drill 4.0mm)

Product Code	Size (mm)	Driver Bit Size	Pack Qty (pcs)	Carton Qty (packs)	Pallet Qty (packs)
<b>BOX (DRIVER BIT INCLUDED)</b>					
00025PSDD	3.5 x 25	PH2	1,000	15	384
00032PSDD	3.5 x 32	PH2	1,000	12	324
00038PSDD	3.5 x 38	PH2	1,000	12	288
00042PSDD	3.5 x 42	PH2	1,000	12	216
00050PSDD	3.5 x 50	PH2	1,000	9	144
00055PSDD	3.5 x 55	PH2	500	6	288
00065PSDD	3.9 x 65	PH2	500	12	288
00075PSDD	4.2 x 75	PH2	500	12	192
00100PSDD	4.8 x 100	PH2	500	8	144
00125PSDD	4.8 x 125	PH2	100	6	540
TYPE - PSD			SUB TYPE - PSD01		
<b>TIMBAG</b>					
00032PSDDB	3.5 x 32	PH2	400	5	600
00042PSDDB	3.5 x 42	PH2	320	5	600
TYPE - BAG			SUB TYPE - BAG10		

# Cement Board Screws

1,500 Hours Salt Spray Resistance

## Twin-Cut Point

Exterior Plus



CORROSION RATING  
1 2 3 4 **5**

Clean, dry & low humidity environments



ALL STUD WORK

Twin-cut point with a hi-low thread for fixing to timber and thin sheet metal (max. 0.6mm)

NEW SIZE

Product Code	Size (mm)	Driver Bit Size	Pack Qty (pcs)	Carton Qty (packs)	Pallet Qty (packs)
<b>BOX (DRIVER BIT INCLUDED)</b>					
217789	4.2 x 25	PH2	200	50	1,200
217283	4.2 x 32	PH2	200	50	1,200
217796	4.2 x 42	PH2	200	35	840
TYPE - CBS			SUB TYPE - CBS01		

## Self-Drilling Point

Exterior Plus



CORROSION RATING  
1 2 3 4 **5**

Clean, dry & low humidity environments



METAL STUD WORK

Self-drilling point with self-tapping thread for fixing to steel (max. 3.0mm)

Product Code	Size (mm)	Driver Bit Size	Pack Qty (pcs)	Carton Qty (packs)	Pallet Qty (packs)
<b>BOX (DRIVER BIT INCLUDED)</b>					
217154	4.2 x 32	PH2	200	50	1,200
217228	4.2 x 42	PH2	200	35	840
TYPE - CBS			SUB TYPE - CBS01		

# Metal Framing Screws

Page 46

# Collated Drywall Screws



## Coarse Thread Screw

### Black Phosphate



PHILLIPS EN 14566

#### CORROSION RATING



Clean, dry & low humidity environments



TIMBER STUD WORK

Used to secure plasterboard to timber stud work.

Note: Partially threaded from 60mm.

Product Code	Size (mm)	Pack Qty (pcs)	Carton Qty (packs)	Pallet Qty (packs)
<b>BOX</b>				
00025COLDYS	3.5 x 25	1,000	10	320
00032COLDYS	3.5 x 32	1,000	10	320
00035COLDYS	3.5 x 35	1,000	10	320
00038COLDYS	3.5 x 38	1,000	10	240
00045COLDYS	3.5 x 45	1,000	10	240
00050COLDYS	3.5 x 50	1,000	10	240
00055COLDYS	3.5 x 55	1,000	10	240
00065COLDYS	4.2 x 65	500	10	240
00075COLDYS	4.2 x 75	500	10	240
TYPE - COL		SUB TYPE - COL01		
<b>TUB</b>				
00035CDRYTUB	3.5 x 35	1,000	6	144
00038CDRYTUB	3.5 x 38	1,000	6	144
00045CDRYTUB	3.5 x 45	1,000	6	144
00055CDRYTUB	3.5 x 55	800	6	144
TYPE - COL		SUB TYPE - COL01		

## Fine Thread Screw

### Zinc



PHILLIPS EN 14566

#### CORROSION RATING



Clean, dry & low humidity environments



METAL STUD WORK

Used to secure plasterboard to wall/ceiling track systems with a max of 0.6mm thickness.

Note: Partially threaded from 60mm.

Product Code	Size (mm)	Pack Qty (pcs)	Carton Qty (packs)	Pallet Qty (packs)
<b>BOX</b>				
00025COLDZYS	3.5 x 25	1,000	10	320
00032COLDZYS	3.5 x 32	1,000	10	320
00035COLDZYS	3.5 x 35	1,000	10	320
00038COLDZYS	3.5 x 38	1,000	10	240
00042COLDZYS	3.5 x 42	1,000	10	240
00050COLDZYS	3.5 x 50	1,000	10	240
00055COLDZYS	3.5 x 55	1,000	10	240
TYPE - COL		SUB TYPE - COL02		

## Self-Drilling Screw

### Zinc



PHILLIPS EN 14566

#### CORROSION RATING



Clean, dry & low humidity environments



METAL STUD WORK

Self-drilling point to aid fixing plasterboard to wall/ceiling track systems with a max. of 2.0mm thickness.

Product Code	Size (mm)	Pack Qty (pcs)	Carton Qty (packs)	Pallet Qty (packs)
<b>BOX</b>				
00035COLLSD	3.5 x 35	1,000	10	320
00040COLLSD	3.5 x 40	1,000	10	240
00045COLLSD	3.5 x 45	1,000	10	240
00050COLLSD	3.5 x 50	1,000	10	240
TYPE - COL		SUB TYPE - COL03		

## Internal Collated Screws



### Flooring Screw

Yellow



SQUARE



EN 14592:2008

CORROSION RATING

**1** 2 3 4 5

Clean, dry & low humidity environments

Product Code	Size (mm)	Pack Qty (pcs)	Carton Qty (packs)	Pallet Qty (packs)
--------------	-----------	----------------	--------------------	--------------------

**BOX**

00055COLLF	4.2 x 55	1,000	4	128
TYPE - COL		SUB TYPE - COL06		

### Solo Woodscrew

Yellow



PHILLIPS



EN 14592:2008

CORROSION RATING

**1** 2 3 4 5

Clean, dry & low humidity environments

For more information about this product please see page 20.

Product Code	Size (mm)	Pack Qty (pcs)	Carton Qty (packs)	Pallet Qty (packs)
--------------	-----------	----------------	--------------------	--------------------

**BOX**

40SCOLY	4.2 x 40	1,000	8	192
50SCOLY	4.2 x 50	1,000	4	128
55SCOLY	4.2 x 55	1,000	4	128
60SCOLY	4.5 x 60	500	8	256
70SCOLY	4.5 x 70	500	10	192
TYPE - COL		SUB TYPE - COL07		

## SOLO Woodscrew

Yellow

An economic single thread woodscrew designed to be consistently reliable in softwood, chipboard, plastic and some hardwoods.

For more information see page

**21**

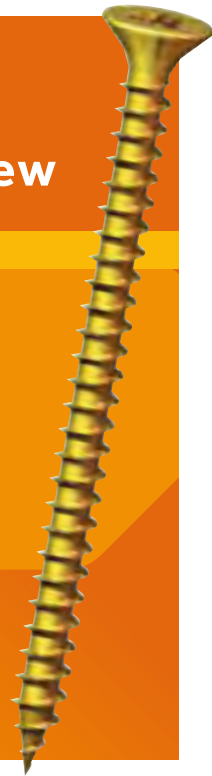

## External Collated Screws



### C2 Deck-Fix

Exterior (Green Organic)



SQUARE



EN 14592:2008

CORROSION RATING

1 2 **3** 4 5

Urban & industrial areas with a low salt atmosphere

A premium decking screw using the C2 twin-cut technology.

See page 31 for more information.

Product Code	Size (mm)	Pack Qty (pcs)	Carton Qty (packs)	Pallet Qty (packs)
--------------	-----------	----------------	--------------------	--------------------

**BOX**

65C2DCOLL	4.5 x 65	500	10	240
TYPE - COL		SUB TYPE - COL08		

### Classic Stainless

A2 Stainless Steel



PHILLIPS



EN 14592:2008

CORROSION RATING

1 2 3 **4** 5

Urban & industrial areas with a moderate salt atmosphere

For more information about this product please see page 18.

Product Code	Size (mm)	Pack Qty (pcs)	Carton Qty (packs)	Pallet Qty (packs)
--------------	-----------	----------------	--------------------	--------------------

**BOX**

4040CLASSCOL	4.0 x 40	1,000	10	240
4050CLASSCOL	4.0 x 50	1,000	8	192
TYPE - COL		SUB TYPE - COL05		

### Wing-Tip Self-Drilling

Exterior (SO)

Zinc



CORROSION RATING

1 2 **3** 4 5

Urban & industrial areas with a low salt atmosphere

CORROSION RATING

**1** 2 3 4 5

Clean, dry & low humidity environments



PHILLIPS

For more information about this product please see page 43.

Product Code	Finish	Size (mm)	Pack Qty (pcs)	Carton Qty (packs)	Pallet Qty (packs)
--------------	--------	-----------	----------------	--------------------	--------------------

**BOX**

00044COLLW	Exterior	4.8 x 44	1,000	4	128
4865COLLW	Zinc	4.8 x 65	500	4	128
TYPE - COL		SUB TYPE - COL04			



# Roofing and General Construction Screws

The TIMco Roofing and General Construction range has been specifically designed and manufactured to meet all the recognised industry standards and performance criteria.

## Plating Guide:

### Bi-Metal - Corrosion Rating 4 out of 5

For industrial areas with a moderate salt atmosphere.

Bi-met screws combine the ultimate corrosion resistance of an A2 stainless steel fastener with the exceptional drilling performance of a hardened carbon steel drill tip.

### Exterior Plating - Corrosion Rating 3 out of 5

Use in urban and industrial areas with a low salt atmosphere.

Exterior plating gives a reliable and durable corrosion resistant coating which resists 1,000 hours salt-spray.

### Zinc Plating - Corrosion Rating 1 out of 5

Use in clean, dry and low humidity environments.

A bright zinc electrolytic plating with a clear toxin free finish.

## What is Effective Thread Length?

This is the threaded section of the fastener which provides the fixing. The threads must have fully penetrated the supporting steel in order for it to achieve a strong and secure fixing.

Quick reference guide for

## Rec. R.P.M

Dia.	Rec. R.P.M
M4.2	1,800 - 2,500
M4.8	1,800 - 2,500
M5.5	1,000 - 1,800
M6.3	1,000 - 1,800



TESTED PRODUCTS\*

Metsec developed and now lead the market when it comes to light gauge, galvanised steel structural framing systems suitable for a wide range of applications in most sectors of construction.

We can confirm that the tested shear and tensile values are within the requirements of Metsec and therefore these fixings can be used with Metsec SFS Framing.

In addition we have reviewed the range of lengths of these fixings and can confirm that where needed these types of screws at longer lengths may also be used with Metsec SFS Framing.

## Stitching Screw - For Sheet to Sheet

Bi-Metal (SO)

Exterior (SO)

Zinc



CORROSION RATING



Urban & industrial areas with a moderate salt atmosphere

CORROSION RATING



Urban & industrial areas with a low salt atmosphere

CORROSION RATING



Clean, dry & low humidity environments



HEX

Used for stitching two metal roofing sheets together without the need to pre-drill a hole (Max. 1.6mm). Self-drilling point and tapered shank, with a washered hexagon head.

Product Code	Size (mm)	Socket Size (mm)	Fixed Washer Ø (mm)	EPDM Washer (mm)	Max. Drill Thickness (mm)	Effective Thread Length (mm)	Pack Qty (pcs)	Carton Qty (packs)	Pallet Qty (packs)
--------------	-----------	------------------	---------------------	------------------	---------------------------	------------------------------	----------------	--------------------	--------------------

### Bi-Metal (Silver Organic)

#### BOX

BMS22W16	6.3 x 22	8.0	11.0	16.0	1.6	9	100	35	840
TYPE - BMR		SUB TYPE - BMR01							

### Exterior (Silver Organic)

#### BOX

S22W16B	6.3 x 22	8.0	12.0	16.0	1.6	9	100	35	840
S25W16B	6.3 x 25	8.0	12.0	16.0	1.6	12	100	35	840

#### TIMBAG

S25W16BB	6.3 x 25	8.0	12.0	16.0	1.6	12	120	5	600
TYPE - RF (BOX), BAG (TIMBAG)		SUB TYPE - RF01, BAG11							

### Zinc

#### BAG

ZS22W16	6.3 x 22	8.0	11.0	16.0	1.6	9	100	22	792
TYPE - RF		SUB TYPE - RF02							

## Self-Drilling Screw - For Heavy Section Steel

Bi-Metal (SO)

Exterior (SO)

Zinc



CORROSION RATING



Urban & industrial areas with a moderate salt atmosphere

CORROSION RATING



Urban & industrial areas with a low salt atmosphere

CORROSION RATING



Clean, dry & low humidity environments



HEX

Used for attaching metal to heavy gauge steel (max 12mm) without the need to pre-drill a hole.

Product Code	Size (mm)	Socket Size (mm)	Fixed Washer Ø (mm)	EPDM Washer (mm)	Max. Drill T (mm)	Effective Thread Length (mm)	Pack Qty (pcs)	Carton Qty (packs)	Pallet Qty (packs)
--------------	-----------	------------------	---------------------	------------------	-------------------	------------------------------	----------------	--------------------	--------------------

### Bi-Metal (Silver Organic)

#### BOX

BMH38	5.5 x 38	8.0	11.0	-	12.0	17	100	35	840
BMH38W16	5.5 x 38	8.0	11.0	16.0	12.0	14	100	15	540
BMH55	5.5 x 55	8.0	11.0	-	12.0	34	100	15	540
BMH55W16	5.5 x 55	8.0	11.0	16.0	12.0	31	100	16	384
TYPE - BMR		SUB TYPE - BMR01						T=THICKNESS	

### Exterior (Silver Organic)

#### BOX

H32B	5.5 x 32	8.0	12.0	-	12.0	13	100	35	840
H32W16B	5.5 x 32	8.0	12.0	16.0	12.0	10	100	15	540
H38B	5.5 x 38	8.0	12.0	-	12.0	19	100	35	840
H38W16B	5.5 x 38	8.0	12.0	16.0	12.0	16	100	15	540
H55B	5.5 x 55	8.0	12.0	-	12.0	36	100	15	540
H55W16B	5.5 x 55	8.0	12.0	16.0	12.0	33	100	16	384
H65B	5.5 x 65	8.0	12.0	-	12.0	46	100	15	540
H65W16B	5.5 x 65	8.0	12.0	16.0	12.0	43	100	16	384
H80B	5.5 x 80	8.0	12.0	-	12.0	56 *P/T	100	16	384
H80W16B	5.5 x 80	8.0	12.0	16.0	12.0	53 *P/T	100	16	288
H100B	5.5 x 100	8.0	12.0	-	12.0	56 *P/T	100	16	288
H100W16B	5.5 x 100	8.0	12.0	16.0	12.0	53 *P/T	100	12	288
TYPE - RF		SUB TYPE - RF01						T=THICKNESS	

#### BAG

H38W16BB	5.5 x 38	8.0	12.0	16.0	12.0	16	100	5	600
TYPE - BAG		SUB TYPE - BAG11						T=THICKNESS	

### Zinc

#### BOX

ZH32B	5.5 x 32	8.0	12.0	-	12.0	13	100	16	768
ZH32W16B	5.5 x 32	8.0	12.0	16.0	12.0	10	100	15	540
ZH38B	5.5 x 38	8.0	12.0	-	12.0	19	100	16	768
ZH38W16B	5.5 x 38	8.0	12.0	16.0	12.0	16	100	15	540
ZH55B	5.5 x 55	8.0	12.0	-	12.0	36	100	15	540
ZH55W16B	5.5 x 55	8.0	12.0	16.0	12.0	33	100	16	384
ZH65B	5.5 x 65	8.0	12.0	-	12.0	46	100	15	540
ZH65W16B	5.5 x 65	8.0	12.0	16.0	12.0	43	100	16	384
ZH80B	5.5 x 80	8.0	12.0	-	12.0	56 *P/T	100	16	384
ZH80W16B	5.5 x 80	8.0	12.0	16.0	12.0	53 *P/T	100	12	288
ZH100B	5.5 x 100	8.0	12.0	-	12.0	56 *P/T	100	12	288
ZH100W16B	5.5 x 100	8.0	12.0	16.0	12.0	53 *P/T	100	12	288
TYPE - RF		SUB TYPE - RF02						T=THICKNESS	

#### BAG

ZH32W16	5.5 x 32	8.0	11.0	16.0	12.0	10	100	26	936
ZH38W16	5.5 x 38	8.0	11.0	16.0	12.0	16	100	24	864
ZH55W16	5.5 x 55	8.0	11.0	16.0	12.0	33	100	18	648
ZH80W16	5.5 x 80	8.0	11.0	16.0	12.0	*53 P/T	100	12	432
TYPE - RF		SUB TYPE - RF02						T=THICKNESS	

\*P/T = Partially Threaded

## Self-Drilling Screw - For Light Section Steel

Bi-Metal (SO)	Exterior (SO)	Zinc
<b>CORROSION RATING</b> 1 2 3 <b>4</b> 5	<b>CORROSION RATING</b> 1 2 <b>3</b> 4 5	<b>CORROSION RATING</b> <b>1</b> 2 3 4 5

Urban & industrial areas with a moderate salt atmosphere

Urban & industrial areas with a low salt atmosphere

Clean, dry & low humidity environments



Used for attaching metal to light section steel (Max. 5mm) without the need to pre-drill a hole.



Product Code	Size (mm)	Socket Size (mm)	Fixed Washer Ø (mm)	EPDM Washer Thickness (mm)	Max. Drill Thickness (mm)	Effective Thread Length (mm)	Pack Qty (pcs)	Carton Qty (packs)	Pallet Qty (packs)
<b>Bi-Metal (Silver Organic)</b>									
<b>BOX</b>									
BML25	5.5 x 25	8.0	11.0	-	5.0	12	100	50	1,200
BML25W16	5.5 x 25	8.0	11.0	16.0	5.0	9	100	35	840
BML32	5.5 x 32	8.0	11.0	-	5.0	19	100	50	1,200
BML38	5.5 x 38	8.0	11.0	-	5.0	25	100	35	840
BML38W16	5.5 x 38	8.0	11.0	16.0	5.0	22	100	15	540
BML50	5.5 x 50	8.0	11.0	-	5.0	37	100	15	540
BML50W16	5.5 x 50	8.0	11.0	16.0	5.0	34	100	15	540
BML70	5.5 x 70	8.0	11.0	-	5.0	57	100	15	540
BML100	5.5 x 100	8.0	11.0	-	5.0	87	100	16	384
BML100W16	5.5 x 100	8.0	11.0	16.0	5.0	84	100	9	216
TYPE - BMR SUB TYPE - BMR01									

Product Code	Size (mm)	Socket Size (mm)	Fixed Washer Ø (mm)	EPDM Washer Thickness (mm)	Max. Drill Thickness (mm)	Effective Thread Length (mm)	Pack Qty (pcs)	Carton Qty (packs)	Pallet Qty (packs)
--------------	-----------	------------------	---------------------	----------------------------	---------------------------	------------------------------	----------------	--------------------	--------------------

<b>Exterior (Silver Organic)</b>									
<b>BOX</b>									
L19B	5.5 x 19	8.0	12.0	-	5.0	7	100	50	1,200
L19W16B	5.5 x 19	8.0	12.0	16.0	5.0	4	100	35	840
L25B*	5.5 x 25	8.0	12.0	-	5.0	13	100	50	1,200
L25W16B*	5.5 x 25	8.0	12.0	16.0	5.0	10	100	35	840
L32B*	5.5 x 32	8.0	12.0	-	5.0	20	100	50	1,056
L32W16B*	5.5 x 32	8.0	12.0	16.0	5.0	17	100	15	540
L38B*	5.5 x 38	8.0	12.0	-	5.0	26	100	35	840
L38W16B*	5.5 x 38	8.0	12.0	16.0	5.0	23	100	15	540
L50B*	5.5 x 50	8.0	12.0	-	5.0	38	100	15	540
L50W16B*	5.5 x 50	8.0	12.0	16.0	5.0	35	100	15	540
L70B*	5.5 x 70	8.0	12.0	-	5.0	58	100	15	540
L70W16B*	5.5 x 70	8.0	12.0	16.0	5.0	55	100	16	384
L100B*	5.5 x 100	8.0	12.0	-	5.0	88	100	12	384
L100W16B*	5.5 x 100	8.0	12.0	16.0	5.0	85	100	9	216
TYPE - RF SUB TYPE - RF01									

<b>TIMBAG</b>									
L25BB*	5.5 x 25	8.0	12.0	-	5.0	13	200	5	600
L25W16BB*	5.5 x 25	8.0	12.0	16.0	5.0	10	140	5	600
L32BB*	5.5 x 32	8.0	12.0	-	5.0	20	160	5	600
L32W16BB*	5.5 x 32	8.0	12.0	16.0	5.0	17	130	5	600
L38BB*	5.5 x 38	8.0	12.0	-	5.0	26	150	5	600
L38W16BB*	5.5 x 38	8.0	12.0	16.0	5.0	23	110	5	600
L50BB*	5.5 x 50	8.0	12.0	-	5.0	38	120	5	600
L50W16BB*	5.5 x 50	8.0	12.0	16.0	5.0	35	85	5	600
L70BB*	5.5 x 70	8.0	12.0	-	5.0	58	100	5	600
TYPE - BAG SUB TYPE - BAG11									

<b>Zinc</b>									
<b>BOX</b>									
00812HWSD	4.2 x 13	6.35	8.5	-	3.0	4	1,000	16	192
00834HWSD	4.2 x 19	6.35	8.5	-	3.0	10	1,000	16	192
01012HWSD	4.8 x 13	8.0	10.0	-	4.5	4	1,000	16	192
01058HWSD	4.8 x 16	8.0	10.0	-	4.5	7	1,000	12	144
01034HWSD	4.8 x 19	8.0	10.0	-	4.5	10	1,000	12	144
01234HWSD	5.5 x 19	8.0	11.0	-	5.0	8	500	16	192
00121HWSD	5.5 x 25	8.0	11.0	-	5.0	14	500	12	144
12114HWSD	5.5 x 32	8.0	11.0	-	5.0	21	500	12	144
12112HWSD	5.5 x 38	8.0	11.0	-	5.0	27	500	12	144
12134HWSD	5.5 x 45	8.0	11.0	-	5.0	34	500	8	96
TYPE - RF SUB TYPE - RF02									

<b>BAG</b>									
ZL19W16	5.5 x 19	8.0	11.0	16.0	5.0	4	100	32	1,152
ZL25W16	5.5 x 25	8.0	11.0	16.0	5.0	10	100	30	1,080
ZL32W16	5.5 x 32	8.0	11.0	16.0	5.0	17	100	26	936
ZL38W16	5.5 x 38	8.0	11.0	16.0	5.0	23	100	24	864
ZL50W16	5.5 x 50	8.0	11.0	16.0	5.0	35	100	20	720
ZL60W16	5.5 x 60	8.0	11.0	16.0	5.0	45	100	16	576
ZL70W16	5.5 x 70	8.0	11.0	16.0	5.0	55	100	14	504
TYPE - RF SUB TYPE - RF02									



## Self-Drilling Screw - For Light Section Composite Panel

Bi-Metal (SO)

Exterior (SO)



HEX



Specifically designed to attach composite panel to light section steel. Self-drilling point with hexagon head.



CORROSION RATING

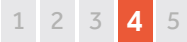

Urban & industrial areas with a moderate salt atmosphere

CORROSION RATING



Urban & industrial areas with a low salt atmosphere

Product Code	Size (mm)	Socket Size (mm)	FW (mm)	EPDM Washer (mm)	MDT (mm)	Min - Max PT (mm)	ETL (mm)	Pack Qty (pcs)	Carton Qty (packs)	Pallet Qty (packs)
--------------	-----------	------------------	---------	------------------	----------	-------------------	----------	----------------	--------------------	--------------------

Bi-Metal (Silver Organic)										
BOX										
BMLH70W16	5.5/6.3 x 70	8.0	12.0	16.0	5.0	20 - 50	27	100	16	384
BMLH100W16	5.5/6.3 x 100	8.0	12.0	16.0	5.0	50 - 80	47	100	9	216
TYPE - BMR					SUB TYPE - BMR01					

EXTERIOR (SILVER ORGANIC)										
BOX										
LH82W16B	5.5/6.3 x 82	8.0	12.0	16.0	5.0	32 - 62	41	100	12	288
LH98W16B	5.5/6.3 x 98	8.0	12.0	16.0	5.0	48 - 78	41	100	9	216
LH115W16B	5.5/6.3 x 115	8.0	12.0	16.0	5.0	65 - 95	41	100	8	192
TYPE - RF					SUB TYPE - RF01					
MDT = MAX DRILL THICKNESS ETL = EFFECTIVE THREAD LENGTH FW = FIXED WASHER PT = PANEL THICKNESS										

## Fibre Cement Board Screw

Exterior (Silver Organic)



HEX



Self-Drilling - For Light Section Steel



Slash Point - For Timber

Used for securing fibre cement profile sheets to light section steel (max. 5mm). Complete with heavy duty EPDM and stainless steel washer to provide a water-tight seal. Also known as a BAZ washer.

CORROSION RATING



Urban & industrial areas with a low salt atmosphere

Product Code	Size (mm)	Socket Size (mm)	Fixed Washer Ø (mm)	EPDM Washer (mm)	Max. Drill T (mm)	ETL (mm)	Pack Qty (pcs)	Carton Qty (packs)	Pallet Qty (packs)
--------------	-----------	------------------	---------------------	------------------	-------------------	----------	----------------	--------------------	--------------------

Exterior (Silver Organic)									
BOX									
Self-drilling - for light section steel									
731816	6.3 x 110	8.0	12.0	25.0	5.0	46	50	8	192
731274	6.3 x 130	8.0	12.0	25.0	5.0	46	50	8	192
Slash point - for timber									
731339	6.3 x 130	8.0	12.0	25.0	-	60	50	8	192
TYPE - RF					SUB TYPE - RF06			ETL = EFFECTIVE THREAD LENGTH T = THICKNESS	

## Slash Point Screw - For Sheet to Timber

Exterior (SO)

Zinc



HEX

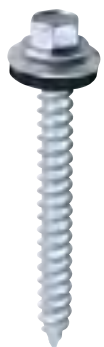

Designed to attach sheet metal (Max 0.9mm) to timber. Slash point for easy pick up.

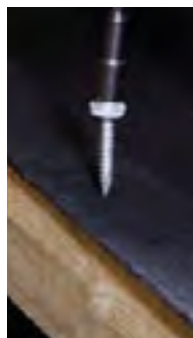

CORROSION RATING



Urban & industrial areas with a low salt atmosphere

CORROSION RATING



Clean, dry & low humidity environments

Product Code	Size (mm)	Socket Size (mm)	Fixed Washer Ø (mm)	EPDM Washer (mm)	Max. Fixture T (mm)	ETL (mm)	Pack Qty (pcs)	Carton Qty (packs)	Pallet Qty (packs)
--------------	-----------	------------------	---------------------	------------------	---------------------	----------	----------------	--------------------	--------------------

Exterior (Silver Organic)									
BOX									
DS25W16B	6.3 x 25	8.0	12.0	16.0	0.9	22	100	35	840
DS32W16B	6.3 x 32	8.0	12.0	16.0	0.9	29	100	15	540
DS45W16B	6.3 x 45	8.0	12.0	16.0	0.9	42	100	15	540
DS45W19B	6.3 x 45	8.0	12.0	19.0	0.9	42	100	18	432
DS60W16B	6.3 x 60	8.0	12.0	16.0	17.0	57	100	18	432
DS60W19B	6.3 x 60	8.0	12.0	19.0	17.0	57	100	12	288
DS80W16B	6.3 x 80	8.0	12.0	16.0	37.0	77	100	12	288
DS100W16B	6.3 x 100	8.0	12.0	16.0	57.0	97	100	9	216
DS125W16B	6.3 x 125	8.0	12.0	16.0	82.0	122	100	8	192
DS150W16B	6.3 x 150	8.0	12.0	16.0	107.0	80 *P/T	100	8	192
TYPE - RF					SUB TYPE - RF01			ETL = EFFECTIVE THREAD LENGTH T = THICKNESS	

TIMBAG									
DS32W16BB	6.3 x 32	8.0	12.0	16.0	0.8	29	120	5	600
DS45W16BB	6.3 x 45	8.0	12.0	16.0	0.8	42	90	5	600
TYPE - BAG					SUB TYPE - BAG11				

Zinc BAG									
ZDS25W16	6.3 x 25	8.0	13.0	16.0	0.8	22	100	20	720
ZDS32W16	6.3 x 32	8.0	13.0	16.0	0.8	29	100	18	648
ZDS45W16	6.3 x 45	8.0	13.0	16.0	0.8	42	100	14	504
ZDS60W16	6.3 x 60	8.0	13.0	16.0	17.0	57	100	12	432
ZDS80W16	6.3 x 80	8.0	13.0	16.0	37.0	77	100	10	360
ZDS100W16	6.3 x 100	8.0	13.0	16.0	57.0	97	100	8	288
TYPE - RF					SUB TYPE - RF02				

\*P/T = Partially Threaded

## Wing-Tip Self-Drilling Screw - For Timber to Light Section Steel

Bi-Metal (SO)

Exterior (SO)

Zinc



CORROSION RATING



Urban & industrial areas with a moderate salt atmosphere

CORROSION RATING



Urban & industrial areas with a low salt atmosphere

CORROSION RATING



Clean, dry & low humidity environments



PHILLIPS

Specifically designed to attach wood to metal. Coarse self-tapping thread with wings designed to ream out the timber, so the screw can achieve Max R.P.M. without burning out. When the wings hit the metal they will break off to permit the thread to self tap into the metal.

Product Code	Size (mm)	Driver Bit Size	Max. Drilling Thickness (mm)	Effective Thread Length (mm)	Pack Qty (pcs)	Carton Qty (packs)	Pallet Qty (packs)
--------------	-----------	-----------------	------------------------------	------------------------------	----------------	--------------------	--------------------

### Bi-Metal (Silver Organic)

#### BOX

BMLW38	4.8 x 38	PH2	4.0	18	200	16	840
BMLW65	5.5 x 65	PH3	5.0	41	200	12	288
BMLW85	5.5 x 85	PH3	5.0	47 *P/T	100	16	384

TYPE - BMR

SUB TYPE - BMR02

### Exterior (Silver Organic)

#### BOX (DRIVER BIT INCLUDED)

LW4238S	4.2 x 38	PH2	3.0	19	200	16	768
LW38S	4.8 x 38	PH2	4.0	16	200	16	768
LW50S	5.5 x 50	PH3	5.0	26	200	16	384
LW65S	5.5 x 65	PH3	5.0	41	200	12	288
LW85S	5.5 x 85	PH3	5.0	61	100	16	384
LW100S	5.5 x 100	PH3	5.0	61 *P/T	100	16	384

TYPE - RF

SUB TYPE - RF03

### Zinc

#### BOX (DRIVER BIT INCLUDED)

LW32B	4.2 x 32	PH2	4.0	10	200	22	1056
LW4238B	4.2 x 38	PH2	3.0	19	200	16	768
LW38B	4.8 x 38	PH2	4.0	16	200	16	768
LW50B	5.5 x 50	PH3	5.0	26	200	16	384
LW65B	5.5 x 65	PH3	5.0	41	200	12	288
LW85B	5.5 x 85	PH3	5.0	61	100	16	384
LW100B	5.5 x 100	PH3	5.0	61 *P/T	100	16	384
LW130B	5.5 x 130	PH3	5.0	61 *P/T	100	8	384
LW150B	5.5 x 150	PH3	5.0	61 *P/T	100	12	288

TYPE - RF

SUB TYPE - RF04

### TIMBAG

LW38BB	4.8 x 38	PH2	4.0	16	260	5	600
LW50BB	5.5 x 50	PH3	5.0	26	150	5	600
LW65BB	5.5 x 65	PH3	5.0	41	120	5	600

TYPE - BAG

\*P/T = PARTIALLY THREADED

SUB TYPE - BAG12

## Wing-Tip Self-Drilling Screw - For Timber to Heavy Section Steel

Bi-Metal (SO)

Zinc



CORROSION RATING



Urban & industrial areas with a moderate salt atmosphere

CORROSION RATING



Clean, dry & low humidity environments



PHILLIPS

Specifically designed to attach wood to metal (Max 12mm). Metric thread with wings designed to ream out the timber, so the screw can achieve Max R.P.M. without burning out. When the wings hit the metal they will break off to permit the thread to self tap into the metal.

Product Code	Size (mm)	Driver Bit Size	Max. Drilling Thickness (mm)	Effective Thread Length (mm)	Pack Qty (pcs)	Carton Qty (packs)	Pallet Qty (packs)
--------------	-----------	-----------------	------------------------------	------------------------------	----------------	--------------------	--------------------

### Bi-Metal (Silver Organic)

#### BOX

BMHW55	5.5 x 55	PH3	12.0	24	200	16	384
BMHW65	5.5 x 65	PH3	12.0	34	200	12	288
BMHW85	5.5 x 85	PH3	12.0	45 *P/T	100	16	384
BMHW120	5.5 x 120	PH3	12.0	45 *P/T	100	8	384

TYPE - BMR

SUB TYPE - BMR02

### Zinc

#### BOX (DRIVER BIT INCLUDED)

HW45B	5.5 x 45	PH3	12.0	15	200	15	540
HW65B	5.5 x 65	PH3	12.0	31	200	12	288
HW85B	5.5 x 85	PH3	12.0	51	100	16	384
HW100B	5.5 x 100	PH3	12.0	51 *P/T	100	16	384
HW120B	5.5 x 120	PH3	12.0	51 *P/T	100	8	384

TYPE - RF

\*P/T = PARTIALLY THREADED

SUB TYPE - RF04

# Washers, Caps & Sheet Fixings



## Hex Head Cover Cap



Cover caps are a perfect way to blend in roofing and construction screws with coloured panels. Please bare in mind we only stock a certain amount of colours, please allow at least one week for dispatch. Poppy Red caps are used for highlighting weaker transparent sheets.

Please note these colours are a guide only. Please refer to [www.e-paint.co.uk](http://www.e-paint.co.uk) and search for the colour name, for a more accurate colour match.

Colour	Code (16mm)	Code (19mm)	Colour Reference	Pack Qty (pcs)
<b>BAG</b>				
BLACK	1600E53CAP	1900E53CAP	(BS) 00 E 53	1,000
WHITE	1600E55CAP	1900E55CAP	(BS) 00 E 55	1,000
TERRACOTTA	1604C39CAP	1904C39CAP	(BS) 04 C 39	1,000
PETRA	1604D44CAP	1904D44CAP	(BS) 04 D 44	1,000
POPPY	1604E53CAP	1904E53CAP	(BS) 04 E 53	1,000
POPPY	29mm Code: 2904E53CAP		(BS) 04 E 53	1,000
TANGERINE	1606E53CAP	1906E53CAP	(BS) 06 E 53	1,000
FLAME RED	16RAL3000CAP	19RAL3000CAP	(RAL) 3000	1,000
BURANO	16RAL3004CAP	19RAL3004CAP	(RAL) 3004	1,000
VANDYKE BROWN	1608B29CAP	1908B29CAP	(BS) 08 B 29	1,000
BEIGE	1608B17CAP	1908B17CAP	(BS) 08 B 17	1,000
BAMBOO	1608C35CAP	1908C35CAP	(BS) 08 C 35	1,000
GOOSEWING GREY	1610A05CAP	1910A05CAP	(BS) 10 A 05	1,000
MUSHROOM	1610B19CAP	1910B19CAP	(BS) 10 B 19	1,000
SVELTE GREY	1610B23CAP	1910B23CAP	(BS) 10 B 23	1,000
HONESTY	1610C31CAP	1910C31CAP	(BS) 10 C 31	1,000
AZTEC	1610E55CAP	1910E55CAP	(BS) 10 E 55	1,000
MEADOWLAND	1612B17CAP	1912B17CAP	(BS) 12 B 17	1,000
MOORLAND GREEN	1612B21CAP	1912B21CAP	(BS) 12 B 21	1,000
EAU DE NIL	1614E49CAP	1914E49CAP	(BS) 14 B 49	1,000
OLIVE GREEN	1612B27CAP	1912B27CAP	(BS) 12 B 27	1,000
JUNIPER GREEN	1612B29CAP	1912B29CAP	(BS) 12 B 29	1,000
SAGE	1612D45CAP	1912D45CAP	(BS) 12 D 45	1,000
PINEWOOD	1614C39CAP	1914C39CAP	(BS) 14 C 39	1,000
VERONA	1614E53CAP	1914E53CAP	(BS) 14 E 53	1,000
HERITAGE	16RAL6002CAP	19RAL6002CAP	(RAL) 6002	1,000
JADE	1614C37CAP	-	(BS) 14 C 37	1,000
ALBATROSS	1618B17CAP	1918B17CAP	(BS) 18 B 17	1,000
MERLIN GREY	1618B25CAP	1918B25CAP	(BS) 18 B 25	1,000
MERLIN GREY	29mm Code: 2918B25CAP		(BS) 18 B 25	1,000
RAVEN/SLATE BLUE	1618B29CAP	1918B29CAP	(BS) 18 B 29	1,000
OCEAN BLUE	1618C39CAP	1918C39CAP	(BS) 18 C 39	1,000
SOLENT BLUE	1618E53CAP	1918E53CAP	(BS) 18 E 53	1,000
BRITANNIA	1618E58CAP	1918E58CAP	(BS) 18 E 58	1,000
WEDGEWOOD BLUE	-	1918C37CAP	(BS) 18 C 37	1,000
CORNFLOWER	1620E51CAP	1920E51CAP	(BS) 20 E 51	1,000
ULTRA MARINE	16RAL5002CAP	19RAL5002CAP	(RAL) 5002	1,000
SARGASSO	16RAL5003CAP	19RAL5003CAP	(RAL) 5003	1,000
GENTIAN BLUE	16RAL5010CAP	19RAL5010CAP	(RAL) 5010	1,000
SQUIRREL	16RAL7000CAP	19RAL7000CAP	(RAL) 7000	1,000
SLATE GREY	16RAL7012CAP	19RAL7012CAP	(RAL) 7012	1,000
ANTHRACITE	16RAL7016CAP	19RAL7016CAP	(RAL) 7016	1,000
OYSTER	16RAL7035CAP	19RAL7035CAP	(RAL) 7035	1,000
QUARTZ	16RAL7039CAP	19RAL7039CAP	(RAL) 7039	1,000
HAMLET	16RAL9002CAP	19RAL9002CAP	(RAL) 9002	1,000
WHITE (CREAMY)	16RAL9003CAP	19RAL9003CAP	(RAL) 9003	1,000
WHITE ALUM	16RAL9006CAP	19RAL9006CAP	(RAL) 9006	1,000
METALLIC SILVER	16S7500CAP	19S7500CAP	-	1,000
DARK SILVER	-	19RAL9007CAP	(RAL) 9007	1,000
PURE WHITE	16RAL9010CAP	19RAL9010CAP	(RAL) 9010	1,000

TYPE - RF SUB TYPE - RF05

## EPDM Washer

Galvanised Aluminium



Metal washer with rubber (EPDM), used to prevent washer ingress.

Product Code	Outer Ø (mm)	Hole Ø (mm)	Pack Qty (pcs)	Carton Qty (packs)	Pallet Qty (packs)
<b>Galvanised</b>					
WG16	16	6.8	100	100	2400
WG19	19	5.8	100	70	1680
<b>Aluminium</b>					
WA29	29	6.8	100	36	864
TYPE - RF			SUB TYPE - RF05		

## BAZ Washer

Stainless Steel



Heavy duty and high grade EPDM washer with A2 stainless steel cap to provide a water-tight seal. Also known as a BAZ washer.

Frequently used with self-drilling screws in roofing applications.

Product Code	Outer Ø (mm)	Hole Ø (mm)	Pack Qty (pcs)	Carton Qty (packs)	Pallet Qty (packs)
BAZ25	25	10	200	9	216
<b>TIMBAG</b>					
BAZ25B	25	10	100	5	500
TYPE - RF / BAG			SUB TYPE - RF05 / BAG13		

## Sela Cover & Washer

Black

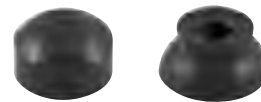

Used when securing roofing sheets to create a watertight seal. When using spring head roofing nails just a washer (SW) is required. If using hook bolts you will also require a Sela Cover (SC) to cover the washer and nut to complete the seal.

Product Code	Outer Ø (mm)	Hole Ø (mm)	Pack Qty (pcs)	Carton Qty (packs)	Pallet Qty (packs)
<b>Cover</b>					
28SC	28	-	75	5	500
<b>Washer</b>					
628SW	28	M6	75	5	500
828SW	28	M8	75	5	500
TYPE - BAG			SUB TYPE - BAG13		

## Dowty Type Washer

Black



Used mainly with drive screw nails and spring head roofing nails for attaching corrugated roofing sheets to wooden purlins. The washer provides a watertight seal when used correctly.

Product Code	Outer Ø (mm)	Hole Ø (mm)	Pack Qty (pcs)	Carton Qty (packs)	Pallet Qty (packs)
6BPRS	30	M6	75	5	500
8BPRS	30	M8	75	5	500
TYPE - BAG			SUB TYPE - BAG13		

## Corrugated Sheet Fixing

Clear Black

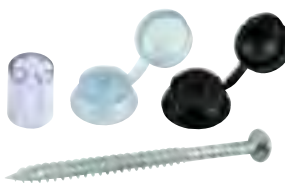

Designed to fix plastic corrugated sheets to timber. Cover caps provide a water tight seal. Spacers help stop splitting of corrugated sheets as the fixings are tightened.

Product Code	Colour	Screw Size (imp.)	Pack Qty (pcs)	Carton Qty (packs)	Pallet Qty (packs)
<b>Cap &amp; Screw</b>					
CSFC	Clear	10 x 3	50	250	600
CSFB	Black	10 x 3	50	250	600
<b>Spacer</b>					
224523	Clear	-	50	250	600
TYPE - BAG			SUB TYPE - BAG13		

# Metal Framing Screws



## Low Profile - Pan Head

Exterior (Silver Organic)



Urban & industrial areas with a low salt atmosphere



STEEL

A light duty metal to metal screw with a reduced pan to give a flush finish. Silver organic plated to withstand over 500 hours salt spray test.

Product Code	Size (mm)	Max. Drilling Thickness (mm)	Pack Qty (pcs)	Carton Qty (packs)	Pallet Qty (packs)
<b>BOX (DRIVER BIT INCLUDED)</b>					
LPP16	4.8 x 16	4.0	500	15	768
TYPE - MFS		SUB TYPE - MFS01			

## Low Profile - Wafer Head

Exterior (Silver Organic)

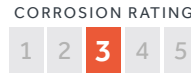
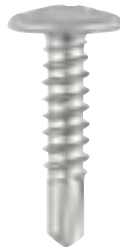

Urban & industrial areas with a low salt atmosphere



STEEL

A light duty metal to metal screw with a large flat surface under the head, making it ideal for fixing thinner sheet material when a flush finish is required. Silver Organic plated to withstand over 500 hours salt spray test.

Product Code	Size (mm)	Max. Drilling Thickness (mm)	Pack Qty (pcs)	Carton Qty (packs)	Pallet Qty (packs)
<b>BOX (DRIVER BIT INCLUDED)</b>					
22LPW	4.8 x 22	4.0	200	35	840
TYPE - MFS		SUB TYPE - MFS01			

## Low Profile - Pancake Head

Exterior (Silver Organic)



Urban & industrial areas with a low salt atmosphere



STEEL

A medium duty metal to metal screw with a large flat surface under the head, making it ideal for fixing thinner sheet material when a flush finish is required. Silver organic plated to withstand over 500 hours salt spray test.



Product Code	Size (mm)	Max. Drilling Thickness (mm)	Pack Qty (pcs)	Carton Qty (packs)	Pallet Qty (packs)
<b>BOX (DRIVER BIT INCLUDED)</b>					
FP19	5.5 x 19	5.0	500	16	540
FP26	5.5 x 26	5.0	500	16	384
TYPE - MFS		SUB TYPE - MFS01			

## Pan Head

Zinc

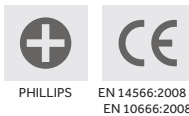
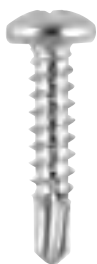

Clean, dry & low humidity environments



STEEL

A light duty metal to metal screw with a phillips recess used for interior applications.

Product Code	Size (imp.)	Max. Drilling Thickness (mm)	Pack Qty (pcs)	Carton Qty (packs)	Pallet Qty (packs)
<b>BOX</b>					
00658PPSD	6 x 3/4	2.5	1,000	15	540
00061PPSD	6 x 1	2.5	1,000	16	384
07716PPSD	7 x 7/16	2.5	1,000	15	540
00812PPSD	8 x 1/2	3.0	1,000	15	540
812PSD	8 x 1/2	3.0	200	15	2,700
00834PPSD	8 x 3/4	3.0	1,000	16	384
834PSD	8 x 3/4	3.0	200	75	2,700
00081PPSD	8 x 1	3.0	1,000	12	288
81PSD	8 x 1	3.0	200	75	2,700
TYPE - PPS		SUB TYPE - PPS01			

## Pan Head

Zinc

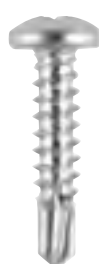

Clean, dry & low humidity environments



STEEL

A light duty metal to metal screw with a square recess used for interior applications.

Product Code	Size (imp.)	Max. Drilling Thickness (mm)	Pack Qty (pcs)	Carton Qty (packs)	Pallet Qty (packs)
<b>BOX</b>					
00812SPSD	8 x 1/2	3.0	1,000	15	540
TYPE - PPS		SUB TYPE - PPS01			

## Wafer Head

Zinc



Clean, dry & low humidity environments



STEEL THIN SHEET

SELF-DRILLING POINT  
EN 10666:2008



SHARP POINT

Used when constructing drywall track and ceiling track systems to stitch the track together

Product Code	Size (mm)	Max. Drilling Thickness (mm)	Pack Qty (pcs)	Carton Qty (packs)	Pallet Qty (packs)
<b>BOX (DRIVER BIT INCLUDED)</b>					
<b>Self-drilling point</b>					
08916WHSD	4.2 x 13	3.0	1,000	15	540
00016WHSD	4.2 x 16	3.0	1,000	16	288
00019WHSD	4.2 x 19	3.0	1,000	12	288
00025WHSD	4.2 x 25	3.0	1,000	12	144
<b>Sharp point</b>					
08916WHSP	4.2 x 13	0.6	1,000	15	540
TYPE - WHS		SUB TYPE - WHS01			



## Self-Tapping Screws

Used for stitching metal or attaching to metal. A pre-drilled hole is required.  
Manufactured to BS4174:1972



### Pan Head

Zinc



POZI



CORROSION RATING

1 2 3 4 5

Clean, dry & low humidity environments



STEEL



THIN SHEET

Pan head for extra clamping.

Product Code	Size (mm)	Driver Bit Size	Pack Qty (pcs)	Carton Qty (packs)	Pallet Qty (packs)
<b>BOX</b>					
00438CPAZS	2.9 x 9.5	PZ1	200	140	5040
00412CPAZS	2.9 x 13	PZ1	200	140	5040
00638CPAZS	3.5 x 9.5	PZ2	200	140	5040
00612CPAZS	3.5 x 13	PZ2	200	140	5040
00658CPAZS	3.5 x 16	PZ2	200	75	2700
00634CPAZS	3.5 x 19	PZ2	200	75	2700
00061CPAZS	3.5 x 25	PZ2	200	75	1800
00838CPAZS	4.2 x 9.5	PZ2	200	75	2700
00812CPAZS	4.2 x 13	PZ2	200	75	2700
00858CPAZS	4.2 x 16	PZ2	200	65	2340
00834CPAZS	4.2 x 19	PZ2	200	65	1560
00081CPAZS	4.2 x 25	PZ2	200	50	1200
08114CPAZS	4.2 x 32	PZ2	200	22	1056
08112CPAZS	4.2 x 38	PZ2	200	35	840
00082CPAZS	4.2 x 50	PZ2	200	15	540
01012CPAZS	4.8 x 13	PZ2	200	50	1200
01058CPAZS	4.8 x 16	PZ2	200	38	1520
01034CPAZS	4.8 x 19	PZ2	200	35	840
00101CPAZS	4.8 x 25	PZ2	200	22	1056
10114CPAZS	4.8 x 32	PZ2	200	16	768
10112CPAZS	4.8 x 38	PZ2	200	15	540
00102CPAZS	4.8 x 50	PZ2	200	15	540
01212CPAZS	5.5 x 13	PZ3	200	35	840
00121CPAZS	5.5 x 25	PZ3	200	16	768
12112CPAZS	5.5 x 38	PZ3	100	35	840
01434CPAZS	6.3 x 19	PZ3	200	16	768
TYPE - STS				SUB TYPE - STS01	
<b>TIMPAC</b>					
00614CPAZP	3.5 x 6.5	PZ2	30	10	-
00638CPAZP	3.5 x 9.5	PZ2	25	10	-
00612CPAZP	3.5 x 13	PZ2	20	10	-
00634CPAZP	3.5 x 19	PZ2	18	10	-
00838CPAZP	4.2 x 9.5	PZ2	16	10	-
00812CPAZP	4.2 x 13	PZ2	16	10	-
00858CPAZP	4.2 x 16	PZ2	14	10	-
00834CPAZP	4.2 x 19	PZ2	14	10	-
00081CPAZP	4.2 x 25	PZ2	12	10	-
01012CPAZP	4.8 x 13	PZ2	10	10	-
01034CPAZP	4.8 x 19	PZ2	10	10	-
01058CPAZP	4.8 x 16	PZ2	10	10	-
TYPE - PAK				SUB TYPE - PAK04	

### Countersunk

Zinc



POZI



CORROSION RATING

1 2 3 4 5

Clean, dry & low humidity environments



STEEL



THIN SHEET

Countersunk head gives a discreet finish into pre-countersunk holes.

Product Code	Size (mm)	Driver Bit Size	Pack Qty (pcs)	Carton Qty (packs)	Pallet Qty (packs)
<b>BOX</b>					
00612CCAAS	3.5 x 13	PZ2	200	140	5040
00658CCAAS	3.5 x 16	PZ2	200	75	2700
00061CCAAS	3.5 x 25	PZ2	200	75	2700
00812CCAAS	4.2 x 13	PZ2	200	75	2700
00834CCAAS	4.2 x 19	PZ2	200	65	2340
00081CCAAS	4.2 x 25	PZ2	200	50	1200
08114CCAAS	4.2 x 32	PZ2	200	22	1056
08112CCAAS	4.2 x 38	PZ2	200	35	840
08134CCAAS	4.2 x 44	PZ2	200	15	540
00082CCAAS	4.2 x 50	PZ2	200	15	540
00101CCAAS	4.8 x 25	PZ2	200	22	1056
10114CCAAS	4.8 x 32	PZ2	200	35	840
10112CCAAS	4.8 x 38	PZ2	200	15	540
00102CCAAS	4.8 x 50	PZ2	200	15	540
12112CCAAS	5.5 x 38	PZ3	100	15	540
TYPE - STS				SUB TYPE - STS01	
<b>TIMPAC</b>					
00634CCAAP	3.5 x 19	PZ2	25	10	-
00812CCAAP	4.2 x 13	PZ2	22	10	-
00834CCAAP	4.2 x 19	PZ2	20	10	-
00081CCAAP	4.2 x 25	PZ2	18	10	-
08114CCAAP	4.2 x 32	PZ2	16	10	-
08112CCAAP	4.2 x 38	PZ2	14	10	-
10114CCAAP	4.8 x 32	PZ2	10	10	-
TYPE - PAK				SUB TYPE - PAK04	

### Flange Head

Zinc



POZI



CORROSION RATING

1 2 3 4 5

Clean, dry & low humidity environments



STEEL



THIN SHEET

Flange head gives an aesthetic finish whilst increasing the clamping ability of the screw. BS4174:1972 approved.

Product Code	Size (mm)	Driver Bit Size	Pack Qty (pcs)	Carton Qty (packs)	Pallet Qty (packs)
<b>BOX</b>					
00634CFAZS	3.5 x 19	PZ2	200	75	2700
00838CFAZS	4.2 x 9.5	PZ2	200	75	2700
00812CFAZS	4.2 x 13	PZ2	200	75	2700
00858CFAZS	4.2 x 16	PZ2	200	75	1800
00834CFAZS	4.2 x 19	PZ2	200	38	1824
00081CFAZS	4.2 x 25	PZ2	200	50	1200
08114CFAZS	4.2 x 32	PZ2	200	22	1056
01034CFAZS	4.8 x 19	PZ2	200	22	1056
TYPE - STS				SUB TYPE - STS01	
<b>TIMPAC</b>					
00838CFAZP	4.2 x 9.5	PZ2	16	10	-
00812CFAZP	4.2 x 13	PZ2	16	10	-
00834CFAZP	4.2 x 19	PZ2	14	10	-
00081CFAZP	4.2 x 25	PZ2	12	10	-
TYPE - PAK				SUB TYPE - PAK04	

### Mixed Tray



Three different head types; pan, countersunk and flange head.

Product Code	Size (mm)	Head Type	Pack Qty (pcs)	Carton Qty (packs)	Pallet Qty (packs)
<b>MIXED TRAY (1,305 PCS)</b>					
STSTRAY	-	-	1305	6	108
	3.5 x 6.5	Pan Head	50		
	3.5 x 13	Pan Head	165		
	3.5 x 19	Countersunk	140		
	4.2 x 13	Pan Head	180		
	4.2 x 13	Flange Head	100		
	4.2 x 19	Pan Head	115		
	4.2 x 19	Countersunk	140		
	4.2 x 25	Pan Head	80		
	4.2 x 25	Countersunk	100		
	4.2 x 38	Countersunk	45		
	4.8 x 13	Pan Head	120		
	4.8 x 16	Pan Head	70		
TYPE - STS				SUB TYPE - STS01	

# Stainless Steel Self-Tapping Screws

Used for stitching metal or attaching to metal. A pre-drilled hole is required. Stainless steel must be used where there is corrosive environment and/or the base material has inherent corrosive characteristics.



## Pan Head (DIN7981)

A2 Stainless Steel



POZI

CORROSION RATING



Urban & industrial areas with a moderate salt atmosphere



STEEL THIN SHEET

Pan head for extra clamping. A2 stainless steel for ultimate resistance to corrosion.

Product Code	Size (mm)	Driver Bit Size	Pack Qty (pcs)	Carton Qty (packs)	Pallet Qty (packs)
BOX					
2965CPASS	2.9 x 6.5	PZ1	200	140	5,040
2995CPASS	2.9 x 9.5	PZ1	200	140	5,040
3595CPASS	3.5 x 9.5	PZ2	200	140	5,040
3513CPASS	3.5 x 13	PZ2	200	75	2,700
3519CPASS	3.5 x 19	PZ2	200	75	1,800
3525CPASS	3.5 x 25	PZ2	200	50	1,200
3938CPASS	3.9 x 38	PZ2	200	50	1,200
4295CPASS	4.2 x 9.5	PZ2	200	75	2,700
4213CPASS	4.2 x 13	PZ2	200	75	1,800
4216CPASS	4.2 x 16	PZ2	200	75	1,800
4219CPASS	4.2 x 19	PZ2	200	75	1,800
4225CPASS	4.2 x 25	PZ2	200	50	1,200
4232CPASS	4.2 x 32	PZ2	200	35	840
4825CPASS	4.8 x 25	PZ2	200	35	840
4832CPASS	4.8 x 32	PZ2	200	35	840
4838CPASS	4.8 x 38	PZ2	200	15	540
4850CPASS	4.8 x 50	PZ2	200	15	360
5519CPASS	5.5 x 19	PZ3	200	50	1,200
5525CPASS	5.5 x 25	PZ3	200	35	840
TYPE - TAS			SUB TYPE - TAS01		

## Countersunk (DIN7982)

A2 Stainless Steel



POZI

CORROSION RATING



Urban & industrial areas with a moderate salt atmosphere

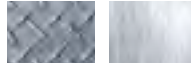

STEEL THIN SHEET

Countersunk head gives a discreet finish into pre-countersunk holes. A2 stainless steel for ultimate resistance to corrosion.

Product Code	Size (mm)	Driver Bit Size	Pack Qty (pcs)	Carton Qty (packs)	Pallet Qty (packs)
BOX					
2913CCASS	2.9 x 13	PZ1	200	140	5,040
2919CCASS	2.9 x 19	PZ1	200	140	5,040
3525CCASS	3.5 x 25	PZ2	200	75	2,700
3995CCASS	3.9 x 9.5	PZ2	200	140	5,040
3913CCASS	3.9 x 13	PZ2	200	140	5,040
3925CCASS	3.9 x 25	PZ2	200	75	1,800
3938CCASS	3.9 x 38	PZ2	200	50	1,200
4295CCASS	4.2 x 9.5	PZ2	200	140	5,040
4213CCASS	4.2 x 13	PZ2	200	75	2,700
4216CCASS	4.2 x 16	PZ2	200	75	2,700
4219CCASS	4.2 x 19	PZ2	200	75	1,800
4225CCASS	4.2 x 25	PZ2	200	50	1,200
4232CCASS	4.2 x 32	PZ2	200	50	1,200
4238CCASS	4.2 x 38	PZ2	200	35	840
4819CCASS	4.8 x 19	PZ2	200	50	1,200
4850CCASS	4.8 x 50	PZ2	200	15	540
TYPE - TAS			SUB TYPE - TAS01		

## Flange Head

A2 Stainless Steel



POZI

CORROSION RATING



Urban & industrial areas with a moderate salt atmosphere

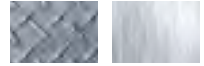

STEEL THIN SHEET

Flange head gives an aesthetic finish whilst increasing the clamping ability of the screw. A2 stainless steel for ultimate resistance to corrosion.

Product Code	Size (mm)	Driver Bit Size	Pack Qty (pcs)	Carton Qty (packs)	Pallet Qty (packs)
BOX					
4295CFASS	4.2 x 9.5	PZ2	200	75	2,700
4213CFASS	4.2 x 13	PZ2	200	75	1,800
4219CFASS	4.2 x 19	PZ2	200	50	1,200
TYPE - TAS			SUB TYPE - TAS01		

# Machine Screws



## Countersunk Machine Screws

Zinc

### Countersunk (DIN965)

Countersunk machine screws with metric thread commonly used in pre-drilled and threaded holes.



### Countersunk (DIN965) & Hex Nut (DIN34)

A countersunk machine screw with hex full nut ideal for general light duty bolting applications where a flush finish is required.



CORROSION RATING



Clean, dry & low humidity environments



STEEL

### Countersunk (DIN965)

Product Code	Size (mm)	Driver Bit Size	Pack Qty (pcs)	Carton Qty (packs)	Pallet Qty (packs)
<b>BOX</b>					
4008CPM	M4 x 8	PZ2	100	75	2700
4010CPM	M4 x 10	PZ2	100	75	2700
4012CPM	M4 x 12	PZ2	100	75	2700
4020CPM	M4 x 20	PZ2	100	75	2700
4025CPM	M4 x 25	PZ2	100	75	2700
4040CPM	M4 x 40	PZ2	100	50	1200
5010CPM	M5 x 10	PZ2	100	75	2700
5012CPM	M5 x 12	PZ2	100	75	2700
5016CPM	M5 x 16	PZ2	100	75	2700
5020CPM	M5 x 20	PZ2	100	75	2700
5025CPM	M5 x 25	PZ2	100	50	1200
5030CPM	M5 x 30	PZ2	100	50	1200
5040CPM	M5 x 40	PZ2	100	50	1200
5050CPM	M5 x 50	PZ2	100	35	840
6010CPM	M6 x 10	PZ3	100	75	2700
6012CPM	M6 x 12	PZ3	100	75	2700
6016CPM	M6 x 16	PZ3	100	75	2700
6020CPM	M6 x 20	PZ3	100	50	1200
6025CPM	M6 x 25	PZ3	100	50	1200
6030CPM	M6 x 30	PZ3	100	35	840
6040CPM	M6 x 40	PZ3	100	50	840
6050CPM	M6 x 50	PZ3	100	15	540

TYPE - MAC

SUB TYPE - MAC01

### Countersunk (DIN965) & Hex Nut (DIN934)

Product Code	Size (mm)	Driver Bit Size	Nut Socket Size (mm)	Pack Qty (pcs)	Carton Qty (packs)
<b>TIMPAC</b>					
4025CPMHNP	M4 x 25	PZ2	7	30	5
5010CPMHNP	M5 x 10	PZ2	8	40	5
5016CPMHNP	M5 x 16	PZ2	8	35	5
5020CPMHNP	M5 x 20	PZ2	8	30	5
5025CPMHNP	M5 x 25	PZ2	8	25	5
5030CPMHNP	M5 x 30	PZ2	8	20	5
5040CPMHNP	M5 x 40	PZ2	8	15	5
6020CPMHNP	M6 x 20	PZ3	10	20	5
6040CPMHNP	M6 x 40	PZ3	10	10	5

TYPE - PAK

SUB TYPE - PAK05

## Pan Head Machine Screws

Zinc

### Pan Head (DIN7985)

Pan head machine screws with metric thread commonly used in pre-drilled and threaded holes. Pan head for extra clamping.



### Pan Head (DIN7985) & Hex Nut (DIN934)

A pan head machine screw with hex full nut ideal for general light duty bolting applications where a pan head is required for extra clamping effectiveness.



CORROSION RATING



Clean, dry & low humidity environments



STEEL

### Pan Head (DIN7985)

Product Code	Size (mm)	Driver Bit Size	Pack Qty (pcs)	Carton Qty (packs)	Pallet Qty (packs)
<b>BOX</b>					
4010PPM	M4 x 10	PZ2	100	75	2700
4012PPM	M4 x 12	PZ2	100	35	2700
4016PPM	M4 x 16	PZ2	100	35	2700
4020PPM	M4 x 20	PZ2	100	35	2700
4025PPM	M4 x 25	PZ2	100	35	2700
4030PPM	M4 x 30	PZ2	100	50	1200
4040PPM	M4 x 40	PZ2	100	50	1200
4050PPM	M4 x 50	PZ2	100	35	840
4080PPM	M4 x 80	PZ2	100	35	840
5008PPM	M5 x 8	PZ2	100	75	2700
5010PPM	M5 x 10	PZ2	100	75	2700
5012PPM	M5 x 12	PZ2	100	35	2700
5016PPM	M5 x 16	PZ2	100	75	2700
5020PPM	M5 x 20	PZ2	100	50	1200
5025PPM	M5 x 25	PZ2	100	50	1200
5030PPM	M5 x 30	PZ2	100	50	1080
5040PPM	M5 x 40	PZ2	100	35	840
5050PPM	M5 x 50	PZ2	100	35	768
5100PPM	M5 x 100	PZ2	100	15	540
6012PPM	M6 x 12	PZ3	100	50	1200
6016PPM	M6 x 16	PZ3	100	50	1080
6020PPM	M6 x 20	PZ3	100	50	960
6025PPM	M6 x 25	PZ3	100	35	840
6040PPM	M6 x 40	PZ3	100	22	792

TYPE - MAC

SUB TYPE - MAC01

### Pan Head (DIN7985) & Hex Nut (DIN934)

Product Code	Size (mm)	Driver Bit Size	Nut Socket Size (mm)	Pack Qty (pcs)	Carton Qty (packs)
<b>TIMPAC</b>					
4012PPMHNP	M4 x 12	PZ2	7	40	5
4020PPMHNP	M4 x 20	PZ2	7	32	5
4025PPMHNP	M4 x 25	PZ2	7	30	5
4030PPMHNP	M4 x 30	PZ2	7	25	5
4040PPMHNP	M4 x 40	PZ2	7	20	5
5030PPMHNP	M5 x 30	PZ2	8	15	5
5050PPMHNP	M5 x 50	PZ2	8	10	5
6016PPMHNP	M6 x 16	PZ3	10	15	5
6040PPMHNP	M6 x 40	PZ3	10	10	5

TYPE - PAK

SUB TYPE - PAK05

Unreinforced  
& Reinforced  
Construction



# PVCu Fabrication Screws

1. Friction Stay Screws (FS)

2. Countersunk Screws

3. Machine Screws

4. Element Screws

5. Cill Screws

6. Baypole Screws



## Carbon Steel Zinc / Yellow

Carbon steel with a zinc or yellow plating, mainly used in low corrosive environment.

CORROSION RATING



Occasionally damp/wet, rural and sheltered areas

## Martensitic Stainless Steel

A magnetic, martensitic stainless steel, with silver organic plating. Silver organic plating is a reliable.

CORROSION RATING



Urban & industrial areas with a low salt atmosphere

## A2 Austenitic Stainless Steel

A non-magnetic austenitic steel suitable where there is a corrosive environment.

CORROSION RATING



Urban & industrial areas with a moderate salt atmosphere

All window  
screws have  
PH2 recess.



PHILLIPS

All tested to BS EN ISO 9227:2006. (UKAS Accredited). In accordance with BS7412 and both the BPF and GGF guidelines.



Salt Spray 240 hours



Salt Spray 504 hours



Salt Spray 504 hours



# Specialist Window Screws



## Element Screw

Yellow



PHILLIPS

- Shallow pan countersunk head
- Self-tapping thread
- AB point tip

Mechanical jointing screw with special truncated head for fixing either frame to frame or frame to mullions.

Product Code	Size (mm)	Driver Bit Size	Pack Qty (pcs)	Carton Qty (packs)	Pallet Qty (packs)
<b>BOX</b>					
<b>Yellow</b>					
191Y	4.8 x 55	PH2	200	8	384
192Y	4.8 x 65	PH2	200	8	384
193Y	4.8 x 80	PH2	200	6	288
194Y	4.8 x 95	PH2	200	8	192

TYPE - WIN

SUB TYPE - WIN03

## Baypole Screw

Zinc

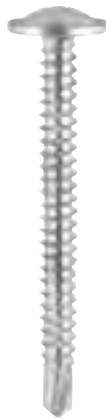

PHILLIPS



EN 14566:2008 & EN 10666:2008

- Wafer head
- Self-tapping thread
- Self drill tip

Specifically designed for the joining of PVCu bay window sections, but frequently used for other window and door fabrication purposes.

Product Code	Size (mm)	Driver Bit Size	Pack Qty (pcs)	Carton Qty (packs)	Pallet Qty (packs)
<b>BOX</b>					
<b>Zinc</b>					
289Z	4.8 x 40	PH2	200	15	540
290Z	4.8 x 50	PH2	200	8	384
291Z	4.8 x 60	PH2	200	6	288
292Z	4.8 x 70	PH2	200	6	288
293Z	4.8 x 80	PH2	200	8	216
294Z	4.8 x 90	PH2	200	8	192
295Z	4.8 x 100	PH2	200	8	192

TYPE - WIN

SUB TYPE - WIN06

## Reinforced Frame Screw

Zinc

Mart SS



PHILLIPS

- Pan head
- Self-tapping thread
- Self-drilling point

Generally used for attaching steel hardware to steel reinforced PVCu sections. The flat underside of the screws head allows it to clamp the materials together firmly.

Product Code	Size (mm)	Driver Bit Size	Pack Qty (pcs)	Carton Qty (packs)	Pallet Qty (packs)
<b>BOX</b>					
<b>Zinc</b>					
130Z	4.2 x 13	PH2	1,000	15	540
131Z	4.2 x 16	PH2	1,000	15	540
132Z	4.2 x 19	PH2	1,000	8	384
133Z	4.2 x 25	PH2	1,000	6	288
<b>410 Martensitic Stainless Steel + Silver Organic</b>					
130SS	4.2 x 13	PH2	1,000	15	540
131SS	4.2 x 16	PH2	1,000	15	540
132SS	4.2 x 19	PH2	1,000	8	384
133SS	4.2 x 25	PH2	1,000	6	288

TYPE - WIN / WSS

SUB TYPE - WIN01 / WSS01

## Machine Screw

Zinc

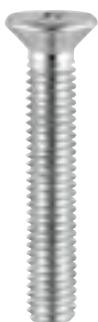

PHILLIPS

- Countersunk head
- Metric thread
- B point tip

Used for fastening handles or espagnolettes into pre-defined holes in frames.

Product Code	Size (mm)	Driver Bit Size	Pack Qty (pcs)	Carton Qty (packs)	Pallet Qty (packs)
<b>BOX</b>					
<b>Zinc</b>					
520Z	M5 x 20	PH2	500	15	540
530Z	M5 x 30	PH2	500	8	384
540Z	M5 x 40	PH2	500	6	288

TYPE - WIN

SUB TYPE - WIN04

## Cill Screw

Zinc

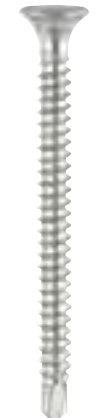

PHILLIPS

- Bugle head
- Self tap thread
- Self drill tip

Used for attaching cills to the base of door or window frames. The self-drilling point permits the screw to drill through both reinforced and unreinforced frames.

Product Code	Size (mm)	Driver Bit Size	Pack Qty (pcs)	Carton Qty (packs)	Pallet Qty (packs)
<b>BOX</b>					
<b>Zinc</b>					
225Z	4.2 x 50	PH2	500	6	288
226Z	4.2 x 55	PH2	500	8	192
227Z	4.2 x 65	PH2	200	8	384

TYPE - WIN

SUB TYPE - WIN05

## Weather Bar Screw

Zinc



PHILLIPS

- Nipple head
- Self-tapping thread
- Self-drilling point

For use when attaching a weather bar or drip rail to PVCu window and door frames to prevent water ingress. Large head provides easy and secure clipping.

Product Code	Size (mm)	Driver Bit Size	Pack Qty (pcs)	Carton Qty (packs)	Pallet Qty (packs)
<b>BOX</b>					
<b>Zinc</b>					
241Z	4.0 x 13	PH2	1,000	6	288

TYPE - WIN

SUB TYPE - WIN02

# Reinforced Frames



## 135 & 141 Range

Zinc Mart SS

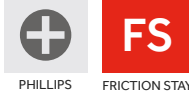
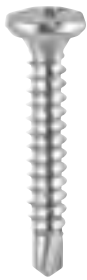

- Shallow pan head
- Self-tapping thread
- Self-drilling point

For attaching friction stays with countersunk holes to steel reinforced PVCu frames. \*Repair screws for stripped holes. (141 range)

Product Code	Size (mm)	Driver Bit Size	Pack Qty (pcs)	Carton Qty (packs)	Pallet Qty (packs)
--------------	-----------	-----------------	----------------	--------------------	--------------------

BOX					
Zinc					
135Z	3.9 x 16	PH2	1,000	15	540
136Z	3.9 x 19	PH2	1,000	15	540
137Z	3.9 x 25	PH2	1,000	6	288
138Z	3.9 x 29	PH2	1,000	6	288
141Z*	4.8 x 16	PH2	1,000	15	540
142Z*	4.8 x 19	PH2	1,000	8	384
143Z*	4.8 x 23	PH2	1,000	8	384

410 Martensitic SS + Silver Organic					
135SS	3.9 x 16	PH2	1,000	15	540
136SS	3.9 x 19	PH2	1,000	15	540
137SS	3.9 x 25	PH2	1,000	6	288
138SS	3.9 x 29	PH2	1,000	6	288
143SS*	4.8 x 23	PH2	1,000	9	216

TYPE - WIN / WSS

SUB TYPE - WIN07 / WSS02

## 150 Range

Zinc Yellow



- Countersunk head
- Metric thread
- Self-drilling point

An alternative to the self-tapping thread version. This metric threaded screw has multiple uses for fitting a variety of hardware to frames where there is a steel reinforcement present.

Product Code	Size (mm)	Driver Bit Size	Pack Qty (pcs)	Carton Qty (packs)	Pallet Qty (packs)
--------------	-----------	-----------------	----------------	--------------------	--------------------

BOX					
Zinc					
150Z	M4 x 16	PH2	1,000	15	540
151Z	M4 x 19	PH2	1,000	15	540
153Z	M4 x 25	PH2	1,000	8	384
154Z	M4 x 32	PH2	1,000	8	192
155Z	M4 x 38	PH2	500	8	384

Yellow					
150Y	M4 x 16	PH2	1,000	15	540
151Y	M4 x 19	PH2	1,000	15	540
153Y	M4 x 25	PH2	1,000	8	384
155Y	M4 x 38	PH2	500	8	384

TYPE - WIN

SUB TYPE - WIN01

## 120 Range

Zinc Yellow Mart SS



PHILLIPS

- Countersunk head (\*with ribs)
- Self-tapping thread
- Self-drilling point

Multiple uses for fitting a variety of hardware to frames where there is a steel or aluminium reinforcement present.

Product Code	Size (mm)	Driver Bit Size	Pack Qty (pcs)	Carton Qty (packs)	Pallet Qty (packs)
--------------	-----------	-----------------	----------------	--------------------	--------------------

BOX					
Zinc					
120Z*	3.9 x 13	PH2	1,000	15	540
121Z*	3.9 x 16	PH2	1,000	15	540
122Z*	3.9 x 19	PH2	1,000	15	540
123Z	3.9 x 25	PH2	1,000	8	384
126Z	3.9 x 29	PH2	1,000	8	384
124Z	3.9 x 32	PH2	1,000	6	288
125Z	3.9 x 38	PH2	1,000	6	288
127Z	3.9 x 45	PH2	500	8	384

Yellow					
120Y*	3.9 x 13	PH2	1,000	15	540
121Y*	3.9 x 16	PH2	1,000	15	540
122Y*	3.9 x 19	PH2	1,000	15	540
123Y	3.9 x 25	PH2	1,000	8	384
124Y	3.9 x 32	PH2	1,000	6	288
125Y	3.9 x 38	PH2	1,000	6	288
127Y	3.9 x 45	PH2	500	8	384

410 Martensitic SS + Silver Organic					
121SS*	3.9 x 16	PH2	1,000	15	540
122SS*	3.9 x 19	PH2	1,000	15	540
123SS	3.9 x 25	PH2	1,000	8	384
124SS	3.9 x 32	PH2	1,000	6	288
125SS	3.9 x 38	PH2	1,000	6	288

TYPE - WIN / WIN / WSS

SUB TYPE - WIN01 / WIN01 / WSS03

## 230 Range

Zinc Mart SS



PHILLIPS

- Countersunk facet head
- Metric thread
- Self-drilling point

Frequently used with auto feed machines when 'pinning' steel reinforcement inside PVCu frames.

Product Code	Size (mm)	Driver Bit Size	Pack Qty (pcs)	Carton Qty (packs)	Pallet Qty (packs)
--------------	-----------	-----------------	----------------	--------------------	--------------------

BOX					
Zinc					
230Z	M4 x 13	PH2	1,000	15	540
231Z	M4 x 16	PH2	1,000	15	540
232Z	M4 x 19	PH2	1,000	15	540

410 Martensitic SS + Silver Organic					
231SS	M4 x 16	PH2	1,000	15	540

TYPE - WIN / WSS

SUB TYPE - WIN01 / WSS03

## 423 Range

Zinc

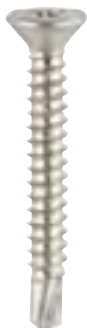

PHILLIPS

- Countersunk head
- Self-tapping thread
- Self-drilling point

A heavier gauge screw, generally used where extra strength is required such as attaching hinges to a steel reinforced frame.

Product Code	Size (mm)	Driver Bit Size	Pack Qty (pcs)	Carton Qty (packs)	Pallet Qty (packs)
--------------	-----------	-----------------	----------------	--------------------	--------------------

BOX					
Zinc					
423Z	4.8 x 25	PH2	1,000	6	288
424Z	4.8 x 32	PH2	500	8	384
425Z	4.8 x 38	PH2	500	8	288
427Z	4.8 x 45	PH2	500	6	288
429Z	4.8 x 60	PH2	200	8	384

TYPE - WIN

SUB TYPE - WIN01

# Shims, Packers & Wedges

For full range, sold in various quantities & sizes

See Page 232

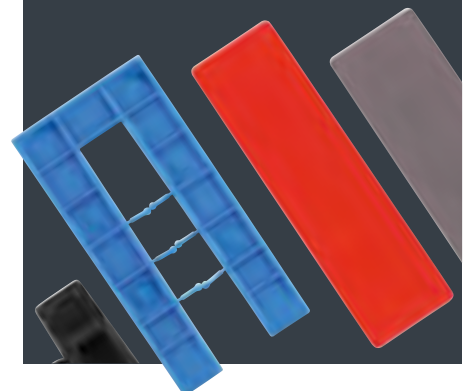

# Unreinforced Frames



## 100 Range

Zinc Yellow



PHILLIPS

- Countersunk head with ribs
- High-Low thread
- Slash tip

Multiple uses for fitting a variety of hardware to frames where there is no steel or aluminium reinforcement present. \*Repair screws for stripped holes.

Product Code	Size (mm)	Driver Bit Size	Pack Qty (pcs)	Carton Qty (packs)	Pallet Qty (packs)
<b>BOX</b>					
<b>Zinc</b>					
104Z	4.3 x 25	PH2	1,000	8	384
105Z	4.3 x 30	PH2	1,000	8	384
106Z	4.3 x 40	PH2	1,000	8	192
109Z*	4.8 x 25	PH2	1,000	8	384
<b>Yellow</b>					
104Y	4.3 x 25	PH2	1,000	8	384
105Y	4.3 x 30	PH2	1,000	8	384
106Y	4.3 x 40	PH2	1,000	8	192
109Y*	4.8 x 25	PH2	1,000	8	384

TYPE - WIN

SUB TYPE - WIN01

## 200 Range

Zinc Yellow A2/Aust. SS



PHILLIPS

- Countersunk head with ribs
- Single thread
- Gimlet tip

Multiple uses for fitting a variety of hardware to frames where there is no steel or aluminium reinforcement present. \*Repair screws for stripped holes.

Product Code	Size (mm)	Driver Bit Size	Pack Qty (pcs)	Carton Qty (packs)	Pallet Qty (packs)
<b>BOX</b>					
<b>Zinc</b>					
201Z	4.3 x 16	PH2	1,000	15	540
202Z	4.3 x 20	PH2	1,000	15	540
204Z	4.3 x 25	PH2	1,000	8	384
205Z	4.3 x 30	PH2	1,000	8	384
203Z	4.3 x 35	PH2	1,000	6	288
206Z	4.3 x 40	PH2	1,000	8	192
207Z	4.3 x 45	PH2	500	8	384
208Z	4.3 x 55	PH2	500	6	288



Product Code	Size (mm)	Driver Bit Size	Pack Qty (pcs)	Carton Qty (packs)	Pallet Qty (packs)
209Z*	4.8 x 25	PH2	1,000	8	384
210Z*	4.8 x 38	PH2	1,000	8	192
<b>BOX</b>					
<b>Yellow</b>					
201Y	4.3 x 16	PH2	1,000	15	540
202Y	4.3 x 20	PH2	1,000	15	540
204Y	4.3 x 25	PH2	1,000	8	384
205Y	4.3 x 30	PH2	1,000	8	384
203Y	4.3 x 35	PH2	1,000	6	288
206Y	4.3 x 40	PH2	1,000	8	192
207Y	4.3 x 45	PH2	500	8	384
208Y	4.3 x 55	PH2	500	6	288
209Y*	4.8 x 25	PH2	1,000	8	384
<b>A2/Aust. Stainless Steel</b>					
202SS	4.3 x 20	PH2	1,000	15	540
204SS	4.3 x 25	PH2	1,000	8	384
205SS	4.3 x 30	PH2	1,000	8	384
203SS	4.3 x 35	PH2	1,000	6	288
206SS	4.3 x 40	PH2	1,000	8	192
209SS*	4.8 x 25	PH2	1,000	8	384

TYPE - WIN / WIN / WSS

SUB TYPE - WIN01 / WIN01 / WSS01

## 111 Range

Zinc



PHILLIPS



FS FRICTION STAY

- Shallow pan countersunk head
- High-Low thread
- Slash tip

For attaching friction stays to PVCu frames. An alternative to the single thread range offering a slash point and a High-Low thread to aid speed of insertion and pull out.

Product Code	Size (mm)	Driver Bit Size	Pack Qty (pcs)	Carton Qty (packs)	Pallet Qty (packs)
<b>BOX</b>					
<b>Zinc</b>					
111Z	4.3 x 20	PH2	1,000	8	384
112Z	4.3 x 25	PH2	1,000	8	384

TYPE - WIN

SUB TYPE - WIN01

## 215 Range

Zinc A2/Aust. SS



PHILLIPS



FS FRICTION STAY

- Shallow pan head with serrations
- Single thread
- Gimlet tip

For attaching friction stays with pre-drilled holes to PVCu frames. The Stainless Steel screw should be used where there is a corrosive environment.

Product Code	Size (mm)	Driver Bit Size	Pack Qty (pcs)	Carton Qty (packs)	Pallet Qty (packs)
<b>BOX</b>					
<b>Zinc</b>					
215Z	4.8 x 16	PH2	1,000	8	384
216Z	4.8 x 20	PH2	1,000	8	384
217Z	4.8 x 25	PH2	1,000	6	288
218Z	4.8 x 30	PH2	1,000	8	192

TYPE - WIN / WSS

SUB TYPE - WIN07 / WSS02

## 211 Range

Zinc A2/Aust. SS



PHILLIPS



FS FRICTION STAY

- Shallow pan countersunk head
- Single thread
- Gimlet tip

For attaching friction stays with countersunk holes to PVCu frames. The Stainless Steel screw should be used where there is a corrosive environment.

Product Code	Size (mm)	Driver Bit Size	Pack Qty (pcs)	Carton Qty (packs)	Pallet Qty (packs)
<b>BOX</b>					
<b>Zinc</b>					
213Z	4.3 x 16	PH2	1,000	15	540
211Z	4.3 x 20	PH2	1,000	8	384
212Z	4.3 x 25	PH2	1,000	8	384

TYPE - WIN / WSS

SUB TYPE - WIN07 / WSS02



# Fasteners & Fixings

## Engineering Fasteners

Carriage Bolts	55
Exterior Carriage Bolts	56
Bolts & Threaded Bar	57
Set Screws	58
Nuts & Washers	59
Rivets	66

## Stainless Steel Fasteners

Carriage Bolts	62
Socket Screws	63
Set Screws	64
Threaded Bar	64
Nuts & Washers	65

## Hanging & Utility Fixings

Hooks & Picture Hangers	66
Cups Hooks, Screw Eyes & Hooks	67
Storage Hooks & Tool Clips	68
Clips & Pins	68

## Electrical Fittings & Fixings

Cable Ties & Clips	69
--------------------	----

## Plumbing Fittings & Fixings

Sanitary Fixings	70
Pipe Fittings	71
Pipe Clips	73
Hose & Jubilee Clips	74
Jubilee Packs, Kits & Dispensers	77
Jubilee Tools	78

Assorted Trays	79
----------------	----





## Carriage Bolts & Hex Nuts



Zinc



DOMED



EN 14592:2008

CORROSION RATING

**1** 2 3 4 5

Clean, dry & low humidity environments

A domed head bolt with a square anti spin shoulder mainly used for clamping timber or attaching ironmongery to timber.

Fully threaded up-to and including 150mm. Partially threaded thereafter.

Also available in Stainless Steel

Product Code	Size (mm)	Nut Socket Size (mm)	Pack Qty (pcs)	Carton Qty (packs)	Pallet Qty (packs)
<b>TIMBAG</b>					
0640CBB	M6 x 40	10	120	5	600
0650CBB	M6 x 50	10	90	5	600
0675CBB	M6 x 75	10	75	5	600
06100CBB	M6 x 100	10	55	5	600
06130CBB	M6 x 130	10	35	5	600
06150CBB	M6 x 150	10	25	5	600
0850CBB	M8 x 50	13	55	5	600
0875CBB	M8 x 75	13	40	5	600
08100CBB	M8 x 100	13	40	5	600
08110CBB	M8 x 110	13	35	5	600
08130CBB	M8 x 130	13	30	5	500
08150CBB	M8 x 150	13	24	5	600
08180CBB	M8 x 180	13	14	5	600
08200CBB	M8 x 200	13	12	5	600
1050CBB	M10 x 50	17	45	5	600
1075CBB	M10 x 75	17	28	5	600
10100CBB	M10 x 100	17	24	5	600
10120CBB	M10 x 120	17	20	5	600
10130CBB	M10 x 130	17	20	5	600
10150CBB	M10 x 150	17	14	5	600
10180CBB	M10 x 180	17	12	5	600
10200CBB	M10 x 200	17	10	5	400
1250CBB	M12 x 50	19	18	5	600
1275CBB	M12 x 75	19	18	5	600
12100CBB	M12 x 100	19	14	5	600
12130CBB	M12 x 130	19	12	5	600
12150CBB	M12 x 150	19	10	5	600
12180CBB	M12 x 180	19	8	5	600
12200CBB	M12 x 200	19	5	5	400
<b>TIMPAC</b>					
0640CBP	M6 x 40	10	8	5	-
0650CBP	M6 x 50	10	4	5	-
0675CBP	M6 x 75	10	6	5	-
06100CBP	M6 x 100	10	4	5	-
06130CBP	M6 x 130	10	4	5	-
06150CBP	M6 x 150	10	2	5	-
0850CBP	M8 x 50	13	4	5	-
0875CBP	M8 x 75	13	4	5	-
08100CBP	M8 x 100	13	4	5	-
08110CBP	M8 x 110	13	3	5	-
08130CBP	M8 x 130	13	3	5	-
08150CBP	M8 x 150	13	2	5	-
08180CBP	M8 x 180	13	2	5	-
1050CBP	M10 x 50	17	2	5	-
1075CBP	M10 x 75	17	3	5	-
10100CBP	M10 x 100	17	2	5	-
10120CBP	M10 x 120	17	2	5	-
10130CBP	M10 x 130	17	2	5	-
10150CBP	M10 x 150	17	2	5	-
10180CBP	M10 x 180	17	2	5	-
1250CBP	M12 x 50	19	2	5	-
1275CBP	M12 x 75	19	2	5	-
12100CBP	M12 x 100	19	2	5	-
12130CBP	M12 x 130	19	2	5	-
12180CBP	M12 x 180	19	2	5	-

TYPE - BAG/PAK

SUB TYPE - BAG15/PAK15

## Grade 4.8 (Box Only)

Product Code	Size (mm)	Nut Socket Size (mm)	Pack Qty (pcs)	Carton Qty (packs)	Pallet Qty (packs)
<b>BOX</b>					
0620CB	M6 x 20	10	200	12	384
0625CB	M6 x 25	10	200	11	352
0630CB	M6 x 30	10	200	11	240
0640CB	M6 x 40	10	200	9	288
0650CB	M6 x 50	10	200	6	192
0660CB	M6 x 60	10	100	12	384
0665CB	M6 x 65	10	100	12	384
0670CB	M6 x 70	10	100	8	240
0675CB	M6 x 75	10	100	9	288
06100CB	M6 x 100	10	100	9	288
06110CB	M6 x 110	10	100	9	288
06120CB	M6 x 120	10	50	10	320
06130CB	M6 x 130	10	50	10	320
06140CB	M6 x 140	10	50	10	320
06150CB	M6 x 150	10	50	10	320
0820CB	M8 x 20	13	200	6	192
0825CB	M8 x 25	13	100	12	384
0830CB	M8 x 30	13	100	8	240
0835CB	M8 x 35	13	100	8	240
0840CB	M8 x 40	13	100	8	240
0845CB	M8 x 45	13	100	8	240
0850CB	M8 x 50	13	100	8	240
0860CB	M8 x 60	13	100	6	192
0865CB	M8 x 65	13	50	12	384
0870CB	M8 x 70	13	50	12	384
0875CB	M8 x 75	13	50	9	288
0880CB	M8 x 80	13	50	9	288
0890CB	M8 x 90	13	50	9	288
08100CB	M8 x 100	13	50	9	288
08110CB	M8 x 110	13	50	9	288
08120CB	M8 x 120	13	50	6	192
08130CB	M8 x 130	13	50	6	192
08140CB	M8 x 140	13	25	10	320
08150CB	M8 x 150	13	25	10	320
08160CB	M8 x 160	13	25	10	320
08180CB	M8 x 180	13	25	10	320
08200CB	M8 x 200	13	25	10	320
1025CB	M10 x 25	17	100	6	204
1030CB	M10 x 30	17	100	6	192
1035CB	M10 x 35	17	50	12	384
1040CB	M10 x 40	17	50	11	352
1050CB	M10 x 50	17	50	9	288
1065CB	M10 x 65	17	50	9	288
1070CB	M10 x 70	17	50	8	240
1075CB	M10 x 75	17	50	8	256
1080CB	M10 x 80	17	50	6	192
1090CB	M10 x 90	17	25	8	240
10100CB	M10 x 100	17	25	9	288
10110CB	M10 x 110	17	25	9	288
10120CB	M10 x 120	17	25	10	320
10130CB	M10 x 130	17	25	10	320
10140CB	M10 x 140	17	25	8	320
10150CB	M10 x 150	17	25	6	192
10160CB	M10 x 160	17	25	6	192
10180CB	M10 x 180	17	25	6	192
10200CB	M10 x 200	17	10	10	320
10220CB	M10 x 220	17	10	10	320
10240CB	M10 x 240	17	10	10	320
10260CB	M10 x 260	17	10	10	320
10280CB	M10 x 280	17	10	9	288
10300CB	M10 x 300	17	10	9	288
1250CB	M12 x 50	19	25	8	240
1265CB	M12 x 65	19	25	9	288
1275CB	M12 x 75	19	25	9	288
1290CB	M12 x 90	19	25	6	192
12100CB	M12 x 100	19	25	6	192
12110CB	M12 x 110	19	25	6	192
12120CB	M12 x 120	19	10	10	320
12130CB	M12 x 130	19	10	10	320
12140CB	M12 x 140	19	10	10	320
12150CB	M12 x 150	19	10	10	320
12160CB	M12 x 160	19	10	10	320
12180CB	M12 x 180	19	10	10	320
12200CB	M12 x 200	19	10	10	320
12220CB	M12 x 220	19	10	10	320
12230CB	M12 x 230	19	10	10	320
12240CB	M12 x 240	19	10	6	192
12250CB	M12 x 250	19	10	6	192
12260CB	M12 x 260	19	10	6	192
12280CB	M12 x 280	19	10	6	192
12300CB	M12 x 300	19	10	6	192
16100CB	M16 x 100	24	10	9	288
16110CB	M16 x 110	24	10	9	288
16150CB	M16 x 150	24	10	6	192
16180CB	M16 x 180	24	5	10	320
16200CB	M16 x 200	24	5	10	320

TYPE - CAB

SUB TYPE - CAB01

# Exterior Carriage Bolts & Hex Nuts



## Exterior Carriage Bolt

### Exterior (Green Organic)



DOMED



EN 14592:2008

CORROSION RATING



Urban & industrial areas with a low salt atmosphere

A domed head bolt with a square anti-spin shoulder mainly used for clamping timber or attaching ironmongery to timber.

Coated with a patented multi-layer corrosion resistant plating to withstand 500 hours

salt spray making it ideal for external applications.

Manufactured to DIN 603, DIN 934 and DIN 125-A.

Product Code	Size (mm)	Nut Socket Size (mm)	Pack Qty (pcs)	Carton Qty (packs)	Pallet Qty (packs)
<b>BAG</b>					
10100INCB	M10 x 100	17	10	10	1000
10150INCB	M10 x 150	17	10	6	600
10160INCB	M10 x 160	17	10	6	600
10200INCB	M10 x 200	17	10	6	600
10220INCB	M10 x 220	17	10	5	500

TYPE - IND

SUB TYPE - IND04

### Exterior (Silver Organic)



DOMED



EN 14592:2008

CORROSION RATING



Urban & industrial areas with a low salt atmosphere

A domed head bolt with a square anti-spin shoulder mainly used for clamping timber or attaching ironmongery to timber.

Coated with a patented multi-layer corrosion resistant plating to withstand 1,000 hours

salt spray test making it ideal for external applications.

Supplied with hex nuts and form A washers.

Product Code	Size (mm)	Nut Socket Size (mm)	Pack Qty (pcs)	Carton Qty (packs)	Pallet Qty (packs)
<b>TIMBAG</b>					
0640CBI	M6 x 40	10	10	5	600
0650CBI	M6 x 50	10	10	5	600
0675CBI	M6 x 75	10	10	5	600
06100CBI	M6 x 100	10	10	5	600
0850CBI	M8 x 50	13	10	5	600
0875CBI	M8 x 75	13	10	5	600
08100CBI	M8 x 100	13	10	5	600
08110CBI	M8 x 110	13	10	5	600
08130CBI	M8 x 130	13	10	5	400
08150CBI	M8 x 150	13	10	5	400
1075CBI	M10 x 75	17	10	5	600
10100CBI	M10 x 100	17	10	5	600
10120CBI	M10 x 120	17	10	5	400
10130CBI	M10 x 130	17	10	5	400
10150CBI	M10 x 150	17	10	5	400
10180CBI	M10 x 180	17	10	5	400
1275CBI	M12 x 75	19	10	5	600
12100CBI	M12 x 100	19	10	5	400
12130CBI	M12 x 130	19	10	5	400

TYPE - CAB

SUB TYPE - CAB03

## HDG Carriage Bolt

### Hot Dipped Galvanised



DOMED



EN 14592:2008

CORROSION RATING



Urban & industrial areas with a moderate salt atmosphere

A domed head bolt with a square anti-spin shoulder mainly used for clamping timber or attaching ironmongery to timber.

Fully threaded up to and including 150mm. Partially threaded thereafter.

Supplied with hex nuts. Manufactured to DIN 603 and DIN 934

Product Code	Size (mm)	Nut Socket Size (mm)	Pack Qty (pcs)	Carton Qty (packs)	Pallet Qty (packs)
<b>BOX</b>					
0850CBG	M8 x 50	13	100	9	288
0875CBG	M8 x 75	13	50	9	288
08130CBG	M8 x 130	13	50	6	288
08150CBG	M8 x 150	13	25	10	192
1075CBG	M10 x 75	17	50	8	320
10100CBG	M10 x 100	17	25	9	256
10110CBG	M10 x 110	17	25	9	288
10130CBG	M10 x 130	17	25	10	288
10150CBG	M10 x 150	17	25	6	320
10180CBG	M10 x 180	17	25	6	192
10200CBG	M10 x 200	17	10	10	192
1275CBG	M12 x 75	19	25	9	320
12100CBG	M12 x 100	19	25	6	288
12110CBG	M12 x 110	19	25	6	192
12130CBG	M12 x 130	19	10	10	192
12150CBG	M12 x 150	19	10	10	320
12180CBG	M12 x 180	19	10	10	320
12200CBG	M12 x 200	19	10	10	320

TYPE - CAB

SUB TYPE - CAB02

## HDG Square Plate Washer

### Hot Dipped Galvanised



Provides a large clamping surface and therefore spreading the load of a fastening.

Product Code	Size Hole Ø x L x W x D (mm)	Pack Qty (pcs)	Carton Qty (packs)	Pallet Qty (packs)
<b>BOX</b>				
WS10503G	M10 x 50 x 50 x 3	100	4	128
WS12503G	M12 x 50 x 50 x 3	100	4	128

TYPE - WSH

SUB TYPE - WSH05

# Bolts & Threaded Bar

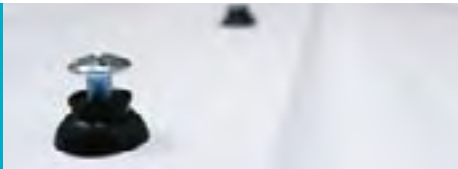

## Roofing Bolt & Square Nut

Zinc



CROSS

Manufactured with a large flat head, making it ideal for clamping thin sheet metal, plastic and wood.

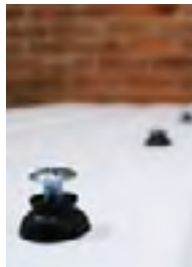

Product Code	Size (mm)	Nut Size (mm)	Pack Qty (pcs)	Carton Qty (packs)	Pallet Qty (packs)
<b>TIMBAG</b>					
0612RBB	M6 x 12	M6	150	5	870
0620RBB	M6 x 20	M6	140	5	870
0625RBB	M6 x 25	M6	130	5	870
0630RBB	M6 x 30	M6	120	5	600
0640RBB	M6 x 40	M6	110	5	600
0650RBB	M6 x 50	M6	90	5	600
0660RBB	M6 x 60	M6	80	5	600
0680RBB	M6 x 80	M6	70	5	600

Product Code	Size (mm)	Nut Size (mm)	Pack Qty (pcs)	Carton Qty (packs)	Pallet Qty (packs)
<b>TIMPAC</b>					
0612RBP	M6 x 12	M6	14	5	-
0620RBP	M6 x 20	M6	12	5	-
0625RBP	M6 x 25	M6	10	5	-
0630RBP	M6 x 30	M6	10	5	-
0640RBP	M6 x 40	M6	8	5	-
0650RBP	M6 x 50	M6	8	5	-
0660RBP	M6 x 60	M6	6	5	-
0680RBP	M6 x 80	M6	4	5	-
06100RBP	M6 x 100	M6	2	5	-

TYPE - BAG/PAK

SUB TYPE - BAG14/PAK14

Product Code	Size (mm)	Nut Size (mm)	Pack Qty (pcs)	Carton Qty (packs)	Pallet Qty (packs)
<b>BOX</b>					
0512RB	M5 x 12	M5	200	18	768
0530RB	M5 x 30	M5	200	10	540
0608RB	M6 x 08	M6	200	18	384
0612RB	M6 x 12	M6	200	10	384
0616RB	M6 x 16	M6	200	10	384
0620RB	M6 x 20	M6	200	10	336
0625RB	M6 x 25	M6	100	18	768
0630RB	M6 x 30	M6	100	18	768
0635RB	M6 x 35	M6	100	10	540
0640RB	M6 x 40	M6	100	10	540
0650RB	M6 x 50	M6	100	10	540
0660RB	M6 x 60	M6	100	8	384
0670RB	M6 x 70	M6	100	8	384
0680RB	M6 x 80	M6	100	8	288
06100RB	M6 x 100	M6	100	8	216
0825RB	M8 x 25	M8	100	10	288
0830RB	M8 x 30	M8	100	10	288
0840RB	M8 x 40	M8	100	8	288
0850RB	M8 x 50	M8	100	8	288
0860RB	M8 x 60	M8	100	8	216
0880RB	M8 x 80	M8	50	8	384
08100RB	M8 x 100	M8	50	8	288
08120RB	M8 x 120	M8	50	8	144
08140RB	M8 x 140	M8	50	8	216
08160RB	M8 x 160	M8	50	6	192
08180RB	M8 x 180	M8	50	6	192
08200RB	M8 x 200	M8	50	6	192

TYPE - ROB

SUB TYPE - ROB01

## Cable Tray Bolt & Flange Nut (DIN6923)

Zinc



CROSS

Specifically designed to provide a rapid and secure fixing when erecting cable trays. Flange nut prevents the nut from falling into the socket driver.

Product Code	Size (mm)	Nut Socket Size (mm)	Pack Qty (pcs)	Carton Qty (packs)	Pallet Qty (packs)
<b>BOX</b>					
CTB612	M6 x 12	10	200	16	192
CTB616	M6 x 16	10	200	16	192
CTB620	M6 x 20	10	200	16	192
CTB625	M6 x 25	10	200	16	192

TYPE - ROB

SUB TYPE - ROB02

## Grade 4.8 Threaded Bar (DIN975)

Zinc



Commonly used with drop in anchors for suspending cable trays from ceilings or can be cut to a required length and used with chemical resin.

Also available in Stainless Steel

Product Code	Thread Ø x Length (mm)	Pack Qty (pcs)	Carton Qty (packs)
<b>300MM BUNDLE</b>			
06300TBZ	M6 x 300	10	25
08300TBZ	M8 x 300	10	30
10300TBZ	M10 x 300	10	10
12300TBZ	M12 x 300	10	9
16300TBZ	M16 x 300	10	5

Product Code	Thread Ø x Length (mm)	Pack Qty (pcs)	Carton Qty (packs)
<b>1000MM BUNDLE</b>			
06TBZ	M6 x 1000	10	-
08TBZ	M8 x 1000	10	-
10TBZ	M10 x 1000	10	-
12TBZ	M12 x 1000	10	-
16TBZ	M16 x 1000	10	-
20TBZ	M20 x 1000	5	-

TYPE - TBA

SUB TYPE - TBA01

## Grade 8.8 High Tensile Threaded Bar

Zinc



Manufactured from grade 8.8 high tensile carbon steel. Commonly used with drop in anchors for suspending cable trays from ceilings or can be cut to a required length and used with chemical resin.

Product Code	Thread Ø x Length (mm)	Pack Qty (pcs)
<b>1000MM BUNDLE</b>		
06TBZHT	M6 x 1000	10
08TBZHT	M8 x 1000	10
10TBZHT	M10 x 1000	10
12TBZHT	M12 x 1000	10
16TBZHT	M16 x 1000	10
20TBZHT	M20 x 1000	5

TYPE - TBA

SUB TYPE - TBA02

# Set Screws



## Grade 8.8 Set Screw (DIN933)

Zinc



HEX

A fully metric threaded bolt used in a wide variety of applications.

Also available in Stainless Steel

Product Code	Size (mm)	Socket Size (mm)	Pack Qty (pcs)	Carton Qty (packs)	Pallet Qty (packs)
<b>BOX</b>					
S612Z	M6 x 12	10	500	10	360
S616Z	M6 x 16	10	500	8	288
S620Z	M6 x 20	10	500	6	216
S625Z	M6 x 25	10	500	6	216
S630Z	M6 x 30	10	500	6	216
S635Z	M6 x 35	10	500	4	144
S640Z	M6 x 40	10	200	10	360
S650Z	M6 x 50	10	200	8	288
S816Z	M8 x 16	13	200	10	360
S820Z	M8 x 20	13	200	8	288
S825Z	M8 x 25	13	200	8	288
S830Z	M8 x 30	13	200	6	216
S835Z	M8 x 35	13	200	6	216
S840Z	M8 x 40	13	200	6	216
S850Z	M8 x 50	13	200	4	144
S860Z	M8 x 60	13	200	4	144
S870Z	M8 x 70	13	200	3	108
S880Z	M8 x 80	13	200	3	108
S8100Z	M8 x 100	13	100	6	216
S1020Z	M10 x 20	17	200	6	144
S1025Z	M10 x 25	17	200	4	144
S1030Z	M10 x 30	17	200	4	144
S1035Z	M10 x 35	17	100	8	288
S1040Z	M10 x 40	17	100	6	216
S1050Z	M10 x 50	17	100	6	216
S1060Z	M10 x 60	17	100	4	144
S1070Z	M10 x 70	17	100	4	144
S1075Z	M10 x 75	17	100	4	144
S1080Z	M10 x 80	17	100	4	144
S10100Z	M10 x 100	17	50	6	216
S1225Z	M12 x 25	19	100	6	216
S1230Z	M12 x 30	19	100	6	216
S1235Z	M12 x 35	19	100	6	216
S1240Z	M12 x 40	19	100	4	144
S1245Z	M12 x 45	19	100	4	144
S1250Z	M12 x 50	19	100	4	144
S1260Z	M12 x 60	19	100	3	108
S1270Z	M12 x 70	19	50	6	216
S1275Z	M12 x 75	19	50	6	216
S1280Z	M12 x 80	19	50	6	216
S12100Z	M12 x 100	19	50	4	144
S12120Z	M12 x 120	19	50	4	144
S1625Z	M16 x 25	24	50	6	216
S1630Z	M16 x 30	24	50	6	216
S1635Z	M16 x 35	24	50	6	216
S1640Z	M16 x 40	24	50	4	144
S1645Z	M16 x 45	24	50	4	144
S1650Z	M16 x 50	24	50	4	144
S1655Z	M16 x 55	24	50	4	144
S1660Z	M16 x 60	24	50	4	108
S1665Z	M16 x 65	24	25	6	288
S1670Z	M16 x 70	24	25	6	216
S1675Z	M16 x 75	24	25	6	216
S1680Z	M16 x 80	24	25	6	216
S16100Z	M16 x 100	24	25	4	144
S2040Z	M20 x 40	30	25	6	216
S2045Z	M20 x 45	30	25	6	216
S2050Z	M20 x 50	30	25	4	144
S2055Z	M20 x 55	30	25	4	144
S2060Z	M20 x 60	30	25	4	144
S2065Z	M20 x 65	30	25	4	144
S2070Z	M20 x 70	30	25	4	144
S2075Z	M20 x 75	30	25	3	144
S2080Z	M20 x 80	30	25	3	108
S2090Z	M20 x 90	30	20	4	144
S20100Z	M20 x 100	30	20	4	144

TYPE - 933

SUB TYPE - 93301

## Grade 8.8 Set Screw (DIN933) & Nut (DIN934)

Zinc

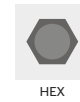
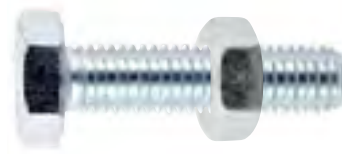

HEX

A fully metric threaded bolt used in a wide variety of applications.

Also available in Stainless Steel

Product Code	Size (mm)	Socket Size (mm)	Pack Qty (pcs)	Carton Qty (packs)	Pallet Qty (packs)
<b>TIMBAG</b>					
616SNZB	M6 x 16	10	130	5	870
620SNZB	M6 x 20	10	115	5	870
625SNZB	M6 x 25	10	100	5	870
630SNZB	M6 x 30	10	140	5	600
650SNZB	M6 x 50	10	70	5	870
820SNZB	M8 x 20	13	60	5	870
825SNZB	M8 x 25	13	55	5	870
840SNZB	M8 x 40	13	45	5	870
850SNZB	M8 x 50	13	40	5	870
870SNZB	M8 x 70	13	30	5	870
880SNZB	M8 x 80	13	25	5	600
8100SNZB	M8 x 100	13	20	5	600
1025SNZB	M10 x 25	17	35	5	870
1030SNZB	M10 x 30	17	32	5	725
1040SNZB	M10 x 40	17	28	5	725
1050SNZB	M10 x 50	17	25	5	725
1070SNZB	M10 x 70	17	20	5	600
1080SNZB	M10 x 80	17	15	5	600
10100SNZB	M10 x 100	17	16	5	600
1225SNZB	M12 x 25	19	25	5	870
1230SNZB	M12 x 30	19	23	5	870
1235SNZB	M12 x 35	19	22	5	870
1240SNZB	M12 x 40	19	20	5	870
1250SNZB	M12 x 50	19	18	5	870
1270SNZB	M12 x 70	19	14	5	870
1280SNZB	M12 x 80	19	10	5	600
12100SNZB	M12 x 100	19	10	5	600
12120SNZB	M12 x 120	19	8	5	600
<b>TIMPAC</b>					
612SNZP	M6 x 12	10	8	10	-
616SNZP	M6 x 16	10	8	10	-
620SNZP	M6 x 20	10	8	10	-
625SNZP	M6 x 25	10	6	10	-
630SNZP	M6 x 30	10	4	10	-
650SNZP	M6 x 50	10	4	10	-
820SNZP	M8 x 20	13	6	10	-
825SNZP	M8 x 25	13	4	10	-
830SNZP	M8 x 30	13	4	10	-
840SNZP	M8 x 40	13	2	10	-
850SNZP	M8 x 50	13	2	10	-
870SNZP	M8 x 70	13	2	10	-
880SNZP	M8 x 80	13	2	10	-
8100SNZP	M8 x 100	13	2	10	-
1025SNZP	M10 x 25	17	2	10	-
1030SNZP	M10 x 30	17	2	10	-
1040SNZP	M10 x 40	17	2	10	-
1050SNZP	M10 x 50	17	2	10	-
1070SNZP	M10 x 70	17	2	10	-
1080SNZP	M10 x 80	17	2	10	-
10100SNZP	M10 x 100	17	2	10	-
1225SNZP	M12 x 25	19	2	10	-
1230SNZP	M12 x 30	19	2	10	-
1235SNZP	M12 x 35	19	2	10	-
1240SNZP	M12 x 40	19	2	10	-
1250SNZP	M12 x 50	19	2	10	-
1270SNZP	M12 x 70	19	2	10	-
1280SNZP	M12 x 80	19	2	10	-
12100SNZP	M12 x 100	19	2	10	-
12120SNZP	M12 x 120	19	2	10	-

TYPE - BAG/PAK

SUB TYPE - BAG16/PAK16







**NEW**

## Grab Packs

Wide range of fasteners in a convenient problem-solving grab pack. Reusable and robust tray with clip shut lids and separate compartments for convenient storage.



### Mixed Bolts, Nuts and Washers Grab Pack



**Zinc**

A selection of commonly used zinc plated bolts, nuts and washers in a handy and reusable storage pack with clip-shut lid.

Note:  
Set Screw DIN933,  
Hex Nut DIN934,  
Form A Washer DIN125A

Product Code	Item	Size (mm)	Pack Qty (pcs)	Carton Qty (packs)
<b>GRAB PACK</b>				
BNWGPACK	-	-	500	5
	Hex Nut	M6	75	
	Hex Nut	M8	30	
	Hex Nut	M10	20	
	Form A Washer	M6	150	
	Form A Washer	M8	60	
	Form A Washer	M10	50	
	Set Screw	M6 x 16	30	
	Set Screw	M6 x 20	20	
	Set Screw	M6 x 25	20	
	Set Screw	M8 x 30	10	
	Set Screw	M8 x 40	10	
	Set Screw	M8 x 50	5	
	Set Screw	M10 x 60	10	
	Set Screw	M10 x 70	6	
	Set Screw	M10 x 75	4	

TYPE - TRY

SUB TYPE - TRY02

### Mixed Washers Grab Pack



**Zinc**

A selection of commonly used zinc plated washers of various sizes in a handy and reusable storage pack with clip-shut lid.

Note:  
Form A Washer DIN125A,  
Penny Washer DIN9054,  
Spring Washer DIN7980

Product Code	Item	Size (mm)	Pack Qty (pcs)	Carton Qty (packs)
<b>GRAB PACK</b>				
WAGPACK	-	-	1000	5
	Form A Washer	M4	120	
	Form A Washer	M5	100	
	Form A Washer	M6	75	
	Form A Washer	M8	60	
	Form A Washer	M10	50	
	Form A Washer	M12	20	
	Penny Washer	M4 x 20	50	
	Penny Washer	M5 x 25	30	
	Penny Washer	M6 x 20	30	
	Penny Washer	M8 x 25	20	
	Penny Washer	M10 x 25	20	
	Penny Washer	M12 x 35	20	
	Spring Washer	M4	100	
	Spring Washer	M5	100	
	Spring Washer	M6	75	
	Spring Washer	M8	60	
	Spring Washer	M10	50	
	Spring Washer	M12	20	

TYPE - TRY

SUB TYPE - TRY02

### Mixed Nuts Grab Pack



**Zinc**

A selection of commonly used zinc plated nuts in a handy and reusable storage pack with clip-shut lid.

Note:  
Nylon Nut (Type T) DIN985,  
Hex Nut DIN934,  
Wing Nuts

Product Code	Item	Size (mm)	Pack Qty (pcs)	Carton Qty (packs)
<b>GRAB PACK</b>				
NUTGPACK	-	-	980	5
	Nylon Nut	M4	150	
	Nylon Nut	M5	110	
	Nylon Nut	M6	80	
	Nylon Nut	M8	40	
	Nylon Nut	M10	15	
	Nylon Nut	M12	10	
	Wing Nut	M6	30	
	Wing Nut	M8	15	
	Wing Nut	M10	10	
	Hex Nut	M4	150	
	Hex Nut	M5	110	
	Hex Nut	M6	100	
	Hex Nut	M8	90	
	Hex Nut	M10	40	
	Hex Nut	M12	30	

TYPE - TRY

SUB TYPE - TRY02

### Mixed Carriage Bolts, Nuts and Washers Grab Pack



**Zinc**

A selection of commonly used zinc plated carriage bolts, nuts and washers of various sizes in a handy and reusable storage pack with clip-shut lid.

Note:  
Carriage Bolt DIN603,  
Nylon Nut (Type T) DIN985,  
Form A Washer DIN125A

Product Code	Item	Size (mm)	Pack Qty (pcs)	Carton Qty (packs)
<b>GRAB PACK</b>				
CBGPACK	-	-	140	5
	Nylon Nut	M6	10	
	Nylon Nut	M8	15	
	Nylon Nut	M10	15	
	Form A Washer	M6	15	
	Form A Washer	M8	25	
	Form A Washer	M10	20	
	Carriage Bolt	M6 x 40	10	
	Carriage Bolt	M8 x 50	10	
	Carriage Bolt	M8 x 75	5	
	Carriage Bolt	M10 x 100	5	
	Carriage Bolt	M10 x 120	5	
	Carriage Bolt	M10 x 150	5	

TYPE - TRY

SUB TYPE - TRY02

# Stainless Steel Fasteners

## SUPERIOR CORROSION RESISTANCE

A2 Stainless steel offers an excellent resistance to corrosion which makes it perfect for many day to day external and corrosive applications.



## SUSTAINABLE STAINLESS STEEL

Stainless steel is regarded as one of the most sustainable metals on the planet.

## Stainless Steel Carriage Bolts

SUPERIOR CORROSION RESISTANCE



### Carriage Bolt (DIN603)

A2 Austenitic Stainless Steel



A cup square carriage bolt in A2 stainless steel. A full metric fine thread.  
Nut not included.

Product Code	Size (mm)	Pack Qty (pcs)	Carton Qty (packs)	Pallet Qty (packs)
<b>BOX</b>				
0625CBSS	M6 x 25	200	8	288
0650CBSS	M6 x 50	200	5	180
1075CBSS	M10 x 75	50	6	216
12100CBSS	M12 x 100	50	3	108
12110CBSS	M12 x 110	25	6	216

TYPE - CAS SUB TYPE - CAS01

### Carriage Bolt (DIN603)

A2 Austenitic Stainless Steel



A cup square carriage bolt in A2 stainless steel. A full metric fine thread.  
Nut not included.

Product Code	Size (mm)	Pack Qty (pcs)	Carton Qty (packs)
<b>SMALL BAG</b>			
0625CBSSX	M6 x 25	10	200
0630CBSSX	M6 x 30	10	100
0640CBSSX	M6 x 40	10	100
0650CBSSX	M6 x 50	10	100
0675CBSSX	M6 x 75	10	50
06100CBSSX	M6 x 100	10	50
0840CBSSX	M8 x 40	10	100
0850CBSSX	M8 x 50	5	100
0860CBSSX	M8 x 60	5	100
0875CBSSX	M8 x 75	5	100
0880CBSSX	M8 x 80	5	100
08100CBSSX	M8 x 100	5	50
08130CBSSX	M8 x 130	5	50
08150CBSSX	M8 x 150	5	50
1075CBSSX	M10 x 75	5	50
1090CBSSX	M10 x 90	5	50
10100CBSSX	M10 x 100	5	50
10110CBSSX	M10 x 110	5	50
10120CBSSX	M10 x 120	5	50
10130CBSSX	M10 x 130	5	50
10150CBSSX	M10 x 150	5	30
1275CBSSX	M12 x 75	5	50
12100CBSSX	M12 x 100	5	30
12110CBSSX	M12 x 110	5	30
12130CBSSX	M12 x 130	5	30

TYPE - SSB SUB TYPE - SSB05

### Carriage Bolt (DIN603) & Hex Nut (DIN934)

A2 Austenitic Stainless Steel



A cup square carriage bolt in A2 stainless steel. A full metric fine thread.

Product Code	Size (mm)	Nut Socket Size (mm)	Pack Qty (pcs)	Carton Qty (packs)
<b>TIMPAC</b>				
08100CBSSP	M8 x 100	13	4	5
08130CBSSP	M8 x 130	13	3	5
08150CBSSP	M8 x 150	17	2	5
1075CBSSP	M10 x 75	17	3	5
10100CBSSP	M10 x 100	17	2	5
10120CBSSP	M10 x 120	17	2	5
10130CBSSP	M10 x 130	17	2	5
10150CBSSP	M10 x 150	13	2	5
12100CBSSP	M12 x 100	19	2	5
12130CBSSP	M12 x 130	19	2	5

TYPE - PAK SUB TYPE - PAK25



# Stainless Steel Socket Screws

SUPERIOR CORROSION RESISTANCE



## Countersunk Socket (DIN7991)

A2 Austenitic Stainless Steel

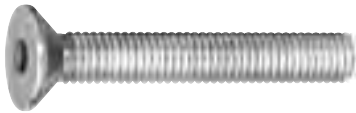

HEX RECESS

Designed for use in applications where the head is flush with joining parts.

Product Code	Size (mm)	Hex Recess (mm)	Pack Qty (pcs)	Carton Qty (packs)	Pallet Qty (packs)
<b>BOX</b>					
616CSKSS	M6 x 16	5.0	500	10	360
620CSKSS	M6 x 20	5.0	200	20	720
625CSKSS	M6 x 25	5.0	200	16	576
825CSKSS	M8 x 25	6.0	100	20	720
830CSKSS	M8 x 30	6.0	100	14	504
<b>SMALL BAG</b>					
616CSKSSX	M6 x 16	5.0	10	200	-
620CSKSSX	M6 x 20	5.0	10	200	-
625CSKSSX	M6 x 25	5.0	10	200	-
825CSKSSX	M8 x 25	6.0	10	200	-
830CSKSSX	M8 x 30	6.0	10	100	-

TYPE - SOS/SSB SUB TYPE - SOS01/SSB04

## Button Socket (ISO7380)

A2 Austenitic Stainless Steel



HEX RECESS

Designed for applications that allow the head to protrude above the joining parts. Button head protects adjoining parts from scrapes or other damage.

Product Code	Size (mm)	Hex Recess (mm)	Pack Qty (pcs)	Carton Qty (packs)	Pallet Qty (packs)
<b>BOX</b>					
612BUTSS	M6 x 12	5.0	500	12	432
620BUTSS	M6 x 20	5.0	500	6	216
625BUTSS	M6 x 25	5.0	200	14	504
630BUTSS	M6 x 30	5.0	200	14	504
<b>SMALL BAG</b>					
612BUTSSX	M6 x 12	5.0	10	500	-
616BUTSSX	M6 x 16	5.0	10	500	-
620BUTSSX	M6 x 20	5.0	10	300	-
625BUTSSX	M6 x 25	5.0	10	200	-
630BUTSSX	M6 x 30	5.0	10	200	-
825BUTSSX	M8 x 25	6.0	10	100	-

TYPE - SOS/SSB SUB TYPE - SOS01/SSB04

## Cap Socket (DIN912)

A2 Austenitic Stainless Steel



HEX RECESS

Socket head cap screws are designed to be used with the head protruding.

Product Code	Size (mm)	Hex Recess (mm)	Pack Qty (pcs)	Carton Qty (packs)	Pallet Qty (packs)
<b>BOX</b>					
516CAPSS	M5 x 16	4.0	500	10	360
520CAPSS	M5 x 20	4.0	500	12	432
616CAPSS	M6 x 16	5.0	200	20	720
620CAPSS	M6 x 20	5.0	200	16	544
625CAPSS	M6 x 25	5.0	200	14	504
820CAPSS	M8 x 20	6.0	200	8	288
825CAPSS	M8 x 25	6.0	200	7	252
<b>SMALL BAG</b>					
516CAPSSX	M5 x 16	4.0	10	100	-
520CAPSSX	M5 x 20	4.0	10	500	-
616CAPSSX	M6 x 16	5.0	10	500	-
620CAPSSX	M6 x 20	5.0	10	200	-
625CAPSSX	M6 x 25	5.0	10	200	-
820CAPSSX	M8 x 20	6.0	10	100	-
825CAPSSX	M8 x 25	6.0	10	100	-

TYPE - SOS/SSB SUB TYPE - SOS01/SSB04

## Countersunk Socket (DIN7991) & Nut (DIN934)

A2 Austenitic Stainless Steel



HEX RECESS

Designed for use in applications where the head is flush with joining parts.

Product Code	Size (mm)	Hex Recess (mm)	Pack Qty (pcs)	Carton Qty (packs)
<b>TIMPAC</b>				
616CSKSSP	M6 x 16	5.0	8	10
620CSKSSP	M6 x 20	5.0	8	10
625CSKSSP	M6 x 25	5.0	6	10
825CSKSSP	M8 x 25	6.0	4	10
830CSKSSP	M8 x 30	6.0	4	10

TYPE - PAK SUB TYPE - PAK27

## Button Socket (ISO7380) & Nut (DIN934)

A2 Austenitic Stainless Steel



HEX RECESS

Designed for applications that allow the head to protrude above the joining parts. Button head protects adjoining parts from scrapes or other damage.

Product Code	Size (mm)	Hex Recess (mm)	Pack Qty (pcs)	Carton Qty (packs)
<b>TIMPAC</b>				
612BUTSSP	M6 x 12	5.0	8	10
616BUTSSP	M6 x 16	5.0	8	10
620BUTSSP	M6 x 20	5.0	8	10
625BUTSSP	M6 x 25	5.0	6	10
630BUTSSP	M6 x 30	5.0	4	10
825BUTSSP	M8 x 25	6.0	4	10

TYPE - PAK SUB TYPE - PAK27

## Cap Socket (DIN912) & Nut (DIN934)

A2 Austenitic Stainless Steel



HEX RECESS

Socket head cap screws are designed to be used with the head protruding.

Product Code	Size (mm)	Hex Recess (mm)	Pack Qty (pcs)	Carton Qty (packs)
<b>TIMPAC</b>				
516CAPSSP	M5 x 16	4.0	8	10
520CAPSSP	M5 x 20	4.0	8	10
616CAPSSP	M6 x 16	5.0	8	10
620CAPSSP	M6 x 20	5.0	8	10
625CAPSSP	M6 x 25	5.0	6	10
820CAPSSP	M8 x 20	6.0	4	10
825CAPSSP	M8 x 25	6.0	4	10

TYPE - PAK SUB TYPE - PAK27

# Stainless Steel Set Screws

SUPERIOR CORROSION RESISTANCE



## Set Screw (DIN933)

A2 Austenitic Stainless Steel



A fully metric threaded bolt used in a wide variety of applications.  
Nut not included.

Product Code	Size (mm)	Socket Size (mm)	Pack Qty (pcs)	Carton Qty (packs)	Pallet Qty (packs)
<b>BOX</b>					
S616SS	M6 x 16	10	200	20	720
S620SS	M6 x 20	10	200	16	576
S625SS	M6 x 25	10	200	14	504
S630SS	M6 x 30	10	200	14	504
S640SS	M6 x 40	10	200	10	360
S650SS	M6 x 50	10	200	8	288
S820SS	M8 x 20	13	200	10	360
S825SS	M8 x 25	13	200	7	252
S830SS	M8 x 30	13	100	14	504
S835SS	M8 x 35	13	100	14	504
S840SS	M8 x 40	13	100	12	432
S860SS	M8 x 60	13	100	7	252
S880SS	M8 x 80	13	50	10	360
S8100SS	M8 x 100	13	50	8	288
S1020SS	M10 x 20	17	100	10	360
S1025SS	M10 x 25	17	100	10	360
S1030SS	M10 x 30	17	100	8	288
S1035SS	M10 x 35	17	100	8	288
S1060SS	M10 x 60	17	50	8	288
S1230SS	M12 x 30	19	50	10	360
S1250SS	M12 x 50	19	50	8	288
S1260SS	M12 x 60	19	50	7	252

TYPE - SSS SUB TYPE - SSS01

## Set Screw (DIN933)

A2 Austenitic Stainless Steel



A fully metric threaded bolt used in a wide variety of applications.  
Nut not included.

Product Code	Size (mm)	Socket Size (mm)	Pack Qty (pcs)	Carton Qty (packs)
<b>SMALL BAG</b>				
S616SSX	M6 x 16	10	10	200
S620SSX	M6 x 20	10	10	200
S625SSX	M6 x 25	10	10	200
S630SSX	M6 x 30	10	10	200
S640SSX	M6 x 40	10	10	100
S650SSX	M6 x 50	10	10	200
S820SSX	M8 x 20	13	10	200
S825SSX	M8 x 25	13	10	100
S830SSX	M8 x 30	13	10	100
S835SSX	M8 x 35	13	10	100
S840SSX	M8 x 40	13	10	100
S850SSX	M8 x 50	13	5	100
S860SSX	M8 x 60	13	5	100
S880SSX	M8 x 80	13	5	100
S8100SSX	M8 x 100	13	5	50
S1020SSX	M10 x 20	17	10	100
S1025SSX	M10 x 25	17	10	100
S1030SSX	M10 x 30	17	10	50
S1035SSX	M10 x 35	17	10	50
S1040SSX	M10 x 40	17	10	50
S1050SSX	M10 x 50	17	5	100
S1060SSX	M10 x 60	17	5	50
S1070SSX	M10 x 70	17	5	50
S1080SSX	M10 x 80	17	5	50
S10100SSX	M10 x 100	17	5	50
S1230SSX	M12 x 30	19	10	50
S1240SSX	M12 x 40	19	10	30
S1250SSX	M12 x 50	19	10	30
S1260SSX	M12 x 60	19	5	50

TYPE - SSB SUB TYPE - SSB03

## Set Screw (DIN933) & Hex Nut (DIN934)

A2 Austenitic Stainless Steel



A fully metric threaded bolt used in a wide variety of applications.

Product Code	Size (mm)	Socket Size (mm)	Pack Qty (pcs)	Carton Qty (packs)
<b>TIMPAC</b>				
S616SSP	M6 x 16	10	8	10
S620SSP	M6 x 20	10	8	10
S625SSP	M6 x 25	10	6	10
S650SSP	M6 x 50	10	4	10
S820SSP	M8 x 20	13	6	10
S825SSP	M8 x 25	13	4	10
S840SSP	M8 x 40	13	2	10
S850SSP	M8 x 50	13	2	10
S1025SSP	M10 x 25	13	2	10
S1030SSP	M10 x 30	17	2	10
S1040SSP	M10 x 40	17	2	10
S1050SSP	M10 x 50	17	2	10
S1070SSP	M10 x 70	17	2	10
S10100SSP	M10 x 100	17	2	10
S1230SSP	M12 x 30	19	2	10
S1240SSP	M 12 x 40	19	2	10
S1250SSP	M12 x 50	19	2	10

TYPE - PAK SUB TYPE - PAK26

# Stainless Steel Threaded Bar

SUPERIOR CORROSION RESISTANCE

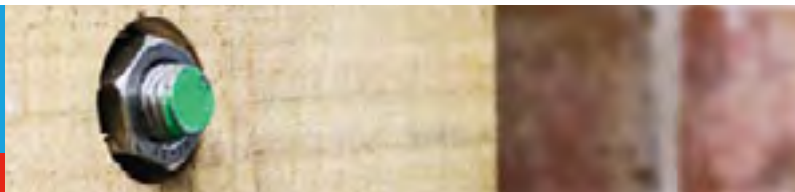

## Threaded Bar (DIN975)

A2 Austenitic Stainless Steel



Commonly used with drop in anchors for suspending cable trays from ceilings or can be cut to a required length and used with chemical resin.

Product Code	Thread Ø x Length (mm)	Pack Qty (pcs)	Pallet Qty (packs)
<b>BUNDLE</b>			
06TBSS	M6 x 1000	5	1,200
08TBSS	M8 x 1000	5	600
10TBSS	M10 x 1000	5	400
12TBSS	M12 x 1000	5	300
16TBSS	M16 x 1000	5	160
20TBSS	M20 x 1000	5	100

TYPE - TBS SUB TYPE - TBS01

# Stainless Steel Nuts & Washers

SUPERIOR CORROSION RESISTANCE



## Hex Full Nut (DIN934)

A2 Austenitic Stainless Steel



A full hex nut in A2 stainless steel, used for all bolting and fastening applications.

Product Code	Size (mm)	Socket Size (mm)	Pack Qty (pcs)	Carton Qty (packs)	Pallet Qty (packs)
<b>BOX</b>					
NH4SS	M4	7	1000	20	720
NH10SS	M10	17	100	20	720
<b>SMALL BAG</b>					
NH4SSX	M4	7	10	1,000	-
NH5SSX	M5	8	10	600	-
NH6SSX	M6	10	10	350	-
NH8SSX	M8	13	10	300	-
NH10SSX	M10	17	10	150	-
NH12SSX	M12	19	5	200	-
NH16SSX	M16	24	5	100	-
<b>TIMPAC</b>					
NH5SSP	M5	8	50	10	-
NH6SSP	M6	10	40	10	-
NH8SSP	M8	13	20	10	-
NH10SSP	M10	17	10	10	-
NH12SSP	M12	19	8	10	-
NH16SSP	M16	24	2	10	-

TYPE - NUS/SSB/PAK      SUB TYPE - NUS01/SSB02/PAK28

## Nylon Nut - Type T (DIN985)

A2 Austenitic Stainless Steel



Type T hexagonal nylon nut with a metric thread. Sometimes known as a 'thin nut'.

• Conforms to ISO 10511

Product Code	Size (mm)	Socket Size (mm)	Pack Qty (pcs)	Carton Qty (packs)	Pallet Qty (packs)
<b>BOX</b>					
NT10SS	M10	17	100	16	576
<b>SMALL BAG</b>					
NT5SSX	M5	8	10	600	-
NT6SSX	M6	10	10	300	-
NT8SSX	M8	13	10	300	-
NT10SSX	M10	17	10	150	-
NT12SSX	M12	19	5	200	-
NT16SSX	M16	24	5	100	-
<b>TIMPAC</b>					
NT5SSP	M5	8	20	10	-
NT6SSP	M6	10	20	10	-
NT8SSP	M8	13	10	10	-
NT10SSP	M10	17	4	10	-
NT12SSP	M12	19	4	10	-

TYPE - NUS/SSB/PAK      SUB TYPE - NUS02/SSB08/PAK29

## Hex Dome Nut (DIN1587)

A2 Austenitic Stainless Steel



A hexagonal dome nut with a metric thread. Ideal for protective or aesthetic uses.

Product Code	Size (mm)	Socket Size (mm)	Pack Qty (pcs)	Carton Qty (packs)	Pallet Qty (packs)
<b>BOX</b>					
ND5SS	M5	8	500	16	576
ND6SS	M6	10	200	20	720
<b>SMALL BAG</b>					
ND5SSX	M5	8	10	500	-
ND6SSX	M6	10	10	300	-
ND8SSX	M8	13	10	200	-
ND10SSX	M10	17	10	100	-
ND12SSX	M12	19	5	100	-

TYPE - NUS/SSB      SUB TYPE - NUS03/SSB09

## Form A Washer (DIN125-A)

A2 Austenitic Stainless Steel



A traditional and commonly used washer for clamping and spacing applications.

Product Code	Size x Outer Ø (mm)	Thickness (mm)	Pack Qty (pcs)	Carton Qty (packs)	Pallet Qty (packs)
<b>BOX</b>					
WA5SS	M5 x 10	1	1,000	40	1440
WA8SS	M8 x 16	1.6	500	24	864
WA12SS	M12 x 24	2.5	200	16	576
WA16SS	M16 x 30	3	100	18	648
<b>SMALL BAG</b>					
WA4SSX	M4 x 9	0.8	50	800	-
WA5SSX	M5 x 10	1	50	600	-
WA6SSX	M6 x 12	1.6	20	700	-
WA8SSX	M8 x 16	1.6	20	500	-
WA10SSX	M10 x 20	2	10	480	-
WA12SSX	M12 x 24	2.5	10	250	-
WA16SSX	M16 x 30	3	10	180	-
<b>TIMPAC</b>					
WA5SSP	M5 x 10	1	50	10	-
WA6SSP	M6 x 12	1.6	50	10	-
WA8SSP	M8 x 16	1.6	30	10	-
WA10SSP	M10 x 20	2	20	10	-
WA12SSP	M12 x 24	2.5	10	10	-
WA16SSP	M16 x 30	3	6	10	-

TYPE - WAS/SSB/PAK      SUB TYPE - WAS01/SSB01/PAK30

## Form B Washer (BS4320)

A2 Austenitic Stainless Steel



Thinner than a Form A, used for clamping and spacing applications.

• Conforms to BS4320

Product Code	Size x Outer Ø (mm)	Thickness (mm)	Pack Qty (pcs)	Carton Qty (packs)	Pallet Qty (packs)
<b>BOX</b>					
WB10SS	M10 x 21	1.25	500	18	864
WB16SS	M16 x 30	2	100	24	864
<b>SMALL BAG</b>					
WB6SSX	M6 x 12.5	0.8	20	900	-
WB8SSX	M8 x 17	1	20	500	-
WB10SSX	M10 x 21	1.25	10	600	-
WB12SSX	M12 x 24	1.6	10	380	-
WB16SSX	M16 x 30	2	10	200	-

TYPE - WAS/SSB      SUB TYPE - WAS03/SSB06

## Penny / Repair Washer (DIN9054)

A2 Austenitic Stainless Steel



A large diameter washer ideal for spreading the clamping load, reducing a hole diameter and packing out. Also known as a 'mudguard' washer.

Product Code	Size x Outer Ø (mm)	Thickness (mm)	Pack Qty (pcs)	Carton Qty (packs)	Pallet Qty (packs)
<b>BOX</b>					
WP1025SS	M10 x 25	1.5	200	24	864
WP1035SS	M10 x 35	1.5	200	12	432
<b>SMALL BAG</b>					
WP525SSX	M5 x 25	1.5	10	380	-
WP625SSX	M6 x 25	1.5	10	380	-
WP825SSX	M8 x 25	1.5	10	380	-
WP835SSX	M8 x 35	1.5	10	250	-
WP1025SSX	M10 x 25	1.5	10	400	-
WP1035SSX	M10 x 35	1.5	10	250	-
WP1235SSX	M12 x 35	1.5	10	250	-
<b>TIMPAC</b>					
WP625SSP	M6 x 25	1.5	10	10	-
WP825SSP	M8 x 25	1.5	8	10	-
WP1035SSP	M10 x 35	1.5	4	10	-

TYPE - WAS/SSB/PAK      SUB TYPE - WAS02/SSB07/PAK31

# Rivets

Need help installing rivets? Please visit [timco.co.uk](http://timco.co.uk) for installation guides.

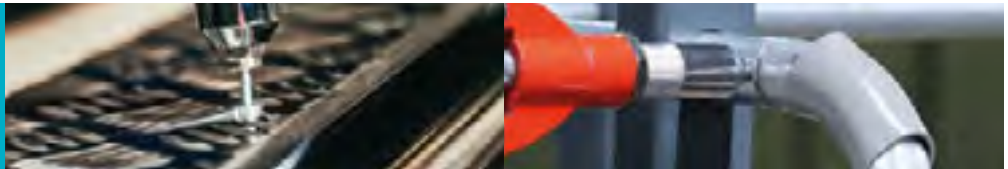

## Dome Head Rivets (DIN7337)

### Aluminium



- Ideal for sheet to sheet applications.
- Aluminium body for an enhanced resistance to corrosion.

#### CORROSION RATING



Urban & industrial areas with a low salt atmosphere

Product Code	Head Ø x L (mm)	Drill Hole Ø (mm)	Grip Range (mm)	Pack Qty (pcs)	Carton Qty (packs)	Pallet Qty (packs)
<b>BOX</b>						
748456	3.2 x 6	3.3	1.5 - 3.5	500	20	20
748741	3.2 x 8	3.3	3.5 - 5.5	500	20	20
748852	3.2 x 10	3.3	5.5 - 7.5	500	20	20
748963	4.0 x 8	4.1	3.0 - 5.0	500	20	20
748369	4.0 x 10	4.1	5.0 - 6.5	500	20	20
748258	4.0 x 12	4.1	6.5 - 8.5	500	20	20
748147	4.8 x 10	4.9	4.5 - 6.0	500	10	10
748951	4.8 x 12	4.9	6.0 - 8.0	500	10	10
748357	4.8 x 14	4.9	8.0 - 10.0	500	10	10

### TIMPAC

748456P	3.2 x 6	3.3	1.5 - 3.5	104	10	-
748741P	3.2 x 8	3.3	3.5 - 5.5	100	10	-
748852P	3.2 x 10	3.3	5.5 - 7.5	90	10	-
748963P	4.0 x 8	4.1	3.0 - 5.0	70	10	-
748369P	4.0 x 10	4.1	5.0 - 6.5	67	10	-
748258P	4.0 x 12	4.1	6.5 - 8.5	63	10	-
748147P	4.8 x 10	4.9	4.5 - 6.0	48	10	-
748951P	4.8 x 12	4.9	6.0 - 8.0	46	10	-
748357P	4.8 x 14	4.9	8.0 - 10.0	41	10	-

TYPE - RIV/PAK

SUB TYPE - RIV01/PAK67

### A2 Austenitic Stainless Steel



- Ideal for sheet to sheet applications.
- A2 stainless steel body for ultimate resistance to corrosion.

#### CORROSION RATING



Urban & industrial areas with a moderate salt atmosphere

Product Code	Head Ø x L (mm)	Drill Hole Ø (mm)	Grip Range (mm)	Pack Qty (pcs)	Carton Qty (packs)	Pallet Qty (packs)
<b>BOX</b>						
748023	3.2 x 6	3.3	1.0 - 3.0	500	20	720
748613	3.2 x 8	3.3	3.0 - 5.0	500	20	720
748100	4.0 x 10	4.1	4.5 - 6.5	500	10	360
748531	4.0 x 12	4.1	6.5 - 8.5	250	20	720
748868	4.8 x 14	4.9	8.0 - 9.5	250	20	720
748305	4.8 x 16	4.9	9.5 - 11.0	250	20	720

### TIMPAC

748023P	3.2 x 6	3.3	1.0 - 3.0	102	10	-
748613P	3.2 x 8	3.3	3.0 - 5.0	99	10	-
748100P	4.0 x 10	4.1	4.5 - 6.5	64	10	-
748531P	4.0 x 12	4.1	6.5 - 8.5	61	10	-
748868P	4.8 x 14	4.9	8.0 - 9.5	39	10	-
748305P	4.8 x 16	4.9	9.5 - 11.0	37	10	-

TYPE - RIV/PAK

SUB TYPE - RIV01/PAK67

## Flange Head Rivets (DIN7337)

### Aluminium



- Ideal for heavy duty sheet to sheet applications.
- Aluminium body for an enhanced resistance to corrosion.

#### CORROSION RATING



Urban & industrial areas with a low salt atmosphere

Product Code	Head Ø x L (mm)	Drill Hole Ø (mm)	Grip Range (mm)	Pack Qty (pcs)	Carton Qty (packs)	Pallet Qty (packs)
<b>BOX</b>						
748918	4.8 x 12	4.9	6.0 - 8.0	250	10	360
748735	4.8 x 16	4.9	10.0 - 12.0	250	10	360
748499	4.8 x 20	4.9	15.0 - 17.0	250	10	360
748264	4.8 x 25	4.9	16.0 - 21.0	250	10	360

### TIMPAC

748918P	4.8 x 12	4.9	6.0 - 8.0	40	10	-
748735P	4.8 x 16	4.9	10.0 - 12.0	37	10	-
748499P	4.8 x 20	4.9	15.0 - 17.0	32	10	-
748264P	4.8 x 25	4.9	16.0 - 21.0	30	10	-

TYPE - RIV/PAK

SUB TYPE - RIV01/PAK67

Available Now!

# Riveters

See page 176

Hand Riveter
Lazy Tongue Riveter

## Hanging & Utility Fixings

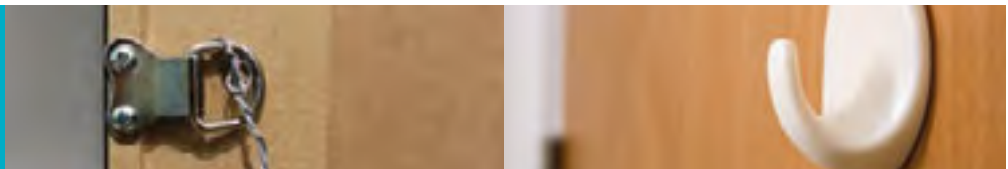

### Adhesive Hook



Handy self adhesive hooks.

Product Code	Size	Pack Qty (pcs)	Carton Qty (packs)
<b>TIMPAC</b>			
SMALLAHOOKP	Small	5	10
LARGEAHOOKP	Large	3	10

TYPE - PAK

SUB TYPE - PAK59

### Curtain Hook



Commonly used plastic curtain hook.

Product Code	Colour	Pack Qty (pcs)	Carton Qty (packs)
<b>TIMPAC</b>			
CHOOKP	White	35	10

TYPE - PAK

SUB TYPE - PAK63

### Snap Hooks



For quick & easy, low security, temporary fastening. Available in aluminium and steel.

Product Code	Length (mm)	Type	Colour	Pack Qty (pcs)	Carton Qty (packs)
<b>TIMPAC</b>					
SSHOOKP	60	Steel	Silver	3	10
ASHOOKP	47	Aluminium	Red	5	10

TYPE - PAK

SUB TYPE - PAK59



**Picture Hanging**

Electro Brass	Zinc
---------------	------



Product Code	Item	Size	Pack Qty (pcs)	Carton Qty (packs)
<b>TIMPAC</b>				
35BWP	Wire	3.5m	1	10
2PHSP	Single Hook	No.2	12	10
3PHDP	Double Hook	No.3	4	10
MPHP	Mixed Hooks	No.2 & 3	8	10

TYPE - PAK SUB TYPE - PAK32

**Mirror Plate**

Electro Brass	
---------------	--

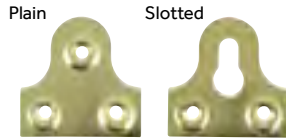

For mounting mirrors onto walls.

Product Code	Type	Size (mm)	Pack Qty (pcs)	Carton Qty (packs)
<b>TIMPAC</b>				
PMP32P	Plain	32	4	5
PMP38P	Plain	38	4	5
SMP32P	Slotted	32	4	5
SMP38P	Slotted	38	4	5

TYPE - PAK SUB TYPE - PKO32

**Sawtooth Hanger**

Electro Brass	
---------------	--



Hanging of canvas and picture frames.

Product Code	Width (mm)	Pack Qty (pcs)	Carton Qty (packs)
<b>TIMPAC</b>			
STOOTH41P	41	20	10
STOOTH63P	63	15	10
MIXSTOOTHP	41 & 63	15	10

TYPE - PAK SUB TYPE - PAK32

**Cup Hooks**

Electro Brass	Zinc / White
---------------	--------------

**Round Cup Hooks**

A light duty horizontal or vertical hook to be used into wood for hanging small items such as keys.



Product Code	Hook Ø (mm)	Thread Ø (mm)	Thread Ø (gauge)	Length (mm)	Pack Qty (pcs)	Carton Qty (packs)
<b>TIMPAC</b>						
<b>Electro Brass</b>						
19SHBP	10.0	3.0	4	19	15	10
25SHBP	13.0	3.0	4	25	10	10
38SHBP	21.0	4.0	8	38	5	10
<b>Zinc / White</b>						
25SHWP	13.0	3.0	4	25	6	10
38SHWP	21.0	4.0	8	38	4	10

**Square Cup Hooks**

A light duty horizontal hook to be used into wood for hanging small items.



Product Code	Bend (mm)	Thread Ø (mm)	Thread Ø (gauge)	Length (mm)	Pack Qty (pcs)	Carton Qty (packs)
<b>TIMPAC</b>						
<b>Electro Brass</b>						
25SQBP	10.0	3.0	4	25	16	10
38SQBP	13.0	4.0	8	38	8	10

TYPE - PAK SUB TYPE - PAK33

**Screw Eye & Screw Hook**

Zinc	
------	--

**Screw Eye**

A medium duty versatile solution for either hanging or attaching items to timber or masonry with the use of a plug.



Product Code	Hook Ø (mm)	Thread Ø (mm)	Thread Ø (gauge)	Length (mm)	Pack Qty (pcs)	Carton Qty (packs)
<b>TIMPAC</b>						
<b>Zinc</b>						
30SEP	9.0	3.9	7	30	15	10
40SEP	12.0	4.2	8	40	10	10
45SEP	12.0	4.9	10	45	5	10
55SEP	16.0	5.5	12	55	4	10

TYPE - PAK SUB TYPE - PAK33

**Screw Hook**

A medium duty versatile solution for either hanging or attaching items to timber or masonry with the use of a plug.



Product Code	Hook Ø (mm)	Thread Ø (mm)	Thread Ø (gauge)	Length (mm)	Pack Qty (pcs)	Carton Qty (packs)
<b>TIMPAC</b>						
<b>Zinc</b>						
60SHP	16.0	5.5	12	60	4	10
80SHP	20.0	5.5	12	80	3	10
100SHP	20.0	5.5	12	100	2	10

**Vine Eye**

Zinc	
------	--



Multiple uses, but commonly used to thread string/wire, and to train plants up fences and walls with the use of a plastic plug.

Product Code	Hook Ø (mm)	Thread Ø (mm)	Thread Ø (gauge)	Length (mm)	Pack Qty (pcs)	Carton Qty (packs)
<b>PACK</b>						
<b>Zinc</b>						
75VEP	16.0	5.5	12	75	4	10
100VEP	16.0	5.5	12	100	2	10

TYPE - PAK SUB TYPE - PAK33



Mixed Hooks & Eyes Tray

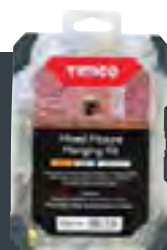

Mixed Picture Hanging Kit

For more information see page:

**81**

## Storage Hooks



### Utility Hook



Product Code	Total Length (mm)	Thread Ø x L (mm)	Pack Qty (pairs)	CDU Qty (pairs)
<b>PAIRS</b>				
457825	150	8.0 x 30	1	12
TYPE - HSK		SUB TYPE - HKS01		

### Tool Hook



Product Code	Total Length (mm)	Thread Ø x L (mm)	Pack Qty (pairs)	CDU Qty (pairs)
<b>PAIRS</b>				
457968	100	6.0 x 25	1	12
TYPE - HSK		SUB TYPE - HKS01		

### Handy Hook



Product Code	Total Length (mm)	Thread Ø x L (mm)	Pack Qty (pairs)	CDU Qty (pairs)
<b>PAIRS</b>				
457469	150	8.0 x 30	1	12
TYPE - HSK		SUB TYPE - HKS01		

### Ladder Hook



Product Code	Total Length (mm)	Thread Ø x L (mm)	Pack Qty (pairs)	CDU Qty (pairs)
<b>PAIRS</b>				
457538	270	10.0 x 40	1	4
TYPE - HSK		SUB TYPE - HKS01		

## Tool Clips



### Zinc

Ideal for tidy storage of a variety of tools, brooms, rakes and brushes in cupboards, garages, sheds and workshops.

Product Code	Ø (mm)	Ø (inch)	Bag Qty (pcs)	Carton Qty (packs)
<b>MIXED BAG</b>				
457025	-	-	70	10
	10	3/8	15	
	12	1/2	15	
	20	3/4	15	
	25	1	15	
	30	1 1/4	5	
	40	1 1/2	5	
TYPE - HKS		SUB TYPE - HKS01		

Product Code	Ø (mm)	Ø (inch)	Pack Qty (pcs)	Carton Qty (packs)
<b>TIMPAC</b>				
725555	10	3/8	12	10
725954	12	1/2	10	10
725843	20	3/4	10	10
725321	25	1	8	10
725017	30	1 1/4	4	10
725661	40	1 1/2	4	10
TYPE - PAK		SUB TYPE - PAK65		

## Clips & Pins

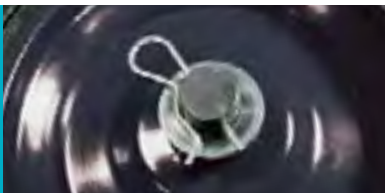

### R Spring Clip

Commonly used to secure the ends of round shafts



### Cotter Pins

A metal split pin used to secure two components



Product Code	Description	Size (mm)	Pack Qty (pcs)	Carton Qty (packs)
<b>TIMPAC</b>				
MIXRSPRINGP	R Spring Clip	Mixed	18	10
MIXCOTTERP	Cotter Pin	Mixed	16	10
TYPE - PAK		SUB TYPE - PAK65		

## Cable Management



### Cable Ties

Natural	Black
---------	-------



Designed to bundle and secure wires, cables, hoses and much more.

Product Code	Size (mm)	Tensile Strength (kg)	Pack Qty (pcs)	Carton Qty (packs)	Pallet Qty (packs)
<b>BAG</b>					
<b>Natural</b>					
25100CTN	2.5 x 100	8.10	100	550	1100
36140CTN	3.6 x 140	18.20	100	300	600
36200CTN	3.6 x 200	18.20	100	200	400
48160CTN	4.8 x 160	22.20	100	150	300
48200CTN	4.8 x 200	22.20	100	120	240
48250CTN	4.8 x 250	22.20	100	110	220
48370CTN	4.8 x 370	22.20	100	90	180
48430CTN	4.8 x 430	22.20	100	75	150
76250CTN	7.6 x 250	54.40	100	60	240
76300CTN	7.6 x 300	54.40	100	50	200
76370CTN	7.6 x 370	54.40	100	40	160
76540CTN	7.6 x 540	54.40	100	20	80
90530CTN	9.0 x 530	79.40	100	20	80
<b>Black</b>					
25100CTB	2.5 x 100	8.10	100	550	1100
36140CTB	3.6 x 140	18.20	100	300	600
36200CTB	3.6 x 200	18.20	100	200	400
48160CTB	4.8 x 160	22.20	100	160	320
48200CTB	4.8 x 200	22.20	100	150	300
48250CTB	4.8 x 250	22.20	100	120	240
48300CTB	4.8 x 300	22.20	100	110	220
48370CTB	4.8 x 370	22.20	100	90	180
48430CTB	4.8 x 430	22.20	100	75	150
76250CTB	7.6 x 250	54.40	100	60	240
76300CTB	7.6 x 300	54.40	100	50	200
76370CTB	7.6 x 370	54.40	100	40	160
76540CTB	7.6 x 540	54.40	100	20	80
90530CTB	9.0 x 530	79.40	100	20	80

TYPE - ECT SUB TYPE - ECT01 / 02

### Mixed Pack Cable Ties

Designed to bundle and secure wires, cables, hoses and much more.



Product Code	Size (mm)	Colour	Cable Tie Qty (pcs)	Pack Qty (pcs)	Carton Qty (packs)
<b>TUBE - 200 PCS</b>					
<b>Natural</b>			<b>Black</b>		
CTMIX200	2.5 x 100	Natural	50	200	80
	2.5 x 100	Black	50		
	3.6 x 200	Natural	50		
	3.6 x 200	Black	50		
<b>TUBE - 500 PCS</b>					
<b>Black Only</b>					
CTMIX500	2.5 x 100	Black	200	500	24
	3.6 x 140	Black	200		
	4.8 x 200	Black	100		
	4.8 x 200	Black	100		

TYPE - ECT SUB TYPE - ECT04

### Coloured Cable Ties

Yellow	Red	Green	Blue
--------	-----	-------	------



Product Code	Size (mm)	Tensile Strength (kg)	Pack Qty (pcs)	Carton Qty (packs)
<b>BAG</b>				
48200CTMIX	4.8 x 200	22.20	200	75
TYPE - ECT SUB TYPE - ECT04				

### Cable Tie Plug

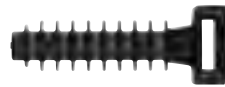

A simple solution for attaching a cable tie to masonry or timber.

Substrate	Masonry	Timber
Hole Size (mm)	8.0	7.0
Min. Hole Depth (mm)	40	40

Product Code	Size (mm)	Pack Qty (pcs)	Carton Qty (packs)	Pallet Qty (packs)
<b>BAG</b>				
840CTP	8.0 x 40	100	85	170
TYPE - ECT SUB TYPE - ECT02				

### Stainless Steel Cable Ties

#### A2 Austenitic Stainless Steel

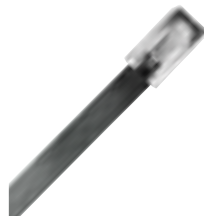

- High tensile strength
- High temperature resistance (-80°C to +500°C)
- Conforms to BS 7671:2018

#### SUPERIOR CORROSION RESISTANCE

Product Code	Size (mm)	Tensile Strength (kg)	Pack Qty (pcs)	Carton Qty (packs)	Pallet Qty (packs)
<b>PACK</b>					
46152CTSS	4.6 x 152	60.00	100	100	1800
46200CTSS	4.6 x 200	60.00	100	50	1600
46300CTSS	4.6 x 300	60.00	100	50	800
46350CTSS	4.6 x 350	60.00	100	50	900
46500CTSS	4.6 x 500	60.00	100	40	640
79350CTSS	7.9 x 350	80.00	100	25	450

TYPE - ECT SUB TYPE - ECT03

### Cable Clips

#### Flat Cable Clip

White
-------



Product Code	Colour	To Suit Cable Ø (mm)	Pack Qty (pcs)	Carton Qty (packs)
<b>BOX</b>				
225101	White	1.0	100	240
TYPE - CCL SUB TYPE - CCL01				

#### Flat Twin & Earth Cable Clip

Grey
------



Product Code	Colour	To Suit Cable Ø (mm)	Pack Qty (pcs)	Carton Qty (packs)
<b>BOX</b>				
225987	Grey	1.5	100	160
225654	Grey	2.5	100	160
225321	Grey	4.0	100	120
225753	Grey	6.0	100	120
225159	Grey	10.0	100	60
TYPE - CCL SUB TYPE - CCL01				

#### Round Cable Clip

White	Black
-------	-------



Product Code	Colour	To Suit Cable Ø (mm)	Pack Qty (pcs)	Carton Qty (packs)
<b>BOX</b>				
225147	White	3.5	100	360
225258	White	4.5	100	360
225369	White	5.0	100	240
225951	White	6.0	100	240
225357	White	7.0	100	160
225222	White	9.0	100	120
225591	White	11.0	100	80
225607	White	14.0	100	60
225999	Black	7.0	100	160
TYPE - CCL SUB TYPE - CCL01				

### Hook & Loop Strap



Convenient and temporary fastening.

Product Code	Pack Qty (pcs)	Carton Qty (packs)
<b>TIMPAC</b>		
HOOKLOOPP	10	10
TYPE - PAK SUB TYPE - PAK66		

## Plumbing Accessories



## Basin Fixing Kits



Designed to securely mount washbasins to a variety of solid building materials. Countersunk nylon bushes designed to ensure no damage is done to the basin during installation. Can also be used into wood without nylon plugs.

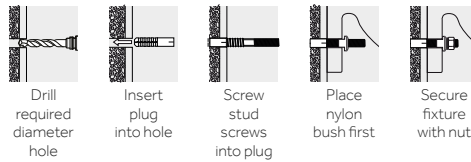

Product Code	Item	Size (mm)	Pack Qty (pcs)	Carton Qty (packs)
<b>TIMPAC</b>				
<b>LIGHT DUTY</b>				
LDBK	-	-	10	20
	Nylon Plugs	10.0 x 50	2	
	Stud Screws	M8 x 100	2	
	Nylon Brushes	M8	2	
	Washers	M8	2	
	Hex Full Nuts	M8	2	
<b>HEAVY DUTY</b>				
HDBK	-	-	10	10
	Nylon Plugs	14.0 x 75	2	
	Stud Screws	M10 x 140	2	
	Nylon Brushes	M10	2	
	Washers	M10	2	
	Hex Full Nuts	M10	2	

TYPE - SFK SUB TYPE - SFK01

## Adjustable WC/Bidet Fixing Kit



Designed to fix WC pan/bidets to a variety of solid building materials. Fully adjustable for a quick easy installation. Countersunk nylon bushes designed to ensure no damage is done to the fixture during installation.

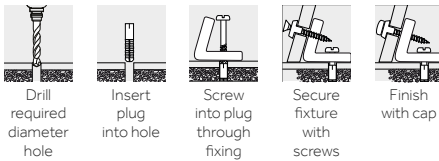

Product Code	Item	Size (mm)	Pack Qty (pcs)	Carton Qty (packs)
<b>TIMPAC</b>				
WCBK	-	-	14	10
	Nylon Brackets		2	
	Nylon Plugs	10.0 x 50	2	
	Coach Screws	6.0 x 70	2	
	Nylon Bushes	5	2	
	Washers	M6	2	
	Screws	4.5 x 40	2	
	Cover Caps	18	2	

TYPE - SFK SUB TYPE - SFK01

## Cloakroom Basin Fixing Kit

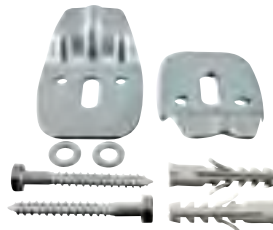

Designed to fix cloakroom basins to a variety of solid building materials. Can also be used into wood without nylon plugs.

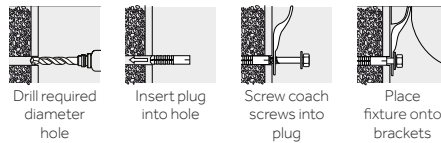

Product Code	Item	Size (mm)	Pack Qty (pcs)	Carton Qty (packs)
<b>TIMPAC</b>				
CBK	-	-	8	20
	Basin Brackets		2	
	Nylon Plugs	10.0 x 50	2	
	Coach Screws	7.0 x 60	2	
	Washers	M7	2	

TYPE - SFK SUB TYPE - SFK01

## Pan/Bidet Fixing Kit



Designed for floor fixing pan/bidets into a variety of solid building materials. Countersunk nylon bushes designed to ensure no damage is done to the fixture during installation. Flat caps for a concealed finish.

Can also be used into wood without nylon plugs.

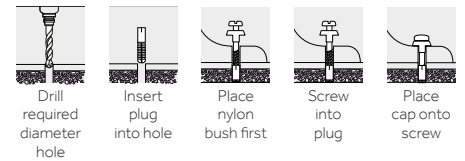

Product Code	Colour	Pack Qty (pcs)	Carton Qty (packs)
<b>TIMPAC</b>			
PBK	White	2	20
PBKCH	Chrome	2	20

TYPE - SFK SUB TYPE - SFK01

Item	Size (mm)	Pack Qty (pcs)
<b>CONTENTS</b>		
Nylon Plugs	10.0 x 50	2
Coach Screws	6.0 x 80	2
Nylon Bushes	6	2
Cover Caps	18	2

## Plug & Chain



Replacement plugs and chains for baths and sinks. (Sold separately)

Product Code	Item	Size (inch)	Pack Qty (pcs)	Carton Qty (packs)
<b>TIMPAC</b>				
BATHPLUG112P	Plug	1 1/2	2	10
BATHPLUG134P	Plug	1 3/4	2	10
CCHAIN12P	Chain	12	2	10
CCHAIN18P	Chain	18	2	10

TYPE - PAK SUB TYPE - PAK62

## Rad-Seal Radiator Pipe Guide & Seal



Radiator pipework installation aid and solution to eliminate potential air leakage and heat loss at vulnerable pipework entry points.

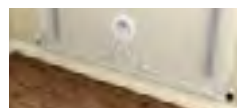

Product Code	Size (mm)	Pack Qty (pcs)
<b>PACK</b>		
LOC1115	140	2

TYPE - RDS SUB TYPE - RDS01

## Radiator Key

Made from Solid Brass



Solid brass radiator key for the bleeding of central heating radiators to remove trapped air.

Product Code	Material	Pack Qty (pcs)	Carton Qty (packs)
<b>TIMPAC</b>			
725741	Solid Brass	2	10

TYPE - PAK SUB TYPE - PAK65



# Pipe Fittings

Manufactured by Elysee

Extensive range of WRAS approved compression fittings for connecting MDPE pipe. Impact resistant and simple push-in & turn action required for installation.



1606380

- Simple push-in & turn connection
- No special tools required
- Durable and high resistance to impact
- Dismountable if required to allow for alteration/adjustments
- Designed to withstand sub-zero temperatures
- WRAS approved for potable water and to ISO 17885



## Assembly Instructions

- Undo the nut up to the last thread. Do not remove the nut from the body.
  - Cut the pipe straight, remove burrs & chamfer the end of the pipe with a chamfering tool.
  - Mark the length on the PE pipe, to which the pipe must be pushed into the fitting.

\*Lubricate the end of the pipe.



- Push the PE pipe into the fitting, through the nut, split ring and O-ring, as far as it will go until it meets the 1st resistance. (The mark on the pipe is now just in front of the nut).
- Firmly hand tighten the nut. For sizes of 40mm and above, use a wrench for a further half turn for final tightening.



### Notes:

- Lubrication of the pipe end is optional and will ease insertion of the pipe (use silicone lubricant).
- The fitting can safely be used again after disassembling.
- The full hydraulic seal is achieved when the pipe passes through the O-ring.

### Coupler



Used to connect two pieces of MDPE pipe. Both pipes should be the same diameter.

Product Code	To Suit Pipe Size (mm)	Pack Qty (pcs)	Carton Qty (packs)
<b>BAG</b>			
733012	20 x 20	1	15
733100	25 x 25	1	15
733111	32 x 32	1	10
TYPE - PPF		SUB TYPE - PPF01	

### Male Adaptor



Used to connect MDPE pipe to a female BSP threaded fitting.

Product Code	To Suit Pipe Size (mm x inch)	Pack Qty (pcs)	Carton Qty (packs)
<b>BAG</b>			
733155	20mm x 1/2"	1	25
733166	25mm x 3/4"	1	20
733177	32mm x 1"	1	10
TYPE - PPF		SUB TYPE - PPF01	

### Female Adaptor



Used to connect MDPE pipe to a male BSP threaded fitting.

Product Code	To Suit Pipe Size (mm x inch)	Pack Qty (pcs)	Carton Qty (packs)
<b>BAG</b>			
733188	20mm x 1/2"	1	25
733199	25mm x 3/4"	1	20
733200	32mm x 1"	1	10
TYPE - PPF		SUB TYPE - PPF01	

### Copper Adaptor



Provides a connection from MDPE pipe to standard copper pipework.

Product Code	To Suit Pipe Size (mm)	Pack Qty (pcs)	Carton Qty (packs)
<b>BAG</b>			
733300	20 x 15	1	10
733311	25 x 15	1	20
733322	25 x 22	1	10
TYPE - PPF		SUB TYPE - PPF01	

### Reducing Set



Used to connect two pieces of MDPE pipe of different diameters.

Product Code	To Suit Pipe Size (mm)	Pack Qty (pcs)	Carton Qty (packs)
<b>BAG</b>			
733333	25 x 20	1	15
733344	32 x 20	1	10
733355	32 x 25	1	10
TYPE - PPF		SUB TYPE - PPF01	

### Imp/Metric Coupler



Allows the connection of metric MDPE pipe to old imperial sized black pipes.

Product Code	To Suit Pipe Size (inch x mm)	Pack Qty (pcs)	Carton Qty (packs)
<b>BAG</b>			
733277	1/2" x 20mm	1	10
733288	1/2" x 25mm	1	10
733299	3/4" x 25mm	1	10
TYPE - PPF		SUB TYPE - PPF01	

### End Plug



Provides a secure and sometimes temporary end to a pipework system.

Product Code	To Suit Pipe Size (mm)	Pack Qty (pcs)	Carton Qty (packs)
<b>BAG</b>			
733122	20	1	20
733133	25	1	20
733144	32	1	10
TYPE - PPF		SUB TYPE - PPF01	

### Wall Plate Elbow (PP)



Used for fitting to a wall and allows the connection of MDPE pipe through to a BSP threaded tap.

Product Code	To Suit Pipe Size (mm x inch)	Pack Qty (pcs)	Carton Qty (packs)
<b>BAG</b>			
733422	20mm x 1/2"	1	10
733433	25mm x 3/4"	1	10
TYPE - PPF		SUB TYPE - PPF01	

### 90 Degree Elbow



Used to change the direction of pipework in a system by 90 degrees. Pipes should be the same diameter.

Product Code	To Suit Pipe Size (mm)	Pack Qty (pcs)	Carton Qty (packs)
<b>BAG</b>			
733244	20 x 20	1	20
733255	25 x 25	1	15
733266	32 x 32	1	5
TYPE - PPF		SUB TYPE - PPF01	

### 90 Degree Tee



Provides the ability to connect three separate lengths of pipe into one. MDPE pipes should all be the same diameter.

Product Code	To Suit Pipe Size (mm)	Pack Qty (pcs)	Carton Qty (packs)
<b>BAG</b>			
733211	20 x 20 x 20	1	15
733222	25 x 25 x 25	1	10
733233	32 x 32 x 32	1	70
TYPE - PPF		SUB TYPE - PPF01	

### Stop Tap (PP)



Used to securely isolate or stop the flow of water in a system.

Product Code	To Suit Pipe Size (mm)	Pack Qty (pcs)	Carton Qty (packs)
<b>BAG</b>			
733399	20 x 20	1	65
733400	25 x 25	1	55
733411	32 x 32	1	40
TYPE - PPF		SUB TYPE - PPF01	

### Pipe Liner



Must be used in all MDPE pipe connections to add strength by supporting the shape of the pipe.

Product Code	To Suit Pipe Size (mm)	Pack Qty (pcs)	Carton Qty (packs)
<b>BAG</b>			
733366	20	1	50
733377	25	1	50
733388	32	1	20
TYPE - PPF		SUB TYPE - PPF01	

# Talon®

More Than Just A Pipe Clip

Introducing  
**EZ CLIP**

Watch Our Video [talon.co.uk/ez-joist-clip](http://talon.co.uk/ez-joist-clip)

**Safer**



Available  
15mm & 22mm

**Quicker**



Attach Side-on

**Easier**



Can be attached  
upside down



[talon.co.uk](http://talon.co.uk)



## Pipe Clips



### Single Open Pipe Clip



The single open clip provides a strong and reliable snap fit pipe fixing.

Product Code	Clip Type	To Suit Pipe Size (mm)	To Fit Screw Ø (mm)	Pack Qty (pcs)	Carton Qty (packs)
<b>BAG</b>					
OPS15	Single	15.0	3.5 - 4.5	50	20
OPS22	Single	22.0	3.5 - 4.5	50	20
OPS28	Single	28.0	3.5 - 4.5	50	20
TALTSP1	Spacer	N/A	3.5 - 4.5	100	10

TYPE - PPC

SUB TYPE - PPC01

### Quick Lock Pipe Clips



#### Single Quick Lock Pipe Clip

Designed to withstand repeated opening and closing offering 360° degree pipe retention. Secure grip and complete security when pipe is in place, with the snap tight locking top. The high stand-off allows for lagging and heat circulation.



#### Quick Lock Spacer

Used with the single quick lock pipe clips.

It allows a greater stand-off where site conditions apply or where thicker lagging is used.

- 15mm Height



#### Double Quick Lock Pipe Clip

Double robust clips designed to withstand repeated opening and closing where needed. 360° pipe retention.

Product Code	Clip Type	To Suit Pipe Size (mm)	To Fit Screw Ø (mm)	Pack Qty (pcs)	Carton Qty (packs)
<b>BAG</b>					
QS15	Single	15.0	3.5 - 4.5	50	20
QS22	Single	22.0	3.5 - 4.5	50	20
QS28	Single	28.0	3.5 - 4.5	50	10
QSP1	Single Spacer	N/A	3.5 - 4.5	50	30
QD15	Double	15.0	3.5 - 4.5	50	10
QD22	Double	22.0	3.5 - 4.5	50	5

TYPE - PPC

SUB TYPE - PPC01

### Hinged Pipe Clips

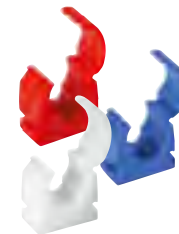

#### Single Hinged Pipe Clip

This high quality polypropylene clip offers a secure 360° fixing. All sizes can be connected together to allow for equal pipe spacing. Available in a range of different colours for identifying pipework.



#### Interlocking Clip Spacer

This universal spacer fits to the base of all Talon hinged, MDPE and snap-in open clips, adding 13mm clearance from the fixing surface.



#### Double Hinged Pipe Clip

Double Clips are easy to fit requiring only a single central screw fixing.

Product Code	Clip Type	Colour	To Suit Pipe Size (mm)	Pack Qty (pcs)	Carton Qty (packs)
<b>BAG</b>					
TALTS15	Single	White	15	100	10
TALTS15BLU	Single	Blue	15	100	10
TALTS15BLU20	Single	Blue	15	20	N/A
TALTS15RED	Single	Red	15	100	10
TALTS15RED20	Single	Red	15	20	N/A
TALTS22	Single	White	22	100	10
TALTS22BLU	Single	Blue	22	100	N/A
TALTS22BLU20	Single	Blue	22	20	N/A
TALTS22RED	Single	Red	22	100	10
TALTS22RED20	Single	Red	22	20	N/A
TALTD15	Double	White	15	50	10
TALTD22	Double	White	22	50	10
TALTSP1	Spacer	White	N/A	100	10

TYPE - PPC

SUB TYPE - PPC01

## MDPE Pipe Clip



The single hinged clip is available in sizes to fit MDPE pipe and in blue to match the pipe colour.

Product Code	Clip Type	To Suit Pipe Size (mm)	To Fit Screw Ø (mm)	Pack Qty (pcs)	Carton Qty (packs)
<b>BAG</b>					
TMS20	Single	19.0 - 21.0	3.5 - 4.5	10	100
TMS25	Single	25.0 - 27.4	3.5 - 4.5	10	50
TMS35	Single	31.8 - 35.0	3.5 - 5.0	10	50
TALTSP1	Spacer	N/A	3.5 - 4.5	100	10
TYPE - PPC			SUB TYPE - PPC01		

## EZ Joist Clip



EZ Joist Clips offer a safe, quick and easy install for pipes in hard to reach places such as overhead and in between joists. Manufactured in the UK using high-quality polypropylene. All sizes of the EZ Joist Clip can be connected together via the dovetail to allow for equal pipe spacing.



Product Code	To Suit Pipe Size (mm)	Pack Qty (pcs)
<b>BAG</b>		
TALEZ15	15.0	100
TALEZ1525	15.0	25
TALEZ22	22.0	100
TALEZ2225	22.0	25
TYPE - PPC		SUB TYPE - PPC01

## Hose Clips



Zinc

Stainless Steel



Worm drive hose clips with a 7mm slotted hex.

- Manufactured to BS 5315-1991

Product Code	Zinc	Stainless Steel	Hose Size (mm)	Pack Qty (pcs)	Carton Qty (packs)
<b>PACK</b>					
HC9512P	-	-	9.5-12	4	10
HC1116P	-	-	11-16	4	10
HC1320P	-	-	13-20	4	10
HC1825P	-	-	18-25	4	10
HC2230P	-	-	22-30	4	10
HC2535P	-	-	25-35	4	10
<b>BAG</b>					
HC9512	HC9512SS	-	9.5 - 12	10	100
HC1116	HC1116SS	-	11 - 16	10	100
HC1320	HC1320SS	-	13 - 20	10	100
HC1622	-	-	16 - 22	10	100
HC1825	HC1825SS	-	18 - 25	10	100
HC2230	HC2230SS	-	22 - 30	10	50
HC2535	HC2535SS	-	25 - 35	10	50
HC3040	-	-	30 - 40	10	50
HC3550	HC3550SS	-	35 - 50	10	50
HC4055	-	-	40 - 55	10	20
HC4560	HC4560SS	-	45 - 60	10	20
HC5570	HC5570SS	-	55 - 70	10	20
HC6080	-	-	60 - 80	10	20
HC7090	HC7090SS	-	70 - 90	10	20
HC90120	HC90120SS	-	90 - 120	10	10
HC110140	HC110140SS	-	110 - 140	10	10
TYPE - PAK / PPC			SUB TYPE - PAK34 / PPC01		

## Nail In Pipe Clip



Manufactured from premium grade polypropylene features a high quality zinc plated hardened and tempered nail, suitable for all types of masonry. Available in red for marking hot water pipework.

Product Code	Colour	To Suit Pipe Size (mm)	Pack Qty (pcs)
<b>BAG</b>			
NCW10	White	10.0	50
NCW15	White	15.0	50
NCW22	White	22.0	50
TALNCH15	Red	15.0	100
TALNCH1520	Red	15.0	20
TALNCH22	Red	22.0	100
TALNCH2220	Red	22.0	20
TYPE - PPC		SUB TYPE - PPC01	

## Snappit Kit



Snappit is a rigid pipe finish product that is great for covering unsightly, visible, copper pipework. It is the best, mess-free, alternative to paint - saving time and improving appearance.

Product Code	Colour	To Suit Pipe Size (mm)	Size (mm)	Pack Qty (pcs)
<b>BAG - KIT</b>				
TALACSNA	Anthracite Grey	18.0	15 x 200	2
TALACSNB	Black	18.0	15 x 200	2
TALACSNC	Chrome	18.0	15 x 200	2
TALACSNRG	Rose Gold	18.0	15 x 200	2
TALACSNG	White	18.0	15 x 200	2
TYPE - PPC		SUB TYPE - PPC01		

## Pipe Collars



Specifically designed for soil and most boiler vent pipes, the 110mm pipe collar is available in other colours to suit application.

Product Code	Colour	To Suit Pipe Size (mm)	Pack Qty (pcs)
<b>BAG</b>			
TALPC110BL	Black	110	1
TALPC110C	Chrome	110	1
TALPC110GR	Grey	110	1
TALPC110WH	White	100	1
TYPE - PPC		SUB TYPE - PPC01	



Pipe collars to conceal unsightly incisions through floors and walls. Ideal for new or retrofit application. Available in a wide range of sizes to fit various pipe sizes. Manufactured from high-grade polypropylene.

Product Code	Colour	To Suit Pipe Size (mm)	Pack Qty (pcs)
<b>BAG</b>			
TALPC1510	White	15	10
TALPC2210	White	22	10
TALPC2810	White	28	10
TALPCC1510	Chrome	15	10
TALPCC2210	Chrome	22	10
TALPCC2810	Chrome	28	10
TYPE - PPC		SUB TYPE - PPC01	

## Mixed Hose Clips



Zinc

Mixed bag containing the 8 most popular sizes. Zinc plated carbon steel worm drive hose clips with a 7mm slotted hex.

Product Code	Hose Size (mm)	Clip Qty (pcs)	Pack Qty (pcs)	Carton Qty (packs)
<b>BAG</b>				
HC MIX	-	-	50	6
	11 - 16	10		
	13 - 20	10		
	18 - 25	10		
	22 - 30	10		
	25 - 35	4		
	35 - 50	2		
	60 - 80	2		
	110 - 140	2		
TYPE - PPC		SUB TYPE - PPC01		



# Jubilee Clips



## Jubilee Clip



The original Jubilee Clip, the product that started it all!

For the vast majority of applications this sturdy worm drive hose clip is more than suitable.

Continuously threaded band enabling extra flexibility when adjusting the clip to the correct size. The smooth inside profile of the band and rolled edges give

protection for all types of hoses including soft hoses made from rubber or silicone.

Available in zinc protected mild steel and stainless steel suitable for marine and offshore oil and gas applications.

## Superclamp



Superclamps are available from size 17mm, with size 64mm and above offering the highest tightening torques with 8.8 high tensile bolts allowing an impressive maximum recommended torque of 25Nm.

Naturally with the smaller clamps using a smaller bolt the torques are lower, but even so the torques are impressive by

comparison to alternatives for the same size range.

Available in zinc protected mild steel and stainless steel suitable for marine and offshore oil and gas applications.

## High Torque Clip



High Torque clips are made of all stainless steel with a two part housing and cut through band, keeping the band straight at the point of engagement and fully engaging

all of the screw thread giving a superior tightening torque.

Ideal where a high clamping force is required, with a flexible band material they can achieve a high level of friction even against a smooth surface such as a metal pole.

Product Code	Product Code	Hose Size (mm)	Pack Qty (pcs)	Carton Qty (packs)
<b>Zinc Protected Mild Steel</b>	<b>304 Stainless Steel</b>			
<b>BOX</b>				
JUB000MS	JUB000SS	9.5-12	10	100
JUBM00MS	JUBM00SS	11-16	10	100
JUB00MS	JUB00SS	13-20	10	100
JUB0MS	JUB0SS	16-22	10	100
JUB0XMS	JUB0XSS	18-25	10	100
JUB1AMS	JUB1ASS	22-30	10	100
JUB1MS	JUB1SS	25-35	10	100
JUB1XMS	JUB1XSS	30-40	10	100
JUB1MMS	JUB1MSS	32-45	10	100
JUB2AMS	JUB2ASS	35-50	10	100
JUB2MS	JUB2SS	40-55	10	100
JUB2XMS	JUB2XSS	45-60	10	100
JUB3MS	JUB3SS	55-70	10	100
<b>BAG</b>				
JUB3XMS	JUB3XSS	60-80	10	150
JUB4MS	JUB4SS	70-90	10	125
JUB4XMS	JUB4XSS	85-100	10	100
JUB5MS	JUB5SS	90-120	10	100
JUB6MS	JUB6SS	110-140	5	75
JUB6XMS	JUB6XSS	120-150	5	50
JUB7MS	JUB7SS	135-165	5	50
JUB75MS	JUB75SS	158-190	5	50
JUB85MS	JUB85SS	184-216	5	50
JUB95MS	-	210-242	5	50
JUB105MS	JUB105SS	235-267	5	50
JUB115MS	JUB115SS	260-292	5	50
JUB125MS	-	286-318	5	50
TYPE - JUB		SUB TYPE - JUB01		

Product Code	Product Code	Hose Size (mm)	Pack Qty (pcs)	Carton Qty (packs)
<b>Zinc Protected Mild Steel</b>	<b>304 Stainless Steel</b>			
<b>BAG</b>				
JUBJSC019MS	-	17-19	10	600
JUBJSC022MS	-	20-22	10	600
JUBJSC025MS	-	23-25	10	520
JUBJSC028MS	JUBJSC028SS	26-28	10	440
JUBJSC031MS	-	29-31	10	380
JUBJSC035MS	JUBJSC035SS	32-35	5	200
JUBJSC039MS	JUBJSC039SS	36-39	5	200
JUBJSC043MS	-	40-43	5	195
JUBJSC047MS	-	44-47	5	150
JUBJSC051MS	JUBJSC051SS	48-51	5	150
JUBJSC055MS	-	52-55	5	150
JUBJSC059MS	JUBJSC059SS	56-59	5	120
JUBJSC063MS	JUBJSC063SS	60-63	2	108
JUBJSC067MS	JUBJSC067SS	64-67	2	80
JUBJSC073MS	-	68-73	2	66
JUBJSC079MS	-	74-79	2	66
JUBJSC085MS	-	80-85	2	48
JUBJSC091MS	-	86-91	2	48
JUBJSC097MS	-	92-97	2	48
JUBJSC103MS	-	98-103	2	40
JUBJSC112MS	-	104-112	2	36
JUBJSC121MS	-	113-121	2	32
JUBJSC130MS	JUBJSC130SS	122-130	2	20
JUBJSC139MS	-	131-139	2	20
JUBJSC148MS	-	140-148	2	20
JUBJSC161MS	-	149-161	2	16
JUBJSC174MS	-	162-174	2	16
JUBJSC187MS	-	175-187	2	16
JUBJSC200MS	-	188-200	2	14
JUBJSC213MS	-	201-213	2	12
JUBJSC226MS	-	214-226	2	10
JUBJSC239MS	-	227-239	2	8
JUBJSC255MS	-	240-255	2	8
JUBJSC265MS	-	253-265	2	8
TYPE - JUB		SUB TYPE - JUB01		

Product Code	Hose Size (mm)	Pack Qty (pcs)	Carton Qty (packs)
<b>304 Stainless Steel</b>			
<b>BAG</b>			
JUBHT035	20-35	10	300
JUBHT040	25-40	10	300
JUBHT100	80-100	10	80
JUBHT120	90-120	5	80
JUBHT140	110-140	5	75
JUBHT300	270-300	5	50
TYPE - JUB		SUB TYPE - JUB01	



## Mixed Packs, Sets & Dispensers

See page 77 for the full range

## Flexiband

### Banding



Flexiband is a band and buckle system offering a high strength fastening solution in 304 Stainless Steel.

Provides 4 different band

widths 9mm, 13mm, 16mm and 19mm.

Flexiband is ideal for strapping items securely and can commonly be seen in applications such as sign fixing where the tamper proof nature of the product is of paramount importance.

Product Code	Size W x L (mm x m)	Pack Qty (pcs)	Carton Qty (packs)
<b>304 Stainless Steel</b>			
<b>BOX</b>			
JUBFB09B	9 x 30	1	5
JUBFB13B	13 x 30	1	5
JUBFB16B	16 x 30	1	5
TYPE - JUB		SUB TYPE - JUB11	

## Wingspade



Based on Light Range Clips and suitable for hand fitting, Jubilee® Wingspade clips are supplied with a thumb screw, allowing easy torquing using just a thumb and forefinger. Suited to fittings that

may need to be removed from time to time such as dust extraction units, or domestic hoses.

Product Code	Size (mm)	Pack Qty (pcs)	Carton Qty (packs)
<b>Zinc Protected Mild Steel</b>			
<b>BOX</b>			
JUBWS012	9.5-12	20	1000
JUBWS016	11-16	20	1000
JUBWS020	13-20	20	900
JUBWS022	12-22	20	800
JUBWS027	16-27	20	700
JUBWS032	20-32	20	600
JUBWS040	25-40	20	440
JUBWS045	30-45	20	300
JUBWS050	32-50	20	240
JUBWS060	40-60	20	200
JUBWS070	50-70	20	160
TYPE - JUB		SUB TYPE - JUB06	

## Multiband

### Banding



Multiband is a self assembly endless banding or screw band system, which allows the user to cut the band to the desired length.

Used in areas such as heating, ventilation and air conditioning (HVAC), sign fixing, conduit and cable retention and lagging, this product is very versatile.

A number of screw and housing designs are available to suit any application.

Available as a zinc protected mild steel or 304 stainless steel clamp.

Product Code	Product Code	Size W x L (mm x m)	Pack Qty (pcs)	Carton Qty (packs)
<b>Zinc Protected Mild Steel</b>	<b>304 Stainless Steel</b>			
<b>BOX</b>				
JUBMB1701	JUBMB1801	11 x 10	1	15
JUBMB1702	JUBMB1802	11 x 30	1	5
TYPE - JUB		SUB TYPE - JUB07/08		

## 'P' Clips



P Clips are manufactured from a flexible stainless steel one piece band with an ethylene-propylene-diene monomer (EPDM) rubber liner.

The band features a stepped design to allow the clip to sit flush with the rubber liner in place. The single piece

construction of our pipe clips means that there are no joints making the clip very strong. The upper hole has an elongated design allowing easy fitting of the clip.

P Clips conform to DIN3016

Product Code	Product Code	Size (mm)	Pack Qty (pcs)	Carton Qty (packs)
<b>Zinc Protected Mild Steel</b>	<b>304 Stainless Steel</b>			
<b>BAG</b>				
JUBJPC005MS	JUBJPC005SS	5	20	800
JUBJPC006MS	JUBJPC006SS	6	20	800
JUBJPC008MS	JUBJPC008SS	8	20	800
JUBJPC010MS	JUBJPC010SS	10	20	700
JUBJPC012MS	-	12	20	600
JUBJPC013MS	JUBJPC013SS	13	20	600
JUBJPC015MS	JUBJPC015SS	15	20	500
JUBJPC016MS	-	16	20	400
JUBJPC017MS	-	17	20	400
JUBJPC018MS	-	18	20	360
JUBJPC019MS	-	19	20	360
JUBJPC020MS	-	20	20	320
JUBJPC021MS	-	21	20	320
JUBJPC022MS	JUBJPC022SS	22	20	300
JUBJPC025MS	-	25	20	280
-	JUBJPC027SS	27	20	280
JUBJPC028MS	-	28	20	260
JUBJPC030MS	-	30	20	240
JUBJPC032MS	JUBJPC032SS	32	20	220
JUBJPC035MS	-	35	20	200
JUBJPC040MS	-	40	20	180
JUBJPC048MS	-	48	20	140
TYPE - JUB		SUB TYPE - JUB01		



## Housing & Screws



11mm width Multiband housing and screws in boxes of 25.

Product Code	Product Code	Size (mm)	Pack Qty (pcs)	Carton Qty (packs)
<b>Zinc Protected Mild Steel</b>	<b>304 Stainless Steel</b>			
<b>BOX</b>				
JUBMB1704	JUBMB1803	11	25	30
TYPE - JUB		SUB TYPE - JUB07/08		

## Captive Screws



11mm width Multiband captive housing and screws in boxes of 25.

Product Code	Size (mm)	Pack Qty (pcs)	Carton Qty (packs)
<b>Zinc Protected Mild Steel</b>			
<b>BOX</b>			
JUBMB1706	11	25	30
TYPE - JUB		SUB TYPE - JUB07/08	

## Housings & Allen Screws



11mm width Multiband housing and allen screws in boxes of 25.

Product Code	Size (mm)	Pack Qty (pcs)	Carton Qty (packs)
<b>Zinc Protected Mild Steel</b>			
<b>BOX</b>			
JUBMB1705	11	25	30
TYPE - JUB		SUB TYPE - JUB07/08	



# Jubilee Dispensers



## Jubilee Clip Handy Pack



This Jubilee Handy Pack contains 100 Jubilee Clips and sits as well on a trade counter as it does in a workshop, or the back of a van!

Product Code	Pack Qty (pcs)	Carton Qty (packs)
<b>CDU</b>		
<b>Zinc Protected Mild Steel</b>		
JUBHP100MS	100	4
<b>304 Stainless Steel</b>		
JUHP100SS	100	4
TYPE - JUB	SUB TYPE - JUB07/08	

Description	Size (mm)	Pack Qty (pcs)
<b>CONTENTS (100 PCS)</b>		
Jubilee Clips	9.5 - 12	10
	11 - 16	10
	13 - 20	10
	16 - 22	10
	18 - 25	10
	22 - 30	10
	25 - 35	10
	30 - 40	10
	32 - 45	10
	35 - 50	10

## Jubilee Clip Dispenser



The Jubilee Clip Dispenser comes with ten, each of the most popular sizes of clip covering an adjustment range from 9.5mm up to 50mm and also includes 3 Jubilee Flexdrivers.

Product Code	Pack Qty (pcs)	Carton Qty (packs)
<b>CDU</b>		
<b>Zinc Protected Mild Steel</b>		
JUBCD100MS	103	4
<b>304 Stainless Steel</b>		
JUBCD100SS	103	4
TYPE - JUB	SUB TYPE - JUB07/08	

Description	Size (mm)	Pack Qty (pcs)
<b>CONTENTS (103 PCS)</b>		
Jubilee Clips	9.5 - 12	10
	11 - 16	10
	13 - 20	10
	16 - 22	10
	18 - 25	10
	22 - 30	10
	25 - 35	10
	30 - 40	10
	32 - 45	10
	35 - 50	10
Flexidriver Tool	-	3

## Jubilee Large Clip Dispenser



The Jubilee Large Clip Dispenser comes with 140 clips, ten of each of the most popular sizes of clip covering an adjustment range from 9.5mm up to 80mm. Also includes 3 Jubilee Flexdrivers.

Product Code	Pack Qty (pcs)	Carton Qty (packs)
<b>CDU</b>		
<b>Zinc Protected Mild Steel</b>		
JUBCD140MS	143	2
<b>304 Stainless Steel</b>		
JUBCD140SS	143	2
TYPE - JUB	SUB TYPE - JUB07/08	

Description	Size (mm)	Pack Qty (pcs)
<b>CONTENTS (143 PCS)</b>		
Jubilee Clips	9.5-12	10
	11-16	10
	13-20	10
	16-22	10
	18-25	10
	22-30	10
	25-35	10
	30-40	10
	32-45	10
	35-50	10
	40-55	10
	45-60	10
	55-70	10
	60-80	10
Flexidriver Tool	-	3

## Mega Clip Dispenser



This latest addition to the range, the Jubilee Mega Dispenser, comes with 920 Jubilee Clips (92 boxes in total) covering an adjustment range from 9.5mm up to 70mm. Also includes 5 Jubilee Flexdrivers.

Product Code	Pack Qty (pcs)	Carton Qty (packs)
<b>CDU</b>		
<b>Zinc Protected Mild Steel</b>		
JUBMD920MS	920	1
<b>304 Stainless Steel</b>		
JUBMD920SS	920	1
TYPE - JUB	SUB TYPE - JUB07/08	

Description	Size (mm)	Pack Qty (pcs)
<b>CONTENTS (920 PCS)</b>		
Jubilee Clips	9.5-12	100
	11-16	100
	13-20	100
	16-22	80
	18-25	80
	22-30	70
	25-35	60
	30-40	60
	32-45	60
	35-50	50
Flexidriver Tool	40-55	50
	45-60	50
	55-70	50
	-	5

# Jubilee Tools



The invaluable Flexidriver with flexible shaft has been designed to reach all those awkward places

Product Code	Socket Size (mm)	Pack Qty (pcs)
<b>BAG</b>		
JUBFLX	7	1
TYPE - JUB	SUB TYPE - JUB12	



Clipdriver has a rigid shaft and is available in the length of 95mm

Product Code	Socket Size (mm)	Pack Qty (pcs)
<b>BAG</b>		
JUBCDR95	7	1
TYPE - JUB	SUB TYPE - JUB12	



The side closing pincer is used to crimp the ear of Jubilee 'O' clips to affect a proper seal. Ideal for use when access to the ear is difficult.

Product Code	Pack Qty (pcs)
<b>BAG</b>	
JUBP1099	1
TYPE - JUB	SUB TYPE - JUB12



Flexiband Tool for tensioning & cutting of 'band and buckle' system.

Product Code	Pack Qty (pcs)	Carton Qty (packs)
<b>BOX</b>		
JUBFBT	1	4
TYPE - JUB	SUB TYPE - JUB11	



## Assorted Trays

Comprehensive range of problem solving handy mixed sets. Offering a wide variety of commonly used items designed to cover the majority of small jobs that need a quick-fix. Packaged in robust trays that can be securely clipped shut, ready for the next task.



### Mixed Screws, Plugs & Drill Bit



Countersunk woodscrews with nylon plugs for fixing to masonry. 6mm masonry drill bit included.

- Zinc
- Yellow
- A2 Aust. SS

Product Code	Pack Qty (pcs)	Carton Qty (packs)
<b>TRAY</b>		
<b>Zinc</b>		
TRAY240	251	15
TRAY300	91	15
<b>Yellow</b>		
TRAY260	251	15
TRAY320	91	15
<b>304 Stainless Steel</b>		
TRAY280	251	15
TRAY340	91	15
TYPE - TRY	SUB TYPE - TRY01	

Item	Size (mm)	Qty (pcs)
<b>CONTENTS (251 PCS)</b>		
Woodscrews	3.5 x 25	50
Woodscrews	4.0 x 25	30
Woodscrews	4.0 x 30	25
Woodscrews	4.0 x 40	25
Woodscrews	5.0 x 40	15
Woodscrews	5.0 x 50	15
Woodscrews	5.0 x 80	15
Nylon Plugs	6.0 x 30	75
Masonry Drill Bit	6.0 x 100	1

Item	Size (mm)	Qty (pcs)
<b>CONTENTS (91 PCS)</b>		
Woodscrews	5.0 x 40	15
Woodscrews	5.0 x 50	15
Woodscrews	5.0 x 80	15
Woodscrews	6.0 x 90	15
Woodscrews	6.0 x 100	10
Nylon Plugs	8.0 x 40	20
Masonry Drill Bit	6.0 x 100	1

### Mixed Woodscrews



Countersunk woodscrews used in various types of timber and manmade boards.

- Zinc
- Yellow
- A2 Aust. SS

Product Code	Pack Qty (pcs)	Carton Qty (packs)
<b>TRAY</b>		
<b>Zinc</b>		
TRAY360	340	15
<b>Yellow</b>		
TRAY370	340	15
<b>304 Stainless Steel</b>		
TRAY380	340	15
TYPE - TRY	SUB TYPE - TRY01	

Size (mm)	Driver Bit Size	Qty (pcs)
<b>CONTENTS (340 PCS)</b>		
3.5 x 15	PZ2	100
3.5 x 25	PZ2	50
4.0 x 20	PZ2	40
4.0 x 25	PZ2	35
4.0 x 30	PZ2	30
4.0 x 40	PZ2	25
5.0 x 50	PZ2	25
5.0 x 70	PZ2	20
5.0 x 80	PZ2	15

### Mixed Nails



Galvanised and bright steel nails for internal and exterior applications.

- Galvanised
- Bright

Product Code	Pack Qty (pcs)	Carton Qty (packs)
<b>TRAY</b>		
TRAY660	300	15
TYPE - TRY	SUB TYPE - TRY01	

Item	Finish	Size (mm)	Qty (pcs)
<b>CONTENTS (300PCS)</b>			
Clout	Galvanised	20 x 3.00	30
Clout	Galvanised	25 x 3.00	20
Presser Point Staples	Galvanised	25 x 2.00	60
Annular Ringshank	Bright	25 x 2.65	50
Annular Ringshank	Bright	30 x 3.26	30
Annular Ringshank	Bright	40 x 3.26	30
Round Wire	Bright	50 x 2.65	40
Round Wire	Bright	65 x 3.35	20
Round Wire	Bright	75 x 3.75	20

### Mixed Self-Tapping Screws



Zinc plated self-tapping screws.

Three different head types for a wide range of metal to metal applications. Please note a pre-drilled hole is required.

- Zinc

Product Code	Pack Qty (pcs)	Carton Qty (packs)
<b>TRAY</b>		
TRAY440	475	15
TYPE - TRY	SUB TYPE - TRY01	

Head Type	Size (imp.)	Recess	Qty (pcs)
<b>CONTENTS (475 PCS)</b>			
Pan Head	6 x 1/2	PZ2	80
Pan Head	6 x 3/4	PZ2	55
Pan Head	8 x 1/2	PZ2	45
Pan Head	8 x 3/4	PZ2	45
Pan Head	8 x 3/4	PZ2	35
Pan Head	8 x 1	PZ2	25
Countersunk	8 x 3/4	PZ2	40
Countersunk	8 x 1	PZ2	30
Countersunk	10 x 1 1/4	PZ2	25
Flange Head	8 x 1/2	PZ2	45
Flange Head	8 x 3/4	PZ2	30
Flange Head	8 x 1	PZ2	20

### Mixed Pins & Nails



Bright nails and pins for a wide range of internal applications.

- Bright

Product Code	Pack Qty (pcs)	Carton Qty (packs)
<b>TRAY</b>		
TRAY680	495	15
TYPE - TRY	SUB TYPE - TRY01	

Item	Finish	Size (mm)	Qty (pcs)
<b>CONTENTS (495 PCS)</b>			
Panel Pins	Bright	25 x 1.60	130
Panel Pins	Bright	30 x 1.60	100
Panel Pins	Bright	40 x 2.00	50
Oval Nails	Bright	40	30
Oval Nails	Bright	50	40
Oval Nails	Bright	65	35
Round Wire Nails	Bright	50 x 2.65	40
Round Wire Nails	Bright	65 x 3.35	25

### Mixed Set Screws, Nuts & Washers



Hex headed set screws with conforming nuts and washers.

Zinc  
A2 Aust. SS

Product Code	Pack Qty (pcs)	Carton Qty (packs)
<b>TRAY</b>		
<b>Zinc</b>		
TRAY620	199	15
<b>304 Stainless Steel</b>		
TRAY640	199	15
TYPE - TRY		SUB TYPE - TRY01
Item	Size (mm)	Qty (pcs)
<b>CONTENTS - 199 PIECES</b>		
Set Screw (DIN 933)	6.0 x 16	20
Set Screw (DIN 933)	6.0 x 25	15
Set Screw (DIN 933)	8.0 x 25	10
Set Screw (DIN 933)	8.0 x 35	4
Set Screw (DIN 933)	10.0 x 40	3
Set Screw (DIN 933)	10.0 x 50	4
Hex Nut (DIN934)	M6	40
Hex Nut (DIN934)	M8	15
Hex Nut (DIN934)	M10	8
Form A Washer (DIN125)	M6	40
Form A Washer (DIN125)	M8	20
Form A Washer (DIN125)	M10	20

### Mixed Nuts



Zinc plated and clear passivated nuts. Contains four commonly used types of nut to suit a wide range of applications.

Zinc

Product Code	Pack Qty (pcs)	Carton Qty (packs)
<b>TRAY</b>		
TRAY540	243	15
TYPE - TRY		SUB TYPE - TRY01
Item	Size (mm)	Qty (pcs)
<b>CONTENTS - 243 PIECES</b>		
Hex (DIN 934)	M4	70
Hex (DIN 934)	M6	50
Hex (DIN 934)	M8	20
Hex (DIN 934)	M10	10
Hex (DIN 934)	M12	8
T Nylon (DIN 985)	M6	30
T Nylon (DIN 985)	M8	15
T Nylon (DIN 985)	M10	8
Wing	M6	15
Wing	M8	10
Connector (DIN 6334)	M8	5
Connector (DIN 6334)	M10	2

### Mixed Washers



Three types of washer to suit a wide range of applications.

Zinc

Product Code	Pack Qty (pcs)	Carton Qty (packs)
<b>TRAY</b>		
TRAY580	291	15
TYPE - TRY		SUB TYPE - TRY01
Item	Size (mm)	Qty (pcs)
<b>CONTENTS - 291 PIECES</b>		
Form A (DIN 125)	M4	40
Form A (DIN 125)	M6	40
Form A (DIN 125)	M8	20
Form A (DIN 125)	M10	30
Form A (DIN 125)	M12	15
Form A (DIN 125)	M14	10
Form A (DIN 125)	M16	8
Penny / Repair	M6 x 25	15
Penny / Repair	M8 x 25	20
Penny / Repair	M8 x 40	4
Penny / Repair	M10 x 25	20
Penny / Repair	M10 x 40	4
Spring - DIN7980	M6	20
Spring - DIN7980	M8	20
Spring - DIN7980	M10	25

### Mixed Machine Screws NEW



Used in pre-tapped holes or used with conforming nuts in through-holes.

Zinc

Product Code	Pack Qty (pcs)	Carton Qty (packs)	
<b>TRAY</b>			
TRAY500	320	15	
TYPE - TRY		SUB TYPE - TRY01	
Head Type	Size (mm)	Recess	Qty (pcs)
<b>CONTENTS - 320 PIECES</b>			
Pan (DIN7985)	M4 x 30	PZ2	25
Pan (DIN7985)	M4 x 40	PZ2	20
Pan (DIN7985)	M5 x 30	PZ2	15
Pan (DIN7985)	M3 x 12	PZ2	80
Pan (DIN7985)	M3 x 20	PZ2	50
Pan (DIN7985)	M4 x 20	PZ2	30
Countersunk (DIN965)	M5 x 40	PZ2	12
Countersunk (DIN965)	M5 x 50	PZ2	10
Countersunk (DIN965)	M6 x 50	PZ3	8
Flange	M3 x 20	PZ2	40
Flange	M4 x 30	PZ2	15
Flange	M4 x 40	PZ2	15

### Mixed Tap Repair Washers



Flat, dome, flex and fibre washers for repairing taps of various sizes.

Rubber  
Fibre

Product Code	Pack Qty (pcs)	Carton Qty (packs)	
<b>TRAY</b>			
TRAY980	159	15	
TYPE - TRY		SUB TYPE - TRY01	
Item	Material	Size (imp.)	Qty (pcs)
<b>CONTENTS - 159 PIECES</b>			
Flat Tap	Rubber	3/8	15
Flat Tap	Rubber	1/2	12
Flat Tap	Rubber	5/8	5
Flat Tap	Rubber	3/4	6
Dome	Rubber	1/2	12
Dome	Rubber	3/4	4
Delta	Rubber	1/2	15
Delta	Rubber	3/4	10
Tanto Flex	Rubber	1/2	10
Tanto Flex	Rubber	3/4	10
Fibre	Fibre	1/2	30
Fibre	Fibre	3/4	30

### Mixed Plasterboard Fixings



Plasterboard anchors and fixings designed for both light and heavy duty applications.  
**Note:** Speed plug screws are pan head and woodscrews are countersunk head.

Zinc  
Yellow

Product Code	Pack Qty (pcs)	Carton Qty (packs)		
<b>TRAY</b>				
TRAY520	102	15		
TYPE - TRY		SUB TYPE - TRY01		
Item	Finish	Recess Type	Size (mm)	Qty (pcs)
<b>CONTENTS - 102 PIECES</b>				
Metal Cavity Anchors	Zinc	Combi	M5 x 37	10
Metal Cavity Anchors	Zinc	Combi	M5 x 52	6
Metal Cavity Anchors	Zinc	Combi	M5 x 65	6
Metal Speed Plugs	Zinc	Cross	31.5	18
Metal Speed Plug Screws	Zinc	Combi	4.5 x 30	22
Woodscrews	Yellow	Pozi	4.0 x 40	20
Multi-Purpose Plugs	Grey	-	M6 x 35	20

### Mixed Hooks & Eyes



PVC coated, zinc and brass plated, hooks and eyes. Nylon plugs included for applications where fixing to masonry is required.

**Zinc**  
**Electro Brass**

Product Code	Pack Qty (pcs)	Carton Qty (packs)
<b>TRAY</b>		
TRAY700	133	15
TYPE - TRY		SUB TYPE - TRY01

Item	Finish/Colour	Size (mm)	Qty (pcs)
<b>CONTENTS - 133 PIECES</b>			
Round Cup Hooks	Zinc / White	25	12
Round Cup Hooks	Zinc / White	32	10
Round Cup Hooks	Zinc / White	38	6
Round Cup Hooks	Zinc / White	48	5
Round Cup Hooks	Electro Brass	25	12
Round Cup Hooks	Electro Brass	38	6
L Hooks	Electro Brass	25	12
L Hooks	Electro Brass	38	10
Screw Eyes	Zinc	37	5
Nylon Plugs	Grey	5.0 x 25	35
Nylon Plugs	Grey	6.0 x 30	20

### Mixed Picture Hanging Kit



Brass plated picture plates, hangers, D-rings, picture nails, sawtooth brackets and hooks. Nylon line and steel hanging wire included.

**Zinc**  
**Electro Brass**

Product Code	Pack Qty (pcs)	Carton Qty (packs)
<b>TRAY</b>		
TRAY720	179	15
TYPE - TRY		SUB TYPE - TRY01

Item	Finish/Material	Size (mm)	Qty (pcs)
<b>CONTENTS - 179 PIECES</b>			
3m Nylon Rope	Nylon	300	1
3m Steel Wire	Steel	300	1
Plastic Hanger	White	31 x 16	6
Picture Plates	Electro Brass	38 x 38	6
Picture Nails	Electro Brass	1.60 x 30	80
D-Rings	Electro Brass	10	6
D-Rings	Electro Brass	15	4
Single Picture Hooks	Electro Brass	25 x 5	25
Single Picture Hooks	Electro Brass	36 x 6	20
Double Picture Hooks	Electro Brass	25 x 32	10
Sawtooth Hanger	Electro Brass	42	2
Round Cup Hooks	Electro Brass	37	6
Round Cup Hooks	Electro Brass	49	12

### Mixed Cable Clips



Nail in cable clips including twin and earth (T&E), flat cable clips, round cable clips and bell wire clips.

**Mixed Colours**

Product Code	Pack Qty (pcs)	Carton Qty (packs)
<b>TRAY</b>		
TRAY780	290	15
TYPE - TRY		SUB TYPE - TRY01

Item	Colour	Size (mm)	Qty (pcs)
<b>CONTENTS - 290 PIECES</b>			
T&E Flat Cable	Grey	1.0	20
T&E Flat Cable	Grey	1.5	30
T&E Flat Cable	Grey	2.5	30
T&E Flat Cable	Grey	6.0	20
Round Cable	White	7	45
Round Cable	Black	7	45
Bell Wire	White	-	100

### Mixed Hose Clips



Zinc plated carbon steel, worm drive hose clips with 7mm slotted hex head screws.

**Steel**

Product Code	Pack Qty (pcs)	Carton Qty (packs)
<b>TRAY</b>		
TRAY970	25	15
TYPE - TRY		SUB TYPE - TRY01

Size (mm)	Qty (pcs)
<b>CONTENTS - 25 PIECES</b>	
11 - 16	8
16 - 22	6
18 - 25	4
22 - 30	2
25 - 35	2
30 - 40	3

### Mixed Key Tags



A multi-coloured key tags with removable card inserts for easy colour coding of keys for identification.

**Mixed Colours**

Product Code	Pack Qty (pcs)	Carton Qty (packs)
<b>TRAY</b>		
TRAY800	48	15
TYPE - TRY		SUB TYPE - TRY01

Colour	Qty (pcs)
<b>CONTENTS - 48 PIECES</b>	
Blue	8
Green	8
Yellow	8
Red	8
White	8
Black	8



# Masonry & Cavity Fixings

## Cavity Fixings

Corefix	84
Zip-Fix	85
Stella-Fix	86
Spring Toggles	87
Metal Cavity Anchors	87
Speed Plugs	87
Hammer-In Fixings	88

## Masonry & Insulation Fixings

Plastic, Nylon & Metal Plugs	88
Express Nails	90
Wirehangers	90
Ceiling Anchor & Bracket	90
Vertical Flange Clips	90
Metal Insulations Fixings	91
Plastic Insulation Fixings	91
Discs & Covers	91

## Concrete & Masonry Fixings

Zamac Nail In Anchors	92
Nylon Fixings	92
Masonry Screws	93
Concrete Screws	94
Masonry Bolts	96
Throughbolts	98
Drop In Anchors	98
Shield Anchors	99
Chemical Anchor Studs	100

## Chemical Resin & Accessories

Chemical Resin	101
Accessories	102



# Anchors & Fixings

## Quick Reference Guide

Zip-Fix	
Stella-Fix	
Corefix	
Metal Cavity Anchors	
Spring Toggles	
Speed Plugs	
Hammer-In Fixings	
Plastic Plugs	
Nylon Universal plugs	
Plugs & Coach Screws	
Metal Expansion Plug	
Express Nails	
Wirehangers	
Ceiling Anchors	
Insulation Fixings	
Nail in Anchors	
Nylon Hammer Fixings	
Nylon Frame Fixings	
Masonry Bolts	
Concrete Screws	
Masonry Screws	
Throughbolts	
Drop-In Anchors	
Shield Anchors	
Chemical Studs *	
Resin	

	Concrete ≥ 25 N/mm <sup>2</sup>	Concrete (Hollow) ≥ 15 N/mm <sup>2</sup>	Fletton Brick ≥ 30N/mm <sup>2</sup>	Solid Cheshire Clay Brick ≥ 45N/mm <sup>2</sup>	Class 'B' Engineering Brick (3 x hole) ≥ 75 N/mm <sup>2</sup>	Dense Solid Concrete Block 7.3 N/mm <sup>2</sup>	Stone Various Strengths	Plasterboard All thicknesses/strengths	Wood Panel i.e. chip/block board
	Concrete		Masonry					Panel	
Zip-Fix		✓						✓	✓
Stella-Fix	✓	✓	✓	✓	✓	✓	✓	✓	✓
Corefix								✓	
Metal Cavity Anchors								✓	✓
Spring Toggles		✓						✓	✓
Speed Plugs								✓	
Hammer-In Fixings								✓	
Plastic Plugs	✓		✓	✓	✓	✓	✓		
Nylon Universal plugs	✓	✓	✓	✓	✓	✓	✓	✓	✓
Plugs & Coach Screws									
Metal Expansion Plug	✓								
Express Nails	✓		✓	✓	✓	✓	✓		
Wirehangers	✓								
Ceiling Anchors	✓								
Insulation Fixings	✓		✓	✓	✓	✓	✓		
Nail in Anchors	✓						✓		
Nylon Hammer Fixings	✓		✓	✓	✓	✓	✓		
Nylon Frame Fixings	✓		✓	✓	✓	✓	✓		
Masonry Bolts	✓		✓	✓	✓	✓	✓		
Concrete Screws	✓		✓	✓	✓	✓	✓		
Masonry Screws	✓		✓	✓	✓	✓	✓		
Throughbolts	✓								
Drop-In Anchors	✓								
Shield Anchors	✓		✓	✓	✓		✓		
Chemical Studs *	✓	✓	✓	✓	✓	✓	✓		
Resin	✓		✓	✓	✓	✓	✓		

### Recommended Tensile Loads

Recommended loads quoted by TIMco are the maximum loads that may be applied in the base material as quoted. Applied loads (unfactored loads) may not exceed these values. (in BS 8539:2012 code of practice for the selection and installation of post-installed anchors in concrete and masonry, recommended loads are referred to as recommended resistances and applied loads as characteristic actions.)

TIMco determines recommended loads from results achieved in their testing facility. Recommended loads are determined from the Characteristic Load ( $x - k_s$ ) divided by a safety factor.

Recommended loads depend on anchors being correctly installed, as per the provided installation instructions, in material of at least the quoted strength and to at least the quoted embedment depth. Recommended loads for masonry are guide values only.

### Embedment depths & hole depths

Where embedment depths are quoted in this brochure they refer to the "Nominal embedment depth" of the anchor in the hole, referred to in BS 8539:2012, with the notation.

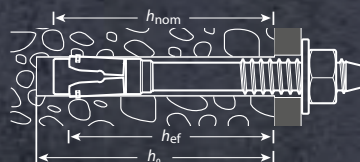

The minimum hole depth is measured to the shoulder of the drill bit,  $h_o$  as per BS 8539, and is valid for the maximum fixture thickness. When using throughbolts, Multi-Fix bolts, shield anchors, nylon frame and nylon hammer fixings, the hole depth should be increased pro rata for thinner fixtures.

### Edge distance & centre spacings

In this brochure the dimensions shown under these headings are the distances for which the full recommended load as quoted here may be used (BS 8539 references are: Edge distance,  $c_{cr}$ , and Centre spacing,  $s_{cr}$ ).

For some products closer edge and centre spacings may be used with reduced loads, refer to our Technical Department for details.

# TIMCO

# COREFIX

## Dot & Dab Wall Fixing Solved!

✓ Lightweight/thermal blockwork

✓ All types of brick & blockwork

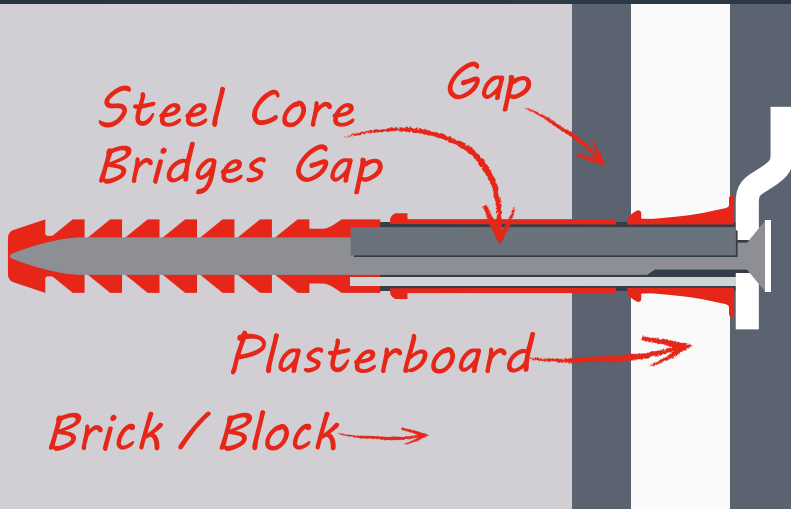

**COREFIX** is suitable for mounting TVs, radiators and cabinets onto Dot & Dab walls, plasterboard over all types of brick and blockwork.



### INSTALL IN JUST 5 EASY STEPS!

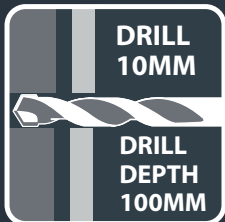

1. Drill hole to required depth using 10mm masonry drill bit. Turn off hammer drill for aerated blocks.

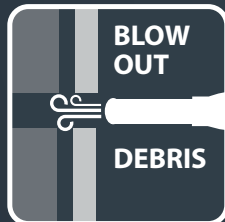

2. Blow to ensure all debris and dust has been removed from the hole.

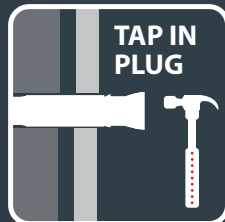

3. Gently tap plug into place until flange contacts the plasterboard.

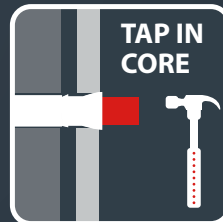

4. Then tap metal core into place.

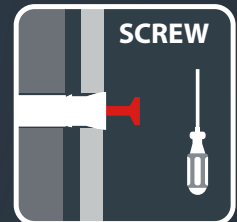

5. Screw fixture to the wall with supplied screw.

## COREFIX 100

5.0 x 100mm Screw  
Max Fixture Thickness - 10mm

Available in:

Box of 24  
Code: CFX024T

Pack of 4  
Code: CFX004T

Clamshell of 6  
(Drill bit included)  
Code: CFX006RVT



## COREFIX 120

5.0 x 120mm Screw  
Max Fixture Thickness - 30mm

Available in:

Box of 24  
Code: CFX024PT

Pack of 4  
Code: CFX004PT



Timber Battons



Shelves

Warning: Always check for cables and pipes before drilling and use suitable protective equipment.

# ZIP-FIX®

## CAVITY FIXING

# RAPID INSTALLATION

Heavy duty cavity wall anchor for use in plasterboards, most hollow concrete blocks, cavity walls and ceilings.

Pack includes both 40mm and 60mm screws for a wider variety of fixture thicknesses.

### WEIGHTS & MATERIALS

**30 KG**  
**DRYWALL / PLASTERBOARD**  
 12.5mm Thickness

**47 KG**  
**DOUBLE BOARD**  
 25mm Thickness

**56 KG**  
**DENSE BOARD**  
 15mm Thickness

Up To  
**60KG**  
**HOLLOW BLOCK**

### PERFECT FOR FITTING

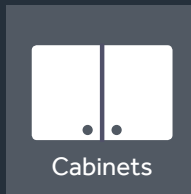
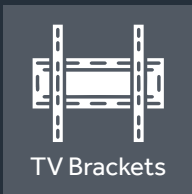

### TECHNICAL DATA

Substrate	Plasterboard 12.5mm Thickness	25mm Double Board	15mm Dense Board	Block
Thread Ø (mm)	M6	M6	M6	M6
Drill Hole Ø (mm)	13	13	13	13
Rec. Tensile Load (kN)	0.30	0.47	0.56	0.60
Max Rec. Load (kg)	30	47	56	60

Product Code	Screw Length (mm)	Thread Ø (mm)	FCH Ø (mm)	MFT (mm)	Pack Qty (pcs)	Carton Qty (packs)	Pallet Qty (packs)
--------------	-------------------	---------------	------------	----------	----------------	--------------------	--------------------

### BOX

ZIP650	40 and 60	M6	6	45	50	8	192
TYPE - ANC	SUB TYPE - ANC03 FCH = Fixture Clearance Hole. MFT = Max. Fixture Thickness						

Product Code	Screw Length (mm)	Thread Ø (mm)	FCH Ø (mm)	MFT (mm)	Pack Qty (pcs)	Carton Qty (packs)	Pallet Qty (packs)
--------------	-------------------	---------------	------------	----------	----------------	--------------------	--------------------

### BAG

ZIP6	40 and 60	M6	6	45	10	42	1260
TYPE - ANC	SUB TYPE - ANC03 FCH = Fixture Clearance Hole. MFT = Max. Fixture Thickness						

## DRILL



Drill a 13mm hole in the substrate. 50mm cavity clearance required behind substrate.

## PUSH



Ensuring the thumb tab faces upwards, insert the metal toggle through the hole, so it pivots down behind the substrate.

## ZIP



Zip the nylon collar towards the wall so the collar sits into the drilled hole. Then snap off the nylon arms.

## FIX

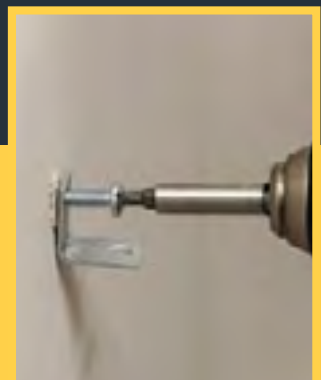

Insert a M6 screw through the fixture and into the threaded part of Zip-Fix and tighten until secure.

# STELLA-FIX

## UNIVERSAL ANCHOR

EASY INSTALLATION, JUST **PUSH & FIX**

A highly effective universal anchor for fixing heavy loads to plasterboard, cavities and solid materials.

### TECHNICAL DATA

Substrate	Plasterboard 12.5mm Thickness	Dense board 15mm Thickness	Double board 25mm Thickness
Anchor Type	Red	Red	Black
Anchor Length (mm)	49	49	59
Drill Hole Ø (mm)	10	10	10
Rec. Tensile Load (kN)	0.33	0.41	0.48
Max Rec. Load (kg)	33	41	48



PERFECT FOR  
DOUBLE  
BOARD

PERFECT FOR  
SINGLE  
BOARD

### WEIGHTS & MATERIALS



**33**  
KG  
DRYWALL /  
PLASTERBOARD  
12.5mm  
Thickness



**41**  
KG  
DOUBLE  
BOARD  
25mm  
Thickness



Up To  
**48**KG  
DENSE  
BOARD  
15mm  
Thickness

### PERFECT FOR FITTING



TV Brackets



Radiators



Cabinets

Product Code	Screw Size (mm)	Plug Length (mm)	Board Thickness (mm)	MFT (mm)	Pack Qty (pcs)	Carton Qty (packs)	Pallet Qty (packs)
<b>BOX</b>							
<b>RED FIXING</b>							
STRED55	M5 x 55	49	3 - 18	15	25	20	1200
STRED80	M5 x 80	49	3 - 18	40	25	10	800
<b>BLACK FIXING</b>							
STBLACK65	M5 x 65	59	18 - 30	12	25	20	1200
STBLACK90	M5 x 90	59	18 - 30	38	25	10	800

TYPE - ANC SUB TYPE - ANC04

MFT = Max Fixture Thickness.

Product Code	Screw Size (mm)	Plug Length (mm)	Board Thickness (mm)	MFT (mm)	Pack Qty (pcs)	Carton Qty (packs)
<b>PACK</b>						
<b>RED FIXING</b>						
725374	M5 x 55	49	3 - 18	15	4	5
725146	M5 x 80	49	3 - 18	40	4	5
<b>BLACK FIXING</b>						
725012	M5 x 65	59	18 - 30	12	4	5
725973	M5 x 90	59	18 - 30	38	4	5

TYPE - PAK SUB TYPE - PAK47

MFT = Max Fixture Thickness.

### DRILL

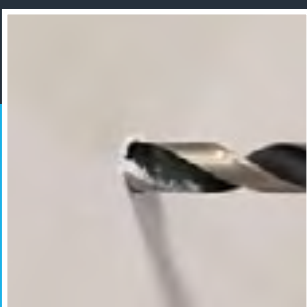

Drill a 10mm hole in the substrate.

### PUSH

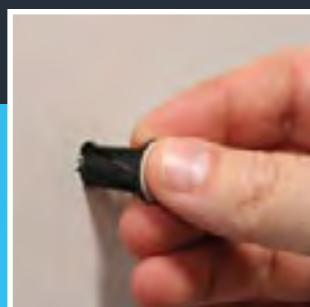

Push the Stella-Fix plug firmly into the hole.

### INSERT

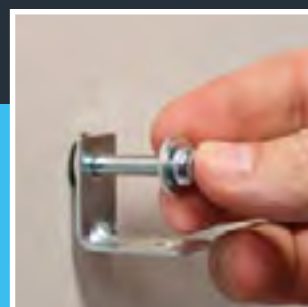

Insert the Stella-Fix screw through the fixing.

### FIX

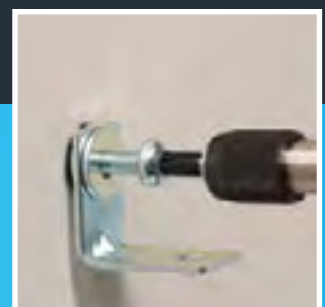

Tighten the screw until the fixing is secure.



## Cavity Fixings



### Spring Toggles

Zinc



COMBI

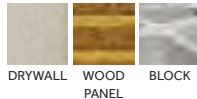

A cavity fixing that is ideal for overhead installations. The wings spread the load over a wider area making them more suited for heavier loads.

spread the load over a wider area making them more suited for heavier loads.

11 - 26KG

#### Technical Data

Substrate	Plasterboard 12.5mm Thickness		
	M3	M5	M6
Screw Ø (mm)	11	14	18
Drill Hole Ø (mm)	20	30	30
Min. Cavity Depth (mm)	0.11	0.22	0.26
Max Rec. Load (kg)	11	22	26

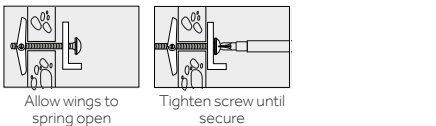
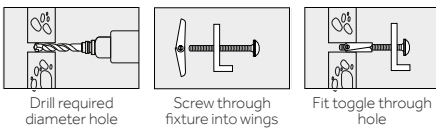

Product Code	Screw Ø x L (mm)	Wall & Fixture Thickness (mm)	Pack Qty (pcs)	Carton Qty (packs)	Pallet Qty (packs)
--------------	------------------	-------------------------------	----------------	--------------------	--------------------

#### BOX

TOG350	M3 x 50	30	100	12	240
TOG550	M5 x 50	20	100	12	192
TOG575	M5 x 75	45	100	12	192
TOG5100	M5 x 100	70	100	6	96
TOG675	M6 x 75	45	100	6	96

#### TIMBAG

TOG550B	M5 x 50	20	55	5	600
TOG575B	M5 x 75	45	50	5	600

#### TIMPAC

TOG550P	M5 x 50	20	4	5	-
TOG575P	M5 x 75	45	4	5	-

## Metal Cavity Anchors

Zinc



COMBI

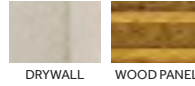

A cavity fixing that is ideal for hanging radiators, brackets, hand rails and shelving units. When installing multiple a setting tool is recommended.

22 - 37KG

#### Technical Data

Substrate	Plasterboard 12.5mm Thickness		
	M4	M5	M6
Screw Ø (mm)	8.0	10.0	12.0
Drill Hole Ø (mm)	4.0	5.0	6.0
Fixt Hole Ø (mm)	0.22	0.22	0.37
Rec. Tensile Load (kN)	22	22	37
Max Rec. Load (kg)	22	22	37

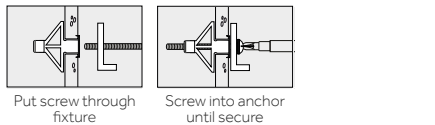
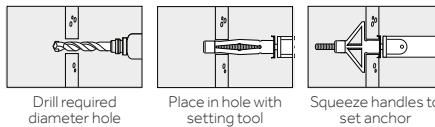

Product Code	Screw Ø x L (mm)	Anchor Length (mm)	Grip Board (mm)	Pack Qty (pcs)	Carton Qty (packs)	Pallet Qty (packs)
--------------	------------------	--------------------	-----------------	----------------	--------------------	--------------------

#### BOX

40038CA	M4 x 45	38	8 - 16	100	20	640
40045CA	M4 x 50	45	16 - 23	100	20	640
50037CA	M5 x 45	37	6 - 13	100	20	480
50052CA	M5 x 60	52	7 - 16	100	10	320
50065CA	M5 x 70	65	17 - 32	100	10	320
60052CA	M6 x 60	52	7 - 16	100	10	320
60065CA	M6 x 70	65	17 - 32	100	10	280

#### TIMBAG

50037CAB	M5 x 45	37	6-13	70	5	600
50052CAB	M5 x 60	52	7-16	60	5	600
60065CAB	M6 x 70	65	17-32	40	5	600

#### TIMPAC

50037CAP	M5 x 45	37	6-13	4	5	-
50052CAP	M5 x 60	52	7-16	3	5	-

## Setting Tool



A handy and efficient tool used to set cavity anchors.

Product Code	Pack Qty (pcs)	Carton Qty (packs)
--------------	----------------	--------------------

#### BOX

SETOOL	1	30
--------	---	----

## Metal Speed Plugs

Zinc



CROSS

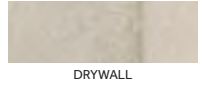

A rapid light duty plasterboard fixing for use in a wide range of applications.

Cross-recess head allows simple installation with a screw driver.

Note: Only metal speed plugs come with screws

5 - 14KG

#### Technical Data

Substrate	Plasterboard 12.5mm Thickness	
	Metal	Nylon
Type		
Max. Fixture Thickness (mm)	6.0	
Rec. Tensile Load (kN)	0.14	0.05
Max Rec. Load (kg)	14	5

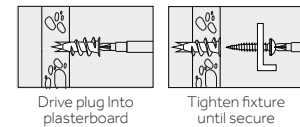

Product Code	Plug Length (mm)	Screw Ø x L (mm)	Pack Qty (pcs)	Carton Qty (packs)	Pallet Qty (packs)
--------------	------------------	------------------	----------------	--------------------	--------------------

#### BOX

TBAZS	31.5	4.5 x 30	100	20	640
-------	------	----------	-----	----	-----

#### TUB

TBAZST	31.5	4.5 x 30	300	20	-
--------	------	----------	-----	----	---

#### TIMBAG

TBAZSB	31.5	4.5 x 30	75	5	870
--------	------	----------	----	---	-----

#### TIMPAC

TBAZSP	31.5	4.5 x 30	5	5	-
--------	------	----------	---	---	---

## Nylon Speed Plugs



Nylon speed plugs are ideal for electrical installation due to non-conductivity of nylon material.

Note: A 6mm pre-drilled hole may be required in harder plasterboards.

Product Code	Plug Length (mm)	Pack Qty (pcs)	Carton Qty (packs)	Pallet Qty (packs)
--------------	------------------	----------------	--------------------	--------------------

#### BOX

TBAN	42	100	10	30,000
------	----	-----	----	--------

## Hammer-In Fixings

Yellow



POZI

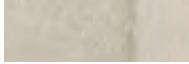

DRYWALL

Rapid light duty plasterboard fixing with zinc plating & yellow passivation, to enhance corrosion resistance.



### Technical Data

Substrate	Plasterboard 12.5mm Thickness
Screw Size (mm)	4.0 x 30
Metal Plug Size (mm)	11 x 30
Max. Fixture Thickness (mm)	6.0
Rec. Tensile Load (kN)	0.15
Max Rec. Load (kg)	15

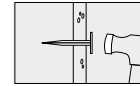

Hammer the metal plug into plasterboard

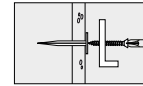

Tighten fixture until secure

Product Code	Screw Ø x L (mm)	Metal Plug Size (mm)	Pack Qty (pcs)	Carton Qty (packs)	Pallet Qty (packs)
<b>BOX</b>					
HPF30	4.0 x 30	11.0 x 30	100	18	648
TYPE - ANP					SUB TYPE - ANP03
<b>TIMPAC</b>					
HPF30P	4.0 x 30	11.0 x 30	10	5	-
TYPE - PAK					SUB TYPE - PAK38

## Plastic Plugs



### Premium Plastic Plugs

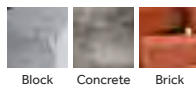

Premium plugs with improved pull-out loads and anti-rotation fins compared to standard plugs. Loose and off the sprig for quicker and more convenient installation on site.



### Technical Data

Substrate	C20/25 Concrete		
Colour	Yellow	Red	Brown
Plug Length (mm)	25	34	42
Drill Hole Ø (mm)*	5.0	5.5	7.0
To Fit Screw Ø (mm)	3.0-4.5	3.5 - 4.8	4.5 - 6.0
To Fit Screw Ø (Imp.)	4-8	6 - 10	8 - 12
Rec.Tensile Load (kN)	0.069	0.18	0.5
Max Rec. Load (kg)	7	18	50
Tested using screw Ø (mm)	3.5	4.0	5.0

\* It may be beneficial to reduce drill diameter in soft materials.

### Plastic Plugs

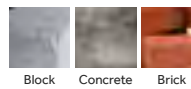

Suitable for all kinds of concrete and masonry substrate materials. Ideal for medium and lightweight applications. It may be beneficial to reduce drill diameter in soft materials.

### Technical Data

Colour	Yellow	Red	Brown	Blue
Plug Length (mm)	25	30	36	48
Drill Hole Ø (mm)*	5.0	5.5	7.0	10.0
MDHD (mm)**	30	35	45	55
To Fit Screw Ø (mm)	3.0 - 4.5	3.5 - 5.0	4.0 - 6.0	6.0 - 8.0
To Fit Screw Ø (Imp.)	4 - 8	6 - 10	8 - 12	12 - 15

\* It may be beneficial to reduce drill diameter in soft materials.

\*\* Min. Drill Hole Depth

Boxes - Yellow, Red and Brown sold in multiples of 1000.  
Blue plug sold in multiples of 400.

Product Code	Colour	Sprig Qty	Pack Qty (pcs)	Carton Qty (packs)	Pallet Qty (packs)
<b>BOX (SPRIGS)</b>					
YPLUG	Yellow	20	100	100	1200
RPLUG	Red	10	100	100	800
BPLUG	Brown	10	100	100	500
BLPLUG	Blue	10	40	100	500
TYPE - PLU					SUB TYPE - PLU01

Product Code	Colour	Sprig Qty	Pack Qty (pcs)	Carton Qty (packs)	Pallet Qty (packs)
<b>TIMBAG (LOOSE)</b>					
RPLUGB	Red	N/A	450	5	600
BPLUGB	Brown	N/A	300	5	600
TYPE - BAG					SUB TYPE - BAG47

Product Code	Colour	Sprig Qty	Pack Qty (pcs)	Carton Qty (packs)	Pallet Qty (packs)
<b>TIMPAC (LOOSE)</b>					
YPLUGP	Yellow	N/A	50	10	-
RPLUGP	Red	N/A	30	10	-
BPLUGP	Brown	N/A	20	10	-
BLPLUGP	Blue	N/A	10	10	-
TYPE - PAK					SUB TYPE - PK39

### Plastic Plugs with Screws

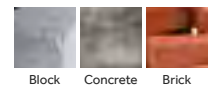

Suitable for all kinds of concrete and masonry substrate materials. Ideal for medium and lightweight applications.

### Technical Data

Colour	Red	Brown
Plug Length (mm)	30	36
Drill Hole Ø (mm)*	5.5	7.0
Min. Drill Hole Depth (mm)	35	45
To Fit Screw Ø (mm)	3.5 - 5.0	4.0 - 6.0
To Fit Screw Ø (Imp.)	6 - 10	8 - 12

\* It may be beneficial to reduce drill diameter in soft materials.

### NOW AVAILABLE IN TIMBAG

Product Code	Colour	Pack Qty (pcs)	Carton Qty (packs)	Pallet Qty (packs)
<b>TIMBAG</b>				
RPLUGPREM200	Red	200	5	-
BPLUGPREM200	Brown	200	5	-
TYPE - BAG				SUB TYPE - BAG25

Product Code	Colour	Pack Qty (pcs)	Carton Qty (packs)	Pallet Qty (packs)
<b>BAG</b>				
YPLUGPREM	Yellow	1000	40	-
RPLUGPREM	Red	1000	30	900
BPLUGPREM	Brown	1000	15	600

Product Code	Colour	Pack Qty (pcs)	Carton Qty (packs)	Pallet Qty (packs)
<b>TUB</b>				
RPLUGPREMT	Red	850	20	-
BPLUGPREMT	Brown	600	20	-
TYPE - PLU				SUB TYPE - PLU01

## Masonry Fixings



### Nylon Universal Plugs

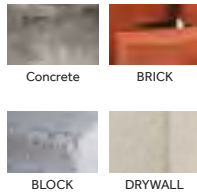

Versatile plugs manufactured from durable nylon. Superior performance in both hollow or solid materials.

Perfect for applications where there is uncertainty with regards to the type of base material.

#### Technical Data

Substrate	Concrete ≥25N/mm <sup>2</sup>			Plasterboard 12.5mm Thickness**		
	6 x 30	8 x 40	10 x 50	6 x 30	8 x 40	10 x 50
Plug Size (mm)	6 x 30	8 x 40	10 x 50	6 x 30	8 x 40	10 x 50
Drill Hole Ø (mm)	6	8	10	6	8	10
Drill Hole Depth (mm)	40	50	60	-	-	-
Test Screw Size (mm)	4.5 x 40	5.0 x 50	6.0 x 60	3.5 x 40	4.0 x 50	4.5 x 70
Rec. Tensile Load (kN)	0.08	0.39	0.9	0.03	0.08	0.12
Max Rec. Load (kg)	8	39	90	3	8	12
Rec. Screw Ø (mm)	4.0 - 4.5	4.5 - 5.0	5.0 - 6.0	3.5	4.0	4.5
Min. Req. Screw Length (mm)*	30	40	50	40	50	60



Product Code	Plug Size (mm)	Pack Qty (pcs)	Carton Qty (packs)	Pallet Qty (packs)
--------------	----------------	----------------	--------------------	--------------------

#### TIMBAG

224411	6.0 x 30	200	5	600
224209	8.0 x 40	100	5	600
224186	10.0 x 50	70	5	600

TYPE - BAG SUB TYPE - BAG50

#### TIMPAC

725411	6.0 x 30	20	10	-
725209	8.0 x 40	10	10	-
725185	10.0 x 50	5	10	-

TYPE - PAK SUB TYPE - PK017

\* Add thickness of fixture to 'Min required screw length.'

\*\* We do not recommend the use of power tools when fixing to plasterboard.

### Coach Screw & Nylon Plug

#### Zinc



BRICK

#### CORROSION RATING



Clean, dry & low humidity environments

A traditional heavy duty woodscrew mainly used for attaching ironmongery to timber or for use with a nylon plug into masonry.

NOTE: Thread length is 2/3 of the overall length screw. E.g. 100mm = 60mm thread.

#### Technical Data

Screw Size (mm)	6.0	8.0
Socket Size (mm)	10	13
Plug Ø (mm)	10.0	12.0
Drill Hole Ø (mm)*	10.0	12.0

Product Code	Screw Size (mm)	Plug Size (mm)	Pack Qty (pcs)	Carton Qty (packs)	Pallet Qty (packs)
<b>TIMBAG</b>					
0660CSCNB	6.0 x 60	10.0 x 50	40	5	200
0680CSCNB	6.0 x 80	10.0 x 50	30	5	150
08100CSCNB	8.0 x 100	12.0 x 60	12	5	60
TYPE - BAG			SUB TYPE - BAG06		
<b>TIMPAC</b>					
0660CSCNP	6.0 x 60	10.0 x 50	2	5	-
0680CSCNP	6.0 x 80	10.0 x 50	2	5	-
08100CSCNP	8.0 x 100	12.0 x 60	2	5	-
TYPE - PAK			SUB TYPE - PAK25		

### Nylon Plug

#### Nylon



BRICK



For use with coach screws into masonry.

#### Technical Data

Plug Ø (mm)	6.0	8.0	10.0	12.0	14.0
Drill Hole Ø (mm)*	6.0	8.0	10.0	12.0	14.0

Product Code	Plug Size (mm)	For Screw Ø (mm)	Pack Qty (pcs)	Carton Qty (packs)	Pallet Qty (packs)
<b>TIMBAG</b>					
06NLBP	6.0 x 30	3.5 - 5.0	200	5	870
08NLBP	8.0 x 40	5.0 - 6.0	100	5	870
10NLBP	10.0 x 50	6.0 - 8.0	70	5	600
TYPE - BAG			SUB TYPE - BAG07		
<b>TIMPAC</b>					
06NLPP	6.0 x 30	3.5 - 5.0	20	10	-
08NLPP	8.0 x 40	5.0 - 6.0	10	10	-
10NLPP	10.0 x 50	6.0 - 8.0	5	10	-
12NLPP	12.0 x 60	8.0 - 10.0	2	10	-
14NLPP	14.0 x 75	10.0 - 12.0	2	10	-
TYPE - PAK			SUB TYPE - PAK13		

### Metal Expansion Plugs

#### Yellow



BLOCK

#### CORROSION RATING



Clean, dry & low humidity environments

An all steel fixing for light weight aggregate blocks. Ideal for fixing in areas such as fire escape routes where regulations restrict the use of plastic anchors or plugs.

• Conforms to BS 7671:2018



All Steel Non-Flammable Fixing



#### Technical Data

Substrate	Concrete Block 7N/mm <sup>2</sup>		
Plug Ø (mm)	6.0	8.0	10.0
Drill Hole Ø (mm)	6.0	8.0	10.0
Min. Embedment Depth (mm)	32	38	60
Test Screw Ø (mm)	4.5	5.0	6.0
Rec. Tensile Load (kN)	0.2	0.4	0.5
Max Rec. Load (kg)	20	40	50

Note: Drill hole size is relative to the compressive strength of the substrate. When fixing into concrete, the above drill hole sizes should be increased to prevent damage to the plug during installation.

Product Code	Size Ø x L (mm)	For Screw Ø (mm)	Pack Qty (pcs)	Carton Qty (packs)	Pallet Qty (packs)
<b>BOX</b>					
632MEP	6.0 x 32	4.5 - 5.0	100	18	864
838MEP	6.0 x 38	5.0 - 6.0	50	18	864
860MEP	8.0 x 60	5.0 - 6.0	50	10	500
1060MEP	10.0 x 60	6.0 - 8.0	50	10	500
TYPE - MEP			SUB TYPE - MEP01		

## Express Nails

Zinc

An underestimated rapid hammer-set anchor for concrete and masonry, ideal for interior timber-work such as battens and frames.

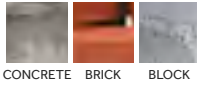

CONCRETE BRICK BLOCK

CORROSION RATING



Clean, dry & low humidity environments

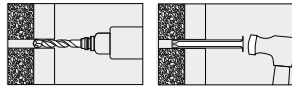

Drill required diameter hole

Hammer nail through fixture

Technical Data

Substrate	Concrete $\geq 25N/mm^2$		Fletton Brick 30N/mm <sup>2</sup>		Cheshire Brick 45N/mm <sup>2</sup>		Class B Eng. Brick 75N/mm <sup>2</sup>	
	6.0	8.0	6.0	8.0	6.0	8.0	6.0	8.0
Size $\varnothing$ (mm)	6.0	8.0	6.0	8.0	6.0	8.0	6.0	8.0
Drill Hole $\varnothing$ (mm)	6.0	8.0	6.0	8.0	6.0	8.0	6.0	8.0
Fixture Clearance Hole $\varnothing$ (mm)	7.0	9.0	7.0	9.0	7.0	9.0	7.0	9.0
Min. Embed. Depth (mm)	30	40	30	40	30	40	30	40
Min. Drill Hole Depth (mm)	40	50	40	50	40	50	40	50
Rec. Tensile Load (kN)	0.52	1.50	0.48	0.61	0.29	0.53	0.28	0.62
Max Rec. Load (kg)	52	150	48	61	29	53	28	62

28-150KG

Product Code Size (mm) MFT\* (mm) Pack Qty (pcs) Carton Qty (packs) Pallet Qty (packs)

BOX					
00650EN	6.0 x 50	20	200	8	240
00660EN	6.0 x 60	30	100	10	300
00680EN	6.0 x 80	50	100	10	300
00870EN	8.0 x 70	30	100	10	300
00890EN	8.0 x 90	50	50	18	648
08110EN	8.0 x 110	70	50	10	300
08130EN	8.0 x 130	90	50	10	300
08150EN	8.0 x 150	110	50	8	240
08180EN	8.0 x 180	140	50	8	240

TIMBAG					
00660ENB	6.0 x 60	30	90	5	600
00680ENB	6.0 x 80	50	70	5	600
00890ENB	8.0 x 90	50	45	5	600
08110ENB	8.0 x 110	70	35	5	600
08150ENB	8.0 x 150	110	30	5	600

TIMPAC					
00660ENP	6.0 x 60	30	8	5	-
00680ENP	6.0 x 80	50	6	5	-
00890ENP	8.0 x 90	50	6	5	-
08110ENP	8.0 x 110	70	4	5	-
08130ENP	8.0 x 130	90	6	5	-

TYPE - EXNO SUB TYPE - EXN01  
TYPE - BAG SUB TYPE - BAG32  
TYPE - PAK SUB TYPE - PAK73

\*MFT = MAX FIXTURE THICKNESS

## Wirehangers

Zinc



CONCRETE

CORROSION RATING



Clean, dry & low humidity environments



All Steel Non-Flammable Fixing

Specifically designed for use in the suspended ceiling industry when securing suspension wires to concrete beams.

• Conforms to BS 7671:2018

188KG

Technical Data	
Substrate	Concrete $\geq 25N/mm^2$
Size $\varnothing$ (mm)	6.0
Drill Hole $\varnothing$ (mm)	6.0
Embedment Depth (mm)	45
Min. Embedment Depth (mm)	50
Rec. Tensile Load (kN)	1.88
Max Rec. Load (kg)	188

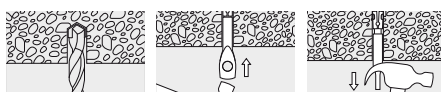

Drill required diameter hole

Lightly tap the anchor into the hole

Set anchor using a claw hammer

Product Code Size  $\varnothing$  x L (mm) Eye  $\varnothing$  (mm) Pack Qty (pcs) Carton Qty (packs) Pallet Qty (packs)

BOX					
0660WH	6.0 x 60	6.3	100	18	648

TYPE - WHG SUB TYPE - WHG01

## Ceiling Anchors

Zinc

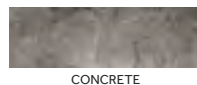

CONCRETE

CORROSION RATING



Clean, dry & low humidity environments

A rapid light duty hammer-set anchor for attaching sheet metal, plastic or wood to concrete or masonry. Made from steel making it ideal for overhead applications.

72KG

Technical Data	
Substrate	Concrete $\geq 25N/mm^2$
Size $\varnothing$ (mm)	6.0
Drill Hole $\varnothing$ (mm)	6.0
Fixture Clearance Hole $\varnothing$ (mm)	6.5
Min. Embedment Depth (mm)	35
Min Drill Hole Depth (mm)	45
Rec. Tensile Load (kN)	0.72
Max Rec. Load (kg)	72

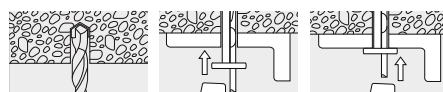

Drill required diameter hole

Insert fixing through attachment

Hammer wedge into anchor to secure

Product Code Size  $\varnothing$  x L (mm) MFT (mm) Pack Qty (pcs) Carton Qty (packs) Pallet Qty (packs)

BOX					
0640CAM	6.0 x 40	5	100	10	300
0665CAM	6.0 x 65	30	100	8	240

TYPE - CAM SUB TYPE - CAM01 MFT = Max Fixture Thickness.

## Vertical Flange Clips

Yellow



High strength vertical flange clip for fixing suspended wire and lighting to steel purlin.

Must only be used in a vertical position

72KG

Technical Data	
Size (mm)	20 x 42
Max Rec. Load (kg)	72

Product Code Size W x L (mm) Hole  $\varnothing$  (mm) Pack Qty (pcs) Carton Qty (packs) Pallet Qty (packs)

BOX					
VFC2042	20 x 42	6.5	100	10	500

TYPE - WHG SUB TYPE - WHG02

## Ceiling Angle Brackets

Galvanised Steel



Versatile bracket most commonly used for installing suspended ceiling systems. Various hole sizes allow different fixings to be used.

Product Code Size L x W x H (mm) Hole  $\varnothing$  (mm) T (mm) Pack Qty (pcs) Carton Qty (packs) Pallet Qty (packs)

BOX						
25ABC	25 x 25 x 22	4.5 & 7.0	1.0	100	18	864

TYPE - WHG SUB TYPE - WHG03



# Insulation Fixings



## Metal Insulation Fixings

Zinc

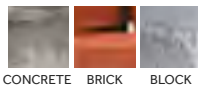

CORROSION RATING



Clean, dry & low humidity environments

Designed to anchor insulation material to concrete and masonry substrate materials.

20KG

Technical Data	
Substrate	Concrete ≥ 25N/mm <sup>2</sup>
Type	Metal
Drill Hole Ø (mm)	8.0
Min. Embedment Depth (mm)	50
Min. Drill Hole Depth (mm)	60
Rec. Tensile Load (kN)	0.20
Max Rec. Load (kg)	20

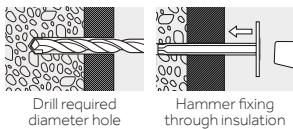

Product Code	Size Ø x L (mm)	Max. Fixture Thickness (mm)	Pack Qty (pcs)	Carton Qty (packs)	Pallet Qty (packs)
<b>BAG</b>					
MIF60	8.0 x 60	10	100	6	240
MIF90	8.0 x 90	40	100	4	160
MIF110	8.0 x 110	60	100	3	120
MIF140	8.0 x 140	90	100	3	120
MIF170	8.0 x 170	120	50	5	200
MIF200	8.0 x 200	150	50	4	160
MIF250	8.0 x 250	200	50	5	200
MIF300	8.0 x 300	250	50	5	200
TYPE - TAF			SUB TYPE - TAF01		

## Plastic Insulation Fixings

Plastic

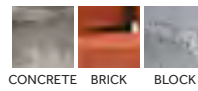

One piece impact resistant copolymer.

Note: Once installed, the head of the fixing should be taped and sealed to avoid any contact with wet plaster. Failure to do so may result in surface damage.

15KG

Technical Data	
Substrate	Concrete ≥ 25N/mm <sup>2</sup>
Type	Plastic
Drill Hole Ø (mm)	8.0
Min. Embedment Depth (mm)	40
Min. Drill Hole Depth (mm)	50
Rec. Tensile Load (kN)	0.15
Max Rec. Load (kg)	15

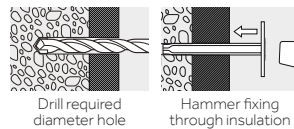

Product Code	Size Ø x L (mm)	Max. Fixture Thickness (mm)	Pack Qty (pcs)	Carton Qty (packs)	Pallet Qty (packs)
<b>BAG</b>					
PIF50	8 x 50	10	100	10	240
PIF70	8 x 70	30	100	10	240
PIF90	8 x 90	50	100	8	192
PIF110	8 x 110	70	100	8	192
PIF130	8 x 130	90	100	8	192
TYPE - TAF			SUB TYPE - TAF01		

## Metal Insulation Discs

Zinc



MID35



MID70



MID80

Large diameter head for use with screws to hold insulation material to battens. Also used for ceiling crack repairs.

Note: Once installed, the head of the fixing should be taped and sealed to avoid any contact with wet plaster. Failure to do so may result in surface damage.

Provides a larger surface area when using metal insulation fixings to hold lighter or softer insulation to masonry. Simply slide the fixing through prior to installation. Use with Metal insulation fixings. Can also be used with large gauge and long screws for fixing insulation to timber

NEW

Stainless Steel



MID36SS

Large diameter head for use with countersunk screws to hold insulation material to battens. Stainless steel material for improved corrosion resistance.

Product Code	Ø (mm)	Hole Size Ø (mm)	Pack Qty (pcs)	Carton Qty (packs)	Pallet Qty (packs)
<b>BOX</b>					
<b>Zinc</b>					
MID35	35	5.0	100	35	840
MID70	70.0	10.0	100	16	384
MID80	85.0	12.0	50	16	384
<b>Stainless Steel</b>					
MID36SS	36	5.5	100	35	840
TYPE - TAF			SUB TYPE - TAF01		

## Plastic Cover Cap For Metal Insulation Fixings



For aesthetics, where metal insulation fixing heads are left exposed after installation.

Product Code	Ø (mm)	Pack Qty (pcs)	Carton Qty (packs)	Pallet Qty (packs)
<b>BAG</b>				
MIFC	38.0	100	25	300
TYPE - TAF		SUB TYPE - TAF01		

## Metal Oval Stress Plate

Zinc



Frequently used with long screws to attach insulation material to timber. Oval type for use in softer materials, accommodates countersunk screws and recesses itself into insulation for a flush finish.

Note: Once installed, the head of the fixing should be taped and sealed to avoid any contact with wet plaster. Failure to do so may result in surface damage.

Product Code	Size (mm)	Hole Ø (mm)	Pack Qty (pcs)	Carton Qty (packs)	Pallet Qty (packs)
<b>BOX</b>					
MID8240	82 x 40	6.5	50	16	384
TYPE - TAF		SUB TYPE - TAF01			



# Masonry & Concrete Screws



**Rapid & Effective**  
Masonry & Concrete Screws



**Ideal for fitting**

- hand rails
- shelf brackets
- security lighting
- metal straps banding



None expansion for close to edge fixing

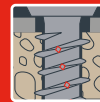

Serrated V-threads for optimum insertion



High-low start threads for rapid pick up

## Masonry Screw - Countersunk

Zinc



TX DRIVE

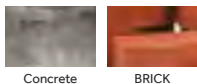

Concrete

BRICK



BLOCK

WOOD

CORROSION RATING



Clean, dry & low humidity environments



All Steel Non-Flammable Fixing



**100-150KG**

Technical Data

Substrate	Concrete ≥25N/mm <sup>2</sup>	
Length (mm)	40-80	100
Drill Hole Ø (mm)	5.0	5.0
Min. Embedment Depth (mm)	25	37
Min. Drill Hole Depth (mm)	35	47
Rec. Tensile Load (kN)	1.00	1.50
Max Rec. Load (kg)	100	150

Product Code	Size (mm)	Driver Bit Size	Max. Fixture Thickness (mm)	Fixture Clearance Hole Ø (mm)	Pack Qty (pcs)	Carton Qty (packs)	Pallet Qty (packs)
<b>BOX (DRIVER BIT INCLUDED)</b>							
640MFCSK	6.0 x 40	TX25	15	6.5	100	18	648
660MFCSK	6.0 x 60	TX25	35	6.5	100	12	432
680MFCSK	6.0 x 80	TX25	55	6.5	100	12	432
6100MFCSK	6.0 x 100	TX25	63	6.5	100	10	360
TYPE - CON					SUB TYPE - CON04		
<b>TIMPAC</b>							
725157	6.0 x 40	TX25	15	6.5	12	10	-
725375	6.0 x 60	TX25	35	6.5	10	10	-
725010	6.0 x 80	TX25	55	6.5	8	10	-
725863	6.0 x 100	TX25	63	6.5	6	10	-
TYPE - PAK					SUB TYPE - PAK45		

## Masonry Screw - Pan Head

Zinc



TX DRIVE

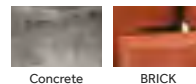

Concrete

BRICK



BLOCK

WOOD

CORROSION RATING



Clean, dry & low humidity environments



All Steel Non-Flammable Fixing



**100-150KG**

Technical Data

Substrate	Concrete ≥25N/mm <sup>2</sup>	
Length (mm)	40-80	100
Drill Hole Ø (mm)	5.0	5.0
Min. Embedment Depth (mm)	25	37
Min. Drill Hole Depth (mm)	35	47
Rec. Tensile Load (kN)	1.00	1.50
Max Rec. Load (kg)	100	150

Product Code	Size (mm)	Driver Bit Size	Max. Fixture Thickness (mm)	Fixture Clearance Hole Ø (mm)	Pack Qty (pcs)	Carton Qty (packs)	Pallet Qty (packs)
<b>BOX (DRIVER BIT INCLUDED)</b>							
640MF PAN	6.0 x 40	TX25	15	6.5	100	18	648
660MF PAN	6.0 x 60	TX25	35	6.5	100	12	432
680MF PAN	6.0 x 80	TX25	55	6.5	100	12	576
6100MF PAN	6.0 x 100	TX25	63	6.5	100	10	360
TYPE - CON					SUB TYPE - CON05		
<b>TIMPAC</b>							
725500	6.0 x 40	TX25	15	6.5	12	10	-
725997	6.0 x 60	TX25	35	6.5	10	10	-
TYPE - PAK					SUB TYPE - PAK46		

# Masonry & Concrete Screws

Designed to replace traditional masonry fixings

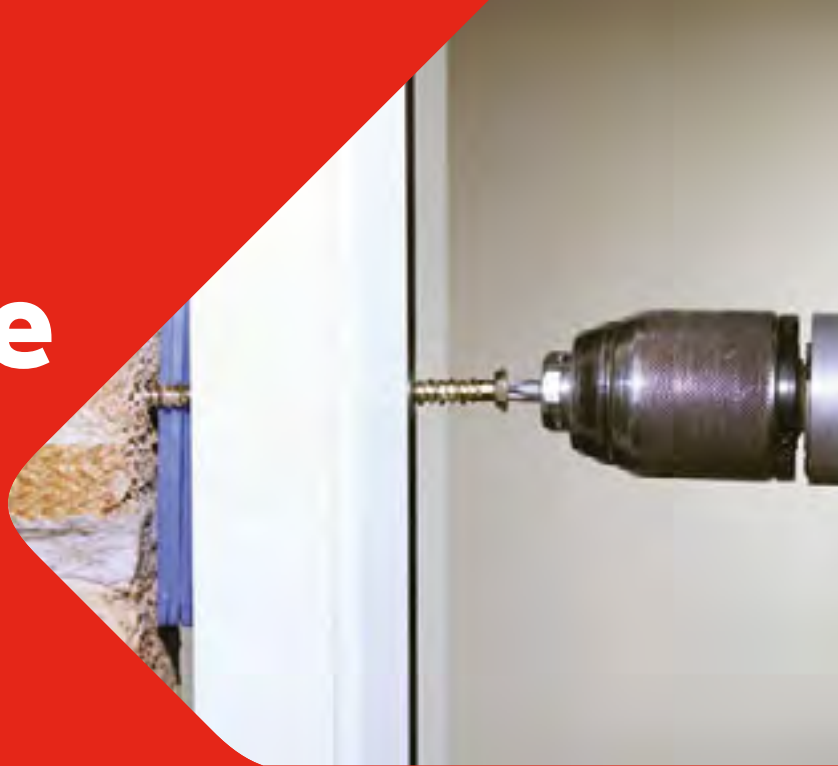

None expansion for close to edge fixing



Serrated V-threads for optimum insertion



High-low start threads for rapid pick up



## Rapid & Effective Masonry & Concrete Screws

### Ideal for fixing

- Concrete
- Brick
- Stone
- Block
- Wood

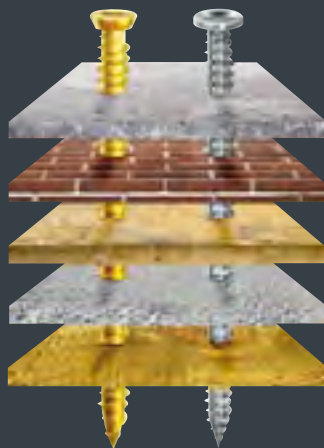

Countersunk



Pan Head

### Install in just 2 easy steps

#### 1 Drill

Drill the hole 90° to the substrate. Always over-drill the hole depth for dust/debris.

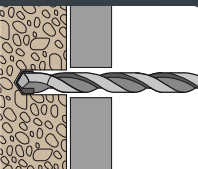

#### 2 Fix

Using a power tool, tighten the fixing firmly against the attachment.

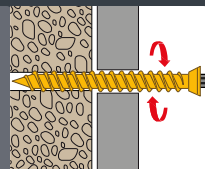



## Concrete Screw - Countersunk

Yellow	Zinc	Exterior (SO)
<b>CORROSION RATING</b> 1 2 3 4 5	<b>CORROSION RATING</b> 1 2 3 4 5	<b>CORROSION RATING</b> 1 2 3 4 5
Clean, dry & low humidity environments	Clean, dry & low humidity environments	Urban & industrial areas with a low salt atmosphere

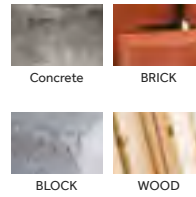
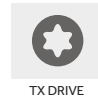

A rapid and effective light duty anchoring system for fixing into concrete, brick, stone, concrete block and wood. This through fixing provides a single solution and replaces traditional fixings such as nylon frame and hammer fixings.



• Conforms to BS 7671:2018



### Technical Data

Substrate	Concrete $\geq 25\text{N/mm}^2$		Fletton Brick 30N/mm <sup>2</sup>		Cheshire Brick 45N/mm <sup>2</sup>		Class B Eng. Brick 75N/mm <sup>2</sup>	
	40-70	80-200	40-80	80-200	40-70	80-200	40-70	80-200
Length (mm)	40-70	80-200	40-80	80-200	40-70	80-200	40-70	80-200
Drill Hole Ø (mm)	6.0	6.0	6.0	6.0	6.0	6.0	6.0	6.0
Min. Embedment Depth (mm)	35	50	35	50	35	50	35	50
Min. Drill Hole Depth (mm)	45	60	40	60	40	60	40	60
Rec. Tensile Load (kN)	1.07	1.82	1.17	1.79	0.75	1.46	0.85	1.22
Max Rec. Load (kg)	107	182	117	179	75	146	85	122

Product Code	Size (mm)	Driver Bit Size	Max. Fixture Thickness (mm)	Fixture Clearance Hole Ø (mm)	Pack Qty (pcs)	Carton Qty (packs)	Pallet Qty (packs)
<b>YELLOW</b>							
<b>BOX (TX30 DRIVER BIT INCLUDED)</b>							
00040TCON	7.5 x 40	TX30	5	8.0	100	18	648
00050TCON	7.5 x 50	TX30	15	8.0	100	12	432
00060TCON	7.5 x 60	TX30	25	8.0	100	10	360
00070TCON	7.5 x 70	TX30	35	8.0	100	10	360
00080TCON	7.5 x 80	TX30	30	8.0	100	10	360
00090TCON	7.5 x 90	TX30	40	8.0	100	10	360
00100TCON	7.5 x 100	TX30	50	8.0	100	10	360
00110TCON	7.5 x 110	TX30	60	8.0	100	10	360
00120TCON	7.5 x 120	TX30	70	8.0	100	8	288
00130TCON	7.5 x 130	TX30	80	8.0	100	8	288
00150TCON	7.5 x 150	TX30	100	8.0	100	8	288
00180TCON	7.5 x 180	TX30	130	8.0	100	6	216
00200TCON	7.5 x 200	TX30	150	8.0	100	6	216
<b>TIMBAG</b>							
00050TCONB	7.5 x 50	TX30	15	8.0	100	5	
00060TCONB	7.5 x 60	TX30	25	8.0	85	5	
00070TCONB	7.5 x 70	TX30	35	8.0	75	5	
00080TCONB	7.5 x 80	TX30	30	8.0	65	5	
00100TCONB	7.5 x 100	TX30	50	8.0	55	5	
00120TCONB	7.5 x 120	TX30	70	8.0	45	5	
00150TCONB	7.5 x 150	TX30	100	8.0	30	5	
<b>TIMPAC</b>							
00050TCONP	7.5 x 50	TX30	15	8.0	8	10	
00060TCONP	7.5 x 60	TX30	25	8.0	6	10	
00070TCONP	7.5 x 70	TX30	35	8.0	5	10	
00080TCONP	7.5 x 80	TX30	30	8.0	5	10	
00100TCONP	7.5 x 100	TX30	50	8.0	4	10	
00120TCONP	7.5 x 120	TX30	70	8.0	3	10	
00150TCONP	7.5 x 150	TX30	100	8.0	2	10	
TYPE - CON/BAG/PAK SUB TYPE - CON01/BAG31/PAK44							
<b>Zinc</b>							
<b>BOX (TX30 DRIVER BIT INCLUDED)</b>							
00080TCONZ	7.5 x 80	TX30	30	8.0	100	10	360
00100TCONZ	7.5 x 100	TX30	50	8.0	100	10	360
00120TCONZ	7.5 x 120	TX30	70	8.0	100	8	288
00150TCONZ	7.5 x 150	TX30	100	8.0	100	8	288
TYPE - CON SUB TYPE - CON03							
<b>Exterior (Silver Organic)</b>							
<b>BOX (TX30 DRIVER BIT INCLUDED)</b>							
80TCONR	7.5 x 80	TX30	30	8.0	100	10	360
100TCONR	7.5 x 100	TX30	50	8.0	100	10	360
120TCONR	7.5 x 120	TX30	70	8.0	100	8	288
TYPE - CON SUB TYPE - CON02							

## Cover Caps (for Countersunk screws only)



Product Code	Colour	Pack Qty (pcs)	Carton Qty (packs)	Pallet Qty (packs)
<b>BAG</b>				
CAPW100	White	100	100	360
CAPO100	Light Oak	100	100	360
CAPM100	Mahogany	100	100	360
TYPE - CON				SUB TYPE - CON01

## Concrete Screw - Pan Head

<b>Zinc</b>																																																							
<b>TX DRIVE</b>																																																							
<b>CORROSION RATING</b> 1 2 3 4 5																																																							
Clean, dry & low humidity environments																																																							
A rapid and effective light duty anchoring system for fixing into concrete, brick, stone, concrete block and wood. This through fixing provides a single solution and replaces traditional fixings such as nylon frame and hammer fixings. Zinc plated with a pan head to improve clamping.																																																							
<table border="1"> <thead> <tr> <th>Product Code</th> <th>Size (mm)</th> <th>Driver Bit Size</th> <th>Max. Fixture Thickness (mm)</th> <th>Fixture Clearance Hole Ø (mm)</th> <th>Pack Qty (pcs)</th> <th>Carton Qty (packs)</th> <th>Pallet Qty (packs)</th> </tr> </thead> <tbody> <tr> <td colspan="8"><b>BOX (TX30 DRIVER BIT INCLUDED)</b></td> </tr> <tr><td>7580MFPAN</td><td>7.5 x 80</td><td>TX30</td><td>30</td><td>8.0</td><td>100</td><td>10</td><td>360</td></tr> <tr><td>75100MFPAN</td><td>7.5 x 100</td><td>TX30</td><td>50</td><td>8.0</td><td>100</td><td>10</td><td>360</td></tr> <tr><td>75120MFPAN</td><td>7.5 x 120</td><td>TX30</td><td>70</td><td>8.0</td><td>100</td><td>8</td><td>288</td></tr> <tr> <td colspan="8">TYPE - CON SUB TYPE - CON03</td> </tr> </tbody> </table>								Product Code	Size (mm)	Driver Bit Size	Max. Fixture Thickness (mm)	Fixture Clearance Hole Ø (mm)	Pack Qty (pcs)	Carton Qty (packs)	Pallet Qty (packs)	<b>BOX (TX30 DRIVER BIT INCLUDED)</b>								7580MFPAN	7.5 x 80	TX30	30	8.0	100	10	360	75100MFPAN	7.5 x 100	TX30	50	8.0	100	10	360	75120MFPAN	7.5 x 120	TX30	70	8.0	100	8	288	TYPE - CON SUB TYPE - CON03							
Product Code	Size (mm)	Driver Bit Size	Max. Fixture Thickness (mm)	Fixture Clearance Hole Ø (mm)	Pack Qty (pcs)	Carton Qty (packs)	Pallet Qty (packs)																																																
<b>BOX (TX30 DRIVER BIT INCLUDED)</b>																																																							
7580MFPAN	7.5 x 80	TX30	30	8.0	100	10	360																																																
75100MFPAN	7.5 x 100	TX30	50	8.0	100	10	360																																																
75120MFPAN	7.5 x 120	TX30	70	8.0	100	8	288																																																
TYPE - CON SUB TYPE - CON03																																																							

# Multi-Fix Bolt

## Heavy Duty Anchor

Silver organic plating to give ultimate corrosion protection

### Rapid & Effective

### Heavy Duty Anchor



Fixing for:

- Concrete
- Brick
- Stone
- Block
- Wood



Kesternich test  
3 cycles



Salt Spray  
400 hours



Non-expansion  
for close to  
edge fixing

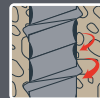

High-low balancing  
thread for ease of  
insertion



Chamfered  
point for rapid  
pick up

#### Exterior

Hex Head

Countersunk

Pan Head



HEX

TX DRIVE

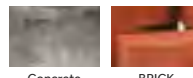

Concrete

BRICK

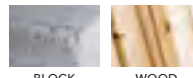

BLOCK

WOOD

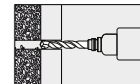

Drill hole to  
substrate. Always  
drill to the stated  
hole depth.

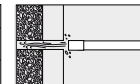

Clean the  
hole by  
blowing out  
the Debris.

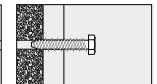

Screw the bolt into  
the hole with slight  
pressure to the bolt.

This stress free, non-expansion through fixing is the new solution for heavy duty anchoring into concrete, brick, stone, wood and concrete block replacing the need for traditional anchors such as throughbolts, shield, sleeve and drop-in anchors.



- Designed to replace traditional expansion anchors
- micro plating (Nano) technology gives a higher resistance to corrosion
- High low parallel threads for ease of insertion and high pull out values
- Removable & adjustable non expansion through fixing
- Conforms to BS 7671:2018

#### CORROSION RATING



Urban & industrial areas with  
a low salt atmosphere



#### Technical Data

Substrate	Concrete ≥25N/mm <sup>2</sup>					Fletton Brick 30N/mm <sup>2</sup>			Cheshire Brick 45N/mm <sup>2</sup>			Class B Eng. Brick 75N/mm <sup>2</sup>						
	6.0	8.0	10.0	12.0	16.0	6.0	8.0	10.0	6.0	8.0	10.0	6.0	8.0	10.0				
Length (mm)	50-75	100-150	All	All	All	All	-	-	-	-	-	-	-	-				
Drill Hole Ø (mm)	6.0	6.0	8.0	10.0	12.0	16.0	6.0	8.0	10.0	6.0	8.0	10.0	6.0	8.0	10.0			
Fixture Clearance Hole Ø (mm)	8.0	8.0	10.0	12.0	14.0	18.0	8.0	10.0	12.0	8.0	10.0	12.0	8.0	10.0	12.0			
Min. Embedment Depth (mm)	30	45	40	50	60	80	30	40	50	30	40	50	30	40	50			
Min. Over-Drill for Dust (mm)	10	10	15	20	25	35	10	15	20	10	15	20	10	15	20			
Min. Drill Hole Depth (mm)	40	55	55	70	85	115	40	55	70	40	55	70	40	55	70			
Min. Centre Spacing (mm)**	90	140	120	150	180	240	-	-	-	-	-	-	-	-	-			
Min. Edge Distance (mm)**	45	70	60	75	90	120	-	-	-	-	-	-	-	-	-			
Min. Structure Thickness (mm)	60	100	90	110	125	175	-	-	-	-	-	-	-	-	-			
Effective Embedment depth (mm)	30	45	40	60	50	75	60	85	80	30	40	50	30	40	50			
Rec. Tensile Load (kN)	2.44	6.23	3.93	8.36	5.49	12.21	8.97	13.00	13.5	2.28	2.68	3.18	1.36	2.19	3.26	3.49	4.33	-
Max Rec. Load (kg)	244	623	393	836	549	1221	897	1300	1350	228	268	318	136	219	326	349	433	-

\*\* Centre spacings and edge distances are based on minimum embedment only.

## Masonry Bolt - Hex Head

Exterior



CORROSION RATING



Urban & industrial areas with a low salt atmosphere

Product Code	Size (mm)	Socket Size (mm)	MFT (mm)	Pack Qty (pcs)	Carton Qty (packs)	Pallet Qty (packs)
--------------	-----------	------------------	----------	----------------	--------------------	--------------------

### BOX

MF650	6.0 x 50*	10	20	100	10	300
MF675	6.0 x 75*	10	45	100	6	180
MF6100	6.0 x 100*	10	55	100	6	180
MF6130	6.0 x 130*	10	85	100	6	180
MF6150	6.0 x 150*	10	105	75	6	180
MF860	8.0 x 60	15	20	100	6	180
MF875	8.0 x 75	15	35	100	6	180
MF8100	8.0 x 100	15	60	50	10	300
MF8130	8.0 x 130	15	90	50	6	180
MF8150	8.0 x 150	15	110	50	6	180
MF1060	10.0 x 60	17	10	50	10	300
MF1075	10.0 x 75	17	25	50	6	180
MF10100	10.0 x 100	17	50	50	6	180
MF10130	10.0 x 130	17	80	50	6	180
MF10150	10.0 x 150	17	100	25	6	180
MF1275	12.0 x 75	19	15	50	9	180
MF12100	12.0 x 100	19	40	25	10	300
MF12130	12.0 x 130	19	70	25	6	180
MF12150	12.0 x 150	19	90	25	6	180
MF12200	12.0 x 200	19	140	25	4	120
MF16100	16.0 x 100	27	20	10	8	240
MF16150	16.0 x 150	27	70	10	6	180

TYPE - SKU

SUB TYPE - SKU01

### TIMBAG

MF650B	6.0 x 50*	10	20	64	5	600
MF860B	8.0 x 60	15	20	30	5	600
MF875B	8.0 x 75	15	35	26	5	600
MF8100B	8.0 x 100	15	60	20	5	600
MF1060B	10.0 x 60	17	10	18	5	600
MF1075B	10.0 x 75	17	25	14	5	600
MF10100B	10.0 x 100	17	50	12	5	600
MF10150B	10.0 x 150	17	100	8	5	600
MF1275B	12.0 x 75	19	15	12	5	600
MF12100B	12.0 x 100	19	40	8	5	600
MF12130B	12.0 x 130	19	70	6	5	600
MF12150B	12.0 x 150	19	90	6	5	600

TYPE - BAG

SUB TYPE - BAG32

### TIMPAC

MF650PRE	6.0 x 50*	10	20	4	5	-
MF875PRE	8.0 x 75	15	35	4	5	-
MF8100PRE	8.0 x 100	15	60	4	5	-
MF1075PRE	10.0 x 75	17	25	4	5	-
MF10100PRE	10.0 x 100	17	50	2	5	-
MF10130PRE	10.0 x 130	17	80	2	5	-
MF10150PRE	10.0 x 150	17	100	2	5	-
MF12100PRE	12.0 x 100	19	40	2	5	-
MF12150PRE	12.0 x 150	19	90	2	5	-
MF16100PRE	16.0 x 100	27	20	2	5	-
MF16150PRE	16.0 x 150	27	70	2	5	-

TYPE - PAK SUB TYPE - PAK43 MFT = MAX FIXTURE THICKNESS

## Masonry Bolt - Countersunk

Exterior



CORROSION RATING



Urban & industrial areas with a low salt atmosphere

Product Code	Size (mm)	Driver Bit Size	MFT (mm)	Pack Qty (pcs)	Carton Qty (packs)	Pallet Qty (packs)
--------------	-----------	-----------------	----------	----------------	--------------------	--------------------

### BOX (DRIVER BIT INCLUDED)

MF860C	8.0 x 60	TX40	20	100	6	180
MF875C	8.0 x 75	TX40	35	100	6	180
MF8100C	8.0 x 100	TX40	60	50	8	240
MF1060C	10.0 x 60	TX50	10	50	8	240
MF1075C	10.0 x 75	TX50	25	50	6	180
MF10100C	10.0 x 100	TX50	50	50	6	180

TYPE - SKU SUB TYPE - SKU02

MFT = MAX FIXTURE THICKNESS

## Masonry Bolt - Pan Head

Exterior



CORROSION RATING



Urban & industrial areas with a low salt atmosphere

Product Code	Size (mm)	Driver Bit Size	MFT (mm)	Pack Qty (pcs)	Carton Qty (packs)	Pallet Qty (packs)
--------------	-----------	-----------------	----------	----------------	--------------------	--------------------

### BOX (DRIVER BIT INCLUDED)

MF860P	8.0 x 60	TX40	20	100	6	180
MF875P	8.0 x 75	TX40	35	100	4	180
MF8100P	8.0 x 100	TX40	60	50	6	300
MF1060P	10.0 x 60	TX50	10	50	6	300
MF1075P	10.0 x 75	TX50	25	50	6	180
MF10100P	10.0 x 100	TX50	50	50	6	180

TYPE - SKU

SUB TYPE - SKU03

MFT = MAX FIXTURE THICKNESS

\* Please note: 6.0mm diameter bolts have a hex flange head.

## Throughbolts

Zinc



CONCRETE

CORROSION RATING



Clean, dry & low humidity environments



A versatile through fixing for use in a wide range of anchoring applications into concrete.

NOTE : If no torque wrench is available, tighten the nut 3 to 4 full turns from finger tight.

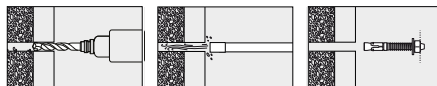

Drill hole through frame into substrate

Clean out the hole

Set the nut just below chamfer



Hammer anchor through fixture

Tighten to the recommended torque

**292-1115KG**

Technical Data

Substrate	Concrete ≥25N/mm <sup>2</sup>				
Size Ø (mm)	M8	M10	M12	M16	M20
Socket Size (mm)	13	17	19	24	30
Drill Hole Ø (mm)	8.0	10.0	12.0	16.0	20.0
Fixture Clearance Hole Ø (mm)	9.0	12.0	14.0	18.0	22.0
Embedment Depth (mm)	35	45	50	65	80
Min. Drill Hole Depth (mm)	45	50	60	75	90
Centre Spacing (mm)	110	140	150	200	240
Edge Distance (mm)	55	70	75	100	120
Min. Structure Thickness (mm)	70	90	100	130	160
Rec. Tightening Torque (Nm)	15	30	45	100	160
Rec. Tensile Load (kN)	2.92	4.11	7.25	8.08	11.15
Max. Rec. Load (kg)	292	411	725	808	1115

Product Code Thread Ø x L (mm) Max. Fixture Thickness (mm) Pack Qty (pcs) Carton Qty (packs) Pallet Qty (packs)

BOX					
0850TB	M8 x 50	5	100	8	216
0865TB	M8 x 65	10	100	6	162
0880TB	M8 x 80	25	50	10	360
08100TB	M8 x 100	45	50	6	162
08130TB	M8 x 130	75	50	6	162
1065TB	M10 x 65	5	50	8	216
1075TB	M10 x 75	10	50	6	162
10100TB	M10 x 100	35	50	6	162
10120TB	M10 x 120	55	50	6	162
1280TB	M12 x 80	5	50	6	162
12100TB	M12 x 100	25	25	6	162
12120TB	M12 x 120	45	25	6	162
12140TB	M12 x 140	65	25	6	162
12180TB	M12 x 180	105	25	6	162
16105TB	M16 x 105	5	25	6	162
16125TB	M16 x 125	20	25	6	162
16150TB	M16 x 150	45	15	6	162
16175TB	M16 x 175	70	15	6	162
20130TB	M20 x 130	5	10	6	162
20160TB	M20 x 160	30	10	6	162
20215TB	M20 x 215	85	8	6	162

TYPE - THB SUB TYPE - THB01

TIMBAG					
0850TBB	M8 x 50	5	40	5	600
10100TBB	M10 x 100	35	18	5	600
12100TBB	M12 x 100	25	12	5	600
12140TBB	M12 x 140	65	10	5	600
12180TBB	M12 x 180	105	8	5	600

TYPE - BAG SUB TYPE - BAG29

TIMPAC					
0850TBP	M8 x 50	5	4	10	-
10100TBP	M10 x 100	35	2	10	-
12100TBP	M12 x 100	25	2	10	-
12140TBP	M12 x 140	65	2	10	-

TYPE - PAK SUB TYPE - PAK48

## Drop in Anchors

Zinc

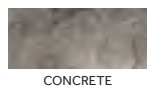

CONCRETE

CORROSION RATING



Clean, dry & low humidity environments

An internally threaded hammer set expansion anchor for heavy duty anchoring into concrete.

Standard version can be inserted below the surface. Also known as wedge anchors.

**129-935KG**

## Lipped Drop in Anchors

Zinc



CONCRETE

CORROSION RATING



Clean, dry & low humidity environments

An internally threaded hammer set expansion anchor for heavy duty anchoring into concrete.

Lip prevents the anchor being inserted too far. Also known as wedge anchors.

**222-316KG**

Technical Data

Substrate	Concrete ≥25N/mm <sup>2</sup>			
Size Ø (mm)	M6	M8	M10	M12
Drill Hole Ø (mm)	8.0	10.0	12.0	16.0
Embedment Depth (mm)	25	30	40	50
Min Drill Hole Depth (mm)	25	30	40	50
Centre Spacing (mm)	75	90	120	150
Edge Distance (mm)	75	90	120	150
Min Structure Thickness (mm)	100	100	100	125
Rec. Tightening Torque (Nm)	3	5	7	16
Rec. Tensile Load (kN)	1.29	2.22	4.65	9.35
Max Rec. Load (kg)	129	222	465	935

Product Code	Thread Ø x L (mm)	Anchor Length (mm)	Min. HD (mm)	FCH Ø (mm)	Pack Qty (pcs)	Carton Qty (packs)	Pallet Qty (packs)
BOX							
06WA	M6 x 10	25	25	8.0	100	20	1380
08WA	M8 x 14	30	30	10.0	100	12	648
10WA	M10 x 15	40	40	12.0	50	12	816
12WA	M12 x 20	50	50	14.0	50	6	324

TYPE - WGA SUB TYPE - WGA01 HD = Hole Depth. FCH = Fixture Clearance Hole.

Technical Data

Substrate	Concrete ≥25N/mm <sup>2</sup>	
Size Ø (mm)	M8	M10
Drill Hole Ø (mm)	10.0	12.0
Embedment Depth (mm)	30	30
Min Drill Hole Depth (mm)	30	30
Centre Spacing (mm)	90	90
Edge Distance (mm)	90	90
Min Structure Thickness (mm)	100	100
Rec. Tightening Torque (Nm)	5	7
Rec. Tensile Load (kN)	2.22	3.16
Max Rec. Load (kg)	222	316

Product Code	Thread Ø x L (mm)	Anchor Length (mm)	Min. HD (mm)	FCH Ø (mm)	Pack Qty (pcs)	Carton Qty (packs)	Pallet Qty (packs)
BOX							
08LWA	M8 x 14	30	30	10	100	12	720
1030LLWA	M10 x 15	30	30	12	50	12	816

TYPE - WGA SUB TYPE - WGA01 HD = Hole Depth. FCH = Fixture Clearance Hole.

## Setting Tool



Setting tool for use with standard and lipped drop in anchors.

\* To suit 40mm anchor length

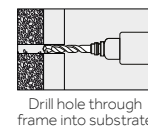

Drill hole through frame into substrate

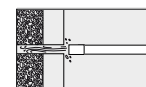

Clean out the hole



Place the anchor into the hole

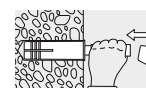

Insert setting tool and hammer to set

Product Code	To Fit Thread Ø (mm)	Pack Qty (pcs)	Carton Qty (packs)	Pallet Qty (packs)
BAG				
06WAS	M6	1	10	360
08WAS	M8	1	10	360
10WAS*	M10	1	10	360
12WAS	M12	1	10	360

TYPE - WGA SUB TYPE - WGA01





## Forged Eye & Shield

**Yellow**

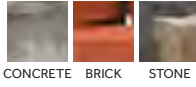

**CORROSION RATING**  
**1** 2 3 4 5

Clean, dry & low humidity environments

Complete with three segment shield anchors, a forged eye for extra strength.

Ideal for attaching ropes or cables.

- Yellow passivated for

improved corrosion resistance

- Nut and washer included
- Grade 4.8

Please see previous page for shield installation

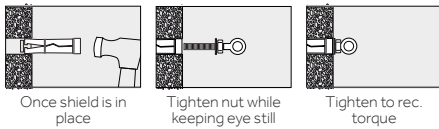

Product Code	Thread Ø x L (mm)	Eye Ø (mm)	Pack Qty (pcs)	Carton Qty (packs)	Pallet Qty (packs)
<b>TIMBAG</b>					
06EYEB	M6 x 50	8.0	18	5	870
08EYEB	M8 x 60	10.0	14	5	870
TYPE - BAG			SUB TYPE - BAG30		

Product Code	Thread Ø x L (mm)	Eye Ø (mm)	Pack Qty (pcs)	Carton Qty (packs)	Pallet Qty (packs)
<b>TIMPAC</b>					
06EYEP	M6 x 50	8	2	10	-
08EYEP	M8 x 60	10	2	10	-
10EYEP	M10 x 73	12	2	10	-
TYPE - PAK			SUB TYPE - PAK49		

## Forged Eye Only

**Yellow**



**CORROSION RATING**  
**1** 2 3 4 5

Clean, dry & low humidity environments

A useful threaded eye bolt for attaching ropes or cables. Manufactured using a forging process for extra strength.

Sold without shield anchor.

Product Code	Thread Ø x L (mm)	Eye Ø (mm)	Pack Qty (pcs)	Carton Qty (packs)	Pallet Qty (packs)
<b>BOX</b>					
06EYE	M6 x 50	8	50	18	648
08EYE	M8 x 60	10	50	10	300
10EYE	M10 x 73	12	50	8	240
12EYE	M12 x 95	16	25	8	240
TYPE - SHA			SUB TYPE - SHA01		

## Forged Hook & Shield

**Yellow**

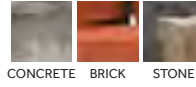

**CORROSION RATING**  
**1** 2 3 4 5

Clean, dry & low humidity environments

Manufactured using a forging process, to prevent opening out the hook when load is applied. Complete with three segment shield anchor.

- Yellow passivated for

improved corrosion resistance

- Nut and washer included
- Grade 4.8

Please see previous page for shield installation

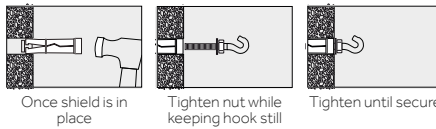

Product Code	Thread Ø x Length (mm)	Pack Qty (pcs)	Carton Qty (packs)	Pallet Qty (packs)
<b>TIMBAG</b>				
06HOOKB	M6 x 50	20	5	870
08HOOKB	M8 x 60	14	5	870
TYPE - BAG		SUB TYPE - BAG30		

Product Code	Thread Ø x Length (mm)	Pack Qty (pcs)	Carton Qty (packs)	Pallet Qty (packs)
<b>TIMPAC</b>				
06HOOKP	M6 x 50	2	10	-
08HOOKP	M8 x 60	2	10	-
TYPE - PAK		SUB TYPE - PAK49		

## Forged Hook Only

**Yellow**



**CORROSION RATING**  
**1** 2 3 4 5

Clean, dry & low humidity environments

A useful threaded hook bolt for attaching ropes or cables. Manufactured using a forging process for extra strength preventing the hook from opening out when the load is applied.

Sold without shield anchor.

Product Code	Thread Ø x L (mm)	Pack Qty (pcs)	Carton Qty (packs)	Pallet Qty (packs)
<b>BOX</b>				
06HOOK	M6 x 50	50	18	648
08HOOK	M8 x 60	50	10	300
10HOOK	M10 x 73	50	6	216
12HOOK	M12 x 90	25	8	240
TYPE - SHA			SUB TYPE - SHA01	

## Chemical Anchor Studs

**Hot Dipped Galvanised**

**Zinc**

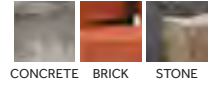

**HDG**

**CORROSION RATING**  
**1** 2 3 **4** 5

Urban & industrial areas with a moderate salt atmosphere

**Zinc**

**CORROSION RATING**  
**1** 2 3 4 5

Clean, dry & low humidity environments

Designed for use when fixing with chemical resins.

- Chisel point, prevents the rod turning when tightening
- External hex drive
- Embedment depth mark
- Zinc plated and passivated or galvanised
- Grade 5.8

### Technical Data

Size Ø (mm)	M8	M10	M12	M16	M20
Drill Hole Ø (mm)	10	12	14	18	24
Fixture Clearance Hole Ø (mm)	10	12	14	18	24

Product Code	Size (mm)	MFT (mm)	Min. ED (mm)	Pack Qty (pcs)	Carton Qty (packs)	Pallet Qty (packs)
<b>BOX (NUT SETTER INCLUDED)</b>						
<b>Hot Dipped Galvanised</b>						
08110CSG	M8 x 110	13	80	10	30	2400
10130CSG	M10 x 130	20	90	10	20	1040
12160CSG	M12 x 160	25	110	10	10	600
16190CSG	M16 x 190	35	125	10	8	304
20270CSG	M20 x 270	55	170	4	9	378
TYPE - CHZ			SUB TYPE - CHZ01			

Product Code	Size (mm)	MFT (mm)	Min. ED (mm)	Pack Qty (pcs)	Carton Qty (packs)	Pallet Qty (packs)
<b>Zinc</b>						
08110CS	M8 x 110	13	80	10	30	2400
10130CS	M10 x 130	20	90	10	20	1040
12160CS	M12 x 160	25	110	10	10	600
16190CS	M16 x 190	35	125	10	8	304
20270CS	M20 x 270	55	170	4	9	378
TYPE - CHZ			SUB TYPE - CHZ01			

Product Code	Size (mm)	MFT (mm)	Min. ED (mm)	Pack Qty (pcs)	Carton Qty (packs)	Pallet Qty (packs)
<b>TIMPAC</b>						
<b>Zinc</b>						
08110CSP	M8 x 110	13	80	2	10	-
10130CSP	M10 x 130	20	90	2	10	-
12160CSP	M12 x 160	25	110	2	10	-
TYPE - PAK			SUB TYPE - PAK50			

MFT = Max Fixture Thickness. Min. ED = Min. Embedment Depth

## Threaded Bar

Grade 4.8 & 8.8 available in zinc.

Stainless steel also available.

See pages 57

### Chemical Resin & Accessories



### Chemical Resin



TIMCO's chemical resin range offers an effective anchoring system for fixing into concrete and masonry. The stress-free nature of this solution gives greater flexibility when anchoring closer to a substrate edge such as balustrade installation.

- Ready to use
- Uses standard tools
- Less wastage
- No leakage
- Faster & easier to use
- Low extrusion force
- T-Flow™ nozzle included
- Close edge & axial spacing

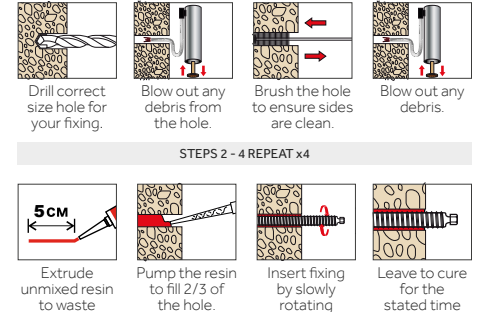

Technical Data							
Resin Type	Rec. Tensile Load (Kn) (Performance Data Concrete >25N/Mm2)						
Stud (5.8 Grade) Size	M8	M10	M12	M16	M20	M24	
PE	4.9	7.5	10.6	12.3	19.9	27.4	
PESF	5.8	8.1	11.6	19.8	29.1	33.1	
VESF	9.1	13.8	19.4	26.8	35.7	44.6	
Embedment Depth (mm)	80	90	110	125	170	210	
Cartridge Size	Approx Holes Per Cartridge (At Standard Embedment Depth)						
300ml	66	41	25	13	5	3	
410ml	92	57	34	18	8	4	
Gel & Cure Times	VESF / PESF / PE						
Base Material (°C)	35	25	15	5	-5	-10*	
Typical Gel Time (mins)	3	5	9	20	40	50	
Min. Load Time (mins)	20	30	60	90	180	240	

\*Resin temperature must be at least 20°C

### Vinylester Styrene Free

NEW SIZE



- European Technically Approved (ETA) low odour resin used in safety critical fixing
- For enclosed, poorly ventilated, damp and wet environments
- High performance resin with consistent results
- Offering exceptional tensile strength in a range of environments and conditions

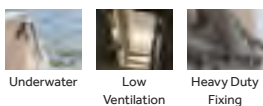
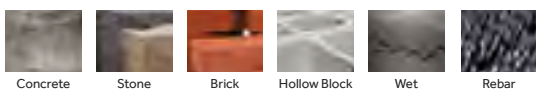

Product Code	Size	Approval	Carton Qty (packs)	Pallet Qty (packs)
<b>CARTRIDGE (T-FLOW NOZZLE INCLUDED)</b>				
VESF300	300ml	ETA / WRAS / CE	12	684
VESF410	410ml	ETA / WRAS / CE	12	672
TYPE - CPE			SUB TYPE - CPE01	

### Polyester Styrene Free



- European Technically Approved (ETA) low odour resin used in non-safety critical fixing
- For enclosed or poorly ventilated environments

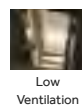
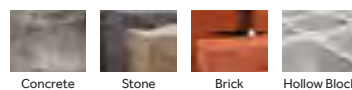

Product Code	Size	Approval	Carton Qty (packs)	Pallet Qty (packs)
<b>CARTRIDGE (T-FLOW NOZZLE INCLUDED)</b>				
PESF310	300ml	ETA / CE	12	684
TYPE - CPE			SUB TYPE - CPE01	

### Polyester



- An economic resin ideal for day to day non-safety critical applications
- For areas that are well ventilated at the time of installation

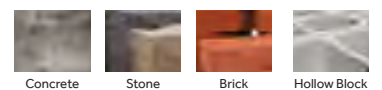

Product Code	Size	Approval	Carton Qty (packs)	Pallet Qty (packs)
<b>CARTRIDGE (T-FLOW NOZZLE INCLUDED)</b>				
PE310	300ml	ETA/CE	12	684
PE410	410ml	ETA/CE	12	672
TYPE - CPE			SUB TYPE - CPE01	

### Professional Resin Gun

Up to 410ml Cartridges



12:1 trigger ratio

- A 64mm heavy duty co-axial resin applicator gun.
- Twin 5mm gripper plates providing four point contact with the plunger rod.
- Non-drip mechanism

Product Code	Pack Qty (pcs)	Carton Qty (packs)
RESINGUN	1	10
TYPE - CAC	SUB TYPE - CAC01	

PACK		
RESINGUN	1	10
TYPE - CAC	SUB TYPE - CAC01	

### Professional Sealant Gun

Up to 380ml Cartridges

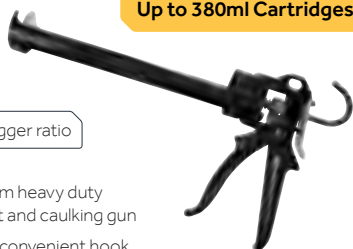

12:1 trigger ratio

- A 48mm heavy duty sealant and caulking gun
- With a convenient hook end for hanging
- Swivel action barrel for easy application into tight corners
- Patented non-drip mechanism

Product Code	Pack Qty (pcs)	Carton Qty (packs)
PROGUN	1	12
TYPE - CAC	SUB TYPE - CAC01	

PACK		
PROGUN	1	12
TYPE - CAC	SUB TYPE - CAC01	

### Skeleton Gun

Up to 380ml Cartridges

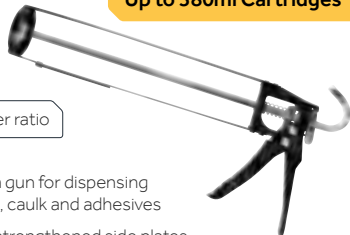

7:1 trigger ratio

- A 48mm gun for dispensing sealants, caulk and adhesives
- 2.3mm strengthened side plates and a 6mm gripper plate
- Convenient hook end for hanging
- Riveted front cap for reinforcement and integrated cleaning pin

Product Code	Pack Qty (pcs)	Carton Qty (packs)
SKELGUN	1	24
TYPE - CAC	SUB TYPE - CAC01	

PACK		
SKELGUN	1	24
TYPE - CAC	SUB TYPE - CAC01	

### Resin Accessories



T-Flow Nozzles      Blow-out Pump      Cleaning Brush

Product Code	Size (mm)	Pack Qty (pcs)	Carton Qty (packs)
--------------	-----------	----------------	--------------------

PACK			
<b>T-Flow Mixing Nozzle</b>			
TNOZ	To Suit All Resin Cartridges	12	100
<b>Blow-Out Pump</b>			
PUMP	N/A	1	24
<b>Hole Cleaning Brush</b>			
B13	Ø 13.0	10	50
B15	Ø 15.0	10	50
B22	Ø 22.0	10	50
TYPE - CAC	SUB TYPE - CAC02		

### Plastic Sleeves



Brick      Hollow Brick

Assists with fixing into hollow block or brick with chemical resins  
To suit M8-M10 studs

Product Code	Size (mm)	To Suit Stud Ø (mm)	Drill Hole Size (mm)	Pack Qty (pcs)	Carton Qty (packs)
--------------	-----------	---------------------	----------------------	----------------	--------------------

BAG					
1585CPS	16.0 x 85	M8 - M10	16.0 x 90	100	25
15130CPS	16.0 x 130	M8 - M10	16.0 x 135	100	25
TYPE - CAC	SUB TYPE - CAC02				

# TIMCO Adhesives & Building Chemicals

We offer a comprehensive range of tapes, adhesives, glues, sealants, foams, maintenance sprays, paints, waxes and fillers

See pages 180





# Nails

## Collated Nails & Fuel Cells

FirmaHold Clipped Head Nails	105
FirmaHold Brad Nails	106
FirmaHold Fuel Cells	107
Paslode Fuel Cells	108
Paslode Nails	108
Paslode Brad Nails	108
Paslode Twisted Shank Nails	108
FirmaHold Staples & Staplers	109

## Loose Nails

Bright Loose Nails	111
Galvanised Loose Nails	111
Sherardised Loose Nails	113
Copper Loose Nails	113
Aluminium Loose Nails	113
Stainless Steel Loose Nails	114
Masonry Nails	114
Upholstery Nails & Cut Tacks	114
Polymer Headed Nails & Pins	115



# FirmaHold

## Collated Nails & Fuel Cells

Designed for use in cordless gas & pneumatic nailers

**FirmaHold collated nails and fuel cells are designed for the fixing of a wide range of timber applications, using various types of pneumatic and cordless nailing tools.**

FirmaHold collated nails are manufactured to conform with EN792-13:2000 7.2.1a and comply with the requirements of all major tool manufacturers. FirmaHold offers a comprehensive range of sizes including, 18 gauge and 16 gauge brads and clipped head nails, available in a choice of rust protection, including stainless steel. Offered either with or without fuel cells, FirmaHold collated nails provide a first class solution to a wide range of timber applications.

### What Is Eurocode 5?

Eurocode 5 is the new regulation for Timber Structures that replaces previous building regulations and stipulates that all nails must be manufactured to comply with BS EN: 14592.

### What is a Service Class?

Within Eurocode 5, structural fasteners must comply to certain levels of rust protection, which are graded by Service Classes.

**Class 1** - For Internal use or where the moisture content of the timber will not exceed 12%. Fasteners conforming to Service Class 1 do not require any rust protective coatings.

**Class 2** - For covered exterior applications where the timber is protected from direct wetting or where the timber moisture content does not exceed 20%. Nails conforming to Service Class 2 must have a minimum of 12 µm of Zinc.

**Class 3** - External application and over 43 microns of hot dipped galvanised protection.

## Clipped Head Nails

Suitable for use in 34° cordless and pneumatic clipped head first fix nailer.

- Diamond Point for maximum penetration.
- Clipped head to increase the number of nails per strip and therefore reduce tool loading times.
- High quality paper to increase performance and reduce risk of nail jam.
- Shank Design:

Plain Shank: Low penetration resistance into all materials.

Part Ring Shank: Partially ringed shank to provide low penetration resistance and improved pull-out resistance.

Ring Shank: Provides a secure fixing with high pull-out resistance.

## Brad Nails

Suitable for use in cordless & pneumatic 16 & 18 gauge second fix brad nailer. Nail & fuel cell packs.

- Sold in one-piece strengthened branded boxes.
- Diamond Point for maximum penetration.
- T Head to give concealed fixings.
- Shank Design: Low penetration resistance into all materials.

### Bright

Suitable for indoor applications. Conforms to Eurocode 5 and service class 1.

### FirmaGalv

Electro galvanised plating, suitable for indoor applications. Conforms to Eurocode 5 and service class 1.

### FirmaGalv +

Electro galvanised plating with 12 microns of zinc (Min), suitable for indoor, and covered outdoor applications. Conforms to Eurocode 5 and service class 2.

### Hot Dipped Galvanised

Suitable for indoor and outdoor applications. Conforms to Eurocode 5 and service class 3.

### A2 Austenitic Stainless Steel

A2 for external applications. Conforms to Eurocode 5 and service class 3.

## FirmaHold Collated Clipped Head Nails

For use in structural applications using high quality paper collation for reduced nail jams. Various levels of rust protection to comply with building regulations and meets with all service classes.

- 34° collation angle
- Diamond Point for maximum penetration
- Clipped head to increase the number of nails per strip and therefore reduce tool loading times



EN 14592:2008



**First Fix Applications**

### Trade Pack

Shank Ø (mm)	Length (mm)	Shank Type	Service Class
<b>Bright</b>			
2.8	50	Ring	1
2.8	63	Ring	1
3.1	75	Ring	1
3.1	90	Plain	1

<b>FirmaGalv</b>			
2.8	50	Ring	1
2.8	63	Ring	1
3.1	75	Ring	1
3.1	90	Plain	1

<b>FirmaGalv +</b>			
2.8	50	Ring	2
2.8	63	Ring	2
3.1	63	Ring	2
3.1	75	Ring	2
3.1	90	Plain	2
3.1	90	Part Ring	2

<b>Hot Dipped Galvanised</b>			
2.8	50	Ring	3
2.8	63	Ring	3
3.1	75	Ring	3
3.1	90	Plain	3

### Retail Pack

Shank Ø (mm)	Length (mm)	Shank Type	Service Class
<b>FirmaGalv</b>			
2.8	50	Ring	1
2.8	63	Ring	1
3.1	75	Ring	1
3.1	90	Plain	1

<b>A2 Stainless Steel</b>			
2.8	50	Ring	3
2.8	63	Ring	3
3.1	80	Ring	3



### With Fuel Cells

Product Code	Fuel Cell Qty	Pack Qty (pcs)	Carton Qty (pcs)	Pallet Qty (packs)
CBRT50G	3	3,300	2	72
CBRT63G	3	3,300	2	72
CBRT75G	2	2,200	2	72
CBRT90G	2	2,200	2	72

TYPE - FRT SUB TYPE - FRT01

CFGT50G	3	3,300	2	72
CFGT63G	3	3,300	2	72
CFGT75G	2	2,200	2	72
CFGT90G	2	2,200	2	72

TYPE - FRT SUB TYPE - FRT01

CPLT50G	3	3,300	2	72
CPLT63G	3	3,300	2	72
CPLT63RG	3	3,300	2	72
CPLT75G	2	2,200	2	72
CPLT90G	2	2,200	2	72
CPLT90PG	2	2,200	2	72

TYPE - FRT SUB TYPE - FRT01

CHDT50G	3	3,300	2	72
CHDT63G	3	3,300	2	72
CHDT75G	2	2,200	2	72
CHDT90G	2	2,200	2	72

TYPE - FRT SUB TYPE - FRT01



### No Fuel Cells

Product Code	Pack Qty (pcs)	Carton Qty (pcs)	Pallet Qty (packs)
CBRT50	3,300	2	72
CBRT63	3,300	2	72
CBRT75	2,200	2	72
CBRT90	2,200	2	72

TYPE - FRT SUB TYPE - FRT01

CFGT50	3,300	2	72
CFGT63	3,300	2	72
CFGT75	2,200	2	72
CFGT90	2,200	2	72

TYPE - FRT SUB TYPE - FRT01

CPLT50	3,300	2	72
CPLT63	3,300	2	72
CPLT63R	3,300	2	72
CPLT75	2,200	2	72
CPLT90	2,200	2	72
CPLT90P	2,200	2	72

TYPE - FRT SUB TYPE - FRT01

-	-	-	-
-	-	-	-
-	-	-	-
-	-	-	-



### With Fuel Cells

Product Code	Fuel Cell Qty	Pack Qty (pcs)	Carton Qty (pcs)	Pallet Qty (packs)
CFGR50G	1	1,100	4	192
CFGR63G	1	1,100	4	192
CFGR75G	1	1,100	4	144
CFGR90G	1	1,100	4	144

TYPE - FRT SUB TYPE - FRT01

CSSR50G	1	1,100	4	192
CSSR63G	1	1,100	4	192
CSSR80G	1	1,100	4	144

TYPE - FRT SUB TYPE - FRT01



### No Fuel Cells

Product Code	Pack Qty (pcs)	Carton Qty (pcs)	Pallet Qty (packs)
CFGR50	1,100	4	192
CFGR63	1,100	4	192
CFGR75	1,100	4	144
CFGR90	1,100	4	144

TYPE - FRT SUB TYPE - FRT01

CSSR50	1,100	4	192
CSSR63	1,100	4	192
CSSR80	1,100	4	144

TYPE - FRT SUB TYPE - FRT01

## FirmaHold Collated Brad Nails

Ideal for internal applications such as skirting, architrave, tongue and groove fixing, with a T head. Also available in stainless steel for hardwood applications.

- Available in straight or 20° collation angle
- T Head to give concealed fixings
- Shank Design: Low penetration resistance into all materials



Second Fix Applications

### Straight Brads

Gauge	Length (mm)	Nails Per Strip	Collation Angle
<b>Galvanised</b>			
16	19	50	Straight
16	25	50	Straight
16	32	50	Straight
16	38	50	Straight
16	45	50	Straight
16	50	50	Straight
16	64	50	Straight
18	16	100	Straight
18	19	100	Straight
18	25	100	Straight
18	32	100	Straight
18	38	100	Straight
18	45	100	Straight
18	50	100	Straight

### A2 Stainless Steel

16	25	50	Straight
16	38	50	Straight
16	50	50	Straight
16	64	50	Straight
18	19	100	Straight
18	25	100	Straight
18	32	100	Straight
18	38	100	Straight
18	50	100	Straight

### Angled Brads

Gauge	Length (mm)	Nails Per Strip	Collation Angle
<b>Galvanised</b>			
16	32	50	20°
16	38	50	20°
16	45	50	20°
16	50	50	20°
16	64	50	20°

### A2 Stainless Steel

16	38	50	20°
16	50	50	20°
16	64	50	20°

### With Fuel Cells

Product Code	Fuel Cell Qty	Pack Qty (pcs)	Carton Qty (packs)
BG1619G	2	2,000	10
BG1625G	2	2,000	10
BG1632G	2	2,000	10
BG1638G	2	2,000	10
BG1645G	2	2,000	10
BG1650G	2	2,000	10
BG1664G	2	2,000	10
TYPE - FRT			
-	-	-	-
-	-	-	-
-	-	-	-
-	-	-	-
-	-	-	-
-	-	-	-
-	-	-	-
-	-	-	-
-	-	-	-

BSS1625G	2	2,000	10
BSS1638G	2	2,000	10
BSS1650G	2	2,000	10
BSS1664G	2	2,000	10
TYPE - FRT			
-	-	-	-
-	-	-	-
-	-	-	-
-	-	-	-
-	-	-	-
-	-	-	-

### With Fuel Cells

Product Code	Fuel Cell Qty	Pack Qty (pcs)	Carton Qty (packs)
ABG1632G	2	2,000	10
ABG1638G	2	2,000	10
ABG1645G	2	2,000	10
ABG1650G	2	2,000	10
ABG1664G	2	2,000	10
TYPE - FRT			
-	-	-	-

ABSS1638G	2	2,000	10
ABSS1650G	2	2,000	10
ABSS1664G	2	2,000	10
TYPE - FRT			
-	-	-	-

### No Fuel Cells

Product Code	Pack Qty (pcs)	Carton Qty (packs)	Pallet Qty (packs)
BG1619	2,000	12	768
BG1625	2,000	12	576
BG1632	2,000	12	576
BG1638	2,000	12	576
BG1645	2,000	12	576
BG1650	2,000	12	576
BG1664	2,000	12	576
TYPE - FRT			
BG1816	5,000	20	1080
BG1819	5,000	20	1080
BG1825	5,000	20	1080
BG1832	5,000	12	648
BG1838	5,000	12	648
BG1845	5,000	12	648
BG1850	5,000	12	648
TYPE - FRT			

BSS1625	2,000	12	768
BSS1638	2,000	12	576
BSS1650	2,000	12	576
BSS1664	2,000	12	768
TYPE - FRT			
BSS1819	5,000	20	1,280
BSS1825	5,000	20	1,280
BSS1832	5,000	12	648
BSS1838	5,000	12	648
BSS1850	5,000	12	648
TYPE - FRT			

### No Fuel Cells

Product Code	Pack Qty (pcs)	Carton Qty (packs)	Pallet Qty (packs)
ABG1632	2,000	6	396
ABG1638	2,000	6	396
ABG1645	2,000	6	396
ABG1650	2,000	6	396
ABG1664	2,000	6	396
TYPE - FRT			
-	-	-	-

ABSS1638	2,000	6	396
ABSS1650	2,000	6	396
ABSS1664	2,000	6	396
TYPE - FRT			
-	-	-	-



# FirmaHold Fuel Cell Packs



## Finishing Nailer Fuel Cell

For use with the second fix brad nailer. The cleaned propane and butane gas with a synthetic oil gives a clean combustion and reduces tool wear.

- Manufactured to European standards
- Cleaned propane and butane gas for cleaner combustion and to improve the working environment
- Fully synthetic oil for reduced carbon deposition
- High quality propellant to prevent leakage and increase shelf life
- Gas filled in accordance with European Regulations (75/324/EWG)



Product Code	Volume (ml)	Pack Qty (pcs)	Carton Qty (packs)
<b>BLISTER PACK</b>			
BFC TYPE - FRT	30	2	6 SUB TYPE - FRT03

## Framing Nailer Fuel Cell

For use with the clipped head first fix nailer. The cleaned propane and butane gas with a synthetic oil gives a clean combustion and reduces tool wear.

- Manufactured to European standards
- Cleaned propane and butane gas for cleaner combustion and to improve the working environment
- Fully synthetic oil for reduced carbon deposition
- High quality propellant to prevent leakage and increase shelf life
- Gas filled in accordance with European Regulations (75/324/EWG)



Product Code	Volume (ml)	Pack Qty (pcs)	Carton Qty (packs)
<b>BLISTER PACK</b>			
CFC TYPE - FRT	80	2	6 SUB TYPE - FRT03

## How to Guide

- Remove dosage valve and transit cap
- Separate the dosage valve from the transit cap
- Tilt the dosage valve forward
- Locate the front of the dosage valve on the fuel cell
- Click the back of the fuel cell down one click firmly then down fully

# Paslode Fuel Cell Packs



## IM65 Fuel Cell

Mini gas fuel cell with added lubricant for cordless finish nailers and staplers.

- Suitable for IM65/IM65A, IM50 gas finishing nailers and IM200 Stapler



Product Code	Volume (ml)	Pack Qty (pcs)	Carton Qty (packs)
<b>BLISTER PACK</b>			
PAS300341 TYPE - PFC	30	2	10 SUB TYPE - PFC01

## IM350+ Fuel Cell

Gas fuel cell with added lubricant for IM350+ and IM350 cordless framing nailers.

- Suitable for IM350+ and IM350 Impulse framing nailers



Product Code	Volume (ml)	Pack Qty (pcs)	Carton Qty (packs)
<b>BLISTER PACK</b>			
PAS300346 TYPE - PFC	80	2	10 SUB TYPE - PFC01

## IM360Ci Fuel Cell

Gas fuel cell with added lubricant for Series-i cordless framing and positive placement nailers.

- Suitable for IM90i and IM360Ci Impulse framing nailers
- Patented lubricant included in gas mixture to ensure optimum performance of the tool at all times
- Patented dosing valve works with fuel injection system of the tool to ensure correct dosage for ambient temperature
- Fuel cell capacity - 1,250 shots at optimum temperature (between -15°C & +49°C)



Product Code	Volume (ml)	Pack Qty (pcs)	Carton Qty (packs)
<b>BLISTER PACK</b>			
PAS300348 TYPE - PFC	80	1	10 SUB TYPE - PFC01



## Collated Nail & Fuel Pack



### IM360Ci Nail & Fuel Packs

Product Code	Dia. (mm)	Length (mm)	Head Type	Shank Type	Service Class	Fuel Cell Qty (pcs)	Pack Qty (pcs)	Carton Qty (packs)
<b>TRADE PACK - WITH FUEL CELLS</b>								
<b>Bright</b>								
PAS141083	2.8	51	Fully Round	Ring	1	3	3,300	10
PAS141078	2.8	63	Fully Round	Ring	1	3	3,300	10
PAS141081	3.1	75	Fully Round	Ring	1	2	3,300	10
PAS141082	3.1	90	Fully Round	Ring	1	2	3,300	10
PAS141076	3.1	90	Fully Round	Plain	1	2	3,300	10
<b>Galvanised +</b>								
PAS141075	2.8	51	Fully Round	Ring	2	3	3,300	10
PAS141071	2.8	63	Fully Round	Ring	2	3	3,300	10
PAS141073	3.1	63	Fully Round	Ring	2	2	3,300	10
PAS141072	3.1	75	Fully Round	Ring	2	2	3,300	10
PAS141074	3.1	90	Fully Round	Ring	2	2	3,300	10
PAS141070	3.1	90	Fully Round	Plain	2	2	3,300	10
<b>Hot Dipped Galvanised</b>								
PAS140631	2.8	63	Fully Round	Ring	3	3	3,300	10
PAS140625	3.1	63	Fully Round	Ring	3	2	3,300	10
PAS140630	3.1	75	Fully Round	Ring	3	2	3,300	10
PAS140628	3.1	90	Fully Round	Ring	3	2	3,300	10
PAS140629	3.1	90	Fully Round	Plain	3	2	3,300	10
TYPE - PNG					SUB TYPE - PNG01			

<b>RETAIL PACK - WITH FUEL CELLS</b>								
<b>Galvanised +</b>								
PAS141080	2.8	51	Fully Round	Ring	2	1	1,100	10
PAS141079	2.8	63	Fully Round	Ring	2	1	1,100	10
PAS141077	3.1	90	Fully Round	Plain	2	1	1,100	10
<b>A2 Stainless Steel</b>								
PAS140624	2.8	51	Fully Round	Ring	3	1	1,100	10
PAS140626	2.8	63	Fully Round	Ring	3	1	1,100	10
PAS140627	3.1	80	Fully Round	Ring	3	1	1,100	10
<b>A4 Stainless Steel</b>								
PAS140632	2.8	63	Fully Round	Ring	3	1	1,100	10
TYPE - PNG					SUB TYPE - PNG01			

### IM350+ Nail & Fuel Packs

Product Code	Dia. (mm)	Length (mm)	Head Type	Shank Type	Service Class	Fuel Cell Qty (pcs)	Pack Qty (pcs)	Carton Qty (packs)
<b>TRADE PACK - WITH FUEL CELLS</b>								
<b>Bright</b>								
PAS141202	2.8	51	Clipped	Ring	1	3	3,300	10
PAS141208	2.8	63	Clipped	Ring	1	3	3,300	10
PAS141226	3.1	75	Fully Round	Ring	1	2	2,200	10
PAS141233	3.1	90	Fully Round	Plain	1	2	2,200	10
<b>Galvanised +</b>								
PAS141204	2.8	51	Clipped	Ring	2	3	3,300	10
PAS141210	2.8	63	Clipped	Ring	2	3	3,300	10
PAS141221	3.1	63	Clipped	Ring	2	2	2,200	10
PAS141227	3.1	75	Fully Round	Ring	2	2	2,200	10
PAS141234	3.1	90	Fully Round	Plain	2	2	2,200	10
<b>Hot Dipped Galvanised</b>								
PAS141205	2.8	51	Clipped	Ring	3	3	3,300	10
PAS141211	2.8	63	Clipped	Ring	3	3	3,300	10
PAS141222	3.1	63	Fully Round	Ring	3	2	2,200	10
PAS141228	3.1	75	Fully Round	Ring	3	2	2,200	10
PAS141236	3.1	90	Fully Round	Uni Lock	3	2	2,200	10
PAS141235	3.1	90	Fully Round	Plain	3	2	2,200	10
TYPE - PNG					SUB TYPE - PNG02			

<b>RETAIL PACK - WITH FUEL CELLS</b>								
<b>Galvanised +</b>								
PAS141256	2.8	51	Clipped	Ring	2	1	1,100	10
PAS141259	2.8	63	Clipped	Ring	3	1	1,100	10
<b>Hot Dipped Galvanised</b>								
PAS141265	3.1	75	Fully Round	Ring	3	1	1,100	10
PAS141267	3.1	90	Fully Round	Plain	3	1	1,100	10
<b>A2 Stainless Steel</b>								
PAS141257	2.8	51	Clipped	Ring	3	1	1,100	10
PAS141261	2.8	63	Clipped	Ring	3	1	1,100	10
PAS141266	3.1	80	Fully Round	Ring	3	1	1,100	10
TYPE - PNG					SUB TYPE - PNG02			



## Collated Brad & Fuel Packs

### IM65 Straight Brad Nail & Fuel Packs

Product Code	Gauge	Length (mm)	Fuel Cell Qty (pcs)	Pack Qty (pcs)	Carton Qty (packs)
<b>STRAIGHT BRADS - WITH FUEL CELLS</b>					
<b>Electro Galvanised</b>					
PAS921585	16	16	2	2,000	10
PAS921586	16	19	2	2,000	10
PAS921587	16	25	2	2,000	10
PAS921588	16	32	2	2,000	10
PAS921589	16	38	2	2,000	10
PAS921590	16	45	2	2,000	10
PAS921591	16	50	2	2,000	10
PAS921592	16	63	2	2,000	10
TYPE - PBG					SUB TYPE - PBG01
<b>A2 Stainless Steel</b>					
PAS921593	16	25	2	2,000	10
PAS921594	16	38	2	2,000	10
PAS921595	16	50	2	2,000	10
PAS921596	16	63	2	2,000	10
TYPE - PBG					SUB TYPE - PBG01

### IM65A Angled Brad Nail & Fuel Packs

Product Code	Gauge	Length (mm)	Fuel Cell Qty (pcs)	Pack Qty (pcs)	Carton Qty (packs)
<b>ANGLED BRADS - WITH FUEL CELLS</b>					
<b>Electro Galvanised</b>					
PAS300270	16	32	2	2,000	10
PAS300271	16	38	2	2,000	10
PAS300272	16	45	2	2,000	10
PAS300273	16	51	2	2,000	10
PAS300274	16	63	2	2,000	10
TYPE - PBG					SUB TYPE - PBG02
<b>A2 Stainless Steel</b>					
PAS300276	16	32	2	2,000	10
PAS300277	16	38	2	2,000	10
PAS300279	16	50	2	2,000	10
PAS300280	16	64	2	2,000	10
TYPE - PBG					SUB TYPE - PBG02

## Collated Twist Shank & Fuel Pack

### PPN35Ci Twist Shank Nail & Fuel Packs

Product Code	Dia. (mm)	L (mm)	Head Type	Cell Qty (pcs)	Pack Qty (pcs)	Carton Qty (packs)
<b>TRADE PACK - WITH FUEL CELLS</b>						
<b>Electro Galvanised</b>						
PAS141185	3.4	35	Fully Round	2	2,500	10
TYPE - PNG					SUB TYPE - PNG03	

Paslode hardened twist nails can be used for nailing connectors and hangers into solid wood. CE marked & EC5 compliant. The electro galvanised finish is suitable for external protected applications - Service Class 2.

# Staples & Staplers



### Dimensions

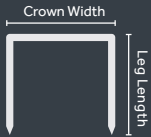

### Finishes/Materials

#### GALVANISED

2 out of 5 corrosion rating. Use in occasionally damp/wet, rural and sheltered areas

#### A2 STAINLESS STEEL

4 out of 5 corrosion rating. Use in urban & industrial areas with a moderate salt atmosphere

## Light Duty Staples

Galvanised



Light duty staples suitable for a wide variety of professional and DIY applications. Ideal for pinning fabrics, decoration and light repairs



- Light duty 0.7mm wire
- 11.35mm crown width
- Flat crown for improved material clamping
- Super sharp chisel point

Product Code	Leg Length (mm)	Pack Qty (pcs)	Carton Qty (packs)	Pallet Qty (packs)
--------------	-----------------	----------------	--------------------	--------------------

#### BOX

Galvanised

377101	6	1,000	200	6,000
377564	8	1,000	200	6,000
377321	10	1,000	200	3,600

TYPE - FRS

SUB TYPE - FRS01

## Heavy Duty Staples

Galvanised

A2 Stainless



Heavy duty staples suitable for a range of professional second fix applications including carpet fitting, roof insulating, woodworking and more.



- Heavy duty 1.2mm wire
- 10.60mm crown width
- Flat crown for improved material clamping
- Super sharp chisel point

### NEW SIZES

Product Code	Leg Length (mm)	Pack Qty (pcs)	Carton Qty (packs)	Pallet Qty (packs)
--------------	-----------------	----------------	--------------------	--------------------

#### BOX

A2 Stainless Steel

377761	8	1,000	100	3000
377023	10	1,000	100	3000
377261	12	1,000	100	3000

Galvanised

377987	6	1,000	100	3000
377258	8	1,000	100	3000
377469	10	1,000	100	3000
377627	12	1,000	100	3000
377861	14	1,000	100	2700

#### BULK BOX

Galvanised

377155	10	5,000	20	600
377188	12	5,000	20	480

TYPE - FRS

SUB TYPE - FRS01

## Divergent Point Staples

Galvanised



Heavy duty divergent point staples are designed to twist during installation creating a stronger fixing. Ideal for wood to wood and second fix applications.



- Heavy duty 1.2mm wire
- 5.95mm crown width
- Flat crown for improved material clamping
- Divergent point for superior retention

Product Code	Leg Length (mm)	Leg Length (inch)	Pack Qty (pcs)	Carton Qty (packs)
--------------	-----------------	-------------------	----------------	--------------------

#### BOX

Galvanised

377963	18	3/4	1,000	40
377666	22	7/8	1,000	40

TYPE - FRS

SUB TYPE - FRS01

## Light Duty Stapler



**124**  
Staple Capacity

**53**  
JT21  
6-10mm

An all steel light duty staple gun, ideal for most professional and DIY applications. Suitable for use with light duty staples.

- Pinch point free design for safe and comfortable grip
- Convenient rear loading magazine
- Also compatible with Type 53, JT21 & A-Type staples

Product Code	Staple Size (mm)	Pack Qty (pcs)	Carton Qty (packs)
370505	6 - 10	1	4

TYPE - FST SUB TYPE - FST01

## Heavy Duty Stapler



**82**  
Staple Capacity

**140**  
T50  
6-14mm

An all steel professional staple gun, ideal for heavy duty applications. Suitable for use with heavy duty staples.

- Adjustable staple depth controller for greater flexibility
- Convenient bottom loading magazine
- Also compatible with Type 140, T50 & G-Type staples

Product Code	Staple Size (mm)	Pack Qty (pcs)	Carton Qty (packs)
370321	6 - 14	1	6

TYPE - FST SUB TYPE - FST01

## Hammer Tacker



**165**  
Staple Capacity

**140**  
T50  
6-10mm

A heavy duty and durable all steel constructed hammer tacker. Ideal for applications requiring rapid and effortless staple installation such as roofing membrane. Suitable for use with heavy duty staples.

- Anti-slip soft grip handle for user comfort
- Complete with convenient rear loading magazine
- Also compatible with Type 140, T50 & G-Type staples

Product Code	Staple Size (mm)	Pack Qty (pcs)	Carton Qty (packs)
370987	6 - 10	1	10

TYPE - FST SUB TYPE - FST01



# Loose Nails



## WHAT IS EUROCODE 5?

Eurocode 5 regulation for Timber Structures replaces previous building regulations and stipulates that all nails must be manufactured to comply with BS EN 14592:2008+A1:2012.

## WHAT IS A SERVICE CLASS?

Within Eurocode 5, structural fasteners must comply to certain levels of rust protection, which are graded by Service Classes.



TIMco nails for structural applications carry CE approval complying with BS EN 14592:2008+A1:2012 or BS EN 14566:2008+A1:2009 for plasterboard systems.

BS EN 14566:2008+A1:2009 mechanical fasteners for gypsum plasterboard systems.

## CLASS 1

For Internal use or where the moisture content of the timber will not exceed 12%. Fasteners conforming to Service Class 1 do not require any rust protective coatings.

## CLASS 2

For covered exterior applications where the timber is protected from direct wetting or where the timber moisture content does not exceed 20%.

## CLASS 3

External application.

### Bright

Suitable for indoor applications.

Conforms to Eurocode 5 and service class 1.

### Galvanised

For medium duty rust protection.

Conforms to Eurocode 5 and service class 2.

### Sherardised

For medium duty rust protection.

Conforms to Eurocode 5 and service class 2.

### Copper

Provides high levels of rust protection.

### Aluminium

Provides high levels of rust protection.





### A2 Austenitic Stainless Steel

A2 for external applications.

Conforms to Eurocode 5 and service class 3.

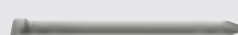
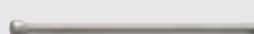

## Bright Loose Nails

Length (mm)	Ø (mm)	Approx. PCS Per 1kg	25kg Box		2.5kg Tub		2.5kg TIMbag		1kg TIMbag		500g TIMbag		TIMpac	
			Each		Each		Each		Carton Qty - 5		Carton Qty - 5		Carton Qty - 10	
			Product Code	Product Code	Product Code	Product Code	Product Code	Product Code	Product Code	Product Code	Product Code	Product Code	Product Code	PCS
<b>Annular Ringshank</b> 			Annular rings provide additional holding power, where increased grip is required.											
20	2.00	1900	BAR20	BAR20T	-	BAR20B	BAR20MB	-	-	-	-	-	-	-
25	2.00	1430	BAR25	BAR25T	-	BAR25B	BAR25MB	BAR25P	150	-	-	-	-	-
30	2.36	840	BAR30	-	-	BAR30B	BAR30MB	-	-	-	-	-	-	-
40	2.36	750	BAR40	BAR40T	-	BAR40B	BAR40MB	-	-	-	-	-	-	-
50	2.65	440	BAR50	BAR50T	-	BAR50B	BAR50MB	BAR50P	50	-	-	-	-	-
65	3.35	230	BAR65	BAR65T	-	BAR65B	BAR65MB	BAR65P	30	-	-	-	-	-
75	3.75	154	BAR75	BAR75T	-	BAR75B	BAR75MB	-	-	-	-	-	-	-
SUB TYPE >			LNA01	TUB01	LBG01	NAG01	NAG01	PAK55						
<b>Round Wire</b> 			General use with full round head for clamping.											
40	2.65	575	BRW40	BRW40T	-	BRW40B	BRW40MB	-	-	-	-	-	-	-
50	2.65	440	BRW50	BRW50T	-	BRW50B	BRW50MB	-	-	-	-	-	-	-
65	3.35	230	BRW65	BRW65T	-	BRW65B	BRW65MB	-	-	-	-	-	-	-
75	3.75	154	BRW75	BRW75T	-	BRW75B	BRW75MB	-	-	-	-	-	-	-
100	4.50	77	BRW100	BRW100T	-	BRW100B	BRW100MB	-	-	-	-	-	-	-
125	5.60	42	BRW125	BRW125T	-	BRW125B	BRW125MB	-	-	-	-	-	-	-
150	6.00	29	BRW150	BRW150T	-	BRW150B	BRW150MB	-	-	-	-	-	-	-
SUB TYPE >			LNA02	TUB02	LBG08	NAG02	NAG02							
<b>Panel Pins</b> 			A light weight nail, commonly used for cabinet making and light duty applications.											
20	1.60	3100	BPP20	-	-	-	BPP20MB	-	-	-	-	-	-	-
25	1.60	2340	BPP25	-	-	BPP25B	BPP25MB	PPB25P	250	-	-	-	-	-
30	1.60	1900	BPP30	-	-	BPP30B	BPP30MB	PPB30P	200	-	-	-	-	-
40	1.60	1590	BPP40	-	-	BPP40B	BPP40MB	PPB40P	100	-	-	-	-	-
50	2.00	770	BPP50	-	-	BPP50B	BPP50MB	PPB50P	50	-	-	-	-	-
SUB TYPE >			LNA03	TUB04	LBG03	NAG03	NAG03	PAK55						
<b>Oval</b> 			Oval head for a concealed finish.											
40	-	940	BON40	BON40T	-	BON40B	BON40MB	-	-	-	-	-	-	-
50	-	470	BON50	BON50T	-	BON50B	BON50MB	-	-	-	-	-	-	-
65	-	230	BON65	-	-	BON65B	BON65MB	-	-	-	-	-	-	-
75	-	125	BON75	-	-	BON75B	BON75MB	-	-	-	-	-	-	-
100	-	64	BON100	-	-	BON100B	BON100MB	-	-	-	-	-	-	-
SUB TYPE >			LNA04	TUB03	LBG02	NAG04	NAG04							
<b>Round Lost Head</b> 			The head can be punched below the surface for a concealed finish.											
40	2.65	760	BLH40	BLH40T	-	BLH40B	BLH40MB	-	-	-	-	-	-	-
50	3.00	360	BLH50	BLH50T	-	BLH50B	BLH50MB	-	-	-	-	-	-	-
65	3.35	240	BLH65	BLH65T	-	BLH65B	BLH65MB	-	-	-	-	-	-	-
SUB TYPE >			LNA05	TUB05	LBG04	NAG05	NAG05							
<b>Cut Clasp</b> 			Cut clasps nails provide a more traditional fixing into timber.											
50	-	286	BCN50	-	-	BCN50B	-	-	-	-	-	-	-	-
65	-	171	BCN65	-	-	BCN65B	-	-	-	-	-	-	-	-
75	-	103	BCN75	-	-	BCN75B	BCN75MB	-	-	-	-	-	-	-
100	-	48	BCN100	BCN100T	-	BCN100B	-	-	-	-	-	-	-	-
SUB TYPE >			LNA06	TUB06	LBG05	NAG06	NAG06							
<b>Cut Flooring Brads</b> 			A traditional nail used for fixing floor boards.											
50	-	264	CFB50	-	-	CFB50B	-	-	-	-	-	-	-	-
65	-	154	CFB65	-	-	CFB65B	-	-	-	-	-	-	-	-
SUB TYPE >			LNA07	TUB07	LBG06	NAG07	NAG07							



## Galvanised Loose Nails

Length (mm)	Ø (mm)	Approx. PCS Per 1kg	10kg Box		1kg TIMbag		500g TIMbag	
			Each		Carton Qty - 5		Carton Qty - 5	
			Product Code	Product Code	Product Code	Product Code	Product Code	Product Code
<b>Slab Nail</b> 			Used for securing insulation to wood.					
100	3.35	82	SLN100	-	-	-	-	-
125	3.75	71	SLN125	-	-	-	-	-
150	3.75	60	SLN150	SLN150B	-	-	-	-
180	4.50	38	SLN180	SLN180B	-	-	-	-
200	4.50	36	SLN200	SLN200B	-	-	-	-
SUB TYPE >			LNA16	NAG23	NAG23	NAG23		

## Galvanised Loose Nails

Length (mm)	Ø (mm)	Approx. PCS Per 1kg	25kg Box		2.5kg Tub		2.5kg TIMbag		1kg TIMbag		500g TIMbag		TIMpac	
			Each	Each	Each	Each	Each	Each	Each	Each	Each	Each	Each	Each
			Product Code	Product Code	Product Code	Product Code	Product Code	Product Code	Product Code	Product Code	Product Code	Product Code	Product Code	Product Code
<b>Round Wire</b>			General use with full round head for clamping.											
40	2.65	575	GRW40	GRW40T	GRW40LB	GRW40B	GRW40MB	GRW40P	75					
50	2.65	440	GRW50	GRW50T	GRW50LB	GRW50B	GRW50MB	GRW50P	50					
65	2.65	350	GRW26565	GRW26565T	GRW26565LB	GRW26565B	GRW26565MB	-	-					
65	3.35	230	GRW65	GRW65T	GRW65LB	GRW65B	GRW65MB	GRW65P	40					
75	3.75	154	GRW75	GRW75T	GRW75LB	GRW75B	GRW75MB	GRW75P	25					
90	4.00	105	GRW90	GRW90T	-	GRW90B	-	GRW90P	15					
100	4.50	77	GRW100	GRW100T	GRW100LB	GRW100B	GRW100MB	GRW100P	15					
125	5.60	42	GRW125	GRW125T	-	GRW125B	GRW125MB	GRW125P	10					
150	6.00	29	GRW150	GRW150T	GRW150LB	GRW150B	GRW150MB	GRW150P	8					
SUB TYPE >			LNA08	TUB08	LBG09	NAG08	NAG08	PAK55						
<b>Square Twist</b>			For use with all types of builders metal work.											
30	3.75	357	GST30	GST30T	GST30LB	GST30B	GST30MB	-	-					
40	3.75	312	GST40	GST40T	GST40LB	GST40B	GST40MB	-	-					
SUB TYPE >			LNA09	TUB09	LBG10	NAG09	NAG09							
<b>Presser Point Staples</b>			Used for fixing fencing and wire mesh.											
20	2.00	1000	PPS20	PPS20T	-	PPS20B	PPS20MB	PPS20P	75					
25	2.65	500	PPS25	PPS25T	-	PPS25B	PPS25MB	PPS25P	60					
30	3.35	227	PPS30	PPS30T	PPS30LB	PPS30B	PPS30MB	PPS30P	30					
40	4.00	135	PPS40	PPS40T	-	PPS40B	PPS40MB	PPS40P	20					
50	4.00	71	PPS50	PPS50T	-	PPS50B	PPS50MB	-	-					
SUB TYPE >			LNA10	TUB10	LBG11	NAG10	NAG10	PAK55						
<b>Barbed Staples</b>			Used for fixing fencing and wire mesh. Barbs for improved grip and resistance to pull out.											
40	4.00	135	-	BS40T	-	BS40B	-	-	-					
SUB TYPE >				TUB11		NAG24								
<b>Jagged Plasterboard</b>			Traditional alternative to the drywall screw.											
30	2.65	700	JPN30	-	-	JPN30B	JPN30MB	-	-					
40	2.65	570	JPN40	-	-	JPN40B	JPN40MB	-	-					
SUB TYPE >			LNA11	TUB12	LBG13	NAG11	NAG11							
<b>Drive Screw</b>			Fixing roofing and cladding sheets to timber purlins.											
50	5.40	87	DSN50	DSN50T	DSN50LB	DSN50B	DSN50MB	-	-					
65	5.40	71	DSN65	DSN65T	DSN65LB	-	DSN65MB	-	-					
75	5.40	55	DSN75	-	DSN75LB	DSN75B	-	-	-					
100	5.40	51	DSN100	-	DSN100LB	DSN100B	DSN100MB	-	-					
125	6.40	30	DSN125	DSN125T	DSN125LB	DSN125B	-	-	-					
150	6.40	24	DSN150	DSN150T	DSN150LB	-	DSN150MB	-	-					
SUB TYPE >			LNA12	TUB13	LBG12	NAG12	NAG12							
<b>Spring Head</b>			Twisted shank gives a very strong purchase.											
65	3.35	140	GSN65 (10kg)	-	GSN65LB	GSN65B	GSN65MB	-	-					
SUB TYPE >			LNA13		LBG14	NAG13	NAG13							
<b>Clout</b>			Perfect for roofing applications.											
25	2.65	815	GCN25	GCN25T	-	GCN25B	GCN25MB	-	-					
30	2.65	660	GCN30	GCN30T	GCN30LB	GCN30B	GCN30MB	GCN30P	125					
40	2.65	570	GCN40	GCN40T	GCN40LB	GCN40B	GCN40MB	GCN40P	100					
40	3.35	350	GCN33540	GCN33540T	-	GCN33540B	GCN33540MB	-	-					
50	2.65	430	GCN50	GCN50T	GCN50LB	GCN50B	GCN50MB	GCN50P	50					
50	3.35	290	GCN33550	GCN33550T	-	GCN33550B	GCN33550MB	-	-					
65	2.65	320	GCN26565	GCN26565T	GCN26565LB	GCN26565B	GCN26565MB	-	-					
65	3.75	180	GCN65	GCN65T	-	GCN65B	GCN65MB	-	-					
75	3.75	150	GCN75	GCN75T	-	GCN75B	GCN75MB	GCN75P	25					
SUB TYPE >			LNA14	TUB15	LBG15	NAG14	NAG14	PAK55						
<b>ELH Clout</b>			Extra large diameter head for extra clamping, perfect for fitting roofing felt and plasterboard.											
13	3.00	780	GEC13	GEC13T	GEC13LB	GEC13B	GEC13MB	-	-					
20	3.00	580	GEC20	GEC20T	GEC20LB	GEC20B	GEC20MB	-	-					
25	3.00	485	GEC25	GEC25T	-	GEC25B	GEC25MB	-	-					
30	3.00	420	GEC30	GEC30T	GEC30LB	GEC30B	GEC30MB	GEC30P	100					
40	3.00	350	GEC40	GEC40T	GEC40LB	GEC40B	GEC40MB	GEC40P	75					
50	3.00	320	GEC50	GEC50T	-	GEC50B	GEC50MB	-	-					
SUB TYPE >			LNA15	TUB16	LBG16	NAG15	NAG15	PAK55						

### Sherardised Loose Nails

Length (mm)	Ø (mm)	Approx. PCS Per 1kg	25kg Box	2.5kg Tub	2.5kg TIMbag	1kg TIMbag	500g TIMbag
			Each	Each	Each	Carton Qty - 5	Carton Qty - 5
			Product Code	Product Code	Product Code	Product Code	Product Code
<b>Annular Ringshank</b>			 Annular rings provide additional holding power, where increased grip is required.				
40	2.65	575	SAR40	SAR40T	-	SAR40B	SAR40MB
50	2.65	440	SAR50	SAR50T	-	SAR50B	SAR50MB
65	3.35	230	SAR65	SAR65T	-	SAR65B	-
75	3.75	154	SAR75	-	-	-	-
100	5.00	66	SAR100	-	-	-	-
SUB TYPE >			LNA17	TUB17	LBG17	NAG17	NAG17
<b>Panel Pins</b>			 A light weight nail, commonly used for cabinet making and light duty applications.				
25	1.60	2340	SPP25	-	-	-	SPP25MB
30	1.60	1900	SPP30	-	-	-	SPP30MB
40	1.60	1590	SPP40	-	-	-	SPP40MB
50	2.00	770	SPP50	-	-	-	SPP50MB
SUB TYPE >			LNA18			NAG16	NAG16
<b>Square Twist</b>			 For use with all types of builders metal work.				
30	3.75	357	SST30	SST30T	SST30LB	SST30B	SST30MB
40	3.75	312	SST40	SST40T	-	SST40B	SST40MB
SUB TYPE >			LNA19	TUB18	LBG20	NAG21	NAG21

### Copper Loose Nails

Length (mm)	Ø (mm)	Approx. PCS Per 1kg	25kg Box	10kg Box	2.5kg Tub	1kg TIMbag	500g TIMbag
			Each	Each	Each	Carton Qty - 5	Carton Qty - 5
			Product Code	Product Code	Product Code	Product Code	Product Code
<b>Clout</b>			 Large diameter head, perfect for attaching roofing felt, slate and shingles.				
25	2.65	710	COP225	-	-	-	-
25	3.35	430	COP325	-	-	-	-
30	2.65	620	COP230	-	COP230T	COP230B	COP230MB
30	3.35	380	COP330	-	COP330T	COP330B	COP330MB
35	3.35	340	COP335	-	-	COP335B	-
38	2.65	500	COP238	-	COP238T	COP238B	COP238MB
38	3.35	300	COP338	COP338BOX	COP338T	COP338B	-
50	3.35	230	COP350	-	COP350T	COP350B	COP350MB
SUB TYPE >			LNA17	LNA34	TUB19	NAG37	NAG36

NEW			5kg Box
Length (mm)	Ø (mm)	Approx. PCS Per 1kg	Each
			Product Code
			<b>Presser Point Staples</b>
38	4.0	240	COPPS38
SUB TYPE >			LNA26

### Aluminium Clout Nails

L (mm)	Ø (mm)	Approx. PCS Per 1kg	10kg Box	1kg Tub	1kg TIMbag	250g TIMbag
			Each	Each	Each	Carton Qty - 5
			Code	Code	Code	Code
<b>Clout</b>			 Large diameter head, perfect for attaching roofing felt, slate and shingles.			
30	2.65	2,000	ACN30	ACN30T	ACN30LB	ACN30B
38	3.35	1,100	ACN38	ACN38T	ACN38LB	ACN38B
45	3.35	870	ACN45	ACN45T	ACN45LB	ACN40B
50	3.35	800	ACN50	ACN50T	ACN50LB	ACN50B
60	3.35	687	ACN60	-	-	-
65	3.35	620	ACN65	-	ACN65LB	ACN65B
70	3.35	583	ACN70	-	-	-
75	3.35	544	ACN75	-	-	-
SUB TYPE >			LNA23	TUB21	LBG19	NAG19

### Copper Roofing Accessories

#### Copper Disc Rivets

Product Code	Length (mm)	Ø (mm)	Head Ø (mm)	Pack Qty (pcs)	Carton Qty (packs)
<b>TUB</b>					
CDRT	20	1.50	20	1000	-
<b>PACK</b>					
CDRB	20	1.50	20	250	5
TYPE - PAK				SUB TYPE - PAK55	

 For fixing fibre cement slates.

#### Copper Straps

Product Code	Length (mm)	Pack Qty (pcs)	Carton Qty (packs)
<b>PACK</b>			
CSS150B	150	100	5
CSS150P	150	10	10
TYPE - PAK		SUB TYPE - PAK55	

 For securing slates and shingles.

CE 14592

CE 14592

### Stainless Steel Loose Nails

Length (mm)	Ø (mm)	Approx. PCS Per 1kg	10kg Box	1kg TIMbag
			Each	Each
			Code	Code
<b>Annular Ringshank</b> 				
Annular rings provide additional holding power where increased grip is required.				
20	2.00	1785	SSAR20	SSAR20B
25	2.00	1465	SSAR25	SSAR25B
30	2.36	890	SSAR30	SSAR30B
40	2.65	546	SSAR40	SSAR40B
50	2.65	442	SSAR50	SSAR50B
50	3.35	276	SSAR50335	SSAR50335B
65	3.35	216	SSAR65	SSAR65B
75	3.75	150	SSAR75	SSAR75B
100	4.50	79	SSAR100	SSAR100B
SUB TYPE >			SSN01	SSN01

CE 14592

<b>Round Lost Head</b> 				
The head can be punched below the surface for a concealed finish.				
Length (mm)	Ø (mm)	Approx. PCS Per 1kg	Code	Code
40	2.65	550	SSLH40	SSLH40B
50	2.65	443	SSLH50	SSLH50B
65	3.35	216	SSLH65	SSLH65B
SUB TYPE >			SSN02	SSN02

<b>Round Wire</b> 				
General use with full round head for clamping.				
Length (mm)	Ø (mm)	Approx. PCS Per 1kg	Code	Code
40	2.65	550	SSRW40	SSRW40B
50	2.65	440	SSRW50	SSRW50B
65	3.35	215	SSRW65	SSRW65B
75	3.75	150	SSRW75	SSRW75B
100	4.00	100	SSRW100	SSRW100B
125	5.60	40	SSRW125	SSRW125B
150	6.00	30	SSRW150	SSRW150B
SUB TYPE >			SSN03	SSN03

CE 14592

### Zinc Masonry Nails

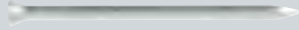
Length (mm)	Ø (mm)	100pcs Box	50 pcs TIMpac
		Each	Each
		Code	Code
<b>Masonry Nails</b> 			
25	2.5	HM25025	HM25025P
30	2.5	HM25030	HM25030P
35	2.5	HM25035	HM25035P
40	2.5	HM25040	HM25040P
50	2.5	HM25050	HM25050P
40	3.0	HM30040	-
50	3.0	HM30050	-
60	3.0	HM30060	HM30060P
65	3.0	HM30065	HM30065P
65	3.5	HM35065	-
75	3.5	HM35075	HM35075P
85	3.5	HM35085	-
100	3.5	HM350100	-
SUB TYPE >		LNA24	PAK55

<b>Masonry - Washered</b> 			
Length (mm)	Ø (mm)	Code	Code
25	3.7	WMN25	-
30	3.7	WMN30	-
35	3.7	WMN35	-
40	3.7	WMN40	-
50	3.7	WMN50	-
60	3.7	WMN60	-
75	3.7	WMN75 (50pcs)	-
SUB TYPE >		LNA24	

<b>Mickey Pins / Capping Nails</b> 			
Length (mm)	Ø (mm)	Code	Code
25	2.5	WMP25 (200pcs)	-
30	2.5	WMP30 (200pcs)	-
SUB TYPE >		LNA25	

### Upholstery Nails & Cut Tacks



#### Upholstery Nails



Bronze finished nail for traditional upholstery applications.

Product Code	L (mm)	Head Ø (mm)	Pack Qty (pcs)	Carton Qty (packs)
BRONZENAILP	15.7	10.5	50	10
TYPE - PAK SUB TYPE - PAK55				

#### Blue Cut Tacks



For fastening underlay, carpets and upholstery.

Product Code	Length (mm)	Pack Qty (pcs)	Carton Qty (packs)
CUTTACKP	19	120	10
TYPE - PAK SUB TYPE - PAK55			



# Polymer Headed Nails & Pins



## Polymer Headed Nails

A4 Stainless Steel



Used for fixing soffits, fascias, roofline trims and where other aesthetic fixings are required.

- UV Stable
- Impact Resistant

CORROSION RATING



Industrial & coastal areas with an aggressive salt atmosphere

Product Code	Colour	Length (mm)	Shank Ø (mm)	Head Ø (mm)	Pack Qty (pcs)	Carton Qty (packs)	Pallet Qty (packs)
<b>BOX</b>							
PN40W	White	40	3.2	12	100	50	1200
PN50W	White	50	3.2	12	100	36	864
PN50CC	Cream	50	3.2	12	100	36	864
PN50CG	Chartwell Green	50	3.2	12	100	36	864
PN50CB	Clay Brown	50	3.2	12	100	36	864
PN50O	Oak	50	3.2	12	100	36	864
PN50BR	Mahogany	50	3.2	12	100	36	864
PN50AG	Anthracite Grey	50	3.2	12	100	36	864
PN50BL	Black	50	3.2	12	100	36	864
PN65W	White	65	3.2	12	100	36	864
PN65CC	Cream	65	3.2	12	100	36	864
PN65CG	Chartwell Green	65	3.2	12	100	36	864
PN65CB	Clay Brown	65	3.2	12	100	36	864
PN65BR	Mahogany	65	3.2	12	100	36	864
PN65AG	Anthracite Grey	65	3.2	12	100	36	864
PN65BL	Black	65	3.2	12	100	36	864

TYPE - PIN

SUB TYPE - PIN01

**TIMPAC**

PN50WP	White	50	3.2	12	25	10	-
PN50BLP	Black	50	3.2	12	25	10	-

TYPE - PAK

SUB TYPE - PAK54

## Clad Pins

A4 Stainless Steel



A4 Stainless Steel cladding pin with ring shank.

- Impact Resistant

Product Code	Length (mm)	Shank Ø (mm)	Head Ø (mm)	Pack Qty (pcs)	Carton Qty (packs)	Pallet Qty (packs)
--------------	-------------	--------------	-------------	----------------	--------------------	--------------------

**TIMPAC**

CP30	30	2.1	4.7	250	76	1824
------	----	-----	-----	-----	----	------

TYPE - PIN

SUB TYPE - PIN03

## Polymer Headed Pins

A4 Stainless Steel



Used for fixing soffits, fascias, roofline trims and where other aesthetic fixings are required.

- UV Stable
- Impact Resistant

CORROSION RATING



Industrial & coastal areas with an aggressive salt atmosphere

Product Code	Colour	Length (mm)	Shank Ø (mm)	Head Ø (mm)	Pack Qty (pcs)	Carton Qty (packs)	Pallet Qty (packs)
<b>BOX</b>							
PP25W	White	25	2.1	6.4	250	76	1824
PP25BEIGE	Beige	25	2.1	6.4	250	35	1824
PP25M	Mahogany	25	2.1	6.4	250	76	1824
PP30W	White	30	2.1	6.4	250	76	1824
PP30CC	Cream	30	2.1	6.4	250	76	1824
PP30CG	Chartwell Green	30	2.1	6.4	250	76	1824
PP30CB	Clay Brown	30	2.1	6.4	250	76	1824
PP30O	Oak	30	2.1	6.4	250	76	1824
PP30BR	Mahogany	30	2.1	6.4	250	76	1824
PP30AG	Anthracite Grey	30	2.1	6.4	250	76	1824
PP30BL	Black	30	2.1	6.4	250	76	1824
PP40W	White	40	2.1	6.4	250	50	1200
PP40CC	Cream	40	2.1	6.4	250	50	1200
PP40CG	Chartwell Green	40	2.1	6.4	250	50	1200
PP40CB	Clay Brown	40	2.1	6.4	250	50	1200
PP40O	Oak	40	2.1	6.4	250	50	1200
PP40BR	Mahogany	40	2.1	6.4	250	50	1200
PP40AG	Anthracite Grey	40	2.1	6.4	250	50	1200
PP40BL	Black	40	2.1	6.4	250	50	1200

TYPE - PIN

SUB TYPE - PIN02

**TIMPAC**

PP25WP	White	25	2.1	6.4	65	10	-
PP30WP	White	30	2.1	6.4	60	10	-
PP40WP	White	40	2.1	6.4	50	10	-
PP30BLP	Black	30	2.1	6.4	60	10	-

TYPE - PAK

SUB TYPE - PAK54



# Powertool Accessories

## Drilling

SDS Plus & Max Hammer Bits	117
Rebar Cutters	118
Masonry Drill Bits	119
Tile & Glass Drill Bits	119
Wood Auger & Flat Bits	120
HSS Drill Bits	122
Step Drills & Countersinks	124
Drill Sets	126

## Cutting

Holesaws & Accessories	128
Dry Diamond Core Bits	130
Diamond Blades	131
Circular Saw Blades	133
Jigsaw Blades	134
Reciprocating Saw Blades	135
Multi-Tool Blades	137

## Abrasives

Hand Sanding	139
Powertool Sanding	140
Powertool Wire Brushes	141
Flap Discs & Preparation Discs	142

## Chucks, Driver Bits & Adaptors

Chucks, Keys & Adaptors	143
Impact Driver Bits, Sockets & Adaptors	144
Driver Bits, Sockets & Adaptors	147

## Mixing

Mixing Paddles	149
----------------	-----



## SDS Plus Hammer Bits

### Professional SDS Plus Hammer Bit



A high performance drill bit with a superior carbide tip to give extended durability. German tested and PGM approved to ensure the bits drill with dimensional precision and performance when used in concrete and masonry.

- Special Nickel Chromoly shank
- High quality BC20 Tungsten Carbide tip
- Cold formed blanks utilised up to 11mm diameter
- Fully heat treated to eliminate bending
- Twin flute design for increased drilling performance
- Shot-peened for increased strength and durability
- P.G.M. approved and marked



**User Caution:** Rebar drilling will result in reduced tool life. All chisel tip SDS drills can shear if the tip snags the reinforcing whilst passing alongside.

**PG.M.** This mark is an international symbol of quality for masonry bits, governed by the independent Prüfgemeinschaft Mauerbohrer e.V. (PGM). The mark guarantees that the bits are manufactured and tested to ensure dimensional precision and performance. The DIBt (German Institute of Construction Technology) specifies that PGM marked drills should be used when geometrically exact holes are required for safety critical fixings. (5.5 & 6.5 do not carry the PGM mark)

Product Code	Ø (mm)	Length (mm)	Pack Qty (pcs)	Carton Qty (packs)
--------------	--------	-------------	----------------	--------------------

CLIP				
AP13260	13.0	260	1	20
AP14160	14.0	160	1	25
AP14210	14.0	210	1	20
AP14260	14.0	260	1	20
AP14310	14.0	310	1	20
AP14450	14.0	450	1	20
AP141000	14.0	1000	1	10
AP15260	15.0	260	1	20
AP16160	16.0	160	1	25
AP16210	16.0	210	1	20
AP16260	16.0	260	1	20
AP16310	16.0	310	1	20
AP16450	16.0	450	1	10
AP16600	16.0	600	1	10
AP161000	16.0	1000	1	10
AP18210	18.0	210	1	10
AP18260	18.0	260	1	10
AP18310	18.0	310	1	10
AP18450	18.0	450	1	10
AP20210	20.0	210	1	10
AP20310	20.0	310	1	10
AP20450	20.0	450	1	10
AP20600	20.0	600	1	5
AP201000	20.0	1000	1	5
AP22260	22.0	260	1	10
AP22450	22.0	450	1	10
AP22600	22.0	600	1	5
AP24260	24.0	260	1	10
AP24450	24.0	450	1	5
AP25260	25.0	260	1	10
AP25450	25.0	450	1	5
AP25600	25.0	600	1	5
AP251000	25.0	1000	1	5
AP28450	28.0	450	1	5
AP30450	30.0	450	1	5

TYPE - APS

SUB TYPE - APS01

**NEW MIXED SET AVAILABLE!**



Product Code	Drill Ø (mm)	Length (mm)	Pack Qty (pcs)	Carton Qty (packs)
--------------	--------------	-------------	----------------	--------------------

CASE (6 PCS)				
AP6DS	-	-	6	30
	5.0	110	1	
	5.5	110	1	
	7.0	110	1	
	6.0	160	1	
	8.0	160	1	
	10.0	160	1	

TYPE - APS

SUB TYPE - APS02

### SDS Plus Hammer Bit



High quality, cost effective drill bit suitable for use in rotary hammers with the SDS plus tool system.

- Fully heat treated to eliminate bending
- Shot blast finish for rust protection
- Most popular sizes up to 600mm length

Product Code	Ø (mm)	Length (mm)	Pack Qty (pcs)	Carton Qty (packs)
--------------	--------	-------------	----------------	--------------------

CLIP				
SDS4160	4.0	160	1	20
SDS5110	5.0	110	1	20
SDS5160	5.0	160	1	20
SDS5210	5.0	210	1	20
SDS55110	5.5	110	1	20
SDS55160	5.5	160	1	20
SDS55210	5.5	210	1	20
SDS6110	6.0	110	1	20
SDS6160	6.0	160	1	20
SDS6210	6.0	210	1	20
SDS6260	6.0	260	1	20
SDS65110	6.5	110	1	20
SDS65160	6.5	160	1	20
SDS65210	6.5	210	1	20
SDS65260	6.5	260	1	20

Product Code	Ø (mm)	Length (mm)	Pack Qty (pcs)	Carton Qty (packs)
--------------	--------	-------------	----------------	--------------------

CLIP				
SDS7110	7.0	110	1	20
SDS7160	7.0	160	1	20
SDS7210	7.0	210	1	20
SDS8110	8.0	110	1	20
SDS8160	8.0	160	1	20
SDS8210	8.0	210	1	20
SDS8260	8.0	260	1	20
SDS8310	8.0	310	1	10
SDS8450	8.0	450	1	10
SDS10160	10.0	160	1	20
SDS10210	10.0	210	1	20
SDS10260	10.0	260	1	20
SDS10310	10.0	310	1	10
SDS10450	10.0	450	1	10
SDS10600	10.0	600	1	10
SDS12160	12.0	160	1	20
SDS12210	12.0	210	1	20
SDS12260	12.0	260	1	20
SDS12310	12.0	310	1	10
SDS12450	12.0	450	1	10
SDS12600	12.0	600	1	10
SDS14160	14.0	160	1	10
SDS14210	14.0	210	1	10
SDS14260	14.0	260	1	10
SDS14310	14.0	310	1	10
SDS14450	14.0	450	1	10
SDS14600	14.0	600	1	10
SDS16160	16.0	160	1	10
SDS16210	16.0	210	1	10
SDS16260	16.0	250	1	10
SDS16310	16.0	300	1	10
SDS16450	16.0	450	1	10
SDS16600	16.0	600	1	10
SDS18210	18.0	200	1	10
SDS18260	18.0	260	1	10
SDS18310	18.0	300	1	10
SDS18450	18.0	450	1	10
SDS20210	20.0	200	1	10
SDS20310	20.0	300	1	10
SDS20450	20.0	450	1	10
SDS20600	20.0	600	1	10
SDS22260	22.0	250	1	10
SDS22450	22.0	450	1	10
SDS25260	25.0	320	1	10
SDS25450	25.0	450	1	10

TYPE - SDS

SUB TYPE - SDS01

### SDS Plus Steels



Point - Breaks up concrete & masonry.

Chisel/Spade - Breaks up concrete & masonry. Also removes plaster or rendering.

Tile - Angled head design for easy removal of tiles, plaster or rendering.

Gouge - Removes mortar from brickwork prior to re-pointing.

Product Code	Type	W (mm)	L (mm)	Pack Qty (pcs)	Carton Qty (packs)
--------------	------	--------	--------	----------------	--------------------

CLIP					
SDSP	Point	N/A	250	1	10
SDSC	Chisel	20	250	1	10
SDSS	Spade	40	250	1	10
SDST	Tile	40	250	1	10
SDSG	Gouge	22	250	1	10

TYPE - SPC

SUB TYPE - SPC01

## SDS Max Hammer Bits

### SDS Max Hammer Bit



For drilling large diameter holes in concrete, stone and masonry. Suitable for use in large rotary hammers with the SDS Max tool holder system.

- Narrow angle 4-cutter head greatly reduces jamming and provides smooth drilling
- High quality Tungsten Carbide tips
- Shot peened for extra strength and durability

Product Code	Ø (mm)	Length (mm)	Pack Qty (pcs)	Carton Qty (packs)
<b>CLIP</b>				
SDSM12340	12	340	1	5
SDSM12540	12	540	1	5
SDSM14340	14	340	1	5
SDSM14540	14	540	1	5
SDSM16340	16	340	1	5
SDSM16540	16	540	1	5
SDSM18340	18	340	1	5
SDSM18540	18	540	1	5
SDSM18690	18	690	1	5
SDSM18920	18	920	1	5
SDSM20340	20	340	1	5
SDSM20540	20	540	1	5
SDSM20690	20	690	1	5
SDSM20920	20	920	1	5
SDSM22340	22	340	1	5
SDSM22540	22	540	1	5
SDSM22690	22	690	1	5
SDSM22920	22	920	1	5
SDSM24340	24	340	1	5
SDSM24540	24	540	1	5
SDSM25340	25	340	1	5
SDSM25540	25	540	1	5
SDSM25690	25	690	1	5
SDSM25920	25	920	1	5
SDSM26340	26	340	1	5
SDSM26540	26	540	1	5
SDSM28340	28	340	1	5
SDSM28540	28	540	1	5
SDSM30340	30	340	1	5
SDSM30540	30	540	1	5
SDSM32340	32	340	1	5
SDSM32540	32	540	1	5

TYPE - MAX SUB TYPE - MAX01

## SDS Rebar Cutters

### SDS Shank Rebar Cutter (Complete)



Rotary rebar cutters are designed for use in SDS plus hammer machines switched to **ROTARY MODE ONLY**.

Drilling with the hammer action switched on will result in serious damage to the tool. Please read the instructions and use the recommended R.P.M.

- High temperature brazing
- Heavy duty Tungsten Carbide tips
- Made in U.S.A

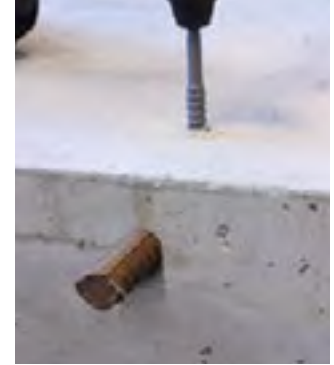

#### How to use Rebar Cutters



Product Code	Ø (mm)	Length (mm)	Rec. R.P.M	Pack Qty (pcs)	Carton Qty (packs)
<b>TUBE</b>					
MSRB10*	10.0	300	750-1000	1	10
MSRB12*	12.0	300	600-850	1	10
MSRB14*	14.0	300	600-850	1	10
MSRB16	16.0	300	500-750	1	10
MSRB18	18.0	300	500-750	1	10
MSRB20	20.0	300	450-600	1	10

TYPE - RBR SUB TYPE - RBR01 \*PRODUCTS ARE NOT VENTED

## SDS Max Steels



Point - Breaks up concrete & masonry.

Chisel - Breaks up concrete & masonry, removes plaster or rendering

Slotting Tool - Removes mortar from brickwork prior to re-pointing

Product Code	Type	W (mm)	L (mm)	Pack Qty (pcs)	Carton Qty (packs)
<b>CLIP</b>					
SDSMP280	Point	N/A	280	1	5
SDSMP400	Point	N/A	400	1	5
SDSMC280	Chisel	25	280	1	5
SDSMC400	Chisel	25	400	1	5
SDSMC40050	Chisel	50	400	1	5
SDSMC30075	Chisel	75	300	1	5
SDSMST	Slotting Tool	25	280	1	5

TYPE - MAX SUB TYPE - MAX01

### Rebar Cutter (Head Only)



Used with rebar adaptor to drill through in-situ rebar when drilling into concrete.

**ROTARY MODE ONLY**

Product Code	Ø (mm)	L (mm)	Rec R.P.M	Carton Qty (packs)
<b>TUBE - 1PCS</b>				
MRB22HO	22.0	115	450-600	10
MRB24HO	24.0	115	350-500	10
MRB25HO	25.0	115	350-500	10

TYPE - RBR SUB TYPE - RBR01

### Adaptor for Cutter Heads



Used with 22, 24 & 25mm rebar cutter heads.

**ROTARY MODE ONLY**

Product Code	Length (mm)	Carton Qty (packs)
<b>TUBE - 1PCS</b>		
STDS212	220	10

TYPE - RBR SUB TYPE - RBR01



## Masonry Drill Bits

### Masonry Drill Bit



A premium quality masonry bit for use in cordless and corded drill drivers in both rotary and hammer action.

Ideal for drilling brick, block and concrete.

- 135° High Grade Industrial Carbide Tip
- Ground flute
- Silver/black finish
- Heat treated

Product Code	Ø (mm)	Length (mm)	Pack Qty (pcs)	Carton Qty (packs)
--------------	--------	-------------	----------------	--------------------

PACK				
APM6100	6.0	100	1	100
APM6150	6.0	150	1	100
APM6200	6.0	200	1	50
APM6300	6.0	300	1	30
APM65100	6.5	100	1	100
APM65150	6.5	150	1	100
APM65200	6.5	200	1	50
APM65300	6.5	300	1	30
APM7100	7.0	100	1	100
APM7150	7.0	150	1	100
APM7300	7.0	300	1	40
APM8120	8.0	120	1	50
APM8150	8.0	150	1	50
APM8200	8.0	200	1	50
APM8300	8.0	300	1	25
APM10120	10.0	120	1	50
APM10150	10.0	150	1	50
APM10200	10.0	200	1	40
APM10300	10.0	300	1	30
APM10400	10.0	400	1	30
APM12150	12.0	150	1	50
APM12200	12.0	200	1	30
APM12300	12.0	300	1	30
APM12400	12.0	400	1	10
APM14150	14.0	150	1	40
APM14200	14.0	200	1	30
APM14400	14.0	400	1	20
APM16150	16.0	150	1	30
APM16200	16.0	200	1	20
APM16300	16.0	300	1	20
APM16400	16.0	400	1	15
APM20200	20.0	200	1	15
APM20400	20.0	400	1	10
APM25400	25.0	400	1	10

TYPE - MPG SUB TYPE - MPG01

Product Code	Ø (mm)	Length (mm)	Pack Qty (pcs)	Carton Qty (packs)
--------------	--------	-------------	----------------	--------------------

PACK				
APM475	4.0	75	1	100
APM4150	4.0	150	1	100
APM585	5.0	85	1	100
APM5150	5.0	150	1	100
APM5585	5.5	85	1	100
APM55150	5.5	150	1	100

### TCT Multi-Purpose Drill Bit



Designed to drill steel, wood, masonry, PVCu, ceramics and concrete.

Diamond-ground cutting edges allow fast drilling even in hard materials.

**ROTARY MODE ONLY.**

- High quality European diamond ground carbide tip with 135° angle point
- High temperature copper brazed
- Ground flute
- Silver and gold finish
- Heat treated



Product Code	Ø (mm)	Length (mm)	Pack Qty (pcs)	Carton Qty (packs)
--------------	--------	-------------	----------------	--------------------

PACK				
MP475	4.0	75	1	100
MP4150	4.0	150	1	100
MP585	5.0	85	1	100
MP5150	5.0	150	1	100
MP55100	5.5	100	1	100
MP55150	5.5	150	1	100
MP6100	6.0	100	1	100
MP6150	6.0	150	1	100
MP65100	6.5	100	1	100
MP65150	6.5	150	1	100
MP7100	7.0	100	1	100
MP7150	7.0	150	1	100
MP8150	8.0	150	1	50
MP10150	10.0	150	1	50

TYPE - MMP SUB TYPE - MMP01

## Ceramic, Tile & Glass Drill Bits

### Dry Diamond Drill Bit



Ideal for drilling a clean hole into hard materials such as porcelain, ceramic, marble, granite and glass.

**ROTARY MODE ONLY.**

- Up to 10x more holes\*
- Over 40% faster\*
- Vacuum brazed diamond technology
- Suitable for dry or wet use
- Wax insert aids cooling and prolongs life
- Non-slip hex shank

**How to use Dry Diamond Drill Bits**



1. Ensure the drill bit is fastened securely in the chuck. Hold the drill firmly in both hands and start to drill at a 45° angle to the work surface. This will produce a small crescent shaped anchor groove.



2. When the anchor groove is formed, slowly bring the drill up to 90° to the work surface. The tool should carry on drilling through the material without slipping.

Product Code	Ø (mm)	Length (mm)	Rec. RPM	Pack Qty (pcs)	Carton Qty (packs)
--------------	--------	-------------	----------	----------------	--------------------

PACK					
VBD5	5.0	65	1500-3000	1	10
VBD6	6.0	65	1500-3000	1	10
VBD7	7.0	80	1500-3000	1	10
VBD8	8.0	80	1500-3000	1	10
VBD10	10.0	80	1500-3000	1	10
VBD12	12.0	80	1500-3000	1	10
VBD15	15.0	80	1500-3000	1	10
VBD20	20.0	80	1500-3000	1	10
VBD25	25.0	80	1500-3000	1	10

TYPE - ATD

SUB TYPE - ATD01

### TCT Tile & Glass Bit



For accurate drilling of glass and ceramics.

A lubricant such as water is recommended when drilling glass.

Use the bit in **ROTARY MODE ONLY** at a low R.P.M.

- Cross ground, spear shaped Tungsten Carbide tip
- Shot blast finish



Product Code	Ø (mm)	Length (mm)	Pack Qty (pcs)	Carton Qty (packs)
--------------	--------	-------------	----------------	--------------------

PACK				
TG5	5.0	70	1	125
TG6	6.0	75	1	125
TG65	6.5	75	1	125
TG7	7.0	80	1	125
TG8	8.0	80	1	125
TG10	10.0	100	1	125

TYPE - TGD

SUB TYPE - TGD01

# Wood Auger Bits

## Wood Auger Bit



A high performance wood drill for drilling a deep hole into various types of timber.

Available with a hex or SDS Plus shank.

- Bright/black finish
- High grade carbon steel
- Screw point



Product Code	Ø (mm)	Length (mm)	Pack Qty (pcs)	Carton Qty (packs)
--------------	--------	-------------	----------------	--------------------

TUBE				
Hex Shank				
HA10100	10.0	100	1	10
HA12100	12.0	100	1	10
HA16100	16.0	100	1	10
HA20100	20.0	100	1	10
HA22100	22.0	100	1	10
HA25100	25.0	100	1	10
HA32100	32.0	100	1	10

TYPE - WAH SUB TYPE - WAH02

Product Code	Ø (mm)	Length (mm)	Pack Qty (pcs)	Carton Qty (packs)
--------------	--------	-------------	----------------	--------------------

TUBE				
Hex Shank				
HA16155	16.0	155	1	10
HA19155	19.0	155	1	10
HA20155	20.0	155	1	10
HA22155	22.0	155	1	10
HA25155	25.0	155	1	10
HA32155	32.0	155	1	10
HA6235	6.0	235	1	10
HA8235	8.0	235	1	10
HA10235	10.0	235	1	10
HA12235	12.0	235	1	10
HA13235	13.0	235	1	10
HA14235	14.0	235	1	10
HA16235	16.0	235	1	10
HA18235	18.0	235	1	10
HA19235	19.0	235	1	10
HA20235	20.0	235	1	10
HA22235	22.0	235	1	10
HA24235	24.0	235	1	10
HA25235	25.0	235	1	10
HA26235	26.0	235	1	10
HA28235	28.0	235	1	10
HA30235	30.0	235	1	10
HA32235	32.0	235	1	10
HA8460	8.0	460	1	10
HA10460	10.0	460	1	10
HA12460	12.0	460	1	10
HA14460	14.0	460	1	10
HA16460	16.0	460	1	10
HA18460	18.0	460	1	10
HA20460	20.0	460	1	10
HA22460	22.0	460	1	10
HA26460	26.0	460	1	10

SDS Shank				
SA6200	6.0	200	1	10
SA8200	8.0	200	1	10
SA10235	10.0	235	1	10
SA12235	12.0	235	1	10
SA16235	16.0	235	1	10
SA20235	20.0	235	1	10
SA22235	22.0	235	1	10
SA25235	25.0	235	1	10

TYPE - WAH SUB TYPE - WAH02

## High Performance Impact Auger Bit



Specifically designed to drill a clean hole into all natural woods.

This high quality drill will out perform a standard Auger drill in lifetime and performance.

Designed for impact drivers.

- 3x longer life
- Spurred cutting edge for a fast even cut
- Unique twist design for clean, smooth chip removal
- Burr-free lead screw for quick, on-target starts without material build up
- High carbon steel (S55C) with precise all hardened treatment
- Made in Japan

Product Code	Ø (mm)	Length (mm)	Pack Qty (pcs)	Carton Qty (packs)
--------------	--------	-------------	----------------	--------------------

PACK				
Hex Shank				
IA6	6.0	160	1	6
IA8	8.0	170	1	6
IA10	10.0	180	1	6
IA16	16.0	200	1	6
IA18	18.0	200	1	6
IA22	22.0	205	1	6
IA32	32.0	205	1	6

TYPE - JAB SUB TYPE - JAB01

## High Performance Deep Cut Auger Bit



A high performance Auger bit specifically designed to drill a clean hole into all natural woods. This high quality drill will out perform a standard Auger drill in lifetime and performance.

- 3x longer life
- Spurred cutting edge for a fast even cut
- Unique twist design for clean, smooth chip removal
- Burr-free lead screw for quick, on-target starts without material build up
- High carbon steel (S55C) with precise all hardened treatment
- Made in Japan

Product Code	Ø (mm)	Length (mm)	Pack Qty (pcs)	Carton Qty (packs)
--------------	--------	-------------	----------------	--------------------

PACK				
Hex Shank				
DA8	8.0	400	1	25
DA10	10.0	460	1	25
DA14	14.0	460	1	25
DA16	16.0	460	1	25
DA18	18.0	460	1	25
DA20	20.0	460	1	25
DA22	22.0	460	1	25
DA25	25.0	460	1	25
DA32	32.0	460	1	25

TYPE - JAB SUB TYPE - JAB01

# PPE

Personal Protective Equipment

From page 213

- Gloves
- Face Shields
- Safety Masks
- Eye & Ear Protection
- Knee Pads
- Hi-Vis Vests
- Coveralls

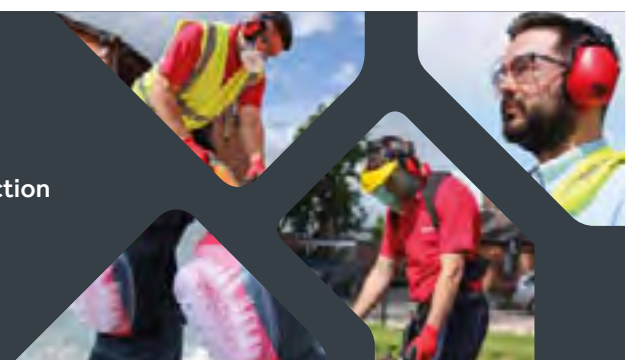

# Wood Bits

## Speed Auger Bit



Speed Augers with a four fluted cutter, designed for rapid chip ejection and cleaner hole drilling in timber.

- Bright finish with painted flutes
- High grade carbon steel
- Screw point

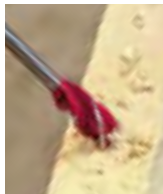

Product Code	Ø (mm)	Length (mm)	Pack Qty (pcs)	Carton Qty (packs)
<b>TUBE</b>				
SPA16	16.0	159	1	12
SPA20	20.0	159	1	12
SPA25	25.0	159	1	10
TYPE - WAH		SUB TYPE - WAH03		

## Flat Wood Bit



The twin cutting edged and integral centre point enhances speed and provides rapid chip removal when drilling various types of timber and man-made boards.

- Three point design for faster, cleaner holes
- Bright finish
- Compound angle, ground recessed cutting edge for superior cutting
- 1/4" Quick release hexagonal shank for use in both 3 jaw chucks and 1/4" quick release adaptors

### Extension Rods

Used where there is restricted access and in conjunction with a 1/4" shank Flat Wood Bit. (Allen key provided).

Product Code	Length (mm)	Pack Qty (pcs)	Carton Qty (packs)
<b>PACK</b>			
<b>Extension Rods</b>			
FBEQR150	150	1	150
FBEQR300	300	1	150

Product Code	Ø (mm)	Length (mm)	Pack Qty (pcs)	Carton Qty (packs)
<b>PACK</b>				
<b>Short Flat Bits</b>				
FB6*	6.0	152	1	250
FB8*	8.0	152	1	250
FB10	10.0	152	1	250
FB12	12.0	152	1	250
FB13	13.0	152	1	250
FB14	14.0	152	1	250
FB15	15.0	152	1	250
FB16	16.0	152	1	250
FB18	18.0	152	1	250
FB19	19.0	152	1	250
FB20	20.0	152	1	250
FB22	22.0	152	1	250
FB24	24.0	152	1	250
FB25	25.0	152	1	250
FB26	26.0	152	1	250
FB28	28.0	152	1	250
FB30	30.0	152	1	250
FB32	32.0	152	1	250
FB35	35.0	152	1	250
FB38	38.0	152	1	250
TYPE - WFB/SUB TYPE - WFB01 *SINGLE POINT TIP				
<b>Long Flat Bits</b>				
932548	10.0	400	1	20
932483	12.0	400	1	20
932276	14.0	400	1	20
932197	16.0	400	1	20
932784	18.0	400	1	20
932356	20.0	400	1	20
932149	22.0	400	1	20
932225	24.0	400	1	20
932108	25.0	400	1	20
932472	28.0	400	1	20
932534	32.0	400	1	20
TYPE - WFB		SUB TYPE - WFB01		

## Brad Point Wood Bit



For drilling small diameter holes into various types of timber and man-made board.

- High grade HSS steel for longer life
- Fully ground
- Up to 3x the heat resistance of standard carbon steel bits

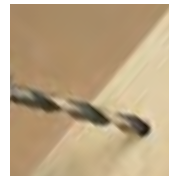

Product Code	Ø (mm)	Length (mm)	Pack Qty (pcs)	Carton Qty (packs)
<b>PACK</b>				
BP3	3.0	60	1	10
BP4	4.0	75	1	10
BP5	5.0	87	1	10
BP6	6.0	92	1	10
BP7	7.0	108	1	10
BP8	8.0	118	1	10
BP10	10.0	133	1	10
BP12	12.0	150	1	10
TYPE - BPW		SUB TYPE - BPW01		

## Carpenters Kit (Speed Augers & Flat Wood Bits)



Short length drills that are ideal for drilling in-between joists and studding when first fixing pipes and cables.

Contains three speed augers, each having four flutes for rapid chip ejection and cleaner drilling plus two flat bits for larger holes.

Ideal for use with impact drivers to further reduce overall tool and drill working length.

Product Code	Description	Ø (mm)	Length (mm)	Pack Qty (pcs)	Carton Qty (packs)
<b>KIT</b>					
CKIT	Speed Auger Bit	16.0	159	1	10
	Speed Auger Bit	20.0	159	1	
	Speed Auger Bit	25.0	159	1	
	Flat Wood Bit	32.0	152	1	
	Flat Wood Bit	40.0	152	1	
TYPE - MHK		SUB TYPE - MHK01			

## TCT Hinge Cutter



- Tungsten Carbide cutting edges for long life
- Bright/black finish
- 12.7mm shank compatible with both pillar drills (13mm capacity) and 1/2" industrial routers (R.P.M)

For cutting blind holes into MDF and chipboard to accept cantilever door hinges.

Product Code	Ø (mm)	Length (mm)	Pack Qty (pcs)	Carton Qty (packs)
<b>CASE</b>				
35HC	35	60	1	10
TYPE - WAH		SUB TYPE - WAH01		

### NEW MIXED SETS AVAILABLE!



5 Piece



8 Piece

Product Code	Description	Pack Qty (pcs)	Carton Qty (packs)
<b>CASE</b>			
BP5DS	2-6mm*	5	30
BP8DS	3-10mm*	8	20
TYPE - BPW		SUB TYPE - BPW02	

\*increments of 1mm

## HSS Drill Bits

### HSS M35 Cobalt Jobber Drill Bit - DIN338



Manufactured from a high quality M35 grade steel. Ideal for drilling holes into stainless steel and other alloy materials.

The 135° split point prevents the bit from drifting and enables faster penetration.

- Fully ground from solid material
- M35 alloyed HSS steel with 5% Cobalt content
- High heat resistance for particularly tough metal drilling
- Manufactured to DIN338
- Dimensionally precise



Product Code	Ø (mm)	Length (mm)	Pack Qty (pcs)	Carton Qty (packs)
<b>PACK</b>				
<b>Metric</b>				
HSSCOR120	12.0	151	1	10
HSSCOR125	12.5	151	1	10
HSSCOR130	13.0	151	1	10

TYPE - HCI SUB TYPE - HCI01

<b>TUBE</b>				
<b>Metric</b>				
HSSCO1	1.0	34	10	10
HSSCO15	1.5	40	10	10
HSSCO2	2.0	49	10	10
HSSCO25	2.5	57	10	10
HSSCO3	3.0	61	10	10
HSSCO32	3.2	65	10	10
HSSCO33	3.3	65	10	10
HSSCO35	3.5	70	10	10
HSSCO4	4.0	75	10	10
HSSCO42	4.2	75	10	10
HSSCO45	4.5	80	10	10
HSSCO48	4.8	86	10	10
HSSCO5	5.0	86	10	10
HSSCO55	5.5	93	10	10
HSSCO6	6.0	93	10	10
HSSCO65	6.5	101	10	10
HSSCO68	6.8	109	10	10
HSSCO7	7.0	109	10	10
HSSCO75	7.5	109	5	10
HSSCO8	8.0	117	5	10
HSSCO85	8.5	117	5	10
HSSCO9	9.0	125	5	10
HSSCO95	9.5	125	5	10
HSSCO100	10.0	133	5	10
HSSCO102	10.2	133	5	10
HSSCO105	10.5	133	5	10
HSSCO110	11.0	142	5	10
HSSCO115	11.5	142	5	10
HSSCO120	12.0	151	5	10
HSSCO125	12.5	151	5	10
HSSCO130	13.0	151	5	10

TYPE - HCI SUB TYPE - HCI01

Product Code	Ø (mm)	Length (mm)	Pack Qty (pcs)	Carton Qty (packs)
--------------	--------	-------------	----------------	--------------------

<b>PACK</b>				
<b>Metric</b>				
HSSCOR1	1.0	34	1	10
HSSCOR15	1.5	40	1	10
HSSCOR2	2.0	49	1	10
HSSCOR25	2.5	57	1	10
HSSCOR3	3.0	61	1	10
HSSCOR32	3.2	65	1	10
HSSCOR33	3.3	65	1	10
HSSCOR35	3.5	70	1	10
HSSCOR4	4.0	75	1	10
HSSCOR42	4.2	75	1	10
HSSCOR45	4.5	80	1	10
HSSCOR48	4.8	86	1	10
HSSCOR5	5.0	86	1	10
HSSCOR55	5.5	93	1	10
HSSCOR6	6.0	93	1	10
HSSCOR65	6.5	101	1	10
HSSCOR7	7.0	109	1	10
HSSCOR75	7.5	109	1	10
HSSCOR8	8.0	117	1	10
HSSCOR85	8.5	117	1	10
HSSCOR9	9.0	125	1	10
HSSCOR95	9.5	125	1	10
HSSCOR100	10.0	133	1	10
HSSCOR105	10.5	133	1	10
HSSCOR110	11.0	142	1	10
HSSCOR115	11.5	142	1	10

### HSS M2 Ground Jobber Drill Bit - DIN338



For drilling carbon and alloy steel, cast iron, non-ferrous metal and plastics.

The 135° split point prevents the bit from drifting and enables faster penetration.

- Fully ground from solid material
- High grade M2 alloyed HSS steel
- Manufactured to DIN338
- Dimensionally precise

Product Code	Ø (mm)	Length (mm)	Pack Qty (pcs)	Carton Qty (packs)
--------------	--------	-------------	----------------	--------------------

<b>TUBE</b>				
<b>Metric</b>				
HSSG1	1.0	34	10	10
HSSG15	1.5	40	10	10
HSSG2	2.0	49	10	10
HSSG24	2.4	57	10	10
HSSG25	2.5	57	10	10
HSSG3	3.0	61	10	10
HSSG31	3.1	65	10	10
HSSG32	3.2	65	10	10
HSSG33	3.3	65	10	10
HSSG35	3.5	70	10	10
HSSG38	3.8	75	10	10
HSSG4	4.0	75	10	10
HSSG41	4.1	75	10	10
HSSG42	4.2	75	10	10
HSSG45	4.5	80	10	10
HSSG48	4.8	86	10	10
HSSG49	4.9	86	10	10
HSSG5	5.0	86	10	10
HSSG51	5.1	86	10	10
HSSG53	5.3	86	10	10
HSSG55	5.5	93	10	10
HSSG6	6.0	93	10	10
HSSG64	6.4	101	10	10
HSSG65	6.5	101	10	10
HSSG68	6.8	109	10	10
HSSG7	7.0	109	10	10
HSSG75	7.5	109	5	10
HSSG8	8.0	117	5	10
HSSG85	8.5	117	5	10
HSSG9	9.0	125	5	10
HSSG95	9.5	125	5	10
HSSG100	10.0	133	5	10
HSSG102	10.2	133	5	10
HSSG105	10.5	133	5	10
HSSG110	11.0	142	5	10
HSSG115	11.5	142	5	10
HSSG120	12.0	151	5	10
HSSG125	12.5	151	5	10
HSSG130	13.0	151	5	10

Product Code	Ø (mm)	Length (mm)	Pack Qty (pcs)	Carton Qty (packs)
--------------	--------	-------------	----------------	--------------------

<b>PACK</b>				
<b>Metric</b>				
HSSGR2	2.0	49	1	10
HSSGR25	2.5	57	1	10
HSSGR3	3.0	61	1	10
HSSGR35	3.5	70	1	10
HSSGR4	4.0	75	1	10
HSSGR45	4.5	80	1	10
HSSGR5	5.0	86	1	10
HSSGR55	5.5	93	1	10
HSSGR6	6.0	93	1	10
HSSGR65	6.5	101	1	10
HSSGR7	7.0	109	1	10
HSSGR8	8.0	117	1	10
HSSGR85	8.5	117	1	10
HSSGR9	9.0	125	1	10
HSSGR100	10.0	133	1	10
HSSGR110	11.0	142	1	10
HSSGR120	12.0	151	1	10
HSSGR130	13.0	151	1	10

TYPE - HGI SUB TYPE - HGI01

<b>Imperial</b>				
HSIG116	1/16	1 1/8	10	10
HSIG132	1/32	1 1/8	10	10
HSIG564	5/64	2	10	10
HSIG332	3/32	2 1/4	10	10
HSIG764	7/64	2 1/2	10	10
HSIG18	1/8	2 1/4	10	10
HSIG964	9/64	2 1/2	10	10
HSIG532	5/32	3 1/8	10	10
HSIG316	3/16	3 1/2	10	10
HSIG1364	13/64	3 3/4	10	10
HSIG732	7/32	3 3/4	10	10
HSIG14	1/4	4	10	10
HSIG516	5/16	4 1/2	5	10
HSIG2164	21/64	4 3/8	5	10
HSIG38	3/8	5	5	10
HSIG12	1/2	6	5	10

TYPE - HGI SUB TYPE - HGI01

### HSS M35 Cobalt Jobber Drill Bit Sets



NEW MIXED SETS AVAILABLE!

Product Code	Description	Pack Qty (pcs)	Carton Qty (packs)
<b>TIN</b>			
HSSCO19DS	1-10mm (increments of 0.5mm)	19	20
HSSCO25DS	1-13mm (increments of 0.5mm)	25	10
<b>CASE</b>			
HSSCO5DS	2-6mm (increments of 1mm)	5	30
HSSCO10DS	1-10mm (increments of 1mm)	10	20

TYPE - HDS SUB TYPE - HDS01

### HSS M2 Ground Jobber Drill Bit Sets



NEW MIXED SETS AVAILABLE!

Product Code	Description	Pack Qty (pcs)	Carton Qty (packs)
<b>TIN</b>			
HSSG19DS	1-10mm (increments of 0.5mm)	19	20
HSSG25DS	1-13mm (increments of 0.5mm)	25	10
<b>CASE</b>			
HSSG5DS	2-6mm (increments of 1mm)	5	30
HSSG10DS	1-10mm (increments of 1mm)	10	20

TYPE - HDS SUB TYPE - HDS01



## HSS Drill Bits

### HSS Roll Forged Jobber Drill Bit - DIN338



An economic HSS drill used for drilling steel, aluminium and non-ferrous metals, as well as plastic

The 135° split point prevents the bit from drifting and enables faster penetration.

- HSS steel
- Black oxide finish
- Roll forged
- Manufactured to DIN338

Product Code	Ø (mm)	Length (mm)	Pack Qty (pcs)	Carton Qty (packs)
--------------	--------	-------------	----------------	--------------------

PACK				
Metric				
HSSRR1	1.0	34	2	10
HSSRR15	1.5	40	2	10
HSSRR2	2.0	49	2	10
HSSRR25	2.5	57	2	10
HSSRR3	3.0	61	2	10
HSSRR33	3.3	65	2	10
HSSRR35	3.5	70	2	10
HSSRR4	4.0	75	2	10
HSSRR45	4.5	80	2	10
HSSRR5	5.0	86	2	10
HSSRR55	5.5	93	2	10
HSSRR6	6.0	93	2	10
HSSRR65	6.5	101	1	10
HSSRR7	7.0	109	1	10
HSSRR8	8.0	109	1	10
HSSRR85	8.5	117	1	10
HSSRR9	9.0	125	1	10
HSSRR100	10.0	133	1	10
HSSRR110	11.0	142	1	10
HSSRR120	12.0	151	1	10
HSSRR130	13.0	151	1	10

TYPE - HRI SUB TYPE - HRI01

Product Code	Ø (mm)	Length (mm)	Pack Qty (pcs)	Carton Qty (packs)
--------------	--------	-------------	----------------	--------------------

TUBE				
Metric				
HSSR1	1.0	34	10	10
HSSR15	1.5	40	10	10
HSSR2	2.0	49	10	10
HSSR25	2.5	57	10	10
HSSR3	3.0	61	10	10
HSSR32	3.2	65	10	10
HSSR33	3.3	65	10	10
HSSR35	3.5	70	10	10
HSSR36	3.6	70	10	10
HSSR4	4.0	75	10	10
HSSR42	4.2	75	10	10
HSSR45	4.5	80	10	10
HSSR48	4.8	86	10	10
HSSR49	4.9	86	10	10
HSSR5	5.0	86	10	10
HSSR52	5.2	86	10	10
HSSR55	5.5	93	10	10
HSSR6	6.0	93	10	10
HSSR65	6.5	101	10	10
HSSR68	6.8	109	10	10
HSSR7	7.0	109	10	10
HSSR72	7.2	109	5	10
HSSR75	7.5	109	5	10
HSSR8	8.0	109	5	10
HSSR85	8.5	109	5	10
HSSR9	9.0	125	5	10
HSSR95	9.5	125	5	10
HSSR96	9.6	133	5	10
HSSR100	10.0	133	5	10
HSSR102	10.2	133	5	10
HSSR105	10.5	133	5	10
HSSR110	11.0	142	5	10
HSSR115	11.5	142	5	10
HSSR120	12.0	151	5	10
HSSR125	12.5	151	5	10
HSSR130	13.0	151	5	10

TYPE - HRI SUB TYPE - HRI01

Imperial				
HSIR116	1/16	1 7/8	10	10
HSIR332	3/32	2 1/4	10	10
HSIR764	7/64	2 3/8	10	10
HSIR18	1/8	2 1/4	10	10
HSIR964	9/64	2 3/8	10	10
HSIR532	5/32	3 1/8	10	10
HSIR316	3/16	3 1/2	10	10
HSIR732	7/32	3 3/4	10	10
HSIR14	1/4	4	10	10
HSIR1764	17/64	4 1/8	10	10
HSIR516	5/16	4 1/2	5	10
HSIR38	3/8	5	5	10
HSIR12	1/2	6	5	10

TYPE - HRI SUB TYPE - HRI01

### HSS M2 Ground Long Jobber Drill Bit - DIN340



For drilling carbon and alloy steel, cast iron, non-ferrous metal and plastics.

The 135° split point prevents the bit from drifting and enables faster penetration.

- Fully ground from solid material
- High grade M2 alloyed HSS steel
- Manufactured to DIN340
- Dimensionally precise

Product Code	Ø (mm)	Length (mm)	Pack Qty (pcs)	Carton Qty (packs)
--------------	--------	-------------	----------------	--------------------

TUBE				
Metric				
HSSGL2	2.0	85	10	10
HSSGL25	2.5	95	10	10
HSSGL3	3.0	100	10	10
HSSGL32	3.2	106	10	10
HSSGL35	3.5	112	10	10
HSSGL4	4.0	119	10	10
HSSGL42	4.2	119	10	10
HSSGL45	4.5	126	10	10
HSSGL48	4.8	132	10	10
HSSGL5	5.0	132	10	10
HSSGL55	5.5	139	10	10
HSSGL6	6.0	139	10	10
HSSGL65	6.5	148	5	10
HSSGL7	7.0	156	5	10
HSSGL8	8.0	165	5	10
HSSGL9	9.0	175	5	10
HSSGL100	10.0	184	5	10

TYPE - HLG SUB TYPE - HLG01

PACK				
Metric				
HSSGLR3	3.0	100	1	10
HSSGLR35	3.5	112	1	10
HSSGLR4	4.0	119	1	10
HSSGLR45	4.5	126	1	10
HSSGLR5	5.0	132	1	10
HSSGLR55	5.5	139	1	10
HSSGLR6	6.0	139	1	10
HSSGLR65	6.5	148	1	10
HSSGLR7	7.0	156	1	10
HSSGLR8	8.0	165	1	10

TYPE - HLG SUB TYPE - HLG01

### HSS Roll Forged Jobber Drill Bit Sets



Product Code	Description	Pack Qty (pcs)	Carton Qty (packs)
--------------	-------------	----------------	--------------------

TIN			
HSSR19DS	1-10mm (increments of 0.5mm)	19	20
HSSR25DS	1-13mm (increments of 0.5mm)	25	10
HSSR170DS	x10pcs 1-8mm (increments of 0.5mm) x5pcs 8.5-10mm (increments of 0.5mm)	170	5

TYPE - HDS SUB TYPE - HDS02

## HSS Drill Bits

### HSS Blacksmiths Drill Bit



Manufactured from a high grade M2 tool steel. This durable engineering quality drill will give a consistent rapid performance when drilling larger diameter holes into all non-alloy materials. Can be used in a 1/2" chuck.

The 118° split point prevents the bit from drifting. Mainly used for drilling sheet metal.

- Milled flute
- Dimensionally precise
- M2 Grade HSS with Black Oxide coating
- 12.5mm diameter shank

Product Code	Ø (mm)	Length (mm)	Pack Qty (pcs)	Carton Qty (packs)
<b>TUBE</b>				
BSD135	13.5	152	1	10
BSD14	14.0	152	1	10
BSD145	14.5	152	1	10
BSD15	15.0	152	1	10
BSD155	15.5	152	1	10
BSD16	16.0	152	1	10
BSD165	16.5	152	1	10
BSD17	17.0	152	1	10
BSD175	17.5	152	1	10
BSD18	18.0	152	1	10
BSD185	18.5	152	1	10
BSD19	19.0	152	1	10
BSD195	19.5	152	1	10
BSD20	20.0	152	1	10
BSD22	22.0	152	1	10
BSD24	24.0	152	1	10
BSD25	25.0	152	1	10

TYPE - HBS SUB TYPE - HBS01

### HSS M2 Ground Stub Drill Bit



Manufactured from a high grade M2 tool steel. This durable engineering quality drill will give a consistent rapid performance into all non-alloy materials.

The 135° split point prevents the bit from drifting. Mainly used for drilling sheet metal.

- Fully ground from solid material
- Dimensionally precise
- Manufactured to DIN1897



Product Code	Ø (mm)	Length (mm)	Pack Qty (pcs)	Carton Qty (packs)
<b>TUBE</b>				
HSSGS32	3.2	49	10	10
HSSGS33	3.3	49	10	10
HSSGS4	4.0	55	10	10
HSSGS41	4.1	55	10	10
HSSGS42	4.2	55	10	10
HSSGS49	4.9	62	10	10
HSSGS5	5.0	62	10	10

TYPE - HGS SUB TYPE - HGS01

## Cutters, Step Drills & Countersinks

### De-Burring Countersink



A single flute countersink designed for cleaning, chamfering or de-burring in alloy and non-alloy metals.

- Transverse hole for burr extraction
- High quality M2 grade HSS steel
- 3 flat shank to prevent slipping in the chuck

Product Code	Ø (mm)	Pack Qty (pcs)	Carton Qty (packs)
<b>TUBE</b>			
CS25	2 - 5	1	10
CS510	5 - 10	1	10
CS1015	10 - 15	1	10
CS1520	15 - 20	1	10

TYPE - DCS SUB TYPE - DCS01

### Cone Cutter



For drilling, enlarging and de-burring holes in thin sheet metal up to a thickness of 2mm.

- High quality M2 grade HSS steel
- 3 flat shank to prevent slipping in the chuck

Product Code	Ø (mm)	Pack Qty (pcs)	Carton Qty (packs)
<b>TUBE</b>			
CC314	3 - 14	1	10
CC520	5 - 20	1	10
CC531	5 - 31	1	10
CC1631	16 - 31	1	10

TYPE - DCS SUB TYPE - DCS02

### Step Drill



Ideal for drilling, enlarging or de-burring a precise hole into thin materials such as alloy and non-alloy metals up to a thickness of 4mm.

- Titanium Nitride coating to reduce friction and prolong life
- High quality M2 grade HSS steel
- 3 flat shank to prevent slipping in the chuck

Product Code	Ø (mm)	Pack Qty (pcs)	Carton Qty (packs)
<b>TUBE</b>			
SD412	4 - 12	1	10
SD420	4 - 20	1	10
SD430	4 - 30	1	10
SD439	4 - 39	1	10

TYPE - DCS SUB TYPE - DCS03

### 3 Flute Countersink



These engineering quality countersinks drill a precise recess to allow a fastener head to sit flush in alloy and non-alloy metals, timber and man-made boards.

- 90° head angle
- High quality M2 grade HSS steel
- 3 flat shank to prevent slipping in the chuck

Product Code	Ø (mm)	For Screw Ø (mm)	Pack Qty (pcs)	Carton Qty (packs)
<b>TUBE</b>				
CS63	6.3	3.0	1	10
CS83	8.3	3.5 - 4.0	1	10
CS104	10.4	4.5 - 5.0	1	10
CS124	12.4	6.0	1	10
CS165	16.5	8.0	1	10
CS205	20.5	-	1	10
CS250	25.0	-	1	10

TYPE - DCS SUB TYPE - DCS01

# Broaching Cutters & Pilot Pins

## Broaching Cutter



**Short**

**Long**

Manufactured from a high grade M2 tool steel for drilling heavy gauge non-alloy materials, with magnetic drills. Pilot pin must be used to prevent drifting.

- Titanium-Aluminium-Nitride (TiAlN) coating ensures long service life due to 20% less friction and 20% greater hardness than even Titanium Nitride (TiN) coating
- High grade M2 HSS steel body
- Broaching cutter supplied complete with pilot pin



Product Code	Ø (mm)	Cut Depth (mm)	Pack Qty	Carton Qty (packs)
--------------	--------	----------------	----------	--------------------

**TUBE**  
**Long Cutter**

BCL12	12	50	1	10
BCL13	13	50	1	10
BCL14	14	50	1	10
BCL15	15	50	1	10
BCL16	16	50	1	10
BCL17	17	50	1	10
BCL18	18	50	1	10
BCL20	20	50	1	10
BCL21	21	50	1	10
BCL22	22	50	1	10
BCL24	24	50	1	10
BCL26	26	50	1	2
BCL28	28	50	1	2
BCL30	30	50	1	2
BCL32	32	50	1	2
BCL39	39	50	1	10

TYPE - BRO

SUB TYPE - BRO01

**PILOT PINS INCLUDED**

Product Code	Ø (mm)	Cut Depth (mm)	Pack Qty (pcs)	Carton Qty (packs)
--------------	--------	----------------	----------------	--------------------

**TUBE**  
**Short Cutter**

BCS12	12	30	1	10
BCS13	13	30	1	10
BCS14	14	30	1	10
BCS15	15	30	1	10
BCS16	16	30	1	10
BCS17	17	30	1	10
BCS18	18	30	1	10
BCS19	19	30	1	10
BCS20	20	30	1	10
BCS21	21	30	1	10
BCS22	22	30	1	10
BCS23	23	30	1	10
BCS24	24	30	1	10
BCS25	25	30	1	10
BCS26	26	30	1	2
BCS27	27	30	1	2
BCS28	28	30	1	2
BCS29	29	30	1	2
BCS30	30	30	1	2
BCS32	32	30	1	2
BCS33	33	30	1	2
BCS35	35	30	1	10
BCS36	36	30	1	10
BCS38	38	30	1	10
BCS39	39	30	1	10
BCS40	40	30	1	10
BCS50	50	30	1	10

TYPE - BRO

SUB TYPE - BRO01

## Replacement Pilot Pin



A pilot pin is used with broaching cutters in order to centre the bit when drilling.

Product Code	Size (mm)	Pack Qty (pcs)	Carton Qty (packs)
--------------	-----------	----------------	--------------------

**TUBE**  
**Short Cutter**

BCP301250	6.35 x 79	1	10
-----------	-----------	---	----

**Long Cutter**

BCP501250	6.35 x 102	1	10
-----------	------------	---	----

TYPE - BRO

SUB TYPE - BRO01

**TIMEO**

**PPE**

**Personal Protective Equipment**

We offer a comprehensive range of eye and ear protection, safety goggles and masks, gloves, coveralls and hi-vis clothing

**From page 213**



## Drilling & Driver Sets

### Brad Point Drill Set

A 15 piece mixed selection of the most popular Brad Point wood drills.



15 PIECE

Set includes:

**Drill Bits** - 3.0 x 60(3), 3.5 x 70(2), 4.0 x 75(2), 4.5 x 80(1), 5.0 x 85(1), 5.5 x 90(1), 6.0 x 90(1), 6.5 x 95(1), 7.0 x 100(1), 8.0 x 110(1), 10.0 x 120(1)

Product Code	Pack Qty (pcs)	Carton Qty (packs)
<b>BLISTER PACK</b>		
B15SET	15	6
TYPE - ADS	SUB TYPE - ADS01	

### Masonry Drill Set

A mixed selection of 15 carbide tipped Masonry Drills. The range covers the most popular hole sizes for plastic plugs.



15 PIECE

Set includes:

**Drill Bits** - 4.0 x 75(1), 5.0 x 85(2), 5.5 x 85(3), 6.0 x 100(2), 7.0 x 100(3), 8.0 x 120(2), 10.0 x 120(2)

Product Code	Pack Qty (pcs)	Carton Qty (packs)
<b>BLISTER PACK</b>		
M15SET	16	6
TYPE - ADS	SUB TYPE - ADS01	

### Flat Wood Bit Set

A selection of quick release Flat Wood drills. The quick release feature is designed to ensure a rapid change of bits making it ideal for multiple applications.



7 PIECE

Set includes:

**Drill Bits** - 10.0 x 152(1), 12.0 x 152(1), 16.0 x 152(1), 19.0 x 152(1), 22.0 x 152(1), 25.0 x 152(1), 32.0 x 152(1)

Product Code	Pack Qty (pcs)	Carton Qty (packs)
<b>BLISTER PACK</b>		
F7SET	7	6
TYPE - ADS	SUB TYPE - ADS01	

### HSS Drill Set

A 15 piece mixed selection of the most popular HSS Ground Metal Drills with a 135° quick start split point, from 3mm and above.



15 PIECE

Set includes:

**Drill Bits** - 1.5 x 40(2), 2.0 x 49(2), 2.5 x 57(2), 3.0 x 61(1), 3.2 x 65(1), 3.5 x 70(1), 4.0 x 75(1), 4.5 x 80(1), 5.0 x 86(1), 6.0 x 93(1), 8.0 x 117(1), 10.0 x 133(1)

Product Code	Pack Qty (pcs)	Carton Qty (packs)
<b>BLISTER PACK</b>		
HSS15SET	15	6
TYPE - ADS	SUB TYPE - ADS01	

### HSS & Masonry Drill Set

A mixed selection of 12 HSS Ground Metal Drills with a 135° quick start split point and 5 carbide tipped Masonry Drills.



17 PIECE

Set includes:

**HSS Drill Bits (mm)** - 1.5 x 40(1), 2.0 x 49(1), 2.5 x 57(1), 3.0 x 61(1), 3.2 x 65(1), 3.5 x 70(1), 4.0 x 75(1), 4.5 x 80(1), 4.8 x 85(1), 5.0 x 86(1), 5.5 x 93(1), 6.0 x 93(1)

**Masonry Drill Bits (mm)** - 5.0 x 85(1), 5.5 x 85(1), 6.0 x 100(1), 7.0 x 100(1), 10.0 x 120(1)

Product Code	Pack Qty (pcs)	Carton Qty (packs)
<b>BLISTER PACK</b>		
MIX17SET	17	6
TYPE - ADS	SUB TYPE - ADS01	

### Driver Bit & HSS Drill Set

A selection of quick release HSS ground metal drills, S2 driver bits, socket drivers and a magnetic adaptor. The quick release feature is designed to ensure a rapid change of bits making it ideal for multiple applications.



20 PIECE

Set includes:

**25mm Bits** - PZ1(1), PZ2(1), PZ3(1), PH1(1), PH2(1), PH3(1), SL5.0(1), SL6.0(1)

**HSS Drill Bits (mm)** - 1.5 x 16(2), 2.0 x 22(2), 3.0 x 40(1), 3.5 x 48(1), 4.0 x 55(1), 4.5 x 55(1), 5.0 x 55(1), 6.0 x 65(1)

**Socket Drivers** - 6mm(1), 8mm(1), 10mm(1)

**Quick Changer**(1).

Product Code	Pack Qty (pcs)	Carton Qty (packs)
<b>BLISTER PACK</b>		
MIX20SET	20	6
TYPE - ADS	SUB TYPE - ADS01	

### Driver Bit Set

A 37 piece mixed selection of the most popular 25mm & 50mm S2 driver bits with a magnetic adaptor and an assortment of socket drivers.



37 PIECE

Set includes:

**25mm Bits** - PZ1(1), PZ2(1), PZ3(1), PH1(1), PH2(1), PH3(1), TX10(1), TX15(1), TX20(1), TX25(1), TX27(1), TX30(1), TX40(1), SL4.0(1), SL4.5(1), SL5.5(1), SL6.0(1), SL6.5(1), SL7.0(1), HX3.0(1), HX4.0(1), HX5.0(1), HX5.5(1), HX6.0(1)

**50mm Bits** - PZ1(1), PZ2(1), PZ3(1), PH1(1), PH2(1), PH3(1), HX3.0(1), HX4.0(1), HX5.0(1), HX5.5(1), HX6.0(1), SL5.5(1), SL7.0(1)

**Socket Drivers** - 5mm(1), 6mm(1), 8mm(1), 10mm(1)

**Magnetic Bit Holder**(1).

Product Code	Pack Qty (pcs)	Carton Qty (packs)
<b>BLISTER PACK</b>		
BIT37SET	37	6
TYPE - ADS	SUB TYPE - ADS01	



**NEW**

## Professional Drilling Sets

### HSS M35 Cobalt Jobber Drill Bit Sets - DIN338

Manufactured from a high quality M35 grade steel. Ideal for drilling holes into stainless steel and other alloy materials.



- Fully ground from solid material
- M35 alloyed High Speed Steel (HSS) with 5% Cobalt content
- High heat resistance for particularly tough metal drilling
- Manufactured to DIN 338
- Dimensionally precise

**NEW MIXED SETS AVAILABLE!**

Product Code	Description	Pack Qty (pcs)	Carton Qty (packs)
<b>TIN</b>			
HSSCO19DS	1-10mm (increments of 0.5mm)	19	20
HSSCO25DS	1-13mm (increments of 0.5mm)	25	10
TYPE - HDS		SUB TYPE - HDS01	
<b>CASE</b>			
HSSCO5DS	2-6mm (increments of 1mm)	5	30
HSSCO10DS	1-10mm (increments of 1mm)	10	20
TYPE - HDS		SUB TYPE - HDS01	

### HSS M2 Ground Jobber Drill Bit Sets - DIN338

Manufactured from a high grade M2 tool steel. This durable engineering quality drill will give a consistent rapid performance into all non-alloy materials.



- Fully ground from solid material
- High grade M2 alloyed High Speed Steel (HSS)
- Manufactured to DIN 338
- Dimensionally precise

**NEW MIXED SETS WAVAILABLE!**

Product Code	Description	Pack Qty (pcs)	Carton Qty (packs)
<b>TIN</b>			
HSSG19DS	1-10mm (increments of 0.5mm)	19	20
HSSG25DS	1-13mm (increments of 0.5mm)	25	10
TYPE - HDS		SUB TYPE - HDS01	
<b>SET</b>			
HSSG5DS	2-6mm (increments of 1mm)	5	30
HSSG10DS	1-10mm (increments of 1mm)	10	20
TYPE - HDS		SUB TYPE - HDS01	

### HSS Roll Forged Jobber Drill Bit - DIN338

An economic HSS drill used for drilling steel, aluminium and non-ferrous metals, as well as plastic



- HSS steel
- Black oxide finish
- Roll forged
- Manufactured to DIN338

Product Code	Description	Pack Qty (pcs)	Carton Qty (packs)
<b>TIN</b>			
HSSR19DS	1-10mm *	19	20
HSSR25DS	1-13mm *	25	10
HSSR170DS	x10pcs 1-8mm* x5pcs 8.5-10mm*	170	5
TYPE - HD / SUB TYPE - HDS02		* increments of 0.5mm	

### HSS Brad Point Wood Bit Sets

**NEW**

For drilling small diameter holes into various types of timber and man-made boards.



- High grade High Speed Steel (HSS) for longer life
- Fully Ground
- Up to 3x the heat resistance of standard carbon steel bits

Product Code	Description	Pack Qty (pcs)	Carton Qty (packs)
<b>CASE</b>			
BP5DS	2-6mm (increments of 1mm)	5	30
BP8DS	3-10mm (increments of 1mm)	8	20
TYPE - BPW		SUB TYPE - BPW02	

### Professional SDS Plus Hammer Bit Set

**NEW**



- Special nickel chromoly shank
- High quality European BC20 Tungsten Carbide tip
- Cold formed blanks utilised up to 11mm diameter
- Fully heat treated to eliminate bending
- Twin flute design for increased drilling performance
- Shot-peened for increased strength and durability

A set of high performance drill bits for drilling concrete and masonry. German tested and PGM approved to ensure drilling precision and performance. Contains the sizes used predominantly in plastic plug and masonry fixing applications

Product Code	Drill Ø (mm)	Length (mm)	Pack Qty (pcs)	Carton Qty (packs)
<b>CASE (6 PCS)</b>				
AP6DS	-	-	6	30
	5.0	110	1	
	5.5	110	1	
	7.0	110	1	
	6.0	160	1	
	8.0	160	1	
	10.0	160	1	
TYPE - APS		SUB TYPE - APS02		

# Holesaws & Accessories

## Variable Pitch



A variable pitch tooth pattern for efficient dust cleaning and gives superior cutting performance in wood, plastic, non-ferrous metals and man-made boards.

- High quality M3 grade HSS steel cutting edge
- Diameter stamped onto body for ease of size recognition
- Cutting Depth (mm):  
Wood - 38.0  
Thin Sheet Metal - 3.0

Product Code	Ø (mm)	Thread Mount (inch)	Arbor to Suit	Pack Qty (pcs)	Carton Qty (packs)
<b>CLAMSHELL</b>					
HS14	14.0	1/2	AA4, AA1, SDSA1	1	6
HS16	16.0	1/2	AA4, AA1, SDSA1	1	6
HS17	17.0	1/2	AA4, AA1, SDSA1	1	6
HS19	19.0	1/2	AA4, AA1, SDSA1	1	6
HS20	20.0	1/2	AA4, AA1, SDSA1	1	6
HS21	21.0	1/2	AA4, AA1, SDSA1	1	6
HS22	22.0	1/2	AA4, AA1, SDSA1	1	6
HS24	24.0	1/2	AA4, AA1, SDSA1	1	6
HS25	25.0	1/2	AA4, AA1, SDSA1	1	6
HS27	27.0	1/2	AA4, AA1, SDSA1	1	6
HS29	29.0	1/2	AA4, AA1, SDSA1	1	6
HS30	30.0	1/2	AA4, AA1, SDSA1	1	6
HS32	32.0	5/8	AA2, SDSA2	1	6
HS35	35.0	5/8	AA2, SDSA2	1	6
HS37	37.0	5/8	AA2, SDSA2	1	6
HS38	38.0	5/8	AA2, SDSA2	1	6
HS40	40.0	5/8	AA2, SDSA2	1	6
HS41	41.0	5/8	AA2, SDSA2	1	6
HS43	43.0	5/8	AA2, SDSA2	1	6
HS44	44.0	5/8	AA2, SDSA2	1	6
HS46	46.0	5/8	AA2, SDSA2	1	6
HS48	48.0	5/8	AA2, SDSA2	1	6
HS51	51.0	5/8	AA2, SDSA2	1	6
HS52	52.0	5/8	AA2, SDSA2	1	6
HS54	54.0	5/8	AA2, SDSA2	1	6
HS57	57.0	5/8	AA2, SDSA2	1	6
HS60	60.0	5/8	AA2, SDSA2	1	6
HS64	64.0	5/8	AA2, SDSA2	1	6
HS65	65.0	5/8	AA2, SDSA2	1	6
HS67	67.0	5/8	AA2, SDSA2	1	6
HS68	68.0	5/8	AA2, SDSA2	1	6
HS70	70.0	5/8	AA2, SDSA2	1	6
HS73	73.0	5/8	AA2, SDSA2	1	6
HS76	76.0	5/8	AA2, SDSA2	1	6
HS79	79.0	5/8	AA2, SDSA2	1	6
HS83	83.0	5/8	AA2, SDSA2	1	6
HS86	86.0	5/8	AA2, SDSA2	1	6
HS89	89.0	5/8	AA2, SDSA2	1	6
HS92	92.0	5/8	AA2, SDSA2	1	6
HS95	95.0	5/8	AA2, SDSA2	1	6
HS98	98.0	5/8	AA2, SDSA2	1	6
HS102	102.0	5/8	AA2, SDSA2	1	6
HS105	105.0	5/8	AA2, SDSA2	1	6
HS108	108.0	5/8	AA2, SDSA2	1	6
HS111	111.0	5/8	AA2, SDSA2	1	6
HS114	114.0	5/8	AA2, SDSA2	1	6
HS121	121.0	5/8	AA2, SDSA2	1	6
HS127	127.0	5/8	AA2, SDSA2	1	6
HS140	140.0	5/8	AA2, SDSA2	1	6
HS152	152.0	5/8	AA2, SDSA2	1	6

TYPE - BMH SUB TYPE - BMH01

## Constant Pitch



A constant pitch tooth pattern ensures smooth cutting and less "chatter" when drilling metal, particularly thin sheet.

Ideal for stainless steel.

- High quality M42 grade HSS steel cutting edge
- Diameter stamped onto body for ease of size recognition
- Cutting Depth (mm):  
Wood - 38.0,  
Sheet Metal - 3.0,  
Stainless Steel - 2.0

Product Code	Ø (mm)	Thread Mount (inch)	Arbor to Suit	Pack Qty (pcs)	Carton Qty (packs)
<b>CLAMSHELL</b>					
HSC16	16.0	1/2	AA4, AA1, SDSA1	1	6
HSC17	17.0	1/2	AA4, AA1, SDSA1	1	6
HSC20	20.0	1/2	AA4, AA1, SDSA1	1	6
HSC22	22.0	1/2	AA4, AA1, SDSA1	1	6
HSC25	25.0	1/2	AA4, AA1, SDSA1	1	6
HSC30	30.0	1/2	AA4, AA1, SDSA1	1	6
HSC32	32.0	5/8	AA2, SDSA2	1	6
HSC35	35.0	5/8	AA2, SDSA2	1	6
HSC40	40.0	5/8	AA2, SDSA2	1	6
HSC46	46.0	5/8	AA2, SDSA2	1	6
HSC48	48.0	5/8	AA2, SDSA2	1	6
HSC51	51.0	5/8	AA2, SDSA2	1	6
HSC60	60.0	5/8	AA2, SDSA2	1	6
HSC64	64.0	5/8	AA2, SDSA2	1	6
HSC68	68.0	5/8	AA2, SDSA2	1	6
HSC70	70.0	5/8	AA2, SDSA2	1	6
HSC76	76.0	5/8	AA2, SDSA2	1	6
HSC79	79.0	5/8	AA2, SDSA2	1	6
HSC102	102.0	5/8	AA2, SDSA2	1	6
HSC165	165.0	5/8	AA2, SDSA2	1	6

TYPE - CMH SUB TYPE - CMH01

## Holesaw Arbors

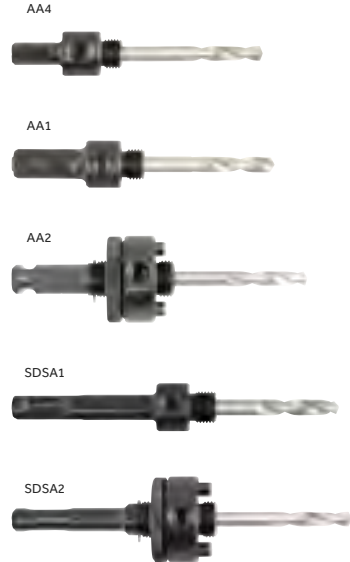

Product Code	For Holesaw Ø (mm)	Shank (mm)	Thread Shank	Pack Qty (pcs)	Carton Qty (packs)
<b>CLAMSHELL</b>					
AA4	14-30	Hex 9.5	1/2"	1	6
AA1	14-30	Hex 11	1/2"	1	6
AA2	32-210	Hex 11	5/8"	1	6
SDSA1	14-30	SDS Plus	1/2"	1	6
SDSA2	32-210	SDS Plus	5/8"	1	6

TYPE - BHA SUB TYPE - BHA01

## Holesaw Pilot Drills & Rod



Product Code	Description	Ø (mm)	Total Length (mm)	Pack Qty (pcs)	Carton Qty (packs)
<b>CLAMSHELL</b>					
HPD	HSS Pilot Drill	6.35	75	1	10
HPDL	HSS Pilot Drill	6.35	105	1	10
HPDC	HSS Cobalt Drill	6.35	75	1	10
HSE	Extension Rod for Hex 11 Shank	-	300	1	6

TYPE - BHA SUB TYPE - BHA01

## Diamond Cores & Blades

### Core Types



#### Premium Dry Diamond Core

A premium quality 10mm turbo segmented universal core with rifled body for dust extraction. For use in most building materials including engineering bricks, clay products, and concrete block.

#### Dry Diamond Core

Universal dry diamond core with 8mm segments. For use in most building materials including engineering bricks, clay products, and concrete block.

### Blade Types



#### Sintered Blades

Concentrate diamond powder segments are baked onto the blade body to form a matrix, giving a strong bond with good cutting performance and working life.

#### Laser Welded Blades

The segments are individually hot pressed separately to the blade body, which causes a super dense matrix to form giving superior life span and cutting ability. The segments are then laser welded to the steel body for a secure bond to prevent damage and guarantee the best cost per cut.

### Cutting Edges

#### Segmented

Each defined cutting segment allows the blade to cool and expand during cutting. This enhances cutting performance, accuracy and the working life of the blade.

#### Turbo Segmented

Similar to segmented blades, these also use slots between segments to cool the blade and allow for expansion but with the added benefit of recess formed segments to give exceptional cutting speed with added dust extraction abilities.

#### Continuous Rim

With a continuous diamond matrix, these blades have exceptional cutting accuracy and chipping reduction. Making them ideally suited to cutting hard and brittle materials such as ceramic tiles and decorative stone such as marble.

#### Continuous Rim Turbo

These are a hybrid between continuous rim and segmented blades, which give a professional finish, superior cutting speed and a long working life.

All TIMCO diamond blades carry the **EN13236** standard

- S** Segmented
- C** Continuous
- Occasional Use
- Frequent Use

### Materials

- Asphalt
- Asphalt over concrete
- Bricks:
  - Class A Engineering
  - Class B Engineering
  - Standard facing bricks
- Cement fibre board
- Clay products
- Concrete:
  - Beams, kerbs, pipes & slabs
  - Block paving, flag stones
  - Flint aggregate
  - General purpose
  - Green (up to 24 hours)
  - Heavy steel reinforcement
  - Light steel reinforcement
  - Roof tiles
- Concrete blocks:
  - Lightweight 3 - 7 Nm
  - Medium density 7 - 12 Nm
  - Solid density 12+ Nm
- Cement screed
- Fibreglass
- Glass reinforced plastic (GRP)
- Laminated products
- PE Polyethylene plastic
- PP Polypropylene plastic
- Rubber
- Slate tiles
- Stone:
  - Granite - Blocks & worktops
  - Gritstone
  - Limestone
  - Marble - Blocks & worktops
  - Sandstone - Abrasive
  - Sandstone - Indian
  - York stone
  - Quartz worktops
- Tiles:
  - Ceramic
  - Granite
  - Limestone
  - Marble
  - Natural Stone
  - Porcelain
  - Slate
  - Terracotta

	Diamond Cores		Diamond Blades				Tile & Glass Blades	
	General Purpose (PDCK5)	Premium (GPCP & PREMDCK)	General Purpose (GPE)	Trade (GPL & GPLC)	Premium (GPL & MM)	General Purpose (TE)	Premium (TP)	
	S	S	S	S C	S C	C	C	
Asphalt								
Asphalt over concrete			○	○	○			
Bricks:								
Class A Engineering	○	■	○	○ ■	○ ■			
Class B Engineering	○	■	○	○ ■	○ ■			
Standard facing bricks	■	■	■	■ ■	■ ■			
Cement fibre board								
Clay products			○	○	○			
Concrete:								
Beams, kerbs, pipes & slabs			■	■ ■	■ ■			
Block paving, flag stones			■	■ ■	■ ■			
Flint aggregate			○	■ ■	■ ■			
General purpose			■	■ ■	■ ■			
Green (up to 24 hours)								
Heavy steel reinforcement			○	○ ■	○ ■			
Light steel reinforcement								
Roof tiles			■	■ ■	■ ■			
Concrete blocks:								
Lightweight 3 - 7 Nm	■	■	○	○ ○	○ ○			
Medium density 7 - 12 Nm	■	■	■	■ ■	■ ■			
Solid density 12+ Nm	○	■	○	○ ■	○ ■			
Cement screed			■	■ ○	■			
Fibreglass								
Glass reinforced plastic (GRP)								
Laminated products								
PE Polyethylene plastic								
PP Polypropylene plastic								
Rubber								
Slate tiles			○	○ ■	○ ■			
Stone:								
Granite - Blocks & worktops					■			
Gritstone		■						
Limestone	■	■	○	○ ■	○ ■			
Marble - Blocks & worktops				○	■			
Sandstone - Abrasive	○	■	○	○ ○	○ ○			
Sandstone - Indian	■	■	○	○ ○	○ ○			
York stone		■	■	■ ■	■ ■			
Quartz worktops		■						
Tiles:								
Ceramic						■	■	
Granite						○	■	
Limestone						■	■	
Marble						○	■	
Natural Stone						○	■	
Porcelain						■	■	
Slate						○	■	
Terracotta						■	■	

# Dry Diamond Core Bits & Accessories

## Premium Dry Diamond Core Bits

NEW IMPROVED DESIGN



Premium grade diamond core drills for fast drilling into masonry, bricks and blocks. During drilling, the self-sharpening diamonds will not only give a clean and precise hole but also increase lifespan. Suitable for wet and dry cutting.

- Long life high quality diamond
- Fast cutting 10mm turbo segments
- Rifled body for excellent dust extraction
- Multiple slots for enhanced cooling
- Precision manufactured for low noise and vibration
- 1/2" BSP fitment
- Rotary use only

Product Code	Drill Ø (mm)	Length (mm)	Segment Height (mm)	Pack Qty (pcs)	Carton Qty (packs)
<b>BOX</b>					
GPCP22300	22	300	10	1	25
GPCP28300	28	300	10	1	25
GPCP32150	32	150	10	1	25
GPCP38150	38	150	10	1	25
GPCP48150	48	150	10	1	25
GPCP52150	52	150	10	1	25
GPCP65150	65	150	10	1	25
GPCP78150	78	150	10	1	25
GPCP82150	82	150	10	1	25
GPCP91150	91	150	10	1	10
GPCP107150	107	150	10	1	10
GPCP117150	117	150	10	1	10
GPCP127150	127	150	10	1	10
GPCP152150	152	150	10	1	6

TYPE - DCT SUB TYPE - DCT02

## Accessories Kit

NEW



Product Code	Drill Ø / To Fit (mm)	Length (mm)	Description	Pack Qty (pcs)	Carton Qty (Packs)
<b>KIT (5 ACCESSORIES)</b>					
DCAK5	-	-	KIT	5	25
	1/2" BSP	240	Extension	1	
	1/2" BSP	88	Hex Adaptor	1	
	1/2" BSP	115	SDS Adaptor	1	
	8	200	Pilot Drill	1	
	8	75	Taper Drift	1	

TYPE - DCT SUB TYPE - DCT02

## Premium Dry Diamond Core Kit

NEW



A selection of 5 premium grade diamond core drills for fast drilling into masonry, bricks and blocks. During drilling, the self-sharpening diamonds will not only give a clean and precise hole but also increase lifespan. Suitable for wet and dry cutting. Supplied with accessories and carry case.

- Long life high quality diamond
- Fast cutting 10mm turbo segments
- Rifled body for excellent dust extraction
- Multiple slots for enhanced cooling
- Precision manufactured for low noise and vibration
- 1/2" BSP fitment
- Rotary use only



Product Code	Drill Ø / To Fit (mm)	Length (mm)	Description	Pack Qty (pcs)
<b>KIT (5 CORES AND 5 ACCESSORIES)</b>				
PREMDCK5	-	-	KIT	10
	38	150	Diamond Core	1
	52	150	Diamond Core	1
	65	150	Diamond Core	1
	117	150	Diamond Core	1
	127	150	Diamond Core	1
	1/2" BSP	240	Extension	1
	1/2" BSP	88	Hex Adaptor	1
	1/2" BSP	115	SDS Adaptor	1
	8	200	Pilot Drill	1
	8	75	Taper Drift	1

TYPE - DCT SUB TYPE - DCT02

## Dry Diamond Core Kit

Five of the most popular sizes and accessories in an aluminium case.

- Long life
- 8mm Segments
- Core removal slots
- Low vibration
- 1/2" BSP fitment
- Rotary use only



Product Code	Drill Ø / To Fit (mm)	Length (mm)	Description	Pack Qty (pcs)
<b>KIT (5 CORES AND 5 ACCESSORIES)</b>				
PDCK5	-	-	KIT	10
	38	150	Diamond Core	1
	52	150	Diamond Core	1
	65	150	Diamond Core	1
	117	150	Diamond Core	1
	127	150	Diamond Core	1
	1/2" BSP	240	Extension	1
	1/2" BSP	88	Hex Adaptor	1
	1/2" BSP	115	SDS Adaptor	1
	8	200	Pilot Drill	1
	8	75	Taper Drift	1

TYPE - DCT SUB TYPE - DCT02

## Adaptors & Extension



**Hex Adaptor** | A 1/2" Hex with 1/2" BSP (male) thread, for use with a standard core drill.



**SDS Adaptor** | An SDS Plus with 1/2" BSP (male) thread, for use with an SDS-Plus drill, when in rotary mode only.



**BSP Extension** | 1/2" BSP thread extension rod used where there is need for a deeper hole.

Product Code	Description	Total Length (mm)	To Fit	Pack Qty (pcs)	Carton Qty (packs)
<b>PACK</b>					
DCAH88P	Hex Adaptor	88	1/2" BSP	1	10
DCAH240P	Hex Adaptor	240	1/2" BSP	1	10
DCAS115P	SDS Adaptor	115	1/2" BSP	1	10
DCAS240P	SDS Adaptor	240	1/2" BSP	1	10
DCE240P	BSP Extension	240	1/2" BSP	1	10

TYPE - DCT SUB TYPE - DCT02

## Pilot Drill, Rod & Taper Drift



**Pilot Drill** | Morse taper TCT masonry drill bit used to prevent the core drifting.



**Pilot Rod** | Used once a hole has been drilled to prevent the core drifting.



**Taper Drift** | Used for knocking taper tools out of spindles and sockets.

Product Code	Description	Ø (mm)	Length (mm)	Pack Qty (pcs)	Carton Qty (packs)
<b>PACK</b>					
DCPD13210	Pilot Drill	13	210	1	10
DCPR225	Pilot Rod	12	225	1	10
DCTD	Taper Drift	8	75	1	10

TYPE - DCT SUB TYPE - DCT02



# Diamond Blades & Wheels

## Premium Diamond Blades

### Turbo Continuous Cutting Edge

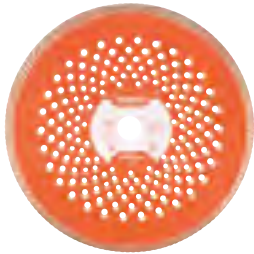

A premium quality diamond blade manufactured using the highest quality diamond powder and continuous turbo cutting edge for superior performance and working life with laser welded technology for strength and durability.

- 10mm segment height
- Extra long life
- Rapid and precise
- Low noise and vibration
- Self cooling



- ★★★★★ Concrete
- ★★★ Brick
- ★★★ Block
- ★★★ Stone
- ★★★★★ Hard Materials

Product Code	Disc Ø (mm)	Disc Ø (Inch)	Bore (mm)	Pack Qty (pcs)	Carton Qty (packs)
<b>PACK</b>					
MM115222	115	4 ½	22.23	1	10
MM125222	125	5	22.23	1	10
MM230222	230	9	22.23	1	25
MM30020	300	12	20.00	1	10
MM300222	300	12	22.23	1	10
MM35020	350	14	20.00	1	10
MM350254	350	14	25.40	1	10
TYPE - DCT			SUB TYPE - DCT01		

### Turbo Segmented Cutting Edge



A premium quality diamond blade manufactured using the highest quality turbo segments for superior cutting performance and working life with laser welded technology for strength and durability.

- 12mm segment height
- Extra long life
- Rapid and precise
- Low noise and vibration
- Self cooling



- ★★★★★ Concrete
- ★★★★★ Brick
- ★★★★★ Block
- ★★★★★ Stone
- ★★★ Hard Materials

Product Code	Disc Ø (mm)	Disc Ø (Inch)	Bore (mm)	Pack Qty (pcs)	Carton Qty (packs)
<b>PACK</b>					
GPPL450254	450	18	25.40	1	5
TYPE - DCT			SUB TYPE - DCT01		

## Trade Diamond Blades

### Continuous Cutting Edge

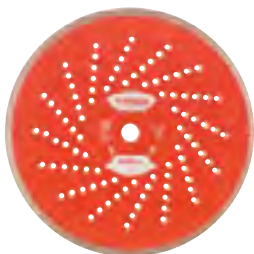

A high quality diamond blade manufactured using premium diamond powder and a continuous turbo cutting edge.

- 10mm segment height
- Long life
- Fast cutting
- Heavy duty body
- Self cooling



- ★★★★★ Concrete
- ★★★★★ Brick
- ★★★★★ Block
- ★★★★★ Stone
- ★★★ Hard Materials

Product Code	Disc Ø (mm)	Disc Ø (Inch)	Bore (mm)	Pack Qty (pcs)	Carton Qty (packs)
<b>PACK</b>					
GPLC30020	300	12	20.00	1	10
TYPE - DCT			SUB TYPE - DCT01		

### Segmented Cutting Edge

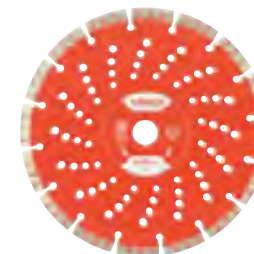

A high quality diamond blade manufactured using premium diamond powder and laser welded turbo segmented cutting edge.

- 10mm segment height
- Long life
- Fast cutting
- Heavy duty body
- Self cooling



- ★★★★★ Concrete
- ★★★★★ Brick
- ★★★★★ Block
- ★★★★★ Stone
- ★★★ Hard Materials

Product Code	Disc Ø (mm)	Disc Ø (Inch)	Bore (mm)	Pack Qty (pcs)	Carton Qty (packs)
<b>PACK</b>					
GPL115222	115	4 ½	22.23	1	10
GPL125222	125	5	22.23	1	10
GPL230222	230	9	22.23	1	25
GPL30020	300	12	20.00	1	10
TYPE - DCT			SUB TYPE - DCT01		

## General Purpose Diamond Blade

### Segmented Cutting Edge



A sintered diamond blade manufactured using a heavy duty body and high quality cold pressed diamond powder into a segmented cutting edge.

- Heavy duty
- Self cooling



- ★★★★ Concrete
- ★★★ Brick
- ★★★ Block
- ★★★ Stone
- ★★ Hard Materials

Product Code	Disc Ø (mm)	Disc Ø (Inch)	Bore (mm)	Segment Height (mm)	Pack Qty (pcs)	Carton Qty (packs)
<b>PACK</b>						
GPE115222	115	4 ½	22.23	10	1	10
GPE115222SET	115	4 ½	22.23	7	3	10
GPE125222	125	5	22.23	7	1	10
GPE230222	230	9	22.23	10	1	25
GPE30020	300	12	20.00	10	1	10
TYPE - DCT			SUB TYPE - DCT01			

## Diamond Blades & Wheels

### Tile & Ceramic Diamond Blades

#### Premium - Thin Turbo Cutting Edge

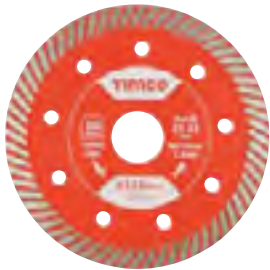

- ★★★★ Tiles
- ★★★★ Marble
- ★★★★ Porcelain
- ★★★★ Stone

- Heavy duty self cooling body
- 10mm segment height

Product Code	Disc Ø (mm)	Disc Ø (Inch)	Bore (mm)	Pack Qty (pcs)	Carton Qty (packs)
<b>PACK</b>					
TP115222	115	4 ½	22.23	1	10
TYPE - DCT				SUB TYPE - DCT01	

#### Mortar Raking Blade

##### Segmented Cutting Edge



- ★★★★ Mortar

- For raking mortar
- 7mm segment height
- 6.35mm segment width
- Heavy duty body

Product Code	Disc Ø (mm)	Disc Ø (Inch)	Bore (mm)	Pack Qty (pcs)	Carton Qty (packs)
<b>PACK</b>					
MRE115	115	4 ½	22.23	1	10
MRE125	125	5	22.23	1	10
TYPE - DCT				SUB TYPE - DCT03	

#### General Purpose - Continuous Cutting Edge



- ★★★★ Tiles
- ★★★ Marble
- ★★★ Porcelain
- ★★★ Stone

- Heavy duty body
- 5mm segment height

Product Code	Disc Ø (mm)	Disc Ø (Inch)	Bore (mm)	Pack Qty (pcs)	Carton Qty (packs)
<b>PACK</b>					
TE10016	100	4	16.00	1	10
TE115222	115	4 ½	22.23	1	10
TE180222	180	7	22.23	1	10
TYPE - DCT				SUB TYPE - DCT01	

#### Cup Grinding Wheel

##### Double Row Segments



- A double row silver brazed blade. For smoothing and removing shutter marks from concrete.
- Vented for dust extraction
- 10mm segment depth

Product Code	Disc Ø (mm)	Disc Ø (Inch)	Bore (mm)	Pack Qty (pcs)	Carton Qty (packs)
<b>BOX</b>					
CGDE115	115	4 ½	22.23	1	10
TYPE - DCT				SUB TYPE - DCT04	

## Bonded Abrasives

### Cutting Disc

- Used for cutting various types of metals.
- Manufactured to European standard EN12413
- High cutting speed
- High stability
- Long life



Product Code	Disc Ø (mm)	Bore (mm)	T (mm)	Max RPM	Pack Qty (pcs)	Carton Qty (packs)
<b>BOX</b>						
FCM115222	115	22.23	2.5	13,300	50	4
FCM230222	230	22.23	3.2	6,500	25	2
FCM30020	300	20.00	3.2	5,000	25	2
TYPE - BAT / SUB TYPE - BAT01				T = THICKNESS		

### Grinding Disc

- Used for grinding various types of metals.
- Manufactured to European standard EN12413
- High cutting speed
- High stability
- Long life



Product Code	Disc Ø (mm)	Bore (mm)	T (mm)	Max RPM	Pack Qty (pcs)	Carton Qty (packs)
<b>BOX</b>						
DGM115222	115	22.2	6.4	13,300	25	4
TYPE - BAT / SUB TYPE - BAT01				T = THICKNESS		

### Slitting Disc

- Used for cutting slits into various types of metals, including stainless steel / inox.
- Manufactured to European standard EN12413
- High cutting speed
- High stability
- Long life



Product Code	Disc Ø (mm)	Bore (mm)	T (mm)	Max RPM	Pack Qty (pcs)	Carton Qty (packs)
<b>TIN</b>						
10FCMT115222	115	22.2	1.0	13,300	10	40
<b>BOX</b>						
FCMT115222	115	22.2	1.0	13,300	25	16
FCMT125222	125	22.2	1.0	12,200	25	16
FCMT230222	230	22.2	1.9	6,500	25	4
TYPE - BAT / SUB TYPE - BAT01				T = THICKNESS		



# Jigsaw Blades



## Blade Material Types

### Bi-M (Bi-Metal)

Combining the flexibility of a HCS body with a HSS hardened cutting edge, resulting in a tough, shatter resistant blade. Longer service life leads to greater cost effectiveness per blade.

### HCS (High Carbon Steel)

High Carbon Steel Blades for use with softer materials, such as hard and soft wood, plastics and laminated boards.

### HSS (High Speed Steel)

Hardened steel designed to cut hard materials such as mild steel, aluminium and other non-ferrous metals.

## Cut Type

### Straight

Standard blade type, comes in a variety of teeth types and blade lengths. Perfect for all general purpose applications.

### Down

Reversed teeth to cut on the down-stroke. This prevents the splintering of decorative surfaces such as kitchen worktops.

### Curve

These blades have a reduced blade depth to allow them to perform curved cuts.

### Precision

These blades are made from a thicker plate to help achieve a 90° cut. It also makes this blade ideal for hardwood.

## Teeth Type

- MSS - Milled & Side Set**

Rough/Coarse Cut  
Basic tooth pattern used on the entry level blades. A quick but fairly rough cut.

- MWS - Milled & Wavy Set**

Fine/Medium Cut  
This pattern is used to give a fine, straight cut.

- SSS - Side Set & Sharpened**

Fast/Medium Cut  
This configuration gives a fast, medium cut.

- GTG - Ground/Taper Ground**

Clean/Quick Cut  
These top quality blades give a clean, quick cut in both wood and plastic.

## Bi-Metal Blades

LONGER SERVICE LIFE!



Product Code	Bosch Equiv.	Materials	Cut Type	Teeth Type	WL (mm)	TL (mm)	Cutting Cap. (mm)	TPI	Pack Qty (pcs)	Carton Qty (packs)
<b>PACK</b>										
<b>Wood Cutting</b>										
AHGS14BI	T144DF	All Wood Types	Straight	SSS ● 75	75	100	5.0-50.0	6	5	100
AHC12BI	T101BF	All Wood / Plastic	Straight	GTG ● 75	75	100	3.0-30.0	10	5	100
AHC12RBI	T101BRF	Laminate	Down	GTG ● 75	75	100	3.0-30.0	10	5	100
<b>Metal Cutting</b>										
AMG11BI	T118AF	Steel / Stainless Steel / Thin Sheet Metal	Straight	MWS ● 50	50	76	1.0-3.0	21	5	100
AMG12BI	T118BF	Steel / Stainless Steel / Alu. / Non-Ferrous	Straight	MWS ● 50	50	76	2.5-6.0	12	5	100

TYPE - JIG / SUB TYPE - JIG01 WL = WORKING LENGTH TL = TOTAL LENGTH TPI = TEETH PER INCH

## TCT High Carbon Steel Blade - Board Cutting



High Carbon Steel body with Tungsten Carbide Tip (TCT) cutting edge resulting in a tough blade which keeps its edge.

Product Code	Bosch Equiv.	Materials	Cut Type	Teeth Type	WL (mm)	TL (mm)	Cutting Cap. (mm)	TPI	Pack Qty (pcs)	Carton Qty (packs)
<b>PACK</b>										
<b>Board Cutting</b>										
APC110	T341HM	Glass Fibre Reinforced Plastic / Plasterboard	Straight	SSS ● 106	106	132	5.0-50.0	6	5	100

TYPE - JIG / SUB TYPE - JIG01 WL = WORKING LENGTH TL = TOTAL LENGTH TPI = TEETH PER INCH

## High Carbon Steel Blades - Wood Cutting



Product Code	Bosch Equiv.	Materials	Cut Type	Teeth Type	WL (mm)	TL (mm)	Cutting Cap. (mm)	TPI	Pack Qty (pcs)	Carton Qty (packs)
<b>PACK</b>										
<b>Wood Cutting</b>										
AHG13	T111C	Softwood / Plastic	Straight	MSS ● 75	75	100	4.0-50.0	8	5	100
AHW12	T119B	Softwood / Insulation Mat.	Straight	MWS ● 50	50	76	2.0-15.0	12	5	100
AHW12K	T119BO	Softwood / Insulation Mat.	Curve	MWS ● 50	50	76	2.0-15.0	12	5	100
AHGS14	T144D	All Wood Types	Straight	SSS ● 75	75	100	5.0-50.0	6	5	100
AHGS24	T244D	All Wood Types	Curve	SSS ● 75	75	100	5.0-50.0	6	5	100
AHC14	T101D	All Wood / Plastic	Straight	GTG ● 75	75	100	10.0-45.0	6	5	100
AHC12	T101B	All Wood / Plastic	Straight	GTG ● 75	75	100	3.0-30.0	10	5	100
AHC14D	T101DP	All Wood / Plastic	Precision	GTG ● 75	75	100	10.0-45.0	6	5	100
AHC12K	T101AO	Softwood / Laminate	Curve	GTG ● 50	50	76	1.5-15.0	18	5	100
AHC12R	T101BR	Wood / Laminate / Plastic	Down	GTG ● 75	75	100	3.0-30.0	10	5	100
AHC32R	-	Wood / Laminate / Plastic	Down	GTG ● 105	105	130	3.0-65.0	10	5	100

TYPE - JIG / SUB TYPE - JIG01 WL = WORKING LENGTH TL = TOTAL LENGTH TPI = TEETH PER INCH

## High Speed Steel Blades - Metal Cutting



Product Code	Bosch Equiv.	Materials	Cut Type	Teeth Type	WL (mm)	TL (mm)	Cutting Cap. (mm)	TPI	Pack Qty (pcs)	Carton Qty (packs)
<b>PACK</b>										
<b>Metal Cutting</b>										
AK14	T127D	Non-Ferrous / Alu. / Steel / Plastic	Straight	MSS ● 75	75	100	3.0 - 15.0	8	5	100
AMG107	T118G	Very Thin Sheet Metal	Straight	MWS ● 50	50	76	0.5 - 1.5	32	5	100
AMG11	T118A	Thin Sheets of Steel and Stainless Steel	Straight	MWS ● 50	50	76	1.0 - 3.0	21	5	100
AMG21	T218A	Thin Sheet / Steel	Curve	MWS ● 50	50	76	1.0 - 3.0	21	5	100
AMG12	T118B	Steel / Stainless Steel / Non-Ferrous / Alu.	Straight	MWS ● 50	50	76	2.5 - 6.0	12	5	100
AMG31	T318A	Pipes / Profiles / Thin Sheet Metal / Non-Ferrous	Straight	MWS ● 110	110	132	1.0 - 3.0	21	5	100
AMG32	T318B	Steel / Non-Ferrous / Pipes	Straight	MWS ● 110	110	132	2.5 - 6.0	12	5	100

TYPE - JIG / SUB TYPE - JIG01 WL = WORKING LENGTH TL = TOTAL LENGTH TPI = TEETH PER INCH



## Jigsaw Blade Sets

Comprehensive set of jigsaw blades to cover a multitude of cutting requirements into wood, metal and plastic.



10 PIECE

Handy re-usable storage case with slide open and close lid.  
Ideal for keeping jigsaw blades in order.



20 PIECE



16 PIECE

Set Code	Blade Code	Bosch Equiv.	Materials	Cut Type	Teeth Type	Working Length (mm)	Total Length (mm)	Cutting Capacity (mm)	TPI	Pack Qty (pcs)	Carton Qty (packs)
<b>MIXED SET ( 10 PIECE)</b>											
JIGSET10	-	-	-	-	-	-	-	-	-	10	10
	AHG13	T111C	Softwood / Plastic	Straight	MSS	75	100	4.0 - 50.0	8.50	1	
	AHGS14	T144D	All Wood	Straight	SSS	75	100	5.0 - 50.0	6.35	1	
	AHC12	T101B	All Wood / Plastic	Straight	GTG	75	100	3.0 - 30.0	10.00	2	
	AHC14	T101D	All Wood / Plastic	Straight	GTG	75	100	10.0 - 45.0	6.35	1	
	AHC12R	T101BR	All Wood / Laminated Board / Plastic	Down	GTG	75	100	3.0 - 30.0	10.00	1	
	AHW12K	T119BO	Softwood / Insulation	Curved	MWS	50	76	1.5 - 15.0	19.00	1	
	AMG11	T118A	Thin Sheet Metal / Stainless Steel	Straight	MWS	50	76	1.2 - 3.0	21.00	2	
	AMG12	T118B	Steel / Stainless Steel / Aluminium Non-Ferrous Metals	Straight	MWS	50	76	2.5 - 6.0	13.00	1	
TYPE - JIG				SUB TYPE - JIG01				TPI = TEETH PER INCH			

Set Code	Blade Code	Bosch Equiv.	Materials	Cut Type	Teeth Type	Working Length (mm)	Overall Length (mm)	Cutting Capacity (mm)	TPI	Pack Qty (pcs)	Carton Qty (packs)
<b>MIXED SET ( 20 PIECE)</b>											
JIGSET20	-	-	-	-	-	-	-	-	-	20	10
	AHG13	T111C	Softwood / Plastic	Straight	MSS	75	100	4.0 - 50.0	8.50	2	
	AHGS14	T144D	All Wood	Straight	SSS	75	100	5.0 - 50.0	6.35	2	
	AHC12	T101B	All Wood / Plastic	Straight	GTG	75	100	3.0 - 30.0	10.00	4	
	AHC14	T101D	All Wood / Plastic	Straight	GTG	75	100	10.0 - 45.0	6.35	2	
	AHC12R	T101BR	All Wood / Laminated Board / Plastic	Down	GTG	75	100	3.0 - 30.0	10.00	2	
	AHW12K	T119BO	Softwood / Insulation	Curved	MWS	50	76	1.5 - 15.0	19.00	2	
	AMG11	T118A	Thin Sheet Metal / Stainless Steel	Straight	MWS	50	76	1.2 - 3.0	21.00	4	
	AMG12	T118B	Steel / Stainless Steel / Aluminium Non-Ferrous Metals	Straight	MWS	50	76	2.5 - 6.0	13.00	2	
TYPE - JIG				SUB TYPE - JIG01				TPI = TEETH PER INCH			

Set Code	Blade Code	Bosch Equiv.	Materials	Cut Type	Teeth Type	Working Length (mm)	Overall Length (mm)	Cutting Capacity (mm)	TPI	Pack Qty (pcs)	Carton Qty (packs)
<b>MIXED SET ( 16 PIECE)</b>											
JIGSET	-	-	-	-	-	-	-	-	-	16	10
	AHG13	T111C	Softwood / Plastic	Straight	MSS	75	100	4.0 - 50.0	8	2	
	AHGS14	T144D	All Wood Types	Straight	SSS	75	100	5.0 - 50.0	6	2	
	AHC12	T101B	All Wood / Plastic	Straight	GTG	75	100	3.0 - 30.0	10	2	
	AHC14	T101D	All Wood / Plastic	Straight	GTG	75	100	10.0 - 45.0	6	1	
	AHC12R	T101BR	All Wood / Laminated Board / Plastic	Down	GTG	75	100	3.0 - 30.0	10	2	
	AHW12K	T119BO	Softwood / Insulation	Curved	MWS	50	76	1.5 - 15.0	12	2	
	AMG11	T118A	Thin Sheet Metal / Stainless Steel	Straight	MWS	50	76	1.2 - 3.0	21	3	
	AMG12	T118B	Steel / Stainless Steel / Aluminium Non-Ferrous Metals	Straight	MWS	50	76	2.5 - 6.0	13	2	
TYPE - JIG				SUB TYPE - JIG01				TPI = TEETH PER INCH			

## Reciprocating Saw Blade Set

Comprehensive set of reciprocating saw blades to cover a multitude of cutting requirements into wood, metal and plastic.

**NEW PRODUCT**



10 PIECE

Includes a handy re-usable storage case

Set Code	Blade Code	Bosch Equiv.	Materials	Cut Type	Teeth Type	Working Length (mm)	Total Length (mm)	Cutting Capacity (mm)	TPI	Pack Qty (pcs)	Carton Qty (packs)
<b>MIXED SET (10 PIECE)</b>											
SABSET10	-	-	-	-	-	-	-	-	-	10	5
	A3029-240	S1531L	Green Wood	Straight	SSS	215	240	<190	5	2	
	A3020-150	S610VF	Thin Sheet Metal / All Wood / Nails	Straight	MSS	125	150	<100	5 - 8	2	
	A3035-240	S1542K	Green / Fuel / Damp Wood	Straight	SSS	215	240	15 - 190	3	2	
	A3015-150	S922AF	Steel / Thin Sheet Metal / Pipes	Straight	MWS	125	150	0.7 - 3.0	24	2	
	A3023-200	S2345X	All Wood / Plastic	Straight	SSS	175	200	6.0 - 150	6 - 10	2	
TYPE - SAB				SUB TYPE - SAB01							

## Reciprocating Saw Blades



### Blade Material Types

#### Bi-M (Bi-Metal)

Combining the flexibility of a HCS body with a HSS hardened cutting edge, resulting in a tough, shatter resistant blade. Longer service life leads to greater cost effectiveness per blade.

#### Tungsten Carbide Tip

Combining the flexibility of a HCS body with TCT cutting edge, resulting in a tough blade which keeps its edge.

#### HCS (High Carbon Steel)

High Carbon Steel Blades for use with softer materials, such as hard and soft wood, plastics and laminated boards.

### Teeth Type

- **MSS - Milled & Side Set**

#### Rough/Coarse Cut

Basic tooth pattern used on the entry level blades. A quick but fairly rough cut.

- **MWS - Milled & Wavy Set**

#### Fine/Medium Cut

This pattern is used to give a fine, straight cut.

- **SSS - Side Set & Sharpened**

#### Fast/Medium Cut

This configuration gives a fast, medium cut.

- **GTG - Ground/Taper Ground**

#### Clean/Quick Cut

These top quality blades give a clean, quick cut in both wood and plastic.

### Cutting Materials

Soft Wood • Green Wood • Plastic • Plasterboard • Some Bricks • Sheet Metal • Sandwich • Aluminium • Non-Ferrous • Stainless Steel

## Bi-Metal Blades - Wood & Metal Cutting

LONGER SERVICE LIFE!



(A3020-150)

Product Code	Bosch Equiv.	Materials	Cut Type	Teeth Type	Working Length (mm)	Total Length (mm)	Cutting Cap. (mm)	TPI	Pack Qty (pcs)	Carton Qty (packs)
<b>PACK</b>										
<b>Wood Cutting</b>										
A3021-300BI	S1411DF	All Wood / Plastic	Straight	MSS ●	275	300	<250	6	5	20
					SUB TYPE - SAB01		TPI = TEETH PER INCH			
<b>Wood with Nails Cutting</b>										
A3020-150	S610VF	Wood with Metal (Nails)	Straight	MSS ●	125	150	<100	5 - 8	5	20
A3020-228	S1110VF	Wood with Metal (Nails)	Straight	MSS ●	203	228	<175	5 - 8	5	20
					SUB TYPE - SAB01		TPI = TEETH PER INCH			
<b>Metal Cutting</b>										
A3018-280	-	Steel / SS / Non-Ferrous	Straight	MWS ●	255	280	3.0 - 12.0	10	5	20
A3013-150	S922BF	Steel / SS / Non-Ferrous	Straight	MWS ●	125	150	3.0 - 8.0	14	5	20
A3013-200	S1122BF	Steel / SS / Non-Ferrous	Straight	MWS ●	200	225	3.0 - 8.0	14	5	20
A3015-150	S922AF	Steel / Sheet Metal	Straight	MWS ●	125	150	0.7 - 3.0	24	5	20
A3015-200	S1122AF	Steel / Sheet Metal	Straight	MWS ●	200	225	0.7 - 3.0	24	5	20
A3014-150	S922EF	Steel / Stainless Steel	Straight	MWS ●	125	150	1.5 - 4.0	18	5	20
A3014-200	S1122EF	Steel / Stainless Steel	Straight	MWS ●	200	225	1.5 - 4.0	18	5	20
					SUB TYPE - SAB01		TPI = TEETH PER INCH			

## Tungsten Carbide Tipped Blade - Block/Brick Cutting

LONGER SERVICE LIFE!



(AB305-215)

Product Code	Bosch Equiv.	Materials	Cut Type	Teeth Type	Working Length (mm)	Total Length (mm)	Cutting Cap. (mm)	TPI	Pack Qty (pcs)	Carton Qty (packs)
<b>PACK</b>										
AB305-215	S1243HM	Aircrete Block / Some Bricks	Straight	MSS ●	260	305	<215	2	1	25
					SUB TYPE - SAB01		TPI = TEETH PER INCH			

## HCS Blades - Wood Cutting

NEW SIZES



(A3029-240)

Product Code	Bosch Equiv.	Materials	Cut Type	Teeth Type	Working Length (mm)	Total Length (mm)	Cutting Cap. (mm)	TPI	Pack Qty (pcs)	Carton Qty (packs)
<b>PACK</b>										
A3021-150	S644D	Wood / Plastic / Sandwich	Curve	SSS ●	125	150	6.0 - 100	6	5	20
A3023-200	S2345X	Wood / Man-Made Board / Plastic	Straight	SSS ●	175	200	6.0 - 150	6-10	5	20
A3029-240	S1531L	Green Wood	Straight	SSS ●	220	215	<190	5	5	20
A3035-240	S1542K	Green / Fuel / Damp Wood	Straight	SSS ●	215	240	15.0 - 190	3	5	20
					SUB TYPE - SAB01		TPI = TEETH PER INCH			

## Multi-Tool Blades

MULTI-PACKS NOW AVAILABLE



### Blade Material Types

#### Titanium Coated

High performance M42 bi-metal blades with a protective hardened titanium coat to improve performance and increase working life.

#### Bi-M (Bi-Metal)

Combining the flexibility of a HCS body with a HSS hardened cutting edge, resulting in a tough, shatter resistant blade. Longer service life leads to greater cost effectiveness per blade.

#### Carbon Steel

Carbon steel are typically used for timber cutting. Available in a range of widths and cutting depths to suit multiple jobs.

### Cutting Materials

#### Titanium Coated

Softwood • Hardwood • Steel • Non-Ferrous • Sheet Metal • Plastic • Laminate

#### Bi-M (Bi-Metal)

Softwood • Hardwood • Steel • Non-Ferrous • Sheet Metal • Plastic • Laminate

#### Carbon Steel

Softwood • Plastic • Plasterboard

## Titanium Coated Bi-Metal Blades - Wood & Metal Cutting

3x LONGER SERVICE LIFE!

### Radial Blade



Radial blades feature a flat side for working flush against a flat work surface. Perfect for cutting skirting or trims.

Product Code	Size Ø (mm)	Cutting Depth (mm)	Teeth Pitch (mm)	Pack Qty (pcs)	Carton Qty (packs)
<b>BLISTER PACK</b>					
MTR87TN	87	26	1.3	1	10
TYPE - MTB			SUB TYPE - MTB01		

### Straight Fine Cut Blade

NEW SIZES



For general work. Flush cut blades are designed for a fine, clean cut into wood, plasterboard and many types of plastic.

Product Code	Size (mm)	Cutting Depth (mm)	Teeth Pitch (mm)	Pack Qty (pcs)	Carton Qty (packs)
<b>BLISTER PACK</b>					
MT32TN	32	54	1.4	1	10
MT32TN5	32	54	1.4	5	5
MT44TN	44	54	1.4	1	10
MT44TN5	44	54	1.4	5	5
MT69TN	69	42	1.4	1	10
TYPE - MTB			SUB TYPE - MTB01		

## Bi-Metal Blades - Wood & Metal Cutting

LONGER SERVICE LIFE!

### Radial Blade



Radial blades feature a flat side for working flush against a flat work surface. Perfect for cutting skirting or trims.

Product Code	Size Ø (mm)	Cutting Depth (mm)	Teeth Pitch (mm)	Pack Qty (pcs)	Carton Qty (packs)
<b>BLISTER PACK</b>					
MTR87BI	87	26	1.3	1	10
TYPE - MTB			SUB TYPE - MTB01		

### Fine Straight Cut Blade

NEW SIZES



Flush cut blades are designed for a fine, clean cut into wood, plasterboard and many types of plastic.

Product Code	Size (mm)	Cutting Depth (mm)	Teeth Pitch (mm)	Pack Qty (pcs)	Carton Qty (packs)
<b>BLISTER PACK</b>					
MT10BI	10	40	1.4	1	10
MT20BI	20	40	1.4	1	10
MT20BI5	20	40	1.4	5	5
MT32BI	32	42	1.4	1	10
MT32BI5	32	42	1.4	5	5
MT44BI	44	54	1.4	1	10
MT44BI5	44	54	1.4	5	5
MT69BI	69	42	1.4	1	10
TYPE - MTB			SUB TYPE - MTB01		

## Carbon Steel Blades - Wood & Plastic Cutting

### Radial Blade



Radial blades feature a flat side for working flush against a flat work surface. Perfect for cutting skirting or trims.

Product Code	Size Ø (mm)	Cutting Depth (mm)	Teeth Pitch (mm)	Pack Qty (pcs)	Carton Qty (packs)
<b>BLISTER PACK</b>					
MTR87	87	26	1.4	1	10
TYPE - MTB			SUB TYPE - MTB01		

### Straight Fine Cut Blade

NEW SIZES



Flush cut blades are designed for a fine, clean cut into wood, plasterboard and many types of plastic.

Product Code	Size (mm)	Cutting Depth (mm)	Teeth Pitch (mm)	Pack Qty (pcs)	Carton Qty (packs)
<b>BLISTER PACK</b>					
MT10FT	10	40	1.4	1	10
MT20FT	20	40	1.4	1	10
MT32FT	32	42	1.4	1	10
MT32FT5	32	42	1.4	5	5
MT44FT	44	54	1.4	1	10
MT69FT	69	42	1.4	1	10
MT69FT5	69	42	1.4	5	5
TYPE - MTB			SUB TYPE - MTB01		

### Straight Coarse Cut Blade

NEW SIZES



Coarse cut blades are designed to give a quick, coarse cut into wood, plasterboard and many types of plastic.

Product Code	Size (mm)	Cutting Depth (mm)	Teeth Pitch (mm)	Pack Qty (pcs)	Carton Qty (packs)
<b>BLISTER PACK</b>					
MT32CT	32	42	1.69	1	10
MT32CT5	32	42	1.69	5	5
MT44CT	44	54	1.69	1	10
MT69CT	69	42	1.69	1	10
MT69CT5	69	42	1.69	5	5
TYPE - MTB			SUB TYPE - MTB01		

### Serrated Wavy Edge Saw Blade



The serrated blade is ideal for cutting soft materials such as cardboard, polystyrene, carpet, rubber and leather.

Product Code	Size (mm)	Cutting Depth (mm)	Pack Qty (pcs)	Carton Qty (packs)
--------------	-----------	--------------------	----------------	--------------------

**BLISTER PACK**

MT69SE	69	42	1	10
TYPE - MTB		SUB TYPE - MTB01		

### Flexible Scraper Blade



Ideal for many scraping applications such as removing paint, glues and silicone.

Product Code	Size (mm)	Cutting Depth (mm)	Pack Qty (pcs)	Carton Qty (packs)
--------------	-----------	--------------------	----------------	--------------------

**BLISTER PACK**

MT52SC	52	35	1	10
TYPE - MTB		SUB TYPE - MTB01		

### Diamond Carbide Grit Carbon Steel Blades

#### Radial Blade



Ideal for cutting tiles, porous concrete and plaster

Product Code	Size Ø (mm)	Cutting Depth (mm)	Pack Qty (pcs)	Carton Qty (packs)
--------------	-------------	--------------------	----------------	--------------------

**BLISTER PACK**

MTR65CG	65	10	1	10
TYPE - MTB		SUB TYPE - MTB01		

#### Boot Blade



Designed to remove grout from in-between tiles. The boot design rapidly removes the grout without damaging the tiles.

Product Code	Size (mm)	Cutting Depth (mm)	Pack Qty (pcs)	Carton Qty (packs)
--------------	-----------	--------------------	----------------	--------------------

**BLISTER PACK**

MTBOOT	59	45	1	10
TYPE - MTB		SUB TYPE - MTB01		

### Delta Sanding Pad



To be used in conjunction with triangular sanding sheets. For sanding wood, metal and plastics.

Product Code	Size (mm)	Pack Qty (pcs)	Carton Qty (packs)
--------------	-----------	----------------	--------------------

**BLISTER PACK**

MT93SP	93	1	5
TYPE - MTB		SUB TYPE - MTB01	

### Sanding Sheets



Universal use on most surfaces, the hook and loop backing makes it easy to remove from the sanding pad.

Product Code	Size (mm)	Grit	Pack Qty (pcs)	Carton Qty (packs)
--------------	-----------	------	----------------	--------------------

**BLISTER PACK**

MTP60	93	60	10	120
MTP80	93	80	10	120
MTP180	93	180	10	120
TYPE - MTB		SUB TYPE - MTB01		

## Multi-Tool Blade Sets



8 PIECE

Convenient eight piece mixed set of popular blades. Ideal for multiple applications.

Product Code	Blade Code	Size (mm)	Cutting Depth (mm)	Teeth Pitch (mm)	Pack Qty (pcs)	Carton Qty (packs)
--------------	------------	-----------	--------------------	------------------	----------------	--------------------

**BLISTER PACK**

MT8PSET	MT10BI	10	40	1.4	1	10
	MT20BI	20	40	1.4	1	
	MT32BI	32	42	1.4	1	
	MT69BI	69	42	1.4	1	
	MTR87BI	Ø87	26	1.3	1	
	MT32CT	32	40	1.69	1	
	MT69CT	69	42	1.69	1	
	MT52SC	52	35	N/A	1	
TYPE - MTB		SUB TYPE - MTB01				



4 PIECE

Convenient four piece mixed set of popular blades. Ideal for multiple applications.

Product Code	Blade Code	Size (mm)	Cutting Depth (mm)	Teeth Pitch (mm)	Pack Qty (pcs)	Carton Qty (packs)
--------------	------------	-----------	--------------------	------------------	----------------	--------------------

**BLISTER PACK**

MT4PSET	MT32BI	32	42	1.4	1	10
	MT69BI	69	42	1.4	1	
	MT32CT	32	40	1.69	1	
	MT69CT	69	42	1.69	1	
TYPE - MTB		SUB TYPE - MTB01				



# Hand Sanding



## Sandpaper Rolls

### Yellow Sandpaper Roll



- Crack resistant
- Long life
- Anti-clog coating

Manufactured using lightweight 180g backing paper, allowing for excellent flexibility and malleability without tearing and cracking. The premium quality aluminium oxide grit allows for excellent material removal.

Ideal for preparation of intricate & delicate applications.

Product Code	Length (m)	Width (mm)	Grit	Abrasive Grade	Pack Qty (pcs)	Carton Qty (packs)
<b>ROLL</b>						
231541	10	115	60	Coarse	1	6
231999	10	115	80	Medium	1	6
231405	10	115	120	Fine	1	6

TYPE - ABR SUB TYPE - ABR01

### Green Sandpaper Roll



- Crack resistant
- Long life
- Anti-clog coating

Manufactured using premium 225g backing paper, allowing for hard wearing and flexible sanding performance. The premium quality aluminium oxide grit allows for excellent material removal.

Ideal for hand and power tool sanding.

Product Code	Length (m)	Width (mm)	Grit	Abrasive Grade	Pack Qty (pcs)	Carton Qty (packs)
<b>ROLL</b>						
231022	10	115	60	Coarse	1	6
231117	10	115	80	Medium	1	6
231823	10	115	120	Fine	1	6

TYPE - ABR SUB TYPE - ABR01

### Red Sandpaper Roll



- Crack resistant
- Long life
- Anti-clog coating

Manufactured using heavy duty 250g backing paper, allowing for long lasting and hard wearing sanding performance. Premium quality calcined aluminium oxide grit allows for excellent material removal.

Ideal for woodworking, painting and decorating.

Product Code	Length (m)	Width (mm)	Grit	Abrasive Grade	Pack Qty (pcs)	Carton Qty (packs)
<b>ROLL</b>						
231004	10	115	60	Coarse	1	6
231210	10	115	80	Medium	1	6
231311	10	115	120	Fine	1	6

TYPE - ABR SUB TYPE - ABR01

## Full Sanding Sheets

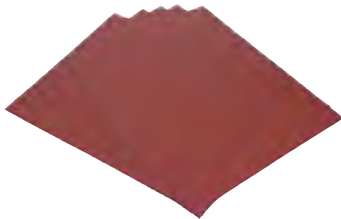

High quality aluminium oxide abrasive with a high strength anti-crack backing paper to provide a superior lifespan. Ideal for heavy hand or power sanding on wood, paint, varnish, plaster and filler.

Product Code	Size W x L (mm)	Grit	Abrasive Grade	Pack Qty (pcs)	Carton Qty (packs)
<b>PACK</b>					
231002	230 x 280	80	Medium	5	10
231191	230 x 280	120	Fine	5	10
231505	230 x 280	180	Extra Fine	5	10
231123	230 x 280	80/120/180	Assorted	5	10

TYPE - ABR SUB TYPE - ABR02

## Wet & Dry Sanding Sheets

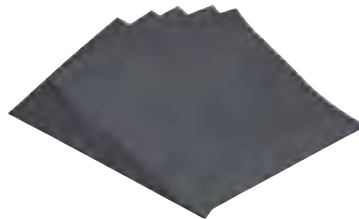

Premium quality silicon carbide abrasive with a flexible waterproof backing paper. When used in conjunction with water this paper gives a smoother surface compared to dry sanding on metal, wood, paint and varnish whilst reducing dust.

Product Code	Size W x L (mm)	Grit	Abrasive Grade	Pack Qty (pcs)	Carton Qty (packs)
<b>PACK</b>					
231485	230 x 280	600	Ultra Fine	5	10
231636	230 x 280	1200	Ultra Fine	5	10
231357	230 x 280	180/320	Assorted	5	10

TYPE - ABR SUB TYPE - ABR02

## Steel Wire Wool



Used by woodworkers and craftsmen when cleaning metal and wood in preparation for lacquers, varnishes and paints.



Product Code	Weight (g)	Abrasive Grade	Pack Qty (pcs)	Carton Qty (packs)
<b>PACK</b>				
231659	200	Coarse	1	48
231308	200	Medium	1	48
231007	200	Fine	1	48

TYPE - ABR SUB TYPE - ABR04

# Powertool Sanding

## Sanding Belts



- Heat resistant backing
- Long life
- Anti-clog coating

Manufactured using a heat resistant cloth backing and premium quality aluminium oxide grit. Designed to maintain sanding performance, prolong lifespan and meet the extreme requirements of modern belt sanders.

Product Code	Size W x L (mm)	Grit	Abrasive Grade	Pack Qty (pcs)	Carton Qty (packs)
<b>PACK</b>					
231069	75 x 533	40	Coarse	5	60
231841	75 x 533	80	Medium	5	60
231645	75 x 533	120	Fine	5	60
231429	75 x 457	40	Coarse	5	60
231987	75 x 457	80	Medium	5	60
231321	75 x 457	120	Fine	5	60
231147	100 x 610	40	Coarse	5	60
231258	100 x 610	80	Medium	5	60
231369	100 x 610	120	Fine	5	60
TYPE - ABR			SUB TYPE - ABR03		

## Punched 1/3 Sanding Sheets



- Crack resistant
- Long life
- Anti-clog coating

High quality aluminium oxide abrasive with a high strength heat and wear resistant backing paper to provide a superior lifespan.

Ideal for heavy power sanding on wood, paint, varnish, plaster and filler.

Product Code	Size W x L (mm)	Grit	Abrasive Grade	Pack Qty (pcs)	Carton Qty (packs)
<b>PACK</b>					
231050	93 x 185	80	Medium	5	50
231855	93 x 185	120	Fine	5	50
231666	93 x 185	180	Extra Fine	5	50
231112	93 x 185	80/120/180	Assorted	5	50
TYPE - ABR			SUB TYPE - ABR03		

## Unpunched 1/3 Sanding Sheets



- Crack resistant
- Long life
- Anti-clog coating

High quality aluminium oxide abrasive with a high strength heat and wear resistant backing paper to provide a superior lifespan.

Ideal for heavy power sanding on wood, paint, varnish, plaster and filler.

Product Code	Size W x L (mm)	Grit	Abrasive Grade	Pack Qty (pcs)	Carton Qty (packs)
<b>PACK</b>					
231467	93 x 230	60	Coarse	5	50
231900	93 x 230	80	Medium	5	50
231751	93 x 230	120	Fine	5	50
231222	93 x 230	180	Extra Fine	5	50
231599	93 x 230	80/120/180	Assorted	5	50
TYPE - ABR			SUB TYPE - ABR03		

## Delta Sanding Pad



- Crack resistant
- Hook & loop
- Anti-clog coating

Ideal for heavy power sanding on wood, paint, varnish, plaster and filler.

Product Code	Size W x L (mm)	Grit	Abrasive Grade	Pack Qty (pcs)	Carton Qty (packs)
<b>PACK</b>					
231005	95 x 95	60	Coarse	5	100
231119	95 x 95	80	Medium	5	100
231410	95 x 95	120	Fine	5	100
231360	95 x 95	180	Extra Fine	5	100
231909	95 x 95	240	Extra Fine	5	100
231333	95 x 95	80/120/180	Assorted	5	100
TYPE - ABR			SUB TYPE - ABR03		

## Detail Sanding Sheet



- Crack resistant
- Hook & loop
- Anti-clog coating

Ideal for heavy power sanding on wood, paint, varnish, plaster and filler.

Product Code	Size W x L (mm)	Grit	Abrasive Grade	Pack Qty (pcs)	Carton Qty (packs)
<b>PACK</b>					
231753	95 x 136	80	Medium	5	100
231081	95 x 136	120	Fine	5	100
231811	95 x 136	180	Extra Fine	5	100
TYPE - ABR			SUB TYPE - ABR08		

## Random Orbital Disc



- Crack resistant
- Hook & loop
- Anti-clog coating

Ideal for heavy power sanding on wood, paint, varnish, plaster and filler.

Product Code	Ø (mm)	Ø (inch)	Grit	Abrasive Grade	Pack Qty (pcs)	Carton Qty (packs)
<b>PACK</b>						
231019	125	5	60	Coarse	5	100
231555	125	5	80	Medium	5	100
231378	125	5	120	Fine	5	100
231200	125	5	180	Extra Fine	5	100
231992	125	5	80/120/180	Assorted	5	100
231084	150	6	60	Coarse	5	100
231080	150	6	80	Medium	5	100
231144	150	6	120	Fine	5	100
231719	150	6	180	Extra Fine	5	100
231859	150	6	80/120/180	Assorted	5	100
TYPE - ABR			SUB TYPE - ABR03			

## Drylining Discs

**BEST SELLER**

High quality sandpaper discs with white aluminium oxide abrasive for effective material removal. Perforated for excellent dust extraction. Available in a wide variety of abrasive grades to allow for varied results, from rapid material removal through to final finishing.



- Anti-slip hook & loop backing
- Lightweight and flexible backing paper
- Designed for use with all leading brands of drywall power sanders

Product Code	Ø (mm)	Ø (inch)	Grit	Abrasive Grade	Pack Qty (pcs)	Carton Qty (packs)
<b>BUNDLE</b>						
231101	225	9	40	Coarse	25	7
231546	225	9	60	Coarse	25	7
231894	225	9	80	Medium	25	8
231434	225	9	100	Medium	25	8
231025	225	9	120	Fine	25	8
231175	225	9	150	Fine	25	8
231232	225	9	180	Extra Fine	25	8
231741	225	9	220	Extra Fine	25	8
TYPE - ABR			SUB TYPE - ABR03			

## Angle Grinder Wire Brushes



### Steel Wire Brushes

Steel • Sheet Metal  
Cast Iron



### Stainless Steel Wire Brushes

Stainless Steel • Non-Ferrous  
Aluminium

## Crimped Steel Wire Brushes

Suitable for use with angle and bench grinders. The crimped wire is ideal for lightly removing loose paint, rust or dirt without scarring the base material. Use stainless steel to reduce the likelihood of cross contamination when cleaning the base material.

### Cup Brushes



Product Code	Ø (mm)	Arbor	Wire Thickness (mm)	Max R.P.M	Pack Qty (pcs)	Carton Qty (packs)
<b>BLISTER PACK</b>						
<b>Steel Wire Cup Brush</b>						
75TCC	75	M14	0.3	12,500	1	5
100TCC	100	M14	0.3	8,500	1	5
125TCC	125	M14	0.3	6,500	1	5
150TCC	150	M14	0.3	6,500	1	5
<b>Stainless Steel Wire Cup Brush</b>						
75TCCSS	75	M14	0.5	8,500	1	5
100TCCSS	100	M14	0.5	8,500	1	5
TYPE - PTB			SUB TYPE - PTB02/PTB09			

### Bevel Brushes



Product Code	Ø (mm)	Arbor	Wire Thickness (mm)	Max R.P.M	Pack Qty (pcs)	Carton Qty (packs)
<b>BLISTER PACK</b>						
<b>Steel Wire Bevel Brush</b>						
115TBC	115	M14	0.3	12,500	1	5
<b>Stainless Steel Wire Bevel Brush</b>						
115TBCSS	115	M14	0.3	12,500	1	5
TYPE - PTB			SUB TYPE - PTB12/PTB13			

### Wheel Brush with Reducer Set



Product Code	Ø (mm)	Arbor	Wire Thickness (mm)	Max R.P.M	Pack Qty (pcs)	Carton Qty (packs)
<b>BLISTER PACK</b>						
<b>Steel Wire Wheel Brush</b>						
150HWC	150	32	0.3	6,000	1	5
200HWC	200	32	0.3	4,500	1	5
TYPE - PTB			SUB TYPE - PTB18			

## Twisted Knot Steel Wire Brushes

Suitable for use with angle and bench grinders. The 0.5mm twist steel wire is hard wearing and gives an aggressive removal of paint, rust, rubber, concrete or dirt. The metal ring can be removed to increase usage life.. Use stainless steel to reduce the likelihood of cross contamination when cleaning the base material.

### Cup Brushes



Product Code	Ø (mm)	Arbor	Wire Thickness (mm)	Max R.P.M	Pack Qty (pcs)	Carton Qty (packs)
<b>BLISTER PACK</b>						
<b>Steel Wire Cup Brush</b>						
80TCT	80	M14	0.5	8,500	1	5
100TCT	100	M14	0.5	8,500	1	5
<b>Stainless Steel Wire Cup Brush</b>						
100TCTSS	100	M14	0.5	8,500	1	5
TYPE - PTB			SUB TYPE - PTB10/PTB11			

### Bevel Brushes



Product Code	Ø (mm)	Arbor	Wire Thickness (mm)	Max R.P.M	Pack Qty (pcs)	Carton Qty (packs)
<b>BLISTER PACK</b>						
<b>Steel Wire Bevel Brush</b>						
100TBT	100	M14	0.5	12,500	1	5
<b>Stainless Steel Wire Bevel Brush</b>						
100TBTSS	100	M14	0.5	12,500	1	5
TYPE - PTB			SUB TYPE - PTB14/PTB15			

### Wheel Brushes



Product Code	Ø (mm)	Arbor	Wire Thickness (mm)	Max R.P.M	Pack Qty (pcs)	Carton Qty (packs)
<b>BLISTER PACK</b>						
<b>Steel Wire Wheel Brush</b>						
115TWT	115	M14	0.5	12,500	1	5
<b>Stainless Steel Wire Wheel Brush</b>						
115TWTSS	115	M14	0.5	12,500	1	5
<b>Steel Wire Wheel Brush</b>						
125HWT	125	22	0.5	12,500	1	5
TYPE - PTB			SUB TYPE - PTB16/PTB17/PTB03			

## Drill Wire Brushes



### Nylon Wire Brushes

Sheet Metal • Wood  
Stone



### Steel Wire Brushes

Steel • Sheet Metal  
Cast Iron

## Nylon Brushes

The nylon brush is less aggressive and ideal for light de-burring, polishing and finishing.



Product Code	Ø (mm)	Shank Ø (inch)	Nylon Thickness (mm)	Max R.P.M	Pack Qty (pcs)	Carton Qty (packs)
<b>BLISTER PACK</b>						
<b>Nylon Cup Brush</b>						
50SCN	50	1/4" Hex	1.3	4,500	1	12
75SCN	75	1/4" Hex	1.3	4,500	1	12
<b>Nylon Wheel Brush</b>						
75SWN	75	1/4" Hex	1.3	4,500	1	12
100SWN	100	1/4" Hex	1.3	4,500	1	12

TYPE - PTB SUB TYPE - PTB08/PTB06

## Crimped Steel Wire Brushes

Crimped wire is ideal for lightly removing loose paint, rust or dirt without scarring the base material.

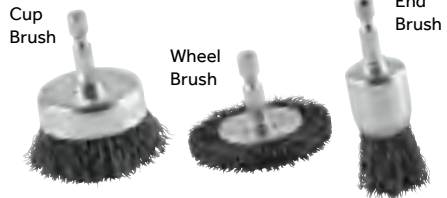

Product Code	Ø (mm)	Shank Ø (inch)	Wire Thickness (mm)	Max R.P.M	Pack Qty (pcs)	Carton Qty (packs)
<b>BLISTER PACK</b>						
<b>Steel Wire Cup Brush</b>						
50SCC	50	1/4" Hex	0.3	4,500	1	12
75SCC	75	1/4" Hex	0.3	4,500	1	12
<b>Steel Wire Wheel Brush</b>						
50SWC	50	1/4" Hex	0.3	4,500	1	12
75SWC	75	1/4" Hex	0.3	4,500	1	12
100SWC	100	1/4" Hex	0.3	4,500	1	12
<b>Steel Wire End Brush</b>						
25SEC	25	1/4" Hex	0.3	4,500	1	20

TYPE - PTB SUB TYPE - PTB07/PTB04/PTB01

## Twisted Knot Steel Wire Brush



The twist brush is ideal for aggressive removal of paint, rust, concrete or dirt.

Product Code	Ø (mm)	Shank Ø (inch)	Wire Thickness (mm)	Max R.P.M	Pack Qty (pcs)	Carton Qty (packs)
<b>BLISTER PACK</b>						
<b>Steel Wire Wheel Brush</b>						
75SWT	75	1/4"	0.5	12,500	1	12

TYPE - PTB SUB TYPE - PTB05

## Flap Discs & Preparation Discs

### Zirconium Flap Discs



A premium, long life and heavy duty zirconium flap disc for consistent and rapid performance whilst grinding, finishing, removing paint and weld dressing.

Suitable for use with Stainless Steel (inox), Cast Iron, Alloy Metals and Wood.

Ideal for flat and curved surfaces.

- Heavy Stripping
- Rapid Abrasive Action
- Type 29
- Approved to EN13743

Product Code	Ø (mm)	Ø (inch)	Bore (mm)	Grit	Abrasive Grade	Pack Qty (pcs)	2nd Qty (packs)	Carton Qty (packs)
<b>PACK</b>								
231020	115	4 1/2	22.23	P40	Coarse	1	10	100
231528	115	4 1/2	22.23	P60	Coarse	1	10	100
231351	115	4 1/2	22.23	P80	Medium	1	10	100
231051	115	4 1/2	22.23	P120	Fine	1	10	100
<b>BOX</b>								
231444	115	4 1/2	22.23	P40	Coarse	10	-	20
231953	115	4 1/2	22.23	P60	Coarse	10	-	20
231862	115	4 1/2	22.23	P80	Medium	10	-	20
231006	115	4 1/2	22.23	P120	Fine	10	-	20

TYPE - ABR

SUB TYPE - ABR05

### Nylon Stripping & Preparation Discs



A hardened nylon fibre strip disc for ultimate stock removal and surface preparation performance. Ideal for removing old paint, weld spatter, rust and corrosion without damaging the work piece.

Ideal for use on flat surfaces and for the removal of thermal bluing.

- Rapid Abrasive Action
- Reduced Loading Required
- Heavy Duty Backing
- Approved to EN13743

Product Code	Ø (mm)	Ø (inch)	Bore (mm)	Pack Qty (pcs)	2nd Qty (packs)	Carton Qty (packs)
<b>PACK</b>						
231363	115	4 1/2	22.23	1	10	100
<b>BOX</b>						
231230	115	4 1/2	22.23	10	-	20

TYPE - ABR

SUB TYPE - ABR05



# Chucks, Keys and Adaptors

## Heavy Duty Keyless Chuck



A keyless hand-tightened three jaw chuck that fits drills with 1/2" shaft. Ideal for impact drills up to 750 watt.

Suitable for 1.5mm – 13mm drills bits.

Product Code	Clamping Capacity (mm)	Capacity Mount (imp)	Pack Qty (pcs)	Carton Qty (packs)
<b>PACK</b>				
HDKC13	1.5 - 13.0	1/2"	1	10
TYPE - KEY			SUB TYPE - KEY01	

## Super Heavy Duty Keyless Chuck



A keyless heavy duty hand-tightened three jaw chuck that fits drills with 1/2" shaft. Ideal for impact drills up to 1000 watt.

Suitable for 1.5mm – 13mm drills bits.

Product Code	Clamping Capacity (mm)	Capacity Mount (imp)	Pack Qty (pcs)	Carton Qty (packs)
<b>PACK</b>				
SHDKC	1.5 - 13.0	1/2"	1	10
TYPE - KEY			SUB TYPE - KEY01	

## Single Handed Keyless Chuck



A keyless single hand-tightened three jaw chuck that fits drills with 1/2" shaft. Ideal for impact drills up to 750 watt.

Suitable for 1.5mm – 13mm drills bits.

Product Code	Clamping Capacity (mm)	Capacity Mount (imp)	Pack Qty (pcs)	Carton Qty (packs)
<b>PACK</b>				
SHKC13	1.5 - 13.0	1/2"	1	10
TYPE - KEY			SUB TYPE - KEY01	

## Keyless Chuck & SDS Plus Adaptor



A keyless hand-tightened three jaw chuck that fits drills with 1/2" shaft. Ideal for impact drills up to 750 watt. Sold with an SDS plus adaptor.

Suitable for 1.5mm – 13mm drills bits.

Product Code	Clamping Capacity (mm)	Capacity Mount (imp)	Pack Qty (pcs)	Carton Qty (packs)
<b>PACK</b>				
KKEY	1.5 - 13.0	1/2"	1	10
TYPE - KEY			SUB TYPE - KEY01	

## Chuck, Key & SDS Sets

A traditional keyed chuck that fits drills with 1/2" shaft.

Suitable for 1.5mm – 13mm drills bits.

C13 - Chuck and Key  
KEY - Chuck, Key and SDS adaptor

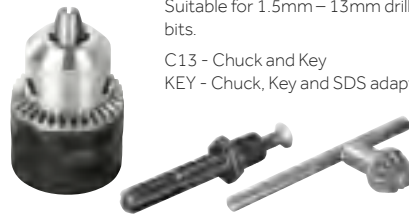

Product Code	Clamping Capacity (mm)	Capacity Mount (imp)	Pack Qty (pcs)	Carton Qty (packs)
<b>PACK</b>				
C13	1.5 - 13.0	1/2"	1	10
KEY	1.5 - 13.0	1/2"	1	10
TYPE - KEY			SUB TYPE - KEY01	

## Chuck Key & SDS Plus Adaptor

Chuck Key (AS2)

SDS Plus Adaptor (SDSCA)



Product Code	To Fit	Pack Qty (pcs)	Carton Qty (packs)
<b>PACK</b>			
AS2	1/2" keyed chuck	1	10
SDSCA	SDS plus to 1/2"	1	10
TYPE - KEY		SUB TYPE - KEY01	

## Impact Driver Bits

### Impact Driver Bits

#### Pozi Impact Driver Bit



Product Code	Bit Size	Length (mm)	Pack Qty (pcs)	Carton Qty (packs)
--------------	----------	-------------	----------------	--------------------

##### HANDY PACK

1PZ25X6	PZ1	25	10	15
2PZ25X6	PZ2	25	10	15
3PZ25X6	PZ3	25	10	15
1PZ50X6	PZ1	50	5	15
2PZ50X6	PZ2	50	5	15
3PZ50X6	PZ3	50	5	15

##### BLISTER CARD

2PZ90X6	PZ2	90	1	24
2PZ150X6	PZ2	150	1	12

TYPE - ABT

SUB TYPE - ABT01

#### Phillips Impact Driver Bit



Product Code	Bit Size	Length (mm)	Pack Qty (pcs)	CDU Qty (packs)
--------------	----------	-------------	----------------	-----------------

##### HANDY PACK

1PH25X6	PH1	25	10	15
2PH25X6	PH2	25	10	15
3PH25X6	PH3	25	10	15
2PH50X6	PH2	50	5	15
3PH50X6	PH3	50	5	15

##### BLISTER CARD

2PH90X6	PH2	90	1	24
2PH150X6	PH2	150	1	12

TYPE - ABT

SUB TYPE - ABT02

#### TX Drive Impact Driver Bit



Product Code	Bit Size	Length (mm)	Pack Qty (pcs)	Carton Qty (packs)
--------------	----------	-------------	----------------	--------------------

##### HANDY PACK

20TX25X6	TX20	25	10	15
25TX25X6	TX25	25	10	15
30TX25X6	TX30	25	10	15
40TX25X6	TX40	25	10	15
25TX50X6	TX25	50	5	15
30TX50X6	TX30	50	5	15
40TX50X6	TX40	50	5	15
50TX50X6	TX50	50	5	15

TYPE - ABT

SUB TYPE - ABT03

#### Square Impact Driver Bit



Product Code	Bit Size	Length (mm)	Pack Qty (pcs)	Carton Qty (packs)
--------------	----------	-------------	----------------	--------------------

##### HANDY PACK

2SQ25X6	SQ2	25	10	15
2SQ50X6	SQ2	50	5	15

TYPE - ABT

SUB TYPE - ABT04

#### Hex Impact Driver Bit



NEW

Product Code	Bit Size	Length (mm)	Pack Qty (pcs)	Carton Qty (packs)
--------------	----------	-------------	----------------	--------------------

##### HANDY PACK

3HX25X6	HX3	25	10	5
4HX25X6	HX4	25	10	5
5HX25X6	HX5	25	10	5
6HX25X6	HX6	25	10	5
8HX25X6	HX8	25	10	5

TYPE - ABT

SUB TYPE - ABT06

### Double Ended Impact Driver Bits

#### Double Ended Pozi Impact Driver Bit



Product Code	Bit Size	Length (mm)	Pack Qty (pcs)	Carton Qty (packs)
--------------	----------	-------------	----------------	--------------------

##### BLISTER PACK

2PZ65X6	PZ2	65	2	24
3PZ65X6	PZ3	65	2	24

TYPE - ABT

SUB TYPE - ABT01

#### Double Ended Phillips Impact Driver Bit



Product Code	Bit Size	Length (mm)	Pack Qty (pcs)	Carton Qty (packs)
--------------	----------	-------------	----------------	--------------------

##### BLISTER PACK

2PH65X6	PH2	65	2	24
3PH65X6	PH3	65	2	24

TYPE - ABT

SUB TYPE - ABT02

#### Double Ended TX Drive Impact Driver Bit



Product Code	Bit Size	Length (mm)	Pack Qty (pcs)	Carton Qty (packs)
--------------	----------	-------------	----------------	--------------------

##### BLISTER PACK

25TX65X6	TX25	65	2	12
30TX65X6	TX30	65	2	12
40TX65X6	TX40	65	2	12

TYPE - ABT

SUB TYPE - ABT03

### Impact Driver Bit Sets



11 PIECE

Convenient pocket sized mixed set of 25mm impact resistant bits with magnetic bit holder.

Set includes: PZ1(1), PZ2(2), PZ3(1), PH2(2), TX15(1), TX20(1), TX25(1), TX30(1), Magnetic Bit Holder (1).

Product Code	Pack Qty (pcs)	Carton Qty (packs)
--------------	----------------	--------------------

##### BLISTER PACK

228447	11	12
--------	----	----

TYPE - ABT

SUB TYPE - ABT07



28 PIECE

Comprehensive mixed set of 25mm impact resistant bits with 60mm impact magnetic bit holder.

Set includes: PZ0(1), PZ1(2), PZ2(3), PZ3(2), PH0(1), PH1(2), PH2(4), PH3(2), TX10(1), TX15(1), TX20(2), TX25(2), TX27(1), TX30(2), TX40(1), Magnetic Bit Holder (1).

Product Code	Pack Qty (pcs)	Carton Qty (packs)
--------------	----------------	--------------------

##### SET

28SETX6	28	12
---------	----	----

TYPE - ABT

SUB TYPE - ABT07



49 PIECE

Comprehensive mixed set of impact resistant bits, nut drivers and an impact magnetic bit holder.

Set includes:  
**25mm Bits** - PZ1(2), PZ2(9), PZ3(3), PH1(2), PH2(8), PH3(2), TX20(1), TX25(2), TX30(3), TX40(2), SQ2(1).  
**50mm Bits** - PZ1(1), PZ2(3), PZ3(1), PH2(2), PH3(1), TX30(2).  
**Sockets** - 8mm(1), 10mm(1), 13mm(1).  
 Magnetic Bit Holder(1).

Product Code	Pack Qty (pcs)	Carton Qty (packs)
--------------	----------------	--------------------

##### BLISTER PACK

228258	49	6
--------	----	---

TYPE - ABT

SUB TYPE - ABT07

## Impact Driver Bit Holders & Adaptors

### Impact Quick Release Bit Holder



Impact resistant quick adaptor chuck allows the user to rapidly change between multiple 1/4" hex drive accessories. Available in longer lengths to assist the user when working in awkward applications.

Product Code	Length (mm)	Pack Qty (pcs)	Carton Qty (packs)
<b>BLISTER CARD</b>			
65MAQX6	65	1	24
150MAQX6	150	1	12
300MAQX6	300	1	12
TYPE - ABT			SUB TYPE - ABT08

### Impact Magnetic Bit Holder



A high quality magnetic 1/4" hex drive adaptor with a unique 'torsion zone' that enables the bit holder to withstand the extreme pressures exerted by an impact driver.

Product Code	Length (mm)	Pack Qty (pcs)	Carton Qty (packs)
<b>BLISTER CARD</b>			
60MAX6	60	1	24
150MAX6	150	1	12
TYPE - ABT			SUB TYPE - ABT08

## Impact HSS Drill Bits

### Impact Quick Release HSS Drill Bits



This durable engineering quality HSS ground drill is designed for drilling sheet metal and wood with a 1/4" chuck impact driver.

The quick change shank can be rapidly interchanged for easy and hassle free drilling.

Product Code	Drill Ø (mm)	Total Length (mm)	Working Length (mm)	Pack Qty (pcs)	Carton Qty (packs)
<b>BLISTER CARD</b>					
HSSG2X6	2.0	67	24	1	24
HSSG25X6	2.5	75	30	1	24
HSSG3X6	3.0	75	33	1	24
HSSG35X6	3.5	84	39	1	24
HSSG4X6	4.0	89	43	1	24
HSSG45X6	4.5	94	47	1	24
HSSG5X6	5.0	100	52	1	24
HSSG6X6	6.0	107	57	1	24
HSSG8X6	8.0	117	75	1	24
HSSG10X6	10.0	133	87	1	24
TYPE - ABT					SUB TYPE - ABT10

### Impact Magnetic Screw Holder



Impact resistant magnetic screw holder has been specifically designed for installation of flat head screws. The sliding magnetic sleeve securely holds the screw in place to allow single handed installations in vertical or horizontal applications.

Product Code	Length (mm)	Pack Qty (pcs)	Carton Qty (packs)
<b>BLISTER CARD</b>			
53MSHX6	53	1	10
TYPE - ABT			SUB TYPE - ABT08

### Impact Quick Release Adaptor



This impact resistant quick change adapter is used for converting an impact wrench into a 1/4" hex drive

- Quick Release.

Product Code	To Fit (imp)	Length (mm)	Pack Qty (pcs)	Carton Qty (packs)
<b>BLISTER CARD</b>				
38QCAX6	3/8"	50	1	24
12QCAX6	1/2"	50	1	24
TYPE - ABT				SUB TYPE - ABT08

### Impact Screw Guide



Impact resistant magnetic screw guide has a sliding sleeve designed so the user always drives the screw in at 90 degrees ensuring a flush finish. It also has the added benefit of reducing risk of finger injury as the sleeve covers the sharp screw threads.

Product Code	To Suit Screw Ø (mm)	To Suit Screw Gauge (imp)	Length (mm)	Pack Qty (pcs)	Carton Qty (packs)
<b>BLISTER CARD</b>					
75SGX6	3.0 - 5.0	4 - 10	75	1	24
TYPE - ABT					SUB TYPE - ABT08

## Impact Sockets

### Impact Socket



High grade impact sockets for use in the most challenging applications. Made from high quality steel, the sockets are hardened and tempered for maximum strength and comes in a phosphate finish for greater corrosion resistance. Ideal for use in air impact wrenches and impact drivers.

Product Code	Socket Size (mm)	Length (imp)	To Fit (imp)	Pack Qty (pcs)	Carton Qty (packs)
<b>CLIP</b>					
8ISHX6	8	3"	1/2"	1	25
10ISHX6	10	3"	1/2"	1	25
12ISHX6	12	3"	1/2"	1	25
13ISHX6	13	3"	1/2"	1	25
14ISHX6	14	3"	1/2"	1	25
15ISHX6	15	3"	1/2"	1	25
16ISHX6	16	3"	1/2"	1	25
17ISHX6	17	3"	1/2"	1	25
18ISHX6	18	3"	1/2"	1	25
19ISHX6	19	3"	1/2"	1	25
21ISHX6	21	3"	1/2"	1	25
24ISHX6	24	3"	1/2"	1	25
TYPE - ABT		SUB TYPE - ABT09			

### Scaffolders Short Impact Socket



21mm short impact socket with pin and ring to ensure a secure retention to power tool.

Ideal when working at heights and frequently used during scaffolding installation.

- Use with Impact drivers with 1/2" Square drive

Product Code	Socket Size (mm)	Length (mm)	Pack Qty (pcs)	Carton Qty (packs)
<b>BLISTER CARD</b>				
228164	21	52	1	24
TYPE - ABT		SUB TYPE - ABT09		

### Impact Socket Adaptor



Impact resistant quick change adaptor is used for converting a 1/4" hex drive into a male (1/2" or 3/8") socket adaptor.

Product Code	Length (mm)	Square Size (imp)	Pack Qty (pcs)	Carton Qty (packs)
<b>BLISTER CARD</b>				
38IAX6	50	3/8"	1	24
12IAX6	50	1/2"	1	24
TYPE - ABT		SUB TYPE - ABT08		

## Impact Socket Drivers

### Impact Magnetic Socket Driver

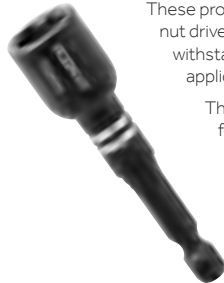

These professional grade impact nut drivers are designed to withstand the toughest fastening applications.

The powerful magnet allows for a secure grip and unyielding bit engagement. Ideal for use on hex head screws when installed with an impact driver.

Product Code	Socket Size	Length (mm)	Pack Qty (pcs)	Carton Qty (packs)
<b>BLISTER CARD</b>				
14SDX6	1/4"	65	1	24
7SDX6	7mm	65	1	24
8SDX6	8mm	65	1	24
10SDX6	10mm	65	1	24
13SDX6	13mm	65	1	24
TYPE - ABT		SUB TYPE - ABT08		

## Socket Drivers

### Socket Driver



Used for installing hexagon headed fasteners with a power tool. Also known as a 1/4" nut setter.

Product Code	Socket Size	Length (mm)	Type	Pack Qty (pcs)	Carton Qty (packs)
<b>BLISTER CARD</b>					
6SDB	6mm	65	Hex	1	24
635SDB	1/4"	65	Hex	1	24
516SDB	5/16"	65	Hex	1	24
10SDB	10mm	65	Hex	1	24
11BHSDB	11mm	65	Bi-Hex	1	24
11SDB	11mm	65	Hex	1	24
13SDB	13mm	65	Hex	1	24
<b>SMALL JAR</b>					
516SDJ15	5/16"	65	Hex	15	30
TYPE - ABT		SUB TYPE - ABT09			



# Driver Bits

## Driver Bits

### Pozi Driver Bit



Made from S2 Carbon Steel



Product Code	Bit Size	Length (mm)	Pack Qty (pcs)	Carton Qty (packs)
<b>HANDY PACK</b>				
1CB25PACK	PZ1	25	10	12
2CB25PACK	PZ2	25	10	12
3CB25PACK	PZ3	25	10	12
1CB50PACK	PZ1	50	5	12
2CB50PACK	PZ2	50	5	12
3CB50PACK	PZ3	50	5	12
<b>MINI BIT PACK</b>				
2CB100GB	PZ2	100	1	12
2CB150GB	PZ2	150	1	12
2CB300GB	PZ2	300	1	12
<b>SMALL JAR</b>				
1CB25GJ	PZ1	25	100	30
2CB25GJ	PZ2	25	100	30
3CB25GJ	PZ3	25	100	30
2CB50GJ	PZ2	50	50	30
<b>DISPENSING JAR</b>				
3CB25TUB	PZ3	25	500	4
TYPE - ABT		SUB TYPE - ABT01		

### Phillips Driver Bit



Made from S2 Carbon Steel



Product Code	Bit Size	Length (mm)	Pack Qty (pcs)	CDU Qty (packs)
<b>HANDY PACK</b>				
1PH25PACK	PH1	25	10	12
2PH25PACK	PH2	25	10	12
3PH25PACK	PH3	25	10	12
2PH50PACK	PH2	50	5	12
3PH50PACK	PH3	50	5	12
<b>MINI BIT PACK</b>				
2PH100GB	PH 2	100	1	12
2PH150GB	PH 2	150	1	12
2PH300GB	PH 2	300	1	12
<b>SMALL JAR</b>				
2PH25GJ	PH 2	25	100	30
2PH50GJ	PH 2	50	50	30
TYPE - ABT		SUB TYPE - ABT02		

### TX Drive Driver Bit



Made from S2 Carbon Steel



Product Code	Bit Size	Length (mm)	Pack Qty (pcs)	Carton Qty (packs)
<b>HANDY PACK</b>				
10TX25PACK	TX10	25	10	12
15TX25PACK	TX15	25	10	12
20TX25PACK	TX20	25	10	12
25TX25PACK	TX25	25	10	12
30TX25PACK	TX30	25	10	12
40TX25PACK	TX40	25	10	12
30TX50PACK	TX30	50	5	12
<b>MINI BIT PACK</b>				
10TX25GB	TX10	25	2	12
<b>SMALL JAR</b>				
30TX25GJ	TX30	25	100	30
30TX50GJ	TX30	50	50	30
<b>DISPENSING JAR</b>				
30TX25TUB	TX30	25	500	4
30TX50TUB	TX30	50	250	4
TYPE - ABT		SUB TYPE - ABT03		

### Square Driver Bit



Made from S2 Carbon Steel



Product Code	Bit Size	Length (mm)	Pack Qty (pcs)	Carton Qty (packs)
<b>HANDY PACK</b>				
2SQ25PACK	SQ2	25	10	12
2SQ50PACK	SQ2	50	5	12
<b>MINI BIT PACK</b>				
2SQ25GB	SQ2	25	2	24
TYPE - ABT		SUB TYPE - ABT05		

### Slotted Driver Bit



Made from S2 Carbon Steel



Product Code	Bit Size	Length (mm)	Pack Qty (pcs)	Carton Qty (packs)
<b>TWIN PACK</b>				
5508SL25GB	5.5	25	2	24
6010SL25GB	6.0	25	2	24
7012SL25GB	7.0	25	2	24
1016SL25GB	10.0	25	2	24
TYPE - ABT		SUB TYPE - ABT05		

### Hex Driver Bit



Made from S2 Carbon Steel



Product Code	Bit Size	Length (mm)	Pack Qty (pcs)	Carton Qty (packs)
<b>TWIN PACK</b>				
3HX25GB	3.0	25	2	24
4HX25GB	4.0	25	2	24
5HX25GB	5.0	25	2	24
6HX25GB	6.0	25	2	24
8HX25GB	7.0	25	2	24
TYPE - ABT		SUB TYPE - ABT06		

## Impact Driver Bits

Available on pages 144

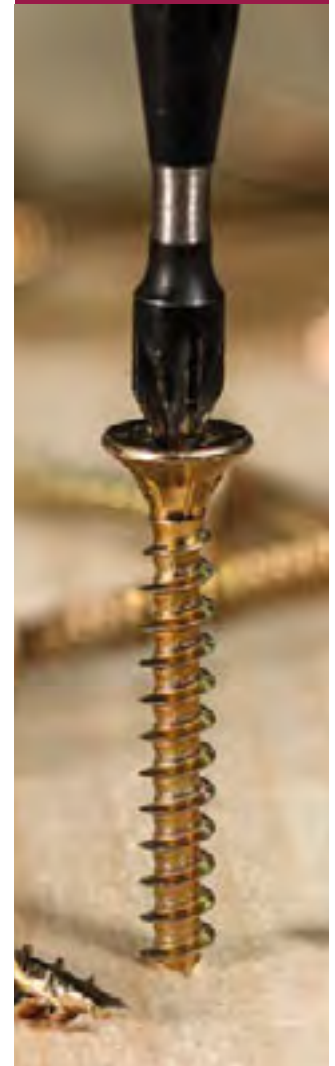

## Driver Bit Sets

### 31 PIECE

Convenient protective case with rubber corners and a handy belt clip.

- Made from S2 Carbon Steel



Set includes: PZ1(1), PZ2(5), PZ3(2), PH1(1), PH2(3), PH3(1), TX10(1), TX15(1), TX20(1), TX25(1), TX30(1), TX40(1), HX4(1), HX5(1), HX6(1), HX7(1), SL3.5(1), SL4.5(1), SL5.0(1), SL5.5(1), SL8.0(1), SQ2(1) Quick Release Bit Holder(1)

Product Code	Pack Qty (pcs)	Carton Qty (packs)
<b>BLISTER PACK</b>		
DBSETG31	31	10
TYPE - ABT   SUB TYPE - ABT07		

### 11 PIECE

Convenient pocket sized mixed set of the most commonly used S2 25mm bits with a magnetic bit holder.

- Made from S2 Carbon Steel

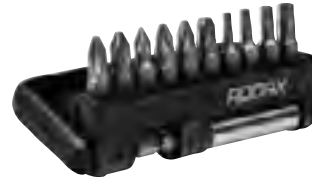

Set includes: PZ1(1), PZ2(2), PZ3(1), PH2(2), TX15(1), TX20(1), TX25(1), TX30(1) Magnetic Bit Holder(1)

Product Code	Pack Qty (pcs)	Carton Qty (packs)
<b>BLISTER PACK</b>		
228030	11	12
TYPE - ABT   SUB TYPE - ABT07		

## Driver Bit Holders

### One Piece Magnetic Bit Holder



A magnetic 1/4" hex drive adaptor machined from a single piece of stainless steel to give extended life and durability. Available with or without a circlip to improve bit retention.

- Made from Stainless Steel

Product Code	Length (mm)	Type	Pack Qty (pcs)	Carton Qty (packs)
<b>MINI BIT PACK</b>				
60MASSB	60	-	1	24
60MASSCB	60	Circlip	1	24
TYPE - ABT			SUB TYPE - ABT08	

### Two Piece Magnetic Bit Holder



An economic magnetic 1/4" hex drive adaptor manufactured from two pieces of carbon steel. Available with or without a circlip to improve bit retention.

- Made from Carbon Steel

Product Code	Length (mm)	Type	Pack Qty (pcs)	Carton Qty (packs)
<b>MINI BIT PACK</b>				
60MAB	60	-	1	24
60MACB	60	Circlip	1	24
150MACB	150	Circlip	1	12
300MACB	300	Circlip	1	12
<b>BIT PACK</b>				
60MAJ	60	-	20	30
60MACJ	60	Circlip	20	30
TYPE - ABT			SUB TYPE - ABT08	

### Quick Release Magnetic Bit Holder



An economic magnetic 1/4" hex drive adaptor.

- Made from Carbon Steel

Product Code	Length (mm)	Pack Qty (pcs)	Carton Qty (packs)
<b>MINI BIT PACK</b>			
60MAQRB	60	1	24
150MAQRB	150	1	12
300MAQRB	300	1	12
<b>BIT PACK</b>			
60MAQRJ	60	20	30
TYPE - ABT			SUB TYPE - ABT08

## SDS Magnetic Bit Holder



A magnetic SDS Plus to 1/4" hex drive adaptor, ideal for converting your SDS-Plus drill in to a screwdriver when in rotary mode only.

- Made from Carbon Steel

Product Code	Length (mm)	Pack Qty (pcs)	Carton Qty (packs)
<b>MINI BIT PACK</b>			
80MASDSCB	80	1	24
TYPE - ABT			SUB TYPE - ABT08

# Mixing Paddles



## Paint Mixer



Hex Shank



A general purpose mixer with a twin propeller design to reduce splashing and blend materials with ease.

Suitable for use with paint, varnish, glaze, floor screed and more.

- Fast mixing
- Easy clean coating
- Multi-purpose hex shank
- Reduced splashing
- Easy material blending

Product Code	Size (mm)	Shank Type	Shank Dia (mm)	Pack Qty (pcs)	Carton Qty (packs)
<b>EACH</b>					
673147	80 x 400	Hex	9.0	1	40
673258	100 x 600	Hex	10.0	1	30
TYPE - MPD			SUB TYPE - MPD01		

## General Purpose Mixing Paddle



Hex Shank



A high quality mixing paddle with helical fin design to allow for rapid and effortless mixing of a variety of viscous building compounds.

Suitable for use with tile adhesive, ready mixed plaster, floor screed, filler, cement compounds and more.

- Rapid & effortless mixing
- Heavy duty construction
- Easy clean coating
- Multi-purpose hex shank
- Protective rim
- Smooth & thorough mixing

Product Code	Size (mm)	Shank Type	Shank Dia (mm)	Pack Qty (pcs)	Carton Qty (packs)
<b>EACH</b>					
673369	100 x 600	Hex	9.0	1	12
673741	120 x 600	Hex	10.0	1	12
TYPE - MPD			SUB TYPE - MPD01		

## Professional Mixing Paddle

**NEW SIZE**



Threaded Shank



A professional grade, heavy duty paddle mixer with helical fin pattern for rapid and effortless mixing of the most viscous building compounds.

Suitable for use with tile adhesive, bonding mortar, jointing compound, board finishes & plaster, floor screed, cement compounds, filler and more.

Compatible with all standard paddle mixers with M14 fitting.

- Rapid & effortless mixing
- Heavy duty construction
- Easy clean coating
- Protective rim
- Smooth & thorough mixing

Product Code	Size (mm)	Shank Type	Pack Qty (pcs)	Carton Qty (packs)
<b>EACH</b>				
673852	120 x 600	M14	1	12
673963	140 x 600	M14	1	12
673001	160 x 600	M14	1	12
TYPE - MPD		SUB TYPE - MPD01		



# Hand Tools

## Striking & Demolition

Hammers	151
Axes	152
Mallets	153
Bolsters & Chisels	153
Pry Bars	154

## Bricklaying & Plastering

Trowels	155
Aluminium Hawk	156
Brick Jointers	157
Grouting Float	157

## Sawing & Cutting

Plasterers Jab Saw	157
Wood Saws	158
Mitre Boxes	158
Rasp Planes	159
Knives & Blades	159

## Pliers, Cutters & Wrenches

Scissors & Wire Strippers	160
Pipe Shears & Tin Snips	161
Pliers, Cutters & Wrenches	162
Bolt Croppers	163

## Spanner Sets, Wood Chisels & Screwdrivers

Spanner Sets & Wood Chisels	164
Screwdriver Sets	165
Bradawl	166
Hex Key Sets	167

## Files & Rasps

Files & Rasps	168
---------------	-----

## Clamps

Bar Clamps	169
G Clamps	169
F Clamps	169
Spring Clamps	169

## Levelling, Measuring & Marking

Spirit Levels	170
Measuring Wheel	172
Tape Measures	172
Squares & Rulers	173
Chalk Line & Powder	174
Builders Line & Rope	174
Stationery	175
Levelling Tools	177

## Riveters & Staplers

Riveters	176
Staplers	176

## Preparation & Finishing Tools

Wire Brushes	177
Glass & Tile Scraper	177
Applicator Guns	178



## Professional Claw Hammer

A premium quality claw hammer, ideal for effortless nail driving, with a straight claw head for prying and to assist with framing construction as well as positioning a workpiece.



**Precision Engineered**  
For Enhanced Striking Force

Product Code	Weight (oz)	Total Length (mm)	Pack Qty (pcs)	Carton Qty (packs)
<b>EACH</b>				
468117	16	400	1	6
TYPE - HAM		SUB TYPE - HAM01		

## Claw Hammer - One Piece

A high quality curved claw hammer, ideal for demanding jobs and fast nail driving. Manufactured from a single piece of hardened steel with a soft-grip handle to enhance comfort and reduce fatigue.



Product Code	Weight (oz)	Total Length (mm)	Pack Qty (pcs)	Carton Qty (packs)
<b>EACH</b>				
468118	16	327	1	6
468119	20	350	1	6
TYPE - HAM		SUB TYPE - HAM02		

## Claw Hammer - Fibreglass Handle



A high quality curved claw hammer, ideal for the toughest jobs and fast nail driving. Made from a two piece design including a fibreglass neck for vibration reduction and breakage resistance.

- Drop forged & heat treated for strength & durability
- Shock absorbing handle
- High strength fibreglass core for vibration resistance & increased user comfort
- Curved claw head for effortless nail & pin removal whilst increasing leverage whilst prying
- Lightweight & balanced
- Ergonomic anti-slip grip for safety, increased user comfort & long lasting performance

Product Code	Weight (oz)	Total Length (mm)	Pack Qty (pcs)	Carton Qty (packs)
<b>EACH</b>				
468120	16	336	1	6
468121	20	336	1	6
TYPE - HAM		SUB TYPE - HAM02		

## Claw Hammer



An ergonomic, durable curved claw hammer manufactured from robust tubular steel with textured rubberised handle. Ideal for a majority of DIY and general purpose applications.

- Solid forged head for strength & durability
- 1.4mm hardened tubular shaft
- Textured grip for increased comfort & shock absorption

Product Code	Weight (oz)	Total Length (mm)	Pack Qty (pcs)	Carton Qty (packs)
<b>EACH</b>				
468266	16	326	1	6
TYPE - HAM		SUB TYPE - HAM05		

## Cross Pein Hammer



A high quality cross pein hammer. The two piece design features a shock and break proof fibreglass neck for comfort and control during any task. Ideal for wood and metalworking tasks.

- Tempered striking faces to prevent chipping
- Precision engineered for maximum control & accuracy
- Ergonomic anti-slip grip for safety, increased user comfort & long lasting performance
- Reduced & polished head for accurate fastener driving & to prevent surface marking
- Shock absorbing handle

Product Code	Weight (oz)	Total Length (mm)	Pack Qty (pcs)	Carton Qty (packs)
<b>EACH</b>				
468122	4	299	1	6
468123	8	304	1	6
TYPE - HAM		SUB TYPE - HAM03		

# Sledgehammer

A professional sledgehammer, constructed from extra heavy duty carbon steel with a lightweight and break resistant fibreglass shaft. Featuring fully polished striking faces and soft-grip handle.

**Fibreglass Core**  
High strength & vibration resistant handle for user comfort

**Protective Rubber Collar**  
Underneath the head to increase user comfort & prevent damage to the shaft

**Robust Handle**  
To prevent splitting & breaking, safer to use than a standard wooden handled sledgehammer



## Heavy Duty

Robust construction for demanding demolition tasks

**Ergonomic Anti-Slip Grip**

Product Code	Head Weight (lb)	Total Length (mm)	Pack Qty (pcs)	Carton Qty (packs)
<b>EACH</b>				
468127	7	894	1	2
468128	10	894	1	2
TYPE - HAM		SUB TYPE - HAM04		

# Axes

Featuring a heavy duty carbon steel head with a precision milled and tempered cutting edge.

The lightweight fibreglass neck provides higher break resistance and a longer tool life than wooden alternatives.

**Hardened Cutting Edge**  
For superior performance

**Ergonomic Anti-Slip Grip**

**Fibreglass Core**  
High strength & vibration resistant handle for user comfort

Product Code	Head Weight (lb)	Total Length (mm)	Pack Qty (pcs)	Carton Qty (packs)
<b>EACH</b>				
468115	1 ½	380	1	6
468116	3 ½	825	1	4
TYPE - SAW		SUB TYPE - SAW02		

# Brick Hammer

A premium quality brick hammer, manufactured from a single piece of toughened and hardened steel, with tempered strike faces and a soft-grip handle to reduce vibrations.

- Precision ground chisel for controlled & accurate shaping of all masonry
- High strength single piece steel to maximise driving force whilst minimising user fatigue
- Ergonomic anti-slip grip for safety, increased user comfort & long lasting performance



Product Code	Weight (oz)	Total Length (mm)	Pack Qty (pcs)	Carton Qty (packs)
<b>EACH</b>				
468124	20	317	1	6
TYPE - HAM		SUB TYPE - HAM06		

# Lump Hammer

A heavy duty and robust two piece lump hammer. The two piece design features a shock and break proof fibreglass handle with a hardened steel head. Ideal for demolition work and more.

- Heavy duty
- High strength fibreglass core for vibration resistance & increased user comfort
- Ergonomic anti-slip grip for safety, increased user comfort & long lasting performance
- Heat treated & tempered strike faces
- Shock absorbing handle



Product Code	Weight (lb)	Total Length (mm)	Pack Qty (pcs)	Carton Qty (packs)
<b>EACH</b>				
468125	2 ½	269	1	6
468126	4	292	1	4
TYPE - HAM		SUB TYPE - HAM04		

NEW

Mallets



A range of multi-purpose mallets, featuring solid rubber heads to deliver a firm blow with a locking and ergonomic ash wood handle which helps to prevent rebound.

- Ash wood handle for shock absorption & resistance to breaking
- Solid rubber head
- Available in black & non-marking white rubber

Product Code	Weight (oz)	Total Length (mm)	Pack Qty (pcs)	Carton Qty (packs)
<b>EACH</b>				
<b>BLACK</b>				
468267	16	322	1	6
468268	24	340	1	6
468269	32	343	1	4
<b>WHITE (NON-MARKING)</b>				
468270	16	322	1	6
468271	24	340	1	6
TYPE - HAM			SUB TYPE - HAM04	

NEW

Bolsters & Chisels



Used to break and shape hard materials such as brick, block, stone and concrete. Featuring hardened and tempered strike faces for longevity and impact resistance. The heavy duty hand guards improve comfort, safety and shock resistance.



Precision ground cutting edge

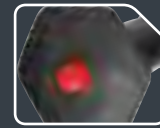

Hardened & tempered strike faces



Shatter resistant

Masonry Bolster and Cold Chisel with Guard

A range of heavy duty masonry bolsters and cold chisels, manufactured from high quality carbon steel with hardened and impact resistant tips for a long working life. Featuring domed striking heads to prevent damage and heavy duty hand guards. Ideal for use on stone, brickwork, mortar and masonry.

- Hardened & tempered
- Shatter resistant
- Tough powder coating

Masonry Bolster



Cold Chisel



Product Code	Size (mm)	Size (inch)	Pack Qty (pcs)	Carton Qty (packs)
<b>CLIP</b>				
<b>MASONRY BOLSTER</b>				
468225	57 x 216	2 ¼ x 8 ½	1	6
468226	100 x 220	4 x 8 ½	1	6
TYPE - BOL			SUB TYPE - BOL01	
<b>COLD CHISEL</b>				
468223	19 x 250	¾ x 10	1	6
468224	19 x 300	¾ x 12	1	6
TYPE - BOL			SUB TYPE - BOL01	

Bolster & Chisel Set

A mixed set containing three popular masonry bolsters and chisels, manufactured from high quality carbon steel with hardened and impact resistant tips for a long working life. Featuring domed striking heads to prevent damage and heavy duty hand guards. Ideal for use on stone, brickwork, mortar and masonry.



Product Code	Item	Size (inch)	Pack Qty (pcs)	Carton Qty (packs)
<b>BOX</b>				
468227	-	-	3	4
	Cold Chisel	¾ x 12	1	
	Point Chisel	12	1	
	Brick Bolster	4 x 8 ½	1	
TYPE - BOL			SUB TYPE - BOL01	

NEW

# Pry Bars



## Utility Bar

A multi-purpose utility bar, designed to pry, lift and remove nails. Featuring dual nail pullers, extra wide chisel tips to prevent surface damage and hardened to withstand hammering.

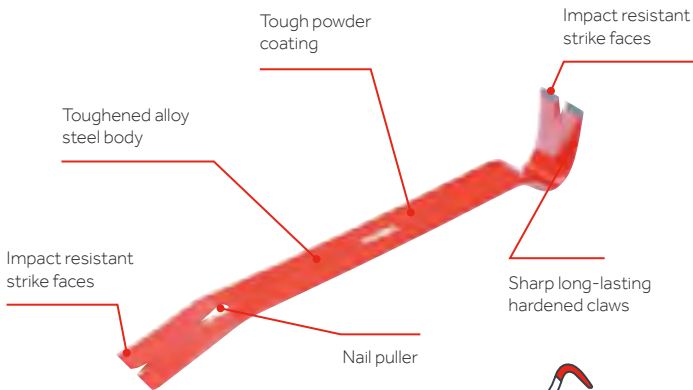

Product Code	Size (mm)	Size (inch)	Pack Qty (pcs)	Carton Qty (packs)
<b>CLIP</b>				
468229	375	15	1	10
TYPE - PRY			SUB TYPE - PRY01	

## Wrecking Bar

A range of Contemporary style, hexagonal shaft wrecking bars manufactured from hardened and tempered carbon steel. Ideal for wrecking, prying and demolition jobs.



- Shatterproof steel
- Nail remover & chisel
- Impact resistant
- Tough powder coating
- Forged heavy duty hex shank
- EN8D steel

Product Code	Size (mm)	Size (inch)	Pack Qty (pcs)	Carton Qty (packs)
<b>CLIP</b>				
468230	300	12	1	6
468231	450	18	1	6
468232	600	24	1	6
468233	750	30	1	6
468234	900	36	1	10
TYPE - PRY			SUB TYPE - PRY02	

## Moulding Pry Bar

A multi-purpose moulding pry bar, for effortless removal of moulding, trimming and decorative timbers. Manufactured from hardened carbon steel with a hard wearing powder coated finish. Featuring an extra wide chisel tip to prevent damage to the surface with impact resistant tips for hammer striking.



- 2 in 1 pry bar & nail puller
- Extra wide chisel tip
- Impact resistant hardened steel
- Tough powder coating
- EN9 Steel

Product Code	Size (mm)	Size (inch)	Pack Qty (pcs)	Carton Qty (packs)
<b>CLIP</b>				
468228	250	10	1	6
TYPE - PRY			SUB TYPE - PRY01	

NEW

# Wrecking & Pry Bar Set

An assortment of traditional wrecking, utility and aligning bars.

Ideal for a wide variety of demanding construction and demolition tasks.

- Hardened & tempered
- Tough powder coating
- Hex shank
- Heavy duty toughened steel
- Impact resistant

Product Code	Item	Size (inch)	Pack Qty (pcs)	Carton Qty (packs)
<b>BOX</b>				
468235	Aligning Bar	24	5	4
	Utility Bars	7 & 15	1	
	Wrecking Bars	12 & 18	2	
TYPE - PRY			SUB TYPE - PRY03	

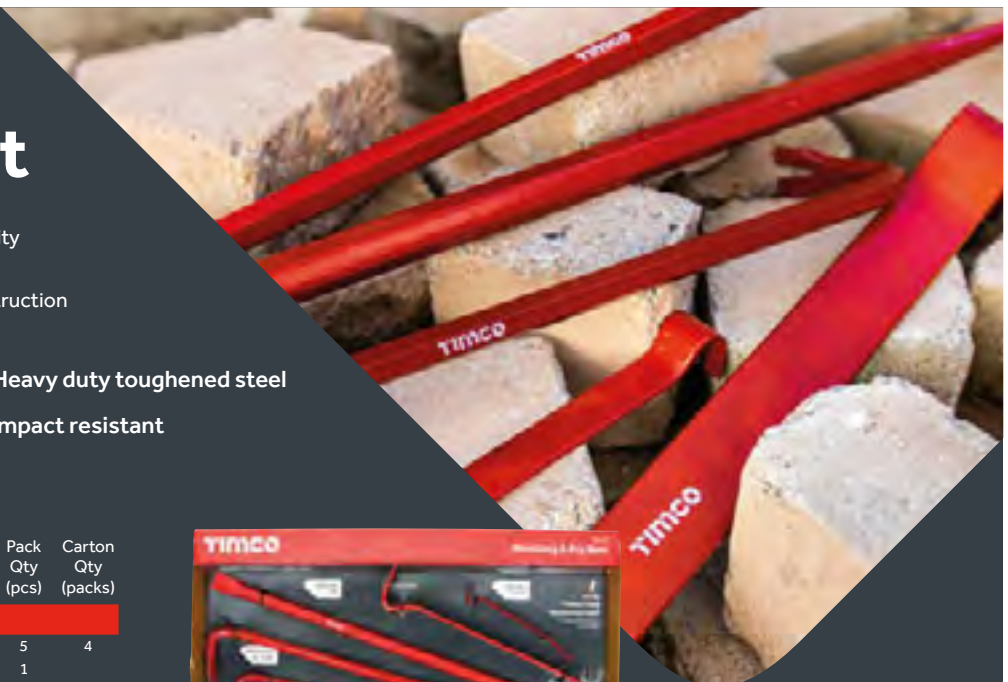



**NEW**

# Bricklaying Trowels

A range of premium tempered and lacquered trowels. Manufactured for strength and durability in a variety of building, groundworking and bricklaying applications.

## Brick Trowel

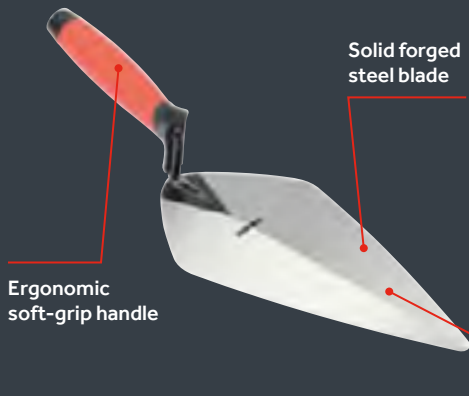

## Gauging Trowel

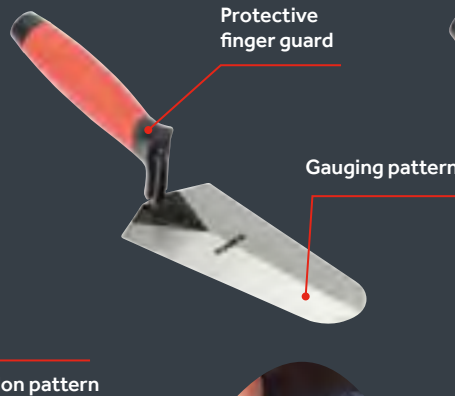

## Pointing Trowel



Product Code	Length (inch)	Width (inch)	Blade Gauge (mm)	Pack Qty (pcs)	Carton Qty (packs)
<b>PACK</b>					
<b>BRICK TROWEL</b>					
468211	11	5 ½	1.1	1	6
<b>GAUGING TROWEL</b>					
468212	7	3 ¾	1.2	1	12
<b>POINTING TROWEL</b>					
468210	6	2 ¾	1.1	1	12
TYPE - TWL			SUB TYPE - TWL04		

## Bucket Trowel

A premium bucket trowel. Manufactured with a forged solid steel shank with an ergonomic soft-grip handle. Featuring rounded edges to prevent the trowel from digging into the bucket.



Product Code	Length (inch)	Width (inch)	Blade Gauge (mm)	Pack Qty (pcs)	Carton Qty (packs)
<b>PACK</b>					
468214	7	-	1.2	1	6
TYPE - TWL			SUB TYPE - TWL04		

## Brick Trowel Set

A set of premium trowels, manufactured with forged solid steel shanks and soft-grip handles. Featuring lacquered blades for quick and easy cleaning. Includes a gauging, pointing and brick trowel.



Product Code	Contents	L x W (inch)	Pack Qty (pcs)	Carton Qty (packs)
<b>PACK</b>				
468213			3	2
	Pointing Trowel	6 x 2 ¾	1	
	Gauging Trowel	7 x 3 ¾	1	
	Brick Trowel	11 x 5 ½	1	
TYPE - TWL		SUB TYPE - TWL04		

## Margin Trowel Set

A set of three premium trowels. Manufactured with forged solid steel shanks and ergonomic soft-grip handles with finger guards for superior user comfort and trowel control.



Product Code	Contents	Width (inch)	Pack Qty (pcs)	Carton Qty (packs)
<b>PACK</b>				
468207			3	2
	Tuck Pointing Trowel	½	1	
	Margin Trowel	1 ½	1	
	Margin Trowel	2	1	
TYPE - TWL		SUB TYPE - TWL04		

NEW

# Plastering Trowels

## Professional Plasterers Trowel

A professional stainless steel plastering trowel, designed to give the best results when plastering. Featuring a hardened and tempered stainless steel blade for toughness and flexibility.

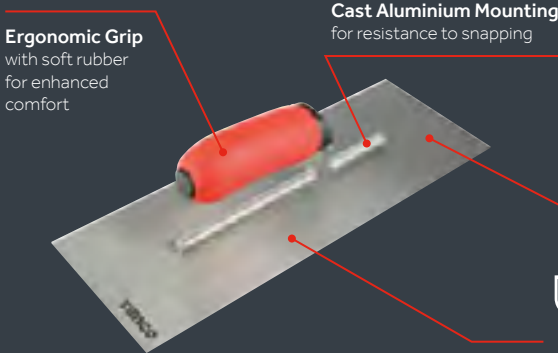

**Stainless Steel**

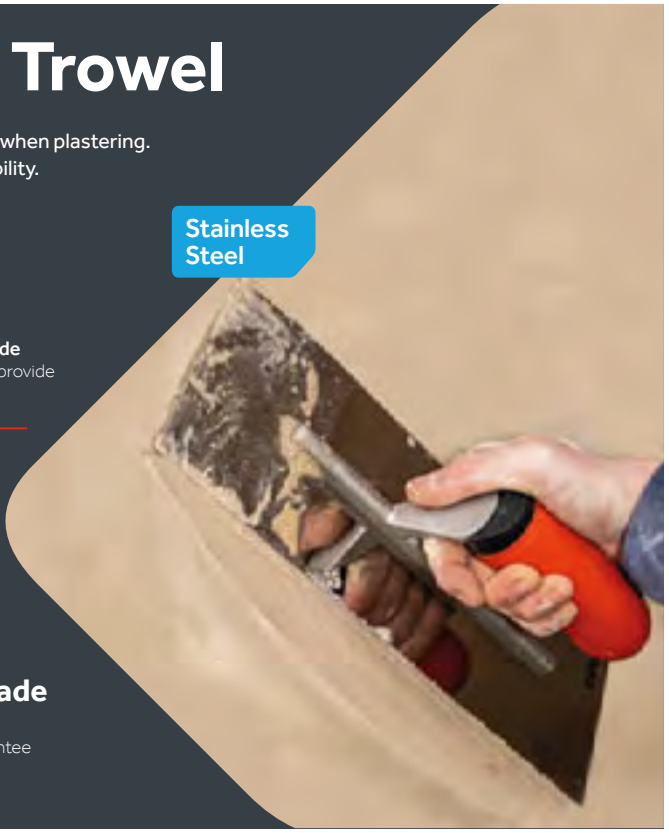

**Tempered Thin Stainless Steel Blade**  
to prevent rusting & provide superior flexibility



**Rustproof Pre-worn Blade**

To prevent dragging & trowel marks to guarantee a professional finish



Product Code	Length (inch)	Width (inch)	Blade Gauge (mm)	Pack Qty (pcs)	Carton Qty (packs)
<b>PACK</b>					
468204	13	4 1/2	0.7	1	6
468205	16	5	0.7	1	6
468206	18	5	0.7	1	6
TYPE - TWL			SUB TYPE - TWL03		

## Plastering Trowel - Carbon Steel

A premium plastering trowel designed for professional application of finishing plaster. Featuring a tough and flexible carbon steel blade with an ergonomically designed soft-grip handle.



- Lacquered finish for easy cleaning
- Tempered blade for a strong working edge
- Lightweight & tough
- Quick & easy to clean

Product Code	Length (inch)	Width (inch)	Blade Gauge (mm)	Pack Qty (pcs)	Carton Qty (packs)
<b>PACK</b>					
468201	13	5	0.7	1	6
468202	14	5	0.7	1	6
468203	16	5	0.7	1	6
TYPE - TWL			SUB TYPE - TWL03		

## Jointing Knife

A hard wearing jointing knife, featuring a carbon steel blade and a soft-grip handle for user comfort. Ideal for applying jointing compound and filling small imperfections and holes.



- Hardened & tempered blade for superior strength

Product Code	Width (inch)	Blade Gauge (mm)	Pack Qty (pcs)	Carton Qty (packs)
<b>PACK</b>				
468209	6	1.1	1	12
TYPE - TWL			SUB TYPE - TWL04	

## Aluminium Hawk

A premium and hard wearing aluminium hawk, manufactured from hard-rolled aluminium for strength and rigidity. Featuring an ergonomic soft-grip handle for user comfort and reduced fatigue and rounded corners for safety.

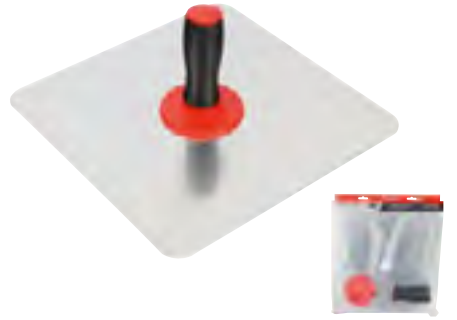

- Strong & lightweight aluminium
- Ergonomic soft-grip handle to reduce fatigue & enhance grip
- Protective hand guard for extra comfort

Product Code	Length (inch)	Width (inch)	Pack Qty (pcs)	Carton Qty (packs)
<b>PACK</b>				
468274	13	13	1	6
TYPE - TWL			SUB TYPE - TWL02	

**NEW**

## Bricklaying & Tiling Accessories



### Radius Edging Trowel

A premium edging trowel with radius edging for finishing concrete bases and pads. Featuring a tough carbon steel blade with an ergonomically designed soft-grip handle and a lightweight aluminium shaft for user comfort, control and reduced fatigue. Polished for quick and easy removal of excess product.

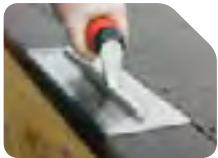

- ½" Radius
- Solid forged steel blade
- Easy to clean laquered finish

Product Code	Length (inch)	Width (inch)	Blade Gauge (mm)	Pack Qty (pcs)	Carton Qty (packs)
<b>PACK</b>					
468208	10	4	0.75	1	12
TYPE - TWL				SUB TYPE - TWL04	

### Brick Jointers

A range of professional brick jointers with chamfered edges for creating seamless mortar joints between bricks.



- Heavy duty
- Carbon steel
- Double sided
- Chamfered edges

Product Code	Size (inch)	Pack Qty (pcs)	Carton Qty (packs)
<b>PACK</b>			
468215	1/2 - 5/8	1	12
468216	5/8 - 3/4	1	12
468217	3/4 - 7/8	1	12
468218	3/8 - 1/2	1	12
TYPE - TWL		SUB TYPE - TWL05	

### Plasterers Jab Saw

A premium jab saw with protective holster. Manufactured from hardened and polished 1.5mm steel for cutting through tough materials without bending. Perfect for punching through plasterboard.



- Hardened 1.5mm blade
- 3D fast cutting teeth
- Protective holster included

Product Code	Length (inch)	Length (mm)	Teeth Per Inch (TPI)	Pack Qty (pcs)	Carton Qty (packs)
<b>PACK</b>					
468198	7	175	7	1	10
TYPE - SAW		SUB TYPE - SAW04			

### Adhesive Trowel - Square Notch

A high quality square notch trowel for spreading adhesives and viscous compounds, for spreading grout using a hardened and polished carbon steel blade for strength and easy cleaning. Ideal for tiling adhesive.

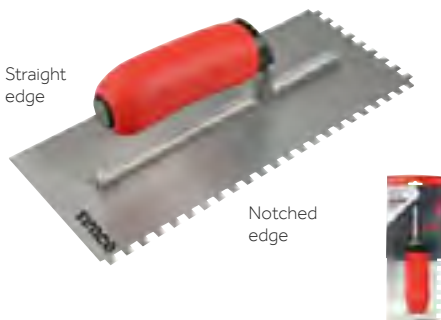

Straight edge

Notched edge

- Heavy duty steel blade

Product Code	L x W (inch)	Notch Size (mm)	Blade Gauge (mm)	Pack Qty (pcs)	Carton Qty (packs)
<b>PACK</b>					
468199	11 x 4½	6	0.7	1	12
468200	11 x 4½	10	0.7	1	12
TYPE - TWL		SUB TYPE - TWL01			

### Grouting Float

A premium application float for spreading grout, which leaves a smooth and professional finish. Featuring an ergonomically designed handle for user comfort, bevelled and rounded edges to assist application.



- Solid & ergonomic handle
- Bevelled & rounded corners
- Rubber blade for a smooth finish
- Robust backing plate for long tool life

Product Code	Length (inch)	Width (inch)	Pack Qty (pcs)	Carton Qty (packs)
<b>PACK</b>				
468273	9	4	1	6
TYPE - TWL		SUB TYPE - TWL02		

## Mixing Paddles

- Paint Mixer
- General Purpose & Professional Mixing Paddles

See Page  
**149**





NEW

# Hand Saws

### Soft-Grip

Ergonomic grip to prevent slipping & increase overall comfort when in use



### Tri-Cut

Fast & clean cutting 3D teeth to sweep out fibres of the wood

45° & 90°  
Marking angles

Available in 14", 20"  
& 22" with tpi's of  
7, 9, 11

**Snag Resistant Coating**  
Polished & lacquered blade for smooth cutting & corrosion resistance

**SK5 Blade**  
Made from high quality carbon steel for flexibility & durability

Product Code	Type	Length (inch)	Length (mm)	Cut Type	Teeth Per Inch (TPI)	Pack Qty (pcs)	Carton Qty (packs)
<b>PACK</b>							
468189	First Fix	20	500	Rip	7	1	10
468190	First Fix	22	550	Rip	7	1	10
468191	Universal	20	500	Cross	9	1	10
468192	Universal	22	550	Cross	9	1	10
468193	Second Fix	20	500	Fine	11	1	10
468194	Second Fix	22	550	Fine	11	1	10
468195	Toolbox	14	350	Fine	11	1	10

TYPE - SAW

SUB TYPE - SAW01 / SAW01 / SAW01 / SAW03

NEW

# Tenon Saws

## Tenon Saw

A premium 11tpi tenon saw. Featuring precision milled 2D teeth for maximum cutting accuracy. The soft-grip handle is designed to give user comfort and to maximise control during cutting.



- 2D precision teeth
- Super-soft-grip handle
- Snag resistant coating
- Reinforced for stability
- Fine cut

Product Code	Length (inch)	Length (mm)	Teeth Per Inch (TPI)	Pack Qty (pcs)	Carton Qty (packs)
<b>PACK</b>					
468196	14	350	11	1	10

TYPE - SAW

SUB TYPE - SAW03

## Tenon Saw & Mitre Box Kit

A premium 14" 11tpi tenon saw with precision milled teeth. Ideal for precise cutting wood. Includes a general purpose mitre box with 45° and 90° cutting angles.



- 2D precision teeth
- Super-soft-grip handle
- Impact & wear resistant
- Fine cut
- Snag resistant coating
- Reinforced for stability
- Mitre box: to cut wood up to 4 3/4" x 3" (120 x 75mm).
- Saw size: 14"

Product Code	Item	Clamping Capacity (inch / mm)	Pack Qty (pcs)	Carton Qty (packs)
<b>PACK</b>				
468197	-	-	2	6
	Tennon Saw	-	1	
	Mitre Box	4 3/4 x 3 / 120 x 75	1	

TYPE - SAW

SUB TYPE - SAW03

## Clamping Mitre Box

A multi-functional mitre box with soft-grip clamps to secure the workpiece in woodworking applications. Manufactured from high strength and wear resistant engineering plastic which features 22.5°, 45° and 90° angles for increased usability and cutting accuracy.



- Multiple cutting angle design
- Soft-grip clamps
- High strength design

Product Code	Clamping Capacity (inch / mm)	Pack Qty (pcs)	Carton Qty (packs)
<b>PACK</b>			
468149	2 1/2 x 4 / 65 x 100	1	10

TYPE - SAW

SUB TYPE - SAW03



**NEW**

# Rasp Planes

## Multi-Purpose Rasp Plane

A multi-purpose rasp plane, used for flattening and shaping a workpiece. Manufactured from solid impact resistant plastic making it ideal for shaping and sanding drywall sheets, timber, foam, soft metals, fibreglass, low density blocks and plastics. The larger size allows for two hand application for larger workpieces.



- Strong plastic body for drop resistance & increased user comfort
- Rapid material removal
- Fine cutting steel blade
- Ergonomic handle
- Two handed use



Product Code	Size	Pack Qty (pcs)	Carton Qty (packs)
<b>BACKING CARD</b>			
468150	255mm / 10"	1	12
TYPE - FLE			SUB TYPE - FLE01

## Heavy Duty Rasp Plane

A heavy duty rasp plane, used for flattening and shaping a workpiece. Manufactured from solid cast aluminium making it ideal for shaping and sanding drywall sheets, timber, foam, soft metals, fibreglass, low density block and plastics.



- High strength aluminium body
- Rapid material removal
- Fine cutting steel blade
- Ergonomic grip
- Single handed use



Product Code	Size	Pack Qty (pcs)	Carton Qty (packs)
<b>BACKING CARD</b>			
468050	145mm / 6"	1	12
TYPE - FLE			SUB TYPE - FLE01

# Knives & Blades

## Folding Utility Knife

Compact and lightweight foldable utility knife with pack of 10 blades.

- Integral belt clip
- Blades manufactured from SK2 tool steel
- Quick & easy release button for changing blade
- Safety catch



**10 BLADES INCLUDED**

Product Code	Blade Size (mm)	Pack Qty (pcs)	Carton Qty (packs)
<b>PACK</b>			
253017	60 x 19 x 0.6	1	10
TYPE - BLD			SUB TYPE - BLD02

## Safety Utility Knife

Retractable safety knife featuring an automatic blade system that retracts as soon as it leaves contact with the cut surface.

- Sure grip comfort handle
- Safety locking mechanism
- Blades manufactured from SK2 tool steel



**5 BLADES INCLUDED**

Product Code	Blade Size (mm)	Pack Qty (pcs)	Carton Qty (packs)
<b>PACK</b>			
253412	60 x 19 x 0.6	1	10
TYPE - BLD			SUB TYPE - BLD02

## Snap Off Utility Knife

Snap off utility knife with anti slip rubber grip handle and retractable blade. Integral storage compartment for spare blades.

- Retractable blade
- Anti-slip rubber grip handle
- Blades manufactured from SK2 tool steel



**2 BLADES INCLUDED**

Product Code	Blade Size (mm)	Pack Qty (pcs)	Carton Qty (packs)
<b>PACK</b>			
253483	100 x 18 x 0.6	1	10
TYPE - BLD			SUB TYPE - BLD02

## Utility Knife Blades

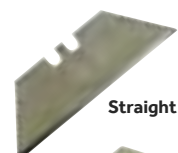

**Straight**

Manufactured using SK2 steel to give a longer life and a sharper cut. For general purpose cutting of linoleum, plastic, wood, carpet, cardboard etc.



**Hooked**

Compatible with all standard utility knives. Hooked blades with a sharp point for penetrating and cutting sheet material in particular floor coverings and plastic sheeting.

Product Code	Type	Blade Size (mm)	Pack Qty (pcs)	Carton Qty (packs)
<b>PACK</b>				
UBDISP	Straight	60 x 19 x 0.6	10	10
HBDISP	Hooked	51 x 19 x 0.6	10	10
<b>CASE</b>				
UBCASE	Straight	60 x 19 x 0.6	100	16
<b>HANGING DISPENSER</b>				
UBHANG	Straight	60 x 19 x 0.6	50	4
UBHANG100	Straight	60 x 19 x 0.6	100	4
TYPE - BLD				SUB TYPE - BLD01

## Snap Off Utility Knife Blades



Snap off blades for standard retractable knives. Multiple cutting edges for longer life. Manufactured using SK2 steel to give a longer life and a sharper cut. For general purpose cutting of linoleum, plastic, wood, carpet, cardboard etc.

Product Code	Blade Size (mm)	Pack Qty (pcs)	Carton Qty (packs)
<b>PACK</b>			
UBSNAP9	80 x 9 x 0.6	10	10
UBSNAP18	100 x 18 x 0.6	10	10
TYPE - BLD			SUB TYPE - BLD01

NEW

# Scissors & Wire Strippers



## Electricians Scissors

Heavy duty electricians scissors with micro serrated stainless steel blades for easily cutting through tough materials such as insulation materials, tapes, cable ties, wires and cables.

**Heat Treated Stainless Steel Blades**  
For a professional finish

**Micro Serrations**  
For self sharpening & superior non-slip cutting performance



**Wire Cutting & Stripping Notch**  
For effortless & convenient operation

**Anti-Pinch Handles**  
For user safety

**Bi-Material Grip**  
For strength, durability & user comfort

**Protective case included**



Product Code	Size (inch)	Size (mm)	Pack Qty (pcs)	Carton Qty (packs)
<b>PACK</b>				
468185	6	150	1	6
TYPE - PLR			SUB TYPE - PLR08	

## Tradesmans Scissors

All purpose scissors manufactured with hardened stainless steel blades for long lasting sharpness with ergonomic plastic handles for user comfort. Featuring tough ABS shatter resistant handles. Ideal for paper/ card, fabric, cardboard, foam, thin plastic, roofing felt, adhesive tape and plastic cable.

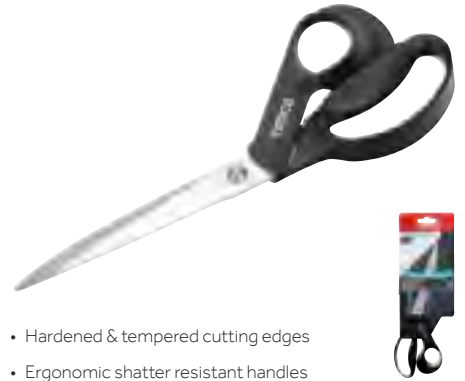

- Hardened & tempered cutting edges
- Ergonomic shatter resistant handles

Product Code	Size (inch)	Size (mm)	Pack Qty (pcs)	Carton Qty (packs)
<b>PACK</b>				
468184	9½	240	1	6
TYPE - PLR			SUB TYPE - PLR08	

## Cable & Wire Cutters

Premium cable and wire cutters, manufactured with hardened cutting jaws capable of cutting copper and aluminium cables. Featuring soft-grip handles to reduce slipping and provide the perfect grip.



- Cuts materials up to 11mm<sup>2</sup>
- Super sharp cutting edge
- Hardened Cr-V jaws for long lasting performance
- Ergonomic soft-grip handle

Product Code	Size (inch)	Size (mm)	Pack Qty (pcs)	Carton Qty (packs)
<b>PACK</b>				
468186	8	200	1	6
TYPE - PLR			SUB TYPE - PLR01	

# Professional Wire Strippers

High performance multi-functional wire strippers. For use with flat or round cable and wire, with integrated wire cutting and crimping capability. To suit wires from 0.2mm<sup>2</sup> to 6mm<sup>2</sup>.

**3 in 1**  
Cuts, Strips & Crimps

Adjusts to wire size automatically

Strips wires effortlessly

Product Code	Length (inch)	Pack Qty (pcs)	Carton Qty (packs)
<b>BLISTER PACK</b>			
468110	8	1	6
TYPE - PLR		SUB TYPE - PLR12	

**NEW**

# Pipe Shears & Tin Snips



## Professional Pipe Shears



Premium high performance pipe shears, featuring a heavy-duty aluminium body with super soft-grip handle and ratcheting mechanism for cutting up to 46mm plastic pipe. The stainless steel V-shaped blade cuts through tough pipe effortlessly whilst the design prevents distortion of softer pipe.

Up to 46mm Pipes

Ratchet Drive for **50% Less Effort**

### Prevents pipe distortion

- Clean & straight cutting
- Stainless steel V-shaped blade
- Heavy duty aluminium body



Product Code	To Suit Pipes (mm)	Pack Qty (pcs)	Carton Qty (packs)
468113	0-46	1	6
<b>BLISTER PACK</b>			
TYPE - PLR		SUB TYPE - PLR02	

## Premium Pipe Shears



Reduces Pipe Distortion



Up to 38mm Pipes

- Ratchet drive for reduced cutting effort
- Clean & straight cutting
- Stainless steel V-shaped blade
- Tough & lightweight

Product Code	To Suit Pipes (mm)	Pack Qty (pcs)	Carton Qty (packs)
468112	0-38	1	6
<b>BLISTER PACK</b>			
TYPE - PLR		SUB TYPE - PLR02	

## Pipe Shears



Reduces Pipe Distortion



Up to 26mm Pipes

- Quickly cuts plastic pipe
- Fast cutting V-shaped blade

Product Code	To Suit Pipes (mm)	Pack Qty (pcs)	Carton Qty (packs)
468111	0-26	1	6
<b>BLISTER PACK</b>			
TYPE - PLR		SUB TYPE - PLR02	

## Aviation Snips Set

A set of premium aviation snips, manufactured from heavy duty chrome vanadium for exceptional performance and tool life. Featuring induction hardened cutting edges to maintain sharpness and provide a clean cut. The set contains left, straight and right cutting snips.

**Cr-V**

Spring loaded release mechanism for rapid cutting

Hardened & tempered cutting edges

Cuts mild steel up to 2mm

Ergonomic moulded handles for superior comfort & grip

Superior clean cutting



Product Code	Item	Size (inch)	Pack Qty (pcs)	Carton Qty (packs)
<b>PACK</b>				
468181	-	-	3	3
	Left	10	1	
	Straight	10	1	
	Right	10	1	
TYPE - PLR			SUB TYPE - PLR09	



## Tin Snips

All purpose tin snips manufactured from hard wearing chrome vanadium, with polished and forged blades for making a variety of left, right and straight cuts. Featuring a rubberised coating for extra grip and comfort.

- Hardened & tempered cutting edges
- Single handed spring mechanism
- Robust solid steel
- Anti-slip grips

**Cr-V**



Product Code	Size (inch)	Size (mm)	Pack Qty (pcs)	Carton Qty (packs)
<b>PACK</b>				
468182	10	250	1	6
468183	12	300	1	6
TYPE - PLR			SUB TYPE - PLR09	



NEW

# Pliers, Cutters & Wrenches

Ergonomic Soft - Grip Handle

## General Purpose Pliers Set

Cr-V



A set of 3 pliers, manufactured from high grade chrome vanadium with hardened jaws and cutting edges ensuring that they stay sharper for longer. Featuring an ergonomic soft-grip handle to maximise user comfort and grip.

- Hardened & tempered Cr-V jaws for long lasting performance
- Precision milled teeth for maximum fastener grip
- Precision angled blades for clean cutting & a longer tool life

Product Code	Contents	Size (inch)	Size (mm)	Pack Qty (pcs)	Carton Qty (packs)
<b>PACK</b>					
468173				3	3
	Long Nose Pliers	6 ½	165	1	
	Combination Pliers	6 ½	165	1	
	Side Cutters	6 ½	165	1	

TYPE - PLR SUB TYPE - PLR04

## Tradesmans Pliers Set

Cr-V



A set of 3 pliers ideal for professional gripping, cutting and snipping tasks. Manufactured from premium grade chrome vanadium with hardened jaws and cutting edges ensuring that they stay sharper for longer.

- Hardened & tempered Cr-V jaws for long lasting performance
- Precision milled teeth for maximum fastener grip
- Precision angled blades for clean cutting & a longer tool life

Product Code	Contents	Size (inch)	Size (mm)	Pack Qty (pcs)	Carton Qty (packs)
<b>PACK</b>					
468174				3	3
	Side Cutters	7	175	1	
	Combination Pliers	8	200	1	
	Water Pump Pliers	10	250	1	

TYPE - PLR SUB TYPE - PLR04

## Side Cutters

Premium multi-purpose side cutters, designed for snipping and cutting plastics and metals in a variety of trade and home tasks. Manufactured from high grade chrome vanadium with heat treated and hardened cutting edges ensuring that they stay sharper for longer. Featuring an ergonomic soft-grip handle to maximise user comfort and grip.

Cr-V



- Cuts hard materials up to 1.6mm
- Hardened & tempered Cr-V jaws for long lasting performance

Product Code	Size (inch)	Size (mm)	Pack Qty (pcs)	Carton Qty (packs)
<b>PACK</b>				
468178	6	150	1	6

TYPE - PLR SUB TYPE - PLR01

## Combination Pliers

Premium multi-purpose pliers, designed for a variety of gripping and snipping tasks. Manufactured from high grade chrome vanadium with hardened jaws and cutting edges ensuring that they stay sharper for longer.

Cr-V



- Cuts hard materials up to 1.6mm
- Hardened & tempered Cr-V jaws for long lasting performance
- Precision milled teeth for maximum fastener grip

Product Code	Size (inch)	Size (mm)	Pack Qty (pcs)	Carton Qty (packs)
<b>PACK</b>				
468175	6	150	1	6
468176	8	200	1	6

TYPE - PLR SUB TYPE - PLR05

## Long Nose Pliers

Premium multi-purpose long nose pliers, designed for a variety of gripping and snipping tasks in tight and difficult to reach places. Manufactured from high grade chrome vanadium with hardened jaws and cutting edges.

Cr-V



- Cuts hard materials up to 1.6mm
- Hardened & tempered Cr-V jaws for long lasting performance
- Precision milled teeth for maximum fastener grip

Product Code	Size (inch)	Size (mm)	Pack Qty (pcs)	Carton Qty (packs)
<b>PACK</b>				
468177	8	200	1	6

TYPE - PLR SUB TYPE - PLR05

## Water Pump Pliers

For gripping slippery surfaces, nuts, bolts and irregular objects. Manufactured from chrome vanadium for wear prevention and long life. The ergonomic handle maximises grip, prevents slipping and assists rotational force.

Cr-V



- Hardened & tempered Cr-V jaws for long lasting performance
- Precision milled teeth for maximum fastener grip

Product Code	Size (inch)	Jaw Opening (mm)	Pack Qty (pcs)	Carton Qty (packs)
<b>PACK</b>				
468170	8	30	1	6
468171	10	34	1	6
468172	12	40	1	6

TYPE - PLR SUB TYPE - PLR03



### Multi-Function Fencing Pliers

Multi-function pliers combining five tools into one, making them an essential tool for all fencing applications. Manufactured from high grade chrome vanadium for robustness and long lasting performance.



- 5 in 1 Cuts, Crimps, Grips, Strikes & Pries
- Hardened & tempered Cr-V jaws
- Precision milled teeth for maximum fastener grip
- Anti-slip handles

Product Code	Size (inch)	Size (mm)	Pack Qty (pcs)	Carton Qty (packs)
<b>PACK</b>				
468179	13 1/2	340	1	6
TYPE - PLR			SUB TYPE - PLR06	

### Professional End Cutters

Premium quality end cutting pliers. Manufactured from hardened and plated chrome vanadium for wear prevention and long working life. Featuring induction hardened tips for a long lasting sharp edge.



- 2 in 1 bevel & pincer for twisting or cutting nails, wires & rivets
- Hardened Cr-V jaws

Product Code	Size (inch)	Size (mm)	Pack Qty (pcs)	Carton Qty (packs)
<b>PACK</b>				
468188	8	200	1	6
TYPE - PLR			SUB TYPE - PLR10	

### End Cutters

Solid carpenters end cutting pliers, manufactured from hardened chrome vanadium with ground and polished jaws for high leverage and long lasting sharpness. Featuring a rubberised coating for extra grip and comfort.



- Cuts hard materials up to 1.6mm
- Pincer head for increased cutting capacity & leverage
- Hardened Cr-V jaws
- Anti-slip handles

Product Code	Size (inch)	Size (mm)	Pack Qty (pcs)	Carton Qty (packs)
<b>PACK</b>				
468187	7	175	1	6
TYPE - PLR			SUB TYPE - PLR10	

### Adjustable Wrench

Professional adjustable wrenches manufactured from heavy duty chrome vanadium, hardened and tempered for exceptional tool life and performance. Featuring ergonomic soft-grip handles for superior user comfort, control and slip resistance.



- Heavy duty chrome vanadium steel
- Ergonomic soft-grip handle
- High strength & durability
- Anti-slip milled teeth
- Smooth adjustment mechanism

Product Code	Size (inch)	Jaw Opening (mm)	Pack Qty (pcs)	Carton Qty (packs)
<b>PACK</b>				
468166	6	24	1	6
468167	8	28	1	6
468168	10	34	1	6
468169	12	38	1	6
TYPE - SPN			SUB TYPE - SPN01	

### Locking Pliers

Professional locking pliers with heavy duty engineered curved jaws for a superior grip on irregular and rounded surfaces. Manufactured from premium grade chrome vanadium with induction hardened teeth for maximum grip and tool life.



- Maximum jaw opening 48mm
- Heat treated locking Cr-V jaws
- Precision milled curved jaws for maximum fastener grip
- Single handed release

Product Code	Size (inch)	Size (mm)	Pack Qty (pcs)	Carton Qty (packs)
<b>PACK</b>				
468180	10	250	1	6
TYPE - PLR			SUB TYPE - PLR07	

### Pipe Wrench

Robust and hard wearing pipe wrenches, manufactured from high grade chrome vanadium and drop forged cast iron to guarantee long tool life and exceptional performance. The precisely milled teeth create more grip as pressure is increased, reducing the chance of slipping and damage to the workpiece.



- Heavy duty chrome vanadium steel
- Drop-forged
- Black powder-coated

Product Code	Size (inch)	Jaw Opening (mm)	Pack Qty (pcs)	Carton Qty (packs)
<b>PACK</b>				
468240	14	48	1	6
468241	18	70	1	3
TYPE - SPN			SUB TYPE - SPN03	

### Bolt Croppers

Heavy duty bolt croppers, designed for effortlessly cutting through wire, chain, padlocks and bolts. Featuring adjustable hardened steel jaws with compound hinges to maximise leverage and cutting force.



- Chrome Molybdenum alloy steel for exceptional strength, cutting performance & corrosion resistance

Product Code	Size (inch)	Cutting Capacity (mm)	Pack Qty (pcs)	Carton Qty (packs)
<b>PACK</b>				
468242	18	6	1	12
468243	24	8	1	6
TYPE - PLR			SUB TYPE - PLR11	

NEW

## Spanner Sets

### Spanner Set - Open-Ended

A set of 8 metric open-ended spanners manufactured from high grade drop forged chrome vanadium steel.

- High strength & durability
- Sold in reusable storage pack
- Anti-slip milled jaws
- Comfort grip
- Polished

Cr-V



Contents:

6 x 7mm (Qty 1), 8 x 9mm (Qty 1),  
10 x 11mm (Qty 1), 12 x 13mm (Qty 1),  
14 x 15mm (Qty 1), 16 x 17mm (Qty 1),  
18 x 19mm (Qty 1), 20 x 22mm (Qty 1)

Product Code	Pack Qty (pcs)	Carton Qty (packs)
<b>PACK</b>		
468236	8	4
TYPE - SPN	SUB TYPE - SPN02	

### Spanner Set - Double Ring

A set of 8 metric double ring spanners manufactured from high grade drop forged chrome vanadium steel.

- High strength & durability
- Sold in reusable storage pack
- Anti-slip milled jaws
- Comfort grip
- Polished

Cr-V



Contents:

6 x 7mm (Qty 1), 8 x 9mm (Qty 1),  
10 x 11mm (Qty 1), 12 x 13mm (Qty 1),  
14 x 15mm (Qty 1), 16 x 17mm (Qty 1),  
18 x 19mm (Qty 1), 20 x 22mm (Qty 1)

Product Code	Pack Qty (pcs)	Carton Qty (packs)
<b>PACK</b>		
468237	8	4
TYPE - SPN	SUB TYPE - SPN02	

### Spanner Sets - Combination

Sets of 8 and 25 metric combination spanners manufactured from high grade drop forged chrome vanadium steel.

- High strength & durability
- Sold in reusable storage pack
- Anti-slip milled jaws

- Comfort grip
- Polished

Cr-V



Contents:

8mm (Qty.1), 9mm (Qty.1),  
10mm (Qty.1), 11mm (Qty.1),  
13mm (Qty.1), 14mm (Qty.1),  
17mm (Qty.1), 19mm (Qty.1)

Product Code	Pack Qty (pcs)	Carton Qty (packs)
<b>PACK</b>		
468238	8	4
TYPE - SPN	SUB TYPE - SPN02	



Cr-V

Contents:

25 Piece Set (6 - 28, 30mm, 32mm)

Product Code	Pack Qty (pcs)	Carton Qty (packs)
<b>PACK</b>		
468239	25	4
TYPE - SPN	SUB TYPE - SPN02	

NEW

## Bevel Edge Wood Chisels & Sets



Tough and hard wearing wood chisels, engineered from hardened and tempered steel. Featuring super soft-grips, split resistant handles and fully forged strike caps for use with hammers.

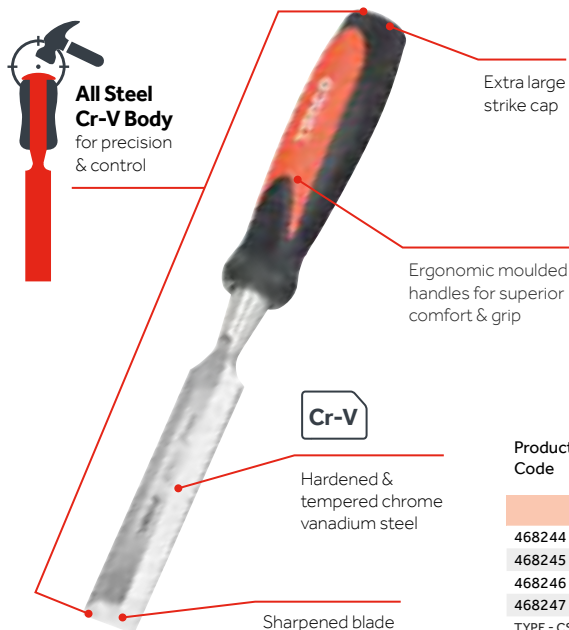

Clip



Set of 3



Set of 7



Sharpening stone included

Product Code	Size	Pack Qty (pcs)	Carton Qty (packs)
<b>CLIP</b>			
468244	6mm	1	6
468245	12mm	1	6
468246	18mm	1	6
468247	25mm	1	6
TYPE - CSL	SUB TYPE - CSL01		

Product Code	Contents	Pack Qty (pcs)	Carton Qty (packs)
<b>SET OF 3</b>			
468248	12mm (Qty 1), 19mm (Qty 1), 25mm (Qty 1)	3	3
<b>SET OF 7</b>			
468249	6mm (Qty 1), 12mm (Qty 1), 19mm (Qty 1), 25mm (Qty 1), 32mm (Qty 1), 38mm (Qty 1), Oilstone (Qty 1)	7	5
TYPE - CSL	SUB TYPE - CSL02		

NEW

# Screwdriver Sets



Set of 4

**Slotted:** 5 x 75mm, 6 x 100mm

**Phillips:** PH1 x 75mm, PH2 x 100mm

Product Code	Pack Qty (pcs)	Carton Qty (packs)
<b>BOX</b>		
468129	4	6
TYPE - SDR		SUB TYPE - SDR01



Set of 6

**Slotted:** 3 x 75mm, 5 x 100mm, 6.5 x 125mm

**Phillips:** PH0 x 75mm, PH1 x 100mm, PH2 x 125mm

Product Code	Pack Qty (pcs)	Carton Qty (packs)
<b>BOX</b>		
468130	6	6
TYPE - SDR		SUB TYPE - SDR01



Set of 8

**Slotted:** 3 x 75mm, 5 x 100mm, 6 x 150mm

**Phillips:** PH0 x 75mm, PH1 x 100mm, PH2 x 150mm

**Pozi:** PZ1 x 100mm, PZ2 x 150mm

Product Code	Pack Qty (pcs)	Carton Qty (packs)
<b>BOX</b>		
468131	8	6
TYPE - SDR		SUB TYPE - SDR01



Set of 9

**Slotted:** 5 x 38mm, 6 x 38mm, 3 x 75mm, 5 x 100mm, 6 x 150mm.

**Phillips:** PH2 x 38mm, PH0 x 75mm, PH1 x 100mm, PH2 x 150mm.

Product Code	Pack Qty (pcs)	Carton Qty (packs)
<b>BOX</b>		
468132	9	6
TYPE - SDR		SUB TYPE - SDR01

Set includes storage case

## Magnetic Tips

For ease of use in hard to reach spaces

Hard Wearing Ground Tips



S2

For toughness & resistance to chipping prolonging tool life & preventing fastener damage



## Ergonomic Handle

Designed with finger & thumb indents for increased user comfort whilst driving, allowing for maximum torque

## Anti-Slip Grip

Rubberised for slip prevention & to maximise user comfort

## Stubby Screwdriver Set

A set of premium stubby screwdrivers, manufactured with hardened and tempered S2 tool steel blades for extra strength and durability with reduced blades and handles making them ideal for working in tight areas.



- Hard wearing ground tips for optimal fastener driving
- Ergonomic handles for controlled & comfortable grip
- Magnetic tips to assist with installation
- High fastener driving torque

**Slotted:** 4 x 38mm, 5.5 x 38mm.

**Phillips:** PH1 x 38mm, PH2 x 38mm.

**Pozi:** PZ1 x 38mm, PZ2 x 38mm.

Product Code	Pack Qty (pcs)	Carton Qty (packs)
<b>PACK</b>		
468133 TYPE - SDR	6	6 SUB TYPE - SDR01

## Ratcheting Screwdriver & Bit Set

A ratcheting handle screwdriver with assorted driver bits and hex sockets. Featuring a soft-grip ratchet handle with adjustable angle control.



- Adjustable angle handle for dual driving function
- Precise ratchet mechanism
- Comfort grip
- Magnetic tips

**Pozi:** PZ0, PZ1, PZ2, PZ3.

**Phillips:** PH0, PH1, PH2, PH3.

**TX Drive:** TX10, TX15, TX20, TX25, TX27, TX30.

**Slotted:** 3mm, 4mm (x2), 5mm (x2), 6mm, 7mm.

**HX:** H3, H4, H5, H6.

**Square:** S0, S1, S2, S3.

**Imperial Sockets:** 3/16", 1/4", 9/32", 5/16", 11/32", 3/8", 7/16".  
**Metric Sockets:** 5mm, 6mm, 7mm, 8mm, 9mm, 10mm, 11mm.  
 25mm 1/4" to Square Adaptor, 60mm Bit Adaptor, Ratchet Screwdriver.

Product Code	Pack Qty (pcs)	Carton Qty (packs)
<b>PACK</b>		
468136 TYPE - SDR	46	6 SUB TYPE - SDR01

## Precision Screwdriver Set

A set of premium precision screwdrivers, manufactured with hardened and tempered S2 tool steel blades for extra strength and durability.



- Hard wearing ground tips for optimal fastener driving
- Magnetised tips & rotating handle ends
- Ergonomic handles for controlled & comfortable grip

**Slotted:** 1.5 x 50mm, 2.0 x 50mm, 2.5 x 50mm, 3.0 x 50mm.

**Phillips:** PH00 x 50mm, PH0 x 50mm.

Product Code	Pack Qty (pcs)	Carton Qty (packs)
<b>PACK</b>		
468134 TYPE - SDR	6	12 SUB TYPE - SDR01

## Precision Screwdriver & Bit Set

A precision screwdriver with interchangeable driver bits, manufactured from hardened and tempered chrome vanadium for extra strength and durability.



- Ergonomic anti-slip grip handle
- Hardened driver bits for strength & durability
- Rotating handle ends

**Phillips:** PH000, PH00, PH0, PH1.

**TX Drive:** TX4, TX5, TX6, TX7.

**Slotted:** 2mm, 2.5mm, 3mm.

**HX:** H0.7, H0.9, H1.3, H1.5, H2.  
100mm Extension

Product Code	Pack Qty (pcs)	Carton Qty (packs)
<b>PACK</b>		
468135 TYPE - SDR	18	12 SUB TYPE - SDR01

## Bradawl

A robust and hard wearing bradawl, manufactured from high grade alloy steel for strength and durability. Featuring a soft-grip handle for user comfort and slip resistance.



- Super sharp round point
- Ergonomic soft-grip handle to increase user comfort
- Robust & hard wearing



Product Code	Length (mm)	Length (inch)	Pack Qty (pcs)	Carton Qty (packs)
<b>PACK</b>				
468137 TYPE - SDR	75	3	1	12 SUB TYPE - SDR02



**NEW**

# Hex Key Sets



## T-Handle Hex Key Set

A set of T-handle metric hex keys, manufactured from hard wearing chrome vanadium with soft-grip handles. The T-handle shape allows for high torque during fastener driving with better user comfort.



Product Code	Contents	Pack Qty (pcs)	Carton Qty (packs)
<b>PACK</b>			
468220	2.0, 2.5, 3.0, 4.0, 5.0, 6.0, 8.0, 10.0	8	5
TYPE - SDR		SUB TYPE - SDR03	

## Hex Key Keyring Set

A set of metric hex keys on a convenient keyring. Manufactured from hardened steel with black oxide coating for rust prevention.



- Hard wearing ground tips, milled to maximise purchase & prevent cam-out
- Black oxide coated for rust protection

Product Code	Contents	Pack Qty (pcs)	Carton Qty (packs)
<b>BAG</b>			
468219	1.5, 2.0, 2.5, 3.0, 4.0, 5.0, 5.5, 6.0	8	12
TYPE - SDR		SUB TYPE - SDR03	

## Long Arm Ball End Hex Key Set

A set of metric hex keys, manufactured from high grade alloy steel for strength and durability. Featuring a standard hex head and ball end for better fastener driving at an angle and a long shaft for increased rotational torque.



- Precision ground tips, milled to maximise purchase & prevent fastener damage
- Long shaft for greater rotational torque
- Corrosion resistant plating

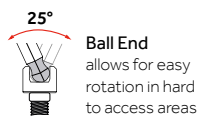

Product Code	Contents	Pack Qty (pcs)	Carton Qty (packs)
<b>PACK</b>			
468221	1.5, 2.0, 2.5, 3.0, 4.0, 5.0, 6.0, 8.0, 10.0	9	6
TYPE - SDR		SUB TYPE - SDR03	

## Long Arm TX Drive Key Set

A set of metric TX drive keys, manufactured from high grade alloy steel for strength and durability. Featuring a long shaft for increased rotational torque with precision ground tips to prevent fastener damage.



- Precision ground tips, milled to maximise purchase & prevent fastener damage
- Long shaft for greater rotational torque
- Corrosion resistant plating
- TX drive

Product Code	Contents	Pack Qty (pcs)	Carton Qty (packs)
<b>PACK</b>			
468222	TX10, TX15, TX20, TX25, TX27, TX30, TX40, TX45, TX50	9	6
TYPE - SDR		SUB TYPE - SDR03	

NEW

# Files & Rasps



## File Cleaning Brush

See page 177



### File & Needle File Set

A set of files and precision needle files, manufactured from hardened high grade steel. Ideal for general purpose and delicate metal fabrication and sharpening. Featuring soft-grip, anti-slip handles for user comfort. Supplied in a tough canvas protective case.

- Rapid material removal
- Long lasting cutting edge
- Double sided



Contains:

- Round    ◐ Half Round
- ▲ Triangle    ◌ Oval    ▬ Flat    ◊ Crossing
- Square    ▼ Knife    ◀ Barrette    ▨ Equalling & Hand

Product Code	Contents	Pack Qty (pcs)	Carton Qty (packs)
<b>PACK</b>			
468251	<b>Files:</b> Round (Qty 1), Half Round (Qty 1), Flat (Qty 1), Hand (Qty 1). <b>Needle Files:</b> Round (Qty 1), Half Round (Qty 1), Flat Square (Qty 2), Square (Qty 1), Triangle (Qty 1), Oval (Qty 1), Crossing (Qty 1), Knife (Qty 1), Barrette (Qty 1), Equalling (Qty 2)	16	10
TYPE - FLE		SUB TYPE -FLE02	

### File & Rasp Set

A set of files and rasps, manufactured from hardened high grade steel. Featuring soft-grip, anti-slip handles for user comfort. Supplied in a tough canvas protective case.

- Rapid material removal
- Long lasting cutting edge
- Double sided



Contains:

- Round    ◐ Half Round
- ▲ Triangle    ■ Square    ▨ Hand

Product Code	Contents	Pack Qty (pcs)	Carton Qty (packs)
<b>PACK</b>			
468250	<b>Files:</b> Hand (Qty 1), Round (Qty 1), Half Round (Qty 1), Triangle (Qty 1), Square (Qty 1). <b>Rasps:</b> Hand (Qty 1), Round (Qty 1), Half Round (Qty 1), Triangle (Qty 1)	9	10
TYPE - FLE		SUB TYPE -FLE02	

### Needle File Set

A set of needle files, manufactured from hardened high grade steel for professional tool life and performance during precision and delicate work. Featuring soft-grip handles for user comfort. Ideal for shaping metal, stone, ceramics, glass and other hard materials.

- Double cut teeth
- Long lasting cutting edge
- Rapid material removal
- Double sided



Contains:

- Round    ◐ Half Round
- ▲ Triangle    ▬ Flat    ■ Square    ▨ Equalling

Product Code	Contents	Pack Qty (pcs)	Carton Qty (packs)
<b>PACK</b>			
468252	Round (Qty 1), Half Round (Qty 1), Flat Square (Qty 1), Triangle (Qty 1), Equalling (Qty 1), Square (Qty 1)	6	10
TYPE - FLE		SUB TYPE -FLE02	

### Rasp Set

A set of three double sided rasps, manufactured from hardened high grade steel for long tool life. Ideal for shaping and finishing timber in carpentry applications such as cabinets and furniture making. Featuring soft-grip handles for user comfort and uniform tooth height to maximise material removal and finish. Supplied in a tough canvas protective case.

- Double cut teeth
- Long lasting cutting edge
- Rapid material removal
- Double sided

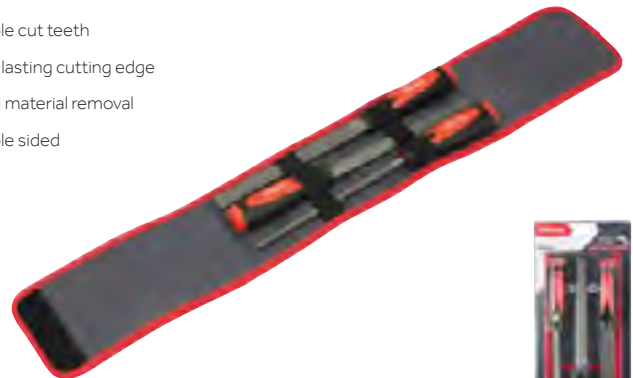

Contains:

- Round    ◐ Half Round    ▬ Flat

Product Code	Contents	Pack Qty (pcs)	Carton Qty (packs)
<b>PACK</b>			
468253	Flat (Qty 1), Round (Qty 1), Half Round (Qty 1)	3	3
TYPE - FLE		SUB TYPE -FLE02	

NEW

# Quick Change Bar Clamp

A heavy duty single handed bar clamp and spreading tool with a maximum grip capacity of 135kg. Featuring super soft-grip handles for comfortable use and a quick release ratcheting mechanism for added convenience. Ideal for assisting the support of materials during heavy gluing and clamping applications. With non-marking full face pads to distribute pressure evenly to reduce the risk of damage to the workpiece.

**\*Up to 135kg Clamping Force**

Ergonomic comfort grip handle

Single-hand quick release



Available in sizes  
6", 12", 18" & 24"



**2 in 1**  
Clamps & Spreads

\* Up to 70kg for Mini Bar Clamps

Product Code	Size Length (mm)	Clamping Capacity (inch / mm)	Clamping Force (kg)	Pack Qty (pcs)	Carton Qty (packs)
<b>QUICK CHANGE BAR CLAMPS</b>					
468138	300	12 / 300	135	2	5
468139	450	18 / 450	135	2	5
468140	600	24 / 600	135	2	4
<b>MINI BAR CLAMPS</b>					
468141	150	6 / 150	70	2	6
468142	300	12 / 300	70	2	6
TYPE - CLM		SUB TYPE - CLM01			

## F Clamp

Heavy duty F clamps with super soft-grip handles for ergonomic and comfortable use. Featuring a hardened slip resistant steel bar with solid jaws to provide a maximum clamping force of 270kg. Featuring soft plastic protective jaws to help prevent damage to the workpiece.



- Ergonomic comfort grip handle
- Non-slip steel bar
- Clamping force: 270kg



Product Code	Size Length (mm)	Clamping Capacity (inch / mm)	Pack Qty (pcs)	Carton Qty (packs)
<b>PACK</b>				
468143	150	6 / 150	1	20
468144	300	12 / 300	1	20
468145	500	20 / 500	1	10
TYPE - CLM		SUB TYPE - CLM02		

## G Clamp

Extra heavy duty, cast iron G clamps. Featuring strong threaded steel spindles and extra tough powder coating for corrosion resistance.



- Heavy duty
- Bend & break resistant
- Tough powder coating



Product Code	Size (inch)	Size (mm)	Clamping Force (kg)	Pack Qty (pcs)	Carton Qty (packs)
<b>PACK</b>					
468146	3 x 1 3/4	75 x 45	400	1	6
468147	4 x 2	100 x 50	470	1	6
TYPE - CLM		SUB TYPE - CLM03			

## Spring Clamp Set

A heavy duty and hard wearing spring clamp set, manufactured from resin infused plastic and using high sprung steel for a super strong clamping up to 15kg.



- Ergonomic comfort grip handle
- Heavy duty gripper pads
- Solid plastic body



Product Code	Contents	Clamping Force (kg)	Pack Qty (pcs)	Carton Qty (packs)
<b>PACK</b>				
468148	2" (Qty 2), 2.5" (Qty 2)	12/15	4	10
TYPE - CLM		SUB TYPE - CLM04		





**NEW**

# Professional Spirit Levels

**Set of 4 Available!**

**Vertical Viewing Window**

**Precision Magnified Vials**  
Precision vials ensure clear visibility from distance or low light environments

**Dual Milled Surfaces**



**Soft-Grip Handle**

**5x Stronger Robust Aluminium Frame**

High strength & durable powder coated profile

**Shock & Drop Proof**

Moulded rubber end caps & reinforced vials protect against drop and shock damage



**Super Strong Magnets**

Rare earth magnets provide a 2x stronger hold



**Highly Accurate**

+/- 0.5mm per metre

Product Code	Length (mm)	Length (inch)	Pack Qty (pcs)	Carton Qty (packs)
<b>EACH</b>				
468159*	400	16	1	10
468160	600	24	1	10
468161	900	32	1	10
468162	1200	48	1	10
468163	1800	71	1	10
<b>SET OF 4</b>				
468164	225, 600, 1200 & 1800	9, 24, 48 & 71	4	4
TYPE - LEV			SUB TYPE - LEV03	

\*Vertical viewing window not included

# Professional Toolbox Spirit Level



A premium quality 9" toolbox level, manufactured using robust aluminium and shock proof end caps with V-grooved milled surfaces for guaranteed accuracy. Featuring three premium encased vials to maximise performance, lifespan and visibility.

Product Code	Length (mm)	Length (inch)	Pack Qty (pcs)	Carton Qty (packs)
<b>PACK</b>				
468152	225	9	1	10
TYPE - LEV			SUB TYPE - LEV03	



## Box Spirit Level

A strong and lightweight aluminium box level, ideally suited for measuring and levelling in carpentry, electrical installing, bricklaying and many other trade and DIY applications.

**Shock resistant end caps**  
To protect against drop & shock damage

**Magnified central vial**  
For easy visibility

**45° vial**

**Robust aluminium frame**  
Comfortable & compact box beam profile

**Accurate levelling**  
Three vials ensure accurate readings of +/- 1mm per metre

\*Two vials on 400mm level

Product Code	Length (mm)	Length (inch)	Pack Qty (pcs)	Carton Qty (packs)
<b>EACH</b>				
468154	400	16	1	10
468155	600	24	1	10
468156	900	32	1	10
468157	1200	48	1	10
468158	1800	71	1	10

TYPE - LEV SUB TYPE - LEV02

## Toolbox Spirit Level

A tough 9" toolbox level, made from solid hard wearing plastic. Features three vials for use at multiple angles with a magnetic base. Ideal for tight and cramped spaces.



- Tough & lightweight body
- Magnetic base
- 3 vials
- +/- 1mm/m accuracy

Product Code	Length (mm)	Length (inch)	Pack Qty (pcs)	Carton Qty (packs)
<b>EACH</b>				
468151	225	9	1	10

TYPE - LEV SUB TYPE - LEV01

## Scaffold Spirit Level

A hard wearing and impact resistant scaffolder's level, manufactured from a solid steel body with protected and shock resistant vials. Featuring rare earth magnets for 2x stronger hold and a milled face for maximum accuracy, making it ideal for use with metal pipework and scaffolding.



- Die-cast aluminium body for maximum durability
- Impact & shock proof
- Magnetised with rare earth magnets for 2x magnetic power
- Magnified vials for easy visibility
- Solid block vials for shock resistance
- Precision engineered for +/- 0.5mm/m accuracy

Product Code	Length (mm)	Length (inch)	Pack Qty (pcs)	Carton Qty (packs)
<b>EACH</b>				
468153	250	10	1	10

TYPE - LEV SUB TYPE - LEV04

## Post Level



A tough and solid plastic post level. Designed for quick and easy levelling of fence and gate posts, structural steel and other vertical applications. Includes two horizontal vials with an elasticated band and magnetic plates for handsfree use.

- Magnetised
- Three vials
- Convenient & lightweight
- Robust solid plastic frame
- For use with timber, metal or concrete posts
- Elasticated for hands free levelling



Product Code	Length (mm)	Length (inch)	Pack Qty (pcs)	Carton Qty (packs)
<b>BACKING CARD</b>				
468165	125	5	1	10

TYPE - LEV SUB TYPE - LEV04

**NEW**

## Tape & Wheel Measures



## Measuring Wheel - Digital

**NEW**

A strong and portable measuring wheel with digital read out. The lightweight aluminium frame features telescopic sections for portability and easy storage. Includes an integrated stand and carry case.

2 x AAA batteries included

Product Code	Measures (m)	Pack Qty (pcs)	Carton Qty (packs)
<b>BOX</b>			
863321	0-99,999.9	1	5
TYPE - TME		SUB TYPE - TME01	

## Open Reel Tape Measure

A heavy duty and robust open reel tape measure, constructed from high strength shock resistant plastic and a 50m anti-stretch fibreglass tape with metric and imperial measurements. Features a soft-grip handle with rubberised edges, high speed winding mechanism and integrated ground spike.



**NEW**

- Anti-stretch & easy clean
- 3x faster winding compared to a standard open reel tape measure
- Built-in ground spike
- Metric & imperial scales
- Drop resistant body
- Class 3 accuracy

Product Code	Size (m x mm)	Pack Qty (pcs)	Carton Qty (packs)
<b>CLAMSHELL</b>			
863987	50 x 13	1	12
TYPE - TME		SUB TYPE - TME06	

## Closed Reel Tape Measure

A professional closed reel tape measure, featuring a robust and soft-grip case, 30m stretch resistant fibreglass tape and geared mechanism for 3x faster winding.



**NEW**

- 30m stretch resistant fibreglass tape
- 3x faster winding compared to a standard closed reel tape measure
- Shock & drop proof
- Non-conductive fibreglass tape
- Metric & imperial scales
- Class 3 accuracy

Product Code	Size (m x mm)	Pack Qty (pcs)	Carton Qty (packs)
<b>CLAMSHELL</b>			
863654	30 x 13	1	6
TYPE - TME		SUB TYPE - TME06	

## Tape Measure

Trade quality tape measure with a locking button, strengthened belt clip, hand strap and a 25mm nylon coated blade to provide a convenient stand out in excess of 2.3m. Class 2 accuracy and MID 2006 compliant for precise measuring in either metric or imperial units.



- Stand out in excess of 2.3m
- Class 2 accuracy
- MID Certified
- Locking button
- Strengthened belt clip
- Hand strap
- Metric & imperial scales

Product Code	Size (m)	Pack Qty (pcs)	Carton Qty (packs)
<b>PACK</b>			
5MTAPEM	5	1	6
8MTAPEM	8	1	6
TYPE - TME		SUB TYPE - TME06	

**NEW**

## Squares & Rulers



### Combination Square

A robust precision engineered square with metric and imperial scales. Features 45° and 90° angles with a built in level vial and scribe. Predominantly used in woodworking, metalworking and stone masonry.

**5 in 1**  
Try & Mitre Square,  
Depth & Height  
Gauge, Spirit Level



- Maximum accuracy
- Etched & indented scales for durability
- Standard head for marking 45° & 90° angles
- Precision milled mechanism for smooth operation
- Built-in scribe
- Stainless steel blade & zinc alloy body

Product Code	Size (mm)	Accuracy (mm)	Pack Qty (pcs)	Carton Qty (packs)
<b>BACKING CARD</b>				
863963	300	±0.25	1	6
TYPE - TME			SUB TYPE - TME05	

### Try Square

A robust and lightweight aluminium try square with metric and imperial scales. An essential tool for woodworking, featuring a precision engineered 90° angle for accuracy. Silver anodised for corrosion resistance and scratch protection with laser engraving easy legibility.



- Solid aluminium
- Maximum accuracy
- Etched scales for durability
- Metric & imperial scales

Product Code	Size (mm)	Accuracy (mm)	Pack Qty (pcs)	Carton Qty (packs)
<b>CLIP</b>				
863852	250	±0.30	1	10
TYPE - TME			SUB TYPE - TME05	

### Steel Ruler

A highly accurate steel ruler, suitable for variety or tasks. Featuring a stainless steel blade with class 2 metric and imperial measurement scales.

- Stainless steel
- Etched scales for durability
- Metric & imperial scales

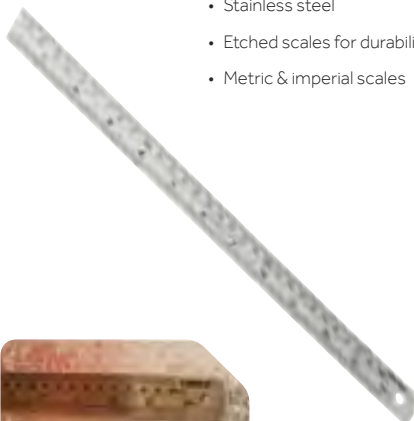

Product Code	Size (inch)	Size (mm)	Accuracy (mm)	Pack Qty (pcs)	Carton Qty (packs)
<b>WALLET</b>					
863741	12	300	±0.15	1	10
863123	24	600	±0.20	1	10
863456	40	1000	±0.20	1	10
TYPE - TME			SUB TYPE - TME03		

### Framing & Carpenter's Square

A long armed solid steel measuring square, manufactured for precise metric and imperial measurements. Suitable for various carpentry applications including cabinetry and laying out hips, rafters and staircases.



- Solid steel blade
- Precision engineered
- Metric & imperial scales



Product Code	Size (inch)	Accuracy (mm)	Pack Qty (pcs)	Carton Qty (packs)
<b>EACH</b>				
863789	16 x 24	±0.25	1	6
TYPE - TME			SUB TYPE - TME05	

### Rafter Square

A lightweight and precise triangular square. This multi-purpose square combines the functions of a try square, combination square and framing square in one. Featuring a 0° to 90° protractor scale for use as a saw guide with embedded degree markings for easy legibility.



- 3 in 1 – combination square, try square & protractor
- Maximum accuracy
- Durable etched scales for ease of visibility
- Calculate angles of roof frames quickly & easily
- Built-in notches for scribing
- Robust aluminium frame

Product Code	Size (mm)	Accuracy (mm)	Pack Qty (pcs)	Carton Qty (packs)
<b>BACKING CARD</b>				
863554	300	±0.25	1	8
TYPE - TME			SUB TYPE - TME05	

NEW

# Chalk Powder & Chalk Line Set

A professional 30m snap resistant chalk line set and premium grade marking chalk suitable for all common building surfaces including wood, concrete, brick and more. Manufactured using high visibility pigments for all internal and external marking applications.

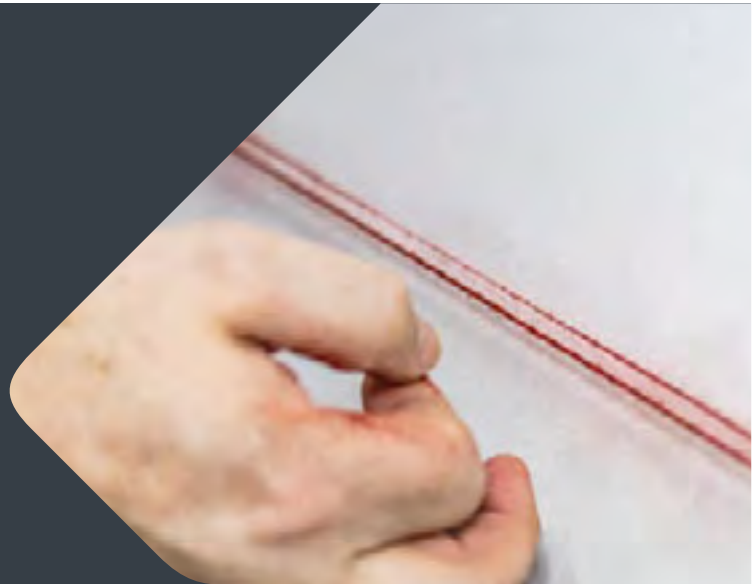

High visibility temporary markings



Claw & loop end

Fast rewind

Quick and easy refill window with 45g chalk capacity

Robust body with rubber grip



**3x**  
Faster & smoother rewind



Product Code	Length (m)	Colour	Size (g)	Pack Qty (pcs)	Carton Qty (packs)
<b>CHALK LINE SET</b>					
<b>WALLET</b>					
863147	30	Red	115	1	6
<b>CHALK POWDER</b>					
<b>WALLET</b>					
863258	-	Blue	225	1	8
863369	-	Red	225	1	8
TYPE - TME			SUB TYPE -TME04		

## Builders Lines & Rope



### Blue Polypropylene Rope



Winder



Short & Long Coil



Wagon Rope

General purpose rope suitable for towing, mooring, barrier rope, lorry tie, agricultural and industrial uses. Also used as a cable draw cord. Ideal for all general purpose building use.

Product Code	Ø x Length (mm x m)	Working Load (kg)	Break Strength (kg)	Pack Qty (pcs)	Carton Qty (packs)	Pallet Qty (packs)
<b>WINDER</b>						
BR330W	3.0 x 30	12	70	1	50	450
BR620W	6.0 x 20	60	350	1	30	240
BR815W	8.0 x 15	100	600	1	20	120
BR1010W	10.0 x 10	160	980	1	18	144
<b>SHORT COIL</b>						
BR630C	6.0 x 30	60	350	1	24	96
BR830C	8.0 x 30	100	600	1	16	144
BR1030C	10.0 x 30	160	980	1	12	48
BR1230C	12.0 x 30	220	1570	1	8	32
<b>LONG COIL</b>						
BR6220C	6.0 x 220	60	350	1	4	-
BR8220C	8.0 x 220	100	600	1	2	-
BR10220C	10.0 x 220	160	980	1	-	-
BR12220C	12.0 x 220	220	1570	1	-	-
TYPE - ROP		SUB TYPE - ROP01				
<b>WAGON ROPE</b>						
767711	9.0 x 27	333	900	1	12	96
TYPE - ROP		SUB TYPE - ROP02				

### Builders Line

Ideal for staking sites prior to concreting, landscaping or bricklaying. Used as guidelines for building & landscaping.



Tube

Tube & Winder

Product Code		Length (m)	Pack Qty (pcs)	Carton Qty (packs)
Pink	Yellow			
<b>TUBE &amp; WINDER</b>				
PBL100W	YBL100W	100	1	30
<b>TUBE ONLY</b>				
PBL100T	YBL100T	100	1	30
TYPE - BLN		SUB TYPE - BLN01		



Stationery



**Carpenters Pencils**

Broad design for easy grip and wider marking on rough surfaces.



- Rectangular shape won't roll away on an inclined surface
- Hard HB lead type

Product Code	Pack Qty (pcs)	Carton Qty (packs)
<b>TUBE</b>		
863946	12	40
SUB TYPE - TME		

**Builders Permanent Markers**

For use on multiple materials including cardboard, paper, plastic, glass, tile, metal, masonry and wood.



- Vivid colour
- Low odour
- Non-toxic ink
- Erases cleanly & easily

Product Code	Colour	Tip Type	Pack Qty (pcs)	Carton Qty (packs)
<b>BLISTER PACK</b>				
736111	Black	Fine	2	12
736222	Black	Chisel	2	12
736333	Black	Fine & Chisel	2	12
<b>BOX</b>				
736444	Black, Red, Blue & Green	Fine	4	12
SUB TYPE - PEN01				

**Whiteboard Markers**

Whiteboard marker pens are manufactured using non-toxic, low odour and easy to erase ink.



- Vivid colour
- Quick drying
- Water & UV resistant

Product Code	Colour	Tip Type	Pack Qty (pcs)	Carton Qty (packs)
<b>BOX</b>				
736555	Black, Red, Blue & Green	Fine	4	12
SUB TYPE - PEN02				

**MARXMAN**  
PROFESSIONAL MARKING TOOL



AS SEEN ON DRAGONS' DEN



DESIGNED & MANUFACTURED IN THE UK



**PRESS**



**MARK** | 250+ MARKS



**DRILL**

**MARKS A FIXING POINT THROUGH FITTINGS, FIXTURES & BATTENS**



Product Code	Type	Pack Qty (pcs)	Carton Qty (packs)
<b>CASE</b>			
MXM025956	Standard	30	1
MXM025932	Deep Hole	30	1
MXM025970	Standard (20) & Deep Hole (10)	30	1
<b>STRIP</b>			
MXM025901	Standard	12	1
SUB TYPE - PEN03			



**STRIP**

12 Marxman marking tools in euro hanging blisters. Includes hanging strip



**CASE**

CDU containing 30 Marxman marking tools

## Riveters



### Hand Riveter



A robust steel hand riveter, with a soft-grip handle for user comfort.  
Ideal for DIY and professional use such as engineering, mechanics, roofing construction and more.

- Powder coated for a long lasting & durable finish
- Soft-grip handle for user comfort
- 4 interchangeable nosepieces
- Nosepiece spanner included

Product Code	To Suit Rivets (mm)	Pack Qty (pcs)	Carton Qty (packs)
<b>BOX</b>			
784555	3.0, 3.2, 4.0 & 4.8	1	10
TYPE - RVG		SUB TYPE - RVG01	

### Lazy Tongue Riveter

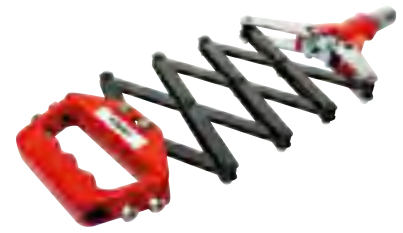

A heavy duty riveter designed for repetitive work. During installation the lattice mechanism increases driving force, reducing work time and effort. Ideal for professional use such as engineering, mechanics, roofing construction and more.

- Lattice mechanism increases driving force
- 5 interchangeable nosepieces
- Nosepiece spanner included
- Powder coated for a long lasting & durable finish

Product Code	To Suit Rivets (mm)	Pack Qty (pcs)	Carton Qty (packs)
<b>BOX</b>			
784101	3.0, 3.2, 4.0, 4.8, 6.0 & 6.4	1	10
TYPE - RVG		SUB TYPE - RVG01	

## Staplers

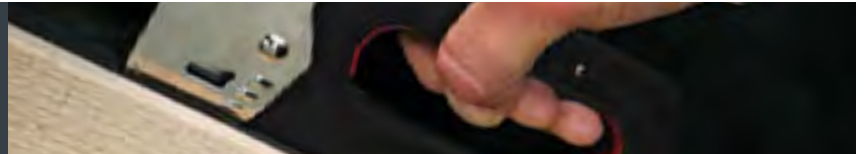

### Light Duty Stapler



**124**  
Staple Capacity

**53**  
**JT21**  
6-10mm

An all steel light duty staple gun, ideal for most professional and DIY applications. Suitable for use with light duty staples.

- Pinch point free design for safe & comfortable grip
- Convenient rear loading magazine
- Also compatible with Type 53, JT21 & A-Type staples

Product Code	Staple Size (mm)	Pack Qty (pcs)	Carton Qty (packs)
<b>BLISTER PACK</b>			
370505	6 - 10	1	4
TYPE - FST		SUB TYPE - FST01	

### Heavy Duty Stapler



**82**  
Staple Capacity

**140**  
**T50**  
6-14mm

An all steel professional staple gun, ideal for heavy duty applications. Suitable for use with heavy duty staples.

- Adjustable staple depth controller for greater flexibility
- Convenient bottom loading magazine
- Also compatible with Type 140, T50 & G-Type staples

Product Code	Staple Size (mm)	Pack Qty (pcs)	Carton Qty (packs)
<b>BLISTER PACK</b>			
370321	6 - 14	1	6
TYPE - FST		SUB TYPE - FST01	

### Hammer Tacker



**165**  
Staple Capacity

**140**  
**T50**  
6-10mm

A heavy duty and durable all steel constructed hammer tacker. Ideal for applications requiring rapid and effortless staple installation such as roofing membrane. Suitable for use with heavy duty staples.

- Anti-slip soft-grip handle for user comfort
- Complete with convenient rear loading magazine
- Also compatible with Type 140, T50 & G-Type staples

Product Code	Staple Size (mm)	Pack Qty (pcs)	Carton Qty (packs)
<b>BLISTER PACK</b>			
370987	6 - 10	1	10
TYPE - FST		SUB TYPE - FST01	

# Wire Brushes



## Wooden Handle Wire Brush



with scraper

Ideal for the professional user when preparing surfaces to remove paint, rust, scale, grout or dirt.

Stainless steel reduces contamination of the base material

Product Code	No. of Rows	Material	Pack Qty (pcs)	Carton Qty (packs)
--------------	-------------	----------	----------------	--------------------

**BOX**

3SBHD	3 x 18	Steel	1	10
4SBHD	4 x 18	Steel	1	10
3SBSS	3 x 16	Stainless	1	10
4SBSS	4 x 16	Stainless	1	10

**WITH SCRAPER - BOX**

45SBHD	4 x 18	Steel	1	10
--------	--------	-------	---	----

TYPE - WBR

SUB TYPE - WBR01

## Plastic Handle Wire Brush



A moisture and chemical resistant ergonomic handle.

Ideal for the professional user when preparing surfaces to remove paint, rust, scale, grout or dirt.

Product Code	No. of Rows	Material	Pack Qty (pcs)	Carton Qty (packs)
--------------	-------------	----------	----------------	--------------------

**BOX**

4SBP	4 x 15	Steel	1	10
6SBP	6 x 15	Steel	1	10

TYPE - WBR

SUB TYPE - WBR01

## File Cleaning Brush



For cleaning embedded filings from both wood and metal files.

Product Code	No. of Rows	Material	Pack Qty (pcs)	Carton Qty (packs)
--------------	-------------	----------	----------------	--------------------

**BOX**

FCB	110 x 40	Steel	1	10
-----	----------	-------	---	----

TYPE - WBR

SUB TYPE - WBR01

## Wire Hand Brush



A high density wire brush with an ergonomic plastic handle. Ideal for a more aggressive removal of paint, rust, scale, grout or dirt. Sold in three brush types to suit a variety of applications.

Product Code	Material	Pack Qty (pcs)	Carton Qty (packs)
--------------	----------	----------------	--------------------

**BOX**

RWHB	Steel	1	12
BWHB	Stainless Steel	1	12
YWHB	Brass	1	12

TYPE - WBR

SUB TYPE - WBR01

# Levelling Tools



## Air Wedge



A strong inflatable air bag that saves time during the fixing and levelling of internal doors, door frames, double glazed windows and external door frames.

Simply place frame into position, slide the deflated wedge into gap and inflate gently, trapping the frame in position allowing fixings to be installed.

Multiple additional uses including lifting and levelling of heavy furniture, washing machines, fridge freezers, kitchen units, water tanks, etc. prior to permanent fixings or levels being installed. Essential problem solving piece of kit for those working alone.

Product Code	Max. Rec. Load (kg)	Pack Qty (pcs)	Carton Qty (packs)
--------------	---------------------	----------------	--------------------

**EACH**

744101	150	1	30
--------	-----	---	----

TYPE - SHI

SUB TYPE - SHI04

## Glazing Shovel



Glazing shovels are mainly used during the professional installation of glazing units to toe and heel in order to prevent dropping and dragging.

The shovel is manufactured from High Impact ABS (Acrylonitrile Butadiene Styrene) for outstanding impact resistance.

They are also used to correctly locate glazing and wedge packers.

Product Code	Length (mm)	Width (mm)	Pack Qty (pcs)	Carton Qty (packs)
--------------	-------------	------------	----------------	--------------------

**EACH**

744665	260	68	1	25
--------	-----	----	---	----

TYPE - SHI

SUB TYPE - SHI03

# Glass & Tile Scraper

Ergonomic plastic body with soft TPR handle for comfort in use

Wider blade for quicker use

Spare blade storage compartment in handle



Perfect for the easy removal of dirt, excess adhesives, sealants and grout from tiles and glazing. Supplied with replaceable blades. Complete with blade guard.

Product Code	Blade Length (mm)	Pack Qty (pcs)	Carton Qty (packs)
--------------	-------------------	----------------	--------------------

**BLISTER PACK**

253258	100	1	6
--------	-----	---	---

TYPE - BLD

SUB TYPE - BLD03

# Applicator Guns



## Professional Foil & Cartridge Applicator Gun

Up to 380ml Cartridges



Constructed with a heavy gauge aluminium barrel, reinforced steel mechanism and ergonomic grip for precise application and long lasting performance.

- Long life & Fast flow
- Comfort grip
- Lightweight
- Non-drip

Product Code	Pack Qty (pcs)	Carton Qty (packs)
<b>BOX</b>		
222551	1	12
TYPE - ASA	SUB TYPE - ASA01	

## Foil & Cartridge Applicator Gun

Up to 380ml Cartridges



Constructed using lightweight materials for ease of use with quick release end caps for fast removal and replacement of foils and cartridges.

- Powder coating
- Fast flow & Non-drip
- Quick release
- Lightweight

Product Code	Pack Qty (pcs)	Carton Qty (packs)
<b>BOX</b>		
222378	1	12
TYPE - ASA   SUB TYPE - ASA01		

## Foil Applicator Gun Nozzles



Manufactured from a 100% recyclable hard wearing material. Designed to form an air tight seal with the foil to prevent premature product expiration.

When replacing foils of the same product, the same nozzle can be reused to reduce nozzle and product wastage.

Product Code	Pack Qty (pcs)	Carton Qty (packs)	Pallet Qty (packs)
<b>BAG</b>			
732845	6	5	400
TYPE - ASA	SUB TYPE - ASA02		

## Professional Resin Gun

Up to 410ml Cartridges



12:1 trigger ratio

- A 64mm heavy duty co-axial resin applicator gun.
- Twin 5mm gripper plates providing four point contact with the plunger rod.
- Non-drip mechanism

Product Code	Pack Qty (pcs)	Carton Qty (packs)
<b>PACK</b>		
RESINGUN	1	10
TYPE - ASA	SUB TYPE - ASA01	

## Professional Sealant Gun

Up to 380ml Cartridges



12:1 trigger ratio

- A 48mm heavy duty sealant and caulking gun
- With a convenient hook end for hanging
- Swivel action barrel for easy application into tight corners
- Patented non-drip mechanism

Product Code	Pack Qty (pcs)	Carton Qty (packs)
<b>PACK</b>		
PROGUN	1	12
TYPE - ASA	SUB TYPE - ASA01	

## Skeleton Gun

Up to 380ml Cartridges



7:1 trigger ratio

- A 48mm gun for dispensing sealants, caulk and adhesives
- 2.3mm strengthened side plates and a 6mm gripper plate
- Convenient hook end for hanging
- Riveted front cap for reinforcement and integrated cleaning pin

Product Code	Pack Qty (pcs)	Carton Qty (packs)
<b>PACK</b>		
SKELGUN	1	24
TYPE - ASA	SUB TYPE - ASA01	



# PU Foam Applicator Guns



## Professional PU Foam Applicator Gun

PTFE Coated



A premium quality professional PU foam applicator gun for use with standard 750ml & 500ml gun grade canisters and foam cleaners. Box also includes two extension tubes and two tapered nozzles for small gaps.

- Excellent flow control
- Lightweight
- Hard wearing PTFE coated internal components

Product Code	Pack Qty (pcs)	Carton Qty (packs)
<b>BOX</b>		
783113	1	20
TYPE - ASA   SUB TYPE - ASA01		

## PU Foam Applicator Gun

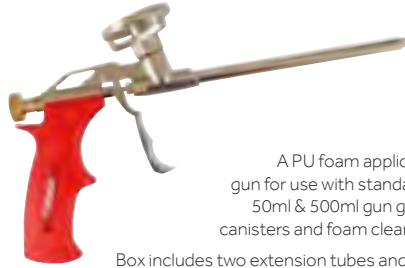

A PU foam applicator gun for use with standard 750ml & 500ml gun grade canisters and foam cleaners. Box includes two extension tubes and two tapered nozzles for small gaps.

- Heavy duty steel body
- Stainless steel non-blocking valve
- Polypropylene hand grip
- Lubricated trigger

Product Code	Pack Qty (pcs)	Carton Qty (packs)
<b>BOX</b>		
783556	1	20
TYPE - ASA   SUB TYPE - ASA01		

## Economy PU Foam Applicator Gun



An economical PU foam applicator gun with an extended barrel for use with 750ml and 500ml PU foam canisters and foam cleaners.

- Constructed from lightweight plastic
- Steel barrel and brass needle
- Ergonomic grip
- Stainless steel internals & non-return valve

Product Code	Pack Qty (pcs)	Carton Qty (packs)
<b>BAG</b>		
783992	1	36
TYPE - ASA   SUB TYPE - ASA01		



# Energizer

## Europe's No.1 Battery Brand\*

Fully stocked stand option available! Includes... 45 Packs!



Stocked Stand code: **ENRSTAND**

ENR414974 x5	ENR297331 x4	ENR414677 x5	ENR295634 x4
ENR414981 x8	ENR297409 x4	ENR083071 x4	ENR248357 x4
ENR297324 x4	ENR414660 x3		



Product Code	Description	Type	Pack Qty (pcs)
<b>PACK</b>			
ENR414974	Alkaline Power AA	AA	5
ENR414981	Alkaline Power AAA	AAA	5
ENR414660	Alkaline Power AA Value Home pack	AA	24
ENR414677	Alkaline Power AAA Value Home pack	AAA	24
ENR297324	Alkaline Power C E93	C	2
ENR297331	Alkaline Power D E95	D	2
ENR297409	Alkaline Power 9v 522	9v	1
ENR083071	Alkaline A76/LR44 Coin	A76	2
ENR295634	Alkaline LR1/E90	LR1/E90	2
ENR248357	Lithium CR2032 Coin	CR2032	2

TYPE - ENG SUB TYPE - ENG 01

\*Source Nielsen global Scan- latest 52 weeks ending July 2019 ©2020 Energizer. Energizer, the Energizer Character design, and certain graphic designs are trademarks of Energizer Brands, LLC and related subsidiaries.



# Adhesives & Chemicals

## Tapes

General Purpose	181
Building	182
Plumbing & Electrical	183
Safety & Hazard	183

## Adhesives, Sealants & Fillers

Contact Adhesives & Superglue	184
Admixtures	184
Wood Adhesives	185
Grip & Fill	185
Adhesive Sealants	186
Sealants & Sealant Remover	187
Acrylic Sealants & Applicator Guns	188
Foams & Applicator Guns	189
Fillers	190

## Metolux

Decor & Wood Fillers	191
Metoset Liquid Mortar	191

## Briwax Woodcare

Finishing Wax & Spray	192
Wax & Sticks	192

## Lubricants

Multi-Purpose Lubricant	193
Silicone Lubricant	193
Copper Anti-Seize	193
Cutting & Tapping Lubricant	193
Chain Lubricant	193
Graphite Lock Lubricant	193

## Greases & Oils

Lithium Greases	194
2 Stroke & 4 Stroke Oil	195
Chainsaw Oil	195

## Cleaning & Maintenance Sprays

Oil & Grease Remover	196
Adhesive Residue Remover	196
Label Remover	196
Welder's Anti-Spatter	196
Air & Gas Leak Detector	196
Cordless Nail Gun Remover	196

## Paints

Galvanising & Metal Paint	197
Finishing Paint	197
Very High Temperature Paint	197
Primer	197
Stain Concealing Paint	197
Survey & Spot Marker	198

## Barrettine

Barrettine Wood Treatment	199
---------------------------	-----

## Cleaners

Exterior Multi-Purpose	202
Brick, Masonry & Patio	202
Path, Patio & Driveway Sealer	202
Wood / PVCU / Glass	203
Cleaner & Degreaser	203
Grout	203
Calcium, Lime & Rust Remover	203

# General Purpose Tapes



## Heavy Duty Cloth Tape



- Easy tear
- High tensile strength
- Strong adhesion
- Temperature resistant from -5 to 60°C
- Water resistant

A super strength tape ideal for use within construction, industry, home and garden. It is designed to be used in multiple indoor and outdoor applications.

Product Code	Colour	Length (m)	Width (mm)	Pack Qty (pcs)	Carton Qty (packs)
<b>ROLL</b>					
HDCTBLACK	Black	50	50	1	24
HDCTSILVER	Silver	50	50	1	24
HDCTWHITE	White	50	50	1	24
TYPE - TAP				SUB TYPE - TAP02	

## Cloth Tape



- Adheres to multiple surfaces
- Easy tear
- Tough and strong
- Weather resistant

A medium quality cloth tape used to repair, fasten, bundle, strengthen, mark, plus much more.

Product Code	Colour	Length (m)	Width (mm)	Pack Qty (pcs)	Carton Qty (packs)
<b>ROLL</b>					
CTBLACK	Black	50	48	1	36
CTSILVER	Silver	50	48	1	36
CTWHITE	White	50	48	1	36
TYPE - TAP				SUB TYPE - TAP02	

## Double Sided Cloth Tape



- Professional results
- Easily removable
- Easy tear

A strong double sided cloth tape designed to stick two surfaces together where an invisible joint is required. Ideal for fixing carpets, signs and protective sheeting to multiple surfaces. (Backing tape is yellow).

Product Code	Colour	Length (m)	Width (mm)	Pack Qty (pcs)	Carton Qty (packs)
<b>ROLL</b>					
DSCT	White	25	50	1	24
TYPE - TAP				SUB TYPE - TAP02	

## Packaging Tape

PACKS OF 3



- Strong
- Excellent Adhesion

A quality tape giving you an instant and secure fixture, ideal for sealing boxes, attaching labels and general packing applications.

Product Code	Colour	Length (m)	Width (mm)	Pack Qty (pcs)	Carton Qty (packs)
<b>ROLL</b>					
PTC	Clear	50	48	3	18
PTB	Brown	50	48	3	18
TYPE - TAP				SUB TYPE - TAP04	

## Masking Tape



- Easy to tear and apply to curved / irregular surfaces
- Compatible with solvent and water based paints
- Excellent adhesion to wide range of surfaces
- Clean and precise removal

Trade quality, general purpose masking tape made from saturated semi-crepe paper with pressure sensitive natural rubber adhesive. Made in Europe.

Product Code	Colour	Length (m)	Width (mm)	Pack Qty (pcs)	Carton Qty (packs)
<b>ROLL</b>					
SMT25	Cream	50	25	1	72
SMT38	Cream	50	38	1	48
SMT50	Cream	50	50	1	36
TYPE - TAP				SUB TYPE - TAP03	

## Hook and Loop Tape

NEW



Versatile stick on hook and loop tape often used to affix products to surfaces and mounting displays at exhibitions. Simply cut to required length.

Product Code	Colour	Length (m)	Width (mm)	Pack Qty (pcs)	Carton Qty (packs)
<b>BOX</b>					
HLT5	White	5	20	1	32
TYPE - TAP				SUB TYPE - TAP14	

## Building Tapes



### Aluminium Foil Tape



- Flame retardant
- Heat & moisture resistant
- Backing paper for easy application

Used in jobs requiring moisture and chemical resistance, thermal conductivity, flame resistance, heat and light reflectance and is weather resistant. Perfect for joining foil covered insulation, sealing off pipes and ducts.

Product Code	Colour	Length (m)	Width (mm)	Pack Qty (pcs)	Carton Qty (packs)
<b>ROLL</b>					
AFT50	Silver	45	50	1	36
AFT75	Silver	45	75	1	24
AFT100	Silver	45	100	1	18
TYPE - TAP				SUB TYPE - TAP07	

### Extreme Temperature Aluminium Foil Tape



- Flame retardant
- Service range -35 to 120°C
- All year around applications

Extreme temperature aluminium tape for use in both cold and warm environments or applications. Ideal for HVAC industry, covered outdoor use or jobs conducted during the winter months.

Product Code	Colour	Length (m)	Width (mm)	Pack Qty (pcs)	Carton Qty (packs)
<b>ROLL</b>					
AFT50ET	Silver	45	50	1	36
TYPE - TAP				SUB TYPE - TAP07	

### Reinforced Aluminium Foil Tape



- Flame retardant
- Heat & moisture resistant
- High strength and tear resistant

Aluminium foil tape with an integral fibre mesh which provides reinforcement for tougher applications where a stronger joint is required.

Product Code	Colour	Length (m)	Width (mm)	Pack Qty (pcs)	Carton Qty (packs)
<b>ROLL</b>					
AFT50RE	Silver	45	50	1	36
TYPE - TAP				SUB TYPE - TAP07	

### Drywall Joint Tape



- Quick and easy to apply
- Strong & thin jointing of plasterboards
- Eliminates blisters and bubbles

A professional grade self-adhesive drywall tape, which is manufactured using a strong 9 x 9 fibreglass weave for high mechanical strength. Made in Europe.

Product Code	Colour	Length (m)	Width (mm)	Pack Qty (pcs)	Carton Qty (packs)
<b>ROLL</b>					
4890DJT	White	90	48	1	24
TYPE - TAP				SUB TYPE - TAP10	

### Double Sided Damp Proof Membrane Jointing Tape



**Damp Proof Membrane**  
See page 201

- High adhesion
- Backing paper for easy application

A high performance double sided butyl tape used for bonding DPMs. Use with TIMCO PVC builders tape to provide a continuous damp proof seal between two sheets, where joints cannot be avoided.

Product Code	Colour	Width (mm)	Length (m)	Pack Qty (pcs)	Carton Qty (packs)
<b>ROLL</b>					
DSDJT	Black	50	10	1	12
TYPE - TAP				SUB TYPE - TAP11	

### High Strength PVC Builders Tape



- Flame retardant
- Perfect for electrical, patching, jointing & masking applications
- Residue free

Used in jobs requiring moisture and chemical resistance, thermal conductivity, flame resistance, heat and light reflectance and is weather resistant. Perfect for joining foil covered insulation, sealing off pipes and ducts.

Product Code	Colour	Length (m)	Width (mm)	Pack Qty (pcs)	Carton Qty (packs)
<b>ROLL</b>					
HSBT	Black	33	75	1	36
TYPE - TAP				SUB TYPE - TAP08	

## Plumbing & Electrical Tapes

### PTFE Thread Seal Tape



- WRAS approved & suitable for potable water
- Convenient storage spool

Thread sealing tape used for a variety of plumbing applications including those involving potable water. Please note: Water use only. Not suitable for gas.

Product Code	Length (m)	Width (mm)	Thickness (mm)	Colour	Pack Qty (pcs)	Carton Qty (packs)
<b>ROLL</b>						
PTFE2	12	12	0.075	White	2	125
PTFE10	12	12	0.075	White	10	25
TYPE - TAP				SUB TYPE - TAP12		

### PVC Insulation Tape

**PACKS OF 10**



- BS EN 60454
- Flame retardant
- Highly dielectric strength

Ideal for insulating electrical wires and joints. Easily torn by hand, can be written on and cleanly removed from smooth surfaces.

Product Code	Colour	Length (m)	Width (mm)	Pack Qty (pcs)	Carton Qty (packs)
<b>ROLL</b>					
ITBLACK	Black	25	18	10	12
ITWHITE	White	25	18	10	12
ITGREY	Grey	25	18	10	12
ITRED	Red	25	18	10	12
ITBLUE	Blue	25	18	10	12
ITGREEN	Green	25	18	10	12
ITYELLOW	Yellow	25	18	10	12
ITBROWN	Brown	25	18	10	12
ITGYSTRIPE	Green/Yellow	25	18	10	12
TYPE - TAP				SUB TYPE - TAP01	

### Self Amalgamating Tape

**NEW**



A self fusing emergency repair tape which will provide a watertight seal to leaking pipes or hoses. Suitable for jointing, splicing and repairing cables, hoses, plastic and metallic tubes.

Product Code	Colour	Length (m)	Width (mm)	Pack Qty (pcs)	Carton Qty (packs)
<b>ROLL</b>					
SAT3	Black	3	25	1	48
TYPE - TAP				SUB TYPE - TAP09	



# Safety & Hazard Tapes



## Hazard Tape



- Weather resistant
- Highly visible
- Tough and strong

A durable self adhesive PVC hazard tape, ideal for marking floors, walls and hazardous areas. Can be used internally and externally.

Product Code	Colour	Length (m)	Width (mm)	Pack Qty (pcs)	Carton Qty (packs)
<b>ROLL</b>					
HAZT	Black/Yellow	33	50	1	36
				TYPE -TAP	SUB TYPE -TAPO5

## Hazard Cloth Tape



- Highly visible
- Tough and strong
- Easy tear

A highly visible cloth tape used for marking out hazardous or restricted areas. Ideal for marking floors, doors and walls. Internal and external use.

Product Code	Colour	Length (m)	Width (mm)	Pack Qty (pcs)	Carton Qty (packs)
<b>ROLL</b>					
CTHAZRW	Red/White	33	50	1	36
CTHAZYB	Black/Yellow	33	50	1	36
				TYPE -TAP	SUB TYPE -TAPO5

## Anti-Slip Tape



Manufactured using a high grade P60 grit to offer excellent grip, commonly used where there is risk of slip hazards such as stairs, shop fronts, ramps and paths etc. Three layers of Acrylic Solvent glue gives excellent adhesion to multiple surfaces.

- Adheres to multiple surfaces
- Backing paper for easy application

Product Code	Colour	Length (m)	Width (mm)	Pack Qty (pcs)	Carton Qty (packs)
<b>ROLL</b>					
ASTSTRIPE	Black/Yellow	10	50	1	36
ASTBLACK	Black	10	50	1	36
				TYPE -TAP	SUB TYPE -TAPO6

## Barrier Tape



- Highly visible
- Weather resistant



A durable non-adhesive polythene barrier tape, ideal for marking out hazardous areas. Can be used internally and externally. 500m comes in a convenient dispensing box for easy storage and application.

Product Code	Colour	Length (m)	Width (mm)	Pack Qty (pcs)	Carton Qty (packs)
<b>ROLL</b>					
BART	Red/White	100	70	1	24
BARTYB	Yellow/Black	100	70	1	24
<b>BOX</b>					
BART500	Red/White	500	70	1	12
BARTYB500	Yellow/Black	500	70	1	12
				TYPE -TAP	SUB TYPE -TAPO5

## High Visibility Wet Paint Tape



- Highly visible
- Weather resistant

**NEW**



Highly visible non-adhesive wet paint tape ideal for the safe marking of hazardous areas during decoration and renovation. 500m comes in a convenient dispensing box for easy storage and application

Product Code	Colour	Length (m)	Width (mm)	Pack Qty (pcs)	Carton Qty (packs)
<b>ROLL</b>					
WPT100	Yellow & Black	100	70	1	24
WPT500	Yellow & Black	500	70	1	12
				TYPE -TAP	SUB TYPE -TAPO5

## Underground Tape



Ideal for burying above service cables and pipes to warn against damage to underground utility lines during subsequent excavation.

Product Code	Type	Length (m)	Width (mm)	Pack Qty (pcs)	Carton Qty (packs)
<b>ROLL</b>					
UTWP	Water Pipe	365	150	1	6
UTSP	Sewer Pipe	365	150	1	6
UTTC	Telephone Cable	365	150	1	6
UTFO	Fibre Optic Cable	365	150	1	6
UTEC	Electric Cable	365	150	1	6
UTGP	Gas Pipe	365	150	1	6
				TYPE -TAP	SUB TYPE -TAP13

## Contact Adhesive & Superglue



### Multi-Purpose Adhesive



A premium grade adhesive initially developed for the carpet and flooring industry. Effectively bonds PU and foam backed carpets, carpet tiles and underlay to concrete, screed, timber and metal. Heat resistant to 60°C

To achieve a higher bonding strength, apply the adhesive to both surfaces.

- Easy application
- 30 sec cure time
- Low odour
- Interior use only



Product Code	Size	Colour	Pack Qty		
			Carton (pcs)	Carton (packs)	Pallet (packs)
<b>SPRAY</b>					
247544	500ml	Amber	1	12	1848
TYPE-AHS			SUB TYPE - AHS01		

### Instant Contact Adhesive



Premium grade high strength, instant adhesive for internal and external applications. Ideal for humid and damp environments such as kitchens and bathrooms.

Suitable for plastic, PVCu, rubber, ceramic, metal, glass, wood, MDF, paper, card, fabric, formica, stone, concrete, cork, linoleum, leather & porcelain.



- The low odour formula has been developed to bond a wide variety of substrates
- Forms an extremely strong instant bond once the two surfaces have been joined
- Heat resistant to 90°C (spray) and 80°C (liquid)
- Easy application
- Water resistant
- Interior & exterior

Product Code	Size	Colour	Pack Qty		
			Carton (pcs)	Carton (packs)	Pallet (packs)
<b>SPRAY</b>					
247789	500ml	Clear	1	12	1848
TYPE-AHS			SUB TYPE - AHS03		
<b>TIN</b>					
247235	250ml	Clear	1	12	1656
247359	500ml	Clear	1	12	768
TYPE-SAA			SUB TYPE - SAA01		

### Mitre Superglue, Mitre Bond Activator & Instant Bond Mitre Kit



Mitre superglue is a fast setting (approx 90 secs) medium to high strength all purpose adhesive.

Use mitre bond activator to create an instant bond (approx 10 secs) when fixing with mitre superglue. Can be used for small gap filling.

Suitable for use on non-porous surfaces such as plastics, PVCu, metal, wood, MDF, leather, rubber, ceramics and much more.

- High viscosity formulation
- Strong adhesive
- Water resistant
- Temperature resistant from -55 to 80°C
- Dries clear
- Interior use only

Product Code	Item	Size	Pack Qty		
			Carton (pcs)	Carton (packs)	Pallet (packs)
<b>KIT</b>					
247321	Instant Bond Kit	-	1	24	1440
TYPE-AHS			SUB TYPE - AHS01		

## Admixtures

### Premium SBR Bond



A premium quality latex based primer, admixture and bonding agent. The reinforced anti-foaming polymer formula increases the durability and flexibility of concrete, mortar, renders, floor screeds and adhesive compounds.

Ideally suited for pointing, patching,

bedding, waterproofing, tanking and flooring, especially in wet, humid, damp environments.

- Salt resistant
- Reduces surface dusting
- Freeze-thaw stable
- Water resistant
- Interior & exterior

Product Code	Size	Pack Qty		
		Carton (pcs)	Carton (packs)	Pallet (packs)
<b>BOTTLE</b>				
236010	5L	1	4	192
TYPE-ADM		SUB TYPE - ADM01		

### PVA Bond



A multi-purpose bonding agent, primer, sealer, cement and plaster admixture.

Ideal for priming unsound surfaces prior to plastering or painting and as an adhesive on wood, cork and textiles. Suitable for most applications where at least one surface is porous, for general dust

sealing on flaking paintwork/walls etc and as a cement and plaster admixture.

- Improves flexibility & frost resistance
- Reduces surface dusting & porosity
- Improves adhesion
- Mortar & Plaster Admixture BS EN 5270
- Concrete additive
- Dries clear

Product Code	Size	Pack Qty		
		Carton (pcs)	Carton (packs)	Pallet (packs)
<b>BOTTLE</b>				
236123	5L	1	4	192
TYPE-ADM		SUB TYPE - ADM01		

## Wood Adhesives



### Internal D3 Wood Adhesive



A high quality, resin based wood adhesive for all wood bonding. It can be used internally and provides a high strength, impact resistant bond. Ideal for all general woodworking and joinery uses, furniture assembly and household DIY use.

Can also be used in short term wet, damp and humid environments such as kitchens, bathrooms, washrooms and covered external applications.

- Fully conforms to the BS 14256
- Dries clear
- Sets in 10 mins
- Hybrid resin formula
- Paintable
- Easy to clean

Product Code	Size	Pack Qty (pcs)	Carton Qty (packs)	Pallet Qty (packs)
<b>BOTTLE</b>				
247458	500ml	1	20	480
247258	1L	1	12	384
TYPE - AHS		SUB TYPE - AHS03		

### Premium Internal & External D4 Wood Adhesive



A solvent free wood adhesive based upon the latest hybrid resin technology. Can be used internally or externally giving a high strength, 100% waterproof, impact and temperature resistant bond.

Ideal for woodworking, joinery and timber construction.

- Hybrid resin formula
- Super strong bonding
- Paintable
- Sets in 10 mins
- Easy to clean
- 100% Weather proof
- Dries clear
- Odourless

Product Code	Size	Pack Qty (pcs)	Carton Qty (packs)	Pallet Qty (packs)
<b>BOTTLE</b>				
247471	1L	1	12	384
TYPE - AHS		SUB TYPE - AHS03		

### PU Wood Adhesive



A premium grade polyurethane wood adhesive that will bond hard, soft, exotic and painted wood. This rapid curing foaming adhesive expands into materials to form an incredibly strong bond with a superior curing time compared to traditional PVA based wood adhesives.

Suitable for use with softwood, hardwood, chipboard, fibreboard, MDF, plywood and most porous and non-porous substrates.

- D4 BS EN 204
- Quickly adheres to all wood types
- 100% Weatherproof
- Medium viscosity
- Initial set in 5 mins
- Internal & external
- Can be applied to damp surfaces
- Polyurethane formula
- Temperature resistant from -30 to 150°C

Product Code	Size	Open Time	Colour	Pack Qty (pcs)	Carton Qty (packs)
<b>BOTTLE - LIQUID</b>					
247708	750g	5min	Brown	1	6
247834	750g	30min	Brown	1	6
<b>CARTRIDGE - GEL</b>					
247010	310ml	5min	Translucent	1	12
247433	310ml	30min	Translucent	1	12
TYPE - AHS		SUB TYPE - AHS03			

## Grip & Fill

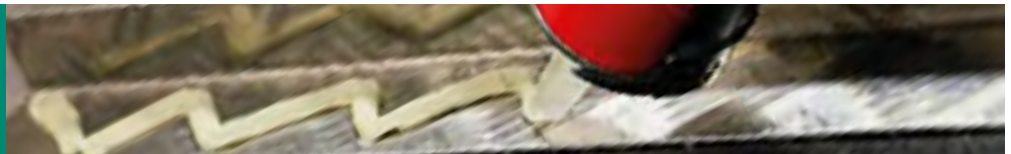

### Grip & Fill

Ideal for fixing skirting & window boards, architraves, dado rails, plastic & metal decorative trim, carpet grippers, stair nosing, junction boxes & trunking and more.

Fast curing direct bond gap filling grab and panel adhesive. The high strength synthetic formula adheres to most common building materials in both interior and exterior applications.



- Medium viscosity
- Easy application
- Strong adhesion
- Movement resistant
- Anti-slump formula
- No double sticking
- Paintable
- Interior & Exterior

Product Code	Size	Colour	Pack Qty (pcs)	Carton Qty (packs)	Pallet Qty (packs)
<b>CARTRIDGE</b>					
247645	350ml	Beige	1	12	576
TYPE - AHS		SUB TYPE - AHS02			

### Grip & Fill - Solvent Free

For plasterboard, skirting boards & architraves, electrical conduit, brick, ferrous metal and more.

A direct bond adhesive formulated for professional users. Designed to give a high adhesive strength to most building materials in trade and DIY applications. The unique formula also achieves exceptional gap filling results on uneven surfaces.



**Grip & Fill Nozzles**  
Bag of 6  
Code: 247121

- Medium viscosity
- Easy application
- Strong adhesion
- Movement resistant
- Adheres to damp surfaces
- Odourless
- Interior

Product Code	Size	Colour	Pack Qty (pcs)	Carton Qty (packs)	Pallet Qty (packs)
<b>CARTRIDGE</b>					
247318	350ml	White	1	12	600
TYPE - AHS		SUB TYPE - AHS02			



# ADHESIVES & SEALANTS

Concrete • Brick • Stone • Wood • MDF • Metal • Plastic • Ceramic • Glass



## INSTANT GRAB ADHESIVE

9 in 1 Instant Grab Adhesive has been developed to give superior bonding strength to all building materials, even in wet conditions.

### Instant Grab Adhesive

- High viscosity for an instant grip!
- Pre-cut notched nozzle for enhanced application!
- Perfect for internal & external applications!

### Clear Grab Adhesive

- Medium viscosity for easy toolability!
- Perfect for internal applications!
- Dries clear making it perfect for kitchen & bathroom applications!

### Features and Benefits:

Hybrid polymer | Sets in 15 minutes | Superior strength | Water resistant | Paintable | Works with wet surfaces | Anti-slump formula | Odourless



Product Code	Size	Colour	Viscosity	Pack Qty (pcs)	Carton Qty (packs)	Pallet Qty (packs)
247138	290ml	White	High	1	12	936
TYPE - AHS				SUB TYPE - AHS02		

Product Code	Size	Colour	Viscosity	Pack Qty (pcs)	Carton Qty (packs)	Pallet Qty (packs)
247972	290ml	Clear	Medium	1	12	936
TYPE - AHS				SUB TYPE - AHS02		

## ADHESIVE & SEALANT

9 in 1 Adhesive & Sealants have been developed to give superior bonding and sealing performance to all building materials, even in wet conditions.

### Universal Adhesive & Sealant

- Medium viscosity for easy toolability!
- Perfect for internal & external applications!
- Available in four colours to suit a variety of applications!

### Crystal Clear Adhesive & Sealant

- Dries crystal clear making it perfect for kitchen & bathroom applications!
- UV protected to stay crystal clear longer!
- Medium viscosity for easy toolability!

### Features and Benefits:

Hybrid polymer | Sets in 15 minutes | Superior strength | Water resistant | Paintable | Works with wet surfaces | Anti-slump formula | Odourless



Product Code	Size	Colour	Viscosity	Pack Qty (pcs)	Carton Qty (packs)	Pallet Qty (packs)
247468	290ml	White	Medium	1	12	936
247357	290ml	Grey	Medium	1	12	936
247697	290ml	Brown	Medium	1	12	936
247146	290ml	Black	Medium	1	12	936
TYPE - AHS				SUB TYPE - AHS02		

Product Code	Size	Colour	Viscosity	Pack Qty (pcs)	Carton Qty (packs)	Pallet Qty (packs)
247336	290ml	Crystal Clear	Medium	1	12	936
TYPE - AHS				SUB TYPE - AHS02		

Spare cartridge nozzles available in bags of 12



Product Code: 247050



# Sealants

## Acetoxy Silicone



A general purpose, single component silicone which offers a flexible water tight seal to most surfaces including glass, painted surfaces, ceramics, sanitaryware and most non-porous surfaces.

For sealing around most types of door and window frames, kitchen units, pipes, sanitary fixtures and duct work. Can also be used for draught proofing.

- Interior & exterior
- Fast curing
- Water resistance
- Absorbs movement
- Strong bond
- Low odour
- Easy tooling
- 12.5% Elasticity

Product Code	Size	Colour	Pack Qty (pcs)	Carton Qty (packs)	Pallet Qty (packs)
<b>CARTRIDGE</b>					
732480	300ml	White	1	12	936
732098	300ml	Clear	1	12	936
732741	300ml	Black	1	12	936
732852	300ml	Brown	1	12	936
TYPE -SEA			SUB TYPE - SEA02		

## Premium LMN Silicone



A premium grade, low modulus neutral curing silicone, which has excellent adhesion to virtually all substrates, both porous and non-porous. A long lasting flexible sealant for a wide variety of domestic, commercial and industrial applications including expansion joints, curtain walling and glazing systems.

Ideal for external sealing around PVCu, timber and aluminium frames.

- Interior & exterior
- Fast curing
- Water resistance
- Absorbs movement
- Strong bond
- Low odour
- Easy tooling
- 12.5% Elasticity

Product Code	Size	Colour	Pack Qty (pcs)	Carton Qty (packs)	Pallet Qty (packs)
<b>CARTRIDGE</b>					
732120	300ml	White	1	12	720
732792	300ml	Clear	1	12	720
TYPE -SEA			SUB TYPE - SEA02		

## Fire Rated Silicone

NEW



A premium grade, neutral curing fire retardant silicone sealant, with a fire resistance of up to 4 hours in linear joints, with excellent elasticity of up to 25%. It withstands temperatures of up to 120°C to prevent the spread of fire, smoke and toxic gases.

Ideal for plaster, glass, metal, wood and masonry.

- B1 fire rated
- Tested in accordance with EN 1366-4
- Up to 4 hours fire resistance
- Water & weather resistant
- Interior & exterior
- UV resistant
- Up to 30mm wide joints
- Anti-slump
- 25% elasticity

Product Code	Size	Colour	Pack Qty (pcs)	Carton Qty (packs)	Pallet Qty (packs)
<b>CARTRIDGE</b>					
732003	300ml	White	1	12	1248
TYPE -SEA			SUB TYPE - SEA02		

## Premium Bathroom Silicone

NEW



A premium grade silicone containing active anti-fungal compounds to prevent bacteria, mildew and black mould growth in areas of very high humidity and condensation. It creates a permanently watertight and flexible seal.

Ideal for tiles, ceramics, metal, glass, wood, plastic, laminate and linoleum.

- Interior & exterior
- Mould & bacteria repellent
- Excellent adhesion
- Permanently waterproof
- 20% Elasticity
- Fast Curing

Product Code	Size	Colour	Pack Qty (pcs)	Carton Qty (packs)	Pallet Qty (packs)
<b>CARTRIDGE</b>					
732004	300ml	White	1	12	1248
732005	300ml	Clear	1	12	1248
TYPE -SEA			SUB TYPE - SEA02		

## Bathroom & Sanitary Silicone



A high grade, sanitary silicone containing powerful anti-fungal compounds to prevent mould growth. Typically used in areas of high humidity such as bathrooms, kitchens and washrooms.

Ideal for domestic or commercial applications. Adheres to most non-porous surfaces without the use of a primer and gives a clean and professional finish.

- Interior
- Permanently elastic
- Waterproof
- Mould repellent
- Low odour
- 20% Elasticity

Product Code	Size	Colour	Pack Qty (pcs)	Carton Qty (packs)	Pallet Qty (packs)
<b>CARTRIDGE</b>					
732750	300ml	White	1	12	936
732653	300ml	Clear	1	12	936
TYPE -SEA			SUB TYPE - SEA02		

## Sealant Remover

NEW



A quick and easy method of removing cured acrylic and silicone sealants from ceramic tiles, glass, painted surfaces and most plastics. The thick gel coat penetrates and breaks down the silicone for effortless removal.

Ideal for shower trays, baths, sinks, toilets, basins, window frames and more.

- For acrylic and silicone
- Safe on all surfaces
- Multi-materials
- Interior & exterior
- Fast acting



Product Code	Size	Colour	Pack Qty (pcs)	Carton Qty (packs)	Pallet Qty (packs)
<b>BOTTLE</b>					
732104	100ml	White	1	12	2976
TYPE -SEA			SUB TYPE - SEA03		

# Acrylic Sealants



## Acrylic Caulk

**NEW SIZE**



A general purpose fast drying and flexible decorator's filler and sealant. Adheres to most substrates and can be overpainted with most paint types or papered over.

For sealing and filling of internal gaps and cracks such as those between plasterwork, decorative mouldings, skirting boards and architraves.

- Interior
- Fast curing
- Water resistance
- Light weight
- Easy tooling
- Low odour

Product Code	Size	Colour	Pack Qty (pcs)	Carton Qty (packs)	Pallet Qty (packs)
<b>CARTRIDGE</b>					
732871	300ml	White	1	12	936
732001	380ml	White	1	12	744
TYPE - SEA			SUB TYPE - SEA04		

## Instant Paintable Caulk

**NEW**



A premium grade, acrylic sealant that has been developed to be overpainted immediately after application with water based and synthetic paints. Formulated for interior use, it will adhere to most surfaces without primers and gives long lasting flexibility in applications where movement can occur.

Ideal for plaster, plasterboard, painted surfaces, decorative moulding, wallpaper and tiles.

- Interior
- Instantly paintable
- Long lasting flexibility
- Reduced cracking
- Low odour
- Reduced discolouration

Product Code	Size	Colour	Pack Qty (pcs)	Carton Qty (packs)	Pallet Qty (packs)
<b>CARTRIDGE</b>					
732002	300ml	White	1	12	1248
TYPE - SEA			SUB TYPE - SEA04		

## Fire Rated Intumescent & Acoustic Acrylic Sealant

**NEW**



Fire & Acoustic Seals Fire Rated Intumescent and Acoustic Acrylic Sealant is an emulsion based sealant that swells when subjected to temperatures in excess of 125°C that restricts the passage of smoke and fire. Suitable for fire rated cladding, doors & walls

- Extensively tested
- Certifire Approved CF5840
- BS 476 Part 20/22: 1987
- 12.5% flexibility
- Flexible & smooth finish
- Crack resistant
- Can be overpainted with most paints
- Excellent adhesion

Product Code	Size	Colour	Pack Qty (pcs)	Carton Qty (packs)	Pallet Qty (packs)
<b>CARTRIDGE</b>					
FAWHITE	310ml	White	1	25	1600
TYPE - PFM			SUB TYPE - PFM02		

# Applicator Guns

## Professional Foil & Cartridge Applicator Gun

Constructed with a heavy gauge aluminium barrel, reinforced steel mechanism and ergonomic grip for precise application and long lasting performance.

Up to 380ml Cartridges



- Long life & Fast flow
- Comfort grip
- Lightweight
- Non-drip

Product Code	Pack Qty (pcs)	Carton Qty (packs)
<b>BOX</b>		
222551	1	12
TYPE - ASA		SUB TYPE - ASA01

## Foil & Cartridge Applicator Gun

Constructed using lightweight materials for ease of use with quick release end caps for fast removal and replacement of foils and cartridges.

Up to 380ml Cartridges

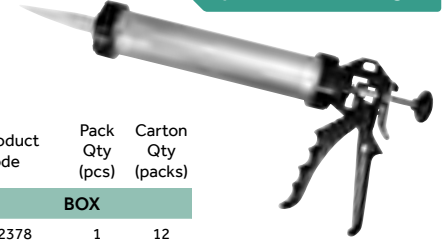

- Powder coating
- Fast flow & Non-drip
- Quick release
- Lightweight

Product Code	Pack Qty (pcs)	Carton Qty (packs)
<b>BOX</b>		
222378	1	12
TYPE - ASA		SUB TYPE - ASA01

## Professional Sealant Gun

- A 48mm heavy duty sealant and caulking gun
- With a convenient hook end for hanging
- Swivel action barrel for easy application into tight corners
- Patented non-drip mechanism

Up to 380ml Cartridges



Product Code	Pack Qty (pcs)	Carton Qty (packs)
12:1 trigger ratio		
<b>PACK</b>		
PROGUN	1	12
TYPE - CAC		SUB TYPE - CAC01

## Skeleton Gun

- A 48mm gun for dispensing sealants, caulk and adhesives
- 2.3mm strengthened side plates and a 6mm gripper plate
- Convenient hook end for hanging
- Riveted front cap for reinforcement and integrated cleaning pin

Up to 380ml Cartridges



Product Code	Pack Qty (pcs)	Carton Qty (packs)
7:1 trigger ratio		
<b>PACK</b>		
SKELGUN	1	24
TYPE - CAC		SUB TYPE - CAC01

## Expanding Foam



### B3 Fill & Fix Expanding PU Foam



A high quality polyurethane based expanding foam designed to give excellent thermal and acoustic characteristics. Expands up to 30 times its original volume.

Ideal for filling and insulating irregular or awkward gaps where the foam can expand and fill the cavity to prevent heat loss and deaden sound. Can be used as a temporary fix prior to mechanical anchors being installed to window and door frames.

- CFC Free
- Paintable
- Fast curing
- Excellent thermal & acoustic insulation
- Fast cut
- Can be plastered
- Sandable
- Up to 30x Expansion

Product Code	Type	Size	Pack Qty (pcs)	Carton Qty (packs)	Pallet Qty (packs)
<b>CAN</b>					
247641	Gun Grade	750ml	1	12	336
247596	Hand Held	750ml	1	12	336
<b>SPARE STRAWS</b>					
247999	-	-	12	20	482
TYPE - PUF			SUB TYPE - PUF01		

### B1 Fill & Fix Fire Rated Expanding PU Foam



A premium quality fire resistant polyurethane based expanding foam formulated to give excellent performance in a majority of fire critical applications.

The complex cell structure also gives the foam excellent thermal and acoustic characteristics

Coloured pink for easy identification.

Please note: For 30 and 60 minute fire door applications, use Fire & Acoustic Seals Fire Door Foam (FAS-750G)

- Fast cut
- Paintable
- 4 hour fire rated
- CFC Free
- Fast curing
- Up to 30x Expansion
- BS 476-20
- EN 1366-4
- DIN 4102-1
- Heat & acoustic insulator
- Can be plastered

Product Code	Type	Size	Pack Qty (pcs)	Carton Qty (packs)	Pallet Qty (packs)
<b>CAN</b>					
247760	Gun Grade	750ml	1	12	624
247704	Hand Held	750ml	1	12	624
<b>SPARE STRAWS</b>					
247999	-	-	1	20	482
TYPE - PUF			SUB TYPE - PUF01		

### Fire & Acoustic Seals FD60 Fire Door Foam



A revolutionary polyurethane foam designed to seal the cavities between walls and fire door frames. The product has been extensively tested to achieve 30 and 60 minutes fire resistance in a wide range of construction and building fire stopping applications.

Tested in accordance with: BS 476: Part 20 & 22 1987, BS EN 1634-1: 2014, BS 8214:2016

Compatible with TIMCO plastic packers.

- No need for mineral fibre wool or mastic
- Quick and easy to apply in just 3 minutes per doorset.
- One can fills the cavities of 3-4 doorsets up to 30mm in width

Product Code	Type	Size	Pack Qty (pcs)	Carton Qty (packs)	Pallet Qty (packs)
<b>CAN</b>					
FAS-750G	Gun Grade	750ml	2	12	120
TYPE - PFM			SUB TYPE - PFM01		

### Fill & Fix PU Foam Cleaner



Designed to rapidly dissolve, remove and clean uncured PU foam from surfaces and for cleaning PU foam applicator guns. Complete with dual fitting nozzle for connecting to guns for cleaning or for direct spraying onto surfaces.

- Cleans tools and surfaces
- Solvent based
- Extends tool life
- Leaves work surfaces clean
- Easy application



Product Code	Size	Pack Qty (pcs)	Carton Qty (packs)	Pallet Qty (packs)
<b>CAN</b>				
247893	500ml	1	12	504
TYPE - PUF		SUB TYPE - PUF01		

## Applicator Guns

### Professional PU Foam Applicator Gun



PTFE Coated

A premium quality professional PU foam applicator gun for use with standard 750ml & 500ml gun grade canisters and foam cleaners.

Box also includes two extension tubes and two tapered nozzles for small gaps.

- Excellent flow control
  - Lightweight
  - Hard wearing PTFE coated internal components
- | Product Code                  | Pack Qty (pcs) | Carton Qty (packs) |
|-------------------------------|----------------|--------------------|
| <b>BOX</b>                    |                |                    |
| 783113                        | 1              | 20                 |
| TYPE - ASA   SUB TYPE - ASA01 |                |                    |

### PU Foam Applicator Gun

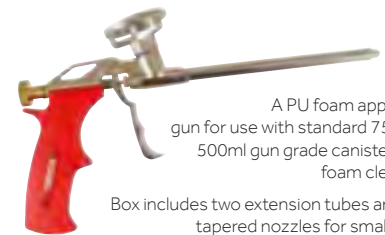

A PU foam applicator gun for use with standard 750ml & 500ml gun grade canisters and foam cleaners.

Box includes two extension tubes and two tapered nozzles for small gaps.

- Heavy duty steel body
  - Stainless steel non-blocking valve
  - Polypropylene hand grip
  - Lubricated trigger
- | Product Code                  | Pack Qty (pcs) | Carton Qty (packs) |
|-------------------------------|----------------|--------------------|
| <b>BOX</b>                    |                |                    |
| 783556                        | 1              | 20                 |
| TYPE - ASA   SUB TYPE - ASA01 |                |                    |

### Economy PU Foam Applicator Gun

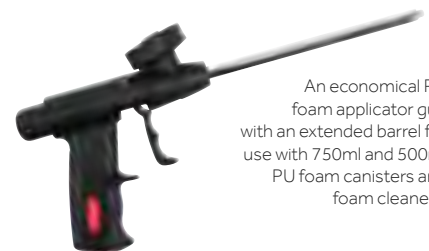

An economical PU foam applicator gun with an extended barrel for use with 750ml and 500ml PU foam canisters and foam cleaners.

- Constructed from lightweight plastic
  - Steel barrel and brass needle
  - Ergonomic grip
  - Stainless steel internals & non-return valve
- | Product Code                  | Pack Qty (pcs) | Carton Qty (packs) |
|-------------------------------|----------------|--------------------|
| <b>BAG</b>                    |                |                    |
| 783992                        | 1              | 36                 |
| TYPE - ASA   SUB TYPE - ASA01 |                |                    |

**NEW**

# Fillers



Made in the UK

## Ready Mixed Surface Filler



A versatile filling and sealing compound, developed to give a tough and durable surface repair to a variety of internal applications.

Ideal for repairing holes, cracks and imperfections in skirting, architraves, plasterwork, render around windows and door frames & more.

- Interior
- Flexible and waterproof seal
- Fully cured in 24 hours
- Easy to apply
- Suitable for oil and water based paints
- Skin formation in 30 minutes



Product Code	Size (kg)	Layer Thickness (mm)	Pack Qty (pcs)	Carton Qty (packs)	Pallets Qty (packs)
<b>TUB</b>					
357003	1	10	1	6	432
TYPE - FLR			SUB TYPE - FLR02		

## Fine Surface Filler



A ready to use, fine grade interior smoothing and filling compound.

Once cured, it forms a tough, durable repair that can be sanded and painted over with oil and water-based paint.

Ideal for repairing cracks, fine nicks and shallow depressions in walls and ceilings.

- Interior
- Fully cured in 24 hours
- Water based
- Easy to overpaint
- Flexible when drying
- Low odour
- Skin formation in 30 minutes

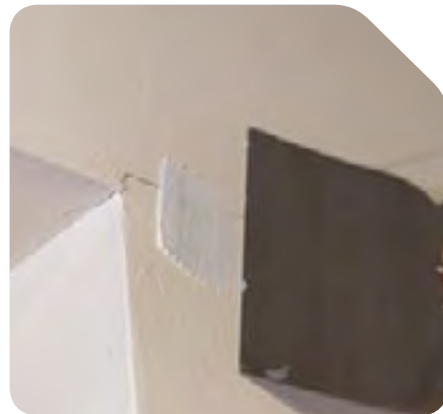

Product Code	Size (g)	Layer Thickness (mm)	Pack Qty (pcs)	Carton Qty (packs)	Pallets Qty (packs)
<b>TUB</b>					
357001	600	3	1	6	432
TYPE - FLR			SUB TYPE - FLR02		

## Multi-Purpose Powder Filler



A multi-purpose plaster based repair compound.

After setting it can be sanded and painted and sets hard enough to accept screws and nails.

Ideal for filling screw holes, scratches and deep cracks on plaster, brick, wood and most other common building materials in internal & external environments before painting.

- Interior & exterior
- Smooth finish
- Dries white
- Easy to mix, apply & sand
- Shrinking and cracking resistant
- 1 part water to 2-2½ parts powder
- Sets in 1 - 2 hours

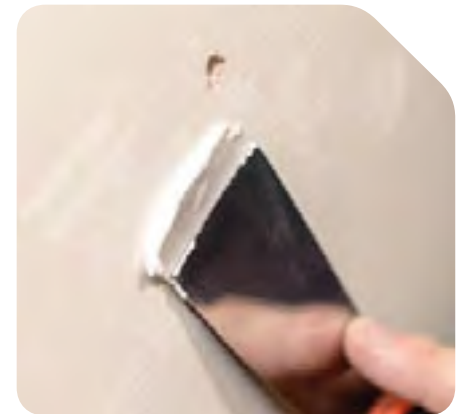

Product Code	Size (kg)	Layer Thickness (mm)	Pack Qty (pcs)	Carton Qty (packs)	Pallets Qty (packs)
<b>BOX</b>					
357002	1.8	10	1	6	240
TYPE - FLR			SUB TYPE - FLR02		



**NEW**

# Metolux Fillers & Liquid Mortar

## Metolux 2 Part Decor All Purpose Filler



Metolux 2 Part Universal Decor Filler is a fast hardening two component polyester filling paste for the repairing of holes and surface imperfections in a wide range of materials including wood, metal, concrete, plaster and fibreglass.

- Easy to sand after 20 minutes
- Easy to blend



Product Code	Size	Colour	Pack Qty (pcs)	Carton Qty (packs)
<b>TIN</b>				
65425	500g	Light Grey	1	6
65427	1.5kg	Light Grey	1	6
65428	6.0kg	Light Grey	1	2
TYPE -MFL			SUB TYPE - MFL01	

## Metolux 1 Part Wood Filler

Metolux 1 Part Wood Filler is a pre-coloured high strength polyester wood filler. Used for the filling and repair of small pinholes and cracks up to 5mm deep in timber. Particularly suited to flat face-up applications and for materials such as MDF and chipboard. Ideal for interior use.



- Fast drying
- Easy application
- Easy to sand
- Handy 250ml pack size
- very low odour



Product Code	Size	Colour	Pack Qty (pcs)	Carton Qty (packs)
<b>TIN</b>				
65388	250ml	White	1	6
65389	250ml	Pine	1	6
65390	250ml	Light Oak	1	6
65394	250ml	Dark Oak	1	6
TYPE -MFL			SUB TYPE - MFL01	

## Metolux 2 Part Styrene Free Wood Filler



2 Part Styrene Free Wood Filler is a two component high strength polyester wood filler. It provides a strong high quality repair to wood imperfections.

Supplied in pre-coloured blends to match your wood type. The weatherproof formulation is ideal for internal and external applications with additives to help flex with the natural movement of timber



- Professional grade
- Easy to mix
- Easy to sand
- Can be painted, stained, varnished and waxed
- Non slump

Product Code	Size	Colour	Pack Qty (pcs)	Carton Qty (packs)
<b>TIN</b>				
65431	275ml	White	1	6
65432	770ml	White	1	6
65433	3.3L	White	1	2
65437	275ml	Pine	1	6
65438	770ml	Pine	1	6
65439	3.3L	Pine	1	2
65440	275ml	Light Oak	1	6
65441	770ml	Light Oak	1	6
65442	3.3L	Light Oak	1	2
65434	275ml	Dark Teak	1	6
65435	770ml	Dark Teak	1	6
65443	275ml	Light Redwood	1	6
65444	770ml	Light Redwood	1	6
65446	275ml	Dark Mahogany	1	6
65447	770ml	Dark Mahogany	1	6
TYPE -MFL			SUB TYPE - MFL01	

## Metolux 2 Part Metoset Liquid Mortar



Metolux 2 Part Liquid is a two component polyester liquid mortar for crack and chip repair. Alternatively it can be used to fix threaded rod or rebar into concrete, stone or plain brick. Ideal for filling cracks and cavities in difficult to reach areas.

- Easy to apply
- Rapid setting
- Internal & external use
- Paintable
- Useful to fill cavities, cracks or difficult access areas
- High mechanical and physical resistance



Product Code	Size	Colour	Pack Qty (pcs)	Carton Qty (packs)
<b>TIN</b>				
65628	1.0kg	Grey	1	6
65627	5.0kg	Grey	1	2
TYPE -MFL			SUB TYPE - MFL01	

## Metolux Hardener



Spare hardener for use with:  
2 Part Styrene Free Wood Filler  
2 Part Decor All Purpose Filler

Product Code	Size	Pack Qty (pcs)	Carton Qty (packs)
<b>TUBE</b>			
78792P	40g	2	10
TYPE -MFL			SUB TYPE - MFL01



# Woodcare

Makers of leading luxury wood finishes in England for discerning wood lovers and furniture makers.



## Original Finishing Wax



Briwax Original is formulated with fast drying, stronger solvents which speed up drying and also increase the cleaning ability of the wax slightly. This means that it will renovate older dirtier furniture and leave you with the deep grain enriching Briwax shine. Unsealed wooden surfaces should be smooth, dry and clean.

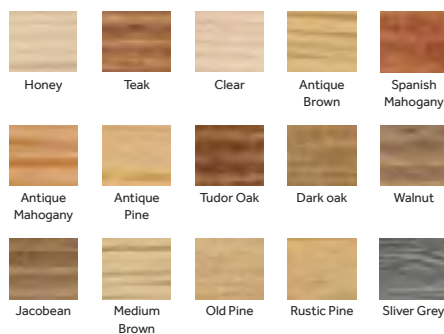

Product Code	Colour	Size	Pack Qty (pcs)	Carton Qty (packs)
<b>TIN</b>				
BW0501241521	Honey	400g	1	36
BW0501464821	Teak	400g	1	36
BW0502000021	Clear	400g	1	36
BW0502101221	Antique Brown	400g	1	36
BW0502101421	Antique Mahogany	400g	1	36
BW0502101521	Antique Pine	400g	1	36
BW0502143121	Tudor Oak	400g	1	36
BW0502161321	Dark Oak	400g	1	36
BW0502280321	Jacobean	400g	1	36
BW0502341921	Medium Brown	400g	1	36
BW0502403621	Old Pine	400g	1	36
BW0502445621	Rustic Pine	400g	1	36
BW0502464721	Spanish Mahogany	400g	1	36
BW0502540121	Walnut	400g	1	36
BW0502542121	Silver Grey	400g	1	36
BW0303000005	Clear	5L	1	4
BW0303101205	Antique Brown	5L	1	4
BW0303101505	Antique Pine	5L	1	4
BW0303280305	Jacobean	5L	1	4
BW0303341905	Medium Brown	5L	1	4
BW0303445605	Rustic Pine	5L	1	4

TYPE - BWX SUB TYPE - BWX01

## Quick Dry Hard Wax Oil



Briwax Hard Wax Oil is a water based clear satin finish that is hard wearing, water and stain resistant that will dry to an attractive, durable, natural finish.

Suitable for use on internal woodwork subject to a high degree of wear.

Brings out the natural beauty of the wood, making the colours richer. Easy to apply and maintain, leaving a wear, water and stain resistant finish to woodwork.

Product Code	Colour	Size	Pack Qty (pcs)	Carton Qty (packs)
<b>TIN</b>				
BWH01LW1000	Satin	1L	1	3
BWH01LW2500	Satin	2.5L	1	2

TYPE - BWX SUB TYPE - BWX01

## Spray Wax



The grain enhancing beauty of a Briwax finish, in an easy to use, convenient aerosol pack.

Can be used in exactly the same way as Briwax or as a regular maintenance product for most types of furniture.

Contains no silicones.

Product Code	Size	Pack Qty (pcs)	Carton Qty (packs)
<b>CAN</b>			
BW9301000018		1	6

TYPE - BWX SUB TYPE - BWX01

## Wax Filler Sticks



Wax Filler Sticks are for the repair of scratches, cracks and small holes on wooden and plastic surfaces. They are available in dark, medium, light and grey. The Wax Filler Sticks are ideal for small damaged areas of furniture.

Apply using light pressure with the tip of the spatula and clean off surplus to leave a

smooth flat surface. Each pack contains 4 shades to help with colour matching. For a close colour match, blend different shades of softwax by successive applications using light to dark colours.

Product Code	Colour	Pack Qty (pcs)	Carton Qty (packs)
<b>PACK</b>			
BWSWSLGT	Light Shades	1	6
BWSWSMED	Medium Shades	1	6
BWSWSDK	Dark Shades	1	6
BWSWSGRY	Grey Shades	1	6

TYPE - BWX SUB TYPE - BWX01

## Beeswax Stick



Pure Beeswax Filler Sticks are ideal for furniture restoration to fill small cracks and holes.

This wax is also handy for odd jobs around the house.

Product Code	Pack Qty (pcs)	Carton Qty (packs)
<b>PACK</b>		
BWBWES	1	6

TYPE - BWX SUB TYPE - BWX01

# Lubricants



Made in the UK

## Multi-Purpose Lubricant



Developed to penetrate, loosen, maintain, protect and clean metal surfaces. Specially formulated to rapidly penetrate into hard to reach areas

Ideal for drying electrical systems, stopping hinges and latches from squeaking, maintaining locking mechanisms, reducing tool wear and tear, priming ignition systems, loosening seized nuts and bolts and much more.

- Premium quality oil suspended in a low viscosity dispersing fluid
- Excellent moisture repelling properties
- Resists corrosion

- Maintains lasting performance of a variety of metal components
- Temperature resistant from -50 to 200°C

Product Code	Size	Packs Carton Pallets		
		Qty (pcs)	Qty (packs)	Qty (packs)
<b>CAN</b>				
237789	480ml	1	12	912
TYPE - AER		SUB TYPE - AER01		

## Silicone Lubricant



Formulated for applications where there are plastic or rubberised components, due to the absence of any chemicals which cause hardening and splitting.

Ideal for window seals and slides, runners, bearings, o-rings, textile equipment and more.



- Low odour
- Non-staining
- Protects
- Temperature resistant from -50 to 200°C

- Long lasting
- No heavy hydrocarbons that can cause cracking, squeaking, splitting and hardening

Product Code	Size	Packs Carton Pallets		
		Qty (pcs)	Qty (packs)	Qty (packs)
<b>CAN</b>				
237357	380ml	1	12	1140
TYPE - AER		SUB TYPE - AER01		

## Copper Anti-Seize



A premium pure copper lubricant with a graphite additive, suspended in a high quality grease.

It maintains and protects steel, stainless steel, cast iron, copper & brass components from high temperatures, corrosion and seizure.

Ideal for all automotive, industrial and construction uses including: threaded fasteners, brake pads and callipers, manifolds and exhausts, boiler parts, flanges and pipes.

- Protects
- Copper formulation resists high temperatures
- Heat resistant up to 1100°C

- Water resistant
- The graphite additive allows for easy assembly and dismantling of a wide range of metal applications

Product Code	Size	Packs Carton Pallets		
		Qty (pcs)	Qty (packs)	Qty (packs)
<b>CAN</b>				
237456	380ml	1	12	1140
TYPE - AER		SUB TYPE - AER01		

## Cutting & Tapping Lubricant



Formulated to significantly reduce friction and wear, increase cutting speeds, protect and extend tool life, and ensure a consistent high quality surface finish.

Ideal for all machine shops, tool-rooms and maintenance departments.

- Contains extreme pressure additives
- Prevents pitting, galling and metal seizure
- Improves tooling accuracy

- Suitable for use on hard to work metals including stainless steel, titanium, aluminium and tool steel
- Complete with an easy-to-use 360° spray nozzle, for precise application in hard to reach and confined spaces

Product Code	Size	Packs Carton Pallets		
		Qty (pcs)	Qty (packs)	Qty (packs)
<b>CAN</b>				
237159	380ml	1	12	1140
TYPE - AER		SUB TYPE - AER01		

## Chain Lubricant



Designed to penetrate, maintain, protect and clean chain, wire rope and moving metal parts. The high viscosity formula gives excellent lubricant retention, preventing "fling off" and unnecessary wear and maintenance.

Ideal for chain, gears, wire rope, pulleys, rollers, bearings and more.

- The Molybdenum disulphide additive gives exceptional long lasting friction reduction

- Prolongs the performance and lifespan of moving metal parts and surfaces
- Prevents corrosion and reduces dirt and grime build up, even in wet and humid environments

Product Code	Size	Packs Carton Pallets		
		Qty (pcs)	Qty (packs)	Qty (packs)
<b>CAN</b>				
237123	380ml	1	12	1140
TYPE - AER		SUB TYPE - AER01		

## Graphite Lock Lubricant

**NEW**



A graphite lock lubricant engineered to penetrate locking, hinging and latching mechanisms, ensuring long lasting, smooth operation. Containing microscopic graphite grains to prevent seizing and stop a build up of grime.

Ideal for mechanisms such as padlocks, hinges, locks, latches and more.



- Easy to use
- Long lasting lubrication
- Excellent water resistance

- Anti-seize formulation
- No grease
- Enhanced durability

Product Code	Size	Packs Carton Pallets		
		Qty (pcs)	Qty (packs)	Qty (packs)
<b>CAN</b>				
237009	80ml	1	12	2016
TYPE - AER		SUB TYPE - AER01		



NEW

# Greases



Made in the UK

## White Lithium Grease



An opaque viscous lubricant with a non-thinning heat resistant formulation to ensure long term performance.

Ideal for industrial, marine and automotive applications where water ingress can be detrimental to lubrication.

- Highly visible
- Superior corrosion resistant
- Temperature resistant from -20 to 140°C
- Extremely effective in areas requiring water resistance



Product Code	Size	Packs Carton Pallets		
		Qty (pcs)	Qty (packs)	Qty (packs)
237482 TYPE - AER	CAN 380ml	1	12	1140
		SUB TYPE - AER01		

## Premium Lithium Complex Grease



A premium quality and long life, lithium complex grease with extreme pressure additives, making it suitable for the most demanding anti-friction and high load applications.

Ideal for effective and long lasting lubrication in harsh, hot, wet and dusty applications in the agriculture, construction and automotive industries.

- Excellent mechanical stability
- High water resistance
- Very high temperature resistance
- Resists oxidation and corrosion
- Excellent pumpability
- Temperature resistant from -30 to 150°C



Product Code	Colour	Size	Carton Pallets	
			Qty (packs)	Qty (packs)
526002 TYPE - LBN	Red	CARTRIDGE 400g	12	1200
			SUB TYPE - LBN01	

## Lithium EP2 Grease



A high quality, multi-purpose lithium grease with high pressure additives, making it suitable for all anti-friction and medium to high load conditions.

Ideal for industrial, construction and automotive applications such hydraulic systems, wheel bearings and pump systems.

- Good mechanical stability
- Water resistant
- High temperature resistance
- Resists oxidation and corrosion
- Good pumpability
- Temperature resistant from -30 to 140°C



Product Code	Colour	Size	Carton Pallets	
			Qty (packs)	Qty (packs)
526001 TYPE - LBN	Cream/Brown	CARTRIDGE 400g	12	1200
			SUB TYPE - LBN01	



NEW

## Oils



Made in the UK

### 2 Stroke Engine Oil



Supplied in a measured dispensing bottle for easy use.

JASO FD

A premium formula, high performance two-stroke engine oil. Using the latest additive technology and synthetic and fine mineral based oils it is capable of withstanding the high demands of modern engines and machinery.

Ideal for lawnmowers, strimmers, motorcycles, scooters, small generators and onboard engines.

- Semi-synthetic
- High performance
- Low smoke formulation
- Prevents power loss
- Protects internal parts
- Reduced exhaust contaminants



Product Code	Size	Packs Qty (pcs)	Carton Qty (packs)	Pallets Qty (packs)
526005	1L	1	12	450
TYPE -LBN		SUB TYPE - LBN02		

### 4 Stroke Engine Oil



API SE

A premium quality lubricant, designed to maintain viscosity in a variety of operating temperatures. Containing a detergent inhibitor to assist sludge control, with added wear resistance and anti-oxidant properties.

Ideal for a wide variety of engines in marine, agricultural and site applications such as lawnmowers, air compressors, small capacity petrol engines and more.

- 10W-30
- Mono-Grade
- Reduces internal sludging
- Prolongs engine life
- Temperature fluctuation tolerant



Product Code	Size	Packs Qty (pcs)	Carton Qty (packs)	Pallets Qty (packs)
526004	1L	1	15	450
TYPE -LBN		SUB TYPE - LBN02		

### Chainsaw Oil



A heavy duty and high viscosity oil formulated using premium base oils and tacky modifiers. Developed to help reduce wear and extend the tool lifetime.

Ideal for lubricating bars and chains on pump fed chainsaws.

- Anti-fling agents
- Anti corrosion
- Extends bar & chain life



Product Code	Size	Packs Qty (pcs)	Carton Qty (packs)	Pallets Qty (packs)
526003	1L	1	15	450
TYPE -LBN		SUB TYPE - LBN02		

## Maintenance & Cleaning Sprays



Made in the UK



### Oil & Grease Remover



A solvent based degreaser, which penetrates, lifts and easily removes heavy oils, grease and tar deposits from most metals and hard plastic surfaces.

Ideal for automotive, industrial, general workshop maintenance, and surface preparation.



- Powerful degreasing performance
- Highly effective at penetrating and lifting unwanted contaminants
- Quick drying
- Immediately emulsifies with water
- Leaves the surface clean and residue free

Product Code	Size	Packs Qty (pcs)	Carton Qty (packs)	Pallets Qty (packs)
<b>CAN</b>				
237156	380ml	1	12	1140
TYPE -AER		SUB TYPE - AER03		

### Adhesive Residue Remover

NEW



A powerful and rapid acting solvent based cleaning solution. Can be used for the safe removal of unwanted adhesive residue, wax, ink, sealants and much more.

Ideal for surface degreasing and cleaning before paint, adhesive and sealant application.



- Powerful cleaning
- Rapid acting
- Degreases
- Removes wax & ink
- Non-aggressive solvent formulation
- Leaves no film
- Low odour

Product Code	Size	Packs Qty (pcs)	Carton Qty (packs)	Pallets Qty (packs)
<b>CAN</b>				
237004	480ml	1	12	912
TYPE -AER		SUB TYPE - AER03		

### Label Remover

NEW



A unique blend of citrus and hydrocarbon oils used to quickly penetrate and neutralise the adhesive, allowing for effortless and safe removal of unwanted self adhesive labels and stickers.

Ideal for removing labels from products including pipe fittings, hand tools, bracketry, and hardware.



- Safe on most materials
- Fast penetration
- Penetrates through paper labels
- Breaks down adhesive residue
- Removes some inks & dyes

Product Code	Size	Packs Qty (pcs)	Carton Qty (packs)	Pallets Qty (packs)
<b>CAN</b>				
237005	200ml	1	12	1680
TYPE -AER		SUB TYPE - AER03		

### Welder's Anti-Spatter



Specifically formulated to eliminate the need to remove unsightly spatter, which significantly reduces working time.

Ideal for welds, working areas and equipment.

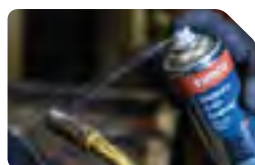

- Can be easily removed after welding
- Low odour and colourless
- Quick drying
- Silicone and petroleum free, so does not interfere with post welding coatings
- Non-flammable

Product Code	Size	Packs Qty (pcs)	Carton Qty (packs)	Pallets Qty (packs)
<b>CAN</b>				
237560	300ml	1	12	1140
TYPE -AER		SUB TYPE - AER01		

### Air & Gas Leak Detector



Professional formulation, designed to quickly and reliably detect the smallest leak in pressurised systems.

Reacts instantly upon contact with gas and air pressure, forming a stream of bubbles to identify the leak.

Ideal for refrigeration units, air conditioning systems, exhausts, pipes, valves, screw connectors, welded seams and more.

- Water based
- Instant reaction
- Non-flammable
- Complete with an easy-to-use 360° spray nozzle, for precise application in hard to reach and confined spaces

Product Code	Size	Packs Qty (pcs)	Carton Qty (packs)	Pallets Qty (packs)
<b>CAN</b>				
237023	300ml	1	12	1140
TYPE -AER		SUB TYPE - AER01		

### Cordless Nail Gun Cleaner

NEW



A powerful and fast acting cleaner, formulated for removing exhaust gas residue, dirt and grime from cordless nail guns. Regular use enhances the performance and extends the life of the power tool.

Suitable for use on most leading brands of cordless nailing tools.



- Powerful cleaning
- Fast acting
- Extends tool life
- Safe on plastics
- Leaves no residue
- Enhances tool performance

Product Code	Size	Packs Qty (pcs)	Carton Qty (packs)	Pallets Qty (packs)
<b>CAN</b>				
237003	300ml	1	12	1140
TYPE -AER		SUB TYPE - AER03		

## Paints



### Galvanising Paint

**NEW COLOUR**



A premium quality zinc spray that gives excellent corrosion resistance, as either a primer or topcoat of metals after grinding, welding, cutting and drilling.

Ideal for threaded fasteners, exposed metal edges and welds, conduit, fencing and railings, gates, signs, rails and more.



- Sacrificial zinc coating forms a hard-wearing bond to ferrous metals
- The high zinc purity blends with previously galvanised coatings
- Paintable
- Gives a professional finish or a suitable base layer for acrylic, alkyd, p/u alkyd and epoxy paints
- Actively fights rust and corrosion

Product Code	Size	Colour	Pack Qty (pcs)	Carton Qty (packs)	Pallet Qty (packs)
<b>CAN</b>					
237750	380ml	Cold Galvanised	1	12	1140
237002	380ml	Bright Galvanised	1	12	1140
TYPE - AER			SUB TYPE - AER02		

### Metal Paint

**NEW**



A quick drying, hard wearing and long lasting paint for metal surfaces. Formulated to be used as a primer, undercoat and top coat in one application.

Ideal for metal gates, fences, doors, garden furniture, railings and more.



- Quick drying
- Hard wearing
- Direct to rust application
- Smooth Finish
- Prevents rusting
- Interior & exterior
- Primer, undercoat and top coat

Product Code	Size	Colour	Pack Qty (pcs)	Carton Qty (packs)	Pallet Qty (packs)
<b>CAN</b>					
237006	380ml	Smooth Black	1	12	1140
237007	380ml	Smooth White	1	12	1140
237008	380ml	Smooth Silver	1	12	1140
TYPE - AER			SUB TYPE - AER02		

### Finishing Paint



A multi-purpose acrylic based finishing paint designed to give a professional and corrosion resistant finish to most substrates including: ferrous metals, stainless steel, aluminium, plaster, wood and some plastics.

Ideal for ironmongery, garden furniture, decorative fixtures, concealing unsightly surfaces and repairing damaged paint surfaces.



- The fast drying, UV resistant and flexible formula gives a drip-free application
- Temperature resistant from -50 to 80°C
- Enhanced colour pigments for a long lasting finish

Product Code	Size	Finish	Pack Qty (pcs)	Carton Qty (packs)	Pallet Qty (packs)
<b>CAN</b>					
237128	380ml	Matt Black	1	12	1140
237190	380ml	Gloss Black	1	12	1140
TYPE - AER			SUB TYPE - AER02		

### Very High Temperature Paint



A hard-wearing heat and flame resistant coating for metal surfaces.

During the curing process a durable silicone matrix is formed to give protection against extreme temperatures.

Ideal for stoves, heaters, fire places and surrounds, boiler flues, machinery, exhausts, radiators, incinerators, furnaces and more.



- Corrosion resistant coating
- Withstands temperatures up to 650°C
- Fast drying formula
- Single coat
- No primer required
- Non-drip and run free
- Interior & exterior

Product Code	Size	Colour	Pack Qty (pcs)	Carton Qty (packs)	Pallet Qty (packs)
<b>CAN</b>					
237896	380ml	Matt Black	1	12	1140
TYPE - AER			SUB TYPE - AER02		

### Primer



Formulated to maximise the adhesion of finishing paints to metals and hard plastics.

Excellent high build formula fills and masks surface imperfections, resulting in a smooth and consistent finish.

Ideal for welded seams, machinery and equipment, ironmongery, fences, gates and commercial steelwork.



- The corrosion resistant properties enhance finishing paint performance
- Temperature resistant from -50 to 80°C
- Protects exposed metal surfaces after welding and fabrication

Product Code	Size	Colour	Pack Qty (pcs)	Carton Qty (packs)	Pallet Qty (packs)
<b>CAN</b>					
237320	380ml	Red Oxide	1	12	1140
237480	380ml	Grey	1	12	1140
TYPE - AER			SUB TYPE - AER02		

### Stain Concealing Paint

**NEW**



A fast drying spray paint which permanently prevents existing stains reappearing through paint finishes. Can be overpainted in 15 minutes.

Ideal for concealing stains caused by water, grease, nicotine, rust, soot, graffiti and more on a wide variety of materials.



- Quick drying
- Low odour
- Cracking & peeling resistant
- Touch dry in 15 mins
- Interior & exterior
- Coverage: 0.7-0.8m<sup>2</sup>

Product Code	Size	Colour	Pack Qty (pcs)	Carton Qty (packs)	Pallet Qty (packs)
<b>CAN</b>					
237001	400ml	Matt White	1	12	840
TYPE - AER			SUB TYPE - AER02		



## Survey & Spot Markers



Made in the UK

### Survey & Spot Markers



A rapid drying marking paint for applying semi-permanent markings to soil, grass, concrete and most hard surfaces.

Ideal for a variety of uses including: highway maintenance, site excavation, turf marking, landscaping and marking cable positions prior to drilling and cutting.

Lasts at least 3 months on most hard surfaces. Applications to wet and damp surfaces may decrease performance.

- Contains built-in bright colour pigments for a bold finish
- Includes a heavy duty, non clogging nozzle for inverted use
- Includes dual trigger pads for compatibility with survey marking applicators

Product Code	Size	Colour	Application*	Packs Qty (pcs)	Carton Qty (packs)	Pallet Qty (packs)
<b>CAN</b>						
237369	750ml	White	General marker	1	12	684
237025	750ml	Yellow	General marker	1	12	684
237798	750ml	Blue	Water	1	12	684
237206	750ml	Red	Electricity	1	12	684
237047	750ml	Green	Cablework	1	12	684
237225	750ml	Black	Covering old lines	1	12	684
237900	750ml	Orange	Hazards	1	12	684

TYPE -AER

SUB TYPE - AER02 \* SURVEY MARKING APPLICATIONS INCLUDE BUT ARE NOT LIMITED TO THE FOLLOWING

NEW

# Barrettine

TRUSTED BY THE PROFESSIONALS

Serving customers in the DIY market, decorating centres, builders merchants, garden centres, agricultural distributors/merchants, shed and fence manufacturers throughout the country.

Part of the J.V. Barrett Group, we are a family owned business with a reputation for quality products and quality brands.

We formulate and manufacture at our factory in Bristol and supply the Barrettine brand nationally through our network of distributors, wholesalers and retailers.





**NEW**

## Barrettine Wood Treatment

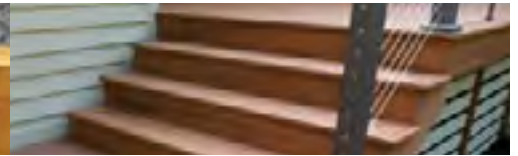

### Wood Protective Treatment

A wood protector for sealing rough, sawn or smooth timber. It contains water repellent resins and a biocide film preserver to prevent the surface growth of mould and algae.

- Low odour formula
- UV fade resistant colour pigments
- Deep penetrating oil/spirit formula
- Up to 6m<sup>2</sup> per litre coverage
- Harmless to beneficial insects & plants when dry

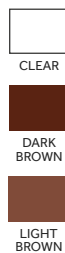

Product Code	Size	Colour	Pack Qty (pcs)	MOQ Qty (packs)	Pallet Qty (packs)
<b>TIN</b>					
PTCL005	5L	Clear	1	2	156
PTDB005	5L	Dark Brown	1	2	156
PTLB005	5L	Light Brown	1	2	156
TYPE - BAR			SUB TYPE - BAR01		

### Universal Preserver

A clear wood preserver and primer that provides a colourless finish for further painting, varnishing.

Can be used on untreated wood or treated timber outdoors.



- Deep penetrating oil/spirit
- Low odour formula
- Up to 5m<sup>2</sup> per litre coverage
- Quality primer resins for excellent adhesion
- High level, long-lasting wood protection & wood preservation



Product Code	Size	Colour	Pack Qty (pcs)	MOQ Qty (packs)	Pallet Qty (packs)
<b>TIN</b>					
UNCL005	5L	Clear	1	2	156
TYPE - BAR			SUB TYPE - BAR01		

### Wood Preserver

A high-quality, low odour oil/Spirit wood preservative that is deep penetrating. Used for protecting wood against wood-destroying fungi (wet rot), wood discolouring fungi and wood-boring insects.



- Deep penetrating oil/spirit
- Low odour formula
- Superb quality water repellent resins
- UV fade resistant colour pigments
- Up to 6m<sup>2</sup> per litre coverage
- High level, long-lasting wood protection & wood preservation



Product Code	Size	Colour	Pack Qty (pcs)	MOQ Qty (packs)	Pallet Qty (packs)
<b>TIN</b>					
WOCL005	5L	Clear	1	2	156
WODB005	5L	Dark Brown	1	2	156
WOLB005	5L	Light Brown	1	2	156
WOST005	5L	Summer Tan	1	2	156
TYPE - BAR			SUB TYPE - BAR01		

### Decking Oil - All In One

Specifically formulated for use on pressure treated and preservative impregnated timber offering superb protection to deck boards, deck tiles and balustrades.



- UV fade-resistant pigments
- Contains a surface biocide preserver to protect against mould
- Harmless to beneficial insects & plants when dry
- Up to 8m<sup>2</sup> per litre coverage

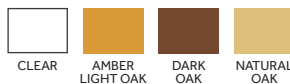

Product Code	Size	Colour	Pack Qty (pcs)	MOQ Qty (packs)	Pallet Qty (packs)
<b>TIN</b>					
DOCL005	5L	Clear	1	2	156
DOCP005	5L	Amber Light Oak	1	2	156
DODO005	5L	Dark Oak	1	2	156
DONO005	5L	Natural Oak	1	2	156
TYPE - BAR			SUB TYPE - BAR01		

### Decking Oil - Anti-Slip

A premium quality topcoat decking oil incorporating anti-slip technology. Improves grip on decking, handrails and wooden steps. Awarded 'Best Garden Product' in the DIY Week awards 2019.



- A low sheen finish with UV stabilisers helps to slow wood turning grey
- Resists flaking or cracking with excellent water beading
- Oils and protects
- Contains a surface biocide to protect against fungal and mould attack
- Harmless to beneficial insects & plants when dry
- Up to 17m<sup>2</sup> per litre coverage

Product Code	Size	Colour	Pack Qty (pcs)	MOQ Qty (packs)	Pallet Qty (packs)
<b>TIN</b>					
DTAS25	2.5L	Clear	1	4	260
TYPE - BAR			SUB TYPE - BAR01		

NEW



## Log Cabin & Decking Treatment



Log Cabin & Complete Decking Treatment is specifically formulated to oil and protect log cabins, decking boards, deck tiles and balustrades made from pretreated, pressure treated or preservative impregnated timber.



- Contains surface biocide to aid in the prevention of surface mould and algae
- Contains added UV Stabilisers
- Regular treatment provides superb water repellency
- Resists flaking/peeling, whilst water repellence helps prevent timber splitting and cracking
- Harmless to beneficial insects and pets when dry
- Up to 8m<sup>2</sup> per litre coverage

Product Code	Size	Colour	Pack Qty (pcs)	MOQ (packs)	Pallet Qty (packs)
<b>TIN</b>					
LCDT005	5L	Clear	1	2	156
TYPE - BAR			SUB TYPE - BAR01		

## Wood Reviver

Wood Reviver will turn back the clock, restoring grey, UV-damaged wood to its original warm tones. Wood Reviver can also rescue wood from stains caused by surface mould, tannin runs, watermarks, iron, rust and light dirt.

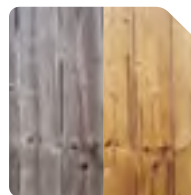

BEFORE AFTER

- Ready to use formulation
- Low VOC and chlorine bleach free
- Instantly renovates blackened/grey wood
- Removes rust stains from fixings
- Restores the original tone of the wood
- Up to 4m<sup>2</sup> per litre coverage

Product Code	Size	Pack Qty (pcs)	Carton Qty (packs)	Pallet Qty (packs)
<b>BOTTLE</b>				
WORE001	1L	1	6	552
TYPE - BAR		SUB TYPE - BAR01		

## Woodworm Killer

A traditional woodworm treatment for a deep penetrating low odour oil/spirit based woodworm killer. It prevents & exterminates woodworm and wood boring insects from treated timber.

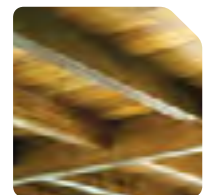

- Low odour formula
- For internal & external timber structures
- Up to 3.3m<sup>2</sup> per litre coverage

Product Code	Size	Pack Qty (pcs)	Carton Qty (packs)	Pallet Qty (packs)
<b>BOTTLE</b>				
SPWW50	500ml	1	6	870
TYPE - BAR		SUB TYPE - BAR01		

## Timber Cut End Preserver

Specially formulated to be used on pressure-treated timber where it has been cut, drilled or worked in any way to expose the untreated inner wood. Protects against decay such as wet rot, discolouring fungus and wood boring insect attack.



- Protects vulnerable exposed end grain
- Deeply penetrates to protect cuts and notches
- Ideal for cladding & other cut pressure treated timbers
- Up to 6m<sup>2</sup> per litre coverage

Product Code	Size	Finish	Pack Qty (pcs)	Carton Qty (packs)	Pallet Qty (packs)
<b>TIN</b>					
TEGR001	1L	Green	1	6	468
TYPE - BAR		SUB TYPE - BAR01			

## Polyurethane Varnish

A high quality satin finish. Gives excellent durability to kitchen furniture, internal doors and other joinery products. Ideal for internal doors & joinery, kitchen furniture and worktops.



- High durability varnish
- Up to 14m<sup>2</sup> per litre coverage

Product Code	Size	Finish	Pack Qty (pcs)	Carton Qty (packs)	Pallet Qty (packs)
<b>TIN</b>					
PSVA001	1L	Clear Satin	1	9	324
TYPE - BAR		SUB TYPE - BAR01			

## Yacht Varnish

A tough, top-quality varnish with a high gloss finish. Protects against cracking and flaking caused by UV light. Also provides complete and long-lasting protection under testing weather conditions.



- High durability varnish
- Tough, top quality varnish
- High gloss finish
- Up to 14m<sup>2</sup> per litre coverage
- For interior and exterior use



Product Code	Size	Finish	Pack Qty (pcs)	Carton Qty (packs)	Pallet Qty (packs)
<b>TIN</b>					
CGYV001	1L	Clear Gloss	1	9	324
TYPE - BAR		SUB TYPE - BAR01			

**NEW**



### Quick Drying Floor Varnish

Nourishes and protects, whilst providing a lasting depth of sheen that naturally enhances the beauty of wood flooring.



- Quality interior floor varnish
- Durable, clear finish for wooden floors and work surfaces
- Up to 14m<sup>2</sup> per litre coverage

Product Code	Size	Finish	Pack Qty (pcs)	Carton Qty (packs)	Pallet Qty (packs)
<b>TIN</b>					
QDFV25	2.5L	Clear Satin	1	4	288
TYPE - BAR			SUB TYPE - BAR01		

### Traditional Floor Wax

A clear quick drying wax finish which nourishes and protects whilst providing a lasting depth of sheen that naturally enhances the beauty of wood flooring.



- Quality interior floor wax
- Long lasting depth of sheen
- Nourishes and protects
- Up to 16m<sup>2</sup> per litre coverage

Product Code	Size	Finish	Pack Qty (pcs)	Carton Qty (packs)	Pallet Qty (packs)
<b>TIN</b>					
CFWX25	2.5L	Clear	1	4	288
TYPE - BAR			SUB TYPE - BAR01		

### Danish Oil

A blend of oils and resin which provide an attractive lustre finish to all woods. Ideal for Scandinavian furnishings, doors, panelling, wood turning and more!



Ideal for doors, panelling, wood turning etc.

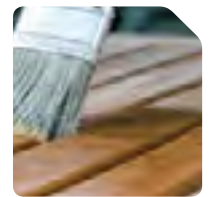

- Apply using a brush or lint-free cloth
- Blend of oils and resins to provide an attractive lustre finish to interior woods
- If using outside, apply wood preservative first
- Up to 10m<sup>2</sup> per litre coverage

Product Code	Size	Pack Qty (pcs)	Carton Qty (packs)	Pallet Qty (packs)
<b>TIN</b>				
OIDA50	500ml	1	12	1056
TYPE - BAR		SUB TYPE - BAR01		

### Teak Oil

An oil for the treatment and enhancement of untreated wood. Teak Oil penetrates unsealed wood leaving a natural, water resistant finish.



Ideal for garden furniture or traditional matt finished interior furniture.

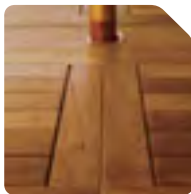

- Quick and easy to apply
- Dries to a satin-matt finish
- Up to 10m<sup>2</sup> per litre coverage
- Preserves the natural beauty of wood

Product Code	Size	Pack Qty (pcs)	Carton Qty (packs)	Pallet Qty (packs)
<b>BOTTLE</b>				
OITE50	500ml	1	12	1056
TYPE - BAR		SUB TYPE - BAR01		

### Raw Linseed Oil

A traditional completely natural oil from the extract of flax seed which penetrates unsealed wood leaving a natural, water resistant finish with a slightly enhanced colour that darkens slightly with age.



Ideal for oak beams, cricket bats, garden canes and instruments.



- Highly water resistant
- Offers a matt finish
- Up to 10m<sup>2</sup> per litre coverage
- Suitable for interior and exterior use

Product Code	Size	Pack Qty (pcs)	Carton Qty (packs)	Pallet Qty (packs)
<b>BOTTLE</b>				
OIRL50	500ml	1	12	1056
TYPE - BAR		SUB TYPE - BAR01		

### Boiled Linseed Oil

A natural linseed oil blended with driers to improve drying times. Boiled Linseed penetrates unsealed wood leaving a natural, water resistant finish with a slightly enhanced colour that darkens slightly with age.



Suitable for interior and exterior use

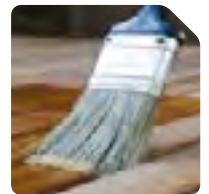

- A quicker drying alternative Linseed oil
- Low VOC content
- Up to 10m<sup>2</sup> per litre coverage
- Blended with driers to improve drying times
- Provides natural protection for wood surfaces

Product Code	Size	Pack Qty (pcs)	Carton Qty (packs)	Pallet Qty (packs)
<b>BOTTLE</b>				
OIBL50	500ml	1	12	1056
TYPE - BAR		SUB TYPE - BAR01		



NEW

# Cleaners



Made in the UK

## Exterior Multi-Purpose Cleaner Concentrated

A multi-purpose cleaning product for removing dirt, algae, mould, fungi and general grime build up from a variety of external surfaces such as PVCu, hard plastics, glass, rubber, metal and more.



The pH neutral and biodegradable formula contains a citronella additive to repel insects and neutralise unwanted odours with added carnauba wax to leave surfaces looking clean and shiny.

- Anti-static agent to reduce dirt and grime build up
- pH neutral to protect delicate plastics and rubbers
- Built in water softener
- Safe & easy to use as a concentrate
- No streaking and spotting
- Easy to use 40 dose dispensing bottle
- One 25ml dose dilutes to 10L of water
- Also suitable for interior cleaning tasks

Ideal for cleaning conservatories, greenhouses, windows, roof lights, flat roofs and more.

Product Code	Size	Packs Qty (pcs)	Carton Qty (packs)	Pallets Qty (packs)
<b>BOTTLE</b>				
257001	1L	1	10	550
TYPE - CLR		SUB TYPE - CLR01		

## Brick, Masonry & Patio Cleaner

A heavy duty acid based cleaner for removing dirt, grime and unwanted stains from stone, concrete, bricks and blocks. Ideal for removing leaf stains from patio slabs, stubborn algae from block paving, cement and mortar stains from brickwork and rust marks.



- Fast acting
- High strength
- Acid based
- Dissolves mortar stains
- Exterior use only
- Water clean up
- Not suitable for use on calcareous or polished stone and tarmacadam

**Up to 3x the coverage of other leading brands. Cleans up to 30m<sup>2</sup>**



Product Code	Size	Packs Qty (pcs)	Carton Qty (packs)	Pallets Qty (packs)
<b>BOTTLE</b>				
257002	4L	1	4	160
TYPE - CLR		SUB TYPE - CLR01		

## Path, Patio & Driveway Cleaner Concentrate

A non-toxic revolutionary cleaning treatment for a variety of exterior surfaces. An easy to use formula that requires no rinsing, scrubbing or pressure washing.



**No rinsing, scrubbing or pressure washing**

Formulated to effectively kill algae, mould, fungi, moss and green growth on concrete, brick, stone, paving, decking, tarmacadam and much more.

- Spray and leave
- Long lasting protection
- Easy to use
- Up to 140m<sup>2</sup> coverage
- Pet and wildlife safe
- Non-toxic and bleach free
- Eco friendly - organic and biodegradable

Product Code	Size	Packs Qty (pcs)	Carton Qty (packs)	Pallets Qty (packs)
<b>BOTTLE</b>				
257112	5L	1	4	128
TYPE - CLR		SUB TYPE - CLR01		

## Path, Patio & Driveway Sealer

A water based environmentally friendly sealing agent, formulated to provide long lasting moisture and UV resistance. It leaves brick, concrete and stonework looking revitalised whilst protecting against weathering, efflorescence moss and mould growth.



**Over 3x the coverage of other leading brands. Seals up to 30m<sup>2</sup>**

Ideal for all types of external masonry, including natural and artificial stone, limestone, sandstone, slate, brick and concrete paving.

- Exterior use only
- Moisture repellent
- Stain resistant
- Enhances appearance
- UV resistant
- Non-yellowing
- Eco friendly
- Concentrated Formula

Product Code	Size	Packs Qty (pcs)	Carton Qty (packs)	Pallets Qty (packs)
<b>BOTTLE</b>				
257003	1L	1	4	360
TYPE - CLR		SUB TYPE - CLR01		

## Exterior Wood Cleaner

A fast acting, water based decking cleaner, formulated for use on all timber, composite and plastic decking. The super concentrated formula removes dirt, grime, fungi and algae making it ideal for light cleaning and thorough restoration.

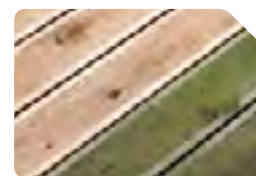

**Treats up to 40m<sup>2</sup>**

Ideal for all external timbers, including fencing, trellis, pergolas, garden furniture and more.

- Exterior use only
- Fast acting
- Just add water
- Easy application
- Concentrated Formula

Product Code	Size	Packs Qty (pcs)	Carton Qty (packs)	Pallets Qty (packs)
<b>BOTTLE</b>				
257004	500ml	1	12	1056
TYPE - CLR		SUB TYPE - CLR01		



## PVCu Cleaner

A heavy duty cleaner for transforming weathered and dirty PVCu surfaces.

It provides protection and makes PVCu look as good as new.



Ideal for window and door frames, conservatories, cladding, soffits, fascias and more.



- Ready to use
- Heavy duty
- No scrubbing
- Removes mould, dirt and grime

Product Code	Size	Packs Qty (pcs)	Carton Qty (packs)	Pallets Qty (packs)
<b>BOTTLE</b>				
257105	1L	1	12	528
TYPE - CLR		SUB TYPE - CLR02		

## Glass Cleaner

A rapid drying glass cleaner that effortlessly removes dirt and grease whilst leaving a streak and static free finish.



Ideal for windows and mirrors but also suitable for tiling, PC monitors and TVs.



- Rapid drying
- Removes dirt & grease
- Streak free
- Static free

Product Code	Size	Packs Qty (pcs)	Carton Qty (packs)	Pallets Qty (packs)
<b>BOTTLE</b>				
257106	1L	1	12	528
TYPE - CLR		SUB TYPE - CLR02		

## Multi-Purpose Citrus Cleaner & Degreaser

A powerful, multi-purpose cleaner and degreaser. It contains natural citrus solvents which penetrate deep into oils, greases, adhesive residue and dirt, allowing for quick and easy cleaning.



Ideal for a variety of hard surfaces such as plastic, metal and wood in home, office, commercial, automotive and agricultural applications.



- Natural solvents
- Interior and exterior
- Streak free & Static free
- Not suitable for use on marble, natural stone or glass

Product Code	Size	Packs Qty (pcs)	Carton Qty (packs)	Pallets Qty (packs)
<b>BOTTLE</b>				
257110	1L	1	12	528
TYPE - CLR		SUB TYPE - CLR02		

## Multi-Purpose Calcium, Lime & Rust Stain Remover

A multi-purpose cleaner and disinfectant that removes fats, soaps, limescale, algae, rust, copper stains and other contaminants from a variety of surfaces around the home and workshop.



Ideal for bathrooms, washrooms, kitchens, hand tools, garden tools, site machinery and automotive applications.

- Interior and exterior
- Concentrated
- Fast acting
- Fresh fragrance
- Chrome safe
- Environment safe

Product Code	Size	Packs Qty (pcs)	Carton Qty (packs)	Pallets Qty (packs)
<b>BOTTLE</b>				
257108	1L	1	12	528
TYPE - CLR		SUB TYPE - CLR02		

## Grout Cleaner

A powerful cleaning agent formulated for removing dirt and grime from grout. Contains buffing and deep cleaning properties to leave grout lines looking as good as new.

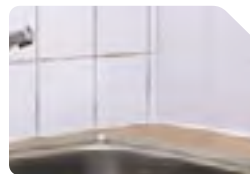

Ideal for all types of grout between wall tiles, floor tiles and brick.

- Interior and exterior
- Fast acting
- Removes black damp stains
- Ready to use
- Acid free
- Coloured grout safe

Product Code	Size	Packs Qty (pcs)	Carton Qty (packs)	Pallets Qty (packs)
<b>BOTTLE</b>				
257107	1L	1	12	528
TYPE - CLR		SUB TYPE - CLR02		

## Heavy Duty Cleaner & Degreaser

A professional degreasing solution, formulated for removing stubborn stains, scuff marks, oils and greases, in the home, garden, on site and in the workshop. It penetrates contaminants and lifts them from the surface, allowing for easy removal.



Ideal for metal, glass, plastic, painted surfaces, wood and masonry.

- Interior and exterior
- High penetration power
- Fast water solubility
- Highly dilutable
- Dissolves grease, oil, dirt, wax & glue
- Removes uncured PU foam



Product Code	Size	Packs Qty (pcs)	Carton Qty (packs)	Pallets Qty (packs)
<b>BOTTLE</b>				
257109	5L	1	4	160
TYPE - CLR		SUB TYPE - CLR02		

## For Wipes, Rags & Cloths

See page 206





# Site Protection & PPE

## Cleaning

Hand Cleaners, Sanitisers & Soaps	205
Wipes	206
Rolls, Rags & Cloths	206

## Site Protection & Refuse

Protective Board	207
Protective Films	208
Dust Sheets	208
Plastic Sheets	208
Tarpaulin & Tie Downs	209
Ratchet Straps & Bungee Cords	210
Lifting Slings	210
Barrier Fencing	211
Safety Signs	211
Sandbags & Rubble Sacks	211

## First Aid & Hand Cleaners

First Aid Kits	212
Eye Care	212
Plasters	212

## PPE & Workwear

Ear Protection	213
Knee Pads	213
Eye Protection	214
Face Shield	216
Safety Masks	217
Gloves & Shoe Covers	218
Coveralls	221
Hi-Vis Clothing	222



## Hand Cleaners, Sanitisers & Soaps



### Extra Heavy Duty Hand Cleaner



Formulated to remove the most stubborn oils, greases, paints, diesel, adhesive residue and general dirt and grime.

Ideal for: Workshops, construction sites, agriculture, engineers, plumbers, landscapers and more.

- Superior cleaning performance
- Pumice scrub
- Moisturising additives
- Orange citrus fragrance
- 100% solvent free

Product Code	Size	Pack Qty (pcs)	Carton Qty (packs)
<b>BOTTLE</b>			
432000	500ml	1	30
432022	4L	1	4
<b>PUMP BOTTLE</b>			
432011	4L	1	4
TYPE - HCL		SUB TYPE - HCL01	

### Heavy Duty Hand Cleaner



Formulated to remove general dirt and grime, light oils, adhesive residue, paint and more. With added walnut scrub to reduce skin irritation after frequent use.

Contains natural citrus oil and moisturisers to leave the skin feeling clean, fresh and smooth.

- Superior cleaning performance
- Pumice scrub
- Moisturising additives
- Lime fragrance
- 100% solvent free

Product Code	Size	Pack Qty (pcs)	Carton Qty (packs)
<b>BOTTLE</b>			
432033	500ml	1	30
432055	4L	1	4
<b>PUMP BOTTLE</b>			
432044	4L	1	4
TYPE - HCL		SUB TYPE - HCL01	

### Alcohol Hand Sanitiser



Alcohol-based hand sanitiser which rapidly kills, protects and stops the spread of germs, bacteria and viruses, including E-coli, Salmonella, Tuberculosis,

Influenza, SARS, Rhinoviruses, Coronaviruses and more.

- Quick drying
- Moisturises and doesn't dry skin out like iso-propanol based sanitisers.
- Contains 62% premium grade alcohol which conforms to BS EN standards
- Suitable for food preparation and healthcare applications

Product Code	Size	Pack Qty (pcs)	Carton Qty (packs)
<b>PUMP BOTTLE</b>			
432066	500ml	1	20
TYPE - HCL		SUB TYPE - HCL02	

### Hospital Grade Anti-Bacterial Hand Soap



Hospital grade, water-based hand cleaner with both anti-bacterial and anti-microbial properties.

Quickly kills viruses, germs and bacteria such as MRSA, C-difficile, E-coli, Salmonella and Listeria.

The gentle, foaming agents help to lift contaminants and leave the hands feeling fresh and clean.

- Hospital grade
- BS EN certified
- Medically certified

Product Code	Size	Pack Qty (pcs)	Carton Qty (packs)
<b>PUMP BOTTLE</b>			
432088	500ml	1	20
TYPE - HCL		SUB TYPE - HCL02	

### Active Hands Cream



A multi-purpose alcohol free sanitiser, moisturiser and barrier cream for use in the workplace.

The moisturising formula will protect skin from cracking and damage, leaving it feeling soft and refreshed, whilst

its anti-bacterial properties kill germs and stop the spread of bacteria for up to two hours.

- Quick drying
- Non-greasy
- Suitable for food preparation and healthcare applications

Product Code	Size	Pack Qty (pcs)	Carton Qty (packs)
<b>PUMP BOTTLE</b>			
432077	250ml	1	12
TYPE - HCL		SUB TYPE - HCL02	

### Active Hands Luxury Soap



A pearlised hand cleaner suitable for all general-purpose cleaning and washroom use.

The premium water blended formula gently removes dirt, grime and kills germs while leaving hands and skin smelling

fresh and clean. Non-ionic surfactants help remove dirt and oil easily without forming a 'soap scum' in hard water.

- Petroleum and solvent free
- Fragrant
- Gentle on hands and skin

Product Code	Size	Pack Qty (pcs)	Carton Qty (packs)
<b>PUMP BOTTLE</b>			
432099	500ml	1	20
TYPE - HCL		SUB TYPE - HCL02	

## Wipes, Rags & Cloths



### Extra Tough Builders Wipes



Multi use wipes formulated to clean and remove wet and semi-cured paint, grease, glues, sealant, adhesive, bitumen, tar, expanding foam, oil, silicone and permanent marker.

Contains aloe vera and an anti-bacterial additive.

Product Code	TUB		
	Pack Qty (pcs)	Carton Qty (packs)	Pallet Qty (packs)
SCRUB TYPE - WPE	100	6	480
		SUB TYPE - WPE01	

### Textured Heavy Duty Wipes



A heavy duty textured wipe designed to remove the most stubborn substances, such as paint, grease, glue, sealant, adhesives, bitumen, tar, expanding foam and many other wet and semi-cured substances.

Contains aloe vera and an anti-bacterial additive.

Product Code	TUB		
	Pack Qty (pcs)	Carton Qty (packs)	Pallet Qty (packs)
HDSCRUB TYPE - WPE	75	6	480
		SUB TYPE - WPE01	

### Stockinette Roll



Ideal for cleaning and polishing. Frequently used to clean up grease and oil.

- 100% cotton
- Highly absorbent
- Easily cut to size

Product Code	Length (m)	Weight (g)	PACK	
			Pack Qty (pcs)	Carton Qty (packs)
SSR400 TYPE - WPE	4.8	400	1	10
			SUB TYPE - WPE02	

### Microfibre Cleaning Cloths



Ultra soft and absorbent cloths, providing lint free and non-abrasive cleaning and polishing to multiple surfaces.

Washable and reusable.

Product Code	Size (mm)	BAG	
		Pack Qty (pcs)	Carton Qty (packs)
973147 TYPE - WPE	380 x 380	10	30
		SUB TYPE - WPE02	

### Assorted Wiping Rags



Large quantity of mixed rags in a vacuum pack for convenient storage and dispensing.

Ideal for general cleaning and wiping jobs on site.

Product Code	Weight (kg)	BAG	
		Pack Qty (pcs)	Carton Qty (packs)
973138 TYPE - WPE	10	N/A	10
		SUB TYPE - WPE02	

### Centrefeed Rolls



Large highly absorbent 2 ply rolls for everyday spills on site, at home and in the office. Can be used with dispensers by removing centre core or used on their own for quick and easy portable cleaning or hand drying.

Product Code	Type	Roll Height (mm)	Length (m)	PACK	
				Pack Qty (pcs)	Carton Qty (packs)
<b>BLUE</b>					
973508	Standard	175	150	6	10
973169	Economy	175	66	6	10
<b>WHITE</b>					
973359 TYPE - WPE	Standard	175	150	6	10
				SUB TYPE - WPE02	



# PROTECTIVE BOARD

Protective Board has been developed to protect and preserve all hard floor and short twill covered floor surfaces from dust, dirt, spills, sprays and site grime. This FSC certified board is made from recycled compressed fibre board and this innovative protection system is also 100% recyclable and reusable. The protective board is also breathable and can be laid on wooden floors and new concrete and will not trap any moisture therefore allowing the substrate to dry whilst protecting it from damage.



## SPILL SHIELD

Water based paints, silicone sealants, adhesives, pu foam, mud, dust, grime & more.



## BREATHABLE

Breathable technology to allow newly laid floors to cure.



## DURABLE

Gives a degree of impact and liquid resistance whilst ensuring a clean and scratch free surface below.



## QUICK INSTALLATION

Simply roll out, cut and tape.



## REUSABLE

Can be reused many times. Simply sweep, roll up and use again.



## NO RESIDUE

Sits securely in place once taped, leaving a clean residue free surface when lifted.



Product Code	Size (m)	Thickness (mm)	Pack Qty (pcs)	FDU Qty (packs)
775250	0.90 x 27.5	0.51	1	9

TYPE - PRO

SUB TYPE - PRO04



Manufactured from 100% recycled material and fully recyclable

## Protective Films & Dust Sheets



### Protective Film



Highly effective self-adhesive protective film. Carpet and hard surface films protect against foot traffic, debris, spills etc. during decoration and building works. Glass film protects both internal and external windows from plaster and paint splashes etc. Film can be left up to 30 days before simple removal.

**Note: Please ensure you have read and fully understood the usage guidelines before installation.**

- Safer than dust sheets
- Protects against spills
- 0.05mm Thickness
- One man application
- Easy peel
- Leaves no residue

Product Code	Length (m)	Width (mm)	Pack Qty (pcs)	Carton Qty (packs)	Pallet Qty (packs)
<b>ROLL</b>					
<b>CARPET</b>					
25CP	25	600	1	9	288
50CP	50	600	1	9	216
100CP	100	600	1	6	108
TYPE - PRO			SUB TYPE - PRO01		
<b>HARD SURFACE (NOT SUITABLE FOR MARBLE)</b>					
25HP	25	600	1	9	288
50HP	50	600	1	9	216
TYPE - PRO			SUB TYPE - PRO03		
<b>GLASS</b>					
25WP	25	600	1	9	288
50WP	50	600	1	9	216
TYPE - PRO			SUB TYPE - PRO02		

### Dust Sheets



**Professional**  
High quality dust sheet for multiple uses including floor and furniture covering during decoration.



**Laminated**  
High quality dust sheet with a lamination to greatly reduce risk of paint and liquid soaking through. Available in handy size ideal for smaller jobs.



**Economy**  
Multi-pack of dust sheets for multiple uses including floor and furniture covering during decoration.



**Stair Runner**  
High quality and cut to a convenient width to suit standard staircases avoiding need to fold which reduces risk of trips and falls.

Helps to protect from dust, dirt, paint splashes and spatter.

Product Code	Type	Length (m)	Width (mm)	Pack Qty (pcs)	Carton Qty (packs)
<b>PACK</b>					
CDS129	Professional	9 x 12	1.71	1	10
CDS1212	Professional	12 x 12	2.00	1	10
CDSL129	Laminated	9 x 12	1.59	1	10
CDSL63	Laminated	3 x 6	0.24	1	50
CDS129P3	Economy	9 x 12	4.20	3	9
CDS5243	Stair Runner	3 x 24	1.12	1	10
TYPE - PRO			SUB TYPE - PRO10		

## Plastic Sheets & Accessories

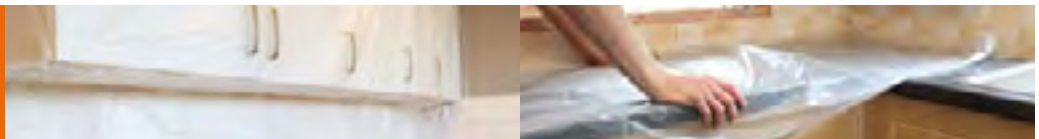

### Protective Cling Sheet

A 200m<sup>2</sup> static charged polythene dust sheet roll that clings to surfaces without the need of tape or adhesive. These static sheets attract dust and over-spray providing excellent protection during decorating and renovation works.



Plastic Sheet Cutter included



Product Code	Size (m)	Thickness (microns)	Pack Qty (pcs)	Carton Qty (packs)	Pallet Qty (packs)
<b>BOX</b>					
PCS504	50 x 4	8.5	1	6	72
TYPE - PRO			SUB TYPE - PRO06		

### Protective Sheet Cutter

Helps cut plastic sheet easily and safely.



Product Code	Box Qty (pcs)	Carton Qty (packs)
<b>BOX</b>		
PSCUTTER	50	25
TYPE - PRO		SUB TYPE - PRO07

### Protective Zipper Door

Provides a dust sealed temporary doorway for concealment of work areas. Transparent for safety and to allow light to pass through.

Caution: Polythene should not be used when hot paint stripping.

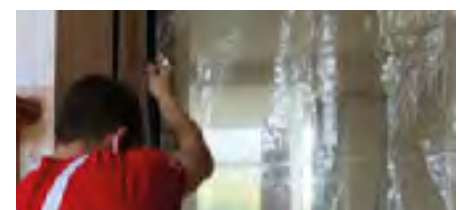

Product Code	Size (m)	Thickness (microns)	Pack Qty (pcs)	Carton Qty (packs)	Pallet Qty (packs)
<b>PACK</b>					
PZD	2.1 x 1.2	100	1	10	360
TYPE - PRO			SUB TYPE - PRO08		

## Polythene Dust Sheet

PDS43 - An economical way to protect possessions and furniture during decoration and renovation works.

PDS502 - Large waterproof polythene sheet for larger scale decoration and renovation works.

Caution: Polythene should not be used when hot paint stripping.



Product Code	Size (m)	Thickness (microns)	Pack Qty (pcs)	Carton Qty (packs)	Pallet Qty (packs)
<b>PACK / ROLL</b>					
PDS43	3.65 x 2.75	8	1	100	1800
PDS502	50 x 2	8	1	20	160
TYPE - PRO			SUB TYPE - PRO10		

## General Purpose Builders Sheet

Large plastic sheets with a thickness of 32 microns providing a waterproof protective barrier during decorating and building renovation work.



Product Code	Size (m)	Thickness (microns)	Pack Qty (pcs)	Carton Qty (packs)
<b>ROLL</b>				
DPS254	25 x 4	32	1	16
DPS504	50 x 4	32	1	16
TYPE - PRO		SUB TYPE - PRO05		

## Support Pole



The highly flexible adjustment make these telescopic supports perfect for drywall construction work. Also function on sloping roofs as the supports find a secure hold with their swivelling PVC contact pads.

Can also used for the quick and easy hanging of plastic sheeting to create sealed areas for dust and dirt retention in work areas on site. Robust design with an extendable range from 1.6m up to 2.9m.



- One-person assembly
- Safe working load - 50kg

Product Code	Size (m)	Pack Qty (pcs)	Carton Qty (packs)
<b>EACH</b>			
775101	1.6 - 2.9	2	10
TYPE - PRO		SUB TYPE - PRO09	

## Tarpaulin & Tie Downs

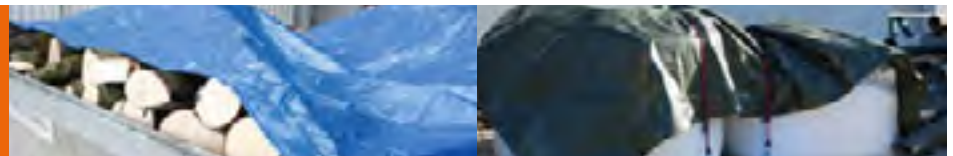

### Light & Heavy Duty Tarpaulin

Great for convenient covering of outdoor equipment and materials to protect from the elements.



Light Duty



Heavy Duty

- UV Treated for extended use outdoors
- Reinforced hem with polypropylene fibre rope
- Rust proof aluminium eyelets

Product Code	Size (m)	Mesh / Weave Count	Weight (gsm)	Pack Qty (pcs)	Carton Qty (packs)	Pallet Qty (packs)
<b>PACK</b>						
<b>HEAVY DUTY</b>						
TTH23	2 x 3	14 x 14	180+	1	18	450
TTH45	4 x 5	14 x 14	180+	1	5	125
TTH58	5 x 8	14 x 14	180+	1	2	50
<b>LIGHT DUTY</b>						
TTL23	2 x 3	8 x 8	80	1	40	1000
TTL45	4 x 5	8 x 8	80	1	12	300
TTL58	5 x 8	8 x 8	80	1	6	150
TYPE - PRO			SUB TYPE - PRO11			

### Tarpaulin Tie Down Clips



**NEW**



Provide instant anchor points when using bungee cords, guylines, tie downs or rope to secure tarpaulins, canopies and covers. Aggressive teeth bite and hold without damaging material.

Product Code	Length (mm)	Width (mm)	Pack Qty (pcs)	Carton Qty (packs)
<b>BAG</b>				
TTC10	80	40	10	50
TYPE - PRO		SUB TYPE - PRO15		

### Tarp Tie Down Bungee Balls



**NEW**



Multiple uses including: securing tarpaulins over frames such as market stalls, boat and vehicle covers, trampoline surrounds and covers. Can also be looped around items for bundling.

Product Code	Length (mm)	Pack Qty (pcs)	Carton Qty (packs)
<b>BAG</b>			
TTB10	230	10	50
TYPE - PRO		SUB TYPE - PRO15	



# Straps, Slings & Bungee Cords



## Ratchet Straps & Tie Down

### Cam Buckle Tie Down



Ideal for quickly securing light loads during transit or storage.

Tested to EN 12195-2

Product Code	W x L (mm x m)	Break Strength (kg)	Pack Qty (pcs)	Carton Qty (packs)
<b>PACK</b>				
<b>WORKING LOAD 122KG</b>				
5CBTD2	25 x 5	245	2	40
TYPE - PAD			SUB TYPE - PAD10	

### Standard Duty Strap



Ideal for quickly securing light loads during transit or storage.

Tested to EN 12195-2

Product Code	W x L (mm x m)	Break Strength (kg)	Pack Qty (pcs)	Carton Qty (packs)
<b>PACK</b>				
<b>S HOOK - WORKING LOAD 250KG</b>				
5RS2S	25 x 5	500	2	10
5RS4S	25 x 5	500	4	5
<b>J HOOK - WORKING LOAD 350KG</b>				
5RS2J	25 x 5	700	2	10
TYPE - PAD			SUB TYPE - PAD09	

### Endless Strap

**NEW**



Ideal for securing light duty loads during transit or storage. Endless design without hooks. Tested to EN 12195-2

Product Code	W x L (mm x m)	Break Strength (kg)	Pack Qty (pcs)	Carton Qty (packs)
<b>PACK</b>				
<b>WORKING LOAD 500KG</b>				
5RSNH	25 x 5	1000	2	10
TYPE - PAD			SUB TYPE - PAD09	

### Commercial Duty Strap



Ideal for quickly securing medium loads during transit or storage.

Tested to EN 12195-2

Product Code	W x L (mm x m)	Break Strength (kg)	Pack Qty (pcs)	Carton Qty (packs)
<b>PACK</b>				
<b>J HOOK - WORKING LOAD 1000KG</b>				
6RS2J	35 x 6	2000	2	5
TYPE - PAD			SUB TYPE - PAD09	

### Heavy Duty Strap



Ideal for quickly securing heavy loads during transit or storage.

Tested to EN 12195-2

Product Code	W x L (mm x m)	Break Strength (kg)	Pack Qty (pcs)	Carton Qty (packs)
<b>PACK</b>				
<b>J HOOK - WORKING LOAD 2500KG</b>				
5RS1J	50 x 5	5000	1	6
10RS1J	50 x 10	5000	1	5
15RS1J	50 x 15	5000	1	4
TYPE - PAD			SUB TYPE - PAD09	

## Lifting Slings

### 2 Tonne Lifting Sling



High quality durable flat lifting slings designed for the safe moving of heavy loads on site. Double stitched duplex layer for maximum durability with reinforced becket eye to ensure strength and longevity. Lightweight for ease of use.

Conforms to current regulations for safe and reliable use on site.



EN 1492-1

### 3 Tonne Lifting Sling



Product Code	Width x Length (mm x m)	Pack Qty (pcs)	Carton Qty (packs)
<b>PACK</b>			
<b>WORKING LOAD 2000KG</b>			
723485	60 x 2	1	16
723413	60 x 3	1	12
TYPE - PAD		SUB TYPE - PAD12	

Product Code	Width x Length (mm x m)	Pack Qty (pcs)	Carton Qty (packs)
<b>PACK</b>			
<b>WORKING LOAD 3000KG</b>			
723604	90 x 2	1	10
723684	90 x 3	1	9
TYPE - PAD		SUB TYPE - PAD12	

Please note: A safety factor of 7:1 has been applied in order to calculate the stated maximum working loads. Working loads should never be exceeded.

## Bungee Cords



Ideal for quickly securing light loads during transit or storage.

- Bungee Cords tested to BS AU 258
- Mixed Bungee Cords tested to BS AU 258 (Excluding size 4.5mm x 25cm)

Product Code	Ø (mm)	Length (cm)	Working Load (kg)	Pack Qty (pcs)	Carton Qty (packs)
<b>BAG - 2 PCS</b>					
60BUN	8.0	60	30	2	100
100BUN	8.0	100	30	2	100
<b>TUBE - 8 PCS MIXED</b>					
BUNMIX8	-	-	-	8	25
	4.5	25	N/A	4	
	8.0	60	30	2	
	8.0	80	30	2	
<b>TUBE - 20 PCS MIXED</b>					
BUNMIX20	-	-	-	20	10
	4.5	25	N/A	4	
	8.0	45	30	4	
	8.0	50	30	4	
	8.0	60	30	4	
	8.0	75	30	4	
TYPE - PAD			SUB TYPE - PAD11		



# Safety & Refuse

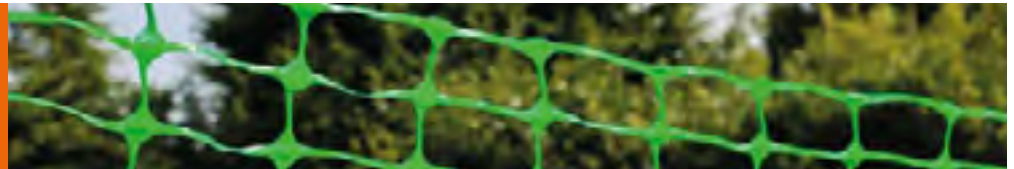

## Barrier Fencing & Pins

**NEW COLOUR**



Temporary fencing made from a durable, weatherproof and reusable plastic. Suitable for cordoning off restricted areas.

The barrier fencing pin is frequently used with barrier fencing, warning tape or rope to fence off building work and other 'off-limit' areas on site.

Zinc plated pins for corrosion resistance.



Product Code	Colour	Length (m)	Height (m)	Pack Qty (pcs)	Carton Qty (packs)
<b>BARRIER FENCING</b>					
<b>PACK</b>					
775248	Orange	50	1	1	20
775123	Green	50	1	1	20
TYPE - PRO SUB TYPE - PRO13 / PRO14					

Product Code	Length (m)	Height (m)	Diameter (mm)	Pack Qty (pcs)	Carton Qty (packs)
<b>PIN</b>					
<b>BOX</b>					
775685	-	1.2	10	10	10
TYPE - PRO SUB TYPE - PRO13 / PRO14					

## A-Frame Safety Signs

Light weight safety signs with double sided printing, for temporary marking of potential hazards in the workplace or in public areas. Foldable for storage.

Size  
H x W x D (mm) -  
610 x 300 x 30



Product Code	Type	Pack Qty (pcs)	Carton Qty (packs)	Pallet Qty (packs)
<b>BAG</b>				
747321	Cleaning in Progress	1	20	80
747015	Slippery Surface	1	20	80
747987	Trip Hazard	1	20	80
747654	Wet Paint	1	20	80
747159	Work in Progress	1	20	80
747753	Wet Floor	1	20	80
747852	Keep Out	1	20	80
747246	Hazardous Area	1	20	80
TYPE - SHS SUB TYPE - SHS01				

## Sandbags

**NEW**

When filled with sand, sandbags provide an effective way to prevent or reduce the risk of flood damage. Also used for temporary weighing down of road signs, gazebos and tarpaulins.

- String at top for convenient tying off
- Ideal for temporary wall building to prevent flood damage
- Reusable

PP Sand Bag



Hessian Sand Bag

- Biodegradable



Product Code	Type	Colour	Size (cm)	Pack Qty (pcs)
<b>PACK</b>				
775666	Polypropylene (PP)	White	33.5 x 80	50
775174	Hessian	Natural	34 x 75	50
TYPE - PRO SUB TYPE - PRO16				

## Heavy Duty Rubble Sacks



Manufactured from strong and durable tear resistant 11 x 10 woven polypropylene, these reusable sacks are available in two sizes and have draw string tops for tying off.

Ideal for use on site for building and landscaping waste.

Product Code	Size (cm)	Weight (gsm)	Weight (g)	Pack Qty (pcs)	Carton Qty (packs)
<b>PACK</b>					
SRSHD6090	60 x 90	60	70/pce	10	35
SRSHD80120	80 x 120	60	132/pce	10	15
TYPE - PRO SUB TYPE - PRO12					

## Rubble Sacks



Convenient and compact rolls of 30 sacks, manufactured from recycled polyethylene.

Ideal for general waste on building sites and landscaping work. A quarter pallet option provides excellent shop floor display for maximising sales opportunities.

Product Code	Size (mm)	Thickness (microns)	Pack Qty (pcs)	Carton Qty (packs)	Pallet Qty (packs)
<b>ROLL</b>					
SRS30	535 x 820	85	30	8	240
TYPE - PRO SUB TYPE - PRO12					

# First Aid



## BS Workplace First Aid Kit



BS8599-1 is the first new standard for statutory First Aid Kits in the workplace since 1997.

These kits reflect the changes in both workplace practice and risks, making them demonstrably more 'fit for purpose' in today's environment, when compared to the old HSE kits.

Durable and stylish polypropylene case. Wall mountable with integrated bracket.

LOW RISK (eg. shops, offices)		HIGH RISK (eg. construction sites, workshops)	
SMALL	Less than 25 people	SMALL	Less than 5 people
MEDIUM	25 - 100 people	MEDIUM	2 - 25 people
LARGE	1 kit per 100 people	LARGE	1 kit per 25 people

Product Code	Description	Carton Qty (packs)
<b>CASE</b>		
MED330	Small Workplace First Aid Kit	10
MED343	Medium Workplace First Aid Kit	10
MED348	Large Workplace First Aid Kit	5
TYPE - FAD		SUB TYPE - FAD01

## HSE Workplace First Aid Kit



Content based on 1997 Approved Code of Practice

Durable polypropylene box with green safety clips, integrated carry handle, and a secure airtight lid provides protection from dust and water.

Product Code	Description	Carton Qty (packs)
<b>CASE</b>		
MED112	10 Person Workplace First Aid Kit	10
MED113	20 Person Workplace First Aid Kit	10
MED114	50 Person Workplace First Aid Kit	5
TYPE - FAD		SUB TYPE - FAD01

## Eye Care



Deluxe eye wash station with eye pods and insert. Durable and stylish polypropylene case. Wall mountable with integrated bracket.

Fast and effective treatment. Meets current hse regulations.

Product Code	Description	Carton Qty (packs)
<b>CASE</b>		
MED904	Deluxe Eye Wash Station	10
<b>BOTTLE / BOX</b>		
MED900	Saline Eye Wash - Bottle of 500ml	10
MED901	Eye Wash Pods 20ml - Box of 25	10
TYPE - FAD		SUB TYPE - FAD01

## Heavy Bleed & Burns Kit



Specifically designed to provide rapid and effective treatment to the kind of serious injuries trades people may face on site. Includes a major bleed trauma dressing and sterile burn dressings.

Durable and Vstylish polypropylene case. Wall mountable with integrated bracket.

Product Code	Description	Carton Qty (packs)
<b>CASE</b>		
MEDX050	Heavy Bleed & Burns Kit	10
TYPE - FAD		SUB TYPE - FAD01

## Car & Van First Aid Kit



Components have been specifically selected for ease of use and for coping with minor road traffic accident injuries without the need for training and during the critical period prior to the arrival of emergency services.

Contained in a convenient soft zip bag, this kit should be considered as essential in every car, taxi, van and truck.

Product Code	Description	Carton Qty (packs)
<b>BAG</b>		
MED3014	Car and Van First Aid Kit	10
TYPE - FAD	SUB TYPE - FAD01	NOTE: MAX. 8 PASSENGERS

## Accident Book



A mandatory requirement for the workplace. These data protection compliant accident books have clear instructions on use and guidance for record keeping included.

Product Code	Description	Number of pages	Pack Qty (pcs)	Carton Qty (Packs)
<b>PACK</b>				
MED999	Accident Book	40	5	7
TYPE - FAD				SUB TYPE - FAD01

## Plasters

Handy packs of washproof, fabric and heavyweight fabric plasters with stretch and cushioning for maximum comfort and protection. Individually wrapped and sterile.

### Washproof Plasters



Product Code	Pack Qty (pcs)	Carton Qty (packs)
<b>BOX</b>		
MED536	100	10
TYPE - FAD		SUB TYPE - FAD01

### Fabric Plasters



Product Code	Pack Qty (pcs)	Carton Qty (packs)
<b>BOX</b>		
MED516	100	10
TYPE - FAD		SUB TYPE - FAD01

### Heavyweight Fabric Plasters



Product Code	Pack Qty (pcs)	Carton Qty (packs)
<b>BOX</b>		
MED2210	100	5
TYPE - FAD		SUB TYPE - FAD01

# Ear Protection

The ear protector chosen should provide enough attenuation to protect your hearing but consideration should also be given to its compatibility with other items of PPE being worn such as safety glasses.

Attenuation is the process of losing noise energy and it is the attenuation data that should be examined when selecting appropriate ear defenders.

The Single Number Rating or SNR value can be used to compare the level of noise attenuation offered by different hearing protectors.

The higher the SNR, the higher the level of noise attenuation or protection is provided by the hearing protection.

To determine acoustic pressure on your ears, subtract the SNR value from the average noise level that has been measured during the risk assessment. For example:

TIMCO's foldable ear defenders (770390) have a SNR of 30.4 dB.

**Warning:** Reducing sound to a lower level than normal talking may be a safety risk.



## Ear Defenders

### Foldable Ear Defenders



**SNR 30.4 dB** Noise level reduction  
 CE Approved to EN 352-1:2002

Ideal for long comfortable use in medium sound environments.

Product Code	Size	Pack Qty (pairs)	Carton Qty (packs)
<b>BLISTER PACK</b>			
770390	One Size	1	6
TYPE - EAR		SUB TYPE - EAR02	

### Ear Defenders



**SNR 27.6 dB** Noise level reduction  
 CE Approved to EN 352-1:2002

An economic cupped ear defender, ideal for periodical wear when in low sound environments.

Product Code	Size	Pack Qty (pairs)	Carton Qty (packs)
<b>BAG</b>			
770111	One Size	1	10
TYPE - EAR		SUB TYPE - EAR02	

## Disposable PU Ear Plugs

Tapered body for easy and precise fit  
 Slow expansion ensures consistent performance and comfortable fit



**SNR 34.0 dB** Noise level reduction  
 CE Approved to EN 352-2:2002

Product Code	Size	Pack Type	Pack Qty (pairs)	Carton Qty (packs)
<b>PACK / JAR / BOX</b>				
770191	One Size	Pack	5	50
770867	One Size	Jar	50	48
770049	One Size	Box	200	10
TYPE - EAR		SUB TYPE - EAR01		

# Knee Pads

## Professional Knee Pads

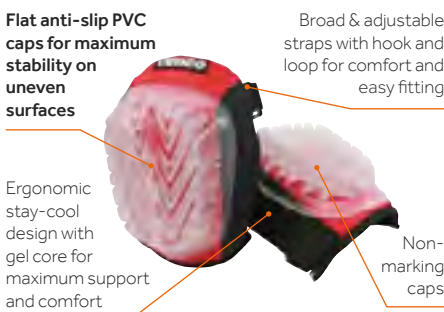

These Professional knee pads mould around your knees to give ultimate protection and comfort for long periods of time.

**CE Approved EN 14404: 2004 Type 1**

Product Code	Size	Pack Qty (pairs)	Carton Qty (packs)
<b>BOX</b>			
770789	One Size	1	15
TYPE - KNE		SUB TYPE - KNE01	

## Knee Pads



These knee pads mould around your knees to give ultimate protection and comfort for long periods of time.

**CE Approved EN 14404: 2004 Type 1**

Product Code	Size	Pack Qty (pairs)	Carton Qty (packs)
<b>BOX</b>			
770456	One Size	1	16
TYPE - KNE		SUB TYPE - KNE01	

## Knee Pad Inserts



Durable foam knee pad inserts for standard pocketed trousers and overalls.

**CE Approved EN 14404: 2004 Type 2**

Product Code	Size	Pack Qty (pairs)	Carton Qty (packs)
<b>PACK</b>			
770301	One Size	1	20
TYPE - KNE		SUB TYPE - KNE01	



# Eye Protection

Safety eyewear is an important form of PPE that protects one of the most important yet exposed parts of the body. Understandably, the European Standards covering eye protection are some of the most comprehensive of all those dealing with any item of PPE.

It's important that the user considers the environment and level of risks involved before selecting the correct eyewear item.

To assist with the selection, all PPE is required to be marked with the specification of its standard, with lettering/numbering acting as an indication of capability.

In accordance with TIMCO's quality standards we only supply glasses with the highest class 1 optical quality lenses. Meaning that there is no optical distortion and they are suitable for long periods of wear.

Example of code on lens

CE 2C - 1.2 1 F

Radiation Protection EN 170 / EN 172		Light Transmission		Optical Quality (Class)		Mechanical Strength EN 166	
2	UV Protection (EN170). The number 2 indicates the filter may effect colour recognition.	1.2	74.4% – 100%	1	High quality for regular use.	B	Medium energy impact. Resists a 6mm/0.86g ball travelling at 120m/s.
2C or 3	UV Protection (EN170). The number 2C (previously 3) indicates the filter allows good colour recognition.	1.7	43.2% – 58.1%	2	Medium quality for occasional use.	F	Low energy impact. Resists a 6mm/0.86g ball travelling at 45 m/s.
5	Solar Protection (EN172). i.e. 100% UV sun glare protection with no infrared (IR) protection.	2.5	17.8% – 29.1%	3	Low quality for rare use.	K	Resistance to surface damage by fine particles. Often referred to as Anti-scratch.
6	Solar Protection (EN172). i.e. 100% UV sun glare protection with infrared (IR) protection.	3.1	8.0% – 17.8%			N	Resistance to lens fogging. Often referred to as Anti-fog or Anti-mist.
						T	Resistance to high speed particles at extremes of temperature, -5°C to +55°C (can be seen in conjunction with F,B and A).

EN 170 : Ultraviolet (UV) filters  
EN 172 : Solar radiation filters

## Premium & Sports Style Safety Glasses

### Sports Style Safety Glasses with Foam Dust Guard - Full Frame

Detachable foam gasket for reduced dust ingress

Anti-scratch lens coating

Moulded silicone comfort lining to temple & nose pad

Includes microfibre storage pouch



Wide vision polycarbonate lenses

A designer pair of safety glasses built for strength, comfort and flexibility. The unique detachable foam gasket around the frame reduces the risk of dust, dirt and liquid ingress whilst providing additional comfort to the user. The soft rubber lining on the arms and around the nose give extra comfort and grip around the ears, temple and nose when worn for long periods. The clear lenses provide excellent visibility and are treated with an advanced micro coating to prevent scratches.



Product Code	Lens Colour	Pack Qty (pcs)	Carton Qty (packs)
<b>BOX</b>			
770123	Clear	1	12
TYPE - EYE		SUB TYPE - EYE01	

Optical Class 1  
Grade F Lens  
UV Protection

CE Approved  
EN 166 F  
EN 170

### Sports Style Safety Glasses with Adjustable Temples - Full Frame

Moulded silicone comfort lining to temple & nose pad

Anti-scratch lens coating

Multi-adjustable temples

Includes microfibre storage pouch



Wide vision polycarbonate lenses

A designer pair of safety glasses built for strength and comfort. The soft rubber dual function adjustable arms and temples guarantee optimal fit and comfort on all head shapes and sizes. The rubber nose piece gives added comfort in all conditions around the bridge of the nose.



Product Code	Lens Colour	Pack Qty (pcs)	Carton Qty (packs)
<b>BOX</b>			
770401	Clear	1	12
TYPE - EYE		SUB TYPE - EYE01	

Optical Class 1  
Grade F Lens  
UV Protection

CE Approved  
EN 166 F  
EN 170

### Premium Safety Glasses - Half Frame

Anti-scratch lens coating

Moulded silicone comfort lining to temple & nose pad

Wide vision polycarbonate lenses

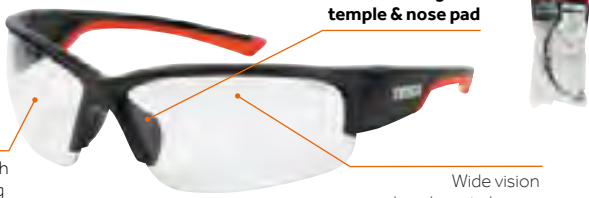

Robust and modern safety glasses giving ultimate comfort and vision on all head shapes and sizes. The soft rubber lining on the arms and around the nose give extra comfort and grip around the ears, temple and nose when worn for long periods. The clear lenses provide excellent visibility and are treated with an advanced micro coating to prevent scratches.



Product Code	Lens Colour	Pack Qty (pcs)	Carton Qty (packs)
<b>BAG</b>			
770379	Clear	1	12
TYPE - EYE		SUB TYPE - EYE01	

Optical Class 1  
Grade F Lens  
UV Protection

CE Approved  
EN 166 F  
EN 170

### Slimfit Safety Glasses - Full Clear Frame

Anti-scratch lens coating

Moulded silicone comfort lining to temple & nose pad

Wide vision polycarbonate lenses

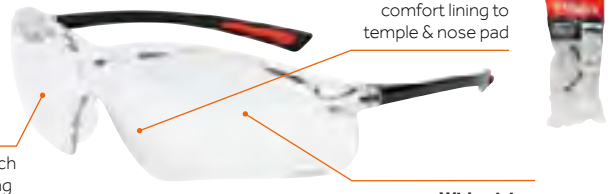

Modern slim fit safety glasses with additional side protection. Ergonomically designed to give ultimate comfort and protection on all head shapes and sizes. The soft rubber lining on the arms and around the nose give extra comfort and grip around the ears, temple and nose when worn for long periods. The clear lenses provide excellent visibility and are treated with an advanced micro coating to prevent scratches.



Product Code	Lens Colour	Pack Qty (pcs)	Carton Qty (packs)
<b>BAG</b>			
770505	Clear	1	12
TYPE - EYE		SUB TYPE - EYE01	

Optical Class 1  
Grade F Lens  
UV Protection

CE Approved  
EN 166 F  
EN 170



**Safety Glasses**

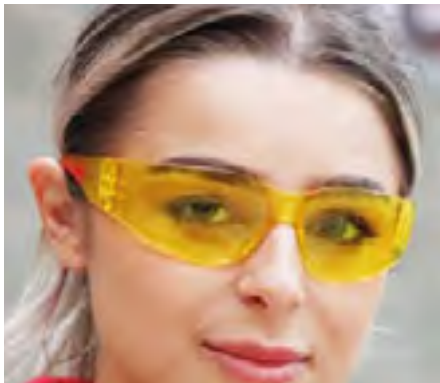

**Clear Lens**

For most applications conducted in normal light conditions.

**Amber Lens**

For brighter vision and improved contrast when working in poor light or overcast weather.

**Smoke Lens**

For bright light or sunny conditions to maintain vision but protect the eyes from sun glare.

**Comfort Safety Glasses**

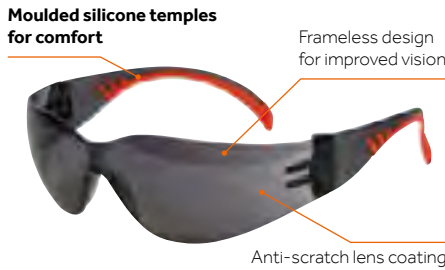

Lightweight safety glasses with soft overmold to arms giving extra comfort and grip around the ears and temples when worn for long periods. Available in three lens types to suit varying light conditions of indoor and outdoor workplace environments. Treated with an advanced coating to prevent scratches.



**Optical Class 1** | **CE Approved**  
**Grade F Lens** | **EN 166 F**  
**UV Protection** | **EN 170 / EN 172 (Smoke lens)**

Product Code	Lens Colour	Pack Qty (pcs)	Carton Qty (packs)
<b>BAG</b>			
770999	Clear	1	12
770010	Amber	1	12
770618	Smoke	1	12
TYPE - EYE		SUB TYPE - EYE01	

**Standard Safety Glasses**

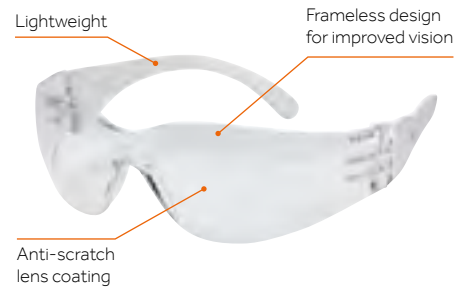

Lightweight economic safety glasses designed to be comfortable and secure. Available in three lens types to suit varying light conditions of indoor and outdoor workplace environments. Treated with an advanced coating to prevent scratches.



**Optical Class 1** | **CE Approved**  
**Grade F Lens** | **EN 166 F**  
**UV Protection** | **EN 170 / EN 172 (Smoke lens)**

Product Code	Lens Colour	Pack Qty (pcs)	Carton Qty (packs)
<b>BAG</b>			
770023	Clear	1	12
770340	Amber	1	12
770800	Smoke	1	12
TYPE - EYE		SUB TYPE - EYE01	

**Overspecs**

**Slimfit Overspecs**

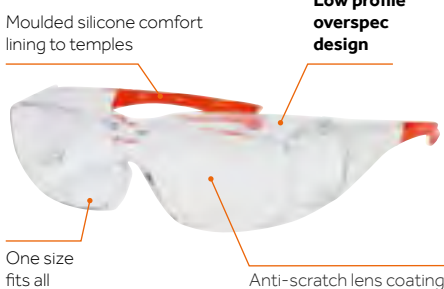

Comfortable overspec glasses to provide a low profile solution when used with spectacles. The arms are extremely flexible and the soft rubber lining gives extra comfort and grip around the ears and temples when worn for long periods. Treated with an advanced micro coating to prevent scratches.



**Optical Class 1** | **CE Approved**  
**Grade F Lens** | **EN 166 F**  
**UV Protection** | **EN 170**



Product Code	Lens Colour	Pack Qty (pcs)	Carton Qty (packs)
<b>BAG</b>			
770753	Clear	1	10
TYPE - EYE		SUB TYPE - EYE01	

**Overspecs**

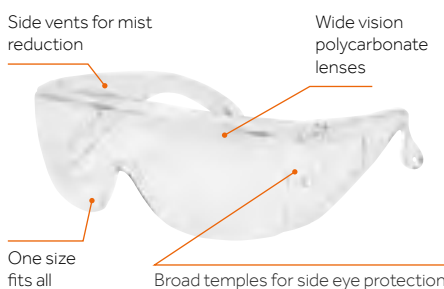

An economic overspec designed to give front and side eye protection. Ideal for short term usage such as visiting factories and workshops. Can also be worn as standard safety glasses. Side vented to reduce mist build-up and the curved arms give increased comfort.



**Optical Class 1** | **CE Approved**  
**Grade F Lens** | **EN 166 F**  
**UV Protection** | **EN 170**



Product Code	Lens Colour	Pack Qty (pcs)	Carton Qty (packs)
<b>BAG</b>			
770159	Clear	1	12
TYPE - EYE		SUB TYPE - EYE01	

**Wraparound Safety Glasses**

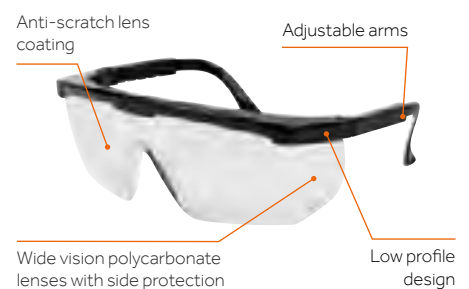

Lightweight wraparound glasses designed to give enhanced peripheral vision whilst also increasing side protection. The arms are adjustable to accommodate all head sizes and the lenses are treated with an advanced coating to prevent scratches.



**Optical Class 1** | **CE Approved**  
**Grade F Lens** | **EN 166 F**  
**UV Protection** | **EN 170**



Product Code	Lens Colour	Pack Qty (pcs)	Carton Qty (packs)
<b>BAG</b>			
770571	Clear	1	12
TYPE - EYE		SUB TYPE - EYE01	

# Safety Goggles & Face Shield



## Safety Goggles

### Sport Style Safety Goggles

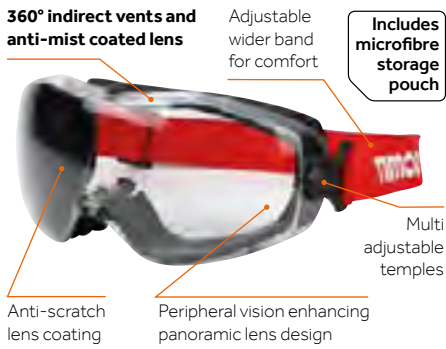

A low profile high end pair of goggles, designed to ensure the user has consistent performance for long periods of wear. The extra soft rubber gasket moulds around the face to give extreme comfort and ultimate protection from liquids, vapours, chemicals and dust. The curved single piece shock and impact resistant lens maximises peripheral vision.



**Optical Class 1**  
Grade B KN Lens  
UV Protection

**CE Approved**  
EN 166 3 4 B (Frame)  
EN 166/EN170 (Lens)



Product Code	Lens Colour	Pack Qty (pcs)	Carton Qty (packs)
770963	Clear	1	6
TYPE - EYE			
SUB TYPE - EYE02			

### Premium Safety Goggles

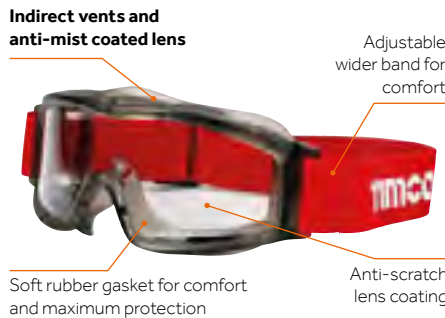

A slim line mid range goggle designed to protect the eyes from impact, dust, chemicals, paints and liquids.

The low profile design ensure consistent comfort around the face when worn for long periods of time. The extra wide adjustable head strap gives additional comfortable around the head and prevents the goggles from slipping when used with a safety helmet or bump cap.



**Optical Class 1**  
Grade BT Lens  
UV Protection

**CE Approved**  
EN 166 F (Frame)  
EN 166 3 4 BT/EN 170 (Lens)



Product Code	Lens Colour	Pack Qty (pcs)	Carton Qty (packs)
770258	Clear	1	10
TYPE - EYE			
SUB TYPE - EYE02			

### Safety Goggles

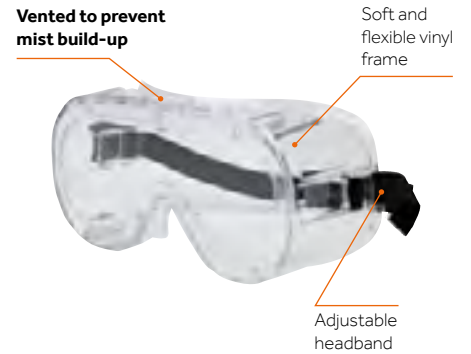

An economic goggle designed to protect the eyes from impact, dust and liquids. Ideal for short term usage such as sanding, spraying and cleaning. The indirect vents will prevent mist build-up and liquid ingress.



**Optical Class 1**  
Grade F Lens  
UV Protection

**CE Approved**  
EN 166 F (Frame)  
EN 166 1 F / EN 170 (Lens)



Product Code	Lens Colour	Pack Qty (pcs)	Carton Qty (packs)
770147	Clear	1	10
TYPE - EYE			
SUB TYPE - EYE02			

## Face Shield



Lightweight flip-up detachable full face visor with an integral brow guard. Sold with an adjustable head harness to fit all head shapes and sizes.

**Optical Class 1**  
Grade B Shield

**CE Approved**  
EN 166 3 B

Product Code	Size	Pack Qty (pcs)	Carton Qty (packs)
770654	One Size	1	24
TYPE - FCV			
SUB TYPE - FCV01			

• CE Approved to EN 166 3 B

## Safety Masks

Our range of dust masks provide clean and safe air when working in potentially hazardous conditions.

Designed using the very latest technology in filtration material, the masks prevent harmful particles passing through.

Often an essential requirement of certain workplaces, all TIMCO masks are fitted with easy-breath exhalation valves and there are various filter protection levels in the range.

**FFP3** - Highest Level  
**FFP2** - Moderate Level



### FFP3 Masks With Valves

**Assigned Protection Factor (APF): 20**  
Equivalent to 99% Filter efficiency.

**CE Approved to EN149**

Protects against medium to high levels of dust from home repair, woodworking, construction or water based mist.

#### Moulded

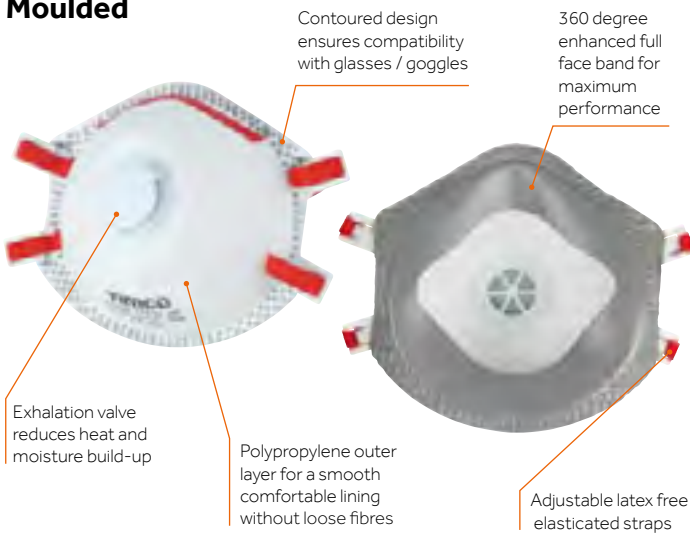

A medium to high protection moulded mask with a 360° full face soft band for optimum comfort, fit and breathing.

Product Code	Size	Pack Qty (pcs)	Carton Qty (packs)
<b>BOX</b>			
770525	One Size	5	20
<b>BAG</b>			
770120	One Size	3	50
TYPE - FCV		SUB TYPE - FCV02	

**Max Comfort** | **360° enhanced full face band**

### FFP2 Masks With Valves

**Assigned Protection Factor (APF): 10**  
Equivalent to 94% Filter efficiency.

**CE Approved to EN149**

Protects against low to medium levels of dust from home repair or water based mist.

#### Moulded

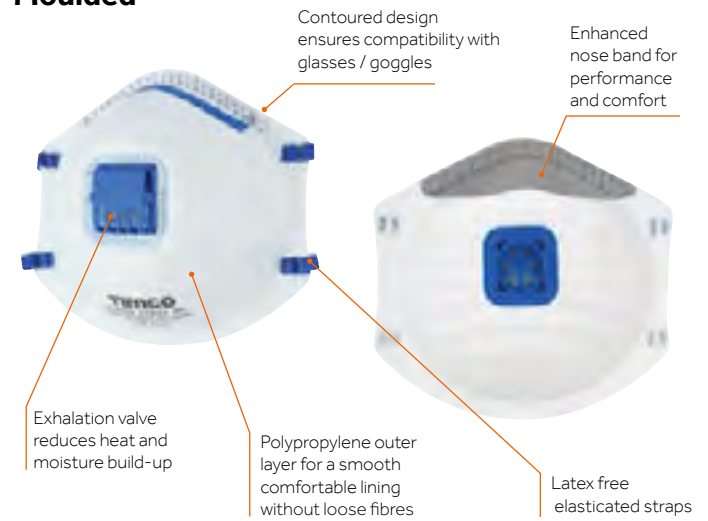

A low to medium protection moulded mask with an enhanced soft nose band for improved comfort, fit and breathing.

Product Code	Size	Pack Qty (pcs)	Carton Qty (packs)
<b>BOX</b>			
770359	One Size	10	20
<b>BAG</b>			
770045	One Size	3	50
TYPE - FCV		SUB TYPE - FCV02	

**Improved Comfort** | **Enhanced nose band**

### Fold Flat



A medium to high protection folding mask for comfort, fit and breathing. Foldable for convenience.

Product Code	Size	Pack Qty (pcs)	Carton Qty (packs)
<b>BOX</b>			
770834	One Size	10	20
<b>BAG</b>			
770008	One Size	3	50
TYPE - FCV		SUB TYPE - FCV02	

**Max Comfort** | **Soft foam nose band for comfort**

### Fold Flat



A low to medium protection folding mask with a soft nose band for improved comfort, fit and breathing. Foldable for convenience.

Product Code	Size	Pack Qty (pcs)	Carton Qty (packs)
<b>BOX</b>			
770919	One Size	10	20
<b>BAG</b>			
770737	One Size	3	50
TYPE - FCV		SUB TYPE - FCV02	

**Improved Comfort** | **Soft foam nose band for comfort**



## Gloves

A comprehensive range of work gloves designed for the toughest and harshest year-round domestic, work site and commercial environments.

Constructed from a variety of innovative materials, the TIMCO safety glove range has been designed to cover multiple environments and applications where there is risk of serious injury such as cuts, abrasion and splinters. Used to provide general comfort and cushioning when regularly handling rough or heavy materials, gloves will enhance grip on hand held equipment to ensure a safe, smooth control and operation of machinery and tools.

### Coloured size guide:



All TIMCO's gloves are CE approved

**CE** CAT II - Intermediate Risk  
EN388 EN ISO 21420

### Glove rating key:

0 = Abrasion Rating 0-4  
0 = Cut Rating 0-5  
0 = Tear Rating 0-4  
0 = Puncture Rating A-F  
X



## High Cut Gloves

PU Coated HPPE Fibre with Glass Fibre Gloves

High anti cut protection level C



Provides a high level of cut and puncture resistance whilst giving excellent grip. Ideal for environments where there is a high risk of cut and puncture.



4 = Abrasion  
X = Cut  
4 = Tear  
2 = Puncture  
C = EN ISO 13997

Product Code	Size	Pack Qty (pairs)	Carton Qty (packs)
<b>PACK</b>			
770885	Medium	1	12
770745	Large	1	12
770228	X Large	1	12
TYPE - GLO		SUB TYPE - GLO08	

## Medium Cut Gloves

PU Coated HPPE Fibre with Glass Fibre Gloves

Medium anti cut protection level B

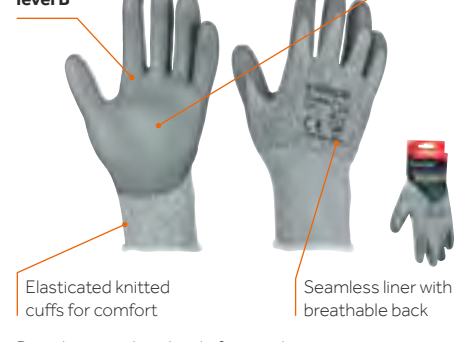

Provides a medium level of cut and puncture resistance whilst giving excellent grip and dexterity. Ideal for environments where there is a medium risk of cut and puncture.



4 = Abrasion  
X = Cut  
4 = Tear  
2 = Puncture  
B = EN ISO 13997

Product Code	Size	Pack Qty (pairs)	Carton Qty (packs)
<b>PACK</b>			
770209	Medium	1	12
770040	Large	1	12
770715	X Large	1	12
TYPE - GLO		SUB TYPE - GLO08	

## Toughlight Grip Gloves

Sandy Latex Coated Polyester Gloves

Sandy textured latex coating for high anti-slip

Ergonomic fit for high dexterity



A highly flexible and extremely comfortable glove. Excellent breathability with good grip and anti-slip properties.



2 = Abrasion  
1 = Cut  
3 = Tear  
1 = Puncture

Product Code	Size	Pack Qty (pairs)	Carton Qty (packs)
<b>PACK</b>			
770558	Medium	1	12
770847	Large	1	12
770347	X Large	1	12
TYPE - GLO		SUB TYPE - GLO03	

## Secure Grip Gloves

Smooth Nitrile Foam Coated Polyester Gloves

Smooth textured nitrile foam coating for a secure grip in wet

Lightweight design



Designed to give excellent grip. A supple, lightweight glove giving a secure grip in wet, dry & oily conditions whilst not impeding dexterity.



4 = Abrasion  
1 = Cut  
2 = Tear  
1 = Puncture

Product Code	Size	Pack Qty (pairs)	Carton Qty (packs)
<b>PACK</b>			
770846	Medium	1	12
770716	Large	1	12
770944	X Large	1	12
TYPE - GLO		SUB TYPE - GLO07	

## Durable Grip Gloves

Excellent dexterity for precise or delicate work

Lightweight ergonomic design

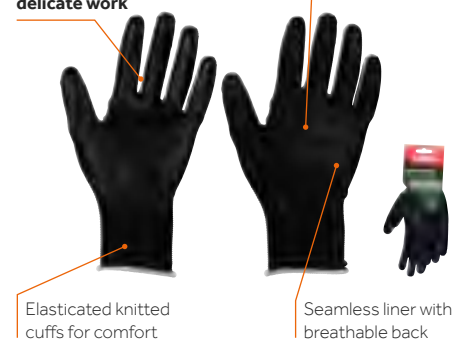

Designed for precision work. This tough, tight fitting and durable glove is ideal when handling small components.



3 = Abrasion  
1 = Cut  
3 = Tear  
1 = Puncture

Product Code	Size	Pack Qty (pairs)	Carton Qty (packs)
<b>PACK</b>			
770249	Medium	1	12
770736	Large	1	12
770649	X Large	1	12
TYPE - GLO		SUB TYPE - GLO06	



## Light Grip Gloves

### Crinkle Latex Coated Polyester Gloves

Crinkle textured coating for strong grip

Tight fit for dexterity



Elasticated knitted cuffs for comfort

Seamless liner with breathable back

A strong general purpose glove with excellent grip and durability. Tight fitting for improved dexterity.



2 = Abrasion  
1 = Cut  
3 = Tear  
1 = Puncture

Product Code	Size	Pack Qty (pairs)	Carton Qty (packs)
<b>PACK</b>			
770852	Medium	1	12
770164	Large	1	12
770746	X Large	1	12
TYPE - GLO		SUB TYPE - GLO02	

## Eco-Grip Gloves

### Crinkle Latex Coated Polycotton Gloves

Crinkle textured coating for a strong grip



Elasticated knitted cuffs for comfort

Seamless liner with breathable back

An economic general use glove with good grip ideal for construction, manufacturing, landscaping, warehousing, farming and many more.

2 = Abrasion  
1 = Cut  
2 = Tear  
1 = Puncture

Product Code	Size	Pack Qty (pairs)	Carton Qty (packs)
<b>PACK</b>			
770226	Medium	1	12
770194	Large	1	12
770667	X Large	1	12
TYPE - GLO		SUB TYPE - GLO01	



Multi-Pack Available



Product Code	Size	Pack Qty (pairs)	Carton Qty (packs)
<b>MULTI-PACK</b>			
770583	Medium	12	10
770189	Large	12	10
770524	X Large	12	10
TYPE - GLO		SUB TYPE - GLO01	

## Warm Grip Gloves

### Crinkle Latex Coated Polyester Gloves

Crinkle textured coating for a strong grip

Ideal for outdoor or cold temperatures



Elasticated knitted cuffs for comfort

Seamless liner with breathable back

Strong general purpose glove with excellent thermal insulation, durability and grip. Ideal for the colder months or in temperature controlled warehouses.



2 = Abrasion  
1 = Cut  
3 = Tear  
1 = Puncture

Product Code	Size	Pack Qty (pairs)	Carton Qty (packs)
<b>PACK</b>			
770826	Medium	1	12
770496	Large	1	12
770766	X Large	1	12
TYPE - GLO		SUB TYPE - GLO05	

## Waterproof Grip Gloves

### Sandy Nitrile Foam Coated Polyester Gloves

Sandy textured nitrile foam coating for secure grip in wet

All season use



Elasticated knitted cuffs for comfort

Double dip process for full hand water resistance

A waterproof, flexible and durable glove designed to grip most surfaces when wet. Ideal when working outdoors or in damp environments.



4 = Abrasion  
1 = Cut  
2 = Tear  
1 = Puncture

Product Code	Size	Pack Qty (pairs)	Carton Qty (packs)
<b>PACK</b>			
770446	Medium	1	12
770775	Large	1	12
770485	X Large	1	12
TYPE - GLO		SUB TYPE - GLO04	

## PVC Grip Gloves

### PVC Coated Cotton Interlock Gloves

Fully waterproof up to wrist

Cotton liner for comfort



Elasticated knitted cuffs for comfort

Designed to resist water, most liquids and oils

Fully waterproof glove, up to the wrist with a soft cotton knit for comfort and excellent protection against a range of substances, chemicals and oils.



3 = Abrasion  
1 = Cut  
2 = Tear  
1 = Puncture

Product Code	Size	Pack Qty (pairs)	Carton Qty (packs)
<b>PACK</b>			
770690	X Large	1	12
TYPE - GLO		SUB TYPE - GLO09	

## PVC Gauntlets

### PVC Coated Cotton Interlock Gloves

Fully waterproof



High abrasion resistance

Designed to resist water, most liquids and oils

Fully waterproof glove, excellent protection against a range of substances, chemicals and oils.



3 = Abrasion  
1 = Cut  
2 = Tear  
1 = Puncture

Product Code	Size	Pack Qty (pairs)	Carton Qty (packs)
<b>PACK</b>			
770333	X Large	1	12
TYPE - GLO		SUB TYPE - GLO09	

## Nitrile Gloves

NEW

### Industrial grade (Non-medical)

Strong and economical, these disposable nitrile gloves are ideal for light work when handling certain chemicals, oils, paints, dirt and grime. Also provides protection against bacteria, fungi, viruses and liquids. Latex free.

Textured fingertips for enhanced grip

Latex free, 100% Nitrile



Powder free

High dexterity

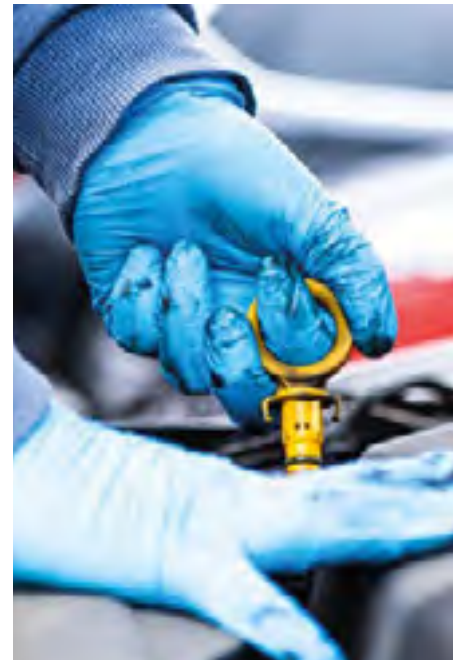

Product Code	Size	Pack Qty (pcs)	Carton Qty (packs)
<b>BOX</b>			
770009	Medium	100	10
770691	Large	100	10
770118	X Large	100	10
TYPE - GLO		SUB TYPE - GLO10	



### Coveralls

#### Cat III Type 5 / 6 Coverall





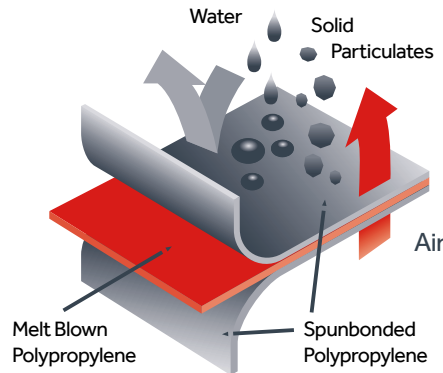

A Cat 3 Type 5/6 SMS protective disposable coverall with hood gives ultimate protection against substances such as vapours, asbestos, paint, dust, spray and splatter.

- Head to ankle protection
- Two way zip
- Tape seal over zip
- Latex & silicone free
- Elasticated hood and cuffs (hands & ankles)

#### SMS triple layer fabric for enhanced protection



**CE 0624**

	Type 5: EN ISO 13982 - 1 Particulate Protection		Class 1: EN 1073 - 2 Barrier to radioactive particulates
	Type 6: EN 13034 Protective clothing against liquid chemicals		EN 1 149-5:2018 Electrostatic Properties

Product Code	Size	Height (inch)	Chest (inch)	Pack Qty (pcs)	Carton Qty (packs)
<b>EACH</b>					
770244	Medium	5'6" - 5'9"	36 - 39"	1	50
770633	Large	5'8" - 6'0"	39 - 43"	1	50
770094	X Large	5'11" - 6'2"	43 - 46"	1	50
770642	XX Large	6'1" - 6'4"	46 - 49"	1	50
770229	XXX Large	6'3" - 6'7"	49 - 52"	1	50

TYPE - COV      SUB TYPE - COV01



#### General Purpose Coverall



A lightweight polypropylene coverall with hood to protect against low risk substances such as paints, dust, sprays and splatters.

- Elasticated, hood, cuffs and ankles ensure a tight seal to prevent ingress
- Lightweight polypropylene protection
- Protects against: paints, dust, sprays and splatter

Product Code	Size	Height (inch)	Chest (inch)	Pack Qty (pcs)	Carton Qty (packs)
<b>EACH</b>					
770334	Medium	5'6" - 5'9"	36 - 39"	1	50
770582	Large	5'8" - 6'0"	39 - 43"	1	50
770167	X Large	5'11" - 6'2"	43 - 46"	1	50
770705	XX Large	6'1" - 6'4"	46 - 49"	1	50
770836	Large	6'3" - 6'7"	49 - 52"	1	50

TYPE - COV      SUB TYPE - COV01



### Shoe Covers



#### Shoe Covers

**NEW**

Industrial grade (Non-medical)



A hard wearing waterproof shoe cover with a breathable and elasticated ankle. Ideal for tradesmen who need to keep footwear on for safety reasons whilst working indoors but want to help keep customers' homes clean and dry. Textured sole for extra grip on slippery surfaces. Suitable for shoe sizes UK5 - UK12.

Product Code	Size	Colour	Pack Qty (pcs)	Carton Qty (packs)
<b>BAG</b>				
770755	UK 5-12	Blue	40	800

TYPE - COV      SUB TYPE - COV02



## Hi-Vis Clothing

The movement of machinery and vehicles in the workplace presents major risks to staff and visitors. There are more than 5,000 incidents involving transport in the workplace each year. Staying visible with the use of high visibility clothing is essential when working on construction sites and in warehouses and significantly reduces this risk.

EN ISO 20471 categorises all Hi-Vis clothing into three classes. The selection of Hi-Vis should be based on a risk assessment of the conditions and risks for a particular worker.

Certification of items into classes is based on the combined surface area of reflective materials for each item:

	Class1	Class 2	Class3
Reflective Tape	0.10 sqm	0.13 sqm	0.20 sqm
Fluorescent Material	0.14 sqm	0.50 sqm	0.80 sqm

**Hi-Vis Class 1** – The lowest level of visibility. An example would be Hi-Vis trousers when worn separately from other High-Vis items.

**Hi-Vis Class 2** – The intermediate level of visibility. An example would be a Hi-Vis sleeveless vest.

**Hi-Vis Class 3** – The highest level of visibility. An example would be a Hi-Vis Jacket.

Class 3 can be achieved in two ways. Simply select an item to Class 3 such as a Parka jacket or combine items with total reflective material equal to or greater than a single Class 3 item.



## Executive Vests

High visibility executive waistcoat with highly reflective panels to body and shoulders for visibility, particularly during the hours of darkness. Secure zip fastening with multiple utility pockets for ID card, mobile phone, pens and two bellowed front pockets plus a radio loop D ring.

- Zipper fastening
- 100% knitted polyester
- 50mm reflective tape on body and shoulders
- Conforms to EN ISO 20471:2013+A1:2016



Product Code	Size	Hi-Vis Class	Pack Qty (pcs)	Carton Qty (packs)
<b>EACH</b>				
<b>YELLOW</b>				
HVEVSML	Small	1	1	50
HVEVMED	Medium	2	1	50
HVEVLRG	Large	2	1	50
HVEVXL	X Large	2	1	50
HVEVXXL	XX Large	2	1	50
HVEV3XL	XXX Large	2	1	50
HVEV4XL	XXXX Large	2	1	50
<b>GREEN</b>				
HVVYGSML	Small	1	1	50
HVVYGMED	Medium	2	1	50
HVVYGLRG	Large	2	1	50
HVVYGXL	X Large	2	1	50
HVVYGXXL	XX Large	2	1	50
HVVYG3XL	XXX Large	2	1	50
HVVYG4XL	XXXX Large	2	1	50
<b>BLUE</b>				
HVVYBSML	Small	1	1	50
HVVYBMED	Medium	2	1	50
HVVYBLRG	Large	2	1	50
HVVYBXL	X Large	2	1	50
HVVYBXXL	XX Large	2	1	50
HVVYB3XL	XXX Large	2	1	50
HVVYB4XL	XXXX Large	2	1	50
TYPE - CTH	SUB TYPE - CTH01			

## Vest



High visibility yellow waistcoat with highly reflective panels to body and shoulders for visibility particularly during the hours of darkness.

- Hook and loop fastening
- 50mm reflective tape on body and shoulders
- 100% knitted polyester
- Conforms to EN ISO 20471:2013+A1:2016

Product Code	Size	Hi-Vis Class	Pack Qty (pcs)	Carton Qty (packs)
<b>EACH</b>				
HVVSML	Small	1	1	50
HVVMED	Medium	2	1	50
HVVLRG	Large	2	1	50
HVVXL	X Large	2	1	50
HVVXXL	XX Large	2	1	50
HVV3XL	XXX Large	2	1	50
HVV4XL	XXXX Large	2	1	50
TYPE - CTH	SUB TYPE - CTH01			

## Polo Shirts

Hardwearing and comfortable high visibility yellow polo shirt with panels that reflect light to maximise visibility, particularly during the hours of darkness. The open collar makes this shirt ideal for use in warm conditions or warehouse environments where visibility is required.

- 50mm reflective tape
- Conforms to EN ISO 20471:2013+A1:2016
- Breathable Bird Eye fabric



Product Code	Size	Hi-Vis Class	Pack Qty (pcs)	Carton Qty (packs)
<b>EACH</b>				
<b>SHORT SLEEVE</b>				
HVSSPSML	Small	2	1	20
HVSSPMED	Medium	2	1	20
HVSSPLRG	Large	2	1	20
HVSSPXL	X Large	2	1	20
HVSSPXXL	XX Large	2	1	20
HVSSP3XL	XXX Large	2	1	20
HVSSP4XL	XXXX Large	2	1	20
<b>LONG SLEEVE</b>				
HVLSPSML	Small	3	1	20
HVLSPMED	Medium	3	1	20
HVLSPLRG	Large	3	1	20
HVLSPXL	X Large	3	1	20
HVLSPXXL	XX Large	3	1	20
HVLSP3XL	XXX Large	3	1	20
HVLSP4XL	XXXX Large	3	1	20
TYPE - CTH	SUB TYPE - CTH02			

## Sweatshirt With Hood

Ideal for colder outdoor and dry working environments. A high visibility yellow fleece sweatshirt with reflective bands for improved visibility during the hours of darkness.



- 50mm reflective tape on body, shoulders and arms
- Ribbed waist and wrists
- Fleece lined

- Conforms to EN ISO 20471:2013+A1:2016

Product Code	Size	Hi-Vis Class	Pack Qty (pcs)	Carton Qty (packs)
<b>EACH</b>				
HVSWEATSMML	Small	3	1	10
HVSWEATMED	Medium	3	1	10
HVSWEATLRG	Large	3	1	10
HVSWEATXL	X Large	3	1	10
HVSWEATXXL	XX Large	3	1	10
HVSWEAT3XL	XXX Large	3	1	10
HVSWEAT4XL	XXXX Large	3	1	10
TYPE - CTH	SUB TYPE - CTH03			



## Fleece

Ideal for colder outdoor and dry working environments, this high visibility yellow polar fleece jacket incorporates reflective bands for improved visibility during the hours of darkness.

- 50mm reflective tape on body, shoulders and arms
- Elasticated wrists



- Conforms to EN ISO 20471:2013+A1:2016

Product Code	Size	Hi-Vis Class	Pack Qty (pcs)	Carton Qty (packs)
<b>EACH</b>				
HVFJSML	Small	3	1	20
HVFJMED	Medium	3	1	20
HVFJLRG	Large	3	1	20
HVFJXL	X Large	3	1	20
HVFJXXL	XX Large	3	1	20
HVFJ3XL	XXX Large	3	1	20
HVFJ4XL	XXXX Large	3	1	20
TYPE - CTH		SUB TYPE - CTH04		

## Bomber Jacket

Bomber jacket in high visibility yellow with reflective bands for improved visibility, particularly during the hours of darkness.

Waterproof hood concealed in collar and multiple utility pockets with zip and hook & loop storm flap fastening. Quilted lining and fleece cuffs for warmth and comfort.



- 50mm reflective tape on body, shoulders and arms
- Two way zippers with storm proof flap
- Hook & loop adjustable wrists

- Conforms to EN ISO 20471:2013+A1:2016
- Waterproof - conforms to EN 343:2019, protection against rain

Product Code	Size	Hi-Vis Class	Pack Qty (pcs)	Carton Qty (packs)
<b>EACH</b>				
HVJSML	Small	3	1	10
HVJMED	Medium	3	1	10
HVJLRG	Large	3	1	10
HVJXL	X Large	3	1	10
HVJXXL	XX Large	3	1	10
HVJ3XL	XXX Large	3	1	10
HVJ4XL	XXXX Large	3	1	10
TYPE - CTH		SUB TYPE - CTH04		

## Parka Jacket

Parka jacket in high visibility yellow with reflective bands for improved visibility during the hours of darkness.

Waterproof hood concealed in collar and multiple utility pockets with zip and hook & loop storm flap fastening. Longer length with quilted lining and fleece cuffs for warmth and comfort.



- 50mm reflective tape on body, shoulders and arms
- Fleece lined collar and wrist cuffs
- Zip with storm proof flap
- Hook & loop adjustable wrists

- Conforms to EN ISO 20471:2013+A1:2016
- Waterproof - conforms to EN 343:2019, protection against rain

Product Code	Size	Hi-Vis Class	Pack Qty (pcs)	Carton Qty (packs)
<b>EACH</b>				
HVPJSML	Small	3	1	10
HVPJMED	Medium	3	1	10
HVPJLRG	Large	3	1	10
HVPJXL	X Large	3	1	10
HVPJXXL	XX Large	3	1	10
HVPJ3XL	XXX Large	3	1	10
HVPJ4XL	XXXX Large	3	1	10
TYPE - CTH		SUB TYPE - CTH04		

## Softshell Jacket

Ideal for colder outdoor and dry working environments, this high visibility yellow polar fleece jacket incorporates reflective bands for improved visibility during the hours of darkness.

- 50mm reflective tape on body, shoulders, arms and wrists
- Conforms to EN ISO 20471:2013+A1:2016
- Showerproof
- Fleece lining



Product Code	Size	Hi-Vis Class	Pack Qty (pcs)	Carton Qty (packs)
<b>EACH</b>				
HVSJSML	Small	3	1	10
HVSJMED	Medium	3	1	10
HVSJLRG	Large	3	1	10
HVSJXL	X Large	3	1	10
HVSJXXL	XX Large	3	1	10
HVSJ3XL	XXX Large	3	1	10
HVSJ4XL	XXXX Large	3	1	10
TYPE - CTH		SUB TYPE - CTH04		

## Trouser

High visibility yellow workwear trousers with reflective tape for extra visibility. Elasticated waist with zip fly. 35% cotton and 65% polyester woven fabric with two hip pockets and two additional utility thigh pockets.



- 50mm reflective tape round both legs
- Elasticated waistband
- Zipper with button
- 2x hip pockets and 2x thigh pockets
- Conforms to EN ISO 20471:2013+A1:2016

Product Code	Size	Hi-Vis Class	Pack Qty (pcs)	Carton Qty (packs)
<b>EACH</b>				
HVTRSMED	Medium	1	1	20
HVTRSLRG	Large	1	1	20
HVTRSXL	X Large	1	1	20
HVTRSXXL	XX Large	1	1	20
HVTRS3XL	XXX Large	1	1	20
TYPE - CTH		SUB TYPE - CTH05		

## Elasticated Waist Trouser

High visibility yellow waterproof over trousers with reflective tape for extra visibility. 100% Polyester.



- 50mm reflective tape round both legs
- Pocket slits to allow easy access to wearers trouser pockets
- Conforms to EN ISO 20471:2013+A1:2016
- Waterproof - conforms to EN 343:2019, protection against rain
- Elasticated waistband

Product Code	Size	Hi-Vis Class	Pack Qty (pcs)	Carton Qty (packs)
<b>EACH</b>				
HVETRSMED	Medium	1	1	20
HVETRSLRG	Large	1	1	20
HVETRSXL	X Large	1	1	20
HVETRSXXL	XX Large	1	1	20
HVETRS3XL	XXX Large	1	1	20
TYPE - CTH		SUB TYPE - CTH05		



# Building Hardware

## Builder's Metalwork

Masonry Hangers	225
Timber Hangers	226
Restraints	227
Wall Starter Kits	227
Truss Clip	228
Angle Bracket	228
Flat Connector Plate	228
Herringbone Joist Strut	228
Nail Plate	228
Universal Framing Anchor	228
Timber Connector	229
Helical Bar	229
Brick Reinforcement Coil	229
Fixing Band	229
Waterbar	229
Drywall Bracket	229
Cramps & Ties	230



## Building Supplies

Damp Proof Membrane	231
Builders Tape	231
Spacers	232
Roof-line & Above	234
Weeps & Drill Vents	234
Underfloor Ventilation	235
Through-Wall Ventilation	235
Internal Grille Vents	236
Loft Doors & Access Panels	236

# Masonry & Multi-Functional Hangers



## Single Piece Masonry Hanger



Straight top flange. No welds. Hangers above 150mm are manufactured 10mm less to allow for notching and regularised timber.



EN 845-1

Technical Data						
Width (mm)	47					
Height (mm)	100	125	140	165	190	215
Bearing (mm)	80		75			
No. of Nail Holes	6					
Characteristic value (kN)*	9.7					
Safe working load (kN)#	5.4					

\*Eurocode 6 | #BS5628

Product Code	W x H x B (mm)	Joist W x H (mm)	MOQ Qty (pcs)	Qty Break (pcs)
<b>BOX</b>				
<b>Galvanised Steel - 2.4mm</b>				
47100MH	47 x 100 x 80	47 x 100	10	50
47125MH	47 x 125 x 80	47 x 125	10	50
47147MH	47 x 140 x 80	47 x 150	10	50
47175MH	47 x 165 x 75	47 x 175	10	5
47200MH	47 x 190 x 75	47 x 200	10	50
47225MH	47 x 215 x 75	47 x 225	10	50

TYPE - BMW

SUB TYPE - BMW01

## Welded Masonry Hanger



Hangers above 150mm are manufactured 10mm less to allow for notching and regularised timber.



EN 845-1

Technical Data					
Width (mm)	47	75	90	100	150
Height (mm)	All				
Bearing (mm)	80		75		
No. of Nail Holes	6				
Characteristic value (kN)*	6.7				
Safe working load (kN)#	3.5				

\*Eurocode 6 | #BS5628

Product Code	W x H x B (mm)	Joist W x H (mm)	MOQ Qty (pcs)	Qty Break (pcs)
<b>BOX</b>				
<b>Galvanised Steel - 2.4mm</b>				
75150WMH	75 x 140 x 80	75 x 150	10	50
75175WMH	75 x 165 x 80	75 x 175	10	50
75200WMH	75 x 190 x 80	75 x 200	10	50
75225WMH	75 x 215 x 80	75 x 225	10	50
90150WMH	90 x 140 x 80	90 x 150	6	30
90175WMH	90 x 165 x 80	90 x 175	6	30
90200WMH	90 x 190 x 80	90 x 200	6	30
90225WMH	90 x 215 x 80	90 x 225	6	30
100150WMH	100 x 140 x 75	100 x 150	6	30
100175WMH	100 x 165 x 75	100 x 175	6	30
100200WMH	100 x 190 x 75	100 x 200	6	30
100225WMH	100 x 215 x 75	100 x 225	6	30
150200WMH	150 x 190 x 90	150 x 200	6	30
150225WMH	150 x 215 x 90	150 x 225	6	30
<b>A2 - 34 Stainless Steel - 2.4mm</b>				
47100WMHS	47 x 100 x 80	47 x 100	6	30
47150WMHS	47 x 140 x 80	47 x 150	6	30
47175WMHS	47 x 165 x 80	47 x 175	6	30
47200WMHS	47 x 190 x 80	47 x 200	6	30
47225WMHS	47 x 215 x 80	47 x 225	6	30
100150WMHS	100 x 140 x 80	100 x 150	6	30
100175WMHS	100 x 165 x 80	100 x 175	6	30
100200WMHS	100 x 190 x 80	100 x 200	6	30
100225WMHS	100 x 215 x 80	100 x 225	6	30

TYPE - BMW

SUB TYPE - BMW01

## Multi-Functional Hanger



Designed for use with different fixings to give greater flexibility and improved performance.

**NOTE:** Total length refers to the length of the hanger when flat.

Technical Data				
Total Length (mm)	240	346	404	504
Width (mm)	47	All		
Bearing (mm)	85			
Characteristic value (kN)*	12.8	19.8	25.1	
SWL (kN)# - Short term	N/A	6.4	9.9	12.55
SWL (kN)# - Medium term	N/A	6.1	9.4	11.95
SWL (kN)# - Long term	N/A	5.3	8.25	10.45

\*Eurocode 6 | #BS5628 SWL-Safe Working Load

Product Code	W x H x B (mm)	Total Length (mm)	No. of Nail Holes	MOQ Qty (pcs)	Qty Break (pcs)
<b>BOX</b>					
<b>Galvanised Steel - 2.0mm</b>					
47346MFH	47 x 150 x 85	346	25	10	50
47404MFH	47 x 179 x 85	404	33	10	50
47504MFH	47 x 229 x 85	504	49	10	50
76346MFH	76 x 135 x 85	346	49	10	50
76404MFH	76 x 164 x 85	404	25	10	50
76504MFH	76 x 214 x 85	504	33	10	50
90504MFH	90 x 207 x 85	504	49	10	50
100346MFH	100 x 123 x 85	346	25	10	50
100404MFH	100 x 152 x 85	404	33	10	50
100504MFH	100 x 202 x 85	504	49	10	50
150404MFH	150 x 127 x 85	404	33	10	50
150504MFH	150 x 177 x 85	504	49	10	50
<b>Mini Multi-Functional Hanger</b>					
47240MMFH	47 x 97 x 85	240	18	10	5

TYPE - BMW

SUB TYPE - BMW02

TYPE - BMW

SUB TYPE - BMW02

### Installation Guidelines

- Ensure the back plate of the hanger sits flat against the wall and is securely fixed.
- A minimum of three block courses (675mm) must be constructed above the hanger before the joist is loaded.
- Nail the side flanges with 3.75 x 30 galvanised square twist nails.
- Allow enough time for the mortar to cure before any load is applied.

- Maximum gap between the wall and joist is 6mm.
- Joist should be square cut and sit tight to the back of the hanger.
- Hangers 150mm and above are manufactured 10mm less to allow for notching and regularised timber.

### Installation Guidelines

- All holes should be nailed using 3.75 x 30 square twist nails or equivalent.

# Timber Hangers



## No Tag Timber Hanger



Superior design allows the use of fewer nails for faster installation. Increased leg lengths, all widths can take up to a 220mm deep joist.

**Rapid Installation Time**

## Standard Timber Hanger



Designed to give a quick and simple solution for various timber to timber connections such as joists and stairwell trimmings.

Increased leg lengths, all widths can take up to a 225mm deep joist.

## Long Leg Timber Hanger



Specifically designed for deeper timber to timber applications. Ideal for loft conversions and "under-slung" floor joist applications where the hanger extends below the supporting beam.

Increased leg lengths, all widths can take up to a 250mm deep joist.

Technical Data	
Width (mm)	All
Length (mm)	All
Bearing (mm)	60
Characteristic value (kN) Eurocode 5	14.41
No. of nail holes	23
Safe working load (kN) BS5628 - Short term	7.21
Safe working load (kN) BS5628 - Medium term	6.86
Safe working load (kN) BS5628 - Long term	6.0

Technical Data	
Width (mm)	All
Length (mm)	All
Bearing (mm)	50
Characteristic value (kN) Eurocode 5	15.44
No. of nail holes	32
Safe working load (kN) BS5628 - Short term	7.72
Safe working load (kN) BS5628 - Medium term	7.35
Safe working load (kN) BS5628 - Long term	6.43

Technical Data	
Width (mm)	All
Length (mm)	All
Bearing (mm)	50
Characteristic value (kN) Eurocode 5	28.04
No. of nail holes	46
Safe working load (kN) BS5628 - Short term	14.02
Safe working load (kN) BS5628 - Medium term	13.35
Safe working load (kN) BS5628 - Long term	11.68

Product Code	W x L x B (mm)	Joist W x H (mm)	MOQ Qty (pcs)	Qty Break (pcs)
<b>BOX</b>				
<b>Galvanised Steel - 0.8mm</b>				
44TH	44 x 281 x 60	44 x 125 to 220	20	100
47TH	47 x 279 x 60	47 x 125 to 220	20	100
63TH	63 x 271 x 60	63 x 125 to 220	20	100
75TH	75 x 265 x 60	75 x 125 to 220	20	100
90TH	90 x 258 x 60	90 x 125 to 220	20	100
100TH	100 x 253 x 60	100 x 125 to 220	10	50
TYPE - BMW			SUB TYPE - BMW03	

Product Code	W x L x B (mm)	Joist W x H (mm)	MOQ Qty (pcs)	Qty Break (pcs)
<b>BOX</b>				
<b>Galvanised Steel - 1.0mm</b>				
125TH	125 x 300 x 50	125 x 100 to 225	10	50
150TH	150 x 300 x 50	150 x 100 to 225	10	50
TYPE - BMW			SUB TYPE - BMW03	
<b>A2 - 304 Stainless Steel - 1.0mm</b>				
47THS	47 x 277 x 50	47 x 100 to 225	20	100
76THS	76 x 300 x 50	76 x 100 to 225	20	100
100THS	100 x 300 x 50	100 x 100 to 225	10	50
TYPE - BMW			SUB TYPE - BMW03	

Product Code	W x L x B (mm)	Joist W x H (mm)	MOQ Qty (pcs)	Qty Break (pcs)
<b>BOX</b>				
<b>Galvanised Steel - 1.2mm</b>				
44450LTH	44 x 453 x 50	44 x 150 to 250	10	50
47450LTH	47 x 445 x 50	47 x 150 to 250	10	50
76450LTH	76 x 435 x 50	76 x 175 to 250	10	50
90450LTH	90 x 425 x 50	90 x 150 to 250	10	50
100450LTH	100 x 420 x 50	100 x 150 to 250	10	50
125450LTH	125 x 450 x 50	125 x 175 to 250	10	50
150450LTH	150 x 450 x 50	150 x 175 to 250	10	50
TYPE - BMW			SUB TYPE - BMW03	

### Installation Guidelines

- Ensure the back plate of the hanger sits flat against the timber.
- Joist should be square cut and sit tight to the back of the hanger.
- Fix the joist in every hole with 3.75 x 30 galvanised square twist nails (for stainless steel applications use 2.36 x 30 stainless steel annular ringshank nails).

## Mini Timber Hanger



Technical Data			
Type	THM	THMS	THMP
Material	Galv	SS	Galv
Width (mm)	All	All	All
Characteristic value (kN) Eurocode 5	8.34	9.5	9.5
Safe working load (kN) BS5628 - Short term	4.17	4.75	4.75
Safe working load (kN) BS5628 - Medium term	3.97	4.53	4.53
Safe working load (kN) BS5628 - Long term	3.47	3.96	3.96

### Installation Guidelines

- Ensure the back plate of the hanger sits flat against the timber.
- Joist should be square cut & sit tight to the back of the hanger.
- Fix the joist in every hole with 3.75 x 30 galvanised square twist nails (for stainless steel applications use 2.36 x 30 stainless steel annular ringshank nails).

Product Code	W x H x B (mm)	Joist W x H (mm)	No. of Nail Holes	MOQ Qty (pcs)	Qty Break (pcs)
<b>BOX</b>					
<b>Galvanised Steel - 1.0mm</b>					
38THM	38 x 75 x 50	38 x 75 to 100	14	20	100
44THM	44 x 68 x 50	44 x 75 to 100	14	20	100
47THM	47 x 67 x 50	47 x 75 to 100	14	20	100
<b>Larger Joist Size</b>					
38THMP	38 x 100 x 50	38 x 100 to 150	20	20	100
44THMP	44 x 97 x 50	44 x 100 to 150	20	20	100
47THMP	47 x 96 x 50	47 x 100 to 150	20	20	100
<b>A2 - 304 Stainless Steel - 1.0mm</b>					
44THMS	44 x 97 x 50	44 x 75 to 100	20	10	50
47THMS	47 x 96 x 50	47 x 75 to 100	20	10	50
TYPE - BMW			SUB TYPE - BMW03		

Timber to timber joist hangers, suitable for light duty applications such as ceiling joists, decking and trimmings.

**NOTE:** Tag on base of the hanger helps avoid rotation.



# Restraints & Wall Starters



## Heavy Duty Restraint Straps



Generally used for horizontal restraint such as roof trusses, rafters and joists tied to masonry. Designed to BS 5268 Part 3 and other building standards for lateral restraint. Manufactured from Galvanised steel, for ultimate corrosion resistance use stainless steel.



EN 845-1

## Light Duty Restraint Straps



Generally used for vertical restraint such as holding down a wall plate. Manufactured from Galvanised steel, for ultimate corrosion resistance use stainless steel.



EN 845-1

## Engineered Heavy Duty Restraint Strap



Horizontal & Vertical Applications

Lightweight design makes it easy to handle, yet retains its structural strength so it can be used instead of traditional heavy duty straps in both horizontal and vertical applications.

Product Code	Length (mm)	Bend (mm)	Total Length (mm)	MOQ Qty (pcs)	Qty Break (pcs)
<b>BUNDLE</b>					
<b>Galvanised Steel - 1.4mm</b>					
600ERSH	500	100	600	10	50
800ERSH	700	100	800	10	50
1000ERSH	900	100	1000	10	50
1200ERSH	1100	100	1200	10	50
1600ERSH	1500	100	1600	10	50
TYPE - BMW			SUB TYPE - BMW07		

### Installation Guidelines

- For horizontal restraint
- Use a minimum of six 3.75 x 30mm square twist nails or equivalent fixed to timber joists/rafters.

## Bent Strap

Product Code	Length (mm)	Bend (mm)	Total Length (mm)	MOQ Qty (pcs)	Qty Break (pcs)
<b>BUNDLE</b>					
<b>Galvanised Steel - 4.0mm</b>					
400BRSH	300	100	400	10	50
600BRSH	500	100	600	10	50
800BRSH	700	100	800	10	50
1000BRSH	900	100	1000	10	50
1200BRSH	1100	100	1200	10	50
1500BRSH	1400	100	1500	10	50
1600BRSH100	1500	100	1600	10	50
1600BRSH	1450	150	1600	10	50
<b>Stainless Steel - 4.0mm</b>					
1000BRSHS	900	100	1000	10	50
1200BRSHS	1100	100	1200	10	50
TYPE - BMW			SUB TYPE - BMW06		

## Bent Strap

Product Code	Length (mm)	Bend (mm)	Total Length (mm)	MOQ Qty (pcs)	Qty Break (pcs)
<b>BUNDLE</b>					
<b>Galvanised Steel - 2.4mm</b>					
300BRSL	200	100	300	10	50
600BRSL	500	100	600	10	50
800BRSL	700	100	800	10	50
1000BRSL	900	100	1000	10	50
1200BRSL	1100	100	1200	10	50
1500BRSL	1400	100	1500	10	50
<b>Stainless Steel - 2.4mm</b>					
1000BRSLs	900	100	1000	10	50
TYPE - BMW			SUB TYPE - BMW08		

## Flat Strap

Product Code	Total Length (mm)	MOQ Qty (pcs)	Qty Break (pcs)
<b>BUNDLE</b>			
<b>Galvanised Steel - 2.4mm</b>			
1000FRSL	1000	10	50
<b>Stainless Steel - 2.4mm</b>			
1000FRSLs	1000	10	50
TYPE - BMW		SUB TYPE - BMW08	

## Flat Strap

Product Code	Total Length (mm)	MOQ QTY (pcs)	Qty Break (pcs)
<b>BUNDLE</b>			
<b>Galvanised Steel - 4.0mm</b>			
1000FRSH	1000	10	50
TYPE - BMW		SUB TYPE - BMW06	

## Twisted Strap

Product Code	Length (mm)	Twist (mm)	Total Length (mm)	MOQ Qty (pcs)	Qty Break (pcs)
<b>BUNDLE</b>					
<b>Galvanised Steel - 4.0mm</b>					
600TRSH	500	100	600	10	50
1000TRSH	900	100	1000	10	50
TYPE - BMW			SUB TYPE - BMW06		

## Twisted Strap

Product Code	Length (mm)	Twist (mm)	Total Length (mm)	MOQ Qty (pcs)	Qty Break (pcs)
<b>BUNDLE</b>					
<b>Galvanised Steel - 2.4mm</b>					
1000TRSL	900	100	1000	10	50
TYPE - BMW			SUB TYPE - BMW08		

### Installation Guidelines

- For horizontal restraint
- Use a minimum of seven 3.75 x 30mm square twist nails or equivalent fixed to timber joists/rafters.

### Installation Guidelines

- For vertical restraint
- Use a minimum of ten 3.75 x 30mm square twist nails or equivalent fixed to timber joists/rafters.
- When used as a vertical restraint to hold down a wallplate. Use a minimum length of 900mm

## Wall Starter Kit

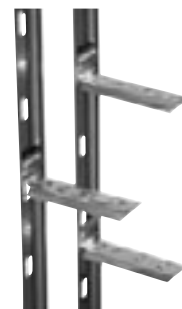

A stainless steel system, designed to join new walls to existing masonry, suitable for both internal and external brick or block walls.

- Kit includes:
- x2 Wall rails
  - x5 Plugs/coach screws/washers
  - x10 Wall rail connectors



Technical Data	
Length (mm)	1170
Design Shear Strength per 2.4m (kN)*	5.1

Fixing into existing AAC block work with a compressive strength of 3.5N/mm<sup>2</sup>

Product Code	Width (mm)	Length (mm)	Kit Length (2 x Profiles) (mm)	MOQ Qty (pcs)	Qty Break (pcs)
<b>BOX</b>					
<b>430 Stainless Steel</b>					
269666	41	1170	2340	12	40
TYPE - BMW			SUB TYPE - BMW14		

# Structural Fixings



## Truss Clip



For fixing trusses, girders and rafters to wall plate. Can also be used for general applications as a multi-purpose connector to provide restraint whenever two timber members cross.

## Angle Bracket



A versatile and general purpose 90° bracket used to strengthen timber joints. Available in galvanised steel. For ultimate corrosion resistance use stainless steel.

## Flat Connector Plates



Versatile flat brackets for timber jointing and general repair work.

### Technical Data

Width (mm)	38	47
Characteristic value (kN) Eurocode 6	6.36	
Safe working load (kN) BS5628 - Short term	3.18	

Product Code	Width (mm)	Total Height (mm)	No. of Nail Holes	MOQ Qty (pcs)	Qty Break (pcs)
<b>BOX</b>					
<b>Galvanised Steel - 1.0mm</b>					
38TC	38	110	12	25	125
47TC	47	110	12	25	125
TYPE - BMW			SUB TYPE - BMW05		

### Technical Data

L x H (mm)	50x50	60x40	90x90	150x90	150x150
Nail Holes (3.75mm)	11	13	15	19	23
Nail Holes (6.0mm)	9	7	-	-	-
Bolt Holes (M8)	-	-	4	5	6
Bolt Holes (M10)	-	-	3	3	3
Bolt Slots (M10)	2	2	2	3	4

Product Code	Length x Height (mm)	Width (mm)	MOQ Qty (pcs)	Qty Break (pcs)
<b>BAG</b>				
<b>Galvanised Steel - 2.0mm</b>				
5050AB*	50 x 50	62	25	100
6040AB*	60 x 40	62	25	100
9090AB	90 x 90	62	25	100
15090AB	150 x 90	62	15	60
150150AB	150 x 150	62	15	45
<b>A2 Stainless Steel - 2.0mm</b>				
6040ABS*	60 x 40	62	25	100
9090ABS	90 x 90	62	25	100
TYPE - BMW		SUB TYPE - BMW09		*NOT REINFORCED

### Technical Data

Length (mm)	100	180	240	300
Nail Holes (3.75mm)	13	15	19	23
Nail Holes (6.0mm)	7	-	-	-
Bolt Holes (M8)	-	4	5	6
Bolt Holes (M10)	-	3	3	3
Bolt Slots (M10)	2	2	3	4

Product Code	Length (mm)	Width (mm)	Pack Qty (pcs)	Qty Break (packs)
<b>BAG</b>				
<b>Galvanised Steel - 2.0mm</b>				
FCP100	100	62	5	10
FCP180	180	62	5	10
FCP240	240	62	5	10
FCP300	300	62	5	10
TYPE - BMW			SUB TYPE - BMW09	

## Herringbone Joist Strut



Prevent sideways movement or the buckling of joints. Simple alternative to timber noggins.

Product Code	Joist Centre (mm)	Strut Length (mm)	Pack Qty (pcs)	Qty Break (packs)
<b>BUNDLE</b>				
<b>Galvanised Steel - 1.0mm</b>				
HJS400	400	480	10	10
HJS450	450	523	10	10
HJS600	600	680	10	10
TYPE - BMW			SUB TYPE - BMW04	

## Nail Plate



A versatile perforated plate used for connecting or repairing timber. Strengthening ribs for added rigidity. All holes are pressed countersunk to aid location of the nail and to give a flush finish.



EN14545-2008

Product Code	Width (mm)	Length (mm)	MOQ Qty (pcs)	Qty Break (pcs)
<b>BOX</b>				
<b>Galvanised Steel - 1.0mm</b>				
42NP	42	178	20	100
85NP	85	178	20	100
104NP	104	154	20	100
169NP	169	178	10	60
178NP	178	338	10	50
<b>A2 Stainless Steel - 1.0mm</b>				
85NPS	85	178	20	100
TYPE - BMW		SUB TYPE - BMW09		

## Universal Framing Anchor



For strong nailed joints and economical secondary connections in timber framing. Framing Anchors are an effective, versatile and economical method of providing strong, mechanical joints.

Product Code	Width (mm)	Height (mm)	MOQ Qty (pcs)	Qty Break (pcs)
<b>BOX</b>				
<b>Galvanised Steel - 1.0mm</b>				
UFA	40 x 40	124	25	500
TYPE - BMW			SUB TYPE - BMW03	

## Timber Connector



Designed to increase the joint strength when bolting two pieces of timber together.



EN14545-2008

Product Code	Outer Ø (mm)	Hole Ø (mm)	Bore (mm)	Pack Qty (pcs)	Qty Break (packs)
<b>Galvanised Steel</b>					
<b>BOX</b>					
TCD50	50	14.0	M12	100	2
TYPE - CAB				SUB TYPE - CAB05	
<b>BAG</b>					
TCD50B	50	14.0	M12	15	5
TYPE - BAG				SUB TYPE - BAG33	
<b>PACK</b>					
TCD50P	50	14.0	M12	6	10
TYPE - PAK				SUB TYPE - PAK51	

## Helical Bar



Frequently used in masonry joints for crack stitching and reinforcing.

Stainless steel for ultimate corrosion resistance.



EN845-1:2013

Product Code	Ø (mm)	Length (mm)	Pack Qty (pcs)	Qty Break (packs)
<b>BUNDLE</b>				
<b>Stainless Steel</b>				
M6HB	6.0	1000	25	10
M8HB	8.0	1000	25	10
TYPE - BMW			SUB TYPE - BMW12	

## Chemical Resin

For helical grout for stitching & repairs.

See page

**101**

## Brick Reinforcement Coil



Produced for brick and block work reinforcement. Its primary usage is to prevent cracking.

For ultimate corrosion resistance use stainless steel.

Product Code	Width (mm)	Length (m)	Pack Qty (pcs)	Qty Break (packs)
<b>COIL</b>				
<b>Galvanised Steel</b>				
63BRCG	65	20	1	20
100BRCG	100	20	1	20
175BRCG	175	20	1	20
<b>Stainless Steel</b>				
63BRCSS	65	20	1	20
100BRCSS	100	20	1	20
175BRCSS	175	20	1	20
225BRCSS	225	20	1	20
TYPE - BMW			SUB TYPE - BMW12	

## Waterbar



A steel bar for fitting into door sills for weather protection.

Traditionally used with wooden doors, the water bar is fitted into the threshold so that the front door closes against it, sealing any gaps and preventing wind and rain from entering the property.

Product Code	Length (m)	Width (mm)	MOQ Qty (pcs)	Qty Break (pcs)
<b>BUNDLE</b>				
<b>Galvanised Steel - 4.0mm</b>				
TWB1	1	28	10	50
TWB2	2	28	10	50
TYPE - BMW			SUB TYPE - BMW11	

## Helical Flat Roof Fixing



Hammer driven fixing frequently used for securing structural 6mm plywood composite insulation board to flat roofing systems.

Made from high tensile steel, the fixing twists into timber without the need for pre-drilling.

Product Code	Size (mm)	MFT (mm)	Pack Qty (pcs)	Qty Break (packs)
<b>BAG</b>				
<b>Zinc</b>				
269745	8.0 x 90	55	25	60
269991	8.0 x 135	100	25	48
269425	8.0 x 165	130	25	48
269637	8.0 x 195	160	25	42
269244	8.0 x 220	185	25	36
269763	8.0 x 250	215	25	32
269278	8.0 x 270	235	25	30
TYPE - BMW			SUB TYPE - BMW16	
MFT= Max. Fixture Thickness				

## Hip Iron

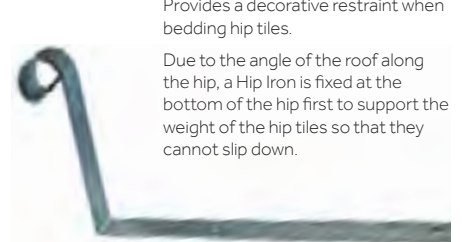

Provides a decorative restraint when bedding hip tiles.

Due to the angle of the roof along the hip, a Hip Iron is fixed at the bottom of the hip first to support the weight of the hip tiles so that they cannot slip down.

Product Code	Length (mm)	MOQ Qty (pcs)	Qty Break (pcs)
<b>BOX</b>			
<b>Hot Dipped Galvanised - 3.0mm</b>			
HI3003	300	10	50
TYPE - BMW			SUB TYPE - BMW15

## Fixing Band



A versatile perforated metal strip which can easily be cut or bent to provide a quick and reliable light weight brace suitable for suspending pipework, cables and doing general repairs.

Product Code	Width (mm)	Length (m)	Pack Qty (pcs)	Qty Break (packs)
<b>CASE* / BAG</b>				
<b>Galvanised Steel</b>				
1210FB*	12	10	1	10
1810FB*	18	10	1	10
2510FB*	25	10	1	10
<b>Stainless Steel</b>				
2010FBS	20	10	1	10
TYPE - BMW			SUB TYPE - BMW13	

## Coloured Fixing Band



Manufactured from galvanised steel to give a high level of corrosion resistance. Colour coated to match the application.

Product Code	Width (mm)	Length (m)	Pack Qty (pcs)	Qty Break (packs)
<b>CASE</b>				
<b>White</b>				
1210FBWHITE	12	10	1	10
<b>Black</b>				
1210FBBLACK	12	10	1	10
TYPE - BMW			SUB TYPE - BMW13	

## Drywall Bracket



Designed especially for connecting plasterboard dry lining systems to masonry walls, concrete soffit and timber joists.

Product Code	Total Length (mm)	Pack Qty (pcs)	Qty Break (packs)
<b>BOX</b>			
<b>Zinc</b>			
DB195	195	100	6
DB295	295	100	4
TYPE - DLB			SUB TYPE - DLB01

# Cramps & Ties



## Safety Frame Cramp

Traditionally used for securing timber windows and door frames into masonry. They can also be used for restraining masonry to new and existing structures in non structural applications. Two 6mm holes and one 9mm hole.



Product Code	Width (mm)	Length (mm)	Upstand (mm)	Pack Qty (pcs)	Qty Break (packs)
<b>BOX</b>					
<b>Stainless Steel - 2.0mm</b>					
100SFCS	19	100	50	250	10
150SFCS	19	150	50	250	10
200SFCS	19	200	50	250	10
TYPE - BMW			SUB TYPE - BMW10		

## Heavy Duty Fishtailed Cramp

Two 6mm holes and one 8mm hole. Manufactured from galvanised steel for superior corrosion resistance.



Product Code	Width (mm)	Length (mm)	Upstand (mm)	MOQ Qty (pcs)	Qty Break (pcs)
<b>BAG</b>					
<b>Galvanised Steel - 2.3mm</b>					
100FFC	25	100	50	25	100
150FFC	25	150	50	25	100
200FFC	25	200	50	25	100
TYPE - BMW			SUB TYPE - BMW10		

## Window Board Tie

A simple solution to tie window boards to masonry.

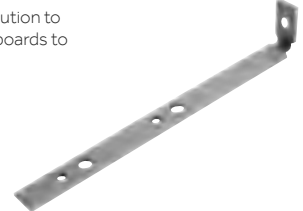

Product Code	Width (mm)	Length (mm)	Upstand (mm)	Pack Qty (pcs)	MOQ Qty (pcs)	Qty Break (packs)
<b>BOX</b>						
<b>Galvanised Steel - 2.0mm</b>						
WBT10	12	147	25	10	-	50
WBT	12	147	25	1	100	-
TYPE - BMW				SUB TYPE - BMW10		

## Timber Frame Tie



- Complies with a DD140 Type 6 tie.
- Meets with the appropriate parts of NHBC standards.
- Supplied with annular ring shank nails.

Product Code	Width (mm)	Length (mm)	Cavity Width (mm)	Pack Qty (pcs)	Qty Break (packs)
<b>BOX</b>					
<b>Stainless Steel</b>					
269413	19	130	50 to 74	250	10
269846	19	155	75 to 99	250	10
269719	19	180	100 to 120	250	10
TYPE - BMW			SUB TYPE - BMW10		

Timber Frame Ties are suitable for tying masonry outer cladding to softwood structural framework of domestic dwellings and industrial/commercial buildings up to 4 storeys and not greater than 15m in height.

## Screw-in Frame Tie NEW

Universal frame and wall ties for connecting wooden window and door frames to masonry and masonry to masonry with the use of a nylon plug.



Product Code	Length (mm)	Thread Length (mm)	Thread Dia (mm)	Pack Qty (pcs)	Qty Break (packs)
<b>BOX</b>					
<b>Zinc &amp; Yellow</b>					
150SFT	150	40	6	100	4
TYPE - BMW			SUB TYPE - BMW10		

## Cavity Wall Ties

Perfect for masonry cavity walls in domestic houses and small commercial buildings of up to three storeys and maximum 15m in height. Manufactured from A2 Stainless Steel for ultimate corrosion resistance.



### Type 2 - General Duty Wall Ties

Product Code	Length x Gauge (mm)	Cavity Width (mm)	Max. Wall Height (m)	Pack Qty (pcs)	Qty Break (packs)
<b>BUNDLE</b>					
<b>A2 Stainless Steel</b>					
225WT2	225 x 3	76 to 100	15	250	10
250WT2	250 x 3	101 to 125	15	250	10
275WT2	275 x 3	Up to 150	15	250	10
TYPE - BMW			SUB TYPE - BMW10		

### Type 4 - Light Duty Wall Ties

Product Code	Length x Gauge (mm)	Cavity Width (mm)	Max. Wall Height (m)	Pack Qty (pcs)	Qty Break (packs)
<b>BUNDLE</b>					
<b>A2 Stainless Steel</b>					
200WT4	200 x 2.3	50 to 75	10	250	10
225WT4	225 x 2.3	76 to 100	10	250	10
250WT4	250 x 2.7	101 to 125	10	250	10
275WT4	275 x 2.7	up to 150	10	250	10
TYPE - BMW			SUB TYPE - BMW10		

## Insulation Retaining Discs

Used with a cavity wall tie to hold insulation material against the inner wall of the cavity.

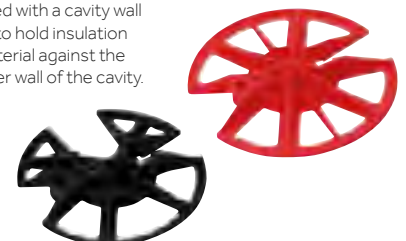

Product Code	Diameter (mm)	Colour	Pack Qty (pcs)	Qty Break (packs)
<b>BAG</b>				
LOCIRD65BL	65	Black	250	6
LOCIRD80R	80	Red	250	4
TYPE - BMW			SUB TYPE - BMW10	



# Damp Proofing



## Damp Proof Membrane



Handy Pack

Commonly used to protect a buildings concrete slab from moisture rising from the foundations.

A damp-proof membrane or DPM is a versatile product and can also be used for a wide range of applications such as creating a protective surface before laying laminate or wood floors. BBA certified.

- Membrane made from 100% recycled materials
- EN 13967:2012

Product Code	Size (m)	Thickness (Microns)	Thickness (Gauge)	Pack Qty (pcs)	Qty Break (packs)
<b>ROLL</b>					
887125	4 x 12.5	500	2000	1	10
887025	4 x 25.0	250	1000	1	10
887425	4 x 25.0	300	1200	1	10
TYPE - TTS				SUB TYPE - TTS01	
<b>HANDY PACK</b>					
887405	4 x 5.0	250	1000	1	10
TYPE - TTS				SUB TYPE - TTS01	

## Damp Proof Course



Damp-proof course or DPC offers a protective barrier and is used within the inner layers of brick or block walls to protect buildings from rising damp.

- 100% recycled materials

Product Code	W (mm)	L (m)	Thickness (Microns)	Thickness (Gauge)	Pack Qty (pcs)	Qty Break (packs)
<b>ROLL</b>						
887100	100	30	500	2000	1	9
887112	112	30	500	2000	1	8
887150	150	30	500	2000	1	6
887225	225	30	500	2000	1	4
887300	300	30	500	2000	1	3
887450	450	30	500	2000	1	2
887600	600	30	500	2000	1	2
TYPE - TTS				SUB TYPE - TTS02		

## Double Sided Damp Proof Membrane Jointing Tape



A high performance double sided butyl tape used for bonding DPMs. Use with High Strength PVC Builders Tape to provide a continuous damp proof seal between two sheets, where joints cannot be avoided.

- High adhesion
- Backing paper for easy application

Product Code	Colour	Length (m)	Width (mm)	Pack Qty (pcs)	Carton Qty (packs)
<b>ROLL</b>					
DSDJT	Black	10	50	1	12
TYPE - TAP				SUB TYPE - TAP11	

## High Strength PVC Builders Tape



A strong versatile PVC tape used for jointing PVC and polythene sheets and membranes.

Frequently used for sealing contamination barriers, polythene dust sheets, silage covers and bales.

- Flame retardant
- Perfect for electrical, patching & jointing applications

Product Code	Colour	Length (m)	Width (mm)	Pack Qty (pcs)	Carton Qty (packs)
<b>ROLL</b>					
HSBT	Black	33	75	1	36
TYPE - TAP				SUB TYPE - TAP08	

**Full Tape Range**

Available on Pages 181

# Spacers



## Horseshoe Shims

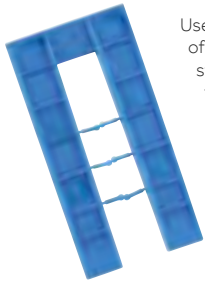

Used for easy and quick levelling of battens, dry lining systems, stud work, door and window frames.

- Polypropylene material
- Resistant to weather changes
- Waterproof
- Bag and tub includes two sizes



## Mixed Packs

Product Code	Size (mm)	T (mm)	Colour	Shim Qty (pcs)	Pack Qty (pcs)	Qty Break (packs)
<b>MIXED TUB - 400 PCS</b>						
	45 x 35	1.0	Yellow	40		
	45 x 35	2.0	Green	40		
	45 x 35	3.0	Blue	40		
	45 x 35	4.0	Red	40		
	45 x 35	5.0	Brown	20		
	45 x 35	6.0	Black	20		
SHIMTUB	100 x 50	1.0	Yellow	40	400	20
	100 x 50	2.0	Green	40		
	100 x 50	3.0	Blue	40		
	100 x 50	4.0	Red	40		
	100 x 50	5.0	Brown	20		
	100 x 50	6.0	Black	20		

TYPE - SHI SUB TYPE - SHI01 T=THICKNESS

Product Code	Size (mm)	T (mm)	Colour	Shim Qty (pcs)	Pack Qty (pcs)	Carton Qty (packs)
<b>MIXED BAG - 100 PCS</b>						
	45 x 35	1.0	Yellow	20		
	45 x 35	3.0	Blue	20		
	45 x 35	5.0	Brown	20		
SHIM100	45 x 35	6.0	Black	10	100	22
	100 x 50	1.0	Yellow	10		
	100 x 50	3.0	Blue	10		
	100 x 50	5.0	Brown	10		

TYPE - SHI SUB TYPE - SHI01 T=THICKNESS

Product Code	Size (mm)	T (mm)	Colour	Shim Qty (pcs)	Pack Qty (pcs)	Carton Qty (packs)
<b>MIXED BAG - 200 PCS</b>						
	45 x 35	1.0	Yellow	20		
	45 x 35	2.0	Green	20		
	45 x 35	3.0	Blue	20		
	45 x 35	4.0	Red	20		
	45 x 35	5.0	Brown	10		
	45 x 35	6.0	Black	10		
SHIM	100 x 50	1.0	Yellow	20	200	8
	100 x 50	2.0	Green	20		
	100 x 50	3.0	Blue	20		
	100 x 50	4.0	Red	20		
	100 x 50	5.0	Brown	10		
	100 x 50	6.0	Black	10		

TYPE - SHI SUB TYPE - SHI01 T=THICKNESS

## Packers



A solution for multiple applications. Used to ensure correct weight distribution of glazed units and increase security around fixing points during frame fitting.

- Polypropylene material
- Resistant to weather changes
- Waterproof
- Strong and durable



## Mixed Packs

Product Code	Size (mm)	T (mm)	Colour	Packer Qty (pcs)	Pack Qty (pcs)	Qty Break (packs)
<b>24MM - BULK BOX - 1,000 PCS</b>						
	24 x 100	1.0	Green	200		
	24 x 100	2.0	Black	160		
744957	24 x 100	3.0	White	200	1,000	10
	24 x 100	4.0	Grey	120		
	24 x 100	5.0	Blue	200		
	24 x 100	6.0	Red	120		
<b>28MM - BULK BOX - 1,000 PCS</b>						
	28 x 100	1.0	Green	200		
	28 x 100	2.0	Black	160		
744224	28 x 100	3.0	White	200	1,000	10
	28 x 100	4.0	Grey	120		
	28 x 100	5.0	Blue	200		
	28 x 100	6.0	Red	120		
<b>32MM - BULK BOX - 1,000 PCS</b>						
	32 x 100	1.0	Green	200		
	32 x 100	2.0	Black	160		
744258	32 x 100	3.0	White	200	1,000	10
	32 x 100	4.0	Grey	120		
	32 x 100	5.0	Blue	200		
	32 x 100	6.0	Red	120		

TYPE - SHI SUB TYPE - SHI02 T=THICKNESS

## Individual Packs

Product Code	Size (mm)	Thickness (mm)	Colour	Pack Qty (pcs)	Carton Qty (packs)
<b>28MM - BULK BOX - 1,000 PCS</b>					
P1GREENBU	28 x 100	1.0	Green	1,000	10
P2BLACKBU	28 x 100	2.0	Black	1,000	10
P3WHITEBU	28 x 100	3.0	White	1,000	10
P4GREYBU	28 x 100	4.0	Grey	1,000	10
P5BLUEBU	28 x 100	5.0	Blue	1,000	10
P6REDBU	28 x 100	6.0	Red	1,000	10
TYPE - SHL					SUB TYPE - SHL01
<b>28MM - BAG - 200 PCS</b>					
P1GREEN	28 x 100	1.0	Green	200	5
P2BLACK	28 x 100	2.0	Black	200	5
P3WHITE	28 x 100	3.0	White	200	5
P4GREY	28 x 100	4.0	Grey	200	5
P5BLUE	28 x 100	5.0	Blue	200	5
P6RED	28 x 100	6.0	Red	200	5
TYPE - SHL					SUB TYPE - SHL01

## Mixed Packs

Product Code	Size (mm)	T (mm)	Colour	Packer Qty (pcs)	Pack Qty (pcs)	Qty Break (packs)
<b>28MM - TUB - 400 PCS</b>						
	28 x 100	1.0	Green	60		
	28 x 100	2.0	Black	80		
PACKERTUB	28 x 100	3.0	White	100	400	20
	28 x 100	4.0	Grey	40		
	28 x 100	5.0	Blue	40		
	28 x 100	6.0	Red	80		

TYPE - SHI SUB TYPE - SHI02 T=THICKNESS

Product Code	Size (mm)	T (mm)	Colour	Packer Qty (pcs)	Pack Qty (pcs)	Carton Qty (packs)
<b>28MM - BAG - 200 PCS</b>						
	28 x 100	1.0	Green	30		
	28 x 100	2.0	Black	40		
PACKER	28 x 100	3.0	White	50	200	5
	28 x 100	4.0	Grey	20		
	28 x 100	5.0	Blue	20		
	28 x 100	6.0	Red	40		

TYPE - SHI SUB TYPE - SHI02 T=THICKNESS

## Wedge Strips



Tapered snap-off wedge strips, manufactured from strong and durable plastic.

Allows convenient, multiple 1mm to 8mm levelling thicknesses in one wedge.

Product Code	Size (mm)	Thickness (mm)	Pack Qty (pcs)	Carton Qty (packs)
<b>TIMBAG</b>				
745233	100 x 20	1-8	50	5
TYPE - BAG				SUB-TYPE - BAG34

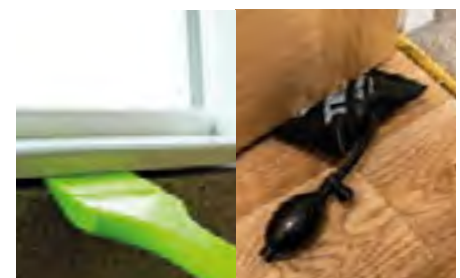

## Glazing Shovel & Air Wedge

See Page 177

## THE NEW (ALMOST) INVISIBLE WALL WEEP FROM TIMLOC

CLEARLY YOU  
CAN (JUST ABOUT)  
SEE WHAT ALL  
THE EXCITEMENT  
IS ABOUT.

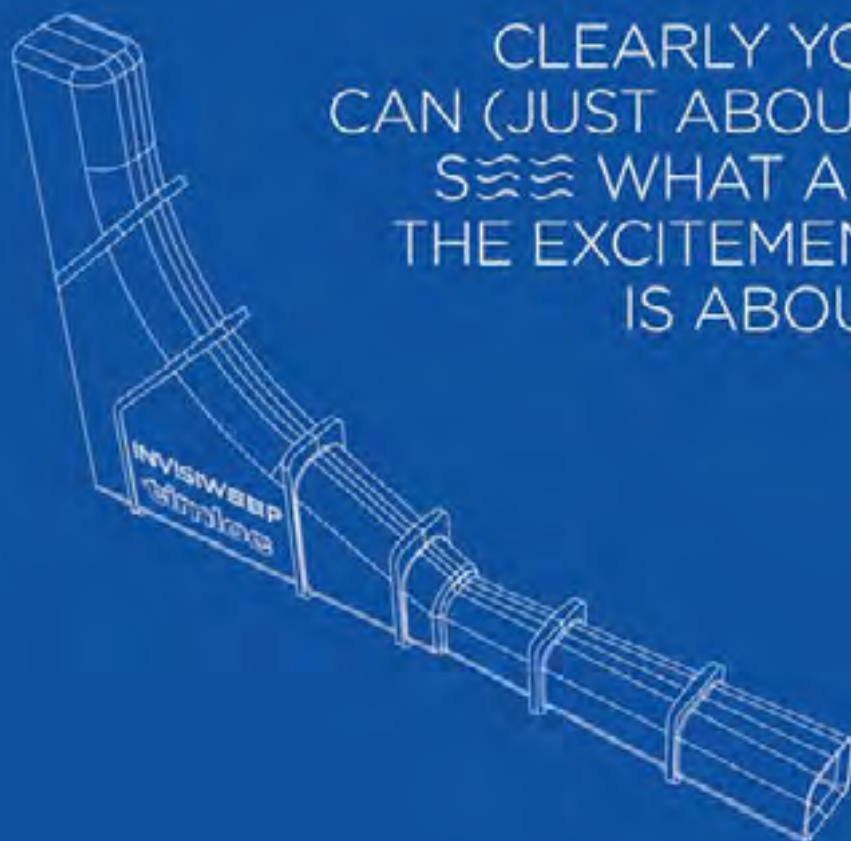

**1**

### **Low profile water outlet**

Ensuring minimal visibility when fitted, the water outlet is unobtrusive to the naked eye.

**2**

### **Venturi effect outlet tube**

Reduces pressure, allowing for optimal water drainage.

**3**

### **Full height upstand to cavity side**

Enables drainage, reducing the risk of blockage if cement builds up in the cavity.

**4**

### **External ribs & tapered profile**

To key mortar for a secure fixing.

**5**

### **Available in two pack quantities**

Can be purchased in boxes of 50 or 200.



## Roof-line & Above



### Push-in Soffit Vent

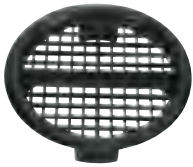

Circular vents used to allow ventilation from the eaves into roofing.

Product Code	Colour	Size (mm)	Pack Qty (pcs)
<b>BOX</b>			
LOC1139	Grey	70.0	10
LOC1140	White	70.0	10
LOC1141	Black	70.0	10
LOC1142	Brown	70.0	10
TYPE - RLN		SUB TYPE - RLN01	

### Roll Out Dry Fix Ridge Pack



Convenient 'single pack' mechanical fixing solution for roof ridge installations.

Product Code	Size (m)	Pack Qty (pcs)
<b>BOX</b>		
LOC54700	6	1
TYPE - RLN		SUB TYPE - RLN01



## Weeps & Drill Vents

### Invisiweep Wall Weep



Used for discharging water from external walls. Available in a range of colours to suit brickwork.

Product Code	Colour	Size H x W x L (mm)	Pack Qty (pcs)
<b>BOX</b>			
LOCIW50BB	Blue/Black	65 x 10 x 102	50
LOCIW50BL	Black	65 x 10 x 102	50
LOCIW50BR	Brown	65 x 10 x 102	50
LOCIW50BU	Buff	65 x 10 x 102	50
LOCIW50CL	Clear	65 x 10 x 102	50
LOCIW50GR	Grey	65 x 10 x 102	50
LOCIW50TE	Terracotta	65 x 10 x 102	50
LOCIW50WH	White	65 x 10 x 102	50
<b>EXTENSION TUBE</b>			
LOCIW500EX	Clear	Ø 6 x 500	10
TYPE - CNA		SUB TYPE - CNA03	

### Dry-Verge Unit



Universal dry fix verge system for profiled roof tiles. A robust, attractive and weather resistant alternative to wet mortar bedding.

Product Code	Colour	Size (mm)	Pack Qty (pcs)
<b>BOX</b>			
LOC99141	Grey	405 x 95/160	20
LOC99142	Brown	405 x 95/160	20
LOC99143	Black	405 x 95/160	20
LOC99144	Terracotta	405 x 95/160	20
TYPE - RLN		SUB TYPE - RLN01	

### Dry-Verge Eaves Starter



Product Code	Colour	Size (mm)	Pack Qty (pcs)
<b>BOX</b>			
LOC99153	Grey	105 x 155	1
LOC99154	Black	105 x 155	1
LOC99155	Brown	105 x 155	1
LOC99156	Terracotta	105 x 155	1
TYPE - RLN		SUB TYPE - RLN01	

### Cavity Wall Weep Vent



Multi-function product for discharging water from external walls and cavity ventilation.

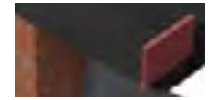

Product Code	Colour	Size H x W x L (mm)	Pack Qty (pcs)
<b>BOX</b>			
LOC1143BB	Blue/Black	65 x 10 x 100	50
LOC1143BL	Black	65 x 10 x 100	50
LOC1143BR	Brown	65 x 10 x 100	50
LOC1143BU	Buff	65 x 10 x 100	50
LOC1143CL	Clear	65 x 10 x 100	50
LOC1143GR	Grey	65 x 10 x 100	50
LOC1143TE	Terracotta	65 x 10 x 100	50
LOC1143WH	White	65 x 10 x 100	50
<b>VENT EXTENSION</b>			
LOC1144	Clear	50mm	10
TYPE - CNA		SUB TYPE - CNA0	

### Universal Verge Ridge/Apex End Cap

Ridge end caps, available in round or angled design.

#### Round End Cap



Product Code	Colour	Size (mm)	Pack Qty (pcs)
<b>BOX</b>			
LOC99136	Black	265 x 240	1
LOC99112	Brown	265 x 240	1
LOC99114	Terracotta	265 x 240	1
LOC99113	Grey	265 x 240	1
TYPE - RLN		SUB TYPE - RLN01	

#### Angled End Cap



Product Code	Colour	Size (mm)	Pack Qty (pcs)
<b>BOX</b>			
LOC99107	Black	265 x 240	1
LOC99108	Brown	265 x 240	1
LOC99110	Terracotta	265 x 240	1
LOC99109	Grey	265 x 240	1
TYPE - RLN		SUB TYPE - RLN01	

### Drill Vent



Cavity ventilator and drainage weeps. Often fitted retrospectively to improve existing ventilation.

Product Code	Colour	Size (mm)	Drill Hole Ø (mm)	Pack Qty (pcs)
<b>BOX</b>				
LOCVD1	Natural	80	25	50
LOCVD2	Buff	80	25	50
LOCVD3	Terracotta	80	25	50
TYPE - CNA		SUB TYPE - CNA03		



## Underfloor Ventilation



### Telescopic Underfloor Ventilator & Extension Accessories

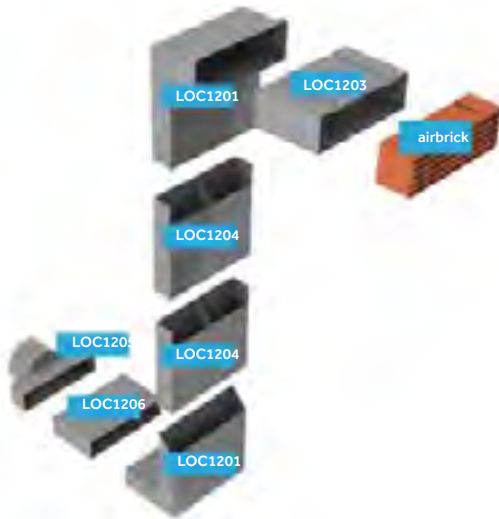

To provide ventilation below suspended ground floors. Telescopic and adjustable to suit numerous brick courses.

Product Code	Size	Pack Qty (pcs)	Carton Qty (packs)
<b>BOX</b>			
<b>TELESCOPIC UNDERFLOOR VENT</b>			
LOC1201	up to 5 course	20	-
LOC1201XL	5 to 7 course	10	-
<b>HORIZONTAL FRONT EXTENSION</b>			
LOC1203	+115mm	20	-
<b>VERTICAL EXTENSION</b>			
LOC1204	+150mm	20	-
<b>HORIZONTAL REAR EXTENSION</b>			
LOC1206	+100mm	1	20
<b>DUCT ADAPTER</b>			
LOC1205	to suit 110mm	1	20
TYPE - CNA		SUB TYPE - CNA01	

### Airbrick - Plastic

Used in conjunction with underfloor vent system and cavity sleeves to provide ventilation below suspended ground floors and through external walls.



Product Code	Colour	Size W x H x D (mm)	Pack Qty (pcs)
<b>BOX</b>			
LOC1201ABBB	Blue/Black	215 x 69 x 60	20
LOC1201ABBL	Black	215 x 69 x 60	20
LOC1201ABBR	Brown	215 x 69 x 60	20
LOC1201ABBU	Buff	215 x 69 x 60	20
LOC1201ABGR	Grey	215 x 69 x 60	20
LOC1201ABTE	Terracotta	215 x 69 x 60	20
LOC1201ABWH	White	215 x 69 x 60	20
TYPE - CNA		SUB TYPE - CNA02	

## Through-Wall Ventilation



### Aero-Core Anti-Draught Ventilators

Combination ventilator sets for background venting and heat producing appliances.

#### Aero-Core with Baffle



#### Aero-Core with Cowl & Baffle



#### Aero-Core with High Rise



Product Code	Colour	Size (mm)	Pack Qty (pcs)
<b>BOX</b>			
<b>AERO-CORE WITH BAFFLE</b>			
LOCACV7BR	Brown	127 x 350	1
LOCACV7TE	Terracotta	127 x 350	1
TYPE - TWV		SUB TYPE - TWV02	
<b>AERO-CORE WITH COWL &amp; BAFFLE</b>			
LOCACV7CBR	Brown	127 x 350	1
LOCACV7CTE	Terracotta	127 x 350	1
LOCACV7CWH	White	127 x 350	1
TYPE - TWV		SUB TYPE - TWV02	
<b>AERO-CORE WITH HIGH RISE</b>			
LOCACV7HRTE	Terracotta	127 x 350	1
TYPE - TWV		SUB TYPE - TWV02	

### Cavity Sleeves

Tough, flexible ventilators for external walls.

#### Cavity Sleeve

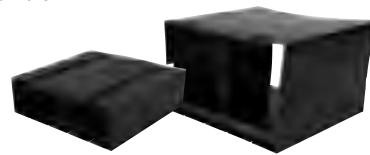

#### Telescopic Extension



#### Baffle



Product Code	Size (inch)	To Suit	Pack Qty (pcs)
<b>BOX</b>			
<b>CAVITY SLEEVE</b>			
LOC12021	9 x 3	Single airbrick	1
LOC12022	9 x 6	Two airbricks stacked	1
TYPE - TWV		SUB TYPE - TWV02	
<b>TELESCOPIC EXTENSION</b>			
LOC1237	9 x 3	+ 90mm	1
LOC1236	9 x 6	+ 90mm	1
TYPE - TWV		SUB TYPE - TWV02	
<b>BAFFLE</b>			
LOC1238	9 x 3	2 x per 9 x 6 sleeve	1
TYPE - TWV		SUB TYPE - TWV02	

### External Cowl

External cowl used to sustain air flow but reduce draughts.



Product Code	Size (mm)	Size (inch)	Pack Qty (pcs)
<b>BOX</b>			
<b>Terracotta</b>			
LOCABC93TE	255 x 95	9 x 3	1
LOCABC96TE	255 x 160	9 x 6	1
LOCABC99TE	255 x 230	9 x 9	1
TYPE - TWV		SUB TYPE - TWV02	
<b>Brown</b>			
LOCABC93BR	255 x 95	9 x 3	1
LOCABC96BR	255 x 160	9 x 6	1
LOCABC99BR	255 x 230	9 x 9	1
TYPE - TWV		SUB TYPE - TWV02	

### Insulation Retaining Discs

Used with a cavity wall tie to hold insulation material against the inner wall of the cavity.



See page **230**

## Internal Grille Vents



### Plastic Grille Vents

Internal white plastic louvre vents for sustaining airflow and reducing drafts. Please note: FLYSCREEN and Hit & Miss vents are not to be used for gas appliance ventilation.

#### Louvre Vent



Product Code	Size (mm)	Size (inch)	Pack Qty (pcs)
<b>BOX</b>			
<b>White</b>			
LOC1218W	165 x 89	6 x 3	1
LOC1207W	242 x 89	9 x 3	1
LOC1211W	242 x 165	9 x 6	1
LOC1212W	242 x 242	9 x 9	1
TYPE - TWV	SUB TYPE - TWV01		

#### Louvre Vent with FLYSCREEN



Product Code	Size (mm)	Size (inch)	Pack Qty (pcs)
<b>BOX</b>			
<b>White</b>			
LOC1218WF	165 x 89	6 x 3	1
LOC1207WF	242 x 89	9 x 3	1
LOC1211WF	242 x 165	9 x 6	1
LOC1212WF	242 x 242	9 x 9	1
TYPE - TWV	SUB TYPE - TWV01		

#### Hit & Miss Louvre Vent



Product Code	Size (mm)	Size (inch)	Pack Qty (pcs)
<b>BOX</b>			
<b>WHITE</b>			
LOC1219W	165 x 89	6 x 3	1
LOC1208W	242 x 89	9 x 3	1
LOC1209W	242 x 165	9 x 6	1
LOC1210W	242 x 242	9 x 9	1
TYPE - TWV	SUB TYPE - TWV01		

### Metal Grille Vents

To cover the inner opening on the cavity sleeve and provide an aesthetically acceptable appearance, while still maintaining a free flow of air. Please note: Hit & Miss vents are not to be used for gas appliance ventilation.

#### Louvre Vent



Product Code	Size (mm)	Size (inch)	Pack Qty (pcs)
<b>BOX</b>			
<b>Aluminium</b>			
LOC1223A	242 x 89	9 x 3	1
LOC1224A	242 x 165	9 x 6	1
LOC1225A	242 x 242	9 x 9	1
<b>Brass Anodised</b>			
LOC1223BA	242 x 89	9 x 3	1
LOC1224BA	242 x 165	9 x 6	1
LOC1225BA	242 x 242	9 x 9	1
<b>Polished Brass</b>			
LOC1223PB	242 x 89	9 x 3	1
LOC1224PB	242 x 165	9 x 6	1
LOC1225PB	242 x 242	9 x 9	1
TYPE - TWV	SUB TYPE - TWV01		

#### Return Air Grille

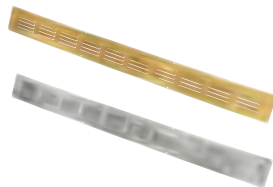

Product Code	Size (mm)	Size (inch)	Pack Qty (pcs)
<b>BOX</b>			
<b>Aluminium</b>			
LOC1226A	648 x 60	25.5 x 2	1
<b>Brass Anodised</b>			
LOC1226BA	648 x 60	25.5 x 2	1
TYPE - TWV	SUB TYPE - TWV01		

#### Hit & Miss Vent



Product Code	Size (mm)	Size (inch)	Pack Qty (pcs)
<b>BOX</b>			
<b>Aluminium</b>			
LOC1220A	242 x 89	9 x 3	1
LOC1221A	242 x 165	9 x 6	1
LOC1222A	242 x 242	9 x 9	1
<b>Brass Anodised</b>			
LOC1220BA	242 x 89	9 x 3	1
LOC1221BA	242 x 165	9 x 6	1
LOC1222BA	242 x 242	9 x 9	1
<b>Polished Brass</b>			
LOC1220PB	242 x 89	9 x 3	1
LOC1221PB	242 x 165	9 x 6	1
LOC1222PB	242 x 242	9 x 9	1
TYPE - TWV	SUB TYPE - TWV01		

## Access Doors & Panels

### Loft Access Door

Plastic insulated loft access doors provide simple, easy access through a ceiling into the loft space.



Product Code	Size (mm)	Pack Qty (pcs)
<b>BOX</b>		
<b>Drop In</b>		
LOC1168	562 x 665	1
TYPE - TAC	SUB TYPE - TAC02	
<b>Hinged</b>		
LOC1169	562 x 662	1
TYPE - TAC	SUB TYPE - TAC02	

### Slotted Loft Door Operating Pole



Product Code	Size (mm)	Pack Qty (pcs)
<b>BAG</b>		
LOCZ1170	600	1
TYPE - TAC	SUB TYPE - TAC02	

### Access Panel



Used in both residential and commercial projects. Access panels (also referred to as access hatches) are vital in order to access concealed electrical, plumbing and building services.

Product Code	Size (mm)	Pack Qty (pcs)
<b>BOX</b>		
<b>Clip Fit</b>		
LOCAP110	115x165	1
LOCAP200	205x205	1
<b>Hinged</b>		
LOCAP150	155x235	1
LOCAP300	305x305	1
LOCAP450	470x470	1
TYPE - TAC	SUB TYPE - TAC01	

# Security & Ironmongery

## Ironmongery

Door Hinges & Cabinet Hinges	238
Specialist Hinges	243
Fire Door Hinges & Accessories	245
Door Locks	250
Door Latches & Catches	253
Door Bolts	254
Door & Window Security	255
Furniture Fixings	256
Door Stops & Hooks	258
Hanging Rails & Accessories	259
Storage & Shelving	260

## Security

Padlocks	261
Key Storage & Accessories	262
Chains & Cables	262
Squire Locks	263

For more information about TIMCO's Security & Ironmongery ranges, including certifications and data sheets please visit [timco.co.uk](http://timco.co.uk)

**NEW**

## Hinges Now Available In TIMpac

Selective hinge ranges now available in TIMpac including Grade 7 and 11 Fire Door Hinges.



## Door & Cabinet Hinges

### Butt Hinge - Fixed Pin (1838)

**NEW**

Electro Brass



Steel butt hinges with a fixed pin that are ideal for use on light duty internal applications.

- Made from steel
- Fixed Pin

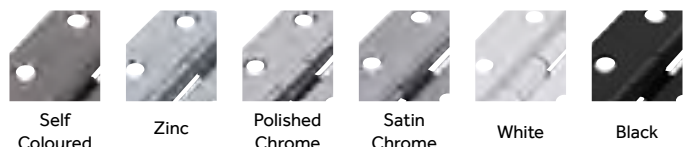

Technical Data						
Size L x W (mm)	25 x 25	38 x 34	63 x 44	75 x 50	90 x 60	100 x 70
Thickness (mm)	1.2	1.2	1.5	1.5	1.7	1.7
Knuckle Ø (mm)	5.0	5.6	6.8	7.3	8.7	9.3
Rec. Screw Ø (mm)	3.0	3.5	3.5	4.0	4.0	4.5
Rec. Screw Gauge (Imp.)	4	6	6	8	8	9
Max. Door Weight (kg)	2	2	10	20	25	30

Product Code

Self Coloured	Zinc	Electro Brass	Polished Chrome	Satin Chrome	White	Black	L x W (mm)	Pack Qty (pair)	Carton Qty (packs)
<b>TIMPAC - FIXINGS INCLUDED</b>									
-	434225P	-	-	-	-	-	38 x 34	1	10
-	434789P	-	-	-	-	-	63 x 44	1	10
434963P	434831P	434701P	434607P	-	-	434329P	75 x 50	1	10
434025P	434158P	434167P	434123P	-	-	434401P	100 x 70	1	10
<b>PLAIN BAG - EXCLUDES FIXINGS</b>									
434005	434364	434652	-	-	-	-	25 x 25	1	200
434475	434225	434587	-	-	-	-	38 x 34	1	200
-	434789	434269	-	-	-	-	63 x 44	1	90
434963	434831	434701	434607	434817	434099	434329	75 x 50	1	90
434841	434069	434456	-	-	-	-	90 x 60	1	50
434025	434158	434167	434123	434555	434303	434401	100 x 70	1	60
TYPE - PAK / IDH							SUB TYPE - PAK68 / IDH01		
<b>BULK BOX - EXCLUDES FIXINGS</b>									
-	434886	-	-	-	-	-	75 x 50	10	200
TYPE - PAK / IDH							SUB TYPE - PAK68 / IDH01		

### Butt Hinge - Loose Pin (1840)

**NEW**

Electro Brass



These steel butt hinges with a loose pin are ideal for use on light duty internal applications. The hinge features a removable pin to enable quick door hanging and removal at a later date.

- Made from steel
- Loose Pin

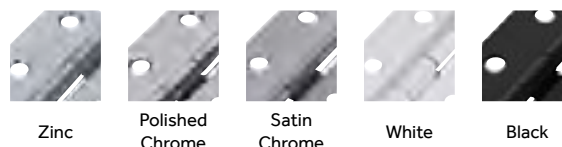

Technical Data			
Size L x W (mm)	75 x 50	90 x 60	100 x 71
Thickness (mm)	1.5	1.7	1.7
Knuckle Ø (mm)	7.2	8.7	9.3
Rec. Screw Ø (mm)	4.0	4.0	4.5
Rec. Screw Gauge (Imp.)	8	8	9
Max. Door Weight (kg)	20	25	30

Product Code

Zinc	Electro Brass	Polished Chrome	Satin Chrome	White	Black	L x W (mm)	Pack Qty (pair)	Carton Qty (packs)
<b>TIMPAC - FIXINGS INCLUDED</b>								
434642P	434659P	434435P	434006P	-	-	75 x 50	1	10
<b>PLAIN BAG - EXCLUDES FIXINGS</b>								
434642	434659	434435	434006	434720	434655	75 x 50	1	90
434317	434208	434237	-	-	-	90 x 60	1	50
434482	434101	434118	434520	434498	434319	100 x 71	1	60
TYPE - PAK / IDH							SUB TYPE - PAK69 / IDH02	

### Strong Steel Butt Hinge (451)

Zinc

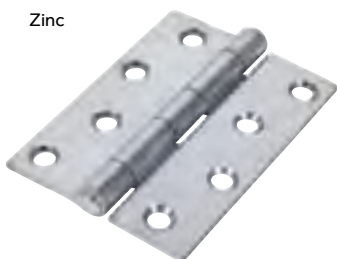

Heavy duty steel butt hinges with a fixed pin are manufactured from a thicker gauge of steel and are ideal for use on heavy duty doors.

- Made from steel

Product Code	L x W (mm)	Pack Qty (pair)	Carton Qty (packs)
<b>PLAIN BAG - EXCLUDES FIXINGS</b>			
<b>Zinc</b>			
434569	100 x 73	1	30
TYPE - IDH		SUB TYPE - IDH03	

Technical Data	
Size L x W (mm)	100 x 73
Thickness (mm)	2.5
Knuckle Ø (mm)	12.0
Rec. Screw Ø (mm)	5.0
Rec. Screw Gauge (Imp.)	10
Max. Door Weight (kg)	40

### Strong Security Hinge (451/S)

Zinc



Strong security butt hinges are ideal for outward opening doors. The hinge features interlocking lugs on the leaf of the hinge which prevent the door being removed in the event of the hinge pin being attacked and removed.

- Made from steel

Product Code	L x W (mm)	Pack Qty (pair)	Carton Qty (packs)
<b>PLAIN BAG - EXCLUDES FIXINGS</b>			
<b>Zinc</b>			
434569	100 x 72.5	1	30
TYPE - IDH		SUB TYPE - IDH10	

Technical Data	
Size L x W (mm)	100 x 72.5
Thickness (mm)	2.5
Knuckle Ø (mm)	12.0
Rec. Screw Ø (mm)	5.0
Rec. Screw Gauge (Imp.)	10
Max. Door Weight (kg)	40



## Narrow Uncranked Butt Hinge (5050)

Self Coloured



An uncranked hinge with a fixed pin and narrow hinge leaves making them ideal for thinner doors in internal applications.

- Made from steel



Zinc

### Technical Data

Size L x W (mm)	75 x 48	100 x 58	127 x 65	150 x 75
Thickness (mm)	1.5	1.5	1.7	2.0
Knuckle Ø (mm)	7.2	8.3	8.8	9.0
Rec. Screw Ø (mm)	4.0	4.0	5.0	5.0
Rec. Screw Gauge (Imp.)	8	8	10	10
Max. Door Weight (kg)	20	30	40	50

### Product Code

Self Coloured	Zinc	L x W (mm)	Pack Qty (pair)	Carton Qty (packs)
<b>PLAIN BAG - EXCLUDES FIXINGS</b>				
434645	434015	75 x 48	1	90
434324	434255	100 x 58	1	60
434422	434149	127 x 65	1	30
434119	434999	150 x 75	1	20
TYPE - IDH		SUB TYPE - IDH14		

## Cast Iron Butt Hinge (200)

Self Coloured



Cast iron butt hinges are ideal for low use domestic doors and are commonly fitted on period properties to match in with existing cast iron door ironmongery.

- Made from cast iron



Black

### Technical Data

Size L x W (mm)	75 x 50	102 x 60
Thickness (mm)	3.5	4.0
Knuckle Ø (mm)	12.0	12.0
Rec. Screw Ø (mm)	4.0	4.5
Rec. Screw Gauge (Imp.)	8	9
Max. Door Weight (kg)	20	30

### Product Code

Self Coloured	Black	L x W (mm)	Pack Qty (pair)	Carton Qty (packs)
<b>PLAIN BAG - EXCLUDES FIXINGS</b>				
434176	434905	75 x 50	1	50
434444	434731	102 x 60	1	30
TYPE - IDH		SUB TYPE - IDH12		

## Double Pressed Butt Hinge (899)

Self Coloured

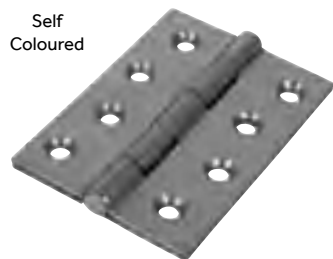

Double pressed hinges feature hinge leaves that are pressed with two layers of steel to increase the strength of the hinge making them ideal for high use internal doors in public areas.

- Made from steel



Zinc

### Technical Data

Size L x W (mm)	102 x 72
Thickness (mm)	4.0
Knuckle Ø (mm)	10.5
Rec. Screw Ø (mm)	5.0
Rec. Screw Gauge (Imp.)	10
Max. Door Weight (kg)	80

### Product Code

Self Coloured	L x W (mm)	Pack Qty (pair)	Carton Qty (packs)
<b>PLAIN BAG - EXCLUDES FIXINGS</b>			
434835	102 x 72	1	20
TYPE - IDH		SUB TYPE - IDH09	

## Double Steel Washered Hinge

**NEW**

Polished Brass



Double steel washered hinges are made to a high specification from solid drawn brass with steel pins. They are ideal for hanging internal doors in domestic applications. Featuring steel washers to prevent knuckle wear and long lasting operation.

### Fixings Included



Polished Chrome



Satin Chrome

- Made from solid brass

### Technical Data

Size L x W (mm)	76 x 50	102 x 67
Thickness (mm)	2.00	2.20
Screw Size (mm)	4.0 x 25	5.0 x 30
Rec. Screw Ø (mm)	4.0	5.0
Rec. Screw Gauge (Imp.)	8	10
Max. Door Weight (kg)	20	25

### Product Code

Polished Brass	Polished Chrome	Satin Chrome	L x W (mm)	Pack Qty (pair)	Carton Qty (packs)
<b>TIMPAC - FIXINGS INCLUDED</b>					
234555P	234731P	234426P	76 x 50	1	10
234898P	234129P	234684P	102 x 67	1	10
<b>BAG - FIXINGS INCLUDED</b>					
234555	234731	234426	76 x 50	1	10
234898	234129	234684	102 x 67	1	10
TYPE - PAK / IDH		SUB TYPE - PAK81 / BDH04			

## Double Stainless Steel Washered Hinge



Polished Chrome

NEW

Double stainless steel washered hinges are made to a high specification from solid drawn brass with stainless steel pins and a high quality long lasting finish. They are ideal for hanging internal and external doors in domestic applications.

### Fixings Included



Satin Chrome

Made from solid brass

### Technical Data

Size L x W (mm)	76 x 50	102 x 67	102 x 75
Thickness (mm)	2.50	3.50	3.50
Knuckle Ø (mm)	8.0	10.0	10.0
Screw Size (mm)	4.0 x 25	5.0 x 30	5.0 x 30
Rec. Screw Ø (mm)	4.0	5.0	5.0
Rec. Screw Gauge (Imp.)	8	10	10
Max. Door Weight (kg)	24	40	60

### Product Code

Polished Chrome	Satin Chrome	L x W (mm)	Pack Qty (pair)	Carton Qty (packs)
<b>BOX - FIXINGS INCLUDED</b>				
234381	234635	76 x 50	1	80
234412	234951	102 x 67	1	40
234708	234210	102 x 75	1	40

TYPE - BDH SUB TYPE - BDH03

## Double Phosphor Bronze Washered Hinge



NEW

Double phosphor bronze washered hinges are made to a high specification from solid drawn brass and brass pins to guarantee no rust and a high quality long lasting finish. They are ideal for hanging internal and external doors in domestic applications. Featuring phosphor bronze washers to prevent knuckle wear and long lasting operation.

### Fixings Included



Antique Brass



Bronze

Made from solid brass

### Technical Data

Size L x W (mm)	76 x 50	102 x 67	102 x 75
Thickness (mm)	2.50	3.50	3.50
Knuckle Ø (mm)	8.0	10.0	10.0
Screw Size (mm)	4.0 x 25	5.0 x 30	5.0 x 30
Rec. Screw Ø (mm)	4.0	5.0	5.0
Rec. Screw Gauge (Imp.)	8	10	10
Max. Door Weight (kg)	24	40	60

### Product Code

Polished Brass	Antique Brass	Bronze	L x W (mm)	Pack Qty (pair)	Carton Qty (packs)
<b>BOX - FIXINGS INCLUDED</b>					
234158	234147	234114	76 x 50	1	80
234269	234100	234249	102 x 67	1	40
234358	234910	234762	102 x 75	1	40

TYPE - BDH SUB TYPE - BDH02

## Twin Ball Bearing Hinge - 201 Stainless Steel



Polished Stainless Steel

Designed for use on medium duty doors in domestic and commercial areas. Lubricated ball bearing washers reduce wear of the knuckles, increasing the life of the hinge and provides a smooth door operation.

### Fixings Included



Satin Stainless Steel

Made from 201 stainless steel

### Technical Data

Size L x W (mm)	76 x 51
Thickness (mm)	2.0
Knuckle Ø (mm)	11.6
Rec. Screw Ø (mm)	4.0
Rec. Screw Gauge (Imp.)	8
Max. Door Weight (kg)	40

### Product Code

Polished Stainless Steel	Satin Stainless Steel	L x W (mm)	Pack Qty (pair)	Carton Qty (packs)
<b>BOX - FIXINGS INCLUDED</b>				
340999	340258	76 x 51	1	50

TYPE - DHB SUB TYPE - DHB01

## Twin Ball Bearing Hinge - Steel



Satin Nickel

Designed for use on medium duty doors in domestic and commercial areas. Lubricated ball bearing washers reduce wear of the knuckles, increasing the life of the hinge and provides a smooth door operation.

### Fixings Included

Made from steel



Electro Brass



Antique Brass



Polished Chrome



Satin Chrome



White



Black

### Technical Data

Size L x W (mm)	76 x 51	102 x 76
Thickness (mm)	2.2	2.7
Knuckle Ø (mm)	10.6	12.6
Hole Ø (mm)	6.0	7.0
Rec. Screw Ø (mm)	4.0	5.0
Rec. Screw Gauge (Imp.)	8	10
Max. Door Weight (kg)	40	80

### Product Code

Satin Nickel	Electro Brass	Antique Brass	Polished Chrome	Satin Chrome	White	Black	L x W (mm)	Pack Qty (pair)	Carton Qty (packs)
<b>BOX - FIXINGS INCLUDED</b>									
340147	340843	340573	340456	340987	340369	340258	76 x 51	1	50
340101	340321	-	340555	340670	-	-	102 x 76	1	40

TYPE - DHB SUB TYPE - DHB01

## Performance Ball Bearing Hinge - Button Tip



Polished Brass

NEW

Performance ball raced hinges are made to the highest specification from solid drawn brass and brass pins to guarantee no rust and a long lasting finish. They are ideal for heavy high quality doors in domestic applications. Featuring 4 ball bearing raced knuckles to prevent knuckle wear and provide a lifetime of silent, smooth door operation.

### Fixings Included



Antique Brass Bronze Polished Chrome Satin Chrome

• Made from solid brass

### Technical Data

Size L x W (mm)	76 x 50	102 x 76
Thickness (mm)	2.50	3.00
Knuckle Ø (mm)	8.0	10.0
Screw Size (mm)	4.0 x 25	5.0 x 30
Rec. Screw Ø (mm)	4.0	5.0
Rec. Screw Gauge (Imp.)	8	10
Max. Door Weight (kg)	40	80

### Product Code

Polished Brass	Antique Brass	Bronze	Polished Chrome	Satin Chrome	L x W (mm)	Pack Qty (pair)	Carton Qty (packs)
<b>BOX - FIXINGS INCLUDED</b>							
234953	234842	234185	234011	234444	76 x 50	1	80
234751	234268	234759	234050	234591	102 x 76	1	40

TYPE - DHB SUB TYPE - BDH05

## Plain Bearing Flush Hinge

NEW



Polished Brass

Brass flush hinges enable quick and easy installation of light internal doors or cabinets as they require no cutting into the door or frame. These flush hinges feature a brass bearing to prevent knuckle wear and provide a lifetime of silent, smooth door operation. They are a popular choice for quality joinery projects with lay over timber, MDF or particle doors as they enable a solid fixing through the face of the door.

• Made from solid brass



Antique Brass Bronze Polished Chrome Satin Chrome

### Fixings Included

### Technical Data

Size L x W (mm)	60 x 41	75 x 50
Thickness (mm)	1.40	1.70
Knuckle Ø (mm)	6.0	6.4
Screw Size (mm)	3.0 x 15	3.5 x 25
Rec. Screw Ø (mm)	3.0	3.5
Rec. Screw Gauge (Imp.)	4	6

### Product Code

Polished Brass	Antique Brass	Bronze	Polished Chrome	Satin Chrome	L x W (mm)	Pack Qty (pair)	Carton Qty (packs)
<b>PLAIN BAG - FIXINGS INCLUDED</b>							
234077	234579	234862	234606	234432	60 x 41	1	100
234316	234685	234111	234553	234797	75 x 50	1	100

TYPE - DHB SUB TYPE - DHB07

## Solid Drawn Hinge



Polished Brass

NEW

Solid drawn hinges are made to a high specification from solid drawn brass and brass pins to guarantee no rust and a high quality long lasting finish. They are ideal for hanging light cupboard and cabinet doors in quality joinery products.

### Fixings Included



Antique Brass Bronze Polished Chrome Satin Chrome

• Made from solid brass

### Technical Data

Size L x W (mm)	38 x 22	50 x 28	64 x 35	75 x 40
Thickness (mm)	1.30	1.45	2.00	2.00
Knuckle Ø (mm)	4.8	5.0	5.0	6.6
Screw Size (mm)	3.0 x 12	3.0 x 15	3.0 x 15	3.5 x 25
Rec. Screw Ø (mm)	3.0	3.0	3.0	3.5
Rec. Screw Gauge (Imp.)	4	4	4	6

### Product Code

Polished Brass	Antique Brass	Bronze	Polished Chrome	Satin Chrome	L x W (mm)	Pack Qty (pair)	Carton Qty (packs)
<b>PLAIN BAG - FIXINGS INCLUDED</b>							
234789	234471	234357	234617	234482	38 x 22	1	250
234654	234582	234204	234329	234593	50 x 28	1	250
234321	234963	234448	234846	234682	64 x 35	1	250
234016	234159	234023	234279	234571	75 x 40	1	250

TYPE - DHB SUB TYPE - BDH01

## Flush Hinge (105)

NEW

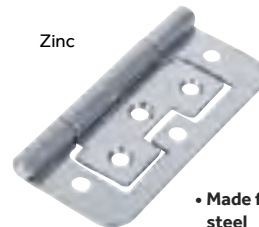

Zinc

Steel flush hinges enable quick and easy installation of light internal doors or cabinets as they require no cutting into the door or frame. The hinge knuckle is flush with the back of the hinge leaf making them a popular choice for lay over doors.

• Made from steel



Electro Brass White

### Technical Data

Size L x W (mm)	38 x 28	50 x 38.5	63 x 37	75 x 51
Thickness (mm)	1.2	1.2	1.2	1.5
Knuckle Ø (mm)	6.5	6.5	6.5	8.0
Rec. Screw Ø (mm)	3.5	3.5	3.5	3.5
Rec. Screw Gauge (Imp.)	6	6	6	6
Max. Door Weight (kg)	2	5	10	12

### Product Code

Zinc	Electro Brass	White	L x W (mm)	Pack Qty (pair)	Carton Qty (packs)
<b>TIMPAC - FIXINGS INCLUDED</b>					
434451P	434464P	-	38 x 28	1	10
434056P	434872P	434915P	50 x 38.5	1	10
434900P	434946P	-	63 x 37	1	10
434777P	434174P	-	75 x 51	1	10
<b>PLAIN BAG - EXCLUDES FIXINGS</b>					
434451	434464	-	38 x 28	1	200
434056	434872	434915	50 x 38.5	1	200
434900	434946	-	63 x 37	1	90
434777	434174	-	75 x 51	1	90

TYPE - PAK / IDH SUB TYPE - PAK72 / IDH07

## Hurlinge - Fixed Pin (104)

Zinc

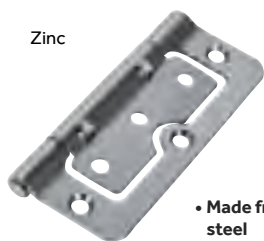

• Made from steel

Hurlinges enable quick door fitting as they require no morticing into the door or frame. They feature lugs on the knuckle for quick and simple lining up.



Electro Brass



Polished Chrome

### Technical Data

Size L x W (mm)	75 x 55	101 x 66
Thickness (mm)	1.5	2.0
Knuckle Ø (mm)	8.0	9.0
Rec. Screw Ø (mm)	3.5	4.0
Rec. Screw Gauge (Imp.)	6	8
Max. Door Weight (kg)	20	30

### Product Code

Zinc	Electro Brass	Polished Chrome	L x W (mm)	Pack Qty (pair)	Carton Qty (packs)
<b>PLAIN BAG - EXCLUDES FIXINGS</b>					
434457	434367	434202	75 x 55	1	90
434142	434819	434666	101 x 66	1	60
TYPE - IDH			SUB TYPE - IDH04		

## Hurlinge - Loose Pin (104Z)

NEW

Zinc



• Made from steel

Hurlinges enable quick door fitting as they require no morticing into the door or frame. They feature lugs on the knuckle for quick and simple lining up. The hinge features a removable pin to enable quick door hanging and removal at a later date.



Electro Brass



Polished Chrome

### Technical Data

Size L x W (mm)	75 x 52	100 x 66
Thickness (mm)	1.5	2.0
Knuckle Ø (mm)	8.0	9.0
Rec. Screw Ø (mm)	3.5	4.0
Rec. Screw Gauge (Imp.)	6	8
Max. Door Weight (kg)	20	30

### Product Code

Zinc	Electro Brass	Polished Chrome	L x W (mm)	Pack Qty (pair)	Carton Qty (packs)
<b>TIMPAC - FIXINGS INCLUDED</b>					
434432P	434728P	-	100 x 66	1	10
<b>PLAIN BAG - EXCLUDES FIXINGS</b>					
434002	434976	434641	75 x 52	1	90
434432	434728	434258	100 x 66	1	60
TYPE - PAK / IDH			SUB TYPE - PAK70 / IDH05		

## Specialist Hinges

### Rising Butt Hinge (466)

NEW

Left Hand



Left

Right Hand



Right

• Made from steel

The spiral knuckle that lifts the door throughout the opening cycle making it ideal for uneven floor surfaces or obstructions. It also enables the door to self close. Door can be lifted off the frame.

### Technical Data

Size L x W (mm)	75 x 72	100 x 86
Thickness (mm)	2.5	3.0
Knuckle Ø (mm)	14.0	15.5
Rec. Screw Ø (mm)	4.0	5.0
Rec. Screw Gauge (Imp.)	8	10
Max. Door Weight (kg)	30	40

### Product Code

Zinc Left Hand	Zinc Right Hand	Electro Brass Left Hand	Electro Brass Right Hand	L x W (mm)	Pack Qty (pair)	Carton Qty (packs)
<b>TIMPAC - FIXINGS INCLUDED</b>						
434910P	434349P	-	-	75 x 72	1	30
<b>PLAIN BAG - EXCLUDES FIXINGS</b>						
434910	434349	434483	434639	75 x 72	1	30
434157	434792	434458	434127	100 x 86	1	20
TYPE - PAK / IDH			SUB TYPE - PAK71 / IDH06			

### Lift Off Hinge (457)

Left Hand

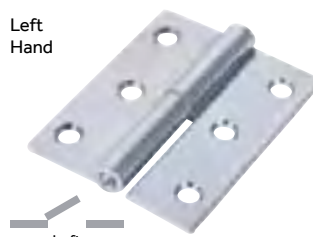

Left

Right Hand



Right

• Made from steel

Lift off hinges are designed to enable the door to be lifted out of the frame after being fitted making them ideal for applications where regular cleaning, decorating or moving of furniture is required.

### Technical Data

Size L x W (mm)	75 x 62	101 x 63
Thickness (mm)	2.0	3.0
Knuckle Ø (mm)	10.3	13
Rec. Screw Ø (mm)	4.0	5.0
Rec. Screw Gauge (Imp.)	8	10
Max. Door Weight (kg)	20	30

### Product Code

Zinc Left Hand	Zinc Right Hand	L x W (mm)	Pack Qty (pair)	Carton Qty (packs)
<b>PLAIN BAG - EXCLUDES FIXINGS</b>				
434706	434467	75 x 62	1	50
434815	434307	101 x 63	1	30
TYPE - IDH			SUB TYPE - IDH15	



## Specialist Hinges

### Cranked Ball Bearing Hinge

**NEW**

Polished Brass



These cranked hinges are manufactured from high quality extruded brass and brass pins to guarantee a rust free long lasting finish. They are ideal for high quality rebated casement door and window projects. The ball bearing raced knuckles prevent knuckle wear and will provide a lifetime of silent and smooth operation.



Polished Chrome



Satin Chrome

- Made from solid brass

#### Technical Data

Size L x W (mm)	64 x 55
Thickness (mm)	2.50
Knuckle Ø (mm)	8.0
Screw Size (mm)	4.0 x 25
Rec. Screw Ø (mm)	4.0
Rec. Screw Gauge (Imp.)	8
Max. Door Weight (kg)	40

#### Product Code

Polished Brass	Polished Chrome	Satin Chrome	L x W (mm)	Pack Qty (pair)	Carton Qty (packs)
234584	234236	234761	64 x 55	1	80
TYPE - BDH					
SUB TYPE - BDH09					

### Stormproof Hinge (1951)

**NEW**

Zinc



Stormproof hinges are designed to fit into the rebate of a stormproof casement frame and allow the casement to pivot away from the frame.



Brown



White

- Made from Steel

#### Technical Data

Size L x W (mm)	63 x 58
Thickness (mm)	1.8
Knuckle Ø (mm)	10.0
Rec. Screw Ø (mm)	4.0
Rec. Screw Gauge (Imp.)	8

#### Product Code

Zinc	Brown	White	L x W (mm)	Pack Qty (pair)	Carton Qty (packs)
TIMPAC - FIXINGS INCLUDED					
434105P	-	-	63 x 58	1	10
PLAIN BAG - EXCLUDES FIXINGS					
434105	434077	434643	63 x 58	1	80
TYPE - PAK / IDH					
SUB TYPE - PAK74 / IDH11					

### Backflap Hinge - Uncranked Knuckle (404)

**NEW**

Self Coloured

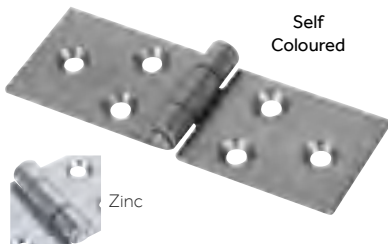

Steel backflap hinges are ideal for a wide variety of applications where a hinge is required to be screwed the face of the door, commonly when the door material is too thin for butt hinges.

- Made from steel
- Uncranked knuckle

#### Technical Data

Size L x W (mm)	25 x 74	32 x 76	38 x 87	50 x 106	65 x 147	75 x 167
Thickness (mm)	1.5	1.5	1.5	2.0	2.3	2.5
Knuckle Ø (mm)	6.6	6.6	7.7	8.8	8.8	8.8
Rec. Screw Ø (mm)	3.5	3.5	4.0	4.5	4.5	4.5
Rec. Screw Gauge (Imp.)	8	8	8	9	9	9

#### Product Code

Self Coloured	Zinc	L x W (mm)	Pack Qty (pair)	Carton Qty (packs)
TIMPAC - FIXINGS INCLUDED				
-	434846P	32 x 76	1	10
-	434715P	38 x 87	1	10
-	434843P	50 x 106	1	10
PLAIN BAG - EXCLUDES FIXINGS				
434328	434534	25 x 74	1	150
434461	434846	32 x 76	1	150
434783	434715	38 x 87	1	100
434029	434843	50 x 106	1	100
434164	434554	65 x 147	1	60
434322	434791	75 x 167	1	30
TYPE - PAK / IDH				
SUB TYPE - PAK73 / IDH08				

### Counter Flap Hinge

**NEW**

Polished Brass

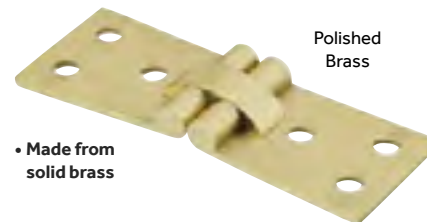

Counter flap hinges are manufactured from high quality extruded brass and brass pins to guarantee a rust free long lasting finish. They are suitable for all counter types and are a popular choice for public bar opening counter tops. Fixings included.

- Made from solid brass



Polished Chrome



Satin Chrome

#### Technical Data

Size L x W (mm)	100 x 40
Thickness (mm)	2.50
Screw Size (mm)	4.0 x 25
Rec. Screw Ø (mm)	4.0
Rec. Screw Gauge (Imp.)	8
Max. Door Weight (kg)	10

#### Product Code

Polished Brass	Polished Chrome	Satin Chrome	L x W (mm)	Pack Qty (pair)	Carton Qty (packs)
BOX - EXCLUDES FIXINGS					
234999	234807	234340	100 x 40	1	100
TYPE - BDH					
SUB TYPE - BDH08					

## Parliament Hinge

NEW

Polished Brass

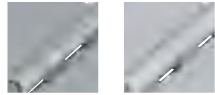

Polished Chrome      Satin Chrome

• Made from solid brass

Brass parliament hinges are made from high quality extruded brass with solid brass pins to guarantee no rust and a long lasting finish. They are ideal for internal and external doors and are commonly fitted when projecting architraves would prevent the door from opening properly when fitted with normal butt hinges. They also allow the door to open to 180 degrees making them ideal for applications when the door is required to fold back on itself and create the maximum opening through a doorway and room space.

### Fixings Included

#### Technical Data

Size L x W (mm)	102 x 100	102 x 125	102 x 150
Thickness (mm)	4.00	4.00	4.00
Knuckle Ø (mm)	11.0	11.0	11.0
Rec. Screw Ø (mm)	5.0	5.0	5.0
Rec. Screw Gauge (Imp.)	10	10	10
Max. Door Weight (kg)	30	30	30
Projection (mm)	50	75	100

#### Product Code

Polished Brass	Polished Chrome	Satin Chrome	L x W (mm)	Pack Qty (pair)	Carton Qty (packs)
<b>BOX - FIXINGS INCLUDED</b>					
234813	234337	234002	102 x 100	1	20
234297	234919	234500	102 x 125	1	20
234460	234364	234222	102 x 150	1	20
TYPE - BDH			SUB TYPE - BDH06		

## Parliament Hinge (488)

Electro Brass



Ideal for internal doors. Commonly fitted when projecting architraves would prevent the door from opening properly. Also allowing the door to open 180° making them ideal for when the door is required to fold back on itself and create the maximum opening through a doorway.

- Made from steel
- Uncranked Knuckle

#### Technical Data

Size L x W (mm)	125 x 155
Thickness (mm)	2.2
Knuckle Ø (mm)	13.3
Rec. Screw Ø (mm)	5.0
Rec. Screw Gauge (Imp.)	10
Max. Door Weight (kg)	40
Projection (mm)	100

#### Product Code

Electro Brass	L x W (mm)	Pack Qty (pair)	Carton Qty (packs)
<b>PLAIN BAG - EXCLUDES FIXINGS</b>			
434780	125 x 155	1	24
TYPE - IDH		SUB TYPE - IDH13	

# Gate & Fence Hardware

We offer a comprehensive range of external door, gate, fieldgate and fence hardware

See page 271

# Fire Door Hinges & Intumescent Accessories

## Ball Bearing Fire Door Hinges

Satin  
Stainless  
Steel



Polished  
Chrome



**Grade 13**  
Ideal for heavy doors  
up to 120kg

**Grade 11**  
Ideal for heavy doors  
up to 80kg

**Grade 7**  
Ideal for heavy doors  
up to 40kg

- Smooth ball bearing action
- Suitable for 30 & 60 minute fire doors
- For doors with heavy traffic - tested to 200,000 cycles
- CE Approved - BS EN 1935
- Fit with intumescent hinge pads (Not included) when fitting fire doors to adhere to fire regulations.

### Fixings Included

Technical Data			
Hinge Grade	13	11	7
Size L x W (mm)	101 x 76	101 x 76	76 x 50
Thickness (mm)	3.0	2.6	2.0
Knuckle Ø (mm)	14.2	12.5	11.0
Rec. Screw Ø (mm / imp)	5.0 / 10	5.0 / 10	4.5
Max. Door Weight (kg)	120	80	40



### Product Code

Electro Brass	Polished Chrome	Satin Chrome	Satin Nickel	Epoxy Black	Epoxy White	Antique Brass	L x W (mm)	Pack Qty (pairs)	Carton Qty (packs)
<b>GRADE 7 - STEEL</b>									
<b>TIMPAC</b>									
334101	334159	334654	-	334321	-	-	76 x 50	1	10
<b>BOX</b>									
334101	334159	334654	334789	334321	334267	334034	76 x 50	1	60
TYPE - PAK / FHB								SUB TYPE - PAK75 / FHB03	

<b>GRADE 11 - STEEL</b>									
<b>TIMPAC</b>									
334753P	334988P	334040P	-	-	-	-	101 x 76	1	10
<b>BOX</b>									
334753	334988	334040	334555	-	-	-	101 x 76	1	40
TYPE - PAK / FHB								SUB TYPE - PAK76 / FHB02	

### Product Code

Electro Brass	Polished Chrome	Satin Chrome	Matt Black	L x W (mm)	Pack Qty (pair)	Carton Qty (packs)
<b>GRADE 13 - STAINLESS STEEL</b>						
<b>BLISTER PACK</b>						
334777	334843	334052	334161	101 x 76	1	5
334617	334080	334903	334741	101 x 76	1.5	5
<b>BOX</b>						
334027	334457	334111	334308	101 x 76	1	40
334006	334444	334519	334366	101 x 76	1.5	40
TYPE - FHB				SUB TYPE - FHB01		

### Grade 7 and 11

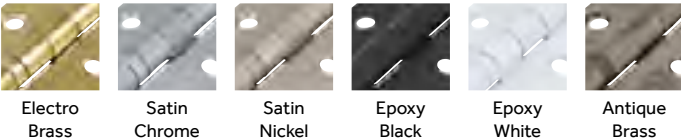

### Grade 13

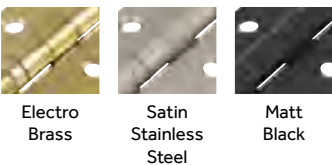

## Intumescent Fire Only Seals



- Tested to BS476 Part 22, BS EN 1634-1
- Laboratory ageing tested for 100 years
- Rapid high-pressure multi-directional expansion
- Supplied with self adhesive backing for ease of installation

Product Code		W x D (mm)	L (mm)	Fire Rating (mins)	Pack Qty (pcs)	Carton Qty (packs)
White	Brown					
<b>SINGLE DOOR PACK</b>						
487762	487284	10 x 4	1050	30	5	20
487661	487097	15 x 4	1050	30 & 60	5	20
<b>BULK PACK</b>						
487053	487964	10 x 4	2100	30	50	4
487222	487773	15 x 4	2100	30 & 60	50	4
TYPE - ITS				SUB TYPE - ITS01		

## Intumescent Fire & Smoke Seals



- Tested to BS476 Part 22, BS EN 1634-1
- Laboratory ageing tested for 100 years
- Rapid high-pressure multi-directional expansion
- Supplied with self adhesive backing for ease of installation

Product Code		W x D (mm)	L (mm)	Fire Rating (mins)	Pack Qty (pcs)	Carton Qty (packs)
White	Brown					
<b>SINGLE DOOR PACK</b>						
487854	487336	10 x 4	1050	30	5	20
487746	487558	15 x 4	1050	30 & 60	5	20
<b>BULK PACK</b>						
487408	487671	10 x 4	2100	30	50	4
487239	487515	15 x 4	2100	30 & 60	50	4
TYPE - ITS				SUB TYPE - ITS01		

## Intumescent Hinge Pads



- Intumescent hinge pads are an essential requirement when fitting hinges to fire doors as they seal any gaps in the rebate and prevent the transfer of heat from the hinge to the door and frame in the event of a fire.
- Tested to BS476 Part 22, BS EN 1634-1

Product Code	W x L (mm)	Depth (mm)	Fire Rating (mins)	Pack Qty (pcs)	Carton Qty (packs)
<b>BAG</b>					
487385	30 x 100	1.0	30	6	250
TYPE - ITS				SUB TYPE - ITS01	

## Butterfly Hinges

NEW



Black Antique Butterfly pattern hinge, surface fixing ideal for small cupboards or boxes.

• Made from steel

Antique Black

Fixings Included

### Technical Data

Size L x W (mm)	70 x 48
Thickness (mm)	2.50
Rec. Screw Ø (mm)	3.5
Rec. Screw Gauge (Imp.)	6

### Product Code

Antique Black	L x W (mm)	Pack Qty (pair)	Carton Qty (packs)
<b>BAG - FIXINGS INCLUDED</b>			
434474	70 x 48	1	5
TYPE - IDH		SUB TYPE - IDH17	

## Unequal Hinges

NEW

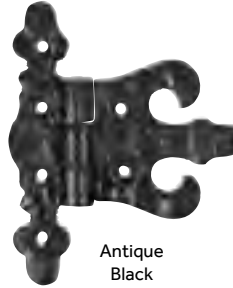

Black Antique Unequal pattern working hinges for internal doors to give a decorative finish.

• Made from steel

Antique Black

Fixings Included

### Technical Data

Size L x W (mm)	105 x 86
Thickness (mm)	5.5
Rec. Screw Ø (mm)	3.5
Rec. Screw Gauge (Imp.)	6

### Product Code

Antique Black	L x W (mm)	Pack Qty (pair)	Carton Qty (packs)
<b>BAG - FIXINGS INCLUDED</b>			
442523	105 x 86	1	5
TYPE - IDH		SUB TYPE - IDH20	

## Curly Tail Casement Fastener

NEW



Curly Tail casement fastener for traditional wooden casement windows.

• Made from steel

Antique Black

Fixings Included

### Technical Data

Size L (mm)	95
Handle Back Plate Size L x W (mm)	62 x 19
Hook Back Plate Size L x W (mm)	62 x 19
Mortice Back Plate Size L x W (mm)	78 x 50
Rec. Screw Ø (mm)	3.5
Rec. Screw Gauge (Imp.)	6

### Product Code

Antique Black	Handle Length (mm)	Pack Qty (pcs)	Carton Qty (packs)
<b>BAG - FIXINGS INCLUDED</b>			
949946	95	1	5
TYPE - WHW		SUB TYPE - WHW02	

## Crown / Coronet Hinges

NEW

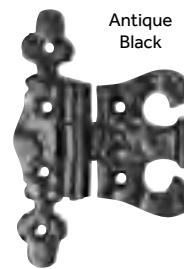

Antique Black

Black Antique Crown/Coronet pattern working hinges for doors to give a decorative finish.

• Made from steel

Fixings Included

### Technical Data

Size L (mm)	317
Thickness (mm)	5
Rec. Screw Ø (mm)	3.5
Rec. Screw Gauge (Imp.)	6

### Product Code

Antique Black	L x W (mm)	Length (mm)	Length (inch)	Pack Qty (pair)	Carton Qty (packs)
<b>BAG - FIXINGS INCLUDED</b>					
442875	317 x 107	105	3.5	1	5
TYPE - IDH		SUB TYPE - IDH19			

## Scroll Necked Bolt

NEW

Necked Slide bolt for doors & cupboards. For use when the door & frame are not flush. Supplied with matching fixing screws.



Antique Black

• Made from steel

Fixings Included

### Product Code

Antique Black	Size L x W (mm)	Bolt Length (mm)	Pack Qty (pcs)	Carton Qty (packs)
<b>BAG - FIXINGS INCLUDED</b>				
200843	128	5	1	10
TYPE - BSA		SUB TYPE - BSA02		

## Spear Hinges



Antique Black

442005



Antique Black

442674

Black Antique spear pattern working hinges for doors to give a decorative finish.

• Made from steel

Fixings Included

### Technical Data

Size L (mm)	161	237
Thickness (mm)	5	5
Rec. Screw Ø (mm)	3.5	3.5
Rec. Screw Gauge (Imp.)	6	6

### Product Code

Antique Black	L x W (mm)	Band Length (mm)	Band Length (inch)	Pack Qty (pair)	Carton Qty (packs)
<b>BAG - FIXINGS INCLUDED</b>					
442005	161 x 90	142	6	1	5
442674	237 x 108	213	9	1	5
TYPE - IDH		SUB TYPE - IDH18			

## Fleur De Lys Pull Handle

NEW



Fleur De Lys Style Pull handle, face fixing.

• Made from steel

Fixings Included

### Technical Data

Size (inch)	4	6
Size (mm)	100	162
Rec. Screw Ø (mm)	3.5	4.0
Rec. Screw Gauge (Imp.)	6	7

200761 200131

### Product Code

Antique Black	Size (mm)	Size (inch)	Pack Qty (pcs)	Carton Qty (packs)
<b>BAG - FIXINGS INCLUDED</b>				
200131	100	4	1	20
200761	162	6	1	20
TYPE - BSA		SUB TYPE - BSA08		



### Curly Tail Casement Stay

**NEW**

Curly Tail casement stay for traditional wooden casement windows. Supplied with two pins.

- Made from steel

Antique Black



**Fixings Included**

**Technical Data**

Size L (mm)	252
Casement Stay Back Plate Size L x W (mm)	51 x 18
Pin Back Plate Size L x W (mm)	48 x 20
Rec. Screw Ø (mm)	3.5
Rec. Screw Gauge (Imp.)	6

**Product Code**

Antique Black	Length (mm)	Length (inch)	Pack Qty (pcs)	Carton Qty (packs)
<b>BAG - FIXINGS INCLUDED</b>				
949002	252	10	1	5
TYPE - WHW SUB TYPE - WHW02				

### Casement Stay (900A)

**NEW**

Casement Stay 900A Pattern, suitable for traditional wooden casement windows.

- Made from steel

Epoxy Black

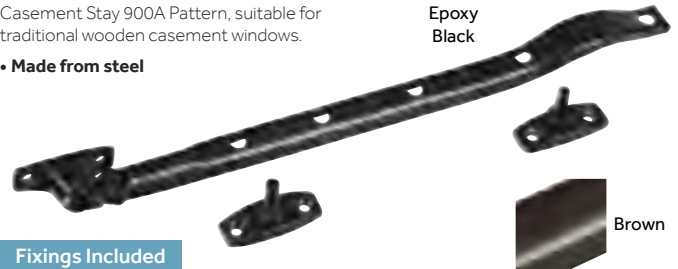

**Fixings Included**

**Technical Data**

Size L (mm)	252
Thickness (mm)	1
Casement Stay Back Plate Size L x W (mm)	40 x 15
Offset Pin Back Plate Size L x W (mm)	40 x 15
Centre Pin Back Plate Size L x W (mm)	40 x 15
Rec. Screw Ø (mm)	3.5
Rec. Screw Gauge (Imp.)	6

**Product Code**

Epoxy Black	Brown	Length (mm)	Length (inch)	Pack Qty (pcs)	Carton Qty (packs)
<b>BAG - FIXINGS INCLUDED</b>					
949437	949855	252	10	1	10
TYPE - WHW SUB TYPE - WHW02					

### Narrow Style Lever Handles

**NEW**

A pair of narrow style lock handles. Available in three styles, Lock, Latch and Bathroom.

- Sprung handles
- Made from steel



**Fixings Included**

**Technical Data**

Size L x W (mm)	155 x 54
Centres (mm)	57
Max Door Thickness (mm)	44

**Product Code**

Antique Black	Type	Pack Qty (pair)	Carton Qty (packs)
<b>BOX - FIXINGS INCLUDED</b>			
200966	Lock	1	10
200314	Latch	1	10
200787	Bathroom	1	10
TYPE - BSA SUB TYPE - BSA09			

### Traditional Lever Handles

**NEW**

A pair of traditional style lock handles. Available in three styles, Lock, Latch and Bathroom.

- Sprung handles
- Made from steel



**Fixings Included**

**Technical Data**

Size L x W (mm)	155 x 54
Centres (mm)	57
Max Door Thickness (mm)	44

**Product Code**

Antique Black	Type	Pack Qty (pair)	Carton Qty (packs)
<b>BOX - FIXINGS INCLUDED</b>			
200898	Lock	1	10
200232	Latch	1	10
200776	Bathroom	1	10
TYPE - BSA SUB TYPE - BSA09			

### Fleur De Lys Ornate Lever Handle

**NEW**

A pair of narrow style lock handles. Available in three styles, Lock, Latch and Bathroom.

- Sprung handles
- Made from steel

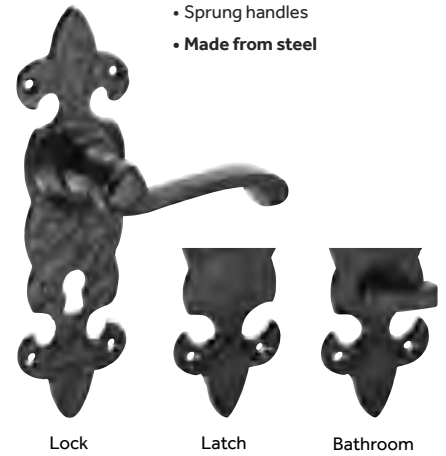

**Fixings Included**

**Technical Data**

Size L x W (mm)	195 x 55
Centres (mm)	57
Max Door Thickness (mm)	44

**Product Code**

Antique Black	Type	Pack Qty (pair)	Carton Qty (packs)
<b>BOX - FIXINGS INCLUDED</b>			
200420	Lock	1	10
200953	Latch	1	10
200007	Bathroom	1	10
TYPE - BSA SUB TYPE - BSA09			

# Internal Door Handle Sets

## Victorian Scroll Internal Latch Pack NEW



Complete internal door set, pack includes everything to hang and operate a latching timber door.

**Contains:** 1 pair of latch handles, 1x 64mm tubular latch & 1 pair of 76mm steel 1838 hinges

Fixings & Spindle Included

Polished Chrome



Satin Chrome



Matt Black

Finish of componets match the handle finish

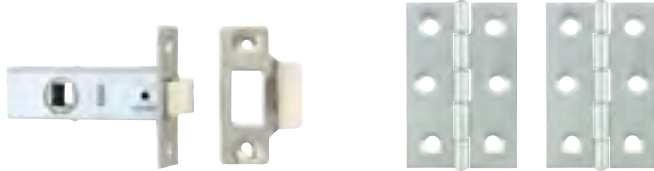

### Technical Data

Handle: Backplate Size Length x Width (mm)	114 x 42
Handle: Length (mm)	88
Latch: Size (mm)	64
Hinge: Size L x W (mm)	76 x 50
Hinge: Knuckle Ø (mm)	7.3
Hinge: Max. Door Weight (kg)	20

### Product Code

Polished Chrome	Satin Chrome	Matt Black	Pack Qty (pack)	Carton Qty (packs)
200003	200753	200818	1	30
<b>BOX - FIXINGS INCLUDED</b>				
TYPE - BSA				
SUB TYPE - BSA11				

## Victorian Straight Internal Latch Pack NEW



Complete internal door set, pack includes everything to hang and operate a latching timber door.

**Contains:** 1 pair of latch handles, 1x 64mm tubular latch & 1 pair of 76mm steel 1838 hinges

Fixings & Spindle Included

Polished Chrome



Satin Chrome



Matt Black

Finish of componets match the handle finish

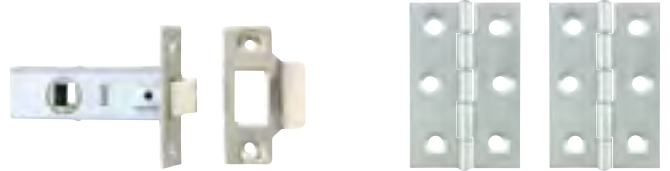

### Technical Data

Handle: Backplate Size Length x Width (mm)	114 x 42
Handle: Length (mm)	90
Latch: Size (mm)	64
Hinge: Size L x W (mm)	76 x 50
Hinge: Knuckle Ø (mm)	7.3
Hinge: Max. Door Weight (kg)	20

### Product Code

Polished Chrome	Satin Chrome	Matt Black	Pack Qty (pack)	Carton Qty (packs)
200246	200368	200952	1	30
<b>BOX - FIXINGS INCLUDED</b>				
TYPE - BSA				
SUB TYPE - BSA11				

## Zeta Internal Door Latch Pack NEW



Complete internal door set, pack includes everything to hang and operate a latching timber door.

**Contains:** 1 pair of latch handles, 1x 64mm tubular latch & 1 pair of 76mm steel 1838 hinges

Fixings & Spindle Included

Polished Chrome



Satin Chrome



Matt Black

Finish of componets match the handle finish

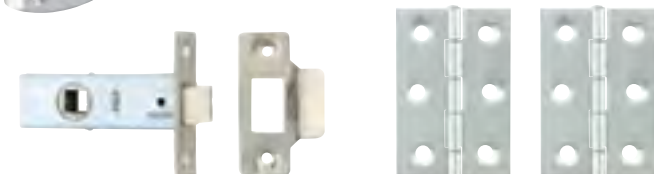

### Technical Data

Handle: Backplate Size Length x Width (mm)	175 x 45
Handle: Length (mm)	113
Latch: Size (mm)	64
Hinge: Size L x W (mm)	76 x 50
Hinge: Knuckle Ø (mm)	7.3
Hinge: Max. Door Weight (kg)	20

### Product Code

Polished Chrome	Satin Chrome	Matt Black	Pack Qty (pack)	Carton Qty (packs)
200853	200159	200397	1	30
<b>BOX - FIXINGS INCLUDED</b>				
TYPE - BSA				
SUB TYPE - BSA11				

## Edeleston Lever On Rose Internal Door Latch Pack

**NEW**

Complete internal door set, pack includes everything to hang and operate a latching timber door.

**Contains:** 1 pair of latch handles, 1x 64mm bolt through tubular latch & 1 pair of 76mm ball bearing hinges



Polished Chrome



Satin Chrome



Matt Black

Fixings & Spindle Included

Finish of components match the handle finish

Bolt through latch for added handle strength

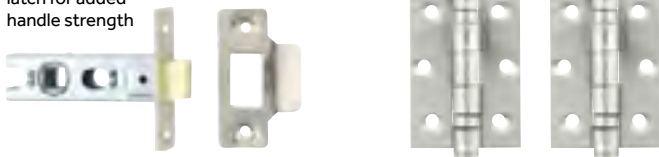

### Technical Data

Handle: Rose Diameter (mm)	49
Handle: Length (mm)	113
Latch: Size (mm)	64
Hinge: Size L x W (mm)	76 x 50
Hinge: Knuckle Ø (mm)	11.5
Hinge: Max. Door Weight (kg)	40

Product Code

Polished Chrome	Satin Chrome	Matt Black	Pack Qty (pack)	Carton Qty (packs)
200403	200352	200080	1	30
TYPE - BSA				
SUB TYPE - BSA11				

### BOX - FIXINGS INCLUDED

## Radmore Lever On Rose Internal Door Latch Pack

**NEW**

Complete internal door set, pack includes everything to hang and operate a latching timber door.

**Contains:** 1 pair of latch handles, 1x 64mm bolt through tubular latch & 1 pair of 76mm ball bearing hinges



Polished Chrome



Satin Chrome



Matt Black

Fixings & Spindle Included

Finish of components match the handle finish

Bolt through latch for added handle strength

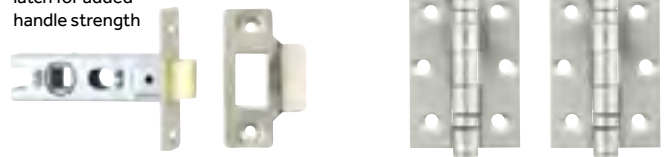

### Technical Data

Handle: Rose Diameter (mm)	49
Handle: Length (mm)	106
Latch: Size (mm)	64
Hinge: Size L x W (mm)	76 x 50
Hinge: Knuckle Ø (mm)	11.5
Hinge: Max. Door Weight (kg)	40

Product Code

Polished Chrome	Satin Chrome	Matt Black	Pack Qty (pack)	Carton Qty (packs)
200699	200544	200836	1	30
TYPE - BSA				
SUB TYPE - BSA11				

### BOX - FIXINGS INCLUDED

## Shavington Lever On Rose Internal Door Latch Pack

**NEW**

Complete internal door set, pack includes everything to hang and operate a latching timber door.

**Contains:** 1 pair of latch handles, 1x 64mm bolt through tubular latch & 1 pair of 76mm ball bearing hinges



Polished/Satin Chrome

Fixings & Spindle Included

Finish of components match the handle finish

Bolt through latch for added handle strength

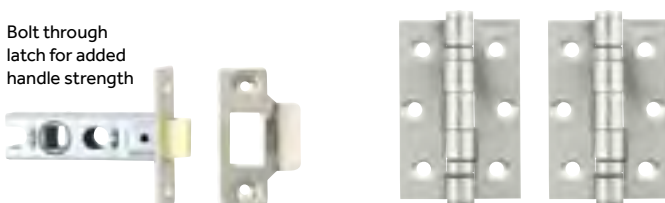

### Technical Data

Handle: Rose Diameter (mm)	49
Handle: Length (mm)	117
Latch: Size (mm)	76
Hinge: Size L x W (mm)	76 x 50
Hinge: Knuckle Ø (mm)	11.5
Hinge: Max. Door Weight (kg)	40

Product Code

Polished/Satin Chrome	Pack Qty (pack)	Carton Qty (packs)
200657	1	30
TYPE - BSA		
SUB TYPE - BSA11		

### BOX - FIXINGS INCLUDED

## Door Locks

### 5 Lever British Standard Sashlock

Satin Stainless Steel



A high security mortice lock for use in interior and exterior doors in commercial and domestic environments.

Rigorously tested to BS 3621:2007 which is a common requirement of building and content insurance policies.

The heavy duty spring mechanism makes this lock ideal for sprung and unsprung door handles.

- Made from Stainless Steel
- Tested to BS 3621:2007



Electro Brass



#### Technical Data

Size (mm)	66 / 45	78 / 57
Case D x H x W (mm)	66 x 110 x 18	78 x 110 x 18
Backset (mm)	45	57
Faceplate H x W (mm)	155 x 25	155 x 25
Centres (mm)	57	57

Product Code

Satin Stainless Steel	Electro Brass	Size (mm)	Pack Qty (pcs)	Carton Qty (packs)
<b>BOX</b>				
675065	675333	66 Case / 45 Backset	1	10
675846	675514	78 Case / 57 Backset	1	10
TYPE - MRL			SUB TYPE - MRL05	

### 3 Lever Sashlock

Satin Nickel



A medium security sashlock that is ideal for use in domestic and commercial applications.

Features a medium duty spring mechanism and is recommended to be used with sprung door handles.

- Made from Steel
- Tested to BS EN 12209



Electro Brass



#### Technical Data

Size (mm)	65 / 45	78 / 58
Case D x H x W (mm)	65 x 102 x 14	78 x 102 x 14
Backset (mm)	45	58
Faceplate H x W (mm)	153 x 22	153 x 22
Centres (mm)	57	57

Product Code

Satin Nickel	Electro Brass	Key Length	Size (mm)	Pack Qty (pcs)	Carton Qty (packs)
<b>BOX</b>					
675321	675987	Standard	65 Case / 45 Backset	1	10
675014	675456	Standard	78 Case / 58 Backset	1	10
TYPE - MRL			SUB TYPE - MRL01		

### 5 Lever British Standard Sashlock Rebate Kit

Satin Nickel



To be used in conjunction with our 5 Lever British Standard Sashlock. Typically used on a pair of rebated doors to offset the lock and keep faceplates.

- Made from Steel



Electro Brass

Product Code

Satin Nickel	Electro Brass	To Suit Door Rebate (mm)	Pack Qty (pcs)	Carton Qty (packs)
<b>BAG</b>				
675759	675135	13	1	20
TYPE - MRL			SUB TYPE - MRL05	

### 3 Lever Sashlock Rebate Kit

Satin Nickel



To be used in conjunction with our 3 lever sashlock. Typically used on a pair of rebated doors to offset the lock and keep faceplates.

- Made from Steel



Electro Brass

Product Code

Satin Nickel	Electro Brass	To Suit Door Rebate (mm)	Pack Qty (pcs)	Carton Qty (packs)
<b>BAG</b>				
675369	675258	13	1	20
TYPE - MRL			SUB TYPE - MRL05	



## Specialist 3 Lever Sashlocks

**NEW**



675546

Satin Nickel

### Narrow backset

3 lever sashlock with a 50mm depth ideal for narrow style glazed doors.

- Made from Steel



675267

Satin Nickel

### Extra long keys

3 lever sashlock with a 64mm depth. Supplied with 2 extra long keys.

- Made from Steel

#### Fixings Included

##### Technical Data

Size (mm)	51 / 31	65 / 45
Case D x H x W (mm)	51 x 106 x 14	65 x 102 x 14
Backset (mm)	31	45
Faceplate H x W (mm)	152 x 22	152 x 24
Centres (mm)	57	57

#### Product Code

Satin Nickel	Key Length	Size (mm)	Pack Qty (pcs)	Carton Qty (packs)
<b>BAG</b>				
675546	Standard	51 Case / 31 Backset	1	10
675267	Extra Long	65 Case / 45 Backset	1	10

TYPE - MRL

SUB TYPE - MRL01

## 3 Lever Narrow Backset Sashlock Rebate Kit

**NEW**



Satin Nickel

To be used in conjunction with our 50mm, 3 lever sashlock. Typically used on a pair of rebated doors to offset the lock and keep faceplates.

- Made from Steel
- Only used with 675546 (50mm Narrow backset 3 Lever Sashlock)

#### Product Code

Satin Nickel	To Suit Door Rebate (mm)	Pack Qty (pcs)	Carton Qty (packs)
<b>BAG</b>			
6750101	13	1	20

TYPE - MRL

SUB TYPE - MRL05

## Euro Profile Sashlock

Satin Nickel



Ideal for medium to high security doors in domestic and commercial applications.

Features a heavy duty spring and can be used with both sprung and unsprung door handles and in conjunction with a Euro profile cylinder.

- Made from Steel
- Tested to BS EN 12209



CF5531



#### Technical Data

Size (mm)	66 / 45	78 / 56
Case D x H x W (mm)	66 x 110 x 15.5	78 x 110 x 15.5
Backset (mm)	45	56
Faceplate H x W (mm)	155 x 25	155 x 25
Centres (mm)	47.5	47.5

#### Product Code

Satin Nickel	Size (mm)	Pack Qty (pcs)	Carton Qty (packs)
<b>BOX</b>			
675020	66 Case / 45 Backset	1	10
675852	78 Case / 56 Backset	1	10

TYPE - MRL

SUB TYPE - MRL03

## Bathroom Lock

Satin Nickel



A medium duty bathroom lock that is ideal for use in domestic and commercial applications.

The lock features a medium duty spring and is recommended to be used with sprung door handles. The deadbolt is operated by a turn with a 5mm spindle.

- Made from Steel
- Tested to BS EN 12209



Electro Brass



CF5531



#### Technical Data

Size (mm)	65 / 45	78 / 57
Case D x H x W (mm)	65 x 102 x 14	78 x 102 x 14
Backset (mm)	45	57
Faceplate H x W (mm)	152 x 22	152 x 22
Centres (mm)	57	57

#### Product Code

Satin Nickel	Electro Brass	Size (mm)	Pack Qty (pcs)	Carton Qty (packs)
<b>BOX</b>				
675359	675861	65 Case / 45 Backset	1	10
675222	675248	78 Case / 57 Backset	1	10

TYPE - MRL

SUB TYPE - MRL02

## 5 Lever British Standard Deadlock

Satin Stainless Steel



A high security mortice lock for use in interior and exterior doors in commercial and domestic environments.  
Rigorously tested to BS 3621:2007 which is a common requirement of building and content insurance policies.

- Made from Stainless Steel
- Tested to BS 3621:2007



Electro Brass



### Technical Data

Size (mm)	66 / 45	78 / 57
Case D x H x W (mm)	66 x 80 x 18	78 x 80 x 18
Backset (mm)	45	57
Faceplate H x W (mm)	125 x 25	125 x 25

Product Code

Satin Stainless Steel	Electro Brass	Size (mm)	Pack Qty (pcs)	Carton Qty (packs)
<b>BOX</b>				
675444	675953	66 Case / 45 Backset	1	10
675220	675157	78 Case / 57 Backset	1	10
TYPE - MRL			SUB TYPE - MRL05	

## Euro Profile Deadlock

Satin Nickel



Ideal for medium to high security doors in domestic and commercial applications.

The lock is to be used in conjunction with a Euro profile cylinder.

- Made from Steel
- Tested to BS EN 12209



CF5531



### Technical Data

Size (mm)	66 / 45	78 / 56
Case D x H x W (mm)	66 x 80 x 15.5	78 x 80 x 15.5
Backset (mm)	45	56
Faceplate H x W (mm)	125 x 25	125 x 25

Product Code

Satin Nickel	Size (mm)	Pack Qty (pcs)	Carton Qty (packs)
<b>BOX</b>			
675513	66 Case / 45 Backset	1	10
675955	78 Case / 56 Backset	1	10
TYPE - MRL		SUB TYPE - MRL03	

## 3 Lever Deadlock

Satin Nickel



A medium security deadlock that is ideal for use in domestic and commercial applications.

- Made from Steel
- Tested to BS EN 12209



Electro Brass



CF5531



### Technical Data

Size (mm)	65 / 45	78 / 58
Case D x H x W (mm)	65 x 70 x 14	78 x 70 x 14
Backset (mm)	45	58
Faceplate H x W (mm)	120 x 22	120 x 22

Product Code

Satin Nickel	Electro Brass	Size (mm)	Pack Qty (pcs)	Carton Qty (packs)
<b>BOX</b>				
675751	675951	65 Case / 45 Backset	1	10
675943	675357	78 Case / 58 Backset	1	10
TYPE - MRL			SUB TYPE - MRL01	

# Door Latches & Catches

## Economy Tubular Latch

Electro Brass

A simple yet reliable latch for use in domestic applications along with sprung door handles.



- Made from Steel
- Bolt through
- Fixed forend

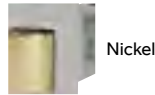

Nickel

Technical Data

Size (mm)	67 / 45	79.5 / 57.5
Case D x H x W (mm)	67 x 20 x 15	79.5 x 20 x 15
Backset (mm)	45	57.5
Faceplate H x W (mm)	59 x 27	59 x 27

Product Code

Electro Brass	Nickel	Size (mm)	Pack Qty (pcs)	Carton Qty (packs)
<b>BOX</b>				
675646	675460	67 Case / 45 Backset	1	10
675001	675647	79.5 Case / 57.5 Backset	1	10

TYPE - MRL

SUB TYPE - MRL04

## Tubular Latch

**NEW**

Electro Brass

A medium duty tubular latch suitable for use in domestic and commercial applications. The latch should be used with sprung door furniture.



Satin Nickel

Includes dust box

- Bolt through
- Suitable for 30 & 60 minute fire doors



Technical Data

Size (mm)	67 / 45	76 / 57
Case D x H x W (mm)	67 x 21 x 15	76 x 21 x 15
Backset (mm)	45	57
Faceplate H x W (mm)	58 x 27	58 x 27

Product Code

Electro Brass	Satin Nickel	Size (mm)	Pack Qty (pcs)	Carton Qty (packs)
<b>TIMPAC (INCLUDES FIXINGS)</b>				
675303P	675900P	67 Case / 45 Backset	1	10
675555P	675783P	76 Case / 57 Backset	1	10
<b>BOX</b>				
675303	675900	67 Case / 45 Backset	1	10
675555	675783	76 Case / 57 Backset	1	10

TYPE - PAK / MRL

SUB TYPE - PAK56 / MRL04

## Architectural Tubular Latch

**NEW**



A heavy duty architectural pattern tubular latch for use in high use domestic and commercial applications.

- Includes both electro brass and satin nickel changeable faceplates



The latch features a heavy duty spring mechanism and be used with sprung and unsprung door handles.

Includes dust box



- Bolt through
- Suitable for 30 & 60 minute fire doors

Technical Data

Size (mm)	64 / 45	78 / 57	103 / 82.5	128 / 107.5
Case D x H x W (mm)	64 x 22.5 x 15	78 x 22.5 x 15	103 x 22.5 x 15	128 x 22.5 x 15
Backset (mm)	45	57	82.5	107.5
Faceplate H x W (mm)	60 x 25	60 x 25	60 x 25	60 x 25

Product Code

Electro Brass & Satin Nickel	Size (mm)	Pack Qty (pcs)	Carton Qty (packs)
<b>TIMPAC (INCLUDES FIXINGS)</b>			
675264P	64 Case / 45 Backset	1	10
675815P	78 Case / 57 Backset	1	10
675673P	103 Case / 82.5 Backset	1	10
675015P	128 Case / 107.5 Backset	1	10

**BOX**

675264	64 Case / 45 Backset	1	10
675815	78 Case / 57 Backset	1	10
675673	103 Case / 82.5 Backset	1	10
675015	128 Case / 107.5 Backset	1	10

TYPE - PAK / MRL

SUB TYPE - PAK56 / MRL04

## Architectural Tubular Deadbolt

**NEW**

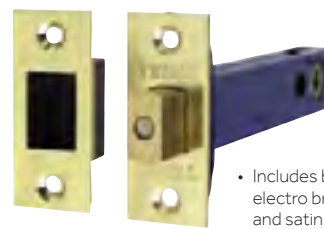

A heavy duty architectural pattern tubular deadbolt for use in high use domestic and commercial applications.

- Includes both electro brass and satin nickel changeable faceplates



The deadbolt is to be used in conjunction with a bathroom turn that has a 5mm spindle.

Includes dust box

- Bolt through

Technical Data

Size (mm)	65.5 / 45	78 / 57	103.5 / 82.5	129 / 108
Case D x H x W (mm)	65.5 x 22.5 x 15	78 x 22.5 x 15	103.5 x 22.5 x 15	129 x 22.5 x 15
Backset (mm)	45	57	82.5	108
Faceplate H x W (mm)	60 x 25	60 x 25	60 x 25	60 x 25

Product Code

Electro Brass & Satin Nickel	Size (mm)	Pack Qty (pcs)	Carton Qty (packs)
<b>TIMPAC (INCLUDES FIXINGS)</b>			
675999P	65.5 Case / 45 Backset	1	10
675606P	78 Case / 57 Backset	1	10
675481P	103.5 Case / 82.5 Backset	1	10
675198P	129 Case / 108 Backset	1	10

**BOX**

675999	65.5 Case / 45 Backset	1	10
675606	78 Case / 57 Backset	1	10
675481	103.5 Case / 82.5 Backset	1	10
675198	129 Case / 108 Backset	1	10

TYPE - PAK / MRL

SUB TYPE - PAK56 / MRL04

# Door Bolts

## Straight Barrel Bolt

**NEW**

Polished Brass



Polished Chrome



Satin Chrome

• Made from solid brass

Ideal for securing flush fitting doors in a closed position.

Product Code			Size L x W (mm)	Bolt Throw (mm)	Pack Qty (pcs)	Carton Qty (packs)
Polished Brass	Polished Chrome	Satin Chrome				
<b>TIMPAC (INCLUDES FIXINGS)</b>						
200945P	200225P	200856P	75 x 25	15	1	10
200328P	200943P	200379P	100 x 25	20	1	10
200496P	200114P	200164P	150 x 25	22	1	10
<b>BAG</b>						
200945	200225	200856	75 x 25	15	1	10
200328	200943	200379	100 x 25	20	1	10
200496	200114	200164	150 x 25	22	1	10

TYPE - PAK / BSA SUB TYPE - PAK56 / BSA02

## Necked Barrel Bolt

**NEW**

Polished Brass



Polished Chrome



Satin Chrome

• Made from solid brass

Ideal for securing recessed fitted doors in a closed position.

Product Code			Size L x W (mm)	Bolt Throw (mm)	Pack Qty (pcs)	Carton Qty (packs)
Polished Brass	Polished Chrome	Satin Chrome				
<b>TIMPAC (INCLUDES FIXINGS)</b>						
200764P	200694P	200367P	75 x 25	12	1	10
200321P	200996P	200158P	100 x 25	16	1	10
200200P	200555P	200645P	150 x 25	20	1	10
<b>BAG</b>						
200764	200694	200367	75 x 25	12	1	10
200321	200996	200158	100 x 25	16	1	10
200200	200555	200645	150 x 25	20	1	10

TYPE - PAK / BSA SUB TYPE - PAK56 / BSA02

## Contract Flat Section Bolt

**NEW**

Polished Brass



Polished Chrome



Satin Chrome

• Made from solid brass

A decorative bolt for securing flush mounted doors. Commonly fitted to french doors.

Product Code			Size L x W (mm)	Bolt Throw (mm)	Pack Qty (pcs)	Carton Qty (packs)
Polished Brass	Polished Chrome	Satin Chrome				
<b>TIMPAC (INCLUDES FIXINGS)</b>						
200336P	200779P	200522P	110 x 25	20	1	10
200852P	200633P	200176P	135 x 30	24	1	10
200136P	200364P	200961P	210 x 35	35	1	10
<b>BAG</b>						
200336	200779	200522	110 x 25	20	1	10
200852	200633	200176	135 x 30	24	1	10
200136	200364	200961	210 x 35	35	1	5

TYPE - PAK / BSA SUB TYPE - PAK56 / BSA02

## Architectural Flat Section Bolt

**NEW**

Polished Brass



Polished Chrome



Satin Chrome

• Made from solid brass

A high quality designer bolt commonly used for securing french doors. The bolt comes supplied with all three keeps required for flush and recessed mounted doors.

Product Code			Size L x W (mm)	Bolt Throw (mm)	Pack Qty (pcs)	Carton Qty (packs)
Polished Brass	Polished Chrome	Satin Chrome				
<b>TIMPAC (INCLUDES FIXINGS)</b>						
200236P	200777P	200464P	100 x 35	25	1	10
200369P	200625P	200222P	150 x 35	25	1	10
200854P	200191P	200946P	210 x 35	25	1	10
<b>BAG</b>						
200236	200777	200464	100 x 35	25	1	5
200369	200625	200222	150 x 35	25	1	5
200854	200191	200946	210 x 35	25	1	5

TYPE - PAK / BSA SUB TYPE - PAK56 / BSA05/06/07

## Lever Action Flush Bolt

**NEW**

Polished Brass

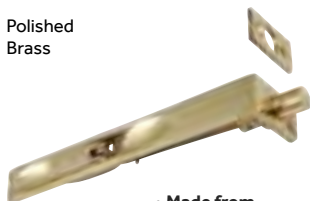

Lever action flush bolts are morticed into the face or leading edge of the door providing a flush door surface finish. They are commonly fitted to double doors to secure the slave door leaf in place.



Polished Chrome



Satin Chrome

• Made from solid brass

Product Code			Size L x W (mm)	Bolt Throw (mm)	Pack Qty (pcs)	Carton Qty (packs)
Polished Brass	Polished Chrome	Satin Chrome				
<b>TIMPAC (INCLUDES FIXINGS)</b>						
200393P	200195P	200285P	150 x 19	15	1	10
200643P	200477P	200648P	200 x 19	15	1	10
<b>BAG</b>						
200393	200195	200285	150 x 19	15	1	5
200643	200477	200648	200 x 19	15	1	5

TYPE - PAK / BSA SUB TYPE - PAK56 / BSA02

## Indicator Bolt

**NEW**

Electro Brass



- Ideal for bathroom and cubicle doors
- External coin release facility
- Indicator to show vacant or engaged
- Max door thickness 50mm



Polished Chrome



Satin Chrome

Product Code			Size (mm)	Bolt Throw (mm)	Pack Qty (pcs)	Carton Qty (packs)
Electro Brass	Polished Chrome	Satin Chrome				
<b>TIMPAC (INCLUDES FIXINGS)</b>						
200112P	200045P	200320P	66	21	1	10
<b>BAG</b>						
200112	200045	200320	66	21	1	40

TYPE - PAK / BSA SUB TYPE - PAK56 / BSA02



# Door & Window Security

## Door Rack Bolt

**NEW**

Electro Brass

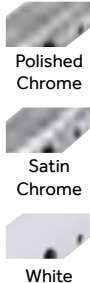

Includes  
1 x rack bolt key

An ideal way to increase security on timber doors. Morticed into the door and operated by a spline/ rack bolt key that throws the bolt into the frame. For optimum security its recommended that the bolts are fitted to the top and the bottom of the door.

Technical Data	
Size (mm)	60 / 31
Case D x Ø (mm)	60 x 16
Backset (mm)	31
Bolt Throw (mm)	18
Bolt Dia. (mm)	13

Spare Rack Bolt Keys - Pack of 2



Product Codes:  
TIMPAC: 200333P  
BAG: 200333

Product Code				Pack	Carton	
Electro Brass	Polished Chrome	Satin Chrome	White	Size (mm)	Qty (pcs)	Qty (packs)
<b>TIMPAC (INCLUDES FIXINGS)</b>						
200020P	200951P	200789P	200456P	60	2	10
<b>BAG</b>						
200020	200951	200789	200456	60	2	10
TYPE - PAK / BSA				SUB TYPE - PAK56 / BSA02		

## Window Rack Bolt

**NEW**

Electro Brass

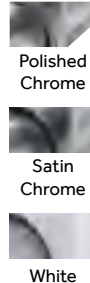

Includes  
1 x rack bolt key

An ideal way to increase security on timber windows. Morticed into the window and operated by a spline/ rack bolt key that throws the bolt into the frame. For optimum security it is recommended that the bolts are fitted to the top and the bottom of the window.

Technical Data	
Size (mm)	42 / 21
Case D x Ø (mm)	42 x 16
Backset (mm)	21
Bolt Throw (mm)	11
Bolt Dia. (mm)	13

Spare Rack Bolt Keys - Pack of 2



Product Codes:  
TIMPAC: 200333P  
BAG: 200333

Product Code				Pack	Carton	
Electro Brass	Polished Chrome	Satin Chrome	White	Size (mm)	Qty (pcs)	Qty (packs)
<b>TIMPAC (INCLUDES FIXINGS)</b>						
949101P	949951P	949456P	949789P	42	2	10
<b>BAG</b>						
949101	949951	949456	949789	42	2	10
TYPE - PAK / BSA				SUB TYPE - PAK78 / WHW01		

## Hinge Bolt

**NEW**

Electro Brass



Zinc

Hinge bolts provide additional security for outward opening doors that have exposed hinge knuckles. They prevent the door being removed from the frame in the event of the hinge knuckle being attacked by interlocking the door into the frame.

Technical Data	
Size (mm)	48
Bolt Dia. (mm)	12.5
Length (mm)	48

Product Code				Pack	Carton
Electro Brass	Zinc	Size (mm)	Qty (pcs)	Qty (packs)	
<b>TIMPAC (INCLUDES FIXINGS)</b>					
200606P	200999P	48	2	10	
<b>BAG</b>					
200606	200999	48	2	10	
TYPE - PAK / BSA				SUB TYPE - PAK56 / BSA07	

## Door Chains

**NEW**

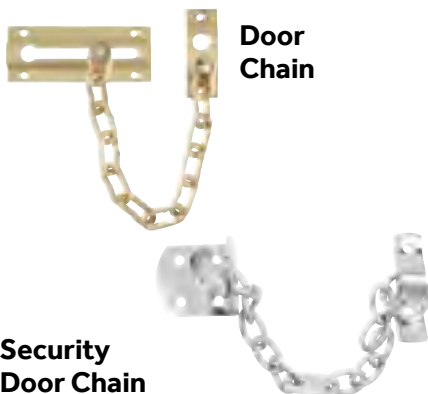

Door Chain

### Security Door Chain

When engaged door chains reduce the opening angle of the door enabling the occupant to identify and speak to the caller before the door is released and restrain against a forced attack.

Product Code					
Electro Brass	Polished Chrome	Satin Chrome	Length (mm)	Pack Qty (pcs)	Carton Qty (packs)
<b>DOOR CHAIN</b>					
<b>BAG</b>					
200357	200485	200654	85	1	10
<b>SECURITY DOOR CHAIN</b>					
<b>TIMPAC (EXCLUDES FIXINGS)</b>					
200987P	200015P	200471P	44	1	10
<b>SECURITY DOOR CHAIN - BAG</b>					
200987	200015	200471	44	1	10
TYPE - PAK / BSA				SUB TYPE - PAK56 / BSA06/07	

## Cabin Hook

**NEW**

Polished Brass

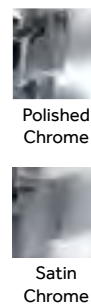

Polished Chrome

Satin Chrome

Ideal for retaining doors in an open position in domestic and light commercial applications. This cabin hook features knuckled connecting joints for quiet operation.

Product Code				Pack	Carton
Polished Brass	Polished Chrome	Satin Chrome	Length (mm)	Qty (pcs)	Qty (packs)
<b>TIMPAC (INCLUDES FIXINGS)</b>					
200495P	200111P	200123P	75	1	10
200665P	200759P	200749P	100	1	10
200436P	200221P	200385P	150	1	10
<b>BAG</b>					
200495	200111	200123	75	1	10
200665	200759	200749	100	1	10
200436	200221	200385	150	1	10
TYPE - PAK / BSA				SUB TYPE - PAK56 / BSA03	

## Door Restrictor

Electro Brass

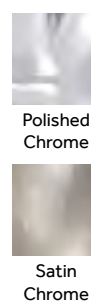
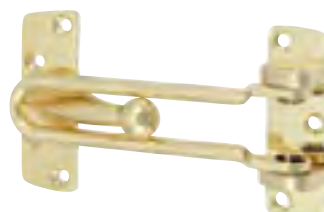

Polished Chrome

Satin Chrome

When engaged door restrictors reduce the opening of the door enabling the occupant to identify and speak to the caller before the door is released and restrain against a forced attack. They are easier to operate and quieter than a standard door chain.

Product Code					
Electro Brass	Polished Chrome	Satin Chrome	Length (mm)	Pack Qty (pcs)	Carton Qty (packs)
<b>BAG</b>					
200741	200258	200963	107	1	10
TYPE - BSA				SUB TYPE - BSA05	

# Furniture Fixings

## Bales Catch

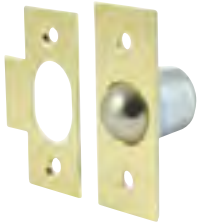

Technical Data	
Size (mm)	20
Case D x Ø (mm)	20 x 21
Faceplate H x W (mm)	57 x 23

Used for securing internal doors that require just a push/pull handle. Adjustable roller to adjust the closing tension of the door. Supplied with matching strike plate in electro brass.

Product Code			
Electro Brass	Size (mm)	Pack Qty (pcs)	Carton Qty (packs)
<b>TIMPAC</b>			
BC19P	20	2	5
TYPE - PAK		SUB TYPE - PAK56	

## Adjustable Roller Catch



Technical Data	
Size (mm)	39
Case D x Ø (mm)	39 x 19
Faceplate H x W (mm)	59 x 23.5

Used for securing internal doors that require just a push/pull handle. Adjustable roller to adjust the closing tension of the door. Supplied with matching strike plate in electro brass or nickel plated finishes.

Product Code			
Electro Brass	Nickel	Size (mm)	Pack Qty (pcs)
<b>TIMPAC</b>			
ARCBRASSP	ARCNICKELP	39	1
TYPE - PAK		SUB TYPE - PAK56	

## Magnetic Catch



A surface mounted light duty magnetic catch for securing cupboard or cabinet doors.

Product Code				
White	Size (mm)	Strength (kg)	Pack Qty (pcs)	Carton Qty (packs)
<b>TIMPAC</b>				
MC4P	40 x 22	4.0	2	5
MC6P	58 x 22	6.0	2	5
TYPE - PAK		SUB TYPE - PAK56		

## Double Ball Catch



A solid brass push fit catch for securing cupboard or cabinet doors.

Product Code				
Electro Brass	Chrome	Size (mm)	Pack Qty (pcs)	Carton Qty (packs)
<b>TIMPAC</b>				
DBC40BRASSP	DBC40CHROME P	43	2	5
DBC50BRASSP	DBC50CHROME P	50	2	5
TYPE - PAK		SUB TYPE - PAK56		

## Double Roller Catch



A surface mounted push fit catch for securing cupboard or cabinet doors.

Product Code			
Zinc	Size (mm)	Pack Qty (pcs)	Carton Qty (packs)
<b>TIMPAC</b>			
DRP	28 x 32	2	5
TYPE - PAK		SUB TYPE - PAK56	

## Modesty Block



A single piece block for joint fixing of cabinet panels or similar at 90°.

- Size - 34 x 13 x 13mm
- Screw Hole Ø - 4.8mm

Product Code			
White	Brown	Pack Qty (pcs)	Carton Qty (packs)
<b>TIMBAG</b>			
MBWHITEB	MBBROWNB	65	5
TYPE - BAG		SUB TYPE - BAG34	
<b>TIMPAC</b>			
MBWHITEP	MBBROWNP	10	5
TYPE - PAK		SUB TYPE - PAK56	

## Knock Down Block



Used for the assembly of boards at 90°. Secured with a bolt into the thread of the second block which draws the two fittings together.

- Size - 35 x 25 x 12mm
- Screw Hole Ø - 4.9mm

Product Code			
White	Brown	Pack Qty (pcs)	Carton Qty (packs)
<b>TIMPAC</b>			
KDWHITEP	KDBROWNP	4	5
TYPE - PAK		SUB TYPE - PAK56	

## Dummy Draw Connector



Used for the semi-permanent fixing of dummy draw fronts to kitchen carcasses. The design allows for some adjustment during fitting to ensure a flush finish.

- Screw Hole Ø - 3.5mm

Product Code		
White	Pack Qty (pcs)	Carton Qty (packs)
<b>TIMPAC</b>		
DDCP	2	10
TYPE - PAK		SUB TYPE - PAK56

## Dual Direction Panel Connector

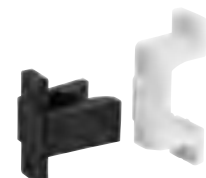

Two piece clip used for flush semi-permanent fixing of panels or dummy drawer fronts. The dual direction design allows fixing onto the base by clipping straight on or at a right angle.

- Screw Hole Ø - 3.5mm

Product Code		
White	Pack Qty (pcs)	Carton Qty (packs)
<b>TIMPAC</b>		
DDPCP	2	10
TYPE - PAK		SUB TYPE - PAK56

## Rigid Joint



Suitable for fixing boards together at right angles.

- Screw Hole Ø - 4.5mm

Product Code	Size (mm)	Pack Qty (pcs)	Carton Qty (packs)
<b>TIMPAC</b>			
WRJP	32 x 17 x 17	10	10
TYPE - PAK		SUB TYPE - PAK56	

## Hinge Hole Cover Cap



Designed to cover unwanted and unsightly holes in all types of kitchen, bedroom and bathroom furniture. To suit a standard 35mm diameter hinge hole.

Product Code	Ø (mm)	Pack Qty (pcs)	Carton Qty (packs)
<b>TIMPAC</b>			
35HHCCP	35	4	10
TYPE - BRA		SUB TYPE - PAK56	

## Plates and Braces

### Mending Plate



### Tee Plate

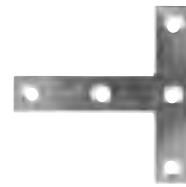

### Stretcher Plate

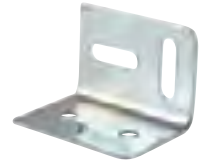

### Corner Plate

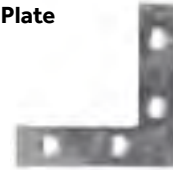

### Angled Brace



### Corner Brace



## Wooden Jointing Biscuit



Used for precise edge jointing of timber. The compressed beech wood expands when used with glue for a secure joint.

- FSC Certified
- Thickness - 4mm

Product Code	Size	Board Thick. (mm)	Pack Qty (pcs)	Carton Qty (packs)
<b>BULK BOX</b>				
270185	No.0	8 - 12	1000	10
270228	No.10	13 - 18	1000	10
270673	No.20	19+	1000	10
<b>TIMPAC</b>				
270364	No.0	8 - 12	100	100
270851	No.10	13 - 18	100	50
270227	No.20	19+	100	50
TYPE - BRA		SUB TYPE - BRA02		

## Wooden Dowel



Used for accurate, reinforced timber and cabinet jointing. Tapered ends for easier application. Fluted shank for good glue distribution along the entire length and to eliminate trapped air.

- FSC Certified

Product Code	Ø x L (mm)	Pack Qty (pcs)	Carton Qty (packs)
<b>TIMPAC</b>			
270491	6 x 30	100	200
270566	8 x 40	100	100
270287	10 x 40	100	100
TYPE - BRA		SUB TYPE - BRA02	
<b>TIMPAC</b>			
WDOWEL630P	6 x 30	25	10
WDOWEL640P	6 x 40	15	10
WDOWEL830P	8 x 30	15	10
WDOWEL840P	8 x 40	10	10
TYPE - PAK		SUB TYPE - PAK61	

## Plastic Cabinet Connector Bolt



For joining cabinets and kitchen units together.

Product Code	Length (mm)	Pack Qty (pcs)	Carton Qty (packs)
<b>PACK</b>			
28PCCBP	28	4	10
TYPE - PAK		SUB TYPE - PAK56	

## Worktop Connector



Provides a concealed and strong joint for worktops eliminating the need for surface mounted joining strips. Frequently used in pairs. Brackets require 35mm jig.

Product Code	Ø (mm)	Pack Qty (pcs)	Carton Qty (packs)
<b>PACK</b>			
WC6150	M6 x 150	6	24
TYPE - BRA		SUB TYPE - BRA01	

Product Code	Size (mm)	Thickness (mm)	Pack Qty (pcs)	Carton Qty (packs)	Pallet Qty (packs)
<b>Mending Plate</b>					
<b>BOX</b>					
75MPL	75 x 16	1.85	50	20	680
100MPL	100 x 16	2.0	50	14	560
<b>TIMPAC</b>					
75MPLP	75 x 16	1.85	4	5	-
100MPLP	100 x 16	2.0	4	5	-
<b>Tee Plate</b>					
<b>BOX</b>					
76TPL	76 x 76 x 16 x 16	2.0	25	28	1680
<b>TIMPAC</b>					
76TPLP	76 x 76 x 16 x 16	2.0	2	5	-
<b>Stretcher Plate</b>					
<b>BOX</b>					
38SPL	38 x 25 x 29	1.8	100	7	350
<b>TIMPAC</b>					
38SPLP	38 x 25 x 29	1.8	4	5	-
<b>Corner Plate</b>					
<b>BOX</b>					
50CPL	50 x 50 x 13	1.5	50	20	840
75CPL	75 x 75 x 16	1.5	50	12	480
<b>TIMPAC</b>					
50CPLP	50 x 50 x 13	1.5	4	5	-
75CPLP	75 x 75 x 16	1.5	4	5	-
<b>Angled Brace</b>					
<b>BOX</b>					
19ABR	19 x 19 x 19	1.0	1,000	5	200
<b>TIMPAC</b>					
19ABRP	19 x 19 x 19	1.0	10	5	-
<b>Corner Brace</b>					
<b>BOX</b>					
25CBR	25 x 25 x 16	1.6	50	44	792
38CBR	38 x 38 x 16	1.6	50	30	1080
50CBR	50 x 50 x 16	1.6	50	20	840
65CBR	65 x 65 x 16	1.7	50	12	600
75CBR	75 x 75 x 16	1.7	50	10	500
100CBR	100 x 100 x 22	2.3	25	10	400
<b>TIMPAC</b>					
25CBRP	25 x 25 x 16	1.6	4	5	-
38CBRP	38 x 38 x 16	1.6	4	5	-
50CBRP	50 x 50 x 16	1.6	4	5	-
65CBRP	65 x 65 x 16	1.7	4	5	-
75CBRP	75 x 75 x 16	1.7	4	5	-
100CBRP	100 x 100 x 22	2.3	2	5	-
TYPE - BRA		SUB TYPE - BRA01			

## Door Stops

### Projection Door Stop NEW

Polished Chrome

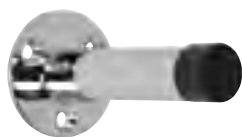

Satin Chrome



Polished Brass



Fits to walls and skirting boards and will prevent damage to walls from door handles. The rubber tip prevents damage to the door. High quality plated finishes.

Product Code					
Polished Chrome	Satin Chrome	Polished Brass	Size (mm)	Pack Qty (pcs)	Carton Qty (packs)
<b>TIMPAC (INCLUDES FIXINGS)</b>					
200624P	200888P	200302P	70	1	10
<b>BAG</b>					
200624	200888	200302	70	1	10
TYPE - PAK / BSA			SUB TYPE - PAK56 / BSA01		

### Oval Door Stop NEW

Polished Chrome



Satin Chrome



Polished Brass



A floor mounted stop that can be mounted at any point of the door opening. The rubber buffer prevents damage to doors. High quality plated finishes.

Product Code					
Polished Chrome	Satin Chrome	Polished Brass	Size (mm)	Pack Qty (pcs)	Carton Qty (packs)
<b>TIMPAC (INCLUDES FIXINGS)</b>					
200090P	200775P	200330P	47	1	10
<b>BAG</b>					
200090	200775	200330	47	1	10
TYPE - PAK / BSA			SUB TYPE - PAK56 / BSA01		

### Cylinder Door Stop NEW

Polished Chrome



Satin Chrome



Polished Brass



A floor mounted stop that can be positioned at any point of the door opening. Concealed fixing for added aesthetics. The rubber buffer prevents damage to doors. High quality plated finishes.

Product Code					
Polished Chrome	Satin Chrome	Polished Brass	Size Ø (mm)	Pack Qty (pcs)	Carton Qty (packs)
<b>TIMPAC (INCLUDES FIXINGS)</b>					
200975P	200049P	200668P	41	1	10
<b>BAG</b>					
200975	200049	200668	41	1	10
TYPE - PAK / BSA			SUB TYPE - PAK56 / BSA01		

### PVC Door Stop

Black



White



A floor mounted door stop used to prevent doors from damaging walls.

Product Code		Size Ø x H (mm)	Pack Qty (pcs)	Carton Qty (packs)
Black	White	32 x 21	1	10
<b>TIMPAC</b>				
DSBLACKP	DSWHITEP			
TYPE - PAK		SUB TYPE - PAK56		

### Spring Door Stop



Electro Brass



Nickel

A wall or skirting board mounted door stop used to prevent doors from damaging walls.

Product Code		Size L x W (mm)	Pack Qty (pcs)	Carton Qty (packs)
Electro Brass	Nickel	78 x 24	2	5
<b>TIMPAC</b>				
SSBRASSP	SSNICKELP			
TYPE - PAK		SUB TYPE - PAK56		

### PVC Door Wedge



A triangular shaped wedge used to temporarily stop doors from closing.

Product Code	Size L x W x H (mm)	Screw Hole Ø (mm)	Pack Qty (pcs)	Carton Qty (packs)
DWEDGE	136 x 43 x 29	4.4	1	5
<b>TIMPAC</b>				
TYPE - PAK				
SUB TYPE - PAK56				

## Door Hooks

### Single Robe Hook NEW

Polished Chrome



Satin Chrome



Polished Brass



Commonly fitted to doors or walls for hanging hats, coats or bathrobes.

Product Code					
Polished Chrome	Satin Chrome	Polished Brass	Size (mm)	Pack Qty (pcs)	Carton Qty (packs)
<b>TIMPAC (INCLUDES FIXINGS)</b>					
200994P	200347P	200064P	44 x 18	1	10
<b>BAG</b>					
200994	200347	200064	44 x 18	1	10
TYPE - PAK / BSA			SUB TYPE - PAK56 / BSA04		

### Double Robe Hook NEW

Polished Chrome



Satin Chrome



Polished Brass



Commonly fitted to doors or walls for hanging hats, coats or bathrobes.

Product Code					
Polished Chrome	Satin Chrome	Polished Brass	Size (mm)	Pack Qty (pcs)	Carton Qty (packs)
<b>TIMPAC (INCLUDES FIXINGS)</b>					
200611P	200207P	200808P	47 x 24	1	10
<b>BAG</b>					
200611	200207	200808	47 x 24	1	10
TYPE - PAK / BSA			SUB TYPE - PAK56 / BSA04		

### Hat & Coat Hook NEW



Satin Chrome



Polished Brass



Commonly fitted to doors or walls for hanging hats, coats or bathrobes.

Product Code					
Polished Chrome	Satin Chrome	Polished Brass	Size (mm)	Pack Qty (pcs)	Carton Qty (packs)
<b>TIMPAC (INCLUDES FIXINGS)</b>					
200674P	200553P	200257P	125 x 32	1	10
<b>BAG</b>					
200674	200553	200257	125 x 32	1	10
TYPE - PAK / BSA			SUB TYPE - PAK56 / BSA04		



# Hanging Rails & Systems

## Round Wardrobe Rail

Polished Chrome



For wardrobes or shopfitting applications. Ideal for many domestic and light commercial applications.



White

Product Code		Size Ø x L (mm)	Pack Qty (pcs)	MOQ (pcs)
Polished Chrome	White			
<b>BAG</b>				
204121	204111	25 x 1219	1	10
204182	204122	25 x 1829	1	10
204250	204133	25 x 2500	1	10
TYPE - CBH		SUB TYPE - CBH01		

## Round End Socket

NEW



End support for tube in wardrobes and other shopfitting applications.

• Fixings included



White

Product Code		To Suit Tube Ø (mm)	Pack Qty (pcs)	Carton Qty (packs)
Polished Chrome	White			
<b>TIMPAC (INCLUDES FIXINGS)</b>				
204025P	204144P	Standard	25	2
204005P	-	Locking	25	2
<b>BAG</b>				
204025	204144	Standard	25	2
204005	-	Locking	25	2
TYPE - PAK / CBH		SUB TYPE - PAK79 / CBH01		

## Round Brackets

NEW



End

Centre

End support for tube being suspended within a wardrobe or other shopfitting applications.

Mid support for longer lengths of tube in wardrobes and other shopfitting applications.

• Fixings included



White

Product Code		To Suit Tube Ø (mm)	Pack Qty (pcs)	Carton Qty (packs)
Polished Chrome	White			
<b>TIMPAC (INCLUDES FIXINGS)</b>				
204125P	204155P	End	25	2
204105P	204166P	Centre	25	1
<b>BAG</b>				
204125	204155	End	25	2
204105	204166	Centre	25	1
TYPE - PAK / CBH		SUB TYPE - PAK79 / CBH01		

## Oval Wardrobe Rail



For wardrobes or shopfitting applications. Ideal for many domestic and light commercial applications.

Product Code		Size H x W x L (mm)	Pack Qty (pcs)	MOQ (pcs)
Polished Chrome	White			
<b>BAG</b>				
204312		30 x 15 x 1219	1	10
204318		30 x 15 x 1829	1	10
204325		30 x 15 x 2500	1	10
TYPE - CBH		SUB TYPE - CBH01		

## Oval End Socket

NEW



End support for tube in wardrobes and other shopfitting applications.

Open top allowing the tube to be removed without unscrewing the socket.

• Fixings included

Product Code		To Suit Tube H x W (mm)	Pack Qty (pcs)	Carton Qty (packs)
Polished Chrome	White			
<b>TIMPAC (INCLUDES FIXINGS)</b>				
204315P		30 x 15	2	10
<b>BAG</b>				
204315		30 x 15	2	500
TYPE - PAK / CBH		SUB TYPE - PAK79 / CBH01		

## Oval Bracket

NEW



Mid support for longer lengths of tube in wardrobes and other shopfitting applications.

Prevents the tube from bending or breaking.

• Fixings included

Product Code		To Suit Tube H x W (mm)	Pack Qty (pcs)	Carton Qty (packs)
Polished Chrome	White			
<b>TIMPAC (INCLUDES FIXINGS)</b>				
204015		30 x 15	1	10
<b>BAG</b>				
204015		30 x 15	1	500
TYPE - PAK / CBH		SUB TYPE - PAK79 / CBH01		

## Steel Handrail Bracket

NEW

Zinc



Ideal for securing timber handrails to the wall.

• Fixings included



Epoxy White



Epoxy Black

Product Code		Projection (mm)	Pack Qty (pcs)	Carton Qty (packs)
Zinc	Epoxy White			
<b>TIMPAC (INCLUDES FIXINGS)</b>				
712331P	712893P	712146P	63	2
<b>BAG</b>				
712331	712893	712146	63	1
TYPE - PAK / SNB		SUB TYPE - PAK80 / SNB03		

## Zinc Handrail Bracket

NEW

Polished Brass

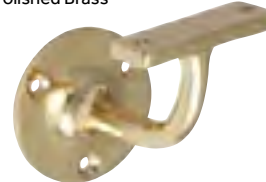

Ideal for securing timber handrails to the wall. High quality plated finishes for a decorative feature.

• Fixings included



Polished Chrome



Satin Chrome

Product Code		Projection (mm)	Pack Qty (pcs)	Carton Qty (packs)
Polished Brass	Polished Chrome			
<b>TIMPAC (INCLUDES FIXINGS)</b>				
712964P	712700P	712327P	64	1
<b>BAG</b>				
712964	712700	712327	64	1
TYPE - PAK / SNB		SUB TYPE - PAK80 / SNB03		

# Storage & Shelving

## Twin Slot Shelving

### Twin Slot Upright



Twin slot uprights feature bracket receiving slots at 32mm increments to allow for shelving to be positioned at varying distances apart as required.

Technical Data						
Length (mm)	425	710	996	1218	1598	1979 2391
Fixing Hole Qty	2	3	4	5	6	
Rec. Screw Ø (mm)	5.0					
Rec. Screw G (Imp.)	10					

Product Code	Length (mm)	W x D (mm)	Pack Qty (pcs)	Carton Qty (packs)
<b>BOX</b>				
712500	425	25 x 16	10	20
712412	710	25 x 16	10	20
712325	996	25 x 16	10	20
712785	1218	25 x 16	10	20
712963	1598	25 x 16	10	20
712111	1979	25 x 16	10	20
712357	2391	25 x 16	10	20
TYPE - SNB			SUB TYPE - SNB01	

### Twin Slot Shelf End



Made from sheet metal and are designed to clip directly into the wall upright. They provide additional support and a barrier to prevent items from falling off the shelf end. The shelf end can be fixed to the underside of the shelf for added support.

Technical Data				
Length (mm)	150	200	250	300
Fixing Hole Qty	3			
Rec. Screw Ø (mm)	4.0			
Rec. Screw Gauge (Imp.)	8			

Product Code	Length (mm)	H x D (mm)	Pack Qty (pairs)	Carton Qty (packs)
<b>PAIR</b>				
712300	150	152 x 25	1	10
712012	200	152 x 25	1	10
712101	250	152 x 25	1	10
712761	300	152 x 25	1	10
TYPE - SNB			SUB TYPE - SNB01	

### Twin Slot Shelf Bracket



Used in conjunction with uprights. Available in varying lengths to suit the depth of shelf required. Max weight loadings are shown but consideration should also be given to the wall structure, types of fixing, shelving types and distances between brackets.

Technical Data							
Length (mm)	126	177	227	280	335	382	484
Shelf Depth (mm)	120	170	220	270	320	370	470
Max. Rec. Load (kg)	153	110	86	72	61	59	81
Fixing Hole Qty	2						
Rec. Screw Ø (mm)	5.0						
Rec. Screw G (Imp.)	10						

Product Code	Length (mm)	D x W (mm)	Pack Qty (pcs)	Box Qty (pcs)	Carton Qty (packs)
<b>EACH</b>					
712159	126	49.0 x 13.5	1	10	50
712028	177	49.0 x 13.5	1	10	50
712987	227	49.0 x 13.5	1	10	50
712321	280	49.0 x 13.5	1	10	50
712654	335	49.0 x 13.5	1	10	50
712147	382	49.0 x 13.5	1	10	50
712258	484	81.5 x 13.5	1	10	30
TYPE - SNB			SUB TYPE - SNB01		

### Twin Slot Flexible Bookend



Flexible bookends locate directly into the twins slots of the upright and help to prevent items from falling off the shelf end.

Product Code	Length (mm)	Pack Qty (pairs)	Box Qty (packs)	Carton Qty (packs)
<b>PAIR</b>				
712369	200	1	20	60
TYPE - SNB			SUB TYPE - SNB01	

## London Pattern Shelf Bracket



London pattern shelf brackets offer a quick and economic way to create shelving.

Technical Data					
Length (mm)	125	200	250	300	350
Max. Rec. Load (kg)	51	40	36	28	21
Fixing Hole Qty	6				
Rec. Screw Ø (mm)	4.0				
Rec. Screw Gauge (Imp.)	8				

Product Code	Length (mm)	Depth (mm)	Pack Qty (pcs)	Box Qty (pcs)	Carton Qty (packs)
<b>EACH</b>					
712523	125	100	1	20	200
712849	200	150	1	20	200
712511	250	200	1	20	100
712607	300	250	1	20	100
712415	350	300	1	20	60
TYPE - SNB			SUB TYPE - SNB02		

## Mitred Shelf Bracket



Mitred brackets are a quick and economic way to create shelving. They feature steel reinforcements at the mitred joint of the bracket to give added strength and durability.

Technical Data					
Length (mm)	200	250	300	350	
Max. Rec. Load (kg)	102	68	60	45	
Fixing Hole Qty	6				
Rec. Screw Ø (mm)	5.0				
Rec. Screw Gauge (Imp.)	10				

Product Code	Length (mm)	Depth (mm)	Pack Qty (pcs)	Box Qty (pcs)	Carton Qty (packs)
<b>EACH</b>					
712273	200	200	1	10	40
712901	250	250	1	10	40
712005	300	300	1	10	40
712557	350	350	1	10	40
TYPE - SNB			SUB TYPE - SNB02		

## TIMCO Padlocks

### Brass Padlock

A durable medium security padlock used for a variety of applications.



**Security Rating**  
**3 to 7**

**Weather Rating**

Product Code	Size (mm)	Shackle Ø (mm)	SR From 1-10	WR From 1-5	Keys	Pack Qty (pcs)	Carton Qty (packs)
<b>Solid Brass</b>							
<b>PACK</b>							
<b>Open Shackle</b>							
P30	30	5.2	3	4	3	1	12
P40	40	6.3	5	4	3	1	12
P40X2	40	6.3	5	4	3	2	4
P50	50	8.1	6	4	3	1	6
P60	60	9.5	7	4	3	1	6
<b>Open Shackle - Keyed Alike</b>							
P40KA	40	6.3	5	4	4	4	4
<b>Long Shackle</b>							
P40L	40	6.3	4	4	3	1	12
P50L	50	8.1	5	4	3	1	6
TYPE - PAD							SUB TYPE - PAD01

### Combination Padlock

A key-less solution commonly used on luggage, tool boxes and storage lockers.

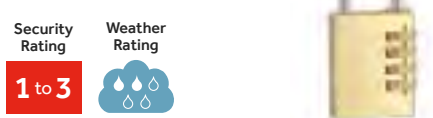

**Security Rating**  
**1 to 3**

**Weather Rating**

Product Code	Size (mm)	Shackle Ø (mm)	SR From 1-10	WR From 1-5	Dials	Pack Qty (pcs)	Carton Qty (packs)
<b>PACK</b>							
<b>Solid Brass</b>							
CP21	21	3.1	1	2	3	1	12
CP28	28	5	2	2	4	1	12
CP38	38	6	3	2	4	1	6
TYPE - PAD							SUB TYPE - PAD02

### Stainless Steel Padlock

A medium to high security stainless steel padlock designed to handle extreme weather conditions. The shrouded shackle ensures maximum resistance against cutting and prying.

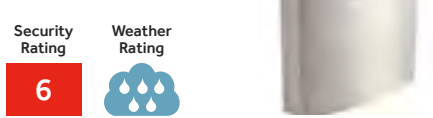

**Security Rating**  
**6**

**Weather Rating**

Product Code	Size (mm)	Shackle Ø (mm)	SR From 1-10	WR From 1-5	Keys	Pack Qty (pcs)	Carton Qty (packs)
<b>PACK</b>							
<b>Stainless Steel</b>							
SS50SS	50	8	6	5	3	1	6
TYPE - PAD							SUB TYPE - PAD07

### Laminated Padlock

An economic padlock ideal for lower security applications.



**Security Rating**  
**4 to 6**

**Weather Rating**

Product Code	Size (mm)	Shackle Ø (mm)	SR From 1-10	WR From 1-5	Keys	Pack Qty (pcs)	Carton Qty (packs)
<b>Laminated</b>							
<b>PACK</b>							
<b>Open Shackle</b>							
LSP40	40	6.1	5	2	3	1	12
LSP50	50	8.8	6	2	3	1	6
<b>Long Shackle</b>							
LSP40L	40	6.1	4	2	3	1	12
LSP50L	50	8.8	5	2	3	1	6
TYPE - PAD							SUB TYPE - PAD04

### Weatherproof Padlock

A laminated padlock with a durable vinyl cover to enhance corrosion resistance and improve weatherproofing.

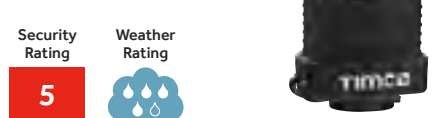

**Security Rating**  
**5**

**Weather Rating**

Product Code	Size (mm)	Shackle Ø (mm)	SR From 1-10	WR From 1-5	Keys	Pack Qty (pcs)	Carton Qty (packs)
<b>PACK</b>							
<b>Laminated with Cover</b>							
WP40	40	8	5	4	3	1	12
TYPE - PAD							SUB TYPE - PAD06

### Weatherproof Combination Padlock NEW

A laminated padlock with a durable vinyl cover to enhance corrosion resistance and improve weatherproofing. 4 digit combination lock mechanism convenient key-less entry.

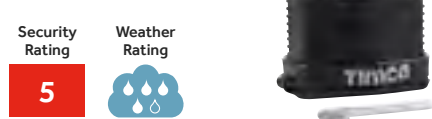

**Security Rating**  
**5**

**Weather Rating**

Product Code	Size (mm)	Shackle Ø (mm)	SR From 1-10	WR From 1-5	Dials	Pack Qty (pcs)	Carton Qty (packs)
<b>PACK</b>							
<b>Laminated with Cover</b>							
WPC50	50	9.5	5	4	4	1	6
TYPE - PAD							SUB TYPE - PAD06

### Brass Rectangular Padlock

A high security padlock used for securing chain, shuttering and catches where there is a risk of cropping, hacksaw or hammer attacks.



**Security Rating**  
**8**

**Weather Rating**

Product Code	Size (mm)	Shackle Ø (mm)	SR From 1-10	WR From 1-5	Keys	Pack Qty (pcs)	Carton Qty (packs)
<b>PACK</b>							
<b>Solid Brass</b>							
RP75	75	11.7	8	4	3	1	4
TYPE - PAD							SUB TYPE - PAD05

### Armoured Rectangular Padlock

A durable medium to high security padlock used for securing chain, shuttering and catches where there is a risk of cropping or hacksaw attacks.



**Security Rating**  
**9**

**Weather Rating**

Product Code	Size (mm)	Shackle Ø (mm)	SR From 1-10	WR From 1-5	Keys	Pack Qty (pcs)	Carton Qty (packs)
<b>PACK</b>							
<b>Solid Brass</b>							
ARP90	90	12	9	4	3	1	4
TYPE - PAD							SUB TYPE - PAD05

### Disc Padlock

A corrosion resistant high security padlock used for securing chain and catches where there is a risk of cropping attacks.



**Security Rating**  
**8**

**Weather Rating**

Product Code	Size (mm)	Shackle Ø (mm)	SR From 1-10	WR From 1-5	Keys	Pack Qty (pcs)	Carton Qty (packs)
<b>PACK</b>							
<b>Stainless Steel</b>							
DP70	70	9	8	5	3	1	10
TYPE - PAD							SUB TYPE - PAD03

## Chains, Cables

### Cable Lock



Protective vinyl coating to enhance corrosion resistance and scratch prevention. Four dial combination, gives multiple locking option.

Product Code	Length (m)	Cable Ø (mm)	Dials	Pack Qty (pcs)	Carton Qty (packs)
<b>EACH</b>					
CL1000	1	8	4	1	10
TYPE - CHA				SUB TYPE - CHA01	

### Looped Cable



Protective vinyl coating to enhance corrosion resistance and scratch prevention. A weather resistant, braided steel security cable for increased strength and flexibility.

Product Code	Length (m)	Cable Ø (mm)	Pack Qty (pcs)	Carton Qty (packs)
<b>EACH</b>				
LC1800	1.8	10	1	10
LC3000	3	15	1	5
TYPE - CHA		SUB TYPE - CHA01		

### Security Chain & Padlock



A hardened steel security chain with a laminated padlock. The anti-crop square links are covered with an anti-scratch nylon protective sleeve. The padlock has a durable vinyl cover to enhance corrosion resistance and improve weatherproofing.

Product Code	Length (m)	Shackle Ø (mm)	Padlock Size (mm)	Pack Qty (pcs)	Carton Qty (packs)
<b>EACH</b>					
SCWP	1	8	40	1	10
TYPE - CHA		SUB TYPE - CHA04			

### Security Chain



A hardened steel security chain with anti-crop square links, covered with an anti-scratch nylon protective sleeve.

Product Code	Length (m)	Shackle Ø (mm)	Pack Qty (pcs)	Carton Qty (packs)
<b>EACH</b>				
SC1000	1	8	1	5
SC1500	1.5	8	1	4
SC2000	2	8	1	6
TYPE - CHA		SUB TYPE - CHA01		

## Key Storage & Accessories

### Key Safe

Convenient and secure storage of keys. Solid and reinforced aluminium door with concealed combination dial for improved weather resistance.

Provides secure and convenient key storage for care workers, cleaners, tradesmen and access to holiday homes.



Product Code	Size L x W x D (mm)	Dials	Pack Qty (pcs)	Carton Qty (packs)
<b>PACK</b>				
KEYSAFE	120 x 85 x 40	4	1	6
TYPE - PAD			SUB TYPE - PAD08	

### Key Cabinet

Provides safe and easy storage of multiple keys.

Steel body with 20 hooks and a changeable 3 digit combination dials.

Please note, key tags are for illustration purposes only.



Product Code	Size L x W x D (mm)	Dials	Hooks	Pack Qty (pcs)	Carton Qty (packs)
<b>BOX</b>					
20KEYCAB	200 x 160 x 75	3	20	1	20
TYPE - PAD		SUB TYPE - PAD08			

### Key Accessories



#### Key Tags

Tidy labelling and coding of keys.



#### Key Caps

Convenient coding of keys for quick identification.

Product Code	Description	Pack Qty (pcs)	Carton Qty (packs)
<b>PACK</b>			
KEYTAGP	Coloured Key Tags	6	10
KEYCAPP	Coloured Key Caps	10	10
TYPE - PK		SUB TYPE - PAK65	





# 240 YEARS

OF LOCKMAKING EXCELLENCE

Squire has been at the forefront of international lock making for over 240 years. As an eighth generation independent family-owned lock manufacturer, Squire continues its tradition of offering high-quality, performance-led products.

## WHICH CATEGORY TO CHOOSE?

### WORK

**Use:** trade use, toolbox, container, commercial vehicle, outbuilding / warehouse, security gate garage forecourt

### HOME

**Use:** all-round home use, garage, shed, front gate, storage

### LEISURE

**Use:** out and about, recreational gear, suitcase, caravan / camping, bbq, sport locker, marine



## SQUIRE QUALITY AND STANDARDS



Squire products are covered by a variety of industry accreditations. Much of the Squire cycle range and certain padlocks are Sold Secure approved meaning that they have been independently attack tested. Sold Secure products are also supported by Secured by Design which was initiated by the British Police Force.

Squire have a number of Stronghold® products that achieve LPCB (Loss Prevention Certification Board) approval which is the UK's most stringent approval body and many other padlocks within the Stronghold range meet the CEN EN 12320 Standard.

# SQUIRE 'Stronghold®' Extra High Security Padlocks



## Stronghold® Key Padlocks

WORK

A premium range of super-tough, high security padlocks that are approved by independent accreditation bodies Sold Secure and Secured by Design.

Made in Britain, these padlocks come in a variety of body widths and shackle versions.

- Extremely corrosion resistant lock
- Hardened boron alloy steel shackle
- Anti-corrosion storm proof cover
- Electrophoretic anti-corrosion finish
- Keyhole cover for protection inside the lock
- Tensile pull tested to 24 tonnes (independently verified) (only applies to SQR701753 and SQR701951)
- Anti-drill protection



Product Code	Size (mm)	Size W x D (mm)	Shackle Ø (mm)	Shackle Clearance WxH (mm)	Cylinder Type	LPCB Rating	CEN Rating	Keys	Pack Qty (pcs)
<b>PACK</b>									
<b>Open Shackle</b>									
SQR701789	50	50 x 26	10.0	22 x 26	6 pin	SR2	CEN 4	2	1
SQR701426	50	50 x 26	10.0	22 x 26	5 pin	-	CEN 3	2	1
SQR701025	65	65 x 31.8	12.7	29.5 x 29	6 pin	-	CEN 5	2	1
SQR701963	80	80 x 40	16.0	32 x 32	6 pin	SR3	CEN 6	2	1
SQR701951*	100	100 x 62	20.0	48 x 40	6 pin	SR4	CEN 6	2	1
<b>Long Shackle</b>									
SQR701456	50	50 x 65	10.0	22 x 65	6 pin	-	CEN 4	2	1
SQR701682	50	50 x 26	10.0	22 x 65	5 pin	-	CEN 3	2	1
SQR701684	65	65 x 31.8	12.7	29.5 x 65	6 pin	-	CEN 5	2	1
<b>Closed Shackle</b>									
SQR701325	50	50 x 26	10.0	16 x 16	6 pin	SR2	CEN 4	2	1
SQR701123	50	50 x 26	10.0	16 x 16	5 pin	-	CEN 3	2	1
SQR701741	65	65 x 31.8	12.7	19 x 19	6 pin	-	CEN 6	2	1
SQR701852	80	80 x 40	16.0	23.5 x 25	6 pin	SR3	CEN 6	2	1
SQR701753*	100	100 x 62	20.0	28 x 33	6 pin	SR4	CEN 6	2	1

TYPE - SQU / SUB TYPE - SQU01 \*Comes with 2 same key cylinders

## Marine - Stronghold® Key Padlocks

WORK

- Extremely corrosion resistant lock
- Stainless steel shackle
- Anti-corrosion storm proof cover
- Keyhole cover for protection inside the lock
- Anti-drill protection



Product Code	Size (mm)	Size W x D (mm)	Shackle Ø (mm)	Shackle Clearance WxH (mm)	Cylinder Type	CEN Rating	Keys	Pack Qty (pcs)
<b>PACK</b>								
<b>Open Shackle</b>								
SQR701351	50	50 x 26	10.0	22 x 26	5 pin	CEN 3	2	1
<b>Closed Shackle</b>								
SQR701759	50	50 x 26	10.0	16 x 16	5 pin	CEN 3	2	1

TYPE - SQU SUB TYPE - SQU01

## Stronghold® Container Lock

WORK

A premium range of super-tough, high security padlocks that are approved by independent accreditation bodies Sold Secure and Secured by Design.

Made in Britain, these padlocks come in a variety of body widths and shackle versions.



- Hardened boron alloy steel shackle
- Hardened steel lock body
- Electrophoretic anti-corrosion finish
- Rekeyable 6 pin tumbler lock
- Anti-bump, anti-pick, highly attack resistant

Product Code	Size (mm)	Size W x D (mm)	Shackle Ø (mm)	Shackle Clearance WxH (mm)	Cylinder Type	CEN Rating	Keys	Pack Qty (pcs)
<b>PACK</b>								
<b>Closed Shackle</b>								
SQR701267	75	80 x 26	12.0	27 x 14	6 pin	CEN 4	2	1

TYPE - SQU SUB TYPE - SQU01

## Stronghold® Combination Padlocks

WORK

A premium range of high performance combination padlocks. Unique in design, these combination locks are manufactured to the highest standards for quality performance.

SQR701843 offers a 11mm rotating hardened steel shackle for extra resistance to attack, solid lock body, 4 wheels offering 10,000 possible combinations and a special pull button mechanism.

SQR701961 / SQR701027 offer a 12.7mm rotating hardened steel shackle for extra resistance to attack, solid lock body and 5 wheels offering 100,000 possible combinations.



Product Code	Size (mm)	Size W x D (mm)	Shackle Ø (mm)	Shackle Clearance WxH (mm)	No. Of Dials	Pack Qty (pcs)
<b>PACK</b>						
<b>Closed Shackle</b>						
SQR701843	65	65 x 19	11.0	20 x 15	4	1
SQR701961	75	75 x 19	12.7	20 x 15	5	1
SQR701027	85	85 x 19	12.7	37 x 17	5	1

TYPE - SQU SUB TYPE - SQU05



## SQUIRE Warehouse Lock & Disc Ranges

### Armoured Brass Block Locks

**WORK**

Warehouse locks designed for securing commercial applications these padlocks are made from a solid brass lock body protected by armoured steel for ultra-resistance to attack.

- Hardened steel rotating shackle to resist sawing
- 5 pin tumbler lock mechanism



Product Code	Size (mm)	Size W x D (mm)	Shackle Ø (mm)	Shackle Clearance WxH (mm)	Cylinder Type	Keys	Pack Qty (pcs)
<b>PACK</b>							
<b>Open Shackle</b>							
SQR701384	60	60 x 25	10.0	22 x 12	5 pin	3	1
SQR701014	80	80 x 30	11.0	29 x 15	5 pin	3	1
				SUB TYPE - SQU02			

### Disc Style Padlock

**WORK**

Stainless Steel lock body with closed shackle design offers high level security for domestic and commercial applications. Offering a 9.5mm hardened steel shackle, hardened steel anti-drill plate and 5 pin tumbler lock mechanism.

- 9.5mm hardened steel shackle
- Hardened steel anti-drill plate
- 5 pin tumbler lock mechanism



Product Code	Size (mm)	Shackle Ø (mm)	Shackle Clearance WxH (mm)	Cylinder Type	Keys	Pack Qty (pcs)
<b>PACK</b>						
<b>Closed Shackle</b>						
SQR701003	70	9.5	17 x 17.5	5 pin	2	1
				SUB TYPE - SQU03		

## SQUIRE 'Vulcan™' Tough Performance Locks

### Vulcan™ Key Padlocks

**HOME**

A mighty tough range of high performance locks. These uniquely designed key operated padlocks with extra tough boron steel shackles offer a medium to high level of security. Available in open, closed and long shackle versions.

- Hardened boron alloy steel shackle
- Steel body with die cast satin chrome body cover
- 4 pin tumbler lock mechanism



Product Code	Size (mm)	Size W x D (mm)	Shackle Ø (mm)	Shackle Clearance WxH (mm)	Cylinder Type	Keys	Pack Qty (pcs)
<b>PACK</b>							
<b>Open Shackle</b>							
SQR701153	40	44 x 27	7.0	19 x 18	4 pin	2	1
SQR701016	45	48 x 28	8.0	20.5 x 19	4 pin	2	1
SQR701913	50	55 x 33	9.5	22 x 23.5	4 pin	2	1
<b>Long Shackle</b>							
SQR701882	40	44 x 27	7.0	19 x 63	4 pin	2	1
SQR701405	50	55 x 33	9.5	23.5 x 63	4 pin	2	1
<b>Closed Shackle</b>							
SQR701111	45	48 x 28	8.0	14 x 15.2	4 pin	2	1
SQR701355	50	55 x 33	9.5	16 x 19	4 pin	2	1
				SUB TYPE - SQU04			

### Vulcan™ Combination Padlocks

**HOME**

Named after Vulcan, the ancient Roman god of fire and metalworking, this mighty tough range of combination padlocks takes some beating. Easy to use in 4 and 5-wheel versions, the Vulcan padlocks are fully recodable and offer up to 100,000 combinations.

- Hardened boron steel shackle with satin chrome finish
- Double locking & fully recodable
- Satin chrome die cast alloy body
- Push button opening
- New patented design



Product Code	Size (mm)	Size W x D (mm)	Shackle Ø (mm)	Shackle Clearance WxH (mm)	No. Of Dials	Pack Qty (pcs)
<b>PACK</b>						
<b>Open Shackle</b>						
SQR701701	40	40 x 22	6.0	17 x 20	4	1
SQR701368	50	50 x 26	8.0	22.6 x 26	4	1
SQR701756	60	60 x 33	10.0	28 x 34	5	1
<b>Long Shackle</b>						
SQR701537	40	40 x 22	6.0	17 x 63	4	1
SQR701157	50	50 x 26	8.0	22.6 x 63	4	1
SQR701010	60	60 x 33	10.0	28 x 63	5	1
<b>Closed Shackle</b>						
SQR701001	40	40 x 22	6.0	13 x 17	4	1
SQR701257	50	50 x 26	8.0	15 x 22	4	1
SQR701999	60	60 x 33	10.0	22 x 29	5	1
				SUB TYPE - SQU04		

## SQUIRE 'Stronglock™'

### Stronglock™ Key Padlocks

HOME

A medium-duty range of laminated double deadlocking padlocks for home use. Featuring a hardened steel shackle and laminated steel padlock body with anti-corrosion finish. Available in open, closed and long shackle versions.



- Hardened steel shackle
- Double deadlocking, ball locking, spring locking
- Covered steel padlock body with anti-corrosion finish gives corrosion resistance
- 4 pin tumbler lock mechanism gives over 1,000 key differs
- Medium duty security



Product Code	Size (mm)	Size W x D (mm)	Shackle Ø (mm)	Shackle Clearance WxH (mm)	Cylinder Type	Keys	Pack Qty (pcs)
<b>PACK</b>							
<b>Open Shackle</b>							
SQR701352	40	38 x 23	7	16 x 17	4 pin	2	1
SQR701020	45	44 x 24	8	20 x 20	4 pin	2	1
SQR701855	50	54 x 29	9	24 x 24	4 pin	2	1
<b>Open Shackle - Twin Pack - Keyed Alike</b>							
SQR701291	40	38 x 23	7	16 x 17	4 pin	4	2
<b>Long Shackle</b>							
SQR701552	40	38 x 23	7	16 x 39	4 pin	2	1
SQR701008	40	38 x 23	7	16 x 64.8	4 pin	2	1
SQR701817	45	44 x 24	8	20 x 64.4	4 pin	2	1
SQR701381	50	54 x 29	9	24 x 39	4 pin	2	1
SQR701556	50	54 x 29	9	24 x 64.5	4 pin	2	1
<b>Closed Shackle</b>							
SQR701449	45	44 x 24	8	20 x 13	4 pin	2	1

TYPE - SQU SUB TYPE - SQU09

### Stronglock™ Key Padlocks Including Chains



- 305mm Chain included
- Hardened steel shackle
- Double deadlocking, ball locking, spring locking
- Covered steel padlock body with anti-corrosion finish gives corrosion resistance
- 4 pin tumbler lock mechanism gives over 1,000 key differs
- Medium duty security

Product Code	Size (mm)	Size W x D (mm)	Shackle Ø (mm)	Shackle Clearance WxH (mm)	Cylinder Type	Keys	Pack Qty (pcs)
<b>PACK</b>							
<b>Open Shackle - With 305mm Chain Attached</b>							
SQR701683	40	38 x 23	7	16 x 17	4 pin	2	1
SQR701642	45	49 x 24	8	20 x 20	4 pin	2	1
SQR701725	50	54 x 29	9	24 x 24	4 pin	2	1

TYPE - SQU SUB TYPE - SQU09

## SQUIRE 'CP Range'

### CP Range Combination Padlocks

HOME



Squire's best-selling, heavy-duty range of recodable combination padlocks. Unique in design, these combination locks are manufactured to the highest standards for quality performance. Easy to use, they are fully recodable and can be coded alike so that one code opens several locks.

- Hardened steel shackle
- Double locking & fully recodable
- Die cast alloy body cover
- Push button opening
- New patented design



Product Code	Size (mm)	Size W x D (mm)	Shackle Ø (mm)	Shackle Clearance WxH (mm)	No. Of Dials	Pack Qty (pcs)
<b>PACK</b>						
<b>Open Shackle</b>						
SQR701367	40	40 x 22	6.0	17 x 20	4	1
SQR701320	50	50 x 26	8.0	22.6 x 26	4	1
SQR701623	60	60 x 33	10.0	28 x 34	5	1
<b>Long Shackle</b>						
SQR701043	40	40 x 22	6.0	17 x 63	4	1
SQR701841	50	50 x 26	8.0	22.6 x 38.1	4	1
SQR701992	50	50 x 26	8.0	22.6 x 63.5	4	1
SQR701730	50	50 x 26	8.0	22.6 x 100	4	1
SQR701915	60	60 x 33	10.0	28 x 63	5	1
<b>Closed Shackle</b>						
SQR701825	50	40 x 22	6.0	13 x 17	4	1
SQR701061	50	50 x 26	8.0	16 x 22	4	1
SQR701744	60	60 x 33	10.0	22 x 29	5	1

TYPE - SQU SUB TYPE - SQU05

### Marine - CP Combination Padlocks

LEISURE



- Rustproof stainless steel shackle and die cast alloy body
- 4 wheels offering 10,000 possible combinations
- Double locking & fully recodable push button opening
- New patented design



Product Code	Size (mm)	Size W x D (mm)	Shackle Ø (mm)	Shackle Clearance WxH (mm)	No. Of Dials	Pack Qty (pcs)
<b>PACK</b>						
<b>Open Shackle</b>						
SQR701361	40	40 x 22	6	17 x 20	4	1
SQR701002	50	50 x 26	8	22.6 x 26	4	1
<b>Long Shackle</b>						
SQR701807	40	40 x 22	6	17 x 63	4	1
SQR701444	50	50 x 26	8	22.6 x 63	4	1

TYPE - SQU SUB TYPE - SQU05



## SQUIRE 'Lion' Solid Brass

### 'Lion' Range - Solid Brass Padlocks HOME

Premium grade, solid brass padlocks offering an optimal level of security for indoor or outdoor use at home. Iconic double locking Lion padlocks with hardened steel shackles are available in a range of body widths from 30mm and include long shackle versions.

- Offers a superior level of security for indoor or outdoor use at home
- Hardened steel shackle
- Double locking
- Solid brass lock body
- Pin tumbler lock mechanism



Product Code	Size (mm)	Size W x D (mm)	Shackle Ø (mm)	Shackle Clearance WxH (mm)	Cylinder Type	Keys	Pack Qty (pcs)
<b>PACK</b>							
<b>Open Shackle</b>							
SQR701437	30	31.5 x 13	5.5	16.5 x 19.5	4 pin	2	1
SQR701113	40	39.5 x 14	6.0	22.5 x 21.1	5 pin	2	1
SQR701754	50	51 x 15.5	8.8	28 x 30	5 pin	2	1
SQR701307	60	60 x 18.6	9.5	33.5 x 35.5	5 pin	2	1
<b>Open Shackle - Twin Pack - Keyed Alike</b>							
SQR701808	40	39.5 x 14	6.0	22.5 x 21.1	5 pin	4	2
SQR701048	50	51 x 15.5	8.8	28 x 30	5 pin	4	2
<b>Long Shackle</b>							
SQR701722	40	39.5 x 14	6.0	22.5 x 64	5 pin	2	1
SQR701023	40	39.5 x 14	6.0	22.2 x 100	5 pin	2	1
SQR701004	50	51 x 15.5	8.8	28 x 65	5 pin	2	1
TYPE - SQU SUB TYPE - SQU08							

### Marine Grade - 'Lion' Range LEISURE

- Offers a superior level of security for indoor or outdoor use at home
- Marine grade stainless steel shackle
- Double locking
- Solid brass lock body
- Pin tumbler lock mechanism



Product Code	Size (mm)	Size W x D (mm)	Shackle Ø (mm)	Shackle Clearance WxH (mm)	Cylinder Type	Keys	Pack Qty (pcs)
<b>PACK</b>							
<b>Open Shackle</b>							
SQR701482	30	31.5 x 13	5.5	16.5 x 19.5	4 pin	2	1
SQR701997	40	39.5 x 14	6.5	22.5 x 22	5 pin	2	1
SQR701689	50	51 x 15.5	8.8	28 x 30	5 pin	2	1
<b>Long Shackle</b>							
SQR701401	40	39.5 x 14	6.5	22.5 x 63	5 pin	2	1
TYPE - SQU SUB TYPE - SQU08							

## SQUIRE Harsh Environment Padlocks

### All Terrain Padlocks HOME

All terrain padlocks comprise of a brass body with stainless steel shackle enclosed within a protective sleeve for optimal resistance to corrosion.



Open Shackle

- All weather, protective body cover for extra resistance to the environment
- Rustproof stainless steel shackle
- Solid brass lock body
- Pin tumbler cylinder

Product Code	Size (mm)	Size W x D (mm)	Shackle Ø (mm)	Shackle Clearance WxH (mm)	Cylinder Type	Keys	Pack Qty (pcs)
<b>PACK</b>							
<b>Open Shackle</b>							
SQR701447	40	44 x 20	6.0	22 x 20	5 pin	2	1
SQR701073	50	58 x 25	8.8	28 x 29	5 pin	2	1
TYPE - SQU SUB TYPE - SQU06							

### Old English Padlocks HOME

Traditional style Old English galvanised steel 4 lever padlocks.



- Featuring a steel shackle and 4-lever lock mechanism
- Key-hole cover for all-weather protection
- Ideal for all outdoor and marine environments

Product Code	Size (mm)	Size W x D (mm)	Shackle Ø (mm)	Shackle Clearance WxH (mm)	Cylinder Type	Keys	Pack Qty (pcs)
<b>PACK</b>							
<b>Open Shackle</b>							
SQR701943	40	51 x 16.5	8.0	18 x 18	4 Lever	2	1
SQR701170	60	64 x 19.7	10.0	21 x 21	4 Lever	2	1
TYPE - SQU SUB TYPE - SQU07							

# SQUIRE 'Stronghold®' Padbars

## Stronghold® Padbars

Extremely tough Stronghold CEN Grade 6 Padbars made from special hardened cast material which makes it ultra strong against all forms of attack.

- High security padbar with hardened hasp and staple
- Hardened rotating stud for extra resistance to attack
- Pin tumbler cylinder
- Easy to fit



Long Shackle

SQR701100  
(Use only with SQR701753)

Product Code	Size (mm)	Size L x W (mm)	Max Shackle Ø (mm)	LPCB Rating	CEN Rating	SR From 1-10	Pack Qty (pcs)
<b>PACK</b>							
SQR701100	184	184 x 86	-	SR4*	CEN 6	10	1
SQR701245	184	184 x 86	16.0	-	CEN 6	10	1
TYPE - SQU				SUB TYPE - SQU10			



**LPCB level SR4\***  
when using SQR701100 with SQR701753 padlock

## SQUIRE Hasps & Staples

### Hasps & Staples

Our wide range of hasp and staples are designed to deliver an extra level of security. Ideal for securing external storage facilities and sheds.

The SQR701615 hasp and staple fits 13mm shackle padlocks and comes with Sold Secure and Secured by Design approval for new home requirements.



SQR701615

- Hardened steel construction with anti-corrosion finish
- Coach bolt fixings for added security
- Concealed fixings
- Can be used on single or double doors



SQR701445



SQR701060



SQR701533

Product Code	Size (mm)	Size L x W (mm)	Staple Clearance (mm)	CEN Rating	Pack Qty (pcs)
<b>PACK</b>					
<b>Hasps &amp; Staples</b>					
SQR701615	231	231 x 76	13	CEN 4	1
SQR701445	216	216 x 54.2	25	-	1
SQR701060	152	152 x 44	12.5	-	1
<b>Hasp &amp; Staple - Intergrated Lock</b>					
SQR701533	152	152 x 44	-	-	1
TYPE - SQU			SUB TYPE - SQU11		

## SQUIRE Locking Bolts

### Keybolt™ Weatherproof Locking Bolt

All weather, key-operated locking bolt. Allows secure entry to sheds, cupboards, storage areas, cabinets and lockers. Four lever lock mechanism for high pick resistance. Security screws included.

- Steel lock body and bolt encased in a weatherproof cover
- Steel components
- 4 lever lock mechanism
- Interior and exterior use



Product Code	Size (mm)	Size L x W (mm)	Lock Type	Keys	Pack Qty (pcs)
<b>PACK</b>					
SQR701883	113	113 x 68	4 Lever	2	1
TYPE - SQU			SUB TYPE - SQU15		

### Combi-Bolt® Recodable Locking Bolts

Recodable die cast combination bolts. Allows convenient keyless and one handed entry to sheds, cupboards, storage areas, cabinets and lockers.

- Die cast lock body
- One handed operation
- Security screws included in pack
- High pick resistance
- Replaces a padlock and hasp & staple



Product Code	Size (mm)	Size L x W (mm)	No. Of Dials	Pack Qty (pcs)
<b>PACK</b>				
SQR701118	92	92 x 35	3	1
SQR701070	120	120 x 50	4	1
SQR701799	150	150 x 60	5	1
TYPE - SQU			SUB TYPE - SQU14	

## SQUIRE Chains

### Stronghold® High Security Chains

A range of high security hardened alloy steel chains that have achieved the Sold Secure Rating making this ultra-tough chain provides motorcycle and scooter owners with a comprehensive range of security solutions.

- Hardened alloy steel chain covered with Squire blue sleeves



Product Code	Link Ø (mm)	Length (mm)	Sold Secure Level	Pack Qty (pcs)
<b>PACK</b>				
<b>Motorcycle</b>				
SQR701074	14	915	Gold (Motorcycle)	1
SQR701837	14	1200	Gold (Motorcycle)	1
SQR701358	16	1500	Gold (Motorcycle)	1
SQR701427	19	1500	Gold (Motorcycle)	1
SQR701859	22	1500	Diamond (Motorcycle)	1
<b>Bicycle</b>				
SQR701917	8	1200	Silver (Bicycle)	1
SQR701410	10	1200	Gold (Bicycle)	1
SQR701225	10	1500	Gold (Bicycle)	1
SQR701803	10	2000	Gold (Bicycle)	1

TYPE - SQU SUB TYPE - SQU12

### Hardened Steel Chains

A range of hardened steel chains. All covered with Squire grey sleeves.



Product Code	Link Ø (mm)	Length (mm)	Pack Qty (pcs)
<b>PACK</b>			
<b>Motorcycle</b>			
SQR701226	10	1200	1
SQR701030	8	1200	1
SQR701800	6.5	1200	1
SQR701333	5	1200	1

TYPE - SQU SUB TYPE - SQU12

## SQUIRE Anchors

### Ground Anchors

Sold Secure Diamond single bridge ground anchors approved for motorcycles. Supplied with security fixings and with a blue powder coated finish.



- Single bridge anchor
- Fully case hardened product to RC 60 spec. Solid construction
- Supplied with four security fixing bolts, steel ball inserts
- Blue powder coated finish

Product Code	Size (mm)	Size L x W (mm)	Clearance (mm)	To Suit Chain Ø up to (mm)	Sold Secure Level	Pack Qty (pcs)
<b>PACK</b>						
SQR701162	200	200 x 150	73 x 76	22	Diamond (Motorcycle)	1
SQR701134	160	160 x 120	65 x 60	19	Gold (Motorcycle) & Diamond (Bicycle)	1

TYPE - SQU SUB TYPE - SQU13

### Wall Anchors

Hardened steel wall anchors for internal and external use.

- 5mm hardened steel construction
- Powder coated
- Easy to fit
- Supplied with security fittings



Product Code	Size (mm)	Size L x W (mm)	Clearance (mm)	To Suit Chain Ø up to (mm)	Pack Qty (pcs)
<b>PACK</b>					
SQR701735	283	77 x 283	58 x 43	10	1
SQR701924	219	48 x 219	37 x 31	8	1

TYPE - SQU SUB TYPE - SQU13



## SQUIRE Key Safes

### KeyKeep™ 2 - Push Button Key Safe

Durable die cast construction and weather resistant cover designed to withstand attack.

The 12 button recodable combination lock has 4000 possible combinations. You can revoke access at any point by changing the code.

Chosen code can be any number of digits, from a 1-12 digit code.

- Easy to recode
- Discrete appearance, dark colour does not attract attention
- Automatic reset feature for extra security
- Attaches easily to any flat surface. Comes with 4 fixing bolts



Product Code	Size L x W x D (mm)	Internal Size L x W x D (mm)	Pack Qty (pcs)
<b>PACK</b>			
SQR701414	121 x 78 x 57	85 x 68 x 13	1
SUB TYPE - SQU16			

### KeyKeep™ 1 - Combination Key Safe

Durable construction, four wheel recodable combination key safe.



- Durable construction
- Four wheel recodable combination lock
- Weather resistant cover
- Easy to fit

Product Code	Size L x W x D (mm)	Pack Qty (pcs)
<b>PACK</b>		
SQR701667	120x 85 x 35	1
SUB TYPE - SQU16		

## SQUIRE Garage Security

### Garage Door Protector

Effective and Sold Secure approved, extra security for garage doors. Simple ground fitting in front of garage door. Tilt action arm locks into place to prevent garage door from being opened. Once opened, drive straight over, no removal needed.



- Extra security for up and over garage doors
- High security hardened steel construction
- 5 pin tumbler lock mechanism
- Surface mounted, all in one, integrated product
- Powder coated finish.

Product Code	Size (mm)	Size L x W (mm)	Sold Secure Level	Pack Qty (pcs)
<b>PACK</b>				
SQR701600	320	320 x 100	Bronze (Domestic)	1
SUB TYPE - SQU17				





# Gate & Fence Hardware

## Gate Hardware

Exterior Gate & Door Hinges	272
Bolts	276
Latches & Catches	280
Hasps & Staples	283
Locks & Handles	285
Gate Kits	287

## Field Gate Hardware

Field Gate Hinge Sets	288
Field Gate Hooks & Eyes	290
Throw-Over Loops	291
Field Gate Wheels	291
Field Gate Catches	292

## Fence Hardware

Fence Post Supports	293
Fencing Accessories	295
Chains and Accessories	297



# Exterior Gate & Door Hinges



## Light Tee Hinge



Ideal for lightweight low use gates, sheds and animal hutches.

**CORROSION RATING**

Zinc				
1	2	3	4	5

Occasionally damp/wet rural and sheltered areas

Technical Data					
Length (mm)	100	150	200	250	300
Thickness (mm)	1.5	1.5	1.5	1.5	1.5
Knuckle Ø (mm)	7.5	7.5	7.5	7.5	7.5
Leaf Size L x W (mm)	72 x 20	72 x 20	80 x 20	80 x 20	90 x 20
To Suit Gate Width (mm)	200 - 300	300 - 450	400 - 600	500 - 750	600 - 900
Max. Gate Weight (kg)	5	5	10	10	10
No. of Screw Holes (Pair)	12	14	14	14	14
Screw Ø (mm)	3.5	3.5	3.5	3.5	3.5

Doors/gates over 7ft height, should be fitted with a third hinge to prevent warping.

Product Code		Band Length (mm)	Band Length (inch)	Pack Qty (pcs)	Carton Qty (packs)
Epoxy Black	Zinc				
BAG					
LTH4BB	LTH4ZB	100	4	1 Pair	200 Pairs
LTH6BB	LTH6ZB	150	6	1 Pair	120 Pairs
LTH8BB	LTH8ZB	200	8	1 Pair	100 Pairs
LTH10BB	LTH10ZB	250	10	1 Pair	100 Pairs
442268	442214	300	12	1 Pair	50 Pairs
TYPE - HGB		SUB TYPE - HGB01			
TIMBAG - FIXINGS INCLUDED					
LTH4B	LTH4Z	100	4	1 Pair	10 Pairs
LTH6B	LTH6Z	150	6	1 Pair	10 Pairs
LTH8B	LTH8Z	200	8	1 Pair	10 Pairs
LTH10B	LTH10Z	250	10	1 Pair	10 Pairs
LTH12B	LTH12Z	300	12	1 Pair	10 Pairs
TYPE - HGP		SUB TYPE - HGP01			

## Medium Tee Hinge



Ideal for medium weight regular use gates, shed and garage doors in domestic applications.

**CORROSION RATING**

Epoxy Black	Zinc
1	2

Occasionally damp/wet rural and sheltered areas

**CORROSION RATING**

Hot Dipped Galvanised				
1	2	3	4	5

Urban & industrial areas with a moderate salt atmosphere

Technical Data						
Band Length (mm)	250	300	350	375	400	450
Band Thickness (mm)	1.8	2.0	2.0	2.0	2.2	2.2
Knuckle Ø (mm)	8.5	9.5	9.5	9.5	11.5	11.5
Leaf Size L x W (mm)	90 x 25	100 x 25	115 x 25	115 x 25	128 x 30	140 x 30
To Suit Gate Width (mm)	500 - 750	600 - 900	700 - 1050	750 - 1125	800 - 1200	900 - 1350
Max. Gate Weight (kg)	30	30	30	40	40	40
No. of Screw Holes (Pair)	14	14	14	16	18	18
Screw Ø (mm)	4.0	4.0	4.0	4.0	5.0	5.0

## Strong Tee Hinge



Ideal for heavy weight high use gates, sheds and garage doors in domestic applications.

**CORROSION RATING**

Epoxy Black				
1	2	3	4	5

Occasionally damp/wet rural and sheltered areas

**CORROSION RATING**

Hot Dipped Galvanised				
1	2	3	4	5

Urban & industrial areas with a moderate salt atmosphere

Technical Data							
Band Length (mm)	250	300	350	400	450	600	
Band Thickness (mm)	2.3	2.3	2.3	2.8	2.8	2.8	
Knuckle Ø (mm)	12.0	12.0	12.0	14.0	14.0	14.0	
Leaf Size L x W (mm)	100 x 20	115 x 30	127 x 30	140 x 30	150 x 30	166 x 40	
To Suit Gate Width (mm)	500 - 750	600 - 900	700 - 1050	800 - 1200	900 - 1350	1200 - 1800	
Max. Gate Weight (kg)	40	40	60	60	80	80	
No. of Screw Holes (Pair)	14	18	18	18	18	20	
Screw Ø (mm)	4.0	4.0	4.0	4.0	5.0	5.0	

Doors/gates over 7ft height, should be fitted with a third hinge to prevent warping.

Product Code		Band Length (mm)	Band Length (inch)	Pack Qty (pcs)	Carton Qty (packs)
Epoxy Black	Zinc	Hot Dipped Galvanised			
BAG					
MTH10BB	MTH10ZB	MTH10GB	250	10	1 Pair 40 Pairs
MTH12BB	MTH12ZB	MTH12GB	300	12	1 Pair 40 Pairs
MTH14BB	MTH14ZB	MTH14GB	350	14	1 Pair 30 Pairs
MTH15BB	MTH15ZB	MTH15GB	375	15	1 Pair 30 Pairs
MTH16BB	MTH16ZB	MTH16GB	400	16	1 Pair 20 Pairs
MTH18BB	MTH18ZB	MTH18GB	450	18	1 Pair 20 Pairs
TYPE - HGB		SUB TYPE - HGB02			
TIMBAG - FIXINGS INCLUDED					
MTH10B	MTH10Z	MTH10G	250	10	1 Pair 10 Pairs
MTH12B	MTH12Z	MTH12G	300	12	1 Pair 10 Pairs
MTH14B	MTH14Z	MTH14G	350	14	1 Pair 8 Pairs
MTH15B	MTH15Z	MTH15G	375	15	1 Pair 10 Pairs
MTH16B	MTH16Z	MTH16G	400	16	1 Pair 8 Pairs
MTH18B	MTH18Z	MTH18G	450	18	1 Pair 6 Pairs
TYPE - HGP		SUB TYPE - HGP02			

Doors/gates over 7ft height, should be fitted with a third hinge to prevent warping.

Product Code		Band Length (mm)	Band Length (inch)	Pack Qty (pcs)	Carton Qty (packs)
Epoxy Black	Hot Dipped Galvanised				
BAG					
STH10BB	STH10GB	250	10	1 Pair	40 Pairs
STH12BB	STH12GB	300	12	1 Pair	30 Pairs
STH14BB	STH14GB	350	14	1 Pair	20 Pairs
STH16BB	STH16GB	400	16	1 Pair	20 Pairs
STH18BB	STH18GB	450	18	1 Pair	10 Pairs
STH24BB	STH24GB	600	24	1 Pair	10 Pairs
TYPE - HGB		SUB TYPE - HGB03			
TIMBAG - FIXINGS INCLUDED					
STH10B	STH10G	250	10	1 Pair	40 Pairs
STH12B	STH12G	300	12	1 Pair	30 Pairs
STH14B	STH14G	350	14	1 Pair	20 Pairs
STH16B	STH16G	400	16	1 Pair	20 Pairs
STH18B	STH18G	450	18	1 Pair	10 Pairs
STH24B	STH24G	600	24	1 Pair	10 Pairs
TYPE - HGP		SUB TYPE - HGP03			

## Scotch Tee Hinge



Ideal for heavy weight high use gates and shed doors in domestic, commercial and agricultural applications.

**CORROSION RATING**

Hot Dipped Galvanised

1	2	3	4	5
---	---	---	---	---

Urban & industrial areas with a moderate salt atmosphere



Technical Data										
Length (mm)	100	150	200	250	300	355	400	450	500	600
Thickness (mm)	2.2	2.2	2.2	2.2	2.8	3.0	3.0	3.0	3.0	3.0
Knuckle Ø (mm)	11	12	12	12	12	16	16	16	16	16
Leaf Size L x W (mm)	90 x 30	90 x 30	100 x 30	100 x 30	145 x 40	145 x 40	175 x 55	175 x 55	175 x 55	175 x 55
To Suit Gate Width (mm)	200-300	300 - 450	400 - 600	500 - 750	600 - 900	700 - 1050	800 - 1200	900 - 1350	1000 - 1500	1200 - 1800
Max. Gate Weight (kg)	10	25	40	50	60	80	80	100	100	100
No. of Screw Holes (Pair)	12	12	12	12	12	16	16	16	16	16
Screw Ø (mm)	4.0	4.0	5.0	5.0	5.0	5.0	5.0	5.0	5.0	5.0

Doors/gates over 7ft height, should be fitted with a third hinge to prevent warping.

Product Code	Band Length (mm)	Band Length (inch)	Pack Qty (pcs)	Carton Qty (packs)
Hot Dipped Galvanised				
<b>BAG</b>				
442270	100	4	1 Pair	50 Pairs
442159	150	6	1 Pair	50 Pairs
442241	200	8	1 Pair	40 Pairs
442657	250	10	1 Pair	30 Pairs
442225	300	12	1 Pair	25 Pairs
442678	355	14	1 Pair	10 Pairs
442336	400	16	1 Pair	10 Pairs
442784	450	18	1 Pair	10 Pairs
442114	500	20	1 Pair	8 Pairs
442878	600	24	1 Pair	8 Pairs
TYPE - HGB			SUB TYPE - HGB04	

Product Code	Band Length (mm)	Band Length (inch)	Pack Qty (pcs)	Carton Qty (packs)
Hot Dipped Galvanised				
<b>TIMBAG - FIXINGS INCLUDED</b>				
447558	100	4	1 Pair	10 Pairs
447254	150	6	1 Pair	10 Pairs
447232	200	8	1 Pair	10 Pairs
447778	250	10	1 Pair	10 Pairs
447669	300	12	1 Pair	10 Pairs
447552	355	14	1 Pair	8 Pairs
447154	400	16	1 Pair	4 Pairs
447785	450	18	1 Pair	4 Pairs
447336	500	20	1 Pair	10 Pairs
447123	600	24	1 Pair	10 Pairs
TYPE - HGP			SUB TYPE - HGP04	

## Medium Strap Hinge



Commonly used for bi-folding garage and shed doors in domestic applications.

**CORROSION RATING**

Zinc

1	2	3	4	5
---	---	---	---	---

Occasionally damp/wet rural and sheltered areas

Technical Data		
Length (mm)	150	200
Thickness (mm)	2.0	2.0
Overall Length (mm)	300	400
Knuckle Ø (mm)	10.0	10.0
To Suit Gate Width (mm)	300 - 450	400 - 600
Max. Gate Weight (kg)	20	20
No. of Screw Holes (Pair)	12	16
Screw Ø (mm)	4.0	4.0

Doors/gates over 7ft height, should be fitted with a third hinge to prevent warping.

Product Code	Band Length (mm)	Band Length (inch)	Pack Qty (pcs)	Carton Qty (packs)
Zinc				
<b>BAG</b>				
SH6ZB	150	6	1 Pair	60 Pairs
SH8ZB	200	8	1 Pair	60 Pairs
TYPE - HGB			SUB TYPE - HGB05	

## Curved Rail Hinge Set

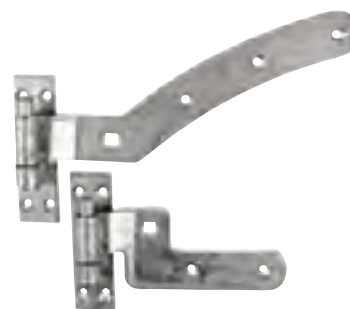

Curved rail hinge sets are ideal for flush mounted fully framed gates with a curved top ledge. Depending on the weight distribution of the gate, the top or bottom pin can be mounted upside down to prevent unwanted removal of the gate.

**CORROSION RATING**

Hot Dipped Galvanised

1	2	3	4	5
---	---	---	---	---

Urban & industrial areas with a moderate salt atmosphere

Technical Data	
Top Band Length (mm)	300
Band Width	40
Band Thickness (mm)	4.8
Pin Ø (mm)	12
Pin Ø (inch)	1/2
Hook Plate L x W (mm)	160 x 50
No. of Bolt Holes (Pair)	2
Carriage Bolt Ø (mm)	M10
No. of Screw Holes (Pair)	13
Screw Ø (mm)	6.0

Product Code	Hand	Top Band Length (mm)	Top Band Length (inch)	Bottom Band Length (mm)	Pack Qty (pcs)	Carton Qty (packs)
Hot Dipped Galvanised						
<b>BAG</b>						
CRHLG	Left	300	12	200	1 Pair	5 Pairs
CRHRG	Right	300	12	200	1 Pair	5 Pairs
TYPE - HGB					SUB TYPE - HGB05	

## Heavy Reversible Hinge



Heavy reversible hinges are ideal for flush mounted heavy gates, garage and stable doors in domestic, commercial and agricultural applications. The pins of the hinges mount into the hinge cups and prevent gates or doors from being lifted off.

Doors/gates over 7ft height, should be fitted with a third hinge to prevent warping.



### CORROSION RATINGS

Epoxy Black				
1	2	3	4	5

Occasionally damp/wet rural and sheltered areas

Hot Dipped Galvanised				
1	2	3	4	5

Urban & industrial areas with a moderate salt atmosphere

Technical Data											
Band Length (mm)	250	300	350	400	450	500	600	750	900	1050	1200
Band Thickness (mm)	4.8	4.8	4.8	4.8	4.8	4.8	5.6	5.6	5.6	5.6	5.6
Band Width (mm)	40	40	40	40	50	50	50	50	50	50	50
Pin Ø (mm)	12	12	12	12	16	16	16	19	19	19	19
Pin Ø (inch)	1/2	1/2	1/2	1/2	5/8	5/8	5/8	3/4	3/4	3/4	3/4
To Suit Gate Width (mm)	500 - 750	600 - 900	700 - 1050	800 - 1200	900 - 1350	1000 - 1500	1200 - 1800	1500 - 2250	1800 - 2700	2100 - 3150	2400 - 3600
No. of Bolt Holes (Pair)	2	2	2	2	2	2	2	2	2	2	2
Carriage Bolt Ø (mm)	M10	M10	M10	M10	M10	M10	M10	M10	M10	M10	M10
No. of Screw Holes (Pair)	22	22	22	26	26	26	26	26	30	30	30
Screw Ø (mm)	6.0	6.0	6.0	6.0	6.0	6.0	6.0	6.0	6.0	6.0	6.0

Product Code		Band Length (mm)	Band Length (inch)	Pack Qty (pcs)	Carton Qty (packs)
Epoxy Black	Hot Dipped Galvanised				
<b>TIMBAG - FIXINGS INCLUDED</b>					
HRH250B	HRH250G	250	10	1 Pair	5 Pairs
HRH300B	HRH300G	300	12	1 Pair	5 Pairs
HRH350B	HRH350G	350	14	1 Pair	5 Pairs
HRH400B	HRH400G	400	16	1 Pair	5 Pairs
HRH450B	HRH450G	450	18	1 Pair	5 Pairs
HRH500B	HRH500G	500	20	1 Pair	5 Pairs

Product Code		Band Length (mm)	Band Length (inch)	Pack Qty (pcs)	Carton Qty (packs)
Epoxy Black	Hot Dipped Galvanised				
<b>TIMBAG - FIXINGS INCLUDED</b>					
HRH600B	HRH600G	600	24	1 Pair	5 Pairs
HRH750B	HRH750G	750	30	1 Pair	5 Pairs
HRH900B	HRH900G	900	36	1 Pair	5 Pairs
HRH1050B	HRH1050G	1050	42	1 Pair	2 Pairs
HRH1200B	HRH1200G	1200	48	1 Pair	2 Pairs
TYPE - FGP		SUB TYPE - FGP02			

## Adjustable Band & Hook on Plate



Adjustable hook and band hinges are for hanging doors or gates flush with the frame or post. They are ideal for heavy weight, high use doors, gates, garages and stables in domestic, commercial and agricultural applications. They feature an adjustable eye bolt to allow for gate alignment whilst being fitted or at a later stage if any movement occurs.

Doors/gates over 7ft height, should be fitted with a third hinge to prevent warping.

### CORROSION RATINGS

Epoxy Black				
1	2	3	4	5

Occasionally damp/wet rural and sheltered areas

Hot Dipped Galvanised				
1	2	3	4	5

Urban & industrial areas with a moderate salt atmosphere

Technical Data						
Band Length (mm)	350	450	600	750	900	1200
Band Thickness (mm)	5.0	5.0	5.0	5.0	5.0	5.0
Band Width (mm)	50	50	50	60	60	70
Pin Ø (mm)	19	19	19	19	19	19
Pin Ø (inch)	3/4	3/4	3/4	3/4	3/4	3/4
Hook Plate L x W (mm)	160 x 50	160 x 50	200 x 60	200 x 60	200 x 60	200 x 60
To Suit Gate Width (mm)	700 - 1050	900 - 1350	1200 - 1800	1500 - 2250	1800 - 2700	2400 - 3600
No. of Bolt Holes (Pair)	2	2	2	2	2	2
Carriage Bolt Ø (mm)	M10	M10	M10	M10	M10	M10
No. of Screw Holes (Pair)	12	14	14	14	18	20
Screw Ø (mm)	6.0	6.0	6.0	6.0	6.0	6.0

Product Code		Band Length (mm)	Band Length (inch)	Pack Qty (pcs)	Carton Qty (packs)
Epoxy Black	Hot Dipped Galvanised				
<b>TIMBAG - FIXINGS INCLUDED</b>					
ABH350B	ABH350G	350	14	1 Pair	4 Pairs
ABH450B	ABH450G	450	18	1 Pair	4 Pairs
ABH600B	ABH600G	600	24	1 Pair	4 Pairs
ABH750B	ABH750G	750	30	1 Pair	4 Pairs
ABH900B	ABH900G	900	36	1 Pair	4 Pairs
ABH1200B	ABH1200G	1200	48	1 Pair	2 Pairs
TYPE - FGH		SUB TYPE - FGH02			



## Straight Band & Hook on Plate



Doors/gates over 7ft height, should be fitted with a third hinge to prevent warping.

The straight pattern hook and band hinges are for hanging the door or gate in front of the frame or post. They are ideal for heavy weight, high use doors, gates, garages and stables in domestic and agricultural applications. Depending on the weight distribution of the gate, the top or bottom pin can be mounted upside down to prevent unwanted removal of the gate.



### CORROSION RATINGS

Epoxy Black				
1	2	3	4	5

Occasionally damp/wet rural and sheltered areas

Hot Dipped Galvanised				
1	2	3	4	5

Urban & industrial areas with a moderate salt atmosphere

### Technical Data

Band Length (mm)	250	300	350	400	450	500	600	750	900
Band Thickness (mm)	4.8	4.8	4.8	4.8	4.8	4.8	5.4	5.4	5.4
Band Width (mm)	40	40	40	40	50	50	50	50	50
Pin Ø (mm)	12	12	12	12	16	16	16	19	19
Pin Ø (inch)	1/2	1/2	1/2	1/2	5/8	5/8	5/8	3/4	3/4
Hook Plate L x W (mm)	115 x 40	115 x 40	115 x 40	115 x 40	160 x 50	160 x 50	160 x 50	200 x 75	200 x 75
To Suit Gate Width (mm)	500 - 750	600 - 900	700 - 1050	800 - 1200	900 - 1350	1000 - 1500	1200 - 1800	1500 - 2250	1800 - 2700
No. of Bolt Holes (Pair)	2	2	2	2	2	2	2	2	2
Carriage Bolt Ø (mm)	M10	M10	M10	M10	M10	M10	M10	M10	M10
No. of Screw Holes (Pair)	12	12	12	14	14	14	14	14	16
Screw Ø (mm)	6.0	6.0	6.0	6.0	6.0	6.0	6.0	6.0	6.0

### Product Code

Epoxy Black	Hot Dipped Galvanised	Band Length (mm)	Band Length (inch)	Pack Qty (pcs)	Carton Qty (packs)
<b>TIMBAG - FIXINGS INCLUDED</b>					
HBS250B	HBS250G	250	10	1 Pair	5 Pairs
HBS300B	HBS300G	300	12	1 Pair	5 Pairs
HBS350B	HBS350G	350	14	1 Pair	5 Pairs
HBS400B	HBS400G	400	16	1 Pair	5 Pairs
HBS450B	HBS450G	450	18	1 Pair	5 Pairs

### Product Code

Epoxy Black	Hot Dipped Galvanised	Band Length (mm)	Band Length (inch)	Pack Qty (pcs)	Carton Qty (packs)
<b>TIMBAG - FIXINGS INCLUDED</b>					
HBS500B	HBS500G	500	20	1 Pair	5 Pairs
HBS600B	HBS600G	600	24	1 Pair	5 Pairs
HBS750B	HBS750G	750	30	1 Pair	5 Pairs
HBS900B	HBS900G	900	36	1 Pair	5 Pairs
TYPE - FGH		SUB TYPE - FGH03			

## Cranked Band & Hook on Plate

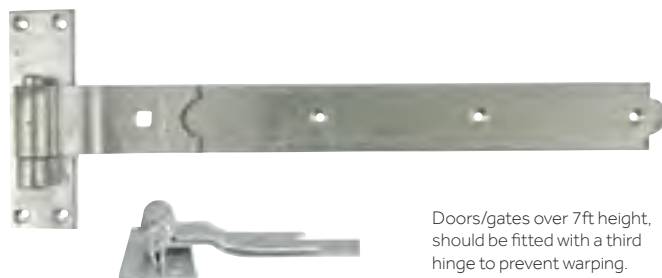

Doors/gates over 7ft height, should be fitted with a third hinge to prevent warping.

The cranked pattern hook and band hinges are for hanging the door or gate flush with the frame or post. They are ideal for heavy weight, high use doors, gates, garages and stables in domestic and agricultural applications. Depending on the weight distribution of the gate, the top or bottom pin can be mounted upside down to prevent unwanted removal of the gate.



### CORROSION RATINGS

Epoxy Black				
1	2	3	4	5

Occasionally damp/wet rural and sheltered areas

Hot Dipped Galvanised				
1	2	3	4	5

Urban & industrial areas with a moderate salt atmosphere

### Technical Data

Band Length (mm)	250	300	350	400	450	500	600	750	900
Band Thickness (mm)	4.8	4.8	4.8	4.8	4.8	4.8	5.4	5.4	5.4
Band Width (mm)	40	40	40	40	50	50	50	50	50
Pin Ø (mm)	12	12	12	12	16	16	16	19	19
Pin Ø (inch)	1/2	1/2	1/2	1/2	5/8	5/8	5/8	3/4	3/4
Hook Plate L x W (mm)	115 x 40	115 x 40	115 x 40	115 x 40	160 x 50	160 x 50	160 x 50	200 x 75	200 x 75
To Suit Gate Width (mm)	500 - 750	600 - 900	700 - 1050	800 - 1200	900 - 1350	1000 - 1500	1200 - 1800	1500 - 2250	1800 - 2700
No. of Bolt Holes (Pair)	2	2	2	2	2	2	2	2	2
Carriage Bolt Ø (mm)	M10	M10	M10	M10	M10	M10	M10	M10	M10
No. of Screw Holes (Pair)	12	12	12	14	14	14	14	14	16
Screw Ø (mm)	6.0	6.0	6.0	6.0	6.0	6.0	6.0	6.0	6.0

### Product Code

Epoxy Black	Hot Dipped Galvanised	Band Length (mm)	Band Length (inch)	Pack Qty (pcs)	Carton Qty (packs)
<b>TIMBAG - FIXINGS INCLUDED</b>					
HBC250B	HBC250G	250	10	1 Pair	5 Pairs
HBC300B	HBC300G	300	12	1 Pair	5 Pairs
HBC350B	HBC350G	350	14	1 Pair	5 Pairs
HBC400B	HBC400G	400	16	1 Pair	5 Pairs
HBC450B	HBC450G	450	18	1 Pair	5 Pairs

### Product Code

Epoxy Black	Hot Dipped Galvanised	Band Length (mm)	Band Length (inch)	Pack Qty (pcs)	Carton Qty (packs)
<b>TIMBAG - FIXINGS INCLUDED</b>					
HBC500B	HBC500G	500	20	1 Pair	5 Pairs
HBC600B	HBC600G	600	24	1 Pair	5 Pairs
HBC750B	HBC750G	750	30	1 Pair	5 Pairs
HBC900B	HBC900G	900	36	1 Pair	5 Pairs
TYPE - FGH		SUB TYPE - FGH02			

## Hook on Rectangular Plate



Spare hook on plate for hook and band hinges.



### CORROSION RATING



Urban & industrial areas with a moderate salt atmosphere

### Product Code

Hot Dipped Galvanised	Pin Ø (mm)	Pin Ø (inch)	Hook Plate L x W (mm)	To Suit Band Size (mm)	No. of Screw Holes	Screw Ø (mm)	Pack Qty (pcs)	Carton Qty (packs)
-----------------------	------------	--------------	-----------------------	------------------------	--------------------	--------------	----------------	--------------------

### TIMBAG - FIXINGS INCLUDED

HRP12G	12	1/2	115-40	250-400	8	6.0	1 Pair	20 Pairs
HRP16G	16	5/8	160 x 50	450-600	8	6.0	1 Pair	20 Pairs
HRP19G	19	3/4	200 x 75	750-900	8	6.0	1 Pair	10 Pairs

TYPE - FGH  
SUB TYPE - FGH04

## Gate Hooks to Build



Gate hooks to build are used for embedding in between layers of the post brickwork and can be used with straight and cranked hook and band hinges.

### CORROSION RATING



Urban & industrial areas with a moderate salt atmosphere

### Product Code

Hot Dipped Galvanised	Pin Ø (mm)	Pin Ø (inch)	Length (mm)	To Suit Brickwork	To Suit Band Size (mm)	Pack Qty (pcs)	Carton Qty (packs)
-----------------------	------------	--------------	-------------	-------------------	------------------------	----------------	--------------------

### TIMBAG - FIXINGS INCLUDED

GHBSB12G	12	1/2	60	Single	250 - 400	1 Pair	10 Pairs
GHBDB12G	12	1/2	180	Double	250 - 400	1 Pair	10 Pairs
GHBSB16G	16	5/8	65	Single	450 - 600	1 Pair	10 Pairs
GHBDB16G	16	5/8	180	Double	450 - 600	1 Pair	10 Pairs
GHBSB19G	19	3/4	65	Single	750 - 900	1 Pair	10 Pairs
GHBDB19G	19	3/4	180	Double	750 - 900	1 Pair	10 Pairs

TYPE - FGH  
SUB TYPE - FGH04

## Bolts



## Brenton Padbolt

NEW



### CORROSION RATINGS

Epoxy Black    Zinc



Occasionally damp/wet rural and sheltered areas

Hot Dipped Galvanised



Urban & industrial areas with a moderate salt atmosphere

Brenton padbolts are used for securing flush mounted gates and shed doors in domestic and light commercial applications. They are pad-lockable and fixed with carriage bolts for added security.

### Technical Data

Bolt Length (mm)	102	100	150	200
Bolt Length (mm)	102	100	150	200
Bolt Ø (mm)	12	12	12	12
Bolt Throw (mm)	12	30	45	45
Plate Size (mm)	120 x 45	130 x 45	180 x 45	225 x 45
Staple Keep Size L x W (mm)	83 x 23	56 x 33	56 x 33	56 x 33
Max. Padlock Shackle Ø (mm)	10	10	10	10
No. of Carriage Bolt Holes	4	4	4	4
Carriage Bolt Ø (mm)	M6	M6	M6	M6
No. of Screw Holes	6	6	6	6
Screw Ø (mm)	4.0	4.0	4.0	4.0

### Product Code

Epoxy Black	Zinc	Hot Dipped Galvanised	Bolt Length (mm)	Bolt Length (inch)	Pack Qty (pcs)	Carton Qty (packs)
-------------	------	-----------------------	------------------	--------------------	----------------	--------------------

### BAG - EXCLUDES FIXINGS

BP4BB	BP4ZB	BP4GB	100	4	1	10
BP6BB	BP6ZB	BP6GB	150	6	1	10
BP8BB	BP8ZB	BP8GB	200	8	1	10

TYPE - BTB  
SUB TYPE - BTB01

### TIMBAG - FIXINGS INCLUDED

BP4BP	BP4ZP	BP4GP	100	4	1	10
BP6BP	BP6ZP	BP6GP	150	6	1	10
BP8BP	BP8ZP	BP8GP	200	8	1	10

TYPE - BTB  
SUB TYPE - BTB01

### BRENTON PADBOLT - ELONGATED KEEP

### BAG - EXCLUDES FIXINGS

282004	102	4	1	5
--------	-----	---	---	---

TYPE - BTB  
SUB TYPE - BTB01

## Heavy Brenton Padbolt



### CORROSION RATING



Urban & industrial areas with a moderate salt atmosphere

Heavy brenton padbolts are used for securing flush mounted gates and shed doors in heavy domestic, commercial and agricultural applications. They are pad-lockable and fixed with carriage bolts for added security.

### Technical Data

Bolt Length (mm)	150	200	250	300
Bolt Length (mm)	150	200	250	300
Bolt Ø (mm)	16	16	16	16
Bolt Throw (mm)	50	50	50	50
Plate Size (mm)	170 x 60	220 x 60	270 x 60	320 x 60
Staple Keep Size L x W (mm)	60 x 40	60 x 40	60 x 40	60 x 40
Max. Padlock Shackle Ø (mm)	14	14	14	14
No. of Carriage Bolt Holes	4	4	4	4
Carriage Bolt Ø (mm)	M6	M6	M6	M6
No. of Screw Holes	6	6	6	6
Screw Ø (mm)	4.0	4.0	4.0	4.0

### Product Code

Hot Dipped Galvanised	Bolt Length (mm)	Bolt Length (inch)	Pack Qty (pcs)	Carton Qty (packs)
-----------------------	------------------	--------------------	----------------	--------------------

### BAG - EXCLUDES FIXINGS

282656	150	6	1	40
282219	200	8	1	35
282953	250	10	1	25
282632	300	12	1	20

TYPE - BTP  
SUB TYPE - BTP01

### TIMBAG - FIXINGS INCLUDED

287258	150	6	1	10
287456	200	8	1	10
287658	250	10	1	10
287477	300	12	1	10

TYPE - BTB  
SUB TYPE - BTB05

## Oval Padbolt

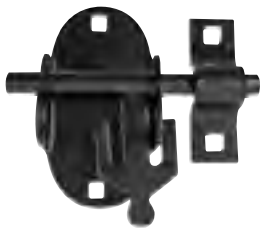

Oval padbolts are ideal for securing flush fitting narrow stile gates and doors in domestic and light commercial applications. They are padlockable and fixed with carriage bolts for added security.

### CORROSION RATINGS

Epoxy Black	Zinc
1	2

Occasionally damp/wet rural and sheltered areas

Hot Dipped Galvanised	
1	2

Urban & industrial areas with a moderate salt atmosphere

Technical Data	
Bolt Length (mm)	100
Bolt Ø (mm)	12
Bolt Throw (mm)	40
Plate Size L x W (mm)	55 x 100
Staple Keep Size L x W (mm)	73 x 24
Max. Padlock Shackle Ø (mm)	10
No. of Carriage Bolt Holes	10
Carriage Bolt Ø (mm)	4.0

Product Code			Bolt Length (mm)	Bolt Length (inch)	Pack Qty (pcs)	Carton Qty (packs)
Epoxy Black	Zinc	Hot Dipped Galvanised				
<b>BAG - EXCLUDES FIXINGS</b>						
OP4BB	OP4ZB	OP4GB	100	4	1	10
TYPE - BTB			SUB TYPE - BTB03			
<b>TIMBAG - FIXINGS INCLUDED</b>						
OP4BP	OP4ZP	OP4GP	100	4	1	10
TYPE - BTP			SUB TYPE - BTP03			

## Slide Action Padbolt



### CORROSION RATING

Epoxy Black	Zinc
1	2

Occasionally damp/wet rural and sheltered areas

Slide action padbolts are ideal for securing flush fitting gates and doors in domestic and light commercial applications when the bolt is exposed externally. They are padlockable and fixed with eight carriage bolts to prevent the bolt being wrenched from the door.

Technical Data	
Bolt Length (mm)	185
Bolt Ø (mm)	9
Bolt Throw (mm)	60
Plate Size L x W (mm)	105 x 72
Staple Keep Size L x W (mm)	76 x 25
Max. Padlock Shackle Ø (mm)	8
No. of Carriage Bolt Holes	8
Carriage Bolt Ø (mm)	M6

Product Code			Bolt Length (mm)	Bolt Length (inch)	Pack Qty (pcs)	Carton Qty (packs)
Epoxy Black	Zinc	Hot Dipped Galvanised				
<b>BAG - EXCLUDES FIXINGS</b>						
282456	282789		185	7 1/4	1	80
TYPE - BTB			SUB TYPE - BTB04			
<b>TIMBAG - FIXINGS INCLUDED</b>						
287114	287585		185	7 1/4	1	10
TYPE - BTP			SUB TYPE - BTP04			

## Necked Tower Bolt



Necked tower bolts are used for securing recessed fitting gates and shed doors in a closed position.

### CORROSION RATINGS

Epoxy Black	Zinc
1	2

Occasionally damp/wet rural and sheltered areas

Hot Dipped Galvanised	
1	2

Urban & industrial areas with a moderate salt atmosphere

Technical Data			
Bolt Length (mm)	100	150	200
Bolt Ø (mm)	10	10	11
Bolt Throw (mm)	40	40	50
Plate Size L x W (mm)	118 x 38	165 x 38	225 x 45
Flat Keep Size L x W (mm)	43 x 27	43 x 27	43 x 27
Flat Keep Hole Size (mm)	12	12	12
No. of Screw Holes	8	10	10
Screw Ø (mm)	4.0	4.0	4.0

Product Code			Bolt Length (mm)	Bolt Length (inch)	Pack Qty (pcs)	Carton Qty (packs)
Epoxy Black	Hot Dipped Galvanised					
<b>BAG - EXCLUDES FIXINGS</b>						
TBN4BB	TBN4GB		100	4	1	15
TBN6BB	TBN6GB		150	6	1	15
TBN8BB	TBN8GB		200	8	1	15
TYPE - BTB			SUB TYPE - BTB02			
<b>TIMBAG - FIXINGS INCLUDED</b>						
TBN4BP	TBN4GP		100	4	1	15
TBN6BP	TBN6GP		150	6	1	15
TBN8BP	TBN8GP		200	8	1	15
TYPE - BTP			SUB TYPE - BTP02			

## Straight Tower Bolt



Straight tower bolts are used for securing flush fitting gates and shed doors in a closed position.

### CORROSION RATINGS

Epoxy Black	Zinc
1	2

Occasionally damp/wet rural and sheltered areas

Hot Dipped Galvanised	
1	2

Urban & industrial areas with a moderate salt atmosphere

Technical Data					
Bolt Length (mm)	75	100	150	200	250
Bolt Ø (mm)	10	10	10	10	10
Bolt Throw (mm)	20	25	25	35	35
Plate Size L x W (mm)	95 x 38	118 x 38	165 x 38	225 x 45	276 x 45
Staple Keep Size L x W (mm)	39 x 25	39 x 25	46 x 33	46 x 33	46 x 33
No. of Screw Holes	6	8	10	10	10
Screw Ø (mm)	4.0	4.0	4.0	4.0	4.0

Product Code			Bolt Length (mm)	Bolt Length (inch)	Pack Qty (pcs)	Carton Qty (packs)
Epoxy Black	Zinc	Hot Dipped Galvanised				
<b>BAG - EXCLUDES FIXINGS</b>						
TBS3BB	TBS3ZB	TBS3GB	75	3	1	100
TBS4BB	TBS4ZB	TBS4GB	100	4	1	120
TBS6BB	TBS6ZB	TBS6GB	150	6	1	100
TBS8BB	TBS8ZB	TBS8GB	200	8	1	40
TBS10BB	TBS10ZB	TBS10GB	250	10	1	40
TYPE - BTB			SUB TYPE - BTB02			
<b>TIMBAG - FIXINGS INCLUDED</b>						
TBS3BP	TBS3ZP	TBS3GP	75	3	1	15
TBS4BP	TBS4ZP	TBS4GP	100	4	1	15
TBS6BP	TBS6ZP	TBS6GP	150	6	1	15
TBS8BP	TBS8ZP	TBS8GP	200	8	1	15
TBS10BP	TBS10ZP	TBS10GP	250	10	1	15
TYPE - BTP			SUB TYPE - BTP02			

## Heavy Cross Pattern Door Bolt



**CORROSION RATING**



Urban & industrial areas with a moderate salt atmosphere

Heavy cross pattern bolts are typically used for securing large garage doors and gates in industrial and agricultural applications. They are extremely strong, padlockable and fixed with carriage bolts for high security.

**Technical Data**

Bolt Length (mm)	300	450	600
Bolt Ø (mm)	16	16	16
Bolt Throw (mm)	70	150	190
Plate Size L x W (mm)	316 x 64	465 x 64	600 x 64
Staple Keep Size L x W (mm)	95 x 64	145 x 64	145 x 64
Staple Plate Size L x W (mm)	65 x 55	65 x 55	65 x 55
Max. Padlock Shackle Ø (mm)	16	16	16
No. of Carriage Bolt Holes	6	6	6
Carriage Bolt Ø (mm)	M8	M8	M8
No. of Screw Holes	14	14	14
Screw Ø (mm)	5.0	5.0	5.0

Product Code	Bolt Length (mm)	Bolt Length (inch)	Pack Qty (pcs)	Carton Qty (packs)
<b>Hot Dipped Galvanised</b>				
<b>BAG - EXCLUDES FIXINGS</b>				
282639	300	12	1	2
282264	450	18	1	2
282852	600	24	1	2
TYPE - BTP				SUB TYPE - BTP05

## Spring Loaded Animal Bolt



**CORROSION RATING**



Urban & industrial areas with a low salt atmosphere

Ideal for securing flush mounted stable doors and gates in a close position. They are spring loaded to prevent animals working the bolt loose and escaping. Our animal bolts come supplied with a staple keep.

**Technical Data**

Bolt Length (mm)	143	225	242
Bolt Ø (mm)	10	12	16
Bolt Throw (mm)	40	65	65
Plate Size L x W (mm)	70 x 40	118 x 40	130 x 50
Staple Plate Size L x W (mm)	50 x 50	50 x 50	65 x 55
No. of Screw Holes	8	8	8
Screw Ø (mm)	5.0	5.0	5.0

Product Code	Bolt Length (mm)	Bolt Length (inch)	Pack Qty (pcs)	Carton Qty (packs)
<b>Hot Dipped Galvanised</b>				
<b>BAG - EXCLUDES FIXINGS</b>				
282454	143	5 ½	1	20
282565	225	9	1	20
282417	242	9 ½	1	20
TYPE - BTP				SUB TYPE - BTP05
<b>TIMBAG - FIXINGS INCLUDED</b>				
287878	143	5 ½	1	5
287663	225	9	1	5
TYPE - BTP				SUB TYPE - BTP05

## Monkey Tail Bolt



Monkey tail bolts are ideal for securing the top and / or bottom of gates and doors. They feature an extended length handle for ease of operation and remain closed under tension. Supplied with a flat plate keep and staple keep for fitting in either flush frame mounting, recess frame mounting or floor mounting applications.

**CORROSION RATINGS**

Epoxy Black



Occasionally damp/wet rural and sheltered areas

Hot Dipped Galvanised



Urban & industrial areas with a moderate salt atmosphere

**Technical Data**

Bolt Length (mm)	300	450
Square Bolt (mm)	16 x 16	16 x 16
Bolt Throw (mm)	70	70
Plate Size L x W (mm)	200 x 50	250 x 50
Staple Keep Size L x W (mm)	51 x 31	51 x 31
Flat Keep Size L x W (mm)	49 x 49	49 x 49
Flat Keep Hole Size L x W (mm)	16 x 16	16 x 16
No. of Screw Holes	10	10
Screw Ø (mm)	4.0	4.0

Product Code	Bolt Length (mm)	Bolt Length (inch)	Pack Qty (pcs)	Carton Qty (packs)	
<b>Epoxy Black</b>					
<b>Hot Dipped Galvanised</b>					
<b>BAG - EXCLUDES FIXINGS</b>					
MBS12BB	MBS12GB	300	12	1	20
MBS18BB	MBS18GB	450	18	1	20
TYPE - BTB				SUB TYPE - BTB08	
<b>TIMBAG - FIXINGS INCLUDED</b>					
MBS12BP	MBS12GP	300	12	1	15
MBS18BP	MBS18GP	450	18	1	15
TYPE - BTP				SUB TYPE - BTP07	

## Bow Handle Bolt



Bow handle bolts are ideal for securing the top and/or bottom of gates and doors. They feature an extended length bow shaped handle for ease of operation and remain closed under tension.

**CORROSION RATINGS**

Epoxy Black



Occasionally damp/wet rural and sheltered areas

Hot Dipped Galvanised



Urban & industrial areas with a moderate salt atmosphere

**Technical Data**

Bolt Length (mm)	300	450
Square Bolt (mm)	16 x 16	16 x 16
Bolt Throw (mm)	70	70
Plate Size L x W (mm)	180 x 50	220 x 50
Staple Keep Size L x W (mm)	51 x 31	51 x 31
Flat Keep Size L x W (mm)	49 x 49	49 x 49
Flat Keep Hole Size L x W (mm)	16 x 16	16 x 16
No. of Screw Holes	10	10
Screw Ø (mm)	4.0	4.0

Product Code	Bolt Length (mm)	Bolt Length (inch)	Pack Qty (pcs)	Carton Qty (packs)	
<b>Epoxy Black</b>					
<b>Hot Dipped Galvanised</b>					
<b>BAG - EXCLUDES FIXINGS</b>					
282582	282998	300	12	1	5
282951	282114	450	18	1	5
TYPE - BTB				SUB TYPE - BTB08	
<b>TIMBAG - FIXINGS INCLUDED</b>					
287665	287771	300	12	1	5
287332	287117	450	18	1	5
TYPE - BTP				SUB TYPE - BTP07	



## Spring Chain Bolt

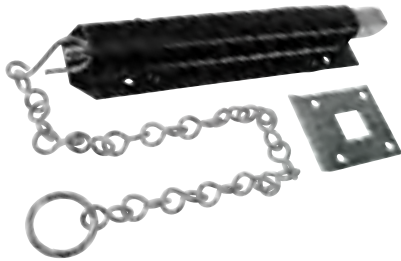

Spring garage chain bolts are ideal for securing the top of garage doors or gates. The bolt remains closed under spring tension and features a 450mm long pull chain for easy operation to release the bolt.

Technical Data	
Chain Length (mm)	450
Bolt Throw (mm)	30
Plate Size L x W (mm)	188 x 56
Flat Keep Size L x W (mm)	63 x 51
Flat Keep Hole Size L x W (mm)	18 x 18
Square Bolt (mm)	16 x 16
No. of Screw Holes	8
Screw Ø (mm)	4.0

### CORROSION RATING

Epoxy Black	Zinc
1	2

Occasionally damp/wet rural and sheltered areas

### Product Code

Epoxy Black	Zinc	Chain Length (mm)	Chain Length (inch)	Pack Qty (pcs)	Carton Qty (packs)
<b>TIMBAG - FIXINGS INCLUDED</b>					
CB18BB	CB18ZB	450	18	1	5
TYPE - BTB		SUB TYPE - BTB06			

<b>TIMBAG - FIXINGS INCLUDED</b>					
CB18BP	CB18ZP	450	18	1	10
TYPE - BTP		SUB TYPE - BTP05			

## Foot Bolt



Garage foot bolts are used for securing the bottom of garage doors and gates. They are foot operated making them ideal for environments where a hands free operation is needed.

### CORROSION RATING

Epoxy Black	Zinc
1	2

Occasionally damp/wet rural and sheltered areas

Technical Data	
Bolt Length (mm)	200
Square Bolt (mm)	16 x 16
Bolt Throw (mm)	30
Plate Size L x W (mm)	188 x 52
Flat Keep Size L x W (mm)	49 x 49
Flat Keep Hole Size L x W (mm)	18 x 18
No. of Screw Holes	8
Screw Ø (mm)	4.0

### Product Code

Epoxy Black	Zinc	Bolt Length (mm)	Bolt Length (inch)	Pack Qty (pcs)	Carton Qty (packs)
<b>TIMBAG - FIXINGS INCLUDED</b>					
GFB8BB	GFB8ZB	200	8	1	30
TYPE - BTB		SUB TYPE - BTB07			

<b>TIMBAG - FIXINGS INCLUDED</b>					
GFB8BP	GFB8ZP	200	8	1	8
TYPE - BTP		SUB TYPE - BTP06			

## Cane Bolt



Ideal for lightweight gates, garages and shed doors in light domestic applications. Supplied with socket bolt keep.

Technical Data	
Bolt Length (mm)	300
Bolt Ø (mm)	12
Plate Size L x W (mm)	75 x 40
Socket Keep Size Ø (mm)	16
No. of Screw Holes	4
Screw Ø (mm)	4.0

### CORROSION RATING

Epoxy Black	Zinc
1	2

Occasionally damp/wet rural and sheltered areas

### Product Code

Epoxy Black	Zinc	Bolt Length (mm)	Bolt Length (inch)	Pack Qty (pcs)	Carton Qty (packs)
<b>BAG - EXCLUDES FIXINGS</b>					
282159		300	12	1	10
TYPE - GAB		SUB TYPE - GAB07			

<b>TIMBAG - FIXINGS INCLUDED</b>					
287254		300	12	1	10
TYPE - GAB		SUB TYPE - GAB07			

## Garage Drop Down Bolt



Ideal for securing the bottom of gates and doors in domestic and industrial applications. Extended bolt length for ease of operation and an adjustable bolt throw by moving the keep position.

Technical Data		
Bolt Length (mm)	300	450
Bolt Ø (mm)	14	14
Handle Plate Size L x W (mm)	45 x 88	45 x 88
Keep Plate Size L x W (mm)	45 x 64	45 x 64
Flat Plate Size L x W (mm)	60 x 29	60 x 29
Flat Keep Hole Ø (mm)	20	20
Socket Keep Size Ø x L (mm)	19 x 50	19 x 50
No. of Screw Holes	16	20
Screw Ø (mm)	4.0	4.0

### CORROSION RATINGS

Epoxy Black	Zinc
1	2

Occasionally damp/wet rural and sheltered areas

### Hot Dipped Galvanised

Epoxy Black	Zinc
1	4

Urban & industrial areas with a moderate salt atmosphere

### Product Code

Epoxy Black	Hot Dipped Galvanised	Bolt Length (mm)	Bolt Length (inch)	Pack Qty (pcs)	Carton Qty (packs)
<b>BAG - EXCLUDES FIXINGS</b>					
DDB12BB	DDB12GB	300	12	1	20
DDB18BB	DDB18GB	450	18	1	16
TYPE - BTB		SUB TYPE - BTB08			

<b>TIMBAG - FIXINGS INCLUDED</b>					
DDB12BP	DDB12GP	300	12	1	15
DDB18BP	DDB18GP	450	18	1	15
TYPE - BTP		SUB TYPE - BTP07			

## Heavy Locking Drop Down Bolt

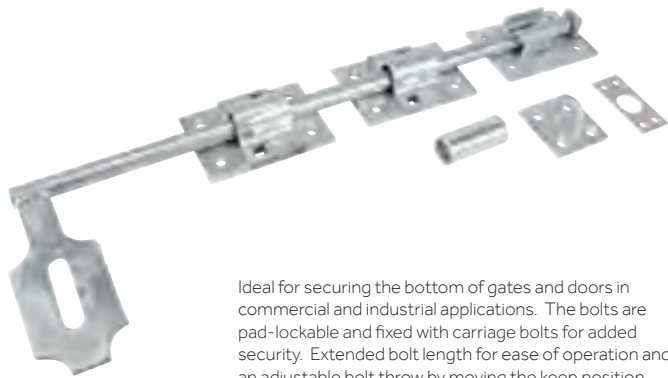

Ideal for securing the bottom of gates and doors in commercial and industrial applications. The bolts are pad-lockable and fixed with carriage bolts for added security. Extended bolt length for ease of operation and an adjustable bolt throw by moving the keep position.



### CORROSION RATING

1	2	3	4	5
---	---	---	---	---

Urban & industrial areas with a moderate salt atmosphere

Technical Data	
Bolt Length (mm)	450
Bolt Ø (mm)	14
Plate Size L x W (mm)	95 x 64
Flat Keep Size L x W (mm)	45 x 64
Flat Plate Size L x W (mm)	60 x 29
Flat Keep Hole Ø (mm)	20
Socket Keep Size Ø x L (mm)	19 x 50
Staple Keep Plate Size L x W (mm)	50 x 50
Max. Padlock Shackle Ø (mm)	16
No. of Carriage Bolt Holes	4
Carriage Bolt Ø (mm)	M6
No. of Screw Holes	16
Screw Ø (mm)	4.0

Product Code	Bolt Length (mm)	Bolt Length (inch)	Pack Qty (pcs)	Carton Qty (packs)
Hot Dipped Galvanised				

BAG - EXCLUDES FIXINGS				
LDDB18GP	450	18	1	10
TYPE - BTP				SUB TYPE - BTP07

## Latches & Catches

### Suffolk Latches

#### Medium Suffolk Latch - Short Thumb Bit 205 x 45mm

For use on light domestic gates. External handle allows gate to be opened from the outside.



#### Heavy Suffolk Latch - Long Thumb Bit 219 x 50mm

For use on heavy domestic gates. External handle allows the gate to be opened from the outside.



Technical Data		
Type	Medium	Heavy
Backplate Size (mm)	205 x 45	219 x 50
Bar Length (mm)	203	203
Catch Projection (mm)	80	110
Max. Gate Thickness (mm)	50	75
No. of Screw Holes - CSK / Pan	12	14
Screw Ø (mm)	4.0	4.0

Product Code		Backplate Size L x W (mm)		Pack Qty (pcs)	Carton Qty (packs)
Epoxy Black	Zinc	Hot Dipped Galvanised			
BAG - EXCLUDES FIXINGS					
SLMBB	SLMZB	SLMGB	205 x 45	1	5
523369	-	523585	219 x 50	1	30
TYPE - LCB			SUB TYPE - LCB01		
TIMBAG - FIXINGS INCLUDED					
SLMBP	SLMZP	SLMGP	205 x 45	1	5
TYPE - LCP			SUB TYPE - LCP01		

### Ring Gate Latch



For use on light domestic gates. External handle allows the gate to be opened from the outside.



### CORROSION RATINGS

Epoxy Black		Zinc		
1	2	3	4	5

Occasionally damp/wet rural and sheltered areas

### Hot Dipped Galvanised

1	2	3	4	5
---	---	---	---	---

Urban & industrial areas with a moderate salt atmosphere

Technical Data	
Size (mm)	150
Bar Length (mm)	150
Backplate Size L x W (mm)	70 x 70
Spindle Length (mm)	100
Max. Gate Thickness (mm)	75
No. of Screw Holes - Pan	12
Screw Ø (mm)	4.0

Product Code		Size (mm)		Size (inch)		Pack Qty (pcs)	Carton Qty (packs)
Epoxy Black	Zinc	Hot Dipped Galvanised					
BAG - EXCLUDES FIXINGS							
RGL6BB	RGL6ZB	RGL6GB	150	6	1	20	
TYPE - LCB			SUB TYPE - LCB02				
TIMBAG - FIXINGS INCLUDED							
RGL6BP	RGL6ZP	RGL6GP	150	6	1	8	
TYPE - LCP			SUB TYPE - LCP02				

### Twisted Ring Gate Latch



For use on light domestic gates. External handle allows the gate to be opened from the outside. The twisted pattern ring handle adds a decorative feature.

### CORROSION RATINGS

Epoxy Black				
1	2	3	4	5

Occasionally damp/wet rural and sheltered areas

### Hot Dipped Galvanised

1	2	3	4	5
---	---	---	---	---

Urban & industrial areas with a moderate salt atmosphere

Technical Data	
Size (mm)	150
Bar Length (mm)	150
Backplate Size L x W (mm)	70 x 70
Spindle Length (mm)	100
Max. Gate Thickness (mm)	75
No. of Screw Holes - Pan	12
Screw Ø (mm)	4.0

Product Code		Size (mm)		Size (inch)		Pack Qty (pcs)	Carton Qty (packs)
Epoxy Black	Hot Dipped Galvanised						
BAG - EXCLUDES FIXINGS							
TRGL6BB	TRGL6GB	150	6	1	30		
TYPE - LCB			SUB TYPE - LCB02				
TIMBAG - FIXINGS INCLUDED							
TRGL6BP	TRGL6GP	150	6	1	8		
TYPE - LCP			SUB TYPE - LCP02				

## Automatic Gate Catches

### Automatic Gate Catch 50mm

Automatically latches when the gate is shut and are pad-lockable for added security. Ideal for use in light domestic applications.



### Heavy Automatic Gate Catch\* 50mm

Automatically latches when the gate is shut and are pad-lockable for added security. Ideal for use in heavy domestic, commercial and agricultural applications.



Technical Data		
Type	Standard	Heavy
Size (mm)	50	50
Bar Length (mm)	110	115
Backplate Size L x W (mm)	50 x 50	50 x 60
Catch Projection (mm)	50	60
Max. Padlock Shackle Ø (mm)	7	7
No. of Screw Holes - CSK / Pan	6	6
Screw Ø (mm)	4.0	4.0

Product Code		Size (mm)	Size (inch)	Pack Qty (pcs)	Carton Qty (packs)
Epoxy Black	Zinc				
	Hot Dipped Galvanised				

BAG - EXCLUDES FIXINGS					
AGLMBB	AGLMZB	AGLMGB	50	2	1 10
-	-	AGLHGB*	50	2	1 10
TYPE - LCB		SUB TYPE - LCB03			

TIMBAG - FIXINGS INCLUDED					
AGLMBP	AGLMZP	AGLMGP	50	2	1 10
-	-	AGLHGP*	50	2	1 10
TYPE - LCP		SUB TYPE - LCP03			

\* Heavy Automatic Gate Catch

## Turn Button Cast Iron NEW



Turn buttons are used for holding flush fitting doors and gates closed.

Use a 4.0 x 30mm screw to attach to door/gate

### CORROSION RATINGS

Epoxy Black	Zinc	Hot Dipped Galvanised
1 2 3 4 5	1 2 3 4 5	1 2 3 4 5

Occasionally damp/wet rural and sheltered areas

Urban & industrial areas with a moderate salt atmosphere

Product Code		Size (mm)	Size (inch)	Pack Qty (pcs)	Carton Qty (packs)
Epoxy Black	Zinc				
	Hot Dipped Galvanised				
BAG - EXCLUDES FIXINGS					
TB2BB	-	TB2GB	50	2	1 600
-	TB2ZB	-	52	2.5	20 20
-	TB2ZB	-	67	2.5	20 20
TYPE - LCB		SUB TYPE - LCB06			
TIMBAG - FIXINGS INCLUDED					
TB2BP	-	TB2GP	50	2	2 20
TYPE - LCP		SUB TYPE - LCP06			

## Gate Spring



Gate springs provide automatic closure for single action gates. The spring tension is adjustable for increasing or decreasing the gate closing force.

### CORROSION RATINGS

Epoxy Black	Zinc
1 2 3 4 5	1 2 3 4 5

Occasionally damp/wet rural and sheltered areas

Technical Data		
Size (mm)	200	250
Spring Length (mm)	141	191
Backplate Size (mm)	30 x 30	30 x 30
No. of Screw Holes	4	4
Screw Ø (mm)	4.0	4.0

Product Code		Size (mm)	Size (inch)	Pack Qty (pcs)	Carton Qty (packs)
Epoxy Black	Zinc				

BAG - EXCLUDES FIXINGS					
GS8BB	GS8ZB	200	8	1	15
GS10BB	GS10ZB	250	10	1	10
TYPE - LCB		SUB TYPE - LCB04			

TIMBAG - FIXINGS INCLUDED					
GS8BP	GS8ZP	200	8	1	15
GS10BP	GS10ZP	250	10	1	10
TYPE - LCP		SUB TYPE - LCP04			

## Cabin Hook Cast Iron



Ideal for retaining doors and gates in an open position in heavy domestic and agricultural applications. Made from cast iron for added strength and durability.

### CORROSION RATINGS

Epoxy Black
1 2 3 4 5

Occasionally damp/wet rural and sheltered areas

### Hot Dipped Galvanised

1 2 3 4 5
-----------

Urban & industrial areas with a moderate salt atmosphere

Technical Data	
Size (mm)	75 - 300
Backplate Size L x W (mm)	45 x 45
No. of Screw Holes	4
Screw Ø (mm)	4.0

Product Code		Size (mm)	Size (inch)	Pack Qty (pcs)	Carton Qty (packs)
Epoxy Black	Hot Dipped Galvanised				

BAG - EXCLUDES FIXINGS					
523467	523656	75	3	1	200
523258	523219	100	4	1	200
523963	523953	150	6	1	150
523458	523632	200	8	1	100
523957	523454	250	10	1	50
523326	523565	300	12	1	50

TIMBAG - FIXINGS INCLUDED					
527115	527568	75	3	1	10
527225	527541	100	4	1	10
527998	527114	150	6	1	10
527651	527554	200	8	1	10
527478	527665	250	10	1	10
TYPE - LCB / LCP		SUB TYPE - LCP05 / LCB05			

## Kick Over Stable Latch

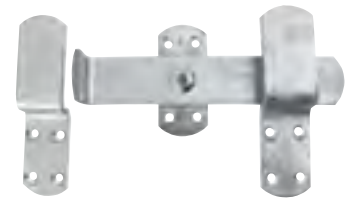

Kick over stable latches are ideal for stables and agricultural applications where a hands free operation is required.

### Hot Dipped Galvanised

1 2 3 4 5
-----------

Urban & industrial areas with a moderate salt atmosphere

Technical Data	
Size (mm)	240
Bar Length (mm)	240
Backplate Size L x W (mm)	110 x 45
Seat Brackets Size L x W (mm)	45 x 170
Seat Brackets Backplate Size L x W (mm)	45 x 80
Catch Projection (mm)	140
No. of Screw Holes - Countersunk / Pan	12
Screw Ø (mm)	5.0

Product Code		Size (mm)	Size (inch)	Pack Qty (pcs)	Carton Qty (packs)
Hot Dipped Galvanised					

TIMBAG - FIXINGS INCLUDED					
KOSLG		240	9 1/2	1	10
TYPE - FGC		SUB TYPE - FGC01			

## Cabin Hook Wire Pattern



Ideal for retaining doors and gates in an open position in light domestic applications.

### CORROSION RATINGS

Epoxy Black	Zinc
1 2 3 4 5	1 2 3 4 5

Occasionally damp/wet rural and sheltered areas

Technical Data	
Size (mm)	100 - 300
Backplate Size L x W (mm)	40 x 40
No. of Screw Holes	8
Screw Ø (mm)	4.0

Product Code		Size (mm)	Size (inch)	Pack Qty (pcs)	Carton Qty (packs)
Epoxy Black	Zinc				

BAG - EXCLUDES FIXINGS					
WCH4BB	WCH4ZB	100	4	1	10
WCH6BB	WCH6ZB	150	6	1	10
WCH8BB	WCH8ZB	200	8	1	10
WCH10BB	WCH10ZB	250	10	1	10
WCH12BB	WCH12ZB	300	12		

TIMBAG - FIXINGS INCLUDED					
WCH4BP	WCH4ZP	100	4	1	10
WCH6BP	WCH6ZP	150	6	1	10
WCH8BP	WCH8ZP	200	8	1	10
TYPE - LCB / LCP		SUB TYPE - LBC / LCP05			

## Garage Door Holders

### Junior Garage Door Holder Wide Lintel 375mm

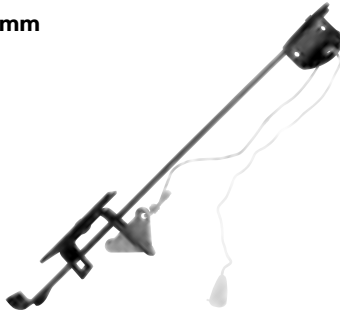

For holding garage and barn doors in an open position. Angle of opening can be varied by adjusting the distance of the lintel bracket from the hinge edge. Automatically engages when the door is opened and released by pulling the cord.

Ideal for applications where the door cannot be propped open or hands free operation is needed.

- Mounts to the underside of the lintel and requires minimum lintel width of 60mm
- For doors below 900mm wide

Technical Data	
Size (mm)	375
To Suit Lintel Type	Wide
Lintel Fixing Plate Size W x L (mm)	45 x 80
Door Fixing Plate Size L x W (mm)	58 x 21
Cord Length (mm)	1020
No. of Screw Holes	8
Screw Ø (mm)	4.0

Product Code				
Epoxy Black	Size (mm)	Size (inch)	Pack Qty (pcs)	Carton Qty (packs)
<b>BAG - EXCLUDES FIXINGS</b>				
523114	375	15	1	20
TYPE - GAB			SUB TYPE - GAB07	

### Senior Garage Door Holder Wide Lintel 635mm



For holding garage and barn doors in an open position. Angle of opening can be varied by adjusting the distance of the lintel bracket from the hinge edge. Automatically engages when the door is opened and released by pulling the cord.

Ideal for applications where the door cannot be propped open or hands free operation is needed.

- Mounts to the underside of the lintel and requires minimum lintel width of 60mm
- For doors over 900mm wide

Technical Data	
Size (mm)	635
To Suit Lintel Type	Wide
Lintel Fixing Plate Size W x L (mm)	45 x 80
Door Fixing Plate Size L x W (mm)	47 x 58
Cord Length (mm)	1020
No. of Screw Holes	8
Screw Ø (mm)	4.0

Product Code				
Epoxy Black	Size (mm)	Size (inch)	Pack Qty (pcs)	Carton Qty (packs)
<b>BAG - EXCLUDES FIXINGS</b>				
523417	635	24	1	20
TYPE - GAB			SUB TYPE - GAB07	

### Senior Garage Door Holder Narrow Lintel 635mm



For holding garage and barn doors in an open position. Angle of opening can be varied by adjusting the distance of the lintel bracket from the hinge edge. Automatically engages when the door is opened and released by pulling the cord.

Ideal for applications where the door cannot be propped open or hands free operation is needed.

- Mounts to the side of the lintel and requires minimum lintel width of 60mm
- For doors over 900mm wide

Technical Data	
Size (mm)	635
To Suit Lintel Type	Narrow
Lintel Fixing Plate Size W x L (mm)	44 x 58
Door Fixing Plate Size L x W (mm)	47 x 58
Cord Length (mm)	660
No. of Screw Holes	8
Screw Ø (mm)	4.0

Product Code				
Epoxy Black	Size (mm)	Size (inch)	Pack Qty (pcs)	Carton Qty (packs)
<b>BAG - EXCLUDES FIXINGS</b>				
523998	635	24	1	20
TYPE - GAB			SUB TYPE - GAB07	



# Hasps & Staples

## Wire Pattern Hasp & Staple



A low security lightweight hasp and staple for sheds and toolboxes in light domestic applications.

**CORROSION RATING**



Occasionally damp/wet rural and sheltered areas

Technical Data			
Size (mm)	75	100	150
Fixing Plate Size - W x L (mm)	35 x 30	40 x 35	57 x 45
Hasp Plate Size - L x W (mm)	45 x 12	65 x 12	100 x 16
Staple Plate Size - L x W (mm)	25 x 25	25 x 30	45 x 35
Max. Padlock Shackle Ø (mm)	6.0	6.0	6.0
No. of Screw Holes - Countersunk	7	7	8
Screw Ø (mm)	3.5	3.5	3.5

**Product Code**

Epoxy Black	Zinc	Size (mm)	Size (inch)	Pack Qty (pcs)	Carton Qty (packs)
<b>BAG - EXCLUDES FIXINGS</b>					
WHS3BB	WHS3ZB	75	3	1	500
WHS4BB	WHS4ZB	100	4	1	400
WHS6BB	WHS6ZB	150	6	1	200
TYPE - HSB				SUB TYPE - HSB01	
<b>TIMBAG - FIXINGS INCLUDED</b>					
WHS4BP	WHS4ZP	100	4	1	10
WHS6BP	WHS6ZP	150	6	1	10
TYPE - HSP				SUB TYPE - HSP01	

## Hybrid Hasp & Staple

**NEW**

Hybrid Hasp & Staple for uneven surfaces to be used with a padlock. For internal & external use.



**CORROSION RATING**



Occasionally damp/wet rural and sheltered areas

Technical Data	
Size (mm)	125
Fixing Plate Size - W x L (mm)	30 x 25
Hasp Plate Size - L x W (mm)	100 x 30
Staple Plate Size - L x W (mm)	25 x 20
Max. Padlock Shackle Ø (mm)	9.5
No. of Screw Holes - Countersunk	7
Screw Ø (mm)	3.0

**Product Code**

Zinc	Size (mm)	Size (inch)	Pack Qty (pcs)	Carton Qty (packs)
<b>BAG - EXCLUDES FIXINGS</b>				
472393	125	5	1	200
TYPE - HSB			SUB TYPE - HSB07	

## Safety Pattern Hasp & Staple



A low security hasp and staple for light domestic gates and shed doors.

**CORROSION RATING**



Occasionally damp/wet rural and sheltered areas

Technical Data			
Size (mm)	75	115	150
Fixing Plate Size - W x L (mm)	30 x 40	40 x 40	58 x 40
Hasp Plate Size - L x W (mm)	75 x 39	115 x 39	150 x 38
Staple Plate Size - L x W (mm)	40 x 40	40 x 40	40 x 40
Max. Padlock Shackle Ø (mm)	10.0	10.0	10.0
No. of Screw Holes - Countersunk	6	8	8
Screw Ø (mm)	4.0	4.0	4.0

**Product Code**

Epoxy Black	Zinc	Size (mm)	Size (inch)	Pack Qty (pcs)	Carton Qty (packs)
<b>BAG - EXCLUDES FIXINGS</b>					
HS3BB	HS3ZB	75	3	1	160
HS4BB	HS4ZB	115	4½	1	100
HS6BB	HS6ZB	150	6	1	120
TYPE - HSB				SUB TYPE - HSB02	
<b>TIMBAG - FIXINGS INCLUDED</b>					
HS3BP	HS3ZP	75	3	1	15
HS4BP	HS4ZP	115	4½	1	15
HS6BP	HS6ZP	150	6	1	5
TYPE - HSP				SUB TYPE - HSP02	

## Hinged Hasp & Staple

Single

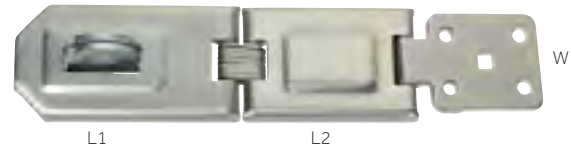

Double

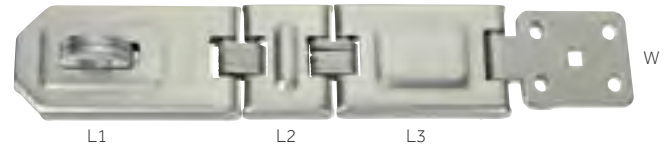

Hinged flexible hasp and staple for use around corners, angles and uneven surfaces where doors do not sit flush with frames.

**CORROSION RATING**



Occasionally damp/wet rural and sheltered areas

Technical Data		
Size (mm)	160	200
Fixing Plate Size - L x W (mm)	45 x 40	45 x 40
Single Hasp Plate Size - L1 x L2 x L3 x W (mm)	88 x 69 x 46	-
Double Hasp Plate Size - L1 x L2 x L3 x W (mm)	-	88 x 45 x 69 x 46
Staple Plate Size - L x W (mm)	42 x 44	42 x 44
Max. Padlock Shackle Ø (mm)	13	13
No. of Screw Holes	8	8
Screw Ø (mm)	4.0	4.0

**Product Code**

Zinc	Type	Size (mm)	Size (inch)	Pack Qty (pcs)	Carton Qty (packs)
<b>BLISTER PACK - FIXINGS INCLUDED</b>					
PHS160	Single	160	6	1	12
PHS200	Double	200	8	1	12
TYPE - HSP				SUB TYPE - HSP07	

## Heavy Secure Bolt on Hasp & Staple



A high security, heavy duty hasp and staple for sheds, gates and doors in heavy domestic, commercial and agricultural applications. Bolt fixed for additional security.

**CORROSION RATINGS**

Epoxy Black				
1	2	3	4	5

Occasionally damp/wet rural and sheltered areas

Hot Dipped Galvanised				
1	2	3	4	5

Urban & industrial areas with a moderate salt atmosphere

Technical Data		
Size (mm)	200	250
Fixing Plate Size - W x L (mm)	105 x 55	158 x 55
Hasp Plate Size - L x W (mm)	92 x 55	92 x 55
Staple Plate Size - L x W (mm)	65 x 55	65 x 55
Max. Padlock Shackle Ø (mm)	15	15
No. of Carriage Bolt Holes	1	1
Carriage Bolt Ø (mm)	M12	M12
No. of Screw Holes - Countersunk	8	8
Screw Ø (mm)	5.0	5.0

Product Code		Size (mm)	Size (inch)	Pack Qty (pcs)	Carton Qty (packs)
Epoxy Black	Hot Dipped Galvanised				
<b>BAG - EXCLUDES FIXINGS</b>					
BHS8BB	BHS8GB	200	8	1	5
BHS10BB	BHS10GB	250	10	1	5
TYPE - HSB		SUB TYPE - HSB03			
<b>TIMBAG - FIXINGS INCLUDED</b>					
BHS8BP	BHS8GP	200	8	1	8
BHS10BP	BHS10GP	250	10	1	8
TYPE - HSP		SUB TYPE - HSP03			

## Heavy Vertical Bolt on Hasp & Staple



A high security, heavy duty hasp and staple for sheds, gates and doors in heavy domestic, commercial and agricultural applications. The vertical pattern fixing plate makes this ideal for fitting to a narrow stile door or frame. Bolt fixed for additional security.

**CORROSION RATINGS**

Epoxy Black				
1	2	3	4	5

Occasionally damp/wet rural and sheltered areas

Hot Dipped Galvanised				
1	2	3	4	5

Urban & industrial areas with a moderate salt atmosphere

Technical Data	
Size (mm)	150
Fixing Plate Size - W x L (mm)	50 x 150
Hasp Plate Size - L x W (mm)	92 x 55
Staple Plate Size - L x W (mm)	65 x 55
Max. Padlock Shackle Ø (mm)	15
No. of Carriage Bolt Holes	2
Carriage Bolt Ø (mm)	M12
No. of Screw Holes - Countersunk	8
Screw Ø (mm)	5.0

Product Code		Size (mm)	Size (inch)	Pack Qty (pcs)	Carton Qty (packs)
Epoxy Black	Hot Dipped Galvanised				
<b>BAG - EXCLUDES FIXINGS</b>					
VHS6BB	VHS6GB	150	6	1	8
TYPE - HSB		SUB TYPE - HSB05			
<b>TIMBAG - FIXINGS INCLUDED</b>					
VHS6BP	VHS6GP	150	6	1	8
TYPE - HSP		SUB TYPE - HSP05			

## Heavy Swivel Pattern Hasp & Staple



A high security, heavy duty hasp and staple for sheds, gates and doors in heavy domestic, commercial and agricultural applications. The swivel pattern hasp and staple is commonly fitted to double doors as the hasp drops away and allows the slave leaf to open independently.

**CORROSION RATINGS**

Epoxy Black				
1	2	3	4	5

Occasionally damp/wet rural and sheltered areas

Hot Dipped Galvanised				
1	2	3	4	5

Urban & industrial areas with a moderate salt atmosphere

Technical Data	
Size (mm)	200
Fixing Plate Size - W x L (mm)	55 x 103
Hasp Plate Size - L x W (mm)	92 x 55
Staple Plate Size - L x W (mm)	65 x 55
Max. Padlock Shackle Ø (mm)	15
No. of Screw Holes - Countersunk	8
Screw Ø (mm)	5.0

Product Code		Size (mm)	Size (inch)	Pack Qty (pcs)	Carton Qty (packs)
Epoxy Black	Hot Dipped Galvanised				
<b>BAG - EXCLUDES FIXINGS</b>					
SHS8BB	SHS8GB	200	8	1	20
TYPE - HSB		SUB TYPE - HSB04			
<b>TIMBAG - FIXINGS INCLUDED</b>					
SHS8BP	SHS8GP	200	8	1	10
TYPE - HSP		SUB TYPE - HSP04			

## Heavy Padlock Protection Bar



**CORROSION RATING**

1	2	3	4	5
---	---	---	---	---

Urban & industrial areas with a moderate salt atmosphere

A high security, heavy duty hasp and staple for sheds, gates and doors in heavy domestic, commercial and agricultural applications. The hasp features a strong cast iron housing to cover and protect the padlock from hammer and cutter attack. Bolt fixed for additional security.

Technical Data	
Size (mm)	185
Fixing Plate Size - L x W (mm)	67 x 56
Hasp Plate Size - L x W (mm)	185 x 65
Staple Plate Size - L x W (mm)	76 x 56
Max. Padlock Shackle Ø (mm)	12
No. of Carriage Bolt Holes	8
Carriage Bolt Ø (mm)	M6

Product Code		To Suit	Opening Side	Size (mm)	Size (inch)	Pack Qty (pcs)	Carton Qty (packs)
Hot Dipped Galvanised							
<b>BAG - EXCLUDES FIXINGS</b>							
472582	Left	185	7 ½	1	20		
472951	Right	185	7 ½	1	20		
TYPE - HSB		SUB TYPE - HSB06					
<b>TIMBAG - FIXINGS INCLUDED</b>							
478225	Left	185	7 ½	1	5		
478741	Right	185	7 ½	1	5		
TYPE - HSP		SUB TYPE - HSP06					

# Locks & Handles

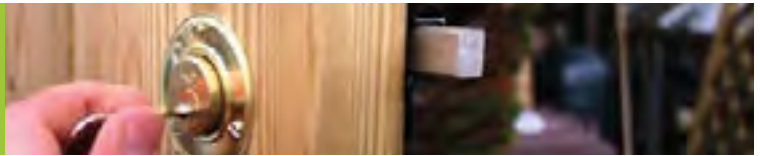

## Long Throw Locks - Single



Outside Only

An ideal high security lock for gates where key access from the outside is required. The lock can be opened from the inside without the use of a key providing quick and easy access.

The lock features a long throw of 50 or 70mm to clear any gate to frame gaps.

Supplied with a brass escutcheon for a clean flush finish around the lock cylinder or alternatively a rim lock escutcheon handle can be used (sold separately).

- Supplied with 3 keys
- Fixings included

## Long Throw Locks - Double



Outside & Inside

An ideal high security lock for gates where key access from the outside and inside is required.

The lock features a long throw of 50 or 70mm to clear any gate to frame gaps.

Supplied with a brass escutcheon for a clean flush finish around the lock cylinder or alternatively a rim lock escutcheon handle can be used (sold separately)

- Supplied with 3 keys
- Fixings included

Technical Data		
Size (mm)	50	70
Max. Door Thickness (mm)	50	70
Keep Size L x W (mm)	125 x 28	
Lock Case Size L x W (mm)	106 x 70	
Cylinder Ø (mm)	26	
No. of Screw Holes	8	
Screw Ø (mm)	5.0	

Product Code				
Epoxy Black	Size (mm)	Pack Qty (pcs)	Carton Qty (packs)	
<b>BOX</b>				
GLS50	50	1	25	
GLS70	70	1	20	
TYPE - GAH		SUB TYPE - GAH01		

Technical Data		
Size (mm)	50	70
Max. Door Thickness (mm)	50	70
Keep Size L x W (mm)	125 x 28	
Lock Case Size L x W (mm)	106 x 70	
Cylinder Ø (mm)	26	
No. of Screw Holes	8	
Screw Ø (mm)	5.0	

Product Code				
Epoxy Black	Size (mm)	Pack Qty (pcs)	Carton Qty (packs)	
<b>BOX</b>				
GLD50	50	1	25	
GLD70	70	1	20	
TYPE - GAH		SUB TYPE - GAH01		

## Escutcheon Handle



A high quality pull handle to suit the Taurus extended throw locks. The pull handle fits over the rim cylinder of the lock to provide a clean finish to the cylinder hole.



### CORROSION RATINGS

Epoxy Black				
1	2	3	4	5
Occasionally damp/wet rural and sheltered areas				
Polished Chrome				
1	2	3	4	5
Occasionally damp/wet rural and sheltered areas				

Technical Data	
Size (mm)	26
To Suit Cylinder Ø (mm)	26
Length (mm)	200
Length (inch)	8
No. of Screw Holes	3
Screw Ø (mm)	3.5

Product Code				
Epoxy Black	Polished Chrome	Size (mm)	Pack Qty (pcs)	Carton Qty (packs)
<b>BAG - EXCLUDES FIXINGS</b>				
RLEH8BB	RLEH8CB	26	1	100
TYPE - GAB		SUB TYPE - GAB01		
<b>TIMBAG - FIXINGS INCLUDED</b>				
427258	427336	26	1	10
TYPE - GAP		SUB TYPE - GAP01		

## Rim Locks

NEW OUTWARD LOCK

### Rim Dead Lock 106 x 74



An ideal medium security lock for shed and internal doors. It is reversible for both left and right hand hung doors and is key operational from both sides.

- Supplied with 2 keys.

**CORROSION RATING**

Epoxy Black				
1	2	3	4	5
Occasionally damp/wet rural and sheltered areas				

Technical Data	
Size (mm)	106 x 74
Lock Case Size L x W (mm)	106 x 74
Keep Size L x W (mm)	75 x 23
Lock Follower Backset (mm)	43
Bolt Throw (mm)	13.5
No. of Screw Holes	5
Screw Ø (mm)	4.0

Product Code					
Epoxy Black	Size (mm)	Pack Qty (pcs)	Carton Qty (packs)		
<b>BAG - EXCLUDES FIXINGS</b>					
RDLB	106 x 74	1	10		
TYPE - GAB		SUB TYPE - GAB02			
<b>TIMBAG - FIXINGS INCLUDED</b>					
427124	106 x 74	1	5		
TYPE - GAP		SUB TYPE - GAP02			

### Rim Sash Lock Fluted 156 x 106



An ideal medium security lock for sheds and internal doors. It is reversible for both left and right hand hung doors and is key operation from both sides.

- Use with rim knob sets to operate the latch.

**CORROSION RATING**

Epoxy Black				
1	2	3	4	5
Occasionally damp/wet rural and sheltered areas				

Technical Data	
Size (mm)	156 x 106
Lock Case Size L x W (mm)	156 x 106
Keep Size L x W (mm)	92 x 24
Lock Follower Backset (mm)	43
Latch Follower Backset (mm)	105
Bolt Throw (mm)	13.5
No. of Screw Holes	6
Screw Ø (mm)	4.0

Product Code					
Epoxy Black	Size (mm)	Pack Qty (pcs)	Carton Qty (packs)		
<b>BAG - EXCLUDES FIXINGS</b>					
RSLFB	156 x 106	1	10		
TYPE - GAB		SUB TYPE - GAB02			
<b>TIMBAG - FIXINGS INCLUDED</b>					
427148	156 x 106	1	5		
TYPE - GAP		SUB TYPE - GAP02			

### Rim Sash Locks 143 x 83



An ideal medium security lock for shed and internal doors. It is reversible for both left and right hand hung doors and is key operational from both sides. Use with rim knob sets to operate the latch.

- Supplied with keep for both inward and outward opening doors and 2 keys.

**CORROSION RATING**

Epoxy Black				
1	2	3	4	5
Occasionally damp/wet rural and sheltered areas				

Technical Data	
Size (mm)	143 x 83
Lock Case Size L x W (mm)	143 x 83
Keep Size L x W (mm)	75 x 23
Lock Follower Backset (mm)	43
Latch Follower Backset (mm)	105
Bolt Throw (mm)	13.5
No. of Screw Holes	5
Screw Ø (mm)	4.0

Product Code						
Epoxy Black	Opening Type	Size (mm)	Includes Fixings	Pack Qty (pcs)	Carton Qty (packs)	
<b>BAG</b>						
RSLB	Inward	143 x 83	No	1	10	
RSLRB	Outward	143 x 83	Yes	1	10	
RSLRPB	Outward	74 x 22	Yes	1	20	
TYPE - GAB		SUB TYPE - GAB02				
<b>TIMBAG - FIXINGS INCLUDED</b>						
427695	Inward	143 x 83	Yes	1	5	
TYPE - GAP		SUB TYPE - GAP02				

## Press Lock

NEW KEY LENGTH



A low security lock commonly fitted to shed and green house doors which is surface mounted for quick and easy installation. The lock bolt engages on or into the door frame and does not require a keep.

- Supplied with 1 key. Additional spare keys are available as one key fits all locks. \*PL3LKB supplied with 2 extra long keys.

**CORROSION RATING**

Epoxy Black				
1	2	3	4	5
Occasionally damp/wet rural and sheltered areas				

Technical Data			
Size (mm)	76	100	125
Lock Case Size L x W (mm)	100 x 76	100 x 100	100 x 125
Lock Follower Backset (mm)	40	52	64
Bolt Throw (mm)	15		
No. of Screw Holes	4		
Screw Ø (mm)	4.0		

Product Code						
Epoxy Black	Size (inch)	Size (mm)	Key Length	Includes Fixings	Pack Qty (pcs)	Carton Qty (packs)
<b>BAG</b>						
PL3BB	3	76	Standard	No	1	100
PL3LKB	3	76	Extra Long*	Yes	1	50
PL4BB	4	100	Standard	No	1	80
PL5BB	5	125	Standard	No	1	50
TYPE - GAB		SUB TYPE - GAB04				
<b>TIMBAG - FIXINGS INCLUDED</b>						
427111	3	76	Standard	Yes	1	10
427754	4	100	Standard	Yes	1	10
TYPE - GAP		SUB TYPE - GAP03				

## Press Lock Spare Keys (x5)



Spare keys that will operate all press locks.

Product Code		
SPAREPLK	Pack Qty (pcs)	Carton Qty (packs)
SPAREPLK	5	50
SUB TYPE - GAB04		



## Plastic Rim / Mortice Knob Set



Ideal for use on shed doors and gates. Can be used with rim or mortice locks. Supplied with two escutcheon plates to cover keyhole cut outs.

Technical Data	
Size (mm)	One Size
Knob Dia. (mm)	50
Rose Ø (mm)	56
Escutcheon Ø (mm)	33
Spindle Length (mm)	115
No. of Screw Holes	12
Rec. Screw Ø (mm)	4.0

Product Code	Pack Qty (pcs)	Carton Qty (packs)
<b>Epoxy Black</b>		
<b>BAG - FIXINGS INCLUDED</b>		
RPKSB	1	50
TYPE - GAB	SUB TYPE - GAB03	
<b>TIMBAG - FIXINGS INCLUDED</b>		
427212	1	5
TYPE - GAP	SUB TYPE - GAP02	

## Hot Bed Handle



A durable and hard wearing handle for gates and shed doors.

Technical Data		
Size (inch)	6	7
Size (mm)	150	175
No. of Screw Holes	4	
Rec. Screw Ø (mm)	4.0	

Product Code	Size (inch)	Pack Qty (pcs)	Carton Qty (packs)
<b>Epoxy Black</b>			
<b>BAG - EXCLUDES FIXINGS</b>			
HBH6B	6	1	160
HBH7B	7	1	160
TYPE - GAB	SUB TYPE - GAB05		
<b>TIMBAG - FIXINGS INCLUDED</b>			
HBH6BP	6	1	20
HBH7BP	7	1	20
TYPE - GAP	SUB TYPE - GAP04		

## Gate Kits

### Pedestrian Gate Kit



#### CORROSION RATINGS

Epoxy Black	Zinc
1 <b>2</b> 3 4 5	1 2 3 4 5

Occasionally damp/wet rural and sheltered areas

Hot Dipped Galvanised	
1 2 3 <b>4</b> 5	1 2 3 4 5

Urban & industrial areas with a moderate salt atmosphere

A complete gate kit for medium weight gates in domestic applications. Automatic gate latch is pad-lockable for additional security.

Kit Contents	
	Medium Tee Hinges
	Automatic Gate Latch
Size (mm)	350 50
Qty (pcs)	2 1
Product Dimensions	
To Suit Gate	700-1050
Max. Gate Weight (kg)	30
Fixings Information	
No. of Pan Screws	6
Pan Screwer Size (mm)	4.0 x 30
No. of Countersunk Screws	18
Countersunk Screw Size (mm)	4.0 x 30

Product Code	To Suit Gate (mm)	Pack Qty (pcs)	Carton Qty (packs)
<b>Epoxy Black</b>			
<b>Zinc</b>			
<b>Hot Dipped Galvanised</b>			
<b>TIMBAG - FIXINGS INCLUDED</b>			
427123	427741	427562	700-1050
TYPE - GAP	SUB TYPE - GAP05		

### Side Gate Kit - Ring Latch

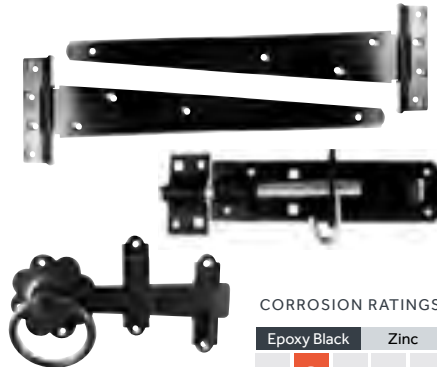

#### CORROSION RATINGS

Epoxy Black	Zinc
1 2 <b>3</b> 4 5	1 2 3 4 5

Occasionally damp/wet rural and sheltered areas

Hot Dipped Galvanised	
1 2 3 <b>4</b> 5	1 2 3 4 5

Urban & industrial areas with a moderate salt atmosphere

A complete gate kit for medium weight gates in domestic applications. Brenton padbolt is pad-lockable and bolt fixed for additional security.

Kit Contents			
	Medium Tee Hinges	Ring Gate Latch	Brenton Padbolt
Size (mm)	450	150	150
Qty (pcs)	2	1	1
Product Dimensions			
To Suit Gate	900-1350		
Max. Gate Weight (kg)	40		
Max. Padlock Shackle Ø (mm)	10		
Fixings Information			
No. of Carriage Bolts	4		
Carriage Bolt Ø (mm)	M6 x 50		
No. of Pan Screws	20		
Pan Screw Size (mm)	4.0 x 30		
No. of Countersunk Screws	20		
Countersunk Screw Size (mm)	5.0 x 30		

Product Code	To Suit Gate (mm)	Pack Qty (pcs)	Carton Qty (packs)
<b>Epoxy Black</b>			
<b>Zinc</b>			
<b>Hot Dipped Galvanised</b>			
<b>TIMBAG - FIXINGS INCLUDED</b>			
427548	427546	427357	900-1350
TYPE - GAP	SUB TYPE - GAP06		

### Side Gate Kit - Suffolk Latch



#### CORROSION RATINGS

Epoxy Black	Zinc
1 2 <b>3</b> 4 5	1 2 3 4 5

Occasionally damp/wet rural and sheltered areas

Hot Dipped Galvanised	
1 2 3 <b>4</b> 5	1 2 3 4 5

Urban & industrial areas with a moderate salt atmosphere

A complete gate kit for medium weight gates in domestic applications. Brenton padbolt is pad-lockable and bolt fixed for additional security.

Kit Contents			
	Medium Tee Hinges	Suffolk Latch	Brenton Padbolt
Size	450	185	150
Qty	2	1	1
Product Dimensions			
To Suit Gate	900-1350		
Max. Gate Weight (kg)	40		
Max. Gate Thickness (mm)	50		
Max. Padlock Shackle Ø (mm)	10		
Fixings Information			
No. of Carriage Bolts	4		
Carriage Bolt Ø (mm)	M6 x 50		
No. of Pan Screws	20		
Pan Screw Size (mm)	4.0 x 30		
No. of Countersunk Screws	20		
Countersunk Screw Size (mm)	5.0 x 30		

Product Code	To Suit Gate (mm)	Pack Qty (pcs)	Carton Qty (packs)
<b>Epoxy Black</b>			
<b>Zinc</b>			
<b>Hot Dipped Galvanised</b>			
<b>TIMBAG - FIXINGS INCLUDED</b>			
427215	427998	427635	900-1350
TYPE - GAP	SUB TYPE - GAP06		

# Field Gate Hinge Sets



## Standard Double Strap Hinge Set



**Ideal for Timber Posts**

**CORROSION RATING**

Hot Dipped Galvanised



Urban & industrial areas with a moderate salt atmosphere

Ideal for use on field gates and driveway gates that are to be hung on timber posts. The hinge set provides exceptional support to the gate as the top band and bottom strap wrap around the gate and are fixed with cup square bolts to firmly secure in place.

The hook to bolt features a 9mm drilled hole for R clips or linch pins (not included) to be fitted to prevent the gate being lifted off. The hooks to drive are barbed to prevent the gate from working loose.

Depending on the weight distribution of the gate, the top or bottom pin can be mounted upside down to prevent unwanted removal of the gate.

- Contents:
- 1 x Top Strap
  - 1 x Bottom Strap
  - 1 x Hook to Drive
  - 1 x Hook to Bolt
  - M10x95mm Galvanised Cup Square Bolts
  - M10 Hex Nuts & Washers
  - 6.0x40mm Exterior Woodscrews

Field Gate Information			
To Suit Gate Width	3 - 4ft / 900 - 1200mm	4 - 9ft / 1200 - 2700mm	9 - 12ft / 2700 - 3600mm
To Suit Gate Thickness	3" / 75mm	3" / 75mm	3" / 75mm
Product Dimensions			
Top Strap Length (TSL)	12" / 300mm	18" / 450mm	24" / 600mm
Bottom Strap Length (BSL)	6" / 150mm	6" / 150mm	6" / 150mm
Hook To Bolt Ø x Length (mm)	M20 x 350	M20 x 350	M20 x 350
Hook To Drive Length (mm)	215	215	215
Pin Ø	3/4" / 19mm	3/4" / 19mm	3/4" / 19mm
Fixings Information			
No. of Carriage Bolts	3	4	4
Carriage Bolt Ø (mm)	M10	M10	M10

Product Code	Top Strap Length (inch)	Top Strap Length (mm)	To Suit Gate Width (ft)	To Suit Gate Width (mm)	Pack Qty (pcs)	Carton Qty (packs)
<b>BAG - FIXINGS INCLUDED</b>						
SFH300G	12	300	3 - 4	900 - 1200	1	4
SFH450G	18	450	4 - 9	1200 - 2700	1	4
SFH600G	24	600	9 - 12	2700 - 3600	1	4
TYPE - FGS SUB TYPE - FGS01						

## Double Strap Hinge Set with Hook on Plate

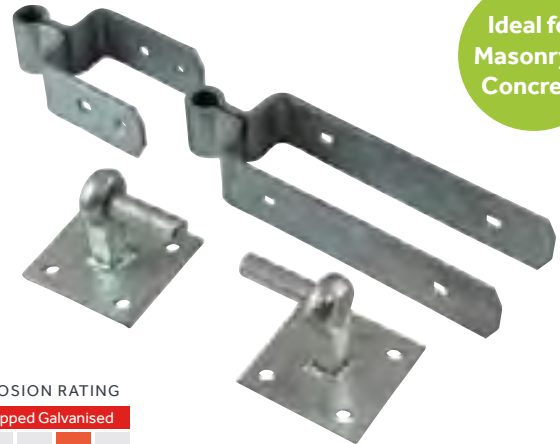

**Ideal for Masonry & Concrete**

**CORROSION RATING**

Hot Dipped Galvanised



Urban & industrial areas with a moderate salt atmosphere

Ideal for use on field gates and driveway gates that are to be hung on timber, concrete or masonry posts.

The hinge set provides exceptional support to the gate as the top band and bottom strap wrap around the gate and are fixed with cup square bolts to firmly secure in place.

Depending on the weight distribution of the gate, the top or bottom pin can be mounted upside down to prevent unwanted removal of the gate.

- Contents:
- 1 x Top Strap
  - 1 x Bottom Strap
  - 2 x Hook on Plates
  - M10x95mm Galvanised Cup Square Bolts
  - M10 Hex Nuts & Washers
  - M10x65mm Galv Coach Screws
  - 6.0x40mm Exterior Woodscrews

Field Gate Information			
To Suit Gate Width	3 - 4ft / 900 - 1200mm	4 - 9ft / 1200 - 2700mm	9 - 12ft / 2700 - 3600mm
To Suit Gate Thickness	3" / 75mm	3" / 75mm	3" / 75mm
Product Dimensions			
Top Strap Length (TSL)	12" / 300mm	18" / 450mm	24" / 600mm
Bottom Strap Length (BSL)	6" / 150mm	6" / 150mm	6" / 150mm
Hook on Plate Length x Width (mm)	100 x 100	100 x 100	100 x 100
Pin Ø	3/4" / 19mm	3/4" / 19mm	3/4" / 19mm
Fixings Information			
No. of Coach Screws	8	8	8
Coach Screws Ø (mm)	M10	M10	M10
No. of Carriage Bolts	3	4	4
Carriage Bolt Ø (mm)	M10	M10	M10

Product Code	Top Strap Length (inch)	Top Strap Length (mm)	To Suit Gate Width (ft)	To Suit Gate Width (mm)	Pack Qty (pcs)	Carton Qty (packs)
<b>BAG - FIXINGS INCLUDED</b>						
DSFH300G	12	300	3 - 4	900 - 1200	1	4
DSFH450G	18	450	4 - 9	1200 - 2700	1	4
DSFH600G	24	600	9 - 12	2700 - 3600	1	4
TYPE - FGS SUB TYPE - FGS01						



## Adjustable Hinge Set

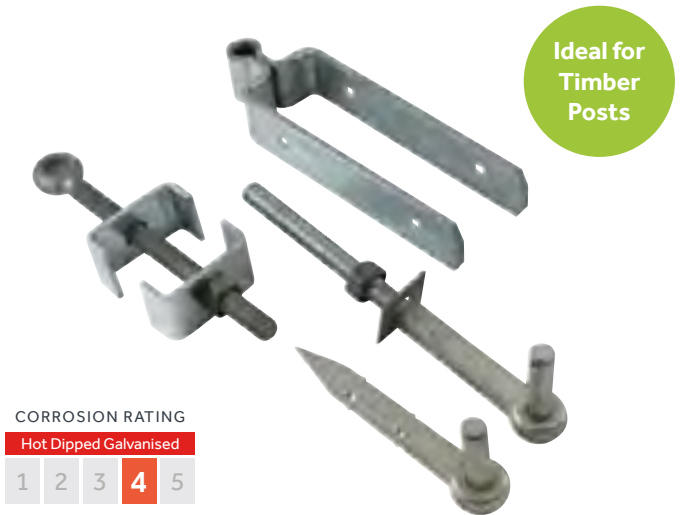

Ideal for  
Timber  
Posts

### CORROSION RATING

Hot Dipped Galvanised

1 2 3 **4** 5

Urban & industrial areas with a moderate salt atmosphere

Ideal for use on field gates and driveway gates that are to be hung on timber posts. The hinge set provides exceptional support to the gate as the top band wraps around the gate and are fixed with cup square bolts to firmly secure in place. The bottom fitting clamps around the heel of the gate and is adjustable to allow for easy gate alignment after fitting. This is particularly useful when hanging pairs of gates.

The hook to bolt features a 9mm drilled hole for R clips or lynch pins (not included) to be fitted to prevent the gate being lifted off. The hooks to drive are barbed to prevent the gate from working loose.

Depending on the weight distribution of the gate, the top or bottom pin can be mounted upside down to prevent unwanted removal of the gate.

Contents:  
1 x Top Strap  
1 x Adjustable Bottom Fitting  
1 x Gate Hook to Drive  
1 x Hook to Bolt  
M10x95 Galvanised Cup Square Bolts  
M10 Hex Nuts & Washers.

Field Gate Information				
To Suit Gate Width	3 - 4ft / 900 - 1200mm	4 - 9ft / 1200 - 2700mm	9 - 12ft / 2700 - 3600mm	
To Suit Gate Thickness	3" / 75mm	3" / 75mm	3" / 75mm	
Product Dimensions				
Top Strap Length (TSL)	12" / 300mm	18" / 450mm	24" / 600mm	
Strap Thickness	6mm	6mm	6mm	
Hook To Bolt Ø x Length (mm)	M20 x 350	M20 x 350	M20 x 350	
Gate Eye Size Ø x Length (mm)	M19 x 250	M19 x 250	M19 x 250	
Heel Clip Size Length x Width x Depth (mm)	86 x 50 x 32	86 x 50 x 32	86 x 50 x 32	
Hook to Drive Size (mm)	215 x 22	215 x 22	215 x 22	
Pin Ø	3/4" / 19mm	3/4" / 19mm	3/4" / 19mm	
Fixings Information				
No. of Carriage Bolts	3	3	3	
Carriage Bolt Ø (mm)	M10	M10	M10	

Product Code	Top Strap Length (inch)	Top Strap Length (mm)	To Suit Gate Width (ft)	To Suit Gate Width (mm)	Pack Qty (pcs)	Carton Qty (packs)
<b>Hot Dipped Galvanised</b>						
BAG - FIXINGS INCLUDED						
AFH300G	12	300	3 - 4	900 - 1200	1	4
AFH450G	18	450	4 - 9	1200 - 2700	1	4
AFH600G	24	600	9 - 12	2700 - 3600	1	4
TYPE - FGS						

SUB TYPE - FGS01

## Adjustable Hinge Set with Hook on Plate

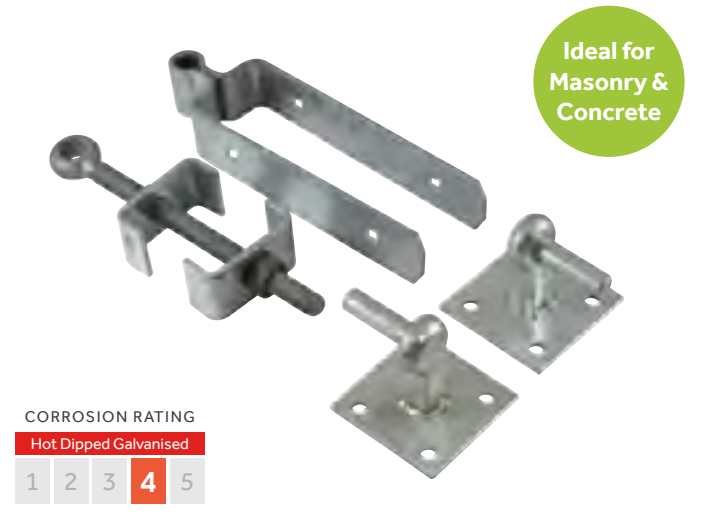

Ideal for  
Masonry &  
Concrete

### CORROSION RATING

Hot Dipped Galvanised

1 2 3 **4** 5

Urban & industrial areas with a moderate salt atmosphere

Ideal for use on field gates and driveway gates that are to be hung on timber, concrete or masonry posts.

The hinge set provides exceptional support to the gate as the top band wraps around the gate and are fixed with cup square bolts to firmly secure in place. The bottom fitting clamps around the heel of the gate and is adjustable to allow for easy gate alignment after fitting.

This is particularly useful when hanging pairs of gates.

Depending on the weight distribution of the gate, the top or bottom pin can be mounted upside down to prevent unwanted removal of the gate.

Contents:  
1 x Top Strap  
1 x Adjustable Bottom Gate Fitting  
2 x Hook on Plates  
M10x95 Galvanised Cup Square Bolts  
M10 Hex Nuts & Washers  
M10x65mm Galv Coach Screws

Field Gate Information				
To Suit Gate Width	3 - 4ft / 900 - 1200mm	4 - 9ft / 1200 - 2700mm	9 - 12ft / 2700 - 3600mm	
To Suit Gate Thickness	3" / 75mm	3" / 75mm	3" / 75mm	
Product Dimensions				
Top Strap Length (TSL)	12" / 300mm	18" / 450mm	24" / 600mm	
Strap Thickness	6mm	6mm	6mm	
Hook on Plate Length x Width (mm)	100 x 100	100 x 100	100 x 100	
Gate Eye Size Ø x Length (mm)	M19 x 250	M19 x 250	M19 x 250	
Heel Clip Size Length x Width x Depth (mm)	86 x 50 x 32	86 x 50 x 32	86 x 50 x 32	
Pin Ø	3/4" / 19mm	3/4" / 19mm	3/4" / 19mm	
Fixings Information				
No. of Coach Screws	8	8	8	
Coach Screws Ø (mm)	M10	M10	M10	
No. of Carriage Bolts	2	3	3	
Carriage Bolt Ø (mm)	M10	M10	M10	

Product Code	Top Strap Length (inch)	Top Strap Length (mm)	To Suit Gate Width (ft)	To Suit Gate Width (mm)	Pack Qty (pcs)	Carton Qty (packs)
<b>Hot Dipped Galvanised</b>						
BAG - FIXINGS INCLUDED						
AFHP300G	12	300	3 - 4	900 - 1200	1	4
AFHP450G	18	450	4 - 9	1200 - 2700	1	4
AFHP600G	24	600	9 - 12	2700 - 3600	1	4
TYPE - FGS						

SUB TYPE - FGH01

# Field Gate Hooks & Eyes



## Gate & Post Fittings

### Gate Hook to Drive



A heavy duty hook for knocking into a timber post and to be used with field gate bands or hook and band hinges. Barbed to prevent the hook from working loose.

Product Code	Size		Pin Ø	Pin Ø	Pack Qty	Carton Qty
Hot Dipped Galvanised	L x W (mm)	Pin Ø (inch)	Pin Ø (mm)	Qty (pcs)	Qty (packs)	
<b>BAG - NO FIXINGS REQUIRED</b>						
GHD19GEA	215 x 19	3/4	19	1	10	
GHD22GEA	215 x 22	7/8	22	1	10	
TYPE - FGH				SUB TYPE - FGH04		

### Gate Hook to Bolt



Heavy duty hook to bolt to suit 4" to 10" timber posts and to be used with field gate bands or hook and band hinges. Supplied with square plate washer and hex nuts.

Product Code	Size Ø x L (mm)	Pin Ø (inch)	Pin Ø (mm)	Pack Qty (pcs)	Carton Qty (packs)
<b>BAG - NO FIXINGS REQUIRED</b>					
GHB19325GEA	M20 x 325	3/4	19	1	10
GHB22325GEA	M20 x 325	7/8	22	1	10
TYPE - FGH				SUB TYPE - FGH04	

### Hook on Square Plate



A heavy duty hook on plate to suit field gate bands. Enables the gate to be lifted off for maintenance purposes. Alternatively, mounting upside down will prevent the gate from being lifted off preventing unwanted access.

Fixings Information						
No. of Coach Screws				8		
Coach Screw Ø (mm)				11		
Product Code	Size		Pin Ø	Pin Ø	Pack Qty	Carton Qty
Hot Dipped Galvanised	L x W (mm)	Pin Ø (inch)	Pin Ø (mm)	Qty (pcs)	Qty (packs)	
<b>BAG - FIXINGS INCLUDED</b>						
HSP19GEA	100 x 100	3/4	19	1	10	
TYPE - FGH				SUB TYPE - FGH04		

### Adjustable Gate Eye



Ideal for use in hanging timber or metal gates and to be used in conjunction with gate hook with matching pin diameter.



Product Code

Hot Dipped Galvanised	Zinc	Ø x L (mm)	Nut Socket Size (mm)	To Suit Pin Ø (inch / mm)	Pack Qty (pcs)	Carton Qty (packs)
<b>BAG - NO FIXINGS REQUIRED</b>						
AGE12100GEA	AGE12100Z	M12 x 100	19	1/2" / 12	1	10
AGE16100GEA	AGE16100Z	M16 x 100	24	5/8" / 16	1	10
AGE19100GEA	AGE19100Z	M19 x 100	30	3/4" / 19	1	10
AGE19150GEA	AGE19150Z	M19 x 150	30	3/4" / 19	1	10
AGE19200GEA	AGE19200Z	M19 x 200	30	3/4" / 19	1	10
AGE19250GEA	-	M19 x 250	30	3/4" / 19	1	10
AGE22150GEA	-	M22 x 150	34	7/8" / 22	1	10
AGE22200GEA	-	M22 x 200	34	7/8" / 22	1	10
AGE22250GEA	-	M22 x 250	34	7/8" / 22	1	10
TYPE - FGH				SUB TYPE - FGH04		

### Adjustable Bottom Gate Fitting

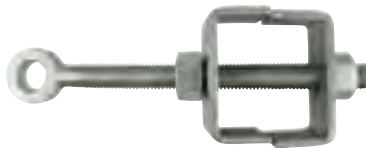

The adjustable bottom band allows for adjustment and easy alignment of the gate after fitting and is to be used with a 19mm diameter gate hook.



Technical Information	
Gate Eye Size Ø x L (mm)	M19 x 250
Heel Clip Size L x W x D (mm)	86 x 50 x 32
To Suit Gate Thickness (mm)	75
To Suit Gate Thickness (inch)	3

Product Code	Ø x L (mm)	Nut Socket Size (mm)	To Suit Pin Ø (inch / mm)	Pack Qty (pcs)	Carton Qty (packs)
<b>BAG - NO FIXINGS REQUIRED</b>					
AGF19GEA	M19 x 250	30	3/4" / 19	1	10
TYPE - FGH				SUB TYPE - FGH04	

## Gate & Post Fittings To Weld

### Gate Hook to Weld



Designed for welding onto a flat metal post and used in conjunction with gate eyes or hook and band hinges.

Product Code	Pin Ø (inch)	Pin Ø (mm)	Base Plate L x W (mm)	Centre Pin Projection (mm)	Pack Qty (pcs)	Carton Qty (packs)
<b>BAG - NO FIXINGS REQUIRED</b>						
GHW12S	1/2	12	45 x 38	26	2	10
GHW16S	5/8	16	63 x 47	38	2	10
GHW19S	3/4	19	63 x 50	38	2	10
GHW22S	7/8	22	63 x 50	38	2	10
TYPE - FGH				SUB TYPE - FGH04		

### Gate Eye to Weld



Designed for welding onto a flat metal post or gate and used with gate hook.

Product Code	To Suit Pin Ø (inch)	To Suit Pin Ø (mm)	Base Plate L x W (mm)	Pack Qty (pcs)	Carton Qty (packs)
<b>BAG - NO FIXINGS REQUIRED</b>					
GEW12S	1/2	12	45 x 38	2	10
GEW16S	5/8	16	63 x 47	2	10
GEW19S	3/4	19	63 x 50	2	10
GEW22S	7/8	22	63 x 50	2	10
TYPE - FGH				SUB TYPE - FGH04	



## Throw-Over Loops



### Throw-Over Gate Loop



**CORROSION RATING**

Hot Dipped Galvanised

1	2	3	4	5
---	---	---	---	---

Urban & industrial areas with a moderate salt atmosphere

Ideal for securing pairs of gates in a closed position.

Product Code	Length (mm)	Thickness (mm)	To Suit Gate Thickness (mm)	Pack Qty (pcs)	Carton Qty (packs)
Hot Dipped Galvanised					
<b>BAG - FIXINGS INCLUDED</b>					
TGL150G	150	6	75	1	10
TGL350G	350	6	75	1	10
TYPE - FGH SUB TYPE - FGH01					

### Throw-Over Gate Loop with Lifting Handle



**CORROSION RATING**

Hot Dipped Galvanised

1	2	3	4	5
---	---	---	---	---

Urban & industrial areas with a moderate salt atmosphere

Ideal for securing pairs of gates in a closed position. Features a loop handle for ease of operation, particularly from the saddle of a horse.

Product Code	Length (mm)	Thickness (mm)	To Suit Gate Thickness (mm)	Pack Qty (pcs)	Carton Qty (packs)
Hot Dipped Galvanised					
<b>BAG - NO FIXINGS REQUIRED</b>					
TGLH350G	350	6	75	1	10
TGLH450G	450	6	75	1	10
TYPE - FGH SUB TYPE - FGH01					

### Throw-Over Locking Gate Loop



**CORROSION RATING**

Hot Dipped Galvanised

1	2	3	4	5
---	---	---	---	---

Urban & industrial areas with a moderate salt atmosphere

Ideal for securing pairs of gates in a closed position. Features a locking hasp and staple to prevent risk of animal / equipment theft or unwanted access.

Product Code	Length (mm)	Thickness (mm)	Staple Plate Size (mm)	To Suit Gate Thickness (mm)	Max. Padlock Shackle Ø (mm)	Pack Qty (pcs)	Carton Qty (packs)
Hot Dipped Galvanised							
<b>BAG - NO FIXINGS REQUIRED</b>							
TLGL450G	450	6	65 x 65	75	12	1	10
TYPE - FGH SUB TYPE - FGH01							

## Field Gate Wheels



### Light Duty Spring Loaded Field Gate Wheel



**CORROSION RATING**

Zinc

1	2	3	4	5
---	---	---	---	---

Occasionally damp/wet rural and sheltered areas

Technical Data	
Length (mm)	270
Wheel Diameter Ø (mm)	100
Backplate Length x Width (mm)	100 x 25
Max. Gate Weight (kg)	50
Max. Spring Compression (mm)	40

A light duty spring loaded gate wheel that is ideal for domestic and light commercial applications. Provides support at the leading edge of gates and doors and self adjusts to overcome sloping or uneven groundwork.

Product Code	Length (mm)	Pack Qty (pcs)	Carton Qty (packs)
Zinc			
<b>PLAIN BAG - FIXINGS INCLUDED</b>			
GW10ZB	270	1	10
TYPE - GAB SUB TYPE - GAB06			

### Heavy Duty Spring Loaded Field Gate Wheel



**CORROSION RATING**

Epoxy Black

1	2	3	4	5
---	---	---	---	---

Occasionally damp/wet rural and sheltered areas

Technical Data	
Length (mm)	370
Wheel Diameter Ø (mm)	102
Backplate Length x Width (mm)	165 x 50
Max. Gate Weight (kg)	135
Max. Spring Compression (mm)	50

A heavy duty spring loaded gate wheel that is ideal for agricultural and heavy commercial applications. This wheel provides support at the leading edge of gates and doors and self adjusts to overcome sloping or uneven groundwork.

Product Code	Length (mm)	Pack Qty (pcs)	Carton Qty (packs)
Epoxy Black			
<b>PLAIN BAG - FIXINGS INCLUDED</b>			
GW14BB	370	1	5
TYPE - GAB SUB TYPE - GAB06			

# Field Gate Catches



## Field Gate Spring Fastener Set with Staple Catch

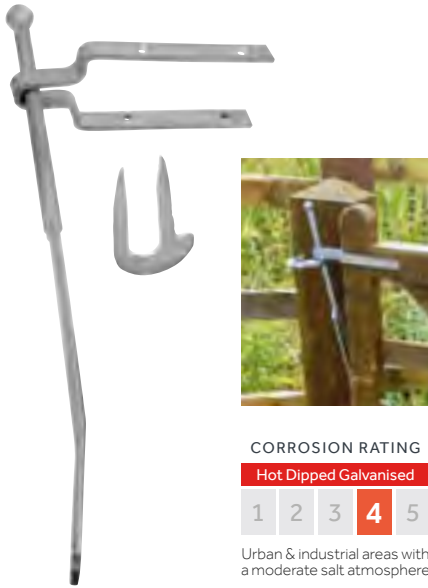

CORROSION RATING

Hot Dipped Galvanised				
1	2	3	4	5

Urban & industrial areas with a moderate salt atmosphere

A heavy duty catch for field gates with a high frequency of use. The gate locates behind the peg of the double leg catch automatically when closed.

The catch requires an in front of post gate mounting.

- Contents:
- 1 x Spring Latch Arm
  - 1 x Arm Holding Gate Bracket
  - 1 x Hammer-In Latch Retainer
  - Exterior Woodscrews

Technical Data	
Size (mm)	610
Overall Length (mm)	610
Handle Length (mm)	310
Spring Keep L x W x H (mm)	250 x 75 x 25
Staple Catch L x W (mm)	180 x 80

Product Code	Size (mm)	Pack Qty (pcs)	Carton Qty (packs)
Hot Dipped Galvanised	610	1	
<b>BAG - FIXINGS INCLUDED</b>			
SFF610G	610	1	
TYPE - FGC SUB TYPE - FGC01			

## Field Gate Hunting Type Lift Catch with Cranked Striker



CORROSION RATING

Hot Dipped Galvanised				
1	2	3	4	5

Urban & industrial areas with a moderate salt atmosphere

A heavy duty catch that is ideal for field and equestrian gates. An elongated handle allows gates to be used by horse riders without the need to dismount. The latch automatically engages when the gate is closed and is pad-lockable for additional security.

The catch requires an in front of post gate mounting.

- Contents:
- 1 x Hunting Type Catch
  - 1 x Spike Peg with Washer and Nut
  - Coach Screws

Technical Data	
Size (mm)	425
Overall Length (mm)	425
Backplate L x W (mm)	150 x 30
Catch Projection (mm)	120
Handle Length (mm)	300
Strike Peg Ø x L (mm)	12 x 150

Product Code	Size (mm)	Pack Qty (pcs)	Carton Qty (packs)
Hot Dipped Galvanised	425	1	
<b>BAG - FIXINGS INCLUDED</b>			
HLC425G	425	1	
TYPE - FGC SUB TYPE - FGC01			

## Field Gate Self Locking Catch with Cranked Striker

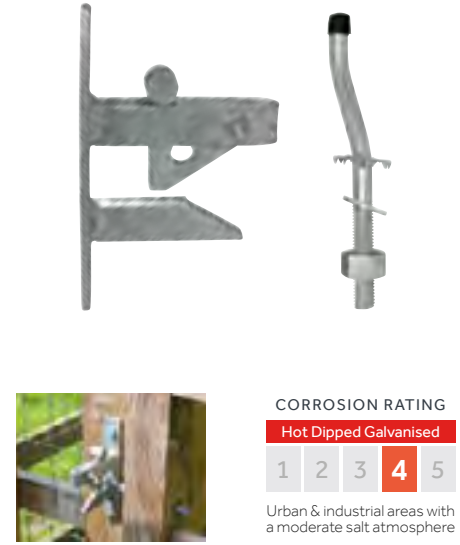

CORROSION RATING

Hot Dipped Galvanised				
1	2	3	4	5

Urban & industrial areas with a moderate salt atmosphere

A heavy duty gate catch that is ideal for field and driveway gates. The latch automatically engages when the gate is closed and is pad-lockable for additional security.

The catch requires an in front of post gate mounting.

- Contents:
- 1 x Self Locking Catch
  - 1 x Spike Peg with Washer and Nut
  - Coach Screws

Technical Data	
Size (mm)	120
Catch Projection (mm)	120
Backplate L x W (mm)	150 x 30
Strike Peg Ø x L (mm)	12 x 150

Product Code	Size (mm)	Pack Qty (pcs)	Carton Qty (packs)
Hot Dipped Galvanised	120	1	
<b>BAG - FIXINGS INCLUDED</b>			
SLCG	120	1	
TYPE - FGC SUB TYPE - FGC01			

# Fence Post Supports



## Drive in Post Spike - Bolt Secure



Drive in post spikes are a quick and easy way to erect fencing and garden posts as they require no digging or concreting into place, saving time and money. They feature a 4 fin steel spike to ensure a solid, permanent, wind resistant fit.

Carriage bolts tighten and clamp the post firmly to prevent any post movement, as well as allowing for over / under sized post tolerance. Allows for removal of the post at a later stage if required. Prevents against post rot and decay as it will hold the base of the post above ground level.

Available in a red oxide powder coat to blend in with the fencing and provides medium rust protection or hot dip galvanized for maximum rust protection. Both options can be over painted if you wish.

For 4ft fencing use a 600mm spike, for 6ft fencing use a 750mm spike.



## Drive in Post Spike - Quick Fit



Drive in post spikes are a quick and easy way to erect fencing and garden posts as they require no digging or concreting into place, saving time and money. They feature a 4 fin steel spike to ensure a solid, permanent, wind resistant fit.

The quick fit version features inverted fins inside the post holder section that will hold the post in a vice like grip. The system prevents against post rot and decay as it will hold the base of the post above ground level.

Available in a red oxide powder coat to blend on with the fencing and provides a medium rust protection or hot dip galvanized for maximum rust protection. Both options can be over painted if you wish.

For 4ft fencing use a 600mm spike, for 6ft fencing use a 750mm spike.



Technical Data						
To Suit Post Size (mm)	50 x 50	70 x 70	75 x 75	90 x 90	100 x 100	
To Suit Post Size (inch)	2 x 2	2 3/4 x 2 3/4	3 x 3	3 1/2 x 3 1/2	4 x 4	
Spike Length (mm)	450	600	600	750	600	750
Spike Length (inch)	18	24	24	30	24	30
Post Holder Length (mm)	150	150	150	150	150	
Total Length (mm)	600	750	750	900	750	900

Product Code		To Suit Post Size (mm)	Spike Length (mm)	Pack Qty (pcs)	Carton Qty (packs)	Pallet Qty (packs)
Oxide Red Powder Coated	Hot Dipped Galvanised					
<b>EACH</b>						
PSB50450	PSB50450G	50 x 50	450	1	10	330
PSB70600	-	70 x 70	600	1	10	180
PSB75600	PSB75600G	75 x 75	600	1	10	180
PSB75750	PSB75750G	75 x 75	750	1	8	144
PSB90600	-	90 x 90	600	1	8	128
PSB100600	PSB100600G	100 x 100	600	1	8	112
PSB100750	PSB100750G	100 x 100	750	1	6	84
TYPE - FCA		SUB TYPE - FCA01				

Technical Data						
To Suit Post Size (mm)	75 x 75		100 x 100			
To Suit Post Size (inch)	3 x 3		4 x 4			
Spike Length (mm)	600	750	600	750		
Spike Length (inch)	24	30	24	30		
Post Holder Length (mm)	150		150			
Total Length (mm)	750	900	750	900		

Product Code		To Suit Post Size (mm)	Spike Length (mm)	Pack Qty (pcs)	Carton Qty (packs)	Pallet Qty (packs)
Oxide Red Powder Coated	Hot Dipped Galvanised					
<b>EACH</b>						
PSQ75600	PSQ75600G	75 x 75	600	1	10	120
PSQ75750	PSQ75750G	75 x 75	750	1	10	200
PSQ100600	PSQ100600G	100 x 100	600	1	8	128
PSQ100750	PSQ100750G	100 x 100	750	1	6	144
TYPE - FCA		SUB TYPE - FCA01				

## Driving Tool



The drive in tool is for use when driving a fence post spike into the ground. The tool is made from hardened plastic and will prevent the post section from being damaged when being driven in.

Product Code	To Suit Post Size (mm)	To Suit Post Size (inch)	Pack Qty (pcs)	Carton Qty (packs)	Pallet Qty (packs)
<b>EACH</b>					
DT75	75 x 75	3 x 3	1	10	450
DT100	100 x 100	4 x 4	1	10	360
TYPE - FCA		SUB TYPE - FCA01			

## Bolt Down Shoes

Bolt down fence post shoes are a quick and easy way to erect fencing and garden posts as they require no digging or concreting into place, saving time and money.

Designed to be fixed down onto an existing concrete base or wall and are perfect for patio fencing, decking, pergolas or car ports.

### CORROSION RATINGS

#### Oxide Red Powder Coated

1	2	3	4	5
---	---	---	---	---

Occasionally damp/wet rural and sheltered areas

#### Hot Dipped Galvanised

1	2	3	4	5
---	---	---	---	---

Urban & industrial areas with a moderate salt atmosphere



### Bolt Secure

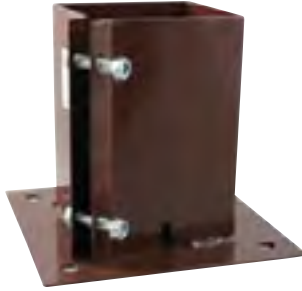

- Bolts secure and clamp the post firmly in place
- Bolts allow for post removal at a later stage
- Prevents against post rot and decay as it holds the base of the post above ground level

- Can be over painted if you wish

### Quick Fit



- Inverted fins hold the post in a vice like grip
- Prevents against post rot and decay as it holds the base of the post above ground level
- Can be over painted if you wish

### Flush Fit - Bolt Secure



- Designed to be fixed down onto an existing concrete base or wall where the post needs to be fitted flush against a wall
- Bolts secure and clamp the post firmly in place
- Bolts allow for post removal at a later stage
- Prevents against post rot and decay

- Can be over painted if you wish.

Technical Data			
To Suit Post Size (mm)	50 to 90	100	150
Post Holder Length (mm)	150		
Base Plate Size (mm)	150 x 150	180 x 180	225 x 225
No. of Fixing Holes	4		
Fixing Hole Size (mm)	11.0		

Product Code	To Suit Post Size (mm)	To Suit Post Size (inch)	Pack Qty (pcs)	Carton Qty (packs)	Pallet Qty (packs)
<b>Oxide Red</b>	<b>HDG</b>				
<b>EACH</b>					
BDB50	BDB50G	50 x 50	2 x 2	1	10 120
BDB70	-	70 x 70	2 1/2 x 2 1/2	1	10 120
BDB75	BDB75G	75 x 75	3 x 3	1	10 480
BDB90	-	90 x 90	3 1/2 x 3 1/2	1	10 120
BDB100	BDB100G	100 x 100	4 x 4	1	10 180
BDB150	BDB150G	150 x 150	6 x 6	1	6 144

TYPE - FCA SUB TYPE - FCA02

Technical Data			
To Suit Post Size (mm)	75 x 75	100 x 100	
Post Holder Length (mm)	150		
Base Plate Size (mm)	150 x 150	180 x 180	
No. of Fixing Holes	4		
Fixing Hole Size (mm)	11.0		

Product Code	To Suit Post Size (mm)	To Suit Post Size (inch)	Pack Qty (pcs)	Carton Qty (packs)	Pallet Qty (packs)
<b>Oxide Red</b>	<b>HDG</b>				
<b>EACH</b>					
BDQ75	BDQ75G	75 x 75	3 x 3	1	10 480
BDQ100	BDQ100G	100 x 100	4 x 4	1	10 180

TYPE - FCA SUB TYPE - FCA02

Technical Data			
To Suit Post Size (mm)	75 x 75	100 x 100	
Post Holder Length (mm)	150		
Base Plate Size (mm)	150 x 90	175 x 115	
No. of Fixing Holes	4		
Fixing Hole Size (mm)	11.0		

Product Code	To Suit Post Size (mm)	To Suit Post Size (inch)	Pack Qty (pcs)	Carton Qty (packs)	Pallet Qty (packs)
<b>Oxide Red</b>	<b>HDG</b>				
<b>EACH</b>					
FBDB75	FBDB75G	75 x 75	3 x 3	1	10 600
FBDB100	FBDB100G	100 x 100	4 x 4	1	10 240

TYPE - FCA SUB TYPE - FCA02

## Concrete in Shoe - Bolt Secure



- Designed to be set into concrete
- Fins hold the support firmly in the concrete
- Bolts secure and clamp the post firmly in place
- Bolts allow for post removal at a later stage
- Prevents against post rot and decay as it holds the base of the post above ground level
- Can be over painted if you wish

Technical Data		
To Suit Post Size (mm)	75 x 75	100 x 100
Spike Length (mm)	200	200
Post Holder Length (mm)	150	150
Total Length (mm)	350	350

Product Code	To Suit Post Size (mm)	To Suit Post Size (inch)	Pack Qty (pcs)	Carton Qty (packs)	Pallet Qty (packs)
<b>Oxide Red Powder Coated</b>	<b>Hot Dipped Galvanised</b>				
<b>EACH</b>					
CSB75	CSB75G	75 x 75	3 x 3	1	10 300
CSB100	CSB100G	100 x 100	4 x 4	1	10 160

TYPE - FCA SUB TYPE - FCA02

## Repair Spike - Bolt Secure



- Designed for the repair and replacement of rotten or damaged fence posts that have been concreted in.
- The spike drives down between the existing wood post and concrete to leave a solid base for installation of a new post
- Bolts secure and clamp the post firmly in place
- Bolts allow for post removal at a later stage
- Prevents against post rot and decay as it holds the base of the post above ground level
- Can be over painted if you wish

Technical Data		
To Suit Post Size (mm)	75 x 75	100 x 100
Spike Length (mm)	300	300
Post Holder Length (mm)	150	150
Total Length (mm)	450	450

Product Code	To Suit Post Size (mm)	To Suit Post Size (inch)	Pack Qty (pcs)	Carton Qty (packs)	Pallet Qty (packs)
<b>Oxide Red Powder Coated</b>	<b>Hot Dipped Galvanised</b>				
<b>EACH</b>					
RS75	RS75G	75 x 75	3 x 3	1	10 100
RS100	RS100G	100 x 100	4 x 4	1	10 80

TYPE - FCA SUB TYPE - FCA03



## Fencing Accessories

### Fence Post Caps

#### Pyramid Post Cap

- Perfect decorative finish to the top of fence post
- Protects the top of the fence post from weather damage
- Can be painted over to match with a different fence colour

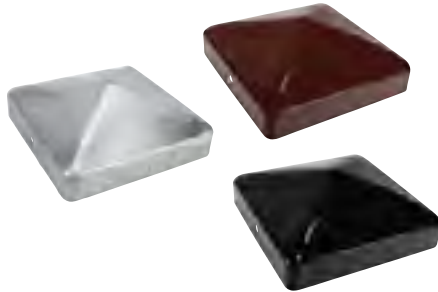

Product Code

Oxide Red	Epoxy Black	Zinc	To Suit Post Size (mm)	To Suit Post Size (inch)	Pack Qty (pcs)	Carton Qty (packs)	Pallet Qty (packs)
<b>EACH</b>							
FPC50	FPC50B	FPC50G	50 x 50	2 x 2	1	25	5400
FPC75	FPC75B	FPC75G	75 x 75	3 x 3	1	25	3000
FPC100	FPC100B	FPC100G	100 x 100	4 x 4	1	25	4000
TYPE - FCA				SUB TYPE - FCA05			

#### Ball Post Cap

- Perfect decorative finish to the top of fence post
- Protects the top of the fence post from weather damage
- Can be painted over to match with a different fence colour



Product Code

Oxide Red	Epoxy Black	Zinc	To Suit Post Size (mm)	To Suit Post Size (inch)	Pack Qty (pcs)	Carton Qty (packs)	Pallet Qty (packs)
<b>EACH</b>							
BPC50	BPC50B	BPC50G	50 x 50	2 x 2	1	45	2700
BPC75	BPC75B	BPC75G	75 x 75	3 x 3	1	30	1080
BPC100	BPC100B	BPC100G	100 x 100	4 x 4	1	24	960
TYPE - FCA				SUB TYPE - FCA05			

### Post Extender - Quick Fit



- Raise the height of fence posts by up to 1m
- Fins hold each post in a vice like grip
- Can be painted over to match with a different fence colour

Product Code	To Suit Post Size (mm)	To Suit Post Size (inch)	Length (mm)	Pack Qty (pcs)	Carton Qty (packs)	Pallet Qty (packs)
<b>Oxide Red</b>						
<b>EACH</b>						
PEX75	75 x 75	3 x 3	180	1	10	360
PEX100	100 x 100	4 x 4	180	1	10	320
TYPE - FCA				SUB TYPE - FCA02		

### Universal Post Extender



- Raise the height of fence posts by up to 1.2m
- x12 4.0mm screw holes

Product Code	Size L x W x W (mm)	Thickness (mm)	Pack Qty (pcs)	Carton Qty (packs)	Pallet Qty (packs)
<b>Galvanised</b>					
<b>EACH</b>					
UPE180	180 x 60 x 60	2.0	1	25	2200
TYPE - FCA			SUB TYPE - FCA04		

### Knee Rail Support Bracket



Designed for securing rails onto birds mouth posts.

Product Code	Size L x W (mm)	Pack Qty (pcs)	Carton Qty (packs)	Pallet Qty (packs)
<b>Galvanised</b>				
<b>EACH</b>				
KRS46	250 x 46	1	50	300
KRS90	250 x 90	1	50	300
TYPE - FCA		SUB TYPE - FCA06		

### Arris Rail Mortice Bracket

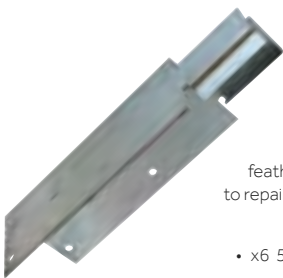

Suitable for securing arris rails to a concrete post when building feather edge fencing or to repair a wooden arris rail to an existing post.

- x6 5.0mm screw holes

Product Code	Size L x W (mm)	Thickness (mm)	Pack Qty (pcs)	Carton Qty (packs)	Pallet Qty (packs)
<b>Galvanised</b>					
<b>EACH</b>					
ARBM200	200 x 62	1.5	1	25	1200
TYPE - FCA			SUB TYPE - FCA06		

### Arris Rail Bracket

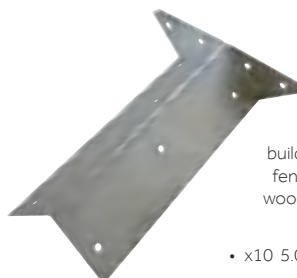

Suitable for securing arris rails to a square fence post when building feather edge fencing or to repair a wooden arris rail to an existing post.

- x10 5.0mm screw holes

Product Code	Size L x W (mm)	Thickness (mm)	Pack Qty (pcs)	Carton Qty (packs)	Pallet Qty (packs)
<b>Galvanised</b>					
<b>EACH</b>					
ARS225	225 x 65	0.75	1	25	2800
ARS300	300 x 65	0.75	1	25	2100
TYPE - FCA			SUB TYPE - FCA06		

### Arris Rail Support Bracket



For fitting arris rails to timber posts when building feather edge fencing or to repair a wooden arris rail to an existing post.

- x4 4.0mm screw holes

Product Code	Size L x W x W (mm)	Thickness (mm)	Pack Qty (pairs)	Carton Qty (packs)	Pallet Qty (packs)
<b>Galvanised</b>					
<b>EACH</b>					
ARBS	90 x 60 x 60	2.0	1	25	2000
TYPE - FCA		SUB TYPE - FCA06			

### Panel Clip



A quick and easy way to secure fence panels and trellis to timber, these can also be plugged and screwed into masonry.

- x4 5.0mm screw holes

Product Code	Size		Pack Qty	Carton Qty	Pallet Qty
	L x W x D (mm)	Thickness (mm)			
<b>Galvanised</b>					
<b>EACH</b>					
PC44	50 x 44 x 25	1.0	1	100	11200
PC50	50 x 50 x 25	1	1	100	10000
TYPE - FCA			SUB TYPE - FCA06		

### Panel Security Bracket



Designed for securing fence panels to 4" concrete posts and helps prevent unwanted removal or theft of fence panels.

- x2 5.0mm screw holes

Product Code	Size		Pack Qty	Carton Qty	Pallet Qty
	L x W (mm)	Thickness (mm)			
<b>Galvanised</b>					
<b>EACH</b>					
PSB233	233 x 40	1.5	1	50	2700
TYPE - FCA			SUB TYPE - FCA06		

### Z Clip



For attaching trellis or timber fence panels to posts.

- x4 4.0mm screw holes

Product Code	Size		Pack Qty	Carton Qty
	L x W x D (mm)	Thickness (mm)		
<b>Galvanised</b>				
<b>EACH</b>				
ZC60	60 x 56 x 15	1.5	1	100
TYPE - FCA		SUB TYPE - FCA06		

### Gravel Board Clip



A quick and easy way to attach timber gravel boards to timber fence posts.

- x2 5.5mm screw holes



Product Code	Size		Pack Qty	Carton Qty	Pallet Qty
	L x W x D (mm)	Thickness (mm)			
<b>Galvanised</b>					
<b>EACH</b>					
GB25	150 x 25 x 30	1.5	1	25	3750
GB50	150 x 50 x 30	1.5	1	25	1925
TYPE - FCA			SUB TYPE - FCA06		

### Twin Pin Gravel Board Clip



Suitable for fitting concrete gravel boards to concrete posts. The backplate mounts to the gravel board and the two pins locate into the post.

Product Code	Size		Pin Ø (mm)	Pack Qty	Carton Qty	Pallet Qty
	L x W (mm)	Thickness (mm)				
<b>Galvanised</b>						
<b>EACH</b>						
GB2P	150 x 50	4	10	1	25	2400
TYPE - FCA		SUB TYPE - FCA06		T=THICKNESS		

### Border Roll Pin



Ideal for securing border roll to the ground. The pin is pre drilled and attached to rear of the border roll using 4.5 x 50mm screws. Use 3 border roll pins equally spaced per 1.8m of border roll.

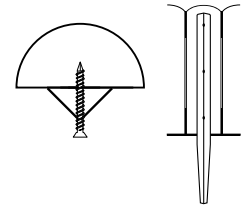

Product Code	Size		Pack Qty	Carton Qty	Pallet Qty
	L x W x D (mm)	Thickness (mm)			
<b>Galvanised</b>					
<b>EACH</b>					
323450	5450 x 23 x 23	1	50	50	4000
TYPE - FCA		SUB TYPE - FCA06			

## Chains and Accessories



### Quick Repair Link



Ideal for connecting lengths of chain or repairing broken chain links.

Product Code	Shackle Ø (mm)	Inner Link Length (mm)	Inner Link Width (mm)	Safe Working Load (kg)	Pack Qty (pcs)	Carton Qty (packs)
<b>Zinc</b>						
<b>PLAIN BAG</b>						
5QLB	5	51	23	50	10	44
6QLB	6	58	27	85	10	30
8QLB	8	74	34	150	5	32
<b>TIMBAG</b>						
5QLP	5	51	23	50	5	15
6QLP	6	58	27	85	5	15
8QLP	8	74	34	150	5	15
TYPE - GAB/GAP			SUB TYPE - GAB02/GAP02			

### Carbine Hook



Spring loaded hook ideal for connecting lengths of chain or attaching to anchor points.

Product Code	Shackle Ø (mm)	Safe Working Load (kg)	Pack Qty (pcs)	Carton Qty (packs)
<b>Zinc</b>				
<b>PLAIN BAG</b>				
5CHB	5	45	10	50
6CHB	6	75	10	30
8CHB	8	125	10	16
<b>TIMBAG</b>				
5CHP	5	45	5	15
6CHP	6	75	5	15
8CHP	8	125	5	15
TYPE - GAB/GAP		SUB TYPE - GAB02/GAP10		

### Ring on Plate



Ideal as an anchor point using chain, rope or wire. Fixings not included.

Product Code	Plate Size L x W (mm)	Ring Ø (mm)	Screw Hole Ø (mm)	Pack Qty (pcs)	Carton Qty (packs)
<b>Hot Dipped Galvanised</b>					
<b>PLAIN BAG</b>					
RP2GB	50 x 50	65	6.0	1	160
<b>TIMBAG - FIXINGS INCLUDED</b>					
RP2GP	50 x 50	65	6.0	1	15
TYPE - GAB/GAP			SUB TYPE - GAB02/GAP07		

### Dee Shackle



Ideal for connecting lengths of chain or fixing to anchor points.

Product Code	Shackle Ø (mm)	Inner Link L (mm)	Inner Link W (mm)	Safe Working Load (kg)	Pack Qty (pcs)	Carton Qty (packs)
<b>Hot Dipped Galvanised</b>						
<b>BAG</b>						
5DSB	5	20	10	80	20	25
6DSB	6	24	12	100	20	17
8DSB	8	32	16	200	20	10
<b>TIMBAG</b>						
5DSP	5	20	10	80	5	15
6DSP	6	24	12	100	5	15
8DSP	8	32	16	200	5	15
TYPE - GAB/GAP		SUB TYPE - GAB02/GAP03 L=LENGTH W=WIDTH				

### Bow Shackle



Ideal for connecting lengths of chain or fixing to anchor points.

Product Code	Shackle Ø (mm)	Inner Link L (mm)	Inner Link W (mm)	Safe Working Load (kg)	Pack Qty (pcs)	Carton Qty (packs)
<b>Hot Dipped Galvanised</b>						
<b>BAG</b>						
5BSB	5	19	15	80	20	25
6BSB	6	24	18	100	20	17
8BSB	8	32	24	200	20	10
<b>TIMBAG</b>						
5BSP	5	20	10	80	5	15
6BSP	6	24	12	100	5	15
8BSP	8	32	16	200	5	15
TYPE - GAB/GAP		SUB TYPE - GAB02/GAP09 L=LENGTH W=WIDTH				

### Hook on Plate



Ideal as an anchor point using chain, rope or wire. Fixings not included.

Product Code	Plate Size L x W (mm)	Hook Proj. (mm)	Screw Hole Ø (mm)	Pack Qty (pcs)	Carton Qty (packs)
<b>Hot Dipped Galvanised</b>					
<b>PLAIN BAG</b>					
HP2GB	50 x 50	73	6.0	1	160
<b>TIMBAG - FIXINGS INCLUDED</b>					
HP2GP	50 x 50	73	6.0	1	10
TYPE - GAB/GAP			SUB TYPE - GAB02/GAP07		

### Welded Link Chain



Welded link chain is ideal for securing farm gates and machinery among a variety of other uses. Not suitable for overhead lifting, load binding or towing.

Product Code	Length (m)	Shackle Ø (mm)	Inner Link L (mm)	Inner Link W (mm)	Safe Working Load (kg)	Pack Qty (pcs)	Carton Qty (packs)
<b>Hot Dipped Galvanised</b>							
<b>EACH</b>							
432HDGC	3.0	4	32	8	80	1	20
642HDGC	2.0	6	42	12	160	1	15
852HDGC	1.5	8	52	16	320	1	10
TYPE - GAB/GAP		SUB TYPE - GAB02/GAP08 L=LENGTH W=WIDTH					

### Staple on Plate

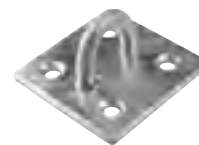

Ideal as an anchor point using chain, rope or wire. Fixings not included.

Product Code	Plate Size L x W (mm)	Staple Proj. (mm)	Inner Staple Width (mm)	Screw Hole Ø (mm)	Pack Qty (pcs)	Carton Qty (packs)
<b>Hot Dipped Galvanised</b>						
<b>PLAIN BAG</b>						
SP2GB	50 x 50	28	15	6.0	1	160
<b>TIMBAG - FIXINGS INCLUDED</b>						
SP2GP	50 x 50	28	15	6.0	1	15
TYPE - GAB/GAP			SUB TYPE - GAB02/GAP07			

## Symbols

90 Degree Elbow .....	72
90 Degree Tee .....	72

## A

Abrasive Brush .....	142
Access Panel .....	236
Accident Book .....	212
Acetoxyl Silicone .....	187
Acrylic Caulk .....	188
Adhesive .....	184
Adhesive Hook .....	66
Adhesive Residue Remover .....	196
Adhesive Trowel - Square Notch .....	157
Adjustable Band & Hook on Plate .....	274
Adjustable Bottom Gate Fitting .....	290
Adjustable Gate Eye .....	290
Adjustable Hinge Set .....	289
Adjustable Roller Catch .....	256
Adjustable WC/Bidet Fixing Kit .....	70
Adjustable Wrench .....	163
Admixture .....	184
Advanced Coach Screw .....	34
Aero-core Anti-Draught Ventilator .....	235
Airbrick .....	235
Air & Gas Leak Detector .....	196
Air Wedge .....	177
Alcohol Hand Sanitiser .....	205
All Purpose Filler .....	191
Aluminium Hawk .....	156
Aluminium Nails .....	113
Angle Bracket .....	228
Angled Brace .....	257
Angled Brad Nails (Collated) .....	108
Angle Grinder Wire Brush .....	141
Animal Bolt .....	278
Annular Ringshank Nail .....	111, 113-114
Anti-Bacterial Hand Soap .....	205
Anti-Draught Ventilators .....	235
Anti-Seize Lubricant .....	193
Anti-Spatter .....	196
Applicator Guns	
Foil & Cartridge Gun .....	178
Professional Sealant Gun .....	188
PU Foam Gun .....	179, 189
Resin Gun .....	102, 178
Sealant Gun .....	102, 178
Skeleton Gun .....	102, 178, 188
Arris Rail Bracket .....	295
Assorted Tray .....	79
Auger Bit .....	120
Automatic Gate Catch .....	281
Aviation Snips Set .....	161
Axes .....	152

## B

Backflap Hinge .....	243
Bales Catch .....	256
Banding .....	76
Barbed Staple .....	112
Bar Clamp .....	169
Barrettine	
Danish Oil .....	201
Decking Oil - All In One .....	199
Decking Oil - Anti-Slip .....	199
Log Cabin & Decking Treatment .....	200
Polyurethane Varnish .....	200
Quick Drying Floor Varnish .....	201
Raw Linseed Oil .....	201
Teak Oil .....	201
Timber Cut End Preserver .....	200
Traditional Floor Wax .....	201
Universal Preserver .....	199
Wood Preserver .....	199
Wood Protective Treatment .....	199
Wood Reviver .....	200
Woodworm Killer .....	200
Yacht Varnish .....	200
Barrier Fencing .....	204, 211
Basin Fixing Kits .....	70
Bath Plug & Chain .....	70
Bathroom Lock .....	251

Bathroom & Sanitary Silicone .....	187
Baypole Screw .....	51
Beeswax Stick .....	192
Bevel Brush .....	141
Bidet/Pan Fixing Kit .....	70
Bi-Metal Jigsaw Blade .....	134
Blackjax Screw .....	26
Blades	
Circular Saw Blade .....	133
Multi-Tool Blade .....	137
Reciprocating Saw Blade .....	135-136
Blow-Out Pump .....	102
Blue Polypropylene Rope .....	174
Bolster & Chisel Set .....	153
Bolt Croppers .....	163
Bolt Down Shoe .....	294
Bolts	
Architectural Flat Section Bolt .....	254
Barrel Bolt .....	254
Carriage Bolt .....	33, 56, 61-62
Carriage Bolt & Nut .....	33, 62
Contract Flat Section Bolt .....	254
Door Rack Bolt .....	255
Eye Bolt .....	100
Hinge Bolt .....	255
Hook Bolt .....	100
Indicator Bolt .....	254
Lever Action Flush Bolt .....	254
Loose Bolt .....	99
Multi-Fix Masonry Bolt .....	96
Necked Barrel Bolt .....	254
Throughbolt .....	98
Window Rack Bolt .....	255
Bomber Jacket .....	223
Bonded Abrasives .....	132
Bonding Agent .....	184
Border Roll Pin .....	296
Bow Handle Bolt .....	278
Bow Shackle .....	297
Bradawl .....	166
Brad Point Wood Bit .....	121
Brass Screw .....	26
Brass Threaded Screw Cap .....	27
Brenton Padbolt .....	276
Brick Hammer .....	152
Brick Jointers .....	157
Bricklaying & Tiling Accessories	
Adhesive Trowel - Square Notch .....	157
Brick Jointers .....	157
Grouting Float .....	157
Plasterers Jab Saw .....	157
Radius Edging Trowel .....	157
Bricklaying Trowels .....	155
Brick Trowel .....	155
Brick Trowel Set .....	155
Bucket Trowel .....	155
Gauging Trowel .....	155
Margin Trowel Set .....	155
Pointing Trowel .....	155
Brick, Masonry & Patio Cleaner .....	202
Brick Reinforcement Coil .....	229
Brick Trowel .....	155
Brick Trowel Set .....	155
Bright Nail .....	111
Briwax Finishing Wax .....	192
Broaching Cutter .....	125
Bucket Trowel .....	155
Builders Line .....	174
Builders Sheet .....	209
Builders Tape .....	182, 231
Builders Wipes .....	206
Bungee Cord .....	210
Butterfly Hinges .....	246
Butt Hinge .....	238-239, 242
Button Socket Screw .....	63
Button Socket Screw & Nut .....	63

## C

C2 Twin-Cut Premium Screws	
C2 Clamp-Fix .....	11
C2 Deck-Fix .....	12, 29-30, 39
C2 Exterior Strong-Fix .....	12
C2 Floor-Fix .....	13

C2 Strong-Fix .....	9
C2 Tongue-Fix .....	13
Cabinet Connector Bolt .....	257
Cabin Hook .....	255, 281
Cabin Hook Cast Iron .....	281
Cable Clip .....	69, 81
Cable Lock .....	262
Cables .....	262
Cable Tie .....	69
Cable Tie Plug .....	69
Cable Ties .....	69
Cable Tray Bolt .....	57
Cable & Wire Cutters .....	160
Calcium, Lime & Rust Stain Remover .....	203
Cam Buckle Tie Down Strap .....	210
Cane Bolt .....	279
Capping Nail .....	114
Cap Socket Screw .....	63
Cap Socket Screw & Nut .....	63
Captive Screws .....	76
Carbine Hook .....	297
Carcass Screw .....	26
Carpenters Pencil .....	175
Carriage Bolts	
Carriage Bolt .....	33, 55-56, 61-62
Carriage Bolt & Nut .....	33, 62
Casement Stay .....	247
Catches .....	253
Caulk .....	188
Caulk Gun .....	100, 102, 178, 188
Cavity Anchor .....	87
Cavity Anchor Setting Tool .....	87
Cavity Fixings	
Corefix Dot & Dab Wall Fixing .....	84
Hammer-In Fixing .....	88
Metal Cavity Anchor .....	87
Metal Cavity Anchor Setting Tool .....	87
Metal Speed Plugs with Screw .....	87
Mixed Tray .....	80
Nylon Speed Plug .....	87
Stella-Fix Universal Anchor .....	86
Zip-Fix Cavity Fixing .....	85
Cavity Wall Tie .....	230
Cavity Wall Weep Vent .....	234
Ceiling Anchor .....	90
Ceiling Angle Bracket .....	90
Cement Board Screw .....	37
Centrefeed Rolls .....	206
Chain	
Welded Link Chain .....	271, 297
Chain Bolt .....	279
Chain Carbine Hook .....	297
Chain Lubricant .....	193
Chain Quick Repair Link .....	297
Chains .....	262, 269
Chainsaw Oil .....	195
Chain Shackle .....	297
Chalk Powder .....	174
Chemical Anchor Stud .....	100
Chemical Resin .....	101
Chuck .....	143
Chuck Adaptor .....	143
Chuck Key .....	143
Cill Screw .....	51
Circular Saw Blade .....	133
Citrus Cleaner & Degreaser .....	203
Clad Pin .....	115
Clamps	
Bar Clamp .....	169
F Clamp .....	169
G Clamp .....	169
Spring Clamp .....	169
CLASSIC	
Black .....	16
Classic Hinge Screw .....	19
Classic Multi-Purpose Screw .....	16-19
Classic Multi-Purpose Screw (Collated) .....	39
Classic Multi-Purpose Screw -	
Double Countersunk .....	19
Classic Multi-Purpose Screw - Pan Head .....	17-18
Claw Hammer .....	151
Cleaner .....	205
Cleaners	
Brick, Masonry & Patio Cleaner .....	202



Calcium, Lime & Rust Stain Remover ..... 203  
 Citrus Cleaner & Degreaser ..... 203  
 Exterior Multi-Purpose Cleaner ..... 202  
 Exterior Wood Cleaner ..... 202  
 Glass Cleaner ..... 203  
 Grout Cleaner ..... 203  
 Heavy Duty Cleaner & Degreaser ..... 203  
 Path, Patio & Driveway Cleaner ..... 202  
 Path, Patio & Driveway Sealer ..... 202  
 PVCu Cleaner ..... 203  
 Clear Adhesive & Sealant ..... 186  
 Clear Instant Grab Adhesive ..... 186  
 Cling Sheet ..... 208  
 Clipdriver Tool ..... 78  
 Clipped Head Nail (Collated) ..... 105-107  
 Clips & Pins ..... 68  
 Cloakroom Basin Fixing Kit ..... 70  
 Closed Reel Tape Measure ..... 172  
 Clout Nail ..... 112  
 Coach Screw & Nylon Plug ..... 89  
 Coach Screws  
     Advanced Coach Screw ..... 34  
     Coach Screw - Exterior ..... 33  
     Coach Screw & Nylon Plug ..... 35  
     Coach Screw - Zinc ..... 35  
 Coarse Thread Drywall Screw ..... 36  
 Collated Nail  
     Clipped Head Nail ..... 105-107  
     Twist Shank Nail ..... 108  
 Collated Screws  
     Decking Screw ..... 38  
     Drywall Screw ..... 38  
     External Screw ..... 39  
     Flooring Screw ..... 39  
     Internal Screw ..... 39  
     Self-Drilling Screw ..... 38  
     Wood Screw ..... 39  
 Coloured Cable Tie ..... 69  
 Coloured Fixing Band ..... 229  
 Combination Pliers ..... 162  
 Combination Square ..... 173  
 Concrete Anchor ..... 98  
 Concrete Bolt ..... 98  
 Concrete Fixing ..... 96  
 Concrete In Shoe ..... 294  
 Cone Cutter ..... 124  
 Connector Plate ..... 228  
 Contact Adhesive ..... 184  
 Copper Adaptor ..... 72  
 Copper Anti-Seize Spray ..... 193  
 Copper Clout Nail ..... 113  
 Copper Disc Rivet ..... 113  
 Copper Roofing Accessories ..... 113  
 Cordless Nail Gun Cleaner ..... 196  
 Corefix Dot & Dab Wall Fixing ..... 84  
 Corner Brace ..... 257  
 Corner Plate ..... 257  
 Counter Flap Hinge ..... 243  
 Countersink ..... 124  
 Countersunk Socket Screw ..... 63  
 Countersunk Socket Screw & Nut ..... 63  
 Coupler ..... 72  
 Coveralls ..... 221  
 Cover Caps  
     Brass Threaded Screw Cap ..... 27  
     Hex Head Cover Cap ..... 45  
     Hinged Screw Cap ..... 28  
     Hinge Hole Cover Cap ..... 257  
     Plastic Cover Cap for Metal Insulation Fixing ..... 91  
     Self-Adhesive Cover Cap ..... 28  
     Two Piece Screw Cap ..... 28  
 Cowl ..... 235  
 Cramp ..... 230  
 Cranked Ball Bearing Hinge ..... 243  
 Cranked Band & Hook on Plate ..... 275  
 Cross Pein Hammer ..... 151  
 Crown / Coronet Hinges ..... 246  
 Cup Grinding Wheel ..... 132  
 Cup Hooks ..... 67  
 Curly Tail Casement Fastener ..... 246  
 Curtain Hook ..... 66  
 Curved Rail Hinge ..... 273  
 Cut Clasp Nail ..... 111  
 Cut Flooring Brad Nail ..... 111

Cut Tack ..... 114  
 Cutters  
     End Cutters ..... 163  
     Side Cutters ..... 162  
 Cutting & Tapping Lubricant ..... 193  
 Cylinder Door Stop ..... 258

**D**

Damp Proof Course ..... 231  
 Damp Proof Membrane ..... 231  
 Damp Proof Membrane Jointing Tape ..... 231  
 Danish Oil ..... 201  
 Deadbolt ..... 253  
 Deadlock ..... 252  
 De-Burring Countersink ..... 124  
 Decking Oil - All In One ..... 199  
 Decking Oil - Anti-Slip ..... 199  
 Decking Screw ..... 30  
 Dee Shackle ..... 297  
 Degreaser ..... 196  
 Delta Sanding Pad ..... 140  
 Dense Board Drywall Screw ..... 37  
 Detail Sanding Sheet ..... 140  
 Diamond Blades ..... 129  
 Diamond Core Bit ..... 130  
 Diamond Drill Bit ..... 119  
 Diamond Wheels ..... 131-132  
 Disposable PU Ear Plugs ..... 213  
 Divergent Point Staples ..... 109  
 Dome Head Rivet ..... 66  
 Door Bolts ..... 254  
 Door Catches ..... 253  
 Door Chains ..... 255  
 Door Handles - Internal ..... 247-248  
 Door Hooks ..... 258  
     Double Robe Hook ..... 258  
     Hat & Coat Hook ..... 258  
     Single Robe Hook ..... 258  
 Door Latches ..... 253  
 Door Restrictor ..... 255  
 Door Security ..... 255  
 Door Stops ..... 258  
     Cylinder Door Stop ..... 258  
     Oval Door Stop ..... 258  
     Projection Door Stop ..... 258  
     PVC Door Stop ..... 258  
     Spring Door Stop ..... 258  
 Door Wedge ..... 258  
 Double Ball Catch ..... 256  
 Double Ended Impact Driver Bits ..... 144  
 Double Quick Lock Pipe Clip ..... 73  
 Double Roller Catch ..... 256  
 Double Strap Hinge Set ..... 288  
 Dowel ..... 257  
 Dowty Type Washer ..... 45  
 Drainage Weep ..... 234  
 Drilling Sets ..... 126-127  
 Drill Vent ..... 234  
 Drill Wire Brush ..... 142  
 Drive in Post Spike ..... 293  
 Drive In Post Spike Driving Tool ..... 293  
 Drive in Post Spike - Quick Fit ..... 293  
 Driver Bits ..... 147  
 Driver Bit Sets ..... 148  
 Drive Screw Nail ..... 112  
 Drop Down Garage Bolt ..... 279  
 Drop In Anchor ..... 98  
 Drop In Anchor Setting Tool ..... 98  
 Dry Diamond Core Bit ..... 130  
 Dry Diamond Drill Bit ..... 119  
 Dry Fix Ridge Pack ..... 234  
 Drylining Disc ..... 140  
 Dry-Verge Eaves Starter ..... 234  
 Dry-Verge Unit ..... 234  
 Drywall Bracket ..... 229  
 Drywall Screw ..... 36-37  
 Drywall Screw (Collated) ..... 38  
 Dual Direction Panel Connector ..... 256  
 Dummy Draw Connector ..... 256  
 Dust Sheets ..... 208

**E**

Ear Defenders ..... 213

Ear Plugs ..... 213  
 Economy PU Foam Applicator Gun ..... 179  
 Edleston Handles ..... 249  
 Elasticated Waist Trouser ..... 223  
 Electrical Tape ..... 182  
 Electricians Scissors ..... 160  
 Element Screw ..... 51  
 ELH Clout Nail ..... 112  
 Elysee Pipe Fittings ..... 71  
 End Cutters ..... 163  
 End Plug ..... 72  
 End Socket ..... 259  
 Engine Oil ..... 195  
 EPDM Washer ..... 45  
 Escutcheon Handle ..... 285  
 Euro Profile Deadlock ..... 252  
 Euro Profile Sashlock ..... 251  
 Executive Vests ..... 222  
 Expanding PU Foam ..... 189  
 Expanding PU Foam Applicator Gun ..... 189  
 Expanding PU Foam Cleaner ..... 189  
 Express Nail ..... 90  
 Exterior Carriage Bolt & Nut ..... 33, 56  
 Exterior Coach Screw ..... 33  
 Exterior Wood Cleaner ..... 202  
 External Collated Screw ..... 39  
 External Cowl ..... 235  
 External Wood Adhesive ..... 185  
 Extra Tough Builders Wipes ..... 206  
 Eye Bolt ..... 100  
 Eye Care ..... 212  
 Eye Protection ..... 214  
     Overspecs ..... 215  
     Premium Safety Glasses ..... 214  
     Premium & Sports Style Safety Glasses ..... 214  
     Safety Glasses ..... 215  
     Safety Goggles ..... 216  
     Slimfit Safety Glasses ..... 214  
     Sports Style Safety Glasses  
         with Adjustable Temples ..... 214  
 EZ Joist Clip ..... 74

**F**

Face Shield ..... 216  
 F Clamp ..... 169  
 Female Adaptor ..... 72  
 Fence Panel Clip ..... 296  
 Fence Post Cap ..... 295  
     Ball Post Cap ..... 295  
     Pyramid Post Cap ..... 295  
 Fence Post Extender ..... 295  
 Fence Post Shoe ..... 294  
 Fence Post Spike ..... 293  
 Fencing Accessories ..... 271, 295  
 Fieldgate Catch ..... 292  
 Fieldgate Hinge ..... 288  
 Fieldgate Hook ..... 290  
 Fieldgate Wheel ..... 291  
 File Cleaning Brush ..... 168, 177  
 Files ..... 168  
 Filler Hardener ..... 191  
 Fillers ..... 180, 190  
 Fine Thread Collated Drywall Screw ..... 38  
 Fine Thread Drywall Screw ..... 36  
 Finishing Nailer Fuel Cell ..... 107  
 Finishing Paint ..... 197  
 Finishing Wax ..... 192  
 Fire Door Foam ..... 189  
 Fire Door Hinges ..... 245  
 Fire Rated Intumescent & Acoustic Acrylic Sealant .. 188  
 FIRMAHOLD  
     Collated Nails ..... 104  
         Clipped Head Nails ..... 105-107  
         Fuel Cells ..... 107  
     First Aid ..... 212  
     First Fix Collated Nails ..... 105-108  
     First Fix Fuel Cell ..... 107  
     Fishtailed Cramp ..... 230  
     Fixing Band ..... 229  
     Flange Clip ..... 90  
     Flange Head Rivet ..... 66  
     Flap Disc ..... 142  
     Flat Connector Plate ..... 228

- Flat Twin & Earth Cable Clip ..... 69  
Flat Wood Bit ..... 121  
Flat Wood Bit Set ..... 126  
Fleece ..... 223  
Fleur De Lys Ornate Lever Handle ..... 247  
Fleur De Lys Pull Handle ..... 246  
Flexiband ..... 76  
Flexiband Operating Tool ..... 78  
Flexible Bookend ..... 260  
Flexidriver Tool ..... 78  
Flooring Nail ..... 111  
Flooring Screw ..... 13  
Flooring Screw (Collated) ..... 39  
Flush Fit Bolt Down Shoe ..... 294  
Flush Hinge ..... 241  
Flyscreen Vent ..... 236  
Foam Applicator Gun ..... 179  
Foil Applicator Gun Nozzle ..... 178  
Foil & Cartridge Applicator Gun ..... 178  
Folding Utility Knife ..... 159  
Foot Bolt ..... 279  
Forged Eye & Shield ..... 100  
Forged Hook & Shield ..... 100  
Form A Washer ..... 60, 65  
Form B Washer ..... 60, 65  
Form C Washer ..... 60  
Frame Fixing ..... 92  
Framing Anchor ..... 228  
Framing & Carpenter's Square ..... 173  
Framing Nailer Fuel Cell ..... 107  
Full Sanding Sheet ..... 139
- G**
- Galvanised Nails ..... 79, 111-112  
Galvanising Paint ..... 197  
Garage Door Holder ..... 282  
Garage Door Holders ..... 282  
Garage Drop Down Bolt ..... 279  
Gate Bottom Fitting ..... 290  
Gate Catch ..... 281  
Gate Eye ..... 290  
Gate Handle ..... 285, 287  
Gate Hinge ..... 272  
Gate Hook ..... 276, 289-290  
Gate Hook to Drive ..... 290  
Gate Kit ..... 287  
Gate Knob ..... 287  
Gate Latch ..... 280  
Gate Lock ..... 285  
Gate Spring ..... 281  
Gate Wheel ..... 291  
Gauging Trowel ..... 155  
Gauntlets ..... 220  
G Clamp ..... 169  
General Purpose Pliers Set ..... 162  
Glass Cleaner ..... 203  
Glass Drill Bit ..... 119  
Glasses ..... 214-215  
Glass & Tile Scraper ..... 177  
Glazing Shovel ..... 177  
Gloves ..... 218-220  
Goggles ..... 216  
Grab Adhesive ..... 186  
Grab Pack ..... 9, 15, 21, 32  
Gravel Board Clip ..... 296  
Grease Remover ..... 196  
Grille Vent ..... 236  
Grip & Fill ..... 185  
Grout Cleaner ..... 203  
Grouting Float ..... 157
- H**
- Hammer  
Brick Hammer ..... 152  
Claw Hammer ..... 151  
Cross Pein Hammer ..... 151  
Lump Hammer ..... 152  
Sledgehammer ..... 152  
Hammer Bits ..... 117  
Hammer Fixing ..... 92  
Hammer-In Fixing ..... 88  
Hammer Tacker ..... 109, 176  
Hand Brush ..... 177  
Hand Cleaner ..... 205  
Handles  
Edleston Handles ..... 249  
Fleur De Lys Ornate Lever Handle ..... 247  
Fleur De Lys Pull Handle ..... 246  
Narrow Style Lever Handles ..... 247  
Radmore Handles ..... 249  
Shavington Excellence Handles ..... 249  
Traditional Lever Handles ..... 247  
Victorian Scroll Handles ..... 248  
Victorian Straight Handles ..... 248  
Zeta Handles ..... 248  
Handrail Bracket ..... 259  
Hand Riveter ..... 66, 176  
Hand Sanitiser ..... 205  
Hand Saws ..... 158  
Hand Soap ..... 205  
Handy Hook ..... 68  
Hanger ..... 225  
Hanging Rail ..... 259  
Hardener ..... 191  
Hard Wax Oil ..... 192  
Hasps & Staples ..... 268  
Hasp & Staple ..... 283  
Heavy Cross Pattern Door Bolt ..... 278  
Heavy Duty Cleaner & Degreaser ..... 203  
Heavy Duty Stapler ..... 109, 176  
Heavy Duty Staples ..... 109  
Heavy Locking Drop Down Bolt ..... 280  
Heavy Secure Bolt on Hasp & Staple ..... 284  
Heavy Swivel Pattern Hasp & Staple ..... 284  
Heavy Vertical Bolt on Hasp & Staple ..... 284  
Helical Bar ..... 229  
Helical Flat Roof Fixing ..... 229  
Herringbone Joist Strut ..... 228  
Hex Connector Nut ..... 59  
Hex Dome Nut ..... 59, 65  
Hex Full Nut ..... 59, 65  
Hex Head Cover Cap ..... 45  
Hex Key ..... 167  
Hex Serrated Flange Nut ..... 59  
High Carbon Steel Jigsaw Blade ..... 134  
High Speed Steel Jigsaw Blade ..... 134  
High Temperature Paint ..... 197  
Hinge Cutter ..... 121  
Hinged Pipe Clips ..... 73  
Hinged Screw Cap ..... 28  
Hinge Hole Cover Cap ..... 257  
Hinges  
Backflap Hinge ..... 243  
Butterfly Hinges ..... 246  
Butt Hinge ..... 238-239, 242  
Counter Flap Hinge ..... 243  
Cranked Ball Bearing Hinge ..... 243  
Crown / Coronet Hinges ..... 246  
Fire Door Hinges ..... 245  
Flush Hinge ..... 241  
Hurlinge ..... 242  
Intumescent  
Hinge Pads ..... 245  
Lift Off Hinge ..... 242  
Parliament Hinge ..... 244  
Performance Ball Bearing Hinge ..... 241  
Rising Butt Hinge ..... 242  
Security Hinge ..... 238  
Solid Drawn Hinge ..... 241  
Spear Hinges ..... 246  
Stormproof Hinge ..... 243  
Twin Ball Bearing Hinge ..... 240  
Unequal Hinges ..... 246  
Washed Hinge ..... 239-240  
Hinge Screw ..... 19  
Hip Iron ..... 229  
Hit & Miss Vent ..... 236  
Hi-Visibility  
Bomber Jacket ..... 223  
Elasticated Waist Trousers ..... 223  
Executive Vests ..... 222  
Fleece ..... 223  
Parka Jacket ..... 223  
Polo Shirts ..... 222  
Softshell Jacket ..... 223  
Sweatshirt ..... 222  
Trousers ..... 223
- Vest ..... 222  
Hole Cleaning Brushes ..... 102  
Hole Cleaning Pump ..... 102  
Holesaw ..... 128  
Holesaw Arbor ..... 128  
Hook Bolt ..... 100  
Hook & Loop Strap ..... 69  
Hook on Plate ..... 297  
Hook on Rectangular Plate ..... 276  
Hook on Square Plate ..... 290  
Hooks  
Adhesive Hook ..... 66  
Curtain Hook ..... 66  
Mixed Tray ..... 81  
Screw Eye ..... 67  
Screw Hook ..... 67  
Vine Eye ..... 67  
Hooks (Fieldgate) ..... 290  
Horseshoe Shim ..... 232  
Hose Clip ..... 74, 81  
Hot Bed Handle ..... 287  
Housings & Allen Screws ..... 76  
Housing & Screws ..... 76  
HSS Drill Bit ..... 122-124, 126-127  
Hunting Type Lift Catch ..... 292  
Hurlinge ..... 242
- I**
- Impact Auger Bit ..... 120  
Impact Driver Bit Adaptors ..... 145  
Impact Driver Bit Holders ..... 145  
Impact Driver Bits ..... 144  
Impact HSS Drill Bits ..... 145  
Impact Socket ..... 146  
Impact Sockets ..... 146  
Imp/Metric Coupler ..... 72  
Industry Pack ..... 9, 15, 21, 29-30  
Instant Bond Mitre Kit ..... 184  
Instant Contact Adhesive ..... 184  
Instant Grab Adhesive ..... 186  
Insulation Disc ..... 91  
Insulation Fixing ..... 91  
Insulation Retaining Disc ..... 230  
Insulation Tape ..... 182  
Internal Collated Screw ..... 39  
Internal Door Handles ..... 248  
Internal Grille Vent ..... 236  
Intumescent & Acoustic Acrylic Sealant ..... 188  
Intumescent Hinge Pad ..... 245  
Intumescent Seals ..... 245  
Invisiweep Wall Weep ..... 234  
Ironmongery Screw ..... 26
- J**
- Jagged Plasterboard Nail ..... 112  
Jigsaw Blade Set ..... 135  
Jointing Biscuit ..... 257  
Jointing Knife ..... 156  
Joist Hanger ..... 225  
Jubilee  
Dispenser ..... 78  
Flexiband ..... 76  
High Torque Clip ..... 75  
Jubilee Clip ..... 75, 77-78  
Multiband ..... 76  
O Clip ..... 77  
P Clip ..... 76  
Superclamp ..... 75  
Wingspade Clip ..... 76
- K**
- Key Cabinet ..... 262  
Key Cap ..... 262  
Keyless Chuck ..... 143  
Key Safe ..... 262, 270  
Key Tag ..... 81, 262  
Kick Over Stable Latch ..... 281  
Knee Pads ..... 213  
Knee Pads & Inserts ..... 213  
Knee Rail Support Bracket ..... 295  
Knife ..... 159  
Knob ..... 287

Knock Down Block ..... 256  
 Knurled Brass Inset Screw Cup ..... 27

## L

Label Remover ..... 196  
 Ladder Hook ..... 68  
 Latches ..... 253  
 Lazy Tongue Riveter ..... 66, 176  
 Leak Detector Spray ..... 196  
 Lifting Sling ..... 210  
 Lift Off Hinge ..... 242  
 Light Duty Stapler ..... 109, 176  
 Light Duty Staples ..... 109  
 Lipped Drop In Anchor ..... 98  
 Liquid Mortar ..... 191  
 Lithium Grease ..... 194  
 LMN Silicone ..... 187  
 Lock  
     Gate Lock ..... 285  
 Locking Bolts ..... 268  
 Locking Pliers ..... 163  
 Locks  
     Bathroom Locks ..... 251  
     Deadlocks ..... 252  
     Sashlock Rebate Kit ..... 250  
     Sashlocks ..... 250  
 Loft Access Door ..... 236  
 Loft Door Operating Pole ..... 236  
 Log Cabin & Decking Treatment ..... 200  
 Log Roll Pin ..... 296  
 London Pattern Shelf Bracket ..... 260  
 Long Leg Timber Hanger ..... 226  
 Long Nose Pliers ..... 162  
 Long Throw Lock ..... 285  
 Long Throw Locks - Double ..... 285  
 Looped Cable ..... 262  
 Loose Aluminium Nails ..... 113  
 Loose Bolt ..... 99  
 Louvre Vent ..... 236  
 Lubricant ..... 193  
 Lump Hammer ..... 152

## M

Machine Screw ..... 49, 51  
 Magnetic Catch ..... 256  
 Magnetic Socket Driver ..... 146  
 Male Adaptor ..... 72  
 Mallet ..... 153  
 Margin Trowel Set ..... 155  
 Marker Pen ..... 175  
 Masonry Bolster and Cold Chisel ..... 153  
 Masonry Bolt ..... 96, 97  
 Masonry & Concrete Screws ..... 93-95  
 Masonry Drill Bit ..... 119  
 Masonry Drill Set ..... 126  
 Masonry Fixing ..... 92  
 Masonry Hanger ..... 225  
 Masonry Nails ..... 114  
 MDPE Pipe Clip ..... 74  
 Measuring Wheel ..... 172  
 Medium Tee Hinge ..... 272  
 Mending Plate ..... 257  
 Metal Cavity Anchor ..... 87  
 Metal Cavity Anchor Setting Tool ..... 98  
 Metal Expansion Plug ..... 89  
 Metal Framing Screw ..... 46  
 Metal Grille Vent ..... 236  
 Metal Insulation Disc ..... 91  
 Metal Insulation Fixing ..... 91  
 Metal Oval Stress Plate ..... 91  
 Metal Paint ..... 197  
 Metal Speed Plug with Screw ..... 87  
 Metolux Filler ..... 191  
 Metoset Liquid Mortar ..... 191  
 Mickey Pin ..... 114  
 Microfibre Cleaning Cloths ..... 206  
 Mini Timber Hanger ..... 226  
 Mirror Plate ..... 67  
 Mirror Screw ..... 27  
 Mitre Bond Activator ..... 184  
 Mitre Box ..... 158  
 Mitred Shelf Bracket ..... 260  
 Mitre Superglue ..... 184

Mixed Hose Clip ..... 74  
 Mixed Pins & Nails ..... 79  
 Mixed Screw Tray ..... 24, 47, 79  
 Mixed Set Screws, Nuts & Washers ..... 80  
 Mixed Tray ..... 79  
 Mixed Woodscrews ..... 79  
 Mixer ..... 149, 157  
 Mixing Nozzle ..... 102  
 Mixing Paddles ..... 149, 157  
 Modesty Block ..... 256  
 Monkey Tail Bolt ..... 278  
 Moulding Pry Bar ..... 154  
 Multiband ..... 76  
 Multiband Pocket Pack ..... 77  
 Multi-fix 9 in 1 Instant Grab Adhesive ..... 186  
 Multi-Fix Masonry Bolt ..... 96  
 Multi-Functional Hanger ..... 225  
 Multi-Function Fencing Pliers ..... 163  
 Multi-Purpose Adhesive ..... 184  
 Multi-Purpose Cleaner ..... 202  
 Multi-Purpose Drill Bit ..... 119  
 Multi-Purpose Lubricant ..... 193  
 Multi-Purpose Masonry Bolt ..... 96  
 Multi-Tool Blade ..... 137  
 Multi-Tool Blades ..... 137  
 Multi-Tool Sanding ..... 137, 138

## N

Nail In Anchor ..... 92  
 Nail In Pipe Clip ..... 74  
 Nail Plate ..... 228  
 Nails  
     Annular Ringshank ..... 111, 113-114  
     Barbed Staples ..... 112  
     Bright Nails ..... 111  
     Clout ..... 112, 113  
     Copper Disc Rivets ..... 113  
     Cut Clasp ..... 111  
     Cut Flooring Brads ..... 111  
     Drive Screw ..... 112  
     Galvanised Nails ..... 79, 111-112  
     Jagged Plasterboard ..... 112  
     Mixed Tray ..... 79  
     Oval ..... 111  
     Panel Pins ..... 111, 113  
     Presser Point Staples ..... 112-113  
     Round Lost Head ..... 111, 114  
     Round Wire ..... 111, 112, 114  
     Sheradised Nails ..... 113  
     Slab Nail ..... 111  
     Spring Head ..... 112  
     Square Twist ..... 112-113  
 Narrow Style Lever Handles ..... 247  
 Nitrile Gloves ..... 220  
 No Tag Timber Hanger ..... 226  
 Nozzle  
     Foil Applicator Gun Nozzle ..... 178  
     Mixing Nozzle ..... 101  
 Nuts  
     Channel Nuts ..... 59  
     Hex Connector Nut ..... 59  
     Hex Dome Nut ..... 59, 65  
     Hex Full Nut ..... 59  
     Hex Serrated Flange Nut ..... 59  
     Mixed Tray ..... 80  
     Nylon Nut - Type P ..... 59  
     Nylon Nut - Type T ..... 59, 65  
     Wing Nut ..... 59  
 Nylon Frame Fixing ..... 92  
 Nylon Hammer Fixing ..... 92  
 Nylon Nut - Type P ..... 59  
 Nylon Nut - Type T ..... 59, 65  
 Nylon Plug ..... 35, 89  
 Nylon Speed Plug ..... 87  
 Nylon Stripping & Preparation Disc ..... 142

## O

Oil & Grease Remover ..... 196  
 Oils ..... 195  
 One Piece Magnetic Bit Holder ..... 148  
 Open Reel Tape Measure ..... 172  
 Oval Bracket ..... 259  
 Oval Door Stop ..... 258

Oval Stress Plate ..... 91  
 Overspecs ..... 215

## P

Packer ..... 232  
 Padbars ..... 268  
 Padbolt ..... 276-277  
 Padlock Protection Bar ..... 284  
 Padlocks  
     Block Lock ..... 265  
     Brass ..... 261, 267  
     Combination ..... 261, 264, 266  
     Disc ..... 261, 265  
     Old English ..... 267  
     Padbars ..... 268  
     Rectangular ..... 261, 264-265  
     Stainless Steel ..... 261, 264, 266-267  
     Weatherproof Padlock ..... 261  
 Paint Mixer ..... 149, 157  
 Paints  
     Finishing Paint ..... 197  
     Galvanising Paint ..... 197  
     Metal Paint ..... 197  
     Primer ..... 197  
     Stain Concealing Paint ..... 197  
     Survey & Spot Markers ..... 198  
     Very High Temperature Paint ..... 197  
 Pan/Bidet Fixing Kit ..... 70  
 Panel Clip ..... 296  
 Panel Pin ..... 111, 113  
 Panel Security Bracket ..... 296  
 Parka Jacket ..... 223  
 Parliament Hinge ..... 244  
 PASLODE  
     Collated Nail & Fuel Packs ..... 108  
     Fuel Cell Packs ..... 107  
 Path, Patio & Driveway Cleaner ..... 202  
 Path, Patio & Driveway Sealer ..... 202  
 Pattern Hasp & Staple ..... 283  
 Pencil ..... 175  
 Penny/Repair Washer ..... 60, 65  
 Performance Ball Bearing Hinge ..... 241  
 Permanent Marker Pen ..... 175  
 Picture Hanging ..... 67, 81  
 Pilot Drill Bit ..... 128  
 Pilot Pin ..... 125  
 Pipe Clip ..... 75, 77-78  
 Pipe Collars ..... 74  
 Pipe Fittings ..... 71  
 Pipe Guide ..... 70  
 Pipe Liner ..... 72  
 Pipe Shears ..... 161  
 Pipe Wrench ..... 163  
 Plasterboard Nail ..... 112  
 Plasterers Jab Saw ..... 157  
 Plastering Trowel - Carbon Steel ..... 156  
 Plastering Trowels ..... 156  
     Aluminium Hawk ..... 156  
     Jointing Knife ..... 156  
     Plastering Trowel - Carbon Steel ..... 156  
     Professional Plasterers Trowel ..... 156  
 Plasters ..... 212  
 Plastic Cabinet Connector Bolt ..... 257  
 Plastic Cover Cap for Metal Insulation Fixing ..... 91  
 Plastic Grille Vent ..... 236  
 Plastic Handle Wire Brush ..... 177  
 Plastic Insulation Fixing ..... 91  
 Plastic Plug ..... 88  
 Plastic Sheet ..... 208  
 Plastic Sleeve for Resin ..... 102  
 Plates ..... 257  
 Pliers  
     Combination Pliers ..... 162  
     Locking Pliers ..... 163  
     Long Nose Pliers ..... 162  
     Multi-Function Fencing Pliers ..... 163  
     Water Pump Pliers ..... 162  
 Plug & Chain ..... 70  
 Plug & Screw ..... 25, 35, 88  
 Pointing Trowel ..... 155  
 Polo Shirts ..... 222  
 Polyester Resin ..... 101  
 Polyester Styrene Free Resin ..... 101

- Polymer Headed Nail ..... 115  
 Polythene Dust Sheet ..... 209  
 Polyurethane Varnish ..... 200  
 Post Caps ..... 295  
 Post Extender ..... 295  
 Post Level ..... 171  
 Powertool Sanding ..... 140  
 PPE ..... 213  
 Premium Plastic Plugs ..... 88  
 Premium Screw ..... 8, 14  
 Preparation Disc ..... 142  
 Presser Point Staple ..... 112-113  
 Press Lock ..... 286  
 Primer ..... 184, 197  
 Professional Gun ..... 88  
 Professional Plasterers Trowel ..... 156  
 Professional Wire Strippers ..... 160  
 Projecting Bolt ..... 99  
 Projection Door Stop ..... 258  
 Protective Board ..... 207  
 Protective Cling Sheet ..... 208  
 Protective Film ..... 208  
 Protective Zipper Door ..... 208  
 Pry Bar ..... 154  
 Moulding Pry Bar ..... 154  
 Utility Bar ..... 154  
 Wrecking and Pry Bar Set ..... 154  
 Wrecking Bar ..... 154  
 PU Foam ..... 189  
 PU Foam Applicator Gun ..... 179, 189  
 PU Wood Adhesive ..... 185  
 PVA Bond ..... 184  
 PVC Builders Tape ..... 231  
 PVCu Cleaner ..... 203
- Q**
- Quick Drying Floor Varnish ..... 201  
 Quick Lock Pipe Clips ..... 73  
 Quick Lock Spacer ..... 73  
 Quick Release Magnetic Bit Holder ..... 148  
 Quick Repair Link ..... 297
- R**
- Radiator Key ..... 70  
 Radiator Pipe Guide & Seal ..... 70  
 Radius Edging Trowel ..... 157  
 Radmore Handles ..... 249  
 Rad-Seal Pipe Guide & Seal ..... 70  
 Rafter Square ..... 173  
 Rag ..... 206  
 Random Orbital Sanding Disc ..... 140  
 Rasp Plane ..... 159  
 Rasps ..... 168  
 Ratchet Strap ..... 210  
 Raw Linseed Oil ..... 201  
 Rebar Cutter ..... 118  
 Rebate Kit ..... 250-251  
 Reciprocating Saw Blade ..... 135-136  
 Reducing Set ..... 72  
 Reinforced Frame Screw ..... 51-52  
 Reinforcement Coil ..... 229  
 Repair/Penny Washer ..... 60, 65  
 Repair Spike ..... 294  
 Replacement Pilot Pin ..... 125  
 Resin ..... 101  
 Restraint Strap ..... 227  
 Return Air Grille Vent ..... 236  
 Reverse Thread Drywall Screw ..... 37  
 Reversible Hinge ..... 274  
 Rigid Joint ..... 257  
 Rim Locks ..... 286  
 Rim/Mortice Knob Set ..... 287  
 Ring Gate Latch ..... 280  
 Ring On Plate ..... 297  
 Rising Butt Hinge ..... 242  
 Riveter ..... 176  
 Roller Catch ..... 256  
 Roll Forged Jobber Drill Bit ..... 122-123, 127  
 Roll Out Dry Fix Ridge Pack ..... 234  
 Roof Fixing (Flat) ..... 229  
 Roofing Bolt ..... 57  
 Roof Vent ..... 234  
 Round Brackets ..... 259
- Round Cable Clip ..... 69  
 Round Lost Head Nail ..... 111, 114  
 Round Wire Nail ..... 111-112, 114  
 Rubble Sack ..... 211
- S**
- Safety Frame Cramp ..... 230  
 Safety Glasses ..... 214-215  
 Safety Goggles ..... 216  
 Safety Masks ..... 217  
 FFP2 Masks ..... 217  
 FFP3 Masks ..... 217  
 Safety Pattern Hasp & Staple ..... 283  
 Safety Signs ..... 211  
 Safety Utility Knife ..... 159  
 Sandbags ..... 211  
 Sanding Belt ..... 140  
 Sanding Disc ..... 140  
 Sanding Sheet ..... 139  
 Sandpaper ..... 139  
 Sanitary & Bathroom Silicone ..... 187  
 Sashlock Rebate Kit ..... 250  
 Sashlocks ..... 250-251  
 Sawtooth Hanger ..... 67  
 SBR Bond ..... 184  
 Scaffolder's Short Impact Socket ..... 146  
 Scaffold Spirit Level ..... 171  
 Scissors ..... 160  
 Scotch Tee Hinge ..... 273  
 Screw Cup ..... 27  
 Screwdriver ..... 165-166  
 Screw Eye ..... 67  
 Screw Hook ..... 67  
 Screw-in Frame Tie ..... 230
- Screws
- Coach Screw ..... 33, 35, 89  
 Collated Drywall Screw ..... 38  
 Collated Screw ..... 38-39  
 Drywall Screw ..... 36  
 Hinge Screw ..... 19  
 Ironmongery Screw ..... 26  
 Machine Screw ..... 49, 51  
 Metal Framing Screw ..... 46  
 Mirror Screw ..... 27  
 Multi-Purpose Screw ..... 9-10, 15-19  
 Rainwater Screw ..... 25  
 Self-Drilling Screw ..... 37  
 Self-Tapping Screw ..... 79  
 Socket Screw ..... 63  
 Window Screw ..... 51-53  
 Wood Screw ..... 21-25, 79
- SDS Magnetic Bit Holder ..... 148  
 SDS Max Bit ..... 118  
 SDS Plus Adaptor ..... 143  
 SDS Plus Hammer Bits ..... 117  
 SDS Shank Rebar Cutter ..... 118  
 Sealant ..... 187  
 Sealant Gun ..... 102, 178-188  
 Second Fix Fuel Cell ..... 107  
 Security Chain ..... 262, 269  
 Security Hinge ..... 238  
 Self Amalgamating Tape ..... 182  
 Self-Drilling Collated Drywall Screw ..... 38  
 Self-Drilling Drywall Screw ..... 37  
 Self-Drilling Point Cement Board Screw ..... 37  
 Self-Drilling Screw ..... 37, 41  
 Self-Tapping Screw ..... 48, 79  
 Set Screw ..... 58, 64  
 Set Screw & Nut ..... 64
- Setting Tools
- Cavity Anchor Setting Tool ..... 87  
 Drop In Anchors Setting Tool ..... 98  
 Shank Rebar Cutter ..... 118  
 Shavington Excellence Handles ..... 249  
 Sheet Cutter ..... 208  
 Shelf End ..... 260  
 Sheradised Nails ..... 113  
 Shield Anchor & Bolt ..... 99  
 Shield Only ..... 99  
 Shoe Covers ..... 221  
 Short Impact Socket ..... 146  
 Side Closing Pincer Tool ..... 78  
 Side Cutters ..... 162  
 Side Gate Kit - Ring Latch ..... 287
- Side Gate Kit - Suffolk Latch ..... 287  
 Silicone ..... 187  
 Silicone Lubricant ..... 193  
 Single Handed Keyless Chuck ..... 143  
 Single Open Pipe Clip ..... 73  
 Single Quick Lock Pipe Clip ..... 73  
 Sink Plug & Chain ..... 70  
 Skeleton Gun ..... 102, 178, 188  
 Slab Nail ..... 111  
 Sledgehammer ..... 152  
 Slide Action Padbolt ..... 277  
 Snap Hook ..... 66  
 Snap Off Utility Knife ..... 159  
 Snap Off Utility Knife Blades ..... 159  
 Snappit Kit ..... 74  
 Soap ..... 205  
 Socket Driver ..... 146  
 Socket Drivers ..... 146  
 Socket Screw ..... 63  
 Soffit Vent ..... 234  
 Softshell Jacket ..... 223  
 Solid Brass Screw ..... 26  
 Solid Brass Screw Cap/Cup ..... 27
- SOLO
- SOLO Woodscrew ..... 20  
 SOLO Woodscrew (Collated) ..... 39
- Spanner ..... 164  
 Spear Hinges ..... 246  
 Specialist Window Screw ..... 51  
 Speed Auger ..... 121  
 Speed Plug ..... 87  
 Speed Plug with Screw ..... 87  
 Spirit Levels ..... 170  
 Spot Marker ..... 198  
 Spray Wax ..... 192  
 Spring Chain Bolt ..... 279  
 Spring Clamp ..... 169  
 Spring Door Stop ..... 258  
 Spring Fastener Set ..... 292  
 Spring Head Nail ..... 112  
 Spring Loaded Animal Bolt ..... 278  
 Spring Toggles ..... 87  
 Spring Washer ..... 60
- Square
- Combination Square ..... 173  
 Framing & Carpenter's Square ..... 173  
 Rafter Square ..... 173  
 Try Square ..... 173
- Square Plate Washer ..... 56, 60  
 Square Twist Nail ..... 112-113  
 Squire Anchors ..... 269  
 Squire Security ..... 263  
 Stable Latch ..... 281  
 Stain Concealing Paint ..... 197  
 Stainless Steel Cable Tie ..... 69  
 Stainless Steel Loose Nails ..... 114  
 Staple On Plate ..... 297  
 Stapler & Staples ..... 109
- Staples
- Barbed Staples ..... 112  
 Presser Point Staple ..... 112-113  
 Staples ..... 109
- Steel Ruler ..... 173  
 Steel Wire Wool ..... 139  
 Stella-Fix Universal Anchor ..... 86  
 Step Drill ..... 124  
 Stockinette Roll ..... 206  
 Stop Tap ..... 72  
 Stormproof Hinge ..... 243  
 Straight Band & Hook on Plate ..... 275  
 Strap ..... 210  
 Strap Hinge ..... 273  
 Stress Plate ..... 91  
 Stretcher Plate ..... 257  
 Stripping Disc ..... 142  
 Strong Tee Hinge ..... 272  
 Styrene Free Resin ..... 101  
 Styrene Free Wood Filler ..... 191  
 Suffolk Latch ..... 280  
 Suffolk Latches ..... 280  
 Superglue ..... 184  
 Support Pole ..... 209  
 Surface Screw Cup ..... 27  
 Survey & Spot Marker ..... 198  
 Sweatshirt ..... 222



**T**

Tape Measure .....	172
Tapes	
Aluminium Foil Tape .....	182
Anti-Slip Tape .....	183
Barrier Tape .....	183
Cloth Tape .....	181
Damp Proof Membrane Joint Tape .....	182
Double Sided Cloth Tape .....	181
Drywall Joint Tape .....	182
Extreme Temp. Aluminium Foil Tape .....	182
Hazard Cloth Tape .....	183
Hazard Tape .....	183
Heavy Duty Cloth Tape .....	181
High Strength PVC Builders Tape .....	182
High Visibility Wet Paint Tape .....	183
Hook and Loop Tape .....	181
Masking Tape .....	181
Packaging Tape .....	181
PTFE Thread Seal Tape .....	182
PVC Builders Tape .....	182
PVC Insulation Tape .....	182
Reinforced Aluminium Foil Tape .....	182
Self Amalgamating Tape .....	182
Underground Tape .....	183
Tap Repair Washer .....	45, 80
Tarpaulin .....	209
TCT Hinge Cutter .....	121
TCT Multi-Purpose Drill Bit .....	119
Teak Oil .....	201
Tee Hinge .....	272
Tee Plate .....	257
Telescopic Underfloor Ventilation .....	235
Tenon Saw & Mitre Box Kit .....	158
Tenon Saws .....	158
Textured Heavy Duty Wipes .....	206
Threaded Bar .....	57
Thread Seal Tape .....	182
Throughbolt .....	98
Throw Lock .....	285
Throw-Over Gate Loop .....	291
Tie .....	230
Tie Down Bungee Balls .....	209
Tie Down Clips .....	209
Tie Down Strap .....	210
Tile Drill Bit .....	119
Timber Connector .....	229
Timber Cut End Preserver .....	200
Timber Frame Tie .....	230
Timber Hanger .....	226
Timber Screws .....	31-33
Timloc .....	233
Internal Grille Vents .....	236
Roof Line & Above .....	234
Through-Wall Ventilation .....	235
Underfloor Ventilation .....	235
Weeps & Drill Vents .....	234
Tin Snips .....	161
Tongue & Groove Screw .....	13
Toolbox Spirit Level .....	171
Tool Hook .....	68
Tower Bolt .....	277
Tradesmans Scissors .....	160
Traditional Floor Wax .....	201
Traditional Lever Handles .....	247
Trousers .....	223
Truss Clip .....	228
Try Square .....	173
Tubular Deadbolt .....	253
Tubular Latch .....	253
Turn Button .....	281
Twin Ball Bearing Hinge .....	240
Twin-Cut Point Cement Board Screw .....	37
Twin Slot Shelving .....	260
Twin-Threaded Screw & Plug .....	25
Twin-Threaded woodscrew .....	23-24
Twisted Ring Gate Latch .....	280
Twist Shank Nail (Collated) .....	108
Two Piece Magnetic Bit Holder .....	148
Two Piece Screw Cap .....	28

**U**

Underfloor Ventilation .....	235
------------------------------	-----

Unequal Hinges .....	246
Universal Framing Anchor .....	228
Universal Preserver .....	199
Unpunched 1/3 Sanding Sheet .....	140
Unreinforced Frame Screw .....	53
Upholstery Nail .....	114
Utility Bar .....	154
Utility Hook .....	68
Utility Knife .....	159

**V**

Velocity Premium Multi-Use Screw .....	14
Vent .....	236
Ventilator .....	235
Vertical Flange Clip .....	90
Very High Temperature Paint .....	197
Vest .....	222
Victorian Scroll Handles .....	248
Victorian Straight Handles .....	248
Vine Eye .....	67
Vinylester Styrene Free Resin .....	101

**W**

Wall Plate Elbow .....	72
Wall Starter Kit .....	227
Wall Weep .....	234
Wardrobe Rail .....	259
Washed Hinge .....	240
Washed Masonry Nail .....	114
Washers	
Dowty Type Washer .....	45
EPDM Washer .....	45
Form A Washers .....	60, 65
Form B Washer .....	65
Form C Washer .....	60
Mixed Tray .....	80
Penny/Repair Washer .....	60, 65
Spring Washer .....	60
Square Plate Washer .....	56, 60
Tap Repair Washer .....	45, 80
Waterbar .....	229
Water Pump Pliers .....	162
Wax Filler Stick .....	192
WC Pan Fixing Kit .....	70
Weather Bar Screw .....	51
Wedge Strip .....	232
Weep .....	234
Welded Link Chain .....	297
Welder's Anti-Spatter .....	196
Wet & Dry Sanding Sheet .....	139
Whiteboard Pen .....	175
White Lithium Grease .....	194
Window Board Tie .....	230
Window Screw .....	51
Window Security .....	255
Wing Nut .....	59
Wipes .....	206
Wiping Rag .....	206
Wire Brush .....	142
Wire Hand Brush .....	177
Wirehangers .....	90
Wire Pattern Hasp & Staple .....	283
Wire Strippers .....	160
Wire Wool .....	139
Wood Adhesive .....	185
Wood Auger Bit .....	120
Wood Bit .....	120
Wood Bit Set .....	126
Wood Chisels .....	164
Wooden Dowel .....	257
Wooden Handle Wire Brush .....	177
Wooden Jointing Biscuit .....	257
Wood Filler .....	191
Wood Filler Hardener .....	191
Wood Preserver .....	199
Wood Protective Treatment .....	199
Wood Reviver .....	200
Wood Screw .....	20-25, 79
Woodworm Killer .....	200
Work-Top Connector .....	257
Wrecking and Pry Bar Set .....	154
Wrecking Bar .....	154
Wrench	
Adjustable Wrench .....	163
Pipe Wrench .....	163

**Y**

Yacht Varnish .....	200
---------------------	-----

**Z**

Zamac Nail In Anchor .....	92
Z Clip .....	296
Zeta Handles .....	248
Zip-Fix Cavity Fixing .....	85
Zipper Door .....	208
Zirconium Flap Disc .....	142



**SASH + DOOR  
HARDWARE**

**Contact Us:**

Tel: 01752 651330

Fax: 01752 253823

Email: [sales@sdhardware.co.uk](mailto:sales@sdhardware.co.uk)

**Address:**

Unit 7, Forge Lane

Enterprise Park

Saltash

Cornwall

PL12 6LX

[www.sdhardware.co.uk](http://www.sdhardware.co.uk)