

Catalog DIN Rail Miniature Circuit Breakers Ex9 Series - B1

B1N1D20

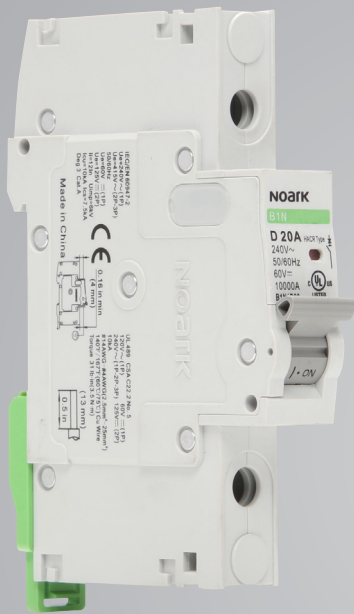

B1H2B1

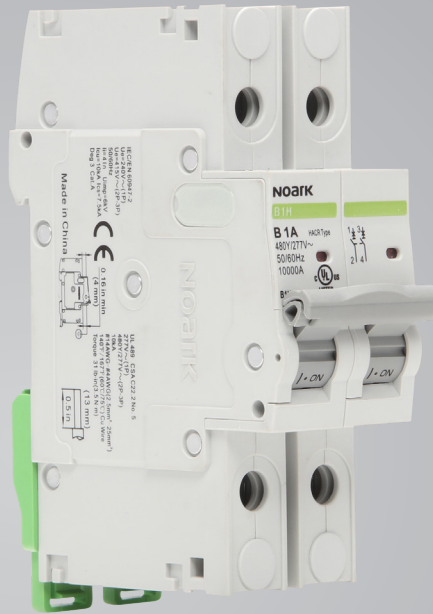

B1E3C20



NOARK Electric

Electrical Equipment Manufacturer for Distribution and Control



NOARK Electric is a global manufacturer of electrical distribution and control products that address a variety of customer needs, ranging from components to intelligent system solutions. Our global product lines include: circuit breakers, contactors, relays and intelligent control. Based in Shanghai, China, NOARK Electric was established in 2007 and covers the globe with regional headquarters in North America, Latin America, Europe and Middle East/Africa.

Globally, NOARK Electric serves the industrial, commercial, utility and residential markets. In North America, NOARK Electric focuses primarily on industrial OEMs, users and associated channel partners. Our motto is "Excellent Product...Exceptional Value," which NOARK Electric delivers to our customer by maintaining local inventory, providing local sales, customer service and support and manufacturing quality, aggressively priced products backed by a five-year limited warranty.

Quality Product

- Backed by a five-year limited warranty*



Exceptional Value

- Reduce the cost of products
- Improve profitability
- Increase margins

Local Support and Local Inventory

- Superb customer service
- Knowledgeable technical support
- Dedicated sales force
- Well-stocked inventory
- North American headquarters

*Contact NOARK Electric for complete details.

NOARK Electric

International Headquarter Locations



Global reach. Local resources.

The best of both worlds come together when customers count on NOARK as their electrical product manufacturer.

NOARK Electric

Table of Contents

A UL 489 Miniature Circuit Breakers

Product Overview.....	A4
National and International Standards	A5
Product Selection Guide	A6
Products	
B1H (UL 489, 480Y/277 Vac)	A7-10
B1N (UL 489, 240 Vac, 60/125 Vdc)	A11-14
B1NQ (UL 489, 120/240 Vac)	A15-20
B1D (UL 489, 125/250 Vdc).....	A21-24
Specifications	A25-27
Wiring Diagram	A27
Trip Curve	A28-29
Dimensions	A29-32
Accessories	
Alarm Switch	A33
Auxiliary Contact	A33
Shunt Trip	A33
Under-Voltage Trip	A34
DIN Rail	A34
Padlock.....	A35
Ring Tongue Terminal.....	A36
Surface Mount Clips.....	A36
Front Mount Clips	A36
Accessory Specifications	A37
Accessory Dimensions.....	A38-41



NOARK Electric

Table of Contents

B B1E 1~63A UL 1077 Supplementary Protectors

Product Overview.....	B43
National and International Standards	B44
Product Selection Guide	B45
Products	
B1E 1-63A (UL 1077, 480Y/277 Vac; 60/125 Vdc).....	B46-48
Specifications	B49-50
Wiring Diagram	B51
Trip Curve.....	B52-53
Dimensions.....	B54
Accessories	
Alarm Switch	B55
Auxiliary Contact.....	B55
Shunt Trip	B56
Under-Voltage Trip	B56
Accessory Specifications	B57
Accessory Dimensions.....	B58



C B1E 80~125A UL 1077 Supplementary Protectors

Product Overview.....	C60
National and International Standards	C61
Product Selection Guide	C62
Products	
B1E 80-125A (UL 1077, 480Y/277 Vac; 110/220 Vdc).....	C63
Specifications	C64-65
Wiring Diagram	C64
Trip Curve.....	C66
Dimensions.....	C67

MINIATURE CIRCUIT BREAKERS



UL 489

Miniature Circuit Breakers

UL 489 Product Overview

Features

- Complete range of UL 489 listed miniature circuit breakers up to a 63 A current rating
- Breakers mount on standard 35 mm DIN rail - B1NQ also provides a flush and surface mount options with additional mounting clips
- Standard ratings of 10 kA at 480Y/277 Vac and 10 kA at 125 Vdc
- Suitable for branch circuit device protection
- Trip-free design — breaker cannot be defeated by holding the handle in the ON position
- Captive screws cannot be lost
- For use in applications for which UL 1077 or CSA C22.2 No.235 are also allowed
- Field installable shunt trip and auxiliary switch subsequent mounting
- Available with provisions for ring tongue terminals
- Module width of only 0.71 in (18 mm) per pole
- Contact position indicator (red/green)
- Possibility for locking the toggle in ON or OFF position

A

Typical Applications

- Branch Circuit Protection
 - ✓ Convenience receptacle circuits (internal/external)
 - ✓ Motor control circuits
 - ✓ Load circuits leaving the equipment (external)
 - ✓ HVACR equipment: heating, ventilation, air conditioning, refrigeration (internal/external)
 - ✓ PLC I/O points
 - ✓ Power supplies
 - ✓ Control instrumentation
 - ✓ Relays
 - ✓ UPS
 - ✓ Power conditioners

Miniature Circuit Breakers

UL 489 National and International Standards

Certifications

UL 489 File Number E355392 / CSA C22.2 No. 5-16 / IEC 60947-2

- Certified for Canada according to Canadian Standards Association CSA C22.2 No. 5-16 standard for branch circuit protection.
- UL 489 file number E355392 standard for connection terminals which allows the user to apply field wiring directly to the breaker.
- UL 486 standard for connection terminals which allows the user to apply field wiring directly to the breaker.
- IEC 60947-2 standard for industrial applications of circuit protection.



RoHS

- These devices are RoHS compliant.



Breakers have UL 486 rated connectors which means the breakers can be wired directly to the load without the need for terminal strips.

Miniature Circuit Breakers

UL 489 Product Selection Guide

Label

These branch circuit breakers are available in two terminal configurations: standard box terminals that accept multiple conductors and ring-tongue terminals. All breakers mount on standard 35 mm DIN rail, while the B1NQ also has flush and surface mounting options with the use of additional mounting clips. Bus connectors and feeder terminal facilitate mounting and wiring of multiple miniature circuit breaker arrays in control panel assemblies. Breakers can also be reverse feed if needed.

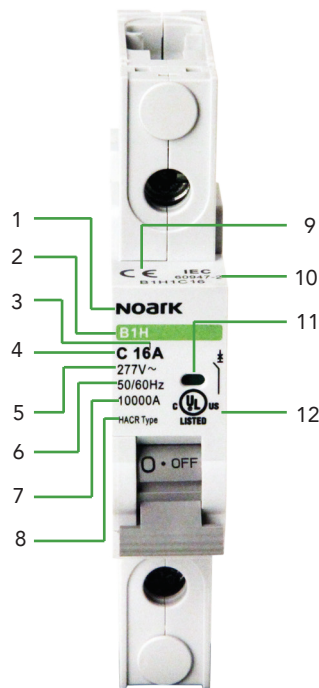

1. Brand
2. Product Type
3. Rated Current
4. Tripping Curve
5. Rated Voltage
6. Frequency
7. Interrupting Rating
8. Utility Type
9. CE Mark
10. IEC Standard
11. Breaker Status Indicator
12. UL Listed Mark

A

Product Selection Guide

B1	N	1	C	20	R
NOARK Ex9 Series - B1	Standard	Pole	Trip Curve	Rated Current	Terminal Option
H: 480Y/277 Vac UL 489 Listed	1: 1 Pole	B: 3~5 In	B1H: 0.5~32 A	Blank: Box Lugs are Standard	
N: 240 Vac; 60/125 Vdc UL 489 Listed	2: 2 Poles	C: 5~10 In 7~15 In (B1D Only)	B1N: 0.5~63 A	R: Ring Tongue Terminal	
NQ: 120/240 Vac (1 & 2 Pole Only) UL 489 Listed	3: 3 Poles	D: 10~20 In 12~22 In (B1D Only)	B1NQ: 0.5~63 A	T: Quick Connection Terminal, Load Side (B1NQ 1 & 2 Pole Only)	
D: 125 Vdc (1P)/250 Vdc (2P) UL 489 Listed			B1D: 0.5~63 A		

Miniature Circuit Breakers

B1H UL 489 480Y/277 Vac 10 kA

Certifications
IEC/EN 60947-2



Rated Amperage (A)	1 Pole - 277 Vac		2 Poles - 480Y/277 Vac		3 Poles - 480Y/277 Vac		
	Product	Part Number	Product	Part Number	Product	Part Number	
B Curve (3~5 In)	0.5	B1H1B0.5	1000723	B1H2B0.5	1000765	B1H3B0.5	1000807
	1	B1H1B1	1000724	B1H2B1	1000766	B1H3B1	1000808
	1.6	B1H1B1.6	1000725	B1H2B1.6	1000767	B1H3B1.6	1000809
	2	B1H1B2	1000726	B1H2B2	1000768	B1H3B2	1000810
	3	B1H1B3	1000727	B1H2B3	1000769	B1H3B3	1000811
	4	B1H1B4	1000728	B1H2B4	1000770	B1H3B4	1000812
	5	B1H1B5	1000729	B1H2B5	1000771	B1H3B5	1000813
	6	B1H1B6	1000730	B1H2B6	1000772	B1H3B6	1000814
	7	B1H1B7	1002104	B1H2B7	1002107	B1H3B7	1002110
	8	B1H1B8	1000731	B1H2B8	1000773	B1H3B8	1000815
	10	B1H1B10	1000732	B1H2B10	1000774	B1H3B10	1000816
	13	B1H1B13	1000733	B1H2B13	1000775	B1H3B13	1000817
	15	B1H1B15	1000734	B1H2B15	1000776	B1H3B15	1000818
	16	B1H1B16	1000735	B1H2B16	1000777	B1H3B16	1000819
	20	B1H1B20	1000736	B1H2B20	1000778	B1H3B20	1000820
	25	B1H1B25	1000975	B1H2B25	1000984	B1H3B25	1000993
30	B1H1B30	1000976	B1H2B30	1000985	B1H3B30	1000994	
32	B1H1B32	1000977	B1H2B32	1000986	B1H3B32	1000995	
C Curve (5~10 In)	0.5	B1H1C0.5	1000737	B1H2C0.5	1000779	B1H3C0.5	1000821
	1	B1H1C1	1000738	B1H2C1	1000780	B1H3C1	1000822
	1.6	B1H1C1.6	1000739	B1H2C1.6	1000781	B1H3C1.6	1000823
	2	B1H1C2	1000740	B1H2C2	1000782	B1H3C2	1000824
	3	B1H1C3	1000741	B1H2C3	1000783	B1H3C3	1000825
	4	B1H1C4	1000742	B1H2C4	1000784	B1H3C4	1000826
	5	B1H1C5	1000743	B1H2C5	1000785	B1H3C5	1000827
	6	B1H1C6	1000744	B1H2C6	1000786	B1H3C6	1000828
	7	B1H1C7	1002105	B1H2C7	1002108	B1H3C7	1002111
	8	B1H1C8	1000745	B1H2C8	1000787	B1H3C8	1000829
	10	B1H1C10	1000746	B1H2C10	1000788	B1H3C10	1000830
	13	B1H1C13	1000747	B1H2C13	1000789	B1H3C13	1000831
	15	B1H1C15	1000748	B1H2C15	1000790	B1H3C15	1000832
	16	B1H1C16	1000749	B1H2C16	1000791	B1H3C16	1000833
	20	B1H1C20	1000750	B1H2C20	1000792	B1H3C20	1000834
	25	B1H1C25	1000978	B1H2C25	1000987	B1H3C25	1000996
30	B1H1C30	1000979	B1H2C30	1000988	B1H3C30	1000997	
32	B1H1C32	1000980	B1H2C32	1000989	B1H3C32	1000998	

SpecificationsA25 to A27
Wiring DiagramA27

Trip CurveA28 to A29
DimensionsA29 to A32

AccessoriesA33 to A41

Miniature Circuit Breakers

B1H UL 489 480Y/277 Vac 10 kA



Rated Amperage (A)	1 Pole - 277 Vac		2 Poles - 480Y/277 Vac		3 Poles - 480Y/277 Vac		
	Product	Part Number	Product	Part Number	Product	Part Number	
D Curve (10~20 In)	0.5	B1H1D0.5	1000751	B1H2D0.5	1000793	B1H3D0.5	1000835
	1	B1H1D1	1000752	B1H2D1	1000794	B1H3D1	1000836
	1.6	B1H1D1.6	1000753	B1H2D1.6	1000795	B1H3D1.6	1000837
	2	B1H1D2	1000754	B1H2D2	1000796	B1H3D2	1000838
	3	B1H1D3	1000755	B1H2D3	1000797	B1H3D3	1000839
	4	B1H1D4	1000756	B1H2D4	1000798	B1H3D4	1000840
	5	B1H1D5	1000757	B1H2D5	1000799	B1H3D5	1000841
	6	B1H1D6	1000758	B1H2D6	1000800	B1H3D6	1000842
	7	B1H1D7	1002106	B1H2D7	1002109	B1H3D7	1002112
	8	B1H1D8	1000759	B1H2D8	1000801	B1H3D8	1000843
	10	B1H1D10	1000760	B1H2D10	1000802	B1H3D10	1000844
	13	B1H1D13	1000761	B1H2D13	1000803	B1H3D13	1000845
	15	B1H1D15	1000762	B1H2D15	1000804	B1H3D15	1000846
	16	B1H1D16	1000763	B1H2D16	1000805	B1H3D16	1000847
	20	B1H1D20	1000764	B1H2D20	1000806	B1H3D20	1000848
	25	B1H1D25	1000981	B1H2D25	1000990	B1H3D25	1000999
30	B1H1D30	1000982	B1H2D30	1000991	B1H3D30	1001000	
32	B1H1D32	1000983	B1H2D32	1000992	B1H3D32	1001001	

A

Specifications	A25 to A27	Trip Curve	A28 to A29	Accessories	A33 to A41
Wiring Diagram	A27	Dimensions	A29 to A32		

Miniature Circuit Breakers

B1H UL 489 480Y/277 Vac 10 kA - Ring Tongue Terminal

Certifications
IEC/EN 60947-2



Rated Amperage (A)	1 Pole - 277 Vac		2 Poles - 480Y/277 Vac		3 Poles - 480Y/277 Vac		
	Product	Part Number	Product	Part Number	Product	Part Number	
B Curve (3~5 In)	0.5	B1H1B0.5R	1000849	B1H2B0.5R	1000891	B1H3B0.5R	1000933
	1	B1H1B1R	1000850	B1H2B1R	1000892	B1H3B1R	1000934
	1.6	B1H1B1.6R	1000851	B1H2B1.6R	1000893	B1H3B1.6R	1000935
	2	B1H1B2R	1000852	B1H2B2R	1000894	B1H3B2R	1000936
	3	B1H1B3R	1000853	B1H2B3R	1000895	B1H3B3R	1000937
	4	B1H1B4R	1000854	B1H2B4R	1000896	B1H3B4R	1000938
	5	B1H1B5R	1000855	B1H2B5R	1000897	B1H3B5R	1000939
	6	B1H1B6R	1000856	B1H2B6R	1000898	B1H3B6R	1000940
	7	B1H1B7R	1002113	B1H2B7R	1002116	B1H3B7R	1002119
	8	B1H1B8R	1000857	B1H2B8R	1000899	B1H3B8R	1000941
	10	B1H1B10R	1000858	B1H2B10R	1000900	B1H3B10R	1000942
	13	B1H1B13R	1000859	B1H2B13R	1000901	B1H3B13R	1000943
	15	B1H1B15R	1000860	B1H2B15R	1000902	B1H3B15R	1000944
	16	B1H1B16R	1000861	B1H2B16R	1000903	B1H3B16R	1000945
	20	B1H1B20R	1000862	B1H2B20R	1000904	B1H3B20R	1000946
	25	B1H1B25R	1001002	B1H2B25R	1001011	B1H2B25R	1001020
30	B1H1B30R	1001003	B1H2B30R	1001012	B1H2B30R	1001021	
32	B1H1B32R	1001004	B1H2B32R	1001013	B1H2B32R	1001022	
C Curve (5~10 In)	0.5	B1H1C0.5R	1000863	B1H2C0.5R	1000905	B1H3C0.5R	1000947
	1	B1H1C1R	1000864	B1H2C1R	1000906	B1H3C1R	1000948
	1.6	B1H1C1.6R	1000865	B1H2C1.6R	1000907	B1H3C1.6R	1000949
	2	B1H1C2R	1000866	B1H2C2R	1000908	B1H3C2R	1000950
	3	B1H1C3R	1000867	B1H2C3R	1000909	B1H3C3R	1000951
	4	B1H1C4R	1000868	B1H2C4R	1000910	B1H3C4R	1000952
	5	B1H1C5R	1000869	B1H2C5R	1000911	B1H3C5R	1000953
	6	B1H1C6R	1000870	B1H2C6R	1000912	B1H3C6R	1000954
	7	B1H1C7R	1002114	B1H2C7R	1002117	B1H3C7R	1002120
	8	B1H1C8R	1000871	B1H2C8R	1000913	B1H3C8R	1000955
	10	B1H1C10R	1000872	B1H2C10R	1000914	B1H3C10R	1000956
	13	B1H1C13R	1000873	B1H2C13R	1000915	B1H3C13R	1000957
	15	B1H1C15R	1000874	B1H2C15R	1000916	B1H3C15R	1000958
	16	B1H1C16R	1000875	B1H2C16R	1000917	B1H3C16R	1000959
	20	B1H1C20R	1000876	B1H2C20R	1000918	B1H3C20R	1000960
	25	B1H1C25R	1001005	B1H2C25R	1001014	B1H3C25R	1001023
30	B1H1C30R	1001006	B1H2C30R	1001015	B1H3C30R	1001024	
32	B1H1C32R	1001007	B1H2C32R	1001016	B1H3C32R	1001025	

Specifications	A25 to A27	Trip Curve	A28 to A29	Accessories	A33 to A41
Wiring Diagram	A27	Dimensions	A29 to A32		

Miniature Circuit Breakers

B1H UL 489 480Y/277 Vac 10 kA - Ring Tongue Terminal

Certifications
IEC/EN 60947-2





Rated Amperage (A)	1 Pole - 277 Vac		2 Poles - 480Y/277 Vac		3 Poles - 480Y/277 Vac		
	Product	Part Number	Product	Part Number	Product	Part Number	
D Curve (10~20 In)	0.5	B1H1D0.5R	1000877	B1H2D0.5R	1000919	B1H3D0.5R	1000961
	1	B1H1D1R	1000878	B1H2D1R	1000920	B1H3D1R	1000962
	1.6	B1H1D1.6R	1000879	B1H2D1.6R	1000921	B1H3D1.6R	1000963
	2	B1H1D2R	1000880	B1H2D2R	1000922	B1H3D2R	1000964
	3	B1H1D3R	1000881	B1H2D3R	1000923	B1H3D3R	1000965
	4	B1H1D4R	1000882	B1H2D4R	1000924	B1H3D4R	1000966
	5	B1H1D5R	1000883	B1H2D5R	1000925	B1H3D5R	1000967
	6	B1H1D6R	1000884	B1H2D6R	1000926	B1H3D6R	1000968
	7	B1H1D7R	1002115	B1H2D7R	1002118	B1H3D7R	1002121
	8	B1H1D8R	1000885	B1H2D8R	1000927	B1H3D8R	1000969
	10	B1H1D10R	1000886	B1H2D10R	1000928	B1H3D10R	1000970
	13	B1H1D13R	1000887	B1H2D13R	1000929	B1H3D13R	1000971
	15	B1H1D15R	1000888	B1H2D15R	1000930	B1H3D15R	1000972
	16	B1H1D16R	1000889	B1H2D16R	1000931	B1H3D16R	1000973
20	B1H1D20R	1000890	B1H2D20R	1000932	B1H3D20R	1000974	
25	B1H1D25R	1001008	B1H2D25R	1001017	B1H3D25R	1002040	
30	B1H1D30R	1001009	B1H2D30R	1001018	B1H3D30R	1002041	
32	B1H1D32R	1001010	B1H2D32R	1001019	B1H3D32R	1002042	

A

Specifications	A25 to A27	Trip Curve	A28 to A29	Accessories	A33 to A41
Wiring Diagram	A27	Dimensions	A29 to A32		

Miniature Circuit Breakers

B1N UL 489 240 Vac; 60/125 Vdc 10 kA

Certifications
IEC/EN 60947-2



Rated Amperage (A)	1 Pole - 240 Vac / 60 Vdc		2 Poles - 240 Vac / 125 Vdc		3 Poles - 240 Vac		
	Product	Part Number	Product	Part Number	Product	Part Number	
B Curve (3~5 In)	0.5	B1N1B0.5	1000000	B1N2B0.5	1000066	B1N3B0.5	1000132
	1	B1N1B1	1000001	B1N2B1	1000067	B1N3B1	1000133
	1.6	B1N1B1.6	1000002	B1N2B1.6	1000068	B1N3B1.6	1000134
	2	B1N1B2	1000003	B1N2B2	1000069	B1N3B2	1000135
	3	B1N1B3	1000004	B1N2B3	1000070	B1N3B3	1000136
	4	B1N1B4	1000005	B1N2B4	1000071	B1N3B4	1000137
	5	B1N1B5	1000006	B1N2B5	1000072	B1N3B5	1000138
	6	B1N1B6	1000007	B1N2B6	1000073	B1N3B6	1000139
	7	B1N1B7	1002122	B1N2B7	1002125	B1N3B7	1002128
	8	B1N1B8	1000008	B1N2B8	1000074	B1N3B8	1000140
	10	B1N1B10	1000009	B1N2B10	1000075	B1N3B10	1000141
	13	B1N1B13	1000010	B1N2B13	1000076	B1N3B13	1000142
	15	B1N1B15	1000011	B1N2B15	1000077	B1N3B15	1000143
	16	B1N1B16	1000012	B1N2B16	1000078	B1N3B16	1000144
	20	B1N1B20	1000013	B1N2B20	1000079	B1N3B20	1000145
	25	B1N1B25	1000014	B1N2B25	1000080	B1N3B25	1000146
	30	B1N1B30	1000015	B1N2B30	1000081	B1N3B30	1000147
	32	B1N1B32	1000016	B1N2B32	1000082	B1N3B32	1000148
	35	B1N1B35	1000017	B1N2B35	1000083	B1N3B35	1000149
40	B1N1B40	1000018	B1N2B40	1000084	B1N3B40	1000150	
50	B1N1B50	1000019	B1N2B50	1000085	B1N3B50	1000151	
60	B1N1B60	1000020	B1N2B60	1000086	B1N3B60	1000152	
63	B1N1B63	1000021	B1N2B63	1000087	B1N3B63	1000153	
C Curve (5~10 In)	0.5	B1N1C0.5	1000022	B1N2C0.5	1000088	B1N3C0.5	1000154
	1	B1N1C1	1000023	B1N2C1	1000089	B1N3C1	1000155
	1.6	B1N1C1.6	1000024	B1N2C1.6	1000090	B1N3C1.6	1000156
	2	B1N1C2	1000025	B1N2C2	1000091	B1N3C2	1000157
	3	B1N1C3	1000026	B1N2C3	1000092	B1N3C3	1000158
	4	B1N1C4	1000027	B1N2C4	1000093	B1N3C4	1000159
	5	B1N1C5	1000028	B1N2C5	1000094	B1N3C5	1000160
	6	B1N1C6	1000029	B1N2C6	1000095	B1N3C6	1000161
	7	B1N1C7	1002123	B1N2C7	1002126	B1N3C7	1002129
	8	B1N1C8	1000030	B1N2C8	1000096	B1N3C8	1000162
	10	B1N1C10	1000031	B1N2C10	1000097	B1N3C10	1000163
	13	B1N1C13	1000032	B1N2C13	1000098	B1N3C13	1000164
	15	B1N1C15	1000033	B1N2C15	1000099	B1N3C15	1000165
	16	B1N1C16	1000034	B1N2C16	1000100	B1N3C16	1000166
	20	B1N1C20	1000035	B1N2C20	1000101	B1N3C20	1000167
	25	B1N1C25	1000036	B1N2C25	1000102	B1N3C25	1000168
	30	B1N1C30	1000037	B1N2C30	1000103	B1N3C30	1000169
	32	B1N1C32	1000038	B1N2C32	1000104	B1N3C32	1000170
	35	B1N1C35	1000039	B1N2C35	1000105	B1N3C35	1000171
40	B1N1C40	1000040	B1N2C40	1000106	B1N3C40	1000172	
50	B1N1C50	1000041	B1N2C50	1000107	B1N3C50	1000173	
60	B1N1C60	1000042	B1N2C60	1000108	B1N3C60	1000174	
63	B1N1C63	1000043	B1N2C63	1000109	B1N3C63	1000175	

Miniature Circuit Breakers

B1N UL 489 240 Vac; 60/125 Vdc 10 kA

Certifications
IEC/EN 60947-2





Rated Amperage (A)	1 Pole - 240 Vac / 60 Vdc		2 Poles - 240 Vac / 125 Vdc		3 Poles - 240 Vac		
	Product	Part Number	Product	Part Number	Product	Part Number	
D Curve (10~20 In)	0.5	B1N1D0.5	1000044	B1N2D0.5	1000110	B1N3D0.5	1000176
	1	B1N1D1	1000045	B1N2D1	1000111	B1N3D1	1000177
	1.6	B1N1D1.6	1000046	B1N2D1.6	1000112	B1N3D1.6	1000178
	2	B1N1D2	1000047	B1N2D2	1000113	B1N3D2	1000179
	3	B1N1D3	1000048	B1N2D3	1000114	B1N3D3	1000180
	4	B1N1D4	1000049	B1N2D4	1000115	B1N3D4	1000181
	5	B1N1D5	1000050	B1N2D5	1000116	B1N3D5	1000182
	6	B1N1D6	1000051	B1N2D6	1000117	B1N3D6	1000183
	7	B1N1D7	1002124	B1N2D7	1002127	B1N3D7	1002130
	8	B1N1D8	1000052	B1N2D8	1000118	B1N3D8	1000184
	10	B1N1D10	1000053	B1N2D10	1000119	B1N3D10	1000185
	13	B1N1D13	1000054	B1N2D13	1000120	B1N3D13	1000186
	15	B1N1D15	1000055	B1N2D15	1000121	B1N3D15	1000187
	16	B1N1D16	1000056	B1N2D16	1000122	B1N3D16	1000188
	20	B1N1D20	1000057	B1N2D20	1000123	B1N3D20	1000189
	25	B1N1D25	1000058	B1N2D25	1000124	B1N3D25	1000190
	30	B1N1D30	1000059	B1N2D30	1000125	B1N3D30	1000191
	32	B1N1D32	1000060	B1N2D32	1000126	B1N3D32	1000192
	35	B1N1D35	1000061	B1N2D35	1000127	B1N3D35	1000193
	40	B1N1D40	1000062	B1N2D40	1000128	B1N3D40	1000194
50	B1N1D50	1000063	B1N2D50	1000129	B1N3D50	1000195	
60	B1N1D60	1000064	B1N2D60	1000130	B1N3D60	1000196	
63	B1N1D63	1000065	B1N2D63	1000131	B1N3D63	1000197	

A

Specifications	A25 to A27	Trip Curve	A28 to A29	Accessories	A33 to A41
Wiring Diagram	A27	Dimensions	A29 to A32		

Miniature Circuit Breakers

B1N UL 489 240 Vac; 60/125 Vdc 10 kA - Ring Tongue Terminal

Certifications
IEC/EN 60947-2



Rated Amperage (A)	1 Pole - 240 Vac / 60 Vdc		2 Poles - 240 Vac / 125 Vdc		3 Poles - 240 Vac		
	Product	Part Number	Product	Part Number	Product	Part Number	
B Curve (3~5 In)	0.5	B1N1B0.5R	1000198	B1N2B0.5R	1000255	B1N3B0.5R	1000312
	1	B1N1B1R	1000199	B1N2B1R	1000256	B1N3B1R	1000313
	1.6	B1N1B1.6R	1000200	B1N2B1.6R	1000257	B1N3B1.6R	1000314
	2	B1N1B2R	1000201	B1N2B2R	1000258	B1N3B2R	1000315
	3	B1N1B3R	1000202	B1N2B3R	1000259	B1N3B3R	1000316
	4	B1N1B4R	1000203	B1N2B4R	1000260	B1N3B4R	1000317
	5	B1N1B5R	1000204	B1N2B5R	1000261	B1N3B5R	1000318
	6	B1N1B6R	1000205	B1N2B6R	1000262	B1N3B6R	1000319
	7	B1N1B7R	1002131	B1N2B7R	1002134	B1N3B7R	1002137
	8	B1N1B8R	1000206	B1N2B8R	1000263	B1N3B8R	1000320
	10	B1N1B10R	1000207	B1N2B10R	1000264	B1N3B10R	1000321
	13	B1N1B13R	1000208	B1N2B13R	1000265	B1N3B13R	1000322
	15	B1N1B15R	1000209	B1N2B15R	1000266	B1N3B15R	1000323
	16	B1N1B16R	1000210	B1N2B16R	1000267	B1N3B16R	1000324
	20	B1N1B20R	1000211	B1N2B20R	1000268	B1N3B20R	1000325
	25	B1N1B25R	1000212	B1N2B25R	1000269	B1N3B25R	1000326
30	B1N1B30R	1000213	B1N2B30R	1000270	B1N3B30R	1000327	
32	B1N1B32R	1000214	B1N2B32R	1000271	B1N3B32R	1000328	
35	B1N1B35R	1000215	B1N2B35R	1000272	B1N3B35R	1000329	
40	B1N1B40R	1000216	B1N2B40R	1000273	B1N3B40R	1000330	
C Curve (5~10 In)	0.5	B1N1C0.5R	1000217	B1N2C0.5R	1000274	B1N3C0.5R	1000331
	1	B1N1C1R	1000218	B1N2C1R	1000275	B1N3C1R	1000332
	1.6	B1N1C1.6R	1000219	B1N2C1.6R	1000276	B1N3C1.6R	1000333
	2	B1N1C2R	1000220	B1N2C2R	1000277	B1N3C2R	1000334
	3	B1N1C3R	1000221	B1N2C3R	1000278	B1N3C3R	1000335
	4	B1N1C4R	1000222	B1N2C4R	1000279	B1N3C4R	1000336
	5	B1N1C5R	1000223	B1N2C5R	1000280	B1N3C5R	1000337
	6	B1N1C6R	1000224	B1N2C6R	1000281	B1N3C6R	1000338
	7	B1N1C7R	1002132	B1N2C7R	1002135	B1N3C7R	1002138
	8	B1N1C8R	1000225	B1N2C8R	1000282	B1N3C8R	1000339
	10	B1N1C10R	1000226	B1N2C10R	1000283	B1N3C10R	1000340
	13	B1N1C13R	1000227	B1N2C13R	1000284	B1N3C13R	1000341
	15	B1N1C15R	1000228	B1N2C15R	1000285	B1N3C15R	1000342
	16	B1N1C16R	1000229	B1N2C16R	1000286	B1N3C16R	1000343
	20	B1N1C20R	1000230	B1N2C20R	1000287	B1N3C20R	1000344
	25	B1N1C25R	1000231	B1N2C25R	1000288	B1N3C25R	1000345
30	B1N1C30R	1000232	B1N2C30R	1000289	B1N3C30R	1000346	
32	B1N1C32R	1000233	B1N2C32R	1000290	B1N3C32R	1000347	
35	B1N1C35R	1000234	B1N2C35R	1000291	B1N3C35R	1000348	
40	B1N1C40R	1000235	B1N2C40R	1000292	B1N3C40R	1000349	

SpecificationsA25 to A27
Wiring DiagramA27

Trip CurveA28 to A29
DimensionsA29 to A32

AccessoriesA33 to A41

Miniature Circuit Breakers

B1N UL 489 240 Vac; 60/125 Vdc 10 kA - Ring Tongue Terminal

Certifications
IEC/EN 60947-2





Rated Amperage (A)	1 Pole - 240 Vac / 60 Vdc		2 Poles - 240 Vac / 125 Vdc		3 Poles - 240 Vac		
	Product	Part Number	Product	Part Number	Product	Part Number	
D Curve (10~20 In)	0.5	B1N1D0.5R	1000236	B1N2D0.5R	1000293	B1N3D0.5R	1000350
	1	B1N1D1R	1000237	B1N2D1R	1000294	B1N3D1R	1000351
	1.6	B1N1D1.6R	1000238	B1N2D1.6R	1000295	B1N3D1.6R	1000352
	2	B1N1D2R	1000239	B1N2D2R	1000296	B1N3D2R	1000353
	3	B1N1D3R	1000240	B1N2D3R	1000297	B1N3D3R	1000354
	4	B1N1D4R	1000241	B1N2D4R	1000298	B1N3D4R	1000355
	5	B1N1D5R	1000242	B1N2D5R	1000299	B1N3D5R	1000356
	6	B1N1D6R	1000243	B1N2D6R	1000300	B1N3D6R	1000357
	7	B1N1D7R	1002133	B1N2D7R	1002136	B1N3D7R	1002139
	8	B1N1D8R	1000244	B1N2D8R	1000301	B1N3D8R	1000358
	10	B1N1D10R	1000245	B1N2D10R	1000302	B1N3D10R	1000359
	13	B1N1D13R	1000246	B1N2D13R	1000303	B1N3D13R	1000360
	15	B1N1D15R	1000247	B1N2D15R	1000304	B1N3D15R	1000361
	16	B1N1D16R	1000248	B1N2D16R	1000305	B1N3D16R	1000362
	20	B1N1D20R	1000249	B1N2D20R	1000306	B1N3D20R	1000363
	25	B1N1D25R	1000250	B1N2D25R	1000307	B1N3D25R	1000364
	30	B1N1D30R	1000251	B1N2D30R	1000308	B1N3D30R	1000365
32	B1N1D32R	1000252	B1N2D32R	1000309	B1N3D32R	1000366	
35	B1N1D35R	1000253	B1N2D35R	1000310	B1N3D35R	1000367	
40	B1N1D40R	1000254	B1N2D40R	1000311	B1N3D40R	1000368	

A

Specifications	A25 to A27	Trip Curve	A28 to A29	Accessories	A33 to A41
Wiring Diagram	A27	Dimensions	A29 to A32		

Miniature Circuit Breakers

B1NQ UL 489 120/240 Vac 10 kA



1 Pole



2 Poles

Rated Amperage (A)	1 Pole			2 Poles	
	Product	Part Number		Product	Part Number
B Curve (3~5 In)	0.5	B1NQ1B0.5	1001716	B1NQ2B0.5	1001739
	1	B1NQ1B1	1001717	B1NQ2B1	1001740
	1.6	B1NQ1B1.6	1001718	B1NQ2B1.6	1001741
	2	B1NQ1B2	1001719	B1NQ2B2	1001742
	3	B1NQ1B3	1001720	B1NQ2B3	1001743
	4	B1NQ1B4	1001721	B1NQ2B4	1001744
	5	B1NQ1B5	1001722	B1NQ2B5	1001745
	6	B1NQ1B6	1001723	B1NQ2B6	1001746
	8	B1NQ1B8	1001724	B1NQ2B8	1001747
	10	B1NQ1B10	1001725	B1NQ2B10	1001748
	13	B1NQ1B13	1001726	B1NQ2B13	1001749
	15	B1NQ1B15	1001727	B1NQ2B15	1001750
	16	B1NQ1B16	1001728	B1NQ2B16	1001751
	20	B1NQ1B20	1001729	B1NQ2B20	1001752
	25	B1NQ1B25	1001730	B1NQ2B25	1001753
	30	B1NQ1B30	1001731	B1NQ2B30	1001754
	32	B1NQ1B32	1001732	B1NQ2B32	1001755
	35	B1NQ1B35	1001733	B1NQ2B35	1001756
	40	B1NQ1B40	1001734	B1NQ2B40	1001757
	45	B1NQ1B45	1001735	B1NQ2B45	1001758
50	B1NQ1B50	1001736	B1NQ2B50	1001759	
60	B1NQ1B60	1001737	B1NQ2B60	1001760	
63	B1NQ1B63	1001738	B1NQ2B63	1001761	

*Standard mount is DIN rail. Order FMC31N clips for flush mount; order SMC31N for surface mount.

Specifications	A25 to A27	Trip Curve	A28 to A29	Accessories	A33 to A41
Wiring Diagram	A27	Dimensions	A29 to A32		

Miniature Circuit Breakers

B1NQ UL 489 120/240 Vac 10 kA

Certifications
IEC/EN 60947-2





1 Pole



2 Poles

Rated Amperage (A)	1 Pole		2 Poles	
	Product	Part Number	Product	Part Number
0.5	B1NQ1C0.5	1001624	B1NQ2C0.5	1001647
1	B1NQ1C1	1001625	B1NQ2C1	1001648
1.6	B1NQ1C1.6	1001626	B1NQ2C1.6	1001649
2	B1NQ1C2	1001627	B1NQ2C2	1001650
3	B1NQ1C3	1001628	B1NQ2C3	1001651
4	B1NQ1C4	1001629	B1NQ2C4	1001652
5	B1NQ1C5	1001630	B1NQ2C5	1001653
6	B1NQ1C6	1001631	B1NQ2C6	1001654
8	B1NQ1C8	1001632	B1NQ2C8	1001655
10	B1NQ1C10	1001633	B1NQ2C10	1001656
13	B1NQ1C13	1001634	B1NQ2C13	1001657
15	B1NQ1C15	1001635	B1NQ2C15	1001658
16	B1NQ1C16	1001636	B1NQ2C16	1001659
20	B1NQ1C20	1001637	B1NQ2C20	1001660
25	B1NQ1C25	1001638	B1NQ2C25	1001661
30	B1NQ1C30	1001639	B1NQ2C30	1001662
32	B1NQ1C32	1001640	B1NQ2C32	1001663
35	B1NQ1C35	1001641	B1NQ2C35	1001664
40	B1NQ1C40	1001642	B1NQ2C40	1001665
45	B1NQ1C45	1001643	B1NQ2C45	1001666
50	B1NQ1C50	1001644	B1NQ2C50	1001667
60	B1NQ1C60	1001645	B1NQ2C60	1001668
63	B1NQ1C63	1001646	B1NQ2C63	1001669

A

*Standard mount is DIN rail. Order FMC31N clips for flush mount; order SMC31N for surface mount.

Specifications	A25 to A27	Trip Curve	A28 to A29	Accessories	A33 to A41
Wiring Diagram	A27	Dimensions	A29 to A32		

Miniature Circuit Breakers

B1NQ UL 489 120/240 Vac 10 kA

Certifications
IEC/EN 60947-2



1 Pole



2 Poles

Rated Amperage (A)	1 Pole		2 Poles	
	Product	Part Number	Product	Part Number
0.5	B1NQ1D0.5	1001280	B1NQ2D0.5	1001303
1	B1NQ1D1	1001281	B1NQ2D1	1001304
1.6	B1NQ1D1.6	1001282	B1NQ2D1.6	1001305
2	B1NQ1D2	1001283	B1NQ2D2	1001306
3	B1NQ1D3	1001284	B1NQ2D3	1001307
4	B1NQ1D4	1001285	B1NQ2D4	1001308
5	B1NQ1D5	1001286	B1NQ2D5	1001309
6	B1NQ1D6	1001287	B1NQ2D6	1001310
8	B1NQ1D8	1001288	B1NQ2D8	1001311
10	B1NQ1D10	1001289	B1NQ2D10	1001312
13	B1NQ1D13	1001290	B1NQ2D13	1001313
15	B1NQ1D15	1001291	B1NQ2D15	1001314
16	B1NQ1D16	1001292	B1NQ2D16	1001315
20	B1NQ1D20	1001293	B1NQ2D20	1001316
25	B1NQ1D25	1001294	B1NQ2D25	1001317
30	B1NQ1D30	1001295	B1NQ2D30	1001318
32	B1NQ1D32	1001296	B1NQ2D32	1001319
35	B1NQ1D35	1001297	B1NQ2D35	1001320
40	B1NQ1D40	1001298	B1NQ2D40	1001321
45	B1NQ1D45	1001299	B1NQ2D45	1001322
50	B1NQ1D50	1001300	B1NQ2D50	1001323
60	B1NQ1D60	1001301	B1NQ2D60	1001324
63	B1NQ1D63	1001302	B1NQ2D63	1001325

*Standard mount is DIN rail. Order FMC31N clips for flush mount; order SMC31N for surface mount.

Specifications	A25 to A27	Trip Curve	A28 to A29	Accessories	A33 to A41
Wiring Diagram	A27	Dimensions	A29 to A32		

Miniature Circuit Breakers

B1NQ UL 489 120/240 Vac 10 kA - Quick Connection, Load Side

Certifications
IEC/EN 60947-2





1 Pole



2 Poles

Rated Amperage (A)	1 Pole		2 Poles		
	Product	Part Number	Product	Part Number	
B Curve (3~5 In)	0.5	B1NQ1B0.5T	1001762	B1NQ2B0.5T	1001785
	1	B1NQ1B1T	1001763	B1NQ2B1T	1001786
	1.6	B1NQ1B1.6T	1001764	B1NQ2B1.6T	1001787
	2	B1NQ1B2T	1001765	B1NQ2B2T	1001788
	3	B1NQ1B3T	1001766	B1NQ2B3T	1001789
	4	B1NQ1B4T	1001767	B1NQ2B4T	1001790
	5	B1NQ1B5T	1001768	B1NQ2B5T	1001791
	6	B1NQ1B6T	1001769	B1NQ2B6T	1001792
	8	B1NQ1B8T	1001770	B1NQ2B8T	1001793
	10	B1NQ1B10T	1001771	B1NQ2B10T	1001794
	13	B1NQ1B13T	1001772	B1NQ2B13T	1001795
	15	B1NQ1B15T	1001773	B1NQ2B15T	1001796
	16	B1NQ1B16T	1001774	B1NQ2B16T	1001797
	20	B1NQ1B20T	1001775	B1NQ2B20T	1001798
	25	B1NQ1B25T	1001776	B1NQ2B25T	1001799
	30	B1NQ1B30T	1001777	B1NQ2B30T	1001800
	32	B1NQ1B32T	1001778	B1NQ2B32T	1001801
	35	B1NQ1B35T	1001779	B1NQ2B35T	1001802
	40	B1NQ1B40T	1001780	B1NQ2B40T	1001803
	45	B1NQ1B45T	1001781	B1NQ2B45T	1001804
50	B1NQ1B50T	1001782	B1NQ2B50T	1001805	
60	B1NQ1B60T	1001783	B1NQ2B60T	1001806	
63	B1NQ1B63T	1001784	B1NQ2B63T	1001807	

A

*Standard mount is DIN rail. Order FMC31N clips for flush mount; order SMC31N for surface mount.

Specifications	A25 to A27	Trip Curve	A28 to A29	Accessories	A33 to A41
Wiring Diagram	A27	Dimensions	A29 to A32		

Miniature Circuit Breakers

B1NQ UL 489 120/240 Vac 10 kA - Quick Connection, Load Side



1 Pole



2 Poles

Rated Amperage (A)	1 Pole			2 Poles	
	Product	Part Number		Product	Part Number
0.5	B1NQ1C0.5T	1001670		B1NQ2C0.5T	1001693
1	B1NQ1C1T	1001671		B1NQ2C1T	1001694
1.6	B1NQ1C1.6T	1001672		B1NQ2C1.6T	1001695
2	B1NQ1C2T	1001673		B1NQ2C2T	1001696
3	B1NQ1C3T	1001674		B1NQ2C3T	1001697
4	B1NQ1C4T	1001675		B1NQ2C4T	1001698
5	B1NQ1C5T	1001676		B1NQ2C5T	1001699
6	B1NQ1C6T	1001677		B1NQ2C6T	1001700
8	B1NQ1C8T	1001678		B1NQ2C8T	1001701
10	B1NQ1C10T	1001679		B1NQ2C10T	1001702
13	B1NQ1C13T	1001680		B1NQ2C13T	1001703
15	B1NQ1C15T	1001681		B1NQ2C15T	1001704
16	B1NQ1C16T	1001682		B1NQ2C16T	1001705
20	B1NQ1C20T	1001683		B1NQ2C20T	1001706
25	B1NQ1C25T	1001684		B1NQ2C25T	1001707
30	B1NQ1C30T	1001685		B1NQ2C30T	1001708
32	B1NQ1C32T	1001686		B1NQ2C32T	1001709
35	B1NQ1C35T	1001687		B1NQ2C35T	1001710
40	B1NQ1C40T	1001688		B1NQ2C40T	1001711
45	B1NQ1C45T	1001689		B1NQ2C45T	1001712
50	B1NQ1C50T	1001690		B1NQ2C50T	1001713
60	B1NQ1C60T	1001691		B1NQ2C60T	1001714
63	B1NQ1C63T	1001692		B1NQ2C63T	1001715

C Curve (5~10 In)

*Standard mount is DIN rail. Order FMC31N clips for flush mount; order SMC31N for surface mount.

Specifications	A25 to A27	Trip Curve.....	A28 to A29	Accessories.....	A33 to A41
Wiring Diagram	A27	Dimensions.....	A29 to A32		

Miniature Circuit Breakers

B1NQ UL 489 120/240 Vac 10 kA - Quick Connection, Load Side

Certifications
IEC/EN 60947-2





1 Pole



2 Poles

Rated Amperage (A)	1 Pole		2 Poles		
	Product	Part Number	Product	Part Number	
D Curve (10~20 In)	0.5	B1NQ1D0.5T	1001326	B1NQ2D0.5T	1001349
	1	B1NQ1D1T	1001327	B1NQ2D1T	1001350
	1.6	B1NQ1D1.6T	1001328	B1NQ2D1.6T	1001351
	2	B1NQ1D2T	1001329	B1NQ2D2T	1001352
	3	B1NQ1D3T	1001330	B1NQ2D3T	1001353
	4	B1NQ1D4T	1001331	B1NQ2D4T	1001354
	5	B1NQ1D5T	1001332	B1NQ2D5T	1001355
	6	B1NQ1D6T	1001333	B1NQ2D6T	1001356
	8	B1NQ1D8T	1001334	B1NQ2D8T	1001357
	10	B1NQ1D10T	1001335	B1NQ2D10T	1001358
	13	B1NQ1D13T	1001336	B1NQ2D13T	1001359
	15	B1NQ1D15T	1001337	B1NQ2D15T	1001360
	16	B1NQ1D16T	1001338	B1NQ2D16T	1001361
	20	B1NQ1D20T	1001339	B1NQ2D20T	1001362
	25	B1NQ1D25T	1001340	B1NQ2D25T	1001363
	30	B1NQ1D30T	1001341	B1NQ2D30T	1001364
	32	B1NQ1D32T	1001342	B1NQ2D32T	1001365
	35	B1NQ1D35T	1001343	B1NQ2D35T	1001366
	40	B1NQ1D40T	1001344	B1NQ2D40T	1001367
	45	B1NQ1D45T	1001345	B1NQ2D45T	1001368
50	B1NQ1D50T	1001346	B1NQ2D50T	1001369	
60	B1NQ1D60T	1001347	B1NQ2D60T	1001370	
63	B1NQ1D63T	1001348	B1NQ2D63T	1001371	

A

*Standard mount is DIN rail. Order FMC31N clips for flush mount; order SMC31N for surface mount.

Specifications	A25 to A27	Trip Curve	A28 to A29	Accessories	A33 to A41
Wiring Diagram	A27	Dimensions	A29 to A32		

Miniature Circuit Breakers

B1D UL 489 125/250 Vdc 10 kA - Box Lugs

Certifications
IEC/EN 60947-2



Rated Amperage (A)	1 Pole		2 Poles		
	Product	Part Number	Product	Part Number	
C Curve (7~15 In)	0.5	B1D1C0.5	1002365	B1D2C0.5	1002411
	1	B1D1C1	1002366	B1D2C1	1002412
	1.6	B1D1C1.6	1002367	B1D2C1.6	1002413
	2	B1D1C2	1002368	B1D2C2	1002414
	3	B1D1C3	1002369	B1D2C3	1002415
	4	B1D1C4	1002370	B1D2C4	1002416
	5	B1D1C5	1002371	B1D2C5	1002417
	6	B1D1C6	1002372	B1D2C6	1002418
	7	B1D1C7	1002373	B1D2C7	1002419
	8	B1D1C8	1002374	B1D2C8	1002420
	10	B1D1C10	1002375	B1D2C10	1002421
	13	B1D1C13	1002376	B1D2C13	1002422
	15	B1D1C15	1002377	B1D2C15	1002423
	16	B1D1C16	1002378	B1D2C16	1002424
	20	B1D1C20	1002379	B1D2C20	1002425
	25	B1D1C25	1002380	B1D2C25	1002426
	30	B1D1C30	1002381	B1D2C30	1002427
	32	B1D1C32	1002382	B1D2C32	1002428
	35	B1D1C35	1002383	B1D2C35	1002429
	40	B1D1C40	1002384	B1D2C40	1002430
50	B1D1C50	1002385	B1D2C50	1002431	
60	B1D1C60	1002386	B1D2C60	1002432	
63	B1D1C63	1002387	B1D2C63	1002433	

SpecificationsA25 to A27
Wiring DiagramA27

Trip Curve.....A28 to A29
Dimensions.....A29 to A32

Accessories.....A33 to A41

Miniature Circuit Breakers

B1D UL 489 125/250 Vdc 10 kA - Box Lugs

Certifications
IEC/EN 60947-2



Rated Amperage (A)	1 Pole		2 Poles		
	Product	Part Number	Product	Part Number	
D Curve (12~22 In)	0.5	B1D1D0.5	1002388	B1D2D0.5	1002434
	1	B1D1D1	1002389	B1D2D1	1002435
	1.6	B1D1D1.6	1002390	B1D2D1.6	1002436
	2	B1D1D2	1002391	B1D2D2	1002437
	3	B1D1D3	1002392	B1D2D3	1002438
	4	B1D1D4	1002393	B1D2D4	1002439
	5	B1D1D5	1002394	B1D2D5	1002440
	6	B1D1D6	1002395	B1D2D6	1002441
	7	B1D1D7	1002396	B1D2D7	1002442
	8	B1D1D8	1002397	B1D2D8	1002443
	10	B1D1D10	1002398	B1D2D10	1002444
	13	B1D1D13	1002399	B1D2D13	1002445
	15	B1D1D15	1002400	B1D2D15	1002446
	16	B1D1D16	1002401	B1D2D16	1002447
	20	B1D1D20	1002402	B1D2D20	1002448
	25	B1D1D25	1002403	B1D2D25	1002449
	30	B1D1D30	1002404	B1D2D30	1002450
	32	B1D1D32	1002405	B1D2D32	1002451
	35	B1D1D35	1002406	B1D2D35	1002452
40	B1D1D40	1002407	B1D2D40	1002453	
50	B1D1D50	1002408	B1D2D50	1002454	
60	B1D1D60	1002409	B1D2D60	1002455	
63	B1D1D63	1002410	B1D2D63	1002456	

A

Specifications	A25 to A27	Trip Curve	A28 to A29	Accessories	A33 to A41
Wiring Diagram	A27	Dimensions	A29 to A32		

Miniature Circuit Breakers

B1D UL 489 125/250 Vac 10 kA - Ring Tongue Terminal

Certifications
IEC/EN 60947-2



Rated Amperage (A)	1 Pole		2 Poles		
	Product	Part Number	Product	Part Number	
C Curve (7 ~ 15 In)	0.5	B1D1C0.5R	1002457	B1D2C0.5R	1002497
	1	B1D1C1R	1002458	B1D2C1R	1002498
	1.6	B1D1C1.6R	1002459	B1D2C1.6R	1002499
	2	B1D1C2R	1002460	B1D2C2R	1002500
	3	B1D1C3R	1002461	B1D2C3R	1002501
	4	B1D1C4R	1002462	B1D2C4R	1002502
	5	B1D1C5R	1002463	B1D2C5R	1002503
	6	B1D1C6R	1002464	B1D2C6R	1002504
	7	B1D1C7R	1002465	B1D2C7R	1002505
	8	B1D1C8R	1002466	B1D2C8R	1002506
	10	B1D1C10R	1002467	B1D2C10R	1002507
	13	B1D1C13R	1002468	B1D2C13R	1002508
	15	B1D1C15R	1002469	B1D2C15R	1002509
	16	B1D1C16R	1002470	B1D2C16R	1002510
	20	B1D1C20R	1002471	B1D2C20R	1002511
	25	B1D1C25R	1002472	B1D2C25R	1002512
	30	B1D1C30R	1002473	B1D2C30R	1002513
	32	B1D1C32R	1002474	B1D2C32R	1002514
35	B1D1C35R	1002475	B1D2C35R	1002515	
40	B1D1C40R	1002476	B1D2C40R	1002516	

SpecificationsA25 to A27
Wiring DiagramA27

Trip Curve.....A28 to A29
Dimensions.....A29 to A32

Accessories.....A33 to A41

Miniature Circuit Breakers

B1D UL 489 125/250 Vac 10 kA - Ring Tongue Terminal

Certifications
 IEC/EN 60947-2
 



Rated Amperage (A)	1 Pole		2 Poles		
	Product	Part Number	Product	Part Number	
D Curve (12~22 In)	0.5	B1D1D0.5R	1002477	B1D2D0.5R	1002517
	1	B1D1D1R	1002478	B1D2D1R	1002518
	1.6	B1D1D1.6R	1002479	B1D2D1.6R	1002519
	2	B1D1D2R	1002480	B1D2D2R	1002520
	3	B1D1D3R	1002481	B1D2D3R	1002521
	4	B1D1D4R	1002482	B1D2D4R	1002522
	5	B1D1D5R	1002483	B1D2D5R	1002523
	6	B1D1D6R	1002484	B1D2D6R	1002524
	7	B1D1D7R	1002485	B1D2D7R	1002525
	8	B1D1D8R	1002486	B1D2D8R	1002526
	10	B1D1D10R	1002487	B1D2D10R	1002527
	13	B1D1D13R	1002488	B1D2D13R	1002528
	15	B1D1D15R	1002489	B1D2D15R	1002529
	16	B1D1D16R	1002490	B1D2D16R	1002530
	20	B1D1D20R	1002491	B1D2D20R	1002531
	25	B1D1D25R	1002492	B1D2D25R	1002532
	30	B1D1D30R	1002493	B1D2D30R	1002533
32	B1D1D32R	1002494	B1D2D32R	1002534	
35	B1D1D35R	1002495	B1D2D35R	1002535	
40	B1D1D40R	1002496	B1D2D40R	1002536	

A

Specifications	A25 to A27	Trip Curve	A28 to A29	Accessories	A33 to A41
Wiring Diagram	A27	Dimensions	A29 to A32		

Miniature Circuit Breakers

UL 489 Specifications

	B1H			B1N			B1NQ		B1D	
Conformed Standard	UL 489									
Number of Poles	1	2	3	1	2	3	1	2	1	2
Rated Operational Voltage (V)	480Y/277 Vac			240 Vac 60 Vdc	240 Vac 125 Vdc	240 Vac	120/240 Vac		125 Vdc	250 Vdc
Rated Frequency (Hz)	50/60									-
Rated Current (A)	0.5~32			0.5~63						
Instantaneous Tripping Type	B (3~5 In), C (5~10 In), D (10~20 In)								C (7~15 In), D (12~22 In)	
Interrupting (kA)	120 Vac	-	10	-	10	-	-	-	-	-
	240 Vac	10	-	10	-	-	-	-	-	-
	277 Vac	-	10	-	-	-	-	-	-	-
	480Y/277 Vac	-	-	-	-	-	-	-	-	-
	60 Vdc	-	-	10	10	-	-	-	10	-
	125 Vdc	-	-	-	-	-	-	-	-	10
	250 Vdc	-	-	-	-	-	-	-	-	10
Inverse Time-Delay Over-Current Release Type	Thermal-Magnetic									
Service Life	Electrical			10,000				6,000		
	Mechanical			20,000				10,000		
Protection Degree	IP 20									
Wire AWG (mm ²)	Single Wire			18~4 (0.75~25)						
	Two Wires			18~6 (0.75~16 / 14~10 (2.5~6)						
Operating Temperature Range	-22 °F to 167 °F (-30 °C to +75 °C)									
Insulation Coordination	Rated Insulation Voltage (Vac)			500						
	Rated Impulse Withstand Voltage (kV)			6						
Pollution Degree	Class III									
Over Voltage Category	Class III									
Mounting	35 mm DIN rail / Flush and surface mount available on B1NQ with the use of additional mounting clips									
Altitude ft (m)	Does not exceed 6,561 (2,000)									
Atmospheric Conditions	At 68 °F (+20°C), the relative humidity does not exceed 90% At 104 °F (+40°C), the relative humidity does not exceed 50%									

Miniature Circuit Breakers

CE Specifications

		B1H			B1N			B1NQ		B1D	
Conformed Standard		IEC60947-2									
Number of Poles		1P	2P	3P	1P	2P	3P	1P	2P	1P	2P
Rated Operational Voltage (V)		AC240	AC415		AC240 /DC60	AC415 /DC125		AC240	AC415	DC125	DC250
Rated Frequency (Hz)		50/60									-
Rated Current (A)		0.5~32			0.5~63						
Instantaneous Tripping Type		B (3~5 In), C (5~10 In), D (10~20 In)								C (7~15 In), D (12~22 In)	
Ics (kA)	240VAC	7.5	-		7.5	-		7.5	-	-	-
	415VAC	-	7.5	7.5	-	7.5	7.5	-	7.5	-	-
	60VDC	-	-		7.5	-		-	-	-	-
	125VDC	-	-		-	7.5	7.5	-	-	7.5	-
	250VDC	-	-		-	-		-	-	-	7.5
Icu (kA)	240VAC	10	-		10	-		10	-	-	-
	415VAC	-	10	10	-	10	10	-	10	-	-
	60VDC	-	-		10	-		-	-	-	-
	125VDC	-	-		-	10	10	-	-	10	-
	250VDC	-	-		-	-		-	-	-	10
Inverse Time-Delay Over-Current Release Type		Thermal-Magnetic									
Service Life	Electrical	10,000						6,000			
	Mechanical	20,000						10,000			
Protection Degree		IP 30 (except for terminals)									
Wire AWG (mm2)		18~4 (0.75~25)									
Operating Temperature Range		-22 °F to 167 °F (-30 °C to +75 °C)									
Insulation Coordination	Rated Insulation Voltage (Vac)	500									
	Rated Impulse Withstand Voltage (kV)	6									
Pollution Degree		Class III									
Over Voltage Category		Class III									
Mounting		35 mm DIN rail/Flush and surface mount available on B1NQ with the use of additional mounting clips									
Altitude ft (m)		Does not exceed 6,561 (2,000)									
Atmospheric Conditions		At 68 °F (+20°C), the relative humidity does not exceed 90%									
		At 104 °F (+40°C), the relative humidity does not exceed 50%									

A

Miniature Circuit Breakers

UL 489 Specifications and Wiring Diagram

Temperature De-rating

When the ambient temperature slightly changes, please refer to the table below for the Temperature Compensation Coefficient

Ambient Temperature °F (°C)	-22 (-30)	-13 (-25)	-4 (-20)	5 (-15)	14 (-10)	23 (-5)	32 (0)	41 (5)	50 (10)	59 (15)	68 (20)	77 (25)	86 (30)	95 (35)	104 (40)	113 (45)	122 (50)	131 (55)	140 (60)	149 (65)	158 (70)	167 (75)							
0.5	1.26	1.24	1.22	1.20	1.18	1.16	1.14	1.10	1.08	1.06	1.04	1.00										0.89	0.86	0.83	0.80	0.76	0.72	0.66	
1	1.21	1.19	1.18	1.16	1.14	1.12	1.10	1.08	1.06	1.04	1.02											0.91	0.89	0.87	0.84	0.80	0.77	0.73	
1.6	1.32	1.29	1.28	1.24	1.21	1.19	1.16	1.13	1.10	1.08	1.03											0.85	0.81	0.77	0.73	0.68	0.63	0.58	
2	1.21	1.19	1.18	1.16	1.14	1.12	1.10	1.08	1.06	1.04	1.02											0.91	0.89	0.87	0.84	0.80	0.74	0.68	
3	1.27	1.25	1.22	1.20	1.18	1.15	1.13	1.11	1.08	1.05	1.03											0.88	0.85	0.82	0.78	0.75	0.71	0.67	
4	1.25	1.23	1.21	1.19	1.17		1.12	1.10	1.07		1.03											1.02	0.89	0.86	0.83	0.80	0.77	0.73	0.68
5	1.26	1.24	1.22		1.15	1.13	1.13	1.10	1.08	1.05												1.02	0.89	0.86	0.83	0.79	0.75	0.70	0.65
6	1.23	1.21	1.19	1.17	1.15	1.13	1.11	1.09	1.07	1.05	1.02											0.90	0.87	0.85	0.82	0.77	0.72	0.68	
7	1.25	1.23	1.21	1.19	1.17	1.15	1.13	1.1	1.05		1.03											0.9	0.88	0.85	0.75	0.72	0.65		
8	1.29	1.26	1.24	1.22	1.19	1.17	1.14	1.11	1.09	1.06	1.03											0.88	0.84	0.80	0.76	0.72	0.64	0.56	
10	1.28	1.25	1.23	1.21	1.18	1.16	1.13		1.08	1.06	1.03											0.88	0.85	0.82	0.78	0.73	0.68	0.62	
13	1.20	1.18	1.16	1.15	1.13	1.11	1.09	1.08	1.06	1.04	1.02											0.92	0.90	0.88	0.85	0.80	0.75	0.68	
15	1.28	1.25	1.23	1.21	1.18	1.16	1.13	1.11	1.08	1.06	1.03											0.88	0.85	0.82	0.78	0.72	0.65	0.58	
16	1.24	1.22	1.20	1.18	1.16	1.14	1.11	1.09	1.07	1.05	1.02											0.90	0.87	0.84	0.81	0.75	0.70	0.64	
20	1.23	1.21	1.19	1.17	1.15	1.13		1.09	1.07	1.05	1.02											0.90	0.87	0.85	0.82	0.77	0.72	0.66	
25	1.24	1.22	1.20	1.18	1.16	1.14	1.15	1.12	1.09	1.06	1.03											0.87	0.83	0.79	0.75	0.69	0.64	0.58	
30	1.30	1.27	1.25	1.22	1.20	1.17		1.15	1.12	1.09	1.06											1.03	0.87	0.83	0.79	0.75	0.69	0.64	0.58
32	1.23	1.21	1.19	1.17	1.15	1.13	1.11	1.09	1.07	1.04	1.02											0.91	0.88	0.85	0.78	0.73	0.68	0.62	
35	1.31	1.29	1.26	1.23	1.21	1.18	1.15	1.12	1.09	1.06	1.03											0.86	0.82	0.78	0.74	0.69	0.64	0.58	
40																													0.56
45	1.23	1.21	1.19	1.17	1.15	1.13	1.11	1.09	1.07	1.05	1.02											0.91	0.88	0.85	0.82	0.74	0.66	0.80	
50																0.75	0.68	0.60											
60	1.29	1.27	1.24	1.22	1.19	1.17	1.14	1.11	1.09	1.06	1.03	0.87	0.84	0.80	0.76	0.70	0.63	0.55											
63	1.27	1.25	1.22	1.20	1.18	1.15	1.13		1.08	1.05	0.87	0.88	0.85	0.82	0.78	0.72	0.65	0.57											

Elevation De-rating (B1H/B1N/B1NQ/B1D)

Breaker elevation de-rating with dielectric strength above 6,561 ft (2,000 m)

Elevation ft (m)	6,561 (2,000)	9,842 (3,000)	13,123 (4,000)	16,404 (5,000)
Dielectric Strength (V)	3,000	2,500	2,000	1,800
Max Working Voltage Per Pole (V)	277 Vac / 60 Vdc			
Rated Amperes at 77 °F (25 °C) (A)	1 x In	0.95 x In	0.93 x In	0.90 x In

Wiring Diagram

AC Connection

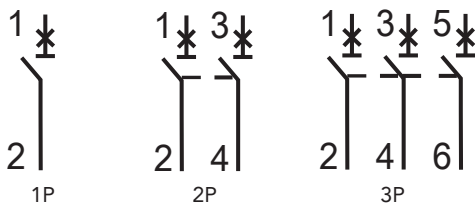

DC Connection

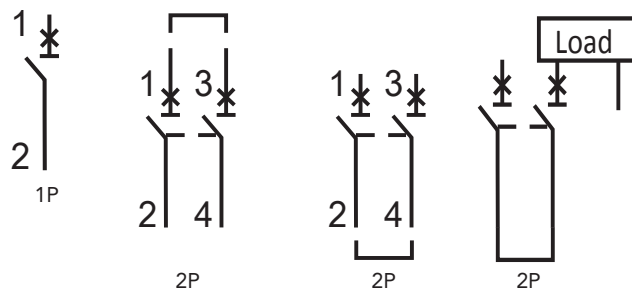

Miniature Circuit Breakers

UL 489 Trip Curve

B Curve
(B1H/B1N/B1NQ)
(3-5 In)

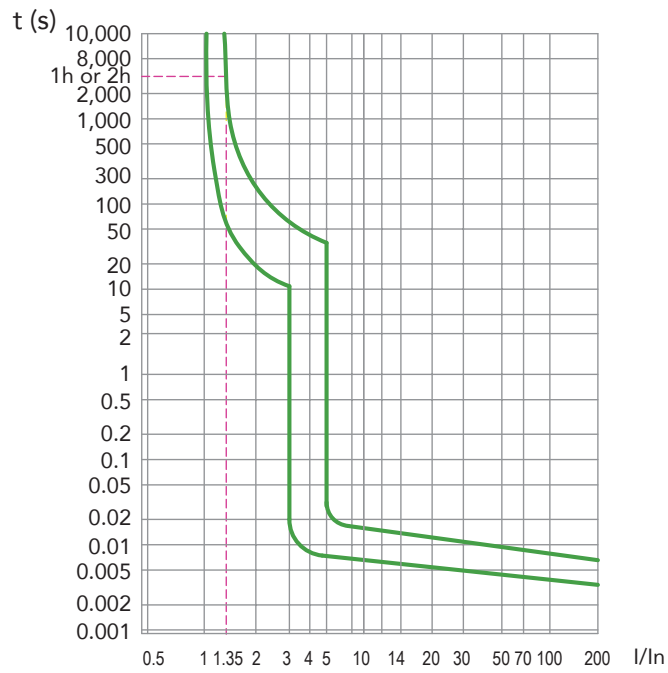

A

C Curve
(B1H/B1N/B1NQ)
(5-10 In)

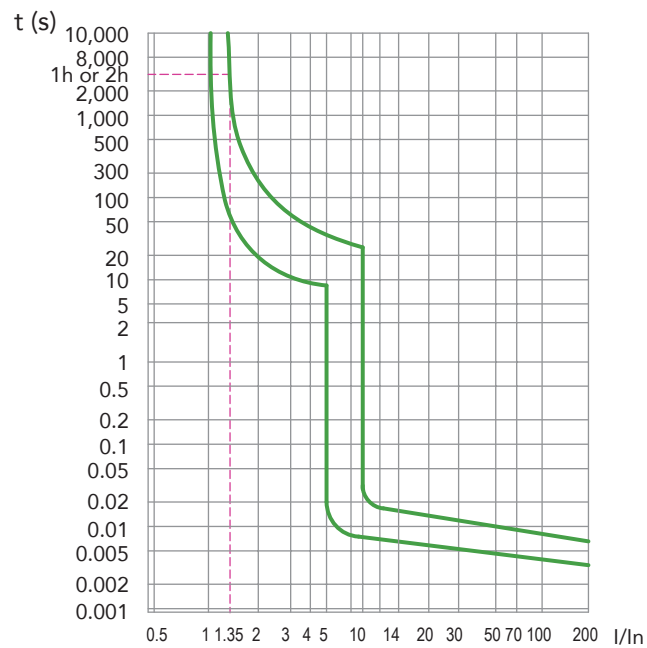

(B1D)
(7-15 In)

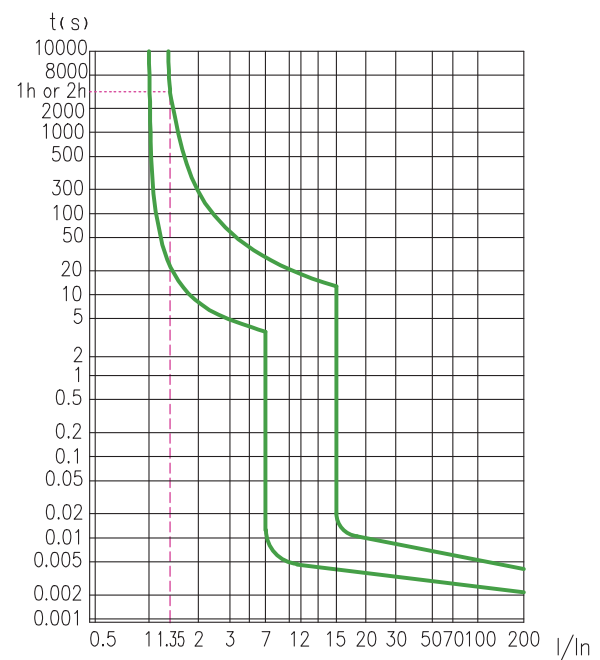

Miniature Circuit Breakers

UL 489 Trip Curve / UL 489 Dimensions

D Curve

(B1H/B1N/B1NQ)
(10~20 In)

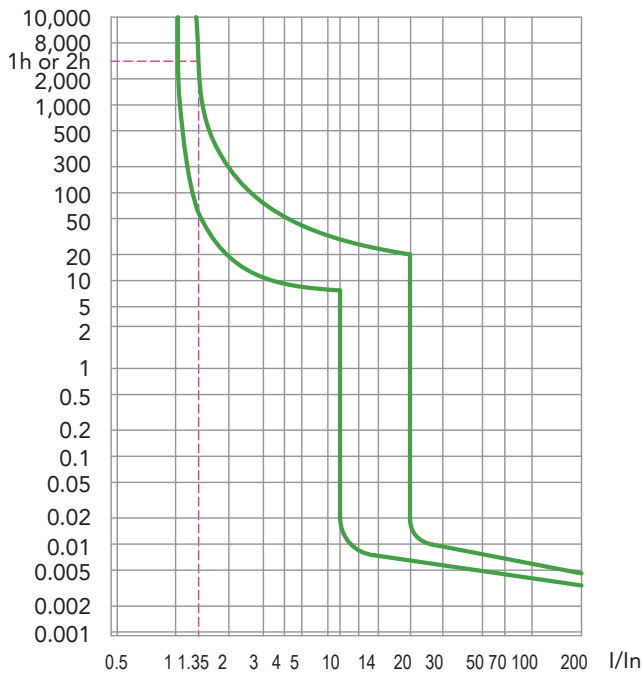

(B1D)

(12~22 In)

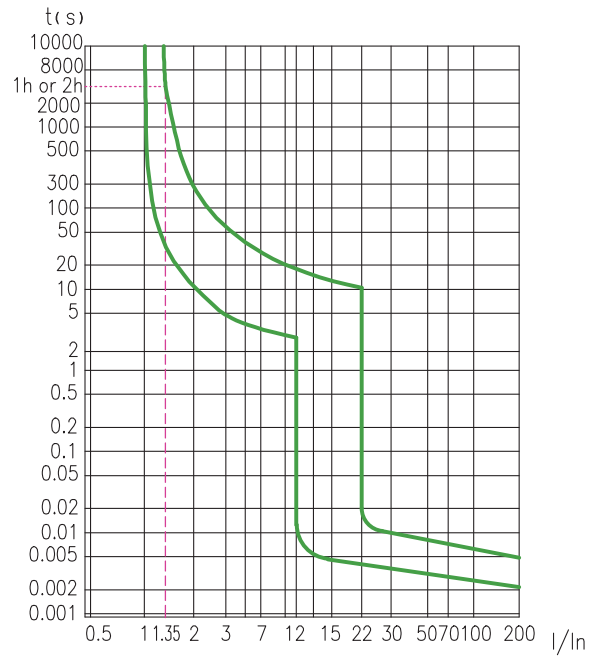

B1H/N/D

1P/2P/3P

Unit: in [mm]

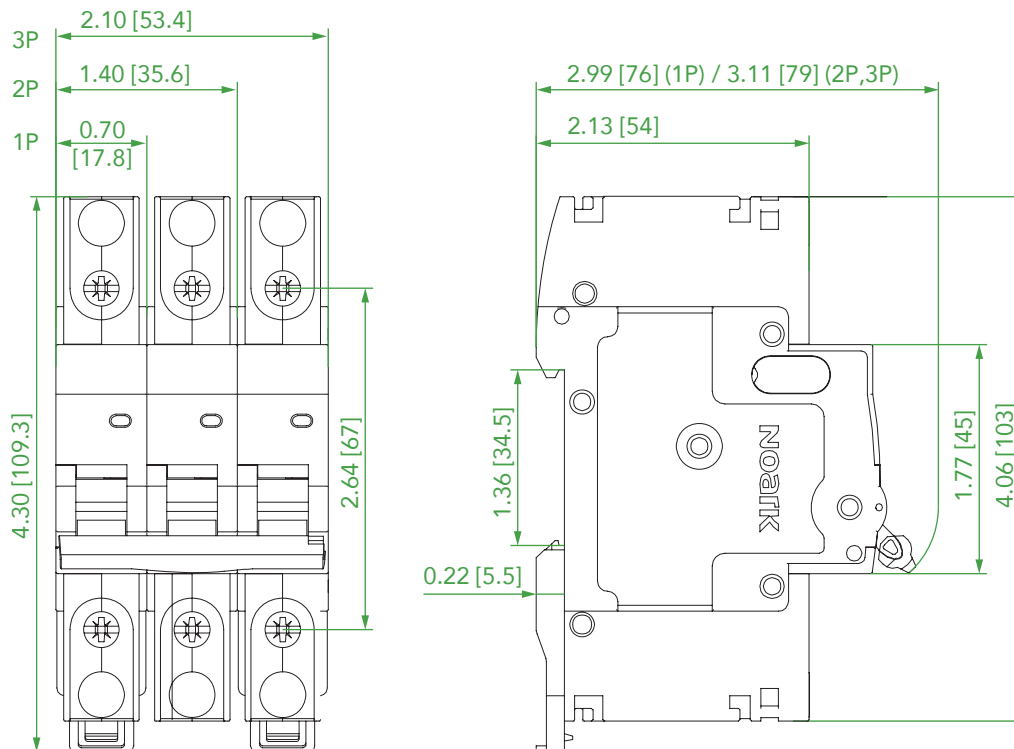

Miniature Circuit Breakers

UL 489 Dimensions

B1H/N/D

with Ring Tongue Terminal
1P/2P/3P

Unit: in [mm]

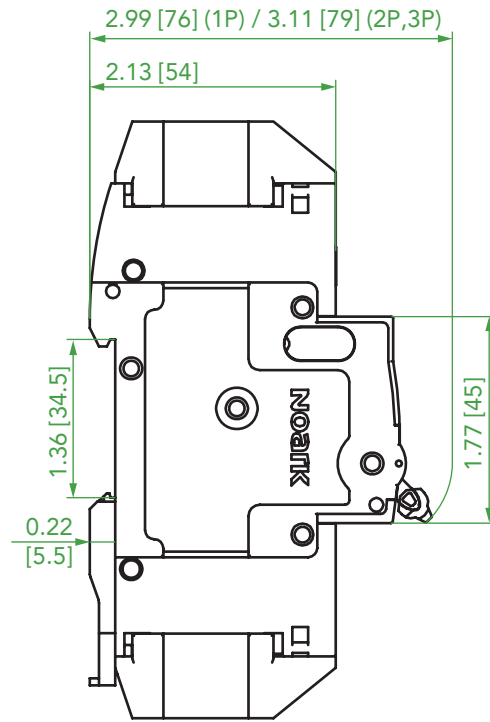
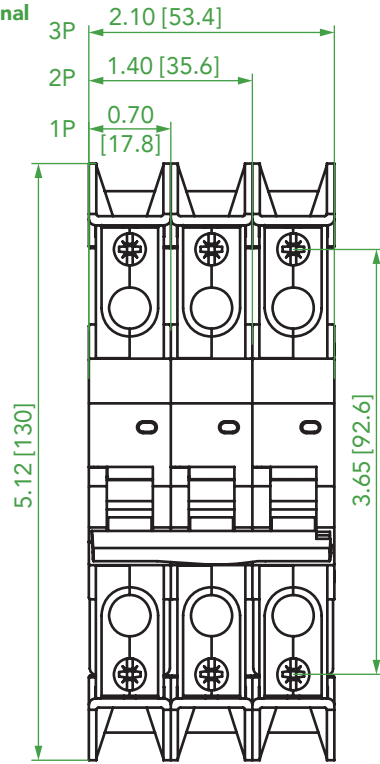

B1NQ

1P/2P

Unit: in [mm]

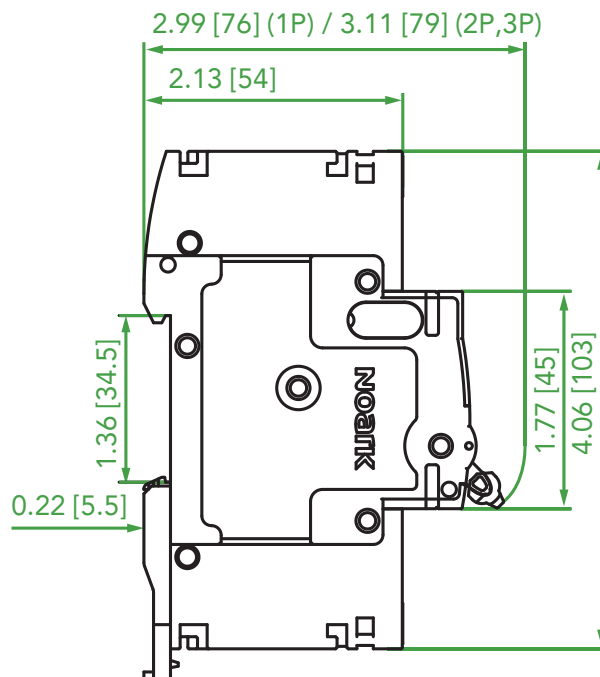
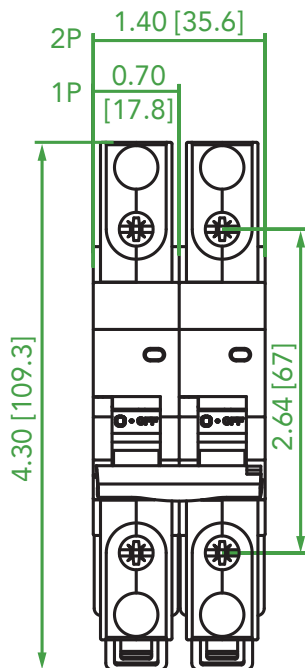

A

Miniature Circuit Breakers

UL 489 Dimensions

B1NQ

with Quick Connection Terminal
1P/2P

Unit: in [mm]

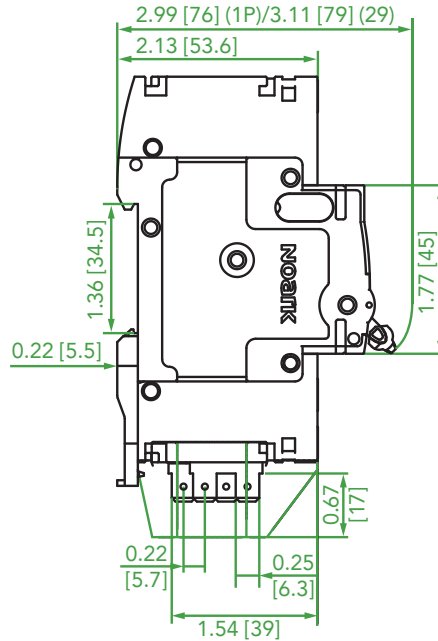
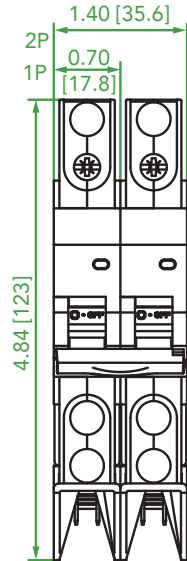

B1NQ

with Flush Mount Clips
1P/2P

Unit: in [mm]

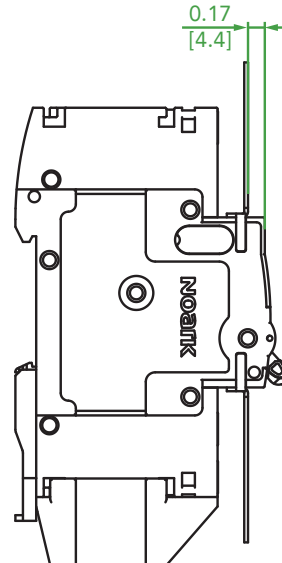
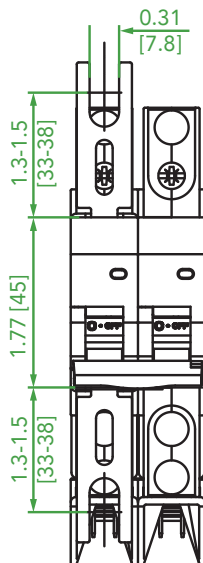

B1NQ

Flush Mount Clips
1P/2P

Unit: in [mm]

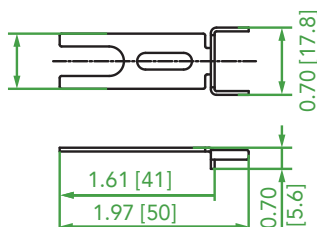

Miniature Circuit Breakers

UL 489 Dimensions

B1NQ
with Surface Mount Clip
1P
Unit: in [mm]

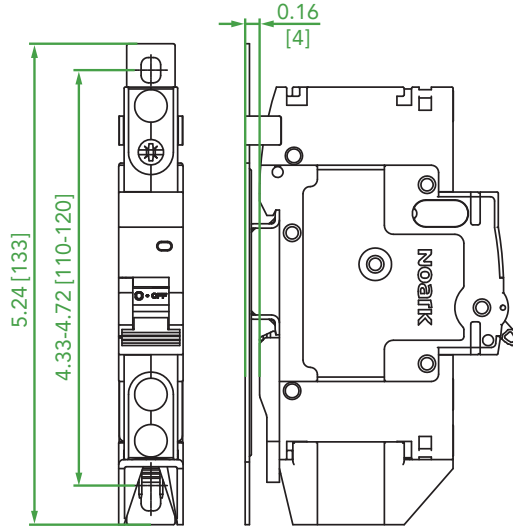

B1NQ
Surface Mount Clip
2P
Unit: in [mm]

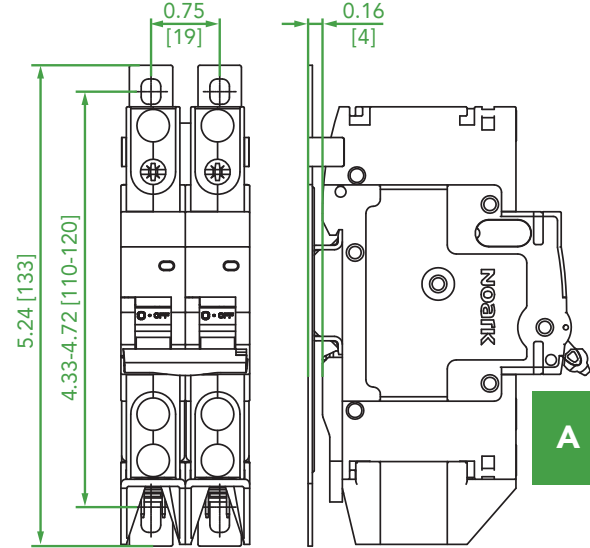

B1NQ
Surface Mount Clip
1P
Unit: in [mm]

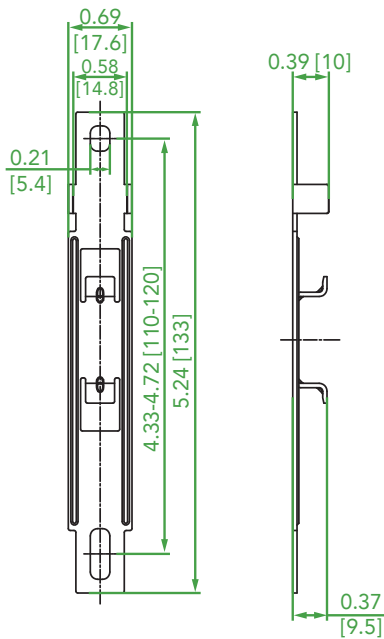

B1NQ
Surface Mount Clip
2P
Unit: in [mm]

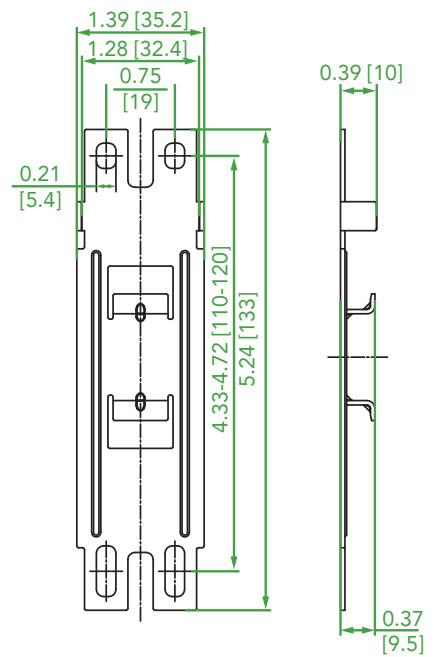

Miniature Circuit Breakers

UL 489 Accessories: Alarm Switch, Aux Contact, Shunt

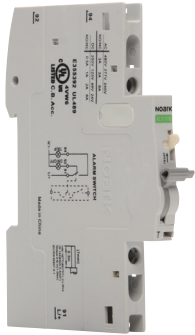

AL31	11	N
Description	Auxiliary Contact	Device Category
Alarm Switch	11: 1NO+1NC	N: UL 489
Accessory Description	Product	Part Number
Alarm Switch	AL3111N	1001201

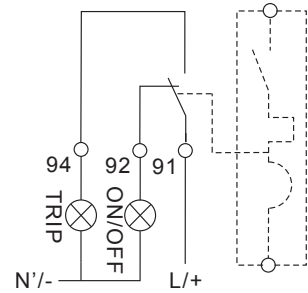

Specifications A37
Dimensions..... A38



AX31	11	N
Description	Auxiliary Contact	Device Category
Auxiliary Contact	11: 1NO+1NC	N: UL 489
Accessory Description	Product	Part Number
Auxiliary Contact	AX3111N	1001200

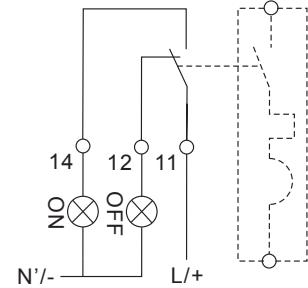

Specifications A37
Dimensions..... A38



SHT31	11	N	A
Description	Auxiliary Contact	Device Category	Rated Voltage
Shunt Trip	11: 1NO+1NC Blank: No Auxiliary Contact	N: UL 489	A: 110~415 Vac, 110~130 Vdc B: 48 Vac/dc C: 12~24 Vac/dc D: 6~12 Vac/dc

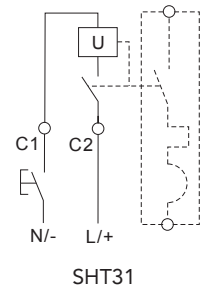

Specifications A37
Dimensions..... A39

Accessory Description	Product	Part Number
1NO+1NC 110-415 Vac/110-130 Vdc	SHT3111NA	1001208
1NO+1NC 48-60 Vac/dc	SHT3111NB	1001209
1NO+1NC 12-24 Vac/dc	SHT3111NC	1001210
1NO+1NC 6-12 Vac/dc	SHT3111ND	1002614
110-415 Vac/110-130 Vdc	SHT31NA	1001211
48-60 Vac/dc	SHT31NB	1001212
12-24 Vac/dc	SHT31NC	1001213
6-12 Vac/dc	SHT31ND	1002613

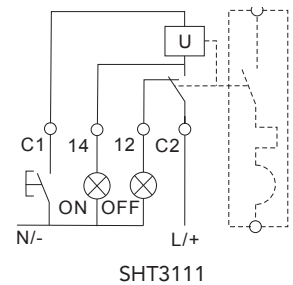

Miniature Circuit Breakers

UL 489 Accessories: Under-Voltage Trip and DIN Rail



UVT31	01	N	A
Description	Auxiliary Contact	Device Category	Rated Voltage
Under-Voltage Trip	01: 1NC 10: 1NO Blank: No Auxiliary Contact	N: UL 489	A: 240 Vac B: 48 Vac/dc C: 120 Vac

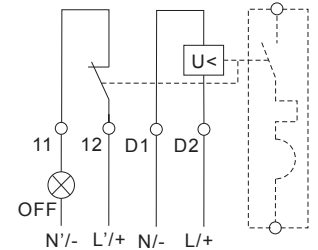

UVT3101

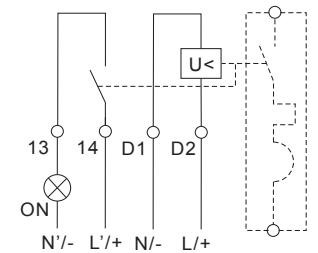

UVT3110

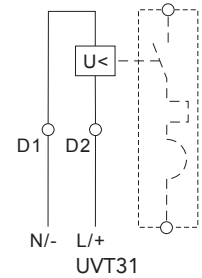

UVT31

Specifications A37
Dimensions A39

Accessory Description	Product	Part Number
Under-Voltage Trip	1NC / 240 Vac	UVT3101NA 1001202
	1NC / 48 Vac/dc	UVT3101NB 1001203
	1NC / 120 Vac	UVT3101NC 1002575
	1NO / 240 Vac	UVT3110NA 1001204
	1NO / 48 Vac/dc	UVT3110NB 1001205
	1NO / 120 Vac	UVT3110NC 1002576
	240 Vac	UVT31NA 1001206
	48 Vac/dc	UVT31NB 1001207
	120 Vac	UVT31NC 1002577



TH	35	A75
Description	Width	Depth
DIN Rail	75: 35 mm	A75: 7.5 mm

Accessory Description	Product	Part Number
35 mm DIN Rail	TH35A75	1001229

Dimensions A39

A

Miniature Circuit Breakers

UL 489 Accessories: Extended Rotary Handle and Padlock

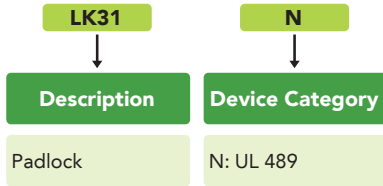

Accessory Description	Product	Part Number
Padlock (Lock Off)	LK31N	1001230

Dimensions..... A40

Miniature Circuit Breakers

UL 489 Accessories: RTT and Clips



RTT31	N
Description	Device Category
Ring Tongue Terminal	N: UL 489

Accessory Description	Product	Part Number
Ring Tongue Terminal	RTT31N	1001214

Dimensions..... A41

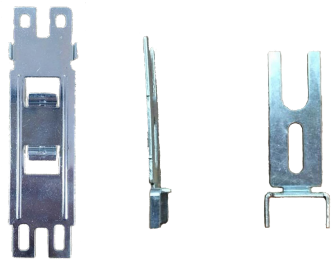

Surface Mount and Flush Mount Clips
Dimensions.....A31 & A32

SMC	311N
Description	Poles
SMC: Surface Mount Clips	311N: 1 Pole (Surface Mount)
FMC: Flush Mount Clips	312N: 2 Pole (Surface Mount)
	31N: Flush Mount

Accessory Description	Product	Part Number
Surface Mount Clip - 1 Pole	SMC311N	1002101
Surface Mount Clip - 2 Pole	SMC312N	1002102
Flush Mount Clip	FMC31N	1001251

A

Miniature Circuit Breakers

UL 489 Accessory Specifications and Dimensions

		Alarm Switch	Auxiliary Contact	Shunt Trip		Under-Voltage Trip	
		AL	AX	SHT	SHT+AX	UVT	UVT+AX
Applicable Standard		UL 489					
Ratings (50/60 Hz)	Vac	480/3 A, 277/3 A, 240/6 A		110~415		120, 240	
	Vdc	250/0.5 A, 125/1 A, 48/2 A, 24/6 A		110~130		-	
	Vac/dc	-		6~12, 48~60, 12~24		48	
Auxiliary Contact Configuration		-	1NO+1NC	-	1NO+1NC	-	1NO+1NC

Miniature Circuit Breakers

UL 489 Accessory Dimensions: Alarm/Aux Contact

AL31N/AX31N

Alarm Switch/Auxiliary Contact

Unit: in [mm]

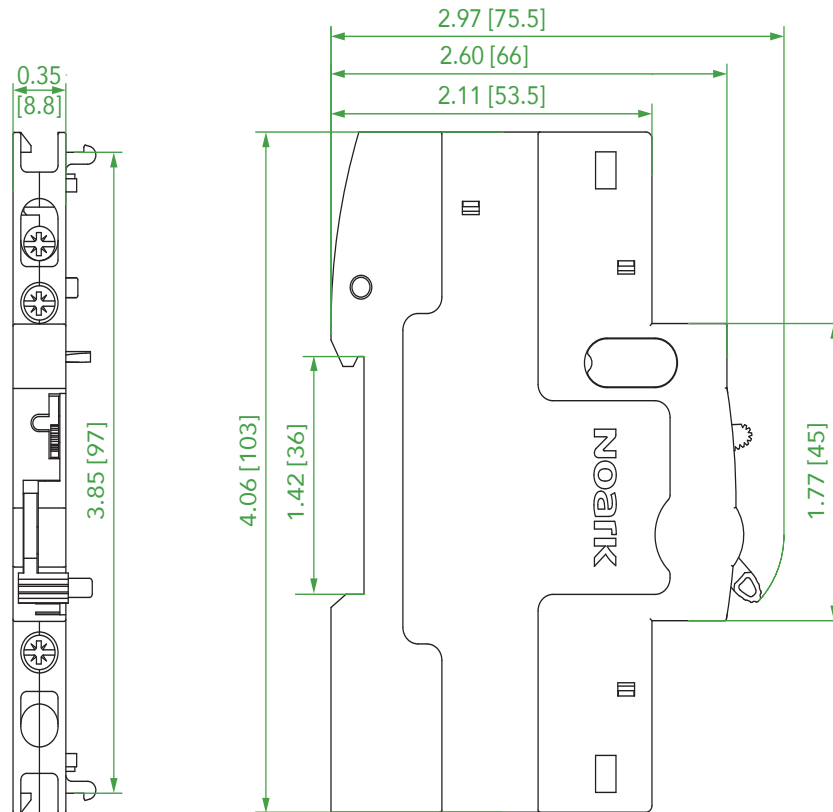

A

Miniature Circuit Breakers

UL 489 Accessory Dimensions: Shunt/UV Trip & DIN

SHT31N/UVT31N

Shunt Trip/
Under-Voltage Trip

Unit: in [mm]

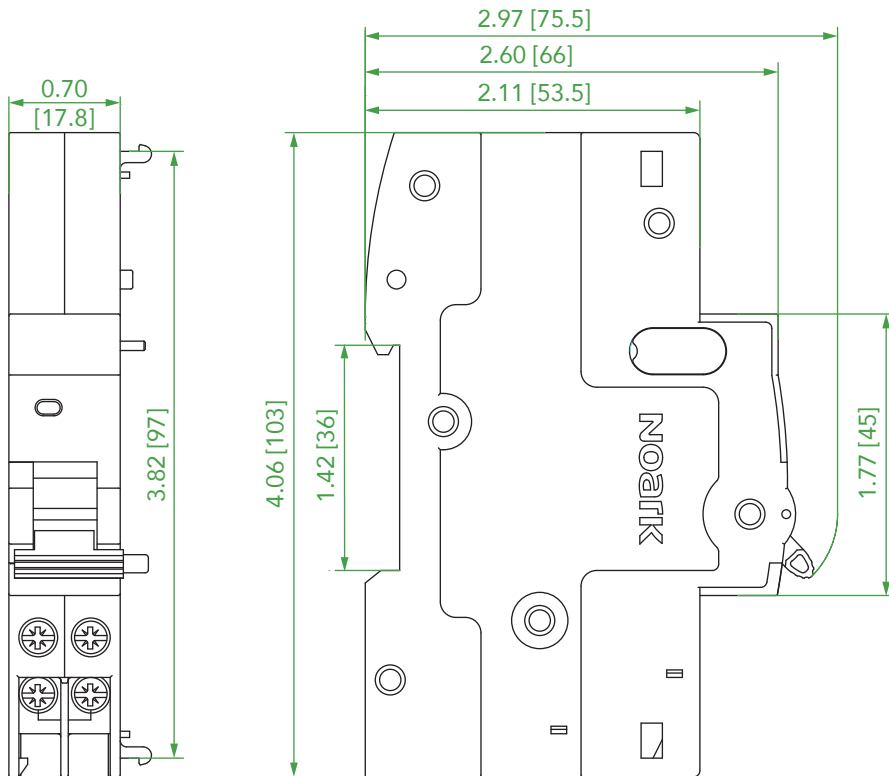

TH35A75

DIN Rail (35 mm)

Unit: in [mm]

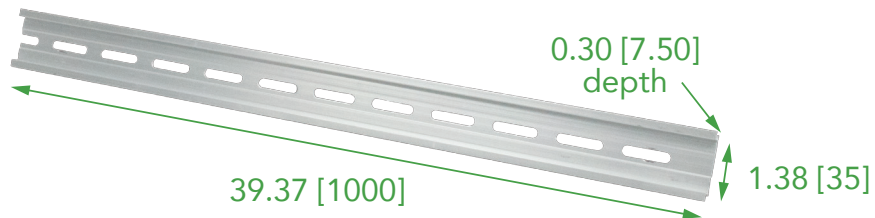

Miniature Circuit Breakers

UL 489 Accessory Dimensions: Handle and Padlock

LK31N

Padlock

Unit: in [mm]

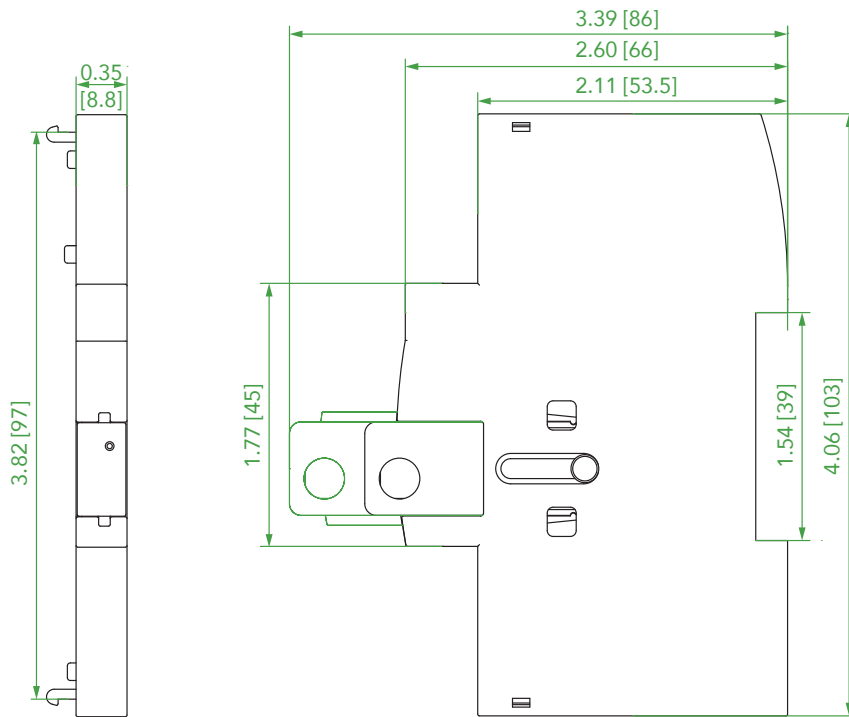

A

Miniature Circuit Breakers

UL 489 Accessory Dimensions: RTT and Clips

RTT31N

Ring Tongue Terminal

Unit: in [mm]

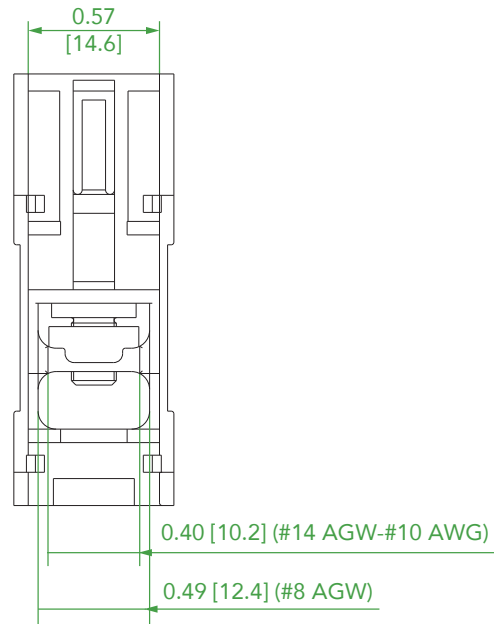
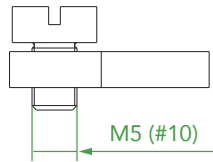
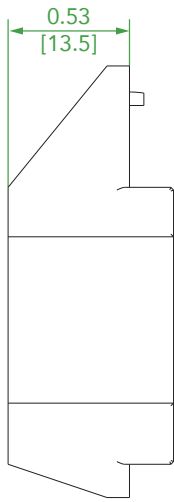

* See Page A31 For B1NQ Surface and Front Mount Dimensions

SUPPLEMENTARY PROTECTORS



UL 1077

Supplementary Protectors

UL 1077 Product Overview

Features

- UL 1077 recognized miniature circuit breakers up to a 63 A current rating
- Breakers mount on standard 35 mm DIN rail
- Standard ratings of 5 kA at 480Y/277 Vac
- Suitable for supplementary protection
- Thermal-magnetic over current protection – three levels of short-circuit protection, categorized by B, C and D curves
- Trip-free design – breaker cannot be defeated by holding the handle in the ON position
- Captive screws cannot be lost
- Fulfill UL 1077, IEC 60947-2 standard
- Field-installable shunt trip and auxiliary switch subsequent mounting
- Module width of only 0.71 in (18 mm) per pole
- Contact position indicator (red/green)
- Possibility for locking the toggle in ON or OFF position

Typical Application

- Supplementary Protection
 - ✓ Control circuits
 - ✓ Lighting
 - ✓ Business equipment
 - ✓ Appliances

Supplementary Protectors

UL 1077 National and International Standards

Certifications

UL 1077 No. E355391 / CSA C22.2 No.235 / IEC 60947-2

- Supplementary Protectors are UL Recognized for use in the United States in accordance with NFPA® 70 (NEC).
- The devices comply with UL 1077 No. E355391 and certified for Canada according to CSA 22.2 No. 235, meeting the requirements for supplementary protectors.
- These devices are for international and domestic use, and also comply with IEC 60947-2 and are CE marked.



RoHS

- These devices are RoHS compliant.



B

Supplementary Protectors

UL 1077 Product Selection Guide

Label

These supplementary protectors are available in two terminal configurations: standard box terminals that accept multiple conductors and ring-tongue terminals. All breakers mount on standard 35 mm DIN rail. Bus connectors and feeder terminal facilitate mounting and wiring of multiple miniature circuit breaker arrays in control panel assemblies. Breakers can also be reverse feed.

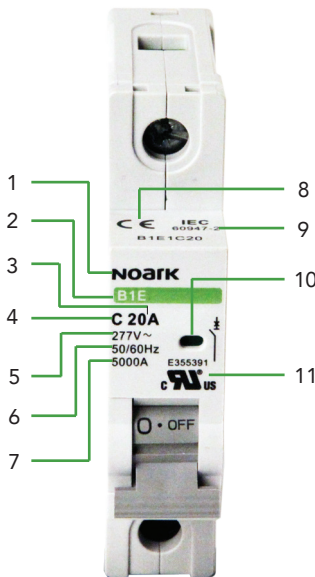

1. Brand
2. Product Type
3. Rated Current
4. Tripping Curve
5. Rated Voltage
6. Frequency
7. Interrupting Rating
8. CE Mark
9. IEC Standard
10. Breaker Status Indicator
11. UL Recognized Component

Product Selection Guide

B1E	1	C	63
NOARK Ex9 Series - B1E	Pole	Trip Curve	Rated Current
	1: 1 Pole	B: 3~5 In	1: 1 A 20: 20 A
	2: 2 Poles	C: 5~10 In	1.6: 1.6 A 25: 25 A
	3: 3 Poles	D: 10~20 In	2: 2 A 30: 30 A
	4: 4 Poles		3: 3 A 32: 32 A
			4: 4 A 40: 40 A
			5: 5 A 50: 50 A
			6: 6 A 60: 60 A
			8: 8 A 63: 63 A
			10: 10 A
			13: 13 A
			15: 15 A
			16: 16 A

Supplementary Protectors

B1E 1-63 A UL 1077 480Y/277 Vac; 60/125 Vdc

Certifications
IEC/EN 60947-2



Rated Amperage (A)	1 Pole - 277 Vac		2 Poles - 480 Vac		3 Poles - 480 Vac		4 Poles - 480 Vac		
	Product	Part Number	Product	Part Number	Product	Part Number	Product	Part Number	
B Curve (3~5 In)	1	B1E1B1	1000420	B1E2B1	1000483	B1E3B1	1000546	B1E4B1	1000609
	1.6	B1E1B1.6	1000421	B1E2B1.6	1000484	B1E3B1.6	1000547	B1E4B1.6	1000610
	2	B1E1B2	1000422	B1E2B2	1000485	B1E3B2	1000548	B1E4B2	1000611
	3	B1E1B3	1000423	B1E2B3	1000486	B1E3B3	1000549	B1E4B3	1000612
	4	B1E1B4	1000424	B1E2B4	1000487	B1E3B4	1000550	B1E4B4	1000613
	5	B1E1B5	1000425	B1E2B5	1000488	B1E3B5	1000551	B1E4B5	1000614
	6	B1E1B6	1000426	B1E2B6	1000489	B1E3B6	1000552	B1E4B6	1000615
	8	B1E1B8	1000427	B1E2B8	1000490	B1E3B8	1000553	B1E4B8	1000616
	10	B1E1B10	1000428	B1E2B10	1000491	B1E3B10	1000554	B1E4B10	1000617
	13	B1E1B13	1000429	B1E2B13	1000492	B1E3B13	1000555	B1E4B13	1000618
	15	B1E1B15	1000430	B1E2B15	1000493	B1E3B15	1000556	B1E4B15	1000619
	16	B1E1B16	1000431	B1E2B16	1000494	B1E3B16	1000557	B1E4B16	1000620
	20	B1E1B20	1000432	B1E2B20	1000495	B1E3B20	1000558	B1E4B20	1000621
	25	B1E1B25	1000433	B1E2B25	1000496	B1E3B25	1000559	B1E4B25	1000622
	30	B1E1B30	1000434	B1E2B30	1000497	B1E3B30	1000560	B1E4B30	1000623
	32	B1E1B32	1000435	B1E2B32	1000498	B1E3B32	1000561	B1E4B32	1000624
	35	B1E1B35	1000436	B1E2B35	1000499	B1E3B35	1000562	B1E4B35	1000625
	40	B1E1B40	1000437	B1E2B40	1000500	B1E3B40	1000563	B1E4B40	1000626
50	B1E1B50	1000438	B1E2B50	1000501	B1E3B50	1000564	B1E4B50	1000627	
60	B1E1B60	1000439	B1E2B60	1000502	B1E3B60	1000565	B1E4B60	1000628	
63	B1E1B63	1000440	B1E2B63	1000503	B1E3B63	1000566	B1E4B63	1000629	

B

Specifications	B49 to 50	Wiring Diagram	B51	Dimensions	B54
De-Rating	B51	Trip Curve	B52 to 53	Accessories	B55 to B58

Supplementary Protectors

B1E 1-63 A UL 1077 480Y/277 Vac; 60/125 Vdc

Certifications
IEC/EN 60947-2

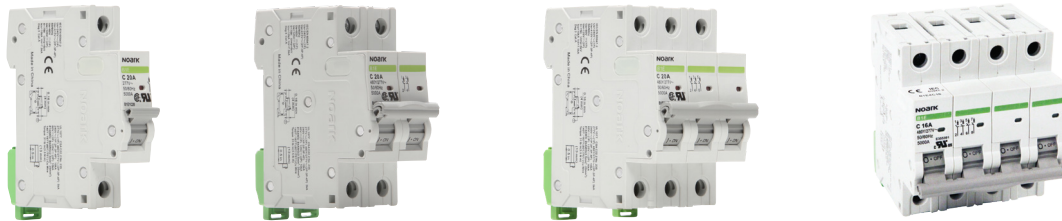
Rated Amperage (A)	1 Pole - 277 Vac		2 Poles - 480 Vac		3 Poles - 480 Vac		4 Poles - 480 Vac	
	Product	Part Number	Product	Part Number	Product	Part Number	Product	Part Number
1	B1E1C1	1000441	B1E2C1	1000504	B1E3C1	1000567	B1E4C1	1000630
1.6	B1E1C1.6	1000442	B1E2C1.6	1000505	B1E3C1.6	1000568	B1E4C1.6	1000631
2	B1E1C2	1000443	B1E2C2	1000506	B1E3C2	1000569	B1E4C2	1000632
3	B1E1C3	1000444	B1E2C3	1000507	B1E3C3	1000570	B1E4C3	1000633
4	B1E1C4	1000445	B1E2C4	1000508	B1E3C4	1000571	B1E4C4	1000634
5	B1E1C5	1000446	B1E2C5	1000509	B1E3C5	1000572	B1E4C5	1000635
6	B1E1C6	1000447	B1E2C6	1000510	B1E3C6	1000573	B1E4C6	1000636
8	B1E1C8	1000448	B1E2C8	1000511	B1E3C8	1000574	B1E4C8	1000637
10	B1E1C10	1000449	B1E2C10	1000512	B1E3C10	1000575	B1E4C10	1000638
13	B1E1C13	1000450	B1E2C13	1000513	B1E3C13	1000576	B1E4C13	1000639
15	B1E1C15	1000451	B1E2C15	1000514	B1E3C15	1000577	B1E4C15	1000640
16	B1E1C16	1000452	B1E2C16	1000515	B1E3C16	1000578	B1E4C16	1000641
20	B1E1C20	1000453	B1E2C20	1000516	B1E3C20	1000579	B1E4C20	1000642
25	B1E1C25	1000454	B1E2C25	1000517	B1E3C25	1000580	B1E4C25	1000643
30	B1E1C30	1000455	B1E2C30	1000518	B1E3C30	1000581	B1E4C30	1000644
32	B1E1C32	1000456	B1E2C32	1000519	B1E3C32	1000582	B1E4C32	1000645
35	B1E1C35	1000457	B1E2C35	1000520	B1E3C35	1000583	B1E4C35	1000646
40	B1E1C40	1000458	B1E2C40	1000521	B1E3C40	1000584	B1E4C40	1000647
50	B1E1C50	1000459	B1E2C50	1000522	B1E3C50	1000585	B1E4C50	1000648
60	B1E1C60	1000460	B1E2C60	1000523	B1E3C60	1000586	B1E4C60	1000649
63	B1E1C63	1000461	B1E2C63	1000524	B1E3C63	1000587	B1E4C63	1000650

Specifications B49 to 50	Wiring Diagram B51	Dimensions B54
De-Rating B51	Trip Curve B52 to 53	Accessories B55 to B58

Supplementary Protectors

B1E 1-63 A UL 1077 480Y/277 Vac; 60/125 Vdc

Certifications
IEC/EN 60947-2

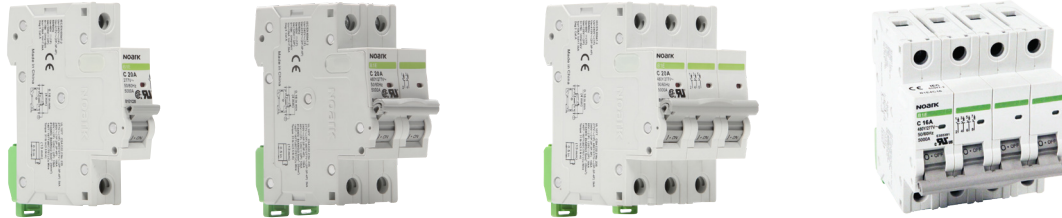
Rated Amperage (A)	1 Pole - 277 Vac		2 Poles - 480 Vac		3 Poles - 480 Vac		4 Poles - 480 Vac	
	Product	Part Number	Product	Part Number	Product	Part Number	Product	Part Number
1	B1E1D1	1000462	B1E2D1	1000525	B1E3D1	1000588	B1E4D1	1000651
1.6	B1E1D1.6	1000463	B1E2D1.6	1000526	B1E3D1.6	1000589	B1E4D1.6	1000652
2	B1E1D2	1000464	B1E2D2	1000527	B1E3D2	1000590	B1E4D2	1000653
3	B1E1D3	1000465	B1E2D3	1000528	B1E3D3	1000591	B1E4D3	1000654
4	B1E1D4	1000466	B1E2D4	1000529	B1E3D4	1000592	B1E4D4	1000655
5	B1E1D5	1000467	B1E2D5	1000530	B1E3D5	1000593	B1E4D5	1000656
6	B1E1D6	1000468	B1E2D6	1000531	B1E3D6	1000594	B1E4D6	1000657
8	B1E1D8	1000469	B1E2D8	1000532	B1E3D8	1000595	B1E4D8	1000658
10	B1E1D10	1000470	B1E2D10	1000533	B1E3D10	1000596	B1E4D10	1000659
13	B1E1D13	1000471	B1E2D13	1000534	B1E3D13	1000597	B1E4D13	1000660
15	B1E1D15	1000472	B1E2D15	1000535	B1E3D15	1000598	B1E4D15	1000661
16	B1E1D16	1000473	B1E2D16	1000536	B1E3D16	1000599	B1E4D16	1000662
20	B1E1D20	1000474	B1E2D20	1000537	B1E3D20	1000600	B1E4D20	1000663
25	B1E1D25	1000475	B1E2D25	1000538	B1E3D25	1000601	B1E4D25	1000664
30	B1E1D30	1000476	B1E2D30	1000539	B1E3D30	1000602	B1E4D30	1000665
32	B1E1D32	1000477	B1E2D32	1000540	B1E3D32	1000603	B1E4D32	1000666
35	B1E1D35	1000478	B1E2D35	1000541	B1E3D35	1000604	B1E4D35	1000667
40	B1E1D40	1000479	B1E2D40	1000542	B1E3D40	1000605	B1E4D40	1000668
50	B1E1D50	1000480	B1E2D50	1000543	B1E3D50	1000606	B1E4D50	1000669
60	B1E1D60	1000481	B1E2D60	1000544	B1E3D60	1000607	B1E4D60	1000670
63	B1E1D63	1000482	B1E2D63	1000545	B1E3D63	1000608	B1E4D63	1000671

B

Specifications	B49 to 50	Wiring Diagram	B51	Dimensions	B54
De-Rating	B51	Trip Curve	B52 to 53	Accessories	B55 to B58

Supplementary Protectors

UL 1077 B1E 1-63 A Specifications

		B1E 1-63 A			
Conformed Standard		UL 1077			
Rated Operational Voltage (V)		480Y/277 Vac; 60/125 Vdc			
Rated Frequency (Hz)		50/60			
Rated Current (A)		1~63			
Number of Poles		1	2	3	4
Instantaneous Tripping Type		B (3~5 In), C (5~10 In), D (10~20 In)			
Interrupting (kA)	120 Vac	10		-	
	120/240 Vac			-	
	208 Vac			-	
	240 Vac			10	
	277 Vac	5		-	
	480 Vac	-		5	
	60 Vdc	10		-	
	110 Vdc				
	125 Vdc	-	10		-
	220 Vdc				
Inverse Time-Delay Over-Current Release Type		Thermal-Magnetic			
Service Life	Electrical	6,000			
	Mechanical	20,000			
Protection Degree		IP 20			
Wire AWG (mm ²)		18~4 (0.75~25)			
Operating Temperature Range		-22 °F to 167 °F (-30 °C to +75 °C)			
Insulation Coordination	Rated Insulation Voltage (Vac)	500			
	Rated Impulse Withstand Voltage (kV)	6			
Pollution Degree		Class III			
Over Voltage Category / Mounting		Class III / 35 mm DIN rail			
Altitude ft (m)		Does not exceed 6,561 (2,000)			
Atmospheric Conditions		At 68 °F (+20°C), the relative humidity does not exceed 90% At 104 °F (+40°C), the relative humidity does not exceed 50%			

Miniature Circuit Breakers

CE B1E 1-63A Specifications

		B1E0.5~63			
Conformed Standard		IEC60947-2			
Number of Poles		1	2	3	4
Rated Operational Voltage (V)		AC240/DC60	AC415/DC125	AC415	
Rated Frequency (Hz)		50/60			
Rated Current (A)		0.5~63			
Instantaneous Tripping Type		B (3~5 In), C (5~10 In), D (10~20 In)			
Ics (kA)	60 Vdc	7.5	-		
	125 Vdc	-	7.5	-	
	240Vac	7.5	-	-	
	415Vac	-	7.5	7.5	
Icu (kA)	60 Vdc	10	-		
	125 Vdc	-	10	-	
	240Vac	10	-	-	
	415Vac	-	10	10	
Inverse Time-Delay Over-Current Release Type		Thermal-Magnetic			
Service Life	Electrical	6000			
	Mechanical	20000			
Protection Degree		IP 30 (except for terminals)			
Wire AWG (mm2)		18~4 (0.75~25)			
Operating Temperature Range		-22 °F to 167 °F (-30 °C to +75 °C)			
Insulation Coordination	Rated Insulation Voltage (Vac)	500			
	Rated Impulse Withstand Voltage (kV)	6			
Pollution Degree		Class III			
Over Voltage Category		Class III			
Mounting		35 mm DIN rail			
Altitude ft (m)		Does not exceed 6,561 (2,000)			
Atmospheric Conditions		At 68 °F (+20°C), the relative humidity does not exceed 90%			
		At 104 °F (+40°C), the relative humidity does not exceed 50%			

B

Supplementary Protectors

UL 1077 B1E 1-63 A Specifications

Temperature De-rating

When the ambient temperature slightly changes, please refer to the table below for the Temperature Compensation Coefficient

Ambient Temperature °F (°C)	-22 (-30)	-13 (-25)	-4 (-20)	5 (-15)	14 (-10)	23 (-5)	32 (0)	41 (5)	50 (10)	59 (15)	68 (20)	77 (25)	86 (30)	95 (35)	104 (40)	113 (45)	122 (50)	131 (55)	140 (60)	149 (65)	158 (70)	167 (75)							
1	1.21	1.19	1.18	1.16	1.14	1.12	1.10	1.08	1.06	1.04	1.02	1.00										0.91	0.89	0.87	0.84	0.80	0.77	0.73	
1.6	1.32	1.29	1.28	1.24	1.21	1.19	1.16	1.13	1.10	1.08	1.03											0.85	0.81	0.77	0.73	0.68	0.63	0.58	
2	1.21	1.19	1.18	1.16	1.14	1.12	1.10	1.08	1.06	1.04	1.02											0.91	0.89	0.87	0.84	0.80	0.74	0.68	
3	1.27	1.25	1.22	1.20	1.18	1.15	1.13	1.11	1.08	1.05	1.03											0.88	0.85	0.82	0.78	0.75	0.71	0.67	
4	1.25	1.23	1.21	1.19	1.17		1.12	1.10	1.07		1.02											0.89	0.86	0.83	0.80	0.77	0.73	0.68	
5	1.26	1.24	1.22		1.13	1.10	1.08	1.05	1.03	0.89	0.86											0.83	0.79	0.75	0.70	0.65			
6	1.23	1.21	1.19	1.17	1.15	1.13	1.11	1.09	1.07	1.02	0.90											0.87	0.85	0.82	0.77	0.72	0.68		
8	1.29	1.26	1.24	1.22	1.19	1.17	1.14	1.11	1.09	1.06	1.03											0.88	0.84	0.80	0.76	0.72	0.64	0.56	
10	1.28	1.25	1.23	1.21	1.18	1.16	1.13		1.08	1.06	1.03											0.88	0.85	0.82	0.78	0.73	0.68	0.62	
13	1.20	1.18	1.16	1.15	1.13	1.11	1.09	1.08	1.06	1.04	1.02											0.92	0.90	0.88	0.85	0.80	0.75	0.68	
15	1.28	1.25	1.23	1.21	1.18	1.16	1.13	1.11	1.08	1.06	1.03											0.88	0.85	0.82	0.78	0.72	0.65	0.58	
16	1.24	1.22	1.20	1.18	1.16	1.14	1.11	1.09	1.07	1.05	1.02											0.90	0.87	0.84	0.81	0.75	0.70	0.64	
20	1.23	1.21	1.19	1.17	1.15	1.13		1.09	1.07	1.05	1.02											0.90	0.87	0.85	0.82	0.77	0.72	0.67	
25	1.24	1.22	1.20	1.18	1.16	1.14	1.15	1.12	1.09	1.06	1.03											0.87	0.83	0.79	0.75	0.69	0.64	0.58	
30	1.30	1.27	1.25	1.22	1.20	1.17	1.15	1.12	1.09	1.06	1.03											0.91	0.88	0.85	0.78	0.73	0.68	0.62	
32	1.23	1.21	1.19	1.17	1.15	1.13	1.11	1.09	1.07	1.04	1.02											0.86	0.82	0.78	0.74	0.69	0.64	0.58	
35	1.31	1.29	1.26	1.23	1.21	1.18	1.15	1.12	1.09	1.06	1.03											0.91	0.88	0.85	0.78	0.73	0.68	0.62	
40	1.23	1.21	1.19	1.17	1.15	1.13	1.11	1.09	1.07	1.05	1.02											0.87	0.83	0.79	0.75	0.76	0.70	0.66	0.56
45																													0.80
50																													0.60
60	1.29	1.27	1.24	1.22	1.19	1.17	1.14	1.11	1.09	1.06	1.03											0.87	0.84	0.80	0.76	0.70	0.63	0.55	
63	1.27	1.25	1.22	1.20	1.18	1.15	1.13		1.08	1.05	0.87											0.88	0.85	0.82	0.78	0.72	0.65	0.57	

Elevation De-rating

Breaker elevation de-rating with dielectric strength above 6,561 ft (2,000 m)

Elevation ft (m)	6,561 (2,000)	9,842 (3,000)	13,123 (4,000)	16,404 (5,000)
Dielectric Strength (V)	3,000	2,500	2,000	1,800
Max Working Voltage Per Pole (V)	277 Vac / 60 Vdc			
Rated Amperes at 77 °F (25 °C) (A)	1 x In	0.95 x In	0.93 x In	0.90 x In

Wiring Diagram

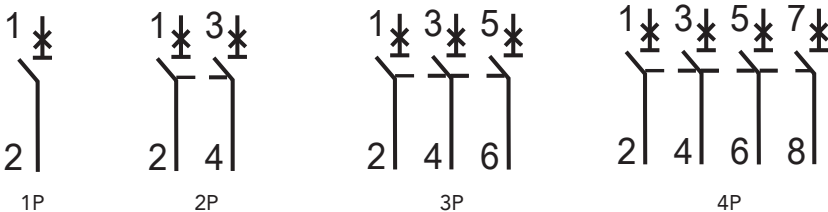

Supplementary Protectors

UL 1077 B1E 1-63 A Trip Curve

B Curve - 1~63 A
(3~5 I_n)

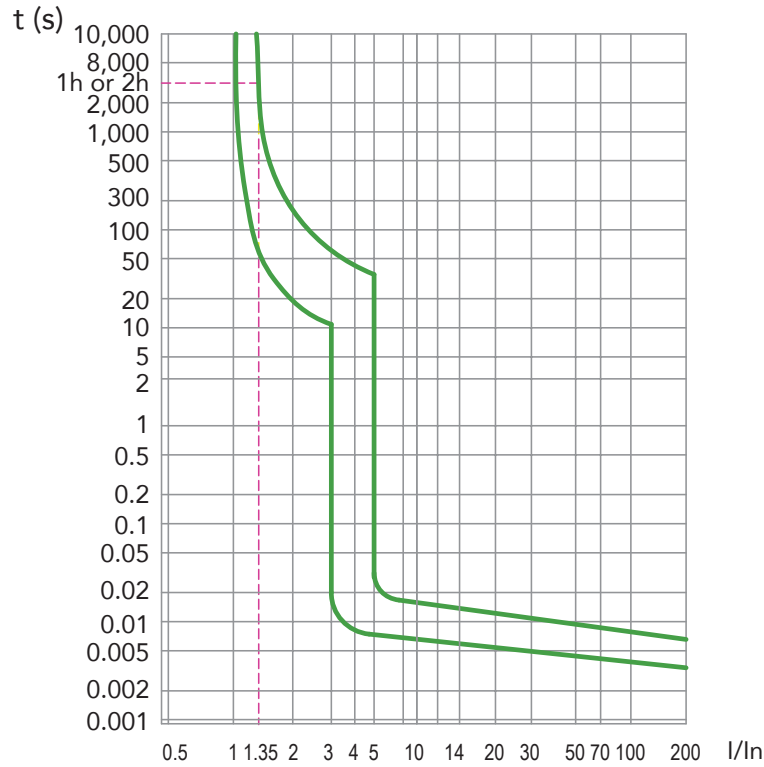

B

C Curve - 1~63 A
(5~10 I_n)

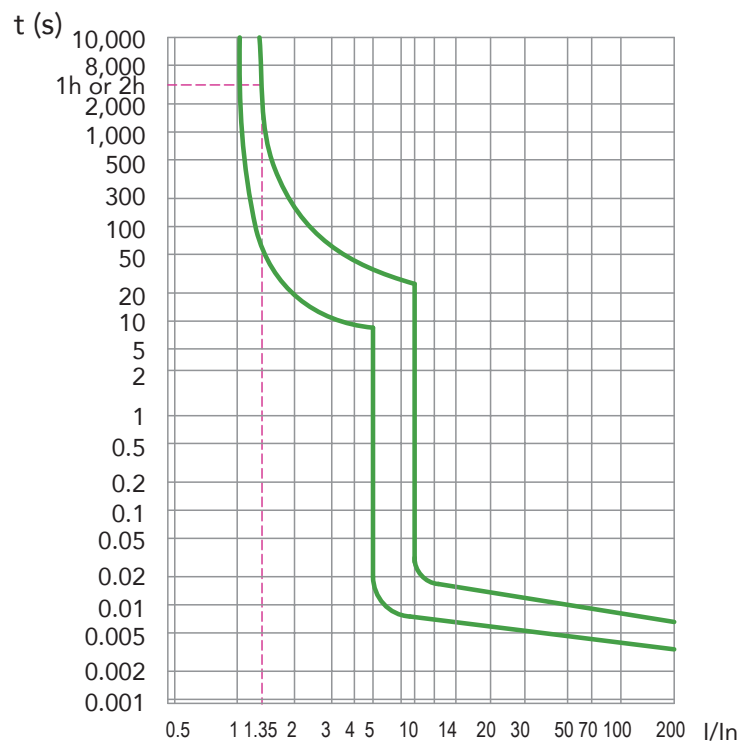

Supplementary Protectors

UL 1077 B1E 1-63 A Trip Curve

D Curve - 1~63 A
(10~20 In)

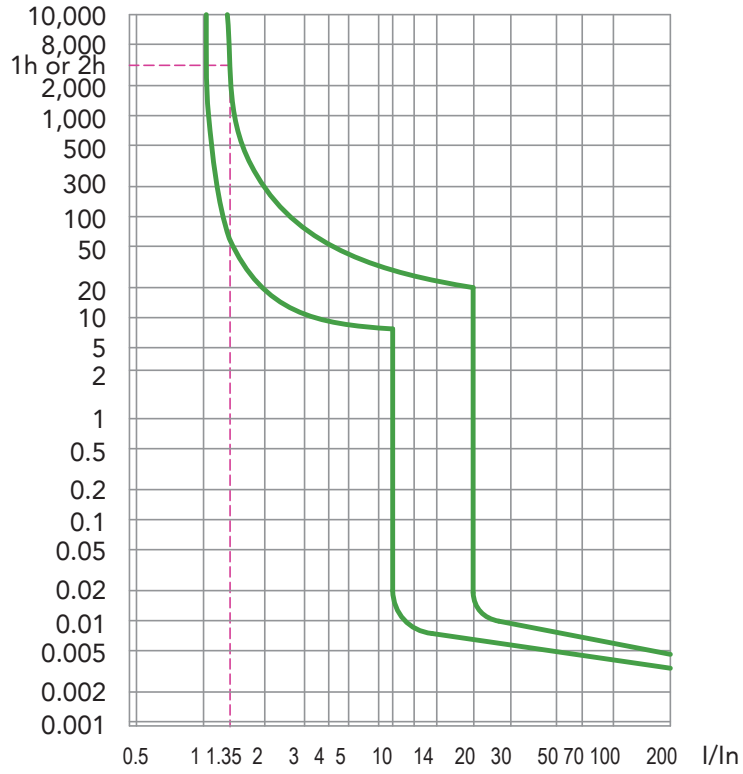

Supplementary Protectors

UL 1077 B1E 1-63 A Dimensions

B1E - 1~63 A
 1P/2P/3P/4P
 Unit: in [mm]

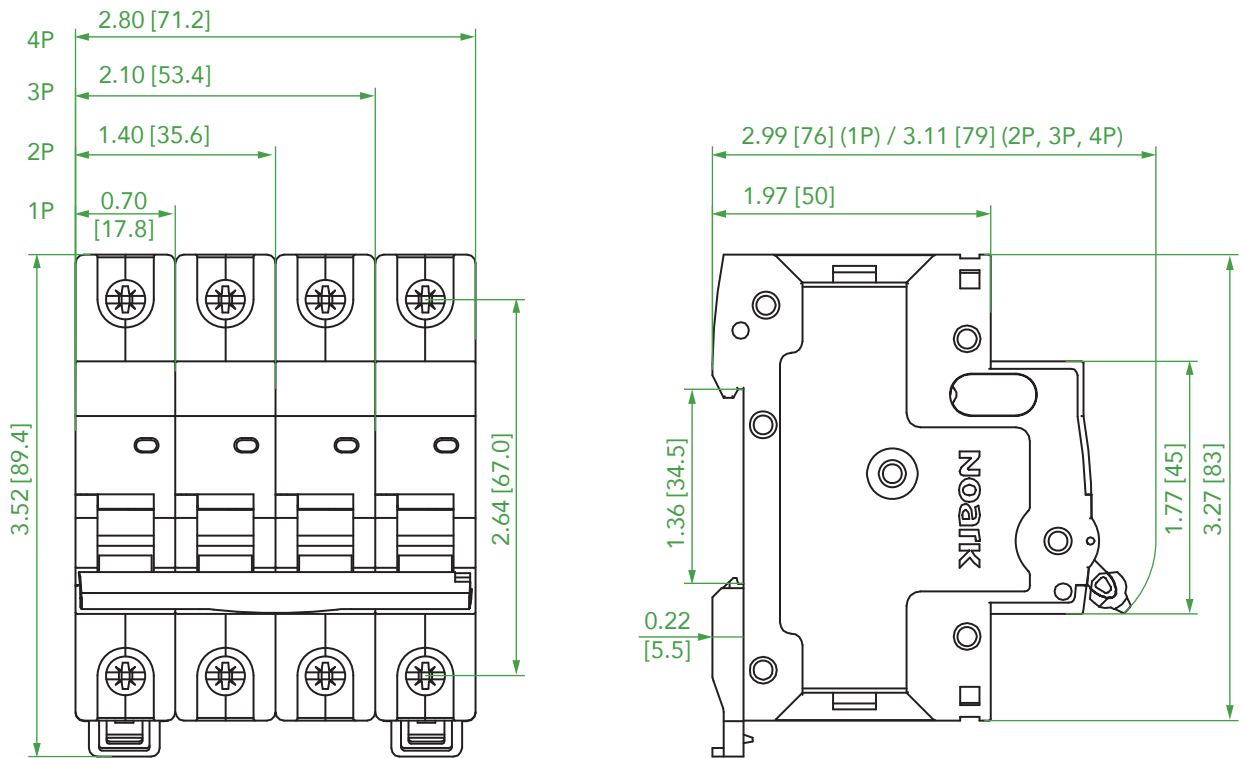

B

Supplementary Protectors

UL 1077 Accessories: Alarm Switch, Auxiliary Contact

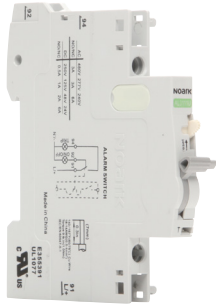

AL31	11	U
Description	Auxiliary Contact	Device Category
Alarm Switch	11: 1NO+1NC	U: UL 1077 (Used for 1~63 A)
Accessory Description	Product	Part Number
Alarm Switch	AL3111U	1001216

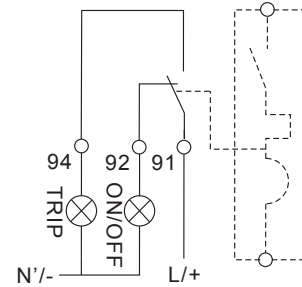

Specifications B57
Dimensions B58

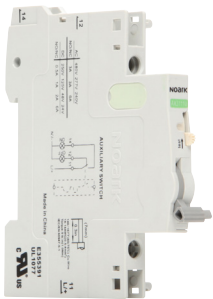

AX31	11	U
Description	Auxiliary Contact	Device Category
Auxiliary Contact	11: 1NO+1NC	U: UL 1077 (Used for 1~63 A)
Accessory Description	Product	Part Number
Auxiliary Contact	AX3111U	1001215

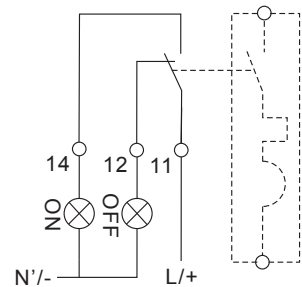

Specifications B57
Dimensions B58

Supplementary Protectors

UL 1077 Accessories: Shunt Trip and Under-Voltage Trip



Specifications B57
Dimensions B58

SHT31	11	U	A
Description	Auxiliary Contact	Device Category	Rated Voltage
Shunt Trip	11: 1NO+1NC Blank: No Auxiliary Contact	U: UL 1077 (Used for 1~63 A)	A: 110~415 Vac, 110~130 Vdc B: 48 Vac/dc C: 12~24 Vac/dc D: 6-12 Vac/dc

Accessory Description	Product	Part Number
Shunt Trip	1NO+1NC 110-415 Vac/110-130 Vdc	SHT3111UA 1001223
	1NO+1NC 48-60 Vac/dc	SHT3111UB 1001224
	1NO+1NC 12-24 Vac/dc	SHT3111UC 1001225
	1NO+1NC 6-12 Vac/dc	SHT3111UD 1002571
	110-415 Vac/110-130 Vdc	SHT31UA 1001226
	48-60 Vac/dc	SHT31UB 1001227
	12-24 Vac/dc	SHT31UC 1001228
	6-12 Vac/dc	SHT31UD 1002574

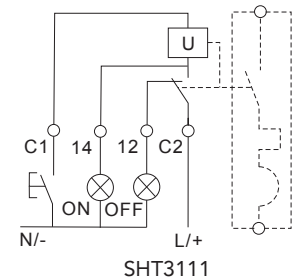
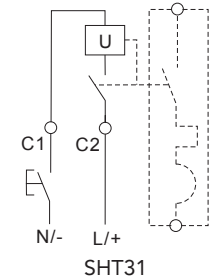

B



Specifications B57
Dimensions B58

UVT31	01	N	A
Description	Auxiliary Contact	Device Category	Rated Voltage
Under-Voltage Trip	01: 1NC 10: 1NO Blank: No Auxiliary Contact	U: UL 1077 (Used for 1~63 A)	A: 240 Vac B: 48 Vac/dc C: 120 Vac

Accessory Description	Product	Part Number
Under-Voltage Trip	1NC / 240 Vac	UVT3101UA 1001217
	1NC / 48 Vac/dc	UVT3101UB 1001218
	1NC / 120 Vac	UVT3101UC 1002578
	1NO / 240 Vac	UVT3110UA 1001219
	1NO / 48 Vac/dc	UVT3110UB 1001220
	1NO / 120 Vac	UVT3110UC 1002579
	240 Vac	UVT31UA 1001221
	48 Vac/dc	UVT31UB 1001222
	120 Vac	UVT31UC 1002580

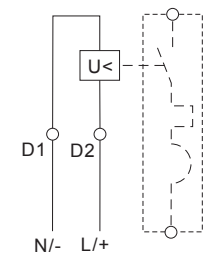
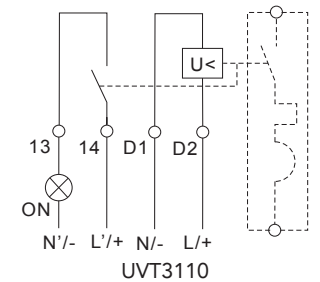
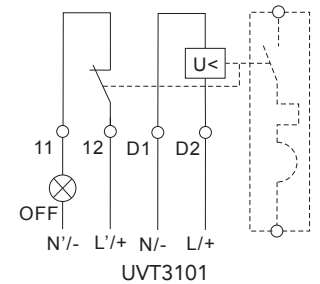

Supplementary Protectors

UL 1077 Accessories: Specifications

		Alarm Contact	Auxiliary Contact	Shunt Trip		Under-Voltage Trip	
		AL	AX	SHT	SHT+AX	UVT	UVT+AX
Applicable Standard		UL 489 / UL 489A					
Ratings (50/60 Hz)	Vac	480/3 A, 277/3 A, 240/6 A		110~415		120, 240	
	Vdc	250/0.5 A, 125/1 A, 48/2 A, 24/6 A		110~130		-	
	Vac/dc	-		6~12, 48~60, 12~24		48	
Auxiliary Contact Configuration		-	1NO+1NC	-	1NO+1NC	-	1NO+1NC

Supplementary Protectors

UL 1077 Accessory Dimensions: Alarm Switch/Aux Contact & Shunt/Under Voltage Trip

AL31/AX31

Alarm Switch/Auxiliary Contact

Unit: in [mm]

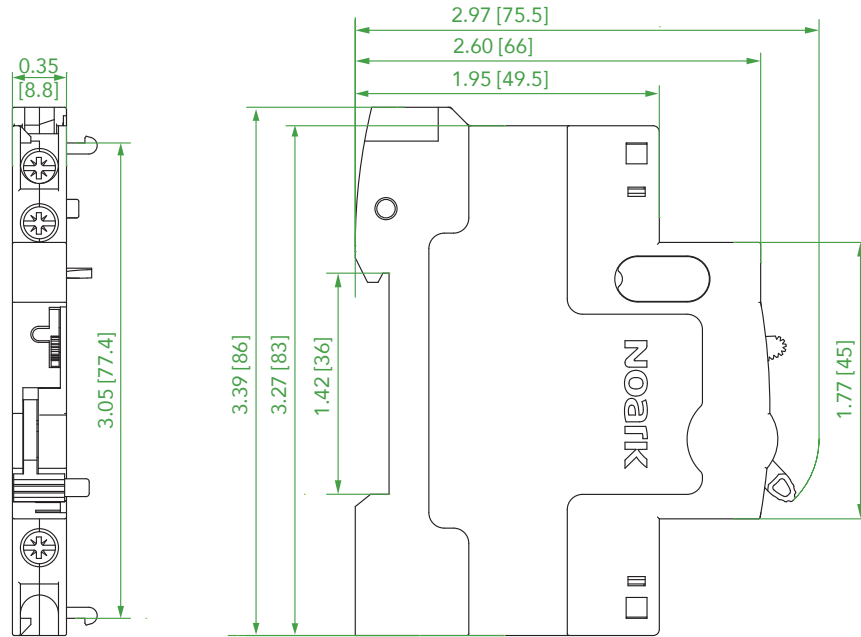

B

SHT31/UVT31

Shunt Trip/
Under-Voltage Trip

Unit: in [mm]

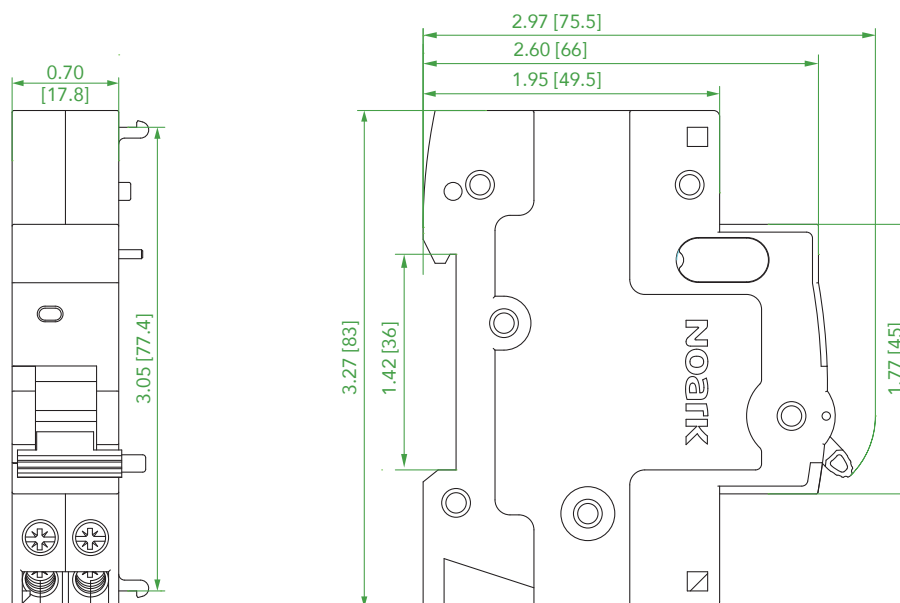

SUPPLEMENTARY PROTECTORS



UL 1077

Supplementary Protectors

UL 1077 Product Overview

Features

- UL 1077 recognized miniature circuit breakers from 80 to 125 A current rating
- Breakers mount on standard 35 mm DIN rail
- Standard ratings of 5 kA at 480Y/277 Vac
- Suitable for supplementary protection
- Thermal-magnetic over current protection – short-circuit protection 8~12 In curve
- Trip-free design – breaker cannot be defeated by holding the handle in the ON position
- Captive screws cannot be lost
- Fulfill UL 1077, IEC 60947-2 standard
- Module width of 1.06 in (27 mm) per pole
- Contact position indicator (red/green)

C

Typical Application

- Supplementary Protection
 - ✓ Control circuits
 - ✓ Lighting
 - ✓ Business equipment
 - ✓ Appliances

Supplementary Protectors

UL 1077 National and International Standards

Certifications

UL 1077 No. E355391 / IEC 60947-2

- Supplementary Protectors are UL Recognized for use in the United States in accordance with NFPA® 70 (NEC).
- The devices comply with UL 1077 No. E355391
- These devices are for international and domestic use, and also comply with IEC 60947-2 and are CE marked.
- B1E 80~125A series has SAA certificate.



RoHS

- These devices are RoHS compliant.



Supplementary Protectors

UL 1077 Product Selection Guide

Label

These supplementary protectors are equipped with: standard box terminals that accept multiple conductors. All breakers mount on standard 35 mm DIN rail. Breakers can also be reverse feed.

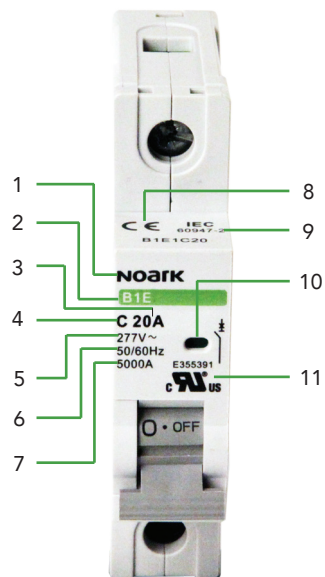

1. Brand
2. Product Type
3. Rated Current
4. Tripping Curve
5. Rated Voltage
6. Frequency
7. Interrupting Rating
8. CE Mark
9. IEC Standard
10. Breaker Status Indicator
11. UL Recognized Component

Product Selection Guide

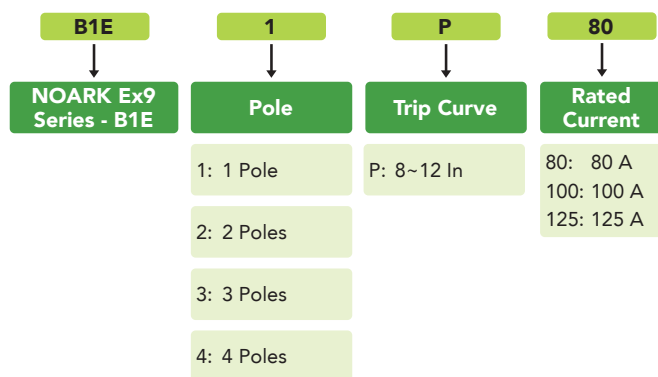

Supplementary Protectors

B1E 80-125 A UL 1077 480Y/277 Vac; 110/220 Vdc

Certifications
IEC/EN 60947-2



Rated Amperage (A)	1 Pole		2 Poles		3 Poles		4 Poles	
	Product	Part Number	Product	Part Number	Product	Part Number	Product	Part Number
80	B1E1P80	1000672	B1E2P80	1000675	B1E3P80	1000678	B1E4P80	1000681
100	B1E1P100	1000673	B1E2P100	1000676	B1E3P100	1000679	B1E4P100	1000682
125	B1E1P125	1000674	B1E2P125	1000677	B1E3P125	1000680	B1E4P125	1000683

Specifications C64 to 65
Wiring Diagram C64

Trip Curve C66
Dimensions C67

Supplementary Protectors

UL 1077 B1E 80-125 A Specifications

		B1E			
Conformed Standard		UL 1077			
Rated Operational Voltage (V)		480Y/277 Vac, 110/220 Vdc			
Rated Frequency (Hz)		50/60			
Rated Current (A)		80~125			
Number of Poles		1	2	3	4
Instantaneous Tripping Type		8~12 In			
Interrupting (kA)	120 Vac	-			
	120/240 Vac	5	-		
	208 Vac		-		
	240 Vac		-		
	277 Vac		-		
	480 Vac	-	5		
	60 Vdc	10	-		
	110 Vdc	10	10	-	
	125 Vdc	-			
220 Vdc	-	10	-		
Inverse Time-Delay Over-Current Release Type		Thermal-Magnetic			
Service Life	Electrical	1,500 (80~100 A) 1,000 (125 A)			
	Mechanical	8,000 (80~100 A) 7,000 (125 A)			
Protection Degree		IP 20			
Wire AWG (mm ²)		4~1/0 (25~50)			
Operating Temperature Range		-22 °F to 167 °F (-30 °C to +75 °C)			
Insulation Coordination	Rated Insulation Voltage (Vac)	500			
	Rated Impulse Withstand Voltage (kV)	8			
Pollution Degree		Class III			
Over Voltage Category / Mounting		Class III / 35 mm DIN rail			
Altitude ft (m)		Does not exceed 6,561 (2,000)			
Atmospheric Conditions		At 68 °F (+20°C), the relative humidity does not exceed 90% At 104 °F (+40°C), the relative humidity does not exceed 50%			

C

Wiring Diagram

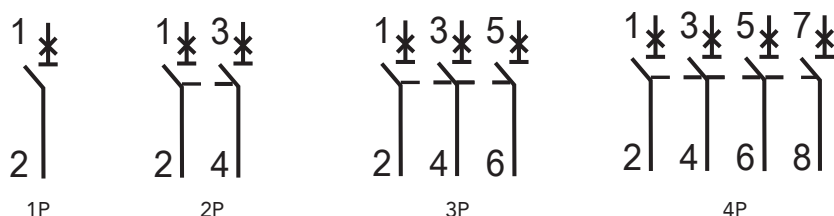

Miniature Circuit Breakers

CE B1E 80-125A Specifications

		B1E 80~125	
Conformed Standard		IEC60947-2	
Number of Poles		1	2
Rated Operational Voltage (V)		DC60/80/110V	DC80/125/220/250V
Rated Current (A)		80~125	
Instantaneous Tripping Type		8~12In	
Ics	60 Vdc	15	-
	80 Vdc	7.5	15
	110 Vdc	7.5	-
	125 Vdc	-	15
	220 Vdc	-	7.5
	250 Vdc	-	7.5
Icu	60 Vdc	20	-
	80 Vdc	10	20
	110 Vdc	10	-
	125 Vdc	-	20
	220 Vdc	-	10
	250 Vdc	-	10
Inverse Time-Delay Over-Current Release Type		Thermal-Magnetic	
Service Life	Electrical	1500 (80~100A); 1000 (125A)	
	Mechanical	8000 (80~100A); 7000 (125A)	
Protection Degree		IP 20	
Wire AWG (mm ²)		4~1/0 (25~50)	
Operating Temperature Range		-22 °F to 167 °F (-30 °C to +75 °C)	
Insulation Coordination	Rated Insulation Voltage (Vac)	500	
	Rated Impulse Withstand Voltage (kV)	4	
Pollution Degree		Class III	
Over Voltage Category		Class III	
Mounting		35 mm DIN rail	
Altitude ft (m)		Does not exceed 6,561 (2,000)	
Atmospheric Conditions		At 68 °F (+20°C), the relative humidity does not exceed 90% At 104 °F (+40°C), the relative humidity does not exceed 50%	

Supplementary Protectors

UL 1077 B1E 80-125 A Trip Curve

Curve - 80~125 A
(8~12 In)

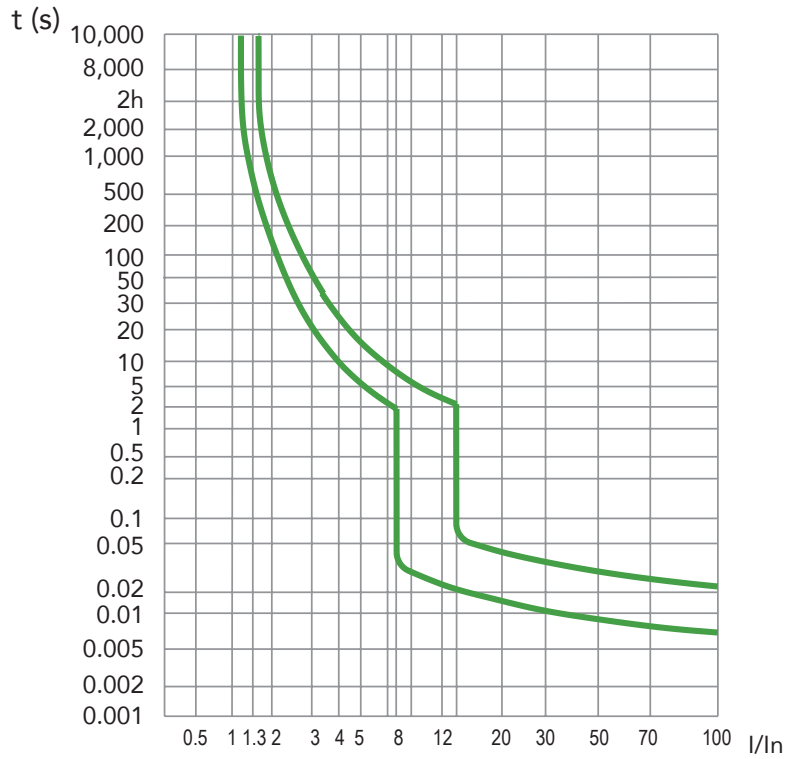

C

Supplementary Protectors

UL 1077 B1E 80-125 A Dimensions

B1E - 80~125 A
1P/2P/3P/4P
Unit: in [mm]

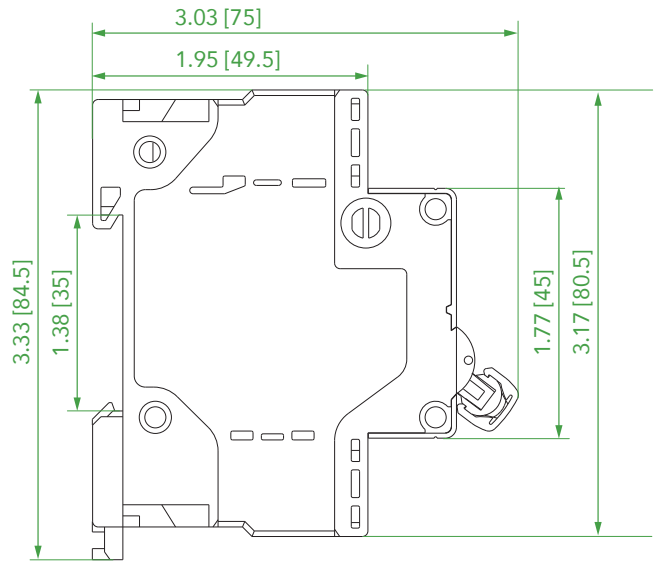
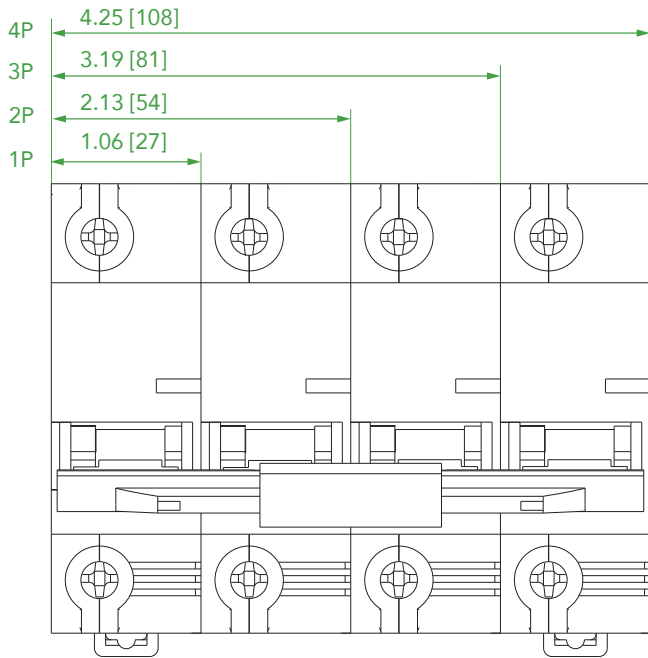

NOARK®



NOARK Electric North America

(626) 330-7007

na.noark-electric.com • nasales@noark-electric.com



Note: NOARK Electric reserves the right to make technical changes or modify the contents of this document without prior notice. With regard to purchase orders, the agreed particulars shall prevail. NOARK Electric does not accept any responsibility whatsoever for potential errors or possible lack of information in this document. NOARK Electric reserves all rights in this document and in the subject matter and illustrations contained therein. Any reproduction, disclosure to third parties or utilization of its contents – in whole or in parts – is forbidden without prior written consent of NOARK Electric.