

Bee Culture's

# BEE Keeping

Spring '16

YOUR FIRST THREE YEARS

WHAT EQUIPMENT?

GETTING BEES

WHERE TO PUT YOUR  
BEES

COOKING WITH  
HONEY

ROOT<sup>®</sup> PUBLICATIONS \$5.99  
Leave on Newsstand Through March



7 1 >  
0 74470 29478 8

# BEE Keeping



Page 7



Page 22

22 **SUCCESSFUL BEEKEEPING**  
YOUR FIRST TWO YEARS  
ROY HENDRICKSON

29 **BEEYARDS**  
WHERE OH WHERE WILL  
YOUR NEW HIVES GO?  
BUZZ PHILLIPS

32 **REGIONAL REPORTS**

36 **WHAT TO DO AND WHY**  
TIPS FOR THE FIRST QUARTER  
ANN HARMAN

38 **10 RULES OF  
MODERN BEEKEEPING**  
KIM FLOTTUM

44 **TOP BAR HIVES**  
MANAGEMENT IDEAS  
LES CROWDER

3 **KATHYS KOOP**  
CHICKENS & BEES JUST GOT TOGETHER  
KATHY SUMMERS

5 **CITY BEES**  
URBAN BEES AND URBAN BEEKEEPERS  
HAVE THEIR OWN SET OF RULES  
TONI BURNHAM

7 **NATURE OR NURTURE**  
CATCH THE BUZZ

8 **GETTING BEES**  
YOU CAN'T GET BEES AT WALMART  
PHIL CRAFT

12 **COOL NEW STUFF!**

14 **EQUIPMENT FOR  
FIRST TIME BEEKEEPERS**  
IT REALLY ISN'T THAT COMPLICATED  
JAMES E. TEW

19 **HELP!**  
I'VE GOT A QUESTION,  
WHERE CAN I FIND THE ANSWER?  
ANN HARMAN



Page 29

## Chickens and Honey Bees

– they just seem to go together. We discovered this almost four years ago when we got our first batch of baby chicks.

We started with 15 chicks of several different varieties. There are still eight of the original batch with us. Spring 2015 we got 12 more chicks and six Call ducks. We lost two of the chicks and four of the ducks. So we now house 18 chickens and two ducks.

My older son asked me “why” when I told him we were getting chickens. It wasn’t something he could imagine me doing. This was way out of his comfort zone and mine as he saw it.

So – why? I kept reading more and more about beekeepers also having chickens. It peaked my interest and one Winter night while we were inside desperately trying to keep warm, I said to Kim – “We should get some chickens.” Kim has a long history with chickens so he was on board with the idea.

The next step was to figure out what sort of coop we wanted. Kim

came up with a wonderful plan and we have a friend who can build almost anything you challenge him with. So Kim gave him his ideas and he came back with a plan.

Our coop is attached to the back of the garage with a door that goes into the garage. This is great especially in the Winter time. I can go through the garage and right into the coop. There is a platform where food is stored and another door and steps down into the area where the birds are. We have four nesting boxes (most information I’ve seen says have one box for every four birds), three perches (two up high and one down low), four windows that can be opened for ventilation in the Summer time. It’s a wonderful coop.

Our chickens are not fully free-range in that they have a penned in area. We have too many predators for us to be comfortable just turning them out every day. There is a Red

Osier Dogwood bush that takes up a big portion of the pen providing not only great shade and protection from the elements, but also challenges the overhead predators.

There is a down side to not having a movable hive –

chickens pretty quickly tear up the area where they are. There is not one blade of grass in their pen. We put bales of straw in every so often to give them something to do and to lessen the mud pit effect.

Their young ones that arrived in the Spring were very flighty and were constantly getting out of the pen and then

freaking out because they couldn’t figure out how to get back in. We finally resorted to clipping their wings – a fairly simple and apparently completely painless procedure. That put a stop to the running loose. We did lose a few and I’m pretty sure that’s what happened – airborne and then wandered off. There are fox, coyote, raccoons and several big dogs in our neighborhood.

We opted not to get a rooster. After lots of contemplating and talking to experienced chicken raisers, it seemed the better way for us. The consensus was

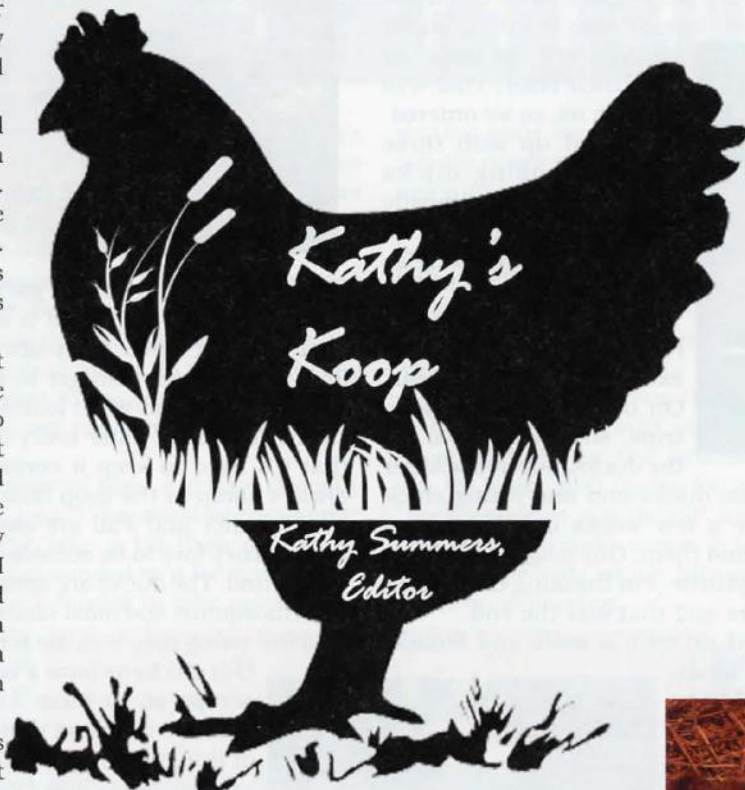

that you need a rooster for only one reason. Otherwise all they do is make a lot of noise and keep everybody else agitated. We have several friends that had pretty nasty roosters that ended up in the soup pot.

Hens, like queen honey bees start to go downhill at about three years. The egg laying really tapers off and if you’re in this to make money you’ll end up culling some of the older chickens out of the flock. But I’m in it for the fun. This was not a money making venture. So the chickens we have lost have gone the way of nature. I can’t bring myself to kill them or to let Kim kill them. They’ll be with us until they are snatched or go from natural causes.

That’s the kind of beekeepers we are also. We don’t make money on our bees or on the honey we get from them. We’re in it because of our jobs partly, but also because we just enjoy the bees.

And when you gain some experience in beekeeping and learn about drone trapping, you can give those drone frames to the chickens and they will be so happy to eat all those larva for you. It’s a pleasure to watch them.

This past Spring we decided to add ducks to our flock. We found a hybrid breed named Call Ducks, at



the county fair and so we started looking for where to get them. The ones we saw at the fair were solid yellow – light yellow, the color of butter and they were beautiful. There were also blue ones. And they are small in comparison to normal duck breeds. So we were on a mission to find those particular ducks.

We were able to special order them at one of the local feed stores in town. We wanted six. They could not guarantee the color. What I learned was that Call ducks



are bred more for their size than their color. That was OK with us, so we ordered. We ended up with three Mallard looking ducks and three that were mostly yellow, but not solid. It didn't matter, they were as cute as could be.

Kim and I travel a lot and 2015 was an exceptionally busy year. On one of the week long trips, shortly after we got the ducks, our house sitter

called and said four of the ducks and one young chick were missing. They were a few weeks old. He looked everywhere and couldn't find them. Our neighbors have a pond with a big snapping turtle. I'm thinking they might have made their way there and that was the end.

Fortunately we ended up with a male and female. They look just like Mallards, only a good bit smaller. Maybe we'll have some baby ducks in the Spring.

The ducks are so much fun and a lot more animated than the chickens. They move almost all of the time as a single unit. She stays right by his side, unless she is swimming in her kiddie pool which she absolutely loves. She runs out of the coop each morning quacky loudly and rapidly and runs for the pool, jumps into that cold water and looks so happy.

If you are wondering, yes the ducks live in the chicken coop and because they are ground



nesters and the chickens roost up top there is plenty of room and nobody seems bothered by anybody else. We're not exactly sure what Winter will bring, but we're going to find out soon.

We have a water heater that we've used for the past three Winters that works quite nicely. It is shaped

and looks like the lid to a garbage can and you put the water container on top of it and it keeps it just warm enough to not freeze. Ours sits on top of the nesting boxes and the chickens can get to it easily. Since the ducks are on the ground we're looking for another solution for them. They need water every day, but they are so messy that it's hard to keep it contained so as not to have it always damp in the coop floor all Winter.

Summer and Fall are easy with the chickens and ducks. They love to be outside. They love to dig around in the ground. The ducks are amazing at eating and catching flies, mosquitos and most kinds of bugs. When the garden is in full swing they love the remnants of the garden also.

Our chickens have a varied diet. Most of our table scraps go to them and they thoroughly enjoy that. Be cautious though because there is a list of things that you shouldn't give your chickens and ducks – chocolate, avocados, raw potatoes and a few more.

Right now we are getting on average nine or 10 eggs per day. Plenty for us, enough to give away and even sell a dozen here and there. And here is where Kim would say 10 eggs and 18 chickens – what's wrong with this picture? But like I said before I like the chickens because they are fun and entertaining.

So if you've got chickens, you should probably have bees and the other way around also. They're both fun to have around and the honey and the eggs are amazing. 

*Kathy Summers*

**800.289.7668**

Publisher - John Root  
 Editor - Kim Flottum, Kim@BeeCulture.com  
 Editor - Kathy Summers, Kathy@BeeCulture.com  
 Layout & Design - Allexandrea Nank, Joy@BeeCulture.com  
 Social Media & Event Specialist - Amanda DeSimone, Amanda@BeeCulture.com  
 Advertising - Jean Newcombe, JNewcombe@BeeCulture.com  
 Spring 2016 Volume 1, Issue 1, is published quarterly  
 By A.I. Root Co., 623 W. Liberty Street, Medina, OH 44256  
 Advertising - 800.289.7668, Ext. 3216; JNewcombe@BeeCulture.com  
 Newstand Price \$6.99  
 Publishes by the A.I. Root Co. Copyright© 2016. All rights reserved



Photo by Kim Flottum

# CITY BEE'S

~TONI BURNHAM



As this beekeeping season comes to a close around here, one recurring theme among our newbees and mentees has been unwelcome changes in hive temperament. Not far behind has been deciding when a hive is too hot for either the beek or the neighbors – then figuring out what to do about it. One of the great lessons of this year is really a very old lesson: if you don't know that you have a gentle, local queen, swap her out for one with an established pedigree. I might go so far as to say that urban beeks might want to pay just about as much attention to this lesson as our colleagues in Africanized Honey Bee zones.

So, who likes temperamental bees, anyway, and why is this a particularly urban topic? The usual worries apply: legalized beekeeping might take a hit from a stinging incident, our apiaries are surrounded by a lot more people who could get stung, and it's harder to take proper care of cranky bees. But survey after survey also indicates that city beekeepers tend to be newer to the craft, more likely to be self-educated, and less likely to be the sole user of the areas where their apiaries are located (meaning we use areas in community gardens, school and church grounds, parks, and so on).

## **When "urban savvy" is not so smart**

Why do "newer" and "self-educated" matter? We all know that so many of our decisions about our bees depend on a solid gut sense of what is going on, what is healthy, and what is normal for the place where we are standing. In the case of a hot hive, a new beekeeper could legitimately believe that the problem was in how they might be fumbling with tools, smoker, and woodenware, and blame themselves. Most urban beekeepers also join up with the idea that they are participating in "saving the honey bee," not squashing ornery queens. They often will not go there on their own. My mentees ask me for permission: a lot.

If your average beekeeper has two years or less under her or his belt, the gut located there still has a lot to learn. And we clever urbanites like our books, webinars, and online videos because they are easy to fit around busy crowded lives: not like a class that takes up tired hours after work, or to which you have to sacrifice a chunk of several weekends. But it's easy to miss key topics when

writing your own syllabus, and many urbanites have simply never had any experience with practical agri- or apiculture.

Wouldn't it help to know what to expect of bee behavior and temperament based on the seasons at your latitude? But it's also hard to find an experienced mentor, especially in these super-growth years of interest.

Nowadays, city beekeepers that have been around awhile are often already fielding questions from a half dozen newbees. Rather than wait around for someone to be available to visit your apiary, for a class seat to be offered, or for the weather to allow a group meet up, it's faster and easier for a city newcomer to Google "beekeeping in a nutshell" and believe the first source that seems to make sense. It is not great preparation for the unexpected, which biology and the bees are never short on delivering.



## **Beggars can't be choosers**

Another unforeseen effect of the recent growth of urban beekeeping, the relative inexperience of practitioners, and the price of space around here is that we have relatively few nuc and queen producers dedicated specifically to our city club. All around here, in suburbs and more rural areas, good hearted and smart beekeeping

communities have been working hard to make up overwintered nucs and local queens for their students, and they sell the extras to us when they can. But we are not yet in a place to supply the 40 or 50 new beekeepers that graduate with every short course with known local stock. So we get bees where we can: usually packages, usually from hundreds of miles South, and we count ourselves lucky that we have the option. In the absence of nucs, many of us make as many splits as we can in the Spring for our mentees, but a lot of these queens are free mated. Catch-22.

## **Shared spaces and getting serious about genes**

This is not a public confession that I make lightly: about once a year, I help destroy a hive: usually a great, big, healthy one. The common factor every year: bees in small and shared spaces where non-beekeepers are getting hurt. This year it was in a place frequented every

day by small children and every evening by passing foot commuters. My group got involved after the police did. I picked up between 100 and 200 stings putting out that fire. It made me think.

There is no villain in this story (or, frankly, any of the others: careless people don't call for help). In most of the recent cases, the queen in question came from a package that was lovingly cared for, except for the requeening-with-someone-local part. The beekeeper that ended up in trouble found the package queen to be productive, gentle and easy to work in 2013, so why change? But she found herself with a fire breather after the 2014 nectar flow. What happened? Well, no one told her a few things.

Here in DC, our packages mostly come from the South, from areas bordered by zones known to harbor Africanized bees. Most package queens come from mating programs complete with drone flooding (or so the assurances go), but in the best of such efforts, who knows which drone found which queen along the way? And bees don't have to be AHB to be jerks, anyway.

What we think happened is an efficient supercedure that resulted in a hot second cross. There was no obvious drop in hive strength or brood rearing to signal queen loss, but after the honey was stored away, the fireworks started.

What do I mean by a second cross? In Mendelian genetics, you can have a parent who breeds true to a desirable characteristic mate with another sporting a not-so-nice quality. The first generation of offspring can still turn out to be just peachy. But if you let *that* generation free mate—no one that I know of is drone flooding downtown—a significant percentage of their young can revert to hell-on-wings. The second cross is, in fact, *cross*. And the package bee producer has no way to tell me whether it will happen, or how often, or which queen.

Our new policy for recommending bees in community gardens, parks, school yards, and anywhere the public can pass within 20 feet of a hive entrance is really knowing the pedigree of the bee lines placed there. We love swarms, we depend on packages, but we want to know everyone's grandma before we put them on public space. And if we don't know at first, we want to know by the time the season is over. By any means necessary.

### **Some basics of thinking about bee temperament**

There are some pretty standard management techniques, seasonal changes, and genetic train wrecks that I consider when figuring whether a hive, or really its mama, is too hot for downtown. I consider these the three tent poles of deciding whether the local royalty has to go. But there is truly one variable you don't need an expert mentor to decide for yourself: is working your bees painful for you? Don't put up with it.

There's a lot of stuff out there right now about working without protective gear, and without smoke. Hey, it's any adult's choice, but I get stung a lot more that way. And the bees are more riled when that happens, what with all the alarm pheromone around the place. If you are in the city, getting stung, and generally getting the girls worked up, please consider trying a veil and a smoker. The next person passing by did not volunteer for the privilege, and the bees will be testy after you leave. But this alone does not mean that they are hot.

And some bees are hotter at some times than others, so you can work with that, within reason. The bees of early Spring around here are a marvel of peace and contentment, right through our nectar flow of April-May-June. After that, you have a full sized colony of underemployed bees, and they are less pleasant company. All this means is that you work them less, and with more awareness of the state of affairs.

I would not recommend requeening every hive that reacted more defensively after a flow, especially when the queen is already from known stock. If putting the empty supers on after harvest is a threat to life and limb, however, I would consider it.

And I would consider it strongly. If you do not know the queen's background, and you do have access to a known quantity, this is your last chance to requeen before colony populations get north of 40 or 50K.

We have a predictable annual dearth in late Summer, when we try to mostly leave colonies that are in good shape alone, if only to prevent robbing. Even I put on the gloves in late Summer around here.

If they continue to get hotter as they grow into our dearth season, and that hive is in a public place, we face the thrilling prospect of attempting to dissect a vigorous volcano of a hive in the middle of all humanity. My so-wise mentor once told me that finding the queen in a normal August hive around here was not about skill, but luck. Luck is not good enough in a major American population center.

Fall requeening is what's generally recommended around here (though there are energetic philosophical wars around the subject), and if I did not remove an unknown queen before now, this is when to go for it. Try to get a friend or four to help: once while making splits, Jennifer Berry showed us how to have multiple beekeepers simultaneously each grab and inspect a single box for the queen before the latter got a chance to run. In late Summer, I also use a hive drape to minimize the number of bees in the air. This is a tremendous way to cut down on time required and pheromone released, while maximizing your chances of success. (If I have described this poorly, it's my fault, not Jennifer's, and you probably should be reading *her* article anyway.)

### **We can manage the heat**

Like you read earlier, there is nothing particularly urban about having a hot, unmanageable hive, but we face elevated risk of getting our approach and our genes wrong, and harming other people when we do. So we need to be thinking about whom we have inside those boxes, what we know about her, and how we are going to manage her succession plan. This reminds me a lot of



the kind of awareness that is common practice in AHB areas, and we could consider taking a page or two from their published recommended practices.

But my main (and somewhat unhappy) advice is to be ready to let go, even of a high-producing, well-behaving queen if you don't know what you have and don't know what you will do if the situation goes bad. The worst case does not happen that often, but it really sucks to kill 50,000 bees (and the stings are no fun, either). The best case is that you are building up the healthy temperament and genetics of your entire urban area each time you introduce known, high quality stock into such a concentrated space. Over time, we will produce more of our own, but until then, we have to be suspicious and a little bit mean ourselves.

One way to deal with a large, hot colony in a very great hurry is to use a very large black plastic garbage bag. Remove the telescoping cover but leave on the inner cover, with the bag at the ready. Slip the bag all the way over and down to and cover the entrance. Tip the colony on its side and put another bag from the bottom up. The heat from the sun and no moving air will suffocate the bees in a matter of minutes, with no free flying bees to be a danger. 

*~Toni Burnham  
Keeps bees on rooftops  
in the Washington, DC  
area where she lives.*



## **CATCH THE BUZZ** Nature or Nurture?

Even as larvae, honey bees are tuned in to the social culture of the hive, becoming more or less aggressive depending on who raises them, researchers report in the journal *Scientific Reports*.

"We are interested in the general issue of how social information gets under the skin, and we decided to take a chance and ask about very young bees that are weeks away from adulthood," said University of Illinois entomology professor and Carl R. Woese Institute for Genomic Biology director Gene Robinson, who led the research with postdoctoral researcher Clare Rittschof and Pennsylvania State University professor Christina Grozinger.

"In a previous study, we cross-fostered adult bees from gentle colonies into more aggressive colonies and vice versa, and then we measured their brain gene expression," Robinson said. "We found that the bees had a complex pattern of gene expression, partly influenced by their own personal genetic identity and partly influenced by the environment of the colony they were living in. This led us to wonder when they become so sensitive to their social environment."

In the new study, the researchers again cross-fostered bees, but this time as larvae in order to manipulate the bees' early life experiences. The larvae were from a variety of queens, with sister larvae divided between high- and low-aggression colonies.

The larvae were removed from their foster hives and put into a neutral laboratory environment one day before they emerged as adults. The researchers tested their aggressiveness by exposing them to an intruder bee.

They were surprised to see that the bees retained the social information they had acquired as larvae. Those raised in aggressive colonies were 10 to 15 percent more aggressive than those raised in the gentler colonies.

"Even sisters born of the same queen but reared in

different colonies differed in aggression, demonstrating the potency of this environmental effect," Robinson said.

The finding was surprising in part because bee larvae undergo metamorphosis, which radically changes the structure of their bodies and brains.

"It's hard to imagine what elements of the brain are influenced during the larval period that then survive the massive reorganization of the brain to bias behavior in this way," Robinson said.

The aggressive honey bees also had more robust immune responses than their gentler counterparts, the team found.

"We challenged them with pesticides and found that the aggressive bees were more resistant to pesticide," Grozinger said. "That's surprising considering what we know from vertebrates, where stress in early life leads to a diminishment of resilience. With the bees, we saw an increase in resilience."

This finding also suggests that the effects of the social environment on young bees could extend beyond brain function and

behavior, Robinson said.

The researchers don't yet know how the social information is being transmitted to the larvae. They tested whether the bees differed in size, which would suggest that they had been fed differently, but found no size differences between aggressive and gentle bees.

"Adult honey bees are well known for their sociality, their communication skills and their ability to adjust their behavior in response to the needs of the hive," Rittschof said.

"In mammals, including humans, the effects of early life social interactions often persist throughout adulthood despite additional social experiences," she said. "A similar pattern in honey bees has broad implications for our understanding of social behavior within the hive and in comparison with other species."

*Source: University of Illinois at Urbana-Champaign*



# Getting Honey Bees

*You Can't Get Them At WalMart, So Where Do You Get Bees?*

~PHIL CRAFT

Each year I look forward to spring in my apiary. With the first warm days and the first opening flower buds, the bees emerge from their winter seclusion and the air is filled with the buzz of their activity. The sweet tang of wax and nectar fill, not only the hives, but the whole bee yard. I see foragers returning, the sacs on their legs bulging with yellow, orange, and red pollen grains. Moving amongst the hives, lit smoker in my hand, hive tool in my back pocket, veil and straw hat on my head, I'm filled with contentment by the sights and sounds and smells. But the ease and joy I feel there are the result of years of work and experience – and a few frustrations. I hope that all of you reading this who are interested in beekeeping will come to know the same satisfaction one day, but first you have to make a start.

There are several ways of acquiring bees. Catching swarms was a common method in the not too distant past, but parasites have drastically reduced the number of unmanaged colonies, and anyway, it's not a job for beginners. Some people inherit hives of bees, and I know one would-be beekeeper who claims that, deterred by the initial cost of setting up hives, he married into them. Most people purchase them in one of the following forms:

## **An established hive from a beekeeper**

I almost never recommend this for beginners. By late spring, a healthy, existing hive will contain over 40,000 bees and it requires active management from day one - a task for which most new beekeepers are not prepared and which can quickly become overwhelming. They may have to deal with swarming almost immediately, and established hives can have existing disease or parasite issues which require diagnosis and decisions about treatment. Also, a novice may not be a good judge of the condition of the wooden ware in a used hive – a significant part of its cost. The only situation in which it makes sense for a novice to buy an established hive is if he or she has a close friend or relative who is an experienced beekeeper willing to commit to spending a lot of time acting as a mentor. Otherwise, it's better to begin with baby steps.

## **A nucleus hive**

More commonly known as nucs, they can be thought of as starter hives, smaller in size and with fewer frames and bees than an established colony, but complete with all the elements of a hive. They are usually available from beekeeping suppliers and some beekeepers make and sell their own. A nuc is created by removing several frames of drawn comb containing stored honey and pollen, eggs, and developing bees (brood) from a strong hive and placing them in a box half the size of a regular hive body along with bees and a queen. A good nuc producer will maintain the nuc for a short time - usually two or three

weeks before offering it for sale - in order to ensure that the queen is laying and that the young colony is off to a good start. The new beekeeper transfers the frames and bees to an empty, full size box where it will grow into a mature colony in a couple of months. The great advantage of a nuc bought from a reputable source is that it already contains a proven and accepted queen along with eggs, brood, and some food stores, but with only about a quarter of the bees of an established hive. However, in purchasing a nuc new beekeepers need to keep in mind that they are buying a small, but fully functioning colony. That includes any pre-existing disease or parasite problems and entails management issues similar to those of a full sized hive, only with fewer bees. Also the quality varies greatly and the supply – especially of local nucs – is limited. Even though they are usually not available until late in the spring, they are typically ordered in advance and, by the end of January, it is difficult to find any that are not already committed.

## **Package bees**

Starting a hive with package bees is starting from scratch. Producers, usually commercial beekeepers in the southern U.S., make them up by shaking frames of bees from a strong hive into a wooden shipping box with screened sides – the package. A queen in a protective cage is placed inside, along with a can of sugar syrup for consumption by the bees during shipping. The beekeeper, after picking the package up from a supplier or receiving it through the mail, installs both bees and queen in a new hive containing only frames and foundation. Once in their new home, the bees free the queen from her cage by eating through a sugar candy plug. If all goes well, she begins laying eggs as soon as the bees have drawn out enough comb and, about three weeks later, new bees begin to emerge and the colony gradually builds up its population. Packages are the most common way of acquiring bees. They offer the advantages of being cheaper than nucs and readily available, having fewer pre-existing pest and disease issues, and allowing a beginner to wade in gradually instead of immediately plunging in over his head. He has the opportunity of watching the process of development unfold from the first comb drawn and egg laid without having to cope with all the management issues inherent in an existing hive. However, packages present their own challenges. The process of setting up a hive from a package is a more complicated than for a nuc and, because they do start from scratch, don't expect honey the first year. Whereas transporting bees is always stressful for them, transit times and extremes of temperature during shipping take an even greater toll on packages. If possible, pick them up from the seller yourself or look for sources that truck the bees to you directly.



Many beekeeping groups purchase in bulk and share the cost of expedited shipping. The most common problems with package bees involve the queen. For a variety of reasons, bees sometimes reject and kill her which can be frustrating and confusing for a new beekeeper (or even an experienced one). Prompt action to acquire a replacement queen will remedy the situation, but it takes vigilance to recognize it in time.

Finding a good, reputable source is important when buying either nucs or packages. An experienced, successful beekeeper, is the best source of advice. Ask members of your local beekeeping association for recommendations.

### Getting ready

When ordering either packages or nucs, consider asking for a marked queen. A dab of bright paint on her upper thorax makes her much easier to locate, especially for a new beekeeper. It also calls the beekeeper's attention to a hive that has superseded (replaced the old queen with a new one) or swarmed, because the replacement will not have a mark. Such a hive bears watching to make sure that the new queen is fertile and laying. Marks also indicate the age of the queen because different years are represented by different colors. The supplier may charge an extra couple of dollars for this service, but it is worth it.

On the day that you install your bees, have all your new equipment ready, including your new hive. Wood surfaces that are exposed to the weather should already be painted, but not frames, inner cover, or inside surfaces of hive bodies. The hive should be set up on a stand at your pre-selected location. Wear your veil and gloves and coveralls if you plan to use them. You will also need your smoker – lit, and your hive tool. When installing package bees a small pocket knife or screw driver is handy for removing the cork separating the bees from the candy plug in the queen cage. Weather conditions are important. Do not attempt to install bees in the rain or after dark and make sure that the temperature is above 50° F.

### Installing nucs

Nuc boxes are usually wood, but are sometimes made of weatherproof cardboard. Beekeepers typically refer to them by the number of frames they contain, five frame nucs being the most common. Make sure you have enough additional frames with foundation on hand to fill out a ten frame brood box. When you first bring home the new nuc, I suggest setting it immediately adjacent to your new hive and opening the entrance to allow the bees to fly. This will make them a little calmer when you open the lid. You can delay installation for several days if the weather is not ideal, but keep the nuc very close to the new hive location. On first leaving home in a new location, bees orient themselves in order to find their way back again. After the initial flight, the setting is familiar and they do not reorient, so they become lost and confused if the nuc or hive is moved more than a foot or two.

When you are ready to install the nuc, *gently* lift the

cover with your hive tool. As you do so, apply a few puffs from the smoker along the edge of the nuc and allow air



*Notice how small this nuc is next to a normal hive*

movement to carry the smoke across the top of the open box. Then use the hive tool to *gently* remove one of the end frames and place it in the new hive box. One by one, *gently* move the remaining frames, maintaining the same order they had in the nuc box. I emphasize *gently* for a reason. On one of these frames is the most important bee in the hive: the queen. Rough handling could injure her. Also slow, gentle movements help keep the bees calm.

Place the frames close together in the middle of the hive box and add frames of foundation at the edges until the box is full and the frames are evenly spaced. It is important to install all the frames the box was designed to hold: ten frames for a standard hive body. If you leave out a frame, the bees will fill the space with extra layers of comb, making removal of the frames difficult. After all the frames are in place, you can *gently* shake the nuc above the new hive to dislodge the bees that are left. Don't worry about getting every one; if you tilt the nuc box against the hive entrance, any remaining bees will move of their own accord. Put the cover on the new hive and you are finished. You can retrieve the nuc box a couple of hours later.

### Installing a package

Packages are slightly more complicated to install than nucs, but not difficult; new beekeepers do it every year. They typically come with instructions, and many package vendors conduct installation demonstrations at the point of pick up. How-to videos abound on YouTube, but not every self-proclaimed expert is reliable. Instead, look for videos on U.S. bee lab websites or those of some beekeeping associations. Be sure to read the directions that come with the package before starting.

There are a few things you need to know, however, even before you get your package. Unlike nucs, packages are not mini hives. They are designed to house bees only for short periods, and the longer bees are contained in them, the poorer their chances of success. Ideally, packages should be installed as soon as you get them – certainly within 48 hours – but in case weather or other circumstances make immediate installation impossible, you should have a plan for storing them. Choose a cool (50 - 60° F), dry, dark place, out



*Five Frame Nuc*

of the sun but not too cold. I often bring them inside. It doesn't bother my family, but the dog never got used to it. You should offer the bees a little sugar syrup when you get them home. (Read about syrup under "feeding" below.) A can of syrup with holes punched in the bottom is included in the package, but if the holes are too small the bees can't extract the syrup. If they are too large, it could drain out prematurely. Even if they are just right, there are many more bees than holes. To make sure they all have enough to sustain them, put some syrup in a spray bottle and spray a small amount onto the screen on the side of the package. DO NOT wet the bees. You want syrup on the screen, not on them. Spray a small amount, wait a few minutes for the bees to consume it, then apply a little more. If you store them overnight you can feed them again in the morning, and later the next day. Give them some more a few minutes before installation. Though package bees are normally pretty calm, letting them fill up with syrup just before you open the package calms them even more.



### Feeding your new hive

Whether you start with nucs or packages, you will need to feed your new hive in the beginning. For this purpose, beekeepers use either high fructose corn syrup or simple sugar syrup as a honey substitute. High fructose corn syrup can be purchased from beekeeping suppliers. DO NOT use the corn syrup sold in grocery stores; it is not the same thing. If you prefer to make your own simple syrup, just mix equal amounts of granulated sugar and hot tap water and stir until the sugar is dissolved. There is no need to heat the mixture on the stove. Nucs should have some stored honey when you purchase them, so they won't need feeding prior to installation. Many types of feeders are available on the market: entrance feeders, frame feeders, top feeders. Like many beekeepers, I make my own top feeder using a glass jar with small holes punched in the metal lid. Placing it on some small sticks on top of the inner cover allows the bees access to the holes in order to suck syrup from the jar. I cover it with an empty hive body.

I suggest making the syrup continuously available until the bees have drawn new comb and stored some syrup or nectar. That means regularly checking and refilling whatever feeder you have decided to use for at least the first week or two. After that, feed intermittently until most of the comb is drawn out in two deep boxes (the

original box and the second one you added after the first was nearly drawn out.) At that point the colony should be self-sufficient and you can remove the feeder. In addition to nectar or syrup, honey bees need pollen, especially when rearing brood. New packages contain zero stored pollen, and nucs may have only a small amount. During the first few weeks when the bees must simultaneously rear young brood and accumulate food stores while at the same time building the new comb in which these activities take place, they will benefit from a pollen substitute. A couple of protein patties from a beekeeping supplier, placed on the top bars of the hive under the inner cover, will sustain them until they have drawn enough comb to store natural pollen

### About this column

In future issues of *BEEkeeping Your First Three Years* my column will have a question and answer format, so I welcome your questions. You can send them to me by email at: [phil@philcrafthivecraft.com](mailto:phil@philcrafthivecraft.com), or by mail to *Bee Culture* magazine. Though only a few will appear in the magazine, I will respond to all questions personally. As in my "Ask Phil" column in *Bee Culture*, I identify correspondents only by state, never by name. I look forward to hearing from you, and wish you the best in getting started in beekeeping. 

~Phil Craft



## Gold Star Honeybees

Backyard beekeeping for the thinking beekeeper.



Treatment-Free Bees



NATURAL SWEETENING TOP BAR HIVES

Top Bar Hive Kits  
Bees • Classes  
Tools & Accessories  
How-to Videos

GOLDSTARHONEYBEES.COM  
207.449.1121

# Equipment Requirements For The First-time Beekeeper

*Its really is not that complicated*

~JAMES C. TEW



Nearly anyplace can be a hive assembly location. Most beekeepers work in the garage or some similar room, but use what you have. You will not need a fully equipped wood shop, but if you have a pneumatic brad nailer and a small compressor; these

are two tools that are really helpful, but not absolutely required.

## Actually a beehive is a simple contraption

A beehive is not very complicated. Handy craftsmen frequently build their own in their home shop. Essentially, the common hive requires an outer cover – or simply a roof. Directly beneath that rooftop is an inner cover that is primarily used to prevent bees from soundly gluing the roof to the top edges of the hive box immediately beneath it. An inner cover is not absolutely necessary, but it is a very useful piece of equipment. Beneath the inner cover is an assemblage of supers and hive bodies that is determined by the annual season. Some beekeepers use a queen excluding device to restrict the queen to the brood chamber(s). During the spring season, something like two supers and two hive bodies would be common in a typical hive. Beneath all the various boxes that are being used, a bottom board provides the landing platform for bees and gives a bottom for the hive. Generally a hive stand supports the entire beehive infrastructure. (Hive Diagram from Skinner, Parkman, Studer, and Williams, 2004<sup>1</sup>)

## At the outset

Since much of the hive equipment is made of wood, many beginning beekeepers already have some of the equipment they will need. Common woodworking tools, such as hammers, a chisel or two, a couple of pairs of pliers to remove bent nails, and a pipe clamp or two are examples of common small shop tools that will be useful when assembling hive components. You will absolutely want a bottle of common exterior glue for various joints in hive equipment and frame parts.



*A small hammer or a brad nailer can be used to assemble frames, but a heavier hammer will be necessary to assemble the heavier hive parts.*

*This expanded hive view shows hive components that are used in the typical beehive. If building hive equipment at home, it is important that standard measurements be used.*

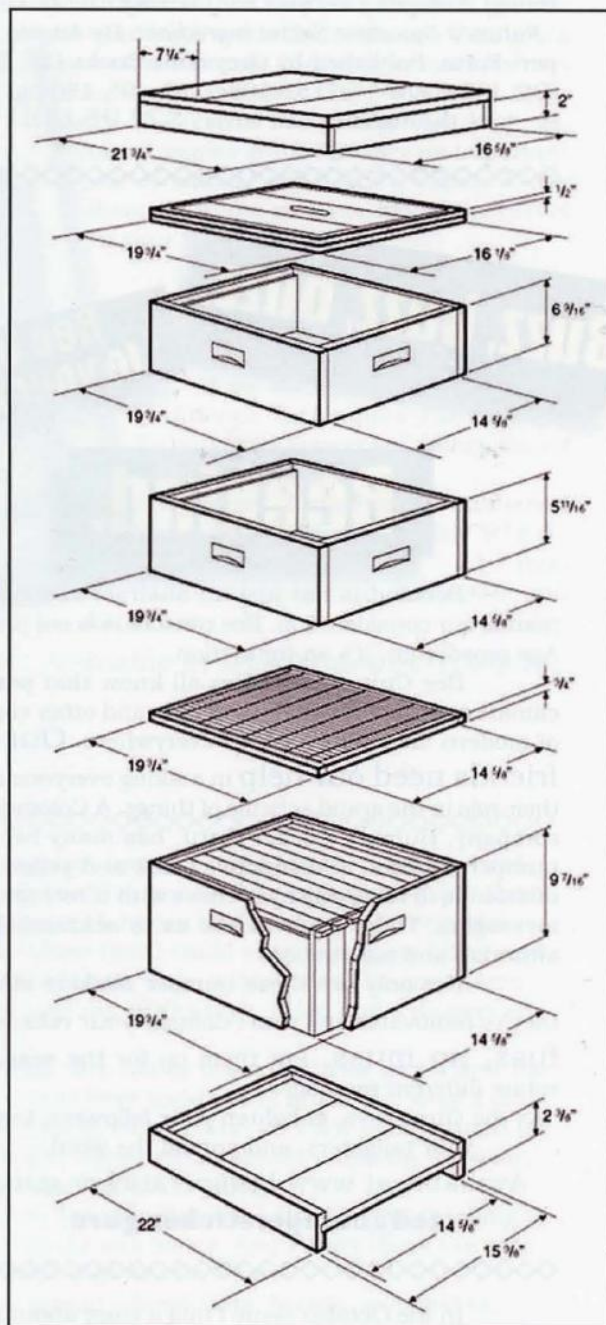



## Two types of joints used in hive equipment

Though some home-built boxes are constructed with simple butt joints, box joints and dado joints are the two



most common hive joints used in traditional wooded hive equipment. Commercially or in the home shop, dado joints are easier to construct than box joints, but they are a bit trickier to assemble.

This is the time to use the pipe clamps referred to above. They are useful when pulling the unassembled parts together and temporarily holding these pieces until gluing and nailing can be completed.

*Either of these joints are acceptable, each having both advantages and shortages. Butt joints are shown in the hive schematic on the page 14. These joints are not the strongest, but are the easiest for the home craftsman to cut in the home shop.*

## Hive roofs

The outermost cover of the hive is made of metal clad wood, or made completely of plastic. Commercial beekeepers routinely use a simple flat board cover. Hobby beekeepers commonly use the telescoping metal covered hive top. Though not a common occurrence, hive tops will occasionally blow off in high winds. Beekeepers occasionally put a weight on the hive top to guard against this rare event.



*Wooden hive tops with metal covers are commonly used by hobby beekeepers. To delay rotting caused by rain and moisture, a wooden rimmed hive cover should be painted occasionally. A flat board cover is a simpler and cheaper top, but nonetheless functional. Plastic covers are essentially maintenance free, but will sometimes warp or bow. Over time, plastic and expanded polystyrene tops will begin to degrade. Ironically, painting plastic equipment will help forestall weather induced degradation.*

## Inner covers and queen excluders - Important, but secondary hive equipment

Some specialized foragers in the colony collect natural rosin to make a bee product (propolis) from trees and occasionally shrubs. Using this basic glue, bees will soundly glue the hive components together. Without an

inner cover, bees would rigidly glue the top to the top box. Banging on the beehive to get it loosened really irritates the bees.

The queen excluder has the same edge dimensions as an inner cover, but has a completely different use. The metal grid is specifically sized to allow worker bees to pass through, but will restrict the queen from squeezing through the grid. In this manner, the queen is confined to a specific area of the hive and will mix brood with honey destined to be removed by the beekeeper.

The inner cover fits flush with the hive edges. Yes, the bees will glue it, too, but the beekeeper can get the sharp end of a hive tool in the crack between the inner cover and the top edge of the hive box and pop it loose. Guard bees are not as testy as they would be if the outermost top had to be bumped to remove it. Keeping the bees calm is always a good thing.



The queen excluder is a surprisingly controversial piece of equipment. Many beekeepers feel that the grid restricts nectar-laden bees from getting through the grid. Yet other beekeepers would not have their hives without one. Using this device or not will be your call.

## The bottom board – the hive's foundation

When all is said and done, the bottom board is just mostly a large board. For many years, it was simply a solid board with a rim on three sides, but now many beekeepers use screened bottom boards. Screened boards offer a bit of *Varroa* mite control, an aggressive parasitic mite that does great harm to honey bees. The screened opening lets mites that happen to fall from the bees drop to the ground below.



*As is so often the case with beekeeping equipment, either style of bottom board works very well. During the winter season, a metal sheet can be inserted to close off the screened opening. The solid bottom board underneath the screened board is more rigid and heavier. This style is used by many beekeepers and exclusively by commercial keepers.*

Equipment	# Needed 1 <sup>st</sup> year	Required/Optional
Outer Cover (Roof)	1	Required
Inner Cover	1	Generally required
Super	1 or 2	Generally required
Queen Excluder	1	Optional
Brood Deeps	2	Generally required
Bottom Board	1	Required
Hive Stand	1	Strongly recommended

Each bee box will require appropriate numbers of frames with foundation inserts. For example, the boxes listed above would require 20 deep frames and 10 frames for the honey storage box (called a super). Obviously, 8-frame equipment would require fewer frames.

### The biggest parts of the beehive – brood boxes and supers



*This hive has a 6 7/8" super on top, a white plastic hive body is second, a dado joint hive body third and a standard box joint hive body on bottom. All of the equipment is from different manufactures, but is all pretty much interchangeable.*

The dimensions and shape of all bee boxes are the same (19 3/4" long x 16 1/4" wide) – except for the depth of some of the boxes. The deepest hive body is about 9 1/2" deep and is commonly used as a brood box for developing bees. Supers are boxes that are used primarily to store honey and can have several depths. Supers that are 6 7/8" deep are common size honey storage boxes.

#### Indeed, there are some variables

Yes, there are some hive equipment variables to be addressed at the outset. The novice beekeeper may very well feel a bit of confusion. This feeling will quickly pass as the procedure becomes comfortable and predictable. Hive equipment required for each beehive setup requirements vary based on annual seasonal nectar flows

### Other than bees, what is actually in the hive?

Not much. Each hive box has ten frames of combs and is generically referred to as ten-frame equipment. There is a second version of hive equipment that is eagerly supported by many beekeepers that uses eight frames and is therefore slightly narrower. Each frame has a wax-coated foundation insert that is embossed with the impression of honey bee cells. These inserts encourage the bees to build straight wax combs rather than the naturally wavy combs bees would build on their own.

The simplistic marvel of the beehive is that it incorporates "bee space." On the tops of the frames, on the ends, on the frame bottom, between the inner cover or between the queen excluders – everywhere in the hive the bee space of 1/4-3/8" is maintained to separate component parts. If not, and the space is wider or narrower, bees will jam everything with bee glue (propolis) or wax. Bee space between the frames and the other hive components is critical to the functionality of today's hive equipment.

### What Else?

#### Used beekeeping equipment

The new beekeeper may come across beekeeping equipment at auctions or from others who have used equipment to sell. There are so many variables on this subject that an entire section could be written. In summary – be careful. If you have a trusted beekeeper friend, ask for advice (*But then he may want to buy it, too.*). Be suspicious of old wax combs. They may harbor disease. Having written this, it is not uncommon for beekeepers to get good deals on used stuff. Again – be careful.

#### Top bar hives

Top bar hives (TBH), of several styles, are popular with some beekeepers. It would not be surprising for the beginning beekeeper to be exposed to these equipment options early in their formative years. While these hive designs are

enjoyable and biologically entertaining, unless the new beekeeper has a TBH mentor, the new beekeeper would be better served starting with traditional equipment. More help and far more information is available to the novice if standard equipment is used.

### Personal protective gear

To keep bees, the new beekeeper will require bees; hive equipment and protective clothing and some management equipment. As is the case with various styles of hive equipment, there are now many models and designs of protective clothing.

Ranging from least to most: (1) a simple veil for face protection, (2) a half suit with attached veil, and (3) a full-length suit with attached veil. Since beginning beekeepers are concerned about the occasional sting and are unsure about this new venture, purchasing a full-length suit is not uncommon. When wearing a full suit with bee gloves and elastic closures at the wrists and ankles, there is little chance that a testy bee could ever find a weak spot to attack. The problem with such an outfit is that wearing the full garb is hot and clumsy. But it is absolutely okay at the start of beekeeping. As beekeeper confidence grows, increasingly lighter protective gear will be worn. But the novice should know, that all experienced beekeepers have a full protective suit somewhere for those special occasions with the bees will be exceptionally defensive. Moving bee colonies at night would be a good time to have on a full suit.

The cardinal rule with protective gear is to always feel safe. If you don't you won't work your bees, and you won't become a beekeeper. Dress for the bees do you always feel secure and safe?

### A smoker and hive tool – that's all you will need

#### Beehive smoker

The beehive smoker is very nearly the beekeeping's industry trademark. Smokers are designed to expose bee colonies to light, fluffy smoke thereby causing some confusion among the guard bees. That's when beekeepers make their move.

Used smokers develop an ambience of old smoke and many memories. Bee smokers will essentially burn any fuel that is burnable, but that is a topic for another session. ALL beekeepers will have at least one smoker. Most experienced beekeepers will have



several. This is a required piece of hive management equipment.

### Hive tool

Remember that bee glue (propolis) that was discussed earlier. A hive tool, which is little more than a pry bar, will be needed to open a hive and remove frames – especially after 8-10 months of bees gluing and waxing. No beekeeper is without one and all beekeepers have lost them in the grass at one time or another. It would not hurt to have a couple of these necessary tools.

### If there is a problem for new beekeepers...

If there is a simple problem for new beekeepers, it is that there is nearly too much information and opinion from many different web pages and from helpful beekeepers. In general, university and USDA information is a good place to review equipment needs and advice. The same is

true for video productions on various video-streaming services. Go to local beekeeper meetings. You will be welcomed and fellow beekeepers will eagerly answer your questions. Buy a couple of basic beekeeping books. There are probably hundreds from which to choose.

The first year is exciting and new. Much will be quickly learned that will stay with the new beekeeper for many years to come. It's not difficult and it always enjoyable. Plus, help is readily available. 

~Dr. James E. Tew  
State Specialist, Beekeeping  
The Alabama Cooperative Extension  
System  
Auburn University



<http://www.extension.org/pages/26743/wooden-components-of-a-modern-beehive#.VjekkISDLTQ>

# Help!

**“There’s some funny-looking stuff in my beehive! What is it? What do I do?”**

Beginning beekeepers do feel a bit helpless when they spot something not seen before in their hive. Fear not. Help can be found in many places and in many ways. Unfortunately today people turn to the Internet for a solution to a question, a problem, a situation. If you are a beginning beekeeper **STOP** before you leap into the Internet Universe. You do not have the knowledge or the background to sift good information from wrong, bizarre from sensible, useless from useful. So here are some ways you can find information.

First, do you belong to a local beekeepers club? If not, you can find your closest one by googling your state beekeepers association. Look for links to local clubs. If you live very close to another state, try that one. One local club there may be close to you.

You can also contact your state or local Cooperative Extension Service to find a local beekeepers club near you.

Once you have found a local association, attend the meetings where you can mingle with both beginning and experienced beekeepers. A local association may give beginning beekeeper classes and also provide mentors for beginners. Some local and even state associations have a newsletter. This will cover topics seasonal for your area.

If you prefer an online course you can try one of these created at universities for beginning beekeepers. North Carolina State University <https://entomology.ces.ncsu.edu/apiculture/bees/> and one from Pennsylvania State University [beekeeping101.psu.edu/](https://www.psu.edu/extension/entomology/beekeeping101)

Plan on attending state association meetings. Speakers at these larger meetings can be the bee scientists from around the U.S. Those speakers will have up-to-date information on our bee problems. Workshops are common at state meetings. A wide range of bee and beekeeping projects can be learned in workshops.

Three regional and two national beekeeper associations are in the U.S. They each have a conference once a year, the regional ones in summer and the national two in January. Information on these can be found on their websites:

Eastern Apicultural Society (EAS)  
[www.easternapiculture.org](http://www.easternapiculture.org)

Heartland Apicultural Society (HAS)  
[www.heartlandbees.org](http://www.heartlandbees.org)

Western Apicultural Society (WAS)  
[www.westernapiculturalsociety.org](http://www.westernapiculturalsociety.org)

American Beekeeping Federation (ABF)  
[www.abfnet.org](http://www.abfnet.org)

American Honey Producers Association (AHPA)  
[www.ahpanet.com](http://www.ahpanet.com)

Next, do you have a good book about beekeeping? You need to start a bee library. It can be a small one but it should be a useful one. Yes, Amazon lists many books about bees and beekeeping but, again, you do not have the background yet to make a sensible selection. Here are a very few titles that would make the start of your library. These books are available from Amazon and from beekeeping equipment suppliers.

**The Backyard Beekeeper**  
3<sup>rd</sup> Edition  
Kim Flottum. Quortous Books.



**The Beekeepers Handbook** 4<sup>th</sup> Edition  
Diana Sammataro and Alphonse Avitabile  
Cornell University Press.

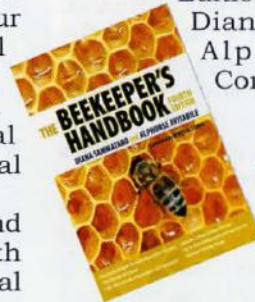

**Haynes Bee Manual**

Claire Waring. Pub. Haynes Manuals.



Another book, well-illustrated and easy reading, is excellent for those contemplating becoming a beekeeper.

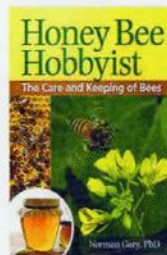

**Honey Bee Hobbyist**  
Norman Gary. Hobby Farm Press.

For disease and pest identification, two books are available and very useful. Both of them are printed on coated paper so they can be carried to the beehives without damage.

**A Field Guide to Honey Bees and Their Maladies.**

MAAREC pub. Available from Walter T. Kelley Co. [www.kelleybees.com](http://www.kelleybees.com) and Mann Lake [www.mannlakeltd.com](http://www.mannlakeltd.com)

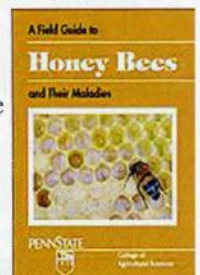

**Diagnosis and Treatment of Common Honey Bee Diseases.**

Diagnosis and Treatment of Common Honey Bee Diseases



Bee Informed Partnership (BIP) \$20, available from Brushy Mountain Bee Farm. [www.BrushyMountainBeeFarm.com](http://www.BrushyMountainBeeFarm.com)  
Two very useful monthly magazines for beekeepers are:



Two very useful monthly magazines for beekeepers are:

**American Bee Journal**  
[www.americanbeejournal.com](http://www.americanbeejournal.com)

**Bee Culture**  
[www.BeeCulture.com](http://www.BeeCulture.com)

To find information about beekeeping equipment you can simply google beekeeping supplies. Here you will find a list and contact information for the major suppliers. If you wish you can request to be put on their catalog mailing list so that a yearly catalog will be part of your library. Beekeepers at your local club may know of a nearby equipment supplier selling some of the national equipment. It is best to buy the actual hive equipment from just one supplier for consistency of fit of parts. However it is not necessary for purchase of ancillary equipment.

One website has excellent information. Although it is based in the mid-Atlantic states much of the information is appropriate to beekeeping anywhere. Its full name is Mid-Atlantic Apiculture Research and Extension Consortium but is better known as MAAREC. You can google that or use this <https://agdev.anr.udel.edu/maarec/>

Quite a number of newsletters are available with an assortment of information. Some will have local information for their area as well as national and world news in beekeeping. Here is a list so that you can sample these and decide if you wish to receive one or more. Today in the beekeeping world news can happen very quickly.

*Apis Information Resource Center News.* ISSN 0089-3764 <http://apis.shorturl.com>

UC-Davis online newsletter [http://elminobeelab.ucdavis.edu/apiculture\\_newsletter.html](http://elminobeelab.ucdavis.edu/apiculture_newsletter.html)

This newsletter includes links to websites for an assortment of beekeeping topics. To subscribe to Items for Beekeepers contact [febach3@gmail.com](mailto:febach3@gmail.com)

For news absolutely 'hot off the press' go to [www.beeculture.com](http://www.beeculture.com) and click on Catch the Buzz where you will see how to subscribe. Don't worry it's FREE!

If you are interested in some worldwide news, you can receive an online newsletter called ApiNews. Here you can also see research results from scientists around the world. Go to [newsletter@apinews.com](mailto:newsletter@apinews.com)

You can keep up with our country's progress in conservation of pollinators on two interesting websites. One is the Pollinator Partnership, [www.pollinator.org](http://www.pollinator.org) and the other is Project apis m. at [www.projectapism.org](http://www.projectapism.org)

Many beekeepers and local beekeeping clubs are participating in projects of the Bee Informed

Partnership (BIP), [www.beeinformed.org](http://www.beeinformed.org). This organization, based at the University of Maryland, is collecting information from beekeepers across the country. On this site you can see information about Winter losses of colonies during several Winters. How other beekeepers are dealing with a variety of issues and which course of action is best choice for where you are.

An excellent site on bee health, as well as other topics, can be found at [www.extension.org/bee\\_health](http://www.extension.org/bee_health).

Another countrywide group with information on honey bee health is the Honey Bee Health Coalition. You can visit their website at

[www.honeybeehealthcoalition.org](http://www.honeybeehealthcoalition.org)

An interesting countrywide project is participating in scale hives. To find out information about this project and its results go to [www.honeybeenet.gsfc.nasa.gov](http://www.honeybeenet.gsfc.nasa.gov)

Once your friends and neighbors find out you are a beekeeper they will have questions about honey. The very best site to visit for an incredible amount of information about honey is that of the National Honey Board. [www.honey.com](http://www.honey.com). Here you can find facts about honey, information about marketing and labeling, nutrition information and much more. In addition you can subscribe to their honey recipes where you will be sent recipes appropriate for the season or holiday. Spend some time exploring all the information on this site even if you have not made your first honey harvest yet.

If you are curious about what defines organic honey, visit the National Honey Board website and put Organic Labeling Requirements in the search box. That will take you to a link explaining the requirements for using the word 'organic' on a honey label.

You may have heard about other kinds of bees that also do pollination. One website that can give you some information about the mason bees and how to attract them is [www.Beediverse.com](http://www.Beediverse.com).

*Becoming a beekeeper is like entering a new world full of ongoing interesting information. It is a world of successes and disasters but good information is available. Pay attention to that good information and you will become a better beekeeper. 🐝*

~Ann W. Harman





# Successful Beekeeping

Your First Couple of Years are Full of Learning and Doing.

~ROY HENDRICKSON

Year One:

## Three Basic Startup Rules all New Beekeepers Should Heed

**Rule 1:** First of all, **keep it simple**. Beekeeping need not be complicated. Don't let anyone lead you astray with complicated manipulations or their particular brand of specialized equipment. Once you become familiar with the basics, you can intelligently make your own decisions regarding colony manipulations, or what type of additional equipment you may require.

**Rule 2:** don't be afraid to open up your colony(s). It's absolutely essential that you become comfortable when working around bees. I'll use myself as the primary example. I started in 1974 (against my better judgment) by catching a couple of swarms nine days apart. It didn't take more than a few days for the hook to set itself. I quickly determined that the only way to become a competent beekeeper was to **practice, practice, and then practice some more**. Consequently I was opening up my two colonies a minimum of three or four times a day! I shed my gloves in less than a week (too cumbersome). And I made a concentrated effort to relate what I was reading in my ABC and XYZ to what was going on inside my colonies.

•That leads to **Rule 3:** Education. You have to educate yourself. Attending local club meetings or entering into a mentoring program is a good way to start, but it's only a start. To really understand what's going on inside a beehive, you have to read. Start with basic bee biology. Actually, bee biology is a continual study, but once you understand the basics move on to management techniques, swarm control and so forth. The mark of a competent beekeeper has nothing to do with how you handle prosperity; competency is defined by how well you react to adversity, and there will be plenty of that. **Knowledge is everything!**

## The Internet

In today's electronic world the internet has become the go to information medium.

Although I lack any supporting data, I'm certain the vast majority of new or aspiring beekeepers use the internet as their primary information resource. While creditable information sources abound, generally speaking **the internet is a morass of beekeeping misinformation**. For new beekeepers the real difficulty lies with their inability to separate fact from fiction.

I'll cite the YouTube video as perhaps the best example of internet folly. Anyone with a cell phone and a bee-veil can become an instant expert, and there is no shortage of candidates. Some of these charlatans are easy to spot, others are not. Beware of the self proclaimed guru claiming years of experience, while offering counter-intuitive advice on just about any topic imaginable. These individuals are quick to tell you how to keep bees, but

they almost never give you any specifics as regards their beekeeping. The "you don't have to treat for mites" crowd typifies this behavior. If you follow their advice you had better have deep pockets. Replacement bees are becoming quite expensive!

Steer clear of anyone offering to teach their system of beekeeping for a fee. If they claim some form of master beekeeper certification, run as fast as you can! The same holds true for anyone selling specialized equipment, feeding systems for example. If you think you require additional equipment, check with the traditional bee supply houses. Better yet, seek the advice of one or more experienced local beekeepers. They're in a position to advise you on the necessities required for your territory. Suffice to say, don't fall victim to someone else's fantasy. **Spend the time and effort to learn beekeeping through time-tested, accredited sources.**

The following are all excellent information resources. *The Beekeepers Handbook* by Diana Sammataro and Alphonse Avitabile, *The Backyard Beekeeper* by Kim Flottom, and *Simple, Smart Beekeeping* by Kirsten and Michael Traynor will all get you off to a great start. And by all means subscribe to a bee magazine, *Bee Culture* for example. It always amazes me that folks will spend hundreds or even thousands of dollars to start keeping bees, but they won't spend twenty five bucks on a magazine to keep abreast of current events?

## Foundation

Wax or plastic, which works best, and why? For brevity, I will explain the pros and cons of plastic foundation. Starting with frames, I much prefer wood frames over their plastic counterparts, primarily due to their greater rigidity and superior spacing advantage. I also prefer plastic snap-in foundation, particularly Pierco snap-in foundation. From a handling perspective, plastic foundation is far more durable and much easier to install than the wax alternative. In addition, plastic foundation is impervious to being "**chewed up**" during a nectar dearth or prolonged periods of inclement weather. This virtually eliminates the time and expense of replacing damaged or destroyed foundation! Perhaps the greatest advantage of plastic over wax is the absence of pesticide contamination. Recent studies indicate that brood combs generally contain a wide variety of both agricultural pesticides, (insecticides and fungicides) and synthetic mite control residues. Rendered brood combs, i.e. beeswax that has been re-manufactured into wax foundation retains many of the original contaminants or their breakdown constituents.

The only real disadvantage of plastic foundation is the increased weight. Ten sheets of deep, crimp wired foundation weigh a tad less than 1 ½ lbs. Ten sheets of deep, plastic foundation weigh slightly over 4 lbs, or roughly triple the weight of wax. While the weight difference is significant, it's a relatively minor issue when compared to all the other advantages that plastic has to offer.

## Year Two:

If you started keeping bees last year and your bees survived their first winter, this article is directed specifically at you. There is a vast difference between your initial startup experience and the couple of years that follow. And as you have no doubt already learned, there is a wide array of options available to the new beekeeper. The purpose of this article is to explain or define a few of the operational basics. In time you'll be able to select or adopt those ideas that best fit your beekeeping goals and the specifics of your operating territory.

### The Second Year and Beyond

While your first venture into beekeeping was all about getting your colony(s) established, the second year is all about expansion. Barring the unexpected, your bee population is about to explode! The first order of business is to acquire and assemble any needed equipment. **You can't wait until the honeyflow starts to begin assembling supers.** Follow that path and year number two will be long remembered as the year of the swarms.

Speaking of supers and such, not all equipment manufacturers build to the same specifications. For example, I've seen tolerances for hive body depth vary by a quarter inch or more. The depth of the rabbit or frame rest, and that of a deep frame can also vary considerably. Mix manufacturer As hive bodies with manufacturer Bs frames and you may end up with a major abuse of the Bee Space. For those who are unfamiliar, the Bee Space was the discovery by the Rev. L.L. Langstroth that made moveable frame beekeeping possible. Through patient observation Langstroth discovered that a separation of approximately one quarter to three eighths of an inch prevented the bees from fastening everything together with either propolis or wax. The development of the moveable frame hive soon followed.

In practical terms most of the Bee Space abuses trend towards the excessive, i.e. the Bee Space is too large. I'll cite two common examples. For manufacturing simplicity, virtually all commercial inner covers have a raised border on both sides. Regardless of which side is turned down, the resulting Bee Space is incorrect, often by as much as a quarter of an inch. **Ever wonder why the bees build burr comb between the top bars and the inner cover?** A more critical example was referenced above. When hive bodies and their corresponding brood frames aren't in sync, the Bee Space abuse can turn deadly. The resulting burr comb, which is often filled with drone brood, is a potential death trap for queens. Every time you remove



*Strong colony working through the excluder, note additional supers to left rear*

a brood frame or raise the upper brood box, you run the risk of crushing the queen upon reassembly. And 99.9 % of the time you'll never know anything is amiss. Be aware of the Bee Space.

### Spring Management

In beekeeper lingo Spring Management is the term used to loosely describe various methods of preparing one or more colonies for the honey flow. While the specifics can vary considerably from one area to another, there is a general theme or methodology to the Spring Management process. The following checklist explains the basics of Spring Management in chronological order.

The first order of business is to check the overwintered colony(s) food supply. This is easily accomplished by hefting the colony from one or both sides. If the colony appears light, some form of emergency feeding may be required. At the first opportunity open the colony and check the cluster location. If the cluster is located off to one side, that's a clear indication the colony is short on stores. In cold climates use a shim or deep rimmed inner cover and place a commercial winter feed patty or homemade wet sugar patty directly above the cluster. This should suffice until warmer weather arrives. In warmer climates, center the cluster and feed 1:1 sugar syrup via the center hole in the inner cover. Colonies that are light on stores coming out of winter should have their food reserve closely monitored until the onset of a recognized honey flow. (Refer below to the section on Feeding Bees)

The next step is to determine colony strength and queen condition. On the first sunny 60-65 degree day with minimal wind, simply observe the flight pattern between 10:00 am and 2:00 pm. (Don't confuse normal flight with play flight, i.e. young bees marking the location of the hive prior to their commencement as foragers) The larger the field force, the stronger the colony. Other than for emergency feeding purposes it's not necessary to re-open the colony(s) until they have had a couple of weeks of warm weather to establish their broodnest.

Once I begin colony examinations I check for a variety of conditions. I start by quickly scanning the brood frames, particularly the capped brood. A solid brood pattern indicates that all is well, including the queen. While examining the brood frames I'm also on the lookout for any signs of disease, primarily AFB. I'm also watching for any sign of virus activity. Wingless bees, bees with shriveled wings, or young bees with stubby abdomens are all signs of trouble ahead. I also take particular note of the pollen band (stored pollen) above the brood and how much pollen is being stored in the active broodnest? I've never had to feed pollen substitute during the spring buildup period, but I keep a wary eye none the less. I also note the amount and the age of the oldest drone brood. Drone brood is a sign of prosperity and is a general early season indicator of colony strength. Pay attention to the drone brood.

Next on the agenda is *Varroa* control. Regardless of your opinion on mite treatments, it's a good idea to sample none the less. Absent treatment, a heavy mite load in early spring will almost certainly spell disaster by the end of summer. (Refer below to the section on *Varroa* Sampling and Control) For a variety of reasons mite loads can increase dramatically anytime throughout the season. Therefore it's a good idea to sample on a periodic basis. Colonies that enter the overwinter period with a heavy mite load rarely survive until spring.

The next consideration, population management, is by far and away the most variable aspect of the spring management equation. In order to produce a good crop of honey the broodnest must be full of bees, brood, and honey at the beginning of the main flow. Once the flow commences, the bees have no choice but to store any surplus up in the supers. To achieve this result you have to manage the colony so that the field force is approaching its maximum population by the start of the main honey flow.

The key or secret rests with the ability to project a colony's growth rate and then act accordingly. Sounds complicated, but it's really nothing more than common sense coupled with a little practice. There are two basic management options. You can either reduce a colony's population in order to maintain the size of the existing broodnest, (move the excess brood and adult bees to another colony, or make up a split) or you can increase the size of the broodnest by supplying additional drawn comb, or foundation when necessary. When adding foundation in the absence of a nectar flow, it may be necessary to feed thin 1:1 syrup to stimulate the bees to produce new comb. (Refer below to the sections on Foundation and How to Make a Split)

Early supering with drawn comb is the last major spring management consideration. The addition of drawn comb above the broodnest has two distinct benefits. First, the supers provide storage space for any incoming nectar, anticipated or otherwise. Secondly, and just as important, they furnish a clustering or parking space for the legions of young adults that are emerging on a daily basis. In other words, early supering goes a long way towards alleviating or minimizing broodnest congestion, perhaps the single greatest contributor to the swarming impulse. I recommend the use of a queen excluder, preferably an all metal excluder, when supering with drawn comb. The excluder greatly simplifies colony management and crop removal. The queen is confined to the intended broodnest area, and the supers remain supers.

Never place full boxes of foundation directly above a queen excluder. In most instances the excluder will act as a barrier. Then once the flow starts the broodnest fills with nectar, and swarm preparations are initiated. If you're starting from scratch, omit the excluder until you have a couple supers of drawn comb. At flow end, run the queen down, install an excluder, and allow any brood to emerge prior to extracting.



## Feeding Bees

From a practical standpoint, top feeding is by far the easiest and most efficient way for small beekeepers to feed. By top feeding I refer to the practice of feeding through the center hole in the inner cover. Feeding in this manner is both economical and extremely effective. The feed container can consist of whatever is handy. Quart Mason jars or plastic gallon jugs make excellent feeders. **The rate of syrup consumption is controlled by the number of holes punched in the lid.** The more holes the



greater the rate of consumption. Ideally the holes should be about 1/16th of an inch in diameter, or about the size of a standard frame nail. Use either 4 or 6D nail and a tack hammer, and tap the nail just hard enough to drive the point partially through the metal lid. With plastic lids, use the

aforementioned 1/16th in diameter drill. When inverted over the inner cover, the feeder should be elevated about a quarter of an inch to allow the colony complete access to the feed holes. Use an empty super or hive body to protect the feeder from the elements. With this system, once feeding has commenced, it's often possible to quickly replace or refill the feeder without the use of either a smoker or veil.

Cane or beet sugar, which works best? Both are sucrose, and they work equally well. Most of the big box wholesale stores tend to feature cane sugar, at least in my area. Cane sugar is always labeled as such; beet sugar is almost never specifically identified. If the bag or box just says sugar, it's invariably beet sugar.

## Syrup Formulas

Sugar syrup formulas are simply ratios of sugar mixed with water. In general there are two basic mixtures, thin syrup consisting of equal parts sugar and water, and thick syrup featuring a two to one ratio of sugar to water. Thin syrup is the basic spring and summer feed. It's primarily used to stimulate early season brood rearing, and to allow the colony to maintain its strength through periods of nectar dearth. Heavy syrup is used to augment the winter food supply, to prevent overwinter or early spring starvation.

For small quantity mixing purposes, sugar and water are almost identical when compared on a weight to volume basis. For example, by volume a 4 lb (64oz) bag of sugar measures out to approximately eight – eight oz measuring cups. Fill that same eight oz measuring cup with water, the water also weighs about eight



oz. Therefore a four lb bag of sugar when mixed with eight cups of water would yield roughly eight lbs of 1:1 syrup. The same bag when mixed with four cups of water would yield about six lbs of 2:1 syrup. For larger quantities simply convert water volume to a weight based mixing formula using eight lbs per gallon as the conversion ratio. For specific sugar weights and the compatible water volumes refer to the table below.

#### 1:1 Mixtures:

8 lbs of sugar into 8 lbs or (1 gallon) of water  
25 lbs of sugar into 25 lbs or (3 gallons + 1 pint) of water

#### 2:1 Mixtures:

8 lbs of sugar into 4 lbs or (2 quarts or ½ gallon) of water  
25 lbs sugar of into 12 ½ lbs or (1 gallon + 2 quarts + 1 cup) of water

Depending on the amount of syrup required, the mixing vessel can be whatever is handy, a bowl or pot, a five gallon bucket, or for larger amounts, a 20 gallon garbage can. To mix any type of syrup, run the predetermined amount of hot tap water (130 to 145 degrees) into the mixing vessel, and then add in all the sugar before you start the mixing process. Stir intermittently until the sugar is dissolved. No additional heat source should be necessary.

### Emergency Feeding

Since early Spring weather patterns and the corresponding honey flows are relatively unpredictable, the potential for early season emergency feeding is always present. If possible, the simplest way to solve this problem is to transfer excess frames of honey from a neighboring colony. If there are no brood disease

issues, don't be afraid to use the leftover honey from a winter deadout. Colonies in weak to average condition should have at least one frame of feed honey placed adjacent to an outside frame of brood. Strong colonies should have frames of feed honey placed on both sides of the active broodnest.

Absent these options, there are two practical alternatives. The winter feed patty, a concentrated sugar patty specifically designed for cold weather feeding. (Available through several bee supply outlets) Some are straight sugar; others are a mixture of sugar and pollen substitute. For emergency feeding purposes, I would place the emphasis on the sugar only patty. The second option is a homemade wet sugar patty. Granulated sugar and cold water are the active ingredients. The basic formula is roughly 10 parts granulated sugar to 1 part cold water, by volume. Preparation consists of mixing the desired amount of sugar with just enough cold water to create a product that has the appearance of wet gravel. To feed, simply place the mixture on a sheet of waxed paper directly above the cluster. Use a deep rimmed inner cover or spacer rim to supply the necessary accommodation



*Close up of bees consuming a homemade wet sugar patty*

space. Within 24 to 36 hours the sugar will harden and the bees will use it exactly as they would the commercially prepared alternative. Once the weather warms into the 55-60 degree range you can revert to feeding sugar syrup as described above.

### Varroa Sampling and Control

In today's beekeeping world **Varroa has become public enemy number one**. You either control Varroa or you perish! By control, I don't mean that you treat as a precaution once the crop has been removed, or prior to winter shutdown. If you practice that type of minimal Varroa control, you had better be prepared to purchase replacement packages or nucs the following spring! In order to keep Varroa and its associated viruses in check, it's imperative that the mite counts remain low throughout the season. The only way to maintain control is to sample on a periodic basis, and treat when mite counts exceed recommended levels.

There are a variety of sampling techniques to choose from. I would recommend an alcohol wash. This sampling technique is quick, accurate, and consistent. Best of all, it immediately allows you to determine whether or not treatment is necessary. Start by selecting a brood comb that contains some older open brood, brood within 24 hrs of being capped. This will provide the highest possible ratio

of mites to adult bees. Check carefully to make sure that the queen isn't on the selected frame. Hold the frame by an end bar and shake a portion of the bees into the collection container. A common eight by ten inch Rubbermaid dishwashing tub works exceedingly well. Once the bees have been shaken into the collection container, check again for the queen. Then tap the bees to one corner of the container and scoop up the desired number of bees. (A level ¼ cup equals approx 150 bees, 1/3 cup 200 bees, and ½ cup 300 bees) I prefer the 150 bee sample size; with the larger samples the additional bees act

as a filter to inhibit mite shake-out. Whichever size you choose, dump the bees into a wide mouth pint Mason jar and install the outer ring fitted with an 8 mesh per inch screen. Tap the bees to the bottom of the jar and pour in enough 70% Isopropyl to cover the sample, and then install the solid center cover. Alcohol doesn't immediately kill *Varroa* mites, so let the sample to sit for a minute or so before shaking. This will allow the mites' time to extricate themselves from under the bee's abdominal segments. When ready, shake the jar vigorously for 15 to 20 seconds. Now reverse the procedure and remove the center cover and replace the screened lid. For easy visibility I prefer to shake the sample into a Cool Whip container, but any light color container will work. Hold, or place the container on a solid level surface. Then with a single motion, invert and vigorously shake the sample jar up and down five or six times. The idea is to use the alcohol to assist in washing the mites out of the sample jar. Once the shake is complete, count the mites collected in the bottom of the container. Take care to count any mites adhering to the center cover or the inside wall of the jar. Currently the recommended treatment thresholds



*Materials required to perform an alcohol wash*

*Shake the bees off a frame containing some older open brood, check for the queen*



*Bounce the bees to one corner of the collection tub*

*Scoop up one quarter cup of bees, ¼ cup equals approximately 150 bees*



*Dump bees in wide mouth pint Mason jar and cover with alcohol*

*Shake sample into a Cool Whip container, the current treatment threshold is 3 mites*

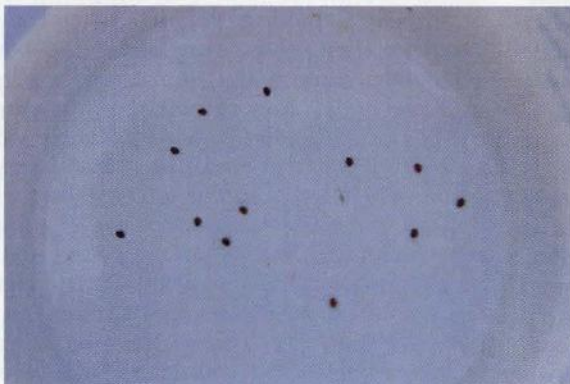

range from two to three mites per hundred bees sampled. Personally I would err on the side of caution and use the lower number. Translated, that means the treatment threshold for a 150 bee alcohol wash is three mites.

There are a variety of different mite treatments ranging from hard synthetics to softer organic products. I favor two of the softer organics, specifically Apiguard and (MAQS) Mite Away Quick Strips. Both of these products are relatively easy to use, and both are effective mite control agents. Best of all, each of these products allows you to adjust the dosage based on colony size and the existing mite load.

Mite Away Quick Strips are my preferred form of mite control for full or medium strength colonies. There are two treatment options. The full treatment consists of two strips per colony containing six or more frames of bees. Under normal conditions this treatment should kill between 93 and 95 % of the mites, including those under the brood cappings. However, under certain conditions two strips can cause varying degrees of brood damage, especially on smaller colonies. Consequently I've switched to the alternate half treatment, or one strip per colony of the same size. This treatment is somewhat less effective, probably eliminating somewhere between 50 to 60% of the mites. To offset the reduced efficacy I treat every three of four weeks depending on the existing mite load. Regardless of treatment size, follow label instructions for handling requirements and temperature tolerances.

Apiguard is a thymol gel marketed in a 50 gram peel off tray for individual colony treatment, or in a 6.6 lb bucket for multiple colony treatment. The recommended dosage is 50 grams per colony, repeated at two or three week intervals. As with Mite Away, the full strength dose can cause varying degrees of brood damage. However, a 25 gram half dose appears to be nearly as effective, with minimal brood loss. Treatment application can be achieved a couple of different ways. For those with only a few colonies simply divide the contents of a 50 gram tray in half. Use a hive tool or small spatula to remove and place each portion on a two inch square piece of waxed paper (dry wax paper works best). Don't spread the gel, leave it in a clump and center the treatment on the top bars between brood boxes. If you're treating a nuc or a single hive body colony, use a spacer or deep rimmed inner cover to provide the necessary accommodation space. For multiple colony treatment remove 25 gram dose from the bucket, (weigh or estimate the volume) and apply in the manner described above. I prefer this product for nucs and small colonies not quite strong enough to tolerate MAQS. **Always Read Labels.**

### **How to Make a Split**

Splitting or dividing colonies is one of the basic tenants of beekeeping. It's the means by which you replace your losses, expand the size of your apiary, or manage the size of your established

colony(s). (Read swarm control). While there are numerous variations on the splitting procedure, the basic idea is to remove excess brood and adult bees from one or more donor colony(s), and then supply the new colony with either a caged queen or mature queen cell. Once the queen has been accepted, the split herein referred to as a nuc, can be allowed to grow at a normal rate. It can be used to requeen a failing colony, or brood and bees can be added to increase the rate of buildup in order to produce a crop of honey. On the other side of the equation, the swarming potential of one or more donor colony(s) is reduced, thereby increasing their chances of producing a profitable crop of honey.



*Just the right amount of brood to start a split, add plenty of young adults*

As with any beekeeping function, there isn't a single "best way" to make up a split. Due to abundant mild weather, southern or middle latitude beekeepers more or less have free reign. Almost any system or equipment variation will work. Cold weather limits the choices for those operating in more northern locations. Since my beekeeping is confined to a cold weather environment, I'll describe my split makeup procedures. Adjust as you deem appropriate.

My current practice is to start splits in five frame nuc boxes. Each split is started with two frames of brood and plenty of extra bees. A frame of honey and two empty combs round out the unit. A caged queen or mature queen cell is installed once the unit has been moved to a new location. Starting the splits in nuc boxes has several advantages over standard ten frame equipment. The smaller nuc box traps or confines a portion of the heat given off by the cluster. This allows the young queen to expand her broodnest at a much faster rate than would be possible in a ten frame box. Once brood from the new queen starts to emerge, the colony will immediately require additional comb space. This is a prime example of a relatively weak colony that will readily draw foundation. If you're in need of more drawn comb, simply add a second five frame box of foundation directly above the established broodnest. If there is a honey flow in progress,



*One month later, seriously in need of more room*

you're all set. If not, you'll have to feed 1:1 syrup until the flow begins. By the time the foundation has been drawn out, the season will have progressed to the point where you can safely transfer the nuc into standard equipment.

Comb Production Tip – Any colony will draw new comb at a much faster rate if it's able to keep the comb production area warm. Heat rises, so whenever possible place foundation directly above the active broodnest. Brood comb produced in this manner will generally be vastly superior to that produced within the actual broodnest. The lower brood box, the box setting on the bottom board, is the very worst place to put foundation. When you see a brood comb with open corners or a gap between the bottom of the comb and the bottom bar, rest assured, that comb originated in a lower brood box.



*Multiple story nuc used for comb production*

**How to Avoid Transferring the Queen When Making Splits**

Locating queens is probably the most vexing problem beekeepers face. Factor in a lack of experience, and the problem is magnified a hundred fold. The following is a sure-fire method of not removing the queen(s) from one or more donor colonies preparatory to making a split. You'll need three pieces of equipment, a temporary holding box, (a nuc box is ideal) a queen excluder, and an extra hive body.



*Newly established split*

In practice, select a brood frame that you're going to use to start the split and gently shake a portion of the bees back into the parent colony. (Shake off just enough bees so that you're sure the queen isn't present) Place the frame into the nuc box and repeat the process as needed. Once the startup frames are set aside, remove two or three additional frames of partially capped brood and repeat the shake-off process. These frames are going to supply the additional nurse bees necessary to jump start the new split. All total, you should end up with four or five frames in the nuc box. Now place the queen excluder and extra hive body on top of the open colony. The final step is to transfer all of the shaken frames from the nuc box back into the empty hive body above the excluder. Close up the colony and find another activity for the next two or three hours. In your absence, young nurse bees will traverse the excluder and repopulate the brood frames above. The queen, unable to pass through the excluder will remain in the lower brood boxes going about business as usual.

Upon your return, transfer the two selected startup brood frames plus the adhering bees into their new abode. The last step is to shake the nurse bees off the frames of partially capped brood. Once shaken, return these frames to the original broodnest. If possible, replace the two startup frames with drawn comb; otherwise add frames of foundation to the outside of the uppermost brood box. The nuc is now ready to be moved to a temporary location at least a mile away. This will prevent any of the nurse bees from returning to the parent colony. Upon arrival, install either a caged queen or mature queen cell.

Spring 2016



So, you've decided to start keeping bees. A lot of folks are doing this and it's always been in the back of your mind...and now's a good time to start everybody says... winter/spring is when to get going they say. So you've joined the local beekeeping club but they all have been doing this for years it seems, and they only meet once a month anyway, and besides, the beginner's class hasn't started yet. And right now you just don't know anybody to talk to about getting started or how to, when to, where to, and all the rest. The book you got at the library is OK but it's kind of old, and there's a ton of stuff on the internet, but this guy says one thing, and that guy says just the opposite and who's right? Anybody can do Youtube or blog or webpage stuff it seems... Well, the good folks here at BEEkeeping magazine have been in the business of teaching beekeeping for over 150 years. We'll get you going the way that's best just for you.

So let's make this as simple and easy as we can, with advice from folks who teach beekeeping for a living with some basics to consider right off.

And right off...where will the bees live? Not the boxes you put them in...you can find that out elsewhere in this issue, but for now it's where will the boxes actually go?

Lots of folks are starting out now with bees in the backyard. If you live miles out in the country and you have to take the car to get to the nearest neighbors you have country bees, and they have different requirements than city bees and we'll talk more about them below. But because most people live in a city, suburb or some kind of semi-urban development, neighbors are close, and you and your family have a relatively small lot to use for everything you do outside. So let's look at city bees.

But first - is keeping bees where you live legal? And - is your family OK with this? What about allergies? And doesn't your spouse have a thing for bugs? What will the neighbors think? And what about the softball games your kids play most days in the backyard, and sitting on the patio and eating on the deck, and gardening and mowing, and do bees like sun or shade, and what else?

Let's look at all these one question at a time.

If you aren't sure if having bees is restricted, or don't know anybody who has bees where you are it's a simple call to city hall. There may be

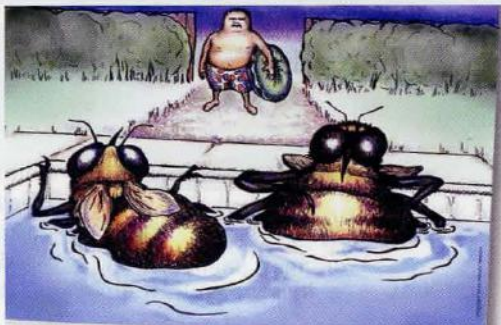

*Water is critical at home so your bees dont find the neighbor's pool.*

some requirements - like how close to your property line a hive can be, how many colonies you can have on a lot the size of yours, insuring a constant water source and the like, but it's been amazing how many municipalities have reversed their No Beekeeping ordinances in the past few years because of the swell in attention honey bees have been getting. But check first if you don't know. And what about your home owner insurance. Check first.

If your family uses their yard for anything they have to be OK with the bees out back. We'll look at ways to make them pretty much disappear so they won't be obvious or in the way, but your family needs to always feel safe. And allergies? Are you allergic to honey bee stings? Do you know for sure? And the rest of the family?

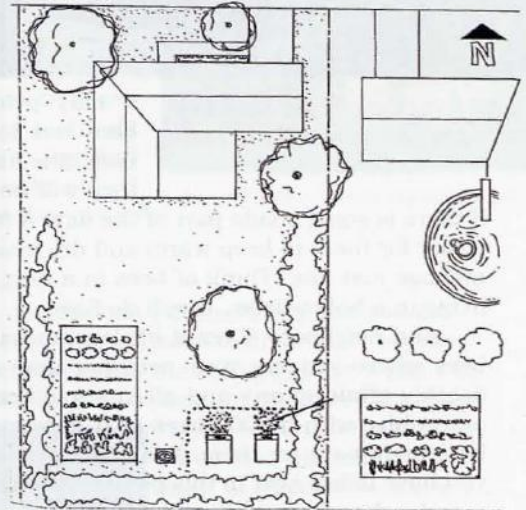

*Screens, Fences, Water- Out of site out of mind.*

If in doubt, contact an allergist and find out before you have to rush to an emergency room. Very, very few people are allergic to honey bees, but some are, so be sure.

There are lots of good reasons to put screening around your beehives. The most obvious is out of sight, out of mind...from neighbors, people walking by your house, daredevil adolescents, visiting friends and the like.

An attractive six foot tall by eight foot long fencing section available from most lumber stores works quite well. You may only need one, perhaps two to keep your bees out of everybody's line of sight. But the real value of this type of fence is that you can control the flight



*a dedicated pool, or pail with flavored water is good, but an automatic animal waterer is even better.*

pattern of bees leaving and returning to the hive. Bees take off much like an airplane, rising somewhat rapidly but staying four to five feet off the ground for anywhere up to twenty or thirty feet. By putting a fence up and facing the hive toward the fence, they rise above it immediately, keeping them from accidently bumping into gardeners, baseball players or neighbors enjoying their backyard.

You can plant hedging plants, either annuals or perennials to make a permanent green screen, but it will take some time for those plants to get high enough to work well. But starting now is a good idea.

A minor drawback to a fence like this is the shade



*Watch for new developments springing up where there used to be forest.*

it may produce. Honey bees love to get as much sunshine as possible, but they will be perfectly fine if there is some shade part of the day. A full-sun hive is easier for them to keep warm and dry inside, but they'll manage just fine. Think of bees in a deep shade forest, living in a hollow tree...they'll do fine.

And neighbors. Even if it's legal to have bees where you are your neighbor may be deathly afraid of any and all kinds of bees, and a hive with 50,000 bees next door may be a nightmare for them. Yes, it's legal, but you have to live next to this person. Allergies may be the cause, or just a fear of insects. But they may be active outdoors people too and bees in their yard may be an issue.

Another positive for a screen is protection in winter. If it's cold where you are your bees need good winter locations, and a wind block is at the top of the list of what they need. Unless you are in the tropics, a good windbreak can only help.

Hand in hand with this is making sure your neighbor's yard isn't too attractive...meaning water. If there's a swimming pool nearby your bees will certainly be attracted to it...especially when you let your water source go dry. Here's a trick to keep them home. Put a small pool...something that holds at least four or five gallons of water...out before you get your bees. Add a scent to it, something bees will find attractive like anis or even better, a honey bee product called Honey Bee Healthy, which is a mix of essential oils that bees can't resist. When your bees arrive they will immediately begin looking for food and water for their nest mates. Have water close and they'll find it and keep returning to it for water and stay close to home. But let it go dry, even once, and they'll find another source...your neighbor's pool. A water source is one of the most important aspects of bees out back you have.



Another thing to keep in mind when looking at where the bees will call home

*Bees on a roof work to keep away kids, and pets, but pose a whole new set of issues.*



*Safe in the backyard.*

extra pieces like the cover and any boxes you have. If you have more than one hive, make your stand, or stands such that you always have that empty spot. When working your hives a good practice is to first put your cover upside down in the empty space designed to accommodate it. Then, any other equipment you remove, honey supers or brood boxes, can be set on the cover. Any bees that fall out are caught by the cover and not lost on the ground.

Another factor to consider is how much does a beehive weigh? If your colony does well the first year it could reach as much as two hundred pounds – equipment, bees and surplus honey. Certainly it will do that year two. Your hive stand then needs to be durable enough to hold two, maybe three of these, so don't make it out of flimsy materials. And that much weight may cause your blocks to sink a bit, making the stand unlevel, or even causing the hives to topple. Prepare the base with ample support so that doesn't happen either.

So for urban or suburban beekeepers that pretty much covers the basics of where will these new



*Can you get to your outyard when it's wet.*

hives go. Practice good neighbor beekeeping by checking first, placing the bees with a screen nearby and keep the flight path high enough so bees and people aren't colliding. Water is important too and your hive stands need to be sturdy

and keep your hives about 18 inches off the ground.

**But what about country bees?**

If you are located in a rural setting things are different. Even if you have a small yard you can point your





*Building a hive stand is simple. Make sure the blocks don't sink, and the front is a tiny bit lower than the back.*



*Skunks are a problem but a hive stand keeps them away.*

to screen them for flight patterns.

But it might be a better idea to put your bees somewhere else.

If you live in town you may not be able to keep your bees there because of family, neighbors or the zoning regulations, so will want them somewhere out in the country, or if you are already in the country it just might be a better place somewhere else because of nearby crops, roads or other issues. So, find what's commonly called an outyard. Another place to put your bees.



*Your hive stands have to be sturdy.*

bees out to the adjacent forested area or empty field and that mostly solves the need for a screen for flight path direction. But a wind break is still needed so think about that. If you can't see your neighbor's house you're off the property line hook, but not the water hook. You still have to make sure your bees always have water on your property, or from a location that does not interfere with people, like a nearby river or pond that is public property.

*Plenty of room to set up equipment when working on hives.*

But your neighbors just might be farmers, right? And what is growing in those fields? It could be something benign, like a pasture for dairy or beef cattle. Or, it could be a crop that is routinely sprayed with insecticides, with some likelihood of drift over to your edge of the field and your bees. Or... well, the possibilities are many, and you need to find out before you put bees where you thought it was safe. So

you need to meet your farmer if you don't already know who uses the land. And it might not be the owner, who simply rents it to someone. And depending on where you live, that renter may not be the sprayer, but simply hire it done so someone comes in, sprays and is gone, never seeing your bees, or you for that matter. So before you

### Outyards

Generally, consider an outyard any place you can put your bees that you will have to drive to, or at least walk a lot to get there. You may already have a place in mind – a friend's farm lot or field for instance. There are things to consider with outyards that will make this easy, or impossible. Let's make it easy.

If it's behind a gate, always make sure you leave



*Fences make all the difference, and will protect your bees from prying eyes, anxious neighbors, and kids.*



*Full sun is best, but...*



*...Afternoon shade is good for the beekeeper.*

the gate the way you found it. Can you drive right up to the hives or will you have to cross a fence, creek or plowed field? Can you get there in the winter time with snow on the ground? If you are next to a field, what will be growing there next season? What about vandals or theft, is someone close enough to discourage this? Is there a cost to put the bees there? Is it legal to put bees on this property? Your best bet if setting up an outyard is to talk to another beekeeper who already has outyards and find out what logistic issues you need to address before you commit your bees.

How much time does it take to keep bees? Figure an hour a week on average, when the weather is good. More during spring when you really need to pay attention and fall at harvest. Bees are a lot like gardening...spring busy, summer some, fall busy, winter is time off. But this changes a bit every year. How many hives will you have, how intensely do you manage them? Do you have help or are you in this alone? How far do you have to travel to your outyard? All must be considered when budgeting time for your bees.

Beyards. Backyards, or outyards, or any place inbetween. Be careful, but have fun. 

*Out yards need to be maintained, too.*



endanger your new colonies, investigate your neighbors and find out what's going on. *A field last year, a production field next.*

Otherwise, having country bees in the backyard is usually less work than city bees. No neighbors to convince, no kids playing ball right next to a hive, water issues are off the table, and you may, or may not have



# Regional

## Reports

### North West

January, February and March are wet, rainy months for PNW bee colonies. Snow is common at higher elevations. Pollen however becomes available in the valley by March and with increasing day length and new pollen, colonies resume brood rearing during the later period of the winter. Venting of excess moisture is critical to successful overwintering so many beekeepers use a moisture trap with vent at top of colonies. Many add rain shelters to deflect rain and hive stands to keep colonies off the ground and away from moisture. About ¼ of beekeepers close screen bottom boards.

The first three months are not colony manipulation opportunities. Flight activity can be confirmed on warmer sunny days over 50 degrees. Hefting the back of the hive from time-to-time to check on winter weight is helpful to check on rate of honey store consumption. If beekeepers find their colonies light on stores, supplemental carbohydrate feeding should be with a dry sugar such as fondant or drivert or mixture of drivert/crystallized sugar. Such feed needs to be placed beneath moisture venting devices.

Some beekeepers may wish to use Oxalic acid drip during this overwintering period before the bees begin rearing brood, if not done before the end of the year. As this is a new *Varroa* control material, it is not known how many beekeepers will use oxalic for mite control. Application should be made on days when bees are more active when subsequent overnight temperatures are not likely to be cold to avoid chilling of clustering bees.

### Some tasks for Jan-March

- Check hives to insure hive covers/rain shelters remain in place, especially following stormy weather events.
- Confirm hive activity on warmer days (sunny days with temperature >50 degrees).
- If colony only has a bottom entrance, insure it remains free and not clogged with dead bodies.
- If deadouts are detected, remove the equipment to storage
- Check food stores by hefting back of hive – feed dry sugar if light.
- Confirm the moisture trap is functioning properly (it should be dry immediately above the bees).
- Take time to read bee books, examine the new bee catalogues and take a bee course.
- If planning to start packages or nucs, line up supply early in the period.

~Dewey M. Caron

### South East

Even though the weather outside may still be frightful, we can't get complacent when it comes to our bees. January, February and March, especially here in the southeast, are critical months. Late winter is not only the time to build and repair equipment inside, but – more importantly – it's the time to be accomplishing numerous tasks outside in the apiary.

Let's discuss what we need to be doing today to insure our bees' survival tomorrow.

In anticipation of spring, the queen is ramping up brood production, which is, in turn, decreasing honey stores. As a result, we must inspect our colonies sooner than later because starvation is one of the main causes of winter losses. Lifting the entire colony from the rear is a quick method for determining quantities of honey stores, but is not always accurate. By January, some colonies may have more weight in brood than in honey, thereby giving a false reading. So, to guarantee your bees have enough honey, quickly tilt each individual super from the back to feel the weight and to locate the cluster. Also, inspect the frames by looking down between the top bars to see if there is enough honey and where it is located.

Now, we've been told for years to not open hives unless the temperatures are well into the 50's. This is good advice; however, the weather may not always cooperate – especially when we need to know what is going on inside our colonies *now*. Remember, the bees are not warming the entire hive but instead only the cluster. Here are a few guidelines you should follow:

1. Never open colonies when temperatures are below 40°F, or on windy and/or rainy days. The best conditions are bright, sunny, windless days.
2. Check the forecast and avoid opening colonies days prior to major weather events moving in. This will break the propolis seal the bees so carefully placed between each super, leaving the bees susceptible to the negative weather conditions.
3. Do not take the supers off and put them on the ground. You should only tilt them from the back in order to feel the weight and inspect.
4. Never remove frames in – or next to – the cluster.
5. Don't dally, work quickly

Also important to note: you should make sure honey stores are within reach of the cluster. With temperatures fluctuating from the mid 50's to the low 20's, bees often get separated from the honey. All the honey in the world is worthless if the bees are too cold to reach it. The rule of thumb is: for every frame of bees and brood you have, you need an equal size frame and a half of capped honey.

If the colony is in need and honey is not available, feed cane sugar syrup with an inverted plastic pail, bucket or jar directly over the cluster. Do not rely on Boardman entrance feeders, division board feeders, baggies, or even top feeders since the bees are unable to travel across cold surfaces, to feed on cold syrup, during cold weather.

Hive reversals can also be performed during inspections. As winter progresses, bees are slowly moving up through the supers, consuming honey along the way, which is why honey should always be located above the cluster. As the bees do this, lower boxes become void of bees and brood. If colonies are not in need of feeding and have a healthy population, take the empty bottom box and place it at the top of the hive. This may buy you some extra time as far as swarming is concerned, since you are providing an additional space for the bees to expand into. Please keep in mind that this isn't a cure-all for swarming, it's just a temporary fix. You should **never** do this if the cluster is still spanning across both supers, otherwise the cluster will be split and bees can die. Mid-winter inspections and solving issues you may encounter, can mean the difference of a live colony verses one suffering, or dead; so get out there and check those bees.

**Best of luck to you and your bees!**

~Jennifer Berry

Spring 2016

## In The North

The first three months of the year in the north...from Maine to Montana, down to the Mason-Dixon line are the challenge of the year for honey bees. They are originally tropical insects and though adaptations and evolution to deal with our northern winters have slowly taken place, honey bees need protection, food and good health to make it from one summer season to the next.

It's never too late to boost the protection you've already provided. The most important protection a beekeeper can provide is a wind break. Everything else comes in second. So if you don't have wind protection, provide some now. Simple breaks include landscape burlap, pine boughs, bales of straw or even temporary fence sections. Anything to break the steady drain a cold wind is on an exposed colony.



If the snow is already hip deep that in itself provides

some insulation from the elements so don't worry about that just yet. But if it's feasible, wrapping a colony in



roofing material or one of the commercial wraps available certainly will help. Don't block the front entrance and make sure warm moist air can escape from the top, but this extra bit of help makes moving in the colony to reach food a tad easier, and your bees will thank you come spring.



Almost always there are is a break in the weather and a sunny, warmish day opens up and you can do a quick inspection of your colony. If you wrapped in extreme you may not be able to, but usually you can pop the top for a



10 second look to see where the bees are. If you can't see them, that's good. They are still down below where the food is. But if they are right at the top of the top box, they,

and you have a problem. They are, or are almost out of food and will starve shortly unless you step in and help. Provide sugar in some form, and this time of year it's usually not sugar water. Fondant is a perfect substitute.



*Feeding with fondant*

Obtained at your local bakery, it is a soft, pliable frosting mix that is available without flavors or colors and is perfect for your bees. Cut a slab, use a shim to provide space and put it right on the top bars of the top box. The heat from the cluster will keep it soft and your bees will consume it with relish.



*Feeding with Protein*

Food shortages are especially critical the closer to spring you get. The queen slowed, even stopped laying eggs at the end of December, and by early February begins again her job. Of course brood needs food, and the demand steadily increases as the days get longer. By early March food is being consumed rapidly, and if there is not enough the workers actually begin turning stored fat into food for the young. They are programmed to do this, but can do it for only so long before it becomes detrimental to their health. Watch for starving colonies in need of both protein and carbohydrates in March. 

~Kim Flottum

## Bee Culture

The Magazine of American Beekeeping



JOIN THE THOUSANDS WHO ENJOY BEE CULTURE EVERY MONTH!

*Delivered right to your front door!*

**OVER 140 YEARS OF HELPING BEEKEEPERS**

[www.Beeculture.com](http://www.Beeculture.com)

# Holiday Treats With Honey

~By Angelo Proseri-Porta



## GINGER LEMON SODA

As with many of my recipes, this is a base on which you can build your imagination, allowing you to experiment freely. Not all flavors blend well together, but the lemon and honey are versatile. This base can be stored in the refrigerator until needed, and multiplying the recipe for larger groups does not pose a problem. The addition of lemoncello, that delicious intense

lemon liqueur from Italy, elevates this drink to a more sophisticated adult version. Try substituting Prosecco, Italian sparkling wine, or another favorite sparkling wine for the soda. Garnish with mint leaves, fresh raspberries, strawberries or lemon wedges.

1/4 cup grated fresh ginger  
1 medium lemon, thinly sliced,  
plus more for serving  
1 cup boiling water  
1/3 cup honey  
Ice cubes  
3 cups soda water

Place the ginger and lemon slices in a heatproof bowl. Pour the boiling water over the mixture and set aside to steep for 15 minutes.

Strain the mixture through a sieve into a tall pitcher, and stir in the honey. Add ice cubes and top with the soda water. Garnish with extra lemon slices. Serves four.

## SPICED HONEY GLAZED ALMONDS

These spicy little guys make a wonderful prelude to an informal dinner. With the refreshing cleansing flavors of the Ginger Lemon Soda, your guests will ask for more. Try experimenting with some favorite spices. An all-curry version works well as does substituting other nuts for the almonds or making a variety mix using hazelnuts, walnuts, pecans, cashews or other favorites. Resist the urge to rush the drying time in the oven by increasing the heat; this may overcook the spices and produce a slightly bitter taste. For large batches, freeze portions and rewarm as needed.

1/2 cup paprika  
3 Tbsp cayenne pepper  
2 tsp ground ginger  
2 tsp ground cumin  
1/2 cup honey  
2 large egg whites  
2 tsp liquid smoke  
1 Tbsp kosher salt  
2 1/2 lb whole almonds

Preheat the oven to 275°F.

Sift together the paprika, cayenne, ginger, and cumin into a bowl.

In a bowl large enough to hold the almonds, whisk together the honey, egg whites, liquid smoke, and salt until slightly foamy. Add the almonds and toss to coat.

Sprinkle the spice mixture into the bowl. Toss to coat the nuts evenly.

Spread out onto parchment paper-lined baking sheets. Try to separate the nuts to keep them from sticking to each other.

Bake for approximately 20 to 30 minutes or until the coating is dry and crispy. Remove and cool completely on the baking sheets. Store in an airtight container. Makes about 6 1/2 cups.



www.dabab.com

dabab.com

# Beekeeping tasks for January through March

- 1.** Want to be a beekeeper? Sign up for classes at a local beekeeping club.
- 2.** Check your equipment needs for the upcoming bee season.
- 3.** Take advantage of January sales from beekeeping supply companies. Order early for quick delivery.
- 4.** When weather permits check if bees have enough stored honey.
- 5.** When weather permits check the queen's performance. If poor, plan to requeen.
- 6.** Planning on requeening this spring? Order queens for delivery at appropriate time for your area.
- 7.** Clean up beeyard from any winter stormy weather.
- 8.** Heavy rains or freeze/thaw can cause hives to tilt. Straighten them.
- 9.** When weather permits, inspect hive. If bees are still clustered, do not disturb cluster.
- 10.** Clean off bottom board, solid or screen, to remove debris and dead bees.
- 11.** Normal bee death is 50 to 100+ per day. If you have a dead colony, block the entrance to prevent robbing.
- 12.** If you have a dead colony have an experienced beekeeper or local bee inspector help determine the cause.
- 13.** Plan your varroa control program for the year.
- 14.** Keep up small hive beetle control.
- 15.** Learn the nectar and pollen sources in your area.
- 16.** Learn the nectar flow time for your area to know when to put honey supers on.
- 17.** Monitor trees and other plants for blossoms. Watch incoming bees at hive entrance. Look for ones carrying pollen.
- 18.** Feed sugar syrup, 1:1 by volume or weight, to stimulate egg laying by queen.
- 19.** Keep records of colony performance and needs.
- 20.** Plan your program of swarm prevention.
- 21.** Always wear your veil.
- 22.** Attend meetings of your local beekeeping club.
- 23.** Read, talk, listen. 



# 10 Rules

Keeping honey bees is little different than raising chickens, goats or cattle, or having pets in your life. When you assume the responsibility of their care there are some fundamental needs all living creatures have that you now have to provide, or at least allow them to pursue. Moreover, some animals are so domesticated they no longer can survive on their own and totally, or almost totally rely on humans for support.

For bees, which are essentially still wild animals that choose to stay with us, at least for a time, the rules are a bit different, but only slightly. Because they can, and will often up and leave, there is less protection from some things needed, but still they have needs. And, because we are using them for certain purposes...honey production and crop pollination...it pays to pay attention.

## 1 Good Queens

What makes a good queen? The first criteria is that she should have been **raised in the lap of luxury**. All the food she could want, all the care she could get, none of the viruses, none of the diseases, none of the stresses that can happen in a hive. When she emerges she should continue to be extremely well cared for until she is ready for her mating flights. And those should be as well attended as possible ~ thousands and thousands of drones in several congregation areas, none related to her in the slightest,



and all from colonies that were chosen for their excellent attributes such that when combined the result would be even better than the best of either . . . Greater than the sum of the parts if you will.

And she should be able to find as many of these as she could possibly desire...20, 30 maybe more, all happening during perfect flying weather so she isn't hindered, delayed, or in any way restricted from joining with all the drones she wants. This is **Extremely Mated**

Once mated, she should be put in charge of a colony, maybe yours, that is as clean as can be. There should be new comb everywhere, lots and lots of food, thousands of nurses overflowing with Queen Food all the time in a hive that has more than enough room to store food, lay eggs, and provide protection. She should never be exposed to pests or diseases that could weaken her, or worse, cause her to pass along viruses or other beasts to her children.

And speaking of children, once she starts laying all the eggs she can produce, unhindered by lack of space,

poor quality food, or nurses to care for her, she should soon be putting out 1000, then 1200, maybe as many as 1500 or 1800 eggs a day, every day. She should be an **Egg Laying Machine**, and she should be comfortably able to do this for three, four, maybe five years without interruption or distraction. Of course she will allow for seasonal differences and delays, but these aren't dangerous or debilitating in the least.

## 2 Good Genetics

Of course after all that good care, Extreme mating and perfect place to live, the offspring should be exactly what you want them to be. This is a combination of Nature and Nurture, and here's what they should be.



They should be perfectly adapted to the place they were born, whether cold, long winters or warm tropical all year. They should absolutely subscribe to your management style... honey producers, pollinators, urbanites, slow to

start in the spring or raring to go on New Year's day. And they certainly should be at least nearly immune to the foibles of the pest, predator and disease world meaning they live full productive lives, unhindered by any of the legion of problems less able honey bees are prone to. In fact, they should be so adapted to all of this that never in her life should she be exposed to the poisons used in other hives to thwart the attacks of the evil ones. Never.

And they should be well behaved. So well behaved that you never fear their wrath or fury, and that they always display good manners toward strangers.

When it comes to Queens, remember that "An average queen in a strong, healthy colony will always do better than a great Queen in a subpar colony."

## 3 Pest Management

The rule is - control *Varroa* or die. Use resistant bees, non-chemical controls like drone trapping, broodless periods, or the organic acids, or even the softer essential oils. Maybe even go to the rougher stuff - but control *Varroa*, and the virus and plagues they carry, or die. The rest are a walk in the park compared to *Varroa*, but don't ignore them, ever.



## 4 Do No Harm

This is directly related to No. 3. The chemicals used to control *Varroa* and other diseases can and do harm bees, too. Always use non-toxic controls first, then soft chemicals, and as a last resort, pull out the big guns, but only as a last resort.



## 5 Provide a Safe environment

The environment in this case is the whole world bees are in. Inside, keep poisons out, and remove any that enter – whether administered by the beekeeper, or those brought home by the bees. Keep equipment in good shape, weather preserved and sound. As far as possible, isolate your bees from other bees, reducing the likelihood of sharing problems. And stay far, far away from agriculture, the second greatest threat to a bee's continued existence after *Varroa*.



## 6 Enough room at the right time

A colony needs enough room for all the bees, brood nest expansion at the peak of the season, incoming nectar and stored honey and pollen. And the bees need that room before even they know they need it, but to be on top of any colony the keeper needs to know when they will need it, and have it ready and waiting.

## 7 Enough good food



This is simply good husbandry. Enough good food in terms of quantity, quality and timing. Good food comes in many forms however. Naturally, when the bees live off the bounty of nature, but also from the beekeeper so there is never a need, even for a day, for enough. And water. Lots of water close to home, always. In fact, the future holds, in my opinion, the promise of islands of forage, grown especially for bees, managed by the beekeeper, directly or hired done, such that the bees never have to forage further than the fence row that keeps them in.



## 8 Only healthy hives

Above all, keep stress, of any kind, out of sight. Do not nurse failing colonies, rather find the cause, cure it and join the weak to the strong so always one survives, even thrives. And as the old axiom says, take your losses in the Fall, rather than clean up the remains in the Spring. Requeen before the bees even know the queen is failing, before there is even a moment's hesitation in the command process.



Always be proactive with food, queens, medications and available room.

## 9 Winter well

Take care of the bees that take care of the bees that go into Winter for starters. Provide enough good food – both carbs and protein – to last until next summer, and have a strong population when the snow starts to fly so there's more than enough bees all Winter long. Provide protection – wrapping with dark colored covers, wind breaks and have excellent ventilation, all Winter long.

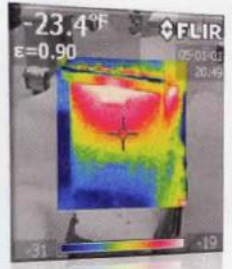

## 10 Food Safety

Prevent harvest contamination with fumes or smoke, and keep honey supers covered well at all times. Never, ever for any reason warm honey past 100F whether when uncapping with a hot knife, or flash heating to filter in-line, or when in a bottling tank to ease and speed the process, to make sure none of the fine things there are driven off or destroyed. Make certain the moisture content is below the magic number, and, simply, use common sense when handling any honey because it is a food, given to friends, family and sold as a luxury food.

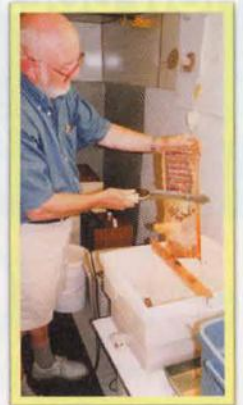

Well, That's the 10 but I imagine there are maybe dozens more. If you have some, feel free to drop me a note and we'll share with the world. Maybe it should be the top 100. 🐝

~Kim Flottum

# Carpets of Gold

~CONNIE KROCHMAL

Beekeepers greet the early Spring dandelion blossoms with much delight. These are often so numerous that the flowers appear as a carpet of gold. The Latin name for the genus, *Taraxacum*, comes from the Arabic for 'bitter herb.' These plants occur in a wide range of habitats. Worldwide, there are around 25 species.

Due to the long taproot extending several feet, these tenacious plants are very difficult to remove. However, those seeking to have immaculate lawns never cease to give up the battle. Dandelion refuses to be suppressed. It has been referred to as "the tramp with a golden crown."

This plant spreads very easily by seed that can blow for miles in the wind and by new shoots arising from the root.

## Habitat and Distribution

The common dandelion (*Taraxacum officinale*) occurs from 6500 feet to sea level. Partial to rich soils, it inhabits a range of habitats, including pastures, damp and dry sand, cultivated and undisturbed ground, waysides, open woods, grasslands, meadows, fields, waste places, and especially lawns. Winter hardy to zone three, the dandelions are generally native to the northern hemisphere.

This can be found pretty much over the entire country, including Hawaii and Alaska.

## Description of the Common Dandelion

Typically a perennial, it sometimes behaves as a biennial. The stem is largely underground out of sight. The most visible part is the basal rosette of foliage.

The leaves are quite variable in shape and size. Up to 10 inches in length, they can be entire, lobed, toothed, notched, or very finely cut.

Much of the flower stem develops underground where it is sheltered from cold and inclement weather. The solitary, orange-yellow to gold, daisy-like flower heads follow the sun. They can vary in size from 1½ to two inches in diameter. These composites have rays resembling petals, which are in fact individual flowers. The underside of the outer rays is purplish.

Below the flower heads are two rows of bracts, some of which bend downwards. The hollow leafless flower stem is about 1½ feet in height.

The globe-like seed head is packed with fluffy seeds. These often freely drift like parachutes on the breezes. Children delight in blowing on these fuzzy heads.

## Red-Seeded Dandelion

Also called rock dandelion and lesser dandelion, the red-seeded dandelion (*Taraxacum erythrospermum* or *T. laevigatum*), a cultivated species, is a special case.

This was one of the four dandelion types that the Massachusetts Horticultural Society displayed at its exhibit in 1871. The others were French large leaved, French thick leaved, and American Improved. When

"The tramp  
with a  
golden  
crown"

grown in a dry soil, red-seeded dandelion leaves will be more finely cut than usual.

Once considered an introduction from Europe, it was later classified as a native species in the U.S. This is found in almost all states, including Alaska and Hawaii. It is absent from New Mexico and the lower half of Louisiana. Red-seeded dandelion occurs on thin dry soils and in waste places, meadows, fields, pastures, and lawns. This is most commonly found along roadsides and railroad tracks.

An easy way to distinguish red-seeded dandelion from the common dandelion is to look at the seeds. These are purplish-red or red, while those of the ordinary dandelion will be green, brown, or olive.

A repeat bloomer, it first begins flowering from March to July. However, it continues for much of the year. Less than six inches tall, red-seeded dandelion is quite tolerant of inclement weather. The deeply dissected leaves are two inches wide.

## Other Species of Dandelions in America

There are perhaps ten species in the U.S. with some of those being cultivated. Several are considered to be natives. These largely resemble the common dandelion other than some minor difference in the height or size of the leaves or blossoms.

The range of the California dandelion (*Taraxacum californicum*) is restricted to California where it is



classified as endangered.

The woolbearing dandelion (*Taraxacum officinale* ssp. *ceratophorum*) was once considered a species by some. It is now classified as a subspecies of the common dandelion. This is found in much of the western half of the country, particularly the Rocky Mountains. It doesn't occur in Arizona and rare in California.

Others that are native to America include the northern dandelion (*Taraxacum phymatocarpum* or *T. alaskanum*). This occurs only in Alaska, parts of Canada, and Greenland. Another species, the fleshy dandelion (*Taraxacum carneocoloratum*), is also found in Alaska as well as in the Yukon. It blooms June to August. Less than six inches tall, it has leaves that are 3¼ inches in length. This occurs on calcareous ledges and meadows.

#### Common Names for Dandelions

The list of common names for this cosmopolitan weed is vast. In fact, one English flora has almost an entire page of preferred names. The name dandelion is based on medieval Latin meaning "tooth of the lion." No one seems to have a good explanation accounting for this peculiar name. Some of the other popular common names include doon-head, Irish daisy, puffballs, fairy clock, clock flower, and cankerwort.

#### Growing and Using Dandelions

Dandelions are made into wine and beer. These have been grown as a vegetable for over a hundred years, especially the larger leaved ones. They can be propagated by seed and root cuttings.

All parts of the plant are edible including roots, flower buds, and tender young leaves as well as mature ones. Since pollen serves as a food coloring, beekeepers might find there's a market for surplus pollen.

I tried one of the coffee substitutes made from roasted dandelion root. It tasted similar to other drinks containing roasted grains and seeds. In some instances, the root is used in place of chicory for flavoring coffee. Typically, the varieties used for drinks have larger roots than the

usual dandelion.

Dandelions are cultivated commercially to a limited extent in the U.S. They're mostly sold at local markets. The cultivated types tend to be larger plants, around two feet across. As a commercial crop, they take about three to four months from sowing to harvest.

Vineland, N.J. is widely known as "the Dandelion Capital of the World." At one point there were at least a dozen or so growers in the town. Each year the Dandelion Dinner Festival takes place in Vineland during the dandelion harvest season. This includes a full course dinner of dandelion dishes.

#### History of the Dandelion

In addition to their culinary uses, dandelions are used as healing herbs, and were touted by herbalist Nicholas Culpeper and John Gerard, both of whom published herbals in the 1500s-1600s, which are still widely popular even today.

It isn't clear as to when or how the common dandelion was introduced to the U.S. What is known is that it became ubiquitous very quickly. Perhaps the French introduced them as a garden vegetable. These could have been a weed seed among garden seeds sent to the American colonies. Dandelion was one of those introduced plants that quickly became quickly widespread after the European settlers arrived.

At one point, the New York Agricultural Station in Geneva had plots of the different cultivated varieties. The fresh salad greens were sold in Boston markets in the 1830s. Native Americans also adapted these as a food source.

Europeans often turned to these during times of hardship, such as famine, wars, crop failure, and droughts. These were particularly popular among the French and Dutch.

The French were likely the first to cultivate it after they could no longer find enough wild dandelions growing in the countryside around Paris to meet the demands of Parisian markets. In the late 1800s the French grew several special varieties. *The Vegetable Garden* by M.M. Vilmorin-Andrieux was first published in English in 1885.





Based on the family's experiences, this title explained how to grow dandelions and its cultivation in France.

Specializing in vegetable seeds, the author's family owned one of the oldest and largest seed companies in the world at the time. The company is still thriving today. Recently, they opened a vegetable seed subsidiary in Moscow and announced plans to move into the Delhi, India market as well.

In his book, Vilmorin-Andrieux described various varieties of dandelions, particularly ones that he and his company bred. These included Improved Early dandelion, a variety of the Thick Leaved.

Very Early dandelion is also known as the Broad-Leaved. It has leaves with few lobes or teeth.

Curled Leaf is a compact form that yields fewer leaves than some others. The Moss-leaved, which is a variety of the Curled Leaf, has very finely cut foliage.

The Thick Leaved or Cabbaging is very productive, and produces large numbers of leaves.

#### Dandelion's Value to Bees

Dandelions begin blooming in the Spring when the temperatures are often still on the cool side. These open before the fruit trees flower buds emerge. In warm regions, they can bloom almost year-round. In colder areas they often have a second blooming period in the Fall, but this crop tends to be smaller than the Spring one.

Considered an excellent bee plant, all of the dandelion species easily attract bees. It remains a mystery as to why the dandelion would bother producing generous quantities of nectar and pollen as the plant isn't doing this as a survival strategy in order to attract pollinators (it can produce viable seeds without pollination).

The nectar and pollen is readily accessible to bees. Each flower head has about 100-300 individual floral tubes – one for each petal or ray of the flower head. In effect, this offers a veritable feast.

If given a choice, honey bees often select dandelion blossoms over those of apple and pear trees. In some cases, orchardists have reportedly mowed orchards in order to remove this competition from the fruit tree blossoms.

Bees visit the dandelion blossoms often during the day for both nectar and pollen. The latter is especially attractive since the large grains are easy for the bees to carry. The golden yellow or yellow color of the pollen, which is quite plentiful, shows up in the comb and ends up in the honey as well.

Typically, dandelion blossoms open between 6-9 a.m. However, the time on a given day varies according to the latitude and month. They tend to open later in the North.

During mid-Summer they open earlier than other times.

The blossoms close some time later in the day before sunset or sooner in case of rain. The fact that they close at night and during stormy, cloudy weather helps to protect them from dewfall and rain.

Both the nectar and pollen play a major role in building up strong colonies. According to USDA, the much valued dandelion is considered a major nectar and pollen plant in the Northeast, North Central, West, and mountainous states, Alaska, and Hawaii. It tends to be an important honey plant in some locations but not in others.

If colonies are strong in the Spring, there is a potential for large honey crops in some locations, although this isn't necessarily common. In some instances the surplus is small, which likely means the colonies are still too weak to harvest all the dandelion nectar and pollen that is available. In most cases, the honey is fed to bees. A typical surplus would be about 30-40 pounds per hive. However, IBRA reports that worldwide there has been as much as 700 to 800 pounds per acre in some areas.

The honey is often a little strong tasting for some American consumers. It typically has a characteristic, rather sharp, strong flavor that mellows somewhat with age.

The honey can be cloudy. It can vary widely in color from any shade of amber to various shades of yellow. This thick honey crystallizes quickly, developing either fine or coarse, hard grains. 

~Connie Krochmal  
Writer and beekeeper  
Black Mountain, North Carolina.



## Rock Bridge Trees

*Trees Grown On Purpose For A Purpose*

### Trees to Fill Your Nectar Flow Gaps

Where are Your Gaps?

Sourwood	30' Zone 5-9	Blooms Jul-Aug
American Linden	80' Zone 3-8	Bloms Late June
Little Leaf Linden	80' Zone 3-7	Blooms Early June
Black Locust	50' Zone 3-8	Blooms May
Seven Sons Tree	25' Zone 5-9	Blooms Aug-Sept
Korean Bee Bee Tree	30" Zone 5-8	Blooms July-Aug
Northern Catalpa	90' Zone 4-8	Blooms Late June
Southern Catalpa	50' Zone 4-8	Blooms Early June
Tulip Poplar	90' Zone 4-9	Blooms May
Tree Lilac	25' Zone 3-7	Blooms May-June
Glossy Abelia	06' Zone 5-9	Blooms May-Frost
Summersweet	3' to 6' Zone 3-9	Blooms July-Aug
Japanese Pagoda Tree	60' Zone 4-8	Blooms July-Aug
Golden Rain Tree	30' Zone 5-9	Blooms June-July
Black Gum	40' to 60' Zone 4-8	Blooms May-June

615-841-3664

199 Dry Fork Creek Road | Bethpage, TN | 37022

## Beginning beekeeping, Start keeping bees in a topbar hive

I kept bees in 100-200 Langstroth hives for about 20 years and began experimenting with topbar hives in 1980. In the mid 90's I sold my Langstroth equipment and began keeping bees entirely in 100 -200 topbar hives. I will occasionally refer to Langstroth management practices that have equivalents in topbar hives. The Langstroth comparisons will mostly help people with Langstroth experience that are curious to read about or try topbar hives. Some people keep bees in both kinds of hive and there are hybrid Langstroth/topbar hives.

My management practices always veer me away from treatments, toxic or not, to help bees survive. I believe that bees can and always do adapt to disease and parasitism. Their ability to adapt may be limited at first and intervening to help the bees may be prudent until the resistance becomes widespread and dependable. But as soon as a parasite or disease becomes



a problem we need to begin searching for resistance in honeybees. Treatments breed resistance into the pest. Feral bees are demonstrating all over the world that bees can live without our "help".

I am a bit of a minimalist and my beekeeping reflects that. I like hives to be as simple and cheap to build as possible. I have made and used topbar hives made out of willows and mud, plastic blue barrels, and wood.

I am a permissive beekeeper, I exert minimal control and do not use queen excluders or try to deny drone production. Honeybees are adapting to the constantly changing world and we can trust that they are not stupid, that they have reasons to raise a lot of brood in many combs certain times of the year, and if they want drones they have their reasons. We should treat them with respect and trust them to run their biology. Our beekeeping practices should be based mostly on a good understanding of natural honeybee biology.

My experience in beekeeping has been primarily in New Mexico, a relatively hard place to keep bees. Cold winters with temperatures regularly 10 - 15 degrees below 0 and warm summer weather getting over 100 degrees with precipitation around eight inches per year make plants bloom fast and furious when they can. My travels to work with beekeepers in California, Arizona Texas, Latin America, Azerbaijan, Portugal, and Jamaica give

## Keeping Bees in Topbar Hives

~LES CROWDER

me some ability to see that timing of operations depends entirely on the climate and flowers where the bees are being kept. Phoenix, Arizona and Taos, New Mexico are not very far apart but Phoenix has a winter honey flow and a hot summer dearth, Taos a long cold winter dearth and a short, sweet summer honey flow.

The best source of information about the timing of local flowers that are important to honeybees is a local beekeeper. Most areas have beekeeping clubs that meet regularly and exist to help us learn from each other. Topbar hives are becoming more common all over the world and most beekeeping clubs are friendly to topbar beekeeping.

### Topbar design

There are many versions of topbar hive in use today, and although there are benefits to standardization there will not be a standard topbar hive any time soon. When choosing a topbar hive to build or buy keep these simple design considerations in mind. The first two are about making it easier and quicker to lift out the combs and put them back in the hive. Beekeeping is mostly lifting combs and putting them back. Saving a few seconds and some frustration every time really adds up.

1. The angle the walls make with the floor makes a difference. The wider the angle the less the bees attach the combs to the walls. If the combs are attached it takes work and time to cut them loose before lifting them out. There are more opportunities to crush bees or get frustrated with bees that are slow to get out of the way when cutting the combs loose from the walls. Although vertical sided topbar hives are possible, if the top is at least slightly wider than the bottom the combs pull up and away without rolling bees.

2. It is better if the top edges of the main hive body have a pointed ridge to rest the topbars on rather than a flat beveled surface for the topbars to sit flat on. A pointed ridge is usually easier to make. There are often bees wandering over the top edge when the beekeeper wants to put the topbars back. Bees get crushed if they don't get out of the way. If there is a pointed ridge and the topbar comes down slowly the bees quickly feel that they have to go one way or the other but can't stay on the ridge. If there is a flat surface under them the bees cannot feel which way to go to get out of the way. They wander back and forth longer and that gets the beekeeper frustrated with the bees. Crushing bees gets the bees frustrated with the beekeeper.

3. The depth of the comb from the underside of the topbar to the bottom of the comb makes a difference. Since the combs are not reinforced with wire, wood or plastic they can be fragile, especially in warm temperatures when the beeswax is soft. Deep combs full of honey get heavy and can break off the topbars more easily than shallow combs.

Otherwise there are many options. I have kept bees in plastic blue barrels and some of those hives still have bees in them now, nearly 20 years later. I have made willow hives plastered on the inside with clay straw, a real wicker hive in Jamaica, stick and shade cloth hives,



adobe mud hives, and I have seen a glass hive, bamboo hives and of course wood.

If there are topbar beekeepers in your area that predominantly use a particular type of topbar hive it may be good to follow their example because occasionally you may want to buy, sell or trade a hive, a nuc or even just a few combs with the local beekeepers and it is easier if the combs fit from hive to hive without messy and destructive trimming of combs.

I like to keep hives as simple and cheap as possible. I can be a bit of a minimalist and often work with subsistence farmers. Beyond my keep-it-simple mantra I am a permissive beekeeper, I let the bees do what they want as much as possible. Lastly I believe that bees can and will adapt to disease and parasites and that we should intervene only as a last resort and strive to breed bees that are resistant rather than use treatments, toxic or not, to help bees survive. I try to keep in mind that my way is not right, just my way, and I welcome you to develop your way.



Timing of operations depends entirely on the climate and flowers where the bees are being kept. Local bee clubs help us discuss the local conditions important to bees with experienced beekeepers. Often topbar beekeep-

ers feel out of place due to the type of hive and the different terms used in langstroth beekeeping. Even though topbar beekeepers don't have supers or uncap and extract, we are all harvesting honey from the local climate and flowers. Most clubs are topbar friendly, there are some clubs that have a general session and then breakout to topbar and langstroth groups.

The midst of apple bloom is when people get inspired and want to keep bees. Beginning beekeeping classes fill up readily at that time of year but for the most part they will not be ready to keep bees until the next year. There is plenty to learn, you need your hives ready, and you need to find as good a source of bees as you can and get them ordered in the winter. Getting a couple of hives set up on stands well before the swarm season or package shipping season is important.

Bees need to be out of the way. Place them in an area with the least activity out their front door. A 5-6 foot tall flight barrier, (a bush, some vines, reed fencing etc.) about 6-10 feet in front of the hive can create a bee zone and they are less inclined to get defensive about what is happening in a garden or swing set over the other side of the barrier. When placing beehives be considerate of your neighbors who may be terrified of bees.

#### **Hiving a swarm or a package in an empty topbar hive.**

When bees swarm into a hollow space they usually start at the back or top, at the opposite end from the entrance. The last few years I have been hiving bees in the back end of topbar hives. If you can get a comb or 2 with some empty worker size cells from another beekeeper, or get some empty drawn out langstroth combs that can be cut and tied under two topbars the combs will greatly encourage the swarm or package to stay in the hive once you have put them in it. Empty light colored combs are the best because they reduce the worry about possible disease transmission. Place any combs you get one topbar from the back end of the hive.

#### **Hiving Packages**

Some feeding can aid them until they get their bearing. The food is controversial. Some beekeepers say they should eat only honey, some say never feed bees honey that may carry foulbrood spores, only sugar. There are formulations that make sugar have a PH. more like honey. Use good clean white sugar, not brown or unrefined, no molasses, bees are not good at digesting impurities or burned sugar. There are recipes with essential oils or garlic extracts are not naturally found in flower nectar and have been found to reduce brood production. I drop a chunk of crystalized honey inside on the bottom when I have to and sugar syrup is better than letting the bees die. I only very rarely feed bees. A jar with a tight fitting lid with 10 or 11 1/16 inch perforations I make with a nail, set up on two sticks so the bees can get under the lid, makes a fine feeder of liquids. The feeder jar should fit under the topbars so the hive can be closed up snug.

Lift the can out or the cover off the package and pull out the queen cage. **DO NOT OPEN ANY PLUG OR CAP THAT WOULD LET THE QUEEN OUT RIGHT AWAY.** She may fall to the ground or fly out if you turn her loose. She is not the mother of the bees in the package so a few more days in the cage will help the bees get used to her. If she stays in the cage a few days that also reduces

the chances that the bees will abscond, leave with her to live somewhere else. Remove any cork or cap that lets the bees outside the cage eat the candy that holds the queen in. If there is no candy some people put a piece of marshmallow in the hole or just come back after three or so days and then release the queen. A thin string like fishing twine will hang the queen cage between the combs or under a topbar if you were unable to procure a comb.

Shake most of the bees out of the package, they will cluster around the queen cage. Set the package box down in front of the hive so the stubborn bees can come out and join the cluster. In 3 days or so look in to make sure the queen is out of the cage and remove the cage. If the queen is still in the cage, open it up while holding the cage down in the hive. Don't shake her out, just lay it down and let her come out calmly on her own.

### Hiving a swarm

Swarms may be the best way to get locally adapted bees. If you are in an area where the feral bees are Africanized you should get help from an experienced beekeeper. You do not want fierce bees in an urban setting with minimal experience. Local beekeepers will have opinions about swarms and swarm season in your area. Swarms are queenright (with their queen) family units looking for homes. A swarm can be gathered into a well ventilated box or bucket, transported and poured into a hive on its stand or they can be hived right into the empty hive. I have a topbar box that only holds 8 combs that is easy to carry and most swarms fit in it fine. I just open the hive, shake them in and then cover the top and let them come in the entrance. Once they begin marching into the hive or box I do not worry about finding the queen. I give them enough time to gather most or all the bees in the swarm and trust the queen is with them. A comb or two at the back will help them decide to move in.

### When flowers begin to bloom. Swarm prevention in topbar hives.

Your bees have been quietly living through a dearth, the winter in much of the U.S. The queen is laying a few eggs to keep the relatively inactive hive populated with a small dearth season cluster. The small population does not gobble up the honey stored many bee lives ago during the last bloom. Hopefully there is still some honey left when spring flowers begin offering your bees sips of nectar

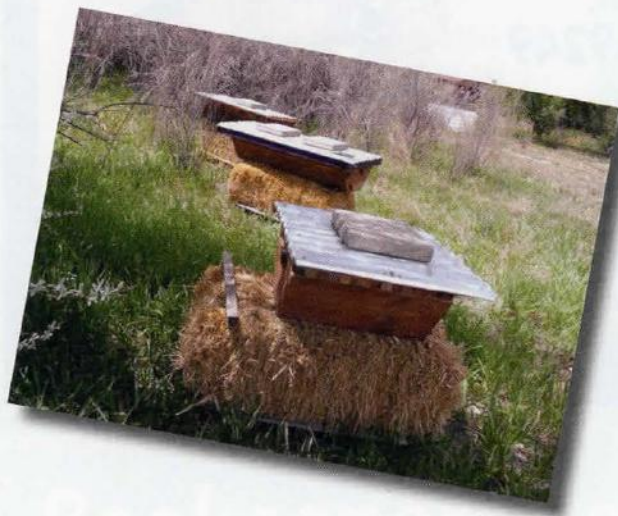

and loads of fresh nutritious pollen. Once the bloom is blazing bright across the landscape tens of thousands of bees could be out in the field gathering. The hive needs to grow from 2,000 - 3,000 bees to 60,000 - 80,000 bees.

The brood nest can grow toward the entrance in the empty combs but if there is honey left over from the last bloom in the back of the hive it will block brood nest expansion into the back of the hive. The bees do not like to have two brood nests separated by honey. If the brood nest cannot expand into the back of the topbar hive it will quickly fill the front, run out of room and feel the urge to swarm. Once I see the brood nest expanding in the spring I put any combs full of honey in the front of the hive. If it is warm enough I may put an empty topbar between the honey combs and the brood combs to give them space to build a new comb or two. I put any empty combs from the front behind the brood nest combs. This is the equivalent to reversing the boxes in langstroth hives. Now the honey barrier has been taken out of the middle of the hive and put to the front where it can still be eaten and the bees can expand the brood nest as far back into the hive as they want. The topbar beekeeper may fit a queen excluder in to restrict brood to a certain area if he/she wants cross-combing.

During the expansion season the bee's instincts are leading them to grow into a much larger population and cast a

swarm. Reversing the honey with the empty combs got them started stretching into the full length of the hive. When the swarm season honey flow is happening I try to get to all my hives every two weeks to check on their growth and make sure they are growing on the topbars and not across them. I pull a few combs back and place empty topbars, or topbars with partial combs on them, between fully built combs to give the bees space to build new combs. Empty topbars in between built combs keep them building on the topbars instead of across them. These quick checks do not have to be long or invasive, just pull back the combs from the back until you see the brood, and put the combs back with 2-4 empty topbars alternating with built combs.

When spreading combs apart to get the hive to expand on the topbars is not wise to spread brood combs too far apart. If they are in a spring buildup and the temperatures are still cool at night the clustered bees may not be able to cover the brood greatly expanded with empty topbars. The empty topbars and comb building is best between partial combs and combs with honey or empty built combs. If the bees are building slowly I just pull back a few combs at the back of the hive, if there is a lot of building going on I put empty topbars between the combs at the front and the back of the brood nest. Often there are a few hives that did not make it through the dearth



and they had empty combs left in them. If they are not full of wax moths or hive beetle larvae they can be taken out and used to give growing hives combs as templates to build new combs between.

### Fat and Skinny Combs.

Some times in good honey flows we put a topbar in between nearly built combs but the bees continue building on the full combs making them bulge into the space of the empty topbar and hardly build any comb on the empty topbar. In rich honey flows the bees are looking for any place to stash nectar fast. The combs they are building can be thickened easier than starting a new comb. This happens at the top of the comb more than the bottom. This happens with uncapped combs, honeycombs that are mostly capped across the top don't usually get extended. If a honey flow is strong I find it better to put the fatter combs together somewhere, usually at the back, and gently press them together (giving the bees time to get out of the way where the bulges touch each other). The bees will mine out and repair the bulges. If they bulge out a lot I sometimes gently brush the bees off them and lop off the bulge into a container or harvesting bucket, which I always carry to harvest broken or crossed pieces

of combs in. In my circles there is always somebody happy to sweeten something with a little honey from my bucket. Really fat combs must be lifted with care because they are heavy and break off the topbar easily.

When I am spacing the combs in a strong honey flow I like to set up regions of construction in which the combs are fairly similar in width, for example, next to a comb with some capped honey at the top (not easily extendable) I might put an empty topbar, a topbar with thin bits of comb just started on it and another empty topbar.

Giving the bees plenty of room to expand is the langstroth equivalent of adding supers, getting more combs in the hive. Bees kept busy building and filling lots of combs are less likely to swarm. But honeybees have a natural tendency to swarm as part of their reproductive cycle. No swarm prevention is guaranteed, and it can even be encouraged. Once queen cells are started we can use the queens and queen cells to re-queen or make divides.

**Now you have honey bees in a box, you are a beekeeper** 

~Les Crowder and Heather Harrell  
 Authors of *Top Bar Beekeeping*  
 Available in bookstores and online.

# QUEENS AVAILABLE

## Year Round

**Healthy Queens  
= Healthy Hives**

**Olivarez Honey Bees, Inc.**



Like Us On  **facebook**

**CALIFORNIA**  
**(530) 865-0298**

**HAWAII**  
**(808) 328-9249**

**TOLL FREE**  
**(877) 865-0298**

P.O. BOX 847 • 6398 CO. RD. 20  
 ORLAND, CA 95963

Premium Quality Queens  
 Produced in the Heart of  
 Northern California



**Big Island Queens**  
A Division of Olivarez Honey Bees, Inc.



**WWW.OHBEEES.COM**

We accept all major credit cards

