

RESCUE *TECH*



QUALITY GEAR THAT
HELPS YOUR TEAM
DO MORE.

VANGUARD-G2 ISC WALES RD70 ARACHNIPOD PORTER PRIME EXTRACTOR AQUALUNG D4 DESCENDER
R-ALF INDUSTRIPOD+ LSP HALF BACK RAPTOR DRYSUIT A-FRAME ANCHOR ACCESS LIFELINE ADVANTAGE-G2
FIREHOUSE MANIKIN FIRSTWATCH SPIN-ANSI PIXA SHOUTBOX MAN OVERBOARD MANIKIN ANTHRON
ASCENDER ROCK EXOTICA OMNI-BLOCK EGRESS+PLUS ULTRASTATIC INSTANT HITCH D2 ESCAPE DESCENDER
SLING-LINK OVALONE DNA CARABINER STRYDER FOOT ASCENDER D5 BELAY DESCENDER REACH & RESCUE

INDEX

540° Belay™	49	Equipment Packs	100-103	Manikins, Training	83-99	Rope, Utility	4
ACCESS™ Lifeline	2	Escape / Search Bag	12-15	Mini-Haul Kit	50, 52	Rope, Sewn Eye	6
AD45 NFPA Carabiners	32	Escape Belt	20	Multipod	65-70	RUTH LEE™ Manikins	83-97
Advanced Water Rescue Manikin ..	91	Escape Kits	18-19	Mustang Survival™	109, 114	Scaffold Hooks	35
ADVANTAGE-G2™ Harness	24	Etrier	64	Packs	100-101, 119	Search Kits	12-15
Air Cart	143	EXTRACTOR™ CSR Kits	59	Patient Handling	73-82	Seat Harness	21
Anchor Plates	48, 51	Fall Protection Devices	50, 68	Personal Flotation Devices ..	105-109	Shock Absorber	62-63
APEX Pulleys	41	Fins	116	Petzl Harnesses	26	Simulaids™	98-99
ARACHNIPOD™ Multipod	65-69	Firefighters' Rescue Sling	22	Positioning Lanyards	50	Sling-Link.....	17
Ascenders	42-43	Fire Resistant Manikin	84	PRIME™ Rescue Harness	25	Slings, Webbing	60-62
Backboards	79	Flexible Stretcher	82	PROBE™ Search Line	6	Slings, Wire	62
Backboard Slings	80	Gloves, Dive	115	Prusik Cord	5	Snorkel	119
Bags, Equipment	11, 100-104	Gloves, Rescue/Rappel	138	Prusik, Sewn	5	SPIN-LOCK™ Rescue Kits	56
Bags, Gear	100-101	Harkin Winch	72	Pulleys, Aluminum	37-41	STR-II Stretcher.....	81
Bags, Rope	11	Harness, Belt	20	Pulleys, Knot Passing	39	Stretchers, Basket	73-75
Belay Device	16, 44-47	Harness, Chest	21	Pulleys, PMP	37-41	Supplied Air Systems	143
Block II Stretcher	75	Harness, Confined Space	23-26	Pulleys, Stainless Steel	38-39	Swivel	36
Bolt Rigging Plate.....	48	Harness, Escape	21	Pulleys, Swivel	40-41	TASK Stretcher	75, 81
Books, Rescue	139	Harness, Fire Resistant	21	Radio Harness	142	Terradaptor	70
Boots	116	Harness, Rescue	23-26	Raft, Inflatable	125	Throw Bags	118, 128
Cable Umbilical	142	Harness, Seat	21	Raft Kit	124	Tower Harness	24
Carabiners, Aluminum	32-34	Harness, Victim	28	R-ALF™ Rescue Kits	31	Trauma Rescue Manikin.....	87
Carabiners, Steel	29-31, 35	Hauling Kits	55	RAMFAN™	144	Tripod	71
Carabiners, Swivel	36	Headlamps	133	Rapid Links	30	UltraLink	33
Cinch Collar.....	127	Helmets, Rescue	136-137	Rappel Racks	47	Umbilical, Cable	142
Command Board	140	Helmets, Water	117	RD2 Belay/Progress Capture	49	VANGUARD-G2™ Harness	23
Communication Equipment	142	Hoist, Tripod	68, 71	Reach & Rescue™ Poles	120-123	Ventilation Equipment	144
Confined Space Rescue Kits ..	53-59	Ice Commander.....	114	Reeves Sleeve	82	Victim Harness	28
Cord, Prusik	5	l'D™ Descender	45	Rescue 8 Descender	46	Water Rescue Equipment.....	105-135
CORONA™ Escape Belt	20	Industripod+™ Tripod	71	Rescue Cradle, Victim	28	Water Rescue Sled	124-125
D1 Tower Escape Kit	19	KED-PRO	81	Rescue Cradle, Man Overboard..	123	Webbing	8
D2 Escape Descender	16	Kits, Rescue	53-59	Rigging Hardware	48, 51	Webbing Ladder	64, 135
D4 Descender / Belay Device	44	Knee Pads	139	Rigging Plate	48	Weight Vest, Manikin	94
D5 Descender / Belay Device	44	Knives	132	Rigging Slings	60-62	Weight Vest, Personnel	99
Decon Stretcher	79	Ladder, Webbing	64, 135	RIT Drag Bags	12	Wetsuits	113
Descenders, Escape	16	Lanyards	50, 63	RIT Kits	12-14	Winch, Rescue	72
Descenders, Figure 8	46	Lights, Dive	133	River Board	124, 127	Winch, Tripod	71-72
Descenders, Rack-type	47	Lights, Handheld	133	Rock Exotica™	36, 40, 41, 48	Wristlet	27
DEWIPE	141	Lights, Strobe	134	Rope & Equipment Bags	11		
Dive Mask	119	Links , Rapid	30	Rope Accessories	10		
Dolphin3 Remote Control Buoy ...	126	Litter Bridles	75	Rope Pad	8		
Dry Suits	110-112	Litter Trailer	77	Rope, ACCESS™ Lifeline	2		
Duffel Bags	102, 104	Litter Wheel	77	Rope, Heat Resistant	3, 5, 6, 7		
Edge Guard	8	Load Cell	45	Rope, NFPA	2-3		
Edge Protection	8, 9	Load Release Strap	61	Rope, Polypropylene	4		
Edge Roller	9	Maestro™	49	Rope, Rescue	2-7		
EGRESS™ Escape Rope	7						



HAPPY ANNIVERSARY!

Rescue Technology was founded over 40 years ago with the goal of providing top quality equipment to technical rescuers. Through the years we have seen growth in all sectors. From our popular NFPA Class III harnesses to Ruth Lee training manikins, we continue to provide the best to top work and rescue professionals around the world. We owe our growth to you!

Our partnerships with other top manufacturers allow us to provide one of the widest range of equipment for Technical Rescue and Training. We hope you enjoy this new catalog and also visit our website: www.rescueTECH1.com

All of us at RescueTECH look forward to working with you to help your team DO MORE!

**STAY SAFE,
GLENN NEWELL
PRESIDENT**



Photo courtesy of Toprope GmbH



NEW PRODUCTS

NEW & IMPROVED AT RESCUETECH

11mm NFPA-G Rope	3
Protec 500 Heat Resistant Rope	3
Edgebot	9
Clampbot	9



Roller Coaster	9
Stealth Hook	16
Bantam Hook	16
Updated D2 Escape Kits	18
Astro Fast Harness	26
Avao Fast Harness	26
Avao Harness	26
X-Perf Harness	26
AD45 Aluminum NFPA Carabiners	32



ISC UltraLink	33
Force Carabiners	33
Ovalone Carabiners	33
Curly Whirly Twisted Carabiner	34
Multi-Use Aluminum Carabiners	34
RollClip Carabiners	34
SwivaEye	36
Petzl Reeve	39
Petzl Spin Pulleys	40
SMC Apex Pulleys	41



Omni SwivaBiner	41
Twin Release Pulley	41
Harken Ninja Multiascend	43
Origin TT	48
Advance Tech HX Pulley	49
RD2 Belay/Progress Capture	49
Twin Release System	50
Harken Wingman	52
Heavy Duty Anchor Sling II	60
Harken Tellumount	72
Task Block II Stretcher	75



Cascade Litter Wheels	77
Inflatable Backboard Flotation System	78
KED PRO	81
Public Safety Training Manikin	84
Trauma Rescue Manikin	87
Advanced Water Rescue Manikin	91
PAX Gear Bag	102
Purest Rescue Duffel Bag	104
Firstwatch PFD's	108



Firstwatch Operators Suit	112
Firstwatch Waders	112
Tactyl Helmet	117
Firstwatch Inflatable Rescue Tube	118
PAX McKinley At Height EMS Pack	119
NRS Rescue Rafts	124, 125
Dolphin3 Self-Propelled Rescue Buoy	126
Force6 Dart Throwbag	128
Firstwatch NVG Helmet Light	133
DeWipe Decontamination Wipes	141



WARNING

Technical rescue and safety is potentially hazardous. Any person using equipment sold by RESCUE TECHNOLOGY in any manner is personally responsible for learning the proper techniques involved, and assumes all risks and accepts full and complete responsibility for any and all damages or injury of any kind, including death, which may result from the use of any RESCUE TECHNOLOGY equipment.

Products in this catalog can expose you to chemicals which are known to the State of California to cause cancer.

For information go to:
www.p65warnings.ca.gov

**251 BEULAH CHURCH RD.
CARROLLTON, GEORGIA 30117
800.334.3368
770.832.1672 FAX
WWW.RESCUETECH1.COM**

RESCUETECH ACCESS LIFELINE™



RescueTECH spent 35 years helping design some of the best known rescue ropes in the world. Now, we have used our knowledge to create a rope design that gives the best combination of all desired characteristics. By building the ropes from the “ground up”, we are able to provide a super-strong rope with low stretch and excellent flexibility and knotability. By using a combination of a 32 strand polyester sheath and nylon core, our ropes actually handle better after 6 months of use than some new ropes from other manufacturers. We specifically address the issue of sheath slippage when constructing all of our top quality Rescue Ropes. Solution dyed color insures that colors won't run. All ropes of the same diameter will perform identically, making multi-rope systems much easier to control. Certified to NFPA 1983 and EN1891. Available in 11 color combinations.

	Diameter*		Color / Stripe	MBS**	WLL***		NFPA Rating	Wgt / 100 ft.
5156xxxORS	3/8"	9.5mm	Orange	6,070 lbf.	27 kN	405 lbs.	Technical	4.7 lbs.
5156xxxBLS			Blue					
5156xxxRDS			Red					
5156xxxBKS			Black					
5157xxxOR	7/16"	11mm	Orange w/ Yellow	7,870 lbf.	35 kN	525 lbs.	Technical	5.4 lbs.
5157xxxBL			Blue w/ Yellow					
5157xxxRD			Red w/ Yellow					
5147xxxWB			White w/ Red					
5147xxxWR			White w/ Blue					
5158xxxOR	1/2"	13mm	Orange w/ Yellow	10,000 lbf.	46 kN	667 lbs.	General	7.0 lbs.
5158xxxBL			Blue w/ Yellow					
5158xxxLG			Lime Green w/ Blue					
5158xxxRD			Red w/ Yellow					
5158xxxYE			Yellow w/ Blue					
5148xxxWR			White w/ Red					
5148xxxWB			White w/ Blue					
5159xxxOR	5/8"	14.5mm	Orange w/ Yellow	11,405 lbf.	45.4 kN	760 lbs.	General	12.2 lbs.
5159xxxBL			Blue w/ Yellow					
5159xxxRD			Red w/ Yellow					

* Nominal Diameter

** Calculated as 3 standard deviations from the average tensile strength.

*** WLL - Recommended Working Load (also known as Safe Working Load) is calculated using the NFPA 15:1 Safe Working Load Ratio.

3/8" Solid Color

5156300xxx	3/8" x 300'	\$378.00
5156600xxx	3/8" x 600'	\$755.00

7/16" Color w/ Stripe

5157150xx	7/16" x 150'	\$210.00
5157200xx	7/16" x 200'	\$280.00
5157300xx	7/16" x 300'	\$420.00
5157600xx	7/16" x 600'	\$800.00

7/16" White w/ Stripe

5147150xx	7/16" x 150'	\$215.00
5147200xx	7/16" x 200'	\$285.00
5147300xx	7/16" x 300'	\$440.00
5147600xx	7/16" x 600'	\$830.00

1/2" Color w/ Stripe

5158150xx	1/2" x 150'	\$247.00
5158200xx	1/2" x 200'	\$330.00
5158300xx	1/2" x 300'	\$495.00
5158600xx	1/2" x 600'	\$990.00

1/2" White w/ Stripe

5148150xx	1/2" x 150'	\$225.00
5148200xx	1/2" x 200'	\$300.00
5148300xx	1/2" x 300'	\$450.00
5148600xx	1/2" x 600'	\$900.00

5/8" Color w/ Stripe

5159300xx	5/8" x 300'	\$650.00
5159600xx	5/8" x 600'	\$1,300.00

TECHNOTE

PRUSIK CORD VS. ACCESSORY CORD

What is the difference between prusik cord and accessory cord? Generally, there is no difference. The key is to provide a cord that has specifications and characteristics that meet the needs of rescuers. Prusik cords work because of their flexibility that allows the initial engagement of the prusik hitch. Additionally, the diameter difference between the main line and the prusik cord is an essential element in the overall holding strength of the hitch.

ROPE END TERMINATION

We developed our rope end terminations after many years of research and development. Our first “knotless termination was a proprietary swaging method. Our process pressed the entire length of the aluminum ferrule rather than multiple 5/16” rings along its length. In response to requests to develop an end loop without the aluminum swages, RescueTECH developed a sewn-eye termination process. We are able to provide end terminations that exceed current NFPA strength requirements for rope-end terminations. The new Sewn-Eye ropes are lighter and more streamlined than the older Swaging process. All of our EXTRACTOR CSR™ Rescue Kits include the new sewn-eye ropes.

KM-G 7/16" / 11MM NFPA G-RATED LIFELINE

KM-G packs a whopping 42.9 kN MBS into an 11mm rope that feels much smaller. Its 32 carrier sheath design adds extra abrasions resistance. And if that isn't enough, it does it while delivering a category leading 1.2% elongation! This rope's performance dramatically exceeds both the NFPA G-rating and every other G-rated 11mm rope. KM G's high strength, anti-rotational core is made of Nylon 6.6, giving it superior handling and knotability. We pair that with an abrasion, UV and chemical resistant sheath made of low elongation, high tenacity polyester. There is not a better G-rated 11mm rope available on the market! Certified to NFPA 2500 (1983).

Diameter	MBS	Wgt / 100 ft.	NFPA Rating	Elong @ 300 lbs	Elong @ 600 lbs	Elong @ 1000 lbs.
7/16" 11 mm	9,644.8 lbf. 42.9 kN	5.74 lbs.	General	1.2	2.4	4.6

	Length	
2391302200xxx	7/16" x 200'	\$275.00
2391302300xxx	7/16" x 300'	\$410.00
2391302600xxx	7/16" x 600'	\$790.00

Available Colors
Grey w/ Red
Grey w/ Blue
Grey w/ Yellow
Grey w/ Black

NFPA-G 11mm ROPE



PROTEC 500

Outstanding Heat Resistance

Protec 500 is a CE EN1891 certified rope with a 100% Technora® cover. It is essential for all rope access professionals who require a work positioning rope with outstanding heat and abrasion resistant properties. The hi-visibility indicators will melt/fuse if exposed to temperatures over 250°C (482°F), providing visual and tactile evidence of high temperature exposure. Ideal for use around hot pipes and in welding operations

	Length	MBS	Wgt / 100 ft.	
25544539330xx	7/16" x 330'	11,038 lbf	49.1	\$836.00
25544539660xx	7/16" x 660'			\$1673.00



Available Colors
Black w/ Lime
Gold w/ Red

TECHNOTE

NUMBER OF SHEATH STRANDS

The number of sheath strands affect the performance of a kernmantle rope. Fewer strands equate to a thicker sheath and can give a greater resistance to abrasion; but make the rope feel rough and may cause sheath slippage. More strands give the rope a smoother "feel". But, more strands mean a thinner sheath and may make the rope stiff; affecting the knot-tying performance. RescueTECH's kernmantle ropes take all factors of sheath design into consideration to give each type of rope, static or dynamic, the best of all handling characteristics.

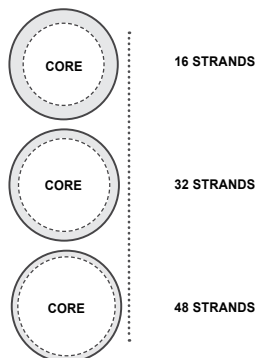

STRIPES VS SOLIDS

Different colors are very useful in distinguishing particular ropes during a rescue or training operation. The addition of stripes to ropes offers the rescuer the ability to see the movement of the rope. When two striped ropes are used side-by-side, the stripes act as index marks. If the stripes on the two ropes are not moving in relationship to each other, then the ropes are travelling at the same speed.



WARNING

Technical rescue and safety is potentially hazardous. Any person using equipment sold by RESCUE TECHNOLOGY in any manner is personally responsible for learning the proper techniques involved, and assumes all risks and accepts full and complete responsibility for any and all damages or injury of any kind, including death, which may result from the use of any RESCUE TECHNOLOGY equipment.

Products in this catalog can expose you to chemicals which are known to the State of California to cause cancer.

For information go to: www.p65warnings.ca.gov

WATER RESCUE

ROPE

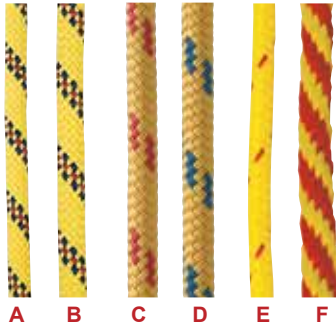

PRO-POLY™ WATER RESCUE ROPE

100% Polypropylene
Kernmantle construction. Smooth sheath construction. Used in our Water Rescue Throwbags. Floats on top of water. Not recommended for rappelling or other heavy uses.

Color: Yellow w/ Red & Blue Stripes

7/16" WATER RESCUE ROPE

Nylon / Polypropylene
A special hybrid filament water rescue rope. Manufactured with a durable nylon sheath and a Multi-Filament Polypropylene core, this floating rope has a tensile strength of 5,000 lbf.

Color: Yellow w/ Red Stripes and Yellow w/ Blue Stripes

8MM NFPA THROWLINE

Polypropylene / Dyneema

UL Certified to NFPA 1983. Double braid construction of high strength core fibers covered in polypropylene to create a floating rope that meets the required strength specifications.

Color: Bright Yellow w/ Red Stripes

3/8" STANDARD POLY THROWLINE

100% Polypropylene

A throwline that gives rescuers an economic choice from the high-tech lines. Soft and easy to stuff and throw. 100% polypropylene solid braid.

Color: Yellow w/ Red Stripes

		Diameter	Strength	Rating	
A. 516600	Pro-Poly	3/8"	2,960 lbf.	Throwline	\$0.85
B. 516700	Pro-Poly	7/16"	3,400 lbf.	Throwline	\$0.99
C. 50517000YR	Water Rescue	7/16"	5,600 lbf.	Throwline	\$1.40
D. 50517000YB	Water Rescue	7/16"	5,600 lbf.	Throwline	\$1.40
E. 50528000	NFPA Throw	5/16"	4,300 lbf.	Throwline	\$1.56
F. 230327000	Standard	3/8"	1,900 lbf.		\$0.32

5MM TECH CORD

Tech Cord's small diameter and 5,000 pound strength are a result of using a unidirectional core of 100% Technora fibers and a tightly woven polyester sheath. Tech Cord is extremely strong and lightweight.

Colors: Green Mix, Blue Mix, Solid Black Strength: 5,000 lbf.

	Length	
23910550	Tech Cord x 50 ft.	\$85.00
239105660	Tech Cord x 660 ft.	\$775.00



UTILITY / HOISTING LINE

100% Multifilament polypropylene for a myriad of utility use. Ideal for hoisting equipment. Soft, supple, easy to grip.

Strength: 4,000 lbf. WLL: 400 lbs. Diameter: 5/8" Colors: Black, Red, Blue, White w/ Red
NOT FOR LIFE SAFETY USE.

	Length	Colors	
230319050xxx	50'	Black, Red, Blue, White w/ Red	\$41.00
230319100xxx	100'	Black, Red, Blue, White w/ Red	\$80.00
230319600xxx	600'	Black, Red, Blue, White w/ Red	\$455.00



WARNING

Technical rescue and safety is potentially hazardous. Any person using equipment sold by RESCUE TECHNOLOGY in any manner is personally responsible for learning the proper techniques involved, and assumes all risks and accepts full and complete responsibility for any and all damages or injury of any kind, including death, which may result from the use of any RESCUE TECHNOLOGY equipment.

Products in this catalog can expose you to chemicals which are known to the State of California to cause cancer.

For information go to: www.p65warnings.ca.gov



Prusik Sling

Prusik Loop



RESCUETECH SEWN PRUSIKS

Our Product Development Department has worked hard to provide a durable sewn 8mm prusik for use in rescue systems. Two styles are available: Prusik Slings and Prusik Loops. Prusik Slings form 2 loops – one that will cinch down onto the carabiner. The Prusik Loops are sewn as a continuous loop. Our heavy duty stitching uses thread that is 150% thicker/stronger than other brands. Since not all PMPs are equally sized, we have created 2 sizes of Short Prusiks to work with the Long Prusiks. The stitches are covered with a transparent shrink tubing. Testing shows that a single RescueTECH Sewn Prusik pulled on RescueTECH's ACCESS 1/2" Lifeline starts "clutching/slipping" at a strength of 3,000 lbf*. When pulled end-to-end the single loop strength exceeds 4,500 lbs. Marked with durable labeling to help product identification.

Best Fit Sizing: • For pulleys with sideplates up to 5" use the 18" and 28" Set • For Pulleys with sideplates up to 6.75" use the 20" and 30" set

* Results may vary depending upon brand and condition/age of the main rope.

		Length	Color	
751180182	Prusik Sling, Short	18"	Yellow	\$12.50
751180202	Prusik Sling, Short	20"	Yellow	\$12.50
751180284	Prusik Sling, Long	28"	Red	\$15.00
751180304	Prusik Sling, Long	30"	Red	\$15.00

		Length	Color	
751280182	Prusik Loop, Short	18"	Yellow	\$12.50
751280202	Prusik Loop, Short	20"	Yellow	\$12.50
751280284	Prusik Loop, Long	28"	Red	\$15.00
751280304	Prusik Loop, Long	30"	Red	\$15.00



DOUBLE END TECHNORA PRUSIK SLING

Made with our 6mm PROBE aramid rope, this prusik design lends itself to more uses than a standard prusik loop. It may be used with a standard prusik, asymmetric prusik, Bachman, Valdotaire Tresse, or Klemheist hitches. When used with a Klemheist hitch, the PROBE Prusik will function on our 7.5mm EGRESS Personal Escape Ropes.

Strength (end-to-end): 2,270 lbf (10 kN) Strength (Basket): 4,555 lbf (20 kN)

		Length	Color	
751161310	Double End Technora Prusik Sling	31"	Tan	\$14.00
751161210	Double End Technora Prusik Sling	20"	Tan	\$13.25



RESCUETECH PRUSIK CORDS

Prusik cords with the same high quality and long wear design as our Rescue Ropes. Size selection should be based upon diameter of main line.

Available by the foot or in Spool Lengths

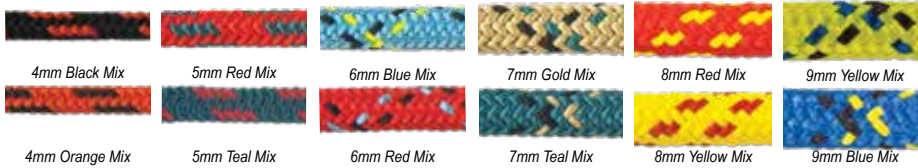

Black Prusik: 4-8mm

	Diameter	Strength	Colors	Main Line	Spool Length	50 ft.	Spool
5094000	4 mm	720 lbf.	Black Mix, Orange Mix	5/16 - 3/8"	300'	\$0.35	\$110.00
5095000	5 mm	1,200 lbf.	Black, Teal Mix, Red Mix	3/8"	300'	\$0.38	\$115.00
5096000	6 mm	1,650 lbf.	Black, Blue Mix, Red Mix	7/16 - 1/2"	300'	\$0.45	\$198.00
5097000	7 mm	2,300 lbf.	Black, Teal Mix, Gold Mix	1/2 - 5/8"	200'	\$0.55	\$150.00
5098000	8 mm	2,900 lbf.	Black, Red Mix, Yellow Mix	1/2 - 5/8"	200'	\$0.71	\$185.00
5099000	9 mm	3,670 lbf.	Blue Mix, Yellow Mix	5/8"	200'	\$0.90	\$190.00



7/16" sewn eye



SEWN EYE LIFELINES

Available in 7/16" or 1/2"

RescueTECH's newest addition to our industrial lifelines. Lighter weight than swaged eyes, these lifelines provide strengths that meet NFPA and federal standards. Each lifeline is labeled with a unique production lot number.

Made to order in our factory with quick turn-around.

Use only with rope grabs designed for kernmantle rope and that match the diameter of the rope selected.

	Rope Diameter	Length	Color	Tensile Strength		
	7/16"	150'		6,300 lbf.	25 kN	
598751150xx			Blue, Orange, Red			\$265.00
	7/16"	200'		6,300 lbf.	25 kN	
598751200xx			Blue, Orange, Red			\$350.00
	1/2"	150'		x.xxx lbf.	41.8 kN	
598851150xx			Blue w/ Yellow, Orange w/ Yellow, Red w/ Yellow			\$315.00
	1/2"	200'		x.xxx lbf.	41.8 kN	
598851200xx			Blue w/ Yellow, Orange w/ Yellow, Red w/ Yellow			\$420.00

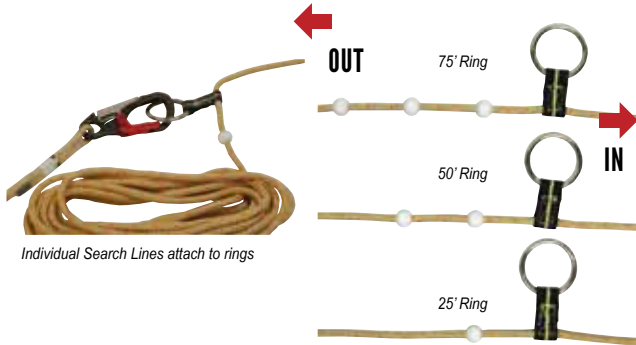

Individual Search Lines attach to rings



MARKER™ SEARCH ROPE

Complete with 2" Rings and Directional / Distance Marking

MARKER™ Search Ropes are complete with 2" rings every 25 ft. The Rope is also marked with 3/4" balls to indicate distance and direction (ex. 3 balls = 75 ft.). No Knots to snag. Using the phrase "Ring, then Bump = Out to the Pump", a firefighter can identify direction and distance to the exit. See Page 15 for Kits with carrying/storage bags.

		Length	
299723200	Marker-H™ Search Rope Only	200 ft.	\$480.00
299724200	Marker+PLUS™ Search Rope Only	200 ft.	\$750.00



PROBE-REFLECTIVE™ FR SEARCH LINE

100% Heat Resistant Technora Sheath with Reflective Stripe

Constructed using the same materials as the standard PROBE™ Search Line with the addition of a 3M Scotchlite® retro-reflective stripe. Precut lengths are finished with a special sealant to prevent unravelling.

Strength: 2,400 lbf.

	Length	
52716035R	35'	\$55.00
52716050R	50'	\$78.00
52716100R	100'	\$160.00
52716200R	200'	\$325.00



PROBE™ FR SEARCH LINE

Fire / Heat Resistant Sheath

6mm diameter Search Line with sheath made from Heat Resistant Technora fiber for extreme durability and resistance to heat (900° F). Firm, yet flexible, design is superior to "Hollow or Flat" braid construction. Maintains cross-section so cord can be easily felt on the floor. Precut lengths are finished with a special sealant to prevent unravelling.

Strength: 2,400 lbf.

	Length	
52716035	35 ft.	\$45.50
52716050	50 ft.	\$65.00
52716100	100 ft.	\$130.00
52716200	200 ft.	\$260.00



PROBE-REFLECTIVE™ SEARCH LINE W/ SNAP

Reflective Stripe for Greater Visibility

Patterned after a major N.E. city's version, the RescueTECH Search Rope w/ Snap combine our PROBE-R™ Technora / Polyester Reflective Search Rope w/ our Double Locking Escape Snap and Swivel Trigger Snap. Durable I.D. labels are sealed under heat shrink tubing.

	Length	Weight	
299722050	50'	1.2 lbs.	\$130.00
299722100	100'	2.4 lbs.	\$205.00
299722200	200'	3.6 lbs.	\$350.00



7.5MM EGRESS™ PERSONAL ESCAPE ROPE

100% Technora Sheath with Nylon Core

A new Heat Resistant Personal Escape Rope (P.E.R.) from RescueTECH™. We redesigned our original Escapeline to provide lighter weight and greater versatility. This tough 7.5mm rope has a strength of 5,200 lbf. Perfect for your high temperature escape line needs. Precut lengths are finished with a special sealant to prevent unravelling.

Strength: 5,000 lbf.

		Length	
52618050	EGRESS™ P.E.R.	50 ft.	\$85.00
52618070	EGRESS™ P.E.R.	70 ft.	\$120.00
52618100	EGRESS™ P.E.R.	100 ft.	\$165.00



7.5MM EGRESS+PLUS™ PERSONAL ESCAPE ROPE

100% Technora Heat Resistant

RescueTECH's superstrong, 100% Technora construction provides both sheath and core resistance to heat. Precut lengths are finished with a special sealant to prevent unravelling.

Heat Resistance: > 900° Strength: 7,194 lbf.

		Length	
52628050	EGRESS+Plus™ P.E.R.	50 ft.	\$150.00
52628070	EGRESS+Plus™ P.E.R.	70 ft.	\$210.00
52628100	EGRESS+Plus™ P.E.R.	100 ft.	\$299.00



7.5MM EGRESS-HYBRID™ PERSONAL ESCAPE ROPE

Aramid / Polyester Hybrid Sheath & Nylon core

The 7.5mm EGRESS-Hybrid™ rope is a blend of Technora and polyester fibers. The tough, heat-resistant aramid fibers in the sheath give the rope its strength and durability. While the polyester fibers lighten the weight and provide greater visibility. The end result is a strong, heat resistant cord that is lighter in weight and more economical than PER made from 100% aramid fibers.

Strength: 4,272 lbf.

		Length	
52617050	EGRESS-Hybrid™ P.E.R.	50 ft.	\$84.00
52617070	EGRESS-Hybrid™ P.E.R.	70 ft.	\$115.00
52617100	EGRESS-Hybrid™ P.E.R.	100 ft.	\$165.00



8.5MM EGRESS-N™ PERSONAL ESCAPE ROPE

EGRESS-N gives firefighters an economic alternative to high priced aramid ropes. The 8.5mm EGRESS-N is certified to NFPA 1983 as a Personal Escape Rope.

Strength: 4,026 lbf.

		Length	
52818050	EGRESS-N™ P.E.R.	50 ft.	\$62.50
52818070	EGRESS-N™ P.E.R.	70 ft.	\$85.50
52818100	EGRESS-N™ P.E.R.	100 ft.	\$119.75



WARNING

Warning: Small diameter cords do not provide the same amount of rappelling friction as do larger ropes. Rescuers should practice rappelling with an 8mm cord to become familiar with the 8mm diameter lines. NFPA 1983 states that Personal Escape Ropes are for single use only.

Products in this catalog can expose you to chemicals which are known to the State of California to cause cancer.

For information go to: www.p65warnings.ca.gov

TECHNOTE

WORKING LOAD LIMIT (WLL)

Working Load Limit (also known as Safe Working Load or Recommended Working Load) is defined as the maximum load that may routinely be applied to an assembly or component in straight tension. Two other strength terms are ultimate strength (or tensile strength) and Minimum Breaking Strength (MBS). Ultimate Strength is the load at which a component or assembly will fail in a test. Minimum Breaking Strength, as defined by NFPA 1983, is the result of subtracting three standard deviations from the mean result of the test lot.

We have chosen to use the NFPA ratio of 15:1 for ropes and the American engineering standard of 10:1 for critical use hardware and auxiliary equipment. We realize that these ratios may exceed proposed standards, but have selected them because they best apply to the rescue community. We show the Working Load Limit (WLL) because the ultimate strength may change during the life of the product. Whereas, the WLL will remain valid during the normal life of the product. For example, a 9,000 lbf. rope will lose tensile strength as it is used. However, the WLL will remain 600 lbs. throughout the normal service life of the rope. Additionally, rescue products should be chosen and matched based upon their WLL. The item with the lowest WLL limits the system working load limit. Remember, a chain is only as strong as its weakest link.



RESCUETECH WEBBING

RescueTECH Rescue-Spec Tubular webbing is specially designed for the demands of rescue by exceeding the strength specifications of normal mil-spec webbing. Additionally, it will outwear any comparably sized tubular webbing. Special Lock-Stitch is used to make RescueTECH tubular webbing superior to all other tubular webbings - even mil-spec. For heavy duty rigging conditions, we recommend the use of our Rescue Technology Heavy Duty Flat Webbing. The Heavy Duty Webbing is more abrasion resistant than standard 1" tubular.

		Strength	Colors Available	50 ft.	150 ft.	300 ft.
7901xx	1" Tubular	4,200 lbf.	Black, Blue, Green, Orange, Red, Yellow, Tan	\$28.00	x	\$165.00
7902xx	2" Tubular	6,800 lbf.	Black, Blue, Red, Yellow	x	\$120.00	x
7945xx	1" Heavy Duty Flat	6,000 lbf.	Black, Blue, Green, Orange, Red, Yellow	\$34.00	\$92.00	x
7921xx	1.75" Heavy Duty Flat	6,000 lbf.	Black	x	\$120.00	x
7932xx	Seat Belt type Flat	6,000 lbf.	Black, Red	x	\$90.00	x

SMC FLEX PAD

The FLEX is FLEXible in its uses and the only limitation is your imagination. The FLEX can be used in a magnitude of configurations providing solutions for an ever-growing amount of problems you might face while in the field or around the house. Use a stand-alone FLEX or connect multiple FLEX pads with the FLEX Clips to help solve everyday problems. The Flex Kit includes two FLEX Pads and two FLEX Connector Clips



Dimensions: 16" x 8" x .4" Weight: 4.5 oz (126g)

234819148200	FLEX Pad Rope Protector	\$23.50
234819148202	FLEX Pad Rope Protector Kit	\$50.00

SMC TRACKER

The SMC Rope Tracker is engineered to secure, capture, protect and manage multiple ropes when negotiating difficult edge transitions. The SMC Rope Tracker is manufactured from a high quality durable abrasion resistant thermoplastic blend to minimize weight and maximize strength. The SMC Rope Tracker channel and rib design gives user the ability to manage ropes up to 16mm and flex to accommodate 90 degree edge angles keeping your ropes out of harms way.

Dimensions: 20.1" x 3.4" x 1" Weight: 14.5 oz (413g)



234819148100 \$87.50



RESCUETECH ROPE GUARD

Super H.D. Cotton Duck Liner

Special protective sleeve made with super heavy cotton canvas. Outside of Rope Guard covered with heavy weight PVC fabric to protect from hazards and to provide distinctive color. Designed to protect ropes from abrasion when stretched across rough surfaces encountered in rappelling, rescue, high rise building maintenance, and other operations. Webbing loops are attached at each end to provide tie-backs to secure rope guard.

Color: Black, Red

	Size	Length	
612412x	Small	12 in.	\$20.00
612418x	Medium	18 in.	\$25.00
612424x	Large	24 in.	\$27.00
612436x	XLarge	36 in.	\$35.00

Substitute "x" with Color Code: (1) Black, (4) Red



RESCUETECH ROPE PAD

Double-Layer, Super-Heavyweight Cotton Duck

Large 100% cotton rope pads are 2 layers thick in the center and use no synthetic material on its protective surface. Narrow pad with Velcro will wrap around rope - secures with hook and loop fastener. Wide pad provides large area coverage. Both pads come complete with rigging grommets for tie-back cords.

Color: Natural

	Size	Dimensions	
612101	Narrow	36" x 12"	\$32.00
612100	Narrow w/ Velcro	36" x 12"	\$40.00
612105	Wide	36" x 30"	\$42.00
612110	Extra-Long	36" x 60"	\$65.00
612111	XX-Long	36" x 102"	\$95.00

EDGE PROTECTION



RESCUETECH ONE PIECE EDGE ROLLER

Single Unit Edge / Roof Roller

Fully protects rope from corners and other points of friction. Uses aluminum rollers mounted on Oilite® bushings for extended wear. Alloy aluminum construction, steel fittings. Lightweight and low profile. Four connecting points for easy attachment and linking units together. Works best on 90 degree corners like window ledges or parapet walls. Can also be used as small diameter hose roller.

Tensile Strength: 10,000 lbf. Dimensions: 5" x 9"
Weight: 27.2 oz. Color: Gold Rating: General Use Exceeds NFPA 1983/ANSI/OSHA strength specifications.

611101 \$110.00

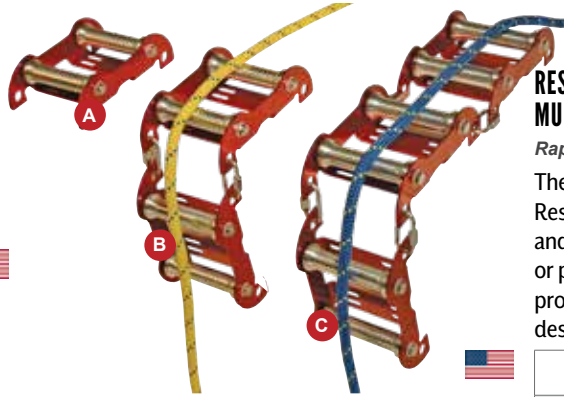

RESCUETECH MULTI-UNIT EDGE ROLLER

Rapid Link Connectors

The next generation edge protection device from RescueTECH. Featuring an alloy aluminum frame and rollers, this unit may be used as a single unit or paired-up with other units to provide large area protection using included rapid link. Low Profile design. All units 5.75" wide.

		Units	Length	Weight (lbs)	
A. 611111	Single	1	8.25"	1.6	\$95.00
B. 611112	Double	2	17.75"	3.35	\$200.00
C. 611113	Triple	3	26.50"	5.1	\$293.00
D. 611114	Quad	4	35.25"	6.85	\$375.00
60510106	6mm Connector Link				\$4.50



EDGEBOT™ & CLAMPBOT™

Ultra compact, high efficiency Rollers

These are uniquely shaped to work on railings, logs, rocks, guard rails, parapets, or anywhere else that friction needs to be addressed. And they can be hobbled down with rope or webbing, hung with carabiners, or even slid along tracks made with 8mm utility cord.

Both feature stainless steel axles, bronze bearings, aircraft aluminum sheaves and powder coated side plates. Triangular openings allow carabiners to redirect off angle ropes. The underside is curved to work on varied surfaces, and sports "crampons" which help with guard rails and parapets

The Clampbot™ is the next evolution to the Edgebot™ Terrain Roller. The Clampbot™ articulates to conform around whatever you attach it too. It has 28 mini crampon points that increase grip on pipes, railings and trees. It also has a lowered center of gravity for increased stability. The truly great feature of the Clampbot™ is its ability to "grasp" thin railings when used with the Rail Roller attachment.

		Dimensions (in.)	Weight (oz.)	
21130301	EdgeBot	4.5 x 2.5 x 3.125	5.6	\$105.00
21130303	ClampBot	5.875 x 1.75 x 3.25	11.2	\$185.00



PETZL ROLLER COASTER

Reversible rope protector on bearings

The ROLLER COASTER protector is designed to help protect a moving rope from abrasion. Reversible, with different frame shapes on either side that allow it to adapt to flat or angled surfaces. Multiple connection holes allow the use of different attachment methods. It's possible to connect multiple modules to better adapt to different types of terrain.

Weight: 470 g

2354180005 \$134.95



ROPE ROLLER SET

3-side Rope Channel

A new edge roller system to protect ropes from damage when working over sharp edges. The system is fully modular, consisting of edge-roller boxes manufactured from high grade aluminum connected

with steel rapid links. Each box has a series of rollers that protect the rope in three directions. Multiple sets can be "chained" to provide a long coverage area.

Individual Roller dimensions: 2.4" x 2" x 2" Maximum rope diameter: 1/2" (13mm)

		Length	Weight	
201404093	Triple	10.5"	43 oz.	\$105.00
201404094	Quad	15"	59 oz.	\$145.00



WARNING

Technical rescue and safety is potentially hazardous. Any person using equipment sold by RESCUE TECHNOLOGY in any manner is personally responsible for learning the proper techniques involved, and assumes all risks and accepts full and complete responsibility for any and all damages or injury of any kind, including death, which may result from the use of any RESCUE TECHNOLOGY equipment.

Products in this catalog can expose you to chemicals which are known to the State of California to cause cancer. For information go to: www.p65warnings.ca.gov

ROPE ACCESSORIES

RescueTECH offers an array rope accessories that aid in the care and maintenance of all your rope products.



ROPE CUTTING BOX

Ideal for cutting and sealing numerous ropes and webbing. Can be mounted to wall or workbench. Capable of cutting ropes up to 1" diameter. 120 volts AC. Blade is designed for longer use than standard blades.

Weight: 44 oz.

901020	Cutting Box	\$145.00
901025	Replacement Blade Box	\$35.00



HEAT SHRINK TUBING

Clear heat shrink tubing for marking rope ends. Mark end of rope with tape, labels, etc., then slip tubing over end. Heat source shrinks tubing tightly around rope and marker. Sold by the foot.

	Tube Size		
599944	1/2"	Fits 3/8" and 7/16" ropes	\$0.85
599945	3/4"	Fits 7/16" and 1/2" ropes	\$0.90
599946	1"	Fits 5/8" ropes	\$1.25



Technical rescue and safety is potentially hazardous. Any person using equipment sold by RESCUE TECHNOLOGY in any manner is personally responsible for learning the proper techniques involved, and assumes all risks and accepts full and complete responsibility for any and all damages or injury of any kind, including death, which may result from the use of any RESCUE TECHNOLOGY equipment.

Products in this catalog can expose you to chemicals which are known to the State of California to cause cancer.

For information go to: www.p65warnings.ca.gov



HARDWARE MARKING PENS

Permanent Opaque Pigmented Ink

Valve-action marker. Ink marks opaque and glossy on light or dark surfaces. Marks on virtually any surface: metal, wood, corrugated, rubber, plastic, glass, etc. Permanent opaque pigment ink resists sun's ultraviolet rays.

For metal parts. Not for use on ropes, harnesses, webbing or other life safety items made from synthetic fibers.

	Color	Price
2435100	Orange	\$5.00
2435101	Black	\$5.00
2435102	Yellow	\$5.00
2435104	Red	\$5.00
2435105	Green	\$5.00
2435106	Light Blue	\$5.00
2435109	White	\$5.00



RESCUETECH ROPE CLEANSER

Reformulated to clean ropes better. Excellent for nylon, polyester, or polypropylene fibers. Excellent cleanser for Harnesses, Slings, and other webbing / fabric products. Concentrated formula can be diluted to suit the dirt or stain encountered.

Biodegradable.

	Size	Weight	
599911	Pint	1.1 lbs.	\$10.00
599910	Concentrate for Gallon	4.4 lbs.	\$25.00



ROPE THIMBLE

Made from an almost indestructible polyolefin polymer that deforms rather than breaks under heavy load. Produces no sharp edges. Rope guards hold the rope in the guide grooves.

Weight: 1 oz.

	Fits rope diameter	
5999246	3/8"	\$1.20
5999248	7/16", 1/2"	\$1.75
5999249	5/8"	\$1.90



MESH WASH SACK

Great for rope washing, packaging slings, webbing, cords, and personal gear.

	Size	Dimensions	Weight	
805401	L	20" x 15"	3.2 oz.	\$15.00
805406	XL	30" x 24"	5.6 oz.	\$29.95

TECHNOTE

Please Remember...

A life is much more valuable than a piece of rope. So replace your rope if there is any doubt as to its condition. It is very important to practice proper usage guidelines on the use and care of your rope. Improper care and use of your rope could result in a serious injury or death.

DOBI ROPE BRUSH

Rope washing the easy way. Just put the rope inside the rope washer, add mild soap and water, and work the Dobi back and forth along the rope. The revolving bristles help to gently remove grime, dirt, and metal oxides from rope. Fits 3/8" - 1/2" ropes.

Weight: 3.2 oz.

5999211	Dobi Rope Brush	\$45.00
---------	-----------------	---------



We take pride in our bags and packs. Made in our factory in Carrollton, Georgia, you are assured of top quality products that will exceed your expectations. Our bags feature no exposed fabric edges that can unravel, reinforced and taped load-bearing seams, and designs that are function driven. Over the years, we have upgraded our shop to include programmable sewing machines, heat presses, and embroidery machines that let us make bags that are rescue-purpose built.



RESCUETECH BAGS & PACKS



Ergonomic Padded Shoulder Straps and Molded Rubber Carry Handle

REFLECTIVE PVC ROPE BAG

Shoulder Straps and Molded handle

As durable as it is visible at night. Manufactured of 14 oz. nylon reinforced PVC fabric and an 18 oz. nylon reinforced PVC Fabric bottom.

Dimensions: Small: 18"H x 10"D Medium: 20"H x 10"D Large: 18"H x 12"D

	Size		
802204	Small	200 ft. of 1/2"	\$95.00
802304	Medium	300 ft. of 1/2"	\$105.00
802404	Large	500 ft. of 1/2"	\$115.00



RESCUETECH ROPE BAGS

Super-Durable Construction



Constructed of heavy duty water resistant Cordura™ nylon and nearly-indestructible Ballistic Nylon fabrics. Side seams of bags are double-stitched so that no fabric edges are exposed for fraying. Bottom seam is double stitched and webbing reinforced for superior strength and resistance to abrasion. Drawstring closure with cord lock. Accommodates rope (capacities listed) or equipment. All units except personal size have log book pouches and grommets in bottom to permit drainage. Handles connected to interior of bag to aid in rope loading.

• Double Stitched and Taped Bottom Seam • Double Stitched • Side Seam • Tough 1000 Denier Cordura® Body Durable Ballistic Fabric Bottom • No Exposed Fabric Edge to Unravel • Drainage Grommet in Bottom • Heavy Duty Cord-Lock Adjusts Drawstring • Interior Log Pouch



		7/16"	Capacity	5/8"	Dimensions	Handles	Shoulder	Colors	
			1/2"		Open		Straps		
80111x	Personal	45'			10" x 6"	2	n/a	OR, BK, BL	\$30.00
80121x	Small	175'	125'	75'	12" x 10"	2	n/a	OR, BK, BL, RD, YE	\$45.00
80131x	Medium	300'	225'	125'	20" x 10"	2	1	OR, BK, BL, RD, YE	\$54.00
80141x	Large	400'	325'	200'	26" x 10"	2	2	OR, BK, BL, RD, YE	\$65.00
80151x	XLarge	600'	400'	250'	20" x 14"	2	2	OR, BK, BL, RD	\$77.00
80161x	Super	750'	600'	325'	26" x 14"	2	2	OR, BK, BL	\$85.00
80171x	Jumbo	1150'	900'	500'	26" x 17"	2	2	OR, BK	\$99.00

Replace X: 0= Orange; 1=Black; 2=Yellow; 4=Red; 5=Green; 6=Blue.



ROPE AND EQUIPMENT BAGS

With Attached Equipment Pockets and Padded Shoulder Straps



Constructed of heavy duty water resistant Cordura™ nylon and nearly-indestructible Ballistic Nylon fabrics. Side seams of bags are double-stitched so that no fabric edges are exposed for fraying. Bottom seam is double stitched and webbing reinforced for superior strength and resistance to abrasion. Drawstring closure with cord lock. Accommodates rope (capacities listed) or equipment. Handles connected to interior of bag to aid in rope loading.

Rope capacity:

Medium: 20" h x 10" d fits 7/16" - 300 ft. or 1/2" - 225 ft.
Large: 25" h x 10" d fits 7/16" - 400 ft. or 1/2" - 325 ft.

	Size	Color	
807434	Medium w/ 1 Pocket	Red	\$102.00
807436	Medium w/ 1 Pocket	Blue	\$102.00
807431	Medium w/ 1 Pocket	Black	\$102.00
807444	Large w/ 2 Pockets	Red	\$112.00
807446	Large w/ 2 Pockets	Blue	\$112.00
807441	Large w/ 2 Pockets	Black	\$112.00

RESCUETECH

RAPID INTERVENTION



(Above)

- A. Shoulder Strap made from Rescue-Grade Heavy Duty Kevlar web, steel adjuster, and aluminum carabiners (included). Can convert to 26" long loop, 52" long single point sling, or can be detached and used as a downed firefighter rescue sling.
- B. One Large External Gusseted Tool Pouch has two full-length compartments to hold buddy air hose and breaching tools. Special pass-through slot is ideal for pre-rigged buddy or quick-fill airlines. Also shown is the optional Embroidered "RIT" Label.
- C. Bag Made from RescueTECH's proprietary Heat Resistant Fabric.
- D. High Temperature Retro-Reflective Strips

299625104	RIT-2 Pack	\$460.00
299625104S	RIT-2 Skid Plate, Replacement	\$50.00

RIT*2 EMERGENCY SCBA PACK

Heat Resistant Multi-Use RIT Packs

The RIT*2 Emergency SCBA Pack is the logical evolution of our popular Deluxe SCBA Pack. The outside shell is manufactured from RescueTECH's proprietary heat-resistant fabric. Comprised of 6 compartments, this pack will hold what your team needs for Rapid Intervention operations. Main Compartment designed for a full SCBA Backpack. Search line pouch holds 200 ft. of 8mm Searchline. Mask pouch and long pocket have hose "pass-through" to the padded main compartment. One 20" and two 10" side compartments holds tools and individual search line bags. Pack features included L.E.D. Strobe for extra visibility. Easily replaceable Skid Plate extends life of the bag. Custom labelling available.



Dimensions: 32"L x 12"W x 12"D **Weight:** 7.7 lbs.



1. Mask Pouch fits masks with extra-long air hose. Pass-through slot to the main compartment allows pre-rigging of airlines and rescue without opening main compartment.
2. Drag Handles on Both Ends are easy to use with Structural Gloves.
3. Zippered Searchline Pouch for Easy Stowing of up to 200 ft of 8mm PROBE™ Searchline.
4. We originated the Skid Plate for RIT Bags in 2003 and still make the best. Our Skid Plate is heavy duty 1/8" Haircell Polyethylene to increase durability. We take the time to pre-contour the Skid Plate to allow the bag to ride up and over obstacles. The extra width helps prevent bag roll-over.
5. Two Small External Gusseted Tool Pouches hold extra search equipment.

Equipment not included.

DELUXE RIT EMERGENCY SCBA PACK

Includes 2 Full-Length Exterior Tool Pouches and Skid Plate

The Deluxe RIT Emergency SCBA Pack is the next generation in multi-use RIT Packs. Comprised of 5 compartments, this pack will hold what your team needs for RIT operations. Main Compartment designed for a full SCBA Backpack. Search line pouch holds 200 ft. of 8mm Searchline. Mask pouch has a regulator hose "pass-through" to the padded main compartment. 20" side compartments hold tools and individual search line bags. Pack features included L.E.D. Strobe for extra visibility. Replaceable Skid plate extends life of the bag. Made from high strength coated nylon fabric.

Dimensions: 32"L x 12"W x 12"D

Equipment not included.



299625103	Deluxe RIT Pack	\$330.00
299625103S	Skid Plate, Replacement	\$47.00



WARNING

Technical rescue and safety is potentially hazardous. Any person using equipment sold by RESCUE TECHNOLOGY in any manner is personally responsible for learning the proper techniques involved, and assumes all risks and accepts full and complete responsibility for any and all damages or injury of any kind, including death, which may result from the use of any RESCUE TECHNOLOGY equipment.

Products in this catalog can expose you to chemicals which are known to the State of California to cause cancer.

For information go to:
www.p65warnings.ca.gov

RESCUETECH ESCAPE / SEARCH KITS



PROBE™ Search Line w/ Snap



PROBE™ SEARCH LINE KITS

Heat-Resistant Design



6mm cord with heat resistant Technora sheath (Temp 900°F). 6mm cord can be felt on ground unlike units made with flat webbing. Bags are specially designed for easy deployment with structural gloves. Autolocking Fixed Eye Snap prevents accidental detachment of carabiner from its anchor. Fixed Eye prevents PROBE™ Search line cord from becoming detached from carabiner. Search Bag manufactured with RescueTECH's proprietary heat resistant fabric. Retro-reflective tape increases visibility of bag.

Notice: PROBE™ search cord is not NFPA Personal Escape Line and cannot be used for a Personal Escape rope.

	Length	
29985035	35 ft.	\$144.00
29985050	50 ft.	\$170.00
29985100	100 ft.	\$250.00



PROBE-Hybrid™ Search Line

PROBE-Hybrid Kit shown with Snap deployed and ready to use



PROBE-HYBRID™ KITS

New Hybrid 6mm Searchline Cord

Assembled with a new hybrid 6mm cord.

The cord's sheath is manufactured using both heat resistant aramid fibers (Temp 900°F) for fire resistance and polyester for lighter weight. The 6mm round cord can be felt on ground unlike units made with flat webbing. Bags are manufactured of RescueTECH's proprietary fire resistant fabric, hook and loop fastener, nylon webbing and features Scotchlite® retro-reflective striping. Bag is specially designed for easy deployment with structural fire fighting gloves. Autolocking Fixed Eye Snap prevents accidental detachment of carabiner from its anchor. Fixed Eye prevents Searchline cord from becoming detached from carabiner. Retro-reflective tape at the end of the rope increases visibility of snap.

Notice: PROBE-Hybrid™ search cord is not NFPA Personal Escape Line and cannot be used for a Personal Escape Rope.

	Length	
29985035H	35 ft.	\$120.00
29985050H	50 ft.	\$135.00
29985100H	100 ft.	\$178.00



PROBE-R™ SEARCH LINE KITS

Heat-Resistant with Reflective Stripe



PROBE-Reflective FR Search Line

The same high quality materials and design as our original PROBE™ Search Line with 3M Scotchlite® added to the sheath. Provides extra visibility of Search Lines during fire operations. Search Bag manufactured with RescueTECH's proprietary heat resistant fabric.

Notice: PROBE-R™ search cord is not NFPA Personal Escape Line and cannot be used for a Personal Escape rope.

	Length	
29985035R	35 ft.	\$150.00
29985050R	50 ft.	\$180.00
29985100R	100 ft.	\$268.00



100 ft. model shown



PROBE-N SEARCH KITS

Now Available with Captive Eye Carabiner

A basic Search Kit featuring our 7mm Nylon SearchLine cord. These kits offer a protective search line at an economical price. Cord is stored in our durable Escape / Search Bags made from Cordura and Ballistic Fabrics. Autolocking Aluminum Search Snap at end of cord can be clipped to rigging point or back onto search line. Bag attaches to waist belt of SCBA or Rescue harness or worn on shoulder with attached strap. Kit includes Bag, Cord, and Carabiner.

Notice: PROBE-Nylon™ search cord is not NFPA Personal Escape Line and cannot be used for a Personal Escape rope.

	Length	
299813035	35 ft.	\$122.00
299813050	50 ft.	\$152.00
299813100	100 ft.	\$180.00

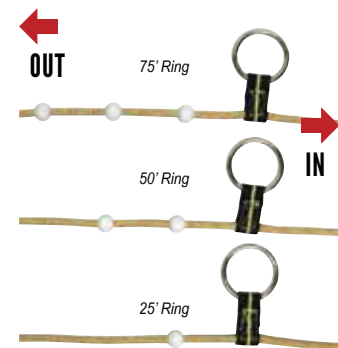

Individual Search Lines attach to rings

MARKER™ SEARCH ROPE KIT

2" Rings and Directional Marking

Durability and quality are prime considerations with this pack. Durable Cordura Nylon fabric with removable, quick-release shoulder strap. The pack also features "daisy chain" web loops on the shoulder strap and reverse side of pack. The kit has 200 feet of our 7.5mm RescueTECH EGRESS-Hybrid™ or EGRESS+Plus™ search rope complete with 2" rings every 25 ft. The Rope is also marked with 3/4" nylon balls to indicate distance and direction (ex. 3 balls = 75 ft.). Using the phrase "Ring, then Bump = Out to the Pump", a firefighter can identify direction and distance to the exit. Kit includes 200 ft. with Autolocking snap sewn to each end and a Searchline Shoulder bag with quick release seatbelt buckles. 200 ft. Marker rope is also available as a separate item.

		Length	
299823200	Marker-H™ Search Rope Kit	200 ft.	\$640.00
299824200	Marker+PLUS™ Search Rope Kit	200 ft.	\$750.00



SEARCHLINE MASTER PACK™

SearchLine Master Pack™ shown with two (2) 100 ft. Master Lines and six (6) 35 ft. Search lines

4/6/8 Person RIT Search Line Set

A Searchline Set ready to deploy for Rapid Intervention. The Master Pack consists of a high quality carrying bag made from 1000 den cordura, Ballistic Cloth, and closed cell foam. Zippered inside pouches can hold items up to 18" in length. Extra room in main compartment can hold tools up to 22" long. The pack contains two (2) 100 foot master deployment lines and six (6) search lines (select 35 ft. or 50 ft. models.) Available with PROBE™ Heat Resistant Aramid Search Line or PROBE-R™ Heat Resistant Search Lines w/ Reflective Stripe.



Dimensions: 23"L x 12"W x 8"D

		Length	
29982006135	Probe™	35 ft.	\$1,495.00
29982006150	Probe™	50 ft.	\$1,675.00
29982006235	Probe™ - Reflective™	35 ft.	\$1,650.00
29982006250	Probe™ - Reflective™	50 ft.	\$1,820.00
29961800	Master Pack, Carrying Bag Only		\$175.00



MARKER GROUP SEARCH KIT™

Our ATX Group Search Kit was designed for a major TX city to fulfill their Large Area Search needs. The Kit is set up for a four person RIT team and provides a means of marking location and a guideline to the outside. Comprised of one Marker Search Rope Kit (see above) and individual search line kits with heat resistant bag. The 200' Marker Search Rope has nylon balls affixed to the rope to mark distance - no knots to slip or snag. The individual search kits are equipped with an autolocking, strength-rated aluminum hook that is fixed to the end of the rope without knots. Search kits can clip to webbing loops on master kit an can either be hung from belt or SCBA frame or can be slid onto waist belt. Search kits feature quick-disconnect strap if threaded on waist belt. Available in 4 and 5 person kits in either 35 ft. or 50 ft. Personal Search kits.

	Rope		Length	
29982017135	Marker+PLUS	4 person Kit - 1 master / 3 Search	35 ft.	\$1,210.00
29982017235	Marker+PLUS	5 Person Kit - 1 master / 4 Search	35 ft.	\$1,300.00
29982017150	Marker+PLUS	4 person Kit - 1 master / 3 Search	50 ft.	\$1,275.00
29982017250	Marker+PLUS	5 Person Kit - 1 master / 4 Search	50 ft.	\$1,385.00



ATX MASTER SEARCH PACK

The pack we designed for our Marker Search Rope Kit and ATX Group Search Kit is now available as a separate item. Durable Cordura Nylon fabric with removable, quick-release shoulder strap. Features "daisy chain" web loops on the shoulder strap and reverse side of pack. ATX Master Pack holds up to 200' of 7.5mm cord. Kit Includes Pack and 200 ft. of PROBE-Reflective Searchline with double locking snap.



		Color	
800120041	ATX Master Search Pack	Black	\$120.00
800120042	ATX Master Search Pack	Yellow	\$120.00
29981222001	ATX PROBE-R Search Kit	Black	\$555.00
29981222002	ATX PROBE-R Search Kit	Yellow	\$555.00
8001295	Double Snap Shoulder Strap	Black	\$40.00

RESCUETECH ESCAPE / SEARCH BAGS

RescueTECH designed our Escape / Search bag to be multi-functional. The Velcro closure secures the content against accidental deployment. The bags are constructed to allow users to clip them to a harness or airpack using the steel "D" rings or thread it onto a waist strap. A quick-release function will detach the bag from a waist belt with a simple pull of the release tab. Heat Resistant retro-reflective stripes increase user visibility. Available in Fire Resistant (red) or Nylon (orange) fabrics.



Front equipment pouch separates hooks and snaps from rope.

Quick-Release Belt Snap System



NYLON ESCAPE / SEARCH BAG

Lined, 2-Layer construction for extra strength and durability. All seams double stitched for extra durability.

Color: Orange
Equipment not included.

	Size	Fits Length	Closed Dimensions	
8001310	XS	25' Escape Rope	5" x 6" x 3"	\$55.00
8001320	S	35' Escape Rope	6" x 6" x 3"	\$55.00
8001330	M	50' Escape Rope	7" x 6" x 3"	\$58.00
8001340	L	70' Escape Rope	9" x 6" x 3"	\$61.00



HEAT-RESISTANT ESCAPE / SEARCH BAG

Heat Resistant Outer Shell

A new design for drop bags featuring a lined, 2-layer construction that protects cord while easing access with structural gloves. Attaches to harness waist belts. All seams double stitched for extra durability. D2 sized bags required for use with the D2 Escape Descender.

Color: Red
Equipment not included.

	Size	Fits Length	Closed Dimensions	
8001414	XS	25' Escape Rope	5" x 6" x 3"	\$51.00
8001424	S	35' Escape Rope	6" x 6" x 3"	\$56.00
8001434	M	50' Escape Rope	7" x 6" x 3"	\$58.00
8001444	L	70' Escape Rope	9" x 6" x 3"	\$60.00
8001634	D2-M	50' Escape Rope	8" x 7" x 4"	\$85.00
8001644	D2-L	70' Escape Rope	10" x 7" x 4"	\$90.00



NYLON DROP BAG

Durable 1000 denier Construction

Designed to hold our 8mm EGRESS™ Personal Escape Rope and PROBE™ Search Line kits, this Drop Bag is perfect to "create-your-own" rescue kit. Hinged Lid with snap closure. Retro-reflective tab makes this bag highly visible and easy to open with structural fire fighting gloves. Attaches to Escape Belt and Harnesses.

Color: Red
Equipment not included.

	Size	Fits Length	Closed Dimensions	
800520	S	35' of 8mm Cord	9" x 6" x 3"	\$62.00
800521	M	70' of 8mm Cord	10" x 7" x 4"	\$65.00
800522	L	100' of 8mm Cord	12" x 7" x 5"	\$70.00



RESCUETECH SEARCHLINE SHOULDER BAG

Holds 200 ft. of 6mm search cord

A new "Over-the-Shoulder" bag that easily holds up to 200 ft. of PROBE™ Search Line. Manufactured of tough Ballistic Nylon to a major Texas city's specification. Inside strap system pre-tensions the cord for an even deployment. Adjustable shoulder strap may be worn on one shoulder or across the body.

Dimensions: 11" x 9" x 5" Weight: 4.9 lbs.
Equipment not included.

800121	Searchline Shoulder Bag	\$59.00
--------	-------------------------	---------



WARNING

Technical rescue and safety is potentially hazardous. Any person using equipment sold by RESCUE TECHNOLOGY in any manner is personally responsible for learning the proper techniques involved, and assumes all risks and accepts full and complete responsibility for any and all damages or injury of any kind, including death, which may result from the use of any RESCUE TECHNOLOGY equipment.

Products in this catalog can expose you to chemicals which are known to the State of California to cause cancer.
For information go to: www.p65warnings.ca.gov

D2 ESCAPE DESCENDER

Our newest Escape Descender for our EGRESS escape ropes. Allows for quick deployment and adjustment before the bail out. Rotating Handle provides exception control. Double Stop for safety. The D2 is a true panic stop device rather than a panic brake device. The difference is that once the panic brake is activated, no other force must be applied to the device. A panic brake style device requires a force input to continue the braking function. Also works well as an emergency lowering device.



Dimensions: 5.7" x 2.85"
Rope Diameters: 7 – 8mm
Load Range: 100 – 300 lbs.

	Color	
201404024	Red	\$149.95
201404021	Black	\$149.95



QXD Escape Descender shown in one of many friction settings.

QXD ESCAPE DESCENDER

Special descender plate with multiple holes that allow a small diameter escape cord to be rigged to accommodate different amounts of friction. ALWAYS test your personal rigging method to assure sufficient friction for a safe descent. Works with 8mm to 11mm diameter escape lines.

Dimensions: 5.75" x 1.75" MBS: 11,500 lbf. Weight: 4 oz.
Rating: General Use. Meets NFPA 2500 (1983)/ANSI construction specifications for Descenders.

200217100 QXD Escape Descender \$37.00



ESCAPE 8

A compact Escape descender with ears for quick personal escapes. Rescue "ears" are situated to provide a compact Rescue 8 design for escape systems.

Dimensions: 2 7/8" x 2 3/4" Strength: 3,150 lbf. WLL: 300 lbs. Weight: 4 oz. Rating: General Use. Certified: NFPA 2500 (1983).

	Color	
20016011	Black	\$29.00



BANTAM HOOK

The Bantam escape hook is a no-frills anchor that was designed and built for FDNY firefighters to use in their personal escape systems. With similar dimensions to the legacy FDNY hook, the Bantam represents a significant weight savings which is important in a kit you carry every day but hope to never use. The clean, simple design is the result of meticulous engineering, will fit in the current Sterling escape system storage bags, and has been tested by UL to meet NFPA standards.

MBS: 3,035 lbf (13.5 kN)
Weight: 6.6 oz.
Dimensions: 7" x 3.625"
UL Certified to NFPA 2500 (1983)

DISCLAIMER: Firefighter escape requires instruction and training. Fire fighting and associated operations are dangerous and may cause injury or death. It is every firefighters responsibility to be trained and knowledgeable on their equipment and its intended use.

2510081003 Bantam Hook \$89.95



LIGHTNING GT ESCAPE HOOK

Weighing 8.5 ounces, the aluminum Lightning GT Hooks offer a functional design with wire gate for secure and rapid remote anchoring.

Made of 7000 series, aircraft grade aluminum and CNC machined to exacting specifications, the Lightning Hooks are certified to hold loads up to 3000 pounds at the tip.

MBS: 3035 lbs.
Weight: 7.8 oz.
Dimensions: 7.5" x 3.75" x .75"
UL Certified to NFPA 2500 (1983)

DISCLAIMER: Firefighter escape requires instruction and training. Fire fighting and associated operations are dangerous and may cause injury or death. It is every firefighters responsibility to be trained and knowledgeable on their equipment and its intended use.

2510081002 Lightning GT \$144.95



STEALTH HOOK

A lightweight and versatile fire escape anchor hook for more secure anchoring and lowering. Stealth hook has more features, in an even lighter package. Continuing with the popularity of our first-of-its-kind gated hitching slot for quick and secure remote anchoring that is 14% lighter than its predecessor. Forged from aircraft grade 7075 aluminum, the truss design reduces weight and preserves strength, making this the lightest NFPA escape hook.

Tool-grade stainless steel tip can be easily replaced
Rounded radius at the back of the hitching slot
Heel ridges and milled grips
Slot at the top of the hook to be used for a pull tab.

MBS: 13.5 kN
Weight: 6 oz.
Dimensions: 7.5" X 4.675"
UL Certified to NFPA 2500 (1983)

DISCLAIMER: Firefighter escape requires instruction and training. Fire fighting and associated operations are dangerous and may cause injury or death. It is every firefighters responsibility to be trained and knowledgeable on their equipment and its intended use.

2510081004 Stealth Hook \$144.95



WARNING All escape descenders should be fully tested to determine compatibility with the brand of rope used. All users of Escape descenders must be fully instructed in the use of the descenders to ensure competency in "bail-out" and "escape" operations.

WARNING

All escape descenders should be fully tested to determine compatibility with the brand of rope used. All users of Escape descenders must be fully instructed in the use of the descenders to ensure competency in "bail-out" and "escape" operations.



SLING LINK

Multiple Application Service Tool for Horizontal Drags and Vertical Lifts

Sling-Link MAST is used by some of the most advanced rescue teams and rescue instructors in the country. The MAST is designed for the fire/rescue service as a tool to be utilized in the “Save Our Own” program, Rapid Intervention Team (RIT) and FAST teams. The functions of the MAST are almost unlimited... The MAST is simple... Always available for the rigging of equipment in seconds, for rescue in moments, and always a way to get out. The MAST is a tool that should be carried in the bunker pant pocket or the specially designed pouch - an absolute must while on the fire floor. The Sling-Link MAST has the versatility of a rope with the convenience and speed of a sling. Available in multiple width webbing and strengths. Patent no. D 602 638.

Useful as:

- High anchor casualty removal system
- Bail Out (Individual/Team)
- Hasty linear 2-1 System
- Rapid stairwell casualty removal
- Confined space/low-visibility search

	Model		Webbing	Strength (Loop-to-Loop)	
708231152	MEN1-31	Standard	1" Flat	4500 lbf.	\$42.00
708231252	MEN1-31L	Technical	1" Flat	3655 lbf.	\$38.00
708261052	MEN1-61	Heavy duty	1" Flat	6000 lbf.	\$70.00
708291052	MEN1-91	Extra Duty	1" Flat	7500 lbf.	\$75.00
708292052	MEN1-92	Super Duty	2" Flat	9000 lbf.	\$104.00



SLING-LINK POUCH

The MAST pouch is an excellent way to mount the MAST or carry the Tool on the Rescuer, a way to keep it clean and ready for use. Manufactured with 1000 den Cordura. Sling-Link not included.

	Model		Color	
7082931x	MB-31	For MEN1-31	Black, Yellow	\$27.00
7082961x	MB-61	For MEN1-61	Black, Yellow	\$28.00
70829911	MB-91	For MEN1-91	Black	\$29.00

SLING-LINK RDP-FIRE

Sling-Link with Rapid Deployment Pouch

The MAST Rapid Deployment Pouch is an excellent way to mount the MAST or carry the Tool on the Rescuer, a way to keep it clean and ready for use. Made from 1000 den cordura. Includes chrome plated swivel snap. Easy to use pull strap deploys Sling-Link. Available as Pouch only or as a kit. Kit includes RDP and MEN1-31 Sling-Link.

		Color	
7082932x	RDP-Fire Pouch	Black, Yellow, Red	\$28.00
29982505BK	RDP-Fire Kit	Black	\$62.00
29982505RD	RDP-Fire Kit	Red	\$62.00
29982505YE	RDP-Fire Kit	Yellow	\$62.00

WARNING

Technical rescue and safety is potentially hazardous. Any person using equipment sold by RESCUE TECHNOLOGY in any manner is personally responsible for learning the proper techniques involved, and assumes all risks and accepts full and complete responsibility for any and all damages or injury of any kind, including death, which may result from the use of any RESCUE TECHNOLOGY equipment.

Products in this catalog can expose you to chemicals which are known to the State of California to cause cancer. For information go to: www.p65warnings.ca.gov

EGRESS RIT RESCUE KITS WITH D2 ESCAPE DESCENDER

EGRESS+PLUS™



D2/EGRESS+PLUS - SNAP

- EGRESS+Plus™ w/ Sewn Eye & Snap*
- D2 Escape Descender • Heat Resistant Pouch
 - 100% Technora Rope with Autolocking Snap
 - Extension Strap

		Length	
5254012050	D2/EGRESS+Plus™ Snap	50'	\$445.00
5254012070	D2/EGRESS+Plus™ Snap	70'	\$495.00

D2/EGRESS+PLUS - BANTAM HOOK

- EGRESS+Plus™ w/ Sewn Eye & Bantam Hook*
- D2 Escape Descender • Heat Resistant Pouch
 - 100% Technora Rope with Aluminum Bantam Hook
 - Extension Strap

		Length	
5254014050	D2/ EGRESS+Plus™ Hook	50'	\$560.00
5254014070	D2/EGRESS+Plus™ Hook	70'	\$620.00

EGRESS™



D2/EGRESS - SNAP

- EGRESS™ w/ Sewn Eye & Snap*
- D2 Escape Descender • Heat Resistant Pouch
 - Technora Sheath Rope with Autolocking Snap
 - Extension Strap

		Length	
5254112050	D2/EGRESS™ Snap	50'	\$395.00
5254112070	D2/EGRESS™ Snap	70'	\$435.00

D2/EGRESS - BANTAM HOOK

- EGRESS™ w/ Sewn Eye & Bantam Hook*
- D2 Escape Descender • Heat Resistant Pouch
 - Technora Sheath Rope with Aluminum Bantam Hook
 - Extension Strap

		Length	
5254114050	D2/ EGRESS+Plus™ Hook	50'	\$500.00
5254114070	D2/EGRESS+Plus™ Hook	70'	\$530.00

EGRESS-HYBRID™

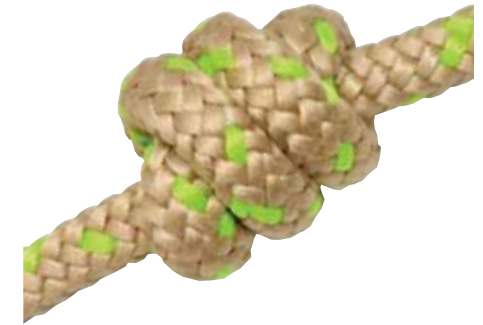

D2/EGRESS - HYBRID - SNAP

- EGRESS-Hybrid™ w/ Sewn Eye*
- D2 Escape Descender • Heat Resistant Pouch
 - Hybrid Technora/Polyester Rope with Autolocking Snap
 - Extension Strap

		Length	
5254212050	D2/EGRESS-Hybrid™ Kit	50'	\$380.00
5254212070	D2/EGRESS-Hybrid™ Kit	70'	\$405.00

D2/EGRESS - HYBRID - BANTAM HOOK

- EGRESS-Hybrid™ w/ Sewn Eye & Bantam Hook*
- D2 Escape Descender • Heat Resistant Pouch
 - Hybrid Technora/Polyester Rope with Bantam Hook
 - Extension Strap

		Length	
5254214050	D2/ EGRESS+Plus™ Hook	50'	\$492.00
5254214070	D2/EGRESS+Plus™ Hook	70'	\$525.00



D1 PRO TOWER ESCAPE KIT

Ideal for Tower and Wind Energy

The D1 PRO Descender is a compact, lightweight device, which can be stored on the user's harness and efficiently deployed, as required. The DIPRO Descender is an auto-stop device (descent ceases when the user releases the control handle). The absence of a panic brake on this 'PRO' model, allows the user the freedom to descend, without accidental activation of the panic brake. This can be useful on longer, faster descents and in emergency situations when an efficient, uninterrupted descent is particularly important. Two 6mm rope types available: Quadra (Technora Sheath / Nylon Core) and Escape6 (Technora Sheath / Technora Core). Includes Bag. WLL: 308 lbs (140 kg) Certification: EN341-D
ISC requires that authorized training be completed before any D1 unit can be purchased either by an individual or by an entire department / company.

	Rope	Length	
20148511020	Quadra	20m	Call
20148511050	Quadra	50 m	Call
20148511100	Quadra	100 m	Call
20148511200	Quadra	200 m	Call
20148512020	Escape 6	20 m	Call
20148512050	Escape 6	50 m	Call
20148512100	Escape 6	100 m	Call
20148512200	Escape 6	200 m	Call



Technical rescue and safety is potentially hazardous. Any person using equipment sold by RESCUE TECHNOLOGY in any manner is personally responsible for learning the proper techniques involved, and assumes all risks and accepts full and complete responsibility for any and all damages or injury of any kind, including death, which may result from the use of any RESCUE TECHNOLOGY equipment.

EGRESS RIT RESCUE KITS WITH QXD ESCAPE DESCENDER



QXD ESCAPE/EGRESS+PLUS - SNAP

EGRESS+Plus™ w/ Sewn Eye & Snap

- QXD Escape Descender • Heat Resistant Pouch
- 100% Technora Rope with Autolocking Snap
- Autolocking Carabiner

		Length	
5253012050	QXD/EGRESS+Plus™ Kit	50'	\$275.00
5253012070	QXD/EGRESS+Plus™ Kit	70'	\$325.00



QXD ESCAPE/EGRESS+PLUS - BANTAM HOOK

EGRESS+Plus™ w/ Sewn Eye & Bantam Hook

- QXD Escape Descender • Heat Resistant Pouch
- 100% Technora Rope with BANTAM Hook
- Autolocking Carabiner

		Length	
5253014050	QXD/EGRESS+Plus™ Kit	50'	\$399.00
5253014070	QXD/EGRESS+Plus™ Kit	70'	\$460.00

EGRESS+PLUS™



QXD/EGRESS - SNAP

EGRESS™ w/ Sewn Eye & Snap

- QXD Escape Descender • Heat Resistant Pouch
- Technora Sheath Rope with Autolocking Snap
- Autolocking Carabiner

		Length	
5253112050	QXD/EGRESS™ Kit	50'	\$215.00
5253112070	QXD/EGRESS™ Kit	70'	\$245.00



QXD/EGRESS - BANTAM HOOK

EGRESS™ w/ Sewn Eye & Bantam Hook

- QXD Escape Descender • Heat Resistant Pouch
- Technora Sheath Rope with BANTAM Hook
- Autolocking Carabiner

		Length	
5253114050	QXD/EGRESS™ Kit	50'	\$335.00
5253114070	QXD/EGRESS™ Kit	70'	\$365.00

EGRESS™



QXD/EGRESS-HYBRID - SNAP

EGRESS-Hybrid™ w/ Sewn Eye

- QXD Escape Descender • Heat Resistant Pouch
- Hybrid Technora/Polyester Rope with Autolocking Snap
- Autolocking Carabiner

		Length	
5253212050	QXD/EGRESS-Hybrid Kit	50'	\$220.00
5253212070	QXD/EGRESS-Hybrid Kit	70'	\$240.00



QXD/EGRESS-HYBRID - BANTAM HOOK

EGRESS-Hybrid™ w/ Sewn Eye & Bantam Hook

- QXD Escape Descender • Heat Resistant Pouch
- Hybrid Technora/Polyester Rope with BANTAM Hook
- Autolocking Carabiner

		Length	
5253214050	QXD/EGRESS-Hybrid Kit	50'	\$335.00
5253214070	QXD/EGRESS-Hybrid Kit	70'	\$365.00

EGRESS-HYBRID™

FIRE RESCUE

BELTS, LANYARDS, AND HARDWARE

RescueTECH has spent many years supplying specialized belts and lanyards for a variety of Escape and "Bail-Out" uses. From original Survival Belt first manufactured in 1983 to our Turnout Escape Harness, we spend the time to select the proper webbing and hardware for each item. Our Escape Belts and Harnesses are available in both Heat Resistant Kevlar brand webbing and high strength nylon and polyester. And since these items are made in our facility in Carrollton, GA, you are assured of top quality and workmanship.



CORONA™ FR TRUCK / ESCAPE BELT WITH LADDER HOOK

Made from Kevlar Brand Heat Resistant Web

Our popular Heat Resistant Corona™ Escape Belt with integral Ladder Hook. Manufactured of Kevlar® Brand fibers from Dupont and forged hardware Retro-reflective striping. One-Size-Fits Most. Ladder Hook manufactured from high strength, alloy aluminum. Lanyard length of 18" is perfect for use in ladders and platforms.

Strength: 6,000 lbs. Hook Strength: 5,000 lbs. Weight: 53.6 oz.

Meets structural test requirements of NFPA Life Safety Escape Belt Standard. Meets ANSI/OSHA Class I Belt design requirements.

	Size	Waist	
701122H	Small	26 - 32"	\$275.00
701132H	Medium/Large	34 - 56"	\$275.00



CORONA FR™ TRUCK / ESCAPE BELT

Made from Kevlar Brand Heat Resistant Web

Belt is easily secured around waist using unique double locking snap hook and 'D' Ring adjuster. Can be used as an equipment belt for carrying axes or forcible entry tools. Two light weight D-rings slide along belt to secure escape rope system bag. Retro-reflective striping.

Strength: 6,000 lbs. Weight: 38.4 oz. Waist: 34 - 56"

Meets structural test requirements of NFPA Life Safety Escape Belt Standard. Meets ANSI/OSHA Class I Belt design requirements.

	Size	Waist	
701122	Small	26 - 32"	\$190.00
701132	Medium/Large	34 - 56"	\$195.00
701152	XLarge	44 - 68"	\$225.00



CORONA™ TRUCK / ESCAPE BELT

This Nylon Escape Belt is the perfect economical substitution for our Kevlar Belt. Belt is easily secured around waist using unique double locking snap hook and 'D' Ring adjuster. Can be used as an equipment belt for carrying axes or forcible entry tools. Two light weight D-rings slide along belt to secure escape rope system. Retro-reflective striping on Gold unit.

Strength: 6,000 lbs. Weight: 33.6 oz. Waist: 34 - 54"

Meets structural test requirements of Life Safety Escape Belt Standard. Meets ANSI/OSHA Class I Belt design requirements.

	Color	Waist	
701032	Gold w/ Scotchlite®	34 - 54"	\$140.00
701031	Black	34 - 54"	\$130.00



UNIFORM EMERGENCY BELT

Quick Adjust Buckle

A modified version of our Survival Belt™. Lightweight forged "V" ring is used for carabiner attachment point and is held securely by a Velcro loop. Steel Adjuster Buckle insures security without slipping. Extra webbing secured with hook and loop fastener.

Tensile Strength: 5,000 lbf. Weight: 10.4 oz. (Standard)

Meets NFPA 2500 (1983) Strength requirements for Escape Belt. Meets ANSI/OSHA Class I Belt design requirements. NFPA Rating: Escape Belt.

	Size	Waist	
703306	Standard	28" - 40"	\$50.00
703308	Large	40" - 55"	\$52.00



SURVIVAL BELT™ II

A multi-purpose belt that can be worn as a uniform belt. With carabiner attached to the forged buckle, the belt allows the user to "get out quick". High strength Adjustable Rigging Buckle. Hook and Loop neatly secures spare length. Manufactured with 1.75" heavy duty webbing.

Tensile Strength: 6,000 lbf. Color: Black Weight: 9.6 oz. (Medium)

Meets NFPA 2500 (1983) Strength requirements for Escape Belt. Meets ANSI/OSHA Class I Belt design requirements. NFPA Rating: Escape belt.

	Size	Waist	
703521	Small	25" - 36"	\$50.00
703531	Medium	32" - 42"	\$50.00
703541	Large	36" - 48"	\$52.00
703551	XLarge	40" - 55"	\$52.00



All escape descenders should be fully tested to determine compatibility with the brand of rope used. All users of Escape descenders must be fully instructed in the use of the descenders to ensure competency in "bail-out" and "escape" operations.

FIRE RESCUE

BELTS, LANYARDS, AND HARDWARE



TURNOUT HARNESS KEEPERS

A handy set of webbing keepers that help hold the harness in place when used either outside the bunker pants or between the thermal layer and shell. Anchors to the suspender attachment of bunker pants. 2 styles of keepers accommodate the 'button-style' or 'loop-style' suspender attachment systems.

7021294	Button-Style Set of 4	\$38.00
7021295	Loop-Style Set of 4	\$42.00

TURNOUT ESCAPE HARNESS

Seat Harness for Inside or Outside of Turnout Pants

Designed to be kept with your turnout gear, this harness may be worn on the outside (Heat Resistant version) or between thermal layer and shell layer. Special Clik-Lok buckle and attachment strap allows this harness to be easily donned. Extended "D" ring rigging point eases attachment. Heat Resistant version manufacture with webbing and thread made from DuPont Kevlar fiber. Sizing should be determined by waist measurement while wearing turnout pants.

Weight: Nylon(M/L) - 31.2 oz.; Kevlar(M/L): 32.8 oz.



	Item Description/Size	Size	Color	Waist	
702113x	Nylon	M/L	Black or Red	28" - 44"	\$115.00
702115x	Nylon	XL	Black or Red	38" - 54"	\$115.00
7021161	Nylon	XXL	Black	40" - 68"	\$130.00
7021231	Kevlar Heat Resistant	M/L	Black	28" - 44"	\$305.00
7021251	Kevlar Heat Resistant	X/L	Black	38" - 54"	\$335.00



Clik-Lok Waist Buckle is connected before closing the pants waist buckle.



"D" Ring rigging point extends up and over waist of pants.



Harness keeper tab snaps around waist belt of harness.



Harness keeper tab attaches to suspender button underneath suspender.



ADJUSTABLE TAC SEAT

The Adjustable TAC Seat built from the trusted Adjustable Seat harness design. From this design we created some improvement. Waist and leg buckles are quick-adjust for rapid sizing. Leg loops are designed for maximum comfort and will rotate slightly with leg movement. Forged D ring rigging point.

	Size	Waist	
7091031	Med/Large	30" - 39"	\$125.00
7091041	XLarge	34" - 44"	\$130.00



STANDARD CHEST HARNESS

General Purpose Chest Harness

A basic style chest harness with "V" ring attachment points that can be connected with a carabiner or rope. The Standard Chest Harness features 2" chest strap webbing and 2" shoulder strap webbing. Fully adjustable. One Size Fits Most.

Color: Black Weight: 15.2 oz.

723321	Standard Chest Harness	\$72.00
--------	------------------------	---------



WARNING

Shoulder straps are not for vertical lifting.



ER-S RIGGING / RESCUE SLING

Rescue Craft™ teamed with Element Rescue and Rescue Technology to evolve and enhance their original extraction strap design. The new Evacuation & Rigging Strap, or ER-S, provides the end-user with multiple casualty evacuation and anchor rigging options in a compact rugged design.

355.1500.100.3BG

ER-S Rescue Sling

\$65.00



DELUXE LANYARD POUCH

Great for search kits. A larger version of our popular Lanyard Pouch. The Deluxe Lanyard Pouch features a “hinged” lid with a “hook and loop” closure. Holds up to 80 ft. of 8mm cord.

Dimensions: 11" H x 7" W x 3" D Weight: 3 oz.

	Color	
8001151	Black	\$37.45
8001150	Orange	\$37.45



PPE CARRIER

Durable system that holds and transports PPE for Fire, Police and Military. Standard version complete with 2 TACLINKs to attach helmet and other equipment. Designed with 2 inch top attachment strap with sturdy handle and a 2 inch wide boot strap with a sliplok and strap keeper for easy customized adjustment that tightly cinches gear for transport. Includes adjustable shoulder strap with movable rubber comfort pad and interlocking side release buckles for quick attachment and release. Configuration designed to ensure a balanced load with no stress on boot loops.

System has slots for up to six carabiners to attach multiple piece of gear to belt and assembles in less than 60 seconds to provide faster deployment of your gear than conventional storage options. Open air assembly allows gear to dry quickly, preventing odor and bacteria build up; connects all primary equipment pieces (helmet, face mask, gloves) to the attachment strap to be hung in the cab as one unit, keeping gear secure and off the floor; use the attachment strap to close around rope and carry other tools.

29962011	PPE Carrier	\$58.00
29962001	PPE Carrier, Berry Compliant	\$60.00

LANYARD POUCH

For lanyards, personal escape rope, gloves, and miscellaneous small equipment. Constructed of Cordura® nylon with fold over hook and loop closure. Built-in loops fit belts up to 4" wide. Holds 40 feet of 3/8" or 75 feet of 7mm nylon tag line.

Dimensions: 8" x 5" x 3" Color: Black Weight: 2.4 oz.



	Color	
800104	Red	\$24.00



YOU CAN NEVER HAVE TOO MANY RUTH LEE MANIKINS

VANGUARD-G2™

TECHNICAL RESCUE HARNESS

VANGUARD-G2

NFPA Class III Rescue Technician Harness

We have updated the Vanguard™ harness to feature our new padding design. Built with Aerospacer™ mesh, the padding is hydrophobic / hydrophilic and works as a “pump” that pulls moisture away from the body and helps cool the rescuer. Designed for function and comfort, we have added polycarbonate stiffeners to the waist pad to increase load distribution.

Easy donning aided by 2-piece color coded leg buckles. Forged D rings at the front waist and chest provide rescuer main and belay attachments. Forged dorsal ‘D’ ring for fall protection and belay attachments. Lifting rings on shoulders allow vertical lifting out of confined spaces. Canted side ‘D’ rings provide attachment point for positioning lanyards and stow out of the way when not in use. The Vanguard II also allows for both side entry and over the shoulder donning of the chest/shoulder section. Shoulder section attached to seat section with Delta Shaped Rapid Link. Weight: 99.2 oz. Made In U.S.A.

Certified Standards: • NFPA 2500 (1983)

	Size	Height	Waist	
7304202	S	5'2" - 6'	27" - 35"	\$365.00
7304302	M/L	5'2" - 6'	31" - 39"	\$365.00
7304502	XL	5'9" - 6'8"	35" - 51"	\$370.00



Cert. Model
NFPA 2500 (1983)

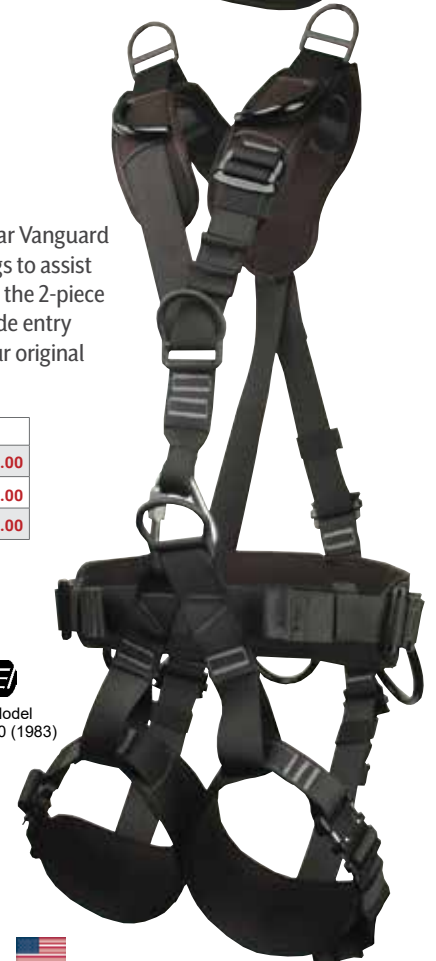

VANGUARD-G2 CLIK

Rapid-Donning Clik-Lok Buckles

The Vanguard-Clík is the next version of our popular Vanguard harness. We have added Clík-Lok buckles to the legs to assist in quick-donning of this harness. We have retained the 2-piece buckles on the waist for ease of adjustment and side entry donning. The same high strength and quality as our original Vanguard. Weight: 108 oz

Certified Standards: • NFPA 2500 (1983)

	Size	Height	Waist	
7305201	S	5'2" - 6'	27" - 35"	\$415.00
7305301	M/L	5'2" - 6'	31" - 39"	\$415.00
7305501	XL	5'9" - 6'8"	35" - 51"	\$430.00

TECHNOTE



QUICK ATTACH LEG BUCKLES

Many RescueTECH harnesses come with Quick-Attach Adjuster Buckles. These buckles allow the user to don a harness without stepping through a leg loop. With the Quick-Attach buckles, the user simply wraps the loop around their leg, attaches the buckles together, and tightens the webbing. These buckles provide an easy way to put a harness onto a victim.



Cert. Model
NFPA 2500 (1983)

ADVANTAGE-G2™

WORK / RESCUE HARNESS

ADVANTAGE-G2 CLIK

NFPA Class III Work/Rescue Harness.

Our new ADVANTAGE harness utilizes a modified version of our new waist pad design and Klik-Lok buckles from ISC. These buckles, rated at 36 kN in a straight pull, offer rapid donning of this comfortable harness. Incorporating the same Aerospace mesh for comfort, the pad is larger than that of the VANGUARD-G2 and has a polycarbonate stiffener to better distribute the load – increasing the comfort of the harness. Fully adjustable design features padded waist, legs, and shoulders. Unique shaped shoulder pad system makes the Advantage™ super-comfortable. Suitable for Work and Rescue, Fall Arrest, Work Positioning, Descent, and Ascent. Buckles make size adjustment quick and secure – no need to tie off webbing tails. Main rigging rings at front waist and chest. Fall arrest ring in dorsal position. Stowable side waist rings for positioning. Shoulder straps have soft connect points for vertical lifting. Made In U.S.A.

Weight: 88 oz. (Med/Lg)

Certified Standards: • NFPA 2500 (1983)

	Size	Height	Waist	
7315201	Small	5'2" - 6'	27" - 35"	\$425.00
7315301	Medium/Large	5'2" - 6'	31" - 39"	\$425.00
7315501	XLarge	5'9" - 6'8"	35" - 51"	\$435.00

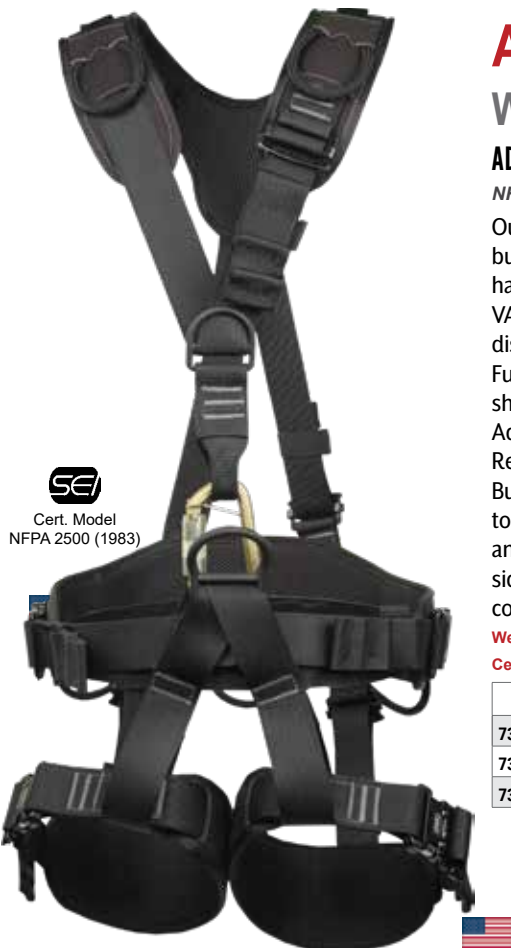

Cert. Model
NFPA 2500 (1983)



TECHNOTE



QUICK FIT BUCKLES

Our high strength Quick-Fit buckle allow quick adjustment to our harnesses. Manufactured from high strength steel and plated for corrosion resistance.



CLIK-LOK BUCKLES

Rated at 36 kN in straight pull (not looped), The Klik-Lok buckle is the strongest buckle of this style. Uses the Quick-fit style adjustment system.

WARNING

Technical rescue and safety is potentially hazardous. Any person using equipment sold by RESCUE TECHNOLOGY in any manner is personally responsible for learning the proper techniques involved, and assumes all risks and accepts full and complete responsibility for any and all damages or injury of any kind, including death, which may result from the use of any RESCUE TECHNOLOGY equipment.

Products in this catalog can expose you to chemicals which are known to the State of California to cause cancer.

For information go to: www.p65warnings.ca.gov

PRIME™

FIRE / RESCUE HARNESS

PRIME FIRE/RESCUE HARNESS

Designed to fit the needs of most rescuers. The PRIME harness features padding in the waist and legs, offering one of the most comfortable rescue harnesses around. Primary rigging points on front waist and chest. Our proprietary pads continue to offer superior force distribution and feature breathable cushioning next to the rescuer's body. The Dorsal D-Ring position can be adjusted to the height requirements of the Rescuer. Once adjusted, the D-ring is fixed at that height and does not slide up when a load is applied. The Front D-Ring is a fixed position ring that distributes the forces directly to the seat portion of the harness. The upper portion of the harness features over the shoulder or side entry donning and connects to the seat with a stainless steel rapid link. The front D-Ring assembly will accept our Harness Ascender Loop for use as a chest ascender attachment point. 2 piece Color coded adjusters on the legs make donning quick and adjustment easy. Strong rigging loops will hold needed equipment.

Certified Standards: • NFPA 2500 (1983)

	Size	Height	Waist	Color	
7321204	S	5'2" - 6'	27" - 35"	Red/Black	\$285.00
7321304	M/L	5'2" - 6'	31" - 39"	Red/Black	\$285.00
7321504	XL	5'9" - 6'8"	35" - 51"	Red/Black	\$285.00



Cert. Model
NFPA 2500 (1983)



Cert. Model
NFPA 2500 (1983)



PRIME II PADDED SEAT HARNESS

NFPA Class II Rescue Harness.

Our newest Class II seat harness will impress you with its versatility and comfort. Special "breathable", laminated foam padding provides comfort not often found in basic seat harnesses. Special 2-piece buckles allow you to don without having to "step-through" the harness. Primary rigging "D" ring floats along the waist strap to better balance the forces placed on the rescue - giving greater comfort. Made In U.S.A.

Certified NFPA 2500 (1983) Class II Harness

	Size	Waist	
7052021	Small	27" - 35"	\$225.00
7052031	Medium	31" - 39"	\$225.00
7050051	XLarge	35" - 51"	\$225.00



CE

PETZL ASTRO FAST

Ultra-comfortable rope access harness

Designed for rope access technicians. The 3D foam padding and semi-rigid waistbelt and leg loop construction provide comfort throughout the workday. The gated ventral attachment point allows the user to efficiently install the necessary equipment. Integrated CROLL L rope clamp improves efficiency for rope ascent. Features metal side attachment points, equipment loops, and tool holder slots. DOUBLEBACK self-locking buckles and FAST opening buckles make donning and adjusting the harness simple and convenient, even while wearing gloves.

Certification(s): ANSI Z359.11, ANSI 459.1, NFPA 2500 class III, CSA Z259.10, CE EN 361, CE EN 358, CE EN 813, CE EN 12841 type B, GB 6095, XF 494

	Size	Waist	
23540308300	0	26" - 32"	\$575.00
23540308310	1	28" - 37"	\$575.00
23540308320	2	33" - 48"	\$575.00



CE

PETZL AVAO FAST

Comfortable and versatile harness for work at height

Specifically designed for workers at height. Its design is specific to work positioning and rope descent. Contoured foam on the semi-rigid waistbelt and leg loops provide comfort during use. The waistbelt features metal side attachment points, equipment loops, and tool holder slots, allowing the user to organize all the necessary equipment for a day of work. Adjustment is quick, easy, and convenient, with self-locking DOUBLEBACK buckles and FAST opening buckles.

Certification(s): CE EN 361, CE EN 813, CE EN 358, ANSI Z359.11, ANSI Z459.1, CSA Z259.10, NFPA 2500 class 3, GB 6095: Q-W-Z

	Size	Waist	
23540371100	0	26" - 32"	\$525.00
23540371110	1	28" - 37"	\$525.00
23540371120	2	33" - 48"	\$525.00



TASK X-PERT NFPA

New, cost effective harness for technical rescue

X-TREME X-PERT® NFPA class III harness has 8 connection points: 2 for fall arrest, 2 for positioning, 1 ventral, 2 for rescuing the shoulders and 1 for restricting movement in the lumbar region.

The waist pad is double thickness with 10.5" padding in the lumbar region for a perfect fit between the user and equipment, guaranteeing comfort for long-term operations.

2 parking loops for lanyard connectors on the shoulders, 4 equipment loops, and 1 backpack holder with a load capacity of 10kg each. The chest to waist connector is an NFPA standard in aluminum, triple lock with 25kN.

Compliant with NFPA 2500 (1983), class III (Fire Rescue), ABNT NBR 15835:2020 and ABNT NBR 15836:2020 standards. Weight: S – 5.6 lbs. | M/L – 5.8 lbs. | XL – 6.02 lbs.

	Size	Waist	
209220292	S	25" - 39"	\$300.00
209220293	M/L	21" - 47"	\$300.00
209220295	XL	33" - 55"	\$300.00



CE

PETZL AVAO

Comfortable harness for fall arrest, work positioning and suspension

The AVAO harness is specifically designed for workers at height. Its design is specific to work positioning and rope descent. Contoured foam on the semi-rigid waistbelt and leg loops provide comfort during use. The waistbelt features metal side attachment points, equipment loops, and tool holder slots, allowing the user to organize all the necessary equipment for a day of work. Adjustment is quick and easy with self-locking DOUBLEBACK buckles.

Certification(s): CE EN 361, CE EN 813, CE EN 358, ANSI Z359.11, ANSI Z459.1, CSA Z259.10, NFPA 2500 class 3, GB 6095: Q-W-Z

	Size	Waist	
23540371000	0	26" - 32"	\$500.00
23540371010	1	28" - 37"	\$500.00
23540371020	2	33" - 48"	\$500.00



RESCUETECH ADJUSTABLE LIFTING BRIDLE

18" Adjustment

The newest addition to our confined space harness lifting equipment is our low-profile Adjustable Spreader Plate. We combine a lightweight aluminum plate with adjustable straps. The adjustment allows the unit to not only work with confined space harnesses, but also with lifting devices such as the LSP Half Back.

Width: 15" Max Height under plate: 21" Min Height under plate: 8"

609028 Adjustable Lifting Bridle \$170.00



RESCUETECH™ HARNESS LIFTING BRIDLE

Double Locking Snaps

Unit attaches to shoulder lifting rings with industrial double locking snaps.

Strength: 6,000 lbf. (26.7 kN) Overall Height: 23" (57.5 cm)
Strap Length: 11" (27.5 cm) Width: 16" (40 cm) Weight:
38.4 oz. (1.08 kg)

609025 Harness Lift Bridle \$99.00



LADDER HOOK EXTENSION™

The Ladder Hook Extension Strap allows the rescuer to attach to a ladder rung. The overall length of 18" provides the perfect length to give the rescuer both comfort and safety. Available with Autolocking Ladder Hook. Forged snap attaches the Ladder Hook Extension to the "D" ring of rescue harnesses.

Strength: 6,000 lbs. (26 kN) Overall Length: 18" (45 cm) Gate Opening: 1.5" (38mm) Rating: General Use. Weight: Steel: 32.8 oz. Aluminum: 25.6 oz.

A. 609012	Alum. AutoLock - Fire Resist.	\$105.00
B. 609011	Steel AutoLock - Fire Resist.	\$92.00

WRISTLET

Ergonomic Comfort Pads

Wrist harness for emergency use and for work locations where a full body harness might create a greater risk. Also excellent for situations requiring special positioning of the victim's arms in conjunction with a full body harness. Manufactured from nylon webbing. Special elastic tensioner helps keep unit secure when used as ankle. Comes complete with 2 wristlets and lifting yoke. Wristlet Set includes Carabiner and storage pouch.

Weight: 5.6 oz.

Meets OSHA requirements.



609200	Wristlet w/ Yoke	\$38.00
94894101	Wristlet Set w/ Carabiner & Bag	\$90.00



WARNING

Technical rescue and safety is potentially hazardous. Any person using equipment sold by RESCUE TECHNOLOGY in any manner is personally responsible for learning the proper techniques involved, and assumes all risks and accepts full and complete responsibility for any and all damages or injury of any kind, including death, which may result from the use of any RESCUE TECHNOLOGY equipment.

Products in this catalog can expose you to chemicals which are known to the State of California to cause cancer.

For information go to: www.p65warnings.ca.gov



Legs store in color-coded pouches and are ready to use.

VICTIM HARNESS

Clik-Lok Waist Buckle Speeds Donning

An innovative dual purpose harness, built to NFPA strength standards. Constructed of 1 3/4" high strength webbing, the Victim Harness utilizes our special Clik-Lok buckle on the waist and either Clik-Lok or Quick-Attach buckles on the legs. Both leg buckle styles are color-coded to aid in proper donning. Leg straps are stored in attached pouch to easily store and transport this harness. Special Clik-Lok waist buckle with pad is quick to don and insures user comfort.

Color: Black w/ color-coded leg straps. **Weight:** 30.1 oz.

Exceeds NFPA 2500 (1983) strength requirements for Class II Harness.

708366 Victim Harness-Clik **\$165.00**



DELUXE VICTIM RESCUE CRADLE

Full Upper Body coverage with padded back panel for greater patient comfort and security. 7 strap support for superior strength. Forged D Tag line anchor helps rescuers control patient in vertical environment. Victim Arm Keepers maintain control of upper extremities. 4 Grab handles aid in maneuvering victim before, during, and after the vertical lift. Manufactured of 1000 den fabric with Cordura brand fibers, high strength webbing and forged steel hardware. (Manikin, Carabiner, and Tether not included.)

Weight: 96 oz. | **WL:** 400 lbs

*Does not replace proper patient packaging using backboard, cervical collar, and head blocks.

A. Forged Steel Attachment Points. B. Heavy Duty Webbing. C. Rolls up for Storage. D. 4 Contoured Grab Handles help with positioning and allow the cradle to perform as a soft stretcher E. Padded Back Panel with internal polycarbonate support frame.

708353

Rescue Cradle*

\$335.00

WAKA LARGE ANIMAL LIFTING HARNESS

Lifting Harness for Large Animal Rescue

Special harness developed for lifting and heli-transport operations of cows and horses in emergency situations. Made of polyester HT for heavy load and low stretching.

Weight: 6.6 lbs. (3 kg.) High quality product, completely developed and made in Italy.

240123400

\$1,982.99



Warning:

Before using the harness it's important to make a training with a animal manikin in a safe place. Incorrect use of the harness could cause the loss of the animal. During transport operations it is best to have a veterinarian on site. Always check the buckles before starting the lift. The lifting time depends on the animal but it never must exceed 15 minutes.



VICTIM CHEST SLING

Attaches to Ladder / Victim Harness, turning the system into a Class III Victim Harness. Wide, padded chest strap supports victim's upper torso during vertical lifts. Quickly attaches around victims chest. Connects with Double Locking Snap. Padded for comfort. Adjustable Chest and seat connector straps.

Weight: 32 oz.

723201 Victim Chest Sling **\$135.00**



LAIKA DOG HARNESS

Intended for transport of the dog from a helicopter or other high angle environments. Universal size. Aluminum-alloy adjusters.

Color: Orange
Capacity: 300 lbs
Weight: 24.8 oz.

23898115

Laika Dog Harness

\$175.00



WARNING

Technical rescue and safety is potentially hazardous. Any person using equipment sold by RESCUE TECHNOLOGY in any manner is personally responsible for learning the proper techniques involved, and assumes all risks and accepts full and complete responsibility for any and all damages or injury of any kind, including death, which may result from the use of any RESCUE TECHNOLOGY equipment.

Products in this catalog can expose you to chemicals which are known to the State of California to cause cancer.

For information go to: www.p65warnings.ca.gov

HARDWARE BY RESCUETECH

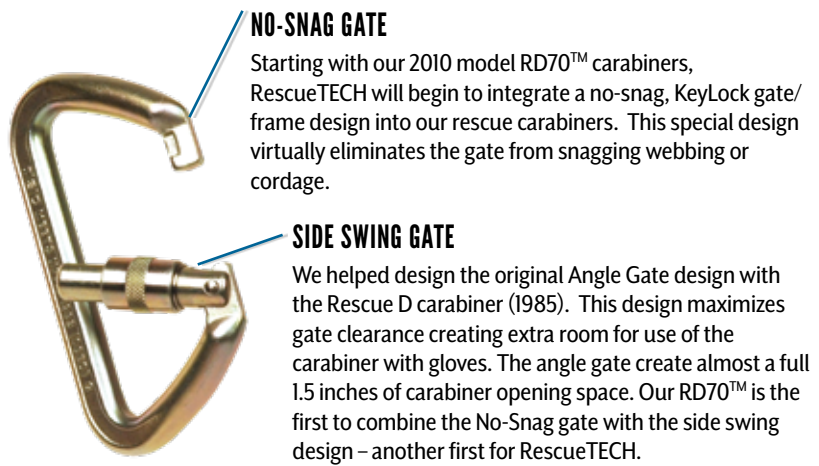

NO-SNAG GATE

Starting with our 2010 model RD70™ carabiners, RescueTECH will begin to integrate a no-snag, KeyLock gate/frame design into our rescue carabiners. This special design virtually eliminates the gate from snagging webbing or cordage.

SIDE SWING GATE

We helped design the original Angle Gate design with the Rescue D carabiner (1985). This design maximizes gate clearance creating extra room for use of the carabiner with gloves. The angle gate create almost a full 1.5 inches of carabiner opening space. Our RD70™ is the first to combine the No-Snag gate with the side swing design – another first for RescueTECH.



CE



CE



CE

RESCUETECH BIG DAN™

Designed to Prevent Cross-Loading

Combines all the ideal design ideas into one carabiner. The Big Dan's unique frame is designed to prevent cross-loading the carabiner. Cross-loads are quickly realigned to the major axis. The curved back modified 'D' design optimizes the strength and handling characteristics. Available in Twistlock (2-stage) and Supersafe (3 stage) safety mechanisms.

WLL: 1,124 lbs. (511 kg) Gate Opening: 1.0" (25mm)
Dimensions: 5.25 x 3.5" (133 x 89mm) Rating: General Use.
NFPA 1983, ANSI/OSHA compliant.

	Style	Strength	Weight	
6051179S	Supersafe	11,241 lbf.	11.2 oz.	\$32.95
6051179T	Twistlock	11,241 lbf.	11.2 oz.	\$25.95

RESCUETECH RD70™ MULTI-STAGE LOCKING GATE

Autolocking Rescue Carabiners

The newest version of our popular RD70™ Rescue Carabiner. Featuring either the 2-stage Twistlock or 3-Stage Supersafe gate design. Features No-Snag, KeyLock gate design.

WLL: 1,574 lbs. (715 kg) Gate Opening: 1.4" (35mm)
Dimensions: 4.9 x 2.9" (125 x 73mm) Rating: General Use
NFPA 1983, ANSI/OSHA compliant

	Style	Strength	Weight	
60511830	Twistlock	15,737 lbf.	10.4 oz.	\$35.95
60511840	Supersafe	15,737 lbf.	10.4 oz.	\$36.95

RESCUETECH RD70™ RESCUE CARABINER

Featuring No-Snag, KeyLock Gate Design

Rescue Tech's newest general use carabiner. Design to meet the tough-use conditions met by Rescue Technicians. Heat-treated alloy steel construction with Gold Chromate corrosion protection.

WLL: 1,574 lbs. (715 kg) Gate Opening: 1.4" (35mm) Di-
mensions: 4.9 x 2.9" (125 x 73mm) Rating: General Use
NFPA 1983, ANSI/OSHA compliant

	Color	Strength	Weight	
60511820	Gold	15,737 lbf.	9.5 oz.	\$33.95
60511821	Black	15,737 lbf.	9.5 oz.	\$39.95



CE

RESCUETECH OD50™ RESCUE CARABINER

A Great Multi-Use Carabiner now with KeyLock Gate

Heat-treated alloy steel construction with Gold Chromate corrosion protection. Made to meet the toughest rescue needs.

WLL: 1,124 lbs. (511 kg) Gate Opening: .8" (20mm) Dimensions: 4.4 x 2.7" (111 x 68mm)
Rating: General Use NFPA 1983, ANSI/OSHA compliant

	Style	Color	Strength	Weight	
A. 60511750	Screwgate	Gold	11,241 lbf.	8.8 oz.	\$20.00
B. 60511751	Screwgate	Black	11,241 lbf.	8.8 oz.	\$22.00
C. 60511730	Twistlock	Gold	11,241 lbf.	8.8 oz.	\$20.95
D. 60511731	Twistlock	Black	11,241 lbf.	8.8 oz.	\$22.95
60511760	Screwgate w/ bar	Gold	11,241 lbf.	8.8 oz.	\$22.00
60511740	Twistlock w/ bar	Gold	11,241 lbf.	8.8 oz.	\$22.95

STEEL CARABINERS



HMS STEEL CARABINER

HMS design for use with munter hitches. Forged frame for high strength and long wear. KeyLock gate reduces snagging.

Gate Opening: 15/16" (23.8mm)

		Strength	Weight	
20141121220	Screwgate	11,240 lbf	10 oz.	\$26.95
20141121230	Twistlock	11,240 lbf	10 oz.	\$28.95
20141121240	Supersafe	11,240 lbf	10 oz.	\$29.95



ISC STEEL OFFSET OVAL

ISC's Offset Oval Carabiner combines the specification of an Oval with that of a 'D' shape carabiner. True Ovals are not capable of achieving high breaking loads, as their symmetrical shape shares the load between the spine and the gate of the carabiner. The Offset Oval has a slight 'D' shape that gives the highest Oval Carabiner strength. Cold Forged with KeyLock style gate. Available in either Screwgate or Twistlock

		Strength	Weight	
201432120	Screwgate	8,800 lbf.	6.8 oz.	\$19.95
201432130	Twistlock	8,800 lbf.	6.8 oz.	\$21.95



ISC STEEL OVAL CARABINER

Improved forged design with KeyLock to reduce snagging. This sleek new look is Zinc Plated.

Strength: 5,620 lbf (25 kN) Gate Opening: .7" (18mm)
Weight: 6.7 oz. (201 gm) BS EN 362.

		Strength	Weight	
201431120	Screwgate	5,620 lbf.	6.7 oz.	\$9.65
201431130	Twistlock	5,620 lbf.	6.7 oz.	\$17.95



ISC KL308 STEEL

A great lightweight steel D-shaped carabiner. Keylock gate design prevents webbing snags.

Dimensions: 4.125" x 2.125" (105 x 55mm) Gate Opening: .625" (17mm)

		Strength	Weight	
20141121220	Screwgate	7,868 lbf	6.2 oz.	\$26.95
20141121230	Twistlock	7,868 lbf	6.2 oz.	\$28.95
20141121240	Supersafe	7,868 lbf	6.2 oz.	\$29.95

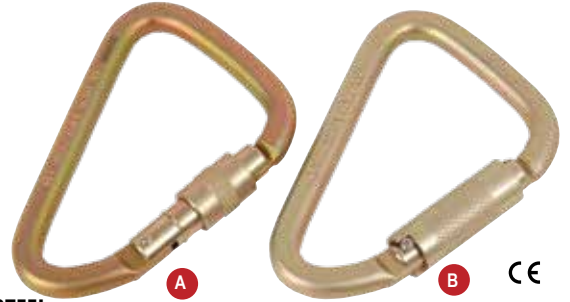

ISC KLETTERSTEIG STEEL

Classic large offset D design that provides more space for ropes and webbings. High strength. 3 gate locking styles.

		Strength	WLL	Weight	Dimensions	Gate	
A. 6053172	Screwgate	10,000 lbf.	1,000 lbs.	8.8 oz.	4.9" x 3.15"	1.0"	\$19.95
B. 6053170	Twistlock	10,000 lbf.	1,000 lbs.	8.8 oz.	4.9" x 3.15"	1.0"	\$21.95
6053171	Supersafe	10,000 lbf.	1,000 lbs.	8.8 oz.	4.7" x 3.15"	1.0"	\$22.95



RAPID LINKS

These links are often an inexpensive alternative to standard carabiners. They are most effective in applications for semi-permanent attachments. The Delta shape link is used where multi-directional loading is encountered. All the links are complete with a long threaded nut closure. Made in France.

	Galvanized Steel		Dimension	Gate	Strength	WLL**	Rating	
A. 60510112		12mm Widegate	4.85 x 2"	15/16"	13,780 lbf.	1,378 lbs.	General	\$18.50
B. 60510110		10mm Widegate	4.13 x 1.75"	13/16"	11,020 lbf.	1,100 lbs.	General	\$12.25
C. 60510108		8mm Widegate	3.4 x 1.45"	11/16"	7,165 lbf.	700 lbs.	Technical	\$8.85
D. 60510214		14mm Delta	4.75 x 3.3"	5/8"	19,840 lbf.	1,984 lbs.	General	\$27.50
E. 60510212		12mm Delta	4.1 x 2.9"	19/32"	12,125 lbf.	1,213 lbs.	General	\$19.25
F. 60510210		10mm Delta	3.4 x 2.6"	7/16"	9,920 lbf.	990 lbs.	General	\$12.50
G. 60510310		10mm Semi -Circle	3.4 x 2.7"	5/16"	9,920 lbf.	990 lbs.	General	\$19.00
	Stainless Steel							
F. 60511212		12 mm Delta	4.1 x 2.9"	19/32"	19,290 lbf.	1,920 lbs.	General	\$60.00
60511210		10 mm Delta	3.4 x 2.6"	7/16"	13,780 lbf	1,378 lbs.	General	\$40.00

STAINLESS STEEL CARABINERS



CE

KLETTERSTIEG STAINLESS STEEL

Stainless Steel version of the Kletterstieg Offset D rescue carabiner.

Strength: 35 kN WLL: 786 lbs. Dimensions: 4.9" x 3.15"
Gate Opening: 7/8"

	Style	Strength	Weight	
2014202230	Twistlock	7,868 lbf	9.5 oz.	\$42.95
2014202240	Supersafe	7,868 lbf	9.5 oz.	\$43.95



CE

FIREMAN STAINLESS STEEL

A high-grade version of the Fireman Carabiner. This unit has a side-open gate, for maximum clearance (48mm). Strength: 40 kN; WLL: 899 lbs; Dimensions: 7" x 3.7"; Gate Opening: 2.3"

	Style	Strength	Weight	
2014307130	Twistlock	8,993 lbf	13 oz.	\$100.95



CE

RD70 STAINLESS STEEL

A high-grade stainless steel version of our popular RD70 Carabiner.

Strength: 50 kN WLL: 1,124 lbs. (510 kg); Gate Opening: 1.4" (35mm) Dimensions: 4.9 x 2.9" (125 x 73mm)
Weight: 10 oz. (286 gm) Rating: General Use NFPA 1983, ANSI/OSHA compliant

	Style	Strength	Weight	
60511850	Screwgate	11,240 lbf.	10 oz.	\$48.95
60511860	Twistlock	11,240 lbf.	10 oz.	\$53.95



CE

STAINLESS STEEL OFFSET 'D'

Stainless Steel provides excellent corrosion resistance.

Strength: 35 kN WLL: 787 lbs. (358 kg) Gate Opening: .8" (20mm) Dimensions: 4.5 x 2.5" (118 x 64mm) Rating: General Use

NFPA 1983, ANSI/OSHA compliant

	Style	Strength	Weight	
6053120	Twistlock	7,870 lbf.	8.8 oz.	\$42.95
6053121	Supersafe	7,870 lbf.	8.8 oz.	\$43.95
6053123	Screwgate	7,870 lbf.	8.8 oz.	\$37.95

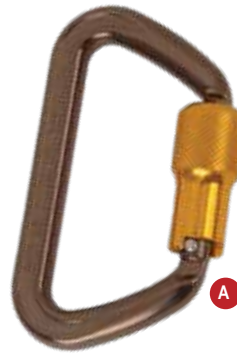

A CE



B CE



C CE



D CE



E CE

ANSI CARABINERS

ANSI COMPLIANT CARABINERS BY ISC

The new version of ANSI Z359.1 introduced a major change to the requirements for connectors. The new edition of the standard require the gates to be tested to 3600 lbf (17kN). All three gate directions (gate face load, side load, and minor axis load) are tested.

Meets NFPA 1983/ANSI/OSHA strength requirements.

		Strength	WLL	Gate	Dimensions	
A. 60528330	AD45 ANSI, Twistlock	10,117 lbf.	1012 lbs.			\$436.95
A. 60528340	AD45 ANSI, Supersafe	10,117 lbs.	1012 lbs.			\$37.95
B. 201420030	Offset D ANSI, Twistlock	11,241 lbf.	1124 lbs.	.8 in.	4.25 x 2.5"	\$25.95
C. 201420230	Kletterstieg ANSI Twistlock	11,240 lbf.	1124 lbs.	1.0 in.	4.9 x 3.2"	\$26.95
C. 201445530	Big Dan ANSI, Twistlock	11,241 lbf.	1,000 lbs.	1.0 in.	4.8 x 3.5"	\$31.95
E. 2014307230	Fireman, Stainless Steel ANSI Twistlock	8,992 lbf.	899 lbs.	1.88 in	7 x 3.7"	\$110.00
E. 2014307240	Fireman, Stainless Steel ANSI Supersafe	8,992 lbf.	899 lbs.	1.88 in	7 x 3.7"	\$115.00

ALUMINUM CARABINERS



AD45 ALUMINUM NFPA RESCUE CARABINERS

The AD45 is an aluminum version of our popular RD70 rescue carabiner. It is a high strength, light-weight carabiner built for rescue. Its shape is designed to bias the load towards the spine—the strongest part of the carabiner. Keylock gate design prevents webbing and rope snags. Meets strength requirements of NFPA 1983.

		Color	Strength		WLL	Weight	Dimensions	Gate	
A. 2014218200	Screwgate	Grey/Black	10,117 lbf.	45 kN	1011 lbs.	4 oz.	5" x 2.875"	1"	\$38.50
B. 2014218220	Screwgate w/ Pin	Grey/Black	10,117 lbf.	45 kN	1011 lbs.	4 oz.	5" x 2.875"	1"	\$40.50
C. 2014218300	Twistlock	Grey/Gold	10,117 lbf.	45 kN	1011 lbs.	4.2 oz.	5" x 2.875"	1"	\$39.50
2014218400	Supersafe	Grey/Red	10,117 lbf.	45 kN	1011 lbs.	4.2 oz.	5" x 2.875"	1"	\$40.50
2014218420	Supersafe w/ Pin	Grey/Red	10,117 lbf.	45 kN	1011 lbs.	4.2 oz.	5" x 2.875"	1"	\$42.50



ISC ALUMINUM CARABINERS

ISC manufactures an extensive line of superior quality aluminum carabiners. All carabiners conform to EN and ANSI standards and meet NFPA Light Use strength requirements. The unique shape of the ISC carabiners are designed to limit cross-loading. Since the sides of the minor axis are not parallel, cross loading causes the rigging point to slide to the ends resulting in transferring the load to the major axis. Available in Screwgate, Twistlock, Supersafe and ISC's exclusive Quadlock. Gates are color-coded to identify locking style. Offset D is complete with field-installable pin.

Meets NFPA 1983/ANSI/OSHA strength requirements.

		Dimension	Gate	Strength		WLL**	Weight	
A. 201420420	HMS, Screwgate	4.9" x 3.0"	.88"	6,745 lbf.	30 kN	675 lbs.	3.5 oz.	\$25.95
201420430	HMS, Twistlock	4.9" x 3.0"	.88"	6,745 lbf.	30 kN	675 lbs.	3.5 oz.	\$26.95
201420440	HMS, Supersafe	4.9" x 3.0"	.88"	6,745 lbf.	30 kN	675 lbs.	3.5 oz.	\$27.95
201420450	HMS, Quadlock	4.9" x 3.0"	.88"	6,745 lbf.	30 kN	675 lbs.	3.5 oz.	\$29.95
B. 201421631	Offset D, Twistlock	4.5" x 2.75"	.83"	6,745 lbf.	30 kN	675 lbs.	3.25 oz.	\$26.95

TECHNOTE

ISC ALUMINUM CARABINER GATE CONFIGURATION

The ISC Aluminum Carabiners have color-coded gate barrels for ease of identification. With the exception of the tactical versions, the gate marking is consistent through the AD40, HMS, Mongoose, and Gecko Lines.



UNITS OF MEASUREMENT

Pounds and kilograms are units of weight measurement (i.e. mass under the influence of gravity). Foot Pounds & kilo Newtons are the correct measurement of the force it takes to break an object. The conversion formula is pounds force(lbf.) = kilo Newtons (kN) divided by .004448.

ANSI REGULATIONS

ANSI fall protection regulations state that "locking type snap hooks shall have a self-closing, self-locking keeper." This statement is normally interpreted as meaning only auto-locking carabiners (snap-hooks) meet the standard.

TECHNOTE

TWISTLOCK VS. SUPERSAFE™

Supersafe gates are triple-action twistlock construction that requires three distinct movements to unlock the carabiner gate.

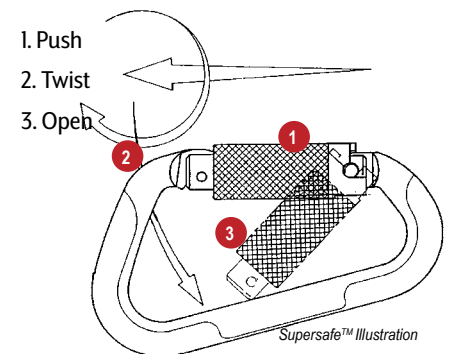

Twistlock gates are the fastest gate locking mechanism to operate. It provides a convenient solution to eliminating the chance that the gate will accidentally be left unlocked.

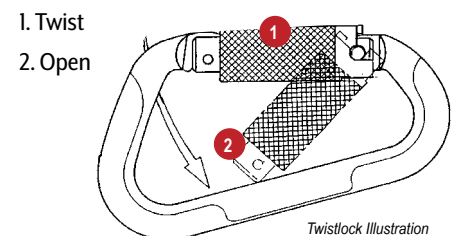



FORCE OVAL

The Force Oval carabiner offers multiple advantages over its D shaped cousin. The rounded external radius of the carabiner moves easily through hardware, and won't catch on webbing or other soft connections. And the symmetrical oval design offers predictable loading, making them perfect for aid climbing and rescue, where you don't want any load shifts when weighted ISO Cold-Forged from aircraft-quality aluminum. Generous gate opening.

Dimensions: 4.2" x 2.2"

	Shape	Style	Color	Strength	Weight	Gate Opening	Strength, Gate Open	
6050200	Oval	Non-Lock	Silver	4,946 lbf.	2.3 oz.	.59"	1,348 lbf.	\$8.95
6050230	Oval	Screwgate	Silver	4,946 lbf.	2.5 oz.	.47"	1,348 lbf.	\$13.50
6050210	D	Non-Lock	Silver	6,969 lbf.	2.3 oz.	.787"	2023 lbf.	\$8.95
6050250	D	Screwgate	Silver	6,969 lbf.	2.6 oz.	.630"	2023 lbf.	\$14.00



FORCE D

At 31kN (almost 7000lbs) the Force D is one of the strongest aluminum carabiners in the world. The Force D is an affordable, rock solid design, that has proven itself in the field around the globe. ISO Cold-Forged from aircraft-quality aluminum. Generous gate opening.

Dimensions: 4.2" x 2.15"



ISC ULTRALINK

Shackle/Roller offers the benefit of allowing a secured locked axle with the convenience of being quickly unlocked without tools. Three actions are required to open the SafeLock mechanism, and can easily be done with one hand using the thumb and forefinger. The specially shaped body of the link guards SafeLock button ensuring that risk of accidental depression is minimized. CE approved and manufactured from corrosion resistant Stainless Steel with a lightweight Aluminium Sheave. The bowed frame shape encourages correct loading, especially in minor axis orientation, and the high-vis sheave aids in locating the wheel if dropped.

Dimensions, Large: 2.3" x 2.7"

Dimensions, Small: 2.1" x 2.6"

MBS, Minor: 5620 lbf ; MBS, Major: 6744 lbf

MBS, w/ Pulley: 8922 lbf

PPE Regulation (EU) 2016/425 (including EN12278:2007)

	Style	Weight	
201412101	Large	6.4 oz.	\$69.95
201412100	Small	6.0 oz.	\$69.95



CLASSIC OVAL ALUMINUM CARABINER

Oval-shaped aluminium Non-Locking carabiner with a circular cross-section which makes it ideal for use with mobile devices (Pulleys, Ascenders, and Fall Arrestors). Key-Lock, Snag-free gate design. Non-Locking and Screwgate locking.

Gate Opening: .88" (22mm) Strength: 22 kN

	Style	Color	Strength (lbf.)	Weight (oz.)	
240173010	Non-Lock	Silver	4,946	2.1	\$12.49
240173011	Non-Lock	Black	4,946	2.1	\$14.49
240173014	Non-Lock	Red	4,946	2.3	\$14.49
240173020	Screwgate	Silver	4,946	2.3	\$15.69
240173021	Screwgate	Black	4,946	2.3	\$15.69
240173024	Screwgate	Red	4,946	2.3	\$16.29



OVALONE OFFSET OVAL ALUMINUM CARABINER

Oval aluminum carabiner with large gate opening. The wide symmetrical shape, allows a better positioning on mobile devices and their correct operation even if not perfectly aligned with the connector. Keylock gate design prevents snags. Slight offset shape gives higher strength than classic oval shape.

Gate Opening: .88" (22mm) Strength: 26 kN

	Style	Color	Strength (lbf.)	Weight (oz.)	
240171210	Non-Lock	Silver	5,845	2.4	\$13.49
240171220	Screwgate	Silver	5,845	2.5	\$15.79
240171222	Screwgate	Gold	5,845	2.5	\$17.29
240171224	Screwgate	Red	5,845	2.5	\$17.29



GUIDE OFFSET ALUMINUM CARABINER

Heavy load aluminum carabiner. The contact surfaces are wider to reduce wear and improve the passage of the rope. The D shape transfers the majority of the load on the main axis of the carabiner. Keylock system prevents snags.

Gate Opening, Non-Lock: .88" (22mm) Gate Opening, Screwgate: .76" (19mm) Strength: 30 kN

	Style	Color	Strength (lbf.)	Weight (oz.)	
24017130040	Non-Lock	Silver	6,745	2.3	\$14.09
24017130041	Non-Lock	Black	6,745	2.3	\$16.49
2401733020	Screwgate	Silver	6,745	2.5	\$16.79
2401733021	Screwgate	Black	6,745	2.5	\$19.99
2401733024	Screwgate	Red	6,745	2.5	\$18.39



CE

CURLYWIRLY TWISTED ALUMINUM CARABINER

The CurlyWirly carabiner from At Height features a 53 degree twisted body to effectively reorient the load from the rigging point. Perfect for use with the RD2 and Clutch. Marked with individual serial numbers.

MBS: 25kN Weight: 85g Gate Opening: 22mm Compliance: CE EN362

	Style	Color	
255111252	Screwgate	Pewter	\$32.00
255111254	Triple-Action	Pewter	\$33.50



CE

LARGE MULTI-USE ALUMINUM CARABINER

Oval aluminum carabiner with large gate opening. The wide symmetrical shape, allows a better positioning on mobile devices and their correct operation even if not perfectly aligned with the connector. Keylock gate design prevents snags. Slight offset shape gives higher strength than classic oval shape.

Dimensions: 4.45" x 3.86" (112 x 72mm) Strength: 27 kN Weight, Screwgate: 2.6 oz. (73 gm) Weight, Twistlock: 2.8 oz. (78 gm)

	Style	Color	Strength	
240173720	Screwgate	Silver	6,070 lbf	\$15.74
240173721	Screwgate	Black	6,070 lbf	\$18.84
240173724	Screwgate	Red	6,070 lbf	\$17.39
240173730	Twistlock	Silver	6,070 lbf	\$20.79
240173731	Twistlock	Black	6,070 lbf	\$21.19



CE

X-LARGE ALUMINUM MULTI-USE

Aluminum Alloy with Wide Opening

Light alloy carabiner with straight gate and wide opening. The particular D shape prevents the rotation of the carabiner and allows to distribute the load along the major axis. Keylock gate system that prevents any snagging on the rope and in the bolts.

Strength: 6745 lbf. (30 kN) Dimensions: 4.5" x 3" (114 x 76.5mm) Weight, Screwgate: 3.2 oz. (90 gm) Weight, Twistlock: 3.35 oz (95 gm)

	Style	Color	Strength	
240191120	Screwgate	Silver	6,745 lbf.	\$20.19
240191121	Screwgate	Black	6,745 lbf.	\$23.19
240191124	Screwgate	Red/Titanium	6,745 lbf.	\$19.75
240191130	Twistlock	Silver	6,745 lbf.	\$25.89
240191134	Twistlock	Red/Silver	6,745 lbf.	\$26.39



CE

PETZL ROLLCLIP-A

Pulley-carabiner with a gate opening on the pulley side that facilitates installation of the rope when the pulley is fixed to the anchor. It is available with an automatic TRIACT-LOCK locking system, or without a locking system. ROLLCLIP-A may be used with a CAPTIV positioning bar to favor loading of the carabiner along the major axis, to limit the risk of it flipping and to keep it integrated with the device.

Strength: 4,496 lbf. (20 kN) Weight: 4 oz. (115 gm) Gate Opening: .88" (22 mm)

	Style	Color	
235416744	Triact- Lock	Gold	\$52.95
235416740	Non-Lock	Gold	\$41.95



CE

PETZL ROLLCLIP-Z

ROLLCLIP Z is a pulley-carabiner with a gate opening on the non-pulley side to facilitate installation on anchors and devices. It is available in two locking systems: automatic TRIACT-LOCK system or manual SCREW-LOCK system.

Strength: 4,496 lbf. (20 kN) Weight: 4 oz. (110 gm) Gate Opening: .79" (20 mm)

	Style	Color	
235416755	Triact-Lock	Pewter	\$52.95
235416752	Screw-Lock	Pewter	\$46.95



CE

KONG OVALONE DNA STEEL ANSI

Special "helical-shaped" connector with a twisted carbon steel body and circular bar, a must-have when an "offset" load is required. The DNA permits 90° rotation of any connected device (descenders, rope clamps, fall arresters, etc.), optimizing the operating alignment. Double-locking Twistlock gate (requires 2 movements to open) or Triple-Locking Autoblock (requires 3 movements to open).

Dimensions: 4.25" x 2.56" Gate Opening: .71" Material: Carbon Steel Color: Black EN 362/M | ANSI/ASSE Z359.12

		Weight	Strength	
240141411031	Twistlock	8.16 oz.	8,993 lbf	\$42.99
240141411041	Autoblock	8.16 oz	8,993 lbf	\$46.39



CE

IRON WIZARD LADDER HOOK

Mid-Sized Rescue Ladder Hook

New Ladder Hook for use where space is limited. Ideal for use in confined spaces to reduce overhead length of rigging systems.

Strength: 70 kN Dimensions: 7 x 4" (125 x 73mm)

Rating: General Use CE EN362, Meets NFPA 1983

	Style	Strength	Weight	
6051186	Twistlock	15,737 lbf.	19.2 oz.	\$72.95
6051187	Supersafe	15,737 lbf.	19.2 oz.	75.95



CE

ISC FIREMAN CARABINER

The Fireman's Carabiner has a side-open gate, for maximum clearance (44mm for auto-locking versions, 49mm for the Screwgate model). The carabiner is supplied with a uninstalled captive-pin.

Strength: 40 kN WLL: 899 lbs Dimensions: 7" x 3.7"; Gate Opening: 2.3"; CE EN362, Meets NFPA 1983

	Style	Strength	Weight	
201430720	Screwgate	8,993 lbf	13 oz.	\$36.00
201430730	Twistlock	8,993 lbf	14.4 oz.	\$42.00



CE

ISC PEAR SCAFFOLD HOOK

Super-Large opening fits scaffold pipes and more.

Strength: 34.7 kN; WLL: 780 lbs; Dimensions: 8.6" x 5"; Gate Opening: 2.1"; CE EN362

	Style	Strength	Weight	
6053184	Twistlock	7,800 lbf	27.5 oz.	\$40.95



CE

ISC RIT RECOVERY HOOK

For Turnout Rescue Loop Attachment

Strong, yet lightweight, alloy aluminum locking hooks easily attach to NFPA Drag Loops. Webbing and rope slings can be attached to the rigging eye. Locking mechanism is easy to use while wearing structural gloves.

Strength: 35 kN WLL: 1,618 lbs. (735kg) Throat Opening: 2.326" (58mm) Dimensions: 9.5 x 5" (125 x 73mm) Rating: General Use CE EN362 NFPA 1983, ANSI/OSHA compliant

	Strength	Weight	
20149994	7,869 lbf	17 oz.	\$46.95



CE

TRIPLE ACTION SNAP HOOK

Our new Triple Action Snaphook requires 3 separate actions to open the gate. It retains the same strength and specifications of our standard Autolocking Snaphook. The standard Autolocking Aluminum Snap Hook was selected by RescueTECH for use in our EGRESS Escape Kits and PROBE Searchline kits because of its ease of use and dependability. Manufactured of forged aluminum.

Strength: 27 kN Gate Opening: .88" (22 mm)

	Strength	Weight	
20149034	6,070 lbf.	4 oz.	\$33.00



CE

AUTOLOCKING ALUMINUM SNAP HOOK

The Autolocking Aluminum Snap Hook was selected by RescueTECH for use in our EGRESS Escape Kits and PROBE Searchline kits because of its ease of use and dependability. Manufactured of forged aluminum, the autolocking gate is easy to open with structural fire fighting gloves. New frame design incorporates feature that protects locking mechanism.

Colors: Grey/Red (shown), Black Dimensions: 5.5" x 2.75" (137.5 x 68.8mm) Strength: 6,070 lbf. (27 kN) Weight: 4 oz. (108 gm) Gate Opening: .88" (22 mm)

		Color	
20149064	AutoLock Snap Hook	Grey/Red	\$28.95
20149081	AutoLock Snap Hook	Black	\$30.95



CE



D

CE



B



A

CE

ISC FORGED STEEL SWIVEL SNAPS

		Dimension	Gate	Strength	WLL**	Wgt	
201426030	Swivel Eye Twistlock	6.4" x 3"	.75"	8,993 lbf.	900 lbs.	12 oz.	\$55.95

Snaps are to be used in accordance with current ANSI / OSHA Fall Protection Standards.

NFPA 1983, ANSI/OSHA/BIS/DIN/EN compliant

**WLL - Recommended Working Load (also known as Safe Working Load) is calculated using the Industrial 10:1 critical use Safe Working Load Ratio.

RIGGING SWIVELS

Bearings Provide a Low Friction Rigging Tool

A handy tool for use where ropes or rigging must be free to rotate. Great for use in confined space rescues. Stainless Steel is stronger and more durable than comparable sized aluminum swivels.

*Certified NFPA 1983-G

**Meets NFPA 1983 Strength Specifications

		Length	Strength	WLL**	Opening Diam.	Weight	
A. 606468**	Stainless Steel	4.45"	10,000 lbf.	1,000 lbs.	.75"	9.6 oz.	\$210.00
B. 2354159*	Petzl Aluminum, Large	4.2"	8,093 lbf.	800 lbs.	.75"	6.4 oz.	\$74.95
C. 2354158	Petzl Aluminum, Small	3.3"	5,000 lbf.	500 lbs.	.5"	4.0 oz.	\$69.95
D. 243803812	Rock Exotica, SwivaEye T/L		6745 lbf	675 lbs.	.84"	5.5 oz.	\$101.00



CE

TWISTER ALUMINUM SWIVEL CARABINER

A forged all-aluminum frame swivel for lanyards and lifelines. Manufactured from forged aluminum, the Twister has an MBS of 5,500 lbf (25kN). Available in 2-stage Twistlock and 3-stage Supersafe gate closures.

Gate Opening: 5/8" (16mm) Rating: Technical Use

	Style	Strength	Weight	
201425530	Twistlock	5,500 lbf	5 oz.	\$47.95
201425540	Supersafe	5,500 lbf	5 oz.	\$48.95



CE

ALUMINUM SWIVEL SNAP HOOK

The Swivel Snap Hook is the next generation of our popular Autolocking Snap Hook. The swivel model takes the twist out of lifelines. It features a Safety Heel to reduce the risk of accidental opening and a 'Blind' nose design, to reduce rope snagging. Manufactured of forged aluminum, the auto-locking gate is easy to open with structural firefighting gloves.

Eye Diameter: .827" (21mm) Min Breaking Strength: 27 kN Gate Opening: .91" (23mm) Dimensions: 4.5" x 2" (112.5 x 50mm) Meets CE EN 362

	Strength	Weight	
20149040	6,070 lbf.	7.13 oz.	\$43.95



CE

QUICK RELEASE SNAP

with Swivel

Quick release under tension. Used where a line might have to be separated quickly from anchor during helicopter lifts, etc. NOT designed for continuous heavy duty use. Full size stainless steel construction.

Strength: 10,500 lbf. (46.7 kN) WLL: 1,050 lbs (477 kg) Bail Diameter: 5/8" (16mm) Dimensions: 4.4 x 2" (110 x 50mm) Rating: General Use



606302 Heavy Duty Quick Release \$215.00

RESCUETECH PULLEYS

SINGLE & DOUBLE

RT PULLEY DESIGN

Rescue Technology's technical rescue pulleys are built to last. Many of our pulleys are designed without the double bend sideplates found on most pulleys and replaces them with a continuous radius bend. This bend prevents the "un-springing" of the sideplates found in traditional double bend sideplates. The Rescue Technology pulleys also feature weight reducing holes in the sideplates. Most of our pulleys also will accommodate ropes up to 5/8" (16mm). This capacity means that one pulley will handle all of today's NFPA General and Technical Use ropes.

BEARING VS. BUSHING

In rescue loads, the friction difference between bushings and bearings is minimal. It is only with loads that are greater than 5,000 lbf. that you begin to see the difference in friction. Sealed bearings can become contaminated with grit and seize. Oil Impregnated bronze bushings are stronger because there is a constant interface between the shaft, bushing, and pulley sheave. The bronze bushing is made from a soft material that will conform to the contaminant.



RESCUETECH NFPA 2" SINGLE

For Ropes Up to 1/2" Diameter

A pulley that works well for all rescue and work needs. A compact, NFPA General Use 2" pulley that will fit almost all rescue needs.

Meets NFPA 1983/ANSI/OSHA strength specifications.

RESCUETECH NFPA 2.5" SINGLE

For Ropes Up to 1/2" Diameter

A new high-strength, long wearing design. Sideplate bend to the 3 carabiner rigging point reduces flexing and stresses put on bends during high load. 3/16" sideplates are designed to protect the rope as it travels through the pulley. 2.5" diameter sheaves are design for smooth running efficiency.

Meets NFPA 1983/ANSI/OSHA strength specifications.

RESCUETECH NFPA 3" SINGLE

For Ropes Up to 5/8" Diameter

The newest addition to our pulley line that will accept ropes up to 5/8" diameter. Built to the same precision standards and quality of our other pulleys, The NFPA Single, Large is the big daddy of our aluminum rescue Pulleys.

2" Single Pulley		Color	
61082104	Single Bushing	Red	\$46.95
61082114	Single Bearing	Red	\$66.95

2.5" Single Pulley		Color	
61083104	Single Bushing	Red	\$66.95
61083114	Single Bearing	Red	\$76.95

3" Single Pulley		Color	
61084104	Single Bushing	Red	\$76.95
61084114	Single Bearing	Red	\$91.95

PULLEY SPECIFICATIONS:

	Dimension	Tread Dia.	Strength	WLL	Weight	Max. Rope Dia.
2" Single	4" x 2.75"	1.6"	8,993 lbf.	899 lbs.	8 oz.	1/2"
2.5" Single	5.1" x 3.45"	2.1"	11,240 lbf.	1124 lbs.	11.2 oz.	1/2"
3" Single	6.25" x 4.15"	2.5"	15,737 lbf.	1574 lbs.	16 oz.	5/8"
2" Double	5" x 2.75" x 2"	1.6"	8,993 lbf.	899 lbs.	13.6 oz.	1/2"
2.5" Double	6.25" x 3.45" x 2"	2.1"	11,240 lbf.	1124 lbs.	19.2 oz.	1/2"
3" Double	7.5" x 4.15" x 2.25"	2.5"	15,737 lbf.	1574 lbs.	28 oz.	5/8"



RESCUETECH NFPA 2" DOUBLE

Compact 2" Double Pulley Design

Designed for ropes up to 1/2" Diameter. Lightweight and strong. Great for Technical rescues including tower and water rescue. NFPA General Use.

Meets NFPA 1983/ANSI/OSHA strength specifications.

RESCUETECH NFPA 2.5" DOUBLE

Small Sized, Heavy Duty Design

Designed for ropes up to 1/2" Diameter. High strength and lightweight makes this the ideal multi-use pulley for rescue. NFPA General Use. Meets NFPA 1983/ANSI/OSHA strength specifications.

RESCUETECH NFPA 3" DOUBLE

High Efficiency Double Pulley

Designed for ropes up to 5/8" Diameter. Larger sheave diameter increases efficiency of hauling systems.

Meets NFPA 1983/ANSI/OSHA strength specifications.

2" Double Pulley		Color	
61082204	Double Bushing	Red	\$76.95
61082214	Double Bearing	Red	\$101.95

2.5" Double Pulley		Color	
61083204	Double Bushing	Red	\$91.95
61083214	Double Bearing	Red	\$116.95

3" Double Pulley		Color	
61084204	Double Bushing	Red	\$126.95
61084214	Double Bearing	Red	\$151.95



2.5" PMP*2 SINGLE PULLEY

With Oilite Bushing

Strength: 50 kN WLL: 1124 lbs. (510 kg) Dimensions: 6.6" x 4.6" (168 x 117mm) Rating: General Use Meets NFPA 1983/ANSI/OSHA strength specifications.

	Strength	Weight	
61063106	11,240 lbf	14 oz.	\$60.00



2.5" DOUBLE PRUSIK MINDING PULLEY

With Oilite Bushing

Strength: 60 kN WLL: 1,000 lbs. (477kg) Dimensions: 7.5" x 4.6" (187.5 x 117mm) Rating: General Use Meets NFPA 1983/ANSI/OSHA strength specifications.

	Strength	Weight	
61063204	13,489 lbf.	23.2 oz.	\$95.00



RESCUETECH SPIN-LOCK PULLEY

Uni-Directional Pulley.

Great for raise / lower systems. Pulley sheave turns one direction making hauling easy and providing friction as the rope is belayed through the device.

Strength: 30 kN WLL: 1,120 lbs. (509 kg) Dimensions: 6.7" x 3.25 x 2.1" (167.5 x 8.3 x 52.5 mm) Rating: General Use Meets NFPA 1983/ANSI/OSHA strength specifications.

	Style	Strength	Weight	
2014700	Double	6,744 lbf.	26 oz.	\$189.95



Compact

Prusik Minding



SINGLE PULLEY WITH BECKET

Specialized rigging pulleys with aluminum or stainless steel sideplates and an aluminum sheave. By using the extra rigging hole at the bottom of the pulley, they can be daisy-chained together in block and tackle fashion.

		Dimensions		Weight	Strength	WLL	Max Rope Dia.	
20140344	Compact, Bushing	5" x 2"	126 x 52mm	6.3 oz.	8,093 lbf.	800 lbs.	1/2" 13 mm	\$50.95
61083504	Bushing	6.25" X 3.5"	157 x 88mm	12 oz.	11,240 lbf.	1124 lbs.	1/2" 13 mm	\$71.95
61083514	Bearing	6.25" X 3.5"	157 x 88mm	12 oz.	11,240 lbf.	1124 lbs.	1/2" 13 mm	\$86.95
61083510	Stainless Steel, Bearing	6.25" X 3.5"	157 x 88mm	12 oz.	11,240 lbf.	1124 lbs.	1/2" 13 mm	\$86.95

RESCUETECH EXTRACTOR™ CSR HAULER

The EXTRACTOR™ CSR HAULER pulley features an integral safety cam to secure the progress of hauling systems. The first in a series of Rescue Technology pulleys that meet the rugged requirements of Rope Rescue Technicians, the EXTRACTOR™ CSR HAULER is designed for 1/2" Life Safety Rope and will accommodate ropes from 3/8" - 9/16". Special safety cam design is rope friendly and can be locked out of the way when a standard double pulley is needed. Super-strong, the EXTRACTOR™ CSR HAULER has an 1,100 lb. safe Working Load Limit. EXTRACTOR-LOK version has special "one-way" roller bearings that allow the sheaves provide friction manually holding the load or when lowering (EXTRACTOR is not a belay device).

Dimensions: 8.75" x 3.1" x 2.2" Rating: General Use Meets NFPA 1983/ANSI/OSHA strength specifications.



		WLL	
614024	RT Extractor CSR, Double	1,100 lbs.	\$259.95
614025	RT Extractor-LOK, Double	1,100 lbs.	\$289.95
614014	RT Extractor CSR, Single	1,100 lbs.	\$219.95
614024C	Replacement Cam Release Cord		\$18.00

RESCUETECH STAINLESS STEEL PMP PULLEY

High strength pulleys designed for ropes up to 5/8" diameter. 2" and 3" sheave diameters. Features high grade stainless steel sideplates and aluminum or Stainless Steel pulley sheave. Extra large rigging point accepts two rescue carabiners. Available with bronze bushing or bearing.

Rating: General Use.

SINGLE PULLEY

		Sheave	Dimensions	Weight	Strength	WLL	Max Rope Dia.		
61082400	2" Single, Bushing	Aluminum	4 x 2.75"	10.1 oz.	8,993 lbf.	899 lbs.	1/2"	13 mm	\$56.95
61082410	2" Single, Bearing	Aluminum	4 x 2.75"	10.1 oz.	8,993 lbf.	899 lbs.	1/2"	13 mm	\$71.95
61084400	3" Single, Bushing	Aluminum	6.25 x 4.15"	22.2 oz.	11,240 lbf.	1124 lbs.	5/8"	16 mm	\$86.95
61084410	3" Single, Bearing	Aluminum	6.25 x 4.15"	22.2 oz.	11,240 lbf.	1124 lbs.	5/8"	16 mm	\$101.95
61082500	2" Single, Bushing	Stainless	4 x 2.75"	13.5 oz.	8,993 lbf.	899 lbs.	1/2"	13 mm	61.95
61082510	2" Single, Bearing	Stainless	4 x 2.75"	13.5 oz.	8,993 lbf.	899 lbs.	1/2"	13 mm	\$76.95
61084500	3" Single, Bushing	Stainless	6.25 x 4.15"	31.8 oz.	11,240 lbf.	1124 lbs.	5/8"	16 mm	\$91.95
61084510	3" Single, Bearing	Stainless	6.25 x 4.15"	31.8 oz.	11,240 lbf.	1124 lbs.	5/8"	16 mm	\$106.95



Single pulley

DOUBLE PULLEY W/ BECKET

		Sheave	Dimensions	Weight	Strength	WLL	Max Rope Dia.		
61082700	2" Double, Bushing	Aluminum	4 x 2.75"	16.9 oz.	8,993 lbf.	899 lbs.	1/2"	13 mm	\$91.95
61082710	2" Double, Bearing	Aluminum	4 x 2.75"	16.9 oz.	8,993 lbf.	899 lbs.	1/2"	13 mm	\$116.95
61084710	3" Double, Bearing	Aluminum	6.25 x 4.15"	38.2 oz.	11,240 lbf.	1124 lbs.	5/8"	16 mm	\$161.95
61082600	2" Double, Bushing	Stainless	4 x 2.75"	23.9 oz.	8,993 lbf.	899 lbs.	1/2"	13 mm	\$101.95
61082610	2" Double, Bearing	Stainless	4 x 2.75"	23.9 oz.	8,993 lbf.	899 lbs.	1/2"	13 mm	\$126.95
61084600	3" Double, Bushing	Stainless	6.25 x 4.15"	57.5 oz.	11,240 lbf.	1124 lbs.	5/8"	16 mm	\$146.95
61084610	3" Double, Bearing	Stainless	6.25 x 4.15"	57.5 oz.	11,240 lbf.	1124 lbs.	5/8"	16 mm	\$171.95



Double pulley w/ Becket



KOOTENAY ULTRA PULLEY

The original Kootenay knot passing pulley was proposed by the legendary Arnor Larson in the late '80's and was made by Rock Exotica. Two holes for tag lines, a dual bearing and other features make the Kootenay Ultra the most advanced pulley of its type.

Fits ropes from: 5/16" to 3/4" Strength: 39 kN WLL: 1350 lbs. (6 kN) Dimensions: 8.57" x 4.1" x 2.94" (218 x 104 x 75 mm)

	Strength	Weight	
2438160301	8,770 lbf.	25 oz.	\$250.00



KOOTENAY PULLEY

Designed for passing knots in rope.

High efficiency sealed ball bearings. Locking pins allow use as an anchor.

Fits ropes from: 5/16" to 3/4" Strength: 40 kN Sheave Diameter: 3" Height: 10.25" MBS: 40 kN WLL: 10 kN Rating: General Use

	Strength	Weight	
2354067	8,992 lbf.	49 oz.	\$229.95



PETZL REEVE

Carriage pulley for rescue on a tensioned highline

Combining two pulleys and a rigging plate, the REEVE carriage pulley is an integrated solution designed to simplify setting up rescue systems on tensioned highlines. It's compact design limits the number of connectors and the height of the system. Two large-diameter sheaves mounted on sealed ball bearings provide excellent efficiency when moving. Multiple connection holes to directly attach ropes, slings, or carabiners, allowing for better organization.

Strength: 36 kN; WLL: 8 kN; Weight: 650 gm; Rope Diameter: 7mm min, 13mm Max. Standard: CE EN 12278, NFPA 2500 General Use, UKCA, XF 494: FZL-H-T 9.5/13

2354160501	Reeve	\$239.95
------------	-------	----------



ROCK EXOTICA P51 OMNI-BLOCK 1.5

The Rock Exotica™ OMNI-BLOCK® is a mix of the old and the new. Up to now, rescue pulleys have been the standard side swing plate models that involve rotating the side plate and the introduction of the rope into the sheave. Increased strength is cited as the main reason that life safety pulleys are designed this way. Incredibly quick to attach, the Rock Exotica Omni-Block is a high strength, swiveling rope block/pulley. Each precision fabricated alloy block has a unique button-activated release feature that allows instant access to the sheave for midline attachment. The attachment eye accepts most carabiners and snaps.

Pulley 1.5" and accepts up to 1/2" rope. Strength: 8,093 lbf. (36 kN) WLL: 899 lbs. (409 kg.) Pulley Tread Dia.: 1.6" Dimensions: 5.25" x 2.5" Weight: 8.8 oz. (single) 14.4 oz. (Double) Rating: General Use Meets NFPA 1983/ANSI/ OSHA strength specifications for Pulleys

		Color	
2438161514	1.5 Single	Red	\$112.00
2438161511	1.5 Single	Black	\$113.00
2438162514	1.5 Double	Red	\$162.50
2438162511	1.5 Double	Black	\$165.00



ROCK EXOTICA AZTEK OMNI PULLEY SET

The special Rock Exotica pulley used in the Aztek "set-of-fours" system. When configured, these double blocks will enable the rescuer greater versatility in a personal mechanical advantage (PMA) for rescue and general rigging. Machined from a solid block of high strength aluminum the Aztek pulleys have two different style blocks and are color-coded for ease of identification.

Strength: 8,093 lbf. (36 kN) Dimensions: 4" x 2" x 1.75" Rating: General Use

	Description	
243816410	Aztek Pulley Set	\$280.00
243816419	Aztek Pin	\$22.00



ROCK EXOTICA P53 OMNI-BLOCK 2.0

A PMP version of Rock Exotica's Omni-Block. The Omni-Block 2.0" features a one-sided PMP function and swiveling rigging point.

Weight: 12.3 oz (348 gm) Breaking Strength, Single: 8,093 lbf (36 kN) Working Load: 800 lbs. (8 kN) Breaking Strength, Double: 8,993 lbf (40 kN) Working Load: 899 lbs. (4 kN) Max Rope Diameter: 1/2" (13 mm) Sheave Diameter: 2.0" (51 mm)

		Color	
24381615210	2.0 Single	Red	\$138.00
24381615211	2.0 Single	Black	\$138.00
24381615220	2.0 Double	Red	\$205.00
24381615221	2.0 Double	Black	\$205.00



ROCK EXOTICA P55 OMNI-BLOCK 2.6

The largest of the Rock Exotica Omni-Block Pulleys. Includes all the features of the other pulleys with a 2.6" diameter sheave.

Weight: 30.4 oz (850 gm) Breaking Strength: 17,986 lbf (80 kN) Working Load: 1,798 lbs. (20 kN) Max Rope Diameter: 1/2" (13 mm) Sheave Diameter: 2.6" (66 mm)

		Color	
2438161630	2.6 Single	Red	\$235.00
2438161631	2.6 Single	Black	\$240.00



PETZL SPIN PULLEY

for 7- 13mm ropes

Openable even when attached to the anchor, the SPIN pulley is designed for maximum simplicity in setting up hauling or load deviation systems, and tyroleans. The large diameter sheave mounted on sealed ball bearings gives it excellent efficiency. The swivel facilitates handling, allowing the pulley to be oriented under load, and direct connection of carabiners, ropes or slings. Efficiency: 95%.

		Sheave	Color	Strength	Weight	
2354160212	L1	Single	Gold	8,093 lbf	10.2 oz.	\$109.95
2354160211	L1	Single	Black	8,093 lbf	10.2 oz.	\$114.95
2354160222	L2	Double	Gold	8,093 lbf	17 oz.	\$159.95
2354160221	L2	Double	Black	8,093 lbf	17 oz.	\$164.95
2354160212D	L1D One-Way	Single	Gold	8,093 lbf	15 oz.	\$189.95



APEX 1.5 DOUBLE SWIVEL PULLEY

The Apex Double is equipped with two parallel sheaves and a becket, making it an excellent choice for setting up complex haul or dynamic deflection systems. Apex Pulleys has a user-friendly one-handed operation. One of the standout features of the Apex Double is its mid-line attach that ensures that the pulley remains securely locked until intentionally opened, enhancing safety during operations. Manufactured in the United States.

NFPA G Rated; MBS: 8,543 lbf.; Weight: 16.9 oz.; Dimensions: 6.68" x 2.89" x 2.27"

	Strength	Weight	
2540165130	8,543 lbf.	16.9 oz.	\$169.00



APEX 1.5 SINGLE SWIVEL PULLEY

This personal sized Apex Swivel Pulley offers both easy one-handed operation and unmatched security. The Apex is a mid-line attachable pulley that secures the rope using a low-profile, patented, triple-action lock mechanism. This lock is operated by three distinct actions: pivot the lock button, depress it, then swing open the side plate. operations. Manufactured in the United States.

NFPA G Rated; MBS 8,543 lbf.; Weight: 10.8 oz.; Dimensions: 5.9" x 2.9" x 1.13"; NPFA, CE, UKCA Certified

	Strength	Weight	
2540165120	5,395 lbf.	6.7 oz.	\$105.00



APEX 1.5 DIRECT

The Apex 1.5 Direct is a fresh approach to the conventional pulley. It's specifically designed to be used with soft attachments like prusiks, slings, and soft shackles. Used in this manner, the Apex Direct aligns the rope with the direction of the pull just like a swivel pulley does. It's compact and over 50% lighter than a comparable swivel pulley/locking carabiner combination. Low-profile, patented, triple-action lock mechanism. This lock is operated by three distinct actions: pivot the lock button, depress it, then swing open the side plate. Simply closing the side plate re-engages the lock mechanism and solidly secures the rope.

MBS: 8,543 lbf.; Sealed Bearings ; PMP Sideplates; Dimensions: 3.8" x 2.9"; Weight: 7.3 oz.;

	Strength	Weight	
2540165110	8,543 lbf.	7.3 oz.	\$91.50



OMNI 1.1 SWIVABINER

The Omni-Block SwivaBiner combines a swiveling carabiner and pulley into one tool, and incorporates a unique sideplate that opens while the pulley is still attached to the anchor. The Omni Swivabiner is available in both single and double sheave versions.

Single	Double
MBS: 23 kN	MBS: 25 kN
WLL: 5 kN	WLL: 7 kN
Max Rope Dia: 13mm	Max Rope Dia: 13mm
Weight: 4.9 oz.	Weight: 10.5 oz.
Dimensions: 4.4" x 2"	Dimensions: 7.2" x 2"
Certification: CE	Certification: CE

2438038211	Single	\$140.00
2438038221	Double	\$175.00



TWIN RELEASE

Releasable double progress capture pulley

Releasable, the TWIN RELEASE progress capture pulley is designed to set up 4:1 haul systems for work in confined spaces or for technical rescue. Releasing the cam is possible with the ergonomic handle. The brake integrated into the moving side plate and the main faceted sheave with single-direction rotation, offer additional braking and better control when lowering heavy loads. The two sheaves provide excellent hauling efficiency. The swivel facilitates operations, allowing the pulley to be oriented under load and direct connection of carabiners, ropes, or slings.

Weight: 800 g; Min Rope Dia: 8mm; Max Rope Dia: 13mm; Strength: 36kN

	Strength	Weight	
235416001	8093 lbf.	28.22 oz.	\$449.95

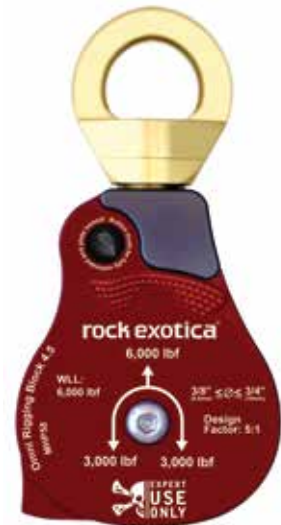

MATERIAL HANDLING PULLEY

A larger version of the Omni-Block 2.0. This high strength pulley is made for those high load material handling needs. Meets ASME B 30.26-15

MHP55: Weight: 1.9 lbs. (850 gm) Working Load: 4500 lbs. (20 kN) Max Rope Diameter: 1/2" (13 mm) Sheave Diameter: 2.6" (66 mm)

MHP58: Weight: 5.8 lbs. (2.6 kg) Working Load: 6000 lbs. (27 kN) Max Rope Diameter: 3/4" (19 mm) Sheave Diameter: 4.5" (114 mm)

		Color	
2438161640	2.6 Single	Red	\$255.00
2438161650	4.5 Double	Red	\$485.00



CE

ANTHRON BLOQUER MINI ASCENDER

Ascender for Rope Access

Manufactured of aluminum, the Bloquer fits ropes 8mm - 1/2" in diameter. The Bloquer may be used as a chest or small ascender. It may be attached to the harness with flat webbing or carabiner. It possess an auxiliary hole into which a second carabiner can be inserted, preventing the rope from falling out of the groove during climbing. Works with our new VANGUARD II, PRIME, and ADVANTAGE harnesses. Fits ropes 8mm - 1/2".

Color: Blue Dimensions: 4.75" x 3.25" x 1.4" (118.8 x 81.3mm) Rating: General Use Certified EN567. Meets NFPA 1983 strength specifications for ascenders.

602305 Bloquer Ascender **\$70.00**

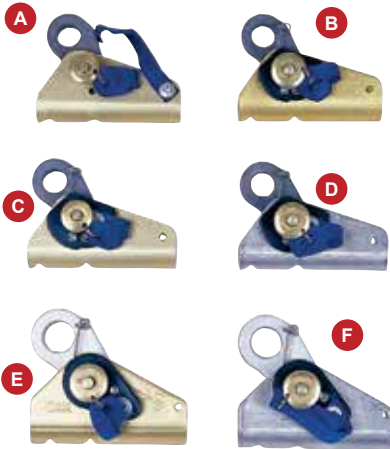

CE

ANTHRON CHEST ASCENDER

Chest Ascender for Rope Access

Manufactured of aluminum, the Anthron fits ropes 8mm - 1/2" in diameter. Works with our new VANGUARD II, PRIME, and ADVANTAGE harnesses.

Color: Blue Dimensions: 4.6" x 2.9" (115 x 72.5mm) Weight: 4.9 oz. (118 gm) Rating: General Use Meets NFPA 1983 strength specifications for ascenders.

602306 Chest Ascender **\$61.25**



CE

ANTHRON HANDLED ASCENDER

A great new handled ascender.

Manufactured of aluminum, the Anthron fits ropes 8mm - 1/2" in diameter. Special grip material on handle is very comfortable and is slip-resistant.

Dimensions: 7.6" x 3.6" (190 x 90mm) Weight: 8.5 oz (204 gm) Rating: General Use Meets NFPA 1983 strength specifications for ascenders.

		Color	
602301	Left Hand	Gold	\$80.00
602302	Right Hand	Blue	\$80.00

GIBBS ASCENDER

One of the strongest closed cam type of rope-grab ascenders. Rounded tooth cam design minimizes rope wear yet holds on wet or icy ropes. New spring attachment increases cam's range of motion to decrease chance of spring breakage. 1/2" model attaches to synthetic ropes 5/16" to 1/2"; 3/4" version accommodates synthetic ropes from 5/8" to 3/4". The spring-loaded type is always in locked position and is recommended for general rescue use. For use on kernmantle rope only.

Meets NFPA 1983 strength specifications for ascenders.

		Cam Type	Strength	Weight	Rating	
A. 602011	1/2" Aluminum, Free Running	Forged	2,500 lbf.	7 oz.	Technical	\$62.00
B. 602012	1/2" Aluminum, Spring Loaded	Forged	2,500 lbf.	7 oz.	Technical	\$62.00
C. 602012F	1/2" Aluminum, Spring Loaded	Forged	5,200 lbf.	9.2 oz.	General	\$75.00
D. 602112	1/2" Stainless Steel, Spring Loaded	Forged	5,200 lbf.	12 oz.	General	\$75.00
E. 602013	3/4" Aluminum, Spring Loaded	Forged	5,200 lbf.	14 oz.	General	\$78.00
F. 602113	3/4" Stainless Steel, Spring Loaded	Forged	5,200 lbf.	20 oz.	General	\$78.00
G. 602201	Replacement Spring Kit					\$24.00
H. 602263	Klimair Mechanical Prusik, 1/2" rope only	Machined	5,000 lbf.	5.6 oz.	General	\$105.00



CE

ISC RESCUE ASCENDER

Manufactured from high strength aluminum alloy. Machined from thick walled extrusion for extra durability. Shell has special curved rope interface section for superior rope strength and minimized rope damage. Rigging point will accommodate all of our carabiners and will pass many locking collars. Quick-attach pip pin for easy attachment. For use on kernmantle rope only.

Rating: General Use Meets NFPA 1983 strength specifications for ascenders. BS EN 567 Certified as Rope Clamps

		Rope Dia.	
602251	Standard	7/16" - 1/2"	\$91.95
602252	Large	5/8"	\$96.95



HARKEN NINJA MULTIASCEND

The Ninja MultiAscend is engineered to provide increased efficiency in a range of applications. The dual cam design enables the MultiAscend to act as both a chest ascender as well as a full point of attachment. The innovative dual-stage locking swingplate ensures consistent engagement with the rope, preventing unwanted detachments. In addition, the external release triggers make adjusting the Ninja MultiAscend safe and easy when used as an ascender or a progress capture device on a safety line. Compatible with rope diameters 9-13mm per EN567:2013 Compatible with rope diameters 11-13mm per EN12841:2006 Type B Max Rated Load: 140kg

233609403 Ninja Multiascend \$189.00



PETZL RESCUCENDER

Openable cam-loaded rope clamp

Simple to use and ergonomic, the RESCUCENDER is an openable cam-loaded rope clamp designed for use in haul systems as a tractor or progress capture device. Independent safety catches on each side of the device allow easy opening while reducing the risk of accidental opening. These safety catches are equipped with indicators that show when they are unlocked. For use with 9mm - 13mm rope.

Certifications: CE EN 12841 type B, NFPA 1983 Technical Use.

23540250 Gold \$109.95



ISC STRYDER FOOT ASCENDER

Durability and functionality were at the top of the list during the development of the STRYDER. By utilizing established ascender geometry, the STRYDER provides smooth upward movement and positive rope engagement. Fully adjustable on both the horizontal and vertical straps. Protective under-foot sleeve is made from a product specific webbing. Using the same unique stainless steel cam as the PRO ascender, the cone-shaped cam face grabs the rope with minimal wear. A removable foot lever can be used to open/close the cam with the other foot.

Fits ropes 5/16" - 1/2" (8-13mm) Dimensions: 3" x 2" x 1" (75 x 52 x 25mm) WLL: 308 lbs. Weight: 7 oz (198 gm)

	Description	MBS	
2014182274	Right	562 lbf	\$86.95
2014182275	Left	562 lbf	\$86.95

DELUXE ASCENDER SLING SET

Can be configured for both Texas and "Frog" style ascending systems. Simply attach slings via rapid link or girth hitch to ascenders. Adjustable harness attachment slings give this set a wide size range. Manufactured of high quality 1" nylon webbing. Two slings attach to a seat/chest harness. The double foot loops connects a second ascender to the rescuers feet. Special adjuster for the foot loops help prevent loops from sliding off boots. Kit includes: Ascender sling set, Ascenders (2), carabiner, rapid links (2), and storage pouch.

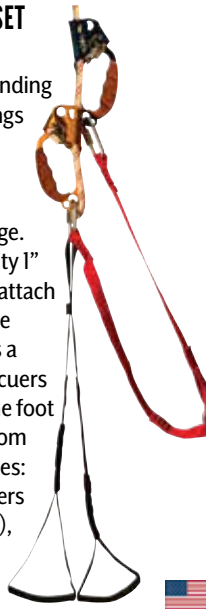

Ascenders, Rapid Links and Carabiners included in Kit only

6024334	Deluxe Ascender Sling Set	\$50.00
6024334A	Deluxe Ascender Sling Kit	\$315.00

CE



DOUBLE FOOT SLING

For those times where a single foot loop will not work, the RescueTECH Double Foot Sling fits the need. A handy sling that, when used with a handled ascender, allows the rescuer to climb up a rope. Easily attaches to ascender with rapid link or girth hitch. Foot loops held open by special stiffener.

6024321	Double Foot Sling	\$42.00
60510106	Connector Link	\$4.50

ADJUSTABLE FOOT SLING

A handy sling that, when used with a handled ascender, allow the rescuer to climb up a rope. Easily attaches to ascender with rapid link (link not included). Adjustable length.



6024301	Adjustable Foot Sling	\$28.00
60510106	Connector Link	\$4.50



CE

ISC D4 / D5 BELAY DESCENDER

Special descender / belay device that easily controls 500-600 lb loads. Side plate rotates to the closed position with a low-profile, spring loaded safety catch. Simple functional design. Can be placed onto the rope without removing rigging carabiner. Rotate handle counter-clockwise to lock in place. Rotate right to descend or lower load. Rotating handle too far clockwise will engage panic stop function. Continued clockwise rotation re-sets the unit. The ISC D4 and D5 are true panic stop devices rather than panic brake devices. The difference is that once the panic stop is activated, no other force must be applied to the device. A panic brake style device requires a force input to continue the braking function. Can be used for progress capture in hauling systems and allows rapid conversion between raising and lower. 4mm high strength sideplates and stainless steel cam for superior durability. 5 kN Slip Load

EN12841; Meets NFPA 1983 General Use, ANSI Z359.4:2013; EN341

	Description	WLL	Rope Size	Dimensions	Weight	Colors	
20148804	D4	530 lbs	7/16" (10.5 - 11.5mm)	5.5" x 3.25" x 3.78"	23 oz.	Red	\$269.95
20148801	D4					Black	2479.95
20148824	D5	530 lbs	1/2" (12.7mm)	6" x 4" x 3.5"	28.8 oz.	Red	\$299.95
20148821	D5					Black	299.95



CE

ISC D4 PRO / D5 PRO BELAY DESCENDER

The standard D4™ Work/Rescue Descender has proven to be a popular Descender amongst Rope Access & Rescue users, all over the world. Many users value the extra peace of mind of having a panic-brake function. But, some users actually need less.

Feedback gathered from highly qualified and experienced 'Pro' users highlighted a demand for a device which does not incorporate a panic-brake function. Enter the D4 PRO and D5 PRO! The PRO style descender is the same great Work/Rescue Descender, but without the panic brake. This can be particularly useful on longer descents and in rescue/belay applications, where a broader 'sweet spot' is welcomed.

As the "PRO" does not incorporate a panic-brake, it is not possible for the device to fully meet the criteria of ANSI Standards. The D4 PRO and D5 PRO are fully certified to EN 12841 (a panic brake is not a compulsory criteria of this standard).

EN12841; Meets NFPA 1983 General Use

	Description	WLL	Rope Size	Dimensions	Weight	Colors	
20148811	D4 PRO	530 lbs	7/16" (10.5 - 11.5mm)	5.5" x 3.25" x 3.78"	24 oz.	Black w/ Red	\$269.95
20148831	D5 PRO	530 lbs	1/2" (12.7mm)	6" x 4" x 3.5"	28.8 oz.	Black w/ Red	\$299.95



CE

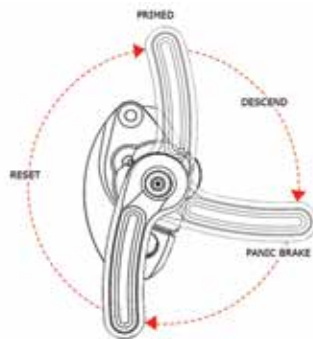



PETZL I'D® EVAC

Self-braking descender with anti-panic function for lowering from an anchor

The I'D EVAC self-braking descender is primarily designed for lowering from an anchor. The ergonomic handle is specifically oriented for managing a load from the anchor and offers comfortable descent control. The integrated anti-panic function and anti-error catch limit the risk of an accident due to user error. The AUTO-LOCK system allows the rope to be automatically locked without having to manipulate the handle or tie off the device. Once locked, the rope can be taken up without having to manipulate the handle. The safety gate allows the rope to be installed with the device remaining connected to the anchor. I'D EVAC is compatible with 10 to 11.5 mm ropes and allows handling of loads up to 250 kg.

Weight: 21.7 oz (615 gm) Maximum working load for one person: 150 kg Maximum working load for two persons (rescue): 250 kg Certification(s): EN 341 type 2 class A, CE EN 12841 type C, ANSI Z359.4, NFPA 1983 Technical Use

		Rope Dia.	
23540320	I'D EVAC (Yellow)	10-11.5 mm	\$359.95
23540321	I'D EVAC (Black)	10-11.5mm	\$379.95



PETZL I'D® NFPA

For Descending and for Belaying, with Anti-Panic

Swinging side plate with safety catch decreases risk of dropping device and allows rapid installation of the rope into the device. Anti-error feature helps avoid accidents due to incorrect installation of the rope in the device. Self-braking system: if the handle is released during descent, the cam rotates to pinch the rope and brake the user's descent. Anti-panic handle: the I'D® will lock onto the rope if the user pulls too hard on the handle. To descend, simply pull on the handle; the rate of descent is controlled by varying the grip on the free end of the rope with the other hand. For work positioning, the handle can be rotated to secure the I'D® in place on the rope, thus eliminating the need to "tie off" the device. May be used as a progress capture device in a haul system; allows rapid conversion between raising and lowering. Individually tested.

Weight: Large: 22.4 oz. (625 gm) NFPA Rating: General Use CE EN 341 class A, Large: NFPA G. Small: NFPA

		Rope Dia.	
2354120N	Large - NFPA G	11.5-13 mm	\$339.95
2354120S	Small - NFPA L	10-11.5 mm	\$339.95

ANTHRON DSD PLUS DESCENDER

Descender with double locking and anti-panic system: self braking in case of accidental loss of descent control. Sensitive rubberized handle enables smooth descent without harmful rope twisting. No movable flanges which makes it a robust and less likely for mistakes. No need to unclip the device for rope insertion. Also suitable for work at a height and for emergency self evacuation. Rope and carabiner not included.



DSD PLUS Features: • Longer Handle – allows gentle and progressive braking • New Cam Tested for higher loads enhanced braking in both stop positions. • Diminished possibility of incorrect insertion of the rope. • Even incorrect insertions will not result in a fall as the rope is blocked. • Integrated WEAR INDICATOR. • High strength plain bearing added to the pivoting cam.

Strength: 4946 lbf (22 kN) Weight: 140 grams Rope diameter: 7/16" (11mm) Certification: EN 341 Class2A:2011 and - EN 12841 TypeC:2006

60100871 DSD Plus Black \$145.00

ROCK EXOTICA ENFORCER LOAD CELL

Rescue Load Cell with Case

Compact aluminum load cell that measures force up to 4,500 lbf (20 kN). Two sampling modes allows monitoring of rescue systems, and log drop testing in high resolution. Unique features like Bluetooth connectivity and swivel attachment. Includes custom Case. Lightweight aluminum construction. Compact & portable design facilitates "in-line" use in rigging systems. Swivel attachment points diminish potentially dangerous torsional and off-axis forces. Features two sampling modes: "Slow" for monitoring and "Fast" for drop testing. Monitor forces wirelessly on your iPhone with built-in Bluetooth connectivity. (Enforcer app required. Sold separately) Record and download graphs of 4-second dynamic events. Measures and records maximum force in kg, lbf and kN.

Max Reading: 4500 lbf (20 kN) MBS: 8093 lbf (36 kN) Accuracy: +/- 2% Length: 8" (203mm) Width: 2.1" (53mm) Weight: 14 oz. (397 gm) w/ batteries Certification: EN795 & EN354 CE 0120

243812031 Enforcer Load Cell \$1,090.00



REMOTE RETRIEVAL HOOK

Hold-Tite Pole Adapter Holds Hook

A Retrieval Hook that allows the attachment of a retrieval line to an entrant without entering the confined space. The Remote Retrieval Hook is held open so the rescuer can connect it to a harness D ring. As soon as the snap is engaged a simple tug will lock the Hook to the harness. Sling may be attached to end of retrieval line for victim rescue. Comes complete with auto-locking snap and nylon sling. Extension Pole with Hook Adapter sold separately. Hook Materials: Stainless Steel w/ protective plastic shroud.

Gate Opening: .75" Hook Strength: 5,000 lbs.

Remote Retrieval Hook and Pole sold separately.

		Length	
616101	Retrieval Hook w/ Sling		\$74.00
616112	Extension Pole	6' - 12'	\$88.00
616124	Extension Pole	8' - 24'	\$120.00
616200	Storage Bag	6' - 12'	\$41.00
616210	Storage Bag	8' - 24'	\$50.00

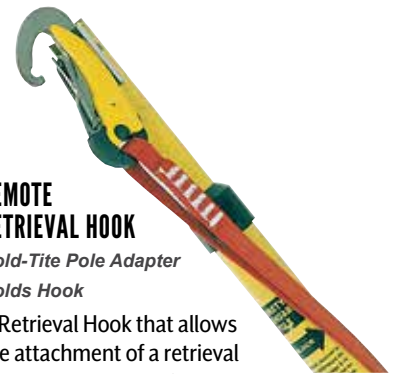



RESCUETECH™ STEEL RESCUE 8

Three Dimensional Design

Forged Steel Rescue 8 Descender. For ropes up to 3/4" diameter. Three dimensional design allows user to vary friction depending on which way the descender is used. Drop forged. Chromium Plated Silver.

Tensile Strength: 15,000 lbf. (66.7 kN) WLL: 1,500 lbs. (682 kg) Dimensions: 6.5" x 6" (16.5 x 15.2 cm) Weight: 24 oz. (680 gm) Rating: General Use

Meets NFPA 1983/ANSI construction specifications for Descenders.

	Color	
6010070	Silver	\$55.00
6010071	Black	\$58.00



CE

ISC ALUMINUM RESCUE 8 DESCENDER

Our alliance with ISC has created several new items such as this classic aluminum rescue descender. Made from forged aluminum for great wear resistance.

Dimensions: 6.75" x 6" (17.2 x 15.2 cm) Weight: 7.2 oz. (204 gm) Minimum Strength: 7,868 lbf. (35 kN) Rating: General Use

Meets NFPA 1983/ANSI construction specifications for Descenders.

	Color	
60114111	Charcoal	\$45.95
60114110	Silver	\$44.95



CE

ISC STAINLESS STEEL RESCUE 8 DESCENDER

The Rescue figure 8 devices have extended side bars to keep the rope in place, preventing the rope from creeping inwards and causing unwanted locking. Made from forged Stainless steel for great wear resistance.

Dimensions: 6.375" x 5.875" (16.2 x 14.9cm) Weight: 21.2 oz. (600 gm) Minimum Strength: 17,985 lbf. (80 kN) Rating: General Use

Meets NFPA 1983/ANSI construction specifications for Descenders.

60114310 \$60.95



CE

RESCUETECH™ STAINLESS STEEL COMPACT RESCUE 8

A small rescue 8 with the durability and strength of Stainless Steel. Only 5.7" long, this tough unit will fit into almost all rescue kits.

Dimensions: 5.7" x 5.3" (14.5 x 13.5 cm) Weight: 15.2 oz. (431 gm) Strength: 9000 lbf.

240180510 \$44.00



RESCUETECH™ FIGURE 8

Traditional Design

The RescueTECH Figure 8 is an economical anodized figure 8 descender for light duty use. Forged aluminum construction.

Rappel/Belay Usage Strength: 7,000 lbf (31 kN) WLL: 700 lbs. (318 kg) Dimensions: 5 1/2" x 2 7/8" (14 x 7.3 cm) Weight: 4 oz. (113 gm) Rating: General Use.

Meets NFPA 1983/ANSI construction specifications for Descenders.

	Color	
601311	Black	\$13.00
601316	Blue	\$13.00



SCARAB

The SCARAB is a small, simple device that can easily control heavy rescue loads, as well as excel at pick offs, twin rope systems and other general rescue techniques. Does not twist the rope and has instantly adjustable friction (just wrap a horn). Lower 600 lb loads with two fingers • Super easy lock off • Right or left handed • Single and double rope capable • Attach rope without unclipping from anchor. The Scarab® FR meets NFPA 1983 (12 ED) "G" (general use) for 12.5mm rope.

		Material	For Rope Diameter	Weight	
21136011	SCARAB Ti	Titanium	6 - 11mm	6.6 oz.	\$249.95
21136010	SCARAB FR	Stainless Steel	9 - 13mm	13.8 oz	\$149.00



Technical rescue and safety is potentially hazardous. Any person using equipment sold by RESCUE TECHNOLOGY in any manner is personally responsible for learning the proper techniques involved, and assumes all risks and accepts full and complete responsibility for any and all damages or injury of any kind, including death, which may result from the use of any RESCUE TECHNOLOGY equipment.

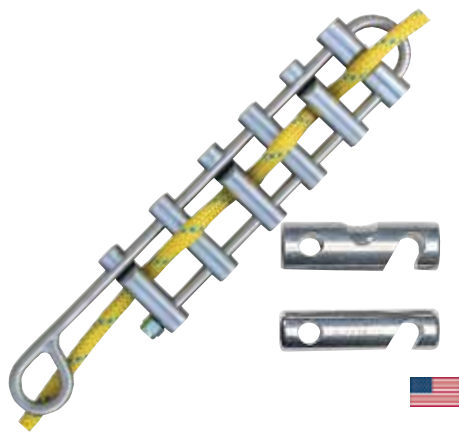

RESCUETECH RAPPEL RACK

This is the classic design developed in the 1960's. Primarily designed as a personal rappel device on a single rope 3/8" to 1/2" in diameter. Top Bar and Top Bar - Hyperbar has a training groove on one side to assist in guiding the rope and aid in proper rigging.

Length: 14" (35 cm) Weight: 24.8 oz. (703 gm) Rating: Technical Use

Meets NFPA 1983/ANSI strength specifications for Descenders.

601024W Rappel Rack \$82.00

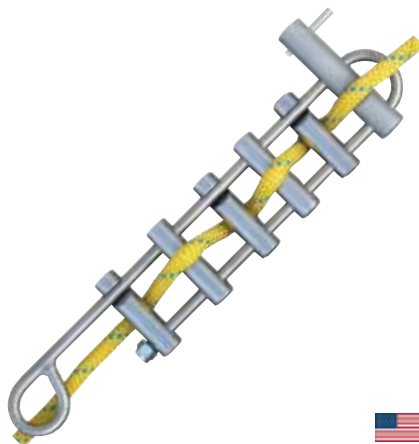

RESCUETECH RESCUE RAPPEL RACK

This is an upgraded version of our popular rappel rack. Large bars provide greater strength and control of rescue loads. Top Hyperbar aids in lock-offs. Grooved bars help guide the rope through the rack.

Length: 14" (35 cm) Weight: 28.8 oz. (816 gm) Rating: General Use

Meets NFPA 1983/ANSI strength specifications for Descenders.

601124 RescueRappel Rack \$96.00

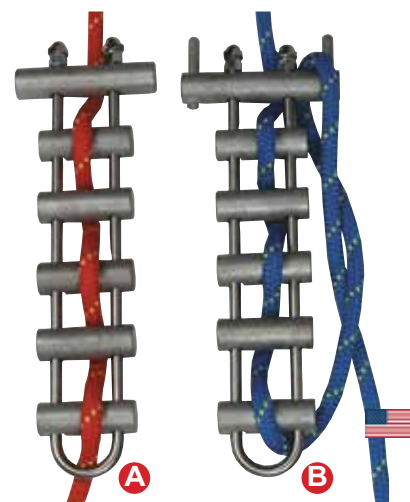

RESCUETECH RESCUE RACK™

Superior Control of Rescue Loads

The safest, heavy duty lowering and rappelling device. Can be placed onto rope at any point. Friction may be varied by sliding easily rigged bars up or down - even while on rappel or during lowering operations. Specially designed straight cut 1" aluminum friction bars help prevent mis-rigging. Extended top bar for quick lock-off. Accommodates ropes from 1/4" to 1 1/2" or double ropes up to 3/4". One person can easily control a 1,000 lb. load. Frame manufactured of 304 stainless steel and will accommodate four 13mm carabiners. Special design of the frame distributes the load between both sides of the unit.

Tensile Strength: 10,000 lbf. (44.5 kN) WLL: 1,000 lbs. (455 kg) Dimensions: 14" (35 cm) Weight: 35.2 oz. (997 gm)

Rating: General Use

Meets NFPA 1983/ANSI strength specifications for Descenders.

A. 601102	Standard	\$80.00
B. 601202	Hyperbar	\$90.00



PETZL RACK

Variable friction descender with brake bars

The design and configuration of the RACK bars make it easy to set up and insert the rope. Compact and lightweight, the device allows the user to adjust the amount of friction during the descent, to adapt to changing conditions.

For ropes: 8 - 11mm WLL: 220 lbs.

23540411 Petzl Rack \$129.95

HALO RIGGING ANCHORS

A standard size multi-hole rigging plate. Manufactured of aerospace grade aluminum and feature uniquely shaped apertures which allow for loading with multiple carabiners simultaneously. CNC machined radiused edges make the apertures rope and webbing friendly.

The HALO Rigging Plates form part of a compatible system and were developed to match the ratings on our carabiners and pulleys, at 40kN/ (8992lbf), 50kN (11,240lbf) and 70kN (15,736lbf).

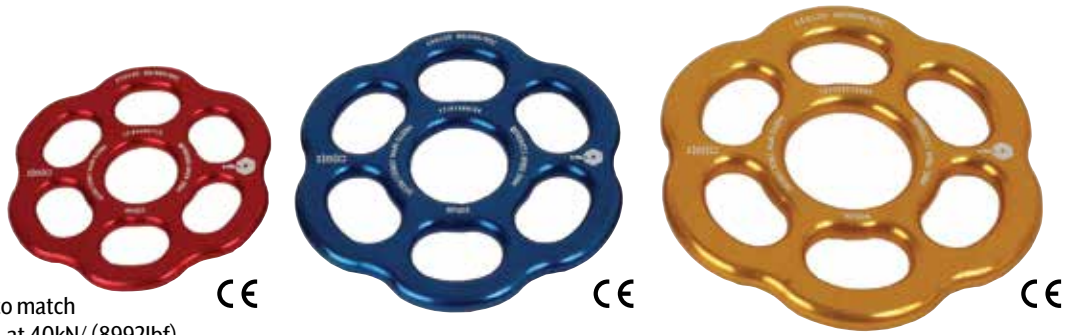

	Description	Color	Strength	Dimensions	
6032244	Small	Red	8,993 lbf (40 kN)	4.57" (115mm)	\$58.95
6032256	Medium	Blue	11,240 lbf (50 kN)	5.72" (144mm)	\$88.95
6032262	Large	Gold	15,737 lbf (70 kN)	6.55" (165mm)	\$111.95



MICRO RIGGING PLATE

The smallest rigging plate in the Rescue Technology line. Made from 1/4" alloy aluminum plate, the Micro Rigging Plate is both strong and lightweight. Ideal for Search and Rescue, Climbing, and Litter Bridles.

Strength: 8,094 lbf (36 kN) WLL: 800 lbs (364 kg) Length: 3.5" (87.5mm) Width: 3.25" (81mm) Hole Size: 3/4" (19mm) Weight: 2.4 oz. (68.2 gm) Rating: General Use

603214	Red	\$32.95
6032141	Black	\$32.95



ROCK EXOTICA ROCKSTAR RIGGING POINT

A new generation of rigging plate. Triangular shaped and allows you to position in three dimensions

Weight: 7.4 oz (209 gm) Height/Width: 3.7" x 3.0" x 2.6" (93 x 75 x 65 mm) Breaking Strength: 8093 lbf. (36 kN)

Certification: CE / NFPA G

243818220	Rockstar 3D RigPlate	\$145.00
-----------	----------------------	----------

TECHNICAL RESCUE RIGGING PLATE

A standard size multi-hole rigging plate. Manufactured of alloy aluminum.

Strength: 12,365 lbf. (55 kN) WLL: 1,236 lbs. (562 kg) Length: 6.25" (165.6mm) Width: 3.75" (108mm) Hole Size: 3/4" (19mm) Weight: 8 oz. (262gm) Rating: General Use

603215	Blue	\$50.95
6032151	Black	\$50.95

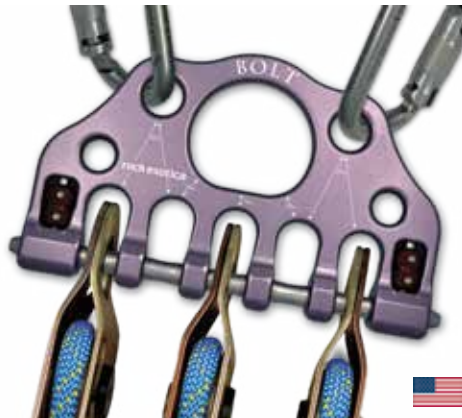

ROCK EXOTICA BOLT RIGGING PLATE

The BOLT rig plate uses a quick-detachable stainless steel rod, or 'bolt', that allows you to connect your gear directly to the five connection points without using carabiners. The result is a cleaner connection, and when pulleys are involved, more efficient use of space when lined up side by side than when using a traditional rigging plate. Carabiners and Pulleys NOT included.

MBS: 36 kN; Dimensions: 8" x 5"; Weight: 17.25 oz.

243818165	The Bolt	\$190.00
-----------	----------	----------

MAGNUM RIGGING PLATE

Large size and 15 holes to accommodate multiple rigging needs. Manufactured of alloy aluminum.

Strength: 12,365 lbf. (55 kN) WLL: 1,236 lbs. (562 kg) Length: 9.75" (249mm) Width: 5.875" (150mm) Hole Size: 3/4" (19mm) Weight: 16 oz. (471gm) Rating: General Use

603216	Magnum Rigging Plate	\$102.95
--------	----------------------	----------



SMC ORIGIN TT

The Origin TT multi-purpose rigging plate improves the rigging and performance of Twin-Tensioned Rope Systems (TTRS). The Origin TT employs two quick-release locking pins. This enables independent attention to either of the twin devices managing ropes in the system, while the other remains safely tensioned. The five attachment points on the anchor side enable rigging of 'SERENE' systems (Systems Strong, Equalized, Redundant, Efficient with No Extension potential.)

Weight: 18.4 oz. (521g) • Dimensions: 7.5" x 4.5" x 7/8" (19 x 11.4 x 2.2cm) MWL: 11kN • MBS: 45kN (10116 lbf) • CE Certified: PPE Regulation (EU) 2016/425. • NFPA Certified: NFPA 2500 (1983) 2022 ED "G" card • Made In USA

2540130400	Origin TT	\$249.00
------------	-----------	----------



ASAP® / ASAP® LOCK

Mobile fall arrest device for rope.

With its unique locking system, the ASAP sets the standard in fall protection for workers at height. In normal use, the device moves freely along the rope without any manual intervention and follows the user in all his/her movements. In case of shock or sudden acceleration, the ASAP locks on the rope and stops the user. Depending on use, the ASAP may also be combined with an ASAP'SORBER or ASAP'SORBER AXESS energy absorber to work at a distance from the rope. For use on 11-13mm lifelines. Stops a fall, a slide or uncontrolled descent and locks even if the device is grabbed during a fall. Works on vertical or angled rope and moves up and down along the rope without manual intervention. Easy to install/remove at any point on the rope.

23540271	ASAP	\$239.95
2354027102	ASAP-Lock	\$299.95
2354127120	Asap'sorber, 20 cm	\$44.95
2354127140	Asap'sorber, 40 cm	\$49.95
235412071	ASAP'Sorber Axess	\$59.95



MAESTRO®

Descender with integrated progress-capture pulley

MAESTRO is a descender designed for technical rescue operations. It facilitates manipulation of heavy loads, for lowering or hauling, and may be used in both the primary system or in a back-up belay. This versatility allows rescuers to adapt to any situation they may encounter on the rescue scene. The ergonomic handle and integrated brake allow for comfortably controlled descent. Shifting from lowering position to hauling position is immediate, without the need to transfer the load. The integrated progress-capture pulley has a large diameter sheave mounted on sealed ball bearings, ensuring excellent hauling efficiency. The AUTO-LOCK system automatically locks the rope when the handle is not in use. Once locked, the rope can be taken up without having to manipulate the handle.

		Weight	Capacity	For Rope	Rating	
2354042420	Maestro-L	1.1 kg	280 kg	12.5 - 13mm	General Use	\$649.95
2354042410	Maestro-S	1.1 kg	280 kg	10.5 - 11.5mm	Technical Use	\$649.95



540 RESCUE BELAY

A mechanical belay device specifically engineered for fire service and industrial rescue teams. Simple and easy to use. Symmetrical design allows for bi-directional loading. Self-locking with sudden falls. Built-in release lever eliminates need for release hitch. Passes rescue belay competence criteria. UL Certified NFPA 1983. 1 year manufacturer's warranty.

Strength: 9,000 lbf. (40 kN) Weight: 24 oz. (680 gm) Rating: General Use

2154540	Large (11.5 - 13mm)	\$725.00
2154541	Small (10.6 - 11.6mm)	\$725.00



RD2 BELAY / PROGRESS CAPTURE DESCENDER

One-Way Sheave 11mm Z-Rig and TTR Systems

The RD2 is a robust self-braking descender designed for experienced users in rescue and rope access. Tested to EN12841:C it has a WLL of 140kg and for rescue purposes a WLL of 200kg. It incorporates a high-efficiency (one-way) pulley wheel with an 88% efficiency on a 1:1 haul making it the perfect belay descender that can be changed over to a low friction haul device for 3:1 hauling systems. The integrated becket allows the user to set up mechanical advantage systems directly off the device.

Efficiency, 1:1: 88% Weight: 27.9 oz. WLL, Std: 309 lbs. WLL, Rescue: 441 lbs Rope Requirement: 11mm EN1894 Compliance: EN12841:C

25511824 RD2 Red \$465.00



ADVANCE TECH HX PULLEY

Progress Capture

The SMC Advance Tech HX Pulley is a double pulley with an integrated cam that provides immediate progress capture. Stainless pins retain the rope when a rigged system is packed so that system can be pulled out and used immediately. Fits rope diameters from 7mm up to 12.5mm. The Advance Tech Mate Pulley is the companion for use in mechanical advantage systems.

Strength: 9,000 lbf. (40 kN) Weight: 9.52 oz. (270 gm); Dimensions: 5.08" x 2.74" x 1.97"; Rating: NFPA 2500(1983) 2022 ED

2540154900	Advance Tech HX	\$183.00
2540154801	Advance Tech Mate	\$108.00



PETZL TWIN RELEASE SYSTEM

Pre-assembled 4:1 hauling and lowering system

With a 4:1 mechanical advantage, and can manage a heavy load up to 600+ lbs. The system is releasable under load and provides additional lowering control when using the auxiliary brake on the TWIN RELEASE. The toothless cam preserves the rope and allows for a smooth transition from hauling to lowering. This kit's maximum working height is 15 meters (~50 feet) when fully extended.

Includes: 1 - TWIN RELEASE progress capture pulley; 1 - SPIN L2 double pulley; 1 - AXIS 11 mm, 60-meter rope with two sewn terminations; 2 - Bm'D carabiners with CAPTIV positioning bar; 1 - three-meter (~ten-foot) cord; 1 - 30-liter BUCKET bag

2354160105 Twin Release Kit \$1,079.95



ASAP LOCK AXESS KIT

The Petzl ASAP Lock Axess Kit is a fall safety system that comes pre-assembled with a mobile fall arrester, energy absorber, and connectors. This kit provides a ready-to-use personal fall arrest system that meets OSHA fall protection regulations and the ANSI Z359.15 standard when used with an 11mm lifeline rope. The ASAP Lock grabs onto the rope in the event of a free fall, and includes a handy little lock button and bypass feature for maneuvering around rocks and redirects. The Axess energy absorber provides a higher weight limit for use in rescue operations.

2354119702 ASAP Lock Axess Kit \$404.95

GRILLON MGO

Adjustable work positioning lanyard with MGO

The GRILLON MGO lanyard is used to make work positioning systems, to complement a fall-arrest system. Its length can be very easily and precisely adjusted as necessary for comfortable positioning at the work station. Connector with very large gate opening is ideal for connection to metal structures or to large-diameter cables and bars. GRILLON MGO is available in two lengths: 2 and 3 m, and is certified to North American and European standards.

	Length	
235412522MG	2 Meter	\$299.95
235412523MG	3 Meter	\$304.95



GRILLON HOOK

Adjustable Work Positioning Lanyard

The GRILLON HOOK adjustable lanyard is used to make work positioning systems, to complement a fall-arrest system. Its length can be very easily and precisely adjusted as necessary for comfortable positioning at the work station. Its HOOK connector is ideal for using the lanyard in double mode on the harness side attachment points. GRILLON HOOK is available in four lengths (2, 3, 4 and 5 m) and is certified to North American and European standards.

	Length	
235412522H	2 Meter	\$269.95
235412523H	3 Meter	\$274.95
235412524H	4 Meter	\$279.95
235412525H	5 Meter	\$284.95



KONG RESCUE TRIMMER

For precise positioning during rescue operations, the TRIMMER provides for a soft adjustment both in recovery and in release of the rope. Equipped with an asymmetric Quick Link for a precise connection to the harness, with the minimum encumbrance. Rope length 51.5" (130 cm), it is suitable for all situations that require the connection to anchor points. Includes storage pouch stores the system and will hold the unused rope when the TRIMMER is in place. The bag is equipped with a self-locking double-slider zip that allows the use on both sides of the harness. The bag fastens to harnesses with double-sided Velcro. Certified: CE EN 358

Kit Includes: TRIMMER, Rope w/ sewn terminations, TANGO snap, Asymmetric Oval Carabiner, and bag.

2401289011 1.3 meter \$194.69



KONG BACKUP FALL ARRESTOR

Safe and simple to use with only one hand! The BACK-UP is the revolutionary fall arrester that follows the operator in both directions and stop them in case of a fall. Shifting the special button to the lock mode, it can be used also as a positioning device or a normal locking device. Due to its special manufacture, BACK-UP supports also the strongest stress in semi dynamic way avoiding the shocking effects on the ropes caused by the traditional self-locking devices with toothed cams. Connector included. Made in Italy!

240180010 BackUP \$189.99





R-ALF 5:1

R-ALF 3:1



CE

R-ALF RESCUE KIT

With Integral Speed Brake

The R-ALF Pulley is the latest innovation in Rescue, Confined Space working and Work Suspension Systems. The R-ALF Pulley has an over-speed brake built in so that the Pulley will lock and hold when a fall occurs. The load rated Becket Eye on the R-ALF means that it can be used in combination with Prussik Pulleys to create a 3:1 or 5:1 Mechanical Advantage System. The unique design of the R-ALF (design patent applied for), means that an external brake is not required and therefore it is capable of several thousand cycles and many arrests (minimum 12 monthly service intervals apply). Kits are complete with rope for a 33 ft. (10m) lift. Complete with T2 Rescue Pack.

29984313150	3:1 R-ALF Kit	\$1,185.00
29984315200	5:1 R-ALF Kit	\$1,275.00



RIGGING RINGS

Traditional forged rings to be used as rigging rings, connection points for rigging a stretcher, and many other uses. Drop forged alloy steel.

Inside Diameter: 3 inches Rating: General Use.

		Strength	Weight	
603230	1/2" Ring	10,000 lbf.	10.4 oz.	\$16.00



CONTERRA HITCH PLATE

The Hitch-Plate™ is CNC machined entirely from billet aluminum. Five large rigging holes give plenty of attachment points. The Hitch-Plate is designed to fit 2" vehicle receiver Hitch. It has an ingenious system that keeps the pin and cotter attached to the device so that they can't be lost.

It comes with its own padded Ballistics nylon case with grab handle and hang loop. For Rope Rescue Rigging only. Not for vehicle recovery or towing
Meets NFPA Standard 1983 (2017 ed.) and is UL certified. Rated for General Use (G) MBS 50 kN.



211318080

\$235.00



INSTANT HITCH ANCHOR

Fits Vehicle Receiver Hitch

A simple solution to a basic problem. How do you use your vehicle as an effective anchor? The IA does this by transforming a receiver hitch into a multi-point technical rescue anchor. Durable steel construction with electrostatic powder painted finish.

Strength: 8,993 lbf. (40 kN) WLL: 900 lbs. (409 kg) Dimensions: 13.25 x 8.5" (331 x 213mm) Weight: 8.1 lbs. Rating: General Use

Must be used with a properly, professionally installed Class III receiver hitch with appropriate hitch pin (not included) installed and secured.

603415	Instant Hitch Anchor	\$190.00
603418	Padded Case, Instant Anchor	80.00

LOAD HANDLING

Pick offs / Mini-Haul

Pull Down 6:1 Mechanical Advantage (theoretical)

Pull Up 7:1 Mechanical Advantage (theoretical)

Tensioning system for short/low load lines

Stretcher management device, using two or more HaulerBiners to easily change or adjust the orientation of the stretcher



ISC HAULERBINER SYSTEM

The HaulerBiner Compact Rescue Kit is a lightweight, compact and simple to use/deploy device. The HaulerBiner is fully rated for lifting people. The HaulerBiner has three pulley wheels incorporated into each carabiner, creating a compact and lightweight 6:1 or 7:1 (theoretical) Mechanical Advantage system. The HaulerBiner also has a purpose-designed progress capture cam with an 'on/off' position. The HaulerBiner utilizes purpose-developed 6mm (1/4") rope, for strength and easy handling/best grip. The kit is supplied in a two-pouch bag, for easy deployment. The length of the system, when fully contracted is only 32cm (12")!

MBS: 3500 lbf (16 kN) WLL: 310 lbs (140 kg) tested as a complete system. As part of a pick-off system

	Length	
201408105	41 in. (105 cm)	\$299.95
201408165	65 in. (165 cm)	\$319.95
201408300	118 in. (300 cm)	\$359.95

HARKEN WINGMAN

Includes Storage Bag

Harken's new Wingman applies new design and technology to achieve more from a compact personal mechanical advantage system. Wingman combines a ratcheting sheave to stop the rope with a composite handle or wing the operator can open and close under load for a well-modulated 'fine-tuned' release. Under full load even with the sheaves pulled completely together, the system may be released quite easily--with full control using one hand on the wing and the other tending the line.

WLL: 674 lbs. (300 kg)



233609404	3M w/ bag	\$525.00
233609409	9M NO Bag	\$605.00
233609415	15M NO Bag	\$675.00

AZTEK 4:1 EDGE MANAGEMENT PULLEY SET

This is a compact mechanical advantage system that provides rescuers with a versatile edge management and rigging set. Some of the uses are as a pick off, travel restrict, adjustable directional, high directional guy-line, high angle attendant tether, high angle litter scoop, load release hitch and much more. Both AZTEK pulleys have their own color-coded Prusik and can be easily activated or deactivated. This means you can have the ratchet at either the top pulley or the bottom pulley. The special 3 on 2 Prusik cannot come off the rope, so the deactivated Prusik will stay ready to be used as soon as you need it. Set includes AZTEK Pulleys, Aztek rope set (50' of 8mm, 2-6mm Ratchet Loops, 1-6mm Travel Restraint Loop) and waist pack.



	Description	
61051301	Aztek (shown)	\$440.00
61051500	Aztek-Pro	\$470.00

PETZL JAG SYSTEM

Haul kit

The JAG SYSTEM haul kit for pickoffs, making a releasable anchor, or tensioning a system, thanks to its 4:1 mechanical advantage and excellent efficiency (sheaves with sealed ball bearings). The collapsed kit is highly compact, allowing it to be used even when the distance to the anchor is very short. The JAG SYSTEM haul kit is quick and easy to deploy: it is ready to use thanks to the flexible cover that prevents any risk of tangling. The haul end is color-coded for instant identification. It is available in three lengths: 1, 2 and 5 meters

WLL: 6 kN; Breaking Strength: 16 kN; Rope Diameter: 8mm

	Length	
23541644001	1 Meter	\$349.95
23541644002	2 Meter	\$369.95
23541644005	5 Meter	\$409.95

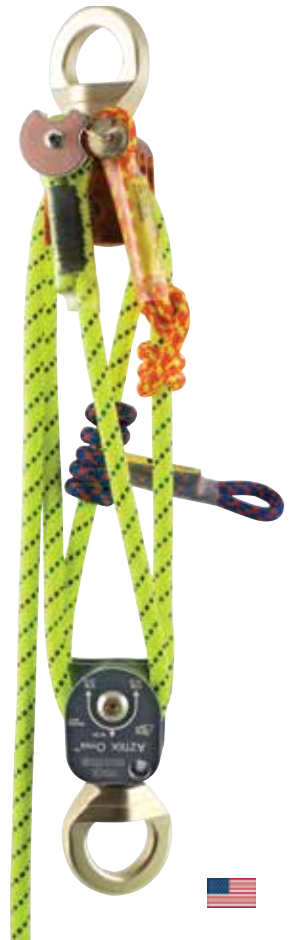

RESCUETECH KITS

EVERYTHING YOU NEED



TECHNICAL RESCUE TEAM SET

The minimum team equipment required to handle most high or low-angle rope rescue responses. Sufficient for rescues that require both raising and lowering of a patient.

- Rescue Stretcher, S.S. (1) • Deluxe Rescue Etrier (1) • Stretcher Patient Harness (1) • Quick-Fit Lashing Kit (1) • Adjustable Bridle Kit (1) • Stretcher Equipment Pack (1) • Rope Bag (2) • Duffle Bag, XL (1) • Equipment Cache (1) • Anchor Sling w/ 'D', 6 ft. (2) • Anchor Sling w/ 'D', 8 ft. (2) • Transfer Sling (1) • Load Release Strap (2) • 8mm Sewn Prusik Sling, 28" (6) • 8mm Sewn Prusik Sling, 18" (1) • 1/2 in. Rescue Ascender (2) • 2.5 PMP Rescue Pulley (5) • RescueTECH Edge Roller, Double (1) • Rope Pad, Wide (1) • 1 in. Yellow HD Web, 12 ft. (2) • 1 in. Orange HD Web, 20 ft. (2) • Rigging Plate (1) • Delta Link (4) • NFPA Offset 'D' Carabiner (1) • NFPA 'D' Screwgate (3) • Rescue Rappel Rack (1) • RD70 Rescue Carabiner (15) • Rope Guard, Red (4) • 1/2 inch. Access Lifeline x 150 ft. (2)

Items shown for illustration purposes - Not to Scale. Items subject to change if new/improved components become available.

29982012 Technical Rescue Team Set \$4,675.00



BASIC FIRST RESPONDER TEAM SET

The basic starter set for most team members.

- Prime Full Body Harness (2) • Vertex 2 Vent Helmet (2) • 12mm Delta Rapid Link (1) • Rescue 8 Descender (2) • Anchor Sling w/ 'D' (1) • Access Lifeline, 1/2 in. x 200 ft. (1) • H.D. Gear/Equipment Bag (1) • Rope Bag (1) • OD50 Rescue Carabiner (5) • Pro Leather Glove (2 pair)

Items shown for illustration purposes - Not to Scale. Items subject to change if new/improved components become available.

29981002 First Responder Set \$1,700.00



2 RESCUER CONFINED SPACE STANDBY SET

The set is the minimum equipment needed to start a standby team and access the patient. Includes harness and personal safety equipment for 2 rescuers.

- Vanguard II Full Body Harness (2) • Vertex 2 Vent helmets (2) • Knee Pads (2) • Rope & Equipment Bags (2) • 1/2 in. Access Lifeline x 150 ft. (2) • EOS Headlamp (2) • 2.5 PMP Rescue Pulley (4) • Rescuer Gear Bag (2) • Presewn Prusik Loop, 20" (2) • Presewn Prusik Loop, 30" (2) • Pro Leather Gloves (2) • RescueTECH Load Release Strap (2) • OD50 Rescue Carabiner (10)

Items shown for illustration purposes - Not to Scale. Items subject to change if new/improved components become available.

29981001 2 Rescuer Confined Space Standby Set \$3,200.00



USAR PACK RESCUE SET

An equipment set designed to provide equipment for basic rigging, access, and rescue.

- USAR Rope & Equipment Pack (1) • 1/2 in. NFPA Rope (1) • NFPA Rescue 8 Descender (1) • RD70 Rescue Carabiner (8) • RescueTECH Anchor Sling, 8 ft. (2) • 2.5 PMP Rescue Pulley (2) • Gibbs Ascender, Free Running (2) • 1/2 in. Rescue Ascender (1) • Rescue Rappel Rack (1) • Anchor Sling w/ D, 6 ft. (2) • 2 in. RescueTECH PMP Bushing Pulley (1) • Rope Guard, 18 in. (2)

Items shown for illustration purposes - Not to Scale. Items subject to change if new/improved components become available.

	Length	Color	
350526	150'	Blue	\$1,600.00
350524	150'	Red	\$1,600.00

	Length	Color	
350536	200'	Blue	\$1,850.00
350534	200'	Red	\$1,850.00



WARNING

Technical rescue and safety is potentially hazardous. Any person using equipment sold by RESCUE TECHNOLOGY in any manner is personally responsible for learning the proper techniques involved, and assumes all risks and accepts full and complete responsibility for any and all damages or injury of any kind, including death, which may result from the use of any RESCUE TECHNOLOGY equipment.

Products in this catalog can expose you to chemicals which are known to the State of California to cause cancer. For information go to: www.p65warnings.ca.gov



Z-RIG HAUL SET

RescueTECH equipment packaged in a ready-to-rig 3:1 Z-Rig system.

- Rope Bag (1) • Anchor Sling w/ D (6') (1) • 2.5 PMP Rescue Pulley (2) • OD50 NFPA Rescue Carabiner (3) • Blue HD Web, 15 ft. (1) • Delta Rapid Link (1) • 1/2 in. Rescue Ascender (1) • 8mm Sewn Prusik Sling, 18" (1) • 8mm Sewn Prusik Sling, 28" (1) • 1/2 in. NFPA Rope x 200 ft. (1)

Items shown for illustration purposes - Not to Scale. Items subject to change if new/improved components become available.

	Length	
29984151150	150'	\$725.00
29984151200	200'	\$810.00



GF-USAR RESCUE PACK SET

RescueTECH equipment packaged in a ready-to-rig 3:1 Z-Rig system.

- Rope Bag (1) • 8mm Cord x 6 ft. (4) • 1/2" Rescue Ascender (1) • Delta Rapid Link (2) • Rescue Rappel Rack (1) • 8mm Cord x 5 ft. (4) • 1 in. Green HD Web, 5 ft. (2) • 1 in. Yellow HD Web, 12 ft. (2) • 1 in. Orange HD Web, 20 ft. (2) • 1 in. Blue HD Web, 15 ft. (2) • OD50 Rescue Carabiner (10) • NFPA Rescue 8 Descender (1) • 540 Belay Device (1) • XL Carabiner (1) • USAR-TECH Pack (1) • XL 2.5" PMP, Single (4) • Rope Pade, Wide (1) • Rescue '8' Descender (1) • 1/2" ACCESS Lifeline, 50 ft. (3) • 9mm Cord x 30' (2)

Items shown for illustration purposes - Not to Scale. Items subject to change if new/improved components become available.

91231001		\$2,775.00
----------	--	------------



RAISE / LOWER SET

Equipment set-up popular at many state fire/rescue academies. Sufficient for a Z-Rig Raise and Rack Lower System.

- Equipment Saddle Bag (1) • NFPA Rescue Rope (1) • Anchor Sling w/ D, 10 ft. (2) • 8mm Sewn Prusik Sling, 28" (2) • 8mm Sewn Prusik Sling, 18" (1) • Rescue Rappel Rack (1) • Rope Bag (1) • Rigging Plate (1) • PMP Rescue Pulley (2) • RD70 Rescue Carabiner (5) • Dogbone Rigging Sling (1)

Items shown for illustration purposes - Not to Scale. Items subject to change if new/improved components become available. *Meets NFPA 1983/ANSI/OSHA strength specifications.

	Length	
29982120	200'	\$1,050.00
29982130	300'	\$1,250.00



CONFINED SPACE RESCUE SET

Designed to provide a 2-person team with a set of equipment that allows for the rescue of victims. Comes complete with Tripod and Extractor CSR Kit for an anchor point and retrieval system. A separate belay may be set up with the included Petzl I'd Belay device and 150 ft. section of 1/2" ACCESS Lifeline. Rigging equipment and edge protection is also included. All personal and team equipment, as well as hardware and tripod storage is included.

- EOS II Headlamp (2) • Vertex Vent Helmets (2) • Pro Leather Glove (pair) (2) • Vanguard G2 Rescue Harness (2) • Technician Tripod w/ Tripod Bag (1) • ISC D5 Belay Device (1) • 1/2" ACCESS Lifeline x 150 ft. (Blue) (1) • Technical Rescue Rigging Plate (1) • OD50 Steel Carabiners, Screwgate (10) • RescueTECH PMP, Bushing (1) • 1/2" Extractor CSR Kit w/ Bag, 150 ft. (1) • Rigging Sling w/ D, 8 ft. (2) • Load Release Sling (1) • 11mm Aluminum Carabiner, Screwgate (1) • Remote Retrieval Hook (1) • Extractor Pole, 12' (1) • RescueTECH Edge Pad, Wide (1) • RescueTECH Rope Guard, 24" (Red) (2) • RescueTECH Rope Bag, Medium (Blue) (1) • RescueTECH Deluxe Equipment Pack (Blue) (1) • RescueTECH Duffel Bag, Large (Blue) (2)

Items shown for illustration purposes - Not to Scale. Items subject to change if new/improved components become available.

2998123 Confined Space Rescue Set \$5,400.00

SPIN-LOCK RESCUE / RETRIEVAL SYSTEM

Locking Pulley for Combination Raise / Lower System

The Spin-Lock Rescue system is a pre-rigged 4:1 Hauling system that utilizes a unique pulley with sheaves that rotate in only one direction. When properly rigged, this system works as an efficient 4:1 mechanical advantage pulley system that also provides friction to control the load when in lowering mode. The special sheave are mounted on a unique one-way bearing that allows the user to easily control a rescue load. Also, included is a Handled Ascender to control and anchor the system when at rest. The attached foot loop also aids the rescue in raising heavier loads. The Spin-Lock Rescue / Retrieval Kit is a pre-rigged kit that combines the RescueTECH Remote Retrieval Hook and Extension Pole access system with a Spin-Lock Rescue / Retrieval system. The remote hook and extension pole allows for non-entry remote attachment of a rescue lifeline to a victim in a confined space or vertical environment.

	Item Description / Length	
29984403	Spin-Lock System / 150 ft.	\$1,600.00
29984423	Spin-Lock Kit / 150 ft.	\$1,800.00



Remote Retrieval Hook and Extension Pole included in Kit ONLY



USAR PACK DELUXE RESCUE SET

An equipment set designed to provide equipment for basic rigging, access, and rescue.

- 1/2" ACCESS Rope x 200 ft. (1) • RescueTECH Large D Carabiner (12) • Gibbs Ascender, Free Running (2) • 1/2" Rescue Ascender (2) • NFPA Rescue 8 Descender (1) • Rescue Rack (1) • Anchor Sling w/ D, 6 foot (4) • 2.5 PMP Rescue Pulley (4) • 1 2.5" Double PMP Rescue Pulley (1) • 2 Rope Guard, 18" (2) • Delta Rapid Link (1) • Technical Rescue Rigging Plate (1) • 10" Steel Cable Sling (1) • Red HD Web, 25 ft. (2) • Orange HD Web, 20 ft. (2) • Blue HD Web, 15 ft. (2) • Yellow HD Web, 12 ft. (2) • Green HD Web, 5 ft. (2) • 8mm Sewn Prusik Sling, 28" (4) • 8mm Sewn Prusik Sling, 18" (4) • USAR Pack (1)

Items shown for illustration purposes - Not to Scale. Items subject to change if new/improved components become available.

	Rope Color	
350566	Blue	\$2,600.00
350564	Red	\$2,600.00



DELUXE EQUIPMENT PACK SET

A set of equipment designed to meet the basic needs of rescuers. Use this set of equipment with two life safety ropes and create a raise / lower system with belay system. Multiple mechanical advantage systems can be built as well as specialized rigging systems.

- Deluxe Equipment Pack (1) • 8mm Sewn Prusik Sling, 18" (2) • 8mm Sewn Prusik Sling, 28" (2) • Rescue Rappel Rack (1) • Aluminum D, S/G (1) • Delta Rapid Link (1) • RD70 Carabiner, S/G (10) • 2.5" Single PMP (3) • 2.5" Double PMP (3) • Rope Guard, 18" (2) • Anchor Sling, 8' (2) • Anchor Sling w/ D, 6' (2) • 1" H.D. Web x 20' (2) • 1" H.D. Web x 25' (1) • Load Release Strap (1)

Items shown for illustration purposes - Not to Scale. Items subject to change if new/improved components become available.

29983420	Deluxe Equipment Pack	\$1410.00
----------	-----------------------	-----------



DELUXE TEAM MEMBER SET RAPPEL RACK

With with Rescue Rappel Rack

Same item list as 2998297 but with the substitution of a Rappel Rack for the D5 descender.

- VANGUARD-G2 Rescue Harness (1) • Vertex Vent Helmet (1) • Pixa 2 Headlamp (1) • Knee Pads, Pair (1) • RescueTECH Uniform Belt (1) • Presewn Prusik Sling 30" (1) • Presewn Prusik Sling 20" (1) • RD70TM Rescue Carabiners (5) • Pro Leather gloves (1) • Glove Cinch (1) • Rescue Rappel Rack (1) • Technical Rescue Field Guide (1) • Rescuer Gear Bag (1) • Shock Absorber (1) • Transfer Sling (1) • Adjustable Rigging Sling (1) • 1 in. Orange HD Web, 20 ft. (1)

Items shown for illustration purposes - Not to Scale. Items subject to change if new/improved components become available.

29982191 Deluxe Team Member - Rack \$ 1,475.00



EQUIPMENT CACHE RESCUE SET

A compact set of equipment suitable for rigging anchor, haul / lower, and belay systems.

- Equipment Cache Pack (5) • RescueTECH Technical Rescue Rigging Plate (1) • H.D. Load Release Strap (2) • Oval Steel Carabiner, Screwgate (3) • RescueTECH Rope Pad, Wide (1) • RescueTECH 2.5" PMP (5) • RescueTECH Rescue Rappel Rack (5) • OD50 Rescue Carabiner, Screwgate (10) • 1" H.D. Flat Webbing x 12' (YE) (2) • 1" H.D. Flat Webbing x 20' (OR) (2) • Presewn Prusik, 18" (YE) (5) • Presewn Prusik, 28" (RD) (2)

29983425 Equipment Cache Rescue Set \$1,110.00





Tripod not included with kit

EXTRACTOR™ CONFINED SPACE RESCUE KIT

Confined Space Personnel Rescue Kit

FOR RESCUE: Used as 4:1 Block and Tackle or “piggy-backed” onto main haul line. Decreases training needs for mechanical advantage systems. Great re-direct pulley with a built-in safety. No loss of haul due to slack in a prusik cord or external camming safety. **FOR INDUSTRY:** Easy to use. Meets OSHA 1910.146 Mechanical Retrieval Device standard. Meets ANSI Z359.1 vertical lifeline standards and autolocking carabiner requirements.

LIFTING SAFETY: Unit works as a hauling system with a “deadman’s” safety. Included safety pin holds cam in either open (rope will run freely in both directions) or in safety position. Rope will move in hauling direction only and cannot be removed or fall out when safety is engaged. Extractor™ may be used horizontally and can be attached to a haul-line to act as a 4:1 hauling system. 1/2” version available in 37 ft. and 50 ft. lift capacity. 7/16” version available in 50 ft. lift capacity. **REMOTE LOWERING CAPABILITY:** The attached cable allows remote control of the safety cam. This makes it possible to place the Extractor™ unit where it cannot be directly accessed. Extractor™ design provides over 135° of hauling line movement. It does not limit hauling team to standing “in-line” with the rope system. The pulley sheaves are equipped with Oilite™ bushings and will accept ropes up to 1/2” diameter. The Extractor™ frame is constructed of high tensile aluminum alloy.

WLL: 1,000 lbs. EXTRACTOR Pulley Dimensions: 9” x 3” Rope Colors: Red, Blue, Yellow, Orange

All Kits include: • ACCESS Lifeline w/ sewn eye (1) • EXTRACTOR™ CSR Pulley (1) • Double or Single Pulley (1) • Autolocking Carabiners (1) • Rope and Equipment Bag (1)



Extractor Kit with Bag.

1/2” EXTRACTOR™ CSR KIT

With Rope / Equipment Bag

Product Code	Description	Price
614481200xx	4:1 Extractor Kit x 200 ft.	\$875.00
614481150xx	4:1 Extractor Kit x 150 ft.	\$800.00
614482200xx	4:1 Extractor Swivel Kit x 200 ft.	\$1,000.00

7/16” EXTRACTOR™ CSR KIT

With Rope / Equipment Bag

Product Code	Description	Price
614471200xx	4:1 Extractor Kit x 200 ft.	\$825.00



Swivel Kits complete with lower swivel pulley.



SUPERCLIP RESCUE TOOL

Extend Rescuers’ Reach

Superclip Rescue is designed for remotely holding autolock carabiners in the open position. Great for confined space rescue situations. Holds most Autolocking 3 Stage Carabiners. Pole kits include Superclip Rescue Tool, 3-Section Pole, and Supersafe 3-stage ANSI carabiner w/ sling. 4-12’ Kit collapses to easily fit into most standard compartments.

Weight, Clip: 1.6 oz.

Product Code	Description	Price
2462002	Super Clip (only)	\$32.00
2462112	4 - 12’ Pole Kit w/ Carabiner/ Sling	\$140.00

4:1 HAULING KIT

Block and Tackle System

Complete hauling kits that are ready to use. Each kit contains 1/2” Rescue rope & prusik cord, high strength pulleys, Gibbs Ascenders and RescueTECH Carabiners complete the system. 4:1 Block and Tackle pulley system is packaged in Rope and Equipment Bag, and is ready for the rescuer to simply reach in and grab the carabiner to attach to the rigging point.

Product Code	Length	Price
610624	200 ft.	\$725.00



SLINGS AND LANYARDS

SUPERIOR WEBBING

RescueTECH Slings and Lanyards outperform the competition

RescueTECH webbing and rope slings are engineered to be stronger and outwear similar brands of straps. We have chosen higher strength webbing that gives better performance and adds to the trust that you can have in your systems. From our Heavy Duty Anchor slings that use a 10,000 lbf webbing with wear indicators to our Super Duty Anchor Slings, you can trust RescueTECH slings for all of your rescue needs.



HEAVY DUTY ANCHOR SLING II

Our next generation of D-Ring Anchor Slings. Computer Controlled sewing increases quality. 1.75" wide Polyester Webbing and Forged D Rings. Each sling has a standard "D" ring (proof load: 5,000 lbf.) and a Wide "D" sewn at the end to provide maximum versatility. Anchor points may be wrapped single, double, triple, and rigged choker-style to suit particular rescue situations. When looped like a basket hitch, anchor slings meet General Use load requirements. Although webbing tensile strength is high, overall tensile strength is limited by the "D" rings.

NFPA Tensile Strength (Basket): 15,760 lbf. (70.1kN) Choker Strength: 7,240 lbf. (32.2kN) Color: Yellow End-to-End Strength: 8,660 lbf. (38.5kN) Rating: General Use

	Length	
75942032	3 ft.	\$32.00
75942042	4 ft.	\$35.00
75942062	6 ft.	\$37.00
75942082	8 ft.	\$40.00
75942102	10 ft.	\$42.00
75942152	15 ft.	\$52.00



SUPER DUTY ANCHOR SLING

Strongest Webbing Slings in the Rescue Industry

Manufactured from 2" wide solid weave high strength webbing. Special RED internal tracers function as edge cut indicators that are exposed when the webbing edge is abraded, cut, or torn. Large heavy duty forged steel links on each end will allow end-to-end, basket, and choker use of the sling. Exceed all standards for two person lifeline strengths.

End-to-End Tensile Strength: 15,000 lbf Color: Yellow Basket Strength: 28,000 lbf (125 kN) WLL: 1,500 lbs. Rating: General Use

	Length	
756504	4 ft.	\$50.00
756506	6 ft.	\$51.00
756508	8 ft.	\$54.00
756510	10 ft.	\$56.00



RESCUE SYSTEM CHANGE-OVER SLINGS

Great Addition To Pre-Rig Systems

Allows rescuers to extend a Z-rig past the lowering device without having to tie a "green" sling.

Super Strong: 8,500 lbf. WLL: 850 lbs.

753105	Dogbone Z-Rig Sling, 16 in.	\$10.00
7531052	Dogbone Z-Rig Sling, 21 in.	\$10.75



HEAVY DUTY ANCHOR SLING

Strongest 1" Heavy Duty Double End Rigging Sling

Eliminates wasted rigging time spent tying knots in rigging lines. Made from 1" solid weave, high strength nylon webbing. The special webbing has RED tracers to indicate cuts in the webbing. Available in multiple lengths, each sling has a sewn loop at each end to provide maximum versatility. Anchor points may be wrapped single, double, triple, etc., to suit particular rescue situations. Anchor Slings exceed all standards and regulations for Light Use Life Support lines. When looped like a basket hitch, anchor slings meet General Use load requirements.

End-to-End Tensile Strength: 8,500 lbf. Color: Yellow Basket Strength: 15,000 lbf. (67 kN) WLL: 850 lbs. Loop Size: 6" Rating: General Use

	Length	
7550032	3 ft.	\$14.50
7550042	4 ft.	\$16.50
7550052	5 ft.	\$17.25
7550062	6 ft.	\$17.75
7550082	8 ft.	\$21.50
7550102	10 ft.	\$23.00

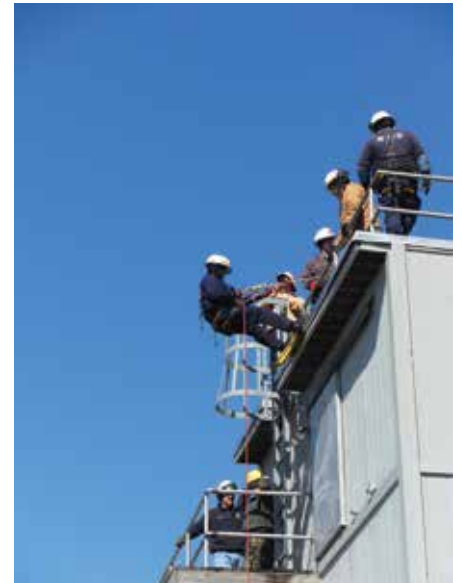



Includes Storage Keeper

TRANSFER SLING

Ideal for Rescue Pick-Off

Manufactured with heavy duty TECHWeb 1 3/4" flat webbing and has a forged "D" ring sewn in one end and an adjustable "V" ring on the other end. Adjusts by pulling on the hand loop. The "V" ring adjuster buckle slips at 4,500 lbf. Hardware Proof Load: 2,500 lbf.

Weight: 14.4 oz. Length: 10" - 54" Rating: General Use

756103 Transfer Slings \$65.00



Includes Storage Keeper

2:1 PICK OFF STRAP

Built-in Mechanical Advantage

Used for patient pick-off situations. Configuration allows for 2:1 and 3:1 mechanical advantage for easier handling of loads. Materials: 1 3/4" Heavy Duty TECHWeb webbing with Forged D-Ring and Adjuster Buckles.

Strength: 7,000 lbf. Weight: 20 oz.

756104 2:1 Pickoff Strap \$62.00



QUIK-PIK STRAP

An updated version of our 2:1 pick-off strap. We have added an aluminum autolocking snap to the patient end of the unit allowing for rapid attachment and adjustment of the unit. Strap design provides mechanical advantage and will help lift load.

Strength: 5,000 lbf. Weight: 18.4 oz.

75610434 Quik-Pik Strap \$92.00



ADJUSTABLE RIGGING SLING

With Heavy Duty TECHWeb

An adjustable length rigging sling. Manufactured of heavy duty TECHWeb 1 3/4" flat webbing and has a forged "D" ring at each end. Adjusts with a slide adjuster.

Webbing Strength: 10,000 lbf. Tensile Strength: 8,000 lbf. WLL: 800 lbs. Length: Adjustable Weight: 24 oz. Color: Gold

	Length	Weight	
756106	2 - 6 ft.	24 oz.	\$70.00
756105	2 - 9 ft.	29.6 oz.	\$75.00



Includes Locking Carabiner

HEAVY DUTY LOAD RELEASE RESCUE STRAP

The Load Release Strap uses 15,000 lbf. Large rigging "D" Rings (3" x 2.55") and a standard 1.75" forged "D" on the adjustment part. 10,000 lbf. TECHWeb is used to provide superior strength and abrasion resistance over units using type 13 webbing. Designed to prevent the adjustment end of the webbing from sliding through the rigging "D" rings. Includes Oval Steel Screwgate carabiner to secure "tail".

Weight: 23.2 oz.

7562032 HD Load Release Strap, Deluxe \$75.00



LARGE RING LOAD RELEASE RIGGING STRAP

The Load Release Strap uses 15,000 lbf. Extra-large rigging "D" Rings (5" x 3.35") and a standard 1.75" forged "D" on the adjustment part. 10,000 lbf. TECHWeb is used to provide superior strength and abrasion resistance over units using type 13 webbing. Designed to prevent the adjustment end of the webbing from sliding through the rigging "D" rings.

Weight: 34.4 oz.

756202 Large Ring Load Release Strap \$63.00



STEEL WIRE SLING WITH PLASTIC COVER

7mm Wire Slings with steel thimble (rigid) eye, Fitted with a protective PVC cover.

End-to-End Strength: 5,620 lbf. (25 kN) WLL: 562 lbs.

	Length	
2014231001	39.3 in. (1 m)	\$50.95
2014231501	59 in. (1.5 m)	\$55.95
2014232001	78.7 in. (2 m)	\$60.95
2014233001	118.1 in. (3 m)	70.95



STEEL CABLE SLING, 3/8"

The highest quality life support slings made from flexible 3/8" steel cable. Manufactured with Flemish eye splices with steel swages per OSHA/ANSI standards. Each unit is tagged with date of manufacture, size, and working load in tons. Steel slings are excellent in areas of extreme high/low temperatures, chemical exposure, and abrasion.

Proof Tested: 5,400 lbf. WLL: 2,700 lbf. Rating: General Use

	Length	
759304	4 ft.	\$22.50
759306	6 ft.	\$27.50
759310	10 ft.	\$41.00



STANDARD RESCUE LOOP

High Strength Continuous Loop

High strength 1" Tubular Webbing (4,500 lbf.) provides a high strength loop. Because of the high strength and abrasion resistance of the Rescue-Spec™ Tubular webbing RescueTECH Standard Rescue Loops will outlast conventional tubular webbing slings.

End-to-End Strength: 7,400 lbf. WLL: 740 lbs. Colors: Assorted

	Length	
7612012	12 in.	\$5.40
7612024	24 in.	\$6.50
7612036	36 in.	\$7.30
7612048	48 in.	\$9.05
7612060	60 in.	\$11.05



HEAVY DUTY ANCHOR LOOP

Heavy Duty Continuous Loop

Constructed of same heavy duty webbing as the Anchor Sling. This unit is sewn to form a continuous high strength rigging loop. Items are sold by linear measurement of the loop laid flat. Anchor Loops meet all standards and regulations for two-person life support lines.

End-to-End Tensile Strength: 13,000 lbf. WLL: 1,300 lbs. Color: Yellow Rating: General Use

	Length	
7540042	4 ft.	\$15.00
7540062	6 ft.	\$18.00
7540082	8 ft.	\$23.00
7540102	10 ft.	\$28.00



RESCUE ANCHOR SET

We have packaged two of our Heavy Duty Anchor Straps with a Wear Guard and Delta Rapid Link to give rescuers a quick, secure, and hard wearing anchor sling set. Includes storage bag.

	Size	Length	
29982101	Large	8 ft.	\$158.00
29982102	Medium	6 ft.	\$150.00



RESCUE SHOCK ABSORBER

This is the highly efficient webbing tear-stitch type shock absorber utilized on our lanyards. The Zorber absorbs energy by means of a controlled destruction. Two layers of webbing are woven together. Limits OSHA style loads to a maximum force of 900 lbf.

Initial Length: 10" Extended Length: 52" Minimum Tensile Strength: 6,000 lbf.

Meets all ANSI, OSHA standards and CSA construction requirements.

		Weight	
753420	Loop & Loop	8.8 oz.	\$45.00
753426	Snap & D Ring	28 oz.	\$66.00



WARNING

Technical rescue and safety is potentially hazardous. Any person using equipment sold by RESCUE TECHNOLOGY in any manner is personally responsible for learning the proper techniques involved, and assumes all risks and accepts full and complete responsibility for any and all damages or injury of any kind, including death, which may result from the use of any RESCUE TECHNOLOGY equipment.

Products in this catalog can expose you to chemicals which are known to the State of California to cause cancer.

For information go to: www.p65warnings.ca.gov



CE

ABSORBICA-Y MGO

Double lanyard with energy absorber

ABSORBICA-Y MGO is a double lanyard with compact energy absorber, designed for progression on a vertical structure or a horizontal lifeline and when passing intermediate anchors. It is available in two lengths: 80 or 150 cm versions (without connectors). The 150 cm version has elasticized arms, to avoid hindering progression. Equipped with two large-opening MGO connectors and a Bm'D connector with a CAPTIV positioning bar, it is certified to American and European standards.

23541264Y080	Absorbica-Y MGO, 80 cm	\$249.95
23541264Y150	Absorbica-Y MGO, 150 cm	\$299.95



CE

ABSORBICA-Y TIE-BACK

Integrated intermediate tie-back rings

The ABSORBICA-Y TIE-BACK is a double lanyard with integrated intermediate tie-back rings and compact energy absorber. It is designed for vertical progression on very large structures and when passing intermediate anchor points. The TIE-BACK system allows the lanyard ends to be reconnected to fit around structures with a very large cross section. The arms are elasticized to avoid hindering progression.

235412021 Absorbica-Y Tie-Back, MGO \$349.95



WEBBING LANYARDS WITH LADDER HOOK

Manufactured from heavy duty 1" wide nylon webbing with a double locking snap at one end and a double locking ladder hook (2.5" gate opening) at the other end. Now available with integral shock absorber (Zorber™). New labeling.

Minimum Tensile Strength: 5,000 lbf.

Meets all ANSI, OSHA standards and CSA construction requirements.

		Length	
752056	Snap / Hook (shown)	6 ft.	\$95.00
752348	Adjustable, Snap / Hook	3-6 ft.	\$110.00



TWIN LEG BYPASS LANYARDS

100% Tie Off

Special design Lanyard with Zorber to be used for 100% tie-off method of climbing safety. One end has a double-locking safety snap or rapid link that attaches to harnesses. The "Legs" of the lanyard are complete with large 2.50" opening double locking Ladder Hooks.

Meets all ANSI, OSHA standards and CSA construction requirements.

752265	AutoLock, Steel	\$160.00
752265A	AutoLock, Aluminum	\$170.00
752264	AutoLock with Shock Absorber	\$225.00



SHOCK ABSORBING LANYARDS WITH LADDER HOOK

Manufactured from heavy duty 1" wide nylon webbing with a double locking snap at one end and a double locking ladder hook (2.5" gate opening) at the other end. Manufactured with integral shock absorber (Zorber™). Minimum Tensile Strength: 5,000 lbf.

Meets all ANSI, OSHA standards and CSA construction requirements.

752156 Snap / Hook / Zorber 6 ft. \$125.00

RESCUETECH DAISY CHAIN

Strong Directional Rigging Loops

Traditional multiple loop rigging sling with “directional” rigging loops for higher strength. Made from 1” Tubular Webbing. Loop strength of 1,500 lbf exceeds that of competing multi-loop straps.

Ultimate Strength: 6,800 lbs. Specify Color: 36” Black (9 pockets); 60” Black (17 pockets.)



	Size	Length	Color	
7581361	Medium	36 in.	Black	\$35.00
7581601	Large	60 in.	Black	\$45.00

RESCUETECH RESCUE ETRIER

A great help in rescue. Can be used as a simple step-up or at the breakover by safety personnel. Constructed of 1” flat webbing with a protective sheath at the carabiner rigging point for extra abrasion resistance. Double thickness of webbing keep steps open and hand loop at top.

Tensile Strength: 5,000 lbf.



		Color	
758342	4 Step	Yellow	\$38.00
758364	6 Step	Red	\$72.00

SINGLE RIG WEBBING LADDER

The Webbing Ladder offers the simplicity of a traditional 1” etrier but with increased comfort. Built in spreader and individual stays in the steps insures that steps remain open without causing “foot pinching”. Built-in wrist loop. 6 steps.

WLL-Step: 300 lbs. WLL-Unit: 600 lbs.



	Length	
758621	6 ft.	\$68.00

DOUBLE RIG WEBBING LADDER

Multi-Unit Connect Ability

The Deluxe Webbing Ladder offers the features of our traditional 1” Webbing Ladder plus the ability to connect multiple units together. Built in spreader and individual semi-rigid stays keeps the steps open without causing “foot pinching”. Multiple ladders may be linked together. 16 steps.

WLL-Step: 300 lbs. WLL-Unit: 600 lbs.



	Length	
758625	15 ft.	\$ 155.00

D1 TOWER RESCUE/ESCAPE KIT

Rappel, Lower, Z-Rig for Tower Rescue

D1 PRO Descender Kits are available with three mid-line attachable components, which can be easily configured in order to transition between descent, ascent and hauling. The A1 Ascender & C1 Combination Pulley combination gives the user an extremely compact, mid-line attachable hauling system. The squeeze-style cam, allows for smooth, ergonomic adjustment. The attachment hole of the A1 Ascender accepts a carabiner Connection (for use as part of a hauling/ ascent system). Alternatively, the C1 Combination Pulley can be clipped directly in to the attachment hole of the A1 Ascender (without the need for a carabiner/ connector). The C1 Combination Pulley has an attachment bollard and a swing-cheek which is fitted with a spring-loaded closure mechanism. The profile of the bollard also allows for carabiner connection. The Pulley is fitted with a super lightweight Acetal wheel. Also included is the Micro Accessory Pulley, an extremely compact (53 x 31mm) pulley with a strength rating of 25kN (5620 lbf).

ISC requires that authorized training be completed before any D1 unit can be purchased either by an individual or by an entire department / company.

	Rope	Length	
20148511020	Quadra	20 m	Call
20148511050	Quadra	50 m	Call
20148511100	Quadra	100 m	Call
20148511200	Quadra	200 m	Call
20148512020	Escape6	20 m	Call
20148512050	Escape6	50 m	Call
20148512100	Escape6	100 m	Call
20148512200	Escape6	200 m	Call



Left to Right: Micro Accessory Pulley, A1 Ascender, C1 Combination Pulley



D1 PRO Tower Escape Device

arachnipod

TOTAL EDGE MANAGEMENT SYSTEM



The Arachnipod, in its most basic form, is a simple tripod with the three legs independently pivoting from an anodized aluminum head. The modular head has a similar design to a door hinge. Inserting or removing a pin through the center of the head allows the quick and simple addition or removal of components to create a configuration to suit any edge management scenario.

Configuration	Height	SWL*	MBS
Gin Pole	6' 9"	600 lbs.	28 kN
Gin Pole	10"	330 lbs.	15 kN
A-Frame, or	8' 10"	600 lbs.	28 kN
Offset A-Frame, or	8'	750 lbs.	34 kN
A-Frame w/ Lazy Leg	7' 6"	880 lbs.	40 kN

Configuration	Height	SWL*	MBS
Tripod or Quadpod	8' 10"	880 lbs.	40 kN
Bridge-2 Meter	8' 10"	600 lbs.	28 kN
Bridge-3 Meter	8' 10"	500 lbs.	28 kN
Bridge-4 Meter	8' 10"	385 lbs.	28 kN
Handrail Recovery Monopole**		600 lbs.	19 kN

* 10:1 Safety Factor with External anchor point ** Dependent upon handrail rating

- A. Offset A-Frame
- B. Handrail Monopole
- C. Bipod
- D. High Directional Tripod w/ remote haul system
- E. Bridge System with controllable Trolley
- F. Gin Pole/Monopod
- G. Quadpod with Steps

ARACHNIPOD MULTIPOD

Intuitive Design - a Multipod for All Rescuers

Innovative design that captures multi-functional capabilities. Simplicity and robust engineering provide the world's most versatile and strongest modular total edge management system (TEMS). The Arachnipod (APOD) is one height safety edge management device that can easily adjust into multiple configurations, providing users with a safe, effective total edge management system. The Arachnipod is based around the concept of an high strength tripod however this product is much more than just a tripod.

Components can be added or removed as required so that the APOD complements existing structural or natural features. The unique design of the patented modular head means the Arachnipod can be constructed into many different configurations including a gin pole/monopole, bipod, tripod, quadpod, bridge system and handrail recovery monopole.

The Arachnipod has been drop test rated for a 616 lbf. rescue load. It has a tested head that has the capability of holding a high directional load as well as a belay system. The recommended rescue belay as tested with a 280 kg rescue load is the Traverse 540 ° Belay Device.

Features:

- Easy set up
- Pins are secured to APOD with coated stainless steel cable.
- Leg stops will not allow lower portion to fall out of end.
- Rectangular Tubing and Large Pins mean less time to adjust
- 2 rigging swivel rings per basic tripod

Ideal for:

- Rescue and emergency services
- Construction
- Military
- Utility services
- Mining
- Film industry
- Maintenance personnel

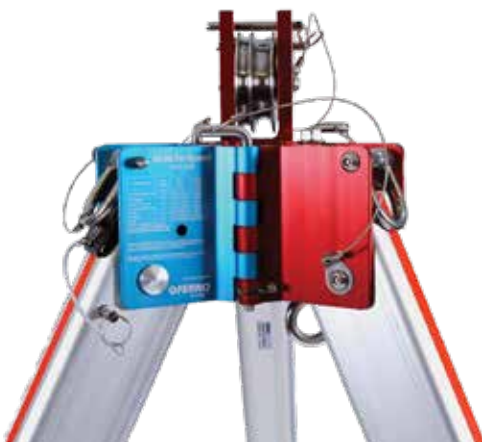

ARACHNIPOD MULTIPOD SYSTEMS

PRE-BUILT KITS

Pre-built systems are ready for use upon delivery. These full systems are fully customizable with the addition of the Standard & Pulley Quadpod Add-On Kits and accessories. The components and accessories may vary from one kit to another. Please review each System's component list before placing your order.



Arachnipod TEMS Bag



ADVANTAGE-BASIC MULTIPOD

Standard legs with 2 Rigging Eyes

The Advantage-Basic model is the starting point for rescue and work use. Based on a traditional tripod design, the Advantage-Basic has 2 swivel rigging points underneath the "head". It is easily upgraded to a Quadpod choosing the appropriate Quadpod Add-on Kit.

Weight: 57 lbs.

Systems Built:

- Tripod with 2 rigging points
- Lazy Leg Tripod
- Bipod/A-Frame
(requires Optional Rigging Plate)
- Lazy Leg A-Frame

Components Included:

- Standard Leg with Swivel Anchor (2)
- Lazy Leg with Adaptor (1)
- Feet Restraining Rope (1)
- Padded Storage Bag (1)
- Manual (1)

24481105 APOD Basic \$4,500.00

ADVANTAGE MULTIPOD

Pulley leg adds over-the-top Capability

The Advantage Multipod is a step up from the Basic Multipod. The exchange of a Pulley Leg for the Standard Leg gives rescuers over-the-top capability for rope and cable systems while retaining a swivel rigging point. It is easily upgraded to a Quadpod choosing the appropriate Quadpod Add-on Kit.

Weight: 60 lbs.

Systems Built:

- Tripod w/ Pulley Head & 1 Rig Point
- Lazy Leg Tripod
- Bipod/A-Frame
(requires Optional Rigging Plate)
- Lazy Leg A-Frame
- Handrail Monopole

Components Included:

- Standard Leg with Swivel Anchor (1)
- Pulley Leg (1)
- Lazy Leg with Adaptor (1)
- Feet Restraining Rope (1)
- Padded Storage Bag (1)
- Manual (1)

24481205 APOD Advantage \$4,800.00

ADVANTAGE-BASIC PLUS MULTIPOD

The "PLUS" upgrade to the Advantage-Basic adds the necessary components to increase the capabilities of the already versatile Advantage-Basic Multipod. The system adds a Gin Head, Rigging and Quad Plate, and a Reverse Head to the Advantage Multipod system.

Systems Built:

- Tripod with 2 rigging points
- Lazy Leg Tripod
- Bipod/A-Frame
- Offset A-Frame
- Gin/Monopole
- Handrail Recovery Monopole

Additional Components Included:

- Rigging Plate (1)
- Quad Plate (1)
- Reverse Head (1)
- Gin Head (1)

24481106 APOD Basic Plus \$5,700.00

ADVANTAGE PLUS MULTIPOD

The "PLUS" systems are the premier multipod systems from Arachnipod. The upgraded component list increases the versatility and gives rescuers advanced capabilities. The system adds a Gin Head, Rigging and Quad Plate, and a Reverse Head to the Advantage Multipod system.

Systems Built:

- Tripod w/ Pulley Head & 1 Rig Point
- Offset A-Frame w/ Pulley High Point
- Lazy Leg Tripod
- Bipod/A-Frame
- Sideways A-Frame
- Gin/Monopole
- Handrail Recovery Monopole

Additional Components Included:

- Rigging Plate (1)
- Quad Plate (1)
- Reverse Head (1)
- Gin Head (1)

24481206 APOD Advantage PLUS \$6,200.00



TOTAL EDGE MANAGEMENT SYSTEM



The Arachnipod Total Edge Management System (TEMS) is an innovative multipod system that captures the functional capabilities of the Arachnipod Multipod platform and turns it into a robust all-edge management system. At the heart of the TEMS is the Advantage Multipod. To this we add the Bridge Add-on and the Full Accessory kit. These features are unique to the Arachnipod TEMS. The Bridge is used to span larger openings or voids where a regular tripod or quadpod won't work. Complete with a trolley rigging point, the TEMS allows rescuers to hoist the patient then move him to the end of the bridge out of the way of the spanned void. Use of an English Reeve System further simplifies the rescue.

Systems Built:

- Tripod w/ Pulley Head & 1 Rig Point
- Lazy Leg Tripod
- Quadpod
- Gin/Monopod
- Bridge System
- Bipod/A-Frame
- Lazy Leg A-Frame
- Handrail Monopole

Components Included:

- Arachnipod Advantage System (1)
- Arachnipod Bridge Kit (1)
- Arachnipod Reverse Head (1)
- Arachnipod Full Accessory Kit(1)
- Padded Storage Bag (1)
- Manual (1)

24481301	2 Meter TEMS	\$14,500.00
24481303	3 Meter TEMS	\$15,000.00
24481304	4 Meter TEMS	\$15,500.00

MONOPOD KIT

Includes the components needed to create a standalone monopod / Gin Pole.

- Components Included:** • (1) Arachnipod Lazy Leg • (1) Gin Head

24482101	APOD Monopod Kit	\$2,500.00
----------	------------------	------------



ADD-ON KITS

QUADPOD

The following add-on kits function perfectly with the Advantage-Basic, Advantage, Advantage-Basic Plus, and Advantage Plus Multipod Systems. It is important to note that the aforementioned Systems must be purchased to utilize the Add-on kits. **(Bridge Kit Add-On page 68)**



STANDARD QUADPOD ADD-ON KIT

The Standard Quadpod Add-On Kit provides the components necessary to add a 4th leg to an Arachnipod Multipod.

- Components Included:** • (1) Arachnipod Standard Leg • (1) Quad Plate • (1) Leg Bag

24481108	APOD Standard Quadpod Kit	\$1,400.00
----------	---------------------------	------------



PULLEY QUADPOD ADD-ON KIT

The Pulley Quadpod Add-On Kit provides the components necessary to add a 4th leg to an Arachnipod Multipod.

- Components Included:** • (1) Arachnipod Pulley Leg • (1) Quad Plate • (1) Leg Bag

24481208	APOD Pulley Quadpod Kit	\$1,800.00
----------	-------------------------	------------



BRIDGE ADD-ON KIT

The Bridge Add-On Kits convert existing Arachnipod Multipods into a Bridge System.

Components Included:

• (1) Arachnipod Bridge • (1) Standard Leg • (1) Feet Restraining Rope

24481702	2 Meter Bridge Add-On	\$4,500.00
24481703	3 Meter Bridge Add-On	\$4,800.00
24481704	4 Meter Bridge Add-On	\$5,200.00



(top) Gin Pole / Monopod
(bottom) Offset A-Frame

ACCESSORIES

WINCHES, KITS, PARTS



ARACHNIPOD WINCH

Drum winch with 6mm cable. Interfaces with pulleys or pulley in the head of the Advantage or TEMS systems.

WLL: 485 lbs.

24481620 66 ft. (20 meter) \$1600.00



FALL PROTECTION LIFELINE WITH RECOVERY WINCH

3-Way Lifeline

Tough Aluminum housing with 3/16" galvanized steel cable with a load-indicating Autolocking Swivel Snap. Working load: 660 lbf. Meets ANSI Z359.1 and CE BS EN 360 requirements. Electrostatic powder painted. 100% inspected. Unit can be reset from winch mode back to fall protection mode. Attaches to the APOD with the mounting bracket listed below. Also, will attach to the IndustriPOD+ (page 82), and Technician Tripod (page 83) with a separate bracket.

61943050	3 Way x 50 ft.	\$2,300.00
61943059	Mounting Bracket	\$550.00



APOD - ACCESSORY KIT

The APOD Full Accessory kit contains many needed options for use with the Arachnipod. Included are steps that allow the user to reach the top of the tripod after set-up. Spike feet for rough terrain. A Rigging Equipment Bracket for control devices or auxiliary pulleys. Rigging Plates for stabilization. And much more.

Components Included:

Accessory Bag (1), Spare Detent Pins (2), Spike Feet (4), Spare Leg Pins w/ Detent (1), Gin Head (1), Steps (2), Soft Ground Shoes (4), Equipment Bracket (1), Hold Down Stakes (4), Rigging Plate (1), M12 Tru-Bolts (8), Quad Plate (1), Spare Quik-Link Head Pins (2)

24481501 Full Accessory Kit \$5,500.00



RIGGING PLATE

The Rigging Plate is an essential piece of equipment when rigging an A-Frame/Bipod system. It provides additional lateral stabilization attachment points. The plate is for stabilization purposes and is NOT a live load rigging point.

24481211 Rigging Plate \$100.00

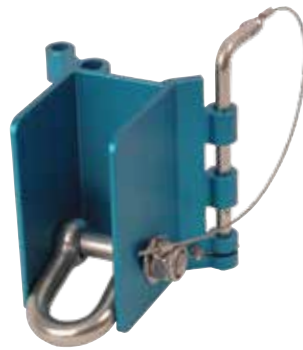

REVERSE HEAD

The Reverse Head is used to change the angle between legs. It allows a standard, equilateral tripod to be transformed into a "flat-front" tripod (Standard or Lazy Leg configurations). The Reverse Head has a large D-Shackle rigging point that centralizes the load between the opposing side legs.

24481412 Reverse Head \$360.00

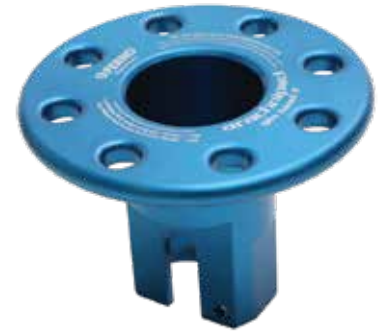

GIN HEAD

The Gin Head is used with the Lazy Leg to form a Gin Pole. Both Parts are colored blue to make leg selection an easy task. The Gin Head may also be used as a large rigging plate when not used in a gin pole configuration.

24481511 Gin Head \$900.00



SPIKE FOOT

The Spike Foot can be used for point loading and ground penetration applications. A stainless steel tip extends the service life of the Spike Foot. Simply remove the Standard Arachnipod Foot and insert the Spike Foot into the socket at the end of the Arachnipod Leg. Foot is held in place by steel detent pin.

24481212 Spike Foot \$120.00



SOFT GROUND SHOE

The Soft Ground Shoe fits over the end of the Leg and is held in place by the Spike Foot. The Soft Ground Shoe limits ground penetration.

24481515 Soft Ground Shoe \$60.00



HOLD DOWN STAKE

The Hold-Down Stake can be used to secure a standard foot to the ground. The foot locating spike lines up with one of the holes in the standard foot.

24481516 Hold Down Stake \$110.00



QUAD PLATE

The Quad Plate is used whenever 4 legs or heads are used together, such as a quadpod or lazy leg / reverse head configurations. The Quad Plate stabilizes the head to maintain the square configuration created.

24481520 Quad Plate \$52.00



LEG RIGGING BRACKET

The Equipment Bracket is attached to the lower leg section for use with mechanical advantage rigging. It can be rigged inward for use with the swivel rigging points or outward for use with the pulley head.

Load ratings per leg settings: A1: 330 lbs.; B2: 485 lbs.; C3: 661 lbs.

24481519 Leg Rigging Bracket \$350.00



LEG STEP

The Leg Step is probably the handiest accessory for the Arachnipod. The Step can be attached to the middle or lower leg sections and is a useful aid when you need to reach the rigging points of a fully extended Arachnipod. The Steps are reversible and may be used inside or outside of the leg. The Step is not rated for rescue load applications.

24481518 Leg Step \$250.00



TERRADAPTOR

Versatile Portable Anchor System

The primary system revolves around the TerrAdaptor Tripod System. This system includes all of the necessary parts to assemble a standard symmetric tripod that provides the ability to reach a height of approximately 10-feet. The system comes packaged in three compact packable bags to make it easy to “grab your bags and go” as well as store the System together in an organized manner.

The TerrAdaptor system has been tested extensively in both lab and field environments. As a result, the TerrAdaptor Portable Anchor system in the standard symmetric tripod and quadpod configurations are the only systems of their kind to be certified by UL to NFPA 1983

Components Included: • (1) TerrAdaptor Tripod Head • (2) Offset Leg clamps w/ Pins • (1) Center Leg Clamp w/ Pins • (12) Leg Coupling Pin • (2) Lash ring • (3) Cotter Pin • (1) Main Attachment Pin • (3) Mid Tube (6) Perf Tube • (3) Leg Kits (Feet, Hobble Plates, Baskets) • (3) Rope Hobble • (1) Head Bag • (2) Leg Bag • (1) User Guide

2348230100N

TerrAdaptor Kit

\$5,350.00

SPACE STATION

Advanced Load Management

Designed for elite rope technicians, the all-new Space Station adds even more capability to the TerrAdaptor, the world’s most versatile industrial tripod. Multiple configurable connections via TerrAdaptor with head and leg couplings. The one fixed and one floating rigging plate enables loads to self-center. Can be split into two halves and attached to either TerrAdaptor grey perf tubes or orange mid tubes. Can be setup as single, lightweight mono-pod head. Beefy 5/8” thick rigging plates can accommodate NFPA G-rated eye-to-eye loads (50kN) and T-rated axial loads (24kN).

Includes: Zippered Case, Large ball detent pin, 2 leg pins, user manual
Weight: 3.04 lbs. (1380 g). WLL, Anchor: 1 kN; WLL, High Directional: 2 kN.



254029210

Space Station

\$675.00



VECTOR

Edge and Load Management

The Vector Edge and Load Management System is a light-weight, portable tool for use in industrial, mountain and urban rescue environments. When combined with high strength - low stretch cord, quality life-safety rope, lightweight pulleys and carabiners, the Vector provides rescuers with a versatile resource which can reduce risk and go virtually anywhere.

Length: 37.74” (96.3cm). **Weight:** 3.04 lbs. (1380 g). **WLL, Anchor:** 1 kN; **WLL, High Directional:** 2 kN.

2540290010

Vector

\$550.00





INDUSTRIPOD+® TRIPOD

Compatible with Many ARACHNIPOD Accessories

The IndustriPOD® tripod is a heavy-duty, versatile and durable tripod that exceed the criteria of most international standards. The design and simplicity of use make this sturdy tripod ideal for any heavy-duty confined space requirement where guaranteed performance is mandatory. For added versatility, IndustriPOD® is compatible with many Arachnipod Total Edge Management Accessories.

- Rectangular, adjustable legs with quick-action ball lock leg pins
- One-piece fabricated steel head
- Two stainless steel 70 mm sheave pulleys
- Pulley detent pins to prevent rope / cable jump
- Three side plate anchor points
- Three tie-off points for rigging or stabilization
- Adjustable feet with aggressive non-slip tread pattern
- Adjustable foot tether
- Storage bag

Weight: 55 lbs. (25 kg)
 Height, Minimum: 5' 9" (1.75m)
 Height, Maximum: 8' 5" (2.6m)
 SWL, Over Pulley: 485 lbs. (220 kg)
 SWL, Anchor Points: 794 lbs. (360 kg)

244836102	IndustriPOD+	\$2,400.00
244836110	IndustriPOD+ Storage Bag	\$190.00



Swivel Eye Rigging Points (2)
 Spring-Lock Mechanism Locks
 Legs into Place

Over-the-Top
 sheaves
 accommodate
 cable or rope.

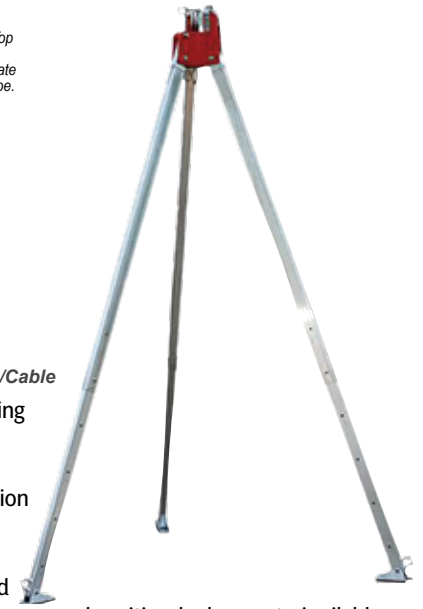

TECHNICIAN+PLUS TRIPOD

Pulley Sheaves in Head for Rope/Cable

2 Swivelling Rigging points. Spring loaded leg locking mechanisms hold legs in place. Sheaves on head of tripod allow for integration of winches and fall blocks while allowing for increased height under the tripod head. Extruded head and snap out legs for quick and positive deployment. Available with optional load indicating attachment eyes. Manufactured from high strength alloy aluminum and stainless steel fittings.

Strength: 8,093 lbf. (36 kN) WLL, Personnel: 794 lbs. (360 kg) WLL, Equipment: 1102 lbs. (500 kg) Weight: 51.75 lbs (23.53 kg) Maximum Open Height: 99.6" Minimum Open Height: 70" Storage Dimensions: 72" x 8.5" x 8.5"

6194101	Technician+PLUS Tripod	\$1,475.00
6194109	Tripod Bag	\$165.00



TECHNICIAN TRIPOD WINCH

Mounts Inside Or Outside of Leg

The ISC Tripod Winch is ideal for use in lifting and lowering applications. The Winch has a working length of 65 ft (20m). To be used with a secondary back-up system such as the EXTRACTOR CSR Kit. Includes Steel Swivel eye, double-action Snaphook. We built the Winch Case to fit the ISC Tripod Winch. The case is built from 1000 den Cordura fabric with foam and hard plastic interior shell to increase durability.

Case dimensions: 21" x 12" x 7"

61946065	Tripod Winch, 65 ft.	\$1,300.00
61945059	Winch Case	\$185.00



Technical rescue and safety is potentially hazardous. Any person using equipment sold by RESCUE TECHNOLOGY in any manner is personally responsible for learning the proper techniques involved, and assumes all risks and accepts full and complete responsibility for any and all damages or injury of any kind, including death, which may result from the use of any RESCUE TECHNOLOGY equipment.

Products in this catalog can expose you to chemicals which are known to the State of California to cause cancer.

For information go to: www.p65warnings.ca.gov



HARKEN RIGGERS WINCH 500

The Riggers Winch provides the user with a lightweight, CE certified, portable winch mounted to a robust adaptor plate. The Riggers Winch 500 weighs 7 kg (15.4 lb) with a 1/2 ton working load limit, the 2 speed winch magnifies the operator pulling power by up to 40 times. The multiple mounting options provides versatility when working in difficult or remote environments.

The mounting plate is sculpted to remove excess weight and provides multiple attachment points without compromising strength. The pigtail line lead ensures correct alignment and loading of the winch for maximum efficiency. Unique drum design maximizes grip on the rope. Designed for use with fiber rope up to 1/2" (12 mm) in diameter.

233623500	Riggers Winch 500	\$2,180.00
2336901104	Ratchet Strap, 10 ft.	\$25.00
2336901204	Ratchet Strap, 20 ft.	\$32.00



LOKHEAD WINCH FIRE/RESCUE KIT - NFPA

The innovative LokHead Winch Fire/Rescue Kit meets NFPA 1983 certification requirements. The winch is a portable or fix-mounted load-lifting, personal-hoisting winch used with an unlimited length of fiber rope. The captive head allows the winch to be used safely, and keeps the rope from accidentally releasing. The Power ratios of 13.5:1 (high speed) and 39.9:1 (Low Speed) makes the haul easier on the rescuers.

Perfect for fixed or temporary applications and rescue. The kit includes the LokHead winch with reversible plate, waterproof carrying case, winch handle, tripod adapter with counter plate, control lever, Variable Anchor strap, and two carabiners. The strap and carabiners also meet NFPA standards.

Maximum line diameter: 1/2" (12.7 mm); Minimum line diameter: 3/8" (10mm); Maximum working load, Equipment: 1100 lbs (500 kg); Maximum working load, Personnel: 485 lbs. (220 kg); Weight, Winch: 14.2 lbs.

23365003	LokHead Winch Kit - NFPA	\$3,940.00
----------	--------------------------	------------

LOKHEAD POWER DRIVE ADAPTOR

This power tool adapter fits 3/8" chucks. Use with the LokHead winch kit for lifting goods or equipment only, not for human suspension.

23367431	\$40.75
----------	---------



TELLUMOUNT

When used in combination with the LokHead winch kit the TelluMount provides a myriad of rigging solutions, either on the ground or other flat surface, or mounted to a wall. The TelluMount is made of durable aluminum and features holes in a variety of sizes enabling it to be mounted in many ways. It's a perfect tool for confined space operations and other rope access operations.

Weight: 1.46 lbs (3.2 kg); Dimensions: 11.2" x 19.9" x 14.8" (281 x 500 x 374mm)

23361011	\$1,100.00
----------	------------



Shown with LokHead Winch

STRETCHERS & LITTERS

PATIENT TRANSPORT



RESCUETECH STAINLESS STEEL RECTANGULAR STOKES STRETCHER

A stainless steel version of our Rectangular Stokes Stretcher. Includes a special Mesh insert with a .25" diamond pattern for greater strength, and better patient packaging than .5" patterns. A new style ABS back plate provides a sturdy, yet comfortable base for the patient. We have also added rescue-grade nylon Quick-Fit Stretcher Straps for securing the patient.

Dimensions: 84" x 24" x 7.25" **Interior Depth:** 6" **Strength using standard rigging points:** 2550 lbf. **Weight:** 29.3 lbs. **Shipping Weight:** 35 lbs.

*Does not replace proper patient packaging using backboard, cervical collar, and headblocks. Shipped via motor freight.

620124 S.S. Rectangular Stokes \$699.00



RESCUETECH TAPERED STOKES STRETCHER

The RT Stretcher provides an economical choice for the rescue professional. Cold Rolled tubing and a full length steel strip backing for strength and rigidity.

Dimensions: 84" x 23.5" x 7.25" **Interior Depth:** 6" **Strength using standard rigging points:** 2550 lbf. **Weight:** 34 lbs. **Shipping Weight:** 40 lbs.

Product features: .25" Diamond Mesh insert • Full length steel strips provide backboard-like rigidity* • Rescue-Grade Patient Straps • Electrostatic Powder Coat Finish

*Does not replace proper patient packaging using backboard, cervical collar, and headblocks. Shipped via motor freight.

620112 Tapered Stokes Stretcher \$430.00



RESCUETECH STAINLESS STEEL TAPERED STOKES STRETCHER

Super Strong to meet Mil-Spec

This stretcher meets the Mil-Spec 2,500 lb. load rating - tested from the ends of the stretcher to give a more accurate measure of strength*. We add a special Mesh insert with a .25" diamond pattern for greater strength, and better patient packaging than .5" patterns. A new style ABS back plate** provides a sturdy, yet comfortable base for the patient. We have also added rescue-grade nylon Quick-Fit Stretcher Straps for securing the patient.

Dimensions: 84" x 24" x 7.25" **Interior Depth:** 6" **Strength using standard rigging points:** 2,500 lbf. **Shipping Weight:** 33 lbs.

Shipped via motor freight. *Other brands test from rigging points to give an artificially higher strength rather than the required Mil-Spec Strength rating. **Does not replace proper patient packaging using backboard, cervical collar, and headblocks.

620122 S.S. Tapered Stokes \$770.00



RESCUETECH RECTANGULAR STOKES STRETCHER

The Rectangular Stretcher builds on our popular Tapered Stretcher design. It is designed to be symmetrical from end-to-end and to allow larger sized, rectangular backboards to easily fit inside. Cold Rolled tubing and a full length steel strip backing for strength and rigidity.

Dimensions: 84" x 23.5" x 7.25" **Interior Depth:** 6" **Strength using standard rigging points:** 2550 lbf. **Weight:** 37 lbs. **Shipping Weight:** 43 lbs.

Product features: .25" Diamond Mesh insert • Full length steel strips provide backboard-like rigidity* • Rescue-Grade Patient Straps • Electrostatic Powder Coat Finish

*Does not replace proper patient packaging using backboard, cervical collar, and headblocks. Shipped via motor freight.

620114 Rectangular Stokes Stretcher \$430.00



RESCUETECH EXTRA-WIDE STOKES

For those special rescues where the basic sized stretcher will not work. 32" wide at the rail and lined with our 0.25" diamond pattern durathene mesh. Included 4 rescue-grade patient straps*.

Dimensions: 85" x 32" x 8" **Strength:** 2550 lbf. **Weight:** 31 lbs.

*Does not replace proper patient packaging using backboard, cervical collar, and headblocks.

620125 RT Extra-Wide Stokes \$825.00



RESCUETECH CONFINED SPACE STOKES STRETCHER

An updated version of the traditional wire mesh stretcher. This version features our popular 0.25" durathene mesh insert and rescue-grade straps. Tested to 1500 lbs.

Dimensions: 81 1/2" x 18 3/8" x 7 3/4" **Strength:** 2550 lbf. **Weight:** 32.6 lbs. **Shipping Weight:** 38 lbs.

*Does not replace proper patient packaging using backboard, cervical collar, and headblocks. Shipped via motor freight.

620113 Stokes Stretcher \$430.00

JUNKIN CONFINED SPACE LITTER

A narrow version of the Wire Basket Stretcher. Only 19" wide and fits through nearly all accessible manholes. Used with either 4 or 6 point litter bridles. Hexagon mesh wire netting. Tested to 1500 lbs.

Dimensions: 81 1/2" x 18 3/8" x 7 3/4" **Weight:** 23.7 lbs. **Shipping Weight:** 29 lbs.

Shipped via motor freight.

620103 Confining Space (JSA-300CS) **\$540.00**



JUNKIN WIRE BASKET STRETCHER

Traditional design wire basket stretcher manufactured from rugged 5/8" tubular steel frame with 3/16" x 3/4" flat wire braces. Hexagon mesh netting (18 gauge). Used with either 4 or 6 point litter bridle. Tested to 1500 lbs.

Length: 80.5" **Widths:** 22 1/2"- chest, 22"- abdomen, 21.5"- thigh, 20.5"- calf **Height:** 8" **Weight:** 25.6 lbs. **Shipping Weight:** 31 lbs.

Shipped via motor freight.

620101 Wire Basket Litter (JSA-300W) **\$460.00**



JUNKIN PLASTIC STRETCHER

The Plastic Stretcher combines the open top railing desirable on standard wire basket litters with the plastic bottom desired for smooth transport. Made from yellow, high density polyethylene shell, supported by a Stainless Steel outer rail. Shell is permanently attached to rail using semi-tubular Stainless Steel rivets (not pop rivets). Steel rail facilitates handling of the stretcher at all points along sides and ends of stretcher. Includes molded runners and a sealed, closed cell foam pad. The Plastic Stretcher will accept a full size rectangular backboard.

Load capacity: 1,200 lbf. **Dimensions:** 84.5" x 24" x 7.5" **Weight:** 31.6 lbs. **Shipping Weight:** 37 lbs. **Color:** Yellow

Shipped via motor freight.

620115	Plastic Stretcher (JSA-200)	\$1,080.00
620116	Plastic Stretcher, 2-Piece (JSA-200-B)	\$1,400.00



MASS CASUALTY FLEXIBLE STRETCHER

Constructed of specially compounded orange or gray 18 oz. vinyl-coated nylon that is easily washed with soap and water. Highly resistant to acids, alkalis and penetration of liquids. Five (5) removable hardwood slats positioned between two layers of the 18 oz. fabric provide strength and rigidity. Shorter slats are placed in torso area only to make stretcher lighter and more compact. Lightweight – 13 lbs. Compact and portable – opens to 78"L x 28"W; closes to 35"L x 6"W. Six (6) handles ergonomically placed for ease of transport. Three (3) polypropylene web patient security straps for immobilization. Load capacity – 350 lbs. Carry bag with shoulder strap. One person can carry up to ten (10) of these stretchers when responding to an incident.

	Color	
20701040	Orange	\$450.00
20701047	Grey	\$450.00





ADJUSTABLE LITTER BRIDLE

Vertical, Horizontal, and Low Angle Lifting

Same as our original 4-Point Litter Bridle but with 1 3/4" forged adjusters. Adjusters allow for independent adjustment of the four support straps during rescue. Complete with 3" forged "O" ring and 4 locking litter snaps. Also available without snaps to use with heavy duty carabiners for litter attachment. Converts for low angle use. Tensile Strength: 5,000 lbf. Color: Orange with contrasting straps. We suggest the 60511830 RescueTECH Large D, Steel Carabiner. Bridle Kit includes: Bridle, Tender Rope and Carrying Bag.

		Weight	
620185	Bridle w/ Snaps	7.15 lbs.	\$285.00
620188	Bridle w/ D-Rings	4.15 lbs.	\$205.00
620189S	Bridle Kit w/ Snaps	8.75 lbs.	\$345.00
620189	Bridle Kit w/ D-rings	5.4 lbs.	\$252.00
6201892	Quik-Pik Bridle w/ D-rings	6.4 lbs.	\$325.00



2-PIECE LITTER PRE-RIG

The Pre-Rig is a fully adjustable bridle intended for use with any Stokes litter. The unique "Y" suspension system drastically reduces congestion at the upper attachment point. Adjustable to a minimum height of 18" above the litter for the tightest helicopter evacuations and a maximum length of 5 feet. One half of the Pre-Rig can be used as a low angle evacuation stretcher harness, eliminating the need to purchase separate harnesses. Combines with a rescuer rigging rope or Transfer Sling for a complete litter/rescuer system. Litter Pre-Rig is made of 6,500 lbf. webbing and quick adjust Mil-Spec forged hardware.

Strength: 5,000 lbf. Weight: 3 lbs.

All webbing and hardware meet NFPA strength specifications.

620183	2 Piece Litter Pre-Rig	\$210.00
--------	------------------------	----------

TASK BLOCK II STRETCHER

Stretcher with Integral Patient harness and Lifting Sling

The BLOCK II® stretcher is a basket-type rescue stretcher, ideal for transporting and rescuing victims in different industrial, urban, marine, vertical, and drag scenarios. The Harness H system allows the victim to be secured with or without a board, thus guaranteeing double safety (DSS). Click Lock patient buckles and stretcher closure.

Color: Black Material: HDPE plate and carbon steel body Weight: 19.2 kg
WLL: 595 lbs. Minimum / Maximum Patient Height: 4'9" / 6'8"
Dimensions: 78" x 23" x 6.3"

209230021	Task Block II Stretcher	\$1,250.00
-----------	-------------------------	------------



LITTER ATTENDANT SLING

A handy adjustable sling that attaches to litter railing with a girth hitch. Similar in design to our standard transfer sling. V-ring adjuster attaches to rescuer. Great for litter transport.

Extended Length: 40" Weight: 8 oz.

756111	Litter Attendant Sling	\$48.00
--------	------------------------	---------



STRETCHER EQUIPMENT PACK

Holds all Harness and Hardware

A new equipment pack designed to hold all items needed for securing patient and stretcher movement in a vertical environment. Two zippered pockets hold webbing, hardware, litter bridles, victim harnesses, and much more (not included). Come complete with carrying handle. Stretcher attachment system is complete with high strength buckles.

Dimensions: 18" x 10" x 5" Weight: 27 oz.

620172	Stretcher Equipment Pack	\$100.00
--------	--------------------------	----------

PATIENT STOKES HARNESS

Special design harness that provides inside patient lashing. Designed to stay attached to stretcher then attached to patient. Complete with chest and seat harness section. Easily donned. To be used in addition to a rescue-grade wire basket or plastic stretcher with proper technical rescue patient lashing.

Weight: 40 oz.

6201540 Patient Stokes Harness \$120.00



*Manikin and Stokes not included

PATIENT PACKAGING SET

Complete system for patient restraint in the vertical environment. Set includes Stokes Harness, Patient Lashing Set (Clik-Lok or Quick-Fit), and Stretcher Equipment pack.

Weight: 7.35 lbs.

299842121	Quick-Fit™ Patient Packaging Set (shown)	\$410.00
299842125	Clik-Lok Patient Packaging Set	\$446.00



*Manikin and Stokes not included



STRETCHER HARNESS SET

An upgraded version of our original Patient Packaging set. We have added Litter Bridle and equipment for the attendant(s).

- *Stretcher Patient Harness (1)* • *Clik-Lok Stretcher Lashing set (1)* • *Stretcher Equipment Pack (1)* • *RD70 Carabiners (4)* • *OD50 Carabiner (1)* • *Litter Attendant Sling (4)* • *Gibbs Ascender (2)* • *Deluxe • Rescue Etrier (1)* • *Adjustable 4 pt Litter Bridle Kit (1)*



299842130

Stretcher Harness Set

\$1,300.00

STRETCHER TRANSPORT

CASCADE ADVANCE SERIES TRAIL TECHNICIAN LITTER WHEEL

The Advance Series Litter Wheels will saddle virtually any basket style litter. The saddle attaches to the top railing of the litter with four nylon straps - simply hook up then use the ratchet levers to cinch it down. The non-skid surface inside the litter saddle keeps the litter firmly in place. Once your patient is loaded, the wheel assembly locks on in less than two seconds and won't come off unless you unlock it. Constructed of 6061 T6 Aluminum, the Advance Series Litter wheels are designed to be packable, durable and help you save lives while saving the energy and effort of your team. The Trail Tech Wheel will not fit litters that have a plastic wrapped top railing. The litter rail must be 1" or less. **Weight: 18.5 lbs.**



254103102 Technician Litter Wheel **\$1,300.00**

CASCADE TERRA TAMER

The Terra Tamer is light, fast and lean. The framework and fork system is constructed of Pure Titanium, making the Terra Tamer the lightest all-purpose patient transport on the market. The super plush 4.25" Fatty tire bounds over trail obstacles and is unbelievably stable. Included is a disc brake and all stainless steel hardware. Simply slip the custom designed hooks over the top railing of your litter and use the compact stainless steel ratchets to cinch it down. The Terra Tamer can even be mounted on most rescue litters that do not have a plastic wrapped top railing (1" diameter or less.)



Weight: 15.40 lbs Height: 32" Width: 29" (Base/Saddle dimensions: 18.5" X 17.5")

254103101	Terra Tamer Litter Wheel	\$1,860.00
254103109	Tamer Transport Pack	\$385.00



STRETCHER TRAILER

Aluminum Litter Trailer for litter transport. Easily disassembles for storage. Nylon Powder Coated. Sets up in approximately 3 minutes. Litter not included.

Ground Clearance: 21" Length: 72" Width: 27" or 40" Weight: 71 lbs.

Litter not included.

620350	Stretcher Trailer	\$2,700.00
620355	ATV Adapter Kit	\$750.00



ATV Adapter Kit

RESCUE ADVANCED SERIES TERRAIN MASTER LITTER WHEEL

The Terrain Master has a tough steel frame, powder coated for durability and sports a machined aluminum rim with a stainless steel hub. The upgraded all-terrain tire gives the Terrain Master even more capability on soft surfaces while providing enhanced patient comfort; all at a great price.



Weight: 30lbs.

254103103 Terrain Master **\$1,065.00**



WARNING

Technical rescue and safety is potentially hazardous. Any person using equipment sold by RESCUE TECHNOLOGY in any manner is personally responsible for learning the proper techniques involved, and assumes all risks and accepts full and complete responsibility for any and all damages or injury of any kind, including death, which may result from the use of any RESCUE TECHNOLOGY equipment.

Products in this catalog can expose you to chemicals which are known to the State of California to cause cancer.

For information go to: www.p65warnings.ca.gov



LITTER COVER

Protects Stretcher from the Elements

Manufactured from durable vinyl coated polyester for extra strength and durability. Double stitched seams and Vislon Zipper. Compression straps secure the bag to the stretcher. Zippered opening of 1/2 of the top panel eases insertion of the stretcher. Fits all standard and confined space stretchers. Stretcher not included.

Dimensions: 90" x 30" x 10"

620175 Litter Cover \$195.00



BASKET STRETCHER FLOTATION KIT

For use with all basket stretchers to provide flotation during patient handling in water. Easily attached with hook and loop fastener to any Stokes type stretcher. Flotation bats are Dow EthaFoam and covered in Cordura™ Nylon. Kit is ready to attach to any Junkin stretcher.

Weight: 5 lbs. Color: Orange.

620321 Flotation Kit \$660.00



STADIUM SEAT

For use in fast, safe transportation of victims from stadiums, sport facilities, arenas, theaters, or anywhere multiple steps create problems in removing patients. Lightweight - weighs only 4.5 lbs. Strong - accommodates up to 350 lbs. Durable - made of 18 oz. vinyl and hardwood slats. Compact - folds to 20" x 7" in carrying bag. Safe - 2 nylon seat belts secures patient. Portable - can be stored in a minimum of space. Easy to use - 5 web handles for lifting and carrying.

20700059 Stadium Seat \$255.00



INFLATABLE BACKBOARD FLOTATION SYSTEM

Inflatable flotation support and stability system for emergency backboard operations. This collar manually inflates, providing 135 lbs of buoyancy to the Backboard. Features 8 Durable hook loop straps attach evenly to any backboard. Two manual 60g inflatable rearming packs provide 80 lbs of buoyancy. The deflated collar folds up for easy storage and transportation.

2171020600 Backboard Flotation System \$640.00



STRETCHER BLANKET

Traditional Packaging Tool

The finest cot and stretcher blanket available for patient packaging. Provides excellent insulation characteristics. Note: Proper basket litter operations require a minimum of two blankets. 70% Wool, 30% Synthetic Fiber.

Size: 82" x 62" Weight: 42 oz.

620160 Stretcher Blanket \$6000



HEAVY DUTY SPACE BLANKET

Lightweight Superinsulator

Reflects and retains up to 80% of radiated body heat to prevent post trauma shock resulting from an accident or natural disaster. Waterproof, windproof and durable. Multiple layers are flexible even in sub-freezing temperatures.

Dimensions: 84" x 60" Weight: 12 oz.

620165 Heavy Duty Space Blanket \$25..75



MYLAR EMERGENCY BLANKET

Known for years as a Space Blanket, this mylar sheet works great as a thermal insulator. Small enough to fit in your shirt pocket, yet opens to a full 56" x 84" size. Stays flexible in freezing temperatures. Wind and waterproof.

Weight: 1.5 oz.

2282127032 Emergency Blanket \$4.50



LIGHTWEIGHT BACKBOARD



X-Ray Translucent Molded Plastic

Manufactured from the highest grade PVC. Special design is lightweight and easy to clean. Compatible with Patient Restraint Straps and Backboard Strap.

Shipping Weight: 22 lbs. Color: Yellow Dimensions: 73" x 17" x 3/4" Capacity: 400 lbs. Weight: 18.3 lbs.

620210	L/W Backboard	\$290.00
620211	L/W Backboard w/ Pins	\$290.00

FOLDING ALUMINUM BACKBOARD

Lightweight backboard that stores in half the length of a standard length backboard. Durable Aluminum construction.

Dimensions: 72 x 16" Folded Dimensions: 36 x 16 x 3" Shipping weight: 17 lbs.



620216 Folding Aluminum Backboard \$490.00



AMBU PER-FIT ACE

The Per-Fit Ace adjusts to ANY adult-size neck with 16 different settings ranging from neckless to tall.

• Stores completely flat • Horizontal sizing line • Radiolucent, CT & MRI compatible • Safety buttons for maximum reliability



23466884	AMBU Per-Fit Ace, Adult	\$12.00
23466882	AMBU Per-Fit Ace, Pediatric	\$12.00

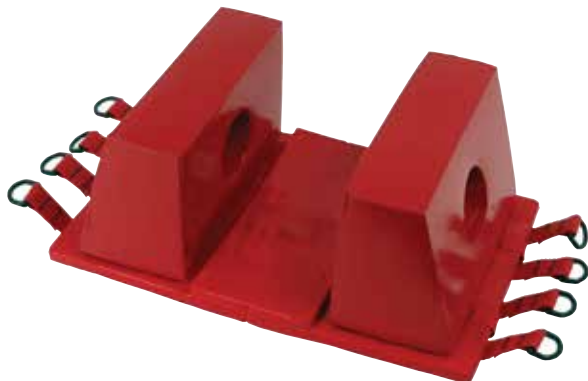

BACKBOARD HEAD IMMOBILIZER

Designed and recommended for immobilization only. Item includes: two head support pillows with ear openings; base with center pad and two backboard retention straps; straps for head positioning; and a vertical stabilization strap to maintain immobilizer placement at head of the board.

620224 Head Immobilizer \$110.00



FOLDING POLYETHYLENE BACKBOARD

The Folding Polyethylene Backboard is a rugged bright yellow polyethylene folding spineboard with twelve large hand holes for easy handling, built-in runners, low profile, and X-ray translucent. 4 patient straps are included. Available in a bright yellow color. Polyethylene construction with Large hand cut-outs for easy handling.

1 Year manufacture limited warranty Dimensions, Folded: 37-1/4" L X 16" W X 3" thick Dimensions, Unfolded: 74-1/4" L X 16" W X 1-3/4" thick Capacity: 375 lbs.

620215 Folding Backboard \$510.00



ALUMINUM DECON POLE STRETCHER

Open Mesh Design

Ideal for decontamination. Easily set up and compact for storing. This Medical Corps type litter is light in weight with shaped hardwood handles. Cover is durable 18 oz. vinyl coated nylon.

Open Dimensions: 87" x 22" x 4.5" Folded Dimensions: 43.5" x 3.5" x 7.5"

2026601M Aluminum Decon Pole Stretcher \$370.00



ALUMINUM SCOOP STRETCHER

Designed to gently maneuver stretcher under a patient without rolling or lifting. Features sturdy, lightweight aluminum construction with an adjustable length and three patient restraint straps. Folds for easy storage and separates in half during application and removal.

Dimensions: 66.25" x 17.5" Adjustable to 80" Folded Length: 49.5" Shipping weight: 21.5 lbs. Capacity: 400 lbs.

620220 Aluminum Scoop Stretcher \$935.00

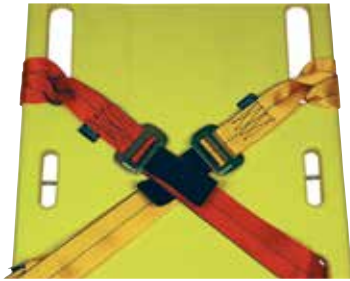

QUICK-FIT PATIENT STRAPS™

For Backboards and Stretchers

A rescue-grade strap for use with stretchers and backboards. 2 piece versions consists of two straps with a loop at one end, to girth hitch around stretcher rail, and a connector at the other end. 1 piece version is a single strap designed to wrap completely around a backboard or litter. An excellent alternative to “seat buckle” style connectors. Two-piece buckle is manufactured of steel and require movement in two planes to detach. Easy to connect and adjust. Suitable for Technical Rescue Use.

Color: Yellow WLL: 600 lbs. Length, 2-pc: 70” Length, 1-pc: 108”

		Color	
6201522	2-Pc Quick-Fit	Yellow	\$27.00
6201524	2-Pc Quick-Fit	Red	\$27.00
6201521	2-Pc Quick-Fit	Black	\$27.00

		Color	
6201532	1-Pc Quick-Fit	Yellow	\$25.00
6201534	1-Pc Quick-Fit	Red	\$25.00
6201531	1-Pc Quick-Fit	Black	\$25.00

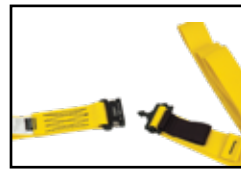

CLIK-LOK PATIENT STRAPS™

For Backboards and Stretchers

Manufactured with our new Clik-Lok Buckle, the 2-Piece version is affixed to backboards and stretchers with a girth hitch. The 1-Piece wraps completely around the backboard or litter. Constructed of 1.75” flat nylon webbing (Tensile Strength: 5,500 lbf.) and Clik-Lok adjuster buckles. We recommend crossing the chest area using different color slings to aid in proper buckle attachment.

Strength: 5,500 lbf. WLL: 600 lbs. Length 2pc.: 70” Length 1pc.: 108” Weight: 11.2 oz.

		Color	
6201512	2-Pc Clik-Lok	Yellow	\$40.00
6201514	2-Pc Clik-Lok	Red	\$40.00
6201511	2-Pc Clik-Lok	Black	\$40.00

		Color	
6201562	1-Pc Clik-Lok	Yellow	\$44.00
6201564	1-Pc Clik-Lok	Red	\$44.00
6201561	1-Pc Clik-Lok	Black	\$44.00

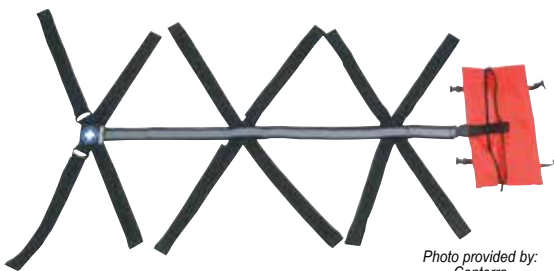

Photo provided by: Conterra



TRIPLE X BACKBOARD STRAP™

Innovative Design from Conterra

New strap system that has twelve separate overlapping Velcro® straps that quickly and securely immobilize a spine injured patient to virtually any spine board. Easy deployment. Simply align the three sets of “X” formation straps over the corresponding weight centers of the body (upper chest, pelvis, legs). Thread tie straps through the backboard holes and pull tight. Machine washable 2” webbing, 1.5” Velcro. Reflective striping on center alignment strap. Complete with zippered carrying case.

Weight: 28 oz.

621131	Triple X BackBoard Strap, Standard	\$130.00
621132	Triple X BackBoard Strap, Clip	\$199.00

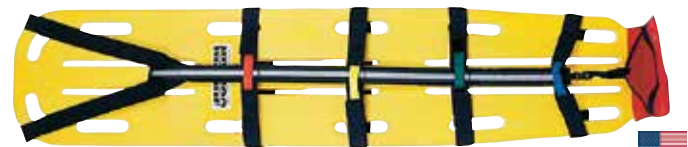

Backboard not Included



STANDARD BACKBOARD MULTI-STRAP

Traditional Design

Strap system that has eight straps that quickly and securely immobilize a spine injured patient to virtually any spine board. Easy deployment from included storage bag. Thread straps through the backboard holes and pull tight. Machine washable 1.5” webbing, 1.5” velcro. Reflective striping on center alignment strap. Complete with zippered carrying bag that will attach to backboard or litter for convenient storage.

Weight: 22.5 oz.

620155	BackBoard Multi-Strap	\$140.00
--------	-----------------------	----------

TASK H-STR II FLEXIBLE HALF STRETCHER

INCLUDES PATIENT HARNESS SYSTEM

A half-sized version of the STR II. Ideal for confined space use and firefighter evacuation. Features patient harness, foot loops and horizontal/vertical lifting straps. Horizontal lift strap loops serve dual use as lifting handles. Color coded strap system: Patient (Yellow), Closure (Black), Lifting (Blue). Can be used to move patient out of a 90 degree turn in a pipe. Automatic rescue strength locking buckles securing patient in the STR II. Features stainless steel no pressure system that allows the unit to envelope the patient without undue shoulder squeeze found in other flexible stretcher.



Dimensions: 47" x 32.5"; Weight: 13.2 lbs.

209220410	Orange	\$775.00
209220411	Black	\$775.00

TASK STR-PLUS FLEXIBLE STRETCHER

INCLUDES PATIENT HARNESS SYSTEM

STR PLUS Flexible Stretcher was developed for technical rope rescue, confined space rescue and dragging transport of patients. With integrated Suspensor steel lifting System, adjustable brim for drag transport protection, Removable transport holders Slim Model for double catching and 6 aluminum fast buckles for packing and fastening the patient. DSS Double Safety System, Color-coded straps for an easy identification and fastening. Removable padding for the back and removable neoprene padding in the femoral region to more comfort. Independent adjustable feet lever with comfort pedals (foot straps) with dual pinch side release plastic buckle for adjustment. Restraint system adapts to hold spinal boards (I-STR System). Easy chest adjustment with Velcro (HI System). Built in HDPE with a new slim design in the head end, new fiberglass No Pressure System, polyester 44 mm (1.73 inches) thickness straps with 24 kN resistance, stainless steel adjustable buckles for brims and steel adjustable buckles for the DSS System.



Dimensions: 95" x 36"; Max Load: 330 lbs.; Weight: 22.5 lbs.; Weight w/ Backpack: 25 lbs.

209220480 Orange \$1,100.00



KED-PRO

The KED® Pro is an emergency patient-handling device designed to aid in the immobilization, short transfer movement, and technical rescue of patients with suspected spinal/cervical injuries. (Technical rescue requires additional equipment and specialized training.)

The KED® Pro is for professional use by a minimum of two trained operators.

- Additional help may be preferred or needed.
- Color-coded webbing & improved wrap-around head/chin straps
- Adjustable Clik-Lok quick-release buckles on chest and leg strap
- Wide padded spine support section
- Additional deceleration strap for holding shoulders back
- Two additional standing take-down maneuver straps
- Fold back chest flaps allow chest access for electrode placement
- Backpack carry bag with room for storage of neck collars
- Padded leg straps, quick connect buckles for confined space rescue operations
- Rated rear handles for confined space rescue lifting with optional KED Pro lifting bridle

WLL, General: 550 lbs. (250 kg) WLL, Technical Rescue: 330 lbs. (150 kg) Weight: 10 lbs. (4.5 kg)

2448061252	KED-PRO	\$725.00
2448061259	KED-PRO Lifting Bridle	\$400.00



WARNING

Improper use of the KED® Pro can cause injury.



REEVES SLEEVE

Immobilizes Patients for Transport

A unique product that converts a full size backboard into a patient immobilization device to be used for vertical and horizontal lifting. Perfect device for confined space rescue because it fits over the backboard (not included). DOES NOT CAUSE FEET TO ANGLE OUTWARD as do popular plastic lifting devices. Sleeve material is a vinyl laminated nylon that meets Mil Spec C 4300 Type I, Class I anti-fungal vinyl and is resistant to acids, alkalis, and liquids. Lifting straps are constructed from 6,000 lbf. Tensile Strength webbing. Reeves Sleeve II has extra webbing reinforcement for greater strength.

Color: Orange. Storage Dimensions: 24" x 12" x 9" Full Dimensions: 76" x 24" Weight: 16.85 lbs.

Note: This product, when used with a quality backboard, provides the best medical access of any confined space immobilization devices.

620401	Reeves Sleeve	\$990.00
620401S	Reeves Sleeve, Metal Buckles	Call
620401R	Reeves Sleeve, Reinforced	Call
620402	Reeves Sleeve II	\$1,065.00

REEVES SLEEVE DRAG VERSION

Tough, Low Friction Bottom

A special conversion of the traditional Reeves Sleeve that adds a special drag sheet. The sheet reduces drag and protects the sleeve in rough environments.

620403	Drag Version	\$1,285.00
620403RS	Drag Version, Metal Buckles	Call



SPEC PAK™

Includes Horizontal Lifting Bridle

Unique Patient Packaging and Extrication System combines' backboard immobilization of a "Short Board" along with the suspension and support of a full body harness. The Spec Pak System utilizes an integrated polyethylene board along the back of the harness system to reduce wear and allow for a smooth sliding surface for confined space operations. Grab handles located on the sides and head of The Spec Pak aid rescuers during movement of patient through confined spaces. The Spec Pak System is very useful for any confined space operations where a vertical environment is encountered. Spec Pak is a fully certified lifting harness (ANSI Z359.1-1992), thus eliminating the need for a separate victim harness. Unique self-adjusting cervical restraint eliminates the problem associated with lifting patients vertically while secured to a rigid backboard. NEW head pad system helps prevent hyper-extension of cervical area. Spec Pak is only intended as a limited spinal immobilization system. Spec Pak must be used with proper spinal immobilization such as the use of a "Cervical Collar" where conditions and protocols dictate.

620410	Spec Pak	\$2,300.00
620411	Replacement Lifting Bridle	\$335.00



SLIX 100 FLEX STRETCHER KIT

A robust, compact and lightweight stretcher. The flexible material combined to a smooth finish allows easy sliding and permits the stretcher to be rolled width ways or lengthways to facilitate transport. No webbing passes under the stretcher preventing damage while dragging. Strong handles around the stretcher allow it to be maneuvered by several rescuers. The stretcher may be hauled vertically or horizontally. The lifting straps secure and allow the stretcher to mould around the casualty.

Conformance: CE 93/42/EEC CLASS 1 Max Recommended User Weight:

880 lbs (400 kg) Width - 36.3" x 91.3" (915 x 2300mm)

2027191100K

\$999.00

Ruth Lee Ltd has designed and manufactured high quality rescue equipment and training manikins for over 35 years in the UK. They have partnered with Rescue Technology to bring their market leading success to the US. All the different have the same basic design, with an inner body weighted with aggregate to human proportions, held inside the outer carcass. The aggregate is distributed around the body in weighted packets in such a way that slumping of the weight is prevented, allowing the dummy to maintain its form during and after use. The three main types, Firehouse (FH), Water Rescue (WR) and Duty Range (DR), all use different materials. The Duty Range replaces the original General Purpose manikins and now uses a durable Polyester fabric carcass and polyurethane foam; the FH models are made using Nomex blend material. The WR manikins use durable polyester fabric, Nylon mesh and non absorbent foam. All manikins apart from the FH models are reinforced using high density polypropylene webbing.



Anatomical Head Shape



Optional weight vest adds up to 36 lbs. of weight

A flexible Inner Core

Protective Coveralls

Lug-sole boots*



Carcass constructed from the same flame retardant material used in Police ballistic/stab vests

Washable Polyester Coverall

Polyester Inner Shell

Lug-sole boots on Youth and Adult Models



Weight Label on Head

Lifting / Storage Loop

High Density Polypropylene webbing on stress points



Nylon Reinforced PVC fabric "hands"

All manikins except the 11 lb. and 22 lb. models are supplied with protective boots

TECHNICAL RESCUE-GEN2 TRAINING MANIKINS

Now with high strength polyester fabric shell

Rugged, realistic in size, weight distribution and handling characteristics. Manufactured using a flexible inner core, a high strength polyester outer shell, and protective overall. The inner core is weighted to human proportions using 4.4 lb. weight packets. For structural integrity, the packets are sewn to a nylon "inner dummy" with all the body parts (arms, legs, chest, etc.) held in place with webbing. The outer layer is manufactured of durable, abrasion resistant polyester fabric that outwears the canvas shells used in competing brands. All seams are double stitched and reinforced with webbing for improved abrasion resistance. The included protective coveralls protect the manikin from dirt and abrasion and are reinforced with high strength webbing in high stress areas. All manikins 44 lbs and up are supplied with lug sole boots that are secured to the manikin. Optional weight vest fits underneath the coverall and allows weight to be added or removed as needed to achieve the desired Manikin weight.

	Description	Weight	Height	
2395001005	Infant	11 lbs.	2' 3"	\$380.00
2395001010	Toddler	22 lbs.	2' 10"	\$600.00
2395001020	Youth	44 lbs.	4' 3"	\$810.00
2395001020A	Extra Light Adult	44 lbs.	5' 11"	\$1,175.00
2395001030	Light Adult	66 lbs.	5' 11"	\$1,200.00
2395001050	Standard Adult	110 lbs.	5' 11"	\$1,225.00
2395001070	Heavy Adult	154 lbs.	5' 11"	\$1,440.00
2395001075	Heavy Adult	165 lbs.	5' 11"	\$1,475.00
2395001080	Heavy Adult	176 lbs.	5' 11"	\$1,500.00
2395001090	Extra Heavy Adult	198 lbs.	5' 11"	\$1,535.00

*Features may vary on manikin models.

SEE PAGE 97 FOR RUTH LEE MANIKIN REPLACEMENT COVERALLS AND BOOTS



PUBLIC SAFETY TRAINING MANIKIN

For Firefighter Carries, Drags, and Downed Operator Training

A new, rugged manikin for Public Safety Use. Built from the Ruth Lee Technical Rescue Manikin design, the Public Safety Manikin uses stronger thread in the carcass and a proprietary tri-laminate fabric in the coveralls. The results are greatly increased abrasion resistance for use in firefighter drag and carry classes, law enforcement downed operator training, and Physical Agility testing.

Rugged, realistic in size, weight distribution, and handling characteristics. Not for use in MRI training. Includes storage loop to hang manikin up to dry (NOT A DRAG HANDLE FOR TRAINING USE).

		Height	Weight	
2395037070	Adult	5' 11"	154 lbs.	\$2,035.00
2395037075	Adult	5' 11"	165 lbs.	\$2,050.00



SHOUTBOX TECH RESCUE MANIKIN KIT

Manikin PLUS User Recordable Talk Unit

The Shoutbox GP Manikin combines the original Ruth Lee Technical Rescue Manikin with the Shoutbox manikin voice box. It give an economical solution to interactive training.

		Weight	
239581020	Youth (4' 3")	44 lbs.	\$2,575.00
239581020A	Adult (5' 11")	44 lbs.	\$2,950.00
239581030	Adult (5' 11")	66 lbs.	\$2,975.00
239581050	Adult (5' 11")	110 lbs.	\$3,000.00



FIREHOUSE TRAINING MANIKIN

Heat Resistant Design

The Fire House Manikins demonstrate a good balance between temperature and abrasion resistance. The Fire House manikin is perfect for fire and general training. The manikin carcass is constructed using heavy duty canvas, reinforced with 38mm Nomex webbing, as opposed to the polypropylene webbing found on the general purpose range – standard Polypropylene webbing, will go brittle and melt at the high temperatures this manikin is designed to withstand.

The protective coveralls are constructed using a Nomex blend material which offers good protection against high temperatures - it is permanently non-flammable and most commonly used in protective clothing to protect against heat and flames. The protective coveralls are also reinforced using Nomex webbing to improve the abrasion resistance and strength – the overalls are fitted using 20mm Kevlar ties, as the standard Velcro fastening melt at these high temperatures. The ends of the arms, which have been identified as a high stress area, are reinforced with 5mm leather to provide extra protection. The Fire House Manikins are designed to withstand temperatures of 280-320°F (140-160°C), the average temperature at floor height for hot fire cell training and only starts to 'fail' at temperatures in excess of 350°F (180°C).



		Weight	
2395005005	Infant (2' 3")	11 lbs.	\$975.00
2395005010	Toddler (2' 10")	22 lbs.	\$1,200.00
2395005020	Youth (4' 3")	44 lbs.	\$1,510.00
2395005020A	Adult (5' 11")	44 lbs.	\$2,080.00
2395005030	Adult (5' 11")	66 lbs.	\$2,100.00
2395005050	Adult (5' 11")	110 lbs.	\$2,175.00
2395005070	Adult (5' 11")	154 lbs.	\$2,275.00





Simulates Full and Partial Amputation of Leg and Arm

Includes Coveralls & Boots



WORKING AT HEIGHT MANIKIN

An extremely tough manikin for all Working at Height training.

Used globally by Special Rescue teams, Arborists, Health & Safety trainers, Industrial Rescue teams and many more. Similar in construction to the Duty Range manikins but utilizes closed cell foam to the trunk to provide greater rigidity and reduce 'slumping' when using a rescue harness. Tough Polypropylene plastic strips running from the shoulders to the knees (as in the Offshore model) prevents excessive flexing when used aloft. Anatomically correct weight distribution gives the 'feel' of an unconscious person - perfect for pole top or tower rescues. Realistic sizes and weights - will demonstrate the difficulties of dealing with an adult unconscious casualty.

		Weight	
2395011030	Adult (5' 11")	66 lbs.	\$1,500.00
2395011050	Adult (5' 11")	110 lbs.	\$1,525.00
2395011070	Adult (5' 11")	154 lbs.	\$1,750.00
2395011075	Adult (5' 11")	165 lbs.	\$1,875.00

MULTI-TRAUMA EXTRICATION MANIKIN

The Multi-Trauma Rescue Manikin evolved from the Blast and Impaled Victim manikin to combine all the features of these manikin in one product. Additionally, the head has been redesigned to allow the fitting of an extrication collar. So now you have in one manikin a General Purpose rescue manikin that can also simulate an amputated arm and leg, an impaled torso and a suspect neck injury. The hole on the left of the torso allows a spike to be firmly held in place. The right arm and right leg are fully detachable to simulate an amputation, or by partially releasing the locking straps the limb can be weakly attached and will fall off if the rescuer does not correctly assess and support the injury. The manikin is supplied complete with sturdy boots that greatly protect the legs if the manikin is dragged along the ground, and are user-replaceable if badly damaged.



Multi-Trauma Training Manikin shown with C-Collar (not included), also Includes Coveralls (not shown).

		Weight	
2395004030	Adult (5' 11")	66 lbs.	\$1,350.00
2395004050	Adult (5' 11")	110 lbs.	\$1,400.00
2395004070	Adult (5' 11")	154 lbs.	\$1,580.00

SHOUTBOX EXTRICATION MANIKIN

Manikin PLUS User Recordable Talk Unit

We have combined our Multi-Trauma Manikin and the Shoutbox manikin voice box to create an advanced extrication training manikin. The Multi-Trauma manikin is clothed in a special reinforced coverall (not shown) and will allow simulation of full and partial amputations of the right arm and right lower extremity. The manikin also has a thoracic impalement feature. The include Shoutbox manikin voice box adds to the realism with looping or sound activated victim response. The Ruth Lee Manikins give the most accurate representation of a trapped victim. All anatomical proportions are correct in length, size and weight.



RUTH LEE SHOUTBOX

Interactive Voice Recorder!

The ShoutBox can be used in conjunction with any Ruth Lee Adult Training Manikin with an anatomically shaped head and will radically change how rescue training is carried out. The ShoutBox is an interactive voice recorder that allows the instructor to record a message specific to the day's training exercise. For example, in a search and rescue exercise, the instructor can have the manikin call out a pre-recorded message to rescuers or make coughing sounds to alert the rescuers of its presence. The ShoutBox can emit sounds in a loop (with user-selectable repeat intervals) or have the message play by sound activation. The ShoutBox Kit (Part #23959512) comes complete with a hood with a mesh front to avoid sound distortion and carries CE certification. Fits adult-sized General Purpose, Haz-Mat, and Multi-Trauma Manikins. Manikin not included.



23959511	ShoutBox	\$1,350.00
23959515	ShoutBox Hood	\$200.00

	Size	Weight	
239586030	Adult (5' 11")	66 lbs.	\$3,150.00
239586050	Adult (5' 11")	110 lbs.	\$3,250.00

RUTH LEE

EMERGENCY RESPONSE



LIGATURE MANIKIN

In high-risk environments or institutions which house vulnerable people, such as Mental Health Hospitals, Learning Disability Centers, Police Stations, Prisons, and Care Homes, suicide by hanging is tragically high. Staff who might face and need to manage suicides and self-harm regularly need the correct training to manage this safely. Training includes the use of a hook knife to release a ligature properly, and this specialist manikin has been designed to allow teams to learn to effectively and sensitively manage this situation.

This manikin has anatomical features that allow you to practice airway management skills to revive someone who has been found hanging.

SPECIAL MATERIALS: The manikin overalls are constructed from the same flame retardant material used in Police ballistic/stab vests, offering four times the strength and abrasion resistance of 16 oz canvas or P.V.C. (conforms to OEKO-TEX Standard 100, BS EN ISO 12947-2 & 14116: 2008) High-density polypropylene webbing (25 mm rated to 207 Kg, 50 mm rated to 440Kg).

FEATURES & BENEFITS:

The manikin has anatomical landmarks, including the sternum, rib cage, and substernal notch. The trainer also contains teeth, uvula, vocal cords, glottis, epiglottis, larynx, arytenoid cartilage, trachea, esophagus, inflatable lungs, and stomach. It allows for the placement of a nasogastric tube and accepts Combitube®, E.O.A., E.G.T.A., P.T.L., and i-gel® airways. Realistic knee joints promoting correct manual handling techniques, including preservation of the C-spine. Special D-ring feature enables easy suspension without damaging the manikin.



	Size	Weight	
2395021025	Adult (5' 11")	55 lbs.	\$4,500.00

PMVA MANIKIN

Prevention and Management of Violence and Aggression

Physical Intervention training is vital in hospitals, mental health facilities, and likewise, with units which may need to manage potentially violent patients or offenders. This manikin comes complete with gloved hands, which articulate at the correct pressure points.

A wide range of different physical intervention techniques can be performed and holds can be performed in a seated or lying position. Tests in training demonstrate that using the manikin greatly minimizes person-to-person contact, allowing teams to complete important assessments quickly in a post-covid era.

At 66 lbs. (30kg) the manikin has enough weight to provide a realistic challenge and the anatomically correct weight distribution helps to add to this realism. Soft body joints eliminate the risk of pinch welts and bruising; common injuries when using plastic bodied manikins. An immobilization/extrication collar can be fitted around the neck of our adult manikins to promote proper casualty care. When used with optional Shoutbox feature, you can personalize a recorded message up to 60 seconds which can be periodically repeated.



Wrist Lock



Arm Bar

	Size	Weight	
2395027030	Adult (5' 11")	66 lbs.	\$1,800.00



FULL BODY AIRWAY MANIKIN

How would your staff manage Airway or IV Training in a confined space or other difficult circumstances such as a traffic collision or if the manikin was trapped by the legs! The Full Body Airway Management manikin features the Simulaids Adult Airway Management torso. The Airway Management torso is not fixed and can easily be removed for cleaning. A padded jacket is supplied to protect the torso and to aid installation and removal from the carcass. Includes replaceable, washable protective overalls. The Airway torso features anatomical landmarks including the sternum, rib cage, substernal notch, teeth, uvula, vocal cords, glottis, epiglottis, larynx, arytenoid cartilage, trachea, esophagus, and inflatable lungs and stomach while allowing naso. Accepts Combitube®, E.O.A., E.G.T.A., P.T.L. and i-gel airways.

	Size	Weight	
2395024020	Adult (5'11")	44 lbs.	\$3,825.00
2395024050	Adult (5'11")	110 lbs.	\$4,100.00
2395026020	Adult, (5'11") w/ IV Arm	44 lbs.	\$4,500.00



TECH RESCUE CPR MANIKIN

Allows for realistic body-weight CPR training in more difficult situations (i.e. confined spaces or with the manikin trapped under a vehicle or collapsed building etc.) This manikin takes CPR / Medical training out of the clean, classroom environment and integrates it into a realistic technical rescue training situation. Can be placed into confined spaces, trapped under a vehicle or train, or under concrete or wooden beams where rescuers might actually come across casualties and may not be able to move them into a 'convenient' position to carry out CPR. This manikin adds an additional dimension to technical rescue and CPR training. The torso isn't actually fixed to the manikin and can simply be lifted out for cleaning or maintenance. The chest cavity of the manikin is also padded to protect the CPR torso, when used in difficult situations.

	Size	Weight	
2395007201	Adult (5'11")	44 lbs.	\$1,750.00
2395007501	Adult (5'11")	110 lbs.	\$1,850.00

TRAUMA RESCUE MANIKIN

The Trauma Rescue Manikin allows training for difficult rescues and extrication, while providing essential first aid for traumatic injuries including heavy bleeding. All models include an advanced airway management torso and a traumatic open wound on the thigh. The 30kg model adds IV and IO capabilities.

The traumatic open wound can help you to train the correct application of a tourniquet or wound packing. The instructor controls the amount of blood pumping through the wound and can stop the blood when they feel the trainee has treated the patient correctly.

The IV Arm has an intramuscular injection site at the top of the arm and allows for venipuncture to the arm and hand. The intraosseous Tibia Task Trainer is designed to simulate intraosseous (IO) needle placement, which includes palpable landmarks at the proximal tibia, allowing trainees to facilitate accurate site location.

		Style	Weight	
23950383030	Trauma Rescue, Adult	Airway/ Bleeding / IO / IV	30 kg	\$7,100.00
23950381050	Trauma Rescue, Adult	Airway / Bleeding	50 kg	\$7,350.00
23950381030	Trauma Rescue, Adult	Airway / Bleeding	30 kg	\$8,200.00



Instructor-Controlled Bleeding Injury



IV Arm and Airway Management Torso



DROP TEST MANIKIN

Similar in construction to the Duty Range manikins but utilizes closed-cell foam in the torso to provide greater rigidity and reduce 'slumping' when using a harness. Anatomically correct weight distribution gives the 'feel' of an unconscious person - perfect for pole top or tower rescues. Realistic size and weight of 220 lbs. - will demonstrate the difficulties of dealing with an adult unconscious casualty. Strong Polypropylene webbing loop to the back allows the manikin to be easily hauled into position prior to training. Strong enough to be dropped from 2 or 3 stories with no damage - these manikins are tough! The Polyester is waterproof, making it suitable for training in wet or dry conditions. Soft body joints eliminate the risk of pinch welts and bruising, a common injury when using plastic bodied manikins. Protective consumables including, coveralls and boots, greatly extended the life of the manikin and help save you costs.

		Height	Weight	
2395006100	Drop Test, Adult	5'11"	220 lbs.	\$1,600.00



PRISONER SECURITY GEN2 MANIKIN

Anatomically correct, the Handcuff Manikin is ideally suited to police and prison services to train for the evacuation of restrained unconscious casualties in an emergency situation. Similar to the Duty Range manikin, the Handcuff manikin has slimmer wrists to accommodate handcuffs. The wrists are reinforced with a heavy duty PVC to prevent damage and there is also a PVC removable/replaceable cuff that will prolong the life of the manikin.



Replaceable Wrist Protectors

		Weight	
2395003050	Adult (5'11")	110 lbs.	\$1,400.00
2395003070	Adult (5'11")	154 lbs.	\$1,475.00
2395003090	Adult (5'11")	198 lbs.	\$1,694.00
23956159	Replacement Wristlet		\$95.00
23950503070	Replacement Coverall		\$268.00



CONFINED SPACE MANIKIN

A modified Technical Rescue manikin designed to make the instructors job easier. This manikin splits into smaller parts with no individual component weighing more than 55 lbs. Detachable limbs make it easier to position the manikin for scenarios. Anatomically correct weight distribution. Tough enough to withstand being buried under concrete or steel.

		Weight	
2395012050	Adult (5' 11")	110 lbs	\$1,590.00



DUTY PLUS CONSCIOUS VICTIM TRAINING MANIKIN

Integral "spine" maintains seated position

The Duty Plus Manikin is designed to be the perfect partner for a range of training scenarios including confined space training, extrication exercises, and other general handling training. Because of the extra rigidity built into the neck, chest and torso area this manikin acts more like a 'conscious casualty'. Constructed with a plastic spine to help prevent head flopping, closed cell foam in the back and Polypropylene strips which run to the waist/hip area allowing flexibility and a more upright position - perfect for sitting in vehicles for example. Anatomically correct weight distribution to give the feel of a conscious casualty. Strong webbing loop at the back allows easy handling, hauling aloft, storage and suspension for drying.

Tough enough to withstand being buried, driven over by a 4x4 vehicle, or dropped from a 2nd floor window without damage. Water repellent material, making it suitable for wet scenarios such as HAZMAT/CBRN.

An immobilization/extrication collar can be fitted around the neck of our adult manikins to promote proper casualty care. Comes complete with boots and overalls, which are easily replaced if damaged

		Height	Weight	
2395023050	Duty Plus, Adult	5'11"	110 lbs.	\$1,850.00



OSCAR MAN OVERBOARD MANIKIN

Built to the same tough construction standard as the General Use Manikin, the water rescue is built to simulate an unconscious victim in the water, floating at an angle of 45 degrees with just the head and shoulders above the water. The head is color-coded with a yellow “face”. Strong plastic strips in the manikin run from the shoulders to the knee and maintain overall flexibility but don't allow the manikin to “flop” in half. The outer carcass is constructed of heavy duty open mesh reinforced with webbing. SAR Hoody may be added to the standard adult Man Overboard manikin to decrease visibility. Thermal Imaging Hood allows the user to put 4 small hand warmers into the slots for thermal imaging practice with the Man overboard Manikins.



		Height	Weight	Color	
2395015040	Adult	5' 11"	88 lbs.	Orange	\$1,500.00
2395015041	Adult	5' 11"	88 lbs.	Black	\$1,550.00
2395015020	Youth	4' 3"	44 lbs.	Orange	\$1,090.00
2395015021	Youth	4' 3"	44 lbs.	Black	\$1,120.00
2395015010	Toddler	2' 10"	17.5 lbs.	Orange	\$765.00
2395015011	Toddler	2' 10"	17.5 lbs.	Black	\$795.00
2395015005	Infant	2' 4"	11 lbs.	Orange	\$650.00



DIVE RESCUE / BODY RECOVERY MANIKIN

Designed for water victim recovery training.

Constructed of reinforced, heavy-duty Nylon mesh for the carcass with non-absorbent closed cell foam for buoyancy. The mesh allows water to flood out of the body as it is being recovered and also allows better ventilation when the manikin hung up to dry.

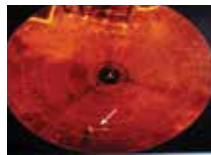

Sonar image of Recovery manikin

Polypropylene strips running from the shoulder area to the knee joint allow flexibility in and out of the water, but do not allow the manikin to bend in half when using stretchers or recovery devices like the Jacob's Cradle. The addition of the face mask and wig gives a realistic look and feel and aids the identification of a human body in poor visibility. The adult manikin has a dry weight of 106 lbs. (48 kg) out of the water and will sink quickly to the desired position. The closed cell foam adds to the buoyancy, giving a weight of approximately 22 lbs (10 kg) in the water providing a realistic training weight for a body in the water. Supplied complete with user-replaceable boots and protective overalls to protect the manikin.

		Height	Weight	
2395019050	Adult	5' 11"	110 lbs.	\$1,375.00
2395019030	Youth	4' 3"	66 lbs.	\$1,075.00
2395019010	Toddler	2' 10"	22 lbs.	\$860.00



SURF RESCUE MANIKIN

For PWC training and competition use

You can now train year round, in the roughest surf, close to the reef, and in the coldest weather to practice fast pick ups as many times as you like. This manikin never complains about the cold water, aching arms, or sore shoulders! This manikins provides a uniformity in the size and weight of casualties being rescued, an important factor in competitions.



	Height	Weight-Dry	Weight-Wet	
2395018020	4'9"	44 lbs.	88 lbs.	\$1,150.00



OFFSHORE MANIKIN

Designed as an amalgamation of the Fire & Rescue, and Man Overboard Rescue Manikin, the Offshore Manikin is a versatile product designed for water and general rescue training on offshore platforms and vessels. The carcass and increased weight make this model stronger and more suitable for simulating rescues from accommodation areas, engine rooms or drilling platforms - used in conjunction with the tough protective overalls, this model will withstand the rigors of general training.

While this manikin will float well in static water it is advisable to use some form of buoyancy aid in open seas or rough water. Weighing in at a respectable 60 kg when dry the offshore manikin is constructed using a P.V.C carcass with mesh to the ends of the arms and legs to aid drainage. As standard with any Ruth Lee Water Rescue manikin there is a polypropylene webbing loop on the back for hauling and hanging to dry as well as SOLAS reflective tape on the head.

The standard protective coveralls are included. The Offshore manikin is supplied complete with protective coveralls, draining sturdy rubber boots; the boots help protect the legs if the manikin is dragged along metal gangways and corridors.

		Weight	
2395017060	Adult, 5'11"	132 lbs	\$1,575.00
2395051760	Replacement Coverall		\$340.00



POOL RESCUE MANIKIN

Ideal for Lifeguard Training

This specialist product has been created as an effective aid to training swimming pool lifeguards. The overall has been created using a rip-stop nylon fabric which is taut on the manikin to make it harder to 'grab' and the shoulder joints have also been adapted to allow for recognized recovery techniques.

Carefully designed and tested to create realistic buoyancy - it will sink, yet is buoyant enough to float when being towed. A more realistic challenge compared to using live volunteers who may try to subconsciously assist the trainee. Reduces the need to use volunteers in training scenarios, avoiding potential injury and any embarrassment caused by close personal contact. Greatly improves performance - trainers can easily spot weaknesses such as slow towing - the manikin's legs will start to sink if a consistent speed is not maintained.

Flexible arms, reinforced with strong webbing allow the arms to be raised aloft, letting lifeguards practice hauling the victim from the water using correct lifting techniques. No need to switch from plastic torso dummy to real volunteer part way through training this manikin can be fetched from the bottom of the pool, towed to the side and recovered from the water - promoting more realistic and more effective training, ultimately making lifeguards even better! Constructed using a reinforced Nylon mesh which allows water ingress, meaning the manikin will sink when placed in water.

Optional Protective Coveralls add abrasion resistance to the manikins. The coveralls slow the water ingress and egress rates but do not affect how the manikin replicates an unconscious victim during retrieval.



Optional Wear Protectors help protect "feel" from abrasive non-slip surfaces.



		Weight	
2395016030	Adult, 5'3"	66 lbs	\$1395.00
2395016016	Youth, 3'9"	35 lbs	\$875.00
23959016901	Wear Protector, Pair		\$35.00
23959016904	Protective Coverall, Adult		\$220.00
23959016903	Protective Coverall, Youth		\$199.00
23959016902	Pool Rescue Parts Kit		\$165.00



Oropharyngeal Suction



BVM Ventilation



RUTH LEE ADVANCED WATER RESCUE TRAINING MANIKIN

Add Life-Like realism and advanced airway management to your water rescue training

The Advanced Water Rescue manikin is designed to mimic a drowned person in the water and delivers realistic medical simulation training which prepares rescuers for the real world. No other rescue manikin provides this level of Realism, with opportunities to practice rescue skills, coupled with the continuation of care to the Hospital and the Intensive Care Unit.

The Advanced Water Rescue manikin floats like an unconscious person but can also be weighted to partially or fully sink to increase the realism of rescue. When in water, the hydrostatic squeeze (pressure of the water) closes a valve within the lung mechanics. Once rescued from the water, the mechanism releases, creating the movement of the lungs and chest. Submerging the manikin creates an amount of water in the oropharynx, the middle part of the throat behind the mouth, which can be removed using manual or suction methods.

The drowning mechanism even allows for the manikin to create “foam” to replicate the noises and foaming commonly seen in drowning people. When people drown they can inhale about 30 ml of water into the lungs, and the manikin is able to replicate this phenomenon, as well as allow for dry lung drownings. The manikin, which is patent-pending, has taken two years of research and development to perfect.

KEY MEDICAL PARAMETERS: Nasopharyngeal Airway insertion, Nasal intubation, Oropharyngeal Airway insertion, Oro tracheal intubation, Laryngeal Mask airway insertion, i-gel® insertion, Combitube insertion, Bag valve Mask ventilation, Mechanical Ventilator compatibility, Manual suction or mechanical suction of nasal and oral cavities.

		Weight	
2395030052	Adult	110 lbs.	\$36,000.00
2395030012	Toddler	26.5 lbs.	\$16,000.00

HELICOPTER WINCH MANIKIN

When using a helicopter to rescue someone who has been in the water for some time, it is vital that they are winched in the correct way to prevent cardiac problems associated with a sudden release of hydrostatic squeeze.

It is preferable to raise the casualty horizontally, so as to minimize the effect of water pressure. Features lighter legs than the standard Man Overboard model, meaning that the legs float more readily when fitting the harness/strops in water. The manikin will sit in a stable “W” position while winched to the helicopter. Compatible with Standard and Hypothermic Lifting straps. Dry weight 40Kg (Adult) increases to approximately 65Kg retrieval weight from water.

Floats horizontally, vertically or at 45 degrees, to simulate a live person or dead body – achieved by redistributing foam pieces within the overalls in a matter of seconds. Bright orange overalls and SOLAS reflective tape on the head make the manikin highly visible in open water. Strong webbing loop at the back allows easy handling, storage and suspension for drying. The soft feet are designed to allow rapid drainage to prevent too much water in the helicopter. Comes complete with overalls and soft feet, which are easily replaced if damaged



Helicopter Manikin shown with two Single Slings.



		Weight	Style	
2395028040	Adult (5' 11")	88 lbs.		\$1,600.00
2395903020	Helicopter Lift Sling, Horizontal		Double	\$190.00

RUTH LEE

HEALTHCARE TRAINING MANIKINS

PATIENT HANDLING MANIKIN

Help your staff avoid the risks - train them to avoid the back injuries associated with unsafe, high risk moves by training with these realistic 'patients'. Anatomically correct weight distribution gives the 'feel' of a real patient/client - adult size and 'real world' weight for realistic training. The Patient Handling manikins totally eliminate the risk of the pinching associated with the joints of the plastic bodied manikins.

The Gen 2 is upgrade from the original Patient Handling Manikin that is 5' 5" tall and weighs either 66 or 110 lbs. Removable arms and legs simulate amputations and make the manikin easier to transport and set up. Weight has been added to the buttocks to help the manikin sit and sling better. Special mesh on bottom of the feet provide additional grip with surfaces when the knees are bent. Add off-the-shelf pajamas for extra realism.



EMERGENCY PATIENT EVACUATION MANIKIN

This lighter weight manikin gives a sufficient weight to train with but is easily transported in a vehicle if it needs to be shared among different sites. Strong webbing loop at the back allows easy handling and storage. Soft body joints to eliminate the risk of pinch welts and bruising; common injuries when using plastic bodied manikins. An immobilization/extrication collar can be fitted around the neck of our adult manikins to promote proper casualty care. Manufactured from an **antibacterial material** which is also flame retardant. Supplied with pajamas which are easily washable for improved hygiene in hospital and care home environments. Comes complete with soft boots which are easily replaced if damaged.

	Size	Weight	
2395035030	Adult (5' 5")	66 lbs.	\$1,400.00
2395035050	Adult (5' 5")	110 lbs.	\$1,400.00
23959710	Replacement Feet, Soft (Pair)		\$115.00
23959711	Replacement Feet, Weighted (Pair)		\$125.00

	Size	Weight	
23950253025	Adult (5' 11")	55 lbs.	\$890.00
23959710	Replacement Feet, Soft (Pair)		\$115.00



RUTH LEE BARIATRIC TRAINING MANIKIN

Realistic Flabby Performance

Designed to achieve a 'fluidity of movement' that simulates an obese patient. The bariatric manikin is based around a 220 lb. Technical Rescue Manikin, the extra bulk is built up with several weighted layers separated by Nylon coated padding. Rather than just adding a 180 lb. 'lump', we have distributed the extra weight around the body in 170 x 1 lb. packets of steel shot (a very time consuming process!). The Nylon coating on the padding allows the different layers to slip and slide over each other creating a real feeling of 'flabby skin'. Includes Reinforced Coveralls and Boots AND Carry Sheet. **Approx. Height: 5' 11" Carry sheet LOLAR certified (SWL: 1322 lbs / 600 kg)**

Ships via Motor Freight Only.

		Weight	Dimensions	
2395008050	"Barry"	110 lbs.		\$4,700.00
2395008090	"Bud"	198 lbs.		\$4700.00
2395008180	"Governor"	397 lbs.		\$5,250.00
2395008270	"Enormous Ed"	595 lbs.		\$5,850.00
23959291	Bariatric Carry Sheet, Std		70.9" x 47.2"	\$435.00
23959292	Bariatric Carry Sheet, Lg		78.7" x 70.9"	\$700.00
23959008905	Bariatric Pajamas			\$201.00





BERNARD™ K-9 MANIKIN

After many requests, the folks at Ruth Lee created the “Bernard” K-9 Manikin to help rescuers deal with either K-9 victims or Working Dogs in the vertical environment.

	Size	Weight	
2395021001	Cocker Spaniel	22 lbs	\$790.00
23950210020	Australian Shepherd	44 lbs	\$940.00
23950210025	Bull Terrier	55 lbs	\$1,035.00

AVALANCHE / SAR MANIKIN

The Avalanche Manikin was developed after a request from Scottish Mountain Rescue. The standard manikins were too heavy to be able to carry up a mountain to set a training scenario for body recovery following an avalanche. The manikin is made from durable PVC and is filled with foam to give the bulk and firmness of a body while also being lightweight (22 lbs) and easy to maneuver. The manikin also comes complete with a backpack that enables the manikin to be folded in half and easily transported. Features the RECCO avalanche recovery system.



- Light Weight – 22 lbs (11kg) • 6 ft tall (1.83m) • ‘Spongy resistance’ when probing • Secure pockets for Avalanche transceivers • Lifelike facial features with mouth cavity and balaclava • Water resistant and non-absorbent

2395010011

Avalanche / SAR Manikin

\$1,630.00



MASS CASUALTY TRAINING MANIKIN

Perfect cost-effective choice for a large, multi-agency exercise where a large number of casualties/bodies are required to be seen but not necessarily rescued. Clothing not included. Constructed in a lightweight water resistant polyester and filled with flame retardant foam pieces and is strong enough to be buried under concrete or steel lintels with no damage.

		Weight	
2395014008	Adult (5'11")	17.5 lbs.	\$512.00



BARIATRIC CONVERSION SUIT

Converts any Standard Adult Ruth Lee Manikin into a Bariatric Manikin

The Water-Fillable suit allows customers to place a manikin where you want it before adding the weight. It is the perfect choice where space is limited or when there are not enough people to position a full-weight bariatric manikin in place ready for training.

The Water-Fillable Bariatric Suit comes complete with soft feet, plus all adapters and two short hoses for filling. A water flow meter is also included and allows you to monitor how much water is being added. This comes complete in a sturdy bag for easy carrying and storage.

The kit is light enough for one person to carry into position and set up the training scenario. Simply place the suit over your existing Duty Range manikin, attach a hose and fill it up with water to achieve the required weight. Up to 150 kg of additional weight can be added. This process takes 15-20 mins from arrival at the venue to have the manikin set up to train. When the training is over, use the special valves and a hosepipe to empty the water, or if you are outside, release the valves to empty the suit.



2395008901

Adult

\$6,200.00

RUTH LEE

Accessories



RUTH LEE SHOUT BOX

The ShoutBox™ can be used in conjunction with any Ruth Lee Adult Training Manikin with an anatomically shaped head and will radically change the way in which rescue training is carried out. The ShoutBox™ is an interactive voice recorder which allows the instructor to record a message specific to the day's training exercise. For example, in a search and rescue exercise, the instructor can have the manikin call out a pre-recorded message to rescuers or make coughing sounds to alert the rescuers of its presence. The ShoutBox can emit sounds in a loop (with user-selectable repeat intervals) or have the message play by sound activation. The ShoutBox™ comes complete with hood with mesh front to avoid distortion of sound and carries CE certification. Fits adult-sized General Purpose, Haz-Mat and Multi-Trauma Manikins. Manikin not included.

23959510	ShoutBox™ Kit (ShoutBox and Hood)	\$1,700.00
23959511	ShoutBox™ Only	\$1,350.00
23959515	ShoutBox™ Hood	\$200.00



MANIKIN DRAG PROTECTOR

These leg protectors protect the manikins when being dragged - particularly during Firefighter drag training. Constructed using tough, heavy duty nylon with a disposable Polypropylene plastic strip. The plastic strip is held in place with 4 heavy duty snap and will last for many exercises before needing to be replaced. Additional plastic strips can be bought in packs of 5. The leg protectors include a harness and two 'dragging' loops. It also include two loops to hold the manikins arms in place to prevent them dragging on the ground; polypropylene webbing and quick release buckles quickly and easily secure the leg protectors to the manikin.

23959310	Drag Protector, Complete	\$226.00
23959311	Replacement Protectors, set of 5	\$210.00



Front

Back

TRAINING MANIKIN WEIGHT VEST

For Adult Training manikin

Special Low-Profile design fits underneath manikin coveralls. Quickly and securely fitted to manikin. Allows one manikin to do the work of many. Now, both heavy and lightweight training needs may be met with a single manikin. (Shown outside of coveralls for clarity).

	Weight	
23959215	15 lbs*	\$195.00
23959225	25 lbs.*	\$275.00
23959236	36 lbs.*	\$340.00

*Nominal weight



MANIKIN FACE MASK

A realistic slip-on face mask that makes any adult training manikin look much more lifelike. Available in standard or wig versions. Velcro opening for easy donning.

23959505	Face Mask, Standard	\$195.00
23959506	Face with Wig	\$232.00



THERMAL IMAGING SUIT

Electronic Heating

The Thermal Imaging Suit was designed to meet the growing demand for a manikin which could be detected on thermal imaging equipment - but instead of creating a manikin which had this capability, we have designed a special suit which goes over the top of your existing manikin to give instant thermal imaging capabilities, with more flexibility.

This robust suit can be worn by any Ruth Lee adult manikin (Up to 90kg) and then a special overall (included in the price) is placed over the thermal suit to provide protection and to help evenly distribute the heat for better imaging using thermal cameras. The battery can be used like a mobile phone whereby the suit is pre-heated and then used for approx. 1-2 hours (depending on ambient temperature), or with the battery attached in a holster on the side of the leg. Having the battery attached prolongs the usage time to approx. 3-4 hours (depending on ambient temperature), especially useful for search and rescue (SAR) or Urban SAR operations.

2395029024

Adult

\$3,100.00



THERMAL IMAGING HOOD

Electronic Heating

The Thermal Imaging Hood gives your water rescue manikins an instant heat source which can be detected by thermal imaging equipment - even from an altitude of 2000 ft! Uses fabric with an embedded electronic cord and waterproof battery.



SAR HOODY FOR MAN OVERBOARD

For Man-Overboard Manikin

The SAR Hoody adds low visibility capability training to the Man Overboard manikin.



BASIC THERMAL HOOD

Using chemical heat pouches, this hood provides an economical way to add thermal imaging training to your manikin.

Note: When used in-water, place the warmers into a waterproof sandwich pouch.

23952049	SAR Hoody for Man Overboard Manikin	\$138.00
23959693	Basic Thermal Imaging Mesh Hood, Adult	\$65.00
23959303	Replacement Heat Packs, Set of 2	\$1.50



2395029006 Adult / Youth \$1,375.00

THERMAL IMAGING TRAINING VEST

Vest designed to aid in thermal imaging training. Low profile design fits underneath coveralls of Manikin. (Shown outside of coveralls for clarity).

23959301	Thermal Imaging Vest	\$90.00
23959303	Thermal Packs, Set of 2	\$1.50





PREGNANCY SIMULATION VEST

The Manikin Pregnancy Simulation Vest lets you transform any adult Ruth Lee manikin (excluding bariatric, Fire House and Water Rescue Manikins) into a lady who is between 4-6 months pregnant. Weighing under 1 kg, this visual simulation lets you add a new challenge to your training and get your teams to think about how they would tackle this casualty – whether that is in a healthcare setting, or during rescues such as vehicle extrication.



- Simply pull the vest over the manikin's head and secure using tie strings and clips
- Simulate a lady approximately 4-6 months pregnant and features a rounded belly and breasts.
- Give your training an interesting challenge
- Pair with our facemask and wig (not included) to give a different appearance during training.

239593210

Pregnancy Vest

\$445.00



MANIKIN STORAGE BAG

A custom-designed bag to fit the youth - Heavy Adult Sized Ruth Lee Training Manikins. Features Heavy Duty PVC material and nylon straps. Includes shoulder straps and end lifting handles.

23959104

Storage Bag, Youth / Adult

\$145.00



CASUALTY EVACUATION MANIKIN

A new manikin with special add-on features making it excellent for Physical training and evaluation. While the Casualty Evacuation Manikin was designed specifically for the UK Fire Fighter Recruitment Test and the CFOA FireFit Role Based Fitness Test, it will work for agencies outside of the UK as well. Constructed in the same flame retardant Polyester used in Police ballistic/stab vests, which typically has 4 times the strength and abrasion resistance of 16 oz. canvas or P.V.C (the materials previously used) – making the manikins even stronger than before.

		Weight	
2395022055	Adult (5' 11")	121 lbs	\$1,625.00



RESCUE MANIKIN DRAG HARNESS

A Full Body Harness with added shoulder handles for use with the Training manikins. Fits all Adult Ruth Lee and Simulaid's manikins.

718130

Manikin Drag Harness

\$95.00



REPLACEMENT COVERALLS, FIREHOUSE MANIKINS

2395050505	Firehouse Coverall, Infant	\$450.00
2395050510	Firehouse Coverall, Toddler	\$625.00
2395050520	Firehouse Coverall, Youth	\$680.00
2395050570	Firehouse Coverall, Adult	\$805.00



REPLACEMENT COVERALLS, WATER RESCUE MANIKIN

2395051540	MO Coverall, Adult	Orange	\$350.00
2395051541	MO Coverall, Adult	Black	\$350.00
2395051520	MO Coverall, Youth	Orange	\$262.00
2395051521	MO Coverall, Youth	Black	\$262.00
2395051510	MO Coverall, Toddler	Orange	\$161.00
2395051505	MO Coverall, Infant	Orange	\$129.00



REPLACEMENT COVERALLS, TECHNICAL RESCUE MANIKINS

2395050105	Tech Rescue Coverall, Infant	\$119.00
2395050110	Tech Rescue Coverall, Toddler	\$157.00
2395050120	Tech Rescue Coverall, Youth	\$201.00
2395050170	Tech Rescue Coverall, Adult	\$300.00

REPLACEMENT COVERALLS, OTHER RUTH LEE MANIKINS

23959037902	Public Safety Coverall, Adult	\$225.00
2395051950	Body Recovery Coverall, Adult	\$330.00
2395051930	Body Recovery Coverall, Youth	\$235.00
2395051910	Body Recovery Coverall, Toddler	\$200.00
2395050470	Multi-Trauma Coverall	\$345.00
2395051760	Offshore Coverall, Adult	\$340.00
23950511070	Working At Height Coverall, Adult	\$300.00
23950503070	Prisoner Security Coverall	\$300.00
23959016904	Pool Rescue, Adult	\$220.00
23959016903	Pool Rescue, Youth	\$199.00
23950522055	Casualty Evac Coverall	\$300.00
23950506100	Drop Test Coverall	\$350.00
23950523050	Duty Plus Coverall	\$375.00
23959025902	Patient Handling	\$232.00

REPLACEMENT MESH HOOD, SAR MANIKIN

23959691	Replacement Mesh Hood, Adult	\$51.00
----------	------------------------------	---------



REPLACEMENT BOOTS

These boots are for all Adult and Youth manikins that include boots.

23959701	Replacement Boots, Adult	\$41.50
23959703	Replacement Boots, Youth	41.50



RUTH LEE REPLACEMENT HEAD COVER

Sometimes your head just wears out. The Ruth Lee Replacement head covers extend the life of your manikins. Each cover is printed with the manikin weight. Easily slips on and closes with velcro.

	Style	
2395901020	44 lbs. (20 kg.)	\$160.00
2395901030	66 lbs. (30 kg.)	\$160.00
2395901050	110 lbs. (50 kg.)	\$160.00
2395901070	154 lbs. (70 kg.)	\$160.00
2395901090	198 lbs. (90 kg.)	\$160.00
2395901100	220 lbs. (100 kg.)	\$160.00



SIMULAIDS

RESCUE TRAINING MANIKINS



RESCUE RANDY

Official Manikin of the Firefighter Combat Challenge

Molded of durable vinyl plastic. Built with 4,200 lbf. test plastic coated cables. Articulated joints. Weight distribution according to human weight distribution chart. Used by U.S. Military, Fire and Police Departments, Safety Teams, and Emergency personnel for rescue and extrication. Ideal for Tower, Confined Space and Trench Rescue.

		Model	Weight	Height	
21544175	Rescue Randy IAFF	#1475	165 lbs.	6' 1"	\$2,090.00
21545175	Rescue Randy IAFF	#1477	175 lbs	6'1"	\$2,360.00
21545200	Rescue Randy IAFF	#1476	200 lbs.	6'1"	\$2,990.00
21544165	Rescue Randy Combat Challenge	#1435	165 lbs.	6' 1"	\$1,890.00
21544145	Rescue Randy Combat Challenge	#1434	145 lbs.	6' 1"	\$1,750.00
24031446	Rescue Randy, Large Body	#1446	250 lbs.	6' 1"	\$3,250.00
21545200	Rescue Randy, Large Body	#1437	200 lbs.	6' 1"	\$2,265.00
21545175	Rescue Randy, Large Body	#1436	175 lbs.	6' 1"	\$1,905.00
21545125	Rescue Randy, Large Body	#1433	125 lbs.	6' 1"	\$1,780.00
21545165	Rescue Randy, Standard Body	#1345	165 lbs.	5' 5"	\$1,885.00
24031344	Rescue Randy, Standard Body	#1344	145 lbs.	5' 5"	\$1,750.00
21544105	Rescue Randy, Standard Body	#1335	105 lbs.	5' 5"	\$1,170.00
21544055	Rescue Randy, Standard Body	#1338	55 lbs.	5' 5"	\$1,250.00
21541355	Rescue Jennifer	#1355	16 lbs.	4'	\$1,120.00
21541355R	Rescue Jennifer II	#1355S	38 lbs.	4'	\$1,390.00
21542094	Storage Bag, Combat Challenge	#2094			\$300.00



RANDY 9000

Designed to be customized by the user for optimal training use. Just add water, sand, or any other substance as long as you can empty the substance out of the parts. Empty manikin weight is less than 40 lbs. The range of motion of the joints, including bending at the waist, mimics real life. Perfect for RIT or Combat Challenge as well as ship-board, heavyweight, horizontal rescues or lightweight packaging exercises like spinal immobilization. Randy 9000 may be used in all weather conditions and the joint design protects rescuers' fingers. Each manikin component is easy to replace.

24039000 Randy 9000 \$2,535.00



COMBAT CHALLENGE KID

Challenging children creates character. Put your kids to the test with this down sized version for the Fire Fighters Combat Challenge, kid style.

24031460 Combat Challenge Kid \$710.00

WATER RESCUE TRAINING MANIKIN

Used by the U.S. Coast Guard, Sheriff's Departments, Lifeguard Trainers and Emergency Personnel for both on water and in water rescue and retrieval. Manufactured of durable vinyl plastic with rust resistant steel skeleton (adult and adolescent models). Articulated joints on Adult and Adolescent. When filled with water manikin will submerge to neck. Add an additional 5 - 10 lb. weight (not supplied) to sink.

			Weight	Height	
A. 21541350	Rescue Cathy, Infant	Model# 1350	5 lbs.	20"	\$295.00
B. 21541352	Rescue Billy, 6 - 9 Month	Model# 1352	7 lbs.	25"	\$310.00
C. 21541351	Rescue Timmy, 3 Year Old	Model# 1351	10 lbs.	32"	\$302.00
D. 21541327	Adolescent	Model# 1327	22 lbs.	4' 0"	\$1,030.00
E. 21541326	Adult	Model# 1326	52 lbs.	5' 5"	\$1,150.00



FLEXIBLE RESCUE RANDY

This standard-sized Rescue Randy unit has been developed especially for the aerospace industry and wing tank fuel cell rescue training, but it can be utilized in any confined space rescue. The waist flexes and the head twists to allow positioning of the manikin in tight spots. Flexible 5 ft. 5" Rescue Randy.

Size: 50" x 21" x 12" Shipping Weight: 60 lbs.



TI RESCUE RANDY

Thermal Imaging Training Manikin

Ideal for rescue training in buildings or search and rescue in the field, Rescue Randy TI will stand out from the background thermal image. TI Rescue Randy has been tested in smoke and steam-filled spaces for fire fighting environments, with demonstrated realistic simulation for rescue and extraction training.

Special heaters in the face and hands operate off of standard 110V or 220V power outlets and reaches desired temperature in 15 minutes. You can set the temperature you want on TI Rescue Randy and he will be visible on scanner for over 45 minutes unplugged. In real world environments, the manikin is not likely to be presented with the entire body or torso exposed for easy heat signature definition. Therefore, you should train with smaller presentations such as the head and hands.

Size: 55" x 27" x 13". Weight: 165 lbs.

240320165	Thermal Image Randy	\$3,800.00
240321482	Thermal Image Baby	\$2,190.00

21542710

Flexible Rescue Randy

\$1,400.00



RESCUE RANDY HARNESS

Moving large rescue manikins of any weight is a challenge. The Fire Fighter Combat Challenge staff developed this Rescue Randy harness to move the manikins back to the starting position. Constructed of 2" nylon webbing, the harness makes grabbing hold of manikins and the arms a simple process. Use the harness to handle manikins in your day-to-day operations. DO NOT USE the harness for hoisting, rescue operations, or any victim use.

24031470

Rescue Randy Harness

\$175.00

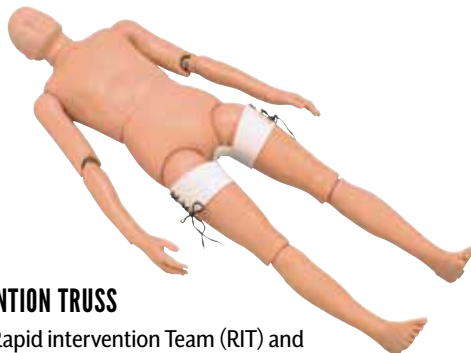

RAPID INTERVENTION TRUSS

Designed with Rapid intervention Team (RIT) and confined space rescues in mind, this adjunct to the Rescue Randy eliminates strap pressure applied to the groin area of the Randy. Harness or waist straps that are passed through the groin during exercises will not hinder the structure of the manikin skeleton, which causes degradation of the pelvis. Use this inexpensive product to protect the investment you made in your Rescue Randy.

21541479

Randy Intervention Truss

\$80.00

SIMULAIDS/I.A.F.F 50 LB. TRAINING WEIGHT VEST



A specially designed (with the assistance of the I.A.F.F.) weight vest to aid in firefighter physical ability testing. The 50 lb. vest simulates the weight of protective clothing and SCBA. Pouches on shoulders accept additional 25 lbs of weight to simulate hose bundle. New design offers better fit and greater comfort for firefighter.

	Size	
21541118	Small	\$645.00
21541120	Medium	\$650.00
21541125	Large	\$660.00
21541000	Extra Shoulder Wgts, 25 lbs.	\$ 217.00

EQUIPMENT BAGS & PACKS

STOWABLE PADDED SHOULDER STRAPS

RescueTECH Shoulder Pads are produced with the highest quality structural webbing, soft and supportive foam, and breathable padding. The system stows in an integral compartment to keep the straps secure during storage; yet are easy to deploy when needed.



Equipment not included

USAR-TECH ROPE & EQUIPMENT PACK

A full backpack style equipment storage/carrier. Features a rope bag section with room for 200 ft. of 1/2" ACCESS Lifeline PLUS space for a pre-rig rescue system (or a single 300' length of ACCESS Lifeline). This feature is easily accessible without opening the main compartment. The main compartment features RescueTECH's exclusive "expanding compartment" storage system. The system effectively doubles the storage space for webbing, slings, and rope guards by placing a divider in the main compartment. Adjustable Shoulder and waist straps will accommodate all rescuers. Waist pads will actually expand to fit larger waists. The semi-rigid internal frame supports gear. All straps may be tucked into special storage areas to prevent tangling with other equipment in the compartment. Manufactured in our Georgia facility from fabric made from Dupont Cordura Brand fibers.

Dimensions: 20"h x 18"w x 10"d.



Rope and Pre-Rig Accessible from exterior through our rapid access opening



First equipment section opens to show webbing, sling, and rope protector storage section



Opening the divider reveals additional sling storage and mesh compartments for hardware and rigging supplies.



Breathable Padded Shoulder strap.

	Color	
808326	Blue	\$470.00
808324	Red	\$470.00



USAR-TECH II ROPE & EQUIPMENT PACK

An upgraded version of our original USAR-TECH Pack. We've added exterior zippered pouches to hold quickly needed equipment. The main compartment features RescueTECH's exclusive "expanding compartment" storage system. The system effectively doubles the storage space for webbing, slings, and rope guards by placing a divider in the main compartment. Adjustable Shoulder and waist straps. The semi-rigid internal frame supports gear. All straps may be tucked into special storage areas to prevent tangling with other equipment in the compartment. Manufactured in our Georgia facility. Available with 2 Interior storage styles - the original heavy duty mesh pouches or webbing equipment storage straps. Extremely durable YKK self-healing zippers and the highest quality side-release buckles for long term use. Holds 200' of 1/2" Access and pre-rig or 300' of 1/2" Access.

Outside Dimensions: 20" H x 22" W x 10" D Interior Panel: 19.5" H x 16.5" W

		Color	
8083510	Mesh System	Orange	\$525.00
8083511	Mesh System	Black	\$525.00



Exclusive Interior Expanding Storage may be detached to transport needed equipment



Mesh Pocket System: Original RescueTECH mesh equipment storage compartments.



USAR-OPS ROPE & EQUIPMENT PACK

A slightly smaller version of our popular USAR Rope and Equipment Pack, the Standard Rescue pack is durable and versatile. 3 interior mesh pockets securely hold small items. Outside 'slash' pockets and full width interior pockets give ample storage space for rope pads, slings and webbing. Horizontal strap system allows for attachment of pulleys and carabiners. Holds 200 ft. of 1/2" ACCESS Lifeline. The USAR-OPS Pack also accommodates a pre-rigged system in rope section. Padded shoulder straps and waist strap are comfortable and easily stowed for bag storage.

Dimensions: Standard: 20"H x 16"W x 10"D



Side View: Padded Shoulder Straps and Slash Pocket



Back View: Stowed Shoulder Straps.



Interior View: multiple mesh pouches, attachment straps and slot pocket.

	Color	Cap.	
8083134	Red	200'	\$315.00



RESCUER EQUIPMENT PACK

A larger version of our Deluxe Equipment pack. Larger dimensions along with our Expanding Compartment Storage System gives rescuers extra room for needed equipment. 5 Mesh Pockets and 2 equipment loops. Padded stow-away shoulder straps. Self-Healing #10 industrial zipper.

Dimensions: 20"h x 16"w x 6"d.



Interior View: multiple mesh pouches, attachment straps and slot pocket.



Side View: Padded Shoulder Straps.



Back View: Stowed Shoulder Straps.

	Color	
808344	Red	\$330.00
808346	Blue	\$330.00

RT DUFFEL BAG

A traditional cylinder bag built with the same high quality and durability as all of our rope and equipment bags. Manufactured from our RescueTECH™ super tough fabric. Seams are double-stitched and taped for superior strength. Optional Adjustable Shoulder Strap.

	Size	Dimensions	Color	
806314x	Large	20" x 12"	Red, Blue	\$68.00
809790		Shoulder Strap, Adj	Black	\$12.50



DELUXE ROPE & EQUIPMENT PACK

2 Compartments

An innovative pack designed to provide organized storage and convenient transport of rescue equipment. The main compartment (16"H x 12"W x 8"D) is fully padded with closed cell foam and has webbing loops to attach equipment. The pack has a webbing carrying-handle and padded contour shoulder straps. A false back stores the shoulder straps when not in use. A front outside compartment is 16"H x 12"W x 2"D. The main compartment has a sleeve for a rescue/rappel rack. Equipment not included.

Weight: 2.2 lbs.

	Color	
808300	Orange	\$250.00
808304	Red	\$250.00
808306	Blue	\$250.00





EQUIPMENT CACHE PACK

A handy storage pack for quickly needed rescue equipment. Padded sides, 4 Mesh Pockets, 8 equipment loops. Padded ergonomic shoulder straps store out of the way when not in use.

Dimensions: Closed: 23" x 12" x 4" Open: 23" x 24" x 2"

81133924 Equipment Cache Pack \$ 162.00



RT GEAR BAG

Heavy Duty Carrying Handles on Ends

A large Duffel design easily stores turnouts, helmet and boots. Great for all rescue personnel. The two-way wrap around zipper allows you to open bag all the way for easy access to contents. A large zipper pocket outside gives you extra storage for personal items, gloves, tools and goggles. Two inch webbed handles wrap completely around the bag to give extra support.

Dimensions: 12" x 16" x 24" Color: Red, Orange, Black Weight: 1.5 lbs.

	Color	
809704	Red	\$125.00



Includes Shoulder Strap

Bag shown in red for clarity



RESCUER GEAR BAG

We took the time to design a bag that a rescuer could keep personal gear ready to go. The main section has a zipper system that allow quick and full access to the contents. The large end pouch will hold an R3 Kiwi helmet, but can also be used for a change of clothes, harness, and other rescue items. The small end pouch works great for gloves, slings, etc. Side pockets hold other personal gear. A zippered see-through panel can be used for personal identification and allows the bag to be used and marked as a specific use rescue kit. Includes adjustable shoulder strap. Made in USA.

Dimensions: 24 x 10 x 10"

809741 Black \$220.00



PAX GEAR BAG

Carries a complete set of protective turnout gear for firefighting. It has a main compartment for a turnout coat and pants, and an extra boot compartment which is separate for reasons of hygiene. The helmet, safety harness and rope bag are also stored in a separate compartment.

Dimensions: 31.5 x 17.3 x 14.9"

25532016104 Red \$195.00



FIRSTWATCH GEAR BAG

Rescue gear bag featuring a reinforced base, multi-handles, and straps. Heavy-duty polyester construction combines with mesh air panels for durable gear storage and ventilation. Easy access U-shaped main compartment end pocket makes keeping your gear organized easy. Heavy Duty webbing handles, shoulder strap and pull handle.

Dimensions: 37" x 20" x 17.5"

2171071004 Red/Black \$174.00



HALL COUNTY SCBA MASK BAG™

After many months of searching and evaluation, Hall County Fire (Georgia) decided upon this design to protect their SCBA masks. Made of durable 1000d Cordura™ fit their needs to a “T”. Closed with a durable #10 Zipper instead of Velcro™ for a long service life. Hall County chose to line the interior with a smooth, coated 200 denier nylon fabric instead of a fleece material. Their evaluations concluded that while the fleece was soft, it trapped dirt and contaminant in the material and between the inner and outer layer. Features a bottom grommet for drainage and a hook and loop strip to attach name plates or accountability tags. A durable 1” wide nylon webbing loop allows the bag to be attached to turnout gear or hooks in the apparatus or equipment lockers.

Dimensions: 14” x 7” Color: Red

8321014 Hall County SCBA Mask Bag \$39.00



BASIC SCBA MASK BAG

A basic, envelope-style SCBA mask Bag. Made from highest quality 300 x 600 PVC coated nylon fabric for durability and water resistance. Full width hook and loop fastener keeps the contents clean and ready for use. Steel ring allows firefighter to attach this bag to turnout gear with a simple key-ring carabiner. Fits most mask-regulator style SCBA Masks (Scott®, Interspiro®, etc.)

Dimensions: 14” x 10” x 4” Color: Red

8321015 Basic Mask Bag \$24.00



HELICOPTER LOADING BAG

This hard-wearing and high-specification bag has been designed to transport fire fighting equipment via helicopter and/or sea going tug, directly on to the ship affected.

The base of the helicopter loading bag is constructed in two parts. The outer base (bottom tray) is constructed with large radii corners to avoid damage to helicopter flooring. The bases are secured through the bottom of the bag and through the webbing straps by steel bolts with Nyloc nuts. All seams are double-stitched. A 7.9” (200mm) rubbing band manufactured from black PVC Nylon is stitched to the bottom of the bag. Interior clear label pouches for easy insertion and removal of labels/ instructions.

Six reinforced grab handles are secured around the lower half of the bag. Two 48mm heavy-duty webbing straps extend 22” above the top of the bag eases use of the bag with helicopter operations.

NATO Stock Number: 8465-991-561-438

Dimensions: 36.3”L x 25.2”W x 25.2” (915 x 635 x 635mm)

SWL: 220 lbs. (100 kg)

Materials: Polyurethane Outer Covering, 10mm Plastizote foam sandwich, and 4 oz. Nylon inner covering. PVC Nylon base with heavy duty Glass Fiber Tray. 8mm heavy duty Zipper. Steel Carabiner-Lock-Safe.

2395060100 Helicopter Load Bag \$3,400.00



HELICOPTER KIT BAG

Special Small bag to fit inside the Ruth Lee Helicopter Loading Bag. When properly loaded, 6 Kit Bags will fit into the Loading Bag.

Dimensions: 11.9”L x 11.9”W x 17.9” (300 x 300 x 450mm)

SWL: 132 lbs. (60 kg)

2395060110 Helicopter Kit Bag \$255.00



Equipment not included



WATER RESCUE TEAM MEMBER BAG

A new, versatile bag for both Surface and Dive Rescue Team Members. Manufactured with side panels of strong Vinyl Coated Nylon mesh, this bag allows for excellent content ventilation. Front panel, zippered mesh-backed pockets hold fins, gloves, snorkels, and other personal gear. Interior compartment is large enough to hold Drysuit, PFD, helmet, Boots, and throw bag. Side compression straps. Top handle and Shoulder Strap D rings.

Dimensions: 26" x 18" x 10"

807542	Rescue Team Member Bag	\$160.00
809790	Adjustable Shoulder Strap	\$12.50



SWIFTWATER TEAM MEMBER MESH DUFFLE

The Purest Mesh Duffel's ripstop nylon lower and mesh upper are built to air out river funk yet withstand the stress of life on the go or in the wild. A cylindrical main compartment makes packing easy while the end pocket separates wet from dry, giving the impression of being well-organized. 420 Ripstop nylon fabric lower protects from abrasive surfaces. Breathable mesh Top.

	Size	Dimensions	Colors	
2084550033x	Medium, 40L	22" x 12"	Red, Blue	\$79.95
2084550034x	Large, 60L	26" x 13.5"	Red, Blue	\$89.95
2084550035x	XLarge, 90L	30" x 15.25"	Red, Blue	\$99.95



PUREST RESCUE DUFFEL BAG

The Rescue Duffel takes the ample space and ventilation of the Purest Mesh Duffel, adding rescue-specific features purpose-built to withstand the demands of SAR professionals. Unique sizes, high-visibility accents, and external lash points keep tactical equipment and personal gear organized and accessible. Manufactured from durable, tear-resistant 420D ripstop nylon fabric and breathable polyester mesh. Includes sturdy webbing handles and detachable padded shoulder strap. Reflective materials, including SOLAS reflective tape increases low-light visibility. Zippered accessory side pocket fits small items, such as wallet, phone and keys.

	Size	Dimensions	Colors	
2084550524x	Large, 80L	28.5" x 14.75"	Red, Black	\$109.95
2084550526x	XLarge, 115L	33" x 16.5"	Red, Black	\$129.95

JUMBO MESH PFD BAG

The Mesh PFD Bag makes it easy to transport and store your damp and difficult-to-carry gear. The top of this bag is made with the same 2-1/2" square mesh netting so that everything inside dries quickly. The bottom is 500 denier PVC for durability. Two sturdy handles and a quick-cinch draw cord opening allow you to pick up and go. Room enough for all your friends' gear, too. Holds up to 18 PFDs.

Dimensions: 40" W x 40" L x 30" H

20843094	Jumbo Mesh PFD Bag	\$159.95
----------	--------------------	----------

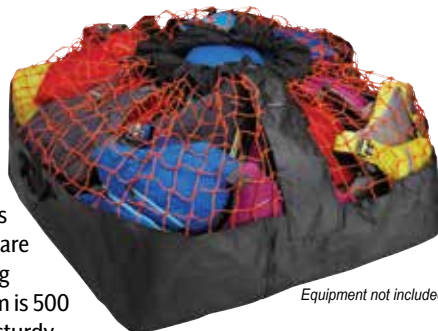

Equipment not included



Equipment not included

DELUXE MESH PFD BAG

Made for storage and transporting PFD's, the Deluxe Mesh PFD Bag is made from polyurethane coated mesh. The bottom is durable PVC coated nylon mesh for durability. Two sturdy handles are included and makes this bag extremely portable. Holds up to 10 Full sized PFDs(not included).

Dimensions: 35" L x 24" W x 18" H

8063282	Deluxe Mesh PFD Bag	\$95.00
---------	---------------------	---------

WATER RESCUE

GEAR & PERSONAL PROTECTION



Water Rescue, whether swiftwater, lake, ice or ocean, is demanding on the rescuer and equipment. We have put together a selection of equipment that will help teams meet the most difficult rescue head on. From wet and drysuits to helmets to throwbags, RescueTECH can fill your equipment requirements.



Whistle Lanyard Not Included



Whistle Lanyard Not Included

FIRST RESPONDER WATER RESCUE SET

Includes equipment most often required for swiftwater rescue classes.

- Rapid Rescuer PFD (1) • ATB Rescue Boots (1 pair) • Utility Water Rescue Glove (1 pair) • Throwbag 70' (1) • Fox 40 Rescue Whistle (1) • River Rescue Short Knife (1) • Havoc Water Rescue Helmet (1)

Deluxe Set Also Includes (shown below in box): Water Rescue Team Member Bag (1) • Shredder Fins (1 pair)



29982001	Standard	\$525.00
29982002	Deluxe	\$795.00

BASIC WATER RESCUE SET

The bare minimum equipment to have while working around water.

- Big Water Guid PFD (1) • 3/8" Throwbag x 50 ft. (1) • River Rescue Short Knife (1) • Fox 40 Rescue Whistle (1) • Mesh Stuff Sack, XL (1)

29982003

Basic Water Rescue Set

\$295.00



WARNING

Technical rescue and safety is potentially hazardous. Any person using equipment sold by RESCUE TECHNOLOGY in any manner is personally responsible for learning the proper techniques involved, and assumes all risks and accepts full and complete responsibility for any and all damages or injury of any kind, including death, which may result from the use of any RESCUE TECHNOLOGY equipment.

Products in this catalog can expose you to chemicals which are known to the State of California to cause cancer.
For information go to: www.p65warnings.ca.gov



NRS RAPID RESPONDER

Designed for water rescue professionals working in the most demanding environments, the Rapid Responder PFD features a MOLLE attachment system to provide unlimited customization for safely carrying the rescue hardware and accessories needed to meet individual needs. Constructed with 400-denier Ripstop Nylon. Design flotation: 22 lbs. Four-panel chest design for enhanced comfort. Zippered front entry for quick on and off with backup buckles for added security under stress. Integrated connection points for leg straps (sold separately). 2" quick-release rescue belt with stainless steel ring. US Coast Guard Certification through testing by Underwriters Laboratories (UL).

Design flotation: 22 lbs. Weight: 3.15 lbs. •

	Color/Item Description	Size	
2084401072	Yellow/Black	Universal	\$239.95
2084401074	Red /Black	Universal	\$239.95
208440136	Accessory Pouch		\$34.95



NRS RAPID RESCUER

Type III/V PFD. With 22 lbs of flotation, adjustable to fit chest sizes from 32 to 56 inches, and all the features you will ever need in a rescue vest. Two huge front pockets stretch to hold anything from a GPS to a VHF. Three lash tabs on the front are great for a knife, whistle or anything else you need to keep handy. A rear D-ring, strobe holder, and tether attachment round out the attachment points on the front with a safety light stick holder on the back and reflective tape everywhere. 8 adjustment points to ensure a secure fit.

Design flotation: 22 lbs. Weight: 3.3 lbs.

	Color/Item Description	Size	
2084400252	Yellow	Universal	\$264.95
2084400254	Red	Universal	\$264.95
20842163	Leg Straps, Pair		\$10.95



cVEST PFD

cVest Life Jacket has lots of reflective tape and a cool mesh back that works great with high-back seats. Six pockets, including one for a radio, provide lots of handy storage. An accessory lash tab and lanyard loops on the front, plus a beacon loop on the back, give you even more options for outfitting this vest. Flotation is concentrated up front and behind the shoulders, with a mesh lower back that lets you recline, relax and stay cool. SOLAS reflective tape on front and back provides outstanding low-light visibility. Eight adjustment points ensure a snug, secure fit. Large arm openings allow for unobstructed movement while paddling or rowing.

• Design flotation: 16.5 lbs. • Small/Medium: 30" - 42" • Large/XLarge: 42" - 52" • XLarge/XXLarge: 50" - 56"

	Color	Size	
20844002822	Lime	SM/M	\$149.95
20844002842	Lime	L/XL	\$149.95
20844002862	Lime	XXL	\$149.95

	Color	Size	
20844002824	Red	SM/M	\$149.95
20844002844	Red	L/XL	\$149.95
20844002864	Red	XXL	\$149.95



BIG WATER GUIDE PFD

High Profile Type III

A high-flotation PFD with customizable accessory features, the NRS Big Water Guide PFD gives users peace of mind in big water. Quick-drying 400-denier ripstop nylon shell. Leg strap compatible to add extra security in big water. (Leg straps sold separately.) • This jacket carries the US Coast Guard Certification through testing by Underwriters Laboratories (UL).

Design Flotation: 22.9 lbs.

	Size	Colors	
2084400142x	XS/M	Orange, Red, Safety Yellow, Black	\$144.95
2084400144	L/XXL	Orange, Red, Safety Yellow, Black	\$144.95



FORCE6 TEC2 PFD

The Best Equipment for the Worst Conditions

The RescueTec PFD is feature loaded. Dual 1 1/2 in QR belts for throw bag attachment, waist belt with Gripp-Loc to prevent ride up. Adjustable shoulders with dual AustriAlpin anodized aluminum buckles, Moulded extraction handle, 4 inch Velcro name attachment back-band, Heavy duty YKK front entry zipper, 12 elastic strap container bands, rear hydration attachment points, neoprene neck water damn, lapel strap tunnels, and reflective material on both the front and the back.

UL listed and United States Coast Guard approved Type 5 Professional Swiftwater Rescue PFD 26 lbs.minimum flotation on both the S/M and L/XL models Gripp-Loc on waist belt to reduce ride up Shell Fabric - High tenacity 420 Denier Fabric

	Size	Color	Chest	
2490122x	S/M	Red, Yellow	28" x 40"	\$390.00
2490124x	L/XL	Red, Yellow	40" - 52"	\$390.00



FORCE6 RESCUEOPS PFD

The RescueOps PFD was designed for water rescue professionals that need a high buoyancy PFD for moving air-rated water, ice and flood rescues. The RescueOps was designed with 26 pounds of lift which makes it the most buoyant universal fit PFD on the market. This PFD has large deeply cut armholes which allow the rescuer a full range of motion. MOLLE pockets designed to fit radios inside and mount anything outside Best-in-class, this Type 5 universal fit PFD fits sizes medium though 3XL. Detachable leg harness designed to ensure a perfect fit to help prevent flush drownings (not included)

The RescueOps has two specially designed molle front pockets that fit most public safety radios. These pockets are also perfect for hauling gloves, carabiners and flashlights. The outside of these pockets allows you the flexibility to mount most accessories Colors - Red, Yellow

US Coast Guard Type V certified 26 lbs.minimum flotation 500 denier Cordura fabric outer shell Extraction handle SOLAS reflective material on front and back.

	Color	Size	
24905217434	Red	Universal	\$279.00
24905217432	Yellow	Universal	\$279.00

FORCE 6 ACCESSORIES



Chest Pouch

Extrication Leash



RescueOPS Leg Loop Assembly



RescueTEC Swim Harness

FORCE 6 RESCUER3 PFD

The Force 6 Rescuer3 is a high buoyancy (26lbs) vest for rescue professionals involved in boat and shore operations or medium to high risk swift water environments. Designed to meet the Personal Protective Equipment (PPE) needs of rescuers that face the challenges of moving water, these IRIA Certified vests are made of rugged, high visibility rip stop nylon and contain extra flotation to combat the reduced buoyancy effects of turbulent water.

An integrated structural harness and single piece over-the-shoulder foam design provide extra strength, structural integrity and body protection. Multiple adjustment points provide a secure fit that prevent ride up and a "live bait" quick release belt helps the rescuer to escape dangerous situations. Fast Tabs on both shoulders act as easy attachment points for accessories such as knives, scissors or strobe lights.



2490521654	Chest Pouch, Red	\$45.00
2490521651	Chest Pouch, Black	\$45.00
237029102	RescueOPS Leg Loop Assembly	\$44.00
24905217901	RescueTEC Swim Harness	\$47.00
2490521604	Force6 Extrication Leash	\$79.00

	Color	Size	
237011334	Red	M/L	\$369.00
237011354	Red	XL	\$369.00



FIRSTWATCH HBV-100 PFD

The HBV-100 high buoyancy rescue vest has been designed and USCG tested to safely carry the gear SAR professionals need to execute their duties. USCG Approved to be worn with Level III- A body armor and USCG Approved with up to 23 lbs of gear worn on the vest .

3-D construction (circular) design ensures optimum comfort/fit; MOLLE System for flexibility in attaching accessories; Features 3 Shoulder (length) adjustment system and includes Crotch-Straps; Quick Release Rescue Belt; SOLAS Reflective tape Front & Back; 400D Cordura nylon shell for rugged performance.

	Color	Size	Chest	
21710810032	Hi-Viz Yellow	M/L	34" - 44"	\$428.00
21710810052	Hi-Viz Yellow	XL/XXL	46" - 54"	\$453.00
21710810034	Red	M/L	34" - 44"	\$428.00
21710810054	Red	XL/XXL	46" - 54"	\$453.00



FIRSTWATCH AV-800 PWC RATED PFD

4-Pocket Design

The AV-800 is engineered for comfort. Pockets allow stowage of essential gear. Extremely light & great fitting. Colors: Hi-Viz Orange, Hi-Viz Yellow, Black, Olive

Features:

Type III PWC Rated; Fleece Lined Collared Vest; Vertical Shoulder Adjustment; Ventilation Port at the base of the collar; Lash Tab; 2 lower pockets have mesh/webbing organizers. 2 Mic loops; Throttle D-ring; SOLAS Reflective Tape on Front and Back

	Size	Chest	
21718002x	S/M	26-36"	\$139.00
21718004x	L/XL	26"-30"	\$139.00
21718006x	2XL/3XL	46"-54"	\$139.00



FIRSTWATCH SWV RESCUE SWIMMER VEST

Designed for optimum freedom of movement, swimming performance, protection of the spine, and backside with a universal fit. Colors: Hi-Viz Yellow, Red/Black Universal Size.

Features:

Adjustable Shoulders; Grasp Handle; 9-Point Adjustment System; Quick-Release Rescue Belt; Spine Protection Pad; Stowed Crotch Straps; Lower Body Butt Protection; Two Stowage Pockets; MOLLE Shoulder & Breast; Buoyancy 99N (10kg)

	Color	
2171191002	Hi-Viz Yellow	\$354.00
2171191004	Red	\$354.00



FIRSTWATCH AV-5001 CREW VEST

Mesh Top

The AV-5001 vest has two storage pockets and breathable mesh backing. Its zipper and straps combine a superb fit with maximum flexibility. Available Colors: Hi-Viz Yellow, Hi-Viz Orange, OD Green.

Features:

SOLAS Tape; Shoulder Mesh; Two flap pockets w/ hook and loop closure; Zipper closure & Double Straps' supersoft PVC flotation foam; Neoprene Collar.

	Size	Chest	
21710150012x	S/M	26-36"	\$113.00
21710150014x	L/XL	26"-30"	\$113.00
21710150016x	2XL/3XL	46"-54"	\$113.00



FIRSTWATCH 40PRO - AUTO

40lbs Buoyancy

Built for optimum comfort – Easily fits over body armor. Straps and yoke will not interfere with law enforcement accessories on the armor. Over 40 lbs. of buoyancy. Zippered Closed Cell cover and neoprene collar for comfort. Zippered accessory pocket and internal CO2 bottle stow pocket.

FEATURES

3-D Foam molded back liner 1-F Single Point Inflator Status Indicator Mic Loops on both lobes Ultra-Strong 2" Nylon Webbing Waist Belt Chest Size: 30" - 56"

	Color	
2171063402	Hi-Viz Yellow	\$310.00
2171063401	Black	\$310.00
2171063403	Olive	\$310.00
217193302	38g Rearm Pack, Automatic	\$45.00



MUSTANG UNIVERSAL SWIFTWATER PFD

The Universal Swift Water Rescue Vest is a high buoyancy (25lbs) USCG approved Type V SAR PFD. Developed with ongoing feedback from the water rescue community to meet the Personal Protective Equipment (PPE) needs of rescue professionals. With an easy to adjust donning system and layered flotation foam, this vest provides a comfortable and secure fit, which improves operational performance both in and out of the water. Over 62 sq. in. of SOLAS tape with fluorescent yellow-green accents, 500 denier Cordura outer shell, MOLLE webbing on shoulders and back provides attachment points, Drag Handle, Durable harness with 2" webbing (730 lbs). All buckles, thread, stitch count, strap material and webbing are UL tested and certified. Quick donning with 7 adjustment tabs fits chest sizes from 32" - 52". Two large self-draining pockets on front. Quick-Release belt

	Color	Size	
2049150312	Black w/ Fluorescent Yellow	Universal	\$285.00



NINJA PRO PFD

A compact Type V rescue vest that delivers superior mobility and comfort and dialed-in rescue essentials. The Orbit Fit System layers multiple pieces of lightweight closed-cell foam cut to conform to your body. Graded Sizing takes into account the appropriate amount of flotation needed for individual body types. Fully-featured rescue vest includes a 1.5" quick-release rescue belt with an aluminum attachment ring. Continuous, interconnected webbing creates an internal harness for maximum security in live bait scenarios and when grabbing users by shoulder straps. Strap garages and a deliberately placed lash tab reduce snag points. Side entry, with adjustments on shoulders, side, and waist to secure the life jacket and customize fit. Silicone-coated inner waistband helps hold the PFD in place when swimming.

Colors: Red, Black

	Size	Chest	Weight	Flotation	
2084401411x	XS/S	30"-38"	90-154 lbs.	15.75 lbs.	\$229.95
2084401413x	M/L	36"-46"	88+	15.75 lbs.	\$229.95
2084401415x	XL/XXL	44"-56"	88+	16.75 lbs.	\$229.95



K-9 PFD

Canine Flotation Device

Whether your dog jumps or falls in the water, the Canine Flotation Device (C.F.D.) keeps them on the surface. With a tough 1000-denier Cordura® shell and heavy-duty straps, the C.F.D. can take the worst your dog can dish out! With the flotation on the back, your dog stays cooler. Wide, soft under-straps for comfort; durable grab loop and leash ring for security. A zippered pocket for a leash, snacks, etc. Reflective safety tape for visibility.

	Size	Chest	Weight	Flotation	
208421402	S	22"-28"	20-40 lbs.	3.4 lbs.	\$59.95
208421403	M	26"-30"	40-60 lbs.	4.9 lbs.	\$59.95
208421404	L	30"-37"	60-80 lbs.	6.4 lbs.	\$59.95
208421405	XL	36"-41"	> 80 lbs.	7.9 lbs.	\$59.95



EXTREME SAR DRYSUIT

Energlo arms help for low or no light conditions. 400-denier TriTon fabric will hold up to years of abuse. Cordura® exterior material reinforces seat, elbows and knees for rugged protection in high-wear areas. Neoprene padding in the elbows and knees provide extra protection while working in the field. Liquid neoprene coating protects latex wrist and neck gaskets from UV rays. TriTon fabric socks. Internal suspenders. Self-draining thigh pocket and a splash proof arm pocket. Heavy-duty YKK® waterproof men's relief zipper and entry zipper seals out water. Neoprene outer cuffs with adjustable hook-and-loop closures on the neck, wrist and ankles protect the latex gaskets. Reflective material on the wrists and piping. Pull cord waist adjustment allows for a more custom fit.

Colors: Red, Hi-Viz

Extreme	Size	
2084225292x	S	\$995.00
2084225293x	M	\$995.00
2084225294x	L	\$995.00
2084225295x	XL	\$995.00

Extreme	Size	
2084225296x	XXL	\$995.00
208422529G3x	Grizzly-M	\$995.00
208422529G4x	Grizzly-L	\$995.00
208422529G6x	Grizzly-XXL	\$995.00

Size	Height	Weight
S	5'2" - 5'6"	115 - 140 lbs.
M/L	5'5" - 6'0"	130 - 195 lbs.
XL/XXL	5'5" - 6'4"	185 - 245 lbs.
Grizzly	5'11" - 6'4"	260 - 305 lbs.

EXTREME SAR GTX DRYSUIT

The NRS Extreme SAR GTX Dry Suit not only keeps rescuers warm and dry, but the durable construction handles the severe demands of the job. Constructed of 100% recycled, 3-Layer GORE-TEX Pro for best-in-class waterproof-breathable performance with a lower environmental footprint. Latex neck gasket features a hook-and-loop overcuff while a 3 mm neoprene overcuffs protects the latex wrist gaskets. Front-entry YKK® Aquaseal zipper with protective flap and Cordura® reinforcements in the knees, seat, and elbows.

• Additional padding protects the elbows and knees. • Hook-and-loop patches on the shoulder are designed for attaching department badges. • Double-pull webbing buckle-closure waist belt provides a custom fit. • SOLAS reflective tape throughout enhances visibility in low-light conditions. • Gathered ankle design features an elastic band to fit snugly over boots. • Silicone dots keep the ankle from riding up. • Cordura® panel at the interior ankle for abrasion resistance. • Features GORE-TEX® Pro fabric socks, relief zipper, and one self-draining cargo pocket.

Extreme GTX	Size	Colors	
2084225602x	S	Red, Hi-Viz	\$1,395.00
2084225603x	M	Red, Hi-Viz	\$1,395.00
2084225604x	L	Red, Hi-Viz	\$1,395.00
2084225605x	XL	Red, Hi-Viz	\$1,395.00
2084225606x	XXL	Red, Hi-Viz	\$1,395.00
208422560G3x	Grizzly-M	Red, Hi-Viz	\$1,395.00
208422560G4x	Grizzly-L	Red, Hi-Viz	\$1,395.00
208422560G6x	Grizzly-XXL	Red, Hi-Viz	\$1,395.00



WATER RESCUE TOW TETHER -

Constructed of Heavy Duty Tubular Webbing, elastic, and steel ring. One end has a 2" ring to attach to the waist strap of Rescue PFD's. The other end is attached to a lightweight non-locking aluminum carabiner.

351101	Short Tether (35" Max)	\$40.00
351105	Long Tether (54" Max)	\$44.00



LONG TOW TETHER, AUTOLOCKING

Constructed of Heavy Duty Tubular Webbing, elastic, and steel ring. One end has a 2" ring to attach to the waist strap of Rescue PFD's. The other end is attached to our Forged Aluminum Autolocking Snap with eye for extra security.

351205	Long Tow Tether, Autolocking	\$55.00
--------	------------------------------	---------

ASCENT SAR GTX DRY SUIT

Breathable 3-Layer GORE-TEX Fabric

The Ascent SAR GTX Dry Suit combines a streamlined design with superior waterproof-breathable fabric construction. It provides the protection rescue professionals need and the durability required to handle unforgiving environments. Constructed of 100% recycled, 3-Layer GORE-TEX® Pro for best-in-class waterproof-breathable performance with a lower environmental footprint. Front-entry YKK® Aquaseal zipper. Armor material reinforces the knees, seat and elbows. Cinch-able neoprene neck seal and neoprene wrists for a less constricting, nearly watertight seal.

• Webbing buckle-closure waist belt provides a custom fit. • Gathered ankle design features an elastic band to fit snugly over boots. • Silicone dots keep the ankle from riding up. • Armored panel at the interior ankle for abrasion resistance. • SOLAS reflective tape throughout enhances visibility in low-light conditions. • Features GORE-TEX® Fabric socks, relief zipper, and hook-and-loop patches on the shoulder designed for attaching department badges. • Weight: 2.8 lbs. • Material: 3-layer GORE-TEX PRO®



Ascent GTX	Size	Colors	
2084225622x	S	Red, Hi-Viz	\$1,295.00
2084225623x	M	Red, Hi-Viz	\$1,295.00
2084225624x	L	Red, Hi-Viz	\$1,295.00
2084225625x	XL	Red, Hi-Viz	\$1,295.00
2084225626x	XXL	Red, Hi-Viz	\$1,295.00
208422562G3x	Grizzly-M	Red, Hi-Viz	\$1,295.00
208422562G4x	Grizzly-L	Red, Hi-Viz	\$1,295.00
208422562G6x	Grizzly-XXL	Red, Hi-Viz	\$1,295.00

ASCENT SAR DRY SUIT

Breathable 3-Layer Triton Fabric

Rescue situations are stressful enough without worrying about discomfort. The Ascent SAR Dry Suit features adjustable neoprene comfort-neck and neoprene wrist gaskets that are less constricting and still seal most of the water. Constructed with durable 3-Layer TriTon fabric for dependable waterproof-breathable protection. Front-entry YKK® Aquaseal zipper. Armor material reinforces the knees, seat and elbows. Cinch-able neoprene neck seal and neoprene wrists for a less constricting, nearly watertight seal.

• Webbing buckle-closure waist belt provides a custom fit. • Gathered ankle design features an elastic band to fit snugly over boots. • Silicone dots keep the ankle from riding up. • Armored panel at the interior ankle for abrasion resistance. • SOLAS reflective tape throughout enhances visibility in low-light conditions. • Features fabric socks, relief zipper, and hook-and-loop patches on the shoulder designed for attaching department badges. • Weight: 2.8 lbs. • Material: 320 den, 3-layer Triton



Ascent SAR	Size	Colors	
2084225612x	S	Red, Hi-Viz	\$895.00
2084225613x	M	Red, Hi-Viz	\$895.00
2084225614x	L	Red, Hi-Viz	\$895.00
2084225615x	XL	Red, Hi-Viz	\$895.00
2084225616x	XXL	Red, Hi-Viz	\$895.00
208422561G3x	Grizzly-M	Red, Hi-Viz	\$895.00
208422561G4x	Grizzly-L	Red, Hi-Viz	\$895.00
208422561G6x	Grizzly-XXL	Red, Hi-Viz	\$895.00

MUSTANG WATER RESCUE CACHE DRY SUIT

The Mustang 576 is the next evolution of Mustang Survival's constant wear "cache" dry suit. This suit is ideal for cache equipment. This suit includes:

• YKK metal entry zipper • Comfort fit relief opening • Closed comfort system AS neck seal • Reinforced wrist and ankle overcuffs with Velcro® closures for adjustability • 1050 Denier ballistic nylon wear protection • Two-point attachment removable suspender system for an improved fit, mobility and comfort • GORE-TEX® waterproof & breathable dry suit fabric • Integrated GORE-TEX® dry socks (size XL+ come with jumbo socks) • Adjustable waist band • SOLAS retro-reflective tape on the arms for increased visibility • Reinforced knee pads and elbow pads help prevent injury • Nylon reinforced seat.



	Size	
204904576332	M	\$1,895.00
204904576342	L	\$1,895.00
204904576352	XL	\$1,895.00
204904576362	XXL	\$1,895.00



WARNING

Technical rescue and safety is potentially hazardous. Any person using equipment sold by RESCUE TECHNOLOGY in any manner is personally responsible for learning the proper techniques involved, and assumes all risks and accepts full and complete responsibility for any and all damages or injury of any kind, including death, which may result from the use of any RESCUE TECHNOLOGY equipment.

Products in this catalog can expose you to chemicals which are known to the State of California to cause cancer. For information go to: www.p65warnings.ca.gov

FRS-900- OPERATOR SUIT

Perfect for Shallow Water Operations

This waterproof breathable lightweight surface suit has been designed for use where immersion above the shoulders is not expected. It's easy to wear and neck adjustable features allow the wearer to best manage heat and humidity in extreme conditions.

FEATURES

- Nearly Dry Neoprene Collar
- Waterproof construction upto shoulders
- Perfect for shallow water operations
- Vertical torso adjustment straps
- Zipper top easily opens for heat release
- Cinch straps on latex wrists
- Waterproof breathable ripstop polyester shell
- Fabric soft feet, fit easily into footwear
- Retro reflective tape on wrists & thighs
- Protective patches on knees and butt
- 2 large zippered thigh cargo pockets



	Size	
217106090022	Small / Medium	\$665.00
217106090042	Large / XLarge	\$665.00
217106090062	2XLarge / 3XLarge	\$665.00

FRP-800 - RESPONDER UTILITY WADERS

Waders are built from waterproof breathable nylon and soft flexible neoprene closures that can be closed or open depending on the wearer's needs. Color: Black/Grey. Waders feature waterproof breathable construction up to the chest; Waterproof neoprene chest; Nylon soft feet fit into boots; Knee and butt patches prevent abrasion protection; Zippered hip cargo pockets



FRS-900 & FRP 800 Size Chart		
Size	Height	Waist
S/M	5'5" - 5'9"	30" - 36"
L/XL	5'5" - 5'9"	36" - 42"
2XL/3XL	6'1" - 6'5"	42" - 48"

	Size	
2171058002	Small / Medium	\$310.00
2171058004	Large / XLarge	\$310.00
2171058006	2XLarge / 3XLarge	\$310.00



FORAY DRY SUIT

Men's and Women's Sizing

The Foray Dry Suit is purpose-built for individuals who want total waterproof-breathable protection. 4-Layer Eclipse™ fabric uses 100% recycled materials for dependable dryness, breathability and toughness. TIZIP® front-entry zipper is waterproof, airtight and pressure-resistant. Features our Paddler's Cut™ for an athletic fit. Extended volcano-style Glideskin™ neoprene neck and wrist overcuffs protect the top-quality latex gaskets. Mesh holes at the wrist and neck drain trapped water. Leg design tapers toward the ankle and features internal elastic and silicone accents for a snug fit that stays in place. Cordura® panel at the interior ankle offers additional abrasion resistance. Eclipse fabric socks are double seam taped in the toe and heel to enhance durability. Sock size increases with overall dry suit size.

Note: Zippers must be cleaned and maintained to ensure maximum dryness and extend the lifespan of a dry suit. Refer to our Dry Wear Care article for suggested zipper care instructions and products.



Glideskin™ Neck Gasket



Entry Zipper



Ankle Cuff

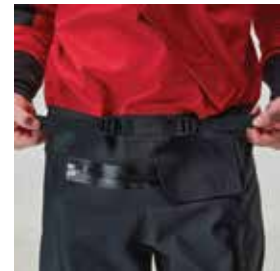

Waist Adjustment

Men's	Size	Height	Chest	Waist	Hip	Colors	
20842255542	S	5'6"-5'10"	35"-38"	29"-32"	36"-39"	Red, Black	\$945.00
20842255543	M	5'8"-6'0"	38"-41"	32"-35"	39"-42"	Red, Black	\$945.00
20842255544	L	5'10"-6'2"	41"-44"	35"-38"	41"-44"	Red, Black	\$945.00
20842255545	XL	6'0"-6'4"	44"-48"	38"-43"	35"-36"	Red, Black	\$945.00
20842255546	XXL	6'2"-6'6"	48"-53"	42"-48"	48"-51"	Red, Black	\$945.00

Women's	Size	Height	Chest	Waist	Hip	Colors	
20842255641	XS	4'8" - 5'2"	32"-33"	25"-27"	33"-35"	Red, Black	\$945.00
20842255642	S	5'1"-5'6"	34"-35"	28"-30"	36"-38"	Red, Black	\$945.00
20842255643	M	5'5"-5'8"	36"-37"	31"-33"	39"-41"	Red, Black	\$945.00
20842255644	L	5'7"-5'10"	38"-39"	34"-36"	42"-44"	Red, Black	\$945.00
20842255645	XL	5'9"-6'0"	40"-41"	37"-39"	45"-47"	Red, Black	\$945.00



STANDARD RESCUE WETSUIT

Front Zipper

A full-coverage suit. 3mm Dupont® neoprene provides insulation, while PowerSpan™ panels on the shoulders, back and arms increase mobility. Zippers on wrists and ankles for easy exit from the suit after a long day. Textured raw neoprene friction zones on the sides help lock a PFD in place. 5 mm seat for extra padding is covered with ToughTex™ for durability. Molded polyurethane knees and shins for long wear and

extra protection. Reflective Lettering and Bright Yellow Panels Color: Yellow/Black. Grizzly Version provides extra room in the chest and waist area.

Standard	Size	
20841727622	Small	\$319.95
20841727632	Medium	\$319.95
20841727642	Large	\$319.95
20841727652	XLarge	\$319.95
20841727662	2XLarge	\$319.95
20841727672	3XLarge	\$319.95
Grizzly		
208417276G42	Large	\$329.95
208417276G62	2XLarge	\$329.95

FARMER JOHN / FARMER JANE

300 High-Stretch Terraprene neoprene insulation provides extreme comfort. Titanium laminate reflects heat back toward rescuer's body. Full Zip YKK entry zipper. Generous sized armholes provide full range of motion. Durable glued and blind-stitched seams.



Farmer John	Size		Farmer Jane	Size	
208422243	M	\$169.95	208422251	XS	\$169.95
208422244	L	\$169.95	208422252	S	\$169.95
208422245	XL	\$169.95	208422253	M	\$169.95
208422246	2XL	\$169.95	208422254	L	\$169.95
208422247	3XL	\$169.95	208422255	XL	\$169.95
			208422256	2XL	\$169.95

GRIZZLY FARMER BILL

Big folks know finding the right size in water gear can be a bear. The Grizzly wetsuit is extra roomy.

- Features 3mm Neoprene for superior insulation.
- Cut large around the chest, waist, thighs and calves.
- Combines the convenience of a full-length front zipper with roomy, over-the-shoulder Farmer Bill-style suspenders.
- Color: All sizes are black - shoulders are color coded by size.



	Size	
20842219G3	Medium	\$153.95
20842219G4	Large	\$153.95
20842219G6	2XLarge	\$153.95
20842219G8	4XLarge	\$153.95

2MM WETSUIT JACKET

Combine the 2mm neoprene Wetsuit Jacket with any of our other wetsuits for maximum warmth in your arms and torso. The Grizzly Wetsuit Jacket gives the greater girth needed by the barrel-chested boater. Pair these items with matching Farmer John suits for the ultimate warmth and comfort. 2mm neoprene with Titanium laminate adhesive increases warmth without adding excess bulk. PowerSpan™ under the arms gives you plenty of mobility. The extended waist and raised collar give you superior coverage and increased warmth and comfort. YKK® wrist and full-front zippers provide easy, trouble-free entry.



	Size	
208422103	M	\$79.95
208422104	L	\$79.95
208422105	XL	\$79.95
208422106	2XL	\$79.95

Grizzly	Size	
20842210G3	GM	\$89.95
20842210G4	GL	\$89.95
20842210G6	G2XL	\$89.95

2MM SHORTY WETSUIT

The Little John and Little Jane Shorty Wetsuits give you a great combination of warmth and comfort. The cut allows more freedom of movement, while 2mm Terraprene™ neoprene provides essential core insulation without unnecessary bulk. Generous armholes give you excellent range of motion. Durable flat-lock seams lie flat on your skin for greater comfort.

- 2mm neoprene retains core body heat and offers cushioning.
- Short-cut legs give increased freedom without sacrificing core warmth.
- Featuring a full-length, double-pull front zipper for ease of entry and relief.



Men's	Size	
208422173	M	\$94.95
208422174	L	\$94.95
208422175	XL	\$94.95
208422176	2XL	\$94.95

Grizzly	Size	
20842217G3	GM	\$94.95
20842217G4	GL	\$94.95
20842217G6	G2XL	\$94.95

Women's	Size	
208422161	XS	\$94.95
208422162	S	\$94.95
208422163	M	\$94.95
208422164	L	\$94.95
208422165	XL	\$94.95

WETSUIT SIZING

Men's	Height	Weight
Small	5'2" - 5'6"	115-140 lbs.
Medium	5'5" - 5'8"	135-165 lbs.
Large	5'7" - 6'0"	150-195 lbs.
XLarge	5'10" - 6'2"	185-225 lbs.
2XLarge	6'1" - 6'4"	215-245 lbs.
3XLarge	6'3" - 6'5"	230-255 lbs.
4XLarge	6'4" - 6'6"	245+

Women's	Height	Weight
XSmall	4'8" - 5'2"	90-115 lbs.
Small	5'1" - 5'6"	110-135 lbs.
Medium	5'5" - 5'8"	130-155 lbs.
Large	5'7" - 5'10"	150-180 lbs.
XLarge	5'9" - 6'0"	175-210 lbs.
2XLarge	5'11" - 6'2"	200-220 lbs.

Grizzly	Height	Weight
G-Med	5'5" - 5'9"	200-235 lbs.
G-Large	5'8" - 6'0"	230-265 lbs.
G-2XL	5'11" - 6'4"	260-305 lbs.
G-4XL	6'3" - 6'6"	275-320 lbs.



ICE COMMANDER RESCUE SUIT

The suit of choice for Coast Guard, SAR, Fire, and all Ice Rescue Professionals. Its Integral chest harness, ice awl pockets, gloves, reinforcements and non-slip soles keep you prepared for any emergency. Highly visible welded nylon shell and removable AirSoft™ foam liner. It's 45% lighter than conventional neoprene suits, giving maximum flexibility and performance.

Size: Adult Universal Body Mass: 110 - 330 lbs.
Height: 4'11" - 6'7" Color: Yellow

20499000	Ice Commander Rescue	\$1,282.26
2049228202	Replacement Liner	\$521.22
20492290	Repair Kit	\$68.00



COLD WATER IMMERSION SUIT

Designed for use in commercial operations, the new Immersion Suit from Mustang Survival is the ideal ship abandonment suit for workboats, transport vessels, drilling rigs, supply ships, steamships and commercial fishermen. Also suitable for the sailing community. Color-Coded storage bags indicate sizing.

• Easy to don in stormy conditions • Five-fingered insulated gloves • Inflatable head pillow give optimal float angle • Water-tight face seal • Wrist and ankle adjustments for a better fit • 5mm fire retardant neoprene • SOLAS grade reflective tape • SOLAS grade hailing whistle • Light Pocket fits a variety of SOLAS lights • Non Slip, durable soles on foot bottom. • USCG approval PENDING; SOLAS compliant • Includes use and inspection manual • Includes tube of zipper lubricant

	Size	
204923030	Universal Size	\$625.00
204923024	Adult Small	\$596.25
204923055	Adult Oversize	\$685.00
204923012	Child	\$596.25

UNION SUIT

Two versions of the Union Suit Base Layer is offered to protect rescuers from cold water while in drysuits.

The Expedition Weight (290 g) Suit delivers ultimate insulation for those cold-water, chilly-air days. Polartec® Power Stretch Pro® fleece provides outstanding warmth, wicking and comfort.

The Lightweight (260 g) version protects from cool water and gives bunch-free cozy comfort and enhanced breathability.

Both feature YKK Double-Pull, front entry zipper and stirrups.



FIRSTWATCH RS-1000 ICE RESCUE SUIT

The RS-1000 Rescue Suit has been engineered to don quickly for cold water and ice rescue operations. Universal fit suit features a rugged hi-tenacity nylon shell that is stitched and taped for the ultimate in durability. A snap out, internal (laminated nylon/foam) liner. Designed as a system to meet the safety, mobility and comfort needs of rescue professionals. Requires thermal undergarments/Union suit for Cold Weather use.

Protective Center Zipper Flap Internal suspenders Registered Serial Number Reflective Rescue Markings Zipper Wax Stow Bag: Mesh Accessory Pocket Colors: Hi-Vis Yellow

	Model	Height	Boot Size	
21710810005	RS-1005	4'6" - 5'8"	Medium	\$1307.00
21710810002	RS-1002	5'0" - 6'4"	Universal	\$1384.00
21710810008	RS-1008	6'0"+	Jumbo	\$1435.00



Expedition Weight	Size	
2084101322	S	\$159.95
2084101323	M	\$159.95
2084101324	L	\$159.95
2084101325	XL	\$159.95
2084101326	XXL	\$159.95

LightWeight	Size	
2084101602	S	\$109.95
2084101603	M	\$109.95
2084101604	L	\$109.95
2084101605	XL	\$109.95
2084101606	XXL	\$109.95



PICK OF LIFE ICE AWLS

Pick-of-Life awls are for self-rescue, allowing you to crawl on top of the ice using the picks as traction. You can also slide them to someone who has fallen through the ice.

208422459 Pick of Life \$27.50



ANKLE WEIGHT SET

For Use with Drysuits

Fully adjustable length with quick-release buckle for safety. Neoprene. Sold in pairs.

Color: Black Weight: 4 lbs. (2 lbs. each)

46001521 Ankle Weight Set \$40.00



UTILITY GLOVE

The Utility Gloves deliver an excellent combination of durability, warmth and dexterity. It's a great choice for rescue work and for the boater who wants maximum palm protection. 2 mm Terraprene neoprene provides excellent warmth for cool to cold conditions. Amara® synthetic leather armor patches on the palm and fingers provide unmatched protection and grip for paddling, rowing and rope handling. A fitted, stretchy slip-on wrist cuff makes the glove easy to put on and take off. Pairing snaps on the wrists help keep the gloves together.

20842502542	S	\$44.95
20842502543	M	\$44.95
20842502544	L	\$44.95
20842502545	XL	\$44.95
20842502546	XXL	\$44.95



TACTICAL GLOVE

With the perfect combination of durability, warmth and paddle feel, the Tactical Glove lives up to the demands of the task at hand, whether for rescue work or play. 2 mm Terraprene™ neoprene provides warmth and cushioning. Textured armor patches on the palm and fingers provide unmatched protection and grip for paddling, rowing and rope handling. For extra grip and durability, we've added sticky GripCote™ between the armored patches. Soft brushed fleece on the thumb and wrist is handy for wiping your nose or brow. The unique elastic wrist strap secures anywhere on the fleece wrist panel.

208424392	S	\$59.95
208424393	M	\$59.95
208424394	L	\$59.95
208424395	XL	\$59.95
208424396	XXL	\$59.95



REACTOR GLOVES

Cold Water Protection

Reactor Rescue Gloves are made with 3 mm neoprene with titanium laminate adhesive for an extremely warm and tough glove. Fingers are pre-curved to relieve hand fatigue while gripping paddles and ropes. PowerSpan™ 4-way stretch fabric adds to the comfort of the Reactor Gloves. Wristband with hook-and-loop closure ensures a secure fit and have pairing snaps to help keep the gloves together.

2084241532	S	\$79.95
2084241533	M	\$79.95
2084241534	L	\$79.95
2084241535	XL	\$79.95
2084241536	XXL	\$79.95



LIGHTWEIGHT .5MM GLOVE

Premium nylon-spandex exterior with a DWR coating sheds water without sacrificing dexterity. 0.5 mm neoprene core for lightweight insulation and soft, smooth and hydrophobic interior feels great against bare skin. Silicone pattern on the palm and fingers provides a better grip when wet. Features a simple, stretchy cuff for easy donning and pairing snaps to keep the gloves together.

2084250142	S	\$39.95
2084250143	M	\$39.95
2084250144	L	\$39.95
2084250145	XL	\$39.95
2084250146	XXL	\$39.95



HYDROSKIN WETSOCK

Protect your feet and keep them warm without the bulk of other wetsocks. The HydroSkin® Socks are the ultimate wetshoe liner. The 0.5 mm neoprene core insulates and protects. 4-way-stretch PowerSpan™ outer layer gives you enhanced mobility and greater durability. The ThermalPlush™ inner lining increases insulation, repels moisture and dries quickly. Titanium laminate adhesive aids body heat retention without adding bulk. DWR coating forces water to "bead" and roll off the material, reducing evaporative cooling.

Size: XS-XL

208430011x	HydroSkin Wet Sock	\$31.95
------------	--------------------	---------



COLD WATER 5/3MM DIVE HOOD

Varied Thickness: 3mm Glide Skin face seal provides a comfortable fit and minimizes cold water from getting into your hood. The rest of the hood is 5mm neoprene which acts as a thermal barrier between you and the cold water. Customizable Face Seal: The face seal is designed to be easily trimmed for the size and shape of your face. Size: SM, M, L, XL

23701450140x	5/3mm Hood	\$38.00
--------------	------------	---------

COOL WATER 3/1MM DIVE HOOD

Flat-lock stitched seams keep you warm. Standard Stretch neoprene for maximum durability. Face seal left unbound for custom trimming. Size: SM, M, L, XL

23701440140x	3/1mm Hood	\$35.00
--------------	------------	---------



RESCUE WETSHOE II

Simple, sturdy, dependable. 5mm comfort insole and 2mm plastic midsole. Zippered entry. Manufactured from 3mm neoprene. Sole is wrapped with heavy duty traction pad. Toe and heel cup offer extra protection.

Sizes: 4 - 15 (whole sizes only, 1/2 sizes order next larger size) Weight: 36 oz. (pair) Color: Black

20842310-xx Rescue Wetshoe II \$57.95



ATB DIVE / RESCUE BOOT

All Terrain Bootie combines the comfort of a sneaker with the warmth of a wetshoe. Full molded, arched sole is reinforced with a 2mm plastic midsole shim to increase stability and comfort. 7mm neoprene cushion insoles and 5mm uppers with glued and blind-stitched seams. Heel and toe caps protect from abrasion. Zippered opening.

Sizes: 6 - 13 (whole sizes only, 1/2 sizes order next larger size) Weight: 47.2 oz. (pair) Color: Black/Gray

20842335-xx ATB Dive / Rescue Boot \$74.95



SWIFTWATER WORKBOOT

Used by river professionals, rescue agencies and Navy SEALs, the Swiftwater Workboot / Wetshoe is the hardest-working river boot on the market today. Lace-up synthetic leather and 5mm neoprene upper provides warmth, unmatched ankle support and a secure fit. 7mm neoprene insole absorbs the shock of every step. Heavy-duty lugged traction sole keeps you on your feet in varied terrain. Wear areas are reinforced with synthetic leather and rubber. When you need a water shoe that works as hard as you do, on and off the water, the Swiftwater Workboot is your best choice.

Sizes: 6-15 (whole sizes only, Women order one size smaller, 1/2 sizes order next size larger.) Weight: 3.1 lbs.

208430037-xx Swiftwater Workboot \$94.95



NRS STORM BOOT

Rugged, wet environments require traction and protection unique from your basic wetshoe or bootie. The NRS Storm Boot is purpose-built for enhanced support and stability while delivering breathable, quick-drying performance.

- Constructed with high abrasion-resistant polyurethane and synthetic rubber overlays.
- Heavy-duty non-marking HyperGrip® lugged rubber sole for unmatched traction in varied terrain.
- Designed for enhanced stability and support.
- Fast drying mesh upper and a 5 mm perforated insole guards against water and debris entry.
- YKK® AquaGuard® ankle zipper and a gusseted tongue keep dirt, rocks and debris out.
- Laces offer adjustable fit.
- Features a swim fin tab on the heel.

20842339-xx Storm Boot \$149.95



SHREDDER RESCUE FINS

Fits over Swiftwater Rescue Boots

Ultra-Light techno polymer optimizes power with up to 50% less weight and bulk. Blade design improves thrust and reduces ankle and leg fatigue. Adjustable buckle with quick-release system secures fins even in swiftwater. Designed to fit all large dive / rescue style boots.

Dimensions: 17" x 9.5" Weight: 4.3 lbs / pair

	Color	
46005341	Black	\$80.00
46005343	Hi-Viz Yellow	\$80.00
46005349	Replacement Strap	\$16.00



UNIVERSAL RESCUE FINS

Designed to meet the demands of swiftwater rescue professionals, the Universal Swim Fins also work well for riverboarding and general river snorkeling. These rigid fins are symmetrical so they fit either foot. The wide heel strap is adjustable with a quick tug of the strap end, then you can unclip the strap and your adjustment stays put. The toe piece has a removable rigid insert that lets you select the stiffness you desire. The fins will fit over your river boots - just step in, click in the heel strap and you're ready to go!

Dimensions: 19.75 x 8.5" Weight: 3.3 lbs. / pair

20841897 Universal Rescue Fins \$64.95



HAVOC WATER RESCUE HELMET

Universal Fit

The Havoc Helmet is your one-size-fits-most solution to whitewater safety. The ratchet-adjust DialFit system lets you custom fit the Havoc with the simple twist of a knob. Plush FIT pads in key contact points provide extra comfort and are fixed, so they won't get lost. Ten ventilation/drainage ports let air in and water out of the lightweight, durable ABS plastic shell. Glued-in EVA foam liner offers excellent impact protection. Meets CE 1385 standards for whitewater safety.

Fits a range from 53-62cm (20.86"-24.4") and has an adjustable chin strap.

	Color	
208420421	Black	\$52.95
208420422	Yellow	\$52.95
208420424	Red	\$52.95
208420426	Blue	\$52.95
208420429	White	\$52.95



CASCADE WATER RESCUE HELMET

Multiple impact polypropylene, patented liner system. Closed cell foam won't absorb moisture. 4 point chin strap. 13 ventilation / drain ports. Stainless Steel hardware.

Weight: 17.6 oz. Colors: Red, Yellow, White

	Size / Item Description	Dimensions	
48042x	Small	21.6" - 22.25"	\$53.00
48043x	Medium	22.5" - 23"	\$53.00
48044x	Large	23.25" - 23.75"	\$53.00
48045x	XLarge	23.75" - 24"	\$53.00
480499	Reflect. 'RESCUE' Crescent		\$5.25
480498	Reflect. 'WATER RESCUE' Crescent		\$5.25



FIRSTWATCH WATER RESCUE HELMET

Rescue Professionals need gear that allows them to respond safely and quickly. The Deluxe WRH is engineered for light weight and comfortable protection. Complies with EN 1385-2012 water helmet standard. Shell manufactured of hi-impact ABS with a closed cell EVA molded foam liner. Easy Fit Ratchet adjuster. Removable foam ear pads. 9 ventilation holes. Accessory side rails and front mounting bracket for NVG/GoPro/EOS II.

Colors: Red, Hi-Viz yellow

	Color, Size	Fits Head Circum.	
21710610032	Hi-Viz, S/M	21.0" - 22.5"	\$90.00
21710610042	Hi-Viz, L/XL	22.5" - 24.4"	\$90.00
21710610034	Red, S/M	21.0" - 22.5"	\$90.00
21710610044	Red, L/XL	22.5" - 24.4"	\$90.00



HYDROSKIN 0.5 HELMET LINER

Fits easily under any helmet, adding just enough insulation for those colder spring and autumn days. 0.5 mm of neoprene provides the core insulation for this helmet liner. Four-way-stretch PowerSpan™ exterior material helps mold the liner snugly to your head. The soft ThermalPlush™ lining adds a bit of extra warmth and feels great against your skin. Titanium-laminate adhesive reflects and retains body heat for superior warmth. Durable Water Repellent (DWR) treatment helps shed water preventing evaporative cooling.

		Head Circumference	
208420272	Small	20 - 21.5"	\$27.95
208420273	Medium	21.5 - 23"	\$27.95
208420274	Large	23 - 24.5"	\$27.95



NRS TACTYL HELMET

Designed for the needs of rescue professionals, the NRS Tactyl Helmet delivers adaptable comfort and rugged protection in a lightweight and refined package. DARC retention system adjusts with a turn of the knob for a precise fit. Front Shroud attachment points and ARC-compatible side rails. Expanded polypropylene (EPP) foam liner is lightweight, does not absorb water and multi-impact certified.

- Lightweight and durable ABS shell dissipates impact and delivers front, side and back of head protection.
- Chin strap features a FidLock® magnetic buckle and Y-strap webbing divider.

Available Colors: Red, Orange, Safety Yellow, White, Black.

Meets CE/EN 1385 standards for whitewater safety.

	Size	Head Circumference	
2084426031x	XS/S	20 - 21.5"	\$99.95
2084426033x	M/L	21.5 - 23"	\$99.95
2084426035x	XL/XXL	23 - 24"	\$99.95



PUBLIC SAFETY DIVER QUICK-RELEASE SNAP

A low profile Marine-Grade, Quick-Release snap to be used between Diver's Chest harness and Tender Line. Webbing release strap. Designed to be tied or girth hitched to tender line.

460135 PSD Quick Release Snap \$88.00



DIVE RESCUE SEARCH LINE

Special 6mm Search Rope reduces resistance and drag as diver works search pattern. Kernmantle design virtually eliminates kinking found in monofilament "tow-line" braid. High quality bag carries 200 ft. of search line.

6mm Rope Strength: 600 lbf. 8mm NFPA Throwline Rope Strength: 3,699 lbf.

		Weight	Length	
460022	6mm Search Line	48 oz.	200'	\$85.00
460122	8mm Search Line	68 oz.	200'	\$235.00



PUBLIC SAFETY DIVER CHEST HARNESS

A must for all PSD dive operations. Made with 2" Chest Webbing, 1" Shoulder webbing, and steel D rings. Shown with Diver's Quick-release connector and rope (not included). NOT for high Angle Rescue.

460133 PSD Chest Harness \$40.00



ICE RESCUE SLING

We have paired our 2" tubular webbing with polypropylene core and 2" welded "O" rings to create a great tool for rescue.

Length: 72"

460301 Ice Rescue Slings \$20.00

FIRSTWATCH INFLATABLE RESCUE TUBE

Six-Foot, inflatable rescue tube that can be tossed, drone-dropped or deployed by a throw bag. The tube automatically inflates and can support up to three adults. Multiple handles. 70 lbs. buoyancy. Can be repacked/reused.



Throwbag version has 100 ft. of high strength 3/8" polypropylene rope with reflective strands.

21711010200	Inflatable Rescue Tube	6 ft.	\$400.00
21711010205	Inflatable Rescue Tube with Throwbag		\$456.00
21711010209	Re-Arm Kit, Pack of 5		\$143.00

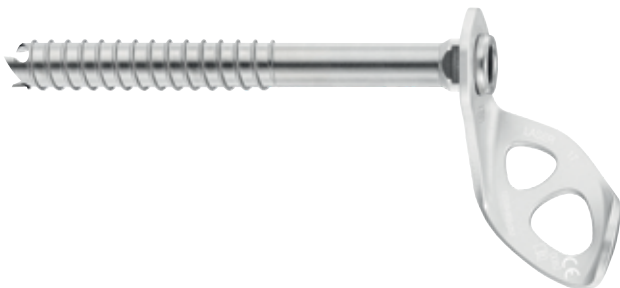

LASER ICE ANCHOR

Lightweight, performance ice screw

LASER is a lightweight, performance ice screw. The shape of the tri-toothed drill improves the bite of the ice screw. The Stainless Steel tube and specific threading make it rugged and durable. Screwing is facilitated by the excellent ergonomics of the aluminum hanger.

Length: 8.3" (21 cm) Weight: 5.4 oz. (120 gm)

2354070521 Laser Ice Anchor \$49.95

WARNING

Technical rescue and safety is potentially hazardous. Any person using equipment sold by RESCUE TECHNOLOGY in any manner is personally responsible for learning the proper techniques involved, and assumes all risks and accepts full and complete responsibility for any and all damages or injury of any kind, including death, which may result from the use of any RESCUE TECHNOLOGY equipment.

Products in this catalog can expose you to chemicals which are known to the State of California to cause cancer. For information go to: www.p65warnings.ca.gov



PLAZMA DIVE MASK

Plazma is the only frameless panoramic diving mask that delivers a perfect fit with excellent comfort from surgical grade premium silicone and enhanced stability zones. The Plazma mask delivers a lightweight and compact, low-profile design in fresh, exciting color combinations. Made in Italy

2370547001 Plazma Dive Mask \$80.00



PAX MCKINLEY PACK

At Height EMS Rescue Backpack

A specialized med pack for At Height Rescue, equipped with a rope holder (up to 200 ft.) as well as a front pocket for holding safety devices and more.

For professional At Height and Mountain Rescue with included pouches for medical equipment. The aluminum "V" carrying system stabilizers directs the weight to the padded, non-slip hip belt improves the wearing comfort.

It has a large front pocket for belay devices, and slings. The floor area is made of robust PAX-Lon to withstand the extreme loads in the vertical environment.

• Includes inner pouch set



2553200350101 PAX McKinley Pack \$640.00

ZEPHYR FLEX SNORKEL

The Zephyr snorkel was designed to keep water out and keep you underwater as long as the conditions hold. The splash guard prevents ingress, but if any water should get in, the purge valve makes this snorkel easy to clear. 2 versions to best fit your need. Flex version has an integrated corrugation zone offers the benefits of a flex snorkel without compromising structural integrity. Rotating lower section for prime positioning.



23701351132 Zephyr FLEX Black/Yellow \$25.00



FIREHOSE INFLATOR SYSTEM

The Firehose Inflation System is useful for both swiftwater and ice rescue. Filled with air, the hose floats and is rigid enough to be passed across water or ice to a victim. This is fast becoming the standard for swiftwater and ice rescue teams. Deluxe kit includes: 2 1/2" female aluminum hose cap with tie down for securing safety lines. The 2-1/2" male aluminum hose cap has standard quick disconnect fitting for attaching your filler hose and a tie down for securing a safety line. The pressure relief valve is set at 35-40 pounds to protect the hose and fittings. SCBA high-pressure valve and wheel, with hose, lets you fill the system with your own SCBA bottles. Includes a custom carrying case.

Weight: 4.25 lbs.

208445216 \$825.00



REACH & RESCUE

Rescue Pole System

The Reach and Rescue Telescopic Rescue Poles are a range of specialist, super long telescopic rescue poles and water safety equipment that make distant casualty retrieval much safer for today's rescuers.

Unless you have trialled or already own some Reach and Rescue equipment, it can be a little bit of a dilemma deciding what you may need to completely equip your team. The kit compilation brings together the most popular tools to accompany a Reach pole, and provides storage options so that you can rest assured that the majority of incidents can be addressed from within the kit recommended.



BASIC POLE KIT

This is the basic "Starter Package" for Reach and Rescue Poles. It provides the Pole and Accessories needed for victim retrieval from on and below the water surface.

- Carbon Fiber Pole
- Clamping Float
- Body Hook
- Stainless Steel Crook
- Stainless Steel Grappler
- Flotation collar
- Pole Bag
- Kit Bag

	Length	
2017186205	5m (16.5')	\$1,550.00
2017186209	9m (29.5')	\$2,400.00
2017186213	13m (42.5')	\$3,150.00
2017186217	17m (55.75')	\$3,700.00
2017186220	20m (65.5')	\$4,200.00



STANDARD POLE KIT

The Standard Pole kit adds animal snare and high point anchor attachment capabilities.

- Carbon Fiber Pole
- Clamping Float
- Body Hook
- Stainless Steel Crook
- Stainless Steel Grappler
- Flotation Collar
- Pro Spring Snare
- Carrago, Scaffold Hook
- Pole Bag
- Kit Bag

	Length	
2017183205	5m (16.5')	\$2,400.00
2017183209	9m (29.5')	\$3,200.00
2017183213	13m (42.5')	\$3,950.00
2017183217	17m (55.75')	\$4,300.00
2017183220	20m (65.5')	\$4,725.00



OFFSHORE POLE KIT

The Offshore Kit adds the Carbon Fiber Line Hook that allows rope to be placed around a pole, and remote line attachment and Rescue Net for remote animal retrieval.

- Carbon Fiber Pole
- Clamping Float
- Body Hook
- Flotation Collar
- Carrago, Scaffold Hook
- Boat Hook
- Line Hook, Carbon
- Rescue Net
- Pole Bag
- Kit Bag

	Length	
2017184205	5m (16.5')	\$2,950.00
2017184209	9m (29.5')	\$3,760.00
2017184213	13m (42.5')	\$4,500.00
2017184217	17m (55.75')	\$5,100.00
2017184220	20m (65.5')	\$5,250.00



REACH AND RESCUE ULTRALITE CARBON FIBER RESCUE POLE

To accurately deploy flotation devices or other tools. The telescopic poles have adjustable clamps. Each clamp releases the section above in a smooth action enabling fast extraction / retraction. Made from Carbon Fiber poles for increased strength and rigidity, and light weight. Durable locking adjusters. Includes internal retrieval line.

	Extended Length	Storage Length	Weight	
201718205	5 meter	70.8"	3.9 lbs.	\$475.00
201718209	9 meter	82.7"	5.7 lbs.	\$1,300.00
201718213	13 meter	94.5"	10.3 lbs.	\$2,000.00
201718217	17 meter	102.4"	12.1 lbs.	\$2,600.00
201718220	20 meter	108.3"	13.2 lbs.	\$3,100.00



TACTICAL POLE

Reach and rescue have created a pole that is only 41.5" when collapsed, making it perfect for close quarter use. Extends to 21 ft.

	Extended Length	Storage Length	Weight	
2017183306	6 meter	41.5"	4.55 lbs.	\$1,179.00



REACH AND RESCUE COLOR WATERPROOF INSPECTION CAMERA

Used for both searching underwater and out of water. It has a powerful LED lights to illuminate murky waters. It utilizes a powerful, rechargeable Lithium Ion Battery and displays via a clear 7" TFT display. Video and Still image capture to SD Card.

Head Dimension: .91" x 1.79" (23mm(D) x 45mm(L)). View Angle: 135° wide angle Lens Cover: Sapphire Glass LEDs: 12 High Bright White LEDs Water Proof: IP68 LCD Resolution: 800 x 480 Pixels Cable Length: 98'(30m) Weight: 22.49 lbs. (10.2 kg)

2017185160 \$2,900.00



REACH AND RESCUE CLAMPING FLOAT

The clamping Float is the main flotation device for use with the Reach and Rescue Pole system. The main function of the clamping float is to support the pole on the surface of the water. Can act as an individual body buoyancy aid.

Dimensions: 11.8" x 8" Weight: 1.8 lb.

2017185101 Clamping Float \$155.00

REACH AND RESCUE RESCUE NET

Used for the safe rescue of small animals. Sturdy bust and very light weight construction. The soft mesh is knot-less and ideal for catch and release purposes. The sleeve fitting should be regularly tested on the pole top fitting as damage will render the attachment from securely fitting.

Diameter: 20"

2017185142 Rescue Net \$475.00



REACH AND RESCUE PRO SPRING SNARE

This tool attaches to the universal sprung button sleeve. It is a spring loaded design which needs to be reset after each snaring. The target is placed inside the loop and a light tug on the pole will release the snare locking onto the target.

This tool is designed to quickly ensnare an inanimate object or when the operator has no cooperation from the target i.e animal control and unconscious human retrieval.

Opening: 16.5" Weight: 13 oz.

2017185127 Spring Snare \$470.00





REACH & RESCUE STAINLESS STEEL CROOK

The sleeved fitting is designed to slide over the pole top fitting which secures it in place using a double sprung button mechanism. Use by extending the pole to the casualty with or without the clamping float (depending on distance). Once engaged, normal procedure applies.

Length: 12.5" Opening: 5" Weight: 10.24 oz.

2017185122 Crook \$135.00



REACH & RESCUE BODY HOOK

Attach the Body hook attachment by sliding onto the gold collar of the pole. This will secure into place with the spring buttons. Extend the pole to desired length and hook the body hook around the casualty's waist and retrieve.

Length: 19.7" Opening: 16.5" Weight: 11.2 oz.

2017185121 Body Hook \$285.00



REACH AND RESCUE STAINLESS STEEL GRAPPLE

The sleeved fitting is designed to slide over the pole top fitting which secures it in place using a double sprung button mechanism. Use by extending the pole to the casualty with or without the clamping float (depending on distance). Once engaged, normal procedure applies.

Length: 11.4" Hook Radius: 4.7" Weight: 19.2 oz.

2017185123 Grapple \$170.00

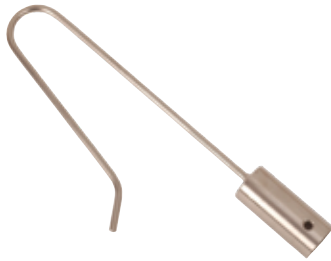

REACH AND RESCUE SWAN HOOK

Designed to enable safe and efficient retrieval of swans and other birds. The hook's smooth curves are designed to ensure retrieval without risk of undue injury to the bird's neck.

2017185125 Swan Hook \$170.00



REACH AND RESCUE BOAT HOOK

Attach the boat hook attachment by sliding it onto the gold collar. This will secure into place with the spring buttons. Extend the pole to desired length and use accordingly.

Dimensions: 7.5" x 3.2" Weight: 8 oz.

2017185120 Boat Hook \$155.00



REACH AND RESCUE CARRAGO, SCAFF HOOK

The Carrago attaches a fixed line and Scaffold Hook to a distant eyelet allowing heavy retrieval. This is a large lightweight aluminium Scaffold Hook for larger diameter anchor points and to be used with poles over 13m.

Dimensions: 9.8" x 6.5" Opening: 1.9" Weight 28.8 oz.

2017185131 Carrago Scaff Hook \$225.00



REACH AND RESCUE LINE HOOK

Attach a line to the eyelet of the carabiner. Attach the Line Hook by sliding the Line Hook over the gold collar on the pole. This will secure into place with the spring buttons. Approach - with the claw point and push through the structure - Engaged - the crossbar snaps shut - Installed - by pulling back the pole, the line threads around the structure.

2017185129 Line Hook, Carbon Fiber \$750.00



REACH AND RESCUE FLOTATION COLLAR

This is a buoyancy aid that is designed to capture and automatically tighten around a victim in the water. It can also be used to lift a human or animal up to a height while providing a cushioned hold.

2017185102 Flotation Collar \$425.00



ROPE BLADE

The rope blade attachment is used to cut other materials i.e harnesses, strapping, fishing wire and netting. Safe deployment with capability to sever heavy lines at length.

Weight: 7 oz (.2kg) Depth: 1.2" (3cm) Mouth Opening: 2.4" (6cm) Fits standard "Stanley" Blade

2017185134 \$300.00



SWIFTWATER RESCUE CURTAIN

The Swiftwater Rescue Curtain provides a versatile tension diagonal grab method to use in moving water. The Curtain rests on top of the water and provides a large grab area for confused swimmers and troubled victims. The 10 ft. wide by 4 ft. tall area enables rescuers to position the Rescue Curtain within the width of a channel to catch a victim who is unable to help himself. When used with a tension diagonal, the Curtain works with the current to hold the swimmer as he or she is pulled to shore. This method reduces the amount of strength the swimmer needs to use to hold onto a device while being pulled out of the current to safety. Attaches to rescue rope with carabiners (not included).

Moving water situations for the Swiftwater Rescue Curtain:
 • Tension Diagonals • Pulling victims onto a boat • Hang from a bridge (downstream) • Float in a low head dam and pull to shore

2414211	Rescue Curtain, 10 ft.	\$200.00
---------	------------------------	----------



REACH AND RESCUE WADING POLE

The Wading Pole is used as a depth and stability aid when wading through unknown terrain and deep waters.

Material: Fiberglass **Color:** Yellow w/ Black Handle **Length:** 5.9' (1.8m) **Weight:** 2.4 lbs. (1.1 kg) **Pole Diameter:** 1.25" (3.2 cm)

2017185151	Wading Pole	\$75.00
------------	-------------	---------



AIRTRACK INFLATABLE RESCUE PATH

The Airtrack is an inflatable rescue walkway for rescues on water, mud, ice and unstable terrain. Constructed in a catamaran type shape, the Airtrack rescue path has two pontoons running lengthways down the underside of the path. This shape provides exceptional stability on water, especially during casualty recovery, and provides extra ground clearance on ice, mud flats and unstable terrain. The unique footprint also prevents suction on to mud and soft surfaces. Several inflatable paths can be connected using the rapid extension link-up feature. Airtracks can either be connected lengthways to extend the path, or sideways to create a rescue raft. The Airtrack inflatable rescue path is compact and portable, packing away neatly into a carrying bag. It can be quickly inflated and deployed allowing water rescue personnel to have access to the casualty within minutes.

• Non-slip top surface • Strong and durable • Stable • Versatile • Low maintenance

	Length	
2458231002	2 Meter, Hypalon	\$4,700.00
2458231005	5 Meter, Hypalon	\$8,100.00
2458231010	10 Meter, Hypalon	\$13,500.00
2458241102	2 Meter, Polyurethane	\$3,200.00
2458241105	5 Meter, Polyurethane	\$5,600.00



REACH AND RESCUE KIT BAG

For storing attachments for your Reach and Rescue Pole kit and or other rescue tools. Drawstring opening for quick release, easy to store.

Dimensions: 29" x 19"

2017185146		\$70.00
------------	--	---------

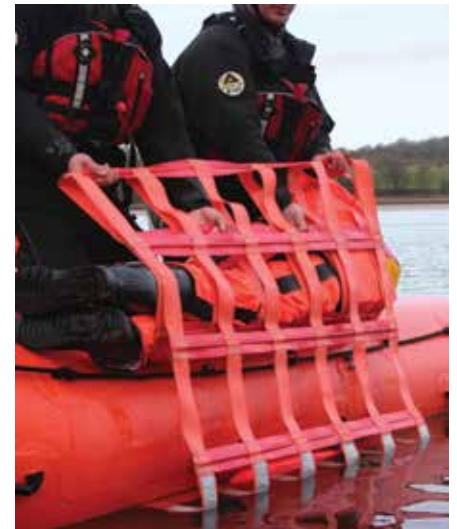

FIBRE-LITE RESCUE CRADLE

For Overboard Recovery, Boarding Ladder and Emergency Stretcher

The Fibrelight Cradle is an innovative new system designed for the recovery of casualties in the water. The Cradle is secured to the craft at the inboard end, with floats attached to the outboard end. The casualty is guided onto the cradle and the outboard end is then hauled in, bring them safely on board in the medically preferred horizontal position. Manufactured from a grid of polyurethane coated polyester webbing reinforced with carbon fibre rods, the Fibrelight Recovery Cradle is exceptionally durable.

Width: 52"

	Length	
2458231501	2 Meter (6.5')	\$ 17450.00
2458231503	3 Meter (9.9')	\$2,350.00
2458231504	4 Meter (13.2')	\$3,000.00
2458231505	5 Meter (16.5')	\$3,500.00
2458231506	6 Meter (19.5')	\$4,200.00
2458231507	7 Meter (23')	\$4,750.00



REACH AND RESCUE POLE BAG

Holds and protects Reach and Rescue poles and closes via Velcro flaps. Keep clean and grease free. Check the Velcro for function.

2017185145-05	5 meter	\$78.00
2017185145-09	9 meter	\$78.00
2017185145-17	13, 17, 20 meter	\$78.00



NRS ASR RESCUE BOAT

On water, ice or snow the NRS ASR (All Surface Rescue) 155 Rescue Boat puts your rescue team where it needs to be. Backed by NRS's many years of boat-building expertise, rescuers rely on rugged dependability and efficient design for success in unpredictable situations. Open design at bow and stern give rescuers better access for pulling a victim onboard. 5 air Chambers. 26 Interior Handles. Textured EVA foam deck on top of a 4" drop-stitch inflatable deck. An armored underside resists the abrasion and damage from water obstacles, ice and crusted snow. Capacity: 3-4 people. Material: PVC. Includes: Heavy-Duty Carry Bag, Two 280cm Red PTR SAR Paddles, Super 2 HP Pump. Quick-fill hose available (page 140).

Dimensions, Overall: 15.5' x 49" Dimensions, Deck: 96" x 25" Openings: 25" x 34" Weight: 87 lbs. Main tube Diameter: 12"

208486090 ASR 155 Rescue Boat \$2,995.00

ICE RESCUE SLED

Thin ice is a trap and every year hundreds of people fall into that trap. The RESCUE ALIVE enables your rescuer to run over very thin ice by distributing his weight over a large surface or to paddle through open water to reach a victim quickly. The unit weighs 88 lbs. and provides 600 lbs. of flotation. This unit is deployed by releasing one Velcro strap, which is then used to tether the modified paddle. Pontoons are made from expanded polystyrene core with high density polyethylene covering.



Width: 23" • Length: 89" • Thickness: 6.25"

2414201	Ice Rescue Sled	\$5,000.00
2414202	Replacement Paddle	\$150.00
2414203	Replacement Strap/Victim Harness	\$100.00

INFLATABLE RESCUE BOARD

Lightweight, rigid and constructed for backcountry durability, the Rescue Board is designed to meet the most demanding needs of swiftwater rescue professionals. Inflated up to 20 psi, rivaling a foam or composite board in rigidity but easily folds for compact transport and storage. Drop-stitch construction with a Leaffield A6 Pressure Relief Valve that engages at 20 psi to protect from over-inflation. A grooved and textured deck pad plus two padded handles help the rescuer maintain board control in rougher conditions. Four additional handles on the sides offer rescue victim support. Two reinforced 1.5" stainless D-rings on the sides of the bow are built to handle the strain of towing and lowering. Includes Super 2 HP Pump and repair kit. Quick-fill hose available (page 129.)



2084186094 Inflatable Rescue Board \$ 495.00

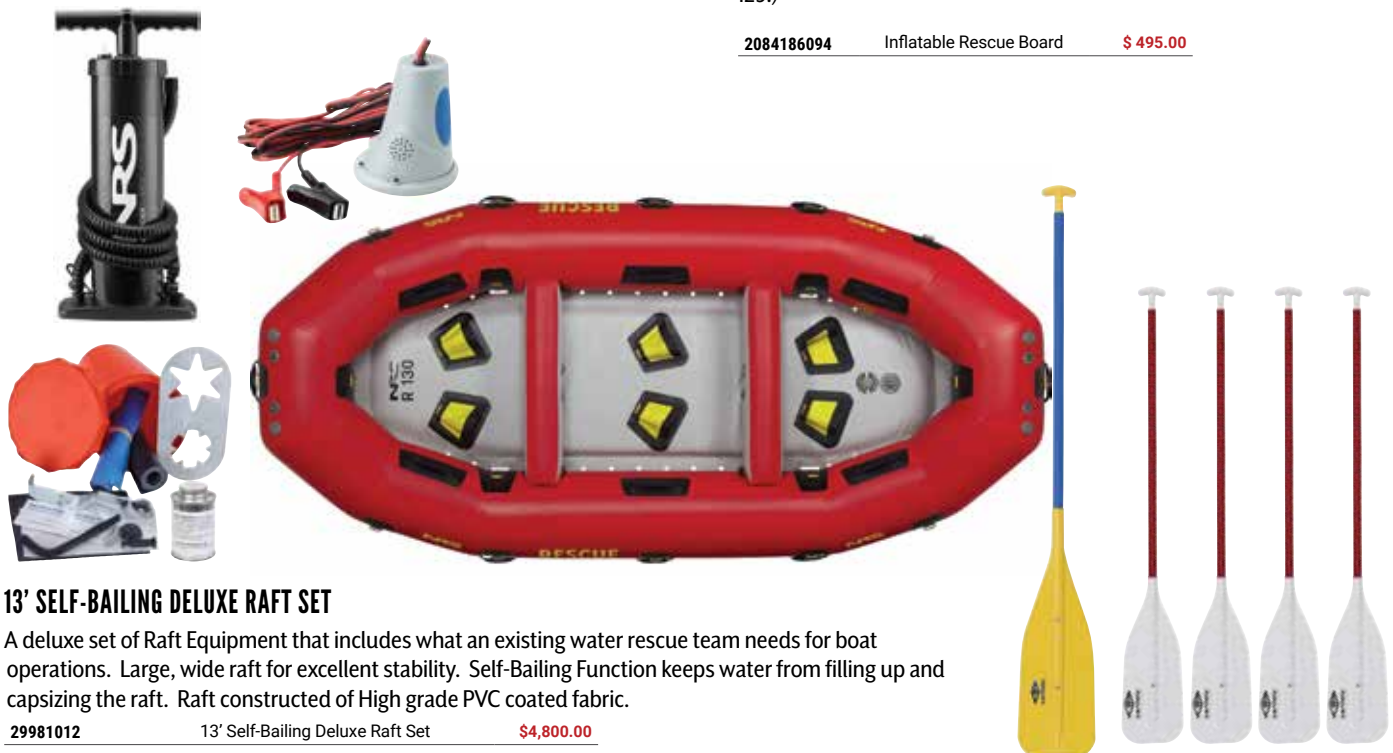

13' SELF-BAILING DELUXE RAFT SET

A deluxe set of Raft Equipment that includes what an existing water rescue team needs for boat operations. Large, wide raft for excellent stability. Self-Bailing Function keeps water from filling up and capsizing the raft. Raft constructed of High grade PVC coated fabric.

29981012 13' Self-Bailing Deluxe Raft Set \$4,800.00



NRS RESCUE RAFT

Constructed with advanced-formula PVC material using state-of-the-art seam-welding technology, results in superior abrasion resistance, longevity and air retention.

A 4" thick drop-stitch floor insert and 7.75" x 10.5" drop-stitch thwarts inflate to a rigid 8-10 psi, giving the boat the stiff and responsive performance needed in unpredictable scenarios. Four outer chambers, drop-stitch floor and two thwarts provide plenty of flotation in the event of an accident. Each inflation chamber has a pressure relief valve to prevent damage from over inflation. This allows you to keep the boat inflated without worrying about blown baffles. Frame wear patches protect the top of the tubes, while extra material reinforces the bottoms of the side tubes.

22 D-rings and 16 handles provide lots of options for gear tiedown and portaging. Features floor slots and intentional D-ring placements to suspend the boat and lower into position. Foot cups and interior handles give stable anchoring for crew members in rough conditions.

Can accommodate up to eight paddlers. Alternatively, you can rig it with a rowing frame and motor mount for an outboard.

The Batten Attachment Thwart system lets you easily remove the thwarts. The 4" floor insert is enclosed in a zippered floor pocket constructed of 4000 denier PVC on the bottom and 1000 denier PVC on top. Outside reflective patches, hi-vis fabric and logos stand out on the water and alert casualties and the public to your mission. Top-quality Leaffield inflation valves and pressure relief valves ensure trouble-free performance. Repair Kit and High-Pressure inflation pump included.

	Model	Length	Width	Thwarts	Weight	
208486092	R120	12' 2"	6' 4"	2	120 lbs	\$3,095.00
208486095	R130	13'	6' 2"	2	133 lbs	\$3,395.00
208486096	R140	14' 1"	7' 3"	3	167 lbs.	\$3,695.00

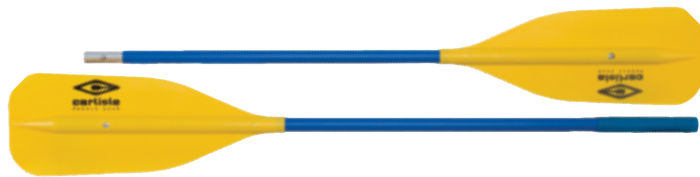

DOUBLE END PADDLE

Strong, thick-walled shafts match up with powerful blades. The take-apart model breaks down easily for transport. With externally reinforced push-button joints, these paddles also lock securely in either right or left hand control positions. This economical paddles' intended use is for inflatable and recreational kayaks. Assembled Length: 8 ft.

208475006 Double-End Paddle 8 ft. **\$ 84.95**



RAFT PADDLE

The industry standard! This 1-1/8" aluminum shaft extends well into the blade for added strength and is covered with polyethylene to provide a warm, secure grip. The 8" x 20" molded blade uses super-strong polypropylene for a powerful yet lightweight paddle.

208415054 Raft Paddle 60" **\$ 44.95**



RESCUE X-SLED 115

The Rescue X-Sled 115 gives rescuers the options needed for swiftwater, ice, low-head dam and floodwater rescues. Accommodate two rescuers and one victim but can easily float 4-5 people. The X-Sled can be paddled, towed or lowered where it's needed most. Heavy-duty material covers the 10" tubes and 4" drop-stitch deck. The drop-stitch deck inflates to 8-10 psi, giving the sled super rigid performance. 6 handles on the back deck are placed in a "ladder pattern" for ease of climbing on-board. 11 handles on the main tubs provide many handhold and lashing options. D-rings are on large surface-area patches to handle the load strain of towing and lowering. Textured foam deck pads. The high bow kick lets the X-Sled rise up and over waves and ice ledges. Top-quality Leaffield inflation and pressure relief valves ensure trouble-free performance. Includes a Super 2 HP Pump and repair kit. Quick-fill hose available (page 140).



Dimensions, Deck: 81" x 28"; Dimensions, Overall: 144" x 48"; Deck Thickness: 4"

	Weight	
208486093	67 lbs.	\$2,495.00



DOLPHIN3 SELF-PROPELLED RESCUE BUOY

Dolphin3 propels itself to rescue a casualty faster than any skilled swimmer, while the rescuer operates it with a remote controller and stays safe and dry. The Dolphin3 is a self-powered, remote-controlled electric water rescue device. The innovative technology fills the gap between traditional foam buoys and jet skis. It is more precise, cheaper to deploy, and safer for rescuer. The Dolphin3 is also designed to be used as a rescuer-controlled powered lifebuoy.

The Dolphin3 uses a single-handed controller with a video screen. Pressing the trigger can drive it forward, while manipulating the joystick moves the Dolphin3 forward, backward, left, or right. Any first-time user can learn to operate it in seconds. Display includes: Dolphin3 and Controller Battery levels

Powerful Propeller & strong Buoyancy - With a maximum 15 mph (7 m/s) speed, Dolphin3 can cut through waves and torrents to reach a troubled swimmer within the golden rescue minute. The Dolphin3 provides a buoyancy equivalent to 2 regular buoys, allowing it to carry multiple casualties in one action. Hull Material: LLDPE

Highly Visible - The Dolphin3 is bright orange and mounted with two high penetration flashing fog lights, making it easy to track by eyesight over long distances and in bad weather.

Reliable & Safe - The batteries are stored in a water-tight independent cabin so that even if the hull is damaged accidentally, the Dolphin 1 can keep functioning and bring a casualty back to shore safely



Features

- Auto-Return, GNSS (Global Navigation Satellite System)
- Camera and remote monitor
- Lights: Left and Right Position Lights and a top center position light
- Forward facing camera
- Dimensions: 39.4" x 27.6" x 9.8" (100(L) x 70(W) x 25cm (H))
- Weight: 36.9 lbs. (16.75 kg)
- Max Speed: 15 mph
- Battery Life, 1/2 thrust: 70 minutes
- Tow Load: 1000+ lbs.
- Control Range: 2625 ft / 875 yards / 800 meter (Line of sight)
- IP Rating: IP 67 (30 minutes at 1-meter depth)
- Battery Type: Lithium-ion (Type: 18650)
- Battery Rating: 21.6V, 12.5Ah, 270Wh
- Recharge time: 3-4 hours
- Two spare impellers
- Battery: 500 Charge/Discharge Cycles

254504104	Dolphin3 PRO	\$8,500.00
254504103	Dolphin3	\$7,000.00

	Dolphin3 PRO	Dolphin3
Immediate On	Yes	Yes
Magnetic Standby Mode	Yes	Yes
On Board Control	Yes	Yes
OLED Display	Yes	Yes
Self-Righting	Yes	Yes
Auto Return	Yes	N/A
Dual GNSS	Yes	N/A
Remote Monitor	Yes	N/A
Charge Stand	Optional	N/A
Search Light & Speaker	Optional	N/A



WARNING

Technical rescue and safety is potentially hazardous. Any person using equipment sold by RESCUE TECHNOLOGY in any manner is personally responsible for learning the proper techniques involved, and assumes all risks and accepts full and complete responsibility for any and all damages or injury of any kind, including death, which may result from the use of any RESCUE TECHNOLOGY equipment.

Products in this catalog can expose you to chemicals which are known to the State of California to cause cancer.
For information go to: www.p65warnings.ca.gov



RING BUOY

USCG Approved

Unicell soft foam. Won't rot or water log. Diameter: 24". Complete with grab lines.

Weight: 44 oz. Color: Orange

460008	Ring Buoy, 24"	\$130.00
460008-060	Ring Buoy w/ 60 ft. Tether	\$145.00
460008-100	Ring Buoy w/ 100 ft. Tether	\$155.00
460008M	Ring Holder	\$16.00



RESCUE TUBE

Yellow vinyl coating for great visibility and lightweight foam body for handling comfort. 3" x 40" with soft, nylon rope and one-piece body belt. USCG approved bronze snap hook.

Weight: 32.8 oz.

460001	Rescue Tube, 40"	\$95.00
--------	------------------	---------



RESCUE CAN

Features hand grips that are secure and comfortable to grasp and help to calm a panicky swimmer. High visibility Bright Day-glow Orange color.

Dimensions: 27.5 x 8.5 x 6" Weight: 54.4 oz.

460005	Rescue Can	\$115.00
460006	Rescue Can, Max Flotation	\$125.00
460005R	Rescue Can Rack	\$56.00
460006R	Rescue Can Rack, Max Float	\$57.00



TECH1 CINCH COLLAR

Easy to use - The victim simply enters the harness with head and arms extended before tension is applied by the rescuer. The victim's weight will release the connector and allow the collar to cinch around him, preventing him from slipping out in the event he becomes unconscious. Durable-The interior of the Cinch is a non-absorbent, closed-cell foam. The outer covering consists of a tough, stain-resistant, washable Cordura which provides protection and comfort to the victim. WLL: 300 lbs.

460401	TECH1 Cinch	\$ 400.00
--------	-------------	-----------

CARGO NET WITH STRAPS

Our cargo net is one of the most versatile rafting accessories on the river. It can be secured over the top of your gear to keep it in the boat, or hung between two crossbars to create a cradle for loose gear. Built with a border of 2" webbing for strength and strap on points for securing miscellaneous gear. Nine 4' HD straps included. Large nets are for boats 16 feet or longer.



	Size		
208418023	S	60" x 80"	\$94.95
208418024	L	70" x 90"	\$99.95



RESCUE STICK

Throwable Emergency Rescue Inflatable

The Rescue Stick™ provides rapid flotation assistance to a person at risk of drowning. Simply remove the baton shaped Rescue Stick™ from its waterproof bag and throw near the person. Once contact is made with the water it inflates in seconds to a large horseshoe shape. Measuring only 14" in length and weighing 15.5 oz., the Rescue Stick™ is the most versatile rescue flotation device available. Easily stowed in a boat, vehicle, backpack or by the pool. The Rescue Stick™ is an invaluable tool for first responders to provide emergency flotation when no water rescue gear is available. Rescue Stick Kit includes Rescue Stick (4), 50' Water Rescue Throwbag (1), and a waterproof storage case.

Weight, Rescue Stick: 25.6 oz.

2049101	Rescue Stick	\$295.00
2049105	Rescue Stick Rearm Kit	\$80.00
59849107	Rescue Stick Kit	\$1,500.00

CARLSON RESCUE BOARD

Lightweight & Maneuverable

For recreation or rescue. Solid Ethafoam with a slick bottom for performance and durability. (3-year warranty against delamination) Oversize Shipping Charges Apply.

Color: Black Weight: 11 lbs.

20841870	Carlson Rescue Board	\$565.00
----------	----------------------	----------



RESCUETECH THROW BAGS



Complete with Throwline and Ready to Use

Our Water Rescue Throwbags have been completely redesigned to give more features and make them easier to use. All bags utilize our Progressive Sewing Technology to give greater strength and resistance to abrasion. All ropes float - even when wet.

All of our bags feature:

- Double Stitched Seams • Reinforced Bottom Seams • Quick-Adjust Bucket Handle • Drawstring with Durable Cord-Lock • Drainage Grommets



STANDARD WATER RESCUE THROW BAG

Standard bags are manufactured with a urethane-coated 400 Denier water-resistant nylon for superior abrasion resistance.

		Length	Strength	Rating	Weight	
598301050	3/8" Pro-Poly	50'	2,960 lbf.	Throwline	1.8 lbs.	\$74.00
598301075	3/8" Pro-Poly	75'	2,960 lbf.	Throwline	2.7 lbs.	\$99.00
598301100	3/8" Pro-Poly	100'	2,960 lbf.	Throwline	3.4 lbs.	\$125.00
598302050	3/8" Standard Poly	50'	1,900 lbf.		1.25 lbs.	\$45.00
598302075	3/8" Standard Poly	75'	1,900 lbf.		2.0 lbs.	\$52.00
598302100	3/8" Standard Poly	100'	1,900 lbf.		2.3 lbs.	\$70.00
598303050	8mm NFPA	50'	4,300 lbf.	Throwline	1.2 lbs.	\$101.00
598303075	8mm NFPA	75'	4,300 lbf.	Throwline	1.7 lbs.	\$137.00
598303100	8mm NFPA	100'	4,300 lbf.	Throwline	2.3 lbs.	\$180.00

DELUXE WATER RESCUE THROW BAG

The Technical bags give the rescuer a top of the line throwbag. Manufactured of 1000 denier Cordura in the bottom end and 400 denier in the sides and open end. The "Tech" bag also features Reflexite retro-reflective trim and elastic lightstick holders. *(Lightstick not included.)*

		Length	Strength	Rating	Weight	
598311050	3/8" Pro-Poly	50'	3,500 lbf.	Throwline	1.95 lbs.	\$88.00
598311075	3/8" Pro-Poly	75'	3,500 lbf.	Throwline	2.4 lbs.	\$115.00
598312050	3/8" Standard Pro-Poly	50'	1,900 lbf.		1.25 lbs.	\$55.00
598312075	3/8" Standard Pro-Poly	75'	1,900 lbf.		2.0 lbs.	\$60.00
598313050	8mm NFPA	50'	4,300 lbf.	Throwline	1.41 lbs.	\$115.00
598313075	8mm NFPA	75'	4,300 lbf.	Throwline	1.81 lbs.	\$149.00



PRO GUARDIAN WAIST THROWBAG

Strong Dyneema Rope

Features an internal throw rope in a bag that pulls completely free from the waist belt. Includes 55 feet of extra-strong 1/4" Dyneema® rope. Clips securely around your waist with an adjustable belt and a quick release buckle. Webbing loops along the belt are provided for carabiners. Maximum load indicated is for the rope alone.

Rope Length: 55' Rope Size: 1/4" Dyneema® Rope Strength: 2,608 lbs. (max)

208418282 Pro Guardian Throwbag **\$109.95**



GUARDIAN WAIST THROWBAG

Lightweight Polypropylene Rope

The Guardian Bag is worn on your waist, so whether you're in your boat or walking the banks, the throw bag is always at your fingertips. Features an internal throw rope in a bag that pulls completely free from the waist belt. Contains 55 feet of 1/4" polypropylene rope. Clips securely around your waist with an adjustable belt with quick release buckle. Webbing loops along the belt are provided for carabiners. Maximum load indicated is for the rope alone.

Rope Length: 55' Rope Size: 1/4" Polypropylene Rope Strength: 950 lbf. (max)

208418281 Guardian Throwbag **\$89.95**



FORCE6 DART THROWBAG, 70 FT

The Dart is the most compact throw bag in the industry and a customer favorite. It features a weight forward design, making it easy to throw and it flies like a football.

Rope Length: 70' Rope Size: 1/4" Polypropylene Rope Strength: 1050 lbf. (max)

2490521204 Dart Throwbag **\$64.95**

WATER RESCUE

ACCESSORIES & DRYSUIT CARE

Accessories for Water Rescue Personnel. Hangers, Bags, Training Aids and more at RescueTECH1.com in our Water Rescue Accessory Section.



WONDER PUMP 6

The Bravo Pump is a great top off pump. This compact pump allows you to connect to even the hard-to-reach valves on any raft. 5' non-kink hose and 7 adaptors are included with the pump. The double action pump, working to inflate on both the upward and downward motions of the handle, speeds inflation. Stroke volume of about 1.6 Gal/6 L.

Dimensions: 4" x 18.5" Weight: 2.25 lbs.

20841701 Wonder Pump 6 \$59.95



BLAST PUMP

12 vDC

Why pump by hand if you don't have to? Let the Blast Inflator Pump do the work for you. Its compact size and rugged durability will last for years. This 12-volt pump is capable of inflating to 1.5 psi for a fast and easy inflation. It also deflates making it quick and easy to get your inflatable packed back up. Comes with an adapter to fit a wide variety of valve types. Inlayed rubber insulates from heat and sound while providing a more secure grip. 12 foot power cord allows you to easily inflate your boat near your vehicle. Alligator clamps allow quick and easy connection to your vehicle's battery. Pump designed to run for up to 20 minutes without overheating.

20841726 Blast Pump \$127.95



SUPER 2 HP PUMP

For Low and High Pressure Inflatables

The Super 2 HP Pump is a patented double-chambered pump for optimal power with minimal effort. Easily inflate high-pressured inflatables up to 25 psi. Sturdy construction ensures long-lasting durability. Includes an integrated pressure gauge for precise inflation. 2 Pump modes: Maximum output and Maximum Pressure. Includes Leaffield C7/D7 Valve Adapter and other adapters that fit Halkey-Roberts New Short, Summit 2 and H3 valves.

Dimensions: 4.5" x 22" Weight: 4 lbs.

208480057 Super 2 HP Pump \$74.95



PRESSURE GAUGE

This Mechanical Pressure Gauge helps you minimize the risk when inflating your boat and monitoring air pressure. This simple tool can save you a ton of headache and expense. This easy to read, accurate gauge helps you keep your boat inflated to the optimal pressure. Avoid costly blowouts by regularly checking your raft, cataraft, inflatable kayak, SUP board's air pressure to prevent over-inflation. The 0-20 psi capacity covers the widest range of inflatable craft. Gauge tip fits Leaffield and military valves. To use with other valves, such as Halkey-Roberts and Summit, order the optional K-Pump Kwik Check Gauge Adapter Tipcrew in gauge tip adjusts for best valve plunger depression. Gauge tip must be in the valve for reading.

208480007 Mechanical Pressure Gauge \$14.95
208480084 K-Pump Adaptor \$6.95



QUICK-FILL HOSE

Hoses to fill your Rafts and Boats equipped Leaffield inflation and overflow valves. Available for SCBA, SCUBA, and DIN tanks. Care must be taken when filling inflatables using a high pressure source.

	Tank Style	
208437270	SCUBA	\$264.95
208437271	SCBA	\$314.95
208437272	DIN	\$314.95



RAFT REPAIR KIT

Hypalon raft and inflatable kayak repair kit. Contains the essentials for emergency boat material and Leaffield valve repair. Repair parts are fitted in a Witz Utility Locker I Dry Box, with gasket-lined, watertight lid. This kit is intended to give you the basics to make an emergency on-the-water repair. Other items, such as Toluene and Clifton Hypalon Accelerator (sold separately), are recommended for more complete, long lasting repair jobs.

• 4 oz Adhesive • One 6"x18" Piece of Tube Material • One 6"x18" Piece of Floor Material • Roller Rasp • Round & Oval Rubber Temporary Patches • Sand Paper • Hypalon glue instructions included • Leaffield Valve Wrench • Leaffield Adapter • Plug for Leaffield PR Valve • C7 Repair Kit: Pin, Spring, Rubber Stopper

208419844	Hypalon (Red)	\$62.00
208419846	Hypalon (Blue)	\$62.00
208419769	PVC (Gray)	\$160.00

303 HIGH TECH FABRIC GUARD

Protects Drysuits and PFD's

Powerful enough to protect fabrics in the harshest environment... outdoors.

303 High Tech Fabric Guard™ helps keep your gear looking and performing like new. Restore lost water repellency and stain repellency without affecting the breathability of the fabric. Use after cleaning fabrics to revive water repellency and stop leaks.

Helps to repel dirt, grease, water, oil-based stains and UV rays. Non-toxic and odorless formula is easy - spray on, let dry.

Weight: 16 oz.



2084190816	303 Fabric Guard	\$24.95
------------	------------------	---------



ZIPPER LUBRICANT STICK

Unstick zippers quickly. More than just a zipper wax, it also protects nylon, plastic, and metal zippers against salt, chlorine, rust, and corrosion – helping hardworking zippers last longer. Stuck zippers on all types of outdoor gear can be unzipped with a simple application. Designed for standard and watertight zippers. Perfect for use on wetsuits, drysuits, and dive gear.

.5 oz.

20842288	Zip Lubricant Stick, 2 Pack	\$5.98
----------	-----------------------------	--------

SILICONE LUBRICANT

Silicone Lubricant Spray protects rubber gaskets and neoprene from the detrimental effects of the outdoors. Plus, it reduces the stiff, rubbery qualities of neoprene and latex letting you gear up hassle-free. Ideal for wetsuits, gaskets, O-rings, and more. Food-grade silicone formula for against-the-skin safety. Powerful, high-quality spray designed for easy, even application.

Lubricates sensitive rubber parts for easy donning or removing of gear. Protects against rust, salt, oxidation, and corrosion. Conditions neoprene and rubber materials to maintain suppleness and appeal. Prolongs neoprene and rubber gasket life.

7 oz.



238120410	Silicone Lubricant	\$10.95
-----------	--------------------	---------

ZIPPER CLEANER & LUBRICANT

The Zipper Cleaner and Lubricant is designed to remove sand, dirt and salt deposits that can make a zipper stick. This zipper lubricant's handy brush top removes debris and delivers its cleaning formula right between the zipper teeth.

Plus, it leaves behind a clear, protective and lubricating film to prevent corrosion of zippers. Use it regularly and experience the joy of gliding zippers on wetsuits, dive bags and outdoor gear.



20842290	Zipper Cleaner & Lubricant	\$6.95
----------	----------------------------	--------

WETSUIT SHAMPOO

Complete, scientifically balanced maintenance system for all neoprene and water sports gear. Ideal for wetsuits, drysuits, boots and gloves, fishing waders, orthopedic supports, lycra body suits and more. Leaves neoprene articles free of organic residue, chlorine and salt deposits. Chlorine-removing agents and conditioners help prevent premature aging and oxidation.



20842249	Gallon	\$52.00
208422481	10 oz.	\$10.95



AQUASEAL WETSUIT REPAIR ADHESIVE

The industry standard for maximum strength repairs to wetsuits, dry suits and all water sports products. Flexible urethane formula waterproofs, seals and protects against abrasion. Hundreds of water sports and household uses. Flexible Urethane formula that waterproofs, seals and protects against abrasion.

Flammable - UPS ground only.

2282572	Aquaseal, .75 oz. Tube	\$8.95
---------	------------------------	--------



DIVE MASK TRAINING BLACKOUT COVER

Finally, a reusable Diving Mask Cover that works. Made from tough, coated nylon fabric and elastic drawstring adjuster. Can be easily removed in an emergency situation. Excellent access to nose cup for clearing ears.

460101	Standard Mask Blackout Cover	\$15.00
460111	Full Face Mask Blackout Cover	\$20.00



TRAINING AIDS

Rescue Diver training aid requirement. Solid rubber. For pool skills training for divers. 5" Donut rings may be used for assorted training exercises.

4600161	Block, 10 lb. (each)	\$45.00
4600162	Donut, 5" (each)	\$13.00



SUPER HANGER

Useful and economical for hanging a variety of dive equipment.

Dimensions: 9" x 16.6" x 1.2" Weight: 9.6 oz.

460012	Super Hanger	\$11.00
--------	--------------	---------



SUPER ACCESSORY HANGER

Ideal for drying and storing gloves, booties and hood.

Dimensions: 13" x 20" x 1.2" Weight: 14.4 oz.

460011	Super Accessory Hanger	\$19.50
--------	------------------------	---------



SUPER B.C. HANGER

Keeps Expensive equipment off the floor for proper drying and storage. Supports up to 20 lbs.

Dimensions: 10" x 16" x 1.2" Weight: 8.8 oz.

460010	Super B.C. Hanger	\$14.00
--------	-------------------	---------

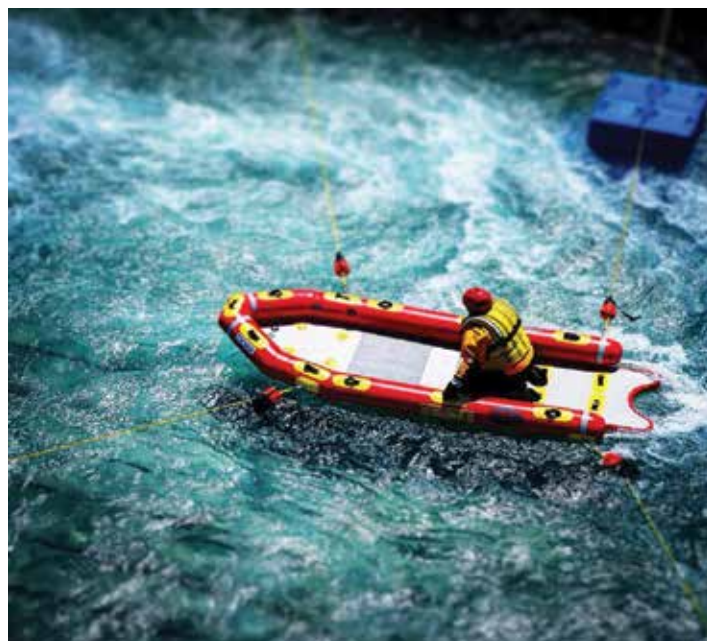

DRYSUIT / EXPOSURE SUIT HANGER

Wide 4.5" hanger "arms" for ultimate protection of expensive Drysuits and Exposure suits.

Dimensions: 15" x 16" x 4.5" Weight: 1.35 lbs.

460013	Drysuit Hanger	\$35.00
--------	----------------	---------



WARNING

Technical rescue and safety is potentially hazardous. Any person using equipment sold by RESCUE TECHNOLOGY in any manner is personally responsible for learning the proper techniques involved, and assumes all risks and accepts full and complete responsibility for any and all damages or injury of any kind, including death, which may result from the use of any RESCUE TECHNOLOGY equipment.

Products in this catalog can expose you to chemicals which are known to the State of California to cause cancer.

For information go to: www.p65warnings.ca.gov



CO-PILOT KNIFE

Great features - smooth and serrated cutting edges, blunt safety tip, bottle opener, etc. Compact design is a fine fit on your PFD. An excellent knife for freshwater rescue. For saltwater use, choose the Titanium Co-Pilot Knife. The Co-Pilot has both super-sharp smooth and serrated sections. The blunt tip design protects against unintentional puncture of your gear or yourself. As another safety feature, the blade is only sharpened on the one edge. The unique sheath firmly locks the knife in place and only lets it go when you squeeze both sides of the release. Comfortable rubberized grip wraps around the contoured handle, giving you maximum control of the blade. The sheath clip attaches firmly to a PFD lash tab.

Total Length: 5.75" Blade Length: 2.25" Weight: 4.6 oz

208427562	Co-Pilot	Yellow	\$44.95
208427561	Co-Pilot	Black	\$44.95
208427563	Co-Pilot	Green	\$44.95
208447304	Co-Pilot, Titanium	Black	\$129.95



Lanyard Not Included

FOX WHISTLE

One of the loudest whistles available. "Pea-less" design functions when wet - even under water.

	Style	Color	
22824640	Fox Mini Whistle	Orange	\$7.95
2282465x	Fox 40 Whistle	Orange, Yellow	\$7.50
2282469x	Fox 40 w/ Coil	Orange, Yellow	\$8.25

PILOT KNIFE

Rescue professionals will really love the features of the Pilot Knife. Features both smooth and serrated sections plus a rope cutting hook. The blunt tip design protects against unintentional punctures! The unique sheath firmly locks the knife in place and only lets it go when you squeeze both sides of the release. Contoured handle and rubberized grip. Clip on sheath attaches firmly to PFD lash tab. Built in glass breaking tip on the end of handle.

Length: 7.5" Overall; 3" Blade.

	Color	
208427550	Orange	\$49.95
208427551	Black	\$49.95



EMT SHEARS

Safer than a knife when used around ropes. Safety bandage tip. Stainless Steel Blades. May be placed in Autoclave. Cuts clothing, ropes, or harnesses. Stainless Steel blades with polypropylene handles.

Length: 7.5" Weight: 2 oz.

	Color	
6301052	Yellow	\$6.00



AKVA RIVER RESCUE SHORT KNIFE

Features quality 420 Stainless Steel 3" blade with serrated top edge for rope cutting, blunt chisel tip and line cutter. Molded Grip. Blade Shank protrudes past handle end to allow use as striking tool. Includes molded Sheath.

Dimensions: 6.75" x 1.25" Weight: 4 oz.

	Color	
6301211	Black	\$29.75
6301212	Yellow	\$29.75



DIVE RESCUE SHEARS

Great for Rescue Diver Safety

EMT Shears in a Pouch that secures to BC Shoulder Strap or autoinflator hose. Includes Stainless Steel 7.5" EMT shears and adjustable pouch.

630111	Dive Rescue Shears	\$23.50
--------	--------------------	---------



FIRSTWATCH FLASHBLADE LIGHTED RESCUE KNIFE

Blunt Tip with Directional Lighting

Features a light that is automatically activated when removed from the sheath. Anti-slip textured grip. Ambidextrous sheath is compatible with lash-tab and molle platforms. Nano-Ceramic Window Breaker.

Brightness: 7 lm; Battery: 1 x AAA; Run Time: 10 hours; Waterproof: IPS7, 1M; Dimensions: Knife - 176 x 44 x 20mm; Blade Length: 76mm

	Color	
217111004	Red	\$100.00
217111002	Hi-Viz Yellow	\$100.00
217111001	Black	\$100.00



EOS II LED

Intrinsically Safe

The EOS II is designed and constructed to meet the most rigorous of demands, both in application and environment. The head unit is self contained, waterproof, and constructed of high grade materials. The technology inside offers the best in long burn times and utilizes advanced circuitry that regulates

Power: 130 lumens **Lamp:** 1 Maxbright LED **Runtime:** 100 hours **Batteries:** 3 AAA Alkaline (Included). **Weight:** 3.7 oz. **Waterproof to 1 Meter.** UL approved intrinsically safe, CL I, Div. 2, Group ABCD **UL Temp Code:** T4

21851051 Black \$65.00



EOS II MPLS

The EOS II Tactical MPLS takes the durable and lightweight EOS headlamp and turns it into a modular option through the time-tested Princeton Tec MPLS kit. An Intrinsically Safe headlamp, the EOS II is designed and built to meet the most rigorous of demands both in application and environment. Waterproof, constructed of high grade materials and self-contained, the EOS II offers long burn times utilizing regulated circuitry. **Mounting Options:** NVG Adaptor, Bracket for MOLLE & Headstrap.

Power: 170 Lumens **Lamp:** 1 Maxbright LED **Burn Time:** 100 hours **Batteries:** 3 AAA Alkaline **Weight:** 3.7 oz. **UL Rating:** Class I Division 1 Groups A, B, C, & D **Waterproof:** 1 meter

218510521 Black \$100.00



TORRENT 500 LED

Power meets versatility in the Torrent LED. With a 500 Lumen Maxbright LED it's got the power to be a main light source. A simple switching mechanism and a 100-meter waterproof rating ensure that the Torrent LED will be shining bright whenever and wherever you need it to go.

Power: 500 Lumens **Lamp:** Maxbright LED **Burn Time:** 1.5 Hours **Batteries:** 8 AA Alkaline (not included) **Weight:** 12.8 oz. **UL RATING APPROVED** Class I Division 2 Groups A, B, C & D

218520102 Torrent LED \$88.99



EOS LED

The EOS is optimized for both close-up and distance needs. The combination of a Luxeon/I watt L.E.D. and a special lens maximizes the beam by balancing long throw with flood light. The EOS provides a self-contained 3AAA battery system that eliminates external wires, and is equipped with (3) brightness levels. Each level provides true current regulation ensuring that the EOS will remain at constant brightness as long as the batteries have sufficient voltage. Durable and water resistant to water.

Weight: 3.7 oz with 3 AAA Batteries (Included). **Waterproof to 1 Meter.** **Burn Time:** 46 hours. **Lumens:** 170

2185105 EOS LED \$57.99



PIXA 3 RECHARGEABLE

Suitable for proximity lighting, movement and long-range vision.

The PIXA 3R headlamp is a rugged, rechargeable headlamp suitable for frequent use by professionals. The multi-beam adapts to all situations: close-range work, movement, and long-range vision. **CONSTANT LIGHTING** technology: brightness does not gradually decrease as the batteries are drained. 90 Lumens.

Weight: 145 gm; **Beam Pattern:** flood, mixed, focused; **Battery:** Lithium-Ion Polymer, 930 mAh; **Recharge Time:** 3 hrs. **Watertightness:** IP67 (waterproof to -1 meter for 30 minutes) **Certification(s):** -ATEX zone 2/22 (II 3 GD Ex ic IIB T4 Gc IIIC T135° C Dc)

2354057803R Pixa 3 Rechargeable \$99.95



SECTOR 7 LED DIVE LIGHT

This pistol grip spotlight packs 700 lumens. Eight C-cell batteries (not included) provide 11 hours of burn time. The trigger switch is easy to pull with gloved hands; access momentary on via a half-pull and constant on via a full-pull. The trigger locks out to prevent accidental activation and battery drain while in transit or storage. **Waterproof to 100 meters.**

Power: 800 Lumens **Lamp:** Maxbright LED **Burn Time:** 30 Hours **Batteries:** 8 C Alkaline **Weight:** 37.9 oz.

2185803102 Sector 7 LED \$133.99



REFUEL INDUSTRIAL

The ReFuel is extremely simple to use. 250 lumen LED lights up your workspace. Easy to find push button to power your headlamp on and off and toggle through modes.

Power: 250 Lumens **Lamp:** 4 Ultrabright LED's **Runtime:** 42 hours **Batteries:** 3 AAA Alkaline (included) **Weight:** 2.75 oz **Water Resistant to splashing water.**

21851311 Refuel Industrial LED \$35.00



FIRSTWATCH NVG HELMET HEADLAMP

The Firstwatch NVG is a high-performance LED, with max output of up to 500 lumens. Fits to Firstwatch and tactical helmets with NVG mount.

Powered by one 18650 rechargeable Li-ion battery.

Attached filter switches between White light and Red light. Single Switch for 3 Intensities + SOS flash.

2171069101 Firstwatch NVG Light \$90.00



C-STROBE LED MANUAL / H2O ACTIVATED

Slim and lightweight design fits easily in a pocket or hangs discreetly when attached to a life jacket or backpack. The flexible lashing loops on the side of the product allow for multiple mounting options including the webbing on your backpack or straps on your life jacket. Velcro® strap can be secured around the lashing loops and creates countless additional mounting possibilities. The light also comes with a clip designed to conveniently slide over your inflatable life jacket's oral inflation tube for storing your light inside your life jacket.

Features: · For location assistance during low-light emergencies; · Exceedingly bright 45 Lumen White LED; · Continuous operating life of greater than 120 hours; · Waterproof – Tested for 24 hrs at 3.3 ft. (1m); · Easy twist On/Off activation; · Impact resistant case; · Uses two AA, 1.5V batteries (not included); · USCG/SOLAS Approved; · Ideal for life jackets, camping, biking, auto, etc.; · Included Velcro® strap (with carded version) used in conjunction with integral lashing loops for mounting flexibility; · Included PFD clip (with carded version) for easy attachment to oral inflation tube.

238019153	C-Strobe LED	\$24.95
238019154	C-Strobe LED, H2O Activated	\$29.95



ECOFLARE

Interchangeable halogen bulb and red Ultrabright LED make the EcoFlare a flashing beacon or area light. Compact and waterproof. A vital part of any outdoor enthusiast's equipment bag, the Eco Flare can be set on constant, high-output, incandescent mode for use as an area/personal locator light, or on flashing, red Ultrabright LED mode for low-visibility, dark nights. The Ultrabright LED will burn in excess of 500+ hours on 2 AAA alkaline batteries. The Eco Flare can also be attached to your dogs collar for easy identification in low light conditions.

Power: 1 watt / 6 Lumens Lamp: High output bulb, 1 Ultrabright red LED Batteries: 2 AAA Alkaline Burn Time: 500 hrs. Weight: 1.48 oz (42g)

488305	EcoFlare	\$24.99
--------	----------	---------



MERIDIAN STROBE

The Meridian LED emergency strobe and locator light is visible for over a mile. The body is designed to be low-profile and adaptable to a wide range of uses: easy attachment to PFD, SCUBA tank or any 1" webbing is possible. The toggle switch allows for operation of red and white strobing modes. Built to withstand the rigors of diving, the light is waterproof to the IPX8 standard. Batteries included.

Power: 100 Lumens; LAMP: 1 White Maxbright LED, 1 Red Maxbright LED; BURN TIME: 100 Hours; BATTERIES: 3 AAA Alkaline; WEIGHT: 5.6 oz (101 Grams)

488307	Meridian Strobe	\$41.99
--------	-----------------	---------



ACR HEMI LIGHT 3

Clip Directly to PFD

Smaller than other approved lights, the HemiLight™ features rounded edges to maintain the integrity of inflatable life jackets. Attachment loops accommodate up to 5 cm (2 in) wide webbing, and the marine tough design ensures years of useful service. The high-intensity flashing LED light automatically activates for 20+ hours when it comes in contact with salt or fresh water, and can be deactivated simply by pushing the red button. Installation is quick and easy (the HemiLight™ 3 can be retrofitted to almost any style life jacket in a matter of seconds). Available in two configurations: the HemiLight™3 offers a basic strobe mode which can be activated either manually or automatically.

248837681	ACR HEMI Light 3	\$29.95
-----------	------------------	---------



CYALUME LIGHT STICK

6" Lightstick give rescuers a great lighting tool. Shelf Life: 5 years. Glow time 8 or 12 hours. Individually wrapped.

24426125	12 hour Green	\$3.00
24426124	12 hour Red	\$3.00
24426120	12 hour Orange	\$3.00
24426122	12 hour Yellow	\$3.00
24426089	8 hour White	\$3.00



CQC SELF-RECOVERY LADDER W/ DEPLOYMENT STROP

A life-saving device for workers operating vessels on their own or with limited crews. Its intended use is for casualties who have fallen overboard to enable them to climb back onto the vessel easily and independently. The Fibrelight Self Recovery Ladder is kept in a burst-zip bag permanently attached to the vessel's side. An adjustable cord allows the ladder to be pulled from the bag by a user who has fallen overboard, the bottom of the ladder falls into the water, and the casualty can climb back into the vessel without further assistance.

The Fibrelight Self-Recovery Ladders are constructed using GRP rods enclosed in flanged tubular webbing, which together create an incredibly strong structure. Exceeds ISO 799 strength test, which is part of the SOLAS approval program.

	Ladder Length	Strop Length	
2087211000	1 meter	.75 meter	\$660.00
2087211510	1.5 meter	1 meter	\$710.00
2087212015	2 meter	1.5 meter	\$750.00
2087212520	2.5 meter	2 meter	\$820.00
2087213025	3 meter	2.5 meter	\$930.00



FIBRELITE EMERGENCY ESCAPE LADDER

for Emergency Escape, Pilot's Ladder, Boarding Ladder

The Fibrelite Emergency Escape Ladder is a SOLAS approved Means of Embarkation and life-saving device. The ladder has been designed for use in emergencies; it can be carried and then deployed by a single person in less than a minute, as it is both lightweight and straightforward. The ladder is a standard width of 600mm and is produced in lengths of up to 30 meters, in either Orange or Black. The ladder contains no metal parts and therefore is suitable for deployment on all vessel types, such as LPG carriers with a flammable risk and cruise ships/yachts with precious surfaces.

A 30-meter ladder weighs less than 30 kilograms. The double-rung ladder is considerably easier and safer to use with a natural step action. The ladder is faster to climb and, more importantly, to descend than a single-rung ladder.

• SOLAS approved • MCA Accepted • Lightweight & Portable • Can be loaded in either direction • No annual Servicing required • 3 years manufacturer's warranty

	Length	Ballast Rungs	Stand Offs	
2458232702	2 Meter (6.5 ft.)	0	2	\$1,350.00
2458232703	3 Meter (9.85 ft.)	0	2	\$1,625.00
2458232705	5 Meter (16.5 ft.)	3	3	\$2,410.00
2458232710	10 Meter (33 ft.)	3	5	\$4,300.00
2458232715	15 Meter (49.2 ft.)	8	5	\$6,100.00
2458232720	20 Meter (65.5 ft.)	8	5	\$8,100.00
2458232725	25 Meter (82 ft.)	8	5	\$9,800.00
2458232730	30 Meter (98.4 ft.)	8	5	\$11,800.00



WARNING

Technical rescue and safety is potentially hazardous. Any person using equipment sold by RESCUE TECHNOLOGY in any manner is personally responsible for learning the proper techniques involved, and assumes all risks and accepts full and complete responsibility for any and all damages or injury of any kind, including death, which may result from the use of any RESCUE TECHNOLOGY equipment.

Products in this catalog can expose you to chemicals which are known to the State of California to cause cancer.

For information go to: www.p65warnings.ca.gov

PERSONAL PROTECTION



VIZIR™

Protective Shield for VERTEX and STRATO helmets

The VIZIR visor ensures eye protection and integrates perfectly into VERTEX and STRATO helmets. It is installed easily with its inserts.

- Easy to mount on VERTEX and ALVEO helmets with purpose-built inserts
- Scratch- and fog-resistant

23540115	VIZIR Eye Shield, Clear	\$64.95
235401151	VIZIR Eye Shield, Smoke	\$69.95



VIZEN™

Face Shield for Protection Against Electric Arc

The VIZEN face shield protects against electric arc hazards. This full-coverage shield offers face and eye protection while preserving peripheral vision. It is easily installed on VERTEX and STRATO helmets, thanks to the EASYCLIP attachment system. It also has scratch-resistant and anti-fog coatings.

- Easy to mount on VERTEX and ALVEO helmets with purpose-built inserts
- Scratch- and fog-resistant

235401140	VIZEN Full Face Shield, Clear	\$79.95
-----------	-------------------------------	---------



WARNING

Technical rescue and safety is potentially hazardous. Any person using equipment sold by RESCUE TECHNOLOGY in any manner is personally responsible for learning the proper techniques involved, and assumes all risks and accepts full and complete responsibility for any and all damages or injury of any kind, including death, which may result from the use of any RESCUE TECHNOLOGY equipment.

Products in this catalog can expose you to chemicals which are known to the State of California to cause cancer.

For information go to: www.p65warnings.ca.gov



VERTEX™ BEST

Helmet for work at height and industry

The adjustment wheel has two height positions and the chin strap can be adjusted for a perfect fit. Side slots and the above-the-ears cut of the shell allow attachment of standard hearing and eye protection. Four clips, on the outside of the helmet, correctly hold a headlamp. Polycarbonate shell, resistant to impact and wear.

Weight: 492 gms

Meets CE and ANSI Z89.1 - 2003 -Type I class E.22.4

	Color	
2354011010	Orange	\$ 99.95
2354011011	Black	\$ 99.95
2354011012	Yellow	\$ 99.95
2354011014	Red	\$ 99.95
2354011016	Blue	\$ 99.95
2354011019	White	\$ 99.95
2354011010HV	HI-VIZ Orange	\$109.95
2354011012HV	HI-VIZ Yellow	\$109.95



VERTEX™ VENT

Vented for Rescuer Comfort

Comfortable and durable helmet with ventilation, meets requirements for working at height. Adjustable ventilation: 5 holes on each side, can be closed with 2 sliding shutters. Chin strap designed to decrease the risk of losing the helmet in case of impact during a fall. Polycarbonate shell, resistant to impact and wear (meets EN 397 industrial helmet standard and EN 12492 standard). Meets optional requirements of the EN 397 standard: lateral deformation and use at low temperatures (down to - 30 °C).

Weight: 465 gm

Meets CE and ANSI Z89.1 - 2003 -Type I class C.

	Color	
2354011040	Orange	\$ 99.95
2354011041	Black	\$ 99.95
2354011042	Yellow	\$ 99.95
2354011044	Red	\$ 99.95
2354011046	Blue	\$ 99.95
2354011049	White	\$ 99.95
2354011040	Hi-Viz Orange	\$109.95
2354011042HV	Hi-Viz yellow	\$109.95



STRATO ANSI

Lightweight helmet

The STRATO helmet is very lightweight and comfortable, thanks to its CENTERFIT and FLIP&FIT systems, which guarantee that the helmet fits securely on the head. The adjustable-strength chinstrap makes it ideal for both work at height and on the ground. The unventilated outer shell protects against electrical hazards, molten metal splash and flames. With its potential for integration of a Petzl headlamp, hearing protection, and multiple accessories, it is an entirely modular helmet, thus meeting the specific additional needs of professionals.

Certification(s): CE EN 397 (1), EN 50365 (2), ANSI Z89.1 Type I Class E, EAC

	Color	
2354015012	Yellow	\$139.95
2354015014	Red	\$139.95
2354015019	White	\$139.95
2354015010HV	HI-VIZ Orange	\$149.95
2354015012HV	HI-VIZ Yellow	\$149.95



STRATO VENT

The STRATO VENT helmet has holes that promote ventilation. The adjustable-strength chinstrap makes it ideal for both work at height and on the ground. It has ventilation holes that allow airflow through the helmet. With its potential for integration of a Petzl headlamp, hearing protection, and multiple accessories, it is an entirely modular helmet, thus responding to the specific additional needs of professionals.

Certification(s): CE, EN 12492, ANSI Z89.1 Type I Class C, EAC

	Color	
2354016012	Yellow	\$139.95
2354016014	Red	\$139.95
2354016019	White	\$139.95
2354016010HV	HI-VIZ Orange	\$149.95
2354016012HV	HI-VIZ Yellow	\$149.95



SPIN-ANSI

Shock-absorbing helmet.

Conforms to ANSI Z89.1-2009 and CE EN 397. Comfortable and well-ventilated interior that also guarantees a perfect fit. Removable and washable padding. Optional Visor and hearing protection can be mounted using the integrated clasp on the shell. Equipped with 4 durable clips for mounting headlamps. Univeral Size.

Weight: 13.58 oz> (385gm)

	Color	
2401997202	Yellow	\$89.95
2401997204	Red	\$89.95
2401997209	White	\$89.95
2401997200	Orange	\$89.95



SPIN VISOR

Helmet visor resistant to surface damage caused by fine particles and mist. Made of high-quality polycarbonate of Japanese origin. Extremely robust, it protects from high-speed projection (120 m/s) of particles at room temperature (class B), molten metals and hot solids, electric arc caused by short-circuit. Includes mounting kit. Available in transparent and smoked version.

Conforms to CE EN 166.

24019970560	Transparent	\$41.50
24019970561	Smoke	\$20.00



SPIN NOISE REDUCTION EARMUFFS

Noise reduction 3M Peltor® earmuffs with different levels of acoustic insulation and colors. All models conform to UNI EN 352-3 norm. Electrically insulated earmuffs.

	Noise Reduction	Color	
2401999130001	32db	Red	\$100.69
2401999140001	30 db	Yellow	\$87.29
2401999160001	26 db	Green	\$67.09



SPIN LONG VISOR

Helmet visor made of high-quality polycarbonate of Japanese origin. Anti-fog treatment on both internal and external side, scratchproof. Long version that allows to completely cover the operator's face. Extremely robust, it protects from high-speed projection (120 m/s) of particles at room temperature (class B), molten metals and hot solids, electric arc caused by short-circuit. Includes mounting kit

Conforms to CE EN 166.

24019970450	Long Visor	\$89.49
-------------	------------	---------



Shown on Cascade Water Rescue Helmet (not included)

ESS STRIKETEAM GOGGLES

Designed for Technical Rescue and Wildland Fire Fighting equipped with a thick polycarbonate lens that has been hardcoated and anti-fog treated both inside and out. Soft open cell facefoam designed to fit over most eye glasses. Comes with flame resistant Velcro™ tabbed elastic strap which features instant fit speed clip.

Exceeds ANSI Z-87.1 and CSA Z94.3-92. Weight: 6.4 oz.

481601	StrikeTeam XTO	\$56.00
481609C	Replacement Lens, Clear	\$27.00
481608	Tear Off Lens Covers	\$12.00

PERSONAL PROTECTION



PRO RESCUE GLOVE

Mesh Back / Leather Palm

The Pro leather gloves are perfect for those jobs that are especially hard on the hands. When anything less than a leather glove won't do. Top quality leather construction throughout. Leather knuckle panel provides increased protection. Easy entry, wide opening elastic cuff (Easy-Fit design). Anatomically-cut, leather palm and heel reinforced panels for extended durability. Smooth surface thumb improves handling of objects. Reinforced thumb and fingertips increase protection and reduce wear.

Weight: 4.8 oz.

	Color	Size	
4912x1	Black	S, M, L, XL, XXL	\$46.00
4912x2	Tan	S, M, L, XL, XXL	\$46.00



RINGERS ROPE RESCUE GLOVES

Omni-directional stretch fabric offers flexibility and excellent airflow. Palm manufactured of Armortan® leather that can be machine washed to remove contaminant. Double thickness in palm with DuPont Kevlar® thread for long wear. Reinforced finger tip and thumb extends glove life. Precurved ergonomic shape and anti vibration gel padding for extra comfort.

Weight: 4.8 oz.

	Color	Size	
4907X1	Black	SM - XXL	\$25.00
4907X4	Red	SM - XXL	\$25.00



BARRIER 1 EXTRICATION GLOVES

A great new extrication / rescue glove. Waterproof and breathable Hipora® barrier to protect hands from micro-organisms such as TB, Hepatitis, Staph and HIV meets O.S.H.A. Bloodborne Pathogens Standards (29CFR 1910.1030). Boxed finger tip design for better fit and comfort. Elastic cuff and gaiter to keep out glass and debris. Molded TPR (Thermal Plastic Rubber) knuckle reduces impact, increases dexterity and features 3M™ Reflective fabric. Molded TPR finger knuckle and finger tip panels. Cut resistant Kevlar® palm and thumb panels, side panels and finger panels. Kevlar® stitching in high wear areas.

	Color	Size	
2022327xx	High-Viz	S, M, L, XL, XXL, XXXL	\$72.00



RIGGING GLOVE

Mesh Shell / Amara™ Palm

Breathable Mesh for increased ventilation. Smooth surface thumb and index finger improve handling of objects. Reinforced thumb and fingertips increase protection and reduce wear. Neoprene knuckle panel provides increased flexibility and protection. Anatomically cut, foam-padded palm lessens impacts and reduces vibration. Soft, flexible, durable and breathable synthetic leather palm. Easy entry, wide opening elastic cuff. Pull cord on wrist for easy entry and for hanging gloves after use.

Weight: 3.2 oz.

	Size	
4902x1	S, M, L, XL, XXL	\$19.95



LEATHER 3/4 FINGER GLOVE

Genuine leather, extra gel-foam padding in palm. Great for rigging and stagehands. 2-way stretch spandex top. Flexible, soft, durable and breathable leather palm.

Weight: 3.2 oz.

	Size	
49061x1	S, M, L, XL, XXL	\$30.00



WARNING

Technical rescue and safety is potentially hazardous. Any person using equipment sold by RESCUE TECHNOLOGY in any manner is personally responsible for learning the proper techniques involved, and assumes all risks and accepts full and complete responsibility for any and all damages or injury of any kind, including death, which may result from the use of any RESCUE TECHNOLOGY equipment.

Products in this catalog can expose you to chemicals which are known to the State of California to cause cancer.
For information go to: www.p65warnings.ca.gov

RESCUETECH GLOVE SIZING

Measure around widest portion of the hand.

XSmall	5 - 7"	Large	9 - 10"
Small	7 - 8"	XLarge	10 - 11"
Medium	8 - 9"	XXLarge	11 - 13"



USAR KNEE AND ELBOW PADS

Great for use in building collapse searches. Velcro closure and tough cap. Provides heavy duty protection for the toughest jobs. Features durable thick flexible cap that provides traction, and resists skidding; and AltaLOK™ Easy On/Off Fastening System. Black cap and cordura nylon cover with compression recovery 1/2" Neoprene foam padding that provides firm, consistent support without bottoming out.

		Weight	
481611	Knee Pad, pair	13.7 oz.	\$41.00
481621	Elbow Pad, pair	7.2 oz.	\$28.00



ELASTIC GLOVE CINCH

Manufactured from durable stretch cord and high quality cordlock. Elastic holds gloves in place. Girth-hitch this Cinch around gear loops, waist belts, and D-rings to keep gloves ready to use.

491902	Elastic Glove Cinch	\$4.00
--------	---------------------	--------

REFLECTIVE HELMET LABELS

Reflective Labels that are a great addition to helmets. Reflectivity adds to safety and identification.

482101	"Rescue" Crescent	\$3.00
482104	"Fire Rescue" Crescent	\$3.00
482103	"Instructor" Crescent	\$3.00
482106	"Rescue Chief" Crescent	\$3.00
482107	"Rescue Squad" Crescent	\$3.00
482108	"Haz-Mat" Crescent	\$3.00
482109	"Chief" Crescent	\$3.00
482212	Stripe, 1" x 4", pair (YE)	\$3.00
482222	Trapezoid, Set of 5 (YE)	\$4.00
482111	Star of Life Decal	\$3.00



GLOVE STRAP

with Steel Trigger Snap

Manufactured from durable nylon webbing with plated steel trigger snap. Closes around glove with quality hook and loop fastener.

491901	Glove Strap	\$10.00
--------	-------------	---------

TECHNICAL RESCUE FIELD OPERATIONS GUIDE 5TH ED

by Tom Pendley

Contains over 150 high quality graphic illustrations, command checklists, and easy to follow, step-by-step procedures for rope rescue, confined space rescue, swiftwater rescue, trench rescue, structural collapse rescue, and helicopter rescue.



Dimensions: 4" x 6.5"

899120-6	Technical Rescue Ops Guide	\$30.00
----------	----------------------------	---------

TECHNICAL RESCUE RIGGERS GUIDE - 4TH ED

Contains dozens of illustrations and photographs to use as a quick reference for modern rope rescue techniques. This handy guide displays



Dimensions: 4" x 6"

899123-4	Technical Riggers Guide	\$35.00
----------	-------------------------	---------

pulley systems, tandem prusik belays, knots, bends, hitches, litter packaging, and much more. Note: This is not an instructional text, but rather a quick reference guide for trained personnel.

TRENCH RESCUE

A must read for those in trench rescue situations, this vital new resource demonstrates a systematic approach to safely and successfully carrying out a trench rescue operation. 258 pages. Over 300 step-by-step photos.

Dimensions: 8.5 x 11"

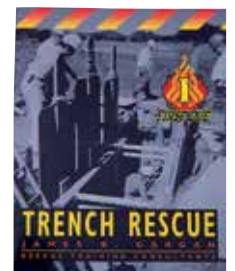

899119	Trench Rescue	\$80.00
--------	---------------	---------



Equipment not included.



COMMAND BOARD

The Accountability / Command board helps keep track of rescuers and organizes your incident command structure. Features an 18" x 24" dry erase board with the ICS structure screened on it. Includes Velcro strip for name tags and twin flashlight harnesses to light the board. Manufactured from padded Ballistic nylon, pockets for two radios or cell telephones and zippered pockets for clipboards, command vests, and writing utensils. The case will stand by itself or hang from a vehicle window or roof gutters to make a handy command station/table.

809801 Command Board **\$210.00**



	Description	Webbing, Fixed	Webbing, Adjuster	Body Color	Adjuster Color	MBS	
A. 139141841	Quick Adjust	45	45	Black	Black	16 kN*	\$5.50
B. 1318110	Clik-Lok	45mm	45mm	Black	Chrome	16 kN*	\$23.45
B. 1318111	Clik-Lok	45mm	45mm	Black	Black	16 kN*	\$23.45
B. 1318140	Clik-Lok	45mm	45mm	Red	Chrome	16 kN*	\$23.45
C. 1318410	Clik-Lok	25	25	Black	Chrome	16 kN*	\$19.95
C. 1318411	Clik-Lok	25	25	Black	Black	16 kN*	\$19.95
C. 1318440	Clik-Lok	25	25	Red	Chrome	16 kN*	\$19.95
D. 1318310	Clik-Lok	25	45	Black	Chrome	16 kN*	\$19.95
D. 1318340	Clik-Lok	25	45	Red	Chrome	16 kN*	\$19.95
E. 201460021	Aluminum D-Ring, Bent (BK)					25 kN	\$12.45
F. 201460011	Aluminum D-Ring, Straight (BK)					25 kN	\$12.45
G. 2014180100	Forged 2" Aluminum "O" Ring					25 kN	\$6.45
H. 2014180110	Forged 3" Aluminum "O" Ring					25 kN	\$7.45

* Single Leg Straight Pull



TRIAGE BELT

This unique belt is designed for use within the S.T.A.R.T. triage system. It utilizes four colors of specially formulated tape to categorize patients.

The triage officer simply tears off a piece of colored tape and ties it around the patients arm, which can be seen and understood from many yards away, unlike tags. The officer then tears a small piece of tape the same color and places it in the side pouch of the belt.

833100	Triage Belt	\$33.95
833111	Triage Tape, Black/White	\$3.95
833112	Triage Tape, Yellow	\$3.60
833114	Triage Tape, Red	\$3.60
833115	Triage Tape, Green	\$3.60



WARNING

Technical rescue and safety is potentially hazardous. Any person using equipment sold by RESCUE TECHNOLOGY in any manner is personally responsible for learning the proper techniques involved, and assumes all risks and accepts full and complete responsibility for any and all damages or injury of any kind, including death, which may result from the use of any RESCUE TECHNOLOGY equipment.

Products in this catalog can expose you to chemicals which are known to the State of California to cause cancer.

For information go to: www.p65warnings.ca.gov

DEWIPE WIPES DECONTAMINATION WIPES

De-Wipe is Scientifically Proven to Remove the Most Harmful Chlorinated Dioxins & PAHs Produced in Fire

De-Wipes can be used on equipment and skin to remove harmful chemicals from yourself and the workplace effectively. Dermatologically tested, they are suitable for use on all areas of the body- particularly the hands, face, ears, and areas around the neck and throat.

Scientifically Tested and proven on:

- 17 of the most toxic Chlorinated Dioxins
- 8 of the most toxic PAH's (Polycyclic Aromatic Hydrocarbons)
- Removes >91 percent Benzo[a]pyrene

Suitable for hands, face, ears, and around the neck and throat - plus wipe down any contaminated areas.

Be Proactive Protecting your Health

The recognition of carcinogens remaining on personal protective equipment (PPE) has resulted in a structured cleaning approach for potentially contaminated equipment in UK Fire and Rescue Services, but what about the person wearing this PPE?

Global studies have demonstrated that firefighters are up to three times more likely than the general population to develop cancer before age 75. This figure rises to five times where there is continuous exposure through a failure to properly clean off contaminants.

Benefits of De-Wipe

De-Wipe is an 'after the fire' wipe for use by first responders. De-Wipe has been designed and tested to provide immediate and long-lasting protection from hazardous contaminants for firefighters and first responders. De-Wipe addresses the risks associated with carcinogens while also avoiding potential skin damaging decontamination materials.

Careful consideration, testing, and development have resulted in the De-Wipe, a solution that is scientifically formulated and scientifically proven to help remove and reduce carcinogens and bacteria through its key ingredient, a proactive compound that defends the skin against hydrocarbons, soot, and dirt with ease.

What does De-Wipe Do?

Put simply, De-Wipe draws out impurities and cleans without drying out the skin. The after-fire decontamination wipe will help reduce the risk and dirt from the wrist and hands, face, ears, jaw and areas around the neck and throat. Additionally, they can also be used to wipe down any other contaminated areas after an event.

De-Wipes are 100% biodegradable so that you can be clean and green.

DE-WIPE Decontamination Wipes



A



B



C



D



E



		Color	
A	254713020	Individual Wipes, 12" x 8", Box of 20	\$20.50
B	25471403020	Individual Wipes, Multipack (40 wipes)	\$20.00
C	25474104	Hair & Body Wash, 4 Liter	\$89.00
D	254731080	Equipment Wipes (80 wipes)	\$29.00
E	25479101	Hair & Body Wash Dispenser	\$40.00
	25479102	Multipack Holder	\$26.00



HOSE/CABLE UMBILICAL

Zippered in Multiple Colors

New style zippered hose / cable protections. Durable YKK Zipper. Four colors to allow accurate selection of hose/cable/lifeline combinations. Length: 100 ft.

	Color	
303011001	Black	\$270.00
303011000	Orange	\$270.00
303011002	Yellow	\$270.00
303011006	Blue	\$270.00
303011004	Red	\$270.00



TECH1 CABLE BAG

Stores and allows for easy transport of your Hardline Cable. Holds 100 ft. - 300 ft. of Con-Space Cable. Cable not included.

Dimensions: 32" L x 11" W x 6" H

30303007	TECH1 Cable Bag	\$118.00
----------	-----------------	----------



HARNES RADIO HOLSTER

A holster that puts your hand-held radio where you need it – on the shoulder strap of your harness. Fully adjustable for radio circumference and height. Attaches with high strength hook and loop. User adjustable elastic sizes for the height of the radio and closes with a high strength Snap.

820307	Harness Radio Holster	\$37.00
--------	-----------------------	---------



Shown with HT-1250 Radio. (Not included)

DOUBLE RADIO CHEST HARNESS

Same suspension and adjustment as the Deluxe Radio Chest Harness. Carries two radios, one on each side of platform with a center pocket for extra batteries, etc. Second radio pocket can also carry GPS unit or cell phone.

Weight: 12 oz. Color: Black

820321	Double Radio Harness	\$90.00
--------	----------------------	---------



Shown with HT-1250 Radio. (Not included)

DELUXE RADIO CHEST HARNESS

One-Size-Fits-All radio harness will adjust to hold any radio snugly to your chest. The vertical orientation of the radio improves reception, extends antenna life, and reduces the chance of chest injury during a fall. The unique suspension system of 1.5" webbing shoulder straps and elastic chest strap, virtually guarantees that the harness will not bounce or swing, even while crawling through confined spaces. Twin buckles ease the donning of the elastic chest strap. The harness features a large bellows cargo pocket, pen pouch, and twin elastic antenna keepers.

Color: Black Weight: 9.6 oz.

820301	Deluxe Radio Chest Harness	\$72.00
--------	----------------------------	---------

WATERPROOF RADIO POUCH

Waterproof to 30 ft.

Total watertight protection, effectively and inexpensively, to hand-held VHF/UHF radios. Waterproofs your radio in seconds. Will float with radio inside. No loss of signal. Salt-water proof. UV-Stabilized. Operating temperatures: -25°C to +90° C. Complies with SOLAS.

		Dimensions	
811139	Standard	13" x 3.9" x 6.9"	\$39.95
811149	Large	15.7" x 5" x 7.9"	\$42.95



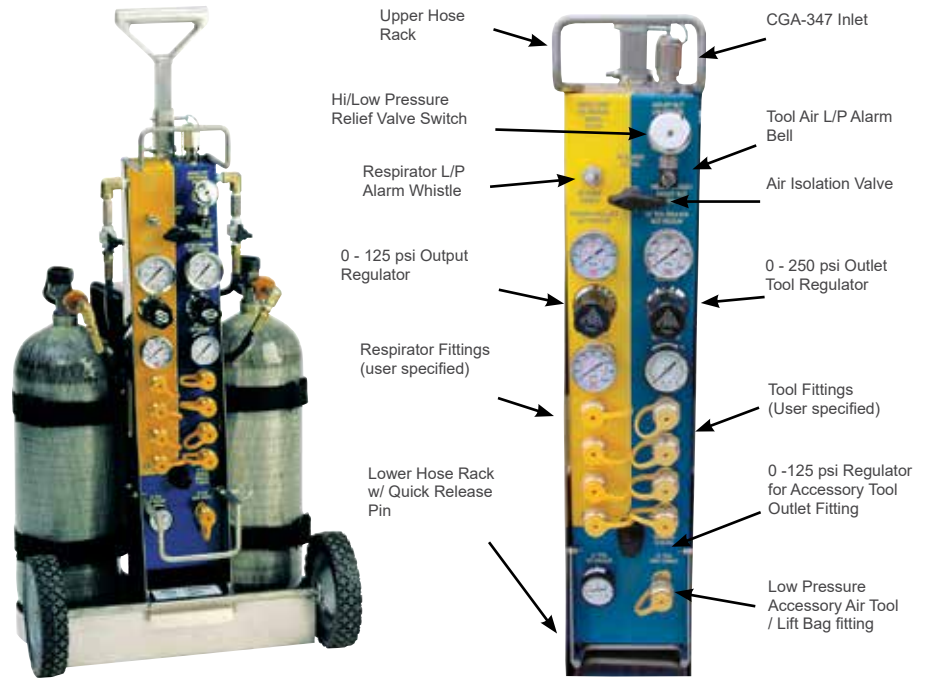

TECHNICAL RESCUE AIR CART

Simultaneous Respirator and Air Tool Operation

Separate high (275 psi) and low (125 psi) pressure regulated air systems. Additional high pressure inlet port allows connection to outside air source for extended use applications. High pressure isolation valve and toggle switch allows user to switch between common or isolated air sources. Operable via cylinder air or mobile air truck. The system includes two connecting hose whips with bleed valves and inline check valves, adjustable heavy duty high flow pressure regulator with relief valve, dual pressure gauges for cylinder and outlet pressure readings, low cylinder pressure alarm, breathing air manifold with quick-disconnect Hansen couplings. 275 psi or 125 psi pressure relief valve. 3 way selector valve allows operation with left cylinder, right cylinder, or High Pressure Inlet. Dimensions: 35" H x 20.5" W x 15" D. Weight: 54.5 lbs (without cylinders). Respirator Regulator: 0 - 5500 psi inlet; 0 - 125 psi outlet. Tool Regulator, High Pressure: 0 - 6000 psi inlet; 0 - 275 psi outlet. Tool Regulator, Low Pressure: 0 - 300 psi inlet; 0 - 125 psi outlet. Flow Rate: 80 cfm @ 120 psi. Outlet Fittings: four (4) 1/4" Quick-Disconnect Fittings. Accepts cylinders up to 4500 psi pressure rating.

Exceeds NIOSH guidelines for point of attachment.

2009114H	Technical Rescue Cart, 1/4" Hansen Fittings	\$5,195.00
2009225	25 ft. High Pressure Connect Whip (for Cascade)	\$525.00
2009119	Cart Cover	\$250.00



MACK NFPA AIR MANIFOLD

Air Distribution System Designed for Confined Space Rescue Teams

The MACK-NFPA series has been developed specifically for the Fire/Rescue teams working under NFPA guidelines. Two separate regulator/manifold systems provide 0-125 psi air to a four outlet respirator manifold. Two SCBA connect whips are provided for each regulator for SCBA cylinder attachment (not included). In the event of regulator malfunction, rescue can be performed on the standby regulator system. A CGA-347 high pressure inlet is also provided to allow continuous operation from truck mounted air cylinders. Low pressure alarm whistle and a 6 volt DC lamp to illuminate the case interior are standard. The MACKNFPA3, has a regulator isolation valve added to allow one or both air sources to be used simultaneously.

• Dual independent regulators with two 3-outlet manifolds • Dual low pressure alarms • 4 each 5 ft. connect whips • Regulator Isolation Valve • CGA-347 High Pressure Inlet

2009133NH	MACK-NFPA 3, Hansen Fittings	\$3,195.00
-----------	------------------------------	------------



AIR SUPPLY HOSE

High quality air supply hose with Hansen fittings to fit the Technical Rescue Air Cart.

20095457H	50'	\$180.00
20095458H	100'	\$260.00



RAMFAN UB20
8" Blower System

Provides the industry's highest certified CFM for either exhausting or discharging air with 8" duct. Easily attached 15 - 25 ft. duct canister works at either end or both ends. The UB-20 has RAMFAN's uniquely designed turbo blade which creates a straight, non-spiraling airflow. Motor: 1/3 hp, 60 Hz, 115 - 230 VAC, 2 amps. Optional DC motor. Manufactured of Double Wall lightweight, rugged polyethylene.

Dimensions: 13" H x 12" W x 13" D Weight: 16 lbs.
Performance measured by CEESI.

Airflow	1-90°	2-90°
Freeflow	1-90°	2-90°
980 cfm	789 cfm	666 cfm

3270015	AC Blower w/ 15 ft duct	\$661.00
3270025	AC Blower w/ 25 ft duct	\$681.00
329015	DC Blower w/ 15 ft duct	\$844.00
329025	DC Blower w/ 25 ft duct	\$864.00
325508	AC Blower ONLY, 115 v	\$461.00
329002	DC Blower ONLY, 12 v	\$644.00
3203605	DC Battery Connector, 5 ft.	\$144.00
32034214	UB20 DC Battery Pack Charger	\$1,118.00



RAMFAN ACCESSORIES

8" Duct		
320815	Standard Duct, 15 ft.	\$136.00
320825	Standard Duct, 25 ft.	\$160.00
320815C	Conductive Duct, 15 ft.	\$170.00
320825C	Conductive Duct, 25 ft.	\$250.00
3210108C	Duct Coupler, 8"	\$46.00
12" Duct		
3211215	Standard Duct, 15 ft.	\$206.00
3211225	Standard Duct, 25 ft.	\$352.00
3212215	Conductive Duct, 15 ft.	\$412.00
3212225	Conductive Duct, 25 ft.	\$675.00
3210112C	Duct Coupler, 12"	\$52.00
321015	Storage Bag, 8" x 25' Conductive	\$38.00



RAMFAN UB30
12" High Output Blower

A new 12" RAMFAN is born. Building on "UB" technology, the patent-pending UB30 is simply the toughest, most durable, easy to maintain and versatile blower in its class. Unmatched performance, dual voltage-dual frequency versatility, tough polymer shell and turbo-impeller design makes for an unbeatable package.

- Thermal Switch provides Overheat Protection • IP65 Rain Tested Switch Enclosure • Ultra Quiet Operation Low Starting Amps • Stackable Design Feature

Airflow	1-90°	2-90°
Freeflow	1-90°	2-90°
2,873 m3/hr	2,550 m3/hr	2,340 m3/hr

329102	12" UB30 Blower	\$900.00
3210112	12" - 8" Duct Adaptor	\$312.00



RAMFAN M.E.D. 8" BLOWER SYSTEM

Complete Confined Space System

Ready-built system for your confined space team. Available with Standard UB20 Blower or UB20XX Extreme hazard Blower and 5 ft. and 15 ft. duct.

220370152	20' System	\$1,144.00
327025XS-S	20' Hazard System	\$3,740.00
327025XS-K	20' Hazard System w/ Kil-Arc Plug	\$4,050.00



RAMFAN EXTREME HAZARD BLOWER

Same high quality blower mechanism as the standard UB20 with a conductive housing and duct. When properly grounded, the system virtually eliminates static discharges. Manufactured with Anti-Static housing. Totally enclosed hazardous location motor rated UL Class I, Group C,D; UL Class II, Group E,F, G. 30 ft. Cord w/ power switch.

Blower Dimensions: 13" H x 12" W x 13" D Blower Weight: 21 lbs.

Performance measured by CEESI. Plug not included.

3270115	8" UB-20XX w/ 15 ft duct AC	\$2,928.00
3270125	8" UB-20XX w/ 25 ft duct AC	\$3,163.00
3270102	8" UB-20XX Blower ONLY	\$2,233.00
327512X	12" Efi75XX Blower ONLY	\$2,526.00
3270115XK	UB-20XX w/15 ft duct/Kil-Arc Plug	\$3,300.00
3270125XK	UB-20XX w/25 ft duct/Kil-Arc Plug	\$3,550.00

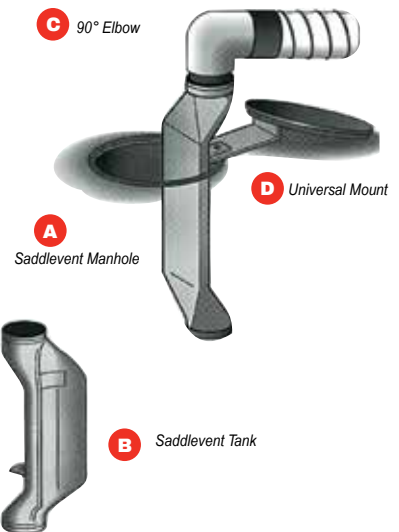

SADDLE VENT

For Use With 8" Duct

A. 3220189	Manhole, Std.	\$150.00
A. 3221189X	Manhole, Conductive	\$295.00
B. 3220189T	Tank, Std.	\$295.00
C. 3220190	90° Elbow	\$72.00
C. 3221190X	90° Elbow, Conductive	\$115.00
C. 3220190T	90° Elbow, Tank Style	\$100.00
D. 322098	Universal Mount	\$90.00