

DIMORE

MASIERO



# DIMORE

MASIERO

# Collections



**Bōzu**

16



**Cordea**

68



**Ebe**

160

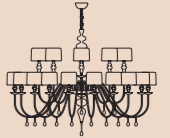

**Eva**

278



**Honicé**

214



**Horo**

202

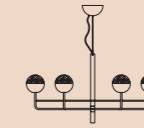

**Iglù**

186

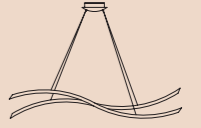

**Libe**

254



**Luppiter**

32



**Nappe**

90

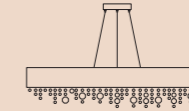

**Olà**

230



**Palm**

292

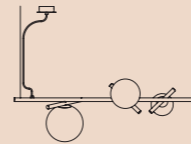

**Posy**

170

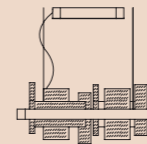

**Ribbon**

266

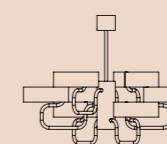

**Sound**

140

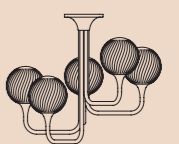

**Tee**

122



**Timeo**

304

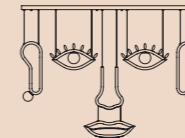

**Visio**

50



**Vollee**

316

# Suspension



**Bōzu**  
16



**Cordea**  
68

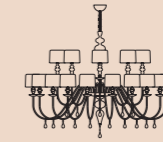

**Eva**  
278



**Honicé**  
214



**Horo**  
202

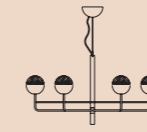

**Iglù**  
186



**Libe**  
254

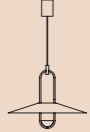

**Luppiter**  
32



**Nappe**  
90

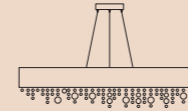

**Olà**  
230

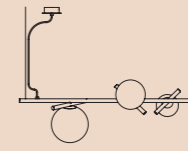

**Posy**  
170

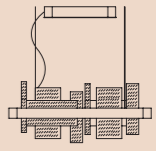

**Ribbon**  
266

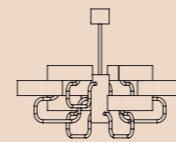

**Sound**  
140



**Tee**  
122



**Timeo**  
304

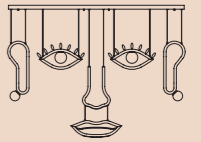

**Visio**  
50



**Vollee**  
316

# Applique

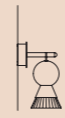

**Bōzu**  
16



**Ebe**  
160



**Eva**  
278

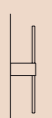

**Honicé**  
214



**Horo**  
202



**Iglù**  
186



**Libe**  
254



**Luppiter**  
32

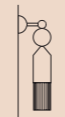

**Nappe**  
90

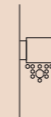

**Olà**  
230



**Palm**  
292

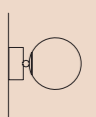

**Posy**  
170

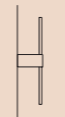

**Ribbon**  
266

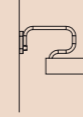

**Sound**  
140



**Tee**  
122



**Timeo**  
304



**Visio**  
50

# Ceiling



**Iglù**  
186

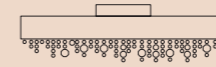

**Olà**  
230

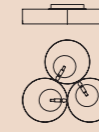

**Sound**  
140

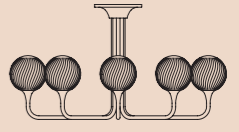

**Tee**  
122

# Table



**Bōzu**  
16



**Cordea**  
68



**Ebe**  
160

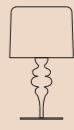

**Eva**  
278

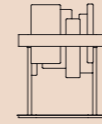

**Honicé**  
214



**Horo**  
202



**Iglù**  
186



**Luppiter**  
32

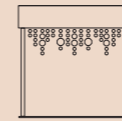

**Olà**  
230



**Posy**  
170

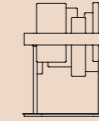

**Ribbon**  
266



**Sound**  
140



**Tee**  
122

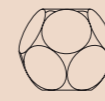

**Timeo**  
304



**Visio**  
50

# Floor



**Ebe**  
160



**Eva**  
278



**Honicé**  
214



**Horo**  
202



**Iglù**  
186



**Luppiter**  
32



**Nappe**  
90



**Olà**  
230



**Posy**  
170



**Ribbon**  
266



**Sound**  
140



**Tee**  
122



**Timeo**  
304



**Visio**  
50

# Collections



# Bōzu

IT Come un antico monaco avvolto di saggezza veglia silenzioso sul mondo Bōzu, nella sua perfetta sinuosità, brilla il calore di un tempo sospeso. Forme geometriche danzano tra di loro incastrandosi in una perfetta eleganza senza tempo, enfatizzata dall'utilizzo di materiali preziosi e finiture di pregio.

EN Like an ancient monk shrouded in wisdom silently watching over the world Bōzu, with its flawless curves, emanates the warmth of a suspended time. Geometric shapes intertwine gracefully, creating a timeless elegance elevated by the use of exquisite materials and refined finishes.

DESIGN BY  
SIGNOROTTO+PARTNERS

SUSPENSION  
APPLIQUE  
TABLE LAMP



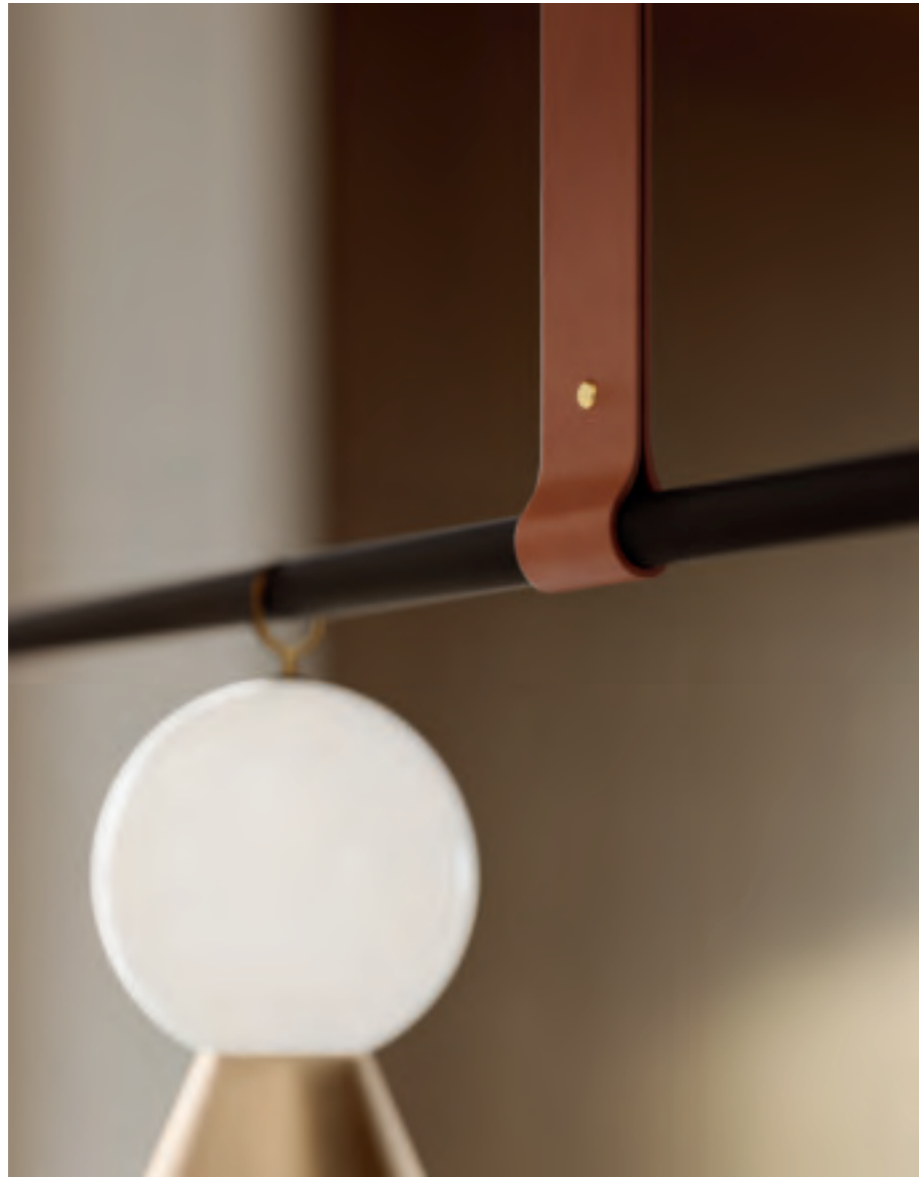









# Bōzu

Struttura in metallo galvanizzato e verniciato nero opaco. Diffusore in vetro triplex di Murano bianco opalino. Illuminazione led.

Galvanized and matt black painted metal frame. Opaline white Murano triplex glass diffuser. LED lighting.

Gestell aus galvanisch beschichtetem Metall, schwarz matt lackiert. Opalweißer Triplex-Diffusor aus Muranoglas. LED Leuchtsystem.

Estructura de metal galvanizado pintado de negro mate. Difusor de cristal triplex de Murano blanco opalino. Iluminación LED.

Structure en métal galvanisé peint en noir mat. Diffuseur triplex en verre de Murano blanc opalin. Éclairage à LED.

КАРКАС ИЗ МЕТАЛЛА С ГАЛЬВАНИЧЕСКИМ И МАТОВО-ЧЕРНЫМ ПОКРЫТИЕМ. РАССЕИВАТЕЛЬ ИЗ ТРЕХСЛОЙНОГО МУРАНСКОГО СТЕКЛА БЕЛОГО ОПАЛОВОГО ЦВЕТА. СВЕТОДИОДНОЕ ОСВЕЩЕНИЕ.

电镀金属灯体结构，刷哑光黑色漆。蛋白石白色穆拉诺三层玻璃灯罩。LED 灯。

BÖZU S1		CE	RoHS
ø	14 cm / 5.50"		
H	26 cm / 10.20"		
STANDARD INTEGRATED LED LIGHTING			
UP	4,7 W CRI>90 3000 K – 725 NOMINAL LM		
DOWN	4,7 W CRI>90 3000 K – 725 NOMINAL LM		
ON REQUEST			
UP	4,7 W CRI>90 2700 K – 672 NOMINAL LM		
DOWN	4,7 W CRI>90 2700 K – 672 NOMINAL LM		
DIMMABLE			
TRIAC			



BÖZU TL		CE	RoHS
ø	14 cm / 5.50"		
H	26 cm / 10.20"		
STANDARD INTEGRATED LED LIGHTING			
UP	6 W CRI>90 3000 K – 725 NOMINAL LM		
ON REQUEST			
UP	6 W CRI>90 2700 K – 672 NOMINAL LM		
DIMMABLE			
OWN BUTTON			



BÖZU A1		CE	RoHS
W	14 cm / 5.50"		
D	22 cm / 8.70"		
H	31 cm / 12.20"		
STANDARD INTEGRATED LED LIGHTING			
UP	4,7 W CRI>90 3000 K – 725 NOMINAL LM		
DOWN	4,7 W CRI>90 3000 K – 725 NOMINAL LM		
ON REQUEST			
UP	4,7 W CRI>90 2700 K – 672 NOMINAL LM		
DOWN	4,7 W CRI>90 2700 K – 672 NOMINAL LM		
DIMMABLE			
TRIAC			

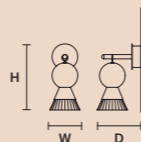

BÖZU C3 RD 40		CE	RoHS
ø	40 cm / 15.74"		
HMAX	160 cm / 63.00"		
STANDARD INTEGRATED LED LIGHTING			
UP	18 W CRI>90 3000 K – 2175 NOMINAL LM		
DOWN	18 W CRI>90 3000 K – 2175 NOMINAL LM		
ON REQUEST			
UP	18 W CRI>90 2700 K – 2016 NOMINAL LM		
DOWN	18 W CRI>90 2700 K – 2016 NOMINAL LM		
DIMMABLE			
0-10V			

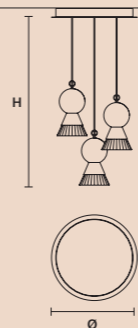

BÖZU C5 RD 60		CE	RoHS
ø	60 cm / 23.60"		
HMAX	160 cm / 63.00"		
STANDARD INTEGRATED LED LIGHTING			
UP	30 W CRI>90 3000 K – 3625 NOMINAL LM		
DOWN	30 W CRI>90 3000 K – 3625 NOMINAL LM		
ON REQUEST			
UP	30 W CRI>90 2700 K – 3360 NOMINAL LM		
DOWN	30 W CRI>90 2700 K – 3360 NOMINAL LM		
DIMMABLE			
0-10V			

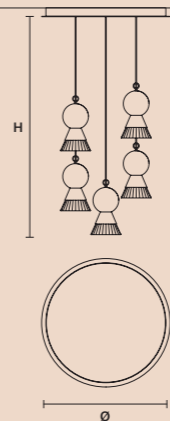

BÖZU C7 RD 80		CE	RoHS
ø	80 cm / 31.50"		
HMAX	160 cm / 63.00"		
STANDARD INTEGRATED LED LIGHTING			
UP	42 W CRI>90 3000 K – 5075 NOMINAL LM		
DOWN	42 W CRI>90 3000 K – 5075 NOMINAL LM		
ON REQUEST			
UP	42 W CRI>90 2700 K – 4704 NOMINAL LM		
DOWN	42 W CRI>90 2700 K – 4704 NOMINAL LM		
DIMMABLE			
0-10V			

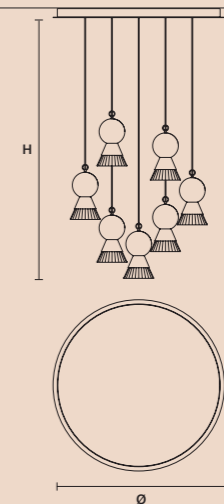

BÖZU S3 LN		CE	RoHS
W	160 cm / 63.00"		
D	14 cm / 5.50"		
H	26 cm / 10.20"		
STANDARD INTEGRATED LED LIGHTING			
UP	18 W CRI>90 3000 K – 2175 NOMINAL LM		
DOWN	18 W CRI>90 3000 K – 2175 NOMINAL LM		
ON REQUEST			
UP	18 W CRI>90 2700 K – 2016 NOMINAL LM		
DOWN	18 W CRI>90 2700 K – 2016 NOMINAL LM		
DIMMABLE			
0-10V			

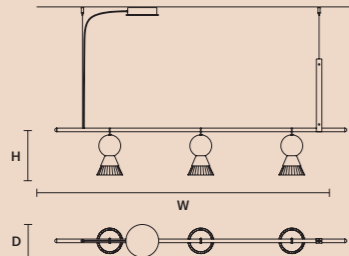

BÖZU S8 OV		CE	RoHS
W	168 cm / 66.10"		
D	72 cm / 27.50"		
H	26 cm / 10.20"		
STANDARD INTEGRATED LED LIGHTING			
UP	48 W CRI>90 3000 K – 5800 NOMINAL LM		
DOWN	48 W CRI>90 3000 K – 5800 NOMINAL LM		
ON REQUEST			
UP	48 W CRI>90 2700 K – 5376 NOMINAL LM		
DOWN	48 W CRI>90 2700 K – 5376 NOMINAL LM		
DIMMABLE			
0-10V			

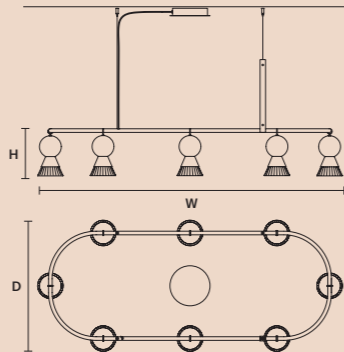

BÖZU S6 OV		CE	RoHS
W	120 cm / 47.25"		
D	72 cm / 27.50"		
H	26 cm / 10.20"		
STANDARD INTEGRATED LED LIGHTING			
UP	36 W CRI>90 3000 K – 4350 NOMINAL LM		
DOWN	36 W CRI>90 3000 K – 4350 NOMINAL LM		
ON REQUEST			
UP	36 W CRI>90 2700 K – 4032 NOMINAL LM		
DOWN	36 W CRI>90 2700 K – 4032 NOMINAL LM		
DIMMABLE			
0-10V			

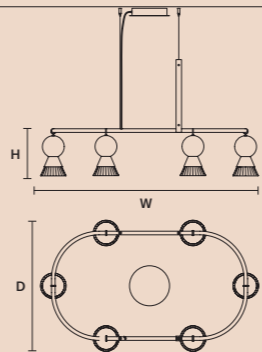

v90 Nero opaco  
Matt Black

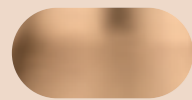

g26 Oro puro spazzolato  
Brushed pure gold



c01 Cuoio marrone  
Brown leather\*

\* ONLY FOR BÖZU S3 LN | S8 OV | S6 OV

DISCOVER MORE



## SINGLE CANOPIES

### SINGLE CANOPY

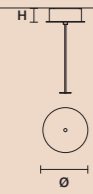

SIZE		FINISHINGS	PRODUCT NAME
Ø	12 cm / 4.70"	G26 + V91	BÖZU S1
H	4 cm / 1.60"		

### SINGLE CANOPY

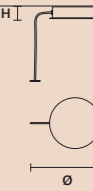

SIZE		FINISHINGS	PRODUCT NAME
Ø	18 cm / 7.10"	G26 + V91	BÖZU S3 LN
H	4 cm / 1.60"		

### SINGLE CANOPY



SIZE		FINISHINGS	PRODUCT NAME
Ø	22 cm / 8.70"	G26 + V91	BÖZU S6 OV
H	4 cm / 1.60"		BÖZU S8 OV

## MULTIPLE CANOPIES

### ROUND CANOPY RD 40

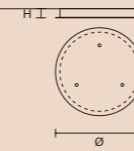

SIZE		FINISHINGS	PRODUCT NAME
Ø	40 cm / 15.70"	V91	BÖZU C3 RD 40
H	4 cm / 1.60"		

### ROUND CANOPY RD 60

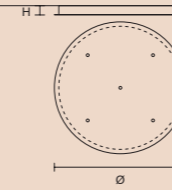

SIZE		FINISHINGS	PRODUCT NAME
Ø	60 cm / 23.60"	V91	BÖZU C5 RD 60
H	4 cm / 1.60"		

### ROUND CANOPY RD 80

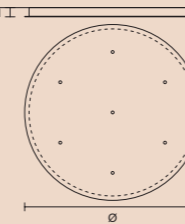

SIZE		FINISHINGS	PRODUCT NAME
Ø	80 cm / 31.50"	V91	BÖZU C7 RD 80
H	4 cm / 1.60"		

# Luppiter

IT Come un gioiello prezioso sospeso tra raffinatezza e armonia, sintesi modulare di elementi geometrici realizzati in diversi materiali e finiture, Luppiter brilla negli spazi di ogni dimensione.

EN A modular synthesis of geometric elements of different materials and finishes, Luppiter shines out in spaces of all sizes like a precious jewel suspended amidst refinement and harmony.

DESIGN BY  
MARCO ZITO

SUSPENSION  
APPLIQUE  
TABLE LAMP  
FLOOR LAMP













# Luppiter

Telaio in metallo verniciato con paralume in metallo e sfera disponibile in metallo o Alabastro. Illuminazione LED.

Painted metal frame with metal lampshade and sphere available in metal or Alabaster. LED lighting.

Gestell aus lackiertem Metall mit Lampenschirm aus Metall und Kugel aus Metall oder Alabaster. LED-Leuchtmittel.

Marco de metal pintado con pantalla de metal y esfera disponible en metal o alabastro. Iluminación LED.

Structure en métal avec abat-jour en métal et sphère disponible en métal ou en albâtre. Éclairage à LED.

КАРКАС ИЗ ОКРАШЕННОГО МЕТАЛЛА С МЕТАЛЛИЧЕСКИМ АБАЖУРОМ И СФЕРОЙ ИЗ МЕТАЛЛА ИЛИ АЛЕБАСТРА. СВЕТОДИОДНЫЙ СВЕТИЛЬНИК.

涂漆金属灯架，带金属灯罩，球体材质有金属或雪花石膏。LED 灯。

إطار معدني مطلي مع عاكس الضوء وكرة معدنية متوفرة بالمعدن أو المرمر. الإنارة ليد.

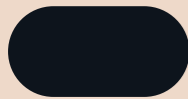

v90 Nero opaco Matt Black



g26 Oro puro spazzolato\* Brushed pure gold

\*INTERNAL SIDE V95



AL Alabastro Alabaster

DISCOVER MORE



LUPPITER S1 P 33		CE	RoHS
ø	33 cm / 13.00"		
H	31 cm / 12.20"		
STANDARD INTEGRATED LED LIGHTING			
UP	1,1 W CRI>90 3000 K – 140 NOMINAL LM		
DOWN	12,5 W CRI>90 3000 K – 1639 NOMINAL LM		
ON REQUEST			
UP	1,1 W CRI>90 2700 K – 130 NOMINAL LM		
DOWN	12,5 W CRI>90 2700 K – 1566 NOMINAL LM		
DIMMABLE			
1-10V + PUSH			

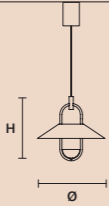

LUPPITER S1 M 33		CE	RoHS
ø	33 cm / 13.00"		
H	44 cm / 17.30"		
STANDARD INTEGRATED LED LIGHTING			
UP	1,1 W CRI>90 3000 K – 140 NOMINAL LM		
DOWN	12,5 W CRI>90 3000 K – 1639 NOMINAL LM		
ON REQUEST			
UP	1,1 W CRI>90 2700 K – 130 NOMINAL LM		
DOWN	12,5 W CRI>90 2700 K – 1566 NOMINAL LM		
DIMMABLE			
1-10V + PUSH			

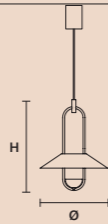

LUPPITER S1 G 33		CE	RoHS
ø	33 cm / 13.00"		
H	59 cm / 23.20"		
STANDARD INTEGRATED LED LIGHTING			
UP	1,1 W CRI>90 3000 K – 140 NOMINAL LM		
DOWN	12,5 W CRI>90 3000 K – 1639 NOMINAL LM		
ON REQUEST			
UP	1,1 W CRI>90 2700 K – 130 NOMINAL LM		
DOWN	12,5 W CRI>90 2700 K – 1566 NOMINAL LM		
DIMMABLE			
1-10V + PUSH			

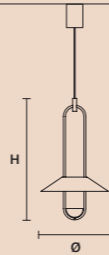

LUPPITER A1		CE	RoHS
W	11 cm / 4.30"		
D	12 cm / 4.70"		
H	42 cm / 16.50"		
STANDARD INTEGRATED LED LIGHTING			
8 W CRI>90 3000 K – 690 NOMINAL LM			
ON REQUEST			
8 W CRI>90 2700 K – 635 NOMINAL LM			
DIMMABLE			
TRIAC			



LUPPITER TL 111		CE	RoHS
ø	11 cm / 4.30"		
H	46 cm / 18.10"		
STANDARD INTEGRATED LED LIGHTING			
5 W CRI>90 3000 K – 526 NOMINAL LM			
ON REQUEST			
5 W CRI>90 2700 K – 515 NOMINAL LM			
DIMMABLE			
OWN BUTTON			



LUPPITER TL 133		CE	RoHS
ø	33 cm / 13.00"		
H	46 cm / 18.10"		
STANDARD INTEGRATED LED LIGHTING			
5 W CRI>90 3000 K – 526 NOMINAL LM			
ON REQUEST			
5 W CRI>90 2700 K – 515 NOMINAL LM			
DIMMABLE			
OWN BUTTON			

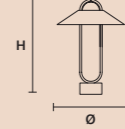

LUPPITER S1 P 55		CE	RoHS
ø	55 cm / 21.70"		
H	31 cm / 12.20"		
STANDARD INTEGRATED LED LIGHTING			
UP	1,1 W CRI>90 3000 K – 140 NOMINAL LM		
DOWN	12,5 W CRI>90 3000 K – 1639 NOMINAL LM		
ON REQUEST			
UP	1,1 W CRI>90 2700 K – 130 NOMINAL LM		
DOWN	12,5 W CRI>90 2700 K – 1566 NOMINAL LM		
DIMMABLE			
1-10V + PUSH			

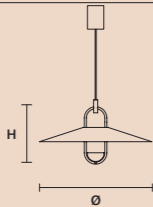

LUPPITER S1 M 55		CE	RoHS
ø	55 cm / 21.70"		
H	44 cm / 17.30"		
STANDARD INTEGRATED LED LIGHTING			
UP	1,1 W CRI>90 3000 K – 140 NOMINAL LM		
DOWN	12,5 W CRI>90 3000 K – 1639 NOMINAL LM		
ON REQUEST			
UP	1,1 W CRI>90 2700 K – 130 NOMINAL LM		
DOWN	12,5 W CRI>90 2700 K – 1566 NOMINAL LM		
DIMMABLE			
1-10V + PUSH			

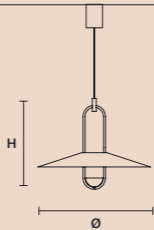

LUPPITER S1 G 55		CE	RoHS
ø	55 cm / 21.70"		
H	59 cm / 23.20"		
STANDARD INTEGRATED LED LIGHTING			
UP	1,1 W CRI>90 3000 K – 140 NOMINAL LM		
DOWN	12,5 W CRI>90 3000 K – 1639 NOMINAL LM		
ON REQUEST			
UP	1,1 W CRI>90 2700 K – 130 NOMINAL LM		
DOWN	12,5 W CRI>90 2700 K – 1566 NOMINAL LM		
DIMMABLE			
1-10V + PUSH			

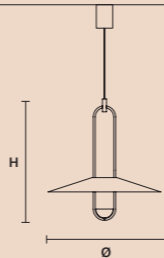

LUPPITER STL 133		CE	RoHS
ø	33 cm / 13.00"		
H	140 cm / 55.10"		
STANDARD INTEGRATED LED LIGHTING			
12,5 W CRI>90 3000 K – 1639 NOMINAL LM			
ON REQUEST			
12,5 W CRI>90 2700 K – 1566 NOMINAL LM			
DIMMABLE			
OWN BUTTON			



LUPPITER STL 111		CE	RoHS
ø	11 cm / 4.30"		
H	140 cm / 55.10"		
STANDARD INTEGRATED LED LIGHTING			
12,5 W CRI>90 3000 K – 1639 NOMINAL LM			
ON REQUEST			
12,5 W CRI>90 2700 K – 1566 NOMINAL LM			
DIMMABLE			
OWN BUTTON			



**LUPPITER C3 RD 60** 

∅ 60 cm / 23.60"  
H MAX 185 cm / 72.80"

**STANDARD INTEGRATED LED LIGHTING**

40,8 W CRI>90  
3000 K – 5337 NOMINAL LM

**ON REQUEST**

40,8 W CRI>90  
2700 K – 5088 NOMINAL LM

**DIMMABLE**

1-10V + PUSH + DALI

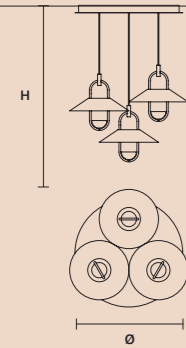

**LUPPITER C5 RD 80** 

∅ 80 cm / 31.50"  
H MAX 185 cm / 72.80"

**STANDARD INTEGRATED LED LIGHTING**

68 W CRI>90  
3000 K – 8895 NOMINAL LM

**ON REQUEST**

68 W CRI>90  
2700 K – 8480 NOMINAL LM

**DIMMABLE**

0-10V

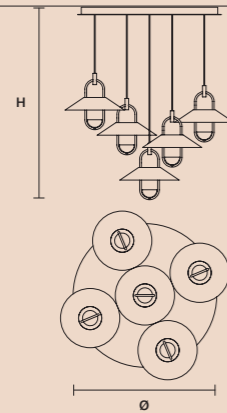

**LUPPITER C3 LN 125** 

W 125 cm / 49.20"  
D 33 cm / 13.00"  
H MAX 185 cm / 72.80"

**STANDARD INTEGRATED LED LIGHTING**

40,8 W CRI>90  
3000 K – 5337 NOMINAL LM

**ON REQUEST**

40,8 W CRI>90  
2700 K – 5088 NOMINAL LM

**DIMMABLE**

1-10V + PUSH + DALI

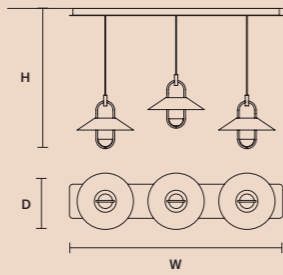

**LUPPITER C5 LN 175** 

W 175 cm / 68.90"  
D 33 cm / 13.00"  
H MAX 185 cm / 72.80"

**STANDARD INTEGRATED LED LIGHTING**

68 W CRI>90  
3000 K – 8895 NOMINAL LM

**ON REQUEST**

68 W CRI>90  
2700 K – 8480 NOMINAL LM

**DIMMABLE**

0-10V

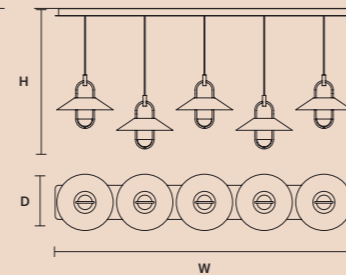

## SINGLE CANOPIES

### SINGLE CANOPY



SIZE		FINISHINGS	PRODUCT NAME
Ø	8,5 cm / 3.30"	● V91	LUPPITER S1 P 33
H	11,5 cm / 4.50"		LUPPITER S1 M 33
			LUPPITER S1 G 33
			LUPPITER S1 P 55
			LUPPITER S1 M 55
			LUPPITER S1 G 55

## MULTIPLE CANOPIES

### LINEAR CANOPY LN 125

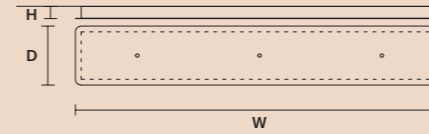

SIZE		FINISHINGS	PRODUCT NAME
W	125 cm / 49.20"	● V91	LUPPITER C3 LN 125
D	20 cm / 7.90"		
H	4 cm / 1.60"		

### LINEAR CANOPY LN 175

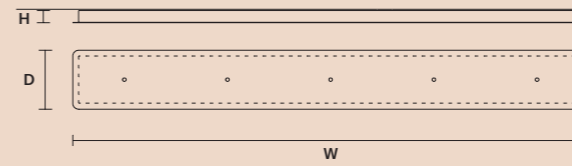

SIZE		FINISHINGS	PRODUCT NAME
W	175 cm / 68.90"	● V91	LUPPITER C5 LN 175
D	20 cm / 7.90"		
H	4 cm / 1.60"		

### ROUND CANOPY RD 60

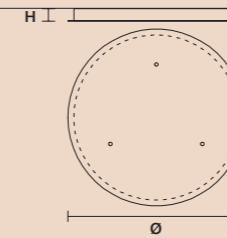

SIZE		FINISHINGS	PRODUCT NAME
Ø	60 cm / 23.60"	● V91	LUPPITER C3 RD 60
H	4 cm / 1.60"		

### ROUND CANOPY RD 80

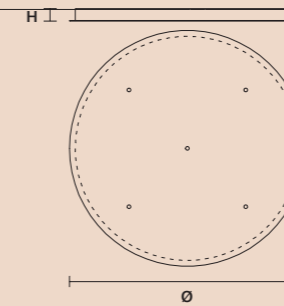

SIZE		FINISHINGS	PRODUCT NAME
Ø	80 cm / 31.50"	● V91	LUPPITER C5 RD 80
H	4 cm / 1.60"		

# Visio

IT Un echeggiare di richiami al mondo surrealista, strati di significato da scoprire a uno a uno nelle tante diverse configurazioni possibili delle geometrie facciali di Visio, un inno all'apparato iconografico e all'espressività del volto. Un vocabolario estetico, quello di Visio, in cui l'unione di misticismo e geometria creano variazioni imprevedibili sul tema dell'immaginazione.

EN An echo of allusions to the Surrealist world, layers of meaning to be discovered one by one in the many different possible configurations of Visio's facial geometries, an homage to the iconographic apparatus and expressiveness of the face. An aesthetic vocabulary, one of Visio, where the union of mysticism and geometry creates unpredictable variations on the theme of imagination.



"As Awarded by The Chicago Athenaeum: Museum of Architecture and Design"

DESIGN BY  
NAVA + AROSIO

SUSPENSION  
APPLIQUE  
TABLE LAMP  
FLOOR LAMP













# Visio

Struttura in metallo verniciato.  
Diffusore in vetro triplex di Murano  
bianco opalino. Illuminazione a Led.

Painted metal structure. Opal white  
Murano triplex glass diffuser. LED  
lighting.

Gestell aus lackiertem Metall.  
Schirm aus weissem Triplex-  
Opalglas aus Murano. LED-  
Leuchtmittel.

Estructura en metal pintado.  
Difusor de vidrio triplex de Murano  
blanco opalino. Iluminación led.

Structure en métal laqué. Diffuseur  
en verre triplex de Murano opale  
blanc. Éclairage LED.

Каркас из окрашенного металла.  
Плафоны из белого опалового  
муранского стекла триплекс.  
Светодиодное освещение.

涂色金属灯体结构。蛋白石白色穆拉  
诺三层玻璃灯罩。Led照明。

هيكل معدني مطلي. ناشر ضوء من زجاج ثلاثي  
أبيض مورانو أوبال. إضاءة ليد.

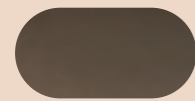

v87 Cioccolato Fondente  
Foundant Chocolate



Vetro triplex di Murano  
Triplex Murano glass

DISCOVER MORE



VISIO S FULL	
W	182 cm / 71.70"
D	12 cm / 4.70"
H	99 cm / 39.00"
STANDARD INTEGRATED LED LIGHTING	
	32,6 W CRI>90 3000 K – 3673 NOMINAL LM
ON REQUEST	
	32,6 W CRI>90 2700 K – 3489 NOMINAL LM
DIMMABLE	
	1-10V + PUSH

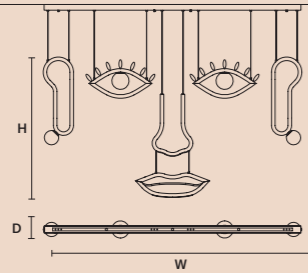

VISIO S M2	
W	28 cm / 11.00"
D	10 cm / 3.90"
H	61 cm / 24.00"
STANDARD INTEGRATED LED LIGHTING	
	5,5 W CRI>90 3000 K – 645 NOMINAL LM
ON REQUEST	
	5,5 W CRI>90 2700 K – 612 NOMINAL LM
DIMMABLE	
	NO



VISIO A SX	
W	117 cm / 46.10"
D	17 cm / 6.70"
H	99 cm / 39.00"
STANDARD INTEGRATED LED LIGHTING	
	21,6 W CRI>90 3000 K – 2383 NOMINAL LM
ON REQUEST	
	21,6 W CRI>90 2700 K – 2263 NOMINAL LM
DIMMABLE	
	NO

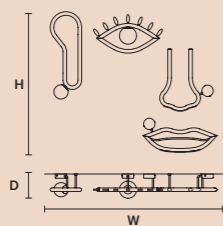

VISIO S 1/2	
W	117 cm / 46.10"
D	12 cm / 4.70"
H	99 cm / 39.00"
STANDARD INTEGRATED LED LIGHTING	
	21,6 W CRI>90 3000 K – 2383 NOMINAL LM
ON REQUEST	
	21,6 W CRI>90 2700 K – 2263 NOMINAL LM
DIMMABLE	
	1-10V + PUSH

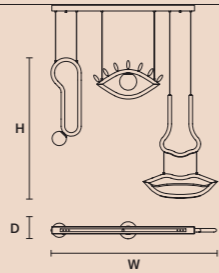

VISIO S M4	
W	52 cm / 20.50"
D	5 cm / 2.00"
H	18 cm / 7.10"
STANDARD INTEGRATED LED LIGHTING	
	6 W CRI>90 3000 K – 615 NOMINAL LM
ON REQUEST	
	6 W CRI>90 2700 K – 584 NOMINAL LM
DIMMABLE	
	NO



VISIO A DX	
W	117 cm / 46.10"
D	17 cm / 6.70"
H	99 cm / 39.00"
STANDARD INTEGRATED LED LIGHTING	
	21,6 W CRI>90 3000 K – 2383 NOMINAL LM
ON REQUEST	
	21,6 W CRI>90 2700 K – 2263 NOMINAL LM
DIMMABLE	
	NO

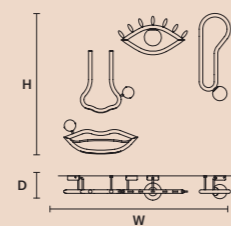

VISIO S M1	
W	48 cm / 18.90"
D	12 cm / 4.70"
H	27 cm / 10.60"
STANDARD INTEGRATED LED LIGHTING	
	5,5 W CRI>90 3000 K – 645 NOMINAL LM
ON REQUEST	
	5,5 W CRI>90 2700 K – 612 NOMINAL LM
DIMMABLE	
	NO

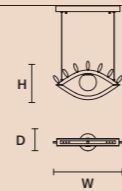

VISIO A FULL	
W	182 cm / 71.70"
D	17 cm / 6.70"
H	99 cm / 39.00"
STANDARD INTEGRATED LED LIGHTING	
	32,6 W CRI>90 3000 K – 3673 NOMINAL LM
ON REQUEST	
	32,6 W CRI>90 2700 K – 3489 NOMINAL LM
DIMMABLE	
	NO

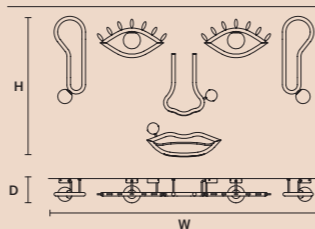

VISIO A M1	
W	48 cm / 18.90"
D	17 cm / 6.70"
H	27 cm / 10.60"
STANDARD INTEGRATED LED LIGHTING	
	5,5 W CRI>90 3000 K – 645 NOMINAL LM
ON REQUEST	
	5,5 W CRI>90 2700 K – 612 NOMINAL LM
DIMMABLE	
	NO

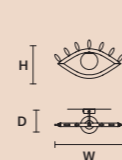

VISIO A M2 SX	
W	22 cm / 8.70"
D	16 cm / 6.30"
H	61 cm / 24.00"
STANDARD INTEGRATED LED LIGHTING	
	5,5 W CRI>90 3000 K – 645 NOMINAL LM
ON REQUEST	
	5,5 W CRI>90 2700 K – 612 NOMINAL LM
DIMMABLE	
	NO

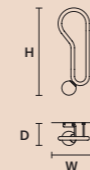

VISIO TL M1	
W	48 cm / 18.90"
D	25.5 cm / 10.00"
H	70 cm / 27.60"
STANDARD INTEGRATED LED LIGHTING	
	5,5 W CRI>90 3000 K – 645 NOMINAL LM
ON REQUEST	
	5,5 W CRI>90 2700 K – 612 NOMINAL LM
DIMMABLE	
	OWN BUTTON



VISIO STL M3	
ø	32 cm / 12.60"
H	155 cm / 61.00"
STANDARD INTEGRATED LED LIGHTING	
	4 W CRI>90 3000 K – 410 NOMINAL LM
ON REQUEST	
	4 W CRI>90 2700 K – 389 NOMINAL LM
DIMMABLE	
	OWN BUTTON

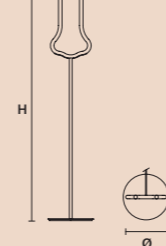

VISIO A M2 DX	
W	22 cm / 8.70"
D	16 cm / 6.30"
H	61 cm / 24.00"
STANDARD INTEGRATED LED LIGHTING	
	5,5 W CRI>90 3000 K – 645 NOMINAL LM
ON REQUEST	
	5,5 W CRI>90 2700 K – 612 NOMINAL LM
DIMMABLE	
	NO

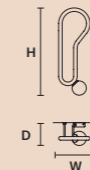

VISIO TL M4	
W	52 cm / 20.50"
D	25.5 cm / 10.00"
H	60 cm / 23.60"
STANDARD INTEGRATED LED LIGHTING	
	5,3 W CRI>90 3000 K – 546,6 NOMINAL LM
ON REQUEST	
	5,3 W CRI>90 2700 K – 519 NOMINAL LM
DIMMABLE	
	OWN BUTTON

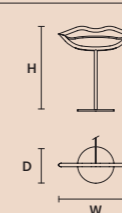

VISIO STL M4	
W	52 cm / 20.50"
D	32 cm / 12.60"
H	129 cm / 50.80"
STANDARD INTEGRATED LED LIGHTING	
	5,3 W CRI>90 3000 K – 546,6 NOMINAL LM
ON REQUEST	
	5,3 W CRI>90 2700 K – 519 NOMINAL LM
DIMMABLE	
	OWN BUTTON

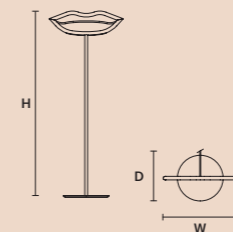

VISIO A M3	
W	37.5 cm / 14.80"
D	12 cm / 4.70"
H	43 cm / 16.90"
STANDARD INTEGRATED LED LIGHTING	
	4,6 W CRI>90 3000 K – 478 NOMINAL LM
ON REQUEST	
	4,6 W CRI>90 2700 K – 454 NOMINAL LM
DIMMABLE	
	NO

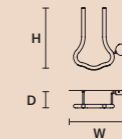

VISIO STL M1	
W	48 cm / 18.90"
D	32 cm / 12.60"
H	166.5 cm / 65.60"
STANDARD INTEGRATED LED LIGHTING	
	5,5 W CRI>90 3000 K – 645 NOMINAL LM
ON REQUEST	
	5,5 W CRI>90 2700 K – 612 NOMINAL LM
DIMMABLE	
	OWN BUTTON

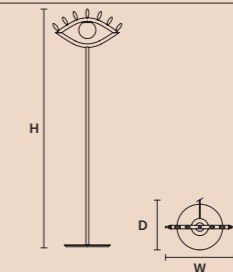

VISIO A M4	
W	52 cm / 20.50"
D	12 cm / 4.70"
H	24 cm / 9.40"
STANDARD INTEGRATED LED LIGHTING	
	6 W CRI>90 3000 K – 615 NOMINAL LM
ON REQUEST	
	6 W CRI>90 2700 K – 584 NOMINAL LM
DIMMABLE	
	NO

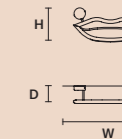

VISIO STL M2	
ø	32 cm / 12.60"
H	166 cm / 65.40"
STANDARD INTEGRATED LED LIGHTING	
	5,5 W CRI>90 3000 K – 645 NOMINAL LM
ON REQUEST	
	5,5 W CRI>90 2700 K – 612 NOMINAL LM
DIMMABLE	
	OWN BUTTON

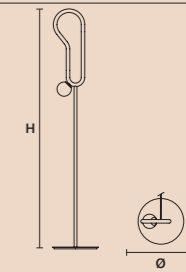

VISIO C3 M1 RD 60 

∅ 60 cm / 23.60"  
H MAX 150 cm / 59.10"

STANDARD INTEGRATED LED LIGHTING

16,5 W CRI>90  
3000 K – 1935 NOMINAL LM

ON REQUEST

16,5 W CRI>90  
2700 K – 1838 NOMINAL LM

DIMMABLE

1-10V + PUSH

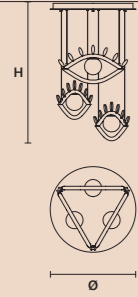

VISIO C3 M2 RD 40 

∅ 40 cm / 15.70"  
H MAX 150 cm / 59.10"

STANDARD INTEGRATED LED LIGHTING

16,5 W CRI>90  
3000 K – 1935 NOMINAL LM

ON REQUEST

16,5 W CRI>90  
2700 K – 1838 NOMINAL LM

DIMMABLE

1-10V + PUSH

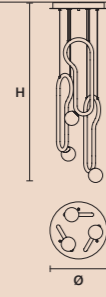

VISIO C5 RD 80 

∅ 80 cm / 31.50"  
H MAX 150 cm / 59.10"

STANDARD INTEGRATED LED LIGHTING

27,5 W CRI>90  
3000 K – 3225 NOMINAL LM

ON REQUEST

27,5 W CRI>90  
2700 K – 3063 NOMINAL LM

DIMMABLE

1-10V + PUSH

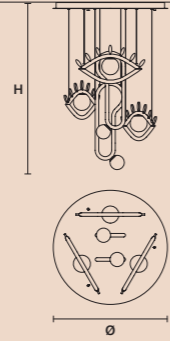

## SINGLE CANOPIES

### SINGLE CANOPY

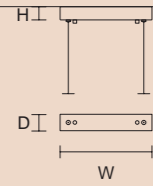

SIZE	FINISHINGS	PRODUCT NAME
W 28 cm / 11.00"	● V87	VISIO S M2
D 5 cm / 2.00"		VISIO S M4
H 4 cm / 1.60"		

### SINGLE CANOPY

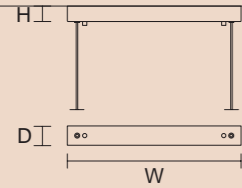

SIZE	FINISHINGS	PRODUCT NAME
W 45 cm / 17.70"	● V87	VISIO S M1
D 5 cm / 2.00"		
H 4 cm / 1.60"		

### SINGLE CANOPY

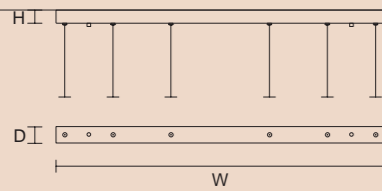

SIZE	FINISHINGS	PRODUCT NAME
W 100 cm / 39.40"	● V87	VISIO S 1/2
D 5 cm / 2.00"		
H 4 cm / 1.60"		

### SINGLE CANOPY

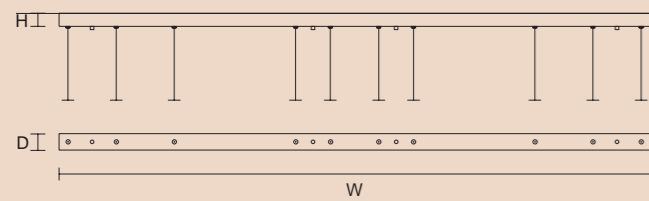

SIZE	FINISHINGS	PRODUCT NAME
W 180 cm / 70.90"	● V87	VISIO S FULL
D 5 cm / 2.00"		
H 4 cm / 1.60"		

## MULTIPLE CANOPIES

### ROUND CANOPY RD 40

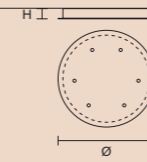

SIZE	FINISHINGS	PRODUCT NAME
Ø 40 cm / 15.70"	● V91	VISIO C3 M2 RD 40
H 4 cm / 1.60"		

### ROUND CANOPY RD 60

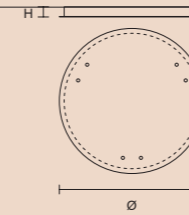

SIZE	FINISHINGS	PRODUCT NAME
Ø 60 cm / 23.60"	● V91	VISIO C3 M1 RD 60
H 4 cm / 1.60"		

### ROUND CANOPY RD 80

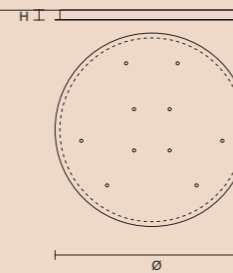

SIZE	FINISHINGS	PRODUCT NAME
Ø 80 cm / 31.50"	● V91	VISIO C5 RD 80
H 4 cm / 1.60"		

# Cordea

IT Cordea nasce dal desiderio di reinterpretare la classica lampada industriale a testa lamellare in alluminio, in chiave contemporanea sotto il punto di vista estetico e materico. Il telaio in metallo sapientemente forgiato è caratterizzato da un cinturino in cuoio a contrasto.

EN Cordea was born out of the desire to reinterpret the classic industrial lamp with an aluminium lamellar head in a contemporary way, from an aesthetic and material perspective. The expertly forged metal frame features a contrasting leather strap.



"As Awarded by The Chicago Athenaeum: Museum of Architecture and Design"

DESIGN BY  
FAVARETTO/PARTNERS

SUSPENSION  
TABLE LAMP















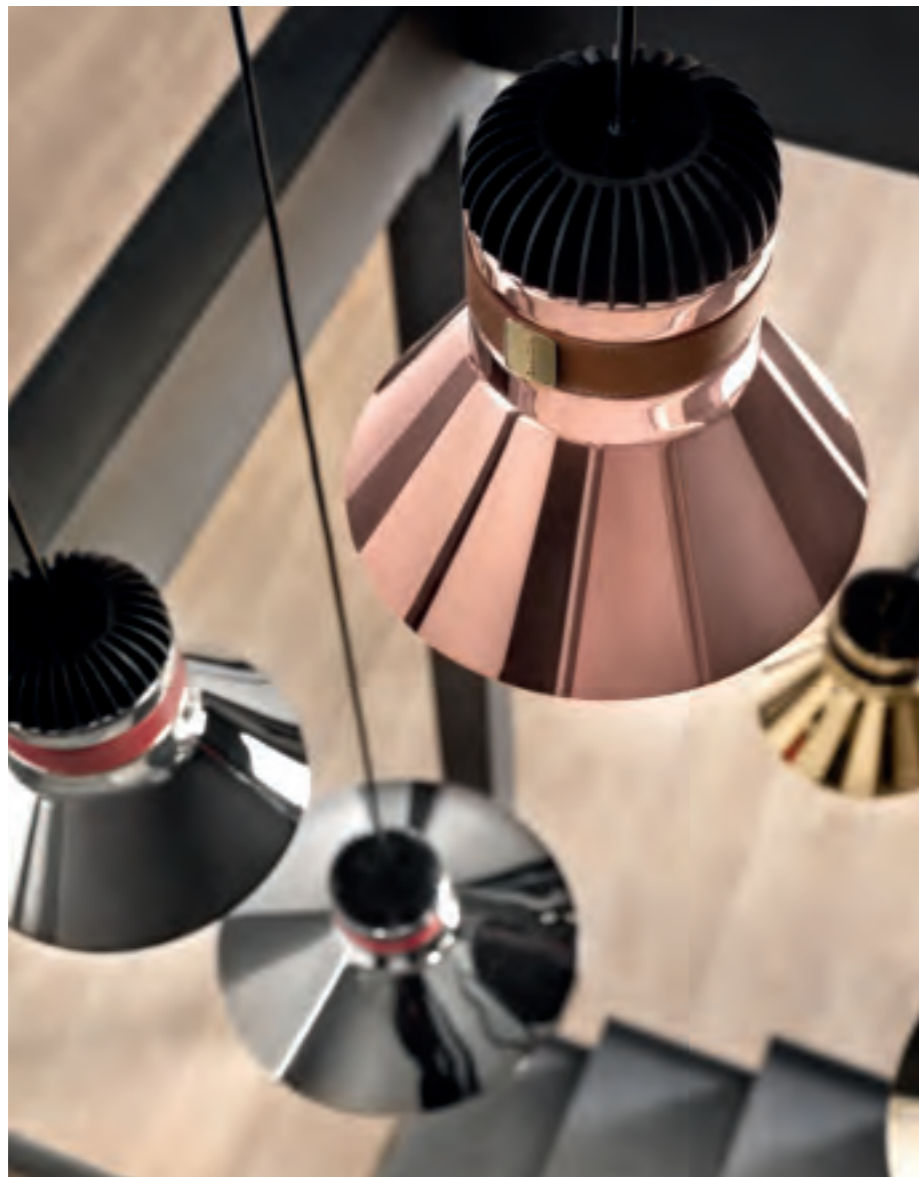

# Cordea

Struttura in metallo galvanizzato decorata con cinturino in cuoio. Diffusore in vetro satinato bianco. Illuminazione a Led.

Galvanised metal structure decorated with a leather strap. White frosted glass diffuser. LED lighting.

Gestell aus galvanisch beschichtetem Metall verziert mit einem Lederband. Schirm aus weissem satiniertem Glas. LED-Leuchtmittel.

Estructura de metal galvanizado decorada con correa de cuero. Difusor de vidrio satinado blanco. Iluminación Led.

Structure en métal galvanisé décorée d'un bracelet en caoutchouc. Diffuseur en verre satiné blanc. Éclairage LED.

КАРКАС ИЗ ОЦИНКОВАННОГО МЕТАЛЛА, ДЕКОР - КОЛЬЦО ИЗ КОЖИ. ПЛАФОН ИЗ БЕЛОГО САТИНИРОВАННОГО СТЕКЛА. СВЕТОДИОДНОЕ ОСВЕЩЕНИЕ.

饰有皮革条带的镀锌金属灯体结构。白色磨砂玻璃灯罩。Led照明。

هيكل معدني مجلفن مزين بحزام جلدي صغير. ناشر ضوء من الزجاج المصقول الأبيض. إضاءة ليد.

## BAND FINISHING



G22 Oro Pure gold



BL1 Black leather



G23 Nickel scuro Dark nickel



BL2 Brown leather



G24 Oro rosa Rose gold



BL3 Red leather



G26 Oro puro spazzolato Brushed pure gold



G27 Nickel scuro spazzolato Brushed dark nickel



G28 Oro rosa spazzolato Brushed rose gold

DISCOVER MORE



CORDEA S S		CE	RoHS	CE	RoHS
ø	14 cm / 5.50"				
H	11 cm / 4.30"				
STANDARD INTEGRATED LED LIGHTING					
5,4W - CRI>90					
3000 K - 688 NOMINAL LM					
ON REQUEST					
5,4W - CRI>90					
2700 K - 653 NOMINAL LM					
DIMMABLE					
NO					

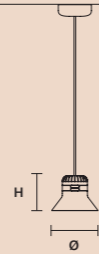

CORDEA S P		CCC	RoHS	CE	RoHS
ø	22 cm / 8.70"				
H	19 cm / 7.50"				
STANDARD INTEGRATED LED LIGHTING					
10 W CRI>90					
3000 K - 1510 NOMINAL LM					
ON REQUEST					
10 W CRI>90					
2700 K - 1270 NOMINAL LM					
DIMMABLE					
NO					



CORDEA S G		CCC	RoHS	CE	RoHS
ø	36 cm / 14.20"				
H	16 cm / 6.30"				
STANDARD INTEGRATED LED LIGHTING					
10 W CRI>90					
3000 K - 1510 NOMINAL LM					
ON REQUEST					
10 W CRI>90					
2700 K - 1270 NOMINAL LM					
DIMMABLE					
NO					

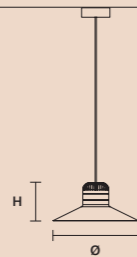

CORDEA TL S		CE
W	14 cm / 5.50"	
D	15 cm / 5.90"	
H	37 cm / 14.60"	
STANDARD INTEGRATED LED LIGHTING		
4,9 W CRI>90		
3000 K - 480 NOMINAL LM		
ON REQUEST		
4,9 W CRI>90		
2700 K - 430 NOMINAL LM		
DIMMABLE		
NO		

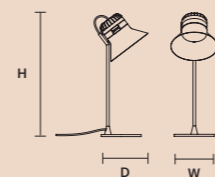

CORDEA C3 RD 40		CCC	RoHS	CE	RoHS
ø	50 cm / 19.70"				
H MAX	170 cm / 66.90"				
STANDARD INTEGRATED LED LIGHTING					
30 W CRI>90					
3000 K - 4530 NOMINAL LM					
ON REQUEST					
30 W CRI>90					
2700 K - 3810 NOMINAL LM					
DIMMABLE					
1-10V + PUSH					



CORDEA C3 RD 60		CCC	RoHS	CE	RoHS
ø	60 cm / 23.60"				
H MAX	170 cm / 66.90"				
STANDARD INTEGRATED LED LIGHTING					
30 W CRI>90					
3000 K - 4530 NOMINAL LM					
ON REQUEST					
30 W CRI>90					
2700 K - 3810 NOMINAL LM					
DIMMABLE					
1-10V + PUSH					



CORDEA C5 RD 80		CCC	RoHS	CE	RoHS
ø	80 cm / 31.50"				
H MAX	170 cm / 66.90"				
STANDARD INTEGRATED LED LIGHTING					
50 W CRI>90					
3000 K - 7550 NOMINAL LM					
ON REQUEST					
50 W CRI>90					
2700 K - 6350 NOMINAL LM					
DIMMABLE					
1-10V + PUSH + DALI					

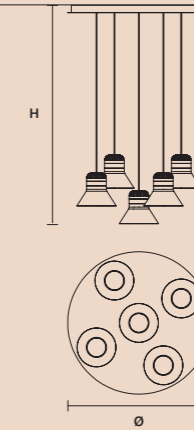

CORDEA C3 LN 75		CCC	RoHS	CE	RoHS
W	75 cm / 29.50"				
D	22 cm / 8.70"				
H MAX	170 cm / 66.90"				
STANDARD INTEGRATED LED LIGHTING					
30 W CRI>90					
3000 K - 4530 NOMINAL LM					
ON REQUEST					
30 W CRI>90					
2700 K - 3810 NOMINAL LM					
DIMMABLE					
1-10V + PUSH					

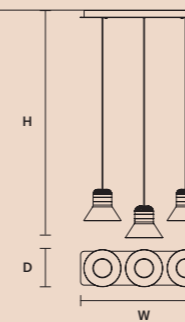

CORDEA C3 LN 125		CCC	RoHS	CE	RoHS
W	125 cm / 49.20"				
D	22 cm / 8.70"				
H MAX	170 cm / 66.90"				
STANDARD INTEGRATED LED LIGHTING					
30 W CRI>90					
3000 K - 4530 NOMINAL LM					
ON REQUEST					
30 W CRI>90					
2700 K - 3810 NOMINAL LM					
DIMMABLE					
1-10V + PUSH					

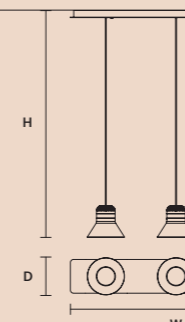

CORDEA C5 LN 175		CCC	RoHS	CE	RoHS
W	175 cm / 68.90"				
D	22 cm / 8.70"				
H MAX	170 cm / 66.90"				
STANDARD INTEGRATED LED LIGHTING					
50 W CRI>90					
3000 K - 7550 NOMINAL LM					
ON REQUEST					
50 W CRI>90					
2700 K - 6350 NOMINAL LM					
DIMMABLE					
1-10V + PUSH + DALI					

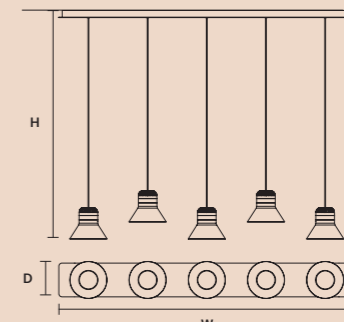

## SINGLE CANOPIES

### SINGLE CANOPY

SIZE	FINISHINGS	PRODUCT NAME
∅ 12 cm / 4.70"	● V91	CORDEA S P
H 4 cm / 1.60"		CORDEA S G

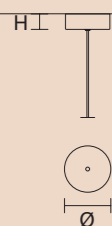

### SINGLE CANOPY

SIZE	FINISHINGS	PRODUCT NAME
∅ 10 cm / 3.90"	● V91	CORDEA S S
H 3,5 cm / 1.40"		

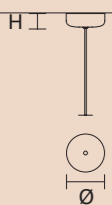

## MULTIPLE CANOPIES

### LINEAR CANOPY LN 75

SIZE	FINISHINGS	PRODUCT NAME
W 75 cm / 29.50"	● V91	CORDEA C3 LN 75
D 20 cm / 7.90"		
H 4 cm / 1.60"		

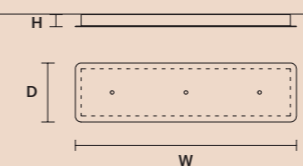

### LINEAR CANOPY LN 125

SIZE	FINISHINGS	PRODUCT NAME
W 125 cm / 49.20"	● V91	CORDEA C3 LN 125
D 20 cm / 7.90"		
H 4 cm / 1.60"		

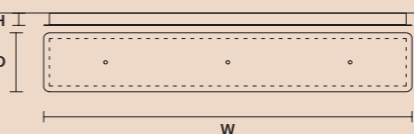

### LINEAR CANOPY LN 175

SIZE	FINISHINGS	PRODUCT NAME
W 175 cm / 68.90"	● V91	CORDEA C5 LN 175
D 20 cm / 7.90"		
H 4 cm / 1.60"		

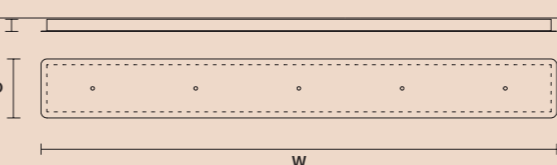

### ROUND CANOPY RD 40

SIZE	FINISHINGS	PRODUCT NAME
∅ 40 cm / 15.70"	● V91	CORDEA C3 RD 40
H 4 cm / 1.60"		

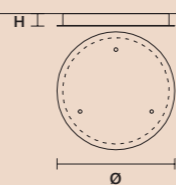

### ROUND CANOPY RD 60

SIZE	FINISHINGS	PRODUCT NAME
∅ 60 cm / 23.60"	● V91	CORDEA C3 RD 60
H 4 cm / 1.60"		

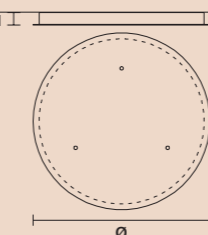





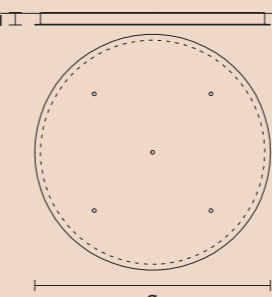







### ROUND CANOPY RD 80

SIZE	FINISHINGS	PRODUCT NAME
∅ 80 cm / 31.50"	● V91	CORDEA C5 RD 80
H 4 cm / 1.60"		



CORDEA COLOR SUGGESTIONS













Finishings

BAND	FRAME*			
BL1 Black leather	G22 Oro Pure gold	G23 Nickel scuro Dark nickel	G24 Oro rosa Rose gold	
				
BL2 Brown leather	G22 Oro Pure gold	G23 Nickel scuro Dark nickel	G24 Oro rosa Rose gold	
				
BL3 Red leather	G22 Oro Pure gold	G23 Nickel scuro Dark nickel	G24 Oro rosa Rose gold	
				

\* Internal side V10 Beige

CORDEA COLOR SUGGESTIONS

Finishings

BAND	FRAME*			
BL1 Black leather	G26 Oro puro spazzolato Brushed pure gold	G27 Nickel scuro spazzolato Brushed dark nickel	G28 Oro rosa spazzolato Brushed rose gold	
				
BL2 Brown leather	G26 Oro spazzolato Brushed pure gold	G27 Nickel scuro spazzolato Brushed dark nickel	G28 Oro rosa spazzolato Brushed rose gold	
				
BL3 Red leather	G26 Oro spazzolato Brushed pure gold	G27 Nickel scuro spazzolato Brushed dark nickel	G28 Oro rosa spazzolato Brushed rose gold	
				

\* Internal side V10 Beige

# Nappe

IT La collezione Nappe è espressione del legame dell'azienda con il territorio. Ispirata alle nappine, ornamento tipico dei salotti veneziani del passato, utilizzate per chiudere le tende. Dalla scomposizione e semplificazione dell'oggetto sono state stilizzate dieci diverse forme di nappa.

EN The Nappe collection is an expression of the company's close ties to the local area. It is inspired by the "nappine" (tassels), typically used to close curtains and adorn Venetian salons in the old days. Ten different tassel shapes have been stylised by disassembling and simplifying these decorative objects.

DESIGN BY  
MARCO ZITO

SUSPENSION  
APPLIQUE  
FLOOR LAMP







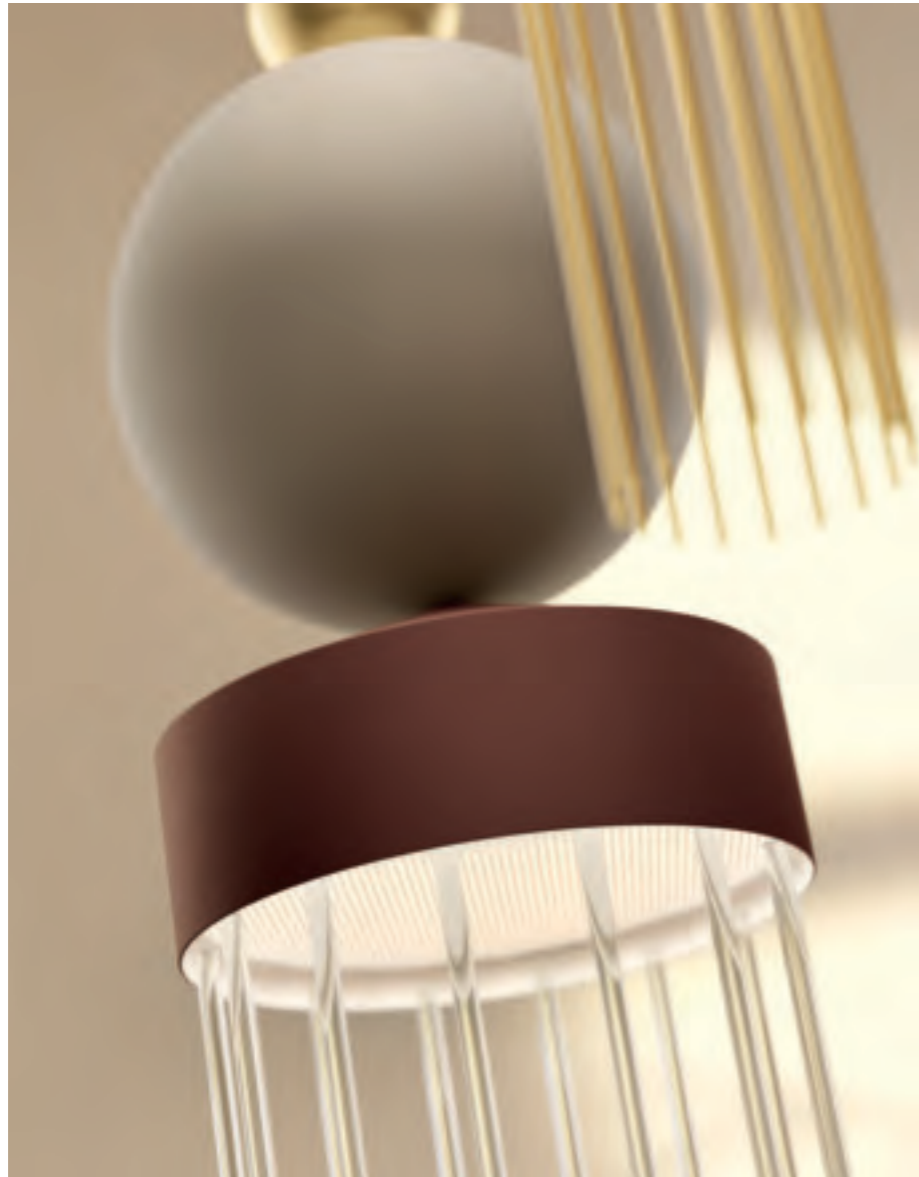

















# Nappe

Struttura in metallo verniciato con astine di metallo o Pyrex. Diffusori in Pyrex. Illuminazione a LED. Nappe XM e XL disponibili con inserti in cuoio.

Painted metal frame with metal or pyrex rods. Pyrex diffusers. LED lighting. Nappe XM and XL available with leather inserts.

Lackierte Metallstruktur mit Metall- oder Pyrex-Stäben. Pyrex-Diffusoren. LED-Beleuchtung. Nappe XM und XL mit Ledereinsätzen erhältlich.

Estructura de metal pintada con varillas metálicas o de Pyrex. Difusores de Pyrex. Iluminación LED. Nappe XM y XL disponibles con inserciones de cuero.

Structure en métal peint avec tiges en métal ou en pyrex. Diffuseurs en pyrex. Éclairage à LED. Nappe XM et XL sont disponibles avec des inserts en cuir.

Каркас из окрашенного металла с металлическими или стеклянными стержнями из пирекса. Рассеиватели из пирекса. Светодиодное освещение. Nappe XM и XL доступны с кожаными вставками.

这种灯具的结构是涂漆的金属，然而光扩散是小金属棒或玻璃做的。LED 照明。  
Nappe XM 和 XL 可提供皮革嵌饰。

هيكل معدني مطلي مع قضبان معدنية أو بيركس. ناشرات ضوء بيركس. إضاءة ليد. تتوفر Nappe XM و XL مزودة بولائح جلدية.

## FRAME FINISHINGS

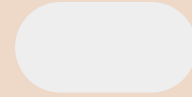

TOTAL WHITE  
v95 Bianco opaco  
Matt white

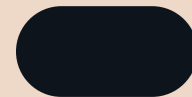

TOTAL BLACK  
v90 Nero opaco  
Matt Black



TOTAL COPPER\*  
g29 Rame spazzolato  
Brushed copper



MIXED COLD  
v95 + v21 + v51 + v72



MIXED WARM  
v35 + v70 + v84



BROWN LEATHER\*\*  
c01 + v70

\* NOT AVAILABLE FOR XM - XL VERSIONS  
\*\* ONLY FOR XM - XL VERSIONS  
\*\*\* ONLY FOR BROWN LEATHER

DISCOVER MORE



## METAL BEAMS



v93 Oro verniciato  
Painted gold



v95 Bianco opaco  
Matt white



g29 Rame spazzolato  
Brushed copper

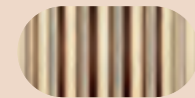

v70 Cemento\*\*\*  
Concrete

## DIFFUSER



Smoky Pyrex

## NAPPE METAL DETAILS



g18 Ottone spazzolato  
Brushed brass



g18 Ottone spazzolato  
Brushed brass



g18 Ottone spazzolato  
Brushed brass



g29 Rame spazzolato  
Brushed copper



g29 Rame spazzolato  
Brushed copper

## NAPPE XM - XL METAL DETAILS



f01 Foglia Oro  
Gold leaf



f01 Foglia Oro  
Gold leaf



v70 Cemento\*\*\*  
Concrete



v70 Cemento\*\*\*  
Concrete

## NAPPE N0

ø 7,5 cm / 3.00"  
H 34 cm / 13.40"

STANDARD INTEGRATED LED LIGHTING	
5,4 W CRI>90	3000 K - 688 NOMINAL LM
ON REQUEST	
5,4 W CRI>90	2700 K - 653 NOMINAL LM
DIMMABLE	
NO	



## NAPPE N1

ø 15 cm / 5.90"  
H 36 cm / 14.20"

STANDARD INTEGRATED LED LIGHTING	
5,4 W CRI>90	3000 K - 688 NOMINAL LM
ON REQUEST	
5,4 W CRI>90	2700 K - 653 NOMINAL LM
DIMMABLE	
NO	

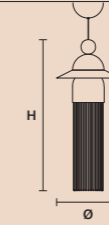

## NAPPE N2

ø 15 cm / 5.90"  
H 40 cm / 15.70"

STANDARD INTEGRATED LED LIGHTING	
5,4 W CRI>90	3000 K - 688 NOMINAL LM
ON REQUEST	
5,4 W CRI>90	2700 K - 653 NOMINAL LM
DIMMABLE	
NO	

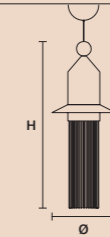

## NAPPE N3

ø 7,5 cm / 3.00"  
H 36 cm / 14.20"

STANDARD INTEGRATED LED LIGHTING	
5,4 W CRI>90	3000 K - 688 NOMINAL LM
ON REQUEST	
5,4 W CRI>90	2700 K - 653 NOMINAL LM
DIMMABLE	
NO	



## NAPPE N4

ø 7,5 cm / 3.00"  
H 38 cm / 15.00"

STANDARD INTEGRATED LED LIGHTING	
5,4 W CRI>90	3000 K - 688 NOMINAL LM
ON REQUEST	
5,4 W CRI>90	2700 K - 653 NOMINAL LM
DIMMABLE	
NO	



## NAPPE N5

ø 15 cm / 5.90"  
H 40 cm / 15.70"

STANDARD INTEGRATED LED LIGHTING	
5,4 W CRI>90	3000 K - 688 NOMINAL LM
ON REQUEST	
5,4 W CRI>90	2700 K - 653 NOMINAL LM
DIMMABLE	
NO	

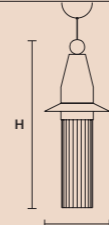

## NAPPE N6

ø 15 cm / 5.90"  
H 32 cm / 12.60"

STANDARD INTEGRATED LED LIGHTING	
5,4 W CRI>90	3000 K - 688 NOMINAL LM
ON REQUEST	
5,4 W CRI>90	2700 K - 653 NOMINAL LM
DIMMABLE	
NO	

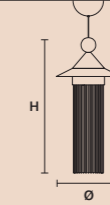

## NAPPE N7

ø 7,5 cm / 3.00"  
H 34 cm / 13.40"

STANDARD INTEGRATED LED LIGHTING	
5,4 W CRI>90	3000 K - 688 NOMINAL LM
ON REQUEST	
5,4 W CRI>90	2700 K - 653 NOMINAL LMC
DIMMABLE	
NO	

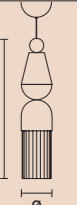

## NAPPE N8

ø 15 cm / 5.90"  
H 39 cm / 15.40"

STANDARD INTEGRATED LED LIGHTING	
5,4 W CRI>90	3000 K - 688 NOMINAL LM
ON REQUEST	
5,4 W CRI>90	2700 K - 653 NOMINAL LM
DIMMABLE	
NO	



## NAPPE N9

ø 7,5 cm / 3.00"  
H 39 cm / 15.40"

STANDARD INTEGRATED LED LIGHTING	
5,4 W CRI>90	3000 K - 688 NOMINAL LM
ON REQUEST	
5,4 W CRI>90	2700 K - 653 NOMINAL LM
DIMMABLE	
NO	



**NAPPE APP N2** 

W	15 cm / 5.90"
D	18 cm / 7.10"
H	42 cm / 16.50"

**STANDARD INTEGRATED LED LIGHTING**

UP	5,4 W CRI>90 3000 K - 688 NOMINAL LM
----	---

**ON REQUEST**

UP	5,4 W CRI>90 2700 K - 653 NOMINAL LM
----	---

**DIMMABLE**

NO
----

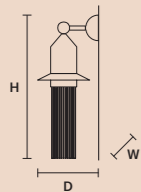

**NAPPE APP N4** 

W	7,5 cm / 3.00"
D	14 cm / 5.50"
H	40 cm / 15.70"

**STANDARD INTEGRATED LED LIGHTING**

UP	5,4 W CRI>90 3000 K - 688 NOMINAL LM
----	---

**ON REQUEST**

UP	5,4 W CRI>90 2700 K - 653 NOMINAL LM
----	---

**DIMMABLE**

NO
----

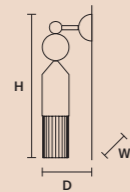

**NAPPE STL XM1** 

ø	30 cm / 11.80"
H	165 cm / 65.00"

**STANDARD INTEGRATED LED LIGHTING**

UP	9 W CRI>90 3000 K - 1520 NOMINAL LM
DOWN	4 W CRI>90 3000 K - 390 NOMINAL LM

**ON REQUEST**

UP	9 W CRI>90 2700 K - 1300 NOMINAL LM
DOWN	4 W CRI>90 2700 K - 335 NOMINAL LM

**DIMMABLE**

OWN BUTTON
------------

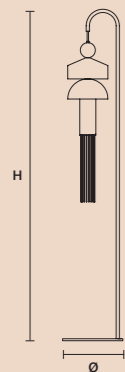

**NAPPE XM1** 

ø	20 cm / 7.90"
H	80 cm / 31.50"

**STANDARD INTEGRATED LED LIGHTING**

UP	9 W CRI>90 3000 K - 1520 NOMINAL LM
DOWN	4 W CRI>90 3000 K - 390 NOMINAL LM

**ON REQUEST**

UP	9 W CRI>90 2700 K - 1300 NOMINAL LM
DOWN	4 W CRI>90 2700 K - 335 NOMINAL LM

**DIMMABLE**

1-10V + PUSH
--------------



**NAPPE XM2** 

ø	24 cm / 9.45"
H	88 cm / 34.60"

**STANDARD INTEGRATED LED LIGHTING**

UP	9 W CRI>90 3000 K - 1520 NOMINAL LM
DOWN	4 W CRI>90 3000 K - 390 NOMINAL LM

**ON REQUEST**

UP	9 W CRI>90 2700 K - 1300 NOMINAL LM
DOWN	4 W CRI>90 2700 K - 335 NOMINAL LM

**DIMMABLE**

1-10V + PUSH
--------------



**NAPPE XM3** 

ø	20 cm / 7.90"
H	70 cm / 27.60"

**STANDARD INTEGRATED LED LIGHTING**

UP	9 W CRI>90 3000 K - 1520 NOMINAL LM
----	--

**ON REQUEST**

UP	9 W CRI>90 2700 K - 1300 NOMINAL LM
----	--

**DIMMABLE**

1-10V + PUSH
--------------



**NAPPE XL1** 

ø	30 cm / 11.80"
H	125 cm / 49.20"

**STANDARD INTEGRATED LED LIGHTING**

UP	6,6 W CRI>90 3000 K - 1150 NOMINAL LM
DOWN	9,2 W CRI>90 3000 K - 1450 NOMINAL LM

**ON REQUEST**

UP	6,6 W CRI>90 2700 K - 1092 NOMINAL LM
DOWN	9,2 W CRI>90 2700 K - 1370 NOMINAL LM

**DIMMABLE**

1-10V + DALI + PUSH
---------------------



**NAPPE XL2** 

ø	35 cm / 13.80"
H	135 cm / 53.10"

**STANDARD INTEGRATED LED LIGHTING**

UP	6,6 W CRI>90 3000 K - 1150 NOMINAL LM
DOWN	9,2 W CRI>90 3000 K - 1450 NOMINAL LM

**ON REQUEST**

UP	6,6 W CRI>90 2700 K - 1092 NOMINAL LM
DOWN	9,2 W CRI>90 2700 K - 1370 NOMINAL LM

**DIMMABLE**

1-10V + DALI + PUSH
---------------------



**NAPPE XL3** 

ø	30 cm / 11.80"
H	110 cm / 43.30"

**STANDARD INTEGRATED LED LIGHTING**

UP	12,2 W CRI>90 3000 K - 2000 NOMINAL LM
----	---

**ON REQUEST**

UP	12,2 W CRI>90 2700 K - 1900 NOMINAL LM
----	---

**DIMMABLE**

1-10V + DALI + PUSH
---------------------



NAPPE C3



<b>STANDARD INTEGRATED LED LIGHTING</b>
3 x 16,2 W CRI>90 3000 K - 2064 NOMINAL LM
<b>ON REQUEST</b>
3 x 16,2 W CRI>90 2700 K - 1960 NOMINAL LM
<b>DIMMABLE</b>
1-10V + PUSH

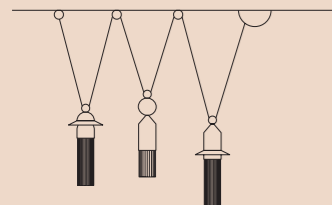

NAPPE C5



<b>STANDARD INTEGRATED LED LIGHTING</b>
5 x 27 W CRI>90 3000 K - 3440 NOMINAL LM
<b>ON REQUEST</b>
5 x 27 W CRI>90 2700 K - 3268 NOMINAL LM
<b>DIMMABLE</b>
1-10V + PUSH + DALI

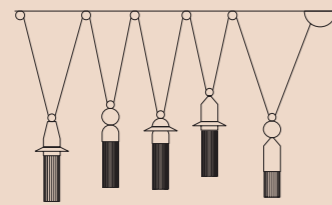

NAPPE C10



<b>STANDARD INTEGRATED LED LIGHTING</b>
10 x 54 W CRI>90 3000 K - 6880 NOMINAL LM
<b>ON REQUEST</b>
10 x 54 W CRI>90 2700 K - 6536 NOMINAL LM
<b>DIMMABLE</b>
1-10V + PUSH + DALI

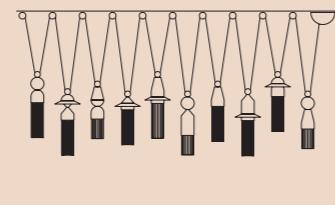

NAPPE C3 LN 75



W	75 cm / 29.50"
D	20 cm / 7.90"
H MAX	155 cm / 61.00"
<b>STANDARD INTEGRATED LED LIGHTING</b>	
3 x 16,2 W CRI>90 3000 K - 2064 NOMINAL LM	
<b>ON REQUEST</b>	
3 x 16,2 W CRI>90 2700 K - 1960 NOMINAL LM	
<b>DIMMABLE</b>	
1-10V + PUSH	

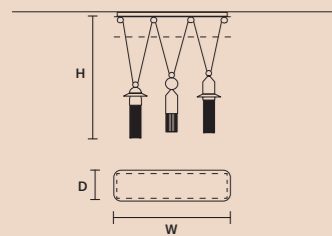

NAPPE C3 LN 125



W	125 cm / 49.20"
D	20 cm / 7.90"
H MAX	155 cm / 61.00"
<b>STANDARD INTEGRATED LED LIGHTING</b>	
3 x 16,2 W CRI>90 3000 K - 2064 NOMINAL LM	
<b>ON REQUEST</b>	
3 x 16,2 W CRI>90 2700 K - 1960 NOMINAL LM	
<b>DIMMABLE</b>	
1-10V + PUSH	

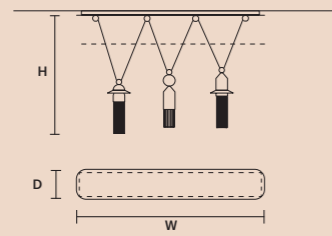

NAPPE C5 LN 175



W	175 cm / 68.90"
D	20 cm / 7.90"
H MAX	155 cm / 61.00"
<b>STANDARD INTEGRATED LED LIGHTING</b>	
5 x 27 W CRI>90 3000 K - 3440 NOMINAL LM	
<b>ON REQUEST</b>	
5 x 27 W CRI>90 2700 K - 3268 NOMINAL LM	
<b>DIMMABLE</b>	
1-10V + PUSH + DALI	

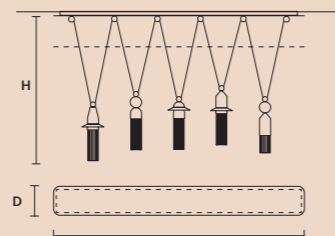

NAPPE C3 RD 40



∅	40 cm / 15.70"
H MAX	155 cm / 61.00"
<b>STANDARD INTEGRATED LED LIGHTING</b>	
3 x 16,2 W CRI>90 3000 K - 2064 NOMINAL LM	
<b>ON REQUEST</b>	
3 x 16,2 W CRI>90 2700 K - 1960 NOMINAL LM	
<b>DIMMABLE</b>	
1-10V + PUSH	

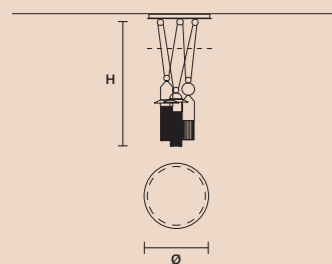

NAPPE C3 RD 60



∅	60 cm / 23.60"
H MAX	155 cm / 61.00"
<b>STANDARD INTEGRATED LED LIGHTING</b>	
3 x 16,2 W CRI>90 3000 K - 2064 NOMINAL LM	
<b>ON REQUEST</b>	
3 x 16,2 W CRI>90 2700 K - 1960 NOMINAL LM	
<b>DIMMABLE</b>	
1-10V + PUSH	

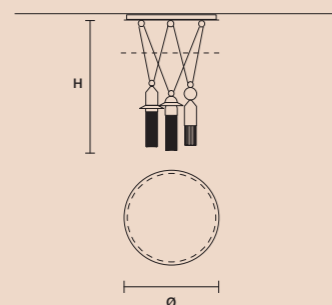

NAPPE C5 RD 80



∅	80 cm / 31.50"
H MAX	155 cm / 61.00"
<b>STANDARD INTEGRATED LED LIGHTING</b>	
5 x 27 W CRI>90 3000 K - 3440 NOMINAL LM	
<b>ON REQUEST</b>	
5 x 27 W CRI>90 2700 K - 3268 NOMINAL LM	
<b>DIMMABLE</b>	
1-10V + PUSH + DALI	

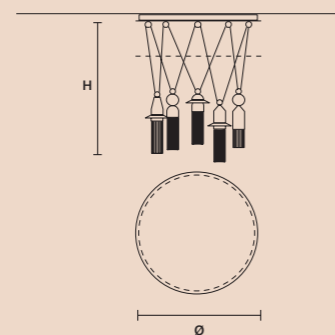

SUGGESTED CONFIGURATION FOR C3

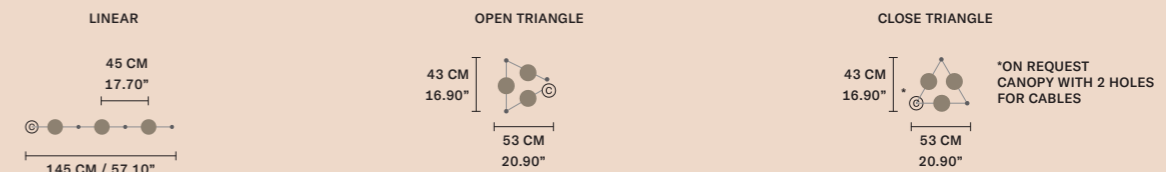

SUGGESTED CONFIGURATION FOR C5

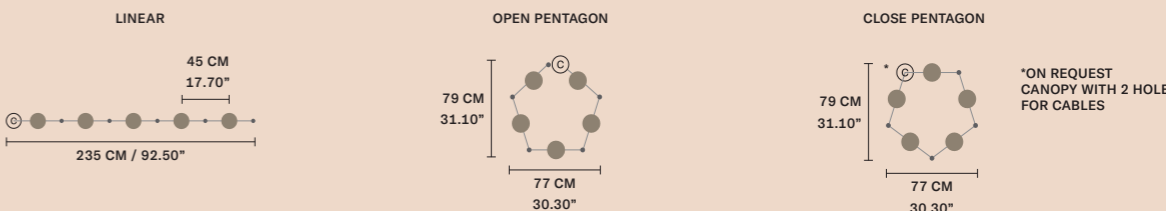

SUGGESTED CONFIGURATION FOR C10

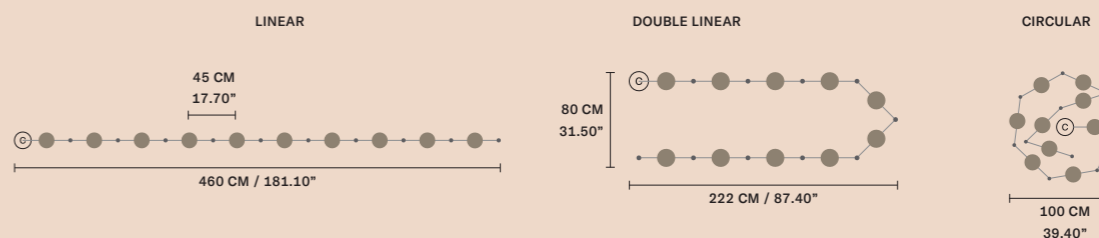

## SINGLE CANOPIES

### SINGLE CANOPY

SIZE	FRAME FINISHINGS	CANOPY FINISHINGS	PRODUCT NAME
∅ 10 cm / 3.90" H 5 cm / 2.00"	● V95	● G12	NAPPE N0-N1-N2-N3-N4
	● V72 ● V51 ● V21 ● V95	● G12	N5-N6-N7-N8-N9
	● V90	● G12	
	● V35 ● V70 ● V84	● G12	
	● G29	● G29	

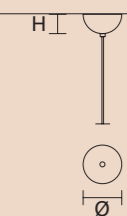

### SINGLE CANOPY

SIZE	FRAME FINISHINGS	CANOPY FINISHINGS	PRODUCT NAME
∅ 22,5 cm / 8.90" H 6 cm / 2.40"	● V95	● F01	NAPPE XL1 - XL2 - XL3
	● V90	● F01	NAPPE XL1 - XL2 - XL3
	● V35 ● V70 ● V84	● F01	NAPPE XL1 - XL2 - XL3
	● V72 ● V51 ● V21 ● V95	● V95	NAPPE XL1
	● V72 ● V51 ● V21 ● V95	● V72	NAPPE XL2
	● V72 ● V51 ● V21 ● V95	● V51	NAPPE XL3
	● C01 ● V70	● V70	NAPPE XL1 - XL2 - XL3

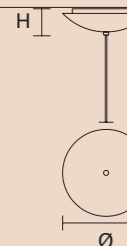

### SINGLE CANOPY

SIZE	FRAME FINISHINGS	CANOPY FINISHINGS	PRODUCT NAME
∅ 14 cm / 5.50" H 6 cm / 2.40"	● V95	● F01	NAPPE XM1 - XM2 - XM3
	● V90	● F01	NAPPE XM1 - XM2 - XM3
	● V35 ● V70 ● V84	● F01	NAPPE XM1 - XM2 - XM3
	● V72 ● V51 ● V21 ● V95	● V95	NAPPE XM1
	● V72 ● V51 ● V21 ● V95	● V72	NAPPE XM2
	● V72 ● V51 ● V21 ● V95	● V51	NAPPE XM3
	● C01 ● V70	● V70	NAPPE XM1 - XM2 - XM3



## MULTIPLE CANOPIES

### LINEAR CANOPY LN 75

SIZE	FINISHINGS	PRODUCT NAME
W 75 cm / 29.50" D 20 cm / 7.90" H 4 cm / 1.60"	● V98	NAPPE C3 LN 75

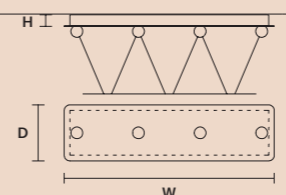

### LINEAR CANOPY LN 125

SIZE	FINISHINGS	PRODUCT NAME
W 125 cm / 49.20" D 20 cm / 7.90" H 4 cm / 1.60"	● V98	NAPPE C3 LN 125

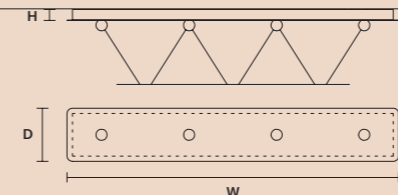

### LINEAR CANOPY LN 175

SIZE	FINISHINGS	PRODUCT NAME
W 175 cm / 68.90" D 20 cm / 7.90" H 4 cm / 1.60"	● V98	NAPPE C5 LN 175

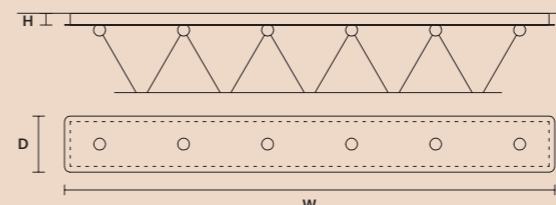

### ROUND CANOPY RD 40

SIZE	FINISHINGS	PRODUCT NAME
∅ 40 cm / 15.70" H 4 cm / 1.60"	● V98	NAPPE C3 RD 40

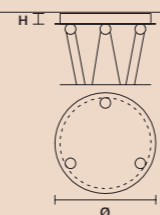

### ROUND CANOPY RD 60

SIZE	FINISHINGS	PRODUCT NAME
∅ 60 cm / 23.60" H 4 cm / 1.60"	● V98	NAPPE C3 RD 60

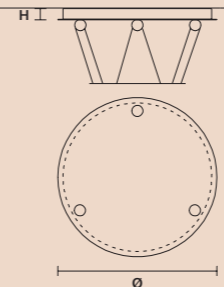

### ROUND CANOPY RD 80

SIZE	FINISHINGS	PRODUCT NAME
∅ 80 cm / 31.50" H 4 cm / 1.60"	● V98	NAPPE C5 RD 80

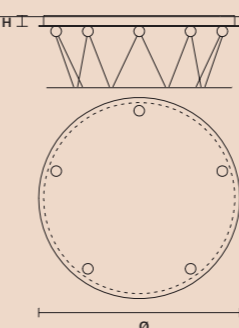

# Tee

IT Tee è un esercizio progettuale di ricerca tra rigore geometrico ed eleganza, contrassegnato esteticamente dalla linea curva. Sfere luminose animate da linee che richiamano la natura ondulatoria della luce e raccordate su steli curvati a foglia organica, ricordano la delicatezza del fiore di calla.

EN Tee is an exploratory design exercise which balances rigour and elegance, aesthetically distinguished by its curved form. Light spheres are brought to life by contours that reflect the undulating nature of light, connected on organically shaped stems, reminiscent of the gracefulness of the calla lily flower.

DESIGN BY  
VALERIO COMETTI  
+V12DESIGN

SUSPENSION  
CEILING  
APPLIQUE  
TABLE LAMP  
FLOOR LAMP

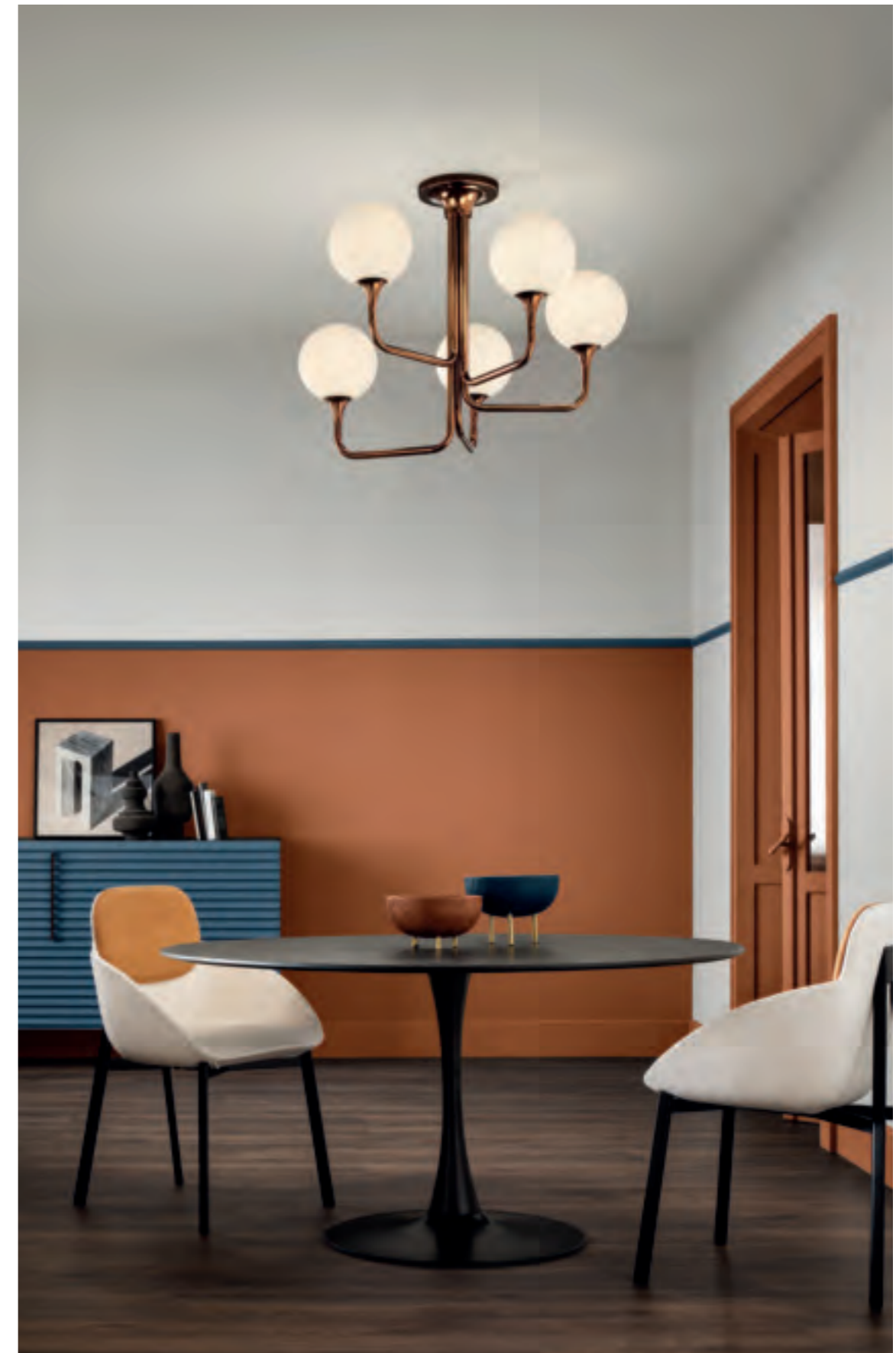





LIGHT OFF







# Tee

Struttura in metallo galvanizzato.  
Diffusori in vetro triplex di Murano.  
Illuminazione tradizionale.

Galvanised metal structure. Murano  
triplex glass diffusers. Traditional  
lighting.

Gestell aus galvanisch  
beschichtetem Metall. Schirme  
aus Triplex-Glas aus Murano.  
Herkömmliche Leuchtmittel.

Estructura de metal galvanizado.  
Difusores de cristal de Murano  
triplex. Iluminación tradicional.

Structure en métal galvanisé.  
Diffuseurs en verre triplex de  
Murano. Éclairage traditionnel.

Каркас из оцинкованного  
металла. Плафоны из  
муранского стекла триплекс.  
Традиционное освещение..

镀锌金属灯体结构。穆拉诺三层玻璃  
灯罩。传统照明。

هيكل من المعدن المجلفن. ناشرات ضوء من زجاج  
مورانو ثلاثي. إضاءة تقليدية.

## TEE S1 20

∅ 20 cm / 7.90"  
H 27 cm / 10.60"

### STANDARD LIGHTING

1×E14×15 W MAX (NOT INCL.)  
\* BULB MAX  
∅ 37 mm/1.50" W max 150 mm/5.90"



## TEE S1 30

∅ 30 cm / 11.80"  
H 37 cm / 14.60"

### STANDARD LIGHTING

1×E27×20 W MAX (NOT INCL.)  
\* BULB MAX  
∅ 62 mm/2.40" W max 185 mm/7.30"



## TEE PL8 RD 120

∅ 120 cm / 47.20"  
H 76,5 cm / 30.10"

### STANDARD LIGHTING

8×E14×15 W MAX (NOT INCL.)  
\* BULB MAX  
∅ 37 mm/1.50" W max 150 mm/5.90"

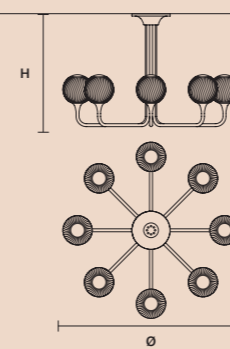

## TEE PL8 RD 160

∅ 167 cm / 65.70"  
H 83,5 cm / 32.90"

### STANDARD LIGHTING

8×E27×20 W MAX (NOT INCL.)  
\* BULB MAX  
∅ 62 mm/2.40" W max 185 mm/7.30"

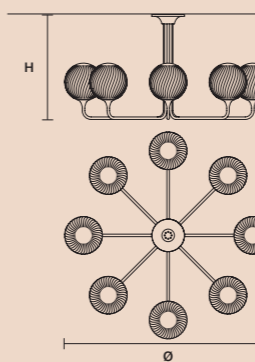

G25 Rame dorato  
Golden copper



Vetro triplex di Murano  
Triplex Murano glass

## TEE PL1 20

∅ 20 cm / 7.90"  
H 49 cm / 19.30"

### STANDARD LIGHTING

1×E14×15 W MAX (NOT INCL.)  
\* BULB MAX  
∅ 37 mm/1.50" W max 150 mm/5.90"



## TEE PL1 30

∅ 30 cm / 11.80"  
H 64 cm / 25.20"

### STANDARD LIGHTING

1×E27×20 W MAX (NOT INCL.)  
\* BULB MAX  
∅ 62 mm/2.40" W max 185 mm/7.30"

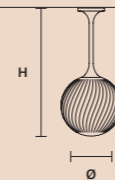

## TEE PL 4+4 RD 100

∅ 100 cm / 39.40"  
H 100 cm / 39.40"

### STANDARD LIGHTING

8×E14×15 W MAX (NOT INCL.)  
\* BULB MAX  
∅ 37 mm/1.50" W max 150 mm/5.90"

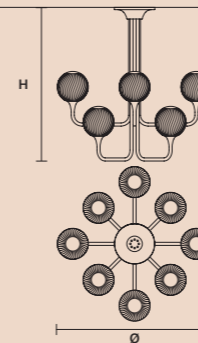

## TEE PL 5+5 RD 120

∅ 120 cm / 47.20"  
H 83.5 cm / 32.90"

### STANDARD LIGHTING

10×E14×15 W MAX (NOT INCL.)  
\* BULB MAX  
∅ 37 mm/1.50" W max 150 mm/5.90"

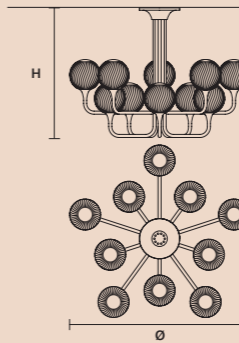

## TEE PL5

∅ 85 cm / 33.50"  
H 68 cm / 26.80"

### STANDARD LIGHTING

5×E14×15 W MAX (NOT INCL.)  
\* BULB MAX  
∅ 37 mm/1.50" W max 150 mm/5.90"

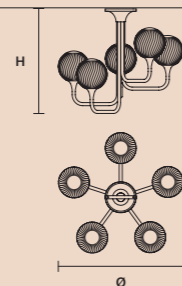

## TEE PL6 95

∅ 94 cm / 37.00"  
H 66,5 cm / 26.20"

### STANDARD LIGHTING

6×E14×15 W MAX (NOT INCL.)  
\* BULB MAX  
∅ 37 mm/1.50" W max 150 mm/5.90"

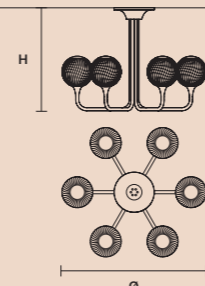

## TEE PL8 OV 120

∅ 120 cm / 47.20"  
D 80 cm / 31.50"  
H 63,5 cm / 25.00"

### STANDARD LIGHTING

8×E14×15 W MAX (NOT INCL.)  
\* BULB MAX  
∅ 37 mm/1.50" W max 150 mm/5.90"

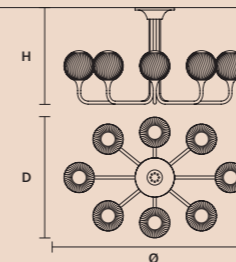

## TEE PL8 OV 160

∅ 160 cm / 63.00"  
D 107 cm / 42.10"  
H 63,5 cm / 25.00"

### STANDARD LIGHTING

8×E14×15 W MAX (NOT INCL.)  
\* BULB MAX  
∅ 37 mm/1.50" W max 150 mm/5.90"

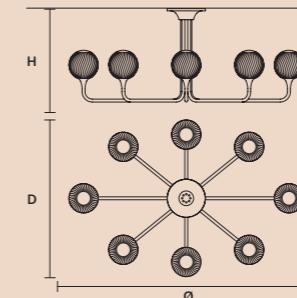

DISCOVER MORE





**TEE A1 20** 

W	20 cm / 7.90"
D	26 cm / 10.20"
H	41 cm / 16.10"

**STANDARD LIGHTING**

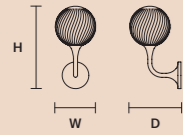
1×E14×15 W MAX (NOT INCL.)\*  
\* BULB MAX  
Ø 37 mm/1.50" W max 150 mm/5.90"



**TEE TL1 20** 

ø	20 cm / 7.90"
H	48 cm / 18.90"

**STANDARD LIGHTING**

1×E14×15 W MAX (NOT INCL.)\*  
\* BULB MAX  
Ø 37 mm/1.50" W max 150 mm/5.90"



**TEE STL1** 

ø	30 cm / 11.80"
H	160 cm / 63.00"

**STANDARD LIGHTING**

1×E27×20 W MAX (NOT INCL.)\*

\* BULB MAX  
Ø 62 mm/2.40" W max 185 mm/7.30"





**TEE STL3** 

W	52 cm / 20.50"
D	45 cm / 17.70"
H	170 cm / 66.90"

**STANDARD LIGHTING**

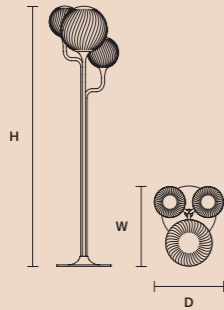
2×E14×15 W MAX (NOT INCL.)\*  
1 ×E27 x 20 W MAX (NOT INCL.)\*\*  
\* BULB MAX  
Ø 37 mm/1.50" W max 150 mm/5.90"  
\*\* BULB MAX  
Ø 62 mm/2.40" W max 185 mm/7.30"





**TEE C3 RD 40** 

ø	44 cm / 17.30"
H MAX	175 cm / 68.90"

**STANDARD LIGHTING**

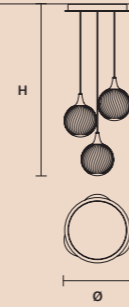
3×E14×15 W MAX (NOT INCL.)\*  
\* BULB MAX  
Ø 37 mm/1.50" W max 150 mm/5.90"





**TEE C5 RD 60** 

ø	62 cm / 24.40"
H MAX	175 cm / 68.90"

**STANDARD LIGHTING**

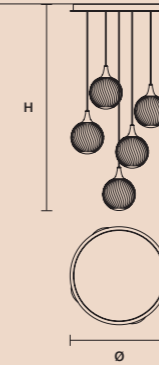
5×E14×15 W MAX (NOT INCL.)\*  
\* BULB MAX  
Ø 37 mm/1.50" W max 150 mm/5.90"





**TEE C7 RD 80** 

ø	80 cm / 31.50"
H MAX	175 cm / 68.90"

**STANDARD LIGHTING**

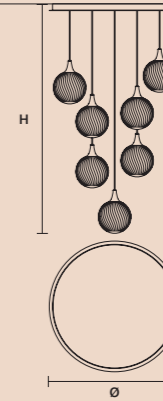
7×E14×15 W MAX (NOT INCL.)\*  
\* BULB MAX  
Ø 37 mm/1.50" W max 150 mm/5.90"



**TEE C3 LN 75** 

W	75 cm / 29.50"
D	20 cm / 7.90"
H MAX	175 cm / 68.90"

**STANDARD LIGHTING**

3×E14×15 W MAX (NOT INCL.)\*

\* BULB MAX  
Ø 37 mm/1.50" W max 150 mm/5.90"

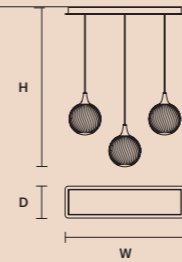

**TEE C5 LN 125** 

W	125 cm / 49.20"
D	20 cm / 7.90"
H MAX	175 cm / 68.90"

**STANDARD LIGHTING**

5×E14×15 W MAX (NOT INCL.)\*

\* BULB MAX  
Ø 37 mm/1.50" W max 150 mm/5.90"

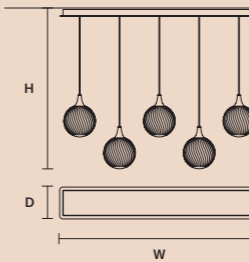

**TEE C7 LN 175** 

W	175 cm / 68.90"
D	20 cm / 7.90"
H MAX	175 cm / 68.90"

**STANDARD LIGHTING**

7×E14×15 W MAX (NOT INCL.)\*

\* BULB MAX  
Ø 37 mm/1.50" W max 150 mm/5.90"

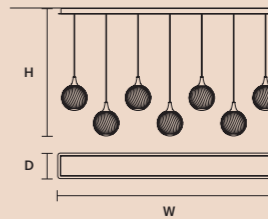

\*  : ONLY FOR THE US MARKET.

## SINGLE CANOPIES

### SINGLE CANOPY

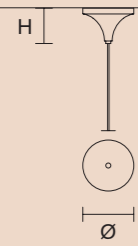

SIZE	FINISHINGS	PRODUCT NAME
Ø 13,2 cm / 5.20"	● G25	TEE S1 20
H 9 cm / 3.50"		TEE S1 30

## MULTIPLE CANOPIES

### LINEAR CANOPY LN 75

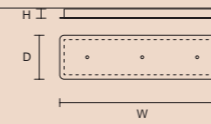

SIZE	FINISHINGS	PRODUCT NAME
W 75 cm / 29.50"	● V91	TEE C3 LN 75
D 20 cm / 7.90"		
H 4 cm / 1.60"		

### LINEAR CANOPY LN 125

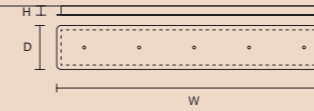

SIZE	FINISHINGS	PRODUCT NAME
W 125 cm / 49.20"	● V91	TEE C5 LN 125
D 20 cm / 7.90"		
H 4 cm / 1.60"		

### LINEAR CANOPY LN 175

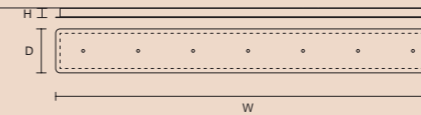

SIZE	FINISHINGS	PRODUCT NAME
W 175 cm / 68.90"	● V91	TEE C7 LN 175
D 20 cm / 7.90"		
H 4 cm / 1.60"		

### ROUND CANOPY RD 40

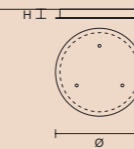

SIZE	FINISHINGS	PRODUCT NAME
Ø 40 cm / 15.70"	● V91	TEE C3 RD 40
H 4 cm / 1.60"		

### ROUND CANOPY RD 60

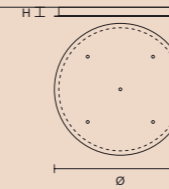

SIZE	FINISHINGS	PRODUCT NAME
Ø 60 cm / 23.60"	● V91	TEE C5 RD 60
H 4 cm / 1.60"		

### ROUND CANOPY RD 80

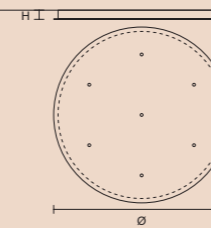

SIZE	FINISHINGS	PRODUCT NAME
Ø 80 cm / 31.50"	● V91	TEE C7 RD 80
H 4 cm / 1.60"		

# Sound

IT Che forma avrebbe il suono se fosse un prodotto? Sound ha un design che parla ai nostri sensi, illuminando la nostra mente e l'anima attraverso l'idea di un'armonica melodia progettuale. Il suono è un esperimento semantico formale. È una sinestesia. Sound è una combinazione di elementi circolari che evoca l'espansione delle onde sonore.

EN What form would sound take if it were a product? The design of Sound speaks to our senses, illuminating our minds and souls through the idea of a harmonious melody of design. Sound is a formal semantic experiment. It is a synaesthesia. Sound is a combination of circular elements evoking the expansion of sound waves.

DESIGN BY  
GIOVANNI BATTISTA  
GIANOLA

SUSPENSION  
CEILING  
APPLIQUE  
TABLE LAMP  
FLOOR LAMP

















# Sound

Struttura in metallo, diffusore in vetro decorato.

Metal frame, decorated glass diffuser.

Metallstruktur, Diffusor aus dekoriertem Glas.

Estructura de metal, difusor de vidrio condecorado.

Structure en métal, diffuseur en verre coloré.

Металлический каркас, рассеиватель из декорированного стекла.

这种灯具有金属结构, 而且光扩散是装饰玻璃做的。

هيكل معدني،  
ناشر ضوء زجاجي  
مزخرف.



G12 Oro spazzolato  
Brushed gold



G18 Ottone spazzolato+Nero opaco  
v90 Brushed brass+Matt black

DISCOVER MORE



SOUND S1	
ø	30 cm / 11.80"
H	60 cm / 23.60"
WITH ROD B**	
STANDARD LIGHTING	
1xG9x10 W MAX (NOT INCL.)*	
STANDARD INTEGRATED LED LIGHTING	
UP	4,4 W CRI>90 3000 K – 650 NOMINAL LM
DOWN	4,4 W CRI>90 3000 K – 650 NOMINAL LM
ON REQUEST	
UP	4,4 W CRI>90 2700 K – 553 NOMINAL LM
DOWN	4,4 W CRI>90 2700 K – 553 NOMINAL LM
DIMMABLE	
1-10V + PUSH	



SOUND S6	
ø	110 cm / 43.30"
H	102 cm / 40.20"
WITH ROD B**	
STANDARD LIGHTING	
6xG9x10 W MAX (NOT INCL.)*	
STANDARD INTEGRATED LED LIGHTING	
UP	26,5 W CRI>90 3000 K – 3900 NOMINAL LM
DOWN	26,5 W CRI>90 3000 K – 3900 NOMINAL LM
ON REQUEST	
UP	26,5 W CRI>90 2700 K – 3315 NOMINAL LM
DOWN	26,5 W CRI>90 2700 K – 3315 NOMINAL LM
DIMMABLE	
1-10V + DALI + PUSH	

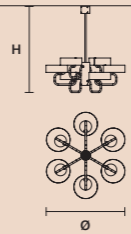

SOUND BIL5	
W	191 cm / 75.20"
D	64 cm / 25.20"
H	58 cm / 22.80"
WITH ROD B**	
STANDARD LIGHTING	
5xG9x10 W MAX (NOT INCL.)*	
STANDARD INTEGRATED LED LIGHTING	
UP	22 W CRI>90 3000 K – 3250 NOMINAL LM
DOWN	22 W CRI>90 3000 K – 3250 NOMINAL LM
ON REQUEST	
UP	22 W CRI>90 2700 K – 2762 NOMINAL LM
DOWN	22 W CRI>90 2700 K – 2762 NOMINAL LM
DIMMABLE	
1-10V + DALI + PUSH	

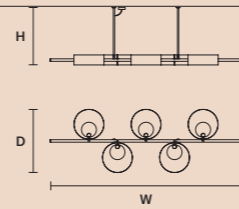

SOUND PL3	
W	60 cm / 23.60"
D	56 cm / 22.00"
H	14 cm / 5.50"
WITH ROD B**	
STANDARD LIGHTING	
3xG9x10 W MAX (NOT INCL.)*	
STANDARD INTEGRATED LED LIGHTING	
DOWN	13,5 W CRI>90 3000 K – 1950 NOMINAL LM
ON REQUEST	
DOWN	13,5 W CRI>90 2700 K – 1657 NOMINAL LM
DIMMABLE	
1-10V + PUSH	

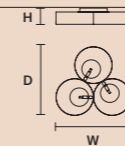

SOUND PL1	
ø	30 cm / 11.80"
H	13 cm / 5.10"
WITH ROD B**	
STANDARD LIGHTING	
1xG9x10 W MAX (NOT INCL.)*	
STANDARD INTEGRATED LED LIGHTING	
DOWN	5,5 W CRI>90 3000 K – 873 NOMINAL LM
ON REQUEST	
DOWN	5,5 W CRI>90 2700 K – 742 NOMINAL LM
DIMMABLE	
1-10V + PUSH	

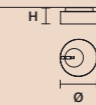

SOUND A1	
W	30 cm / 11.80"
D	45 cm / 17.70"
H	30 cm / 11.80"
WITH ROD B**	
STANDARD LIGHTING	
1xG9x10 W MAX (NOT INCL.)*	
STANDARD INTEGRATED LED LIGHTING	
UP	4,4 W CRI>90 3000 K – 650 NOMINAL LM
DOWN	4,4 W CRI>90 3000 K – 650 NOMINAL LM
ON REQUEST	
UP	4,4 W CRI>90 2700 K – 552 NOMINAL LM
DOWN	4,4 W CRI>90 2700 K – 552 NOMINAL LM
DIMMABLE	
NO	

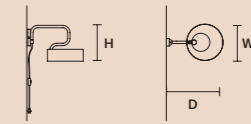

SOUND BIL3	
W	134 cm / 52.80"
D	64 cm / 25.20"
H	58 cm / 22.80"
WITH ROD B**	
STANDARD LIGHTING	
3xG9x10 W MAX (NOT INCL.)*	
STANDARD INTEGRATED LED LIGHTING	
UP	13,5 W CRI>90 3000 K – 1950 NOMINAL LM
DOWN	13,5 W CRI>90 3000 K – 1950 NOMINAL LM
ON REQUEST	
UP	13,5 W CRI>90 2700 K – 1657 NOMINAL LM
DOWN	13,5 W CRI>90 2700 K – 1657 NOMINAL LM
DIMMABLE	
1-10V + PUSH	

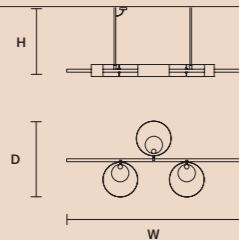

SOUND OR6	
W	120 cm / 47.20"
D	80 cm / 31.50"
H	11 cm / 4.30"
WITH ROD B**	
STANDARD LIGHTING	
6xG9x10 W MAX (NOT INCL.)*	
STANDARD INTEGRATED LED LIGHTING	
UP	26,5 W CRI>90 3000 K – 3900 NOMINAL LM
DOWN	26,5 W CRI>90 3000 K – 3900 NOMINAL LM
ON REQUEST	
UP	26,5 W CRI>90 2700 K – 3315 NOMINAL LM
DOWN	26,5 W CRI>90 2700 K – 3315 NOMINAL LM
DIMMABLE	
1-10V + DALI + PUSH	

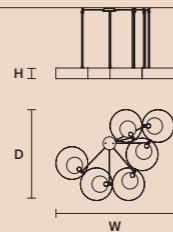

SOUND OR3	
W	60 cm / 23.60"
D	56 cm / 22.00"
H	11 cm / 4.30"
WITH ROD B**	
STANDARD LIGHTING	
3xG9x10 W MAX (NOT INCL.)*	
STANDARD INTEGRATED LED LIGHTING	
UP	13,5 W CRI>90 3000 K – 1950 NOMINAL LM
DOWN	13,5 W CRI>90 3000 K – 1950 NOMINAL LM
ON REQUEST	
UP	13,5 W CRI>90 2700 K – 1657 NOMINAL LM
DOWN	13,5 W CRI>90 2700 K – 1657 NOMINAL LM
DIMMABLE	
1-10V + PUSH	

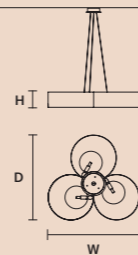

SOUND TL1	
W	30 cm / 11.80"
D	11 cm / 4.30"
H	30 cm / 11.80"
WITH ROD B**	
STANDARD LIGHTING	
1xG9x10 W MAX (NOT INCL.)*	
STANDARD INTEGRATED LED LIGHTING	
DOWN	8,8 W CRI>90 3000 K – 1300 NOMINAL LM
ON REQUEST	
DOWN	8,8 W CRI>90 2700 K – 1104 NOMINAL LM
DIMMABLE	
OWN BUTTON	



SOUND STL5	
W	46 cm / 18.10"
D	10 cm / 3.90"
H	225 cm / 88.60"
WITH ROD B**	
STANDARD LIGHTING	
5xG9x10 W MAX (NOT INCL.)*	
STANDARD INTEGRATED LED LIGHTING	
DOWN	44 W CRI>90 3000 K – 6500 NOMINAL LM
ON REQUEST	
DOWN	44 W CRI>90 2700 K – 5520 NOMINAL LM
DIMMABLE	
OWN BUTTON	

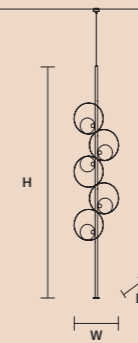

# Accessories

\*\* IT IS POSSIBLE TO CHOOSE A SPECIFIC HEIGHT FOR FIXED ROD OF ITEMS SOUND S1, SOUND S6, SOUND BIL5, SOUND BIL3. WHEN NOT SPECIFIED IN THE ORDER CONFIRMATION, THE STANDARD HEIGHT FOR THE ROD IS "B".  
 É POSSIBILE SCEGLIERE UN'ALTEZZA SPECIFICA PER LE ASTE RIGIDE DEGLI ARTICOLI SOUND S1, SOUND S6, SOUND BIL5, SOUND BIL3. SE NON SPECIFICATO IN FASE D'ORDINE, L'ALTEZZA DELL'ASTA RIGIDA STANDARD È "B".

## SOUND ROD S1\*\*

H	A: 11 cm / 4.30" B: 31 cm / 12.20" C: 51 cm / 20.10"
---	--

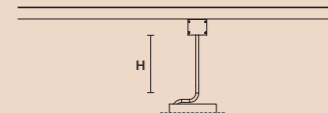

## SOUND ROD S6\*\*

H	A: 30 cm / 11.80" B: 50 cm / 19.70" C: 70 cm / 27.60"
---	---

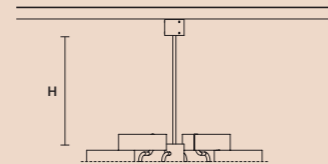

## SOUND ROD BIL5\*\* - BIL3\*\*

H	A: 30 cm / 11.80" B: 50 cm / 19.70" C: 70 cm / 27.60"
---	---

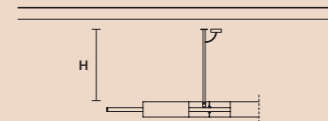

## FLOOR LAMP BASE

H	1 cm / 0.40"
∅	40 cm / 15.70"

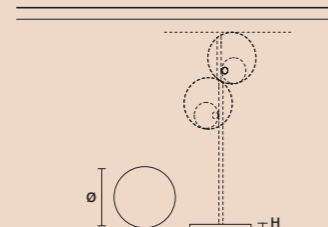

\* ETL only for US market.  
 \*G9 bulbs also valid for USA market.

# SINGLE CANOPIES

## SINGLE CANOPY

SIZE	FRAME FINISHINGS	CANOPY FINISHINGS	PRODUCT NAME	LIGHTING
∅ 12,1 cm / 4.80"	G12	G12	SOUND S1	LED
H 10 cm / 3.90"	G18+V90	V90	SOUND S1	STANDARD
			SOUND S6	STANDARD

## SINGLE CANOPY

SIZE	FRAME FINISHINGS	CANOPY FINISHINGS	PRODUCT NAME	LIGHTING
∅ 12,1 cm / 4.80"	G12	G12	SOUND S6	LED
H 15 cm / 5.90"	G18+V90	V90		

## SINGLE CANOPY

SIZE	FRAME FINISHINGS	CANOPY FINISHINGS	PRODUCT NAME	LIGHTING
∅ 7 cm / 2.80"	G12	G12	SOUND BIL 5	STANDARD
H 2,5 cm / 1.00"	G18+V90	V90	SOUND BIL 3	STANDARD

## SINGLE CANOPY

SIZE	FRAME FINISHINGS	CANOPY FINISHINGS	PRODUCT NAME	LIGHTING
∅ 18 cm / 7.10"	G12	G12	SOUND BIL 5	LED
H 4 cm / 1.60"	G18+V90	V90	SOUND BIL 3	LED

## SINGLE CANOPY

SIZE	FRAME FINISHINGS	CANOPY FINISHINGS	PRODUCT NAME	LIGHTING
∅ 18 cm / 7.10"	G12	G12	SOUND OR 3	LED
H 4 cm / 1.60"	G18+V90	V90	SOUND OR 3	STANDARD

## SINGLE CANOPY

SIZE	FRAME FINISHINGS	CANOPY FINISHINGS	PRODUCT NAME	LIGHTING
∅ 18 cm / 7.10"	G12	G12	SOUND OR 6	LED
H 4 cm / 1.60"	G18+V90	V90	SOUND OR 6	STANDARD

# Ebe

IT Ebe è ispirata all'eleganza mitologica delle statue del Canova. Metallo, marmo e una rete di maglia in filo di ottone intergiscono tra di loro creando geometrie luminose di una bellezza austera, senza tempo.

EN Ebe is inspired by the mythological elegance of Canova's statues. Metal, marble and a brass wire mesh are intertwined to create luminous geometries of timeless, austere beauty.

DESIGN BY  
NICOLA GALLIZIA

APPLIQUE  
TABLE LAMP  
FLOOR LAMP









# Ebe

Struttura in metallo verniciato. Rete in maglia metallica in filo di ottone. Base in onice. Illuminazione a Led.

Painted metal structure. Brass wire mesh design. Onyx base. LED lighting.

Gestell aus lackiertem Metall. Metalldrahtgeflecht aus Messingdraht. Fuss aus Onyx. LED-Leuchtmittel.

Estructura de metal barnizado. Red de malla de alambre de latón. Base de ónix. Iluminación Led.

Structure en métal laqué. Maille métallique en fil de laiton. Base en onyx. Éclairage LED.

Каркас из окрашенного металла. Металлическая сетка из латунной проволоки. Основание из оникса. Светодиодное освещение.

涂色金属灯体结构。黄铜丝金属网格。玛瑙底座。Led照明。

هيكل معدني مطلي . شبكة معدنية من أسلاك النحاس الأصفر . قاعدة من العقيق . إضاءة ليد.

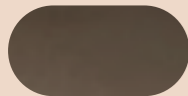

v87 Cioccolato Fondente  
Foundant Chocolate



Brass wire mesh

EBE A		CCC	RoHS	CE	EN
W	27 cm / 10.60"				
D	14 cm / 5.50"				
H	40 cm / 15.70"				
STANDARD INTEGRATED LED LIGHTING					
1xE14x10 W MAX (NOT INCL.)					

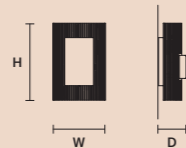

EBE TL		CCC	RoHS	CE	EN
W	30 cm / 11.80"				
D	21 cm / 8.30"				
H	40 cm / 15.70"				
STANDARD INTEGRATED LED LIGHTING					
11 W CRI>95 3000 K – 1200 NOMINAL LM					
ON REQUEST					
11 W CRI>95 2700 K – 1140 NOMINAL LM					
DIMMABLE					
OWN BUTTON					

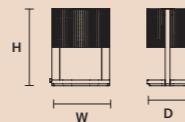

EBE STL		CCC	RoHS	CE	EN
W	30 cm / 11.80"				
D	21 cm / 8.30"				
H	140 cm / 55.10"				
STANDARD INTEGRATED LED LIGHTING					
35 W CRI>95 3000 K – 3770 NOMINAL LM					
ON REQUEST					
35 W CRI>95 2700 K – 3580 NOMINAL LM					
DIMMABLE					
OWN BUTTON					



DISCOVER MORE



# Posy

IT Equilibrio e semplicità sono le parole chiave di Posy. Sfera e stelo interagiscono tra di loro fino a trovare un equilibrio naturale che crea stupore per la naturale bellezza.

EN Balance and simplicity are the keywords of Posy. The sphere and stem interact with each other to achieve a natural balance that amazes for its natural beauty.

DESIGN BY  
SARA MORONI

SUSPENSION  
APPLIQUE  
TABLE LAMP  
FLOOR LAMP













# Posy

Struttura in metallo galvanizzato.  
Diffusore in vetro triplex di Murano  
bianco opalino.

Galvanic metal structure . Triplex  
opal white Murano glass diffuser.

Galvanisierte Metallstruktur.  
Opalweisser Triplex-Diffusor aus  
Muranglas.

Estructura de metal galvanizado.  
Difusor de vidrio triplex de Murano  
blanco opalino.

Structure en métal galvanisé.  
Diffuseur en verre triplex de  
Murano opale blanc.

Металлическая структура с  
гальваническим покрытием.  
Рассеиватель из триплексного  
муранского стекла бело-  
опалового цвета.

这种灯具的结构是电镀的金属，光扩  
散是白色Murano三层玻璃做的。

هيكل من المعدن المجلفن.  
ناشر ضوء من زجاج ثلاثي أبيض  
مورانو أوبال.



G18 Ottone spazzolato  
Brushed brass



Vetro triplex di Murano  
Triplex Murano glass

POSY S1 12	
W	18 cm / 7.10"
D	12 cm / 4.70"
H	14 cm / 5.50"
STANDARD LIGHTING	
1xG9x10 W MAX (NOT INCL.)*	

* BULB MAX	Ø 37 mm/1.50" W 70 mm/2.80"
------------	-----------------------------

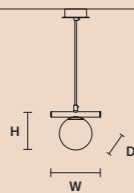

POSY S1 16	
W	22 cm / 8.70"
D	16 cm / 6.30"
H	18 cm / 7.10"
STANDARD LIGHTING	
1xE14x10 W MAX (NOT INCL.)*	

* BULB MAX	Ø 37 mm /1.50" W 110 mm/4.30"
------------	-------------------------------

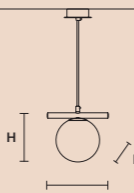

POSY S1 20	
W	26 cm / 10.20"
D	20 cm / 7.90"
H	22 cm / 8.70"
STANDARD LIGHTING	
1xE14x10 W MAX (NOT INCL.)*	

* BULB MAX	Ø 37 mm /1.50" W 150 mm/5.90"
------------	-------------------------------

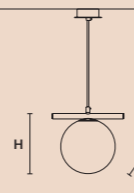

POSY A1 P	
W	22 cm / 8.70"
D	22 cm / 8.70"
H	16 cm / 6.30"
STANDARD LIGHTING	
1xE14x10 W MAX (NOT INCL.)*	

* BULB MAX	Ø 37 mm /1.50" W 110 mm/4.30"
------------	-------------------------------

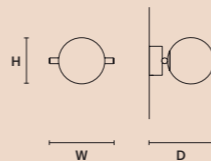

POSY A1 G	
W	26 cm / 10.20"
D	26 cm / 10.20"
H	20 cm / 7.90"
STANDARD LIGHTING	
1xE14x10 W MAX (NOT INCL.)*	

* BULB MAX	Ø 37 mm /1.50" W 110 mm/4.30"
------------	-------------------------------

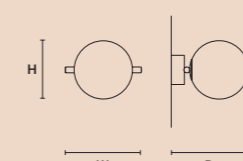

POSY TL	
W	26 cm / 10.20"
D	20 cm / 7.90"
H	20 cm / 7.90"
STANDARD LIGHTING	
1xE12x10 W MAX (NOT INCL.)*	

* BULB MAX	Ø 37 mm /1.50" W 110 mm/4.30"
------------	-------------------------------

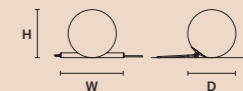

POSY STL	
W	39 cm / 15.40"
D	32 cm / 12.60"
H	152 cm / 59.80"
STANDARD LIGHTING	
1xG9x10 W MAX (NOT INCL.)* 2xE12x10 W MAX (NOT INCL.)**	

* BULB MAX	Ø 37 mm/1.50" W 70 mm/2.80"
** BULB MAX	Ø 37 mm /1.50" W 110 mm/4.30"

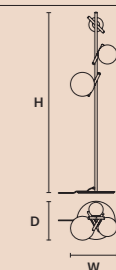

POSY S1 25	
W	31 cm / 12.20"
D	25 cm / 9.80"
H	29 cm / 11.40"
STANDARD LIGHTING	
1xE27x20 W MAX (NOT INCL.)*	

* BULB MAX	Ø 62 mm/2.40" W 185 mm/7.30"
------------	------------------------------

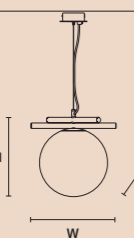

POSY BIL3	
W	100 cm / 39.40"
D	33 cm / 13.00"
H	34 cm / 13.40"
STANDARD LIGHTING	
1xG9x10 W MAX (NOT INCL.)* 2xE14x10 W MAX (NOT INCL.)**	

* BULB MAX	Ø 37 mm/1.50" W 70 mm/2.80"
** BULB MAX	Ø 37 mm /1.50" W 110 mm/4.30"

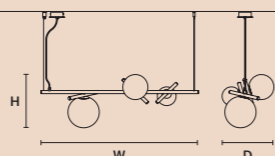

POSY BIL4	
W	140 cm / 55.10"
D	38 cm / 15.00"
H	29 cm / 11.40"
STANDARD LIGHTING	
1xG9x10 W MAX (NOT INCL.)* 3xE14x10 W MAX (NOT INCL.)**	

* BULB MAX	Ø 37 mm/1.50" W 70 mm/2.80"
** BULB MAX	Ø 37 mm /1.50" W 110 mm/4.30"

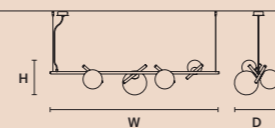

POSY S3	
Ø	40 cm / 15.70"
H MAX	160 cm / 63.00"
STANDARD LIGHTING	
1xG9x10 W MAX (NOT INCL.)* 2xE14x10 W MAX (NOT INCL.)**	

* BULB MAX	Ø 37 mm/1.50" W 70 mm/2.80"
** BULB MAX	Ø 37 mm /1.50" W 110 mm/4.30"

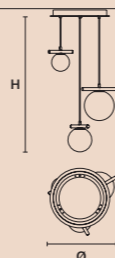

POSY S5	
Ø	60 cm / 23.60"
H MAX	160 cm / 63.00"
STANDARD LIGHTING	
2xG9x10 W MAX (NOT INCL.)* 3xE14x10 W MAX (NOT INCL.)**	

* BULB MAX	Ø 37 mm/1.50" W 70 mm/2.80"
** BULB MAX	Ø 37 mm /1.50" W 110 mm/4.30"

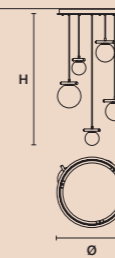

POSY C5 RD 40	
Ø	40 cm / 15.70"
H MAX	160 cm / 63.00"
STANDARD LIGHTING	
5xG9x10 W MAX (NOT INCL.)*	

* BULB MAX	Ø 37 mm/1.50" W 70 mm/2.80"
------------	-----------------------------



POSY C7 RD 60	
Ø	60 cm / 23.60"
H MAX	160 cm / 63.00"
STANDARD LIGHTING	
7xG9x10 W MAX (NOT INCL.)*	

* BULB MAX	Ø 37 mm/1.50" W 70 mm/2.80"
------------	-----------------------------

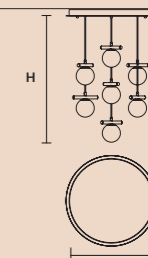

POSY BIL6	
W	180 cm / 70.90"
D	42 cm / 16.50"
H	31 cm / 12.20"
STANDARD LIGHTING	
2xG9x10 W MAX (NOT INCL.)* 4xE14x10 W MAX (NOT INCL.)**	

* BULB MAX	Ø 37 mm/1.50" W 70 mm/2.80"
** BULB MAX	Ø 37 mm /1.50" W 110 mm/4.30"

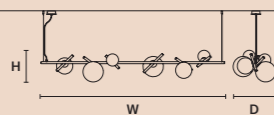

POSY VERT 2	
W	42 cm / 16.50"
D	20 cm / 7.90"
H	102 cm / 40.20"
STANDARD LIGHTING	
2xE14x10 W MAX (NOT INCL.)*	

* BULB MAX	Ø 37 mm/1.50" W 70 mm/2.80"
------------	-----------------------------

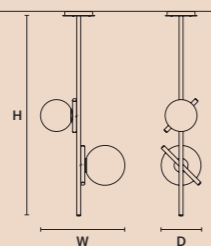

POSY VERT 3	
W	39 cm / 15.40"
D	32 cm / 12.60"
H	142 cm / 55.90"
STANDARD LIGHTING	
1xG9x10 W MAX (NOT INCL.)* 2xE14x10 W MAX (NOT INCL.)**	

* BULB MAX	Ø 37 mm/1.50" W 70 mm/2.80"
** BULB MAX	Ø 37 mm /1.50" W 110 mm/4.30"

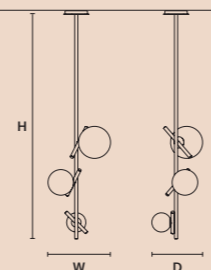

POSY C10 RD 80	
Ø	80 cm / 31.50"
H MAX	160 cm / 63.00"
STANDARD LIGHTING	
10xG9x10 W MAX (NOT INCL.)*	

* BULB MAX	Ø 37 mm/1.50" W 70 mm/2.80"
------------	-----------------------------

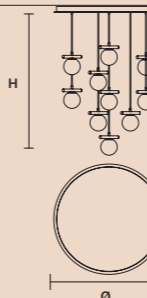

POSY C5 LN 75	
W	75 cm / 29.50"
D	20 cm / 7.90"
H MAX	160 cm / 63.00"
STANDARD LIGHTING	
5xG9x10 W MAX (NOT INCL.)*	

* BULB MAX	Ø 37 mm/1.50" W 70 mm/2.80"
------------	-----------------------------

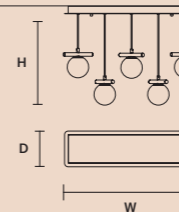

POSY C7 LN 125	
W	125 cm / 49.20"
D	20 cm / 7.90"
H MAX	160 cm / 63.00"
STANDARD LIGHTING	
7xG9x10 W MAX (NOT INCL.)*	

* BULB MAX	Ø 37 mm/1.50" W 70 mm/2.80"
------------	-----------------------------

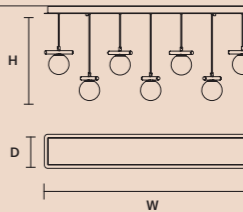

POSY C10 LN 175	
W	175 cm / 68.90"
D	20 cm / 7.90"
H MAX	160 cm / 63.00"
STANDARD LIGHTING	
10xG9x10 W MAX (NOT INCL.)*	

* BULB MAX	Ø 37 mm/1.50" W 70 mm/2.80"
------------	-----------------------------

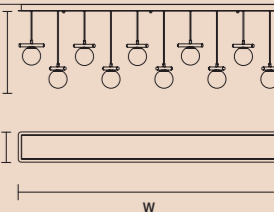

DISCOVER MORE



\* : ONLY FOR THE US MARKET.

## SINGLE CANOPIES

### SINGLE CANOPY

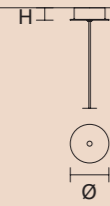

SIZE	FINISHINGS	PRODUCT NAME
Ø 10 cm / 3.90"	● V91	POSY S1 12
H 3,2 cm / 1.30"		POSY S1 16
		POSY S1 20
		POSY BIL3
		POSY BIL4
		POSY BIL6

### SINGLE CANOPY

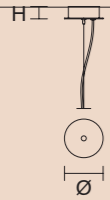

SIZE	FINISHINGS	PRODUCT NAME
Ø 10 cm / 3.90"	● V91	POSY S1 25
H 3,2 cm / 1.30"		

## MULTIPLE CANOPIES

### LINEAR CANOPY LN 75

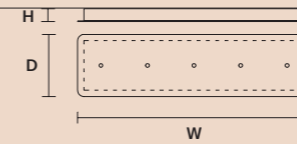

SIZE	FINISHINGS	PRODUCT NAME
W 75 cm / 29.50"	● V91	POSY C5 LN 75
D 20 cm / 7.90"		
H 4 cm / 1.60"		

### LINEAR CANOPY LN 125

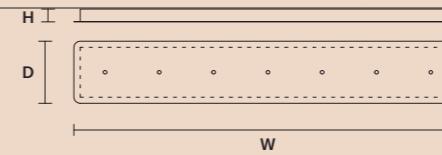

SIZE	FINISHINGS	PRODUCT NAME
W 125 cm / 49.20"	● V91	POSY C7 LN 125
D 20 cm / 7.90"		
H 4 cm / 1.60"		

### LINEAR CANOPY LN 175

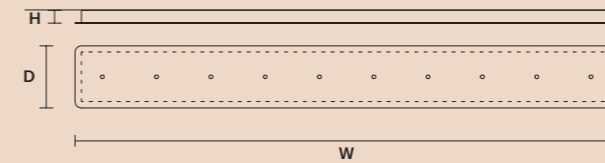

SIZE	FINISHINGS	PRODUCT NAME
W 175 cm / 68.90"	● V91	POSY C10 LN 175
D 20 cm / 7.90"		
H 4 cm / 1.60"		

### ROUND CANOPY RD 40

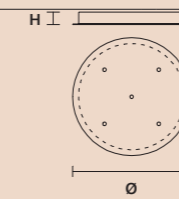

SIZE	FINISHINGS	PRODUCT NAME
Ø 40 cm / 15.70"	● V91	POSY C5 RD 40
H 4 cm / 1.60"		POSY S5

### ROUND CANOPY RD 60

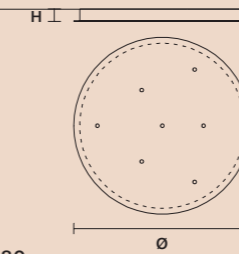

SIZE	FINISHINGS	PRODUCT NAME
Ø 60 cm / 23.60"	● V91	POSY C7 RD 60
H 4 cm / 1.60"		POSY S7

### ROUND CANOPY RD 80

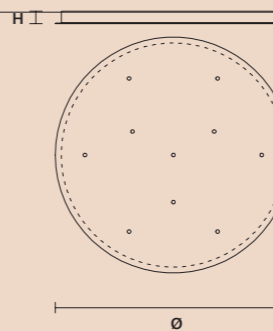

SIZE	FINISHINGS	PRODUCT NAME
Ø 80 cm / 31.50"	● V91	POSY C10 RD 80
H 4 cm / 1.60"		

# Iglù

IT Iglù è un'intuizione che nasce osservando la perfezione dell'elemento sfera, che diventa una forma perfetta, riconoscibile ed unica grazie ad una rete che non trattiene la luce ma crea un disegno di luci e ombre, trasformando il metallo in un gioiello luminoso.

EN Iglù is an intuition born from observing the perfection of the sphere, transformed into a perfect, recognisable and unique shape by mesh that, rather than obstruct the light, instead creates a pattern of light and shadow, transforming the metal into a luminous jewel.

DESIGN BY  
ORIANO FAVARETTO

SUSPENSION  
CEILING  
APPLIQUE  
TABLE LAMP  
FLOOR LAMP











# Iglù

Struttura in metallo verniciato con patina spazzolata. Illuminazione a LED.

Metal structure painted with brushed patina. LED lighting.

Metallstruktur mit gebürsteter Patina. LED-Beleuchtung.

Estructura de metal pintado con pátina cepillada. Iluminación led.

Structure en métal laqué avec patine brossé. Eclairage en LED.

Окрашенная металлическая структура с матовой патиной. Светодиодное освещение.

这种灯具的结构是涂漆的金属。LED照明。

هيكل معدني مطلي بطبقة مصقولة. إضاءة ليد.

IGLÙ S125	
ø	25,5 cm / 10.00"
H	25,5 cm / 10.00"
STANDARD INTEGRATED LED LIGHTING	
15,5 W CRI>90	
3000 K – 2100 NOMINAL LM	
ON REQUEST	
15,5 W CRI>90	
2700 K – 2000 NOMINAL LM	
DIMMABLE	
NO	



IGLÙ S2	
W	58 cm / 22.80"
D	18 cm / 7.10"
H	18 cm / 7.10"
STANDARD INTEGRATED LED LIGHTING	
19,8 W CRI>90	
3000 K – 2600 NOMINAL LM	
ON REQUEST	
19,8 W CRI>90	
2700 K – 2440 NOMINAL LM	
DIMMABLE	
NO	

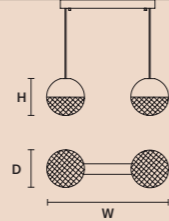

IGLÙ S6+1	
ø	96 cm / 37.80"
H	52 cm / 20.50"
STANDARD INTEGRATED LED LIGHTING	
26,6 W CRI>90	
3000 K – 3626 NOMINAL LM	
ON REQUEST	
26,6 W CRI>90	
2700 K – 3444 NOMINAL LM	
DIMMABLE	
NO	

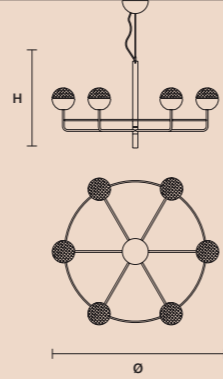

IGLÙ PL 13	
ø	13 cm / 5.10"
H	13 cm / 5.10"
STANDARD INTEGRATED LED LIGHTING	
5,4 W CRI>90	
3000 K – 688 NOMINAL LM	
ON REQUEST	
5,4 W CRI>90	
2700 K – 653 NOMINAL LM	
DIMMABLE	
NO	



IGLÙ PL 18	
ø	18 cm / 7.10"
H	18 cm / 7.10"
STANDARD INTEGRATED LED LIGHTING	
11,4 W CRI>90	
3000 K – 1450 NOMINAL LM	
ON REQUEST	
11,4 W CRI>90	
2700 K – 1232 NOMINAL LM	
DIMMABLE	
NO	



IGLÙ PL 25	
ø	25,5 cm / 10.00"
H	25,5 cm / 10.00"
STANDARD INTEGRATED LED LIGHTING	
15,5 W CRI>90	
3000 K – 2100 NOMINAL LM	
ON REQUEST	
15,5 W CRI>90	
2700 K – 2000 NOMINAL LM	
DIMMABLE	
NO	



IGLÙ S12+1	
ø	96 cm / 37.80"
H	68 cm / 26.80"
STANDARD INTEGRATED LED LIGHTING	
49,4 W CRI>90	
3000 K – 6734 NOMINAL LM	
ON REQUEST	
49,4 W CRI>90	
2700 K – 6397 NOMINAL LM	
DIMMABLE	
TRIAC	

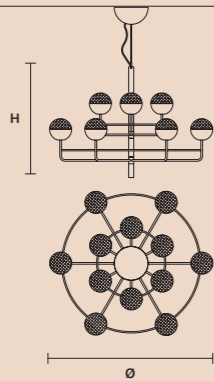

IGLÙ S18+1	
ø	136 cm / 53.50"
H	82 cm / 32.30"
STANDARD INTEGRATED LED LIGHTING	
73,5 W CRI>90	
3000 K – 10258 NOMINAL LM	
ON REQUEST	
73,5 W CRI>90	
2700 K – 9745 NOMINAL LM	
DIMMABLE	
TRIAC	

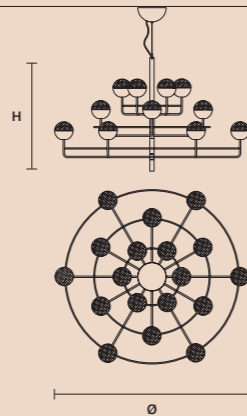

IGLÙ A1	
W	24 cm / 9.40"
D	28 cm / 11.00"
H	18 cm / 7.10"
STANDARD INTEGRATED LED LIGHTING	
UP	2,6 W CRI>90
3000 K – 346 NOMINAL LM	
DOWN	8,4 W CRI>90
3000 K – 1150 NOMINAL LM	
ON REQUEST	
UP	2,6 W CRI>90
2700 K – 335 NOMINAL LM	
DOWN	8,4 W CRI>90
2700 K – 977 NOMINAL LM	
DIMMABLE	
TRIAC	

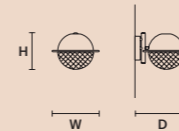

IGLÙ TL1	
W	24 cm / 9.40"
D	28 cm / 11.00"
H	55 cm / 21.70"
STANDARD INTEGRATED LED LIGHTING	
UP	3,7 W CRI>90
3000 K – 462 NOMINAL LM	
DOWN	11,4 W CRI>90
3000 K – 1450 NOMINAL LM	
ON REQUEST	
UP	3,7 W CRI>90
2700 K – 448 NOMINAL LM	
DOWN	11,4 W CRI>90
2700 K – 1232 NOMINAL LM	
DIMMABLE	
OWN BUTTON	

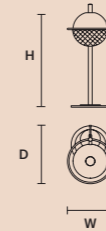

IGLÙ STL1	
W	24 cm / 9.40"
D	28 cm / 11.00"
H	162 cm / 63.80"
STANDARD INTEGRATED LED LIGHTING	
UP	3,7 W CRI>90
3000 K – 462 NOMINAL LM	
DOWN	11,4 W CRI>90
3000 K – 1450 NOMINAL LM	
ON REQUEST	
UP	3,7 W CRI>90
2700 K – 448 NOMINAL LM	
DOWN	11,4 W CRI>90
2700 K – 1232 NOMINAL LM	
DIMMABLE	
OWN BUTTON	

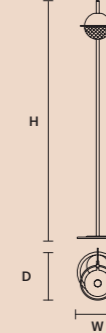

DISCOVER MORE



**IGLÙ S7** 

∅ 60 cm / 23.60"  
H MAX 150 cm / 59.10"

**STANDARD INTEGRATED LED LIGHTING**

52,3 W CRI>90  
3000 K - 6700 NOMINAL LM

**ON REQUEST**

52,3 W CRI>90  
2700 K - 6030 NOMINAL LM

**DIMMABLE**

1-10V + PUSH

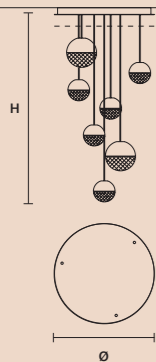

**IGLÙ C5 RD 40** 

∅ 40cm/ 15.70"  
H MAX 150 cm / 59.10"

**STANDARD INTEGRATED LED LIGHTING**

27W CRI>90  
3000K - 3440 NOMINAL LM

**ON REQUEST**

27 W CRI>90  
2700K - 3268 NOMINAL LM

**DIMMABLE**

1-10V + PUSH



**IGLÙ C7 RD 60** 

∅ 60cm/ 23.60"  
H MAX 150 cm / 59.10"

**STANDARD INTEGRATED LED LIGHTING**

37,8 W CRI>90  
3000K - 4816 NOMINAL LM

**ON REQUEST**

37,8 W CRI>90  
2700K - 4575 NOMINAL LM

**DIMMABLE**

1-10V + PUSH

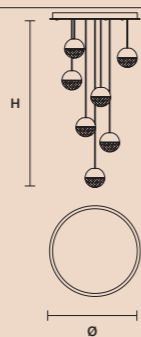

**IGLÙ C10 RD 80** 

∅ 80cm/ 31.50"  
H MAX 150 cm / 59.10"

**STANDARD INTEGRATED LED LIGHTING**

54 W CRI>90  
3000K - 6880 NOMINAL LM

**ON REQUEST**

54 W CRI>90  
2700 K - 6536 NOMINAL LM

**DIMMABLE**

1-10V + PUSH + DALI

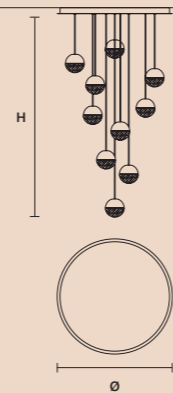

**IGLÙ C5 LN 75** 

w 75 cm / 29.50"  
D 20 cm / 7.90"  
H MAX 150 cm / 59.10"

**STANDARD INTEGRATED LED LIGHTING**

27 W CRI>90  
3000K - 3440 NOMINAL LM

**ON REQUEST**

27 W CRI>90  
2700K - 3268 NOMINAL LM

**DIMMABLE**

1-10V + PUSH

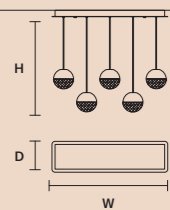

**IGLÙ C7 LN 125** 

w 125 cm / 49.20"  
D 20 cm / 7.90"  
H MAX 150 cm / 59.10"

**STANDARD INTEGRATED LED LIGHTING**

37,8 W CRI>90  
3000K - 4816 NOMINAL LM

**ON REQUEST**

37,8 W CRI>90  
2700K - 4575 NOMINAL LM

**DIMMABLE**

1-10V + PUSH

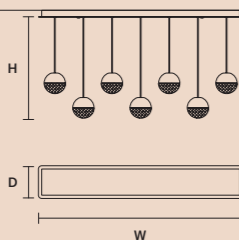

**IGLÙ C10 LN 175** 

w 175 cm / 68.90"  
D 20 cm / 7.90"  
H MAX 150 cm / 59.10"

**STANDARD INTEGRATED LED LIGHTING**

54W CRI>90  
3000K - 6880 NOMINAL LM

**ON REQUEST**

54 W CRI>90  
2700 K - 6536 NOMINAL LM

**DIMMABLE**

1-10V + PUSH + DALI

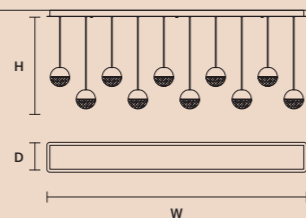

## SINGLE CANOPIES

### SINGLE CANOPY



SIZE		FINISHINGS	PRODUCT NAME
Ø	12 cm / 4.70"	● V86	IGLÚ S1 25
H	6 cm / 2.40"		

### SINGLE CANOPY

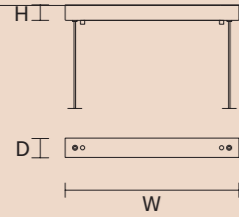

SIZE		FINISHINGS	PRODUCT NAME
W	45 cm / 17.70"	● V86	IGLÚ S2
D	5 cm / 2.00"		
H	4 cm / 1.60"		

### SINGLE CANOPY

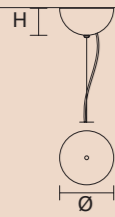

SIZE		FINISHINGS	PRODUCT NAME
Ø	14 cm / 5.50"	● V86	IGLÚ S 6+1
H	7 cm / 2.80"		

### SINGLE CANOPY

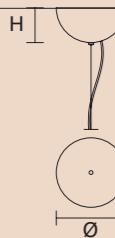

SIZE		FINISHINGS	PRODUCT NAME
Ø	18 cm / 7.10"	● V86	IGLÚ S 12+1
H	9 cm / 3.50"		

### SINGLE CANOPY



SIZE		FINISHINGS	PRODUCT NAME
Ø	20 cm / 7.90"	● V86	IGLÚ S 18+1
H	10 cm / 3.90"		

## MULTIPLE CANOPIES

### LINEAR CANOPY LN 75

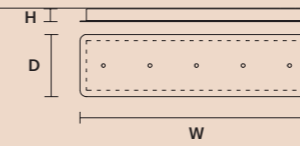

SIZE		FINISHINGS	PRODUCT NAME
W	75 cm / 29.50"	● V86	IGLÚ C5 LN 75
D	20 cm / 7.90"		
H	4 cm / 1.60"		

### LINEAR CANOPY LN 125

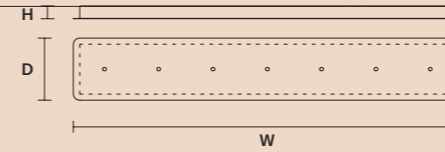

SIZE		FINISHINGS	PRODUCT NAME
W	125 cm / 49.20"	● V86	IGLÚ C7 LN 125
D	20 cm / 7.90"		
H	4 cm / 1.60"		

### LINEAR CANOPY LN 175

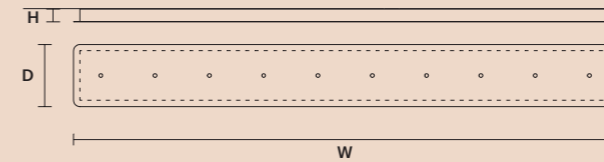

SIZE		FINISHINGS	PRODUCT NAME
W	175 cm / 68.90"	● V86	IGLÚ C10 LN 175
D	20 cm / 7.90"		
H	4 cm / 1.60"		

### ROUND CANOPY RD 40

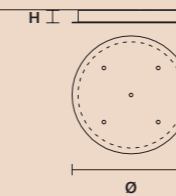

SIZE		FINISHINGS	PRODUCT NAME
Ø	40 cm / 15.70"	● V86	IGLÚ C5 RD 40
H	4 cm / 1.60"		

### ROUND CANOPY RD 60

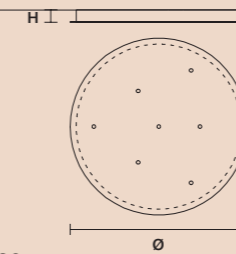

SIZE		FINISHINGS	PRODUCT NAME
Ø	60 cm / 23.60"	● V86	IGLÚ C7 RD 60
H	4 cm / 1.60"		IGLÚ S7

### ROUND CANOPY RD 80

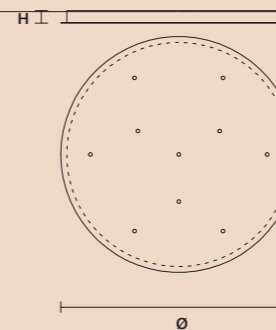

SIZE		FINISHINGS	PRODUCT NAME
Ø	80 cm / 31.50"	● V86	IGLÚ C10 RD 80
H	4 cm / 1.60"		

# Horo

IT Horo trae ispirazione dalla forma del cerchio nelle sue infinite espressioni come il sole, disco di luce e simbolo universalmente noto e antico quanto il mondo. Horo è una collezione minimal, semplice, una 'forma grafica' che assume un mood vintage grazie alle particolari finiture di metallo e vetro.

EN Horo is inspired by the shape of a circle in all its infinite expressions such as the sun, a disc of light and a universally recognised symbol, as old as the world itself. Horo is a simple, minimal collection, a "graphic form" given a vintage mood by the special metal and glass finishes.

DESIGN BY  
PIERRE GONALONS

SUSPENSION  
APPLIQUE  
TABLE LAMP  
FLOOR LAMP









# Horo

Struttura in metallo con diffusore in vetro prismatico o decorazione spectrum. Illuminazione a LED.

Metal frame with prism or spectrum finishing glass diffuser. LED lighting.

Gestell aus Metall mit Diffusor aus Prismen oder Spectrum Glass. LED-Beleuchtung.

Estructura de metal con difusor de vidrio prismatico o decoración espectral. Iluminación LED.

Structure en métal avec diffuseur en verre prismatique ou décoration spectrum. Éclairage LED.

Металлический каркас с рассеивателем из призматического стекла или цветного стекла Spectrum. Светодиодное освещение.

这种灯具有金属结构, 然而它有一个棱镜玻璃的光扩散。LED照明。

هيكل معدني مع ناشر ضوء زجاجي موشوري أو زخرفة طيفية. إضاءة LED.



G18 Ottone spazzolato  
Brushed Brass



TR Vetro trasparente  
Transparent glass



FM Vetro fumè  
Smoky glass



VD Vetro verde  
Green glass



AZ Vetro azzurro  
Light Blue glass



RS Vetro rosa  
Pink glass



SA Spectrum ambra  
Amber spectrum

## HORO S1

W 30 cm / 11.80"  
D 8 cm / 3.10"  
H 34 cm / 13.40"

STANDARD INTEGRATED LED LIGHTING  
14,4 W CRI>95  
3000 K – 1536 NOMINAL LM

ON REQUEST  
14,4 W CRI>95  
2700 K – 1464 NOMINAL LM

DIMMABLE  
NO



## HORO S3

W 30 cm / 11.80"  
D 12 cm / 4.70"  
H 30 cm / 11.80"

STANDARD INTEGRATED LED LIGHTING  
43,2 W CRI>95  
3000 K – 4608 NOMINAL LM

ON REQUEST  
43,2 W CRI>95  
2700 K – 4392 NOMINAL LM

DIMMABLE  
0-10V



## HORO S5

W 30 cm / 11.80"  
D 12 cm / 4.70"  
H 30 cm / 11.80"

STANDARD INTEGRATED LED LIGHTING  
72 W CRI>95  
3000 K – 7680 NOMINAL LM

ON REQUEST  
72 W CRI>95  
2700 K – 7320 NOMINAL LM

DIMMABLE  
0-10V



## HORO A

W 30 cm / 11.80"  
D 12 cm / 4.70"  
H 30 cm / 11.80"

STANDARD INTEGRATED LED LIGHTING  
14,4 W CRI>95  
3000 K – 1536 NOMINAL LM

ON REQUEST  
14,4 W CRI>95  
2700 K – 1464 NOMINAL LM

DIMMABLE  
NO



## HORO TL

W 30 cm / 11.80"  
D 20 cm / 7.90"  
H 60 cm / 23.60"

STANDARD INTEGRATED LED LIGHTING  
14,4 W CRI>95  
3000 K – 1536 NOMINAL LM

ON REQUEST  
14,4 W CRI>95  
2700 K – 1464 NOMINAL LM

DIMMABLE  
OWN BUTTON

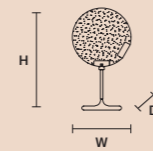

## HORO STL

W 30 cm / 11.80"  
D 25 cm / 9.80"  
H 150 cm / 59.10"

STANDARD INTEGRATED LED LIGHTING  
14,4 W CRI>95  
3000 K – 1536 NOMINAL LM

ON REQUEST  
14,4 W CRI>95  
2700 K – 1464 NOMINAL LM

DIMMABLE  
OWN BUTTON



## HORO C3 LN 125

W 125 cm / 49.20"  
D 20 cm / 7.90"  
H MAX 155 cm / 61.00"

STANDARD INTEGRATED LED LIGHTING  
43,2 W CRI>95  
3000 K – 4608 NOMINAL LM

ON REQUEST  
43,2 W CRI>95  
2700 K – 4392 NOMINAL LM

DIMMABLE  
0-10V

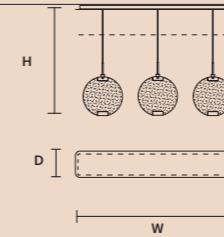

## HORO C5 LN 175

W 175 cm / 68.90"  
D 20 cm / 7.90"  
H MAX 155 cm / 61.00"

STANDARD INTEGRATED LED LIGHTING  
72 W CRI>95  
3000 K – 7680 NOMINAL LM

ON REQUEST  
72 W CRI>95  
2700 K – 7320 NOMINAL LM

DIMMABLE  
0-10V

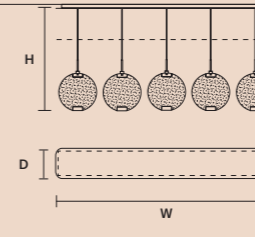

## HORO C3 RD 60

ø 60 cm / 23.60"  
H MAX 155 cm / 61.00"

STANDARD INTEGRATED LED LIGHTING  
43,2 W CRI>95  
3000 K – 4608 NOMINAL LM

ON REQUEST  
43,2 W CRI>95  
2700 K – 4392 NOMINAL LM

DIMMABLE  
0-10V

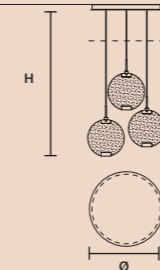

## HORO C5 RD 80

ø 80 cm / 31.50"  
H MAX 155 cm / 61.00"

STANDARD INTEGRATED LED LIGHTING  
72 W CRI>95  
3000 K – 7680 NOMINAL LM

ON REQUEST  
72 W CRI>95  
2700 K – 7320 NOMINAL LM

DIMMABLE  
0-10V

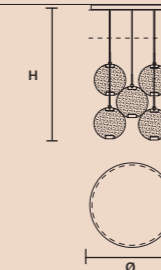

DISCOVER MORE



## SINGLE CANOPIES

### SINGLE CANOPY

	SIZE	FINISHINGS	PRODUCT NAME
	<p>Ø 10 cm / 3.90"</p> <p>H 4,3 cm / 1.70"</p>	G18	HORO S1

### SINGLE CANOPY

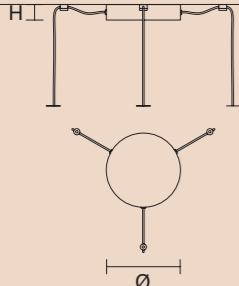
	SIZE	FINISHINGS	PRODUCT NAME
	<p>Ø 19,2 cm / 7.60"</p> <p>H 4 cm / 1.60"</p>	G18	HORO S3

### SINGLE CANOPY

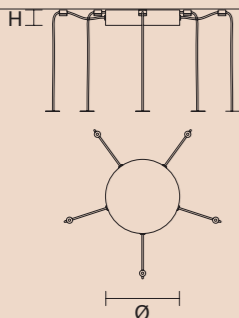
	SIZE	FINISHINGS	PRODUCT NAME
	<p>Ø 19,2 cm / 7.60"</p> <p>H 4 cm / 1.60"</p>	G18	HORO S5

## MULTIPLE CANOPIES

### LINEAR CANOPY LN 125

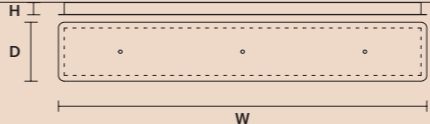
	SIZE	FINISHINGS	PRODUCT NAME
	<p>W 125 cm / 49.20"</p> <p>D 20 cm / 7.90"</p> <p>H 4 cm / 1.60"</p>	V98	HORO C3 LN 125

### LINEAR CANOPY LN 175

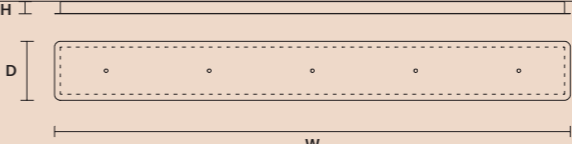
	SIZE	FINISHINGS	PRODUCT NAME
	<p>W 175 cm / 68.90"</p> <p>D 20 cm / 7.90"</p> <p>H 4 cm / 1.60"</p>	V98	HORO C5 LN 175

### ROUND CANOPY RD 60

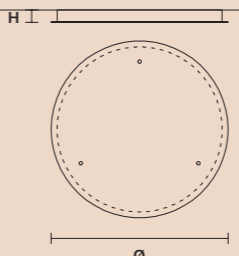
	SIZE	FINISHINGS	PRODUCT NAME
	<p>Ø 60 cm / 23.60"</p> <p>H 4 cm / 1.60"</p>	V98	HORO C3 RD 60

### ROUND CANOPY RD 80

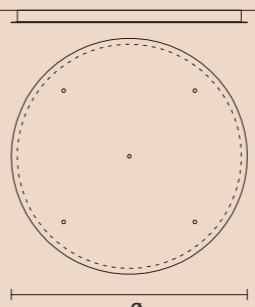
	SIZE	FINISHINGS	PRODUCT NAME
	<p>Ø 80 cm / 31.50"</p> <p>H 4 cm / 1.60"</p>	V98	HORO C5 RD 80

# Honicé

IT Honicé si ispira alla bellezza e maestosità di una delle pietre più antiche del mondo: l'onice. Secondo la leggenda l'onice sarebbe stata creata quando Cupido tagliò le unghie a Venere. Poichè le parti di una creatura divina non sono mortali, le divinità le trasformarono in una gemma, l'Onice. C'è della magia in lei, una pelle sottile, trasparente pur se di pietra. Honicé rende luminosa e leggera la solidità del marmo.

EN Honicé is inspired by the beauty and majesty of onyx, one of the oldest stones in the world. Legend has it that onyx was created when Cupid cut Venus' nails. Since the parts of a divine being cannot be mortal, the gods transformed them into a gemstone, onyx. It has something magical about it, a thin skin of stone, but transparent. Honicé brings brightness and luminosity to the solidity of marble.

DESIGN BY  
ORIANO FAVARETTO

SUSPENSION  
APPLIQUE  
TABLE LAMP  
FLOOR LAMP



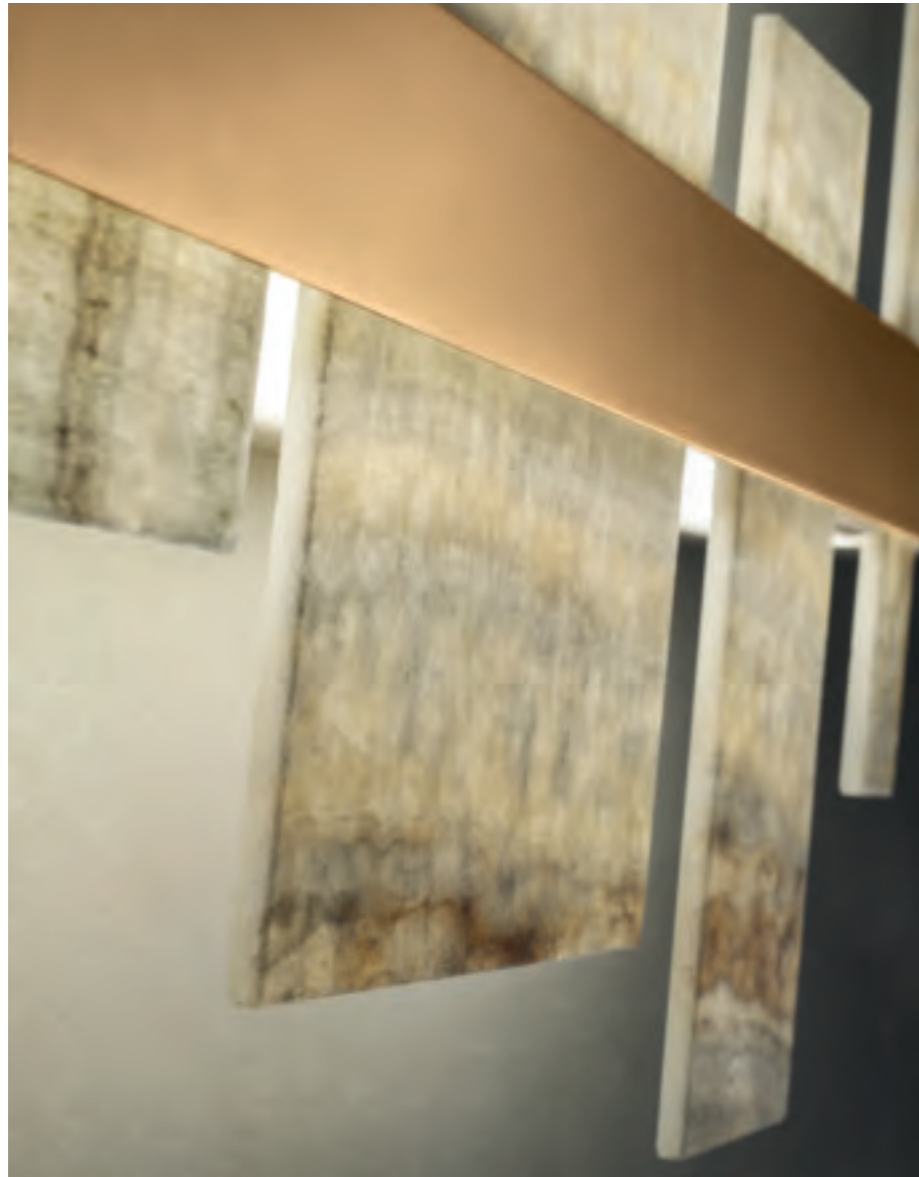









224

MASIERO



225

HONICÉ STL

HONICÉ TL

Honicé

# Honicé

Struttura in metallo con diffusore in onice naturale. Illuminazione a LED.

Metal frame with natural onyx diffuser. LED lighting.

Gestell aus Metall mit Diffusor aus natürlichem Onyx. LED-Beleuchtung.

Estructura de metal con difusor en ónix natural. Iluminación LED.

Structure en métal avec diffuseur en onyx naturel. Éclairage à LED.

Металлический каркас с рассеивателем из природного оникса. Светодиодное освещение.

这种灯具具有金属结构，然而光扩散是缟玛瑙。LED照明。

هيكل معدني مع ناشر من الأونيكس الطبيعي. إضاءة ليد.



v99 Oro opaco verniciato  
Painted matt gold

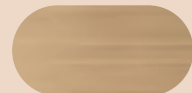

g01 Brunito\*  
Burnished

\*NOT AVAILABLE FOR HONICÉ S80 AND HONICÉ S50

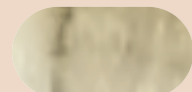

Onice  
Onyx

DISCOVER MORE



HONICÉ S200	
W	200 cm / 78.70"
D	8 cm / 3.10"
H	33 cm / 13.00"
STANDARD INTEGRATED LED LIGHTING	
UP	21,1 W CRI>95 3000 K – 2250 NOMINAL LM
DOWN	44,46 W CRI>95 3000 K – 4742 NOMINAL LM
ON REQUEST	
UP	21,1 W CRI>95 2700 K – 2145 NOMINAL LM
DOWN	44,46 W CRI>95 2700 K – 4520 NOMINAL LM
DIMMABLE	
0-10V	

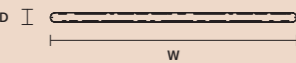
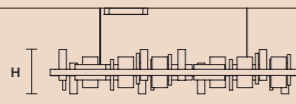

HONICÉ S150	
W	150 cm / 59.10"
D	8 cm / 3.10"
H	33 cm / 13.00"
STANDARD INTEGRATED LED LIGHTING	
UP	17 W CRI>95 3000 K – 1813 NOMINAL LM
DOWN	33,5 W CRI>95 3000 K – 3573 NOMINAL LM
ON REQUEST	
UP	17 W CRI>95 2700 K – 1728 NOMINAL LM
DOWN	33,5 W CRI>95 2700 K – 3405 NOMINAL LM
DIMMABLE	
0-10V	

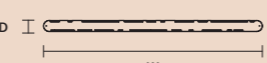

HONICÉ S100	
W	100 cm / 39.40"
D	8 cm / 3.10"
H	33 cm / 13.00"
STANDARD INTEGRATED LED LIGHTING	
UP	9,36 W CRI>95 3000 K – 998 NOMINAL LM
DOWN	21,1 W CRI>95 3000 K – 2250 NOMINAL LM
ON REQUEST	
UP	9,36 W CRI>95 2700 K – 951 NOMINAL LM
DOWN	21,1 W CRI>95 2700 K – 2145 NOMINAL LM
DIMMABLE	
0-10V	

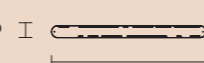

HONICÉ A65	
W	65 cm / 25.60"
D	10 cm / 3.90"
H	33 cm / 13.00"
STANDARD INTEGRATED LED LIGHTING	
UP	5,8 W CRI>95 3000 K – 618 NOMINAL LM
DOWN	5,8 W CRI>95 3000 K – 618 NOMINAL LM
ON REQUEST	
UP	5,8 W CRI>95 2700 K – 589 NOMINAL LM
DOWN	5,8 W CRI>95 2700 K – 589 NOMINAL LM
DIMMABLE	
1-10V + PUSH	

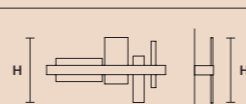

HONICÉ A37	
W	37 cm / 14.60"
D	10 cm / 3.90"
H	33 cm / 13.00"
STANDARD INTEGRATED LED LIGHTING	
UP	3,51 W CRI>95 3000 K – 375 NOMINAL LM
DOWN	3,51 W CRI>95 3000 K – 375 NOMINAL LM
ON REQUEST	
UP	3,51 W CRI>95 2700 K – 357 NOMINAL LM
DOWN	3,51 W CRI>95 2700 K – 357 NOMINAL LM
DIMMABLE	
1-10V + PUSH	

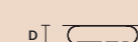
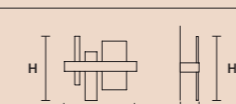

HONICÉ S70	
W	70 cm / 27.60"
D	8 cm / 3.10"
H	33 cm / 13.00"
STANDARD INTEGRATED LED LIGHTING	
UP	7 W CRI>95 3000 K – 746 NOMINAL LM
DOWN	15 W CRI>95 3000 K – 1600 NOMINAL LM
ON REQUEST	
UP	7 W CRI>95 2700 K – 711 NOMINAL LM
DOWN	15 W CRI>95 2700 K – 1525 NOMINAL LM
DIMMABLE	
0-10V	

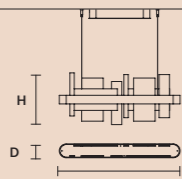

HONICÉ S80	
W	80 cm / 31.50"
D	80 cm / 31.50"
H	33 cm / 13.00"
STANDARD INTEGRATED LED LIGHTING	
UP	28,1 W CRI>95 3000 K – 2997 NOMINAL LM
DOWN	60,85 W CRI>95 3000 K – 6490 NOMINAL LM
ON REQUEST	
UP	28,1 W CRI>95 2700 K – 2856 NOMINAL LM
DOWN	60,85 W CRI>95 2700 K – 6186 NOMINAL LM
DIMMABLE	
0-10V	

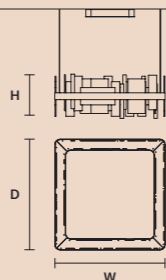

HONICÉ S50	
W	50 cm / 19.70"
D	50 cm / 19.70"
H	33 cm / 13.00"
STANDARD INTEGRATED LED LIGHTING	
UP	15,21 W CRI>95 3000 K – 1622 NOMINAL LM
DOWN	32,76 W CRI>95 3000 K – 3494 NOMINAL LM
ON REQUEST	
UP	15,21 W CRI>95 2700 K – 1546 NOMINAL LM
DOWN	32,76 W CRI>95 2700 K – 3330 NOMINAL LM
DIMMABLE	
0-10V	

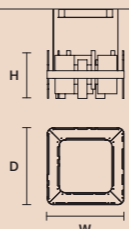

HONICÉ TL	
W	38 cm / 15.00"
D	16 cm / 6.30"
H	48 cm / 18.90"
STANDARD INTEGRATED LED LIGHTING	
UP	6 W CRI>95 3000 K – 640 NOMINAL LM
DOWN	6 W CRI>95 3000 K – 640 NOMINAL LM
ON REQUEST	
UP	6 W CRI>95 2700 K – 610 NOMINAL LM
DOWN	6 W CRI>95 2700 K – 610 NOMINAL LM
DIMMABLE	
OWN BUTTON	

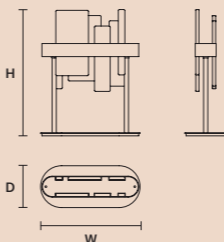

HONICÉ STL	
W	38 cm / 15.00"
D	16 cm / 6.30"
H	160 cm / 63.00"
STANDARD INTEGRATED LED LIGHTING	
UP	6 W CRI>95 3000 K – 640 NOMINAL LM
DOWN	6 W CRI>95 3000 K – 640 NOMINAL LM
ON REQUEST	
UP	6 W CRI>95 2700 K – 610 NOMINAL LM
DOWN	6 W CRI>95 2700 K – 610 NOMINAL LM
DIMMABLE	
OWN BUTTON	

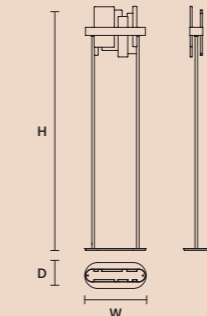

## SINGLE CANOPIES

### SINGLE CANOPY

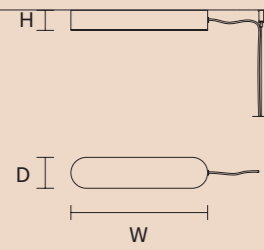

SIZE		FRAME FINISHINGS	CANOPY FINISHINGS	PRODUCT NAME
W	35,5 cm / 14.00"	● V99	● V99	HONICÉ S200
D	8 cm / 3.10"	● G01*	● G01*	HONICÉ S150
H	5,2 cm / 2.00"			HONICÉ S100
				HONICÉ S70
				HONICÉ S80
				HONICÉ S50

\*NOT AVAILABLE FOR HONICÉ S80  
AND HONICÉ S50

# Olà

IT Un gioiello di design che nasce da una sintesi di esperienza e creatività. Progettata più di dieci anni fa dal laboratorio creativo Masiero, con il contrasto tra la sua semplice struttura in metallo e la lussuosa cascata di pendenti, Olà è un'icona Masiero.

EN A jewel of design born from a synthesis of experience and creativity. Designed more than a decade ago by Masiero's creative atelier, the contrast between its simple metal frame and luxurious cascade of pendants makes Olà a Masiero icon.

DESIGN BY  
MASIERO LAB

SUSPENSION  
CEILING  
APPLIQUE  
TABLE LAMP  
FLOOR LAMP









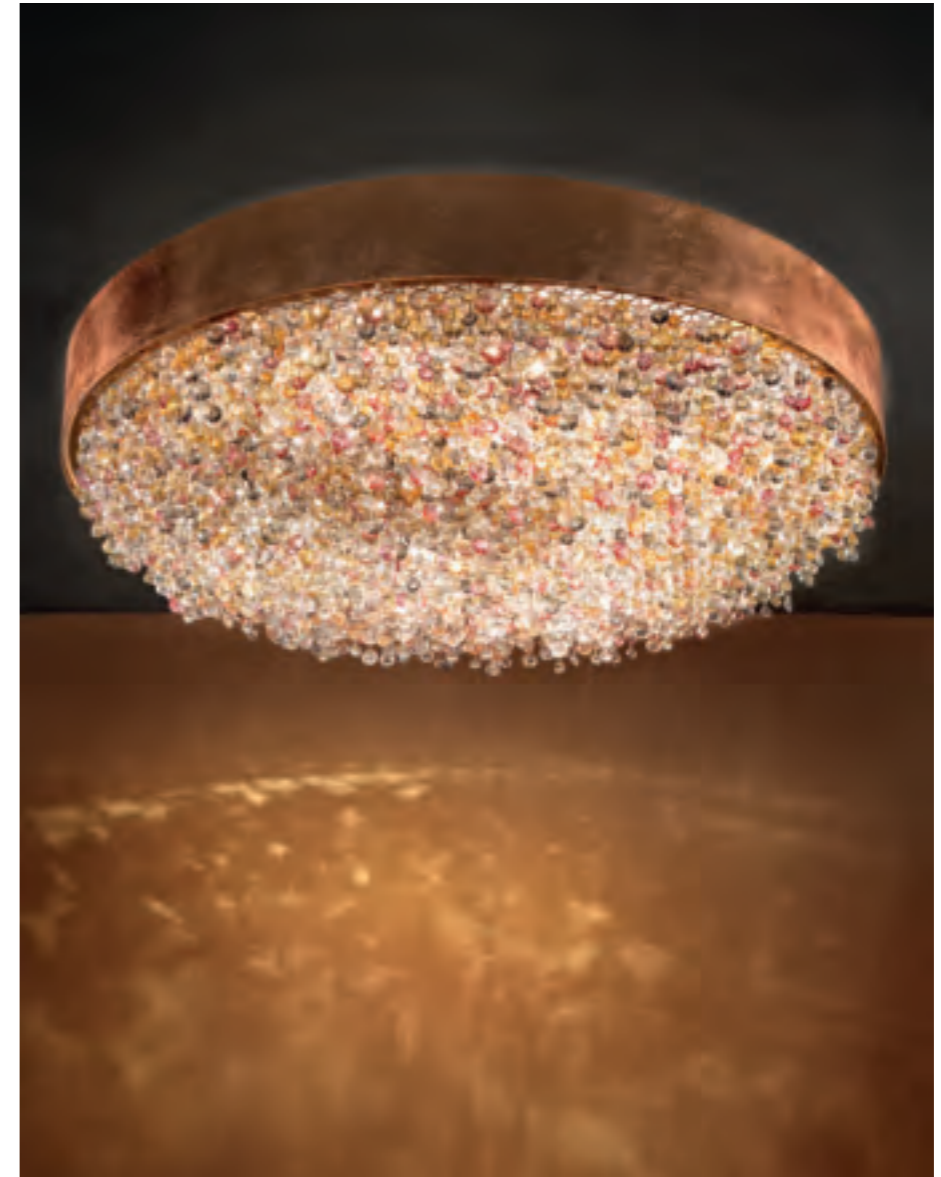







# Olà

Struttura in metallo verniciato con pendagli.

Painted metal frame with pendants.

Gestell aus lackiertem Metall mit Behang.

Estructura de metal pintado con colgantes.

Structure en métal verni avec pampilles.

Металлический окрашенный каркас с подвесками.

这种灯具的结构是涂漆的金属, 而且它有水晶吊坠们。

هيكل معدني مطلي مع دلايات.



G01 Burnished frame amber pendants



V83 Matt bronze frame warm pendants



F01 Gold leaf frame amber pendants



V90 Matt black frame smoky pendants



F02 Silver leaf frame transparent pendants

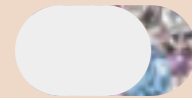

V95 Matt white frame cold pendants

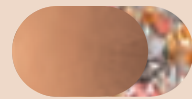

F03 Copper leaf frame copper pendants



WARM



TRANSPARENT



COLD



AMBER



COPPER



SMOKY

DISCOVER MORE



OLÀ S12 120	
Ø	120 cm / 47.20"
H	20 cm / 7.90"
STANDARD LIGHTING	
12×E27×20 W MAX (NOT INCL.)	
STANDARD INTEGRATED LED LIGHTING	
UP	15,6 W CRI>95 3000 K – 1536 NOMINAL LM
DOWN	62,4 W CRI>95 3000 K – 6144 NOMINAL LM
ON REQUEST	
UP	15,6 W CRI>95 2700 K – 1464 NOMINAL LM
DOWN	62,4 W CRI>95 2700 K – 5856 NOMINAL LM
DIMMABLE	
0-10V	



OLÀ S6 90	
Ø	90 cm / 35.40"
H	20 cm / 7.90"
STANDARD LIGHTING	
8×E27×20 W MAX (NOT INCL.)	
STANDARD INTEGRATED LED LIGHTING	
UP	10,4 W CRI>95 3000 K – 1024 NOMINAL LM
DOWN	31,2 W CRI>95 3000 K – 3072 NOMINAL LM
ON REQUEST	
UP	10,4 W CRI>95 2700 K – 976 NOMINAL LM
DOWN	31,2 W CRI>95 2700 K – 2928 NOMINAL LM
DIMMABLE	
0-10V	

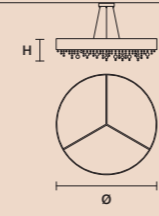

OLÀ S6 60	
Ø	60 cm / 23.60"
H	20 cm / 7.90"
STANDARD LIGHTING	
6×E27×20 W MAX (NOT INCL.)	
STANDARD INTEGRATED LED LIGHTING	
UP	7,8 W CRI>95 3000 K – 768 NOMINAL LM
DOWN	23,4 W CRI>95 3000 K – 2304 NOMINAL LM
ON REQUEST	
UP	7,8 W CRI>95 2700 K – 732 NOMINAL LM
DOWN	23,4 W CRI>95 2700 K – 2196 NOMINAL LM
DIMMABLE	
0-10V	



OLÀ S6 40	
Ø	40 cm / 15.70"
H	20 cm / 7.90"
STANDARD LIGHTING	
6×E14×10 W MAX (NOT INCL.)	
STANDARD INTEGRATED LED LIGHTING	
UP	13,7 W CRI>95 3000 K – 1348 NOMINAL LM
DOWN	13,7 W CRI>95 3000 K – 1348 NOMINAL LM
ON REQUEST	
UP	13,7 W CRI>95 2700 K – 1285 NOMINAL LM
DOWN	13,7 W CRI>95 2700 K – 1285 NOMINAL LM
DIMMABLE	
0-10V	

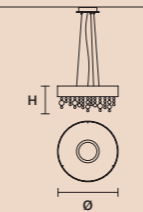

OLÀ S2 15	
Ø	15 cm / 5.90"
H	26 cm / 10.20"
STANDARD LIGHTING	
2×G9×10 W MAX (NOT INCL.)	
STANDARD INTEGRATED LED LIGHTING	
DOWN	7,5 W CRI>90 3000 K – 1080 NOMINAL LM
ON REQUEST	
DOWN	7,5 W CRI>90 2700 K – 1026 NOMINAL LM
DIMMABLE	
1-10V + PUSH	

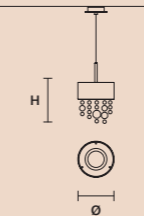

OLÀ S8 OV 210	
W	210 cm / 82.70"
D	20 cm / 7.90"
H	20 cm / 7.90"
STANDARD LIGHTING	
8×E14×10 W MAX (NOT INCL.)	
STANDARD INTEGRATED LED LIGHTING	
UP	15,6 W CRI>95 3000 K – 1536 NOMINAL LM
DOWN	70,2 W CRI>95 3000 K – 6912 NOMINAL LM
ON REQUEST	
UP	15,6 W CRI>95 2700 K – 1464 NOMINAL LM
DOWN	70,2 W CRI>95 2700 K – 6588 NOMINAL LM
DIMMABLE	
0-10V	

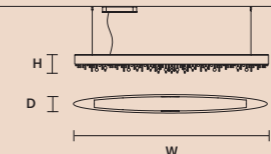

OLÀ S2 OV 50	
W	50 cm / 19.70"
D	8 cm / 3.10"
H	18 cm / 7.10"
STANDARD LIGHTING	
2×E27×20 W MAX (NOT INCL.)	
STANDARD INTEGRATED LED LIGHTING	
UP	5,2 W CRI>95 3000 K – 512 NOMINAL LM
DOWN	7,8 W CRI>95 3000 K – 768 NOMINAL LM
ON REQUEST	
UP	5,2 W CRI>95 2700 K – 488 NOMINAL LM
DOWN	7,8 W CRI>95 2700 K – 732 NOMINAL LM
DIMMABLE	
1-10V + PUSH	

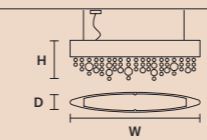

OLÀ S1 OV 30	
W	30 cm / 11.80"
D	7 cm / 2.80"
H	18 cm / 7.10"
STANDARD LIGHTING	
1×E14×10 W MAX (NOT INCL.)	
STANDARD INTEGRATED LED LIGHTING	
UP	4 W CRI>95 3000 K – 390 NOMINAL LM
DOWN	4 W CRI>95 3000 K – 390 NOMINAL LM
ON REQUEST	
UP	4 W CRI>95 2700 K – 375 NOMINAL LM
DOWN	4 W CRI>95 2700 K – 375 NOMINAL LM
DIMMABLE	
1-10V + PUSH	

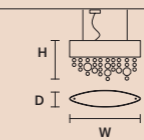

OLÀ S6 OV 160	
W	160 cm / 63.00"
D	14 cm / 5.50"
H	20 cm / 7.90"
STANDARD LIGHTING	
6×E14×10 W MAX (NOT INCL.)	
STANDARD INTEGRATED LED LIGHTING	
UP	10,4 W CRI>95 3000 K – 1024 NOMINAL LM
DOWN	50,7 W CRI>95 3000 K – 4992 NOMINAL LM
ON REQUEST	
UP	10,4 W CRI>95 2700 K – 976 NOMINAL LM
DOWN	50,7 W CRI>95 2700 K – 4758 NOMINAL LM
DIMMABLE	
0-10V	

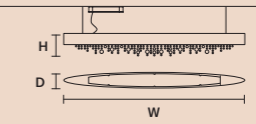

OLÀ S4 OV 100	
W	100 cm / 39.40"
D	13 cm / 5.10"
H	20 cm / 7.90"
STANDARD LIGHTING	
4×E14×10 W MAX (NOT INCL.)	
STANDARD INTEGRATED LED LIGHTING	
UP	5,2 W CRI>95 3000 K – 512 NOMINAL LM
DOWN	25,35 W CRI>95 3000 K – 2496 NOMINAL LM
ON REQUEST	
UP	5,2 W CRI>95 2700 K – 488 NOMINAL LM
DOWN	25,35 W CRI>95 2700 K – 2379 NOMINAL LM
DIMMABLE	
0-10V	

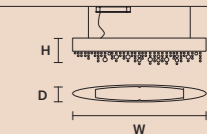

OLÀ PL12 120	
Ø	120 cm / 47.20"
H	26 cm / 10.20"
STANDARD LIGHTING	
12×E27×20 W MAX (NOT INCL.)	
STANDARD INTEGRATED LED LIGHTING	
DOWN	62,4 W CRI>95 3000 K – 6144 NOMINAL LM
ON REQUEST	
DOWN	62,4 W CRI>95 2700 K – 5856 NOMINAL LM
DIMMABLE	
0-10V	

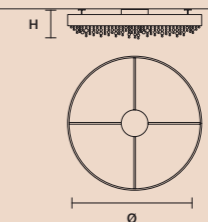

OLÀ PL6 90	
Ø	90 cm / 35.40"
H	26 cm / 10.20"
STANDARD LIGHTING	
8×E27×20 W MAX (NOT INCL.)	
STANDARD INTEGRATED LED LIGHTING	
DOWN	31,2 W CRI>95 3000 K – 3072 NOMINAL LM
ON REQUEST	
DOWN	31,2 W CRI>95 2700 K – 2928 NOMINAL LM
DIMMABLE	
0-10V	

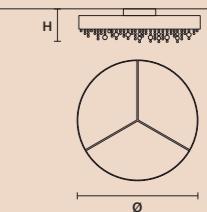

### OLÀ PL6 60

Ø 60 cm / 23.60"  
H 26 cm / 10.20"

STANDARD LIGHTING 

6×E27×20 W MAX (NOT INCL.)

STANDARD INTEGRATED LED LIGHTING 

DOWN 23,4 W CRI>95  
3000 K – 2304 NOMINAL LM

#### ON REQUEST

DOWN 23,4 W CRI>95  
2700 K – 2196 NOMINAL LM

#### DIMMABLE

0-10V



### OLÀ PL6 40

Ø 40 cm / 15.70"  
H 26 cm / 10.20"

STANDARD LIGHTING 

6×E14×10 W MAX (NOT INCL.)

STANDARD INTEGRATED LED LIGHTING 

DOWN 13,7 W CRI>95  
3000 K – 1348 NOMINAL LM

#### ON REQUEST

DOWN 13,7 W CRI>95  
2700 K – 1285 NOMINAL LM

#### DIMMABLE

1-10V + PUSH



### OLÀ PL8 OV 210

W 210 cm / 82.70"  
D 20 cm / 7.907"  
H 26 cm / 10.20"

STANDARD LIGHTING 

8×E14×10 W MAX (NOT INCL.)

STANDARD INTEGRATED LED LIGHTING 

DOWN 70,2 W CRI>95  
3000 K – 6912 NOMINAL LM

#### ON REQUEST

DOWN 70,2 W CRI>95  
2700 K – 6588 NOMINAL LM

#### DIMMABLE

0-10V

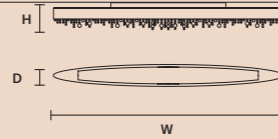

### OLÀ PL6 OV 160

W 160 cm / 63.00"  
D 13 cm / 5.10"  
H 26 cm / 10.20"

STANDARD LIGHTING 

6×E14×10 W MAX (NOT INCL.)

STANDARD INTEGRATED LED LIGHTING 

DOWN 50,7 W CRI>95  
3000 K – 4992 NOMINAL LM

#### ON REQUEST

DOWN 50,7 W CRI>95  
2700 K – 4758 NOMINAL LM

#### DIMMABLE

0-10V

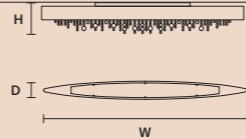

### OLÀ A1 OV 30

W 30 cm / 11.80"  
D 10 cm / 3.90"  
H 18 cm / 7.10"

STANDARD LIGHTING 

1×E14×10 W MAX (NOT INCL.)

STANDARD INTEGRATED LED LIGHTING 

UP 4 W CRI>95  
3000 K – 390 NOMINAL LM  
DOWN 4 W CRI>95  
3000 K – 390 NOMINAL LM

#### ON REQUEST

UP 4 W CRI>95  
2700 K – 375 NOMINAL LM  
DOWN 4 W CRI>95  
2700 K – 375 NOMINAL LM

#### DIMMABLE

1-10V + PUSH

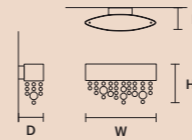

### OLÀ TL2

W 50 cm / 19.70"  
D 16 cm / 6.30"  
H 50 cm / 19.70"

STANDARD LIGHTING 

2×E27×20 W MAX (NOT INCL.)

STANDARD INTEGRATED LED LIGHTING 

UP 5,2 W CRI>95  
3000 K – 512 NOMINAL LM  
DOWN 7,8 W CRI>95  
3000 K – 768 NOMINAL LM

#### ON REQUEST

UP 5,2 W CRI>95  
2700 K – 488 NOMINAL LM  
DOWN 7,8 W CRI>95  
2700 K – 732 NOMINAL LM

#### DIMMABLE

OWN BUTTON

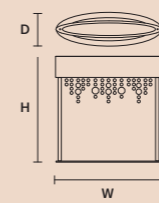

### OLÀ STL2

W 50 cm / 19.70"  
D 24 cm / 9.40"  
H 180 cm / 70.90"

STANDARD LIGHTING 

2×E27×20 W MAX (NOT INCL.)

STANDARD INTEGRATED LED LIGHTING 

UP 5,2 W CRI>95  
3000 K – 512 NOMINAL LM  
DOWN 7,8 W CRI>95  
3000 K – 768 NOMINAL LM

#### ON REQUEST

UP 5,2 W CRI>95  
2700 K – 488 NOMINAL LM  
DOWN 7,8 W CRI>95  
2700 K – 732 NOMINAL LM

#### DIMMABLE

OWN BUTTON

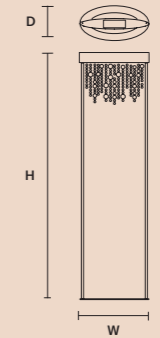

### OLÀ PL4 OV 100

W 100 cm / 39.40"  
D 13 cm / 5.10"  
H 26 cm / 10.20"

STANDARD LIGHTING 

4×E14×10 W MAX (NOT INCL.)

STANDARD INTEGRATED LED LIGHTING 

DOWN 25,35 W CRI>95  
3000 K – 2496 NOMINAL LM

#### ON REQUEST

DOWN 25,35 W CRI>95  
2700 K – 2379 NOMINAL LM

#### DIMMABLE

0-10V

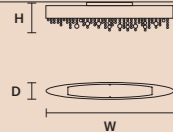

### OLÀ A6 OV 160

W 160 cm / 63.00"  
D 20 cm / 7.90"  
H 20 cm / 7.90"

STANDARD LIGHTING 

6×E14×10 W MAX (NOT INCL.)

STANDARD INTEGRATED LED LIGHTING 

UP 10,4 W CRI>95  
3000 K – 1024 NOMINAL LM  
DOWN 50,7 W CRI>95  
3000 K – 4992 NOMINAL LM

#### ON REQUEST

UP 10,4 W CRI>95  
2700 K – 976 NOMINAL LM  
DOWN 50,7 W CRI>95  
2700 K – 4758 NOMINAL LM

#### DIMMABLE

NO

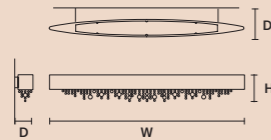

### OLÀ A2 OV 70

W 70 cm / 27.60"  
D 20 cm / 7.90"  
H 20 cm / 7.90"

STANDARD LIGHTING 

2×E27×20 W MAX (NOT INCL.)

STANDARD INTEGRATED LED LIGHTING 

UP 11,7 W CRI>95  
3000 K – 1152 NOMINAL LM  
DOWN 19,5 W CRI>95  
3000 K – 1920 NOMINAL LM

#### ON REQUEST

UP 11,7 W CRI>95  
2700 K – 1098 NOMINAL LM  
DOWN 19,5 W CRI>95  
2700 K – 1830 NOMINAL LM

#### DIMMABLE

NO

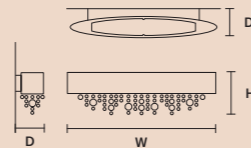

### OLÀ A2 OV 50

W 50 cm / 19.70"  
D 12 cm / 4.70"  
H 18 cm / 7.10"

STANDARD LIGHTING 

2×E27×20 W MAX (NOT INCL.)

STANDARD INTEGRATED LED LIGHTING 

UP 5,2 W CRI>95  
3000 K – 512 NOMINAL LM  
DOWN 7,8 W CRI>95  
3000 K – 768 NOMINAL LM

#### ON REQUEST

UP 5,2 W CRI>95  
2700 K – 488 NOMINAL LM  
DOWN 7,8 W CRI>95  
2700 K – 732 NOMINAL LM

#### DIMMABLE

1-10V + PUSH

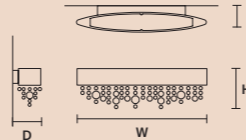

### OLÀ C3 LN 75

W 75 cm / 29.50"  
D 20 cm / 7.90"  
H MAX 180 cm / 70.90"

STANDARD LIGHTING 

6xG9x10 W MAX (NOT INCL.)

STANDARD INTEGRATED LED LIGHTING 

DOWN 22,5 W CRI>90  
3000 K – 3240 NOMINAL LM

ON REQUEST

DOWN 22,5 W CRI>90  
2700 K – 3078 NOMINAL LM

DIMMABLE

1-10V + PUSH

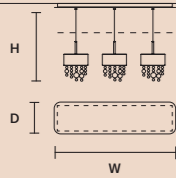

### OLÀ C5 LN 125

W 125 cm / 49.201"  
D 20 cm / 7.90"  
H MAX 180 cm / 70.90"

STANDARD LIGHTING 

10xG9x10 W MAX (NOT INCL.)

STANDARD INTEGRATED LED LIGHTING 

DOWN 37,5 W CRI>90  
3000 K – 5400 NOMINAL LM

ON REQUEST

DOWN 37,5 W CRI>90  
2700 K – 5130 NOMINAL LM

DIMMABLE

1-10V + DALI + PUSH

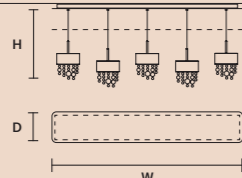

### OLÀ C7 LN 175

W 175 cm / 68.90"  
D 20 cm / 7.90"  
H MAX 180 cm / 70.90"

STANDARD LIGHTING 

14xG9x10 W MAX (NOT INCL.)

STANDARD INTEGRATED LED LIGHTING 

DOWN 52,5 W CRI>90  
3000 K – 7560 NOMINAL LM

ON REQUEST

DOWN 52,5 W CRI>90  
2700 K – 7182 NOMINAL LM

DIMMABLE

1-10V + DALI + PUSH

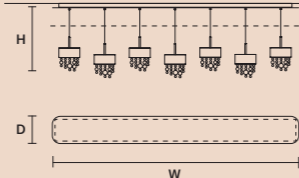

### OLÀ C3 RD 40

Ø 40 cm / 15.70"  
H MAX 180 cm / 70.90"

STANDARD LIGHTING 

6xG9x10 W MAX (NOT INCL.)

STANDARD INTEGRATED LED LIGHTING 

DOWN 22,5 W CRI>90  
3000 K – 3240 NOMINAL LM

ON REQUEST

DOWN 22,5 W CRI>90  
2700 K – 3078 NOMINAL LM

DIMMABLE

1-10V + PUSH

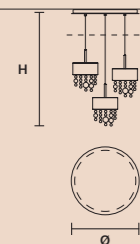

### OLÀ C5 RD 60

Ø 60 cm / 23.60"  
H MAX 180 cm / 70.90"

STANDARD LIGHTING 

10xG9x10 W MAX (NOT INCL.)

STANDARD INTEGRATED LED LIGHTING 

DOWN 37,5 W CRI>90  
3000 K – 5400 NOMINAL LM

ON REQUEST

DOWN 37,5 W CRI>90  
2700 K – 5130 NOMINAL LM

DIMMABLE

1-10V + DALI + PUSH

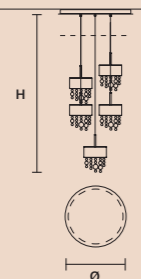

### OLÀ C7 RD 80

Ø 80 cm / 31.50"  
H MAX 180 cm / 70.90"

STANDARD LIGHTING 

14xG9x10 W MAX (NOT INCL.)

STANDARD INTEGRATED LED LIGHTING 

DOWN 52,5 W CRI>90  
3000 K – 7560 NOMINAL LM

ON REQUEST

DOWN 52,5 W CRI>90  
2700 K – 7182 NOMINAL LM

DIMMABLE

1-10V + DALI + PUSH

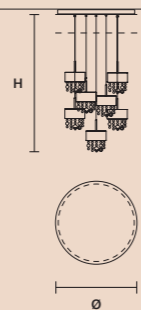

## SINGLE CANOPIES

### SINGLE CANOPY

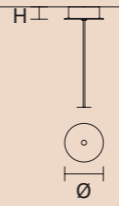
	SIZE	FRAME FINISHINGS	CANOPIY FINISHINGS	PRODUCT NAME	LIGHTING
	Ø 10 cm / 3.90"	● V95	● V95	OLÁ S2 15	STANDARD
	H 3,2 cm / 1.30"	● V83	● V83	OLÁ S1 OV 30	STANDARD
		● V90	● V90	OLÁ S4 OV 100	STANDARD
		● F01	● F01	OLÁ S8 OV 210	STANDARD
		● F02	● F02	OLÁ S2 OV 50	STANDARD
		● F03	● F03	OLÁ S6 OV 160	STANDARD
		● G01	● G01	OLÁ S12 120	STANDARD

### SINGLE CANOPY

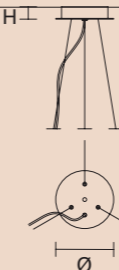
	SIZE	FRAME FINISHINGS	CANOPIY FINISHINGS	PRODUCT NAME	LIGHTING
	Ø 15 cm / 5.90"	● V95	● V95	OLÁ S6 40	STANDARD
	H 3 cm / 1.20"	● V83	● V83	OLÁ S6 60	STANDARD
		● V90	● V90	OLÁ S6 90	STANDARD
		● F01	● F01		
		● F02	● F02		
		● F03	● F03		
		● G01	● G01		

STANDARD LIGHTING:  
THE COLOR OF THE CABLE CHANGES ACCORDING TO THE FRAME

## SINGLE CANOPIES

### SINGLE CANOPY/LED LIGHTING

SIZE	FRAME FINISHINGS	CANOPY FINISHINGS	PRODUCT NAME	LIGHTING
∅ 12 cm / 4.70" H 4 cm / 1.60"	<ul style="list-style-type: none"> <li>● V95</li> <li>● V83</li> <li>● V90</li> <li>● F01</li> <li>● F02</li> <li>● F03</li> <li>● G01</li> </ul>	<ul style="list-style-type: none"> <li>● V95</li> <li>● V83</li> <li>● V90</li> <li>● F01</li> <li>● F02</li> <li>● F03</li> <li>● G01</li> </ul>	OLÁ S2 15	LED

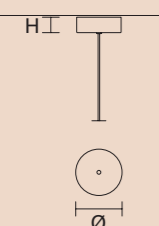

### SINGLE CANOPY/LED LIGHTING

SIZE	FRAME FINISHINGS	CANOPY FINISHINGS	PRODUCT NAME	LIGHTING
∅ 14 cm / 5.50" H 3,2 cm / 1.30"	<ul style="list-style-type: none"> <li>● V95</li> <li>● V83</li> <li>● V90</li> <li>● F01</li> <li>● F02</li> <li>● F03</li> <li>● G01</li> </ul>	<ul style="list-style-type: none"> <li>● V95</li> <li>● V83</li> <li>● V90</li> <li>● F01</li> <li>● F02</li> <li>● F03</li> <li>● G01</li> </ul>	OLÁ S1 OV 30 OLÁ S2 OV 50	LED LED

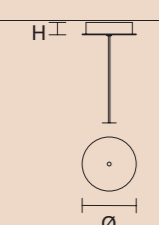

### SINGLE CANOPY/LED LIGHTING

SIZE	FRAME FINISHINGS	CANOPY FINISHINGS	PRODUCT NAME	LIGHTING
∅ 20 cm / 7.90" H 4,2 cm / 1.70"	<ul style="list-style-type: none"> <li>● V95</li> <li>● V83</li> <li>● V90</li> <li>● F01</li> <li>● F02</li> <li>● F03</li> <li>● G01</li> </ul>	<ul style="list-style-type: none"> <li>● V95</li> <li>● V83</li> <li>● V90</li> <li>● F01</li> <li>● F02</li> <li>● F03</li> <li>● G01</li> </ul>	OLÁ S6 40 OLÁ S6 60 OLÁ S6 90	LED LED LED

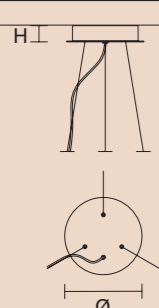

### SINGLE CANOPY/LED LIGHTING

SIZE	FRAME FINISHINGS	CANOPY FINISHINGS	PRODUCT NAME	LIGHTING
∅ 26 cm / 10.20" H 5,2 cm / 2.00"	<ul style="list-style-type: none"> <li>● V95</li> <li>● V83</li> <li>● V90</li> <li>● F01</li> <li>● F02</li> <li>● F03</li> <li>● G01</li> </ul>	<ul style="list-style-type: none"> <li>● V95</li> <li>● V83</li> <li>● V90</li> <li>● F01</li> <li>● F02</li> <li>● F03</li> <li>● G01</li> </ul>	OLÁ S12 120	LED

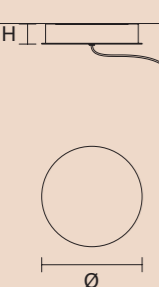

### SINGLE CANOPY/LED LIGHTING

SIZE	FRAME FINISHINGS	CANOPY FINISHINGS	PRODUCT NAME	LIGHTING
W 35,5 cm / 14.00" D 8 cm / 3.10" H 5,2 cm / 2.00"	<ul style="list-style-type: none"> <li>● V95</li> <li>● V83</li> <li>● V90</li> <li>● F01</li> <li>● F02</li> <li>● F03</li> <li>● G01</li> </ul>	<ul style="list-style-type: none"> <li>● V95</li> <li>● V83</li> <li>● V90</li> <li>● F01</li> <li>● F02</li> <li>● F03</li> <li>● G01</li> </ul>	OLÁ S6 OV 100 OLÁ S6 OV 160 OLÁ S8 OV 210	LED LED LED



INTEGRATED LED LIGHTING:  
TRANSPARENT CABLE

## MULTIPLE CANOPIES

### LINEAR CANOPY LN 75

SIZE	FINISHINGS	PRODUCT NAME
W 75 cm / 29.50" D 20 cm / 7.90" H 4 cm / 1.60"	● V98	OLÀ C3 LN 75

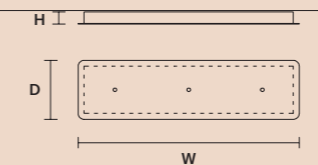

### LINEAR CANOPY LN 125

SIZE	FINISHINGS	PRODUCT NAME
W 125 cm / 49.20" D 20 cm / 7.90" H 4 cm / 1.60"	● V98	OLÀ C5 LN 125

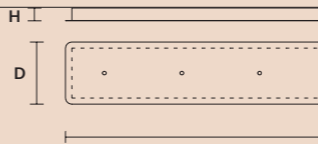

### LINEAR CANOPY LN 175

SIZE	FINISHINGS	PRODUCT NAME
W 175 cm / 68.90" D 20 cm / 7.90" H 4 cm / 1.60"	● V98	OLÀ C7 LN 175

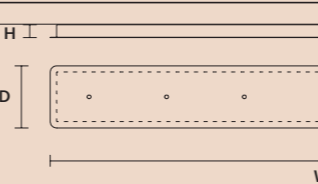

### ROUND CANOPY RD 40

SIZE	FINISHINGS	PRODUCT NAME
∅ 40 cm / 15.70" H 4 cm / 1.60"	● V98	OLÀ C3 RD 40

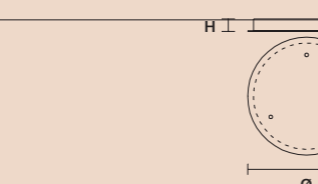

### ROUND CANOPY RD 60

SIZE	FINISHINGS	PRODUCT NAME
∅ 60 cm / 23.60" H 4 cm / 1.60"	● V98	OLÀ C5 RD 60

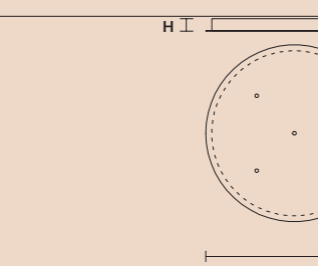

### ROUND CANOPY RD 80

SIZE	FINISHINGS	PRODUCT NAME
∅ 80 cm / 31.50" H 4 cm / 1.60"	● V98	OLÀ C7 RD 80

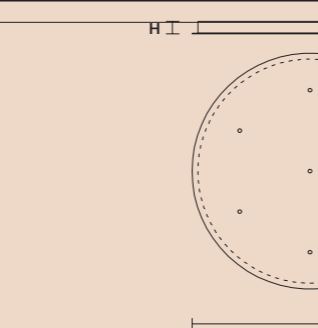

STANDARD LIGHTING: THE COLOR OF THE CABLE CHANGES ACCORDING TO THE FRAME  
INTEGRATED LED LIGHTING: TRANSPARENT CABLE

# Libe

IT Un disegno perfetto, dove le forme geometriche semplici e lineari si concretizzano in un oggetto. Come magia un tratto di matita diventa realtà per mezzo di sapienti mani e pregiati materiali, come l'ottone e le losanghe di cristallo.

EN A perfect design, where simple, linear geometric shapes take concrete form in an object. As if by magic, a pencil stroke becomes reality, thanks to skilful hands and precious materials such as brass and crystal lozenges.

DESIGN BY  
GIAMPAOLO RAMPOLLA  
E ANDREA LIGUORI

SUSPENSION  
APPLIQUE



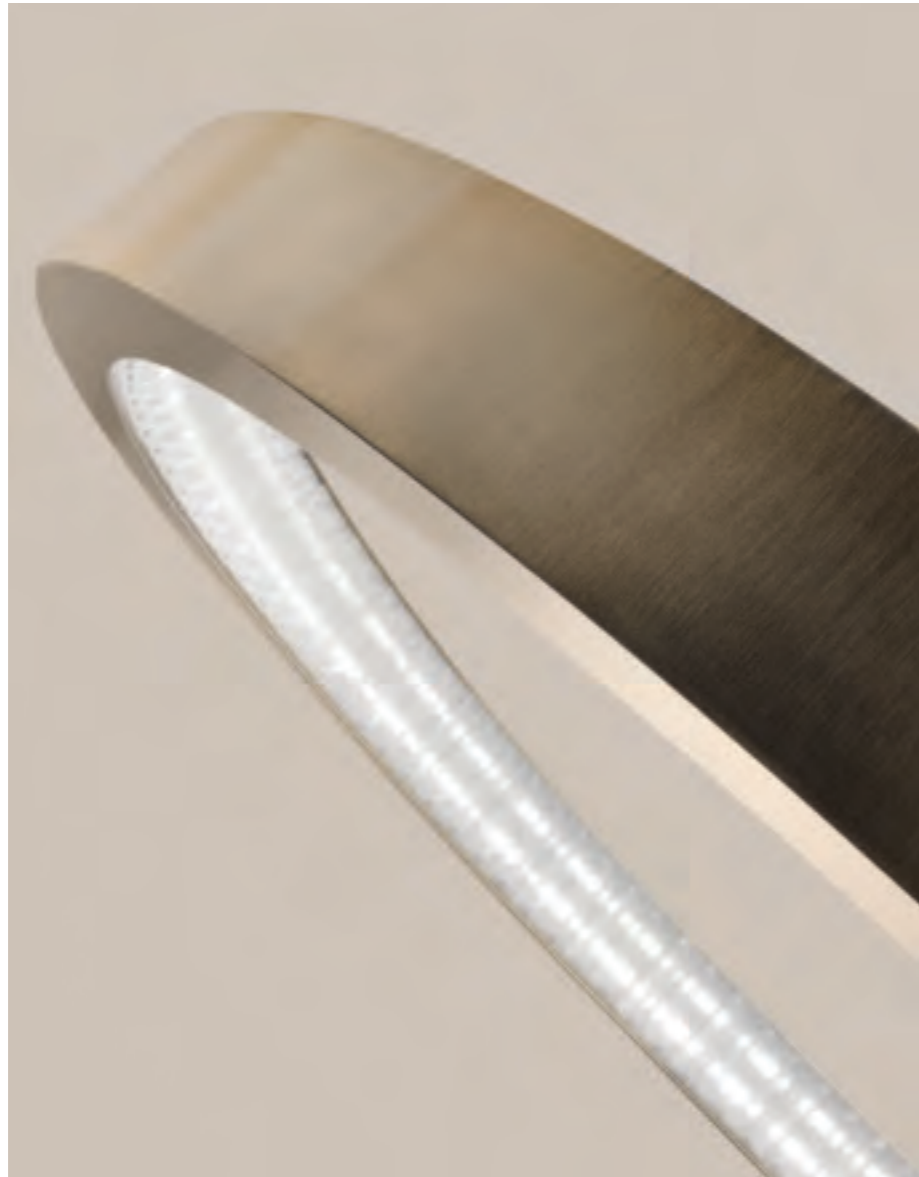



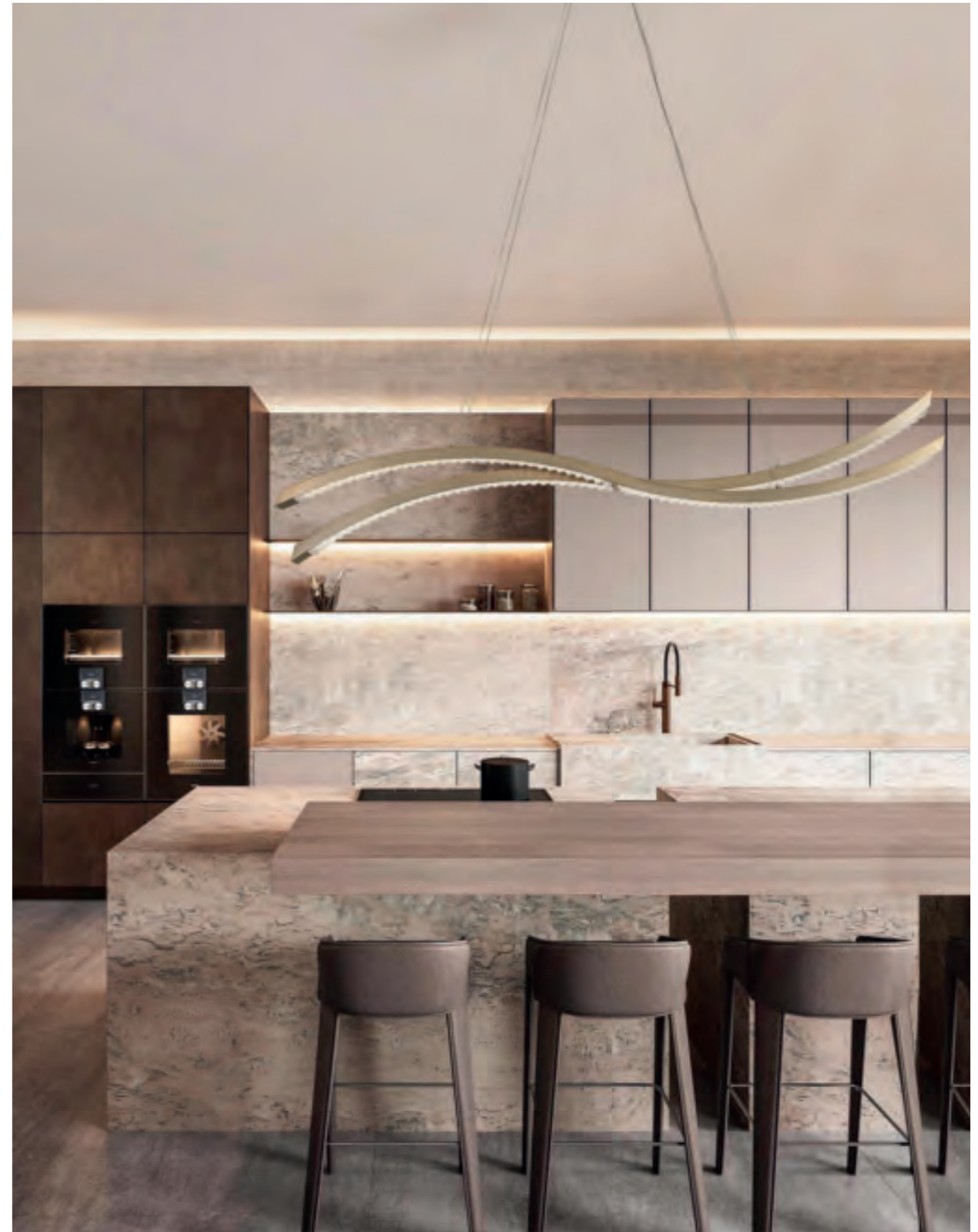

# Libe

Telaio in metallo galvanizzato con diffusore in losanghe di cristallo opaco. Illuminazione LED.

Galvanised metal frame with a matt crystal lozenge diffuser. LED lighting.

Gestell aus galvanisch beschichtetem Metall mit Diffusor in matten Kristallrauten. LED-Leuchtmittel.

Marco de metal galvanizado con difusor en pastillas de cristal opaco. Iluminación LED.

Structure en métal galvanisé avec diffuseur en losanges en cristal mat. Éclairage à LED.

Каркас из оцинкованного металла с рассеивателем из пластин матового хрусталя. Светодиодный светильник.

电镀金属灯架，带不透明水晶菱形散光罩。LED 灯。

إطار معدني مجلفن مع ناشر من المعينات الكريستالية غير شفافة. الإنارة ليد.



G14 Ottone brunito  
Burnished brass

DISCOVER MORE



LIBE S160	
W	160 cm / 63.00"
D	16 cm / 6.30"
H	30 cm / 11.80"
STANDARD INTEGRATED LED LIGHTING	
104 W CRI>90 3000 K – 9770 NOMINAL LM	
ON REQUEST	
104 W CRI>90 2700 K – 9280 NOMINAL LM	
DIMMABLE	
1-10V	

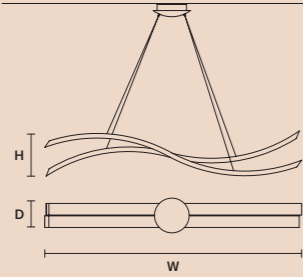

LIBE ROUND S115	
∅	115 cm / 45.30"
H	8,5 cm / 3.30"
STANDARD INTEGRATED LED LIGHTING	
116 W CRI>90 3000 K – 10904 NOMINAL LM	
ON REQUEST	
116 W CRI>90 2700 K – 10350 NOMINAL LM	
DIMMABLE	
1-10V	

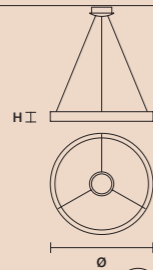

LIBE ELLIPSE S120	
W	120 cm / 47.20"
D	40 cm / 15.70"
H	8,5 cm / 3.30"
STANDARD INTEGRATED LED LIGHTING	
86,5 W CRI>90 3000 K – 8131 NOMINAL LM	
ON REQUEST	
86,5 W CRI>90 2700 K – 7720 NOMINAL LM	
DIMMABLE	
0-10V	

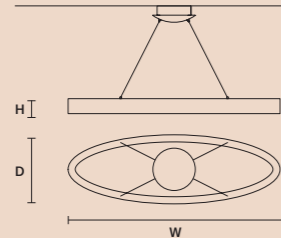

LIBE S100	
W	100 cm / 39.40"
D	16 cm / 6.30"
H	20 cm / 7.90"
STANDARD INTEGRATED LED LIGHTING	
63 W CRI>90 3000 K – 5922 NOMINAL LM	
ON REQUEST	
63 W CRI>90 2700 K – 5620 NOMINAL LM	
DIMMABLE	
0-10V	

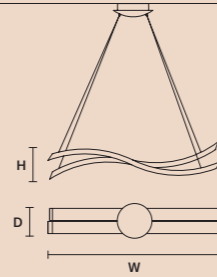

LIBE ROUND S90	
∅	90 cm / 35.40"
H	8,5 cm / 3.30"
STANDARD INTEGRATED LED LIGHTING	
90 W CRI>90 3000 K – 8460 NOMINAL LM	
ON REQUEST	
90 W CRI>90 2700 K – 8030 NOMINAL LM	
DIMMABLE	
0-10V	

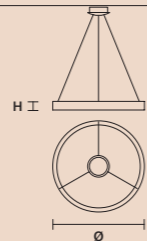

LIBE ELLIPSE S90	
W	90 cm / 35.40"
D	30 cm / 11.80"
H	8,5 cm / 3.30"
STANDARD INTEGRATED LED LIGHTING	
62,5 W CRI>90 3000 K – 5875 NOMINAL LM	
ON REQUEST	
62,5 W CRI>90 2700 K – 5580 NOMINAL LM	
DIMMABLE	
0-10V	

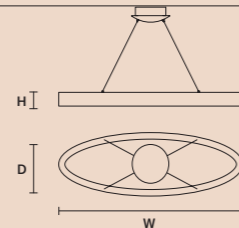

LIBE ROUND S140	
∅	140 cm / 55.10"
H	8,5 cm / 3.30"
STANDARD INTEGRATED LED LIGHTING	
144 W CRI>90 3000 K – 13536 NOMINAL LM	
ON REQUEST	
144 W CRI>90 2700 K – 12850 NOMINAL LM	
DIMMABLE	
1-10V	

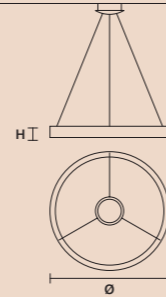

LIBE ROUND S60	
∅	60 cm / 23.60"
H	8,5 cm / 3.30"
STANDARD INTEGRATED LED LIGHTING	
59 W CRI>90 3000 K – 5546 NOMINAL LM	
ON REQUEST	
59 W CRI>90 2700 K – 5264 NOMINAL LM	
DIMMABLE	
0-10V	



LIBE A55	
W	55 cm / 21.70"
D	8 cm / 3.10"
H	8,5 cm / 3.30"
STANDARD INTEGRATED LED LIGHTING	
7 W CRI>90 3000 K – 658 NOMINAL LM	
ON REQUEST	
7 W CRI>90 2700 K – 625 NOMINAL LM	
DIMMABLE	
NO	

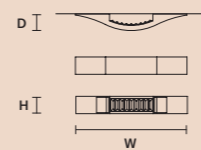

LIBE COMBO S140	
∅	140 cm / 55.10"
HMAX	300 cm / 118.00"
STANDARD INTEGRATED LED LIGHTING	
350 W CRI>90 3000 K – 32900 NOMINAL LM	
ON REQUEST	
350 W CRI>90 2700 K – 31230 NOMINAL LM	
DIMMABLE	
1-10V	

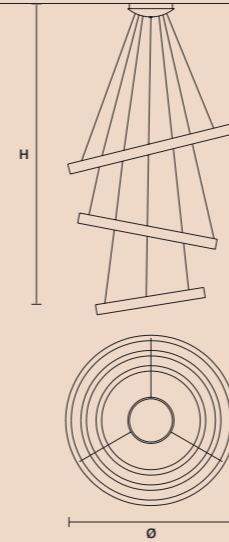

## SINGLE CANOPIES

### SINGLE CANOPY

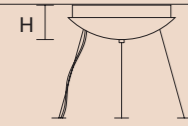

SIZE  
 ø 27,5 cm / 10.80"  
 H 9 cm / 3.50"

FINISHINGS  
 ● G14

PRODUCT NAME  
 LIBE ROUND S140  
 LIBE ROUND S115  
 LIBE ROUND S90  
 LIBE ROUND S60

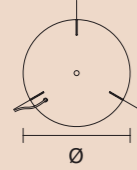

### SINGLE CANOPY

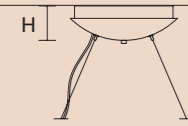

SIZE  
 ø 27,5 cm / 10.80"  
 H 9 cm / 3.50"

FINISHINGS  
 ● G14

PRODUCT NAME  
 LIBE S100  
 LIBE S160  
 LIBE ELLIPSE S90  
 LIBE ELLIPSE S120

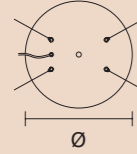

### SINGLE CANOPY

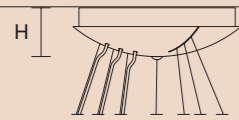

SIZE  
 ø 38 cm / 15.00"  
 H 11 cm / 4.30"

FINISHINGS  
 ● G14

PRODUCT NAME  
 LIBE COMBO S140

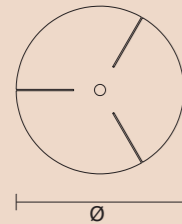

# Ribbon

IT Ribbon parla di leggerezza contemporanea delle linee, purezza dei materiali e minimalismo dei colori. Questo è Ribbon, dove il metallo cinge il vetro come chiffon bianco avvolto da un nastro nero dalle abili mani di una sarta.

EN Ribbon expresses contemporary lightness in its lines, purity in its materials and minimalism in its colours. This is Ribbon, where metal encircles the glass like white chiffon wrapped in a black ribbon by the skilled hands of a seamstress.

DESIGN BY  
ORIANO FAVARETTO

SUSPENSION  
APPLIQUE  
TABLE LAMP  
FLOOR LAMP









# Ribbon

Telaio in metallo verniciato. Vetri in piastra. Illuminazione a LED.

Painted metal frame. Plate glasses. LED lighting.

Struktur aus lackiertem Metall. Glas aus gegossenen Glasplatten. LED-Beleuchtung.

Marco de metal pintado. Vidrio en placa. Iluminación LED.

Structure en métal peint. Verre plat. LED éclairage.

Окрашенный металлический каркас. Венецианское рельефное стекло. Светодиод.

这种灯具的结构是涂漆的金属，而且结构也有一些特别的意大利制造玻璃线条们。LED照明。

إطار معدني مطلي. زجاج في لوح. إضاءة ليد.

RIBBON S200	
W	200 cm / 78.70"
D	8 cm / 3.10"
H	33 cm / 13.00"
STANDARD INTEGRATED LED LIGHTING	
UP	21,1 W CRI>95 3000 K – 2250 NOMINAL LM
DOWN	44,46 W CRI>95 3000 K – 4742 NOMINAL LM
ON REQUEST	
UP	21,1 W CRI>95 2700 K – 2145 NOMINAL LM
DOWN	44,46 W CRI>95 2700 K – 4520 NOMINAL LM
DIMMABLE	
0-10V	

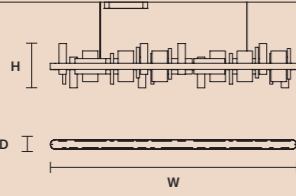

RIBBON S150	
W	150 cm / 59.10"
D	8 cm / 3.10"
H	33 cm / 13.00"
STANDARD INTEGRATED LED LIGHTING	
UP	17 W CRI>95 3000 K – 1813 NOMINAL LM
DOWN	33,5 W CRI>95 3000 K – 3573 NOMINAL LM
ON REQUEST	
UP	17 W CRI>95 2700 K – 1728 NOMINAL LM
DOWN	33,5 W CRI>95 2700 K – 3405 NOMINAL LM
DIMMABLE	
0-10V	

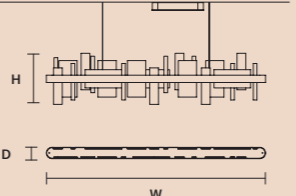

RIBBON S100	
W	100 cm / 39.40"
D	8 cm / 3.10"
H	33 cm / 13.00"
STANDARD INTEGRATED LED LIGHTING	
UP	9,36 W CRI>95 3000 K – 998 NOMINAL LM
DOWN	21,1 W CRI>95 3000 K – 2250 NOMINAL LM
ON REQUEST	
UP	9,36 W CRI>95 2700 K – 951 NOMINAL LM
DOWN	21,1 W CRI>95 2700 K – 2145 NOMINAL LM
DIMMABLE	
0-10V	

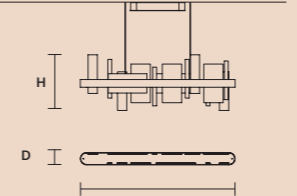

RIBBON A65	
W	65 cm / 25.60"
D	10 cm / 3.90"
H	33 cm / 13.00"
STANDARD INTEGRATED LED LIGHTING	
UP	5,8 W CRI>95 3000 K – 618 NOMINAL LM
DOWN	5,8 W CRI>95 3000 K – 618 NOMINAL LM
ON REQUEST	
UP	5,8 W CRI>95 2700 K – 589 NOMINAL LM
DOWN	5,8 W CRI>95 2700 K – 589 NOMINAL LM
DIMMABLE	
1-10V + PUSH	

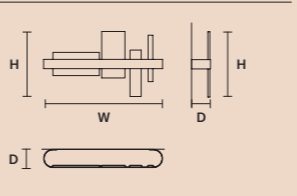

RIBBON A37	
W	37 cm / 14.60"
D	10 cm / 3.90"
H	33 cm / 13.00"
STANDARD INTEGRATED LED LIGHTING	
UP	3,51 W CRI>95 3000 K – 375 NOMINAL LM
DOWN	3,51 W CRI>95 3000 K – 375 NOMINAL LM
ON REQUEST	
UP	3,51 W CRI>95 2700 K – 357 NOMINAL LM
DOWN	3,51 W CRI>95 2700 K – 357 NOMINAL LM
DIMMABLE	
1-10V + PUSH	

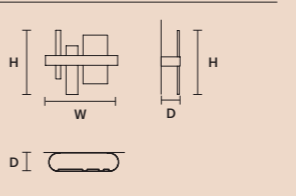

v90 Nero opaco  
Matt black



g01 Brunito\*  
Burnished

\*NOT AVAILABLE FOR RIBBON S80  
AND RIBBON S50



Vetro trasparente  
Transparent glass

RIBBON S70	
W	70 cm / 27.60"
D	8 cm / 3.10"
H	33 cm / 13.00"
STANDARD INTEGRATED LED LIGHTING	
UP	7 W CRI>95 3000 K – 746 NOMINAL LM
DOWN	15 W CRI>95 3000 K – 1600 NOMINAL LM
ON REQUEST	
UP	7 W CRI>95 2700 K – 711 NOMINAL LM
DOWN	15 W CRI>95 2700 K – 1525 NOMINAL LM
DIMMABLE	
0-10V	

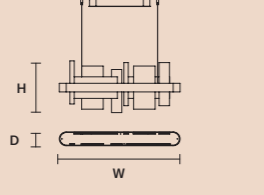

RIBBON S80	
W	80 cm / 31.50"
D	80 cm / 31.50"
H	33 cm / 13.00"
STANDARD INTEGRATED LED LIGHTING	
UP	28,1 W CRI>95 3000 K – 2997 NOMINAL LM
DOWN	60,85 W CRI>95 3000 K – 6490 NOMINAL LM
ON REQUEST	
UP	28,1 W CRI>95 2700 K – 2856 NOMINAL LM
DOWN	60,85 W CRI>95 2700 K – 6186 NOMINAL LM
DIMMABLE	
0-10V	

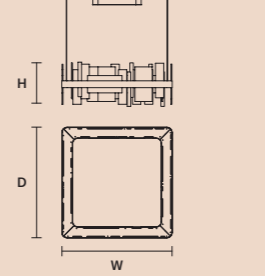

RIBBON S50	
W	50 cm / 19.70"
D	50 cm / 19.70"
H	33 cm / 13.00"
STANDARD INTEGRATED LED LIGHTING	
UP	15,21 W CRI>95 3000 K – 1622 NOMINAL LM
DOWN	32,76 W CRI>95 3000 K – 3494 NOMINAL LM
ON REQUEST	
UP	15,21 W CRI>95 2700 K – 1546 NOMINAL LM
DOWN	32,76 W CRI>95 2700 K – 3330 NOMINAL LM
DIMMABLE	
0-10V	

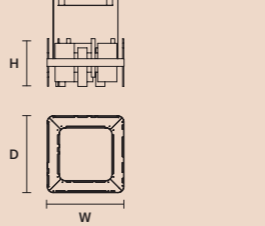

RIBBON TL	
W	38 cm / 15.00"
D	16 cm / 6.30"
H	48 cm / 18.90"
STANDARD INTEGRATED LED LIGHTING	
UP	6 W CRI>95 3000 K – 640 NOMINAL LM
DOWN	6 W CRI>95 3000 K – 640 NOMINAL LM
ON REQUEST	
UP	6 W CRI>95 2700 K – 610 NOMINAL LM
DOWN	6 W CRI>95 2700 K – 610 NOMINAL LM
DIMMABLE	
OWN BUTTON	

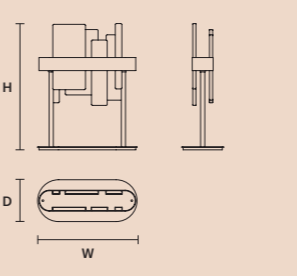

RIBBON STL	
W	38 cm / 15.00"
D	16 cm / 6.30"
H	160 cm / 63.00"
STANDARD INTEGRATED LED LIGHTING	
UP	6 W CRI>95 3000 K – 640 NOMINAL LM
DOWN	6 W CRI>95 3000 K – 640 NOMINAL LM
ON REQUEST	
UP	6 W CRI>95 2700 K – 610 NOMINAL LM
DOWN	6 W CRI>95 2700 K – 610 NOMINAL LM
DIMMABLE	
OWN BUTTON	

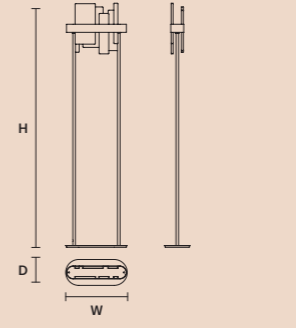

DISCOVER MORE



## SINGLE CANOPIES

### SINGLE CANOPY

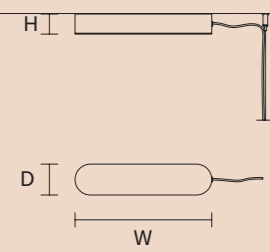

SIZE		FRAME FINISHINGS	CANOPY FINISHINGS	PRODUCT NAME
W	35,5 cm / 14.00"	● V90	● V90	RIBBON S200
D	8 cm / 3.10"	● G01*	● G01*	RIBBON S150
H	5,2 cm / 2.00"			RIBBON S100
				RIBBON S70
				RIBBON S80
				RIBBON S50

\*NOT AVAILABLE FOR RIBBON S80  
AND RIBBON S50

# Eva

IT L'abbiamo chiamata Eva, non a caso. La collezione Eva incarna magnificamente la trasposizione in chiave moderna dei lampadari classici. Come un fiore appena sbocciato ti incanta per la sua fluida sinuosità, trasmettendo un senso di pace e appagamento.

EN Not by chance we named it Eva. The Eva collection magnificently embodies the modern interpretation of classic chandeliers. Like a freshly opened flower, it enchants you with its fluid sinuosity, conveying a sense of peace and contentment.

DESIGN BY  
MASIERO LAB

SUSPENSION  
APPLIQUE  
TABLE LAMP  
FLOOR LAMP











# Eva

Lampada con struttura in resina e poliuretano. Paralumi in alluminio.  
Lamp with resin and polyurethane frame. Aluminium lampshades.

Lampe mit Resin und Polyurethanstruktur.  
Lampenschirme aus Aluminium.

Lámpara con estructura de resina y poliuretano. Pantallas de aluminio.

Lampe avec structure en resin et polyurethane. Abat-jour en aluminiumi.

Лампа с каркасом из полиуретана. Алюминиевые абажуры.

这种灯具具有一个树脂和聚氨酯的结构。灯罩们是铝材做的。

مصباح  
بهيكل من الراتنج  
والبولي يوريثان. عاكس ضوء (غطاء  
مصباح) من الألمنيوم.



F01 Foglia oro  
Gold leaf



F02 Foglia argento  
Silver leaf

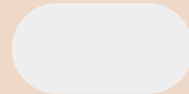

v95 Bianco opaco  
Matt white



v72 Grigio scuro  
Dark grey

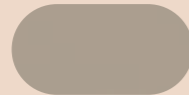

v70 Cemento  
Concrete

## EVA S20+10

ø 270 cm / 106.30"  
H 200 cm / 78.70"

STANDARD LIGHTING  
30×E27×20 W MAX (NOT INCL.)

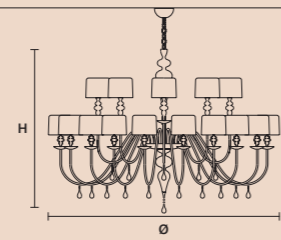

## EVA S10

ø 110 cm / 43.30"  
H 75 cm / 29.50"

STANDARD LIGHTING  
10×E14×10 W MAX (NOT INCL.)

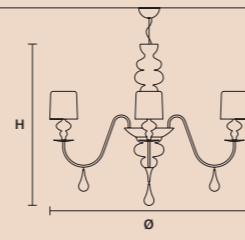

## EVA S8

ø 90 cm / 35.40"  
H 75 cm / 29.50"

STANDARD LIGHTING  
8×E14×10 W MAX (NOT INCL.)

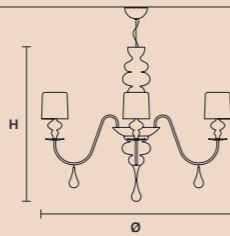

## EVA S5

ø 70 cm / 27.60"  
H 60 cm / 23.60"

STANDARD LIGHTING  
5×E14×10 W MAX (NOT INCL.)

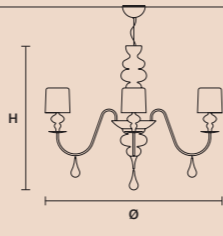

## EVA S3+1

ø 50 cm / 19.70"  
H 75 cm / 29.50"

STANDARD LIGHTING  
3×E27×20 W MAX (NOT INCL.)  
1×E14×10 W MAX (NOT INCL.)

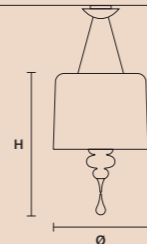

## EVA A3

w 40 cm / 15.70"  
D 20 cm / 7.90"  
H 70 cm / 27.60"

STANDARD LIGHTING  
3×E27×20 W MAX (NOT INCL.)

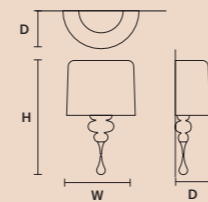

## EVA A1 M

w 30 cm / 11.80"  
D 15 cm / 5.90"  
H 54 cm / 21.30"

STANDARD LIGHTING  
1×E27×20 W MAX (NOT INCL.)

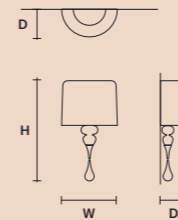

## EVA A2

w 40 cm / 15.70"  
D 18 cm / 7.10"  
H 55 cm / 21.70"

STANDARD LIGHTING  
2×E14×10 W MAX (NOT INCL.)

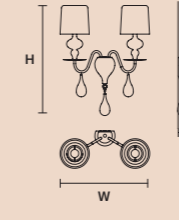

## EVA TL1 P

ø 14 cm / 5.50"  
H 28 cm / 11.00"

STANDARD LIGHTING  
1×E14×10 W MAX (NOT INCL.)

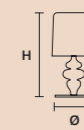

## EVA TL1 M

ø 30 cm / 11.80"  
H 53 cm / 20.90"

STANDARD LIGHTING  
1×E27×20 W MAX (NOT INCL.)

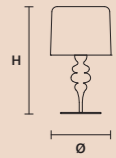

## EVA TL3+1 G

ø 40 cm / 15.70"  
H 75 cm / 29.50"

STANDARD LIGHTING  
3×E27×20 W MAX (NOT INCL.)  
1×E14×10 W MAX (NOT INCL.)

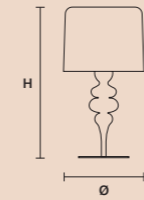

## EVA STL3+1

ø 50 cm / 19.70"  
H 180 cm / 70.90"

STANDARD LIGHTING  
3×E27×20 W MAX (NOT INCL.)  
1×E14×10 W MAX (NOT INCL.)

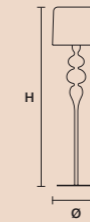

DISCOVER MORE



\* ETL only for US market.

## SINGLE CANOPIES

### SINGLE CANOPY



SIZE		FRAME FINISHINGS	CANOPY FINISHINGS	PRODUCT NAME
Ø	12 cm / 4.70"	V95	V95	EVA S5
H	6 cm / 2.40"	V72	V72	EVA S8
		V70	V70	EVA S10
		F01	F01	
		F02	F02	

### SINGLE CANOPY

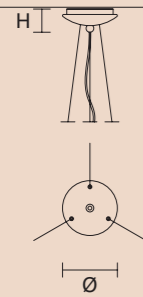

SIZE		FRAME FINISHINGS	CANOPY FINISHINGS	PRODUCT NAME
Ø	14,2 cm / 5.60"	V95	V95	EVA S3+1
H	5 cm / 2.00"	V72	V72	
		V70	V70	
		F01	F01	
		F02	F02	

### SINGLE CANOPY

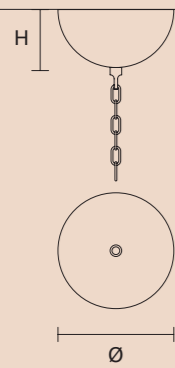

SIZE		FRAME FINISHINGS	CANOPY FINISHINGS	PRODUCT NAME
Ø	30 cm / 11.80"	V95	V95	EVA S20+10
H	15 cm / 5.90"	V72	V72	
		V70	V70	
		F01	F01	
		F02	F02	

# Palm

IT La applique Palm è un sistema modulare da parete che ricorda il movimento leggiadro delle foglie. Perfette per la decorazione murale grazie alla loro componibilità, Palm trae ispirazione dalla natura. Un progetto pensato per essere composto come un puzzle grazie alle forme che si incastrano.

EN The Palm applique is a modular wall system reminiscent of the graceful movement of leaves. Inspired by nature, Palm's modularity makes it perfect as a wall decoration. Made up of interlocking shapes, the project is conceived to be composed like a jigsaw puzzle.

DESIGN BY  
LETIZIA MAMMINI  
E VALERIA CANDIDO

APPLIQUE





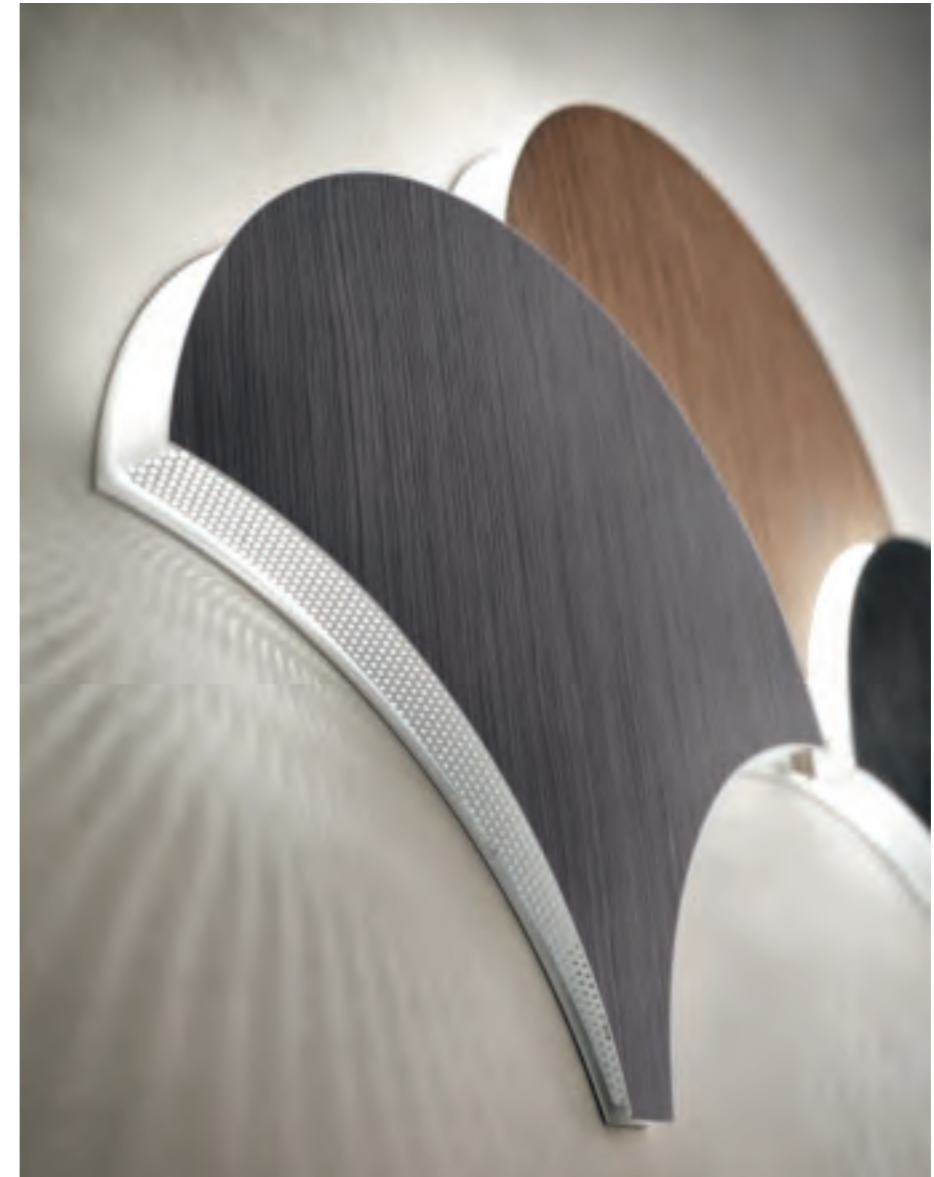

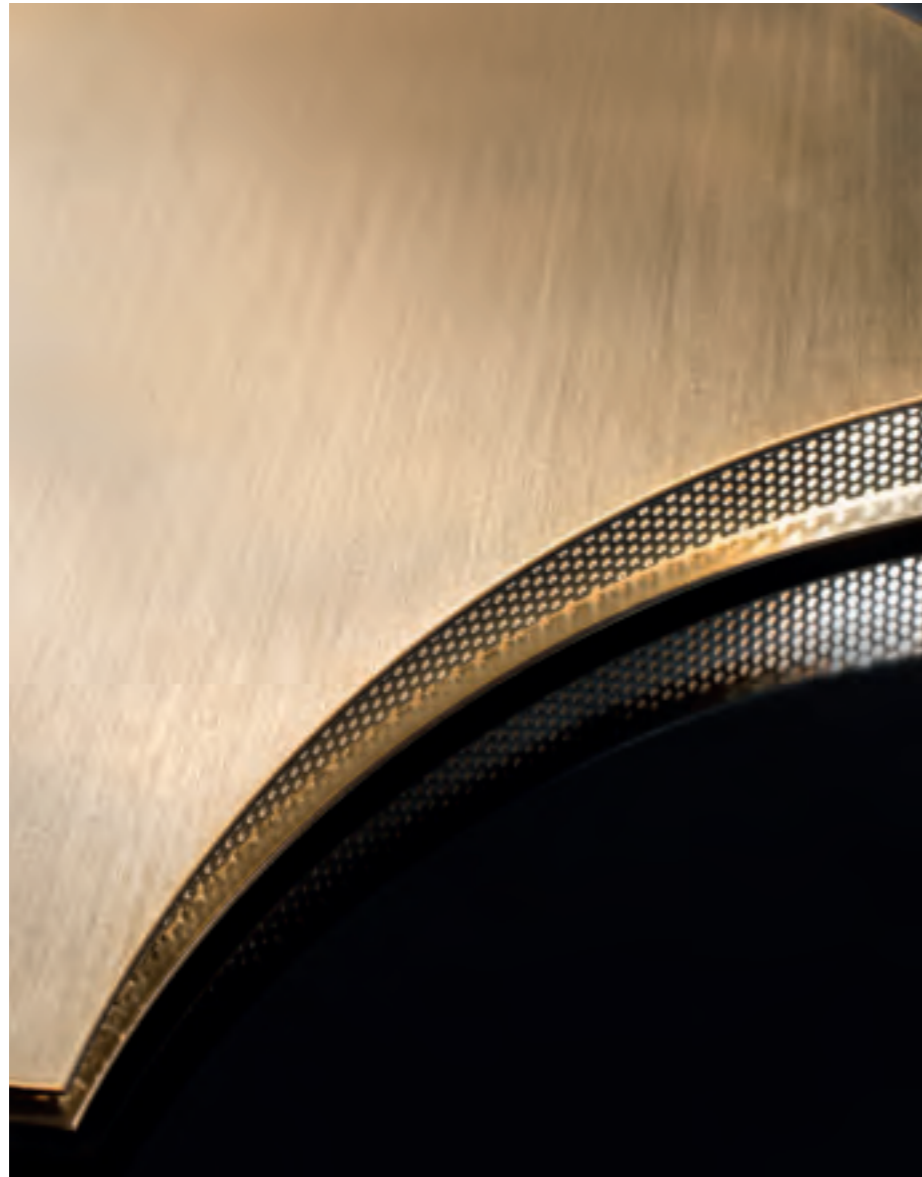



PALM F01

PALM F02

PALM F03

PALM L02

PALM L03

PALM W04

PALM W05

PALM W06

PALM W07

PALM G14



# Palm

Struttura in metallo verniciato, rivestimento in diverse finiture. Illuminazione a LED.

Painted metal frame, different finishes cover. LED lighting.

Struktur aus lackiertem Metall, in verschiedenen Ausführungen erhältlich. LED-Leuchtsystem.

Estructura de metal pintado, revestimiento en diferentes acabados. Iluminación LED.

Structure en metal verni, différentes finitions disponibles, éclairage LED.

Окрашенный металлический каркас, подвесы с различной отделкой, светодиодное освещение.

这种灯具的结构是涂漆的金属, 而且在框架上可能选择不同的材料类型。 LED 照明。

هيكل معدني مطلي،  
مغطي بلمسات نهائية متنوعة.  
إضاءة ليد.

PALM A40		CCC	RoHS	CE
W	40 cm / 15.70"			
D	5 cm / 2.00"			
H	34 cm / 13.40"			
STANDARD INTEGRATED LED LIGHTING				
11 W CRI>95				
3000 K - 1173 NOMINAL LM				
ON REQUEST				
11 W CRI>95				
2700 K - 1118 NOMINAL LM				
DIMMABLE				
NO				

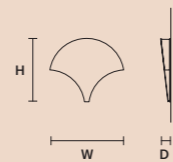

PALM A21		CCC	RoHS	CE
W	21 cm / 8.30"			
D	4 cm / 1.60"			
H	18 cm / 7.10"			
STANDARD INTEGRATED LED LIGHTING				
5 W CRI>95				
3000 K - 533 NOMINAL LM				
ON REQUEST				
5 W CRI>95				
2700 K - 508 NOMINAL LM				
DIMMABLE				
NO				

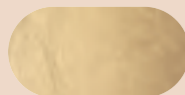
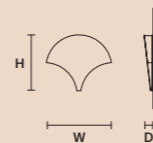

f01 Foglia oro  
Gold leaf

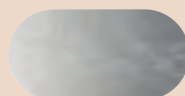

f02 Foglia argento  
Silver leaf



f03 Foglia rame  
Copper leaf



G14 Ottone brunito  
Burnished brass

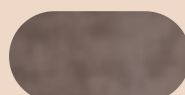

L03 Ecopelle 3  
Eco leather 3

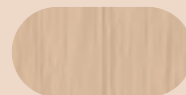

w04 Pale oak



w05 Walnut



w06 Grey ayous

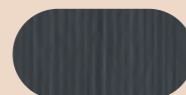

w07 Black&Silver

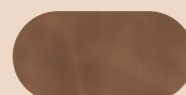

L02 Ecopelle 2  
Eco leather 2

DISCOVER MORE



# Timeo

IT È il gioco delle geometrie e la regolarità delle forme che caratterizzano questa collezione di lampade. Timeo prende il nome dal dialogo di Platone, Timeo, il testo base della cosmogonia in cui si delinea il concetto di solidi platonici.

EN This collection of lamps stands out for the interplay of geometries and regularity of the shapes. It takes its name from Plato's dialogue, the Timaeus, the basic text of cosmogony outlining the concept of Platonic solids.

DESIGN BY  
OMRI REVESZ

SUSPENSION  
APPLIQUE  
TABLE LAMP  
FLOOR LAMP









# Timeo

Struttura in metallo verniciato.  
Illuminazione LED.

Painted metal frame.  
LED Lighting.

Gestell aus lackiertem Metall.  
LED-Beleuchtung.

Estructura de metal pintado.  
Iluminación LED.

Structure en métal peint.  
LED éclairage.

Структура из окрашенного  
металла. Светодиодное  
освещение.

这种灯具的结构是涂漆的金属。LED  
照明。

هيكل معدني مطلي.  
إضاءة LED.

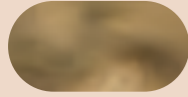

G14 Ottone brunito  
Burnished brass



v91 Nero gofrato  
Embossed black



v98 Bianco gofrato  
Embossed white

TIMEO S1 20		CE
ø	21 cm / 8.30"	
H	17 cm / 6.70"	
STANDARD INTEGRATED LED LIGHTING		
	4 W CRI>90	
	3000 K - 460 NOMINAL LM	
ON REQUEST		
	4 W CRI>90	
	2700 K - 437 NOMINAL LM	
DIMMABLE		
	NO	



TIMEO A		CE
W	21 cm / 8.30"	
D	19 cm / 7.50"	
H	20 cm / 7.90"	
STANDARD INTEGRATED LED LIGHTING		
	4 W CRI>90	
	3000 K - 460 NOMINAL LM	
ON REQUEST		
	4 W CRI>90	
	2700 K - 437 NOMINAL LM	
DIMMABLE		
	NO	

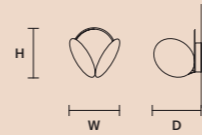

TIMEO STL		CE
ø	35 cm / 13.80"	
H	160 cm / 63.00"	
STANDARD INTEGRATED LED LIGHTING		
	9 W CRI>90	
	3000 K - 1458 NOMINAL LM	
ON REQUEST		
	9 W CRI>90	
	2700 K - 1385 NOMINAL LM	
DIMM		
	OWN BUTTON	



TIMEO TL		CE
ø	35 cm / 13.80"	
H	30 cm / 11.80"	
STANDARD INTEGRATED LED LIGHTING		
	9 W CRI>90	
	3000 K - 1458 NOMINAL LM	
ON REQUEST		
	9 W CRI>90	
	2700 K - 1385 NOMINAL LM	
DIMM		
	OWN BUTTON	

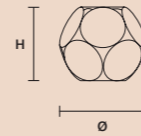

TIMEO C3 LN 75		CE
W	75 cm / 29.50"	
D	20 cm / 7.90"	
H MAX	140 cm / 55.10"	
STANDARD INTEGRATED LED LIGHTING		
	12 W CRI>90	
	3000 K - 1350 NOMINAL LM	
ON REQUEST		
	12 W CRI>90	
	2700 K - 1282 NOMINAL LM	
DIMMABLE		
	1-10V + PUSH	

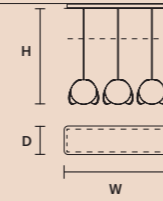

TIMEO C5 LN 125		CE
W	125 cm / 49.20"	
D	20 cm / 7.90"	
H MAX	140 cm / 55.10"	
STANDARD INTEGRATED LED LIGHTING		
	20 W CRI>90	
	3000 K - 2300 NOMINAL LM	
ON REQUEST		
	20 W CRI>90	
	2700 K - 2185 NOMINAL LM	
DIMMABLE		
	1-10V + DALI + PUSH	

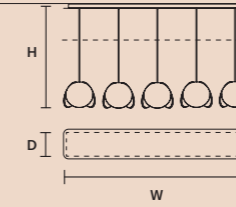

TIMEO C7 LN 175		CE
W	175 cm / 68.90"	
D	20 cm / 7.90"	
H MAX	140 cm / 55.10"	
STANDARD INTEGRATED LED LIGHTING		
	28 W CRI>90	
	3000 K - 3150 NOMINAL LM	
ON REQUEST		
	28 W CRI>90	
	2700 K - 2992 NOMINAL LM	
DIMMABLE		
	1-10V + DALI + PUSH	

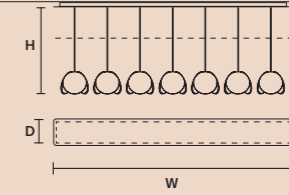

TIMEO C3 RD 40		CE
ø	40 cm / 15.70"	
H MAX	140 cm / 55.10"	
STANDARD INTEGRATED LED LIGHTING		
	12 W CRI>90	
	3000 K - 1350 NOMINAL LM	
ON REQUEST		
	12 W CRI>90	
	2700 K - 1282 NOMINAL LM	
DIMMABLE		
	1-10V + PUSH	

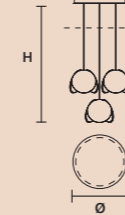

TIMEO C5 RD 60		CE
ø	60 cm / 23.60"	
H MAX	140 cm / 55.10"	
STANDARD INTEGRATED LED LIGHTING		
	20 W CRI>90	
	3000 K - 2300 NOMINAL LM	
ON REQUEST		
	20 W CRI>90	
	2700 K - 2185 NOMINAL LM	
DIMMABLE		
	1-10V + DALI + PUSH	

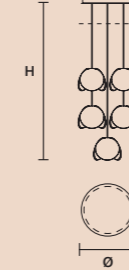

TIMEO C7 RD 80		CE
ø	80 cm / 31.50"	
H MAX	140 cm / 55.10"	
STANDARD INTEGRATED LED LIGHTING		
	28 W CRI>90	
	3000 K - 3150 NOMINAL LM	
ON REQUEST		
	28 W CRI>90	
	2700 K - 2992 NOMINAL LM	
DIMMABLE		
	1-10V + DALI + PUSH	

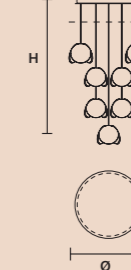

DISCOVER MORE



## SINGLE CANOPIES

### SINGLE CANOPY

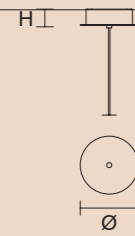

SIZE	FINISHINGS	PRODUCT NAME
Ø 15 cm / 5.90"	● V91	TIMEO S1 20
H 4 cm / 1.70"		

## MULTIPLE CANOPIES

### LINEAR CANOPY LN 75

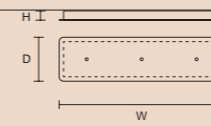

SIZE	FINISHINGS	PRODUCT NAME
W 75 cm / 29.50"	● V98	TIMEO C3 LN 75
D 20 cm / 7.90"		
H 4 cm / 1.60"		

### LINEAR CANOPY LN 125

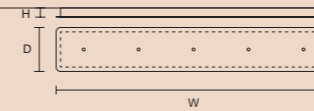

SIZE	FINISHINGS	PRODUCT NAME
W 125 cm / 49.20"	● V98	TIMEO C5 LN 125
D 20 cm / 7.90"		
H 4 cm / 1.60"		

### LINEAR CANOPY LN 175

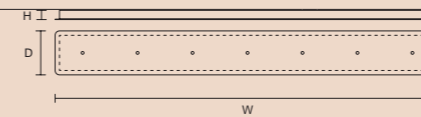

SIZE	FINISHINGS	PRODUCT NAME
W 175 cm / 68.90"	● V98	TIMEO C7 LN 175
D 20 cm / 7.90"		
H 4 cm / 1.60"		

### ROUND CANOPY RD 40

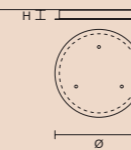

SIZE	FINISHINGS	PRODUCT NAME
Ø 40 cm / 15.70"	● V98	TIMEO C3 RD 40
H 4 cm / 1.60"		

### ROUND CANOPY RD 60

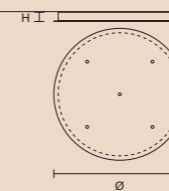

SIZE	FINISHINGS	PRODUCT NAME
Ø 60 cm / 23.60"	● V98	TIMEO C5 RD 60
H 4 cm / 1.60"		

### ROUND CANOPY RD 80

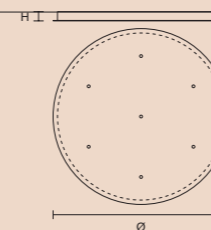

SIZE	FINISHINGS	PRODUCT NAME
Ø 80 cm / 31.50"	● V98	TIMEO C7 RD 80
H 4 cm / 1.60"		

# Vollee

IT Hai mai sognato di partire senza una meta? Volare in luoghi sconosciuti, in qualche modo? Vollee è una collezione ispirata alla leggerezza e intangibilità della luce. Le vele di metallo aleggiano nella stanza come paracadute liberi nel cielo.

EN Have you ever dreamed of setting out without a destination? To somehow fly to unknown places? The Vollee collection is inspired by the lightness and intangibility of light. The metal sails hover in the room like free parachutes in the sky.

DESIGN BY  
LORENZ + KAZ  
SUSPENSION





# Vollee

Struttura in metallo verniciato.  
Illuminazione a LED.

Painted metal frame. LED Lighting.

Gestell aus lackiertem Metall.  
LED-Beleuchtung.

Estructura de metal Pintado.  
Iluminación LED.

Structure en métal peint. LED  
éclairage.

Структура из окрашенного  
металла. Светодиодное  
освещение.

这种灯具的结构是涂漆的金属。LED  
照明。

هيكل معدني مطلي.  
إضاءة ليد.

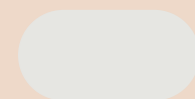

v95 Bianco opaco  
Matt white

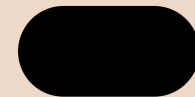

v90 Nero opaco  
Matt black



v99 Oro opaco verniciato  
Painted matt gold

DISCOVER MORE



VOLLEE S1P DOWN		CE	RoHS
W	25 cm / 9.80"		
D	17,5 cm / 6.90"		
H	44 cm / 17.30"		
STANDARD INTEGRATED LED LIGHTING			
	6,6 W CRI>90		
	3000 K – 825 NOMINAL LM		
ON REQUEST			
	6,6 W CRI>90		
	2700 K – 783 NOMINAL LM		
DIMMABLE			
	NO		

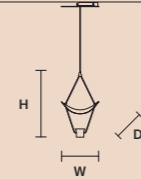

VOLLEE S1P UP		CE	RoHS
W	25 cm / 9.80"		
D	17,5 cm / 6.90"		
H	44 cm / 17.30"		
STANDARD INTEGRATED LED LIGHTING			
	6,6 W CRI>90		
	3000 K – 825 NOMINAL LM		
ON REQUEST			
	6,6 W CRI>90		
	2700 K – 783 NOMINAL LM		
DIMMABLE			
	NO		

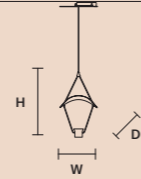

VOLLEE C5 P		CE	RoHS
STANDARD INTEGRATED LED LIGHTING			
	31 W CRI>90		
	3000 K – 3900 NOMINAL LM		
ON REQUEST			
	31 W CRI>90		
	2700 K – 3705 NOMINAL LM		
DIMMABLE			
	1-10V + DALI + PUSH		

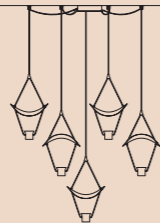

VOLLEE C4P LN 125		CE	RoHS
W	125 cm / 49.20"		
D	20 cm / 7.90"		
H MAX	200 cm / 78.70"		
STANDARD INTEGRATED LED LIGHTING			
	25,6 W CRI>90		
	3000 K – 3200 NOMINAL LM		
ON REQUEST			
	25,6 W CRI>90		
	2700 K – 3040 NOMINAL LM		
DIMMABLE			
	1-10V + PUSH		

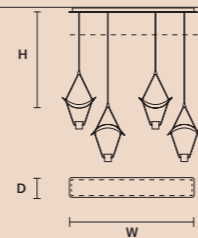

VOLLEE C4P RD 60		CE	RoHS
ø	60 cm / 23.60"		
H	200 cm / 78.70"		
STANDARD INTEGRATED LED LIGHTING			
	25,6 W CRI>90		
	3000 K – 3200 NOMINAL LM		
ON REQUEST			
	25,6 W CRI>90		
	2700 K – 3040 NOMINAL LM		
DIMMABLE			
	1-10V + PUSH		

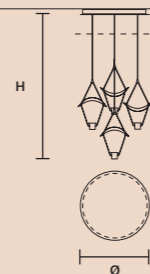

VOLLEE C8P RD 80		CE	RoHS
ø	80 cm / 31.50"		
H	200 cm / 78.70"		
STANDARD INTEGRATED LED LIGHTING			
	52,8 W CRI>90		
	3000 K – 6600 NOMINAL LM		
ON REQUEST			
	52,8 W CRI>90		
	2700 K – 6270 NOMINAL LM		
DIMMABLE			
	1-10V + DALI + PUSH		

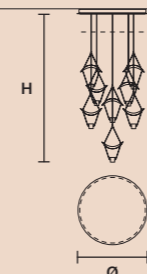

## SUGGESTED CONFIGURATION FOR C5 P

CE

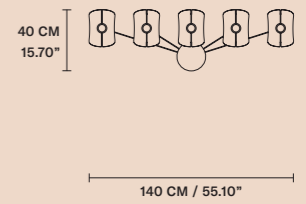
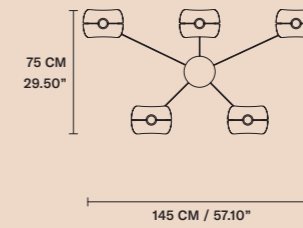
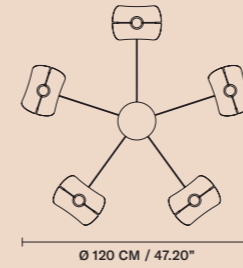

## SUGGESTED CONFIGURATION FOR C5 P X4

CE

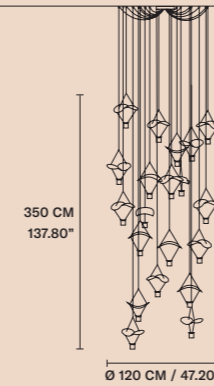

## SINGLE CANOPIES

### SINGLE CANOPY

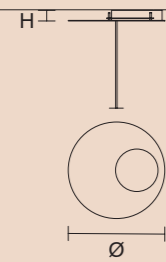

SIZE	FRAME FINISHINGS	CANOPY FINISHINGS	PRODUCT NAME
Ø 25 cm / 9.80"	● V95 ● V90 ● V99	● V91 + ● V98	VOLLEE S1 P UP/DOWN
H 3 cm / 1.20"			

### SINGLE CANOPY

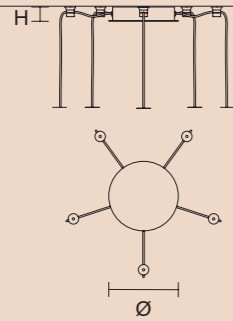

SIZE	FRAME FINISHINGS	CANOPY FINISHINGS	PRODUCT NAME
Ø 18 cm / 7.10"	● V95 ● V90 ● V99	● V91	VOLLEE C5 P
H 4 cm / 1.60"			

## MULTIPLE CANOPIES

### LINEAR CANOPY LN 125

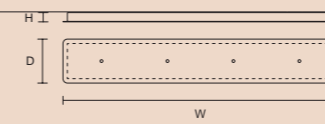

SIZE	FINISHINGS	PRODUCT NAME
W 125 cm / 49.20"	● V98	VOLLEE C4P LN 125
D 20 cm / 7.90"		
H 4 cm / 1.60"		

### ROUND CANOPY RD 60

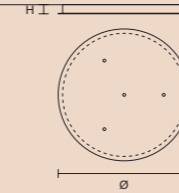

SIZE	FINISHINGS	PRODUCT NAME
Ø 60 cm / 23.60"	● V98	VOLLEE C4P RD 60
H 4 cm / 1.60"		

### ROUND CANOPY RD 80

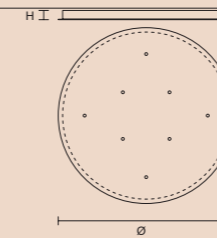

SIZE	FINISHINGS	PRODUCT NAME
Ø 80 cm / 31.50"	● V98	VOLLEE C8P RD 80
H 4 cm / 1.60"		

# Technical info



# Finishings

## VERNICIATURA OPACA MATT PAINTED



v21 Sabbia  
Sand

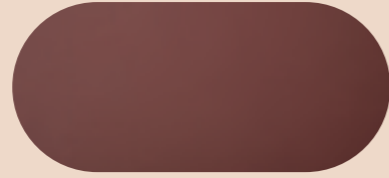

v35 Rosso Jaipur  
Jaipur red



v51 Celeste  
Pale blue

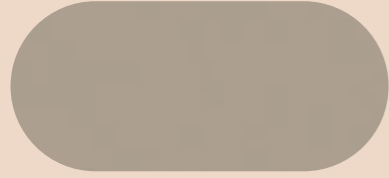

v70 Cemento  
Concrete



v72 Grigio scuro  
Dark grey



v83 Bronzo  
Bronze

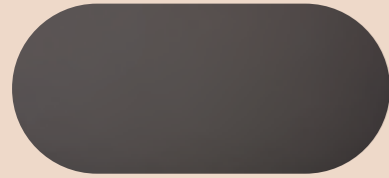

v84 Cioccolato  
Chocolate



v86 Bronzo patinato  
Coated bronze



v90 Nero opaco  
Matt black

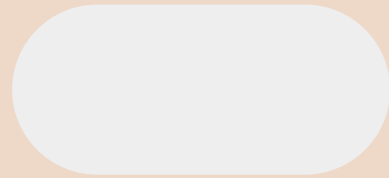

v95 Bianco opaco  
Matt white

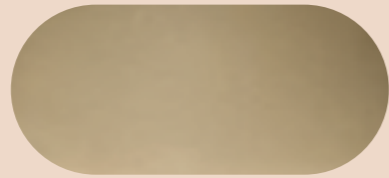

v99 Oro opaco verniciato  
Painted matt gold

Verificare la disponibilità di ciascuna finitura per specifici articoli.

Availability of each finish to be confirmed for specific items.

## VERNICIATURA GOFRATA EMBOSSED PAINTED

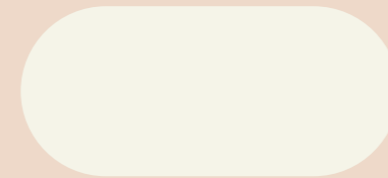

v98 Bianco gofrato  
Embossed white



v91 Nero gofrato  
Embossed Black

## VERNICIATURA LUCIDA GLOSSY PAINTED



v87 Cioccolato fondente  
Foundant Chocolate

## DECORAZIONE A FOGLIA LEAF DECORATION



F01 Foglia oro  
Gold leaf



F02 Foglia argento  
Silver leaf



F03 Foglia rame  
Copper leaf



F04 Foglia champagne  
Champagne leaf

Verificare la disponibilità di ciascuna finitura per specifici articoli.

Availability of each finish to be confirmed for specific items.

# Finishings

## BAGNO GALVANICO GALVANIC BATH

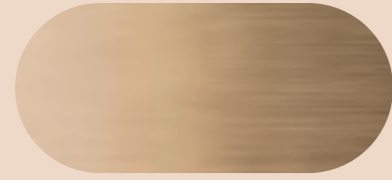

G01 Brunito  
Burnished

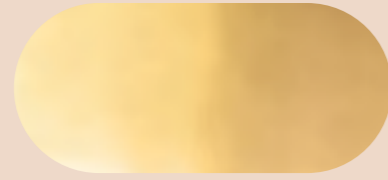

G03 Oro lucido  
Shiny gold

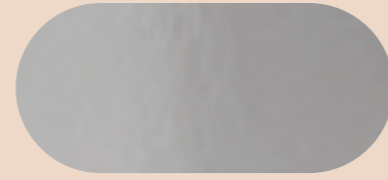

G04 Cromo lucido  
Shiny chrome



G05 Oro opaco  
Matt gold

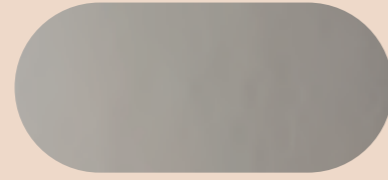

G06 Cromo opaco  
Matt chrome

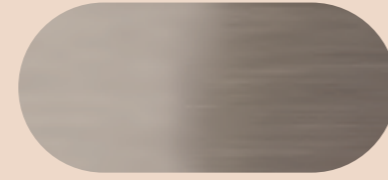

G07 Nickel spazzolato  
Brushed nickel



G12 Oro spazzolato  
Brushed gold



G14 Ottone brunito  
Burnished brass

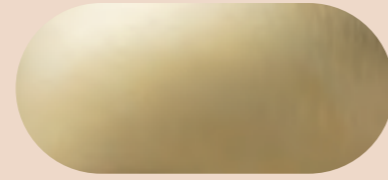

G18 Ottone spazzolato  
Brushed brass

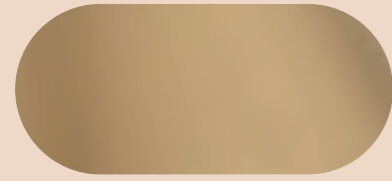

G22 Oro  
Pure gold

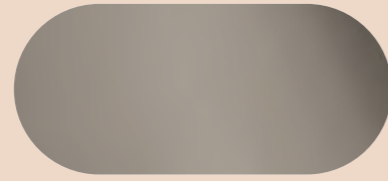

G23 Nickel scuro  
Dark nickel

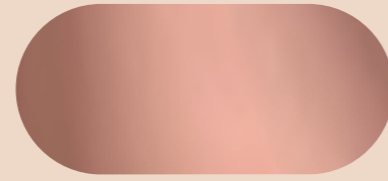

G24 Oro rosa  
Rose gold



G25 Rame dorato  
Golden copper



G26 Oro spazzolato  
Brushed pure gold



G27 Nickel scuro spazzolato  
Brushed dark nickel



G28 Oro rosa spazzolato  
Brushed rose gold

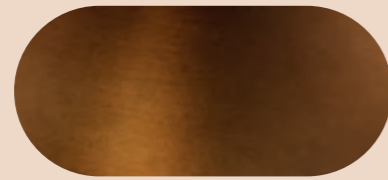

G29 Rame spazzolato  
Brushed copper

Verificare la disponibilità di ciascuna finitura per specifici articoli.  
Availability of each finish to be confirmed for specific items.

## FINITURE LEGNO WOOD FINISHING



W04 Pale oak



W05 Walnut



W06 Grey ayous



W07 Black&silver

## ECOPELLE ECO LEATHER



L02 Ecopelle 2  
Eco Leather 2



L03 Ecopelle 3  
Eco Leather 3

## CUOIO LEATHER

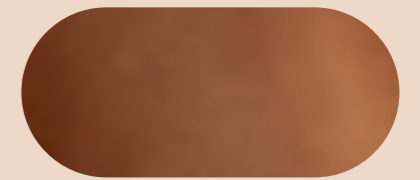

C01 Cuoio marrone  
Brown leather

Verificare la disponibilità di ciascuna finitura per specifici articoli.  
Availability of each finish to be confirmed for specific items.

## General informations

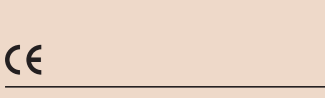

Attesta la conformità del prodotto alle disposizioni delle Direttive comunitarie.

It certifies the conformity of the products to the European Community provisions.

Konformität des Produktes mit den Richtlinien der europäischen Gemeinschaft.

Certifica la conformidad del producto según las disposiciones de las directivas comunitarias.

Il atteste la conformité du produit aux dispositions des directives communitaires.

НАСТОЯЩИМ ПОДТВЕРЖДАЕТСЯ СООТВЕТСТВИЕ ПРОДУКЦИИ ПОЛОЖЕНИЯМ ДИРЕКТИВ ЕС.

CE 标记是指产品的制造商证明该产品符合适用的EC指令的所有基本要求.

يُشَهِد بمطابقة المنتج لأحكام توجيهات الاتحاد الأوروبي.



Il logo “ETL” si riferisce agli articoli che possono essere modificati con componenti certificati ETL. W'elenco degli articoli ETL si riferisce a prodotti testati e valutati in base agli standard di sicurezza del mercato statunitense. Per il mercato USA fare riferimento al listino dedicato.

“ETL” logos refers to articles which can be modified with ETL-compliance components. The “ETL” listing articles stands for tested and evaluated product to recognrized US safety standards. For the US market, refer to the relevant price list.

Das "ETL"-Logo bezieht sich auf Artikel, die mit ETL-zertifizierten Komponenten modifiziert werden können. Die Liste der ETL-Artikel bezieht sich auf Produkte, die nach den Sicherheitsstandards des US-Marktes getestet und bewertet wurden. Für den US-Markt beachten Sie bitte die entsprechende Preisliste.

El logo “ETL” indica los artículos, que pueden modificarse con componentes certificados ETL. La lista de los artículos ETL se refiere a los productos sometidos a prueba y evaluados en función de los estándares de seguridad del mercado estadounidense. Consultar la lista de precios específica para el mercado de los Estados Unidos.

“ETL” logo se réfère aux articles qui peuvent être modifiées par des composants certifiés ETL. la liste des articles ETL se réfère à des produits testés et évalués selon les normes de sécurité du marché américain. Pour le marché américain se référer à la liste des prix.

логотип «ETL» относится к элементам, которые могут быть модифицированы спомощью сертифицированных ETL компонентов. список элементов eTL относится к продукции, протестированной и оцененной в соответствии с признанными стандартами безопасности США. для потребителей Находящихся в США см. соответствующий прайс-лист.

“ETL” 徽标是指可以使用ETL认证的组件进行修改的项目。ETL项目列表是指根据美国市场的安全标准进行测试和评估的产品。 对于美国市场，请参考美国市场价格表。

يشير شعار "ETL" إلى المنتجات التي يمكن تعديلها باستخدام مكونات مُعتمدة من ETL. تشير قائمة منتجات ETL إلى المنتجات التي تم اختبارها وتقييمها وفقًا لمعايير السلامة في السوق الأمريكي. بالنسبة لسوق الولايات المتحدة الأمريكية، يُرجى الرجوع إلى قائمة الأسعار المُخصصة.



CCC sta per China Compulsory Certificate, una certificazione di prodotto obbligatoria richiesta per determinati prodotti destinati al mercato cinese.

CCC stands for China Compulsory Certificate, a mandatory product certification required for certain products meant to the Chinese market.

CCC steht für China Compulsory Certificate, eine obligatorische Produktzertifizierung, die für bestimmte Produkte erforderlich ist, die für den chinesischen Markt bestimmt sind.

CCC significa China Compulsory Certificate, una certificación de producto obbligatoria requerida para ciertos productos destinados al mercado chino.

CCC signifie China Compulsory Certificate, une certification de produit obligatoire requise pour certains produits destinés au marché chinois.

ССС РАСШИФРОВЫВАЕТСЯ КАК CHINA COMPULSORY CERTIFICATE, ОБЯЗАТЕЛЬНАЯ СЕРТИФИКАЦИЯ НЕОБХОДИМАЯ ДЛЯ ОПРЕДЕЛЕННЫХ ПРОДУКТОВ, ПРЕДНАЗНАЧЕННЫХ ДЛЯ ВНУТРЕННЕГО РЫНКА КИТАЯ.

认证的全称为“中国强制性产品认证”，英文名称China Compulsory Certification, 英文缩写CCC。这种认证是针对某些面向中国市场的产品所必需的强制性产品认证。

يرمز CCC إلى الشهادة الإلزامية الصينية، وهي شهادة اعتماد منتج إلزامية مطلوبة لبعض المنتجات المخصصة للسوق الصينية.



Lo schema IECEE CB è un sistema internazionale per w'accettazione reciproca di rapporti di prova e certificati relativi alla sicurezza di componenti, apparecchiature e prodotti elettrici ed elettronici operative e dei prodotti sulla base di un accordo multilaterale tra i paesi partecipanti e gli organismi di certificazione.

IECEE CB is an international system for the mutual acceptance of test reports and certificates of the safety of components, operational electrical and electronic equipment and products on the basis of a multilateral agreement between participating countries and certification bodies.

Das IECEE CB Schema ist ein internationales System zur gegenseitigen Anerkennung von Testberichten und Zertifikaten bezüglich der Sicherheit von Komponenten, betriebsbereite elektrische und elektronische Geräte und Produkte auf der Grundlage eines multilateralen Abkommens zwischen teilnehmenden Ländern und Zertifizierungsstellen.

IECEE CB es un sistema internacional para la aceptación mutua de informes de ensayo y certificados de seguridad de componentes, equipos y productos eléctricos y electrónicos operativos y de productos, sobre la base de un acuerdo multilateral entre los países participantes y los organismos de certificación.

Le système IECEE CB est un système international d'acceptation mutuelle des rapports d'essai et des certificats de sécurité des composants, équipements et produits électriques et électroniques opérationnels et des produits, sur la base d'un accord multilatéral entre les pays participants et les organismes de certification.

СХЕМА ІЕСЕЕ СВ ПРЕДСТАВЛЯЕТ СОБОЙ МЕЖДУНАРОДНУЮ СИСТЕМУ ВЗАИМНОГО ПРИЗНАНИЯ СЕРТИФИКАТОВ И ОТЧЕТОВ ОБ ИСПЫТАНИЯХ, КАСАЮЩИХСЯ БЕЗОПАСНОСТИ ЭЛЕКТРИЧЕСКИХ И ЭЛЕКТРОННЫХ КОМПОНЕНТОВ И ОБОРУДОВАНИЯ, ОСНОВАННУЮ НА МНОГОСТОРОННЕМ СОГЛАШЕНИИ МЕЖДУ СТРАНАМИ-УЧАСТНИЦАМИ И ОРГАНАМИ ПО СЕРТИФИКАЦИИ.

认证是电工产品测试证书互认体系（CB 体系） 是国际电工委员会电工产品合格测试与认证组织。

مخطط IECEE CB هو نظام دولي للقبول المتبادل لتقارير الاختبار والاعتمادات المتعلقة بسلامة المكونات، والمعدات، والمنتجات الكهربائية والإلكترونية التشغيلية والمنتجات بناءً على اتفاقية متعددة الأطراف بين الدول المشاركة وهيئات الاعتماد.

## Im

Flusso luminoso nominale. W'indicazione si riferisce al valore in assenza di rifrazione, come dichiarato dal produttore del componente.

Nominal luminous flux. It refers to the value without any refraction, as declared by the component manufacturer.

Die Masseinheit für den Lichtstrom. Die Angabe bezieht sich auf den Wert in der Abwesenheit von Brechung, wie vom Hersteller der Komponente angegeben.

Flujo luminoso nominal. La indicación se refiere al valor sin refracción, como declarado por el fabricante del componente.

W'unité SI de flux lumineux. W'indication corresponds à la valeur en w'absence de réfraction, comme indiqué par le fabricant du composant.

НОМИНАЛЬНЫЙ СВЕТОВОЙ ПОТОК. УКАЗАНИЕ ОТНОСИТСЯ К ЗНАЧЕНИЮ В ОТСУТСТВИЕ РЕФРАКЦИИ, КАК ЗАЯВЛЕНО ПРОИЗВОДИТЕЛЕМ КОМПОНЕНТОВ.

标称光通量。指示是指组件制造商声明的没有折射的值。

التدفق الضوئي الاسمي.يشير المؤشر إلى القيمة في حالة عدم وجود انكسار للضوء، كما هو مُعلن من قبل الشركة المصنعة للعنصر.

## MASIERO

Masiero si riserva il diritto di apportare ai propri articoli, senza nessun preavviso, qualsiasi modifica ritenesse opportuna.

Masiero reserves the right to introduce any changes to its own products, without notice in advance.

Masiero behalt sich das Recht vor nderungen vorzunehmen, ohne sofortige Benachrichtigung.

Masiero se reserva el derecho de aportar modificaciones consideradas oportunas a sus artículos sin preaviso.

Masiero se réserve le droit d'apporter une quelconque modification à les modèles sans préavis.

КОМПАНИЯ MASIERO ОСТАВЛЯЕТ ЗА СОБОЙ ПРАВО БЕЗ ПРЕДВАРИТЕЛЬНОГО УВЕДОМЛЕНИЯ, ЕСЛИ ЭТО БУДЕТ СОЧТЕНО ЦЕЛЕСООБРАЗНЫМ, ВНОСИТЬ В СОБСТВЕННЫЕ МОДЕЛИ ЛЮБЫЕ ИЗМЕНЕНИЯ.

Masiero 保留对其认为适当的任何更改的权利，恕不另行通知。

تحتفظ شركة مازيرو "Masiero" بالحق في إجراء أي تعديلات تراها مناسبة على منتجاتها، دون إشعار مسبق.

ART DIRECTION, DESIGN  
Designwork

LAYOUT  
Masiero

PHOTO, REPRO  
Loris Casonato  
Nudesign

DIREZIONE ARTISTICA FOTOGRAFICA, STYLING  
NOOII

PRINT  
Italy, January 2025  
by Grafiche Antiga

Masiero srl

via Peschiere, 53  
31032 Casale sul Sile  
Treviso, Italy  
T +39 0422 7861  
F +39 0422 786250

info@masierogroup.com  
masierogroup.com

Masiero USA LTD

100 Park Avenue  
Suite 1600  
New York, NY 10017  
T +1 212 4666754

sales@masiero-usa.com  
masiero-usa.com

Masiero Shanghai Trading Co., Ltd

2nd Floor, n. 979 Yunhan Road  
Ligang New Area  
Shanghai, China  
91310000MACC5XK63U

sales@masiero-group.cn  
masiero-group.cn

THANKS TO

Alessandra Salaris  
Doimo Salotti  
Miniform  
Saba  
Trabà



