

OUTDOOR CATALOG

GREATER THAN YESTERDAY

2024

7' BESTRONG



BESTRONG

GREATER THAN YESTERDAY

DESIGNED AND MANUFACTURED
IN EUROPE

VERSATILE
CONFIGURATIONS

HIGH-QUALITY
MATERIALS

ROBUST SPORTS
EQUIPMENT

ASSEMBLED
WITHIN THE US

STATE-OF-THE-ART
TECHNOLOGY

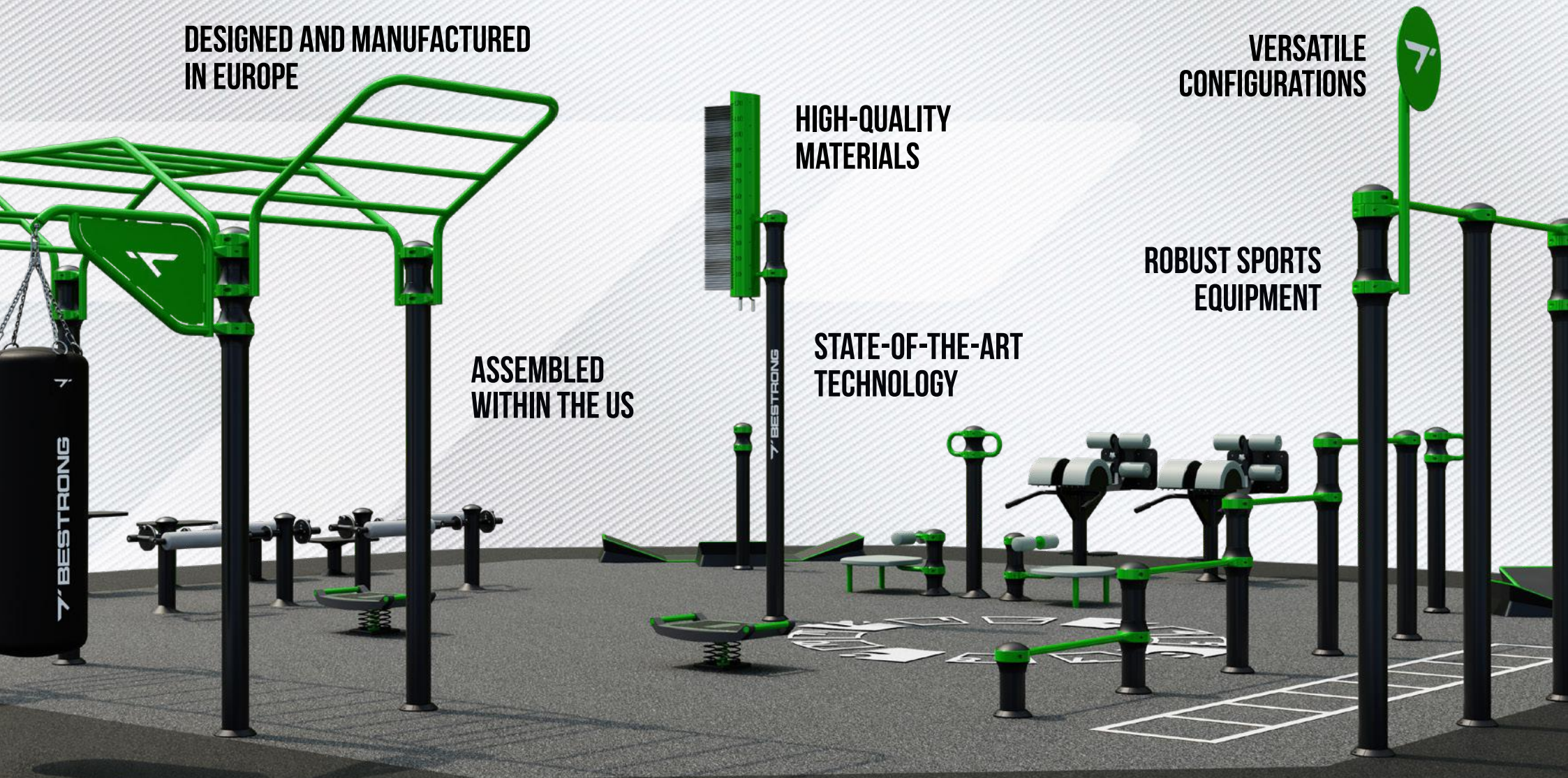

TABLE OF CONTENTS



04 About Us	09 Designed For Champions	28 Recreational	42 Adjustable Weight	56 Padel	62 Material Specification
05 BESTRONG U.S.A.	10 FitCampus	32 Calisthenics	44 Soccer Specific	58 3D & AR	63 Warranty
06 Mission	14 FitLiving	36 Cross-Training	47 Accessories	59 Design Your Fitness Park	64 Contacts
07 Values	18 FitSociety	38 Fitness	50 Sporting Kansas	60 Craftsmanship	
08 Accomplishments	24 FitStay	41 Accessible Equipment	51 Arenas	61 Manufacturing	

Story

In 2007, our owner Zoltán Katona embarked on a journey to Australia for a much-needed vacation. While wandering through the picturesque landscapes of Australia, Zoltán noticed a unique trend that captured his attention – the widespread use of outdoor fitness equipment in parks and public spaces. Intrigued by the idea of combining exercise with the beauty of nature, he saw an opportunity to bring this concept back to Hungary.

The company

KATKER 2005 Ltd, the owner of the BESTRONG brand, has been a prominent player in the Hungarian sports industry for over 20 years. Our company is involved in designing, manufacturing, installing, and selling outdoor and indoor sports equipment, sports parks, sports fields, and outdoor furniture. Our dedicated team of over 80 professionals continuously works to expand our product range, tailoring it to various sports, age groups, and fitness levels.



BESTRONG USA, INC.

BESTRONG FACTORY

Vision

Zoltán envisioned BeStrong as more than just a fitness brand. He saw it as a movement that would inspire individuals to break free from sedentary lifestyles, embrace their inner strength, and achieve their full potential. BeStrong's mission was simple yet profound: to make strength accessible to everyone, regardless of their background, fitness level, or age. The story of BeStrong is not just about building muscles. It's about building stronger, more resilient communities, united by the common goal of living life to its fullest potential.

Portfolio

BESTRONG offers a diverse range of products, including sport-specific fitness, cardio, calisthenics, and recreational fitness equipment systems, as well as multifunctional sports fields and arenas. Starting in 2024, we will introduce outdoor adjustable load sports equipment, solutions for people with disabilities, and state-of-the-art padel courts in our portfolio.



USA

After receiving positive feedback and experiencing successful market expansion in Europe, we turned our attention to the lucrative US market. The introduction of our unique, soccer-specific equipment led to a fruitful partnership with Sporting Kansas City, one of the most well-known MLS teams. This partnership will soon result in the construction of our own soccer-specific fitness park and arena at Sporting Kansas City's facility, which will also serve as the home for the U.S. National Soccer Team. This significant milestone marked the establishment of our subsidiary, BESTRONG USA, Inc.

BESTRONG USA, INC.

To solidify our presence in the US market, we planned to build an assembly hall in Port Orange, Florida, with groundbreaking having occurred in the fall of 2023 followed by construction starting in the summer of 2024, a fully equipped BESTRONG office center will be ready to provide high-quality services to our US customers and distributors.



OUR MISSION

Through daily physical activity and outdoor exercise, we strive to educate individuals on how to lead healthy lifestyles. We are dedicated to assisting people in achieving better health, increased strength, and enhanced fitness levels through the use of high-quality sports equipment.



Self-control

04.



05.

Community



06.

Development

VALUES

As a result of recognizing the diverse needs of sports enthusiasts, we continuously develop and improve our products and services. We have great confidence in seeking and incorporating the advice of renowned professionals and athletes in the design of our products. We genuinely value and attentively listen to the communities' perspectives that utilize our sports equipment and parks. Innovation in sports remains one of our top priorities.



INTERNATIONAL EXPERIENCE

We have faith in the unifying power of sports and believe that a shared love for sports brings people together. In addition to our many locations in Hungary, our nearly 2000 sports fields and parks have already been installed in over 27 countries in Europe, Africa, Asia, and North America. Furthermore, we are very proud that athletes attending the 2023 World Athletics Championships took advantage of our training center during the event.

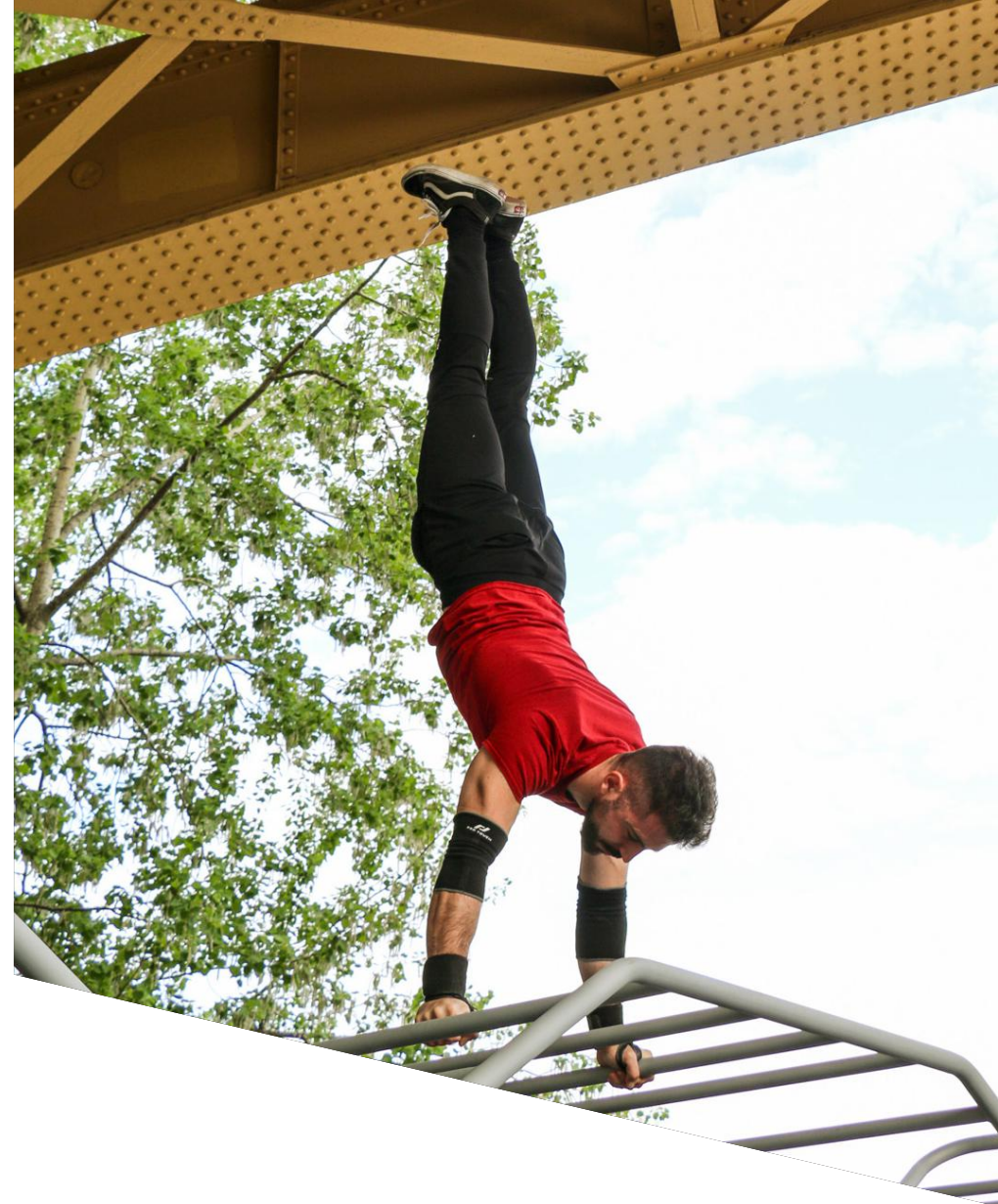

OUR VISION

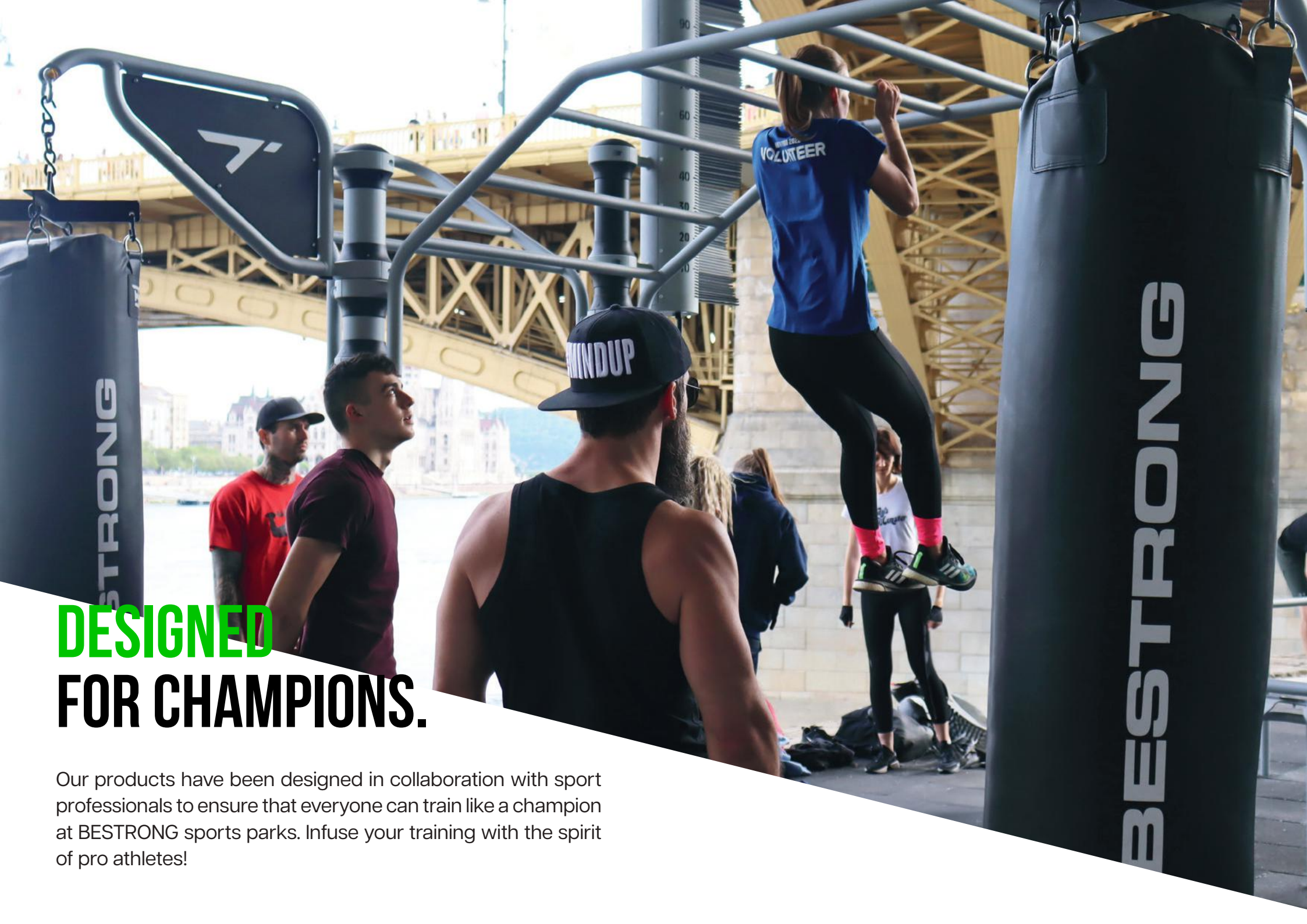

DESIGNED FOR CHAMPIONS.

Our products have been designed in collaboration with sport professionals to ensure that everyone can train like a champion at BESTSTRONG sports parks. Infuse your training with the spirit of pro athletes!

FITCAMPUS

For the full range of FitCampus

- < click on the QR code, or
- < scan with your mobile device





The BESTRONG FitCampus introduces a new dimension to sports in schools and educational centers. Our sport equipment in this setup promotes an active and health-conscious culture, contributing to the diversification of daily physical education. With FitCampus, you can underscore the significance of physical well-being in a holistic education approach and establish an environment that fosters the balanced development of both body and mind.

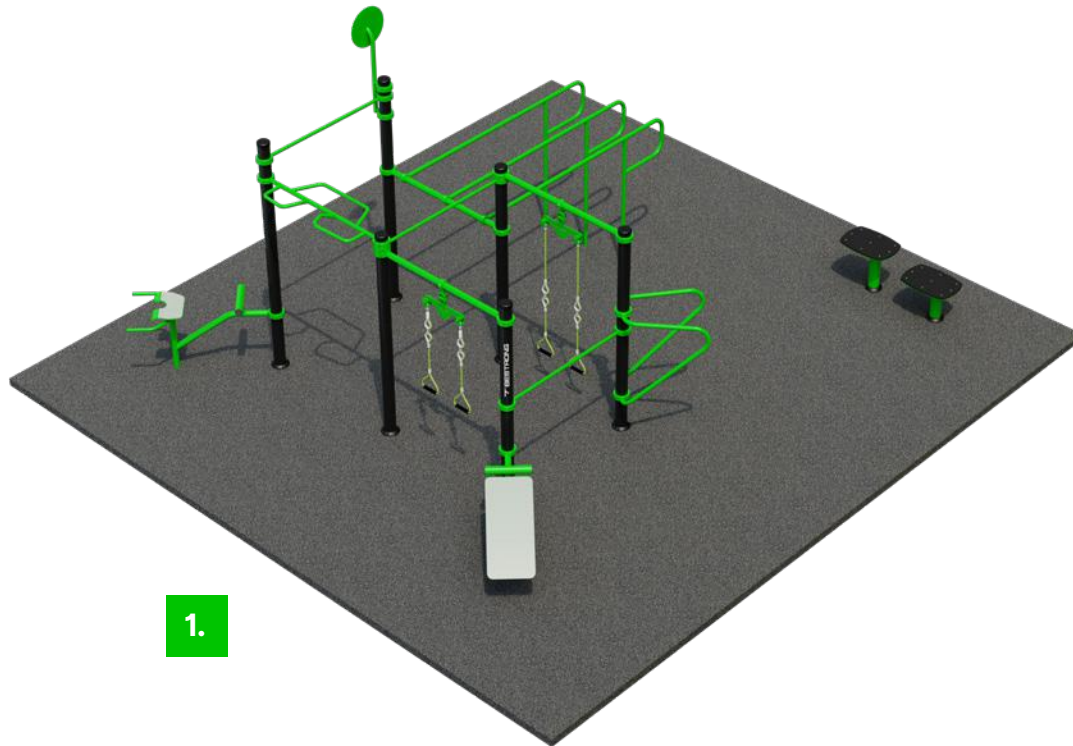

	ID.	Product Name	Certificate	Age Group	Capacity	Total Area	Number of equipment	Fall height	Net weight
1.	1-3-233	FitCampus 1	EN 16630, ASTM F3101	14 + years	24 people	565.10 ft ² (24'-7,28" x 22'-11,59")	12	4'-11.06" ft	1047 lbs
2.	1-3-261	FitCampus 3	EN 16630, ASTM F3101	14 + years	24 people	1355.8 ft ² (39'-4,44" x 34'-5,39")	12	3.1 ft	1719.5 lbs



3.

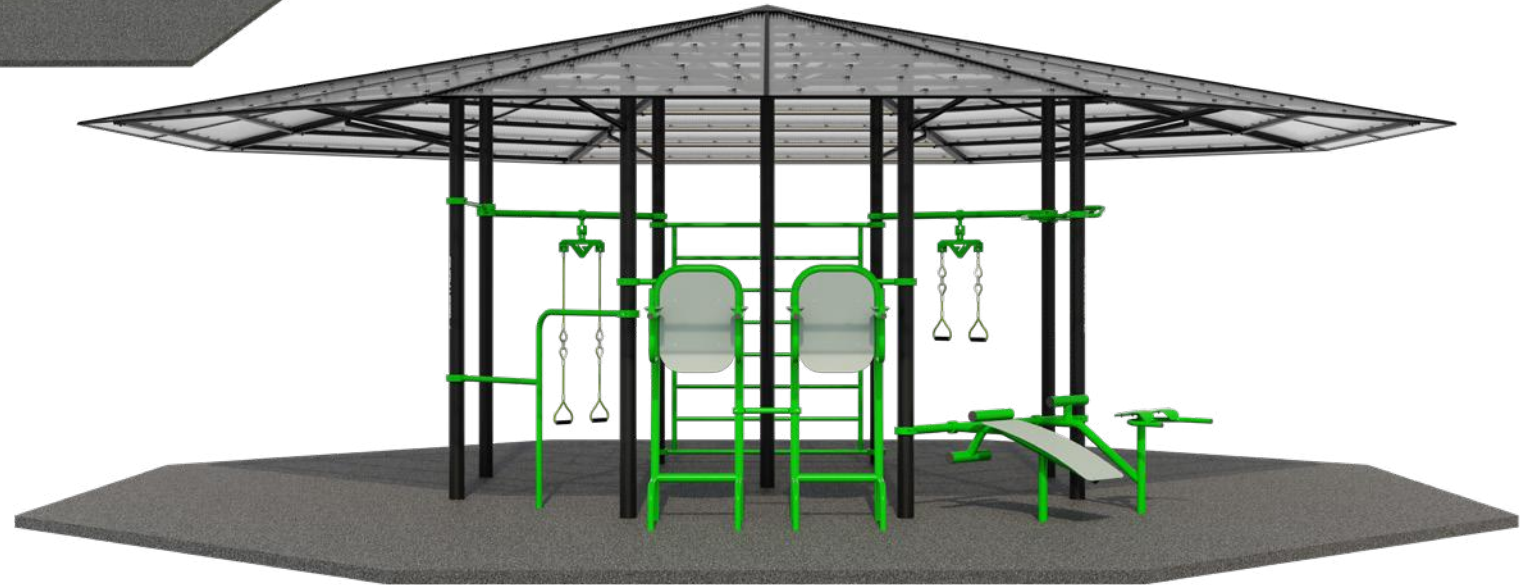
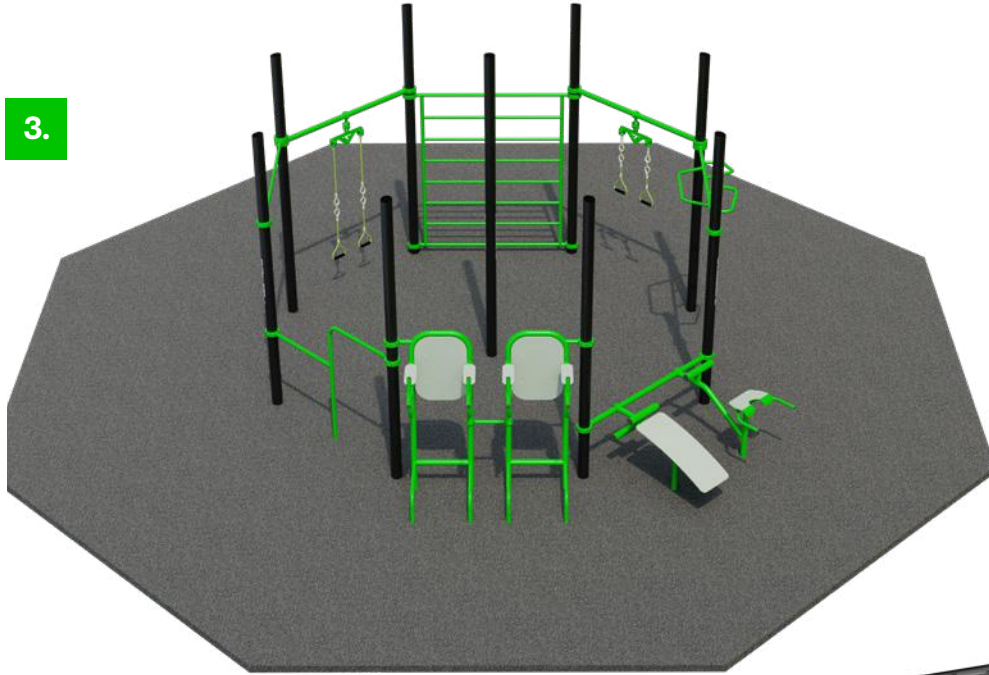

ID.	Product Name	Certificate	Age Group	Capacity	Total Area	Number of equipment	Fall height	Net weight	
3.	1-3-243	FitCampus 2	EN 16630, ASTM F3101	14 + years	20 people	960.8 ft' (34'-0,66" x 34'-0,66")	10	6.9 ft	4108.5 lbs

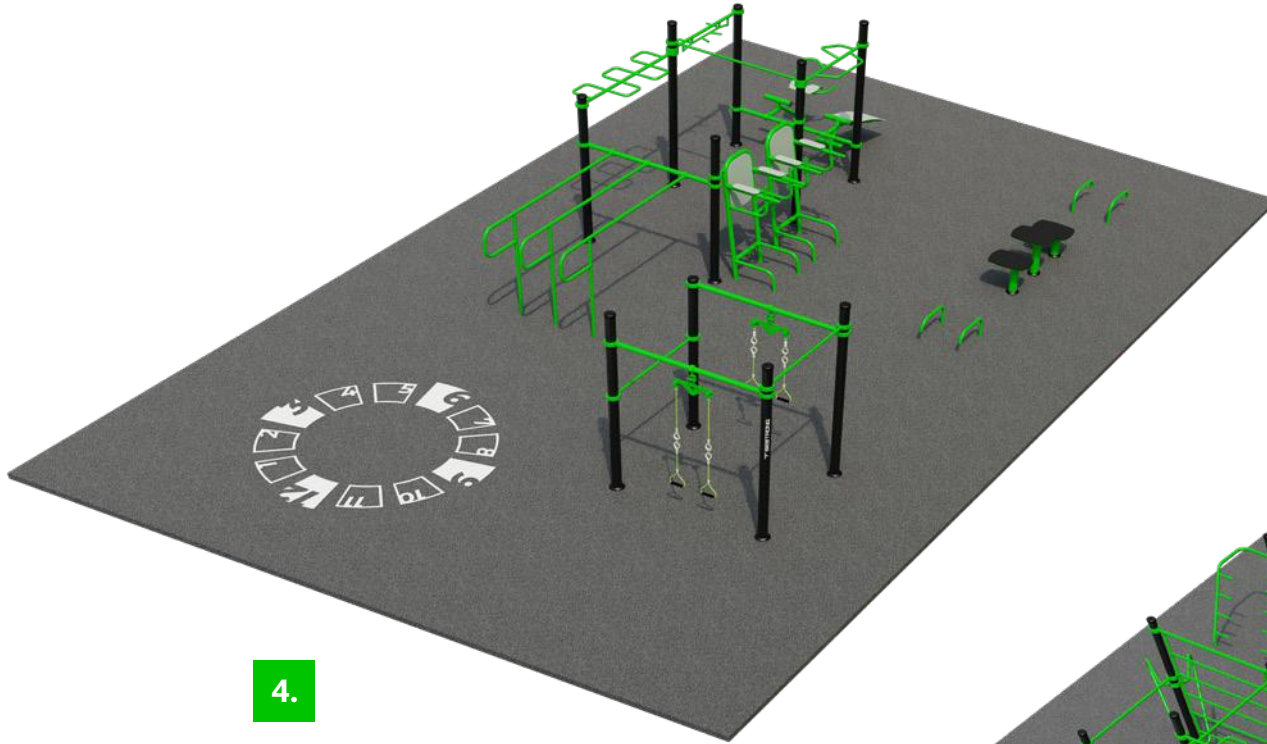

4.

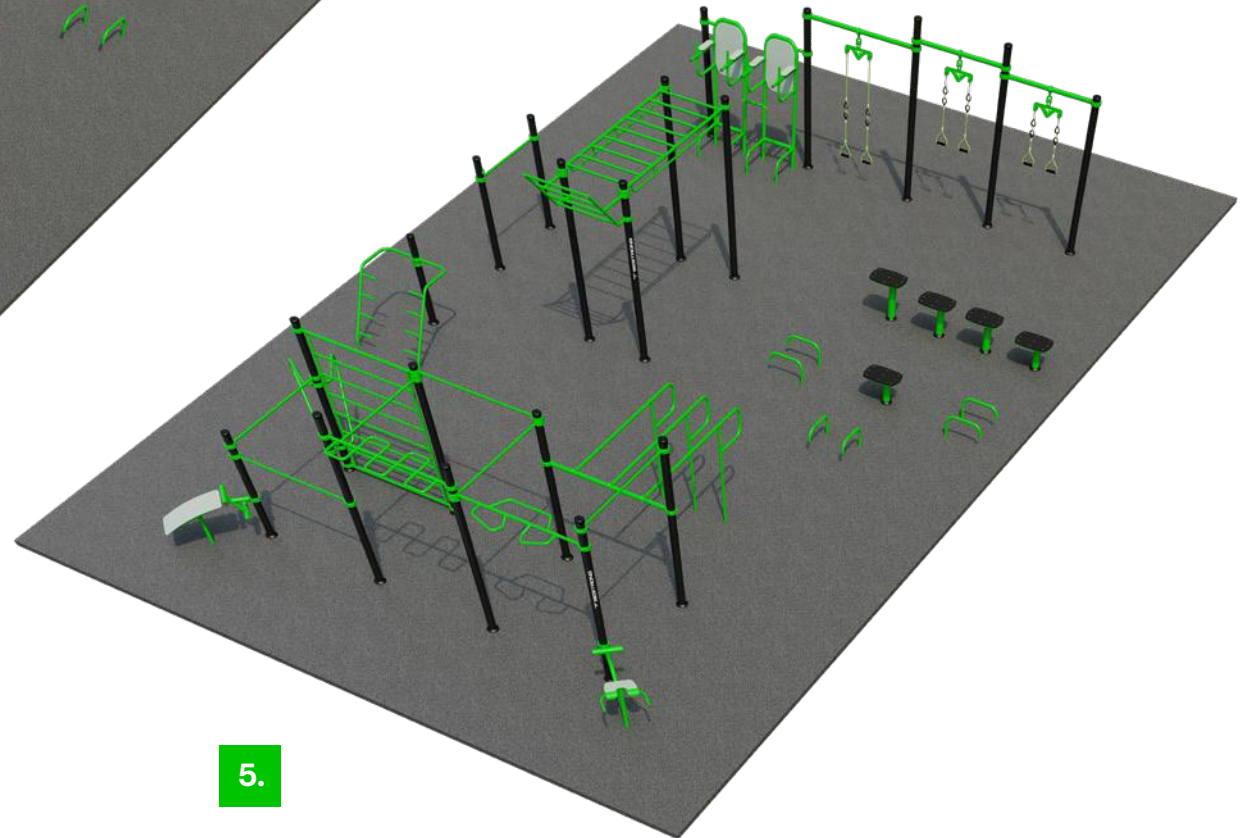

5.

	ID.	Product Name	Certificate	Age Group	Capacity	Total Area	Number of equipment	Fall height	Net weight
4.	1-3-245	FitCampus 4	EN 16630, ASTM F3101	14 + years	32 people	1355.8 ft' (45'-11,18" x 29'-6,33")	16	4.92 ft	1880 lbs
5.	1-3-249	FitCampus 5	EN 16630, ASTM F3101	14 + years	46 people	2189.7 ft' (60'-8,35" x 36'-1,07")	23	4.92 ft	3255 lbs

FITLIVING

For the full range of FitLiving

- < click on the QR code, or
- < scan with your mobile device





We designed the BESTRONG FitLiving configuration to enhance the quality of life in residential complexes. Our fitness equipment, integrated into communal spaces, allows residents to conveniently embrace an active lifestyle. FitLiving parks offer an excellent solution for investors in residential projects, as they combine functionality, a unique lifestyle experience, and design, all with an attractive cost-to-value ratio and low maintenance requirements. The appearance and active use of our parks facilitate social interaction among residents, promoting the development of a harmonious and healthy community.

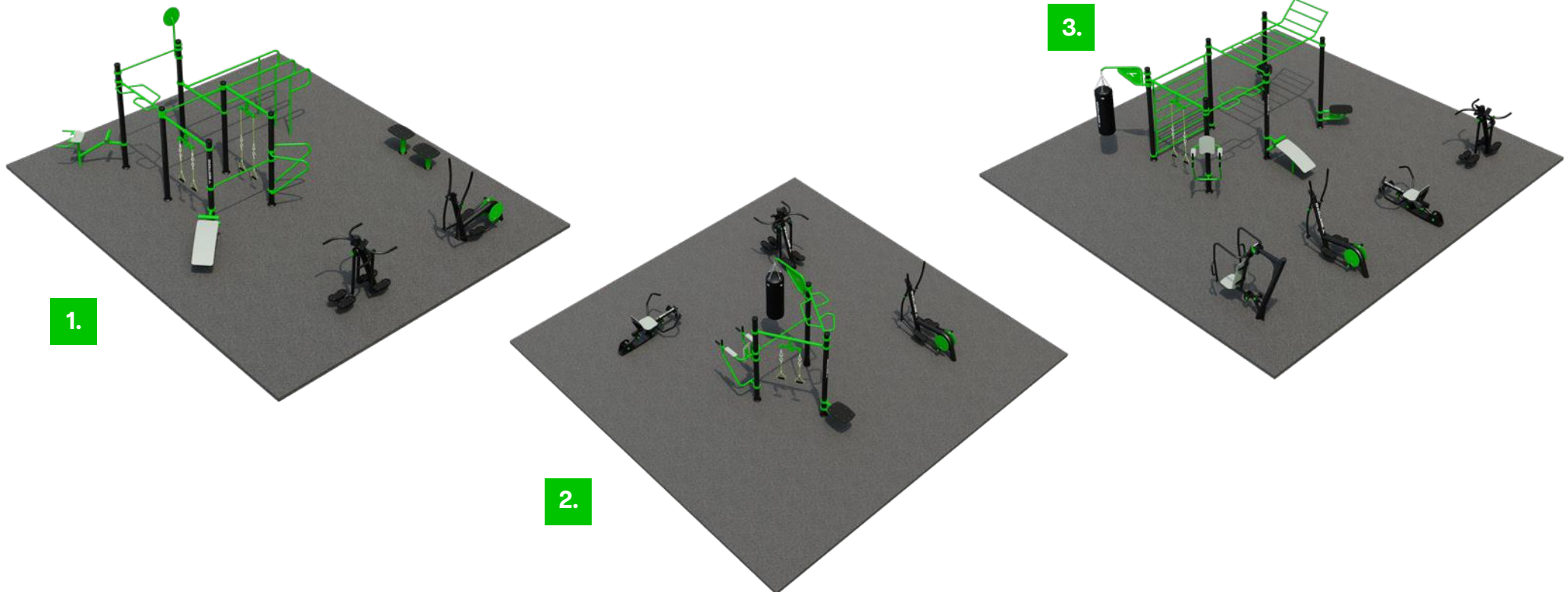

	ID.	Product Name	Certificate	Age Group	Capacity	Total Area	Number of equipment	Fall height	Net weight
1.	1-3-232	FitLiving 1	EN 16630, ASTM F3101	14 + years	34 people	726.56 ft ² (24'-7.28" x 29'-6,33")	17	4'-11.06" ft	1520 lbs
2.	1-3-250	FitLiving 2	EN 16630, ASTM F3101	14 + years	20 people	871.6 ft ² (29'-6.33" x 29'-6,33")	9	4.6 ft	1622 lbs
3.	1-3-252	FitLiving 3	EN 16630, ASTM F3101	14 + years	24 people	1022.2 ft ² (32'-9.70" x 31'-2,02")	12	4.6 ft	1951 lbs



4.



5.

	ID.	Product Name	Certificate	Age Group	Capacity	Total Area	Number of equipment	Fall height	Net weight
4.	1-3-251	FitLiving 4	EN 16630, ASTM F3101	14 + years	28 people	1022.2 ft ² (32'-9,70" x 31'-2,02")	14	4.6 ft	1725 lbs
5.	1-3-253	FitLiving 5	EN 16630, ASTM F3101	14 + years	28 people	1506.4 ft ² (45'-11,18" x 32'-9,70")	14	6.9 ft	2845 lbs



6.

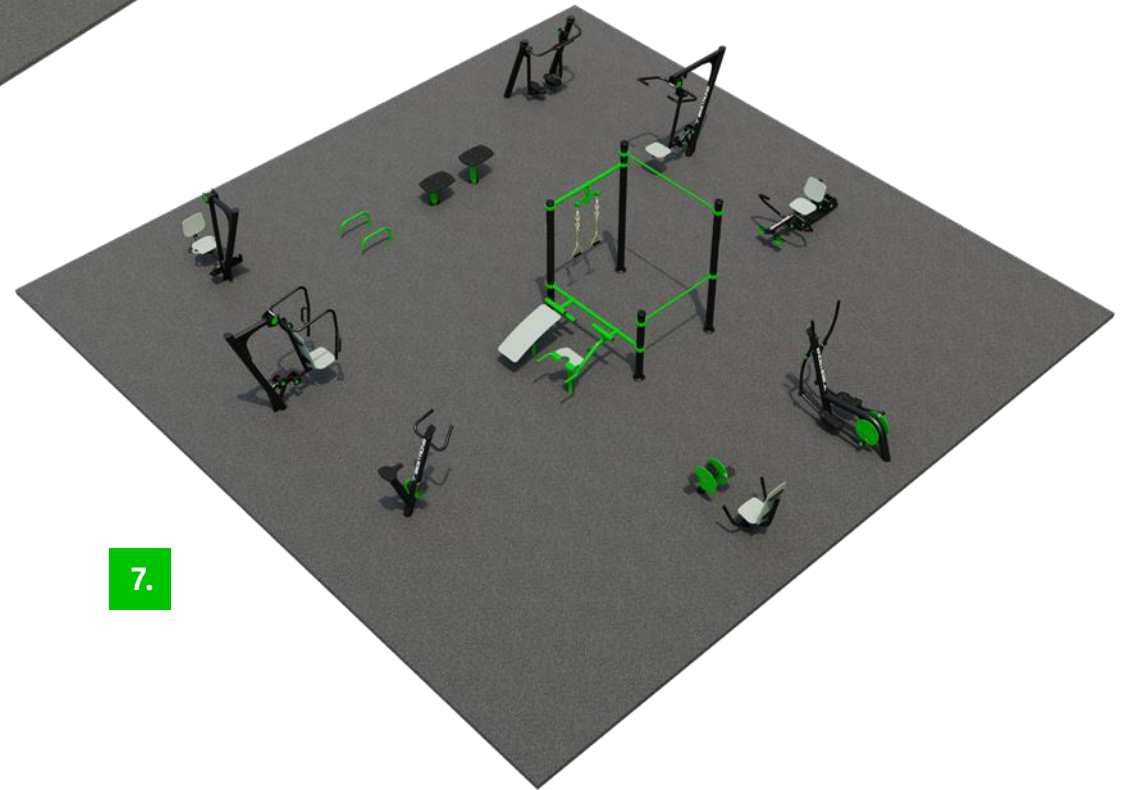

7.

	ID.	Product Name	Certificate	Age Group	Capacity	Total Area	Number of equipment	Fall height	Net weight
6.	1-3-259	FitLiving 6	EN 16630, ASTM F3101	14 + years	28 people	1549.4 ft' (39'-4.44" x 39'-4,44")	14	3.1 ft	2250.5 lbs
7.	1-3-255	FitLiving 7	EN 16630, ASTM F3101	14 + years	32 people	1549.4 ft' (39'-4.44" x 39'-4,44")	16	4.3 ft	2587 lbs

FITSOCIETY

For the full range of FitSociety

- < click on the QR code, or
- < scan with your mobile device





BESTRONG's FitSociety configuration features an impressive range of fitness equipment designed to revitalize public spaces and foster community engagement. Our experience has demonstrated that making sports accessible in public parks and other outdoor areas encourages active lifestyles. This configuration promotes comprehensive exercise, caters to various fitness levels and age groups, and fosters increased community interaction.

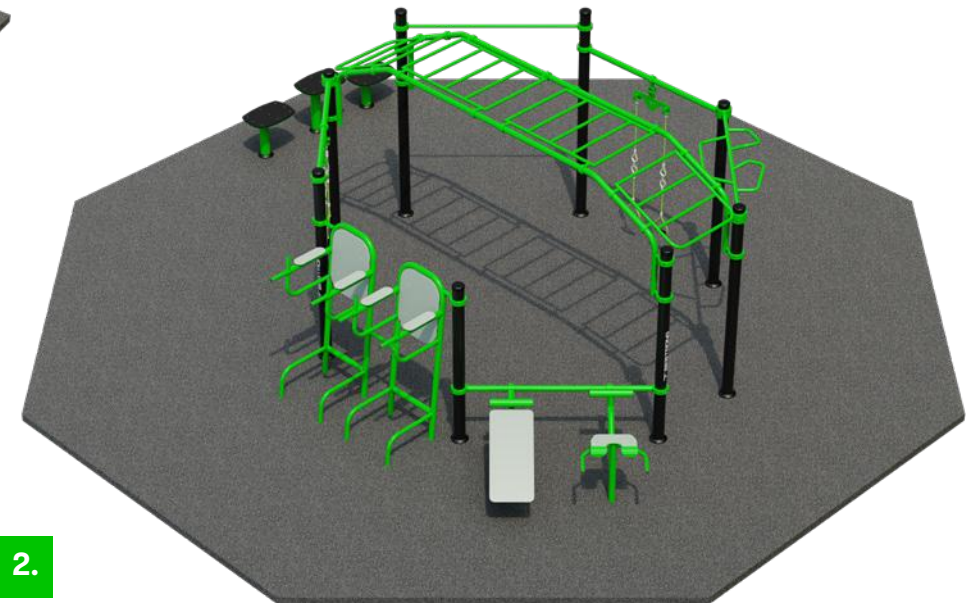
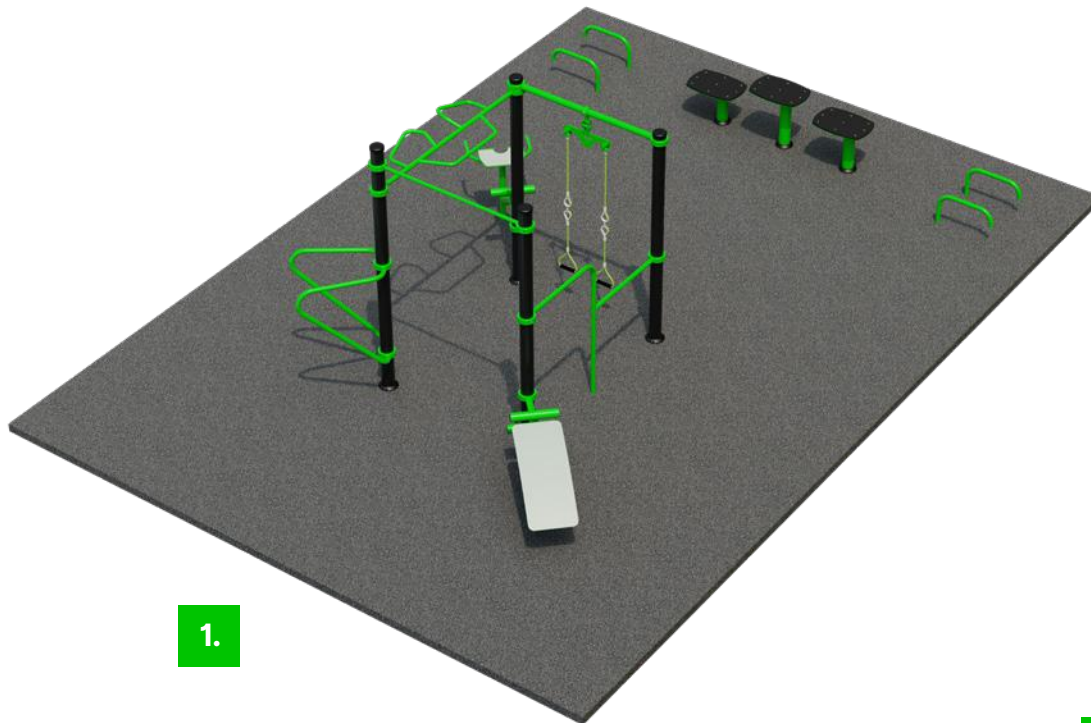

	ID.	Product Name	Certificate	Age Group	Capacity	Total Area	Number of equipment	Fall height	Net weight
1.	1-3-231	FitSociety 1	EN 16630, ASTM F3101	14 + years	26 people	548.96 ft ² (27'-10.65" x 19'-8.22")	13	4.92 ft	1023.5 lbs
2.	1-3-238	FitSociety 2	EN 16630, ASTM F3101	14 + years	24 people	753.5 ft ² (30'-1.02" x 30'-1.02")	12	5'-2.99 ft	1580 lbs

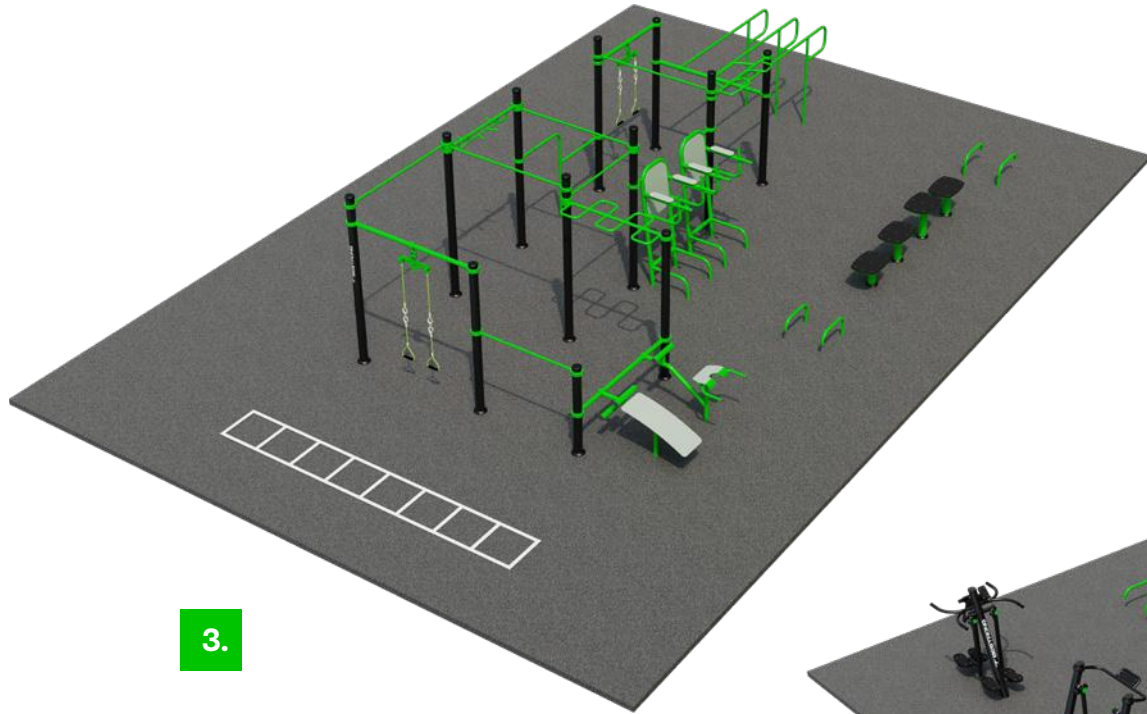

3.



4.

	ID.	Product Name	Certificate	Age Group	Capacity	Total Area	Number of equipment	Fall height	Net weight
3.	1-3-247	FitSociety 3	EN 16630, ASTM F3101	14 + years	36 people	1431.1 ft' (45'-11,18" x 31'-2,02")	18	4.92 ft	1907.5 lbs
4.	1-3-256	FitSociety 4	EN 16630, ASTM F3101	14 + years	40 people	1549.4 ft' (39'-4,44" x 39'-4,44")	20	4.3 ft	3173.5 lbs

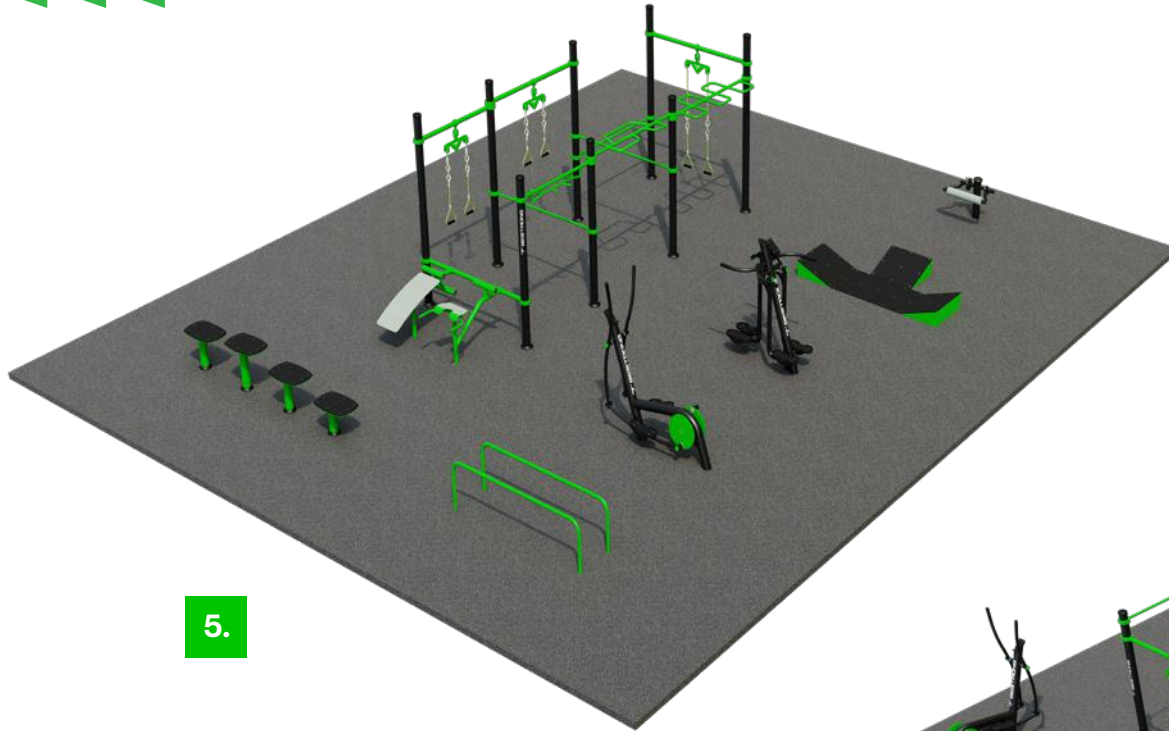

5.

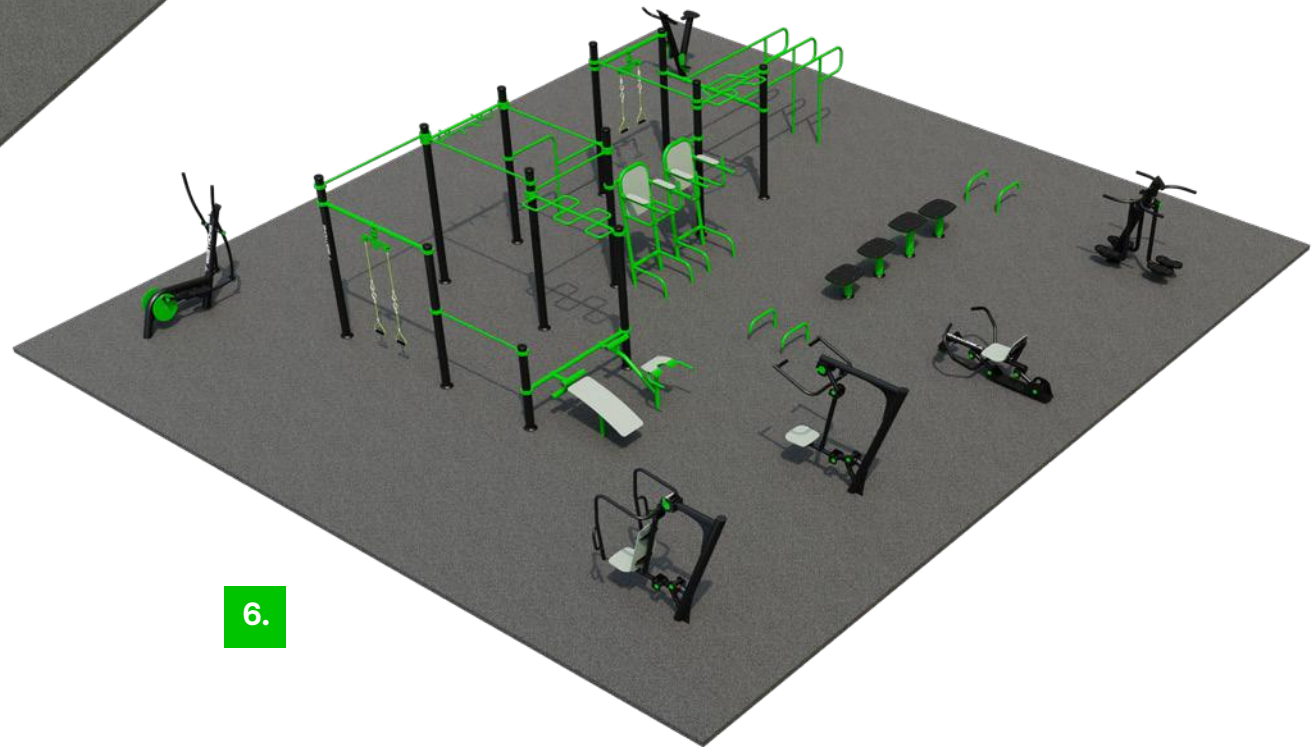

6.

	ID.	Product Name	Certificate	Age Group	Capacity	Total Area	Number of equipment	Fall height	Net weight
5	1-3-260	FitSociety 5	EN 16630, ASTM F3101	14 + years	32 people	1597.9 ft ² (44'-3,50" x 36'-1,07")	16	3.1 ft	2546.5 lbs
6.	1-3-246	FitSociety 6	EN 16630, ASTM F3101	14 + years	48 people	1807.7 ft ² (45'-11,18" x 39'-4,44")	24	4.92 ft	3192.5 lbs



7.

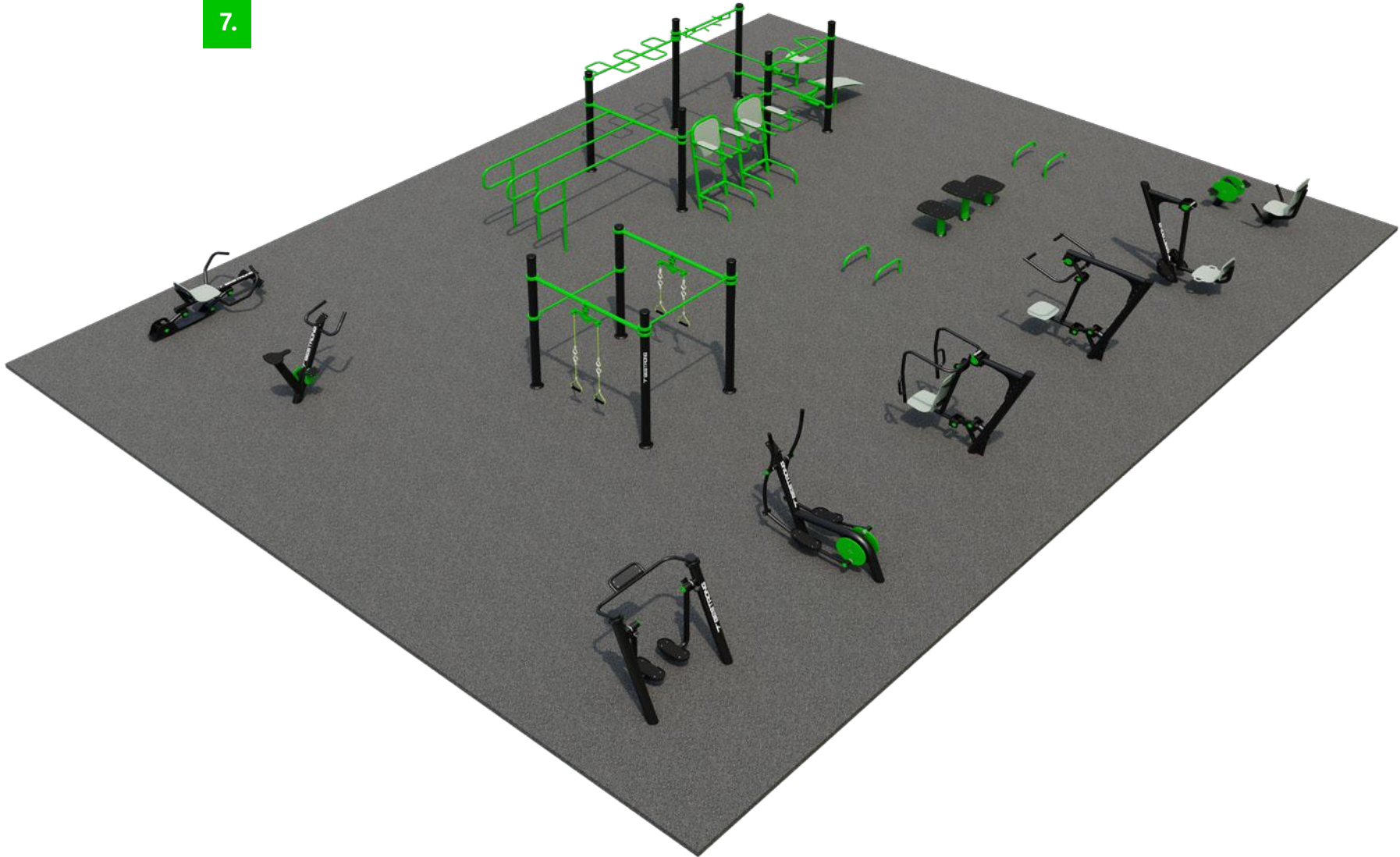

ID.	Product Name	Certificate	Age Group	Capacity	Total Area	Number of equipment	Fall height	Net weight	
7.	1-3-244	FitSociety 7	EN 16630, ASTM F3101	14 + years	48 people	1936.8 ft' (49'-2,55" x 39'-4,44")	24	4.92 ft	3711 lbs



8.

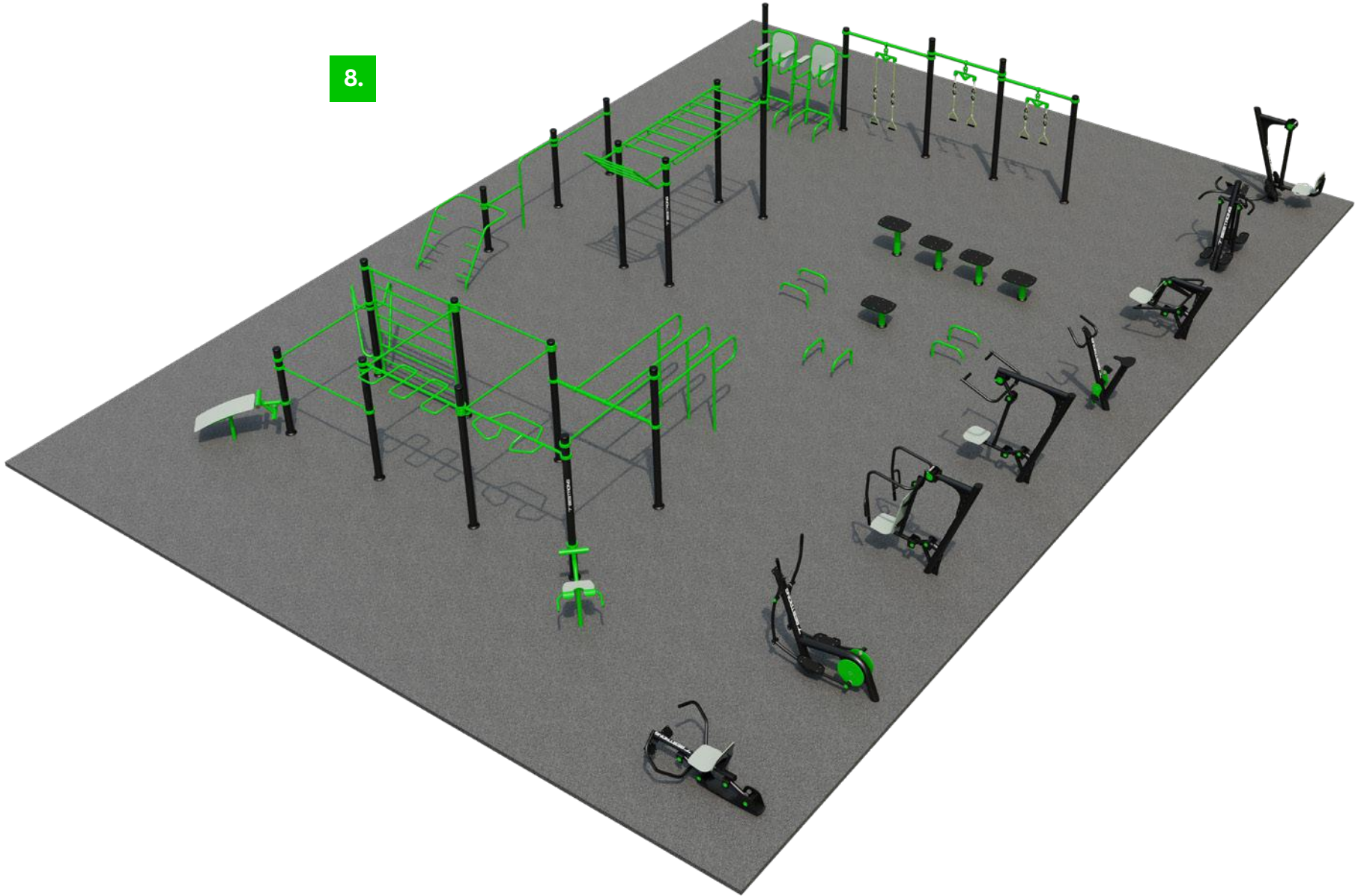

ID.	Product Name	Certificate	Age Group	Capacity	Total Area	Number of equipment	Fall height	Net weight	
8.	1-3-248	FitSociety 8	EN 16630, ASTM F3101	14 + years	62 people	2937.5 ft' (63'-11,72" x 45'-11,18")	31	6.9 ft	3173.5 lbs

FITSTAY

For the full range of FitStay
◀ click on the QR code, or
◀ scan with your mobile device





With our FitStay configuration, BESTRONG provides hotels and resorts with premium-quality outdoor fitness equipment. Beyond offering visually striking designs, we present a comprehensive solution for guests seeking exercise and mobility. FitStay enables you to broaden the wellness offerings of your hotels, significantly enhancing the overall guest experience.

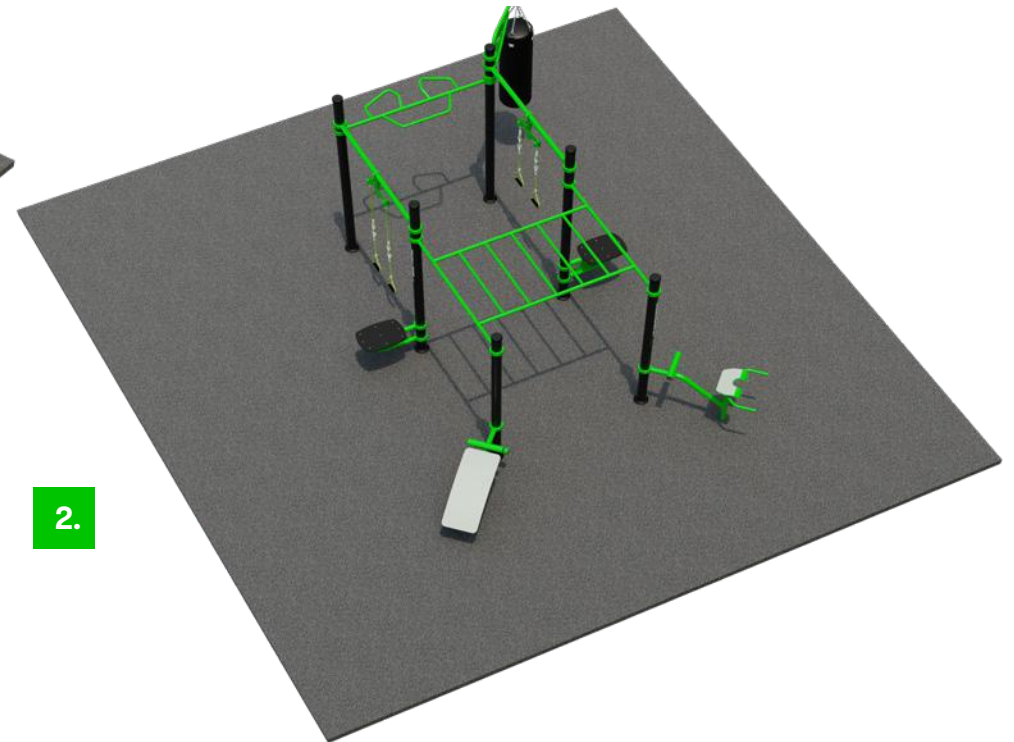
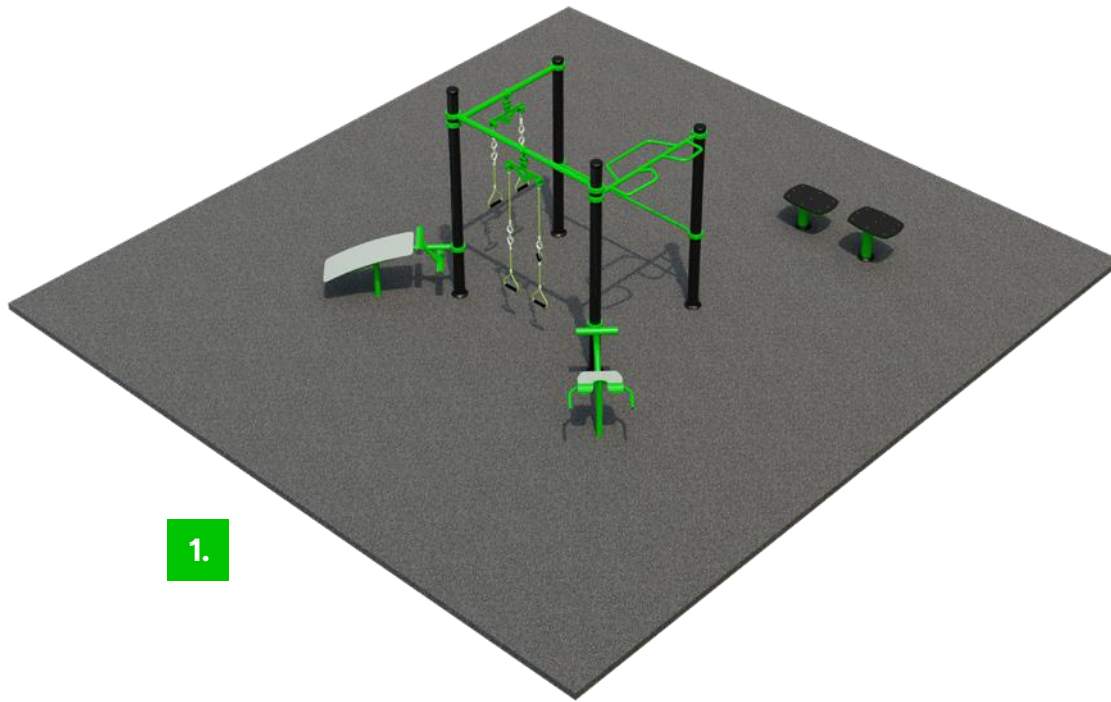

	ID.	Product Name	Certificate	Age Group	Capacity	Total Area	Number of equipment	Fall height	Net weight
1.	1-3-257	FitStay 1	EN 16630, ASTM F3101	14 + years	16 people	731.7 ft ² (26'-2,96" x 27'-10,65")	8	3.1 ft	781.5 lbs
2.	1-3-258	FitStay 2	EN 16630, ASTM F3101	14 + years	14 people	823.1 ft ² (29'-6,33" x 27'-10,65")	7	3.1 ft	1467 lbs

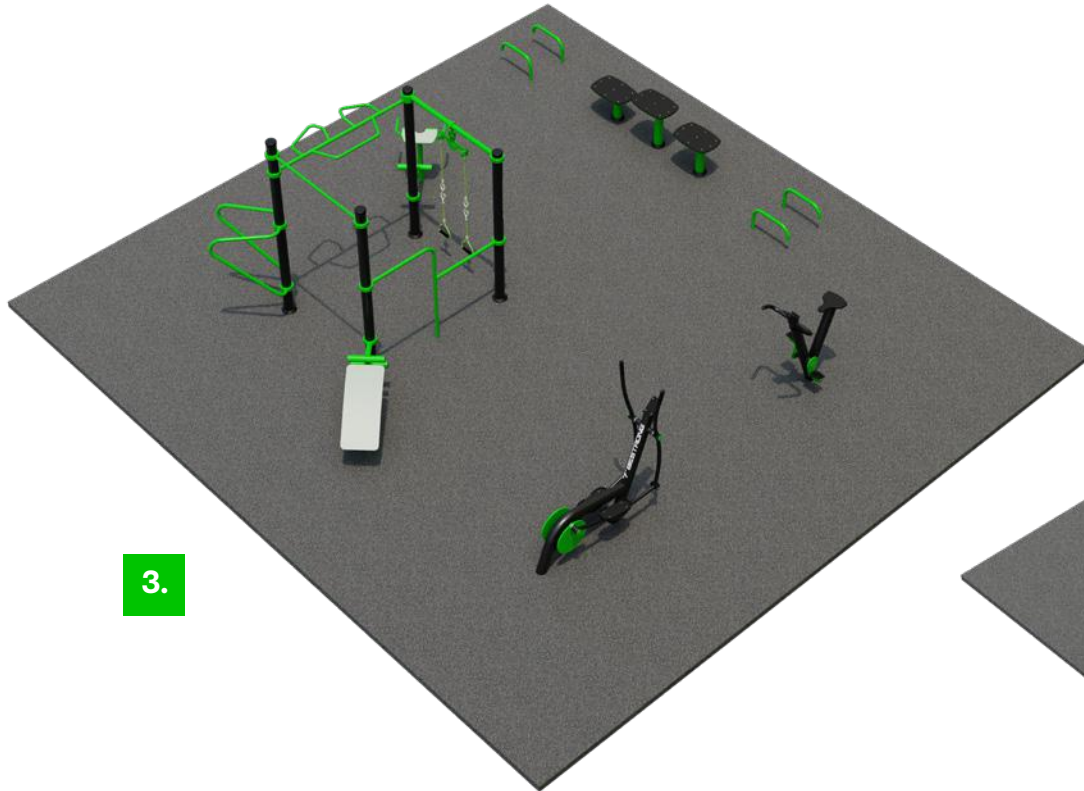

3.

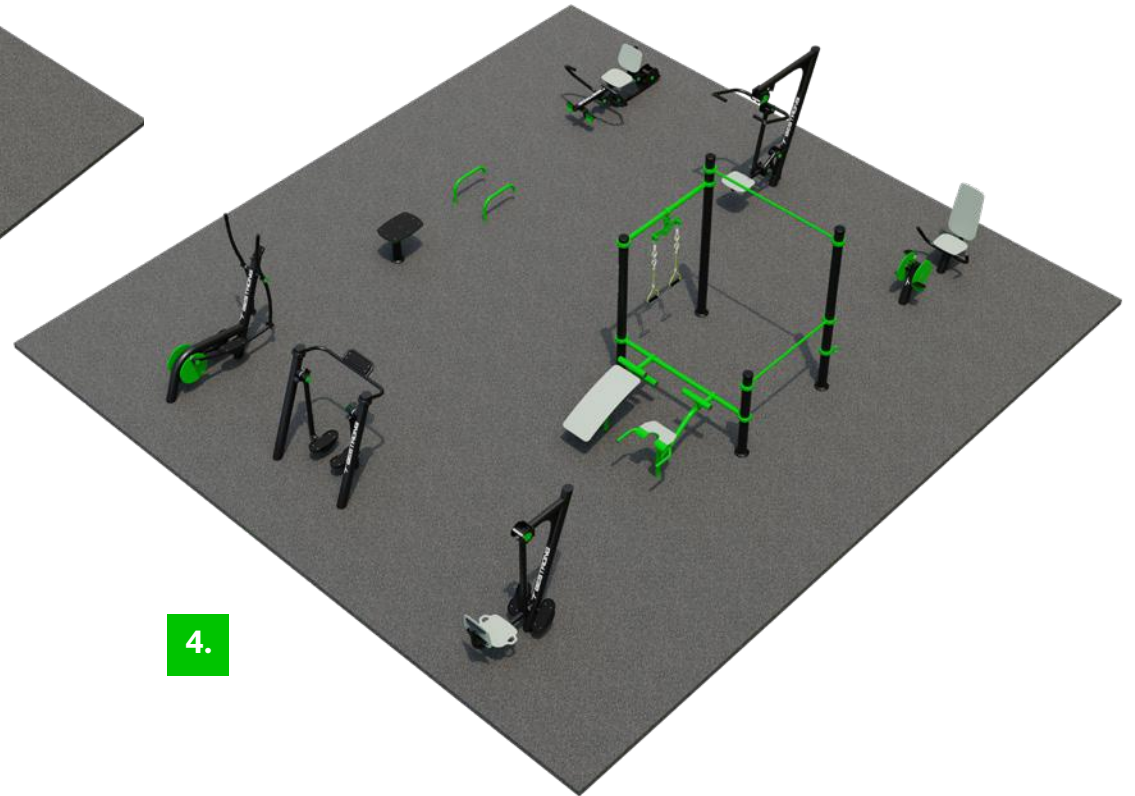

4.

	ID.	Product Name	Certificate	Age Group	Capacity	Total Area	Number of equipment	Fall height	Net weight
3.	1-3-230	FitStay 3	EN 16630, ASTM F3101	14 + years	30 people	823.44 ft' (27'-10,65" x 29'-6,33")	15	4.92 ft	1033.5 lbs
4.	1-3-254	FitStay 4	EN 16630, ASTM F3101	14 + years	28 people	1022.2 ft' (32'-9,70" x 31'-2,02")	14	4.26 ft	2080 lbs

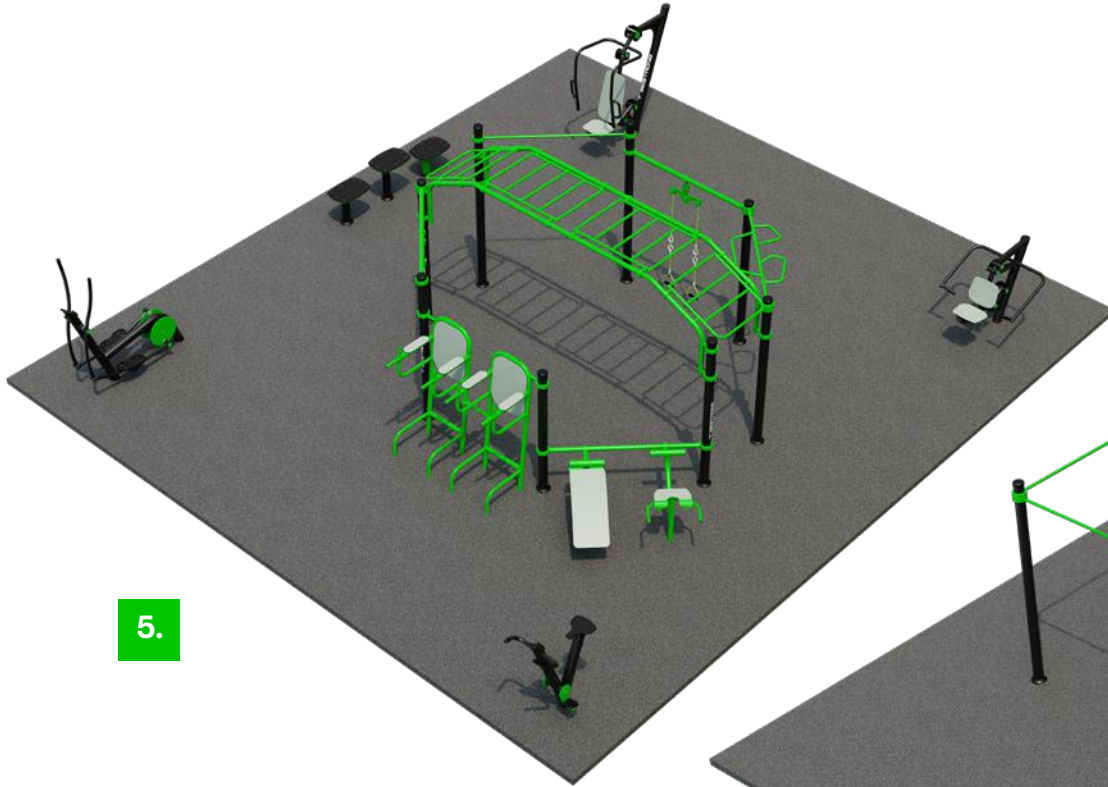

5.

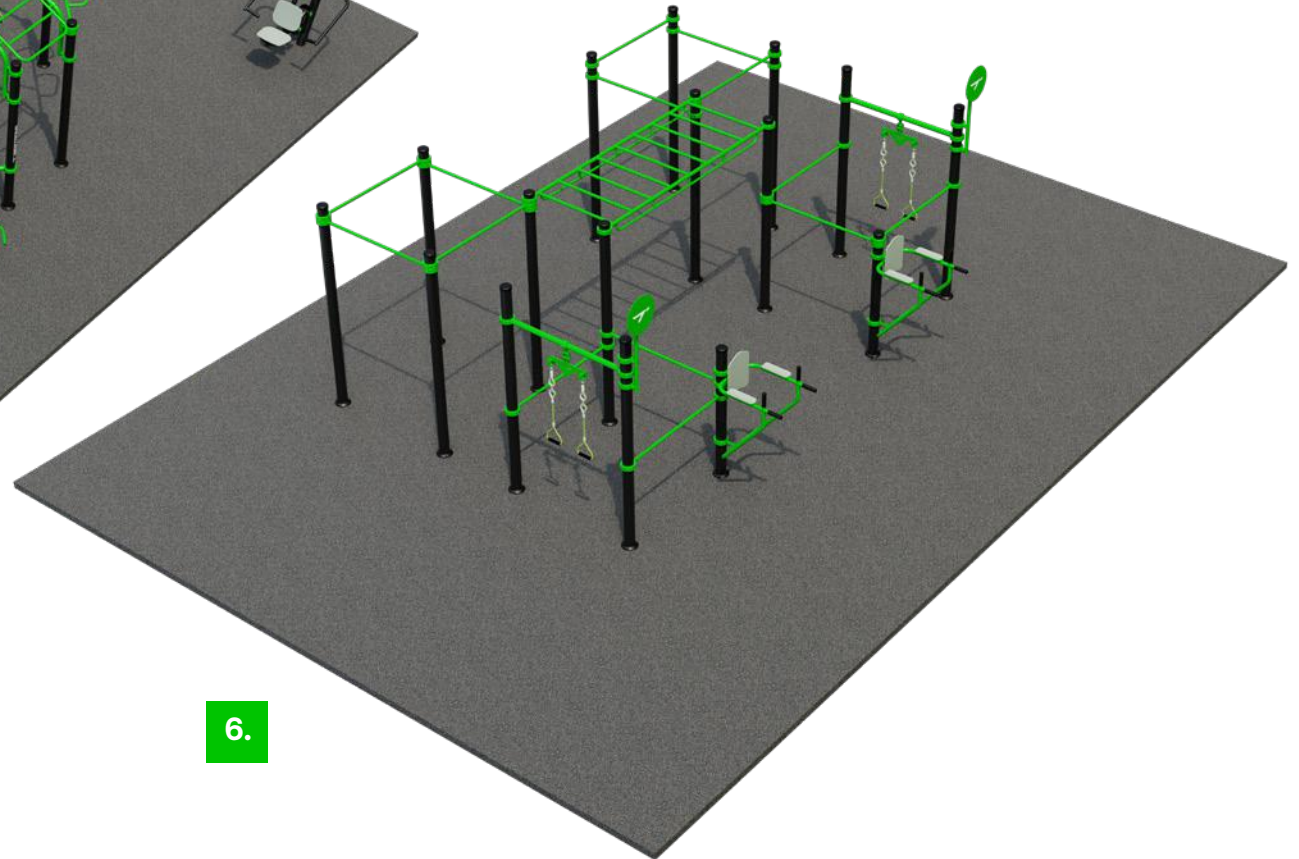

6.

	ID.	Product Name	Certificate	Age Group	Capacity	Total Area	Number of equipment	Fall height	Net weight
5.	1-3-239	FitStay 5	EN 16630, ASTM F3101	14 + years	28 people	1936.8 ft ² (49'-2,55" x 39'-4,44")	14	5.25 ft	2390 lbs
6.	1-3-240	FitStay 6	EN 16630, ASTM F3101	14 + years	44 people	1098 ft ² (39'-4,44" x 27'-10,65")	21	6.9 ft	3173.5 lbs

RECREATIONAL

For the full range of Recreational

- < click on the QR code, or
- < scan with your mobile device





Experience an exhilarating outdoor cardio workout with BESTRONG recreational cardio equipment! In designing our collection, our top priority was to provide an effective and enjoyable workout suitable for all age groups. These ergonomic products are especially advantageous for seniors, as they support the maintenance of fitness and mobility through low-impact exercises. The diversity and versatility of our outdoor cardio collection cater to all fitness levels and preferences, promoting and sustaining a healthy lifestyle.



	ID.	Product Name	Certificate	Age Group	Capacity	Difficulty level	Concrete volume	Anchoring options	Critical fall height
1.	1-3-300	Elliptical Trainer	EN 16630, ASTM F3101	14 + years	1 person	Easy	40,61 ft³	Surface mounted	22.83"
2.	1-3-301	Leg Abductor	EN 16630, ASTM F3101	14 + years	1 person	Easy	17,66 ft³	Surface mounted	31.5"
3.	1-3-302	Hip Swing	EN 16630, ASTM F3101	14 + years	1 person	Easy	33,9 ft³	Surface mounted	31.5"
4.	1-1-303	Leg Abductor And Hip Swing	EN 16630, ASTM F3101	14 + years	2 people	Easy	22,95 ft³	Surface mounted	31.5"



ID.	Product Name	Certificate	Age Group	Capacity	Difficulty level	Concrete volume	Anchoring options	Critical fall height
5.	Air Walker	EN 16630, ASTM F3101	14 + years	1 person	Easy	42,38 ft³	Surface mounted	29.53"
6.	Hand Bike	EN 16630, ASTM F3101	14 + years	1 person	Easy	17,66 ft³	Surface mounted	-
7.	Hand Bike With Seat	EN 16630, ASTM F3101	14 + years	1 person	Easy	40,61 ft³	Surface mounted	22.05"
8.	Recumbent Bike	EN 16630, ASTM F3101	14 + years	1 person	Easy	42,38 ft³	Surface mounted	18.9"
9.	Spinning Bike	EN 16630, ASTM F3101	14 + years	1 person	Easy	17,66 ft³	Surface mounted	43.31"
10.	Leg Press	EN 16630, ASTM F3101	14 + years	1 person	Medium	17,66 ft³	Surface mounted	18.9"
11.	Ski Walker	EN 16630, ASTM F3101	14 + years	1 person	Easy	40,61 ft³	Surface mounted	22.83"
12.	Rower	EN 16630, ASTM F3101	14 + years	1 person	Medium	26,84 ft³	Surface mounted	35.43"



13.



14.



15.



16.



17.



18.



19.



ID.	Product Name	Certificate	Age Group	Capacity	Difficulty level	Concrete volume	Anchoring options	Critical fall height
13.	Tai Chi Wheel	EN 16630, ASTM F3101	14 + years	2 people	Easy	18.08 ft ³	Surface mounted	-
14.	Lateral Pull-Down	EN 16630, ASTM F3101	14 + years	1 person	Medium	33,9 ft ³	Surface mounted	31.5"
15.	Mechanical Stepper	EN 16630, ASTM F3101	14 + years	1 person	Easy	33.9 ft ³	Surface mounted	2' – 3.55"
16.	Chest Press	EN 16630, ASTM F3101	14 + years	1 person	Medium	33,9 ft ³	Surface mounted	31.5"
17.	Twister	EN 16630, ASTM F3101	14 + years	1 person	Easy	23.73 ft ³	Surface mounted	1' – 3.74"
18.	Biceps Trainer	EN 16630, ASTM F3101	14 + years	1 person	Easy	17,65 ft ³	Surface mounted	2'-1.58"
19.	Leg Curl	EN 16630, ASTM F3101	14 + years	1 person	Easy	17,66 ft ³	Surface mounted	18.9"

CALISTHENICS

For the full range of Calisthenics

< click on the QR code, or
< scan with your mobile device



Elevate your outdoor training with BESTRONG's innovative calisthenics equipment! Meticulously designed by our team of qualified engineers and renowned athlete advisors. Using this collection will enhance your weight training experience. We offer a wide range of shapes and sizes to accommodate individuals of all skill levels, from beginners to professionals. Our calisthenics equipment embodies the perfect blend of durability, aesthetic appeal, and functional efficiency, providing a versatile platform for configuring any fitness park.

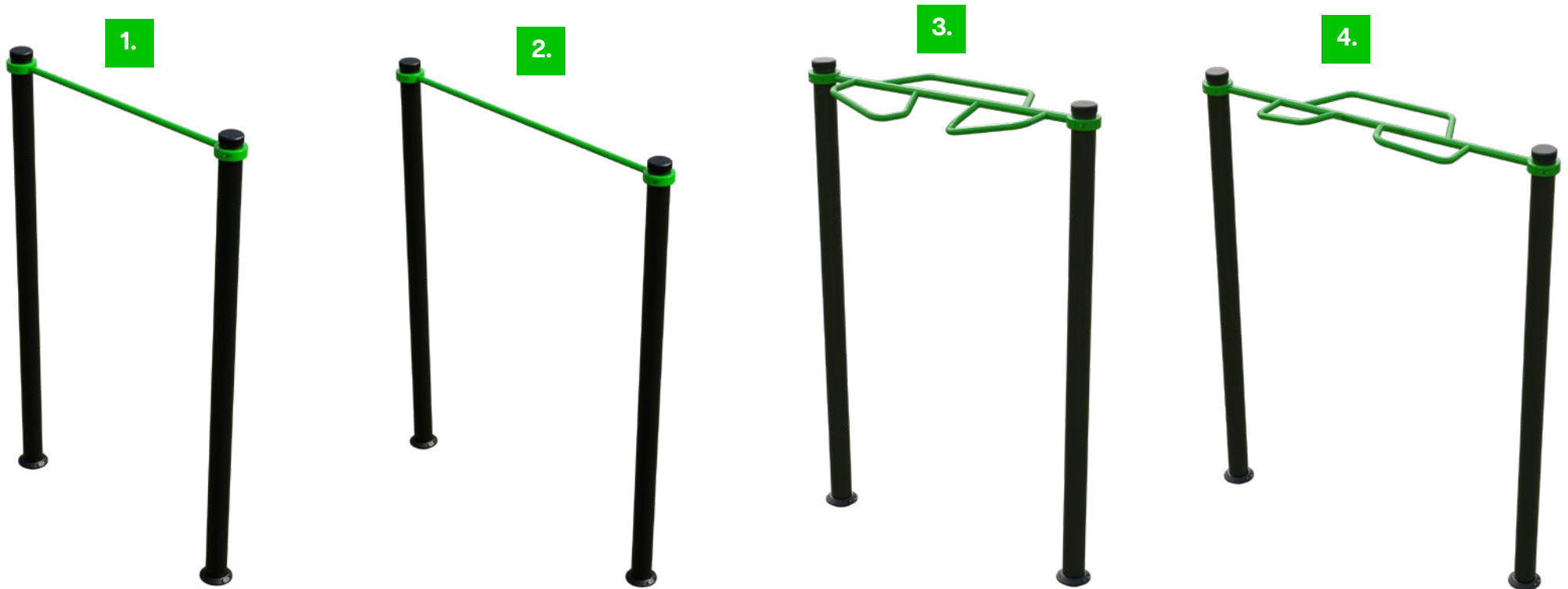

	ID.	Product Name	Certificate	Age Group	Capacity	Difficulty level	Concrete volume	Anchoring options	Critical fall height
1.	1-1-015	Straight Pull-Up Bar 1500	EN 16630, ASTM F3101	14 + years	1 person	Hard	14,13 ft'	In-ground or surface	55.12"
2.	1-1-016	Straight Pull-Up Bar 1900	EN 16630, ASTM F3101	14 + years	1 person	Hard	14,13 ft'	In-ground or surface	55.12"
3.	1-1-033	Combined Pull-Up Bar 1500	EN 16630, ASTM F3101	14 + years	1 person	Hard	14,13 ft'	In-ground or surface	43.31"
4.	1-1-034	Combined Pull-Up Bar 1900	EN 16630, ASTM F3101	14 + years	1 person	Hard	14,13 ft'	In-ground or surface	43.31"



ID.	Product Name	Certificate	Age Group	Capacity	Difficulty level	Concrete volume	Anchoring options	Critical fall height
5.	Multifunctional Pull-Up Bar 1500	EN 16630, ASTM F3101	14 + years	1 person	Hard	14,13 ft³	In-ground or surface	47.24"
6.	Multifunctional Pull-Up Bar 1900	EN 16630, ASTM F3101	14 + years	1 person	Hard	14,13 ft³	In-ground or surface	47.24"
7.	Narrow Pull-Up Bar 1500	EN 16630, ASTM F3101	14 + years	1 person	Hard	14,13 ft³	In-ground or surface	43.31"
8.	Narrow Pull-Up Bar 1900	EN 16630, ASTM F3101	14 + years	1 person	Hard	14,13 ft³	In-ground or surface	43.31"
9.	Horizontal Wave 1500	EN 16630, ASTM F3101	14 + years	1 person	Hard	14,13 ft³	In-ground or surface	43.31"
10.	Horizontal Wave 1900	EN 16630, ASTM F3101	14 + years	1 person	Hard	14,13 ft³	In-ground or surface	43.31"
11.	Wall Bars 1500	EN 16630, ASTM F3101	14 + years	1 person	Hard	14,13 ft³	In-ground or surface	81.69"
12.	Wall Bars 1900	EN 16630, ASTM F3101	14 + years	1 person	Hard	14,13 ft³	In-ground or surface	81.69"

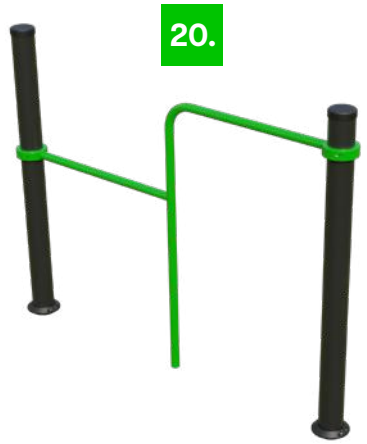

ID.	Product Name	Certificate	Age Group	Capacity	Difficulty level	Concrete volume	Anchoring options	Critical fall height	
13.	1-1-065	Combined Ladder	EN 16630, ASTM F3101	14 + years	2 people	Hard	28,25 ft ³	In-ground or surface	5'-10.85"
14.	1-1-046	Street Workout Ladder	EN 16630, ASTM F3101	14 + years	2 people	Hard	28,25 ft ³	In-ground or surface	47.24"
15.	1-1-029	Horizontal Ladder	EN 16630, ASTM F3101	14 + years	2 people	Hard	28,25 ft ³	In-ground or surface	54.13"
16.	1-1-058	Rising Ladder	EN 16630, ASTM F3101	14 + years	2 people	Hard	28,25 ft ³	In-ground or surface	47.24"
17.	1-1-045	Trapeze Ladder	EN 16630, ASTM F3101	14 + years	2 people	Hard	28,25 ft ³	In-ground or surface	62.99"
18.	1-1-035	Maximum Ladder	EN 16630, ASTM F3101	14 + years	2 people	Hard	28,25 ft ³	In-ground or surface	63.78"
19.	1-1-049	Monkey Rack	EN 16630, ASTM F3101	14 + years	1 person	Hard	14,13 ft ³	In-ground or surface	64.96"
20.	1-1-030	Low Pull-Up & Dip Bar	EN 16630, ASTM F3101	14 + years	2 people	Easy	21,19 ft ³	In-ground or surface	55.12"

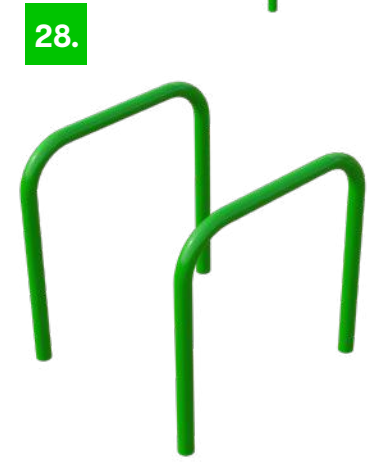
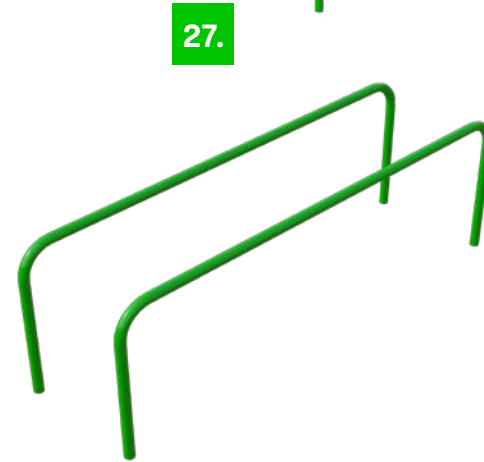
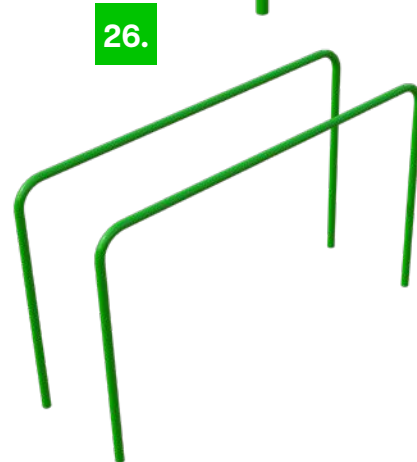
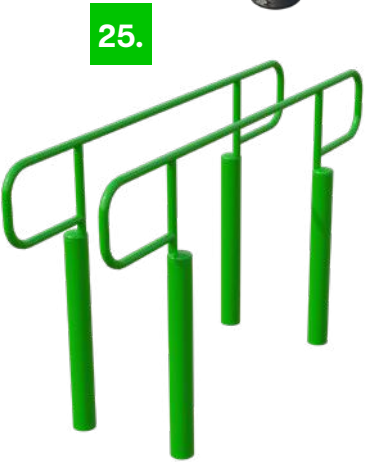

ID.	Product Name	Certificate	Age Group	Capacity	Difficulty level	Concrete volume	Anchoring options	Critical fall height
21.	Dip Bar	EN 16630, ASTM F3101	14 + years	1 person	Medium	7,06 ft³	In-ground or surface	54.13"
22.	Z Dip Bar	EN 16630, ASTM F3101	14 + years	1 person	Medium	21,19 ft³	In-ground or surface	37.95"
23.	Three Element Parallel Bar 1500	EN 16630, ASTM F3101	14 + years	2 people	Medium	22,95 ft³	In-ground or surface	59.06"
24.	Three Element Parallel Bar 1900	EN 16630, ASTM F3101	14 + years	2 people	Medium	26,49 ft³	In-ground or surface	59.06"
25.	Parallel Bars	EN 16630, ASTM F3101	14 + years	2 people	Medium	28,25 ft³	In-ground or surface	59.06"
26.	Practicing Parallel Bars	EN 16630, ASTM F3101	14 + years	2 people	Medium	30,9 ft³	In-ground or surface	51.18"
27.	Low Parallel Bars	EN 16630, ASTM F3101	14 + years	2 people	Medium	30,9 ft³	In-ground or surface	51.18"
28.	Mini Parallel Bars	EN 16630, ASTM F3101	14 + years	1 person	Medium	18,54 ft³	In-ground or surface	23.62"

CROSS-TRAINING

For the full range of Cross-Training

< click on the QR code, or
< scan with your mobile device



Embark on a journey toward enhanced functional fitness with BESTRONG's dynamic Cross-training tools! This collection is meticulously designed to target various muscle groups, enrich the workout experience, and boost endurance and flexibility. The sturdy design of our equipment ensures safety during use. The array of exercises that can be performed makes it an ideal choice for both beginners and advanced athletes. Enjoy an outdoor training experience that harnesses the power of tools to elevate your performance to new heights!



	ID.	Product Name	Certificate	Age Group	Capacity	Difficulty level	Concrete volume	Anchoring options	Critical fall height
1.	1-1-226	Suspension Trainer 1500 600	EN 16630, ASTM F3101	14 + years	1 person	Easy	14,13 ft³	In-ground or surface	-
	1-1-230	Suspension Trainer 1900 600	EN 16630, ASTM F3101	14 + years	1 person	Easy	14,13 ft³	In-ground or surface	-
2.	1-1-227	Suspension Trainer 1500 930	EN 16630, ASTM F3101	14 + years	1 person	Easy	14,13 ft³	In-ground or surface	-
	1-1-229	Suspension Trainer 1900 930	EN 16630, ASTM F3101	14 + years	1 person	Easy	14,13 ft³	In-ground or surface	-
3.	1-1-125	Suspension Trainer 1500 1430	EN 16630, ASTM F3101	14 + years	1 person	Easy	14,13 ft³	In-ground or surface	-
	1-1-228	Suspension Trainer 1900 1430	EN 16630, ASTM F3101	14 + years	1 person	Easy	14,13 ft³	In-ground or surface	-



4.



5.



6.



7.



	ID.	Product Name	Certificate	Age Group	Capacity	Difficulty level	Concrete volume	Anchoring options	Critical fall height
4.	1-1-061	Rope Holder	EN 16630, ASTM F3101	14 + years	1 person	Easy	7,06 ft³	In-ground or surface	-
5.	1-1-054	Boxing Bag Holder	EN 16630, ASTM F3101	14 + years	1 person	Easy	7,06 ft³	In-ground or surface	-
6.	1-1-020	Climbing Rope Frame	EN 16630, ASTM F3101	14 + years	1 person	Medium	14,13 ft³	In-ground or surface	125.98"
7.	1-1-055	Medicine Ball Target	EN 16630, ASTM F3101	14 + years	1 person	Easy	7,06 ft³	In-ground or surface	-

FITNESS

For the full range of Fitness

- < click on the QR code, or
- < scan with your mobile device



Unlock the advantages of comprehensive outdoor training with BESTRONG's general fitness equipment! By utilizing a combination of our equipment, co-designed by our team of professional fitness experts and engineers, you can craft a fitness regimen that targets all major muscle groups. Whether your focus is on strengthening core muscles, sculpting muscle tone, or improving flexibility, our equipment will support your fitness objectives. Explore a new dimension of outdoor fitness with our collection, which intensifies your workouts while ensuring safety, and allows you to customize your fitness equipment to meet your specific needs.

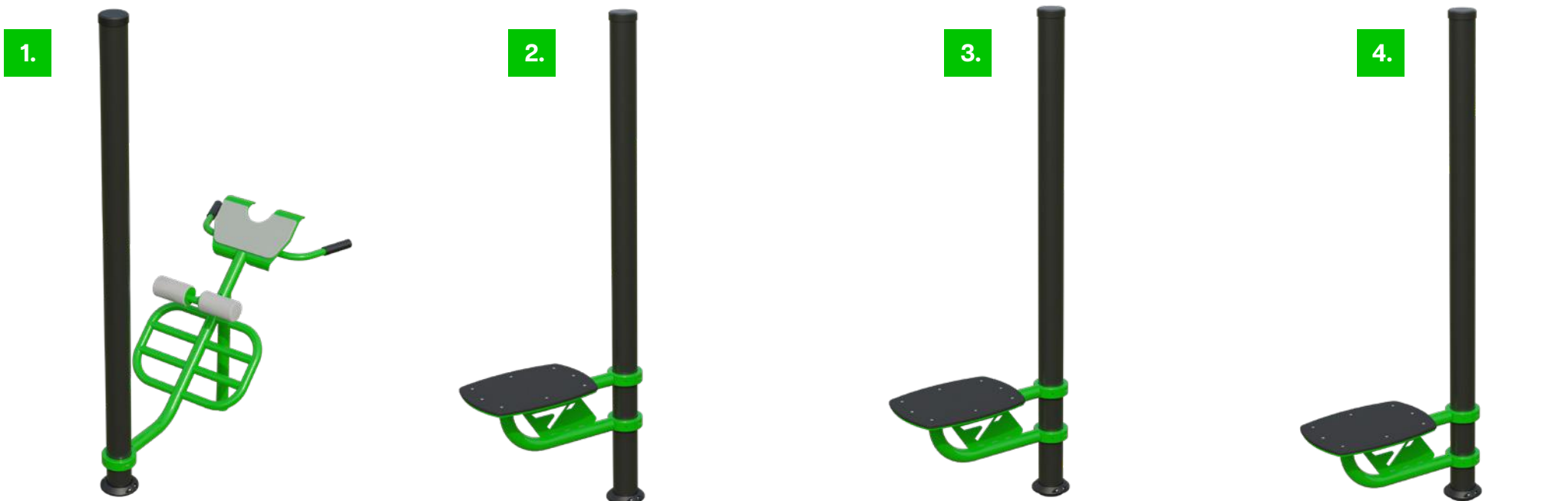

ID.	Product Name	Certificate	Age Group	Capacity	Difficulty level	Concrete volume	Anchoring options	Critical fall height	
1.	1-1-167	Hyperbending Bench	EN 16630, ASTM F3101	14 + years	1 person	Medium	7,06 ft'	In-ground or surface	3' – 3.36"
2.	1-1-129	Stepper on Pillar 400	EN 16630, ASTM F3101	14 + years	1 person	Easy	7,06 ft'	In-ground or surface	15.75"
3.	1-1-129	Stepper on Pillar 500	EN 16630, ASTM F3101	14 + years	1 person	Easy	7,06 ft'	In-ground or surface	19.69"
4.	1-1-129	Stepper on Pillar 600	EN 16630, ASTM F3101	14 + years	1 person	Easy	7,06 ft'	In-ground or surface	23.62"

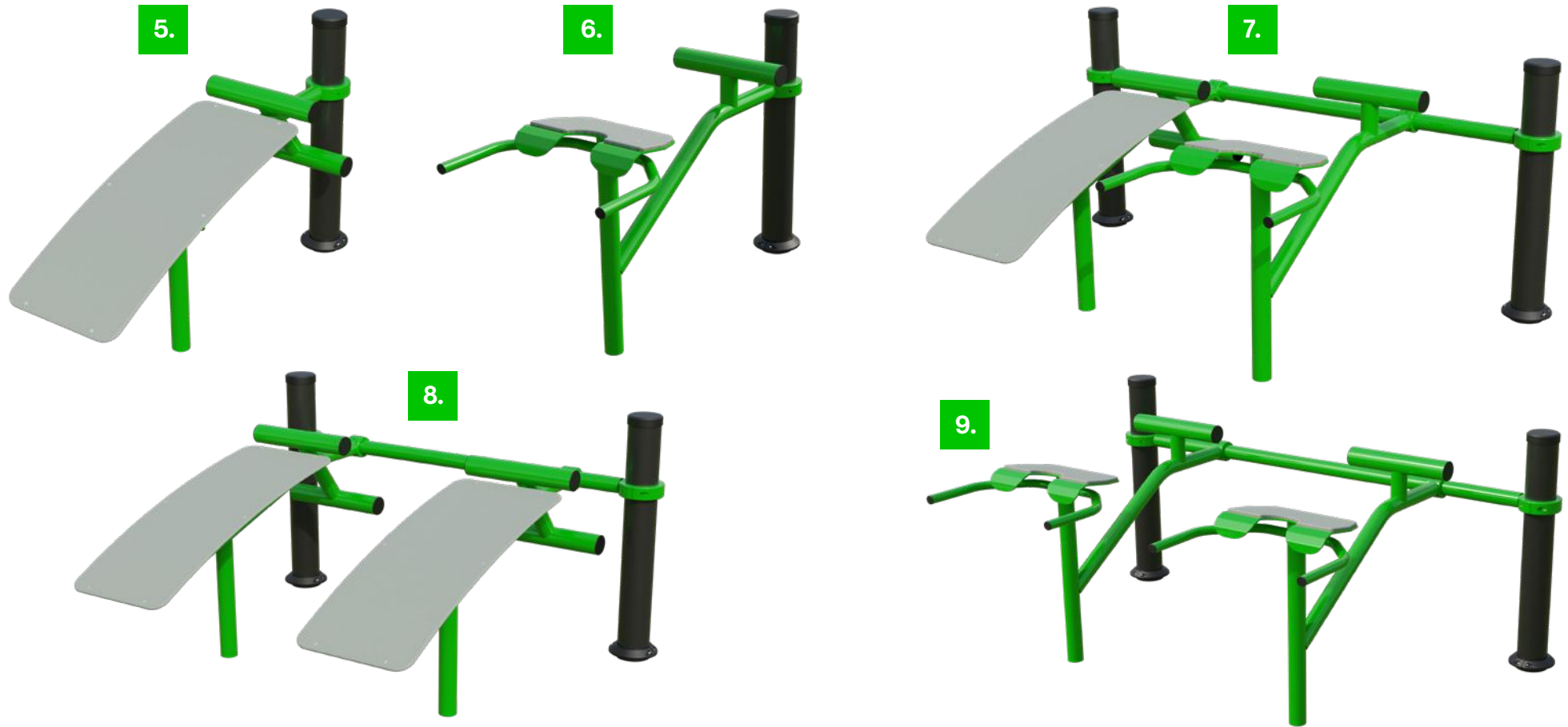

	ID.	Product Name	Certificate	Age Group	Capacity	Difficulty level	Concrete volume	Anchoring options	Critical fall height
5.	1-1-053	Ab Trainer	EN 16630, ASTM F3101	14 + years	1 person	Easy	14,13 ft³	In-ground or surface	22.83"
6.	1-1-050	Back Trainer	EN 16630, ASTM F3101	14 + years	1 person	Easy	14,13 ft³	In-ground or surface	28.54"
7.	1-1-041	Ab & Back Trainer 1500	EN 16630, ASTM F3101	14 + years	2 people	Easy	28,25 ft³	In-ground or surface	31.5"
	1-1-040	Ab & Back Trainer 1900	EN 16630, ASTM F3101	14 + years	2 people	Easy	28,25 ft³	In-ground or surface	31.5"
8.	1-1-039	Double Ab Training Bench 1500	EN 16630, ASTM F3101	14 + years	2 people	Easy	28,25 ft³	In-ground or surface	27.56"
	1-1-038	Double Ab Training Bench 1900	EN 16630, ASTM F3101	14 + years	2 people	Easy	28,25 ft³	In-ground or surface	27.56"
9.	1-1-023	Double Back Training Bench 1500	EN 16630, ASTM F3101	14 + years	2 people	Easy	28,25 ft³	In-ground or surface	34.65"
	1-1-026	Double Back Training Bench 1900	EN 16630, ASTM F3101	14 + years	2 people	Easy	28,25 ft³	In-ground or surface	34.65"

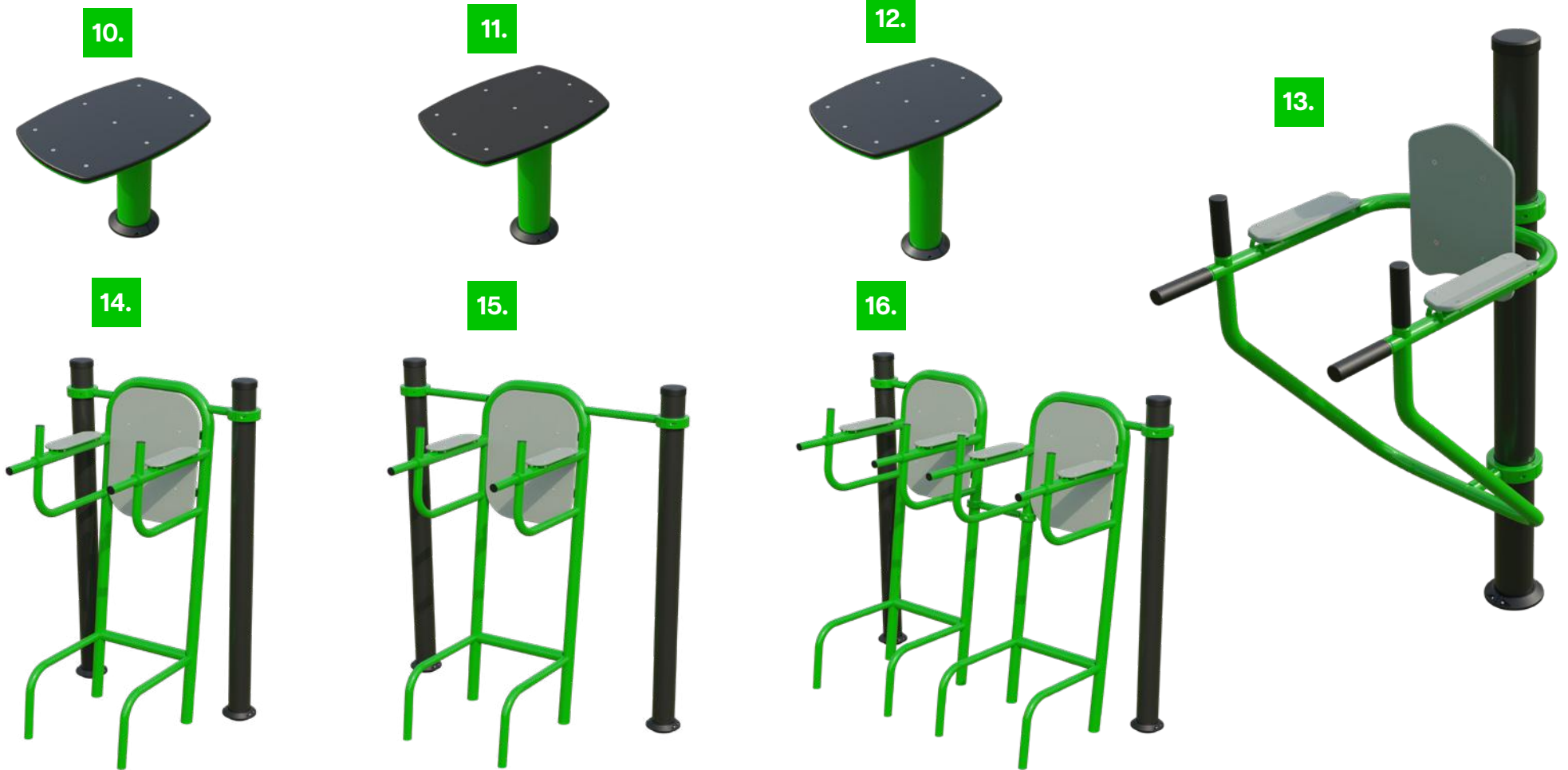

ID.	Product Name	Certificate	Age Group	Capacity	Difficulty level	Concrete volume	Anchoring options	Critical fall height
10.	Stepper 400	EN 16630, ASTM F3101	14 + years	1 person	Easy	18,08 ft³	In-ground or surface	19.09"
11.	Stepper 500	EN 16630, ASTM F3101	14 + years	1 person	Easy	18,08 ft³	In-ground or surface	23.03"
12.	Stepper 600	EN 16630, ASTM F3101	14 + years	1 person	Easy	18,08 ft³	In-ground or surface	26.97"
13.	Multifunctional Trainer On Pillar	EN 16630, ASTM F3101	14 + years	1 person	Medium	17,66 ft³	In-ground or surface	54.33"
14.	Multifunctional Trainer 950	EN 16630, ASTM F3101	14 + years	1 person	Medium	27,55 ft³	In-ground or surface	53.94"
15.	Multifunctional Trainer 1500	EN 16630, ASTM F3101	14 + years	1 person	Medium	37,08 ft³	In-ground or surface	53.94"
16.	Double Multifunctional Trainer	EN 16630, ASTM F3101	14 + years	2 people	Medium	45,91 ft³	In-ground or surface	53.94"

ACCESSIBLE EQUIPMENT



Our message at BeStrong USA is simple: sport is for everyone. From 2024 we are proud to offer accessible outdoor exercise equipment for everyone, including disabled individuals. In addition to strengthening different parts of the body, physical activity improves your mental health, overall fitness, and quality of life. Our innovative outdoor fitness equipment is designed to be accessible, safe, and easy to use.

1.



2.



3.



	ID.	Product Name	Certificate	Age Group	Capacity	Difficulty level	Concrete volume	Anchoring options	Critical fall height
1.	1-1-331	Shrug	EN 16630, ASTM F3101	14 + years	1 person	Medium	18.08 ft³	Surface mounted	18.5"
2.	1-1-332	Lateral Pull-Down	EN 16630, ASTM F3101	14 + years	1 person	Medium	18.08 ft³	Surface mounted	18.5"
3.	1-1-020	Chest Press	EN 16630, ASTM F3101	14 + years	1 person	Medium	18.08 ft³	Surface mounted	18.5"

ADJUSTABLE WEIGHT



Elevate your outdoor workouts with our adjustable load outdoor collection! Offering versatility and resilience in the face of today's extreme weather conditions, this range is tailored for the contemporary fitness enthusiast. Whether your goal is to build muscle, tone, lose weight, or enhance endurance, the adjustable weight features enable you to customize the direction and intensity of your workout effortlessly. Our collection blends innovative design with robust construction, ensuring that you can experience the functionality and versatility of an indoor gym in the great outdoors, closer to nature. Join us as we redefine your outdoor exercise experience together!



	ID.	Product Name	Certificate	Age Group	Capacity	Difficulty level	Concrete volume	Anchoring options	Critical fall height
1.	1-1-322	Tricep Press	EN 16630, ASTM F3101	14 + years	1 person	-	14.12 ft ³	Surface mounted	-
2.	1-1-323	Squat	EN 16630, ASTM F3101	14 + years	1 person	-	21.19 ft ³	Surface mounted	-
3.	1-1-325	Leg Curl	EN 16630, ASTM F3101	14 + years	1 person	-	56.50 ft ³	Surface mounted	18.5"



4.



5.



6.

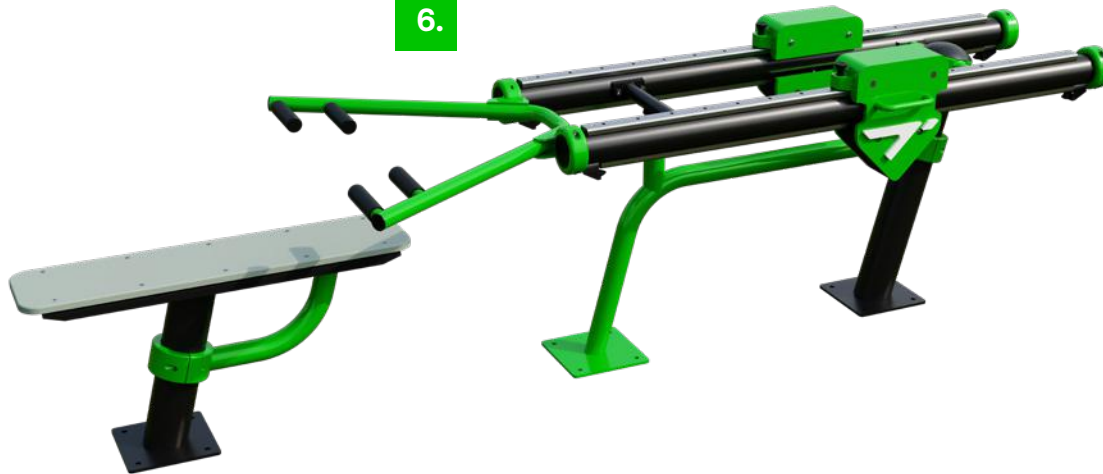

	ID.	Product Name	Certificate	Age Group	Capacity	Difficulty level	Concrete volume	Anchoring options	Critical fall height
4.	1-1-321	Biceps Curl	EN 16630, ASTM F3101	14 + years	1 person	-	14.12 ft ³	Surface mounted	-
5.	1-1-320	Low Row	EN 16630, ASTM F3101	14 + years	1 person	-	35.31 ft ³	Surface mounted	-
6.	1-1-020	Bench Press	EN 16630, ASTM F3101	14 + years	1 person	-	42.38 ft ³	Surface mounted	19.7"

SOCCER SPECIFIC

For the full range of Soccer Specific

- < click on the QR code, or
- < scan with your mobile device





BESTRONG's exclusive, football-specific equipment adds a new dimension to the sport's training culture. Developed with input from a wide range of professional athletes, our carefully designed equipment is intended to enhance athletes' skill development and overall performance. Whether it's for stabilization or mobilization, strength training, or simple warm-ups, our sport-specific equipment can meet the needs of various sports and performance levels. Our outdoor-specific solutions are crafted with extreme precision to fulfill your high-quality training requirements.

1.



2.



3.



	ID.	Product Name	Certificate	Age Group	Capacity	Difficulty level	Concrete volume	Anchoring options	Critical fall height
1.	1-1-184	Nordic Hamstring Station Pro	EN 16630, ASTM F3101	14 + years	1 person	Medium	14,83 ft ³	In-ground or surface	13.03"
2.	1-1-162	Glute-Ham Developer Pro	EN 16630, ASTM F3101	14 + years	1 person	Medium	17,66 ft ³	In-ground or surface	47.87"
3.	1-1-161	Balance Board Pro	EN 16630, ASTM F3101	14 + years	1 person	Medium	7,06 ft ³	In-ground or surface	13.31"

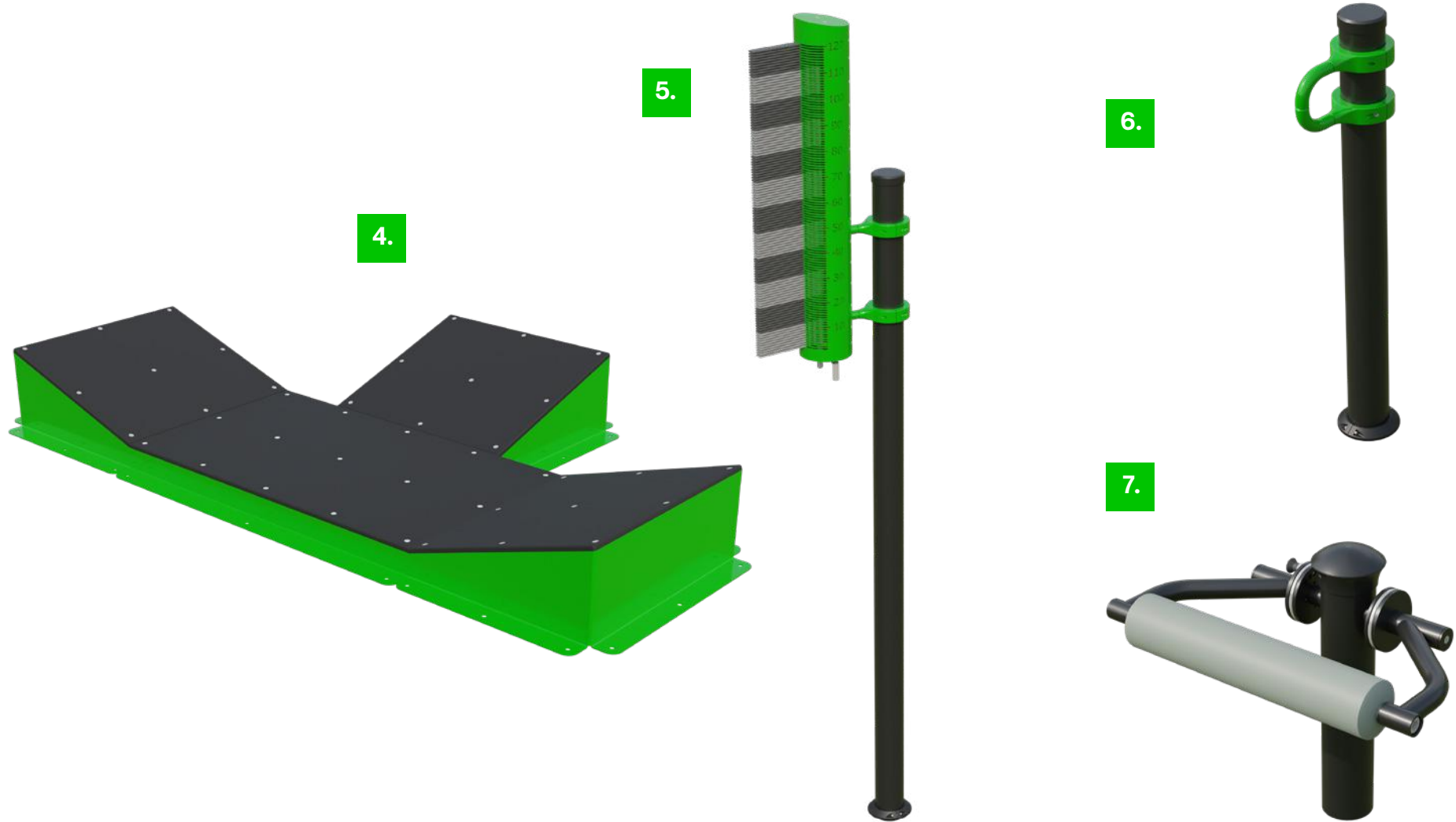

	ID.	Product Name	Certificate	Age Group	Capacity	Difficulty level	Concrete volume	Anchoring options	Critical fall height
4.	1-1-186	Lateral Plyo Box Pro	EN 16630, ASTM F3101	14 + years	1 person	Easy	49,44 ft³	In-ground or surface	11.93"
5.	1-1-189	Vertec Pro	EN 16630, ASTM F3101	14 + years	1 person	Easy	17,66 ft³	In-ground or surface	-
6.	1-1-164	Resistance Band Anchor Pro	EN 16630, ASTM F3101	14 + years	1 person	Easy	17,65 ft³	In-ground or surface	-
7.	1-1-163	Split Squat Stand Pro	EN 16630, ASTM F3101	14 + years	1 person	Easy	17,66 ft³	In-ground or surface	26.1"

ACCESSORIES



ID.	Product Name	Height	Width	Description	
1.	1-0-001	Bicycle Rack	32.91"	30.70"	Our outdoor bike racks are made with a bent steel tube structure and a durable powder coated finish.
2.	1-0-002	Waste Bin	39.60"	15.90"	Our outdoor waste bins are finished with a durable powder coating and have curved columns for greater stability.
3.	1-0-003	Outdoor Bench	39.76"	68.38"	The frame of our outdoor benches is made of 114.3 x 2 mm tubing with a durable powder coating. The seat and back are made of WPC planks.



4.

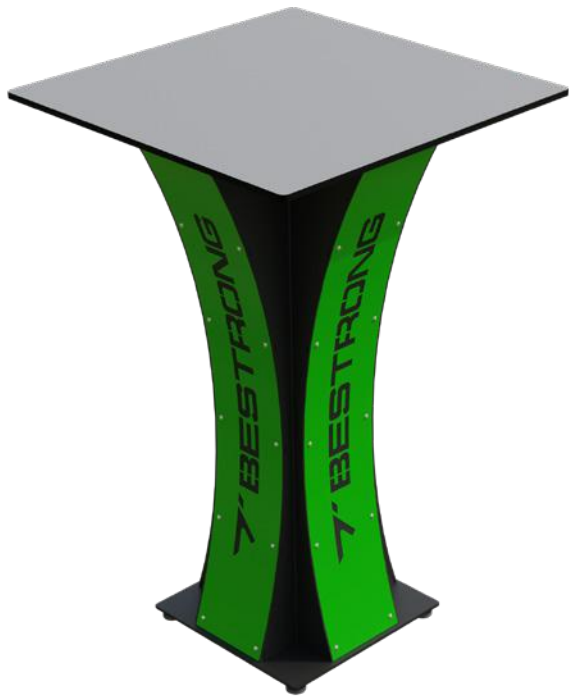

5.



6.

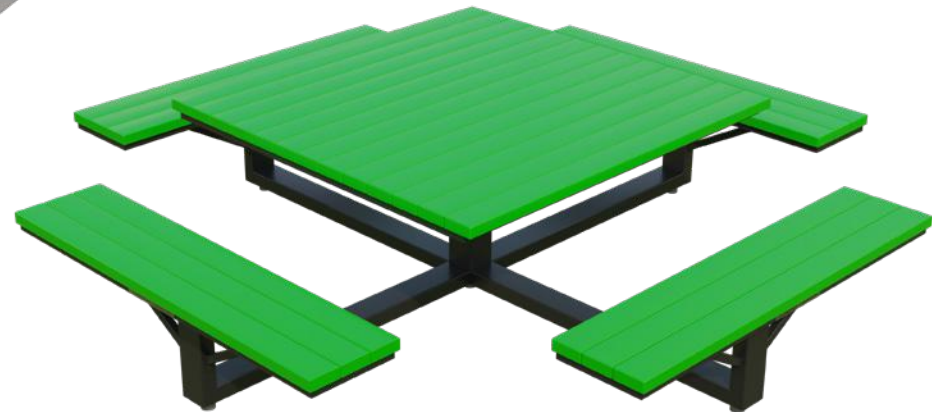

	ID.	Product Name	Height	Width	Description
4.	1-0-008	Outdoor Bar Table	39.60"	15.90"	Aesthetically pleasing and robust bar table, perfect for enhancing outdoor social spaces.
5.	1-0-005	Bench with Integrated Table	27.55"	78.74"	Functional outdoor bench with a durable metal frame and attached table, suited for outdoor seating.
6.	1-0-006	Parkside Table Bench	31.49"	116.53"	Elegant outdoor bench with a powder-coated frame and WPC trim, featuring a convenient table.



7.



8.

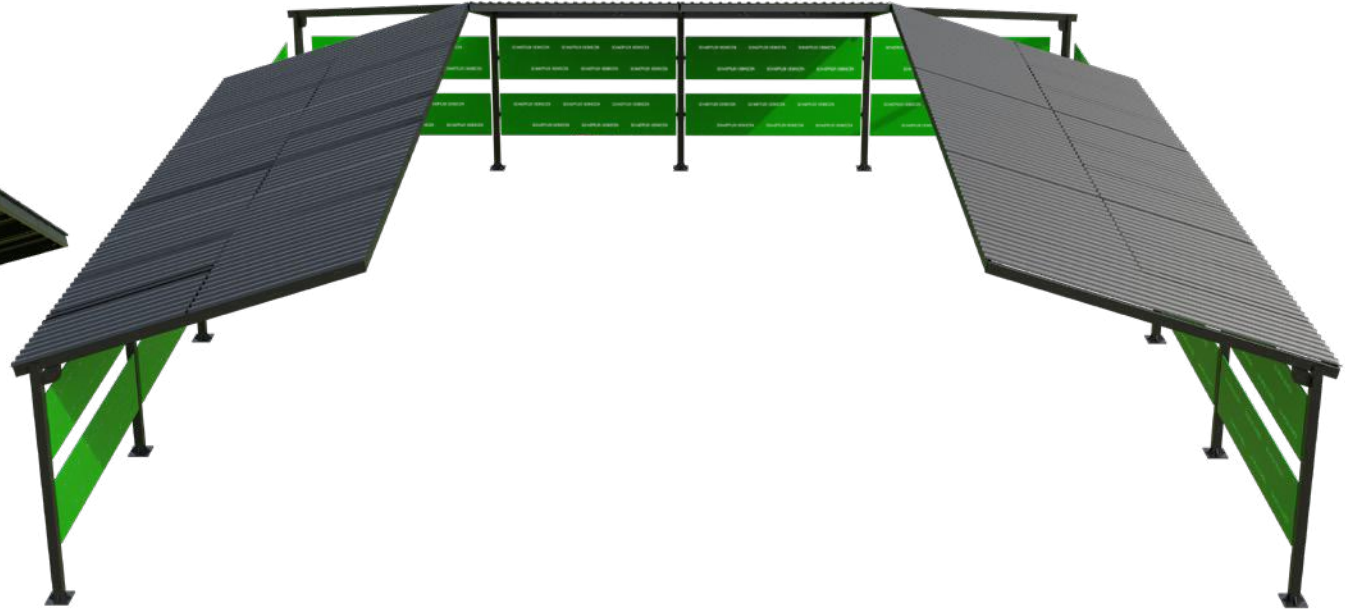

Please consult our engineers for detailed specifications of the visual designs shown.

	ID.	Product Name	Height	Width	Description
7.	1-0-009	Modern Outdoor Lounge	-	-	Sleek outdoor lounge with metal support and a solid roof, designed to be a stylish outdoor shelter.
8.	1-0-010	U-Shape Outdoor Lounge	-	-	Contemporary metal U-shaped lounge, creating a fashionable and durable outdoor shelter.

SPORTING KANSAS CITY



ARENAS

For the full range of Arenas

- < click on the QR code, or
- < scan with your mobile device



1.



2.



3.



4.

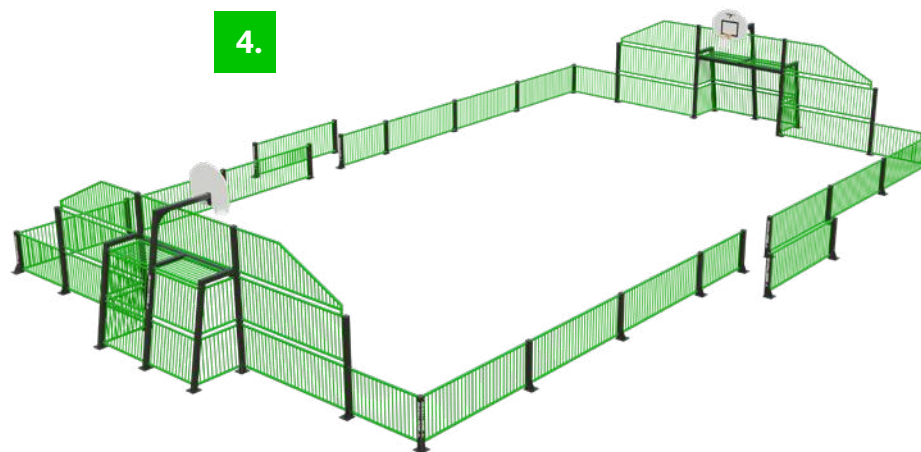

ID.	Product Name	Type	Age Group	Fence height	Length	Width	Height	Total area	Anchoring options	Anti-corrosion possibility
1.	MUGA Goal End M	MUGA	3 + years	9'-10.11"	30'-7.72"	7'-11.44"	12'-4.47"	-	Surface mounted	Galvanized
2.	MUGA Basketball Hoop	MUGA	3 + years	-	6'-3.79"	3'-10.46"	12'-4.98"	-	Surface mounted	Galvanized
3.	MUGA Goal End S	MUGA	3 + years	9'-10.11"	10'-6.77"	7'-11.49"	12'-4.47"	-	Surface mounted	Galvanized
4.	Athens	MUGA	3 + years	3'-3.71"	77'-5.84"	50'-3.94"	12'-4.47"	3900 ft'	Surface mounted	Galvanized



5.

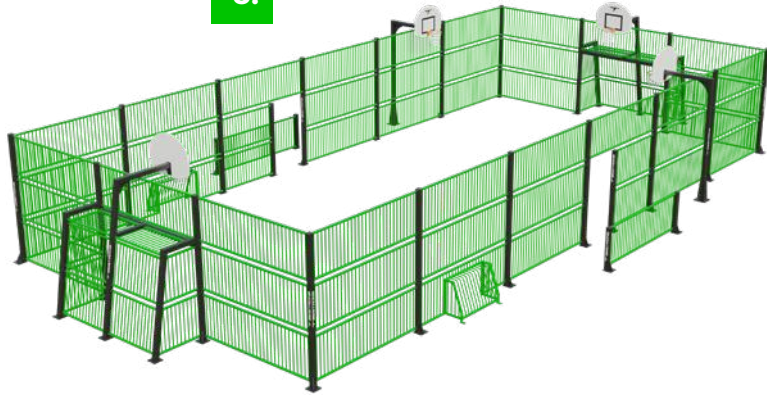

6.

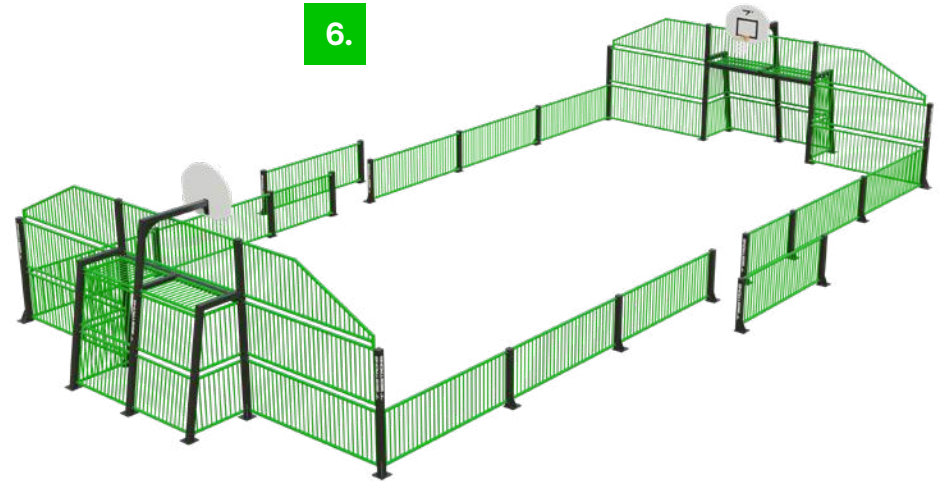

7.

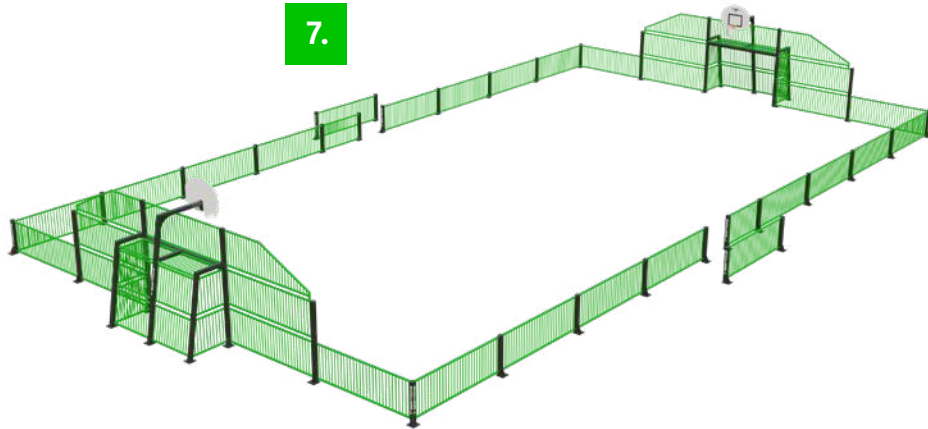

8.

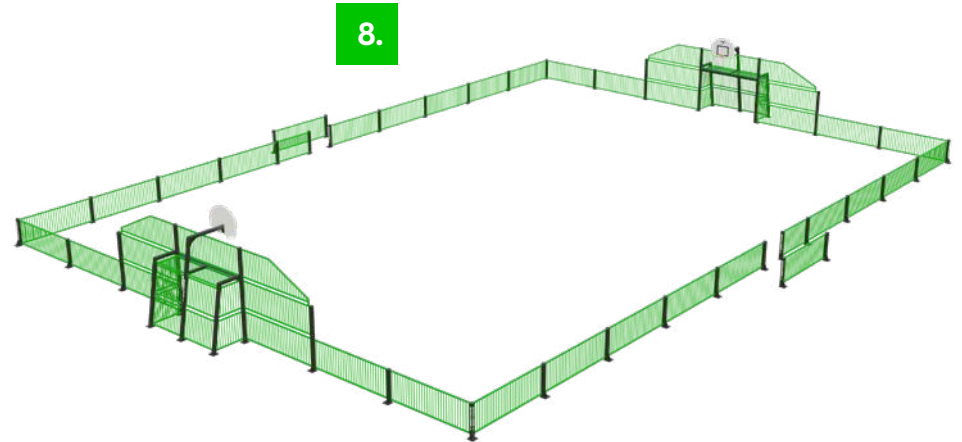

ID.	Product Name	Type	Age Group	Fence height	Length	Width	Height	Total area	Anchoring options	Anti-corrosion possibility	
5.	4-3-009	Alexandria	MUGA	3 + years	9'-10.11"	67'-7.73"	38'-6.20"	12'-4.47"	2605 ft'	Surface mounted	Galvanized
6.	4-3-024	Pompeii	MUGA	3 + years	3'-3.71"	67'-7.73"	38'-6.20"	12'-4.47"	2605 ft'	Surface mounted	Galvanized
7.	4-3-025	Syracuse	MUGA	3 + years	3'-3.71"	97'-2,07"	58'-2.43"	12'-4.47"	5656 ft'	Surface mounted	Galvanized
8.	4-3-026	Verona	MUGA	3 + years	3'-3.71"	107'-0.18"	77'-10.62"	12'-4.47"	8335 ft'	Surface mounted	Galvanized



9.

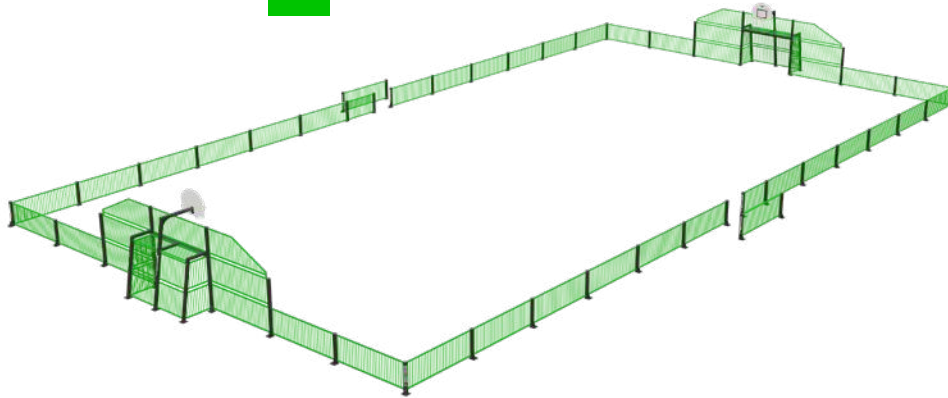

10.

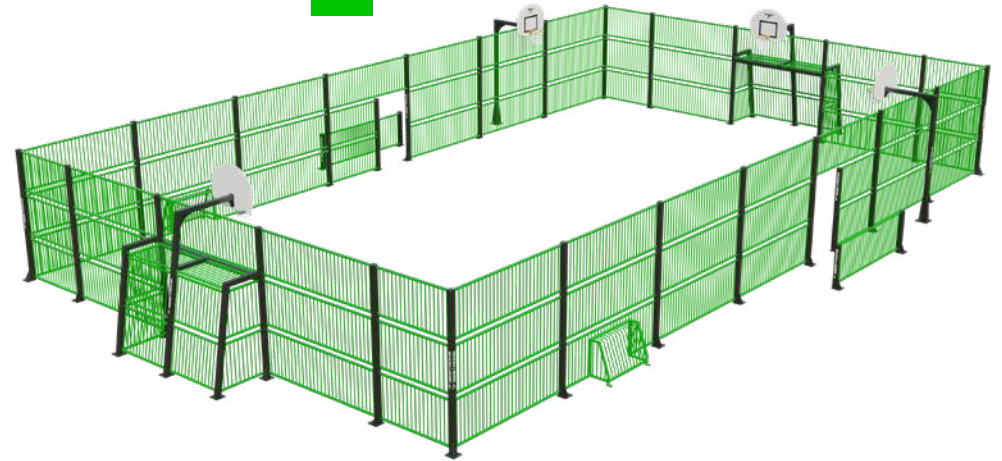

11.

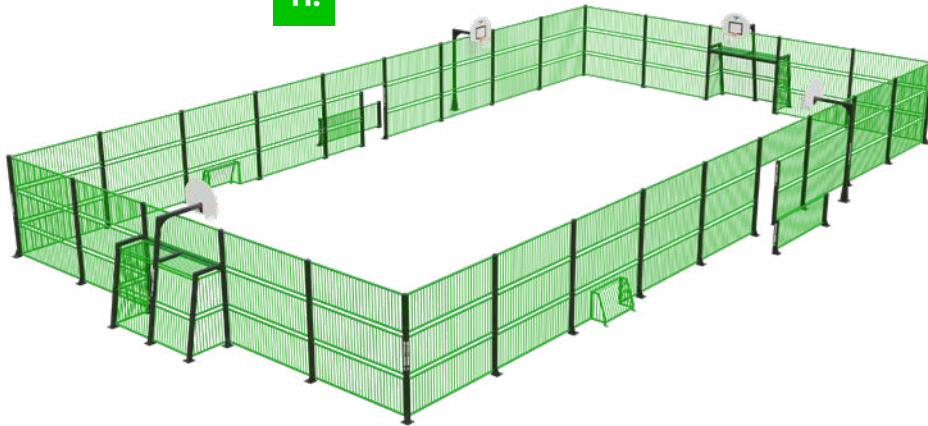

12.

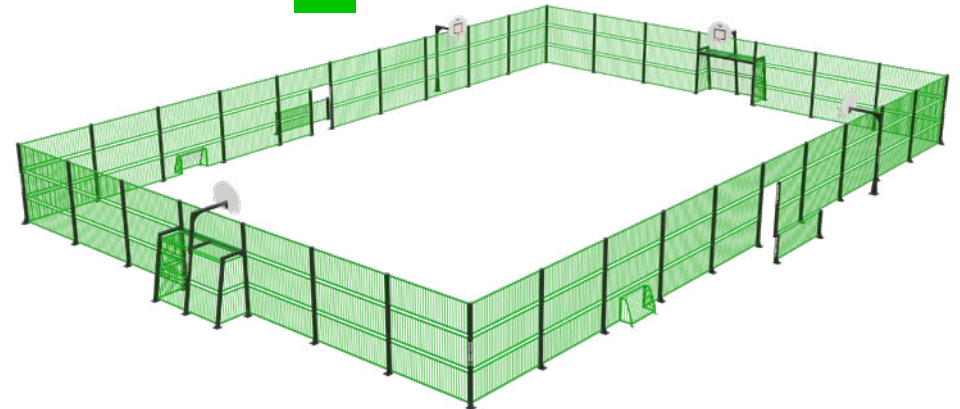

ID.	Product Name	Type	Age Group	Fence height	Length	Width	Height	Total area	Anchoring options	Anti-corrosion possibility
9.	Rome	MUGA	3 + years	3'-3.71"	136'-6.51"	77'-10.65"	12'-4.47"	10635 ft'	Surface mounted	Galvanized
10.	Constantinople	MUGA	3 + years	9'-10.11"	77'-5.84"	50'-3.94"	12'-4.47"	3900 ft'	Surface mounted	Galvanized
11.	Pergamon	MUGA	3 + years	9'-10.11"	97'-2.07"	58'-2.43"	12'-4.47"	5656 ft'	Surface mounted	Galvanized
12.	Merida	MUGA	3 + years	9'-10.11"	107'-0.18"	77'-10.65"	12'-4.47"	8335 ft'	Surface mounted	Galvanized



13.

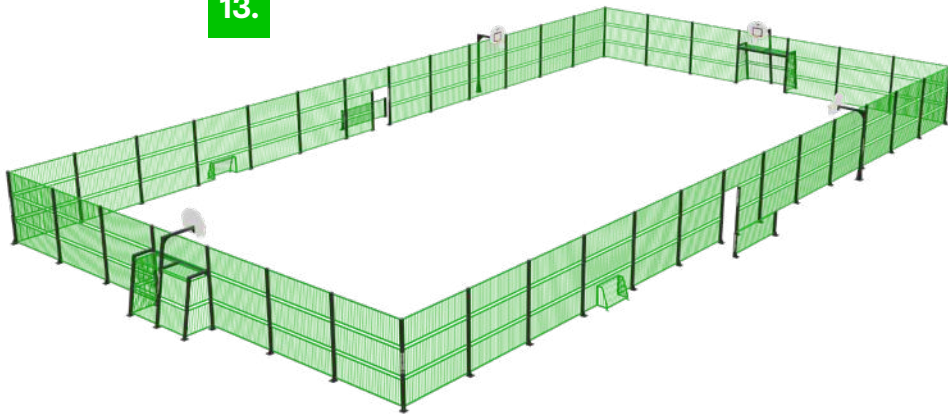

14.

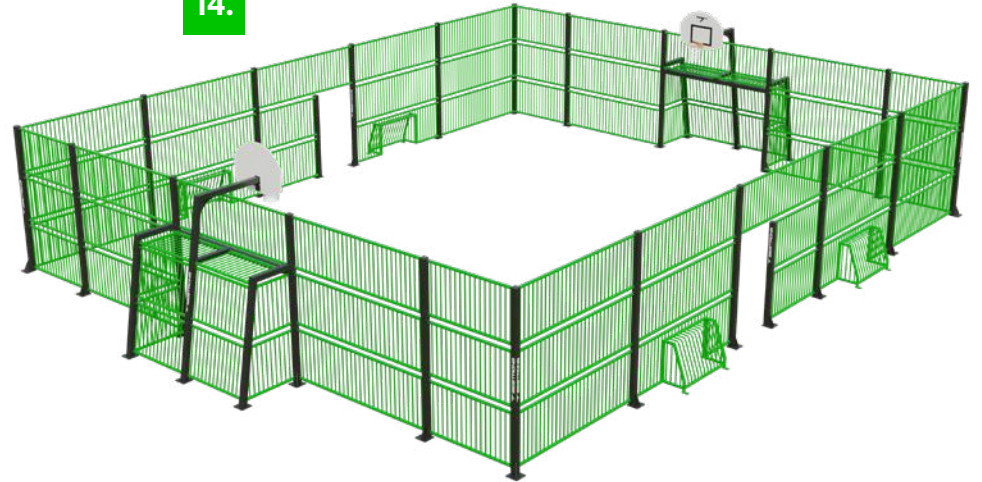

15.

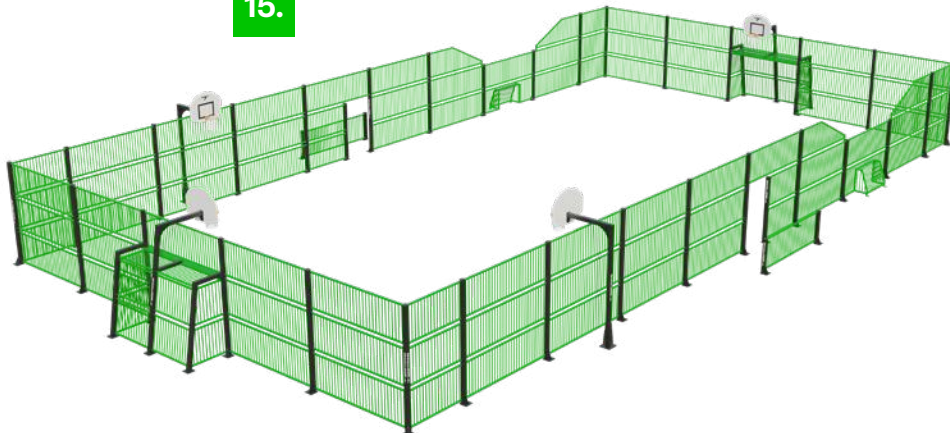

16.

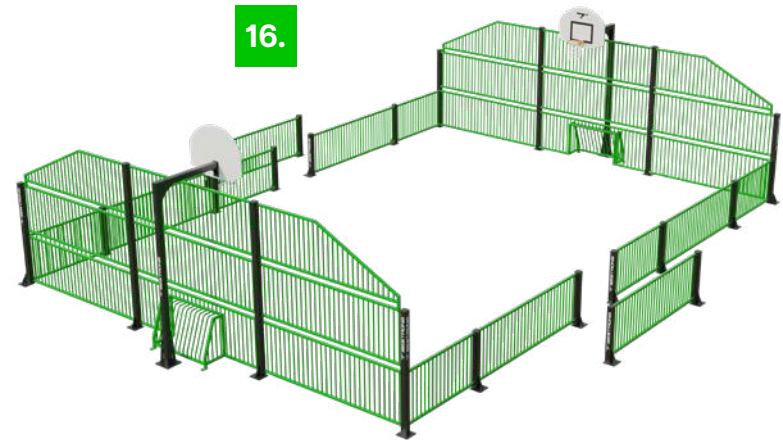

ID.	Product Name	Type	Age Group	Fence height	Length	Width	Height	Total area	Anchoring options	Anti-corrosion possibility
13.	Palmyra	MUGA	3 + years	9'-10.11"	136'-6.51"	77'-10.65"	12'-4.47"	10635 ft'	Surface mounted	Galvanized
14.	Aquincum	MUGA	3 + years	9'-10.11"	57'-9.62"	44'-7.19"	12'-4.47"	2578 ft'	Surface mounted	Galvanized
15.	Delphi	MUGA	3 + years	9'-10.11"	99'-1.69"	58'-2.43"	12'-4.47"	5770 ft'	Surface mounted	Galvanized
16.	Pompeii Mini	MUGA	3 + years	3'-3.71"	46'-7.84"	38'-6.20"	12'-4.47"	1797 ft'	Surface mounted	Galvanized



17.

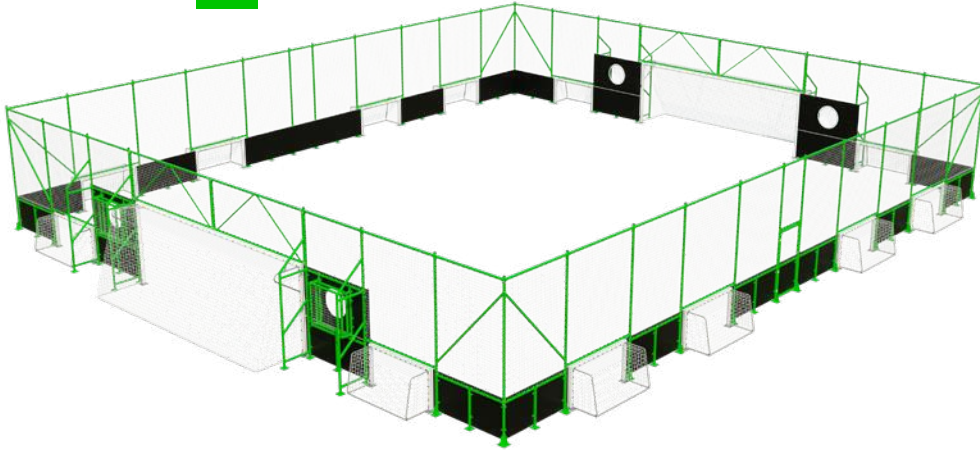

18.



19.



20.



ID.	Product Name	Type	Age Group	Fence height	Length	Width	Height	Total area	Anchoring options	Anti-corrosion possibility
17.	1-1-189 SKC ARENA	FOOTBALL ARENA	3 + years	6'-6.74"	31'-4.52"	26'-10.05"	6'-7.02"	842 ft'	Surface mounted	Galvanized
18.	4-3-035 Octagon	PANNA	3 + years	3'-3.71"	28'-1.11"	24'-11.37"	3'-3.65"	676 ft'	Surface mounted	Galvanized
19.	4-3-036 Ellipse	PANNA	3 + years	6'-6.74"	31'-4.52"	26'-10.05"	6'-7.02"	842 ft'	Surface mounted	Galvanized
20.	4-3-037 Hexagon	PANNA	3 + years	3'-3.71"	20'-4.94"	21'-1.02"	3'-3.65"	430 ft'	Surface mounted	Galvanized

PADEL





Padel was invented in 1969 in Mexico. Today it is a highly popular sport in Spain and Latin America and is rapidly gaining popularity in other parts of the world: there are over 25 million active padel players in over 110 countries. Come and join one of the world's fastest-growing sports with BeStrong. Starting in the fourth quarter of 2024, we will introduce our state-of-the-art padel courts in our portfolio. Our courts are carefully designed, and made from exceptional and durable materials, ensuring safety and security in any weather conditions. Our padel courts are the result of a combination of aesthetics, innovation, and a high-tech manufacturing process using only the highest-quality materials. Padel is a unique and exciting sport that offers a range of physical and social benefits for players of all ages and skill levels.

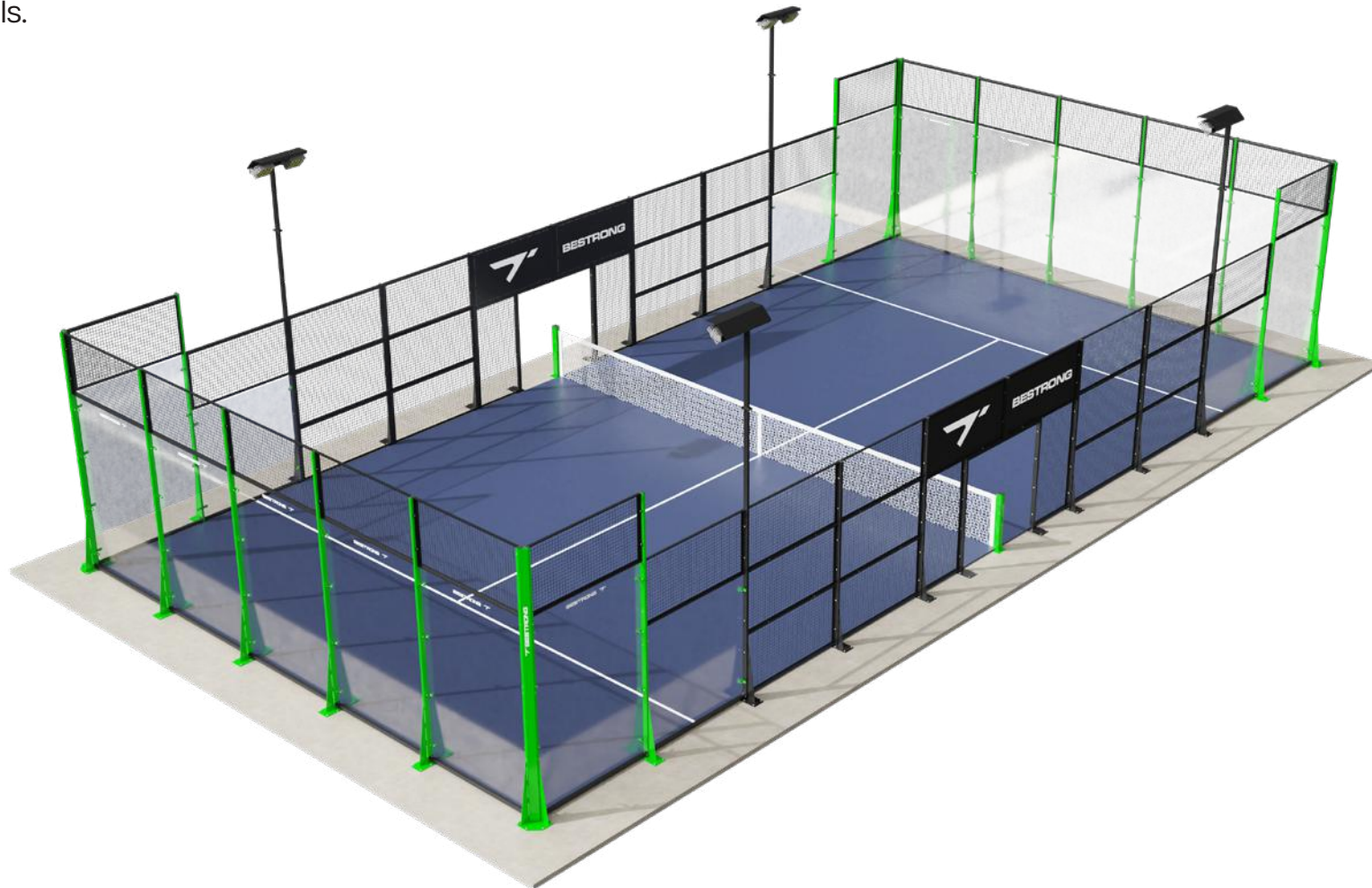

VIEW IT IN 3D & AR



Users can now explore our sports parks not only through conventional images but also in 3D and within an augmented reality (AR) environment. Through AR, you can not only obtain a close-up view of the finest details and dimensions of our sports equipment but also interactively zoom into any location in real-time using your mobile device's camera to view 3D renditions of our designed collections and assemblies. Our innovation enables you to enter, experiment with, and explore your future sports park within a virtual environment of your choosing. Try our new AR functionality today and discover the most suitable sports park for you in a truly unique experience.



DESIGN YOUR FITNESS PARK

Full support
for your needs

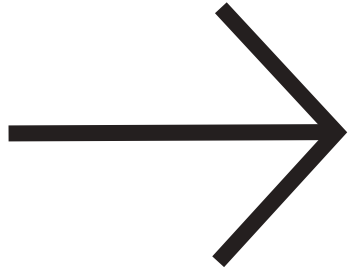

BESTRONG 3D PLANNER is a user-friendly 3D software that enables you to design and visualize your very own outdoor fitness park with remarkable precision. Our complete array of sports equipment and accessories is at your disposal for custom design. High-quality 3D models can be viewed from various angles, freely combined, and colorized using the software. Craft your unique sports park with BESTRONG 3D PLANNER!

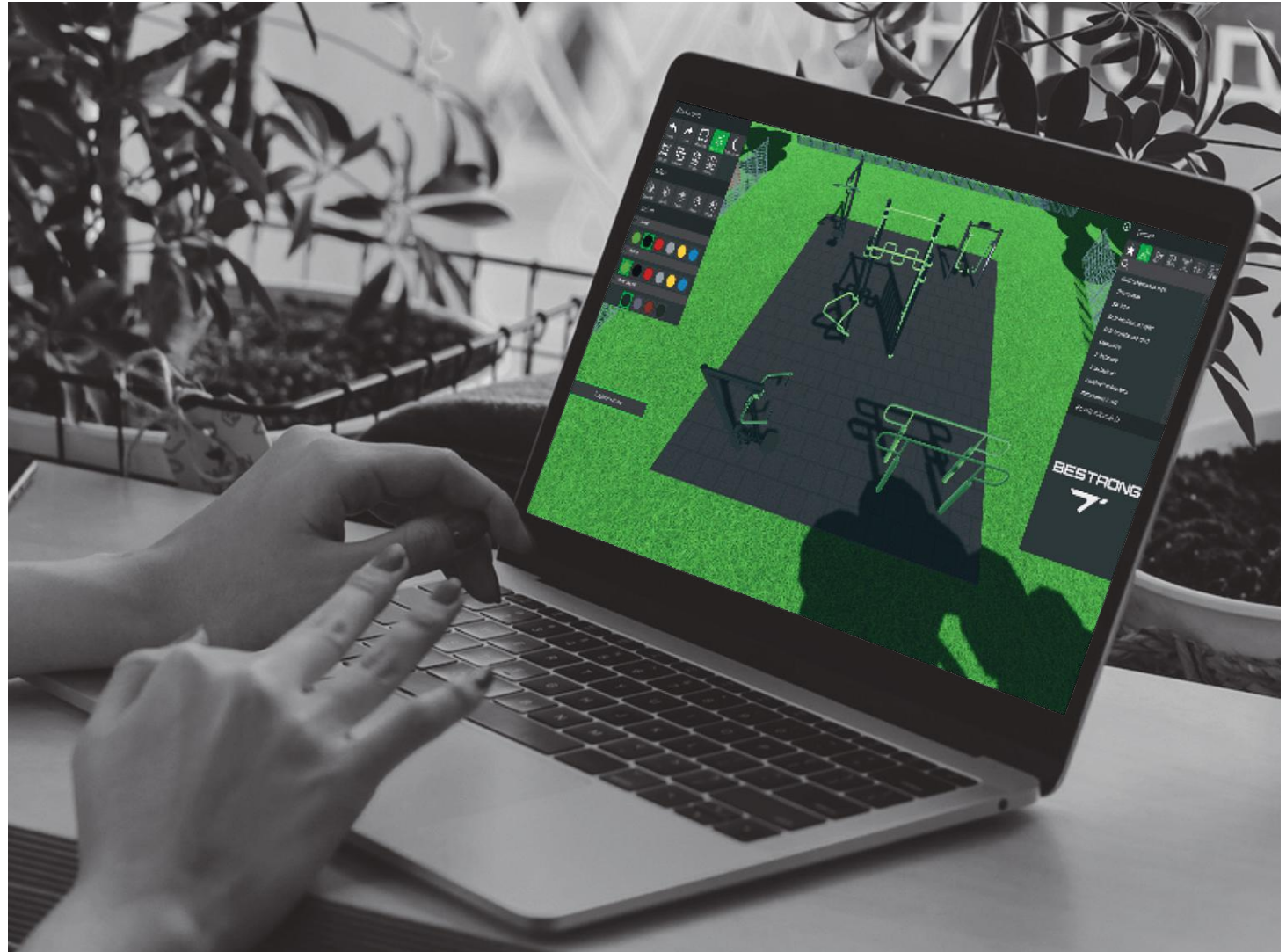

CRAFTSMANSHIP

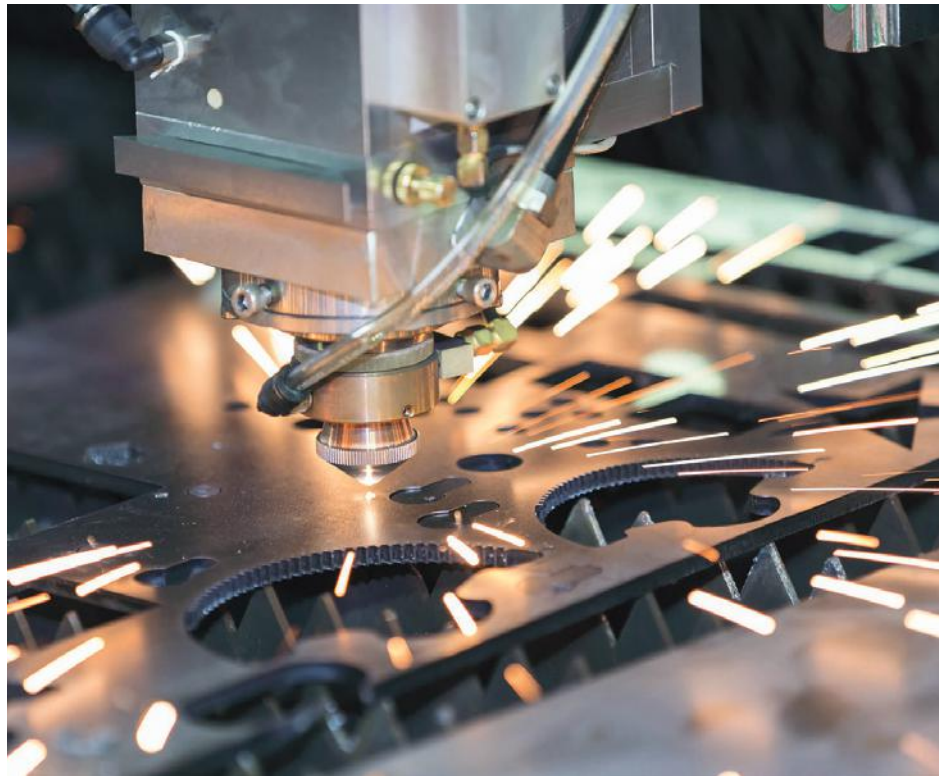

At our manufacturing facility, we employ state-of-the-art technology such as laser cutting, edge bending, and CNC machining to produce our sports equipment. Skilled technicians oversee welding operations with rigorous quality control.



The majority of surface treatments are conducted in-house. In addition to our shot blasting chambers, our facility houses a high-capacity powder coating unit and a solvent paint booth that complement the manufacturing process. We ensure corrosion protection through methods such as hot-dip galvanizing or EPD technology, a widely-used process in the automotive industry worldwide.

INNOVATIVE



MANUFACTURING

Function

Aesthetic

Safety

Quality

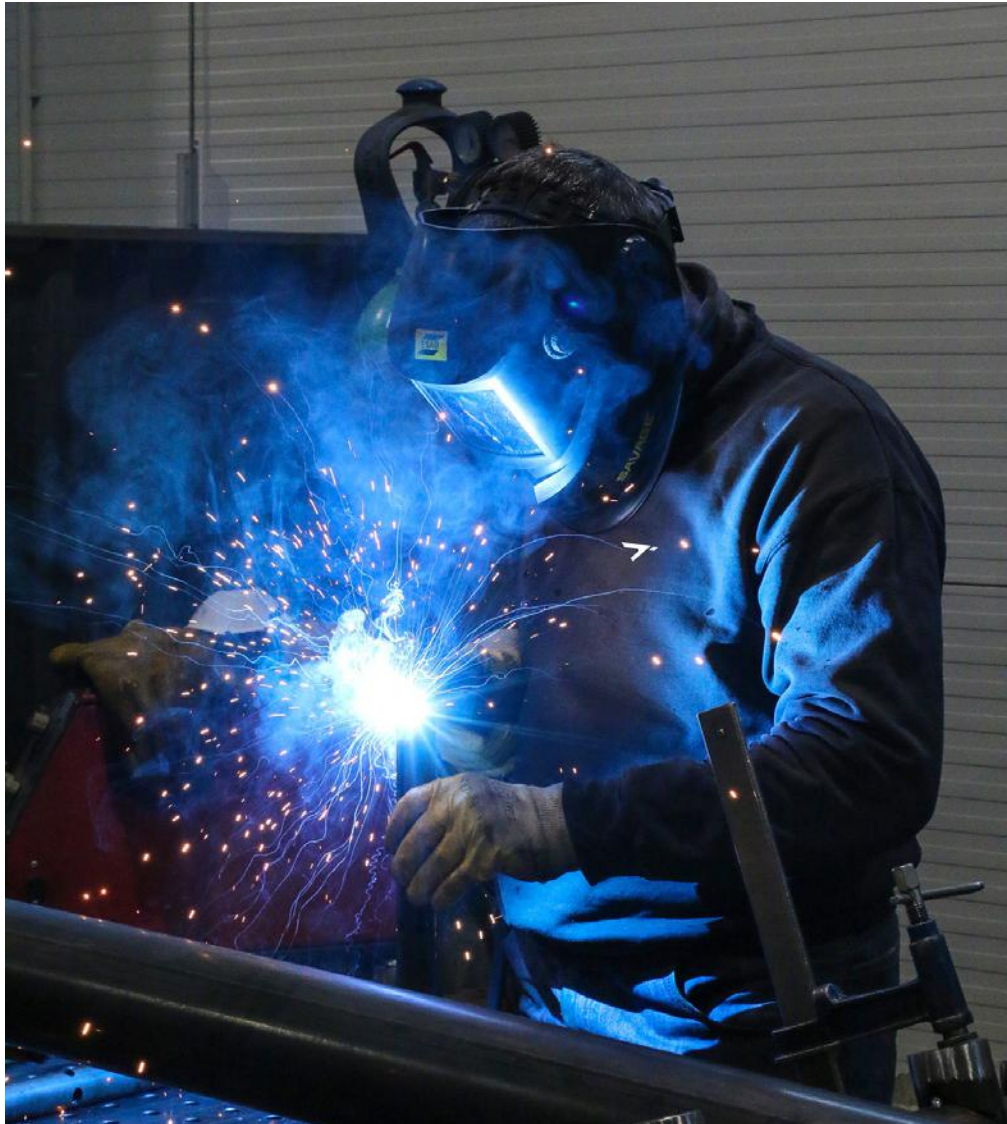

PRODUCTION

Our foremost priority is to ensure that our products meet the highest standards of functionality, aesthetics, and safety. To achieve this, we maintain meticulous oversight of our manufacturing and quality control processes, which adhere to the MSZ EN ISO 9001:2015 standard, audited by TÜV SÜD.

Environmental preservation holds significant importance for us, and as such, our production and installation processes are aligned with the EN ISO 14001:2015 environmental management system standard.

MATERIAL SPECIFICATION



At the end of the arms, the handle is rubber-coated for a more comfortable and secure grip.



The seats and backrests are made of strong HDPE material. Which is fully heat, moisture and UV resistant.



The top surface of the Lateral Plyo Box is covered with the highest quality non-slip HDPE.



The bumpers of the devices are made of durable rubber material.



The top surface of the device is covered with the highest quality non-slip HDPE.



The clamp system allows for easy assembly and extreme stability.



The top surface of the Balance Board Pro is covered with the highest quality non-slip HDPE.

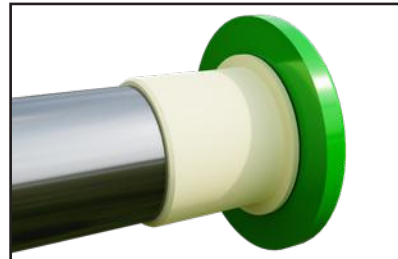

The recreational and cardio devices are fitted with composite bearings that are weather-resistant. The bearing does not require regular maintenance.



The rope is fully heat, moisture and UV resistant.



The ends of the bars and posts are sealed with injection-moulded plastic caps.



Steel ropes with a 0.63" mm diameter, galvanized and sheathed in nylon, are joined using connectors made of plastic. These ropes are UV radiation, abrasion, and rot-resistant.



The device is equipped with an ergonomic non-slip HDPE phone holder for convenience.



The footrests are made of premium quality non-slip HDPE with a high wear resistance.

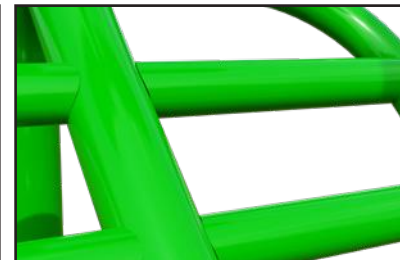

The element is made of high quality S235 steel, which has been cleaned via sandblasting. A corrosion resistant powder coating finish is then applied. Also available with galvanized surface for even greater protection and longevity!



The internal structure has 120 moveable plastic "bars". The levers are rubber-coated for a more comfortable grip and to prevent head injuries

WARRANTY



15-year limited warranty on failures of steel elements and steel components due to material or manufacturing defects and **25 years** on structural integrity.

10-year limited warranty for defects in plastic HDPE components due to material or workmanship and **5 years** for defects in all other plastic components (except colour fading).

5-year limited warranty for significant corrosion of painted metal parts that inhibit the use of the equipment and **10 years** warranty for galvanized and cataphoretic painted steel parts.

3-year limited warranty on failure of all rubber based parts and **1 year** on rubber bumpers.

2-year limited warranty on powder coated paint integrity.

2-year limited warranty for bearings of moving elements.

For the full range of Warranty

- < click on the QR code, or
- < scan with your mobile device



CONTACTS

BESTRONG USA, INC.



@bestrongworld



@bestrongworld



BeStrong USA



usa.bestrong.com



**182 S. Young Street,
Ormond Beach, FL, 32174, USA**



usa@bestrong.com

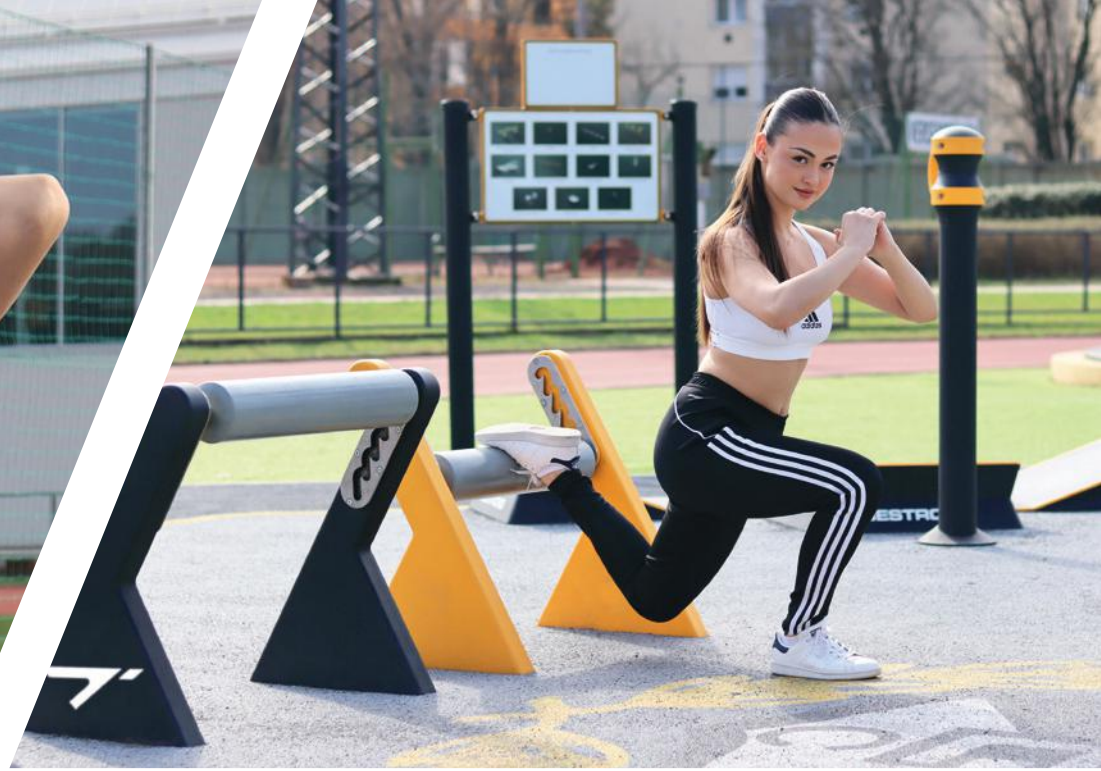



7. BESTRONG