



FINITURE
LEGNO



REGISTRATI AL
QUICK SHIP



LACCATI
LUCIDI



LACCATI
OPACHI



MODELLI
CAD



MONTAGGIO
E GARANZIA



Back Office
Mercato Italia ordini@horm.it
0434 1979 102

Back Office
Export Markets orders@horm.it
+39 0434 1979 101

IT – I montanti sono posizionati a coppie (un elemento davanti ed uno dietro rispetto al ripiano), e fissati ai ripiani mediante viti. I fori per le viti sono nascosti da un cerchietto in massello di noce che si aggancia alla testa della vite mediante una calamita per facilitarne l'eventuale smontaggio. I ripiani sono un pezzo unico fino ad un massimo di 290cm.

EN – The uprights are positioned in pairs (one element in front of and one behind the shelf), and fixed to the shelves with screws. The holes for the screws are hidden by a solid walnut cap which is attached to the head of the waist by means of a magnet to make it easier to dismantle the bookcase. The shelves are a single piece up to a maximum of 290cm.

FR – Les montants sont positionnés par paires (un élément devant et un derrière l'étagère) et fixés aux étagères à l'aide de vis. Les trous pour les vis sont cachés par un capuchon en noyer massif qui est fixée à la tête de la taille à l'aide d'un aimant pour faciliter le démontage éventuel. Les étagères sont d'une seule pièce jusqu'à un maximum de 290cm.

DE – Pfosten werden paarweise positioniert (ein Element vor und hinter dem Regal) und mit Schrauben an den Regalen befestigt; Löcher für Schrauben werden durch eine massive Nussbaumkappe mittels eines Magneten verdeckt, um deren eventuelle Demontage zu erleichtern. Die Regale sind einteilig bis maximal 290 cm.

ES – Los montantes son posicionados en pares (un elemento delante y uno detrás respecto a la repisa), fijados con tornillos, cuyos foros están escondidos por un botón en nogal macizo magnético para facilitar un posible desmontaje. Las repisas son una pieza única hasta un máximo de 290 cm.

MATERIALI:

Montanti in noce
canaletto massello.
Ripiani in mdf laccato.
Piedini regolabili

MATERIALS:

Uprights in solid walnut.
Shelves in lacquered
mdf.
Adjustable feet

MATÉRIAUX :

Montants en noyer
massif.
Étagères en mdf laqué.
Pieds réglables

MATERIALEN:

Pfosten aus massivem
Kanalnussbaum.
Regale aus lackiertem
MDF. Verstellbare Füße

MATERIALES:

Montantes en nogal
macizo. Estantes en MDF
lacado. Pies regulables

**MODULI PER LA
COMPONIBILITA':**

[A] Vani con montanti
- 32cm
- 58cm
[B] Vani aperti, tra un
montante e l'altro:
- 26cm
- 52cm
- 64cm
- 80cm
- 128cm (per TV max 42")
- [C] montante finale,
da utilizzare solo se la
libreria termina con un
vano aperto.

**MODULES FOR
MODULARITY:**

[A] Compartments with
uprights
- 32cm
- 58cm
[B] Open compartments,
between one upright and
the next:
- 26cm
- 52cm
- 64cm
- 80cm
- 128cm (for TV max 42")
- [C] Final upright, to be
used only if the library
ends with an open
compartment.

**MODULES POUR LA
MODULARITÉ :**

[A] Compartiments avec
montants
- 32cm
- 58cm
[B] Compartiments
ouverts, entre un montant
et l'autre :
- 26cm
- 52cm
- 64cm
- 80cm
- 128cm (pour TV max
42")
[C] Montant final, à
utiliser uniquement si la
bibliothèque se termine
par un compartiment
ouvert.

**MODULE ZUR
ZUSAMMENSTELLUNG
DER BIBLIOTHEK:**

[A] Fächer mit Pfosten
- 32cm
- 58cm
[B] Offene Fächer
zwischen den Ständern:
- 26cm
- 52cm
- 64cm
- 80cm
- 128cm (TV max 42")
[C] Endpfosten, nur zu
verwenden, wenn das
Bücherregal mit einem
offenen Fach endet.

**MÓDULOS PARA
COMPONER LA
BIBLIOTECA:**

[A] Compartimentos con
montantes
- 32cm
- 58cm
[B] Compartimientos
abiertos, entre
montantes:
- 26cm
- 52cm
- 64cm
- 80cm
- 128cm (para TV max
42")
[C] montante final
que se utiliza si la
librería termina con un
compartimiento abierto.

COME COMPORRE UNA
LIBRERIA:

HOW TO COMPOSE A
LIBRARY:

COMMENT COMPOSER
UNE BIBLIOTHÈQUE :

WIE MAN EINE BIBLIOTHEK
ZUSAMMENSTELLT:

CÓMO COMPONER
UNA LIBRERÍA:

ESEMPIO #01

EXAMPLE #01

EXEMPLE #01

BEISPIEL #01

EJEMPLO #01

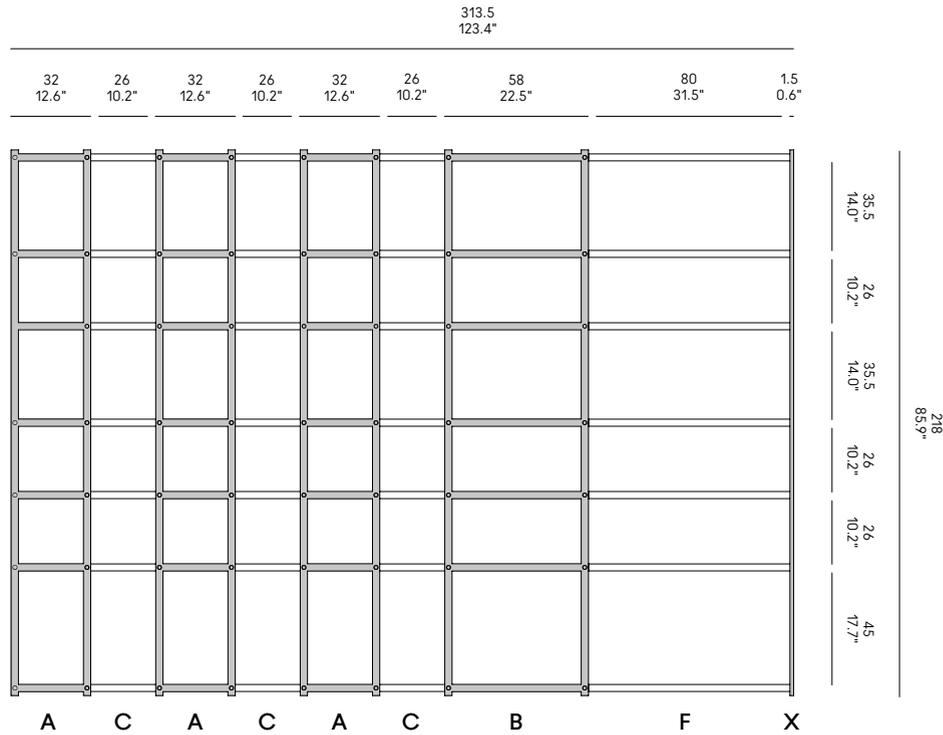

LA LIBRERIA SOPRA
RAPPRESENTATA
È COMPOSTA DAI
SEGUENTI ELEMENTI:

THE LIBRARY ABOVE
IS COMPOSED BY THE
FOLLOWING
ELEMENTS:

LA BIBLIOTHÈQUE
DESSUS ET FAIT DES
ELEMENTS SUIVANTS:

DAS BÜCHERREGAL
OBEN BESTEHT AUS
FOLGENDEN
ELEMENTEN:

LA LIBRERÍA DE ARRIBA
ESTÁ COMPUESTA POR
LOS SEGUENTES
ELEMENTOS:

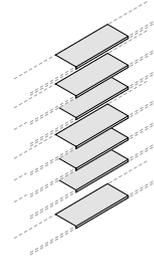
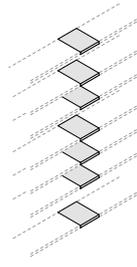
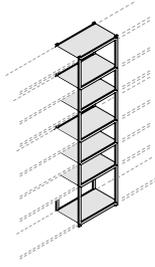
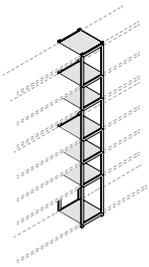

[A] x 3
L. cm 32

[B] x 1
L. cm 58

[C] x 3
L. cm 26

[F] x 1
L. cm 80

[X] x 1

Vano con montanti

Vano con montanti

Vano aperto

Vano aperto

Montante finale

Compartment with
uprights.

Compartment with
uprights.

Open compartment

Open compartment

Final upright.

Compartment avec
montants

Compartment avec
montants

Compartment ouvert

Compartment ouvert

Montant final

Fächer mit Pfosten

Fächer mit Pfosten

Offenes Fach

Offenes Fach

Endpfosten

Compartimiento con
montantes

Compartimiento con
montantes

Compartimiento abierto

Compartimiento abierto

Montante final

COME COMPORRE UNA
LIBRERIA:

HOW TO COMPOSE A
LIBRARY:

COMMENT COMPOSER
UNE BIBLIOTHÈQUE :

WIE MAN EINE BIBLIOTHEK
ZUSAMMENSTELLT:

CÓMO COMPONER
UNA LIBRERÍA:

ESEMPIO #02

EXAMPLE #02

EXEMPLE #02

BEISPIEL #02

EJEMPLO #02

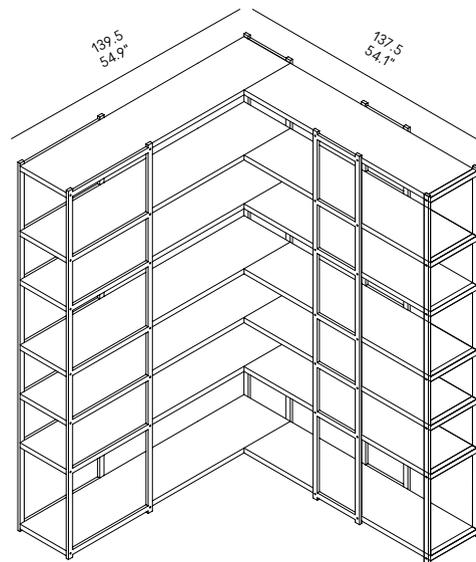
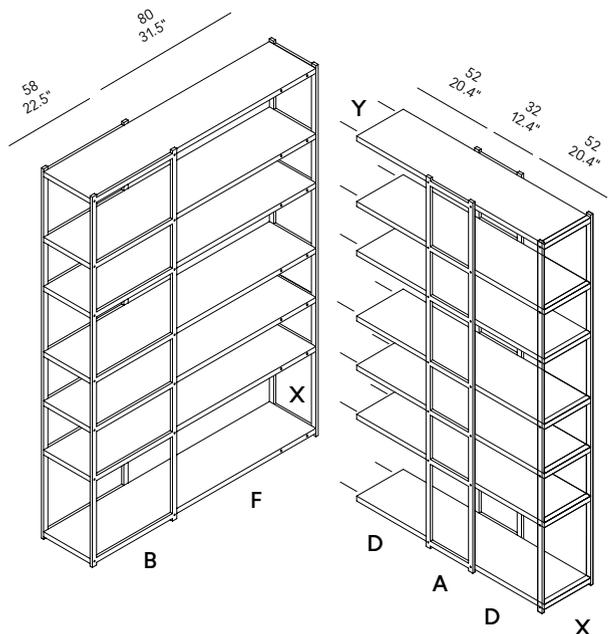

LA LIBRERIA SOPRA
RAPPRESENTATA
È COMPOSTA DAI
SEGUENTI ELEMENTI:

THE LIBRARY ABOVE
IS COMPOSED BY THE
FOLLOWING
ELEMENTS:

LA BIBLIOTHÈQUE
DESSUS ET FAIT DES
ELEMENTS SUIVANTS:

DAS BÜCHERREGAL
OBEN BESTEHT AUS
FOLGENDEN
ELEMENTEN:

LA LIBRERÍA DE ARRIBA
ESTÁ COMPUESTA POR
LOS SEGUIENTES
ELEMENTOS:

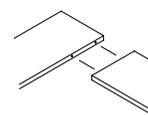
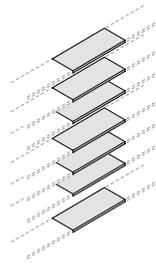
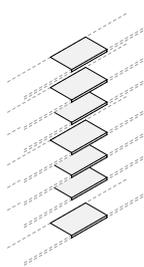
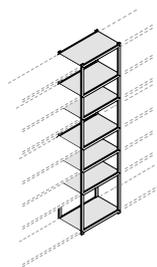
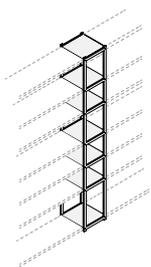

[A] x 1
L. cm 32

[B] x 1
L. cm 58

[D] x 2
L. cm 52H

[F] x 1
L. cm 80

[X] x 2

[Y] x 1

Vano con montanti

Vano con montanti

Vano aperto

Vano aperto

Montante finale

Giunzione

Compartment with
uprights.

Compartment with
uprights.

Open compartment

Open compartment

Final upright.

Joint

Compartment avec
montants

Compartment avec
montants

Compartment
ouvert

Compartment
ouvert

Montant final

Jonction

Fächer mit Pfosten

Fächer mit Pfosten

Offenes Fach

Offenes Fach

Endpfosten

Verbindung

Compartimento con
montantes

Compartimento con
montantes

Compartimento
abierto

Compartimento
abierto

Montante final

Junta

L › LUCIDO
O › OPACOL › GLOSSY
O › MATTL › BRILLANTE
O › MATL › GLÄNZEND
O › MATTL › BRILLANTE
O › OPACO

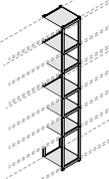
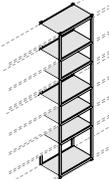
[A] VANO CON MONTANTI COMPARTMENT WITH UPRIGHTS COMPARTIMENT AVEC MONTANTS FÄCHER MIT PFOSTEN COMPARTIMIENTO CON MONTANTES		Nero Black Noir Schwarz Negro RAL 9011	Bianco White Blanc Weiß Blanco RAL 9016	Polvere Dusty grey Gris poussière Staubgrau Gris polvo RAL 7037	Beige Beige grey Gris beige Beigegrau Gris beige RAL 7006	Rosso vino Wine red Rouge vin Weinrot Rojo vino RAL 3005	Bruno Brown grey Gris brun Braungrau Gris parduzco RAL 7013	Grafite Graphite Graphite Graphit Grafito RAL 7024
 A cm 32 x 34.5 x 218H 12.4" x 13.6" x 85.9"H	L	KX03-R9011L	KX03400L	KX03-R7037L	KX03-R7006L	KX03-R3005L	KX03-R7013L	KX03-R7024L
	O	KX03-R9011	KX03400	KX03-R7037	KX03-R7006	KX03-R3005	KX03-R7013	KX03-R7024
 B cm 58 x 34.5 x 218H 22.5" x 13.6" x 85.9"H	L	KX05-R9011L	KX05400L	KX05-R7037L	KX05-R7006L	KX05-R3005L	KX05-R7013L	KX05-R7024L
	O	KX05-R9011	KX05400	KX05-R7037	KX05-R7006	KX05-R3005	KX05-R7013	KX05-R7024

MONTANTE FINALE
FINAL UPRIGHT
MONTANT FINAL
ENDPFOSTEN
MONTANTE FINAL



X
cm 31.5 x 1.5 x 218H
12.4" x 0.5" x 85.9"H

KX00000

Y

GIUNZIONE
JOINT
JONCTION
VERBINDUNG
JUNTA

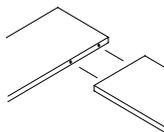

KBL1000

Z

TAGLIO SU MISURA
CUSTOM-CUT
COUPE SUR MESURE
ZUSCHNITT AUF MASS
CORTE A MEDIDA

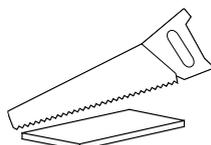

KBL2000

L › LUCIDO
O › OPACOL › GLOSSY
O › MATTL › BRILLANTE
O › MATL › GLÄNZEND
O › MATTL › BRILLANTE
O › OPACO

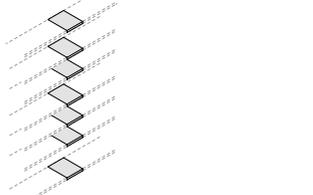
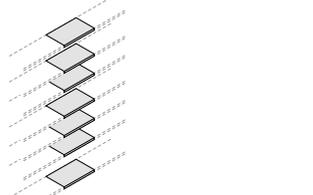
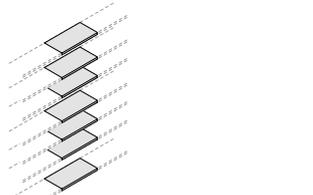
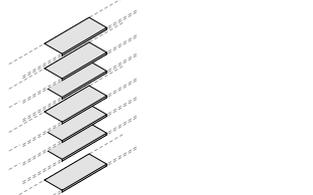
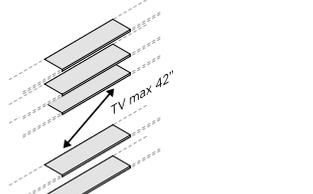
[B] VANO APERTO OPEN COMPARTMENT COMPARTIMENT OUVERT OFFENES FACH COMPARTIMIENTO ABIERTO		Nero Black Noir Schwarz Negro RAL 9011	Bianco White Blanc Weiß Blanco RAL 9016	Polvere Dusty grey Gris poussière Staubgrau Gris polvo RAL 7037	Beige Beige grey Gris beige Beigegrau Gris beige RAL 7006	Rosso vino Wine red Rouge vin Weinrot Rojo vino RAL 3005	Bruno Brown grey Gris brun Braungrau Gris parduzco RAL 7013	Grafite Graphite Graphite Graphit Grafito RAL 7024
 <p>C cm 26 x 31.5 x 218H 10.2" x 12.4" x 85.9"H</p>	L	KB02-R9011L	KB02000L	KB02-R7037L	KB02-R7006L	KB02-R3005L	KB02-R7013L	KB02-R7024L
	O	KB02-R9011	KB02000	KB02-R7037	KB02-R7006	KB02-R3005	KB02-R7013	KB02-R7024
 <p>D cm 52 x 31.5 x 218H 20.4" x 12.4" x 85.9"H</p>	L	KB05-R9011L	KB05000L	KB05-R7037L	KB05-R7006L	KB05-R3005L	KB05-R7013L	KB05-R7024L
	O	KB05-R9011	KB05000	KB05-R7037	KB05-R7006	KB05-R3005	KB05-R7013	KB05-R7024
 <p>E cm 64 x 31.5 x 218H 25.2" x 12.4" x 85.9"H</p>	L	KB06-R9011L	KB06000L	KB06-R7037L	KB06-R7006L	KB06-R3005L	KB06-R7013L	KB06-R7024L
	O	KB06-R9011	KB06000	KB06-R7037	KB06-R7006	KB06-R3005	KB06-R7013	KB06-R7024
 <p>F cm 80 x 31.5 x 218H 31.5" x 12.4" x 85.9"H</p>	L	KB08-R9011L	KB08000L	KB08-R7037L	KB08-R7006L	KB08-R3005L	KB08-R7013L	KB08-R7024L
	O	KB08-R9011	KB08000	KB08-R7037	KB08-R7006	KB08-R3005	KB08-R7013	KB08-R7024
 <p>G Vano TV / TV compartment cm 128 x 31.5 x 218H 50.4" x 12.4" x 85.9"H</p>	L	KB12-R9011L	KB12000L	KB12-R7037L	KB12-R7006L	KB12-R3005L	KB12-R7013L	KB12-R7024L
	O	KB12-R9011	KB12000	KB12-R7037	KB12-R7006	KB12-R3005	KB12-R7013	KB12-R7024

L › LUCIDO
O › OPACO

L › GLOSSY
O › MATT

L › BRILLANTE
O › MAT

L › GLÄNZEND
O › MATT

L › BRILLANTE
O › OPACO

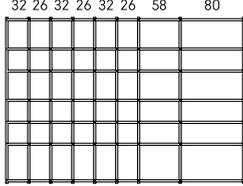
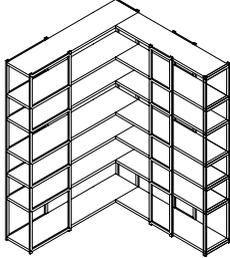
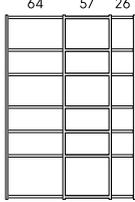
ESEMPLI DI COMPOSIZIONE EXAMPLE OF COMPOSITIONS EXEMPLES DE COMPOSITIONS BEISPIELE VON KOMPOSITIONEN EJEMPLOS DE COMPOSICIONES	Nero Black Noir Schwarz Negro RAL 9011	Bianco White Blanc Weiß Blanco RAL 9016	Polvere Dusty grey Gris poussière Staubgrau Gris polvo RAL 7037	Beige Beige grey Gris beige Beigegrau Gris beige RAL 7006	Rosso vino Wine red Rouge vin Weinrot Rojo vino RAL 3005	Bruno Brown grey Gris brun Braungrau Gris parduzco RAL 7013	Grafite Graphite Graphite Graphit Grafito RAL 7024	
 <p>EXAMPLE #01</p> <p>cm 32 x 34.5 x 218H 12.4" x 13.6" x 85.9"H</p>	L							
 <p>EXAMPLE #02</p> <p>cm 123 x 34.5 x 218H 48.6" x 13.6" x 85.9"H</p>	L							
 <p>EXAMPLE #03</p> <p>cm 113 x 34.5 x 218H 44.5" x 13.6" x 85.9"H</p>	L							
 <p>EXAMPLE #04</p> <p>cm 150 x 34.5 x 218H 59.1" x 13.6" x 85.9"H</p>	L							
	O							

L › LUCIDO
O › OPACO

L › GLOSSY
O › MATT

L › BRILLANTE
O › MAT

L › GLÄNZEND
O › MATT

L › BRILLANTE
O › OPACO

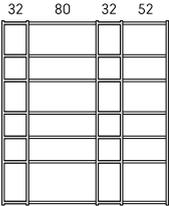
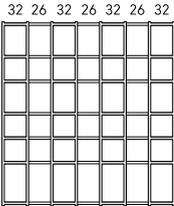
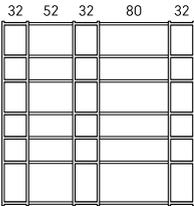
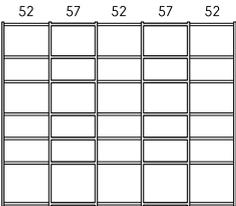
ESempi di composizione EXAMPLE OF COMPOSITIONS EXEMPLES DE COMPOSITIONS BEISPIELE VON KOMPOSITIONEN EJEMPLOS DE COMPOSICIONES	Nero Black Noir Schwarz Negro RAL 9011	Bianco White Blanc Weiß Blanco RAL 9016	Polvere Dusty grey Gris poussière Staubgrau Gris polvo RAL 7037	Beige Beige grey Gris beige Beigegrau Gris beige RAL 7006	Rosso vino Wine red Rouge vin Weinrot Rojo vino RAL 3005	Bruno Brown grey Gris brun Braungrau Gris parduzco RAL 7013	Grafite Graphite Graphite Graphit Grafito RAL 7024
 <p>EXAMPLE #05</p> <p>cm 197 x 34.5 x 218H 77.6" x 13.6" x 85.9"H</p>	L						
	O						
 <p>EXAMPLE #06</p> <p>cm 205 x 34.5 x 218H 80.8" x 13.6" x 85.9"H</p>	L						
	O						
 <p>EXAMPLE #07</p> <p>cm 227 x 34.5 x 218H 89.4" x 13.6" x 85.9"H</p>	L						
	O						
 <p>EXAMPLE #08</p> <p>cm 274 x 34.5 x 218H 108" x 13.6" x 85.9"H</p>	L						
	O						