



# DUROPAL- HPL- TECHNO- LOGY

---

PRODUCT PROPERTIES,  
PROCESSING AND HANDLING

**DUROPAL**  
HPL IS OUR WORLD

# CONTENTS



- 03 \_ Product characteristics of Duropal-HPL and Duropal-HPL-Solid
- 12 \_ Recommendations for processing Duropal-HPL, Duropal-HPL-Solid and Duropal-HPL-elements
- 41 \_ Cleaning and care of Duropal-HPL





PRODUCT CHARACTERISTICS

**DUROPAL-HPL**  
**DUROPAL-HPL-SOLID**

# VERSATILE CHARACTER: THE PRODUCT CHARACTERISTICS

Duropal high pressure laminates (HPL) are hard-wearing, versatile, and available in many attractive designs. In order to get the best use from the product and ensure that its attractive appearance is retained, please observe the chemical, mechanical and physical properties of our Duropal high pressure laminates (HPL).

In terms of reaction to fire, protection against formaldehyde emission and surface processing are concerned, there are some minor differences between Duropal-HPL and Duropal-HPL-Solid. All other points apply to both high pressure laminates.

## 1. CHEMICAL CHARACTERISTICS

The surfaces of Duropal-HPL and Duropal-HPL-Solid are resistant to contact with most normal chemicals and substances. Cleaning products such as acetone and substances such as vinegar, coffee and blood will not stain the surface.

Nor will spillages of any of the following (listed here as examples) affect the surface provided they are wiped up promptly (e.g. within 10-15 minutes). This means the tops must be wiped with a wet cloth and rubbed dry within 10-15 minutes.

SUBSTANCE	CHEMICAL FORMULA	SUBSTANCE	CHEMICAL FORMULA
Antacid (more than 10%)	HCOOH	Lacquers/paints and adhesives (chemically hardening)	
Aminosulphonic acid (to 10%)	NH <sub>2</sub> SO <sub>3</sub> H	Methylene blue	C <sub>16</sub> H <sub>18</sub> N <sub>3</sub> ClS
Aniline dyes		Millon's reagent	OHg <sub>2</sub> NH <sub>2</sub> Cl
Inorganic acids (to 10%)		Sodium hydrosulphate	NaHSO <sub>4</sub>
Arsenic acid (to 10%)	H <sub>3</sub> AsO <sub>4</sub>	Sodium hypochlorite	NaOCl
Boric acid	H <sub>3</sub> BO <sub>3</sub>	Sodium thiosulphate	Na <sub>2</sub> S <sub>2</sub> O <sub>3</sub>
Iron (II) chloride solution	FeCl <sub>2</sub>	Sodium hydroxide (more than 10%)	NaOH
Iron (III) chloride solution	FeCl <sub>3</sub>	Nylanders reagent	
Esbachs reagent		Oxalic acid	COOH x COOH
Fuchsin solution	C <sub>19</sub> H <sub>19</sub> N <sub>3</sub> O	Phosphoric acid (to 10%)	H <sub>3</sub> PO <sub>4</sub>
Hair dyes and bleaches		Picric acid	C <sub>6</sub> H <sub>2</sub> OH(NO <sub>2</sub> ) <sub>3</sub>
Iodine solution	I	Mercury dichromate	HgCr <sub>2</sub> O <sub>7</sub>
Limescale remover		Nitric acid (to 10%)	HNO <sub>3</sub>
Potassium hydroxide (more than 10%)	KOH	Hydrochloric acid (to 10%)	HCl
Potassium chromate	K <sub>2</sub> CrO <sub>4</sub>	Sulphuric acid (to 10%)	H <sub>2</sub> SO <sub>4</sub>
Potassium dichromate	K <sub>2</sub> Cr <sub>2</sub> O <sub>7</sub>	Sulphurous acid (to 10%)	H <sub>2</sub> SO <sub>3</sub>
Potassium hydrogen sulphate	KHSO <sub>4</sub>	Silver nitrate	AgNO <sub>3</sub>
Potassium iodide	KI	Mercury bichloride solution	HgCl <sub>2</sub>
Potassium permanganate	KMnO <sub>4</sub>	Hydrochloric peroxide (3-30% perhydrol)	H <sub>2</sub> O <sub>2</sub>
Methyl violet	C <sub>28</sub> H <sub>28</sub> N <sub>3</sub> Cl		



The following chemicals are examples of substances that will destroy a Duropal-HPL surface and must be removed immediately. The surface will very quickly become dull and rough.

CHEMICAL; EACH IN CONCENTRATION OVER APPROX. 10%	CHEMICAL FORMULA	CHEMICAL; EACH IN CONCENTRATION OVER APPROX. 10%	CHEMICAL FORMULA
Aminosulphic acid	$\text{NH}_2\text{SO}_3\text{H}$	Phosphoric acid	$\text{H}_3\text{PO}_4$
Arsenic acid	$\text{H}_3\text{AsO}_4$	Hydrochloric acid	HCl
Chromic sulphuric acid	$\text{K}_2\text{Cr}_2\text{O}_7 + \text{H}_2\text{SO}_4$	Sulphuric acid	$\text{H}_2\text{SO}_4$
Hydrofluoric acid	HF	Hydrogen bromide	HBr
Nitrohydrochloric acid	$\text{HNO}_3 + \text{HCl} = 1 : 3$		

Frequent exposure to the following aggressive gases will cause changes to the Duropal-HPL surface.

CHEMICAL	CHEMICAL FORMULA	CHEMICAL	CHEMICAL FORMULA
Bromine	$\text{Br}_2$	Sulphur dioxide	$\text{SO}_2$
Chlorine	$\text{Cl}_2$	Acid vapours	
Nitrous gases	$\text{N}_x\text{O}_y$		

# 2.1 MECHANICAL AND PHYSICAL PROPERTIES OF DUROPAL-HPL

DIN EN 438-3: 2005 REQUIREMENTS FOR APPLICATION CLASSIFICATION					HPL CLASSIFICATION TO DIN EN 438-3: 2005 THICKNESS <2 MM ALPHABETICAL CLASSIFICATION*		
QUALITY CRITERION	PROCESS DIN EN 438-2 OR TEST STANDARD	PROPERTY	UNIT				
				HDS	HGS	VGS	
				HDF	HGF	VGF	
				HDP	HGP	VGP	
Resistance to surface abrasion	10	Abrasion resistance	Revs. (min.) (IP + FP)/2	1,000	350	150	
			Numerical classification	4	3	2	
Resistance to shock loading (small ball)	20	Elastic force	N (min.)	25	20	15	
			Numerical classification	4	3	2	
Scratch resistance	25	Force	Level	4	3	2	
			Numerical classification	4	3	2	
<b>GENERAL REQUIREMENTS AND PROPERTIES</b>							
Dimensional stability at higher temperature	17	Dimensional change (cum.)	% (max.)				
			lengthwise	0.45	0.55	0.75	
Resistance to boiling water	12	Appearance	Level (min.)				
			Glossy surface	3	3	3	
Resistance to dry heat (180 °C)	16	Appearance	Level (min.)				
			Glossy surface	3	3	3	
Resistance to moist heat (100 °C)	EN 12721	Appearance	Level (min.)				
			Glossy surface	4	3	3	
Stain resistance	26	Appearance	Level (min.)				
			Substances groups 1 & 2	5	5	5	
Lightfastness (Xenon arc lamp)	27	Contrast	Grey scale	4-5	4-5	4-5	
			Substances group 3	4	4	4	
Resistance to steam	14	Appearance	Level (min.)				
			Glossy surface	3	3	3	
Resistance to a glowing cigarette	30	Appearance	Level (min.)				
			Other surface	4	4	4	
Crack resistance under load	23	Appearance	Level (min.)	4	4	4	
Thickness	5	Thickness tolerance	mm				
			HPL thick: 0.5 – ≤1.0	Maximum deviation ±0.10			
Dimensional stability	9	Levelness	mm/m	Maximum deviation 60			
			Length and width	mm	+10/-0		
			Edge straightness	mm/m	Maximum deviation 1.5		
			Right angularity	mm/m	Maximum deviation 1.5		
Surface texture Dirt, stains and similar surface flaws; fibres, hair and scratches	Section 4	Sight check		Permitted fault size/length			
			mm <sup>2</sup> /m <sup>2</sup>	max. 1.0			
			mm <sup>2</sup> /m <sup>2</sup>	max. 10.0			
<b>OTHER REQUIREMENTS TYPE P (POST-FORMING)</b>							
QUALITY CRITERION	PROCESS	PROPERTY	UNIT	HDP	HGP	VGP	
Post-formability	32	Radius	mm				
			lengthwise	≤10 x HPL nominal thickness			
Resistance to blistering	34	Time to blistering	Seconds				
			crosswise	≤20 x HPL nominal thickness			
Resistance to blistering	34	Time to blistering	Seconds				
				nominal thickness <0.8 mm: ≥10			
				nominal thickness ≥0.8 mm: ≥15			

**FIGURES ACHIEVED BY DUROPAL-HPL**

Print designs conventional 375-500	Plain designs 500-700	Print designs special effects approx. 50-70
3	3	** (see footnote)
Thickness 1.2 mm ≥25	Thickness 0.8 mm ≥20	Thickness 0.5 mm ≥15
4	3	2
Texture deep 4	Texture medium 3	Non-textured 2
4	3	2
Thickness 1.2 mm ≤0.45	Thickness 0.8 mm ≤0.55	Thickness 0.5 mm ≤0.75
≤0.90	≤1.05	≤1.25
Min. level 3		
Depending on surface texture 4-5		
Min. level 3		
Depending on surface texture 4-5		
Min. level 3		
Depending on surface texture 4-5		
Level 5		
Min. level 4		
Depending on design or colour 4-5		
Min. level 3		
Depending on design or colour 4-5		
Min. level 3		
Min. level 4		
Requirement fulfilled		
Requirement fulfilled		
Requirement fulfilled		
<b>ACHIEVABLE RADIUS AT BENDING TEMPERATURE OF APPROX. 190 °C</b>		
Thickness 1.2 mm R: approx. 10 mm	Thickness 0.8 mm R: approx. 6 mm	Thickness 0.5 mm R: approx. 3 mm
Not given	Not given	Not given
Thickness 1.2 mm ≥20 sec	Thickness 0.8 mm ≥15 sec	Thickness 0.5 mm ≥10 sec

**TYPICAL APPLICATIONS AND CLASSIFICATION SYSTEM FOR DUROPAL-HPL**

EXAMPLES OF TYPICAL APPLICATIONS	STRESS	FIGURES OF NUMERICAL CLASSIFICATION			EQUIVALENT ALPHABETICAL CLASSIFICATION
		WEAR RESISTANCE	IMPACT RESISTANCE	SCRATCH RESISTANCE	
Cash desks, municipal facilities (military establishments, correctional facilities etc.)	Very high resistance to surface abrasion, very high impact and scratch resistance	4	4	4	HDS (horizontal heavy-duty standard) HDF (horizontal heavy-duty flame retardant) HDP (horizontal heavy-duty postforming)
Kitchen and office work-tops, hotel and restaurant tables, wall panelling and doors in public areas, interior walls of public transport	High resistance to surface abrasion, high impact and scratch resistance	3	3	3	HGS (horizontal general-purpose standard) HGF (horizontal general-purpose flame-retardant) HGP (horizontal general-purpose postforming)
Front elements on kitchen, bathroom and office furniture, wall and ceiling panels, shelving and furniture elements	Average resistance to surface abrasion, average impact and scratch resistance	2	2	2	VGS (vertical general-purpose standard) VGF (vertical general-purpose flame retardant) VGP (vertical general-purpose postforming)

Other combinations of the figures for abrasion, impact and scratch resistance than those contained in the table are possible.

**\* Information on alphabetical classification:**

1 <sup>st</sup> letter	2 <sup>nd</sup> letter	3 <sup>rd</sup> letter
H (horizontal application) or V (vertical application)	G (general purpose) or D (heavy duty)	S (standard quality) or P (postforming) or F (fire retardant)

\*\* Print designs with optical special effects: approx. 50-75 rev. Only suitable for vertical applications

## 2.2 MECHANICAL AND PHYSICAL CHARACTERISTICS OF DUROPAL-HPL-SOLID

DIN EN 438-4: 2005					
GENERAL REQUIREMENTS					
QUALITY CRITERION	PROCESS DIN EN 438-2 OR TEST STANDARD	PROPERTY	UNIT		
Resistance to surface abrasion	10	Abrasion resistance	Rev. (min.)	(IP + FP)/2	
Resistance to shock loading (large ball)	21	Drop height	mm (min.)	HPL thickness: 2 mm to <6 mm	
				HPL thickness: ≥6 mm	
Scratch resistance	25	Force	Level (min.)	Glossy surface	
				Other surface	
Resistance to dry heat (180 °C)	16	Appearance	Level (min.)	Glossy surface	
				Other surface	
Resistance to moist heat (100 °C)	EN 12721	Appearance	Level (min.)	Glossy surface	
				Other surface	
Resistance to boiling water	12	Weight increase	% (max.)	HPL thickness: 2 mm to <5 mm	
				HPL thickness: ≥5 mm	
		Thickness increase	% (max.)	HPL thickness: 2 mm to <5 mm	
				HPL thickness: ≥5 mm	
		Appearance	Level (min.)	Glossy surface	
				Other surface	
Dimensional stability at raised temperature	17	Dimensional change (cumulative)	% (max.)	HPL thickness: 2 mm to <5 mm	
				lengthwise	
				crosswise	
				HPL thickness: ≥5 mm	
				lengthwise	
				crosswise	
Stain resistance	26	Appearance	Level (min.)	Substances groups 1 & 2	
				Substances group 3	
Lightfastness (Xenon arc lamp)	27	Contrast	Grey scale		
Resistance to steam	14	Appearance	Level (min.)	Glossy surface	
				Other surface	
Resistance to a glowing cigarette	30	Appearance	Level (min.)		
Crack risk under stress	24	Appearance	Level (min.)		
Bending module	EN ISO 178	Stress	Mpa (min.)		
Bending strength	EN ISO 178	Stress	Mpa (min.)		
Tensile strength	EN ISO 1183-1	Stress	Mpa (min.)		
Thickness	5	Thickness tolerance	mm	HPL nominal thickness:	
				2.0 to <3.0	
				3.0 to <5.0	
				5.0 to <8.0	
				8.0 to <12.0	
				12.0 to <16.0	
				16.0 to <20.0	
20.0 to <25.0					
Dimensional stability	9	Levelness	mm/m	HPL nominal thickness:	
				2.0 to <6.0	
	6.0 to <10.0				
	≥10				
	6	Length and width	mm		
7	Edge straightness	mm/m			
8	Right angularity	mm/m			
Surface texture Dirt, stains and similar surface flaws; fibres, hair and scratches	Section 4	Sight check	mm <sup>2</sup> /m <sup>2</sup>		
			mm/m <sup>2</sup>		



CLASSIFICATION FOR HPL-SOLID TO DIN EN 438-4: 2005		FIGURES ACHIEVED BY DUROPAL-HPL-SOLID	
CGS*	CGF*	CGS* STANDARD	CGF* FIRE RETARDANT
		Print designs**	Plain designs
350	350	375-500	500-700
1.400	1.400	≥1,400	≥1,400
1.800	1.800	≥1,800	≥1,800
2	2	≥2	≥2
3	3	3-4	3-4
3	3	≥3	≥3
4	4	≥4	≥4
3	3	≥3	≥3
4	4	≥4	≥4
5.0	7.0	≤5.0	≤7.0
2.0	3.0	≤2.0	≤3.0
6.0	9.0	≤6.0	≤9.0
2.0	6.0	≤2.0	≤6.0
3	3	≥3	≥3
4	4	≥4	≥4
0.4	0.4	≤0.4	≤0.4
0.8	0.8	≤0.8	≤0.8
0.3	0.3	≤0.3	≤0.3
0.6	0.6	≤0.6	≤0.6
5	5	5	5
4	4	4-5	4-5
4-5	4-5	4-5	4-5
3	3	≥3	≥3
4	4	≥4	≥4
3	3	≥3	≥3
4	4	≥4	≥4
9,000	9,000	Requirement fulfilled	
80	80	Requirement fulfilled	
60	60	Requirement fulfilled	
Maximum deviation ±0.20		Requirement fulfilled	
Maximum deviation ±0.30			
Maximum deviation ±0.40			
Maximum deviation ±0.50			
Maximum deviation ±0.60			
Maximum deviation ±0.70			
Maximum deviation ±0.80			
To be agreed			
Maximum deviation 8		Requirement fulfilled	
Maximum deviation 5			
Maximum deviation 3			
+10 /-0			
Maximum deviation 1.5		Requirement fulfilled	
Maximum deviation 1.5			
Permitted fault size/-length			
Max. 1		Requirement fulfilled	
Max. 10			

\* Information on alphabetical classification:

1 <sup>st</sup> letter	2 <sup>nd</sup> letter	3 <sup>rd</sup> letter
C (compact laminates)	G (general purpose)	S (standard quality) or F (fire retardant)

\*\* Print designs with optical special effects: approx. 50-75 r.  
Only suitable for vertical applications

### **3. DUROPAL REAL METAL LAMINATES MATERIAL PROPERTIES**

Since sensitivity to scratches is greater than that of ordinary Duropal-HPL, Duropal Real Metal laminates are used solely for vertical applications. In the event that they are to be used horizontally, we recommend covering them e.g. with a thin glass sheet. Mild surface unevenness may occur during the production of Duropal Real Metal laminates. Slight impressions may also become visible, although these are regarded as normal by today's technical standards. There may also be slight deviations in colouring, although these will not affect the general overall appearance. The variations in texture and colour are not quality flaws, but proof that the item in question is a real metal surface and not an imitation. We therefore advise using products from the same batch for a particular application.

### **4. REACTION TO FIRE**

Duropal-HPL and Duropal-HPL-Solid are suitable for fire protection and the highly flame-resistant version is approved for use in the production of construction elements to DIN 4102/B 1. The following applies for Duropal-HPL: non-dripping, non-softening.

- Construction classes to DIN 4102-1 - postforming quality: B2 (normal fire resistance)
- Highly flame resistant quality: B 1
- Use in maritime applications IMO Res. A 653 (16) B, US Coast Guard ASTM E 84 / NFPA 255 (A+C)

### **5. PHYSIOLOGICAL PROPERTIES**

Duropal-HPL and Duropal-HPL-Solid are physiologically safe and suitable for use in rooms where food is stored, handled and consumed. This property is confirmed by a safety declaration from research and testing company ISEGA-Forschungs- und Untersuchungs-GmbH (tested to DIN EN 1186 / DIN EN 13130).

### **6. PROTECTION AGAINST THE EMISSION OF FORMALDEHYDE FROM CORE MATERIALS**

When Duropal-HPL and the core material are bonded, Duropal-HPL offers highly effective protection against the possible diffusion of formaldehyde from the core material even in the lowest thickness.

### **7. ANTISTATIC BEHAVIOUR**

The specific surface resistance of Duropal-HPL under ordinary ambient conditions is between  $1 \times 10^9$  and  $1 \times 10^{12}$  Ohm (tested in accordance with DIN EN 61349). There is therefore little likelihood of an electro-static charge building up, and they do not attract dust.

### **8. QUALITY MONITORING**

Duropal guarantees that the following standards are fulfilled e.g. with regard to the product properties:

EN 438: 2005, ISO 4586 part 1: 2004, DIN EN ISO 9001: 2000

and with regard to its reaction to fire:

DIN 4102, AFNOR NFP 92.501, B/S 476 - parts 6.7, Önorm B 3800-1

## **COLOURS AND SURFACES**

Thanks to the extensive variety of colours and surface textures in which our Duropal high pressure laminates are available, they are ideal for the widest range of applications. We will be pleased to advise you in choosing the perfect solution for your requirements. You will find all the relevant details in our brochures.

Duropal-HPL is sanded lengthwise ready for bonding for further processing. The same information applies to the reverse of Duropal-HPL-Solid as for the fronts.

## **PRODUCT AND COLOUR MATCH**

One design – lots of possibilities: You can combine wodego melamine faced decorative panels (DP), Duropal high-pressure laminate (HPL) and edges in the same designs in the wodego colour match collection – just as you require.

## **OVER- AND UNDER-DELIVERIES**

Minor flaws due to the production process and/or raw materials that do not impair the quality and are acceptable for 1<sup>st</sup> quality goods are assessed in accordance with the Duropal selection regulations (based on EN 438, part 3, and the international ISO standard). We also reserve the right to minor under- or over-deliveries if necessary for technical/production reasons and in accordance with Duropal's terms and conditions.

## **STORAGE**

The optimum storage conditions are in closed rooms under normal inner room conditions (temperature 18-25 °C, relative humidity 50-65%). Items are to be stored horizontally with the whole surface supported, including the edges, on a level base and wrapped in plastic film. The whole surface of the top sheet is to be covered by a cover board.

## **DISPOSAL**

**Incineration:** Duropal-HPL and Duropal-HPL-Solid are perfectly safe to incinerate, and may be disposed of in officially approved industrial incineration facilities.



RECOMMENDATIONS FOR PROCESSING

**DUROPAL-HPL,  
DUROPAL-HPL-SOLID AND  
DUROPAL-HPL-ELEMENTS**

## 1. TRANSPORTATION

Ensure that any loose sheets are handled correctly during loading and unloading. The décor side should be face up when removed from the vehicle. Individual small sheets are to be carried with the decorative side held against the body. Avoid bending larger sizes by carrying them arched lengthwise or with the decorative side rolled up to the inside. Avoid any type of movement which might cause abrasion. When transporting a large quantity, we recommend stacking the sheets on a pallet, always with adequate protection of the decor side.

## 2. STORING HPL

Duopal-HPL must be well protected against moisture and should be stored in rooms with normal climatic conditions. Stacks of sheets are to be stored horizontally with the whole area supported or angled at 80°; in the latter case, again ensure that the surface of the board is supported and that there is protection on the floor to prevent them from slipping. Always stack with the decorative sides of two sheets facing each other. Please observe the climatisation instructions before processing; see chapter 7.3 "Pre-treatment". **Duopal-HPL is available with a heat-resistant (to 80 °C or 180 °C) protective film on request. This film is to be removed after six months at the most, otherwise it may be extremely difficult to remove the film or adhesive residues.**

### 2.1 STORAGE OF DUROPAL REAL METAL LAMINATES

The optimum storage conditions are provided by closed rooms under normal indoor room conditions (temperature 18-25 °C, relative humidity 50-65%). Items are to be stored horizontally with the whole surface supported, including the edges, on a level base and wrapped in plastic film. Where this is not possible, then store the items angled at 80° with the whole area of the board supported and suitable protection on the floor to prevent the boards from slipping. The entire surface of the top board is to be covered by a cover panel. **Duopal Real Metal laminates are delivered with a heat-resistant (to 180 °C) protective film. This film is to be removed after six months at the most, otherwise the metal surface may be damaged.**

### 2.2 STORAGE OF DUROPAL-HPL-ELEMENTS

Store on a level surface, dry, at normal climate if possible, i.e. in a warehouse, so that the Duopal-HPL-elements are not exposed to direct water or moisture. Avoid direct sunlight. **Duopal-HPL is available with a heat-resistant (to 80 °C) protective film on request. This film is to be removed after six months at the most, as otherwise the surface may be damaged.**

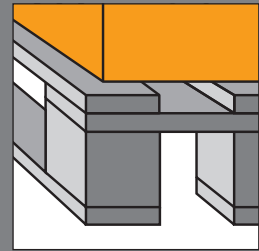
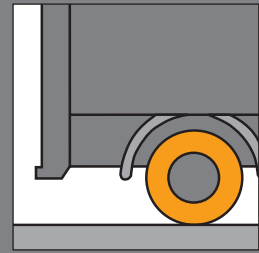

# PROCESSING DUROPAL-HPL DUROPAL-HPL-ELEMENTS

---

## **1. TIP: „PLEASE NOTE“**

The strain on tools when processing Duropal-HPL is relatively high, due to the hardness of the surface, which is coated with melamine resin. Use tools with carbide-tipped blades, and diamond-tipped blades for certain processes. Please observe the following to ensure the best results with unbonded panels:

- Make sure you always work on a level, firm base
- The boards must not vibrate or wobble under any circumstances
- Ensure that you cut sharply and that your tools run smoothly. Should the decorative side break out, splinter or arch upwards, this will almost always be due to inappropriate handling or the use of unsuitable tools. Warning: any notches or nicks will crack or tear when subjected to fluctuations in temperature or humidity.
- If the decorative surface is pushed over the supporting base, please ensure that a guide or support is used to protect the Duropal-HPL. When processing with machine tools, surfaces may also be grooved to ensure that the contact area is kept to a minimum.

## 2. CUTTING

### 2.1 DUROPAL-HPL WITHOUT CORE

Many tools are suitable for cutting Duropal-HPL, but they must all possess a number of specific features.

#### Hand saw

Fine-toothed saws with slightly straight-set saw blades are recommended for single cuts. Always saw from the top surface of the board and at a steep angle.

#### Electric nibbling tool

Ideal for rounded cuts; can also be used for stationary fitting on bench-tops.

#### Handheld circular saw

Always turn the decor side down when processing. Please always use a fence to achieve straight, clean cuts.

#### Electric jigsaw

Always turn the decor side down when processing. Ensure you have a clean base to work on, ideally with a felt cover.

#### Table (bench) saw

The decor side must always be face up. A good amount of pressure is required around the cutting blade, i.e. place a batten on top or, ideally, height-adjustable pressure rollers. Ensure that the saw runs tightly in the correct blade position. You can also cut stacks of sheets with a table saw. Although they are extremely durable, carbide-tipped circular saw blades must be handled carefully because they are highly sensitive to impacts and blows.

Tooth spacing:	10 – 15 mm
Rotations:	3,000 – 4,000 rpm
Cutting speed:	50 – 100 m/s
Feed speed:	10 – 30 m/min

The best cutting results are achieved with carbide-tipped saw blades that cut on both sides and with a hollow tooth front. Blades of less than 2 mm are usually too soft, and will result in rough edges.

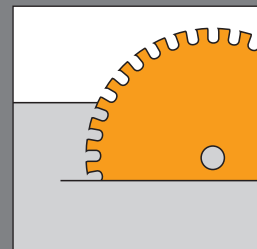



## STANDARD TOOTH SHAPES

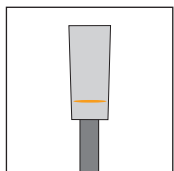

Flat tooth

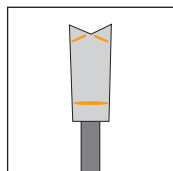

Alternating tooth

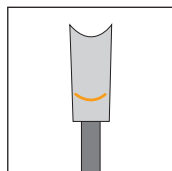

Duplovit tooth  
(high tooth front)

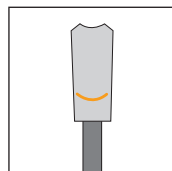

Duplovit tooth,  
chamfered on  
both sides

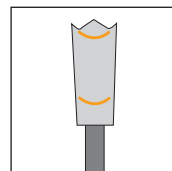

Roof Duplovit

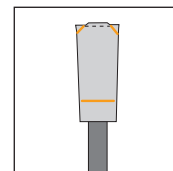

Trapezoid flat tooth

The **flat tooth**, the most basic variant, is easy and cheap to sharpen.

The **alternating tooth** is the universal tooth shape for counter direction sizing and splitting cuts. The cutting width division and tip feed are advantageous.

The **Duplovit tooth** is hollow cut for minimum tip feed and double-sided angle of the axis. Another advantage is that the teeth grab from both sides, although this version does not have the cutting width division. Maintenance is more time-consuming and complex.

The **Duplovit tooth with chamfers on both sides** is the special version, and usually the only option for achieving a clean top and bottom cutting edge without use of a scoring blade and in a counter direction. Maintenance is even more time-consuming.

The **roof Duplovit** is the combination of a roof and a Duplovit tooth. The roof tooth is responsible for the pre-cutting and holds the saw blade very firmly at the sides.

The tip feed of the Duplovit tooth with the double-sided angle of the axis provides clean edge work with a long tool life.

Advantages:

- four-fold cutting division for optimum edges
- universal circular saw blade for professional use

The **trapezoid flat tooth**: as well as the individual tooth shapes, there are several others that are grouped together and are known accordingly as grouped teeth. The trapezoid flat tooth has a slightly higher flat tooth with chamfers on both sides, followed by a slightly lower flat tooth without chamfer. The very good cutting edge that is achieved by the fivefold cutting width separation is advantageous, although that is offset by the more time-consuming maintenance required.





## **2.2 DUROPAL-HPL-ELEMENTS ON ONE OR BOTH SIDES OF A CORE MATERIAL**

### **Cutting with circular saws**

The quality of the cutting edge is determined by the height at which the saw blade is set. If the top cut edge on a core panel that is covered on both sides is unclean, then we advise setting the saw blade higher; if the bottom edge is unclean then set the blade lower.

The best stop position must be determined in advance in each case. You will achieve the best results with a pre-cutting saw. The combination of various other factors will also influence the quality of the cut edges:

- tooth shape
- number of teeth
- cutting speed
- feed speed
- entry and exit angle

## **2.3 CUTTING DUROPAL WINDOWBOARDS**

Use vibration-free, carbide-tipped circular saws or finely toothed, slightly straight-set hand saws.

## **2.4 PLASTIC END CAPS FOR DUROPAL WINDOWBOARDS**

The ABS plastic caps make it easier to seal the top edges, and are available in all profile variants and the matching colours white, grey and beige. The end caps are to be adapted to the size of the windowboard. Cover the whole surface of the end caps and top edges with a single-component polyurethane sealant such as Sikaflex-221 (from: [www.sika-industry.de](http://www.sika-industry.de)), leave for approx. 2 minutes, and then firmly press the cover caps into place. The bond will have hardened after approx. one hour, and you will have an attractive professional seal to the top edges.

## **2.5 CUTTING AND FEED SPEEDS**

Chapter 6, "Technical information", explains how the cutting and feed speed determine the quality of the cut.

### 3. PROCESSING CUT EDGES AND PROFILING DUROPAL-HPL-ELEMENTS

Always saw from the top surface of the board (decor side).

#### 3.1 MANUAL EDGE PROCESSING

##### a) File, sandpaper, scraper

These materials are suitable for smoothing edges. When processing an edge, please always file from the decor towards the core material.

Edges should be smoothed with fine files, sandpaper (100–150) or scrapers. Milled edges should be lightly milled with sandpaper, then scraped with the scraper and smoothed again using fine sandpaper. Please ensure that all traces of sanding particles are removed.

##### b) Plane

For manual planing, we recommend the use of metal planes with HSS blades, working at a cutting angle of approx. 15°.

##### c) Hand router

Protruding Duropal-HPL panel edges can be milled flush with this tool. In order to protect the surface when working, cover the surface of the router with non-abrasive material. Remove all off-cuts before every new application of the tool.

Router diameter:	10 – 25 mm
Speed:	20,000 rpm
Cutting speed:	10 – 25 m/s

Carbide-tipped router cutters are ideal, and especially ones with reversible carbide tips for larger diameters.

You will be able to make better use of your tools with height adjustment and parallel-axis cutting. To protect your tool, make sure that the board overhangs by no more than 2–3 mm.

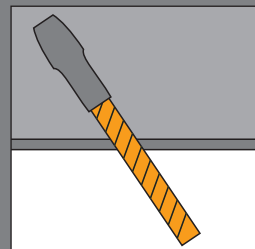

## 3.2 EDGE PROCESSING WITH STATIONARY MACHINES

### Spindle moulder

Routing and blade heads with replaceable carbide-tipped blades and reversible carbide tips are ideal for this tool.

Cylindrical tools need to be differentiated according to use:

- parallel axis cutting for boards that are coated on one or both sides
- one-sided angled upright cutting for boards that are coated on one side
- herringbone-tooth cutters for boards that are coated on both sides.

If only the Duropal high pressure laminate is to be milled, then choose 12,000 rpm for a thickness of up to approx. 5 mm and a tool diameter of e.g. 100 mm. (Please also observe your tool's maximum output in this instance.)

If the boards are bonded, then we recommend a lower rpm of 3,000–6,000. The tool travel per height setting will vary, often considerably, according to the type of tool and its shape, as well as the material in question and the core material. The use of carbide-tipped tools is advisable for large production runs.

### Tabletop router (Routers used as spindle moulders)

Tabletop routers require single- or double-bladed carbide tipped tools with a cutting speed of 10–15 m/s. This tool should also be used for internal recesses (see chapter 5).

Core boards that are coated on one side can be guided for vertical milling on a template; boards that are coated on both sides and loose Duropal high pressure laminates are best milled all round with a single clamping device. 2 mm cutting allowance is usually sufficient in most cases. If the edges are rounded, the milling work can be minimised if you pre-cut the approximate shape with a band saw first.

### Surface planer

Feed speed:	5–15 m/min
Cutting speed:	12–15 m/s
Rotations:	3,000 rpm

Use carbide tipped blades for large production runs, as the standard blades have only a very short tool life.

### Double-end profiler/tenoner

Economical processing, especially for large runs, is a key feature of this process. It is also appropriate to fit the spindle moulder with tip material (see above) in this instance.

## 3.3 EDGE FINISHING OF DUROPAL WINDOWBOARDS

It is advisable to sand the edges in order to avoid stress cracking under temperature and/or moisture.

## 3.4 PROFILING THE EDGES OF ELEMENTS

Profiling elements edges, e.g. for the postforming or softforming process, requires tools such as a hand router, spindle moulder or double-end profiler.

## 4. DRILLING DUROPAL-HPL AND DUROPAL-HPL-ELEMENTS

### 4.1 GENERAL

Please note: drill holes in Duropal-HPL must always be made 0.5 mm bigger than the screw diameter. The screws need this clearance on all sides in order to prevent cracks around the drill holes resulting from variations in temperature and humidity. Raised countersunk head screws require a rosette washer. Please use plastic washers for our Duropal windowboards.

### 4.2 DRILL TOOLS

#### Twist bits

Twist bits specially designed for plastics have a steep angle (twist) and broad chip space (groove). Acute angles of 60°-80° are ideal for drilling Duropal-HPL.

#### Combi-bits

Combi-bits - also known as carbide disc drills - are suitable for drilling larger diameters.

#### Step bits

Step bits are ideal for all kinds of drill holes; this technique avoids the need for double drilling.

#### Hole cutter

For larger drill hole diameters please use a hole cutter with guide pins. If you use adjustable hole cutters with guide pins, the hole will have to be drilled from both sides.

### 4.3 DRILLING TECHNIQUE

With regard to the drilling rate, please ensure that the melamine surface of the Duropal-HPL is not damaged.

The cutting speed of high-speed steel (HSS) drills is approx. 0.8 m/s, and of carbide-tipped drills up to 1.6 m/s. The advisable feed rate is 0.02-0.05 mm/rev, which at 1000 rpm equates to a drilling depth/min of 20-50 mm.

Prevent the material from accumulating at the drill outlet by using a hard wood or laminate base. For large production runs, the results will be even better if you use drilling rigs with drill bushes on both sides so they can be firmly clamped into position. When countersinking, the guideline speeds should be halved.

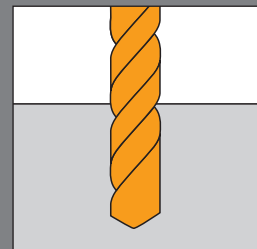

## 5. INTERNAL RECESSES AND CUT-OUTS OF Duropal-HPL-ELEMENTS

### 5.1 GENERAL

The corners of cut-outs must never have sharp angles as they will quickly crack or tear. Sharp edges can only be achieved by combining different cut-outs.

The internal cut corners must always be rounded; remember the minimum radius should be 5 mm. For internal recesses and cut-outs with a side length of more than 250 mm, the radius must be increased incrementally according to the side length. Internal recesses can be made directly with a router, but for precise results pre-drill the corresponding radius.

Please ensure that the edges are all free of notches. If you are planning to install heat sources, e.g. halogen lamps, the cut-out must be planed with sufficient clearance or should be insulated. The temperature of the Duropal-HPL surface must not exceed a constant 70 °C. Furthermore, if combining various different materials, remember to consider the varying coefficients of expansion.

### 5.2 PROCESSING DUROPAL-HPL-ELEMENTS

The high quality surface of the top and reverse reliably protects the Duropal-HPL-elements against penetration by water and steam. Unprotected edges and butt joints etc. may however occur during processing, and these must always be sealed during the final installation of the Duropal-HPL-elements. In all other respects the general information in item 5.1 applies.

### 5.3 TOOLS

Please refer to chapters 2, 3 and 4. The tools and uses described here also apply for the production of internal recesses and cut-outs.

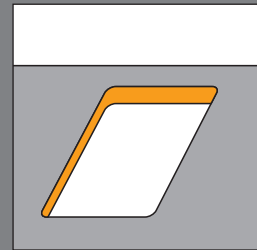

## 6. TECHNICAL INFORMATION

### 6.1 TOOL INFORMATION

MATERIAL	PRODUCTION STEP	TOOL	CUTTING SPEED IN M/S	RPM	FEED IN M/MIN
HPL	Panel cutting	Circular saw bench	40–60	approx. 3,000–4,000	10–30
HPL on raw chipboard	Format cutting	Circular saw bench	40–60	approx. 3,000–4,000	manually approx. 10
HPL on raw chipboard	Format cutting	Double-end profiler (pre-grooving, cutting)	40–60	approx. 6,000	manually approx. 6–20
HPL on raw chipboard	Milling edges	Spindle moulder or edge processing machine	40–60	approx. 6,000–9,000	approx. 6–15
HPL on raw chipboard	Milling edges	Double-end profiler (postmilling)	40–60	approx. 6,000	approx. 6–20
HPL on raw chipboard	Grooving	Circular saw bench	40–60	approx. 3,000–4,000	approx. 3–8
HPL on raw chipboard	Grooving	Spindle moulder	40–60	approx. 6,000	approx. 3–8
HPL on raw chipboard	Grooving	Double-end profiler	40–60	approx. 6,000–9,000	approx. 6–20
HPL on raw chipboard	Grooving	Router		approx. 12,000–18,000	approx. 3–8
HPL on raw chipboard	Grooving	Drill, dowelling machine		approx. 3,000–6,000	

### 6.2 FEED SPEED

Feed speed in m/min based on the processing length and time

TIME FOR TRAVEL IN S	FEED SPEED IN M/MIN AND PROCESSING LENGTH IN M								
	1	2	3	4	5	6	7	8	9
1	60	120	180	240	300	360	420	480	540
2	30	60	90	120	150	180	210	240	270
3	20	40	60	80	100	120	140	160	180
4	15	30	45	60	75	90	105	120	135
5	12	24	36	48	60	72	84	96	108
6	10	20	30	40	50	60	70	80	90
7	9	17	26	34	43	52	60	69	77
8	7.5	15	22.5	30	37.5	45	52.5	60	67.5
9	6.7	13	20	27	34	40	47	54	60
10	6	12	18	24	30	36	42	48	54

Example: processing length 5 m, feed speed 50 m/min – travel time needed: 6 s



### 6.3 CUTTING SPEED

Cutting speed  $v$  in m/s based on tool diameter and rotational speed

TOOL DIAMETER IN MM	CUTTING SPEED $v$ IN M/S														
	20	40	60	80	100	120	140								
400															
380															
360															
340															
320															
300 <sup>1)</sup>															
280															
260								104							
240								96	108						
220								88	99	110					
200								80	90	100	120				
180 <sup>2)</sup>								72	81	90	108	135			
160								64	72	80	96	120	144		
140								56	63	70	84	105	126		
120								48	54	60	72	90	108	126	
100								40	45	50	60	75	90	105	
80								32	36	40	48	60	72	84	
60								24	27	30	36	45	54	63	
40								16	18	20	24	30	36	42	
20								8	9	10	12	15	18	21	
10								4	4.5	5	6	7.5	9	10.5	
Tool shaft rpm	1,000	2,000	3,000	4,000	5,000	6,000	7,000	8,000	9,000	10,000	12,000	15,000	18,000	20,000	

Examples:

<sup>1)</sup> Carbide-tipped circular saw blade

<sup>2)</sup> Synchronously adjustable router head with clamped herringbone-shaped reversible carbide tips



## 7. PROCESSING DUROPAL-HPL AND DUROPAL-HPL-ELEMENTS

### 7.1 GENERAL

Duropal-HPL in thicknesses less than 2 mm needs a level, tension-free core material with minimum flex. A smooth surface is one of the main prerequisites for permanently good results; the right adhesive, quantity applied, forming pressure and press temperature are equally important.

Please take into account when processing Duropal-HPL that temperature and humidity may cause some slight dimensional changes in it.

### 7.2 CORE MATERIAL

The following table illustrates the suitability of various materials as cores and their application possibilities. In all instances, please remember that the properties of a core material consisting of various components (e.g. honeycomb with frame) may have different effects on the surface of Duropal-HPL. This should be checked first, and must be taken into account.

#### MATERIAL/CONSISTENCY AND SUITABILITY AS A CORE

##### Chipboard

The necessary thickness is to be taken into account on self-supporting constructions. The fixing of the flat bonded elements is determined by the thickness and size of the panel. The surface quality of the Duropal-HPL-element is determined largely by the structure of the chipboard panel, i.e. the shape of the chips, amount of resin, density and - above all - the sanding quality of the surface. Multiply chipboard is suitable as the core. The boards should be evenly sanded on both sides in order to prevent bowing and visual surface defects.

In order to facilitate a short bonding and pressing time, ensure that the surface has good absorption properties if you are going to use a water-based bonding system. The top layer must have a minimum resistance to delamination of 1.2 N/mm in order to prevent the laminate from delaminating (DIN 52366).

Should you have any questions concerning these special chipboard panels, please contact us.



### **MDF boards**

Particularly suitable for profiling, but lower thicknesses will not be self-supporting.

### **High density fibreboard**

Not self-supporting. Surfaces that contain paraffin need to be sanded before bonding, but are usually processed before delivery. Density 850 kg/m<sup>3</sup>; all other properties as per EN 622.

### **Panels plywood**

Self-supporting. In order to guarantee a smooth surface, ideally use laminboard with narrow strips and a softwood top layer.

### **Veneered panels**

Thin boards are not self-supporting; the fixing construction depends on the thickness and size. Softwoods such as poplar and abachi are suitable for bonding.

### **Solid timber**

Should only be used for small areas. Risk of deformation.

### **Honeycomb panels**

Suitable as a component in composite cores or in combination with a framework construction.

### **Foam materials**

Self-supporting on vertical surfaces; also suitable as a component of composite boards. Excellent heat insulation. Use a hard foam made from artificial resin for bonding, e.g. polystyrene, PVC, phenol, polyurethane. Please consult the manufacturer before bonding.

## **7.3 PRE-TREATMENT**

The Duropal-HPL and core materials must be conditioned together before use in order to balance the moisture content in the components. Materials that are too damp will tend to contract after a drying period. This can result in cracks and distortion. Materials that are too dry are difficult to process and may expand later, which could also result in distortion. The right climatisation is achieved at a room temperature of approx. 18-25 °C and 50-65% humidity. Please also ensure that the following requirements are met:

- Sufficient air circulation around the Duropal-HPL for at least ten days.
- Alternatively, the core boards and laminates may be stacked and stored for at least three days in the same order in which they will later be bonded together. In this case, ensure that the air humidity is similar to that of the proposed size of installation.
- Duropal-HPL which is intended for use as a Duropal-HPL element is to be stacked for at least three days with the reverse sides together. Climatisation together with the core material is not necessary if it has been stored for long enough under these circumstances. If the Duropal-HPL element is to be exposed to a constant low relative humidity, it is advisable to carry out the conditioning accordingly, e.g. 20 hours at 40 °C or ten hours at 50 °C.

The adhesives are to be pre-stored at room temperature. The bonding process is to be carried out immediately after conditioning.

**PLEASE NOTE:** This information applies only for processing in temperate climates. Please contact us if extreme conditions are likely to be experienced.

#### **7.4 STRESS EQUALISATION**

If two different materials are to be bonded together, tension will occur. That is why cores need to be laminated on both sides with materials that undergo the same dimensional changes under the influence of heat and moisture. This applies in particular if the finished composite board is to be self-supporting and not held by a rigid construction. As the size of the surface increases, the more attention you must pay to the type of balancers and the density, the symmetry of the structure and the rigidity of the core.

You will achieve the best results if you use the same type of Duropal-HPL in the same thickness on both sides. If using HPL with a film (for surface protection), make sure that the construction is symmetrical. Cut-outs in Duropal-HPL must always be made in the same direction of grain. Duropal-HPL must be bonded to both sides of the core in the same sanding direction. Our balancer boards of the same thickness are ideal.

#### **7.5 PROCESSING DUROPAL REAL METAL ELEMENTS**

Processing different types of materials to make composite elements always causes tension between the various materials. Both sides of the core material should be laminated with the same material that has the same dimensional changes under the influence of moisture and heat. Pay particular care to achieving a symmetrical construction if the composite element is to be self-supporting in use. **Observe the direction of the decor pattern when processing Duropal real metal laminates. The protective film is marked with arrows in the direction of the decor to make this easier.**

## 7.6 BONDING

**Please note:** When gluing and bonding Duropal-HPL, always use adhesives with a good adhesive strength and which will be resistant to the subsequent influences of temperature and moisture.

### 7.6.1 ADHESIVES, OVERVIEW

- Dispersion adhesives (e.g. PVAC glue)
- Condensation resin adhesives (urea, resorcin and phenolic resin adhesives)
- Contact adhesives (e.g. polychloroprene adhesives PCB)
- Mixed adhesives (e.g. epoxy, unsaturated polyester and polyurethane adhesives)
- Hot melt adhesives (only for special applications)

**PLEASE CONSULT THE FOLLOWING TABLE TO FIND THE APPROPRIATE ADHESIVE:**

	DISPERSION ADHESIVES (E.G. PVAC GLUE)	CONDENSATION RESIN ADHESIVES (E.G. UREA RESORCIN AND PHENOLIC RESIN ADHESIVES)	CONTACT ADHESIVES (E.G. POLYCHLOROPRENE ADHESIVES)	MIXED ADHESIVES (E.G. EPOXY, POLY- URETHANE ADHESIVES)	HOT MELT ADHESIVES
Core wood-based (boards or honeycomb)	■	■	■	■	■
Paper honeycomb	■	■	■	■	■
Foams and honeycomb in:					
- polystyrene			■ <sup>1)</sup>	■ <sup>1)</sup>	
- PVC			■ <sup>2)</sup>	■ <sup>2)</sup>	■
- phenol	■	■	■	■	■
- polyurethane	■ <sup>2)</sup>	■	■	■	■
<sup>1)</sup> Contains no components that attack polystyrene <sup>2)</sup> PVC/polyurethane adhesives need to be suited to each other.					

## 7.6.2 GUIDELINE FIGURES FOR THE LOAD CAPACITY OF ADHESIVES (EMPIRICAL)

TYPE OF ADHESIVE	TEMPERATURE RESISTANCE (APPROX.) <sup>1)</sup>	LOAD CAPACITY ACCORDING TO DIN EN 204 <sup>2)</sup>
<b>Dispersion adhesives:</b>		
PVAC adhesives	-20 to +70 °C	D 1/D 2
Two-component adhesives	-20 to +100 °C	D 3
<b>Condensation resin adhesives:</b>		
Urea resin with a high content of thinner	-20 to +120 °C	D 2
Melamine/urea resin	-20 to +120 °C	D 3/D 4
Phenolic, resorcin resin	-20 to +140 °C	D 3/D 4
<b>Contact adhesives:</b>		
Contact adhesives without hardener	-10 to +50 °C	D 1
Contact adhesives with hardeners	-10 to +100 °C	D 2
Contact adhesives with built-in resin hardeners	contact manufacturer	contact manufacturer
<b>Reaction adhesives:</b>		
Epoxy, unsaturated polyester and polyurethane adhesives	-20 to +100 °C	D 3/D 4
Hot melt adhesives	-10 to +60 °C	D 1
Special hot melt adhesives	-10 to +90 °C	D 1
The figures quoted here refer solely to the bonded joint.		
<sup>1)</sup> The plus figures are based on a short-term load (up to 30 mins.) up to these maximum temperatures.		
<sup>2)</sup> Core material and edge protection must correspond to the respective stresses.		

The information concerning temperature resistance applies only for short-term stress to the bonded joint. The long-term load-bearing ability depends on a number of factors, including e.g. the type and class of Duropal-HPL, humidity, temperature influences and the core material. Since the adhesives listed in the various groups all have various properties and are constantly undergoing further development, please always contact the manufacturer when dealing with special applications.

### 7.6.3 BONDING PROCESS

Preparation: please clean both sides of the core material and the Duropal-HPL thoroughly. Dust, grease, oil and/or perspiration stains may leave marks on the surface after bonding, but can easily be removed using organic solvents (e.g. acetone, white spirit and benzine).

For further information on cleaning and caring for Duropal-HPL please refer to the chapter "Duropal-HPL".

Ensure that the temperature for bonding is approx. 18–25 °C with a relative air humidity of 50–65%.

We recommend testing first under the same conditions as for the bonding process. With all kinds of solvents and hardeners, please observe the safety regulations issued by the professional trade organisations.

### 7.6.4 EDGING OF DUROPAL WINDOWBOARDS

Duropal windowboard is a wood-based material. Wood-based materials are always likely to swell under the effects of moisture. We therefore recommend that all open edges be sealed professionally before installation. This may be done using high quality Duropal-HPL edging strips or end caps, but also with simpler edging materials. Current experience tells us that in some cases it is sufficient to seal the item with water- and temperature-resistant adhesives or a single-component polyurethane sealant such as Sikaflex®-221 (source: [www.sika-industry.de](http://www.sika-industry.de)) to prevent moisture penetration (please also observe the corresponding information and instructions for the adhesive or sealant). Every pack comes with the appropriate Duropal-HPL edging strip to seal open edges. However, if the front profile edge is to be plastered, or if there is a risk of it coming into direct contact with water, the front edge in the profile area must always be sealed professionally. This also applies if the dimensions of the original width are to be reduced. In this case, the rear long edge must be sealed for all types.

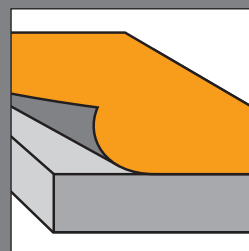



**Please follow the guideline values in the following table for good results.**  
Remember to take into account that the figures depend on the processing and climate conditions as well as on the type of core material and the quality of the adhesive.

#### GUIDE FIGURES FOR BONDING

TYPE OF ADHESIVE	APPLICATION OF ADHESIVE IN G/M <sup>2</sup>	WAITING TIME (OPEN) <sup>1)</sup> IN MIN	PRESSURE <sup>2)3)</sup>	PRESSURE TEMP./TIME <sup>4)</sup>			PROCESS
				20 °C	40 °C	60 °C	
Dispersion adhesives: – PVAc adhesives	90–150 on HPL or core	1–30	approx. 3	8–60 mins	4–12 mins	45–160 s	a)
– Two-component PVAc adhesives	90–150 on HPL or core	1–30 depending on the composition of the component	approx. 3	as per the manufacturer's instruction			a)
Condensation resin adhesives: – urea resin, melamine urea resin	90–150 on HPL or core	2–20	3–5	15–180 mins	5–30 mins	1–12 mins	b)
– Phenolic resin, resorcine resin	100–180 on HPL or core	Ca. 2–15	3–5	approx. 8 h	pressing time depends on the hardener system		b)
Contact adhesive: – with and without hardener	150–200 each on HPL and hardener	depending on ambient temperature + type of adhesive (finger test)	min. 5	min. 1 min pressed			c)
– with built-in resin hardeners	These are special adhesive settings for which no general guidance figures can be given.						
Mixed adhesives: – epoxy, unsaturated polyester and polyurethane adhesives	100–250 on HPL or core	depending on type	stack pressure, store flat!	depends on the type and hardener system			d)
Hot melt adhesive	180–300 on HPL or core	extremely short	pressure roller	195–220 °C (adhesive application temperature range)			e)

<sup>1)</sup> 1) Waiting time (open) = time from the application of the adhesive until the glued surfaces are placed together. Then there is also the waiting time (closed)

= time from the placing together of the glued surfaces until the full forming pressure or the measures that bring about the bond (hardening, curing), such as the hardening temperature, are achieved. When gluing in a heating press, the full pressure needs to be applied as soon as the press has been charged to prevent the composite element from distorting and/or the adhesive layer drying too soon.

<sup>2)</sup> 1 bar ≈ 1 kp/cm<sup>2</sup> = 0.1 N/mm<sup>2</sup> ≈ 100 k Pa

<sup>3)</sup> To calculate the forming pressure on hydraulic presses cf. appendix (figure 8)

<sup>4)</sup> The pressing time is not always the same as the time to reach final strength. Depending on the particular procedure, a certain amount of time needs to be left after pressing before continuing with further processing.

## THE PRESS TEMPERATURE

A press temperature of approx. 20 °C is recommended for the production of tension-free Duropal-HPL elements. The setting times can be reduced at higher temperatures. As a general rule, 60 °C should not be exceeded when pressing, as it could result in bowing and changes to the surface.

For special bonding at higher press temperatures, please observe the following guideline values to prevent damage to the material. For gluing systems that require a higher temperature, please contact us.

Temperature	Time
70 °C	10 mins.
80 °C	5 mins.
90 °C	3 mins.
100 °C	2 mins.

## APPLYING THE ADHESIVE AND THE PRESSING PROCESS

Apply the adhesive evenly and sparingly over the entire surface. Both sides of Duropal-HPL elements need to be covered with the same amount of adhesive in order to prevent bowing. This applies in particular for water-based adhesive systems.

## GENERAL CALCULATION OF THE PRESSURE FOR HYDRAULIC PRESSES

In order to set the correct pressure for various board diameters it is important to calculate the piston pressure and the corresponding manometer pressure.

Please use the following formula for general calculations:

$$\frac{\text{required pressure in bar}}{\text{number of pistons}} \times \frac{\text{panel area in cm}^2}{\text{piston area in cm}^2} = \text{manometer pressure in bar}$$

$$\text{piston area} = r^2 \pi$$

## THE APPLICATION OF VARIOUS ADHESIVES IS EXPLAINED BELOW:

### a) DISPERSION ADHESIVES

These include PVAc glues and two-component PVAc dispersion glues. You can apply the adhesive with a small stopping knife or hand roller, or if you want to work mechanically with a glue application or four-roller machine. Cold-pressing is undertaken on screw presses, spindle presses or single/multi-daylight presses; hot pressing with single or multi-daylight presses, short-cycle presses, roller presses or double band presses. Please observe the press times/temperatures with minimal and even application of the adhesive.

### b) CONDENSATION RESIN ADHESIVES

These include e.g. urea resin, melamine urea resin, phenolic resin and resorcinol resin. Phenolic and resorcinol resin are used primarily on Duropal-HPL elements that must have a high resistance to flames. Condensation resins need the appropriate additives to make the adhesive joint elastic. The guideline values may vary depending on the hardness type. Contamination from leftover adhesive or hardener cannot be removed from the Duropal-HPL surface after gluing without damaging the material. Please make sure that all traces are removed. In cold and hot pressing, the same tooling requirements apply as for dispersion adhesives.

### **c) CONTACT ADHESIVES**

**Without hardener:** When applying with a stopping knife, the direction of application on the core material and laminate should be at right angles to each other. A brush or spraying or casting system may also be used for application. Whatever your choice, do take the greatest care when processing and ensure that there is adequate ventilation. Contact adhesives require short, firm pressure. The open time can be reduced by accelerating the drying of the adhesive films, but do make sure not to over-dry. Dried-on adhesive can be removed by heat, e.g. infrared rays. The pressure process is as follows.

**With hardener:** This adhesive makes the joint suitable for greater stresses and more resistance to temperatures. For further information please consult the manufacturer.

### **d) MIXED ADHESIVES**

We are unable to provide general recommendation for processing since this category is divided into various types, and is only used for special bonding applications.

### **e) HOT MELT ADHESIVES**

Used mainly on edging.

## **7.6.5 POSTFORMING**

### **THE CORE MATERIAL**

It is important to choose a material in which the chips have the same thickness or size throughout, such as chipboard or MDF. Coarse chips in the middle layer of the chipboard may cause the HPL to crack or tear, depending on the quality of the milling

### **PROFILE MILLING**

Ensure that the transitions between round and flat areas on the profile are even and that all cuts are smooth and clean. The radius of a postformed product is defined as the radius of the profiled core material.

### **CONDITIONING**

Please observe the recommendations for storage and pre-treating. The postforming results may be adversely affected if not, especially if the environment is too dry.

### **BONDING METHODS FOR POSTFORMING AND COATING**

In order to prevent tears and cracks, all traces of adhesive must be removed. This is particularly essential at the transition between rounded and flat areas. The same special adhesive, e.g. PVAc glue or contact adhesive, is to be used for Duropal-HPL and the balancer.

### **PROCESS BASED ON THE SYSTEM CONFIGURATION (EXAMPLE)**

The continuous process consists of the following steps:

- Cut and profile mill the core material
- Compress the Duropal-HPL (standard type P = postformable) and balancer
- Router the edges of the balancer
- Apply adhesive to the underside and edge of the Duropal-HPL (approx. 120–180 g/m<sup>2</sup>)
- Postform at 160–210°C. It is advisable to test first. If postforming continuously, the feed speed should be 11–17 m/min.
- Use a coarse cutter to remove any projecting Duropal-HPL, then finish with a fine cutter at an angle of approx. 30°.



## **HEAT TRANSFER**

Basically, two different methods can be used.

- Infrared heat: stationary or continuous.
- Directly applied heat: stationary.

With both systems, care must be taken to ensure that enough heat is available to facilitate postforming. Thin Duropal high pressure laminates heat up very quickly, and so must be processed quickly. With continuous postforming, bending should commence at the end of the heating zone.

All machine systems should be set to their ideal dosage before the actual postforming process because every material responds to a different speed and temperature. It is important that Duropal-HPL is exposed to uniform heat throughout before you commence the bending process. The temperature depends on the thickness of the laminate, the surface structure and the bending profile.

With continual processing machines, the maximum heat output needs to be set at the corresponding variable speed. Continuous postforming should, if at all possible, be done using a fixed bending block.

On stationary machines, perform a trial run first in order to establish the optimum heat effect on the bending speed. Ideally, start at a high temperature and adjust the speed accordingly. Use a heating rail to keep the initial stage low and continuous for postforming. Avoid having the temperature too low in order to prevent cracks/tears. Discoloration may result from too high temperatures, along with cracks/tears, distortion or blistering.

## **POSTFORMING PROPERTIES OF DUROPAL REAL METAL LAMINATES**

All Duropal real metal laminates are made in postforming quality. With a thickness of 0.8 mm, radius of 8 mm or greater can be produced for brushed surfaces, and on smooth surfaces a radius of 10 mm or more is possible.



## **8. INSTALLATION OF DUROPAL WINDOWBOARDS**

Please observe the following recommendations when installing our Duropal windowboards.

### **8.1 INSTALLATION / ATTACHMENT**

Duropal windowboards are high quality composite elements made of Duropal high pressure laminate (HPL) and wood-based chipboard E1, and are easy to process. They are glued to a dowelled substructure (chipboard strips V100 or equivalent laminate strips) around the parapet. They can also be bonded using a PU adhesive on an appropriately prepared core board. If using ventilation bricks, they can be laid with underscrewed anchor bolts in the bedding compound (plaster). If, for structural reasons, the Duropal windowboard has to go on a closed, large bed of mortar, then a moisture barrier will be required between the Duropal windowboard and the mortar (e.g. roofing felt, aluminium foil). Where no continuous base is planned, e.g. on brackets, the Duropal windowboard must be attached in at least three places in order to prevent bending/buckling or distortion. We advise against two-point fastenings. The distance between the supports is determined mainly by the expected load, but should not exceed 80–100 cm.

### **8.2 CONNECTING AND SEALING TO BRICKWORK**

Plastic sealants, available in tubes, are the ideal solution here. They provide a perfect seal between the plaster and Duropal windowboard and prevent moisture from penetrating. Particularly good seals are achieved if the Duropal windowboards are degreased before applying the sealant, e.g. silicone, and pre-treating with a primer.

### **8.3 DISTANCE FROM RADIATORS**

The distance between the radiator and the Duropal windowboard should not be less than 50 mm. It is advisable to insulate the underside of the windowboard with insulant, and is essential in the case of heat sources with high temperatures.

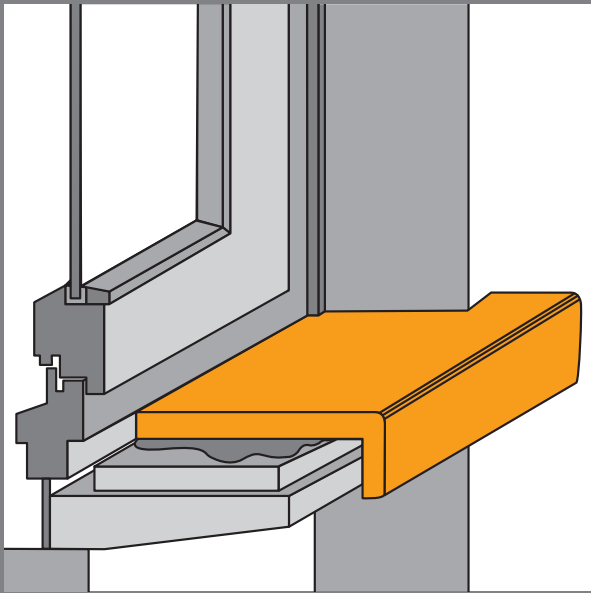

Bonding on wood subconstruction

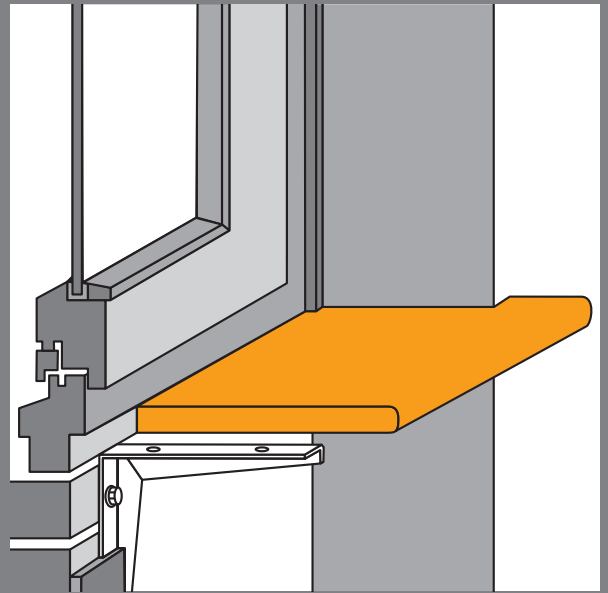

Installation on brackets

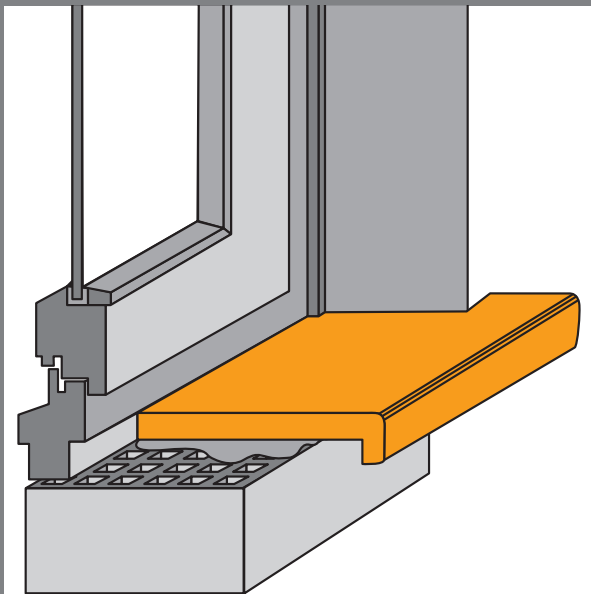

Installation with anchor screws  
on bedding compound

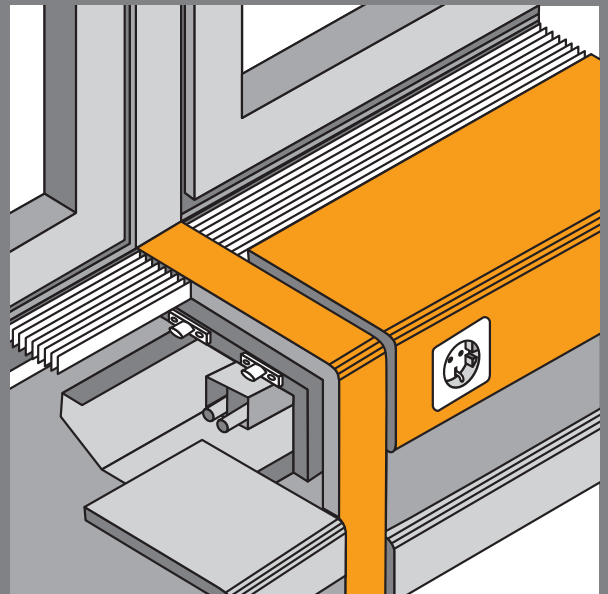

Installation with cable duct

# RECOMMENDATIONS FOR PROCESSING DUROPAL-HPL-SOLID

Duropal-HPL-Solid has a high net weight. The value of the material is considerable so please observe the following recommendations for handling and processing.

---

## RECOMMENDATIONS FOR THE HANDLING AND PROCESSING OF DUROPAL-HPL-SOLID

### TRANSPORTATION AND STORAGE

#### TRANSPORTATION

- Please ensure that, if transporting on pallets, they are sufficiently large, flat and strong.
- The pallets and stacks of boards must be secured against slipping and sliding.
- Foreign bodies and abrasive impurities on the stack of boards should be avoided as they may cause indentations and damage.
- When loading and unloading the stacks by hand or with suction lifter, lift each one individually; do not push or pull them against each other.

#### STORAGE

- You will achieve the optimum storage conditions in closed rooms under normal indoor room conditions (temperature 18-25 °C, relative humidity 50-65%).
- Items are to be stored horizontally on a flat surface, with the edges flush, and the whole stack wrapped in plastic film. The whole surface of the top board must be covered by a cover panel.
- Stacks of boards must be wrapped in plastic film.

#### 2. CONDITIONING

- Before processing, Duropal-HPL-Solid and the core material must be stored together for at least eight days at 20 °C and 50% relative humidity.
- Please ensure that the materials do not get too damp.

### **3. PROCESSING**

#### **CUTTING**

- We recommend carbide or diamond tipped saw blades for cutting, as for the processing of Duropal-HPL.
- Work with a lower feed rate on Duropal-HPL-Solid than on Duropal-HPL-elements.
- If using compact laminate with decor on both sides, you can avoid tearing the lower layer by changing the exit angle. You can achieve this by adjusting the height of the saw blade – good results can also be achieved by placing chipboard, MDF or Duropal-HPL underneath.
- You will achieve the optimum cutting quality of the lower edge if you use a pre-scoring device.

#### **ROUTING AND DRILLING**

- We recommend carbide or diamond tipped routers with a high rotational accuracy in order to minimise chatter marks. The use of special router heads has proved worthwhile for high volumes.
- Secure tool guides and fences are essential due to the high cutting pressure.
- Cutting marks on the milled surface are unavoidable. If guided mechanically, they can be reduced by milling at an even speed. Any remaining marks can be removed by sanding and polishing.
- The appearance of the edges can also be improved by treating them with silicone-free furniture oils.
- Freestanding corners and edges must be chamfered to avoid the risk of injury.
- Drills for plastics are the most suitable.
- Working on a firm base and constant reduction of the feed speed will prevent the Duropal-HPL-Solid from splintering on the exit side.
- Ideally, use drills with a tip angle of 50-60° for through-holes.
- When centre-drilling, please remember to retain the minimum board material. For blind hole drills, you will need to leave at least 1.5 mm, and for drills parallel to the board level at least 3 mm.
- Threads can easily be cut and self-tapping screws can be used in any Duropal-HPL-Solid variety.

#### **INTERNAL RECESSES AND CUT-OUTS**

- The corners of internal recesses and cut-outs must be rounded with particular care and generosity.
- The inner radius must be at least 5 mm.

#### **BONDING SHEET MATERIAL**

- The bonded joints are to be made so that they do not prevent any dimensional changes in the Duropal-HPL-Solid. Furthermore, ensure that the boards are all bonded in the same direction of pattern.

## **POSTFORMING**

- Mill one side of the area for forming to approx. 1 mm, depending on the desired radius.
- Avoid overheating during the milling process and ensure that the tool and work piece are guided correctly so as not to jeopardise the postforming properties.
- Duropal-HPL-Solid is shaped under heat in a stationary postforming press.
- Once the moulded Duropal-HPL-Solid has cooled, the remaining cavity is filled out with hardening synthetic resin or secured using adaptor pieces.

## **FIXINGS**

- When attaching rigid objects (e.g. profiles, strips, fittings), make the drill holes in the Duropal-HPL-Solid a little larger for continuous screw attachments. With non-continuous screw attachments (e.g. splay dowels) make the drill holes for the objects being attached a little larger as well. Here, too, we advise the use of a lubricant film between the object and the Duropal-HPL-Solid.
- Self-tapping screws with a slight angle offer good screw-holding values. However, pre-drilling is always required. The drill hole diameter must be one thread depth less than the outer diameter of the screw. When inserting screws, the drill hole must be at least 1 mm deeper than the penetration depth of the screw. Screws should be lubricated before insertion.
- The highest screw-holding value is achieved with splay dowels, although they should not have any cutting burrs. The residual thickness of the Duropal-HPL-Solid must be at least 1.5 mm. The use of expansion plugs parallel to the panel plane is not recommended.
- For a thorough attachment, the drill holes should be at least 2-3 mm larger than the diameter of the fixing material. The required freedom of movement can be achieved by using elastic sleeves (e.g. polyamide).

## **DOORS**

- Small doors (e.g. for furniture) in Duropal-HPL-Solid can be fitted with two hinges.
- Large doors for toilet cubicles and changing rooms should be attached by more than two hinges in order to guarantee the necessary stability.
- When choosing hinges, take account of the necessary expansion play for Duropal-HPL-Solid. In order to keep it small, the door panel should be cut lengthwise out of the board. The frame construction must be stable, level and stress-free; the door latch, locks and any rubber seals must not create constant tension in the door panel.
- A constant increase in humidity and/or temperature on one side of the door may distort the panel. You should therefore ensure that there is an adequate circulation of air.

## **INSTALLATION**

- The subconstruction and Duropal-HPL-Solid will change under the influence of relative humidity and different temperatures. You must therefore ensure during installation that there is sufficient play around the attachment so that the subconstruction and panelling can move accordingly.
- With panelling, you must also note the following:
- The stability of panelling is determined by the subconstruction and the thickness of the panelling material.
- The subconstruction must be protected against corrosion and rotting.
- Ensure that there is adequate back ventilation. If there is inadequate ventilation, then varying climatic conditions may cause distortion on the front and reverse side. If no adequate back ventilation is provided for reasons concerning planning laws, then our Duropal-HPL-Solid quality Duropal DPHPL Solid FR with moisture barrier must be used to counteract the distortion.
- The Duropal-HPL-Solid must have sufficient freedom of movement (expansion and retraction).
- One particular advantage of Duropal-HPL-Solid is that joints or partitions in the boards can be arranged so that the installations will also be accessible at a later date.

## JOINTS

- If two Duropal-HPL-Solid panels are to be connected with tongue-and-groove, then the following guidance figures will apply:
  - groove width  $a$  approx.  $d/3$
  - groove cheek thickness  $b$  approx.  $d/3$
  - tongue length  $c$   $\geq 10$  mm
  - board thickness  $d$   $\geq 10$  mm
- Due to possible dimensional changes, the Duropal-HPL-Solid must be installed with sufficient play between the tongue and groove.
- Duropal-HPL-Solid of less than 10 mm thickness should not be connected to tongue-and-groove.
- Connection with a "false tongue" is also advantageous, as it facilitates full use of the panel size and makes processing easier.
- Corner connections should only be carried out using brackets or corner rails, according to the expected load.

## 4. CLEANING

- Like Duropal-HPL and Duropal-HPL-elements, Duropal-HPL-Solid is highly resilient and requires nothing in the way of special care.
- Remove light dirt with a soft, damp cloth.
- Heavier dirt can be removed with soap suds or normal household cleaning products, and although detergents with mildly abrasive components may be used, we advise against them.  
Remove stubborn dirt with an organic solvent (white spirit, acetone etc.).  
Detailed information on cleaning and caring for Duropal-HPL-Solid is to be found in the next chapter.

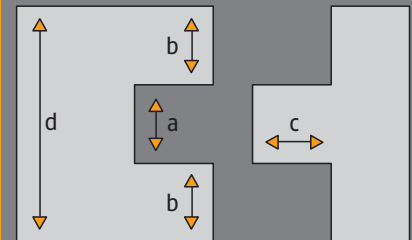



# CLEANING AND CARING FOR DUROPAL-HPL

## PLEASE OBSERVE OUR ADVICE ON CLEANING AND CARING FOR DUROPAL-HPL

The following information applies for the surfaces of decorative Duropal-HPL to EN 438 and any elements made therefrom. The cleaning information applies both for the dirt that occurs in normal use and for more severe dirt that can occur during the processing and installation of Duropal-HPL-elements.

Duropal Real Metal laminates are cleaned with a soft cloth and mild detergents with no abrasive components. Stubborn stains can be removed with benzine. Acetone is not recommended.

---

## GENERAL INFORMATION

Thanks to its highly resistant, hygienic closed surface, Duropal-HPL needs nothing particular in the way of care. It is easy to clean.

Special cleaning products are not needed. Furniture polish and cleaning products containing wax must not be used. Use the mildest cleaning products possible. In particular, do not use any products with abrasive components.

It may occasionally be necessary to use special cleaning products that are caustic, contain solvents or are flammable. In these cases the relevant accident prevention regulations must be observed and the rooms ventilated adequately. The identification stamp applied at our factory is in water-soluble dye, and so should only be removed with water.

## CLEANING RECOMMENDATIONS

Please find below cleaning information and some sample descriptions of specific problems. Needless to say, always start with the mildest method.



Light, fresh dirt



Normal dirt, longer effect



Severe, stubborn dirt, old marks/stains

## DUST, DIRT, A MIXTURE OF DUST AND GREASE, PENCIL, CHALK

Paper towels; soft, clean cloths (dry or damp); sponge or similar. Dry with absorbent cloth after wet cleaning.

Clean hot water, clean cloth or towels, soft sponge or brush. Microfibre cloths dipped in hot water are ideal. Allow a standard cleaning product with no abrasive components, soap powder, soft or hand soap to work according to the level of dirt, and afterwards rinse to remove all traces and prevent smears. Wipe dry with clean, absorbent cloths (preferably paper towels), changing the cloth frequently.

## GREASE, OIL, FINGERPRINTS, FELT AND HIGHLIGHTER PEN, INK, NICOTINE, RUBBER MARKS

Clean as for dust, dirt, pencil and chalk.

Clean as for dust, dirt, pencil and chalk. Organic solvents such as acetone, white spirit, benzene, nail varnish remover.

Leave a solution with soap powder or detergent and water to work overnight; liquid cleaner with the finest polishing chalk. **Not to be used on high gloss surfaces!** Mild bleaches (with care). **Only to be used occasionally. Remove all traces of bleach after a short time (10–15 minutes).**

## LIMESCALE, CHALKY DEPOSITS (WATERMARKS), RUST

Clean as for dust, dirt, pencil and chalk.

Clean as for dust, dirt, pencil and chalk.

Leave a solution with soap powder or detergent and water to work overnight; liquid cleaner with the finest polishing chalk. **Not to be used on high gloss surfaces!** Mild bleaches (with reservation). **Only to be used occasionally. Remove all traces of bleach after a short time (10–15 minutes).** Particularly stubborn chalk marks may be removed with an acidic detergent (10% acetic or citric acid).

## COFFEE, TEA, FRUIT JUICE, SUGAR SOLUTIONS

Clean as for dust, dirt, pencil and chalk.

Clean as for dust, dirt, pencil and chalk.

Leave a solution with soap powder or detergent and water to work overnight; liquid cleaner with the finest polishing chalk. **Not to be used on high gloss surfaces!** Mild bleaches (with reservation). **Only to be used occasionally. Remove all traces of bleach after a short time (10–15 minutes).**

## WAX MARKS, WAX CRAYONS

 Clean as for dust, dirt, pencil and chalk.

 Clean as for dust, dirt, pencil and chalk. Organic solvents such as acetone, white spirit, benzene, nail varnish remover. Remove paraffin and wax residues by mechanical means. Avoid scratching; use a plastic or wooden scraper. Iron off residue over blotting paper.

 Leave a solution with soap powder or detergent and water to work overnight; liquid cleaner with the finest polishing chalk. **Not to be used on high gloss surfaces!** Mild bleaches (with reservation). **Only to be used occasionally. Remove all traces of bleach after a short time (10-15 minutes).**

## LIPSTICK, SHOE POLISH, FLOOR POLISH, WAX POLISH

 Clean as for dust, dirt, pencil and chalk.

 Clean as for dust, dirt, pencil and chalk. Organic solvents such as acetone, white spirit, benzene, nail varnish remover.

 Leave a solution with soap powder or detergent and water to work overnight; liquid cleaner with the finest polishing chalk. **Not to be used on high gloss surfaces!** Mild bleaches (with reservation). **Only to be used occasionally. Remove all traces of bleach after a short time (10-15 minutes).**

## BACTERIOLOGICAL CONTAMINATION (SOAP RESIDUE, SKIN CELLS, PATHOGENS, BLOOD, URINE, FAECES)

 Clean as for dust, dirt, pencil and chalk.

 Clean as for dust, dirt, pencil and chalk.  
Additional treatment with disinfectant in accordance with the relevant regulations. May be steam cleaned.

 Leave a solution with soap powder or detergent and water to work overnight; liquid cleaner with the finest polishing chalk. **Not to be used on high gloss surfaces!** Mild bleaches (with reservation). **Only to be used occasionally. Remove all traces of bleach after a short time (10-15 minutes).**

### **SHADING AFTER TREATMENT WITH SOLVENTS (SMEARS)**

 Clean as for dust, dirt, pencil and chalk.

 Clean as for dust, dirt, pencil and chalk.

### **WATER-SOLUBLE DYES, STAINS, EMULSION PAINTS, ADHESIVES, EMULSIONS (PVAC)**

 Clean as for dust, dirt, pencil and chalk.

 Clean as for dust, dirt, pencil and chalk.  
Water or organic solvents.

 Soften with water or organic solvents, then peel or pull off.

### **SOLVENT-BASED LACQUERS, PAINTS AND ADHESIVES (PAINT RESIDUE, SPLASHES, SPRAY AND STAMP DYE)**

 Organic solvents.

 Organic solvents such as acetone, white spirit, benzine.  
In production processes using adhesives and lacquers, it is advisable to consult with the manufacturer regarding the most suitable cleaner for removing any dirt or marks left over from the manufacturing process.

 Soften with water or organic solvents, then peel or pull off.  
Dye residues can sometimes be removed mechanically once dry.

### **TWO-COMPONENT LACQUERS AND ADHESIVES AND ARTIFICIAL RESINS E.G. UREA RESIN**

 Remove immediately! Water or organic solvents.

 Can only be removed before hardening.  
Remove directly after contact with water or organic solvents.  
In production processes using adhesives and lacquers, it is advisable to consult with the manufacturer regarding the most suitable cleaner for removing any dirt or marks left over from the manufacturing process.

 Cannot be cleaned! It is not usually possible to remove residues of condensation and reaction resin adhesives once they have hardened.

### **SILICONES, SEALANTS, FURNITURE CARE PRODUCTS**

 Rub dry; silicone remover.

 Silicone remover.



### **IMPORTANT INFORMATION**

Please clean your Duropal-HPL surfaces regularly during use. Special cleaning products are not generally required. Smears may occur when cleaning with organic, oil-based solvents (e.g. benzine), with cold water and cloths or chamois leathers that have been used repeatedly. In order to clean without shading or smears, we recommend rinsing the items with hot water and then drying them with paper towels.

Furniture polish and wax-based detergents may fill the structure in Duropal-HPL surfaces and build up to form a layer that attracts dirt. Do not use abrasive or scouring products for regular cleaning, and avoid furniture polish, furniture cleaners and products with bleach. Detergents with strong acids or saline will damage the surface (limescale remover with antacid and aminosulphonic acid, drain cleaner, hydrochloric acid, silver cleaner and oven cleaner).

### **PLEASE OBSERVE THE FOLLOWING WHEN CLEANING WITH SOLVENTS:**

- Accident prevention regulations
- Open windows
- No open flames

Should you have any questions, we will be pleased to be of assistance.

### **CLOSING STATEMENT:**

The information contained here is based on the latest findings from science and technology. It does not represent a guarantee. It is the personal responsibility of the individual user to observe the products described in this data sheet, the current laws and regulations.

**DUROPAL GMBH**

---

Westring 19–21  
59759 Arnsberg  
Germany

Tel.: +49 (0) 2932/302-0  
Fax: +49 (0) 2932/302-341  
info@duropal.com  
www.duropal.com

A Pfeleiderer company

As at 10/2010  
Errors and omissions excepted.