



2026

BROCHURE

HORIZONS



To become the leading provider of finishes for residential projects throughout Mexico.

PROPÓSITO

To meet our clients' needs by creating comprehensive solutions for their projects, offering personalized service before, during, and after their construction or remodeling process, ensuring complete satisfaction.

CULTURA

These are the values we share with our team. They guide the way we serve our clients, always striving to deliver tailored solutions and achieve outstanding results.

-  Commitment
-  Responsibility
-  Honesty
-  Respect
-  Efficiency
-  Loyalty
-  Communication

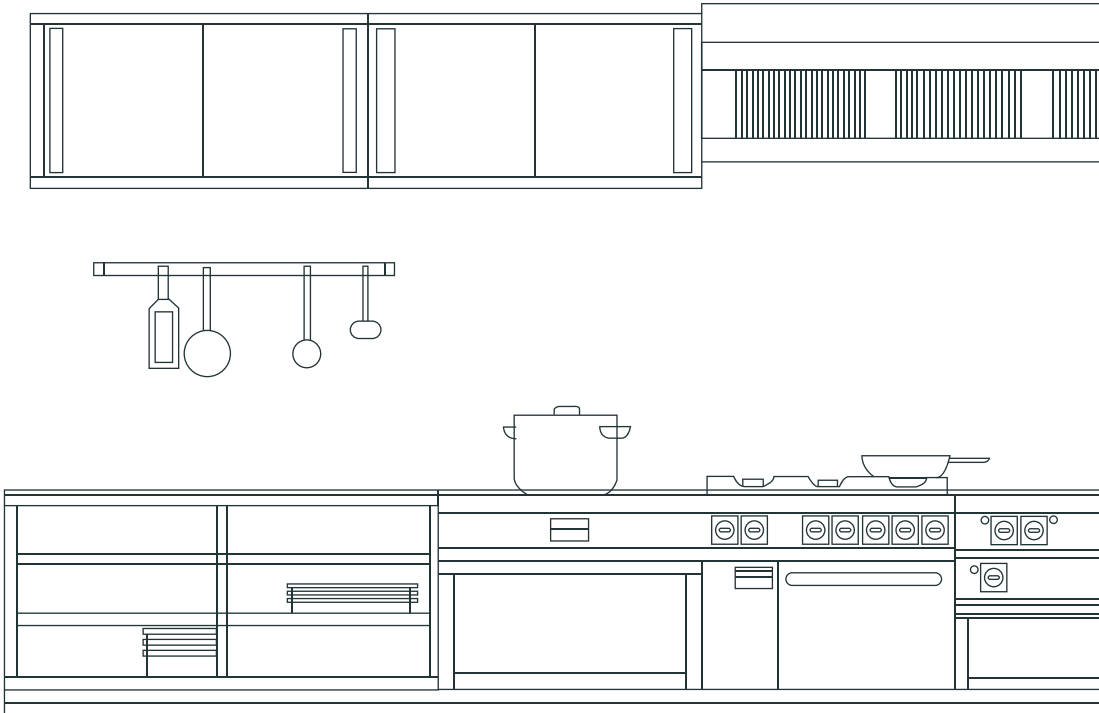

¿WHY DO WE EXIST?

At Somerlanne, we **believe every space has the potential to transform into a reflection of people's dreams and aspirations.**

We are passionate about **turning concepts into reality, blending aesthetics, comfort, and sustainability.**

We strive to create livable spaces that are not only visually striking, but also warm, welcoming, and enduring.

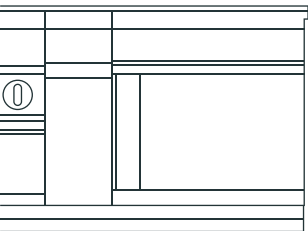

FUTURE VISION

Our vision is to leave a lasting legacy through aesthetic, eco-friendly, and long-lasting finishes.

We are **committed to minimizing our environmental impact by implementing sustainable practices** and using environmentally responsible materials.

We believe the spaces we create today should endure for future generations, serving as a clear testament to our commitment to excellence and responsibility.

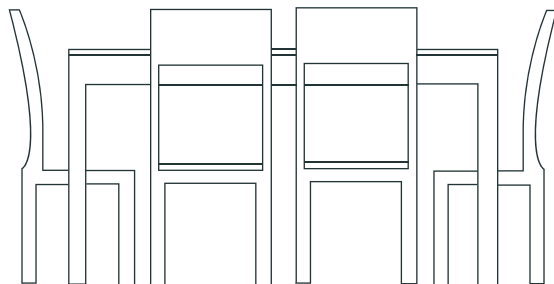

OUR PHILOSOPHY

Consistency, sincerity, loyalty, integrity, and respect for the environment.

These core principles define our company's foundation and guide all our actions. **We strive to deliver the highest quality products and services,** providing our clients with an exceptional experience at every interaction.

Innovation drives our continuous growth, pushing us to constantly develop new solutions and exceed expectations.

CONTENT

01



KITCHENS

02



CLOSETS

03



BATHROOMS

04



DOORS

05



PRODUCTS

06



PROCESSES

07



SOMERLANNE
PRESENCE



KITCHENS

In this special edition, we present a curated selection of the latest trends and styles in kitchen design. From modern, minimalist kitchens to classic and inviting spaces, we offer solutions for every taste and lifestyle.

Allow us to inspire you as you explore our main kitchen design collections:

MIA: A kitchen defined by freshness and youthful character. A personalized canvas that reflects diverse styles through a refined palette of innovative finishes and materials.

ERIKA: A rational, modular design that blends Italian elegance with adaptable and sophisticated functionality.

LICIA: A synthesis of classic and contemporary kitchen design, combining the warmth of wood with forward-thinking aesthetics.

MAGISTRA: Contemporary kitchens with a touch of nostalgia, merging materials to create a distinctive character.

VOLARE: Design-driven kitchens with strong personality, natural materials, and striking finishes.

MIA

MIA is a fresh and youthful kitchen, **designed to become a personal and expressive space.** It reflects the style and needs of those who live in it, offering a wide range of finishes and refined details.

From sleek, linear doors to the innovative backlit Magneto Lab backsplash, MIA **adapts to every taste and requirement.** We offer a broad selection of materials, including glass, colored laminates, wood, and textured surfaces with tactile finishes.



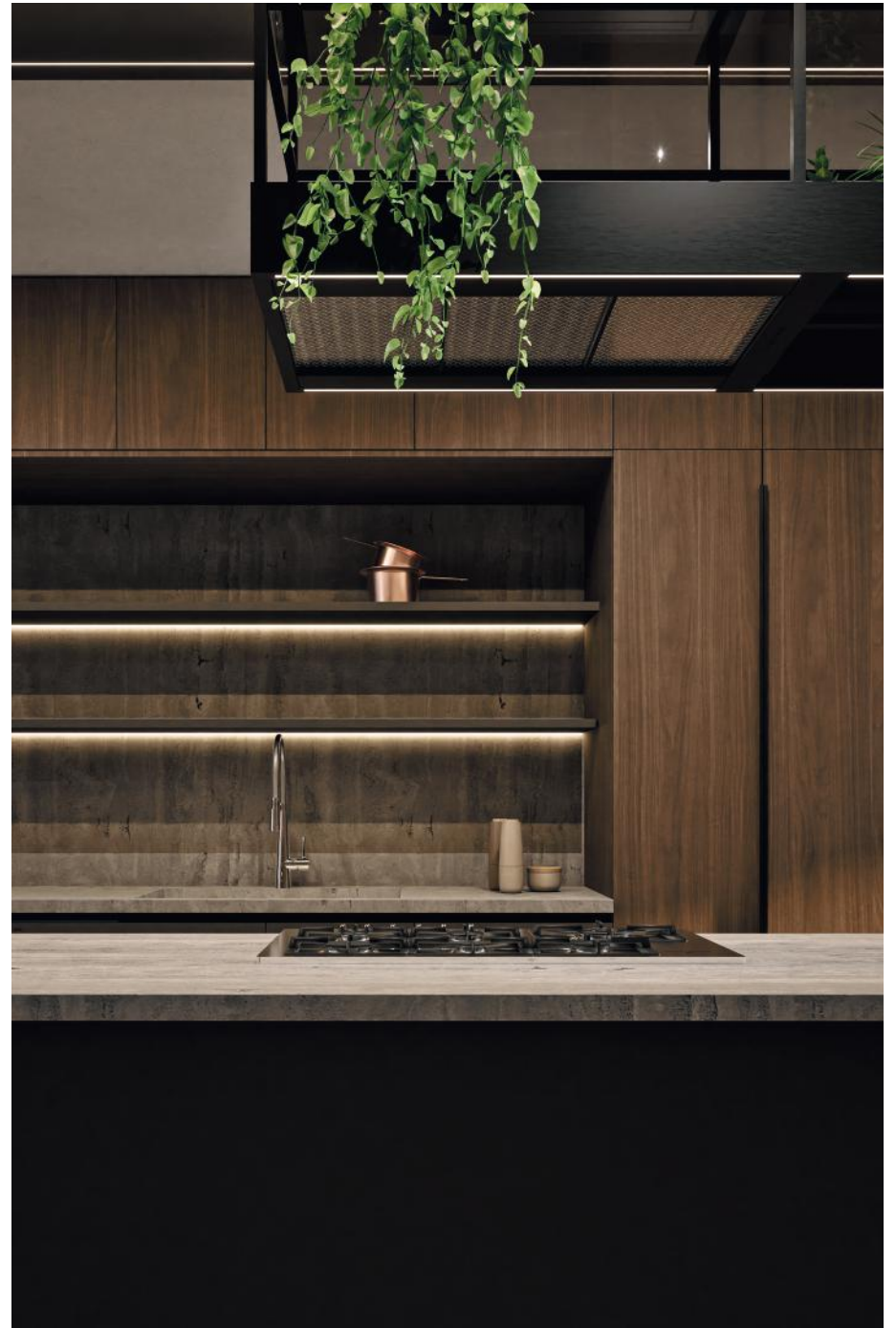



SOMERLANNE

SOMERLANNE



MAGISTRA

MAGISTRA is a kitchen collection **defined by a modern, metropolitan aesthetic that subtly evokes past eras**, adapting effortlessly to any environment.

Its design brings together a rich **combination of materials, including steel panels, silver-framed detailing, and finishes in white ash, clay, titanium, and green.** These elements are complemented by refined handles and integrated pulls that enhance its visual harmony.

This thoughtful blend creates a distinctive character, giving magistra a personality all its own.

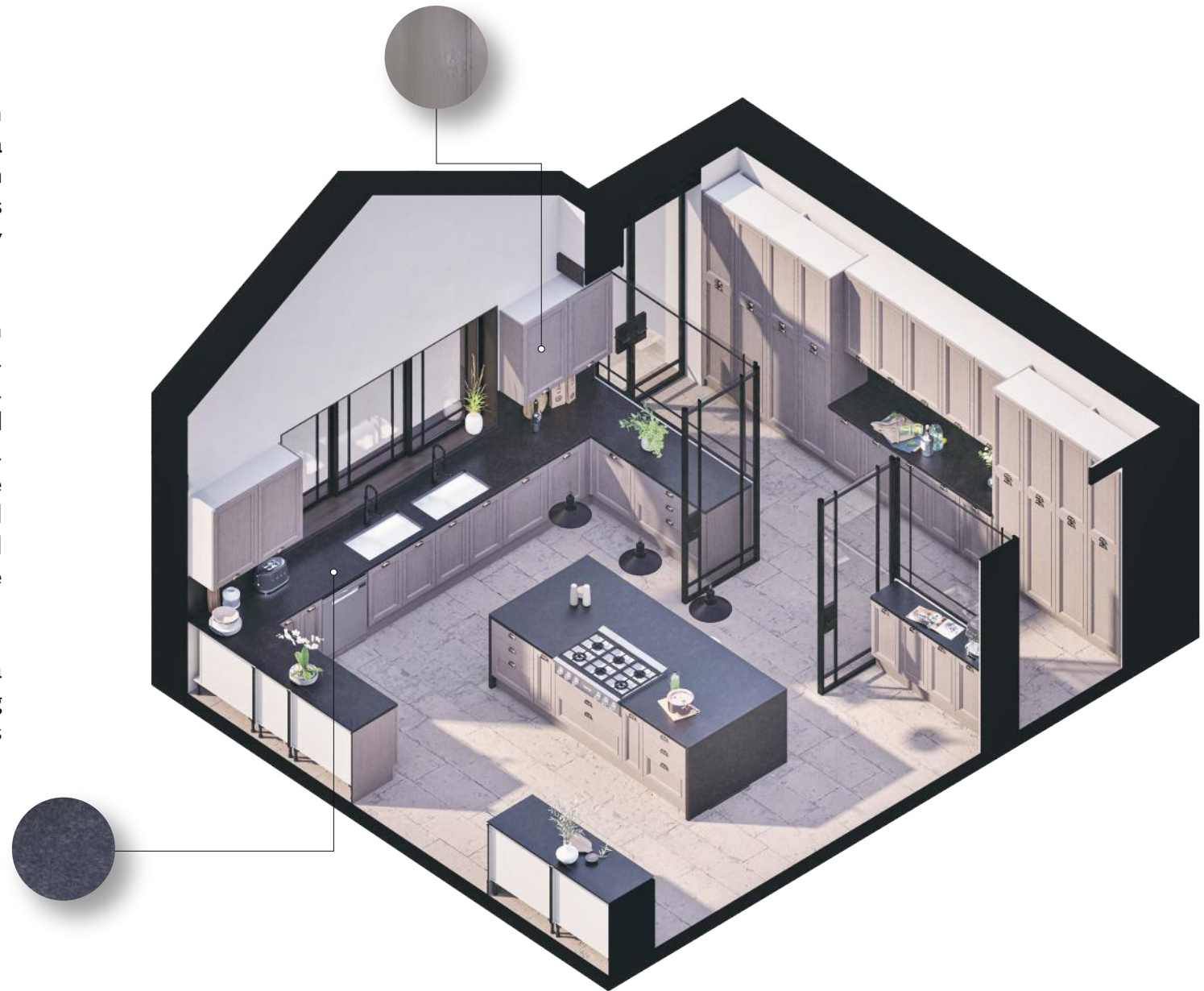



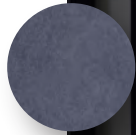



ERIKA

ERIKA is a **rational and modular furniture collection that delivers versatile solutions** for both spacious and compact environments.

Its cabinetry, shelving systems, and decorative accessories together with a wide range of finishes allow for the creation of tailored, ergonomic spaces, achieving a seamless integration of design and functionality.





ERIKA's refined and elegant design is expressed through its careful selection of premium materials and meticulous attention to detail. This collection **embodies the excellence of Made in Italy, offering versatile and aesthetically sophisticated furnishings.**

It is the perfect choice for those seeking functional yet elegant furniture that adapts seamlessly to their lifestyle.



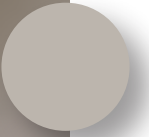
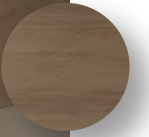
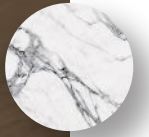

VOLARE

VOLARE is distinguished by its strong stylistic identity, defined by clean, essential forms.

Its **structural systems are carefully engineered to deliver maximum functionality, with meticulous attention to every detail.**

The materials used such as iron, wood, stone, and glass evoke the fundamental elements of nature.

Its rich range of finishes conveys both solidity and lightness, creating visually striking spaces.

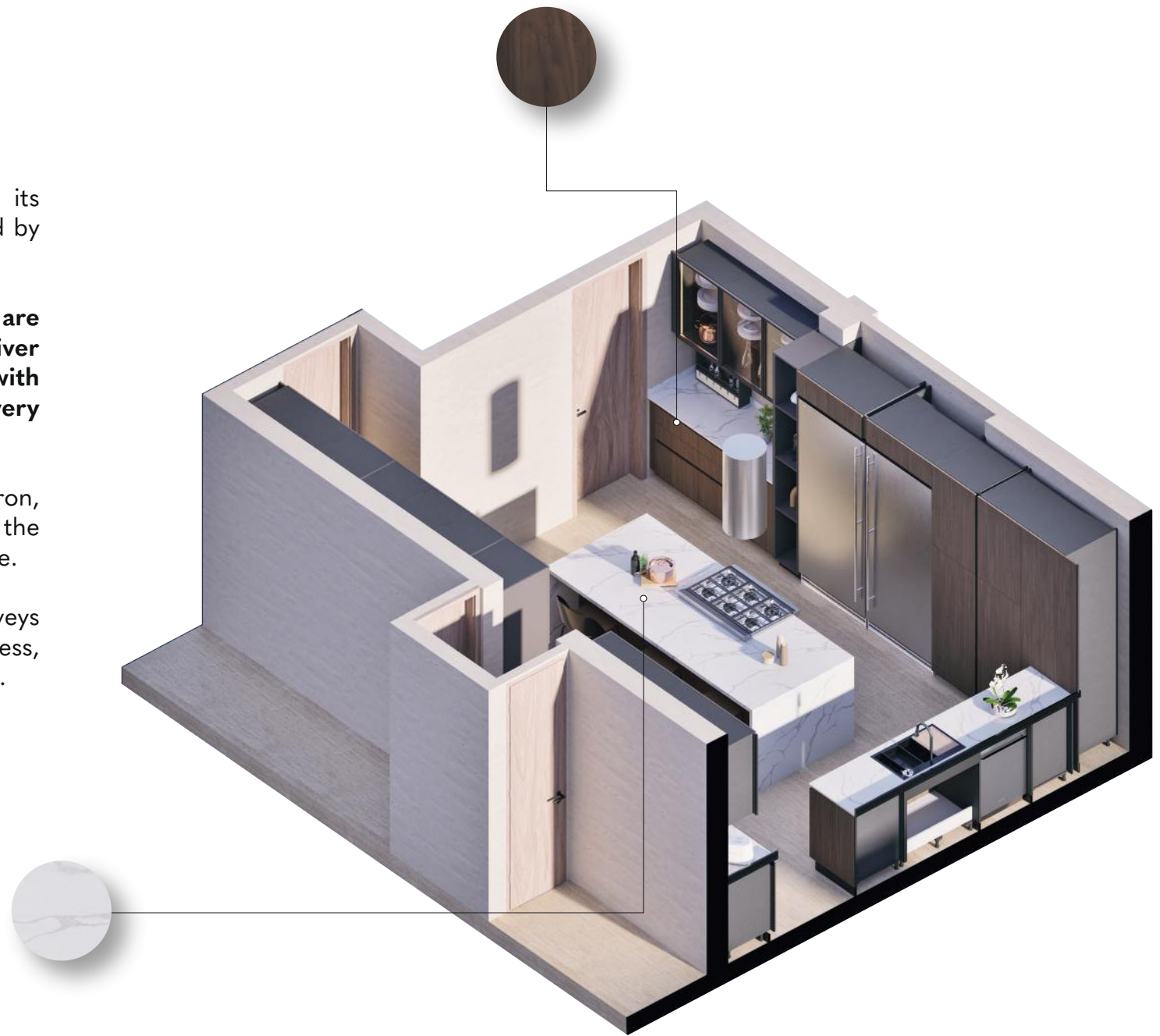







LICIA

LICIA is a kitchen collection that blends the warmth of wood with modern design, creating a concept of innovative tradition.

Crafted from classic materials such as solid oak, licia features handle-free doors without visible profiles, reinterpreting the concept of the dining space.

Its simple, essential forms combined with the natural warmth of wood create inviting and welcoming environments.

Licia is the **perfect choice for those seeking a kitchen that harmoniously combines tradition and modernity.**

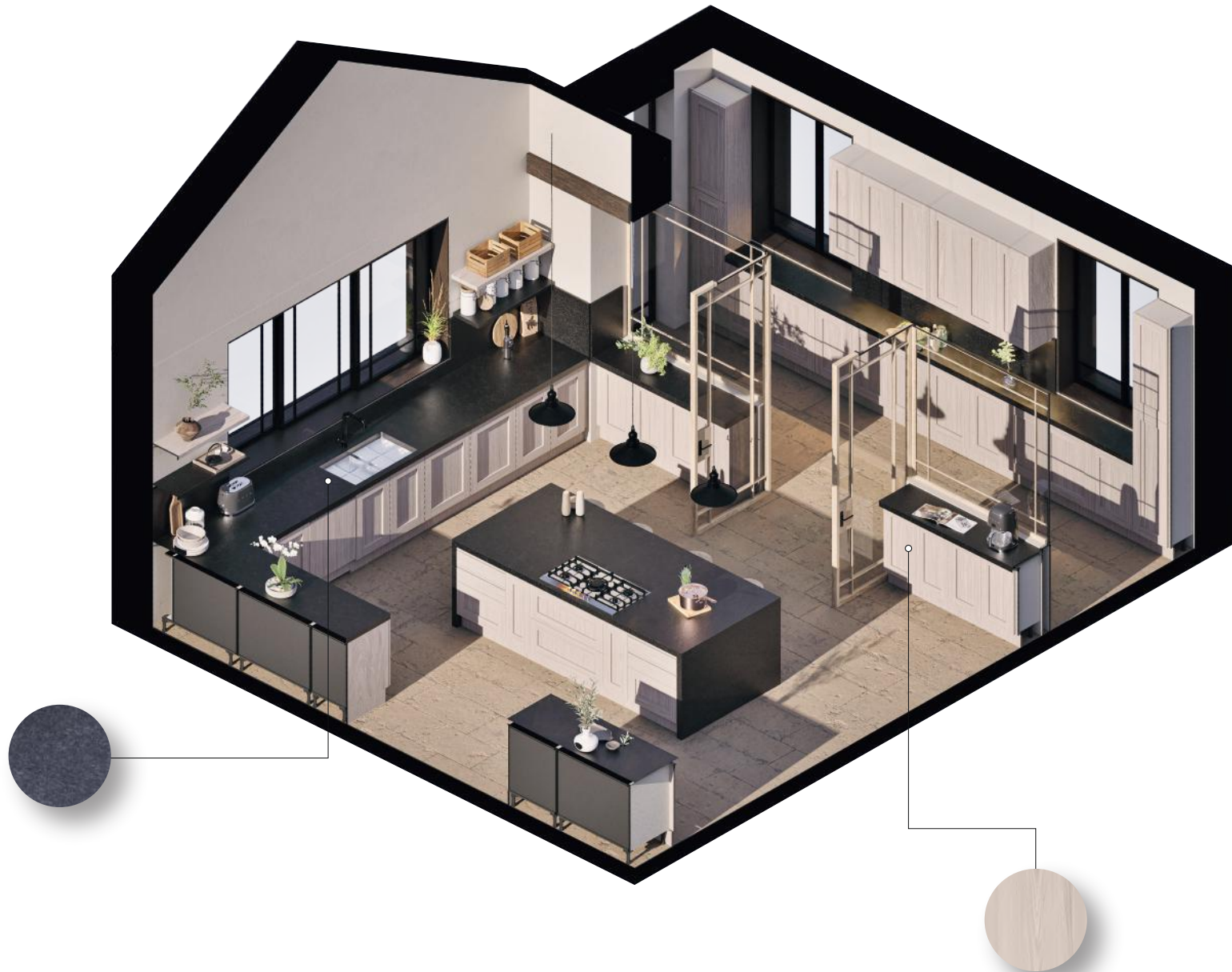







TA

maizinos
Verdes
rigo

Cebolla
ajo
de pin
Aceite

6



recetar los tomates,
el aceite, la cometa
A los pimientos
las berenjenas, Mele
leños

colado refresco, caldo
de repollo
o en dos litros
a un poco de agua
para conseguir una
Zade el pan con
aceite y se hace para
para conseguir que
en trébol y

lo frío y mezclar
obrar el punto de la

un colador chino
res para eliminar la
miga. Al haberlos
por los por
para así conseguir
PIMIENTO

(hollandés y es muy
al paladar.

los que si se
para que quede un
crema ligada. Para
para así conseguir
lo descaida y
para de servir reci
para de aceite de
para que mezcle
una cuchara de



LAB 13

LAB 13 is a constantly evolving kitchen collection where design and research converge to deliver innovative solutions. This line incorporates the latest technologies, both in premium materials and in advanced automation systems applied to cabinetry.

The inspiration behind LAB 13 stems from the desire to offer a wide variety of finishes and door styles that cater to contemporary tastes, while consistently maintaining versatility and modernity.

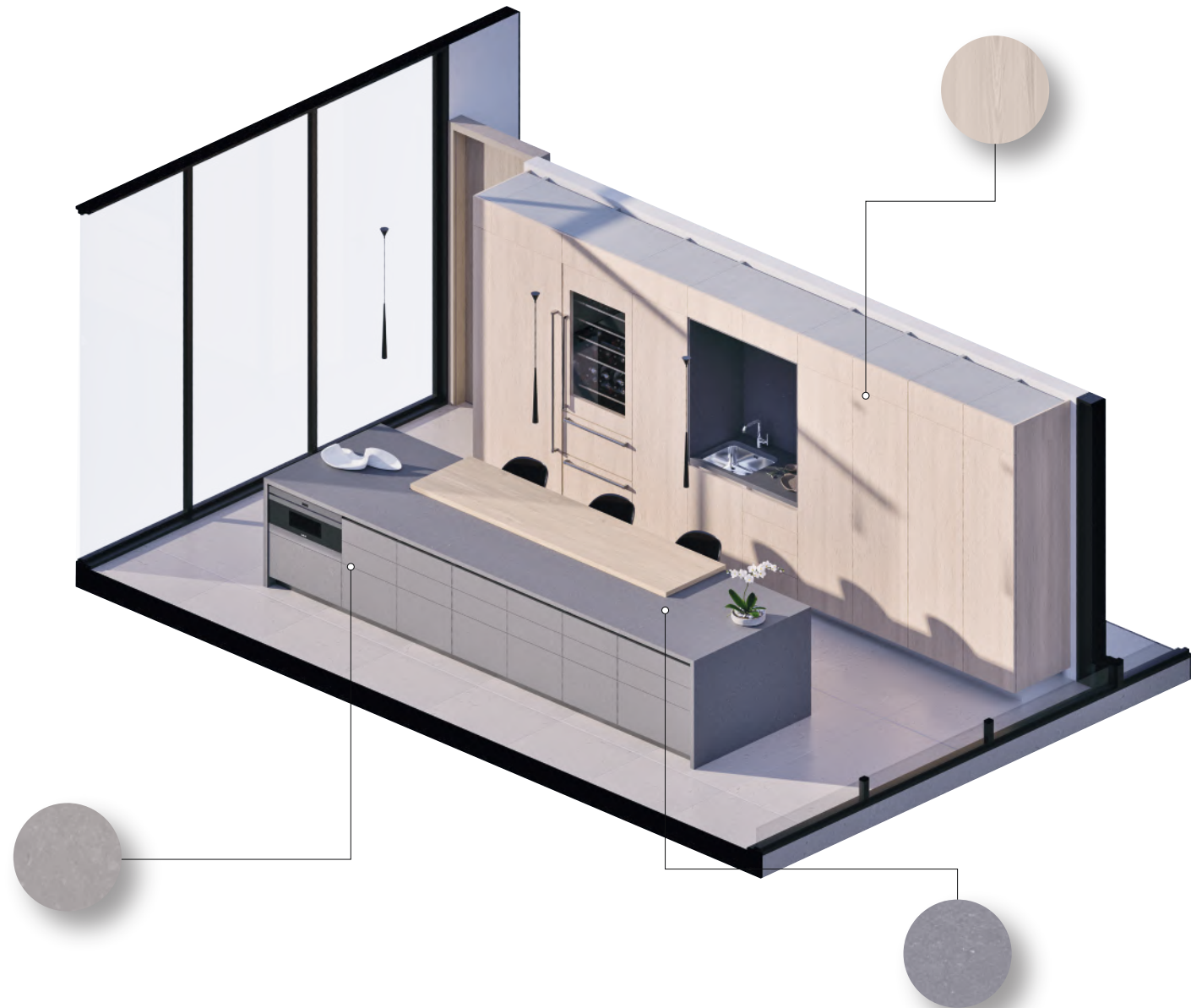





QUADRO

QUADRO is a collection that harmoniously blends form, materials, and finishes, driven by a constant pursuit of perfection in volumes and detailing.

Crafted in MDF coated with a poly-laminate finish, this model stands out for its slim 12 mm frame, giving it a refined and timeless aesthetic.

Available in versions with a handle or a concave integrated pull, quadro is the ideal choice for elegant, design-focused projects where color takes center stage. **A perfect balance between sophistication and functionality,** created to shape distinctive spaces full of character.

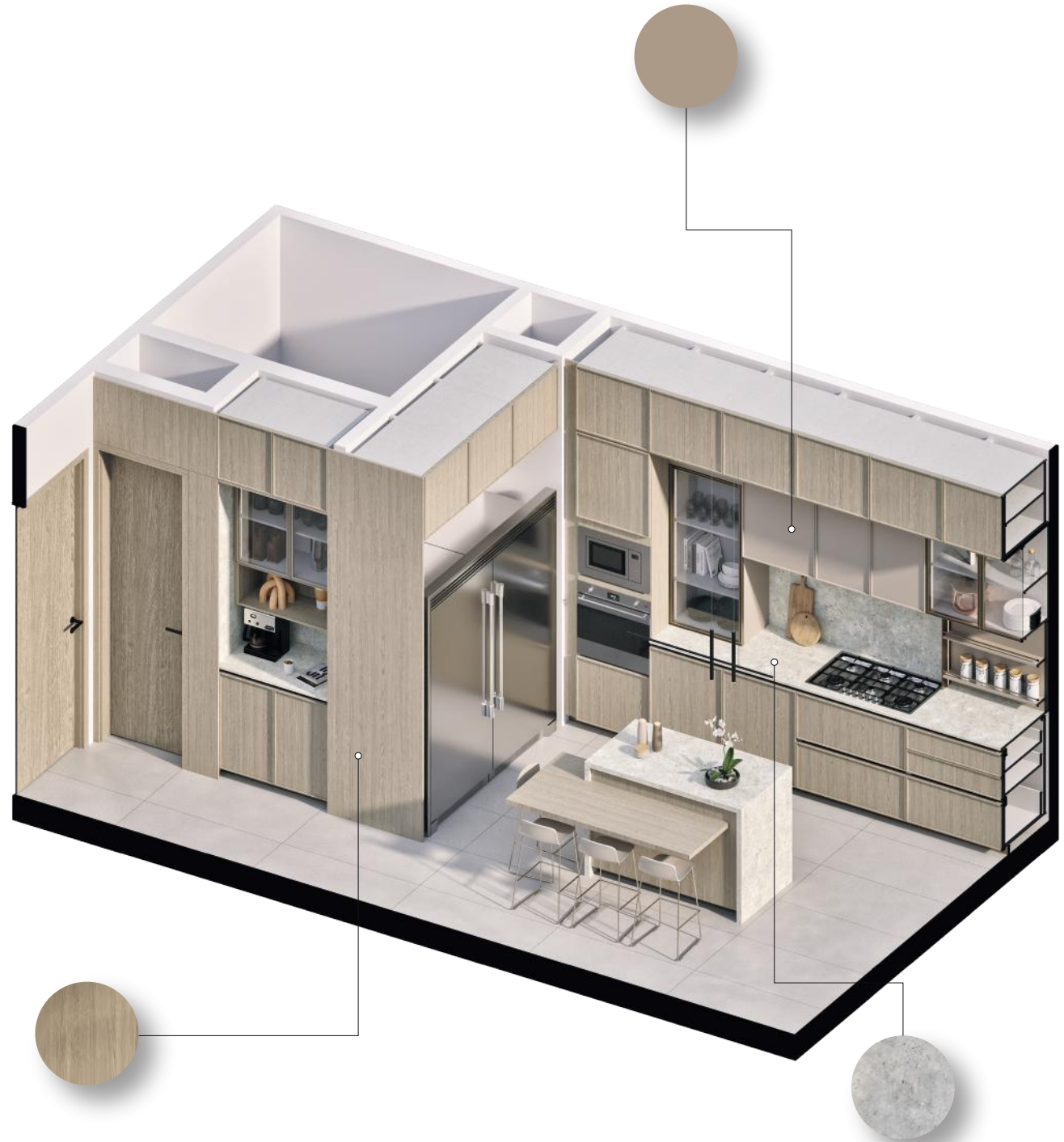









CLOSETS

In the following section, we introduce the world of closets essential spaces that keep the home organized with style.

We develop two main types of closets, designed to meet a variety of needs:

Exposed Closets: A practical and elegant solution for any type of space, offering a more traditional approach to storage.

Walk-in Closets: The dream of every fashion enthusiast, walk-in closets provide generous space for clothing, shoes, and accessories.

¡PREPÁRATE PARA TRANSFORMAR TU CLOSET
EN UN SANTUARIO DE ORDEN ESTILO!

EXPOSED

Designed to showcase each element with intention, the exposed closet transforms organization into an integral part of the design.

Its **open structure allows for a clear and functional display of garments, accessories, and essentials**, making everyday use effortless.

The combination of shelves, hanging rods, and open modules creates a balanced and aesthetically refined composition.

This **type of closet invites a more dynamic and contemporary way of experiencing the space.**









WALK-IN CLOSET

Everything is perfectly organized within a dedicated room or defined space that simplifies your daily wardrobe selection from storage organizers to glass-top islands designed for a tailored and visually refined layout.

Modular and versatile solutions with a minimalist and elegant aesthetic are thoughtfully developed to meet every need.

This panel-free, minimalist proposal enhances the sense of openness in any space, while creating a modern and comfortable atmosphere.







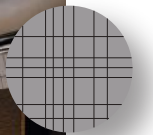



BATHROOM

In today's fast-paced world, our homes have become sanctuaries where we seek relaxation and rejuvenation.

The bathroom, **in particular, has evolved beyond being merely a functional space, transforming into a true oasis of well-being.**

In this section, we explore the concept of the bathroom as a space dedicated to self-care, unwinding, and revitalization.

Discover how design **elements, materials, and lighting** can come together to create an environment that promotes comfort and relaxation. Prepare to uncover the transformative potential of the bathroom as a space devoted to wellness and personal care.

¡LET YOUR BATHROOM BECOME YOUR SANCTUARY,
A PLACE WHERE YOU CAN RECHARGE AND UNWIND!











DOORS

Doors are architectural elements that frame spaces, provide privacy, and add a distinctive touch of style to any home. **We offer two main options** which, combined with our wide range of finishes, **allow for customization down to the finest detail.** In addition, our doors feature acoustic and thermal properties that enhance overall comfort and performance.

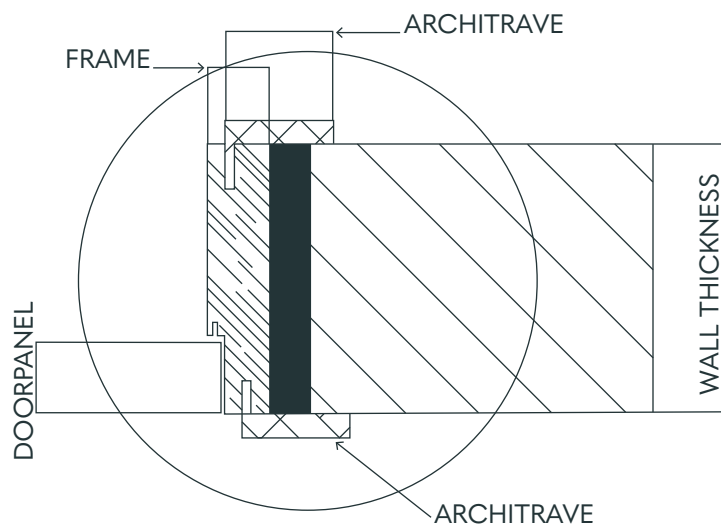

FRAME WITH ARCHITRAVE

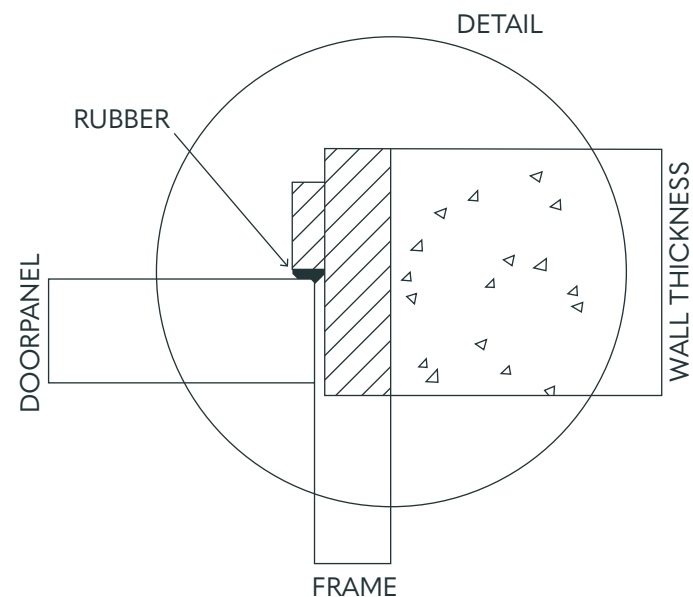

FRAME WITHOUT ARCHITRAVE

FINISHES

Beyond aesthetics, our products feature a semi-solid construction that provides enhanced control and insulation, both acoustic and thermal. We guide you through the advantages and strengths of each style to help you make the perfect choice for your home.

This is complemented by a selection of finishes in handles and hinges among the most popular are black and chrome adding a refined touch of sophistication and elegance.







PRODUCTS

Our products are designed to complement and transform spaces through a perfect balance of design and functionality.

Our collection of **faucets, kitchen and bathroom accessories, among other elements**, offers versatile solutions that adapt to a variety of styles and needs. The wide range of finishes and configurations allows for precise customization, delivering quality, durability, and an elegant character that enhances the experience in every environment.

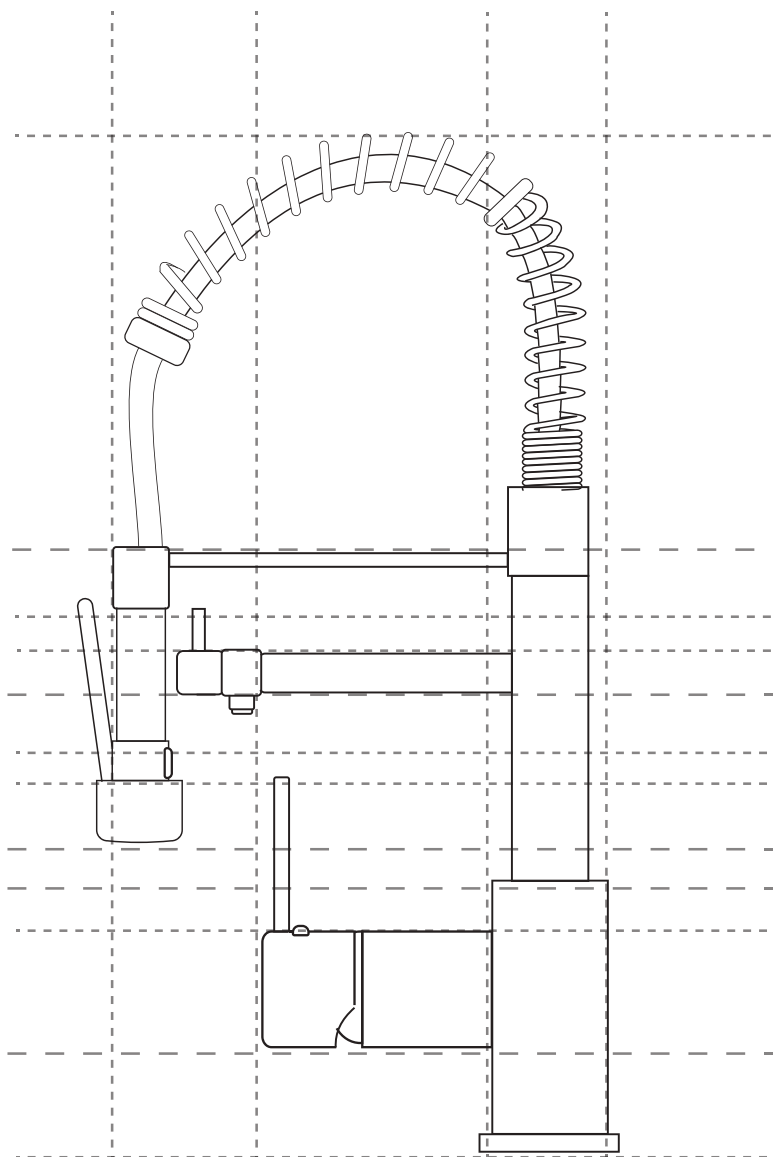



BATHROOM PRODUCTS



LOW SINGLE-HANDLE
FAUCET

196.5 * 141 * 46Ø MM / 7.74 * 5.55 * 1.81 Ø IN



CERAMIC
WC TOILET

360 * 95 * 130 MM / 14.17 * 3.74 * 5.12 IN



STAINLESS STEEL
SOAP DISH

30 * 187 * 100 MM/1.2 * 7.4 * 3.9 in



LUXURY
SHOWER KIT

531 * 500 * 379 MM/20.9 * 19.7 * 14.9 in (DEPENDS OF INSTALACION)



COUNTERTOP
BASIN

400 * 600 * 110 MM/15.75 * 23.62 * 4.33 in



TALL BASIN
MIXER

290 * 40 MM/11.42 * 1.57 in



TALL BASIN
MIXER

300 * 220 * 95 MM/11.81 * 8.66 * 3.74 in



COUNTERTOP
BASIN

400 * 120 MM/15.8 * 4.7 in



TALL KITCHEN
FAUCET

408 * 295 * 190 MM / 16.1 * 11.6 * 7.5 in



SINGLE STAINLESS
STEEL SINK

360 * 420 * 203 MM / 14.17 * 16.54 * 7.99 in



TALL SINGLE-HANDLE
FAUCET

304 * 161 * 460 MM / 11.97 * 6.34 * 1.81 Ø in



DOUBLE STAINLESS
STEEL SINK

458 * 750 * 220 MM / 18.03 * 29.53 * 8.66 in



TALL KITCHEN
MIXER

310 * 500 MM / 12.20 * 19.69 in



KITCHEN
SINK KIT

458 * 750 MM



KITCHEN PRODUCTS



SINGLE
KITCHEN SINK

300 * 600 MM



KITCHEN MIXER
FAUCET

530 * 230 MM







PROCESSES

Our processes are designed to support each project comprehensively, ensuring an organized, precise development aligned with every client's needs.

From **architectural surveying and information gathering**, a detailed analysis is carried out to define functional and aesthetic solutions from the earliest stages.

Project design and presentation evolve collaboratively, leading to carefully executed production and installation supervised down to the finest detail. Even after completion, continuous support is maintained to ensure proper implementation and optimal performance of every solution creating spaces that reflect quality, coherence, and a high level of design.

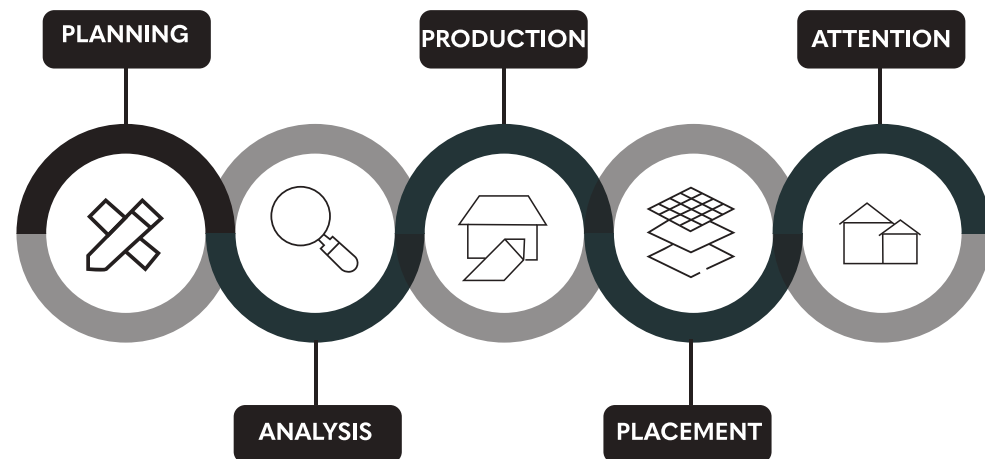



Each project is developed through a structured process that prioritizes clarity, functionality, and design at every stage. From the initial planning phase, spatial needs and project requirements are carefully analyzed to define effective solutions.

Analysis and execution work in constant coordination, enabling an organized and coherent development that attends to every detail from decision-making to final implementation.

This type of comprehensive approach ensures consistent results with high quality standards, addressing both technical and aesthetic criteria to create well-resolved, lasting spaces.

Production and installation are fundamental parts of the process, ensuring that each project is brought to life in accordance with the original plan from its earliest stages.

Every **element is developed under defined quality standards, with careful attention to materials, finishes, and execution timelines.** During installation, constant supervision ensures that each component is properly integrated into the space, maintaining consistency between design and functionality.

This level of execution control guarantees a precise, durable final result that remains faithful to the original concept where every detail fulfills both its aesthetic and technical purpose.



The process does not end with project delivery; **it extends into ongoing support** that ensures proper performance over time.

Post-completion follow-up allows for adjustments, addresses additional needs, and ensures that every element maintains its quality and functionality.

This continuity **reinforces trust and commitment to each project**, providing solutions that endure and evolve alongside the spaces they inhabit always prioritizing the client experience and satisfaction.











SOMERLANNE PRESENCE

Somerlanne's presence is strengthened through a network of partner brands and projects that reflect its vision and expertise.

Each collaboration **is carefully selected to ensure quality, design, and solutions** that integrate seamlessly across different types of spaces.

Success stories are the result of this synergy projects where functionality, attention to detail, and aesthetics come together in well-executed, cohesive proposals.

This **trajectory supports the trust of architects, interior designers, and clients**, positioning each project as a benchmark for design and performance.

OUR PARTNERSHIPS



rochebobois
PARIS

ROCHE BOBOIS



ELIE SAAB



DESIGNO
by pininfarina

TORRE DESIGNO



ASTON MARTIN



KARL LAGERFELD

KARL LAGERFELD



BOSQUE REAL
SKY VIEW



SERENA BY THE SEA



NAUTICA RESIDENCES



GRUPO BOSQUE REAL



SILENZIO RESIDENCES

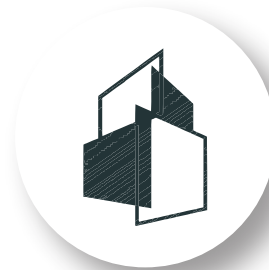

THE SKY VIEW
400 CLEVELAND

rochebobojs









SUCCESS STORIES

Across a wide range of projects, accumulated experience is translated into solutions that respond precisely to the specific needs of each space.

These success stories consolidate a trajectory built on trust, where every completed project strengthens brand presence and reinforces the quality of the work delivered.

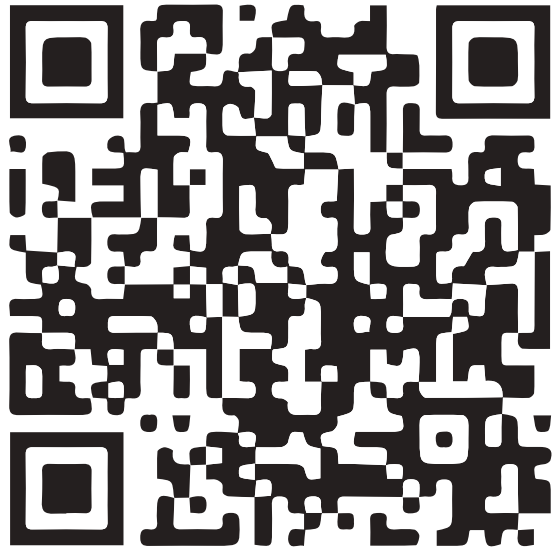

Discover every detail by scanning the code with your phone.





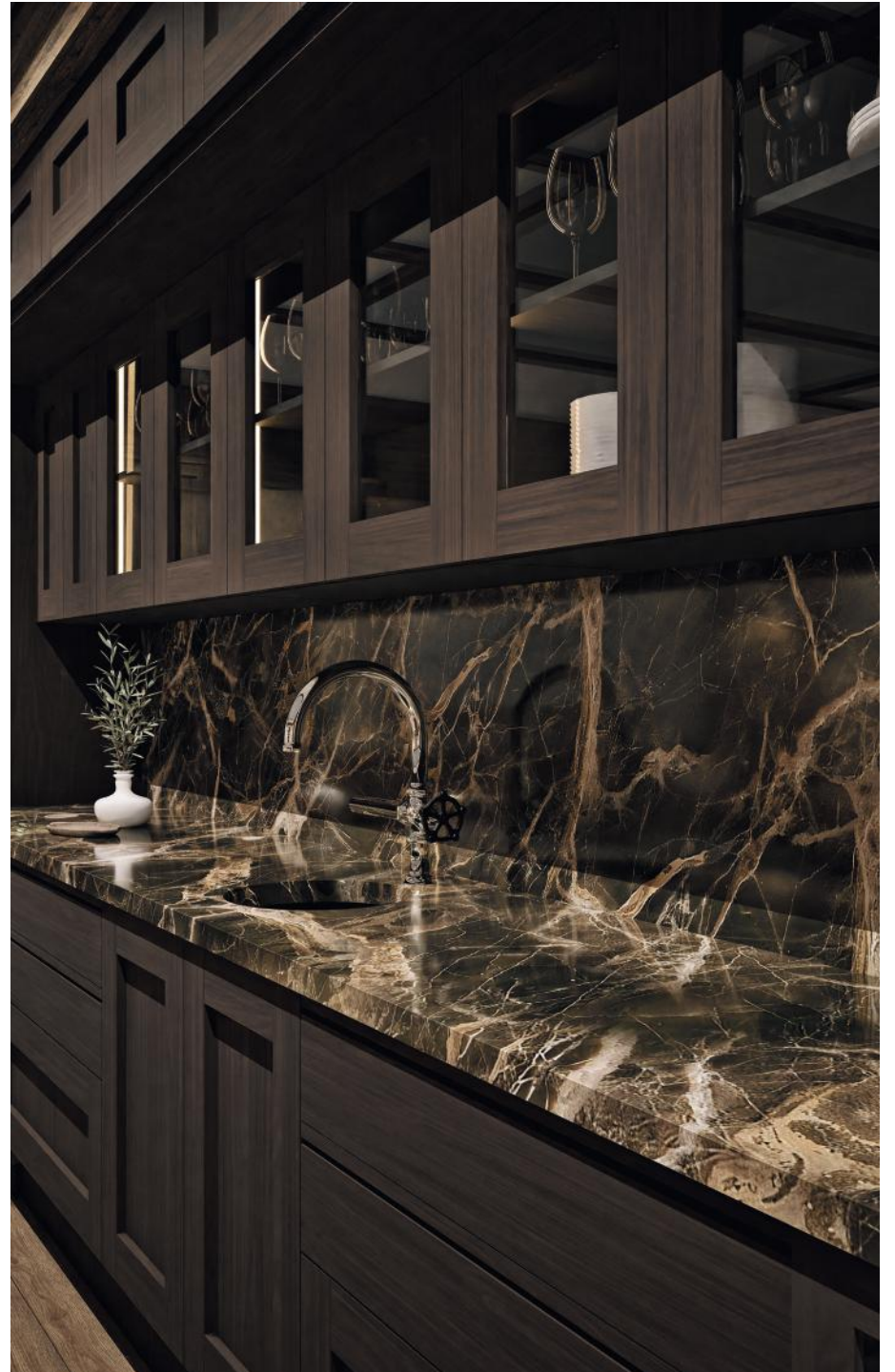
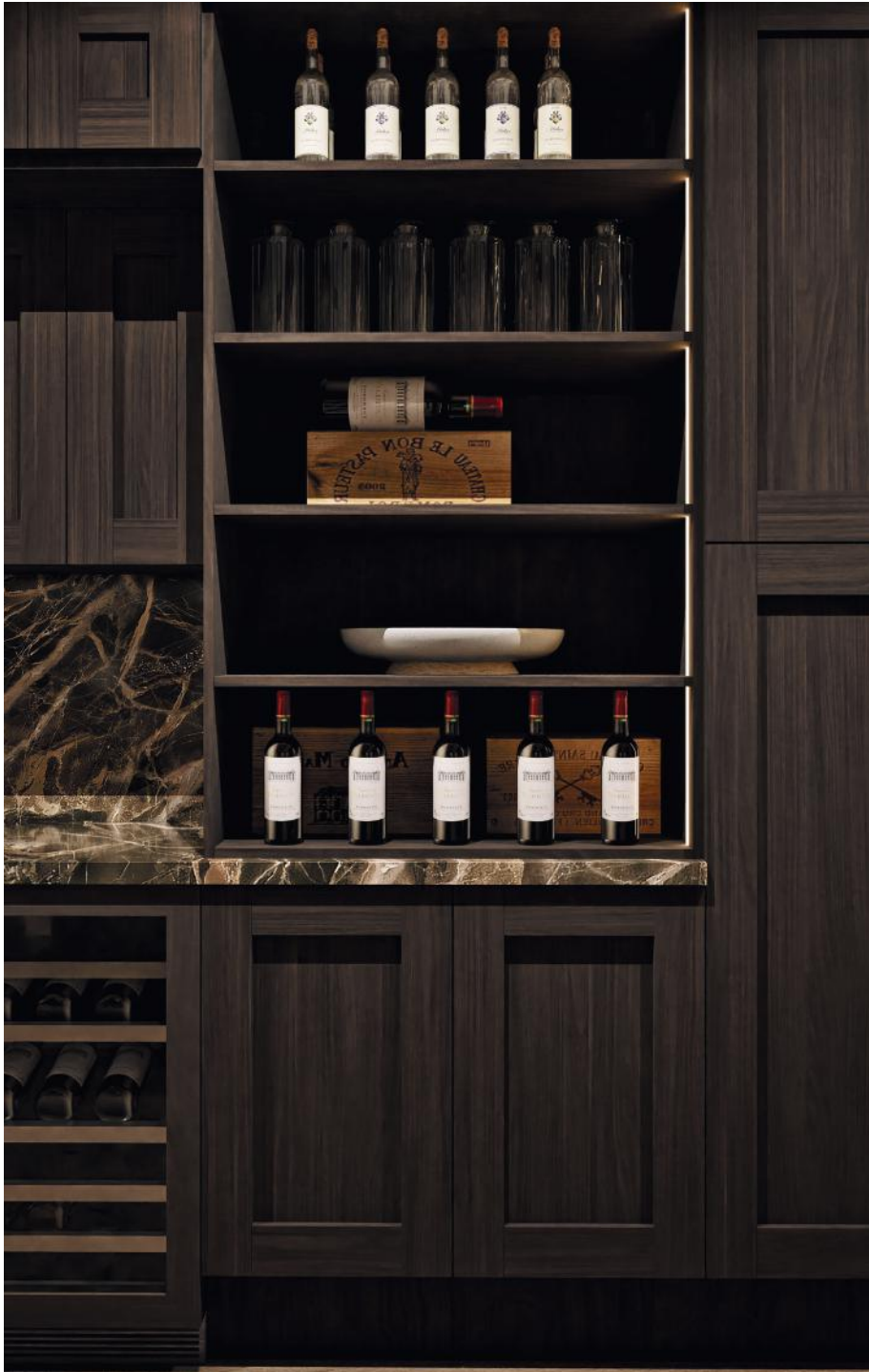

Success stories reflect the proper execution of each project and the ability to transform concepts into functional, well resolved spaces.

Each development is the result of precise planning, a carefully curated product selection and implementation aligned with the project's objectives.

These are **experiences that consolidate a trajectory supported by results**, where quality, design, and attention to detail translate into projects that become benchmarks.









GET TO KNOW US

 contacto@somerlanne.com

 52 55 91 55 71 / 52 55 91 55 71

 www.somerlanne.com

 www.facebook.com/somerlanne

 www.instagram.com/somerlanne



SOMERLANNE



