



Furniture for Early Learning Spaces



Table of Contents

- Introduction** **04**
- European standards** **08**
- Harmony Line** **12**
 - Elegance Table 16
 - Chairs (Deluxe - Elegance) 22
 - Woody 26
 - Woody Curvy 27
 - Ladder 28
 - Star 29
 - Classic S 30
 - Classic Plus 31
- Prime Line** **34**
 - Ultra table 38
 - Chairs (Simple) 42
 - Dynamic 44
 - Action 45
- Grand Line** **48**
 - Tables (Flexo - Multi) 52
 - Chairs (Simple) 56
 - Dynamic 58
 - Action 59
- Vivid Line** **62**
 - Curvy Table 66
 - Chair (Flexo) 72



- Teacher Chair** **78**
- Stool & Benches** **82**
- Soft Seating** **86**
- Storage Units** **92**
 - Ultimate 94
 - Materials Cabinets 100
- Coat Locker &** **104**
- Cubbies Soft Play** **108**
- Platform** **112**
 - Large Platform 114
 - Small Platform 116

Toddler	118
Chairs	122
Table	126
s	130
Reading Centres	132
Mobile Book Browser Units	133
Curved Storage Box Units	134
Double Sided Display Book Units	136
.....	138
Art Centres	140
Equipment storage unit	142
Easels	144
.....	146
Drama Centres	148
Kitchen	150
Iron Set & Cloth Rack	151
Children's lounge	152
Dress unit
Modern Theater
Activity Play Table



Welcome to our World

The background of our company goes back a long way, as the founders were educators with many years of experience in establishing schools. They believed in education as the best way for developing societies and people. This belief was the motivation to establish our company, and is still driving it through years and years of success.



Children are our priority

EduFun® products are always designed with children in mind. With our experience in the educational field, we understand carefully classroom furniture can stimulate their development. Classrooms should be inviting, environments that make children feel good to be there.

We listen carefully

At EduFun®, we strive to serve and support our customers around the world. We always listen to our customers concerns and demands. We develop our products upon their needs. You will find our furniture is modular and able to adjust in order to be able to change the learning environment all the time.



We care about our environment

Since the first day, we chose to use wood in our production, to create a healthy warm environment for children. Wood is the most environmentally friendly raw material, which are healthy for our climate, prevent climate changes and has Zero Waste. The beauty of wood is that it engages all of our senses. It is warm, rich and affecting, and its surface has a tactile and sensuous strength. We use real wood from sustainable forestry to help protect our environment. Contributing to the preservation of the environment is almost of our responsibility.





Production

Since EduFun® first began, we have been expanding our production lines to fulfill growing demand. Likewise, the collections of the EduFun® range have been continuously expanding to meet our customers' desires. New state of the art machines have been added to our production lines offering quality and on-time production. We are able to develop new product ranges with the execution of OME products with our factories and our production lines (solid wood, panel board, tube bending, wooden toys and puzzle).

1- Solid Wood Production Line 2- Panel Board Production Line 3- Tube Bending Production Line 4- Educational Resources Production Line



Materials

EduFun® aims to build sustainable long-lasting furniture for the most active and ruthless children. Besides smart designs, durability depends on using the highest quality materials. To that end, EduFun® imports high quality natural European Beechwood and the longest lasting non-toxic German paints safety lacquers. We spare no expense to make certain you're getting the best products made of the highest quality materials.



Introduction

Design

EduFun® designs furniture for preschool and kindergarten children, for educators, for learning institutions, to make everyone at your school safe, happy and comfortable from the start of the day till the last moment of the day. EduFun® designs are synonymous with creative, versatile, and practical learning spaces. Our Research and Development Department has collaborated with experts from all-over the world to research, develop and create innovative products. Ergonomically designed furniture for growing children. Storage units of all kinds for organized and efficient classrooms. Reading Centres, play corners and role play furniture for a complete and holistic learning experience. The finest materials, vibrant Colours and exquisite textures come together for relentless beauty. Durability for furniture that looks new for years to come. Edu fun reserves the right to change any specifications and make upgrades of its products at any time without notice. Information in this catalogue was correct at the time of printing. While our team has made every effort to ensure the accuracy of information, Edu fun cannot accept any responsibility for any errors or omissions and this catalogue does not oblige of any form of contract.



Dreams can come true

We have a very wide range of any customer with what they need. Our products vary from chairs, tables, storage units, platforms and role play furniture. However, sometimes special specifications are requested. With our production capabilities, we can make your dreams come true.



International Standards

EduFun® is keen on our childrens' health and for that reason the product range and production facilities are certified by meeting the latest high international standards of safety such as:

- BS EN 1729
- ANSI/BIFMA
- ISO 9001
- ISO 14001
- OHSAS 18001



BS EN 1729
For dimensions



ISO 9001
ISO 14001
OHSAS 18001

Central Locations

Edu fun® group is streamlining its activities to keep pace with the growing markets and is becoming a leader in the region and as an international player. As a place to do business, and as a hub for the region and beyond, the United Arab Emirates (UAE) continues to be increasingly important, relevant and attractive to businesses from around the world. For these reasons, we have moved our head office to UAE. EduFun® produces and ships from Egypt, the historic hub of trade and shipments. With its northern ports on the Mediterranean Sea to serve Europe and the Americas and eastern ports on the Red Sea to serve Africa, Asia and Australia is centrally located, meaning you get your order in record time.

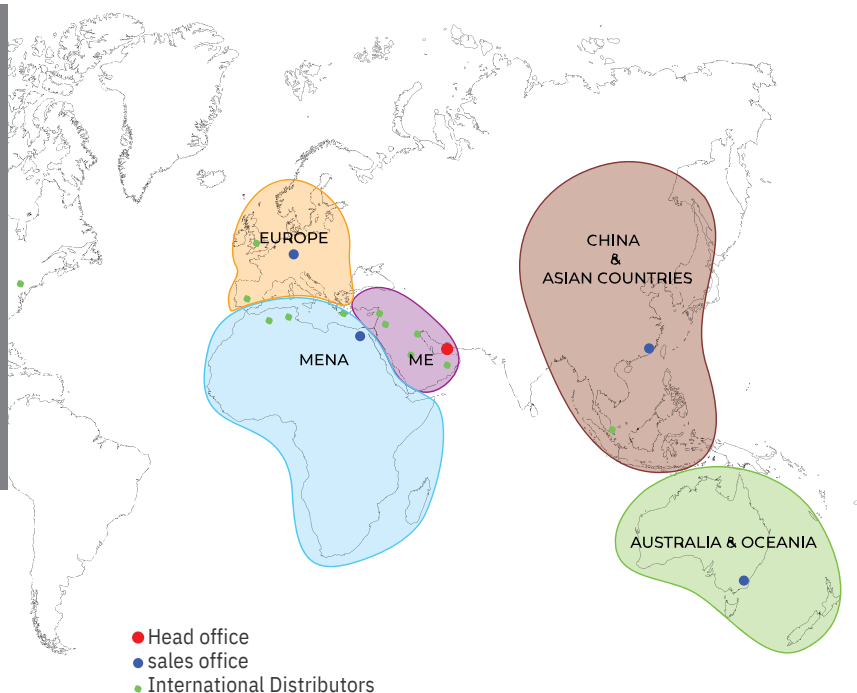

Visit Us

Our customers are warmly invited to visit our factory in Egypt or any of our subsidiaries in Germany, Australia or China. We are pretty sure that visiting our integrated manufacturing complex will leave a positive impression on you.

We are not just a manufacturer but we are artists as well. You can feel yourself that when you meet in person with our skilled workers under a supervision of well-educated professional engineers and how they are working with the latest technological machinery and how they turn a piece of tree into a piece of art.



What benefits can you get from buying from us?

Zero Customs duty is one of the most advantages that you can get if you import directly from Egypt and that's why we have established our factory in Egypt from the early beginning as Egypt is a signatory to several multilateral trade agreements, which give a great potential to its export products. The following are the "Trade Agreements" which between Egypt as country of Export and the whole world : - Egypt - EU Partnership - Mercosur Agreement - COMESA Agreement - EFTA Agreement - Egypt - Turkey Free Trade Agreement - Agadir Agreement - League of Arab States - Generalized system of preferences (G.S.P) - Generalized System of Trade Preferences (G.S.T.P)



European standards

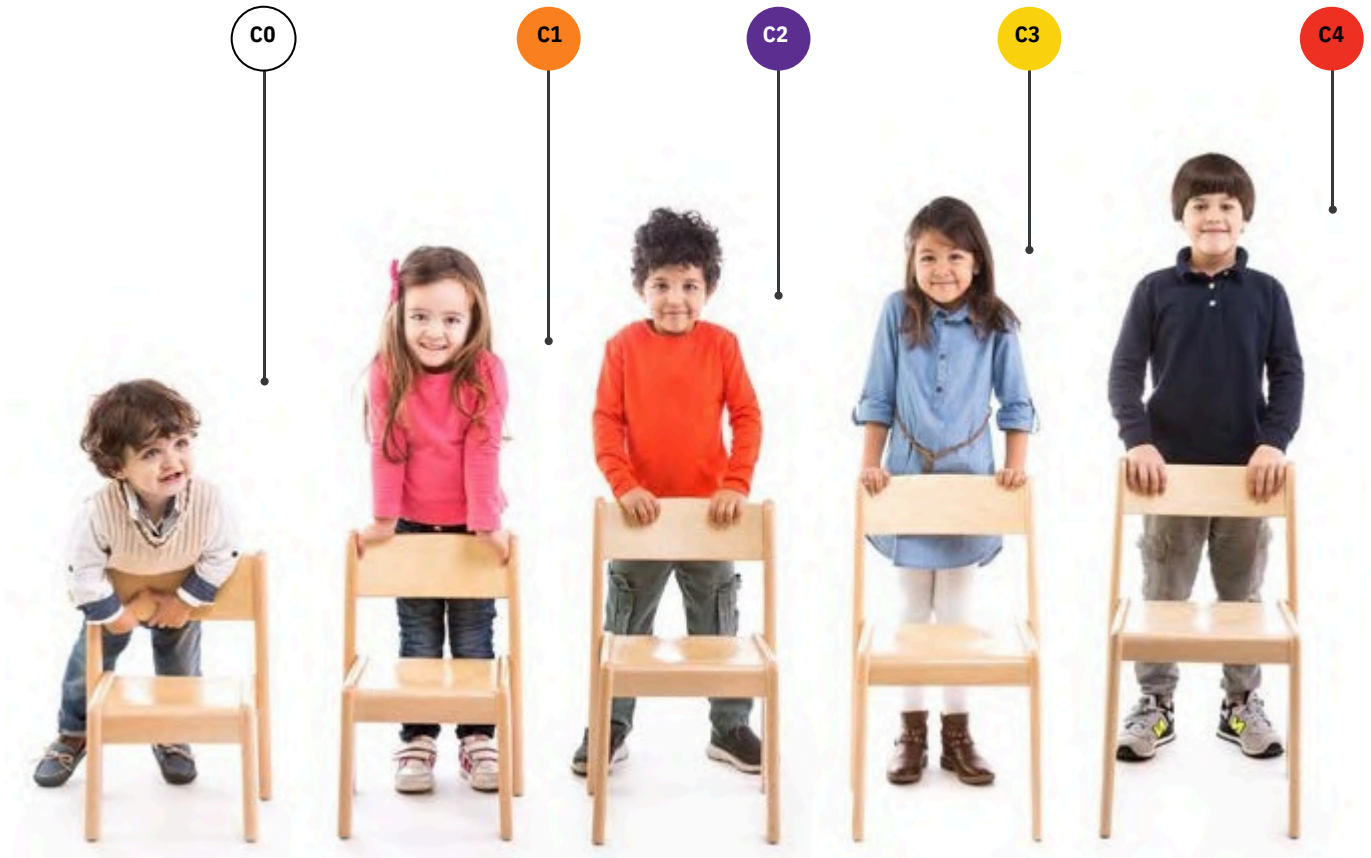

Chairs	21	26	31	35 cm	38
Tables	40	46	53	59 cm	64

We design all of our furniture collection according to the European standards for chairs and tables for educational institutions which was approved in January 2007. Children should always use the appropriate size of chairs or table to ensure good posture and prevent causing problems or distortions for them while growing. Ergonomic seating requires adjustable furniture to suits different body heights. In this table you can choose the correct seat and table height suitable for the student age:

BS EN 1729 European standards for chairs and tables

Children`s ages	0 - 2yrs		2 - 3yrs	2 - 4yrs	4 - 6yrs	6 - 8yrs	8 - 11yrs
Chairs & Tables Symbol	C 01	C 02	C 0	C 1	C 2	C 3	C 4
Chairs seat height	13 cm	17 cm	21 cm	26 cm	31 cm	35 cm	38 cm
Tables height - Fixed legs	30 cm	36 cm	40 cm	46 cm	53 cm	59 cm	64 cm

Infant/toddler chairs & tables
Pages : 118 - 129

Preschool/elementary chairs & tables
Pages : 12 - 77

How to Order

Section Name → Product Name

Prime Line

Simple Chair

Sturdy, durable and light chairs. Chairs are constructed with superior formed metal chairs, seat and back from environmental-friendly plywood for comfortable seating. Available in seven metal frame colours. Chairs are stackable or put on table top allowing easy floor-to-ceiling storage.

Chair Code	Chair Size	Chair Height	Recommended Table Height
43421	28.5 x 28.5 cm - H. 21 cm	40 cm	40 cm
43424	28.5 x 28.5 cm - H. 26 cm	46 cm	46 cm
43505	30 x 30 cm - H. 31 cm	53 cm	53 cm
43506	30 x 30 cm - H. 35 cm	59 cm	59 cm
43425	36 x 36 cm - H. 38 cm	64 cm	64 cm

Chair Size ← Chair Height ← Suitable Table Height

Product Details

Coloured back & seat with Grey metal frame

Stage ↑

Chair & Tables	Chair Size	Chair Code	Recommended Tables Height
⊙	28.5 x 28.5 cm - H. 21 cm	43421	40 cm
⊙	28.5 x 28.5 cm - H. 26 cm	43424	46 cm
⊙	30 x 30 cm - H. 31 cm	43505	53 cm
⊙	30 x 30 cm - H. 35 cm	43506	59 cm
⊙	36 x 36 cm - H. 38 cm	43425	64 cm

Chair Size ← Chair Height ← Suitable Table Height

Natural back & seat with coloured metal frame

• For Example



Chair Code — **43505 - 01 - 48**

Your choice of colour _____

Section Name → Product Name → Frame Style

Prime Line

Ultra Tables

Table Code	Table Size	Table Frame Color	Table Top Color
44611	60 x 60 cm	Grey	Light Wood
44612	60 x 60 cm	Red	Light Wood
44613	60 x 60 cm	Blue	Light Wood
44614	60 x 60 cm	Yellow	Light Wood
44615	60 x 60 cm	Green	Light Wood
44616	60 x 60 cm	Orange	Light Wood
44617	60 x 60 cm	Purple	Light Wood
44618	60 x 60 cm	Pink	Light Wood
44619	60 x 60 cm	White	Light Wood
44620	60 x 60 cm	Black	Light Wood

Table Frame color ← Table Top color

Table Plan

Table Frame color

Table Top color

Number of Chairs suitable for table

Stage ↑

Table Size	Table Code	Table with caster Code	
Ultra Table 60 x 60 cm	⊙ C0	44611	44616
	⊙ C1	44612	44617
	⊙ C2	44613	44618
	⊙ C3	44614	44619
	⊙ C4	44615	44620

Table Size ← Table Code ← Table with caster Code

• For Example



Table Code — **44612 - 11 - 43**

Your choice of colour _____

European standards

Edu Fun colours Variety

We have different materials in our catalogue with a variety of bright and neutral colours to meet different tastes and activities. Please always remember to choose your colour code while you are choosing your piece of furniture.

HPL / Melamine Colours



Woody
11

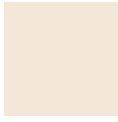

Beige
12



Blue
15



Green
16



yellow
19



Orange
17



Red
18

Birch plywood Colours



Natural plywood
01



Blue
05



Green
06



yellow
09



Orange
07



Red
08

Shell Colours

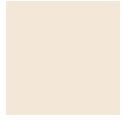

Beige
32

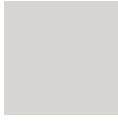

Gray
33



Blue
35



Light Blue
34



Green
36



yellow
39



Orange
37



Red
38

Metal Frame Colours



Beige
42



Gray
43



Blue
45



Green
46



yellow
49



Orange
47



Red
48

Leather Colours



Beige
52

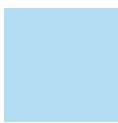

Light Blue
54



Green
56



yellow
59



Orange
57



Red
58



Brown
60

* Colours may vary from pictures



Harmony Line

**Natural European Beechwood
The Classic Natural European Wood Series.**

**Ergonomically Solid European Beech Wood Chairs
and table frames. Natural European Birch plywood
seat and back rest.**

Harmony line has been developed with a vast range of products so you can create a natural look environment, which help children to learn efficiently. The construction and materials used ensures that it will last forever. With all modular designs, the natural look pieces transform classes into creative expressions, with infinite arrangements, and infinite possibilities. It is ergonomically designed for active children in their early years to gently encourage healthy posture.



Tables:

Tops made from:

- 22 mm thick MDF - (Medium density fiberboard)-
- Laminated with HPL - high pressure laminate- with high scratch and shock resistance surface.
- New designed Solid Wood Edges, curved and rounded for safety. No grooves when tables grouped or combined.
- Varnished solid beech wood Edges, curved and rounded for safety.
- Available in Wood Grain and Beige color.
- 5 years Guarantee.



Table frame made from:

- Varnished solid Beech Wood with rounded corners (according to European standards).
- Legs are fitted with glides to provide floor leveling and reduce noise.
- Legs come unassembled, and can be fixed to table tops solid beech wood frame easily using the strong metal fixing Bracket. through strong metal fixing bracket



Wooden Chairs

- Frame made from European Beech Wood.
- Seat and back rest made from curved multi layered Birch Ply wood.
- Comes assembled.
- Multi Stack Chairs.
- Wide range of seat and back rests available in natural or coloured range.
- Legs have a glide to protect floors and reduce noise.
- Very Strong and can hold the weight of an adult.
- 5 years Guarantee.

Harmony Line

We suggest the Elegance Table with the Elegance Chair or Deluxe Chair as the main choice in the harmony line. Any wooden chair - from our collection - can also be used with our Elegance Table. (page 26 to 33)



● Elegance Table

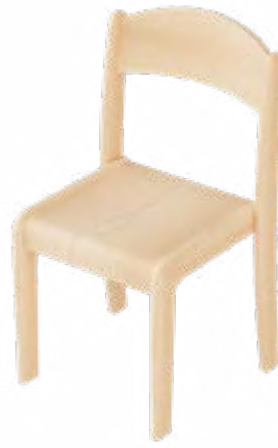

● Deluxe Chair



● Elegance Chair



Table combination



Another shapes of Elegance Tables



Legs / Rails Colours

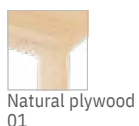
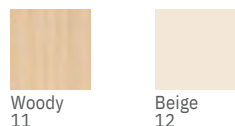

Table - Top Colours



Seat & back colours with wooden frame



Harmony Line

Elegance Tables

Our lines of Elegance Tables come packed flat for your convenience. The tables are easily assembled with the simple instructions provided. When correctly assembled, our tables are solid, stable and durable. Tables come in 5 convenient heights and 6 functional shapes. All our tables are modular and can be arranged in many different configurations.

Legs and rails are made of either:

- Solid wood.
- Metal.

Plastic glides or coasters can be added upon your request.

- Table top made from extremely strong medium density fiberboard (MDF) laminated with high pressure laminate (HPL) (22 mm). Edges made from solid beechwood with protective varnish. they are gently smoothed and lightly rounded to avoid any risk or injury.



22mm MDF Laminated HPL solid beech edges

Table top 22mm thickness made from extremely strong medium density fiberboard (MDF) insulation, stiff, has no knots, will produce fine and better edges and tops laminated with high pressure laminated HPL (under heat (80-90 Celsius) and pressure (250 kgs/m²) - (NAF) no added formaldehyde, (Ivory color or Beige wood theme) Edges made from solid beechwood painted with protective varnish, gently and safety rounded edges



Very Special rounded Edge design without any spacing (shark nose Edges)

Wooden Legs

There are five different heights for these wooden legs which is convenient to children different heights. These tables come packed flat for your convenience. The tables are easily assembled with the simple instructions provided.



Available with or without Casters



Connection



Easy to assemble



Glides

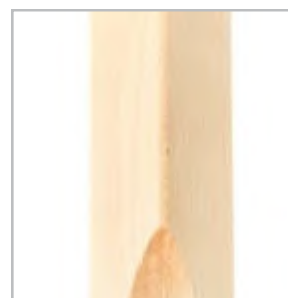

Rounded Edges

Table Heights

- C4** 64 cm
- C3** 59 cm
- C2** 53 cm
- C1** 46 cm
- C0** 40 cm



C0

Nursery 1

C1

Nursery 2

C2

K.G. 1

C3

K.G. 2

C4

Primary

* Number of legs & Casters are upon table shape

Harmony Line

Elegance Tables



■ U-Shape Table 180 x 120 cm



ø 120 cm

■ Circular Table ø 120 cm

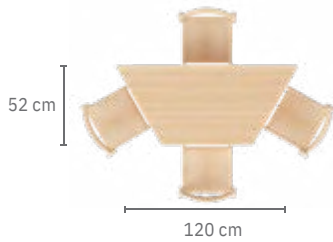

52 cm

120 cm

■ Trapezoidal Table 120 x 52 cm

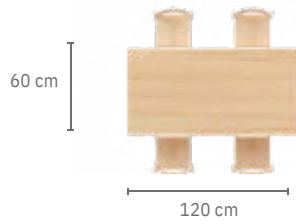

60 cm

120 cm

■ Rectangular Table 120 x 60 cm

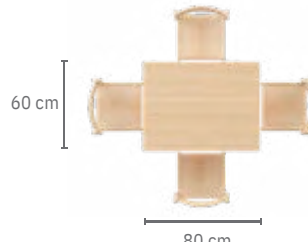

60 cm

80 cm

■ Rectangular Table 80 x 60 cm



ø 90 cm

■ Circular Table ø 90 cm

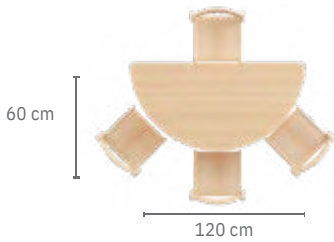

60 cm

120 cm

■ Smi-Circular Table 120 x 60 cm

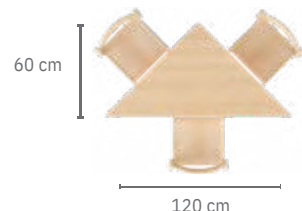

60 cm

120 cm

■ Triangle Table 120 x 60 cm

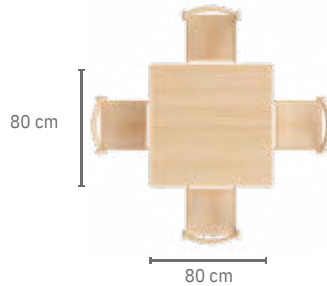

80 cm

80 cm

■ Square Table 80 x 80 cm

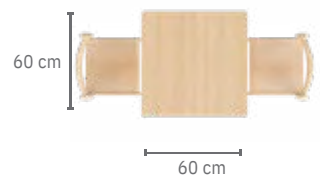

60 cm

60 cm

■ Square Table 60 x 60 cm

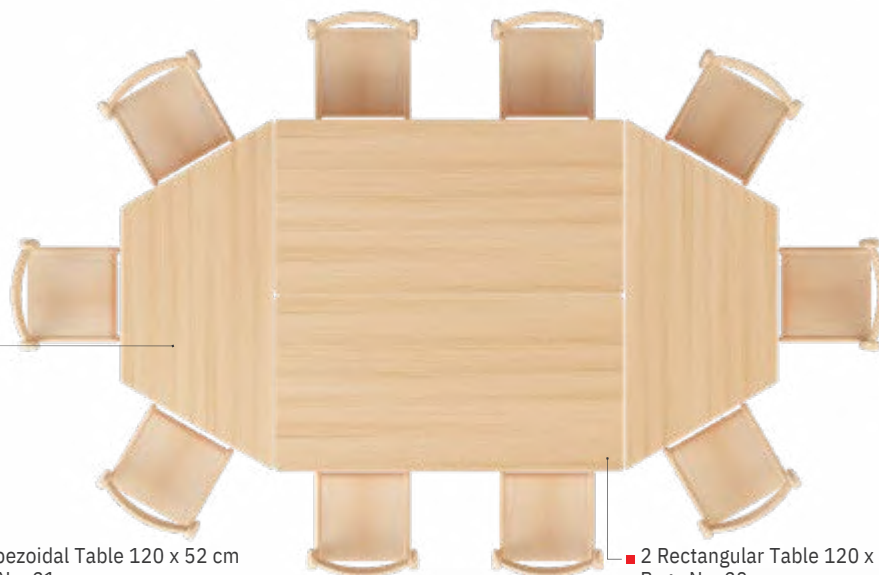

■ 2 Trapezoidal Table 120 x 52 cm
Page No. 21

■ 2 Rectangular Table 120 x 60 cm
Page No. 20



■ 2 Trapezoidal Table 120 x 52 cm
Page No. 21

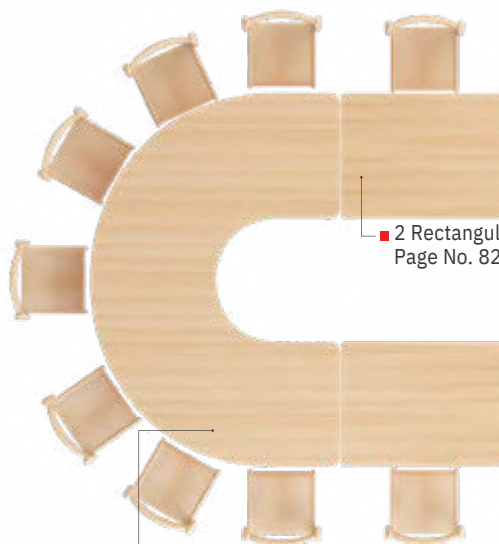

■ 2 Rectangular Table 60 x 80 cm
Page No. 82-79

■ 1 U-Shape Table 180 x 120 cm
Page No. 21

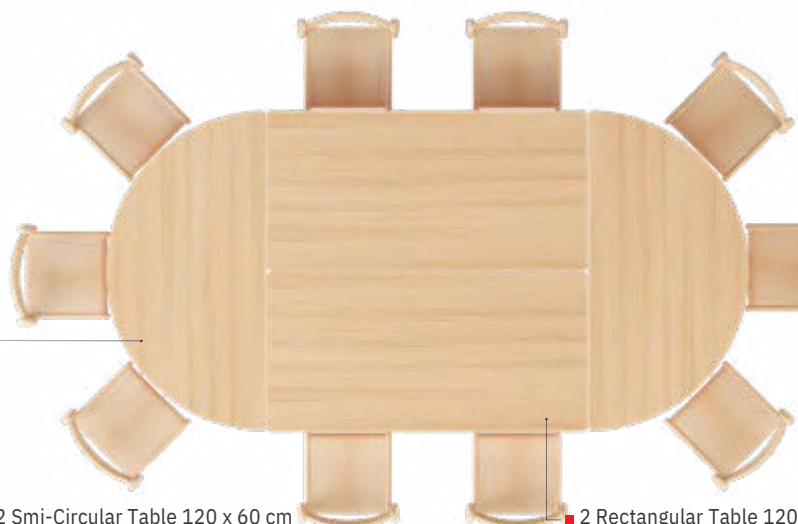







■ 2 Smi-Circular Table 120 x 60 cm
Page No. 20

■ 2 Rectangular Table 120 x 60 cm
Page No. 20

Harmony Line

Elegance Tables

		Wooden Frame	Wooden Frame With Casters	
Stages & Symbol C0 - Nursery 140 cm C1 - Nursery 246 cm C2 - K.G 1 53 cm C3 - K.G 2 59 cm C4 - Primary 64 cm				
	4  Rectangular Table 60 x 80 cm	C0	44321	47860
		C1	44322	47861
		C2	44323	47862
		C3	44324	47863
C4		44325	47864	
4  Rectangular Table 120 x 60 cm	C0	44331	47865	
	C1	44332	47866	
	C2	44333	47867	
	C3	44334	47868	
	C4	44335	47869	
6  Circular Table ø 120 cm	C0	44410	47875	
	C1	44411	47876	
	C2	44412	47877	
	C3	44413	47878	
	C4	44408	47879	
4  Circular Table ø 90 cm	C0	44415	47880	
	C1	44416	47881	
	C2	44417	47882	
	C3	44418	47883	
	C4	44419	47884	
5  Smi-Circular Table 120 x 60 cm	C0	44511	47870	
	C1	44512	47871	
	C2	44513	47872	
	C3	44514	47873	
	C4	44516	47874	

Legs / Rails Colours



Natural plywood
01

Table - Top Colours



Woody
11



Beige
12

Stages & Symbol C0 - Nursery 140 cm C1 - Nursery 246 cm C2 - K.G 1 53 cm C3 - K.G 2 59 cm C4 - Primary 64 cm		Wooden Frame	Wooden Frame With Casters
4 	C0	44675	47895
	C1	44676	47896
	C2	44677	47897
	C3	44678	47898
	C4	44679	47899
Triangle Table 120 x 60 cm			
5 	C0	44201	47885
	C1	44202	47886
	C2	44203	47887
	C3	44204	47888
	C4	44205	47889
Trapezoidal Table 120 x 52 cm			
7 	C0	44670	47900
	C1	44671	47901
	C2	44672	47902
	C3	44673	47903
	C4	44674	47904
U-Shape Table 180 x 120 cm			
4 	C0	44305	47915
	C1	44306	47916
	C2	44307	47917
	C3	44308	47918
	C4	44309	47919
Square Table 80 x 80 cm			
2 	C0	44690	47910
	C1	44691	47911
	C2	44692	47912
	C3	44693	47913
	C4	44694	47914
Square Table 60 x 60 cm			

Legs / Rails Colours

 Natural plywood
01

Table - Top Colours

 Woody
11

 Beige
12

Deluxe Chair

An ergonomic chair that will last for generations. Each chair is made of solid, top-quality lacquered beechwood & plywood. There are five different heights to be suitable for different aged children. Can be stacked for saving space. Available with arms.



Ergonomic seat



Ergonomic backrest



Arm



Soft Edges

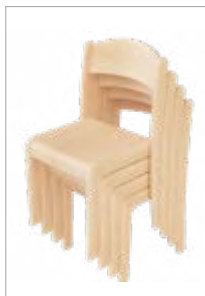

Stackable up to 5



Protective Glides



Chairs & Tables	Chairs Size	Chairs Code	Recommended Tables Height
C0	28.5 x 28.5 cm - H. 21 cm	43270	40 cm
C1	28.5 x 28.5 cm - H. 26 cm	43275	46 cm
C2	30 x 30 cm - H. 31 cm	43280	53 cm
C3	30 x 30 cm - H. 35 cm	43285	59 cm
C4	36 x 36 cm - H. 38 cm	43284	64 cm



Seat & back colours with wooden frame



Chairs & Tables	Chairs Size	Chairs Code	Recommended Tables Height
C0	28.5 x 28.5 cm - H. 21 cm	43265	40 cm
C1	28.5 x 28.5 cm - H. 26 cm	43266	46 cm
C2	30 x 30 cm - H. 31 cm	43267	53 cm
C3	30 x 30 cm - H. 35 cm	43268	59 cm
C4	36 x 36 cm - H. 38 cm	43269	64 cm



with arm rest

Seat & back colours with wooden frame



Elegance Chair

These beautifully crafted stackable chairs would look great in any classroom. Each chair is made of solid, top-quality lacquered beechwood and is built to last. Five convenient seat heights are available to correspond with Elegance tables. Available with arms.



Ergonomic seat



Ergonomic backrest



Arm



Soft Edges



Stackable up to 5



Protective Glides



Chairs & Tables	Chairs Size	Chairs Code	Recommended Tables Height
C0	28.5 x 28.5 cm - H. 21 cm	43201	40 cm
C1	28.5 x 28.5 cm - H. 26 cm	43202	46 cm
C2	30 x 30 cm - H. 31 cm	43203	53 cm
C3	30 x 30 cm - H. 35 cm	43204	59 cm
C4	36 x 36 cm - H. 38 cm	43205	64 cm



Seat & back colours with wooden frame



Chairs & Tables	Chairs Size	Chairs Code	Recommended Tables Height
C0	28.5 x 28.5 cm - H. 21 cm	43206	40 cm
C1	28.5 x 28.5 cm - H. 26 cm	43207	46 cm
C2	30 x 30 cm - H. 31 cm	43208	53 cm
C3	30 x 30 cm - H. 35 cm	43209	59 cm
C4	36 x 36 cm - H. 38 cm	43210	64 cm

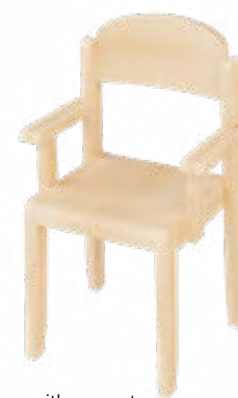

with arm rest

Seat & back colours with wooden frame



Recommended Chairs



Woody Chair

These chairs are perfect companions to our wooden student desks (Elegance- Classic). Chairs have ergonomic designs and provide proper back support. Children can easily move these light chairs around. Seats are available in 5 sizes.



Massive beech curved seat



Curved top & mid rail
Ergonomic backrest



Soft Edges



Protective Glides

Chairs & Tables	Chairs Size	Chairs Code	Recommended Tables Height
C0	28.5 x 28.5 cm - H. 21 cm	43213	40 cm
C1	28.5 x 28.5 cm - H. 26 cm	43214	46 cm
C2	30 x 30 cm - H. 31 cm	43215	53 cm
C3	30 x 30 cm - H. 35 cm	43216	59 cm
C4	36 x 36 cm - H. 38 cm	48101	64 cm



Woody Curvy Chair

This curved woody chair combines the durability with curved edges for softer look. The ergonomic designs provide proper back support. It is suitable for children to move these chairs around. Seats are available in 3 sizes.



Natural beechwood frame



Curved top & mid rail
Ergonomic backrest



Safe rounded corners



Protective Glides



Chairs & Tables	Chairs Size	Chairs Code	Recommended Tables Height
C0	28.5 x 28.5 cm - H. 21 cm	43103	40 cm
C1	28.5 x 28.5 cm - H. 26 cm	43104	46 cm
C2	30 x 30 cm - H. 31 cm	43107	53 cm
C3	30 x 30 cm - H. 35 cm	43109	59 cm
C4	36 x 36 cm - H. 38 cm	43108	64 cm



Recommended Chairs



Ladder-Back Chair

A classic timeless chair that was redesigned for children. This chair encourages good posture, in addition to the curved back legs that prevent from tipping. Three rails properly spaced for child safety and easy lifting. Its strong solid construction, safe edges and environmentally friendly finish make it a great choice.



Curved top & rails
Ergonomic backrest



Massive beech curved seat



Protective Glides



Soft Edges

Chairs & Tables	Chairs Size	Chairs Code	Recommended Tables Height
C0	28.5 x 28.5 cm - H. 21 cm	43295	40 cm
C1	28.5 x 28.5 cm - H. 26 cm	43296	46 cm
C2	30 x 30 cm - H. 31 cm	43297	53 cm
C3	30 x 30 cm - H. 35 cm	43298	59 cm
C4	36 x 36 cm - H. 38 cm	43299	64 cm



Star Chair

The Star Chair boasts an ultra-modern design, manufactured with a high quality beechwood frame. Ergonomically shaped back and seat give maximum comfort and ease of use. Seats are available in 3 sizes.



Massive beech curved seat



Comfort birch plywood backrest



Soft Edges



Protective Glides



Chairs & Tables	Chairs Size	Chairs Code	Recommended Tables Height
C2	30 x 30 cm - H. 31 cm	48120	53 cm
C3	30 x 30 cm - H. 35 cm	48121	59 cm
C4	36 x 36 cm - H. 38 cm	48125	64 cm



Harmony Line

Recommended Chairs



Classic S Chair

This chair combines all the advantages of the classic chair in addition to stacking. It is a top quality, colourful chair that will last for generations. The frame is made of solid beechwooden and the seat is made from coloured laminated MDF boards. This durable chair can easily bear the weight of an adult to stand on. Leg-tips have plastic caps to prevent noise and marring of floor surface when moved.



Curved backrest



Birch Plywood seat

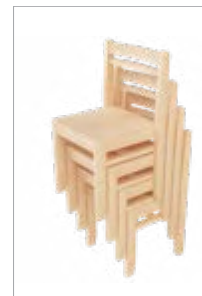

Stackable up to 5



Soft Edges



Protective Glides

Chairs & Tables	Chairs Size	Chairs Code	Recommended Tables Height
C0	33 x 30 cm - H. 21 cm	43140	40 cm
C1	33 x 30 cm - H. 26 cm	43141	46 cm
C2	35 x 30 cm - H. 31 cm	43142	53 cm
C3	35 x 30 cm - H. 35 cm	43143	59 cm
C4	35 x 30 cm - H. 38 cm	43144	64 cm



Seat & back colours with wooden frame



- Natural plywood
01-01
- Blue
05-01
- Green
06-01
- yellow
09-01
- Orange
07-01
- Red
08-01

Classic Plus Chair

Natural beechwood with HQ finishes, this very light and sturdy design offers durability and ease of movement. The Colourful birch plywood seats are available in 4 colours.



Birch Plywood seat



Curved backrest



Soft Edges



Protective Glides



Chairs & Tables	Chairs Size	Chairs Code	Recommended Tables Height
C0	28.5 x 28.5 cm - H. 21 cm	43120	40 cm
C1	28.5 x 28.5 cm - H. 26 cm	43121	46 cm
C2	30 x 30 cm - H. 31 cm	43122	53 cm
C3	30 x 30 cm - H. 35 cm	43123	59 cm
C4	36 x 36 cm - H. 38 cm	43124	64 cm

Seat & back colours with wooden frame



Natural plywood
01-01



Blue
05-01



Green
06-01



yellow
09-01



Orange
07-01



Red
08-01

Classroom Fit Outs

We offer custom designed room plans to fit your needs. We have a team of experts in translating your vision into functional yet inspirational learning spaces. Here are some ideas for how you can use our Harmony Line furniture pieces to create integrated kindergarten classroom.

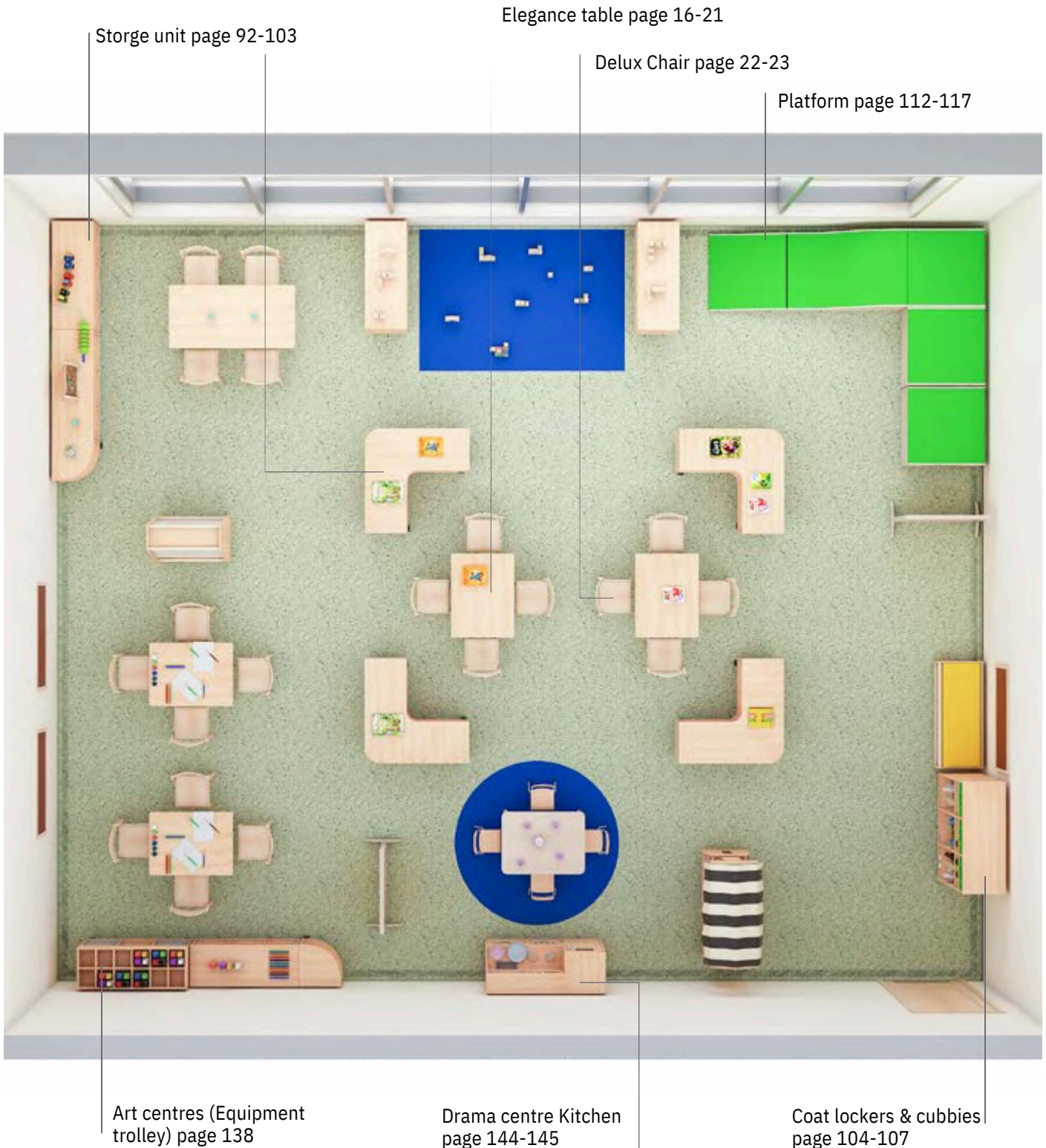

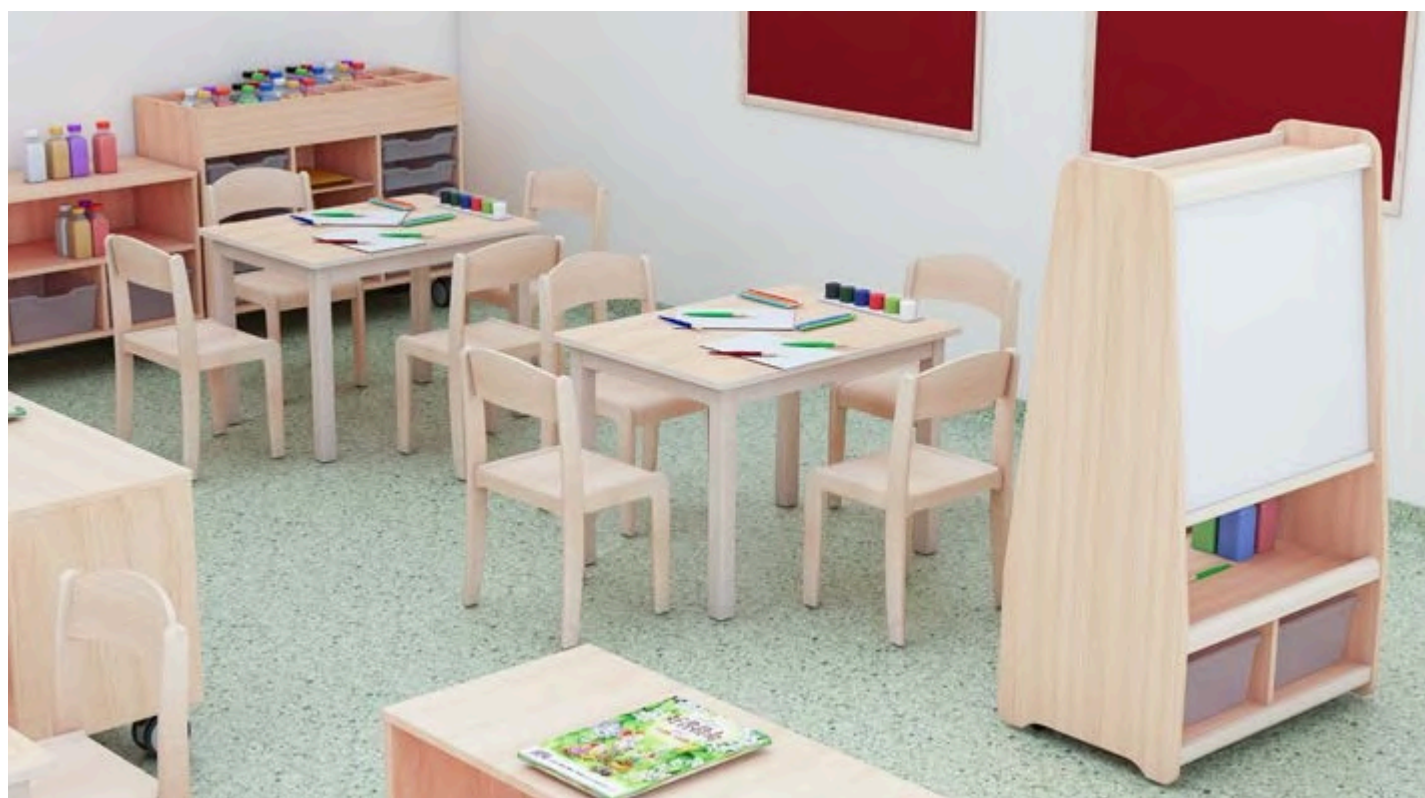

Prime Line

Metal tube frame & birch plywood seat & back rest. The Metal Framed Series.

Ergonomically rigged Metal tubes Chairs and table frames. Natural Birch Plywood seat and back rest.

Using prime line range helps you create an evolving learning space for children to grow and develop confidently in. Durable wooden tables & chairs with metal frame to ensure years of durability. Modular & ergonomically designed for years of safe and efficient kindergarten furniture. The wide range of colours available gives you the flexibility to create many classroom outfits that satisfy all tastes.



Tables:

Tops made from:

- 28 mm thick MDF - (Medium Density Fiberboard)- laminated with HPL - high pressure laminate,
- Table tops are available in wood grain and beige color high scratch and shock resistance surfaces.
- New design Solid Wood Edges curved and rounded for safety. No grooves when tables are grouped together or combined.



Table frame made from:

- Table frame and legs are made from rigged welded metal tubes, with strong scratch resistance epoxy paints.
- Metal Legs are fitted with glides to protect floors, provide floor leveling and reduce noise.
- Table Frame comes assembled. Table tops are easily fixed to the metal frame using threaded metal insert and screws.
- 5 years Guarantee



Chairs

- Frame made from rigged metal tubes with strong scratch resistance epoxy paints.
- Seat and back rest made from ergonomically curved, multi layered Birch Ply wood.
- Special leg design provides stability
- Metal frames are fitted with glides to protect floors, and reduce noise.
- Multi stack Chairs
- Comes assembled.
- Wide range of natural and colors range available (for chair frame and for seat and back rest).

- Very Strong and can hold the weight of an adult.
- 5 years Guarantee

Prime Line

We suggest the Ultra Table with Simple Chair as the main choice in the Prime line. Any wooden chair with metal frame - from our collection - can also be used with our Ultra Table. (page 44 to 45)



● Ultra Table



● Simple Chair



Table combination

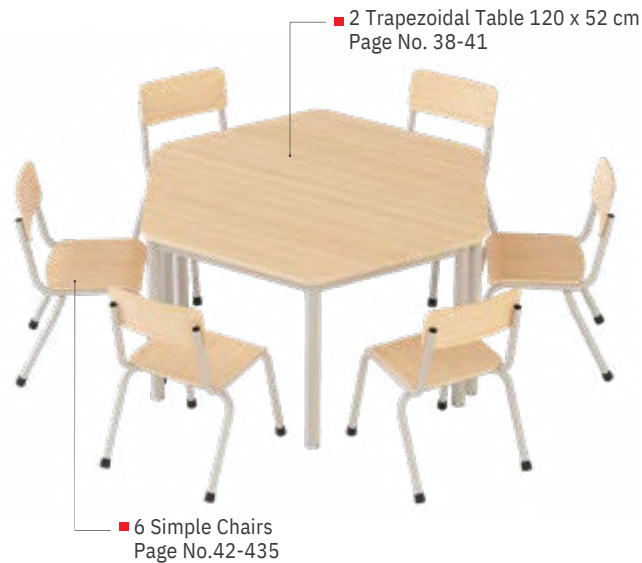

Another shapes of Ultra Tables



Legs / Rails Colours

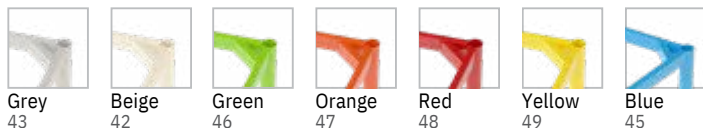
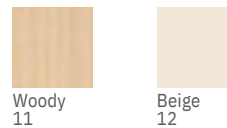
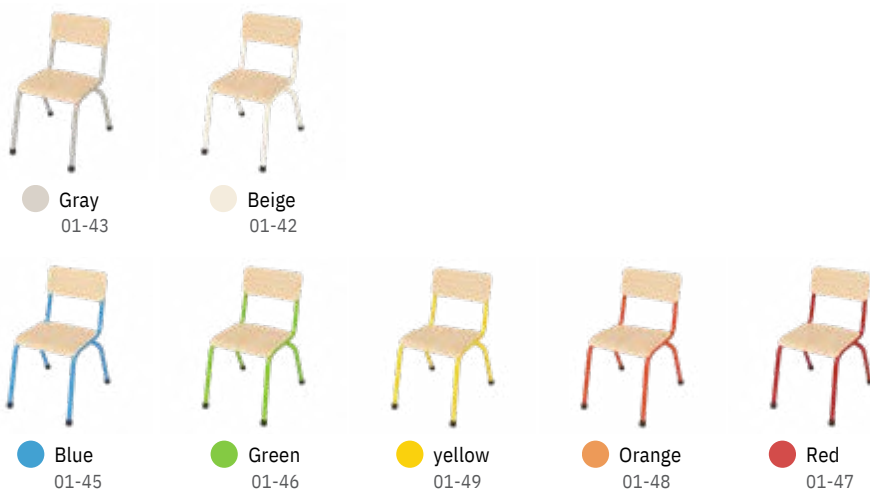

Table - Top Colours



wooden seat & back with colored metal frame



Seat & back colours with grey metal frame



Prime Line

Ultra Tables

This range offers durable tables with metal frame and two options of laminated tabletop with natural edge colour. The plastic glides for soft and hard floors. Casters are available in one side for easy moving.



22mm MDF Laminated HPL solid beech edges

Table top 22mm thickness made from extremely strong medium density fiberboard (MDF) insulation, stiff, has no knots, will produce fine and better edges and tops laminated with high pressure laminated HPL (under heat (80-90 Celsius) and pressure (250 kgs/m²) - (NAF) no added formaldehyde, (Ivory color or Beige wood theme) Edges made from solid beechwood painted with protective varnish, gently and safety rounded edges



Very Special rounded Edge design without any spacing (shark nose Edge)

Metal Legs / Rails

There are five different heights for these metal legs which is convenient to children different heights. These tables come packed flat for your convenience. The tables are easily assembled with the simple instructions provided.

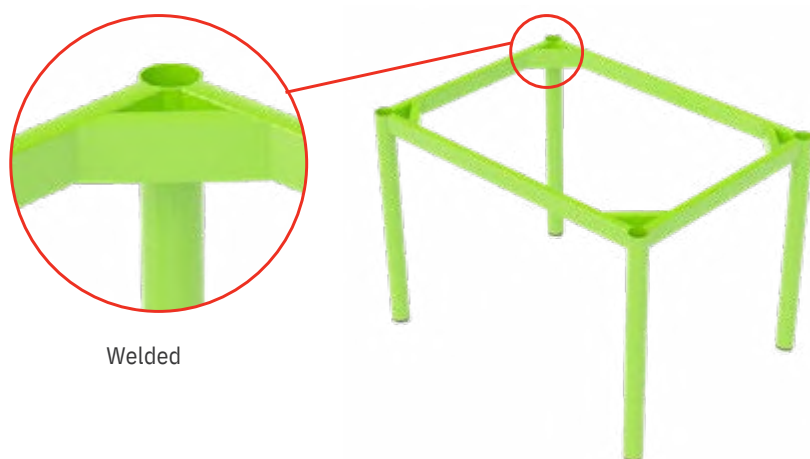

Welded



Available with or without Lockable Casters



Electrostatic



Adjustable P.P glide

Table Heights

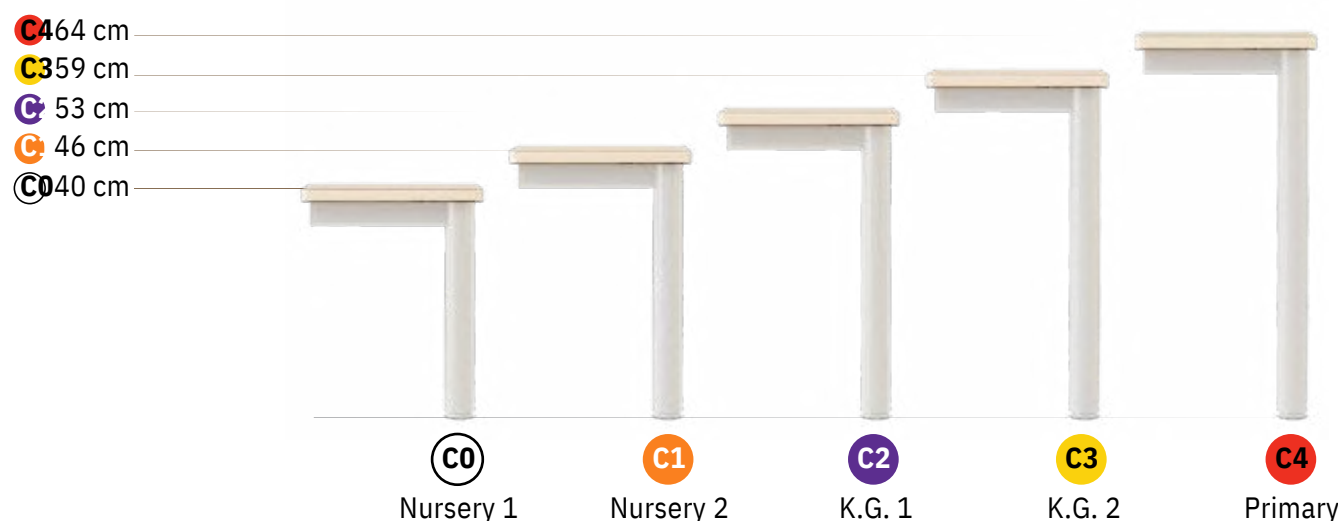

* Number of legs & Casters are upon table shape



ø 90 cm

■ Circle Table ø 90 cm



ø 120 cm

■ Circle Table ø 120 cm

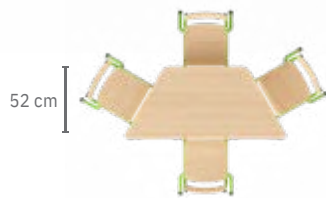

52 cm

120 cm

■ Trapezoidal Table 120 x 52 cm

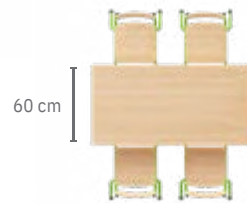

60 cm

120 cm

■ Rectangular Table 120 x 60 cm

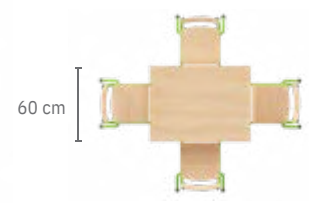

60 cm

80 cm

■ Rectangular Table 60 x 80 cm

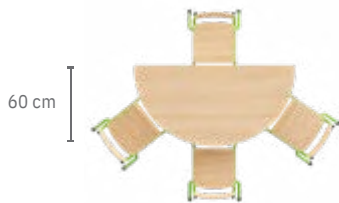

60 cm

120 cm

■ Semi-Circle Table 120 x 60 cm



60 cm

120 cm

■ Triangle Table 120 x 60 cm



60 cm

60 cm

■ Square Table 60 x 60 cm

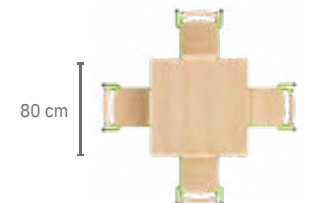

80 cm

80 cm

■ Square Table 80 x 80 cm





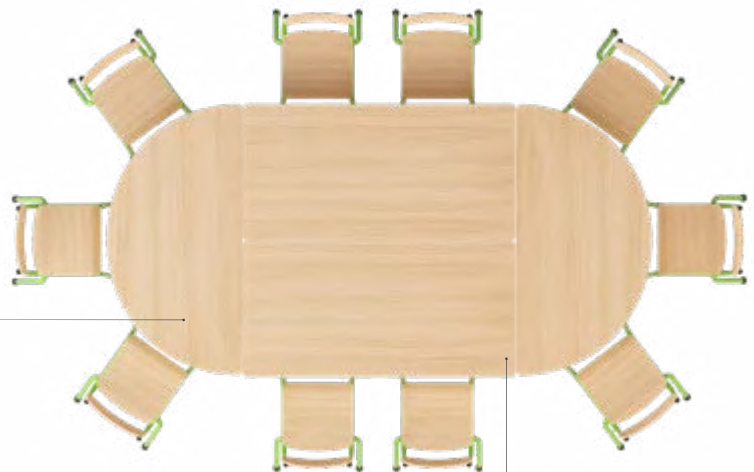





■ 2 Trapezoidal Table 120 x 52 cm
Page No.40-41



■ 2 Semi-Circle Table 120 x 60 cm
Page No. 40-41

■ 2 Rectangular Table 120 x 60 cm
Page No. 40-41

Stages & Symbol	Metal Frame		Metal Frame With Casters		Metal Frame		Metal Frame With Casters	
4  Rectangular Table 120 x 60 cm	(C0)	44530	44531	5  Triangle Table 120 x 60 cm	(C0)	44560	44561	
	(C1)	44532	44533		(C1)	44562	44563	
	(C2)	44621	44640		(C2)	44631	44635	
	(C3)	44626	44645		(C3)	44632	44636	
	(C4)	44534	44535		(C4)	44564	44565	
4  Rectangular Table 80 x 60 cm	(C0)	47920	47950	5  Trapezoidal Table 120 x 52 cm	(C0)	44548	44549	
	(C1)	47921	47951		(C1)	44550	44551	
	(C2)	47922	47952		(C2)	44623	44641	
	(C3)	47923	47953		(C3)	44628	44646	
	(C4)	47924	47954		(C4)	44552	44553	
6  Circle Table ø 120 cm	(C0)	44542	44543	4  Square Table 80 x 80 cm	(C0)	44650	44655	
	(C1)	44544	44545		(C1)	44651	44656	
	(C2)	44625	44643		(C2)	44652	44657	
	(C3)	44630	44648		(C3)	44653	44658	
	(C4)	44546	44547		(C4)	44654	44659	
4  Circle Table ø 90 cm	(C0)	47926	47955	2  Square Table 60 x 60 cm	(C0)	44611	44616	
	(C1)	47927	47956		(C1)	44612	44617	
	(C2)	47928	47957		(C2)	44613	44618	
	(C3)	47929	47958		(C3)	44614	44619	
	(C4)	47930	47959		(C4)	44615	44620	
5  Semi-Circle Table 120 x 60 cm	(C0)	44536	44537					
	(C1)	44538	44539					
	(C2)	44624	44642					
	(C3)	44629	44647					
	(C4)	44540	44541					

Legs / Rails Colours

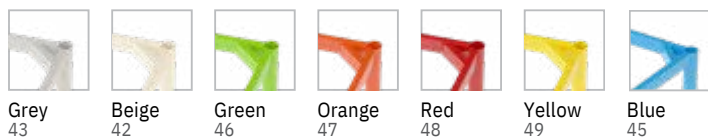

Table - Top Colours



Simple Chair

Sturdy, durable and light chairs. Chairs are constructed with superior formed metal pipes, seat and back from environmental-friendly plywood for comfortable seating. Available in seven metal frame colours. Chairs are stackable or put on table-top allowing easy classroom cleaning.



Curved Birch plywood seat & backrest

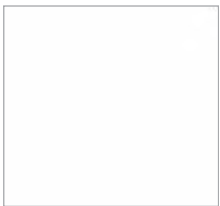

Plastic Cap



Stackable up to 5



Chairs & Tables	Chairs Size	Chairs Code	Recommended Tables Height
C0	28.5 x 28.5 cm - H. 21 cm	48423	40 cm
C1	28.5 x 28.5 cm - H. 26 cm	48424	46 cm
C2	30 x 30 cm - H. 31 cm	43505	53 cm
C3	30 x 30 cm - H. 35 cm	43506	59 cm
C4	36 x 36 cm - H. 38 cm	48425	64 cm



Chairs - Metal Frame Colours

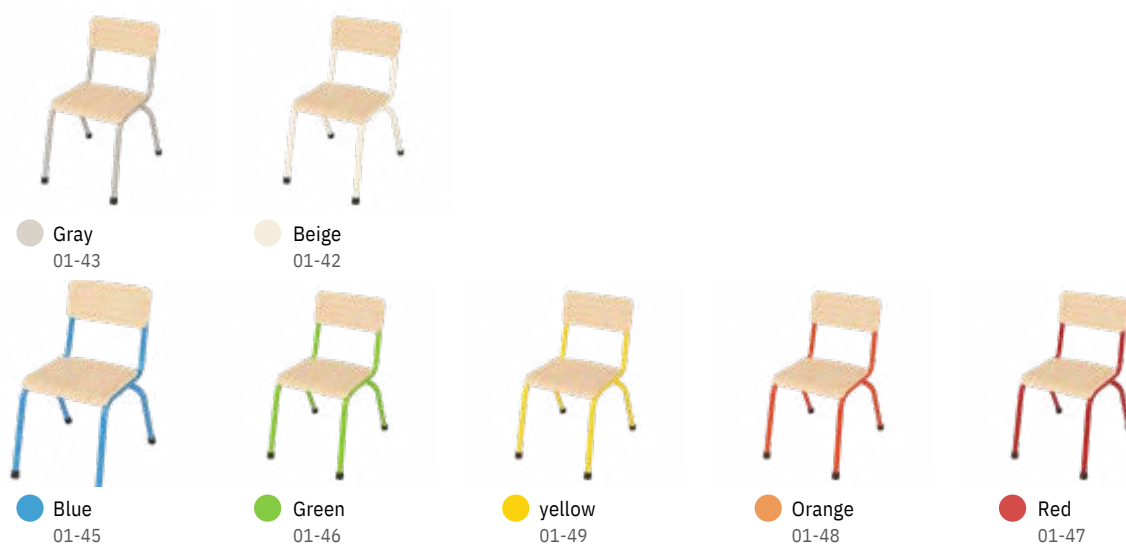

Seat & back colours with grey metal frame



Recommended Chairs



Dynamic Chair

Sturdy, durable & light chair. Constructed with superior formed metal pipes. Ergonomically designed back and seat to increase seating comfort. Seat and back surface are made from environmental friendly plywood for comfort seating. The design of legs makes them stackable for easy storage.



Curved Birch plywood seat & backrest



Stackable up to 5



Plastic Glides

Chairs & Tables	Chairs Size	Chairs Code	Recommended Tables Height
C2	30 x 30 cm - H. 31 cm	43502	53 cm
C3	30 x 30 cm - H. 35 cm	43503	59 cm
C4	36 x 36 cm - H. 38 cm	48165	64 cm

Metal Frame Colours



Gray
01-43



Beige
01-42



Red
01-48



Orange
01-47



Yellow
01-49



Green
01-46



Blue
01-45



Seat & back rest Colours



Red
18-43



Orange
17-43



Yellow
19-43



Green
16-43



Blue
15-43

Action Chair

Modern and Ergonomically designed back and seat to increase seating comfort. The environmental friendly plywood seat surface resists scratches and is easy to clean. Glides guarantee stability and minimum abrasion on all types of floors. The design of legs makes them stackable for easy storage.



Stackable up to 5



Curved Birch plywood seat & backrest



Plastic Glides



Chairs & Tables	Chairs Size	Chairs Code	Recommended Tables Height
C2	30 x 30 cm - H. 31 cm	43507	53 cm
C3	30 x 30 cm - H. 35 cm	43508	59 cm
C4	36 x 36 cm - H. 38 cm	48325	64 cm

Metal Frame Colours



Beige
01-42



Gray
01-43



Blue
01-45



Green
01-46



Yellow
01-49



Orange
01-47



Red
01-48

Seat & back rest Colours



Blue
15-43



Green
16-43



Yellow
19-43



Orange
17-43



Red
18-43

Classroom Fit Outs

We offer custom designed room plans to fit your needs. We have a team of experts in translating your vision into functional yet inspirational learning spaces. Here are some ideas for how you can use our Prime Line furniture pieces to create integrated kindergarten classroom.

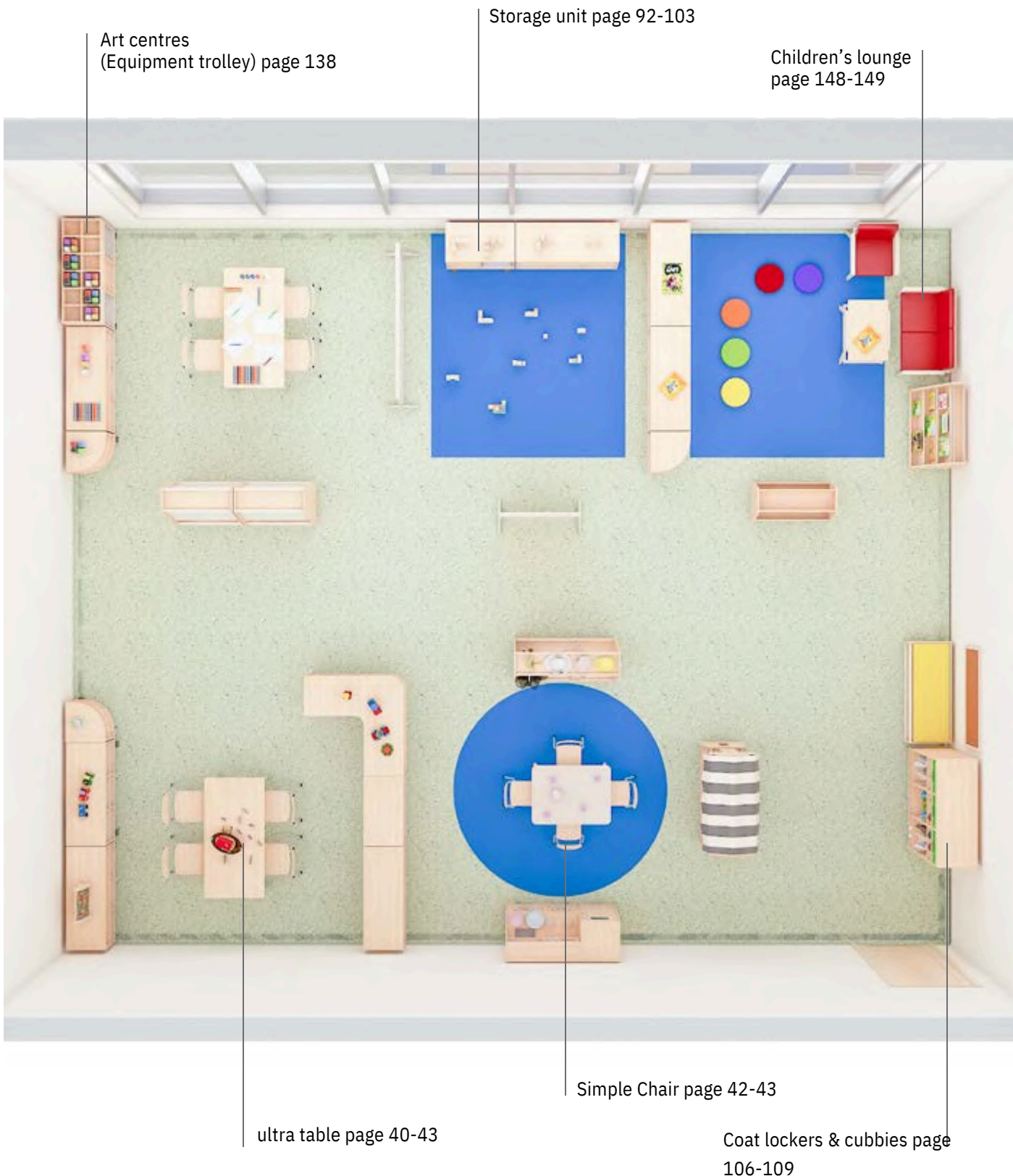



Grand Line

The Metal / Wood Series

New Unique design of multi adjustable metal/ wooden table legs. Rigged Metal tubes Chairs frames with natural birch plywood seat and back rest.

Grand line is the ideal choice for encouraging creativity and cooperation among children. The construction and materials used ensures that it will remain durable in their everyday use. The wide range of colours available gives you the flexibility to create many classroom outfits that satisfy all tastes. It is ergonomically designed for active children in their early years to gently encourage healthy posture. The modular designs offers infinite arrangements, and infinite possibilities.



Tables:

Tops made from:

- Tops made from 28 mm thick MDF - (Medium density fiberboard)- laminated with HPL - high pressure laminate.
- Table tops are available in wood grain and beige color with high scratch and shock resistance laminates.
- New designed Solid Wood Edges curved and rounded for safety. No grooves with table when grouped together or combined.



Table legs made from:

- Adjustable Metal/ wood table legs new design construction.
- Table legs made from unique easy adjustable varnished solid beech wood , with strong anti-scratch epoxy paint finish steel base.
- Legs are fitted with glides to protect floor; floor leveling and reduce noise.
- Legs come separate, and can fit to any table top size and design. They are easy and quick to assemble and fix using metal threaded insert and screws.
- Table tops legs are adjustable up to 5 heights.
- 5 years Guarantee.



Chairs

- Frame made from rigged Metal tubes with strong scratch resistance epoxy paints.
- Seat and back rest made from ergonomically curved multi layered birch ply wood.
- Special leg design provide stability.
- Metal frame are fitted with glides to protect floors and reduce noise.
- Multi stack Chairs.
- Comes assembled.
- Wide range of colored range available (for chair frame, and for seat and back rest).
- Very Strong and can hold the weight of an adult.
- 5 years Guarantee.

Grand Line

We suggest the Flexo Table with Simple Chair as the main choice in the Grand line. Any wooden chair with metal frame - from our collection - can also be used with our Flexo Table. (page 58 to 59)



● Flexo Table



● Simple Chair



Table combination

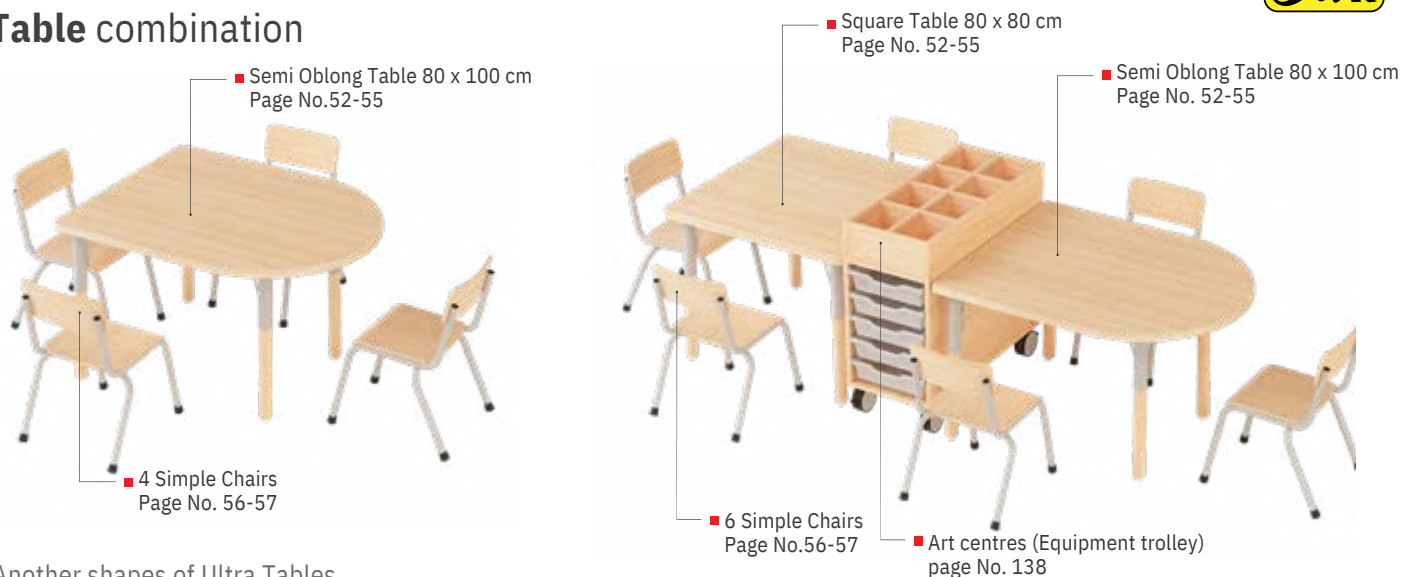

Another shapes of Ultra Tables



Legs / Rails Colours

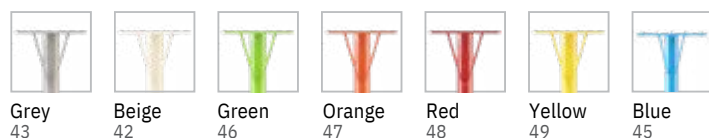
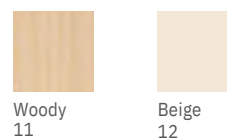

Table - Top Colours



wooden seat & back with colored metal frame



Seat & back colours with grey metal frame



Grand Line

Flexo Tables

These flexible movable creative tables combine contemporary looks, functionality as well as flexibility and encourage social behaviour, creativity and cooperation among students. It comes in a variety of unique shapes and sizes. Each shape and size has its merits and benefits, depending on the learning situation. Tables can be combined with each other or with other tables combining a multitude of layouts creating an attractive look. Tables are made of Medium-density fiberboard (MDF) covered by high-pressure laminate (HPL). Legs are either fixed or adjustable to offer different heights, an advantage for mixed age groups.



As everyone has his/her own choices, we have enabled you to choose your table just as you like! Choose the table-top material and then decide if you want a fixed or adjustable leg. Also you can decide if you want coasters (in two legs) or glides.

28mm MDF Laminated HPL solid beech edges

Table top 28mm thickness made from extremely strong medium density fiberboard (MDF) insulation, stiff, has no knots, will produce fine and better edges and tops laminated with high pressure laminated HPL (under heat (80-90 Celsius) and pressure (250 kgs/m²) - (NAF) no added formaldehyde, (Ivory color or Beige wood theme) Edges made from solid beechwood painted with protective varnish, gently and safety rounded edges



Very Special rounded Edge design without any spacing (shark nose Edge)

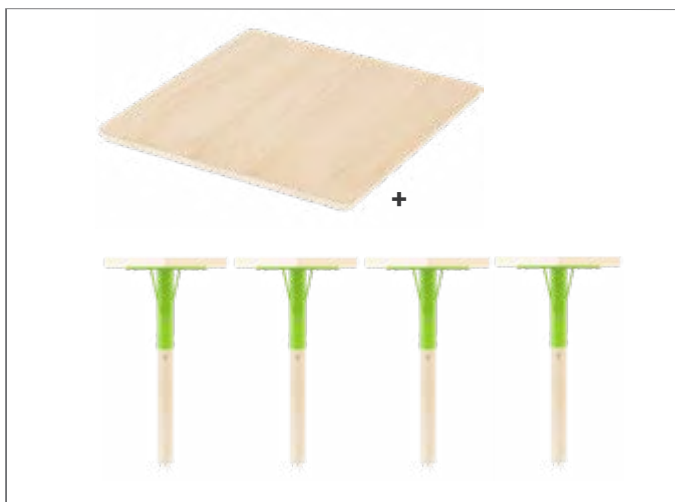

=



Wood/Metal legs

These legs can be adjusted according to children different heights. Metal adjustable leg can be used from (C0 - C4) stage. It is ideal for mixed age classrooms.



Metal insert & Adjustable P.P glide



Available with or without Lockable Casters

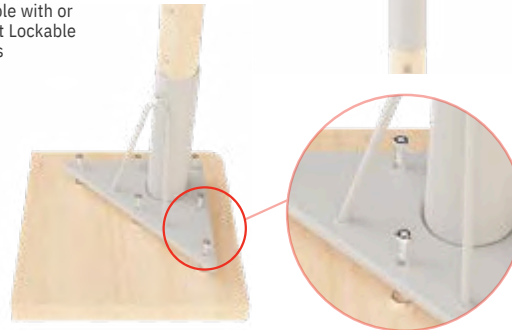

Metal insert & hex heads screws



Metal tube welded to bracket angel

Adjustable Leg Heights

C4 64

C3 cm

C2 59

C1 cm

C0 53

cm

46

cm

40

cm

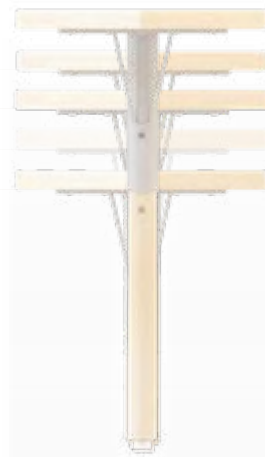

Metal legs

There are five different heights for these metal legs which is convenient to children different heights.



Available with or without Lockable Casters



Adjustable P.P glide

Metal insert & hex heads screws



Metal tube welded to bracket angel

Available for Size C0 to C4

C4 64

C3 cm

C2 59

C1 cm

C0 53

cm

46

cm

40

cm



* Number of legs & Casters are upon table shape

Grand Line

Flexo Tables

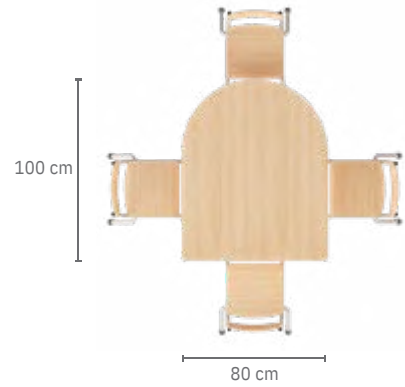

■ Semi Oblong Table 80 x 100 cm

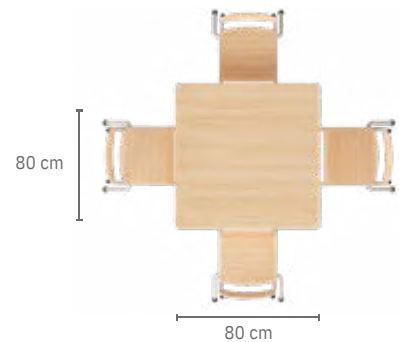

■ Square Table 80 x 80 cm

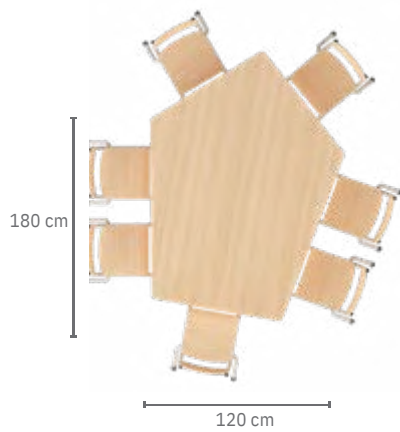

■ Large Pentagon Table 120 x 180 cm

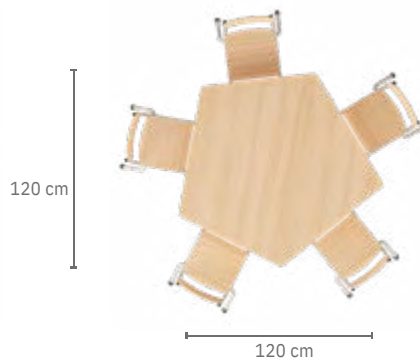

■ Small Pentagon Table 120 x 120 cm

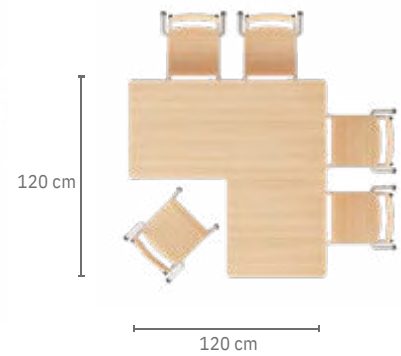

■ L-Shape Table 120 x 120 cm

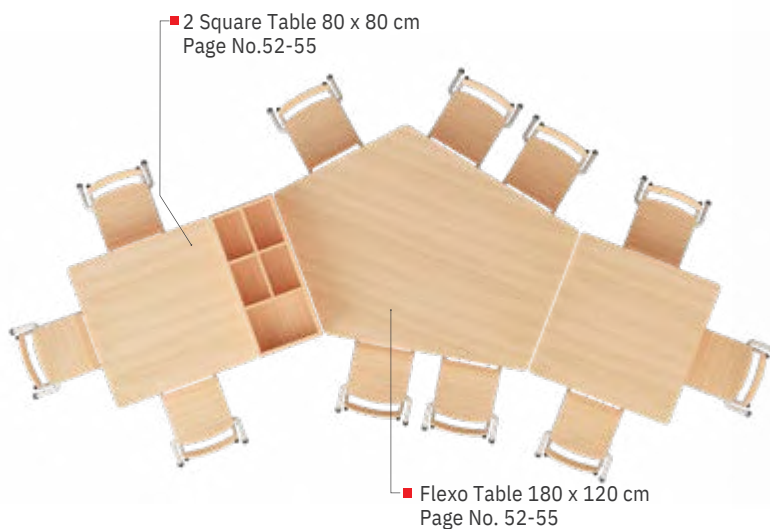

■ 2 Square Table 80 x 80 cm
Page No.52-55

■ Flexo Table 180 x 120 cm
Page No. 52-55

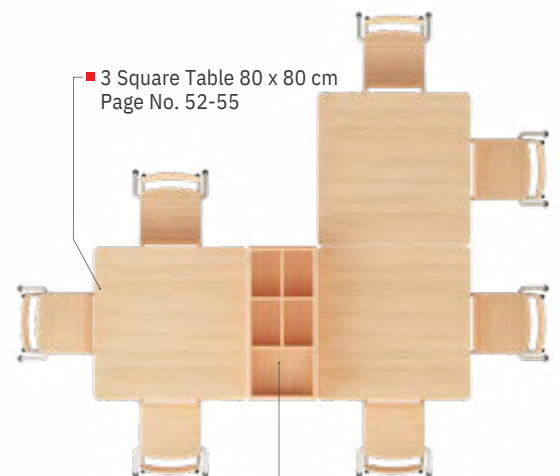

■ 3 Square Table 80 x 80 cm
Page No. 52-55

■ Art centres (Equipment trolley)
70.2 x 40 x 92 cm
64103
Page No. 138

Stages & Symbol	Metal Legs		Metal Legs with Casters		Metal & Wood Legs		Metal & Wood Legs with Casters	
5 Chairs Small Pentagon Table 120 x 120 cm	(C0)	44800		44803	44808	44961		
	(C1)	44801		44804				
	(C2)	44700		44805				
	(C3)	44702		44806				
	(C4)	44802		44807				
7 Chairs Large Pentagon Table 180 x 120 cm	(C0)	44810		44813	44818	44963		
	(C1)	44811		44814				
	(C2)	44704		44815				
	(C3)	44706		44816				
	(C4)	44812		44817				
4 Chairs Square Table 80 x 80 cm	(C0)	44830		44833	44838	44969		
	(C1)	44831		44834				
	(C2)	44712		44835				
	(C3)	44714		44836				
	(C4)	44832		44837				
5 Chairs L-shape Table 120 x 120 cm	(C0)	44890		44893	44898	44981		
	(C1)	44891		44894				
	(C2)	44736		44895				
	(C3)	44738		44896				
	(C4)	44892		44897				
4 Chairs Semi Oblong Table 80 x 100 cm	(C0)	44780		44785	44878	44879		
	(C1)	44781		44786				
	(C2)	44782		44787				
	(C3)	44783		44788				
	(C4)	44784		44789				

Legs / Rails Colours

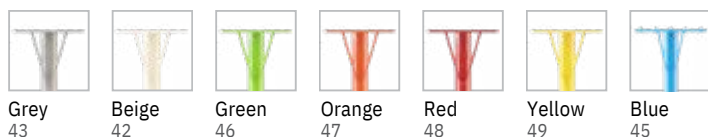
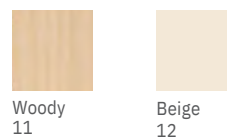

Table - Top Colours



Simple Chair

Sturdy, durable and light chairs. Chairs are constructed with superior formed metal pipes, seat and back from environmental-friendly plywood for comfortable seating. Available in seven metal frame colours. Chairs are stackable or put on table-top allowing easy classroom cleaning.



Curved Birch plywood seat & backrest

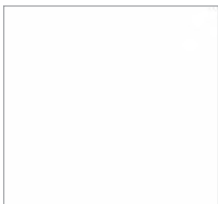

Plastic Cap



Stackable up to 5



Chairs & Tables	Chairs Size	Chairs Code	Recommended Tables Height
C0	28.5 x 28.5 cm - H. 21 cm	48423	40 cm
C1	28.5 x 28.5 cm - H. 26 cm	48424	46 cm
C2	30 x 30 cm - H. 31 cm	43505	53 cm
C3	30 x 30 cm - H. 35 cm	43506	59 cm
C4	36 x 36 cm - H. 38 cm	48425	64 cm



Chairs - Metal Frame Colours

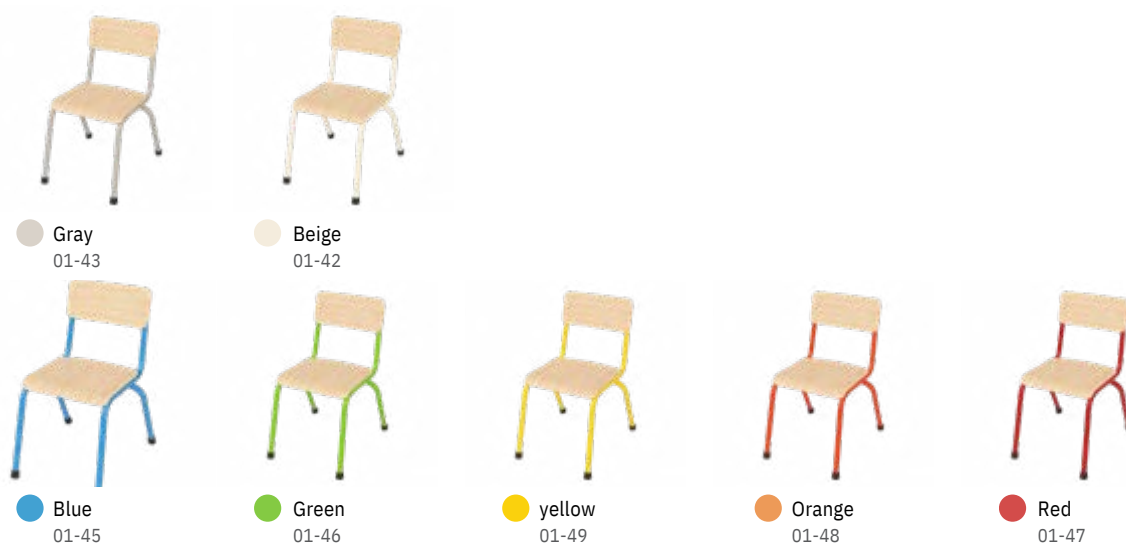

Seat & back colours with grey metal frame



Recommended Chairs



Dynamic Chair

Sturdy, durable & light chair. Constructed with superior formed metal pipes. Ergonomically designed back and seat to increase seating comfort. Seat and back surface are made from environmental friendly plywood for comfort seating. The design of legs makes them stackable for easy storage.



Curved Birch plywood seat & backrest



Stackable up to 5



Plastic Glides

Chairs & Tables	Chairs Size	Chairs Code	Recommended Tables Height
C2	30 x 30 cm - H. 31 cm	43502	53 cm
C3	30 x 30 cm - H. 35 cm	43503	59 cm
C4	36 x 36 cm - H. 38 cm	48165	64 cm

Metal Frame Colours



Gray
01-43



Beige
01-42



Red
01-48



Orange
01-47



Yellow
01-49



Green
01-46



Blue
01-45

Seat & back rest Colours



Red
18-43



Orange
17-43



Yellow
19-43



Green
16-43



Blue
15-43



Action Chair

Modern and Ergonomically designed back and seat to increase seating comfort. The environmental friendly plywood seat surface resists scratches and is easy to clean. Glides guarantee stability and minimum abrasion on all types of floors. The design of legs makes them stackable for easy storage.



Stackable up to 5



Curved Birch plywood seat & backrest



Plastic Glides



Chairs & Tables	Chairs Size	Chairs Code	Recommended Tables Height
C2	30 x 30 cm - H. 31 cm	43507	53 cm
C3	30 x 30 cm - H. 35 cm	43508	59 cm
C4	36 x 36 cm - H. 38 cm	48325	64 cm

Metal Frame Colours



● Beige
01-42



● Gray
01-43



● Blue
01-45



● Green
01-46



● Yellow
01-49



● Orange
01-47



● Red
01-48

Seat & back rest Colours



● Blue
15-43



● Green
16-43



● Yellow
19-43



● Orange
17-43



● Red
18-43

Classroom Fit Outs

We offer custom designed room plans to fit your needs. We have a team of experts in translating your vision into functional yet inspirational learning spaces. Here are some ideas for how you can use our Grand Line furniture pieces to create integrated kindergarten classroom.

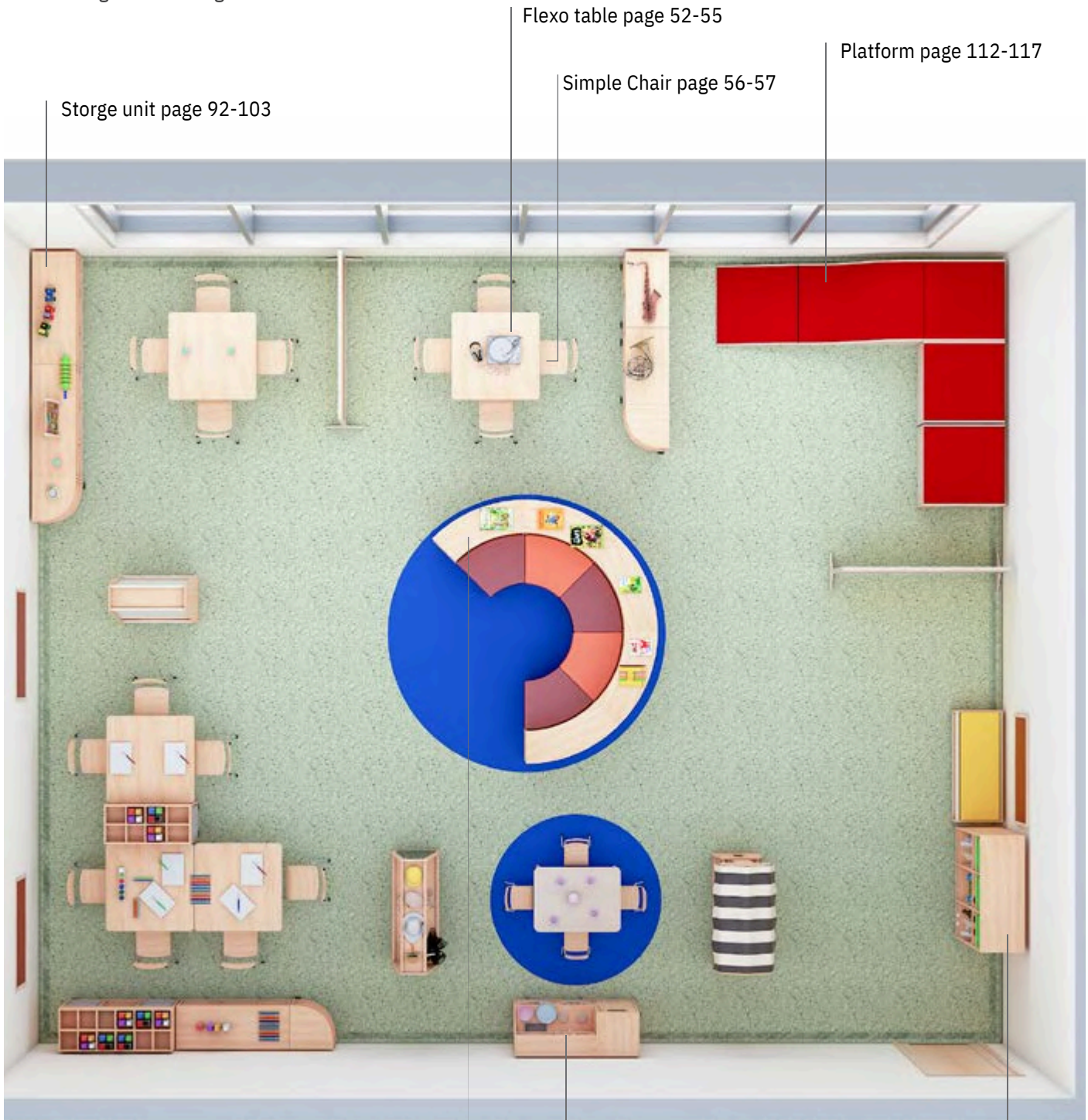

Storage unit page 92-103

Flexo table page 52-55

Simple Chair page 56-57

Platform page 112-117

Curved Storage Box Units
page 133

Drama centre
Kitchen
page 144-145

Coat lockers & cubbies
page 104-107

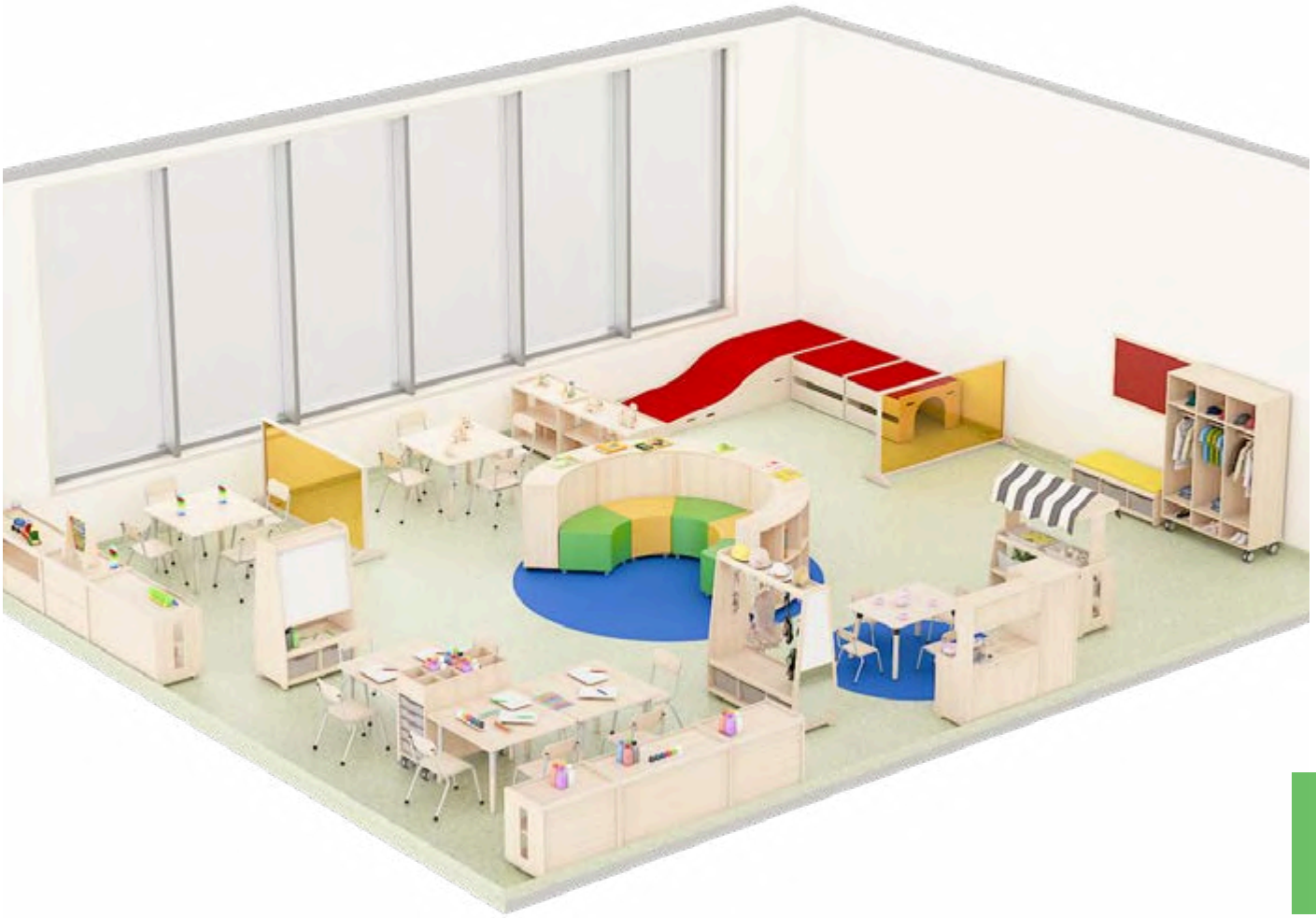

VividLine

The new modern design selection

New Unique design of one piece ergonomically curved, colored plastic chair shells. Rigid Multi adjustable metal table legs with protective T molding section table top edging.

Vivid line is great for provoking group play and discussions with their peers and educators. Colourful style to suit certain tastes. Tables come in a variety of unique shapes and sizes. Each shape and size has its merits and benefits, depending on the learning environment. Chairs are Modern and ergonomically designed with plastic shells to increase seating comfort. High durability to ensure years of safe use



Tables:

Tops made from:

- Tops made from 28mm thick MDF - (Medium density fiberboard)- laminated with HPL - high pressure laminate.
- Table tops are available in wood grain and beige color with high scratch and shock resistance laminates.
- Colored Curved and rounded T molding plastic edges for safety.



Table legs made form:

- Adjustable Metal/ Metal table legs.
- Table legs are easy adjustable strong metal tube. Legs are in two adjustable parts. Anti-Scratch Chrome plated legs, and strong epoxy paint finish steel base.
- Legs are fitted with glides to protect floor; floor leveling and reduce noise.
- Legs come separate, and can fit to any table top size and design. They are easy and quick to assemble and fix using metal threaded insert and screws.
- Table tops legs are adjustable heights.
- 5 years Guarantee.



Chairs

- New ergonomically designed colored plastic shells.
- Frame made from rigged metal tubes with strong scratch resistance epoxy paints.
- Special leg designs provide stability.
- Metal frame are fitted with glides to protect floors and reduce noise.
- Multi stack Chairs.
- Comes assembled using smart and easy locking.
- Wide range of colours available.
- Very Strong and can hold the weight of an adult.
- Easy to clean.
- 5 years Guarantee.

Vivid Line

We suggest the Curvy Table with Flexo L Chair as the main choice in the Grand line. Any chair with plastic shell & metal frame - from our collection - can also be used with our Curvy Table. (page 72 to 75)



● Curvy Table



● Flexo L Chair



Table combination

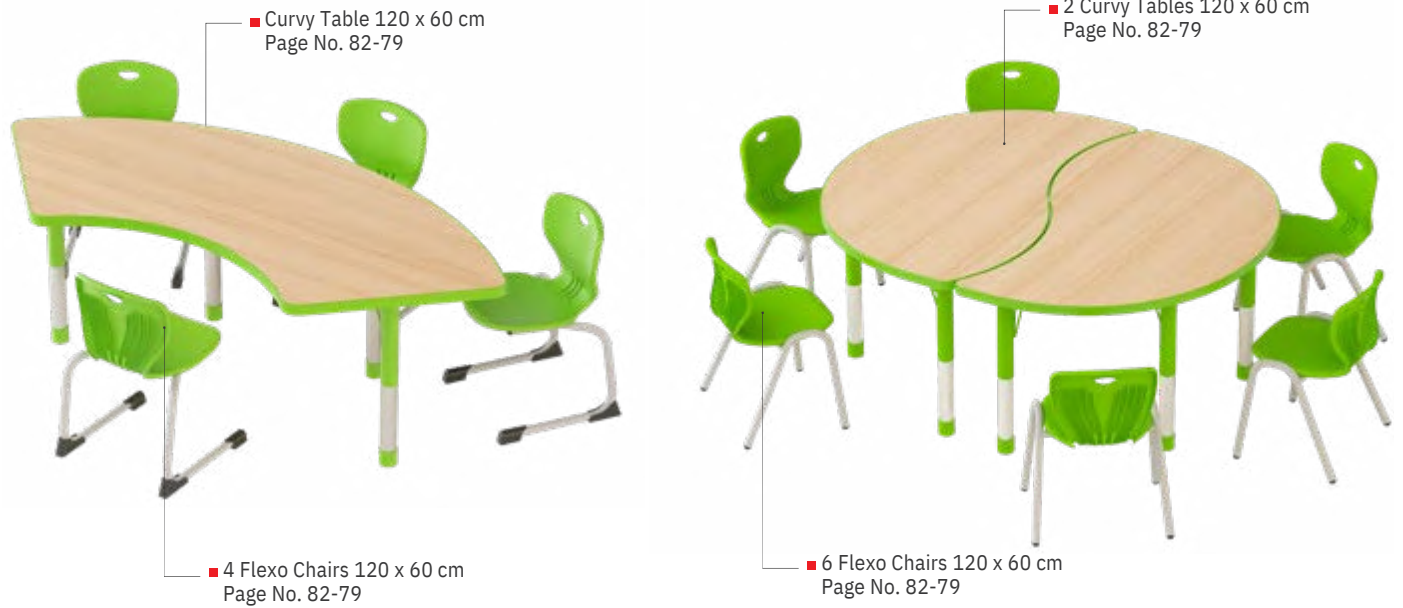

Another shapes of Ultra Tables



Legs / Rails Colours



Table - Top Colours

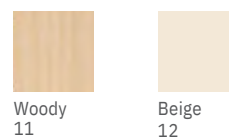

Shell colours with grey metal frame



Vivid Line

Curvy Tables

Well - designed Curvy tables can handle any activity and are a wide range of shapes. Curvy tables can accommodate a number of children. The leg's height can be adjusted with an easy turn of the screw.



As everyone has his/her own choices, we have enabled you to choose your table just as you like! Choose the table- top material and then decide if you want a fixed or adjustable leg. Also you can decide if you want coasters (in two legs) or glides.



=



28mm MDF Laminated HPL solid beech edges band

Table top 28mm thickness made from extremely strong medium density fiberboard (MDF) insulation, stiff, has no knots, will produce fine and better edges and tops laminated with high pressure laminated HPL (under heat (80-90 Celsius) and pressure (250 kgs/m²) - (NAF) no added formaldehyde, (Ivory color or Beige wood theme) Edges made from p.p with gently and safety rounded edges



Metal legs

There are five different heights for these metal legs which is convenient to children different heights.



Adjustable P.P glide

Metal insert & hex heads screws



Metal tube welded to bracket angel



Available for Size **C0 to C4**

- C4** 64
- C3** cm
- C2** 59
- C1** cm
- C0** 53
- cm
- 46
- cm
- 40
- cm



* Number of legs are upon table shape

Vivid Line

Curvy Tables

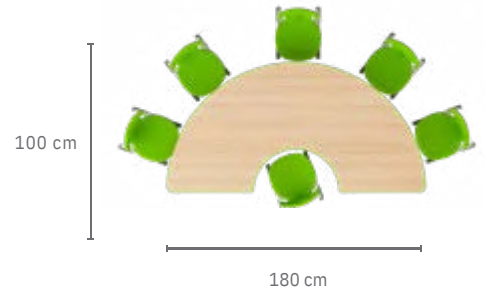

■ Half Dounat Table 180 x 90 cm

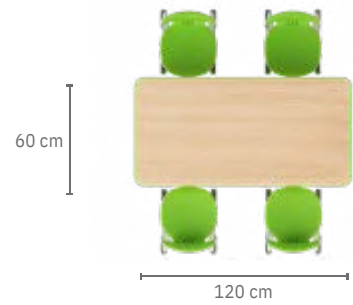

■ Rectangular Table 120 x 60 cm

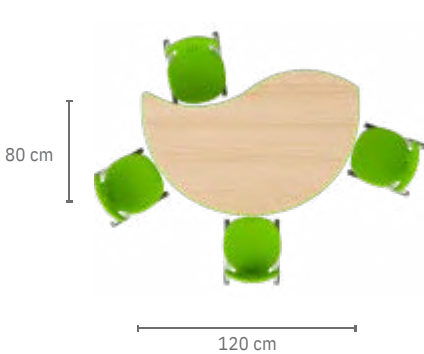

■ Wavy Circle Table 120 x 80 cm

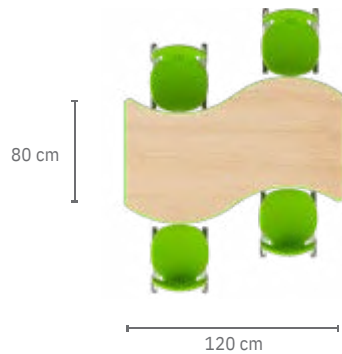

■ Wavy Table 120 x 80 cm

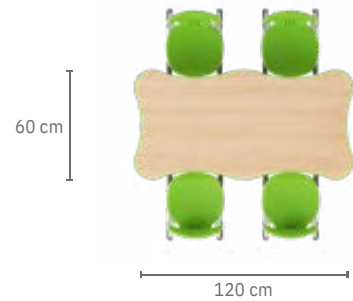

■ Rectangular Wavy Table 120 x 60 cm

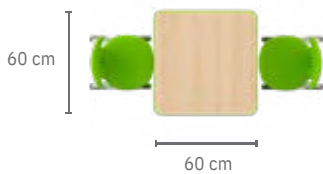

■ Square Table 60 x 60 cm

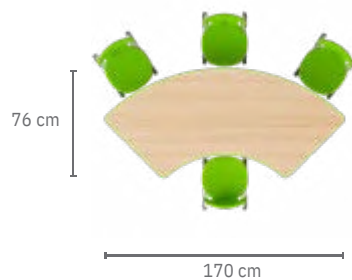

■ Quarter Dounat Table 170 x 76 cm

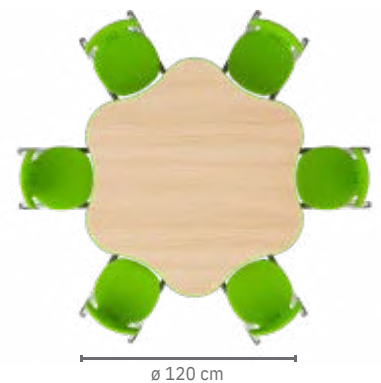

■ Flower Table \varnothing 120 cm

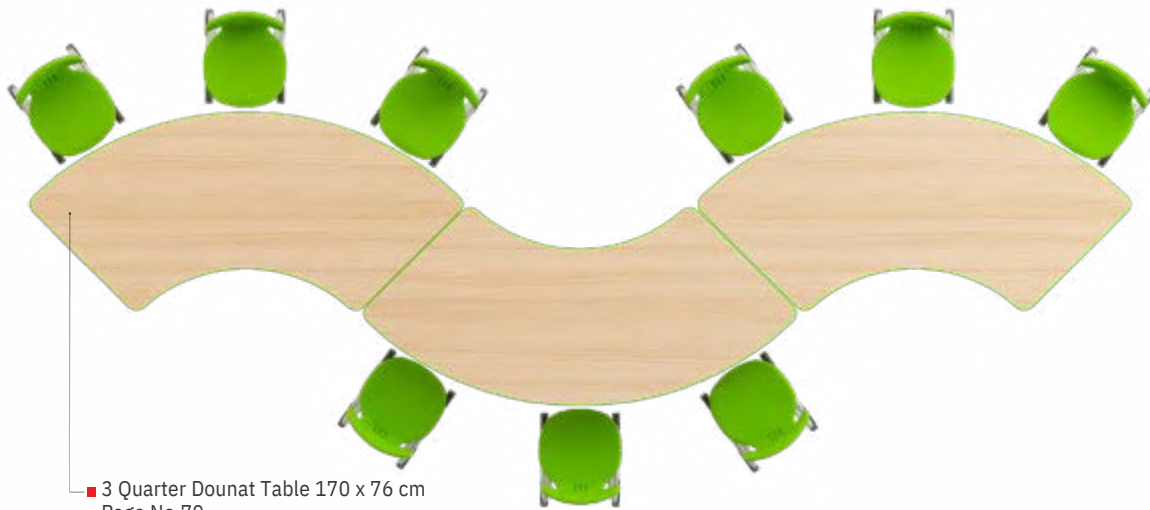

■ 3 Quarter Dounat Table 170 x 76 cm
Page No.70

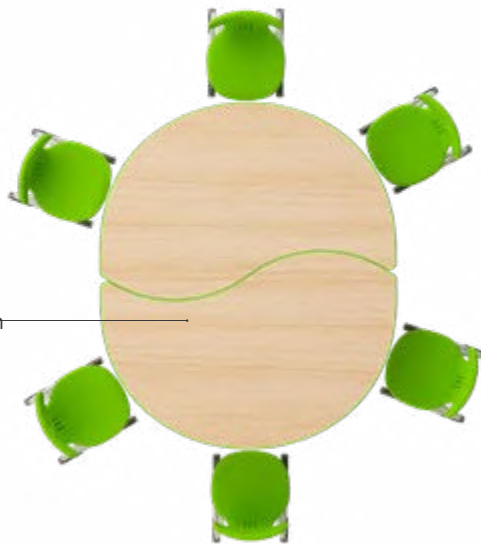

■ 2 Wavy Circle Table 120 x 80 cm
Page No. 70

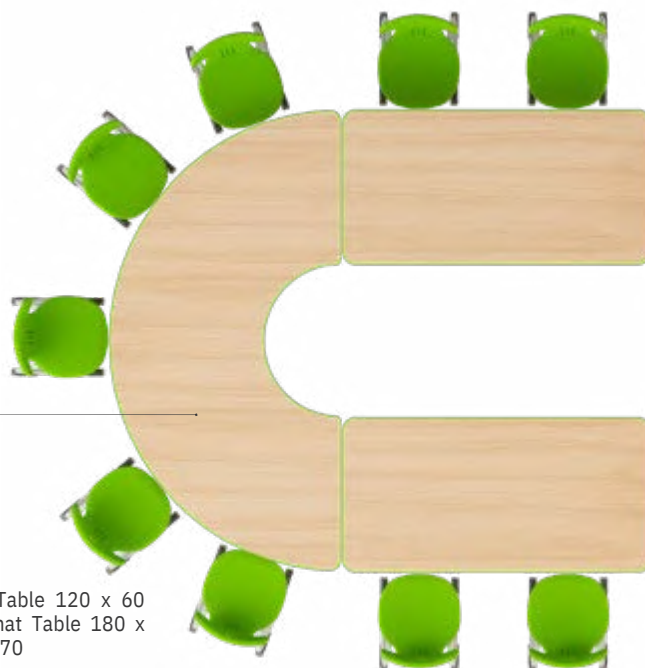

■ 2 Rectangular Table 120 x 60 cm
1 Half Dounat Table 180 x 90 cm
Page No. 70

Vivid Line

Curvy Tables

Stages & Symbol					
C0 - Nursery 140 cm C1 - Nursery 246 cm C2 - K.G 1 53 cm C3 - K.G 2 59 cm C4 - Primary 64 cm					
2 Square Table 60 x 60 cm	C0 C1 C2 C3 C4	44440	4 Quarter Dounat Table 170 x 76 cm	C0 C1 C2 C3 C4	44448
4 Rectangular Table 120 x 60 cm	C0 C1 C2 C3 C4	44443	6 Flower Table ø 120 cm	C0 C1 C2 C3 C4	44430
4 Rectangular Wavy Table 120 x 60 cm	C0 C1 C2 C3 C4	44433	4 Wavy Table 120 x 80 cm	C0 C1 C2 C3 C4	44431
5 Half Dounat Table 180 x 100 cm	C0 C1 C2 C3 C4	44449	5 Wavy Circle Table 120 x 80 cm	C0 C1 C2 C3 C4	44432

Legs / Rails Colours

Grey 43	Beige 42	Green 46	Orange 47	Red 48	Yellow 49	Blue 45

Table - Top Colours

Wood 11	Beige 12



Flexo L Chair

Modern and Ergonomically designed plastic shell to increase seating comfort. The robust seat surface resists scratches and is easy to clean. Glides guarantee stability and minimum abrasion on all types of floors. The design of legs makes them stackable for easy storage.



Ergonomic Plastic Shell



Stackable up to 5



Plastic Glides



Plastic Glides



Chairs & Tables	Chairs Size	Chairs Code	Recommended Tables Height
C2	30 x 30 cm - H. 31 cm	43527	53 cm
C3	30 x 30 cm - H. 35 cm	43528	59 cm



Shell colours with grey metal frame



Gray
33-43



Beige
32-43



Blue
35-43



Light Blue
34-43



Green
36-43



yellow
39-43



Orange
37-43



Red
38-43



Flexo N Chair

Modern and Ergonomically designed plastic shell to increase seating comfort. The robust seat surface resists scratches and is easy to clean. Glides guarantee stability and minimum abrasion on all types of floors. The design of legs makes them stackable for easy storage.



Ergonomic Plastic Shell

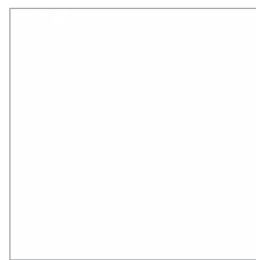

Plastic Glides



Chairs & Tables	Chairs Size	Chairs Code	Recommended Tables Height
C2	30 x 30 cm - H. 31 cm	43525	53 cm
C3	30 x 30 cm - H. 35 cm	43526	59 cm



Shell colours with grey metal frame



Gray
33-43



Beige
32-43



Blue
35-43



Light Blue
34-43



Green
36-43



yellow
39-43



Orange
37-43



Red
38-43



Classroom Fit Outs

We offer custom designed room plans to fit your needs. We have a team of experts waiting to transform your vision into functional and inspirational learning spaces. Here are some ideas for how you can use our **Vivid Line furniture** pieces to create integrated kindergarten classroom

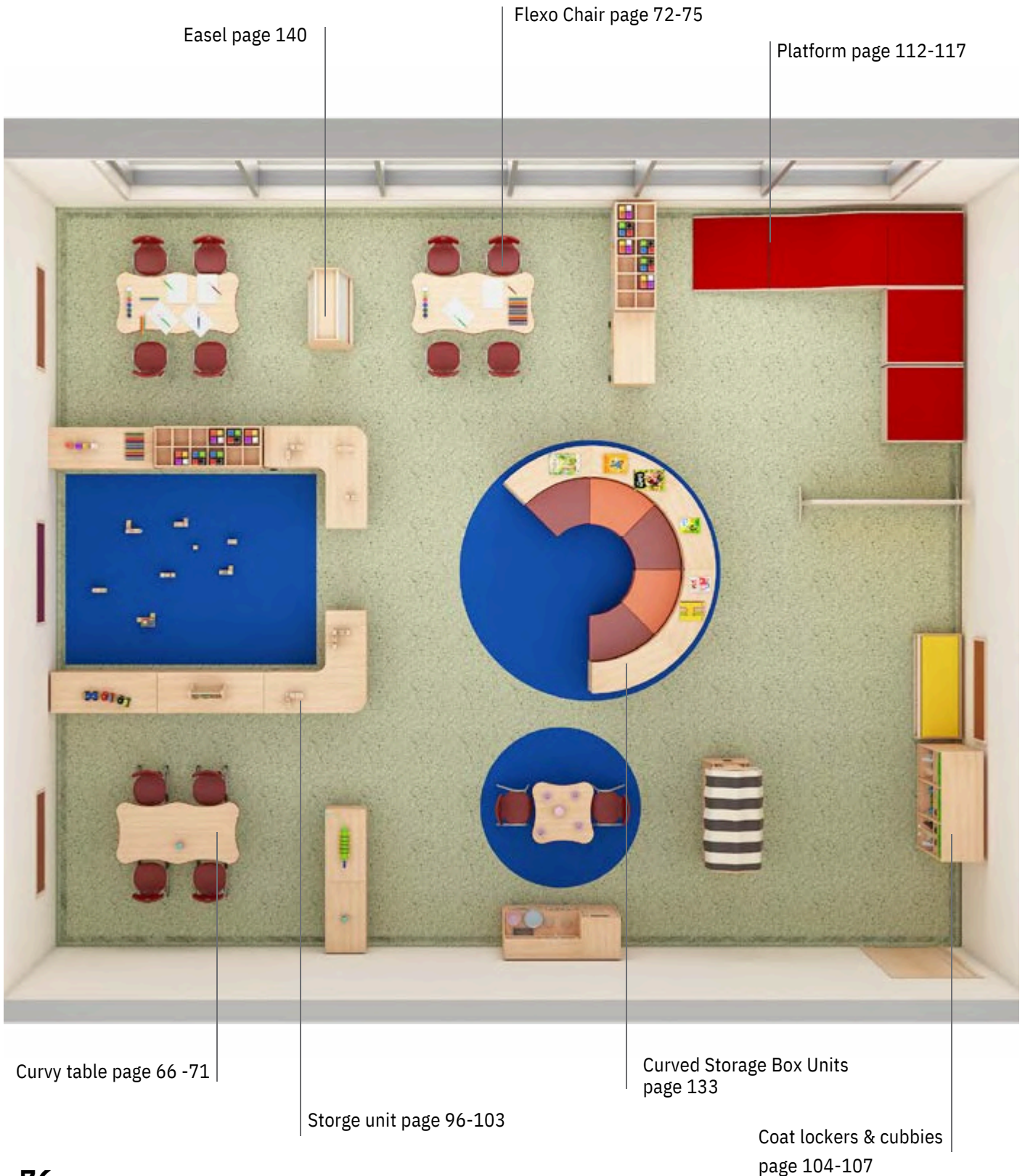



Teacher Chair

A great item for all teachers and child Care Givers! This chair is designed to keep adults comfortable while still interacting with the class on their level. Unlike standard child-sized chairs, the adult sized seat and back provide appropriate room and support for adults to sit comfortably. Made of solid beechwood.







40 x 38 cm - H. 35 cm
43281

Teacher **Deluxe** Chair

Ergonomically designed chairs that will last for generations. Each chair is made of solid, top-quality lacquered beechwood & plywood. Chairs have a curved seat and back rest.

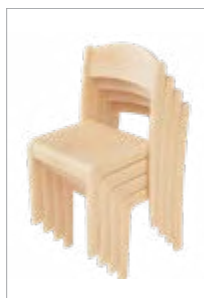

Stackable up to 5

Avalibale Seats & backs Colours

- Natural plywood
01-01
- Orange
07-01
- Blue
05-01
- Green
06-01
- Red
08-01
- yellow
09-01

Teacher **Simple** Chair

Sturdy, durable and light chairs. Chairs are constructed with superior formed metal pipes, seat and back from environmental-friendly plywood for comfortable seating. Chairs are stackable and sit sturdily and securely on table-tops without risk of toppling, allowing for easy classroom tidying.



40 x 38 cm - H. 35 cm
48428



Stackable up to 5

Avalibale Seats & backs Colours

- Green
06-01
- Orange
07-01
- Blue
05-01
- Red
08-01
- yellow
09-01

Avalibale frame Colours

- Gray
01-43
- Beige
01-42
- Orange
01-47
- Green
01-46
- Red
01-48
- yellow
01-49
- Blue
01-45



Stool & Benches

Our smart variety of stools & benches allow for more space in any learning environment. Comfortable yet practical stools & benches will suit almost anyone's needs. They are Gentle on the floor due to the plastic glides, even after years of use. Their construction assures strength, stability and support.





Stool & Benches

Stool

A very high quality piece of furniture. This stool is made of solid Beechwood frame and laminated plywood seat. Stool legs have double dowel connection lines to guarantee maximum stability. Curved leg design has no corners on which little ones can get themselves caught. Easy to assemble for storage. The neutral tone makes them perfect companions with many of our tables. The doweled plastic glides ensure no marks or divots are left on the floor even after years of use.



Stackable up to 3



C0 ø 34 cm
H. 21 cm
43320



C1 ø 34 cm
H. 26 cm
43321



C2 ø 34 cm
H. 30 cm
43322



C3 ø 34 cm
H. 35 cm
43323

Deluxe Bench

This bench is made of solid Beechwood frame with laminated plywood seat. Created without sharp corners for safety. The neutral tone makes it compatible with many tables. Gentle to the floor Doweled plastic legs. Its construction assures strength, stability and support.



C	96.5 x 25 cm - H. 26	4328
1	cm 96.5 x 31 cm - H.	6
C	31 cm 96.5 x 31 cm -	4328
2	H. 35 cm	7
C		4328
3		8

Elegance Stool & Bench

This stool & bench is made of solid Beechwood frame with laminated plywood seat. The neutral tone makes it compatible with many tables. One of our absolute best sellers, the elegance is gentle on the floors, Doweled plastic legs glide even after years of use. Its construction assures strength, stability and support.



Elegance Stool



Elegance Bench

Elegance Stool

C	32 x 33 cm - H. 21	4333
0	cm 32 x 33 cm - H.	0
C	26 cm 32 x 33 cm -	4333
1	H. 31 cm 32 x 33 cm	1
C	- H. 35 cm 32 x 33	4333
2	cm - H. 38 cm	2
		4333

Elegance Bench

C	96 x 33 cm - H. 21	4333
0	cm 96 x 33 cm - H.	4333
C	26 cm 96 x 33 cm -	4333
1	H. 31 cm 96 x 33 cm	6
C	- H. 35 cm 96 x 33	4333
2	cm - H. 38 cm	7
C		4333

Soft Seating

Our attractive soft seating collection is the best choice for inspirational learning areas. It can be used in many different ways within any learning environment. Latest studies show that children do learn better when they are in activity-based spaces. Available in a range of fabric and leather options to suit your needs.

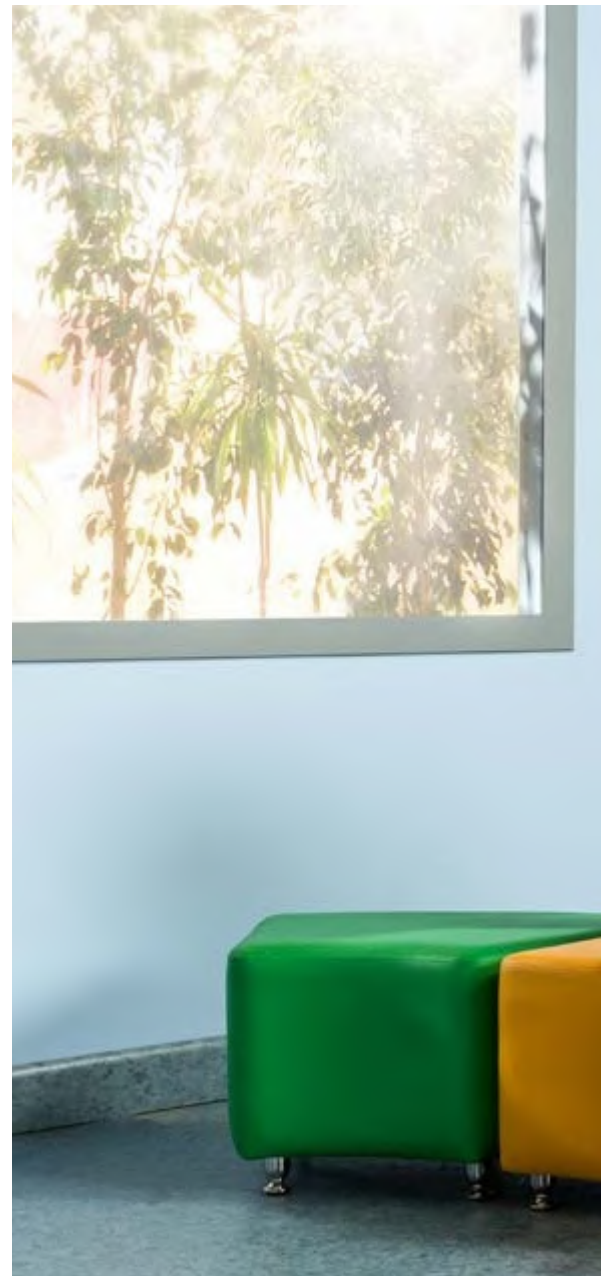



Curves - Soft Seating

Little reading corners, open spaces, reception areas all come to life, with our line of pre-school and school seating, as they welcome every passer-by for a little response. Six shapes snuggle into one another as you fit them together like puzzle pieces to create 3D masterpieces of art. It can be composed in to different formations to give a funky, modern look to your interior.



Available Colours



Beige
52



Light Blue
54



Green
56



yellow
59



Orange
57



Red
58



Brown
60



 <p>Circle</p>	 <p>Semi- circle</p>	 <p>Bites</p>
<p>C2 H. 31 cm - ø 45 cm - C3 43530 H. 35 cm - ø 45 cm - 43540</p>	<p>C2H. 31 cm - ø 45 cm - 43533 C3 H. 35 cm - ø 45 cm - 43543</p>	<p>C2H. 31 cm - ø 45 cm - 43531 C3 H. 35 cm - ø 45 cm - 43541</p>
 <p>Infinity</p>	 <p>Corner</p>	 <p>Big Circle</p>
<p>C2 H. 31 cm - 90 cm - 43532 C3 H. 35 cm - 90 cm - 43542</p>	<p>C2H. 31 cm - ø 45 cm - 43534 C3 H. 66.5 cm - ø 47.5 cm - 43544</p>	<p>C2H. 31 cm - ø 60 cm - 43535 C3 H. 35 cm - ø 60 cm - 43545</p>

Cushions seating

These soft cushions are the best choice for modern way in learning. They offer children the opportunity to sit comfortably without feeling restricted, which helps them concentrate better. Children can use them in reading corners at story time or just sitting on them looking at their favourite books. It is also compatible with our elegance & ultra from (C01 : C0) tables so they can be used for different activities & ages in which a table is required.

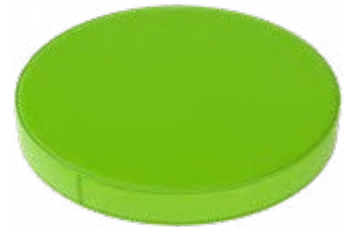

Circle
H.7.5 cm - ø 40 cm - 43550



Available Colours



Beige
52



Light Blue
54



Green
56



yellow
59



Orange
57



Red
58



Brown
60



35 x 35 x 70 cm - 43555

Storage Units

Offering versatile storage Systems, our range will keep your preschool educational spaces more functional and looking neat and tidy. With modern styling, our storage is available in natural or colourful themes to match all the creative educational functional environment spaces and can be configured to suit the requirements of any of layout. Our range has been designed also to separate spaces for different activities and to match with our table and chair systems. Available in an array of sizes and colours.

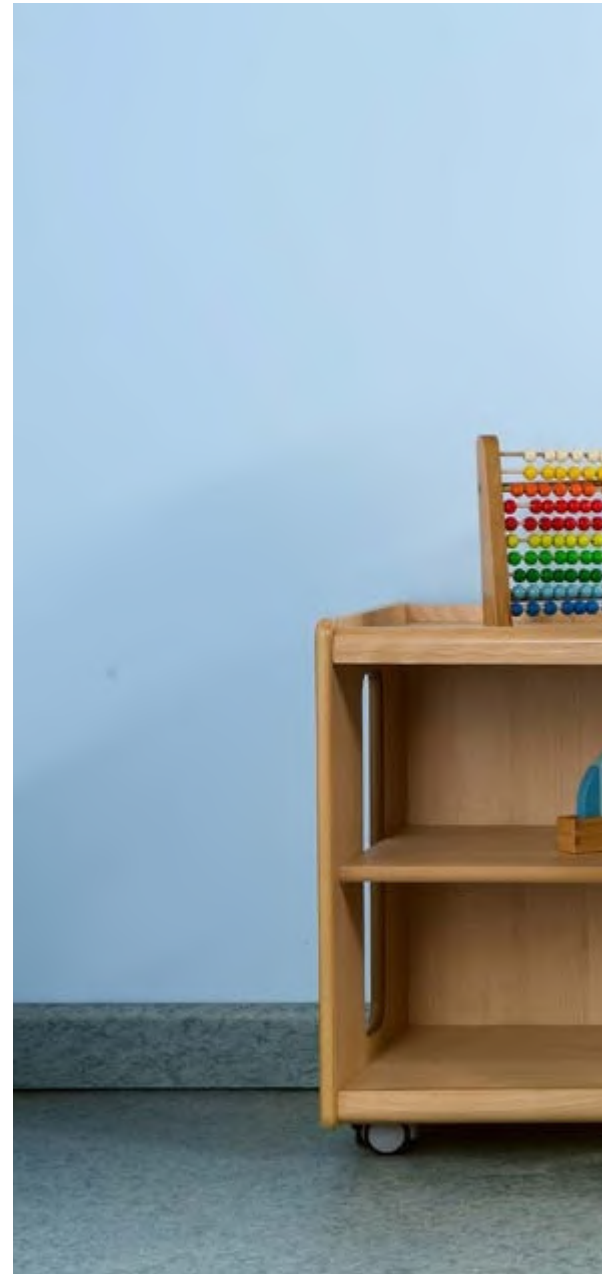



Storage Units

Ultimate N Storage Units

As well as looking attractive, this series of tray storage units are flexible and versatile. This collection was designed to fulfill the storage needs of any learning environment like Kindergarten Classrooms and art classrooms. The transparent trays & natural shelves give you the ability to make simple layouts with neutral designs while being able to see what you have stored with ease.



Curvy edges for more safety



Solid beech Profile



Heavy-duty lockable casters

Trays Supplier



Made in UK





Ultimate N Storage Units

W 70 x D 45 x H 62 cm

45490



45491



Units Colour



Wood
01

W 103.5 x D 45 x H 87 cm

45492



45493



Units Colour



Wood
01

Ultimate N Storage Units

W 103.5 x D 45 x H 62 cm

45494



45495



Units Colour



Wood
01

45496



45497



Units Colour



Wood
01

Storage Units

Materials Cabinets

The style of this collection is based on following curves, organic forms and natural colour. The beauty of high-quality beechwood is demonstrated in each piece of this collection. Fantastic for both Montessori classrooms and normal classrooms. Some cabinets are designed according to some of Montessori approved materials such as Pink Tower or Brown Stairs materials.



Safety edges



Heavy-duty lockable casters

As well as looking attractive, this series of storage units are flexible and versatile. This collection was designed to fulfill the storage needs of any learning





With Steel base
 100 x 37 x H.13.5 cm **99698**
 67 x 37 x H.13.5 cm **99690**



Storage Units

W 70 x D 40 x H 42 cm

W 103.5 x D 40 x H 42 cm

Materials Cabinets



45440



45441

W 103.5 x D 40 x H 69 cm



45446



45448

W 70 x D 40 x H 96 cm



45455

W 103.5 x D 40 x H 96 cm



45451



45450

W 70 x D 40 x H 69 cm



45443

W 103.4 x D 103.4 x H 69 cm



67375

Coat Lockers & cubbies

With our classroom-friendly storage lockers & cubbies, you can keep all your students' belongings in one convenient location. All lockers are easily accessible for little ones to hang up coats and backpacks all by themselves! The upper shelf is ideal for storing lunches, extra clothes and more. They can be paired with the ultimate storage units, which have a perfect seat for children to sit while putting on their shoes, ready to go out to play.





Coat locker unit

These sturdy units provide convenient storage space for organizing classrooms. It is available in double, triple and quadruples units. Each unit contains two plastic trays with anti-fall safety runners included. Also it can be equipped with shelf for shoes. Made of high quality MDF.



138 x 40 x 112 cm **64105**



103.6 x 40 x 112 cm **64106**



70.2 x 40 x 112 cm **64107**

Ultimate Storage Units

These ultimate storage units have a perfect seat for children to sit while putting on their shoes, ready to go out to play. Three sizes available: single, double & triple units to suit different requirements.



35 x 45 x 35 cm

45171



70 x 45 x 35 cm

45172



103.5 x 45 x 35 cm

45173



Soft Play

Studies show that active play aids a child's physical, mental, social and emotional well-being as they mature. Soft play corners are the most comprehensive and safe ways for children to develop. Our collection of soft play pieces are designed to give children a safer place to play. Our collection of soft play suits little children and offers them endless hours of fun and joy.





Multi Activity **Soft Play**

Children will have a lot of fun with these geometric shapes. Each shape's edge invites another shape to nestle encouraging interactive play among the soft shapes. The warm natural colours helps children to relax and concentrate. Made of high-density foam covered with leather. Easy to clean with soapy water. Recommended for ages between 2 and 3 years.

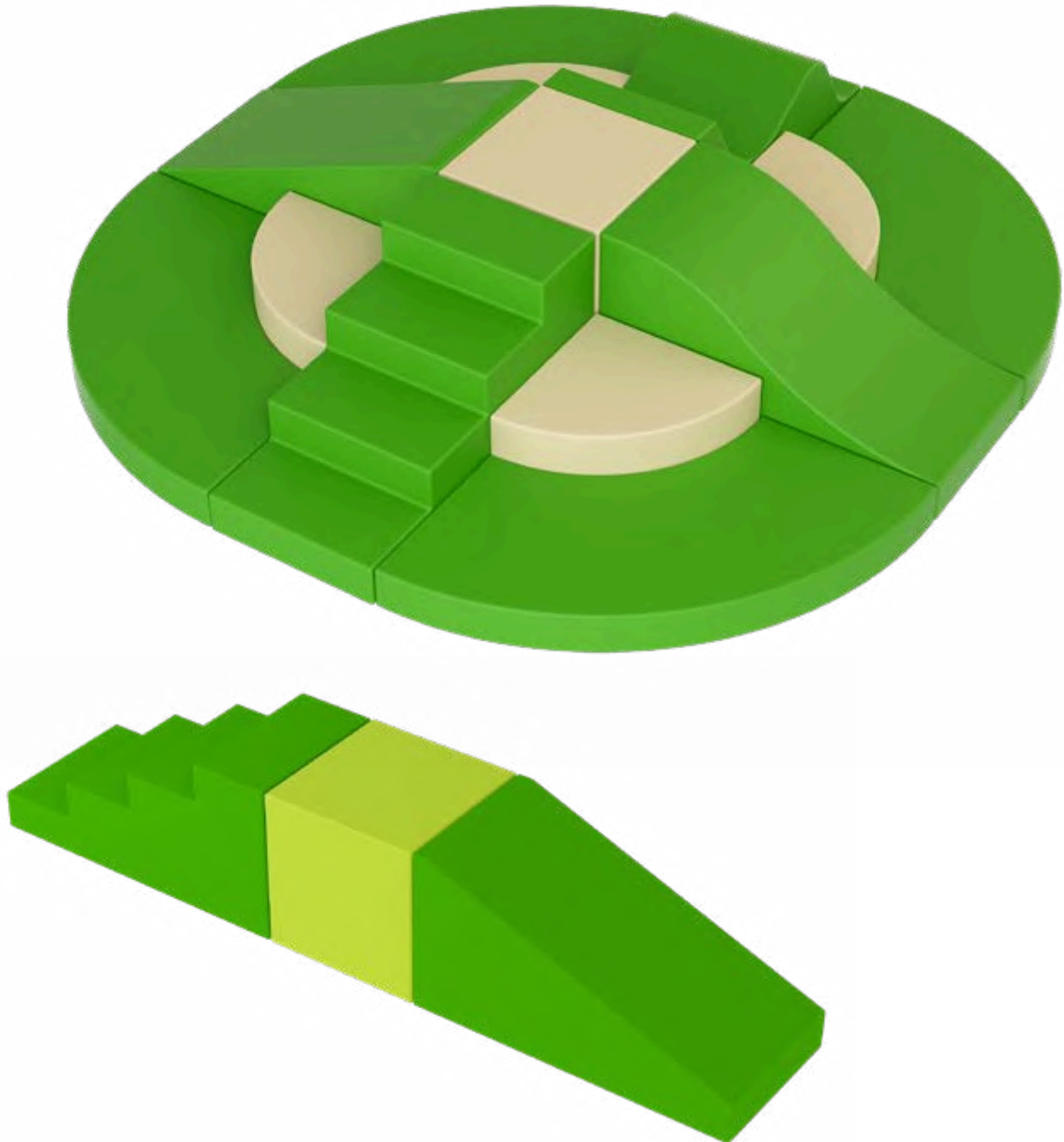

Available Colours



Beige
52



Light Blue
54



Green
56



yellow
59



Orange
57



Red
58





Brown
60

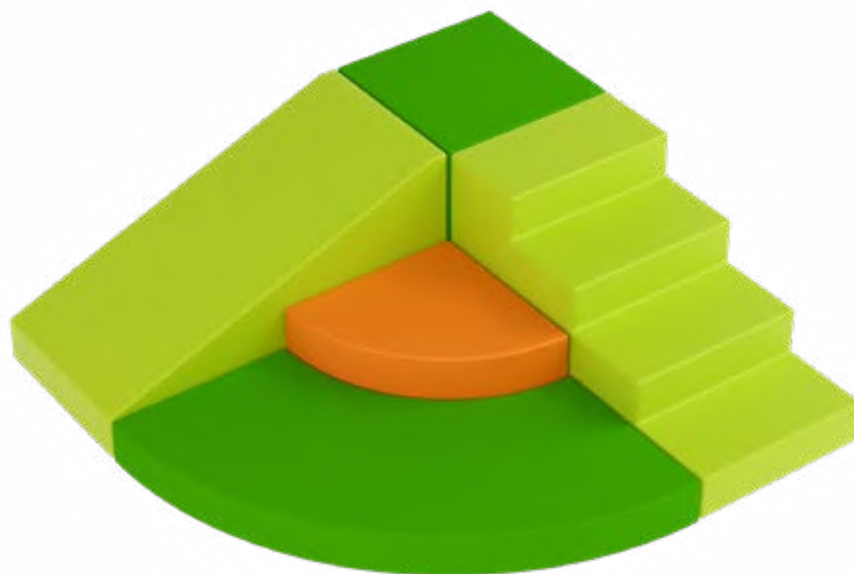

Semi-Circular Mat

100 x 50 x 12.5 cm **45986**

Slide

100 x 50 x 50 cm **45980**



Ladder

100 x 50 x 50 cm **45981**



Gentle Wave

100 x 50 x 50 cm **45982**



Two waves

100 x 50 x 50 cm **45983**



Square

50 x 50 x 50 cm **45984**



Quadrant Corner

50 x 50 x 25 cm **45985**

Platform

An ideal way to create the best play area for children. Platforms create interest, height differentiation and lots of fun. . Made of solid beechwood for durability. Our platforms promote balance and spatial cognition because children have to move in many different ways to manoeuvre the platforms.

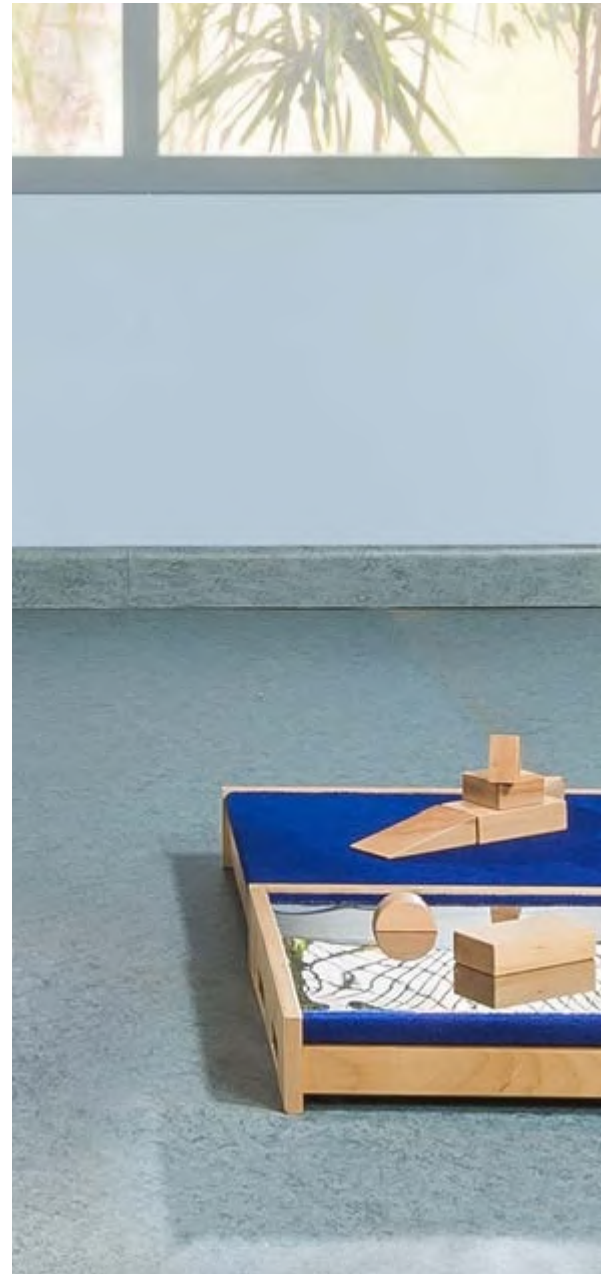



Platform

Large Platform

These platforms are available in 9 shapes in 3 different heights. The varying heights encourage movement for children. It can also be used as a playing corner. Handles are available to move and carry easily. High units have a tunnel system to add more fun for children to crawl under. Surfaces are covered with heavy-duty carpets or a safe mirror.





<p>112.5 X 75 X 30 cm 45968</p>	<p>75 X 75 X 30 cm 45960</p>	<p>112.5 X 75 X 45 cm 45963</p>
<p>75 X 75 X 45 cm 45967</p>	<p>75 X 75 X 15 cm 45962</p>	<p>75 X 37.5 X 15 cm 45964</p>
<p>75 X 75 X 15 cm 45961</p>	<p>75 X 75 X 15 cm 45966</p>	<p>75 X 75 X 15 cm 45965</p>

Platform

Small Platform

Designed especially for young children. It can also be used as a playing corner in your learning spaces. Nine shapes are available in 3 different heights. The varying heights encourage movement and imagination for children. Handles are available to move and carry easily. High units have a tunnel system to add more fun for children to crawl under. Surfaces are covered with heavy-duty carpets or a safe mirror.

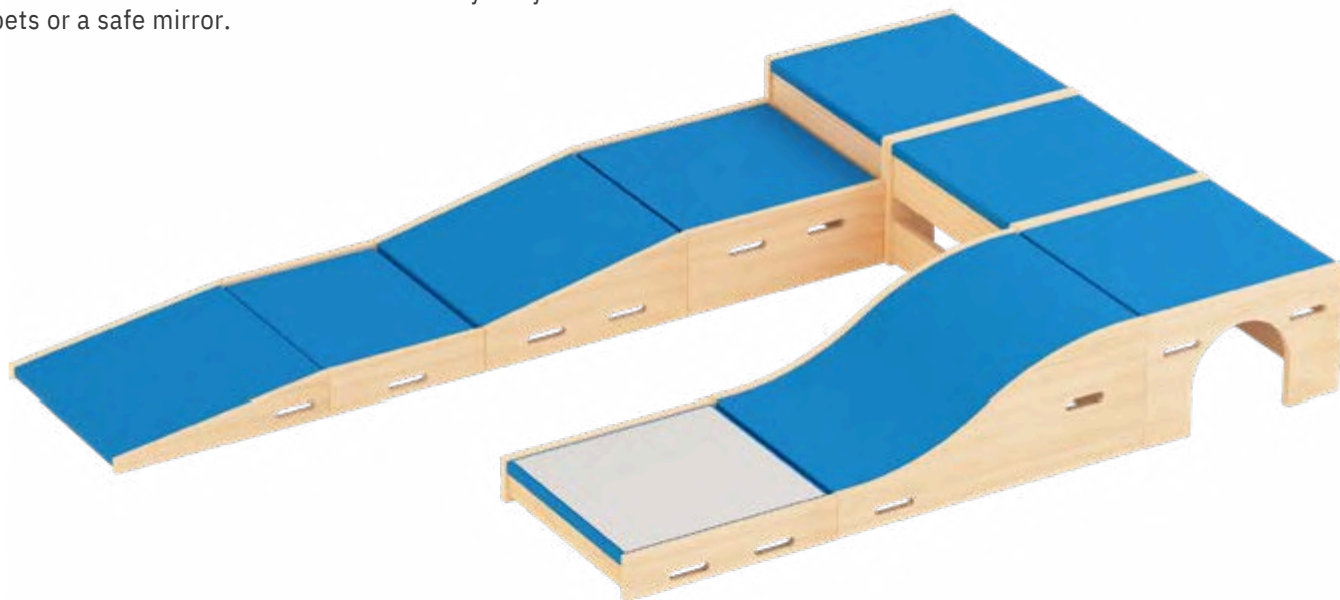

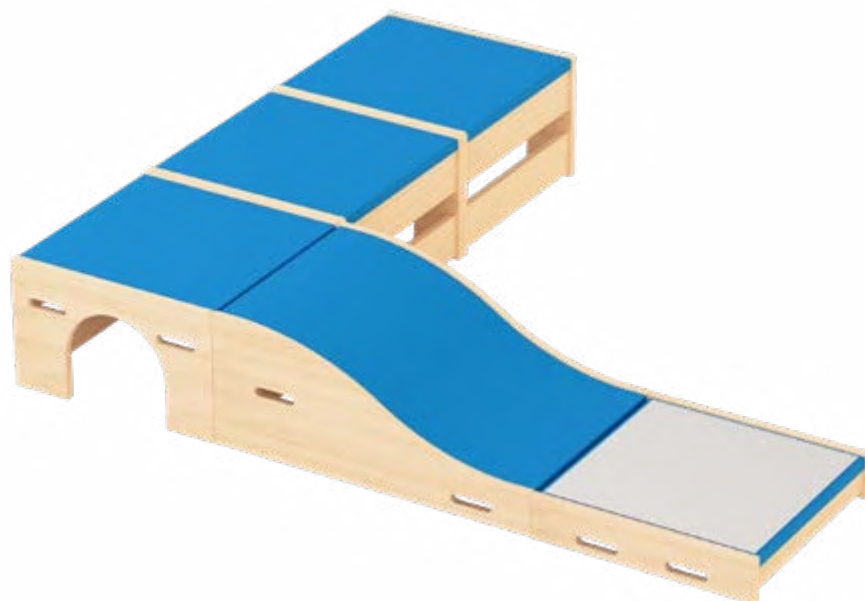

		
<p>50 x 50 x 20 cm 45970</p>	<p>50 x 50 x 20 cm 45971</p>	<p>75 x 50 x 30 cm 45972</p>
		
<p>50 x 50 x 30 cm 45973</p>	<p>50 x 50 x 10 cm 45976</p>	<p>50 x 37.5 x 10 cm 45975</p>
		
<p>50 x 50 x 10 cm 45977</p>		

Toddler

The toddler years are a time of great cognitive, emotional and social development. Toddler children from 1 to 4 years need to have their own classroom furniture that embrace their psychical development at this age. We have designed in this section a variety of chairs & tables, which will suit your needs every time.





Chairs

Tables



Size Chart

We design all of our furniture collection according to the European standards for 'chairs and tables for educational institutions' which was approved in January 2007. Children should always use the appropriate size of chairs or table to ensure good posture and prevent causing problems or distortions for them while growing. Ergonomic seating requires adjustable furniture to suits different body heights. In this table you can choose the correct seat and table height suitable for the student age:

BS EN 1729 European standards for chairs and tables

Children `s ages	0 - 2yrs		2 - 3yrs	2 - 4yrs	4 - 6yrs	6 - 8yrs	8 - 11yrs
Chairs & Tables Symbol	C 01	C 02	C 0	C 1	C 2	C 3	C 4
Chairs seat height	13 cm	17 cm	21 cm	26 cm	31 cm	35 cm	38 cm
Tables height - Fixed legs	30 cm	36 cm	40 cm	46 cm	53 cm	59 cm	64 cm
	Infant/toddler chairs & tables Pages : 118 - 129			Preschool/elementary chairs & tables Pages : 12 - 77			





Elegance Toddler Chair

This beautifully crafted armed chair would look great in any nursery or day care centre. Special sizes are made specifically for little ones to give them comfort and support. It is made of solid, top-quality lacquered beechwood and is built to last.

Available Colours _____

- Natural plywood
01-01
- Orange
07-01
- Green
06-01
- Blue
05-01
- yellow
09-01
- Red
08-01

CO 28.5 x 28.5 cm - H. 21 cm

43206



Deluxe Toddler Chair

A natural armed chair that will last for generations. The ergonomically curved seat and backrest provide the most comfortable seating for little children. Its special size is made specifically for toddlers. It is made of solid, top-quality lacquered beechwood & plywood.

Available Colours _____

- Natural plywood
01-01
- Orange
07-01
- Green
06-01
- Blue
05-01
- yellow
09-01
- Red
08-01

CO 28.5 x 28.5 cm - H. 21 cm

43265





Captain Toddler Chair

A classic style seating made from high quality solid beechwood with a recessed wooden seat base and a wrap-around seat back, providing back and side support for children. Suitable for growing toddlers who are starting to become more independent but still providing much needed security. Durable varnish in natural polished finish, robustly constructed for heavy usage and long lasting.



Metal bracket & solid massive beech leg



C01 45 x 40 cm - H. 13 cm
43513



C02 45 x 40 cm - H. 17 cm
43514



C0 45 x 40 cm - H. 21 cm
43515

Toddler

Chairs & Benches

These wooden chairs are the perfect choice for toddlers. Excellent for child-care centres, nurseries or children's rooms at home. It encourages your young ones to sit in a proper way. Designed with safe edges and manufactured from HQ beechwood and with a lacquered finish. Kinder chairs & benches are available in three sizes. Toddler chair is available in one size.



Kinder Chair & Benches

Toddler Chair



- C01 43241 70 x 40 cm - H. 13
- C02 43242 cm 70 x 40 cm - H.
- C0 43240 17 cm 70 x 40 cm - H. 21 cm

- C01 43236 36 x 40 cm - H. 13
- C02 43237 cm 36 x 40 cm - H.
- C0 43235 17 cm 36 x 40 cm - H. 21 cm

43501 37 x 38 x 41.5 cm

Flip around Chair

This infant to toddler-sized chair is perfect for small children. The chair is light and children can reposition it themselves. The seat height is different when you turn it over, or can be used as a small independent desk. Oval holes on its sides facilitate handling. Chairs are made from laminated plywood. Benches are also available.



Chair



Chair	4334	30 x 32 cm - H. 31
Bench	0	cm 67 x 30 cm - H.
	4334	31 cm
	5	

seat h 21
Chair 30 x 26 x 32 cm

seat h 13
Chair 30 x 26 x 32 cm

Table 30 x 32 x 26 cm

Bench



seat h 21
Bench 67 x 26 x 32 cm

seat h 13
Bench 67 x 26 x 32 cm

Table 67 x 32 x 26 cm



Elegance Tables

These flexible, portable, creative tables as well as flexibility and encourage social behaviour, creativity and cooperation among students. It comes in a variety of unique shapes and sizes. Each shape and size has its merits and benefits, depending on the learning situation. Tables can be combined with each other or with other tables combining a multitude of layouts creating an attractive look. Tables are made of Medium-density fiberboard (MDF) covered by high-pressure laminate (HPL), with PVC edge banding. Legs are either fixed or adjustable to offer different heights, an advantage for mixed age groups.

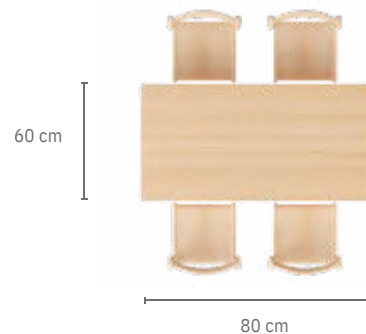
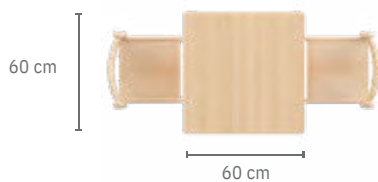
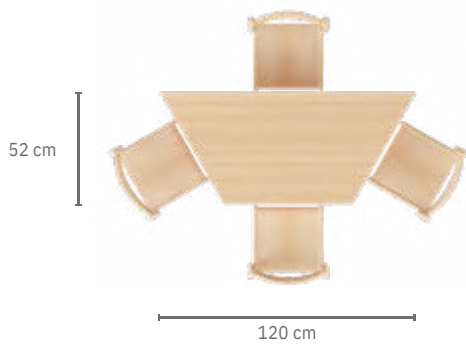
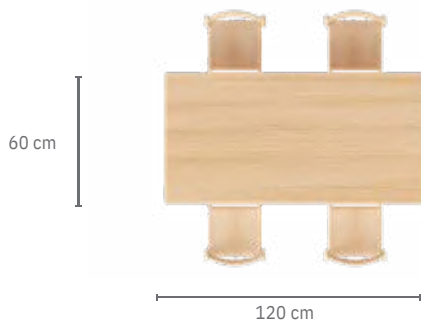

Stages & Symbol	C01	-	30
	Toddler1	C02	cm
	Toddler2	C01	36
	Toddler3	C01	cm
	Toddler4	C01	40



Table Top Option 28 mm MDF Laminated HPL solid beech edges

	C 01	48020
	C 02	48021
	C 0	44201
Elegance Table 52 x 120 cm		
	C 01	48022
	C 02	48023
	C 0	44321
Elegance Table 60 x 80 cm		
	C 01	48024
	C 02	48025
	C 0	44331
Elegance Table 60 x 120 cm		
	C 01	48026
	C 02	48027
	C 0	44670
Elegance Table 120 x 180 cm		
	C 01	48028
	C 02	48029
	C 0	44410
Elegance Table ø 120 cm		
	C 01	48030
	C 02	48031
	C 0	44690
Elegance Table 60 x 60 cm		

Legs / Rails Colours



Natural plywood
01

Table - Top Colours



Woody
11



Beige
12

Kinder Tables

Robust solid tables that will last for generations. Kinder Tables come packed- flat for your convenience and they are easily assembled with the simple instructions provided. Tables come in 3 convenient heights and 4 functional shapes. Legs and rails are made of solid wood. Ideal for little children from one to three years.

All tables can be produced in three options of Table-tops as follows:

- Table top 28mm made from extremely strong medium density fibreboard (MDF) laminated with high pressure laminate (HPL) . Edges made from solid beechwood with protective varnish .they are gently smoothed and lightly rounded to avoid any risk or injury.

- Table top 28mm made from extremely strong medium density fibreboard (MDF) laminated with high pressure laminate (HPL) . Edges with protective varnish .they are gently smoothed and lightly rounded to avoid any risk or injury.

- Table top 28mm thickness made from massive solid Beechwood (KD) – traditional wooden joints, using high quality European standard adhesive , (NAF) no added formaldehyde, The Top and Edges painted with protective lacquer and varnish, gently and safety rounded edges



ø 60 cm



ø 90 cm



60 cm

80 cm

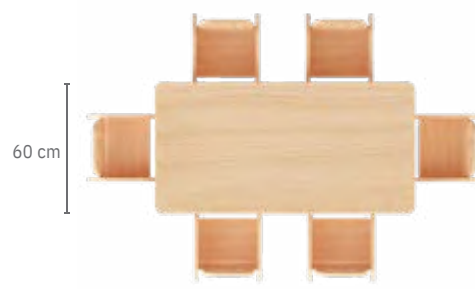

60 cm

120 cm



60 cm

60 cm



80 cm

80 cm



Table Top Option 28 mm MDF Laminated HPL solid beech edges

	C 01	48063
	C 02	48064
	C 0	48065
	C 01	48072
	C 02	48073
	C 0	48074
	C 01	48050
	C 02	48051
	C 0	48052
	C 01	48055
	C 02	48056
	C 0	48057
	C 01	48081
	C 02	48082
	C 0	48083
	C 01	48045
	C 02	48046
	C 0	48047

Table - Top Colours



Woody 11 Beige 12

Reading Centres

Reading centres provide a space for sharing, discussion, solitude and relaxation. The furniture and ambience need to reflect this to provide the perfect secure learning environment.

Our reading centre furniture meets all of these requirements. All units can be configured to your preferred layout design. We offer a truly functional system that allows growth with the needs of your organization.





Reading Centres

Mobile Book Browser Units

Each unit features easy-access bins for children to choose and pick books. Available in three designs: two bins, four bins, four bins with drawers. Supplied assembled.



35.6 x 45 x 37 cm **45152**



69.4 x 45 x 37 cm **45153**



Curved Storage Box Units

These smooth designed storage units are very helpful for reading corners. Its curved exterior and module design are ideal for making different corners depending on the space available. Supplied assembled.



91.8 x 36.9 x 81.6 cm **45150**

Reading Centres

Double Sided Display Book Units

These units are double sided, which means you can display the books on either or both sides. There are two design options to choose from with drawers and without drawers. Units are suitable for books and magazines. Supplied assembled.



Available with Casters



80 x 40 x 100 cm **45157**



80 x 40 x 60 cm **45158**



Art Centres

The world around us is full of colours and shapes. Help children to appreciate their world and express their joy in a creative way. Our arts section aims to develop creativity, imagination, and a gives the children a solid grasp of colour and shapes.





Equipment trolley

This Multi-function storage trolley is ideal for all organizing materials and resources. It is equipped with shelves, plastic trays and wooden trays which allows storage of art & crafts materials. Coasters can be added to give the ability to move resources from area to area. Made of high quality MDF.



With or without casters **99697**
Height with casters + 12 cm



69.7 x 40 x 53.2 cm **64037**



80 x 36 x 92 cm **64102**

Island unit



80 x 36 x 80 cm **64104**

Island unit



80 x 36 x 80 cm **64103**



Art Centres

Easel

A top quality easels that are perfect for art & craft classrooms. They fold flat for compact easy storage, they also come optionally with plastic drawers for organizing art supplies. It can be used from both sides. Heavy-duty lockable casters are included for easy movement.



Double sided easel
41 x 5 x 95 cm

21505



Double Sided Metal Easel with Trays
108 x 42 x 140 cm

21520



Double Sided Wooden Easel with Trays
70 x 45 x 120 cm

21521



Drama Centres

Imagination, going shopping, having a tea party for a favourite toy are some of the best activities children can have. Some children have interpersonal intelligence which means they are sensitive to others' moods, feelings, temperaments and motivations, and their ability to cooperate in order to work as part of a group. This section helps to enhance interpersonal intelligence for children who need to break down walls of shyness and help those who have it already to excel with it, as they role play different characters.





Drama Centres

Children Play Kitchen

Our natural look kitchen set will make your home corner the most attractive in town! In this kitchen set we have combined play value with the highest quality, durability and, of course, value for money. There are 3 units in this set: (Cooker/oven - Sink / Washing Machine - Fridge). All units are constructed from quality lacquered beechwood which has a tough protective finish. It is designed to withstand even the most boisterous environment.



35 x 40 x 85 cm **21625**



35 x 38.5 x 52 cm **21626**



35 x 38.5 x 52 cm **21627**



112.5 x 40 x 105 cm **21660**



Drama Centres

Role play Clothes Rack

This beautiful natural look child-size clothes rack will keep the children happy for hours, super role playing fun! It can be folded flat for storage. Compatible with the iron set.



21571
L 55.3 X W 34 X H 55.3 cm



21570
Fun Pretend Clothes Rack
Size : 55.3 X 34 X 55.3 cm

Role play Iron Set

This natural looking ironing set has been specially designed to be true to life. Little ones adore role play and pretending and can keep them happy for hours. It comes with a wooden iron & ironing board that can be folded flat for storage.



21566
Iron 16.4 x 10.3 x 10 cm
Iron table 82.5 x 28 x 55 cm



21565
Fun Pretend Iron Set
Iron Size : 16.4 x 10.3 x 10 cm
Iron table Size : 82.5 x 28 x 55 cm



Drama Centres

Children's lounge

This high quality lounge setting is an attractive addition to pre-school classrooms or role play areas. Frames are manufactured from natural solid wood. Back and seat cushions are made from high density fibre covered with either fabric or leather covering. It encourages social interaction for children as they sit on the lounge during play or when reading books. It is a timeless design that will create a warm and inviting atmosphere.





43906
Lounge sofa
Lounge chair
Lounge table



Lounge sofa
89 x 52 x 60 cm **43907**



Lounge chair
49 x 52 x 60 cm **43908**



Lounge table
60 x 45 x 40 cm **43909**

Available in Two Colours



Drama Centres

Fantasy dress-up unit

Children just love playing dress up, it is so much fun! This Dress-up unit has 10 hooks for costumes, a top shelf for hats or smaller items, and three plastic transparent trays in the base. Heavy-duty casters included for mobility. Full-length acrylic mirrors on both ends. It is a timeless piece of furniture addition for any pre-schools or activity centres.

45820

Size : 103 x 45 x 120 cm



Puppet Theater

Our attractive theatre invites your child to put on a show the audience will never forget. The wooden design features a sturdy, non-tip base to protect your child and the audience, and there is plenty of room inside for a puppeteer or two.

21560

Size : 91 x 35 x 167 cm



Drama Centres

Activity Play Table

These tables are designed especially for play. The stand-up working height makes them perfect for playtime. Its colourful landscape mat was built to last. Curved edges for safety. Transparent plastic drawers for easy storage for toys. It can be used from all sides for group play.



Plastic Trays



116 x 78 x 40 cm **45187**



116 x 78 x 56 cm **45188**



75 x 75 x 40 cm **45189**



75 x 75 x 56 cm **45190**



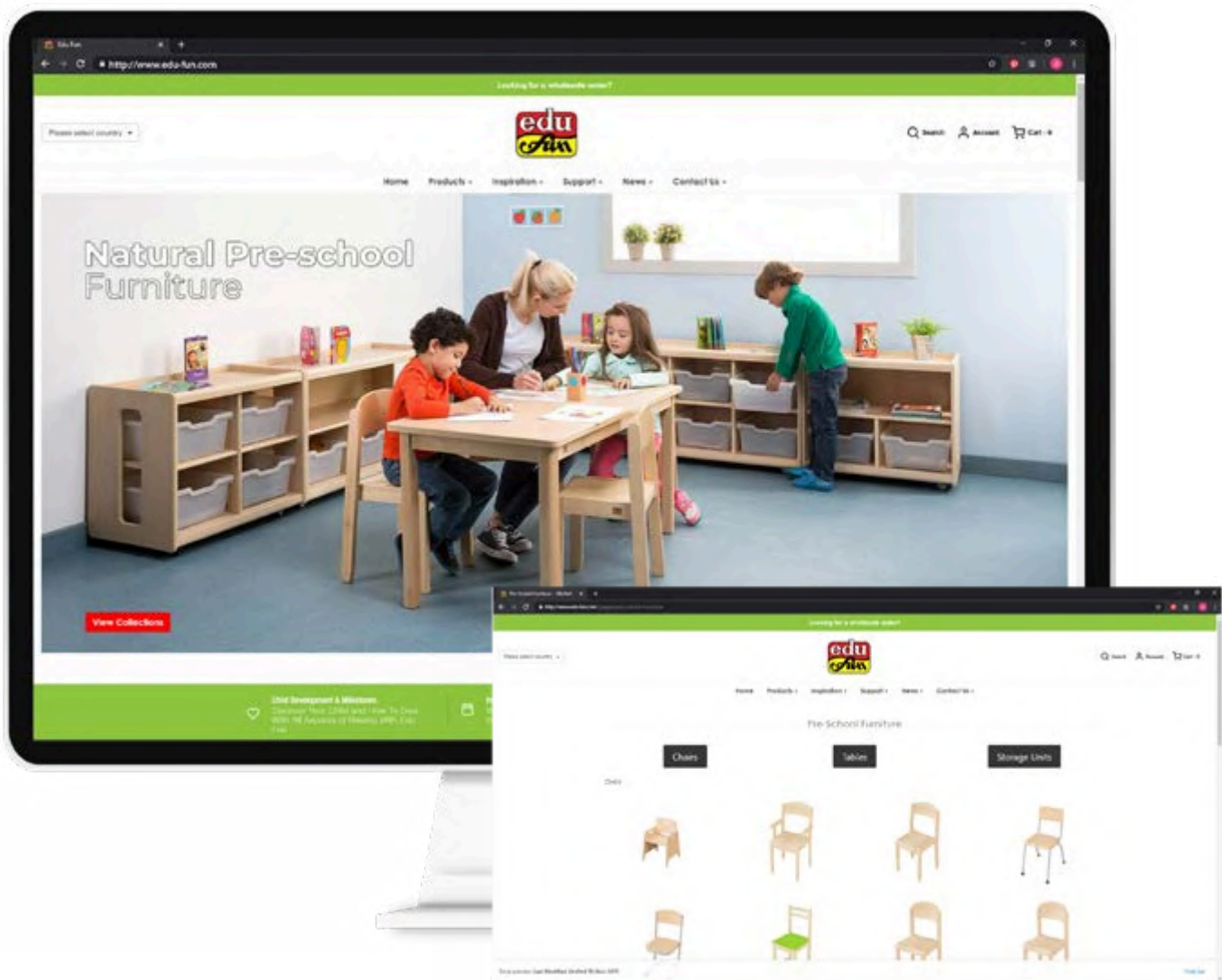

Visit our website
www.edu-fun.com





■ **Head Office
& Edu fun® Middle East Sales Office
Dubai -UAE**

- Showroom & Outlet
- Marketing & Sales Office
- R&D Department
- Warehouse & workshop

No.1, ASAS Building, Maliha Rd
Industrial Area 18, Sharjah, UAE
Tel.: +971 6 556 8255, Fax: +971 6 556 8334
Cell: +971 50462 2134,
e-mail: uae@edu-fun.com
web: www.ae.edu-fun.com

■ **Europe Sales Office**

**Edu fun® GmbH
Deutschland**

- Showroom & Outlet
- Marketing & Sales Office
- Warehouse

Neuried Ichenheim - Germany
Rheinstrasse 7 - 77743 Neuried
Tel.: +49 [0]7807 / 0000
Fax: +49 [0]7807
e-mail: info@edufun.de
web: www.de.edu-fun.com

■ **Australia & Oceania Sales Office**

**Edu fun® Pty Ltd
Australia**

- Marketing & Sales Office
- Warehouse

1 Envision Close , 19 Corporate terrace
Pakenham, Victoria 3810,
Australia
Tel.: 1300-EDUFUN
Tel: + 61 402 266 852
Email: aus@edu-fun.com
web: www.edu-fun.com.au

■ **MENA Region Sales Office**

**Edu fun® MENA
Egypt**

- Showroom & Outlet
- Production Facilities
- Technical & OEM Office
- Marketing & Sales Office
- Warehouse

No. 27 Mohammed Tawfik Diab
Makram Ebied, Nasr City
Cairo, Egypt
Tel.: + 202 227 07 649
Fax: + 202 227 07 571
Email: egypt@edu-fun.com
web: www.eg.edu-fun.com



**Head Office
Dubai -UAE**

No.1, ASAS Building, Maliha Rd
Industrial Area 18, Sharjah, UAE
Tel: +971 6 556 8255, Fax: +971 6 556 8334
Cell: +971 50462 2134,
e-mail: uae@edu-fun.com
web: www.ae.edu-fun.com



**Distributed in Morocco by Edusens
Edusens SARL**

No.66, Lotissement Communal Sidi
Maârouf
Tel : +212 6 77 28 23 79
+212 7 64 88 67 83
e-mail: contact@edusens.ma
web: www.eveil-montessori.ma