

PLUS & Campus

Catálogo



01		ADHESIVOS Y PEGAMENTOS ADHESIVES AND GLUES ADESIVOS E COLA ADESIVI E COLLE	PAG 1
02		CORRECCION CORRECTION CORREÇÃO CORREZIONE	PAG 15
03		ESCRITURA WRITING ESCRITA SCRITTURA	PAG 29
04		GRAPADORAS Y TALADROS STAPLERS AND PUNCHERS GRAMPEADORES E FURADORES CUCITRICI E PERFORATRICI	PAG 57
05		CALCULADORAS ELECTRONIC CALCULATOR CALCULADORAS CALCOLATRICI	PAG 73
06		MATERIAL DE OFICINA Y COMPLEMENTOS OFFICE MATERIAL & ACCESSORIES ARTIGOS DE ESCRITORIO E SUPLEMENTOS CANCELLERIA	PAG 81
07		ARCHIVO Y CLASIFICACION FILE AND CLASSIFICATION ARQUIVO E CLASIFICA ARCHIVIO E CLASSIFICA	PAG 133
08		SILLAS DE OFICINA OFFICE CHAIR CADEIRAS DE ESCRITÓRIO SEDIE DEL UFFICIO	PAG 165
09		DIBUJO Y MATERIAL ESCOLAR DRAWING AND SCHOOL MATERIAL ARTIGOS DE ESCOLAR E DESENHO DISEGNO E SCUOLA	PAG 171
10		FANTASÍA FANTASY FANTASÍA FANTASIA	PAG 243
11		BLOCS Y CUADERNOS WRITING PADS AND NOTEBOOKS BLOCO E CADERNOS BLOC E CUADERNOS	PAG 265



01

ADHESIVOS Y PEGAMENTOS

ADHESIVES AND GLUES

ADESIVOS E COLA

ADESIVI E COLLE



PEGAMENTO ROLLER LE

Nueva fórmula adhesiva

PLUS
JAPAN



Punto 1

Tiene el tamaño perfecto para la oficina

Como es tan pequeño y lo puedes transportar, podrás usarlo siempre que lo necesites, allá donde vayas.



Punto 2

Pegamento con nueva fórmula de fibras de carbón

Adhesivo muy fuerte que se adhiere firmemente al papel. Además las fibras de carbón permiten una aplicación limpia y cómoda.



Punto 3

Con tapa que lo protege

Para evitar manchar accidentalmente de pegamento los estuches o portatodos.



Punto 4

Diseño ergonómico

Diseño ovalado en forma de huevo, que resulta muy confortable y ergonómico para la aplicación.



← LARGO CINTA **12 m**

DESECHABLE

CABEZA DE RODILLO

PERMANENTE

SEGURO PARA FOTOS



Material: Plástico reciclado
(Carcasa principal:
Poliestireno reciclable (PS))
Anchura de la cinta: 6 mm
Dimensiones : 60x15x32 mm

CÓDIGO	COLOR	ENVASE
040772	● Azul	Blíster 1 ud. / 10
040773	● Verde	Blíster 1 ud. / 10



Los códigos en **color amarillo** permiten apertura de envase

PEGAMENTO ROLLER SL

Novedoso y muy práctico pegamento de rodillo

PLUS
JAPAN

Punto 1

Retráctil con tapa

Puedes cerrar la tapa para proteger la cinta de pegamento del polvo mientras no lo uses.



Punto 2

Múltiples usos

Se puede usar para pegar diversos materiales y en infinidad de ocasiones: papel de regalo, álbumes de fotos, collages, sobres, etc.



LARGO CINTA **8 m.**

DESECHABLE

CABEZA FLEXIBLE

PERMANENTE

SEGURO PARA FOTOS

Cinta de abeja

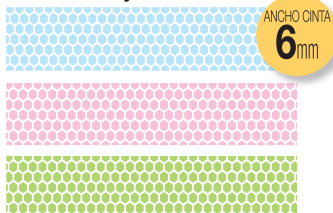

ANCHO CINTA **6mm**



CÓDIGO	COLOR	ENVASE
040682	● Azul, ● Rosa, ● Verde	Blister 1 ud. /10

CÓDIGO	COLOR	ENVASE
040681	● Azul, ● Rosa, ● Verde	Exp. 18 ud.

PLUS
JAPAN

PEGAMENTO ROLLER PRO

Máquina de pegamento roller con cinta recambiable

LARGO CINTA **20 m**

RECARGABLE

CABEZA DE RODILLO

PERMANENTE

SEGURO PARA FOTOS



Cinta de abeja



ANCHO CINTA **8.4mm**

Material: Plástico reciclado
(Carcasa principal:
Poliestireno reciclable (PS))
Anchura de la cinta : 8.4mm

CÓDIGO	DESCRIPCIÓN	ENVASE
040683	Máquina	10 blíster
040684	Recambio	10 blíster



RECAMBIO CINTA

LARGO CINTA **20 m**

PERMANENTE



Punto 1

Tiene el tamaño perfecto para la oficina

Como es tan pequeño y lo puedes transportar, podrás usarlo siempre que lo necesites, allá donde vayas.

Fácil recambio con un solo gesto

El recambio de la cinta es un simple proceso de un solo gesto. Tira el viejo cartucho y reemplázalo con uno nuevo en la unidad principal.

Punto 3

Compacto pero con alta capacidad

Cinta de 20 metros de largura

Nuestro nuevo diseño de cartucho recambiable y el uso de un fino material exfoliado (12µ PET film) permite meter 20 metros de cinta en esta unidad compacta.

Punto 2

Desliza el pegamento con un suave gesto

Nuevo sistema de rodillo de cinta

Nuestro nuevo sistema de rodillo de cinta hace la aplicación del pegamento un 50% más fácil. Se desenrolla ligera y suavemente desde el inicio hasta el final.

Cabeza de rodillo

La aplicación es suave y ligera. El rodillo aplica la cinta a la superficie con más efectividad. El movimiento de la cinta lateral está también minimizado.

Pegamento con pegado firme y corte limpio

El pegamento se aplica bien y se adhiere firmemente hasta el final del área.



Los códigos en **color amarillo** permiten apertura de envase

PEGAMENTO ROLLER ST

Novedoso y muy práctico pegamento de rodillo



Punto 1

Muy práctico y de fácil sujeción

Grip de puntos

Diseñado de forma alargada para una cómoda sujeción.



Punto 2

La cinta se adhiere firmemente al papel

Cabezal flexible

El cabezal flexible permite una firme y nítida adherencia en el papel.



Diseño de cabezal flexible

LARGO CINTA 8 m.

Cinta de abeja

ANCHO CINTA 8.4mm

RECARGABLE

CABEZA DE RODILLO

PERMANENTE

SEGURO PARA FOTOS

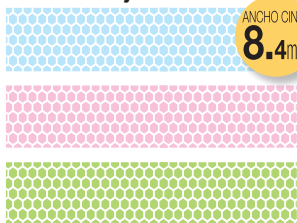

RECAMBIO CINTA

CÓDIGO	COLOR	ENVASE
040525	● Azul	1 / 10
040526	● Rosa	1 / 10
040527	● Verde	1 / 10

EXPOSITOR

CÓDIGO	COLOR	ENVASE
040524	3 Surtidos	Exp. 12 ud.

MAQUINA ROLLER

CÓDIGO	COLOR	ENVASE
040521	● Azul	Blister 1 ud. / 10

PEGAMENTO ROLLER TG

Dos tipos de pegamento en cinta desechable que satisfacen todas tus necesidades



LARGO CINTA 10 m

DESECHABLE

CABEZA DE RODILLO

SEGURO PARA FOTOS



TG-210

PERMANENTE

Adhesivo continuo

ANCHO CINTA 8.4mm

Material: Plástico reciclado
(Carcasa principal: Poliestireno reciclable (PS))
Anchura de la cinta : 8.4mm
Dimensiones : 92x20x45mm

CÓDIGO	COLOR	ENVASE
040446	● Azul	Blister 1 ud. / 10



TG-211

REMOVIBLE

Adhesivo continuo

ANCHO CINTA 8.4mm

CÓDIGO	COLOR	ENVASE
040445	● Amarillo	Blister 1 ud. / 10

Punto 1

Se aplica suavemente

Cabeza de rodillo

La aplicación es suave y ligera. El rodillo aplica la cinta a la superficie con más efectividad. Los movimientos laterales de la cinta también se minimizan.



Punto 2

Pegado limpio para un resultado nítido

Una limpia, precisa y cuidada aplicación sin ensuciar.



Punto 3

Ideal para álbumes de fotos

Nuestro pegamento "seguro para fotos" no decolorará tus fotos

Para nuestro pegamento "seguro para fotos" hemos reducido la cantidad de ácidos que causan el deterioro del papel y la decoloración de la foto, por lo que te puedes sentir seguro de usar este pegamento para tus álbumes de recortes.



PLUS
JAPAN

PEGAMENTO ROLLER HYPER MX

Super adhesivo doble capa.



LARGO CINTA **12 m**

RECARGABLE

CABEZA DE RODILLO

Material: Plástico
Anchura de la cinta : 15 mm
Dimensiones : 100 x 28 x 60 mm

TG-0944 PERMANENTE

Adhesivo continuo

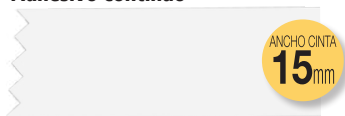

CÓDIGO	DESCRIPCIÓN	ENVASE
040615	Máquina	Blíster 1 ud. / 10
040617	Recambio	Blíster 1 ud. / 10



LARGO CINTA **12 m**

RECARGABLE

CABEZA DE RODILLO

Material: Plástico
Anchura de la cinta : 15 mm
Dimensiones : 100 x 28 x 60 mm

TG-0945 REMOVIBLE

Adhesivo continuo

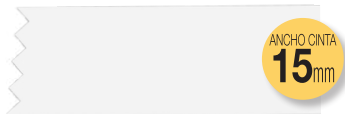

CÓDIGO	DESCRIPCIÓN	ENVASE
040616	Máquina	Blíster 1 ud. / 10
040618	Recambio	Blíster 1 ud. / 10

Punto 1

Cómodo agarre, dos posiciones

Su diseño permite un cómodo agarre para un uso tanto horizontal como vertical, siendo igualmente adecuado sobre una mesa o sobre la pared. Pegado firme y corte limpio.



Horizontal



Vertical

Punto 2

Fácil método de recambio

En un sólo gesto, pulsando el botón superior accedemos rápidamente al compartimento del recambio.



RECAMBIO

Pulsando el botón superior cambiamos rápidamente el recambio





PEGAMENTO EN BARRA PLUS STICK

Adhesivo super rápido

Nueva fórmula



- 🇪🇸 Sin disolventes. Instantáneo. Apto para uso escolar. Ideal para pegar papel, cartón, fotos, cartulina y tejidos de una forma limpia y rápida.
- 🇬🇧 Without dissolvents. Instantaneous. Suitable for scholastic use. Ideal to stick paper, cardboard, photos, card and weaves cleanly and quickly.
- 🇵🇹 Sem dissolventes. Instantânea. Para uso escolar. Ideal para colar: cartão, papel, fotos, cartolina e tecidos e uma forma limpa e rápida.
- 🇮🇹 Senza solventi istantaneo. Adatto per uso scolastico. Ideale per incollare carta, cartone, buste e tessuti in modo pulito e veloce.



CÓDIGO	CONTENIDO	ENVASE
040039	8 g.	Exp. 24 ud.
040597	21 g.	Exp. 24 ud.
040041	36 g.	Exp. 12 ud.

CÓDIGO	CONTENIDO	ENVASE
040644	2 x 8 g.	Blisters 2 ud. / 12
040645	21	Blisters 1 ud. / 24
040646	36	Blisters 1 ud. / 12



PISTOLA DE COLA 40W

Gran precisión



CÓDIGO	CONTENIDO
040818	Pistola 40W
Recambio	
040815	10 barras



Pistola termo-fusible que funde la barra de cola y la transforma en adhesivo líquido.

Perfecta para todo tipo de trabajos. Gran precisión. Materiales: plástico, cerámica, piel, textiles, madera, etc. Recambio: diámetro de 0,70 mm. Longitud de 10 cm. Se funde y se transforma en adhesivo líquido. Blister de 10 barras.



Hot-melt gun that melts the glue and transforms it into liquid adhesive.

Perfect for all types of work. Great accuracy. Materials: plastic, ceramic, leather, textiles, wood, etc. Spare part: diameter of 0.70 mm. Length of 10 cm. It melts and transforms into liquid adhesive. 10-bar blister pack.



Pistola de fusão a quente que derrete a barra de cola e a transforma em adesivo líquido.

Perfeito para todos os tipos de trabalho. Alta precisão. Materiais: plástico, cerâmica, couro, têxteis, madeira, etc. Peça de reposição: diâmetro de 0,70 mm. Comprimento de 10 cm. Derrete e transforma-se em adesivo líquido. Pacote de bolhas de 10 barras.



Pistola a caldo che fonde la barra di colla e la trasforma in adesivo liquido.

Perfetto per tutti i tipi di lavoro. Alta precisione. Materiali: plastica, ceramica, cuoio, tessuti, legno, ecc. Ricambio: diametro 0,70 mm. Lunghezza di 10 cm. Si scioglie e si trasforma in adesivo liquido. Confezione blister da 10 barrette.



PISTOLA DE COLA 80W

Gran precisión

CÓDIGO	CONTENIDO
040817	Pistola 80W
Recambio	
040816	10 barras



Pistola termo-fusible que funde la barra de cola y la transforma en adhesivo líquido.

Perfecta para todo tipo de trabajos. Gran precisión. Materiales: plástico, cerámica, piel, textiles, madera, etc. Recambio: diámetro de 1,10 mm. Longitud de 17,8 cm. Se funde y se transforma en adhesivo líquido. Blister de 10 barras.



Hot-melt gun that melts the glue and transforms it into liquid adhesive.

Perfect for all types of work. Great accuracy. Materials: plastic, ceramic, leather, textiles, wood, etc. Spare part: 1.10 mm diameter. Length of 17.8 cm. Melts and turns into liquid adhesive. Blister pack of 10 bars.



Pistola de fusão a quente que derrete a barra de cola e a transforma em adesivo líquido.

Perfeito para todos os tipos de trabalho. Alta precisão. Materiais: plástico, cerâmica, couro, têxteis, madeira, etc. Peça de reposição: 1,10 mm de diâmetro. Comprimento de 17,8 cm. Derrete e transforma-se em adesivo líquido. Embalagem com 10 barras.



Pistola a caldo che fonde la barra di colla e la trasforma in adesivo liquido.

Perfetto per tutti i tipi di lavoro. Alta precisione. Materiali: plastica, ceramica, cuoio, tessuti, legno, ecc. Ricambio: diametro 1,10 mm. Lunghezza di 17,8 cm. Si scioglie e si trasforma in adesivo liquido. Confezione blister da 10 barrette.



Los códigos en color amarillo permiten apertura de envase

PEGAMENTO COLA BLANCA

Gran poder de adhesión. Para manualidades y bricolaje



Aplicador y pincel

Con pincel en el aplicador en el bote de 125 y 250 g. Mayor limpieza y precisión



Alta calidad. Para trabajos de arte y manuales. Excelentes resultados. Secado rápido, limpio y transparente. NO TÓXICA. El aplicador no se bloquea. Sin disolventes. Con pincel en el aplicador en botes de 125 g y 250 g. Utilizable en materiales porosos y semiporosos.

High quality. For manual and art works. Great results. Clean, fast and transparent drying. NON TOXIC. Tip is not blocked. Solvent free. With brush in the tip of 125 g and 250 g bottles. Usable in porous and semiporous materials.

Alta qualidade. Para trabalhos manuais e de arte. Excelentes resultados. Seca rápido, limpo e transparente. Não tóxica. Isento de solventes. O aplicador não bloqueia. Com pincel no aplicador em garrafas de 125g e 250g. Utilizável em materiais porosos e semi porosos.

Alta qualità. Per lavori d'arte e manuali. Risultati eccellenti. Asciugatura rapida, pulita e trasparente. NON TOSSICO. Senza solventi. L'applicatore non si blocca. Con pennello nell'applicatore in flaconi da 125 g e 250 g. Utilizzabile in materiali porosi e semi-porosi.

CÓDIGO	CONTENIDO	ENVASE
040029	60 g.	24
040030	125 g.	24
040031	250 g.	12
040566	1000 g.	12

SILICONA LIQUIDA

Sin metanol



Silicona líquida. Ideal para manualidades: goma EVA, fieltro, cartulina, madera, plástico, etc. Apto para uso escolar y de oficina. No tóxica.

Liquid silicone. Ideal for handicrafts: EVA foam, felt, cardboard, wood, plastic, etc. Suitable for school and office use. Non toxic.

Silicone líquida. Ideal para o artesanato: goma EVA, feltro, cartolina, madeira, plástico, etc. Adequado para uso escolar e de escritório. Não tóxico.

Silicone liquido Ideale per lavori manuali: gomma EVA, feltro, cartone, legno, plastica, ecc. Adatto a scuola e ufficio. Non tossico.

CÓDIGO	CONTENIDO	ENVASE
040575	60 ml.	24
040576	100 ml.	12

PEGAMENTO UNIVERSAL GEL

30 ml



Alta calidad. Rápido, permanente y ajustable. Resistente a la luz, al calor y al agua. Ideal para trabajos manuales, escolares y de oficina, o reparaciones domésticas.

High quality. Fast, permanent and adjustable. Light, heat and water resistant. Ideal for manual, school and office work, or home repairs.

Alta qualidade. Rápido, permanente e ajustável. Resistência ao calor, luz e água. Ideal para a escola, artesanato e escritório, e para reparos domésticos.

Alta qualità. Veloce, permanente e regolabile. Resistente alla luce, al calore e all'acqua. Ideale per lavori manuali, scolastici e d'ufficio, nonché per riparazioni domestiche.

CÓDIGO	CONTENIDO	ENVASE
040552	30 ml.	24



PEGAMENTO SUPER RAPIDO

Pegamento cianocrilato

Nueva fórmula

- Pegamento cianocrilato instantáneo. Boquilla extralarga. Multiuso para plásticos, madera, metal y cerámica.
- Instantaneous glue. Extralong tip. For plastic, wood, metal and ceramics.
- Cola Super rápida. Cianocrilato instantáneo. Bico extralargo. Multiusos para plástico, madeira e cerâmica.
- Colla istantanea in cianoacrilato. Ugello extra lungo. Multiuso per plastica, legno, metallo e ceramica.



	CÓDIGO	CONTENIDO	ENVASE
1	040475	1 g. x 3 tubos	Blíster 3 ud. / 24
2	040044	3 g.	Blíster 1 ud. / 32

- Láminas de masilla adhesiva extrafuerte para fijar cualquier objeto de poco peso. Sustituye a cinta adhesiva, chinchetas, grapas, etc. Permite su reutilización. Sobres de 50 g. Color azul.
- Tack to fix any light object. Extra strong. It replaces the adhesive tape, push pins, staples, etc. It can be reused. 50 g. bags. Blue color.
- Massa adesiva em pacotes de 50 gr. Extra forte. Fixa qualquer objecto de pouco peso. Substitui a fita adesiva, pioneses ou agrafes. Permite reutilizar. Pacote de 50 g. Cor azul.
- Fogli di mastice adesivo extra forte per riparare qualsiasi oggetto leggero. Sostituisce il nastro adesivo, puntine, graffette, ecc. Può essere riutilizzato. 50 g. borse. Colore blu.



Reutilizable

Amasa ligeramente y vuelve a utilizarla

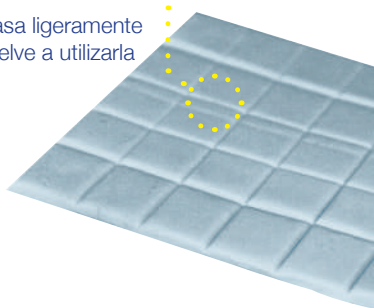

MASILLA ADHESIVA TACK EXTRA FUERTE



CÓDIGO	CONTENIDO	ENVASE
040621	50 g.	12

- Display de 36 unidades con 12 diseños de cinta diferentes.
- 36 pcs display with tapes in 12 different designs.
- Espositor 36 unidades con 12 diseños diferentes.
- Espositore di 36 unità con 12 disegni diversi di nastri.



CINTAS ADHESIVAS DECORADAS DISPLAY

Modelos surtidos



CÓDIGO	MODELO	MEDIDAS	ENVASE
040609	Surtidos	5 m. x 15 mm	36 ud.



Los códigos en color amarillo permiten apertura de envase

CINTAS ADHESIVAS DECORADAS

Dale un toque de color a tus trabajos



040564 - Topos

040595 - Surtido 1

040596 - Surtido 2

040565 - Vichy

- Cuatro cintas adhesivas de papel. 4 diseños diferentes. Con cortador.
- Four paper adhesive tapes. 4 different designs. With cutter.
- Quatro fitas adesivas de papel. 4 desenhos diferentes. Com cortador.
- Quattro nastri adesivi di carta. 4 diversi modelli, con taglierina

CÓDIGO	MODELO	MEDIDA	PACK	ENVASE
040564	Topos	5 m x 15 mm.	4 ud.	1 / 24
040565	Vichy	5 m x 15 mm.	4 ud.	1 / 24
040595	Surtido 1	5 m x 15 mm.	4 ud.	1 / 24
040596	Surtido 2	5 m x 15 mm.	4 ud.	1 / 24

CINTA AISLANTE

Medidas 20 m. x 19 mm.



- Cinta aislante flexible en película de PVC suave. Auto-extinguible. Resistente a la abrasión, envejecimiento e inclemencias. Alta fuerza adhesiva. Fácil de cortar.
- Flexible insulating tape in smooth PVC. Autoextinguishable. Resistant to abrasion, ageing and harshness. Very sticky. Easy to cut.
- Fita isolante flexível em filme de PVC macio. Retardantes de chama. Resistente à abrasão, envelhecimento e mau. Alta resistência adesiva. Fácil de cortar.
- Nastro isolante flessibile in film di PVC morbido. Autoestinguente. Resistente all'abrasione, all'invecchiamento e all'inclemenza. Elevata forza adesiva Facile da tagliare

CÓDIGO	COLOR	MEDIDAS	ENVASE
040520	○ Blanca	20 m. x 19 mm	5 ud.

ARANDELAS AUTOADHESIVAS REFORZADAS

Para proteger los documentos perforados

Dispensador

Cuenta con dispensador en la propia caja para mayor comodidad



- Arandelas autoadhesivas reforzadas. Caja de 200 unidades.
- Washers. 200 self-adhesive washers in every bag.
- Reforços em plástico auto adesivos. Caixa de 200 unidades.
- Rondelle autoadesive rinforzate. Scatola da 200 unità.

CÓDIGO	DIÁMETRO	ENVASE
001590	Ø 13 mm	1 / 12

CINTA ADHESIVA EN MINIPORTARROLLOS

Medidas 12 m. x 10 mm.



- Cinta adhesiva transparente de fácil corte y gran adherencia. Con Miniportarrollos. Grosor: 45 micras.
- Transparent adhesive tape with easy cut and high adherence. With mini-tape dispenser. Thickness: 45 microns.
- Fita adesiva com mini desenrolador plástico de grande utilidade para trabalhos escolares. Espessura: 45 microns.
- Nastro adesivo trasparente per un taglio facile e una grande adesione. Con mini porta rotolo. Spessore: 45 micron.

CÓDIGO	MEDIDAS	ENVASE
040591	12 m x 10 mm	Exp. 48 ud.





CINTA ADHESIVA TRANSPARENTE

Super adhesivo. Bolsa individual.

 Cinta adhesiva transparente de alta calidad, fuerte y segura. Fácil de cortar con la mano. Elevada fuerza adhesiva. No amarillea con el tiempo.

 High-quality, strong and secure transparent adhesive tape. Easy to cut with your hand. Big adhesive power. It does not yellow with time.

 Fita adesiva transparente de alta qualidade. Forte, segura e fácil de cortar com a mão. Forte aderência. Não fica amarelada com o tempo.

 Nastro adesivo trasparente di alta qualità, resistente e sicuro, facile da tagliare a mano. Elevata forza adesiva. Non ingiallisce con il tempo.

CÓDIGO	MEDIDAS	ENVASE
040002	33 m x 12 mm	12
040003	33 m x 19 mm	8
040004	66 m x 12 mm	12
040005	66 m x 19 mm	8
040619	33 m x 19 mm	Bolsa 3 ud./ 60
040589	33 m x 12 mm	Exp. 30 ud.
040590	33 m x 19 mm	Exp. 30 ud.



Se corta con la mano

 Cinta adhesiva transparente económica y de calidad. Fuerte y segura. No amarillea con el tiempo. Elevada fuerza adhesiva.

 Economic, transparent and good quality adhesive tape. Strong and secure. It does not yellow with time. High adhesive strength.

 Fita adesiva transparente, acessível e de qualidade. Forte e segura. Não amarela com o tempo. Força adesiva elevada.

 Nastro adesivo trasparente di alta qualità, resistente e sicuro, facile da tagliare a mano. Elevata forza adesiva. Non ingiallisce con il tempo.

CÓDIGO	MEDIDAS	ENVASE
1 040498	33 m x 19 mm	8
2 040497	33 m x 12 mm	12



CINTA ADHESIVA EN BULK

Corte tradicional. En bulk.

CINTA ADHESIVA DOBLE CARA

Medidas 10 m. x 19 mm.

 Cinta adhesiva de doble adherencia, ideal para la oficina, manualidades. Extra fuerte.

 Adhesive tape of double adhesion, ideal for office, manual craft. Extra strong.

 Fita adesiva dupla face, ideal para escritórios e outros trabalhos. Extra forte.

 Nastro adesivo a doppia faccia, ideale per l'ufficio, manualità. Extra forte.

CÓDIGO	MEDIDAS	ENVASE
040253	10 m. x 19 mm	10



Los códigos en color amarillo permiten apertura de envase

CINTA ADHESIVA INVISIBLE MINIPORTARROLLOS

Medidas 7,5 m. x 19 mm.

Escribe sobre ella
Permite escribir sobre ella con cualquier tipo de bolígrafo o rotulador



- Cinta adhesiva invisible de alta adherencia. Con Miniportarrollos. 7,5 m. x 19 mm.
- Invisible adhesive tape. High adherence. With mini-tape dispenser. 7,5 m. x 19 mm.
- Fita adesiva invisível de alta adesão. Com mini desenrolador plástico. 7,5 m. x 19 mm.
- Nastro adesivo invisibile ad alta aderenza. Con mini portarrotolo.

CÓDIGO	MEDIDAS	ENVASE
040392	7,5 m. x 19 mm	24

CINTA ADHESIVA INVISIBLE

Medidas 33 m. x 19 mm.



Escribe sobre ella
Permite escribir sobre ella con cualquier tipo de bolígrafo o rotulador



- Cinta adhesiva invisible en las fotocopias, que permite escribir sobre ella. No amarillea con el tiempo. Alta adherencia.
- Adhesive tape invisible in photocopies. You can write on it. It does not yellow with time. High adherence.
- Fita adesiva invisível nas fotocópias. Permite escrever sobre ela. Não fica amarelada com o tempo. Forte aderência.
- Nastro adesivo invisibile nelle fotocopie, che ti permette di scrivere su di esso. Non ingiallisce con il tempo, alta adesione.

CÓDIGO	MEDIDAS	ENVASE
040016	33 m. x 19 mm	10
040620	33 m. x 19 mm	Bolsa 1 ud./ 60

PORTARROLLOS PLUS 515

Universal. Base estable antideslizante. Cinta 33 m.



Cuchilla de acero especial.
Super afilada y duradera

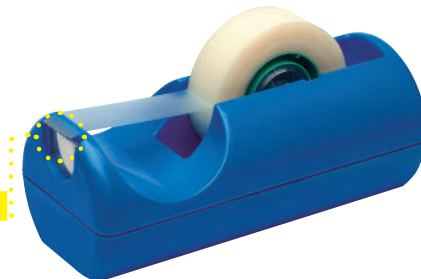

- Cuerpo de plástico ABS con base de caucho antideslizante. Cuchillas de acero. No incluye cinta. Para cinta de 33 m.
- Tape dispenser. Body made of ABS plastic and base made in nonskid rubber. Steel blade. Does not include tape. For tape of 33 m.
- Corpo em plástico ABS com base em borracha anti-deslizante. Laminas am aço. Não inclui fita. Para rolo de 33 m.
- Corpo in plastica ABS con base in gomma antiscivolo. Lame d'acciaio Non include il nastro. Per nastro da 33 m.

CÓDIGO	MEDIDAS	COLOR
040469	14,5 x 6,5 x 5,5 cm	● Azul

PORTARROLLOS PLUS 405

Plástico ABS. Base estable antideslizante. Cinta 33 m.



Cuchilla de acero especial.
Super afilada y duradera



- Cuerpo de plástico ABS con base de caucho antideslizante. Cuchillas de acero. Para cinta de 33 m. No incluye cinta.
- Tape dispenser. Body made of ABS plastic and base made in nonskid rubber. Steel blade. For tape of 33 m. Does not include tape.
- Corpo em plástico ABS com base em borracha anti-deslizante. Laminas am aço. Para rolo de 33 m. Não inclui fita.
- Portanastro. Corpo in plastica ABS e base in gomma antiscivolo. Acciaio inossidabile. Per nastro di 33 m. Non include il nastro.





CÓDIGO	MEDIDAS	COLOR
040394	12,2 x 5 x 6,6 cm	● Azul
040669	12,2 x 5 x 6,6 cm	● Rojo
040695	12,2 x 5 x 6,6 cm	● Negro



Los códigos en color amarillo permiten apertura de envase

PORTARROLLOS PLUS 530

Plástico ABS. Base estable antideslizante. Cinta 33 m.

-  Base de caucho antideslizante. Cuchillas de acero. Para cinta de 33 m. No incluye cinta.
-  Tape dispenser. Base made in nonskid rubber. Steel blade. For tape of 33 m. Does not include tape.
-  Base em borracha anti-deslizante. Laminas am aço. Para rolo de 33 m. Não inclui fita.
-  Base in gomma antiscivolo. Lame d'acciaio Per nastro da 33 m. Non include il nastro.







CÓDIGO	MEDIDAS	COLOR
040673	16 x 6,5 x 6,7 cm	● Gris
040672	16 x 6,5 x 6,7 cm	● Negro



PORTARROLLOS PLUS 520

Plástico ABS. Base estable antideslizante. Cinta 33 m.

-  Base de caucho antideslizante. Cuchillas de acero. Para cinta de 33 m. No incluye cinta.
-  Tape dispenser. Base made in nonskid rubber. Steel blade. For tape of 33 m. Does not include tape.
-  Base em borracha anti-deslizante. Laminas am aço. Para rolo de 33 m. Não inclui fita.
-  Base in gomma antiscivolo. Lame d'acciaio Per nastro da 33 m. Non include il nastro.







CÓDIGO	MEDIDAS	COLOR
040410	19 x 7,2 x 8,5 cm	● Negro



PORTARROLLOS PLUS 505

Plástico ABS. Base estable antideslizante. Cinta 33 m.

-  Base de caucho antideslizante. Cuchillas de acero. Para cinta de 33 m. No incluye cinta.
-  Tape dispenser. Base made in nonskid rubber. Steel blade. For tape of 33 m. Does not include tape.
-  Base em borracha anti-deslizante. Laminas am aço. Para rolo de 33 m. Não inclui fita.
-  Base in gomma antiscivolo. Lame d'acciaio Per nastro da 33 m. Non include il nastro.

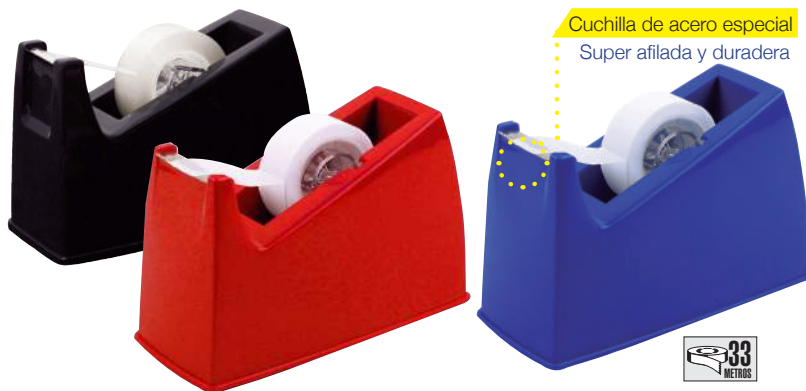





CÓDIGO	MEDIDAS	COLOR
040395	14,5 x 6 x 8,9 cm	● Azul
040670	14,5 x 6 x 8,9 cm	● Rojo
040694	14,5 x 6 x 8,9 cm	● Negro



PORTARROLLOS PLUS 605 INDUSTRIAL CON PORTALÁPICES

Plástico ABS. Base estable antideslizante. Cinta 33 y 66 m.

-  Base de caucho antideslizante. Cuchillas de acero. Doble posicionamiento del cilindro portacintas. Con portaplápices. Para cinta de 33 mtr y 66 mtr. No incluye cinta.
-  Tape dispenser. Base made in nonskid rubber. Steel blade. Double positioning for cylinder. For tape of 33 m and 66 m. Does not include tape.
-  Base em borracha anti-deslizante. Laminas am aço. Posicionamento dupla para cilindro. Para rolo de 33 mts e 66 mts. Não inclui fita.
-  Base in gomma antiscivolo. Lama d'acciaio. Doppio posizionamento per il cilindro portanastro. Per nastro di 33 me 66 m. Non include il nastro.



CÓDIGO	MEDIDAS	COLOR
040705	22,2 x 8,6 x 10,3 cm	● Negro
040671	22,2 x 8,6 x 10,3 cm	● Azul



Los códigos en color amarillo permiten apertura de envase

CINTA DE PRECINTO

Alta resistencia



Cinta adhesiva soporte polipropileno de alta calidad. Fácil corte y gran adherencia. Envase de 6 ud.



High quality polypropylene support adhesive tape. Easy cut and great adhesion. Package of 6 units.



Fita adesiva de suporte em polipropileno de alta qualidade. Fácil corte e ótima aderência. Pacote de 6 unidades.



Nastro adesivo di supporto in polipropilene di alta qualità. Taglio facile e ottima adesione. Confezione da 6 unità.

1



2 Sin Ruido.

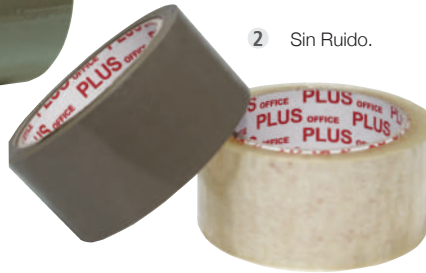

3

Kraft



1 Grosor 45 micras

CÓDIGO	MEDIDAS	COLOR
040011	50 mm x 66 m	Transparente
040012	50 mm x 132 m	Transparente
040013	50 mm x 66 m	○ Blanco
040014	50 mm x 66 m	● Marrón
040361	50 mm x 132 m	● Marrón

2 Grosor 50 micras. Sin Ruido.

CÓDIGO	MEDIDAS	COLOR
040491	50 mm x 66 m	Transparente
040490	50 mm x 66 m	● Marrón

3 Cinta Kraft especial embalaje

CÓDIGO	MEDIDAS	COLOR
040829	75 mm x 25 m	● Kraft

PRECINTADORAS PLUS OFFICE

Cómodas y eficaces



Máquinas precintadoras para todo tipo de cintas de embalaje. Con cuchilla de corte en acero de gran resistencia. Ligeras de peso. Con tensor de cinta.



Sealing machines for all types of packaging tapes. With high resistance steel cutting blade. Light in weight. With belt tensioner.



Máquinas de selar para todos os tipos de fitas de embalagem. Com lâmina de corte em aço de alta resistência. Leve em peso. Com tensor de correia.



Sigillatrici per tutti i tipi di nastri da imballo. Con lama di taglio in acciaio ad alta resistenza. Leggero. Con tendicinghia.

1

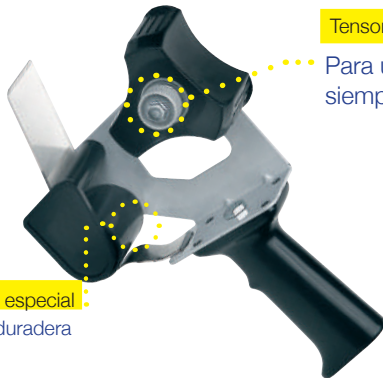

Tensor de cinta

Para un embalaje siempre perfecto

1 Precintadora Plus 270N metálica

CÓDIGO	MANDRIL	COLOR
040015	50 mm.	● Negro

2 Precintadora Plus de plástico

CÓDIGO	MANDRIL	COLOR
069957	75 mm.	● Rojo

3 Precintadora Plus metálica

CÓDIGO	MANDRIL	COLOR
069958	75 mm.	● Rojo

Cuchilla de acero especial.
Super afilada y duradera

2



3

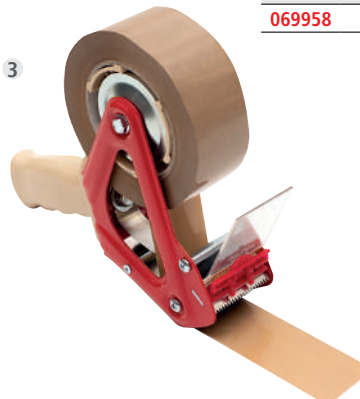

02

CORRECCIÓN
CORRECTION
CORREÇÃO
CORREZIONE

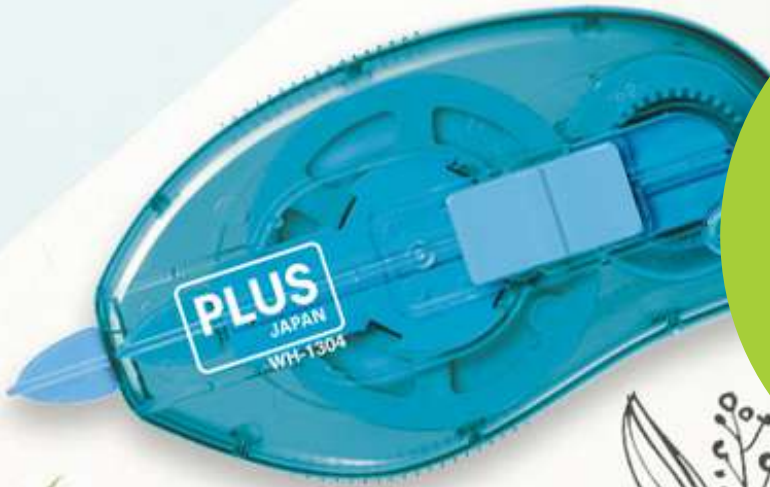

CINTA CORRECTORA ROLLER MR

Líder MUNDIAL

PLUS
JAPANANCHO CINTA
4.2mmANCHO CINTA
4.2mmANCHO CINTA
4.2mm← LARGO CINTA **6 m****RECARGABLE**

Materiales : Plástico reciclado
(Carcasa principal : Poliestireno reciclado (PS))
Dimensiones externas:
25×18×110mm

Punto 1**Cómodo agarre**

Diseño ergonómico en forma de bolígrafo para un agarre más cómodo.

Punto 2**Dos formas de uso**

Arrastre para corregir una frase completa.
Presione para corregir una letra.

**Punto 3****Cabezal flexible**

Con un mini rodillo para una aplicación perfecta y más precisa.
Capuchón de fácil y rápida apertura.

**Punto 4****Método de fácil recarga**

Los recambios se quitan y se ponen fácilmente.



CÓDIGO	COLOR	ENVASE
081073	Rosa	Blíster 1 ud./ 10
081074	Azul	Blíster 1 ud./ 10
081075	Verde	Blíster 1 ud./ 10

CINTA CORRECTORA + 1 RECAMBIO**RECAMBIO CINTA**

CÓDIGO	ENVASE
080806	Blíster 1 ud./ 10

CÓDIGO	ENVASE
080915	10 bolsas

CÓDIGO	COLOR	ENVASE
081019	Surtidos	Exp. 15 correctores + 5 recambios



Los códigos en **color amarillo** permiten apertura de envase

PLUS
JAPAN

CINTA CORRECTORA ROLLER MR ANIMALES

Edición Limitada



Rodillo metálico en la punta

Mini rodillo de cabezal que ofrece correcciones suaves y consistentes.

Función de cabezal flexible

Se aplica la cinta firmemente en el papel y su cabezal flexible se puede maniobrar para llevar a cabo correcciones más precisas.

Recargable

El cartucho de recarga se puede quitar y colocar de forma rápida y sencilla.



CÓDIGO	MODELO	ENVASE
081116	Cebra	Blíster 1 ud./ 10
081117	Jirafa	Blíster 1 ud./ 10
081118	Pantera	Blíster 1 ud./ 10

Materiales : Plástico reciclado
(Carcasa principal : Poliestireno reciclado (PS))

← LARGO CINTA 6 m

Dimensiones externas: 25x18x110mm

RECARGABLE

PLUS
JAPAN

CINTA CORRECTORA ROLLER MR PASTEL

Diseño ergonómico en forma de bolígrafo

Punto 1

Cómodo agarre

Diseño ergonómico en forma de bolígrafo para un agarre más cómodo.

Punto 2

Dos formas de uso

Arrastre para corregir una frase completa.
Presione para corregir una letra.



CÓDIGO	COLOR	ENVASE
081385	Azul pastel / azul	Blíster 1 ud. / 10 blíster
081387	Verde pastel / Rosa pastel	Blíster 1 ud. / 10 blíster
081388	Violeta pastel / Blanco	Blíster 1 ud. / 10 blíster

← LARGO CINTA 6 m

RECARGABLE



Los códigos en **color amarillo** permiten apertura de envase

CINTA CORRECTORA MR2 - MINI

La nueva era de correctores



Punto 1

Tamaño mini

Su tamaño es como el de una goma de borrar, pero con 6 metros de cinta, para poder guardarlo en tu portatodos.

Punto 2

Dos formas de uso

Arrastre para corregir una frase completa. Presione para corregir una letra.

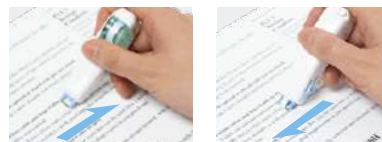

Punto 3

Mecanismo de fácil recarga

El cartucho de recarga se puede quitar y colocar de forma rápida y sencilla. Empuje la pestaña deslizante hacia adelante y la cabeza sale.



ANCHO CINTA
5mm

ANCHO CINTA
5mm

ANCHO CINTA
5mm

LARGO CINTA 6 m

- RECARGABLE
- MINI RODILLO
- PUNTA FLEXIBLE

Dimensiones externas:
22x74x26mm



CÓDIGO	MODELO	COLOR	ENVASE
081092	Corrector	Rosa	Blister 1 ud. / 10
081093	Corrector	Azul	Blister 1 ud. / 10
081094	Corrector	Verde	Blister 1 ud. / 10
081095	Recambio	Surtidos	Bolsa 1 ud. / 10

CINTA CORRECTORA WHIPER MINI

El pequeño gigante



Punto 1

Cómodo agarre

Su práctico tamaño es adecuado para guardarlo en bolsillos y organizadores.

Punto 2

Alta calidad a buen precio

7 metros de cinta correctora en un corrector de tamaño mini.

Punto 3

Desechable

100% reciclable.

CÓDIGO	COLOR	ENVASE
080989	Verde	Bolsa 1 ud. / 20



ANCHO CINTA
4.2mm

LARGO CINTA 7 m

DESECHABLE

Materiales : Plástico reciclado
(Carcasa principal : Poliestireno reciclado (PS))
Dimensiones externas:
65x35x15mm



Los códigos en color amarillo permiten apertura de envase

PLUS
JAPAN**Punto 1****Cómodo agarre**

Su práctico tamaño es adecuado para guardarlo en bolsillos y organizadores.

Punto 2**Alta calidad a buen precio**

5 metros de cinta correctora en un corrector de tamaño mini.

Punto 3**Desechable**

100% reciclable.

**CINTA CORRECTORA WHIPER MINI**

El pequeño gigante

ANCHO CINTA
4.2mm**5 m** ← LARGO CINTA**DESECHABLE**

Materiales : Plástico reciclado
(Carcasa principal : Poliestireno reciclado (PS)
Dimensiones externas:
65×35×15mm

CÓDIGO	COLORES	ENVASE
080991	Rosa, Amarillo, Verde, Azul y Violeta	Bote 50 ud.

PLUS
JAPAN**BOTE CINTA CORRECTORA MINI PASTEL**

El pequeño gigante

Punto 1**Cómodo agarre**

Su práctico tamaño es adecuado para guardarlo en bolsillos y organizadores.

Punto 2**Alta calidad a buen precio**

6 metros de cinta correctora en un corrector de tamaño mini.

Punto 3**Desechable**

100% reciclable.

ANCHO CINTA
5mm← **6 m**
LARGO CINTA**DESECHABLE**

Materiales : Plástico reciclado
(Carcasa principal : Poliestireno reciclado (PS)
Dimensiones externas:
65×35×15mm

CÓDIGO	COLORES	ENVASE
081389	Pastel: Rosa, Azul, Verde Claro, Verde, Violeta y Melocotón	Bote 50 ud.



Los códigos en **color amarillo** permiten apertura de envase

PACK CINTA CORRECTORA MINI RAYAS 3 UD.

El pequeño gigante

PLUS
JAPANANCHO CINTA
4.2mm

CAJA de 3 unidades

← LARGO CINTA **5 m****DESECHABLE**

Materiales : Plástico reciclado
 (Carcasa principal : Poliestireno reciclado (PS)
 Dimensiones externas:
 65x35x15mm

Punto 1**Cómodo agarre**

Su práctico tamaño es adecuado para guardarlo en bolsillos y organizadores.

Punto 2**Alta calidad a buen precio**

5 metros de cinta correctora en un corrector de tamaño mini.

Punto 3**Desechable**

100% reciclable.



CÓDIGO	COLORES	ENVASE
081076	Surtidos	Exp. 20 Blisters de 3 ud.

CINTA CORRECTORA PS

Mecanismo retráctil

PLUS
JAPANANCHO CINTA
4.2mmANCHO CINTA
4.2mmANCHO CINTA
4.2mmANCHO CINTA
4.2mm**Punto 1****Dos formas de uso**

Arrastre para corregir una frase completa.
 Presione para corregir una letra.

**Punto 2****Cabezal flexible**

Con un mini rodillo para una aplicación perfecta y más precisa.

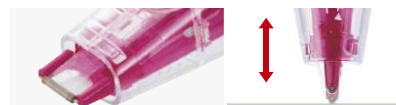

Mecanismo de cabeza acolchada. El cabezal puede usarse verticalmente, de esta forma se controla la presión para que la cinta se adhiera con mayor firmeza.

CÓDIGO	COLOR	ENVASE
080675	Azul	Blíster 1 ud./ 10
080676	Naranja	Blíster 1 ud./ 10
080677	Verde	Blíster 1 ud./ 10
080732	Surtidos	Exp. 24 ud.

← LARGO CINTA **6 m****DESECHABLE****RODILLO METÁLICO****MECANISMO AMORTIGUADO****CABEZA RETRÁCTIL****2 FORMAS DE USO**

Materiales : Plástico reciclado
 (Carcasa principal : Poliestireno reciclado)
 Dimensiones externas:
 23x9,8x109mm



Los códigos en **color amarillo** permiten apertura de envase

Punto 1**PLUS**
JAPAN**Punta flexible****Mini rodillo de cabezal**

Mini rodillo de cabezal que ofrece correcciones suaves y consistentes.

**Punto 2****2 formas de corrección**

Arrastre para una frase completa, presione para una sola letra.

Consiga correcciones nítidas vigilando las partes a corregir al mismo tiempo que hace las correcciones.

**Punto 3****Mecanismo de fácil recarga**

CÓDIGO	MODELO	ENVASE
081197	Corrector	Blistér 1 ud./ 10
081198	Recambio	Blistér 1 ud./ 10



Recambio

CINTA CORRECTORA SWITCH

Correcciones perfectas para la oficina.

ANCHO CINTA
4.2mm**12 m** ← LARGO CINTA

RECARGABLE

MINI RODILLO

PUNTA FLEXIBLE

CORRECCIÓN EN 2 SENTIDOS

Materiales : Plástico reciclado
(Carcasa principal : Poliestireno reciclado (PS))
Dimensiones externas: 83×20×41 mm.

Punto 1**PLUS**
JAPAN**Punta flexible****Mini rodillo de cabezal**

Mini rodillo de cabezal que ofrece correcciones suaves y consistentes. Se aplica la cinta firmemente en el papel y su cabezal flexible se puede maniobrar para llevar a cabo correcciones más precisas.

**Punto 2****2 formas de corrección**

Arrastre para una frase completa, presione para una sola letra.

Consiga correcciones nítidas vigilando las partes a corregir al mismo tiempo que hace las correcciones.



Arrastre para una frase entera

Apriete para una sola letra

CÓDIGO	MODELO	ENVASE
080820	TW	Blistér 1 ud./ 10
080900	1 TW + 1 MINI	Blistér 2 ud./ 10
080821	TW	Exp. 20 ud.

**CINTA CORRECTORA TW**

Correcciones perfectas para la oficina.

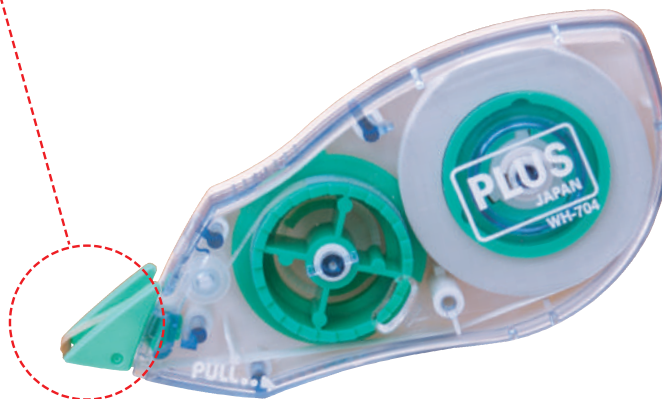
Sin DESGARROS← LARGO CINTA **12 m**

DESECHABLE

MINI RODILLO

PUNTA FLEXIBLE

CORRECCIÓN EN 2 SENTIDOS

Materiales : Plástico reciclado
(Carcasa principal : Poliestireno reciclado (PS) Cabezal:
Poliacetil reciclado (POM))
Dimensiones externas: 89×16×39mm

Los códigos en **color amarillo** permiten apertura de envase

CINTA CORRECTORA MINI

Tamaño mini pero duradero

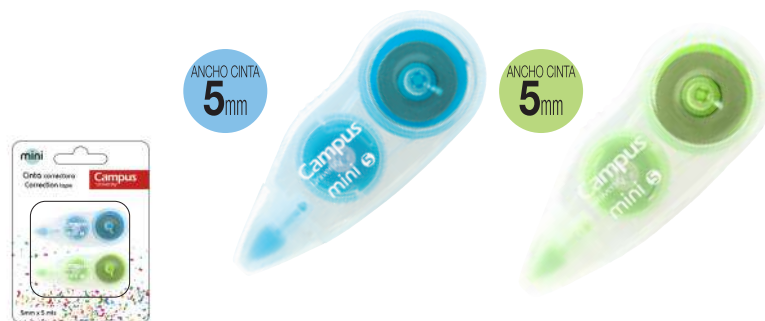

← LARGO CINTA 5 m

DESECHABLE

Materiales : Plástico reciclado
(Carcasa principal : Poliestireno reciclado (PS))
Dimensiones externas: 55 x 23 x 13 mm



Punto 1

Tamaño mini

Su tamaño es como el de una goma de borrar, pero con 5 metros de cinta, para poder guardarlo en tu portatodos.

Mini size

Its size is like that of an eraser, but with 5 meters of tape, to be able to save it in your pencilcase.

Tamanho mini

Seu tamanho é como o de uma borracha, mas com 5 metros de fita, para poder salvá-lo em seus lapiseira.

Mini dimensioni

La sua dimensione è simile a quella di una gomma, ma con 5 metri di nastro, per poterla salvare nei tuoi portatodi.

CÓDIGO	COLOR	ENVASE
081290	Azul y Verde	Blister 2 ud.

CINTA CORRECTORA TWIST

Tamaño mini pero duradero



CÓDIGO	COLOR	ENVASE
081288	Azul	Blister 1 ud.
081300	Rosa	Blister 1 ud.
081301	Verde claro	Blister 1 ud.

CÓDIGO	COLOR	ENVASE
081302	Azul	Blister 1 ud.

Punto 1

Tamaño mini

Su tamaño es como el de una goma de borrar, pero con 5 metros de cinta, para poder guardarlo en tu portatodos.

Mini size

Its size is like that of an eraser, but with 5 meters of tape, to be able to save it in your pencilcase.

Tamanho mini

Seu tamanho é como o de uma borracha, mas com 5 metros de fita, para poder salvá-lo em seus lapiseira.

Mini dimensioni

La sua dimensione è simile a quella di una gomma, ma con 5 metri di nastro, per poterla salvare nei tuoi portatodi.

Punto 2

Ergonómico

Con goma en el lateral para una mejor sujeción y una corrección más precisa.

Ergonomic

With rubber on the side for a better grip and a more accurate correction.

Ergonômico

Com borracha no lado para uma melhor aderência e uma correção mais precisa.

Ergonomico

Con gomma sul lato per una presa migliore e una correzione più accurata.



← LARGO CINTA 5 m

DESECHABLE

Materiales : Plástico reciclado
(Carcasa principal : Poliestireno reciclado (PS))
Dimensiones externas: 65 x 36 x 15 mm



Los códigos en color amarillo permiten apertura de envase

CINTA CORRECTORA MAXI

Correcciones perfectas para la oficina

**Punto 1****Corrección suave**

Su mecanismo permite una aplicación suave desde el principio hasta el final.

Smooth corrections

Its mechanism allows a smooth application from the beginning to the end.

Correções suaves

Seu mecanismo permite uma aplicação suave do começo ao fim.

Correzione regolari

Il suo meccanismo consente un'applicazione uniforme dall'inizio alla fine.

**Punto 2****Larga duración**

10 metros de cinta correctora, que dura más tiempo.

Long life

10 meters of corrective tape, which lasts longer.

Longa duração

10 metros de fita correctiva, que dura mais tempo.

Lunga durata

10 metri di nastro correttivo, che dura più a lungo.

Punto 3**Cómodo agarre**

Avanzada forma ergonómica. Fácil de corregir textos escritos horizontalmente. Aplicación lateral.

Comfortable grip

Advanced ergonomic shape. Easy to correct texts written horizontally. Lateral application.

Aderência confortável

Forma ergonômica avançada. Fácil de corrigir textos escritos horizontalmente. Aplicação lateral.

Presu confortevole

Forma ergonomica avanzata. Facile da correggere i testi scritti orizzontalmente. Applicazione laterale.

**Punto 4****Desechable**

100% material reciclable.

Smooth corrections

100% recyclable material.

Correções suaves

Material 100% reciclável.

Correzione regolari

Materiale riciclabile al 100%.



← LARGO CINTA 10 m

DESECHABLE

Materiales : Plástico reciclado
(Carcasa principal : Poliestireno reciclado (PS)
Dimensiones externas: 90 x 42 x 15 mm

CÓDIGO	COLOR	ENVASE
081289	Verde	Blister 1 ud.



Los códigos en **color amarillo** permiten apertura de envase

CINTA CORRECTORA CR

Una gran cinta correctora en un diseño compacto!



mini

2 usos



← LARGO CINTA 12 m

DESECHABLE

MINI RODILLO

CORRECCIÓN EN 2 SENTIDOS

PUNTA FLEXIBLE

Materiales :
(Carcasa principal : Poliestireno (PS))
Dimensiones: 70 x 16 x 30 mm.

CÓDIGO	COLOR	ENVASE
081480	Verde	Blíster 1 ud.
081481	Azul	Blíster 1 ud.

ANCHO CINTA 4.2mm



ANCHO CINTA 4.2mm



Punto 1

Uso cómodo y suave

Mini cabezal de rodillo suave
Transfiere la cinta firmemente a la superficie.



Controlador de par
Permite una aplicación ligera y fácil de principio a fin.

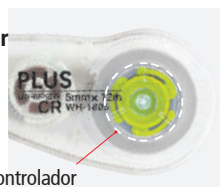

Controlador

Cabezal flexible
Cabezal de rodillo flexible y giratorio.



Punto 2

Cuerpo compacto

Apta para almacenar en bolsillos y pequeñas superficies.



Punto 3

2 formas de corrección

Arrastre para una frase completa, presione para una letra
Correcciones precisas con un acabado perfecto.



Arrastre para una frase completa.



Presione para una letra.

Punto 4

Tapa de apertura/cierre

Tapa que se puede cerrar con un solo dedo. Protege la cinta cuando no está en uso.



CINTA CORRECTORA DS XTRA LONG

Extra-Larga 20 metros

PLUS
JAPAN**Punto 1****Mecanismo de deslizamiento**

Deslice el botón hacia atrás para guardar el cabezal después del uso.

Punto 2**Cabezal flexible**

Con un mini rodillo para una aplicación perfecta y más precisa.

**Punto 3****Dos formas de uso**

Arrastre para corregir una frase completa.
Presione para corregir una letra.

ANCHO CINTA
4.2mm

4.2mm x 20m

← **20 m**
LARGO CINTA**DESECHABLE****RODILLO METÁLICO****PUNTA RETRÁCTIL****CORRECCIÓN EN 2 SENTIDOS****PUNTA FLEXIBLE**

Materiales : Plástico reciclado
(Carcasa principal : Poliestireno reciclado (PS) Cabezal: Poliacetal reciclado (POM))

PLUS
JAPAN**Punto 1****Mecanismo de deslizamiento**

Deslice el botón hacia atrás para guardar el cabezal después del uso.

Punto 2**Cabezal flexible**

Con un mini rodillo para una aplicación perfecta y más precisa.

Punto 3**Dos formas de uso**

Arrastre para corregir una frase completa.
Presione para corregir una letra.

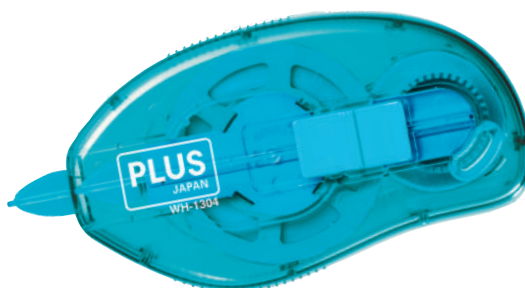
ANCHO CINTA
4.2mmANCHO CINTA
4.2mmANCHO CINTA
4.2mm← **10 m**
LARGO CINTA**DESECHABLE****RODILLO METÁLICO****PUNTA RETRÁCTIL****CORRECCIÓN EN 2 SENTIDOS****PUNTA FLEXIBLE**

Materiales : Plástico reciclado
(Carcasa principal : Poliestireno reciclado (PS) Cabezal: Poliacetal reciclado (POM))

CÓDIGO	COLOR	ENVASE
081077	3 Surtidos	Exp. 18 ud.



Los códigos en **color amarillo** permiten apertura de envase

CINTA DECORACION DECO RUSH

Decora tus cuadernos o blocs de notas como quieras



DECO RUSH

← LARGO CINTA 6 m

RECARGABLE

MINI RODILLO

MECANISMO AMORTIGUADO

CABEZA FLEXIBLE

SURTIDO 1



SURTIDO 2



SURTIDO NAVIDAD



RECAMBIO CINTA

← LARGO CINTA 6 m







CÓDIGO	DESCRIPCIÓN	SURTIDO	ENVASE
080824	Exp. Deco Rush	1	Exp. 20 ud.
080800	Deco Rush	1	Blister 1 ud./ 10
080802	Deco Rush	2	Blister 1 ud./ 10
080803	Recambio 10 ud.	1	Blister 1 ud./ 10
080804	Recambio 10 ud.	2	Blister 1 ud./ 10
080837	Deco Navidad	Navidad	Blister 3 ud. / 6 (maquina+2 recambios)



Los códigos en color amarillo permiten apertura de envase

LAPIZ CORRECTOR CAMPUS UNIVERSITY

Punta metálica. Contenido 8 ml.





-  Lápiz corrector de cuerpo flexible. Ofrece una corrección rápida y precisa. Agitar ligeramente antes de usar.
-  Correction pen of flexible body. It offers a fast and precise correction. Shake slightly before using.
-  Caneta correctora de corpo flexível. Correção rápida e precisa. Agitar ligeiramente.
-  Correttore a penna flessibile. Offre una correzione rapida e accurata. Agitare leggermente prima dell'uso.



CÓDIGO	CONTENIDO	ENVASE
080690	8 ml.	Exp. 24 ud.

CORRECTOR LIQUIDO PLUS OFFICE

Pincel de esponja. Contenido 20 ml.

-  Líquido corrector con esponja de secado rápido. Pincel de espuma. No necesita diluyente. 20 ml.
-  Correction fluid of fast drying. Foam brush. No diluent needed. 20 ml.
-  Líquido corrector de secagem rápida. Pincel de espuma. Não necessita diluente. 20 ml.
-  Líquido correttore con spugna con rapida asciugatura. Pennello di schiuma. Non ha bisogno di diluente. 20 ml.







Pincel esponja
Limpieza y precisión



CÓDIGO	CONTENIDO	ENVASE
080005	20 ml.	12 ud.

PORTAGOMAS XT ERASER





Mecanismo automático

-  Portagomas. Borra el lápiz de grafito sobre cualquier tipo de papel. Mecanismo automático.
-  Eraser holder. It erases the graphite writing on any type of paper. Automatic mechanism.
-  Porta borrachas. Apaga sobre qualquer tipo de papel. Mecanismo automatico.
-  Portagomma. Cancella la matita di grafite su qualsiasi tipo di carta. Meccanismo automatico.



CÓDIGO	DESCRIPCIÓN	ENVASE
080022	Portagomas	Exp. 20 ud.
080023	Recambio	Caja 24 ud.

GOMA CAMPUS DUO

-  Goma de borrar, 2 en 1. Por un lado borra grafito y por otro tintas termosensibles. Colores: azul y verde.
-  Eraser 2 in 1. One side erases graphite and the other thermosensitive inks. Colors: blue and green.
-  Borracha 2 em 1. Um lado apaga a grafite e o outro as tintas termosensíveis. Cores: azul e verde.
-  Gomma 2 in 1. Un lato cancella la grafite e l'altro gli inchiostri termosensibili. Colori: blu e verde.



CÓDIGO	MEDIDAS	ENVASE
081422	70 x 20 x 11 mm.	Blister 1 ud./ 12



Los códigos en **color amarillo** permiten apertura de envase

GOMA CAMPUS 30



- Plástica. Para lápices de grafito.
- Plastic eraser. For graphite pencils.
- Borrachas plásticas para lápiz de grafito.
- Gomma di plastica, per matite di grafito.

CÓDIGO	MEDIDAS	ENVASE
080478	30x30x10 mm	Caja 30 ud.
080822	30x30x10 mm	Bolsa de 4 ud. / 24

GOMAS US20-US30



- Plástica. Para papel y poliéster.
- Plastic eraser. For paper and polyester.
- Borrachas plásticas para papel e polyester.
- Gomma di plastica, per carta e poliestere.

	CÓDIGO	MODELO	MEDIDAS	ENVASE
1	080014	US20	21x61x10	Caja 20 ud.
2	080013	US30	18x41x10	Caja 30 ud.
3	080969	US20	21x61x10	Bolsa 2 ud./24

GOMA CAMPUS NI



- Plástica. Para lápices de grafito. En bolsa retráctil individualmente.
- Plastic eraser. For graphite pencils. In individually shrink bag.
- Borrachas plásticas para lápiz de grafito. Em saco retráctil individualmente.
- Gomma di plastica, per matite di grafito. In sacchetto termoretraibile singolarmente.

CÓDIGO	MEDIDAS	ENVASE
081003	37x32x15 mm	Exp. 24 ud.

GOMAS DE BORRAR CAMPUS SHAPE

Forma triangular y ovalada



- Gomas de borrar para uso escolar. Ideal para lápiz.
- Erasers for school use. Ideal for pencil.
- Borracha para uso escolar. Ideal para lápiz.
- Gomma da cancellare per uso scolastico, ideale per matita.

CÓDIGO	ENVASE
080770	Bote 30 ud.

GOMA CAMPUS "FRUIT"



- Goma de borrar plástica, suave. Colores: blanca, verde, negra, violeta, azul, rojo, rosa y azul claro.
- Plastic eraser, soft. Colours: white, green, black, violet, blue, red, pink and light blue.
- Borracha plástica, suave. Cores: branco, verde, preto, violeta, azul, vermelho, rosa e azul claro.
- Gomma da cancellare morbida. Colori: bianco, verde, nero, viola, blu, rosso, rosa e azzurro.

Tamaño PEQUEÑO

CÓDIGO	MEDIDAS	ENVASE
081044	50 x 16 x 15 mm	Exp. 32 ud.

Tamaño GRANDE

CÓDIGO	MEDIDAS	ENVASE
081043	66 x 16 x 16 mm	Exp. 32 ud.



03





ESCRITURA

WRITING
ESCRITA
SCRITTURA



LAPIZ CAMPUS GRAPHITE

Hexagonal. Fácil afilado. Nueva mina más suave HB · N°2



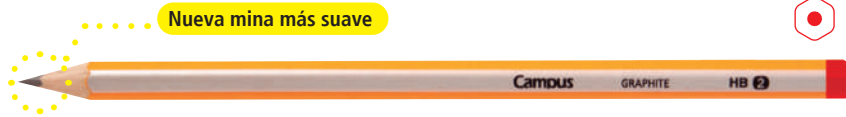

-  Lápiz de grafito. Ideal para escritura y dibujo. Alta resistencia a la rotura de la mina.
-  Lápiz triangular de grafito. Para escrita e desenho. Mina de alta resistência.
-  Graphite pencil. Ideal for writing and drawing. High resistance to breakage of lead.
-  Matita di grafite ideale per scrivere e disegnare. Alta resistenza alla rottura di mina.



CÓDIGO	MINA	ENVASE
080535	2.HB	12 ud.
081042	2.HB	4 ud./ 24

LAPIZ BICOLOR CAMPUS

Dos colores en un lápiz: azul y rojo.

-  Lápiz hexagonal, bicolor azul/rojo. Alta resistencia a la rotura de la mina. Para uso escolar y de oficina.
-  Hexagonal pencil, bicolor blue / red. High resistance to breakage of the mine. For school and office use.
-  Lápiz hexagonal, bicolor azul / vermelho. Alta resistência à quebra da mina. Para a escola e uso de escritório.
-  Matita esagonale, bicolore blu / rossa. Elevata resistenza alla rottura della mina. Per uso scolastico e d'ufficio.

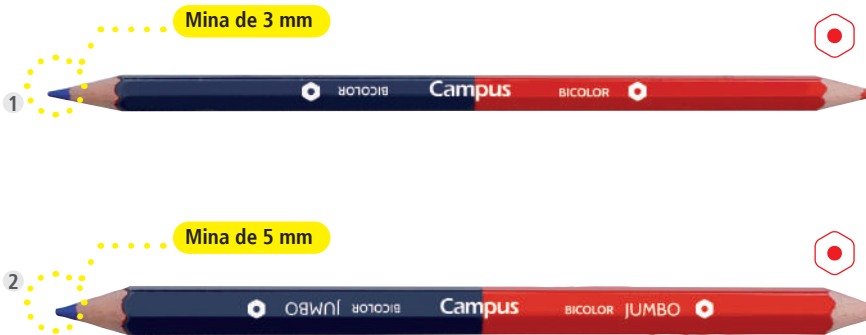

	CÓDIGO	MINA	ENVASE
1	630447	3 mm.	12 ud.
2	081119	5 mm.	12 ud.

LAPIZ TRIANGULARES NEÓN Y METALLIC

Madera negra

-  Lápiz de madera con forma triangular. Aptos para uso escolar e ideales para crear diseños llamativos. Se presentan en bolsa de plástico de seis colores.
-  Wooden pencil with triangular shape. Suitable for school use and ideal for creating striking designs. Presented in plastic bag of six colors.
-  Lápiz de madeira com forma triangular. Adequado para uso escolar e ideal para a criação de desenhos chamativos. Eles vêm em saco plástico de seis cores.
-  Matite di legno a forma triangolare. Adatto per uso scolastico e ideale per creare disegni accattivanti. Sono presentate in un sacchetto di plastica di sei colori.



	CÓDIGO	COLORES	ENVASE
3	080563	NEÓN	Bolsa 6 ud. / 24
4	080562	METAL	Bolsa 6 ud. / 24



PORTAMINAS P1

Retráctil. Mina 0,5 mm.

Portaminas con cuerpo de plástico con un moderno diseño. Grip ergonómico. Incorpora goma de borrar. Puntera metálica. Colores: gris oscuro, azul, verde, rosa.

Plastic body. Ergonomic Grip. Includes eraser. Metal toe. Contemporary design. Body colors: dark grey, blue, green, pink.

Corpo de plástico. Grip ergonómico. Inclui borracha. Ponta metálica. Desenho contemporâneo. Cores: cinza escuro, azul, verde, rosa.

Portamine con corpo in plastica dal design moderno. Presa ergonomica con gomma inclusa sul pulsante. Punta metálica. Colores: grigio scuro, blu, verde, rosa.



0.5 mm.

CÓDIGO	COLOR	ENVASE
080938	4 Surtidos	Caja 12 ud.
080921	4 Surtidos	Exp. 36 ud.

PORTAMINAS P3

Retráctil. Mina 0,5 mm.

Portaminas con cuerpo de plástico con un atractivo diseño. Incorpora goma de borrar. Puntera metálica. Color de cuerpo: negro/naranja, verde claro/verde oscuro, rosa/violeta y azul/verde.

Plastic body. Includes eraser. Metal toe. Attractive design. Body colors: black/orange, light green/dark green, pink/purple and blue/green.

Corpo de plástico. Inclui borracha. Ponta metálica. Desenho atrativo. Cor de corpo: preto/laranja, verde claro/verde escuro, rosa/violeta e azul/verde.

Portamine corpo in plastica che include gomma sul pulsante. Punta di metallo. Design accattivante. Colori corpo: nero / arancio, verde chiaro / verde scuro, rosa / porpora e blu / verde.



0.5 mm.

CÓDIGO	COLOR	ENVASE
080922	4 Surtidos	Exp. 24 ud.

PORTAMINAS P15

Retráctil. Mina 0,5 mm.

Cuerpo de plástico. Clip metálico y grip de caucho antideslizante. Goma de borrar en el pulsador. Punta metálica retráctil.

Plastic body. Metallic clip and rubber grip non-slip. Eraser on pushbutton. Metallic toe retractable.

Corpo plastico. Clip metalico e grip de borracha anti-derrapante. Borracha na botão. Ponta metálica retratil.

Corpo in plastica, clip metálica e impugnatura in gomma antiscivolo. Gomma sul pulsante. Punta di metallo retrattile.



0.5 mm.

CÓDIGO	COLOR	ENVASE
080917	Azul	12 ud.







Los códigos en color amarillo permiten apertura de envase

PORTAMINAS PLUS RETRO

Retráctil. Mina 0,5 mm.



0.5
mm.

-  Cuerpo de plástico en color azul. Clip y punta metálica retráctil. Grip antiestrés.
-  Plastic body in blue colour. Clip and retractable metal tip.
-  Corpo em plástico azul. Clip e ponta metálica retráctil. Grip anti-deslizante.
-  Corpo in plastica di colore blu. Clip e punta di metallo retrattile. Impugnatura antistress.





CÓDIGO	COLOR	ENVASE
080659	Azul	12 ud.

PORTAMINAS PLUS SHAKER

Retráctil. Mina 0,5 mm.



0.5
mm.

-  Sistema de extracción: agite o pulse. Grip ergonómico. Con goma de borrar.
-  Extraction system: shake or pulse. Ergonomic grip. With eraser.
-  Sistema de extração: agitar ou pulsar. Pega ergonômica. Com borracha.
-  Sistema di estrazione: shake o pulse. Impugnatura ergonomica. Con gomma.

CÓDIGO	COLOR	ENVASE
080741	Verde	12 ud.

PORTAMINAS P17

Retráctil. Mina 0,7 mm.



0.7
mm.

-  Cuerpo de plástico. Clip metálico y grip de caucho antideslizante. Goma de borrar en el pulsador. Punta retráctil. Surtido 3 colores: 4 unidades por color.
-  Plastic body. Metallic clip and rubber grip non-slip. Eraser on pushbutton. Retractable tip. 3 colors assorted: 4 units by color.
-  Corpo plástico. Clip metálico e grip de borracha anti-derrapante. Borracha na botão. Ponta retratil. Sortido 3 cores: 4 unidades por cor.
-  Corpo in plastica, clip metallica e impugnatura in gomma antiscivolo. Gomma sul pulsante. Punta retrattile Assortimento 3 colori: 4 unità per colore.

CÓDIGO	COLOR	ENVASE
080918	3 Surtidos	12 ud.



PORTAMINAS SOFT PENCIL

Mina 0,7 mm.

Portaminas con cuerpo de plástico transparente. Grip ergonómico con tacto de goma. Incorpora goma de borrar. Punta metálica. Colores: negro, azul, azul claro, verde, naranja y rosa.

Transparent plastic body. Ergonomic grip with rubber touch. Includes eraser. Metal tip. Colors: black, blue, light blue, green, orange and pink.

Corpo de plástico transparente. Grip ergonómico com toque de borracha. Inclui borracha. Ponta metálica. Cores: preto, azul, azul claro, verde, laranja e rosa.

Portamine con corpo in plastica trasparente. Impugnatura ergonomica con tatto di gomma. Punta metallica, colori: nero, blu, azzurro, verde, arancione e rosa.



CÓDIGO	COLOR	ENVASE
080964	Surtidos	Display 24 ud.
080965	Surtidos	Bolsa 1 ud. + 1 tubo minas / 24 bolsas

0.7 mm.

PORTAMINAS CAMPUS COLLEGE

Cuerpo con tacto de goma. Mina 1,3 mm.

Portaminas con cuerpo de plástico. Diseño ergonómico. Incorpora goma de borrar. Punta metálica. Colores: verde, azul, naranja y rosa.

Plastic body. Ergonomic design. Includes eraser. Metal tip. Colors: green, blue, orange and pink.

Corpo de plástico. Desenho ergonómico. Inclui borracha. Ponta metálica. Cores: verde, azul, laranja e rosa.

Portamine in plastica, disegno ergonómico con gomma. Punta metallica, Colori: verde, blu, arancione e rosa.



Gira para sacar la goma



CÓDIGO	ENVASE
080966	Display 20 ud.
080967	Blistér 1 ud. + 1 tubo 6 minas / 20 blisters

1.3 mm.



Los códigos en color amarillo permiten apertura de envase

PORTAMINAS PLUS 1.3

Retráctil. Mina 1,3 mm.



1.3 mm.



- Portaminas con cuerpo de plástico. Grip de goma. Diseño ergonómico. Incorpora goma de borrar. Punta metálica. Colores: fucsia, azul, verde y naranja.
- Plastic body. Rubber grip. Ergonomic design. Includes eraser. Metal tip. Colours: fuchsia, blue, green and orange.
- Corpo de plástico. Grip de borracha. Desenho ergonómico. Inclui borracha. Ponta metálica. Cores: fúcsia, azul, verde e laranja.
- Portamine con corpo in plastica. Impugnatura in gomma. Design ergonomico con gomma. Punta metallica. Colori: fucsia, blu, verde e arancione.

CÓDIGO	COLOR	ENVASE
080840	4 Surtidos	Display 24 ud.

PORTAMINAS HEXAGONAL

Retráctil. Mina 2,0 mm.



2.0 mm.



- Pulsador, grip y clip metálico. Afilaminas en el pulsador. Punta metálica. Con indicador para seleccionar la dureza. 8 unidades por color.
- Metallic push button, grip and clip. Sharpener on the push button. Metallic tip. With indicator to select the hardness. 8 units by colour.
- Botão, grip e clip de metal. Apontador no botão. Ponta metálica. Com indicador para selecionar a dureza. 8 unidades por cor.
- Pulsante, impugnatura e clip in metallo. Temperamine sul pulsante. Punta metallica. Con indicatore per selezionare la durezza. 8 unità per colore.

CÓDIGO	COLOR	ENVASE
080960	3 Surtidos	Display 24 ud.

MINAS PLUS

Para toda clase de portaminas



- Para toda clase de portaminas. Altamente resistentes a la rotura.
- For any mechanical pencil. High resistance against leads breaking.
- Para todos os tipos de lapiseiras. Altamente resistentes.
- Per tutti i tipi di portamine. Altamente resistente alla rottura.

	CÓDIGO	MINA	DUREZA	Nº MINAS	ENVASE
1	080083	0,5 mm.	HB	12	24 tubos
2	080867	0,5 mm.	HB	24	12 tubos
3	080968	0,5 mm.	HB	12/tubo	Bolsa 3 tubos / 20 bolsas
4	080084	0,7 mm.	HB	12	24 tubos
5	600351	1,3 mm.	B	12	12 tubos
6	080591	2,0 mm.	HB	12	12 tubos

MINAS PARA COMPÁS



2.0 mm.

- Minas de grafito para todo tipo de compás de gran resistencia.
- Leads for compass. Graphite leads for all types of high resistance compasses.
- Minas grafito para todo tipo de compassos e de grande resistência.
- Mine di grafite per tutti i tipi di compassi, ad alta resistenza.

CÓDIGO	MINA	Nº MINAS	ENVASE
080925	2,0 mm.	4/tubo	Blíster 3 tubos / 24 blisters



Los códigos en **color amarillo** permiten apertura de envase

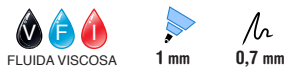

BOLÍGRAFO PLUS BASIC

El más económico.

- Cuerpo traslúcido y resistente. Tinta fluida viscosa, escribe de forma rápida, fluida y sin borrones. Trazo: 0,7 mm. Capuchón del color de la tinta.
- 🇬🇧 Pen with 0.7 mm stroke. Translucent and resistant body. Viscous fluid ink, writes quickly, smoothly and without smudges. Cap ink colour.
- Esferográfica com traço 0.7 mm. Tinta fluido viscoso, escreve rapidamente, suavemente e sem manchas. Corpo traslúcido e resistente. Tampa de cor de tinta.
- Corpo traslucido e resistente. Inchiostro fluido viscoso, scrive velocemente, senza intoppi e senza sbavature. Spessore: 0,7 mm. Cappuccio di colore dell'inchiostro.

CÓDIGO	COLOR TINTA	ENVASE
080834	● Azul	50 ud.
080835	● Negro	50 ud.
080836	● Rojo	50 ud.



CÓDIGO	COLOR TINTA	ENVASE
081049	● Azul	Bolsa 10 ud. / 10
081050	Surtidos*	Bolsa 10 ud. / 10

* 5 Azules, 3 Negros y 2 Rojos.

CÓDIGO	COLOR TINTA	ENVASE
080829	Surtidos	Bolsa 10 ud. / 10



BOLÍGRAFO PLUS TRIO

- Tinta fluida viscosa, escribe de forma rápida, fluida y sin borrones. Cuerpo del mismo color que la tinta. Punta de níquel: 1 mm.
- 🇬🇧 Viscous fluid ink, quick, fluid and without smudges writing. Body ink colour. Nickel tip: 1 mm.
- Tinta fluido viscoso, escreve rapidamente, de forma suave e sem borões. Corpo da mesma cor que a tinta. Ponta níquel: 1 mm.
- Inchiostro viscoso fluido, scrive rapidamente, senza intoppi e senza sbavature. Corpo dello stesso colore dell'inchiostro. Punta di nichel: 1 mm.

CÓDIGO	COLOR TINTA	ENVASE
080930	● Azul	50 ud.
080931	● Negro	50 ud.
080932	● Rojo	50 ud.
080933	● Verde	50 ud.
081088	● Rosa	12 ud.
081089	● Violeta	12 ud.
081140	● Turquesa	12 ud.
081141	● Verde Flúor	12 ud.



CÓDIGO	COLOR TINTA	ENVASE
080981	● Negro	Bolsa 3 ud. / 24 bolsas
080980	● Azul	Bolsa 5 ud. / 24 bolsas
081444	● Negro	Bolsa 5 ud. / 24 bolsas
080982	● 2 Azul ● 2 Negro ● 1 Rojo	Bolsa 5 ud. / 24 bolsas

CÓDIGO	COLOR TINTA	ENVASE
081087	10 Surtidos	Bolsa 10 ud. / 10

BOLÍGRAFO PLUS GP



● Tinta fluida viscosa, escribe de forma rápida, fluida y sin borrones. Grip. Punta de níquel: 1.0 mm.

🇬🇧 Viscous fluid ink, quick, fluid and without smudges writing. Grip. Nickel tip: 1.0 mm.

● Tinta fluido viscoso, escreve rapidamente, de forma suave e sem borrões. Grip. Ponta níquel: 1.0 mm.

● Inchiostro viscoso fluido, scrive rapidamente, senza intoppi e senza sbavature. Impugnatura. Punta di nichel: 1,0 mm.



CÓDIGO	TINTA	ENVASE
080934	● Azul	12
080935	● Negro	12
080936	● Rojo	12
080937	● Verde	12
081086	Surtidos	Exp. 60 ud.



CÓDIGO	COLOR TINTA	ENVASE
080983	● Azul	Blíster 3 ud. / 24
080984	● Negro	Blíster 3 ud. / 24
080985	● Rojo	Blíster 3 ud. / 24
081008	● Azul ● Negro ● Rojo	Blíster 3 ud. / 24

BOLÍGRAFO CAMPUS COLOURS

Tacto de goma. Colores intensos



● Escritura ultrarápida, fluida y sin borrones. Grip de caucho antideslizante. Retráctil. Punta: 1.0 mm.

🇬🇧 Ultra-fast, fluid and without smudges writing. Rubber grip. Retractable. Tip: 1.0 mm.

● Escrita ultra-rápida, de forma suave e sem borrones. Grip de borracha. Retrátíl. Ponta: 1.0 mm.

● Scrittura ultraveloce, senza intoppi e senza sbavature. Impugnatura antiscivolo in gomma. Retrattile. Suggestimento: 1.0 mm.



CÓDIGO	COLOR TINTA	ENVASE
081335	● Azul	Blíster 3 ud. / 12
081336	● Azul ● Negro ● Rojo	Blíster 3 ud. / 12

CÓDIGO	COLOR TINTA	ENVASE
081304	● Azul	12 ud.
081306	● Negro	12 ud.
081305	● Rojo	12 ud.
081307	● Verde	12 ud.
081310	● Rosa	12 ud.
081311	● Violeta	12 ud.
081303	Surtidos	Exp. 48 ud.





BOLÍGRAFO AEROGRIP

Novedosa tinta

- Escritura ultrarápida, fluida y sin borrones. Grip de caucho antideslizante. Punta: 1 mm.
- Ultra-fast, fluid and without smudges writing. Rubber grip. Tip: 1 mm.
- Escritura ultra-rápida, de forma suave e sem borões. Grip de borracha. Ponta: 1 mm.
- Scrittura ultraveloce, senza intoppi e senza sbavature. Impugnatura antiscivolo in gomma. Suggerimento: 1 mm.



CÓDIGO	COLOR TINTA	ENVASE
081121	● Azul	12 ud.
081122	● Negro	12 ud.
081123	● Rojo	12 ud.
081124	3 Surtidos	Exp. 48 ud.



BOLÍGRAFO ULTRAGLIDE STEEL GEL

Tinta de gel

- Tinta Quick Dry Ink de gel. Cuerpo y grip del color de la tinta. Con clip. Punta: 0.7 mm.
- Gel Quick Dry Ink. Body and grip ink color. With clip. Tip: 0.7 mm.
- Tinta Quick Dry Ink de gel. Corpo e grip da mesma cor que a tinta. Com clip. Ponta: 0.7 mm.
- Inchiostro Quick Dry Ink gel. Corpo e presa del colore dell'inchiostro. Con clip, tratto: 0,7 mm.



CÓDIGO	COLOR TINTA	ENVASE
081079	● Azul	12 ud.
081081	● Rojo	12 ud.

CÓDIGO	COLOR TINTA	ENVASE
081084	● Rojo	Blistér 1 ud. / 24
081085	● Negro	Blistér 1 ud. / 24
081083	● Azul	Blistér 3 ud. / 24
081082	● Azul ● Negro ● Rojo	Blistér 3 ud. / 24



BOLÍGRAFO TOP TEK

Retráctil

- Tinta fluida viscosa. Escribe de forma rápida, fluida y sin borrones. Cuerpo ahumado. Grip del mismo color que la tinta. Pulsador y clip metálicos. Punta: 1.0 mm.
- Viscous fluid ink. Quick, fluid and without smudges writing. Smoked body. Grip ink colour. Metallic push button and clip. Tip: 1.0 mm.
- Tinta fluido viscoso. Escreve rapidamente, de forma suave e sem borões. Corpo afumado. Grip da mesma cor que a tinta. Botão e clip metálicos. Ponta: 1.0 mm.
- Inchiostro viscoso fluido. Scrive rapidamente, senza intoppi e senza sbavature. Corpo affumicato, impugnatura dello stesso colore dell'inchiostro. Pulsante e clip metallica. Tratto: 1,0 mm.



CÓDIGO	COLOR TINTA	ENVASE
081012	● Negro	12 ud.
081013	● Rojo	12 ud.

CÓDIGO	COLOR TINTA	ENVASE
081014	● Azul	Blistér 1 ud. / 24
081015	● Negro	Blistér 1 ud. / 24
081016	● Rojo	Blistér 1 ud. / 24



Los códigos en color amarillo permiten apertura de envase

BOLÍGRAFO ROLLER BUTTERGLIDE

Con clip de acero



- Capucha transparente con detalle del color de la tinta, super resistente. Grip de goma del color de la tinta. Punta: 0.7 mm
- Transparent hood with ink color detail, super tough. Rubber grip color ink. Tip: 0.7 mm.
- Capa transparente com detalhe de cor da tinta, super durável. Grip de borracha de cor da tinta. Ponta: 0.7 mm.
- Cappuccio trasparente con dettaglio color inchiostro, super resistente. Impugnatura in gomma color inchiostro. Suggestimento: 0,7 mm



CÓDIGO	COLOR TINTA	ENVASE
081010	Surtidos*	Exp. 24 ud.

*12 Azules, 8 Negros y 4 Rojos.

CÓDIGO	COLOR TINTA	ENVASE
080987	● Azul	Blíster 1 ud. / 24
080988	● Rojo	Blíster 1 ud. / 24

BOLÍGRAFO PLUS SOFT



- Retractable. Cuerpo con tacto de goma. Trazo: 0,7 mm. Cuerpo del color de la tinta.
- Retractable. Pen with 0.7 mm stroke. Body with rubber touch. Body ink colour.
- Retratil. Esferográfica com traço 0.7 mm. Corpo com tato de borracha Corpo de cor da tinta.
- Penna retrattile. Corpo con sensazione di gomma morbina. Tratto: 0,7 mm. Corpo del colore dell'inchiostro.



CÓDIGO	COLOR TINTA	ENVASE
080902	● Azul	25 ud.
080903	● Negro	25 ud.
080904	● Rojo	25 ud.

CÓDIGO	COLOR TINTA	ENVASE
080929	● Azul	Blíster 3 ud. / 12
080907	● Negro, ● Azul, ● Rojo	Blíster 3 ud. / 12





BOLÍGRAFO PLUS SOFT 2

- Retrácil. Cuerpo con tacto de goma. Cuerpo del color de la tinta.
- Retractable. Body with rubber touch. Body ink colour.
- Retratil. Corpo com tato de borracha Corpo de cor da tinta.
- Penna retrattile. Corpo con sensazione di gomma morbina. Corpo del colore dell'inchiostro.



CÓDIGO	COLOR TINTA	ENVASE
081104	Violeta	25 ud.



BOLÍGRAFO PLUS T

Retrácil. Tinta azul

- Bolígrafo de cuerpo metálico con grip de caucho y clip de metal negro. Trazo: 0.7 mm. Colores de cuerpo: azul, naranja, verde, gris, rojo y negro.
- Metallic body with rubber grip and black metal clip. Stroke: 0.7 mm. Body colours: blue, orange, green, gray, red and black.
- Corpo metalico com grip de borracha e clip de metal preto. Traço: 0.7 mm. Cores do corpo: azul, laranja, verde, cinza, vermelho e preto.
- Penna a sfera con corpo in metallo e impugnatura in caucciù + clip in metallo nero. Tratto: 0,7 mm. Colori del corpo: blu, arancione, verde, grigio, rosso e nero.



CÓDIGO	TINTA	ENVASE
080871	● Azul	Display 24 ud.

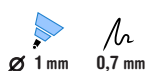

BOLÍGRAFO CON PEANA

Ideal para uso en mostradores

- Bolígrafo unido a una base pesada mediante cadena cromada de 52 cm. Tinta azul. Base antideslizante de 300 g.
- Ballpoint pen attached to a heavy base by 52 cm chrome chain. Blue ink. With 300 g anti-slip pedestal.
- Caneta esferográfica presa a uma base pesada por corrente cromada de 52 cm. Com base antiderapante 300 g.
- Penna a sfera collegata a una base ttraverso catena cromata da 52 cm. Inchiostro blu. Base antiscivolo da 300 g.



CÓDIGO	COLOR TINTA	ENVASE
785252	● Azul	1 ud.



Los códigos en color amarillo permiten apertura de envase

BOLÍGRAFO BORRABLE PLUS MAGIC GEL

Con capuchón



Bolígrafo borrable. La tinta de gel se borra limpiamente y no traspasa el papel. Puede borrar fácilmente su trabajo sin dejar virutas ni deteriorar la hoja. Trazo: 0.7 mm.

Erasable pen. The gel ink is cleanly erased and doesn't pass through the paper. Can easily erase your work without leaving shavings or deteriorating the paper. Stroke: 0.7 mm.

Esferográfica borrable. A tinta de gel é borra limpiamente e não traspasa o papel. Pode borrar facilmente seu trabalho sem deixar virutas nem deteriorar a folha. Traço: 0.7 mm.

Penna a sfera cancellabile. L'inchiostro gel viene cancellato in modo pulito e non penetra nella carta. Puoi facilmente cancellare il tuo lavoro senza lasciare resti o danneggiare il foglio. Tratto: 0,7 mm.



CÓDIGO	COLOR TINTA	ENVASE
081172	● Azul	12 ud.
081173	● Negro	12 ud.
081174	● Rojo	12 ud.
081171	Surtidos *	Bote 36 ud.

*20 Azules, 8 Negros y 8 Rojos.

BOLÍGRAFO BORRABLE PLUS MAGIC CLICK

Retráctil



Bolígrafo borrable retráctil. La tinta de gel se borra limpiamente y no traspasa el papel. Puede borrar fácilmente su trabajo sin dejar virutas ni deteriorar la hoja. Trazo: 0.7 mm.

Retractable erasable pen. The gel ink is cleanly erased and doesn't pass through the paper. Can easily erase your work without leaving shavings or deteriorating the paper. Stroke: 0.7 mm.

Esferográfica borrable retratil. A tinta de gel é borra limpiamente e não traspasa o papel. Pode borrar facilmente seu trabalho sem deixar virutas nem deteriorar a folha. Traço: 0.7 mm.

Penna cancellabile a scomparsa. L'inchiostro gel viene cancellato in modo pulito e non penetra nella carta. Puoi facilmente cancellare il tuo lavoro senza lasciare resti o danneggiare il foglio. Tratto: 0,7 mm.



CÓDIGO	COLOR TINTA	ENVASE
080997	● Azul	12 ud.
080998	● Rojo	12 ud.
080999	● Negro	12 ud.
081091	Surtidos	Exp. 36 ud.*

*24 Azules, 6 Negros y 6 Rojos.

CÓDIGO	TINTA	ENVASE
081096	● Azul	Blíster 1 ud. / 12





BORRABLE

- Recambio para Plus Magic. Trazo: 0.7 mm.
- Refill for Plus Magic. Stroke: 0.7 mm.
- Refill para Plus Magic. Traço: 0.7 mm.
- Ricambio per Plus Magic. Tratto: 0,7 mm.

CÓDIGO	COLOR	ENVASE
081523	● Azul	Blistér 3 ud. / 12
081524	● Negro	Blistér 3 ud. / 12
081525	● Rojo	Blistér 3 ud. / 12



RECAMBIO PLUS MAGIC CLICK



BORRABLE

- Recambio para Plus Magic. Trazo: 0.7 mm.
- Refill for Plus Magic. Stroke: 0.7 mm.
- Refill para Plus Magic. Traço: 0.7 mm.
- Ricambio per Plus Magic. Tratto: 0,7 mm.

CÓDIGO	COLOR	ENVASE
081046	● Azul	Blistér 3 ud. / 12
081047	● Negro	Blistér 3 ud. / 12
081048	● Rojo	Blistér 3 ud. / 12



RECAMBIO PLUS MAGIC CLICK

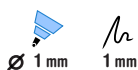

Ø 1 mm 1 mm

- Cuerpo de plástico. Ancho de trazo: 1.0 mm. Cuatro colores de escritura. Normal: verde, rojo, azul y negro. Fluor: verde, rojo, azul y negro. Pastel: verde, rojo, azul y violeta.
- Plastic body. Stroke: 1.0 mm. Four writing colours. Normal: green, red, blue and black. Fluor: green, red, blue and black. Pastel: green, red, blue and violet.
- Corpo de plástico. Traço: 1,0 mm. Quatro cores de escrita. Normal: verde, vermelho, azul e preto. Fluor: verde, vermelho, azul e preto. Pastel: verde, vermelho, azul e violeta.
- Corpo in plastica. Tratto: 1,0 mm. Quattro colori di scrittura. Normale: verde, rosso, blu e nero. Fluore: verde, rosso, blu e nero. Pastello: verde, rosso, blu e viola.

CÓDIGO	TINTA	ENVASE
081417	Normal	12 ud.
081420	Normal	Blistér 1 ud.

CÓDIGO	TINTA	ENVASE
081416	Surtidos*	Exp. 36 ud.

*Modelos: normal, fluor y pastel.

BOLÍGRAFO CAMPUS 4 COLORES

4 colores en 1



081417 y 081420 - Tinta normal



081416 - Tinta normal



081416 - Tinta pastel



081416 - Tinta flúor







Los códigos en color amarillo permiten apertura de envase

BOLÍGRAFO PLUS 4 COLORES PASTEL

4 colores en 1



-  Cuerpo de plástico. Grip de caucho. Cuatro colores de escritura: verde, turquesa, rosa y violeta. Ancho de trazo: 0,7 mm.
-  Plastic body. Rubber grip. Four writing colours: green, blue, pink and purple. Stroke: 0,7 mm.
-  Corpo de plástico. Empunhadura de borracha. Quatro cores de escrever: verde, azul, rosa e violeta. Traço: 0,7 mm.
-  Corpo in plastica, impugnatura in caucciù. Quattro colori di scrittura: verde, turchese, rosa e viola. Tratto: 0,7 mm.

CÓDIGO	TINTA	ENVASE
081045	4 Colores	Exp. 36 ud.

BOLÍGRAFOS CAMPUS PURPURINA

Colores brillantes



-  Bolígrafo Glitter gel. Cuerpo transparente con tapa translúcida de color con clip. 8 colores: Azul, Amarillo, Rojo, Naranja, Plata, Verde, Violeta y Rosa. Trazo 1.0 mm.
-  Glitter gel pen. Transparent body with translucent colored cap with clip. 8 colours: Blue, Yellow, Red, Orange, Silver, Green, Violet and Pink. Stroke: 1 mm.
-  Caneta de gel glitter, corpo transparente com tampa colorida translúcida com clip. 8 cores: azul, amarelo, vermelho, laranja, prata, verde, violeta e rosa. Traço 1,0 mm.
-  Penna gel glitterata, corpo trasparente con cappuccio colorato traslucido con clip. 8 colori: blu, giallo, rosso, arancione, argento, verde, viola e rosa. Tratto 1,0 mm.

CÓDIGO	COLOR	ENVASE
081429	8 surtidos	Bote 48 ud.





ROTULADOR PLUS EXTRAFINE

Punta de fibra. Colores brillantes

- Rotulador con tinta a base de agua. Punta de fibra sintética con refuerzo metálico. Ideal para escribir y dibujar.
- Marker with water-based ink. Synthetic fiber tip with metal reinforcement. Ideal for writing and drawing.
- Marcador com tinta à base de água. Ponta de fibra sintética com reforço de metal. Ideal para escrever e desenhar.
- Pennarello con inchiostro a base d'acqua. Punta in fibra sintetica con rinforzo metallico. Ideale per scrivere e disegnare.

CÓDIGO	COLOR	REF.	ENVASE
081165	● Negro	46	10
081157	● Azul	41	10
081151	● Rojo	40	10
081155	● Verde	36	10
081145	● Verde pino	53	10
081154	● Verde manz.	33	10
081147	● Celeste	57	10
081158	● Ultramar	32	10
081159	● Azul noche	22	10
081153	● Turquesa	51	10
081149	● Amarillo	44	10
081144	● Carmesí	50	10
081150	● Rosa	56	10
081152	● Lila	58	10
081160	● Violeta	55	10
081146	● Naranja	54	10
081162	● Ocre	89	10
081163	● Marrón	45	10
081164	● Gris oscuro	96	10
081168	● Albaricque	26	10

Colores neón

081148	● Amarillo neón	024	10
081156	● Verde neón	033	10
081161	● Naranja neón	054	10
081143	● Violeta neón	099	10

CÓDIGO	COLOR	ENVASE
A	081166 12 surtidos	1 / 12
B	081167 24 surtidos	1 / 6
C	081027 12 surtidos	1 / 12
D	081028 20 surtidos	1 / 12





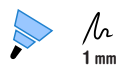

Los códigos en color amarillo permiten apertura de envase

ROTULADOR PLUS 1200

Trazo: 1 mm.



-  Rotulador con tinta a base de agua. Punta de fibra sintética. Ideal para escribir y dibujar.
-  Marker with water-based ink. Synthetic fiber tip. Ideal for writing and drawing.
-  Marcador com tinta à base de água. Ponta de fibra sintética. Ideal para escrever e desenhar.
-  Pennarello con inchiostro a base d'acqua. Punta in fibra sintetica. Ideale per scrivere e disegnare.

CÓDIGO	COLOR	ENVASE
080763	● Negro	10
080764	● Verde	10
080765	● Azul	10
080766	● Rojo	10
080881	● Naranja	10
080882	● Amarillo	10
080883	● Verde claro	10
080884	● Turquesa	10
080885	● Violeta	10
080886	● Carmin	10
080887	● Rosa	10
080888	● Marrón oscuro	10
080889	● Azul cielo	10
080890	● Violeta claro	10
080893	● Marrón claro	10
080896	● Azul medio	10
080891	● Caqui	10
080892	● Verde jade	10
080894	● Gris claro	10
080895	● Gris oscuro	10

MARCADOR METALLIC MARKER

Trazo: 1,2 mm.

Para escribir, pintar, marcar cualquier tipo de materiales con un efecto METÁLICO muy denso. Para superficies oscuras o transparentes. Ideal para felicitaciones y manualidades.

For writing, painting, marking any kind of material with a very dense METAL effect. For dark or transparent surfaces. Ideal for greeting cards and crafts.

Para escrever, pintar, marcar qualquer tipo de materiais com um efeito METÁLICO muito denso. Para superfícies escuras ou transparentes. Ideal para parabéns e ofícios.

Per scrivere, disegnare e segnare su qualsiasi tipo di materiale con un effetto METALLICO molto denso. Per superfici scure o trasparenti. Ideale per biglietti di auguri e manualità.



CÓDIGO	TINTA	ENVASE
081051	Surtidos*	Estuche 4 ud. / 24

* 1 Oro, 1 Plata, 1 Púrpura y 1 Azul.



CÓDIGO	TINTA	ENVASE
080602	● Oro	12 ud.
080603	● Plata	12 ud.
080604	● Púrpura	12 ud.
080605	● Verde	12 ud.
080606	● Azul	12 ud.



Marcadores con tinta a base de agua. Punta de fibra de 1.0 mm. Colores: plata, oro, rojo, azul, verde y violeta.

Water based ink markers. 1.0 mm fiber tip. Colours: silver, gold, red, blue, green and violet.

Marcadores de tinta à base de água. Ponta de fibra de 1,0 mm. Cores: prata, ouro, vermelho, azul, verde e violeta.

Marcatori di inchiostro a base d'acqua. Punta in fibra da 1,0 mm. Colori: argento, oro, rosso, blu, verde e viola.

MARCADORES CAMPUS GLITTER MARKER

Colores brillantes



CÓDIGO	COLOR	ENVASE
081428	6 surtidos	Caja 6 ud.

Marcadores blanco, oro y plata, ideales para escribir, pintar o marcar cualquier tipo de materiales con un efecto muy denso. Para superficies oscuras.

White, gold and silver markers, ideal for writing, painting or marking any any kind of material with a very dense effect. For dark surfaces.

Marcadores brancos, dourados e prateados, ideais para escrever, pintar ou marcar qualquer tipo de material com um efeito muito denso. Para superfícies escuras.

Marcatori bianchi, oro e argento, ideali per scrivere, dipingere o marcare qualsiasi tipo di materiale con un effetto molto denso. Per superfici scure.

MARCADORES ORO, PLATA Y BLANCO

Dos tamaños de trazo



CÓDIGO	COLOR	TRAZO	ENVASE
080869	Blanco	0,7 mm.	12 ud.
081424	Plata	0,7 mm.	12 ud.
081423	Oro	0,7 mm.	12 ud.

CÓDIGO	COLOR	TRAZO	ENVASE
081427	Blanco	2 mm.	12 ud.
081426	Plata	2 mm.	12 ud.
081425	Oro	2 mm.	12 ud.



Los códigos en color amarillo permiten apertura de envase

ROTULADOR CALIBRADO DRAWING PEN



CÓDIGO	TRAZO	ENVASE
600392	0.2-0.4-0.8 mm.	Estuche 3 ud. / 24

- Tinta líquida pigmentada que proporciona un flujo constante al escribir. Evita el goteo y las manchas excesivas de tinta. Punta de aguja y grip antifatiga.
- 🇬🇧 Liquid pigment ink that provides a constant flow when writing. Anti drip design. Needle tip and grip anti-tiredness.
- Marcador de tinta líquida que proporciona um fluxo constante ao escrever. Design anti go-tejamento. Ponta de agulha e grip antifadiga.
- Inchiostro liquido pigmentato che fornisce un flusso costante durante la scrittura. Design antigoccia. Punta dell'ago e impugnatura anti-fatica.

CÓDIGO	TRAZO	ENVASE
600307	0,2 mm.	12
600308	0,4 mm.	12
600309	0,6 mm.	12
600310	0,8 mm.	12

ROTULADOR PLUS PERMANENTE

3 trazos diferentes

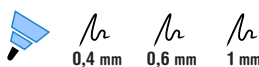
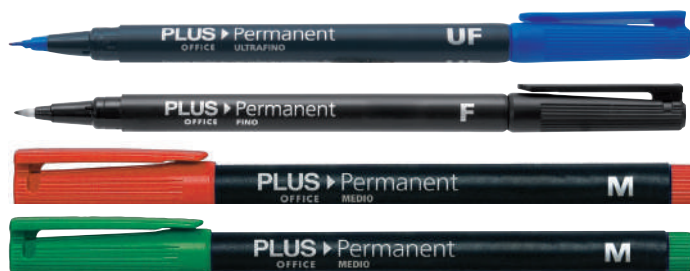

COLOR	UF 0,4	F 0,6	M 1,0	ENVASE
● Negro	080498	080502	080506	12 ud.
● Azul	080499	080503	080507	12 ud.
● Rojo	080500	080504	080508	12 ud.
● Verde	080501	080505	080509	12 ud.
BOLSA 4 COLORES*	080544	080545	080546	Bolsa 4 ud. / 24

* 1 Azul, 1 Negro, 1 Rojo y 1 Verde.

- Rotulador permanente que permite escribir en casi todas las superficies. Resistente al agua. No se borra.
- 🇬🇧 Permanent marker. It allows to write in most surfaces. Water resistant. Non erasable.
- Permite escrever em quase todas as superfícies. Resistente à água. Não borra.
- Marcatore permanente che consente di scrivere su quasi tutte le superfici. Resistente all'acqua, non si cancella.

MARCADOR PLUS MARKER PERMANENTE

Trazo: 1.3 mm



CÓDIGO	TINTA	ENVASE
080975	● Azul	Blíster 1 ud. / 36
080974	● Negro	Blíster 1 ud. / 36
080976	● Rojo	Blíster 1 ud. / 36

- Marcador de cuerpo de plástico. Resistente al agua y a la luz. Idóneo para rotular, marcar, pintar y dibujar sobre cualquier tipo de superficie. Tinta permanente. Punta cónica.
- 🇬🇧 Plastic body marker. Water and light resistant. It allows to write on any type of surfaces. Permanent ink. Conical tip.
- Marcador de corpo plastico. À prova de água e luz. Escreve sobre qualquer tipo de superficie. Tinta permanente. Ponta cônica.
- Marcatore con corpo in plastica. Resistente all'acqua e alla luce. Ideale per etichettare, segnare, dipingere e disegnare su qualsiasi tipo di superficie. Inchiostro permanente, punta cônica.

CÓDIGO	TINTA	ENVASE
080300	● Azul	12
080299	● Negro	12
080301	● Rojo	12
080302	● Verde	12



Los códigos en color amarillo permiten apertura de envase

MARCADOR DE PIZARRA

Trazo: 2.0 mm.



- Marcador de pizarra. Cuerpo y capuchón de plástico. Especiales para cualquier tipo de pizarra blanca. Punta cónica.
- Whiteboard marker. Plastic body and cap. Special for any type of white board .Conical tip.
- Marcador de quadro branco. Corpo e tampa em plástico. Especial para qualquer tipo de quadro branco. Ponta cónica.
- Marcatore per lavagna bianca. Corpo e cappuccio in plastica. Speciale per qualsiasi tipo di lavagna bianca Punta conica.



CÓDIGO	TINTA	ENVASE
081441	● Azul	12 ud.
081440	● Negro	12 ud.
081442	● Rojo	12 ud.
081443	● Verde	12 ud.

CÓDIGO	TINTA	ENVASE
081516	● Negro	Blíster 1 ud. / 36
081517	● Azul	Blíster 1 ud. / 36
081518	● Rojo	Blíster 1 ud. / 36
081519	Surtido	Blíster 4 ud. / 12

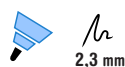

Recargable

MARCADOR DE PIZARRA BOARD LIQUID

Trazo: 2.0 mm.

- Rotuladores para pizarra blanca de tinta líquida. Punta cónica. Recarga mediante cartucho. La tinta se agota hasta la última gota. Intensidad y luminosidad de los colores.
- Whiteboard markers with liquid ink. Conical tip. Rechargeable by cartridge. Ink rushes down to the last drop. Intensity and luminosity of the colours.
- Marcadores de quadro branco com tinta líquida. Ponta cónica. Recarregável por cartucho. A tinta desce até a última gota. Intensidade e luminosidade das cores.
- Marcatori per lavagne bianche con inchiostro liquido. Punta conica. Ricaricabile a cartuccia. L'inchiostro scorre fino all'ultima goccia. Intensità e luminosità dei colori.



CÓDIGO	COLOR	ENVASE
Recambios		
081436	● Azul	12 ud.
081435	● Negro	12 ud.
081437	● Rojo	12 ud.
081438	● Verde	12 ud.
081439	● Naranja	12 ud.

CÓDIGO	TINTA	ENVASE
Marcadores		
081431	● Azul	12 ud.
081430	● Negro	12 ud.
081432	● Rojo	12 ud.
081433	● Verde	12 ud.
081434	● Naranja	12 ud.



Recargable

MARCADOR DE PIZARRA RECARGABLE

Trazo: 2.0 mm.

- Marcador recargable de cuerpo y capuchón de plástico. Especiales para cualquier tipo de pizarra blanca. Punta cónica.
- Rechargeable marker with plastic body and cap. Special for any type of white board. Conical tip.
- Marcador recarregável de quadro branco. Corpo plástico e tampa de plástico. Especiais para todos os tipos de quadro branco. Ponta cónica.
- Pennarello ricaricabile con corpo e cappuccio in plastica. Speciali per qualsiasi tipo di lavagna. Punta conica.



CÓDIGO	TINTA	ENVASE
080979	● Rojo	Blíster 1 ud. / 36



Los códigos en color amarillo permiten apertura de envase

FLUORESCENTE PEN HIGHLIGHTER CAMPUS UNIVERSITY

Subrayar. Destacar. Dibujar. Trazo: 1-4 mm.



NEW!!



HIGHLIGHTER

- Marcador fluorescente de tinta pigmentada al agua con punta biselada. Cuerpo de plástico del color de la tinta. Colores brillantes. Trazo 1-4 mm.
- Fluorescent marker with water-based pigmented ink with a chisel tip. Plastic body in the color of the ink. Bright colors. Line 1-4 mm.
- Marcador fluorescente com tinta pigmentada à base de água com ponta de cinzel. Corpo de plástico na cor da tinta. Cores brilhantes. Linha 1-4 mm.
- Pennarello fluorescente con inchiostro pigmentato a base d'acqua con punta a scalpello. Corpo in plastica nel colore dell'inchiostro. Colori luminosi. Linea 1-4 mm.

CÓDIGO	COLOR	ENVASE
Colores neón		
081623	Amarillo	10
081624	Verde	10
081625	Azul	10
081626	Rosa	10
081627	Naranja	10

CÓDIGO	COLOR	ENVASE
Colores pastel		
081629	Amarillo	10
081630	Verde	10
081631	Azul	10
081632	Rosa	10
081633	Violeta	10

CÓDIGO	COLOR	ENVASE
Blisters		
081628	Surtidos Neón	Blisters 5 ud.
081634	Surtidos Pastel	Blisters 5 ud.
081635	Neón + Pastel	Blisters 10 ud.
Expositor		
081636	Neón + Pastel	Exp. 60 ud.





MARCADOR FLUORESCENTE PLUS TEXT LINER 3.2

Mayor capacidad de tinta: 3,2 gramos. Trazo: 2-5 mm.

New!!

- Marcador fluorescente con tinta pigmentada al agua. Punta biselada. Tinta brillante de principio a fin, 3,2 gramos de tinta.
- Fluorescent marker with water pigmented ink. Beveled tip. Bright ink from start to finish. 3.2 grams of ink.
- Marcador fluorescente com tinta pigmentada a água. Ponta biselada. Tinta brilhante do início ao fim, 3,2 grammas de tinta.
- Evidenziatore fluorescente con inchiostro pigmentato all'acqua. Punta smussata, inchiostro brillante dall'inizio alla fine. 3,2 grammi di inchiostro.



CÓDIGO	COLOR	ENVASE
Colores neón		
081528	● Azul	10
081527	● Verde	10
081526	● Amarillo	10
081530	● Naranja	10
081529	● Rosa	10
081531	● Violeta	10

CÓDIGO	COLOR	ENVASE
Colores pastel		
081541	● Azul	10
081539	● Verde	10
081538	● Amarillo	10
081543	● Naranja	10
081542	● Rosa	10
081540	● Violeta	10

CÓDIGO	COLOR	ENVASE
081532	4 surtidos neón	Bolsa 4 ud. / 24
081533	6 surtidos neón	Bolsa 6 ud. / 24
081534	4 surtidos pastel	Blíster 1 ud. / 12
081535	6 surtidos pastel	Blíster 1 ud. / 12
081536	12 surtidos (neón+pastel)	Blíster 1 ud. / 12
081537	6 surtidos neón	Expositor 36 ud



MARCADOR FLUORESCENTE PLUS TEXT LINER

Tinta super brillante. Capacidad de tinta 2,6 g. Trazo: 2-5 mm.

- Marcador fluorescente con tinta pigmentada al agua. Apto para todo tipo de papeles de escritura, fax, autocopiativo y fotocopia. Punta biselada. Tinta brillante de principio a fin.
- Fluorescent marker with water pigmented ink. Suitable for any type of writing paper, fax and photocopy. Beveled tip. Bright ink from start to finish.
- Marcador fluorescente com tinta pigmentada a água. Uso em todo o tipo de papéis de escrita, fax, autocopiativo e fotocópia. Ponta biselada. Tinta brilhante do início ao fim.
- Evidenziatore fluorescente con inchiostro pigmentato all'acqua. Adatto a tutti i tipi di carta da scrivere, fax, carte per copie e fotocopia. Punta smussata, inchiostro brillante dall'inizio alla fine.



CÓDIGO	COLOR	ENVASE
Colores neón		
081339	● Violeta	10
081350	● Naranja	Blíster 1 ud. / 12
081347	● Violeta	Blíster 1 ud. / 12
081348	● Azul	Blíster 1 ud. / 12
081464	Surtidos	Exp. 36 ud.

CÓDIGO	COLOR	ENVASE
Colores pastel		
081354	● Azul	10
081352	● Verde	10
081351	● Amarillo	10
081356	● Naranja	10
081355	● Rosa	10
081353	● Violeta	10
081360	● Amarillo	Blíster 1 ud. / 12
081365	● Naranja	Blíster 1 ud. / 12
081362	● Violeta	Blíster 1 ud. / 12
081363	● Azul	Blíster 1 ud. / 12
081364	● Rosa	Blíster 1 ud. / 12
081361	● Verde	Blíster 1 ud. / 12
081357	Surtidos	Exp. 36 ud.



CÓDIGO	COLOR	ENVASE
080898	● Violeta	12



Los códigos en **color amarillo** permiten apertura de envase

MARCADOR FLUORESCENTE PLUS HIGHLIGHTER

Trazo: 1-3 mm.



CÓDIGO	COLOR TINTA	ENVASE
080264	5 Surtidos	Display 36 ud.

- Rotulador fluorescente de tinta líquida resistente al borrado y al agua. Cuerpo de plástico transparente con visor de nivel de tinta. Tinta líquida pigmentada. Punta biselada.
- Fluorescent marker made of liquid ink resistant to erasing and water. Transparent plastic body with ink level viewer. Pigmented liquid ink. Beveled tip.
- Marcador fluorescente de tinta líquida resistente ao borrão e á água. Corpo de plástico transparente com visor de nível de tinta. Ponta biselada.
- Penna fluorescente con inchiostro liquido resistente alla cancellazione e all'acqua. Corpo in plastica trasparente con visore di livello dell'inchiostro. Inchiostro liquido pigmentato. Punta smussata.

CÓDIGO	COLOR	ENVASE
080259	● Azul	12
080260	● Rosa	12
080261	● Verde	12
080262	● Amarillo	12
080263	● Naranja	12

MARCADOR TEXTILE MARKER



- Rotulador permanente ideal para decorar cualquier tipo de tela. Tiempo de secado: 24 h. Puede lavarse a máquina o en seco. Resistente al agua. No tóxico.
- Permanent marker ideal for decorating any type of fabric. Drying time: 24 h. Machine washable or dry cleanable. Water resistant. Non toxic.
- Marcador permanente ideal para decorar qualquer tipo de tecido. Tempo de secagem: 24 h. Pode ser lavada na máquina ou seco. Resistente a água. Não tóxico.
- Marcatore permanente ideale per decorare qualsiasi tipo di tessuto. Tempo di asciugatura: 24 ore. Può essere lavato in lavatrice o a secco. Resistente all'acqua e non tossico.

CÓDIGO	COLOR	ENVASE
080870	● Negro	Blister 1 ud. / 36
081053	6 surtidos	Blister 6 ud. / 12

ROTULADOR DETECTOR DE BILLETES FALSOS

Punta redonda



- Si el trazo se desvanece, el billete está bien. Si el trazo queda en color oscuro, el billete es falso. 5,5 g. de tinta.
- If the line fades, the bill is fine. If the line is dark, the bill is false. 5,5 g. ink.
- Se o traço se desvanece a nota é verdadeira, se o traço permanece e fica uma cor escura, a nota é falsa. 5,5 g. de tinta.
- Se la linea si dissolve, la banconota è legale. se la linea è scura, la banconota è falsa. 5,5 g. di inchiostro.

CÓDIGO	ENVASE
080709	Blister 1 ud. / 10



PLUMA ESTILOGRÁFICA STYLO

Tinta azul

- Pluma estilográfica con cuerpo traslúcido de colores: azul, violeta, humo y verde. Tinta azul. Sistema de control de la tinta que la libera uniformemente.
- Fountain pen with coloured translucent body: blue, violet, smoke and green. Blue ink. Ink Controlled System: the ink released evenly.
- Caneta-tinteiro com corpo translúcido de cores: azul, violeta, fumo e verde. Tinta azul. Sistema de controle de tinta que libera uniformemente.
- Stilografica con corpo traslucido di colori: blu, viola, fumo e verde. Inchiostro blu. Sistema di controllo dell'inchiostro che lo libera in modo uniforme.



CÓDIGO	CUERPO	ENVASE
081299	● Humo, ● Azul, ● Verde y ● Violeta	Exp. 24 ud.



TINTA DE GEL

BOLÍGRAFO CUERPO METÁLICO

Color de la tinta negro. Trazo 0,5 mm.

- Cuerpo de aluminio. Trazo: 0,5 mm. Color de escritura: negro. Cuatro colores de cuerpo: negro, azul, plata y gris. Con capuchón.
- Aluminum body. Stroke: 0.5 mm. Writing colour: black. Four body colours: black, blue, silver and gray. With cap.
- Corpo de alumínio. Traço: 0,5 mm. Cor da escrita: preto. Quatro cores do corpo: preto, azul, prata e cinza. Com tampa.
- Corpo di alluminio. Tratto: 0,5 mm. Colore di scrittura: nero. Quattro colori di carrozzeria: nero, blu, argento e grigio. Con tappo.

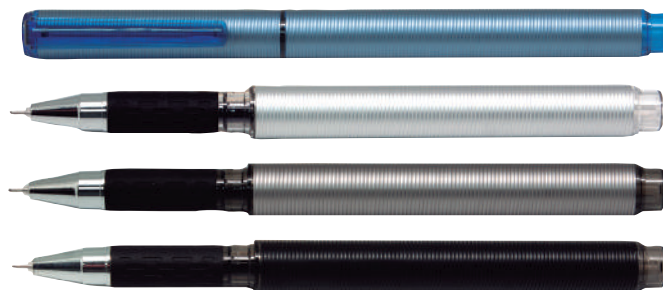

CÓDIGO	TINTA	ENVASE
081415	● Negro	Exp. 24 ud.

BOLÍGRAFO METÁLICO COLORES

Bolígrafo metálico retráctil

- Cuerpo metálico. Con clip. Tinta azul, base de aceite. Trazo 1.0 mm. Estuche de regalo.
- Metal body. With clip. Blue ink, oil base. Stroke 1.0 mm. Gift box.
- Corpo de metal. Com clip. Tinta azul, base de óleo. Traço 1.0 mm. Caixa de presente.
- Corpo e clip in metallo. Inchiostro blu, base olio. Tratto 1.0 mm. Pacco regalo.

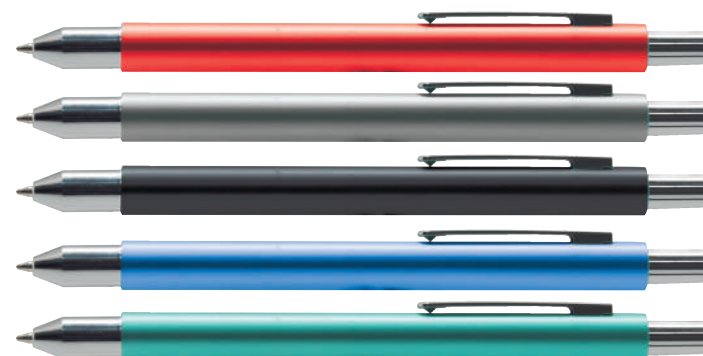

CÓDIGO	CUERPO	ENVASE
081293	● Rojo	Estuche 1 ud.
081294	● Plata	Estuche 1 ud.
081295	● Negro	Estuche 1 ud.
081296	● Azul	Estuche 1 ud.
081297	● Verde	Estuche 1 ud.



Los códigos en color amarillo permiten apertura de envase

BOLÍGRAFO + PORTAMINAS



- Bolígrafo con 3 opciones de escritura: tinta azul, tinta roja y portaminas de 0,5 mm. Cuerpo metálico. Decorado con puntos en relieve antiestrés.
- Ball pen with 3 writing options: blue ink, red ink and mechanical pencil of 0.5 mm. Metal body. Decorated with anti-stress relief dots.
- Caneta esferográfica com 3 opções de escrita: tinta azul, tinta vermelha e lapiseira de 0,5 mm. Corpo de metal. Decorado com pontos anti-stress.
- Penna a sfera con 3 opzioni di scrittura: inchiostro blu, inchiostro rosso e portamine da 0,5 mm. Corpo in metallo. Decorato con puntini antistress.

CÓDIGO	CUERPO	ENVASE
080530	● Azul oscuro, Verde, ● Azul y ● Rojo	Estuche 1 ud.

SWING BOLÍGRAFO Y PORTAMINAS



- Set de bolígrafo y portaminas de 0,5 mm. Cuerpo metálico. Grip ergonómico antideslizante. Gris, gris oscuro, rojo y azul.
- Set of ballpoint pens and 0.5 mm pencils with metal body. Ergonomic non-slip grip. Grey, dark grey, red and blue.
- Conjunto de esferográfica e lápis de 0,5 mm. Corpo de metal. Pega ergonómica antideslizante. Cinza, cinzento escuro, vermelho e azul.
- Set di penne a sfera e matite da 0,5 mm. con corpo in metallo. Impugnatura ergonomica antiscivolo. Grigio, grigio scuro, rosso e blu.

CÓDIGO	CUERPO	ENVASE
080551	● Gris, ● Azul ● Gris oscuro y ● Rojo	Estuche 2 ud.

BOLÍGRAFO ALUMINIO

Con capuchón



- Bolígrafo con cuerpo de aluminio. Se presenta en estuche de regalo. Tinta azul. Mecanismo de giro.
- Pen with aluminum body. It is presented in a gift box. Blue ink. Turning mechanism.
- Caneta esferográfica com corpo de alumínio. Apresentado em uma caixa de presente. Tinta azul. Mecanismo de giro.
- Penna a sfera con corpo in alluminio. Presentato in una confezione regalo. Inchiostro blu. Meccanismo di rotazione.

CÓDIGO	CUERPO	ENVASE
081291	● Azul	Estuche 1 ud.
081292	● Negro	Estuche 1 ud.

BOLÍGRAFO SWING RETRÁCTIL







- Bolígrafo retráctil con cuerpo de aluminio y plástico. Color negro.
- Retractable pen with aluminium and plastic body. Black colour.
- Caneta retráctil com corpo em alumínio e plástico. Cor preta.
- Penna retrattile con corpo in alluminio e plastica. Colore nero.

CÓDIGO	CUERPO	ENVASE
080860	● Negro	Estuche 1 ud.



BOLÍGRAFO TWIST





Mecanismo de giro

-  Cuerpo metálico lacado en negro. Con clip. Tinta azul. Estuche de regalo.
-  Black lacquered metal body. With clip. Blue ink. Gift box.
-  Corpo de metal lacado preto. Com clip. Tinta azul. Caixa de presente.
-  Corpo in metallo laccato nero. Con clip. Inchiostro blu. Pacco regalo.



CÓDIGO	CUERPO	PRESENTACIÓN
081022	● Negro/ ● Cromado	Estuche 1 ud.

BOLÍGRAFO Y ROLLER





-  Set de bolígrafo y roller de cuerpo metálico.
-  Pen and roller set with metal body.
-  Set caneta e rollerball com corpo de metal.
-  Set di penna e roller con corpo in metallo.



CÓDIGO	CUERPO	PRESENTACIÓN
080846	● Azul	Estuche 2 ud.

BOLÍGRAFO DE LUXE

Mecanismo de giro

-  Bolígrafo con tapa de latón sólido. Con clip. Recambio tipo parker metal. Tinta azul.
-  Pen with solid brass cap. With clip. Type metal parker refill. Blue ink.
-  Esferográfica com tampa de latão maciço. Com clip. Recarga tipo parker. Tinta azul.
-  Penna a sfera con cappuccio in ottone massiccio. Con clip. Ricambio tipo Parker in metallo. Inchiostro blu.



CÓDIGO	CUERPO	PRESENTACIÓN
080843	● Marrón y ● Gris	Estuche 1 ud.

BOLÍGRAFO + PUNTERO PARA TABLET "TATOO"

-  Bolígrafo para Tablet y SmartPhone táctil. Cuerpo lacado. Tinta azul. Recambio tipo parker de plástico.
-  Tablet and SmartPhone touch ball pen. Lacquered body. Blue ink. Plastic type parker Refill
-  Esferográfica para Tablet e SmartPhone tátil. Corpo lacado. Tinta azul. Recarga de plástico tipo parker.
-  Penna per tablet e smartphone. Corpo laccato. Inchiostro blu. Ricarica tipo parker in plastica.







CÓDIGO	CUERPO	PRESENTACIÓN
080815	● Rojo	Estuche 1 ud.
080816	● Negro	Estuche 1 ud.



BOLÍGRAFO 3 EN 1

Bolígrafo + Portaminas + Puntero PDA







-  Cuerpo metálico mate. Con clip. Tinta azul. Portaminas. 0.5 mm. Estuche de regalo.
-  Matte metal body. With clip. Blue ink. 0.5 mm mechanical pencil. Gift box.
-  Corpo de metal fosco. Com clip. Tinta azul. Lapiseira de 0.5 mm. Caixa de presente.
-  Corpo e clip in metallo opac. Inchiostro blu. Portamine di 0.5 mm. Pacco regalo.

CÓDIGO	CUERPO	PRESENTACIÓN
081021	● Dorado	Estuche 1 ud.

BOLÍGRAFO MINI

Retráctil







-  Cuerpo de metal superficie nacarada. Con clip. Tinta azul. Estuche de regalo.
-  Metal body and nacreous surface. With clip. Blue ink. Gift box.
-  Corpo de metal superficie nacarada. Com clip. Tinta azul. Caixa de presente.
-  Corpo di metallo, superficie perlata. inchiostro blu e clip. Pacco regalo.

CÓDIGO	CUERPO	PRESENTACIÓN
080570	● Azul, ● Verde y ● Negro	Estuche 1 ud.

BOLÍGRAFO DELUXE

Mecanismo de giro







-  Cuerpo de latón sólido. Con clip. Tinta azul. Recambio de metal tipo Parker.
-  Solid brass body. With clip. Blue ink. Parker type metal refill.
-  Corpo de latão maciço. Com clip. Tinta azul. Substituição de metal tipo Parker.
-  Corpo in ottone massiccio. Con clip, inchiostro blu. Sostituzione del metallo di tipo Parker.

CÓDIGO	CUERPO	PRESENTACIÓN
080842	● Negro, ● Azul y ● Gris	Estuche 1 ud.

BOLÍGRAFO

Mecanismo de giro. Tinta azul







-  Cuerpo cromado envejecido. Con clip metálico. Tinta azul. Recambio tipo Parker.
-  Aged chrome body. With metal clip. Blue ink. Parker type refill.
-  Corpo cromado envelhecido. Com clipe de metal Tinta azul. Recarga do tipo Parker.
-  Corpo cromato invecchiato. Con clip in metallo. Inchiostro blu; ricambio tipo Parker in plastica.

CÓDIGO	CUERPO	PRESENTACIÓN
080469	● Marrón	Estuche 1 ud.

BOLÍGRAFO

Mecanismo de giro







-  Cuerpo de metal. Con clip. Tinta azul. Estuche de regalo.
-  Metal body. With clip. Blue ink. Gift box.
-  Corpo de metal. Com clip. Tinta azul. Caixa de presente.
-  Corpo in metallo, con clip e inchiostro blu. Pacco regalo.



CÓDIGO	CUERPO	PRESENTACIÓN
080747	● Negro	Estuche 1 ud.







RECAMBIO PARA PLUMAS

-  Recambio tipo cartucho.
-  Pen cartridge refill.
-  Recarga para canetas de tinta permanente.
-  Ricambio tipo cartuccia





CÓDIGO	COLOR	ENVASE
080392	 Azul	Cajita 6 ud.
080393	 Negro	Cajita 6 ud.





RECAMBIOS PARA BOLÍGRAFOS UNIVERSAL

-  Recambio de plástico universal. Trazo medio.
-  Universal plastic refill. Middle stroke.
-  Substituição universal de plástico. Traço médio.
-  Sostituzione universale della plastica. Tratto medio.



Universal





CÓDIGO	COLOR	ENVASE
080727	 Azul	12 ud.
080728	 Negro	12 ud.
080729	 Rojo	12 ud.

-  Recambio de metal universal. Trazo medio.
-  Universal metal refill. Middle stroke.
-  Substituição universal de metais. Traço médio.
-  Sostituzione universale del metallo. Tratto medio.





Corto





CÓDIGO	COLOR	ENVASE
080720	 Azul	Bolsa 5 ud.
080721	 Negro	Bolsa 5 ud.
080722	 Rojo	Bolsa 5 ud.
080723	 Verde	Bolsa 5 ud.

-  Recambio de metal tipo Parker. Trazo medio.
-  Parker type metal replacement. Middle stroke.
-  Substituição de metal tipo Parker. Traço médio.
-  Sostituzione del metallo di tipo Parker. Tratto medio.





Depósito grande

CÓDIGO	COLOR	ENVASE
080724	 Azul	Bolsa 5 ud.
080725	 Negro	Bolsa 5 ud.
080726	 Rojo	Bolsa 5 ud.

-  Recambio de metal para bolígrafos de giro. Trazo medio.
-  Metallic refill for rotation ball pens. Middle stroke.
-  Recarga para esferográfica ball pen de rotação em metal. Traço médio.
-  Ricambio in metallo per penne girevoli. Tratto medio.



Con rosca

CÓDIGO	COLOR	ENVASE
080395	 Azul	Bolsa 10 ud.
080396	 Negro	Bolsa 10 ud.



Los códigos en **color amarillo** permiten apertura de envase

Robustas y fáciles de usar



TALADRO
Easy 30



GRAPADORA
Easy 10

Las nuevas máquinas **Easy** permiten trabajar en la oficina sin esfuerzo.

Su diseño ergonómico y su mecanismo proporcionan un 60% menos de esfuerzo que las máquinas convencionales.

04

GRAPADORAS Y TALADROS

*STAPLERS AND PUNCHERS
GRAMPEADORES E FURADORES
CUCITRICI E PERFORATRICI*



Un nuevo concepto derivado de la seguridad del producto y de una mejora desde el punto de vista ecológico

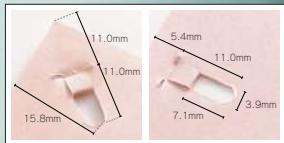

Sujección en la esquina Sujección en el lateral

MINI GRAPADORA SIN GRAPAS

Diseño compacto especial para manos pequeñas

Mini



CAPACIDAD GRAPADO
4h

Dobla las hojas de papel para sujetarlas sin utilizar grapas. Mecanismo que reduce la fuerza necesaria en el grapado, grapa hasta cuatro hojas sin esfuerzo. Fijación en esquinas o en lados. Ecológica: permite el reciclado del papel. Expositor de seis unidades (dos por color: verde, azul y fucsia), en blíster individuales.

Punto 1

No más grapas

Nuevo concepto de la grapadora que dobla las hojas de papel para sujetarlas sin utilizar grapas. Con la grapadora sin grapas, no tendrá que preocuparse más por las grapas y de conseguir los recambios.

Punto 2

Mecanismo de fuerza asistida

Grapa hasta 4 hojas sin esfuerzo. Compacta y eficiente.



Menor esfuerzo

Punto 3

Diseño compacto



Tamaño adecuado para cualquier espacio



Ideal para manos pequeñas

CÓDIGO	COLOR	ENVASE
040607	Surtidos	Exp. 6 ud.





GRAPADORA SIN GRAPAS

Punto 1

No más grapas

Nuevo concepto de la grapadora que dobla las hojas de papel para sujetarlas sin utilizar grapas. Con la grapadora sin grapas, no tendrá que preocuparse más por las grapas y de conseguir los recambios.

Punto 2

Mecanismo de fuerza asistida

Grapa hasta 5 hojas sin esfuerzo. Compacta y eficiente.



CÓDIGO	DESCRIPCIÓN	ENVASE
040559	● Blíster Azul	1 / 5
040560	○ Blíster Blanco	1 / 5
040562	● Blíster Verde	1 / 5
040563	Display Surtidos	Exp. 6 ud.

CAPACIDAD GRAPADO
5h

Dimensiones externas: 35x108x74mm

Peso: 130gr.

Materiales : Plástico reciclado



GRAPADORA SIN GRAPAS Y TALADRO

Diseño con dos funciones a la vez : grapado y taladrado

Punto 1

Dos funciones

Nuevo concepto de la grapadora que dobla las hojas de papel para sujetarlas sin utilizar grapas. Y taladro con visor para ubicar correctamente los agujeros y regleta.



Regleta para regular el perforado



Visor para el perforado

Punto 2

Mecanismo de fuerza asistida

Grapa hasta 10 hojas sin esfuerzo. Compacta y eficiente.



Menor esfuerzo

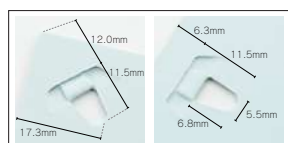

Sujección en la esquina Sujección en el lateral



CAPACIDAD GRAPADO
10h

Dobla las hojas de papel para sujetarlas sin utilizar grapas creando los agujeros para encuadernación (5,5 x 6,5 mm) a la distancia necesaria. Mecanismo que reduce la fuerza necesaria en el grapado.

Con visor para ubicar correctamente los agujeros.

Regleta para regular el perforado.

Medidas: 110 x 130 x 70 mm.

CÓDIGO	COLOR	ENVASE
040636	● Azul	1 / 20
040665	● Verde	1 / 20



Los códigos en **color amarillo** permiten apertura de envase

GRAPADORA ST-010X

Grapa plano

PLUS
JAPAN

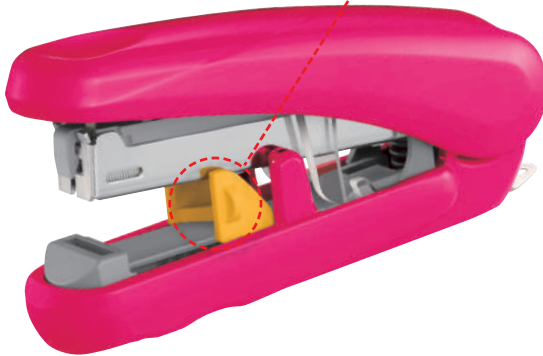

Punto 1

Profundidad de grapado ajustable

Con guía ajustable de profundidad

Con la guía de profundidad del grapado (la profundidad del grapado va de 3 mm a 20 mm, ajustable en 7 diferentes profundidades de grapado)



Punto 2

Reduce el bloque de papel en un 30%. Grapa plano.

Las grapas planas consiguen una reducción del volumen de los documentos grapados.

Un 30% menos de bloque de papel que otras grapadoras, con lo que se ahorra espacio.

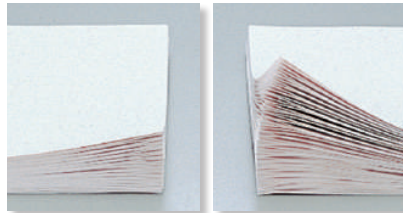

Con grapa plana

Con grapa estándar

Punto 3

Capacidad de carga de 100 grapas

Mecanismo de carga sin desperdicio

Se pueden cargar hasta 100 grapas (2 tiras) El mecanismo de carga que asegura que no se desperdician grapas.



TIPO DE GRAPA No. 10	CAPACIDAD GRAPADO 20h	CAPACIDAD DE CARGA 100	PROFUND. GRAPAS 20mm
-------------------------	--------------------------	---------------------------	-------------------------

GRAPA PLANO

Dimensiones externas: 25x96x48mm

Sacagrapas incorporado

Peso: 50 g

Tipo de grapa:

Nº. 10 (SS-010M, SS-010, SS-010BB)

*Capacidad de grapado basada en papel de 64 g.



Tamaño pequeño y compacta



Extrae-grapas

CÓDIGO	DESCRIPCIÓN	ENVASE
040529	● Blister Naranja +grapas	Blister 1 ud. + grapas
040530	○ Blister Blanco +grapas	Blister 1 ud. + grapas
040531	● Blister Rosa +grapas	Blister 1 ud. + grapas
040532	● Blister Verde +grapas	Blister 1 ud. + grapas
040594	Bolsa 1 ud. +grapas surtidos	Blister 1 ud. + grapas
040548	Display surtidos*	Blister 1 ud. + grapas

* 4 azul, 2 blanco, 2 rosa y 2 verde



PLUS
JAPAN

GRAPADORA SIN ESFUERZO ST-010AH

High Tech

Punto 1

Tamaño mini

Tamaño compacto y ergonómico ideal para manos pequeñas.



INCLUYE GRAPAS



Extragrapaspas

Punto 2

Capacidad de carga de 100 grapas

Mecanismo de carga sin desperdicio

Se pueden cargar hasta 100 grapas (2 tiras). El mecanismo de carga que asegura que no se desperdician grapas.

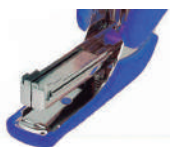

TIPO DE GRAPA No. 10	CAPACIDAD GRAPADO 20h	CAPACIDAD DE CARGA 100	PROFUND. GRAPAS 30mm
-------------------------	--------------------------	---------------------------	-------------------------

CARGA SUPERIOR

Dimensiones externas: 25x76x52mm

Sacagrapas incorporado

Materiales : Acero y plástico reciclado

*Sin función de grapa plana

*Capacidad de grapado basada en papel de 64 g.

CÓDIGO	COLOR	ENVASE
040454	● Azul	Blisters 1 ud. + grapas
040771	● Negro	Blisters 1 ud. + grapas

PLUS
JAPAN

GRAPADORA SIN ESFUERZO ST-010VH

Grapa plano

Punto 1

Reduce la fuerza requerida para grapar

Mecanismo fuerza asistida

Usando el principio del apoyo de la palanca hemos aumentado el poder de grapado en un 50% (comparado con nuestros productos estándar) por lo que puedes grapar documentos mas fácil y rápidamente. Puedes usar esta grapadora durante muchas horas ya que el grapado es muy ligero.



Punto 2

Simplifica el cambio de grapas

Mecanismo de carga superior

Con un gesto se introducen las grapas, sólo abre el cargador y mete las grapas. Su tamaño pequeño hace que quepa en la palma de tu mano y tiene capacidad para 100 grapas (2 tiras). La recarga de las grapas es fácil y rápida. Nuestro mecanismo de ahorro de grapas te asegura que no desperdiciarás ninguna.

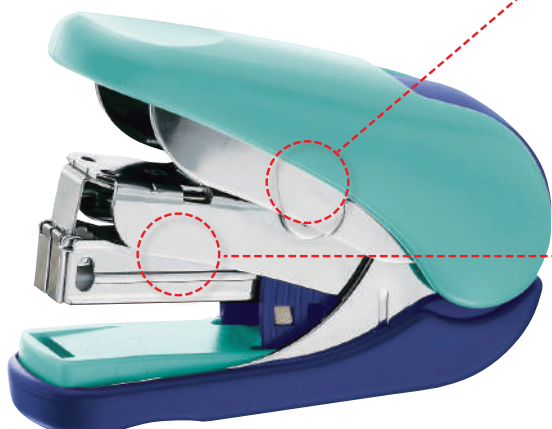

INCLUYE GRAPAS

Punto 3

Reduce el bloque de papel en un 30%. Grapa plano.

Las grapas planas consiguen una reducción del volumen de los documentos grapados. Un 30% menos de bloque de papel que otras grapadoras con lo que se ahorra espacio.

TIPO DE GRAPA No. 10	CAPACIDAD GRAPADO 20h	CAPACIDAD DE CARGA 100	PROFUND. GRAPAS 30mm
-------------------------	--------------------------	---------------------------	-------------------------

CARGA SUPERIOR

GRAPA PLANO

Dimensiones externas: 30x81x60 mm

Sacagrapas incorporado

Materiales : Acero y plástico reciclado

*Capacidad de grapado basada en papel de 64 g.



Grapa plana

Grapa estándar



Extragrapaspas

CÓDIGO	COLOR	ENVASE
040464	● Rojo	Blisters 1 ud. + grapas
040807	● Azul	Blisters 1 ud. + grapas
040808	○ Blanco	Blisters 1 ud. + grapas



Los códigos en **color amarillo** permiten apertura de envase

GRAPADORA SIN ESFUERZO EASY 0

60% menos esfuerzo en el grapado



TIPO DE GRAPA	CAPACIDAD GRAPADO	PROFUND. GRAPAS
24/6 26/6	20h	55mm

- Cuerpo en plástico ABS y mecanismo metálico. 60% menos esfuerzo en el grapado. Indicador de nivel de grapas. Cargador de grapas integrado fácil de abrir. Capacidad de grapado: 20 hojas de 80 g. Presentación en blister.
- ABS plastic body and metal mechanism. 60% less effort in stapling. Staple level indicator. Integrated staple loader easy to open. Stapling capacity: 20 sheets of 80 g. paper. Blister presentation.
- Corpo em plástico ABS, mecanismo metálico. 60% de esforço ao agrafar. Indicador do conteúdo dos agrafes. Compartimento de grampos integrado de fácil abertura. Capacidade para agrafar: 20 folhas papel 80 g. Apresentação em blister.
- Corpo in plastica ABS e meccanismo in metallo. 60% in meno di sforzo nella pinzatura. Indicatore di livello di greffette. Magazzino punti integrato di facile apertura. Capacità di pinzatura: 20 fogli da 80 g. Presentazione in blister.

CÓDIGO	COLORES	ENVASE
040623	● Negro	Blister 1 ud.

GRAPADORA SIN ESFUERZO EASY 10

60% menos esfuerzo en el grapado. Presentación en blister.



TIPO DE GRAPA	CAPACIDAD GRAPADO	PROFUND. GRAPAS
24/6 26/6	25h	55mm

- Cuerpo en plástico ABS y mecanismo metálico. 60% menos esfuerzo en el grapado. Indicador de nivel de grapas. Capacidad de grapado: 25 hojas de 80 g.
- ABS plastic body and metal mechanism. 60% less effort in stapling. Staple level indicator. Stapling capacity: 25 sheets of 80 g. paper.
- Corpo em plástico ABS, mecanismo metálico. 60% de esforço ao agrafar. Indicador do conteúdo dos agrafes. Capacidade para agrafar: 25 folhas papel 80 g.
- Corpo in plastica ABS e meccanismo in metallo. 60% in meno di sforzo nella pinzatura. Indicatore di livello di greffette. Capacità di pinzatura: 25 fogli da 80 g.

CÓDIGO	COLORES	ENVASE
040535	● Negro	Caja 1 ud.

GRAPADORA SIN ESFUERZO EASY 20

60% menos esfuerzo en el grapado. Presentación en blister.



TIPO DE GRAPA	CAPACIDAD GRAPADO	PROFUND. GRAPAS
24/6 26/6	25h	85mm



- Cuerpo en plástico ABS y mecanismo metálico. 60% menos esfuerzo en el grapado. Indicador de nivel de grapas. Capacidad de grapado: 25 hojas de 80 g.
- ABS plastic body and metal mechanism. 60% less effort in stapling. Staple level indicator. Stapling capacity: 25 sheets of 80 g. paper.
- Corpo em plástico ABS, mecanismo metálico. 60% de esforço ao agrafar. Indicador do conteúdo dos agrafes. Capacidade para agrafar: 20 folhas papel 80 g.
- Corpo in plastica ABS e meccanismo in metallo. 60% in meno di sforzo nella pinzatura. Indicatore di livello di greffette. Capacità di pinzatura: 25 fogli da 80 g.

CÓDIGO	COLORES	ENVASE
040536	● Negro	Caja 1 ud.
040538	● Gris	Caja 1 ud.



MINI GRAPADORA PLUS OFFICE 100

Presentación en blíster con cajita de grapas

- Cuerpo en plástico ABS y mecanismo metálico. Cargador de grapas integrado fácil de abrir. Presentación en blíster con cajita de grapas nº 10.
- 🇬🇧 ABS plastic body and metal mechanism. Integrated staple loader easy to open. Blister presentation with a no.10 staple box.
- Corpo em plástico ABS, mecanismo metálico. Compartimento de grampos integrado de fácil abertura. Apresentação em blister com 1 caixa de agrafes nº 10.
- Corpo in plastica ABS e meccanismo in metallo. Magazzino punti integrato di facile apertura. Presentazione in blister con scatola di graffette nº 10.



CÓDIGO	COLORES	ENVASE
040626	● Azul	Blíster 1 ud. + grapas
040679	● Rojo	Blíster 1 ud. + grapas

TIPO DE GRAPA NO. 10	CAPACIDAD GRAPADO 20h	PROFUND. GRAPAS 20mm
-------------------------	--------------------------	-------------------------

- Cuerpo, mecanismo y empuñadura metálicos. Sistema de cargador deslizante antibloqueo. Capacidad de grapado: 20 hojas papel 80 g.
- 🇬🇧 Metallic body, mechanism and handle. Anti-locking sliding refill system. Stapling capacity: 20 sheets of 80 g. paper.
- Corpo, mecanismo e punho metálicos. Sistema do carregador deslizante e antibloqueio. Capacidade para agrafar: 20 folhas papel 80 g.
- Corpo, meccanismo e maniglia in metallo. Sistema di caricamento antibloccaggio. Capacità di pinzatura: 20 fogli di carta da 80 g.

GRAPADORA 235M METALICA



CÓDIGO	COLOR	ENVASE
040430	● Gris	Caja 1 ud.

TIPO DE GRAPA 24/6 26/6	CAPACIDAD GRAPADO 20h	PROFUND. GRAPAS 45mm
-------------------------------	--------------------------	-------------------------

- Cuerpo metálico. Empuñadura y base en plástico ABS antichoque. Sistema de cargador deslizante antibloqueo. Capacidad de grapado: 25 hojas papel 80 g.
- 🇬🇧 Metal body. Handle and base in anti-shock ABS plastic. Anti-locking sliding refill system. Stapling capacity: 25 sheets of 80 g. paper.
- Corpo metálico. Punho e base em plástico. ABS antichoque. Sistema do carregador deslizante e antibloqueio. Capacidade de agrafar: 25 folhas papel 80 g.
- Corpo in metallo; maniglia e base in plastica ABS antiurto. Sistema di caricamento antibloccaggio. Capacità di pinzatura: 25 fogli di carta da 80 g.

GRAPADORA 250M METALICA

Con carga frontal. Grapa suavemente



CÓDIGO	COLOR	ENVASE
040450	● Negro/Gris	Caja 1 ud.

TIPO DE GRAPA 24/6 26/6	CAPACIDAD GRAPADO 25h	PROFUND. GRAPAS 55mm
-------------------------------	--------------------------	-------------------------

- Grapadora de mano. Especial para la industria y la agricultura. Empuñadura de plástico ABS. Interior y base metálica. Capacidad para 75 grapas.
- 🇬🇧 Hand-stapler. Special for industry and agriculture. Handle made of ABS plastic. Interior and base made in metal. 75 staples capacity.
- Agrafador de mão. Especial para a indústria e agricultura. Punho em plástico ABS. Interior e base metálica. Capacidade 75 agrafes.
- Cucitrice di mano speciale per l'industria e l'agricoltura. Manico in plastica ABS. Interno e base in metallo. Capacità per 75 graffette.

GRAPADORA 240 INDUSTRIAL

La única mini de grapa 22/6



CÓDIGO	COLOR	ENVASE
040063	Metálico / Negro	Caja 1 ud.

TIPO DE GRAPA 22/6 24/6	CAPACIDAD GRAPADO 20h	PROFUND. GRAPAS 70mm
-------------------------------	--------------------------	-------------------------



Los códigos en color amarillo permiten apertura de envase

GRAPADORA 270N

Diseño ergonómico



TIPO DE GRAPA	CAPACIDAD GRAPADO	PROFUND. GRAPAS
24/6 26/6	25h	55mm



- Cuerpo en plástico ABS antichoque. Mecanismo metálico y empuñadura de caucho. Sistema cargador deslizante antibloqueo. Capacidad para 100 grapas. Capacidad de grapado: 25 hojas de 80 g.
- Anti-shock ABS plastic body. Metal mechanism and rubber grip. Anti-locking sliding refill system. Capacity for 100 staples. Stapling capacity: 25 sheets, 80 g paper.
- Corpo em plástico ABS antichoque. Mecanismo metálico e punho em borracha. Sistema do carregador deslizante antibloqueio. Capacidade para 100 agrafes. Capacidade para agrafar: 25 folhas papel 80 g.
- Corpo in plastica ABS antiurto. Meccanismo in metallo e manico in gomma. Sistema di caricamento scorrevole anticarbonato. Capacità per 100 graffette. Livello di pinzatura: 25 fogli da 80 g.

CÓDIGO	COLORES	ENVASE
040602	● Negro	Caja 1 ud.
040666	● Gris	Caja 1 ud.

GRAPADORA 275N

Diseño ergonómico



TIPO DE GRAPA	CAPACIDAD GRAPADO	PROFUND. GRAPAS
24/6 26/6	25h	80mm



- Cuerpo en plástico ABS antichoque. Mecanismo metálico y empuñadura de caucho. Sistema cargador deslizante antibloqueo. Capacidad para 150 grapas. Capacidad de grapado: 25 hojas papel 80 g.
- Anti-shock ABS plastic body. Metal mechanism and rubber grip. Anti-locking sliding refill system. Capacity for 150 staples. Stapling capacity: 25 sheets, 80 g paper.
- Corpo em plástico ABS antichoque. Mecanismo metálico e punho em borracha. Sistema do carregador deslizante antibloqueio. Capacidade para 150 agafes. Capacidade para agafar: 25 folhas de papel 80 g.
- Corpo in plastica ABS antiurto. Meccanismo metallico e impugnatura in gomma. Sistema di caricamento scorrevole e antibloccaggio. Capacità per 150 geffette. Capacità di pinzatura: 25 fogli di carta da 80 g.

CÓDIGO	COLORES	ENVASE
040603	● Negro	Caja 1 ud.
040667	● Gris	Caja 1 ud.

GRAPADORA DE TENAZA DX-10

Para uso cotidiano y profesional

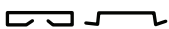

TIPO DE GRAPA	TIPO DE GRAPA	CAPACIDAD GRAPADO	PROFUND. GRAPAS
24/6 24/8	26/6 26/8	30h	55mm







- Grapadora de tenaza metálica cromada. Calidad garantizada. Tamaño: 175 x 82 mm. Capacidad de grapado: 30 hojas de 80 g.
- Chromed metal clamp stapler. Guaranteed quality. Size: 175x82mm. Stapling capacity: 30 sheets 80 g. paper
- Alicates metálico cromado. Qualidade garantida. Tamanho 175 x 82 mm. Capacidade para agrafar: 30 folhas de papel 80 g.
- Cucitrice con morsetto in metallo cromato. Qualità garantita. Dimensioni: 175 x 82 mm. Capacità di pinzatura: 30 fogli da 80 g.

CÓDIGO	COLOR	ENVASE
040601	Cromado	Caja 1 ud.



GRAPADORA 285M METALICA

De sobremesa

-  Cuerpo y mecanismo metálicos y empuñadura de caucho. Capacidad de grapado: 25 hojas papel 80 g.
-  Metal body and mechanism and rubber grip. Stapling capacity: 25 sheets of 80 grs paper.
-  Corpo e mecanismo metálicos e punho em borracha. Capacidade para agrafar: 25 folhas de papel 80 g.
-  Corpo e meccanismo in metallo e impugnatura in gomma. Capacità di pinzatura: 25 fogli di carta da 80 g.



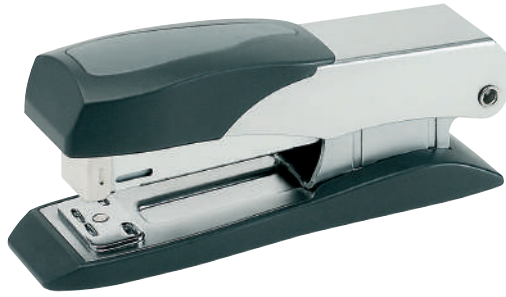

CÓDIGO	COLOR	ENVASE
040249	Metálico / Negro	Caja 1 ud.



TIPO DE GRAPA	CAPACIDAD GRAPADO	PROFUND. GRAPAS
24/6	25h	55mm
26/6		

GRAPADORA 287M METALICA

Con carga frontal. Grapa suavemente.

-  Cuerpo y mecanismo metálicos y empuñadura de caucho. Pulsador en su parte posterior para extraer el cargador. Capacidad de grapado: 45 hojas papel 80 g.
-  Metal body and mechanism and rubber grip. Push button on the back to remove the front staples charger. Stapling capacity: 45 sheets of 80 g. paper.
-  Corpo e mecanismo metálicos e punho em borracha. Pulsador na parte posterior para extrair o carregador. Capacidade para agrafar: 45 folhas de papel 80 g.
-  Corpo e meccanismo in metallo e impugnatura in caucci. Pulsante pulsante sul retro per rimuovere il caricatore. Capacità di pinzatura: 45 fogli di carta da 80 g.



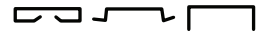

CÓDIGO	COLOR	ENVASE
040248	Metálico / Negro	Caja 1 ud.



TIPO DE GRAPA	CAPACIDAD GRAPADO	PROFUND. GRAPAS
24/6	45h	85mm
24/8		

GRAPADORA 289 METALICA

Con carga frontal. Grapa suavemente.

-  Cuerpo y mecanismo metálicos y empuñadura de caucho. Pulsador en su parte posterior para extraer el cargador. Capacidad de grapado: 45 hojas papel 80 g.
-  Metal body and mechanism and rubber grip. Push button on the back to remove the front staples charger. Stapling capacity: 45 sheets 80 g. paper.
-  Corpo e mecanismo metálicos e punho em borracha. Pulsador na parte posterior para extrair o carregador. Capacidade para agrafar: 45 folhas de papel 80 g.
-  Corpo e meccanismo in metallo e impugnatura in caucci. Premere il pulsante sul retro per rimuovere il caricatore. Capacità di pinzatura: 45 fogli di carta 80 g.

CÓDIGO	COLOR	ENVASE
040247	Metálico / Negro	Caja 1 ud.



TIPO DE GRAPA	CAPACIDAD GRAPADO	PROFUND. GRAPAS
24/6	45h	85mm
26/6		

GRAPADORA 280 METALICA

Cromada

-  Cuerpo metálico cromado. Empuñadura de caucho. Sistema cargador deslizante antibloqueo. Capacidad para 75 grapas. Capacidad de grapado: 20 hojas papel 80 g.
-  Chromed metal body. Rubber grip. Anti-locking sliding refill system. Capacity for 75 staples. Stapling capacity: 20 sheets of 80 g. paper.
-  Corpo metálico cromado. Empunhadura de borracha. Sistema do carregador deslizante antibloqueio. Capacidade para 75 agrafes. Capacidade para agrafar: 20 folhas de papel 80 g.
-  Corpo in metallo cromato. Impugnatura di gomma. Sistema di caricamento del caricatore anti-bloccaggio. Capacità per 75 graffette; capacità di pinzatura: 20 fogli di carta da 80 g.

CÓDIGO	COLOR	ENVASE
040078	Metálico / Negro	Caja 1 ud.

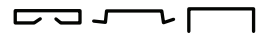

TIPO DE GRAPA	CAPACIDAD GRAPADO	PROFUND. GRAPAS
24/6	20h	65mm
22/6		



GRAPADORA DE GRUESOS HS-1000

Grapa hasta 100 hojas



TIPO DE GRAPA	TIPO DE GRAPA
24/6	23/6
24/8	23/8
24/10	23/10
24/10	23/13
CAPACIDAD GRAPADO	PROFUND. GRAPAS
100h	6-55 _{mm}



- Grapadora de gruesos en plástico ABS. Mecanismo metálico. Capacidad para 75 grapas. Capacidad de grapado: 100 hojas papel 80 g.
- 🇬🇧 Heavy duty stapler in ABS plastic. Metallic mechanism. Capacity for 75 staples. Stapling capacity: 100 sheets 80 g. paper.
- Agrafador de grande capacidade em plástico ABS. Mecanismo metálico. Capacidade para 75 agrafes. Capacidade de agrafar: 100 fls de papel 80 g.
- 🇮🇹 Cucitrice per spessori in plastica ABS. Mecanismo metallico. Capacità per 75 graffette. Capacità di pinzatura: 100 fogli di carta da 80 g.

CÓDIGO	COLOR	ENVASE
040427	● Negro	1 / 6

GRAPADORA DE GRUESOS HS-2000

Grapa hasta 140 hojas



TIPO DE GRAPA	TIPO DE GRAPA
23/10	23/20
23/13	23/20
23/17	23/23
CAPACIDAD GRAPADO	PROFUND. GRAPAS
170h	6-55 _{mm}



- Grapadora de gruesos en plástico ABS. Mecanismo metálico. Capacidad para 75 grapas. Capacidad de grapado: 170 hojas papel 80 g.
- 🇬🇧 Heavy duty stapler in ABS plastic. Metallic mechanism. Capacity for 75 staples. Stapling capacity: 170 sheets 80 g. paper
- Agrafador de grande capacidade em plástico ABS. Mecanismo metálico. Capacidade para 75 agrafes. Capacidade para agrafar: 170 folhas de papel 80 g.
- 🇮🇹 Cucitrice per spessori in plastica ABS. Mecanismo metallico. Capacità per 75 graffette. Capacità di pinzatura: 170 fogli di carta da 80 g.

CÓDIGO	COLOR	ENVASE
040081	● Negro	1 / 3

GRAPADORA DE GRUESOS HS-3000

Grapa hasta 210 hojas



TIPO DE GRAPA	TIPO DE GRAPA
23/10	23/20
23/13	23/20
23/17	23/23
CAPACIDAD GRAPADO	PROFUND. GRAPAS
200h	6-55 _{mm}







- Grapadora de gruesos en plástico ABS. Mecanismo metálico. Capacidad para 75 grapas. Capacidad de grapado: 200 hojas papel 80 g.
- 🇬🇧 Heavy duty stapler in ABS plastic. Metal mechanism. Capacity for 75 staples. Stapling capacity: 200 sheets 80 g. paper
- Agrafador grande capacidade em plástico ABS. Mecanismo metálico. Capacidade para 75 agrafes. Capacidade de agrafar: 200 folhas de papel 80 g.
- 🇮🇹 Cucitrice per spessori in plastica ABS. Mecanismo metallico. Capacità per 75 graffette. Capacità di pinzatura: 200 fogli di carta da 80 g.

CÓDIGO	COLOR	ENVASE
040080	● Negro	1 / 2



GRAPADORA DE BRAZO LARGO 295

Para grapar al centro

-  Grapadora para realizar pequeñas encuadernaciones con grapado al centro. Capacidad 150 grapas. Capacidad de grapado: 25 hojas papel 80 g.
-  Stapler for thin bindings. Staple is placed in the centre. Capacity of 150 staples. Stapling capacity: 25 sheets 80 g. paper
-  Agrafador para fazer pequenas encadernações com agrafes ao centro. Capacidade 150 agrafes. Capacidade de agrafar: 25 folhas de papel 80 g.
-  Cucitrice per realizzare piccole rilegature con pinzatura centrale. Capacità 150 graffette. Capacità di pinzatura: 25 fogli di carta da 80 g.







TIPO DE GRAPA	CAPACIDAD GRAPADO	PROFUND. GRAPAS
24/6 26/6	25h	317mm



CÓDIGO	COLOR	ENVASE
040245	● Negro/Gris	1 / 6

CLAVADORA 201

Económica

-  En plástico ABS. Mecanismo metálico. Manual. Palanca plegable. Cierre de seguridad. Capacidad para 100 grapas.
-  ABS plastic. Stapler. Metallic mechanism. Manual. Folding handle. Safety closing. Capacity of 100 staples.
-  Plástico ABS. Agrafador tipo pistola. Mecanismo metálico. Manual. Fecho de segurança. Capacidade para 100 agrafes.
-  In plastica ABS. Meccanismo metallico manuale. Leva pieghevole. Chiusura di sicurezza; capacità per 100 graffette.



Cierre de seguridad

Plástico ABS







CÓDIGO	COLOR	ENVASE
040190	● Azul / Cromo	Caja 1 ud.

TIPO DE GRAPA	CAPACIDAD DE CARGA
23/8 24/6	100

CLAVADORA 202

Fiable y segura

-  Mecanismo metálico. Manual. Palanca plegable. Cierre de seguridad. Capacidad para 100 grapas.
-  Stapler. Metallic mechanism. Manual. Folding handle. Safety closing. 100 staples capacity.
-  Agrafador tipo pistola. Mecanismo metálico. Manual. Fecho de segurança. Capacidade para 100 agrafes.
-  In plastica ABS. Meccanismo metallico manuale. Leva pieghevole. Chiusura di sicurezza; capacità per 100 graffette.



Cierre de seguridad



CÓDIGO	COLOR	ENVASE
040340	● Negro / Cromo	Caja 1 ud.

TIPO DE GRAPA	CAPACIDAD DE CARGA
23/8 24/6	100



Los códigos en **color amarillo** permiten apertura de envase

GRAPADORA ELÉCTRICA 5990

Grapadora automática y eficaz. 220V.



- Electrónica. Automática. Capacidad para 150 grapas.
- Electric staplers. Automatics. Capacity of 150 staples.
- Agrafador electrónico. Automático. Capacidade para 150 agrafes.
- Elettronica, automatica. Capacità per 150 graffette.

TIPO DE GRAPA	CAPACIDAD GRAPADO	PROFUND. GRAPAS
24/6 26/6	25h	10mm

CÓDIGO	COLOR	ENVASE
040101	● Gris	1 / 12

GRAPAS

Cobreadas y galvanizadas



GRUESOS / HEAVY DUTY / GROSSO

Modelo / Type / Modelo	10	22-24/6	22-24/6	23/6-200	23/6	22-24/6	23/8	23/10	23/13	23/15	23/17	23/20	23/23
CÓDIGO / CODE / CODE	040085	040087	040647	040826*	040806	040710	040090	040091	040092	040093	040094	040095	040096
Material	Cobreadas / Copper plated / Cobreados						Galvanizadas / Galvanized / Galvanizados						
Uds./Caja / Pcs./Box / Uds./Caixa	1000 ud.	5000 ud.	1000 ud.	1000 ud.	1000 ud.	1000 ud.	1000 ud.						
Envase / Packing / Embalagem	25	6	25	10	25	10							

* 040826 Grapas compatibles con grapadora Liliput de Petrus

EXTRAEGRAPAS 310

Delgado y ligero, tipo lápiz



- Ergonómico. Uso cómodo y sencillo. Fácil de extraer las grapas de los documentos. Punta de acero inoxidable.
- Ergonomic. Comfortable and easy to use. Easy to remove staples from documents. Stainless steel tip.
- Ergonômico. Confortáveis e fáceis de usar. Fácil de remover grampos de documentos. Ponta de aço inoxidável.
- Ergonomico. Uso comodo e semplice. Facile da estrarre graffette dai documenti. Punta in acciaio inossidabile

CÓDIGO	COLOR
040628	● Negro

EXTRAEGRAPAS 300

Eficacia y ergonomía







- Plástico ABS. Mecanismo metálico. Tipo tenaza. Muy fácil extracción.
- Staple remover. ABS plastic. Metallic mechanism. Pliers shaped. Very easy removal.
- Saca agrafes com punho em lástico ABS. Mecanismo metálico. Tipo pinça. Remoção muito fácil.
- Plastica ABS. Meccanismo metallico, tipo a pinza. Rimozione molto facile.

CÓDIGO	COLOR	ENVASE
040104	● Azul	12



Los códigos en color amarillo permiten apertura de envase





-  Perforador de 1 punzón de Ø 5 mm. Metálico y pintado.
-  One Ø 5 mm hole punch. Metallic and Painted.
-  Furador de 1 furo de Ø 5 mm. Metálico e pintado.
-  Perforatore con 1 punzone di Ø 5 mm; metallico e dipinto.

CÓDIGO	COLOR	ENVASE
040108	● Azul	1 / 12



PERFORADOR 120

Perforador de 1 punzón

-  Dos punzones de Ø 5 mm. Metálico y pintado. Sin esfuerzo.
-  Two Ø 5 mm hole punches. Metallic and Painted.
-  Furador de dois furos de Ø 5mm. Metálico e pintado.
-  Perforatore con 2 punzoni di Ø 5 mm. Metallico e dipinto. Senza sforzo.

CÓDIGO	COLOR	ENVASE
040557	● Gris oscuro	1 / 6

PERFORADOR SIN ESFUERZO EASY 30

Un 60% menos de esfuerzo al perforar

Sistema de bloqueo



Guía papel

Mayor precisión. Con guía para el papel de tamaño mediano



PERFORADOR SIN ESFUERZO PU-830A

50% menos de esfuerzo al perforar
Asa ergonómica

PLUS
JAPAN

Punto 1

Reduce el esfuerzo requerido en taladrar a la mitad

Mecanismo de fuerza asistida

Minimiza el esfuerzo del taladro requerido en un 50% (comparado con otros taladros similares)



Punto 2

Construido con metal duradero para una larga duración

CAPACIDAD TALADRO
25 Hojas

Dimensiones externas:
146×120×151mm
Peso: 630 g



Distancia entre los agujeros: 80 mm
Diámetro del agujero: 6 mm
Número de agujeros: 2
Profundidad de margen: 12 mm
Materiales: Base, brazo y asa = Hierro
Cubierta inferior = Polipropileno



CÓDIGO	COLOR	ENVASE
040499	● Rojo	1 / 20



Los códigos en color amarillo permiten apertura de envase

PERFORADOR 160

Básico



- Dos punzones de Ø 5 mm. Metálico y pintado.
- Two Ø 5 mm hole punches. Metallic and Painted.
- Furador de dois furos de Ø 5 mm. Metálico e pintado.
- Due punzoni di Ø 5 mm. Metallico e verniciato.

CÓDIGO	COLOR	ENVASE
040110	● Negro	1 / 24
040696	● Gris	1 / 24
040697	● Rojo	1 / 24
040698	● Azul	1 / 24

PERFORADOR 170

Standard



- Dos punzones de 5 mm. Ø. Metálico y pintado. Regleta para regular el perforado.
- Two Ø 5 mm hole punches. Metallic and painted. With a ruler to regulate the punch.
- Furador de dois furos de Ø 5 mm. Metálico e pintado. Régua para regular a furação.
- Due punzoni da Ø 5 mm. Metallico e verniciato; linguetta per regolare la perforazione.

CÓDIGO	COLOR	ENVASE
040111	● Negro	1 / 12
040699	● Gris	1 / 12
040700	● Rojo	1 / 12
040701	● Azul	1 / 12

PERFORADOR 175

Robusto y fiable



- Dos punzones de Ø 5 mm. Metálico y pintado. Regleta para regular el perforado. Empuñadura ergonómica.
- Two Ø 5 mm hole punches. Metallic and painted. With a ruler to regulate the punch. Ergonomic grip.
- Furador de dois furos de Ø 5mm. Metálico e pintado. Régua para regular a furação. Punho ergonómico.
- Due punzoni da Ø 5 mm. Metallico e verniciato; linguetta per regolare la perforazione. Impugnatura ergonomica.

CÓDIGO	COLOR	ENVASE
040113	● Negro	1 / 6
040702	● Gris	1 / 6
040703	● Azul	1 / 6





PERFORADOR 190

Media capacidad



- Dos punzones de Ø 5 mm. Metálico y pintado. Regleta para regular el perforado. Empuñadura ergonómica.
- Two Ø 5 mm hole punches. Metallic and painted. With a ruler to regulate the punch. Ergonomic grip.
- Furador de dois furos de Ø 5 mm. Metálico e pintado. Régua para regular a furação. Punho ergonómico.
- Due punzoni da Ø 5 mm. Metallico e verniciato; linguetta per regolare la perforazione. Impugnatura ergonomica.

CÓDIGO	COLOR	ENVASE
040115	● Gris	1 / 6





-  Dos punzones de Ø 5 mm. Metálico y pintado. Regleta para regular el perforado.
-  Two Ø 5 mm hole punches. Metallic and painted body. With a ruler to regulate the punch.
-  Furador de dois furos de Ø 5 mm. Corpo metálico e pintado. Régua para regular a perfuração.
-  Due punzoni da Ø 5 mm. Metallico e verniciato; linguetta per regolare la perforazione.

CÓDIGO	COLOR	ENVASE
040447	● Negro	1 / 12
040668	● Gris	1 / 12



PERFORADOR T20

Standard



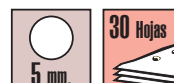

-  Cuerpo metálico y pintado. Regleta para regular el perforado. Sistema de bloqueo que permite plegar la palanca para ahorrar espacio.
-  Metallic and painted body. With a ruler to regulate the punch. Locking system that allows the lever to be folded to save space.
-  Furador de dois furos. Corpo metálico e pintado. Régua para regular a perfuração. Sistema de bloqueio permitindo dobrar a alavanca para economizar espaço.
-  Corpo metallico e verniciato. Linguetta per regolare la perforazione. Sistema di blocco che consente di piegare la leva per risparmiare spazio.

CÓDIGO	COLOR	ENVASE
040448	● Negro	1 / 6
040704	● Gris	1 / 6



PERFORADOR T30

Standard

-  Cuerpo metálico y pintado. Regleta para regular el perforado. Sistema de bloqueo que permite plegar la palanca para ahorrar espacio.
-  Metallic and painted body. With a ruler to regulate the punch. Locking system that allows the lever to be folded to save space.
-  Corpo metálico e pintado. Régua para regular a perfuração. Sistema de bloqueio permitindo dobrar a alavanca para economizar espaço.
-  Corpo metallico e verniciato. Linguetta per regolare la perforazione. Sistema di blocco che consente di piegare la leva per risparmiare spazio.

CÓDIGO	COLOR	ENVASE
040449	● Negro	1 / 3







PERFORADOR T40

Standard



PERFORADOR 4 PUNZONES

Calidad extra

-  Cuatro punzones fijos de Ø 5 mm. Metálico de calidad extra y pintado en negro.
-  Four Ø 5 mm hole punch. Extra quality metal body and painted in black.
-  Furador de quatro furos de Ø 5 mm. Metálico de grande capacidade e na cor preto.
-  Quattro punzoni da 5 mm. Metallico di ottima qualità e dipinto in nero.





CÓDIGO	COLOR	ENVASE
040814	● Negro	1 / 10



PERFORADOR P-865

Gran capacidad. Perfora hasta 65 hojas



-  Metálico y pintado. Regleta para regular el perforado.
-  Metal and painted body. With a ruler to regulate the punch.
-  Furador metálico e pintado. Regua para regular a furacão.
-  Metallico e dipinto. Linguetta per regolare la perforazione.

CÓDIGO	COLOR	ENVASE
040398	● Gris	1 / 3

PERFORADOR GRAN CAPACIDAD P-1000

Sin esfuerzo perfora hasta 100 hojas



-  Metálico y pintado. Guía para el papel auto-centrable. Menos esfuerzo en el perforado. Compartimento para el confetti. Color negro/plata. Incluye 2 punzones.
-  Metallic and painted. With a ruler to regulate the punch. Less perforation effort. Compartment for confetti. Colour: black/silver. Includes 2 punches.
-  Metálico e pintado. Regua para regular papel. Menos esforço para furar. Compartimento para confetti. Cor preto/prata. Inclui 2 socos.
-  Metallico e verniciato. Guida per centrare i fogli. Manico ergonomico per diminuire sforzi nella perforazione. Scomparto per coriandoli. Colore nero / argento. Include 2 punzoni.

CÓDIGO	COLOR	ENVASE
040466	● Negro	1 / 6

PERFORADOR GRAN CAPACIDAD P-1500

Sin esfuerzo perfora hasta 150 hojas



-  Regleta para regular el perforado desde A3 hasta B6. Menos esfuerzo en el perforado. Un compartimento para piezas de repuesto y otro para el confetti. Incluye 2 punzones.
-  With a ruler to regulate the punch from A3 to B6. Less perforation effort. One compartment for spare parts and one for confetti. Includes 2 punches.
-  Régua para regular o perfurado desde A3 até B6. Menos esforço para furar. Um compartimento para peças de reposição e outro para confetes. Inclui 2 socos.
-  Guida per centrare i fogli da A3 a B6. Diminuire sforzi nella perforazione. Uno scomparto per i pezzi di ricambio e uno per i coriandoli. Include 2 pugni.

CÓDIGO	COLOR	ENVASE
040426	● Negro	1 / 4

CÓDIGO	DESCRIPCIÓN
040428	Recambio: 2 punzones + 4 bases
040429	Recambio: 10 bases



Los códigos en **color amarillo** permiten apertura de envase

A top-down view of a desk with two calculators, a pen, a paperclip jar, and a notebook. The scene is set on a light grey surface. In the top left, a portion of a notebook with a light brown cover and three punch holes is visible. In the top center, a clear glass jar is filled with several copper-colored paperclips. In the bottom left, a white pen with a copper-colored barrel and a silver clip lies diagonally. Two white calculators are the central focus. The calculator on the left is a basic model with a green LCD screen showing '12345678'. The calculator on the right is a more advanced model with a blue LCD screen showing 'E 12345678'. Both calculators have standard numeric and function keys.

05

CALCULADORAS

CALCULATORS
CALCULADORAS
CALCOLATRICI

CALCULADORA PLUS FX- 82 PLUS CIENTIFICA

224 Funciones



DIGITOS 10+2	AUTO POWER OFF	POWER 	LCD DISPLAY BIG	224 FUNCIONES
------------------------	--------------------------	-----------	---------------------------	-------------------------

Pantalla de 2 líneas - 10+2 dígitos. Funciones hiperbólicas y trigonométricas. Funciones de repetición que permite visualizar y corregir la fórmula ingresada. Lógica de ingreso perfecto, como se lee la fórmula se ingresa a la calculadora.

2 lines screen - 10+2 digits. Hyperbolic and trigonometry functions. Repetition functions that allows to visualize and correct the formula entered. Perfect entering logic, as it is read in the formula entered in the calculator.

2-display linha - 10 +2 dígitos. Hiperbólicas e funções trigonométricas. Funções de repetição que permite visualizar e editar a fórmula inserida. Lógica de entrada perfeito, como se lê a fórmula é inserida na calculadora.

Schermo di 2 righe - 10 + 2 cifre. Funzioni iperboliche e trigonometriche. Funzioni di ripetizione che consente di visualizzare e correggere la formula inserita. Logica del inserimento perfetto, come si legge la formula si inserisci nella calcolatrice.

CÓDIGO	MEDIDAS
220567	85 x 156 x 20 mm.

CALCULADORA PLUS FX-224 CIENTIFICA

224 Funciones



DIGITOS 10+2	AUTO POWER OFF	POWER 	LCD DISPLAY BIG	224 FUNCIONES
------------------------	--------------------------	-----------	---------------------------	-------------------------

Pantalla de 2 líneas - 10+2 dígitos. Funciones hiperbólicas y trigonométricas. Funciones de repetición que permite visualizar y corregir la fórmula ingresada. Lógica de ingreso perfecto, como se lee la fórmula se ingresa a la calculadora.

2 lines screen - 10+2 digits. Hyperbolic and trigonometry functions. Repetition functions that allows to visualize and correct the formula entered. Perfect entering logic, as it is read in the formula entered in the calculator.

2-display linha - 10 +2 dígitos. Hiperbólicas e funções trigonométricas. Funções de repetição que permite visualizar e editar a fórmula inserida. Lógica de entrada perfeito, como se lê a fórmula é inserida na calculadora.

Schermo di 2 righe - 10 + 2 cifre. Funzioni iperboliche e trigonometriche. Funzioni di ripetizione che consente di visualizzare e correggere la formula inserita. Logica del inserimento perfetto, come si legge la formula si inserisci nella calcolatrice.

CÓDIGO	MEDIDAS
220506	80 x 160 x 11 mm.

CALCULADORA PLUS FX-283 CIENTIFICA

283 Funciones



DIGITOS 10+2	AUTO POWER OFF	POWER 	LCD DISPLAY BIG	283 FUNCIONES
------------------------	--------------------------	-----------	---------------------------	-------------------------

Calculadora científica electrónica. Pantalla de 2 líneas. 10+2 dígitos. Alimentación: Pilas. Estuche protector rígido.

Electronic scientific calculator. 2 lines screen. 10+2 digits. Feeding: Batteries. Rigit protective case.

Calculadora científica electrónica. Visor de 2 linhas. 10+2 dígitos. Alimentação a pilhas. Estojo protector rígido.

Calcolatrice scientifica elettronica. Schermo di 2 linee. 10 + 2 cifre. Alimentazione a batterie. Custodia protettiva rigida.

CÓDIGO	MEDIDAS
220415	85 x 163 x 16 mm.



CALCULADORAS ANTIBACTERIAS

- Antibacteriana y resistente a los gérmenes. Material reciclado. Fuente de alimentación doble: luz solar y pila. Apagado automático.
- Antibacterial and germ resistant. Recycled materials. Dual power source: solar and battery. Auto Power Off.
- Antibacteriano e resistente a germes. Materiais reciclados. Dupla fonte de alimentação: solar e bateria. Auto Power Off.
- Antibatterico e resistente ai germi. Materiale riciclato. Doppia alimentazione: luce solare e batteria. Spegnimento automatico.



	CÓDIGO	MODELO	MEDIDAS mm.
1	220512	BS-180	62 x 113 x 10
2	220513	SS-230	94 x 151 x 24

DIGITOS: 8 | TECLAS MEMORIA: 3 | POWER: | AUTO POWER: OFF

DIGITOS: 10 | TECLAS MEMORIA: 4 | POWER: | AUTO POWER: OFF | LCD DISPLAY: BIG | VISOR INCLINADO:

CALCULADORA PLUS SS-180 MARGIN DE SOBREMESA

Con cálculo de costo, venta y margen. Tecla de corrección.

- Pantalla LCD de 10 dígitos. Gran display inclinado y ajustable. 3 Teclas de memoria. Carcasa de aluminio. Alimentación: solar y pila botón.
- 10 digit LCD screen. Large inclined and adjustable display. 3 memory keys. Aluminum case. Power: solar and battery button
- Visor LCD com 10 digitos. Grande visor inclinado e ajustável. 3 teclas de memória. Carcaça de alumínio. Alimentação de energia: solar e pilha de botão.
- Schermo LCD a 10 cifre. Ampio display inclinato e regolabile. 3 tasti di memoria. Corpo in alluminio. Potenza: solare e batteria a bottone.

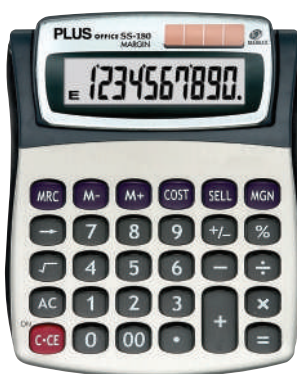

DIGITOS: 10 | TECLAS MEMORIA: 3 | AUTO POWER: OFF | LCD DISPLAY: BIG | POWER: | VISOR INCLINADO:

CÓDIGO	COLOR	MEDIDAS mm.
220425	Gris/Negro	88 x 120 x 20

CALCULADORA PLUS BS-115 DE BOLSILLO

- Pantalla LCD de 8 dígitos. Carcasa de aluminio. 4 Teclas de memoria. Alimentación: pila botón/solar.
- 8 digit LCD screen. Aluminum case. 4 memory keys. Power: button battery/solar.
- Visor LCD com 8 digitos. Carcaça de alumínio. 4 teclas de memória. Alimentação de energia: pilha de botão/solar.
- Schermo LCD a 8 cifre. Corpo in alluminio. 4 tasti di memoria. Alimentazione: pulsante / batteria solare.



DIGITOS: 8 | TECLAS MEMORIA: 4 | AUTO POWER: OFF | | POWER:

CÓDIGO	COLOR	MEDIDAS
220578	● Gris	67 x 118 x 7 mm

CALCULADORA PLUS SS-200 DE SOBREMESA

Función MARK UP

- Pantalla LCD de 10 dígitos. Gran visor inclinado. 4 Teclas de memoria. Carcasa de plástico. Alimentación: solar y pila botón.
- 10-digit LCD display. Large inclined viewer. 4 memory keys. Plastic case. Power: solar and battery button.
- Visor LCD com 10 digitos. Grande visor inclinado. 4 teclas de memória. Carcaça de plástico. Alimentação de energia: solar e pilha de botão.
- Schermo LCD a 10 cifre. Grande mirino inclinato, 4 tasti di memoria. Custodia in plastica. Alimentazione: solare e batteria a bottone.



DIGITOS: 10 | TECLAS MEMORIA: 4 | AUTO POWER: OFF | POWER: | LCD DISPLAY: BIG

CÓDIGO	COLOR	MEDIDAS mm.
220579	● Gris	103 x 145 x 32

CALCULADORA PLUS SS-245 DE SOBREMESA

Cálculo de impuestos.



DIGITOS	TECLAS MEMORIA	AUTO POWER	MEMORIA
10	4	OFF	GT
POWER	VISOR INCLINADO	LCD DISPLAY	CÁLCULO IMPUESTO
		BIG	TAX

🇪🇸 Pantalla LCD de 10 dígitos. Gran visor inclinado. 4 Teclas de memoria, tecla de función GT y de corrección. Carcasa de plástico. Alimentación: solar y pila botón.

🇬🇧 10-digit LCD display. Large inclined viewer. 4 memory keys, GT function and correction key. Plastic case. Power: solar and button battery.

🇵🇹 Visor LCD com 10 dígitos. Grande visor inclinado. 4 teclas de memória, tecla de função GT e de correção. Carcaça de plástico. Alimentação de energia: solar e pilha de botão.

🇮🇹 Schermo LCD a 10 cifre. Grande mirino inclinato. 4 tasti di memoria, tasto funzione GT e tasto di correzione. Custodia in plastica. Alimentazione: solare e batteria a bottone.

CÓDIGO COLOR MEDIDAS mm.

220580 ● Gris 115 x 155 x 25

CALCULADORA PLUS SS-265 DE SOBREMESA

Cálculo de impuestos.

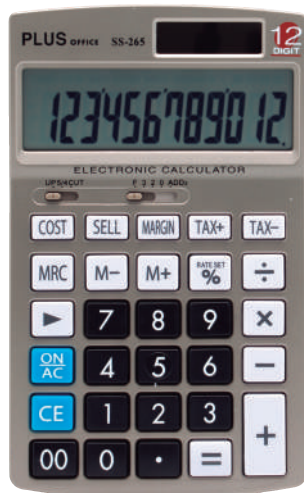

DIGITOS	TECLAS MEMORIA	CÁLCULO IMPUESTO	AUTO POWER
12	4	TAX	OFF
POWER	VISOR INCLINADO	LCD DISPLAY	
		BIG	

🇪🇸 Pantalla LCD de 12 dígitos. Gran visor inclinado. 4 Teclas de memoria, tecla de corrección. Carcasa de plástico. Alimentación: solar y pila botón.

🇬🇧 12-digit LCD display. Large inclined viewer. 4 memory keys and correction key. Plastic case. Power: solar and battery button.

🇵🇹 Visor LCD com 12 dígitos. Grande visor inclinado. 4 teclas de memória, tecla de correção. Carcaça de plástico. Alimentação de energia: solar e pilha de botão.

🇮🇹 Schermo LCD a 12 cifre. Grande mirino inclinato. 4 tasti di memoria, tasto di correzione. Custodia in plastica. Alimentazione: solare e batteria a bottone.

CÓDIGO COLOR MEDIDAS mm.

220581 ● Gris 100 x 170 x 25

CALCULADORA PLUS SS-285 DE SOBREMESA

Cálculo de impuestos.

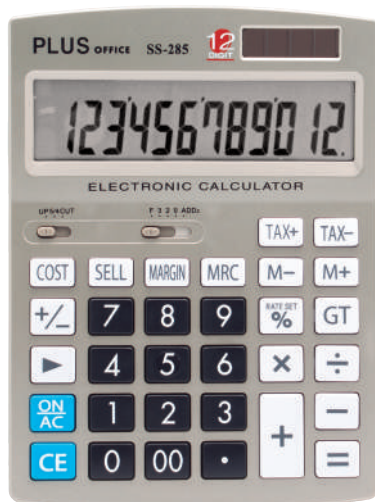

DIGITOS	TECLAS MEMORIA	AUTO POWER	MEMORIA
12	4	OFF	GT
POWER	VISOR INCLINADO	LCD DISPLAY	CÁLCULO IMPUESTO
		BIG	TAX

🇪🇸 Pantalla LCD de 12 dígitos. Gran visor inclinado. 4 Teclas de memoria, tecla de función GT y de corrección. Carcasa de plástico. Alimentación: solar y pila botón.

🇬🇧 12-digit LCD display. Large inclined viewer. 4 memory keys, GT function and correction key. Plastic case. Power: solar and button battery.

🇵🇹 Visor LCD com 12 dígitos. Grande visor inclinado. 4 teclas de memória, tecla de função GT e de correção. Carcaça de plástico. Alimentação de energia: solar e pilha de botão.

🇮🇹 Schermo LCD a 12 cifre. Grande mirino inclinato. 4 tasti di memoria, tasto funzione GT e tasto di correzione. Custodia in plastica. Alimentazione: solare e batteria a bottone.

CÓDIGO COLOR MEDIDAS mm.



220582 ● Gris 140 x 190 x 30



CALCULADORA PLUS SS-210 DE SOBREMESA

-  Pantalla LCD de 8 dígitos. Gran visor inclinado. 4 Teclas de memoria, tecla de función MU y de corrección. Alimentación: solar y pila botón.
-  8-digit LCD display. Large inclined viewer. 4 memory keys, MU function and correction key. Power: solar and button battery.
-  Visor LCD com 8 dígitos. Grande visor inclinado. 4 teclas de memória, tecla de função GT, função MU e de correção. Alimentação de energia: solar e pilha de botão.
-  Schermo LCD a 8 cifre. Grande mirino inclinato. 4 tasti di memori, tasto funzione MU e tasto di correzione. Alimentazione: solare e batteria a bottone.



DIGITOS	TECLAS MEMORIA	AUTO POWER	POWER
8	4	OFF	
VISOR INCLINADO	LCD DISPLAY	BIG	
			

CÓDIGO	COLOR	MEDIDAS mm.
220600	● Gris	138 x 104 x 31

CALCULADORA PLUS SS-280N DE SOBREMESA

Selector de decimales y redondeo.

-  Pantalla LCD de 10 dígitos. Gran visor inclinado. 4 Teclas de memoria, tecla de función GT y de corrección. Tecla de función MU. Alimentación: solar y pila botón.
-  10-digit LCD display. Large inclined viewer. 4 memory keys, GT function, MU function and correction key. Power: solar and button battery.
-  Visor LCD com 10 dígitos. Grande visor inclinado. 4 teclas de memória, tecla de função GT, função MU e de correção. Alimentação de energia: solar e pilha de botão.
-  Schermo LCD a 10 cifre. Grande mirino inclinato. 4 tasti di memori, tasto funzione GT, funzione MU e tasto di correzione. Alimentazione: solare e batteria a bottone.



DIGITOS	TECLAS MEMORIA	AUTO POWER	POWER
10	4	OFF	
MEMORIA	LCD DISPLAY	VISOR INCLINADO	
GT	BIG		

CÓDIGO	COLOR	MEDIDAS mm.
220591	● Gris	171 x 122 x 32

CALCULADORA PLUS SS-295 DE SOBREMESA

Incorpora cálculo de costo, margen e impuestos.
Selector de decimales y redondeo.

-  Pantalla LCD de 12 dígitos. Gran visor inclinado. 3 Teclas de memoria (una doble), tecla de función GT y de corrección. Cálculo de impuestos y márgenes. Carcasa de plástico. Alimentación: solar y pila botón.
-  12-digit LCD display. Large inclined viewer. 3 memory keys, GT function and correction key. Calculation of taxes and margins. Plastic case. Power: solar and button battery.
-  Visor LCD com 12 dígitos. Grande visor inclinado. 3 teclas de memória, tecla de função GT e de correção. Cálculo de impostos e margens. Carcaça de plástico. Alimentação de energia: solar e pilha de botão.
-  Schermo LCD a 12 cifre. Grande mirino inclinato. 3 tasti di memoria (uno doppio), tasto funzione GT e tasto di correzione. Calcolo di tasse e margini. Custodia in plastica. Alimentazione: solare e batteria a bottone.



DIGITOS	TECLAS MEMORIA	AUTO POWER	POWER
12	3	OFF	
MEMORIA	LCD DISPLAY	CÁLCULO IMPUESTO	VISOR INCLINADO
GT	BIG	TAX	





CÓDIGO	COLOR	MEDIDAS mm.
220596	● Gris	220 x 165 x 40



Los códigos en **color amarillo** permiten apertura de envase

CALCULADORA PLUS SS-140







-  Pantalla LCD de 8 dígitos. Alimentación: solar y pila botón. 4 Teclas de memoria y tecla de corrección.
-  8-digit LCD display. Power: solar and button cell. 4 Memory keys and correction key.
-  Visor LCD de 8 dígitos. Potência: célula solar e botão. 4 Teclas de memória e tecla de correção.
-  Schermo LCD a 8 cifre. Potenza: solare e batteria a bottone. 4 chiavi di memoria e tasto di correzione.

CÓDIGO	COLOR	MEDIDAS mm.
220493	● Plata	95 x 170 x 12

DIGITOS	TECLAS MEMORIA	AUTO POWER	POWER
8	4	OFF	

CALCULADORA PLUS SS-165 DE BOLSILLO



-  Pantalla LCD de 8 dígitos. 4 Teclas de memoria, tecla de cambio de signo. Alimentación: solar/batería.
-  8 digit LCD display. 4 memory keys, sign change key. Power: solar/battery.
-  Visor LCD com 8 dígitos. 4 teclas de memória, tecla de mudar o signo. Alimentação solar/bateria.
-  Schermo LCD a 8 cifre. 4 tasti per memoria, tasto di cambio di segno. Alimentazione: solare / batteria.

CÓDIGO	COLOR	MEDIDAS mm.
220568	● Verde	65 x 115 x 12
220569	● Naranja	65 x 115 x 12
220516	● Azul	65 x 115 x 12

DIGITOS	TECLAS MEMORIA	AUTO POWER	POWER
8	4	OFF	

CALCULADORA PLUS SS-COLOR 1 DE SOBREMESA

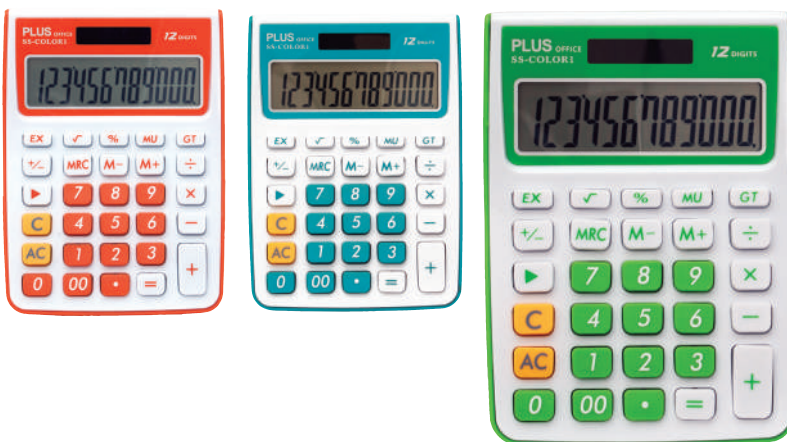

-  Pantalla LCD de 12 dígitos. Display inclinado. 4 Teclas de memoria, memoria Gran Total y tecla de corrección. Alimentación: solar y pila botón. Presentación en blister.
-  12-digit LCD display. Display inclined. 4 memory keys, Total memory and correction key. Power: solar and battery button. Blister presentation.
-  Visor LCD com 12 dígitos. Visor inclinado. 4 teclas de memória, memória Grande Total e tecla de correção. Alimentação de energia solar e pila de botão. Apresentação em blister.
-  Schermo LCD a 12 cifre. Display inclinato. 4 tasti per memoria, Grand Total Memory e tasto di correzione. Alimentazione: solare e batteria. Presentazione in blister.





CÓDIGO	COLOR	MEDIDAS mm.
220504	● Azul	105 x 145 x 15
220570	● Naranja	105 x 145 x 15
220571	● Verde	105 x 145 x 15

DIGITOS	TECLAS MEMORIA	MEMORIA	AUTO POWER
12	4	GT	OFF
	VISOR INCLINADO	LCD DISPLAY	BIG





CALCULADORA PLUS TABLET



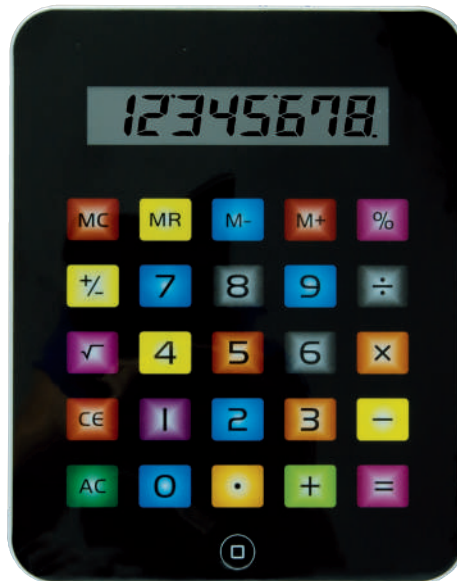

-  Calculadora tipo Tablet. Pantalla LCD de 8 dígitos, tecla de corrección y tecla de cambio de signo. Alimentación: pila. Con apagado automático. Presentación en blíster.
-  Tablet type calculator. 8-digit LCD screen, correction key and sign change key. Power: battery. With automatic shutdown. Blister presentation.
-  Calculadora de tipo de tablet. Tela LCD de 8 dígitos, tecla de correção e chave de alteração de sinal. Potência: bateria. Com desligamento automático. Apresentação em blister.
-  Calcolatrice di tipo tablet. Schermo LCD a 8 cifre, tasto di correzione e tasto di modifica del segno. Potenza: batteria. Con spegnimento automatico. Presentazione in blister.



DIGITOS	TECLAS MEMORIA	AUTO POWER	POWER
8	4	OFF	

CÓDIGO	COLOR	MEDIDAS mm
785298	● Negro	190 x 240 x 8

CALCULADORA PLUS A4 EM635

-  Calculadora electrónica. Pantalla LCD de 8 dígitos. Tamaño A4. 3 Teclas de memoria y tecla de corrección. Alimentación: solar y pila botón.
-  Electronic calculator. 8-digit LCD screen. A4 size. 3 Memory keys and correction key. Power: solar and cell button.
-  Calculadora eletrônica Tela LCD de 8 dígitos. Tamanho A4. 3 Teclas de memória e tecla de correção. Potência: célula solar e botão.
-  Calcolatrice elettronica Schermo LCD a 8 cifre. Formato A4 3 chiavi di memoria e tasto di correzione. Potenza: solare e batteria a bottone.



DIGITOS	TECLAS MEMORIA	AUTO POWER	POWER
8	3	OFF	

CÓDIGO	COLOR	MEDIDAS mm.
785255	● Rojo ● Plata	210 x 297



Los códigos en **color amarillo** permiten apertura de envase



DISEÑO Y PRACTICIDAD
Calculadoras de alta calidad.



Calidad y diseño
en tu calculadora

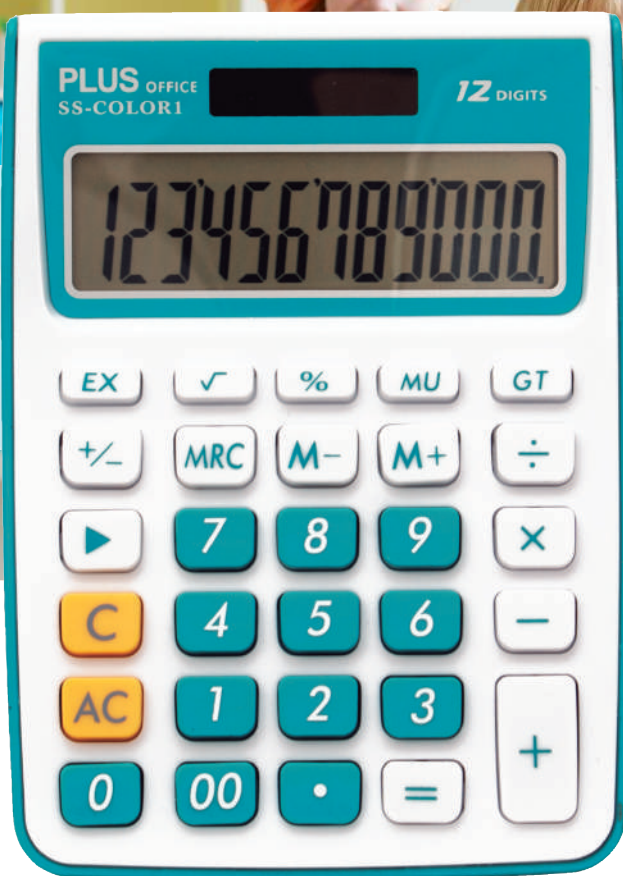

Plus SS-Color 1

3 colores a elegir

Características

- Pantalla LCD de 12 dígitos.
- Display inclinado.
- 4 Teclas de memoria,
- memoria Gran Total
- tecla de corrección.
- Alimentación: solar y pila botón.
- Presentación en blíster.

DIGITOS	TECLAS MEMORIA	MEMORIA	AUTO POWER	POWER	VISOR INCLINADO	LCD DISPLAY
12	4	GT	OFF			BIG

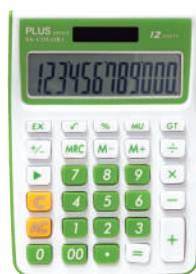

220571

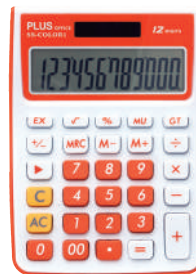

220570

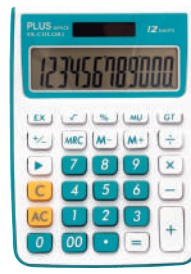

220504



Los códigos en color amarillo permiten apertura de envase

06

MATERIAL DE OFICINA

OFFICE SUPPLIES
MATERIAL DE ESCRITÒRIO
CANCELLERIA



for you



Pasty

2年B組 時間割表

	月	火	水	木	金	土
1	日本史 B	総合	理科 漢語	古典	古典	現代文
2	化学	数学 II B	数学 II B	世界史 B	体育	英語
3	数学 II B	体育	コミュ II	数学 II B	現代文	化学
4	数学 II B	古典	音楽 美術	日本史 B	コミュ II	国語
5	現代文	世界史 B	現代文	コミュ II	数学 II B	
6	コミュ II	理科 漢語	英語 表現	英語 表現	LHR	

TALONARIOS PLUS OFFICE

Facturas

 Talonarios de facturas impresos en dos colores.

001387-001386-028926

001389-001383-001390

001385

001388

029632

Formato natural. Original 100 hojas. Autocopiativo 50 juegos.

CÓDIGO	MEDIDAS mm	JUEGO	REF.	ENVASE
001387	109 x 153	Original	T-46	5
001386	109 x 153	Duplicado	T-68	5
028926	109 x 153	Triplicado	T-70	5
001389	145 x 207	Original	T-6	5
001383	145 x 207	Duplicado	T-63	5
001390	145 x 207	Triplicado	T-65	5
001388	210 x 300	Duplicado	T-56	5

Formato apaisado. Autocopiativo 50 juegos.

CÓDIGO	MEDIDAS mm	JUEGO	REF.	ENVASE
001385	153 x 109	Duplicado	T-67	10
029632	207 x 145	Duplicado	T-64	5

TALONARIOS PLUS OFFICE

Entregas

 Talonarios de entregas impresos en dos colores.

001401-029625

001404-001402-001403

001400-001398-001399

Formato natural. Autocopiativo 50 juegos.

CÓDIGO	MEDIDAS mm	JUEGO	REF.	ENVASE
001401	145 x 207	Duplicado	T-91	5
029625	145 x 207	Triplicado	T-92	5

Formato apaisado. Original 100 hojas. Autocopiativo 50 juegos.

CÓDIGO	MEDIDAS mm	JUEGO	REF.	ENVASE
001404	153 x 109	Original	T-32	5
001402	153 x 109	Duplicado	T-79	5
001403	153 x 109	Triplicado	T-54	5
001400	207 x 145	Original	T-26	5
001398	207 x 145	Duplicado	T-49	5
001399	207 x 145	Triplicado	T-47	5



TALONARIOS PLUS OFFICE

Recibos

Talonarios de recibos impresos en dos colores.

Formato apaisado. Original 100 hojas. Autocopiativo 50 juegos.

CÓDIGO	MEDIDAS mm	JUEGO	REF.	ENVASE
001376	215 x 100	Original	T-19	5
001381	207 x 109	Duplicado	T-60	5

Formato apaisado. Original 100 hojas. Con matriz.

CÓDIGO	MEDIDAS mm	JUEGO	REF.	ENVASE
001375	207 x 109	Original	T-16	5

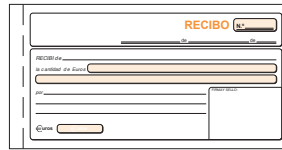

001381

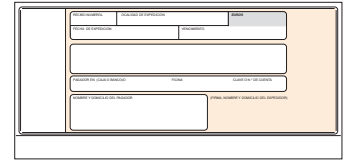

001376

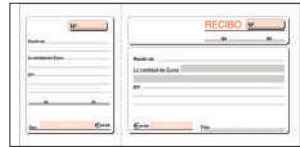

001375

TALONARIOS PLUS OFFICE

Pedidos

Talonarios de pedidos impresos en dos colores.

Formato natural. Original 100 hojas. Autocopiativo 50 juegos.

CÓDIGO	MEDIDAS mm	JUEGO	REF.	ENVASE
001394	145 x 207	Original	T-27	5
001393	145 x 207	Duplicado	T-71	5
029614	145 x 207	Triplicado	T-72	5



TALONARIOS PLUS OFFICE

Albaranes

Talonarios de albaranes impresos en dos colores.

Formato natural. Autocopiativo 50 juegos.

CÓDIGO	MEDIDAS mm	JUEGO	REF.	ENVASE
001397	146 x 207	Duplicado	T-120	5
001405	146 x 207	Triplicado	T-122	5

Formato apaisado. Autocopiativo 50 juegos.

CÓDIGO	MEDIDAS mm	JUEGO	REF.	ENVASE
002462	207 x 146	Duplicado	T-119	5

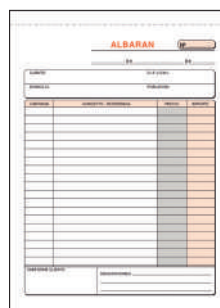

001397 - 001405

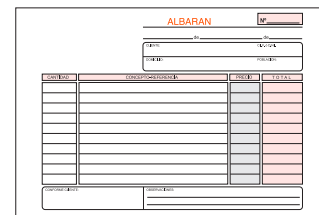

002462

TALONARIOS PLUS OFFICE

Vales

Talonarios de 100 hojas impresos en dos colores. Con matriz. Formato apaisado.

CÓDIGO	MEDIDAS mm	JUEGO	REF.	ENVASE
001418	207 x 109	Original	T-14	5

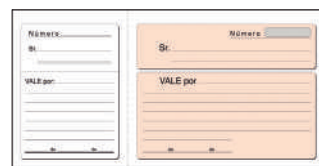

Los códigos en color amarillo permiten apertura de envase

TALONARIOS PLUS OFFICE

Camareros

 Talonarios de camareros impresos en dos colores.

Formato natural. Autocopiativo 50 juegos.

CÓDIGO	MEDIDAS mm	JUEGO	REF.	ENVASE
029099	73 x 155	Duplicado	T-575/2	10
029100	73 x 155	Triplicado	T-576/3	5
001408	88 x 135	Duplicado	T-140	5
003343	90 x 160	Duplicado	T-1	10
003342	90 x 216	Duplicado	T-2	10
001406	109 x 153	Duplicado	T-88	5
001410	109 x 153	Triplicado	T-89	5

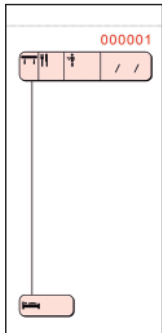

029099 - 029100

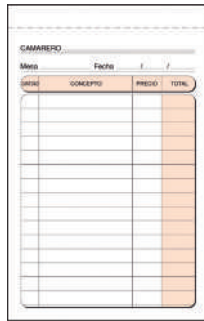

001408

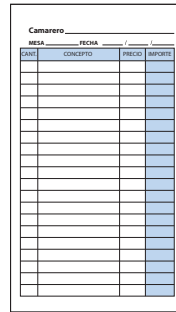

003343 - 003342

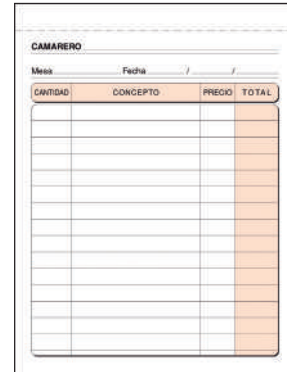

001406 - 001410

TALONARIOS PLUS OFFICE

Loterías

 Talonarios de lotería impresos en dos colores. Formato apaisado. Con matriz.

100 hojas

CÓDIGO	MEDIDAS mm	JUEGO	REF.	ENVASE
001380	207 x 109	Original	T-15	10

50 hojas

CÓDIGO	MEDIDAS mm	JUEGO	REF.	ENVASE
002330	207 x 109	Original	T-15-50H	10

25 hojas

CÓDIGO	MEDIDAS mm	JUEGO	REF.	ENVASE
002331	207 x 109	Original	T-15-25H	20



TALONARIOS PLUS OFFICE

Inquilinato, Alquiler y Comunidad

 Talonarios de inquilinato, alquiler y comunidad impresos en dos colores.

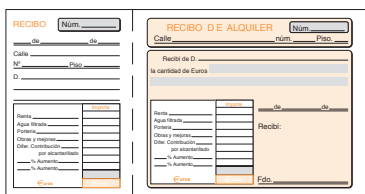

001374- Inquilinato

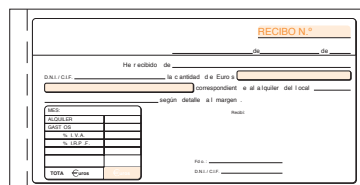

001379- Alquiler

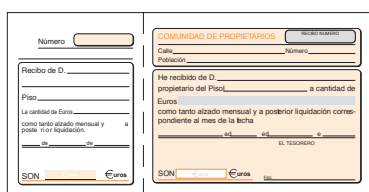

003341- Comunidad

Inquilinato. 100 hojas. Apaisado. Con matriz.

CÓDIGO	MEDIDAS mm	JUEGO	REF.	ENVASE
001374	210 x 105	Original	T-40	5

Alquiler. Apaisado. Autocopiativo 50 juegos.

CÓDIGO	MEDIDAS mm	JUEGO	REF.	ENVASE
001379	207 x 109	Duplicado	T-52	5

Comunidad. 100 hojas. Apaisado. Con matriz.

CÓDIGO	MEDIDAS mm	JUEGO	REF.	ENVASE
003341	210 x 105	Original	T-48	5



TALONARIOS PLUS OFFICE

Presupuestos

Talonarios de presupuestos impresos en dos colores.

Formato natural. Autocopiativo 50 juegos.

CÓDIGO	MEDIDAS mm	JUEGO	REF.	ENVASE
001395	145 x 207	Duplicado	T-90	5

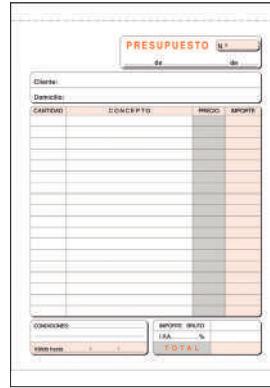

TALONARIOS CAJA T-29

Ideal para asociaciones, comerciantes, tómbolas,...

Talonarios de caja numerados.

CÓDIGO	MEDIDAS mm	COLOR	HOJAS	ENVASE
001416	100 x 50	Blanco	100	20
001417	100 x 50	Naranja	100	20
001412	100 x 50	Amarillo	100	20
001413	100 x 50	Azul	100	20
001414	100 x 50	Rosa	100	20
001415	100 x 50	Verde	100	20

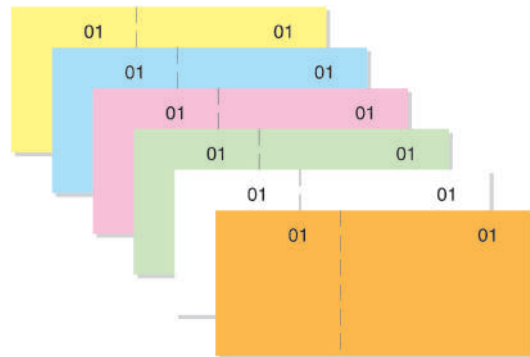

TIRAS DE RIFA

Ideal para asociaciones, comerciantes, tómbolas,...

Talonarios de rifa numerados. Formato vertical. Troquelado para un corte más fácil. Colores surtidos.

CÓDIGO	NÚMEROS	ENVASE
002186	1 al 1000	60
002192	1 al 2000	30
002191	1 al 3000	15
002187	1 al 5000	10
002188	1 al 10000	5



BLOC DE MENSAJES

Llamadas telefónicas

Bloc de 100 hojas para mensajes. Sin duplicado autocopiativo.

CÓDIGO	MEDIDAS mm	HOJAS	REF.	ENVASE
001419	153 x 100	100	T-62	10

A la atención del Sr. _____

DURANTE SU AUSENCIA

D. _____

de _____

Nº de Teléc. _____

E. mail _____

ha telefonado ha venido al visitado para su información

volverá a llamar desea que Ud. vaya a verlo para su aprobación

desea que Ud. lo llame URGENTE

ha dejado el siguiente encargo para Ud.

Recibido por _____ Hora _____ Fecha _____



BANDERITAS "PAPER IN" EN BOLSA

Medidas 12x45 mm

100 BANDERITAS



Solapa trasera

Sobre soporte de plástico con solapa para tenerlas siempre a mano



- Autoadhesivas "Quita y Pon". Polipropileno. Cinco colores surtidos.
- Self-adhesive notes. Removable. Polypropylene. Five assorted colours.
- Tiras autoadesivas "tira e põe". Polipropileno. Cinco cores sortidos.
- Segnapagine autoadesivo "Rimuovere e mettere". Polipropilene. Cinque colori assortiti.

CÓDIGO	COLORES	MEDIDAS	ENVASE
001485	5	12 x 45 mm	1 / 24

BANDERITAS "PAPER IN" EN BLISTER

Medidas 12x45 mm

160 BANDERITAS



- Se puede escribir sobre su superficie. Dispensador de 40 banderitas por color. Polipropileno.
- You can write on their surface. Self-Adhesive notes. Dispenser 40 units per colour. Polypropylene.
- Você pode escrever sobre sua área. Dispensador de 40 bandeirinhas adesivas por color. Polipropileno.
- Si può scrivere sulla sua superficie. Dispenser da 40 segnapagine per colore. Polipropilene.

CÓDIGO	COLORES	MEDIDAS	ENVASE
002219	4	12 x 45 mm	1 / 24

BANDERITAS "PAPER IN" INDEX

Medidas 25x45 mm

50 BANDERITAS



- Se puede escribir sobre su superficie. Dispensador de 50 banderitas. Polipropileno.
- You can write on their surface. Self-adhesive notes. Dispenser 50 units. Polypropylene.
- Você pode escrever sobre sua área. Dispensador de 50 bandeirinhas adesivas. Polipropileno.
- Si può scrivere sulla sua superficie. Dispenser da 50 segnapagine per colore. Polipropilene.

CÓDIGO	COLORES	MEDIDAS mm.	ENVASE
001639	Amarillo	25 x 45	1 / 24
001640	Rosa	25 x 45	1 / 24
001641	Azul	25 x 45	1 / 24
001650	Verde	25 x 45	1 / 24
001651	Naranja	25 x 45	1 / 24

ÍNDICES "PAPER IN" RÍGIDOS

Plástico rígido de colores

24 INDEX







- Se puede escribir sobre su superficie. 24 índices (seis por color).
- It can be written on its surface. 24 indexes (6 per colour).
- Se pode escrever na superfície. 24 índices (6 por cor).
- Si può scrivere sulla sua superficie. 24 indici (sei per colore).

CÓDIGO	COLORES	MEDIDAS	ENVASE
002242	4	40 x 44 mm	1 / 10



NOTAS ADHESIVAS "PAPER IN" AMARILLAS

-  Nota autoadhesivas "Quita y Pon" amarillas. Bloco de 100 hojas.
-  Removable yellow self-adhesive notes. 100 sheets pad.
-  Bloco de notas autoadesivas "tira e põe" amarelas. Bloco de 100 folhas.
-  Foglietti autoadesivi gialli. Blocco da 100 fogli.



	CÓDIGO	MEDIDAS	ENVASE
1	001205*	40 x 50 mm	1 / 12
2	001628	50 x 75 mm	1 / 12
3	001206	75 x 75 mm	1 / 12
4	001835	75 x 75 mm (Zig-Zag)	1 / 12
5	001207	75 x 125 mm	1 / 12



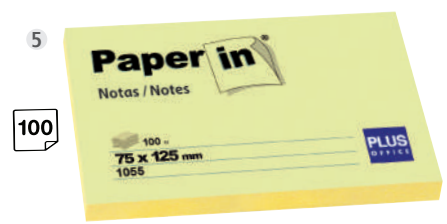

* Pack de 3 blocs

1 3x 100 = 300



NOTAS "PAPER IN" NEON

Medidas 75x75 mm





-  Notas autoadhesivas "Quita y Pon". NEON. Bloco de 80 hojas. 75 x 75 mm.
-  Self-adhesive notes. Removable. NEON. 80 notes. 75 x 75 mm.
-  Bloco de notas autoadesivas NEON "tira e põe" amarelas. Bloco de 80 folhas. 75 x 75 mm.
-  Foglietti autoadesivi NEON. Blocco da 80 fogli. 75 x 75 mm.

	CÓDIGO	COLORES	ENVASE
	001208	 Amarillo	1 / 12
	001209	 Verde	1 / 12
	001210	 Rosa	1 / 12



CUBO "PAPER IN" COLOR PASTEL

Medidas 75x75 mm

-  Autoadhesivas "Quita y Pon". Bloc de 300 hojas. CINCO colores PASTEL o NEÓN.
-  Colours. Self-adhesive notes. Removable. 300 notes. FIVE PASTEL or NEON colours.
-  Bloco de notas. Autoadesivas "Tira e Põe". 300 folhas. CINCO cores PASTEL o NEON.
-  Foglietti autoadesivi. Blocco da 300 fogli. CINQUE colori PASTELLO o NEON.

	CÓDIGO	MEDIDAS	ENVASE
6	001221	75 x 75 mm	1 / 6
7	001629	75 x 75 mm	1 / 6

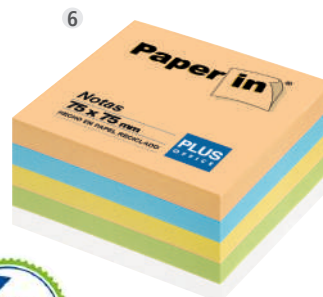

Los códigos en color amarillo permiten apertura de envase

TACO DE NOTAS BLANCAS

500 hojas



- Papel blanco. Hojas encoladas a la cabeza.
- White paper. Sheets glued to the head.
- Papel branco. Folhas coladas na cabeça.
- Carta bianca. Fogli incollati alla testa.

CÓDIGO	ENCOLADO	MEDIDAS	ENVASE
029306	Sí	90 x 90 mm	1 / 10

TACO DE NOTAS COLORES

500 hojas



- 5 colores. Hojas encoladas a la cabeza.
- 5 colors. Sheets glued to the head.
- 5 cores. Folhas coladas na cabeça.
- 5 colori. Fogli incollati alla testa.

CÓDIGO	ENCOLADO	MEDIDAS	ENVASE
001240	Sí	90 x 90 mm	1 / 10

SOBRES DE COLOR C6

Cierre con tira autoadhesiva de silicona

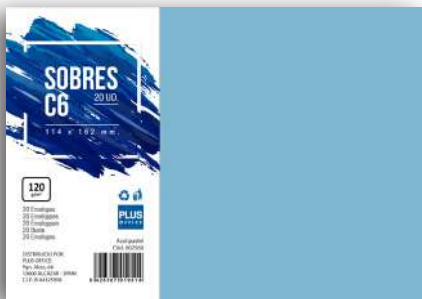

- Papel de 120 g. Imprimibles en impresoras InkJet y láser. Sin ventana. Formato C6.
- 120 g paper. Printable on InkJet and laser printers. No window. Format C6.
- Papel 120 g. Imprimível em impressoras jato de tinta e laser. Sem janela. Formato C6.
- Carta da 120 g. Stampabile su stampanti a getto d'inchiostro e laser. Nessuna finestra. Formato C6.

CÓDIGO	COLOR	MEDIDAS	UD. / PAQ.
002560	Azul pastel	114 x 162 mm.	20
002561	Crema	114 x 162 mm.	20
002562	Verde	114 x 162 mm.	20
002563	Rojo	114 x 162 mm.	20
002564	Naranja	114 x 162 mm.	20
002565	Amarillo pastel	114 x 162 mm.	20
002566	Verde claro	114 x 162 mm.	20
002567	Rosa pastel	114 x 162 mm.	20
002568	Azul	114 x 162 mm.	20

SOBRES DE COLOR DL

Cierre con tira autoadhesiva de silicona







- Papel de 120 g. Imprimibles en impresoras InkJet y láser. Sin ventana. Formato C6.
- 120 g paper. Printable on InkJet and laser printers. No window. Format C6.
- Papel 120 g. Imprimível em impressoras jato de tinta e laser. Sem janela. Formato C6.
- Carta da 120 g. Stampabile su stampanti a getto d'inchiostro e laser. Nessuna finestra. Formato C6.

CÓDIGO	COLOR	MEDIDAS	UD. / PAQ.
002569	Azul pastel	110 x 220 mm.	20
002570	Crema	110 x 220 mm.	20
002571	Verde	110 x 220 mm.	20
002572	Rojo	110 x 220 mm.	20
002573	Naranja	110 x 220 mm.	20
002574	Amarillo pastel	110 x 220 mm.	20
002575	Verde claro	110 x 220 mm.	20
002576	Rosa pastel	110 x 220 mm.	20
002577	Azul	110 x 220 mm.	20

SOBRES + TARJETAS DE COLORES METALIZADOS C6

Cierre con tira de silicona







-  Sobres de 120 g. con tarjeta de 220 g. Imprimibles en impresoras InkJet y láser. Sin ventana. Formato C6.
-  120 g sachets. with 220 g card. Printable on InkJet and laser printers. No window. Format C6.
-  Saquetas de 120 g. com cartão de 220 g. Imprimível em impressoras jato de tinta e laser. Sem janela. Formato C6.
-  Bustine da 120 g. con cartoncino da 220 g. Stampabile su stampanti a getto d'inchiostro e laser. Nessuna finestra. Formato C6.



CÓDIGO	COLOR	MEDIDAS	UD. / PAQ.
003125	Oro	114 x 162 mm.	3
003126	Plata	114 x 162 mm.	3
003127	Rojo	114 x 162 mm.	3
003128	Gris	114 x 162 mm.	3

SOBRES PORTADOCUMENTOS TRANSPARENTES

Para el envío de cualquier documento

-  Sobres autoadhesivos para el envío de documentación en el exterior de las cajas.
-  Self-adhesive envelopes for sending documentation on the outside of the boxes.
-  Envelopes auto-adesivos para o envio de documentos fora das caixas.
-  Buste autoadesive per l'invio di documenti da porre all'esterno delle scatole.



CÓDIGO	MEDIDAS	UD. / CAJA	ENVASE
003373	130 x 120 mm.	1000	1 / 10
001591	162 x 120 mm.	100	1 / 10
001592	228 x 120 mm.	100	1 / 10
003374	228 x 165 mm.	1000	1 / 10
003375	320 x 250 mm.	500	1 / 10



Los códigos en **color amarillo** permiten apertura de envase

ETIQUETAS PARA LIBROS

Autoadhesivas



- Etiquetas para nombrar y marcar libros y cuadernos.
- Labels to name and mark books and notebooks.
- Etiquetas para nomear e marcar livros e cadernos.
- Etichette per nominare e contrassegnare libri e quaderni.



	CÓDIGO	MEDIDAS mm.	HOJAS	BOLSA	ENVASE
1	630150	56 x 36	5	20 ud.	1 / 10
2	630558	28 x 65	7	42 ud.	1 / 10
3	630557	37 x 65	7	28 ud.	1 / 10

ETIQUETAS AUTOADHESIVAS EN HOJAS

Para múltiples usos • 5 hojas



- Blancas, para etiquetaje y oficina. Sobres con cinco hojas de etiquetas con adhesivo permanente.
- White self-adhesive labels for labeling and office. Five sheets of labels with permanent adhesive.
- Etiquetas autoadhesivas brancas de rotulagem e escritório. Envelopes com cinco folhas de etiquetas com adesivo permanente.
- Bianche, per etichettatura e ufficio. Buste con cinque fogli di etichette con adesivo permanente.

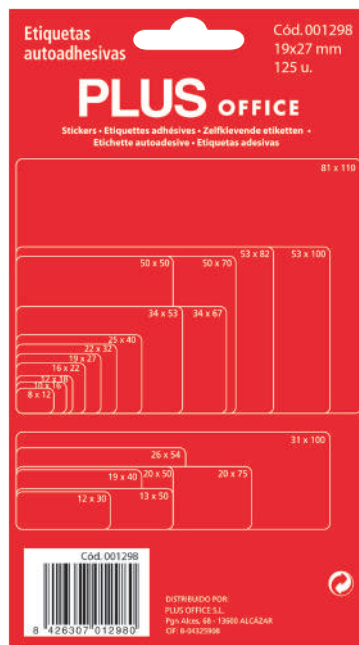
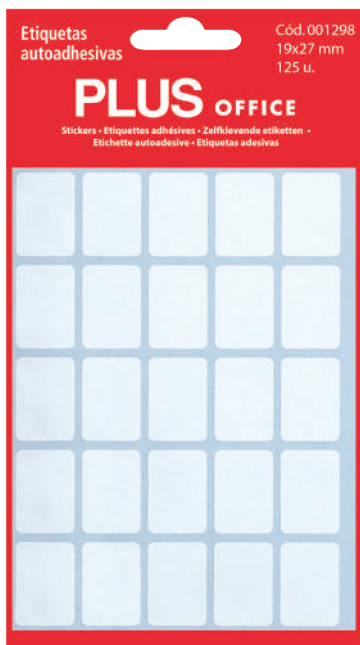

CÓDIGO	MEDIDAS	ETIQUETAS/SOBRE
001291	8 x 12 mm	600
001293	10 x 16 mm	405
001294	12 x 18 mm	280
001295	12 x 30 mm	175
001296	13 x 50 mm	105
001297	16 x 22 mm	210
001298	19 x 27 mm	125
001299	19 x 40 mm	100
001300	20 x 50 mm	75
001301	20 x 75 mm	50
001302	22 x 32 mm	100
001303	25 x 40 mm	80
001304	26 x 54 mm	60
001289	31 x 100 mm	25
001305	34 x 53 mm	45
001306	34 x 67 mm	30
001307	50 x 50 mm	30
001308	50 x 70 mm	20
001309	53 x 82 mm	20
001290	53 x 100 mm	15
001292	81 x 110 mm	10



ETIQUETAS POLIVALENTES

Adhesivo más fuerte



Etiquetas autoadhesivas blancas. Para impresoras de inyección de tinta, láser y fotocopiadoras. Formato de las etiquetas predefinido en la mayoría de los softwares.

White self-adhesive labels. For ink jet and laser printers and copiers. Predefined format tags in most softwares.

Etiquetas autoadesivas brancas. Para impresoras a jacto de tinta, laser e fotocopiadoras. Formato de etiqueta predefinido na maioria dos softwares.

Etichette autoadesive bianche per stampanti a getto d'inchiostro, laser e fotocopiatrici. Formato delle etichette predefinite nella maggior parte dei software.



Cantos redondeados - Caja 100 hojas			
CÓDIGO	MEDIDAS mm	ETIQUETAS / CAJA	ENVASE
001637	99,1 x 38	1400	1 / 10

Cantos rectos - Caja 100 hojas			
CÓDIGO	MEDIDAS mm	ETIQUETAS / CAJA	ENVASE
001635	48,5 x 16,9	6400	1 / 10
001638	52,5 x 21,2	5600	1 / 10
001534	38 x 21,2	6500	1 / 10
002528	48,5 x 25,5	4000	1 / 10
001535	70 x 25	3600	1 / 10
002363	52 x 30	4000	1 / 10
001630	70 x 32	2700	1 / 10
001537	70 x 37	2400	1 / 10
001536	70 x 35	2400	1 / 10
001631	70 x 42	2100	1 / 10
001539	105 x 37	1600	1 / 10
001538	105 x 35	1600	1 / 10
002365	97 x 42,3	1200	1 / 10
001541	105 x 42,3	1400	1 / 10
001540	105 x 41	1400	1 / 10
001663	105 x 48	1200	1 / 10
001632	105 x 57	1000	1 / 10
001633	105 x 74	800	1 / 10
001634	105 x 148	400	1 / 10
001542	210 x 148	200	1 / 10
001543	210 x 297	100	1 / 10

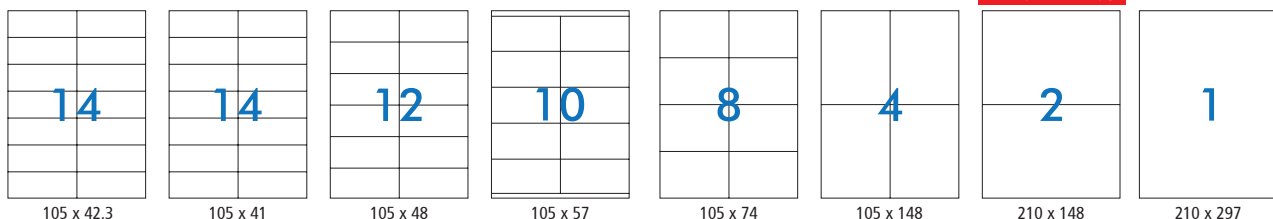
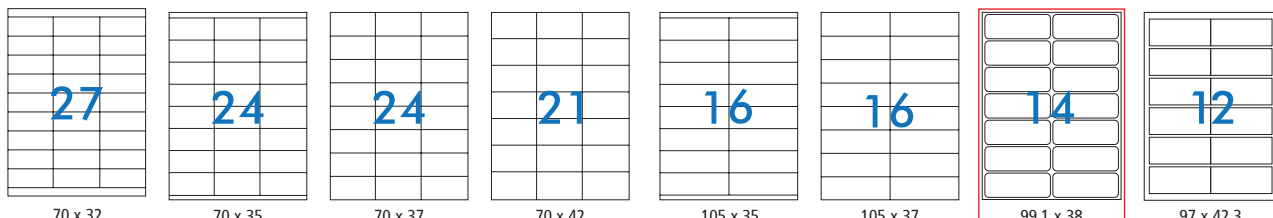
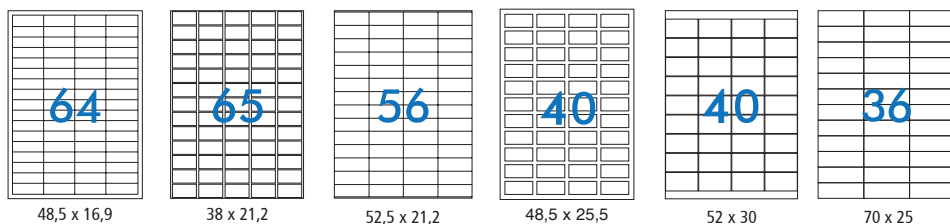



99,1 x 38
CANTOS REDONDEADOS

INKJET PAPER PHOTO QUALITY - 1440 DPI

Para impresiones de alta calidad



 Para InkJet. Recomendado para gráficos, ilustraciones, folletos, etc. Colores resistentes. Gramaje: 100 g. Formato A4.

 For InkJet. Recommended for graphics, illustrations, brochures, etc. Resistant colors. Weight: 100 g. A4 format.

 Para a InkJet. Recomendado para gráficos, ilustrações, brochuras, etc. Cores resistentes. Peso: 100 g. Formato A4.

 Per InkJet. Consigliato per grafica, illustrazioni, brochure, ecc. Colori resistenti. Peso: 100 g. formato A4.

CÓDIGO	RESOLUCIÓN	HOJAS	ENVASE
001569	1440 DPI	100	1 / 10

INKJET PAPER PHOTO QUALITY - 2880 DPI

Para impresiones de alta calidad



 Para InkJet. Recomendado para gráficos, ilustraciones, folletos, etc. Colores resistentes. Gramaje: 100 g. Formato A4.

 For InkJet. Recommended for graphics, illustrations, brochures, etc. Resistant colors. Weight: 100 g. A4 format.

 Para a InkJet. Recomendado para gráficos, ilustrações, brochuras, etc. Cores resistentes. Peso: 100 g. Formato A4.

 Per InkJet. Consigliato per grafica, illustrazioni, brochure, ecc. Colori resistenti. Peso: 100 g. formato A4.

CÓDIGO	RESOLUCIÓN	HOJAS	ENVASE
001648	2880 DPI	100	1 / 20

INKJET PAPER PHOTO QUALITY - 5760 DPI

Para imágenes fotográficas



 Para InkJet. Recomendado para presentaciones, reproducción de fotos e ilustraciones, etc. Gramaje: 180 g. Formato A4. Papel blanco brillante. Alta calidad fotográfica.

 For InkJet. Recommended for presentations, photo and illustration reproduction, etc. Weight: 180 g. A4 format. Bright white paper. High photographic quality.

 Para a InkJet. Recomendado para apresentações, reprodução de fotos e ilustrações, etc. Peso: 180 g. Formato A4. Papel branco brilhante. Alta qualidade fotográfica.

 Per InkJet. Consigliato per presentazioni, riproduzione di foto e illustrazioni, ecc. Peso: 180 g. formato A4. Carta bianca brillante. Alta qualità fotografica.

CÓDIGO	RESOLUCIÓN	HOJAS	ENVASE
001646	5760 DPI	20	1 / 50



INKJET PAPER PHOTO QUALITY - 5760 DPI

Gran calidad - Precio excelente

🇪🇸 Para InkJet. Recomendado para presentaciones, reproducción de fotos e ilustraciones. Gramaje: 230g. Formato A4. Papel blanco brillante. Alta calidad fotográfica.

🇬🇧 For InkJet. Recommended for presentations, photo reproduction and illustrations. Weight: 230g. A4 format. Bright white paper. High photographic quality.

🇵🇹 Para a InkJet. Recomendado para apresentações, reprodução de fotos e ilustrações. Peso: 230g. Formato A4. Papel branco brilhante. Alta qualidade fotográfica.

🇮🇹 Per InkJet. Consigliato per presentazioni, riproduzione di foto e illustrazioni. Peso: 230g. Formato A4. Carta bianca brillante. Alta qualità fotografica.



CÓDIGO	RESOLUCIÓN	HOJAS	ENVASE
001570	5760 DPI	20	1 / 50

INKJET PAPER PHOTO QUALITY - 5760 DPI

Gran calidad - Precio excelente

🇪🇸 Para InkJet. Recomendado para presentaciones, reproducción de fotos e ilustraciones. Gramaje: 250 g. Formato A4. Papel blanco brillante. Alta calidad fotográfica.

🇬🇧 For InkJet. Recommended for presentations, photo reproduction and illustrations. Weight: 250 g. A4 format. Bright white paper. High photographic quality.

🇵🇹 Para a InkJet. Recomendado para apresentações, reprodução de fotos e ilustrações. Peso: 250 g. Formato A4. Papel branco brilhante. Alta qualidade fotográfica.

🇮🇹 Per InkJet. Consigliato per presentazioni, riproduzione di foto e illustrazioni. Peso: 250 g. formato A4. Carta bianca brillante. Alta qualità fotografica.



CÓDIGO	RESOLUCIÓN	HOJAS	ENVASE
002912	5760 DPI	20	1 / 50

FUNDAS PARA PLASTIFICAR

🇪🇸 Aptas para cualquier tipo de plastificado. Grueso de 75 y 125 micras.

🇬🇧 Plastic to cover. Apt for any type of lamination. Thickness 75 and 125 microns.

🇵🇹 Para qualquer tipo de plastificação. Espessura 75 y 125 micras.

🇮🇹 Adatto a qualsiasi tipo di laminazione. Spessore di 75 e 125 micron.

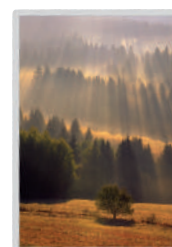

125 micras			
CÓDIGO	FORMATO	MEDIDAS	ENVASE
220198	DNI	92 x 60 mm	100
220199	A7	110 x 80 mm	100
220200	-	130 x 90 mm	100
220535	A6	154 x 111 mm	100
220534	A5	216 x 154 mm	100
220417	A4	303 x 216 mm	100
220197	FOLIO	325 x 220 mm	100
220201	A3	426 x 303 mm	100

75 micras			
CÓDIGO	FORMATO	MEDIDAS	ENVASE
220538	A6	154 x 111 mm	100
220537	A5	216 x 154 mm	100
248576	A4	303 x 216 mm	100
220536	A3	426 x 303 mm	100



Los códigos en **color amarillo** permiten apertura de envase

CUBIERTAS PARA ENCUADERNAR EN PVC

Compatibles con cualquier tipo de encuadernación. 150 micras



- Cubierta de plástico PVC de 150 micras.
- PVC plastic cover of 150 microns.
- Capa de plástico PVC de 150 micras.
- Copertina in plastica PVC 150 micron.

CÓDIGO	FORMATO	COLOR	ENVASE
220139	A3	○ Transparente	100

CÓDIGO	FORMATO	COLOR	ENVASE
220140	A4	○ Transparente	100

CÓDIGO	FORMATO	COLOR	ENVASE
220132	A4	● Azul	100
220136	A4	● Rojo	100
220418	A4	● Humo	100

*Colores traslucidos

CUBIERTAS PARA ENCUADERNAR EN POLIPROPILENO

Compatibles con cualquier tipo de encuadernación.



- Cubierta de polipropileno dos caras, lisa y granulada. En 500 y 800 micras.
- Two-sided smooth and grainy polypropylene cover. In 500 and 800 microns.
- Capa de polipropileno de duas faces, lisa e granulada. Em 500 e 800 micras.
- Copertina in polipropilene nei due lati, liscia e granulata. In 500 e 800 micron.



CÓDIGO	FORMATO	COLOR	MICRAS	ENVASE
220122	A4	○ Transparente	500	100
220123	A4	● Azul opaco	500	100
220124	A4	● Negro opaco	500	100

CÓDIGO	FORMATO	COLOR	MICRAS	ENVASE
220126	A4	○ Transparente	800	50
220447	A4	● Azul opaco	800	50
220127	A4	● Negro opaco	800	50

CUBIERTAS PARA ENCUADERNAR EN CARTULINA

Acabado en piel 230 g. Compatibles con cualquier tipo de encuadernación.



- Cubierta de cartulina acabado piel 230 g.
- 230 g. cardboard cover with leather finish.
- Capa de papelão com acabamento em pele 230 g.
- Coperchio in cartone con finitura in pelle 230 g.







CÓDIGO	FORMATO	COLOR	ENVASE
220618	A4	● Azul	100
220740	A4	● Negro	100



Los códigos en color amarillo permiten apertura de envase

CARTULINA A4 PARA ENCUADERNAR

180g. Compatibles con cualquier tipo de encuadernación.

-  Ideal para encuadernación, trabajos de oficina, dibujo, etc. Colores vivos. 180 g.
-  Ideal for binding, office work, drawing, etc. Vivid colours. 180 g.
-  Ideal para encadernações, trabalhos de escritório, desenho, etc. Cores vivas. 180 g.
-  Ideale per rilegatura, lavori d'ufficio, disegno, ecc. Colori vivaci 180 g.



CÓDIGO	FORMATO	COLOR	ENVASE
220142	A4	○ Blanco	100
220143	A4	● Amarillo canario	100
220144	A4	● Azul celeste	100
220145	A4	● Azul ultramar	100
220147	A4	● Crema	100
220151	A4	● Rojo	100
220152	A4	● Rosa	100
220154	A4	● Verde manzana	100
220155	A4	● Verde pino	100
220419	A4	● Azul maldivas	100
220420	A4	● Lila	100
220422	A4	● Gris claro	100
220424	A4	● Granate	100
220459	A4	● Negro	100
220505	A4	● Naranja	100
220550	A4	● Fucsia	100
220551	A4	● Azul turquesa	100
220552	A4	● Azul marino	100
220553	A4	● Verde billar	100
220554	A4	● Amarillo limón	100
220555	A4	● Cuero	100
220556	A4	● Gris oscuro	100
220557	A4	● Amarillo gualda	100
220558	A4	● Verde selva	100
220559	A4	● Marrón	100
220560	A4	● Violeta	100
220561	A4	● Tomate	100
220572	A4	● Carne	100
220573	A4	● Verde menta	100
220574	A4	● Rosa chicle	100

CÓDIGO	COLOR	ENVASE
220742	10 Surtidos	100



Los códigos en **color amarillo** permiten apertura de envase

NUMERADOR AUTOMATICO

28752 4,5 mm.



- Numerador automático de 6 dígitos y 7 funciones. Metálico.
- Automatic numbering machine. 6 digits and 7 functions. Metallic.
- Numerador automático de 6 algarismos e 7 funções. Metálico.
- Numeratore automatico a 6 cifre e 7 funzioni. Metallico.

CÓDIGO	IMPRESIÓN
040127	4,5 mm.

ALMOHADILLAS METALICAS PARA SELLAR

Para toda la vida

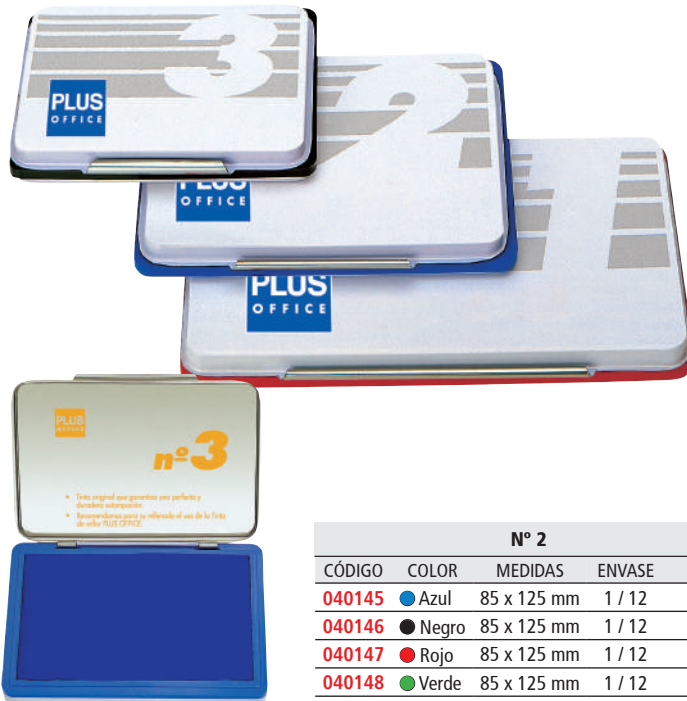

- Almohadilla entintada en caja metálica.
- Stamp pad in metallic box.
- Almofada para carimbos. Caixa metálica.
- Cuscinetti d'inchiostro in scatola metallica.

Nº 1			
CÓDIGO	COLOR	MEDIDAS	ENVASE
040140	Azul	100 x 140 mm	1 / 12
040141	Negro	100 x 140 mm	1 / 12
040142	Rojo	100 x 140 mm	1 / 12
040143	Verde	100 x 140 mm	1 / 12
040144	Violeta	100 x 140 mm	1 / 12

Nº 2			
CÓDIGO	COLOR	MEDIDAS	ENVASE
040145	Azul	85 x 125 mm	1 / 12
040146	Negro	85 x 125 mm	1 / 12
040147	Rojo	85 x 125 mm	1 / 12
040148	Verde	85 x 125 mm	1 / 12
040149	Violeta	85 x 125 mm	1 / 12

Nº 3			
CÓDIGO	COLOR	MEDIDAS	ENVASE
040150	Azul	70 x 105 mm	1 / 12
040151	Negro	70 x 105 mm	1 / 12
040152	Rojo	70 x 105 mm	1 / 12
040153	Verde	70 x 105 mm	1 / 12
040154	Violeta	70 x 105 mm	1 / 12

TINTA PARA ALMOHADILLAS

Tinta de secado rápido



- Sin alcohol. Presentación en frasco de plástico de 30 ml. Producto de alta calidad.
- No alcohol. Presentation in plastic bottle of 30 ml. High quality product.
- Sem álcool. Frascos plásticos de 30 ml. Produto de alta qualidade.
- Senza alcol. Presentazione in bottiglia di plastica da 30 ml. Prodotto di alta qualità

CÓDIGO	COLOR	ENVASE
040158	Azul	1 / 12
040159	Negro	1 / 12
040160	Rojo	1 / 12
040161	Verde	1 / 12
040162	Violeta	1 / 12



Los códigos en **color amarillo** permiten apertura de envase



SELLO CAMUFLAJE AUTOENTINTADO IS-250CM - GRANDE

Se puede sellar hasta 1000 veces con una cobertura perfecta

Punto 1

Protección para tu identidad personal

Dibujo del sello diseñado específicamente
El dibujo está diseñado especialmente para cubrir caracteres góticos y sans-serif, los cuales son los más comunes en el correo.

Punto 2

Tinta permanente
Tinta permanente especial para cubrir.
Resistente al agua y a los productos químicos.
Secado rápido.
*Tinta sólo disponible en color negro.

Punto 3

Tipo de tinta propia
No se requiere almohadilla de tinta por separado.



Tamaño real de superficie del estampado 70x24mm

CÓDIGO	COLOR	ENVASE
040517	○ Blanco	1 / 5
040518	● Verde	1 / 5



SELLO CAMUFLAJE AUTOENTINTADO IS-200CM - PEQUEÑO

Se puede sellar hasta 1000 veces con una cobertura perfecta



Tamaño real de superficie del estampado 38 x 13 mm.



CÓDIGO	COLOR	ENVASE
040516	○ Blanco	1 / 5
040514	● Verde	1 / 5
040515	● Rosa	1 / 5



Los códigos en color amarillo permiten apertura de envase

TIJERAS DE BOLSILLO FITCUT CURVE TWIGGY

Corta papel, plástico, hilo, lana, etc.

Punto 1

Diseño de cuchilla curva-Bernoulli

El óptimo ángulo de hoja a hoja se mantiene gracias a sus cuchillas especialmente curvadas, para un corte suave y sin esfuerzo desde la base hasta la punta de la cuchilla.

Punto 2

Cuchilla larga

Largura óptima de las cuchillas para cortar objetos alargados como sobres y paquetes pequeños.



Corte preciso con una mano

El mango más corto está especialmente diseñado para cortar con una sola mano de forma precisa y sin esfuerzo.



Punto 3

Sistema de bloqueo fácil

Quite la tapa y deslice el pulgar hacia arriba del mango para desbloquear y se abrirán las cuchillas. Para volver a bloquearlas apriete el mango con el pulgar y deslicelo hacia abajo. Incluso al poner la tapa las cuchillas se bloquean automáticamente.



CÓDIGO	COLOR	ENVASE
040707	Blanco	Blíster 1ud. / 6



CÓDIGO	COLOR	ENVASE
040765	Azul claro	Blíster 1ud. / 6



Punto 4

Tamaño compacto

Gracias a su pequeño tamaño es fácil de transportar en un portatodos, neceser, bolso,... para usarlo siempre que sea necesario.



Punto 5

Orificio para la correa

Dispone de un pequeño orificio en el que puede enganchar una correa con accesorios.



CARACTERÍSTICAS

← LARGO TUJERA 135 m.

← LARGO CUCHILLA 42 m.

ENVASE 6 BLÍSTER

Material : Plástico ABS
Cuchilla: Acero inoxidable
Dimensiones : 135 x 12 mm.



CÓDIGO	COLOR	ENVASE
040708	Rosa	Blíster 1ud. / 6



CÓDIGO	COLOR	ENVASE
040766	Salmón	Blíster 1ud. / 6







CÓDIGO	COLOR	ENVASE
040709	Azul/Negro	Blíster 1ud. / 6



CÓDIGO	COLOR	ENVASE
040767	Verde	Blíster 1ud. / 6



TIJERAS CURVE ACERO

-  Tijeras de acero inoxidable de alto contenido en carbono. Cuchilla en curva. Corte sin esfuerzo. Empuñadura de plástico reciclado y goma en el interior. Anillo central de giro duradero.
-  High carbon stainless steel scissors. Curved blade. Effortless cutting. Recycled plastic and rubber grip inside. Durable turning center ring.
-  Tesoura de aço inoxidável de alto carbono. Lâmina curva. Corte sem esforço. Plástico reciclado e alça de borracha no interior. Anel central de giro durável.
-  Forbici in acciaio inossidabile ad alto tenore di carbonio. Lama curva. Taglio senza sforzo. Plastica riciclata e impugnatura in gomma all'interno. Anello centrale girevole durevole.

CÓDIGO	LONGITUD	MANGO/CUCHILLA	ENVASE
040579	174 mm	Verde/Acero	1 / 10
040674	215 mm	Verde/Acero	1 / 12



TIJERAS CURVE TEFLON

-  Tijeras de acero inoxidable de alto contenido en carbono y recubierta de teflón. Diseño de cuchilla en curva. Corte sin esfuerzo. Empuñadura de plástico reciclado. Anillo central de giro duradero.
-  Stainless steel scissors with a high carbon content and coated with Teflon. Curve blade design. Effortless cutting. Recycled plastic handle. Durable turning center ring.
-  Tesoura de aço inoxidável de alto conteúdo em carbono e recuberta de teflon. Desenho de lâmina em curva. Corte sem esforço. Punho de plástico reciclado. Anel central de giro durável.
-  Forbici in acciaio inossidabile ad alto contenuto di carbonio e rivestite in Teflon. Design della lama curva. Taglia senza fatica. Manico in plastica riciclata. Anello centrale girevole durevole.

CÓDIGO	LONGITUD	MANGO/CUCHILLA	ENVASE
040677	174 mm	Gris/Negro	1 / 12
040678	215 mm	Gris/Negro	1 / 12



TIJERAS CURVE TITANIO

-  Tijeras de acero inoxidable de alto contenido en carbono y recubiertas de titanio de alta duración. Diseño de cuchilla en curva. Suavidad. Corte sin esfuerzo. Empuñadura de plástico reciclado. Resiste el óxido y las manchas. Anillo central de giro duradero.
-  Stainless steel scissors with high carbon content and high titanium coated. Curve blade design. Effortless cutting. Recycled plastic handle. It resists rust and stains. Durable turning center ring.
-  Tesoura de aço inoxidável de alto conteúdo de carbono e recoberta de titânio de alta duração. Desenho de lâmina em curva. Corte sem esforço. Punho de plástico reciclado. Resiste ao óxido e às manchas. Anel central de giro durável.
-  Forbici in acciaio inossidabile ad alto contenuto di carbonio e rivestimento in carbonio e titanio ad alta durabilità. Design della lama curva. Taglia senza fatica. Manico in plastica riciclata. Resiste alla ruggine e alle macchie. Anello centrale girevole durevole.

CÓDIGO	LONGITUD	MANGO/CUCHILLA	ENVASE
040675	174 mm	Marrón/Marrón	1 / 12
040676	215 mm	Marrón/Marrón	1 / 12



Resiste el óxido y las manchas, siendo la tijera ideal para la cocina, el baño o cualquier lugar donde se use el agua.



TIJERAS STANDARD

Imprescindible



🇪🇸 Tijeras de acero inoxidable endurecido. Empuñadura ergonómica recubierta en plástico ABS. Fijación por tornillo. Pueden ser utilizadas con ambas manos. Punta roma. Presentación en blíster. Color azul/acero.

🇬🇧 Scissors made of hardened stainless steel. Ergonomic handle covered in ABS plastic. Fixed by screw. They can be used with both hands. Blunt point. Presentation in blister. Blue/steel colour.

🇵🇹 Tesouras de aço inoxidável endurecido. Punho ergonómico recoberto em plástico ABS. Fixado por parafuso. Podem ser utilizadas com ambas as mãos. Ponta redonda. Apresentação em blister. Cor azul / aço.

🇮🇹 Impugnatura ergonomica rivestita in plastica ABS. Fissaggio a vite. Possono essere usate con entrambe le mani. Punta smussata. Presentazione in blister. Colore blu / acciaio.

CÓDIGO	LONGITUD	ENVASE
040277	135 mm	1 / 12
040048	180 mm	1 / 12
040049	210 mm	1 / 12

TIJERAS PLUS LUXE "INOX"

Diseñadas para el confort



🇪🇸 Tijeras de acero inoxidable endurecido. Empuñadura ergonómica recubierta en plástico ABS. Fijación por tornillo. Pueden ser utilizadas con ambas manos. Punta roma. Presentación en blíster. Color azul/acero.

🇬🇧 Scissors made of hardened stainless steel. Ergonomic handle covered in ABS plastic. Fixed by screw. They can be used with both hands. Blunt point. Presentation in blister. Blue/steel colour.

🇵🇹 Tesouras de aço inoxidável endurecido. Punho ergonómico recoberto em plástico ABS. Fixado por parafuso. Podem ser utilizadas com ambas as mãos. Ponta redonda. Apresentação em blister. Cor azul / aço.

🇮🇹 Impugnatura ergonomica rivestita in plastica ABS. Fissaggio a vite. Possono essere usate con entrambe le mani. Punta smussata. Presentazione in blister. Colore blu / acciaio.

CÓDIGO	LONGITUD	ENVASE
040284	140 mm	1 / 12
040353	180 mm	1 / 12
040354	215 mm	1 / 12
040355	250 mm	1 / 12







TIJERAS PLUS I+D

-  Tijeras de acero inoxidable endurecido. Empuñadura ergonómica recubierta en plástico ABS. Fijación por tornillo. Pueden ser utilizadas con ambas manos. Punta roma. Presentación en blíster.
-  Scissors made of hardened stainless steel. Ergonomic handle covered in ABS plastic. Fixed by screw. They can be used with both hands. Blunt point. Presentation in blister.
-  Tesoura de aço inoxidável endurecido. Punho ergonómico recoberta de plástico ABS. Fixado por parafuso. Podem ser utilizadas com ambas as mãos. Ponta redonda. Apresentação em blister.
-  Impugnatura ergonomica rivestita in plastica ABS; fissaggio a vite. Possono essere usate con entrambe le mani. Punta smussata, presentazione in blister.



CÓDIGO	LONGITUD	MANGO/CUCHILLA	ENVASE
040506	170 mm	Azul/Acero	1 / 12

TIJERAS CAMPUS





-  Tijeras de acero inoxidable endurecido. Empuñadura recubierta en plástico ABS. Fijación por tornillo. Punta roma. Presentación en blíster.
-  Scissors made of hardened stainless steel. Ergonomic handle covered in ABS plastic. Fixed by screw. Blunt point. Blister presentation.
-  Tesoura de aço inoxidável endurecido. Punho ergonómico recoberto em plástico ABS. Fixado por parafuso. Ponta redonda. Apresentação em blister.
-  Forbici in acciaio inossidabile temprato. Impugnatura ergonomica rivestita in plastica ABS. Fissate con vite. Punta smussata; presentazione in blister.



CÓDIGO	LONGITUD	MANGO/CUCHILLA	ENVASE
040508	165 mm	Azul/Acero	1 / 12
040509	205 mm	Azul/Acero	1 / 12

PLANCHA DE CORTE

Cada cara de un color

-  Superficie muy resistente perfecta para manualidades y trabajos de corte. Superficie impresa.
-  Very resistant surface perfect for crafts and cutting jobs. Printed area.
-  Superficie muito resistente, perfeita para trabalhos manuais e trabalhos de corte. Superficie impressa.
-  Superficie molto resistente perfetta per lavori artigianali e di taglio. Superficie stampata.

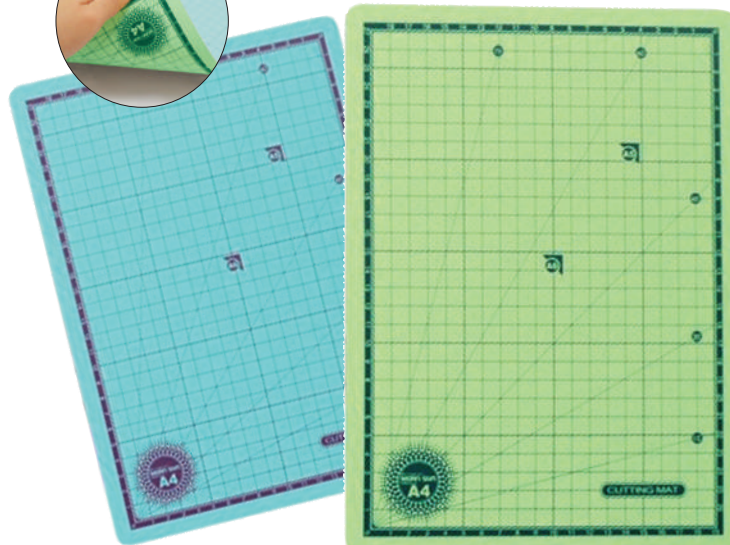
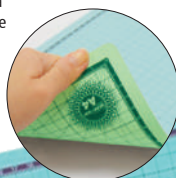
Doble cara
Azul / Verde

CÓDIGO	MEDIDAS	ENVASE
220564	A3. 297 x 420 mm	1 / 20
220563	A2. 450 x 600 mm	1 / 20

Los códigos en **color amarillo** permiten apertura de envase

CUTTER METÁLICO 135 M



RECAMBIO CUCHILLA Blíster 10 ud.

CÓDIGO	LONGITUD	ANCHO	ENVASE
040057	80 mm	9 mm	5



- Cuerpo metálico. Alta precisión. Cuchilla acero frakturable. Sistema de bloqueo de cuchilla. Retráctil.
- Metal body. High precision cutting. Fracturable steel blade. Blade locking system. Retractable.
- Corpo em metal. Alta precisão. Lamina de aço fraturável. Sistema de bloqueio da lamina. Retráctil.
- Corpo in metallo; elevata precisione. Lama d'acciaio frakturabile. sistema di bloccaggio della lama. Retrattile.

CÓDIGO	LONGITUD	ANCHO	ENVASE
040377	130 mm	9 mm	6

CUTTER 90



RECAMBIO CUCHILLA Blíster 10 ud.

CÓDIGO	LONGITUD	ANCHO	ENVASE
040057	80 mm	9 mm	5



- Cuerpo metálico. Alta precisión. Cuchilla de acero frakturable. Sistema de bloqueo de cuchilla. Retráctil.
- Metal body. High precision of cutting. Fracturable steel blade. Blade locking system. Retractable.
- Corpo em metal. Alta precisão. Lamina de aço fraturável. Sistema de bloqueio da lamina. Retráctil.
- Corpo in metallo; elevata precisione. Lama d'acciaio frakturabile. Sistema di bloccaggio della lama. Retrattile.

CÓDIGO	LONGITUD	ANCHO	ENVASE
040052	135 mm	9 mm	1 / 6

CUTTER PROFESIONAL 110



RECAMBIO CUCHILLA Blíster 10 ud.

CÓDIGO	LONGITUD	ANCHO	ENVASE
040057	80 mm	9 mm	5



- Cuerpo en plástico ABS. Alta precisión. Cuchilla acero frakturable. Sistema de bloqueo de cuchilla. Retráctil.
- ABS plastic body. High precision of cutting. Fracturable steel blade. Blade locking system. Retractable.
- Corpo em plástico ABS. Alta precisão. Lamina de aço fraturável. Sistema de bloqueio da lamina. Retráctil.
- Corpo in plastica ABS. Elevata precisione. Lama d'acciaio frakturabile. Sistema di bloccaggio della lama. Retrattile.

CÓDIGO	LONGITUD	ANCHO	ENVASE
040433	135 mm	9 mm	1 / 6

CUTTER 130



RECAMBIO CUCHILLA Blíster 10 ud.

CÓDIGO	LONGITUD	ANCHO	ENVASE
040058	100 mm	18 mm	1/5



- Cuerpo metálico. Alta precisión. Cuchilla de acero. Sistema de bloqueo de cuchilla. Retráctil.
- Metal body. High precision of cutting. Steel blade. System of blade blockade. Retractable.
- Corpo em metal. Alta precisão. Lamina de aço fracionadas. Sistema de bloqueio da lamina. Retráctil.
- Corpo in metallo; elevata precisione. Lama d'acciaio; sistema di bloccaggio della lama. Retrattile.

CÓDIGO	LONGITUD	ANCHO	ENVASE
040053	170 mm	18 mm	1 / 3

CUTTER PROFESIONAL 170

Ideal para almacenes



RECAMBIO CUCHILLA Blíster 10 ud.

CÓDIGO	LONGITUD	ANCHO	ENVASE
040058	100 mm	18 mm	1/5



- Plástico ABS. Cuchilla de acero alta precisión. Bloqueo de cuchilla. 2 cuchillas de repuesto. En blíster.
- ABS plastic. Steel blade high accuracy. Blade locking system. 2 replacement blades. In blister.
- Plástico ABS. Lamina de aço fracionadas alta precisão. 2 lâminas de substituição. Em blister.
- Plastica ABS. Lama d'acciaio alta precisione. Bloccaggio della lama. 2 lame di ricambio. In blister.

CÓDIGO	LONGITUD	ANCHO	ENVASE
040432	170 mm	18 mm	3



CUTTER 145

- Metálico. Alta precisión de corte. Cuchilla de acero fraturable. Presentación en blíster.
- Metal body. High precision cutting. Fractureable steel blade. Blister presentation.
- Metal. Alta precisão de corte. Lamina de aço fraturável. Apresentação em blister.
- Metallo. Elevata precisione di taglio. Lama d'acciaio fraturabile. Presentazione in blister.



RECAMBIO CUCHILLA Blíster 10 ud.

CÓDIGO	LONGITUD	ANCHO	ENVASE
040057	80 mm	9 mm	5



CÓDIGO	LONGITUD	ANCHO	ENVASE
040533	135 mm	9 mm	6

CUTTER CABEZA GIRATORIA 80M

Intercambiable

- Metálico. Cuchilla de acero. 2 cuchillas de recambio. Presentación en blister. Alta precisión.
- Metal body. Steel blade. 2 blades refill. Blister presentation. High accuracy.
- Metal. Lamina de aço. 2 lâminas de reposição. Apresentação em blister. Alta precisão.
- Metallo. Lama d'acciaio. 2 lame di ricambio. Presentazione in blister. Alta precisione.



CÓDIGO	LONGITUD	ANCHO	ENVASE
040056	145 mm	9 mm	3

CUTTER PROFESIONAL REDONDO 190

Versátil, práctico y retractable

- Cuchillas de acero. Mango ergonómico. Plástico ABS. Retráctil.
- Steel blades. Ergonomic handle. ABS plastic. Retractable.
- Lâminas de aço. Pega ergonômica. Plástico ABS. Retráttil.
- Lame d'acciaio. Manico ergonomico in plastica ABS, retrattile.



CÓDIGO	LONGITUD	ANCHO	ENVASE
040534	170 mm	45 mm	1 / 12

CUCHILLAS DE CUTTERS

Acero inoxidable

- Cuchillas de acero. 10 cuchillas por caja.
- Steel blade for cutter knife. 10 blade per box.
- Recargas de laminas em aço. 10 lâminas por caixa
- Lame d'acciaio, 10 lame per scatola.



	CÓDIGO	LONGITUD	ANCHO	ENVASE
1	040057	80 mm	9 mm	10 tubos
2	040058	100 mm	18 mm	10 tubos



Los códigos en color amarillo permiten apertura de envase

AFILALÁPICES METÁLICOS PREMIUM

SUPER CUCHILLA



- Metálico. Cuchilla de acero. Cortado con láser. Colores: rojo, violeta, azul y verde.
- Sharpener. Metallic with steel blade. Laser Cut. Colour: red, violet, blue and green.
- Apáralápis metálico. Lâmina de aço. Cortado com laser. Cores: vermelho, violeta, azul y verde.
- In metallo. Lama d'acciaio, tagliata con il laser. Colori: rosso, viola, blu e verde.

	CÓDIGO	MODELO	ENVASE
1	081181	Cuña	Caja 16 ud.
2	081183	Doble	Caja 12 ud.
3	081185	Twist	Caja 24 ud.
4	081182	Cuña	Blíster 2 ud./ 18
5	081184	Doble	Blíster 1 ud./ 18

AFILALÁPICES METÁLICOS

Cuchilla japonesa de alta calidad y larga duración



- Metálico. Cuchilla de acero. Cortados con láser.
- Sharpener. Metallic with steel blade. Laser cut.
- Apára - lápis metálico. Lâmina de aço. Corte à laser.
- Metallico, lama d'acciaio. Taglio laser.

	CÓDIGO	MODELO	ENVASE
1	080060	Rectangular	Caja 20 ud.
2	080061	Cuña	Caja 20 ud.
3	080062	Doble	Caja 20 ud.

AFILALÁPIZ ELÉCTRICO

Afilalápiz eléctrico a la red



Piloto encendido
Mayor seguridad

- Afilalápiz eléctrico. Depósito de residuos extraíble. Protección contra el sobrecalentamiento. Almohadilla antideslizante.
- Electric sharpener. Waste drawer. Protection against overheating. Non-slip pad.
- Apára lápis eletrico. Depósito de resíduos, fácil de tirar. Proteção contra sobreaquecimento. Almofada antiderrapante.
- Temperamatite elettrico. Deposito per rifiuti extraibile. Protezione contro il surriscaldamento. Pad antiscivolo.

	CÓDIGO	MEDIDAS	ENVASE
	080776	130 x 105 x 120 mm	12

AFILALÁPIZ 307A

Manual







- Mecanismo metálico. Plástico ABS. Con depósito. Para afilar lápices de hasta 8 mm. de diámetro. Medidas: 70 x 70 x 130 mm. Con soporte para fijarlo.
- Sharpener. Metallic mechanism. ABS plastic. With deposit. To sharp pencils until 8 mm. of diameter. Size: 70 x 70 x 130 mm. With support to fix it.
- Apára - lápis de mesa. Mecanismo metálico. Plástico ABS. Com depósito. Para afiar os lápis até 8 mm. diâmetro. Tamanho: 70 x 70 x 130 mm. Com suporte para consertar.
- Meccanismo metallico. Plastica ABS; con deposito. Per temperare matite fino a 8 mm. di diametro. Misure: 70 x 70 x 130 mm. Con il supporto per risolverlo.

	CÓDIGO	COLOR	ENVASE
	080064	● Azul	1 / 6
	081169	● Rojo	1 / 6
	081170	● Verde	1 / 6



AFILALÁPICES CON DEPÓSITO

De colores

-  Afilalápices con depósito. Cuchilla de acero.
-  Pencil sharpener. Steel blade.
-  Afiador de lápis com reservatório. Lâmina de aço.
-  Temperamatite con serbatoio. Lama in acciaio.





CON DEPÓSITO



CÓDIGO	COLOR	ENVASE
081366	   	Exp. 24 ud.

AFILALÁPICES CON DEPÓSITO

Expositor de 24 unidades





-  Afilalápices con depósito. Cuchilla de acero.
-  Pencil sharpener. Steel blade.
-  Afiador de lápis com reservatório. Lâmina de aço.
-  Temperamatite con serbatoio. Lama in acciaio.

CON DEPÓSITO







CÓDIGO	COLOR	ENVASE
081367	   	Exp. 24 ud.

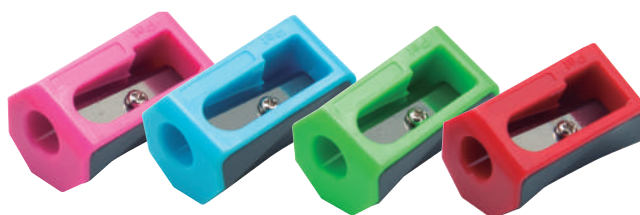



AFILALÁPIZ TWISTER

-  Forma hexagonal. Cuchilla de acero cortada por láser.
-  Hexagonal shape. Laser cut steel blade.
-  Forma hexagonal. Lâmina de aço cortada a laser.
-  Forma esagonale. Lama in acciaio tagliata al laser.



CÓDIGO	COLOR	ENVASE
081368	   	Bote 100 ud.

AFILALÁPICES DOBLE CON DEPÓSITO

-  Afilalápices con depósito. Cuchilla de acero.
-  Pencil sharpener. Steel blade.
-  Afiador de lápis com reservatório. Lâmina de aço.
-  Temperamatite con serbatoio. Lama in acciaio.

CON DEPÓSITO



CÓDIGO	COLOR	ENVASE
081369	   	Exp. 24 ud.

Los códigos en **color amarillo** permiten apertura de envase

DEDILES

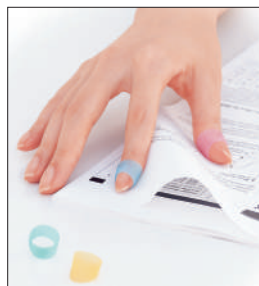

PLUS
JAPAN

Dediles que facilitan la manipulación de hojas de papel. Tres tallas. Colores surtidos: rosa, azul y blanco. Bolsas de 5 unidades. Envase 10 bolsas.

CÓDIGO	TALLA
002342	2 ud. S (Ø 12,0 mm y 3 ud. M (Ø 14,5 mm)
002340	5 ud. M (Ø 14,5 mm)
002341	2 ud. S (Ø 12,0 mm y 3 ud. L (Ø 16,5 mm)

FASTENER

De plástico y Metálico



- Fastener de plástico o metálico. Con compresor.
- Plastic or metallic fastener. With compressor.
- Fastener em plástico o metálicas. Com compressor.
- Fastener in plastica o metallo. Con compressore.

CÓDIGO	MATERIAL	ENVASE
180295	Plástico	Caja 50 ud.
180296	Metálico	Caja 50 ud.

CHINCHETAS



- Chinchetas cromadas. Cabezal de 10 mm.
- Chromed pushpin. Head of 10 mm.
- Pioneses cromados. Cabeça de 10 mm.
- Puntine da disegno cromato. 10 mm di testa.

CÓDIGO	CAJA	ENVASE
040343	50 ud.	12
040191	100 ud.	12

AGUJAS SEÑALIZADORAS COLORES



- Señalizadores de metal con cabeza de plástico.
- Push pin. Metallic with head of plastic.
- Alfinetes de sinalização em metal e cabeça plástica.
- Puntine in metallo con testa di plastica.

CÓDIGO	COLOR	CAJA	ENVASE
040192	● Azul	35 ud.	1 / 12
040193	● Negro	35 ud.	1 / 12
040194	● Rojo	35 ud.	1 / 12
040195	● Verde	35 ud.	1 / 12
040196	○ Blanco	35 ud.	1 / 12
040198	○ Transp.	35 ud.	1 / 12
040199	●●●●●	35 ud.	12

PORTACLIPS 340

80 (an) x 40 (alt) x
85 (prof) mm.







- Portaclips de plástico ABS, con rodillo imantado. Alta calidad. Incorpora 20 clips.
- Clip dispenser of ABS plastic. Magnetized roller. High quality. Incorporates 20 clips.
- Portaclips em plástico ABS, com cilindro magnético. Alta qualidade. Incorpora 20 cliques.
- Clip in plastica ABS, con rullo magnetizzato. Alta qualità, include 20 clip.

CÓDIGO	COLOR	ENVASE
040173	● Negro	1 / 24
040680	● Gris	1 / 24



Abertura imantada





PORTACLIPS 330

-  Portaclips magnético. Contenedor transparente.
-  Magnetic clip dispenser. Transparent.
-  Portaclips magnético. Depósito transparente.
-  Porta greffette magnético; contenitore trasparente.



49 (an) x 60 (alt) x
49 (prof) mm.





CÓDIGO	COLOR	ENVASE
040172	● Azul	1 / 10

-  Inoxidables. De zinc. Cajitas 100 unidades.
-  Clips. Stainless. Carfted in zinc. Boxes of 100 units.
-  Clips labiados. Inoxidáveis. Feito de zinco. Caixa de 100 unid.
-  Inossidabili, di zinco, scatole da 100 unità.

CLIPS ZINC LABIADOS







CÓDIGO	Nº	CALIBRE	ENVASE
040749	Nº 2 - 32 mm	0,80	1 / 24

-  Inoxidables. Acero niquelado. Cajitas 100 unidades.
-  Clips. Stainless. Plated nickel steel. Boxes of 100 units.
-  Clips labiados. Aço niquelado inoxidável. Caixa de 100 unid.
-  Inossidabili, acciaio nichelato, scatole da 100 unità.

CLIPS NIQUELADOS LABIADOS







CÓDIGO	Nº	CALIBRE	ENVASE
040164	Nº 1.5 - 28 mm	0,93	24
040165	Nº 2 - 32 mm	0,93	24
040166	Nº 3 - 43 mm	1,15	12
040167	Nº 4 - 50 mm	1,15	10

-  Metálicos. Forrados en plástico.
-  Colour clips. Metallics. Covered by plastic.
-  Clips de cores metálicos, forrados a plástico.
-  Graffette metalliche, rivestite in plastica.

CLIPS DE COLORES



CÓDIGO	LONGITUD	CAJA	ENVASE
040170	28 mm	100 ud.	12
040171	50 mm	30 ud.	12

-  Clips mariposa inoxidables. Acero niquelado.
-  Clips clamps. Stainless. Plated nickel steel.
-  Clips Mariposa em aço niquelado inoxidável.
-  Morsetti a farfalla inossidabili. Acciaio nichelato.

CLIPS MARIPOSA

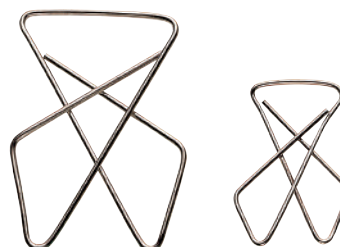

CÓDIGO	LONGITUD	CAJA	ENVASE
040168	41 mm	50 ud.	10
040169	62 mm	12 ud.	10



Los códigos en **color amarillo** permiten apertura de envase

SEÑALIZADORES MAGNÉTICOS



- Blister de 5 señalizadores imantados.
- Colour magnet. 5 units blister.
- Sinalizadores magnéticos em blister com 5 ud.
- Blister di 5 puntine magnetiche.

CÓDIGO	DIÁMETRO	ENVASE
040200	30 mm	Blíster 5 ud.

PINZA SUJETAPAPELES REVERSIBLE DORADAS



- Tipo foldback. Acero de gran calidad. Color oro.
- Double clip. Foldback type. High quality steel. Colour: gold.
- Molas reversíveis tipo foldback. Aço de grande qualidade. Cor: ouro.
- Tipo foldback, acciaio di alta qualità. Colore oro.

CÓDIGO	MEDIDAS	ANCHO	ENVASE
040629	42 x 25 mm	10 mm	12
040630	52 x 32 mm	14 mm	12

PINZA SUJETAPAPELES REVERSIBLE



- Tipo foldback. Acero de gran calidad. Color negro.
- Double clip. Foldback type. High quality steel. Colour: black.
- Molas reversíveis tipo foldback. Aço de grande qualidade. Cor: preto.
- Tipo foldback, acciaio di alta qualità. Colore nero.

*Envase 12 udes.

CÓDIGO	MEDIDAS mm.	ANCHO
040179	Nº 20: 20 x 9	8 mm
040180	Nº 25: 25 x 11,2	10 mm
040181	Nº 30: 30 x 15,5	14,5 mm
040182	Nº 40: 40 x 22	21 mm
040183	Nº 50: 50 x 30	29 mm

MINI PINZAS DE MADERA



- Fabricadas en madera. Colores surtidos.
- Mini wood pegs. Assorted colours.
- Mini pinças de madeira. Cores sortidos.
- Pinze fabbricate in legno, colori assortiti.

CÓDIGO	MEDIDAS	CAJA	ENVASE
630685	30 x 4 mm	50 ud.	12
630686	35 x 8 mm	25 ud.	12

BOLA DE GOMAS ELASTICAS



- Bola de anillos de goma 105 g. Colores surtidos. Diámetro de la bola 6 cm.
- Rubber ring ball 105 g. Assorted colours. Diameter of the ball 6 cm.
- Bola de elásticos 105 g. Cores sortidas. Diámetro da bola 6 cm.
- Sfera di anelli di gomma 105 g. Colori assortiti. Diametro della palla 6 cm.

CÓDIGO	ESPESOR	LONGITUD	ENVASE
040587	3 mm	60 mm	5



- Caucho natural. La dimensión indicada corresponde a la longitud del anillo sin estar estirado.
- Natural rubber. The suitable dimension corresponds to the longitude of the ring without being stretched.
- Elásticos em borracha natural. A medida corresponde ao comprimento do elástico não esticado.
- Caucciú naturale. La dimensione indicata corrisponde alla lunghezza dell'anello senza essere allungata.

BANDAS ELÁSTICAS

Ancho de la goma 10 mm. Muy resistentes a la rotura.



Caja 100 g.			
CÓDIGO	LONGITUD	ANCHO	ENVASE
040820	70 mm	5 mm	1 / 200
040809	100 mm	10 mm	1 / 200
040604	120 mm	10 mm	1 / 200
040605	150 mm	10 mm	1 / 200
040606	180 mm	10 mm	1 / 200
040821	180 mm	15 mm	1 / 200

Bolsa 1 kg.			
CÓDIGO	LONGITUD	ANCHO	ENVASE
040822	70 mm	5 mm	1 / 20
040810	100 mm	10 mm	1 / 20
040811	120 mm	10 mm	1 / 20
040812	150 mm	10 mm	1 / 20
040823	180 mm	10 mm	1 / 20
040813	180 mm	15 mm	1 / 20

- Caucho natural. La dimensión indicada corresponde a la longitud del anillo sin estar estirado.
- Natural rubber. The suitable dimension corresponds to the longitude of the ring without being stretched.
- Elásticos em borracha natural. A medida corresponde ao comprimento do elástico não esticado.
- Caucciú naturale. La dimensione indicata corrisponde alla lunghezza dell'anello senza essere allungata.

GOMAS ELÁSTICAS

Gran elasticidad y resistencia.



Caja 100 g.			
CÓDIGO	LONGITUD	MODELO	ENVASE
040207	40 mm	Nº 4	1 / 200
040208	60 mm	Nº 6	1 / 200
040209	80 mm	Nº 8	1 / 200
040210	100 mm	Nº 10	1 / 200
040211	120 mm	Nº 12	1 / 200
040212	140 mm	Nº 14	1 / 200
040759	160 mm	Nº 16	1 / 200
040760	180 mm	Nº 18	1 / 200
040761	200 mm	Nº 20	1 / 200

Bolsa 1 kg.			
CÓDIGO	LONGITUD	MODELO	ENVASE
040213	40 mm	Nº 4	1 / 20
040214	60 mm	Nº 6	1 / 20
040215	80 mm	Nº 8	1 / 20
040216	100 mm	Nº 10	1 / 20
040217	120 mm	Nº 12	1 / 20
040218	140 mm	Nº 14	1 / 20
040762	160 mm	Nº 16	1 / 20
040763	180 mm	Nº 18	1 / 20
040764	200 mm	Nº 20	1 / 20

- De 4 dígitos. Con palanca de reinicio de conteo. Cuenta de 0 a 9.999.
- 4 digits. With counting reset lever. Counts from 0 to 9,999.
- 4 dígitos. Com alavanca de reset de contagem. Conta de 0 a 9.999.
- 4 cifre. Con leva di reset del conteggio. Conta da 0 a 9.999.

CONTADOR MANUAL



CÓDIGO	PESO
040819	50 g.

- Varilla y base metálicas. Altura 150 mm.
- Invoice hook. Metallic base. Height: 150 mm.
- "Pica-Papéis". Varão y base metálicas. Altura 150 mm.
- Asta e base in metallo nero. Altezza 150 mm.

PINCHA-PAPELES



CÓDIGO	ALTURA	ENVASE
040188	150 mm	1 / 12

Peso en la base



Los códigos en color amarillo permiten apertura de envase

ENCUADERNADORES LATÓN

Encuadernación tradicional



CON ARANDELA		
CÓDIGO	LONGITUD	ENVASE
069132	25 mm	100
069133	30 mm	100
069134	41 mm	100
069135	50 mm	100

- Encuadernadores con o sin arandela.
- Binders with or without washer.
- Ataches com e sem anilhas.
- Puntine per rilegare libri con o senza rondella.

SIN ARANDELA		
CÓDIGO	LONGITUD	ENVASE
069207	19 mm	100
069208	25 mm	100
069209	32 mm	100
069210	40 mm	100

SET DE SUJETALIBROS



- Set de 2 sujetalibros. Negro.
- Set of 2 bookends. Black.
- Conjunto de 2 suportes para livros. Preto.
- Set di 2 fermalibri. Nero.

CÓDIGO	MEDIDAS	ENVASE
260138	170 x 175 mm	1 / 5

BANDEJA PORTAMONEDAS



- Plástico. Para monedas de 1, 2, 5, 10, 20 y 50 céntimos + 1 y 2 Euros.
- Plastic coin tray for 1, 2, 5, 10, 20 and 50 cents + 1 and 2 Eur.
- Bandeja mortamoedas em plástico. Para moedas de 1, 2, 5, 10, 20 e 50 centimos e de 1 e 2 euros.
- Plastica. Per monete di 1, 2, 5, 10, 20 e 50 centesimi + 1 e 2 euro.

CÓDIGO	MEDIDAS	ENVASE
040231	328 x 180 x 20 mm	1 / 48

LUPAS PLUS OFFICE



- Bifocales. Con empuñadura de plástico.
- Magnifying glass. Bifocals. With plastic handle.
- Lupas bifocais com punho em plástico.
- Lenti bifocali. Con manico in plastica.

CÓDIGO	DIÁMETRO	AUMENTOS	ENVASE
040224	50 mm	x2,5 - x5	2 / 36
040225	63 mm	x2 - x4	2 / 24
040226	75 mm	x2 - x4	2 / 24

MOJASELLOS PLUS 320







- Mojasellos de esponja sintética. Plástico ABS.
- Stamp dampener with synthetic sponge. ABS plastic.
- Espongeira em plástico. Esponja sintética.
- Umettatore in spugna sintetica, plastica ABS.

CÓDIGO	DIÁMETRO
040461	100 mm



CENICEROS

Aluminio





-  Cenicero de diseño metálico en color plata.
-  Metal ashtray of design in silver.
-  Cinzeiro de desenho metálico em prata.
-  Posacenere di design in metallo color argento.



CÓDIGO	MEDIDAS
785189	11,5 x 8,5 cm

CÓDIGO	MEDIDAS
785188	7,5 x 3,5 cm

CÓDIGO	MEDIDAS
810004	Ø 8 x 3,5 cm





-  Reloj de pared de aluminio. Ideal para la oficina. Mecanismo de gran precisión de cuarzo. Alimentación: 1 x AA 1,5 V.
-  Aluminum wall clock. Ideal for the office. High precision quartz mechanism. Power supply: 1 x AA 1.5 V.
-  Relógio de parede em alumínio. Ideal para escritório. Mecanismo de quartzo de alta precisão. Fonte de alimentação: 1 x AA 1,5 V.
-  Orologio da parete in alluminio. Ideale per l'ufficio. Meccanismo al quarzo di alta precisione. Alimentazione: 1 x AA 1,5 V.

RELOJES DE PARED

Aluminio



CÓDIGO	MEDIDAS
785212	30 cm. - 12"
785213	35 cm. - 14"

-  Reloj meteorológico para interior y exterior. Hora, alarma, calendario, temperatura y humedad.
-  Indoor and outdoor meteorological clock. Time, alarm, calendar, temperature and humidity.
-  Relógio de tempo interior e exterior. Hora, alarme, calendário, temperatura e umidade.
-  Orologio per il tempo interno ed esterno. Ora, sveglia, calendario, temperatura e umidità.





ESTACIONES METEOROLÓGICAS



	CÓDIGO	MEDIDAS
1	785260	9 x 17,5 x 3
2	785284	17,7 x 14,5 x 8

PESACARTAS

Práctico y fiable

-  Plástico ABS. Escala de 10 y 20 gramos.
-  ABS Plastic. With 10 and 20 g. scale.
-  Plástico ABS. Escala de 10 e 20 g.
-  Plastica ABS. Scala di 10 e 20 grammi.



CÓDIGO	CAPACIDAD
001487	Hasta 1 kg
040356	Hasta 5 kg



Los códigos en **color amarillo** permiten apertura de envase

PORTACALENDARIOS



- Fabricado en plástico rígido de color negro con anillas metálicas.
- Made of black rigid plastic with metallic rings.
- Fabricada em plástico duro preto com anéis de metal.
- Realizzato in plastica nera rigida con anelli metallici.

CÓDIGO	COLOR
040266	● Negro

PLACA CON PINZA

Fabricada en plástico ABS

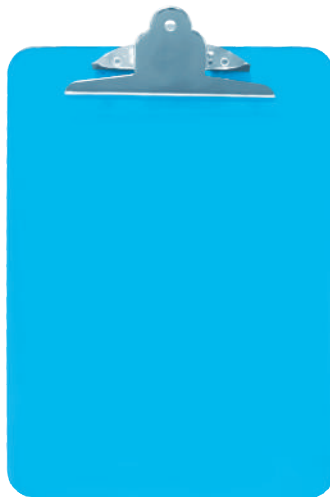

- Placa ABS con pinza metálica. Ideal para la oficina, colegio, hogar, etc. Grosor: 2,3 mm.
- Clip board. Board made of ABS plastic with metallic clip. Ideal for office, school, home, etc. Thickness: 2.3mm.
- Placa em plástico ABS com mola metálica. Ideal para escritórios, colégios, lar, etc. Espesura: 2,3 mm.
- Portadocumenti in ABS con morsetto in metallo. Ideale per l'ufficio, la scuola, la casa, ecc. Spessore: 2,3 mm.

CÓDIGO	COLOR	MEDIDAS	ENVASE
040223	● Azul	225 x 315 mm	1 / 24

PLACA CON PINZA

Fabricada en aluminio



- Placa de aluminio con pinza metálica. Ideal para colegio, hogar, etc.
- Clip board. Board made of aluminum with metallic clip. Ideal for office, school, home, etc.
- Placa em alumínio com mola metálica. Ideal para escritórios, colégios, lar, etc.
- Portadocumenti forma clip. Cartoncino in alluminio con clip metallica. Ideale per ufficio, scuola, casa, ecc.

CÓDIGO	COLOR	MEDIDAS mm	ENVASE
040411	○ Blanco	230 x 335	1 / 24

LLAVERO PORTAETIQUETAS

Llavero de plástico rígido



Portaetiquetas





Abertura lateral para etiquetas

- Llavero de plástico ABS rígido con etiqueta para identificación. Aro metálico. 6 Colores surtidos.
- Key tag. Body made of ABS plastic and tag for identification. Metallic ring. 6 Assorted colours.
- Porta-chaves com corpo em plástico ABS, aro metálico e etiqueta para identificação. 6 Cores sortidas.
- Portachiavi in plastica ABS rigido con targhetta identificativa. Anello di metallo, 6 colori assortiti.

CÓDIGO	COLORES	ENVASE
260127	Surtidos	Bolsa de 20 ud. / 5





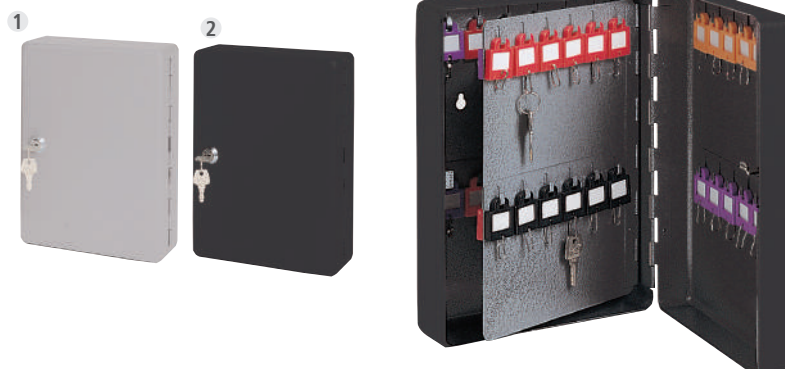

ARMARIO DE LLAVES

-  Metálico. Con cerradura. Fijación a la pared mediante tornillos. Incluye llaveros.
-  Key cabinet. Metallic. Lockable. Fixation to the wall by screws. It includes key tags.
-  Armário de chaves metálico. Com fechadura. Fixação á parede por parafusos. Inclui chaveiros.
-  Armadietto metallico con chiusura a chiave; fissaggio al muro mediante viti. Include portachiavi.



	CÓDIGO	MEDIDAS mm.	CAPACIDAD
1	260121	255 x 185 x 75	20 Llaves
2	260122	310 x 230 x 80	45 Llaves





CAJA DE CAUDALES MEDIANA

-  Caja metálica con bandeja de 6 compartimentos para monedas. Cerradura con llave.
-  Metal box with 6 compartment trays for coins. Key lock system.
-  Cofre metálico com bandeja de 6 compartimentos para moedas. Fechadura com chave.
-  Scatola di metallo con vassoio a 6 scomparti per monete. Chiusura con chiave.



CÓDIGO	COLOR	MEDIDAS
040228	● Azul	250 x 75 x 180 mm





CAJA DE CAUDALES GRANDE

-  Caja metálica con bandeja de 5 compartimentos para monedas y 4 para billetes. Cerradura con combinación y llave.
-  Metallic box with 5 compartment trays for coins and 4 for notes. Key and combination lock system.
-  Cofre metálico com bandeja com 5 compartimentos para moedas e 4 para notas. Fechadura com combinação e chave.
-  Scatola di metallo con vassoio a 5 scomparti per monete e 4 per banconote. Chiusura con combinazione e chiave.



CÓDIGO	COLOR	MEDIDAS mm
040230	● Azul	300 x 90 x 240

CAJA DE CAUDALES CON BANDEJA PORTAMONEDAS

-  Caja metálica con bandeja de 7 compartimentos para monedas. Cerradura con combinación y llave.
-  Metal case with 7 compartment trays for coins. Key and combination lock system.
-  Cofre metálico com bandeja com 7 compartimentos para moedas. Fechadura com combinação e chave.
-  Scatola di metallo con vassoio a 7 scomparti per monete. Chiusura con combinazione e chiave.



CÓDIGO	COLOR	MEDIDAS mm
040496	● Negro	300 x 90 x 240









CUBILETE COLORES 190

Ø 90 x 100 (alt) mm.







-  Cubilete metálico de rejilla.
-  Metallic pencil cup. Grille.
-  Portalápis em rede metálico.
-  Portapenna metallico forma griglia in 4 colori diversi.

CÓDIGO	COLOR	ENVASE
040650	 Verde	1 / 12
040651	 Violeta	1 / 12
040652	 Rosa	1 / 12
040653	 Turquesa	1 / 12

CUBILETE 185

Ø 90 x 105 (alt) mm.







-  Cubilete metálico de rejilla.
-  Metallic pencil cup. Grille.
-  Portalápis em rede metálico.
-  Portapenna metallico forma griglia.

CÓDIGO	COLOR	ENVASE
040298	 Plata	1 / 12
040346	 Grafito	1 / 12

PORTACLIPS







Ø 80 x 40 (alt) mm.

-  Portaclips metálico de rejilla. Base antideslizante.
-  Clip dispenser. Grille. Nonskid base.
-  Portaclips em rede metal. Base antiderrapante.
-  Porta graffettei griglia metallica. Base antiscivolo.

CÓDIGO	COLOR	ENVASE
040399	 Plateado	1 / 12







CUBO PORTANOTAS DE REJILLA

-  Portanotas con 400 hojas de papel blanco. Medidas: 100 x 80 x 100 mm.
-  400 white notes in a box. Size: 100 x 80 x 100 mm.
-  Porta notas com 400 folhas de papel branco. Tamanho: 100 x 80 x 100 mm.
-  Porta note con 400 fogli di carta bianca. Misura: 100 x 80 x 100 mm.



CÓDIGO	COLOR	ENVASE
001241	● Plateado	1 / 12

ORGANIZADOR METÁLICO DE REJILLA





-  Bandeja metálica de sobremesa con tres compartimentos.
-  Desktop metal tray with three compartments.
-  Tabuleiro metálico para secretária triplo.
-  Vassoio in metallo da tavolo con tre scomparti.

205 x 105 x 100 mm.



CÓDIGO	COLOR	ENVASE
040654	● Plata	1 / 24

PORTACARTAS METÁLICO DE REJILLA 49





-  Portacartas metálico de rejilla. Tres separadores.
-  Metallic letter shelf. Grille. 3 spacers.
-  Porta cartas em rede metálico com 3 divisórias.
-  Portacarte in metallo con 3 scomparti.

175 x 135 x 80 mm.



CÓDIGO	COLOR	ENVASE
040280	● Plata	1 / 6
040347	● Grafito	1 / 6

REVISTERO METÁLICO DE REJILLA 178

-  Archivo boxer metálico de rejilla. Lomo 75 mm. Medidas: 75 x 320 x 250 mm.
-  File box. Metallic grille. Spin 75 mm. Size: 75 x 320 x 250 mm.
-  Arquivador em rede metálico. Lombo 75 mm. Tamanho: 75 x 320 x 250 mm.
-  File di griglia metallica. Dorso 75 mm. Misura: 75 x 320 x 250 mm.

Sistema fijación

Posee dos orificios traseros para poder colgarlos o fijarlos







CÓDIGO	COLOR	ENVASE
180110	● Plata	1 / 4
180426	● Grafito	1 / 4

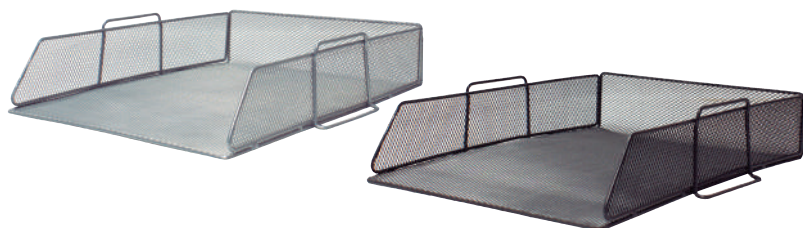

Los códigos en color amarillo permiten apertura de envase

BANDEJA DE REJILLA



-  Bandeja metálica de rejilla. Medidas: 290 x 77 x 340 mm.
-  Metallic tray. Colours: silver, black. Size: 290 x 77 x 340 mm.
-  Tabuleiro metálico de rede simples. Tamanho: 290 x 77 x 340 mm.
-  Vassoio Griglia metallica. Misure: 290 x 77 x 337 mm.

CÓDIGO	COLOR	ENVASE
180370	● Plata	1 / 6
180427	● Grafito	1 / 6





TORRE BANDEJAS METÁLICAS DE REJILLA

Dos bandejas



Bandejas extraíbles

Las bandejas salen a modo cajón para una mayor comodidad

-  Bandejas metálicas de rejilla con soporte para su sujeción. Medidas: 300 x 180 x 350 mm.
-  Metallic tray with support for attachment. Size: 300 x 180 x 350 mm.
-  Tabuleiro metálico em rede com suporte. Tamanho: Tamanho: 300 x 180 x 350 mm.
-  Vassoio grigliati metallici con supporto per il fissaggio. Misure: 300 x 180 x 350 mm.

2 bandejas		
CÓDIGO	COLOR	ENVASE
180368	● Plata	1 / 12
180428	● Grafito	1 / 12





TORRE BANDEJAS METÁLICAS DE REJILLA

Tres bandejas



Bandejas extraíbles





Las bandejas salen a modo cajón para una mayor comodidad

-  Bandejas metálicas de rejilla con soporte para su sujeción. Medidas: 300 x 270 x 350 mm.
-  Metallic tray with support for attachment. Size: 300 x 270 x 350 mm.
-  Tabuleiro metálico em rede com suporte. Tamanho: 300 x 270 x 350 mm.
-  Vassoio grigliati metallici con supporto per il fissaggio. Misure: 300 x 270 x 350 mm.

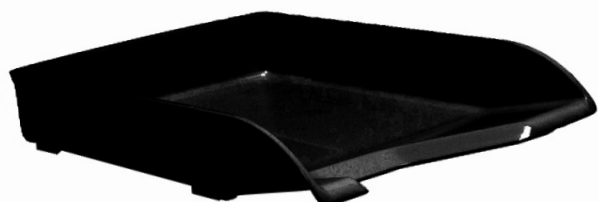
3 bandejas		
CÓDIGO	COLOR	ENVASE
180369	● Plata	1 / 6
180429	● Grafito	1 / 6

BANDEJAS PLUS LUXE







-  Apilable en torre. Admite documentos de hasta 235 x 330 mm. Dimensiones: 250 x 350 x 60 mm. Poliestireno de alto impacto.
-  Tower stacking. For documents of upto 235 x 330 mm. Dimensions: 250 x 350 x 60 mm. High impact polystyrene.
-  Torre empilháveis. Aceita documentos de até 235 x 330 mm. Dimensões: 250 x 350 x 60 mm. Poliestireno de alto impacto.
-  Poliestireno ad alto impatto. Per documenti fino a 235 x 330 mm. Dimensioni: 250 x 350 x 60 mm. Polistirolo ad alto impatto.

CÓDIGO	COLOR	ENVASE
180590	● Negro opaco	1 / 6







BANDEJAS DE COLORES

-  Poliestireno de alto impacto. Apilable. Compatible folio y A4. Medidas: 256 x 66 x 348 mm.
-  High impact polystyrene. Compatible with folio and A4. Size: 256 x 66 x 348 mm.
-  Poliestireno de alto impacto. Empilhável. Folio e A4 compatível. Tamanho: 256 x 66 x 348 mm.
-  Poliestireno ad alto impatto, compatibile con folio e A4. Dimensioni: 256 x 66 x 348 mm.

CÓDIGO	COLOR	ENVASE
180357	● Transparente	1 / 10
180358	● Azul opaco	1 / 10
180359	● Negro opaco	1 / 10
181185	○ Blanca opaco	1 / 10
181186	● Rojo opaco	1 / 10





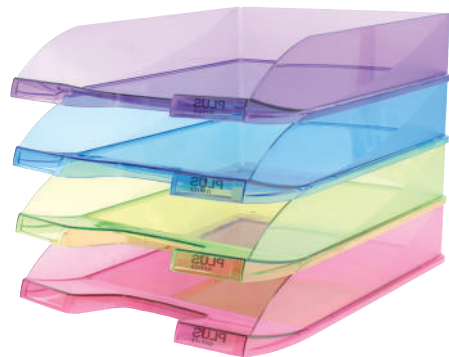

BANDEJAS DE COLORES TRASLÚCIDOS

-  Poliestireno de alto impacto. Apilable. Compatible folio y A4. Medidas: 256 x 66 x 348 mm.
-  High impact polystyrene. Compatible with folio and A4. Size: 256 x 66 x 348 mm.
-  Poliestireno de alto impacto. Empilhável. Folio e A4 compatível. Tamanho: 256 x 66 x 348 mm.
-  Poliestireno ad alto impatto, compatibile con folio e A4. Dimensioni: 256 x 66 x 348 mm.

CÓDIGO	COLOR	ENVASE
180361	● Azul traslúcido	1 / 10
180423	● Rosa traslúcido	1 / 10
180362	● Violeta traslúcido	1 / 10
180424	● Verde traslúcido	1 / 10







-  Papelera fabricada en polipropileno, de gran calidad y resistencia a golpes y rayaduras. Colores opacos. Capacidad de 8,9 litros.
-  Bin made of high quality polypropylene and resistance to blows and scratches. Opaque colours. 8.9 Litre capacity.
-  Cesto fabricado em polipropileno de grande qualidade e resistência a golpes e arranhões. Cores opacas. Capacidade para 8,9 litros.
-  Cestino carte realizzato in polipropilene, alta qualità e resistenza a urti e graffi. Colori opachi con 8,9 litri di capacità.

CÓDIGO	COLOR	MEDIDAS
040631	● Azul	25,8 x 28 cm
040632	● Negro	25,8 x 28 cm



PAPELERA CON ARO Y ASAS

-  Papelera de plástico rígido. Capacidad de 14 litros.
-  Wastebasket. Rigid plastic. Capacity 14 liters.
-  Cesto para papéis em plástico rígido. Capacidad 14 litros.
-  Cestino di plastica rigida quadrato. Capacità di 14 litri.

CÓDIGO	COLOR	MEDIDAS
040438	● Rojo	25 x 19 cm







PAPELERA CUADRADA





Los códigos en color amarillo permiten apertura de envase

PAPELERA OVALADA







-  Papelera de plástico rígido. Capacidad de 14 litros.
-  Wastebasket. Rigid plastic. Capacity 14 liters.
-  Cesto para papéis em plástico rígido. Capacidade 14 litros.
-  Cestino di plastica rigida ovale. Capacità di 14 litri.

CÓDIGO	COLOR	MEDIDAS
040442	 Azul Celeste	30 x 25 cm
040443	 Verde claro	30 x 25 cm
040444	 Rosa	30 x 25 cm

PAPELERA MATERIAL RECICLADO







-  Papelera de plástico rígido. Capacidad de 14 litros.
-  Wastebasket. Rigid plastic. Capacity 14 liters.
-  Cesto para papéis em plástico rígido. Capacidade 14 litros.
-  Cestino di plastica riciclata. Capacità di 14 litri.





CÓDIGO	COLOR	MEDIDAS
040473	 Azul oscuro	30 x 25 cm

PAPELERAS METÁLICAS DE REJILLA EN COLORES

Fondo cerrado. Capacidad 13 litros.







-  Papelera cónica metálica de rejilla. Medidas: Ø 27,5 x 28 (alt) cm. Capacidad de 13 litros.
-  Conical wastebasket. Metallic grille. Size: Ø 27,5 x 28 (height) cm. Capacity: 13 liters.
-  Cesto cônico para papéis em rede metálica. Tamanho: Ø 27,5 x 28 (alt) cm. Capacidade de 13 litros.
-  Pattumiera a forma di griglia metallica. Misure: Ø 27,5 x 28 (alt) cm. Capacità di 13 litri.



CÓDIGO	COLOR	MEDIDAS
040572	 Verde	27,5 x 28 cm
040573	 Azul	27,5 x 28 cm
040574	 Violeta	27,5 x 28 cm
040648	 Rosa	27,5 x 28 cm
040649	 Turquesa	27,5 x 28 cm

PAPELERAS METÁLICAS DE REJILLA PLUS 508

Fondo cerrado. Capacidad 13 litros.







-  Papelera cónica metálica de rejilla. Capacidad 13 L. Medidas: Ø 26 x 28 (alt) cm.
-  Conical wastebasket. Metallic grille. Capacity 13 L. Size: Ø 26 x 28 (height) cm.
-  Cesto cônico para papéis em rede metálica. Capacidad 13 L. Tamanho: Ø 26 x 28 (alt) cm.
-  Pattumiera a forma di griglia metallica. Capacità 13 L. Misure: Ø 26 x 28 (alt) cm.

CÓDIGO	COLOR	MEDIDAS
040282	 Plata	Ø 26 x 28 cm
040345	 Grafito	Ø 26 x 28 cm



PAPELERAS METÁLICAS DE REJILLA PLUS 158

Fondo cerrado. Capacidad 20 litros.

-  Papelera cónica metálica de rejilla. Capacidad 20 L. Medidas: Ø 29 x 35 (alt) cm.
-  Conical wastebasket. Metallic grille. Capacity 20 L. Size: Ø 29 x 35 (height) cm.
-  Cesto cónico para papéis em rede metálica. Capacidade 20 L. Tamanho: Ø 29 x 35 (alt) cm.
-  Pattumiera a forma di griglia metallica. Capacità 20 L. Misure: Ø 29 x 35 (alt) cm.

CÓDIGO	COLOR	MEDIDAS
040281	● Plata	Ø 29 x 35 cm
040344	● Grafito	Ø 29 x 35 cm







SET DE 4 PIEZAS REJILLA

-  SET compuesto de:
 - Portaclips de 80 x 40 mm.
 - Cubilete de Ø,80 x 100 mm.
 - Organizador de 147 x 100 mm.
 - Papelera de 235 x 270 mm. 9L.
-  SET composed of:
 - Clips dispenser 80 x 40 mm.
 - Pencil Holder Ø,80 x 100 mm.
 - Organizer 147 x 100 mm.
 - Bin 235 x 270 mm. 9L.
-  CONJUNTO composto por:
 - Portaclips de 80 x 40 mm.
 - Porta lápis de Ø,80 x 100 mm.
 - Organizador de 147 x 100 mm.
 - Cesto de 235 x 270 mm. 9L.
-  SET composto da:
 - Portaclip da 80 x 40 mm.
 - Portapenna da 80 x 100 mm.
 - Organizzatore di 147 x 100 mm.
 - Bidone di 235 x 270 mm. 9L.



CÓDIGO	COLOR	ENVASE
040655	● Verde	1 / 2
040656	● Violeta	1 / 2
040657	● Rosa	1 / 2
040658	● Turquesa	1 / 2

PORTANOTAS EN SIMIL-PIEL

-  Accesorios para su escritorio fabricados en simil-piel. Medidas: 115 x 115 x 65 mm.
-  Accessories for your desk made of leather-like. Size: 115 x 115 x 65 mm.
-  Acessórios para escritório em semi-pele. Tamanho: 115 x 115 x 65 mm.
-  Accessori per la tua scrivania in similpelle. Misure: 115 x 115 x 65 mm.

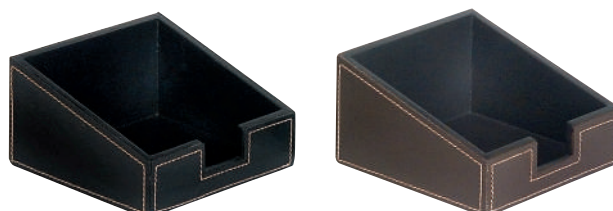

CÓDIGO	COLOR	MEDIDAS mm
040390	● Marrón	115 x 115 x 65
040391	● Negro	115 x 115 x 65



CONJUNTO ESCRITORIO EN SIMIL-PIEL Y CAÑA

Forro interior

Forrados por dentro en un material similar al terciopelo en color chocolate

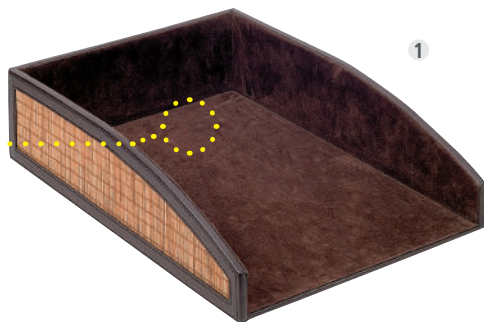

1

Cajetín superior

Incluye cajetín superior con tapa



2

🇪🇸 Conjunto de escritorio de diseño moderno y exclusivo, elaborado en Simil-Piel de color marrón y aplicaciones de caña.

🇬🇧 Desk accessories with a modern and exclusive design, made of brown fake leather and cane applications.

🇵🇹 Conjunto de secretária moderna e exclusivo, feito em uma cor de pele semelhantes e aplicações de cana-de-marron.

🇮🇹 Set di scrivania dal design moderno ed esclusivo, realizzato in pelle scamosciata marrone e applicazioni di canna.

Bandeja

	CÓDIGO	COLOR	MEDIDAS cm
1	040417	● Marrón	34 x 24 x 8

Organizador

	CÓDIGO	COLOR	MEDIDAS cm
2	040416	● Marrón	36,5 x 27 x 11

SEPARADORES PARA AGENDA ANILLAS



🇪🇸 20 separadores.

🇬🇧 20 dividers.

🇵🇹 20 separadores.

🇮🇹 20 separatori di fogli.

CÓDIGO	MEDIDAS
001431	5" - 77 x 127 mm
001425	7" - 97 x 170 mm
001427	8,5" - 146 x 210 mm

DIRECCIONES PARA AGENDA ANILLAS

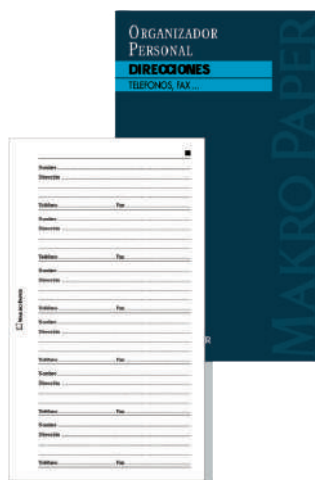

🇪🇸 20 hojas

🇬🇧 20 sheets

🇵🇹 20 folhas

🇮🇹 20 fogli

CÓDIGO	MEDIDAS
001426	8,5" - 146 x 210 mm



IDENTIFICADOR DE POLIPROPILENO

- Con sujeción de pinza o alfiler.
- Name plate. Safety: pin or clip.
- Porta identificação com pinça e alfinete.
- Con clip e spilla.

Dos en uno



CÓDIGO	MEDIDAS	ENVASE
180292	54 x 89 mm	50 ud.

IDENTIFICADORES DE POLIPROPILENO

- Sujeción de pinza o cinta. Posición vertical y horizontal.
- Safety: pin or band. Position: vertically or horizontally.
- Com pinça e fita. Posição: vertical e horizontal.
- Pinza o nastro. Posizione verticale e orizzontale.



CÓDIGO	MEDIDAS	ENVASE
180573	54 x 87 mm	50 ud.
180571	64 x 111 mm	50 ud.
180574	85 x 54 mm	50 ud.
180572	100 x 71 mm	50 ud.

IDENTIFICADORES SIMIL-PIEL VERTICALES

- Anilla para cordón, para documentos de 54 x 85 mm.
- Ring for cord, it fits for documents of 54 x 85 mm.
- Anel para o cordão, documentos de 54 x 85 mm.
- Anello per cordoncino, per documenti de 54 x 86 mm.



CÓDIGO	COLOR	MEDIDAS	ENVASE
180840	● Azul	110 x 76 mm	25 ud.
180845	● Marrón	110 x 76 mm	25 ud.

IDENTIFICADORES TARJETA EXTRAÍBLE

- Con sujeción de cordón.
- With cord fastening.
- Com cabo de fixação.
- Con cordino.



CÓDIGO	MEDIDAS	ENVASE
181111	54 x 85 mm	30 ud.

PINZA PARA IDENTIFICADORES

- Pinza de plástico.
- Plastic clip.
- Mola plástica.
- Pinza di plastica.



CÓDIGO	MEDIDAS	ENVASE
180581	70 x 12 mm	50 ud.

CORDÓN PARA IDENTIFICADORES

- Cordón de nylon.
- Nylon cord.
- Cordão de nylon.
- Cavo di nylon con morsetto di metallo.

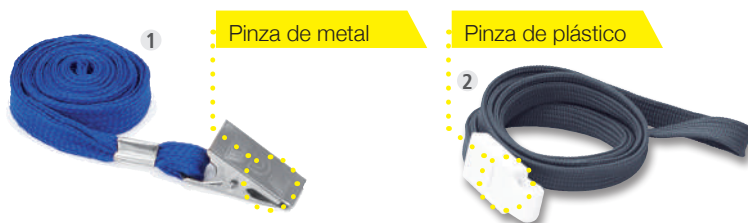

CÓDIGO	CORDÓN	ENVASE
1	180582 760 x 8 mm	25 ud.
2	180841 840 x 10 mm	25 ud.



Los códigos en color amarillo permiten apertura de envase

MINI CIZALLA

Ideal para uso doméstico

Cierre de seguridad

Sistema mediante el cual se oculta la cuchilla para evitar cortes

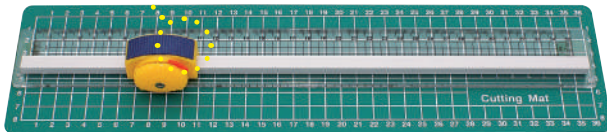

🇪🇸 Cizalla de rodillo portátil. Largo de corte A4-350 mm. Capacidad de corte: 10 hojas de 80 g. Corte recto. Guías de corte en diagonal y en regla. Base de plástico.

🇬🇧 Portable paper cutter. Long cut A4-350 mm. Cut capacity: 10 sheets of 80 g. Straight cut. Diagonal and ruler cutting guides. Plastic base.

🇵🇹 Cizalha de rolo portátil, largura de corte A4 de 350 mm. Capacidade de corte de 10 folhas de 80 g. Guias de corte diagonal e régua. Base de plástico.

🇮🇹 Taglierino a rullo portatile. Lunghezza di taglio A4- 350 mm. Capacità di taglio: 10 fogli da 80 g. Taglio dritto. Guide di taglio diagonali e righello. Base in plastica.

CÓDIGO	FORMATO	MEDIDAS
220495	A4	380 x 100 mm

CIZALLAS DE RODILLO A4

Guía de corte Din-A

Máxima precisión. Todas las cizallas cuentan con guías correspondientes a los distintos formatos Din-A

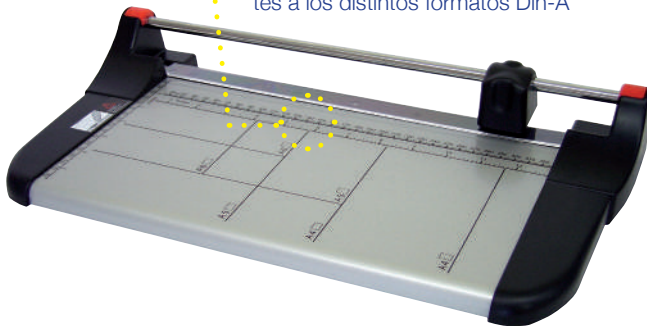

🇪🇸 Cizalla de rodillo A4, largo de corte 330 mm. Capacidad de corte 10 hojas. Medidas grabadas en la base. Dimensiones: 210 x 435 mm.

🇬🇧 A4 Paper cutter, long cut 330 mm. Capacity of cutting: 10 pages. Measures stuck on the base. Dimensions: 210 x 435 mm.

🇵🇹 Guilhotina de cilindro A4. Largura de corte 330 mm. Capacidade de corte: 10 folhas. Medidas gravadas na base. Dimensões 210 x 435 mm.

🇮🇹 Taglierino a rullo A4, lunghezza di taglio 330 mm. Capacità di taglio 10 fogli. Misure disegnate sullo sfondo. Dimensioni: 210 x 435 mm.

CÓDIGO	FORMATO	MEDIDAS
220481	A4	435 x 210 mm

CIZALLAS DE RODILLO A3

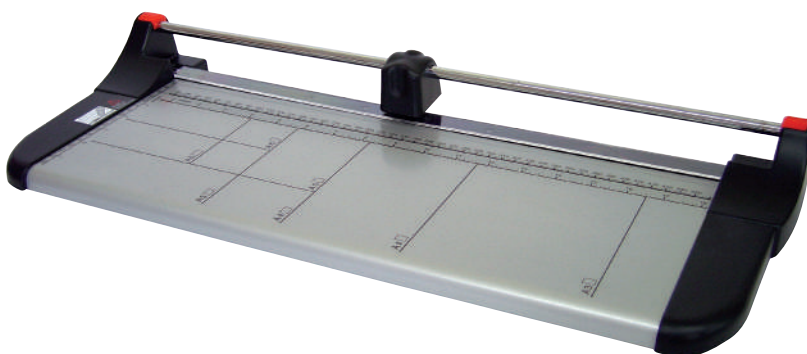

🇪🇸 Cizalla de rodillo A3, largo de corte 460 mm. Capacidad de corte 7 hojas. Medidas grabadas en la base. Dimensiones: 210 x 570 mm.

🇬🇧 A3 Paper cutter, long cut 460 mm. Capacity of cutting: 7 pages. Measures stuck on the base. Dimensions: 210 x 570 mm.

🇵🇹 Guilhotina de cilindro A3. Largura de corte 460 mm. Capacidade de corte: 7 folhas. Medidas gravadas na base. Dimensões 210 x 570 mm.

🇮🇹 Taglierino a rullo A3, lunghezza di taglio 460 mm. Capacità di taglio 7 fogli. Misure designate sullo sfondo. Dimensioni: 210 x 570 mm.

CÓDIGO	FORMATO	MEDIDAS
220482	A3	570 x 210 mm

RECAMBIO CUCHILLA CIZALLA DE RODILLO



🇪🇸 Cuchilla de recambio para cizalla de rodillo. Presentación en blíster. Corte recto.

🇬🇧 Replacement blade for shearing machine roller. Blister presentation. Straight cut.

🇵🇹 Lâmina de substituição para cisalha de rolo. Apresentação blister. Corte reto.

🇮🇹 Lama di ricambio per taglierino a rullo. Presentazione in blister. Taglio dritto

CÓDIGO	ENVASE
220496	Blíster 1 ud.



GUILLOTINA BASE METÁLICA 3912

Para A4 • Hasta 20 hojas. Gran resistencia.

Base metálica. Capacidad de corte: 20 hojas de 80 g. Protector de seguridad de ABS. Longitud de corte hasta 335 mm. Indicador de formatos de corte. Maneta ergonómica. Corte recto. Guía de papel ajustable. Regla en milímetros.

Paper cutter. Metallic base. Capacity of cut: 20 pages of 80 g. Safety shield ABS. Cutting length until 335 mm. Cutting format indicator. Ergonomic handle. Straight cut. Adjustable paper guide. Ruler in millimeters.

Guilhotina com base metálica. Capacidade de corte: 20 folhas de 80 g. Segurança protetor ABS. Comprimento de corte até 335 mm. Indicador de formatos de corte. Pega ergonómica. Corte reto. Guia de papel ajustável. Régua em milímetros.

Base metallica; capacità di taglio: 20 fogli da 80 g. Protezione di sicurezza in ABS. Lunghezza di taglio fino a 335 mm. Indicatore di formati di taglio. Manico ergonomico e taglio dritto. Guida carta regolabile. Righello in millimetri.

CÓDIGO	FORMATO	MEDIDAS
220090	A4	380 x 305 mm

**GUILLOTINA BASE DE PLASTICO 3921**

Para A4 • Hasta 10 hojas

Base de plástico. Capacidad de corte: 10 hojas de 80 g. Protector de seguridad de ABS. Trazados de formatos. Maneta ergonómica. Corte recto. Longitud de corte 335 mm. Guía de papel ajustable. Regla en milímetros.

Plastic base. Cutting capacity: 10 sheets of 80g. paper. ABS safety guard. Traced formats. Ergonomic handle. Straight cut. Cutting length until 335 mm. Adjustable paper guide. Ruler in millimeters.

Base em plástico. Capacidade de corte 10 folhas de 80 g. Protector de segurança ABS. Traçados dos formatos. Manete ergonómica. Corte direito. Comprimento de corte até 335 mm. Guia de papel ajustável. Régua em milímetros.

Base di plastica; capacità di taglio: 10 fogli da 80 g. Protezione di sicurezza in ABS. Layout di formati. Manico ergonomico e taglio dritto. Lunghezza di taglio fino a 335 mm. Guida carta regolabile. Righello in millimetri.

CÓDIGO	FORMATO	MEDIDAS
220092	A4	350 x 305 mm

**GUILLOTINA BASE DE PLASTICO 3914**

Para A3 • Hasta 10 hojas

Base de plástico. Capacidad de corte: 10 hojas de 80 g. Protector de seguridad de ABS. Trazados de formatos. Maneta ergonómica. Corte recto. Longitud de corte 440 mm. Guía de papel ajustable. Regla en milímetros.

Plastic base. Cutting capacity: 10 sheets of 80g. paper. ABS safety guard. Traced formats. Ergonomic handle. Straight cut. Cutting length until 440 mm. Adjustable paper guide. Ruler in millimeters.

Base em plástico. Capacidade de corte 10 folhas de 80 g. Protector de segurança ABS. Traçados dos formatos. Manete ergonómica. Corte direito. Comprimento de corte até 440 mm. Guia de papel ajustável. Régua em milímetros.

Base di plastica; capacità di taglio: 10 fogli da 80 g. Protezione di sicurezza in ABS. Layout di formati. Manico ergonomico e taglio dritto. Lunghezza di taglio fino a 440 mm. Guida carta regolabile. Righello in millimetri.

CÓDIGO	FORMATO	MEDIDAS
220091	A3	455 x 360 mm



ESTUCHE PORTA CD DE POLIPROPILENO



- Cierre con cremallera. Colores metalizados: negro, azul y plata.
- Zippered. Metallic colours: black, blue and silver.
- Zippered. Cores metálicas: preto, azul e prateado.
- Con la cerniera. Colori metallici: nero, blu e argento.

CÓDIGO	CAPACIDAD	MEDIDAS
130305	24 Discos	16 x 16 x 5 cm.

ESTUCHE PORTA CD Y DVD



- Fundas muy suaves. Colores metalizados. Con cremallera.
- Very soft covers. Metallic colours. With a zipper.
- Capas muito macias. Cores metálicas. Com zíper.
- Coperture molto morbide. Colori metallici. Com una cerniera.

CÓDIGO	CAPACIDAD	MEDIDAS
130430	72 Discos	29,5 x 18 cm.
130431	96 Discos	29,5 x 18 cm.

PILAS ALCALINAS



- Pilas alcalinas no recargables. Polivalentes.
- Non-rechargeable alkaline batteries. Versatile.
- Pilhas alcalinas não recarregáveis. Versáteis.
- Batterie alcaline non ricaricabili. Versatile.

TIPO	AAA	AAA	AA	AA	BABY C	MONO D	6LR61	6LR23
CÓDIGO	220746	220747	220748	220749	220751	220752	220750	220754
VOLTIOS	1,5	1,5	1,5	1,5	1,5	1,5	9	12
BLISTER	4 ud.	24 ud.	4 ud.	24 ud.	2 ud.	2 ud.	1 ud.	1 ud.
ENVASE	12 Blisters	10 Blisters	12 Blisters	10 Blisters	6 Blisters	6 Blisters	12 Blisters	6 Blisters

PILAS BOTÓN







- Ideales para usar con dispositivos del día a día (pilas, reloj, calculadora).
- Ideal for use with everyday devices (batteries, clock, calculator).
- Ideal para uso com dispositivos diários (baterias, relógio, calculadora).
- Ideale per l'uso con i dispositivi di tutti i giorni (batterie, orologio, calcolatrice).

TIPO	LR44	CR2025	CR2032	CR2450
CÓDIGO	220753	220755	220756	220757
VOLTIOS	1,5	3	3	3
BLISTER	10 ud.	4 ud.	4 ud.	5 ud.
ENVASE	20 Blisters	12 Blisters	12 Blisters	12 Blisters







RATÓN ÓPTICO CON CABLE USB

-  Plug and Play. Seguimiento óptico de alta definición. 2 botones y rueda de desplazamiento.
-  Plug and Play. High-definition optical tracking. 2 buttons and scroll wheel.
-  Plug and Play. Seguimento óptico de alta definição. 2 botões e roda de procura.
-  Plug and Play. Tracciamento ottico di alta definizione. 2 pulsanti e rotella di scorrimento.

CÓDIGO	COLOR	ENVASE
130502	● Negro	Blíster 1 ud.
130503	● Rojo	Blíster 1 ud.







RATÓN ÓPTICO INALÁMBRICO

-  Con tecnología inalámbrica avanzada de 2,4 GHz. Forma ergonómica.
-  With advanced 2.4 GHz wireless technology. Ergonomic shape.
-  Com tecnologia inalambrica avançada de 2,4 GHz. Forma ergonomica.
-  Con tecnologia wireless avanzata a 2,4 GHz. Forma ergonomica.

CÓDIGO	COLOR	ENVASE
130504	● Negro	Blíster 1 ud.
130505	● Rojo	Blíster 1 ud.





TECLADO CLASSIC CON CABLE USB

-  Teclado con cable. Teclas planas que apenas hacen ruido.
-  Keyboard with cable. Flat keys that barely make noise.
-  Teclado com cabo. Teclas planas que fazem ruido.
-  Tastiera con cavo. Tasti piatti che appena fanno rumore.

CÓDIGO	COLOR
130507	● Negro



TECLADO MULTIMEDIA CON CABLE USB





-  Teclado con cable. Funcionalidades con tecla directa. Teclas planas que apenas hacen ruido.
-  Keyboard with cable. Functionality with direct key. Flat keys that barely make noise.
-  Teclado com cabo. Funcionalidade com chave direta. Teclas planas que apenas fazem ruido.
-  Tastiera robusta con cavo. Funzionalità con chiave diretta. Tasti piatti che fanno appena rumore.

CÓDIGO	COLOR
130506	● Negro



ALFOMBRILLA PARA RATÓN







-  Superficie de poliester.
-  Mouse pads. Polyester surface.
-  Almofada para rato. Superficie em polyester.
-  Superficie in poliester.

CÓDIGO	COLOR	MEDIDAS
130027	● Negro	180 x 220 x 3 mm

REPOSAMUÑECAS DE GEL PARA RATÓN







-  Reposamuñecas relleno de gel con alfombrilla. Ergonómico. Superficie textil.
-  Stuffed wristrest with pad. Ergonômico. Textile surface.
-  Imofada coberta a gel para rato. Ergonomico. Superficie têxtil.
-  Poggiapolsi con imbottitura in gel. Ergonomico. Superficie tessile.

CÓDIGO	COLOR	MEDIDAS mm.
130026	● Negro	255 x 220 x 20

REPOSAMUÑECAS DE GEL PARA TECLADO







-  Ajustable en altura. Desplazamiento de la barra de la muñeca, hacia adelante o atrás.
-  Wristrest. Adjustable in height. Displacement of the bar of the wrist forwards or back.
-  Apoio de mãos. Ajustável em altura. Desliza facilmente para a frente e para trás.
-  Regolabile in altezza. Spostamento della barra del polso in avanti o indietro.

CÓDIGO	COLOR	MEDIDAS
130001	● Negro	472 x 70 x 20 mm

SOPORTE PARA PORTÁTIL







-  Inclinación ajustable a 10° y 13°. Plataforma de aluminio. Con un ventilador de refrigeración. 4 puertos USB.
-  Adjustable tilt at 10° and 13°. Aluminium platform. Laptop cooling fan. 4 USB ports.
-  Inclinção ajustável a 10° e 13°, plataforma em alumínio. Com ventilador na base para a refrigeração. 4 portos USB.
-  Inclinazione regolabile a 10° e 13°, con una piattaforma in alluminio. Ventola nella base per il raffreddamento del laptop. 4 porte USB.



CÓDIGO	MEDIDAS
130481	297 x 257 x 18 mm







ATRIL METÁLICO

-  Atril metálico. Resistente y rígido.
-  Metal lectern. Resistant and rigid.
-  Suporte metálico. Resistente e rígido.
-  Leggio in metallo Resistente e rigido.



CÓDIGO	COLOR
040220	● Plata





FUNDAS PARA TABLETS Y PORTÁTILES

-  Fabricada en neopreno elástico e impermeable. Amplia cremallera.
-  Made of elastic or waterproof neoprene. Wide zipper.
-  Fabricada em neopreno elástico e impermeável. Zipper largo.
-  Realizzate in neoprene elastico e impermeabile. Ampia cerniera.

CÓDIGO	PULGADAS	MEDIDAS mm
130492	15"	355 x 290







MALETIN PARA PORTATIL 15" - 3 BOLSILLOS

-  Compartimento interior acolchado para portátil de hasta 15". Bolsillos interiores de malla. Bolsillos exteriores en la parte frontal y en la trasera. Bandolera acolchada, extraíble y ajustable.
-  Padded interior compartment for laptop up to 15". Interior mesh pockets. Exterior pockets on the front and back. Padded bag, removable and with adjustable shoulder strap
-  Compartimento interior acolchoado para computador até 15". Bolsas interiores de malha. Bolsos exteriores na parte frontal e na parte traseira. Asa acolchoada, que se pode tirar e é ajustável.
-  Comparto interno imbottito per laptop fino a 15". Tasche interne a rete. Tasche esterne sul davanti e sul retro. Tracolla imbottita, rimovibile e regolabile.

CÓDIGO	MEDIDAS
040592	385 x 285 x 65 mm
3 BOLSILLOS INTERIORES	



MALETIN PARA PORTATIL 15" - 2 BOLSILLOS





-  Compartimento interior acolchado para portátil de hasta 15". Bolsillos interiores de malla. Bolsillos exteriores en la parte frontal y en la trasera. Bandolera acolchada, extraíble y ajustable.
-  Padded interior compartment for laptop up to 15". Interior mesh pockets. Exterior pockets on the front and back. Padded bag, removable and with adjustable shoulder strap
-  Compartimento interior acolchoado para computador até 15". Bolsas interiores de malha. Bolsos exteriores na parte frontal e na parte traseira. Asa acolchoada, que se pode tirar e é ajustável.
-  Comparto interno imbottito per laptop fino a 15". Tasche interne a rete. Tasche esterne sul davanti e sul retro. Tracolla imbottita, rimovibile e regolabile.

CÓDIGO	MEDIDAS
040593	370 x 290 x 65 mm
2 BOLSILLOS INTERIORES	



REPOSAPIES MOD. 5







-  Reposapiés con inclinación y altura regulables. Poliestireno de alto impacto. Patas antideslizantes. 2 posiciones.
-  Footrest with adjustable inclination and height. High impact polystyrene. Non-slip feet. 2 positions.
-  Apoio para os pés com altura e inclinação ajustáveis. Poliestireno de alto impacto. Pés antiderrapantes. 2 posições.
-  Poggiapiedi con altezza e inclinazione regolabili. Polistirolo ad alto impatto. Piedi antiscivolo. 2 posizioni.

CÓDIGO	MEDIDAS
130529	355 x 255 x 135 mm

REPOSAPIES MOD. 10







-  Reposapiés con inclinación variable. Poliestireno de alto impacto. Patas antideslizantes.
-  Footrest with variable inclination. High impact polystyrene. Non-slip feet. 2 positions.
-  Descanso para os pés com inclinação variável. Poliestireno de alto impacto. Pés antiderrapantes. 2 posições.
-  Poggiapiedi con inclinazione variabile. Polistirolo ad alto impatto. Piedi antiscivolo. 2 posizioni.

CÓDIGO	MEDIDAS
130518	473 x 354 x 100 mm

REPOSAPIES MOD. 20







-  Reposapiés ajustable en altura y con inclinación variable. Poliestireno de alto impacto. Patas antideslizantes.
-  Height adjustable footrest with variable inclination. High impact polystyrene. Non-slip feet. 2 positions.
-  Descanso para os pés ajustável em altura e com inclinação variável. Poliestireno de alto impacto. Pés antiderrapantes. 2 posições.
-  Poggiapiedi regolabile in altezza e con inclinazione variabile. Polistirolo ad alto impatto. Piedi antiscivolo. 2 posizioni.

CÓDIGO	MEDIDAS
130520	460 x 340 x 110 mm

REPOSAPIES MOD. 30





-  Reposapiés con huellas de goma. Ajustable en altura y con inclinación variable. Poliestireno de alto impacto. Patas antideslizantes.
-  Height adjustable footrest with variable inclination. High impact polystyrene. Non-slip feet. 2 positions.
-  Descanso para os pés ajustável em altura e com inclinação variável. Poliestireno de alto impacto. Pés antiderrapantes. 2 posições.
-  Poggiapiedi con impronte di gomma. Regolabile in altezza e con inclinazione variabile. Polistirolo ad alto impatto. Piedi antiscivolo. 2 posizioni.

CÓDIGO	MEDIDAS
130519	450 x 330 x 100 mm



PIZARRA CABALLETE EASY EASEL

 Pizarra caballete no magnética de borrado en seco. Pinza sujeta papeles con ganchos móviles para blocs. Bandeja portarotuladores. Pies telescópicos con altura regulable hasta 195 cm. Muy ligera y transportable.

 Dry erase and non-magnetic slate board. Clip holds papers with movable hooks for pads. Container tray for markers. Telescopic feet with adjustable height up to 195 cm. Very light and transportable.

 Quadro cabaleta não magnética se limpa em seco. Mola para papeis, com ganchos móveis para blocos. Base para colocar marcadores. Pés telescópicos com altura regulável até 195 cm. Muito leve e transportável.

 Lavagna con cavalletto non magnetica. Con pinza portadocumenti con ganci mobili per blocos. Vassoio per pennarelli. Piedi telescopici con altezza regolabile fino a 195 cm. Molto leggero e trasportabile.

CÓDIGO	MEDIDAS
220549	100 x 70 cm





**ALTURA REGULABLE
HASTA 195 CM.**

PIZARRA BLANCAS NO MAGNÉTICA

Marco de madera

 Pizarra blanca de superficie estratificada con el marco natural de madera.

 Stratified whiteboard surface with natural wood frame.

 Quadro branco com superfície estratificada com caixilho natural em madeira.

 Lavagna bianca con superficie stratificata con cornice in legno naturale.

CÓDIGO	MEDIDAS
220217	30 x 40 cm
220214	60 x 40 cm
220215	60 x 90 cm
220216	90 x 120 cm





PIZARRA BLANCA NO MAGNÉTICA

Marco de aluminio

 Pizarra laminada para escribir con rotuladores de borrado en seco. Se suministra con cajetín portaobjetos de aluminio. Esquinas plásticas redondeadas.

 Laminated board to write with dry erase markers. Comes with aluminum box. Rounded plastic corners.

 Quadro laminado para escrever com marcadores e apagar em seco. Se vende com caixa porta objetos em alumínio. Cantos de plástico arredondados.

 Lavagna laminata per scrivere con pennarelli cancellabili a secco. Fornita con scatola di alluminio. Angoli arrotondati in plastica.

CÓDIGO	MEDIDAS
220473	60 x 90 cm
220474	90 x 120 cm
220475	120 x 150 cm
220476	120 x 180 cm
220477	120 x 240 cm



PIZARRA BLANCA MAGNETICA LACADA

Marco de aluminio



LACADA

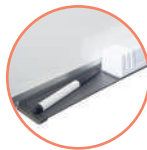

Pizarra magnética con superficie de porcelana durable y resistente, enmarcada en aluminio. Con porta rotuladores.

Magnetic board with durable and resistant porcelain surface, framed with aluminum. With pen holders.

Quadro magnético com superfície em porcelana durável e resistente. Caixilho de alumínio. Com porta marcadores.

Lavagna magnetica con superficie in porcellana durevole e resistente, incorniciata con alluminio. Con portapenne.

CÓDIGO	MEDIDAS
220468	60 x 90 cm
220469	90 x 120 cm
220470	120 x 150 cm
220471	120 x 180 cm
220472	120 x 240 cm

PIZARRA MAGNÉTICA ACERO VITRIFICADO

Marco de aluminio



VITRIFICADA

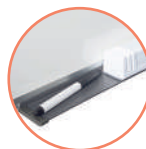

Alta resistencia a manchas de tinta, marcas de rotulador, arañazos y abolladuras.

High resistance to ink stains, marker marks, scratches and dents.

Alta resistência a manchas de tinta, marcas de marcadores, arranhões e amolgadelas.

Elevata resistenza alle macchie d'inchiostro, ai segni di pennarello, ai graffi e alle ammaccature.

CÓDIGO	MEDIDAS
220601	90 x 60 cm
220602	120 x 92 cm
220603	150 x 100 cm
220604	180 x 120 cm
220605	240 x 120 cm

PIZARRA NEGRA PARA TIZA

Marco de madera

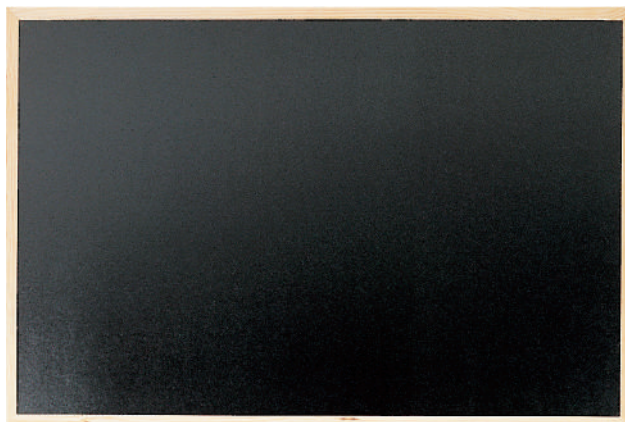

Pizarra mural negra de superficie lacada, para escribir con tiza. Con el marco natural de madera de pino.

Wall black and lacquered surface whiteboard. With natural pine wood.

Quadro mural preta com superfície lacada, para escrever com giz. Com caixilho em madeira de pinho.

Lavagna nera con superficie laccata, per scrivere con il gesso. Con la cornice naturale di legno di pino.

CÓDIGO	MEDIDAS
220226	90 x 60 cm
220227	90 x 120 cm



TIZAS ANTIPOLVO

- Forma redondeada y antipolvo. No manchan.
- Rounded and dust-proof shape. They do not stain.
- Forma arredondada e à prova de pó. Eles não mancham.
- Forma arrotondata e antipolvere. Non si macchiano.



CÓDIGO	COLOR	ENVASE
630777	Blanco	Caja 10 ud.
630779	Surtidos	Caja 10 ud.
630778	Blanco	Caja 100 ud.
630780	Surtidos	Caja 100 ud.

MARCADOR DE PIZARRA BÁSICO

- Marcador de pizarra. Cuerpo y capuchón de plástico. Especiales para cualquier tipo de pizarra blanca. Punta cónica.
- Whiteboard marker. Plastic body and cap. Special for any type of white board. Conical tip.
- Marcador de quadro branco. Corpo e tampa em plástico. Especial para qualquer tipo de quadro branco. Ponta cônica.
- Marcatore per lavagna bianca. Corpo e cappuccio in plastica. Speciale per qualsiasi tipo di lavagna bianca. Punta conica.



CÓDIGO	TINTA	ENVASE
081441	● Azul	12 ud.
081440	● Negro	12 ud.
081442	● Rojo	12 ud.
081443	● Verde	12 ud.

CÓDIGO	TINTA	ENVASE
081516	● Negro	Blister 1 ud. / 36
081517	● Azul	Blister 1 ud. / 36
081518	● Rojo	Blister 1 ud. / 36
081519	Surtido	Blister 4 ud. / 12

MARCADOR DE PIZARRA BOARD LIQUID

- Rotuladores para pizarra blanca de tinta líquida. Punta cónica. Recarga mediante cartucho. La tinta se agota hasta la última gota. Intensidad y luminosidad de los colores.
- Whiteboard markers with liquid ink. Conical tip. Rechargeable by cartridge. Ink runs down to the last drop. Intensity and luminosity of the colours.
- Marcadores de quadro branco com tinta líquida. Ponta cônica. Recarregável por cartucho. A tinta desce até a última gota. Intensidade e luminosidade das cores.
- Marcatori per lavagne bianche con inchiostro liquido. Punta cônica. Ricaricabile a cartuccia. L'inchiostro scorre fino all'ultima goccia. Intensità e luminosità dei colori.



Recargable



CÓDIGO	TINTA	ENVASE
Marcadores		
081431	● Azul	12 ud.
081430	● Negro	12 ud.
081432	● Rojo	12 ud.
081433	● Verde	12 ud.
081434	● Naranja	12 ud.

CÓDIGO	COLOR	ENVASE
Recambios		
081436	● Azul	12 ud.
081435	● Negro	12 ud.
081437	● Rojo	12 ud.
081438	● Verde	12 ud.
081439	● Naranja	12 ud.







Los códigos en color amarillo permiten apertura de envase

BORRADOR DE FIELTRO PARA PIZARRA

Para pizarra de tiza





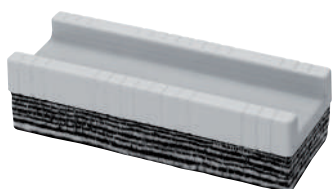

-  Empuñadura de madera.
-  Wooden grip.
-  Empunhadura de madeira.
-  Impugnatura in legno.

CÓDIGO	MEDIDAS	ENVASE
630006	8 x 12 x 3,5 cm.	1 / 12

BORRADOR DE PIZARRA BLANCA







-  16 Capas de tejido desechable.
-  16 layers of disposable tissue.
-  16 capas de tecido descartável.
-  16 strati di tessuto monouso.

CÓDIGO	MEDIDAS	ENVASE
630001	5,5 x 14,5 x 3,5 cm.	1 / 12

TABLERO DE CORCHO

Marco de madera







-  Tablero de corcho aglomerado con marco natural de madera. Con señalizadores.
-  Corkboard with natural wood frame. With push pins.
-  Quadro cortiça aglomerado com caixilho de madeira com alfinetes de sinalização.
-  Lastra in sughero agglomerato con cornice in legno naturale. Contiene puntine.

CÓDIGO	MEDIDAS
220225	30 x 40 cm
220222	60 x 40 cm
220223	60 x 90 cm
220224	90 x 120 cm

TABLERO MOQUETA AZUL

Marco de aluminio



-  Tableros de anuncios murales con tapizado en moqueta azul. Enmarcado en aluminio. Con chinchetas o agujas.
-  Wall boards with carpet upholstered in blue. Framed with aluminium. With pins or needles.
-  Quadros de anúncios de parede forrado em pano azul. Moldura de alumínio. Com pioneses e alfinetes de sinalização.
-  Tavola/base tapezzata con colore blu; cornice in alluminio. Contiene puntine.

CÓDIGO	MEDIDAS
220464	60 x 90 cm
220465	90 x 120 cm
220466	120 x 150 cm
220467	120 x 180 cm





07

ARCHIVO Y CLASIFICACIÓN

FILE AND CLASSIFICATION
ARQUIVO E CLASSIFICAÇÃO
ARCHIVO E CLASSIFICA

PLUS

DOSSIER EXTENSIBLE DE ALTA CAPACIDAD

La solución perfecta para archivar en su oficina

PLUS
JAPAN



FL-021SS
AZUL



FL-021SS
BEIGE



FL-021SS
VERDE

ZERO MAX

Materiales : Cubiertas = Pulpa de papel reciclado
Fastener = Polipropileno reciclado
Dimensiones externas: 302x220 mm
Anchura del lomo: 18 ~ 118mm
Agujeros: 2
Tamaño hasta el extremo: 80mm
Capacidad: 1000 hojas (basado en papel de 70 gr)

Punto 1

La columna expandible se ajusta a sus documentos

Se expande hasta 10 cm

El lomo se expande para almacenar hasta 1.000 páginas o pilas de 10 cm de espesor del papel

Basado en papel de 70 g.

Guías de punto doble

Los números impresos en el cierre con dientes de la guía y el interior del lomo indica aproximadamente por dónde debes doblar el lomo.

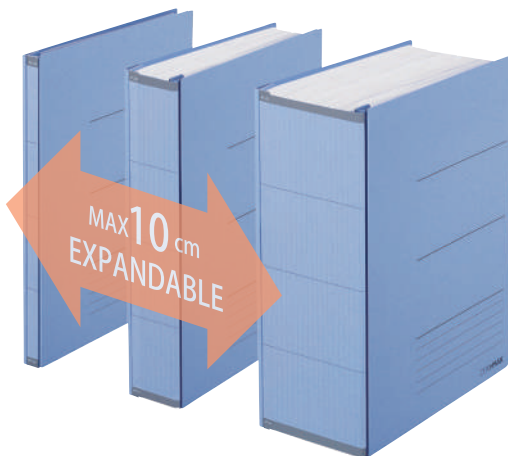

Punto 2

Fácil de archivar

Cierre con un solo gesto lateral

Simplemente tire hacia arriba y empuje hacia abajo la pestaña de extracción amarilla para abrir la cerradura. Después de meter las hojas en su lugar, insertar el cierre con dientes en el lado del sujetador. Con este cierre de desarrollo original, te ahorras la molestia de poner un cierre entre los agujeros.

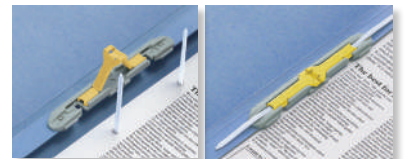

Guías de punto doble



Tamaño A4 - 220 x 302 mm

CÓDIGO	COLOR	ENVASE
180562	● Beige	10
180560	● Azul	10
180559	● Verde	10



Pasty

Organiza de una forma divertida con los nuevos dossier color pastel



DOSSIER PASTY

- Fabricado en polipropileno flexible. 4 bolsillos interiores y 2 exteriores. Tamaño A4.
- Made of flexible polypropylene. 4 inside and 2 outside pockets. A4 size.
- Fabricado em polipropileno flexível. 4 bolsos internos e 2 externos. Tamanho A4.
- Realizzato in polipropilene flessibile. 4 tasche interne e 2 esterne. Formato A4.

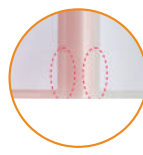

Bolsillos exteriores

Tope



Tamaño A4 - 240 x 310 mm		
CÓDIGO	COLOR	ENVASE
181267	Azul	10
181268	Verde	10
181269	Amarillo	10
181270	Gris	10

DOSSIER PASTY CON FÁSTENER

- Fabricado en polipropileno flexible. 1 bolsillo interior y 2 exteriores. Tamaño A4.
- Made of flexible polypropylene. 1 inside and 2 outside pockets. A4 size.
- Fabricado em polipropileno flexível. 1 bolso interno e 2 externos. Tamanho A4.
- Realizzato in polipropilene flessibile. 1 tasche interne e 2 esterne. Formato A4.



Fástener



Tamaño A4 - 240 x 310 mm		
CÓDIGO	COLOR	ENVASE
181263	Azul	10
181264	Verde	10
181265	Amarillo	10
181266	Gris	10



Los códigos en **color amarillo** permiten apertura de envase

DOSSIER "CAMUFLAJE" ÁNGULO RECTO

El dibujo en la portada impide la lectura de los documentos

Punto 1

Patrón de camuflaje

El patrón especial impreso en la parte frontal y posterior de la carpeta de polipropileno hace que los documentos sean difíciles de leer. Sin embargo, aún puede leer letras grandes para confirmar el contenido de la carpeta sin tener que sacar los documentos. Lleve y organice con estilo sus documentos confidenciales mientras protege su información privada.

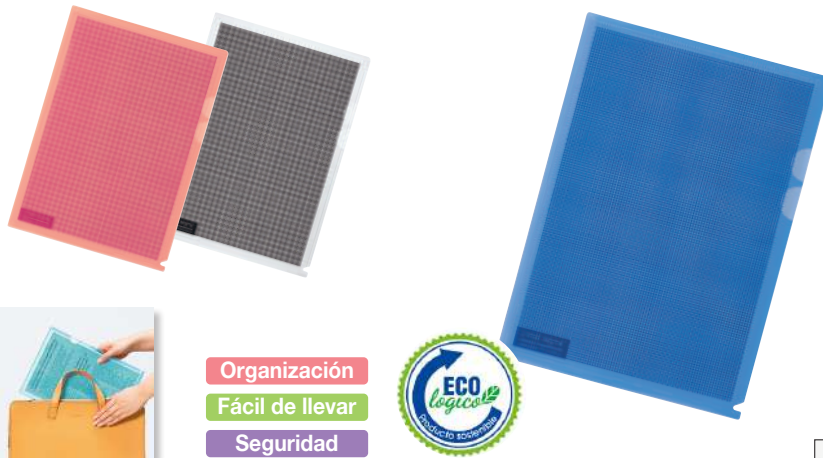

- Organización
- Fácil de llevar
- Seguridad

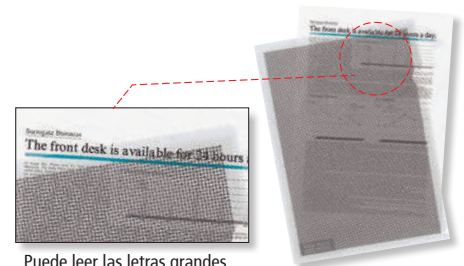

Puede leer las letras grandes pero no las pequeñas

Pack de 5 unidades. Tamaño A4 - 220 x 310 mm

COLOR	<input checked="" type="radio"/> Azul	<input type="radio"/> Rosa	<input type="radio"/> Transparente
CÓDIGO	180602	180605	180606
ENVASE 20 UNIDADES / PACKING 20 PIECES			

DOSSIER ÁNGULO RECTO "113" CON BOLSILLO

Punto 1

Dossier con bolsillo

Dossier de polipropileno transparente con uñero en el lateral para facilitar la extracción de los documentos y bolsillo frontal. Para documentos de tamaño A4. Set de 3 unidades.



Pack de 3 unidades

Tamaño A4 - 220 x 310 mm

COLOR	<input type="radio"/> Transparente
CÓDIGO	180530
ENVASE 20 UNIDADES / PACKING 20 PIECES	

DOSSIER ÁNGULO RECTO CON BOLSA CD

Punto 1

Dossier con porta CDs

Dossier de polipropileno transparente con uñero en el lateral para facilitar la extracción de los documentos. Además dispone de compartimento con solapa para CD. Set de 5 unidades. Para documentos de tamaño A4.



Pack de 5 unidades

Tamaño A4 - 220 x 310 mm





COLOR	<input type="radio"/> Transparente
CÓDIGO	180525
ENVASE 20 UNIDADES / PACKING 20 PIECES	



DOSSIER "2001" ÁNGULO RECTO

Tamaño Folio • Medidas 325x235 mm

Super RESISTENTE







-  Polipropileno transparente. Con uñero.
-  Transparent polypropylene clear holder.
-  Polipropileno transparente com abertura de dedo.
-  Polipropilene trasparente con apertura a dito.



Dossiers 2001. Tamaño A4+ - 225 x 325 mm

COLOR	Surtidos: 2 azul, 2 rojo, 2 verde, 2 violeta, 2 naranja y 2 amarillo.
CÓDIGO	180867
SET 12 UNIDADES / 10 SETS	

Dossiers 2001. Tamaño Folio - 235 x 325 mm





COLOR	 Transparente	 Azul	 Rojo	 Verde	 Violeta	 Naranja	 Amarillo
CÓDIGO	180229	180230	180231	180232	180233	180402	180403
ENVASE 12 UNIDADES / PACKING 12 PIECES							



200 g.





SUBCARPETAS CARTULINA DE COLORES

200 gr. Colores vivos. Cartulina Premium.

-  Para documentos de formato A4 y Folio. Cartulina de 200 g/m². Con hendiduras para fastener.
-  For A4 documents and Folio. Cardboard 200 g/m². With holes for fastener.
-  Para documentos A4 e Folio. Papelão 200 g/m². Com ranhuras para ferragem.
-  Per documenti A4 e Folio. Cartone da 200 g/m². Con fessure per il fissaggio.



Tamaño A4+ - 310 x 230 mm

COLOR	 Blanco	 Amarillo	 Azul	 Naranja	 Rojo	 Verde	 Lila	 Azul marino	 Rosa
CÓDIGO	180588	180004	180005	180006	180007	180008	180720	181337	180721
ENVASE 25 UNIDADES / PACKING 25 PIECES									

Tamaño Folio - 345 x 230 mm

COLOR	 Blanco	 Amarillo	 Azul	 Naranja	 Rojo	 Verde	 Lila	 Azul marino	 Rosa
CÓDIGO	180589	180010	180011	180012	180013	180014	180724	181338	180725
ENVASE 25 UNIDADES / PACKING 25 PIECES									







Los códigos en **color amarillo** permiten apertura de envase

SOBRE DE POLIPROPILENO CON TALADROS - SET 2 UD.

180 MICRAS. 100% reciclable







-  Sobre multitaladro, 11 agujeros. Cierre de velcro.
-  Multi-drill envelope, 11 holes. Velcro closure.
-  Envelope multi-perfuração, 11 buracos. Fecho de velcro.
-  Busta multitrapano, 11 fori. Chiusura con velcro.

Pack de 2 unidades	
Tamaño A4+ - 235 x 310 mm	
COLOR	 Humo
CÓDIGO	181193
ENVASE 12 UNIDADES / PACKING 12 PIECES	

SOBRE APAISADO CON VELCRO



-  Polipropileno transparente. Capacidad para 50 hojas.
-  Dossier. Transparent polypropylene. Capacity of 50 sheets.
-  Dossier com mola. Polipropileno transparente. Capacidade para 50 folhas.
-  Polipropilene trasparente con capacità per 50 fogli.





Dossiers con Velcro 2030. Tamaño A4+ - 335 x 225 mm

COLOR	 Transparente	 Verde	 Azul	 Amarillo	 Humo	 Violeta	 Naranja	 Rojo
CÓDIGO	040539	040542	040540	040543	040544	040541	040545	040546

ENVASE 12 UNIDADES / PACKING 12 PIECES

SOBRE NATURAL CON BROCHE



-  Polipropileno transparente. Capacidad para 50 hojas.
-  Dossier. Transparent polypropylene. Capacity of 50 sheets.
-  Dossier com mola. Polipropileno transparente. Capacidade para 50 folhas.
-  Polipropilene trasparente con capacità per 50 fogli.

Sobre 2021. Tamaño A4+ - 340 x 245 mm





COLOR	 Transparente	 Azul	 Verde	 Naranja
CÓDIGO	180238	180239	180240	180400

ENVASE 12 UNIDADES / PACKING 12 PIECES



SOBRE APAISADO CON BROCHE

Ideal para entrega de documentos

-  Polipropileno transparente. Capacidad para 50 hojas.
-  Transparent polypropylene. Capacity of 50 sheets.
-  Polipropileno transparente. Capacidade para 50 folhas.
-  Polipropilene trasparente con capacità per 50 fogli.



Sobre 2017. Tamaño A7 - 105 x 74 mm				
COLOR	Transparente	Verde	Azul	Rojo
CÓDIGO	180473	180474	180475	180476

ENVASE 12 UNIDADES / PACKING 12 PIECES

Sobre 2016. Tamaño A6 - 168 x 125 mm				
COLOR	Transparente	Verde	Azul	Rojo
CÓDIGO	180469	180470	180471	180472

ENVASE 12 UNIDADES / PACKING 12 PIECES

Sobre 2015. Tamaño A5 - 240 x 178 mm				
COLOR	Transparente	Verde	Azul	Rojo
CÓDIGO	180465	180466	180467	180468

ENVASE 12 UNIDADES / PACKING 12 PIECES

Sobre 2020. Tamaño A4+ - 335 x 225 mm								
COLOR	Transparente	Verde	Azul	Amarillo	Humo	Violeta	Naranja	Rojo
CÓDIGO	180234	180236	180235	180237	180386	180387	180404	180405



ENVASE 12 UNIDADES / PACKING 12 PIECES

Sobre 2023. Tamaño A3 - 320 x 450 mm				
COLOR	Transparente	Verde	Azul	Rojo
CÓDIGO	180850	180852	180851	180853

ENVASE 6 UNIDADES / PACKING 6 PIECES

SET 12 SOBRES CON BROCHE

Colores surtidos

-  Polipropileno transparente. Para 50 hojas. 12 colores: 3 transparentes, 1 gris, 1 violeta, 2 azules, 1 verde, 1 amarillo, 1 naranja, 2 rojos.
-  Transparent polypropylene. For 50 sheets. 12 colours: 3 transparent, 1 gray, 1 violet, 2 blue, 1 green, 1 yellow, 1 orange, 2 red.
-  Polipropileno transparente. Para 50 folhas. 12 cores: 3 transparentes, 1 cinza, 1 violeta, 2 azules, 1 verde, 1 amarelo, 1 laranja, 2 vermelho.
-  Polipropilene trasparente. Per 50 fogli. 12 colori: 3 trasparenti, 1 grigio, 1 viola, 2 blu, 1 verde, 1 giallo, 1 arancione, 2 rossi.



Pack de 12 Tamaño A4+ - 325 x 235 mm	
COLOR	Surtidos
CÓDIGO	180747

ENVASE 5 PACKS / PACKING 5 PACKS



Los códigos en **color amarillo** permiten apertura de envase





DOSSIER CON FASTENER PLÁSTICO

Tamaño A4 • Medidas 310x240 mm • Capacidad 100 hojas



Nuevo mecanismo



-  Dossiers fabricados en PP. Portada transparente rígida. Mecanismo plástico.
-  A4 PP dossier. Transparent, rigid cover. Plastic mechanism.
-  Dossier com ferragem plástico, fabricado em PP, Capa transparente rígida e mecanismo plástico.
-  Dossier fabbricati in PP. Copertina rigida trasparente, meccanismo di plastica.

Tamaño A4 - 240 x 310 mm





COLOR	○ Blanco	● Azul	● Azul claro	● Rojo	● Negro	● Verde
CÓDIGO	180642	180643	180644	180645	180646	180647

ENVASE 12 UNIDADES / PACKING 12 PIECES

DOSSIER F-08 CON PINZA PLASTICO

Tamaño A4 • Medidas 310x240 mm • Capacidad: 30 hojas



-  Polipropileno. Tapa transparente rígida. Base opaca. Pinza grande de plástico. CLIP con el mismo color que el dossier
-  Dossier Polypropylene. Transparent rigid cover. Opaque base. Big clip made of plastic. CLIP with the same color as the dossier
-  Dossier em polipropileno. Capa transparente rígida. Base opaca. Mola grande em plástico. CLIP com a mesma cor que o dossier
-  Polipropilene. Copertina rigida trasparente. Base opaca con grande morsetto di plastica. CLIP stesso colore del dossier.

Tamaño A4 - 240 x 310 mm





COLOR	○ Transparente	● Rojo	● Gris	● Azul	● Verde
CÓDIGO	180271	180272	180273	180270	180282

ENVASE 12 UNIDADES / PACKING 12 PIECES

DOSSIER F-18 CON PINZA METALICA

Tamaño A4 • Medidas 310x240 mm



-  PVC rígido. Tapa transparente rígida. Base opaca. Pinza metálica negra. Capacidad: 50 hojas.
-  Rigid PVC dossier. Transparent rigid cover. Opaque base. Black metallic clip. Capacity: 50 sheets.
-  Dossier em PVC rígido. Capa transparente rígida. Base opaca. Mola metálica preta. Capacidade: 50 folhas.
-  PVC rígido. Copertina rigida trasparente; base opaca con morsetto di metallo nero. Capacità: 50 fogli.

Tamaño A4 - 240 x 310 mm

COLOR	● Azul	● Negro	● Rojo	● Verde	○ Blanco
CÓDIGO	180266	180267	180268	180269	181029

ENVASE 12 UNIDADES / PACKING 12 PIECES





CARPETA CAMPUS GOMAS / SOLAPAS EN CARTON

400 g. Etiqueta en el lomo.

- Fabricada en cartón. Con solapas y cierre de gomas. Etiqueta en el lomo.
- Cardboard folder. With flaps and elastic bands. Label on the back.
- Fabricada em cartão de com abas e elástico. Rótulo na parte de trás.
- Fatto in cartone, con lembi chiusura con l'elastico. Etichetta sul dorso.

Colores vivos



Tamaño A4+ - 245 x 320 mm						
COLOR	Azul	Rojo	Verde	Naranja	Violeta	Amarillo
CÓDIGO	180575	180576	180577	180578	180579	180580
ENVASE 12 UNIDADES / PACKING 12 PIECES						

CARPETA CAMPUS BRILLO, GOMAS / SOLAPAS EN CARTÓN

600 g. Colores vivos. Cartón Brillo.



- Fabricada en cartón. Con solapas y cierre de gomas.
- Cardboard folder. With flaps and elastic bands.
- Fabricada em cartão com abas e elástico.
- Fatto in cartone, con lembi chiusura con l'elastico.



Tamaño A4+ - 245 x 320 mm						
COLOR	Verde	Amarillo	Azul claro	Rosa claro	Azul marino	Verde claro
CÓDIGO	180870	180871	180872	180873	180874	180875
						180876
ENVASE 10 UNIDADES / PACKING 10 PIECES						

CARPETA PLUS SOFT CON GOMAS / SOLAPAS EN POLIPROPILENO

Colores vivos.



- Fabricada en polipropileno. Tres solapas y cierre de gomas en el color de la carpeta.
- Folder made of polypropylene. With 3 flaps and elastic bands in same colour.
- Fabricado em polipropileno. Com 3 abas e elástico mesma cor.
- Realizzato in polipropilene. Tre lembi e chiusura con elastici nel colore della cartella.



Tamaño A4 + - 245 x 320 mm						
COLOR	Verde claro	Verde oscuro	Violeta	Naranja	Rojo	Azul
CÓDIGO	180889	180890	180891	180892	180893	180894
ENVASE 10 UNIDADES / PACKING 10 PIECES						







Los códigos en **color amarillo** permiten apertura de envase







CARPETA CON GOMAS / SOLAPAS POLIPROPILENO

Colores vivos translúcidos









-  Fabricada en polipropileno. Con solapas y cierre de gomas.
-  Folder made of polypropylene. With flaps and elastic bands.
-  Fabricada em polipropileno com abas e elástico.
-  Realizzato in polipropilene. Con lembi e chiusura con elastici.

Tamaño A5 - 180 x 245 mm

COLOR	 Rojo	 Verde	 Violeta	 Naranja	 Humo	 Azul
CÓDIGO	180540	180541	180542	180543	180544	180545





ENVASE 60 UNIDADES / PACKING 60 PIECES

Tamaño A4 - 247 x 320 mm

COLOR	 Rojo	 Verde	 Violeta	 Naranja	 Humo	 Azul
CÓDIGO	180534	180535	180536	180537	180538	180539

ENVASE 60 UNIDADES / PACKING 60 PIECES

Tamaño A3 - 320 x 440 mm





COLOR	 Rojo	 Verde	 Humo	 Azul
CÓDIGO	180509	180511	180510	180508

ENVASE 40 UNIDADES / PACKING 40 PIECES







CARPETA CON GOMAS / SOLAPAS TRASLUCIDA POLIPROPILENO

Colores vivos. Polipropileno rayado.



-  Fabricada en polipropileno rayado. Con solapas y cierre de gomas.
-  Made of lined polypropylene. With flaps and elastic bands.
-  Fabricada em polipropileno listrado. Com abas e fecho de elástico.
-  Realizzato in polipropilene rigato. Con lembi e chiusura con elastici.

Tamaño A4+ - 235 x 318 mm





COLOR	 Violeta	 Verde	 Verde claro	 Naranja	 Azul	 Turquesa
CÓDIGO	180635	180636	180637	180638	180639	180688

ENVASE 60 UNIDADES / PACKING 60 PIECES



CARPETA DE GOMAS / SOLAPAS LOMO DE 3 CM



Tamaño A4+ • Medidas 335x245x30 mm

-  Carpeta proyectos de polipropileno. Lomo de 3 cm. Etiqueta de polipropileno en el lomo.
-  Project polypropylene folder. Back of 3 cm. Polypropylene label on the spine.
-  Pastas em polipropileno com elásticos e lombada de 3 cm. Para projetos. Rótulo de polipropileno na lombada.
-  Cartella per i progetti in polipropilene, dorso di 3 cm. Etichetta in polipropilene sul dorso.







Etiqueta en el lomo









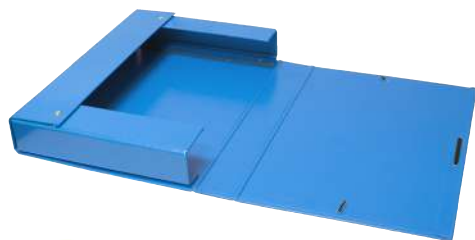

Tamaño A4+ - 345 x 240 mm - LOMO 30 mm.			
COLOR	 Azul	 Verde	 Rojo
CÓDIGO	181032	181031	181030
ENVASE 16 UNIDADES / PACKING 16 PIECES			







CARPETA PROYECTO DE GOMAS CARTÓN, LOMO DE 3, 5 Y 7 CM





Colores vivos. Cartón Mate anti rayado.

-  Fabricada en cartón. Con solapas y cierre de gomas.
-  Cardboard dossier. With flaps and elastic bands.
-  Fabricada em cartão com abas e elástico.
-  Prodotte in cartone, con lembi e chiusura con l'elastico.



Tamaño A4+ - 340 x 240 mm - LOMO 30 mm							
COLOR	 Negro	 Rojo	 Turquesa	 Verde	 Amarillo	 Violeta	 Rosa
CÓDIGO	180947	180948	180949	180950	180951	180952	180953
ENVASE 12 UNIDADES / PACKING 12 PIECES							

Tamaño A4+ - 340 x 240 mm - LOMO 50 mm							
COLOR	 Negro	 Rojo	 Turquesa	 Verde	 Amarillo	 Violeta	 Rosa
CÓDIGO	180955	180956	180957	180958	180959	180960	180961
ENVASE 8 UNIDADES / PACKING 8 PIECES							

Tamaño A4+ - 340 x 240 mm - LOMO 70 mm					
COLOR	 Negro	 Rojo	 Turquesa	 Verde	 Amarillo
CÓDIGO	181322	181324	181323	181325	181326
ENVASE 8 UNIDADES / PACKING 8 PIECES					



Los códigos en **color amarillo** permiten apertura de envase

ETIQUETAS PARA LOMO ARCHIVADOR

Personalice sus archivadores

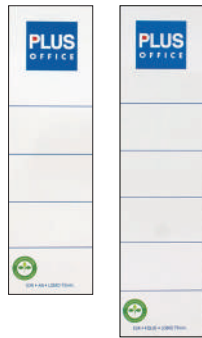

- Etiquetas lomerías para insertarlas en los archivadores de 75 mm. de lomo.
- Spine labels to be inserted in 75 mm spine lever arch files.
- Etiquetas para archivadores col lombada de 75 mm.
- Etichette per il dorso da inserirle negli archiviatori da 75 mm.

PARA ARCHIVADORES DE 75 mm LOMO		
MEDIDAS	A4 - 161 x 48 mm.	FOLIO - 188 x 48 mm.
CÓDIGO	002291	002299
ETIQUETAS BOLSA 10 UNIDADES / LABELS BAGS 10 PIECES		

ARCHIVADOR RADO DE PALANCA - LOMO ANCHO

Tamaño FOLIO • Medidas 350 x 290 mm • SUPER STRONG



- Archivadores en cartón forrado interior y exterior con polipropileno. Ollado, rado y tarjetero en el lomo. Palanca de máxima calidad, compresor y cantoneras metálicas.
- Lever in cardboard lined inside and outside with polypropylene. Finger ring, rado and card holder on the spine. Top quality lever, compressor and metal corners.
- Ficheiros em cartão revestidos por dentro e por fora com polipropileno. Anel de dedo, rado e porta-cartões na lombada. Alavanca, compresor e cantos metálicos de alta qualidade.
- Lime in cartone rivestite all'interno e all'esterno con polipropilene. Anello per le dita, rado e portacarte sul dorso. Leva, compressore e angoli in metallo di alta qualità.

Tamaño Folio - 350 x 290 mm - LOMO 80 mm				
COLOR	Azul	Negro	Rojo	Verde
CÓDIGO	181160	181161	181162	181163
ENVASE 20 UNIDADES / PACKING 20 PIECES				

ARCHIVADOR RADO DE PALANCA - LOMO ANCHO

Tamaño FOLIO • Medidas 350 x 290 mm • SUPER STRONG • Colores pastel





- Archivadores en cartón forrado interior y exterior con polipropileno. Ollado, rado y tarjetero en el lomo. Palanca de máxima calidad, compresor y cantoneras metálicas.
- Lever in cardboard lined inside and outside with polypropylene. Finger ring, rado and card holder on the spine. Top quality lever, compressor and metal corners.
- Ficheiros em cartão revestidos por dentro e por fora com polipropileno. Anel de dedo, rado e porta-cartões na coluna vertebral. Alavanca, compresor e cantos metálicos de alta qualidade.
- Lime in cartone rivestite all'interno e all'esterno con polipropilene. Anello per le dita, rado e portacarte sulla colonna vertebrale. Leva, compressore e angoli in metallo di alta qualità.

Tamaño A4 - 322 x 280 mm - LOMO 80 mm					
COLOR	Azul pastel	Rosa pastel	Verde pastel	Violeta pastel	Naranja pastel
CÓDIGO	181150	181151	181152	181153	181154
ENVASE 20 UNIDADES / PACKING 20 PIECES					



 Archivadores en cartón forrado interior y exterior con polipropileno. Ollado, rado y tarjetero en el lomo. Con palanca de máxima calidad, compresor y cantoneras metálicas.

 Filing cabinets in cardboard lined inside and outside with polypropylene. Finger ring, rado and card holder on the spine. With top quality lever, compressor and metal edges.

 Armários de arquivo em papelão forrado por dentro e por fora com polipropileno. Anel de dedo, rado e porta-cartões na lombada. Com alavanca, compressor e bordas metálicas de primeira qualidade.

 Armadi archiviazione in cartone rivestito internamente ed esternamente in polipropilene. Anello per le dita, rado e portacarte sul dorso. Con leva, compressore e bordi in metallo di prima qualità.

**POSIBLEMENTE
EL MEJOR
ARCHIVADOR DEL
MERCADO**

ARCHIVADOR RADO

Forrado en polipropileno exterior e interior



Tamaño A4 - 320 x 290 mm - LOMO 75 mm

COLOR	● Negro	● Azul	● Rojo	● Verde lima	● Violeta	● Azul claro	● Rosa	○ Blanco	● Naranja
CÓDIGO	181001	181002	181003	180739	180740	180741	180742	180755	180756

ENVASE 12 UNIDADES / PACKING 12 PIECES

Tamaño Folio - 350 x 290 mm - LOMO 75 mm

COLOR	● Negro	● Azul	● Rojo	● Verde lima	● Violeta	● Azul claro	● Rosa	○ Blanco	● Naranja
CÓDIGO	181004	181005	181006	180743	180744	180745	180746	180754	180751

ENVASE 12 UNIDADES / PACKING 12 PIECES

 Archivadores en cartón forrado con polipropileno en la parte exterior y papel de color en la parte interior. Ollado, rado y tarjetero en el lomo. Palanca de máxima calidad, compresor y cantoeras metálicas.

 Cardboard file cabinets lined with polypropylene on the outside and colored paper on the inside. Finger ring, rado and card holder on the spine. Top quality lever, compressor and metal edges.

 Arquivo de papelão forrado a polipropileno na parte externa e papel colorido na parte interna. Anel de dedo, rado e porta-cartões na lombada. Alavanca, compressor e bordas metálicas de primeira qualidade.

 Classificatori in cartone rivestiti esternamente in polipropilene e internamente carta colorata. Anello per le dita, rado e portacarte sul dorso. Leva, compressore e bordi in metallo di prima qualità.

ARCHIVADOR RADO

Forrado exterior en polipropileno y papel interior



Tamaño A4+ - 290 x 320 mm - LOMO 75 mm

COLOR	● Azul	● Negro	● Rojo	● Verde	● Amarillo	● Gris
CÓDIGO ARCHIVADOR	180377	180378	180379	180380	180381	180382

ENVASE 12 UNIDADES / PACKING 12 PIECES

CÓDIGO CAJA	181138	181139	181140	181141	181142	-
-------------	--------	--------	--------	--------	--------	---

ENVASE 25 UNIDADES / PACKING 25 PIECES

Tamaño Folio - 290 x 350 mm - LOMO 75 mm

COLOR	● Azul	● Negro	● Rojo	● Verde	● Amarillo	● Gris
CÓDIGO ARCHIVADOR	180057	180058	180059	180060	180061	180062

ENVASE 12 UNIDADES / PACKING 12 PIECES

CÓDIGO CAJA	181144	181145	181146	181147	181148	-
-------------	--------	--------	--------	--------	--------	---

ENVASE 12 UNIDADES / PACKING 12 PIECES



Los códigos en color amarillo permiten apertura de envase

ARCHIVADOR RADO DE PALANCA - LOMO ESTRECHO

Tamaño A4 • Medidas 322x280 mm

Mecanismo de palanca

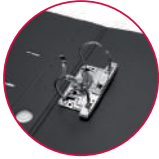



Sistema Rado

-  Archivador de palanca fabricado en polipropileno. Mecanismo de palanca extraíble para su archivo. Para uso intensivo. Con tarjetero, etiqueta extraíble, ollado y sistema Rado.
-  Lever arch file with lever made of polypropylene. Removable lever mechanism. Intensive use. With card holder, removable label, Rado system.
-  Arquivo de alavanca de polipropileno. Mecanismo de alavanca removível para arquivamento. Para uso intensivo. Com cartão, etiqueta removível, ollado e sistema Rado.
-  Cartella archivio con leva in polipropilene. Mecanismo a leva rimovibile. Per uso intensivo. Con porta titolo sul dorso, etichetta rimovibile, foro e sistema Rado.



Tamaño A4 - 322 x 280 mm - LOMO 50 mm





COLOR	 Azul	 Verde	 Gris	 Rojo
CÓDIGO	180598	180607	180608	180609

ENVASE 20 UNIDADES / PACKING 20 PIECES

CARPETA DE ANILLAS CON COMPRESOR

Tamaño FOLIO • Medidas 335 x 260 mm



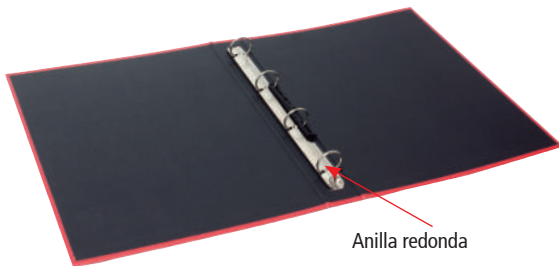

-  Fabricada en cartón forrado en polipropileno por la parte exterior. Acabado brillante. Incluye compresor de plástico.
-  Made of cardboard lined with polypropylene on the outside. Glossy finish. Includes plastic compressor.
-  Feito de papelão revestido com polipropileno no exterior. Acabamento brilhante. Inclui compressor de plástico.
-  Prodotta in cartone foderato in polipropilene all'esterno. Finitura brillante. Include compressore in plastica.



Anilla redonda

Anillas redondas 4 / 25 mm



Tamaño Folio - 335 x 260 mm - LOMO 35 mm

COLOR	 Rojo	 Azul	 Negro
CÓDIGO	181078	181076	181077

ENVASE 20 UNIDADES / PACKING 20 PIECES

Anillas redondas 4 / 40 mm

Tamaño Folio - 335 x 260 mm - LOMO 55 mm





COLOR	 Rojo	 Azul	 Negro
CÓDIGO	181081	181079	181080

ENVASE 20 UNIDADES / PACKING 20 PIECES



CARPETA DE ANILLAS CARTÓN FORRADO PP

Tamaño FOLIO • Medidas 335 x 269 mm

-  Fabricada en cartón forrado en polipropileno por ambas caras.
-  Made of cardboard lined in polypropylene on both sides.
-  Fabricada em cartão forrado a polipropileno em ambos os lados.
-  Realizzata in cartone foderato in polipropilene su entrambi i lati.

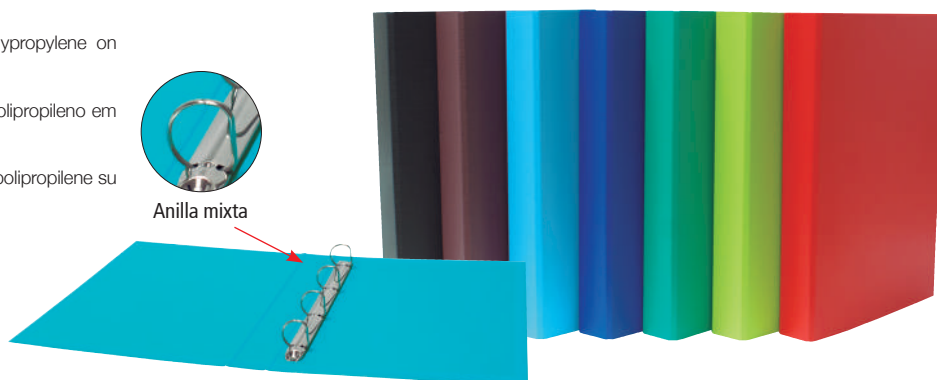







Anillas mixtas 2 / 25 mm. Tamaño Folio - 335 x 269 mm - LOMO 35 mm

COLOR	 Azul	 Verde claro	 Verde	 Rojo	 Azul claro	 Negro	 Marrón	6 surtidos
CÓDIGO	180767	180762	180766	180765	181175	180764	180768	180769

ENVASE 20 UNIDADES / PACKING 20 PIECES

Anillas mixtas 2 / 40 mm. Tamaño Folio - 335 x 269 mm - LOMO 50 mm

COLOR	 Azul	 Verde claro	 Verde	 Rojo	 Azul claro	 Negro	6 surtidos
CÓDIGO	180783	180778	180782	180781	181174	180780	180785



ENVASE 20 UNIDADES / PACKING 20 PIECES

Anillas mixtas 4 / 25 mm. Tamaño Folio - 335 x 269 mm - LOMO 35 mm

COLOR	 Azul	 Verde claro	 Verde	 Rojo	 Azul claro	 Negro	6 surtidos
CÓDIGO	180775	180770	180774	180773	181271	180772	180777

ENVASE 20 UNIDADES / PACKING 20 PIECES





Anillas mixtas 4 / 40 mm. Tamaño Folio - 335 x 269 mm - LOMO 50 mm

COLOR	 Azul	 Verde claro	 Verde	 Rojo	 Azul claro	 Negro	6 surtidos
CÓDIGO	180791	180786	180790	180789	181272	180788	180793

ENVASE 20 UNIDADES / PACKING 20 PIECES



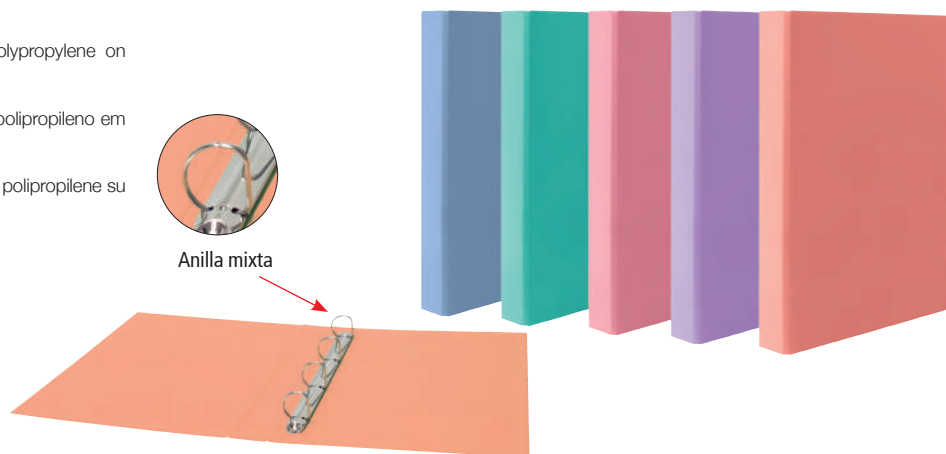

CARPETA DE ANILLAS CARTÓN FORRADO PP PASTEL

Colores pastel • Tamaño FOLIO • Medidas 335 x 269 mm

-  Fabricada en cartón forrado en polipropileno por ambas caras.
-  Made of cardboard lined in polypropylene on both sides.
-  Fabricada em cartão forrado a polipropileno em ambos os lados.
-  Realizzata in cartone foderato in polipropilene su entrambi i lati.



Anillas mixtas 4 / 25 mm. Tamaño Folio - 335 x 269 mm - LOMO 35 mm

COLOR	 Azul pastel	 Verde pastel	 Naranja pastel	 Violeta pastel	 Rosa pastel
CÓDIGO	181155	181156	181159	181158	181157

ENVASE 20 UNIDADES / PACKING 20 PIECES



Los códigos en **color amarillo** permiten apertura de envase

CARPETA DE ANILLAS SOFT CON RECAMBIO - SISTEMA RADO

Tapa extradura de cartón forrado con acabado mate SOFT

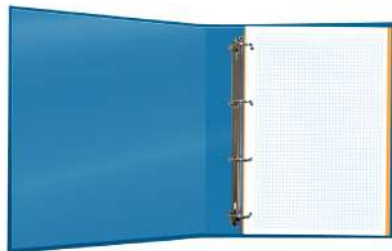

Recambio de 100 hojas con bandas de color



● Carpeta de cartón forrado con 4 anillas de 35 mm, sistema Rado y cierre con goma elástica. Lomo ergonómico. Tapas con acabado de tacto suave. Guarda interior a juego con las tapas y la goma. Incluye recambio muy resistente de 100 hojas de 90 g con bandas de color, rayado cuadrícula 5x5 mm. Tamaño A4.

🇬🇧 Lined cardboard folder with 4 rings of 35 mm, Rado system and elastic band closure. Ergonomic spine. Covers with a soft touch finish. Inner guard to match the covers and the rubber. It includes a very resistant refill of 100 sheets of 90 g with color bands, 5x5 mm grid lines. A4 size.

● Pasta de papelão forrada com 4 argolas de 35 mm, sistema Rado e fecho de banda elástica. Coluna ergonômica. Capas com acabamento de toque suave. Protetor interno para combinar com as tampas e a borracha. Inclui uma recarga muito resistente de 100 folhas de 90 g com bandas de cores, linhas de grelha 5x5 mm. Tamanho A4.

🇮🇹 Cartella in cartone rivestita con 4 anelli da 35 mm, sistema Rado e chiusura con elastico. Colonna vertebrale ergonomica. Copertine con finitura soft touch. Protezione interna in tinta con le coperture e la gomma. Include una ricarica molto resistente da 100 fogli da 90 g con bande colorate, linee griglia 5x5 mm. Formato A4.

Anillas 4 / 35 mm mixtas. Tamaño A4 - 320 x 260 mm - LOMO 60 mm

COLOR	● Azul	● Rojo	● Turquesa	● Rosa	● Negro	● Azul cielo	● Fucsia	● Verde
CÓDIGO	181327	181328	181329	181330	181331	181347	181346	181345

ENVASE 5 UNIDADES / PACKING 5 PIECES

CARPETA DE ANILLAS CON RECAMBIO - SISTEMA RADO

Interior y exterior forrado con polipropileno



Recambio de 100 hojas y 5 separadores



● Carpeta de cartón con 4 anillas, sistema Rado y cierre con goma. Cartón entrecollado de 2,2 mm de espesor. Incluye recambio A4 de 100 hojas de 90 g. Cuad. 5x5 mm. y 5 separadores.

🇬🇧 Cardboard folder with 4 rings, finger ring system and elastic band closure. 2.2 mm thick interleaved cardboard. It includes A4 refill of 100 sheets of 90 g. paper. Ruling 5x5 mm and 5 indexes.

● Pasta em cartão com 4 argolas, sistema Rado e fecho com elástico. Cartão intercalado com 2,2 mm de espessura. Inclui recarga de papel A/4 de 100 fls de 90 g. Em xadrez 5x5 e 5 separadores.

🇮🇹 Cartella in cartone con 4 anelli, sistema Rado e chiusura con l'elastico. Cartone interlacciato di spessore 2,2 mm. Include un ricambio A4 de 100 fogli da 90 g. Griglia 5x5 mm. e 5 separatori.

Anillas 4 / 30 mm mixtas - 5 Separadores. Tamaño A4 - 320 x 250 mm - LOMO 60 mm

COLOR	○ Blanco	● Rosa oscuro	● Rosa	● Azul claro	● Azul	● Verde	● Rojo	● Violeta
CÓDIGO	180963	180964	180965	180966	209353	209354	209282	209356

ENVASE 8 UNIDADES / PACKING 8 PIECES

Anillas 4 / 20 mm redondas. Tamaño A4 - 310 x 240 mm - LOMO 32 mm





COLOR	● Azul	● Verde	● Rojo	● Violeta
CÓDIGO	209326	209327	209281	209329

ENVASE 10 UNIDADES / PACKING 10 PIECES



CARPETA CANGURO TAPA RÍGIDA POLIPROPILENO

Personalizable en portada y lomo

-  Dos y cuatro anillas. Con funda transparente en portada y lomo para su personalización y fácil identificación. Dos bolsillos interiores.
-  Two and four rings. With transparent cover on the cover and spine for personalization and easy identification. Two interior pockets.
-  Dois e quatro anéis. Com capa transparente na capa e lombada para personalização e fácil identificação. Dois bolsos interiores.
-  Due e quattro anelli. Con copertina trasparente su copertina e dorso per personalizzazione e facile identificazione. Due tasche interne.



Anillas mixtas



Tamaño A4 - 318 x 266 mm - LOMO 37 mm





ANILLAS	2 / 25 mm.	4 / 25 mm.
CÓDIGO	180513	180505
ENVASE 20 UNIDADES / PACKING 20 PIECES		

Tamaño A4 - 318 x 276,5 mm - LOMO 56 mm

ANILLAS	2 / 40 mm.	4 / 40 mm.
CÓDIGO	180514	180512
ENVASE 20 UNIDADES / PACKING 20 PIECES		

CARPETA DE 4 ANILLAS POLIPROPILENO

Polipropileno de 0,7 mm. Incluye sobre de pp con cierre de velcro.

-  Cierre de goma. Polipropileno de 0,7 mm rayado por fuera. Ribete de tela. Anillas redondas.
-  Elastic band. Made of 0,7 mm polypropylene striped on the outside. Fabric edging. Round rings.
-  Fecho de borracha. Polipropileno de 0,7 mm listrado por fora. Costura de tecido. Anéis redondos.
-  Chiusura con l'elastico. Polipropilene di 0,7 mm rigato all'esterno. Bordo in tessuto. Anelli circolari.



4 x 20mm



Anillas 4 / 20 mm.

Tamaño A4 - 250 x 330 x 35 mm

COLOR	 Azul	 Verde
CÓDIGO	181109	181110
ENVASE 12 UNIDADES / PACKING 12 PIECES		







Los códigos en color amarillo permiten apertura de envase

CARPETA FLEXIBLE DE ANILLAS

Tamaño A4 • Medidas 315x245 mm • Nº Anillas : 4 / 16 mm



-  Polipropileno traslúcida. Lomo de 20 mm.
-  Translucid polypropylene. Spine of 20 mm.
-  Polipropileno traslucido. Lombada de 20 mm.
-  Polipropilene traslucido. Dorso di 20 mm.







Anillas redondas 4 / 16 mm. Tamaño A4 - 245 x 315 mm - LOMO 20 mm.					
COLOR	Azul	Verde	Rojo	Naranja	Violeta
CÓDIGO	180501	181071	181070	181072	181073
ENVASE 12 UNIDADES / PACKING 12 PIECES					

CARPETA DE 2 ANILLAS DE POLIPROPILENO

Polipropileno de 0,7 mm. y ribete negro de tela



-  Polipropileno rayado por fuera y liso por dentro.
-  Polypropylene lined on the outside and smooth on the inside.
-  Polipropileno listrado por fora e liso por dentro.
-  Foderato in polipropilene all'esterno e liscio all'interno.







Anillas 2 / 25 mm redondas. Tamaño A4 - 260 x 315 mm - LOMO 35 mm				
COLOR	Azul	Verde	Violeta	Naranja
CÓDIGO	180882	180883	180884	180885
ENVASE 5 UNIDADES / PACKING 5 PIECES				

CARPETA DE 4 ANILLAS DE POLIPROPILENO

Polipropileno de 0,7 mm. y ribete negro de tela



-  Polipropileno rayado por fuera y liso por dentro.
-  Polypropylene lined on the outside and smooth on the inside.
-  Polipropileno listrado por fora e liso por dentro.
-  Foderato in polipropilene all'esterno e liscio all'interno.



Anillas 4 / 25 mm redondas Tamaño A4 - 260 x 315 mm - LOMO 35 mm					
COLOR	Azul	Rosa	Naranja	Violeta	Verde
CÓDIGO	180834	180835	180836	180837	180838
ENVASE 5 UNIDADES / PACKING 5 PIECES					



CARPETA CON CREMALLERA

Tamaño A4+ • Medidas 330x260 mm

- Polipropileno. Traslúcida. 1 bolsillo interior para los documentos. Total seguridad para los documentos gracias a su cremallera.
- Polypropilene. Translucid. One inside pocket for documents. Total security for the documents thanks to the zip.
- Polipropileno. Traslúcida. Com bolsa interior para documentos, graças ao fecho.
- Polipropilene. Traslucida. 1 tasca interna per i documenti, sicurezza garantita grazie alla sua cerniera.



Tamaño A4+ - 330 x 260 mm			
COLOR	Verde	Azul	Rojo
CÓDIGO	180555	180556	180557
ENVASE 12 UNIDADES / PACKING 12 PIECES			



CARPETA CON 4 ANILLAS Y CREMALLERA

Medidas 328x272 mm • 5 divisores

- Carpeta rígida de polipropileno reforzada con nylon en el lomo. Con 5 divisores de colores. 2 compartimentos con solapa, bolsillos para tarjetas y bolígrafos en su interior, y bolsillo con cremallera en el exterior.
- Super rigid polypropylene briefcase and nylon reinforced back. With 5 colour compartments. 2 flap compartments, interior card and pen pockets, and exterior zip pocket.
- Pasta rígida de polipropileno reforçada com nylon na parte de trás. Com 5 divisores de cores. 2 compartimentos de aba, bolsos internos para cartão e caneta e bolso externo com zíper.
- Cartella rigida in polipropilene rinforzata con nylon sul retro. Con 5 divisori di colore. 2 scomparti con patta, tasche interne per carte e penne e tasca esterna con cerniera.



Anillas 4 / 30 mm			
Tamaño A4 - 328 x 272 mm			
COLOR	Azul	Rojo	Verde
CÓDIGO	181166	181167	181168
ENVASE 12 UNIDADES / PACKING 12 PIECES			



CARPETA CON BLOC

Incluye bloc de 30 hojas

- Tapas de polipropileno rígido. Con dos bolsillos interiores transparentes y tarjetero.
- Rigid polypropylene covers. With two transparent inner pockets and card holder.
- Pasta em polipropileno rígido, com duas bolsas interiores para cartões de visita.
- Copertine rigide in polipropilene. Con due tasche interne trasparenti e porta carte.



Tamaño A4 - 245 x 310 x 7 mm	
COLOR	● Negro
CÓDIGO	180842
ENVASE 12 UNIDADES / PACKING 12 PIECES	









Los códigos en color amarillo permiten apertura de envase

CARPETA CON BLOC

Incluye bloc de 30 hojas







-  Polipropileno rígido. Bloc de 30 hojas. 2 Compartimentos, porta-tarjetas y bolsillo con cremallera.
-  Rigid polypropilene. Bloc of 30 sheets. 2 compartments, card pockets and pocket with zip.
-  Polipropileno rígido. Bloco A4 de 30 folhas, 2 Compartimentos, porta cartões, bolsa com fecho.
-  Polipropilene rigido. Blocco da 30 fogli. 2 scomparti, tasche per carte e tasca con zip.

Tamaño A4 - 270 x 320 mm			
COLOR	 Negro/Azul	 Negro/Gris	 Negro/Rojo
CÓDIGO	180496	181085	181084
ENVASE 12 UNIDADES / PACKING 12 PIECES			

CARPETA LUXE CON FUNDAS

Con lomo personalizable







-  Polipropileno rígido. Fundas transparentes de 45 micras antirreflejo y resistentes a las fotocopias. Soldadas al lomo.
-  Transparent 45 micron anti-glare and photocopy resistant covers. Welded to the back.
-  Pastas rígidas. Tampas transparentes anti-reflexo de 45 microns e resistentes a fotocópias. Soldado na parte traseira.
-  Polipropilene rigido. Cover trasparenti 45 micron antiriflesso e resistenti alle fotocopie. Saldato alla schiena.



30 FUNDAS	
Tamaño A4+ - 245 x 308 mm	
COLOR	 Azul
CÓDIGO	180566
ENVASE 12 UNIDADES / PACKING 12 PIECES	

CARPETA CON MINICLIP SUPERIOR





Tamaño A4 • Medidas 330x255 mm



-  Carpeta en polipropileno con broche. Con solapa, tarjetero y porta CD.
-  Polypropylene folder with clasp. With flap, card holder and CD holder.
-  Pasta de polipropileno com fecho. Com aba, porta-cartões e porta CD.
-  Cartella in polipropilene con chiusura. Con patta, porta carte e porta CD.

Tamaño A4 - 255 x 330 mm	
COLOR	 Azul  Humo
CÓDIGO	180449
ENVASE 12 UNIDADES / PACKING 12 PIECES	



-  Fabricada en polipropileno con miniclip superior.
-  Folder made in polypropylene with superior miniclip.
-  Pasta di polipropileno con superior miniclip.
-  Polipropilene con miniclip superiore.



CARPETA A4 CON MINICLIP SUPERIOR





Tamaño A4



Tamaño A4 - 260 x 315 mm - LOMO 35 mm				
COLOR	Rojo	Azul	Gris	Negro
CÓDIGO	180735	180736	180737	180738
ENVASE 12 UNIDADES / PACKING 12 PIECES				

CARPETA LUXE CLASIFICADORA 6 COMPARTIMENTOS

6 compartimentos

-  Polipropileno flexible. 6 compartimentos para clasificar y 2 portacarnets. Incluye bloc 30 hojas. Cierre de velcro.
-  Flexible polypropylene. 6 compartments to classify and 2 card holders. It includes 30 sheets pad. Velcro closure.
-  Polipropileno flexível. 6 divisórias e mais duas divisórias para cartões. Inclui um bloco com 30 fls. Fechamento de velcro.
-  Polipropilene flessibile. 6 scomparti per la classifica e 2 portascchede. Include blocco di 30 fogli. Chiusura in velcro.







Tamaño A4 - 246 x 331 x 36 x 0.7 mm	
COLOR	Azul / Negro
CÓDIGO	180629
ENVASE 12 UNIDADES / PACKING 12 PIECES	



CARPETA LUXE CLASIFICADORA CON BLOC

6 compartimentos

-  Polipropileno flexible. Con bloc de 30 hojas. 2 portacarnets. Cierre de goma. Borde de tela.
-  Flexible polypropylene. With bloc of 30. 2 card holders. Elastic band closure. Edges of fabric.
-  Polipropileno flexível. Bloco com 30 fls. 2 porta cartões. Fecha com elastico. Rebordo de tela.
-  Polipropilene flessibile. Blocco da 30 fogli. 2 portascchede. Chiusura con gomma. Bordo in tessuto.







Tamaño A4 - 255 x 330 x 30 x 0.7 mm	
COLOR	Azul Negro
CÓDIGO	180567
ENVASE 12 UNIDADES / PACKING 12 PIECES	



CARPETA CLASIFICADORA "RECIBOS"

12 Compartimentos

-  Polipropileno. Tamaño RECIBOS. Cierre con goma.
-  Expanding file. Polypropylene. Size RECEIPTS. Elastic band closure.
-  Pasta "RECIBOS" clasificadora. Formato RECIBOS. Fecho con elástico.
-  Polipropilene. Stesse dimensioni RICEVUTE. Chiusura con l'elastico.

Etiquetas identificadoras



12 Compartimentos. Tamaño - 260 x 130 mm			
COLOR	Negro	Azul	Rojo
CÓDIGO	180214	181086	181087
ENVASE 12 UNIDADES / PACKING 12 PIECES			



Los códigos en **color amarillo** permiten apertura de envase

CARPETA CLASIFICADORA COLORES SOLIDOS

Tamaño A4

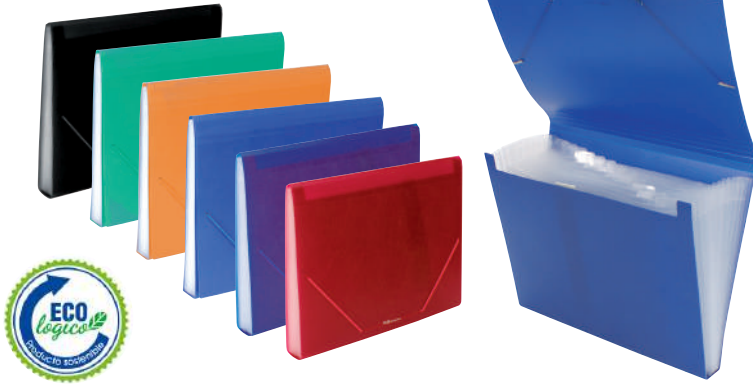

- Polipropileno. 12 compartimentos. Con gomas. Colores sólidos.
- Expanding file. Polypropylene. 12 compartments. Elastic bands. Solid colours.
- Pasta A4 classificadora com 12 separadores, fabricada em polipropileno. Fecho com elástico. Cores sólidas.
- Polipropilene. 12 scomparti, chiusura con elastici. Colori solidi

12 Compartimentos. Tamaño A4 - 330 x 240 mm

COLOR	Azul	Negro	Rojo	Violeta	Naranja	Verde
CÓDIGO	180213	180695	180700	180701	180702	180703

ENVASE 12 UNIDADES / PACKING 12 PIECES

CARPETA CLASIFICADORA TRASLUCIDA

Tamaño A4

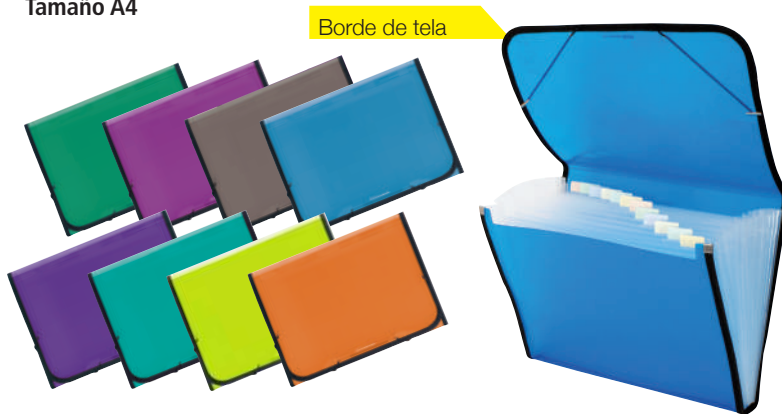

Borde de tela

- Polipropileno. 12 Compartimentos. Con gomas y borde de tela.
- Expanding file. Polypropylene. 12 compartments. Elastic band closure and edges of fabric.
- Pasta A4 classificadora com 12 separadores fabricada em polipropileno. Com fechos de elástico.
- Polipropilene. 12 scomparti, chiusura con elastici e bordi in tessuto.



12 Compartimentos. Tamaño A4 - 330 x 240 mm

COLOR	Azul	Humo	Verde	Fucsia	Naranja	Verde claro	Turquesa	Violeta
CÓDIGO	180413	180704	180706	180707	180705	180713	180714	180715

ENVASE 12 UNIDADES / PACKING 12 PIECES

CARPETA CLASIFICADORA TRASLUCIDA CON BROCHE

12 compartimentos

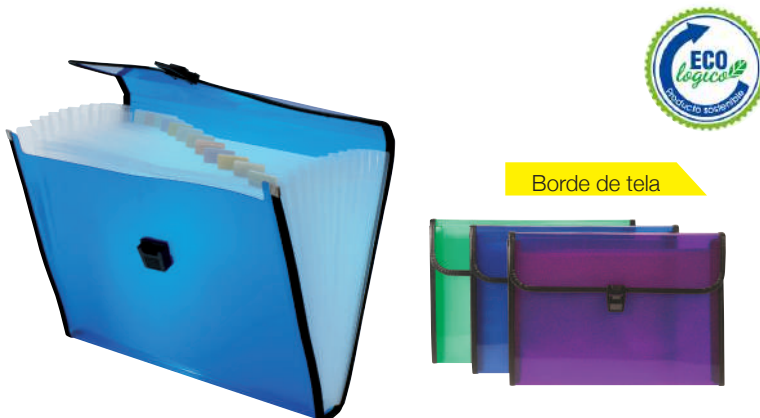

Borde de tela



- Polipropileno. Borde de tela. 12 compartimentos. Con broche.
- Polypropylene. Edges of fabric. 12 polypropylene compartments. With clasp.
- Polipropileno. Rebordo de tela. 12 separadores. Com broche.
- Polipropilene. Bordo in tessuto. 12 scomparti. Chiusura con spilla.

Tamaño - 330 x 250 mm

COLOR	Azul	Violeta	Verde
CÓDIGO	180422	180708	180709

ENVASE 12 UNIDADES / PACKING 12 PIECES



CARPETA CLASIFICADORA CON BROCHE

12 compartimentos

- Polipropileno. Bordes de tela y broche. 12 compartimentos.
- Polypropylene. Fabric edges and brooch. 12 compartments.
- Polipropileno. Bordas de tecido e broche. 12 separadores.
- Polipropileno. Bordi e spilla in tessuto. 12 scomparti.

Tamaño - 330 x 240 mm		
COLOR	● Negro	● Azul
CÓDIGO	180412	181025
ENVASE 12 UNIDADES / PACKING 12 PIECES		



Borde de tela



CARPETA CLASIFICADORA PREMIUM

Tamaño A4 • 330x240 mm • N° Compartimentos: 12

- Polipropileno. Con bordes de tela. 12 compartimentos.
- Polypropylene. Edges of fabric. 12 compartments.
- Polipropileno. Cantos de pano. 12 separadores.
- Polipropileno. Bordi in tessuto. 12 scomparti.

12 Compartimentos. Tamaño A4 - 330 x 240 mm				
	SOLIDOS		METALIZADOS	
COLOR	● Negro	● Azul	● Gris	● Azul
CÓDIGO	180411	181026	180425	180962
ENVASE 12 UNIDADES / PACKING 12 PIECES				

Sólidos



Metalizados



MALETIN 2 DEPARTAMENTOS TRASLUCIDO

Medidas 385x270 mm

- Con asas. Polipropileno traslúcido. 2 departamentos.
- With handles. Translucent polypropylene. 2 departments.
- Pasta em polipropileno traslúcido. Com alças, 2 compartimentos.
- Valigetta con manici. Polipropilene traslucido. 2 scomparti.

Tamaño A4+ - 385 x 270 x 35 mm			
COLOR	● Azul	● Violeta	● Verde
CÓDIGO	180216	180712	180711
ENVASE 10 UNIDADES / PACKING 10 PIECES			

Borde de tela



Cierre broche

CARPETA DE GOMAS CON FUELLE DE TELA

Tamaño A4+ • Medidas 340x260 mm

- Carpeta de polipropileno traslúcido con fuelle y gomas. Lomo y ribete de tela.
- Translucent polypropylene folder. With back and stitching around edge.
- Pastas em polipropileno traslúcido com elásticos.
- Cartella in polipropilene traslucido con soffietto ed elastici. Dorsò e finiture in tessuto.

Tamaño A4+ - 340 x 260 mm			
COLOR	● Humo	● Azul	● Verde
CÓDIGO	180204	181023	181024
ENVASE 12 UNIDADES / PACKING 12 PIECES			

Borde de tela

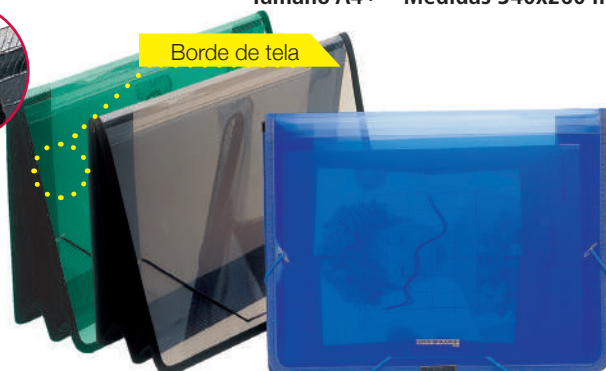

Los códigos en color amarillo permiten apertura de envase

MALETÍN CLASIFICADOR TRASLÚCIDO

3 departamentos, asa y cierre con cremallera.



- Polipropileno. 3 compartimentos. Cierre de cremallera.
- Polypropylene. 3 compartments. Zip closure.
- Polipropileno. 3 compartimentos. Fecho éclair.
- Polipropilene. 3 scomparti. Chiusura a cerniera.

3 Compartimentos. Tamaño 400 x 300mm		
COLOR	Azul	Violeta Verde
CÓDIGO	180503	181088 181089
ENVASE 6 UNIDADES / PACKING 6 PIECES		

PORTAFOLIO

Tamaño A4 • Medidas 335x270 mm



Gran capacidad

Gracias a sus múltiples bolsillos y su espacio interior



- Polipropileno rígido con aplicaciones de nylon en el lomo y tapa. Cierre con correa de velcro.
- Rigid polypropylene with nylon inserts on the spine and lid. With security velcro strap fastener.
- Polipropileno rígido com inserções de náilon na lombada e na tampa. Fecho com correia de velcro.
- Polipropilene rígido con inserti in nylon su dorso e coperchio. Chiusura con cinturino in velcro.

Tamaño A4 - 335 x 270 mm	
COLOR	Negro
	Solapas surtidas
CÓDIGO	180494
ENVASE 12 UNIDADES / PACKING 12 PIECES	

CARPETA DE DIBUJO "LUXE"



Máxima protección

- Polipropileno preformado. Varios compartimentos. Cierre con cremallera. Correa para la sujeción de los documentos en su interior.
- Super rigid polypropylene briefcase. Several compartments. With zip. Strap for holding documents inside.
- Polipropileno super rígido. Possui porta cartões e porta esferográficas. Vários compartimentos. Fecho éclair. Correia para guardar documentos no interior.
- Cartella in polipropilene preformato. Parecchi scomparti. Chiusura a zip. Cinghia per contenere documenti all'interno.

TAMAÑO	A4 - 360 x 290 mm	A2 - 670 x 490 mm.
CÓDIGO	180489	180491
ENVASE	6	6

LIBRO PORTAFIRMAS

18 Separadores



- Cubierta rígida. Lomo con fuelle encolado. Perforaciones en cada departamento.
- Rigid cover. Spine with glue bellow. Perforations in each department.
- Capa rígida. Lombada com fole colado. Perfurações em cada departamento.
- Libro portafirme, copertina rigida, dorso con soffietto incollato. Perforazioni in ogni reparto.

18 Compartimentos Tamaño A4 - 240 x 330 mm	
COLOR	Negro
CÓDIGO	040547
ENVASE 16 UNIDADES / PACKING 16 PIECES	



CARPETA DE FUNDAS TAPA BASICA

Tamaño A4 • Medidas 310x240 mm

- Tapas de polipropileno flexibles. Fundas transparentes de polipropileno antirreflejo de 35 micras y resistentes a las fotocopias. Soldadas al lomo.
- Folder with pockets. Flexible polypropylene covers. Transparent covers of polypropylene of 35 microns antireflection resistant to photocopies. Welded to the back.
- Capas em polipropileno flexíveis, com bolsas transparentes antirreflexo em 35 microns e resistentes a fotocópias. Bolsas soldadas na capa.
- Copertine flessibili in polipropilene. Con buste trasparenti in polipropilene antiriflesso da 35 micron resistenti alle fotocopie. Foderate sul dorso.



10 FUNDAS. Tamaño A4 - 240 x 310 mm

COLOR	● Azul	● Rojo	● Naranja	● Verde
CÓDIGO	180648	180649	180650	180651

ENVASE 10 UNIDADES / PACKING 10 PIECES

30 FUNDAS. Tamaño A4 - 240 x 310 mm

COLOR	● Azul	● Rojo	● Naranja	● Verde
CÓDIGO	180656	180657	180658	180659

ENVASE 10 UNIDADES / PACKING 10 PIECES

20 FUNDAS. Tamaño A4 - 240 x 310 mm

COLOR	● Azul	● Rojo	● Naranja	● Verde
CÓDIGO	180652	180653	180654	180655

ENVASE 10 UNIDADES / PACKING 10 PIECES

40 FUNDAS. Tamaño A4 - 240 x 310 mm

COLOR	● Azul	● Rojo	● Naranja	● Verde
CÓDIGO	180660	180661	180662	180663

ENVASE 10 UNIDADES / PACKING 10 PIECES

- Polipropileno. Con 12 fundas transparentes de polipropileno antirreflejo 120 micras con uñero. Cierre con goma.
- Polypropylene. With 12 transparent anti-reflective polypropylene 120 micron covers with fingernail. Closure with elastic bands.
- Polipropileno. Com 12 tampas transparentes de polipropileno anti-reflexo de 120 microns com unha. Fecha com elástico.
- Realizzato in polipropilene. Con 12 coperture in polipropilene trasparente antiriflesso 120 micron con unghia. Chiudi con elastico.

360°



12 FUNDAS Tamaño A4+ - 253,5 x 325 mm

COLOR	● Azul
CÓDIGO	181044

ENVASE 12 UNIDADES / PACKING 12 PIECES

CARPETA DE FUNDAS ESPIRAL TAPA DURA

Tamaño A4 • Medidas 238x313 mm • Giro 360°

- Tapas de polipropileno opacas. Fundas transparentes de polipropileno antirreflejo de 90 micras. Giro 360°.
- Opaque polypropylene caps. Antireflective transparent covers 90 micron polypropylene. 360° rotation.
- Capas de polipropileno opaco. Bolsas em cristal antirreflexo de 90 micras. Se pode virar a 360°.
- Copertine in polipropilene opaco. Buste trasparenti in polipropilene antiriflesso da 90 micron. Giro 360°.

360°



Tamaño A4 - 238 x 313 mm

20 FUNDAS				30 FUNDAS				40 FUNDAS				
COLOR	● Naranja	● Rojo	● Verde	● Azul	● Naranja	● Rojo	● Verde	● Azul	● Naranja	● Rojo	● Verde	● Azul
CÓDIGO	180613	180614	180615	180616	180617	180618	180619	180620	180623	180628	180621	180622

ENVASE 12 UNIDADES / PACKING 12 PIECES







Los códigos en color amarillo permiten apertura de envase

CARPETA DE FUNDAS, ESPIRAL Y CON GOMAS

Polipropileno de colores traslúcidos







-  Polipropileno de colores. Cierre de gomas. Con sobre dossier en el interior. Fundas transparentes de polipropileno antirreflejo de 90 micras. Giro 360°.
-  Polypropylene covers. With elastic bands closure. With dossier envelope on the inside. Transparent 90 microns anti-reflective polypropylene pockets. 360° rotation.
-  Polipropileno ás cores. Fecha com elásticos. Envelope dossier plástico no interior. Bolsas transparentes de polipropileno anti reflexo de 90 micras. Se pode virar a 360°.
-  Polipropilene colorato, chiusura con la gomma. All'interno dossier tipo busta. Fodere in polipropilene antiriflesso trasparenti da 90 micron. Giro di 360°.

Tamaño A4 - 240 x 310 mm												
20 FUNDAS			30 FUNDAS			40 FUNDAS			50 FUNDAS			
COLOR	Azul	Verde	Violeta	Azul	Verde	Violeta	Azul	Verde	Violeta	Azul	Verde	Violeta
CÓDIGO	180759	181033	181034	180760	181035	181036	180761	181037	181038	180954	181074	181075
ENVASE 12 UNIDADES / PACKING 12 PIECES										ENVASE 6 UNIDADES / PACKING 6 PIECES		

CARPETA DE FUNDAS TAPA DURA TRASLUCIDA

Tamaño A5 y A4



-  Polipropileno flexible. Fundas transparentes de polipropileno antirreflejo de 45 micras y resistentes a las fotocopias. Soldadas al lomo.
-  Flexible polypropylene covers. Transparent covers of polypropylene of 45 microns antireflection resistant to photocopies. Welded to the back.
-  Polipropileno flexível, com bolsas transparentes antirreflexo em 45 microns e resistentes a fotocópias. Bolsas soldadas na capa.
-  Polipropilene flessibili. Buste in polipropilene antiriflesso trasparenti da 45 micron e resistenti alle fotocopie. Saldate sul dorso.

Tamaño A5 - 167 x 224 mm				
10 FUNDAS			20 FUNDAS	
COLOR	Verde	Azul	Verde	Azul
CÓDIGO	180855	180856	180857	180858
ENVASE 20 UNIDADES / PACKING 20 PIECES				

Tamaño A4 - 230 x 305 mm										
10 FUNDAS					20 FUNDAS					
COLOR	Verde	Azul	Rosa	Rojo	Violeta	Verde	Azul	Rosa	Rojo	Violeta
CÓDIGO	180666	180668	180878	180859	180860	180672	180674	180879	180861	180862
ENVASE 20 UNIDADES / PACKING 20 PIECES										





30 FUNDAS					40 FUNDAS					
COLOR	Verde	Azul	Rosa	Rojo	Violeta	Verde	Azul	Rosa	Rojo	Violeta
CÓDIGO	180678	180680	180880	180863	180864	180684	180686	180881	180865	180866
ENVASE 20 UNIDADES / PACKING 20 PIECES										

60 FUNDAS					
COLOR	Verde	Azul	Rosa	Rojo	Violeta
CÓDIGO	181333	181332	181334	181335	181336
ENVASE 20 UNIDADES / PACKING 20 PIECES					



CARPETA DE FUNDAS TAPA DURA NEGRA

Color negro

-  Polipropileno flexible. Fundas transparentes de polipropileno antirreflejo de 45 micras y resistentes a las fotocopias. Soldadas al lomo.
-  Flexible polypropylene covers. Transparent covers of polypropylene of 45 microns anti-reflection resistant to photocopies. Welded to the back.
-  Polipropileno flexíveis, sem lombada, com bolsas transparentes antireflexo em 45 microns e resistentes a fotocópias. Bolsas soldadas na capa.
-  Polipropilene flessibili. Buste in polipropilene antiriflesso trasparenti da 45 micron e resistenti alle fotocopie. Saldate sul dorso.



Tamaño A5 - 167 x 224 mm		
	10 FUNDAS	20 FUNDAS
COLOR	● Negro	● Negro
CÓDIGO	180868	180869
ENVASE 20 UNIDADES / PACKING 20 PIECES		



Tamaño A4 - 230 x 305 mm				
	10 FUNDAS	20 FUNDAS	30 FUNDAS	40 FUNDAS
COLOR	● Negro	● Negro	● Negro	● Negro
CÓDIGO	180225	180226	180227	180228
ENVASE 24 UNIDADES / PACKING 24 PIECES			ENVASE 12 UNIDADES / PACKING 12 PIECES	

CARPETA DE FUNDAS PREMIUM

Tamaño A4 • Medidas 308x245 mm • Colores sólidos. Lomo personalizable

-  Polipropileno rígido. Porta identificación transparente en el lomo. Fundas de polipropileno transparentes de 50 micras.
-  Rigid polypropylene covers. It brings transparent identification in the back. Transparent covers of polypropylene of 50 microns anti-reflection.
-  Pastas rígidas com lombada e bolsas transparentes. Porta identificação na lombada. Com bolsas transparentes antireflexo em 50 microns
-  Rigide polipropilene. Porta identificazione trasparente sul dorso. Bueste trasparenti in polipropilene da 50 micron.



Tamaño A4 - 245 x 308 mm						
	20 FUNDAS			40 FUNDAS		
COLOR	● Azul	● Negro	● Rojo	● Azul	● Negro	● Rojo
CÓDIGO	180221	180689	180690	180222	180691	180692
ENVASE 12 UNIDADES / PACKING 12 PIECES				ENVASE 10 UNIDADES / PACKING 10 PIECES		
	60 FUNDAS			80 FUNDAS		
COLOR	● Azul	● Negro	● Rojo	● Azul	● Negro	● Rojo
CÓDIGO	180223	180693	180694	180224	180696	180697
ENVASE 8 UNIDADES / PACKING 8 PIECES				ENVASE 10 UNIDADES / PACKING 10 PIECES		







Los códigos en color amarillo permiten apertura de envase

CARPETA DE FUNDAS CON SEPARADORES EN "L"



Con 6 divisores dobles (12)



-  Polipropileno. Cubierta transparente e interior de color. Con etiqueta en el lomo y cierre de gomas
-  Polypropylene. Transparent cover and color inside. With label on the spine and elastic band closure.
-  Polipropileno. Capa trasparente e interior de cor. Com etiqueta na lombada, fecha com elástico.
-  Polipropilene. Copertina trasparente e interno a colore. Con etichetta sul dorso e chiusura con elastico.



Etiqueta en el lomo

Tamaño A4+ - 253,5 x 325 x 80 mm			
COLOR	 Azul	 Rojo	 Verde
CÓDIGO	180886	180887	180888
ENVASE 12 UNIDADES / PACKING 12 PIECES			





FUNDA MULTITALADRO SUPERCRIстал

Tamaño A4, A3 y Folio



100% TRANSPARENTE!



-  Apertura superior. 100% de polipropileno reciclable. Acabado en CRISTAL. Totalmente transparente.
-  Top opening. 100% recyclable polypropylene. GLASS finish. Totally transparent.
-  Bolsas catalogo A/4. Apertura superior em polipropileno 100% reciclável em cristal totalmente transparente.
-  Apertura superiore. Polipropilene riciclabile al 100%. Finito in CRISTAL. Completamente trasparente.

Tamaño A3		
CÓDIGO	GROSOR	ENVASE
181090	90 micras	250 unidades 10 bolsas con 25 ud.

Tamaño F°		
CÓDIGO	GROSOR	ENVASE
180758	40 micras	200 unidades 2 bolsas con 100 ud.
180274	60 micras	100 unidades
180586	60 micras	250 unidades 25 bolsas con 10 ud.
180275	90 micras	100 unidades
180587	90 micras	250 unidades 25 bolsas con 10 ud.
180552	120 micras	100 unidades





Tamaño A4		
CÓDIGO	GROSOR	ENVASE
180757	40 micras	200 unidades 2 bolsas con 100 ud.
180459	60 micras	100 unidades
180554	60 micras	250 unidades 25 bolsas con 10 ud.
180276	90 micras	100 unidades
180563	90 micras	250 unidades 25 bolsas con 10 ud.
180551	120 micras	100 unidades



Los códigos en **color amarillo** permiten apertura de envase

FUNDA MULTITALADRO "PIEL DE NARANJA"

60 MICRAS. 100% reciclable

-  Funda multitaladro A4. No deja huellas dactilares gracias a su acabado en piel de naranja. Apertura superior.
-  A4 multi-drill cover. Does not leave fingerprints thanks to its orange peel finish. Top opening.
-  Tampa A4 multi-perfurações. Não deixa impressões digitais, graças ao seu acabamento em casca de laranja. Abertura superior.
-  Coperchio multitaladro A4. Non lascia impronte digitali grazie alla sua finitura a buccia d'arancia. Apertura dall'alto.





60 micras		
FORMATO	A4	Folio
CÓDIGO	181164	181165
ENVASE 100 UNIDADES / PACKING 100 PIECES		



Textura
PIEL DE NARANJA



FUNDAS PROTECTORAS RIGIDAS DELUXE PARA DOCUMENTOS





-  Funda para documentos muy resistente, especial para preservar documentos muy utilizados.
-  Cover for documents, very resistant, special to preserve very used documents.
-  Bolsa para documentos muito resistente, especial para preservar documentos muito utilizados.
-  Busta per documenti molto resistenti, speciale per conservare i documenti molto usati.



TAMAÑO	A7 - 105 x 74 mm	A6 - 148 x 105 mm	A5 - 210 x 148 mm	A4 - 297 x 210 mm	A3 - 420 x 297 mm
CÓDIGO	180455	180456	180457	180396	180458
ENVASE	100	100	50	50	20

INDICES DE POLIPROPILENO ALFABETICO

Tamaño A4 • Medidas 210 x 297 mm

-  Separadores ALFABÉTICOS de polipropileno de 150 micras. Resistentes al agua, a la suciedad y las manchas. Larga duración.
-  Alphabetic indexes made of polypropylene 150 microns. Resistant to water, dirt and spots. Long duration.
-  Separadores ALFABÉTICOS em polipropileno 150 microns. Resistentes á água, sujidades e manchas. Longa duração.
-  Separatori ALFABETICI in polipropilene 150 micron. Resistenti all'acqua, sporco e macchie. Lunga durata.

Tamaño A4 - 210 x 297 mm	
	21 SEPARADORES
CÓDIGO	180445
ENVASE 10 SETS / PACKING 10 SETS	



Los códigos en color amarillo permiten apertura de envase

INDICES DE POLIPROPILENO NUMÉRICOS

Tamaño A4 • Medidas 210 x 297 mm



- Polipropileno 150 micras. Larga duración.
- Polypropylene 150 microns. Long duration.
- Polipropileno 150 microns. Longa duração.
- Polipropilene 150 micron. Lunga durata.

Tamaño A4 - 210 x 297 mm			
	6 SEPARADORES	12 SEPARADORES	31 SEPARADORES
CÓDIGO	180895	180625	180896
ENVASE	1 / 100 Sets	1 / 50 Sets	1 / 30 Sets

SEPARADORES DE POLIPROPILENO EN COLORES

Tamaño A4 • 8 colores



- Separadores en polipropileno, muy duraderos. Con 8 divisores de colores translúcidos.
- Polypropylene indexes. Resistant to water and dirt. Long live. 8 assorted translucent colors.
- Índices de polipropileno. Resistente á água e á sujidade. Larga duração. 8 cores sortidas translúcidas.
- Separatori in polipropilene, molto resistenti. Con 8 divisori di colori assortiti traslucidos.

Tamaño A4 - 210 x 297 mm	
	8 SEPARADORES
CÓDIGO	181027
ENVASE	1 / 15 Sets

SEPARADORES DE POLIPROPILENO EN COLORES

Tamaño A4 • 5 y 10 colores



- Polipropileno. Resistentes al agua, a la suciedad y las manchas. Larga duración.
- Polypropylene. Resistant to water, dirt and spots. Long duration.
- Separadores coloridos, em polipropileno. Resistentes á água, sujidades e manchas. Longa duração.
- Separatori in polipropilene. Resistenti all'acqua, sporco e macchie. Lunga durata.

Tamaño A4 - 210 x 297 mm		
	5 SEPARADORES	10 SEPARADORES
CÓDIGO	180463	180464
ENVASE	1 / 200 Sets	1 / 100 Sets

FUNDA PARA TARJETAS DE VISITA

Capacidad 20 tarjetas • Tamaño A4 • Medidas 240 x 302 mm







- Polipropileno. Para tarjetas de 9 x 5,5 cm. Funda multitalladro con refuerzo.
- Polypropilene. For cards size: 9 x 5,5 cm. Multi-punched pocket with reinforcement.
- Polipropileno. Cartão de 9 cm x 5,5. Processo multitalladro com reforço.
- Polipropilene. Per le dimensioni delle carte da visita: 9 x 5,5 cm. Tasca multiforo con rinforzo.

240 x 302 mm	
CAPACIDAD	20 TARJETAS
CÓDIGO	180597
ENVASE 10 UNIDADES / PACKING 10 PIECES	



TARJETERO DE POLIPROPILENO

Práctico y moderno





-  Tapas de polipropileno. Fundas soldadas.
-  Polypropylene caps. Welded covers.
-  Capas em polipropileno, bolsas soldadas.
-  Copertine in polopropilene, fodere saldate.



Con Cajetín. 192 x 107 x 29 mm	
CAPACIDAD	168 TARJETAS
CÓDIGO	180345
ENVASE 24 UNIDADES / PACKING 24 PIECES	

TARJETERO DE TAPA RIGIDA

Con cantoneras



-  Tarjetero con tapas de PVC. Fundas soldadas. Con cantoneras.
-  Card holder with PVC covers. Welded pockets. With hard corners.
-  Porta cartões com capa em PVC. Bolsas soldadas. Com cantoneiras.
-  Porta biglietti da visita con copertina in PVC. Fodere saldate con proteggi angoli.



	196 x 114 x 24 mm	198 x 115 x 30 mm
CAPACIDAD	120 TARJETAS	240 TARJETAS
CÓDIGO	180795	180794
ENVASE 1 UNIDAD / PACKING 1 PIECE		

CARTERA PORTATARJETAS





Con cierre de broche

-  Cartera portatarjetas vertical con cierre de broche. Capacidad para 20 tarjetas.
-  Vertical card holder with clasp closure. Capacity 20 cards.
-  Carteira porta cartões na vertical, fecha com mola. Capacidade para 20 cartões.
-  Porta biglietti da visita verticale con chiusura a scatto. Capacità per 20 biglietti.



20 TARJETAS. 75 x 110 mm	
COLOR	
CÓDIGO	180796
ENVASE 12 UNIDADES / PACKING 12 PIECES	

BOLSAS MULTIUSOS

-  Nylon. Práctica. 2 compartimentos. Negra.
-  Nylon. Useful. 2 compartments. Black.
-  Nylon. Prática. 2 compartimentos. Preto.
-  Nylon. Pratica. 2 scomparti. Nera.



Tamaño A4. 250 x 365 mm	
CÓDIGO	040478
ENVASE 1 UNIDAD / PACKING 1 PIECE	









Los códigos en **color amarillo** permiten apertura de envase



BOLSAS MULTIUSO CON CREMALLERA



De colores pastel



-  Bolsa multiusos con cremallera. Muy práctica. Dos compartimentos. Diferentes tamaños y colores.
-  Multipurpose bag with zipper. Very practical. Two compartments. Different sizes and colours.
-  Saco multifunções com fecho de correr. Muito prático. Dois compartimentos. Tamanhos e cores diferentes.
-  Borsa multiuso con cerniera. Molto pratico. Due scomparti. Diverse dimensioni e colori.





Tamaño 140 x 105 mm			
COLOR	 Verde	 Rosa	 Azul
CÓDIGO	040756	040757	040758
ENVASE 12 UNIDADES / PACKING 12 PIECES			

Tamaño 230 x 130 mm			
COLOR	 Verde	 Rosa	 Azul
CÓDIGO	040753	040754	040755
ENVASE 12 UNIDADES / PACKING 12 PIECES			

Tamaño 240 x 170 mm			
COLOR	 Verde	 Rosa	 Azul
CÓDIGO	040750	040751	040752
ENVASE 12 UNIDADES / PACKING 12 PIECES			

BOLSAS CIERRE ZIP CON LOMO EXTENSIBLE



-  Bolsa de polipropileno, con lomo de 3 cm. para mayor capacidad.
-  Bag of polypropylene, with spine of 3 cm. for greater capacity.
-  Bolsa de polipropileno, com lombada de 3 cm. para maior capacidade.
-  Borsa di polipropilene, con dorso di 3 cm. per una maggiore capacità.

TAMAÑO	A5 - 240 x 178 mm	A4 - 330 x 250 mm
CÓDIGO	180641	180640
ENVASE 12 UNIDADES / PACKING 12 PIECES		



A photograph of two office chairs, one blue and one orange, positioned in front of a wooden desk. The desk has a spiral notebook and a microscope on it. The background shows a white wall with two framed abstract art pieces. A large green circle is overlaid on the right side of the image, containing the number '08' and text in multiple languages.

08

SILLAS DE OFICINA

OFFICE CHAIRS
CADEIRAS DE ESCRITÓRIO
SEDIE DEL UFFICIO

ELIJA LA SILLA QUE USTED NECESITA

La elección de una silla adecuada a sus necesidades dependerá principalmente del tiempo que permanezca en ella a lo largo del día. Si usted permanece sentado seis horas al día o más, la silla debe permitirle cambiar de postura, manteniendo una posición correcta de la columna vertical, en este caso, le aconsejamos una silla de mecanismo basculante, ergonómica y de gran calidad.



DISEÑO

En salas de reuniones donde las sillas reciben un uso menos frecuente, es aconsejable una silla más enfocada a la imagen y el diseño



CONFORT

En puestos de dirección sin duda lo más adecuado es un sillón tipo ejecutivo, fabricado en material de piel, que aporte una imagen profesional y sea confortable



COMODIDAD

El respaldo debe ser ajustable en altura y profundidad y los apoyabrazos deben ser regulables. Para mayor confort elija una silla basculante.

SILLA BASIC

Respaldo y banqueta de tela

EN 16139



Gran resistencia

Estructura completamente metálica



🇪🇸 Silla fija apilable de cuatro patas. Estructura metálica. Asiento y respaldo tapizados en colores azul o negro. Dimensiones: 46 x 56 x 80 cm.

🇧🇷 Empilhamento cadeira conjunto de 4 pernas. Estructura metálica. Assento e encosto em azul ou preta. Dimensões: 46 x 56 x 80 cm.



CÓDIGO	RESPALDO	ASIENTO
260181	● Negro	● Negro
260182	● Azul	● Azul

SILLA MESH NEGRA

Respaldo de rejilla y banqueta de tela

EN 16139



Máxima comodidad

Diseño ergonómico que confiere una gran sujeción a la espalda



🇪🇸 Silla apilable. Estructura cromada. Con respaldo de malla y asiento tapizado en varios colores. Su ergonomía junto con su respaldo, posibilitan una confortable posición. Dimensiones: 83 x 62,5 x 56 cm.

🇧🇷 Cadeira de escritório. Estrutura Chrome. Com encosto de malha de cor preta, e assento em tecido em varias cores. A ergonomia junto com o encosto, possibilita uma confortável posição. Dimensões: 83 x 62,5 x 56 cm.



CÓDIGO	RESPALDO	ASIENTO
260170	● Negro	● Negro





SILLA GIRO PLUS

Respaldo y banqueta de tela

Ø 60 cm

EN 1335 1-2-3

 Silla de oficina giratoria de gran resistencia y durabilidad. Asiento ajustable en altura. Regulación del respaldo en vertical y en inclinación. Asiento y respaldo acolchados. Brazos en PVC de alta resistencia. Base de cinco radios con ruedas. Dimensiones: 47 x 56 x 95-107 cm.

 Cadeiras de escritório giratórias grande força e durabilidade. Ajuste de altura do assento. Regulagem de inclinação de backup e vertical. Estofos dos assentos e costas. Braços de PVC de alta resistência. Base 5-falou rodas. Dimensões: 47 x 56 x 95-107 cm.



CÓDIGO	RESPALDO	ASIENTO
260171	● Negro	● Negro
260172	● Azul	● Azul
260288	● Naranja	● Naranja
260289	● Rojo	● Rojo

SILLA MESH BASIC

Respaldo de rejilla y banqueta de tela

Ø 70 cm

EN 1335 1-2-3

 Silla de oficina giratoria con respaldo de malla para un perfecto ajuste de la espalda. Asiento ajustable en altura. Regulación en inclinación. Asiento acolchado. Brazos en PVC de alta resistencia. Base de cinco radios con ruedas. Dimensiones: 55 x 58 x 85-94 cm.

 Cadeira giratória de escritório com malha de volta para um ajuste perfeito para trás. A altura ajustável. Ajuste de inclinação. Acolchoado assento. Braços pvc de alta resistência. Base rodas de 5 raios. Dimensões: 55 x 58 x 85-94 cm.



Máxima comodidad

Diseño ergonómico que confiere una gran sujeción a la espalda



CÓDIGO	RESPALDO	ASIENTO
260290	● Azul	● Negro
260161	● Negro	● Negro



Los códigos en color amarillo permiten apertura de envase

SILLA GIRO MESH ERGO

Respaldo de rejilla y banqueta de tela

Ø 70 cm

EN 1335 1-2-3



🇪🇸 Silla de oficina giratoria con respaldo de malla con marco de PP negro, para un perfecto ajuste de la espalda. Asiento ajustable en altura (80 cm). Regulación en inclinación. Asiento acolchado. Brazos abatibles. Base cromada de cinco radios con ruedas. Dimensiones: 62 x 66 x 97-105 cm.

🇵🇹 Cadeira de escritório giratória com moldura de encosto de malha com PP preto, para um ajuste perfeito para trás. Altura do assento ajustável (80 m). Ajuste de inclinação. Assento acolchoado. Braços dobráveis. Cromo base de rodas de cinco raios. Dimensões: 62 x 66 x 97-105 cm.



CÓDIGO	RESPALDO	ASIENTO
260291	● Azul	● Negro
260292	● Negro	● Negro

SILLA GIRO CONFORT

Respaldo y banqueta de tela

Ø 70 cm

EN 1335 1-2-3



🇪🇸 Silla de oficina giratoria con respaldo y asiento acolchados. Asiento ajustable en altura (10 cm). Brazos en PP de alta resistencia. Base de cinco radios con ruedas. Dimensiones: 62 x 59 x 96-106 cm.

🇵🇹 Cadeira de escritório giratória com assento acolchoado e encosto. Altura do assento ajustável (10 cm). PP braços de alta resistência. Base de cinco estrelas com rodas. Dimensões: 62 x 59 x 96-106 cm.



CÓDIGO	RESPALDO	ASIENTO
260293	● Azul	● Azul
260294	● Negro	● Negro



SILLA PLANET

Simil piel

🇪🇸 Silla ejecutiva con apoyabrazos curvos y base de aluminio. Asiento ajustable en altura. Sistema basculante centrado, con aumento y disminución de la resistencia. Sistema antichoque para el retorno. Apoyabrazos en aluminio revestido en simil piel. Base con ruedas de cinco radios en aluminio. Dimensiones: 61 x 65 x 113 cm.

🇧🇷 Feita de couro cadeira executiva com braços e limitar base de alumínio. Ajuste de altura do assento. Sistema centralizado com inclinação de aumento e diminuição da resistência. Sistema de retorno de choque. Apoios de braço em alumínio revestido em couro sintético. Base com rodas de 5 raios em alumínio. Dimensões: 61 x 65 x 113 cm.

Ø 70 cm

EN 1335 1-2-3



Máxima comodidad

Diseño pensado para un descanso y comodidad completa a lo largo del día



SÍMIL PIEL

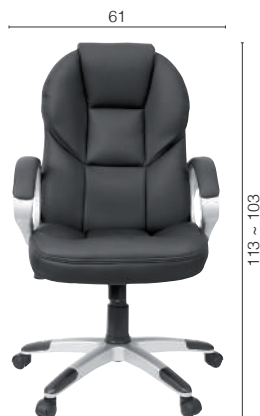

CÓDIGO RESPALDO ASIENTO

260183 ● Negro ● Negro

SILLA GENIUS CONFIDENTE

Con respaldo medio

🇪🇸 Silla fabricada en simil piel con respaldo a media altura. Asiento y respaldo acolchados. Reposabrazos revestidos en simil piel. Perfiles laterales, estribos de sujeción y estructura de patín en tubo de acero cromado. Dimensiones: 59 x 63 x 100 cm.

🇧🇷 Cadeira de simil couro feitos com o apoio de estatura média. Estofos dos assentos e costas. Apoio de braços cobertos de simil couro. Perfis laterais, estribos e segurando a estrutura Skate em tubo de aço cromado. Dimensões: 59 x 63 x 100 cm.

EN 16139



SÍMIL PIEL



CÓDIGO RESPALDO ASIENTO

260188 ● Negro ● Negro

260189 ● Marrón ● Marrón



Los códigos en color amarillo permiten apertura de envase

SILLA GENIUS PLUS

Con respaldo alto



Ø 65 cm

EN 1335 1-2-3



SÍMIL PIEL

● Sillón de dirección con respaldo alto. Fabricado en simil piel. Asiento ajustable en altura. Sistema basculante centrado, con aumento y disminución de la resistencia. Sistema antichoque para el retorno. Apoyabrazos en aluminio revestido en simil piel. Base con ruedas de cinco radios en acero cromado. Dimensiones: 65 x 60 x 127 cm.

● Poltrona alta direção para trás. Fabricado em simil couro. Ajuste de altura do assento. Sistema centralizado com inclinação de aumento e diminuição da resistência. Sistema de retorno de choque. Braços em alumínio revestido com simil couro. Base 5-falou rodas de aço cromado. Dimensões: 65 x 60 x 127 cm.



CÓDIGO	RESPALDO	ASIENTO
260187	● Marrón	● Marrón

SILLA KRONOS

La silla de oficina más famosa del mundo



Ø 64 cm

EN 1335 1-2-3



SÍMIL PIEL

● La silla de oficina presente en numerosas colecciones y museos del mundo. Asiento ajustable en altura. Sistema basculante, con aumento y disminución de la resistencia. Sistema antichoque para el retorno. Apoyabrazos en acero cromado. Tapizada en PVC de alta calidad. Base con ruedas de cinco radios en acero cromado. Dimensiones: 54 x 68 x 104 cm.

● Cadeira de simil couro preto com a meia altura para trás. Estofos dos assentos e costas. Revestido em simil couro braços. Perfis estribos laterais e estrutura de fixação da flange no tubo de aço cromado. Dimensões: 54 x 68 x 104 cm.



CÓDIGO	RESPALDO	ASIENTO
260165	● Negro	● Negro



09

DIBUJO Y MATERIAL ESCOLAR

DRAWING AND SCHOOL MATERIAL

DESENHO E MATERIAL DA ESCOLA

DISEGNO E SCUOLA



LAPIZ CAMPUS GRAPHITE

Hexagonal. Fácil afilado. Nueva mina más suave, HB · Nº2



🇪🇸 Lápiz de grafito. Cuerpo de madera. Ideal para escritura y dibujo. Alta resistencia a la rotura de la mina.

🇬🇧 Graphite pencil. Wooden body. Ideal for writing and drawing. High resistance against leads breaking.

🇵🇹 Lápiz triangular de grafito. Corpo de madeira. Para escrita e desenho. Mina de alta resistência.

🇮🇹 Matita di grafite ideale per scrivere e disegnare; elevata resistenza alla rottura della mina. Corpo in legno.

Mina mejorada más suave



CÓDIGO	ENVASE
080535	Caja 12 ud.
081042	Blíster 4 ud. / 24

ADAPTADOR PARA LÁPIZ

Válido para diestros y zurdos

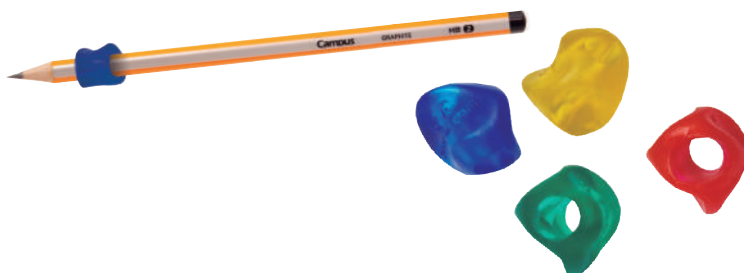

🇪🇸 Ideal para aprender a utilizar correctamente el lápiz o bolígrafo. Plástico inyectado lavable. Ergonómico. A partir de 3 años.

🇬🇧 Ideal for learning how to correctly use the pen or pencil. Four colours. Washable injected plastic. Ergonomic. From 3 years on.

🇵🇹 Ideal para aprender como usar corretamente a caneta ou lápis. Plástico injetado lavável. Ergonómico. A partir de 3 anos.

🇮🇹 Ideale per imparare a usare correttamente la penna o la matita. Plastica iniettata lavabile. Ergonomico. Da 3 anni in poi.

CÓDIGO	COLOR	ENVASE
630028	Surtido	Bolsa 20 ud.

LÁPIZ TRIANGULAR COLORES NEÓN Y METÁLICOS

Madera negra



🇪🇸 Lápices de madera con forma triangular. Aptos para uso escolar e ideales para crear diseños llamativos. Se presentan en bolsa de plástico de 6 colores.

🇬🇧 Wooden pencils with triangular shape. Suitable for school use and ideal for creating striking designs. Presented in a 6 colours plastic bag.

🇵🇹 Lápiz de madeira com forma triangular. Adequado para uso escolar e ideal para a criação de desenhos chamativos. Eles vêm em saco plástico de 6 cores.

🇮🇹 Matite di legno a forma triangolare. Adatte per uso scolastico e ideale per creare disegni accattivanti. Presentate in un sacchetto di plastica di 6 colori.



	CÓDIGO	COLORES	ENVASE
1	080563	6 neón	1 / 6
2	080562	6 metálicos	1 / 6

LÁPICES DE COLORES RAINBOW

Minas Arco Iris

Jumbo

Formato ideal para los más pequeños gracias a su facilidad de sujeción



🇪🇸 Lapiceros de madera con minas arco iris. Muy resistentes. Fácil de sujetar por manos pequeñas.

🇬🇧 Wood pencils with rainbow leads. Very resistant. Easy to handle for small hands.

🇵🇹 Lápiz de madeira com minas com cores do arco iris. Muito resistente. Fácil para mãos pequenas.

🇮🇹 Matite di legno con mine color arcobaleno. Molto resistente. Ideali per mani piccole.



CÓDIGO	ENVASE
630411	Bote 20 ud.





CRAYONES DE PLÁSTICO

Colores brillantes y mezclables.

 Crayones de plástico de cuerpo cilíndrico sin envoltura. Se puede afilar y pintar con cualquier parte de la cera, para mayor precisión. 12 colores intensos. Borrables. Trazo suave. Se afilan fácilmente. Mezclables para crear una infinidad de tonalidades, no ensucian. No tóxicas. Ideal para uso escolar.



 Cylindrical plastic crayons without wrapping to sharpen and paint with any part of the crayon with a greater precision. 12 intense colours. Erasable. Smooth stroke. They sharpen easily. Mixable to create an infinity of tonalities, they do not mess up. Non-toxic. Ideal for school use.

 Giz de cera de plástico de corpo cilíndrico sem embalagem que permita afiar e pintar com qualquer parte da cera, para maior precisão. 12 cores intensas. Apagável. Trazo suave. Eles afiam facilmente. Mixable para criar uma infinidade de tonalidades, eles não mexem. Não tóxico. Ideal para uso escolar.

 Pastelli a cera con corpo cilindrico senza imballaggio. Si può dipingere e affilare con qualsiasi parte della cera, per maggiore precisione. 12 colori intensi. Tratto morbido. Mischiabili facilmente per creare un'infinità di colori, non tossico. Ideale per uso scolastico.





CÓDIGO	COLORES	ENVASE
630735	12 colores	1 / 12
630776	24 colores	6

LÁPICES DE COLORES PASTEL

Cuerpo de madera.



 Lápices hexagonales de madera con minas de colores pastel. Escritura suave. Ideales para uso escolar.

 Hexagonal wooden pencils with pastel coloured leads. Smooth writing. Ideal for school use.

 Lápis de madeira hexagonal com fios de cor pastel. Escrita suave. Ideal para uso escolar.

 Matite esagonali in legno con mina color pastello. Scrittura fluida. Ideale per uso scolastico.



CÓDIGO	COLORES	ENVASE
630772	12	1 / 12

LÁPICES DE COLORES

Cuerpo de plástico.



Sin madera

 Lápices de colores con cuerpo de resina de plástico. Fáciles de sacar punta. Mina muy resistente. Colores intensos. Escritura suave. Ideales para uso escolar.

 Coloured pencils with plastic resin body. Easy to sharpen. Very strong lead. Intense colours. Smooth writing. Ideal for school use.

 Lápis coloridos com corpo de resina plástica. Fácil de apontar. Mina muito resistente. Cores intensas. Escrita suave. Ideal para uso escolar.

 Matite colorate con corpo in resina plastica. Facile da affilare. Il mio molto resistente. Colori intensi. Scrittura fluida. Ideale per uso scolastico.

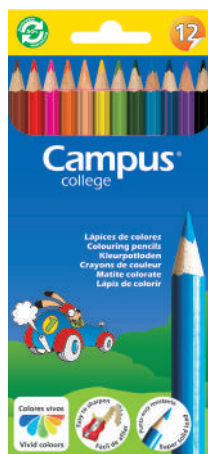

CÓDIGO	COLORES	ENVASE
630716	12 colores	12
630717	24 colores	6



Los códigos en color amarillo permiten apertura de envase

LÁPICES DE COLORES

Minas gruesas y duraderas



- 🇪🇸 Lápices hexagonales de madera con minas de colores más gruesas y duraderas. Son ideales para el uso escolar. Escritura suave.
- 🇬🇧 Hexagonal wood pencils with thicker and more durable coloured leads. They are ideal for school use. Smooth writing.
- 🇵🇹 Lápiz de madeira hexagonal com minas cores mais espessa e durável. Ele são ideais para uso escolar. Escrita suave.
- 🇮🇹 Matite di legno esagonali con mine colorate più spesse e resistenti. Sono ideali per l'uso scolastico. Sono presentati in una scatola di cartone. Scrittura fluida.

CÓDIGO	COLORES	ENVASE
080564	12 colores	12
630480	24 colores	6

LÁPICES JUMBO

Ideal para manos pequeñas

Afilalápiz

Especial para lápices gruesos



- 🇪🇸 Lápices triangulares de madera con minas de colores gruesas. Son ideales para manos pequeñas. Incluye sacapuntas.
- 🇬🇧 Triangular wood pencils with thick coloured leads. They are ideal for small hands. Includes pencil sharpener.
- 🇵🇹 Lápiz de madeira triangular com minas de cores espessas. Eles são ideais para mãos pequenas. Inclui afila-lápiz.
- 🇮🇹 Matite triangolari in legno con mine colorate spesse. Ideali per le mani piccole. Include temperamatite.

CÓDIGO	DESCRIPCIÓN	ENVASE
630044	10 colores + afilalápiz	10

LÁPICES DE COLORES ACUARELABLES

Estuche metálico



- 🇪🇸 Forma triangular, fabricados en madera. Atractivo estuche de metal. Alta concentración de pigmento, poco polvoriento. Resistentes a la rotura y a la luz en base al color.
- 🇬🇧 Triangular shape, made of wood. Attractive metal case. High concentration of pigment, little dusty and tear. Light and breakage resistant. Based on colour.
- 🇵🇹 Triangular em madeira. Caixa metálica. Elevado concentração de pigmento, pouco empoeirado e Resistente à ruptura. Resistência a luz excelente. Com base na cor.
- 🇮🇹 Forma triangolare, realizzata in legno. Custodia in metallo. Elevata concentrazione di pigmento con poca polvere. Resistente alla rottura.

CÓDIGO	COLORES	ENVASE
630367	12 colores	1 / 12
630368	24 colores	1 / 6



ROTULADORES DE ANIMALES

Rotuladores de colores con forma de animales de granja. Se mantienen tanto vertical como horizontalmente. Colores brillantes. El color de la tinta es el de la parte trasera de la figura. Ideal para uso escolar.

Coloured markers in the shape of farm animals. They are held both vertically and horizontally. Bright colours. The color of the ink is that of the back of the figure. Ideal for school use.

Marcadores coloridos com a forma de animais da quinta. Eles são mantidos tanto vertical quanto horizontalmente. A cor da tinta é a do verso da figura. Cores brilhantes. Ideal para uso escolar.

Marcatori colorati a forma di animali da fattoria. Sono tenuti sia verticalmente che orizzontalmente. Il colore dell'inchiostro è quello del retro della figura. Colori brillanti. Ideale per uso scolastico.

CÓDIGO	COLORES	ENVASE
081386	6	1 / 6



Violeta



Azul claro

Amarillo

Verde

Rosa

Marrón

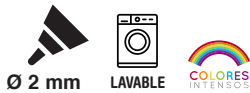

ROTULADORES KEKKO TINTA LAVABLE

Punta fina. Hexagonales.

Rotuladores lavables hexagonales. Capuchón ventilado. Colores brillantes. Ideal para uso escolar.

Hexagonal washable markers. Ventilated cap. Brilliant colours. Ideal for school use.

Marcadores hexagonais laváveis. Tampa ventilada. Cores brilhantes. Ideal para uso escolar.

Pennarelli esagonali lavabili. Tappo ventilato. Colori vivaci, ideale per uso scolastico.

CÓDIGO	COLORES
630938	12
630939	24



ROTULADORES JUMBO TINTA LAVABLE

Punta de 2 y 6 mm.

Punta de fibra, muy resistente a los golpes. Capuchón ventilado. Colores brillantes. Ideal para uso escolar. Perfectos para manos pequeñas.

Shock resistant fiber tip. Brilliant colours. Ventilated cap. Ideal for school use. Perfect for small hands.

Ponta de fibra resistente ao choque. Tampa ventilada. Cores brilhantes. Ideal para uso escolar. Perfeito para mãos pequenas.

Punta in fibra resistente agli urti. Cappuccio ventilato. Colori vivaci. Ideale per uso scolastico, perfetto per mani piccole.

2 mm.

6 mm.



CÓDIGO	COLORES	ENVASE
630560	12	12 / 24



Los códigos en color amarillo permiten apertura de envase

ROTULADORES PUNTA PINCEL

Punta de pincel resistente

NEW!!



- Punta pincel muy resistente. Capuchón ventilado. Colores vivos. Ideal para uso escolar, dibujo, lettering.
- Very resistant brush tip. Ventilated cap. Vivid colors. Ideal for school use, drawing, lettering.
- Ponta pincel muito resistente. Tampa ventilada. Cores vivas. Ideal para uso escolar, desenho, letras.
- Punta del pennello molto resistente. Capuccio ventilato. Colori vividi. Ideale per uso scolastico, disegno, lettere.

CÓDIGO	COLORES	ENVASE
630843	12	24
630844	24	12

ROTULADORES TINTA LAVABLE

Punta fina de 3 mm.

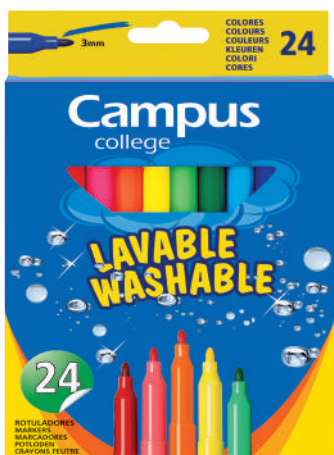
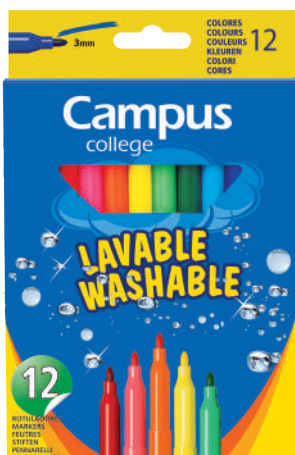

- Punta resistente a los golpes. Capuchón ventilado. Colores brillantes. Ideal para uso escolar.
- Shock resistant tip. Ventilated cap. Brilliant colours. Ideal for school use.
- Ponta resistente ao choque. Tampa ventilada. Cores brilhantes. Ideal para uso escolar.
- Punta resistente ai colpi. Tappo ventilato. Colori vivaci, ideale per uso scolastico.

CÓDIGO	COLORES	ENVASE
630562	12	12
630563	24	12

ROTULADORES DOBLE PUNTA TINTA LAVABLE

Punta de 2 y 4 mm.







- Punta de fibra resistente a los golpes. Colores brillantes. Capuchón ventilado. Ideal para uso escolar.
- Shock resistant fiber tip. Brilliant colours. Ventilated cap. Ideal for school use.
- Ponta de fibra resistente ao choque. Tampa ventilada. Cores brilhantes. Ideal para uso escolar.
- Punta in fibra resistente agli urti. Colori vivaci; tappo ventilato, ideale per uso scolastico.

CÓDIGO	COLORES	ENVASE
080923	12	12 / 24
080924	24	12 / 12



ROTULADORES GLITTER MARKER

Tinta glitter





-  Tinta glitter. Cuerpo traslúcido que permite ver el nivel de tinta. Capuchón ventilado.
-  Glitter ink. Translucent body that allows you to see the ink level. Ventilated cap.
-  Tinta brilhante. Corpo translúcido que permite ver o nível de tinta. Tampa ventilada.
-  Inchiostro glitterato. Corpo traslucido che consente di vedere il livello di inchiostro. Tappo ventilato.



Ø 1 mm



CÓDIGO	COLORES	ENVASE
081428	6	1 / 6

-  Pasteles al óleo de textura suave y sedosa. Colores brillantes. Se difuminan fácilmente.
-  Oil pastels with soft and silky texture. Bright colours. They blur easily.
-  Pastéis de óleo com textura macia e sedosa. Cores brilhantes. Eles se confundem facilmente.
-  Pastelli all'olio, consistenza morbida e setosa. Colori vivaci che si sfumano facilmente.







BARRAS DE PASTEL

CÓDIGO	COLORES	ENVASE
600391	12	1 / 12

ESTUCHE DE DIBUJO GALLERY

79 componentes





-  Maletín de madera. Contiene: 24 lápices de colores, 24 ceras de colores, 24 acuarelas, 1 afilalápiz doble, 2 lápices de grafito, 1 goma de borrar y 1 lija.
-  Wood case. Contains: 24 colour pencils, 24 coloured waxes, 24 watercolour, 1 double sharpener, 2 pencils, 1 rubber and 1 sandpaper.
-  Caixa de madeira. Contém: 24 lápis de cores, 24 ceras coloridas, 24 aguarelas, 1 afila-lápis duplo, 2 lápis, 1 borracha e 1 lixa.
-  Valigetta per disegno in legno, contenuto: 24 matite colorate, 24 cere colorate, 24 acquerelli, 1 matita doppia affilata, 2 matite, 1 gomma e 1 carta vetrata.



CÓDIGO	MEDIDAS	CONTENIDO
630022	37,5 x 22 x 4,5 cm	79 pcs.

MALETÍN DE DIBUJO

45 componentes

-  Contiene: 12 tubos de pintura acrílica, 12 lápices de colores, 12 pinturas de cera, cuchillo de plástico, 2 lapiceros 2B, 3 pinceles (tamaños 2, 4 y 6), goma de borrar, sacapuntas de metal, y maniquí de madera.
-  Contains: 12 tubes of acrylic paint, 12 colour pencils, 12 crayons, 1 plastic knife, 2 pencils 2B, 3 brushes (sizes 2, 4 and 6), 1 rubber, 1 metal sharpener and 1 wooden mannequin.
-  Contem: 12 tubos de tinta acrílica, 12 lápis de cor, 12 crayons, faca de plástico, 2 lápis 2B, 3 pincéis (tamanhos 2, 4 e 6), borracha, afila-lápis de metal e manequim de madeira.
-  Contiene: 12 tubi di vernice acrilica, 12 matite colorate, 12 colori a cera, coltello in plastica, 2 matite 2B, 3 pennelli (misure 2, 4 e 6), gomma, temperamatite in metallo e manico in legno.



CÓDIGO	MEDIDAS	CONTENIDO
630559	36 x 23,5 x 5 cm	45 pcs.



Los códigos en **color amarillo** permiten apertura de envase

MALETÍN DE PINTURA ACRÍLICA

22 componentes



Maletín de madera con cinco compartimentos. Contiene: 3 tablillas enteladas de 20 x 30 cm, 12 tubos de colores acrílicos, 4 pinceles Nº 2, 4, 6 y 8, lápiz de mina HB, espátula cortante de plástico y paleta de madera de 20 x 30 cm.

Wood case with five compartments. Contains: 3 wood with canvas of 20 x 30 cm. 12 tubes of acrylic colours, 4 brushes Nº2, 4, 6 and 8, 1 HB pencil, 1 plastic spatula and 1 wood palette of 20 x 30 cm.

Caixa de madeira com cinco compartimentos. Contém: 3 tabelas com lona de 20 x 30 cm. 12 tubos de cores acrílicas, 4 pincéis Nº 2, 3, 6 e 8, lápis de mina HB, espátula de plástico e paleta de madeira.

Valigetta in legno con cinque scomparti. Contiene: 3 stecche da 20 x 30 cm, 12 tubi di colori acrilici, 4 pennelli n. 2, 4, 6 e 8, matita miniera HB, spatola da taglio in plastica e tavoletta di legno di 20 x 30 cm.

CÓDIGO	MEDIDAS	CONTENIDO
630394	32 x 24 x 7,2 cm	22 pcs.

SET DE ARTE

46 componentes



Incluye: Caballete, 1 Lienzo, 1 Paleta de pintura, 5 Pinceles, 1 Espátula, 12 Pinturas de óleo, 24 Lápices de cera, 1 Bloc de dibujo de 30 hojas de 120 g.

It includes: 1 Easel, 1 cloth (canvas), 1 palette, 5 paintbrushes, 1 palette knives, 12 oil paintings, 24 crayons, 1 drawing bloc of 30 sheets 120 g.

Inclui: cavaleta, 1 tela, 1 paleta de tintas, pincéis 5, 1 espátula, 12 pinturas a óleo, lápis de cor 24, 1 Bloco de 30 folhas de 120 g.

Include: Cavalletto, 1 tela, 1 tavoletta di vernice, 5 pennelli, 1 spatola, 12 dipinti ad olio, 24 matite per cera, 1 blocco da disegno di 30 fogli di 120 g.

CÓDIGO	CONTENIDO
630420	46 pcs.

PINCELES

En bolsas de 6 pcs



Bolsitas de 6 pinceles en tamaños surtidos. Pinceles de madera y de plástico. Aptos para uso escolar.

Bags of 6 brushes in assorted sizes. Wooden and plastic brushes. Suitable for school use.

Sacos de 6 escovas em tamanhos sortidos. Escovas de madeira e plástico. Adequado para uso escolar.





Sacchetti da 6 spazzole di dimensioni assortite. Spazzole di legno e plastica. Adatto per uso scolastico.

	CÓDIGO	Nº PINCEL	ENVASE
A	600400	1,3,5,7,9 y 11	1 / 30
B	600401	2,4,6,8,10 y 12	1 / 30



PINCELES PARA ACUARELA

Pelo natural de pony

-  Mango de madera barnizada. Virola metálica. Indicados para t mpera, acuarela y manualidades.
-  Brushes. Varnished wood handle. Hair of pony. Metallic ferrule. Indicated for, watercolour and manual craft.
-  Pinc is de madeira envernizada. Pelo de p nei. Suporte de pelo met lico. Para trabalhos manuais, guache, aguarela, etc.
-  Manico in legno verniciato. Supporto dei peli in metallo. Indicato per tempere, acquerelli e manualit .



C�DIGO	N� PINCEL	ENVASE
600090	N�mero 00	12
600082	N�mero 0	12
600089	N�mero 1	12
600086	N�mero 2	12
600087	N�mero 3	12
600088	N�mero 4	12
600091	N�mero 5	12
600092	N�mero 6	12
600083	N�mero 7	12
600093	N�mero 8	12
600094	N�mero 9	12
600095	N�mero 10	12
600085	N�mero 11	12
600084	N�mero 12	12

C�DIGO	ENVASE
600081	Display 144 uds.







-  Pinceles escolares para t mpera. Ideales para las manos de los ni os. Con puntas grandes especiales para los primeros artistas. No ruedan, no gotean. Mango pl stico de f cil agarre.
-  School gouache brushes. Ideal for children's hands. With special big tips for the first artists. They don't roll, they don't drip. Easy grip plastic handle.
-  Escovas de guache da escola. Ideal para as m os das crian as. Com grandes dicas especiais para os primeiros artistas. Eles n o rolam, eles n o pingam. Cabo de pl stico de f cil manuseio.
-  Pennelli a guazzo per la scuola. Ideale per le mani dei bambini. Con speciali grandi consigli per i primi artisti. Non rotolano, non gocciolano. Manico in plastica di facile presa.

PINCELES INFANTILES

C�DIGO	N� PINCEL	ENVASE
A 600402	Largos / Medianos / Peque�os	Bolsa de 3 ud. / 30
B 600403	Largos	Bote 20 ud.



-  Caja de pl stico con doce pastillas de acuarela de 30 mm de di metro. Incluye pincel. Colores mezclables.
-  Plastic box with twelve 30 mm diameter watercolour tablets. Includes a brush. Mixable colors.
-  Caixa de pl stico com doze tabletes de aquarela 30 mm de di metro. Inclui pincel. Cores mistur veis.
-  Astuccio di plastica con dodici pastiglie d'acqua da 30 mm di diametro. Include un pennello. Colori miscelabili.

ACUARELAS CAMPUS

C�DIGO	COLORES	ENVASE
630564	12	6
630821	28	12



Los c digos en color amarillo permiten apertura de envase

MALETÍN TÉMPERAS



- Contiene: 10 colores de 20 ml cada unidad, dos botes vacíos para mezclas con capacidad para 20 ml cada unidad y un pincel.
- Contains: 10 colours of 20 ml each, two empty mixing bottles with a capacity of 20 ml each and a brush.
- Contém: 10 cores de 20 ml cada, dois frascos de mistura vazios com uma capacidade de 20 ml cada e uma escova.
- Contiene: 10 colori da 20 ml ciascuno, due flaconi vuoti da 20 ml ciascuno e un pennello.

CÓDIGO	COLORES	CONTENIDO
630634	Surtidos	12 botes + pincel

CAJA DE TÉMPERAS ESCOLARES DE 40 ML



- Colores vivos. Al agua y sin grumos. Caja con botes de t mpera de 40 ml en colores surtidos. Incluye un bote para las mezclas o el agua. Alta calidad.
- Vivid colours. Water-based and without lumps. Box with cans of tempera of 40 ml in assorted colours. Includes a pot for mixtures or water. High quality.
- Cores vivas.   base de  gua e suave. Caixa com potes de tempera 40 ml em cores sortidas. Inclui um pote para misturas ou  gua. Alta qualidade.
- Colori vivaci all'acqua e senza grumi. Scatola con barattoli di tempera da 40 ml in colori assortiti. Include una pentola per miscele o acqua. Alta qualit .

CÓDIGO	COLORES	CONTENIDO
1 630395	*7 Surtidos	8 botes + pincel

* Blanco, Cian, Rojo, Amarillo, Verde, Marr n y Negro. Incluye bote vac o para mezclas y pincel.

CÓDIGO	COLORES
2 630787	*5 Surtidos

* Blanco, Cian, Magenta, Amarillo y Negro.

TEMPERA ESCOLAR DE 40 ML

Gran surtido de colores







- 5 botes de t mpera de 40 ml. Alta calidad. Al agua y sin grumos.
- 5 cans of tempera of 40 ml. High quality. Water based and without lumps.
- 5 potes de tempera 40 ml. Alta qualidade. Base de  gua e sem grumos.
- 5 barattoli di tempera da 40 ml. Alta qualit . Abase d'acqua e senza grumi.

CÓDIGO	COLOR	ENVASE
630377	● Naranja	Caja 5 ud.
630378	● Rojo	Caja 5 ud.
630379	● Magenta	Caja 5 ud.
630380	● Marr�n	Caja 5 ud.
630381	● Verde	Caja 5 ud.
630382	● Azul ultramar	Caja 5 ud.
630383	● Negro	Caja 5 ud.
630396	○ Blanco	Caja 5 ud.
630397	● Amarillo	Caja 5 ud.
630548	● Azul cyan	Caja 5 ud.



TEMPERA ESCOLAR EN BOTELLA

Nuevos colores antimoho

-  Colores vivos. Al agua y sin grumos. Alta calidad.
-  Vivid colours. Water-based and without lumps. High quality.
-  Cores vivas. À base de água e suave. Alta qualidade.
-  Colori vivaci all'acqua e senza grumi. Alta qualità, specifico per i lavori scolastici.



Botellas de 250 ml

CÓDIGO	COLOR	ENVASE
630571	Naranja	6
630573	Rojo	6
630569	Magenta	6
630570	Marrón	6
630574	Verde	6
630567	Azul ultramar	6
630572	Negro	6
630568	Blanco	6
630565	Amarillo	6
630566	Azul cyan	6

Botellas de 500 ml

CÓDIGO	COLOR	ENVASE
630386	Naranja	6
630387	Rojo	6
630388	Magenta	6
630389	Marrón	6
630390	Verde	6
630391	Azul ultramar	6
630392	Negro	6
630384	Blanco	6
630385	Amarillo	6
630549	Azul cyan	6





Botellas de 250 ml. Colores metalizados.

CÓDIGO	COLOR	ENVASE
630575	Rojo	6
630576	Naranja	6
630577	Azul	6
630578	Verde	6
630579	Violeta	6

BLOCS DE DIBUJO

50 Hojas - 70 g.



-  Papel de dibujo 70 g. 50 hojas formato A4.
-  Paper of 70 g. 50 sheets A4 size.
-  Papel de 70 g. 50 folhas de formato A4.
-  Carta da disegno da 70 gr, 50 fogli A4.



	CÓDIGO	PAPEL	ENVASE
1	600371	Color negro	2 / 10

	CÓDIGO	PAPEL	ENVASE
2	630691	6 colores	2 / 10



Los códigos en **color amarillo** permiten apertura de envase

BLOC DE DIBUJO

Tapa cartón. 20 Hojas - 135 g.



1

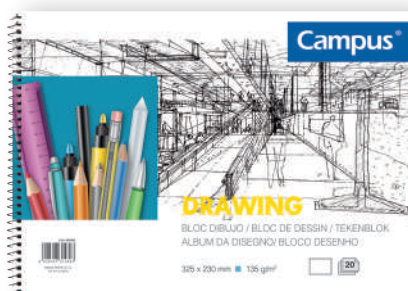

2

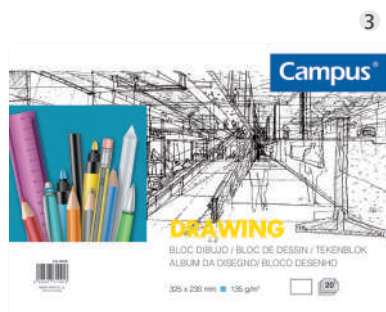

3

Papel de color blanco natural. Ligeramente satinado. Medidas: 325 x 230 mm.

White natural paper. Slightly satin-finished. Measures: 325 x 230 mm.

Papel branco natural ligeiramente acetinado. Dimensões: 325 x 230 mm.

Carta di color bianco naturales; leggermente satinata. Misure: 325 x 230 mm.

	CÓDIGO	GRAMAJE	ENCUAD.	FORMATO	ENVASE	PRECIO
1	600282	135 g.	Espiral	Liso A4	5 / 30	1,81 €
2	600283	135 g.	Espiral	Recuadro A4	5 / 30	1,94 €
3	600281	130 g.	Encolado	Recuadro A4	5 / 30	1,94 €

BLOC DE DIBUJO LUXE A4

30 Hojas - 160 g.



4



5

Papel de color blanco natural. Ligeramente satinado. Encuadernación doble espiral.

White natural paper. Slightly satin-finished. Double spiral binding.

Papel branco natural ligeiramente acetinado. Encadernação em espiral dupla.

Carta di color bianco naturales; leggermente satinata. Legatura a doppia spirale.

	CÓDIGO	FORMATO	ENVASE	PRECIO
4	600302	Liso A4	5 / 50	3,47 €
5	600303	Liso A3	5 / 25	6,94 €





BLOC DE ACUARELA A4

20 Hojas - 190 g.

Papel de color blanco natural con algodón, de grano medio y gelatinado en masa y superficie, permite la máxima absorción del agua. Ideal para acuarela, aguada y ténpera.

White natural paper with cotton, medium grain and gelatinized in mass and surface, allows maximum water absorption. Ideal for watercolour and tempera.

Papel branco natural com algodão, grão médio e gelatinizado em massa e superfície, permite máxima absorção de água. Ideal para aquarela, guache e ténpera.

Carta di colore bianco naturale con cotone, granulato medio e gelatinata nella massa e superficie, consente il massimo assorbimento d'acqua. Ideale per acquerello e tempera.

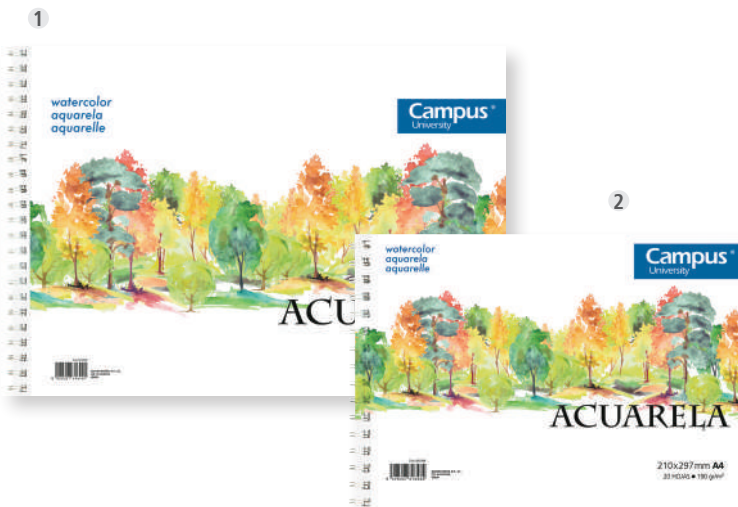

	CÓDIGO	FORMATO	ENVASE
1	600304	Liso A4	2 / 50
2	600305	Liso A3	2 / 25

ROTULADOR CALIBRADO DRAWING PEN



Tinta líquida pigmentada que proporciona un flujo constante al escribir. Punta de aguja y grip antifatiga.

Liquid ink that provides a constant flow when writing. Needle tip and grip.

Marcador de tinta líquida que proporciona um fluxo constante ao escrever. Ponta de agulha e grip antifadiga.

Inchiostro liquido pigmentato che fornisce un flusso costante durante la scrittura. Punta dell'ago e impugnatura anti-fatica.



	CÓDIGO	TRAZO	ENVASE
	600307	0,2 mm.	12
	600308	0,4 mm.	12
	600309	0,6 mm.	12
	600310	0,8 mm.	12
	600392	0.2-0.4-0.8 mm.	Bolsa 3 ud.

Bloc de esbozo con espiral superior. Papel blanco natural 100g de grano ligero para buen agarre del grafito y otras técnicas secas. 100 hojas.

Top spiral sketch pad. 100g light grain natural white paper for good grip of graphite and other dry techniques. 100 sheets.

Bloco de desenho em espiral superior. 100g de papel branco natural de grão leve para uma boa aderência de grafite e outras técnicas secas. 100 folhas.

Blocco da disegno a spirale superiore. Carta bianca naturale a grana chiara da 100 g per una buona presa di grafite e altre tecniche a secco. 100 fogli.

BLOCS DE ESBOZO

100 Hojas - 100 g.



	CÓDIGO	FORMATO	MEDIDAS
	600488	A5	150x210
	600486	A4	210x297
	600487	A3	297x420



Los códigos en color amarillo permiten apertura de envase

COMPÁS TÉCNICO-0 COLOR

Una articulación • 140 mm.



Articulado en un brazo. Con adaptador universal. Tubo con 1 mina de 2 mm de repuesto. Estuche de plástico con colgador y tapa transparente abatible. Circunferencia: 22 cm.

Compass. Articulated on one arm. With universal adapter. Tube with 1 spare 2mm lead. Plastic case with hanger and hinged transparent lid. Circumference: 22 cm.

Compasso articulado em um braço. Com adaptador universal. Tubo com 1 cabo sobressalente de 2 mm. Caixa de plástico com cabide e tampa transparente articulada. Circunferência: 22 cm.

Articolato su un braccio. Con adattatore universale. Tubo con 1 cavo di ricambio da 2 mm. Valigetta in plastica con gancio e coperchio trasparente a cerniera. Circunferenza: 22 cm.

CÓDIGO	COLOR	ENVASE
600388	● Rojo	1 / 5
600389	● Verde	1 / 5
600390	● Azul claro	1 / 5

COMPÁS TÉCNICO-0

Una articulación • 140 mm.



Articulado en un brazo. Con adaptador universal. Tubo con 1 mina de 2 mm de repuesto. Estuche de plástico con colgador y tapa transparente abatible. Circunferencia: 22 cm.

Compass. Articulated on one arm. With universal adapter. Tube with 1 spare 2mm lead. Plastic case with hanger and hinged transparent lid. Circumference: 22 cm.

Compasso articulado em um braço. Com adaptador universal. Tubo com 1 cabo sobressalente de 2 mm. Caixa de plástico com cabide e tampa transparente articulada. Circunferência: 22 cm.

Articolato su un braccio. Con adattatore universale. Tubo con 1 cavo di ricambio da 2 mm. Valigetta in plastica con gancio e coperchio trasparente a cerniera. Circunferenza: 22 cm.

CÓDIGO	COLOR	ENVASE
600015	● Azul	1 / 10

COMPÁS BK-500

Sin articulación • 170 mm.



Ajuste rápido. Adaptador universal. Tubo con 1 mina de 2 mm de repuesto. Estuche de plástico con colgador y tapa transparente abatible. Circunferencia: 18,3 cm.

Compass. Quick adjustment. Universal adapter. Tube with 1 spare 2mm lead. Plastic case with hanger and hinged transparent lid. Circumference: 18,3 cm.

Compas. Ajuste rápido. Adaptador universal. Tubo com 1 cabo sobressalente de 2 mm. Caixa de plástico com cabide e tampa transparente articulada. Circunferência: 18,3 cm.

Regolazione rapida. Adattatore universale. Tubo con 1 cavo di ricambio da 2 mm. Valigetta in plastica con gancio e coperchio trasparente a cerniera. Circunferenza: 18,3 cm.

CÓDIGO	COLOR	ENVASE
600366	● Azul claro	1 / 12
600367	● Naranja	1 / 12
600368	● Verde	1 / 12



 Ajuste rápido y preciso. Adaptador universal. Tubo con 1 mina de 2 mm de repuesto. Estuche de plástico con colgador y tapa transparente abatible. Circunferencia: 19,5 cm.

 Compass. Quick and precise adjustment. Universal adapter. Tube with 1 spare 2mm lead. Plastic case with hanger and hinged transparent lid. Circumference: 19,5 cm.

 Compas. Ajuste rápido e preciso. Adaptador universal. Tubo com 1 cabo sobressalente de 2 mm. Caixa de plástico com cabide e tampa transparente articulada. Circunferência: 19,5 cm.

 Regolazione rapida e precisa. Adattatore universale. Tubo con 1 cavo di ricambio da 2 mm. Valigetta in plastica con gancio e coperchio trasparente a cerniera. Circonferenza: 19,5 cm.

CÓDIGO	COLOR	ENVASE
600347	● Verde	1 / 12
600348	● Naranja	1 / 12
600349	● Azul	1 / 12
600350	● Rojo	1 / 12
600364	● Negro	1 / 12





COMPÁS BK-510

Sin articulación • 170 mm.
Apertura con bigotera

 Ajuste rápido y preciso. Tubo con 2 minas de 2 mm de repuesto. Estuche de plástico con colgador y tapa transparente abatible. Incluye 1 aguja de repuesto. Circunferencia: 19,5 cm.

 Compass. Quick and precise adjustment. Tube with 2 spares 2mm lead. Plastic case with hanger and hinged transparent lid. Includes 1 replacement needle. Circumference: 19,5 cm.

 Compas. Ajuste rápido e preciso. Tubo com 2 cabos sobressalentes de 2 mm. Caixa de plástico com cabide e tampa transparente articulada. Inclui 1 agulha de reposição. Circunferência: 19,5 cm.

 Regolazione rapida e precisa. Tubo con 2 cabos di ricambio da 2 mm. Valigetta in plastica con gancio e coperchio trasparente a cerniera. Include 1 ago sostitutivo. Circonferenza: 19,5 cm.

CÓDIGO	COLOR	ENVASE
600342	● Verde	1 / 10
600343	● Azul	1 / 10





COMPÁS BK-308

Sin articulación • 170 mm.
Apertura con bigotera

 Ajuste rápido y preciso. Adaptador universal. Tubo con 1 mina de 2 mm de repuesto. Estuche de plástico con colgador y tapa transparente abatible. Incluye portaminas y tubo de minas de 0,5 mm. Circunferencia: 17 cm.

 Compass. Quick and precise adjustment. Universal adapter. Tube with 1 spare 2mm lead. Plastic case with hanger and hinged transparent lid. Includes mechanical pencil and lead tube of 0,5 mm. Circumference: 17 cm.

 Compas. Ajuste rápido e preciso. Adaptador universal. Tubo com 1 cabo sobressalente de 2 mm. Caixa de plástico com cabide e tampa transparente articulada. Inclui lapiseira e tubo de chumbo de 0,5 mm. Circunferência: 17 cm.

 Regolazione rapida e precisa. Adattatore universale. Tubo con 1 cavo di ricambio da 2 mm. Valigetta in plastica con gancio e coperchio trasparente a cerniera. Include portamine e tubo di piombo da 0,5 mm. Circonferenza: 17 cm.

CÓDIGO	COLOR	ENVASE
600344	● Azul	1 / 10
600345	● Rojo	1 / 10
600346	● Verde	1 / 10



COMPÁS BK-310

Con articulación • 170 mm.
Apertura con bigotera.



COMPÁS PK-204

Doble articulación • 150 mm.



Articulado. Con adaptador universal. Tubo con 1 mina de 2 mm de repuesto. Incluye portaminas 0,5 mm. Estuche de plástico con colgador y tapa transparente abatible. Circunferencia: 25,5 cm.

Compass. Articulated. With universal adapter. Includes mechanical pencil 0.5 mm. Tube with 1 spare 2mm lead. Plastic case with hanger and hinged transparent lid. Circumference: 25,5 cm.

Compasso articulado. Com adaptador universal. Inclui lapiseira 0.5 mm. Tubo com 1 cabo sobressalente de 2 mm. Caixa de plástico com cabide e tampa transparente articulada. Circunferência: 25,5 cm.

Articolato. Con adattatore universale. Include portamine da 0,5. Tubo con 1 cavo di ricambio da 2 mm. Valigetta in plastica con gancio e coperchio trasparente a cerniera. Circunferenza: 25,5 cm.

CÓDIGO	COLOR	ENVASE
--------	-------	--------

600384	● Azul	1 / 10
--------	--------	--------

COMPÁS BK-320

Doble articulación • 170 mm.

Apertura con bigotera



Ajuste rápido y preciso. Adaptador universal. con 1 mina de 2 mm de repuesto. Incluye portaminas 0,5 mm. Estuche de plástico con colgador y tapa transparente abatible. Circunferencia: 17,5 cm.

Compass. Quick and precise adjustment. Universal adapter. Includes mechanical pencil 0.5 mm. Tube with 1 spare 2mm lead. Plastic case with hanger and hinged transparent lid. Circumference: 17,5 cm.

Compasso. Ajuste rápido e preciso. Adaptador universal. Inclui lapiseira 0.5 mm. Tubo com 1 cabo sobressalente de 2 mm. Caixa de plástico com cabide e tampa transparente articulada. Circunferência: 17,5 cm.

Regolazione rapida e precisa. Adattatore universale; Include portamine da 0,5. Tubo con 1 cavo di ricambio da 2 mm. Valigetta in plastica con gancio e coperchio trasparente a cerniera. Circunferenza: 17,5 cm.

CÓDIGO	COLOR	ENVASE
--------	-------	--------

600385	● Azul	1 / 10
--------	--------	--------

COMPÁS BK-403

Doble articulación • 170 mm.

Apertura con bigotera de ajuste rápido



Ajuste de radio preciso. Adaptador universal. Tubo con 1 mina de 2 mm de repuesto. Estuche de plástico con colgador y tapa transparente abatible. Circunferencia: 17,3 cm.

Compass. Precise radius adjustment. Universal adapter. Tube with 1 spare 2mm lead. Plastic case with hanger and hinged transparent lid. Circumference: 17,3 cm.

Compasso. Ajuste preciso do raio. Tubo com 1 cabo sobressalente de 2 mm. Caixa de plástico com cabide e tampa transparente articulada. Circunferência: 17,3 cm.

Regolazione precisa del raggio. Articolazioni in entrambe le braccia. Adattatore universale. Tubo con 1 cavo di ricambio da 2 mm. Valigetta in plastica con gancio e coperchio trasparente a cerniera. Circunferenza: 17,3 cm.

CÓDIGO	COLOR	ENVASE
--------	-------	--------

600013	● Azul	1 / 10
--------	--------	--------



Articulaciones en ambos brazos. Apertura rápida tirando de los dos brazos sin necesidad de usar la ruleta. Ajuste de radio preciso. Adaptador universal. Tubo con 1 mina de 2 mm de repuesto. Estuche de plástico con colgador y tapa transparente abatible. Circunferencia: 17,3 cm. Con alargadera.

Compass. Joints in both arms. Quick opening by pulling both arms without using the roulette wheel. Precise radius adjustment. Universal adapter. Tube with 1 spare 2mm lead. Plastic case with hanger and hinged transparent lid. Circumference: 17,3 cm. With extension.

Compasso articulado nos dois braços. Abertura rápida puxando ambos os braços sem usar a roda da roleta. Ajuste preciso do raio. Com adaptador universal. Tubo com 1 cabo sobressalente de 2 mm. Caixa de plástico com cabide e tampa transparente articulada. Circunferência: 17,3 cm. Com alargadeira.

Articolazioni in entrambe le braccia. Apertura rapida tirando entrambe le braccia senza usare la ruota della roulette. Regolazione precisa del raggio. Adattatore universale. Tubo con 1 cavo di ricambio da 2 mm. Valigetta in plastica con gancio e coperchio trasparente a cerniera. Circonferenza: 17,3 cm. Con allungatore.



COMPÁS BK-404

Doble articulación • 170 mm.

Apertura con bigotera de ajuste rápido

CÓDIGO	COLOR	ENVASE
--------	-------	--------

600011	● Azul	1 / 10
--------	--------	--------

Minas de grafito para todo tipo de compás de gran resistencia.

Leads for compass. Graphite leads for all types of high resistance compasses.

Minas grafito para todo tipo de compassos e de grande resistência.

Mine di grafite per tutti i tipi di compassi, ad alta resistenza.

CÓDIGO	MINA	Nº MINAS	ENVASE
080925	2,0 mm.	4/tubo	Blistér 3 tubos / 6 blisters



MINAS PARA COMPÁS

Con regulador de grosor para adaptar a todo tipo de bolígrafos, lápices, etc.

Universal adapter. With regulator of thickness to adapt to all type of pens, pencils, etc.

Adaptador universal. Com regulador de espessura para se adaptar a todos os tipos de canetas, etc.

Con regolatore di spessore per adattarsi a tutti i tipi di penne, matite, ecc.

CÓDIGO	ENVASE
--------	--------

600019	5 / 50
--------	--------

ADAPTADOR UNIVERSAL PARA COMPAS



Extensible fabricado en polipropileno.

Extensible, made of polypropilene.

Extensível, feita de polipropileno.

Estensibile, in polipropilene.

Máxima comodidad
Con asa lateral para transportarlos facilmente

TUBO PORTAPLANOS

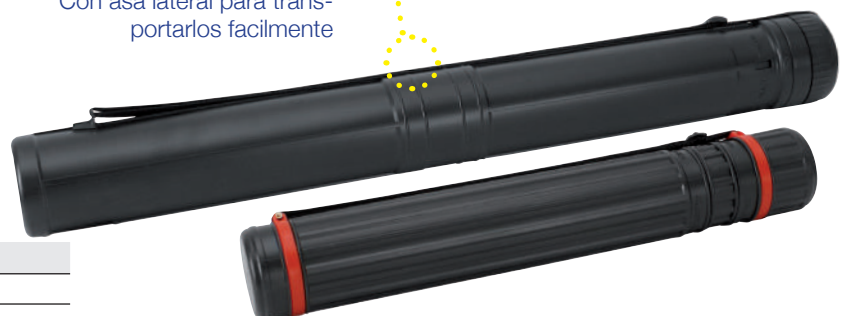

CÓDIGO	EXTENSIBLE	DIÁMETRO
--------	------------	----------

600022	45 - 74 cm.	7 cm.
--------	-------------	-------

619954	78 - 135 cm.	8,5 cm.
--------	--------------	---------





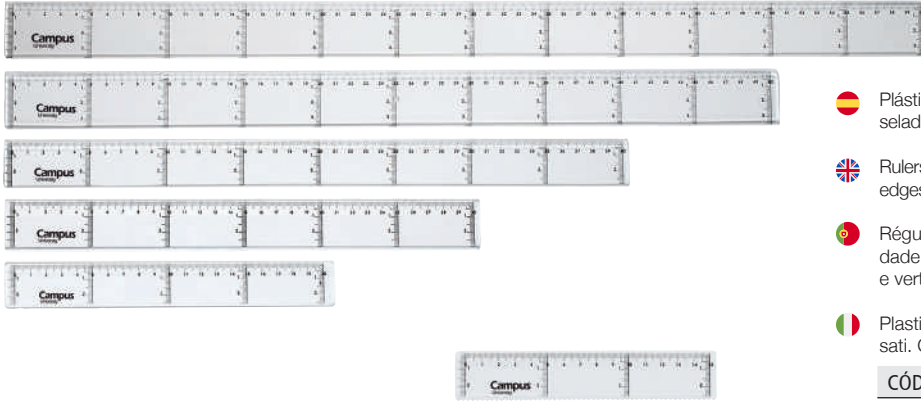

Los códigos en color amarillo permiten apertura de envase

REGLAS DE PLÁSTICO ESCOLARES BÁSICAS



Tamaño especial portatodos





CÓDIGO	LONGITUD	ENVASE
600097	15 cm.	Bote 60 ud.

-  Plástico transparente de alta calidad. Bordes biselados. Graduación horizontal y vertical.
-  Rulers. Transparent plastic of high quality. Beveled edges. Horizontal and vertical graduation.
-  Régua em plástico transparente de alta qualidade. Bordas chanfradas. Graduação horizontal e vertical.
-  Plastica trasparente di alta qualità. Bordi smussati. Graduazione orizzontale e verticale.

CÓDIGO	LONGITUD	ENVASE
600029	20 cm.	20
600027	30 cm.	20
600042	40 cm.	20
600026	50 cm.	20
600028	60 cm.	20

ESCUADRAS Y CARTABONES ESCOLARES BÁSICAS



-  Plástico transparente de alta calidad. Biseladas y graduadas. Escuadra y cartabón.
-  High quality transparent plastic. Beveled and graduated. Square and bevel.
-  Plástico transparente de alta qualidade. Biselada e graduada. Quadrado e biselado.
-  Plastica trasparente di alta qualità. Smussato e laureato. Quadrato e smussato.

Escuadras





CÓDIGO	LONGITUD	ENVASE
600030	25 cm.	20
600032	30 cm.	20

Cartabones

CÓDIGO	LONGITUD	ENVASE
600034	25 cm.	20
600035	30 cm.	20

SEMICÍRCULO ESCOLAR BÁSICO





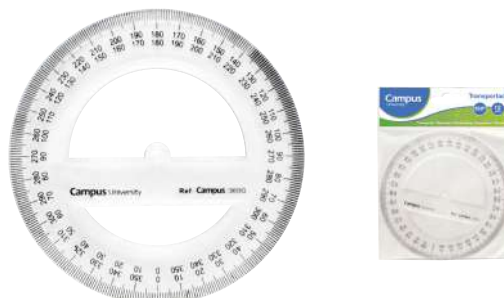

-  Plástico transparente de alta calidad. Biselado y graduado.
-  Semicircle. Transparent plastic of high quality. Beveled and graduated.
-  Transferidor em plástico transparente de alta qualidade. Biselado e graduado.
-  Plastica trasparente di alta qualità, smussato e con indicazione gradi.

CÓDIGO	LONGITUD	ENVASE
600033	13 cm.	20

CÍRCULO TRANSPORTADOR ESCOLAR



-  Plástico transparente de alta calidad. Biselado y graduado.
-  Transparent plastic of high quality. Beveled and graduated.
-  Plástico transparente de alta qualidade. Biselado e graduado.
-  Plastica trasparente di alta qualità, smussato e con indicazione gradi.





CÓDIGO	DIÁMETRO	ENVASE
600369	12 cm.	20

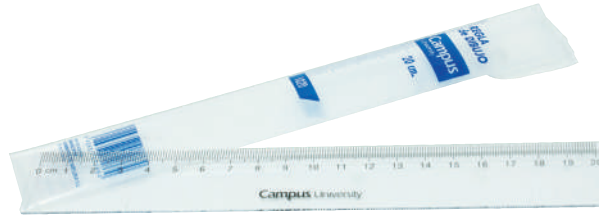

REGLAS DE PLÁSTICO TÉCNICAS BISELADAS

En bolsa individual







-  Plástico de alta calidad. Biseladas y graduadas. En bolsa individual.
-  Plastic of high quality. Bevelled and graduated. In an individual bag.
-  Plástico de alta qualidade. Biseladas e graduadas. Num único saco.
-  Plastica di alta qualità. Smussato e graduato. In una sola borsa.

CÓDIGO	LONGITUD	ENVASE
600352	20 cm.	30
600353	30 cm.	20
600354	40 cm.	20
600355	50 cm.	20
600356	60 cm.	20

SET DE ESCUADRA Y CARTABÓN TÉCNICO

En bolsa. No biseladas.

-  Compuesto de: cartabón y escuadra con semicírculo integrado de 10 cm. Transparentes y graduadas.
-  Set composed by: bevel and square with 10 cm integrated semicircle. Transparent and graduated.
-  Conjunto de esquadros com transferidor de 10 cm integrado. Transparente e graduado.
-  Composto da: triangolo e squadra con semicerchio integrato di 10 cm. Trasparente e graduato.

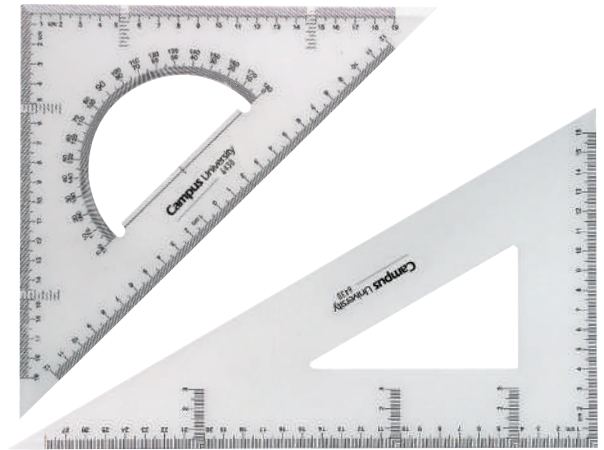

CÓDIGO	LONGITUD	ENVASE
600288	25 cm.	12
600096	30 cm.	12
600289	35 cm.	12

-  Triangular de plástico. Con funda de plástico. Escalas de 1:100, 1:200, 1:250, 1:300, 1:400 y 1:500. Hendiduras en color. Longitud: 30 cm.
-  Triangular made of plastic. With plastic cover. Scales of: 1:100, 1:200, 1:250, 1:300, 1:400 and 1:500. Color indentations. Length: 30 cm.
-  Triangular plástico com bolsa. Escalas de 1:100, 1:200, 1:250, 1:300, 1:400 e 1:500. Recuos de cor. Comprimento: 30 cm.
-  Plastica triangolare. Con fodera in plastica. Scale 1: 100, 1: 200.1: 250, 1: 300, 1: 400 e 1: 500. Rientranze di colore. Lunghezza: 30 cm.

CÓDIGO	ENVASE
600025	1 / 10

ESCALÍMETRO 30 CM - 6 ESCALAS



Los códigos en **color amarillo** permiten apertura de envase

SET DE DIBUJO 4 PIEZAS ESCOLAR BÁSICO

4 componentes. Biseladas y graduadas

Estuche

Hecho de material muy resistente traslúcido

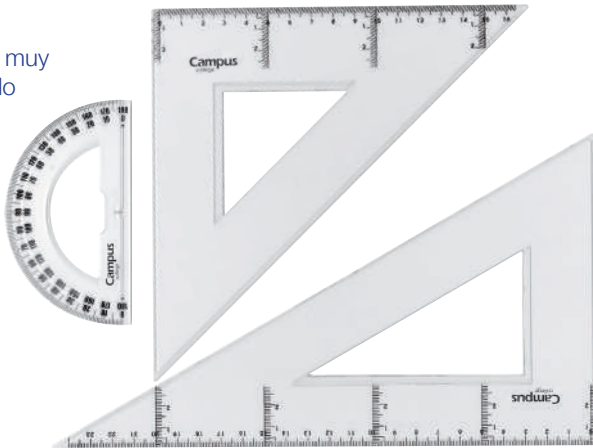

- Contiene:
 - Regla de 30 cm.
 - Cartabón de 24 cm.
 - Escuadra de 16 cm.
 - Semicírculo de 180°.

- Contains:
 - Ruler 30 cm.
 - Cartabon 24 cm.
 - Square 16 cm.
 - Semicircle 180°.

- Contém:
 - Régua de 30 cm.
 - Esquadra 24 cm.
 - Esquadro 16 cm.
 - Tranferidor 180°.

- Contenuto:
 - Righello da 30 cm.
 - Triangolo 24 cm.
 - Squadra di 16 cm.
 - Semicerchio di 180°.

CÓDIGO	ENVASE
--------	--------

600381	12
--------	----

SET DE DIBUJO 4 PIEZAS

Set básico en bolsa. Biseladas.

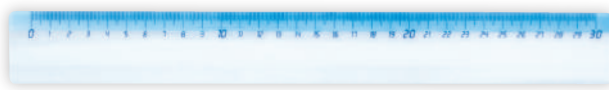
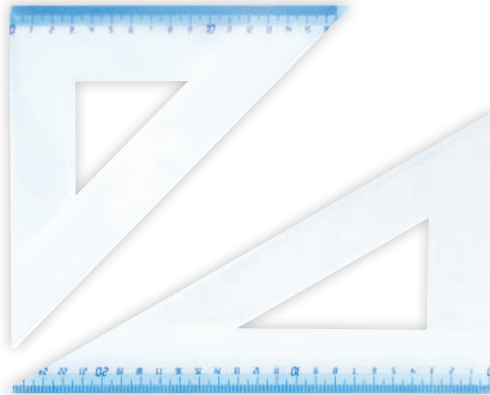
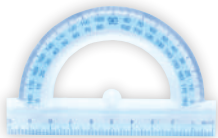

- Contiene:
 - Regla de 30 cm.
 - Cartabón de 24 cm.
 - Escuadra de 16 cm.
 - Semicírculo de 180°.

- Contains:
 - Ruler 30 cm.
 - Cartabon 24 cm.
 - Square 16 cm.
 - Semicircle 180°.

- Contém:
 - Régua de 30 cm.
 - Esquadra 24 cm.
 - Esquadro 16 cm.
 - Tranferidor 180°.

- Contenuto:
 - Righello da 30 cm.
 - Triangolo 24 cm.
 - Squadra di 16 cm.
 - Semicerchio di 180°.

CÓDIGO	ENVASE
--------	--------

600024	24
--------	----

SET DE DIBUJO 4 PIEZAS IRROMPIBLE

4 componentes. Biseladas y graduadas.

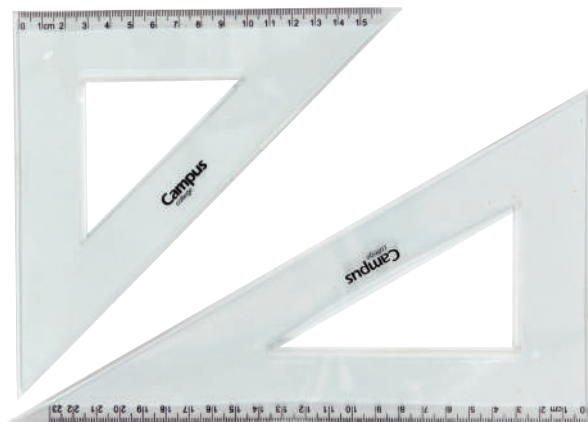
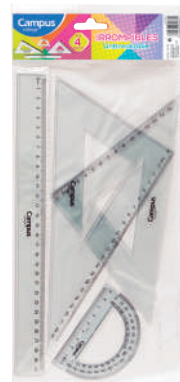

- Contiene:
 - Regla de 30 cm.
 - Cartabón de 23 cm.
 - Escuadra de 16 cm.
 - Semicírculo de 180°.

- Contains:
 - Ruler 30 cm.
 - Cartabon 23 cm.
 - Square 16 cm.
 - Semicircle 180°.

- Contém:
 - Régua de 30 cm.
 - Esquadra 23 cm.
 - Esquadro 16 cm.
 - Tranferidor 180°.

- Contenuto:
 - Righello da 30 cm.
 - Triangolo 23 cm.
 - Squadra di 16 cm.
 - Semicerchio di 180°.

CÓDIGO	ENVASE
--------	--------

600382	12
--------	----



REGLAS DE ALUMINIO

- Aluminio. Biseladas y graduadas. Presentación en bolsa individual con colgador.
- Aluminium rulers. Bevelled and graduated. Presentation in individual bag with hanger.
- Réguas. Biseladas e graduadas. Apresentação no saco individual com cabide.
- Alluminio. smussato e graduato. Presentazione in borsa individuale con gancio.



CÓDIGO	LONGITUD	ENVASE
600261	15 cm.	24
600262	20 cm.	24
600361	30 cm.	24
600276	50 cm.	36

- Aluminio. Biseladas y graduadas. Colores: rojo, naranja y azul. Presentación en bolsa individual con colgador.
- Aluminium. Bevelled and graduated. Colours: red, orange and blue. Presentation in individual bag with hanger.
- Aluminio. Biseladas e graduadas. Cores: vermelho, laranja e azul. Apresentação no saco individual com cabide.
- Alluminio. Smussato e graduato. Colori: rosso, arancione e blu. Presentazione in borsa individuale con gancio.

REGLAS DE ALUMINIO EN COLORES

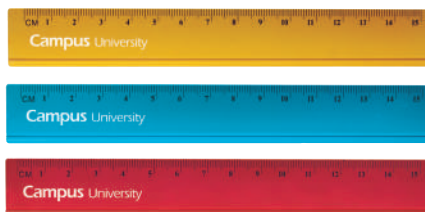

CÓDIGO	LONGITUD	ENVASE
600360	15 cm.	24



- Flexible. Graduada. Transparente. Color: rosa, azul y verde. No se rompe.
- Flexible. Graduated. Transparent. Colours: pink, blue and green. Does not break.
- Flexível. Graduado. Transparente. Cores: rosa, azul e verde. Não quebra.
- Flessibile. Graduato. Trasparente. Colori: rosa, blu e verde. Non si rompe.

REGLA FLEXIBLE DE 15 CM.

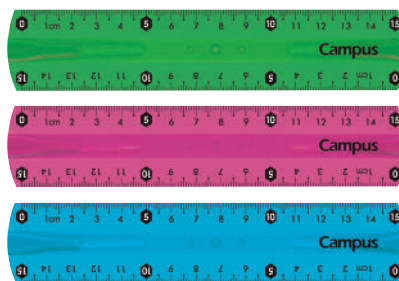

CÓDIGO	LONGITUD	ENVASE
600365	15 cm.	Bote 36 ud.

REGLA FLEXIBLE DE 30 CM.



- Flexible. Graduada. Transparente. Color: rosa, azul y verde. No se rompe.
- Flexible. Graduated. Transparent. Colours: pink, blue and green. Does not break.
- Flexível. Graduado. Transparente. Cores: rosa, azul e verde. Não quebra.
- Flessibile. Graduato. Trasparente. Colori: rosa, blu e verde. Non si rompe.

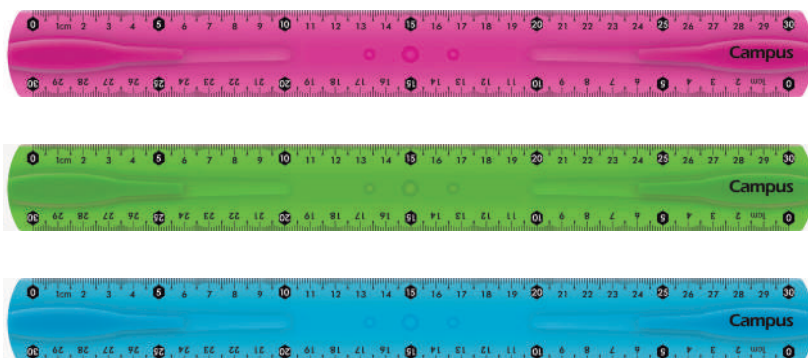

CÓDIGO	LONGITUD	ENVASE
600359	30 cm.	24



Los códigos en color amarillo permiten apertura de envase

PLANTILLA DE CÍRCULOS

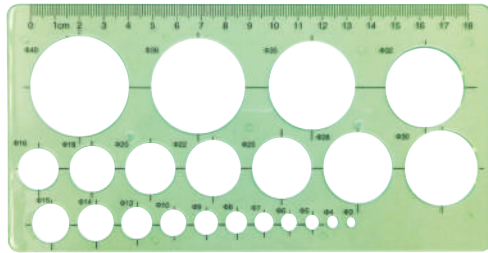

- Plantillas para diferentes formatos de círculos, de 1 a 35 mm. Plástico. Longitud: 180 mm.
- Different circle format patterns, from 1 to 35 mm. Plastic. Length: 180 mm.
- Escantilhão de círculos com vários formatos de 1 a 35 mm. Plástico. Comprimento: 180 mm.
- Maschera per formati di cerchi diversi, da 1 a 35 mm. Plastica. Lunghezza: 180 mm.

CÓDIGO	CÍRCULOS	ENVASE
600048	22	1 / 12

PLANTILLA DE ELIPSES

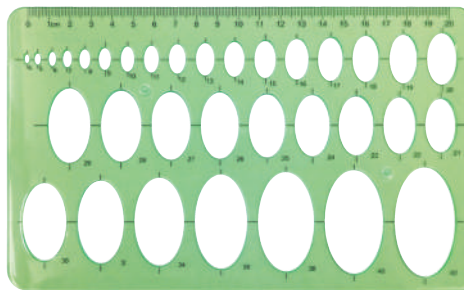

- Plantillas para diferentes formatos de elipses. Plástico. Longitud: 200 mm.
- Different ellipse format patterns. Plastic. Length: 200 mm.
- Escantilhão de elipses com vários formatos. Plástico. Comprimento: 200 m.
- Maschera per diversi formati di ellisse. Plastica. Lunghezza: 200 mm.

CÓDIGO	ELIPSES	ENVASE
600055	33	1 / 12

PLANTILLA DE CURVAS



- Juego de 3 plantillas para diferentes formatos de curvas. Plástico.
- Set of 3 patterns for different curve formats. Plastic.
- Jogo de 3 modelos para diferentes formatos de curvas.
- Set di 3 maschere per diversi formati di curve. Plastica.

CÓDIGO	ENVASE
600049	1 / 24

PLANTILLAS NORMÓGRAFOS



- Plástico ABS. Letras y números.
- Patterns: ABS Plastic. Letters and numbers.
- Escantilhões em plástico ABS. Letras e números.
- Plastica ABS Lettere e numeri.

	CÓDIGO	ALTURA LETRA	ENVASE
1	600052	5 mm.	1 / 30
2	600047	10 mm.	1 / 30
3	600050	20 mm.	1 / 30
4	600051	30 mm.	1 / 30
5	600054	50 mm.	1 / 8
6	600053	100 mm.	1 / 6



AFILALÁPIZ TWISTER PREMIUM

- Afilalápices de colores con cuchilla de acero cortada por láser. Forma hexagonal.
- Colored sharpener with laser-cut steel blade. Hexagonal shape.
- Afiaador de lápis colorido com lâmina de aço cortada a laser. Forma hexagonal.
- Temperamatite colorate con lama in acciaio tagliata al laser. Forma esagonale.



CÓDIGO	COLORES	ENVASE
081368		Bote 100 ud.

AFILALÁPIZ NERO PREMIUM

- Plástico. Goma en los laterales. Cuchilla de acero.
- Plastic sharpener. Steel blade. Rubber on the sides.
- Apáralápis de plástico. Lâmina de aço. Borracha nas laterais.
- Plastica. Gomma suilati. Lama d'acciaio.



CÓDIGO	COLORES	ENVASE
080656	/ - /	Bote 50 ud.
	/ - /	
	/ - /	

AFILALÁPIZ CON DEPÓSITO PREMIUM

- Afilalápis con depósito. Cuatro colores disponibles: turquesa, verde, rojo y morado.
- Sharpener with deposit. Four colours available: turquoise, green, red and purple.
- Afiaador de lápis com depósito. Quatro cores disponíveis: turquesa, verde, vermelho e púrpura.
- Temperamatite con deposito. Quattro colori disponibili: turchese, verde, rosso e viola.

CON DEPÓSITO



CÓDIGO	COLORES	ENVASE
081366		Exp. 24 ud.

AFILALÁPIZ CON DEPÓSITO PREMIUM

- Afilalápis con depósito. Cuatro colores disponibles: azul, verde, rojo y morado.
- Sharpener with deposit. Four colours available: blue, green, red and purple.
- Afiaador de lápis com depósito. Quatro cores disponíveis: azul, verde, vermelho e púrpura.
- Temperamatite con deposito. Quattro colori disponibili: blu, verde, rosso e viola.

CON DEPÓSITO



CÓDIGO	COLORES	ENVASE
081367		Exp. 24 ud.



AFILALÁPICES METÁLICOS



CUCHILLA JAPONESA

- Metálico. Cuchilla de acero. Cortado con láser.
- Sharpener. Metallic with steel blade. Laser Cut.
- Apáralápis metálico. Lâmina de aço. Cortado com laser.
- In metallo. Lama d'acciaio, tagliata con il laser.

	CÓDIGO	MODELO	ENVASE
1	080060	Rectangular	Caja 20 ud.
2	080061	Cuña	Caja 20 ud.
3	080062	Doble	Caja 20 ud.

AFILALÁPICES METÁLICOS PREMIUM CUÑA SUPER CUCHILLA



- Metálico. Cuchilla de acero. Cortado con láser. Colores: rojo, violeta, azul y verde.
- Sharpener. Metallic with steel blade. Laser Cut. Colour: red, violet, blue and green.
- Apáralápis metálico. Lâmina de aço. Cortado com laser. Cores: vermelho, violeta, azul y verde.
- In metallo. Lama d'acciaio, tagliata con il laser. Colori: rosso, viola, blu e verde.

	CÓDIGO	MODELO	ENVASE
	081181	Cuña	Caja 16 ud.
	081182	Cuña	Blíster 2 ud./ 18

AFILALÁPICES METÁLICOS PREMIUM DOBLE SUPER CUCHILLA



- Metálico doble. Cuchilla de acero. Cortado con láser. Colores: rojo, violeta, azul y verde.
- Double metal sharpener. Metallic with steel blade. Laser Cut. Colour: red, violet, blue and green.
- Apáralápis duplo metálico. Lâmina de aço. Cortado com laser. Cores: vermelho, violeta, azul y verde.
- Doppio temperamatite in metallo. Lama d'acciaio, tagliata con il laser. Colori: rosso, viola, blu e verde.

	CÓDIGO	MODELO	ENVASE
	081183	Doble	Caja 12 ud.
	081184	Doble	Blíster 1 ud./ 18

AFILALÁPICES METÁLICO PREMIUM TWIST SUPER CUCHILLA







- Metálico. Cuchilla de acero. Cortado con láser. Colores: rojo, violeta, azul y verde.
- Sharpener. Metallic with steel blade. Laser Cut. Colour: red, violet, blue and green.
- Apáralápis metálico. Lâmina de aço. Cortado com laser. Cores: vermelho, violeta, azul y verde.
- In metallo. Lama d'acciaio, tagliata con il laser. Colori: rosso, viola, blu e verde.

	CÓDIGO	MODELO	ENVASE
	081185	TWIST	Caja 24 ud.



AFILALÁPIZ DOBLE CON DEPÓSITO PREMIUM SUPER CUCHILLA





CON DEPÓSITO

-  Afilalápiiz doble con depósito. 4 colores disponibles: turquesa, verde, amarillo y rosa.
-  Double sharpener with reservoir. 4 colours available: turquoise, green, yellow and pink.
-  Afilador de lápis duplo com reservatório. 4 cores disponíveis: turquesa, verde, amarelo e rosa.
-  Doppio temperamatite con serbatoio. 4 colori disponibili: turchese, verde, giallo e rosa.

CÓDIGO	COLORES	ENVASE
081369	   	Exp. 24 ud.







AFILALÁPIZ PREMIUM RECTANGULAR SUPER CUCHILLA

-  Plástico. Cuchilla de acero.
-  Sharpener. Plastic with steel blade.
-  Apáralápis de plástico. Lâmina de aço.
-  Plastica, lama d'acciaio.

CÓDIGO	COLORES	ENVASE
080654	   	Bote 140 ud.







AFILALÁPIZ REDONDO 645

-  Plástico. Cuchilla de acero.
-  Sharpener. Plastic with steel blade.
-  Apáralápis de plástico. Lâmina de aço.
-  Plastica, lama d'acciaio.

CÓDIGO	COLORES	ENVASE
080059	   	Bote 50 ud.



AFILALÁPIZ DOBLE 699



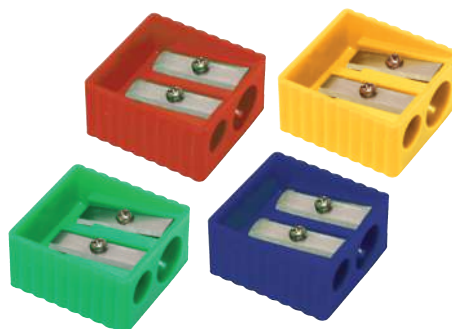

-  Plástico. Doble cuchilla de acero, para lápices normales y gruesos.
-  Plastic sharpener. Double steel blade, for normal and thick pencils.
-  Apáralápis de plástico. Lâmina de aço duplo, para lápis normais e grossa.
-  Plastica. Doppia lama in acciaio, per matite normali e spesse.

CÓDIGO	COLORES	ENVASE
080612	   	Bote 24 ud.



AFILALÁPIZ ULTRA COMPACTO



-  Plástico. Ergonómico. Cuchilla de acero.
-  Plastic sharpener. Ergonomic. Steel blade.
-  Apáralápis de plástico. Ergonómico. Lâmina de aço.
-  Plastica, Ergonomico. Lama d'acciaio.





CÓDIGO	COLORES	ENVASE
080864	  	Bote 48 ud.

AFILALÁPIZ 809



CON DEPÓSITO



-  Plástico. Con depósito. Cuchilla de acero.
-  Plastic sharpener. With deposit. Steel blade.
-  Apáralápis de plástico. Com depósito. Lâmina de aço.
-  Plastica, con serbatoio. Lama d'acciaio.





CÓDIGO	COLORES	ENVASE
080614	 	Exp. 12 ud.
080992	 	Blister 1 ud.

AFILALÁPIZ SPACE



CON DEPÓSITO







-  Plástico. Con depósito. Cuchilla de acero. Goma en los laterales.
-  Plastic sharpener. Steel blade. Rubber on the sides. With deposit.
-  Apáralápis de plástico. Lâmina de aço. Borracha nas laterais. Com depósito.
-  Plastica. Con deposito. Lama d'acciaio e gomma sui lati.

CÓDIGO	COLORES	ENVASE
080673	 /  -  / 	Exp. 24 ud.
	 /  -  / 	



AFILALÁPIZ FLUOR CON DEPÓSITO

CON DEPÓSITO





-  Plástico. Con depósito traslúcido fluor. Cuchilla de acero.
-  Plastic sharpener. With translucent fluorine deposit. Steel blade.
-  Apàralàpis de plàstic. Com depòsit translúcid fluor. Làmina de aço.
-  Plastica. Con serbatoio di fluor traslucido e lama d'acciaio.

CÓDIGO	COLORES	ENVASE
080832	   	Exp. 24 ud.



AFILALÁPIZ DOBLE CON DEPÓSITO Y GOMA DE BORRAR

CON DEPÓSITO





-  Plástico. Con depósito y goma de borrar. Cuchilla de acero.
-  Plastic sharpener. With deposit and rubber. Steel blade.
-  Apàralàpis de plàstic. Com depòsit e borracha. Làmina de aço.
-  Plastica. Con deposito e cancellino. Lama d'acciaio.

CÓDIGO	COLORES	ENVASE
080909	  	Blistér 1 ud.
080901	  	Exp. 24 ud.



AFILALÁPIZ CON GOMA DE BORRAR

CON DEPÓSITO

-  Plástico. Con goma de borrar. Cuchilla de acero. Forma ovalada.
-  Plastic sharpener. With rubber. Steel blade. Oval shaped.
-  Apàralàpis de plàstic. Com borracha. Làmina de aço. Forma oval.
-  Plastica, con gomma e lama d'acciaio; forma ovale.

CÓDIGO	COLORES	ENVASE
080863	  	Exp. 24 ud.



TIJERA ESCOLAR FITCUT JUNIOR

PLUS
JAPAN



Punto 1

La empuñadura gruesa está diseñada para facilitar el uso con las manos de los niños. Los materiales suaves evitan que dañen sus manos.

The thick grip is designed for ease of use with children's hands. Soft materials prevent them from damaging his hands.

A alça grossa é projetada para uso fácil com as mãos das crianças. Os materiais macios evitar danificar suas mãos.

Punto 3

Punta redondeada para su seguridad.

Rounded tip for your safety.

Ponta arredondada para a segurança.

Punto 2

Arandelas a prueba de sacudidas y para amortiguar la fricción del movimiento de las cuchillas. Para su uso de larga duración, suave y cómodo.

Shock-proof washers, to cushion the friction of the movement of the blades. For long-lasting use, soft and comfortable.

Anilhas anti-vibração e fricção, para amortecer o movimento das lâminas. Para uso de longa duração, macio e confortável.



Hojas: Alto carbono recubiertas de flúor, evitando que se adhieran la cinta y el pegamento. Acero inoxidable. Mango: Polietileno (PE)

Blades: High carbon coated with fluoride, avoiding to adhere the tape and glue. Stainless steel. Handle: Polyethylene (PE)

Folhas: alto carbono revestido flúor, evitando aderir a fita e cola. Aço inoxidável. Alça: polietileno (PE)

CÓDIGO	COLOR	ENVASE
630511	● ● ●	Blíster 1 ud.
630512	● ● ●	Exp. 24 ud.

LARGO
145mm

CUCHILLA
52mm



VERDE

AZUL

ROSA



Los códigos en **color amarillo** permiten apertura de envase

PLUS
JAPAN

Punto 1

Nuevo diseño de cuchillas curvas

Corte sin esfuerzo de principio a fin de la cuchilla.

Punto 2

Cuchillas antiadherentes

El revestimiento de flúor resiste la adhesión de la cinta y el pegamento

Punto 3

Mango ergonómico

Muy suave y ergonómico que se adapta a la forma de la mano. Punta roma. Con capuchón.

CÓDIGO	COLOR	ENVASE
040715	● Azul	Blistér 1 ud.
040716	● Rosa	Blistér 1 ud.



LARGO	CUCHILLA
145mm	52mm

PLUS
JAPAN

Punto 1

Corte definido

Corte sin esfuerzo de principio a fin de la cuchilla. Acero inoxidable endurecido. Anillo de giro en material de baja fricción.



CÓDIGO	COLOR	ENVASE
040686	● ● ●	Exp. 24 ud.



LARGO	CUCHILLA
155mm	59mm

TIJERA ESCOLAR PRINT

Cuchillas impresas a color.

- Hoja de acero inoxidable impresas en 4 colores. Mango super suave. Puntas redondeadas. Ergonómica.
- Stainless steel blade printed in 4 colours. Super soft handle. Rounded tips. Ergonomic.
- Chapa de aço inoxidável impresso em 4 cores. Manga super macio. Pontas arredondadas. Ergonómica.
- Lama di acciaio inossidabile stampato a 4 colori. Manico super morbido e punte arrotondate. Ergonomica.

CÓDIGO	COLOR	ENVASE
630608	● ● ● ●	Exp. 12 ud.



LARGO
135mm



Los códigos en color amarillo permiten apertura de envase

TIJERA ESCOLAR SOFT

Manto flexible.



- Hoja de acero inoxidable. Mango super suave. Puntas redondeadas. Ergonómica.
- Stainless steel. Super soft handle. Rounded tips. Ergonomic.
- Tesoura em aço inoxidável. Alça super macia. Ponta arredondada. Ergonómica.
- Lama di acciaio inossidabile; manico super morbido, punte arrotondate. Ergonomica.

CÓDIGO	COLOR	ENVASE
630513		12 blíster

LARGO
130mm

TIJERA ESCOLAR BÁSICA

Punta roma antipinchazos



- Hoja de acero inoxidable. Cantos pulidos. Mango anatómico de poliestireno. Puntas redondeadas.
- Stainless steel blade. Polished edges. Anatomical angle of polystyrene. Rounded tips.
- Lâmina de aço inoxidável. Bordas polidas. Alça anatómica de poliestireno. Pontas arredondadas.
- Lama di acciaio inossidabile, bordi lucidati. Impugnatura anatomico in polistirolo. Punte arrotondate.

CÓDIGO	COLOR	ENVASE
630090		Exp. 24 ud.

LARGO
130mm

TIJERA ESCOLAR PARA ZURDOS

Las hojas permiten la visión del corte a los zurdos



- Hoja de acero inoxidable. Empuñadura ergonómica en plástico ABS. Puntas redondeadas.
- Stainless steel. Ergonomic handle in ABS plastic. Rounded tips.
- Tesoura em aço inoxidável. Alça ergonómica em plástico ABS. Pontas arredondadas.
- Acciaio inossidabile. Impugnatura ergonomica in plastica ABS. Punte arrotondate.

CÓDIGO	COLOR	ENVASE
630089		Blíster 1 ud.

LARGO
140mm

TIJERA ESCOLAR CON CORTE ZIG-ZAG



- Hoja de acero inoxidable. Empuñadura en plástico ABS.
- Stainless steel. Handle in ABS plastic.
- Tesoura em aço inoxidável. Alça ergonómica em plástico ABS.
- Lama di acciaio inossidabile; impugnatura in plastica ABS.

CÓDIGO	COLOR	ENVASE
630088		Blíster 1 ud.





LARGO
165mm



Los códigos en **color amarillo** permiten apertura de envase

GOMAS DE BORRAR



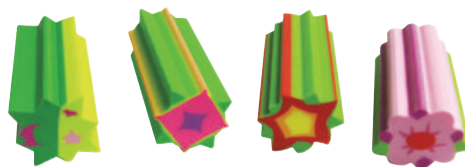

4 diseños surtidos

-  Gomas de borrar en barra pequeña. Ideal para lápiz.
-  Erasers in small bar. Great for pencil.
-  Borrachas em barra pequena. Ótimo para lápis.
-  Gomme in forma di stick. Ottimo per la matita.



CÓDIGO	BOLSA	ENVASE
080868	4 ud.	12

GOMAS DE BORRAR FORMAS





-  Gomas de borrar infantiles con diseños de animales y objetos. Ideal para lápiz.
-  Childrens erasers with designs of animals and objects. Great for pencil.
-  Borrachas para crianças com desenhos de animais e objetos. Ótimo para lápis.
-  Gomme per bambini con disegni di animali e oggetti. Ottimo per la matita.



CÓDIGO	ENVASE
081325	Bote 25 ud.

GOMAS DE BORRAR MEDIANA - 16 CM.

El dibujo se mantiene en todo el interior





-  Gomas de borrar con diversos diseños y colores. Ideal para lápiz.
-  Erasers with various designs and colours. Great for pencil.
-  Borrachas com diferentes modelos e cores. Ótimo para lápis.
-  Gomme con disegni e colori diversi. Ottimo per la matita.



CÓDIGO	ENVASE
860081	Bote 16 ud.

GOMAS DE BORRAR MEDIANA - 16 CM.





El dibujo se mantiene en todo el interior

-  Gomas de borrar con diversos diseños y colores. 1 cm. de diámetro. Ideal para lápiz.
-  Erasers with various designs and colours. 1 cm. diameter. Great for pencil.
-  Borrachas com diferentes modelos e cores. 1 cm. diâmetro. Ótimo para lápis.
-  Gomme con disegni e colori diversi. 1 cm. diametro. Ottimo per la matita.



CÓDIGO	ENVASE
081005	Bote 40 ud.

GOMAS DE BORRAR SHAPE

-  Gomas de borrar con forma triangular y ovalada. Ideal para lápiz.
-  Triangular and oval shaped erasers. Ideal for pencil.
-  Borrachas triangulares e ovais. Ideal para lápis.
-  Gomme triangolari e ovali. Ideale per la matita.



CÓDIGO	ENVASE
080770	Bote 30 ud.



Los códigos en color amarillo permiten apertura de envase

LAPICES INFANTILES JUICY FRUITS



- Lápicos de madera negra con goma en forma de frutas. Seis motivos diferentes. Las gomas se pueden sacar.
- Black wooden pencils with fruit shape eraser. Six different designs. The erasers can be removed.
- Lápis de madeira preto com borracha em forma de frutas. Seis modelos diferente. As borrachas podem ser removidas.
- Matite di legno nere con gomma a forma di frutta. Sei diversi modelli; le gomme possono essere rimosse.

CÓDIGO	ENVASE
081097	Exp. 36 ud.

LAPICES INFANTILES VEHÍCULOS



- Lápicos de madera negra con goma en forma de medios de transporte. Cinco motivos diferentes. Las gomas se pueden sacar.
- Black wooden pencils with transportation shape eraser. Five different designs. The erasers can be removed.
- Lápis de madeira preto com borracha em forma de meios de transporte. Cinco modelos diferentes. As borrachas podem ser removidas.
- Matite di legno nero con gomma nella forma di mezzi di trasporto. Cinque diversi tipi. Le gomme possono essere rimosse.

CÓDIGO	ENVASE
081099	Exp. 36 ud.

LAPICES INFANTILES CRAZY SPORTS



- Lápicos de madera negra con goma en forma de artículos deportivos. Seis motivos diferentes. Las gomas se pueden sacar.
- Black wooden pencils with sport goods shape eraser. Six different designs. The erasers can be removed.
- Lápis de madeira preto com borracha em forma de artigos de esportes. Seis modelos diferente. As borrachas podem ser removidas.
- Matite di legno nere con gomma sagomata con motivi di sport, 6 modelli diversi. Le gomme possono essere rimosse.

CÓDIGO	ENVASE
081098	Exp. 36 ud.

AFILALÁPIZ 307A

Manual

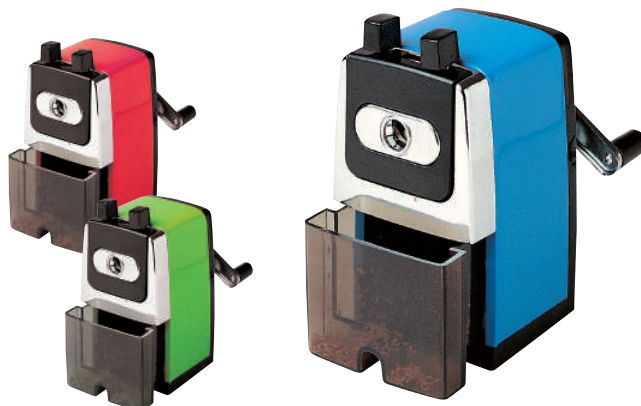





- Mecanismo metálico. Incorpora depósito y soporte para su fijación. Medidas: 70 x 70 x 130 mm. Para lápices de hasta 8 mm. de diámetro.
- Metal mechanism. Sharpener incorporates deposit and support for its attachment. Size: 70 x 70 x 130 mm. For pencils up to 8 mm. diameter.
- Mecanismo de metal. Apáralápis de mesa. Incorpora depósito e suporte para fixação. Tamanho: 70 x 70 x 130 mm. Para lápis de até 8 mm. diâmetro.
- Meccanismo in metallo. Con serbatoio e supporto per la sua fissazione. Misura: 70 x 70 x 130 mm. Per matite fino a 8 mm. di diametro.

CÓDIGO	COLOR	ENVASE
080064	● Azul	1 / 6
081169	● Rojo	1 / 6
081170	● Verde	1 / 6



ESFERAS LUMINOSAS

Con enchufe a la red

-  Con cartografía y meridiano. Alta resistencia.
-  With Cartography and Meridian. High resistance.
-  Globo com cartografia e meridiano. Alta resistencia.
-  Con cartografia e meridiano. Alta resistenza.

CÓDIGO	COLOR	DIÁMETRO
630289	Azul	25 cm.
630374	Azul	32 cm.
630290	Crema	25 cm.
630375	Crema	32 cm.



-  Caja de seguridad electrónica pequeña. Reconocimiento de moneda. Ranura para moneda. Contador digital. Suma el total. Cierre con combinación de melodía y voz. Usa 3 pilas AAA.

-  Small electronic safe-deposit box. Currency recognition feature. Coin slot. Digital counter. Add the total. Closing with a combination of melody and voice. Uses 3 batteries AAA.

-  Cofre eletrônico pequeno. Reconhecimento de moeda. Slot de moeda. Contador digital. Some o total. Fechando com uma combinação de melodia e voz. Utiliza 3 pilhas AAA.

-  Piccola cassetta di sicurezza elettronica. Riconoscimento della valuta. Slot per monete. Contatore digitale. Aggiungi il totale. Chiusura con una combinazione di melodia e voce. Utilizzare 3 batterie AAA.

CAJA DE SEGURIDAD PEQUEÑA

CÓDIGO	MEDIDAS cm.
630478	9,5 x 10,7 x 11,8

-  Caja fuerte con diseño de camuflaje en forma de diccionario de inglés. Con llave.

-  Safetybox with an english dictionary camouflag design. With key.

-  Cofre com desenho da camuflagem como dicionário de Inglês. Trancada.

-  Cassetta sicurezza con disegno mimetico a forma di un dizionario inglese. Con chiave.

CAJA LIBRO

Diseño de diccionario de inglés



CÓDIGO	MEDIDAS
040494	15,5 x 24 x 5,5 cm.

Los códigos en **color amarillo** permiten apertura de envase

TIZAS JUMBO DE COLORES

6 Colores



LAVABLE

- 🇪🇸 Tizas extragrandes y de fácil agarre. Fáciles de lavar de manos y tejidos. Ideales para los más pequeños. Para jugar o marcar en el suelo.
- 🇬🇧 Extra-large, easy-to-grip chalk. Easy to wash hands and fabrics. Ideal for children. To play or mark on the ground.
- 🇵🇹 Giz extra-grande e fácil de agarrar. Fácil de lavar as mãos e os tecidos. Ideal para crianças. Para jogar ou marcar no chão.
- 🇮🇹 Gesso extra-large, facile da impugnare. Facile da lavare mani e tessuti. Ideale per i bambini. Per giocare o segnare a terra.

CÓDIGO	COLORES	ENVASE
630775	● ● ● ● ● ●	Caja 6 ud.

TIZAS ANTIPOLVO

No manchan. Blancas y de colores



- 🇪🇸 Tizas redondeadas. Antipolvo. No manchan. Escritura suave.
- 🇬🇧 Rounded chalk. Dustproof. They don't stain. Smooth writing.
- 🇵🇹 Giz arredondado. À prova de pó. Eles não mancham. Escrita suave.
- 🇮🇹 Gesso arrotondato. A prova di polvere. Non si macchiano. Scrittura fluida.

CÓDIGO	COLOR	ENVASE
630777	Blanco	Caja 10 ud.
630778	Blanco	Caja 100 ud.

CÓDIGO	COLOR	ENVASE
630779	Surtidos	Caja 10 ud.
630780	Surtidos	Caja 100 ud.

PORTATIZAS AUTOMÁTICO



- 🇪🇸 Con pulsador automático. Facilita la escritura y aumenta la duración de la tiza.
- 🇬🇧 With automatic button. It makes writing easier and increases the life of the chalk.
- 🇵🇹 Com pulsador automático. Facilita a escrita e aumenta a vida útil do giz.
- 🇮🇹 Con pulsante automatico. Facilita la scrittura e aumenta la durata del gesso.

CÓDIGO	MEDIDAS	ENVASE
630009	11 cm.	1 / 30

BORRADORES DE PIZARRA

- 🇪🇸 Empuñadura de madera.
- 🇬🇧 Wooden grip.
- 🇵🇹 Empunhadura de madeira.
- 🇮🇹 Impugnatura in legno.



BORRADOR DE FIELTRO PARA PIZARRA DE TIZA

CÓDIGO	MEDIDAS	ENVASE
630006	8 x 12 x 3,5 cm.	12

- 🇪🇸 16 capas de tejido desechable.
- 🇬🇧 16 layers of disposable fabric.
- 🇵🇹 16 camadas de tecido descartável.
- 🇮🇹 16 strati di tessuto usa e getta.

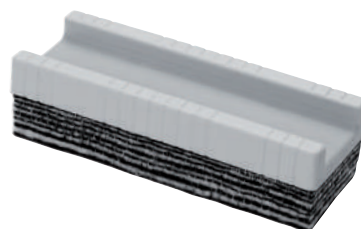

BORRADOR PARA PIZARRA BLANCA

CÓDIGO	MEDIDAS	ENVASE
630001	5,5 x 14,5 x 3,5 cm.	12



 Pizarra magnética de borrado en seco. Incluye un marcador con borrador en la parte superior del tapón y 2 imanes para marcar. Medidas: 21,6 x 28 cm.



 Magnetic board of dry erase. Includes an eraser marker on the top of the cap and 2 marking magnets. Size: 21,6 x 28 cm.

 Quadro branco magnético. Inclui um marcador de borracha na parte superior da tampa e 2 ímãs de marcação. Tamanho: 21,6 x 28 cm.

 Lavagna magnetica per cancellazione a secco. Include un pennarello e 2 magneti. Misure: 21,6 x 28 cm.

CÓDIGO	COLOR	ENVASE
220528	● Azul	1 / 12
220597	● Verde	1 / 12

PIZARRA MAGNÉTICA

Incluye un rotulador y dos imanes





PIZARRA MAGNÉTICA MARCO DE ALUMINIO

Incluye 2 imanes, 1 rotulador y 4 pegatinas

 Incluye 2 imanes, 4 pegatinas de goma eva de 25x25 mm y un rotulador. Material resistente y duradero.



 Includes 2 magnets, four 25x25 mm foam stickers and a marker. Durable and resistant material.

 Inclui 2 ímãs, 4 autocolantes de borracha eva de 25x25 mm e um marcador. Material durável e resistente.

 Include 2 magneti, 4 adesivi in gomma eva 25x25 mm e un pennarello. Materiale resistente e resistente.

CÓDIGO	MEDIDAS	ENVASE
220598	35 x 28 cm	1 / 24





PIZARRA MAGNÉTICA MARCO DE MADERA

Incluye 2 imanes

 Pizarra magnética de borrado en seco con marco de madera. Incluye 2 imanes No incluye rotulador.

 Magnetic board of dry erase with wooden frame. Includes 2 magnets. Doesn't include marker.

 Quadro branco magnético com moldura de madeira. Ele inclui 2 ímãs. Não inclui marcador.

 Lavagna magnetica per cancellazione a secco con cornice in legno. Include 2 magneti. Non include il marker.

CÓDIGO	MEDIDAS	ENVASE
220590	40 x 30 cm	1 / 24
220589	60 x 45 cm	1 / 12



TABLERO DE CORCHO MARCO DE ALUMINIO

Incluye 4 pegatinas

 Incluye 4 pegatinas de goma eva de 25x25 mm. Material resistente y duradero.

 Includes four 25x25 mm foam stickers. Durable and resistant material.

 Inclui 4 autocolantes de borracha eva de 25x25 mm. Material durável e resistente.

 Include 4 adesivi in gomma eva 25x25 mm. Materiale resistente e resistente.

CÓDIGO	MEDIDAS	ENVASE
220599	35 x 35 cm	1 / 24



BOLÍGRAFOS TATTOO CON PURPURINA



- Bolígrafos de tinta gel con efecto purpurina. 6 colores. Soluble al agua. No tóxico. Incluye plantillas.
- Gel ink pen with glitter effect. 6 colours. Soluble in water. Not toxic. Includes templates.
- Canetas gel com efeito de glitter. 6 cores. Solúvel em água. Não tóxico. Ele inclui modelos.
- Penne a inchiostro gel con effetto glitter. 6 colori. Solubile all'acqua Non tossico.

CÓDIGO	ENVASE
630393	Blister 6 colores + plantillas / 12 blister

PURPURINA EN POLVO



- Bote de Purpurina de 8 g. Para sus decoraciones y trabajos manuales.
- Glitter Pot 8 oz. For decorations and crafts. Various colours.
- Frasco de purpurina de 8 g. Para decoração e artesanato. Várias cores.
- Barattolo di 8 g glitter. Per le tue decorazioni e lavori manuali.

CÓDIGO	COLOR	ENVASE
860095	● Plata	24
860096	● Oro	24

Colores metálicos

CÓDIGO	COLOR	ENVASE
860097	● Rojo, ● Granate, ● Morado, ● Verde, ● Azul y ● Azul claro	24

Colores arco iris

CÓDIGO	COLOR	ENVASE
860098	● Naranja, ● Rosa, ● Morado, ● Verde, ● Azul claro y ● Amarillo	24

PEGAMENTO CON PURPURINA



- Pegamento con purpurina. Blister de 5 tubitos de 13 g por unidad. Punta fina para una mejor aplicación.
- Glue with glitter. Blister of 5 tubes of 13 g per unit. Fine tip for better application.
- Cola glitter. Blister de 5 tubos de 13 g por unidade. Dica fina para melhor aplicação.
- Colla con glitter. Blister di 5 tubetti da 13 g per unità. Punta fine per una migliore applicazione.

CÓDIGO	ENVASE
862346	Caja 12 blister

PEGAMENTO CON PURPURINA







- Pegamento con purpurina en bote de 60 g. No tóxico. Punta dosificadora.
- Glue with glitter. Pot of 60 g. Not toxic. Dosing tip.
- Cola glitter. Frasco de 60 g. Não é tóxico. Dica de dosagem.
- Colla con glitter in vaso da 60 g. Non tossico. Punta di dosaggio.

CÓDIGO	COLOR	ENVASE
862124	● Rojo	Exp. 6 ud.
862125	● Azul	Exp. 6 ud.
862126	● Verde	Exp. 6 ud.
862127	● Rosa	Exp. 6 ud.
862128	● Oro	Exp. 6 ud.
862129	● Plata	Exp. 6 ud.
862130	Surtidos	Exp. 6 ud.







PLASTILINA EN BARRA

Sin gluten

-  Barras de plastilina para modelar. Gran plasticidad y consistencia. No se seca. Se puede barnizar. Uso escolar. Sin gluten. Colores mezclables.
-  Plasticine bars for modeling. Great plasticity and consistency. It does not dry out. It can be varnished. School use. Gluten free. Mixable colors.
-  Barras de plastilina para modelagem. Ótima plasticidade e consistência. Não seca. Pode ser envernizado. Uso escolar. Sem glúten. Cores misturáveis.
-  Barre di plastilina per modellare. Grande plasticità e consistenza. Può essere verniciato. Non si secca. Uso scolastico. Senza glutine. Colori miscelabili.



CÓDIGO	CONTENIDO	ENVASE
630580	100 g.	Blíster 6 colores / 12
630715	200 g.	Blíster 12 colores / 12

-  Bote de plastilina para modelar. Apta para uso escolar. Incluye 4 moldes con diferentes figuras. Sin gluten. Colores mezclables entre sí.
-  Jar of modeling clay. Suitable for school use. Includes 4 moulds with different figures. Gluten free. Mixable colors with each other.
-  Frasco de barro para modelar. Adequado para uso escolar. Inclui 4 moldes com diferentes figuras. Sem glúten. Cores misturáveis umas com as outras.
-  Vaso di argilla da modellismo. Adatto per uso scolastico. Comprende 4 stampi con figure diverse. Senza glutine. Colori miscelabili tra loro.







BOTE DE PLASTILINA DE 400 G.

Sin gluten. Incluye 5 barras de plastilina



CÓDIGO	COLORES
630769	5 Surtidos

-  Bote de plastilina para modelar. Apta para uso escolar. Incluye 4 moldes con diferentes figuras. Sin gluten. Colores mezclables entre sí.
-  Jar of modeling clay. Suitable for school use. Includes 4 moulds with different figures. Gluten free. Mixable colors with each other.
-  Frasco de barro para modelar. Adequado para uso escolar. Inclui 4 moldes com diferentes figuras. Sem glúten. Cores misturáveis umas com as outras.
-  Vaso di argilla da modellismo. Adatto per uso scolastico. Comprende 4 stampi con figure diverse. Senza glutine. Colori miscelabili tra loro.







BOTE DE PLASTILINA DE 1240 G.

Sin gluten. Incluye 4 moldes y 13 barras de plastilina







CÓDIGO	COLORES
630768	13 Surtidos

HERRAMIENTAS PARA MODELAR

-  5 herramientas de doble punta. Blíster con colgador.
-  5 double-ended tools. Blister with hanger.
-  5 ferramentas de ponta dupla. Blister com cabide.
-  5 strumenti a doppia estremità. Blister con gancio.



-  10 moldes y un rodillo. Bolsa con colgador.
-  10 molds and a rolling pin. Hanger bag.
-  10 moldes e um rolo de massa. Bolsa de cabide.
-  10 stampini e un mattarello. Borsa appendiabiti.



CÓDIGO	COMPONENTES
630771	5

CÓDIGO	COMPONENTES
630770	11



Los códigos en **color amarillo** permiten apertura de envase



PLASTILINA DE COLORES CAMPUS COLLEGE

Sin gluten



Plastilina para modelar. Apta para uso escolar. Sin gluten. Muy moldeable. Se alisa bien con los dedos. Gran plasticidad y consistencia. No se seca. Se puede barnizar. Colores mezclables.



Plasticine bars for modeling. Suitable for school use. Gluten free. Very moldable. It smooths well with your fingers. Great plasticity and consistency. It does not dry out. It can be varnished. Mixable colors.



Barras de plasticina para modelagem. Adequado para uso escolar. Sem glúten. Muito moldável. Alisa bem com os dedos. Ótima plasticidade e consistência. Não seca. Pode ser envernizado. Cores misturáveis.



Plastilina per modellare. Adatto per uso scolastico. Senza glutine. Molto moldabile. Si liscia bene con le dita. Grande plasticità e consistenza. Può essere verniciato. Cores misturáveis.



60 gramos

CÓDIGO	COLOR	ENVASE
630622	● Amarillo	24
630623	● Azul claro	24
630624	● Azul	24
630625	○ Blanco	24
630626	● Carne	24
630627	● Violeta	24
630628	● Marrón	24
630629	● Naranja	24
630630	● Negro	24
630631	● Rojo	24
630632	● Rosa	24
630633	● Verde claro	24
630534	12 Surtidos	24



200 gramos

CÓDIGO	COLOR	ENVASE
630536	● Amarillo	12
630537	● Azul claro	12
630538	● Azul	12
630539	○ Blanco	12
630540	● Carne	12
630541	● Violeta	12
630542	● Marrón	12
630543	● Naranja	12
630544	● Negro	12
630545	● Rojo	12
630546	● Rosa	12
630547	● Verde claro	12

CÓDIGO	COLOR	ENVASE
630288	12 Surtidos	Exp. 12 ud.
630535	4 Surtidos*	Exp. 12 ud.

*3 amarillos, 3 rojos, 3 verde claro y 3 azul claro.



400 gramos

CÓDIGO	COLOR	ENVASE
630932	● Amarillo	12
630929	● Azul claro	12
630930	○ Blanco	12
630931	● Carne	12
630933	● Naranja	12
630934	● Rojo	12
630935	● Rosa	12
630936	● Verde claro	12

CÓDIGO	COLOR	ENVASE
630937	8 Surtidos	Exp. 12 ud.

*2 azul claro, 2 blanco, 2 amarillo, 2 verde claro, 1 carne, 1 naranja, 1 rojo y 1 rosa.



Campus BABY



SUPER DOUGH 50G



Pasta para modelar Super Dough apta para uso escolar. A base de ingredientes naturales. Muy moldeable. Se alisa bien con los dedos. Gran plasticidad y consistencia. No mancha y no ensucia. 6 colores surtidos. Moldes en las tapas. Incluye rodillo y cuchilo de plástico.



Super Dough modeling paste suitable for school use. Based on natural ingredients. Very moldable. Smooths well with fingers. Great plasticity and consistency. It doesn't stain and doesn't dirty. 6 assorted colors. Molds on the lids. Includes roller and plastic knife.



Pasta de modelar Super Dough indicada para uso escolar. Com base em ingredientes naturais. Muito moldável. Alisa bem com os dedos. Grande plasticidade e consistência. Não mancha e não suja. 6 cores sortidas. Moldes nas tampas. Inclui rolo e faca de plástico.



Pasta modellabile Super Dough adatta all'uso scolastico. A base di ingredienti naturali. Molto modellabile. Liscia bene con le dita. Grande plasticità e consistenza. Non macchia e non sporca. 6 colori assortiti. Muffe sui coperchi. Include rullo e coltello di plastica.

NEW!!



50 gramos

CÓDIGO	COLOR	ENVASE
630852	● ● ● ● ● ●	Caja 6 ud.



Pasta para modelar Super Dough apta para uso escolar. A base de ingredientes naturales. Muy moldeable. Se alisa bien con los dedos. Gran plasticidad y consistencia. No mancha y no ensucia.



Super Dough modeling paste suitable for school use. Based on natural ingredients. Very moldable. Smooths well with fingers. Great plasticity and consistency. It doesn't stain and doesn't dirty.



Pasta de modelar Super Dough indicada para uso escolar. Com base em ingredientes naturais. Muito moldável. Alisa bem com os dedos. Grande plasticidade e consistência. Não mancha e não suja.



Pasta modellabile Super Dough adatta all'uso scolastico. A base di ingredienti naturali. Molto modellabile. Liscia bene con le dita. Grande plasticità e consistenza. Non macchia e non sporca.

NEW!!



100 gramos

CÓDIGO	COLOR	ENVASE
630854	● ● ● ●	Caja 4 ud.



6 colores surtidos. Incluye moldes, rodillo y cuchilo de plástico.

6 assorted colors. Includes moulds, roller and plastic knife.

6 cores sortidas. Inclui moldes, rolo e faca de plástico.

6 colori assortiti. Include stampi, rullo e coltello di plastica.



CÓDIGO	COLOR	ENVASE
630830	● ● ● ● ● ●	Caja 6 ud.



Los códigos en color amarillo permiten apertura de envase

Campus
college



Todo para tus
manualidades



CARTULINA DE COLORES

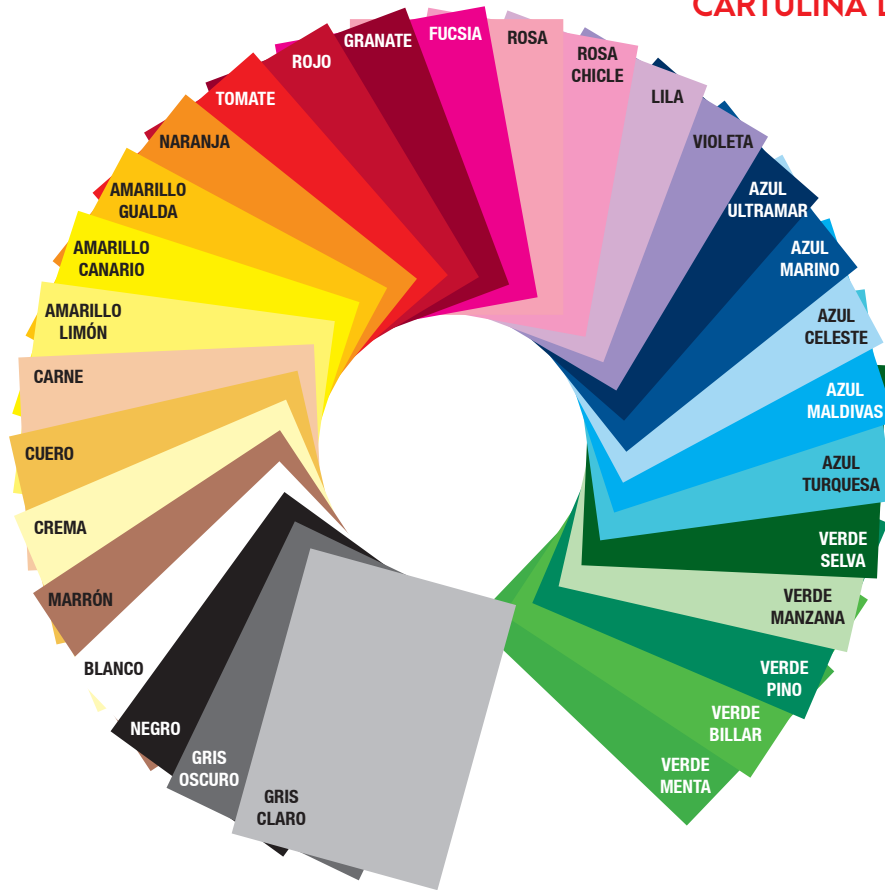

TAMAÑO A4 - 180 g.

CÓDIGO	COLOR	ENVASE
220142	○ Blanco	100
220143	● Amarillo canario	100
220144	● Azul celeste	100
220145	● Azul ultramar	100
220147	● Crema	100
220151	● Rojo	100
220152	● Rosa	100
220154	● Verde manzana	100
220155	● Verde pino	100
220419	● Azul maldivas	100
220420	● Lila	100
220422	● Gris claro	100
220424	● Granate	100
220459	● Negro	100
220505	● Naranja	100
220550	● Fucsia	100
220551	● Azul turquesa	100
220552	● Azul marino	100
220553	● Verde billar	100
220554	● Amarillo limón	100
220555	● Cuero	100
220556	● Gris oscuro	100
220557	● Amarillo gualda	100
220558	● Verde selva	100
220559	● Marrón	100
220560	● Violeta	100
220561	● Tomate	100
220572	● Carne	100
220573	● Verde menta	100
220574	● Rosa chicle	100

TAMAÑO A3 - 180 g.

CÓDIGO	COLOR	ENVASE
630736	○ Blanco	50
630737	● Amarillo canario	50
630738	● Azul celeste	50
630739	● Crema	50
630740	● Rojo	50
630741	● Verde manzana	50
630742	● Negro	50
630743	● Azul turquesa	50

TAMAÑO 50 x 65 cm. - 180 g.

CÓDIGO	COLOR	ENVASE
630497	● Naranja	25
630499	● Fucsia	25
630502	● Azul turquesa	25
630503	● Azul marino	25
630504	● Verde billar	25
630482	● Amarillo limón	25
630484	● Azul celeste	25
630486	● Verde manzana	25
630489	● Cuero	25
630491	● Gris oscuro	25
630494	● Amarillo gualda	25
630496	● Crema	25
630498	● Rosa	25
630501	● Lila	25
630505	● Gris claro	25
630488	● Verde selva	25
630490	● Marrón	25
630492	● Violeta	25
630500	● Rojo	25
630506	● Negro	25
630507	● Azul ultramar	25
630508	● Granate	25
630483	● Tomate	25
630485	● Azul maldivas	25
630487	● Verde pino	25
630495	● Amarillo canario	25
630493	○ Blanco	25
630724	● Carne	25
630725	● Verde menta	25
630726	● Rosa chicle	25

TAMAÑO A4 - 180 g.



CÓDIGO	COLOR	ENVASE
220742	10 Surtidos	100



Los códigos en **color amarillo** permiten apertura de envase

CARTULINA METALIZADA

50 x 65 cm



250 gramos. Paquete 10 hojas. Cartulina de colores metalizados a una cara y reverso blanco. Tamaño: 50 x 65 cm.

250 g. 10 sheets package. Metallic color cardboard on one side and white back. Size: 50 x 65 cm.

250 g. Pacote de 10 folhas. Papelão de cores metálicos para um lado e reverso branco. Tamanho: 50 x 65 cm.

250 grammi. Confezione da 10 fogli. Colori metallici su un lato e sul retro bianco. Dimensioni: 50 x 65 cm.

CÓDIGO	COLOR	ENVASE
630398	● Azul	Bolsa 10 h.
630399	● Oro	Bolsa 10 h.
630400	● Plata	Bolsa 10 h.
630401	● Rojo	Bolsa 10 h.
630402	● Verde	Bolsa 10 h.

CARTULINA GLITTER

A4

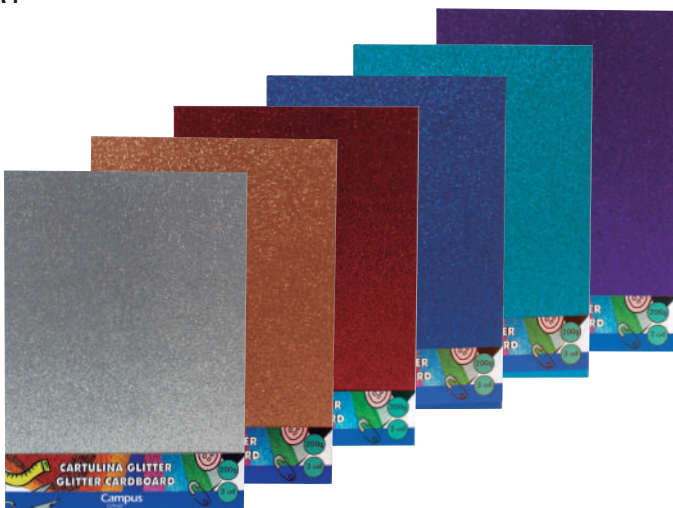

200 gramos. Cartulina de colores con glitter a una cara y reverso blanco.

200 g. Glitter color cardboard on the front side and white on the back.

200 g. Papelão de cores glitter para um lado e reverso branco.

200 grammi. Colori con glitter su un lato e sul retro bianco.

CÓDIGO	COLOR	ENVASE
630702	● Plata	Bolsa 3 ud. / 36
630703	● Bronce	Bolsa 3 ud. / 36
630704	● Azul	Bolsa 3 ud. / 36
630705	● Violeta	Bolsa 3 ud. / 36
630706	● Rojo	Bolsa 3 ud. / 36
630766	● Azul Claro	Bolsa 3 ud. / 36

EXPOSITOR PARA CARTULINA



Expositores decorados vacíos con bandejas para cartulinas. Dos tamaños.

Empty decorated displays with cardboard trays. Two sizes.

Expositores vazios decorados com bandejas de papelão. Dois tamanhos.

Espositori vuoti decorati con vassoi di cartone. Due dimensioni.

	CÓDIGO	MEDIDAS cm.	BANDEJAS	PARA
1	600404	50 x 180 x 36	15	A4
2	600363	78 x 198 x 48	30	50 x 65 cm.





PAPEL SEDA

 Formato: 50x76 cm. En bolsas de 10 hojas dobladas. Las resmas de 500 pliegos van separadas en manos de 25 hojas. Colores intensos. Ideal para manualidades, decoración, etc.



 Format: 50x76 cm. In bags of 10 folded sheets. The reams of 500 sheets are separated in hands of 25 sheets. Intense colours. Ideal for crafts, decoration, etc.

 Formato: 50x76 cm. Em sacos de 10 folhas dobradas. Resmas de 500 folhas são separados nas mãos de 25 folhas. Cores intensas. Ideal para artesanato, decoração, etc.

 Formato: 50x76 cm. In sacchetti di 10 fogli piegati. Le risme di 500 fogli sono separate in gruppi di 25 fogli. Colori intensi. Ideale per artigianato, decorazione, ecc.



Resma de 500 hojas.

CÓDIGO	COLOR
001096	○ Blanco
600163	● Amarillo
600164	● Azul oscuro
600165	● Azul celeste
600166	● Marrón
600167	● Naranja
600168	● Negro
600169	● Rojo
600170	● Rosa claro
600171	● Rosa oscuro
600172	● Verde claro
600287	● Verde oscuro
600173	● Violeta

Bolsa de 10 hojas.

CÓDIGO	COLOR
600372	○ Blanco
600151	● Amarillo
600152	● Azul oscuro
600153	● Azul celeste
600154	● Marrón
600155	● Naranja
600156	● Negro
600157	● Rojo
600158	● Rosa claro
600159	● Rosa oscuro
600160	● Verde claro
600161	● Verde oscuro
600162	● Violeta

 Bolsas de 10 hojas dobladas.

 Bags of 10 folded sheets.

 Sacos de 10 folhas dobradas.

 Sacchetti di 10 fogli piegati.



ESTÁNDAR

70% DE CREPADO - Formato: 0.5 x 2 mts.

CÓDIGO	COLOR
600185	● Amarillo claro
600186	● Amarillo oscuro
600187	● Azul claro
600188	● Azul cobalto
600189	● Azul marino
600312	● Azul cielo
600190	○ Blanco
600314	● Carne
600191	● Granate
600192	● Marrón claro
600193	● Marrón oscuro
600194	● Violeta
600195	● Naranja
600196	● Negro
600197	● Rojo
600198	● Rosa medio
600313	● Rosa claro
600199	● Magenta
600200	● Verde claro
600201	● Verde medio
600202	● Verde oscuro



20% DE CREPADO - Formato: 0.5 x 2 mts.

CÓDIGO	COLOR
600316	● Oro metalizado
600317	● Plata metalizado



30% DE CREPADO - Formato: 0.5 x 2 mts.

CÓDIGO	COLOR
600315	● Multicolor

PAPEL CRESPÓN



SUPERIOR

150% DE CREPADO - Formato: 0.5 x 2,5 mts.

CÓDIGO	COLOR
600319	● Rojo
600320	○ Blanco
600321	● Amarillo
600322	● Amarillo oscuro
600323	● Naranja
600324	● Rosa
600325	● Violeta
600326	● Azul
600327	● Azul marino
600328	● Verde claro
600329	● Verde medio
600330	● Verde oscuro
600331	● Marrón claro
600332	● Marrón oscuro
600333	● Negro
600334	● Rosa claro
600335	● Azul claro



Los códigos en **color amarillo** permiten apertura de envase

HOJAS DE FIELTRO

A4

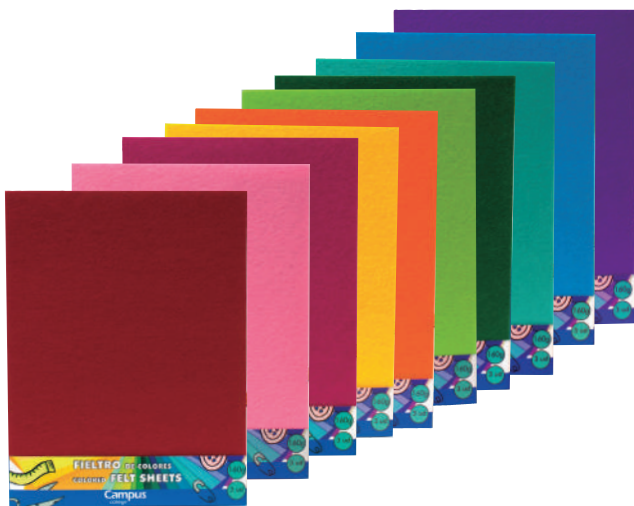

160 gramos. Hojas de fieltro de colores. Tamaño: 230 x 305 mm. Espesor: 1 mm. Ideal para manualidades.

160 g. Felt color sheets. Size: 230 x 305 mm. Thickness: 1 mm. Ideal for crafts.

160 g. Folhas de fieltro de cores. Tamanho: 230 x 305 mm. Espessura: 1 mm. Ideal para artesanato.

160 grammi. Fogli di fieltro colorato Dimensioni: 230 x 305 mm. Spessore: 1 mm. Ideale per l'artigianato.

CÓDIGO	COLOR	ENVASE
630692	Violeta	Bolsa 3 ud. / 36
630693	Amarillo	Bolsa 3 ud. / 36
630694	Rosa oscuro	Bolsa 3 ud. / 36
630695	Rosa claro	Bolsa 3 ud. / 36
630696	Rojo	Bolsa 3 ud. / 36
630697	Naranja	Bolsa 3 ud. / 36
630698	Verde	Bolsa 3 ud. / 36
630699	Azul claro	Bolsa 3 ud. / 36
630701	Verde claro	Bolsa 3 ud. / 36

GOMA EVA



Goma EVA útil para moldear, pintar, cortar, coser, pegar, etc. Grosor de 2 mm. No mancha, no se decolora, no es dañino con el medio ambiente, es impermeable, no es tóxico y es lavable. Colores vivos.

EVA foam useful for modeling, painting, cutting, sewing, gluing, etc. Thickness: 2 mm. Doesn't stain, doesn't discolor, environmentally friendly. Impermeable. Non toxic. Washable. Vivid colors.

Borracha EVA, útil para moldagem, pintura, corte, costura, colagem, etc. 2 mm de espessura. Não mancha, não se desvanece, não é prejudicial para o meio ambiente, é à prova de água, não tóxico e lavável. Cores vivas.

Gomma EVA utile per la stampa, verniciatura, il taglio, il cucito, l'incollaggio, ecc. Spessore di 2 mm. Non macchia, non scolorisce, non è dannoso per l'ambiente, è impermeabile, non è tossico ed è lavabile. Colori vivaci.

Medidas: 20 x 30 cm.

CÓDIGO	COLOR	ENVASE
630450	Surtido	12
630451	Rojo	10
630452	Naranja	10
630453	Violeta	10
630454	Marrón	10
630455	Azul	10
630456	Amarillo	10
630457	Blanco	10
630458	Verde	10
630459	Negro	10
630460	Rosa	10
630461	Azul claro	10
630519	Carne	10
630462	Verde oscuro	10

Medidas: 40 x 60 cm.

CÓDIGO	COLOR	ENVASE
630464	Rojo	10
630465	Naranja	10
630466	Marrón	10
630467	Azul	10
630468	Amarillo	10
630469	Blanco	10
630470	Verde	10
630471	Negro	10
630472	Rosa	10
630473	Azul claro	10
630474	Verde oscuro	10
630475	Violeta	10
630518	Carne	10

Medidas: 40 x 60 cm.

CÓDIGO	COLOR	ENVASE
630463	Surtido	Exp. 48 ud.



Medidas: 40 x 60 cm. PURPURINA

CÓDIGO	COLOR	ENVASE
630552	Oro	5
630553	Plata	5
630554	Azul	5
630555	Verde	5
630556	Rojo	5



BLOC DE PAPEL SEDA

- 10 hojas de papel de seda. 10 colores surtidos. Bloc encolado.
- 10 silk paper sheets. 10 assorted colours. Glued pad.
- 10 folhas de papel de seda 10 cores sortidos. Bloco colado.
- 10 fogli di carta seta. 10 colori assortiti. Pad incollato.

CÓDIGO	MEDIDAS cm.	ENVASE
630093	23,5 x 32	10



BLOC DE PAPEL CELOFÁN

- 10 hojas de papel celofán. 5 colores surtidos. Bloc encolado.
- 10 cellophane paper sheets. 5 assorted colours. Glued pad.
- 10 folhas de papel celofane. 5 cores sortidas. Bloco colado.
- 10 fogli di carta cellophane. 5 colori assortiti. Pad incollato.

CÓDIGO	MEDIDAS cm.	ENVASE
630095	24 x 32	10



BLOC DE CARTULINAS

- 10 hojas de cartulinas de 185 g. 10 colores surtidos. Bloc encolado.
- 10 cardboard sheets. 10 assorted colours. Glued pad.
- 10 folhas de cartão. 10 cores sortidas. Bloco colado.
- 10 fogli di cartoncino da 185 g. 10 colori assortiti. Pad incollato.

CÓDIGO	MEDIDAS cm.	ENVASE
630094	23,5 x 32	10



BLOC DE PAPEL CHAROL

- 10 hojas de papel charol. 10 colores surtidos. Bloc encolado.
- 10 shiny paper sheets. pad for manual work. 10 sheets of 10 assorted colours. Glued pad.
- 10 folhas de papel charão 10 cores sortidas. Bloco colado.
- 10 fogli di carta patinata. 10 colori assortiti. Pad incollato.

CÓDIGO	MEDIDAS cm.	ENVASE
630096	23,5 x 32	10



BLOC MÚLTIPLE 65 HOJAS

- 10 hojas de cartulina, 10 papel charol, 10 papel celofán, 30 papel seda y 5 cartulina metalizada.
- 10 cardboards, 10 shiny paper, 10 cellophane paper, 30 silk paper and 5 metallized cardboard.
- 10 cartão, 10 papel charão, 10 papel celofane, 30 papel de seda e 5 cartão metalizada.
- 10 fogli di cartoncino, 10 fogli di carta patinata, 10 fogli di cellophane, 30 fogli di seta e 5 di cartone metallizzato.





CÓDIGO	MEDIDAS cm.	ENVASE
630520	24 x 32	10



ACCESORIOS MANUALIDADES





1



-  Confeti de estrellas plateadas. Bolsa 14 g.
-  Silver stars confetti. Bag: 14 g.
-  Confetti estrela de prata. Saco 14 g.
-  Coriandoli di stelle d'argento. Borsa da 14 g.





2



-  Confeti de estrellas de colores. Bolsa 14 g.
-  Coloured stars confetti. Bag: 14 g.
-  Confetti estrela de cores. 14 saco de g.
-  Coriandoli di stelle colorate. Borsa da 14 g.

3



-  Confeti de corazones. Bolsa de 14 g.
-  Hearts confetti. Bag: 14 g.
-  Confetti de corações. Saco de 14 g.
-  Coriandoli di cuori. Borsa 14 g.

4



-  Lentejuelas 9 mm. Bolsa de 14 g.
-  Sequins 9 mm. Bag: 14 g.
-  Lentejoulas 9 mm. Saco de 14 g.
-  Paillettes 9 mm. Borsa di 14 g.





5



-  Lentejuelas 12 mm. Bolsa de 14 g.
-  Sequins 12 mm. Bag: 14 g.
-  Lentejoulas 12 mm. Saco de 14 g.
-  Paillettes 12 mm. Borsa di 14 g.

6



-  Confeti Smiley. Bolsa de 14 g.
-  Smiley confetti. Bag: 14 g.
-  Confetti Smiley. Saco de 14 g.
-  Coriandoli Smiley. Borsa di 14 g.

7

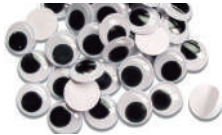

-  Ojos blancos 10 mm. Bolsa de 100 ud.
-  White eyes 10 mm. 100 pcs bag.
-  Olhos brancos 10 mm. Saco 100 ud.
-  Occhi bianchi 10 mm. Borsa di 100 unità

8

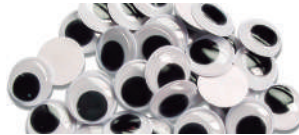





-  Ojos blancos 15 mm. Bolsa de 60 ud.
-  White eyes 15 mm. 60 pcs bag.
-  Olhos brancos 15 mm. Saco de 60 ud.
-  Occhi bianchi 15 mm. Borsa di 60 unità

9



-  Ojos colores móviles 10 mm. 100 ud.
-  Coloured eyes 10 mm. 100 pcs bag.
-  Olhos de cores 10 mm. Saco 100 ud.
-  Occhi colorate 10 mm. Borsa di 100 unità

10

-  Mix flores y mariposas 14g. Colores surtidos.
-  Mix flowers and butterflies 14g. Assorted colors.
-  Misture flores e borboletas 14g. Cores sortidas.
-  Mescolare fiori e farfalle 14 g. Colori assortiti.







11

-  Mariposas de fieltro. 2 tamaños. Bolsa de 6 ud.
-  Felt butterflies. 2 sizes. Bag of 6 units.
-  Senti borboletas. 2 tamanhos. Saco de 6 ud.
-  Farfalle in feltro. 2 taglie. Borsa da 6 unità.



	CÓDIGO	MODELO	ENVASE
1	630612	Confeti estrellas plateadas	1 / 36
2	630682	Confeti estrellas colores	1 / 36
3	630610	Confeti corazones	1 / 40
4	630611	Lentejuelas 9 mm.	1 / 40
5	630683	Lentejuelas 12 mm.	1 / 40
6	630614	Confeti Smiley	1 / 40
7	630615	Ojos blancos 10 mm.	1 / 36
8	630616	Ojos blancos 15 mm.	1 / 36
9	630684	Ojos colores móviles 10 mm.	1 / 36
10	630836	Mix flores y mariposas 14g	1 / 36
11	630837	Mariposas fieltro 6 ud.	1 / 20
12	630613	Confeti Mix	1 / 40

12





-  Confeti Mix formas, colores y tamaños. Bolsa de 14 g.
-  Mix shapes, colours and sizes confetti. Bag: 14 g.
-  Confetti Mix formas, cores e tamanhos. Saco de 14 g.
-  Coriandoli Mix forme, colori e dimensioni. Borsa di 14 g.



ACCESORIOS MANUALIDADES





13



-  Letras adhesivas EVA. Bolsa de 20 letras.
-  EVA adhesive letters. Bag: 20 letters.
-  Letras adesivas EVA. Saco de 20 letras.
-  Lettere adesive EVA. Borsa di 20 lettere.





14



-  Números adhesivos EVA. Bolsa 30 ud.
-  EVA adhesive numbers. Bag: 30 ud.
-  Números adesivos EVA. Saco 30 ud.
-  Numeri adesivi EVA. Borsa da 30 pezzi





15



-  Flores adhesivas EVA. Bolsa de 10 ud.
-  EVA adhesive flowers. Bag: 10 ud.
-  Flores adesivas EVA. Saco de 10 ud.
-  Fiori adesivi EVA. Borsa di 10 unità





16



-  Estrellas adhesivas EVA. Bolsa 30 estrellas.
-  EVA adhesive stars. Bag: 30 stars.
-  Estrelas adesivas EVA. Saco 30 estrelas.
-  Stelle adesive EVA. Borsa a 30 stelle.





17



-  Pompones 15 mm. Bolsa de 60 ud.
-  Pompoms 15 mm. Bag: 60 ud.
-  Pompons 15 mm. Saco de 60 ud.
-  Pompoms 15 mm. Sacchetto di 60 unità





18



-  Smiley fieltro. Bolsa de 60 smileys.
-  Smiley felt. Bag: 60 smileys.
-  Smiley fieltro. Saco de 60 smileys.
-  Faccina sentita. Borsa di 60 smileys.





19



-  Botones Corazones. Bolsa de 25 ud.
-  Heart buttons. Bag: 25 ud.
-  Botões corações. Saco de 25 ud.
-  Pulsanti cuori. Borsa di 25 unità





20



-  Botones Flores. Bolsa de 25 ud.
-  Flower buttons. Bag: 25 ud.
-  Botões Flores. Saco de 25 ud.
-  Bottoni di fiori. Borsa di 25 unità





21



-  Confeti de estrellas de purpurina. Bolsa 14 g.
-  Glitter stars confetti. Bag: 14 g.
-  Confetti estrela de brilho. Saco de 14g.
-  Glitter stelle confetti. Borsa da 14 g.

22



-  Pompones purpurina 20 mm. Bolsa de 25 ud.
-  20mm glitter pompoms. Bag of 25 units
-  Pompons de glitter 20mm. Saco de 25 unidades
-  Pompoms glitterati da 20 mm. Borsa da 25 unità.

	CÓDIGO	MODELO	ENVASE
13	630620	Letras adhesivas Eva	1 / 20
14	630619	Números adhesivos EVA	1 / 20
15	630618	Flores adhesivas EVA	1 / 20
16	630617	Estrellas adhesivas EVA	1 / 20
17	630621	Pompones 15 mm.	1 / 20
18	630677	Smiley fieltro	1 / 36
19	630678	Botones Corazones	1 / 36
20	630679	Botones Flor	1 / 40
21	630734	Estrellas Purpurina	1 / 40
22	630835	Pompones glitter 20 mm	1 / 20
23	630838	Chenillas glitter 30 cm.	1 / 24
24	630680	Chenillas colores 30 cm.	1 / 24
25	630681	Chenillas negras 30 cm.	1 / 24

23

-  Chenillas purpurina. 30 ud.
-  Glitter chenilles. 30 ud.
-  Chenille brilhante. 30 ud.
-  Ciniglia glitterata. 30 unità.

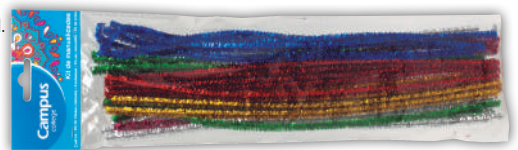

24

-  Chenillas de colores. 30 ud.
-  Colored chenille. 30 ud.
-  Chenille colorido. 30 ud.
-  Ciniglia colorata. 30 unità.



25





-  Chenillas negras. 30 ud.
-  Black chenille. 30 ud.
-  Chenille preto. 30 ud.
-  Ciniglia nera. 30 unità.



Los códigos en **color amarillo** permiten apertura de envase

POSTER PARA COLOREAR







-  Medidas: 40 x 50 cm.
-  Size: 40 x 50 cm.
-  Medidas: 40 x 50 cm.
-  Misure: 40 x 50 cm.

CÓDIGO	MODELO	ENVASE
630416	Coches	1
630417	Princesas	1

DIBUJO MÁGICO



-  Láminas de color negro para rascar y descubrir los dibujos y colores que se encuentran debajo.
-  Black color sheets to scratch and discover the drawings and colours that are underneath.
-  Folhas de cor preta para arranhar e descobrir os padrões e cores que estão por baixo.
-  Fogli neri magici da grattare e scoprire i disegni e i colori sottostanti.

MARIPOSAS

CÓDIGO	CONTENIDO
630689	4 láminas para rascar 12 chenillas 1 lápiz rascador 1 libro de instrucciones

PÁJAROS

CÓDIGO	CONTENIDO
630690	4 láminas para rascar 12 chenillas 1 lápiz rascador 1 libro de instrucciones

MÁSCARAS

CÓDIGO	CONTENIDO
630687	3 láminas para rascar 3 gomas elásticas 1 lápiz rascador 1 libro de instrucciones

POSTALES

CÓDIGO	CONTENIDO
630688	4 láminas para rascar 6 lápices de colores 1 lápiz rascador 1 libro de instrucciones



FORROS HECHOS PARA LIBROS

Con tira adhesiva incorporada.

CALIDAD MEJORADA

Forro transparente de 130 micras PVC Reach. Con tira adhesiva. Cortado en forma de libro y ajustable. Gran resistencia. Forrado cómodo e inmediato. Cajas de 20 bolsas. Bolsas de 5 unidades.

Transparent cover of 130 micras PVC Reach. With adhesive strip. Cutting book form and adjustable. Great resistance. Comfortable and immediate lined. Boxes of 20 bags. Bags of 5 units.

Forro de PVC transparente de 130 microns. Com fita adhesiva. Cortadas em forma de livro e ajustável. Grande resistência. Forro confortável e imediato. Caixas de 20 sacos. Sacos de 5 unidades.

Fodera per libri; rivestimento in PVC trasparente da 130 micron. Con striscia adesiva. Taglio a forma di libro e regolabile. Grande resistenza. Foderato comodo e immediato. Scatole da 20 buste. Sacchetti da 5 unità.



120 MICRAS

CÓDIGO	MEDIDAS	ENVASE
630581	212 x 390 - Nº21	Bolsa 5 ud.
630530	285 x 530 - Nº28	Bolsa 5 ud.
630532	305 x 530 - Nº30	Bolsa 5 ud.

130 MICRAS

CÓDIGO	MEDIDAS	ENVASE
630812	216 x 390 - Nº21	Bolsa 5 ud.
630813	222 x 415 - Nº22	Bolsa 5 ud.
630814	285 x 530 - Nº28	Bolsa 5 ud.
630815	296 x 530 - Nº29	Bolsa 5 ud.
630816	305 x 530 - Nº30	Bolsa 5 ud.
630817	315 x 530 - Nº31	Bolsa 5 ud.

FORRO PARA LIBROS ADHESIVO

Forro de libros transparente CPP con adhesivo removible. Plástico de la máxima calidad.

Transparent book cover CPP with removable adhesive. Plastic of the highest quality.

Forro de livros transparente CPP com adesivo removível. Plástico de alta qualidade.

Fodera per libri in CPP trasparente con adesivo rimovibile. Plastica di altissima qualità.

Cuadrícula guía

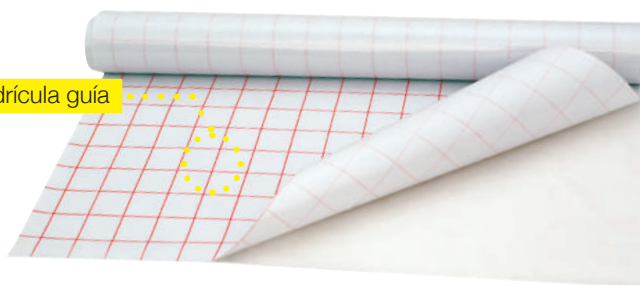

50 Micras

CÓDIGO	MEDIDAS cm.	ENVASE
630182	33 x 150	25 rollos
630181	50 x 150	25 rollos
630187	50 x 300	25 rollos

80 Micras

CÓDIGO	MEDIDAS cm.	ENVASE
630419	50 x 200	25 rollos
630418	50 x 2000	4 rollos



Los códigos en color amarillo permiten apertura de envase

GOMETS CON FORMAS GEOMÉTRICAS

864 gomets

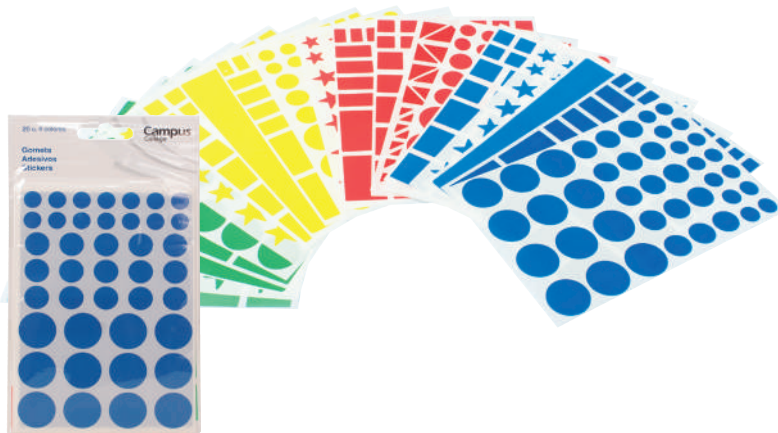





-  Gomets en 4 colores diferentes y 5 formas geométricas: círculos, triángulos, rectángulos, cuadrados y estrellas. 1 hoja por color y forma. Adhesivo permanente.
-  Gomets in 4 different colours and 5 geometric designs: circles, triangles, squares and stars. 1 sheet per color and shape. Permanent adhesive.
-  Gomets em 4 cores e 5 desenhos geométricos: círculos, triângulos, retângulos, quadrados e estrelas. 1 folha por cor e forma. Adesivo permanente.
-  Gomets in 4 diversi colori e 5 forme geometriche: cerchi, triangoli, rettangoli, quadrati e stelle. 1 foglio per colore e forma. Adesivo permanente.

CÓDIGO	ENVASE
630607	Bolsa de 20 hojas

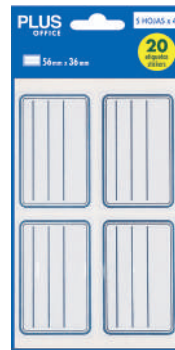
ETIQUETAS PARA LIBROS

Autoadhesivas







-  Etiquetas para nombrar y marcar libros y cuadernos.
-  Labels to name and mark books or notebooks.
-  Etiquetas para nome e etiqueta livros e cadernos.
-  Etichette per nominare e contrassegnare libri e quaderni.

CÓDIGO	MEDIDAS	UD./BOLSA	ENVASE
630150	56 x 36 mm.	20 ud.	1 / 200

ETIQUETAS DE COLOR

Autoadhesivas



-  Etiquetas para nombrar y marcar libros y cuadernos. 4 colores surtidos.
-  Labels to name and mark books or notebooks. 4 assorted colours.
-  Etiquetas para nome e etiqueta livros e cadernos. 4 cores sortidos.
-  Etichette per nominare e contrassegnare libri e quaderni. Quattro colori assortiti.

CÓDIGO	MEDIDAS	UD./BOLSA	ENVASE
630558	28 x 65 mm.	42 ud.	1 / 10
630557	37 x 65 mm.	28 ud.	1 / 10



FLAUTA DULCE

- Flauta dulce. Con limpiador y funda. Plástico robusto. Color marfil. Ideal uso escolar.
- Recorder. With cleaner and cover. Robust plastic. Ivory color. Ideal school use.
- Flauta. Com limpador e bolsa. Plástico robusto. Cor de marfim. Uso escolar ideal.
- Flauto dolce con spugnetta per pulizia e fodera. Plastica robusta. Colore avorio. Ideale uso scolastico.



CÓDIGO	ENVASE
630149	4

LIMPIAFLAUTAS

- De plástico y espuma. 1,5 cm de diámetro.
- Plastic and foam. 1.5 cm diameter.
- Plástico e espuma. 1,5 cm de diámetro.
- Di plastica e schiuma. Diametro di 1,5 cm.



CÓDIGO	ENVASE
630421	12

PORTAFLAUTAS

- Estuche de poliéster para flautas. 4 diseños diferentes.
- Polyester flute case. 4 different designs.
- Caso para flautas de poliéster. 4 desenhos diferentes.
- Custodia in poliesterre per flauti. 4 diversi modelli



CÓDIGO	MEDIDAS cm.	ENVASE
685460	37 x 8,5 x 1,5	4



- Tapa de cartón 350 g. 4 pentagramas por página.
- Cardboard lid 350 g. 4 staves per page.
- Capa de papelão 350 g. 4 pautas por página.
- Copertina in cartone 350 g. 4 righe per pagina.

CÓDIGO	FORMATO	ENVASE
630266	A5	10

BLOC DE MÚSICA A5

Pentagrama 4 mm. interlineado.



- Tapa de cartón 350 g. A5: 8 pentagramas/página. A4: 12 pentagramas/página.
- Cardboard lid 350 g. A5: 8 staves/page. A4: 12 staves/page.
- Capa de papelão 350 g. A5: 8 pautas/página. A4: 12 pautas /página.
- Copertina in cartone 350 g. A5: 8 righe/pagina. A4: 12 righe /pagina.

CÓDIGO	FORMATO	ENVASE
630151	A5	10
001902	A4	10



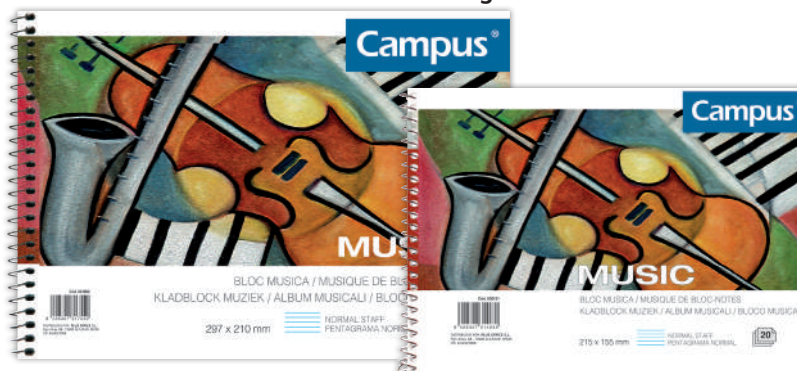

BLOC DE MÚSICA A5 Y A4

Pentagrama 2 mm. interlineado.



PORTATODO TRIPLE 4 CREMALLERAS







-  Estuche de nylon con 3 compartimentos y bolsillo exterior. 4 cremalleras. Colores: rojo, verde, rosa, azul y turquesa.
-  Nylon case with 3 compartments and outside pocket. 4 zippers. Colors: red, green, pink, blue and turquoise.
-  Estojo em nylon com 3 compartimentos e bolso exterior. 4 zíperes. Cores: vermelho, verde, rosa, azul e turquesa.
-  Custodia in nylon con 3 scomparti e tasca esterna. 4 cerniere. Colori: rosso, verde, rosa, blu e turchese.

CÓDIGO	MEDIDAS cm	ENVASE
690748	22,5 x 11 x 8,5	5

PORTATODO CUADRADO 1 CREMALLERA







-  Estuche de nylon cuadrado. 1 cremallera. Colores: rosa, verde, azul, turquesa y rojo.
-  Square nylon case. 1 zipper. Colors: pink, green, blue, turquoise and red.
-  Estojo quadrada de nylon. 1 zíper. Cores: rosa, verde, azul, turquesa e vermelho.
-  Custodia quadrata in nylon. 1 cerniera. Colori: rosa, verde, blu, turchese e rosso.

CÓDIGO	MEDIDAS cm	ENVASE
690750	22 x 8 x 7	5

PORTATODO REDONDO 1 CREMALLERA







-  Estuche de nylon redondo 1 cremallera. Colores: rosa, verde, azul, turquesa y rojo.
-  Round nylon case with 1 zipper. Colors: pink, green, blue, turquoise and red.
-  Estojo redondo de nylon com 1 zíper. Cores: rosa, verde, azul, turquesa e vermelho.
-  Custodia rotonda in nylon con 1 cerniera. Colori: rosa, verde, blu, turchese e rosso.

CÓDIGO	MEDIDAS cm	ENVASE
690751	22 x 7 x 3,5	5

PORTATODO TRIPLE 1 CREMALLERA



-  Estuche de nylon tripe, con 3 compartimentos. 1 cremallera. Colores: rosa, verde, azul, turquesa y rojo.
-  Triple nylon case, with 3 compartments. 1 zipper. Colors: pink, green, blue, turquoise and red.
-  Mala tripla em nylon, com 3 compartimentos. 1 zíper. Cores: rosa, verde, azul, turquesa e vermelho.
-  Tripla custodia in nylon, con 3 scomparti. 1 cerniera. Colori: rosa, verde, blu, turchese e rosso.

CÓDIGO	MEDIDAS cm	ENVASE
690749	22 x 8 x 10	5



PORTATODO TRIANGULAR EFECTO PAPEL

 Estuche efecto papel con 1 cremallera. Base negra. Con forro interior. Tres colores: rojo, azul y plata.

 Paper effect case with 1 zip. Black base. With inner lining. Three colors: red, blue and silver.

 Estojo de efeito papel com 1 fecho. Base preta. Com forro interno. Três cores: vermelho, azul e prata.

 Astuccio effetto carta con 1 zip. Base nera. Con rivestimento interno. Tre colori: rosso, blu e argento.

CÓDIGO	MEDIDAS cm.	ENVASE
687907	21 x 5 x 9	3



PORTATODO RECTANGULAR EFECTO PAPEL

 Estuche efecto papel con 2 compartimentos. 2 cremalleras. Base negra. Forro interior. Tres colores: rojo, azul y plata.

 Paper effect pencil case with 2 compartments. 2 zippers. Black base. Inner lining. Three colors: red, blue and silver.

 Estojo para lápis de efeito papel com 2 compartimentos. 2 zíperes. Base preta. Revestimento interno. Três cores: vermelho, azul e prata.

 Astuccio effetto carta con 2 scomparti. 2 cerniere. Base nera. Fodera interna. Tre colori: rosso, blu e argento.

CÓDIGO	MEDIDAS cm.	ENVASE
687908	20,5 x 9 x 6	3



PORTATODO REJILLA TRIANGULAR

 Estuche con 1 cremallera. Base negra y rejilla a rayas. 4 colores rejilla: rojo, azul, azul claro y blanco.

 Case with 1 zipper. Black base and striped grid. 4 grid colours: red, blue, light blue and white.

 Estojo com 1 fecho de correr. Base preta e grade listrada. 4 cores de grelha: vermelho, azul, azul claro e branco.

 Custodia con 1 cerniera. Base nera e griglia a strisce. 4 colori della griglia: rosso, blu, azzurro e bianco.

CÓDIGO	MEDIDAS cm.	ENVASE
687899	23 x 6 x 7,5	4



PORTATODO REJILLA NEGRA RECTANGULAR

 Estuche con 1 cremallera. Con asa. Colores: azul / blanco, gris oscuro / gris, negro / naranja.

 Case with 1 zipper. With handle. Colours: blue / white, dark grey / grey, black / orange.

 Estojo com 1 fecho de correr. Com alça. Cores: azul / branco, cinza escuro / cinza, preto / laranja.





 Custodia con 1 cerniera. Con maniglia. Colori: blu / bianco, grigio scuro / grigio, nero / arancione.

CÓDIGO	MEDIDAS cm.	ENVASE
688840	19,5 x 5 x 6,5	3



PORTATODO TRIANGULAR 3 CREMALLERAS







-  Estuche de nylon con 3 compartimentos. 3 cremalleras. Colores: verde, rojo y azul.
-  Nylon case with 3 compartments. 3 zippers. Colours: green, red and blue.
-  Caso de nylon com 3 compartimentos. 3 zíperes. Cores: verde, vermelho e azul.
-  Custodia di nylon con 3 scomparti. 3 cerniere. Colori: verde, rosso e blu.

CÓDIGO	MEDIDAS cm	ENVASE
685594	21 x 5 x 9	3

PORTATODO RECTANGULAR 3 CREMALLERAS







-  Estuche de nylon con 3 compartimentos. 3 cremalleras. Colores: verde, rojo y azul.
-  Nylon case with 3 compartments. 3 zippers. Colours: green, red and blue.
-  Caso de nylon com 3 compartimentos. 3 zíperes. Cores: verde, vermelho e azul.
-  Custodia di nylon con 3 scomparti. 3 cerniere. Colori: verde, rosso e blu.

CÓDIGO	MEDIDAS cm	ENVASE
685596	21 x 11,8 x 6	3

PORTATODO CUADRADO 2 CREMALLERAS







-  Estuche con 2 compartimentos. 2 cremalleras. Colores: azul, violeta, verde y rojo.
-  Case with 2 compartiments. 2 zippers. Colours: blue, violet, green and red.
-  Estojo com 2 compartimentos. 2 zíperes. Cores: azul, violeta, verde e vermelho.
-  Custodia con 2 scomparti. 2 cerniere. Colori: blu, viola, verde e rosso.

CÓDIGO	MEDIDAS cm	ENVASE
685592	20 x 5,7 x 6	4

PORTATODO RECTANGULAR 2 CREMALLERAS



-  Estuche con 2 compartimentos. 2 cremalleras. Colores: azul, violeta, verde y rojo.
-  Case with 2 compartiments. 2 zippers. Colours: blue, violet, green and red.
-  Estojo com 2 compartimentos. 2 zíperes. Cores: azul, violeta, verde e vermelho.
-  Custodia con 2 scomparti. 2 cerniere. Colori: blu, viola, verde e rosso.

CÓDIGO	MEDIDAS cm	ENVASE
685593	21 x 5,5 x 10	4



PORTATODO 1 CREMALLERA TRIPLE CON VENTANA

Estuche triple de poliéster. 2 cremalleras. Con ventana de PVC para usar el smartphone. Colores: azul, granate y verde.

Polyester triple case. 2 zippers. With PVC window to use the smartphone. Colours: blue, garnet and green.

Caso tripla de poliéster. 2 zíperes. Com janela de PVC para usar o smartphone. Cores: azul, granada e verde.

Astuccio tripla di poliester. 2 cerniere. Con finestra in PVC per usare lo Smartphone. Colori: blu, granata e verde.

CÓDIGO	MEDIDAS cm	ENVASE
685464	20,5 x 11 x 5,5	3



PORTATODO 3 CREMALLERAS WATERPROOF

Estuche de poliéster cuadrado. Resistente al agua. 3 cremalleras. Colores: gris, azul, rojo y marrón.

Square polyester case. Waterproof. 3 zippers. Colours: grey, blue, red, brown.

Caso tripla. Com janela para usar o smartphone. 3 zíperes. Cores: cinza, azul, vermelho, marrom.

Astuccio quadrato in poliester. Resistente all'acqua. 3 cerniere. Colori: grigio, blu, rosso e marrone.

CÓDIGO	MEDIDAS cm	ENVASE
685465	20,5 x 9 x 5	4



PORTATODO 1 CREMALLERA TRIANGULAR BICOLOR

Estuche de poliéster triangular. Colores: gris/violeta, gris/azul, gris/rojo y gris/naranja.

Triangular polyester case. Colours: grey / violet, grey / blue, grey / red and grey / orange.

Caso de poliéster triangular. Cores: cinza / violeta, cinza / azul, cinza / vermelho e cinza / laranja.

Astuccio triangolare in poliester. Colori: grigio / viola, grigio / blu, grigio / rosso e grigio / arancio.

CÓDIGO	MEDIDAS cm	ENVASE
685466	22 x 6,5 x 5,5	4



PORTATODO 1 CREMALLERA PLANO BICOLOR

Estuche de poliéster. Compartimento interior de rejilla con cremallera y compartimento con gomas para bolígrafos. Colores: azul/negro, rojo/negro, gris/negro y violeta/negro.

Polyester case. Inner mesh compartment with zip and compartment with elastic bands for pens. Colours: blue / black, red / black, grey / black and violet / black.

Caso de poliéster. Compartimento de malha interna com zíper e compartimento com elásticos para canetas. Cores: azul / negro, preto / negro, preto / violeta / preto.





Astuccio in poliester. Scomparto interno in rete con zip e scomparto con gommini per penne. Colori: blu / nero, rosso / nero, grigio / nero e viola / nero.

CÓDIGO	MEDIDAS cm	ENVASE
685467	22 x 11	4



PORTATODO 1 CREMALLERA CLASSIC PLANO







-  Estuche de nylon. Colores: verde, rojo, gris, granate, azul y azul oscuro.
-  Nylon case. Colours: green, red, gray, maroon, blue and dark blue.
-  Caso de nylon. Cores: verde, vermelho, cinza, marrom, azul e azul escuro.
-  Astuccio in nylon. Colori: verde, rosso, grigio, marrone, blu e blu scuro.

CÓDIGO	MEDIDAS cm	ENVASE
685283	21 x 6	6

PORTATODO 2 CREMALLERAS CLASSIC PLANO







-  Estuche de nylon con dos compartimentos. Colores: verde, rojo, gris, granate, azul y azul oscuro.
-  Nylon case with two compartments. Colours: green, red, gray, maroon, blue and dark blue.
-  Caso de nylon com dois compartimentos. Cores: verde, vermelho, cinza, marrom, azul e azul escuro.
-  Astuccio in nylon con due scomparti. Colori: verde, rosso, grigio, marrone, blu e blu scuro.

CÓDIGO	MEDIDAS cm	ENVASE
685286	20 x 7	6

PORTATODO 1 CREMALLERA CLASSIC MINI







-  Estuche de nylon. Colores: verde, rojo, gris, granate, azul y azul oscuro.
-  Nylon case. Colours: green, red, gray, maroon, blue and dark blue.
-  Caso de nylon. Cores: verde, vermelho, cinza, marrom, azul e azul escuro.
-  Astuccio in nylon mini. Colori: verde, rosso, grigio, marrone, blu e blu scuro.

CÓDIGO	MEDIDAS cm	ENVASE
685285	19,5 x 2,5 x 2,5	6

PORTATODO 1 CREMALLERA CLASSIC CUADRADO







-  Estuche de nylon. Colores: verde, rojo, gris, granate, azul y azul oscuro.
-  Nylon case. Colours: green, red, gray, maroon, blue and dark blue.
-  Caso de nylon. Cores: verde, vermelho, cinza, marrom, azul e azul escuro.
-  Astuccio in nylon. Colori: verde, rosso, grigio, marrone, blu e blu scuro.

CÓDIGO	MEDIDAS cm	ENVASE
685287	19,5 x 4 x 3,5	6







PORTATODO 1 CREMALLERA "ESSENTIAL" =

-  Estuche de nylon con cremallera del color del cuerpo. Colores: rojo, azul y gris.
-  Nylon case with zipper body color. Colours: red, blue and grey.
-  Caso de nylon com zíper de cor de corpo. Cores: vermelho, azul e cinza.
-  Astuccio in nylon con cerniera dello stesso colore. Colori: rosso, blu e grigio.

CÓDIGO	MEDIDAS cm	ENVASE
685288	21,5 x 10,5 x 2	3







PORTATODO 1 CREMALLERA "ESSENTIAL" ∅

-  Estuche de nylon con cremallera del color del cuerpo. Colores: rojo, azul y negro.
-  Nylon case with zipper body color. Colours: red, blue and black.
-  Caso de nylon com zíper de cor de corpo. Cores: vermelho, azul e preto.
-  Astuccio in nylon con cerniera dello stesso colore. Colori: rosso, blu e nero.

CÓDIGO	MEDIDAS cm	ENVASE
685291	18,5 x 6 x 5	3







PORTATODO 2 CREMALLERAS "ESSENTIAL" +

-  Estuche de nylon con dos compartimentos con cremallera del color del cuerpo. Colores: rojo, azul y gris.
-  Nylon case with two compartments with zipper body color. Colours: red, blue and grey.
-  Caso de nylon con dois compartimentos com zíper de cor de corpo. Cores: vermelho, azul e cinza.
-  Astuccio in nylon con due scomparti con cerniera stesso colore. Colori: rosso, blu e grigio.

CÓDIGO	MEDIDAS cm	ENVASE
685289	21 x 11	3



PORTATODO 2 CREMALLERAS PLANO DELUXE





-  Estuche de nylon con 2 compartimentos. Colores: violeta, verde y granate.
-  Nylon case with 2 compartments. Colours: violet, green and garnet.
-  Caso de nylon com 2 compartimentos. Cores: violeta, verde e grená.
-  Astuccio in nylon con 2 scomparti. Colori: viola, verde e granata.

CÓDIGO	MEDIDAS cm	ENVASE
685418	20,5 x 10 x 2,5	3



PORTATODO TRIPLE 3 CREMALLERAS







-  Estuche triple con 3 cremalleras. Colores: verde, gris y azul. Waterproof.
-  Triple case with 3 zippers. Colours: green, grey and blue. Waterproof.
-  Caso tripla com 3 ziperes. Cores: verde, cinza e azul. Waterproof.
-  Custodia tripla con 3 cerniere. Colori: verde, grigio e blu. Waterproof.

CÓDIGO	MEDIDAS cm	ENVASE
685595	21,3 x 7 x 9,3	3

PORTATODO 1 CREMALLERA REJILLA RECTANGULAR







-  Estuche traslúcido de rejilla. Colores: rosa, azul, verde y violeta.
-  Traslucent grid case. Colours: pink, blue, green and violet.
-  Caso traslúcido de grade. Cores: rosa, azul, verde e violeta.
-  Astuccio rettangolare griglia traslucida. Colori: rosa, blu, verde e viola.

CÓDIGO	MEDIDAS cm	ENVASE
685416	21 x 8 x 5,5	4

PORTATODO 2 CREMALLERAS REJILLA RECTANGULAR







-  Estuche traslúcido de rejilla con 2 compartimentos. Colores: rosa, azul, verde y violeta.
-  Traslucent grid case with 2 compartments. Colours: pink, blue, green and violet.
-  Caso traslúcido de grade com 2 compartimentos. Cores: rosa, azul, verde e violeta.
-  Astuccio 2 cerniere griglia traslucida con 2 scomparti. Colori: rosa, blu, verde e viola.

CÓDIGO	MEDIDAS cm	ENVASE
685417	21 x 11 x 4	4

PORTATODO 1 CREMALLERA ANTE







-  Estuche simil cuero. Colores: turquesa, cuero, violeta y marrón.
-  Simil leather case. Colours: turquoise, leather, violet and brown.
-  Couro sintético case. Cores: turquesa, couro, violeta e marrom.
-  Astuccio similpelle. Colori: turchese, pelle, viola e marrone.

CÓDIGO	MEDIDAS cm	ENVASE
685413	19,2 x 3,5 x 5	4





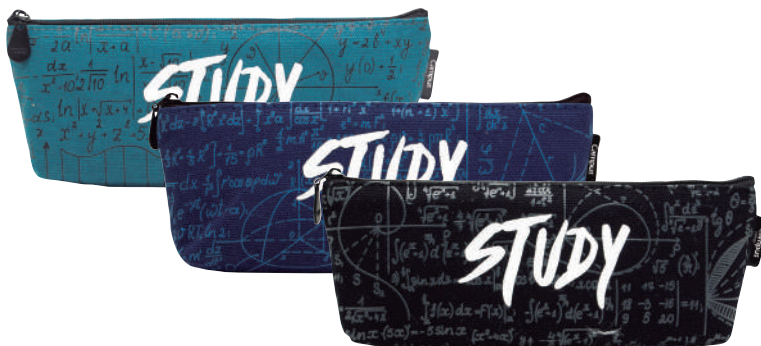

PORTATODO 1 CREMALLERA "STUDY"

-  Estuche de nylon rectangular. 1 cremallera. Colores: negro, azul y azul oscuro.
-  Rectangular nylon case. 1 zipper. Colours: black, blue and dark blue.
-  Caso de nylon retangular com 1 fecho de correr. Cores: preto, azul e azul-escuro.
-  Custodia di nylon rettangolare. 1 cerniera. Colori: nero, blu e blu scuro.

CÓDIGO	MEDIDAS cm	ENVASE
687905	20 x 7,4 x 3,4	3







PORTATODO PLANO "PIANO"

-  Estuche de nylon y rejilla. Colores: negro/negro, negro/blanco y blanco/verde.
-  Nylon and mesh case. 1 zipper case. Colours: black/black, black/white and white/green.
-  Caso de nylon e grade. Cores: preto/preto, preto/branco e branco/verde.
-  Custodia di nylon e cremagliera. Colori: nero/nero, nero/bianco e bianco/verde.

CÓDIGO	MEDIDAS cm	ENVASE
687906	19,5 x 7,4 x 3,3	3



PORTATODO 1 CREMALLERA REJILLA

-  Estuche de rejilla con 1 cremallera. Con asa. Colores: gris claro y negro.
-  1 zipper mesh case. With handle. Colours: light grey and black.
-  Mala de rede com 1 fecho de correr. Com alça. Cores: cinzento claro e preto.
-  Custodia in rete con 1 cerniera. Con maniglia. Colori: grigio chiaro e nero.

CÓDIGO	MEDIDAS cm	ENVASE
687902	23 x 8,5 x 3,5	6



PORTATODO PELUCHE MENSAJE GLITTER





-  Estuche de peluche plano con 1 cremallera. Pompón a juego. Aplicación glitter con bordado en la parte delantera. Con forro interior. Colores: azul claro, rosa y gris.
-  1 zipper stuffed case. Flat. Matching pom-pom. Glitter appliqué with embroidery on the front. With inner lining. Colours: light blue, pink and grey.
-  Mala recheada com 1 fecho. Plano. Pompon a condizer. Aplique de glitter com bordado na frente. Com forro interno. Cores: azul claro, rosa e cinza.
-  Custodia imbottita con 1 cerniera. Piatto. Pompon abbinato. Applicazione glitterata con ricamo sul davanti. Con rivestimento interno. Colori: azzurro, rosa e grigio.

CÓDIGO	MEDIDAS cm	ENVASE
687904	21,8 x 7,8 x 3,5	3



PORTATODO 2 CREMALLERAS "CHANEL"







-  Estuche de poliéster triangular. 2 compartimentos. Colores: azul, violeta y negro.
-  Triangular polyester case. 2 compartments. Colours: blue, violet and black.
-  Caso de poliéster triangular. 2 compartimentos. Cores: azul, violeta e preto.
-  Astuccio triangolare in poliester. 2 scomparti. Colori: blu, viola e nero.

CÓDIGO	MEDIDAS cm	ENVASE	PRECIO
685343	20 x 6 x 3	3	7,15 €

PORTATODO LOVELY DOG 2 CREMALLERAS







-  Estuche de tela con 2 compartimentos. 2 cremalleras. Colores: rosa, marrón, gris y azul. Diseños surtidos.
-  Fabric case with 2 compartments. 2 zippers. Colours: pink, brown, grey and blue. Assorted designs.
-  Caso de tecido com 2 compartimentos. 2 zíperes. Cores: rosa, marrom, cinza e azul. Desenhos variados.
-  Custodia in tessuto con 2 scomparti. 2 cerniere. Colori: rosa, marrone, grigio e blu. Disegni assortiti

CÓDIGO	MEDIDAS cm	ENVASE
685597	19,5 x 8,8 x 3,5	4

PORTATODO PLANO 1 CREMALLERA







-  Estuche de nylon y rejilla con 1 cremallera. 4 diseños surtidos con frase y animal.
-  Nylon and mesh flat case with 1 zipper. 4 assorted designs with a phrase and an animal.
-  Caso plana de nylon e grade com 1 zíper. 4 desenhos variados com frase e animal.
-  Custodia piatto di nylon e rete con 1 cerniera. 4 disegni assortiti con frase e animali.

CÓDIGO	MEDIDAS cm	ENVASE
685598	20,4 x 9,5	4

PORTATODO 1 CREMALLERA TIRA CUERO







-  Estuche de nylon. Plano. Con tirador de cuero. 3 diseños diferentes.
-  Nylon case. Flat. With leader pull. 3 different designs.
-  Caso de nylon. Plano. com puxão de couro 3 desenhos diferentes.
-  Astuccio in nylon. Piatto. Com tirante in pelle. 3 diversi modelli.

CÓDIGO	MEDIDAS cm	ENVASE
685411	18 x 2,8 x 8,2	3







PORTATODO 1 CREMALLERA PERROS Y GATOS

-  Estuche de tela rectangular. 4 diseños diferentes.
-  Rectangular fabric case. 4 different designs.
-  Caso de pano rectangular. 4 desenhos diferentes.
-  Astuccio rettangolare in tessuto. 4 diversi modelli.



CÓDIGO	MEDIDAS cm	ENVASE
685457	19,3 x 8,5 x 3,2	4





PORTATODO 1 CREMALLERA TRIPLE PLANO

-  Estuche de nylon con tres compartimentos. Con bolsillo exterior. Colores: violeta, naranja y azul.
-  Nylon case with three compartments. With exterior pocket. Colours: violet, orange and blue.
-  Caso de nylon com três compartimentos. Cores: violeta, laranja e azul.
-  Astuccio in nylon con tre scomparti. Con tasca esterna. Colori: viola, arancio e blu.



CÓDIGO	MEDIDAS cm	ENVASE
685377	19,5 x 10,3	3





PORTATODO 1 CREMALLERA NYLON DE REJILLA

-  Estuche de nylon de rejilla. Colores: negro y plata.
-  Nylon grid case. Colours: black and silver.
-  Caso de nylon de grade. Cores: preto e prata.
-  Astuccio in nylon a griglia. Colori: nero e argento.



CÓDIGO	MEDIDAS cm	ENVASE
685452	20 x 5 x 4,5	4

PORTATODO 2 CREMALLERAS NYLON DE REJILLA

-  Estuche de nylon de rejilla. 2 compartimentos. Colores: negro y plata.
-  Nylon grid case. 2 compartiments. Colours: black and silver.
-  Caso de nylon de grade. 2 compartimentos. Cores: preto e prata.
-  Astuccio 2 cerniere in nylon a griglia. 2 scomparti. Colori: nero e argento.







CÓDIGO	MEDIDAS cm	ENVASE
685451	21 x 11 x 4,5	4



PORTATODO DE SILICONA BANANA 1 CREMALLERA







-  Estuche mini de silicona con cremallera dorada. Tacto suave. Colores pastel: azul y verde.
-  Mini silicone case with gold zipper. Soft touch. Pastel colours: blue and green.
-  Mini caixa de silicone com zíper dourado. Toque suave. Cores do pastel: azul e verde.
-  Mini custodia in silicone con cerniera dorata. Tocco leggero. Colori pastello: blu e verde.

CÓDIGO	MEDIDAS cm	ENVASE
687903	22 x 5 x 3	4

PORTATODO SILICONA CUADRADO 1 CREMALLERA







-  Estuche de silicona. Tacto suave. Colores: rojo, rosa, azul y verde.
-  Silicone case. Soft touch. Colours: red, pink, blue and green.
-  Caso de silicone. Toque suave. Cores: vermelho, rosa, azul e verde.
-  Astuccio in silicone. Tocco leggero. Colori: rosso, rosa, blu e verde.

CÓDIGO	MEDIDAS cm	ENVASE
685379	18 x 7 x 5	4

PORTATODO 2 CREMALLERAS NYLON RECTANGULAR







-  Estuche de nylon. 2 compartimentos. Colores: gris, y negro.
-  Nylon case. 2 compartments. Colours: grey and black.
-  Caso de nylon. 2 compartimentos. Cores: cinza e preto.
-  Astuccio in nylon. 2 scomparti. Colori: nero e argento

CÓDIGO	MEDIDAS cm	ENVASE
685453	19 x 6 x 4,8	4

PORTATODO REJILLA NEGRA 2 CREMALLERAS CUADRADO







-  Estuche de nylon y rejilla negra. 2 compartimentos. Colores: verde, rosa, azul y violet.
-  Nylon case and black grid. 2 compartments. Colours: green, pink, blue and violet.
-  Caso de nylon e gride cor preto. 2 compartimentos. Cores: verde, rosa, azul e violeta.
-  Astuccio in nylon e griglia nera. 2 scomparti. Colori: verde, rosa, blu e viola.

CÓDIGO	MEDIDAS cm	ENVASE
685370	20 x 4,5 x 2	4







PORTATODO 1 CREMALLERA "OJITOS"

-  Estuche de nylon y pvc. Con asa. Colores: rojo, azul y gris.
-  Nylon and pvc case. With handle. Colours: red, blue and grey.
-  Caso de nylon e pvc. Com alça. Cores: vermelho, azul e cinza.
-  Custodia di nylon e pvc. Con maniglia. Colori: rosso, blu e grigio.



CÓDIGO	MEDIDAS cm	ENVASE
688838	19,5 x 5 x 7	3





PORTATODO 2 CREMALLERAS BRILLO SOFT

-  Estuche de tela brillante. Colores pastel: verde, rosa, azul y violeta.
-  Shiny fabric case. Pastel colours: green, pink, blue and violet.
-  Caso de tecido brilhante. Cores pastel: verde, rosa, azul e violeta.
-  Case di tessuto lucido. Cores pastel: verde, rosa, azul e violeta.



CÓDIGO	MEDIDAS cm	ENVASE
687900	21,5 x 5,5 x 8	4

PORTATODO 1 CREMALLERA "MUSIC"

-  Estuche pvc brillante con diseño de graffiti. Colores: rosa claro, violeta y verde claro.
-  Shiny pvc case with graffiti design. Colours: light pink, violet and light green.
-  Mala de pvc brilhante com desenho de graffiti. Cores: rosa claro, violeta e verde claro.
-  Scatola di pvc lucida con disegno a graffiti. Colori: rosa chiaro, viola e verde chiaro.







CÓDIGO	MEDIDAS cm	ENVASE
688837	22 x 3,5 x 8,5	3



PORTATODO 1 CREMALLERA COMBI "TOPOS"







-  Estuche de nylon bicolor. Base de colores con topos. Colores: rosa/azul, verde/haranja, azul claro/rosa.
-  Bicolor nylon case. Coloured base with dots. Colors: pink/blue, green/orange, light blue/pink.
-  Caso de nylon bicolor. Base de cores com pontos: rosa/azul, verde/laranja, azul claro/rosa.
-  Astuccio in nylon bicolore. Base con design di punti. Colori: rosa / blu, verde / arancio, azzurro / rosa.

CÓDIGO	MEDIDAS cm	ENVASE
685384	19,2 x 4 x 5	3

PORTATODO EFECTO ESPEJO 1 CREMALLERA







-  Estuche pvc translúcido. Colores rosa, violeta y verde.
-  Pvc translucent case. Colours pink, violet and green.
-  Caso pvc translúcido. Cores: rosa, violeta e verde.
-  Caso pvc traslucido. Colori rosa, viola e verde.

CÓDIGO	MEDIDAS cm	ENVASE
688841	20 x 4 x 3,5	3

PORTATODO 2 CREMALLERAS POLIÉSTER







-  Estuche de poliéster con 2 compartimentos. Colores: azul, naranja y beige.
-  Polyester case with 2 compartments. Colours: blue, orange and beige.
-  Caso de poliéster com 2 compartimentos. Cores: azul, laranja e bege.
-  Custodia in poliesterre con 2 scomparti. Colori: blu, arancione e beige.

CÓDIGO	MEDIDAS cm	ENVASE
685591	20 x 6,5 x 4	3

PORTATODO NEOPRENO 1 CREMALLERA MINI



-  Estuche de neopreno. Colores: azul claro, azul oscuro, violeta y negro.
-  Neoprene case. Colours: light blue, dark blue, violet and black.
-  Caso de neoprene. Cores: azul claro, azul escuro, violeta e preto.
-  Astuccio in neoprene. Colori: blu chiaro, blu scuro, viola e nero.

CÓDIGO	MEDIDAS cm	ENVASE
685307	18,5 x 4 x 3	4



PORTATODO 1 CREMALLERA TRIANGULAR "WILD"

Estuche pvc con una cremallera. Estampado de hojas y texto bordado en la parte delantera. Con forro interior.

1 zipper pvc case. Leaf print and embroidered text on the front. With inner lining.

Estojo pvc com fecho. Folha impressa e texto bordado na frente. Com forro interno.

Custodia pvc con cerniera. Stampa foglia e scritta ricamata sul davanti. Con rivestimento interno.



CÓDIGO	MEDIDAS cm	ENVASE
687914	20,5 x 8	4

PORTATODO 1 CREMALLERA PLANO

Estuche de tela plano. 2 diseños diferentes.

Fabric case. 2 different designs.

Caso de pano. 2 desenhos diferentes.

Astuccio in tela piatto. 2 diversi modelli



CÓDIGO	MEDIDAS cm	ENVASE
685450	20,5 x 11,5	4

PORTATODO 2 CREMALLERAS TELA CUADRADO

Estuche de nylon. 2 compartimentos. 4 diseños diferentes.

Nylon case. 2 compartimtns. 4 different designs.

Caso de nylon. 2 compartimentos. 4 desenhos diferentes.

Astuccio in nylon. 2 scomparti. 4 modelli diversi.



CÓDIGO	MEDIDAS cm	ENVASE
685334	19,7 x 6,5 x 4,7	4

PORTATODO TRIPLE PLANO TELA

Estuche de nylon con 3 compartimentos. 2 cremalleras. 6 diseños diferentes.

Nylon case with three compartments. 2 zippers. 6 different designs.

Caso de nylon com três compartimentos. 2 zíperes. 6 desenhos diferentes.

Astuccio in nylon con tre scomparti. 2 cerniere. 6 modelli diversi.







CÓDIGO	MEDIDAS cm	ENVASE
685311	21 x 11 x 4	12



PORTATODO POMPÓN 1 CREMALLERA







-  Estuche pvc brillante. Con pompón en la cremallera. Colores: azul y rosa.
-  Shiny pvc case. With pompom on the zipper. Colours: blue and pink.
-  Mala pvc brilhante. Com pompom no zíper. Cores: azul e rosa.
-  Valigetta pvc lucida. Con pompon sulla cerniera. Colori: blu e rosa.

CÓDIGO	MEDIDAS cm	ENVASE
687912	20,5 x 5 x 5,5	4

PORTATODO PELUCHE UNICORNIO 1 CREMALLERA







-  Estuche de peluche. Figura de silicona en la parte delantera. Base metalizada. Con asa. Colores: violeta, azul y rosa.
-  Stuffed case. Silicone figure on the front. Metallic base. With handle. Colours: violet, blue and pink.
-  Mala recheada. Figura de silicone na frente. Base metálica. Com alça. Cores: violeta, azul e rosa.
-  Valigetta imbottita. Figura in silicone sul davanti. Base metallica. Con manico. Colori: viola, blu e rosa.

CÓDIGO	MEDIDAS cm	ENVASE
688839	19,5 x 5 x 7	3

PORTATODO METALIZADO POMPÓN 1 CREMALLERA







-  Estuche pvc efecto metalizado. Tacto suave. Con asa y pompón a juego. Colores: naranja y azul.
-  Metallic effect pvc case. Soft touch. With handle and matching pompom. Colours: orange and blue.
-  Caso efeito pvc metálico. Toque suave. Com alça e pompom combinando.
-  Custodia in pvc effetto metallizzato. Tocco leggero. Con manico e pompon abbinato. Colori: arancione e blu.

CÓDIGO	MEDIDAS cm	ENVASE
687911	19,5 x 5 x 7	4

SET PORTATODO RAYAS PLANO







-  Estuche de rejilla de rayas. Colores: rosa, azul y negro. Incluye: 1 regla, 1 lapicero y 1 afilalápiz a juego.
-  Striped grid case. Colours: pink, azul and black. Includes: 1 ruler, 1 pencil and 1 sharpener with same colours.
-  Caso de grade listrada. Cores: rosa, azul e preto. Inclui: 1 regra, 1 lápis e 1 afila-lápis com mesmo cor.
-  Astuccio tipo griglia a strisce. Colori: rosa, blu e nero. Include: 1 righello, 1 penna e 1 temperino da abbinare.

CÓDIGO	MEDIDAS cm	ENVASE
685331	20 x 7,5	3







PORTATODO PLANO "PEGASO"

-  Estuche de nylon.
-  Nylon case.
-  Caso de nylon.
-  Astuccio piatto in nylon.

CÓDIGO	MEDIDAS cm	ENVASE
685337	21 x 11	1 / 24







PORTATODO CUADRADO "PEGASO"

-  Estuche de nylon.
-  Nylon case.
-  Caso de nylon.
-  Astuccio quadrato in nylon.

CÓDIGO	MEDIDAS cm	ENVASE
685339	21 x 6 x 6	1 / 12







PORTATODO 1 CREMALLERA "OH-OH!"

-  Estuche de nylon brillante. Ilustración de perrito.
-  Brilliant nylon case. Puppy illustration.
-  Caso de nylon brilhante. Ilustração de cachorro.
-  Astuccio in nylon brillante. Illustrazione di cucciolo.

CÓDIGO	MEDIDAS cm	ENVASE
685336	22 x 7 x 7	1 / 12



SET PORTATODO + 3 COMPLEMENTOS

-  Estuche de nylon. Incluye: 1 regla, 1 lapicero y 1 afilalápiz. 4 diseños diferentes.
-  Nylon case. Includes: 1 ruler, 1 pencil and 1 sharpener. 4 different designs.
-  Caso de nylon. Inclui: 1 regra, 1 lápis e 1 afila-lápis. 4 desenhos diferentes.
-  Astuccio in nylon; include: 1 righello, 1 penna e 1 temperino. 4 diversi modelli

CÓDIGO	MEDIDAS cm	ENVASE
685295	18,2 x 2,5 x 4	1 / 20



PORTATODO TRANSPARENTE CON GLITTER I CREMALLERA



- Estuche pvc transparente. Estampación en la parte delantera con interior líquido y elementos glitter. Colores pastel: violeta, verde y rosa.
- Pvc transparent case. Stamping on the front with liquid interior and glitter elements. Pastel colours: violet, green and pink.
- Estojo pvc transparente. Estampado na frente com interior líquido e elementos de glitter. Cores do pastel: violeta, verde e rosa.
- Custodia pvc trasparente. Timbratura frontale con interno líquido ed elementi glitterati. Colori pastello: viola, verde e rosa.

CÓDIGO MEDIDAS cm ENVASE

687910 20 x 6,5 x 5,5 3

PORTATODO PLANO GLITTER POMPÓN I CREMALLERA



- Estuche plano pvc transparente. Estampación en la parte delantera con fondo de confetti glitter. Con pompón. Colores pastel: violeta, azul y rosa.
- Pvc transparent flat case. Print on the front with glitter confetti background. With pom-pom. Pastel colours: violet, blue and pink.
- Estojo plano pvc transparente. Impressão na frente com fundo de confete glitter. Com pom-pom. Cores do pastel: violeta, azul e rosa.
- Custodia piatta pvc trasparente. Stampa frontale con sfondo di coriandoli glitterati. Con pompon. Colori pastello: viola, blu e rosa.

CÓDIGO MEDIDAS cm ENVASE

687909 21 x 14 3

CARRITOS PORTAMOCHILAS



Plataforma con inclinación para una mayor sujeción

Empuñadura ergonómica

Enganche para sujeción de la mochila

- Fabricados en polipropileno. Plegables. Super ligero y resistente. Asa extensible. Ruedas silenciosas. Medidas abierto: 86 x 23 x 26 cm.
- Manufactured in polypropylene. Folding. Super light and resistant. Extendable handle. Silent wheels. Size when opened: 86 x 23 x 26 cm.
- Fabricado em polipropileno. Dobrável. Super leve e resistente. Alça extensível. Rodas silenciosas. Tamanho quando aberto: 86 x 23 x 26 cm.
- Prodotto in polipropilene. Pieghevole. Super leggero e resistente. Manico allungabile. Ruote silenziose. Dimensioni aperte: 86 x 23 x 26 cm.

CÓDIGO COLOR

685387 ● Negro

685388 ● Azul oscuro

685389 ● Rosa

685390 ● Violeta

685391 ● Rojo

685392 ● Azul claro





MOCHILA JUVENIL

NEW!!

 Mochila juvenil de poliéster muy ligera. Bolsillo frontal. Espalda y tirantes acolchados. 3 colores disponibles. Medidas: 26 x 37 x 12 cm.

 Very light polyester youth backpack. Front pocket. Padded back and shoulder straps. 3 colors available. Measurements: 26 x 37 x 12 cm.

 Muito leve mochila juventude poliéster. Bolso frontal. Alças acolchoadas nas costas e ombros. 3 cores disponíveis. Medidas: 26 x 37 x 12 cm.

 Zaino giovanile in poliesterre molto leggero. Tasca frontale. Schienale e spallacci imbottiti. 3 colori disponibili. Misurazioni: 26 x 37 x 12 cm.

CÓDIGO	COLOR
691744	● Negro
691746	● Azul oscuro
691745	● Gris



MOCHILA ESCOLAR

 Mochila juvenil de poliéster muy ligera. Bolsillo frontal. Espalda y tirantes acolchados. 6 colores disponibles. Medidas: 42 x 32 x 17 cm.

 Very light polyester youth backpack. Front pocket. Padded back and shoulder straps. 6 colors available. Measurements: 42 x 32 x 17 cm.

 Muito leve mochila juventude poliéster. Bolso frontal. Alças acolchoadas nas costas e ombros. 6 cores disponíveis. Medidas: 42 x 32 x 17 cm.

 Zaino giovanile in poliesterre molto leggero. Tasca frontale. Schienale e spallacci imbottiti. 6 colori disponibili. Misurazioni: 42 x 32 x 17 cm.

CÓDIGO	COLOR
685393	● Negro
685394	● Azul oscuro
685395	● Gris
685396	● Azul claro
685397	● Rojo
685398	● Verde



MOCHILA INFANTIL ANIMALES

 Mochilas infantiles con diseños de animales. Con asa para colgar y tirantes acolchados.

 Children's backpacks with animal designs. With hanging handle and padded shoulder straps.

 Mochilas infantis com desenhos de animais. Com alça de suspensão e alças acolchoadas.

 Zaini per bambini con disegni di animali. Con manico sospeso e spallacci imbottiti.

CÓDIGO	MEDIDAS cm
A 685399	20 x 22 x 8
B 685404	19 x 30 x 6
C 685403	24 x 31 x 6,5



POLICÍA



Misión POLICIAL ¡ATRAPA AL LADRÓN!

Con muchos accesorios para
mayor diversión







Cód. 710227
Contiene 127 piezas
con 3 figuras.

Y muchos más juegos de
bloques CLICK IT.
¡Descúbrelos todos!



JUEGOS DE BLOQUES



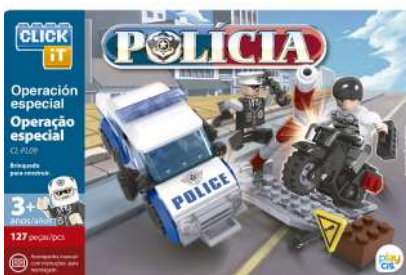

POLICÍA "Operación especial"

-  Juego de bloques para construir una patrulla policial. 127 piezas con 3 figuras.
-  Police patrol child block game. 127 pieces with 3 figures.
-  Jogo de blocos para construir uma patrulha policial. 127 peças com 3 figuras.
-  Gioco con blocchi per costruire una pattuglia della polizia. 127 pezzi con 3 figure.



CÓDIGO	EDAD
710227	+3 años





EJÉRCITO "Batalla"

-  Juego de bloques para construir un escenario de batalla. 253 piezas con 3 figuras.
-  Battle scene child block game. 253 pieces with 3 figures.
-  Jogo de blocos para construir um estágio de batalha. 253 peças com 3 figuras.
-  Gioco con blocchi per costruire una scena di battaglia. 253 pezzi con 3 figure.



CÓDIGO	EDAD
710228	+3 años





EVOLUTION 3 en 1 "Coches"

-  Juego de bloques para construir 3 modelos de coches. 124 piezas.
-  Block game to build 3 car models. 124 pieces.
-  Jogo de blocos para construir 3 modelos de carros. 124 peças.
-  Gioco con blocchi per costruire 3 modelli di auto. 124 pezzi.



CÓDIGO	EDAD
710230	+3 años

EVOLUTION 3 en 1 "Motos"

-  Juego de bloques para construir 3 modelos de motos. 142 piezas.
-  Block game to build 3 motorcycle models. 142 pieces.
-  Jogo de blocos para construir 3 modelos de motos. 142 peças.
-  Set di blocchi per costruire 3 modelli di moto. 142 pezzi.



CÓDIGO	EDAD
710231	+3 años



EXPOSITOR MIX FASHION. JUEGOS DE BLOQUES



🇪🇸 Juego de bloques para construir. Contiene:
6 Bolsitas "Paseo en bicicleta". 24 piezas.
6 Bolsitas "Columpio en el jardín". 33 piezas.
6 Bolsitas "Sala de estar". 31 piezas.
6 Bolsitas "Un día en la playa". 31 piezas.

🇬🇧 Block game to build. It contains:
6 bags "Bike ride". 24 pieces.
6 bags "Swing in the garden". 33 pieces.
6 bags "Living room". 31 pieces.
6 bags "A day on the beach". 31 pieces.

🇵🇹 Jogo de blocos para construir. Contém:
6 sacos "Paseio de bicicleta". 24 peças.
6 sacos "Balanço no jardim". 33 peças.
6 sacos "Sala de estar". 31 peças
6 sacos "Um dia na praia". 31 peças.

🇮🇹 Set di blocchi da costruire. Contiene:
6 borse "Bike ride". 24 pezzi.
6 borse "Swing in the garden". 33 pezzi.
6 borse "Soggiorno". 31 pezzi.
6 borse "Una giornata in spiaggia". 31 pezzi

CÓDIGO	EDAD
710234	+3 años



10

FANTASÍA

FANTASY
FANTASÍA
FANTASIA



LIBRETA DE BOLSILLO TAPA BÁSICA





40 Hojas. - 70 g.



70 G.

A7

A6



-  Libreta encolada. Rayado horizontal.
-  Glued notebook. Horizontal scratching.
-  Caderno colado. Arranhões horizontais.
-  Notebook incollato Scratch orizzontale.

CÓDIGO	FORMATO	MEDIDAS (mm.)	HOJAS	RAYADO	COLOR CUBIERTA	ENVASE PAQ./CAJA
002175	A7	74 x 105	40	Horizontal		4 / 360
002176	A6	105 x 148	40	Horizontal		5 / 240

BLOC MICROPERFORADO DE ESPIRAL DE TAPA DE POLIPROPILENO





60 Hojas. - 70 g.



70 G.

A7

A6



-  Bloc de espiral doble con cierre de goma elástica. Las hojas vienen microperforadas. Estampación en color plata.
-  Double spiral pad with elastic rubber closure. Microperforated sheets. Stamping in silver.
-  Almofada espiral dupla com fecho de borracha elástica. As folhas vêm microperforadas. Estamparia em prata.
-  Doppia spirale con chiusura in gomma elastica. Le foglie vengono microforate. Stampaggio in argento.

CÓDIGO	FORMATO	MEDIDAS (mm.)	HOJAS	RAYADO	COLOR CUBIERTA	EXPOSITOR
001834	A7	75 x 120	60	Cuadrícula 4 mm.		15
001833	A6	105 x 148	60	Cuadrícula 4 mm.		15

BLOC "CANGURO" CON BOLSA CIERRE ZIP





32 Hojas - 70 g.

70 G.

A6

A5



-  Bloc encolado de tapa de cartón con funda protectora transparente con cierre zip para guardar objetos. Papel interior de 70 g. 32 hojas.
-  Glued cardboard lid with transparent protective cover with zip closure for storing objects. 70 g inner paper 32 sheets.
-  Tapa de papelão colado com tampa protetora transparente com fecho de correr para guardar objetos. Papel interno de 70 g 32 folhas.
-  Coperchio in cartone incollato con coperchio protettivo trasparente con chiusura a cerniera per riporre oggetti. 70 g di carta interna 32 fogli.

CÓDIGO	FORMATO	MEDIDAS (mm.)	HOJAS	RAYADO	COLOR CUBIERTA	ENVASE PAQ./CAJA
002530	A6	148 x 105	32	Horizontal		8 / 80
002529	A5	210 x 148	32	Horizontal		8 / 160



LIBRETA COSIDA DE COLORES PASTEL

36 Hojas. - 70 g. Tamaño: 190 x 255 mm

- Libreta cosida de 5 colores pastel surtidos. 36 hojas de 70 g. Logo impreso metalizado.
- Sewn-in notebook in 5 assorted pastel colours. 36 sheets of 70 g. Metallic printed logo.
- Caderno costurado em 5 cores pastel surtido. 36 folhas de 70 g. Logótipo impresso metálico.
- Notebook cuciti in 5 colori pastello assortiti. 36 fogli da 70 g. Logo stampato metallizzato.

70 G.
A4

CÓDIGO	FORMATO	MEDIDAS (mm.)	HOJAS	RAYADO	COLOR CUBIERTA	ENVASE PAQ./CAJA
002881	A4	190 x 255	36	Liso	● ● ● ● ●	5 / 40

BLOC ESPIRAL MICROPERFORADO "RED NOSE"

80 Hojas - 70 g.

- Portadas impresas a todo color laminado brillo. Encuadernación espiral color plateado con terminación coil-lock.. El tamaño A4 incluye: funda transparente portapapeles, hoja de pegatinas y hoja para datos personales. Los tamaños A5 y A6 incluyen: doble bolsillo portapapeles de 180 g., hoja de pegatinas y hoja para datos personales.

- Capas laminadas impresas a cores. Encadernação em espiral de cor prata com acabamento em bobina.. O tamanho A4 inclui: caso de área de transferência transparente, folha de adesivo e folha de dados pessoais. Os tamanhos A5 e A6 incluem: 180 g, bolsa de prancheta, folha de adesivos e folha para dados pessoais.

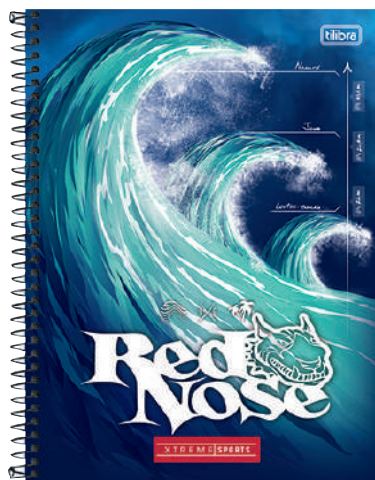
70 G.

CÓDIGO	MEDIDAS (mm.)	HOJAS	RAYADO	COLOR CUBIERTA	ENVASE PAQ./CAJA
002469	110 x 154	80	Cuadrícula 4 x 4 mm.	4 Diseños surtidos	8 / 96
002466	140 x 200	80	Cuadrícula 4 x 4 mm.	4 Diseños surtidos	5 / 40
002472	200 x 275	80	Cuadrícula 4 x 4 mm.	4 Diseños surtidos	4 / 32

Los códigos en **color amarillo** permiten apertura de envase

BLOC ESPIRAL MICROPERFORADO "CAPRICHITO"

80 Hojas - 70 g.

70 G.

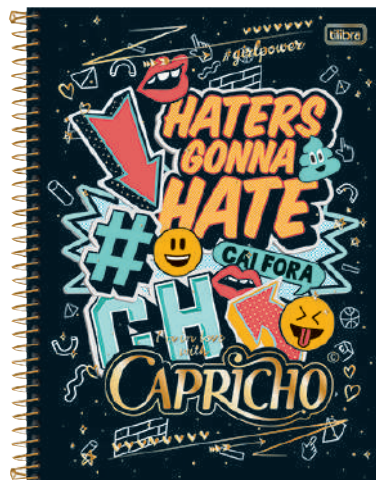

Portadas impresas a todo color laminado brillo. Encuadernación espiral color dorado con terminación coil-lock. Incluye: bolsa portapapeles de 180 g., hoja de pegatinas y hoja para datos personales.

Capas laminadas impresas a cores. Encadernação em espiral dourada com terminação em bobina. Inclui: saco para prancheta de 180 g, folha de adesivos e folha de dados pessoais.

CÓDIGO	MEDIDAS (mm.)	HOJAS	RAYADO	COLOR CUBIERTA	ENVASE PAQ./CAJA
002467	110 x 154	80	Cuadrícula 4 x 4 mm.	4 Diseños surtidos	8 / 96
002464	140 x 200	80	Cuadrícula 4 x 4 mm.	4 Diseños surtidos	5 / 40
002470	200 x 275	80	Cuadrícula 4 x 4 mm.	4 Diseños surtidos	4 / 32

BLOC ESPIRAL MICROPERFORADO "LOVE PINK"

80 Hojas - 70 g.

70 G.





Portadas impresas a todo color laminado brillo. Encuadernación espiral color dorado con terminación coil-lock. Incluye: bolsa portapapeles de 180 g., hoja de pegatinas y hoja para datos personales.

Capas laminadas impresas a cores. Encadernação em espiral dourada com terminação em bobina. Inclui: saco para prancheta de 180 g, folha de adesivos e folha de dados pessoais.

CÓDIGO	MEDIDAS (mm.)	HOJAS	RAYADO	COLOR CUBIERTA	ENVASE PAQ./CAJA
002468	110 x 154	80	Cuadrícula 4 x 4 mm.	4 Diseños surtidos	8 / 96
002465	140 x 200	80	Cuadrícula 4 x 4 mm.	4 Diseños surtidos	5 / 40
002471	200 x 275	80	Cuadrícula 4 x 4 mm.	4 Diseños surtidos	4 / 32



CONTENIDO DE LOS BLOCS ESPIRAL

-  Incluyen: doble bolsillo portapapeles de 180 g., hoja de pegatinas y hoja para datos personales.
-  Eles incluem: bolso de prensa dupla 180g, folha de adesivos e folha de dados pessoais.



Datos personales

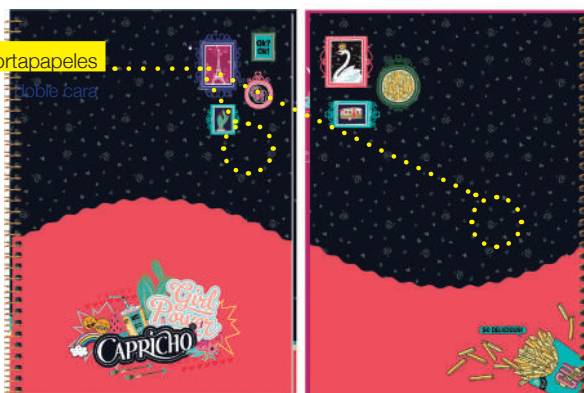

Bolsa portapapeles

doble cara

Cuadrícula 4 mm.

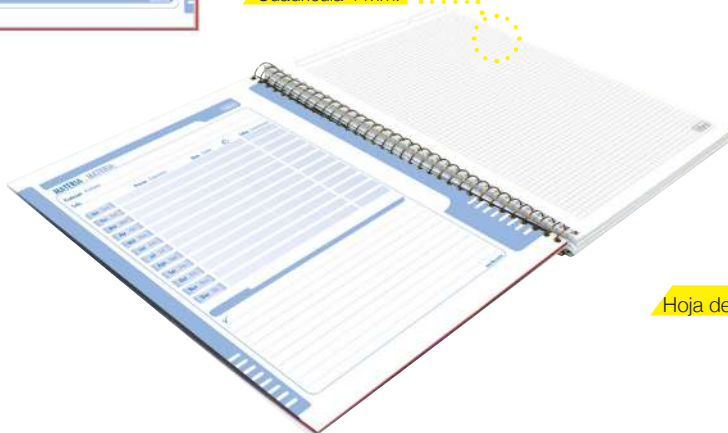





Hoja de pegatinas



LIBRETA ENCUADERNADA FORRADA EN TELA

80 Hojas. - 80 g.

-  Cierre de goma elástica. Papel interior color beige. Con marcador.
-  Elastic rubber closure. Beige interior paper. With a bookmark.
-  Fechamento de borracha elástica. Papel interior bege. Com um marcador.
-  Chiusura in gomma elastica. Carta interna beige. Con un pennarello.

80 G.
A6



Rosas



Girl

CÓDIGO	MEDIDAS (mm.)	HOJAS	RAYADO	COLOR CUBIERTA	ENVASE PAQ./CAJA
002309	90 x 140	80	Horizontal	Girl	6 / 72
002311	90 x 140	80	Horizontal	Rosas	6 / 72



Los códigos en **color amarillo** permiten apertura de envase

LIBRETA DE BOLSILLO CON TAPAS DURAS FORRADAS "NOTEBOOK"

96 Hojas. - 80 g.

80 G.

A6



-  Portada con texto grabado. Cierre de goma elástica acabado glitter. Hojas color ivory. Incluye cinta marcapáginas del color de las tapas.
-  Cover with engraved text. Elastic rubber closure with glitter finish. Ivory colored leaves. Includes bookmark tape in the color of the caps.
-  Capa com texto gravado. Fecho de borracha elástica com acabamento glitter. Folhas de cor marfim. Inclui fita de marcador na cor das tampas.
-  Copertina con testo inciso. Chiusura in gomma elastica con finitura glitterata. Foglie color avorio. Include nastro segnalibro nel colore dei cappucci.

CÓDIGO	FORMATO	MEDIDAS (mm.)	HOJAS	RAYADO	COLOR CUBIERTA	ENVASE PAQ./CAJA
002958	A6	90 x 140	96	Liso		24 / 96
002959	A6	90 x 140	96	Liso		24 / 96
002960	A6	90 x 140	96	Liso		24 / 96

LIBRETA DE BOLSILLO DE TAPAS DURAS FORRADAS "JOURNAL"

96 Hojas. - 80 g.



80 G.

A5

A6



-  Portada con texto grabado color oro. Cierre de goma elástica del color de las tapas. Con 96 hojas de 80 g. Formatos A5 y A6. Hojas color ivory. Incluye cinta marcapáginas. Bolsillo expandible en la parte interior trasera.
-  Cover with engraved text in gold color. Elastic rubber closure in the color of the caps. With 96 sheets of 80 g. Formats A5 and A6. Ivory colored leaves. Includes bookmark ribbon. Expandable pocket on the inside back.
-  Capa com texto gravado na cor ouro. Fecho em borracha elástica na cor das tampas. Com 96 folhas de 80 g. Formatos A5 e A6. Folhas de cor marfim. Inclui fita de favoritos. Bolso expansível na parte interna das costas.
-  Copertina con testo inciso in colore oro. Chiusura in gomma elastica nel colore delle calotte. Con 96 fogli da 80 g. Formati A5 e A6. Foglie color avorio. Include nastro segnalibro. Tasca espandibile sul retro interno.





CÓDIGO	FORMATO	MEDIDAS (mm.)	HOJAS	RAYADO	COLOR CUBIERTA	ENVASE PAQ./CAJA
002966	A6	90 x 140	96	Liso		Exp. 10 piezas
002967	A5	130 x 210	96	Cuadrícula de puntos		Exp. 10 piezas

LIBRETA VOCABULARIO IDIOMAS

80 Hojas. - 80 g.

80 G.



-  Libreta de espiral con 80 hojas de 80 g. color ivory. Hoja interior con printing "vocabulario" y "significado".
-  Spiral notebook with 80 sheets of 80 g. ivory color. Inside sheet with "vocabulary" and "meaning" printing.
-  Caderno em espiral com 80 folhas de 80 g. cor de marfim. Folha interior com impressão de "vocabulário" e "significado".
-  Quaderno a spirale con 80 fogli da 80 g. colore avorio. Foglio interno con la stampa del "vocabolario" e del "significato".

CÓDIGO	MEDIDAS (mm.)	HOJAS	COLOR CUBIERTA	ENVASE PAQ./CAJA
002957	73 x 130	80		6 / 160



BLOC DE NOTAS "RAINBOW"

Portada tacto peluche

🇪🇸 Tapa acolchada y forrada de tela tacto peluche. Aplicaciones de lentejuelas y estrellas brillantes en la portada. Doble cinta marcapáginas con pompones. 64 hojas de 80 g. color blanco. Rayado horizontal.

🇬🇧 Padded lid lined with plush-touch fabric. Sequin appliques and sparkling stars on the cover. Double ribbon bookmark with pompoms.

🇵🇹 Tampa acolchoada forrada com tecido de pelúcia. Apliques de lentejoulas e estrelas cintilantes na capa. Marcador de fita dupla com pompons.

🇮🇹 Coperchio imbottito rivestito in tessuto felpato. Applicazioni di paillettes e stelle scintillanti sulla copertina. Segnalibro doppio nastro con pompon.



80 G.

A5

CÓDIGO	MEDIDAS mm.	ENVASE
002968	130 x 180	1 / 12

LIBRETA DE ESPIRAL DE TAPA DURA FORRADA EN TELA

80 Hojas - 100 g.

🇪🇸 Tapa dura forrada en tela. Estampado y espiral en color cobre. Papel interior de 100 g. 80 hojas.

🇬🇧 Hard cover lined in fabric. Stamped and spiral in copper colour. 100 g inner paper 80 sheets.

🇵🇹 Capa dura revestida em tecido. Estampado e espiral em cor de cobre. Papel interno de 100 g 80 folhas.

🇮🇹 Copertina rigida rivestita in tessuto Timbrato e spirale in color rame. 100 g di carta interna 80 fogli.



100 G.

A6

CÓDIGO	FORMATO	MEDIDAS (mm.)	HOJAS	RAYADO	COLOR CUBIERTA	ENVASE PAQ./CAJA
002524	A6	105 x 148	80	Horizontal	● Marrón	24 / 96

LIBRETA ENCUADERNADA DE TAPAS DURAS FORRADAS "MY BULLET JOURNAL"

80 Hojas. - 100 g.

🇪🇸 Libreta con letras estampadas en oro. Cierre de goma elástica color dorado. Con cuadrícula de puntos, 80 hojas de 100 g. Formato de A5. Hojas de color blanco. Incluye cinta marcapáginas.

🇬🇧 Notebook with gold stamped letters. Golden elastic rubber closure. With dot grid, 80 sheets of 100 g. A5 format. White sheets. Includes bookmark ribbon.

🇵🇹 Caderno com letras estampadas em ouro. Fecho de borracha elástica dourada. Com grelha de pontos, 80 folhas de 100 g. Formato A5. Folhas brancas. Inclui fita de favoritos.

🇮🇹 Taccuino con lettere stampate in oro. Chiusura in gomma elastica dorata. Con griglia a punti, 80 fogli da 100 g. Formato A5. Foglie bianche. Include nastro segnalibro.



100 G.

A5

CÓDIGO	FORMATO	MEDIDAS (mm.)	HOJAS	RAYADO	COLOR CUBIERTA	ENVASE PAQ./CAJA
002964	A5	140 x 200	80	Cuadrícula de puntos	●	12 / 24
002965	A5	140 x 200	80	Cuadrícula de puntos	○	12 / 24



Los códigos en color amarillo permiten apertura de envase

LIBRETA DE BOLSILLO CON TAPAS DURAS FORRADAS MENSAJE

80 Hojas. - 100 g.

100 G.

A5



🇪🇸 Libreta con frase grabada color oro en las tapas. Cinta marcapáginas y cierre de goma elástica del color de las tapas. Con cuadrícula de puntos, 80 hojas de 100 g. Formato de A5. Hojas de color blanco.

🇬🇧 Notebook with a phrase engraved in gold on the covers. Bookmark ribbon and elastic rubber closure in the color of the caps. With dotted grid, 80 sheets of 100 g. A5 format. White sheets.

🇵🇹 Caderno com uma frase gravada em ouro nas capas. Fita de marcador e fecho de borracha elástica na cor das gorros. Com grelha pontilhada, 80 folhas de 100 g. Formato de A5. Folhas brancas.

🇮🇹 Taccuino con una frase incisa in oro sulle copertine. Nastro segnalibro e chiusura in gomma elastica nel colore dei cappucci. Con griglia tratteggiata, 80 fogli da 100 g. Formato A5. Foglie bianche.

CÓDIGO	FORMATO	MEDIDAS (mm.)	HOJAS	RAYADO	COLOR CUBIERTA	ENVASE PAQ./CAJA
002961	A5	140 x 200	80	Cuadrícula de puntos	●	12 / 24
002962	A5	140 x 200	80	Cuadrícula de puntos	●	12 / 24
002963	A5	140 x 200	80	Cuadrícula de puntos	●	12 / 24

BLOC ESPIRAL SUPERIOR TAPA BÁSICA

Formato apaisado. 48 Hojas - 80 g.

80 G.



🇪🇸 Espiral superior. 6 diseños diferentes. Papel interior color crema. Rayado horizontal.

🇬🇧 Upper spiral 6 different designs. Cream coloured interior paper. Horizontal scratching.

🇵🇹 Espiral superior 6 designs diferentes. Papel interior colorido creme. Arranhões horizontais.

🇮🇹 Spirale superiore 6 diversi modelli. Carta interna color crema. Scratch orizzontale.

CÓDIGO	MEDIDAS (mm.)	HOJAS	RAYADO	COLOR CUBIERTA	ENVASE PAQ./CAJA
002453	105 x 141	48	Horizontal	6 Diseños surtidos	6 ud. / 180 ud.



Campus[®]

University



AGENDA INTERIOR FANTASÍA

DÍA PÁGINA

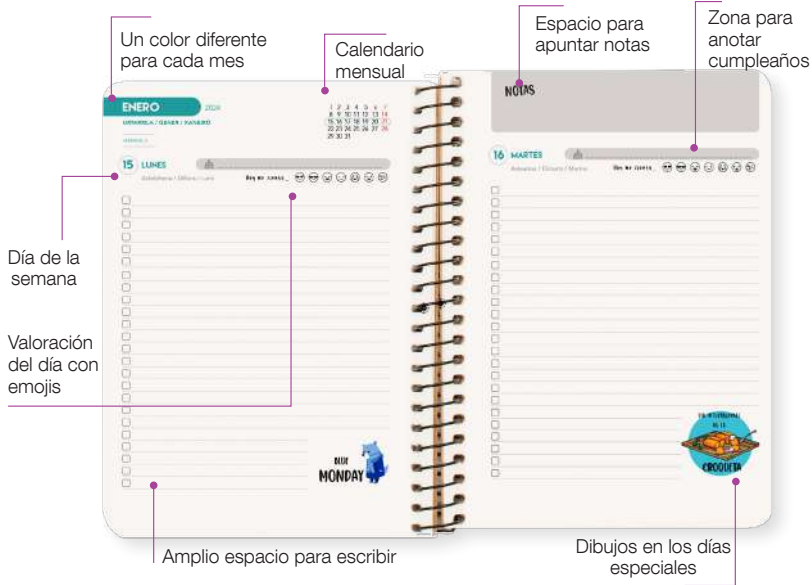

Pegatinas

4 hojas de pegatinas para decorar tu agenda



Hojas interiores



Calendario



Datos personales



Destacados por mes



Horarios



Exámenes



Entretenimiento



Gastos



Notas



AGENDA INTERIOR ESTÁNDAR

DÍA PÁGINA

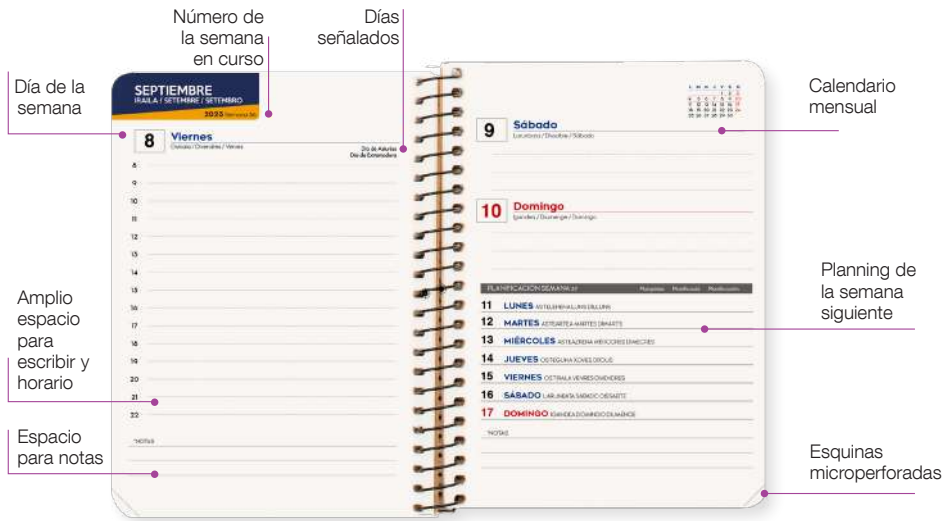

SEMANA VISTA

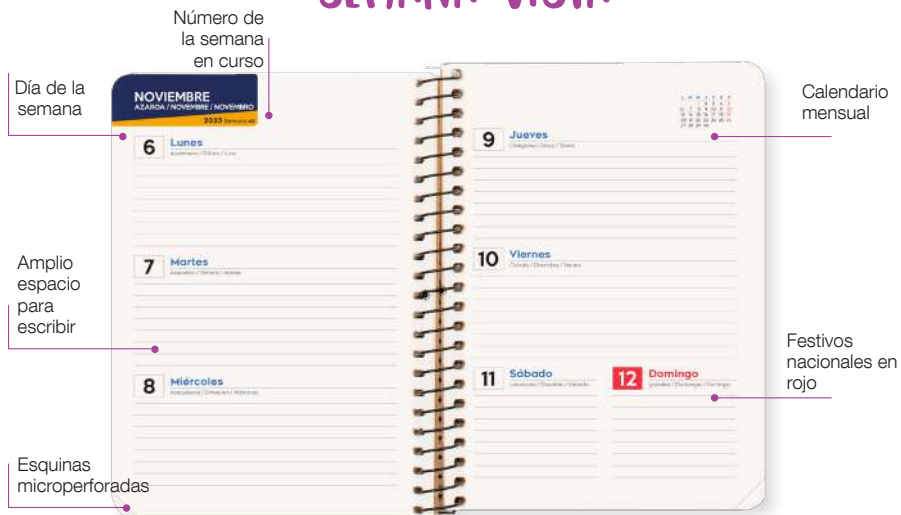

Pegatinas

4 hojas de pegatinas para decorar tu agenda



Calendario



Horarios



Exámenes

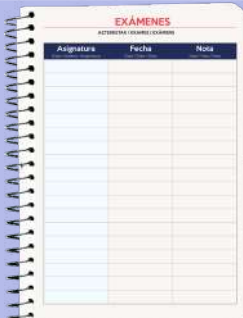

Notas



Los códigos en color amarillo permiten apertura de envase

AGENDA ESCOLAR A5 NUEVO ESTÁNDAR

Tapa forrada. 80 Hojas - 80 g.

NEW!!

CUBIERTAS:

- Tapas cartón forrada.
- Impresas a todo color.
- Cantos redondeados.

PAPEL INTERIOR: 80 g

Nº HOJAS: 80

ENCUADERNACIÓN: espiral Coil Lock negro.

CIERRE: goma plana color 8 mm.

FORMATOS: A5

MODELOS: 6

INTERIOR:

- Semana vista
- 4 páginas de pegatinas.

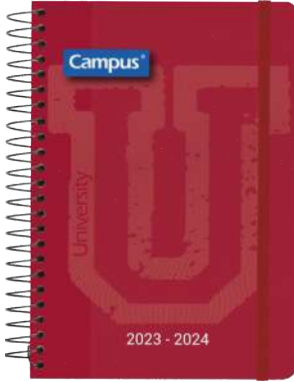

"University Rojo"

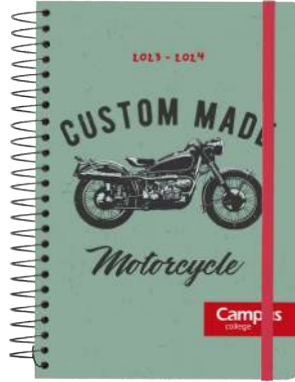

"Motorcycle"



"Just Keep Pedaling"



"Best Playlist"



"University Negro"



"Malditos Bichos"

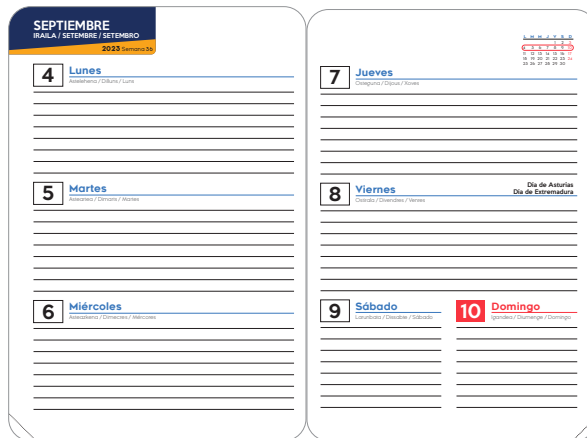

INTERIOR A5
SEMANA VISTA **ESTÁNDAR**



CÓDIGO	FORMATO	MEDIDAS (mm.)	HOJAS	INTERIOR	COLOR CUBIERTA	ENVASE PAQ./CAJA
003439	A5	140 x 195	80	SEMANA VISTA	6 diseños ESTÁNDAR	6 / 48



CUBIERTAS:

- Tapa polipropileno.
- Impresas a todo color.
- Cantos redondeados.

PAPEL INTERIOR: 80 g

Nº HOJAS: 160

ENCUADERNACIÓN: espiral transparente.

CIERRE: goma redonda color.

FORMATOS: A6+

MODELOS: 12 (6 fantasía, 6 estándar)

INTERIOR:

- Día página.
- 4 páginas de pegatinas.

AGENDA ESCOLAR A6+

Tapa polipropileno. 160 Hojas - 80 g.

NEW!!



"Malditos Bichos"



"Just Keep Pedaling"



"Tropical"



INTERIOR A6+ DÍA PÁGINA
DISEÑO FANTASÍA

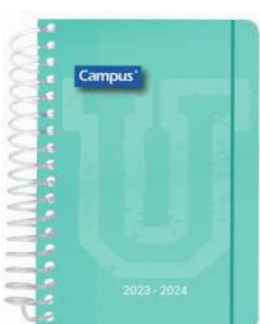

"University Verde"



"Let's Rock"



"Osaka"

NEW!!



"University Azul"



"Best Playlist"



"University Rojo"

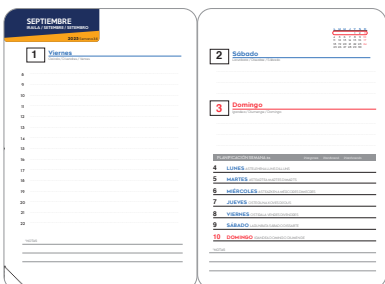

INTERIOR A6+ DÍA PÁGINA
DISEÑO ESTÁNDAR



"Unlimited"



"University Negro"



"Motorcycle"

CÓDIGO	FORMATO	MEDIDAS (mm.)	HOJAS	INTERIOR	COLOR CUBIERTA	ENVASE PAQ./CAJA
003437	A6+	115 x 168	160	DÍA PÁGINA	6 diseños FANTASÍA	6 / 36
003438	A6+	115 x 168	160	DÍA PÁGINA	6 diseños ESTÁNDAR	6 / 36



Los códigos en color amarillo permiten apertura de envase

AGENDA ESCOLAR A5

Tapa extradura. 160 Hojas - 80 g.

NEW!!

CUBIERTAS:

- Tapas cartón forrada.
- Impresas a todo color.
- Cantos redondeados.

PAPEL INTERIOR: 80 g

Nº HOJAS: 160

ENCUADERNACIÓN: espiral Coil Lock negro.

CIERRE: goma plana color 8 mm.

FORMATOS: A5

MODELOS: 8 (4 fantasía, 4 estándar)

INTERIOR:

- Día página.
- 4 páginas de pegatinas.

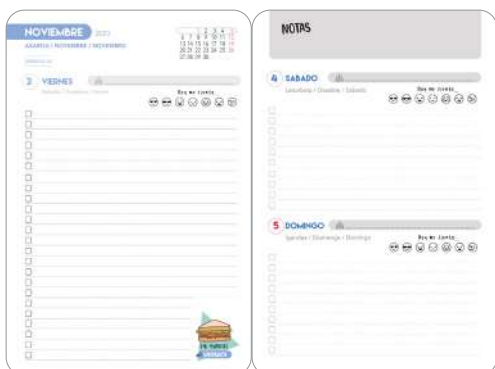

INTERIOR A5 DÍA PÁGINA
DISEÑO FANTASÍA



"Osaka"



"Let's Rock"



"Tropical"

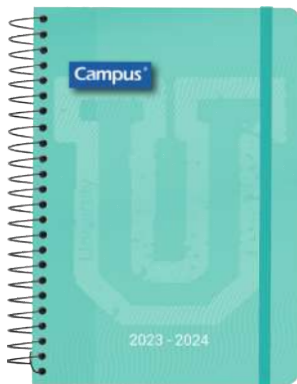

"University Verde"

NEW!!

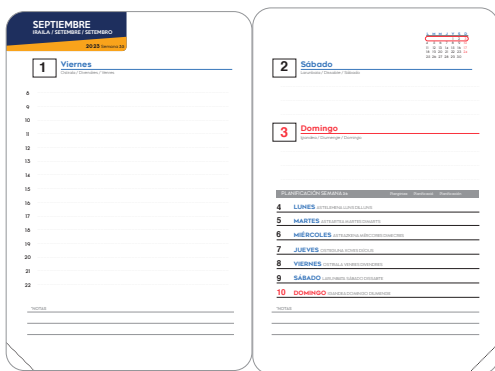

INTERIOR A5 DÍA PÁGINA
DISEÑO ESTÁNDAR

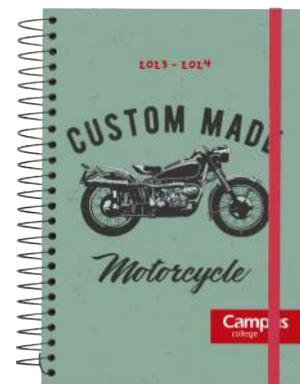

"Motorcycle"



"Best Playlist"

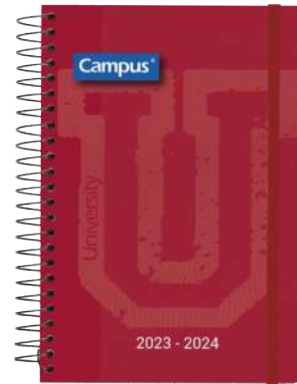

"University Rojo"

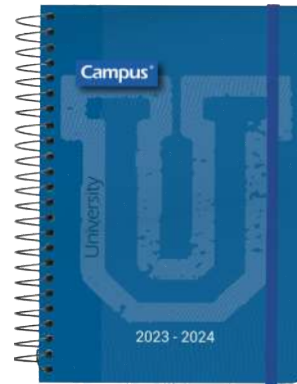

"University Azul"

CÓDIGO	FORMATO	MEDIDAS (mm.)	HOJAS	INTERIOR	COLOR CUBIERTA	ENVASE PAQ./CAJA
003443	A5	140 x 195	160	DÍA PÁGINA	4 diseños FANTASÍA	4 / 32
003444	A5	140 x 195	160	DÍA PÁGINA	4 diseños ESTÁNDAR	4 / 32



AGENDA ESCOLAR A5

New!!

Tapa polipropileno. 160 Hojas - 80 g.

CUBIERTAS:

- Tapas polipropileno.
- Impresas a todo color.
- Cantos redondeados.

PAPEL INTERIOR: 80 g

N° HOJAS: 160

ENCUADERNACIÓN: espiral transparente.

CIERRE: goma redonda color.

FORMATOS: A5

MODELOS: 8 (4 fantasía, 4 estándar)

INTERIOR:

- Día página.
- 4 páginas de pegatinas.



"Malditos Bichos"



"Just Keep Pedaling"

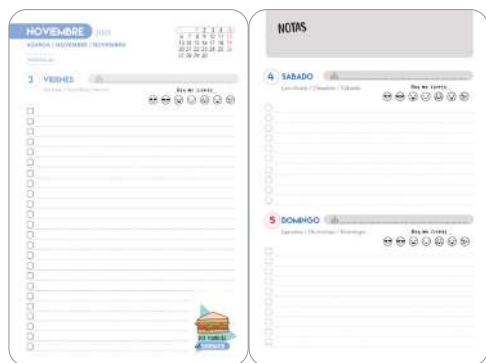

INTERIOR A5 DÍA PÁGINA
DISEÑO FANTASÍA



"Best Playlist"



"University Rojo"



"Let's Rock"



"University Azul"

New!!

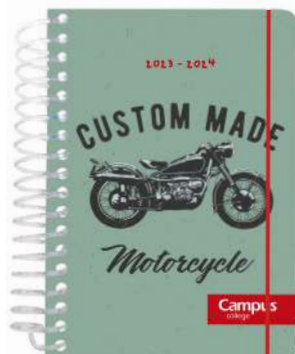

"Motorcycle"



"Unlimited"

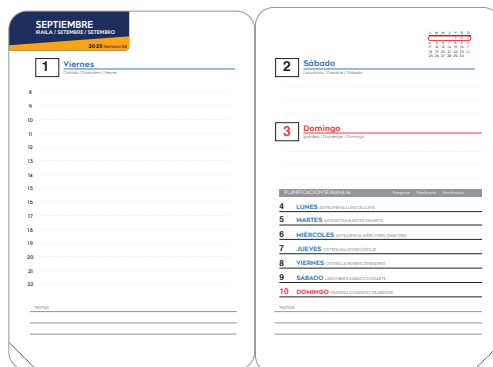

INTERIOR A5 DÍA PÁGINA
DISEÑO ESTÁNDAR

CÓDIGO	FORMATO	MEDIDAS (mm.)	HOJAS	INTERIOR	COLOR CUBIERTA	ENVASE PAQ./CAJA
003440	A5	140 x 195	160	DÍA PÁGINA	4 diseños FANTASÍA	4 / 32
003441	A5	140 x 195	160	DÍA PÁGINA	4 diseños ESTÁNDAR	4 / 32



Los códigos en **color amarillo** permiten apertura de envase

EXPOSITOR AGENDAS ESCOLARES A6+

12 UNIDADES. 160 Hojas - 80 g.

NEW!!

CONTENIDO:

- 12 Modelos (6 fantasía, 6 estándar)
- Tapas polipropileno, A6+



INTERIOR A6+ DÍA PÁGINA
DISEÑO FANTASÍA

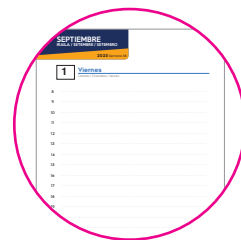

INTERIOR A6+ DÍA PÁGINA
DISEÑO ESTÁNDAR

CÓDIGO	FORMATO	MEDIDAS (mm.)	HOJAS	INTERIOR	COLOR CUBIERTA	ENVASE
003442	A6+	115 x 168	160	DÍA PÁGINA	12 diseños surtidos	Expositor 12 ud.

¡HOJAS DE PEGATINAS!

4 páginas de pegatinas por cada agenda



Pegatinas FANTASÍA



Pegatinas ESTÁNDAR



- 150 clips de 28 mm en caja transparente con forma de panda.
- 150 clips of 28mm in transparent panda box.
- 150 cliques de 28 mm numa caixa panda transparente.
- 150 clip da 28 mm in una scatola di panda trasparente.

CÓDIGO	COLORES	ENVASE
862529	●●●●●●○●●●●●●	1 / 12



CLIPS PANDA

7 colores surtidos

- 16 pinzas sujetapapeles de 19mm en 4 colores surtidos.
- 16 paper clips of 19mm in 4 different colours.
- 16 cliques de papel de 19mm em 4 cores sortidas.
- 16 graffette da 19 mm in 4 colori assortiti.

CÓDIGO	COLORES	ENVASE
862530	●●●●	1 / 12



PINZAS SUJETAPAPELES PANDA

4 colores surtidos

SET DE ESCRITORIO "LLAMA"

Set de 5 piezas.

- Juego de escritorio de 5 piezas compuesto por un bolígrafo, un bloc de notas adhesivas, una libreta, una lista de la compra y una carpeta con miniclip.
- Desktop set of 5 pieces composed by a pen, sticky notes, a notepad, a shopping list and a folder with miniclip.
- Conjunto de 5 peças de mesa composto por uma caneta, um bloco de notas adesivas, um caderno, uma lista da compra e uma pasta com miniclip.
- Set da 5 pezzi composto da una penna a sfera, un blocco note appiccicoso, un taccuino, una lista della spesa e una cartella con il miniclip.







CÓDIGO	COMPOSICIÓN	ENVASE
002627	5 piezas	1 / 12 sets



SET DE ESCRITORIO

Set de 3 piezas.







-  Juego de escritorio de 3 piezas compuesto por un bloc de notas adhesivas, un bolígrafo y una lista de la compra.
-  Desktop set of 3 pieces composed by a sticky notes, a pen and a shopping list.
-  Conjunto de 3 peças de mesa composto por um bloco de notas adesivas, uma caneta e uma lista da compra.
-  Set da 3 pezzi composto da un blocco note appiccicoso, una penna e una lista della spesa.

CÓDIGO	COMPOSICIÓN	ENVASE
003270	3 piezas	1 / 12 sets

SET DE ESCRITORIO "PASTEL"

Set de 7 piezas.







-  Juego de escritorio de 7 piezas compuesto por un bolígrafo, un bloc A5, un bloc de notas adhesivas, una libreta A6 y tres pinzas reversibles doradas.
-  Desktop set of 7 pieces composed by a pen, A5 notebook, sticky notes, A6 pad and 3 golden foldback clips.
-  Conjunto de 7 peças de mesa composto por uma caneta, um caderno A5, um bloco de notas adesivas, bloco A6 e 3 clips dobráveis dourados.
-  Set da 7 pezzi composto da una penna a sfera, un blocco note A5, un blocco note appiccicoso, un blocco note A6 e tre clip dorate reversibili.

CÓDIGO	COMPOSICIÓN	ENVASE
003271	7 piezas	1 / 12 sets

SET DE ESCRITORIO "WATERCOLOR"

Set de 3 piezas.







-  Juego de escritorio de 3 piezas compuesto por un planning semanal de 80 hojas de 80 g., un lápiz con goma y una lista de la compra.
-  Desktop set of 3 pieces composed by a weekly planner of 80 sheets (80 g.), a pencil with rubber and a shopping list.
-  Conjunto de 3 peças de mesa composto por um planning semanal de 80 folhas (80 g), um lápis com borracha e uma lista da compra.
-  3-piece desk set consisting of a 80-sheet 80-sheet weekly schedule, a pencil with a rubber band and a shopping list.

CÓDIGO	COMPOSICIÓN	ENVASE
002626	3 piezas	1 / 12 sets



SET DE ESCRITORIO NOTAS

Set de 8 piezas.



-  Juego de escritorio de 8 piezas compuesto por 8 modelos diferentes de notas adhesivas en varios tamaños. 40 hojas, 80 g.
-  Desktop set of 8 pieces composed by 8 different models and sizes of sticky notes. 40 sheets, 80 g.
-  Conjunto de 8 peças de mesa composto por 8 modelos diferentes de notas em vários tamanhos. 40 folhas, 80 g.
-  8-piece desk set composed of 8 different models of sticky notes in various sizes. 40 sheets, 80 g.



CÓDIGO	MODELO	ENVASE
003269	PÁJAROS	1 / 12 sets

ORGANIZADORES SEMANALES

Set de 5 piezas.

-  Planning semanal 52 hojas de 80 g. y notas adhesivas.
-  Weekly planner. 52 sheets of 80 g. and sticky notes.
-  Planning semanal 52 folhas de 80 g. e notas pegajosas.
-  Pianificazione settimanale 52 fogli da 80 g. e note adesive.

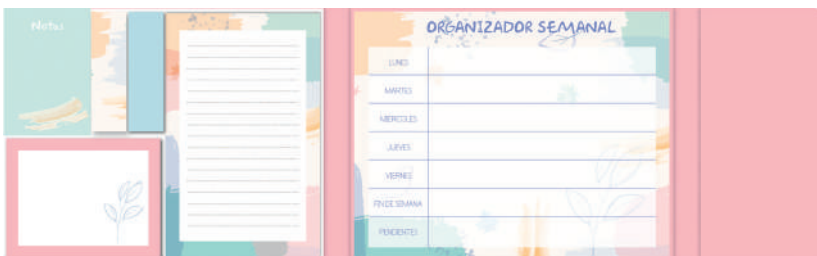
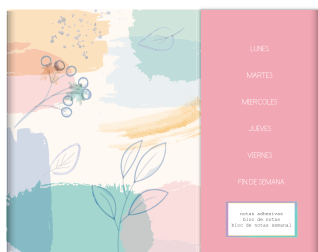
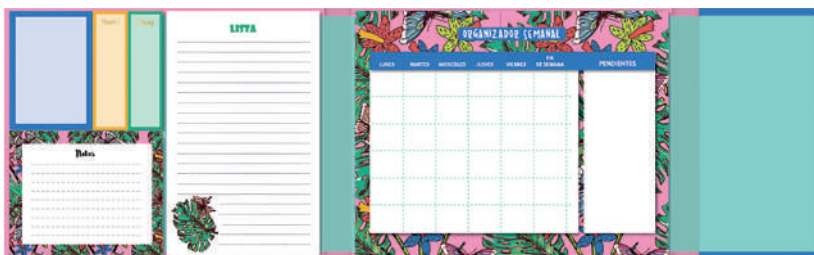

CÓDIGO	MODELO	COMPOSICIÓN	ENVASE
003272	FANTASTIC	6 piezas	1 / 12 sets
003273	PASTEL	6 piezas	1 / 12 sets
003274	PÁJARO	6 piezas	1 / 12 sets



Los códigos en **color amarillo** permiten apertura de envase

SET DE PAPELERÍA

Set de 23 piezas.



● Compuesto por: 1 bloc de notas motivos florale (11,4 x 6,9 cm.), 1 bloc de notas color azul (7,8 x 5,8 cm.), 3 lápices de grafito, 3 pinzas metálicas doradas, 1 rollo de cinta adhesiva de papel color azul, 1 afilalápiz metálico dorado, 1 goma de borrar, 3 clips dorados en forma de corazón, 9 agujas señalizadoras color azul pastel.

🇬🇧 Consisting of: 1 florale motif notepad (11.4 x 6.9 cm.), 1 blue notepad (7.8 x 5.8 cm.), 3 graphite pencils, 3 gold metal clips, 1 roll of blue paper tape, 1 gold metallic pencil sharpener, 1 eraser, 3 gold heart-shaped clips, 9 pastel blue marker needles.

● Composto por: 1 bloco de notas com motivos florais (11,4 x 6,9 cm), 1 bloco de notas azul (7,8 x 5,8 cm), 3 lápis de grafite, 3 cliques de metal dourado, 1 rolo de fita de papel azul, 1 metálico dourado apontador de lápis, 1 borraça, 3 cliques de ouro em forma de coração, 9 agulhas de marcador azul pastel.

● Composto da: 1 blocco note con motivi floreali (11,4 x 6,9 cm.), 1 blocco note blu (7,8 x 5,8 cm.), 3 matite grafite, 3 clip in metallo dorato, 1 rotolo di nastro di carta blu, 1 oro metallizzato temperamatite, 1 gomma, 3 fermagli dorati a forma di cuore, 9 pennarelli blu pastello.

CÓDIGO	MEDIDAS (mm.)	ENVASE
002969	215 x 165 x 27	1 / 12 sets

SET DE PAPELERÍA ORGANIZADOR

Set de 3 piezas.



● Contiene: 1 bloc de notas TO DO LIST (11,5 x 21 cm.), 1 bloc de notas WEEK (15 x 12 cm.), 1 bloc de notas REMINDER (15 x 9 cm.)

🇬🇧 Contains: 1 TO DO LIST notepad (11.5 x 21 cm.), 1 WEEK notepad (15 x 12 cm.), 1 REMINDER notepad (15 x 9 cm.)

● Contém: 1 bloco de notas TO DO LIST (11,5 x 21 cm.), 1 bloco de notas WEEK (15 x 12 cm.), 1 bloco de notas REMINDER (15 x 9 cm.)

● Contiene: 1 blocco note TO DO LIST (11,5 x 21 cm.), 1 blocco note SETTIMANA (15 x 12 cm.), 1 blocco note PROMEMORIA (15 x 9 cm.)

CÓDIGO	MEDIDAS (mm.)	ENVASE
002970	265 x 210	1 / 12 sets

SET DE PAPELERÍA ORGANIZADOR SEMANAL

Set de 35 piezas.



● Contiene: 1 organizador semanal (29,2 x 21 cm.), 30 clips dorados, 3 pinzas metálicas doradas, 1 bolígrafo estampado de tinta negra.

🇬🇧 Contains: 1 weekly organizer (29.2 x 21 cm.), 30 gold clips, 3 gold metal clips, 1 black ink stamped pen.





● Contém: 1 organizador semanal (29,2 x 21 cm.), 30 cliques de ouro, 3 cliques de metal ouro, 1 caneta estampada em tinta preta.

● Contiene: 1 organizer settimanale (29,2 x 21 cm.), 30 fermagli dorati, 3 fermagli in metallo dorato, 1 penna con inchiostro nero stampato.

CÓDIGO	COMPOSICIÓN	ENVASE
002971	35 piezas	1 / 12 sets



EXPOSITORES PAPEL DE REGALO

-  Papel de regalo en diseños surtidos. Medidas del rollo 0,70 x 2 m.
-  Gift wrapping paper in assorted designs. Measurements of the roll 0,70 x 2 m.
-  Papel de embrulho em desenhos sortidos. Medidas do rolo 0,70 x 2 m.
-  Carta da regalo in disegni assortiti. Misure del rotolo 0,70 x 2 m.

Surtido 1







Surtido 2



CÓDIGO	SURTIDO	ENVASE
003066	Surtido 1	Exp. 60 ud.
003067	Surtido 2	Exp. 60 ud.

EXPOSITOR PAPEL DE REGALO INFANTIL

-  Papel de regalo en diseños surtidos. Medidas del rollo 0,70 x 2 m.
-  Gift wrapping paper in assorted designs. Measurements of the roll 0,70 x 2 m.
-  Papel de embrulho em desenhos sortidos. Medidas do rolo 0,70 x 2 m.
-  Carta da regalo in disegni assortiti. Misure del rotolo 0,70 x 2 m.







CÓDIGO	ENVASE
003068	Exp. 60 ud.



Los códigos en **color amarillo** permiten apertura de envase

EXPOSITOR PAPEL DE REGALO NAVIDAD

-  Papel de regalo en diseños surtidos. Medidas del rollo 0,70 x 2 m.
-  Gift wrapping paper in assorted designs. Measurements of the roll 0,70 x 2 m.
-  Papel de embrulho em desenhos sortidos. Medidas do rolo 0,70 x 2 m.
-  Carta da regalo in disegni assortiti. Misure del rotolo 0,70 x 2 m.







CÓDIGO	ENVASE
003218	Exp. 60 ud.

COCAS METALIZADAS

Con autoadhesivo







-  Cintas metalizadas. Variedad de colores.
-  Metallic strips. Assorted colours.
-  Fita metalizada. Cores sortidas.
-  Nastri metallizzato. Varietà di colori.

CÓDIGO	TAMAÑO	ENVASE
001768	Pequeño	100

BOLSA DE PAPEL RAYAS

Reforzada. Con asa de cordón



-  Bolsa de papel de 128 g. Colores surtidos.
-  128 g paper bag. Assorted colours.
-  Saco de papel de 128 g. Cores variados.
-  Sacchetto di carta da 128 g Colori assortiti

CÓDIGO	MEDIDAS	ENVASE
029096	33 x 43 x 10 cm.	12 ud.





11

BLOCS Y CUADERNOS

NOTEBOOKS AND PADS

BLOCOS E CADERNOS

BLOC E CUADERNOS



TIPOS DE CUBIERTA

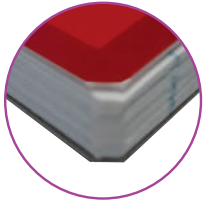

TAPA BLANDA PAPEL 60/70/90G 48/80 HOJAS

Cubiertas:
cartón 300g.
Contracubierta:
cartón 400g.
Tipo de hoja:
normal.
Formatos:
A4, A5, 16°, 12° y 8°.

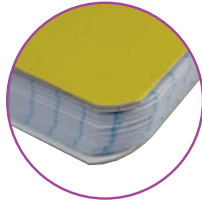

TAPA DURA PAPEL 60/70G 80/160 HOJAS

Cubiertas:
cartón 700g.
Contracubierta:
cartón 700g.
Tipo de hoja:
normal, microperforada
4 taladros.
Formatos:
A5 y A4.

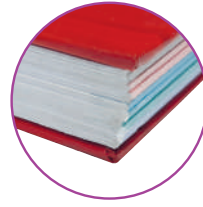

TAPA FORRADA PAPEL 70/90G 80/120/160 HOJAS

Cubiertas:
encuadrada 1100g.
Contracubierta:
encuadrada 1100g.
Tipo de hoja:
normal, microperforada
4 taladros.
Formatos:
A5 y A4.

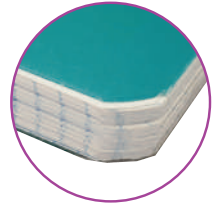

TAPA POLIPROPILENO PAPEL 60/70/90G 48/80/120 HOJAS

Cubiertas:
PP 300/500/700g. a todo color.
Contracubierta:
PP 300/500/700g. a todo color.
Tipo de hoja:
normal, microperforada, 4
taladros.
Formatos:
A4, A5, A6, A7, 16°, 12° y 8°.

TIPOS DE ENCUADERNACIÓN



ESPIRAL

Permite giro de
360°. Sistema
Coil-Lock para
evitar enganches.



GRAPADO

Encuadración
grapada en el
lomo, tipo revista.

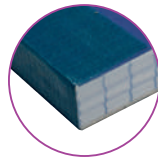

ENCOLADO

Lomo encolado
que permite
arrancar hojas
sin dañarlas.

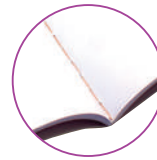

COSIDO

Pliegos de
hojas cosidos,
y encolados al
lomo.

ÍNDICE DE SÍMBOLOS



Gramaje



Formato



Número
de hojas



Con margen



Microperforado



Hoja con
taladros



Hoja con
taladros y
microperforado



Sistema
Coil-Lock



Apaisado



Papel
100%
reciclable



Artículo
nuevo

TIPOS DE RAYADOS DE BLOCS, CUADERNOS, LIBRETAS, ETC.

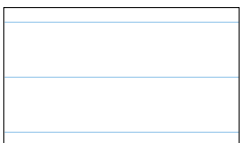

Horizontal

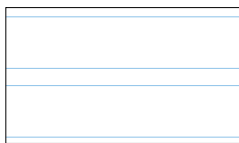

Doble raya 2,5

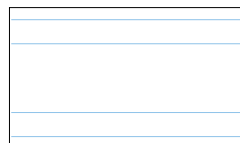

Doble raya 3,5

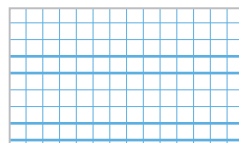

Cuadrícula 2,5 mm. C.P.

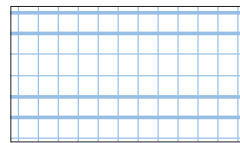

Cuadrícula 3 mm. C.P.

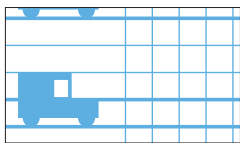

Cuadrícula 4 mm. C.P.

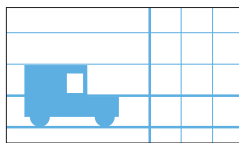

Cuadrícula 5 mm. C.P.

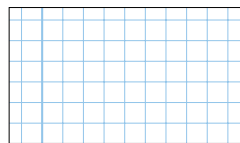

Cuadrícula 3 mm.

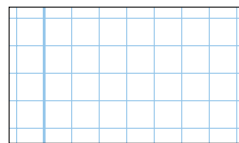

Cuadrícula 4 mm.

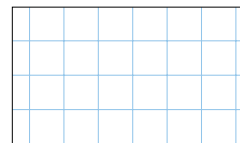

Cuadrícula 5 mm.



Cuadrícula 6 mm.

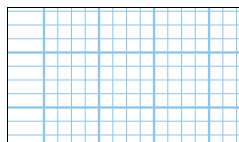

Milimetrado

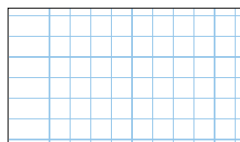

Milimetrado mod. 46

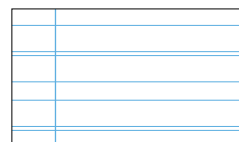

Montessori 3,5 mm.

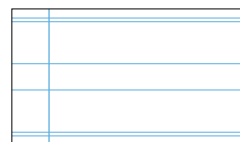

Montessori 5 mm.



LIBRETA GRAPADA CUADRÍCULA PAUTADA



TAPA POLIPROPILENO

CUBIERTAS:

- Tapas de polipropileno 300 g.
- Impresas a todo color.
- Cantos redondeados.

PAPEL INTERIOR: 90 g.

Nº HOJAS: 48

ENCUADERNACIÓN: grapado.

FORMATOS: A5+ y A4

COLORES:



CÓDIGO	FORMATO	MEDIDAS (mm.)	HOJAS	RAYADO	COLOR CUBIERTA	ENVASE PAQ./CAJA
002753	A5+	170 x 220	48	C. Pautada 3 mm.	●●●●●●●●	6 / 72
002754	A5+	170 x 220	48	C. Pautada 4 mm.	●●●●●●●●	6 / 72
003316	A5+	170 x 220	48	C. Pautada 5 mm.	●●●●●●●●	6 / 72
002758	A4	210 x 297	48	C. Pautada 3 mm.	●●●●●●●●	6 / 72
002759	A4	210 x 297	48	C. Pautada 4 mm.	●●●●●●●●	6 / 72
002948	A4	210 x 297	48	C. Pautada 5 mm.	●●●●●●●●	6 / 72

LIBRETA GRAPADA CUADRÍCULA PAUTADA



TAPA CARTONCILLO

CUBIERTAS:

- Cartón flexible 300 g.
- Impresas a todo color.
- Cantos redondeados.

PAPEL INTERIOR: 90 g.

Nº HOJAS: 48

ENCUADERNACIÓN: grapado.

FORMATOS: A5+

COLORES:



CÓDIGO	FORMATO	MEDIDAS (mm.)	HOJAS	RAYADO	COLOR CUBIERTA	ENVASE PAQ./CAJA
002208	A5+	170 x 220	48	C. Pautada 3 mm.	●●●●●●●●	6 / 72
002209	A5+	170 x 220	48	C. Pautada 4 mm.	●●●●●●●●	6 / 72
003312	A5+	170 x 220	48	C. Pautada 5 mm.	●●●●●●●●	6 / 72



Los códigos en color amarillo permiten apertura de envase

BLOC DE ESPIRAL CUADRÍCULA PAUTADA

90g

TAPA POLIPROPILENO

Campus

CUBIERTAS:

- Tapas de polipropileno 700 g.
- Impresas a todo color.
- Cantos redondeados.

PAPEL INTERIOR: 90 g.

Nº HOJAS: 80

ENCUADERNACIÓN: espiral Coil-Lock.

FORMATOS: A5+ y A4

COLORES:

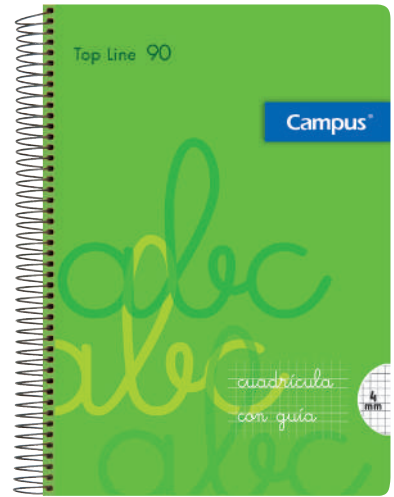
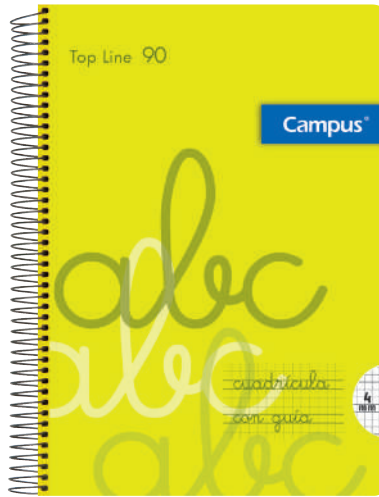
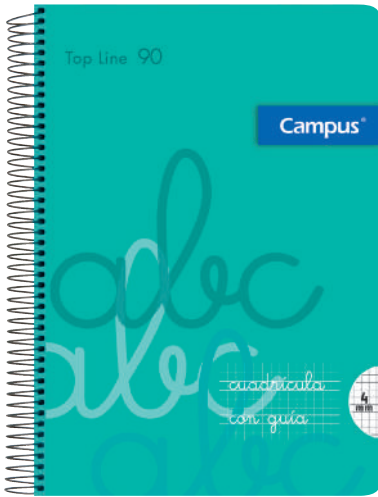
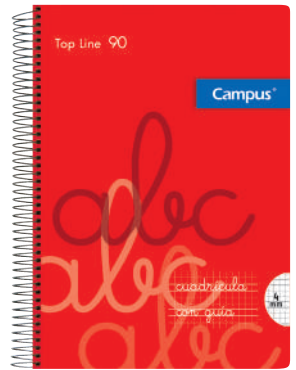
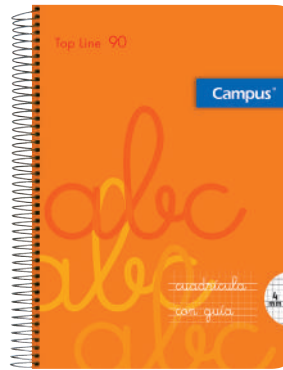
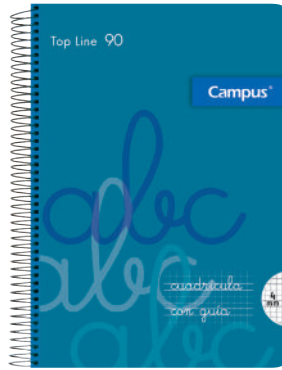

CÓDIGO	FORMATO	MEDIDAS (mm.)	HOJAS	RAYADO	COLOR CUBIERTA	ENVASE PAQ./CAJA
002764	A5+	170 x 220	48	C. Pautada 3 mm.	●●●●●●●●	5 / 50
002765	A5+	170 x 220	48	C. Pautada 4 mm.	●●●●●●●●	5 / 50
003317	A5+	170 x 220	48	C. Pautada 5 mm.	●●●●●●●●	5 / 50
003222	A4	210 x 297	48	C. Pautada 2,5 mm.	●●●●●●●●	6 / 24
002431	A4	210 x 297	48	C. Pautada 3 mm.	●●●●●●●●	6 / 24
002432	A4	210 x 297	48	C. Pautada 4 mm.	●●●●●●●●	6 / 24
002949	A4	210 x 297	48	C. Pautada 5 mm.	●●●●●●●●	6 / 24

RECAMBIOS CUADRÍCULA PAUTADA

90g

Campus

CUBIERTAS:

- Portada 120 g.
- Impresa a todo color.
- Cantos rectos.

PAPEL INTERIOR: 90 g, 4 taladros.

Nº HOJAS: 100

FORMATOS: A4

COLORES:

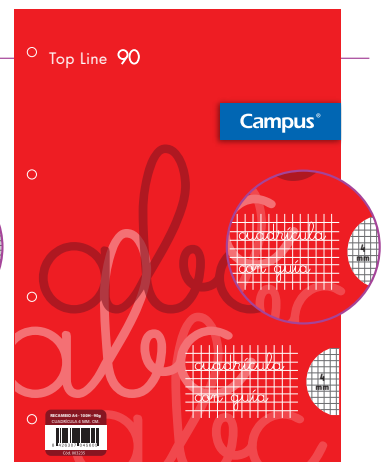
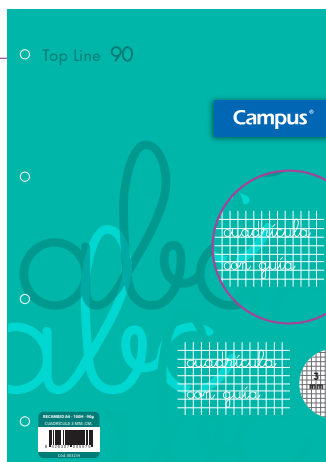

CÓDIGO	FORMATO	MEDIDAS (mm.)	HOJAS	RAYADO	COLOR CUBIERTA	ENVASE PAQ./CAJA
003234	A4	210 x 297	100	C. Pautada 3 mm.	●●●●●●●●	6 / 60
003235	A4	210 x 297	100	C. Pautada 4 mm.	●●●●●●●●	6 / 36



Los códigos en **color amarillo** permiten apertura de envase

BLOC DE ESPIRAL CUADRÍCULA PAUTADA



TAPA DURA

Campus

CUBIERTAS:

- Cartón 700 g.
- Impresas a todo color.
- Cantos rectos.

PAPEL INTERIOR: 70 g.

Nº HOJAS: 80

ENCUADERNACIÓN:

espiral Coil-Lock.

FORMATOS: A4

COLORES:

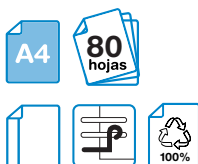

CÓDIGO	FORMATO	MEDIDAS (mm.)	HOJAS	RAYADO	COLOR CUBIERTA	ENVASE PAQ./CAJA
003225	A4	210 x 297	80	C. Pautada 2,5 mm.		6 / 36
003226	A4	210 x 297	80	C. Pautada 3 mm.		6 / 36
003227	A4	210 x 297	80	C. Pautada 4 mm.		6 / 36

BLOC DE ESPIRAL CUADRÍCULA PAUTADA



TAPA BÁSICA

Campus

CUBIERTAS:

- Cartón 350 g.
- Impresas a todo color.
- Cantos rectos.

PAPEL INTERIOR: 70 g.

Nº HOJAS: 80

ENCUADERNACIÓN:

espiral Coil-Lock.

FORMATOS: A5+ y A4

COLORES:

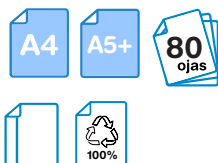

CÓDIGO	FORMATO	MEDIDAS (mm.)	HOJAS	RAYADO	COLOR CUBIERTA	ENVASE PAQ./CAJA
002367	A5+	170 x 220	80	C. Pautada 4 mm.		6 / 60
002368	A5+	170 x 220	80	C. Pautada 3 mm.		6 / 60
002306	A4	210 x 297	80	C. Pautada 3 mm.		6 / 36



Los códigos en **color amarillo** permiten apertura de envase

LIBRETA GRAPADA



TAPA POLIPROPILENO

Campus

CUBIERTAS:

- Tapas de polipropileno 300 g.
- Impresas a todo color.
- Cantos redondeados.

PAPEL INTERIOR: 90 g.

Nº HOJAS: 48

ENCUADERNACIÓN: grapado.

FORMATOS: A5+ y A4

COLORES:

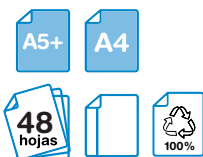

CÓDIGO	FORMATO	MEDIDAS (mm.)	HOJAS	RAYADO	COLOR CUBIERTA	ENVASE PAQ./CAJA
002747	A5+	170 x 220	48	Cuadrícula 4 mm.	●●●●●●●●	6 / 72
002748	A5+	170 x 220	48	Milimetrado mod.46	●●●●●●●●	6 / 72
002749	A5+	170 x 220	48	Doble raya 2,5 mm.	●●●●●●●●	6 / 72
002750	A5+	170 x 220	48	Horizontal	●●●●●●●●	6 / 72
002751	A5+	170 x 220	48	Milimetrado	●●●●●●●●	6 / 72
002752	A5+	170 x 220	48	Cuadrícula 3 mm.	●●●●●●●●	6 / 72
002755	A5+	170 x 220	48	Liso	●●●●●●●●	6 / 72
002756	A5+	170 x 220	48	Doble raya 3,5 mm.	●●●●●●●●	6 / 72
002993	A4	210 x 297	48	Cuadrícula 4 mm.	●	6 / 48
002994	A4	210 x 297	48	Cuadrícula 4 mm.	●	6 / 48
002995	A4	210 x 297	48	Cuadrícula 4 mm.	●	6 / 48
002996	A4	210 x 297	48	Cuadrícula 4 mm.	●	6 / 48
002553	A4	210 x 297	48	Cuadrícula 4 mm.	●●●●●●●●	6 / 48
002554	A4	210 x 297	48	Milimetrado mod.46	●●●●●●●●	6 / 48
002555	A4	210 x 297	48	Doble raya 2,5 mm.	●●●●●●●●	6 / 48
002556	A4	210 x 297	48	Horizontal	●●●●●●●●	6 / 48
002557	A4	210 x 297	48	Milimetrado	●●●●●●●●	6 / 48
002757	A4	210 x 297	48	Cuadrícula 3 mm.	●●●●●●●●	6 / 48
002760	A4	210 x 297	48	Liso	●●●●●●●●	6 / 48
002761	A4	210 x 297	48	Doble raya 3,5 mm.	●●●●●●●●	6 / 48



LIBRETA GRAPADA



TAPA CARTONCILLO

Campus

CUBIERTAS:

- Cartón flexible 300 g.
- Impresas a todo color.
- Cantos redondeados.

PAPEL INTERIOR: 90 g.

N° HOJAS: 48

ENCUADERNACIÓN: grapado.

FORMATOS: A5, A5+ y A4

COLORES:

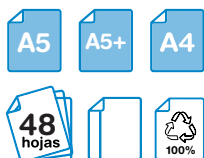

CÓDIGO	FORMATO	MEDIDAS (mm.)	HOJAS	RAYADO	COLOR CUBIERTA	ENVASE PAQ./CAJA
002162	A5	150 x 210	48	Cuadrícula 3 mm. C.P.	● ● ● ● ● ● ● ●	10 / 80
002201	A5+	170 x 220	48	Cuadrícula 4 mm.	● ● ● ● ● ● ● ●	6 / 72
002207	A5+	170 x 220	48	Cuadrícula 6 mm.	● ● ● ● ● ● ● ●	6 / 72
002202	A5+	170 x 220	48	Milimetrado	● ● ● ● ● ● ● ●	6 / 72
002204	A5+	170 x 220	48	Doble raya 3,5 mm.	● ● ● ● ● ● ● ●	6 / 72
002203	A5+	170 x 220	48	Horizontal	● ● ● ● ● ● ● ●	6 / 72
002205	A5+	170 x 220	48	Milimetrado mod.46	● ● ● ● ● ● ● ●	6 / 72
002206	A5+	170 x 220	48	Doble raya 2,5 mm.	● ● ● ● ● ● ● ●	6 / 72
002745	A5+	170 x 220	48	Liso	● ● ● ● ● ● ● ●	6 / 72
002146	A4	210 x 297	48	Cuadrícula 4 mm.	● ● ● ● ● ● ● ● ● ●	8 / 48
002152	A4	210 x 297	48	Cuadrícula 6 mm.	● ● ● ● ● ● ● ● ● ●	8 / 48
002149	A4	210 x 297	48	Milimetrado	● ● ● ● ● ● ● ● ● ●	8 / 48
002151	A4	210 x 297	48	Doble raya 3,5 mm.	● ● ● ● ● ● ● ● ● ●	8 / 48
002150	A4	210 x 297	48	Horizontal	● ● ● ● ● ● ● ● ● ●	8 / 48
002153	A4	210 x 297	48	Milimetrado mod.46	● ● ● ● ● ● ● ● ● ●	8 / 48
002164	A4	210 x 297	48	Doble raya 2,5 mm.	● ● ● ● ● ● ● ● ● ●	8 / 48
002746	A4	210 x 297	48	Liso	● ● ● ● ● ● ● ● ● ●	8 / 48
003314	A4	210 x 297	48	Montessori 3,5 mm.	● ● ● ● ● ● ● ● ● ●	8 / 48
003315	A4	210 x 297	48	Montessori 5 mm.	● ● ● ● ● ● ● ● ● ●	8 / 48



Los códigos en color amarillo permiten apertura de envase

BLOC DE ESPIRAL



TAPA POLIPROPILENO

Campus

CUBIERTAS:

- Tapas de polipropileno 700 g.
- Impresas a todo color.
- Cantos redondeados.

PAPEL INTERIOR: 90 g.

Nº HOJAS: 80

ENCUADERNACIÓN: espiral Coil-Lock.

FORMATOS: A5+ y A4

COLORES:

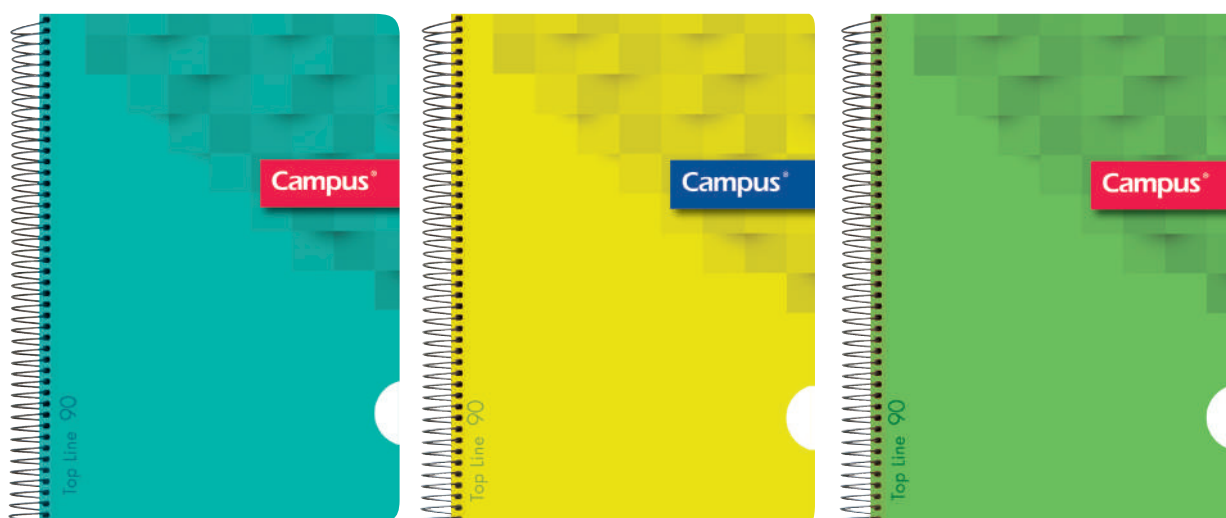
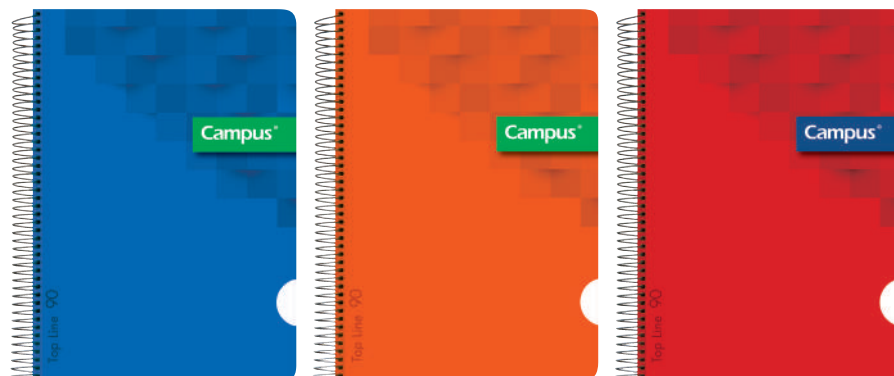

CÓDIGO	FORMATO	MEDIDAS (mm.)	HOJAS	RAYADO	COLOR CUBIERTA	ENVASE PAQ./CAJA
002434	A5+	170 x 220	80	Cuadrícula 4 mm.	● ● ● ● ● ●	5 / 50
002435	A5+	170 x 220	80	Milimetrado	● ● ● ● ● ●	5 / 50
002763	A5+	170 x 220	80	Milimetrado mod.46	● ● ● ● ● ●	5 / 50
002436	A5+	170 x 220	80	Horizontal	● ● ● ● ● ●	5 / 50
002437	A5+	170 x 220	80	Doble raya 2,5 mm.	● ● ● ● ● ●	5 / 50
002762	A5+	170 x 220	80	Doble raya 3,5 mm.	● ● ● ● ● ●	5 / 50
002549	A5+	170 x 220	80	Liso	● ● ● ● ● ●	5 / 50
002997	A4	210 x 297	80	Cuadrícula 4 mm.	●	6 / 24
002998	A4	210 x 297	80	Cuadrícula 4 mm.	●	6 / 24
002999	A4	210 x 297	80	Cuadrícula 4 mm.	●	6 / 24
003000	A4	210 x 297	80	Cuadrícula 4 mm.	●	6 / 24
002426	A4	210 x 297	80	Cuadrícula 4 mm.	● ● ● ● ● ●	6 / 24
002427	A4	210 x 297	80	Cuadrícula 3 mm.	● ● ● ● ● ●	6 / 24
002766	A4	210 x 297	80	Cuadrícula 5 mm.	● ● ● ● ● ●	6 / 24
002428	A4	210 x 297	80	Horizontal	● ● ● ● ● ●	6 / 24
002429	A4	210 x 297	80	Doble raya 2,5 mm.	● ● ● ● ● ●	6 / 24
002547	A4	210 x 297	80	Doble raya 3,5 mm.	● ● ● ● ● ●	6 / 24
002548	A4	210 x 297	80	Liso	● ● ● ● ● ●	6 / 24
002430	A4	210 x 297	80	Milimetrado	● ● ● ● ● ●	6 / 24
002433	A4	210 x 297	80	Milimetrado mod.46	● ● ● ● ● ●	6 / 24



BLOC DE ESPIRAL TAPAS PASTEL

90g

TAPA POLIPROPILENO

Campus

CUBIERTAS:

- Tapas de polipropileno Pastel 700 g.
- Primera hoja con diseño.
- Cantos redondeados.

PAPEL INTERIOR: 90 g.

N° HOJAS: 80

ENCUADERNACIÓN: espiral Coil-Lock.

FORMATOS: A4

COLORES:



CÓDIGO	FORMATO	MEDIDAS (mm.)	HOJAS	RAYADO	COLOR CUBIERTA	ENVASE PAQ./CAJA
003221	A4	210 x 297	80	Cuadrícula 4 mm	● ● ● ● ●	5 / 30

BLOC DE ESPIRAL TAPA COLORES VIVOS

90g

TAPA POLIPROPILENO

Campus

CUBIERTAS:

- Tapas de polipropileno Colores vivos.
- Primera hoja con diseño.
- Cantos redondeados.

PAPEL INTERIOR: 90 g.

N° HOJAS: 80

ENCUADERNACIÓN: espiral Coil-Lock.

FORMATOS: A4

COLORES:



CÓDIGO	FORMATO	MEDIDAS (mm.)	HOJAS	RAYADO	COLOR CUBIERTA	ENVASE PAQ./CAJA
003325	A4	210 x 297	80	Cuadrícula 4 mm	● ● ● ● ●	5 / 35



Los códigos en color amarillo permiten apertura de envase

BLOC DE ESPIRAL



TAPA POLIPROPILENO

Campus

CUBIERTAS:

- Tapas de polipropileno 700 g.
- Impresas a todo color.
- Cantos redondeados.

PAPEL INTERIOR: 90 g.

Nº HOJAS: 80

ENCUADERNACIÓN: espiral Coil-Lock.

FORMATOS: A4

COLORES:

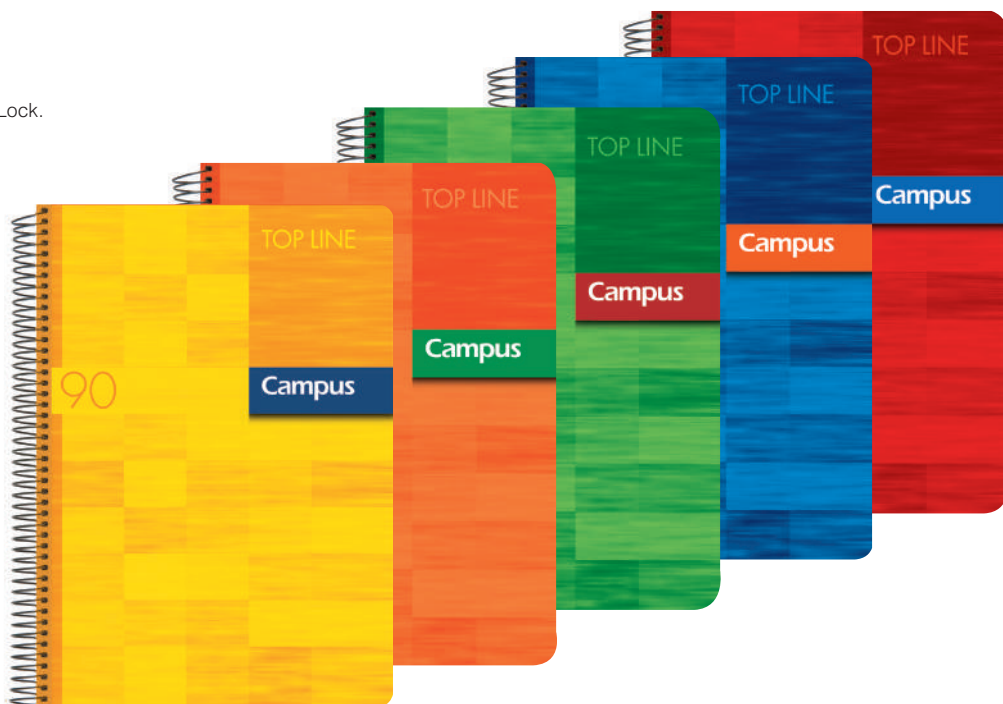

CÓDIGO	FORMATO	MEDIDAS (mm.)	HOJAS	RAYADO	COLOR CUBIERTA	ENVASE PAQ./CAJA
002196	A4	210 x 297	80	Milimetrado	●●●●●	5 / 20
002197	A4	210 x 297	80	Doble raya 2,5 mm.	●●●●●	5 / 20

BLOC DE ESPIRAL



TAPA POLIPROPILENO

Campus

CUBIERTAS:

- Tapas de polipropileno 700 g.
- Impresas a todo color.
- Cantos redondeados.

PAPEL INTERIOR: 90 g.

Nº HOJAS: 120

ENCUADERNACIÓN: espiral Coil-Lock.

FORMATOS: A4

COLORES:

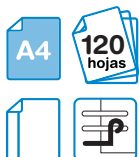

CÓDIGO	FORMATO	MEDIDAS (mm.)	HOJAS	RAYADO	COLOR CUBIERTA	ENVASE PAQ./CAJA
002767	A4	210 x 297	120	Cuadrícula 4 mm	●●●●●●	6 / 18



BLOCS DE ESPIRAL "U"

90g

TAPA EXTRADURA

Campus

CUBIERTAS:

- Cartón 1100 g.
- Forradas, impresas a todo color.
- Cantos rectos.

PAPEL INTERIOR: 90 g.

Nº HOJAS: 80

ENCUADERNACIÓN: espiral Coil-Lock.

FORMATOS: A5+ y A4

COLORES:

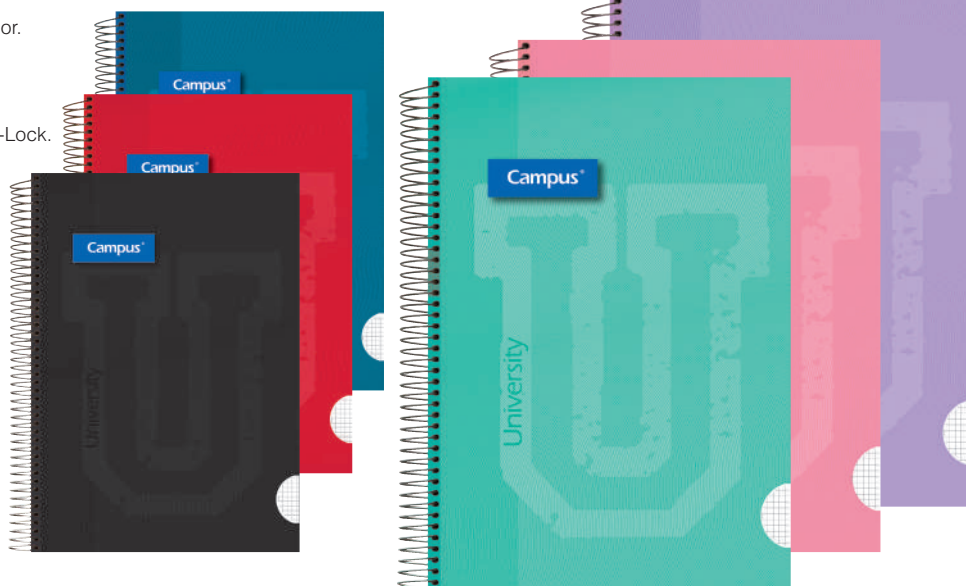
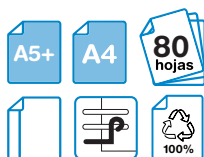

CÓDIGO	FORMATO	MEDIDAS (mm.)	HOJAS	RAYADO	COLOR CUBIERTA	ENVASE PAQ./CAJA
003318	A5+	160 x 220	80	Cuadrícula 4 mm.	● ● ● ● ● ●	6 / 36
003319	A5+	160 x 220	80	Cuadrícula 5 mm.	● ● ● ● ● ●	6 / 36
003320	A5+	160 x 220	80	Horizontal	● ● ● ● ● ●	6 / 36
003321	A5+	160 x 220	80	Liso	● ● ● ● ● ●	6 / 36
003322	A4	210 x 297	80	Cuadrícula 4 mm.	● ● ● ● ● ●	6 / 36
003323	A4	210 x 297	80	Cuadrícula 5 mm.	● ● ● ● ● ●	6 / 36
003324	A4	210 x 297	80	Horizontal	● ● ● ● ● ●	6 / 36
003313	A4	210 x 297	80	Liso	● ● ● ● ● ●	6 / 36

BLOC DE ESPIRAL

90g

TAPA EXTRADURA

Campus

CUBIERTAS:

- Cartón 1100 g.
- Forradas, impresas a todo color.
- Cantos rectos.

PAPEL INTERIOR: 90 g.

Nº HOJAS: 80

ENCUADERNACIÓN: espiral Coil-Lock.

FORMATOS: A4

COLORES:

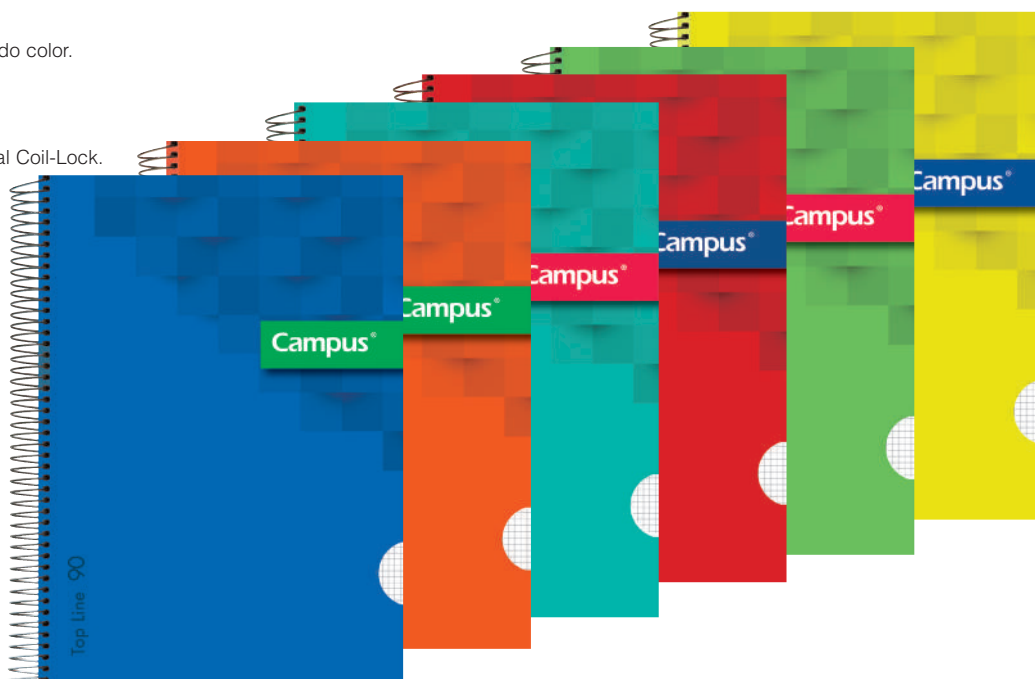
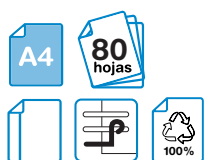

CÓDIGO	FORMATO	MEDIDAS (mm.)	HOJAS	RAYADO	COLOR CUBIERTA	ENVASE PAQ./CAJA
001772	A4	210 x 297	80	Cuadrícula 4 mm.	● ● ● ● ● ●	6 / 36
001825	A4	210 x 297	80	Milimetrado	● ● ● ● ● ●	6 / 36
001826	A4	210 x 297	80	Horizontal	● ● ● ● ● ●	6 / 36



Los códigos en color amarillo permiten apertura de envase

BLOC DE ESPIRAL



TAPA CARTONCILLO

Campus

CUBIERTAS:

- Cartón 400 g.
- Impresas a todo color.
- Cantos redondeados.

PAPEL INTERIOR: 90 g.

Nº HOJAS: 80

ENCUADERNACIÓN: espiral Coil-Lock.

FORMATOS: A4

COLORES:

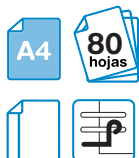
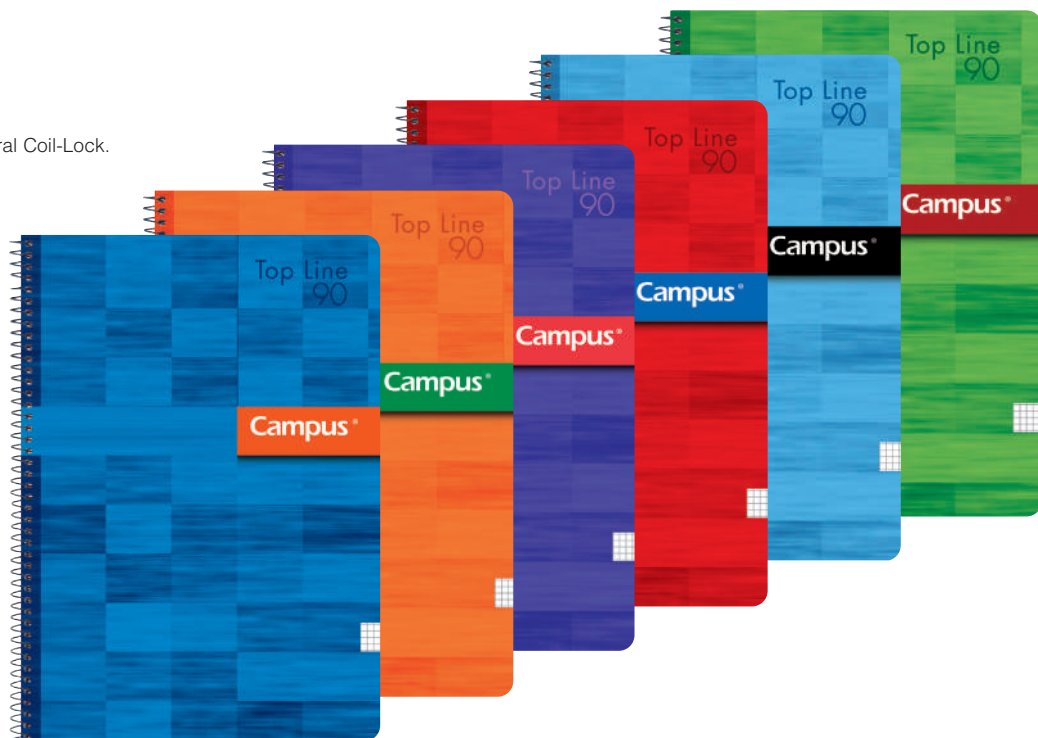

CÓDIGO	FORMATO	MEDIDAS (mm.)	HOJAS	RAYADO	COLOR CUBIERTA	ENVASE PAQ./CAJA
002361	A4	210 x 297	80	Cuadrícula 4 mm.	● ● ● ● ● ●	6 / 36

BLOC DE ESPIRAL



TAPA POLIPROPILENO

Campus

CUBIERTAS:

- Tapas de polipropileno 700 g.
- Impresas a todo color.
- Cantos redondeados.

PAPEL INTERIOR: 70 g.

Nº HOJAS: 80

ENCUADERNACIÓN: espiral Coil-Lock.

FORMATOS: A4

COLORES:

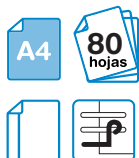

CÓDIGO	FORMATO	MEDIDAS (mm.)	HOJAS	RAYADO	COLOR CUBIERTA	ENVASE PAQ./CAJA
002362	A4	210 x 297	80	Cuadrícula 4 mm.	● ● ● ● ● ●	6 / 36



BLOC DE ESPIRAL



TAPA EXTRADURA

CUBIERTAS:

- Cartón 1100 g.
- Forradas, impresas a todo color.
- Cantos rectos.

PAPEL INTERIOR: 70 g.

Nº HOJAS: 80

ENCUADERNACIÓN:

espiral Coil-Lock.

FORMATOS: A4

COLORES:

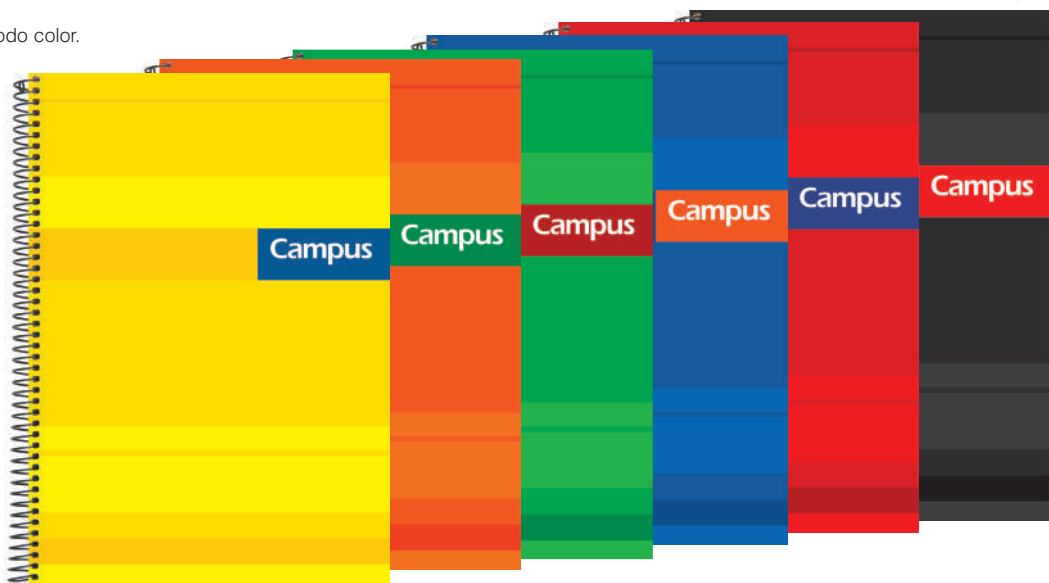

Campus

CÓDIGO	FORMATO	MEDIDAS (mm.)	HOJAS	RAYADO	COLOR CUBIERTA	ENVASE PAQ./CAJA
001154	A4	210 x 297	80	Milimetrado	● ● ● ● ● ●	6 / 36

BLOC DE ESPIRAL



TAPA DURA

CUBIERTAS:

- Cartón 700 g.
- Impresas a todo color.
- Cantos rectos.

PAPEL INTERIOR: 70 g.

Nº HOJAS: 80

ENCUADERNACIÓN:

espiral Coil-Lock.

FORMATOS: A5, A5+ y A4

COLORES:

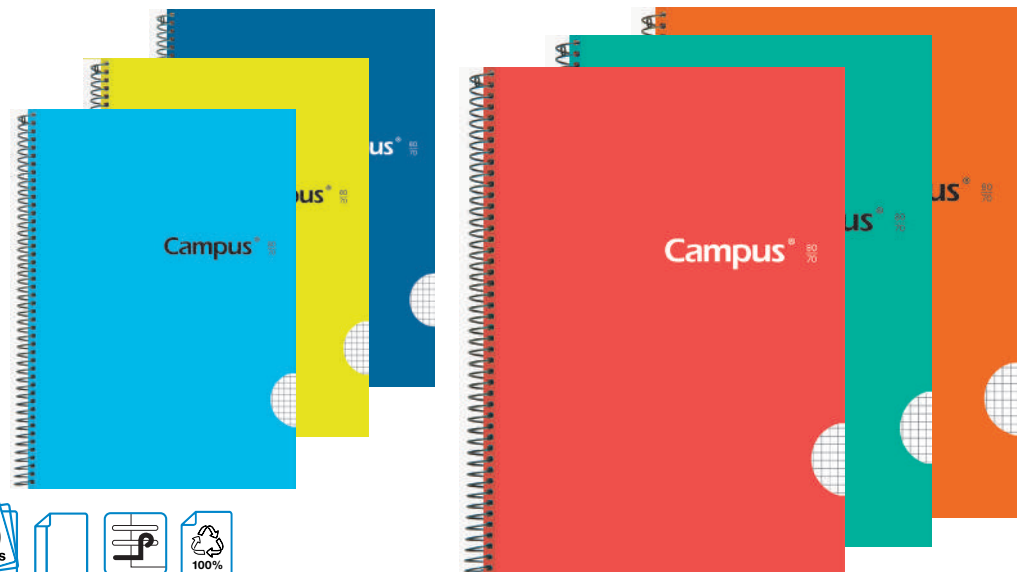

Campus

CÓDIGO	FORMATO	MEDIDAS (mm.)	HOJAS	RAYADO	COLOR CUBIERTA	ENVASE PAQ./CAJA
001602	A5	148 x 210	80	Milimetrado	● ● ● ● ● ●	6 / 60
001156	A5+	160 x 220	80	Cuadrícula 4 mm.	● ● ● ● ● ●	6 / 60
001157	A5+	160 x 220	80	Horizontal	● ● ● ● ● ●	6 / 60
001658	A5+	160 x 220	80	Doble raya 3,5 mm.	● ● ● ● ● ●	6 / 60
002951	A5+	160 x 220	80	Doble raya 2,5 mm.	● ● ● ● ● ●	6 / 60
003223	A5+	160 x 220	80	C.P. 3 mm.	● ● ● ● ● ●	6 / 60
003224	A5+	160 x 220	80	C.P. 4 mm.	● ● ● ● ● ●	6 / 60
001961	A4	210 x 297	80	Cuadrícula 3 mm.	● ● ● ● ● ●	6 / 36
001158	A4	210 x 297	80	Cuadrícula 4 mm.	● ● ● ● ● ●	6 / 36
001159	A4	210 x 297	80	Horizontal	● ● ● ● ● ●	6 / 36
001561	A4	210 x 297	80	Doble raya 2,5 mm.	● ● ● ● ● ●	6 / 36
001599	A4	210 x 297	80	Liso	● ● ● ● ● ●	6 / 36
001603	A4	210 x 297	80	Milimetrado	● ● ● ● ● ●	6 / 36
001665	A4	210 x 297	80	Doble raya 3,5 mm.	● ● ● ● ● ●	6 / 36



Los códigos en color amarillo permiten apertura de envase

BLOC DE ESPIRAL



TAPA BÁSICA

CUBIERTAS:

- Portada: cartón 300 g., impresa a todo color.
- Contraportada: cartón 400 g.
- Cantos rectos.

PAPEL INTERIOR: 60 g.

Nº HOJAS: 80

ENCUADERNACIÓN: espiral Coil-Lock.

FORMATOS: A5+ y A4

COLORES:

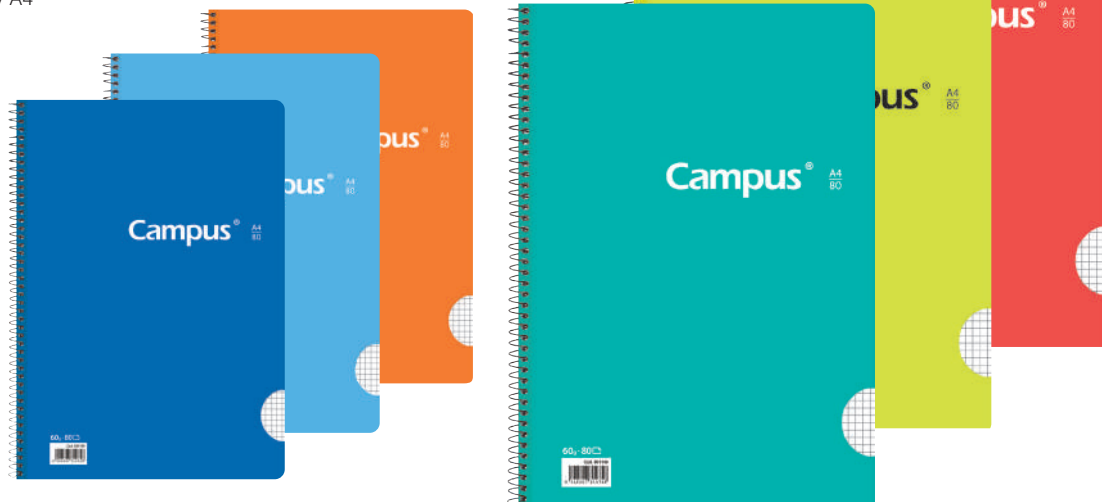

Campus college



CÓDIGO	FORMATO	MEDIDAS (mm.)	HOJAS	GRAMAJE	RAYADO	COLOR CUBIERTA	ENVASE PAQ./CAJA
001143	A5+	170 x 220	80	60 g.	Cuadrícula 4 mm.	●●●●●●●●	6 / 60
001144	A5+	170 x 220	80	60 g.	Horizontal	●●●●●●●●	6 / 60
001145	A5+	170 x 220	80	60 g.	Milimetrado	●●●●●●●●	6 / 60
001146	A5+	170 x 220	80	60 g.	Doble raya 2,5 mm.	●●●●●●●●	6 / 60
001148	A5+	170 x 220	80	60 g.	Liso	●●●●●●●●	6 / 60
001562	A5+	170 x 220	80	60 g.	Doble raya 3,5 mm.	●●●●●●●●	6 / 60
001901	A4	210 x 297	80	60 g.	Cuadrícula 3 mm.	●●●●●●●●	6 / 36
001149	A4	210 x 297	80	60 g.	Cuadrícula 4 mm.	●●●●●●●●	6 / 36
001151	A4	210 x 297	80	60 g.	Horizontal	●●●●●●●●	6 / 36
001152	A4	210 x 297	80	60 g.	Milimetrado	●●●●●●●●	6 / 36
001150	A4	210 x 297	80	60 g.	Doble raya 2,5 mm.	●●●●●●●●	6 / 36
001153	A4	210 x 297	80	60 g.	Liso	●●●●●●●●	6 / 36
001659	A4	210 x 297	80	60 g.	Doble raya 3,5 mm.	●●●●●●●●	6 / 36
002244	A4	210 x 297	80	60 g.	Milimetrado mod.46	●●●●●●●●	6 / 36

BLOC DE ESPIRAL APAISADO



TAPA BÁSICA

CUBIERTAS:

- Portada: cartón 300 g., impresa a todo color.
- Contraportada: cartón 400 g.
- Cantos rectos.

PAPEL INTERIOR: 60 g.

Nº HOJAS: 80

ENCUADERNACIÓN: espiral Coil-Lock.

FORMATOS: A5

COLORES:

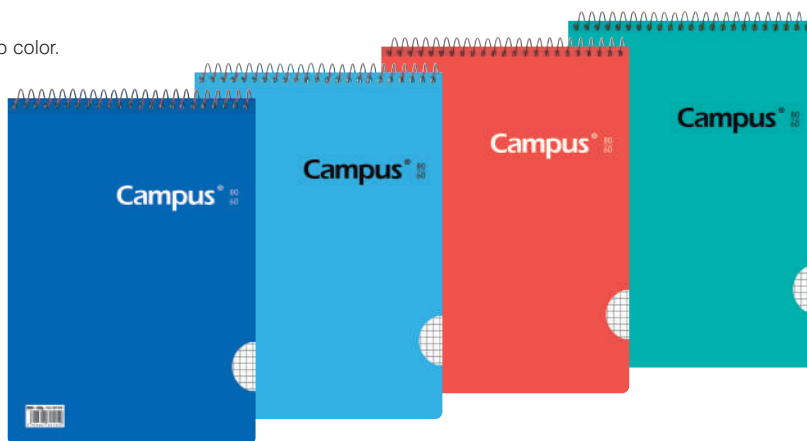

Campus college



CÓDIGO	FORMATO	MEDIDAS (mm.)	HOJAS	RAYADO	COLOR CUBIERTA	ENVASE PAQ./CAJA
002329	A5	148 x 210	80	Cuadrícula 4 mm.	●●●●	10 / 60



BLOCS MICROPERFORADOS

BLOC DE ESPIRAL CON 5 BANDAS DE COLOR

90g

TAPA POLIPROPILENO

Campus

CUBIERTAS:

- Tapas de polipropileno 700 g.
- Primera hoja con diseño.
- Impresas a todo color.
- Cantos redondeados.

PAPEL INTERIOR: 90 g.

- Microperforado y 5 bandas de color.

Nº HOJAS: 120

ENCUADERNACIÓN: espiral Coil-Lock.

FORMATOS: A4

COLORES:

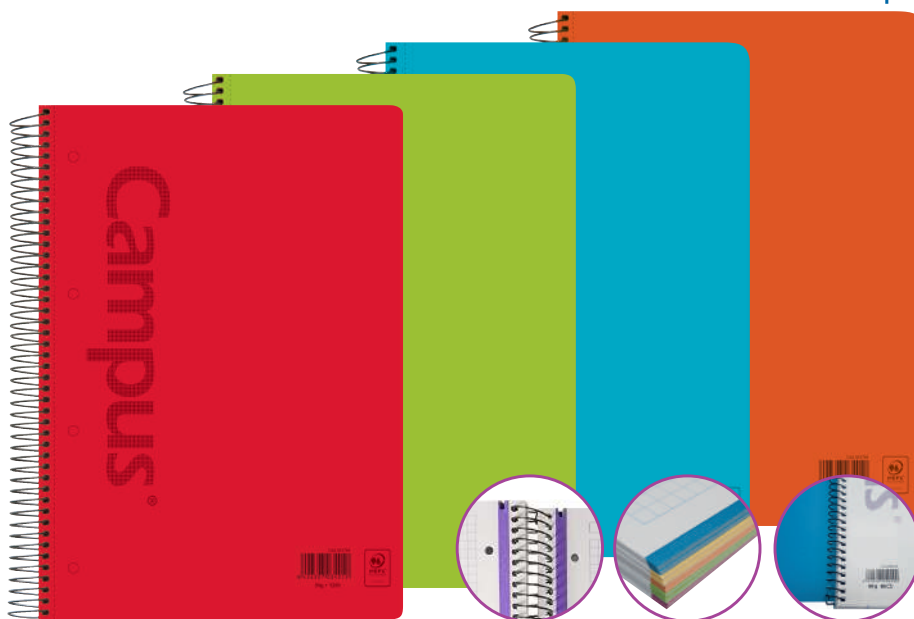
Blancura
ISO11475:
CIE 145Alta opacidad
ISO2471: 82%

CÓDIGO	FORMATO	MEDIDAS (mm.)	HOJAS	RAYADO	COLOR CUBIERTA	ENVASE PAQ./CAJA
002768	A4	210 x 297	120	Cuadrícula 5 mm	● ● ● ● ●	6 / 18

BLOC DE ESPIRAL CON BANDA UNICOLOR

90g

TAPA EXTRADURA

Campus

CUBIERTAS:

- Cartón 1100 g.
- Forradas, impresas a todo color.
- Cantos rectos.

PAPEL INTERIOR: 90 g.

- Microperforado y bandas de color.

Nº HOJAS: 80

ENCUADERNACIÓN:

espiral Coil-Lock.

FORMATOS: A4

COLORES:

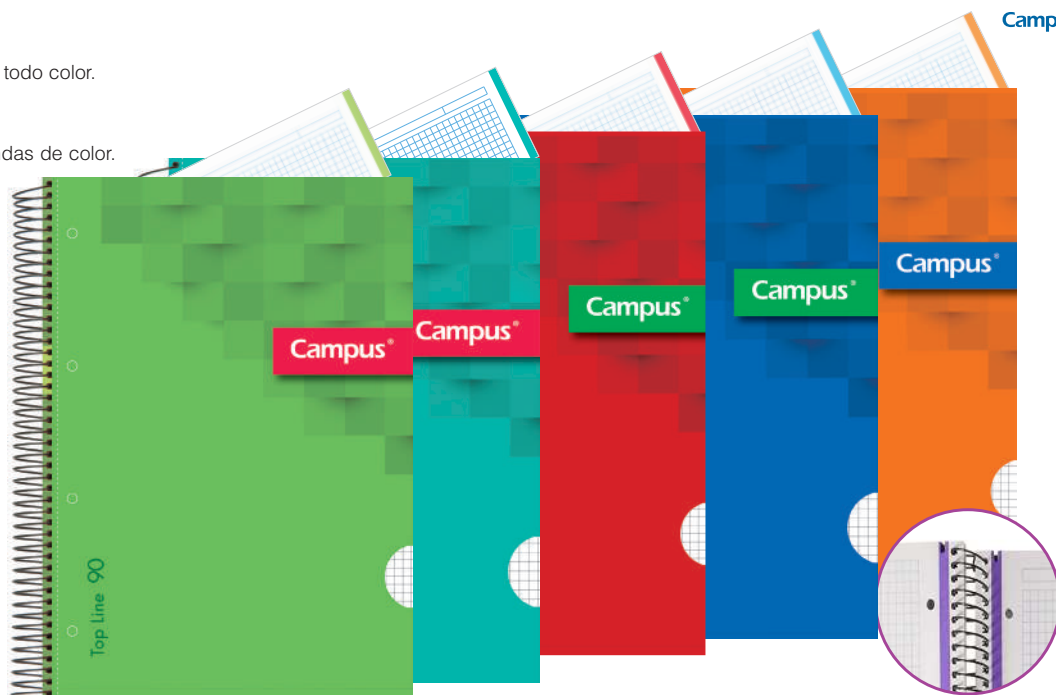
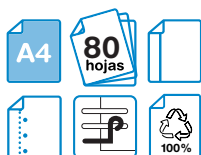

CÓDIGO	FORMATO	MEDIDAS (mm.)	HOJAS	RAYADO	COLOR CUBIERTA	ENVASE PAQ./CAJA
002300	A4	210 x 297	80	Cuadrícula 5 mm.	●	5 / 30
002301	A4	210 x 297	80	Cuadrícula 5 mm.	●	5 / 30
002302	A4	210 x 297	80	Cuadrícula 5 mm.	●	5 / 30
002303	A4	210 x 297	80	Cuadrícula 5 mm.	●	5 / 30
002304	A4	210 x 297	80	Cuadrícula 5 mm.	●	5 / 30



Los códigos en color amarillo permiten apertura de envase

BLOCS MICROPERFORADOS

BLOC DE ESPIRAL "U" CON 5 BANDAS DE COLOR

90g

TAPA EXTRADURA

Campus

CUBIERTAS:

- Cartón 1100 g.
- Forradas, impresas a todo color.
- Cantos rectos.

PAPEL INTERIOR: 90 g.

- Microperforado y bandas de color.

Nº HOJAS: 120

ENCUADERNACIÓN: espiral Coil-Lock.

FORMATOS: A4

COLORES:



Blancura
ISO11475:
CIE 145



Alta opacidad
ISO2471: 82%

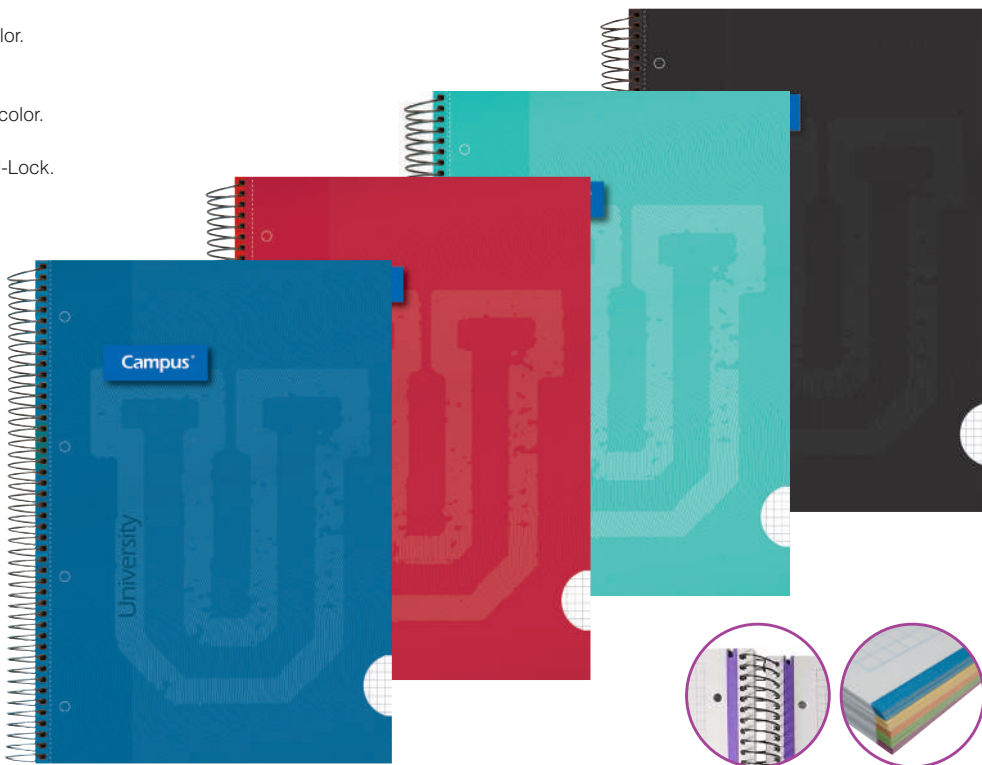
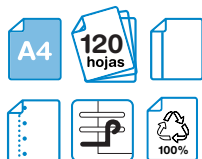

CÓDIGO	FORMATO	MEDIDAS (mm.)	HOJAS	RAYADO	COLOR CUBIERTA	ENVASE PAQ./CAJA
001828	A4	210 x 297	120	Cuadrícula 5 mm	● ● ● ●	4 / 16

BLOC DE ESPIRAL CON 5 BANDAS DE COLOR

70g

TAPA EXTRADURA

Campus

CUBIERTAS:

- Cartón 1100 g.
- Forradas, impresas a todo color.
- Cantos rectos.

PAPEL INTERIOR: 70 g.

- Microperforado y bandas de color.

Nº HOJAS: 160

ENCUADERNACIÓN: espiral Coil-Lock.

FORMATOS: A5

COLORES:



Blancura
ISO11475:
CIE 145



Alta opacidad
ISO2471: 82%

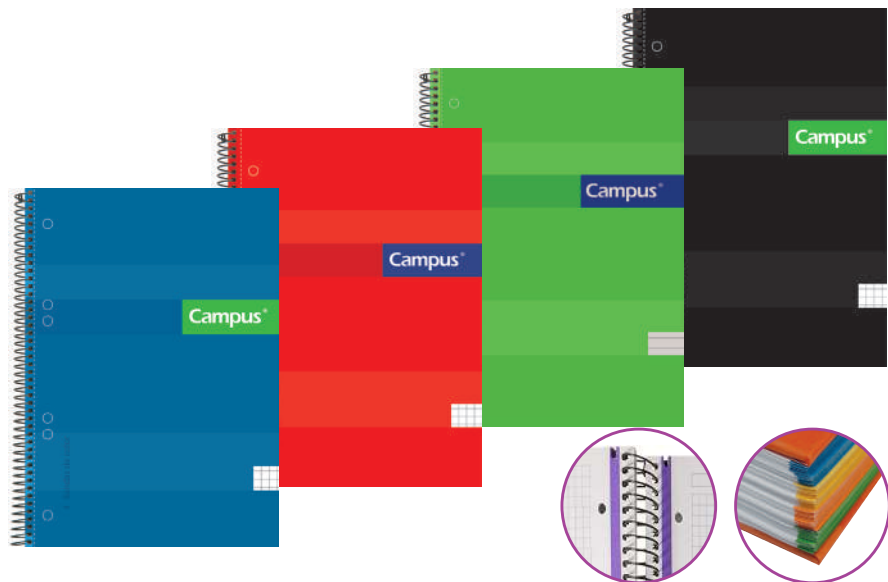

CÓDIGO	FORMATO	MEDIDAS (mm.)	HOJAS	RAYADO	COLOR CUBIERTA	ENVASE PAQ./CAJA
001167	A5	148 x 210	160	Cuadrícula 5 mm	● ● ● ●	4 / 16
001973	A5	148 x 210	160	Horizontal	● ● ● ●	4 / 16



BLOCS MICROPERFORADOS

BLOC DE ESPIRAL CON 5 BANDAS DE COLOR

70g

TAPA EXTRADURA

Campus

CUBIERTAS:

- Cartón 1100 g.
- Forradas, impresas a todo color.
- Cantos rectos.

PAPEL INTERIOR: 70 g. Con bandas de color.

N° HOJAS: 160

ENCUADERNACIÓN:

espiral Coil-Lock.

FORMATOS: A4

COLORES:

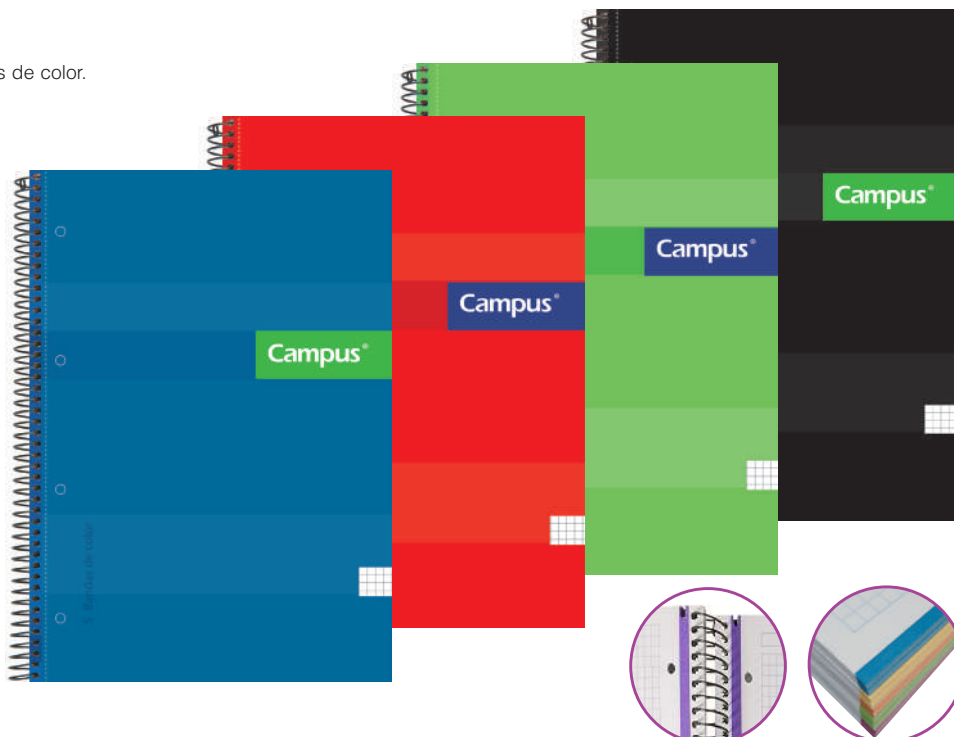
Blancura
ISO11475:
CIE 145Alta opacidad
ISO2471: 82%

CÓDIGO	FORMATO	MEDIDAS (mm.)	HOJAS	RAYADO	COLOR CUBIERTA	ENVASE PAQ./CAJA
001172	A4	210 x 297	160	Cuadrícula 5 mm	● ● ● ●	4 / 16
001171	A4	210 x 297	160	Horizontal	● ● ● ●	4 / 16
001594	A4	210 x 297	160	Liso	● ● ● ●	4 / 16

BLOC DE ESPIRAL CON 5 BANDAS DE COLOR

60g

TAPA DURA

Campus

CUBIERTAS:

- Cartón 700 g.
- Impresas a todo color.
- Cantos redondeados.

PAPEL INTERIOR: 60 g.

· Microperforado y bandas de color.

N° HOJAS: 160

ENCUADERNACIÓN:

espiral Coil-Lock.

FORMATOS: A4

COLORES:

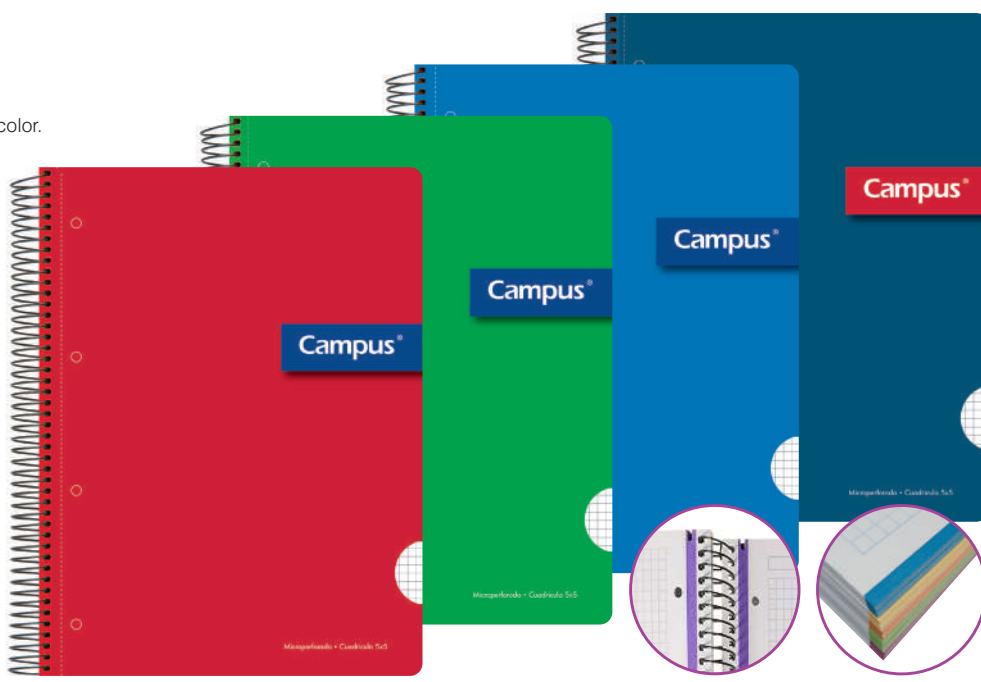
Blancura
ISO11475:
CIE 145Alta opacidad
ISO2471: 82%

CÓDIGO	FORMATO	MEDIDAS (mm.)	HOJAS	RAYADO	COLOR CUBIERTA	ENVASE PAQ./CAJA
001168	A4	210 x 297	160	Cuadrícula 5 mm	● ● ● ●	4 / 20



Los códigos en color amarillo permiten apertura de envase

CARPETA DE ANILLAS FORRADO DE PP CON RECAMBIO

90g

TAPA POLIPROPILENO



CUBIERTAS:

- Carpeta de cartón entrecolado de 2,2 mm de espesor.
- Interior y exterior forrado con polipropileno.
- Lomo ergonómico 32 mm y 60 mm.
- 4 anillas de 20 mm y 35 mm.
- Sistema Rado.
- Cierre con goma elástica plana, a juego con las tapas.
- Incluye 5 separadores.

PAPEL RECAMBIO: 90 g.

Nº HOJAS RECAMBIO: 100

FORMATO RECAMBIO: A4

COLORES:



CÓDIGO	MEDIDAS mm.	FORMATO RECAMBIO	HOJAS RECAMBIO	LOMO ANCHO	RAYADO	COLOR	PAQ./CAJA
209326	240 x 310	A4	100	32 mm	Cuadrícula 5 mm.	●	1 / 10
209327	240 x 310	A4	100	32 mm	Cuadrícula 5 mm.	●	1 / 10
209281	240 x 310	A4	100	32 mm	Cuadrícula 5 mm.	●	1 / 10
209329	240 x 310	A4	100	32 mm	Cuadrícula 5 mm.	●	1 / 10
209353	250 x 320	A4	100	60 mm	Cuadrícula 5 mm.	●	1 / 8
209354	250 x 320	A4	100	60 mm	Cuadrícula 5 mm.	●	1 / 8
209282	250 x 320	A4	100	60 mm	Cuadrícula 5 mm.	●	1 / 8
209356	250 x 320	A4	100	60 mm	Cuadrícula 5 mm.	●	1 / 8
180964	250 x 320	A4	100	60 mm	Cuadrícula 5 mm.	●	1 / 8
180965	250 x 320	A4	100	60 mm	Cuadrícula 5 mm.	●	1 / 8
180966	250 x 320	A4	100	60 mm	Cuadrícula 5 mm.	●	1 / 8
180963	250 x 320	A4	100	60 mm	Cuadrícula 5 mm.	○	1 / 8



CARPETA DE ANILLAS SOFT "U" CON RECAMBIO

90g

TAPA EXTRADURA

CUBIERTAS:

- Carpeta de cartón extradura con tacto suave, impresa a todo color.
- Guarda interior a juego con las tapas.
- Lomo ergonómico 60 mm.
- Sistema Rado.
- Cierre con goma elástica plana, a juego con las tapas.
- Cantos rectos.
- 4 Anillas de 35 mm.

PAPEL RECAMBIO: 90 g.

Nº HOJAS RECAMBIO: 100

FORMATO RECAMBIO: A4

COLORES:



4 x 35mm



CÓDIGO	MEDIDAS mm.	FORMATO RECAMBIO	HOJAS RECAMBIO	RAYADO	COLOR	PAQ./CAJA
181327	260 x 320	A4	100	Cuadrícula 5 mm.		1 / 5
181328	260 x 320	A4	100	Cuadrícula 5 mm.		1 / 5
181329	260 x 320	A4	100	Cuadrícula 5 mm.		1 / 5
181330	260 x 320	A4	100	Cuadrícula 5 mm.		1 / 5
181331	260 x 320	A4	100	Cuadrícula 5 mm.		1 / 5
181345	260 x 320	A4	100	Cuadrícula 5 mm.		1 / 5
181346	260 x 320	A4	100	Cuadrícula 5 mm.		1 / 5
181347	260 x 320	A4	100	Cuadrícula 5 mm.		1 / 5

Los códigos en **color amarillo** permiten apertura de envase

BLOC DE ESPIRAL



TAPA POLIPROPILENO

CUBIERTAS:

- Tapas de polipropileno 500 g.
- Primera hoja con diseño.
- Impresas a todo color.
- Cantos rectos.

PAPEL INTERIOR: 60 g.

Nº HOJAS: 80

ENCUADERNACIÓN: espiral Coil-Lock.

FORMATOS: 16°, 12° y 8°

COLORES:



Campus

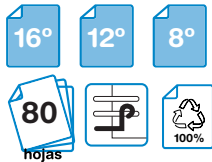

CÓDIGO	FORMATO	MEDIDAS (mm.)	HOJAS	RAYADO	COLOR CUBIERTA	PAQ./CAJA
003228	16° Natural	77 x 105	80	Cuadrícula 4 mm.	● ● ● ● ● ● ● ●	16 / 288
003229	16° Apaisado	105 x 77	80	Cuadrícula 4 mm.	● ● ● ● ● ● ● ●	16 / 288
003230	12° Natural	85 x 125	80	Cuadrícula 4 mm.	● ● ● ● ● ● ● ●	12 / 192
003231	12° Apaisado	125 x 85	80	Cuadrícula 4 mm.	● ● ● ● ● ● ● ●	8 / 192
003232	8° Natural	105 x 155	80	Cuadrícula 4 mm.	● ● ● ● ● ● ● ●	8 / 144
003233	8° Apaisado	155 x 105	80	Cuadrícula 4 mm.	● ● ● ● ● ● ● ●	8 / 144

BLOC DE ESPIRAL MICROPERFORADO



TAPA POLIPROPILENO

CUBIERTAS:

- Tapas de polipropileno.
- Impresas a todo color.
- Estampación logotipo en plata.
- Cantos redondeados.

PAPEL INTERIOR: 70 g.

Nº HOJAS: 60

ENCUADERNACIÓN: doble espiral.

CIERRE: goma plana.

FORMATOS: A7 y A6

COLORES:



Campus

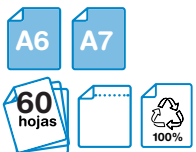

CÓDIGO	FORMATO	MEDIDAS (mm.)	HOJAS	RAYADO	COLOR CUBIERTA	EXPOSITOR
001834	A7 apaisado	75 x 120	60	Liso	● ● ● ● ● ● ● ●	15
001833	A6 natural	105 x 148	60	Liso	● ● ● ● ● ● ● ●	15

BLOC DE ESPIRAL



TAPA BÁSICA

CUBIERTAS:

- Portada: cartón 300 g., impresa a todo color.
- Contraportada: cartón 400 g.
- Cantos rectos.

PAPEL INTERIOR: 60 g.

Nº HOJAS: 80

ENCUADERNACIÓN: espiral Coil-Lock.

FORMATOS: 16°, 12° y 8°

COLORES:

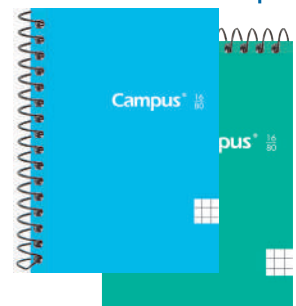
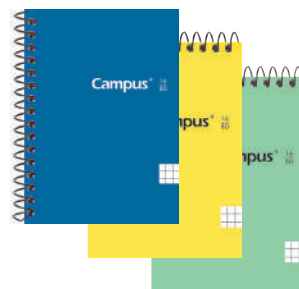
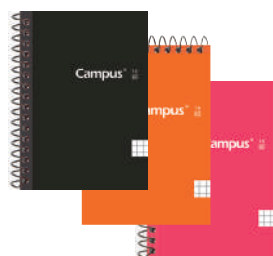

Campus

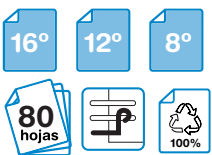

CÓDIGO	FORMATO	MEDIDAS (mm.)	HOJAS	RAYADO	COLOR CUBIERTA	PAQ./CAJA
001142	16° Natural	77 x 105	80	Cuadrícula 4 mm.	● ● ● ● ● ● ● ●	12 / 288
001139	16° Apaisado	105 x 77	80	Cuadrícula 4 mm.	● ● ● ● ● ● ● ●	12 / 288
001141	12° Natural	85 x 125	80	Cuadrícula 4 mm.	● ● ● ● ● ● ● ●	12 / 192
001138	12° Apaisado	125 x 85	80	Cuadrícula 4 mm.	● ● ● ● ● ● ● ●	12 / 192
001140	8° Natural	105 x 155	80	Cuadrícula 4 mm.	● ● ● ● ● ● ● ●	12 / 144
001137	8° Apaisado	155 x 105	80	Cuadrícula 4 mm.	● ● ● ● ● ● ● ●	12 / 144



BLOC DE ESPIRAL



TAPA POLIPROPILENO



CUBIERTAS:

- Tapas de polipropileno.
- Impresas a todo color.
- Ventanas ovaladas en portada.

PAPEL INTERIOR: 70 g.

Nº HOJAS: 120, y 5 separadores.

ENCUADERNACIÓN: doble espiral.

CIERRE: goma plana del color de la portada.

FORMATOS: A5

COLORES:

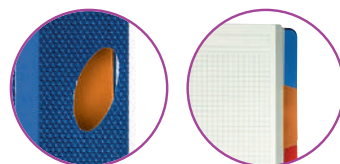
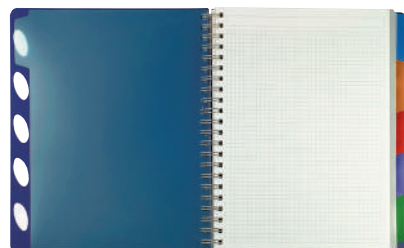

CÓDIGO	FORMATO	MEDIDAS (mm.)	HOJAS	RAYADO	COLOR CUBIERTA	ENVASE PAQ./CAJA
001767	A5	150 x 210	120	Cuadrícula 4 mm	● ● ●	1 / 8

LIBRETA DE APUNTES



TAPA BLANDA



CUBIERTAS:

- Cartón 250 g.
- Impresas a todo color.
- Cantos rectos.

PAPEL INTERIOR: 90 g.

Nº HOJAS: 40

ENCUADERNACIÓN: encolado.

FORMATOS: B5 y A4

COLORES:

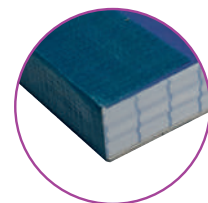

CÓDIGO	FORMATO	MEDIDAS (mm.)	HOJAS	RAYADO	COLOR CUBIERTA	ENVASE PAQ./CAJA
002200	B5	176 X 250	40	Cuadrícula 5 mm.	● ● ● ●	5 / 120
002199	A4	210 X 297	40	Cuadrícula 5 mm.	● ● ● ●	5 / 60



Los códigos en **color amarillo** permiten apertura de envase

LIBRETA ENCUADERNADA ÍNDICE A-Z

90g

TAPA BLANDA

CUBIERTAS:

- Cartón 350 g.
- Impresas a todo color.
- Cantos redondeados.

PAPEL INTERIOR: 90 g.

Índice lateral.

Nº HOJAS: 96

ENCUADERNACIÓN: cosida.

FORMATOS: A5

COLORES:

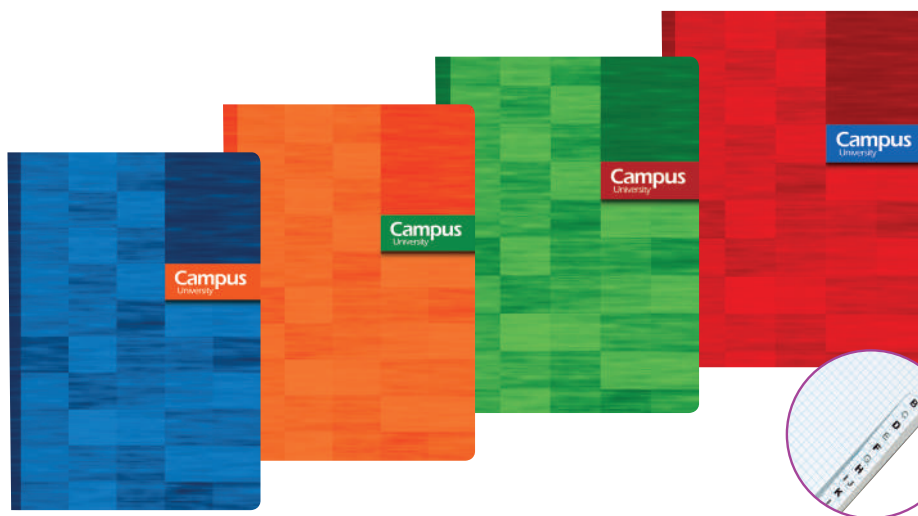

CÓDIGO	FORMATO	MEDIDAS (mm.)	HOJAS	RAYADO	COLOR CUBIERTA	ENVASE PAQ./CAJA
002179	A5	148 x 210	96	Cuadrícula 4 mm	● ● ● ●	5 / 60

BLOC DE NOTAS MICROPERFORADO

60g

TAPA FLEXIBLE

CUBIERTAS:

- Portada: cartón flexible 210 g, impresa a color.
- Contraportada: cartón 400 g blanca.
- Cantos rectos.

PAPEL INTERIOR: 60 g. Microperforado.

Nº HOJAS: 80

ENCUADERNACIÓN: grapado.

FORMATOS: A7, A6, A5 y A4

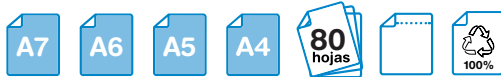
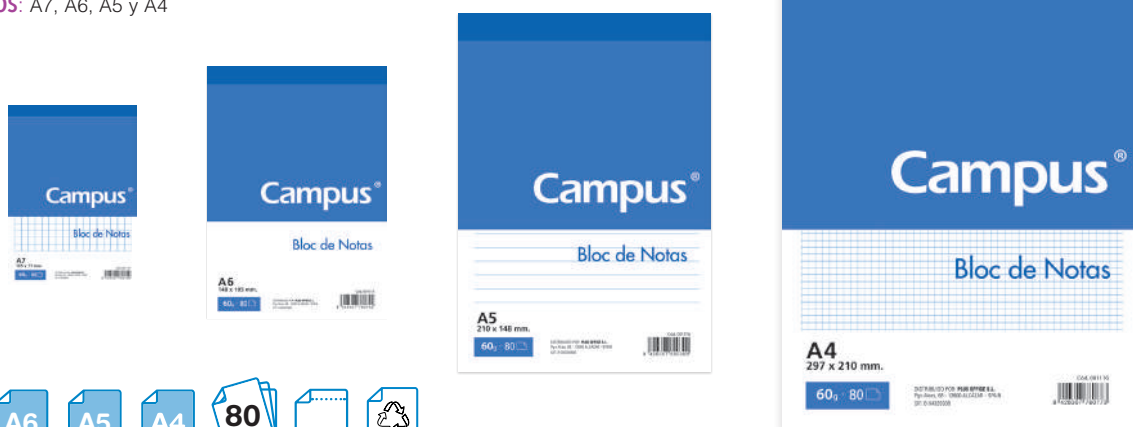
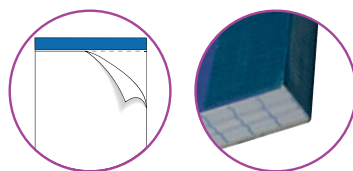

CÓDIGO	COLOR	FORMATO	MEDIDAS (mm.)	HOJAS	RAYADO	ENVASE PAQ./CAJA
001118	● Azul	A7	77 x 105	80	Cuadrícula 4 mm.	10 / 80
001119	● Azul	A7	77 x 105	80	Liso	10 / 80
001974	● Azul	A7	77 x 105	80	Horizontal	10 / 80
001114	● Azul	A6	105 x 148	80	Cuadrícula 4 mm.	10 / 40
001115	● Azul	A6	105 x 148	80	Liso	10 / 40
001975	● Azul	A6	105 x 148	80	Horizontal	10 / 40
001112	● Azul	A5	148 x 210	80	Cuadrícula 4 mm.	10 / 40
001113	● Azul	A5	148 x 210	80	Liso	10 / 40
001976	● Azul	A5	148 x 210	80	Horizontal	10 / 40
001116	● Azul	A4	210 x 297	80	Cuadrícula 4 mm.	5 / 20
001117	● Azul	A4	210 x 297	80	Liso	5 / 20
001977	● Azul	A4	210 x 297	80	Horizontal	5 / 20



BLOC DE NOTAS MICROPERFORADO PAPEL AMARILLO

60g

CUBIERTA TRASERA:

- Cartón 400 g.
- Cantos rectos.

PAPEL INTERIOR: 60 g.

- Papel amarillo microperforado.

Nº HOJAS: 50

ENCUADERNACIÓN: grapado.

FORMATOS: A5 y A4

Nº1
EN USA

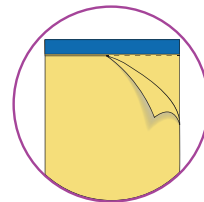
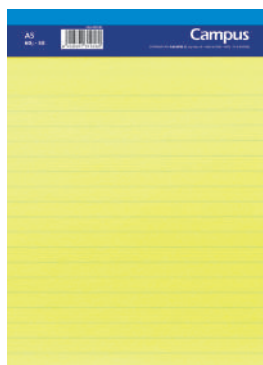

Sin tapa



CÓDIGO	COLOR	FORMATO	MEDIDAS (mm.)	HOJAS	RAYADO	ENVASE PAQ./CAJA
002182	● Amarillo	A5	148 x 210	50	Horizontal	6 / 144
002181	● Amarillo	A4	210 x 297	50	Horizontal	5 / 50

BLOC DE EXÁMENES

60g

TAPA BLANDA

CUBIERTAS:

- Portada: impresa a todo color 120 g.
- Contraportada: cartón 400 g.
- Cantos rectos.

PAPEL INTERIOR: 60 g. Cabecera de alumno.

Nº HOJAS: 40

ENCUADERNACIÓN: encolado.

FORMATOS: A4

Campus
college

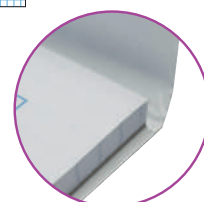
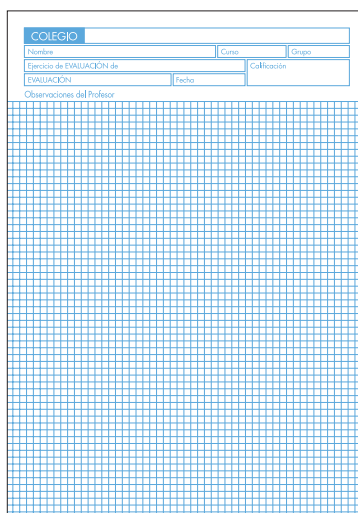
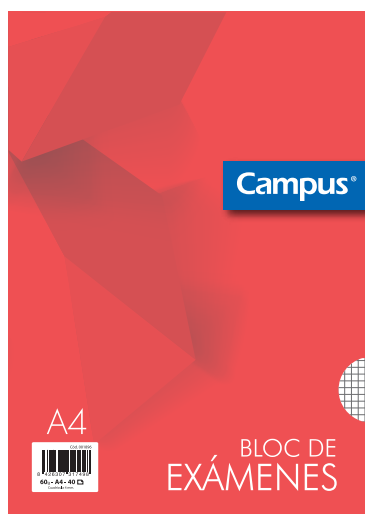

CÓDIGO	FORMATO	MEDIDAS (mm.)	HOJAS	RAYADO	ENVASE PAQ./CAJA
001896	A4	210 x 297	40	Cuadrícula 4 mm.	10 / 120



Los códigos en color amarillo permiten apertura de envase

RECAMBIOS



Campus

CUBIERTAS:

- Portada 120 g.
- Impresa a todo color.
- Cantos rectos.

PAPEL INTERIOR: 90 g, 4 taladros.

Nº HOJAS: 100, 100+20 y 200

FORMATOS: A4

COLORES:



CÓDIGO	FORMATO	MEDIDAS (mm.)	HOJAS	RAYADO	COLOR CUBIERTA	ENVASE PAQ./CAJA
002185	A4	210 x 297	100	Cuadrícula 4 mm.		5 / 25
002438	A4	210 x 297	100	Cuadrícula 3 mm.		5 / 25
002439	A4	210 x 297	100	Milimetrado		5 / 25
002440	A4	210 x 297	100	Horizontal		5 / 25
002366	A4	210 x 297	100	Doble raya 2,5		5 / 25
002441	A4	210 x 297	100	Liso		5 / 25
002447	A4	210 x 297	100 + 20	Cuadrícula 4 mm.		5 / 25
002950	A4	210 x 297	200	Cuadrícula 4 mm.		5 / 25

RECAMBIO CON 5 BANDAS DE COLOR



Campus

CUBIERTAS:

- Portada 120 g.
- Impresa a todo color.
- Cantos rectos.

PAPEL INTERIOR: 90 g, 4 taladros.

Nº HOJAS: 100

FORMATOS: A4

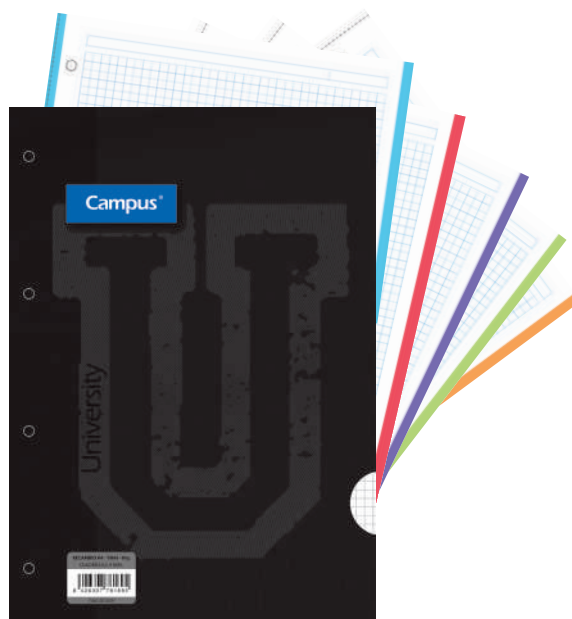

CÓDIGO	FORMATO	MEDIDAS (mm.)	HOJAS	RAYADO	COLOR CUBIERTA	ENVASE PAQ./CAJA
001829	A4	210 x 297	100	Cuadrícula 5 mm		5 / 25



RECAMBIO ENCUADERNADO BANDA UNICOLOR

90g

Campus

CUBIERTAS:

- Portada: cartón 300 g.
- Contraportada: cartón 400 g.
- Impresas a todo color
- Cantos rectos.

PAPEL INTERIOR: 60 g, 4 taladros.

- Bandas del color de la portada.

Nº HOJAS: 80**ENCUADERNACIÓN:** encolado.**FORMATOS:** A4

COLORES:

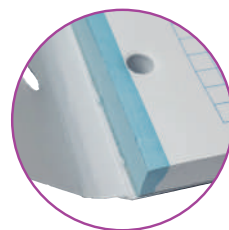
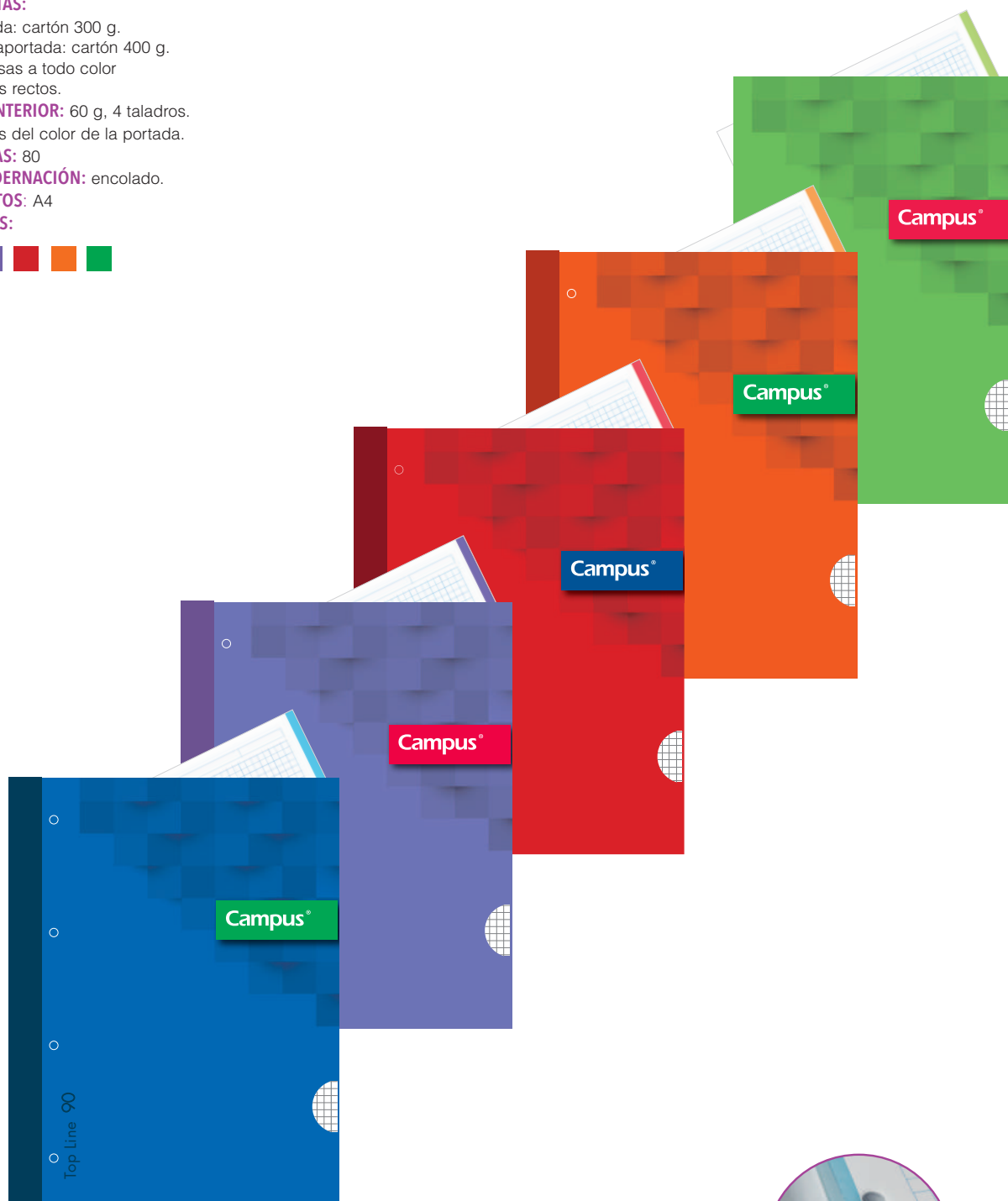

CÓDIGO	FORMATO	MEDIDAS (mm.)	HOJAS	RAYADO	COLOR CUBIERTA	ENVASE PAQ./CAJA
002830	A4	210 x 297	80	Cuadrícula 5 mm.	●	5 / 25
002832	A4	210 x 297	80	Cuadrícula 5 mm.	●	5 / 25
002831	A4	210 x 297	80	Cuadrícula 5 mm.	●	5 / 25
002829	A4	210 x 297	80	Cuadrícula 5 mm.	●	5 / 25
002833	A4	210 x 297	80	Cuadrícula 5 mm.	●	5 / 25

Los códigos en **color amarillo** permiten apertura de envase

RECAMBIOS CUADRÍCULA 5 MM BANDA UNICOLOR

90g

Campus

CUBIERTAS:

- Portada 120 g.
- Impresa a todo color
- Cantos rectos.

PAPEL INTERIOR: 90 g, 4 taladros.

· Bandas del color de la portada.

Nº HOJAS: 100

FORMATOS: A4

COLORES:

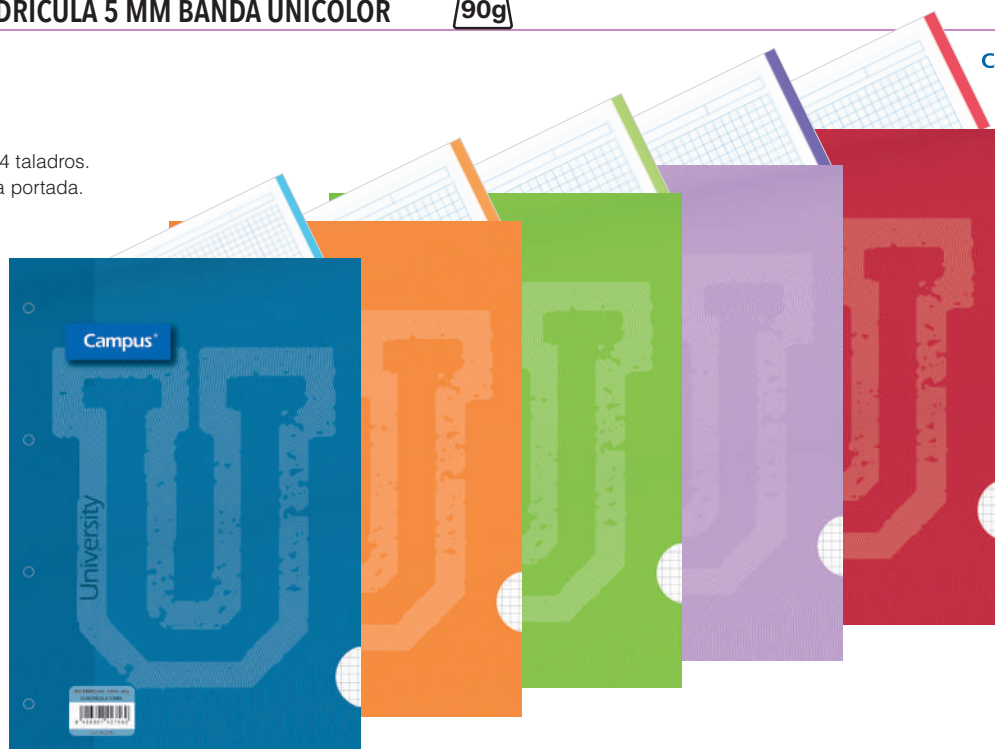

CÓDIGO	FORMATO	MEDIDAS (mm.)	HOJAS	RAYADO	COLOR CUBIERTA	ENVASE PAQ./CAJA
002298	A4	210 x 297	100	Cuadrícula 5 mm	●	5 / 25
002294	A4	210 x 297	100	Cuadrícula 5 mm.	●	5 / 25
002295	A4	210 x 297	100	Cuadrícula 5 mm.	●	5 / 25
002296	A4	210 x 297	100	Cuadrícula 5 mm.	●	5 / 25
002297	A4	210 x 297	100	Cuadrícula 5 mm.	●	5 / 25

RECAMBIOS

60g

Campus

CUBIERTAS:

- Portada 120 g.
- Impresa a todo color
- Cantos rectos.

PAPEL INTERIOR: 60 g

· 4 y 16 taladros.

Nº HOJAS: 100

FORMATOS: 4° y A4

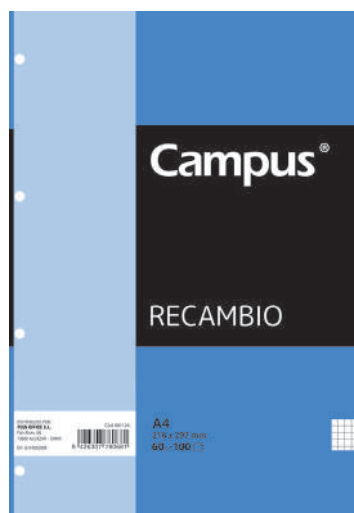
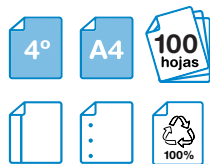

CÓDIGO	FORMATO	MEDIDAS (mm.)	HOJAS	RAYADO	TALADROS	ENVASE PAQ./CAJA
001120	4°	155 x 215	100	Cuadrícula 4 mm.	4	1 / 50
001121	4°	155 x 215	100	Doble raya 2,5 mm.	4	1 / 50
001122	4°	155 x 215	100	Horizontal	4	1 / 50
001123	4°	155 x 215	100	Milimetrado	4	1 / 50
001124	A4	210 x 297	100	Cuadrícula 4 mm.	4	1 / 25
001125	A4	210 x 297	100	Cuadrícula 4 mm.	16	1 / 30
001126	A4	210 x 297	100	Doble raya 2,5 mm.	4	1 / 25
001127	A4	210 x 297	100	Horizontal	4	1 / 25
001128	A4	210 x 297	100	Liso	4	1 / 25
001129	A4	210 x 297	100	Milimetrado	4	1 / 25
001130	A4	210 x 297	100	Milimetrado	16	1 / 30



PAPEL BLANCO CUADRICULADO



Campus

CUBIERTAS:

- Portada 120 g.
- Impresa a todo color
- Cantos rectos.

PAPEL INTERIOR: 80 g

Nº HOJAS: 100

FORMATOS: A4



CÓDIGO	FORMATO	MEDIDAS (mm.)	RAYADO	ENVASE PAQ./CAJA
001604	A4	210 x 297	Cuadrícula 4 mm.	1 / 40

PAPEL BLANCO



Campus

CUBIERTAS:

- Portada 120 g.
- Impresa a todo color
- Cantos rectos.

PAPEL INTERIOR: 80 g

· Excelente blancura.

Nº HOJAS: 100

FORMATOS: A4



CÓDIGO	FORMATO	MEDIDAS (mm.)	ENVASE PAQ./CAJA
001019	A4	210 x 297	1 / 40

PAPEL BLANCO



CUBIERTAS:

- Bolsa impresa a todo color.
- Cantos rectos.

PAPEL INTERIOR: 80 g

· Calidad premium.

Nº HOJAS: 100 y 250

FORMATOS: A4



Blancura
ISO11475:
CIE 169



CÓDIGO	FORMATO	MEDIDAS (mm.)	RAYADO	ENVASE PAQ./CAJA
002874	A4	210 x 297	100 hojas	1 / 24
002473	A4	210 x 297	250 hojas	1 / 10



Los códigos en **color amarillo** permiten apertura de envase

PAPEL DE COLORES



CUBIERTAS:

- Portada 120 g.
- Impresa a todo color
- Cantos rectos.

PAPEL INTERIOR: 80 g

Nº HOJAS: 100 y 500

FORMATOS: A4

15 colores

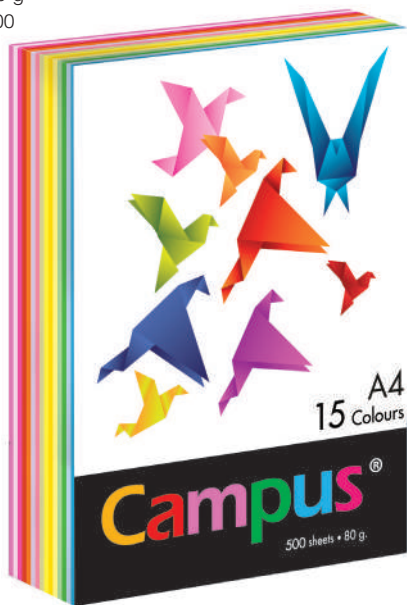

CÓDIGO	MEDIDAS (mm.)	HOJAS/PAQ.	ENVASE
002210	210 x 297 mm	500	5

10 colores

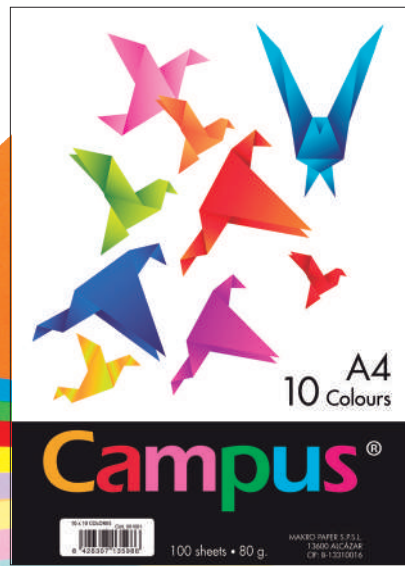

CÓDIGO	COLOR	HOJAS/PAQ.	ENVASE
001001	10 surtidos	100	10 / 22

100 hojas unicolor



CÓDIGO	COLOR	HOJAS/PAQ.	ENVASE
002889	Verde neón	100	1 / 22
002890	Amarillo neón	100	1 / 22
002891	Rosa neón	100	1 / 22
002892	Naranja neón	100	1 / 22

100 hojas unicolor

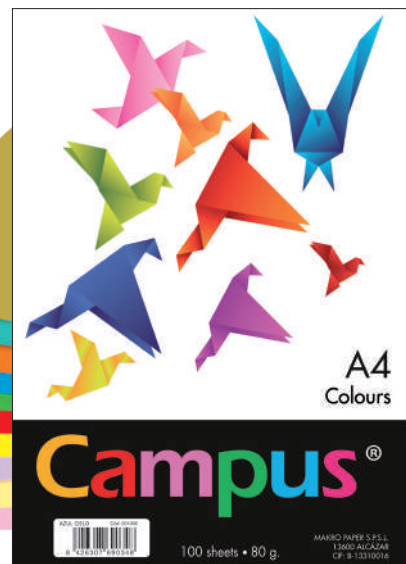

CÓDIGO	COLOR	HOJAS/PAQ.	ENVASE
001160	Amarillo	100	1 / 22
001002	Azul cielo	100	1 / 22
002044	Rosa	100	1 / 22
001577	Verde manzana	100	1 / 22
001009	Verde claro	100	1 / 22
001576	Marfil	100	1 / 22
001161	Rojo	100	1 / 22
001162	Naranja	100	1 / 22
002885	Turquesa	100	1 / 22
002886	Amarillo Limón	100	1 / 22



BLOC MÚSICA

80g

Campus

CUBIERTAS:

- Portada: cartón impreso a todo color, 350 g.
- Trasera: cartón 400 g blanca.
- Cantos rectos.

PAPEL INTERIOR: 80 g

- Pentagrama: normal y grande.

Nº HOJAS: 20

ENCUADERNACIÓN: espiral.

FORMATOS: A4 y A5

- 3 Modelos.

1 PENTAGRAMA 2 MM INTERLINEADO
12 PENTAGRAMAS POR PÁGINA



2 PENTAGRAMA 4 MM INTERLINEADO
4 PENTAGRAMAS POR PÁGINA



3 PENTAGRAMA 2 MM INTERLINEADO
8 PENTAGRAMAS POR PÁGINA



	CÓDIGO	FORMATO	MEDIDAS (mm.)	PENTAGRAMA	HOJAS	ENCUADERNACIÓN	ENVASE
1	001902	A4	210 x 297	Normal	20	Espiral	10
2	630266	A5	155 x 215	Grande	20	Espiral	10
3	630151	A5	155 x 215	Normal	20	Espiral	10

BLOC DE DIBUJO

135g

TÉCNICA SECA

Campus University

CUBIERTAS:

- Portada: cartón impreso a todo color, 350 g.
- Trasera: cartón 400 g blanca.
- Cantos rectos.

PAPEL INTERIOR: 135 g

- Papel blanco natural ligeramente satinado.

Nº HOJAS: 20

ENCUADERNACIÓN: espiral y encolado.

FORMATOS: Recuadro A4 y Liso A4

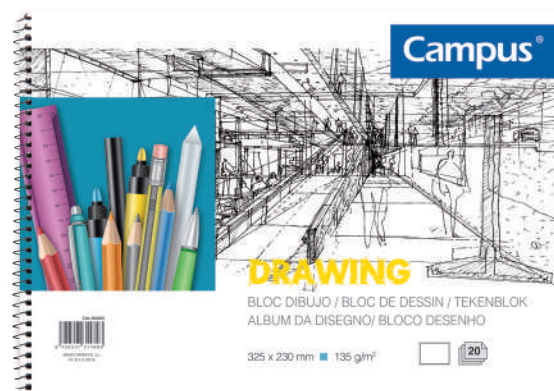
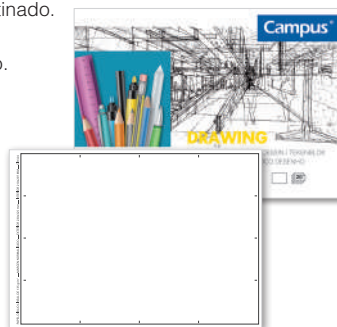

	CÓDIGO	FORMATO	MEDIDAS (mm.)	HOJAS	ENCUADERNACIÓN	ENVASE PAQ./CAJA
	600283	Recuadro A4	325 x 230	20	Espiral	5 / 30
	600281	Recuadro A4	325 x 230	20	Encolado 2 taladros	5 / 30
	600282	Liso A4	325 x 230	20	Espiral	5 / 30



Los códigos en color amarillo permiten apertura de envase

BLOC DE ACUARELA



TÉCNICA HÚMEDA



CUBIERTAS:

- Portada: cartón impreso a todo color, 350 g.
- Trasera: cartón 400 g.
- Cantos rectos.

PAPEL INTERIOR: 190 g

- Papel blanco natural con algodón, gelatinado en masa y superficie.

Nº HOJAS: 20

ENCUADERNACIÓN: espiral.

FORMATOS: A4 y A3



CÓDIGO	FORMATO	MEDIDAS (mm.)	HOJAS	ENCUADERNACIÓN	ENVASE PAQ./CAJA
600304	A4	297 x 210	20	Espiral	2 / 50
600305	A3	420 x 297	20	Espiral	2 / 25

BLOC DE DIBUJO LUXE



TÉCNICA SECA



CUBIERTAS:

- Portada: cartón impreso a todo color, 350 g.
- Trasera: cartón 400 g.
- Cantos rectos.

PAPEL INTERIOR: 160 g

- Papel blanco natural ligeramente satinado.

Nº HOJAS: 30

ENCUADERNACIÓN: espiral.

FORMATOS: A4 y A3



CÓDIGO	FORMATO	MEDIDAS (mm.)	HOJAS	ENCUADERNACIÓN	ENVASE PAQ./CAJA
600302	Liso A4	297 x 210	30	Espiral	5 / 50
600303	Liso A3	420 x 297	30	Espiral	5 / 25



A collection of colorful, 3D-printed mathematical symbols and numbers scattered around the text. The symbols include numbers 1 through 9, 0, and mathematical operators like plus, minus, multiplication, and division. The colors are vibrant and varied, including red, yellow, blue, green, purple, and pink. The symbols are scattered across the page, some overlapping the text.

ÍNDICES

alfabéticos
y
numéricos

INDICE ALFABÉTICO – PAPELERÍA

ALPHABETICAL INDEX – STATIONERY

INDICE ALFABÉTICO – PAPELARIA

INDICE ALFABETICO – CARTOLERIA

ÍNDICE POR CÓDIGOS - CODE INDEX - ÍNDICE POR CÓDIGOS - INDICE PER CODICI

INDICE ALFABÉTICO - PAPELERÍA

A	Página				
Acuarelas	179	Contador manual	109	Lápices de colores metalizados	30, 172
Adaptador compás	187	Correctores en cinta	16–25	Lápices de colores neón	30, 172
Adaptador para lápices	172	Correctores líquidos	27	Lápices de colores Rainbow	172
Afilalápices	104–105, 193–197	Cubiertas para encuadernación	94–95	Lápices de fantasía	202
Afilalápiz eléctrico	104	Cuchillas recambios cutters	103	Lápices de grafito	30, 172
Agendas escolares	252–258	Cutters	102–103	Llaveros portaetiquetas	112
Agujas señalizadoras	106	D		Lupas	110
Alfombrillas ratón	126	Dediles	106	M	
Almohadillas metálicas para sellar	96	Dossiers extensibles	134	Maletines	127
Arandelas autoadhesivas	10	Dossiers fastener	135, 140	Marcadores de pizarra	47, 131
Armarios de llaves	113	Dossiers pinza lateral	140	Marcadores fluorescentes	48–50
Atriles	127	Dossiers polipropileno	134–140	Marcadores permanentes	46
B		E		Marcadores textiles	50
Bandejas portadocumentos	116–117	Encuadernadores latón	110	Masilla Adhesiva	9
Bandejas portamonedas	110	Escalímetro	189	Minas	34
Banderitas señalizadoras	86	Escuadras y cartabones plástico	188–190	Minas para compás	34, 187
Blocs de acuarela	183, 294	Esferas luminosas	203	Mini pinzas de madera	108
Blocs de dibujo	182–183, 294	Estuches de dibujo	177	Mochilas infantiles	239
Blocs de examen	287	Etiquetas autoadhesivas en hojas	90	Mochilas juveniles	239
Blocs de manualidades	215	Etiquetas autoadhesivas polivalentes	91	Mojasellos	110
Blocs de música	221, 293	Etiquetas para libros	90, 220	N	
Blocs, cuadernos y libretas	266–294	Extrae grapas	68	Notas adhesivas Paper In	87
Bolígrafos	35–42	F		Numerador automático	96
Bolígrafos para regalo	51–54	Fastener metálico	106	O	
Bolígrafos para tablet	53	Fastener plástico	106	Organizador metálico	115
Bolsas de papel regalo	264	Flauta	221	Organizadores semanales	260–262
Bolsas multiusos	163–164	Forro de libros	219	P	
Borradores de pizarra	132, 204	Fundas multitaladro	160–161	Papel A4	291
C		Fundas multitaladro colores	161	Papel A4 colores	292
Cajas de caudales	113	Fundas para documentos	161	Papel crespón	213
Calculadoras	74–80	Fundas para plastificar	93	Papel de regalo	263–264
Calculadoras científicas	74	Fundas para tablets	127	Papel fotográfico	92–93
Carpeta con bloc	151–152	Fundas para tarjetas visita	162	Papel seda	213, 215
Carpetas gomas / solapas	141–143	G		Papeleras	117–119
Carpetas canguro	149	Goma EVA	214	Pasteles al óleo	177
Carpetas clasificadoras	153–155	Gomas de borrar	27–28	Pegamento cinta	2–5
Carpetas con anillas	146–151	Gomas de borrar infantiles	201	Pegamento cola blanca	8
Carpetas con fundas	157–160	Gomas elásticas	108–109	Pegamento con purpurina	206
Carpetas con miniclip	152–153	Gomets de colores	220	Pegamento en barra	6
Carpetas cremallera	150–151	Grapadora eléctrica	68	Pegamento instantáneo	9
Carpetas de Dibujo	156	Grapadoras de gruesos	66	Pegamento universal	8
Carritos portamochilas	240	Grapadoras de tenaza	64	Perforador 4 punzones	71
Cartulina	95, 211–212	Grapadoras sin grapas	58–59	Perforadores	69–72
Cartulina metalizada	212	Grapas	68	Perforadores gran capacidad	72
Ceniceros	111	H		Pesacartas	111
Ceras plásticas	173	Huchas	113	Pilas alcalinas	124
Chinchetas	106	I		Pinceles acuarela	178–179
Cinta adhesiva	10–12	Identificadores	121	Pincha–papeles	109
Cinta adhesiva aislante	10	Indíces numéricos y alfabéticos	161–162	Pinzas sujetapapeles	108, 259
Cinta adhesiva decorada	9–10	J		Pistolas de cola	7
Cinta adhesiva invisible	12	Juegos de bloques	241–242	Pizarra caballete	129
Cinta decoración	26	L		Pizarras blancas	129–130, 205
Cinta doble cara	11	Lápices bicolor	30	Pizarras magnéticas	130, 205
Cinta precinto	14	Lápices de colores	172–174	Pizarras negras	130
Cizallas y guillotinas	122–123	Lápices de colores acuarelables	174	Placa con Pinza	112
Clavadoras	67			Planchas de corte	101
Clips de colores	107			Plantillas de dibujo	192
Clips labiados	107			Plantillas normógrafo	192
Clips mariposa	107			Plastilina	207–208
Cocas metalizadas	264			Plumas	51
Compases	184–187			Portacalendario	112
				Portacartas	115
				Portaclips	106–107
				Portafirmas	156
				Portafautas	221
				Portafolios	156
				Portagomas	27
				Portaminas	31–34
				Portanotas	115
				Portanotas símil piel	119
				Portarrollos	13–14
				Portatizas	204
				Portatodos	222–238
				Posters para colorear	218
				Precintadora	14
				Purpurina	208
				R	
				Ratones ordenador	125
				Recambios para bolígrafos	55
				Recambios para carpetas de anillas	268, 288–290
				Recambios para perforadores	72
				Recambios para plumas	55
				Reglas de aluminio	191
				Reglas de plástico	188–190
				Relojes	111
				Reposamuñecas	126
				Reposapiés	128
				Revisteros	115
				Rotulador billetes falsos	50
				Rotuladores calibrados	46, 183
				Rotuladores de colores	175–177
				Rotuladores doble punta	176
				Rotuladores permanentes	46
				Rotuladores punta de fibra	44–45
				S	
				Sellos camuflaje	97
				Semicírculo	188
				Señalizadores magnéticos	108
				Separadores de polipropileno	161–162
				Set de dibujo	190
				Set de escritorio	259–262
				Set de pintura	178
				Set portatodo	236–237
				Set sujetalibros	110
				Silicona líquida	8
				Sillas	166–170
				Sobres polipropileno	138–139
				Sobres portadocumentos	89
				Soporte para portátil	126
				Subcarpetas cartón	137
				T	
				Tableros corcho	132, 205
				Talonarios	82–85
				Tarjeteros	163
				Teclados ordenador	125
				Témperas	180–181
				Tijeras	98–101, 198–200
				Tijeras de bolsillo	98
				Tijeras escolares	198–200
				Tinta para almohadillas	96
				Tubos portaplanos	187

ALPHABETICAL INDEX - STATIONERY

A	PAGE	Dossiers fastener	135, 140	Metal organiser	115	Rucksacks	110
A4 paper	291	Double sided tape	12	Metal sealing pads	96	S	
Adhesive Putty	9	Double-ended felt-tip pens	176	Metallic cardboard	212	Scalimeter	189
Adhesive tape	10–12	Drawing cases	177	Metallic coloured pencils	30, 172	School diaries	252–258
Alkaline batteries	124	Drawing folders	156	Metallised clips	264	School scissors	198–200
Aluminium rulers	191	Drawing set	190	Mini clip folders	152–153	Scientific calculators	74
Ashtrays	111	Drawing templates	192	Mini wooden tweezers	108	Scissors	98–101, 198–200
Automatic Numbering Machine	96	E		Money boxes	113	Sealing tape	14
B		Electric pencil sharpener	104	Mouse pads	126	Self-adhesive labels in sheets	90
Backpack trolleys	238	Electric stapler	68	Multi-purpose bags	163–164	Self-adhesive washers	10
Backpacks for children	239	Envelopes for documents	89	Multi-purpose self-adhesive labels	91	Semicircle	188
Beaker pencil holders	114	Erasers	27–28	Multidrill sleeves	160–161	Shears and guillotines	122–123
Binding covers	94–95	Erasers for children	201	Music pads	221, 293	Side clamp files	140
Blackboard easel	129	EVA erasers	214	N		Signalling banners	86
Blackboards	130	Exam pads	287	Nailers	67	Signature Holder	156
Block sets	241–242	Extra staples	68	Neon coloured pencils	30, 172	Silk paper	213, 215
Book cover	219	F		Normograph stencils	192	Sketch pads	182–183, 294
Book labels	90, 220	Fancy coloured pencils	202	Notebook stand	126	Staplers	58–68
Bookends set	110	Fibre-tip pens	44–45	Notepad folders	151–152	Staplers for thick staples	66
Brass binders	110	File folders	153–155	Notepad holders	115	Staples	68
Briefcases	127	Fluorescent markers	48–50	Notepads, notebooks and notepads	266–294	Stapless staplers	58–59
Business card sleeves	162	Flute	221	Numerical and alphabetical indexes	161–162	Strongbox	113
Butterfly clips	107	Flute holder	221	O		T	
C		Footrests	128	Oil pastels	177	Tablet pens	53
Calculators	74–80	Fountain Pens	51	P		Tablet sleeves	127
Calendar holder	112	G		Painting set	178	Tape correctors	16–25
Calibrated markers	46, 183	Gift pens	51–54	Paper baskets	117–119	Taper	14
Camouflage stamps	97	Gift wrapping paper	263–264	Paper clips	108, 259	Tempera pens	180–181
Card holders	163	Glitter	206	Paper gift bags	264	Textile markers	50
Card weigher	111	Glitter glue	206	Paper In sticky notes	87	Thimbles	106
Cardboard	95, 211–212	Glue guns	7	Pencil adaptor	172	Tissue holders	204
Cardboard subfolders	137	Glue stick	6	Pencil holder set	236–237	Two-coloured pencils	30
Chairs	166–170	Glue tape	2–5	Pencil holders	222–238	U	
Checkbooks	82–85	Glue white glue	8	Pencil sharpener	104–105, 193–197	Universal glue	8
Children's backpacks	239	Graphite pencils	30, 172	Pens		W	
Clip boards	112	H		Permanent markers	46	Watches	111
Clip holder	106–107	Hole punch	69–72	Photo paper	92–93	Watercolour brushes	178–179
Coin trays	110	I		Pincer staplers	64	Watercolour pads	183, 294
Coloured A4 paper	292	Identifiers	121	Plan Holder tube	187	Watercolour pencils	174
Coloured clips	107	Ink pads	96	Plastic crayons	173	Watercolours	179
Coloured erasers	220	Instant glue	9	Plastic Fastener	106	Weekly organisers	260–262
Coloured marker pens	175–177	Insulating adhesive tape	10	Plastic rulers	188–190	Whiteboard erasers	132, 204
Coloured multidrill sleeves	161	Invisible adhesive tape	12	Plastic squares and bevels	188–190	Whiteboard markers	47, 131
Coloured pencils	172–174	K		Plasticine	207–208	Whiteboards	129–130, 205
Colouring posters	218	Kangaroo folders	149	Pocket scissors	98	Wrist rests	126
Compass adapter	187	Key cabinets	113	Poke papers	109	Z	
Compass leads	34, 187	Key-ring label holders	112	Polypropylene bags	134–140	Zip folders	150–151
Compasses	184–187	L		Polypropylene dividers	161–162		
Computer keyboards	125	Laminating sleeves	93	Polypropylene envelopes	138–139		
Computer mice	125	Large capacity punch	72	Portfolio	156		
Cork boards	132, 205	Leads	34	Punch refills	72		
Counterfeit marker	50	Leatherette notepad holder	119	Puncher 4 punches	71		
Cover folders	157–160	Lecterns	127	Pushpins	106		
Craft blocks	215	Letter holder	115	R			
Crepe paper	213	Lip clips	107	Rainbow coloured pencils	172		
Cutter replacement blades	103	Liquid correctors	27	Refills for fountain pens	55		
Cutters	102–103	Liquid silicone	8	Refills for pens	55		
Cutting boards	101	Luminous spheres	203	Ring binder refills	268, 288–290		
D		M		Ring binders	146–151		
Decorated adhesive tape	9–10	Magazine racks	115	Roll holder	13–14		
Decoration tape	26	Magnetic boards	130, 205	Rubber bands	108–109		
Desk set	259–262	Magnetic markers	108	Rubber folders / flap folders	141–143		
Document sleeves	161	Magnifying glasses	110	Rubber holder	27		
Document trays	116–117	Manual counters	109				
Dossiers extensibles	134	Marking needles	106				
		Mechanical pencils	31–34				
		Metal Fastener	106				

ÍNDICE ALFABÉTICO - PAPELARIA

A	Página	Conjunto de secretária	259–262	Lápis mecânicos	31–34	Porta–assinaturas	156
Adaptador de bússola	187	Conjuntos de blocos	241–242	Lecterns	127	Porta–calendário	112
Adaptador de lápis	172	Conjuntos de desenho	177	Líderes	34	Porta–cartões	115
Afiador de lápis	104–105, 193–197	Contadores manuais	109	Livros de cheques	82–85	Porta–etiquetas de porta– chaves	112
Afiador de lápis eléctrico	104	Correctores de fita	16–25	Lupas de aumento	110	Porta–lâpis	222–238
Agrafadores de pinça	64	Correctores de líquidos	27	M		Porta–lâpis	114
Agrafos extra	68	Cortadores	102–103	Mangas coloridas multidiscos	161	Portaborrachas	27
Aquarelas	179	D		Mangas de documentos	161	Portfólio	156
Almofadas de aquarela	183, 294	Descansos para os pulsos	126	Mangas de tabuleiro	127	Pré–venda	14
Almofadas de rato	126	Diário escolar	252–258	Mangas laminadoras	93	Pregadores	67
Almofadas de vedação metálicas	96	Divisores de polipropileno	161–162	Mangas multidítil	160–161	Punção de grande capacidade	72
Almofadas musicais	221, 293	Dossiers de fixação	135, 140	Mangas para cartões de visita	162	Puncher 4 socos	71
Anilhas auto–adesivas	10	Dossiers extensíveis	134	Máquina de numeração automática	96	Pushpins	106
Apagadores de quadros brancos	132, 204	E		Marcação de agulhas	106	Q	
Armários de chaves	113	Encuadernadoras de latão	110	Marcador de contrafacção	50	Quadrados e biséis de plástico	188–190
B		Envelopes de polipropileno	138–139	Marcadores calibrados	46, 183	Quadrados brancos	129–130, 205
Bandejas de documentos	116–117	Envelopes para documentos	89	Marcadores de quadro branco	47, 131	Quadrados magnéticos	130, 205
Banners de sinalização	86	Esboços	182–183, 294	Marcadores fluorescentes	48–50	Quadrados negros	130
Blocos de artesanato	215	Escalímetro	189	Marcadores magnéticos	108	R	
Blocos de exame	287	Esferas luminosas	203	Marcadores permanentes	46	Ratos de computador	125
Blocos de notas, cadernos e blocos de notas	266–294	Estantes para revistas	115	Marcadores têxteis	50	Recargas de anéis de aglutinante	268, 288–290
Borracha EVA	214	Estênceis normográficos	192	Massa Adesiva	9	Recargas de furos	72
Borrachas	27–28	Etiquetas auto–adesivas polivalentes	91	Mini pinça de madeira	108	Recargas para canetas	55
Borrachas para crianças	201	Etiquetas autocolantes em folhas	90	Mochilas	110	Recargas para canetas	55
Briefcases	127	Etiquetas de livros	90, 220	Mochilas para crianças	239	Réguas de alumínio	191
Bússolas	184–187	F		Mochilas para crianças	239	Réguas plásticas	188–190
C		Fecho de Plástico	106	Modelos de desenho	192	Relógios	111
Cadeiras	166–170	Ficheiros de grampos laterais	140	O		S	
Caixas de dinheiro	113	Fita adesiva	10–12	Organizador de metais	115	Sacos de oferta de papel	264
Caixas de lápis	113	Fita adesiva	14	Organizadores semanais	260–262	Sacos de polipropileno	134–140
Calculadoras	74–80	Fita adesiva	2–5	P		Sacos polivalentes	163–164
Calculadoras científicas	74	Fita adesiva decorada	9–10	Papel A4	291	Selos de camuflagem	97
Canetas	35–42	Fita adesiva decorada	9–10	Papel A4 colorido	292	Semicírculo	188
Canetas de feltro de ponta dupla	176	Fita adesiva invisível	12	Papel crepado	213	Silicone líquido	8
Canetas de fibra	44–45	Fita adesiva isolante	10	Papel de embrulho para presentes	263–264	Soco de furo	69–72
Canetas de mesa	53	Fita de dupla face	12	Papel de seda	213, 215	Subpastas de papelão	137
Canetas de oferta	51–54	Fita decorativa	26	Papel em notas adesivas	87	Suporte de rolos	13–14
Canetas marcadoras coloridas	175–177	Fitas de borracha	108–109	Papel fotográfico	92–93	Suporte do plano do tubo	187
Canetas marcadoras permanentes	46	Fixador metálico	106	Papelão	95, 211–212	Suporte para cadernos	126
Canetas Tempera	180–181	Flauta	221	Papelão metálico	212	Suporte para livros set	110
Capa do livro	219	Footrests	128	Pastas com mangas	157–160	T	
Capas de encadernação	94–95	G		Pastas de anéis	146–151	Tábua de grampos	112
Carrinhos de mochila	238	Glitter	206	Pastas de bloco de notas	151–152	Tábuas de corte	101
Caso set	236–237	Gometas coloridos	220	Pastas de borracha / pastas de aba	141–143	Tábuas de cortiça	132, 205
Cavalete de quadro negro	129	Grampeador eléctrico	68	Pastas de classificação	153–155	Tabuleiros de moedas	110
Cestos de papel	117–119	Grampeadores	58–68	Pastas de desenho	156	Teclados de computador	125
Cinzeiros	111	Grampeadores para agrafos grossos	66	Pastas de fecho de correr	150–151	Tesoura	98–101, 198–200
Clipes labiais	107	Grampeadores sem agrafagem	58–59	Pastas de mini cliques	152–153	Tesoura de bolso	98
Clips borboleta	107	Grampos	68	Pastas de Kangaroo	149	Tesouras e guilhotinas	122–123
Clips de papel	108, 259	I		Pastéis de óleo	177	Tesouras escolares	198–200
Clips de papel colorido	107	Identificadores	121	Pesador de cartões	111	Thimbles	106
Clips metalizados	264	Índices numéricos e alfabéticos	161–162	Pilhas alcalinas	124	Tinta para almofada de tinta	96
Clique nos papéis	109	L		Pincéis aquarelados	178–179	Titulares de cartões	163
Cola em bastão	6	Lâminas de substituição do cortador	103	Pistas da bússola	34, 187	Titulares de cartões	163
Cola glitter	206	Lápis bicolores	30	Pistolas de cola	7	Todos os titulares	221–237
Cola instantânea	9	Lápis coloridos	172–174	Plasticina	207–208	Tubos planos	187
Cola universal	8	Lápis de aquarela	174	Plumas	51		
Colar cola branca	8	Lápis de cera de plástico	173	Porta bloco de notas em pele	119		
Colorir cartazes	218	Lápis de cor Arco–íris	172	Porta blocos de notas	115		
Conjunto de desenho	190	Lápis de cor fantasia	202	Porta cliques	221		
Conjunto de pintura	178	Lápis de cor metálica	30, 172	Porta cliques	106–107		
		Lápis de cor néon	30, 172	Porta lenços	204		
		Lápis de grafite	30, 172				

INDICE ALFABETICO - CARTOLERIA

A	Pagina	Correttori per liquidi	27	Matite di grafite	30, 172	Punzone di grande capacità	72
Acquerelli	179	Cucitrice elettrica	68	Matite meccaniche	31-34	Punzone per buchi	69-72
Adattatore per bussola	187	Cucitrici	58-68	Mini pinzette di legno	108	Q	
Adattatore per matite	172	Cucitrici a pinza	64	Modelli di disegno	192	Quaderni di disegni	82-85
Aghi per marcare	106	Cucitrici per punti spessi	66	Mouse per computer	125	Quadri e smussi in plastica	188-190
Armadietti per chiavi	113	Cucitrici senza punti metallici	58-59	N		R	
B		D		Nastro adesivo	10-12	Raccoglitori ad anelli	146-151
Batterie alcaline	124	Diari scolastici	252-258	Nastro adesivo decorato	9-10	Raccoglitori in ottone	110
Blocchi per acquerello	183, 294	Ditali	106	Nastro adesivo invisibile	12	Ricariche per penna	55
Blocchi per appunti, quaderni e taccuini	266-294	Divisori in polipropilene	161-162	Nastro adesivo isolante	10	Ricariche per penne	55
Blocchi per esami	287	Dossiers extensibles	134	Nastro biadesivo	12	Ricariche per punzoni	72
Blocchi per l'artigianato	215	E		Nastro decorativo	26	Ricariche per raccoglitori ad anelli	268, 288-290
Blocchi per la musica	221, 293	Elastici	108-109	Nastro di colla	2-5	Righelli in alluminio	191
Blocchi per schizzi	182-183, 294	Etichette autoadesive in fogli	90	Nastro sigillante	14	Righelli in plastica	188-190
Borse multiuso	163-164	Etichette autoadesive multiuso	91	O		Rondelle autoadesive	10
Borse regalo in carta	264	Etichette per libri	90, 220	Organizzatore in metallo	115	S	
Brillantini	206	F		Organizzatori settimanali	260-262	Sacchetti in polipropilene	134-140
Bussole	184-187	Fascicoli con morsetto laterale	140	Orologi	111	Salvadanai	113
Buste in polipropilene	138-139	Fascicoli di fissaggio	135, 140	P		Scalimetro	189
Buste per biglietti da visita	162	Fermagli per carta	108, 259	Pastelli a olio	177	Sedie	166-170
Buste per documenti	89	Fissaggio in metallo	106	Pastelli di plastica	173	Semicerchio	188
C		Fissaggio in plastica	106	Pennarelli a doppia punta	176	Set da disegno	190
Calcolatrici	74-80	Flauto	221	Pennarelli colorati	175-177	Set da pittura	178
Calcolatrici scientifiche	74	Forbici	98-101, 198-200	Pennarelli con punta in fibra	44-45	Set da scrivania	259-262
Carrelli per zaini	238	Forbici da scuola	198-200	Pennarelli fluorescenti	48-50	Set di blocchi	241-242
Carta A4	291	Forbici tascabili	98	Pennarelli magnetici	108	Set di fermalibri	110
Carta A4 colorata	292	G		Pennarelli per lavagne bianche	47, 131	Set di portamatite	236-237
Carta crespata	213	Gomme	27-28	Pennarelli per tessuti	50	Sfere luminose	203
Carta da pasticci	109	Gomme colorate	220	Pennarelli permanenti	46	Silicone liquido	8
Carta da regalo	263-264	Gomme EVA	214	Pennarelli permanenti	46	Stencil normografici	192
Carta fotografica	92-93	Gomme per bambini	201	Penne	35-42	Striscioni di segnalazione	86
Carta in sticky notes	87	Gomme per lavagne bianche	132, 204	Penne a tempera	180-181	Stucco adesivo	9
Carta seta	213, 215	I		Penne da regalo	51-54	Supporto per notebook	126
Cartelle a canguro	149	Identificatori	121	Penne per tablet	53	T	
Cartelle a zip	150-151	Indici numerici e alfabetici	161-162	Penne stilografiche	51	Taglierine	102-103
Cartelle con copertina	157-160	L		Pennelli per acquerello	178-179	Tamponi d'inchiostro	96
Cartelle con mini clip	152-153	Lame di ricambio per taglierine	103	Pesatrice di carte	111	Taper	14
Cartelle da disegno	156	Lavagne	130	Piombi	34	Tappetini per mouse	126
Cartelle di cartone	137	Lavagne a clip	112	Piombi per bussole	34, 187	Tappetini sigillanti in metallo	96
Cartelle di gomma / cartelle ad alette	141-143	Lavagne bianche	129-130, 205	Pistole per colla	7	Tastiere per computer	125
Cartelle per appunti	151-152	Lavagne in sughero	132, 205	Plastilina	207-208	Tavole da taglio	101
Cartelle portadocumenti	153-155	Lavagne magnetiche	130, 205	Poggiapiedi	128	Temperamatite	104-105, 193-197
Cartone	95, 211-212	Leggio	127	Poggiapolsi	126	Temperamatite elettrico	104
Cartone metallico	212	Lenti d'ingrandimento	110	Porta calendario	112	Timbri mimetici	97
Cassetta di sicurezza	113	M		Porta clip	106-107	Tubetto portapianta	187
Cavalletto per lavagna	129	Macchina numeratrice automatica	96	Porta flauto	221	V	
Cesoie e ghigliottine	122-123	Maniche per laminazione	93	Porta gomma	27	Valigette	127
Cestini di carta	117-119	Maniche per tablet	127	Porta lettere	115	Valigette da disegno	177
Chiodatrici	67	Manicotti multidrill	160-161	Porta rotolo	13-14	Vassoi per documenti	116-117
Clip a farfalla	107	Manicotti multidrill colorati	161	Portablocchi	115	Vassoi per monete	110
Clip a labbro	107	Manicotti per documenti	161	Portablocco in similpelle	119	Z	
Clip colorate	107	Marcatori calibrati	46, 183	Portacarte	163	Zaini	110
Clip metallizzate	264	Marcatori contraffatti	50	Portachiavi per etichette	112	Zaini per bambini	239
Colla bianca	8	Matite acquerellabili	174	Portafazzoletti	204	Zaini per bambini	239
Colla glitterata	206	Matite bicolori	30	Portafirme	156		
Colla istantanea	9	Matite colorate	172-174	Portafoglio	156		
Colla stick	6	Matite colorate arcobaleno	172	Portamatite	222-238		
Colla universale	8	Matite colorate fantasia	202	Portamatite a bicchiere	114		
Contatori manuali	109	Matite colorate metallizzate	30, 172	Portariviste	115		
Copertina del libro	219	Matite colorate neon	30, 172	Posacenere	111		
Coperture per rilegatura	94-95			Poster da colorare	218		
Correttori a nastro	16-25			Punti metallici	68		
				Punti metallici extra	68		
				Puntine	106		
				Punzonatrice 4 fustelle	71		

ÍNDICE NUMÉRICO
CÓDIGO POR PÁGINA



ÍNDICE POR CÓDIGOS - CODE INDEX - ÍNDICE POR CÓDIGOS - INDICE PER CODICI

Código Code	Página Page	Código Code	Página Page	Código Code	Página Page	Código Code	Página Page	Código Code	Página Page	Código Code	Página Page
0		001241	115	001485	86	001902	221	002329	278	002567	88
001001	292	001289	90	001487	111	001902	293	002330	84	002568	88
001002	292	001290	90	001534	91	001961	277	002331	84	002569	88
001009	292	001291	90	001535	91	001973	280	002340	106	002570	88
001019	291	001292	90	001536	91	001974	286	002341	106	002571	88
001096	213	001293	90	001537	91	001975	286	002342	106	002572	88
001112	286	001294	90	001538	91	001976	286	002361	276	002573	88
001113	286	001295	90	001539	91	001977	286	002362	276	002574	88
001114	286	001296	90	001540	91	002044	292	002363	91	002575	88
001115	286	001297	90	001541	91	002146	271	002365	91	002576	88
001116	286	001298	90	001542	91	002149	271	002366	288	002577	88
001117	286	001299	90	001543	91	002150	271	002367	269	002626	260
001118	286	001300	90	001561	277	002151	271	002368	269	002627	259
001119	286	001301	90	001562	278	002152	271	002426	272	002745	271
001120	290	001302	90	001569	92	002153	271	002427	272	002746	271
001121	290	001303	90	001570	93	002162	271	002428	272	002747	270
001122	290	001304	90	001576	292	002164	271	002429	272	002748	270
001123	290	001305	90	001577	292	002175	244	002430	272	002749	270
001124	290	001306	90	001590	10	002176	244	002431	268	002750	270
001125	290	001307	90	001591	89	002179	286	002432	268	002751	270
001126	290	001308	90	001592	89	002181	287	002433	272	002752	270
001127	290	001309	90	001594	281	002182	287	002434	272	002753	267
001128	290	001374	84	001599	277	002185	288	002435	272	002754	267
001129	290	001375	83	001602	277	002186	85	002436	272	002755	270
001130	290	001376	83	001603	277	002187	85	002437	272	002756	270
001137	284	001379	84	001604	291	002188	85	002438	288	002757	270
001138	284	001380	84	001628	87	002191	85	002439	288	002758	267
001139	284	001381	83	001629	87	002192	85	002440	288	002759	267
001140	284	001383	82	001630	91	002195	275	002441	288	002760	270
001141	284	001385	82	001631	91	002196	274	002447	288	002761	270
001142	284	001386	82	001632	91	002197	274	002453	251	002762	272
001143	278	001387	82	001633	91	002199	285	002462	83	002763	272
001144	278	001388	82	001634	91	002200	285	002464	246	002764	268
001145	278	001389	82	001635	91	002201	271	002465	246	002765	268
001146	278	001390	82	001637	91	002202	271	002466	245	002766	272
001148	278	001393	83	001638	91	002203	271	002467	246	002767	274
001149	278	001394	83	001639	86	002204	271	002468	246	002768	279
001150	278	001395	84	001640	86	002205	271	002469	245	002829	289
001151	278	001397	83	001641	86	002206	271	002470	246	002830	289
001152	278	001398	82	001646	92	002207	271	002471	246	002831	289
001153	278	001399	82	001648	92	002208	267	002472	245	002832	289
001154	277	001400	82	001650	86	002209	267	002473	291	002833	289
001156	277	001401	82	001651	86	002210	292	002524	249	002874	291
001157	277	001402	82	001658	277	002219	86	002528	91	002881	245
001158	277	001403	82	001659	278	002242	86	002529	244	002885	292
001159	277	001404	82	001663	91	002244	278	002530	244	002886	292
001160	292	001405	83	001665	277	002291	144	002547	272	002889	292
001161	292	001406	84	001767	285	002294	290	002548	272	002890	292
001162	292	001408	84	001768	264	002295	290	002549	272	002891	292
001167	280	001410	84	001772	275	002296	290	002553	270	002892	292
001168	281	001412	85	001825	275	002297	290	002554	270	002912	93
001171	281	001413	85	001826	275	002298	290	002555	270	002948	267
001172	281	001414	85	001828	280	002299	144	002556	270	002949	268
001205	87	001415	85	001829	288	002300	279	002557	270	002950	288
001206	87	001416	85	001833	244	002301	279	002560	88	002951	277
001207	87	001417	85	001833	284	002302	279	002561	88	002957	250
001208	87	001418	83	001834	244	002303	279	002562	88	002958	248
001209	87	001425	120	001834	284	002304	279	002563	88	002959	248
001210	87	001426	120	001835	87	002306	269	002564	88	002960	248
001221	87	001427	120	001896	287	002309	247	002565	88	002961	250
001240	88	001431	120	001901	278	002311	247	002566	88	002962	250

ÍNDICE POR CÓDIGOS - CODE INDEX - ÍNDICE POR CÓDIGOS - INDICE PER CODICI

Código Code	Página Page	Código Code	Página Page	Código Code	Página Page	Código Code	Página Page	Código Code	Página Page	Código Code	Página Page
002963	250	003342	84	040108	69	040216	109	040449	71	040587	108
002964	249	003343	84	040110	70	040217	109	040450	63	040589	11
002965	249	003373	89	040111	70	040218	109	040454	61	040590	11
002966	248	003374	89	040113	70	040220	127	040461	110	040591	10
002967	248	003375	89	040115	70	040223	112	040464	61	040592	127
002968	249	003437	255	040127	96	040224	110	040466	72	040593	127
002969	262	003438	255	040140	96	040225	110	040469	12	040594	60
002970	262	003439	254	040141	96	040226	110	040473	118	040595	10
002971	262	003440	257	040142	96	040228	113	040475	9	040596	10
002993	270	003441	257	040143	96	040230	113	040478	164	040597	6
002994	270	003442	258	040144	96	040231	110	040479	163	040601	64
002995	270	003443	256	040145	96	040245	67	040481	163	040602	64
002996	270	003444	256	040146	96	040247	65	040490	14	040603	64
002997	272	028926	82	040147	96	040248	65	040491	14	040604	109
002998	272	029096	264	040148	96	040249	65	040494	203	040605	109
002999	272	029099	84	040149	96	040253	11	040496	113	040606	109
003000	272	029100	84	040150	96	040266	112	040497	11	040607	58
003066	263	029306	88	040151	96	040277	100	040498	11	040609	9
003067	263	029614	83	040152	96	040280	115	040499	69	040615	5
003068	263	029625	82	040153	96	040281	119	040504	10	040616	5
003125	89	029632	82	040154	96	040282	118	040505	203	040617	5
003126	89	040002	11	040158	96	040284	100	040506	101	040618	5
003127	89	040003	11	040159	96	040298	114	040508	101	040619	11
003128	89	040004	11	040160	96	040340	67	040509	101	040620	12
003218	264	040005	11	040161	96	040343	106	040514	97	040621	9
003221	273	040011	14	040162	96	040344	119	040515	97	040623	62
003222	268	040012	14	040164	107	040345	118	040516	97	040626	63
003223	277	040013	14	040165	107	040346	114	040517	97	040628	68
003224	277	040014	14	040166	107	040347	115	040518	97	040629	108
003225	269	040015	14	040167	107	040353	100	040520	10	040630	108
003226	269	040016	12	040168	107	040354	100	040521	4	040631	117
003227	269	040029	8	040169	107	040355	100	040524	4	040632	117
003228	284	040030	8	040170	107	040356	111	040525	4	040636	59
003229	284	040031	8	040171	107	040361	14	040526	4	040644	6
003230	284	040039	6	040172	107	040377	102	040527	4	040645	6
003231	284	040041	6	040173	106	040390	119	040529	60	040646	6
003232	284	040044	9	040179	108	040391	119	040530	60	040647	68
003233	284	040048	100	040180	108	040392	12	040531	60	040648	118
003234	268	040049	100	040181	108	040394	12	040532	60	040649	118
003235	268	040052	102	040182	108	040395	13	040533	103	040650	114
003269	261	040053	102	040183	108	040398	72	040534	103	040651	114
003270	260	040056	103	040188	109	040399	114	040535	62	040652	114
003271	260	040057	102	040190	67	040410	13	040536	62	040653	114
003272	261	040057	103	040191	106	040411	112	040538	62	040654	115
003273	261	040058	102	040192	106	040416	120	040547	156	040655	119
003274	261	040058	103	040193	106	040417	120	040548	60	040656	119
003312	267	040063	63	040194	106	040426	72	040552	8	040657	119
003313	275	040078	65	040195	106	040427	66	040557	69	040658	119
003314	271	040080	66	040196	106	040428	72	040559	59	040665	59
003315	271	040081	66	040198	106	040429	72	040560	59	040666	64
003316	267	040085	68	040199	106	040430	63	040562	59	040667	64
003317	268	040087	68	040200	108	040432	102	040563	59	040668	71
003318	275	040090	68	040207	109	040433	102	040564	10	040669	12
003319	275	040091	68	040208	109	040438	117	040565	10	040670	13
003320	275	040092	68	040209	109	040442	118	040566	8	040671	13
003321	275	040093	68	040210	109	040443	118	040572	118	040672	13
003322	275	040094	68	040211	109	040444	118	040573	118	040673	13
003323	275	040095	68	040212	109	040445	4	040574	118	040674	99
003324	275	040096	68	040213	109	040446	4	040575	8	040675	99
003325	273	040101	68	040214	109	040447	71	040576	8	040676	99
003341	84	040104	68	040215	109	040448	71	040579	99	040677	99

ÍNDICE POR CÓDIGOS - CODE INDEX - ÍNDICE POR CÓDIGOS - INDICE PER CODICI

Código Code	Página Page	Código Code	Página Page	Código Code	Página Page	Código Code	Página Page	Código Code	Página Page	Código Code	Página Page
040678	99	040819	109	080530	52	080804	26	080932	35	081076	20
040679	63	040820	109	080535	30	080806	16	080933	35	081077	25
040680	106	040821	109	080535	172	080815	53	080935	36	081078	25
040681	3	040822	109	080539	138	080816	53	080936	36	081079	37
040682	3	040823	109	080540	138	080820	21	080937	36	081081	37
040683	3	040826	68	080541	138	080821	21	080938	31	081082	37
040684	3	040829	14	080542	138	080822	28	080960	34	081083	37
040686	199	069132	110	080543	138	080824	26	080964	32	081084	37
040694	13	069133	110	080544	46	080829	35	080965	32	081085	37
040695	12	069134	110	080544	138	080832	197	080966	33	081086	36
040696	70	069135	110	080545	46	080834	35	080967	33	081087	35
040697	70	069207	110	080545	138	080835	35	080968	34	081088	35
040698	70	069208	110	080546	46	080836	35	080969	28	081089	35
040699	70	069209	110	080546	138	080837	26	080974	46	081091	40
040700	70	069210	110	080551	52	080840	34	080975	46	081092	18
040701	70	069957	14	080562	30	080842	54	080976	46	081093	18
040702	70	069958	14	080562	172	080843	53	080979	47	081094	18
040703	70	080005	27	080563	30	080846	53	080980	35	081095	18
040704	71	080013	28	080563	172	080863	197	080981	35	081096	40
040705	13	080014	28	080564	175	080864	196	080982	35	081097	202
040707	98	080022	27	080570	54	080867	34	080983	36	081098	202
040708	98	080023	27	080591	34	080868	201	080984	36	081099	202
040709	98	080059	195	080602	45	080869	45	080985	36	081104	39
040710	68	080060	104	080603	45	080870	50	080987	38	081116	17
040715	199	080060	194	080604	45	080871	39	080988	38	081117	17
040716	199	080061	104	080605	45	080881	44	080989	18	081118	17
040749	107	080061	194	080606	45	080882	44	080991	19	081119	30
040750	164	080062	104	080612	195	080883	44	080992	196	081121	37
040751	164	080062	194	080614	196	080884	44	080997	40	081122	37
040752	164	080064	104	080654	195	080885	44	080998	40	081123	37
040753	164	080064	202	080656	193	080886	44	080999	40	081124	37
040754	164	080083	34	080659	32	080887	44	081003	28	081140	35
040755	164	080084	34	080673	196	080888	44	081005	201	081141	35
040756	164	080259	50	080675	20	080889	44	081006	35	081143	45
040757	164	080260	50	080676	20	080890	44	081008	36	081144	45
040758	164	080261	50	080677	20	080891	44	081010	38	081145	45
040759	109	080262	50	080690	27	080892	44	081012	37	081146	45
040760	109	080263	50	080709	50	080893	44	081013	37	081147	45
040761	109	080264	50	080720	55	080894	44	081014	37	081148	45
040762	109	080299	46	080721	55	080895	44	081015	37	081149	45
040763	109	080300	46	080722	55	080896	44	081016	37	081150	45
040764	109	080301	46	080723	55	080898	49	081019	16	081151	45
040765	98	080302	46	080724	55	080900	21	081021	54	081152	45
040766	98	080392	55	080725	55	080901	197	081022	53	081153	45
040767	98	080393	55	080726	55	080902	38	081027	45	081154	45
040771	61	080395	55	080727	55	080903	38	081028	45	081155	45
040772	2	080396	55	080728	55	080904	38	081042	30	081156	45
040773	2	080469	54	080729	55	080907	38	081042	172	081157	45
040806	68	080478	28	080732	20	080909	197	081043	28	081158	45
040807	61	080498	46	080741	32	080915	16	081044	28	081159	45
040808	61	080499	46	080747	54	080917	31	081045	41	081160	45
040809	109	080500	46	080763	44	080918	32	081046	40	081161	45
040810	109	080501	46	080764	44	080921	31	081047	40	081162	45
040811	109	080502	46	080765	44	080922	31	081048	40	081163	45
040812	109	080503	46	080766	44	080923	176	081049	35	081164	45
040813	109	080504	46	080770	28	080924	176	081050	35	081165	45
040814	71	080505	46	080770	201	080925	34	081051	45	081166	45
040815	7	080506	46	080776	104	080925	187	081053	50	081167	45
040816	7	080507	46	080800	26	080929	38	081073	16	081168	45
040817	7	080508	46	080802	26	080930	35	081074	16	081169	104
040818	7	080509	46	080803	26	080931	35	081075	16	081169	202

ÍNDICE POR CÓDIGOS - CODE INDEX - ÍNDICE POR CÓDIGOS - INDICE PER CODICI

Código Code	Página Page	Código Code	Página Page	Código Code	Página Page	Código Code	Página Page	Código Code	Página Page	Código Code	Página Page
081170	104	081363	49	081443	131	130506	125	180296	106	180503	156
081170	202	081364	49	081444	35	130507	125	180345	163	180505	149
081171	40	081365	49	081464	49	130518	128	180357	117	180508	142
081172	40	081366	105	081480	24	130519	128	180358	117	180509	142
081173	40	081366	193	081481	24	130520	128	180359	117	180510	142
081174	40	081367	105	081516	47	130529	128	180361	117	180511	142
081181	104	081367	193	081516	131	180004	137	180362	117	180512	149
081181	194	081368	105	081517	47	180005	137	180368	116	180513	149
081182	104	081368	193	081517	131	180006	137	180369	116	180514	149
081182	194	081369	105	081518	47	180007	137	180370	116	180525	136
081183	104	081369	195	081518	131	180008	137	180377	145	180530	136
081183	194	081385	17	081519	47	180010	137	180378	145	180534	142
081184	104	081386	175	081519	131	180011	137	180379	145	180535	142
081184	194	081387	17	081523	41	180012	137	180380	145	180536	142
081185	104	081388	17	081524	41	180013	137	180381	145	180537	142
081185	194	081389	19	081525	41	180014	137	180382	145	180538	142
081197	21	081415	51	081526	49	180057	145	180386	139	180539	142
081198	21	081416	41	081527	49	180058	145	180387	139	180540	142
081288	22	081417	41	081528	49	180059	145	180396	161	180541	142
081289	23	081420	41	081529	49	180060	145	180400	138	180542	142
081290	22	081422	27	081530	49	180061	145	180402	137	180543	142
081291	52	081423	45	081531	49	180062	145	180403	137	180544	142
081292	52	081424	45	081532	49	180110	115	180404	139	180545	142
081293	51	081425	45	081533	49	180204	155	180405	139	180551	160
081294	51	081426	45	081534	49	180213	154	180411	155	180552	160
081295	51	081427	45	081535	49	180214	153	180412	155	180554	160
081296	51	081428	45	081536	49	180216	155	180413	154	180555	151
081297	51	081428	177	081537	49	180221	159	180422	154	180556	151
081299	51	081429	42	081538	49	180222	159	180423	117	180557	151
081300	22	081430	47	081539	49	180223	159	180424	117	180559	134
081301	22	081430	56	081540	49	180224	159	180425	155	180560	134
081302	22	081430	131	081541	49	180225	159	180426	115	180562	134
081303	36	081431	47	081542	49	180226	159	180427	116	180563	160
081304	36	081431	56	081543	49	180227	159	180428	116	180566	152
081305	36	081431	131	081623	48	180228	159	180429	116	180567	153
081306	36	081432	47	081624	48	180229	137	180445	161	180571	121
081307	36	081432	56	081625	48	180230	137	180449	152	180572	121
081310	36	081432	131	081626	48	180231	137	180455	161	180573	121
081311	36	081433	47	081627	48	180232	137	180456	161	180574	121
081325	201	081433	56	081628	48	180233	137	180457	161	180575	141
081330	43	081433	131	081629	48	180234	139	180458	161	180576	141
081331	43	081434	47	081630	48	180235	139	180459	160	180577	141
081332	43	081434	56	081631	48	180236	139	180463	162	180578	141
081333	43	081434	131	081632	48	180237	139	180464	162	180579	141
081334	42	081435	47	081633	48	180238	138	180465	139	180580	141
081335	36	081435	131	081634	48	180239	138	180466	139	180581	121
081336	36	081436	47	081635	48	180240	138	180467	139	180582	121
081339	49	081436	131	081636	48	180266	140	180468	139	180586	160
081347	49	081437	47	1		180267	140	180469	139	180587	160
081348	49	081437	131	130001	126	180268	140	180470	139	180588	137
081350	49	081438	47	130026	126	180269	140	180471	139	180589	137
081351	49	081438	131	130027	126	180270	140	180472	139	180590	116
081352	49	081439	47	130305	124	180271	140	180473	139	180597	162
081353	49	081439	131	130430	124	180272	140	180474	139	180598	146
081354	49	081440	47	130431	124	180273	140	180475	139	180602	136
081355	49	081440	131	130481	126	180274	160	180476	139	180605	136
081356	49	081441	47	130492	127	180275	160	180489	156	180606	136
081357	49	081441	131	130502	125	180276	160	180491	156	180607	146
081360	49	081442	47	130503	125	180282	140	180494	156	180608	146
081361	49	081442	131	130504	125	180292	121	180496	152	180609	146
081362	49	081443	47	130505	125	180295	106	180501	150	180613	157

ÍNDICE POR CÓDIGOS - CODE INDEX - ÍNDICE POR CÓDIGOS - INDICE PER CODICI

Código Code	Página Page	Código Code	Página Page	Código Code	Página Page	Código Code	Página Page	Código Code	Página Page	Código Code	Página Page
180614	157	180701	154	180788	147	180895	162	181085	152	181327	148
180615	157	180702	154	180789	147	180896	162	181086	153	181328	283
180616	157	180703	154	180790	147	180947	143	181087	153	181328	148
180617	157	180704	154	180791	147	180948	143	181088	156	181329	283
180618	157	180705	154	180793	147	180949	143	181089	156	181329	148
180619	157	180706	154	180794	163	180950	143	181090	160	181330	283
180620	157	180707	154	180795	163	180951	143	181109	149	181330	148
180621	157	180708	154	180796	163	180952	143	181110	149	181331	283
180622	157	180709	154	180834	150	180953	143	181111	121	181331	148
180623	157	180711	155	180835	150	180954	158	181138	145	181332	158
180625	162	180712	155	180836	150	180955	143	181139	145	181333	158
180628	157	180713	154	180837	150	180956	143	181140	145	181334	158
180629	153	180714	154	180838	150	180957	143	181141	145	181335	158
180635	142	180715	154	180839	121	180958	143	181142	145	181336	158
180636	142	180720	137	180840	121	180959	143	181144	145	181337	137
180637	142	180721	137	180841	121	180960	143	181145	145	181338	137
180638	142	180724	137	180842	151	180961	143	181146	145	181345	283
180639	142	180725	137	180845	121	180962	155	181147	145	181345	148
180640	164	180735	153	180850	139	180963	282	181148	145	181346	283
180641	164	180736	153	180851	139	180963	148	181150	144	181346	148
180642	140	180737	153	180852	139	180964	282	181151	144	181347	283
180643	140	180738	153	180853	139	180964	148	181152	144	181347	148
180644	140	180739	145	180855	158	180965	282	181153	144	2	
180645	140	180740	145	180856	158	180965	148	181154	144	209281	282
180646	140	180741	145	180857	158	180966	282	181155	147	209281	148
180647	140	180742	145	180858	158	180966	148	181156	147	209282	282
180648	157	180743	145	180859	158	181001	145	181157	147	209282	148
180649	157	180744	145	180860	158	181002	145	181158	147	209326	282
180650	157	180745	145	180861	158	181003	145	181159	147	209326	148
180651	157	180746	145	180862	158	181004	145	181160	144	209327	282
180652	157	180747	139	180863	158	181005	145	181161	144	209327	148
180653	157	180751	145	180864	158	181006	145	181162	144	209329	282
180654	157	180754	145	180865	158	181023	155	181163	144	209329	148
180655	157	180755	145	180866	158	181024	155	181164	160	209353	282
180656	157	180756	145	180867	137	181025	155	181165	160	209353	148
180657	157	180757	160	180868	159	181026	155	181166	151	209354	282
180658	157	180758	160	180869	159	181027	162	181167	151	209354	148
180659	157	180759	158	180870	141	181029	140	181168	151	209356	282
180660	157	180760	158	180871	141	181030	143	181174	147	209356	148
180661	157	180761	158	180872	141	181031	143	181175	147	220090	123
180662	157	180762	147	180873	141	181032	143	181185	117	220091	123
180663	157	180764	147	180874	141	181033	158	181186	117	220092	123
180666	158	180765	147	180875	141	181034	158	181193	138	220122	94
180668	158	180766	147	180876	141	181035	158	181263	135	220123	94
180672	158	180767	147	180878	158	181036	158	181264	135	220124	94
180674	158	180768	147	180879	158	181037	158	181265	135	220126	94
180678	158	180769	147	180880	158	181038	158	181266	135	220127	94
180680	158	180770	147	180881	158	181044	157	181267	135	220132	94
180684	158	180771	147	180882	150	181070	150	181268	135	220136	94
180686	158	180772	147	180883	150	181071	150	181269	135	220139	94
180688	142	180773	147	180884	150	181072	150	181270	135	220140	94
180689	159	180774	147	180885	150	181073	150	181271	147	220142	95
180690	159	180775	147	180886	160	181074	158	181271	147	220142	211
180691	159	180777	147	180887	160	181075	158	181272	147	220143	95
180692	159	180778	147	180888	160	181076	146	181272	147	220143	211
180693	159	180780	147	180889	141	181077	146	181322	143	220144	95
180694	159	180781	147	180890	141	181078	146	181323	143	220144	211
180695	154	180782	147	180891	141	181079	146	181324	143	220145	95
180696	159	180783	147	180892	141	181080	146	181325	143	220145	211
180697	159	180785	147	180893	141	181081	146	181326	143	220147	95
180700	154	180786	147	180894	141	181084	152	181327	283	220147	211

ÍNDICE POR CÓDIGOS - CODE INDEX - ÍNDICE POR CÓDIGOS - INDICE PER CODICI

Código Code	Página Page	Código Code	Página Page	Código Code	Página Page	Código Code	Página Page	Código Code	Página Page	Código Code	Página Page
220148	94	220506	74	220599	205	600034	188	600194	213	600343	185
220151	95	220512	75	220600	77	600035	188	600195	213	600344	185
220151	211	220513	75	220601	130	600042	188	600196	213	600345	185
220152	95	220516	78	220602	130	600047	192	600197	213	600346	185
220152	211	220528	205	220603	130	600048	192	600198	213	600347	185
220154	95	220534	93	220604	130	600049	192	600199	213	600348	185
220154	211	220535	93	220605	130	600050	192	600200	213	600349	185
220155	95	220536	93	220618	94	600051	192	600201	213	600350	185
220155	211	220537	93	220740	94	600052	192	600202	213	600351	34
220197	93	220538	93	220742	211	600053	192	600261	191	600352	189
220198	93	220549	129	220742	95	600054	192	600262	191	600353	189
220199	93	220550	95	220746	124	600055	192	600276	191	600354	189
220200	93	220550	211	220747	124	600081	179	600281	182	600355	189
220201	93	220551	95	220748	124	600082	179	600281	293	600356	189
220214	129	220551	211	220749	124	600083	179	600282	182	600359	191
220215	129	220552	95	220750	124	600084	179	600282	293	600360	191
220216	129	220552	211	220751	124	600085	179	600283	182	600361	191
220217	129	220553	95	220752	124	600086	179	600283	293	600363	212
220222	132	220553	211	220753	124	600087	179	600287	213	600364	185
220223	132	220554	95	220754	124	600088	179	600288	189	600365	191
220224	132	220554	211	220755	124	600089	179	600289	189	600366	184
220225	132	220555	95	220756	124	600090	179	600302	182	600367	184
220226	130	220555	211	220757	124	600091	179	600302	294	600368	184
220227	130	220556	95	248576	93	600092	179	600303	182	600369	188
220415	74	220556	211	260121	113	600093	179	600303	294	600371	181
220417	93	220557	95	260122	113	600094	179	600304	183	600372	213
220419	95	220557	211	260127	112	600095	179	600304	294	600381	190
220419	211	220558	95	260138	110	600096	189	600305	183	600382	190
220420	95	220558	211	260161	167	600097	188	600305	294	600384	186
220420	211	220559	95	260165	170	600151	213	600307	46	600385	186
220422	95	220559	211	260170	166	600152	213	600307	183	600388	184
220422	211	220560	95	260171	167	600153	213	600308	46	600389	184
220424	95	220560	211	260172	167	600154	213	600308	183	600390	184
220424	211	220561	95	260181	166	600155	213	600309	46	600391	177
220425	75	220561	211	260182	166	600156	213	600309	183	600392	46
220447	94	220563	101	260183	169	600157	213	600310	46	600392	183
220459	95	220564	101	260187	170	600158	213	600310	183	600400	178
220459	211	220567	74	260188	169	600159	213	600312	213	600401	178
220464	132	220568	78	260189	169	600160	213	600313	213	600402	179
220465	132	220569	78	260288	167	600161	213	600314	213	600403	179
220466	132	220570	78	260289	167	600162	213	600315	213	600404	212
220467	132	220570	80	260290	167	600163	213	600316	213	600486	183
220468	130	220571	78	260291	168	600164	213	600317	213	600487	183
220469	130	220571	80	260292	168	600165	213	600319	213	600488	183
220470	130	220572	95	260293	168	600166	213	600320	213	619954	187
220471	130	220572	211	260294	168	600167	213	600321	213	630001	132
220472	130	220573	95	6		600168	213	600322	213	630001	204
220473	129	220573	211	600011	187	600169	213	600323	213	630006	132
220474	129	220574	95	600013	186	600170	213	600324	213	630006	204
220475	129	220574	211	600015	184	600171	213	600325	213	630009	204
220476	129	220578	75	600019	187	600172	213	600326	213	630022	177
220477	129	220579	75	600022	187	600173	213	600327	213	630028	172
220481	122	220580	76	600024	190	600185	213	600328	213	630044	174
220482	122	220581	76	600025	189	600186	213	600329	213	630088	200
220493	78	220582	76	600026	188	600187	213	600330	213	630089	200
220495	122	220589	205	600027	188	600188	213	600331	213	630090	200
220496	122	220590	205	600028	188	600189	213	600332	213	630093	215
220504	78	220591	77	600029	188	600190	213	600333	213	630094	215
220504	80	220596	77	600030	188	600191	213	600334	213	630095	215
220505	95	220597	205	600032	188	600192	213	600335	213	630096	215
220505	211	220598	205	600033	188	600193	213	600342	186	630149	221

ÍNDICE POR CÓDIGOS - CODE INDEX - ÍNDICE POR CÓDIGOS - INDICE PER CODICI

Código Code	Página Page	Código Code	Página Page	Código Code	Página Page	Código Code	Página Page	Código Code	Página Page	Código Code	Página Page
630150	90	630461	214	630543	208	630631	208	630779	131	685396	239
630150	220	630462	214	630544	208	630632	208	630779	204	685397	239
630151	221	630463	214	630545	208	630633	208	630780	131	685398	239
630151	293	630464	214	630546	208	630634	180	630780	204	685399	239
630181	219	630465	214	630547	208	630677	217	630787	180	685403	239
630182	219	630466	214	630548	180	630678	217	630812	219	685404	239
630187	219	630467	214	630549	181	630679	217	630813	219	685411	230
630266	221	630468	214	630552	214	630680	217	630814	219	685413	228
630266	293	630469	214	630553	214	630681	217	630815	219	685416	228
630287	181	630470	214	630554	214	630682	216	630816	219	685417	228
630288	208	630471	214	630555	214	630683	216	630817	219	685418	227
630289	203	630472	214	630556	214	630684	216	630821	179	685450	235
630290	203	630473	214	630557	90	630685	108	630830	209	685451	231
630367	174	630474	214	630557	220	630686	108	630835	217	685452	231
630368	174	630475	214	630558	90	630687	218	630836	216	685453	232
630374	203	630478	203	630558	220	630688	218	630837	216	685457	231
630375	203	630480	174	630559	177	630689	218	630838	217	685460	221
630377	180	630482	211	630560	175	630690	218	630843	176	685464	225
630378	180	630483	211	630562	176	630691	181	630844	176	685465	225
630379	180	630484	211	630563	176	630692	214	630852	209	685466	225
630380	180	630485	211	630564	179	630693	214	630854	209	685467	225
630381	180	630486	211	630565	181	630694	214	630929	208	685591	234
630382	180	630487	211	630566	181	630695	214	630930	208	685592	224
630383	180	630488	211	630567	181	630696	214	630931	208	685593	224
630384	181	630489	211	630568	181	630697	214	630932	208	685594	224
630385	181	630490	211	630569	181	630698	214	630933	208	685595	228
630386	181	630491	211	630570	181	630699	214	630934	208	685596	224
630388	181	630492	211	630571	181	630701	214	630935	208	685597	230
630389	181	630493	211	630572	181	630702	212	630936	208	685598	230
630390	181	630494	211	630573	181	630703	212	630937	208	687899	223
630391	181	630495	211	630574	181	630704	212	630938	175	687900	233
630392	181	630496	211	630575	181	630705	212	630939	175	687902	229
630393	206	630497	211	630576	181	630706	212	685283	226	687903	232
630394	178	630498	211	630577	181	630715	207	685285	226	687904	229
630395	180	630499	211	630578	181	630716	173	685286	226	687905	229
630396	180	630500	211	630579	181	630717	173	685287	226	687906	229
630397	180	630501	211	630580	207	630724	211	685288	227	687907	223
630398	212	630502	211	630581	219	630725	211	685289	227	687908	223
630399	212	630503	211	630607	220	630726	211	685291	227	687909	238
630400	212	630504	211	630608	199	630726	211	685295	237	687910	238
630401	212	630505	211	630610	216	630734	217	685307	234	687911	236
630402	212	630506	211	630611	216	630735	173	685311	235	687912	236
630411	172	630507	211	630612	216	630736	211	685331	236	687914	235
630416	218	630508	211	630613	216	630737	211	685331	236	688837	233
630417	218	630511	198	630614	216	630738	211	685334	235	688838	233
630418	219	630512	198	630615	216	630739	211	685336	237	688839	236
630419	219	630513	200	630616	216	630740	211	685337	237	688840	223
630420	178	630518	214	630616	216	630741	211	685339	237	688841	234
630421	221	630518	214	630617	217	630742	211	685343	230	690748	222
630447	30	630519	214	630618	217	630743	211	685370	232	690749	222
630450	214	630520	215	630619	217	630766	212	685377	231	690750	222
630451	214	630530	219	630620	217	630768	207	685379	232	690751	222
630452	214	630532	219	630621	217	630769	207	685384	234	691744	239
630452	214	630534	208	630622	208	630770	207	685387	238	691745	239
630453	214	630535	208	630623	208	630771	207	685388	238	691746	239
630454	214	630536	208	630624	208	630772	173	685389	238		
630455	214	630537	208	630625	208	630775	204	685390	238	7	
630456	214	630538	208	630626	208	630775	173	685391	238	710227	239
630457	214	630539	208	630627	208	630776	131	685392	238	710227	241
630458	214	630540	208	630628	208	630777	204	685393	239	710228	241
630459	214	630541	208	630629	208	630778	131	685394	239	710230	241
630460	214	630542	208	630630	208	630778	204	685395	239	710231	241

PLUS & Campus

