

WWW.UNITROL.PL

UNI-TROL

GARAGE EQUIPMENT

1988
2023

35



HIGH QUALITY
INNOVATION
DESIGN

WYWAŻARKI DO KÓŁ | WHEEL BALANCING MACHINES
БАЛАНСИРОВОЧНЫЕ СТЕНДЫ | AUSWUCHTMASCHINEN

MODEL	MICRO	2312 S 2312 CLASSIC	2312 USG 2312 L	24/7	2451 USG / L / P
					
Średnica obręczy Rim diameter Диаметр диска Felgendurchmesser	10-30"	10-30"	10-30"	10-30"	10-30"
Szerokość obręczy Rim width Ширина диска Felgenbreite	2-15"	2-15"	2-15"	2-15"	2-15"
Dokładność wyważania Balancing accuracy Точность определения дисбаланса Auswuchtgenauigkeit	1 g	1 g	1 g	1 g	1 g
Maks. masa koła Max. wheel weight Макс. вес колеса Max. Radgewicht	70 kg	70 kg	70 kg	70 kg	70 kg
Program „ukryty ciężarek” „The hidden weight” „Спрятанный грузик” „Hinter-Speichen-Platzierung”	✓	✓	✓	✓	✓
Ilość prog. ALU Number of ALU programmes Количество программ ALU ALU Programme	4+2	4+2	4+2	6+2 (easy)	6+2 (easy)
Optymalizacja Optimization Оптимизация Optimierung	✓	✓	✓	✓	✓
Syntezaator mowy Voice synthesizer Синтезатор речи Sprachsynthesizer	-	-	-	✓	✓
Automatyczny nastawnik Automatic data input Автоматический ввод данных Automatische Dateneingabe	-	- / ✓	✓	✓	✓
Wskaźnik laserowy Laser pointer Лазерный указатель Laserpointer	-	-	- / ✓	-	- / ✓
Wyświetlacz, Monitor LCD LED display, LCD monitor LED дисплей, LCD монитор LED Display, LCD Monitor	 LED	 LED	 LED	 LCD	 LCD
Uchwyt pneumatyczny Pneumatic clamp Пневматический зажим Pneumatische Radspannung	-	-	-	-	✓
Sonar(USG)	-	-	- / ✓	-	✓
Bezdotykowy pomiar koła Contactless wheel measurement Бесконтактное измерение колеса Berührungslose Radparameter Messsystem	-	-	-	-	✓
Minimalizacja Minimization Минимизация Minimierung	-	-	-	-	-
Drukarka Printer Принтер Drucker	-	-	-	-	-
Zasilanie elektryczne Power supply Электропитание Stromversorgung	230V / 50 Hz	230V / 50 Hz	230 V / 50 Hz	230 V / 50 Hz	230 V / 50 Hz
Zasilanie pneumatyczne Air supply Пневмопитание Luftversorgung	-	-	-	-	8-10 bar
Moc silnika Driving motor power Мощность двигателя Motorleistung	80 W	80 W	80 W	80 W	80 W
Wymiary Dimensions Размеры Abmessungen (mm)	720x850x1420	880x1070x1500	880x1070x1490	880x1070x1490	1000x1170x1450

WYWAŻARKI DO KÓŁ | WHEEL BALANCING MACHINES
 БАЛАНСИРОВОЧНЫЕ СТЕНДЫ | AUSWUCHTMASCHINEN





3305 LP	TOTEM	MONOLITH + LOT	2322	2362 L
				
10-30"	10-30"	10-30"	10-30"	10-30"
2-15"	2-15"	2-15"	2-20"	2-20"
1 g	1 g	1 g	1 g / 10 g	1 g / 10 g
70 kg	80 kg	80 kg	200 kg	200 kg
✓	✓	✓	-	✓
7+2 (easy)	5+2	∞	6	7
✓	✓	✓	-	✓
✓	✓	✓	-	✓
✓	✓	✓	-	✓
✓	✓	✓	-	✓
 LCD	 LCD (TOUCH)	 LCD (TOUCH)	 LED	 LCD
✓	- / ✓	✓	-	-
✓	✓	✓	-	-
✓	✓	Kamera Camera	-	-
✓	-	-	-	-
✓	✓	✓	-	-
230 V / 50 Hz	230 V / 50 Hz	230 V / 50 Hz	230 V / 50 Hz	230 V / 50 Hz
8-10 bar	(8-10) bar	8-10 bar	8-10 bar	8-10 bar
80 W	80 W	80 W	150 W	150 W
900x1170x1450	1010x1350x1550	980x1250x1490	1100x1630x1580	1100x1630x1580

MICRO

-  – podprogram „ukryty ciężarek”
– optymalizacja
-  – programme „hidden weight”
– optimization
-  – спрятанный грузик
– оптимизация
-  – Hinter-Speichen-Platzierung
– Optimierung

MICRO H – Ręczny napęd, bez osłony koła
Manually operated, without hood
Ручной привод, без кожуха
Manuell Antrieb, ohne Radschutz

MICRO M

-  – podprogram „ukryty ciężarek”
– podprogram statyczny
– podprogram dynamiczny
– optymalizacja
-  – programme „hidden weight”
– static programme
– dynamic programme
– optimization
-  – спрятанный грузик
– статическая программа
– динамическая программа
– оптимизация
-  – Hinter-Speichen-Platzierung
– statisches Programm
– dynamisches Programm
– Optimierung

Ø19 - Standard
Ø14 - Optional



Średnica koła (Wheel diameter): 360 – 740 mm
Maks. szerokość opony (Max. tire width): 265 mm

2312 S

-  - manualny nastawnik
-  - podprogram „ukryty ciężarek”
-  - optymalizacja
-  - manual data input
-  - programme “hidden weight”
-  - optimization
-  - ручной ввод данных
-  - спрятанный грузик
-  - оптимизация
-  - manuelle Dateneingabe
-  - Hinter-Speichen-Platzierung
-  - Optimierung

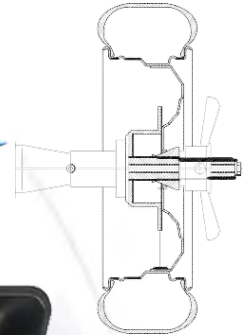

2312 CLASSIC

-  - autonaprowadzanie
-  - automatyczny nastawnik
-  - podprogram „ukryty ciężarek”
-  - optymalizacja
-  - automatyczny wybór programu ALU
-  - automatic positioning lock
-  - automatic data input
-  - programme “hidden weight”
-  - optimization
-  - automatic ALU programme selection
-  - автоматическая блокировка
-  - автоматический ввод данных
-  - спрятанный грузик
-  - оптимизация
-  - автоматический выбор программы ALU
-  - automatische Positionierung
-  - automatische Dateneingabe
-  - Hinter-Speichen-Platzierung
-  - Optimierung
-  - automatische ALU Programmauswahl



2312 USG



- autonaprowadzanie
- automatyczny nastawnik
- podprogram „ukryty ciężarek”
- optymalizacja
- ultradźwiękowy pomiar szerokości
- automatyczny wybór programu ALU



- automatic positioning lock
- automatic data input
- programme “hidden weight”
- optimization
- ultrasonic rim width measurement sensor
- automatic ALU programme selection



- автоматическая блокировка
- автоматический ввод данных
- спрятанный грузик
- оптимизация
- ультразвуковой датчик измерения ширины диска
- автоматический выбор программы ALU



- automatische Positionierung
- automatische Dateneingabe
- Hinter-Speichen-Platzierung
- Optimierung
- USG Sensor für Felgenbreitemessung
- automatische ALU Programmauswahl



2312 L



- autonaprowadzanie
- laserowy nastawnik
- podprogram „ukryty ciężarek”
- optymalizacja
- ultradźwiękowy pomiar szerokości
- automatyczny wybór programu ALU



- automatic positioning lock
- laser measuring arm
- programme “hidden weight”
- optimization
- ultrasonic rim width measurement sensor
- automatic ALU programme selection



- автоматическая блокировка
- лазерная линейка
- спрятанный грузик
- оптимизация
- ультразвуковой датчик измерения ширины диска
- автоматический выбор программы ALU



- automatische Positionierung
- Lasermessarm
- Hinter-Speichen-Platzierung
- Optimierung
- USG Sensor für Felgenbreitemessung
- automatische ALU Programmauswahl



24/7



- autonaprowadzanie
- laser liniowy
- podprogram „ukryty ciężarek”
- optymalizacja
- syntezytor mowy
- automatyczny nastawnik
- drukowanie do pliku



- automatic positioning lock
- line laser
- programme “hidden weight”
- optimization
- voice synthesizer
- automatic data input
- print to file



- автоматическая блокировка
- линейный лазер
- спрятанный грузик
- оптимизация
- синтезатор речи
- автоматический ввод данных
- печать в файл



- automatische Positionierung
- Linienlaser
- Hinter-Speichen-Platzierung
- Optimierung
- Sprachsynthesizer
- automatische Dateneingabe
- Ausgabe in Datei



3305 LP



- autonaprowadzanie
- laserowy nastawnik
- podprogram „ukryty ciężarek”
- optymalizacja
- syntezytor mowy
- bezdotkowy pomiar parametrów koła
- minimalizacja
- pomiar bicia koła
- drukarka



- automatic positioning lock
- laser measuring arm
- programme “hidden weight”
- optimization
- voice synthesizer
- contactless wheel parameters measurement
- minimization
- run-out measurement sensor
- printer



- автоматическая блокировка
- лазерная линейка
- спрятанный грузик
- оптимизация
- синтезатор речи
- бесконтактное измерение параметров колеса
- минимизация
- датчик измерения биения колеса
- принтер



- automatische Positionierung
- Lasermessarm
- Hinter-Speichen-Platzierung
- Optimierung
- Sprachsynthesizer
- Berührungslose Radparameter Messsystem
- Minimierung
- Höhengschlagdiagnose
- Drucker







2451 USG

- 
 - autonaprowadzanie
 - laser liniowy
 - podprogram „ukryty ciężarek”
 - optymalizacja
 - syntezytor mowy
 - automatyczny nastawnik
 - ultradźwiękowy pomiar szerokości
 - drukowanie do pliku
- 
 - automatic positioning lock
 - line laser
 - programme “hidden weight”
 - optimization
 - voice synthesizer
 - contactless wheel parameters measurement
 - ultrasonic rim width measurement sensor
 - print to file
- 
 - автоматическая блокировка
 - линейный лазер
 - спрятанный грузик
 - оптимизация
 - синтезатор речи
 - бесконтактное измерение параметров колеса
 - ультразвуковой датчик измерения ширины диска
 - печать в файл
- 
 - automatische Positionierung
 - Linienlaser
 - Hinter-Speichen-Platzierung
 - Optimierung
 - Sprachsynthesizer
 - Berührungslose Radparameter Messsystem
 - USG Sensor für Felgenbreitemessung
 - Ausgabe in Datei



2451 L

- 
 - autonaprowadzanie
 - laserowy nastawnik
 - podprogram „ukryty ciężarek”
 - optymalizacja
 - syntezytor mowy
 - ultradźwiękowy pomiar szerokości
 - drukowanie do pliku
- 
 - automatic positioning lock
 - laser measuring arm
 - programme “hidden weight”
 - optimization
 - voice synthesizer
 - ultrasonic rim width measurement sensor
 - print to file
- 
 - автоматическая блокировка
 - лазерная линейка
 - спрятанный грузик
 - оптимизация
 - синтезатор речи
 - ультразвуковой датчик измерения ширины диска
 - печать в файл
- 
 - automatische Positionierung
 - Lasermessarm
 - Hinter-Speichen-Platzierung
 - Optimierung
 - Sprachsynthesizer
 - USG Sensor für Felgenbreitemessung
 - Ausgabe in Datei



WATCH VIDEO



SCAN ME

OPTIMIZATION AND HIDDEN WEIGHT (3P) PROGRAM

Program optymalizacji i rozdziału ciężarków (3P)
 Optimierung und Hinter-Speichen-Platzierung (3P)
 Оптимизация и программа "Спрятанный грузик" (3P)



STAT

DYN

ALU



SMALL
SIGNAL
FILTER

POSITION LOCK

NEW VOICE
SYNTH

HIGH PRECISION

Wysoka dokładność
 Hohe Präzision
 Высокая точность



TOTEM



TOTEM + LOT

ADAPTER FOR MOTORBIKES

Uchwyt motocyklowy
 Adapter für Motorradrader
 Мотоциклетный адаптер



AVAILABLE COLOURS

Dostępne kolory
 Verfügbare Farben
 Доступные цвета



MULTILINGUAL SYSTEM

System wielojęzyczny
 Mehrsprachiges System
 Мультиязычная система

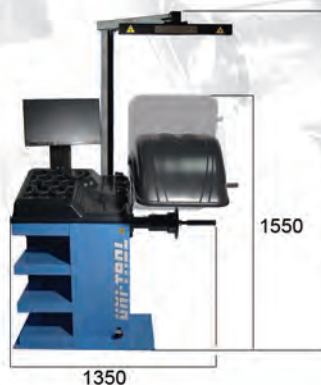

1350

1550

2070



1010

RIM WIDTH SONAR

Automatyczny pomiar szerokości koła

PRECISE LASER INDICATOR

Nastawnik laserowy

WORK LIGHT

Oświetlenie robocze

AUTOMATIC WHEEL POSITIONING

Autonaprowadzanie

LCD MONITOR

Monitor LCD

LASER LINE

Laser liniowy

TOUCH SCREEN

Monitor dotykowy

PRINTER

Drukarka

LIFT

Winda

LASER ON TOP

Laser i oświetlenie robocze

TOTEM

TOTEM
+ LOT



OPTION

OPTION

OPTION

OPTION

OPTION



RIM DIAMETER Średnica obręczy

10" – 30"

RIM WIDTH Szerokość obręczy

2" – 15"

MAX. WHEEL WEIGHT Maks. ciężar koła

80 kg

BALANCING ACCURACY Dokładność niewyważenia

0.1 g

IMBALANCE POSITION INDICATOR ACCURACY
 Dokładność sygnalizacji miejsca niewyważenia

0.45 °

MEASURING SPEED Prędkość obrotowa

140 rpm

MOTOR POWER Moc silnika napędzającego

80 W

POWER SUPPLY Zasilanie elektryczne

230V/50 Hz

AIR SUPPLY Zasilanie pneumatyczne

8 - 10 Bar

DIMENSIONS(L/W/H)MM Wymiary (G/SZ/W) mm

1010/1350/1550

WEIGHT Masa całkowita

120 kg

NEW INTERFACE AND GRAPHIC DESIGN

Nowy interfejs i grafika
Neue Interface und Grafikdesign
Новый интерфейс и графический дизайн

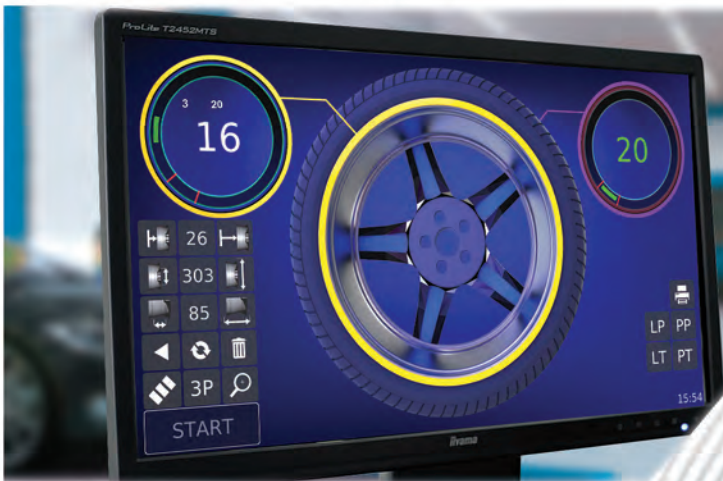

TOUCH SCREEN (OPTION)

Monitor dotykowy
Touchscreen-Monitor
Сенсорный монитор

PRECISE LA

Precyzyjny wskaźnik
Präzise Laseranzeige
Точный лазерный и



SOFTWARE UPDATE

Aktualizacja programu
Programmaktualisierung
Обновление программы



EASY CALIBRATION

Łatwa kalibracja
Einfache Kalibrierung
Простая калибровка



PRINT TO FILE (PRINTER OPTION)

Wydruk do pliku
Ausgabe in Datei
Печать в файл





LASER INDICATOR

laserowy
e
ндикатор



**MENU NAVIGATION
WITHOUT KEYBOARD**

Navigacja bez klawiatury
Menü Navigation ohne Tastatur
Навигация по меню без клавиатуры



TOTEM



WORK LIGHT

Oświetlenie robocze
Arbeitslicht
Рабочее освещение



AUTOMATIC WHEEL POSITIONING

Automatyczne pozycjonowanie koła
Automatische Radpositionierung
Автоматическое позиционирование колес



PNEUMATIC WHEEL GRIP

Pneumatyczny uchwyt koła
Pneumatische Radspannung
Пневматический зажим колеса



LANGUAGE:

-  ENGLISH
-  POLSKI
-  DEUTSCH
-  РУССКИЙ



MODELS:

- MONOLITH S
- MONOLITH
- MONOLITH + LOT

HIGH QUALITY INNOVATION DESIGN

WHEEL BALANCER



WWW.UNITROL.PL

UNI-TROL

GARAGE EQUIPMENT

WATCH VIDEO



SCAN ME

MONOLITH

OPTIMIZATION AND HIDDEN WEIGHT (3P) PROGRAM

Program optymalizacji i rozdziału ciężarków
 Optimierung und Hinter-Speichen-Platzierung (3P)
 Оптимизация и программа "Спрятанный грузик" (3P)



STAT

DYN

ALU

0,1g

SMALL
SIGNAL
FILTER

VOICE
SYNTH

HIGH PRECISION

Wysoka dokładność
 Hohe Präzision
 Высокая точность



MONOLITH S



MONOLITH



MONOLITH+LOT



AVAILABLE COLOURS

Dostępne kolory
 Verfügbare Farben
 Доступные цвета



MULTILINGUAL SYSTEM

System wielojęzyczny
 Mehrsprachiges System
 Мультиязычная система



PNEUMATIC WHEEL CLAMP

Uchwyt pneumatyczny

MONOLITH S

MONOLITH

MONOLITH + LOT

-

✓

✓

RIM WIDTH SONAR

Automatyczny pomiar szerokości koła

✓

✓

✓

TOUCH SCREEN

Monitor dotykowy

✓

✓

✓

PRINTER

Drukarka

OPTION

OPTION

OPTION

3 x CONES

3 x Stożki

-

✓

✓

AUTOMATIC WHEEL COVER

Automatyczna osłona koła

-

✓

✓

LASER ON TOP

Laser i oświetlenie robocze

-

-

✓

WHEEL LIFT

Winda koła

OPTION

OPTION

OPTION

RIM DIAMETER Średnica obręczy

10" - 30"

RIM WIDTH Szerokość obręczy

2" - 20"

MAX. WHEEL WEIGHT Maks. ciężar koła

80 kg

BALANCING ACCURACY Dokładność niewyważenia

0.1 g

IMBALANCE POSITION INDICATOR ACCURACY Dokładność sygnalizacji miejsca niewyważenia

0.45 °

MEASURING SPEED Prędkość obrotowa

140 rpm

MOTOR POWER Moc silnika napędzającego

80 W

POWER SUPPLY Zasilanie elektryczne

230V/50 Hz

AIR SUPPLY Zasilanie pneumatyczne

8 - 10 Bar

DIMENSIONS(L/W/H)MM Wymiary (G/SZ/W) mm

980/1250/1490

WEIGHT Masa całkowita

150 kg

PATENTED INNOVATIVE SYSTEM BASED ON THE REAL WHEEL IMAGE

Opatentowany system pomiaru oparty na rzeczywistym obrazie koła

Patentiertes Messsystem basierend auf dem realen Radbild

Запатентованная измерительная система на основе реального изображения колеса



AUTOMATIC RIM WIDTH ACQUISITION BY SONAR

Pomiar szerokości obręczy za pomocą sonaru

Felgenbreitenmessung mit Sonar

Измерение ширины диска с помощью сонара



SERVICE ONLINE AND SOFTWARE UPDATE

Zdalny serwis i aktualizacja programu

Fernwartung und Programmaktualisierung

Дистанционное обслуживание и обновление программы



EASY CALIBRATION

Łatwa kalibracja

Einfache Kalibrierung

Простая калибровка



PRINTED REPORT / PRINT TO FILE (PRINTER OPTION)

Drukowany raport / Wydruk do pliku

Druckprotokoll / Ausgabe in Datei

Печать протокола / Печать в файл



TOUCH SCREEN

Monitor dotykowy
Touchscreen-Monitor
Сенсорный монитор

LASER ON TOP AND WORK LIGHT

Laser i światło robocze
Laser und Arbeitslicht
Лазер и рабочее освещение



AUTOMATIC WHEEL POSITIONING

Automatyczne pozycjonowanie koła
Automatische Radpositionierung
Автоматическое позиционирование колес



MONOLITH



PNEUMATIC WHEEL GRIP













Pneumatyczny uchwyt koła
Pneumatische Radspannung
Пневматический зажим колеса



PERSONALIZATION AND MODERN DESIGN

Personalizacja i nowoczesny projekt
Personalisierung und modernes Design
Персонализация и современный дизайн

2322

-  – pneumatyczny podnośnik koła
-  – uchwyt do kół samochodów osobowych
-  – wyświetlacz LED
-  – pneumatic lift
-  – car wheels adapter
-  – LED display
-  – пневматический подъемник
-  – зажим для колес легковых автомобилей
-  – LED дисплей
-  – pneumatische Radheber
-  – PKW-Räder Adapter
-  – LED Display

2362 L

-  – pneumatyczny podnośnik koła
-  – uchwyt do kół samochodów osobowych
-  – monitor LCD
-  – laserowy nastawnik
-  – syntezytor mowy
-  – pneumatic lift
-  – car wheels adapter
-  – LCD monitor
-  – laser measuring arm
-  – voice synthesizer
-  – пневматический подъемник
-  – зажим для колес легковых автомобилей
-  – LCD монитор
-  – лазерная линейка
-  – синтезатор речи
-  – pneumatische Radheber
-  – PKW-Räder Adapter
-  – LCD Monitor
-  – Lasermessarm
-  – Sprachsynthesizer



Uniwersalny uchwyt ciężarowy
 Universal truck wheels adapter
 Универсальный зажим для
 грузовых автомобилей
 Universaladapter für LKW

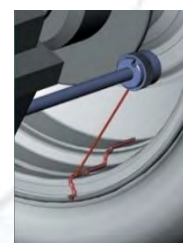



WN-04 (for drive shafts)
 (do wałów napędowych)



W-WA-001 (for crankshafts)
 (do wałów korbowych)



2451 WFP (for rims)
 (do felg)



2451 WKZ (for flywheels)
 (do kół zamachowych)

DANE TECHNICZNE	TECHNICAL DATA	ТЕХНИЧЕСКИЕ ДАННЫЕ	TECHNISCHE DATEN	WN-04	W-WA-001	2451 WFP	2451 WKZ
Maks. długość wyważanych obiektów	Max. length	Макс. длина	Max. Länge	3550 mm	1800 mm	-	-
Maks. średnica wyważanych obiektów	Max. diameter	Макс. диаметр	Max. Durchmesser	300 mm	300 mm	600 mm	600 mm
Dokładność niewyważenia	Accuracy	Точность	Genauigkeit	1 g	1 g	1 g	1 g
Moc silnika napędu	Motor power	Мощность электродвигателя	Motorleistung	0,75 kW	0,75 kW	0,1 kW	0,1 kW
Prędkość obrotowa (obr./min.)	Shaft rotation speed (rpm)	Скорость вращения вала (rpm)	Wellendrehzahl (rpm)	920	920	150	150
Zasilanie elektryczne	Electric supply	Электропитание	Stromversorgung	3x400 V 50 Hz	3x400 V 50 Hz	230 V 50 Hz	230 V 50 Hz
Zasilanie pneumatyczne	Air power supply	Пневмообеспечение	Pneumatische Versorgung	6 – 10 bar	6 – 10 bar	6 – 10 bar	6 – 10 bar

MOUNTING NUTS Nakrętki / Spannmuttern / Монтажные гайки



P-NAK-001 (Ø36)



P-NAK-002 (Ø40)



P1-5000 TR40X3



P-NAK-003



144.403.000



143.403.003 (40 X 3MM)
143.405.003 (40 X 4MM)

FLANGES AND ADAPTERS Dociski i adaptery / Flansche und Adapter / Зажимы и адаптеры



DO-P3



DO-P4



DO-P5



DISC CLAMP



190.008.002



190.008.065



06.01.109



06.05.023



06.05.022



06.01.126



06.01.125A / 06.01.125B

CONES ø36 Stożki ø36 / Konusse ø36 / Конусы ø36



06.04.046 (42-65 mm.)

06.04.001.36 (43-80 mm.)

06.04.002.36 (P 43-80 mm.)

06.04.003.36 (65-110 mm.)

CONES ø36 PNEUMATIC Stożki ø36 Pneumat / Konusse ø36 / Конусы ø36



06.04.055.36 (43-67 mm.)

06.04.056.36 (54-78 mm.)

06.04.057.36 (70-94 mm.)

06.04.058.36 (88-112 m.)

CONES ø36 Stożki ø36 / Konusse ø36 / Конусы ø36

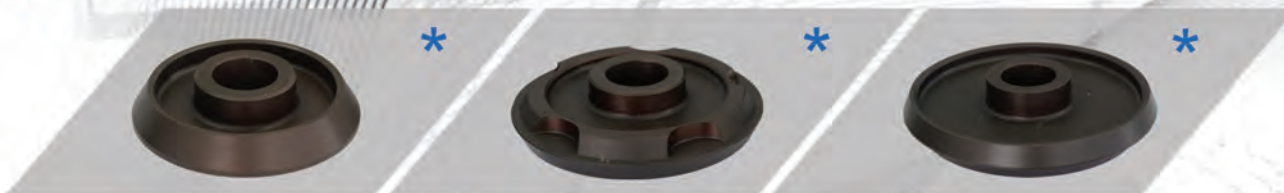

06.04.017 (110-125 mm.)

06.04.008 (125-145 mm.)

06.04.009 (145-165 mm.)

CONES ø40 Stożki ø40 / Konusse ø40 / Конусы ø40



150.400.008 (42-64,5 mm.)

150.400.009 (54-79,5 mm.)

150.400.012 (74-111,5 mm.)

150.400.049 (95-132 mm.)

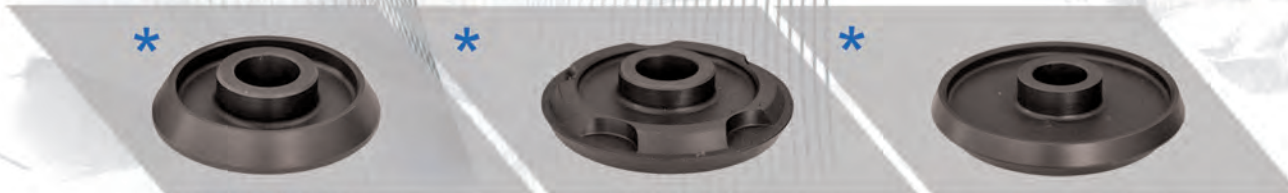

06.04.017.40 (110-125 mm.)

06.04.008.40 (125-145 mm.)

06.04.009.40 (145-165 mm.)

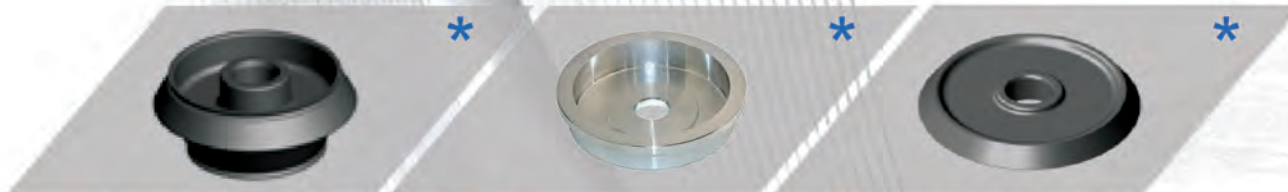

150.400.043 (122-174 mm.)

190.400.018

150.400.022 (168,5-194,5 mm.)

OTHERS Inne / Andere / Другие

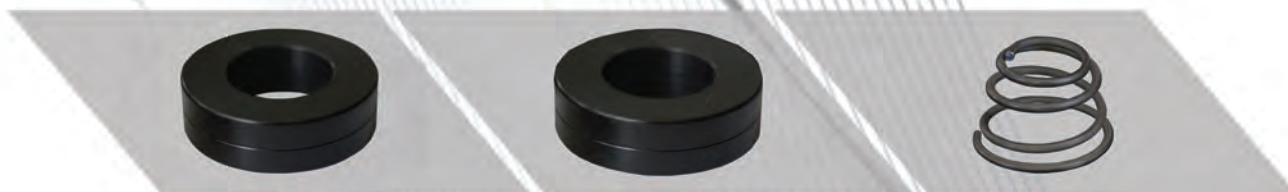

06.01.127.36

06.01.127.40

06.01.092

* - OPTIONAL EQUIPMENT / OPCJONALNE WYPOSAŻENIE.

CAR ADAPTERS Uchwyty do samochodów osobowych / PKW-Adapter / Адаптеры для легковых автомобилей



W-U-1.36 Ø36

UP-1 PNEUMATIC Ø40



W-U-1.40 Ø40

104.818.038



W-U-2AH

WU-2P

TRUCK ADAPTERS Uchwyty ciężarowe / LKW-Adapter / Грузовой адаптеры



702.818.175

702.400.190

W-U-5

EXTENSION

* - OPTIONAL EQUIPMENT / OPCJONALNE WYPOSAŻENIE.

WHEEL BALANCER

MOTORCYCLE ACCESSORIES

MOTORCYCLE ADAPTER Uchwyt motocyklowy / Motorrad Adapter / Адаптер для мотоцикла



W-U-5AH

W-U-5P



W-003 (Ø14)

W-004 (Ø19)

HAWEKA MOTO SET 815 008 003

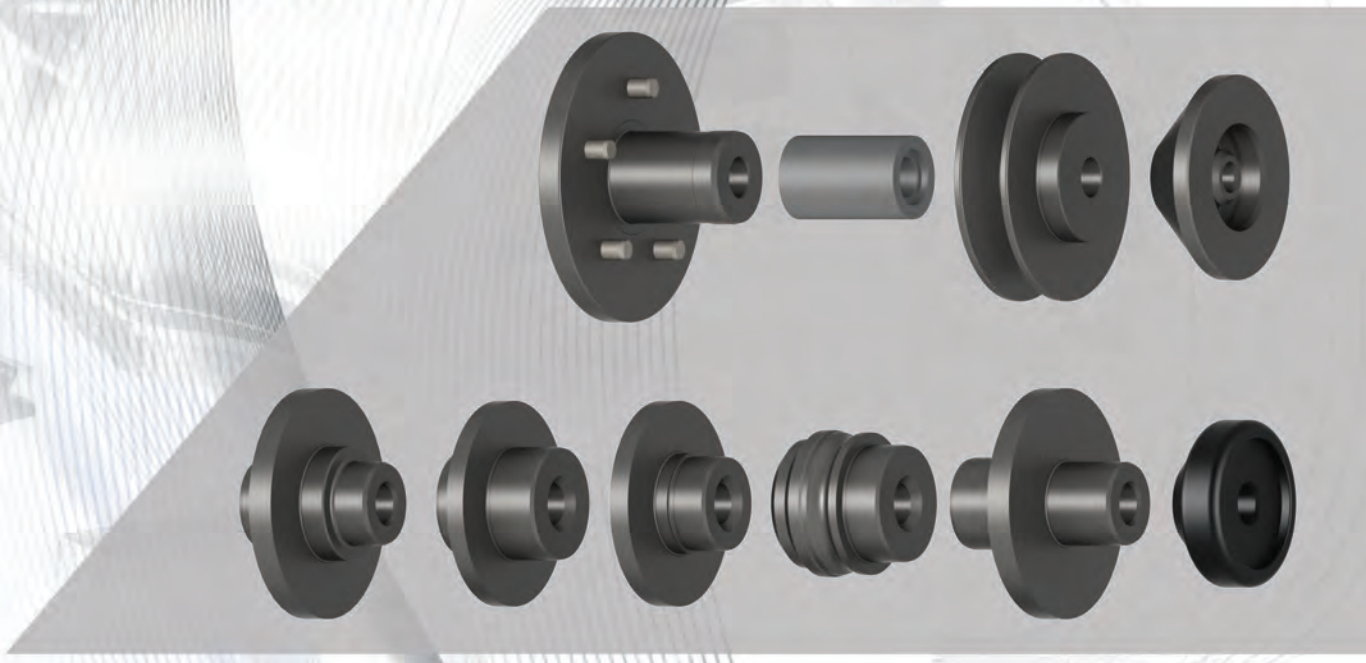

BMW MOTORCYCLE SET 860 008 009

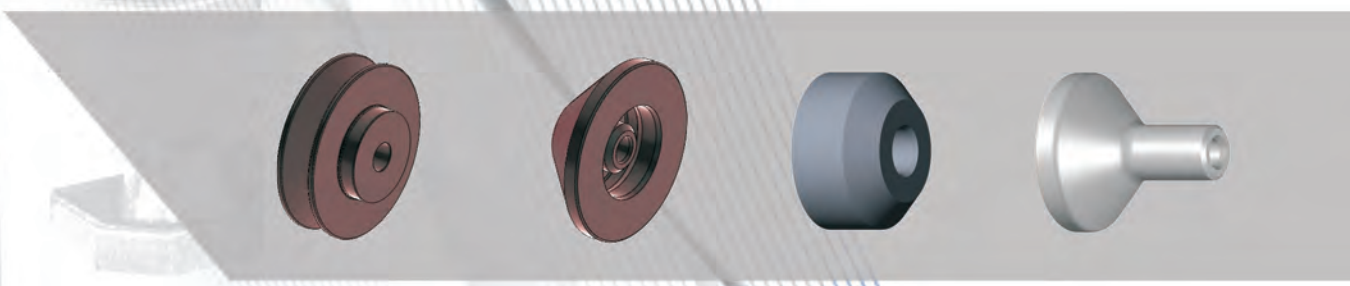

WHEEL LIFT Winda / Radheber / Подъемник



PPK-1



AIRGOLIFT

OTHER ACCESSORIES Pozostałe akcesoria / Sonstiges Zubehör/ Прочие аксессуары



LOT (LASER ON TOP)



PRINTER
Drukarka / Drucker / Принтер



STAND
Stojak / Stand / Стенд



T-CĘG-001
PLIERS / Szczypce / Zangel / Клещи



CYR-001
CALLIPER / Cyrkiel / Zirkel / Циркуль



WK-1
CASSETTE-SHELF FOR WEIGHTS
Kaseta / Gewichtsregal / Полка для грузиков



SCRAPER
Skrobak / Schaber / Скребок

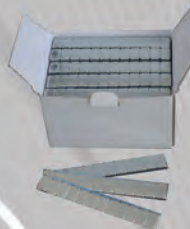

WEIGHTS (EASY TAPE)
Ciężarki / Gewichte / Грузики



RUBBER GRINDING WHEEL
Ściernica gumowa / Gummischleifscheibe / Резиновый шлифовальный круг

TYRE CHANGERS

MONTAŻOWNICE DO KÓŁ
ШИНОМОНТАЖНЫЕ СТАНКИ
REIFENMONTIERMASCHINEN



МОНТАЖОУНИЦЕ ДО КÓŁ | TYRE CHANGERS
 ШИНОМОНТАЖНЫЕ СТАНКИ | REIFENMONTIERMASCHINEN

MODEL	OLA	UNIT 202B + HP1	JANKA LITE JANKA K LITE
<p>WWW.UNITROL.PL</p> <p>UNI-TROL</p> <p>GARAGE EQUIPMENT</p>			
Zewnętrzne mocowanie obręczy Outer clamping range Диапазон зажима снаружи Aussenspannbereich	10-20"	10-22"	10-20"
Wewnętrzne mocowanie obręczy Inner clamping range Диапазон зажима изнутри Innenspannbereich	13-23"	12-24"	13-23"
Maks. szerokość koła Max. wheel width Макс. ширина колеса Max. Radbreite	15"	15"	15"
Maks. średnica kół Max. wheel diameter Макс. диаметр колеса Max. Raddurchmesser	1070 mm	1200 mm	1070 mm
Siła nacisku odpiekacza przy 10 barach Bead-breaker cylinder force at 10 bar Сила отжима при 10 бар Abdruckerkraft (10 bar)	2800 kg	2000 kg	2800 kg
Ciśnienie robocze Operating pressure Рабочее давление Arbeitsdruck	8-10 bar	8-10 bar	8-10 bar
Prędkość obrotowa stołu Turntable rotating speed Скорость вращения стола Drehgeschwindigkeit	7 (14) rpm	7 (14) rpm	7 (14) rpm
Zasilanie elektryczne Electric supply Электропитание Stromversorgung	3 x 400 V / 50 Hz	3 x 400 V / 50 Hz	3 x 400 V / 50 Hz
Moc silnika Motor power Мощность двигателя Motorleistung	0,75 kW	0,75 / 1,1 kW	0,75 kW
Silnik pompy Pump motor Двигатель насоса Hydraulikmotor	-	-	-
Masa Weight Вес Gewicht	180 kg	350 kg	200 kg
Wymiary Dimensions Размеры Abmessungen (mm)	800x1520x900	1580x2250x1642	850x1520x900
Uchwyt koła Wheel chuck Крепление колеса Radspannung	Pneumatyczny Pneumatic	Pneumatyczny Pneumatic	Pneumatyczny Pneumatic

MONTAŻOWNICE DO KÓŁ | TYRE CHANGERS
 ШИНОМОНТАЖНЫЕ СТАНКИ | REIFENMONTIERMASCHINEN

JANKA / K / KK			YANKA K INV	MANAGER S	MANAGER 12-26	40.3.E
						
10-26"			10-28"	10-24"	12-26"	12-30"
12-28"			10-28"	10-24"	14-28"	12-30"
15"			15"	15"	15"	13"
1070 mm			1020 mm	1000 mm	1100 mm	1100 mm
2800 kg			2800 kg	3000 kg	3000 kg	3000 kg
8-10 bar			8-10 bar	8 bar	8-10 bar	8-10 bar
7 (14) rpm			3 (16) rpm	8 (16) rpm	6 (12) rpm	7 (14) rpm
3 x 400 V / 50 Hz			230 V / 50 Hz	3 x 380 V / 50 Hz	3 x 400 V / 50 Hz	230 V / 50 Hz
0,75 kW / 1,1 kW			0,85 kW	1,0 / 1,3 kW	1,3 / 1,8 kW	1,3 / 1,8 kW
-			-	-	1,5 kW	-
200 kg	250 kg	300 kg	300 kg	220 kg	380 kg	420 kg
800x1520x900	850x1520x900	950x1520x900	1950x950x1200	1820x1135x1620	1430x860x1550	1930x970x1200
Pneumatyczny Pneumatic			Pneumatyczny Pneumatic	Pneumatyczny Pneumatic	Pneumatyczny Pneumatic	Mechaniczny Mechanic

REINFORCED HORIZONTAL SLIDE

Wzmocnione suwadło poziome
Verstärkter horizontal Schieber
Усиленный узел горизонтального ползуна

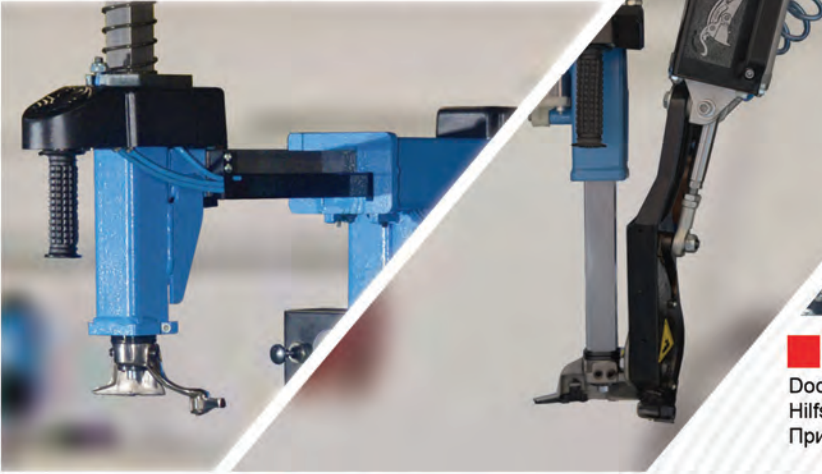

HELPER FOR RUN-FLAT AND LOW-PROFILE TYRES

Dodatkowe przystawki do opon niskoprofilowych i run-flat
Hilfsmontagearm für UHP- und Runflat-Rädern
Приспособление для низкопрофильных шин и шин run-flat

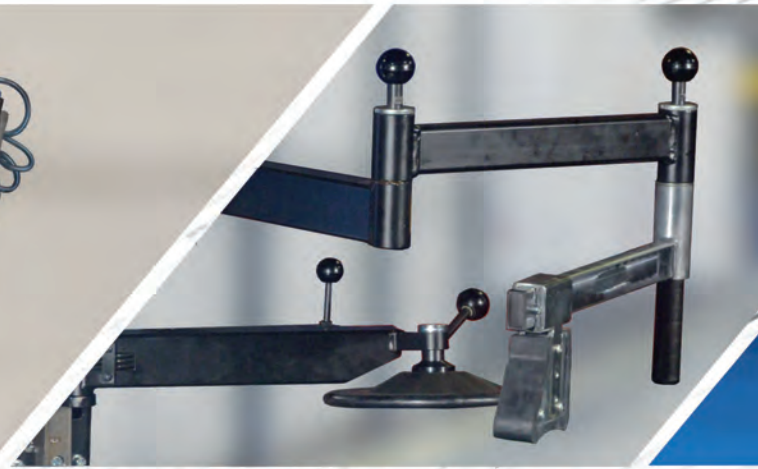

LEVERLESS

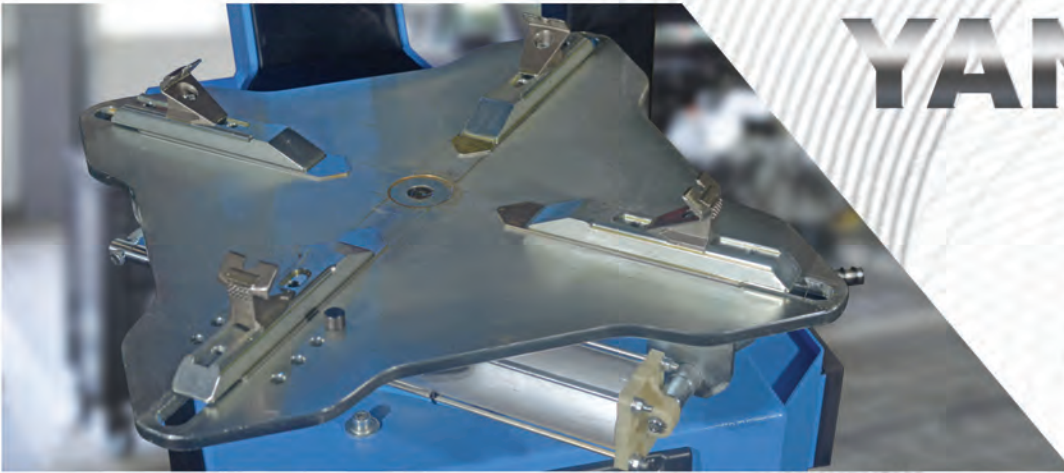

YANKA K

TABLE WITH ADJUSTABLE JAW SPACING

Stół montażowy z regulacją rozsuwu
Montagetisch mit einstellbarem Montierklauenabstand
Стол с регулируемым расстоянием между зажимами

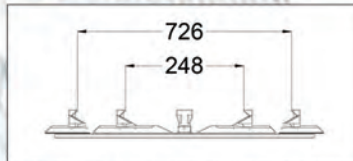

VERY STRONG COLUMN

Bardzo sztywna kolumna
Sehr starke Säule
Очень мощная колонка

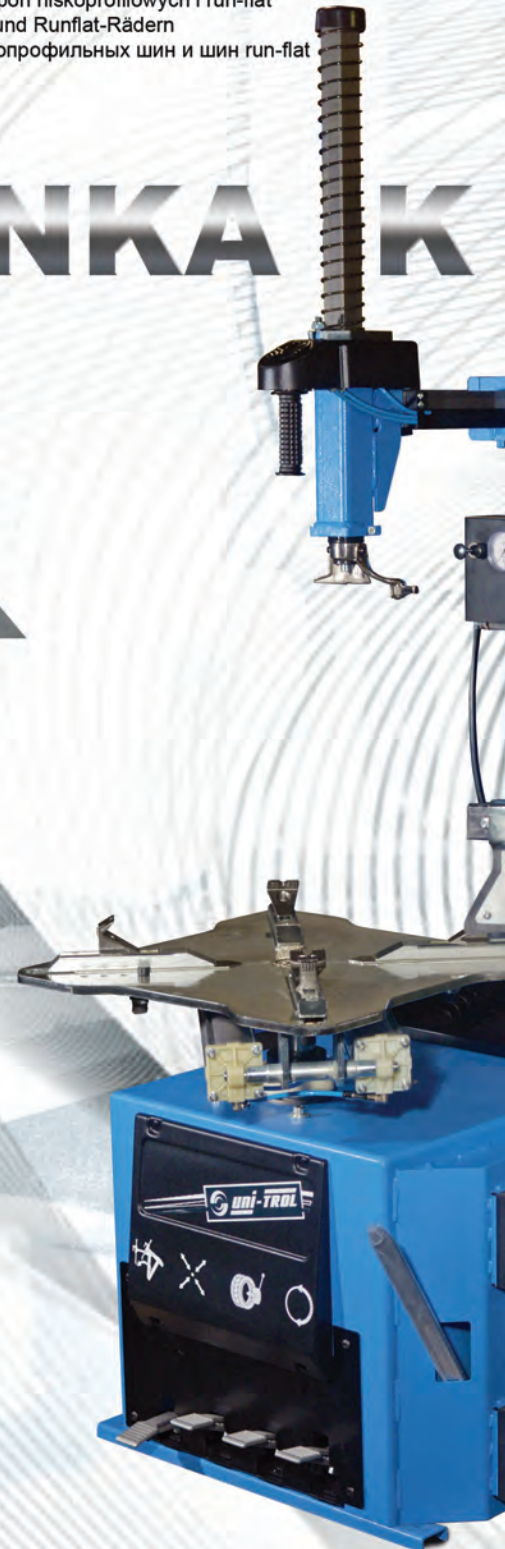



PRESSURE ROLLER

Rolka dociskowa
Druckwalze
Прижимной ролик

PLATE FACILITATING TYRE LIFTING

Talerz ułatwiający podnoszenie opony
Platte zum leichteren Anheben des Reifens
Тарелка облегчающая подъем шины

INV



PEDAL CONTROLLED WHEEL PUMPING SYSTEM

System pompowania koła sterowany pedałem
Pedalgesteuertes Radpumpensystem
Система подкачки колес с педальным управлением

LEVER

Łyżka
Abdrückschaufel
Лопатка

BEAD-BREAKER

Regulowany odpiekacz
Abdrücker
Отжим

JANKA SERIES

TYRE CHANGERS

ACCESSORIES

Akcesoria
Zubehör
Аксессуары



OPTION



ROLLER PROTECTOR, PROTECTORS FOR ALU RIMS, LEVER, INFLATING GUN

Oslona rolki, nakładki na szczęki, tyżka wulkanizatorska i pistolet.
Montagerollerschutz, Kunststoffschutz für Aluminiumfelgen, Abdrückschaufel, Reifenfüllmesser
Защита ролика, Накладки для алюминиевых дисков, Лопатка, Устройство накачки



JANKA



JANKA K



JANKA KK



AVAILABLE COLOURS

Dostępne kolory
Verfügbare Farben
Доступные цвета



780



900

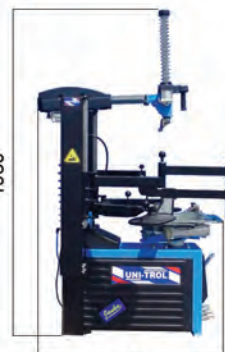

1010

Helper for RUN FLAT and low-profile tyres Przystawka do opon RUN FLAT i NISKOPROFILOWA	-	1	2
Tyre inflating gun with manometer Pistolet do pompowania	✓	✓	✓
Roller protector Oslona rolki	✓	✓	✓
Adapter for motorcycle wheels Nakładki do kół motocyklowych	OPTION	OPTION	OPTION
2-speed motor 2 biegi	OPTION	OPTION	OPTION
One phase motor Jednofazowy motor	OPTION	OPTION	OPTION

	JANKA	JANKA K	JANKA KK
Helper for RUN FLAT and low-profile tyres	-	1	2
Tyre inflating gun with manometer	✓	✓	✓
Roller protector	✓	✓	✓
Adapter for motorcycle wheels	OPTION	OPTION	OPTION
2-speed motor	OPTION	OPTION	OPTION
One phase motor	OPTION	OPTION	OPTION

OUTER CLAMPING Zewn. mocowanie obręczy	10" – 26"
INNER CLAMPING Wewn. mocowanie obręczy	12" – 28"
MAX. WHEEL WIDTH Maks. szerokość koła	15"
MAX. WHEEL DIAMETER Maks. średnica koła	1070 mm
BEAD BREAKER FORCE Siła nacisku odbicia	1500 kg
WORKING PRESSURE Ciśnienie robocze	8 - 10 bar
WEIGHT Masa maszyny	200/250/300 kg
WHEEL GRIP Uchwyt koła	Pneumatic
VOLTAGE Napięcie zasilania	3x400 V / 50 Hz
TURNTABLE ROTATING SPEED Prędkość obrotowa stołu	7 (14) rpm

MANAGER

- automatyczne odchylenie kolumny
- przystawka PLUS dla opon high performance
- automatyczny odpiekacz nowej generacji
- dodatkowe półki z zaworem do pompowania
- nowy system pedałów sterujących i system blokowania

- automatically tilting column
- assistant PLUS
- automatic bead-breaker
- additional shelves with inflator
- new steering pedal system and locking system

- автоматический наклон колонны
- устройство PLUS
- автоматическая отжимная лопата
- дополнительные полки с инфлятором
- новая педальная система и система блокировки

- Automatische Säulenneigung
- Assistant PLUS
- Automatischer Abdrücker
- Zusätzliche Regale mit Inflator
- Neues Steuerpedalsystem und Schließsystem



Option:
- Leverless
- Inflator

WATCH VIDEO



SCAN ME

40.3 E

- podwójny system blokowania
- pneumatyczna kontrola wznoszenia i opadania
- automatyczna stopka Leverless
- przystawki pomocnicze do opon niskoprofilowych lub Run-Flat
- system pedałów sterujących
- elektryczny odpiekacz

- double locking system
- pneumatic control of rising and falling.
- automatic Leverless finger
- auxiliary supports for low-profile or run-flat tyres
- pedal control
- electric bead-breaker

- системой двойной блокировки
- пневматическим управлением подъема и опускания.
- автоматический палец Leverless
- вторичные опоры для низкопрофильных и шин Run-Flat
- педальный узел
- электрическое устройство отрыва

- Doppelverriegelungssystem
- Pneumatischer Steuerung des Hebens und Senkens.
- Automatischer Leverless Finger
- Hilfsstützen für Niederquerschnitts- oder Runflat-Reifen.
- Pedalsteuerung
- Elektrische abdrücke



WATCH VIDEO



SCAN ME

TYRE CHNAGER



LEVERLESS

Leverless
Leverless
Leverless



ADAPTER

Adapter
Адаптер
Adapter



QUICK-EXCHANGE DEVICE WITH PLASTIC OR METAL HEAD

Zestaw do szybkiego montażu ze stopką plastikową / metalową
Быстросъемное устройство с пластиковой или металлической головкой
Schnellwechsellvorrichtung mit Kunststoff- oder Metallkopf



INFLATION PEDAL

Pompowanie w pedale
Педаль накачки
Aufblaspedal

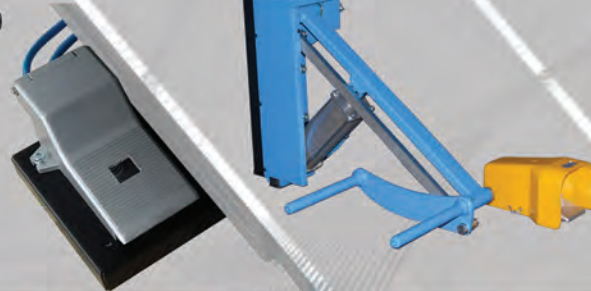

WHEEL LIFT

Winda
Подъемник колеса
Radheber



INFLATOR

Inflator
Инфлятор
Inflator



BEAD-BREAKER PAD

Oslona na odbijak
Подушка отбортовки
Abdrückerpad



BEAD-BREAKER PROTECTOR

Oslona na zbijak
Протектор отбортовки
Abdrückerschutz



LEVER PROTECTOR

Oslona na łyżkę
Протектор лопатки
Abdrückschaufelschutz



LEVER 500MM - 600MM

Łyżka 500mm i 600mm
Лопатка
Abdrückschaufel



CLAMP

Imadło
Зажим
Klemme



INFLATION GUN

Pistolet
Пистолет накачки
Aufblaspistole

ACCESSORIES

TRUCK TYRE-CHANGERS







MONTAŻOWNICE DO KÓŁ CIĘŻAROWYCH

ШИНОМОНТАЖНЫЕ СТАНКИ ДЛЯ ГРУЗОВИКОВ

Reifenmontiermaschinen für LKW



MONTAŻOWNICE DO KÓŁ | TYRE CHANGERS
 ШИНОМОНТАЖНЫЕ СТАНКИ | REIFENMONTIERMASCHINEN

MODEL	UT-26	UT-27	AT-26	UT-56	AT-56
					
Mocowanie obręczy Clamping range Диапазон зажима Spannbereich	14-26"	13-27"	14-28"	14-56" *	14-56" *
Maks. szerokość koła Max. wheel width Макс. ширина колеса Max. Radbreite	780 mm	780 mm	820 mm	1065 mm	1065 mm
Maks. średnica kół Max. wheel diameter Макс. диаметр колеса Max. Raddurchmesser	1600 mm	1600 mm	1640 mm	2300 mm	2300 mm
Siła nacisku odpiekacza przy 10 barach Bead-breaker cylinder force at 10 bar Сила отжима при 10 бар Abdruckerkraft (10 bar)	1900 kg	1500 kg	2500 kg	2500 kg	2500 kg
Ciśnienie robocze Operating pressure Рабочее давление Arbeitsdruck	130 bar	130 bar	130 bar	130 bar	130 bar
Prędkość obrotowa stołu Turntable rotating speed Скорость вращения стола Drehgeschwindigkeit	6 rpm	6 (12) rpm	6 (12) rpm	6 (12) rpm	6 (12) rpm
Zasilanie elektryczne Electric supply Электропитание Stromversorgung	3 x 400 V / 50 Hz	3 x 400 V / 50 Hz	3 x 400 V / 50 Hz	3 x 400 V / 50 Hz	3 x 400 V / 50 Hz
Moc silnika Motor power Мощность двигателя Motorleistung	1,1/1,5 kW	1,5 kW	1,5 kW	1,3/1,8 kW	1,3/1,8 kW
Silnik pompy Pump motor Двигатель насоса Hydraulikmotor	2,2 kW	1,5 kW	1,5 kW	1,5 kW	1,5 kW
Masa Weight Вес Gewicht	600 kg	560 kg	530 kg	770 kg	850 kg
Wymiary Dimensions Размеры Abmessungen (mm)	1600x1050x1200	1430x860x1550	1390x700x1400	1640x800x2000	2257x1720x1540
Uchwyt koła Wheel chuck Крепление колеса Radspannung	Hydrauliczny Hydraulic	Hydrauliczny Hydraulic	Hydrauliczny Hydraulic	Hydrauliczny Hydraulic	Hydrauliczny Hydraulic

* Option

MONTAŻOWNICE DO KÓŁ | TYRE CHANGERS
 ШИНОМОНТАЖНЫЕ СТАНКИ | REIFENMONTIERMASCHINEN

MAXI-56	UT-27 M	AT-26 M	UT-356	UT-360
				
14-56" *	13-26"	14-26"	14-56" *	14-60" *
1300 mm	600 mm	600 mm	1500 mm	1800 mm
2400 mm	1300 mm	1300 mm	2600 mm	3000 mm
2500 kg	2550 kg	2500 kg	3500 kg	3800 kg
130 bar	130 bar	110 bar	130 bar	180 bar
6 (12) rpm	6 (12) rpm	6 (12) rpm	5/10 rpm	4/6/10 rpm
3 x 400 V / 50 Hz	3 x 400 V / 50 Hz	3 x 400 V / 50 Hz	3 x 400 V / 50 Hz	3 x 400 V / 50 Hz
1,5 kW	1,5 kW	1,5 kW	4,0 kW	4,8 kW 5,6 kW 2-prędkości
1,5 kW	2,2 kW	1,5 kW	2,6 / 3,2 kW	5,0 kW
1048 kg	450 kg	550 kg	1600 kg	2460 kg
1430x860x1550	1640x800x2000	1055x1020x1453	2700x1800x1000	2990x2290x1330
Hydrauliczny Hydraulic	Hydrauliczny Hydraulic	Hydrauliczny Hydraulic	Hydrauliczny Hydraulic	Hydrauliczny Hydraulic

* Option

MAXI-56

TRUCK TYRE CHANGER

AUTOMATIC TOOL ROTATION

Narzędzie automatycznego obracania
Автоматическое вращение инструмента
Automatische Werkzeugdrehung



5 FIXING POSITIONS

Pięć pozycji mocowania
5 позиций крепления
5 Befestigungspositionen



AVAILABLE COLOURS

Dostępne kolory
Доступные цвета
Verfügbare Farben



Wi Fi

WIRELESS

Beprzewodowa
Беспроводной
Kabellos

CONTROL PANEL

Sterowanie
Панель управления
Schalttafel



2 GEARS

Dwa biegi
2 Скорости
2-Gang

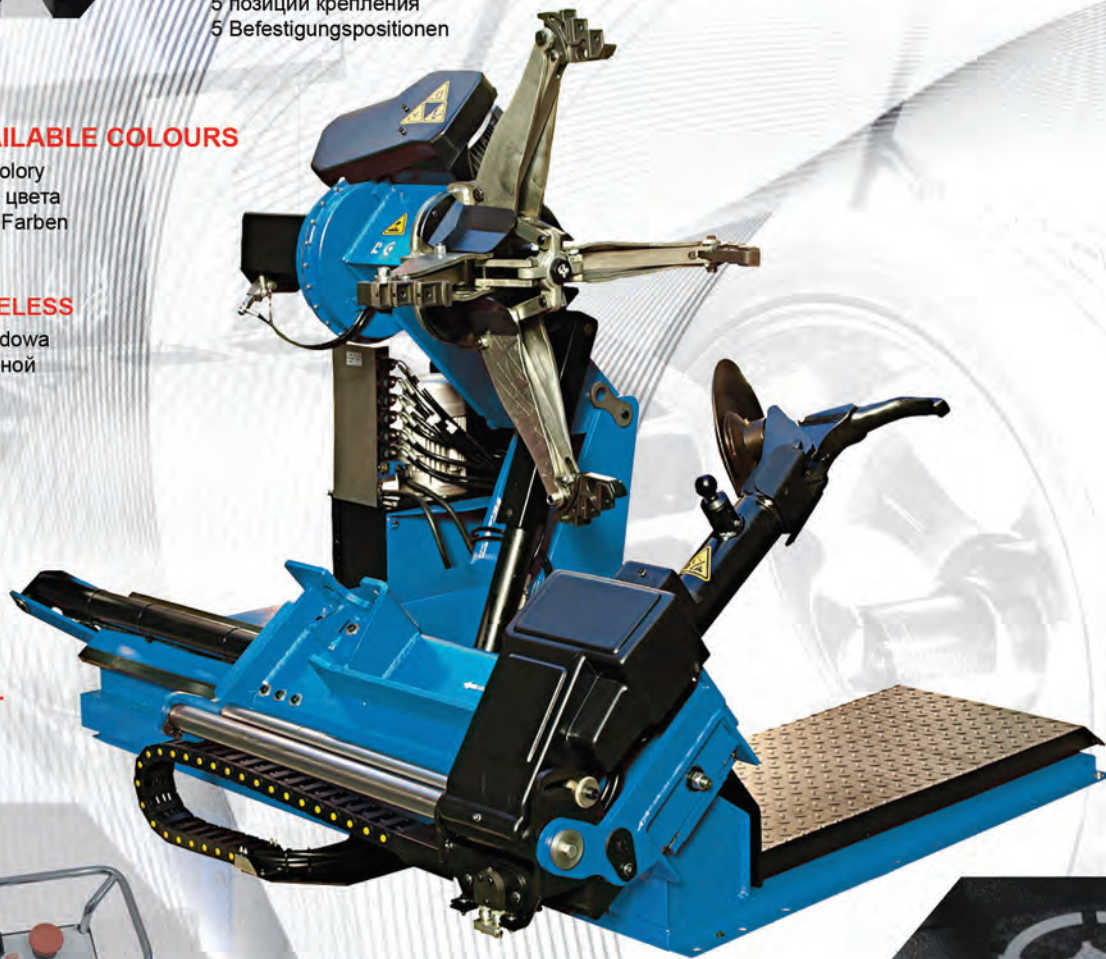

860

1430

1550

CLAMPING RANGE	Zakres mocowania obręczy	14" - 56"
MAX. WHEEL DIAMETER	Maks. średnica koła	2400 mm
MAX. WHEEL WIDTH	Maks. szerokość koła	1300 mm
MAX. WHEEL WEIGHT	Maks. waga koła	1800 kg
ELECTRIC SUPPLY	Zasilanie elektryczne	400 V / 50Hz
WEIGHT	Waga	1048 kg
DIMENSIONS (D/W/H) MM	Wymiary	1550 x 1430 x 860



CLAMP AT-26 | AT-56

Imadło
Зажим
Klemme



CLAMP UT-56 | UT-27

Imadło
Зажим
Klemme



TRUCK LEVER L-900

Łyżki do montażownic ciężarowych
Лопатка для грузовиков
LKW-Abdrückschaufel



TRUCK LEVER L-1200

Łyżki do montażownic ciężarowych
Лопатка для грузовиков
LKW-Abdrückschaufel



ALU COVER AT-56

Nakładka aluminiowa
Лопатка для грузовиков
LKW-Abdrückschaufel



ALU COVER UT-56

Nakładka aluminiowa
Лопатка для грузовиков
LKW-Abdrückschaufel



ALU COVER AT-26

Nakładka
Накладка
Abdeckung

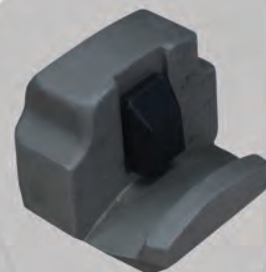

ALU COVER UT-27

Nakładka
Накладка
Abdeckung

RIM STRAIGHTENING MACHINES

PROSTOWARKI
СТАНКИ ДЛЯ ПРАВКИ ДИСКОВ
FELGENRICHTMASCHINEN



PO-30 SERIES

RIM STRAIGHTENER

ACCESSORIES

Aksesoria
Zubehör
Аксессуары



* H model only
Tylko dla wersji H
Nur für H-Modell
Только для модели H



PO-22



PO-30H



PO-30 2S



PO-30H 2S



AVAILABLE COLOURS

Dostępne kolory
Verfügbare Farben
Доступные цвета

NOISE LEVEL Poziom hałas	75 dB
DRIVE MOTOR POWER Moc silnika napędu	0.55 kW
HYDRAULIC PUMP MOTOR POWER Moc silnika pompy hydraulicznej	0.55 kW
WEIGHT Masa urządzenia	450 kg
STRAIGHTENING PISTON FORCE Siła rozwijana przez siłownik prostujący	45 kN
MAX. HYDRAULIC PUMP PRESSURE Max ciśnienie pompy hydraulicznej	200 Bar
RIM DIAMETER RANGE Max zakres średnic naprawianych obręczy	24" / 30"
POWER SUPPLY Zasilanie elektryczne	3x400V / 50Hz

	PO-22	PO-22 2S	PO-22H	PO-22H 2S	PO-30	PO-30 2S	PO-30H	PO-30H 2S
HYDRAULIC SPINDLE Hydrauliczne wrzeciono	-	-	✓	✓	-	-	✓	✓
MECHANICAL SPINDLE Mechaniczne wrzeciono	✓	✓	-	-	✓	✓	-	-
HYDRAULIC CYLINDERS Siłownik hydrauliczny	1	2	1	2	1	2	1	2
LATHE Tokarka	✓	✓	✓	✓	✓	✓	✓	✓
WORK LIGHTING Oświetlenie robocze	-	-	-	-	✓	✓	✓	✓
MAX. RIM DIAMETER Max średnica felg	24"	24"	24"	24"	30"	30"	30"	30"
PROFI FRAME Rama PROFI (ilość otworów)	-	-	-	-	✓	✓	✓	✓
HIGHER DESK Wyższe biurko	-	-	-	-	✓	✓	✓	✓



SOLID FRAME UP TO 30"

Solidna rama do 30"
Fester Rahmen bis 30"
Прочная рама до 30"

HOLES FOR MOUNTING PISTONS

Otworky do mocowania siłowników
Löcher zur Montage von Zylinder
Отверстия для крепления цилиндров



LATHE

Tokarka
Drehbank
Токарный станок

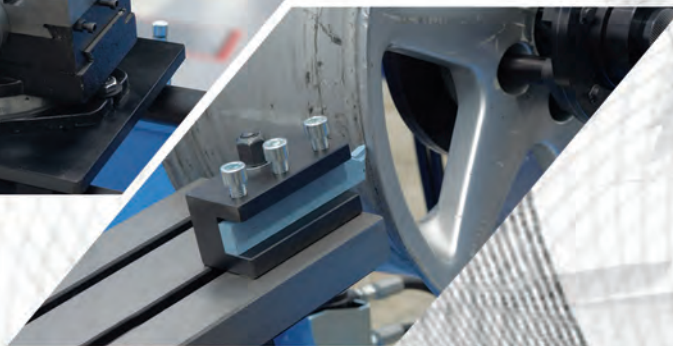

2 X PISTON

2 x Siłownik
2 x Zylinder
2 x Цилиндр



PISTON HOLDERS

Uchwyty na siłowniki
Zylinderhalter
Держатели цилиндров

PISTON CONTROL

Sterowanie siłownikami
Zylindersteuerung
Контроль цилиндров

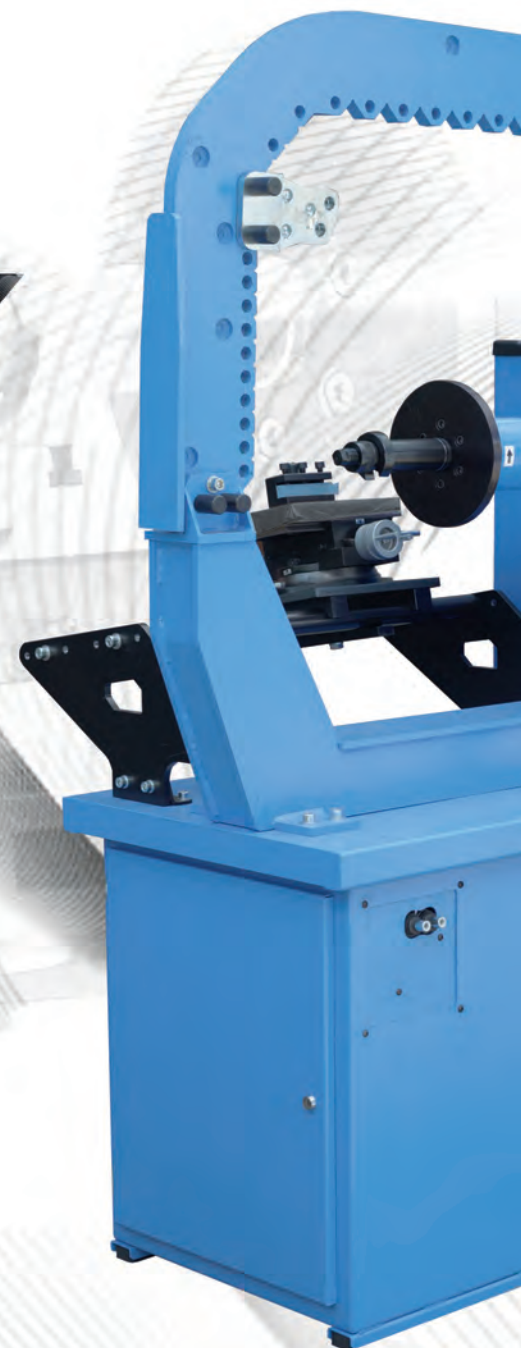



MANOMETER

Manometr
Manometer
Манометр

HYDRAULIC SPINDLE

Hydrauliczne wrzeciono
Hydraulische Spindel
Гидравлический шпindel

SAFETY SWITCH

Wyłącznik awaryjny
Schutzschalter
Выключатель безопасности

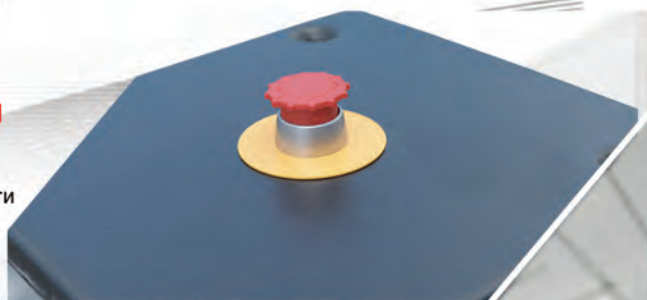

PO-30H



BOTH SIDE CLAMP CONTROL

Sterowanie uchwytem z obu stron
Beidseitige Griffsteuerung
Управление зажимом с обеих сторон



STYLUS WITH MAGNETIC HOLDER

Stylus z rysikiem
Stift mit Magnetständer
Стилус с магнитным штативом

LED LIGHTING

Oświetlenie LED
LED-Beleuchtung
Светодиодное освещение



PO-14 S*



PO-18



PO-ROLLER



PO-DIGITAL

*PO-14 S model bez tokarki, z napędem ręcznym.

Модель с ручным приводом и без токарного приспособления.

Hand operated model without lathe.

Model mit manuell Antrieb und ohne Drehbank

DANE TECHNICZNE	TECHNICAL DATA	ТЕХНИЧЕСКИЕ ДАННЫЕ	TECHNISCHE DATEN	PO-14 S	PO-18	PO-ROLLER	PO-DIGITAL
Zakres średnic naprawianych obręczy	Max. rim diameter	Макс. диаметр диска	Max. Felgendurchmesser	Do 24"	Do 24"	10" - 19"	10" - 26"
Max. ciśnienie pompy hydraulicznej	Max. hydraulic pump pressure	Макс. давление гидравлического насоса	Max. Pumpedruck	160 bar	160 bar	200 bar	200 bar
Zasilanie elektryczne	Power supply	Электропитание	Stromversorgung	3x400V 50Hz	3x400V 50Hz	3x400V 50Hz	3x400V 50Hz
Moc silnika pompy hydraulicznej	Pump motor power	Мощность электродвигателя насоса	Pumpeleistung	0,55 kW	0,55 kW	0,55 kW	1,5 kW
Moc silnika napędu	Drive motor power	Мощность электродвигателя привода	Motorleistung	-	0,55 kW	0,75 kW	1,1 kW
Głośność urządzenia	Noise level	Уровень шума	Geräuschpegel	75 dBA	75 dBA	75 dBA	75 dBA
Masa urządzenia	Weight	Вес	Gewicht	165 kg	350 kg	368 kg	720 kg

CNC ELEGANCE

RIM LATHE

WATCH VIDEO



SCAN ME

SIMULATION MODE

Tryb symulacji
Режим моделирования
Simulationsmodus



CONTROL PANEL AND 3 OPERATING MODES

Panel sterowania i 3 tryby pracy
Панель управления и 3 режима работы
Schalttafel und 3 Betriebsmodus

ULTRA-ACCURATE TOUCH SENSOR

Ultra dokładny czujnik dotykowy
Сверхточный сенсорный датчик
Ultrapräziser Berührungssensor

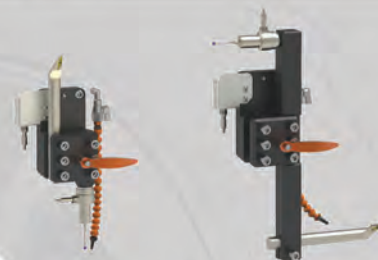

2 WORKING PLANES

2 płaszczyzny pracy
2 рабочие плоскости
2 Arbeitsebenen



1990

2245

1320

RIM DIAMETER RANGE	Zakres średnic naprawianych obręczy	22" / 28"
ACCURACY	Dokładność	± 0.001
PUMP MOTOR POWER	Moc silnika pompy hydraulicznej	1,1 kW
DRIVE MOTOR POWER	Moc silnika napędu	5,5 kW
POWER SUPPLY	Zasilanie elektryczne	380 V
WEIGHT	Waga	970 kg
DIMENSIONS (D/W/H) MM	Wymiary	1320 x 2245 x 1620



PLS

DANE TECHNICZNE	TECHNICAL DATA	ТЕХНИЧЕСКИЕ ДАННЫЕ	TECHNISCHE DATEN	PLS
Zasilanie elektryczne	Electric supply	Электропитание	Stromversorgung	3 x 400V / 50Hz
Moc silnika napędu	Motor power	Мощность электродвигателя	Motorleistung	1,1 kW
Maks. średnica polerowanych obręczy	Max. polished rim diameter	Макс. диаметр диска	Max. Felgendurchmesser	30"
Prędkość obrotowa silnika (obr./min)	Motor rotation speed (rpm.)	Скорость вращения мотора (обор./мин.)	Motordrehzahl (rpm.)	3000

PRZETACZARKA DO TARCZ HAMULCOWYCH | BRAKE DISC LATHE
 ТОКАРНЫЙ СТАНОК ДЛЯ ТОРМОЗНЫХ ДИСКОВ | BREMSSCHEIBENDREHBANK

DANE TECHNICZNE	TECHNICAL DATA	BL1718 / BL17 S
Maks. grubość tarczy	Max. disc thickness	39 mm
Dokładność	Accuracy	≤ 0.002 – 0.005 mm
Posuw	Stroke	8.5 mm/min.
Prędkość obrotowa	Rotation speed	98 rpm



BL17 S - Tylko do pracy na samochodzie / Only for operations on car
 Только для работ на автомобиле / nur für Operationen am Auto



WULKAN 300



WULKAN 360 HP



WULKAN 4x4 HP



WULKAN 500

* HP – opcje ogrzewania / heating option

DANE TECHNICZNE	TECHNICAL DATA	WULKAN 300	WULKAN 360 HP	WULKAN 4x4 HP	WULKAN 500
Zakres średnicy koła	Wheel diameter range	560 – 800 mm	560 – 800 mm	560 – 850 mm	740 – 1200 mm
Zakres szerokości koła	Wheel width range	135 – 305 mm	135 – 360 mm	135 – 360 mm	240 – 490 mm
Maksymalna waga koła	Maximum wheel weight	60 kg	60 kg	60 kg	150 kg
Czasy mycia	Washing times	20, 40, 60 s	20, 40, 60 s	20, 40, 60 s	60, 120, 240 s
Czas osuszania	Drying time	15 s	15 s	15 s	30 s
Zasilanie	Power supply	3x400 V	3x400 V	3x400 V	3x400 V
Wymiary (szer. x głęb. x wys.)	Dimensions (width x depth x height)	1130x1210x1450 mm	960x1210x1450 mm	960x1210x1510 mm	2400x1950x1902 mm
Waga netto	Netto weight	310 kg	330 kg	330 kg	630 / 780 kg
Limit włączeń procesów mycia (blokada serwisowa)	Activation limit of washing processes (service lock)	500	500	500	200

UNI-TROL VISIONLITH LIFT

Urządzenie do pomiaru geometrii w technologii 3D z kamerami na ruchomej belce. Przygotowane do pracy z podnośnikami nożycowymi i 4 kolumnowymi. Słup na mobilnej platformie ułatwia ustawienie na warsztacie.

3D Wheel aligner with cameras on a moving beam. Works with scissor and 4-column lifts. The pole on the mobile platform simplifies the installation in workshop.



UNI-TROL VISIONLITH PIT

Urządzenie do pomiaru geometrii w technologii 3D z kamerami na sztywnej belce mocowanej do ściany. Przygotowane do pracy na kanale. Regulacja pochylenia kamer ułatwia dopasowanie do warsztatu.

3D Wheel aligner with cameras on a beam attached to wall. Ready to work on pit. Tilting cameras simplify the installation in workshop.





DANE TECHNICZNE	TECHNICAL DATA	ТЕХНИЧЕСКИЕ ДАННЫЕ	TECHNISCHE DATEN	VISIONLITH
Liczba kamer	Cameras	Количество камер	Anzahl der Kameras	2
Zakres zbieżności	Toe range	Диапазон схождения	Spureinstellung	± 20°
Zakres pochylenia koła	Camber range	Диапазон развала	Radsturz	± 10°
Zakres kąta wyprzedzenia sworznia zwrotnicy	Caster range	Диапазон кастера	Lenkkopfwinkel	± 20°
Zasilanie	Power	Напряжение питания	Versorgungsspannung	230V, 50Hz
Uchwyty głowic	Pim clamping range	Диапазон адаптеров	Felgenklemmbereich	10" - 24"

VISIONLITH

-  – 2 kamery wysokiej rozdzielczości
- 4 punktowe uchwyty do koła z pasywnymi targetami
- Baza danych Autodata
- Kompensacja poprzez przetoczenie auta
- Intuicyjne oprogramowanie
- Pomiar przesunięcia osi pojazdu

-  – 2 high definition cameras
- 4-points wheel clamps with passive targets
- Autodata database
- Compensation by rolling the car backwards-forwards.
- Intuitive software
- Axis offset measurement

-  – 2 kamery vysokého rozřešení.
- 4-točkové kolésné adaptéry s pasívnými mířenými
- Baza daných Autodata
- Kompensácia prokátávaním automobilu
- Intuítivné programové zabezpečenie
- Izmerenie smičenia osí automobilu

-  – 2 hochauflösende Kameras
- 4-Punkt-Radklemmen mit passiven Targets
- Autodaten-Datenbank
- Radschlagkompensation durch hin- und herrollen des Autos
- Intuitive Software
- Messung der Achsenversätze

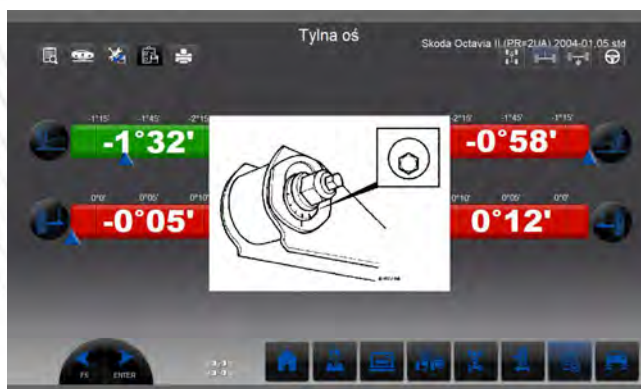
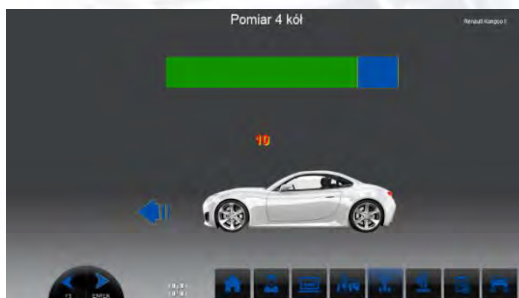
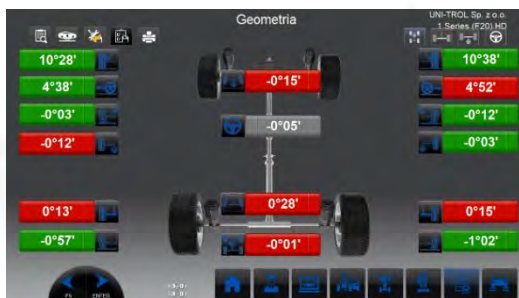

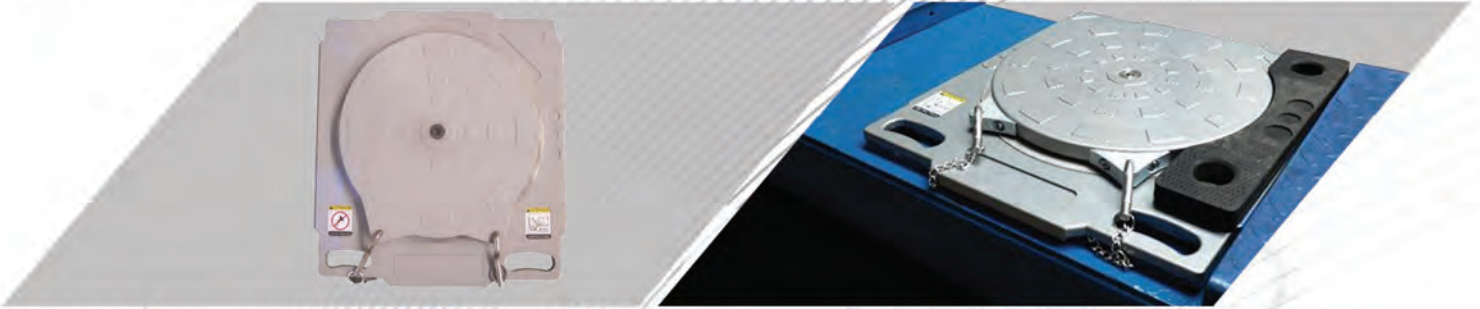

ALUMINIUM TURNABLE PLATES, 2 PCS. Obrotnice aluminiowe 2szt. / Alu-Drehteller, 2 Stk. / Алюминиевые поворотные плиты, 2 шт.
VIS-AK011 Dimensions / Wymiary / Abmessungen / Размеры - 510 x 470 x 50 mm



EXPANSION PLATE Płyta rozprężająca / Expansionsplatte / Расширительная плита
VIS-AK015 Dimensions / Wymiary / Abmessungen / Размеры - 460 x 400 x 50 mm



RAMPS 2PC. Najazdy 2 szt. / Rampen, 2 Stk. / Рампы, 2 шт.
VIS-AK010 Dimensions / Wymiary / Abmessungen / Размеры - 1130 x 533 x 53 mm



VIS-AK016

VIS-AK017

VIS-AK012

VIS-AK009

ACCESSORIES FOR MERCEDES AND VW Akcesoria do aut Mercedes i Vw / Zubehör für Mercedes und Vw / аксессуары для Mercedes и Vw



VIS-AK020

VIS-AK021

913 009 024

DANE TECHNICZNE	TECHNICAL DATA	PK
Udźwig	Capacity	65 kg
Wysokość podnoszenia	Lifting height	≤ 1,2 m
Moc silnika	Motor power	Pneumat.
Zasilanie	Supply	8 bar
Czas ładowania	Charging time	-
Wymiary	Dimensions	750x700x1650 mm
Masa	Weight	60 kg
Sterowanie	Control	Pneumatyczne



WANNY WULKANIZATORSKIE | LEAK-PROOF TESTER | ТЕСТЕР ГЕРМЕТИЧНОСТИ КОЛЕС | TESTWANNE



PNEUBAD-1



PNEUBAD TRUCK



PNEUBAD-2

DANE TECHNICZNE	TECHNICAL DATA	PNEUBAD-1	PNEUBAD-2	PNEUBAD TRUCK
Wymiary zewn.	Outside dimensions	1265 x 1040 x 2300 mm	1265 x 1040 x 1200 mm	1200 x 1360 x 1500 mm
Ciśnienie powietrza zasilającego	Air supply pressure	Od 6 do 10 bar	-	Od 6 do 10 bar
Pojemność całkowita zbiornika	Total tank capacity	437 l	437 l	280 l
Średnica wewn. zbiornika	Inside tank diameter	980 mm	980 mm	1180 mm



PN-1M



PN-2M

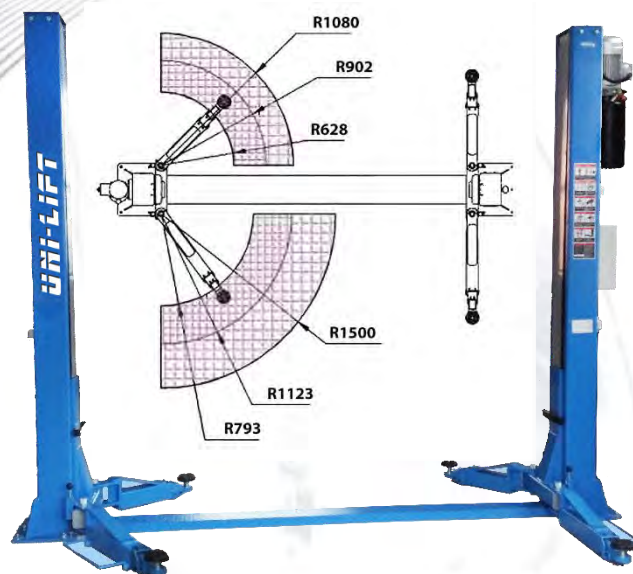
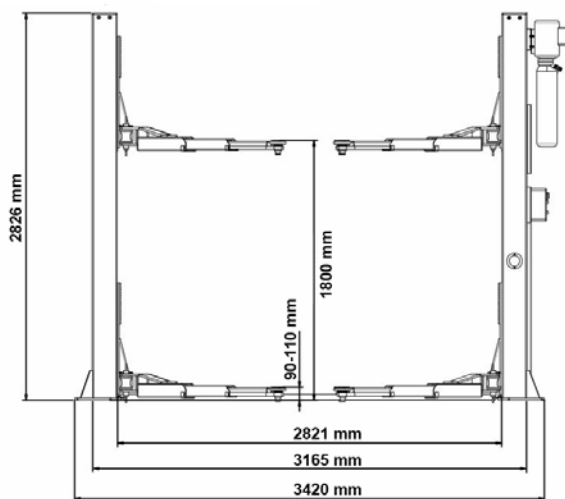

PD-2A

DANE TECHNICZNE	TECHNICAL DATA	ТЕХНИЧЕСКИЕ ДАННЫЕ	TECHNISCHE DATEN	PN-2M	PN-1M	PD-2A
Nośność	Capacity	Грузоподъемность	Tragfähigkeit	3000 kg	3000 kg	4000 kg
Zasilanie	Electric supply	Электропитание	Stromversorgung	3x 400V / 50Hz	3x 400V / 50Hz	3x 400V / 50Hz
Wysokość w stanie spoczynku	Min. height	Мин. высота	Min. Höhe	115 mm	110 mm	110 mm
Wysokość podnoszenia	Max. height	Макс. высота	Max. Höhe	1830 mm	1000 mm	1900 mm
Masa	Weight	Вес	Gewicht	850 kg	480 kg	640 kg

PPS-5 / PPS-3000

LIFT

WATCH VIDEO



SCAN ME

TELESCOPIC ADJUSTABLE ARMS

Łapy obrotowe
Телескопические регулируемые лапы
verstellbare Teleskoparme



RAILINGS

Barierki
Перила
Geländer



RUBBER PADS (H-40 and H-60)

Gumowe poduszki
Резиновые прокладки
Gummipads

CONTROL UNIT

Sterowanie
Пульт управления
Steuergerät



SHORT AND LONG DRIVE-ON RAMPS

Najazdy krótkie i długie
Короткие и длинные ramпы
Kurze und lange Auffahrampen

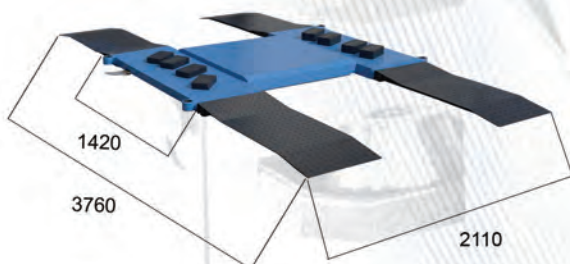
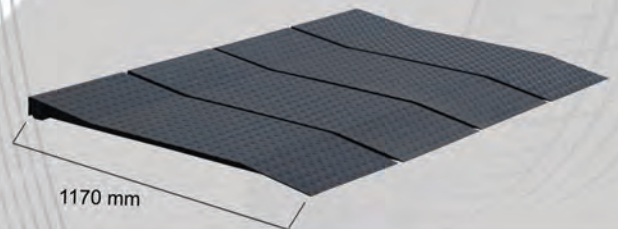

	PPS-5	PPS-3000
CAPACITY Nośność	2000 kg	3000 kg
MIN. HEIGHT Wysokość w stanie spoczynku	80 mm	80 mm
MAX. HEIGHT Wysokość podnoszenia	380 mm	380 mm
PRESSURE Zasilanie	7 bar	7-10 bar
WEIGHT Masa	400 kg	500 kg
DIMENSIONS WITHOUT DRIVE-ON RAMPS Wymiary bez najazdów	2110 x 1420 mm	2110 x 1420 mm



PP-1



PP-11



PH-30 LP



PP-3.3



HP-50



HPJ50T3

DANE TECHNICZNE	TECHNICAL DATA	ТЕХНИЧЕСКИЕ ДАННЫЕ	TECHNISCHE DATEN	PH-30 LP	PP-1	PP-11	PP-3.3	HP-50	HPJ50T3
Nośność	Capacity	Грузоподъемность	Tragfähigkeit	3000 kg	1150 kg	1150 kg	3000 kg	10/20/50 ton	15/30/50 ton
Zasilanie	Electric supply	Электропитание	Stromversorgung	-	8 bar	8 bar	8 bar	12 bar	8 bar
Wys. w stanie spoczynku	Min. height	Мин. высота	Min. Höhe	75 mm	140 mm	140 mm	145 mm	151 mm	156 mm
Wysokość podnoszenia	Max. height	Макс. высота	Max. Höhe	500 mm	360 mm	340 mm	400 mm	442 mm	497 mm
Masa	Weight	Вес	Gewicht	33 kg	14 kg	13 kg	20 kg	56 kg	70 kg



DANE TECHNICZNE	TECHNICAL DATA	PREMIUM
Wydajność pompy próżniowej	Vacuum pump efficiency	130 l/min
Szybkość odzysku	Recovery rate	300 g/min
Dokładność dozowania czynnika	Resolution gas scale	1 g
Długość przewodów	Hoses length	300 cm
Zbiornik czynnika	Tank	22 kg
Podłączenie elektryczne	Voltage	230 V
Drukarka	Printer	✓
Czynnik do wyboru	Gas option	R 134-A / R 1234-YF

GENERATOR AZOTU | NITROGEN GENERATOR | ГЕНЕРАТОР АЗОТА | STICKSTOFFGENERATOR

DANE TECHNICZNE	TECHNICAL DATA	E-1136	E-1170
Stężenie azotu	Concentration of nitrogen	95%	95-99+%
Pojemność zbiornika	Tank capacity	47 l	120 l
Wydajność	Efficiency	50 l/min.	228 l/min
Maks. ciśnienie azotu	Max. pressure of nitrogen	8 bar	10-12 bar
Ciśnienie azotu na wyjściu	Output pressure	< 7,5 bar	0,3 – 11,2 bar
Zasilanie elektryczne	Power supply	230 V / 50 Hz	240V / 50 Hz
Masa	Weight	104 kg	207 kg





UT-10-O3



UT-20-O3



TUBA UT-10-O3



O₃ sensor + USB report

DK-20

DANE TECHNICZNE	TECHNICAL DATA	UT-10-O3	UT-20-O3	TUBA UT-10-O3	DK-20
Wydatek ozonu	Ozone output	10 g/h	20 g/h	10 g/h	20 g/h
Wydajność	Efficiency	170 m ³ /h	170 m ³ /h	170 m ³ /h	304 m ³ /h
Metoda gen. ozonu	Ozone generation method	Wyładowania koronowe / Corona discharge			
		Płytką	Płytką	Rura	Płytką
Przepływ powietrza	Air flow	do 2.8 m ³ /min	do 2.8 m ³ /min	do 2.8 m ³ /min	304 m ³ /h
Chłodzenie	Cooling	Powietrzem / Air			
Zasilanie	Supply	230V / 50Hz	230V / 50Hz	230V / 50Hz	230V / 50-60Hz
Poziom hałasu	Noise level	< 35 dB (A)	< 35 dB (A)	< 35 dB (A)	55 dB (A)
Trwałość	Durability	> 8000 h	> 8000 h	> 20 000 h	> 20 000 h
Wilgotność względna	Humidity	< 85%	< 85%	< 85%	< 85%
Temperatura pracy	Working temperature	5 - 40 C°	5 - 40 C°	5 - 40 C°	5 - 40 C°
Lampa UVC	UVC lamp	-	-	-	✓
Wymiary (mm)	Dimensions (mm)	261x169x155	261x169x155	330x230x175	500x360x230
Waga	Weight	3 kg	3 kg	5 kg	10 kg
Środowisko pracy	Working environment	Pomieszczenie zamknięte / Closed interiors			

KOSZ DO POMPOWANIA KÓŁ | CAGE FOR WHEELS INFLATING
КЛЕТКА ДЛЯ НАКАЧИВАНИЯ КОЛЕС | REIFENFÜLLKÄFIG



DANE TECHNICZNE	TECHNICAL DATA	S	M	L	K-1	K-2
Maks. ciśnienie	Max. pressure	12 bar	12 bar	12 bar	12 bar	12 bar
Wymiary wew.(mm)	Inside dimensions	1190x1195x550	1285x1285x650	1505x1510x750	1300x1300x640	1430x1390x740
Wymiary zewn.(mm)	Outside dimensions	1340x1270x735	1445x1370x850	1655x1584x936	1330x1340x750	1480x1550x850
Masa	Weight	180 kg	220 kg	270 kg	180 kg	200 kg

PRZYRZĄD PA-12K DO POMIARU I REGULACJI CIŚNIENIA W OGUMIENIU POJAZDÓW | TIRE PUMPING DEVICE PA-12K
АВТОМАТ ДЛЯ НАКАЧИВАНИЯ ШИН PA-12K | AUTOMATISCHER DIGITALER REIFENFÜLLER PA-12K





Przyrząd zalecany do SKP
Certyfikat GUM



bar / psi

DANE TECHNICZNE	TECHNICAL DATA	ТЕХНИЧЕСКИЕ ДАННЫЕ	TECHNISCHE DATEN	PA-12 K
Zasilanie elektryczne	Electric supply	Электропитание	Stromversorgung	230 V / 50 Hz
Pobór mocy	Power consumption	Потребление мощности	Leistungsaufnahme	30 W
Zasilanie pneumatyczne	Air supply	Пневмо-питание	Pneumatische Versorgung	max. 14 bar
Zakres wskazań	Measuring range	Диапазон измерения	Indikationsspektrum	0 – 12 bar
Dokładność pomiaru	Accuracy	Точность	Genauigkeit	+/- 0,01 bar
Masa	Weight	Вес	Gewicht	10 kg
Wymiary	Dimensions	Размеры	Abmessungen	255 x 245 x 125 mm
Temperatura pracy	Temperature range	Диапазон температуры	Temperaturbereich	0 – 45°C
Wilgotność	Humidity	Влажность	Feuchtigkeit	< 95 %



-  Rozpierzacz R-1
-  Tyres expander R-1
-  Распиратель R-1
-  Reifenexpander R-1



- Rozpierzacz WR-3
- Tyres expander WR-3
- Распиратель WR-3
- Reifenexpander WR-3
- 110 mm ÷ 405 mm



- Rozpierzacz ciężarowy R-2
- Tyres expander for trucks R-2
- Распиратель шин грузовиков R-2
- LKW Reifenexpander R-2





WULKANIZATOR | VULCANIZER
ВУЛКАНИЗАТОР | VULKANISATOR

DANE TECHNICZNE	TECHNICAL DATA	WULKAN 2000
Zakres regulacji temperatury grzania	Heating temperature range	110-165 °C
Zakres regulacji czasu grzania	Heating time range	0 - 120 min
Moc grzałek	Heater power	2 x 350 W
Zasilanie elektryczne	Electric power supply	220V / 50Hz
Zasilanie pneumatyczne	Air pressure supply	6 - 10 bar



NACINARKA DO OPON | TYRES REGROOVING MACHINE
МАШИНКА ДЛЯ НАРЕЗКИ ПРОТЕКТОРА | REIFENNACHSCHNEIDGERÄTE







-  Nacinarka do opon PSO 15
-  Tyres regrooving machine PSO 15
-  Машинка для нарезки протектора PSO 15
-  Reifennachschneidegeräte PSO 15

DANE TECHNICZNE	TECHNICAL DATA	GD 200/475	GD 270/560	GD 500/1210
Wydajność teoretyczna	Air displacement	476 l/min (29 m ³ /h)	560 l/min (33,6 m ³ /h)	1210 l/min (73 m ³ /h)
Il. tłoków / il. stopni sprężania	Compression ration	2 / 2	2 / 2	2 / 2
Hałas	Noise	80 dB	80 dB	82 dB
Zbiornik	Receiver	200 l	270 l	500 l
Napięcie zasilania	Power supply	400V / 50Hz	400V / 50Hz	400V / 50Hz
Moc silnika	Motor power	3,0 kW	3,0 kW	7,5 kW
Ciśnienie	Pressure	10 bar	10 bar	10 bar
Masa	Weight	125 kg	140 kg	285 kg



AKCESORIA DO POMPOWANIA | INFLATING DEVICES
 ПРИБОРЫ НАКАЧКИ | INFLATING GERÄTE







-  Pistolet EUR 1280
-  Inflating gun EUR 1280
-  пистолет EUR 1280
-  Pistole EUR 1280



- Pistolet 2015 W
- Inflating gun 2015 W
- пистолет 2015 W
- Pistole 2015 W



-  Dopełniacz P-7A
-  Portable inflating tank P-7A
-  Переносный ресивер P-7A
-  Tragbarer Tank P-7A



- Inflator IFL-25
- Inflator IFL-25
- Инфлятор IFL-25
- Inflator IFL-25

ONE-SENSOR

- Szeroki zakres zastosowania - 98% pojazdów na rynku
 - Regulowane pochylenie zaworu
 - 5 różnych typów zaworów
 - Mały rozmiar czujnika
 - Programowane urządzeniami ATEQ
 - Programowanie bezprzewodowe, klonowanie numeru ID

- One-sensor supports 98% of cars available on the market
 - Adjustable valves
 - 5 types of valves
 - Small size sensor
 - Programmable devices ATEQ
 - Wireless programming, clone ID number`s

- One-sensor поддерживает 98% автомобилей на рынке
 - Регулируемые клапаны
 - 5 типов клапанов
 - Датчик малых размеров
 - Программируемые устройства ATEQ
 - Беспроводное программирование, идентификационный номер клона

- One-Sensor unterstützt 98% der Autos auf dem Markt
 - Einstellbare Ventile
 - 5 Arten von Ventilen
 - Kleiner Sensor
 - Programmierbare Geräte ATEQ
 - Drahtlose Programmierung, Klon-ID-Nummer

ONE- SENSOR

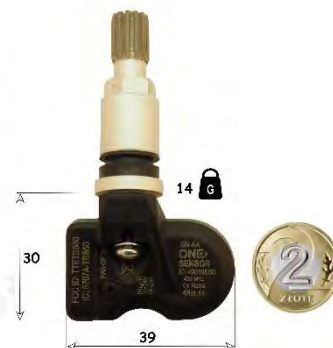

**ONE-
SENSOR**

ONE- SENSOR ATEQ VT46 + OBDII

-  – Bezprzewodowy odczyt czujników TPMS w kole
- Programowanie czujników uniwersalnych One-Sensor
- Programowanie centralki TPMS poprzez gniazdo OBD
- Instrukcje manualnego programowania nowych czujników
- 5-let aktualizacji w cenie / Możliwość rozszerzenia oprogramowania o wszystkie czujniki uniwersalne





-  – Activates and reads TPMS sensors of all light vehicle brands
- Programs universal TPMS ONE-SENSOR
- OBD2 module gives access to OBD relearns for 60% of all car models worldwide
- Provides indirect, manual and auto relearn procedure information.
- 5 years free update / Possibility to upgrade the software for all universal sensor

-  – Активирует и считывает датчики TPMS всех марок легковых автомобилей по всему миру
- Программы универсальные TPMS ONE-SENSOR
- Модуль OBD2 дает доступ к переобучению OBD для 60% всех моделей автомобилей по всему миру
- Предоставляет информацию о процедурах косвенного, ручного и автоматического повторного обучения.
- 5 лет бесплатного обновления / Возможность обновления программного обеспечения для всех универсальных датчиков

-  – Aktiviert und liest TPMS-Sensoren aller Light Vehicle-Marken weltweit
- Programmiert den universellen TPMS ONE-SENSOR
- Das OBD2-Modul ermöglicht 60% aller Automodelle weltweit den Zugriff auf OBD-Neulernen
- Bietet Informationen zu indirekten, manuellen und automatischen Neulernvorgängen
- 5 Jahre kostenloses Update / Möglichkeit die Software für alle Universalsensoren zu aktualisieren



ZESTAW NARZĘDZI / SET OF TOOLS / ИНСТРУМЕНТЫ / WERKZEUGSET

-  – Profesjonalny zestaw narzędzi do montażu czujników TPMS z wkrętakiem dynamometrycznym 0-9 Nm
-  – Professional toolkit for mounting TPMS sensors with a torque screwdriver 0-9Nm
-  – Профессиональный набор инструментов для монтажа датчиков TPMS с помощью динамометрической отвертки 0-9 Нм
-  – Professionelles Werkzeugset zur Montage von TPMS-Sensoren mit einem Drehmomentschraubendreher von 0-9 Nm





DANE TECHNICZNE	TECHNICAL DATA	ТЕХНИЧЕСКИЕ ДАННЫЕ	TECHNISCHE DATEN	MULTI
Zasilanie elektryczne	Electric supply	Электрическое питание	Stromversorgung	3 x 400V / 50Hz
Moc silnika napędu	Motor power	Мощность электродвигателя	Motorleistung	1,1 kW
Znamionowa prędkość (obr./min)	Motor rotation speed (rpm.)	Скорость вращения мотора (обор./мин.)	Motordrehzahl (rpm.)	1400
Moment udarowy	Stroke strength	Момент силы	Schlagkraft	400 – 2500 Nm
Rozmiar nasadki	Wrench spanner size	Размер насадки	Schlüsselweite	1"
Masa	Weight	Вес	Gewicht	64 kg

NITOWNICA | RIVETING MACHINE | КЛЕПАЛЬНЫЙ СТАНОК | NIETMASCHINE



* dodatkowa podstawa

DANE TECHNICZNE	TECHNICAL DATA	ТЕХНИЧЕСКИЕ ДАННЫЕ	TECHNISCHE DATEN	PUN-1
Skok trzpienia roboczego	Stroke of rivet header	Ход рабочего стержня	Gesamthub	28 mm
Zasilanie pneumatyczne	Air pressure supply	Пневматическое питание	Luftversorgung	7 - 10 bar
Ciśnienie robocze	Working pressure	Рабочее давление	Arbeitsdruck	4 - 7 bar
Gniazdo kowadełka	Seat of anvil	Гнездо наковальни	Ambossloch	ruhome movable
Zakres temperatur pracy	Range of working temperature	Интервал рабочих температур	Arbeitstemperatur	0°C - 40°C
Wymiary	Dimensions	Размеры	Abmessungen	675x550x200 mm
Masa	Weight	Вес	Gewicht	~ 60 kg
Siła nacisku	Equipment force	Рабочая сила	Nietkraft	45 kN (7 bar)

FIRMA | OUR COMPANY | НАША КОМПАНИЯ | UNTERNEHMEN



TECHNOLOGIE | TECHNOLOGIES | ТЕХНОЛОГИИ | TECHNOLOGIEN



PRODUKCJA | PRODUCTION | ПРОИЗВОДСТВО | HERSTELLUNG



EKSPOZYCJA | EXPOSITION | ЭКСПОЗИЦИЯ | EXPOSITION



Uni-trol produkuje od 1988 r. maszyny i urządzenia do obsługi kół pojazdów. W naszej nowoczesnej fabryce w Warszawie produkujemy wyroby oparte na własnych, oryginalnych rozwiązaniach konstrukcyjnych. Wieloletnie doświadczenie zawodowe naszych pracowników oraz stosowane procesy technologiczne gwarantują wysoką jakość i trwałość naszych produktów.

UNI-TROL has been manufacturing machinery and equipment for handling vehicle wheels since 1988. In our modern factory in Warsaw we create the products on our own engineering solutions and design. Many years of experience and technological process we use ensure the high quality and durability of our products.

UNI-TROL выпускает с 1988 года станки и оборудование для обслуживания колес транспортных средств. На нашем современном заводе в Варшаве мы производим продукты на основе собственных оригинальных конструкторских решений. Многолетний опыт наших сотрудников и используемые технологические процессы обеспечивают высокое качество и долговечность наших изделий.

UNI-TROL produziert Werkstattausrüstung seit 1988. Die Geräte entstehen ausschließlich nach eigenen Konstruktionsbearbeitungen. Die fast 30-jährige Anwesenheit auf dem Markt erlaubt uns nicht nur die Ansprüche der Kunden zu erkennen, sondern auch unsere Vielfalt an Produkten ständig zu erweitern und Ihre Qualität zu verbessern.



ONE
SENSOR



WWW.UNITROL.PL

UNI-TROL
GARAGE EQUIPMENT

ul. Estrady 56, 01-932 Warszawa, Polska
tel. +48 (22) 817 94 21-22, 817 94 34-35, 834 90 13-14,
SPRZEDAŻ wew. 118 i 121 SERWIS wew. 131 i 134
www.unitrol.pl - office@unitrol.pl

CATALOG PDF



SCAN ME

WEBSITE



SCAN ME