

# Grounding Kits

Product Catalogue





# Grounding Kits

Grounding kits. FIMO Grounding Kits offer multiple solutions for the earthing of coaxial cables, hybrid cables and elliptical and rectangular waveguides.

*Kit di messa a terra. I kit di messa a terra FIMO offrono molteplici soluzioni per la connessione a massa di cavi coassiali, cavi ibridi e guide d'onda ellittiche e rettangolari.*



### CERTIFICATION

<b>Waterproof</b>	IP 67 IEC 60529
<b>Lightning Test (CESI)</b>	IEC 61312-1 grade III
<b>Temperature Range</b>	-50°/+80°C
<b>Contact Resistance</b>	<1 mOhm

### MATERIAL

<b>Contact Bar</b>	Tinned Brass
<b>Internal Contact</b>	Tinned Copper Mesh
<b>Protection</b>	NAS Black Self-Agglomerating Tape, U.V. Resistant
<b>Cable**</b>	16 mm <sup>2</sup> Copper, P.E. Insulated Black, According to CEI 20-22
<b>Colour</b>	Black

### UEK - Universal Earthing Kit

For coaxial cables and elliptic or rectangular waveguides.  
Only five items for the whole cable range.  
Easy to handle, safe, quick to install.  
Complete with connecting cable.

### UEK - Kit di Messa a Terra Universale

Per cavi coassiali e guide d'onda ellittiche e rettangolari. Solo cinque misure per tutta la gamma di cavi.  
Semplice, sicuro, veloce.  
Completo di cavo di connessione.

CODE	ARTICLE	CABLE ø	COAX CABLES	ELLIPT. GUIDES	**L	CONNECTING SCREW	BAG	BOX	WEIGHT
61 1502 0001	UEK 1	5 - 11	RG 223 - RG58-RG59 RG 8 - RG213/214 1/4" - 3/8"	220-380	500	M8	1	10	145
61 1502 0002	UEK 2	12 - 30	1/2"S - 3/8" - 1/2" - 5/8" 7/8"S - 7/8"	105-127-130 150-190	500	M8	1	10	180
61 1502 0003	UEK 3	31 - 60	1.1/4" - 1.5/8" - 2.1/4"	38-46-48-54 60-70-77-78-90	500	M8	1	10	210
61 1502 0004	UEK 4	40 - 115	1.1/4" - 1.5/8" 2.1/4" - 3"; 3.1/8" - 4.1/8"	38-46-48-54	500	M8	1	10	275
61 1502 0005	UEK 5	40 - 223	1.1/4" - 1.5/8"; 2.1/4" - 3" 2.1/4" - 3"; 3.1/8" - 4.1/8" - 5"; 6.1/8" - 8"	11-15-19-22 38-46-48-54	500	M8	1	10	350

**Storage** : UEK kit does not require a particular care in storing, apart from keeping it in its original packing, which protects it from water, grease and dust. Even extreme temperature conditions do not negatively affect the product.

# UEK M

## Grounding Kits

### UEK M - Monobloc Earthing Kit

For coaxial cables and elliptic or rectangular wave guides. Easy to handle, safe and quick to install. Earthing cable riveted directly to contact bar.

### UEK M - Kit di Messa a Terra Monoblocco

Per cavi coassiali e guide d'onda ellittiche e rettangolari. Montaggio semplice, sicuro e veloce. Cavo di terra prefissato sul contatto mediante rivetti.

CERTIFICATION	
Waterproof	IP 67 IEC 60529
Lightning Test (CESI)	IEC 61312-1 grade III
Temperature Range	-50°/+80°C
Contact Resistance	<1 mOhm

MATERIAL	
Contact Bar	Tinned Brass
Rivets	AISI 304 Stainless Steel
Internal Contact	Tinned Copper Mesh
Protection	NAS Black Self-Agglomerating Tape, U.V. Resistant
Cable**	16 mm <sup>2</sup> Copper, P.E. Insulated Black, According to CEI 20-22
Colour	Black



CODE	ARTICLE	CABLE ø	COAX CABLES	ELLIPT. GUIDES	**L	BAG	BOX	WEIGHT
61 1505 0001	UEK 1 M	5 - 11	RG 223 - RG58-RG59 RG 8 - RG 213/214; 1/4" - 3/8"	220 - 250 - 380	500	1	10	180
61 1505 0002	UEK 2 M	12 - 30	1/2"S - 3/8" - 1/2" - 5/8" 7/8"S - 7/8"	105 - 127 - 130 150 - 190	500	1	10	220
61 1505 0003	UEK 3 M	31 - 60	1.1/4" - 1.5/8" - 2.1/4"	52 - 54 - 60 - 63 - 64 70 - 77 - 78 - 90	500	1	10	245

**Storage :** UEK M kit does not require a particular care in storing, apart from keeping it in its original packing, which protects it from water, grease and dust. Even extreme temperature conditions do not negatively affect the product.



### UGK - Monobloc Earthing Kit

For coaxial cables and elliptic or rectangular waveguides.  
Easy to handle, safe, quick to install.  
Complete with connecting cable.

### UGK - Kit di Messa a Terra Monoblocco

*Per cavi coassiali e guide d'onda ellittiche e rettangolari.  
Semplice, sicuro, veloce.  
Completo di cavo di connessione.*

#### CERTIFICATION

<b>Waterproof</b>	IP 67 IEC 60529
<b>Lightning Tested (CESI)</b>	IEC 61312-1 grade III-IV
<b>Temperature Range</b>	-50°/+80°C
<b>Contact Resistance</b>	<1 mOhm

#### MATERIAL

<b>Contact Bar</b>	Tin-plated Copper
<b>Rivets</b>	AISI 304 Stainless Steel
<b>Internal Contact</b>	Tinned Copper Mesh
<b>Protection</b>	NAS Black Self-Agglomerating Tape, U.V. Resistant
<b>Cable**</b>	16 mm <sup>2</sup> Copper, P.E. Insulated Black, According to CEI 20-22
<b>Colour</b>	Black

CODE	ARTICLE	CABLE ø	COAX CABLES	ELLIPT. GUIDES	**L	BAG	BOX	WEIGHT (gr)
65 1502 0001	UGK 1	5 - 11	RG 223 - RG58-RG59 RG 8 - RG 213/214; 1/4" - 3/8"	220 - 380	500	1	10	150
65 1502 0002	UGK 2	12 - 30	1/2"S - 3/8" - 1/2" - 5/8" 7/8"S - 7/8"	105 - 127 - 130 150 - 190	500	1	10	185
65 1502 0003	UGK 3	31 - 60	1.1/4" - 1.5/8" - 2.1/4"	52 - 54 - 60 - 63 - 64 - 65 70 - 77 - 78 - 90	500	1	10	220

**Storage :** UGK kit does not require a particular care in storing, apart from keeping it in its original packing, which protects it from water, grease and dust. Even extreme temperature conditions do not negatively affect the product.

# KMT P E PAT.

## Grounding Kits

GROUNDING KITS  
PRODUCT CATALOGUE

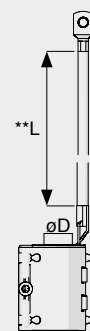

• KMT  
Open

• KMT  
Closed

**KMT P E - Grounding Kit**  
For Copper or Aluminum corrugated coaxial  
Cables. Parallel Cable exit

Technical features:

- Compact structure
- Fast and easy installation
- Closure with a single screw
- Hinged rigid shell
- No loose parts
- No extra taping needed

**KMT P E - Kit di Messa a Terra**  
per cavi coassiali corrugati, in rame o alluminio. Uscita parallela

Caratteristiche:

- Struttura compatta
- Installazione veloce
- Chiusura con una singola vite
- Guscio rigido incernierato
- Senza parti sciolte
- Nastratura supplementare non necessaria

### MATERIAL

Shell	AISI 304 Stainless Steel
Gasket	EPDM Rubber U.V. Resistant
Inner Contact	Tinned Brass
Cable	16 mm <sup>2</sup> Copper (*10 mm <sup>2</sup> copper), Black PVC Insulated, Conforming to CEI 20-22 norms (Yellow/Green on Request)
Lug	Tinned Copper, ø 8 Hole (ø10 on re- quest)

### CERTIFICATION

Waterproof	IP 68 IEC 60529 (Fimo Test)
Environmental Test	IEC 68-2-14
Contact Resistance	<1 mOhm
Lightning Test (CESI)	MIL STD 1757
Corrosion Resistant	✓

CODE	ARTICLE	FOR COAXIAL CABLES	ø D	L	BOX	WEIGHT
61 1540 9006	KMT 6 P E	RG 223-RG 58 (ø 5-6)	19	500*	10	240
61 1540 9007	KMT 7 P E	RG59 (ø 6-7)	19	500*	10	215
61 1540 9009	KMT 9 P E	1/4" superflex (ø 8-9)	19	500*	10	240
61 1540 9014	KMT 11 P E	RG 213/214-1/4"-3/8" (ø 10-11)	19	500	10	235
61 1540 9016	KMT 14- P E	1/2" superflex (ø 13-14)	25	500	10	246
61 1540 9012	KMT 1/2"- P E	1/2" (ø 16-17)	25	500	10	242
61 1540 9078	KMT 7/8"- P E	7/8"+ 7/8" superflex (ø 26-28)	36	500	10	258
61 1540 9114	KMT 1.1/4"- P E	1.1/4" (ø 38-40)	48	500	10	480

## Compact Grounding Kits

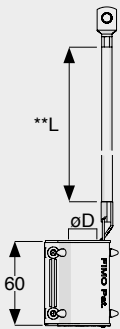

CGK M ◀  
Open

CGK M ▶  
Closed

### MATERIAL

<b>Shell</b>	AISI 304 Stainless Steel
<b>Gasket</b>	EPDM Rubber U.V. Resistant
<b>Inner Contact</b>	Tinned Brass
<b>Cable**</b>	16 mm <sup>2</sup> Copper, Black PVC Insulated, Conforming to CEI 20-22 Norms (yellow/green on request)
<b>Lug</b>	Tinned Copper, ø 8 hole (ø10 on request)

### CERTIFICATION

<b>Waterproof</b>	IP 68 IEC 60529 (Fimo Test)
<b>Environmental Test</b>	IEC 68-2-14
<b>Contact Resistance</b>	<1 mOhm
<b>Corrosion Resistant</b>	✓

### CGK M - Compact Monobloc Grounding Kit For Copper or Aluminum RF Coaxial Cables. Parallel Cable Exit

#### Technical features:

- Compact structure
- Fast and easy installation
- Closure with pressure plate
- Flexible metal shell
- No loose parts
- No extra taping needed

### CGK M - Kit di Terra Monoblocco Compatto Per Cavi Coassiali RF, in Rame o Alluminio. Uscita Parallela

#### Caratteristiche:

- *Struttura compatta*
- *Installazione veloce*
- *Chiusura con piastrino*
- *Guscio metallico deformabile*
- *Senza parti sciolte*
- *Nastratura supplementare non necessaria*

CODE	ARTICLE	FOR COAXIAL CABLES	øD	**L	BOX	WEIGHT
61 1509 0016	CGK 1/2" S M	ø d 13-14 (1/2" superflex)	24	500	10	161
61 1509 0012	CGK 1/2" M	ø d 16-17 (1/2")	24	500	10	161
61 1509 0078	CGK 7/8" M	ø d 26-28 (7/8" + 7/8" superflex)	35	500	10	166
61 1509 0114	CGK 1.1/4" M	ø d 38-40 (1.1/4")	47	500	10	179
61 1509 0158	CGK 1.5/8" M	ø d 50-52 (1.5/8")	57	500	10	208





• EGK  
Open

• EGK  
Closed

MATERIAL	
Shell	PA 6, U.V. Resistant
Sealant	Isobutylene Strip
Inner Contact	Tinned Brass
Cable**	16 mm <sup>2</sup> Copper, Black PVC Insulated, Conforming to CEI 20-22 Norms (yellow/green on request)
Lug	Tinned Copper, ø 8 hole (* ø10 on request)

CERTIFICATION	
Waterproof	IP 68 IEC 60529 (Fimo Test)
Contact Resistance	<1 mOhm

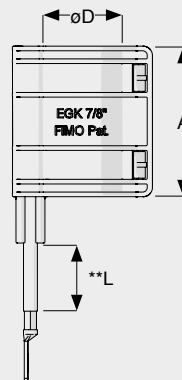

### EGK

No Tools Compact Grounding Kit With Plastic Shell

For Copper or Aluminum RF coaxial cables. Parallel cable exit.

#### Technical features:

- Compact plastic structure
- Fast and easy installation, without the use of tools
- No loose parts
- No lubricant required
- No extra taping needed

### EGK

Kit di Terra Compatto con Guscio in Plastica, Installazione Senza Utensili.

Per cavi coassiali RF, in rame o alluminio. Uscita parallela.

#### Caratteristiche:

- Struttura compatta in plastica
- Installazione veloce senza l'utilizzo di utensili
- Senza parti sciolte
- Lubrificante non necessario
- Nastratura supplementare non necessaria

CODE	ARTICLE	FOR COAXIAL CABLES	øD	**L	BOX	WEIGHT
61 1508 0012	EGK 1/2" M	ø d 16-17 (1/2")	26.5	500	10	145
61 1508 0078	EGK 7/8" M	ø d 26-28 (7/8" + 7/8" superflex)	37.5	500	10	152
61 1508 0114	EGK 1.1/4" M	ø d 38-40 (1.1/4")	49.5	500	10	158
61 1508 0158	EGK 1.5/8" M	ø d 50-52 (1.5/8")	61.5	500	10	165



Connecting Cable

FMT



**FMT 15/80 - Earthing Kit for Connectors**

Complete with 16 mm<sup>2</sup> connecting cable.  
Lightning test according to standard IEC 61312-1 grade III (CESI).

**FMT 15/80 - Messa a Terra per Connettori**

Completo di cavo di connessione 16 mm<sup>2</sup>.  
Testato alle scariche atmosferiche in accordo alla norma IEC 61312-1 grado III (CESI).

### MATERIAL

Contact	Tin Plated Copper
Connecting Cable	P.E. Insulated Copper According to CEI 20-22.
Colour	Black
M8 Screws	AISI 304 Stainless Steel

CODE	ARTICLE	DESCRIPTION	FOR CONNECTORS	øD	BAG	BOX	WEIGHT
61 1503 1580	FMT 15/80	Punched tinned copper strip 30x0,5, adjustable length	1/4" - 2.1/4"	15-80	10	100	170

# IST 8 · BTC

## Grounding Bolts

### IST 8 - Grounding Bolt

Sliding nut for **PCI 40x22** sections. Complete with M8 Threaded bar, nuts and washers.

### IST 8 - Bullone di Messa a Terra

Inserto scorrevole per profilati **PCI 40x22**, completo di barra filettata M8, dadi e rondelle.



#### MATERIAL

AISI 304 Stainless Steel

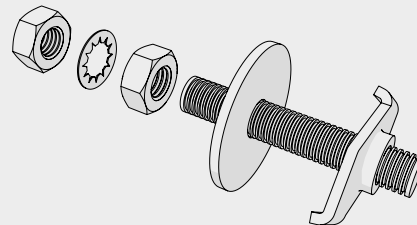
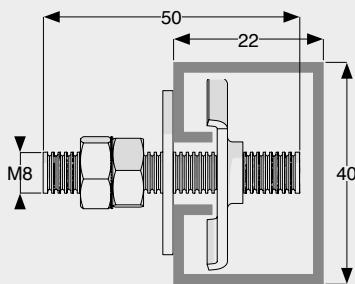

CODE	ARTICLE	SUITABLE TO	BAG	BOX	WEIGHT
61 1543 0008	IST 8	PCI	20	100	40

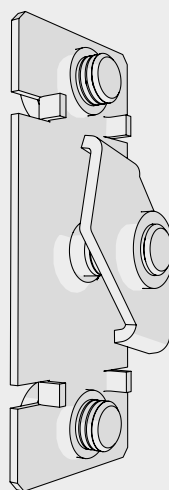

### BTC - Grounding Plate

BTC grounding socle with M8 screw for connection Z to sections **PCI 40x22**.

### BTC - Piastra di Messa a Terra

Piastra con vite M8 per la connessione a terra su profil **PCI 40x22**.

#### MATERIAL

AISI 304 Stainless Steel

CODE	ARTICLE	SUITABLE TO	BAG	BOX	WEIGHT
61 1543 0009	BTC	PCI 40x22	20	100	55

# BEI · BEC · BES

## Grounding Bars

GROUNDING KITS  
PRODUCT CATALOGUE

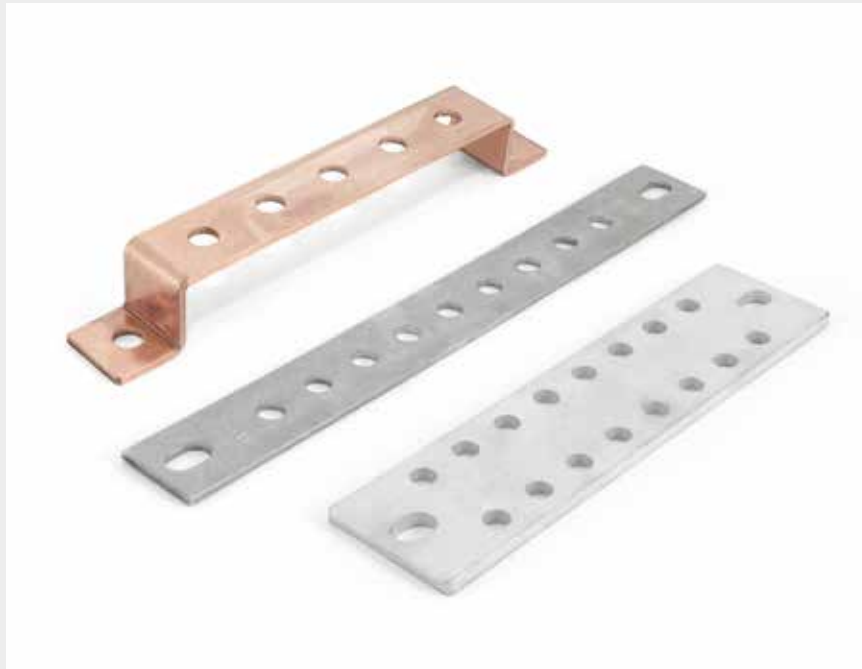

**BEI - AISI 304 Grounding Bar**  
**BEC - Copper Grounding Bars**  
**BES - Tinned Copper Grounding Bars**

Suitable for **PMR** and **PPS** wall entries.

**BEI - Barra Equipotenziale AISI 304**  
**BEC - Barre Equipotenziali di Rame**  
**BES - Barre Equipotenziali di Rame Stagnato**

Applicabile ai passanti a muro **PMR** e **PPS**.

### MATERIAL

<b>BEI</b>	AISI 304 Stainless Steel
<b>BEC</b>	Copper
<b>BES</b>	Tinned Copper

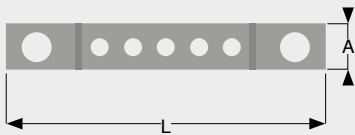

**BEC**

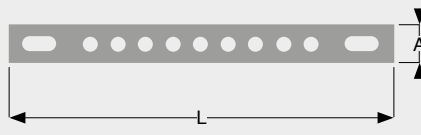

**BEI / BEC / BES**

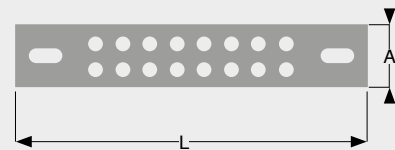

**BEI / BEC / BES**

CODE	ARTICLE/DESCRIPTION	L	A	N° HOLES	SHAPE	SUITABLE TO	BAG	BOX	WEIGHT
61 1517 9350	BEI 9x8	250	30	9 x Ø 8.5	FLAT	PMR - PPS	1	10	235
61 1517 9352	BEI 20xM8	300	40	20 x M8	FLAT	-	1	10	288
61 1517 0510	BEC 5x10	215	30	5 x Ø 10,5	ANGULAR	-	1	10	210
61 1517 9300	BEC 9xM8	250	30	9 x M8	FLAT	PMR - PPS	1	10	270
61 1517 9301	BEC 16xM8	300	40	16 x M8	FLAT	-	1	10	470
61 1517 9302	BEC 20xM8	300	40	20 x M8	FLAT	-	1	10	435
61 1517 9305	BEC 28xM8	300	50	28 x M8	FLAT	-	1	10	667
61 1517 9304	BES 5xM8	170	30	5 x M8	FLAT	-	1	10	136
61 1517 9306	BES 16x8	200	50	16 x Ø 8.5	FLAT	-	1	10	445
61 1517 9307	BES 16/2x8	250	50	16 x Ø 8.5	FLAT	PMR - PPS	1	10	556
61 1517 9303	BES 20xM8	300	40	16 x M8	FLAT	-	1	10	320



**ISO**  
**Electrical Insulators**

**ISO** Electrical Insulators are used to insulate grounding bars fixed on towers or other metal structures.

Installed between the equipotential bar and the metal structure, **ISO** insulators guarantee electrical insulation of the bar with respect to the structure.

**ISO**  
**Isolatori Elettrici per Barre Equipotenziali**

*Gli isolatori ISO sono usati per isolare le barre equipotenziali fissate alle torri o ad altre strutture metalliche. Installati tra la barra equipotenziali e la struttura metallica gli isolatori ISO garantiscono l'isolamento elettrico della barra rispetto alla struttura.*

**MATERIAL**

Fiberglass Reinforced Polyester

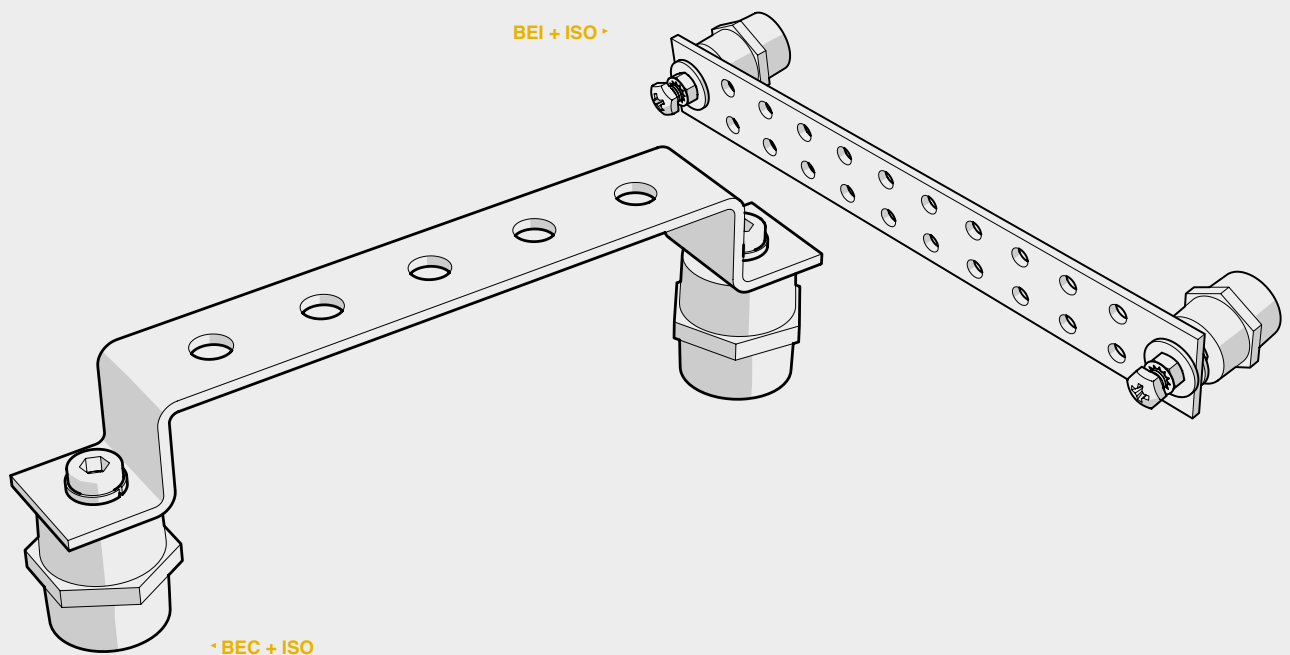

CODE	ARTICLE/DESCRIPTION	DIMENSIONS (mm)	THREAD	BOX	WEIGHT (gr)
61 7001 0001	ISO 3235 M8	32x35	M8	10	60
61 7001 0002	ISO 3030 M6	30x30	M6	10	76

# SCJ · SPJ

## Cables Stripper

GROUNDING KITS  
PRODUCT CATALOGUE

### SCJ

Cable Stripper for Mesh Shielded Cables

Quick and safe sheath stripping.

### SCJ

*Spellacavi per Cavi a Maglia*

*Spellatura rapida e sicura della guaina.*



CODE	ARTICLE/DESCRIPTION	FOR CABLES	COAXIAL CABLES	BOX	WEIGHT
U3 2107 0001	SCJ 1	Ø 4.8 - 7.5	RG	1	37
U3 2107 0015	SCJ 15	Ø 8 - 13	RG 213 - RG 214	1	60

### SPJ - Universal Cable Strippers

Quick, precise and safe sheath stripping of coaxial cables. Circular and longitudinal cut in the same operation.

### SPJ - Spellacavi Universali

*Spellatura rapida, sicura e precisa di cavi coassiali. Operazione unica di taglio circolare e longitudinale.*



CODE	ARTICLE/DESCRIPTION	FOR CABLES	COAXIAL CABLES	BOX	WEIGHT
U3 2101 0016	SPJ 16	Ø 4 - 16	1/4", 3/8", 1/2"	1	94
U3 2101 0027	SPJ 27	Ø 8 - 28	1/2", 5/8", 7/8"	1	92
U3 2101 0035	SPJ 35	Ø 8 - 35	7/8"	1	125
U3 2101 0050	SPJ 50	Ø 35 - 50	1.1/8", 1.1/4", 1.5/8"	1	134



