

# The Coop Run

assembly manual

**farm your yard.**

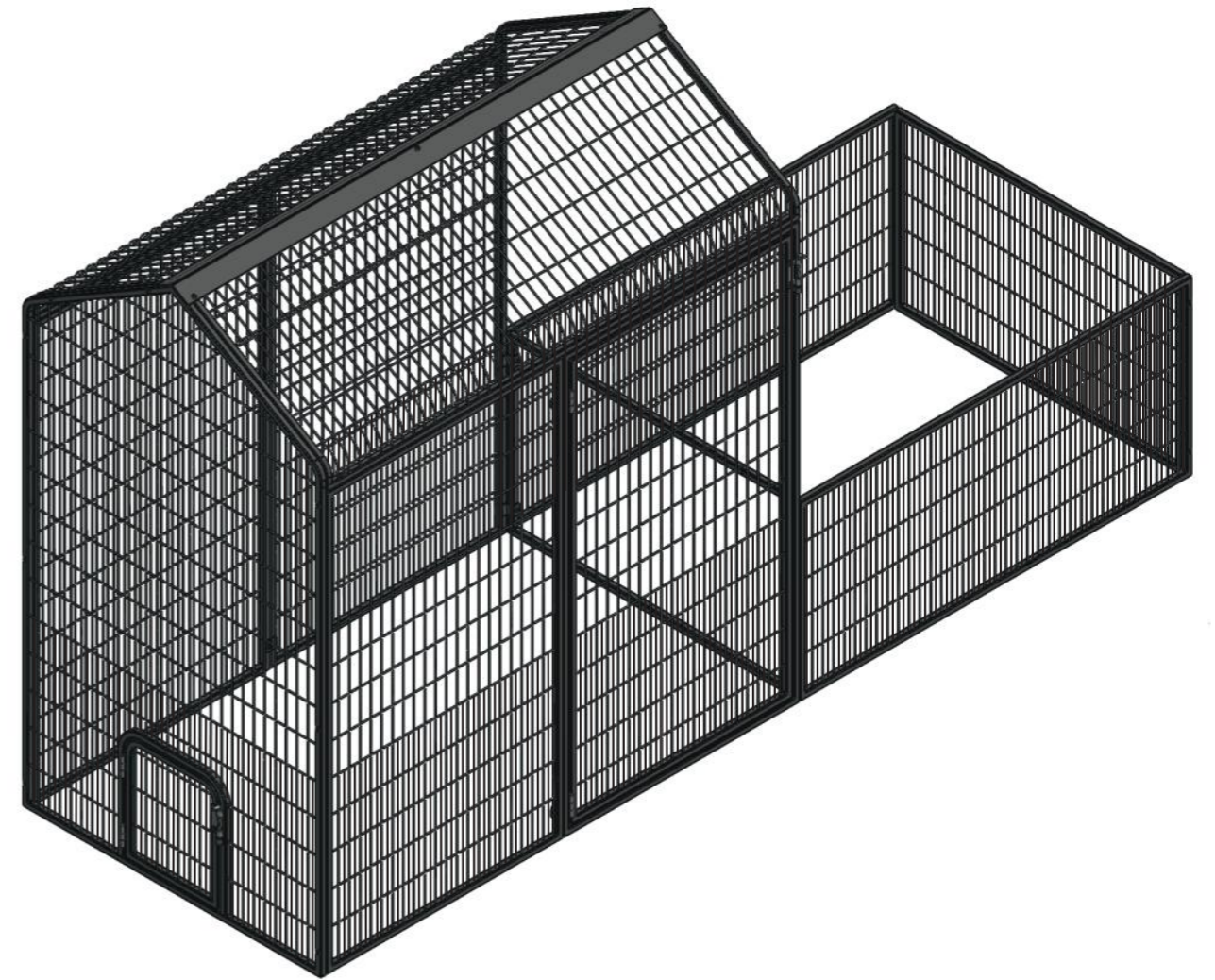

**coop**

You can watch a video of assembly by the link



If you have any questions visit our FAQ section on  
the web-site: [www.coop.farm](http://www.coop.farm) or  
shoot us an email at [help@coop.farm](mailto:help@coop.farm)

[www.coop.farm](http://www.coop.farm)  
15807 Booth Circle, Volente, TX, USA 78641  
(c) Coop, Inc. 2023  
Model: RNBSV1  
p/n 100-715 rev. June 2023  
Designed in Texas, made in P.R.C.

## what you need

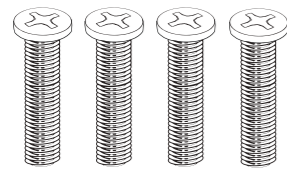

x4  
long



x4  
gasket

Through holes  
for coop mounting

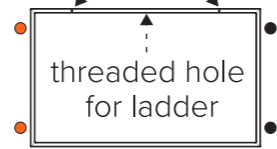

Base Front Panel

## what you need

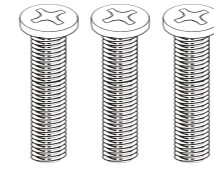

x3  
long



x3  
gasket

Threaded  
holes  
SIDE

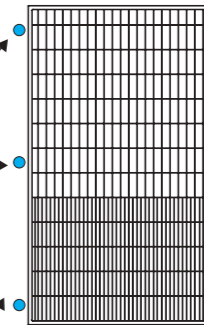

Threaded  
holes  
INSIDE

Right Panel A

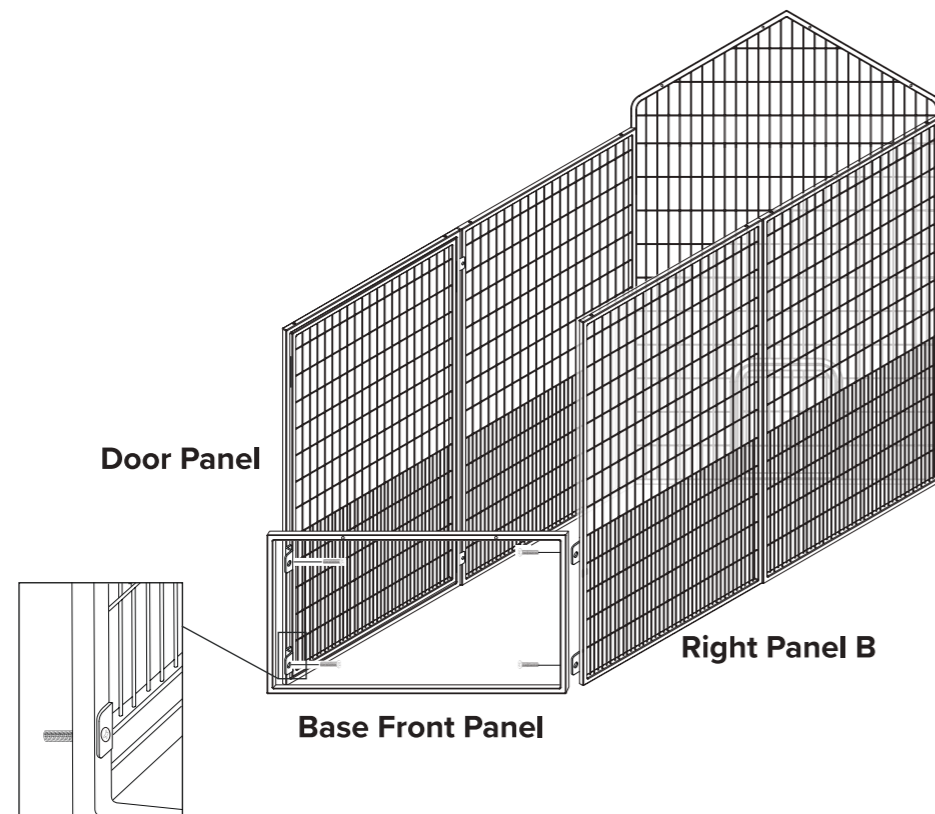

Find **Base Front Panel** and place it behind flanges from **Door Panel** and **Right Panel B** such that **ORANGE** stickers are on the left side and **BLACK** stickers are on the right side.

**NOTE!** Make sure that the side which has 2 through holes and a threaded hole for ladder is at the top.

Insert 4 long screws in the through holes to prepare for the following step on the next page.

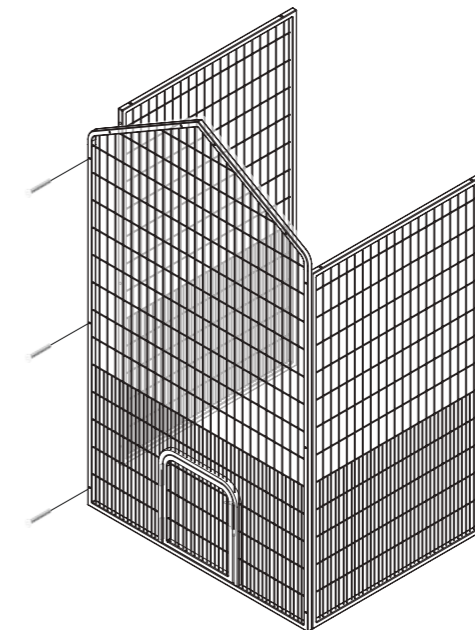

Repeat the same steps for **Right Panel A** with 3 long screws as shown on the picture. You will be connecting sides with **BLUE** stickers on **Right Panel A** and **Front Panel**. Keep 1/2" mesh cells are at the bottom.

Do not tighten screws too much just yet.

## what you need

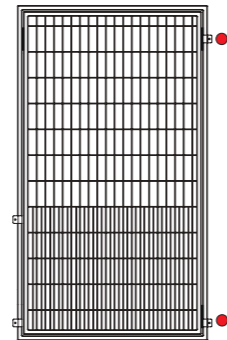
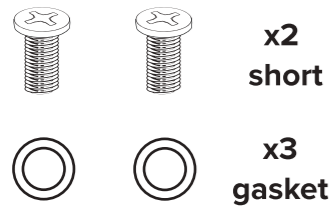

Door Panel

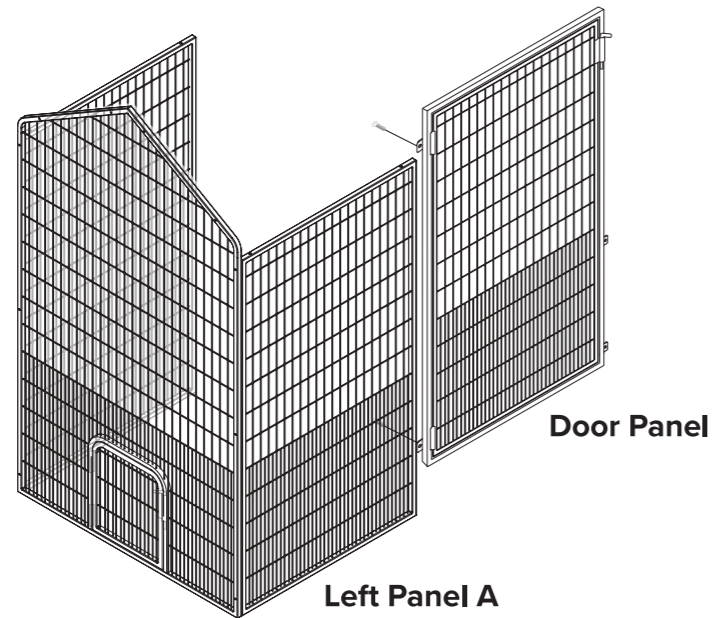

Identify two panels that have flanges. One of them will have a pre-installed hinged door and two **RED** stickers. This is **Door Panel**. (The other panel with **YELLOW** stickers with flanges will be Right Panel B, on the next page.)

Connect **Door Panel** to the **Left Panel A** matching **RED** stickers and using 2 short machine screws from the inside.

Human door should be opening outwards.

## what you need

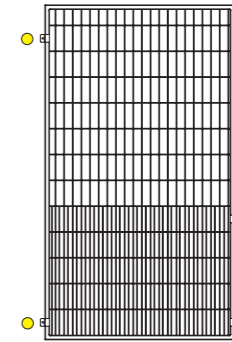
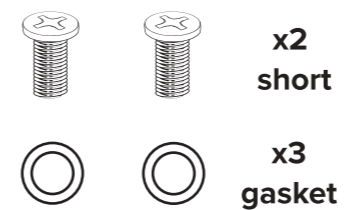

Right Panel B

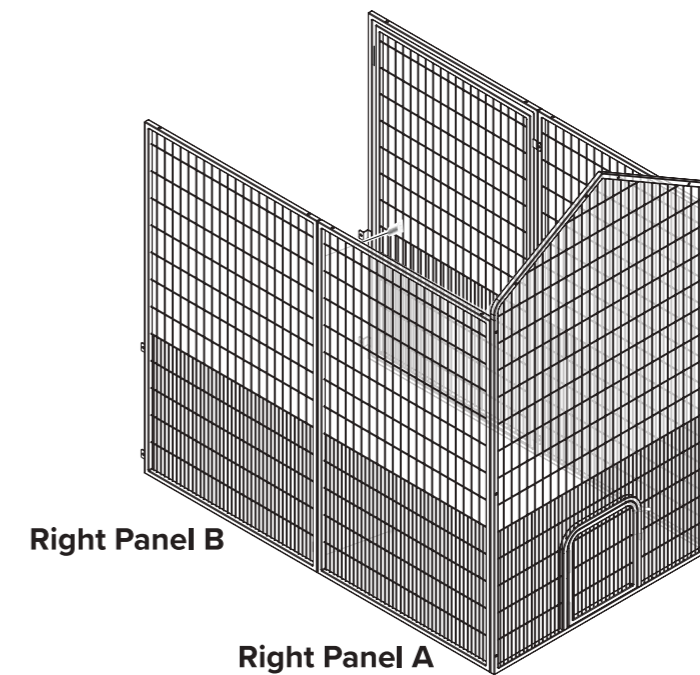

Connect **Right Panel B** to the **Right Panel A** matching **YELLOW** stickers using 2 short machine screws from the inside.

Now, let's move on to the coop base. We will do the roof at the end.

## what you need

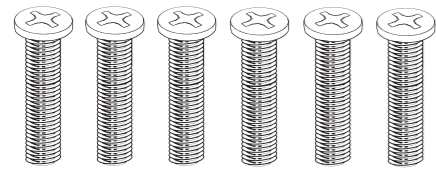

x6  
long

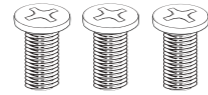

x3  
short



x9  
gasket

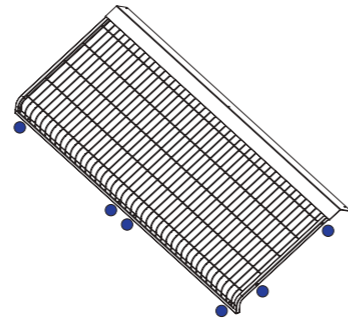

Right Roof Panel

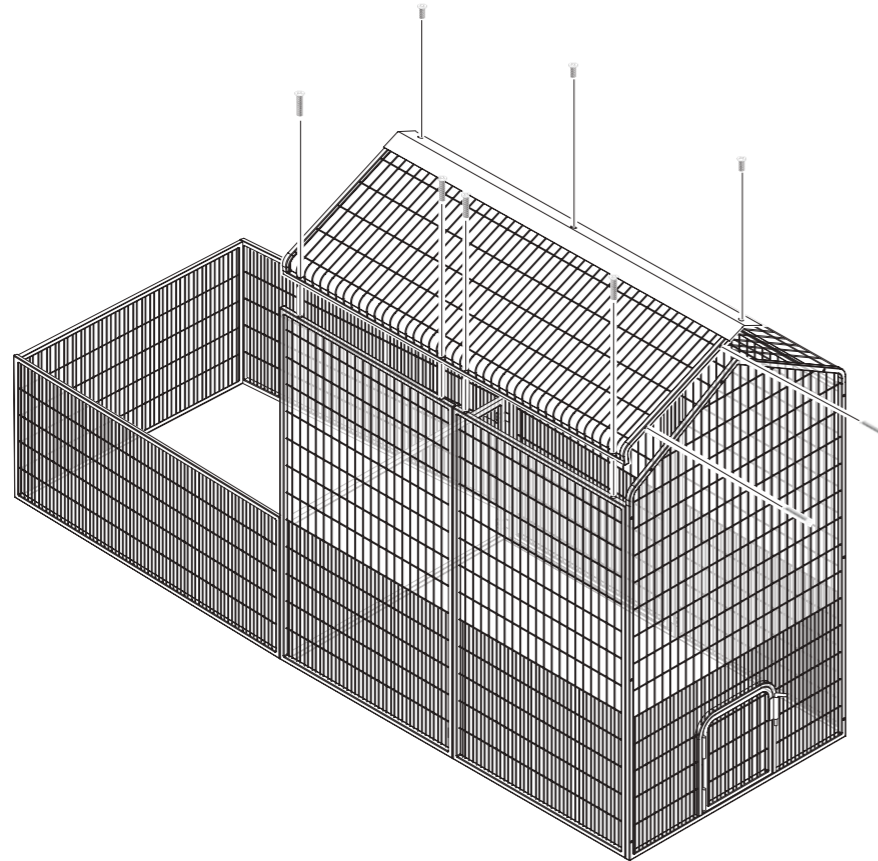

The last piece you have should be **Right Roof Panel** that has a cap. Attach it from the top and put in 2 long screws from the **Front Panel** side and 4 from the top to connect Roof Panel with **Right Panel A and B** matching **NAVY** stickers. Then insert 3 short screws in the cap to connect both Roof Panels.

**NOTE! At this point, check that all panels are aligned, after that tighten up all screws with a screwdriver.**

Congratulations, you've completed The Run! Now move on to assemble plastic coop part. If you have any questions or need further assistance, our customer support team is always here to help. Thanks for choosing Coop and happy Farming your yard!

Hey Farmer!

We are thrilled for you and your flock in the backyard! The following manual will help you to assemble The Coop Chicken Run. We encourage you to start assembling the metal frame and **then assemble plastic coop on top of the frame.**

Before we dive in, let's make sure you have everything you need and recognize all the pieces. Take a look at the diagram to familiarize yourself with the different pieces and screws included in the set. **Then, lay out all the panels in front of you with the wire mesh facing downwards**, and match them up with the diagram noting the location of **color stickers that will need to match** during the **assembly process**. It will save you a lot of hassle and confusion later on.

THE COOP RUN MUST BE ASSEMBLED ON FLAT GROUND TO PREVENT ANY OPTIONS FOR PREDATORS OR PESTS TO GET IN.

Set aside about 60 minutes for complete assembly.

It is highly recommended to have a companion for the assembly process.

**NOTE: All directional instructions are based of inside facing the small chicken door. We also recommend you watch the instructional video before starting the assembly.**

Watch a 5 minutes assembly video  
**BEFORE** proceeding

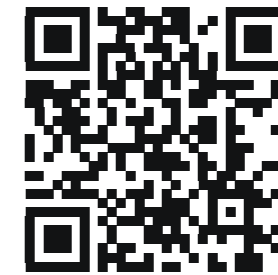

**WARNING:** Panels are not expected to balance on their own before they are screwed together. Make sure the assembly spot you defined is not accessible by children or small pets. In case a panel falls before it gets connected to other panels, it may cause serious or fatal injuries.

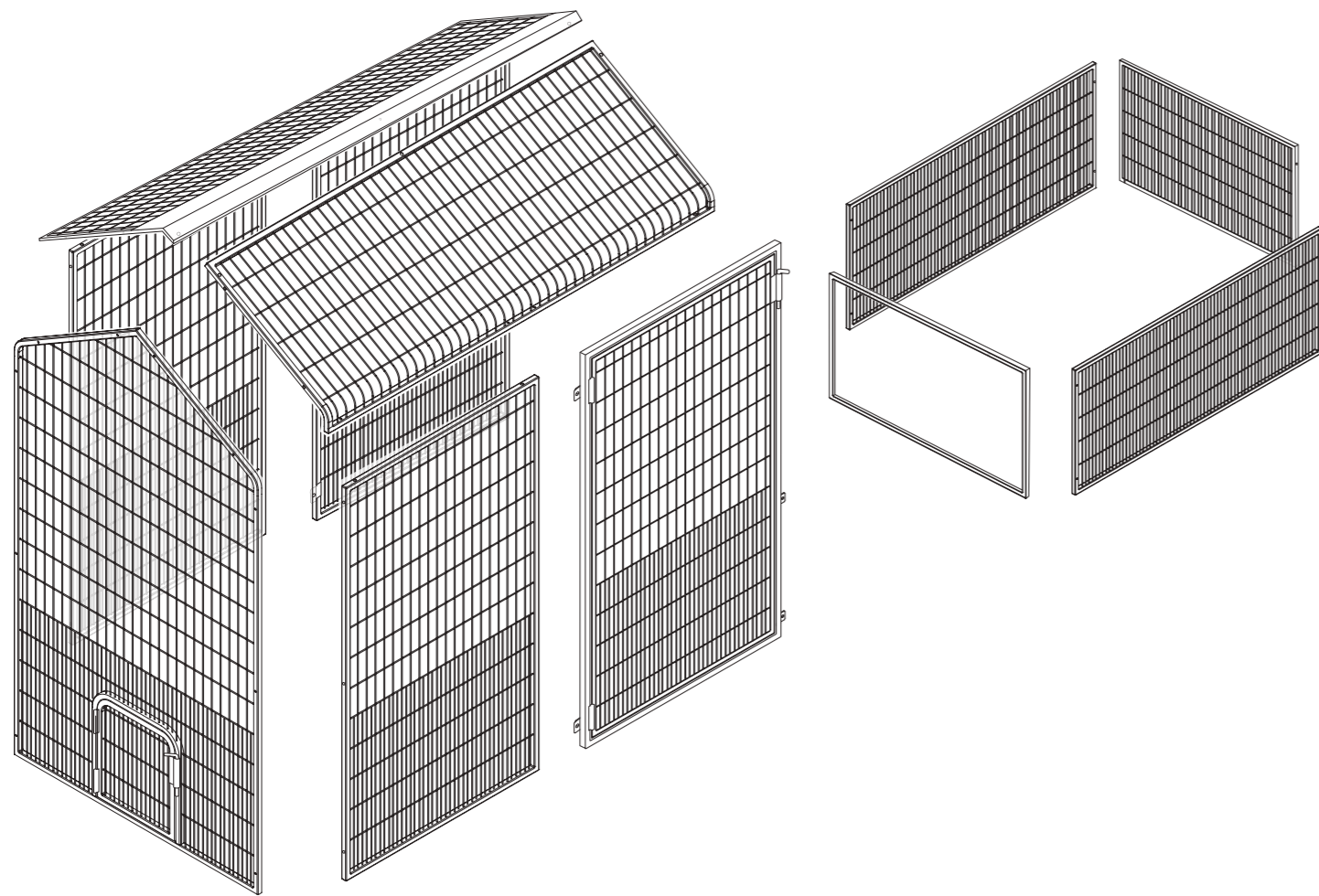

## what you need

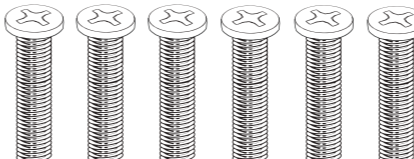

**x6  
long**



**x6  
gasket**

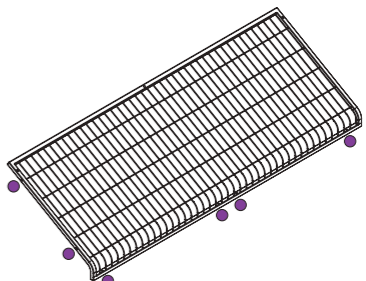

**Left Roof Panel**

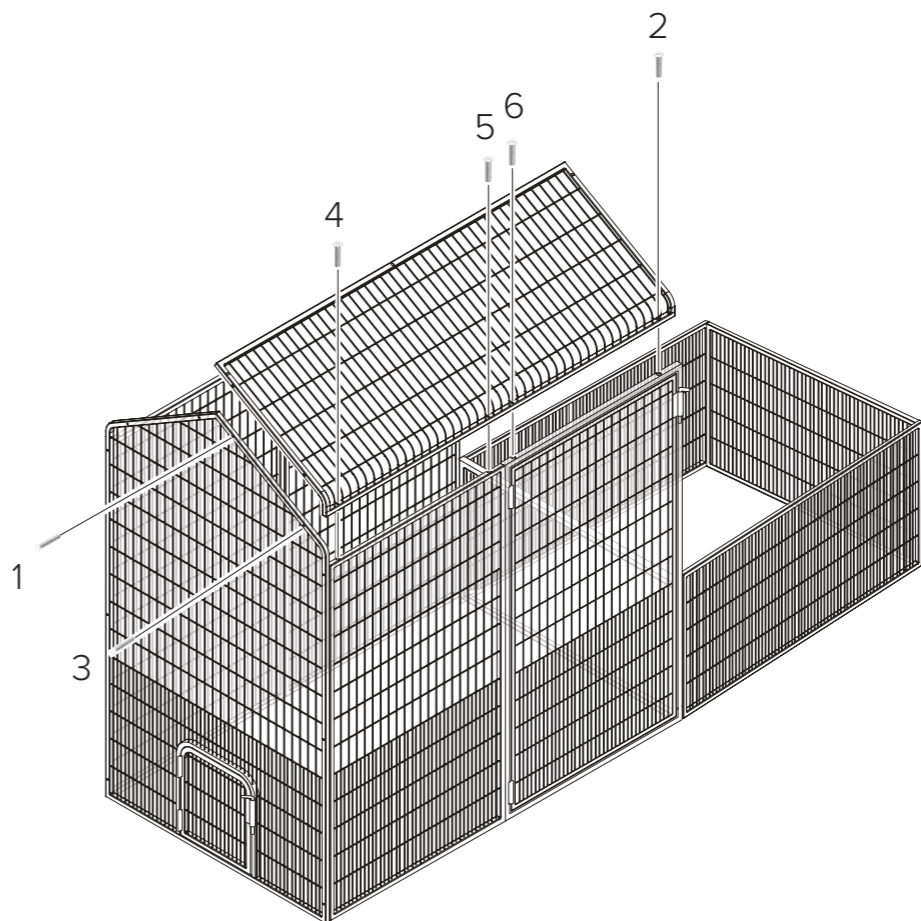

Now, let's put the roof on. Find Roof Panel that does not have a cap which is **Left Roof Panel**.

Place it on top of **Left Panel A and Door Panel** matching **PURPLE** stickers. Insert 2 long screws from the side of **Front Panel** and 4 long screws from the top to connect **Left Roof Panel** with **Left Panel A and Door Panel**.

Follow the sequence outlined with numbers. First insert two most distant screws (for holding the roof panel in place) and then the rest of them.

# what you need

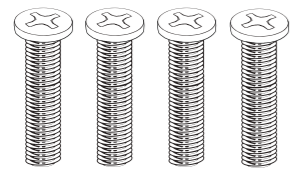

x4  
long



x4  
gasket

Through holes  
for coop mounting

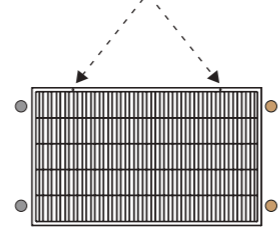

Base Rear Panel

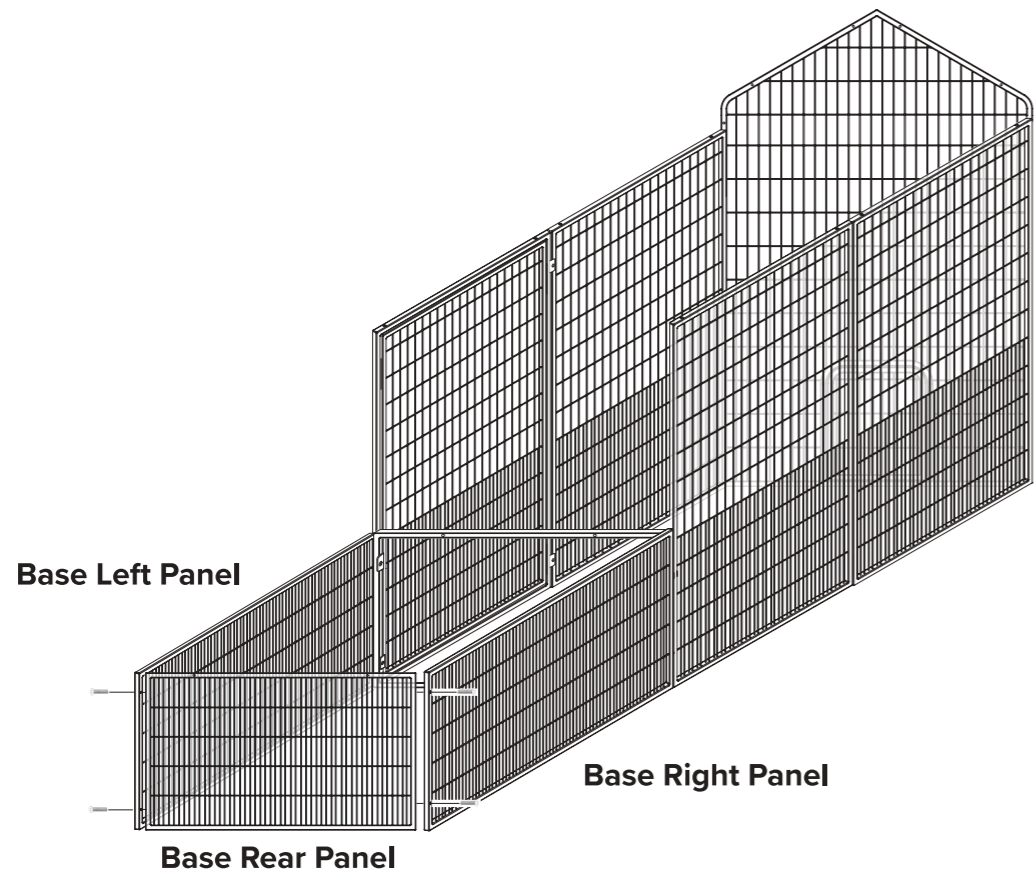

Find the last **Base Rear Panel** and insert it between **Base Right Panel** and **Base Left Panel** matching **SILVER** on the left and **GOLD** stickers on the right. Mind that through-holes on Base Rear Panel should be on top. Insert 4 long screws on the sides and tighten them up.

# for run section

actual size



x25  
gasket



x7  
short



x18  
long



x1

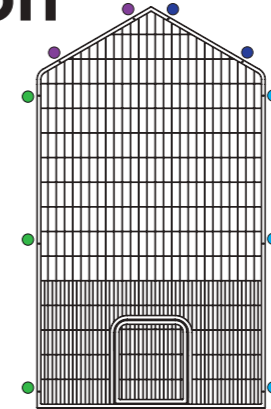

Front Panel

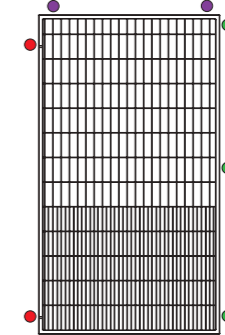

Left Panel A

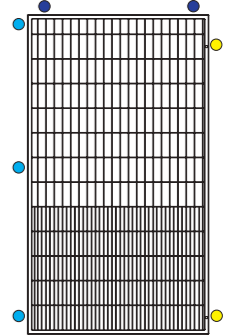

Right Panel A

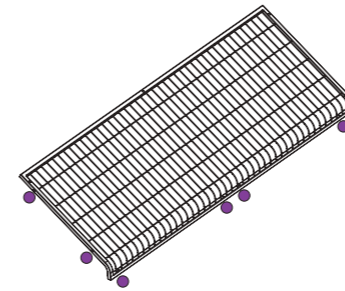

Left Roof Panel

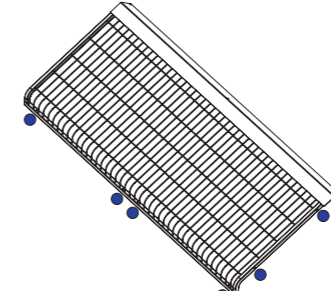

Right Roof Panel

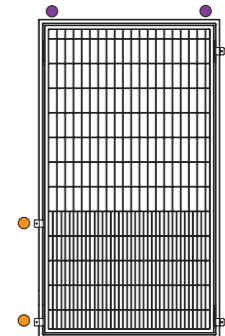

Door Panel

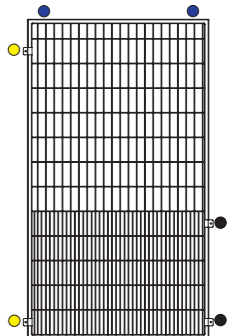

Right Panel B

# for coop base section

actual size



x8  
gasket



x8  
long



Base Front Panel

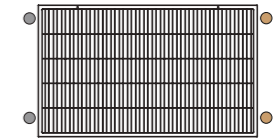

Base Rear Panel

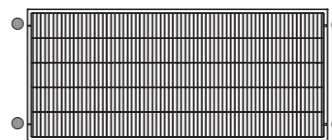

Base Left Panel

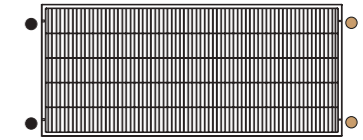

Base Right Panel

## what you need

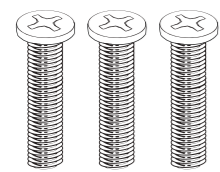

x3  
long



x3  
gasket

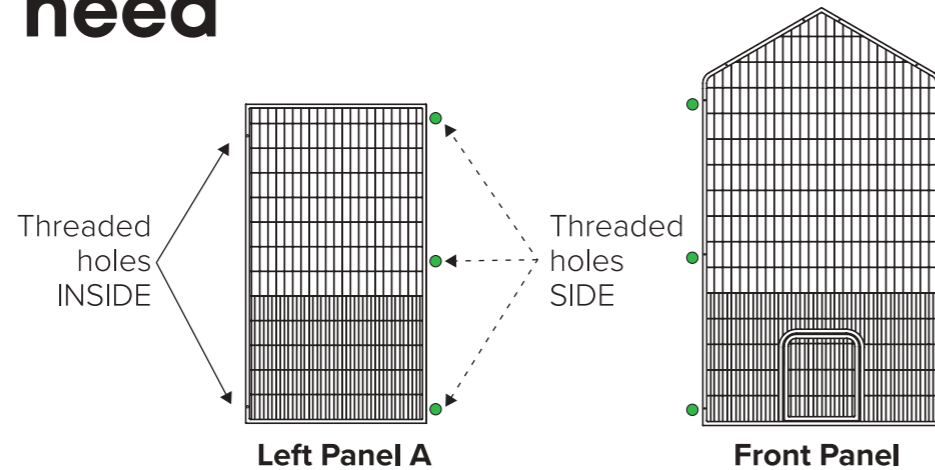

## what you need

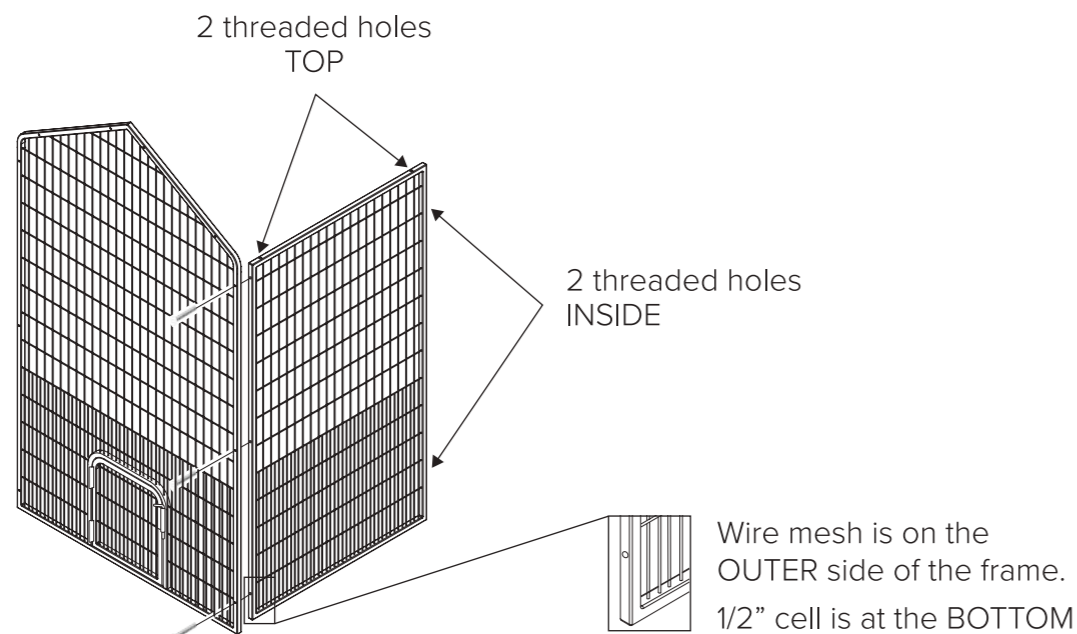
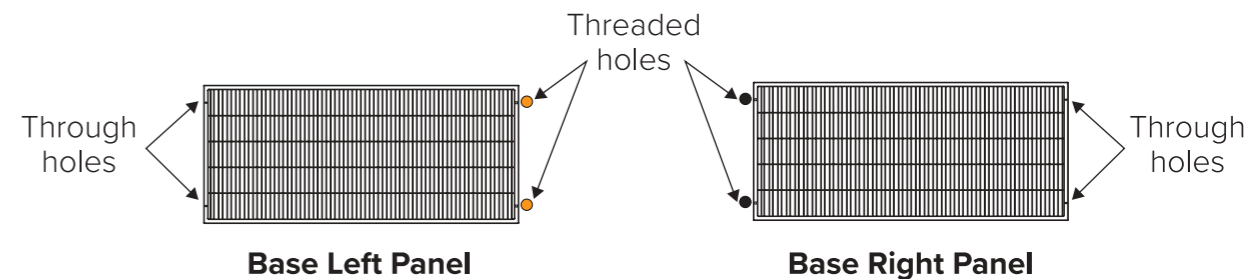

Identify the tallest panel with small chicken door at the bottom. It is called **The Front Panel**.

Identify two similar panels that does not have any flanges and have 3 threaded holes on the long side and **GREEN** and **BLUE** stickers. Place them both with wire mesh on the outer edge away from you , with 2 threaded holes on top facing upwards while 1/2" mesh cells are at the bottom.

The one that has 3 threaded holes on the right side and **GREEN** stickers is a **Left Panel A**, while the other one with **BLUE** stickers will be Right Panel A (on the next page.) Connect **Left Panel A** with 3 long screws as shown on the picture to the side of Front Panel matching **GREEN** stickers.

Chicken door on the **Front Panel** should be opening to the outside.

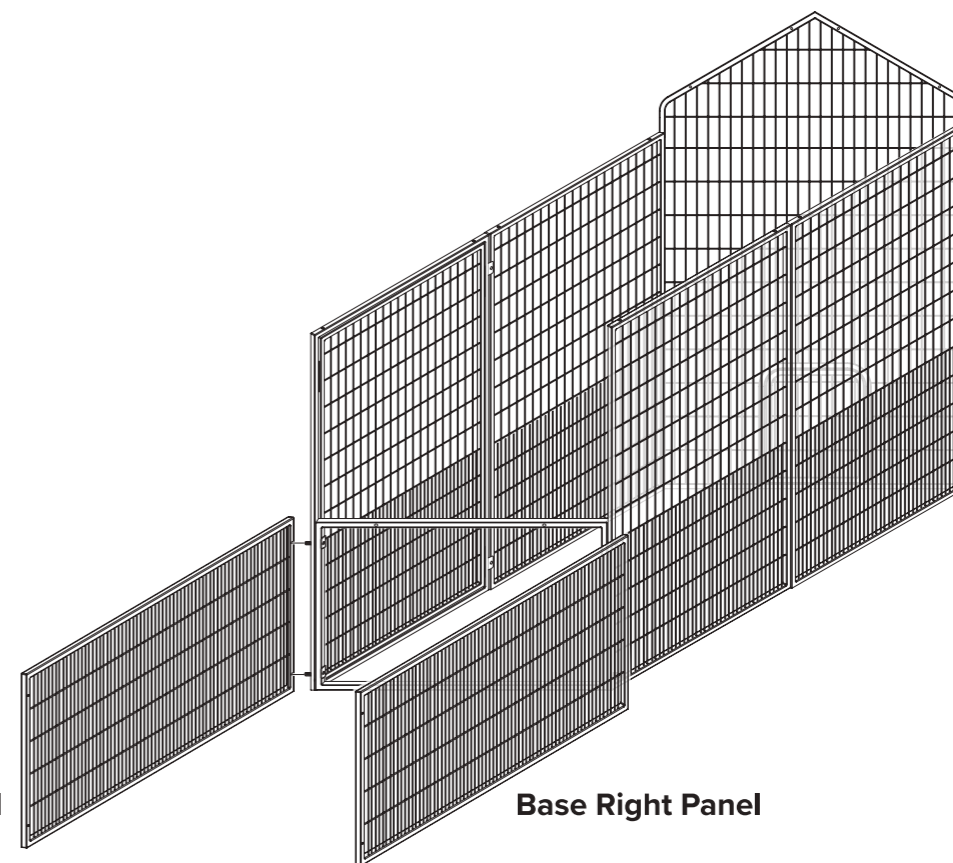

Attach **Base Left Panel** to 2 long screws that went through flanges of **Door Panel** and **Base Front Panel** in a previous step while matching **ORANGE** stickers. Lightly tighten up.

Repeat for **Base Right panel** attaching it to screws that went through flanges of **Right Panel B** and **Base Front Panel** matching **BLACK** stickers.