

2



Section 2

Tables and Desks

Contact us for a quote!



sales@educatedfurniture.co.nz



0508 645 397



educatedfurniture.co.nz



We have been using Educated Furniture for many years for the furniture requirements of our school.

We are always happy with Educated Furniture, staff and the products. They are truly amazing, the staff are approachable, are always happy to help and have great follow up service

Office Manager
Puhinui School | Auckland



Section 2

Tables and Desks

Classroom Tables	2-36
Computer and Lab Tables.....	2-44
Student Desks.....	2-45
Teacher Desks.....	2-48
Office Desks and Workstations.....	2-49
Ergonomic Desking and Accessories.....	2-51
Library and Reception Desks	2-55
Meeting Room and Staffroom Tables	2-56
Bar Leaners and Coffee Tables.....	2-58
Collapsible Tables and Trolleys.....	2-61

Classroom Tables

85 Classroom Tables

Eighth standard sizes or request a custom size

- **A** - 800L x 600D x Height
- **B** - 800L x 800D x Height
- **C** - 1200L x 600D x Height
- **D** - 1200L x 800D x Height
- **E** - 1600L x 600D x Height
- **F** - 1600L x 800D x Height
- **G** - 1800L x 600D x Height
- **H** - 1800L x 800D x Height
- Choose your height from our standard options
- Solid steel powder coated frame with 32mm round legs
- 18mm Melteca top in your choice of colour/finish
- Rounded corners with solid 2mm PVC edges

Custom options

- Whiteboard tops
- Adjustable legs - 530 | 625 | 685 | 725mm
- Turn into Tall Tables 800 or 900H
- Add 4 locking castors for portability
- Upgrade to heavy duty frame with 51mm round legs (not available with adjustable leg heights)



Whiteboard top

Locking castor

Adjustable legs

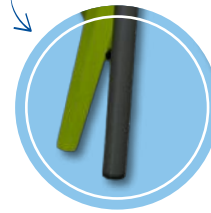
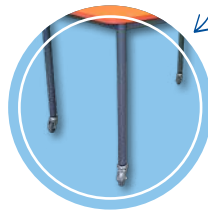

Standard Table Heights

- Kneeler - 400mm high
- Pre-School - 500mm high
- Year 1 - 2 - 530mm high
- Year 1 - 2 - 560mm high
- Year 3 - 4 - 625mm high
- Year 5 - 6 - 685mm high
- Year 7 - 8+ - 725mm high

Replacement Tops

Use your existing frames and refresh your school's tables with replacement tops. Available in our full range of colours/finishes, shapes and sizes



87 Round Tables



- **A** - 900 diameter
- **B** - 1200 diameter
- Choose your height from our standard options
- Solid steel powder coated frame with 32mm round legs
- 18mm Melteca top in your choice of colour/finish
- Solid 2mm PVC edges

Custom options

- Whiteboard tops
- Adjustable legs - 530 | 625 | 685 | 725mm
- Add 4 locking castors for portability

89 Kneeler Tables



- **A** - 1200L x 400D x 400H
- **B** - 1200L x 600D x 400H
- Solid steel powder coated frame with 32mm round legs
- 18mm Melteca top in your choice of colour/finish
- Rounded corners with solid 2mm PVC edges

Custom options

- Whiteboard tops for a collaborative work surface

Colour range - all of our Melteca units can be made in any of the colours/finishes below



86 Desk Tray Tables



- **A** - 1200L x 800D x Height (4 trays/4 students)
- **B** - 1600L x 800D x Height (4 trays/4 students)
- **C** - 1800L x 800D x Height (6 trays/6 students)
- Choose your height from our standard options
- Solid steel powder coated frame with 32mm round legs
- 18mm Melteca top in your choice of colour/finish
- Rounded corners with solid 2mm PVC edges
- Choose between Standard or Deep desk trays

Custom options

- Whiteboard tops
- Adjustable legs - 530 | 625 | 685 | 725mm
- Add 4 locking castors for portability

388 Jellybean Tables

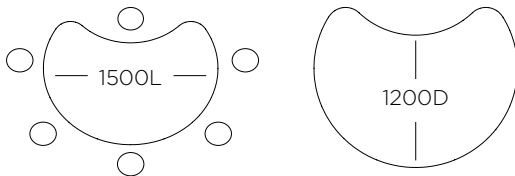

- 1500L x 1200D x Height
- Choose your height from our standard options
- Solid steel powder coated frame with 32mm round legs
- 18mm Melteca top in your choice of colour/finish
- Solid 2mm PVC edges

Custom options

- Whiteboard tops
- Adjustable legs - 530 | 625 | 685 | 725mm
- Add 4 locking castors for portability

123 Desk Trays

Standard



Deep



A - Standard 520W x 400D x 80H

B - Deep 520W x 400D x 120H

Colours - Dark Grey only

162 Horseshoe Tables

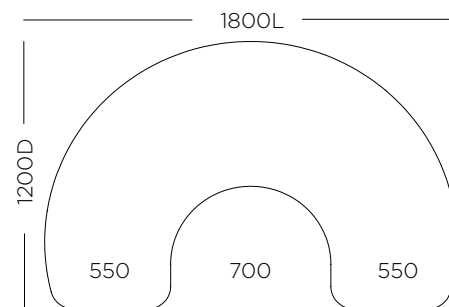

- 1800L x 1200D x Height
- We recommend a gas lift teacher chair to provide a comfortable and ergonomic sitting position
- Choose your height from our standard options
- For Years 1 - 4 we recommend using the 625H table with 400H MLE stools or Cube stools.
- Solid steel frame with 32mm round legs
- 18mm Melteca top in your choice of colour/finish
- Rounded corners with solid 2mm PVC edges

Custom options

- Whiteboard tops
- Adjustable legs - 530 | 625 | 685 | 725mm
- Add 4 locking castors for portability

Colour range - all of our Melteca units can be made in any of the colours/finishes below



90 Trap Tables

- 1200L x 700L x 600D x Height
- Choose your height from our standard options
- Solid steel powder coated frame with 32mm round legs
- 18mm Melteca top in your choice of colour/finish
- Rounded corners with solid 2mm PVC edges

Custom options

- Whiteboard tops
- Adjustable legs - 530 | 625 | 685 | 725mm
- Add 4 locking castors for portability
- Upgrade to heavy duty frame with 51mm round legs (not available with adjustable leg heights)

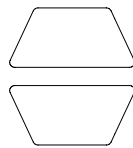
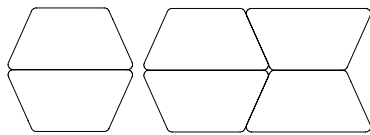
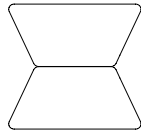
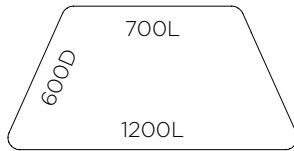

163 Switch Tables

- **A** Years 1- 6 - 800L x 800D x Height
- **B** Year 7+ - 1000L x 1000D x Height
- Choose your height from our standard options
- Solid steel powder coated frame with 32mm round legs
- 18mm Melteca top in your choice of colour/finish
- Rounded corners with solid 2mm PVC edges

Custom options

- Whiteboard tops
- Adjustable legs - 530 | 625 | 685 | 725mm
- Add 4 locking castors for portability

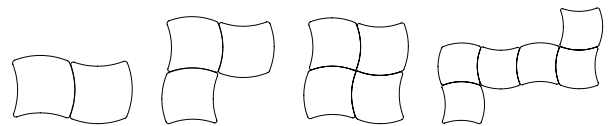
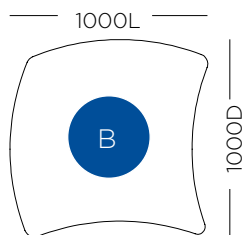
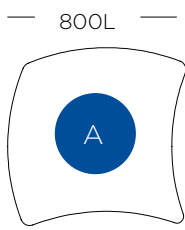

Standard Table Heights

- Kneeler - 400mm high
- Pre-School - 500mm high
- Year 1 - 2 - 530mm high
- Year 1 - 2 - 560mm high
- Year 3 - 4 - 625mm high
- Year 5 - 6 - 685mm high
- Year 7 - 8+ - 725mm high

Replacement Tops

Use your existing frames and refresh your school's tables with replacement tops. Available in our full range of colours/finishes, shapes and sizes



Colour range - all of our Melteca units can be made in any of the colours/finishes below



170 Alpha Tables

Our Alpha Tables come in two shapes and are a smaller classroom table for students working in groups of 2-4. They are popular in primary schools and ECE's, particularly at a kneeler height (400H) and teamed up with our Fritter floor cushions.

- **A** - Alpha 3 - 1100L x 1020D x Height
- **B** - Alpha 4 - 800L x 800D x Height
- Choose your height from our standard options
- Solid steel powder coated frame with 32mm round legs
- 18mm Melteca top in your choice of colour/finish
- Solid 2mm PVC edges

Custom options

- Whiteboard tops
- Adjustable legs - 530 | 625 | 685 | 725mm
- Add 4 locking castors for portability

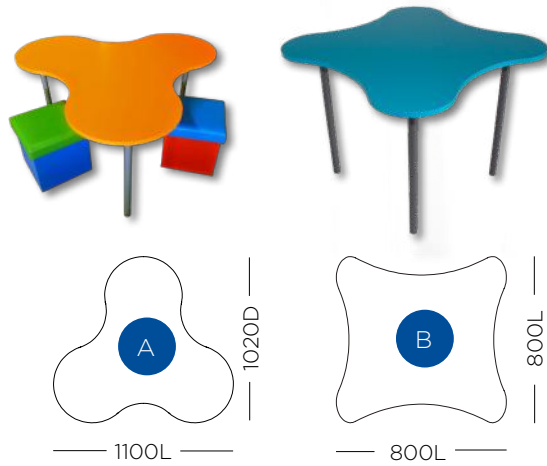

163 Omega Tables

Omega Tables are available at all our standard heights and can be made in all our colours/finishes, as well as with whiteboard tops.

- **A** Years 1-6 - 950 diameter
- **B** Years 1-6 - 950 diameter
- **C** Years 1-6 - Connecta 1600L x 800W
- **D** Years 7-13 - 1100 diameter
- **E** Years 7-13 - 1100 diameter
- **F** Years 7-13 - Connecta 1800L x 950W
- Choose your height from our standard options
- Solid steel frame with 32mm round legs
- 18mm Melteca top in your choice of colour/finish
- Rounded corners with solid 2mm PVC edges

Custom options

- Whiteboard tops
- Adjustable legs - 530 | 625 | 685 | 725mm
- Add 4 locking castors for portability

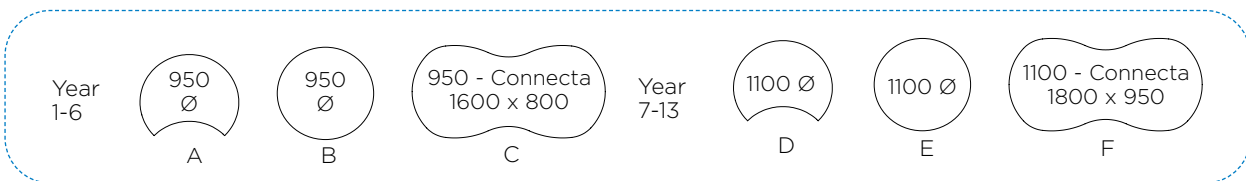
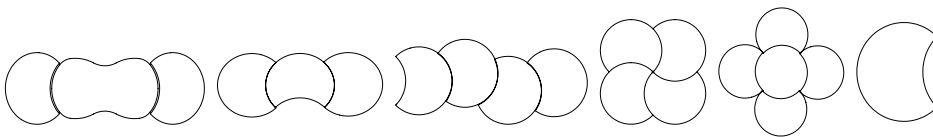

Standard Table Heights

- Kneeler - 400mm high
- Pre-School - 500mm high
- Year 1 - 2 - 530mm high
- Year 1 - 2 - 560mm high
- Year 3 - 4 - 625mm high
- Year 5 - 6 - 685mm high
- Year 7 - 8+ - 725mm high

Replacement Tops

Use your existing frames and refresh your school's tables with replacement tops. Available in our full range of colours/finishes, shapes and sizes



Colour range - all of our Melteca units can be made in any of the colours/finishes below



164 Swerve Tables

Our Swerve Table is a “stretched” Switch Table that enables two children to sit on each side of the table. It replaces the traditional group table with the flexibility to separate them into individual units or pull them together for collaborative tasks.

- 1200L x 800D x Height
- Choose your height from our standard options NB: Swerve Tables are available at all our standard heights but are most popular as Tall Tables
- Solid steel frame with 32mm round legs
- 18mm Melteca top in your choice of colour/finish
- Rounded corners with solid 2mm PVC edges

Custom options

- Whiteboard tops
- Made as a Tall Table at 800 or 900H
- Adjustable legs - 530 | 625 | 685 | 725mm
- Add 4 locking castors for portability
- Upgrade to heavy duty steel powder coated frame with 51mm round legs

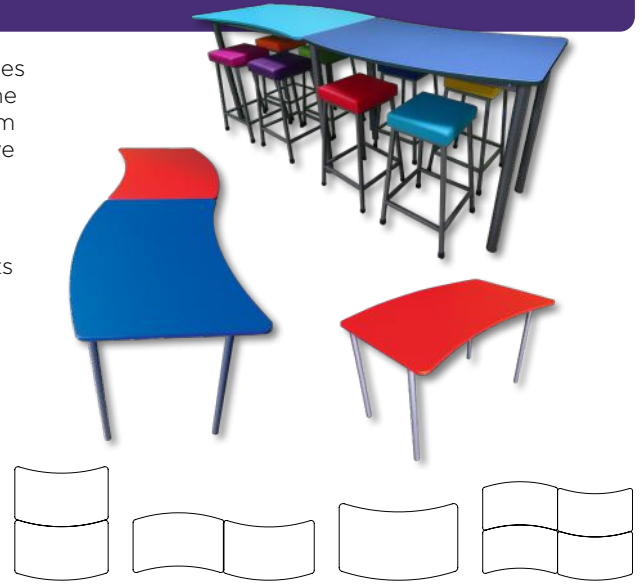

130 Tall Tables

Our Tall Tables come in a range of shapes and sizes and are perfect for students working in small groups when paired with our Pepper Stools or MLE Stools. Tall Tables come in two height options to suit different year levels.

- **A** Rectangle - 1200L x 600D x 800/900H
- **A** Rectangle - 1600L x 600D x 800/900H
- **A** Rectangle - 1800L x 600D x 800/900H
- **A** Rectangle - 1200L x 800D x 800/900H
- **A** Rectangle - 1600L x 800D x 800/900H
- **A** Rectangle - 1800L x 800D x 800/900H
- **A** Rectangle - 1200L x 1200D x 800/900H
- **A** Rectangle - 1800L x 1200D x 800/900H
- **A** Rectangle - 2400L x 1200D x 800/900H
- **B** Swerve - 1200L x 800D x 800/900H
- **C** Sigma - 1200L x 730D x 800/900H
- **Year 1 - 4 Height** - 800H
- **Year 4 - 13 Height** - 900H
- Heavy duty steel powder coated frame with 51mm round legs
- 18mm Melteca top in your choice of colour/finish
- Solid 2mm PVC edges
- Any of our tables be made into a ‘Tall Table’ upon request

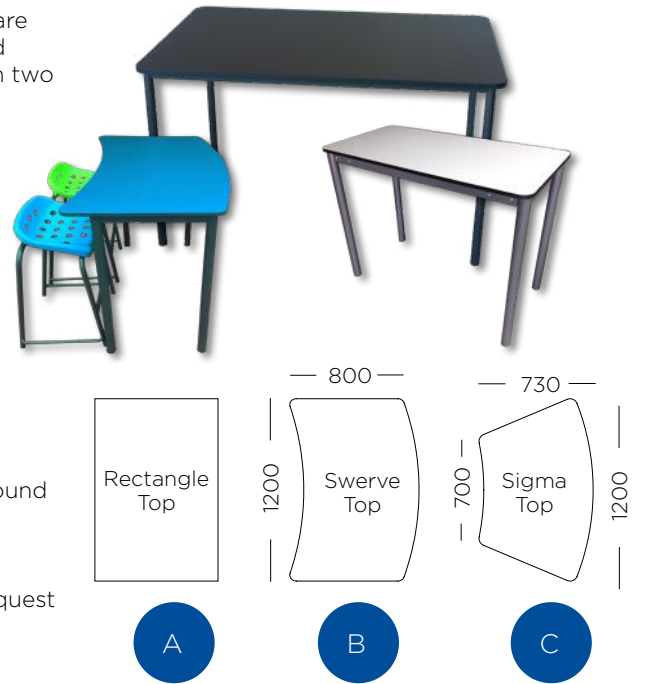

94 Limpet Tables

- 1500L x 1200D x Height
- Choose your height from our standard options
- Solid steel frame with 32mm round legs
- 18mm Melteca top in your choice of colour/finish
- Rounded corners with solid 2mm PVC edges

Custom options

- Whiteboard tops
- Adjustable legs - 530 | 625 | 685 | 725mm
- Add 4 locking castors for portability



Colour range - all of our Melteca units can be made in any of the colours/finishes below



174 Sigma Tables

These versatile tables can be set up as individual units, arranged in a circle/semi-circle for conferencing activities or snaked around the classroom acting as a working space and room divide.

- 1200L x 730D x Height
- Choose your height from our standard options
- Solid steel frame with 32mm round legs
- 18mm Melteca top in your choice of colour/finish from our range
- Rounded corners with solid 2mm PVC edges



Custom options

- Whiteboard tops
- Can be made as a Tall Table at 800 or 900H
- Adjustable legs - 530 | 625 | 685 | 725mm
- Add 4 locking castors for portability
- Upgrade to heavy duty steel powder coated frame with 51mm round legs

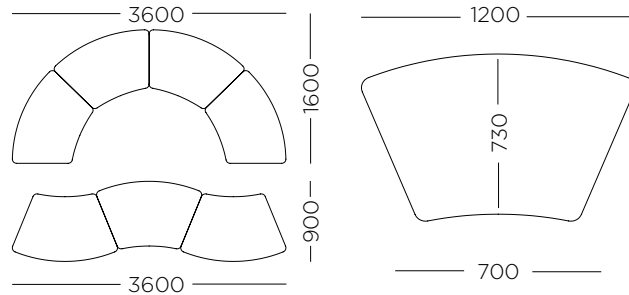

92 Starfish Tables

Our Starfish Tables create a fun, yet functional place for up to 6 students to work and are especially popular in the primary school setting. They can be made in any of our standard heights to suit any age group and are available in all our colours/finishes to suit any environment.

- 1500L x 1200D x Height
- Choose your height from our standard options
- Solid steel frame with 32mm round legs
- 18mm Melteca top in your choice of colour/finish
- Rounded corners with solid 2mm PVC edges

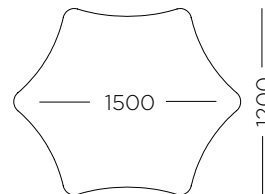

Custom options

- Whiteboard tops
- Adjustable legs - 530 | 625 | 685 | 725mm
- Add 4 locking castors for portability

93 Jellyfish Tables

Our Jellyfish Tables create a fun, yet functional place for up to 4 students to work and are especially popular in the primary school setting.

- 1200L x 1200D x Height
- Choose your height from our standard options
- Solid steel frame with 32mm round legs
- 18mm Melteca top in your choice of colour/finish from our range below
- Rounded corners with solid 2mm PVC edges

Custom options

- Whiteboard tops
- Adjustable legs - 530 | 625 | 685 | 725mm
- Add 4 locking castors for portability

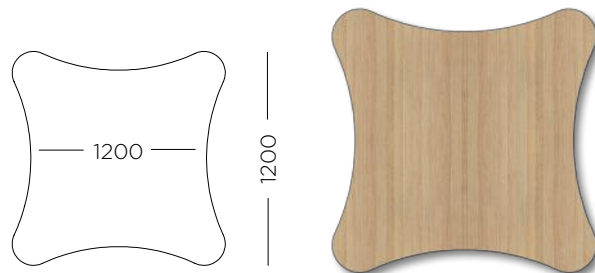

Colour range - all of our Melteca units can be made in any of the colours/finishes below



96 Scallop Tables

Our Scallop Tables create a fun, yet functional place for up to 7 students to work and are especially popular in the primary school setting.

- 1800L x 1200D x Height
- Choose your height from our standard options
- Solid steel frame with 32mm round legs
- 18mm Melteca top in your choice of colour/finish
- Rounded corners with solid 2mm PVC edges

Custom options

- Whiteboard tops
- Adjustable legs - 530 | 625 | 685 | 725mm
- Add 4 locking castors for portability

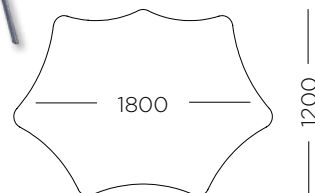

97 Octopus Tables

Our Octopus Tables create a fun, yet functional place for up to 8 students to work and are especially popular in the primary school setting.

- 1800L x 1200D x Height
- Choose your height from our standard options
- Solid steel frame with 32mm round legs
- 18mm Melteca top in your choice of colour/finish
- Rounded corners with solid 2mm PVC edges

Custom options

- Whiteboard tops
- Adjustable legs - 530 | 625 | 685 | 725mm
- Add 4 locking castors for portability

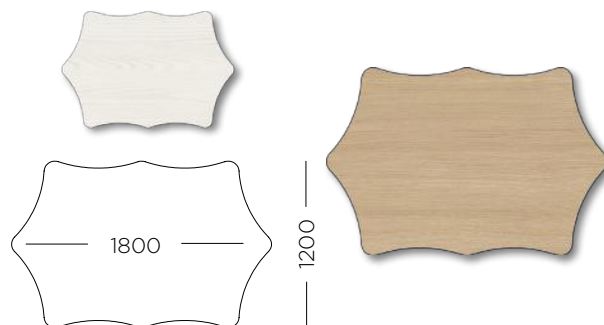

92 Hexagon Tables

Our Hexagon Tables create a fun, yet functional place for up to 6 students to work and are especially popular in the primary school setting.

- 1200L x 1200D x Height
- Choose your height from our standard options
- Solid steel frame with 32mm round legs
- 18mm Melteca top in your choice of colour/finish
- Rounded corners with solid 2mm PVC edges

Custom options

- Whiteboard tops
- Adjustable legs - 530 | 625 | 685 | 725mm
- Add 4 locking castors for portability

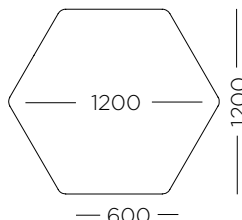

99 Octagon Tables

Our Octagon Tables create a fun, yet functional place for up to 8 students to work and are especially popular in the primary school setting.

- 1200L x 1200D x Height
- Choose your height from our standard options
- Solid steel frame with 32mm round legs
- 18mm Melteca top in your choice of colour/finish
- Rounded corners with solid 2mm PVC edges

Custom options

- Whiteboard tops
- Adjustable legs - 530 | 625 | 685 | 725mm
- Add 4 locking castors for portability

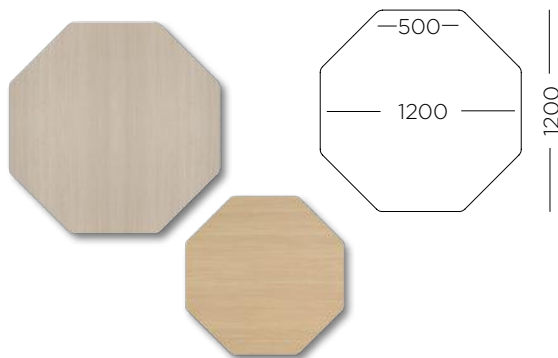

Colour range - all of our Melteca units can be made in any of the colours/finishes below



101 Semi-circle Tables

Our Semi-circle Tables work well placed individually or in a pair in the classroom setting or as a meeting rooms table.

- 1200L x 600D x Height
- Choose your height from our standard options
- Solid steel frame with 32mm round legs
- 18mm Melteca top in your choice of colour/finish
- Rounded corners with solid 2mm PVC edges

Custom options

- Whiteboard tops
- Adjustable legs - 530 | 625 | 685 | 725mm
- Add 4 locking castors for portability

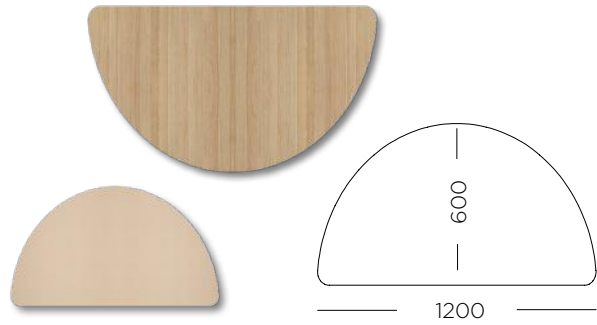

100 O's and Bow Tables

Our O's and Bow Tables are a flexible and fun group of tables that work well as individual tables and also joined together to form bigger groups.

- **A** O Table - 950 diameter
- **B** Curved Bow - 1200L x 800D
- **C** Straight Bow - 1200L x 800D
- Choose your height from our standard options
- Solid steel frame with 32mm round legs
- 18mm Melteca top in your choice of colour/finish
- Rounded corners with solid 2mm PVC edges

Custom options

- Whiteboard tops
- Adjustable legs - 530 | 625 | 685 | 725mm
- Add 4 locking castors for portability

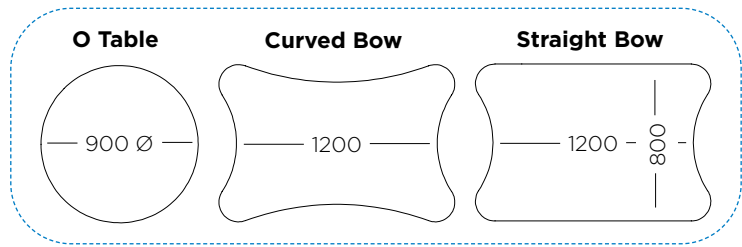
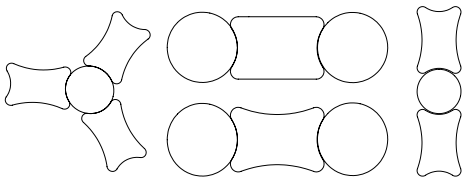

165-167 Delta and Gamma Tables

Our Delta and Gamma Table range is a flexible and multi-functional set of 3 tables that can be placed alone or in a wide range of group configurations. They offer huge flexibility to change the arrangement of the tables to suit different classroom activities.

- **165** Gamma Left Table - 1380L x 900D
- **166** Gamma Right Table - 1380L x 900D
- **167** Delta Table - 900L x 945D
- Choose your height from our standard options
- Heavy duty steel frame with 51mm round legs
- 18mm Melteca top in your choice of colour/finish
- Rounded corners with solid 2mm PVC edges

Custom options

- Whiteboard tops

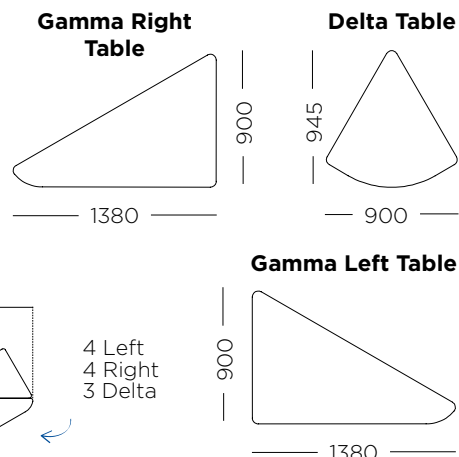
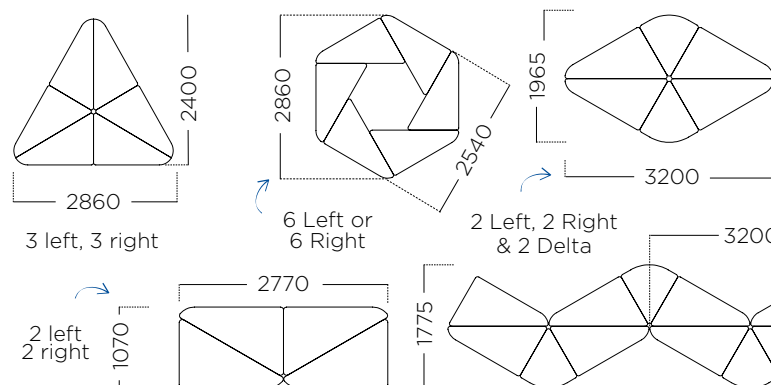

Computer and Lab Tables

91 Two Tiered Tables



- 1200L x 600D x 725H
- Solid steel frame with 32mm round legs
- 18mm Melteca top in your choice of colour/finish
- Rounded corners with solid 2mm PVC edges

Custom options

- Whiteboard tops
- Add 4 locking castors for portability

129 Lab Benches



- **A** - 1200L x 600D x 900H
- **B** - 1800L x 600D x 900H
- Solid steel frame with 32mm square legs
- 30mm High Pressure Laminate top in your choice of colour/finish from the Laminex Laminate Formica range
- Long sides with rolled edges and flat clash at each end

399 iQuad Computer Tables



- **A** - 1200L x 600D x Height (1 computer)
- **B** - 1800L x 600D x Height (2 computers)
- **C** - 2400L x 600D x Height (3 computers)
- Solid steel frame with 50 x 25mm rails and 50mm square legs
- 25mm Melteca top in your choice of colour/finish
- Square corners with solid 2mm PVC edges
- Heights available - 530 | 625 | 685 | 725mm

Custom options

- Add cable ports
- Add 4 locking castors for portability
- Can be made to our size specifications

389 Heavy Duty Tables (with shelf)



- **A** - 1200L x 600D x 900H
- **B** - 1800L x 600D x 900H
- Solid steel frame with 51mm round legs and heavy duty rails
- 30mm High Pressure Laminate top in your choice of colour/finish from the Laminex Laminate Formica range
- Long sides with rolled edges and flat clash at each end

Custom options

- Tables can also be custom made to your dimensions

Colour range - all of our Melteca units can be made in any of the colours/finishes below



277 Laptop Trolley



- 600L x 600D shaped top
- Solid steel frame on heavy duty castors
- 18mm Melteca top in your choice of colour/finish
- Rounded corners with solid 2mm PVC edges

Custom options

- Height adjustable frame with a minimum height of 530mm and maximum height of 725mm

169 Concave Table

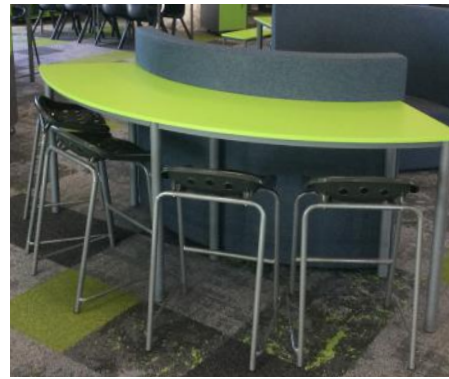

- **A** - 2000L x 550D x 900H - to fit behind 1130 Ottoman with Back
- **B** - 2400L x 550D x 900H - to fit behind our 1500 Ottoman with Back
- Pair **Table A** with our 1130 Ottoman with Back or **Table B** with our 1500 Ottoman with Back in a break out space, classroom or library
- 18mm Melteca tops with square corners
- Powdercoated 51mm round steel legs
- All 900mm high
- Works well paired with our Pepper Stool, High Bob Stool or MLE Stool (See Section 3 - Seating)
- You can find the Ottomans with Back in Section 4 - Soft Furnishings

Student Desks

299 Study Carrels

Study carrels come in a double or single size and are perfect for students who need their own space and want to work independently. When you have a large learning environment, there are always children who like working on their own with no interruptions and our Study Carrels cater perfectly to this.

Study Carrels can be made in any of our standard heights to suit any age group and are available in all our colours/finishes to suit any environment.

- **A - Single:** 800L x 600D x 400H sides x Height
- **B - Double:** 1600L x 600D x 400H sides x Height
- Choose your height from the following options:
Year 1 - 2 - 530mm
Year 1 - 2 - 560mm
Year 3 - 4 - 625mm
Year 5 - 6 - 685mm
Year 7- 8 - 725mm
- 200mm shelf above the table top for additional storage
- Solid steel frame with 32mm round legs
- 18mm Melteca top in your choice of colour/finish
- Rounded corners with solid 2mm PVC edges

Custom options

- Upgrade to heavy duty frame with 50 x 25mm rails and 51mm round legs
- Add 4 Locking Castors (not available with Adjustable leg heights)
- Remove the middle shelf on this unit



Colour range - all of our Melteca units can be made in any of the colours/finishes below



106 Zed Desk

Our Zed Desk is built to last and is ideal for senior classrooms where individual and collaborative learning arrangements may be needed.

With a generous work top and frame that does not protrude from edges, Zed's can form groups or be easily set apart to create individual exam spaces that help minimise distractions. Available in a straight top and contoured top in any of our colours/finishes.

Zed's are perfectly paired with our Summit Chair or our En One Chair - See Section 3.

- **A - Straight:** 600L x 600D
Standard top with rounded corners
- **B - Contoured:** 600L x 600D
Contour shaped top with rounded corners
- Generous space of 525mm between desk legs for chairs to fit. We recommend pairing with our En One Chair or Summit Chair
- Heavy duty 50 x 25 grey hammertone powdercoated steel frame
- Solid 2mm PVC edges

Custom options

- Can also be made in 800L or 1200L on request
- Add modesty panel

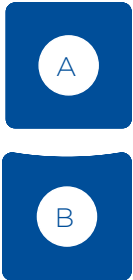

Standard Desk Heights

- Year 1 - 2 - 560mm high
- Year 3 - 4 - 625mm high
- Year 5 - 6 - 685mm high
- Year 7 - 8+ - 725mm high

160 Modesty Panel

You can add a modesty panel to the following desks:

- Lift Top | Contour Top |
- Fixed top | Zed Desk |
- Wooden Pen Rail Desk



102 Lift Top Desk



Available at all our standard desk heights and all our colours/finishes to suit any age group and environment.

- 600L x 600D x Height
- Straight legs so desks can be placed together
- Heavy duty steel hinge with steel pivot
- Solid steel frame with 32mm round legs
- 18mm Melteca top in your choice of colour/finish
- Rounded front corners with 2mm PVC edges
- Choose height from our standard desk options
- Comes complete with desk trays. Choose between Standard or Deep desk trays

Custom options

- Add modesty panel

105 Fixed Top Desk



Available at all our standard desk heights and all our colours/finishes to suit any age group and environment.

- 600L x 475D x Height
- Straight legs and square back corners so desks can be placed neatly together
- Solid steel frame with 32mm round legs
- 18mm Melteca top in your choice of colour/finish
- Rounded front corners with 2mm PVC edges
- Choose your height from our standard desk options
- Comes with or without desk trays. Choose between Standard or Deep desk trays

Custom options

- Add modesty panel

Colour range - all of our Melteca units can be made in any of the colours/finishes below



104 Contour Desk

Available at all our standard desk heights and all our colours/finishes to suit any age group and environment.

- 600L x 500D x Height
- Straight legs so desks can be placed together
- Solid steel frame with 32mm round legs
- 18mm Melteca top in your choice of colour/finish
- Rounded corners with solid 2mm PVC edges
- Choose your height from our standard desk options
- Comes with or without desk trays. Choose between Standard or Deep desk trays
- Works well paired with our Summit Chair or our En One Chair - See Section 3



Custom options

- Add modesty panel

123 Desk Trays

- A** - Standard 520W x 400D x 80H
- B** - Deep 520W x 400D x 120H
- Colours** - Dark Grey Only

Standard



Deep



319 Double Desk



Available at all our standard desk heights and all our colours/finishes to suit any age group and environment.

- 1200L x 600D x Height
- Straight legs so desks can be placed together
- Solid steel frame with 32mm round legs
- 18mm Melteca top in your choice of colour/finish
- Rounded front corners with 2mm PVC edges
- Comes with or without desk trays. Choose between Standard or Deep desk trays
- Works well paired with our Summit Chair or our En One Chair - See Section 3

103 Wooden Pen Rail Desk



Our Wooden Pen Rail Desk is a solid construction single desk with a wooden fixed top that can be stand alone or placed together to form groups. We have a number of these in stock that are ready for immediate dispatch!

- 600L x 500D x Height
- Straight legs so desks can be placed together
- Solid steel frame with 32mm round legs
- Heavy duty steel hinge with steel pivot
- Comes complete with deep desk tray for desk heights 685H and 725H
- Choose your desk height from our standard desk options
- Works well paired with our Summit Chair or our En One Chair - See Section 3

Custom options

- Add modesty panel

Colour range - all of our Melteca units can be made in any of the colours/finishes below



Teacher Desks

338 Teacher Desk (1200)

Our Teacher Desk (1200mm) is a compact, heavy duty and affordable desking option designed especially for teachers to use in the classroom.

- 1200L x 700D x 725H
- Both drawers on solid steel runners
- Modesty panels along the front and sides of the desk for added privacy
- Solid steel frame with 50mm square legs
- 18mm Melteca top in your choice of colour/finish
- Rounded corners with solid 2mm PVC edges
- Works well paired with our range of ergonomic Office and Teacher chairs in Section 3 - Seating

Custom options

- Add locks to top drawer for increased security



339 Teacher Desk (1500)

Our Teacher Desk (1500mm) is a compact, heavy duty and affordable desking option designed especially for teachers.

- 1500L x 700D x 725H
- Two standard drawers on one side and one deep drawer on the other side, all on solid steel runners
- Modesty panels along the front and sides of the desk for added privacy
- Solid steel frame with 50mm square legs
- 18mm Melteca top in your choice of colour/finish
- Contoured top for added comfort and access to the work surface
- Rounded corners with solid 2mm PVC edges
- Works well paired with our range of ergonomic Office and Teacher chairs in Section 3 - Seating

Custom options

- Add lock to file drawer and top drawer for increased security



322 Teacher Desk with Upstand

Our Teacher Desk with Upstand is a compact, heavy duty and affordable desking option designed especially for teachers.

- 1500L x 700D x 725H
- Two standard drawers on one side and one deep drawer on the other side, all on solid steel runners
- 100mm upstand around the back as well as modesty panels along the front and sides of the desk for added privacy
- Solid steel frame with 50mm square legs
- 18mm Melteca top in your choice of colour/finish
- Contoured top for added comfort and access to the work surface
- Rounded corners with solid 2mm PVC edges
- Works well paired with our range of ergonomic Office and Teacher chairs in Section 3 - Seating

Custom options

- Add lock to file drawer and top drawer for increased security



Colour range - all of our Melteca units can be made in any of the colours/finishes below



Office Desks and Workstations

Workstation Range

Our workstations are made to order so you can customise them to suit your environment. Choose your base/leg system, the shape of the top you want and then the top size.

Choose your base/legs



Slab End (SKU: 533)

- 25mm Melteca tops and base with rounded corners
- Complete with 400mm modesty panel
- Full modesty panel can be added on request

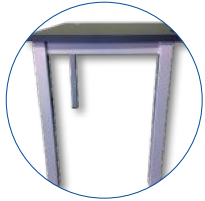

iQuad Legs (SKU: 806)

- 25mm Melteca tops with square corners
- Solid welded steel frame
- 50x50 square legs with 50x25 support rails
- Modesty panels can be added



iQuad+ Legs (SKU: 831)

- 25mm Melteca tops with square corners
- Solid welded steel frame
- 50x50 square legs with ladder detail
- Modesty panels can be added

Specifications required:

- Left and right measurement as well as depth
i.e 1200L x 600D & 1800L x 800D R
- Workstations come standard with a cable port in the corner of the top. More can be added on request.
- Custom made sizes all P.OA



Comes fully assembled

All our workstations are high quality, heavy duty and built to last

Choose your top shape and colour/finish

Workstation tops can be made in any of the following shapes and in any of our colours/finishes below

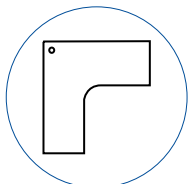

Q300

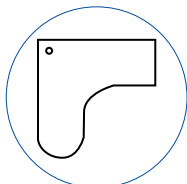

Oval End

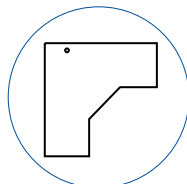

Alpine

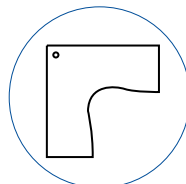

Ele (Scallop)

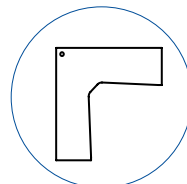

Duo

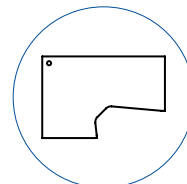

Duo

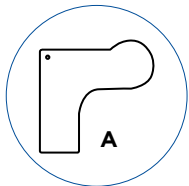

A

Contour P-End

Right & Left Hand 'P' Facing away
Must be 2200L

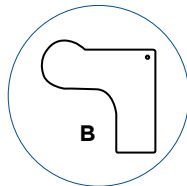

B

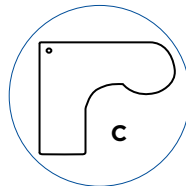

C

Contour P-End

Left & Right Hand 'P' Facing away
Must be 2200L

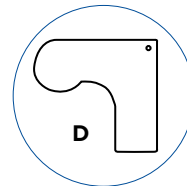

D

Choose the top length and width

Standard lengths available 1200, 1800, 2000, 2400

- | | |
|-------------------------------|-------------------------------|
| 1200L x 1800W (left or right) | 1800L x 2000W (left or right) |
| 1200L x 2000W (left or right) | 1800L x 2400W (left or right) |
| 1200L x 2400W (left or right) | 2000L x 2000 (left or right) |
| 1800L x 1800W (left or right) | 2400L x 2400 (left or right) |

Any combination is available with length, width and depth. See the measurement diagram for a better understanding.



Choose the top depth

600D, 700D, 750D, 800D

Or any other increment you specify



Colour range - all of our Melteca units can be made in any of the colours/finishes below



Desk Range

Our desks are made to order so you can customise them to suit your environment. Choose your base/leg system, the shape of the top you want and then the dimensions, remembering to note which side the "Ovals & P's" are on.

Choose your base/legs



Slab End (SKU: 533)

- 25mm Melteca tops and base with rounded corners
- Complete with 400mm modesty panel
- Full modesty panel can be added on request

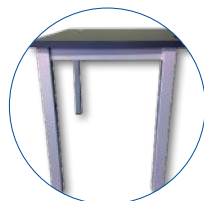

iQuad Legs (SKU: 806)

- 25mm Melteca tops with square corners
- Solid welded steel frame
- 50x50 square legs with 50x25 support rails
- Modesty panels can be added



iQuad+ Legs (SKU: 831)

- 25mm Melteca tops with square corners
- Solid welded steel frame
- 50x50 square legs with ladder detail
- Modesty panels can be added

Specifications required:

- Provide desk length, depth and top shape
i.e 1800L x 800D Contour top
- Desks come standard with a cable port. More can be added on request.
- Custom made sizes all P.O.A



All our desks are high quality, heavy duty and built to last

Comes fully assembled

Choose your top shape, dimensions and colour/finish

Workstation tops can be made in any of the following shapes and in any of our colours/finishes below

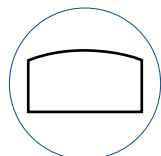

Curve Desk - This curved front desk adds an inviting impression and extra depth for additional work space.
Lengths: 1600, 1800, 2000L, 2400L
Depths: 800 to 900D

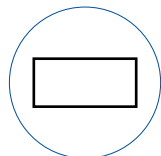

Straight Desk - This practical desk fits well in any symmetrical room
Lengths: 1200, 1600, 1800, 2000, 2200, 2400L
Depths: 600, 700, 750, 800D

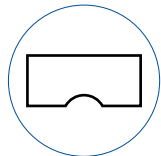

Contour Desk - Comfort curve in middle of desk
Lengths: 1600, 1800, 2000, 2400L
Depths: 600, 700, 750, 800D

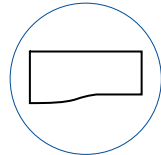

Wave Desk - An elegant curved desk featuring a deeper work space on one side.
Lengths: 600, 1800, 2000, 2400L
Depths: 600 to 800D

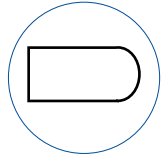

Oval End Desk - A user friendly design that can be used as a meeting/boardroom table end.
Lengths: 1600L, 1800L, 2000L, 2400L
Depths: 600, 700, 750, 800D



P-End Desk - A conference end desk. Ideal for meetings or just additional workspace. Available in left hand or right hand options with the P-end facing or away.

Lengths: 2200, 2400L
Depths: 700D with 900mm 'P'



Colour range - all of our Melteca units can be made in any of the colours/finishes below



Ergonomic Desking and Accessories

880 Lift Desk Range - Elevate your work experience





Introducing our new Lift Electric Desks, designed to elevate your work experience to new heights. Featuring smooth, whisper-quiet electric motors, our Lift Electric Desks adjust to your desired height with just the touch of a button, allowing you to effortlessly transition between sitting and standing positions throughout your workday.

Uniquely customisable, you have the flexibility to design the Lift Desk to look exactly how you want it. Choose from three frame colours and a range of sizes, then choose the top shape, top finish and the addition of any cable ports and cable ways. A truly tailor-made electric desk like no other on the market.

- Load capacity of 100kgs
- Dual drive electric motors
- Anti-collision function
- 700 - 1200mm electric height adjustment
- Memory settings to save 4 different heights
- Choose your size from 1200L x 700D to 2000L x 800D and everything in between
- 25mm Melteca top in desired shape and colour/finish
- Frames available in White, Grey and Black
- 5 year warranty
- NB: Basic assembly is required or you can contact us for on-site assistance

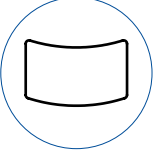

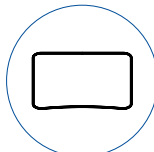
Lift Top Shape Options

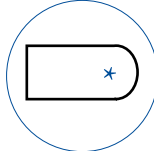
	Swerve Desk 1200, 1400, 1600 or 1800L 700 or 800D		P-End Desk 1800-2000L 700 or 800D		Contour Desk 1200, 1400, 1600 or 1800L 700 or 800D
	Straight Desk 1200, 1400, 1600 or 1800L 700 or 800D				Oval End Desk 1800-2000L 700 or 800D

* Available at 1800 or 2000 long only

807 iQuad Modesty Panels

Modesty panels can be added to all our desks and workstations to provide added privacy for the user. Choose between steel mesh panels or Melteca panels to match the desk or workstation/desk top.

- Steel mesh panels can be added to fit 1200, 1800 and 2000L workstations and desks
- Melteca panels can be made to fit any desk or workstation dimensions and come in a 400D option or a full length option. The panels can be made in any of our colours/finishes to match you desk or workstation top



Colour range - all of our Melteca units can be made in any of the colours/finishes below



566 Agile 2 Electric Workstations

The Agile Electronic 3 Column Workstation offers electric height adjustment so that users can alternate between seated and standing work positions. The understated simplicity of these desks make them perfect for collaborative offices, administration areas, meeting areas or at home.

- **A** - 1500L x 1500D x 700D x 680-1130mm H
- **B** - 1800L x 1800D x 700D 680-1130mm H
- Smooth silent path, single motor system - so no co-worker disturbance or irritation
- Two column height range 680 - 1130mm
- Up and down speed 22mm/second
- Digital height readout with 4 point memory
- 25mm work surface constructed from melamine with matching PVC edge
- Available in all our colours/finishes
- 15 year guarantee on frame and motor
- 100kg weight rating

Frame colours

- Black, White or Silver powder coated finish

Custom options

- Optional cable trays are available



520 Arise Deskalator

The Arise Deskalator sits on an existing desk and lets you change posture throughout the day. The scissor structure with gas spring features smooth height adjustment.

- **Small size** - 890W x 580D x 150-500mm H
- **Medium size** - 680W x 580D x 150-500mm H
- Height easily adjusts straight up and down via two activation paddles
- Gas spring offers smooth supported height transition
- 13 available options for height adjustment to suit all users
- Support groove on the surface to mount a smart phone and tablet
- Three hole mounts for easy-fit single or dual monitor arms
- Max weight 15kg
- 10 year warranty
- Deskalator colours - Black or White



White



Black



Colour range - all of our Melteca units can be made in any of the colours/finishes below



564 Adjustable Wave Desk

The Wave desk is a portable, lightweight sit to stand desk with two height options allowing the user to alternate between a seated and standing position throughout the day. Its two powder-coated caster wheels make the desk a breeze to move around.

- 950L x 520D x 740 - 1040H
- Compact adjustable height desk
- Great health benefits with the sit to stand options
- Two gas lift heights making height adjustment simple and safe
- Maximum weight limit 50kg - it will handle all of your daily work needs
- White PVC desktop
- White powdercoated steel frame
- Features caster wheels for easy manoeuvrability
- Compact enough to fit in any environment, but big enough to fit all your working needs on it, making it ideal in a work or home office



526 Upanatom Laptop Sit/Stand Desk

The Upanatom mobile laptop sit/stand desk is a compact and economical manual solution for the classroom or office. It features a single lever gas assist height adjustable polypropylene platform that is large enough to suit a laptop up to 17 inch.

- Footprint: 630W x 625D
- Desk Height: 720 - 980H
- Top size: 600W - 385D
- Locking castors and two handles for easy manoeuvrability
- Gas assist height adjustable, allowing the user to alternate between seated and standing positions
- Extra wide starship base for maximum stability
- Includes a retractable mouse pad and cup holder
- 10 year warranty
- Comes in Black



522 Arise Standsoft Anti Fatigue Mat

This Arise Standsoft Anti-Fatigue Mat is ideal for use where long periods of standing are required and is recommended for use with our range of sit/stand desks and workstations. The PU rubber platform has a bevelled edge and is designed to slide easily across carpet, enabling the user to shift it with their foot without having to bend over.

- 100% PU moulded mats provide a platform that transfers downward pressure away from the hips, knees, ankles and feet.
- Beveled edge reduces any tripping hazards
- An intricate embossed leafy design
- Standsoft is the perfect companion to our sit-stand desks/workstations and is a necessity to anyone standing over a long period of time,



Colour range - all of our Melteca units can be made in any of the colours/finishes below

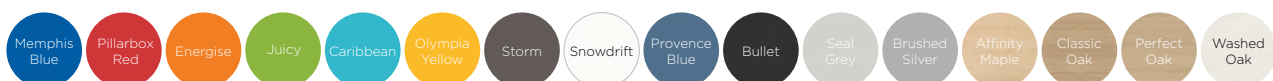

521 Arise Compulator

The Compulator is the ideal sit/stand solution for people who are doing mixed computer and written tasks. It is much more compact than a full width desktop unit and frees up desk top space.

- 800W x 520D x 150-430H
- Adjusts straight up and down. Easy height adjustment via two activation paddles
- Gas spring offers smooth height transition
- 13 available options for height adjustment
- Wide adjustment to suit all users
- Support groove on the surface to mount smart phone and tablet
- 3 hole mounts for single/dual monitor arms
- Fold up keyboard surface with two keyboard positions, flat or negative tilt
- 10 year warranty
- 15kg weight capacity
- Desk colours - Black



525 Gladius Monitor Arms

Gladius arms offer a full range of ergonomic adjustment and a large gas-lift counterbalance range of monitor weights (2 to 9 kgs) making this the obvious choice for large scale office fitouts,

- **A** - Single Arm
- **B** - Double Arm
- **C** - Adapter plate for laptops and tablets
- Gladius arms allow mounting of monitors with 75mm or 100mm VESA hole centres
- On the double version, independent gas height adjustable arms allow the user to mount different sized monitors side by side
- Full rotation, 360 degrees at any position
- Up to 30 inch monitor
- 85 degrees upward, 15 degrees downward
- Cable management
- Grommet or clamp mount included in the box
- 10 year warranty
- Desk colours - Black standard colour and White for contract quantities on longer lead times

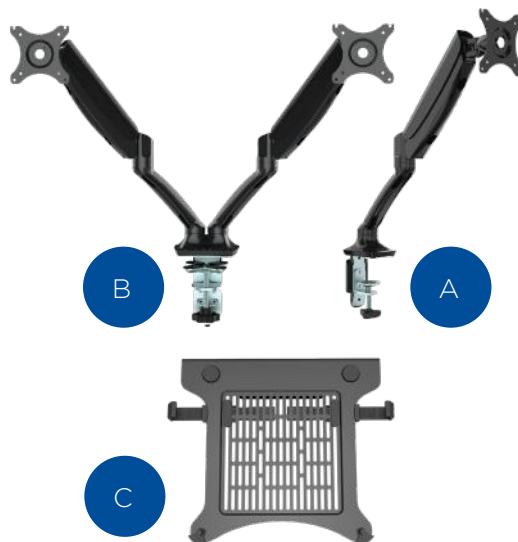

524 Cutlass Monitor Arms

Cutlass arms combine contemporary slim styling, better cable management and built in USB ports right on the desktop. A higher adjustment range and an improved desk clamp make it one of the best monitor mounting options on the market.

- **A** - Single Arm
- **B** - Double Arm
- Screen tilt adjustment
- Integrated cable management
- Double USB Ports
- Grommet or clamp mount included in the box
- Made of aircraft aluminium
- 360° free switch between portrait and landscape orientation and supports monitors up to 30"
- Tablet and laptop mounts also available
- 10 year warranty
- Single - Balanced gaslift height adjustable arm
- Double - Dual independent balanced height adjustable arm
- Available in white



Colour range - all of our Melteca units can be made in any of the colours/finishes below



Library and Reception Desks

830 Library and Reception Desks

Our Reception and Library desks are always custom made in our factory and are designed and built to suit the unique space and environment they are made for. We have a range of materials and styles that we can recommend and our Territory Account Managers will work closely with you from start to finish to ensure your desk fits perfectly in its new home. Below are just a few examples of the Library and Reception Desks we have produced for our customers.



Corner workstation desk
Made in Melteca board with overlay decorative panels



Corner workstation desk
With reception hutch and return book slot



U-shaped library or reception desk
50 x 50 steel post frame with Melteca inserts and overlay panels



Rectangle workstation desk
Made in Melteca board



Colour range - all of our Melteca units can be made in any of the colours/finishes below

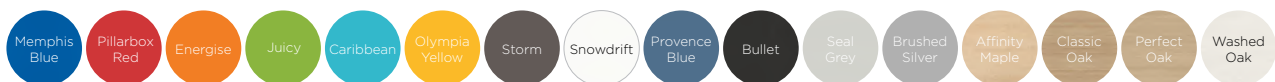

Meeting Room and Staffroom Tables

852 iQuad+ Tables

Our iQuad+ Tables are stylish and heavy duty large tables designed for boardrooms, staffrooms and meeting rooms. They look great mixed and matched with the rest of our iQuad range.

- **A** - 1800L x 800D x 725H
- **B** - 2000L x 1000D x 725H
- **C** - 2400L x 1200D x 725H
- Solid welded and powdercoated steel frame
- 25mm Melteca top in your choice of colour/finish with 2mm PVC edge
- 50mm square legs with 50 x 25 heavy duty rails
- All table sizes made at 725H

Top shape options

- Rectangle, Capsule, Barrell & D-End



802 iQuad Tables

Our iQuad Tables are a stylish and heavy duty option for boardrooms, meeting rooms, staffrooms, offices or classrooms. They look great mixed and matched with the rest of our iQuad range and can be made in a range of different top shapes and sizes

- **A** - 800L x 800D x 725H
- **B** - 1200L x 800D x 725H
- **C** - 1600L x 800D x 725H
- **D** - 1800L x 800D x 725H
- **E** - 2000L x 800D x 725H
- **F** - 2200L x 800D x 725H
- **G** - 2400L x 800D x 725H
- **H** - 1200L x 1200D x 725H
- **I** - 1200L x 1800D x 725H
- **J** - 1200L x 2400D x 725H
- Solid welded and powdercoated steel frame
- 25mm Melteca top in your choice of colour/finish with 2mm PVC edge
- 50mm square legs with 50 x 25 heavy duty rails
- All table sizes made at 725H

Top shape options

- Square, Rectangle, Capsule, Barrell & D-End

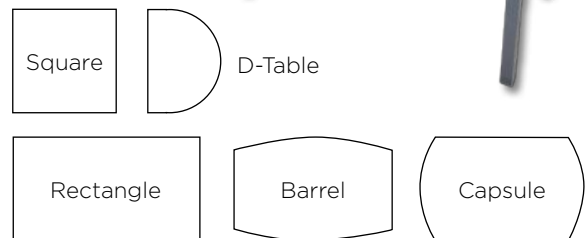

642 D-End Boardroom Table

Our D-End Boardroom Tables are elegant and sturdy and can be customised to suit any boardroom, staffroom or meeting room. When ordered as a 3 Section D-Table they offer the versatility to be placed together to cater to larger groups or pulled apart into individual tables for smaller groups.

- **A** - 1800L x 1000D x 725H
- **B** - 1800L x 1200D x 725H
- **C** - 2000L x 1000D x 725H
- **D** - 2000L x 1200D x 725H
- **E** - 2400L x 1200D x 725H
- **F** - D Table 1200L x 800D x 725H
- **G** - 1200L x 1200D x 725H
- **H** - 1800L x 1200D x 725H
- 25mm Melteca top in your choice of colour/finish with 2mm PVC edge
- All table sizes made at 725H

Top shape options

- D-End, D-Table, Square, Rectangle

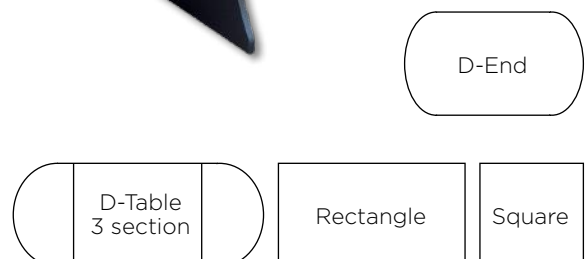

Colour range - all of our Melteca units can be made in any of the colours/finishes below



803 iQuad Conference Tables

Our iQuad Conference Tables are a stylish and heavy duty option for boardrooms, staffrooms and meeting rooms. They offer the versatility to be placed together to cater to larger groups or as individual tables for smaller groups.

- **A** - Square 1200L x 1200D x 725H
- **B** - Rectangle 1200L x 800D x 725H
- **C** - D Table 1200L x 800D x 725H
- Solid welded and powdercoated steel frame
- 25mm Melteca top in your choice of colour/finish with 2mm PVC edge
- 50mm square legs with 50 x 25 heavy duty rails
- All tables sizes made at 725H

Top shape options

- Square, Rectangle, D-Table

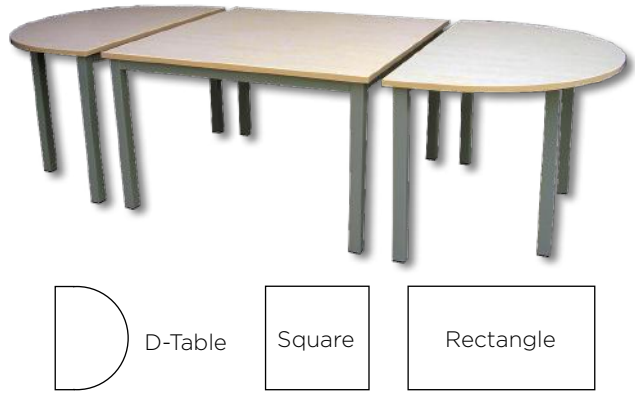

635 Cross Base Tables

Our Cross Base Tables come in a range of sizes and all our colours/finishes. They are cost effective and a great option for fitting out meeting rooms and staffrooms.

- **A** - 800 Diameter x 725H
- **B** - 900 Diameter x 725H
- **C** - 1000 Diameter x 725H
- **D** - 1100 Diameter x 725H
- **E** - 1200 Diameter x 725H
- 25mm Melteca top and base in your choice of colour/finish with 2mm PVC edge
- Also available in a curved base
- All tables sizes made at 725H



853 Orion Tables

Our Orion Tables come in three sizes with a round base and work well in staffrooms and meeting rooms as a multi-functional option. The tops can be made in a range of colours/finishes to suit your environment.

- **Round** - 900 Diameter
- **Round** - 1000 Diameter
- **Round** - 1200 Diameter
- Brushed stainless steel round base
- 25mm Melteca top in your choice of colour/finish with 2mm PVC edge
- All tables sizes made at 750H

Top shape options

- Round, Oval and Rectangle



854 Pavo Tables

Our Pavo Tables come in three sizes with a square base and work well in staffrooms and meeting rooms as a multi-functional option.

Square - 800L x 800D

- **Square** - 900L x 900D
- **Square** - 1000L x 1000D
- Brushed stainless steel square base
- 25mm Melteca top in your choice of colour/finish with 2mm PVC edge
- All tables sizes made at 750H

Top shape options

- Square and Rectangle



Colour range - all of our Melteca units can be made in any of the colours/finishes below



Bar Leaners and Coffee Tables

762A Pavo Bar Leaners

Our Pavo Bar Leaners are stylish and practical high tables with a heavy duty brushed stainless steel square base and a square top. These tables work really well in a staffroom setting and look great teamed up with our range of bar stools featured in Section 3 - Seating.

- **A1** - 600L x 600D x 1085H
- **A2** - 700L x 700D x 1085H
- **A3** - 800L x 800D x 1085H
- 25mm Melteca top and base in your choice of colour/finish with 2mm PVC edge
- Square top with square corners
- Brushed stainless steel base square base
- Adjustable feet under base for uneven surfaces



762B Orion Bar Leaners

Our Orion Bar Leaners are stylish and practical high tables with a heavy duty brushed stainless steel round base and a round top. These tables work really well in a staffroom setting and look great teamed up with our range of bar stools in Section 3 - Seating.

- **B1** - 600 diameter x 1085H
- **B2** - 700 diameter x 1085H
- 25mm Melteca top and base in your choice of colour/finish with 2mm PVC edge
- Brushed stainless steel round base and round top
- Adjustable feet for uneven surfaces



766 Converse Bar Leaner



Our Converse Bar Leaners are stylish, high quality and robust high tables. Designed especially for staffrooms/break rooms, these bar leaners are great paired with one of our stools in Section 3 - Seating.

- **A** - 1500L x 700D x 900H or 1050H
- **B** - 1600L x 800D x 900H or 1050H
- **C** - 1800L x 800D x 900H or 1050H
- 25mm Melteca tops with solid 2mm PVC edges and square corners
- Available in any of our Melteca colours
- Powdercoated 50 x 50mm steel A frame with footrest and 50 x 25 rails
- Works well purchased with any of our stools in Section 3 - Seating

761 Strongbow Leaner



Our Strongbow Leaner is a more traditional high table with a footrest and optional shelf. Designed for staffrooms/break rooms, the Strongbow works well paired with one of our adult stools.

- 1200L x 500D x 1020H
- 25mm Melteca tops with solid 2mm PVC edges and rounded or square corners in your choice of colour/finish
- Can be made with or without the 18mm shelf
- 32mm powdercoated round steel frame
- Can be custom made to a specified size/ shape

Colour range - all of our Melteca units can be made in any of the colours/finishes below



762 Kompact Bar Leaner



Our Kompact Bar Leaners are a minimalist and robust high table with a black powdercoated frame. Designed especially for staffrooms but can be used anywhere, these bar leaners are great paired with one of our adult stools in the Section 3 Seating.

- **A** - 1500L x 700D x 900H or 1050H
- **B** - 1600L x 800D x 900H or 1050H
- **C** - 1800L x 800D x 900H or 1050H
- 25mm Melteca tops with square corners in your choice of colour/finish
- Black powdercoated 32 x 32mm steel H frame with footrest
- Works well purchased with any of our stools in Section 3

801 iQuad Coffee Table



Our iQuad Coffee Tables include our stylish and heavy duty iQuad steel legs and are available in range of different colours/finishes. They come in three standard size options and can be custom made to your specifications.

- **Small (square):** 600L x 600D x 450H
- **Medium (rectangle):** 800L x 600D x 450H
- **Large (rectangle):** 1200L x 600D x 450H
- 25mm Melteca tops with square corners in your choice of colour/finish
- 50mm square legs with 50 x 25 heavy duty rails
- Powdercoated frame
- Can be custom made to your specifications
- Ideal in staffrooms/lunchrooms and waiting areas

859 iQuad Cube Coffee Table



Our iQuad Cube Coffee Tables are 25mm solid Melteca construction with square corners and cubby hole storage for books or magazines. The unit comes on our stylish iQuad steel feet and can be made in a range of different colours/finishes. A popular option in staffrooms, lunchrooms and waiting areas where a combination of storage and low surfaces are required.

- 600L x 600D x 450H
- 25mm Melteca construction with square corners and available in a range of colours/finishes
- 50 x 50 stylish heavy duty steel feet
- Ideal in staffrooms/lunchrooms and waiting areas
- Can be custom made to your specifications

375 iQuad Tri-Cube Coffee Table



Our iQuad Tri-Cube Coffee Tables are solid Melteca construction with square corners and three open cubby slots for storage of books or magazines that can be accessed from either side. The unit comes on our stylish iQuad steel feet and can be made in a range of different colours/finishes. A popular option in staffrooms, lunchrooms and waiting areas where a combination of storage and low tables are required.

- 900L x 400D x 400H
- 25mm Melteca construction with square corners and available in a range of colours/finishes
- 50 x 50 heavy duty iQuad steel feet
- Ideal in staffrooms/lunchrooms and waiting areas
- Can be custom made to your specifications

Colour range - all of our Melteca units can be made in any of the colours/finishes below



374 Tri-Cube Coffee Table

Our iQuad Tri-Cube Coffee Tables are solid Melteca construction with square corners and three open cubby slots for storage of books or magazines that can be accessed from either side. The unit comes on a plinth base and can be made in a range of different colours/finishes. A cost effective and popular option in staffrooms, lunchrooms and waiting areas where a combination of storage and low tables are required.

- 900L x 400D x 400H
- 25mm Melteca construction with square corners and available in a range of colours/finishes
- Plinth base
- Ideal in staffrooms/lunchrooms and waiting areas
- Can be custom made to your specifications



857 Orion Round Coffee Table

Our stylish and heavy duty Orion Coffee Tables are available in two sizes and come on a brushed stainless steel round base. They work well in staffrooms and meeting rooms as a multi-functional surface. The 25mm Melteca top can be made in a range of colours/finishes to suit your environment.

- **Round** - 600 Diameter
- **Round** - 900 Diameter
- Stainless steel round base
- 25mm Melteca top in your choice of colour/finish with 2mm PVC edge
- All tables sizes made at 465H



858 Pavo Square Coffee Table

Our Pavo Square Coffee Tables are available in three sizes with a brushed stainless steel square base. They work well in staffrooms and meeting rooms as a multi-functional surface. The tops can be made in a range of colours/finishes to suit your environment.

- 800L x 800D
- 900L x 900D
- 1000L x 1000D
- Stainless steel square base
- 25mm Melteca top in your choice of colour/finish with 2mm PVC edge
- All tables sizes made at 465H

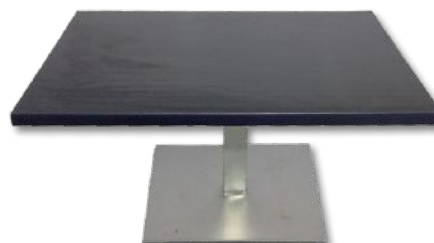

Colour range - all of our Melteca units can be made in any of the colours/finishes below



Collapsible Tables and Trolleys

930 Team Flip Tables

Simply roll a flip-top table wherever you need to create extra work surfaces at a moment's notice. Available in three sizes and four top colours to suit any environment.

- **A** - 1400L x 700W
- **B** - 1600L x 800W
- **C** - 1800L x 900W
- Powder coated silver, black, white or chrome strong, stable steel frame
- Create space through their compact storage
- Very durable, one handed flip mechanism
- 25mm Melteca top with 2mm PVC edges
- 60mm Locking castors

White

Nordic Maple

Silver

Atlantic Oak



928 Life Standard Folding Table



The Life Standard Folding Table is heavy duty and super easy to fold away, move and store, making it ideal for a wide range of environments where flexible use of space is required.

- **A** - 1200L x 770W x 740H
- **B** - 1830L x 770W x 740H
- **C** - 2428L x 760W x 740H
- **D** - 2438L x 760W x 740H (2 piece folding top)
- Heavy duty 45mm white polypropylene top
- 25-28mm tubular steel legs to make tables easy to fold away, move and store
- Waterproof, easy clean and UV resistant

937 Standard Folding Table Trolley



Our Standard Folding Table Trolley is designed to hold up to 10 Standard Folding Tables 1800 - 2400mm for easy storage and movement.

- Fits 10 x 1800mm to 2400mm long tables
- 1600L x 700W x 700H (825mm high inc castors)
- 18mm MDF Top with strips of carpet glued to help reduce fatigue to table tops
- Standard 32mm square powder coated frame with heavy duty braked castors

929 Life Round Folding Table



The Life Round Folding Table is heavy duty and super easy to fold away, move and store, making it ideal for a wide range of environments where flexible use of space is required.

- **A** - 1200 diameter x 740H
- **B** - 1500 diameter x 740H
- **C** - 1800 diameter x 740H
- Heavy duty 45mm white polypropylene top
- 25-28mm tubular steel legs to make tables easy to fold away, move and store
- Waterproof, easy clean and UV resistant

938 Round Folding Table Trolley



Our Round Folding Table Trolley is designed to fit 10 x 1800mm round tables for easy movement and storage when folded down.

- 1900L x 1200D x 1200H
- 1325H including castors
- 18mm MDF Top with strips of carpet glued to help reduce fatigue to table tops
- Standard 32mm square powder coated frame with heavy duty braked castors
- Can also be made to fit to the other sized tables

Colour range - all of our Melteca units can be made in any of the colours/finishes below

