



# SPORTING INTENTIONS.

Continuing a lineage that began with the BMW 2002, the BMW 2 Series is set to make every drive a thrill. With powerful TwinPower Turbo engines, precise reflexes and typical BMW refinement, the 2 Series proudly continues the 2002's sporting legacy.

COUPE AND CONVERTIBLE

BMW 2 SERIES





## COUPE D'ÉTAT.

Performance is paramount in the BMW 2 Series Coupe. Available with an M-tuned Suspension and M Performance TwinPower Turbo engine, the 2 Series makes every drive a qualifying event for pole position.

## BMW 2 SERIES COUPE

[EXTERIOR COLORS](#)

[UPHOLSTERY](#)

[INTERIOR TRIMS](#)

[WHEELS / TIRES](#)

[PACKAGES](#)

[TECHNICAL DATA](#)



## A CHANCE TO MHANCE.

The M Sport Package for the BMW 2 Series provides a boost of M adrenaline. The Aerodynamic kit, shadowline exterior trim and 18-inch M light alloy wheels pump up the muscle outside. Inside, the optional 10-way adjustable sport seats, three-spoke M steering wheel and M aluminum footrest get your senses ready for the starting grid.



## RACE SPACE.

The refined interior of the BMW 2 Series offers both relaxation and performance. Leather graces the steering wheel and sport seats and is complemented by Fineline Wood, Aluminum Hexagon or high-gloss Black trim. The easy-to-read gauge cluster and control interfaces help keep you focused on the road ahead.



# SERIES COUPE

## EXTERIOR

### NON-METALLIC



**300** Alpine White (Non-metallic)



**668** Jet Black (Non-metallic)

### METALLIC



**A96** Mineral White Metallic



**B39** Mineral Gray Metallic

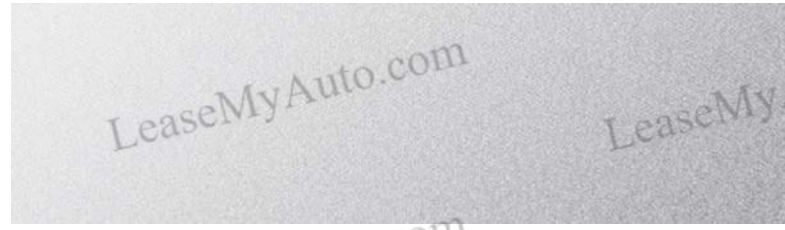

**A83** Glacier Silver Metallic



**B66** Moonlight Silver Metallic



**B53** Sparkling Brown Metallic



**B44** Valencia Orange Metallic



**B38** Midnight Blue Metallic



**A76** Deep Sea Blue Metallic



**475** Black Sapphire Metallic



**A75** Melbourne Red Metallic



**B45** Estoril Blue Metallic

Not all features are available on all models. Get the latest information on standard and optional features, packages and technical specifications. Visit [bmwusa.com](http://bmwusa.com) and select the BMW model of your choice.

# SERIES COUPE

## UPHOLSTERY

### SENSATEC



**KCSW** Black SensaTec

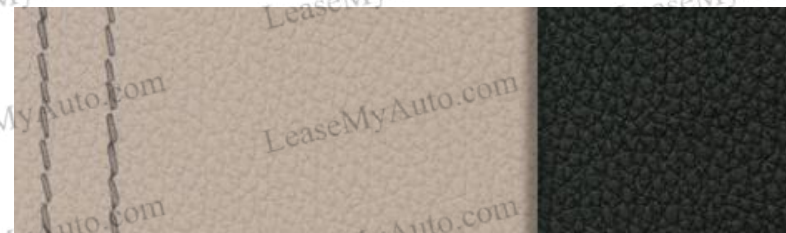

**KCCX** Oyster / Black SensaTec

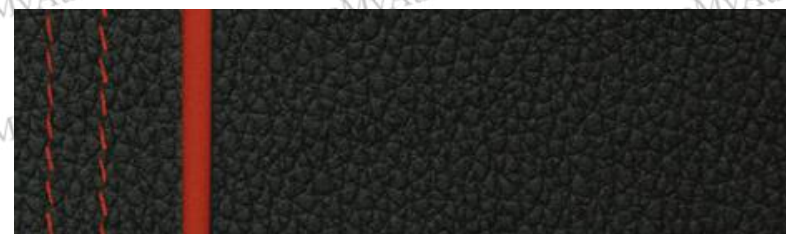

**KCL3** Black SensaTec / Red highlight

### DAKOTA LEATHER

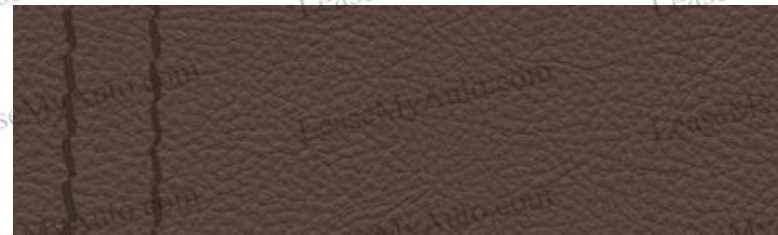

**LCB8** Terra Dakota Leather

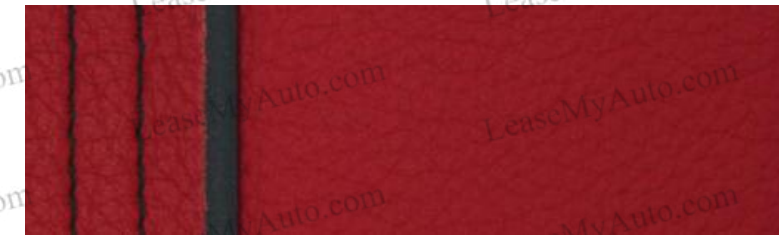

**LCL5** Coral Red Dakota Leather / Black highlight

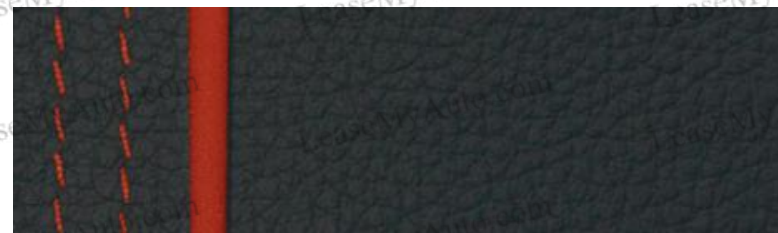

**LCL3** Black Dakota Leather / Red highlight

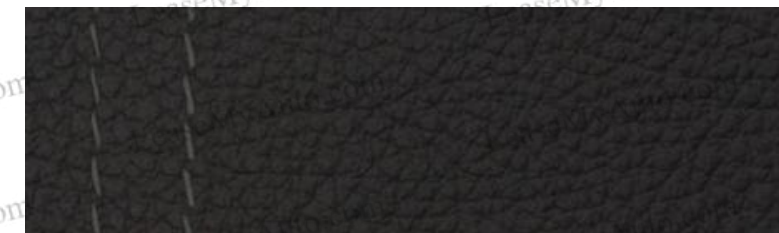

**LCSW** Black Dakota Leather

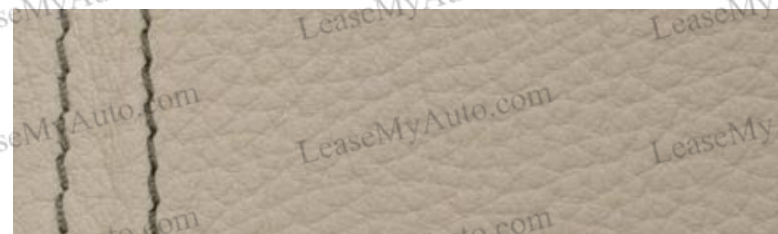

**LCOM** Oyster Dakota Leather

Not all features are available on all models. Get the latest information on standard and optional features, packages and technical specifications. Visit [bmwusa.com](http://bmwusa.com) and select the BMW model of your choice.

# SERIES COUPE

## INTERIOR TRIMS

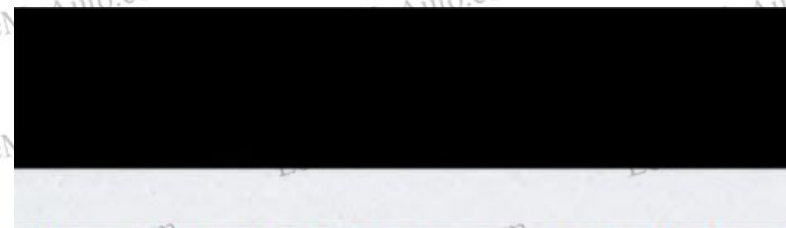

**4GD** Black high-gloss trim /  
Oxide Silver highlight



**4WF** Aluminum Hexagon trim /  
Estoril Blue matte highlight



**4LC** Fineline Stream Wood trim /  
Oxide Silver matte highlight



**4FT** Brushed Aluminum trim /  
Black high-gloss highlight



**4WG** Aluminum Hexagon trim /  
Black high-gloss highlight



**4LV** Black high-gloss trim / Coral Red  
matte highlight

Not all features are available on all models. Get the latest information on standard and optional features, packages and technical specifications. Visit [bmwusa.com](http://bmwusa.com) and select the BMW model of your choice.

# SERIES COUPE

## WHEELS / TIRES



**Double Spoke Ferric Gray light alloy wheels (Style 384)**  
18 x 7.5 front, 18 x 8.0 rear; and 225/40 front, 245/35 rear non-run-flat Michelin® Pilot Super Sport performance tires<sup>1,2,3</sup>



**Double Spoke light alloy wheels (Style 384)**  
18 x 7.5 front, 18 x 8.0 rear; and 225/40 front, 245/35 rear performance tires<sup>1,2,3</sup>  
18 x 7.5 front and rear; and 225/40 front and rear all-season tires<sup>1</sup>



**Double Spoke Ferric Gray light alloy wheels (Style 461M)**  
18 x 7.5 front, 18 x 8.0 rear; and 225/40 front, 245/35 rear non-run-flat Michelin® Pilot Super Sport performance tires<sup>1,2,3</sup>



**Double Spoke light alloy wheels (Style 461M)**  
18 x 7.5 front, 18 x 8.0 rear; and 225/40 front, 245/35 rear non-run-flat summer tires<sup>1,2</sup>  
18 x 7.5 front and rear; and 225/40 front and rear all-season tires<sup>1</sup>



**Double Spoke Orbit Gray light alloy wheels (Style 436M)**  
18 x 7.5 front, 18 x 8.0 rear; and 225/40 front, 245/35 rear non-run-flat summer tires<sup>1,2</sup>

18 x 7.5 front and rear; and 225/40 front and rear all-season tires<sup>1</sup>



**Double Spoke light alloy wheels (Style 436M)**  
18 x 7.5 front, 18 x 8.0 rear; and 225/40 front, 245/35 rear non-run-flat summer tires<sup>1,2</sup>

18 x 7.5 front and rear; and 225/40 front and rear all-season tires<sup>1</sup>



**Star Spoke light alloy wheels (Style 379)**  
17 x 7.5 front and rear; and 225/45 front and rear all-season tires<sup>1</sup>

<sup>1</sup> Does not come equipped with spare wheel and tire.

<sup>2</sup> Driving over rough or damaged road surfaces, as well as debris, curbs and other obstacles, can cause serious damage to wheels, tires and suspension parts. This is more likely to occur with low-profile tires, which provide less cushioning between the wheel and the road. Be careful to avoid road hazards and reduce your speed, especially if your vehicle is equipped with low-profile tires.

<sup>3</sup> Performance tires include Mobility Kit; not recommended for driving in ice and snow conditions.

Not all features are available on all models. Get the latest information on standard and optional features, packages and technical specifications. Visit [bmwusa.com](http://bmwusa.com) and select the BMW model of your choice.

# SERIES COUPE

# PACKAGES

## COLD WEATHER PACKAGE

- Heated steering wheel
- Heated front seats
- Retractable headlight washers

## DRIVER ASSISTANCE PACKAGE

- Rear-view Camera
- Park Distance Control

## DRIVER ASSISTANCE PLUS

- Automatic high beams
- Active Driving Assistant<sup>2</sup>
- Speed Limit Info

## LIGHTING PACKAGE<sup>1</sup>

- Xenon headlights
- Adaptive light control

## TRACK HANDLING PACKAGE<sup>1</sup>

- 18-inch Double Spoke Ferric Gray wheels (Style 384) (options available)
- M Sport brakes
- Adaptive M Suspension
- Variable Sport Steering

## M SPORT PACKAGE<sup>1</sup>

- 18-inch Double Spoke wheels (Style 461M) (options available)
- Aluminum Hexagon trim / Estoril Blue Matte highlight (options available)
- M Sport suspension
- M steering wheel
- Aerodynamic kit
- Rear spoiler
- Shadowline exterior trim
- Increased top-speed limiter when equipped with performance tires

## LUXURY PACKAGE<sup>1</sup>

- Fineline Stream Wood trim with Oxide Silver matte highlight (options available)

## PREMIUM PACKAGE<sup>1</sup>

- Universal garage-door opener
- Comfort Access keyless entry
- Moonroof
- Automatic-dimming interior rear-view mirror and driver's-side exterior mirror
- Power front seats
- Lumbar support
- Ambiance lighting
- SiriusXM<sup>®</sup> Satellite Radio with 1-year subscription

<sup>1</sup>Available only on the 230i and 230i xDrive Coupe and Convertible.

<sup>2</sup>Active Driving Assistant is not a substitute for the driver's own responsibility in maintaining safe control of the vehicle.

Not all features are available on all models. Get the latest information on standard and optional features, packages and technical specifications. Visit [bmwusa.com](http://bmwusa.com) and select the BMW model of your choice.

# SERIES COUPE

# TECHNICAL DATA

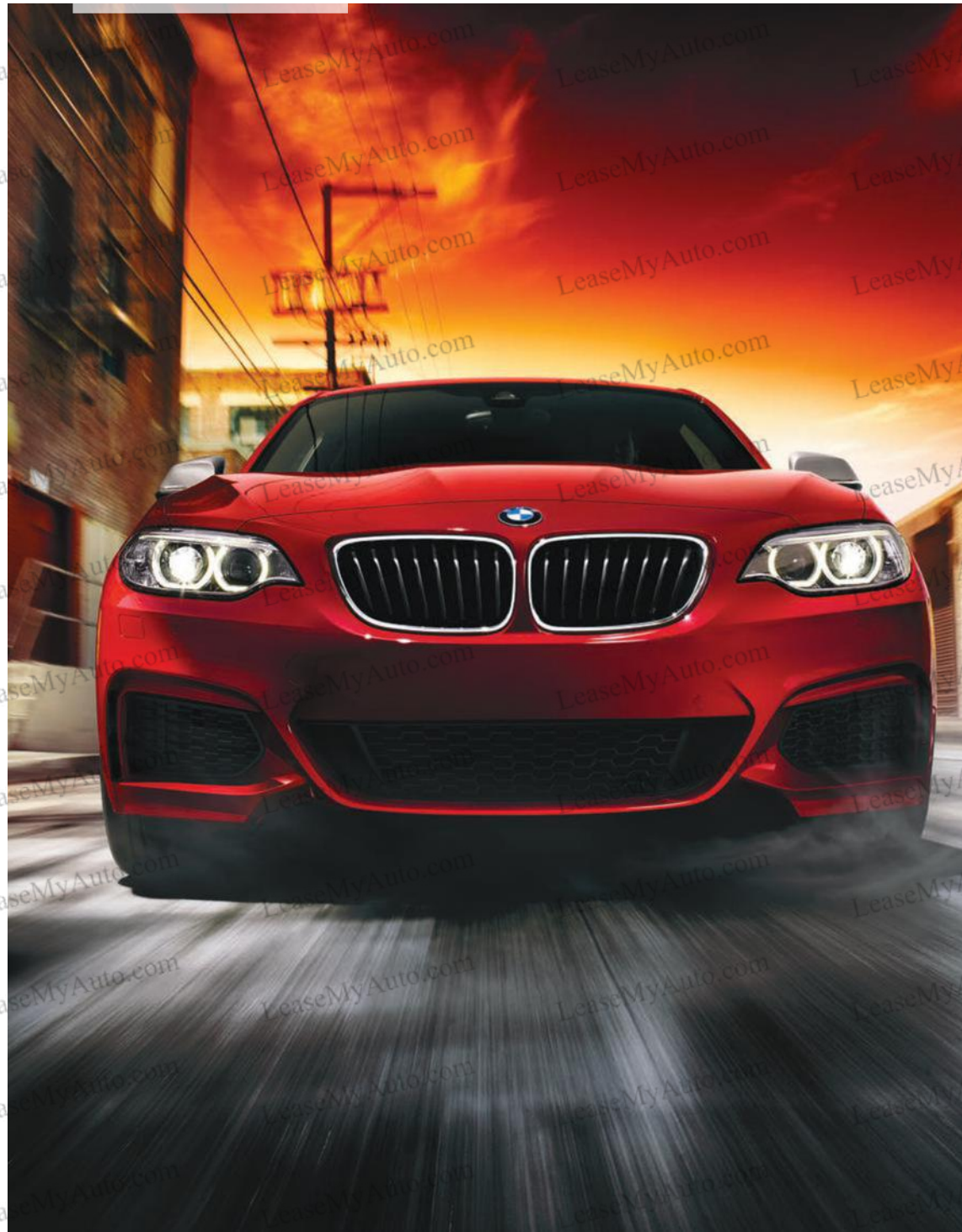

	BMW 230i / 230i xDrive	BMW M240i / M240i xDrive
ENGINE	2.0-liter TwinPower Turbo inline 4-cylinder	3.0-liter M Performance TwinPower Turbo inline 6-cylinder
OUTPUT @ RPM	248 hp @ 5200 / 258 lb-ft @ 1450-4800	335 hp @ 5500 / 369 lb-ft @ 1520-4500
0-60 MPH (sec) <sup>1</sup>	5.3 [5.5] / 5.2	4.4 [4.6] / 4.2
CITY / HIGHWAY / COMBINED MPG	[21/32/25] / 24/33/27	21/32/25 [19/28/22] / 21/31/25

All dimensions in technical drawings are given in inches. Dimensions shown apply to 230i and 230i xDrive Coupe.

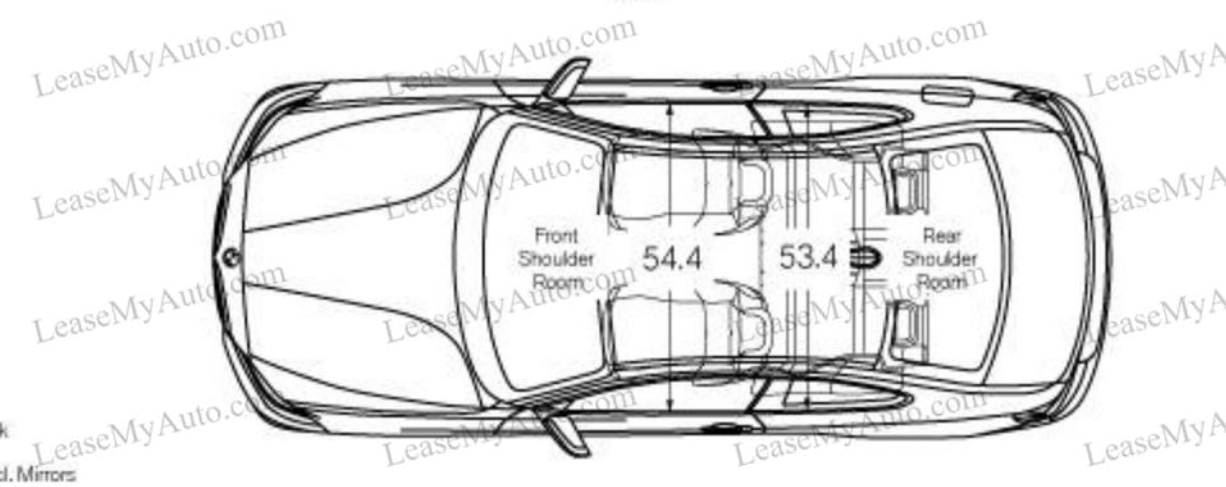
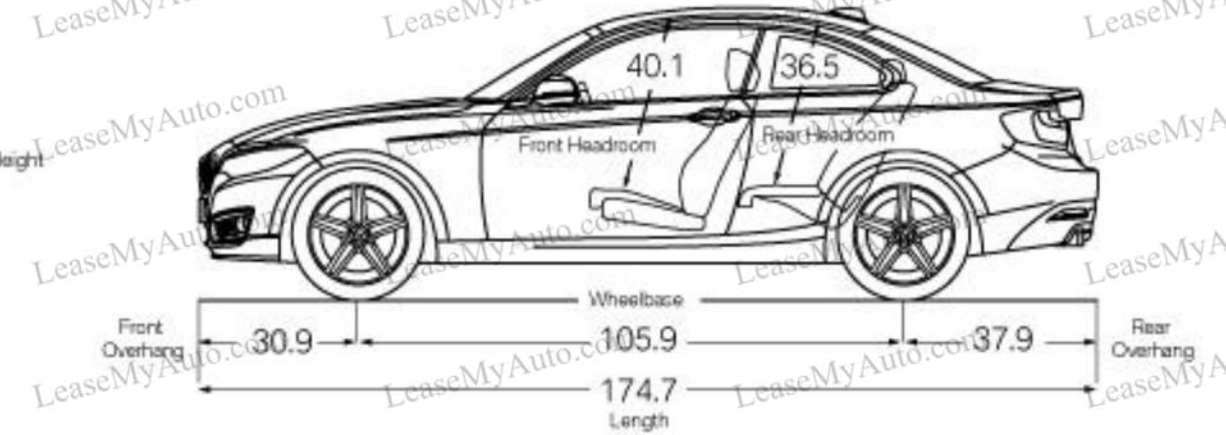

Figures in [ ] refer to vehicles with manual transmission. Figures subject to change. Not all packages available in all models. Please visit your BMW Retailer or [bmwusa.com](http://bmwusa.com) for the most up-to-date information.

<sup>1</sup>BMW AG preliminary test results. Actual acceleration results may vary, depending on specification of vehicle; road and environmental conditions; testing procedures and driving style.

These results should be used for comparison only and verification should not be attempted on public roads. BMW urges you to obey all posted speed laws and always wear safety belts.

Not all features are available on all models. Get the latest information on standard and optional features, packages and technical specifications. Visit [bmwusa.com](http://bmwusa.com) and select the BMW model of your choice.



X Close

## SOLAR FLAIR.

With its power-folding soft top that drops in 20 seconds, the 2 Series Convertible adds some sun to the Coupe's blistering performance. Let the wind try to catch up with you for a change.

# BMW 2 SERIES CONVERTIBLE

[EXTERIOR COLORS](#)

[UPHOLSTERY](#)

[INTERIOR TRIMS](#)

[WHEELS / TIRES](#)

[PACKAGES](#)

[TECHNICAL DATA](#)



## SUN STUNNER.

The 2Series Convertible may love the sun, but with xDrive intelligent all-wheel drive and a weather-proof softtop, it's always at the ready. Dynamic Stability Control utilizes multiple sensors to measure speed and steering angle to help you maintain control.



## A TOP PERFORMER.

Sitting in the BMW 2 Series Convertible reveals the same focus on performance as its Coupe stablemate. You can enjoy the lightning-fast shifts of the 8-speed Sport Automatic transmission, or go the purist route and take control with a 6-speed manual.

# SERIES CONVERTIBLE

## EXTERIOR COLORS

### NON-METALLIC

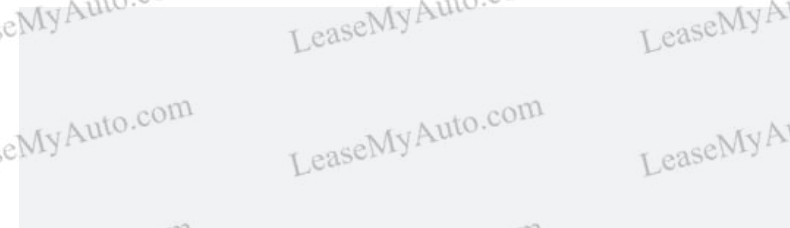

**300** Alpine White (Non-metallic)



**668** Jet Black (Non-metallic)

### METALLIC

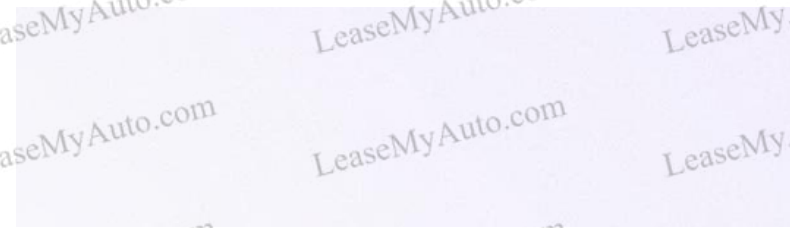

**A96** Mineral White Metallic

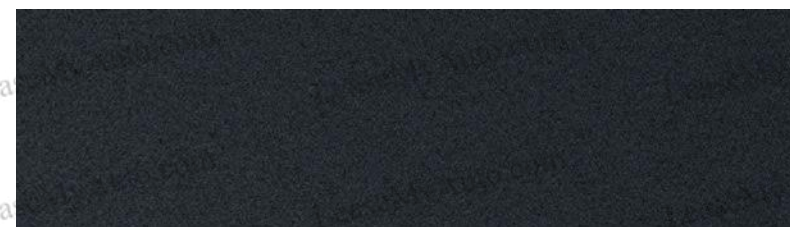

**B39** Mineral Gray Metallic

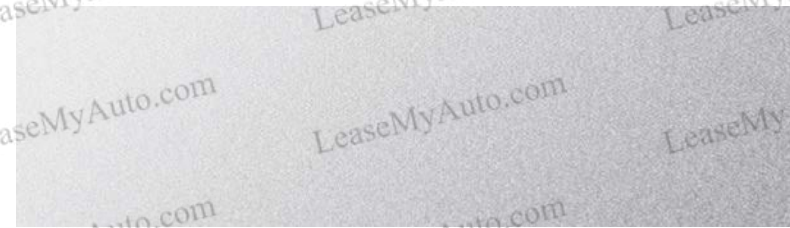

**A83** Glacier Silver Metallic

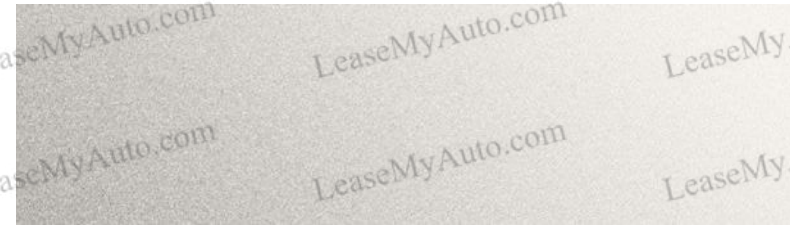

**B66** Moonlight Silver Metallic

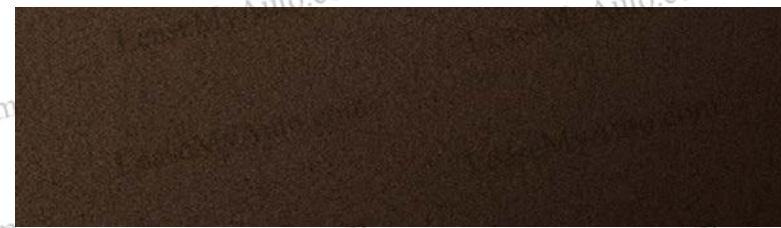

**B53** Sparkling Brown Metallic

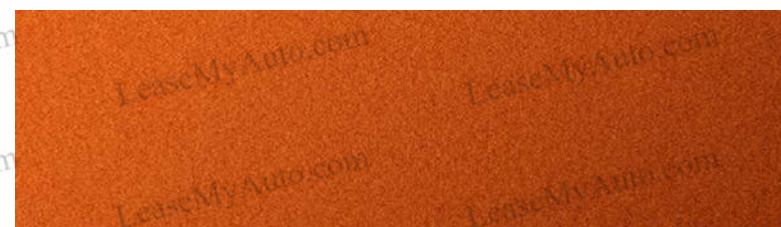

**B44** Valencia Orange Metallic



**B38** Midnight Blue Metallic



**A76** Deep Sea Blue Metallic

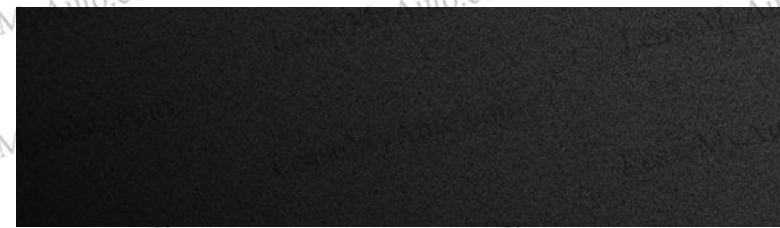

**475** Black Sapphire Metallic

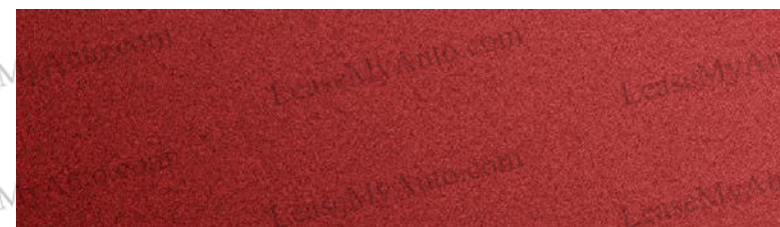

**A75** Melbourne Red Metallic

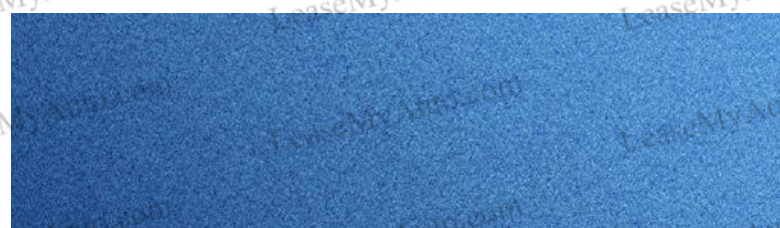

**B45** Estoril Blue Metallic

Not all features are available on all models. Get the latest information on standard and optional features, packages and technical specifications. Visit [bmwusa.com](http://bmwusa.com) and select the BMW model of your choice.

# SERIES CONVERTIBLE

## UPHOLSTERY

### SENSATEC



**KCSW** Black SensaTec

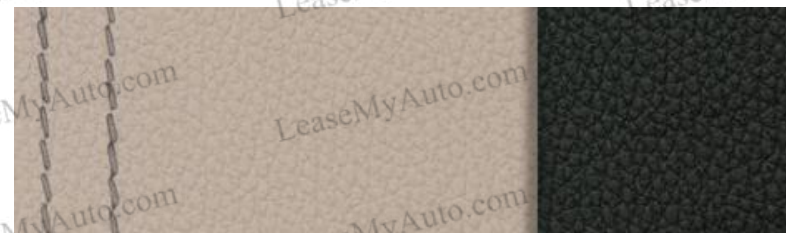

**KCCX** Oyster / Black SensaTec



**KCL3** Black SensaTec / Red highlight

### DAKOTA LEATHER

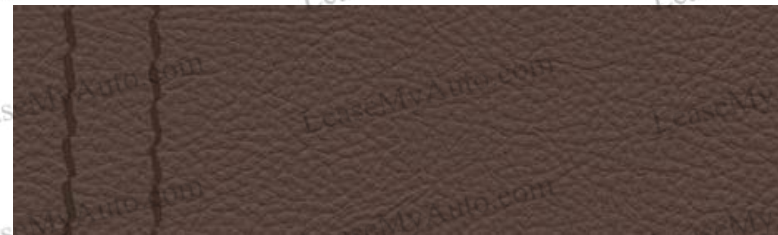

**LCB8**Terra Dakota Leather

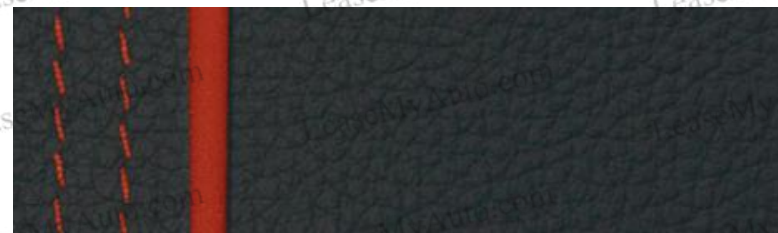

**LCL3** Black Dakota Leather / Red highlight

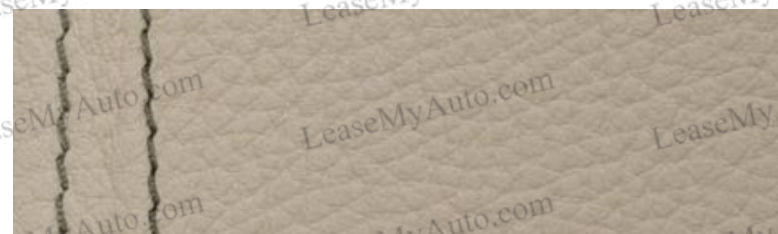

**LCOM** Oyster Dakota Leather

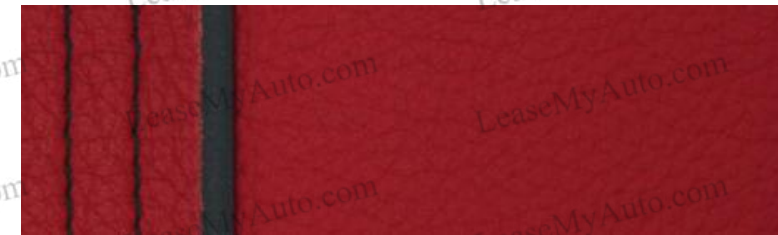

**LCL5** Coral Red Dakota Leather/  
Black highlight

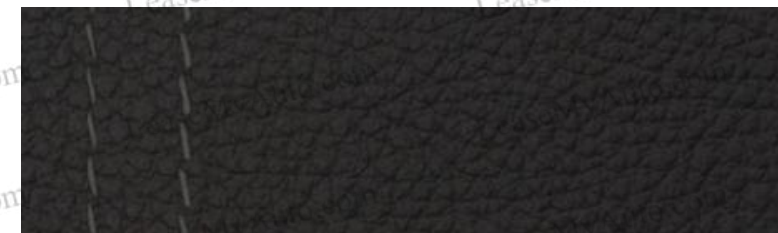

**LCSW** Black Dakota Leather

Not all features are available on all models. Get the latest information on standard and optional features, packages and technical specifications. Visit [bmwusa.com](http://bmwusa.com) and select the BMW model of your choice.

# SERIES CONVERTIBLE

## INTERIOR TRIMS

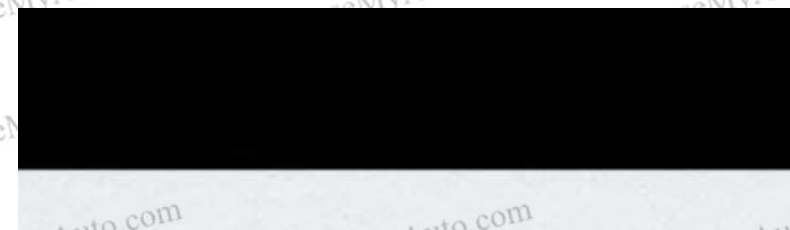

**4GD** high-gloss Black trim /  
Oxide Silver highlight



**4WF** Aluminum Hexagon trim /  
Estoril Blue matte highlight



**4LC** Finline Stream Wood trim /  
Oxide Silver matte highlight



**4FT** Brushed Aluminum trim /  
high-gloss Black highlight



**4WG** Aluminum Hexagon trim /  
high-gloss Black highlight



**4LV** high-gloss Black trim / Coral Red  
matte highlight

Not all features are available on all models. Get the latest information on standard and optional features, packages and technical specifications. Visit [bmwusa.com](http://bmwusa.com) and select the BMW model of your choice.

# SERIES CONVERTIBLE

## WHEELS / TIRES



Double Spoke Ferric Gray light alloy wheels (Style 384)  
18 x 7.5 front, 18 x 8.0 rear; and 225/40 front, 245/35 rear non-run-flat Michelin® Pilot Super Sport performance tires<sup>1,2,3</sup>



Double Spoke light alloy wheels (Style 384)  
18 x 7.5 front, 18 x 8.0 rear; and 225/40 front, 245/35 rear performance tires<sup>1,2,3</sup>  
18 x 7.5 front and rear; and 225/40 front and rear all-season tires<sup>1</sup>



Double Spoke Ferric Gray light alloy wheels (Style 461M)  
18 x 7.5 front, 18 x 8.0 rear; and 225/40 front, 245/35 rear non-run-flat Michelin® Pilot Super Sport performance tires<sup>1,2,3</sup>



Double Spoke light alloy wheels (Style 461M)  
18 x 7.5 front, 18 x 8.0 rear; and 225/40 front, 245/35 rear non-run-flat Michelin® Pilot Super Sport performance tires<sup>1,2,3</sup>  
18 x 7.5 front, 18 x 8.0 rear; and 225/40 front, 245/35 rear summer tires<sup>1,2</sup>



Double Spoke Orbit Gray light alloy wheels (Style 436M)  
18 x 7.5 front, 18 x 8.0 rear; and 225/40 front, 245/35 rear non-run-flat summer tires<sup>1,2</sup>



Double Spoke light alloy wheels (Style 436M)  
18 x 7.5 front, 18 x 8.0 rear; and 225/40 front, 245/35 rear non-run-flat summer tires<sup>1,2</sup>



Star Spoke light alloy wheels (Style 379)  
17 x 7.5 front and rear; and 225/45 front and rear all-season tires<sup>1</sup>

<sup>1</sup> Does not come equipped with spare wheel and tire.

<sup>2</sup> Driving over rough or damaged road surfaces, as well as debris, curbs and other obstacles, can cause serious damage to wheels, tires and suspension parts. This is more likely to occur with low-profile tires, which provide less cushioning between the wheel and the road. Be careful to avoid road hazards and reduce your speed, especially if your vehicle is equipped with low-profile tires.

<sup>3</sup> Performance tires include Mobility Kit; not recommended for driving in ice and snow conditions.

Not all features are available on all models. Get the latest information on standard and optional features, packages and technical specifications. Visit [bmwusa.com](http://bmwusa.com) and select the BMW model of your choice.



# SERIES CONVERTIBLE

## PACKAGES

### COLD WEATHER PACKAGE

- Heated steering wheel
- Heated front seats
- Retractable headlight washers

### DRIVER ASSISTANCE PACKAGE

- Rear-view Camera
- Park Distance Control

### DRIVER ASSISTANCE PLUS

- Automatic high beams
- Active Driving Assistant<sup>1</sup>
- Speed Limit Info

### LIGHTING PACKAGE

- Xenon headlights
- Adaptive light control

### TRACK HANDLING PACKAGE

- 18-inch Double Spoke Ferric Gray wheels (Style 384) (options available)
- M Sport brakes
- Adaptive M Suspension
- Variable Sport Steering

### M SPORT PACKAGE

- 18-inch Double Spoke wheels (Style 461M) (options available)
- Aluminum Hexagon trim / Estoril Blue Matte highlight (options available)
- M Sport suspension
- M steering wheel
- Aerodynamic kit
- Shadowline exterior trim
- Increased top-speed limiter when equipped with performance tires

### LUXURY PACKAGE

- Fineline Stream Wood trim with Oxide Silver matte highlight (options available)

### PREMIUM PACKAGE

- Universal garage-door opener
- Comfort Access keyless entry
- Automatic-dimming interior and driver's exterior mirror
- Auto-dimming rear-view mirror
- Power front seats
- Lumbar support
- Ambient lighting
- SiriusXM<sup>®</sup> Satellite Radio with 1-year subscription

<sup>1</sup>Active Driving Assistant is not a substitute for the driver's own responsibility in maintaining safe control of the vehicle.

Not all features are available on all models. Get the latest information on standard and optional features, packages and technical specifications. Visit [bmwusa.com](http://bmwusa.com) and select the BMW model of your choice.



# SERIES CONVERTIBLE

## TECHNICAL DATA



	BMW 230i / 230i xDrive	BMW M240i / M240i xDrive
ENGINE	2.0-liter TwinPower Turbo inline 4-cylinder	3.0-liter M Performance TwinPower Turbo inline 6-cylinder
OUTPUT @ RPM	248 hp @ 5200 / 258 lb-ft @ 1450-4800	335 hp @ 5500 / 369 lb-ft @ 1520-4500
0-60 MPH (sec) <sup>1</sup>	5.6	4.5 [4.7] / 4.4
CITY / HIGHWAY / COMBINED MPG	23/34/27 / 23/33/26	21/32/25 [19/29/23] / 21/31/25

All dimensions in technical drawings are given in inches. Dimensions shown apply to 230i and 230i xDrive Convertible.

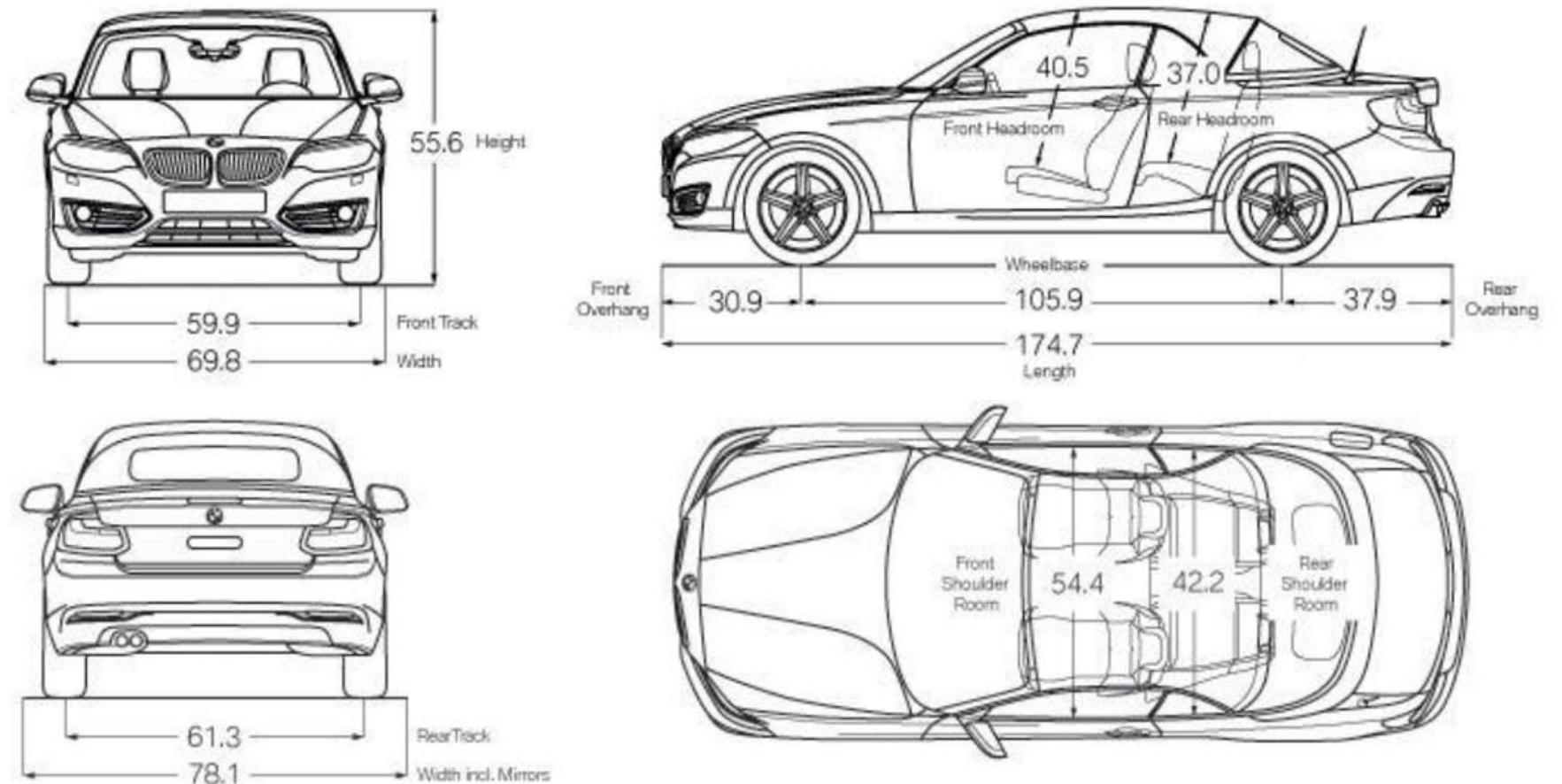

Figures in [ ] refer to vehicles with manual transmission. Figures subject to change. Not all packages available in all models. Please visit your BMW Retailer or [bmwusa.com](http://bmwusa.com) for the most up-to-date information.

<sup>1</sup>BMW AG preliminary test results. Actual acceleration results may vary, depending on specification of vehicle; road and environmental conditions; testing procedures and driving style. These results should be used for comparison only and verification should not be attempted on public roads. BMW urges you to obey all posted speed laws and always wear safety belts.

Not all features are available on all models. Get the latest information on standard and optional features, packages and technical specifications. Visit [bmwusa.com](http://bmwusa.com) and select the BMW model of your choice.