



3 WORKSHOP SOLUTIONS



PERTH
(08) 9459 8600
KALGOORLIE
(08) 9021 8300

ADELAIDE
(08) 8231 1513
NEWMAN
(08) 9175 1164

DARWIN
(08) 8963 5621
MT ISA
(07) 4743 6458

✉ sales@bendtechgroup.com.au
🌐 bendtechgroup.com.au

2-10 Kewdale Road, Welshpool WA 6106



WORKSHOP SOLUTIONS**INDEX**

GENERAL PURPOSE PLATFORMS	///	3 - 7
WORKSHOP TRESTLES	///	9 - 11
WORKSHOP BENCHES/CUTTING TABLES	///	13 - 17
WORKSHOP STORAGE RACKS	///	19 - 26



GENERAL PURPOSE PLATFORMS

GENERAL PURPOSE PLATFORMS

ACCESS PLATFORM 430MM

Part No. 5502890



CONSTRUCTION

- Heavy-duty aluminium
- Length: 750mm
- Width: 850mm
- Safety handrails
- Self-closing gates
- Non-slip stairway and work area

ACCESS STEP PLATFORM 500MM

Part No. 5504040



CONSTRUCTION

- Heavy-duty aluminium
- WLL: 150kg
- Length: 850mm
- Width: 650mm
- Safety handrails
- Boom rail
- Non-slip stairway and work area

ACCESS PLATFORM 500MM

Part No. 5502630



CONSTRUCTION

- Heavy-duty aluminium
- WLL: 150kg
- Length: 2000mm
- Width: 500mm
- Safety handrails
- Fitted with a Boom Rail
- Non-slip stairway and work area

ACCESS PLATFORM 700MM

Part No. 5502631



CONSTRUCTION

- Heavy-duty aluminium
- WLL: 150kg
- Length: 2000mm
- Width: 500mm
- Safety handrails
- Fitted with a Boom Rail
- Non-slip stairway and work area

GENERAL PURPOSE PLATFORMS

ACCESS STEP PLATFORM 800MM

Part No. 5504041



CONSTRUCTION

- Heavy-duty aluminium
- WLL: 150kg
- Length: 1200mm
- Width: 650mm
- Safety handrails
- Boom rail
- Non-slip stairway and work area

ACCESS PLATFORM 1100MM

Part No. 5503138



CONSTRUCTION

- Heavy-duty aluminium
- WLL: 200kg
- Length: 1191mm
- Width: 850mm
- Safety handrails
- Boom rail
- Non-slip stairway and work area

ACCESS PLATFORM 1200MM

Part No. 5412174



CONSTRUCTION

- Heavy-duty aluminium
- Length: 1100mm
- Width: 1000mm
- Self-levelling jacks
- Self-closing gate and safety handrails
- Non-slip stairway and work area

ACCESS PLATFORM 1400MM

Part No. 5401235



CONSTRUCTION

- Heavy-duty aluminium
- Length: 2783mm
- Width: 900mm
- Self-levelling jacks
- Self-closing gate
- Safety handrails
- Non-slip stairway and work area

GENERAL PURPOSE PLATFORMS

DOOR ACCESS PLATFORM 1500MM

Part No. 5501803



CONSTRUCTION

- Heavy-duty aluminium
- Length: 1100mm
- Width: 800mm
- Fitted with removable handrails
- Fitted with self-closing gates
- Fitted with Heavy-duty castors

ACCESS PLATFORM 1600MM

Part No. 5401183



CONSTRUCTION

- Heavy-duty aluminium
- Length: 824mm
- Width: 780mm
- Self-closing gate
- Safety handrails
- Non-slip stairway and work area

ACCESS PLATFORM WITH OVERHANG 1600MM

Part No. 5001982



CONSTRUCTION

- Heavy-duty aluminium
- WLL: 150kg
- Drop-in type boom rail
- Non-Slip Gridmesh Decking
- Lifting lugs included for easy lifting
- SWL markings attached to platform
- Counterweights included for stability

ACCESS PLATFORM 1700MM

Part No. 5414112



CONSTRUCTION

- Heavy-duty aluminium
- Length: 1200mm
- Width: 950mm
- Self-levelling jacks
- Self-closing gate
- Safety handrails
- Non-slip stairway and work area

GENERAL PURPOSE PLATFORMS

ACCESS PLATFORM 1800MM

Part No. 5502287



CONSTRUCTION

- Heavy-duty aluminium
- WLL: 250kg
- Self-closing gates
- Fitted with leveling jacks
- Fitted with forklift slots and wheels
- Non-slip serrated grating stairway and work area

ACCESS PLATFORM 1850MM

Part No. 5414025



CONSTRUCTION

- Heavy-duty aluminium
- Length: 2000mm
- Width: 1200mm
- Safety handrails
- Non-slip stairway and work area

ACCESS PLATFORM 1900MM

Part No. 5412036



CONSTRUCTION

- Heavy-duty aluminium
- Length: 3903mm
- Width: 1000mm
- Self-levelling jacks
- Self-closing gate and safety handrails
- Non-slip stairway and work area

ACCESS PLATFORM 2200MM

Part No. 5412038



CONSTRUCTION

- Heavy-duty aluminium
- Length: 4003mm
- Width: 1100mm
- Self-levelling jacks
- Self-closing gate and safety handrails
- Non-slip stairway and work area

GENERAL PURPOSE PLATFORMS

ACCESS PLATFORM 2400MM

Part No. 5502756



CONSTRUCTION

- Heavy-duty aluminium
- WLL: 150kg
- Length: 2062mm
- Width: 1276mm
- Boom rail
- Non-slip stairway and work area

ACCESS PLATFORM 2500MM

Part No. 5401237



CONSTRUCTION

- Heavy-duty aluminium
- Length: 4480mm
- Width: 1200mm
- Self-levelling jacks
- Self-closing gate and safety handrails
- Non-slip stairway and work area

“ **MAKING MAINTENANCE
ON-SITE SAFE, EFFICIENT
AND EASY** ”



WORKSHOP TRESTLES

 www.bendtechgroup.com.au

WORKSHOP TRESTLES

2 TONNE TRESTLE STAND 1000MM (L) X 900MM (H)

Part No. 5001747



CONSTRUCTION

- Heavy-duty steel
- Width: 660mm
- Replaceable top section
- Fully engineered and certified
- Stocked off-the-shelf, available for immediate delivery

5 TONNE TRESTLE STAND 1000MM (L) X 900MM (H)

Part No. 5001805



CONSTRUCTION

- Heavy-duty steel
- Width: 660mm
- Replaceable top section
- Fully engineered and certified
- Stocked off-the-shelf, available for immediate delivery

2 TONNE TRESTLE 1000MM (L) X 500MM (H)

Part No. 5503752



CONSTRUCTION

- Heavy-duty steel
- Width: 320mm
- Replaceable top section
- Fully engineered and certified
- Stocked off-the-shelf, available for immediate delivery

5 TONNE TRESTLE STAND 2400MM (L) X 900MM (H)

Part No. 5001760



CONSTRUCTION

- Heavy-duty steel
- Width: 656mm
- Replaceable top section
- Fully engineered and certified
- Stocked off-the-shelf, available for immediate delivery

WORKSHOP TRESTLES

10 TONNE TRESTLE STAND 2400MM (L) X 650MM (H)

Part No. 5001813



CONSTRUCTION

- Heavy-duty steel
- Width: 515mm
- Replaceable top section
- Fully engineered and certified
- Stocked off-the-shelf, available for immediate delivery

10 TONNE TRESTLE STAND 1200MM (L) X 1000MM (H)

Part No. 5504266



CONSTRUCTION

- Heavy-duty steel
- Replaceable top section
- Fully engineered and certified
- Stocked off-the-shelf, available for immediate delivery

2 TONNE TRESTLE WITH WHEELS

Part No. 5503294



CONSTRUCTION

- Heavy-duty steel
- Width: 760mm
- Replaceable top section
- Fully engineered and certified
- Stocked off-the-shelf, available for immediate delivery

2 TONNE TRESTLE REPLACEMENT TOP 1000MM (L) X 90MM (H)

Part No. 5503163

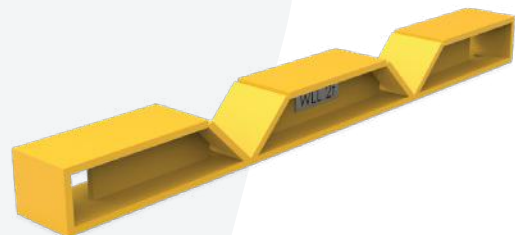

CONSTRUCTION

- Heavy-duty steel
- Height: 85mm
- Width: 100mm
- Length: 1000mm
- Bolts straight to the trestle
- Solution for stable and safer support of pipe

WORKSHOP TRESTLES

ADJUSTABLE TRESTLE 2T

Part No. 5502938



CONSTRUCTION

- Heavy-duty steel
- Height: 700mm - 900mm
- Length: 1000mm
- Replaceable top section
- Height adjustable by 200mm via jacking stands
- Stocked off-the-shelf, available for immediate delivery

ADJUSTABLE TRESTLE 5T

Part No. 5502940



CONSTRUCTION

- Heavy-duty steel
- Height: 700mm - 900mm
- Length: 1000mm
- Replaceable top section
- Height adjustable by 200mm via jacking stands



WORKSHOP BENCHES / CUTTING TABLES

WORKSHOP BENCHES / CUTTING TABLES

2 TONNE WORKBENCH 900MM (H)

Part No. 5500766

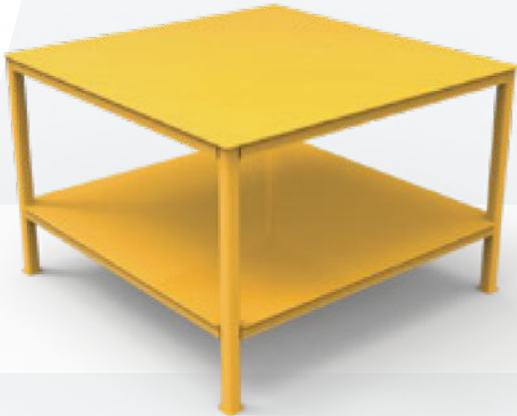

CONSTRUCTION

- Heavy-duty steel
- Certified and compliant with Australian Standards
- This item can be customised to meet your specific needs

WORKBENCH 2 TONNE 1800MM (L) X 880MM (H)

Part No. 5504008



CONSTRUCTION

- Heavy-duty steel
- Fitted with 12mm bench top
- Certified and compliant with Australian Standards

WORK BENCH 1.5T

Part No. 5502217



CONSTRUCTION

- Heavy-duty steel
- Length: 2500mm
- Width: 1200mm
- Height: 1000mm
- Finished in Y-14 safety yellow
- Certified and compliant with Australian Standards

WORK BENCH WITH BACKBOARD

Part No. 5502194



CONSTRUCTION

- Heavy-duty steel
- Length: 1800mm
- Width: 800mm
- Height: 900mm
- Customised to meet specific requirements
- Certified and compliant with Australian Standards

WORKSHOP BENCHES / CUTTING TABLES

WORK BENCH 5T
2400MM (L) X 1200MM (W)
Part No. 5502201



CONSTRUCTION

- Heavy-duty steel
- Height: 900mm
- Fitted with adjustable feet
- Frame blasted, primed and painted red oxide, top unpainted

HEAVY DUTY WORK BENCH
2400 X 1200MM
Part No. 5502330



CONSTRUCTION

- Heavy-duty steel
- Height: 965mm
- 25mm top
- Bottom shelf for storage
- OSHA high-visibility Bench Vise included

HEAVY DUTY WORK BENCH
3000MM X 2000MM
Part No. 5502331



CONSTRUCTION

- Heavy-duty steel
- Height: 965mm
- 25mm top
- Bottom shelf for storage
- OSHA high-visibility Bench Vise included
- Angle drain channel around edge with drain point

WORKBENCH WITH VICE 1 TONNE
Part No. 5503002



CONSTRUCTION

- Heavy-duty steel
- Length: 3000mm
- Includes Dawn 150mm Offset Standard Vise (Part no: 60181)
- Fitted with 10mm bench top

WORKSHOP BENCHES / CUTTING TABLES

WORK BENCH WITH ENCLOSED STORAGE

Part No. 5503297



CONSTRUCTION

- Heavy-duty steel and hinges
- Length: 2500mm
- Width: 1270mm
- Height: 965mm
- Oil drain lip around perimeter with drain point
- Includes storage underneath with latched access doors

HEAVY DUTY WORK BENCH 3000MM X 2000MM

Part No. 5504057



CONSTRUCTION

- Heavy-duty steel and caster wheels
- Height: 965mm
- 25mm top
- Enclosed bottom shelf for storage
- Angle drain channel around edge with drain point

HEAVY DUTY WORK BENCH 2400MM X 1500MM

Part No. 5503412



CONSTRUCTION

- Heavy-duty steel
- Height: 965mm
- Bottom shelf for storage
- DAWN right hand offset bench vise included

WELDING WORK BENCH 3000MM (L) X 1800MM (W)

Part No. 5504542



CONSTRUCTION

- Heavy-duty steel with vice
- Height: 900mm
- 4x welding torch holsters
- Earth cable connection point

WORKSHOP BENCHES / CUTTING TABLES

A Work Stand And Bench designed and engineered for the maintenance of pump drives.

TOOL STORAGE AND WORKBENCH

Part No. 5503327

CONSTRUCTION

- Heavy-duty steel
- Length: 6500mm
- Width: 800mm
- Height: 2850mm
- LED lighting fitting at top
- 3x BAC storage modules
- 6x power outlets
- Large shadow boards
- Finished in heavy-duty Y-14 safety yellow



MOBILE WORK BENCH WITH COVER

Part No. 5602050

CONSTRUCTION

- Heavy-duty steel
- Length: 3600mm
- Height: 1100mm
- Certified and compliant with Australian Standards
- Heavy-duty German made lockable castors
- Heavy-duty mine spec construction
- Can be customised to meet specific needs



CATERPILLAR 793F STEERING PUMP DRIVE WORK STAND AND BENCH

Part No. 5503047

CONSTRUCTION

- Heavy-duty steel
- WLL: 600kg
- Length: 1600mm
- Width: 700mm
- Height: 1830mm
- Fitted with lifting lugs
- Fitted with forklift slots
- Finished in Y-14 safety yellow



WORKSHOP BENCHES / CUTTING TABLES

MOBILE FLAME CUTTING TABLE

Part No. 5501032



CONSTRUCTION

- SWL: 1T
- Length: 1200mm
- Height: 900mm
- Replaceable support bars
- Heavy duty lockable wheels
- Safer slag collection and easy to empty slag bin

ALUMINIUM HANDRAIL MOUNTED WORK BENCHES

Part No. 5504026



CONSTRUCTION

- Heavy-duty aluminium
- SWL: 1T
- Length: 1000mm
- Width: 500mm
- Edging to stop items falling off
- Attaches securely to handrails

HEAVY DUTY PLATE CUTTING TABLE

Part No. 5501163



CONSTRUCTION

- SWL: 3T
- Length: 2830mm
- Height: 1000mm
- Replaceable support bars
- Heavy duty lockable wheels
- Safer slag collection and easy to empty slag bin

WORKSHOP TROLLEY AND LOCK BOX

Part No. 5501443



CONSTRUCTION

- Heavy-duty steel
- Certified and compliant with Australian Standards
- Fitted with lockable toolbox
- Fitted with heavy-duty castors



WORKSHOP STORAGE RACKS

WORKSHOP STORAGE RACKS

FLAT PLATE STEEL STORAGE RACK - LONG

Part No. 5503197

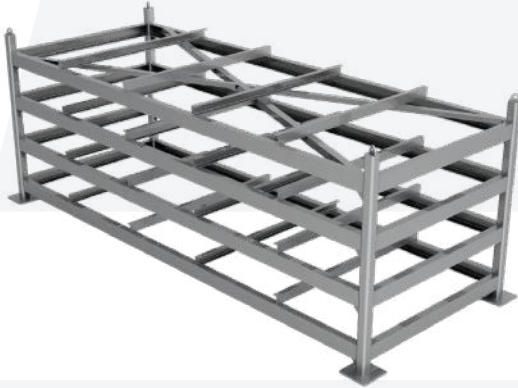

CONSTRUCTION

- Heavy-duty steel
- WLL: 4T per shelf
- Height: 2075mm
- Length: 5500mm
- Width: 2100mm
- 4 shelves with easy forklift access

STEEL FREE STANDING STORAGE RACK

Part No. 5003285

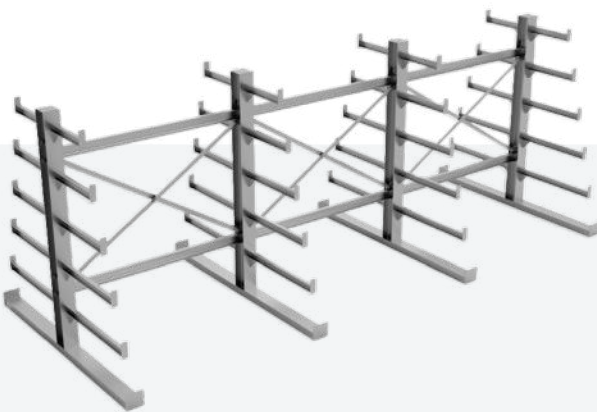

CONSTRUCTION

- Heavy-duty steel
- SWL: 4.8 Tonne Capacity or 400kg per shelf
- Height: 2250mm
- Length: 6000mm
- Lifting eyes for ease of transport
- Forklift friendly for loading your product

FLAT PLATE STEEL STORAGE RACK

Part No. 5500831



CONSTRUCTION

- Heavy-duty steel
- WLL: 12T
- Height: 3010mm
- Length: 4625mm
- Width: 2525mm
- 4 shelves with easy fork truck access
- Engineered and certified

HORIZONTAL PLATE STORAGE RACK

Part No. 5000220



CONSTRUCTION

- Heavy-duty steel
- SWL: 6.5 Tonne per level (bottom level 10 Tonne)
- Height: 2004mm
- Length: 8000mm
- Forklift friendly for plate loading
- Cantilevered to ensure optimum space utilisation
- Modular design for ease of transport and erection on site

WORKSHOP STORAGE RACKS

GENERAL PURPOSE STEEL RACK – LARGE

Part No.

6m – 5000222

7.5m – 5000221

9m – 5000219

CONSTRUCTION

- Heavy-duty steel
- SWL: 3 Tonne per shelf
- 8 shelves (4 either side)
- Fully engineered and certified
- Lifting eyes for ease of transport
- Modular construction for ease of transport and erection on site
- Cantilevered to ensure optimum space utilisation

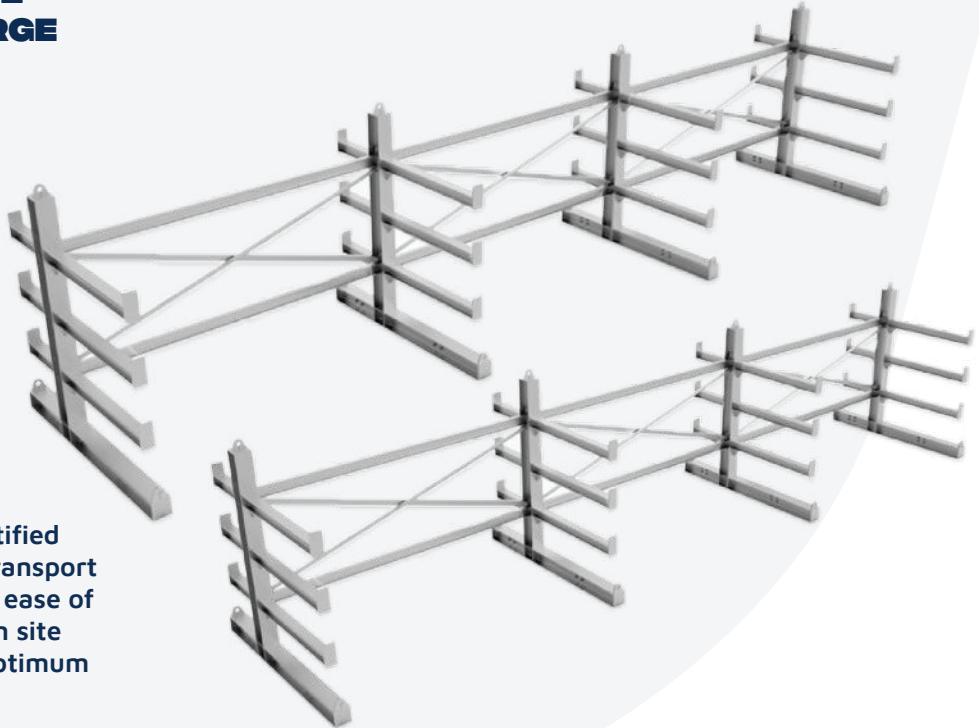

SLOPING VERTICAL STEEL PLATE RACK

Part No. 5501254

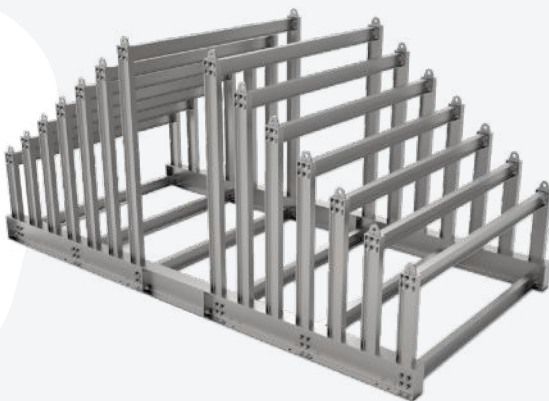

CONSTRUCTION

- Heavy-duty steel
- WLL: 4.25T per bay
- Height: 2617mm
- Length: 5747mm
- Width: 2865mm
- Modular design and Lifting eyes for ease of transport

GENERAL PURPOSE STEEL RACK – SMALL

Part No. 5501168

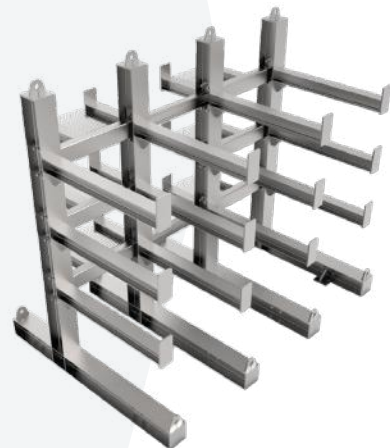

CONSTRUCTION

- Heavy-duty steel
- WLL: 3T per level
- Height: 2144mm
- Length: 2500mm
- Width: 1852mm
- Modular design and Lifting eyes for ease of transport

WORKSHOP STORAGE RACKS

VERTICAL STORAGE RACK, STEEL PLATE

Part No. 5500758



CONSTRUCTION

- Heavy-duty steel
- WLL: 8.5T per bay (51T total)
- Height: 2617mm
- Length: 8175mm
- Width: 2423mm
- Modular design and Lifting eyes for ease of transport

DRILL ROD RACK

Part No. 5501719



CONSTRUCTION

- Heavy-duty steel
- Height: 2525mm
- Length: 1784mm
- 5 shelves
- Modular design for easy transport and assembly
- Cantilevered to maximise space utilisation

HALF SLOPING VERTICAL STEEL RACK

Part No. 5000232



CONSTRUCTION

- Heavy-duty steel
- WLL: 4.25T per bay
- Height: 2650mm
- Length: 3325mm
- Width: 2865mm
- Modular design and Lifting eyes for ease of transport

EXTRA HEAVY DUTY VERTICAL PLATE STORAGE RACK

Part No. 5503023



CONSTRUCTION

- Heavy-duty steel
- WLL: 42T (6T per bay)
- Height: 1500mm
- Length: 4090mm
- Width: 2865mm
- Fitted with lifting eyes for ease of transport

WORKSHOP STORAGE RACKS

ALUMINIUM CHAIN RACK

Part No. 5001978



CONSTRUCTION

- Heavy-duty aluminium
- WLL: 2T
- Height: 600mm
- Length: 700mm
- Completely TIG welded
- Fitted with handles on each end

BORE PUMP CRADLE FRAME

Part No. 5501688



CONSTRUCTION

- Heavy-duty steel
- WLL: 1T per level (4T total)
- On-sided Steel Storage rack
- Finished in Safety Yellow
- SWL marking attached

ELECTRICAL CABLE RACKING

Part No. 5502253

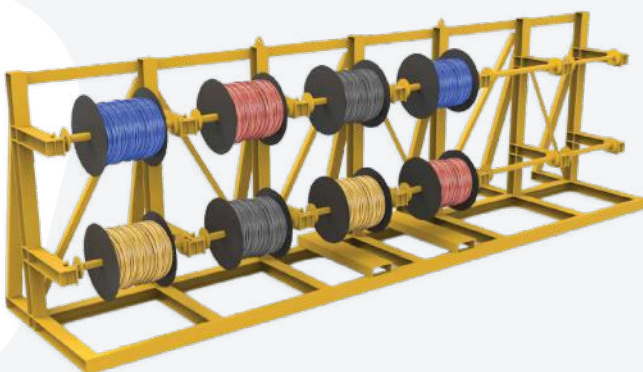

CONSTRUCTION

- Heavy-duty steel
- 600kg WLL Bottom Horizontal Bar
- 300kg WLL Top Horizontal Bar
- Finished in Safety Yellow

LIGHTWEIGHT STEEL RACK

Part No. 5501352

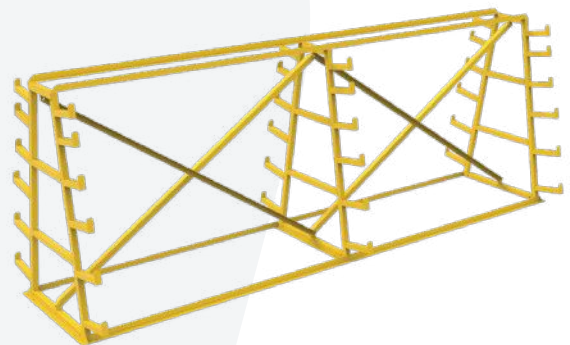

CONSTRUCTION

- Heavy-duty steel
- WLL: 180kg per shelf
- Height: 1855mm
- Length: 5080mm
- Designed to store pipework and steel sections
- Finished in Y14 safety yellow

WORKSHOP STORAGE RACKS

SHEET STORAGE RACK

Part No. 5502120



CONSTRUCTION

- Heavy-duty steel
- WLL: 300kg per shelf
- Height: 1700mm
- Length: 2800mm
- Lifting eyes
- Cantilevered to ensure optimum space utilisation

FLEXIBLE SHEETING AND GRIDMESH STORAGE RACK

Part No. 5502251

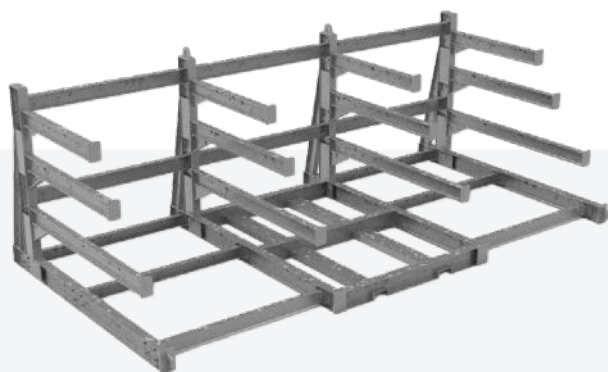

CONSTRUCTION

- Heavy-duty steel
- WLL: 3T per shelf
- Height: 2080mm
- Length: 5850mm
- Lifting eyes
- Cantilevered to ensure optimum space utilisation

ELECTRICAL EQUIPMENT STORAGE RACK

Part No. 5502091



CONSTRUCTION

- Heavy-duty steel
- WLL: 400kg per level
- Modular design and Lifting eyes for ease of transport
- Finished in Y-14 safety yellow
- Certified and compliant with Australian Standards

STEEL PLATE RACK ON WHEELS

Part No. 5502344



CONSTRUCTION

- Heavy-duty steel
- WLL: 3T
- Height: 1510mm
- Length: 2900mm
- Handles for easy mobility
- Fitted with high quality German made Caster Wheels

WORKSHOP STORAGE RACKS

STEEL PIPE STORAGE RACK - SMALL

Part No. 5502817



CONSTRUCTION

- Heavy-duty steel
- WLL: 400kg per shelf
- Height: 1200mm
- Length: 5808mm
- Free standing
- Finished in Y-14 safety yellow

STEEL PIPE STORAGE RACK

Part No. 5502089



CONSTRUCTION

- Heavy-duty steel
- WLL: 400Kg per level
- Finished in Safety Yellow
- Free standing, eliminating the need to bolt to the ground

TRAY ROPES STORAGE RACK

Part No. 5502714

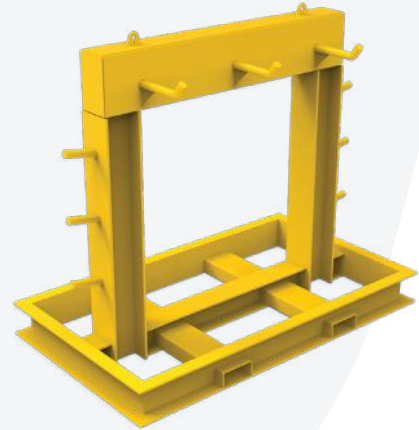

CONSTRUCTION

- Heavy-duty steel
- WLL: 250kg per arm
- Height: 1700mm
- Length: 2050mm
- Fitted with lifting lugs
- Finished in Y-14 safety yellow

MOBILE STORAGE SIGN RACK

Part No. 5413086



CONSTRUCTION

- Heavy-duty steel
- WLL: 500kg
- Height: 850mm
- Length: 1200mm
- Width: 1200mm
- Compact design for back of ute transport

WORKSHOP STORAGE RACKS

**GENERAL WORKSHOP
STORAGE RACK**
Part No. 5412138



CONSTRUCTION

- Heavy-duty steel
- WLL: 250kg per shelf
- Height: 1795mm
- Length: 2200mm
- Width: 1000mm
- Wheel chock storage compartment

MOBILE STEEL PLATE RACK
Part No. 5501647

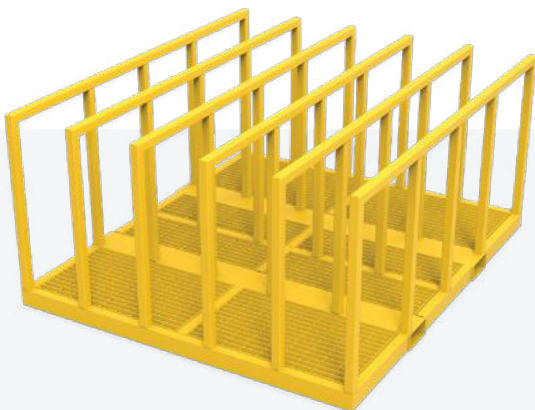

CONSTRUCTION

- Heavy-duty steel
- Height: 1000mm
- Length: 2000mm
- Width: 2300mm
- Can be customised to your requirements

STEEL CHAIN RACK
Part No. 5501752



CONSTRUCTION

- Heavy-duty steel
- WLL: 100kg per hook on outside of frame
- WLL: 200kg per hook on other location
- Height: 1450mm
- Fitted with lifting lugs

FREESTANDING CHAIN RACK
Part No. 5501441



CONSTRUCTION

- Heavy-duty steel
- WLL: 50kg per hanger
- Finished in Y-14 safety yellow
- Certified and compliant with Australian Standards

WORKSHOP STORAGE RACKS

DRILL HAMMER STORAGE RACK

Part No. 5500867



CONSTRUCTION

- Heavy-duty steel
- WLL: 720kg
- Height: 1000mm
- Engineered and certified
- Chain restraints for drill hammers
- Easily moved around

LIFTING CHAIN STORAGE RACK

Part No. 5502174



CONSTRUCTION

- Heavy-duty steel
- WLL: 200kg per arm (2T total)
- Height: 1670mm
- Length: 2000mm
- Width: 1000mm
- Certified and compliant with Australian Standards

CABLE DRUM STAND

Part No. 5501144



CONSTRUCTION

- Heavy-duty steel
- WLL: 3T
- Height: 1460mm
- Length: 1800mm
- Width: 1600mm
- Certified and compliant with Australian Standards



DARWIN
08 8963 5621

MOUNT ISA
07 4743 6458

NEWMAN
08 9175 1164

PERTH
08 9459 8600

KALGOORLIE
08 9021 8300

ADELAIDE
08 8231 1513

 sales@bendtechgroup.com.au

 www.bendtechgroup.com.au

