

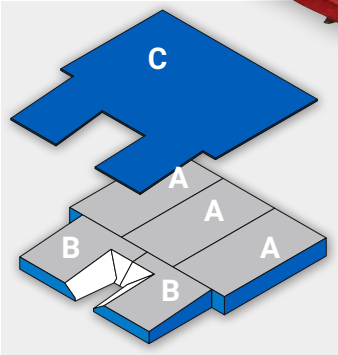

2023 TRACK & FIELD

www.fisherathletic.com



- 10 year warranty
- 18 oz. coated vinyl
- 2" thick landing pad
- Zinc coated steel snap hooks & "D" rings
- Heat sealed for a stronger seam
- Meets NFHS & NCAA guidelines
- No upcharge for custom colored pits

VINYL COLORS

- GOLD
- BLACK
- RED
- FOREST GREEN
- KELLY GREEN
- BROWN
- MAROON
- ORANGE
- GRAY
- ROYAL
- NAVY

MESH COLORS

- GOLD
- BLACK
- RED
- GREEN
- ORANGE
- GRAY
- BLUE

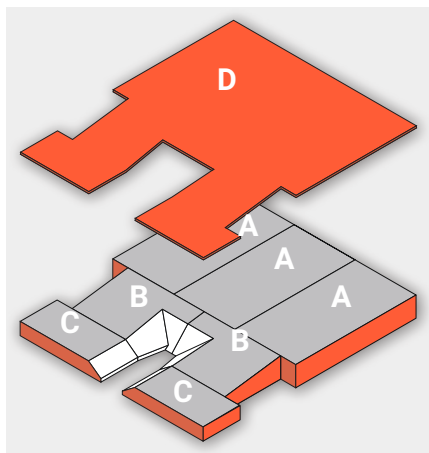

POLE VAULT PITS

Model	Size
PV202126.....	19' 9" W x 21' D x 26" H
PV202128.....	19' 9" W x 21' D x 28" H
PV202132.....	19' 9" W x 21' D x 32" H

OPTIONS

Model	Description
WC202126.....	Weather Cover for PV202126
WC202128.....	Weather Cover for PV202128
WC202132.....	Weather Cover for PV202132
GC2021	Ground Cover for PV202126-32

UNITS

- (A) Base Unit (3)
- (B) Entrance Unit (2)
- (C) 2" Foam Breather Unit

POLE VAULT PITS

Model	Size
PV202326.....	19' 9"W x 23'D x 26"H
PV202328.....	19' 9"W x 23'D x 28"H
PV202332.....	19' 9"W x 23'D x 32"H

OPTIONS

Model	Description
WC202326.....	Weather Cover for PV202326
WC202328.....	Weather Cover for PV202328
WC202332.....	Weather Cover for PV202332
GC2023	Ground Cover for PV202326-32

UNITS

- (A) Base Unit (3)
- (B) Entrance Unit (2)
- (C) Front Extensions (2)
- (D) 2" foam Breather

POLE VAULT PITS

Model	Size
PV222428.....	22'W x 24'D x 28"H
PV222432.....	22'W x 24'D x 32"H

OPTIONS

Model	Description
WC222428.....	Weather Cover for PV222426
WC222432.....	Weather Cover for PV222432
GC2224.....	Ground Cover for PV222426 & 32

- (A) Base Unit (3) (B) Entrance Unit (2)
 (C) Front Extensions (2) (D) 2" foam Breather

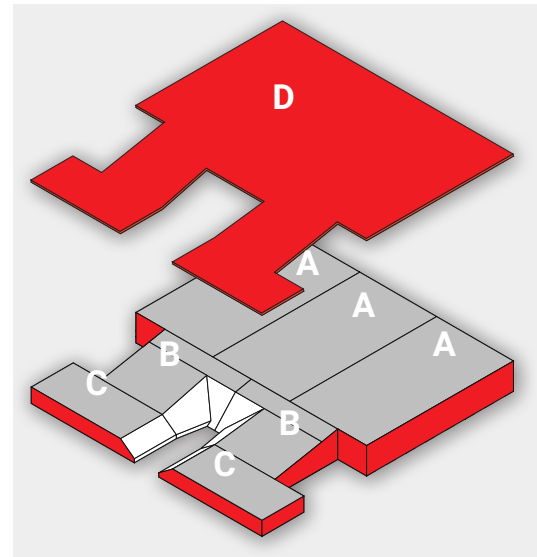

POLE VAULT PITS

Model	Size
PV222728.....	22'W x 27'D x 28"H
PV222732.....	22'W x 27'D x 32"H

OPTIONS

Model	Description
WC222728.....	Weather Cover for PV222728
WC222732.....	Weather Cover for PV222732
GC2227.....	Ground Cover for PV222726 & 32

UNITS

- (A) Base Unit (3) (B) Entrance Unit (2)
 (C) Front Extensions (2) (D) 2" foam Breather

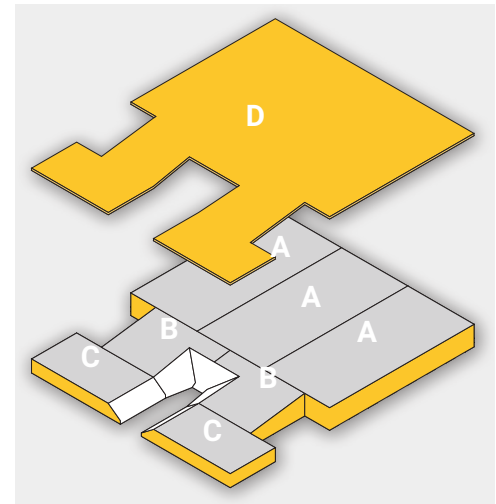

PV222732 Pit w/optional Standard Pads

Model# PLZ

8' x 10' Preferred Landing Zone Option



PV202126



HJ101824
10' x 18' x 24"

ALL FISHER HIGH JUMP PITS INCLUDE:

- 10 year warranty
- Meets NFHS & NCAA guidelines
- 2" thick landing pad
- Heat sealed for a stronger seam
- Steel snap hooks
- Steel "D" rings

*No upcharge for custom colored pits.

VINYL COLORS

GOLD

BLACK

RED

FOREST GREEN

KELLY GREEN

BROWN

MAROON

ORANGE

GRAY

ROYAL

NAVY

MESH COLORS

GOLD

BLACK

RED

GREEN

ORANGE

GRAY

BLUE



Weather Cover
(order separately)

HIGH JUMP PITS

Model	Size
HJ81620	16'-6" W x 8' D x 20" H
HJ81624	16'-6" W x 8' D x 24" H
HJ81626	16'-6" W x 8' D x 26" H
HJ81628	16'-6" W x 8' D x 28" H

OPTIONS

Model	Description
WC81620	Weather Cover for HJ81620
WC81624	Weather Cover for HJ81624
WC81626	Weather Cover for HJ81626
WC81628	Weather Cover for HJ81628
GC816	Ground Cover for HJ81620-28

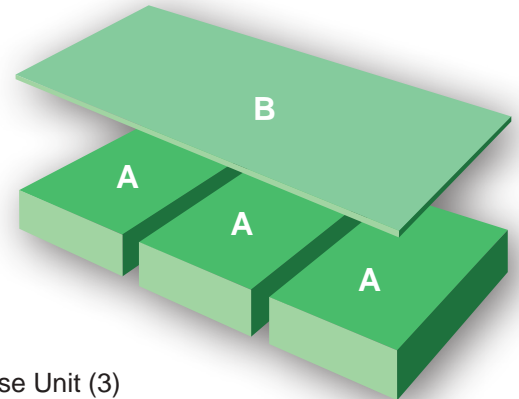

(A) Base Unit (3)
(B) Breather Pad (1)

HIGH JUMP PITS

Model	Size
HJ101824	18' W x 10' D x 24" H
HJ101826	18' W x 10' D x 26" H
HJ101828	18' W x 10' D x 28" H
HJ101832	18' W x 10' D x 32" H

OPTIONS

Model	Description
WC101824	Weather Cover for HJ101824
WC101826	Weather Cover for HJ101826
WC101828	Weather Cover for HJ101828
WC101832	Weather Cover for HJ101832
GC1018	Ground Cover for HJ101824-32

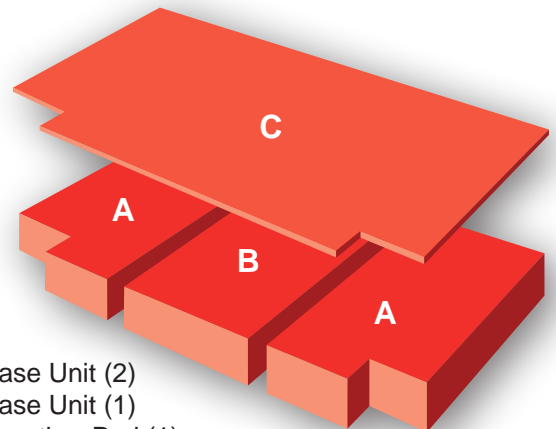

(A) Base Unit (2)
(B) Base Unit (1)
(C) Breather Pad (1)

HIGH JUMP PITS

Model	Size
HJ112224	22' W x 11' D x 24" H
HJ112226	22' W x 11' D x 26" H
HJ112228	22' W x 11' D x 28" H
HJ112232	22' W x 11' D x 32" H

OPTIONS

Model	Description
WC112224	Weather Cover for HJ112224
WC112226	Weather Cover for HJ112226
WC112228	Weather Cover for HJ112228
WC112232	Weather Cover for HJ112232
GC1122	Ground Cover for HJ112224-32

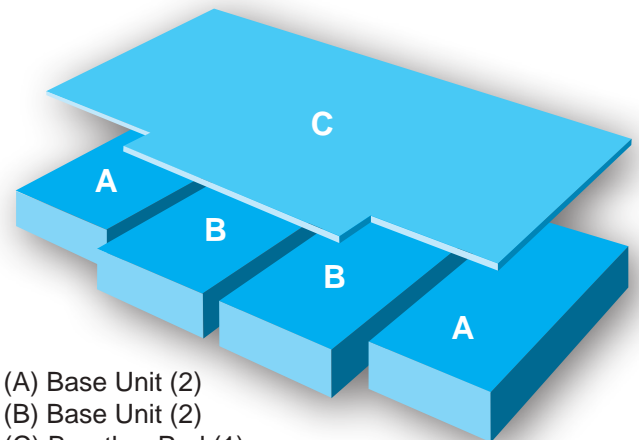

(A) Base Unit (2)
(B) Base Unit (2)
(C) Breather Pad (1)



POLE VAULT PIT PACKAGE

Model	Description
PV202126PK	Pole Vault Pit Pkg.

Includes:

- 1 - PV202126.....Pole Vault Pit
- 1 - PVST1510.....Pole Vault Standards (pair)
- 1 - BM1502.....Fiberglass Crossbar
- 1 - CBL100.....Steel Crossbar Lifter
- 2 - PVS246016.....Pole Vault Standard Pads
- 1 - WC202126.....Weather Cover

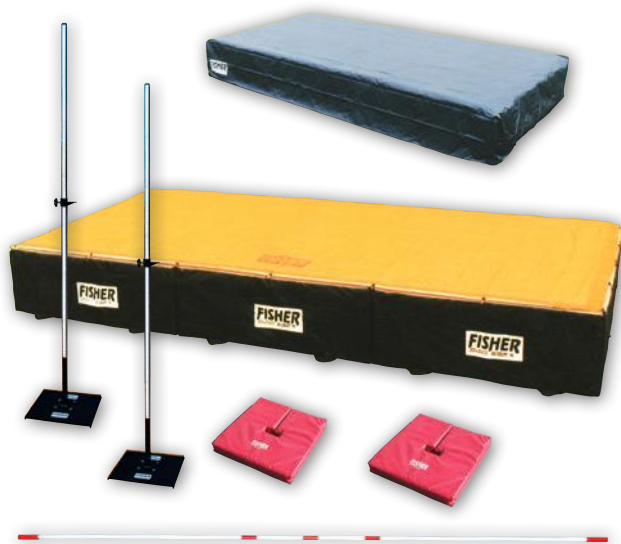

HIGH JUMP PIT PACKAGE

Model	Description
HJ81624PK	High Jump Pit Pkg.

Includes:

- 1 - HJ81624.....High Jump Pit
- 1 - HJST1210.....High Jump Standards (pair)
- 1 - BM1501.....Fiberglass Crossbar
- 2 - SS100.....High Jump Standard Pads
- 1 - WC81624.....Weather Cover

**OTHER PIT SIZES CAN BE QUICKLY AND EASILY SUBSTITUTED IN ALL OF OUR PIT PACKAGES
CALL 1-800-438-6028 FOR PRICING**

COMBINATION POLE VAULT & HIGH JUMP PIT PACKAGE



Pole Vault Pit

- 1 - PV202126.....Pole Vault Pit
- 1 - PVST1510.....Pole Vault Standards (pair)
- 1 - BM1502.....Fiberglass Crossbar
- 1 - CBL100.....Steel Crossbar Lifter
- 2 - PVS246016.....Pole Vault Standard Pads
- 1 - WC202126.....Weather Cover

High Jump Pit

- 1 - HJ81624.....High Jump Pit
- 1 - HJST1210.....High Jump Standards (pair)
- 1 - BM1501.....Fiberglass Crossbar
- 2 - SS100.....High Jump Standard Pads
- 1 - WC81624.....Weather Cover

Model	Description
PVHJ2624C	Comb. Pole Vault Pit Pkg + High Jump Pit

**OTHER PIT SIZES CAN BE QUICKLY AND EASILY SUBSTITUTED IN ALL OF OUR PIT PACKAGES
CALL 1-800-438-6028 FOR PRICING**



JR61224

(A) Base Unit (1)

FISHER **Junior Pits** are designed specifically for the Junior High track program. They are manufactured using heavy duty 18 oz. vinyl and vinyl mesh with a full **10 year warranty**. The sizes and dimensions offered are geared toward junior programs and are not intended for use with more advanced programs. Optional weather and ground covers are available.

JR61218 Jr. High Jump Pit (6' x 12' x 18")
 WC61218..... Weather Cover (6' x 12' x 18")
 GC612 Ground Cover (6' x 12')

JR61224 Jr. High Jump Pit (6' x 12' x 24")
 WC61224..... Weather Cover (6' x 12' x 24")
 GC612 Ground Cover (6' x 12')

TRACK ACCESSORIES

Article 7-4-7 states "Any hard or unyielding surfaces, such as concrete, metal, wood or asphalt, around the landing pad must be padded or cushioned with a minimum of 2" dense foam or other suitable material."



WM240 Tri-Mat Safety Pad

Dimensions: 2' x 4', Shipping wt. 5 lbs. ea.



WM480 Tri-Mat Safety Pad

Dimensions: 4' x 8', Shipping wt. 10 lbs. ea.

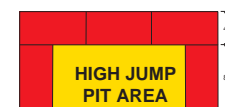
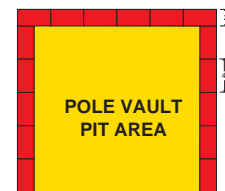



10 Year Warranty	Fisher takes pride in manufacturing a quality product and guarantees all workmanship. Warranty covers all seams, handles, zippers and vinyl.
Foam	Our foam is manufactured to provide a soft landing surface and a firm bottom.
Seams	Seams are folded and triple stitched for extra strength.
Hardware	Zinc plated "D" rings and snap hooks. Nylon zippers
Fabrics / Materials	Vinyl: 18 oz. coated vinyl, UV resistant Mesh: vinyl coated woven polyester mesh Thread: UV resistant nylon
Top Pad / Breather	2" foam enclosed in vinyl coated mesh
Weather Covers	Made out of 18 oz. coated vinyl and heat sealed for seamless construction.
Regulations	All Fisher pits meet NFHS and NCAA regulations.
Replacements	Fisher pits are manufactured for the customer. Replacement covers can be purchased by calling customer service.

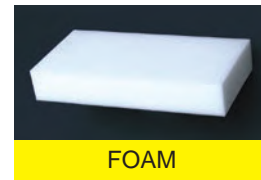

FOAM

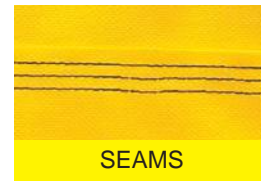

SEAMS

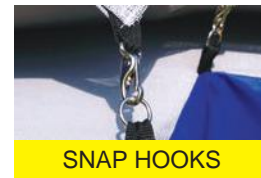

SNAP HOOKS



BREATHER



WEATHER COVER

VINYL COLORS

- GOLD
- BLACK
- RED
- FOREST GREEN
- KELLY GREEN
- BROWN
- MAROON
- ORANGE
- GRAY
- ROYAL
- NAVY
- PURPLE
- TAN
- WHITE
- SKY BLUE

MESH COLORS

- GOLD
- BLACK
- RED
- GREEN
- ORANGE
- GRAY
- BLUE

FISHER pole vault and high jump pits meet NCAA, and National Federation of High School Athletics regulations.



PVST1510 Pole Vault Standards

- 1" x 3" powder coated steel tube
- Height from 6' to 18'
- Meets NCAA and NFHS specifications

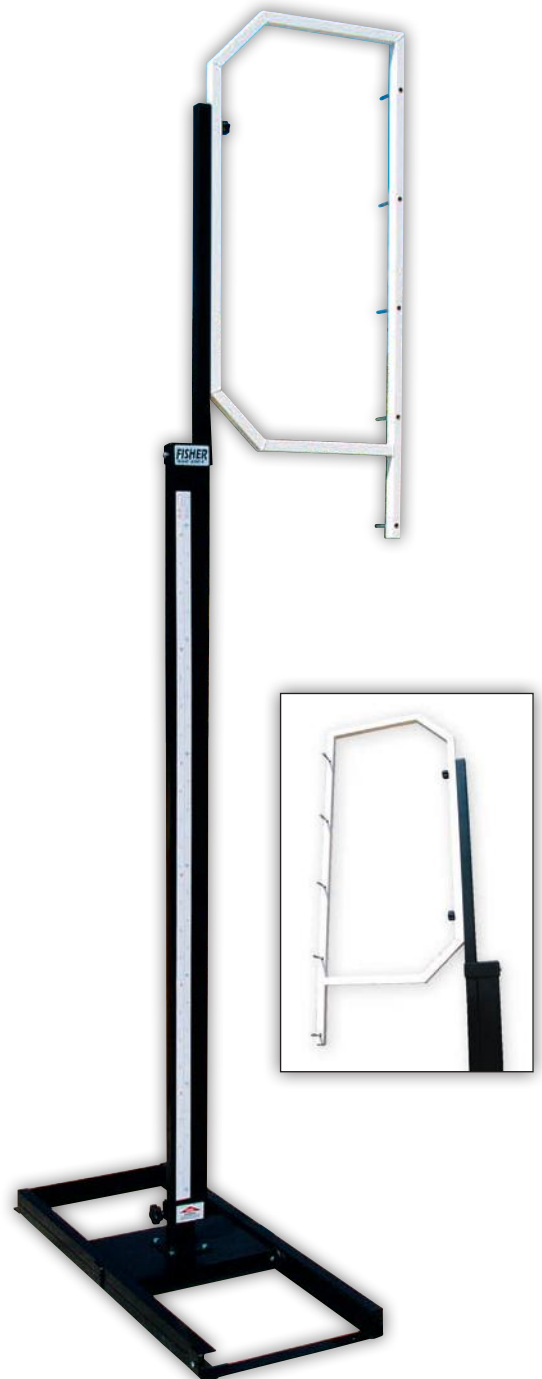

PVST1520 Deluxe Pole Vault Standards

- 1" x 3" powder coated steel tube
- Height from 6' to 18'
- Meets NCAA and NFHS specifications

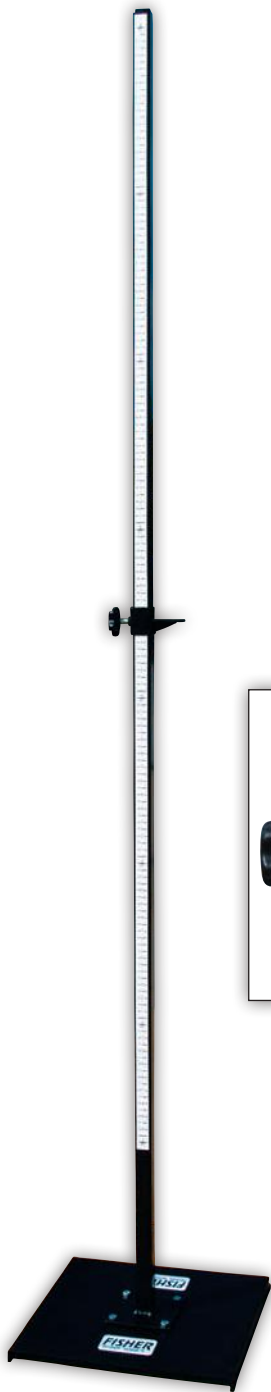

**HJWK1220
Wheel Kit (optional)**

- Fits HJST1220 high jump standards

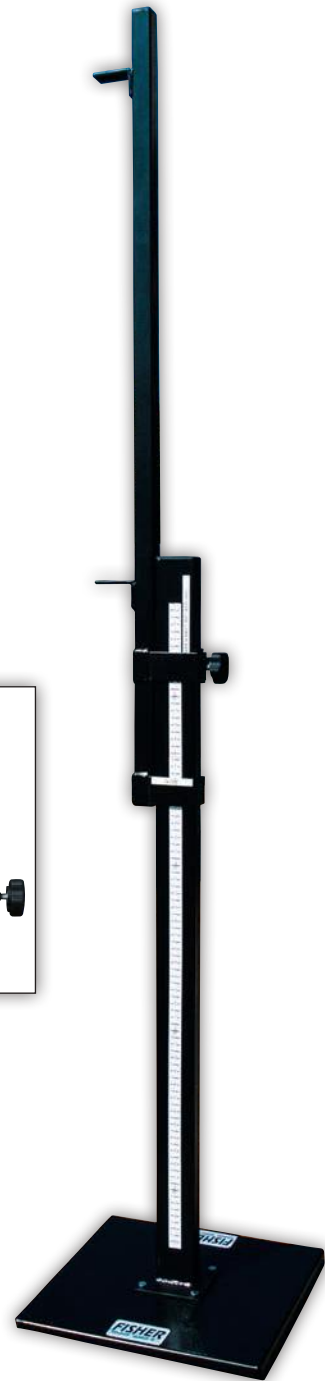

HJST1210 High Jump Standards

- 1.5" x 1.5" powder coated steel tube
- Height from 2'3" to 8'6"
- Meets NCAA and NFHS specifications

HJST1220 Deluxe High Jump Standards

- 1" x 3" powder coated steel tube
- Height from 2'3" to 8'6" with heavy base for stability
- Meets NCAA and NFHS specifications

POLE VAULT STANDARD PADS

PVS246016



PVS26T



PVTAPEMT
Metric scale
PVTAPEIN
Inch scale

**Fits Standards on
pg 10**

**Pole Vault Standard Pad
Model# PVS246016**

Most economical standard pad
Outside Dim: 28"W x 65"L x 16"H
Inside Dim: 24"W x 60"L x 8"H

**26" Tapered P.V. Standard Pad
Model# PVS26T**

Fits all Fisher 26" tall pits
Outside Dim: 28"W x 65"L x 26">22"H
Inside Dim: 24"W x 60"L x 8"H

**32" Tapered P.V. Standard Pad
Model# PVS32T**

Fits all Fisher 32" tall pits
Outside Dim: 28"W x 65"L x 32">25"H
Inside Dim: 24"W x 60"L x 8"H

- Meets ASTM recommendations with at least 8" of padding on top surface and 2" of padding on all sides
- 2 piece units are easy to set up and remove

- Covered in 18 oz. vinyl
- Comes with Velcro® measurement tape for accurate placement of standards through full range of motion

HIGH JUMP STANDARD PAD

VAULT BOX PAD



Fits Standards on pg 11

SS100..... Square High Jump Standard Pad

Dimensions: 22" sq. x 3"H

- Encloses the entire standard base
- 2" x 5" cutout to fit around HJ Standard
- 18 oz. vinyl
- 4 lbs. each



VBP200 Vault Box Pad

- Brightly colored gold pad protects athletes from sharp metal or fiberglass vault box edges
- Does not interfere with the plant area or pole action
- Bright color highlights target area of the vault box
- 18 oz. heavy duty vinyl and 4" thick high density foam
- One size fits all...use with any pit
- Meets ASTM standard F2949 for 2015 track season

All Fisher pole vault and high jump standard pads meet safety standards as set by the National Federation of State High Schools.

CROSSBARS

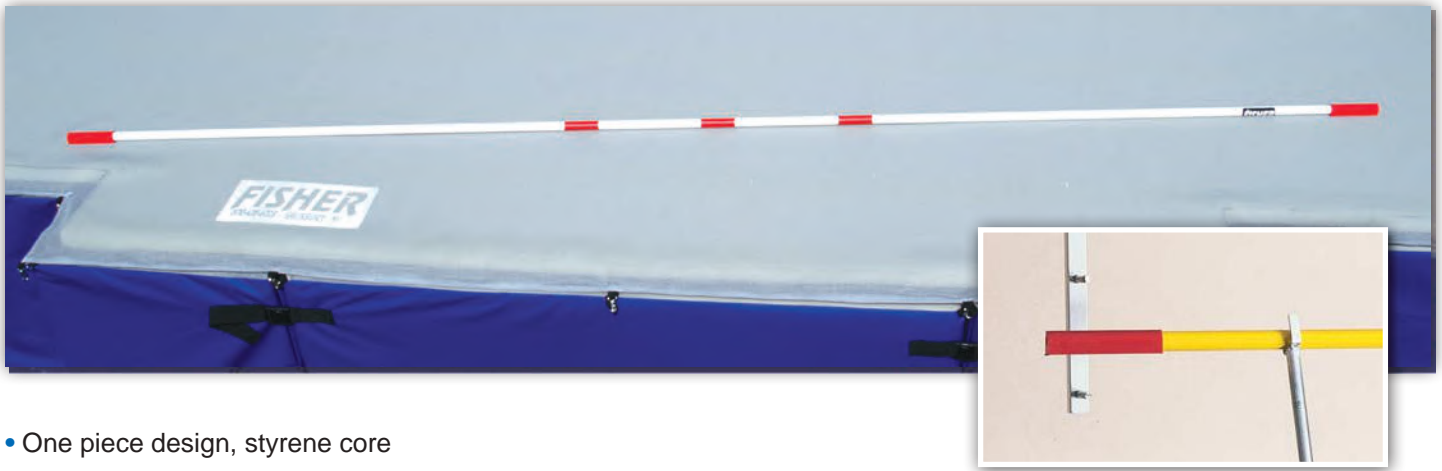

- One piece design, styrene core

Model#	Description	Wt.	Length
BM1502	Standard Pole Vault Crossbar	7 lbs.....	14'-10"
BM1501	Standard High Jump Crossbar	7 lbs.....	13'-1/2"

CROSSBAR LIFTER

Model#	Description	Wt.
CBL100	Steel Crossbar Lifter ..	3 lbs.

A. Cast Aluminum Vault Box

This high quality vault box is designed to give years of trouble-free use. The thick walled aluminum casting will not warp, crack or rust. Inside corners are rounded for easy rotation of pole in box. Ideal for universities, colleges & high schools who are looking for a top of the line vault box that meets all IAAF, NCAA & NFHS specifications.

TAVB Ground 66 lbs.

B. Cast Aluminum Lid

This lid is designed to give attractive level top surface for when TAVB not in use. Lid has textured finish to match look of TAVB but may also have synthetic surface applied to match runway.

TAVBL Ground 33 lbs.

C. Steel Vault Box

Heavy gauge steel featuring a curved front lip which eliminates it as a pole obstacle even when the runway is worn down. Has flared sides and 105 degree angle.

VBS100 Ground 65 lbs.

D. Steel Lid

Steel lid for TSVB

TSVBL Ground 35 lbs.

E. Stainless Steel Vault Box

Smooth, finished stainless steel made of 12 gauge stainless steel will not rust, crack or split. The preferred box for universities, colleges & high schools, where they are looking for a top quality box that will give years of trouble-free use.

TSSVB Ground 65 lbs.

F. Pole Vault Slide Box

This lightweight fiberglass slide box is reinforced for years of heavy use. Bright white, it is highly visible and slides straight way. Use indoors or out for fast development of the most crucial part of the vault: the run and plant.

TPVSB Ground 15 lbs.

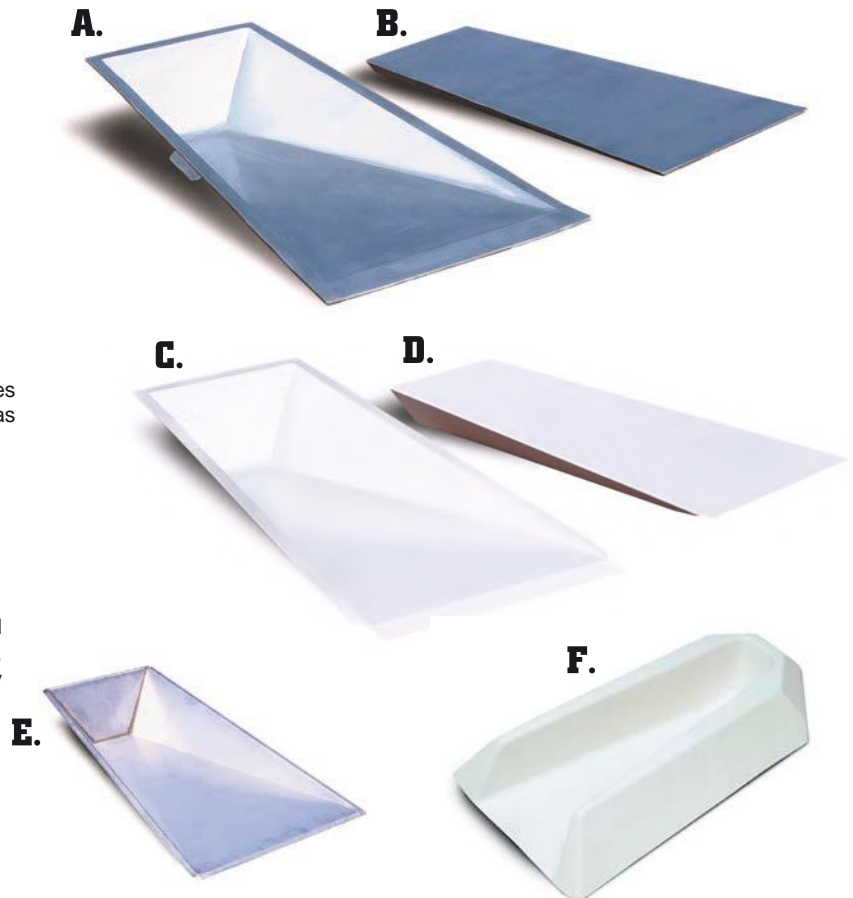

HS1250RA Aluminum Hurdle

- Hurdle height adjusts from 30" to 42"
- Aluminum round tube construction
- Push button adjustment every 3"
- Uprights available in 11 colors
- Free screening on 24 or more hurdles
- Meets National Federation regulations
- Lexan® gate board



HS1450SA Aluminum Hurdle

- Hurdle height adjusts from 30" to 42"
- Aluminum square tube construction
- Push button adjustment every 3"
- Uprights available in 11 colors
- Free screening on 24 or more hurdles
- Meets National Federation regulations
- Lexan® gate board



HSGB Replacement Gate Board
MFG 5842

JACKETS
KINSTON
SAVANNAH H.S.
JACKSONVILLE
PANTHERS
RED DEVILS
LAKE CITY
FAYETTEVILLE
WEST LOWNDES
MONTICELLO H.S.
Bulldogs
COLUMBIA
M. P. MUSTANGS
EAGLES
PIRATES
Sedgefield
BRUNSWICK
BRAVES
VIKINGS
CONCORD

COLORS

Upper frames are available in 11 standard powder coated colors plus natural aluminum.

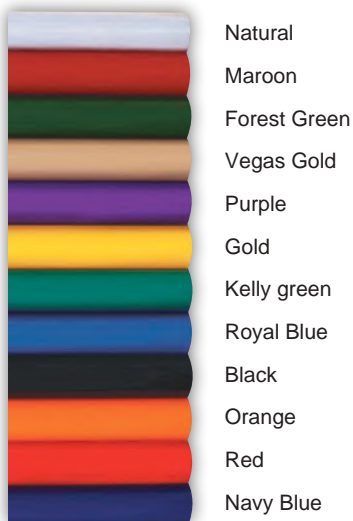

5 position adjustable height

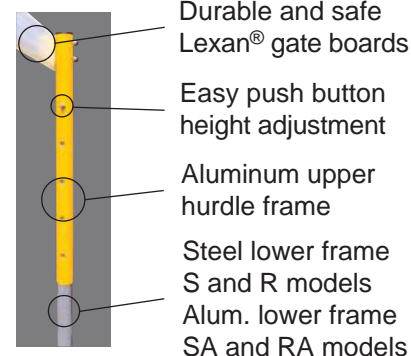



DC1300

DC100 Discus Cage

- Weather treated nylon netting
- 57-½' x 11-½' safe practice area
- (6) 14" sq. steel bases with anchor holes
- 18 anchor stakes for added support

DC100P Portable Discus Cage

- Weather treated nylon netting
- 57-½' x 11-½' safe practice area
- (6) 24" square steel bases
- (6)sand bags included for added support

DC1300 Alumium Discus Cage with ground sleeve

- (6) 2.5" square x 13' 6" angled poles
- (6) 3" x 3" x 30" ground sleeves
- (1) 504 Barrier Net

DC100NET Discus Cage Net (fits DC100 and DC100P)

Hurdle Cart

Model	Description
MHC	Hurdle Cart

- All aluminum construction
- Holds up to 16 hurdles
- 4 pneumatic wheels
- Wheels at handle end swivel for easy handling





Tray System

This 8" wide tray system is the most popular tray system for both the college and high school market. The 8" wide board meets all the specifications for college and high school. The weatherproof high-density urethane top surface of the board makes an excellent rake off surface. The take-off board is mounted to a steel framework with 6 adjusting bolts so that you can level the board with the runway surface. The heavy-duty tray is made of bright zinc plated steel.

TTSS Ground 75 lbs.

International Take-Off Tray System

Made the same as our TTSS board with the addition of a foul board and cover. Foul board is made of 1/2" plywood and can easily be taken out and plasticine put in for meets. Cover is made of heavy-duty steel.

TTICS Ground 105 lbs

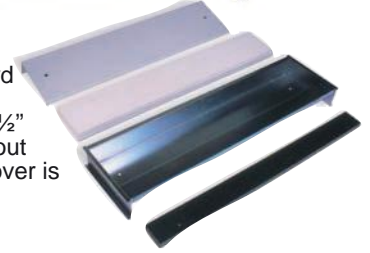

Poly High School Take-Off Board

New problem solving technology Poly take-off board eliminates durability and cracking problems often experienced in wood boards. Long lasting poly surface comes with a 5-year warranty. This two part poly board has a softer texture 3/4" top board for better plants. Attached to high density 3/4" grey poly under board to eliminate warping.

TPOLYTB Ground 48 lbs.

Long Jump/Triple Jump Take-Off Board

This official take-off board is made with the same technology as our TPOLYTB board. 48" long by 8" wide. 3/4" polyurethane top surface on 1-1/2" x 8" plastic underboard.

TLT Ground 32 lbs.



Official High School Take-Off Board

Complies with current high school rules. 1-1/4" X 20" X 48" marine grade plywood board sealed, primed, and finished with a white enamel paint.

THSTB Ground 32 lbs.



Tray for THSTB

For permanent installation in synthetic runways, this 48" x 20" stainless steel tray system works with our THSTB take-off board. Drain holes for all weather conditions.

THSTBT Ground 36 lbs.

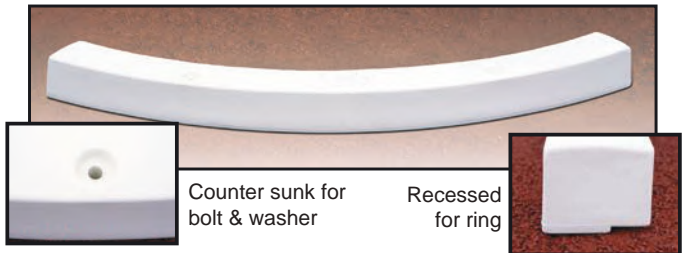

Poly Toe Board

Our Poly Toe Board has been redesigned with cross-link polyethylene and UV stabilizer for maximum durability. This design eliminates the potential for rusting, common in metal boards, and its solid construction prevents chipping and cracking often seen with wood or fiberglass boards.

TPTB Ground 15 lbs.



A. Cast Aluminum Toe Board

Cast aluminum construction, meets all rule specifications. Designed for level pads.

TATB For level pad (most common) Ground 24 lbs.

TATB-DP Depressed Pad Ground 20 lbs.



Wood Discus

- Seasoned hardwood with steel outer rim
- Meets H.S. & college reg's.

DW476.....2 Kilos-College
DW477.....1 Kilo Discs
DW478.....1.61 Kilo-HS Boys
DISC200...2-Discus Bag

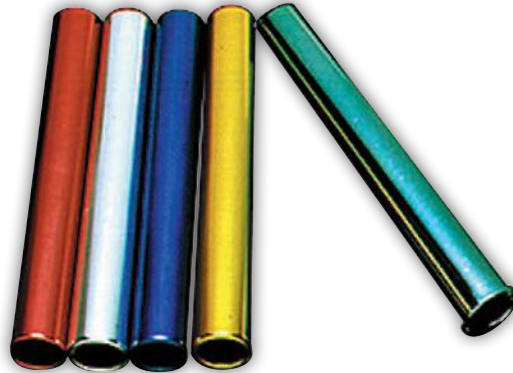

Batons

- PB**..... Plastic Baton (gold only)
AB Aluminum Baton (specify colors)
- Safety rounded ends
 - 6 colors: black, gold, green, royal, scarlet, silver



Rubber Discus

- Solid 1 piece construction
- Molded for close tolerance in size and weight
- Meets H.S. & college reg's.

DR576 2 Kilos-College
DR577 1Kilo Discus
DR578 1.61 Kilo-HS Boys
DISC200.. 2-Discus Bag



Cast Iron Shots

- Conform to all high school and collegiate specifications

SPC6 6 Pound Shot
SPC8 8 Pound Shot
SPC12... 12 Pound Shot
SPC16... 16 Pound Shot
SPC4K... 4 Kilo Shot



Indoor Shots

- Lead filled and sealed with a plastic plug
- PVC plastic shell

SPP8 8 Pound Shot
SPP12 ... 12 Pound Shot
SPP16 ... 16 Pound Shot
SPP4K... 4 Kilo Shot

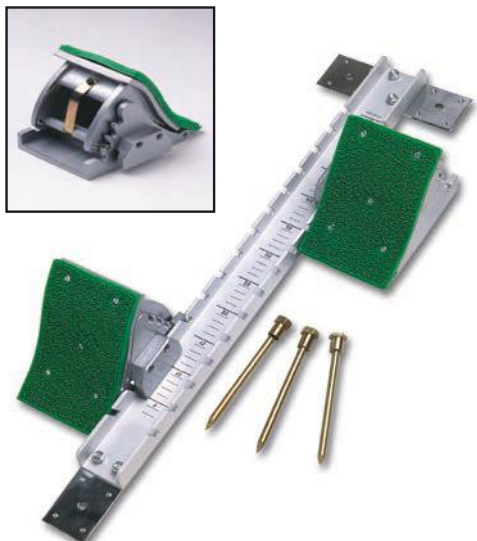

Championship Starting Block

- 5" wide 4-position adjustable pedals
- 2-½" center rail
- Lightweight aluminum construction
- Fitting High School and College competition
- Anchor spikes and all-weather spikes included

TCHAMP Ground 11 lbs.

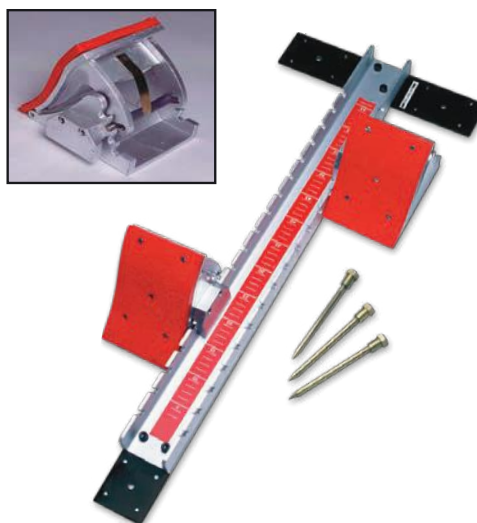

Cheetah Elite Aluminum Starting Blocks

- 5" wide 4-position adjustable pedals
- 3" center rail
- Lightweight aluminum construction
- Fitting Collegiate and International competition
- Anchor spikes and all-weather spikes included

TCEB Ground 16 lbs.

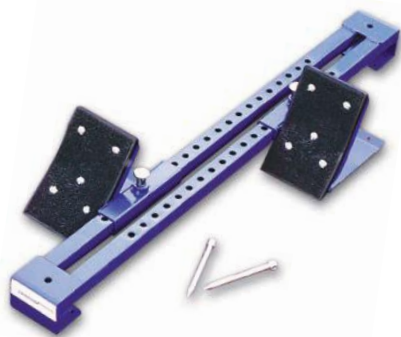

Olympian Adjustable Starting Block

- 4" adjustable pedals
- Pedal adjusts to virtually ANY angle
- Snap lock plunger locks pedals into position quickly
- Includes all-weather and anchor spikes with adjustment wrench

TOLY Ground 12 lbs.

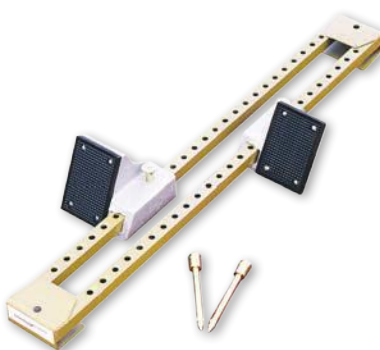

Speed Star Starting Block

- Adjustment pins are spring loaded so pedals can be quickly moved
- Includes all-weather spikes and anchor spikes

TSTAR Ground 11lbs.



Wide Track Starting Block

- 5" wide pedals
- Spring loaded pedal adjustment pins
- Includes all-weather and anchor spikes

TTRACK Ground 11 lbs.



Indoor Starting Blocks

- Red rubber blocks (color may vary)
- Adhere to any clean floor without glue
- NO holes in floor
- Removes easily from floor surfaces

TISB Pair Ground 9 lbs.

Long Jump Pit Covers

Mesh Pit Covers

- Protects your pits from weather
- 12' x 18' mesh
- 14 anchor pockets
- Made with vinyl coated mesh

LJC100..... Pit Cover
LJPC1125 Pit Cover
LJCSO..... Special Size Pit Cover



Roll Out Runway

Roll Out Runway

- Made to be rolled over existing worn out runways
- Use as a protective surface on all-weather track during football games or other activities
- Made with black rubber/urethane mix.
- Custom lengths are available
- Minimum order of 50'

SR34B 3' W x 1/4" thick Quote
SR44B 4' W x 1/4" thick Quote
SR38B 3' W x 3/8" thick ... Quote
SR48B 4' W x 3/8" thick Quote
 (prices per square foot)



TITAN SIDELINE TRACK PROTECTOR

Track Protectors available in our 12 oz. Titan Mesh material. Titan Mesh is available in (11) color options: grey, beige, black, red, royal, columbia blue, purple, orange, navy, forest green and maroon. Custom color graphics available.

Titan mesh allows for water to easily flow through without retaining any moisture. Titan Mesh is spike-proof, which means there is no risk of players walking over it on the way to the field. Available sizes listed below.

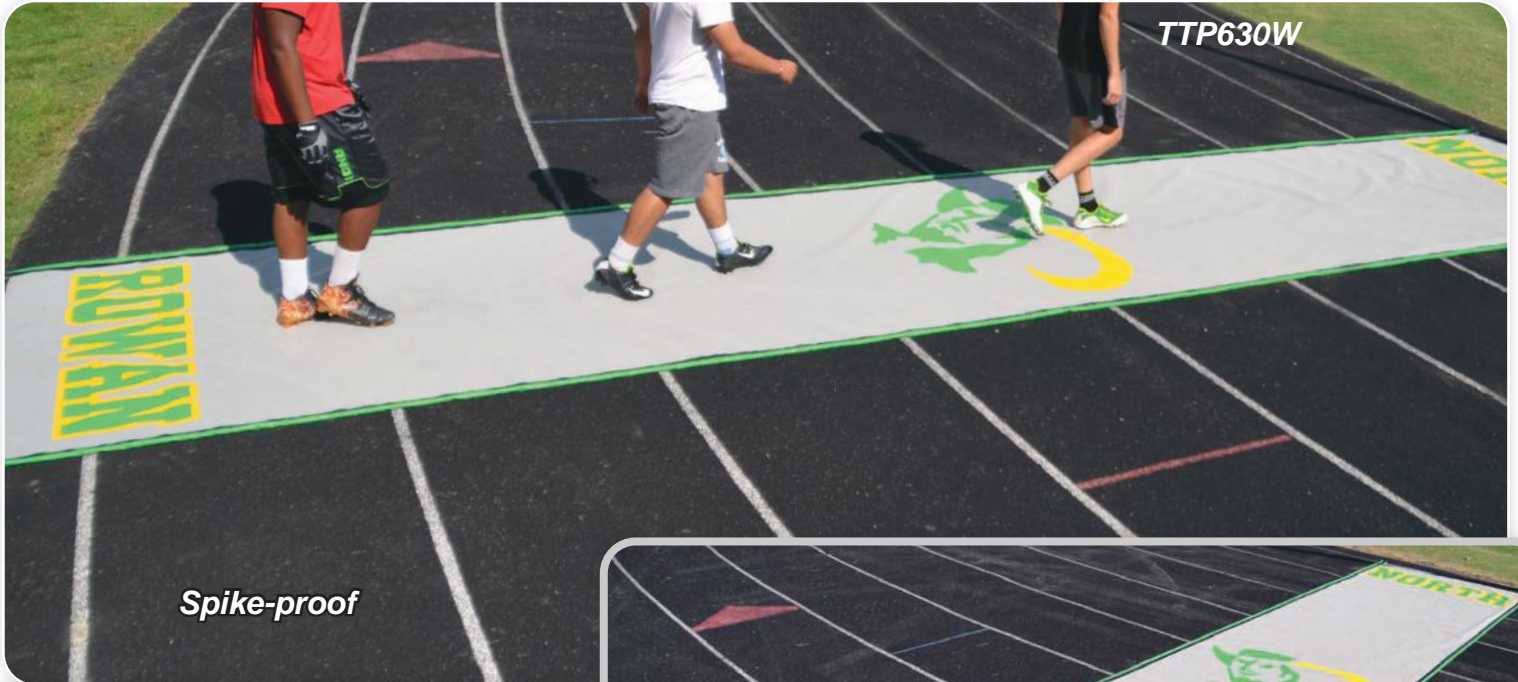

Spike-proof



Customize with school colors and add your team mascot or logo.

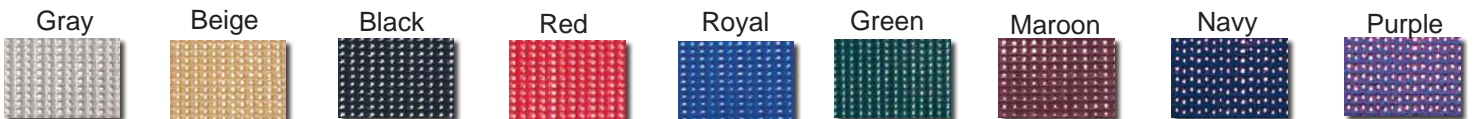

Model#	Description	Dimensions
TTP630	Titan Track Protector.....	6' W x 30' Long
TTP630W	Titan Track Protector weighted	6' W x 30' Long
TTP1230	Titan Track Protector.....	12' W x 30' Long
TTP1230W	Titan Track Protector weighted	12' W x 30' Long
TTP1830	Titan Track Protector.....	18' W x 30' Long
TTP1830W	Titan Track Protector weighted	18' W x 30' Long
TTPSO	Custom Titan Track Protector	
TTPSOW	Custom Titan Track Protector weighted	