

GENORAY



**Plus**  
**PAPAYA Slim**

The World's First & Only  
3-in-1 OPG Unit  
Panoramic  
Cephalometric &  
Semi-Tomography Imaging

**UNICORN DenMart** <sup>®</sup>  
Behind The Best Indian Dentists

## In House Manufacturing

**G**enoray is a Medical & Dental equipment manufacturer that offers in-house manufacturing of its products. This means that the company has complete control over the production process, from design to assembly, allowing for strict quality control. Genoray's in-house manufacturing capabilities include injection molding, PCB assembly, cable assembly, and final product assembly. By keeping manufacturing in-house, Genoray ensures that its products meet high standards of quality and reliability while also allowing for faster turnaround times and the ability to make modifications quickly. This approach enables Genoray to maintain a competitive edge in the market and provide its customers with top-quality medical & dental equipment.

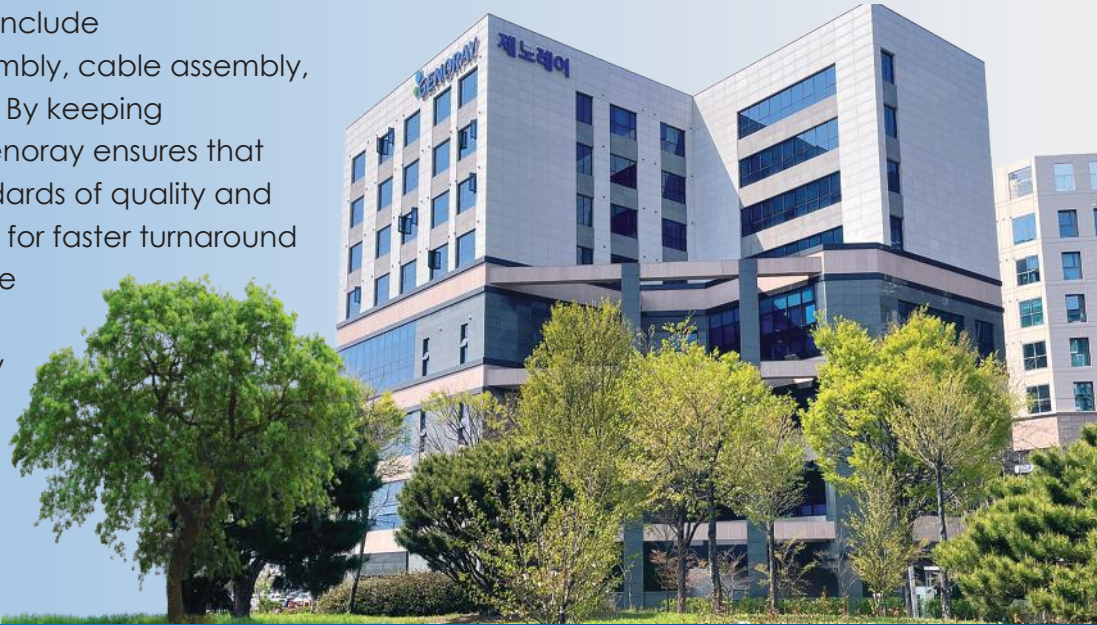

### Continuous R&D Investment

- ▲ 8-10% Investment in Annual Sales
- ▲ 30% of all Researchers have Masters & Doctorates
- ▲ R&D Performance - 72 Cases (Government, External & Self)
- ▲ Intellectual Property - 47 Patents, 27 Trademarks
- ▲ Certification Status - 85 Cases (Domestic & International)



### R&D through cross-over by Different Sectors

- ▲ Integrated Management of Medical & Dental Research
- ▲ Specialized Technology by Sector - R&D



### Internalization of Core Technology

- ▲ Manufacturing Technology of X-Ray Generators
- ▲ Inhouse development of Flat Panel Detectors
- ▲ 3D Image Processing with Correction Algorithm
- ▲ Dedicated Software Development - THEIA, TRIANNA

## Ultimate Panoramic Imaging

High Resolution X-Ray Imaging System

PAPAYA uses the advanced CMOS sensor, which improves image quality while keeping radiation exposure to a minimum, Genoray has shown that it puts patient's safety first.



## Multi-Focus Function

Improves Image Analysis & avoids the need of re-exposure.

The Multi-focus function overcomes patient mis-positioning. The user is therefore able to find the most optimally-focused choice from a selection of images.

**5 panoramas**  
**OPTIMAL IMAGE**



## Protection From Unwanted Radiation

Segmental selection 2D scan saves from unwanted radiation.

## User Friendly

PAPAYA increases user friendliness while maximizing efficiency



**Face-to-face positioning**



**Multi-role remote with emergency stop switch**

Machine's and hand switch's LED display shows the current status of machine



**9 different jaw shapes**

Fit each individual's jaw shape



**Voice support system**

Machine's operation status is guided by voice support system



**Wheelchair accessible**



**Dental Crop**

Provides full mouth IOS images

According to exposure mode, LED color changes.



## 20 Different Exposure Modes

Different 2D images for various diagnosis purpose

PAPAYA supports various exposure programs, fulfilling all diagnostic needs.

Standard panoramic, orthogonal panoramic, bitewing panoramic, child panoramic, TMJ lateral double, horizontal & vertical X-ray segmentation, TMJ PA double, TMJ LAT-PA, TMJ LAT-PA double, sinus lateral, sinus PA and CUST are supported.



<b>Panoramic</b>	Standard	Orthogonal	Bitewing	<b>TMJ</b>	Lateral	PA	Double Lat-PA
<b>Sinus</b>	Lateral	Lateral Mid	PA	<b>CUST</b>	Cross Section		
<b>Cephalometric</b>	Lateral	AP	PA	Water's View	SMV	Carpus	

## Smart & compact design!

Papaya: This smart design will allow for easy and fast setting installation.

Not only that, its compact design requires minimum space & is easily accessible for your patients.



Fast, HD & Normal Scan Mode



User friendly LED indication

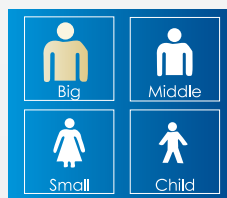

4 different patient selection



Even more, Tomography! (optional)

## Tomography Imaging

### Cubical Semi-Tomography Technology (CUST)

PAPAYA CUST is a 3D imaging function that provides cross-sectional information for **implant planning**.

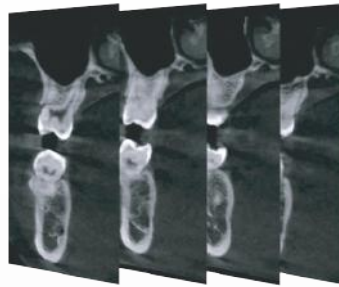
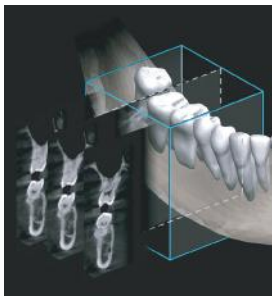

**Dental Cross Sectional View**

- ▲ Complements the panoramic image and provides a tomographic image required for implant planning
- ▲ When planning the implant, CUST images help the patient understand the procedure
- ▲ PAPAYA with CUST function is economical compared to CBCT



## Exposure Programs

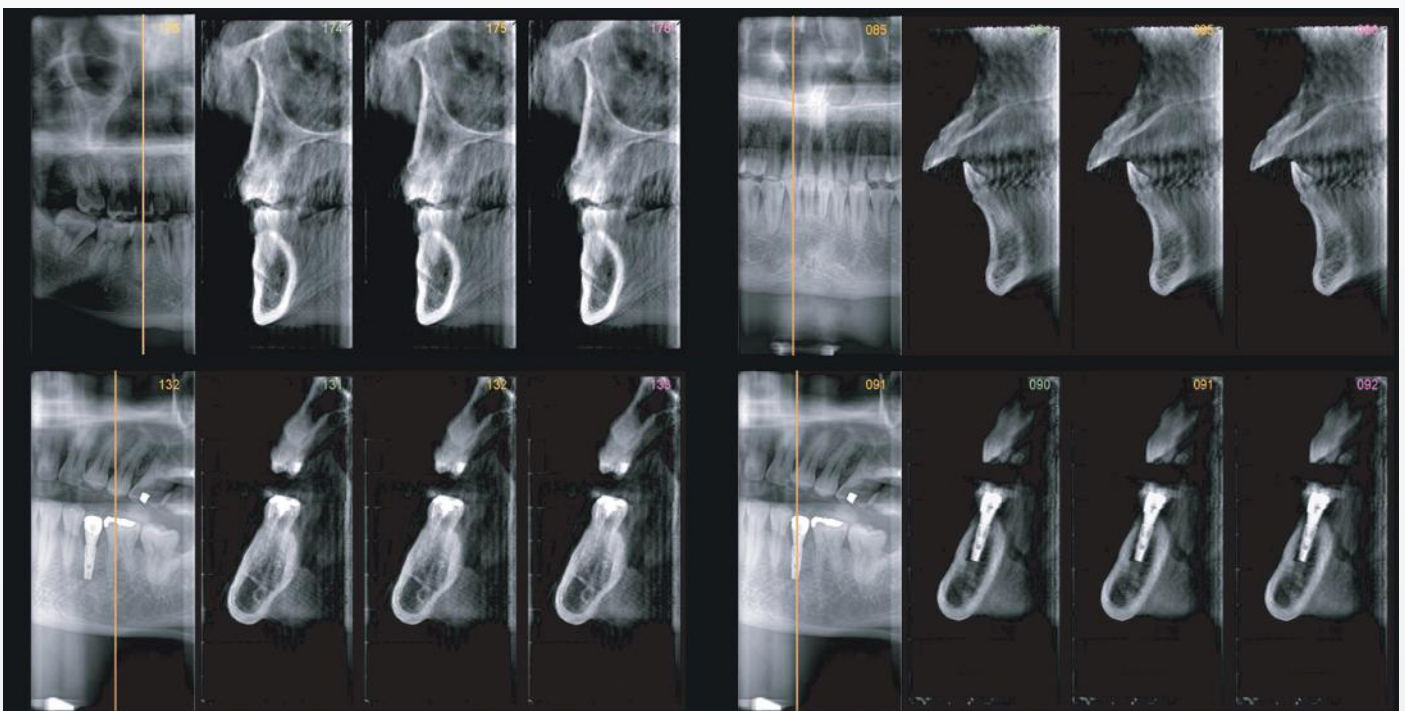

## Cephalometric

Advanced Solution For Orthodontic Diagnosis

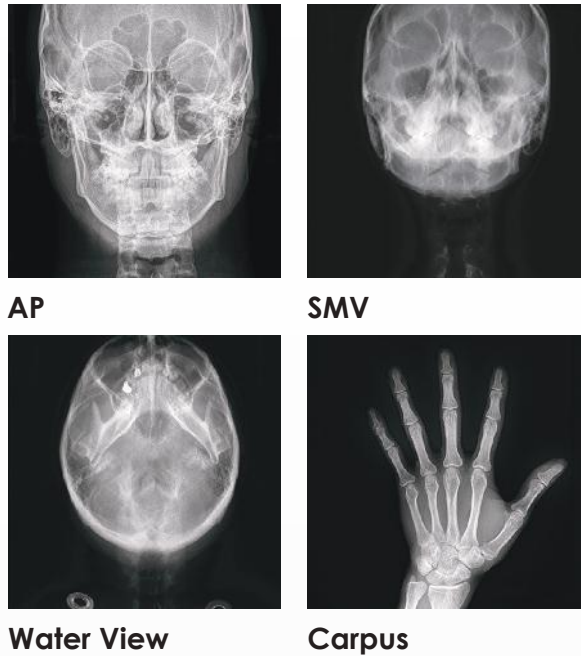

- ▲ The optimized mechanical structure is designed for symmetrical balance, enhanced safety and durability
- ▲ To optimise result, the sensor automatically positions for each exposure mode
- ▲ Only 4 seconds for scanning, a cephalo image in fast mode reduces motion artifacts

## PAPAYA Operational Software

PAPAYA exposure modes are prepared and initiated using clear step by step pictorial software.



# TRIANA

TRIANA is able to manage all images from all devices. (panoramic, cephalometric, intraoral sensor, CBCT, Intraoral camera and digital camera)

Image viewing	Zoom, Panning, Comparing, Window leveling
Measurement	Distance, Angle
Annotations	Line, Arrow, Text, Stamp
Implant simulation, DICOM 3.0 compatibility	Storage (DICOM send), film printer, worklist etc
Image enhancement, Printing	Paper, Film printer, WYSWYG
Image import/export	bmp, jpg, gif, png, dcm etc

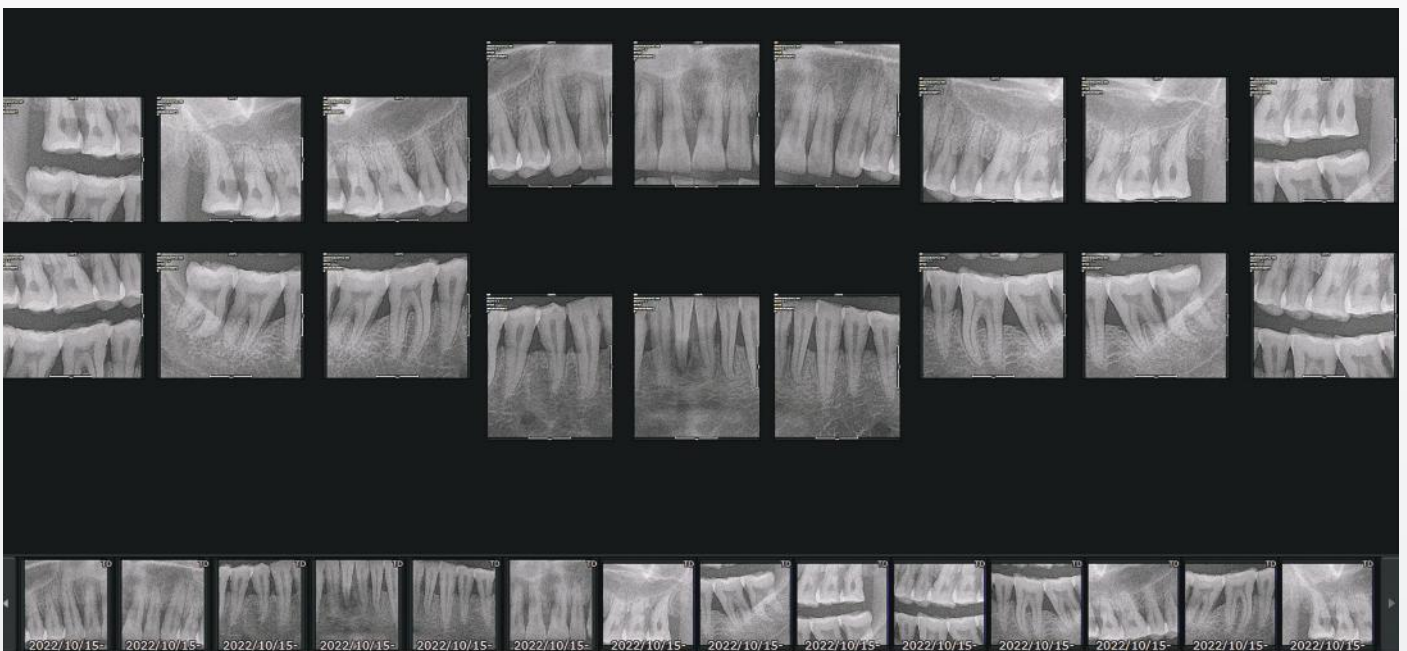
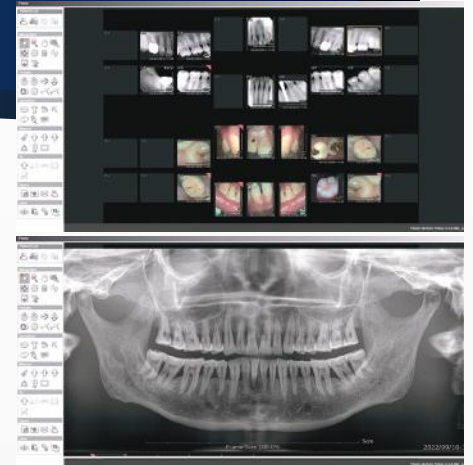

### Technical Specification - PAPAYA

Exposure Time	4-17 sec
Focal Spot	0.5mm
Target Angle	5°
Sensor Tehnology	CMOS
Maximum Tube Voltage	90kV
Minimum Tube Voltage	60kV
X-Ray Tube	Canon

### Sensor

	PAPAYA	PAPAYA Plus
Pixel Pitch	75x75 µm	75x75 µm
Active Area	152x6.5 mm	228x6.5 mm

### CUST Specification

X-ray beam	Fan Beam
Volumetric image size	50X50X103 mm
Number of slices	256
Slice thickness	0.195 mm
Measurement error	<1 mm

## Dimensions

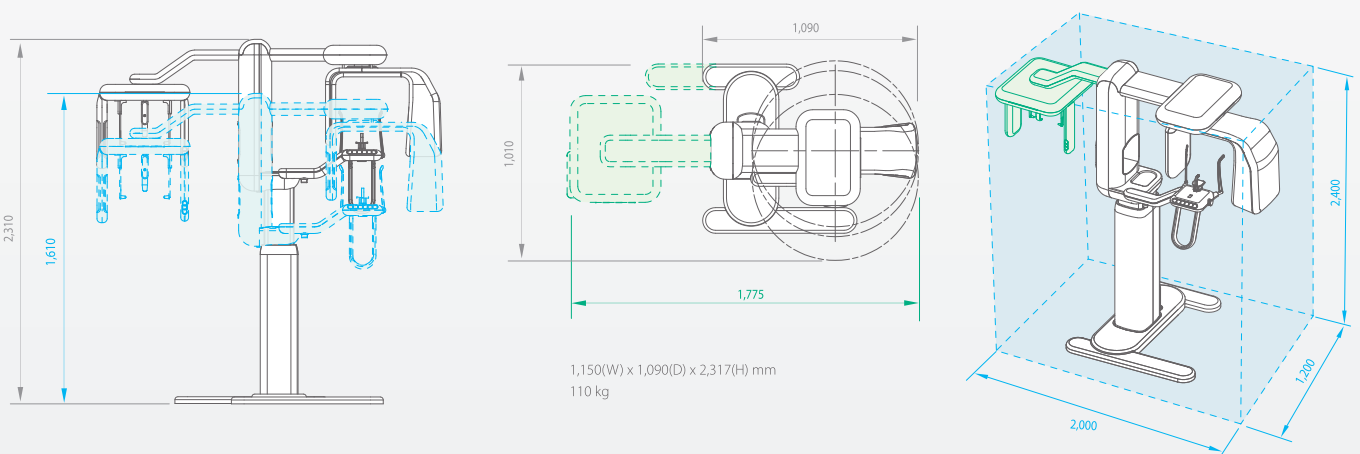



**GENORAY**

# PAPAYA 3D<sup>Plus</sup>

Combination Imaging System

**1 Scan 3 Images**

**3 Dedicated Detectors**

CBCT

Panoramic

Cephalometric



**UNICORN DenMart<sup>®</sup>**  
Behind The Best Indian Dentists

**FUTURE OF IMAGING**

### 3 Dedicated Detectors

The Genoray Papaya 3D is equipped with three dedicated detectors that enhance its imaging capabilities. These dedicated detectors of the Genoray Papaya 3D work in synergy, enabling clinicians to obtain high-quality, detailed images for accurate diagnoses and effective treatment interventions.



### 1 Scan 3 Images

The Genoray Papaya 3D imaging system revolutionizes dental diagnostics with its advanced capabilities. One scan with this cutting-edge device captures three highly detailed images, providing clinicians with a comprehensive view of the patient's condition.

### All Axis Motorized Movement

(Up/Down/Left/Right)



CBCT



Panoramic

Ceph



## Multi-FOV Selection

Multi-F.O.V. selection enables accurate scanning whilst keeping dose levels to a minimum.

**φ 4X5**



### Endo

Endodontic

75 μm

Endo mode shows high definition images

**φ 7X7**



### Teeth

High Resolution | High Definition

100 μm | 150 μm

High contrast images of upper / lower jaw enable accurate diagnosis

**φ 8X8**



**φ 16X8**

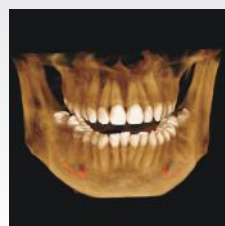

### Jaw

Normal Resolution

200 μm

Provides an image of the full arch

**φ 16X14**

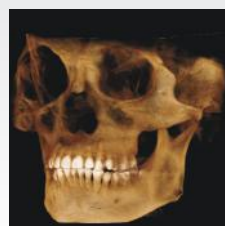
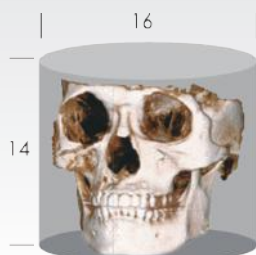

### Face

Normal Resolution

400 μm

Full arch including relevant bone areas

# High Resolution Computed Tomography Technology

Clearly defined images in three dimensions provide users with accurate diagnostic information

## 3 in 1 CBCT



**CBCT**



**PANORAMIC**



**CEPHALOMETRIC**

### Automated Sensor Switching

#### Auto-Swing



### Fast Scanning Mode

Scanning times as low as 7.7 seconds reduces dose, motion artifacts and image distortion.

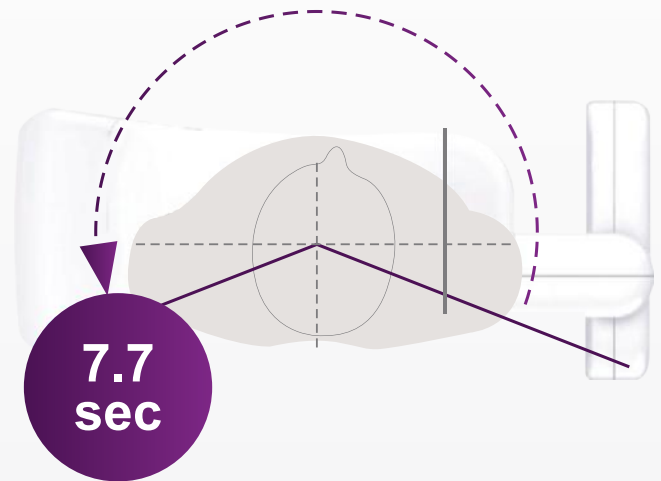

### Auto Dual Scanning CT Technology

The wide high definition images can be enhanced by auto dual scanning technology.

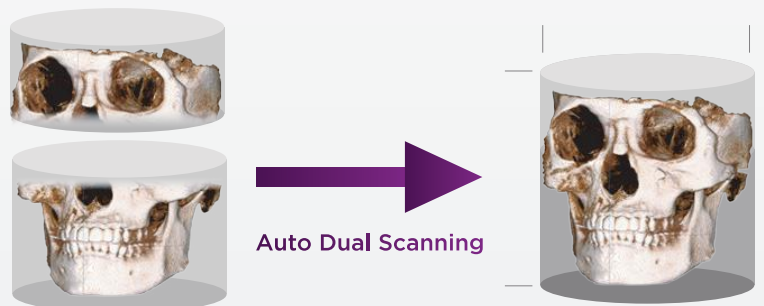

## Improved Image Processing

**SMARF™ (Smart Metal Artifact Reduction Function)** minimizes the effect of metal artifacts caused by prosthetics to prevent image degradation.



Without SMARF



With SMARF

## Cephalometric

Advanced Solution For Orthodontic Diagnosis



AP

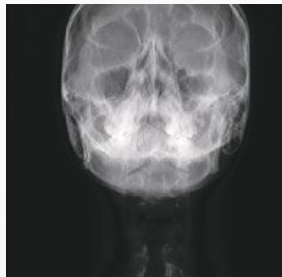

SMV

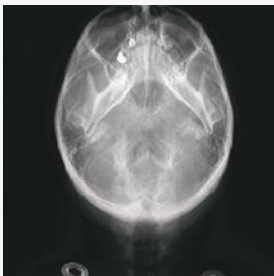

Water View



Carpus



- The optimized mechanical structure is designed for symmetrical balance, enhanced safety and durability
- To optimise result, the sensor automatically positions for each exposure mode
- Only 4 seconds for scanning, a cephalo image in fast mode reduces motion artifacts

# PAPAYA 3D Operation Software

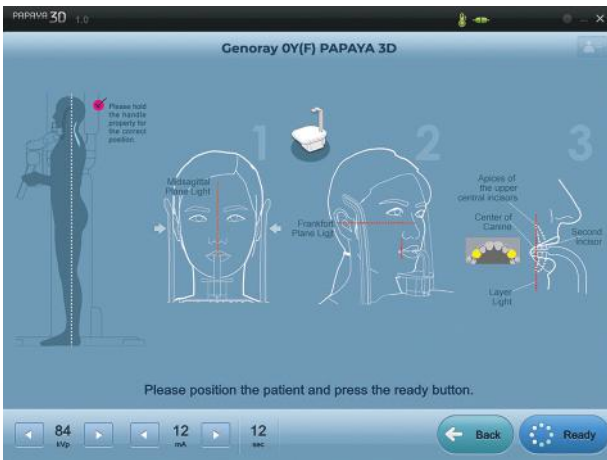

Panoramic Patient Positioning Guide



CBCT Mode

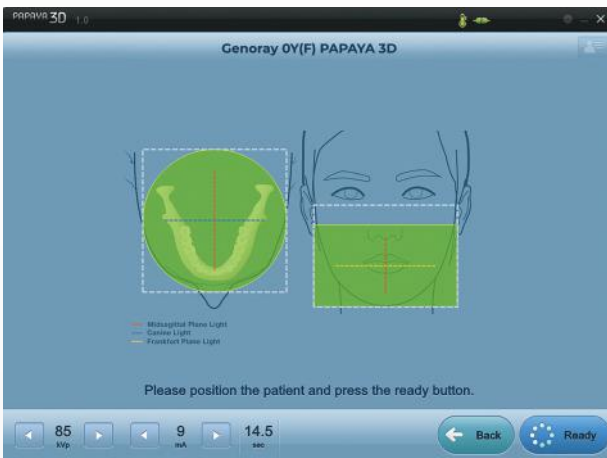

CBCT Patient Positioning Guide

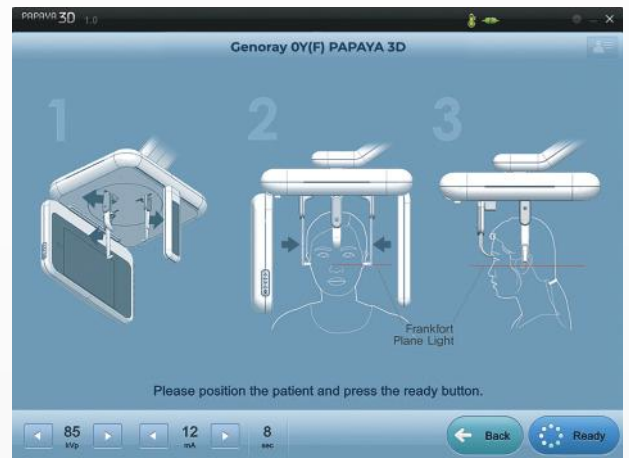

Cephalometric Patient Positioning Guide



Cephalometric Mode



Auto-Positioning Function

# **Invivo6**

Advanced 3D Imaging Software

The Invivo dental software is backend by Anatomage, Inc. Which is a medial imaging company composed of a cross-functional team consisting of the most elite researchers, mathematicians, engineers, software developers, business analyst, industry leaders, academic faculty and dental specialists.

**POWERFUL**

**MARKET LEADER**

**ONE SOFTWARE FOR ALL MODALITIES**

**RELIABLE**

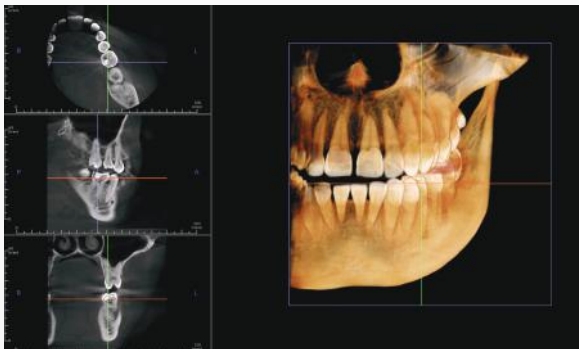
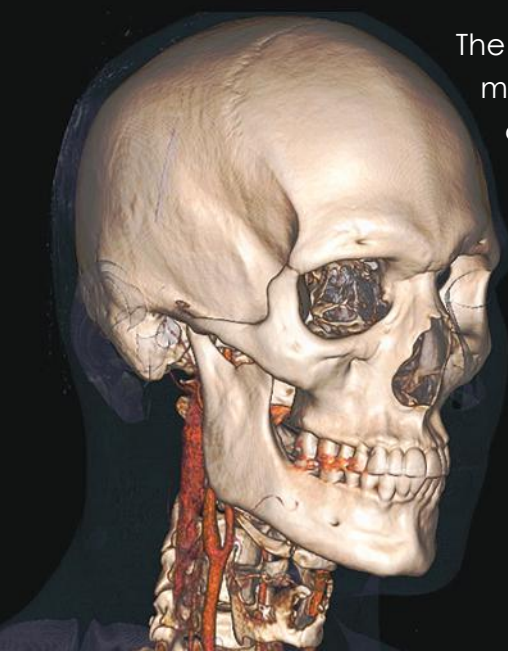

**Layout**

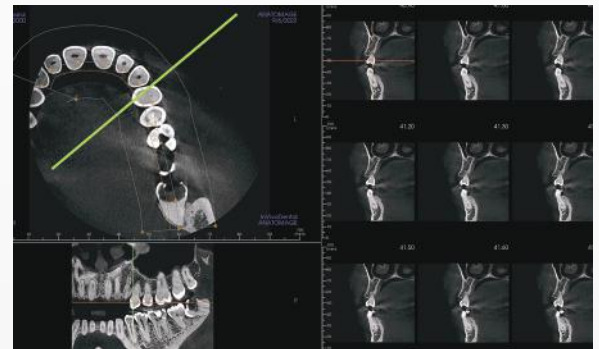

**MPR**



**Section View**



**Pano View**

# In vivo 6

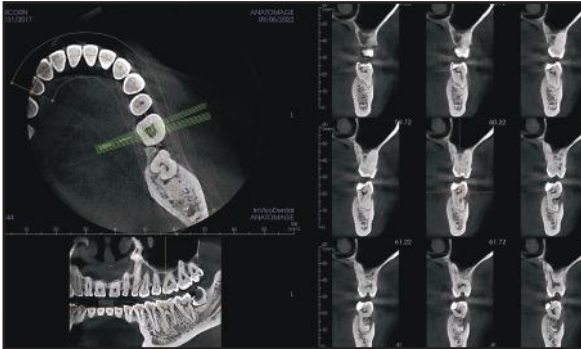

Arch View

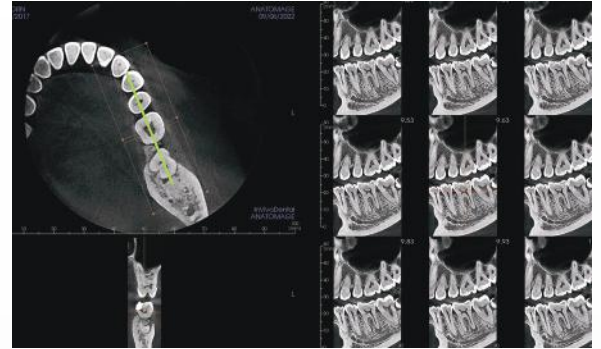

Arch View

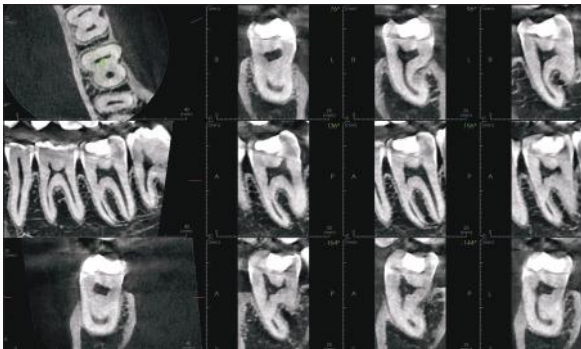

Endo View

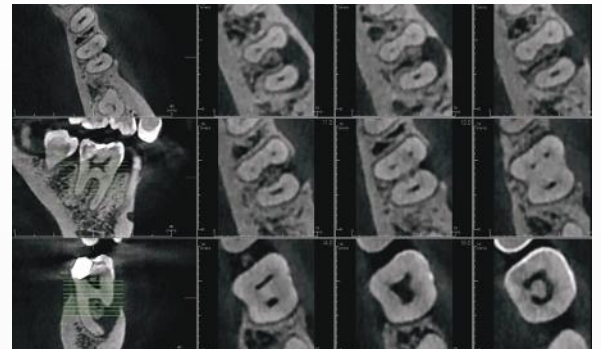

Endo View

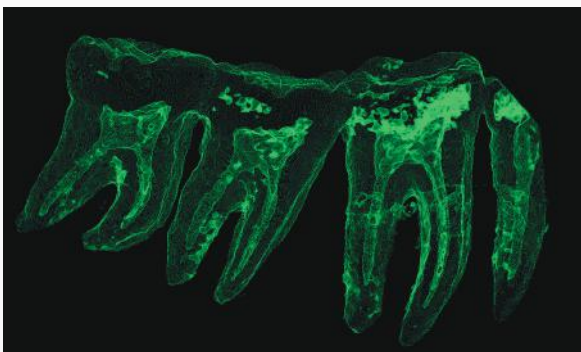

Endo View

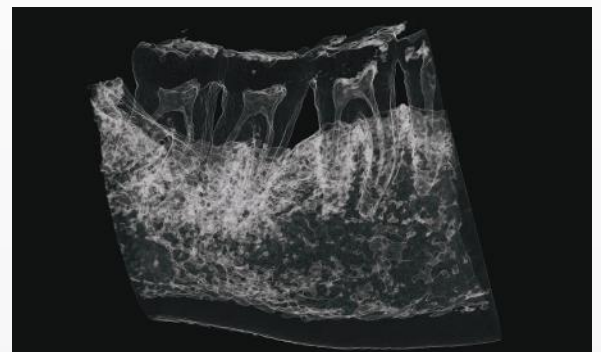

Endo View



TMJ View

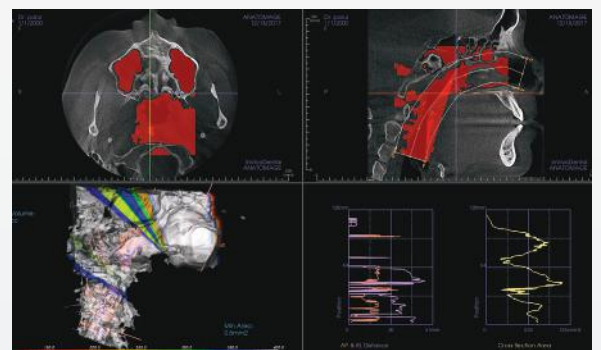

Airway Analysis View



## 3D CT

### PAPAYA 3D Technical Specification

Exposure Time	Panoramic	9 ~ 17 sec
	Cephalometric	-
	CT	7.7/14.5 sec
Voxel Size	75~400 μm	
Focal Spot	0.5mm	
Target Angle	5°	
Tube Voltage	60 ~ 90kV	
Tube Current	4~12 mA	
Gray Scale	14 bit	

### Sensor

Exposure Time	CT	Panoramic	Cephalometric
Pixel Pitch	100 x 100 μm	75 x 75 μm	75 x 75 μm
Active Area	130.2 x 128 mm	152 x 6.5 mm	228 x 6.5 mm

## Dimensions

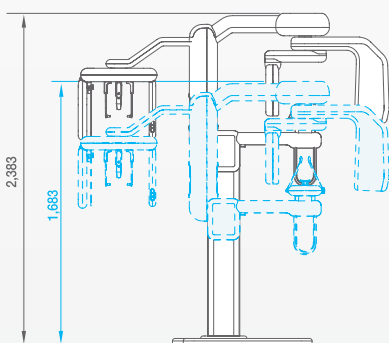

#### PAPAYA 3D

1,203(W) x 1,131(D) x 2,383(H) mm  
145 kg

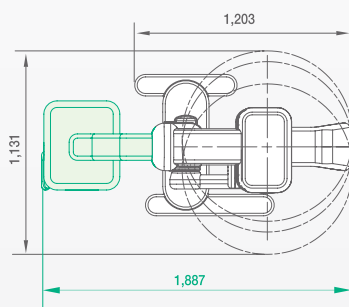

#### PAPAYA 3D Plus

1,887(W) x 1,131(D) x 2,383(H) mm  
160 kg

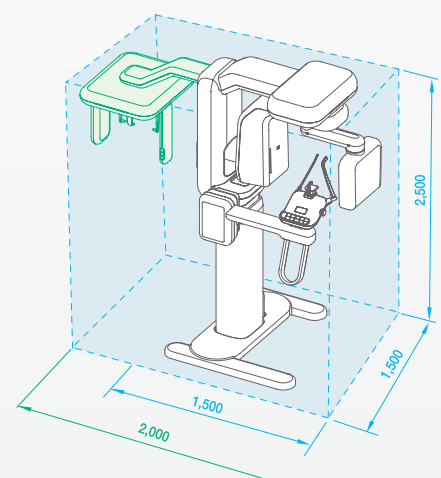

# RADIOGRAPHIC EXCELLENCE



**GENORAY**

CBCT, Panoramic, Cephalometric, Model Scanning

**PAPAYA 3D** Premium Plus

4-in-1 CBCT Machine



**UNICORN DenMart**®  
Behind The Best Indian Dentists

## CBCT

### Free F.O.V & Dose Reduction:

Provides various F.O.V sizes and resolutions for all diagnostic needs.

Produces optimized images with minimal radiation exposure.

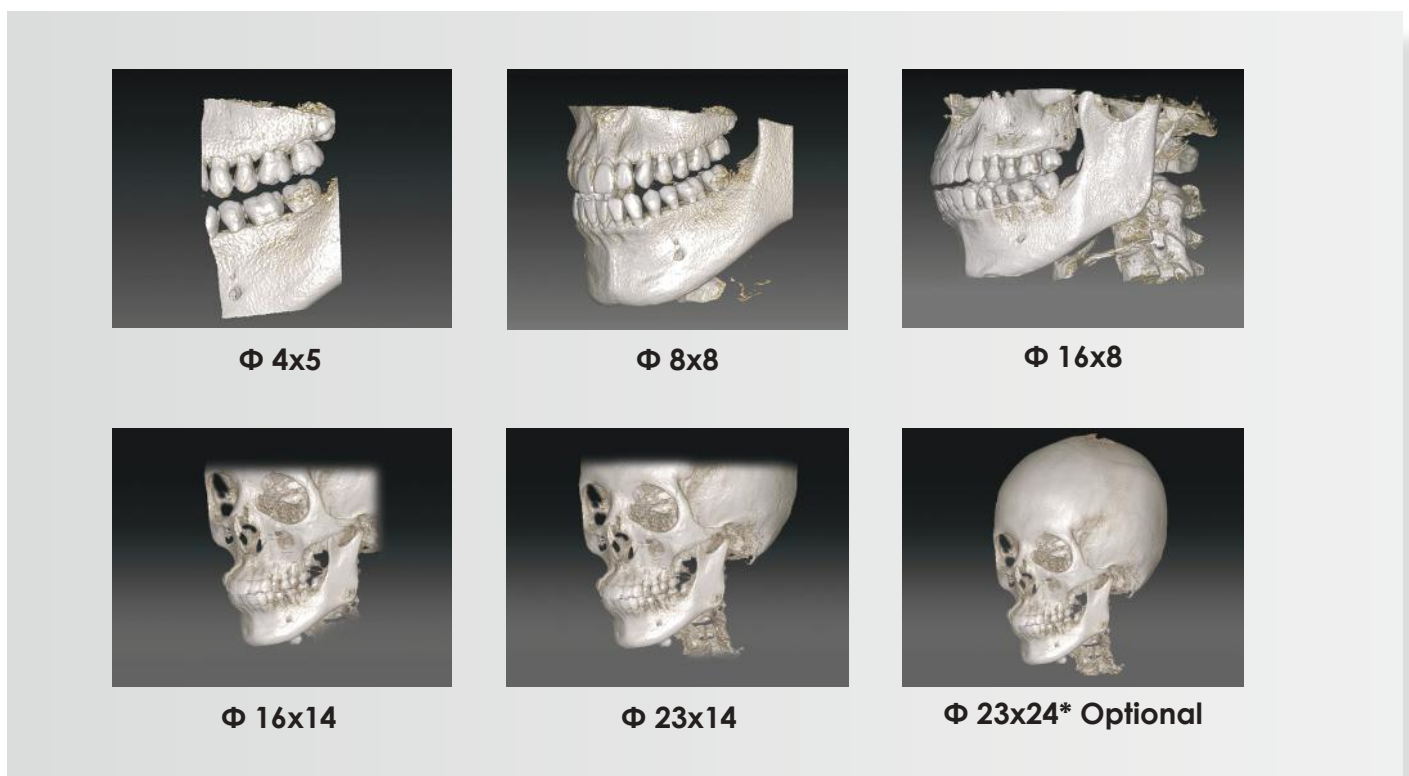

# Panoramic

## Multi Focus

Helps acquire the best optimized image from the multiple panoramic images acquired. The multi-focus function overcomes patient mis-positioning. The user is therefore able to find the most optimally-focused choice from a selection of images.



Standard Panoramic  
Orthogonal Panoramic  
Bitewing Panoramic  
TMJ PA Double  
TMJ LAT-PA Double

TMJ Lateral Double  
TMJ LAT-PA  
Sinus Lateral & Sinus PA  
Child Panoramic  
Segmented View

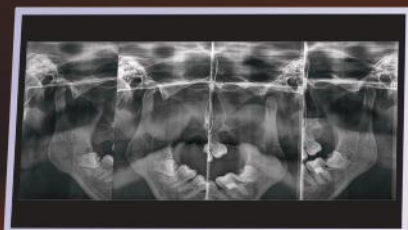
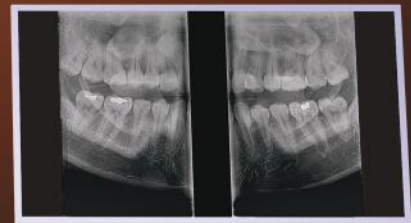

# Ceph



Ultra fast mode (2 sec)

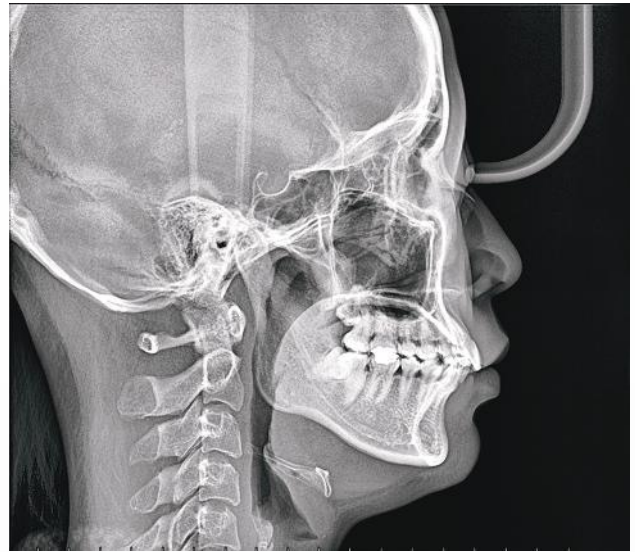

Normal mode (8 sec)

## Various Radiation Exposures



**HD**



**Normal**

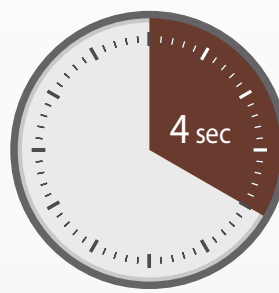

**Fast**

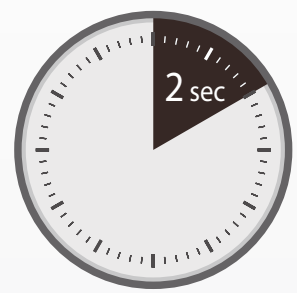

**Ultra fast**

## Multiple Exposure Modes For Cephalometric

Lateral, AP, PA, Water's view, Submento vertex and Carpus

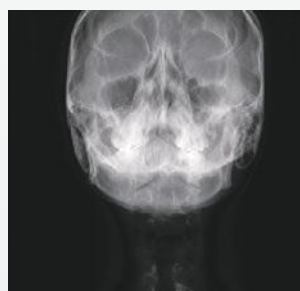
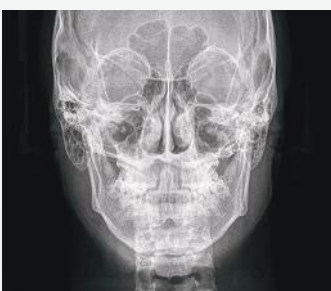

## Foldable Chinrest System

Convenient patient positioning while saving room space

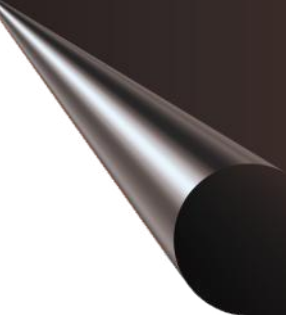

Easy access for disabled patients

## Chair \*Optional

Minimizes the patient's movements to help reduce patient's motion artifacts



One-Shot Cephalometric system provides distortion-free images with minimal motion artifacts

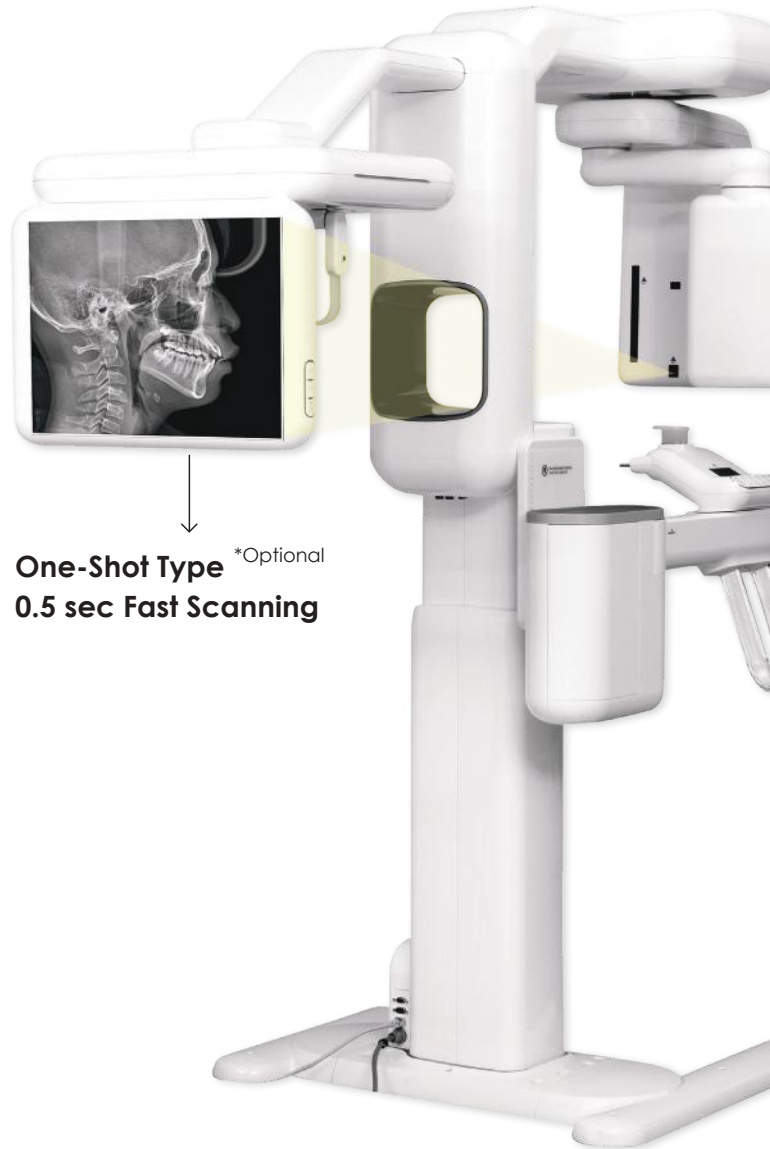

**One-Shot Type** \*Optional  
**0.5 sec Fast Scanning**



### 3D Volume Rendering

Various volume rendering options such as, X-Ray, MIP etc provide 3D image visualization



### MPR (Multi-Planar Formatting)

MPR mode provides three plain view (axial, coronal and sagittal) on one screen for focused area diagnosis



### Curved MPR

Possible to reconstruct the sectional images which is via any curves from Panoramic, Cross-sectional, Longitudinal



### Dental Reformatting

Using panoramic, cross-sectional and longitudinal 2D view, you can plan your 'perfect' implant positioning

### Improved image processing

SMARF™ (Smart Metal Artifact Reduction Function) minimizes the effect of metal artifacts caused by prosthetics to prevent image degradation.

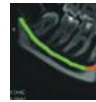

### Image Color-Mapping

Color mapping increases the visibility of lesions



### Measuring Tools

Distance, Angle, Profile and arrow provides easy to use measuring tools.



### Implant Planning

Multiple layout support and nerve implementation enables accurate implant planning



### Complete Implant Library



### Support for DICOM 3.0

### STL Export

Enables 3D printer and CAD/CAM to be used by converting 3D images to STL data.

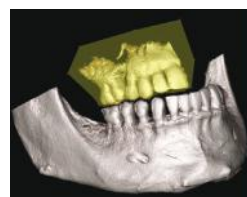

Patient Scan



Stone Model Scan

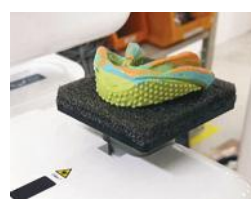

Impression Model Scan

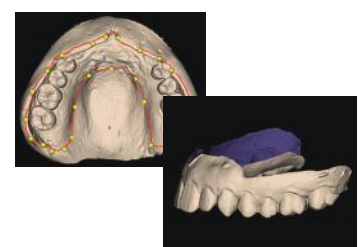

## General Specifications

Items	Option	FOV/ROI (max, mm)	Voxel ( $\mu\text{m}$ )	Detector		Exp. Time sec
				Pitch ( $\mu\text{m}$ )	Size (mm)	
CT	NV	40X50~ 160 X 140	75~400	100 X 100	130 X 130	7.7/14.5
	LV	40X50~ 230 X 245	75~400	179 X 179	229X229	7.7/14.5
Cephalometric	SC	300X225	-	75X75	228X6.5	2~12
	OS	317X254	-	124X124	310X250	0.5~3.0
Panoramic	PX	--	-	75x75	152x6.5	9~17
NV (Normal Volume), LV (Large Volume), SC (Scan Ceph), OS (One-Shot Ceph)						
Focal Spot	0.5 mm					
Target Angle	5°					
Tube Voltage	60~90kV					
Tube Current	4~12 mA					

## Dimensions

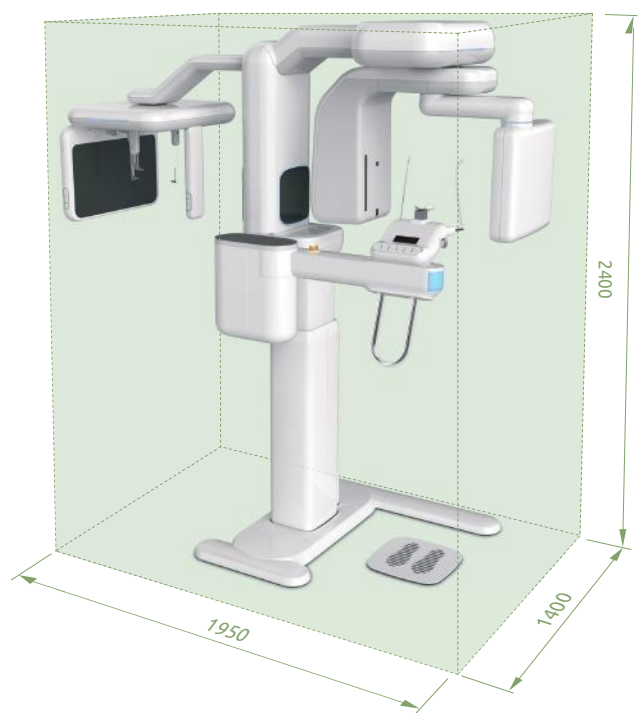
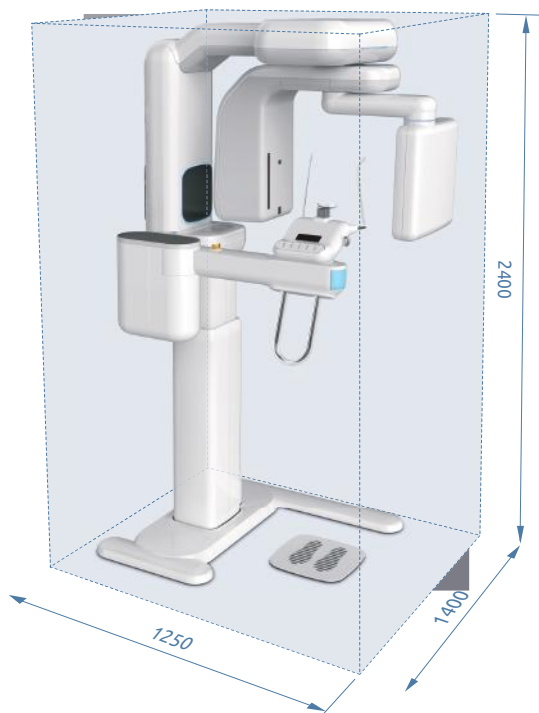



# PAPAYA 3D Premium Operation Software

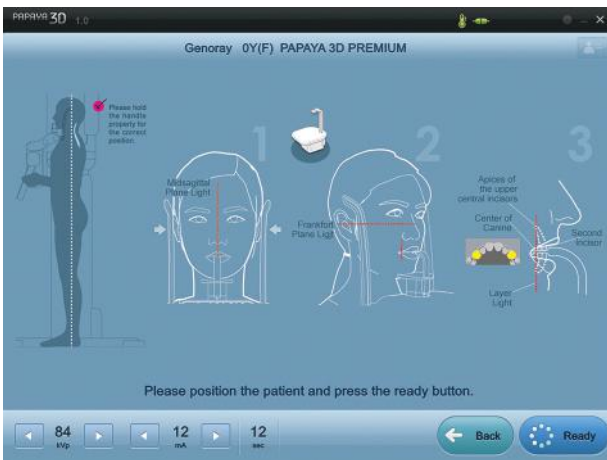

Panoramic Patient Positioning Guide



CBCT Mode

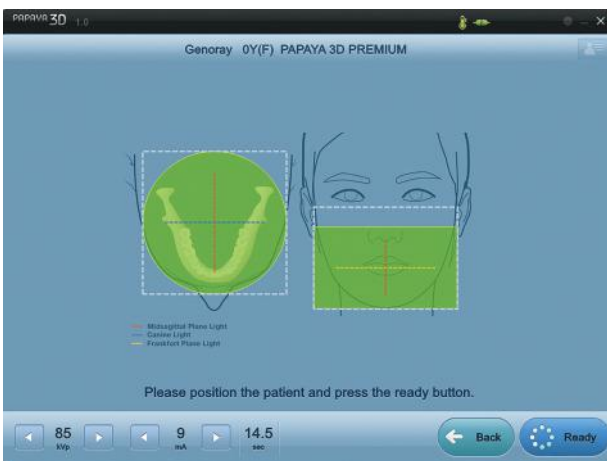

CBCT Patient Positioning Guide

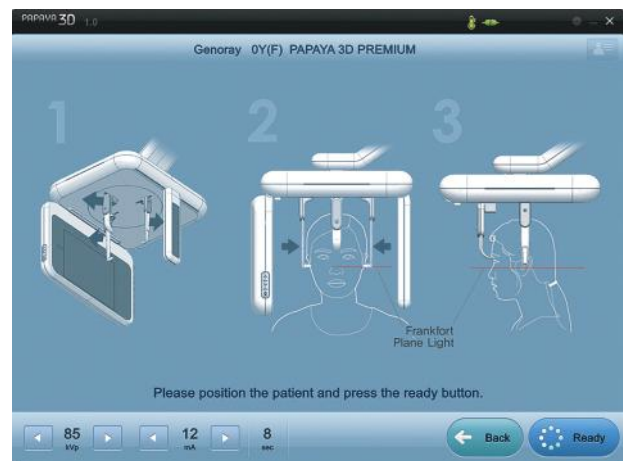

Cephalometric Patient Positioning Guide



Cephalometric Mode



Auto-Positioning Function

# in vivo 7

Advanced 3D Imaging Software

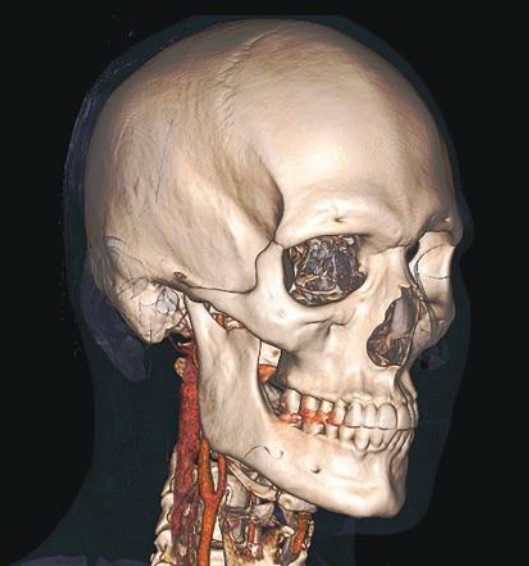

POWERFUL

MARKET LEADER

ONE SOFTWARE FOR ALL MODALITIES

RELIABLE

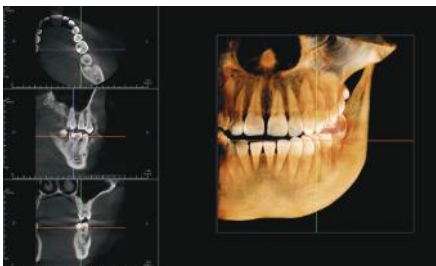

Layout

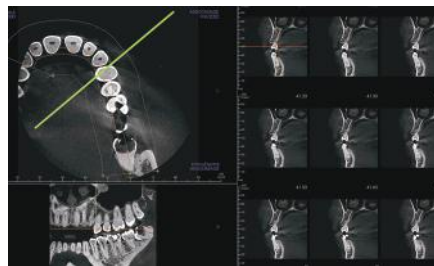

MPR



Section View



Pano View

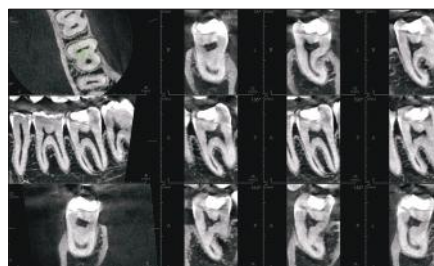

Endo View

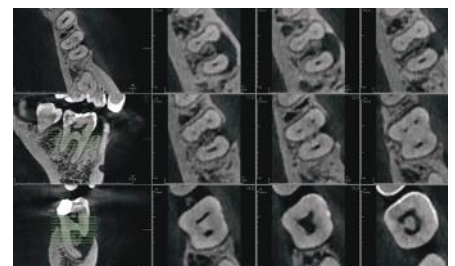

Endo View

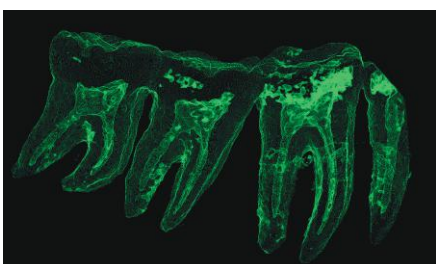

Endo View

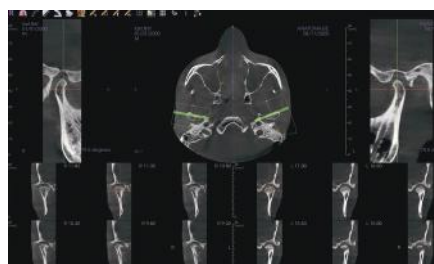

TMJ View

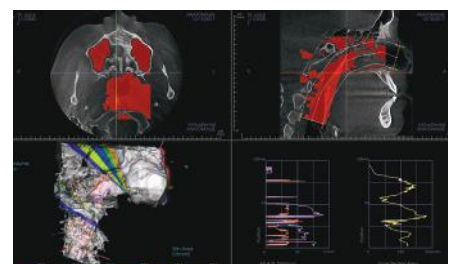

Airway Analysis View

## Our Esteemed Clients of OPG

Andhra Pradesh		
S. No.	Doctor Name	City
1	CMC Vellore Hospital	Chittoor
2	Dr. Tirumal Rao	Kadapa
3	Dr. Sarveshwara Rao	Eluru
4	Star Dental Centre Pvt Ltd	Kakinada
5	Maj Dr Batchu Santhosh	Nandyal
6	Dr. A Swaroop Kumar Reddy	Nellore
7	Sri Sarga Multi Speciality Dental Clinic	Vijaywada
8	Thomson Scan	Vishakhapatnam
9	Dr. Ambati Ishwarya	Warangal
10	Dr. Deepthi Gadam	Srikakulam
11	Dr. Nemaly Chaitanyaa	Madanapalle
12	Dr. Podugu Kalyan Chakravarthy	Srikakulam
13	Dr. S Chandra Sekhara Reddy	Anantapur
14	Dr. Surya Kumari Ittamsetti	Visakhapatnam
15	Dr. V. Rammohan Reddy	Chittoor
16	Dr. Vinod Birra	Visakhapatnam
17	Dr. Y Ramana Reddy	Nellore
18	Dr. Sowmya	Anantapur
19	Krishna Institute of Medical Sciences Limited	Nellore
20	Sowjanya Dental Hospital	Guntur
21	Sri Chaitanya Multi Speciality Dental Hospital	Jangareddigudem
22	Amrutha Multispeciality Dental Clinic	Srikakulam
23	Dr. A Swaroop Kumar Reddy	Nellore
24	Dr. A Swaroop Kumar Reddy	Nellore
25	Dr. A Swaroop Kumar Reddy	Nellore
26	Dr. Anupoju Someswara Rao	Visakhapatnam
27	Dr. G Leela Krishna Mohan	Vijaywada
28	Dr. Kalyan Chakravarthy P	Srikakulam
29	Dr. M. Venkata Gangadhar	Rajahmundry
30	Dr. Sajjan Anand Gubbala	Amalapuram
31	Dr. V. Raghvendra	Kadiri
32	Dr. Deepthi Gadam	Srikakulam
33	Dr. Deepthi Gadam	Srikakulam
34	Dr. Kranthikumar Yangla	Vijaywada
35	Dr. Lakshman Rao	Tiruvuru
36	Dr. Ravi Chandra Koganti	Visakhapatnam
37	Dr. Vinjamuri Anil Dev Dutt	Visakhapatnam
38	Dr. Kishor	Kurnool
39	Dr. Ramamoorthy	Amalapuram
40	Dr. Y. Indraneel	Kavali
41	Krishna Institute Of Medical Sciences Limited	Ongole
42	R N Labs & Diagnostic	Vizianagaram
43	Vijju Dental Clinic	Elamanchili
44	Aditya Educational Society	Srikakulam
45	Dr. Alapati Kranthi Kumar	Visakhapatnam
46	Dr. Bharath	Godavari

47	Dr. Bonthu Jagadesh Babu	Narsipatnam
48	Dr. Ch. Venkateshwararao	Vijaywada
49	Dr. Chandra Sekhar Chadalavada	Guntur
50	Dr. Raviteja Borugadda	Vijaywada
51	Dr. Rohini Gouda	Warangal
52	Dr. Sanjay Dutt	Vijaywada
53	Dr. Anil Kumar Katta	Guntur
54	Dr. G Vamsi Krishna	Srikakulam
55	Dr. Kalyan Ksvk	Rajahmundry
56	Dr. Lakshmi Narayana Metta	Srikakulam
57	Dr. Ramesh Naidu Balaga	Srikakulam
58	Dr. S. Suryaprakash	Kadapa
59	Dr. Venkat Kale	Prakasam
60	Dr. Venkata Ranjit Kumar Peravali	Guntur
61	Dr. Votturi Kartheek	Chittoor
62	Dr. V. Sunil Kumar Reddy	Kadapa
63	Gadam Multispeciality Dental Hospital And Implant Centre	Visakhapatnam
64	Garlapati Kavitha Reddy	Warangal
65	Sms Dental Hospital	Visakhapatnam
66	Star Dental Centre Pvt. Ltd	Vijaywada
67	Tirumala Multi Speciality Hospitals (India) Private Limited	Vizianagaram
68	Vamsi Krishna Dental Hospital	Kadapa
69	Dr. Raviteja Borugadda	Vijaywada
70	Dr. G Kanchan Sagar	West Godavari
71	Dr. Ram Chand Bandla	Guntur
72	Ravitej Dental Care	Chirala
73	Dr. A Swaroop kumar reddy	Nellore
74	Sri Padmavathi Diagnostic Centre	Nellore
75	Dr. Prathyusha	Guntur
76	Sri Sarga Multi Speciality Dental Clinic	Vijaywada
77	Dr. Sana Naqvi	Hyderabad
78	Vijju Dental Clinic	Yelamanchili
79	Dr. Kopuri Raj Kumar	Guntur
80	Dr. C Tejadeepthi	Hyderabad
81	Dr. Lakshmi Narayana Metta	Srikakulam
82	Harikrishna Inst. of Oncology Pvt. Ltd.	Hyderabad
83	Dr. Vijay Kumar Reddy	Hyderabad
84	Dr. Kishor	Kurnool
85	Aaradhya Dental Clinic	Kadapa
86	All India Inst. of Medical Sciences (A.P)	Vijaywada
87	Sun Imaging & Diagnostics	Visakhapatnam
88	Dr. J Ravi Rakesh Dev	Guntur
89	Dr. Siva Nagini	Hyderabad
Assam		
90	Dr. Santanu Borah	Nagaon
91	Dr. Abhijit Das	Tinsukia
Bihar		
92	Dr. Kumar Sharad Bhusan	Darbhanga

## Our Esteemed Clients of OPG

93	Dr. Sanjeev Kumar Bisen	Patna West
94	Dr. Amod Kumar Srivastava	Gopalganj
95	Dr. Ashutosh Trivedi C/o Oro Dental Speciality Clinic	Patna West
96	Dr. Parthsarathi Gautam	Chapra
97	Sarjug Dental College & Hospital	Darbhanga
98	Dr. Atish Kumar	Sitamarhi
99	Dr. Fahad Siddiquee	Gaya
100	Dr. Shaheed Akhtar	West Champaran
101	Gautam Digital X-Ray And Opg Centre	Patna West
102	Global Health Patliputra Pvt Ltd.	Patna East
103	Lalan Kumar Patel	Patna West
104	Mr. Surendra Prasad Singh	Gaya
105	Vaishnavi Diagnostic Centre	Patna East
106	Dr. Vivek Kumar	Bhagalpur
107	Mr. Surjit Jha	Madhubani
108	Mr. Vivek Kumar	Bihar Sarif
109	Narayan Medical College & Hospital	Sasaram
<b>Chandigarh</b>		
110	Dr. Kuldeep Singh	Mohali
111	Dr. Pushpinder Mangat	Chandigarh
112	Dr. Avni Dixit	Chandigarh
113	Puneet Singh Talwar	Panchkula
114	Dr. Poonam Rani	Chandigarh
115	Dr. Harjap Singh	Chandigarh
116	Dr. Sarabjeet Singh	Chandigarh
117	Dr. Kochars House Of Smiles	Chandigarh
118	Star Dental Center Pvt Ltd,	Panchkula
119	Star Dental Centre Pvt Ltd	Chandigarh
120	Dr. Ravi Kumar	Chandigarh
121	Dr. Navneet Randhawa	Mohali
<b>Chhattisgarh</b>		
122	Dr. Abhay Premprakash Agrawal	Bilaspur
123	Dr. Pooja Verma	Nagri
124	Asa Diagnostic	Rajnandgao
125	Dr. Abhishek Goyal	Dhamtari
126	Dr. Shobhan S Shahare	Durg
127	Dr. Manu Rajmohan	Raipur
128	Dr. Saurabh Kumar Jain	Raipur
129	Dr. Ashish Soni	Bilaspur
130	Dr. Ayush Singh	Koriya
131	Dr. Shailendra Singh Chaturvedi	Bilaspur
132	Dr. Dilpreet Kaur Rajkhokar	Mahasamund
133	O. M. R. Diagnostics	Ambikapur
134	Adwani Diagnostics Centre	Raipur
135	Dr. Pooja Verma - Chhattisgarh	Nagri
<b>Delhi</b>		
136	Dr. Praful Mehra	Sarvodhya Enclave
137	Dr. Anurag Gupta	Safdarjung Enclave
138	Dr. Abu Nasar	Jamia Nagar

139	Dr. Manish Gupta	Greater Kailash-2
140	Dr. Manish Gupta	Greater Kailash-2
141	Dr. Shashi Bhushan	Gulmohar Park
142	Dr. Shashi Bhushan	Gulmohar Park
143	Star Dental Centre Pvt. Ltd, Sda	Safdarjung
144	Dr. Gautam Suhag C/O National Industrial Training Centre	Dwarka Mod
145	Dr. Reema Nafis	Sarita Vihar
146	Dr. Sachin Gupta	Shahdara
147	Dr. Saurabh Gupta	South Extension
148	Global Health Research Group	Greater Kailash
149	Shanti Dental Clinic	Patel Nagar
150	Star Dental Center Pvt. Ltd.	Mayur Vihar
151	Star Dental Center	Dwarka
152	Star Dental Center	Shivalik
153	Star Dental Center	Vikasपुरi
154	Star Dental Center	Rohini
155	Star Dental Center	Saket
156	Star Dental Centre Pvt. Ltd.	Derawal Nagar
157	Star Dental Centre Pvt. Ltd.	Janak Puri
158	Venkateshwar Centre Of Dental Excellent Pvt Ltd	Dwarka
159	Dr. Kapil Arora	Lajpat Nagar
160	Dr. Mona Singh Kawatra	Janak Puri
161	Dr. Nitesh Chitkara	Rohini
162	Dr. Hemant Gupta	Rohini
163	Manipal Hospitals	Dwarka
164	Star Dental Centre Pvt. Ltd.	Adarsh Nagar
165	Star Dental Centre Pvt. Ltd.	Vasant Kunj
166	The Dental Experience	Greater Kailash
167	Star Dental Centre Pvt. Ltd.	Vikasपुरi
168	Dr. Rohit Yadav	Ghaziabad
169	Dr. Tara Khilnani	Panchsheel Enclave
170	Dr. Kunal Puri	Greater Kailash-1
171	Dr. Smita Saraf	Pitampura
172	Dr. Pankaj Madhukar	Saket
173	Dr. Honey Verma	Gurugram
174	Dr. Shivani Nivedita	Dwarka Mod
175	Dr. Vaibhav Gulati	Pitampura
176	Mata Gujri Society For Medical Aid & Research	Greater Kailash
177	Care Redefined - UP	Noida
178	First Consult	East Of Kailash
179	Dr. Pranjal Sirohi	Greater Noida
180	Dr. Javed	Jasola
181	Dr. Viney Sachdeva	Greater Kailash-2
182	Dr. Satendra Singh	Bhajanpura
183	Dr. Anshul Phogaat	Safdarjung Enclave
184	Apollo Clinic Model Town	Gujrawala Town
185	Kailash Dental	Patel Nagar
186	The Dental Hub And Implant Centre	Vasant Kunj

## Our Esteemed Clients of OPG

187	Dr. Sapna Siwatch	Pitampura
<b>Goa</b>		
188	Dr. Suhail Ahmed Shariff	Goa
189	Dr. Karishma Parkar	Goa
190	Dr. Dhiraj Vivekanand Naik	Madgaon
<b>Gujarat</b>		
191	Dr. Amit Parikh	Vadodara
192	Dr. Vipul Patel	Rajkot
193	Dr. Vikas Kumbhani	Ahmedabad
194	Dr. Aadarsh Desai	Ahmedabad
195	Dr. Snehal Chauhan	Gandhidham
196	Dr. Vikas Bhambhani	Gandhidham
197	Dr. Vijay Bhatiya	Jamnagar
198	Haria L G Rotary Hospital	Vapi
199	Goenka Dental College & Hospital	Gandhi Nagar City
200	Dr. Rishma Ankitkumar Patel	Navasari
201	Dr. Shailesh B Modh	Banaskantha
202	Dr. Dhvani Patel	Vapi
203	Dr. Sweta Patel	Vapi
204	Dr. Jigar Soni	Vadodara
205	Dr. Mihir Shah	Ahmedabad
206	Zaveri M V Dispensary	Palanpur
207	Dr. Vipul Patel	Rajkot
208	Denta Scan	Ahmedabad
209	Dr. Abhishek Jain	Bardoli
210	Dr. Nirav Surani	Rajkot
211	Dr. Nutan D Thakkar	Gandhi Nagar City
212	Dr. Rajni B Patel	Mehsana
213	Dr. Prashant Shah	Vadodra
214	Dr. Dhaval Trivedi	Vadodra
215	Dr. Khushbu Patel	Valsad
216	Dr. Nirali Patel	Surat
217	Dr. Samir Rateda	Lunawada
218	Dr. Saroj Singh	Kachchh
219	Dr. Ghanshyam Patel	Ahmedabad
220	Dr. Jolly D. Patel	Ahmedabad
221	Dr. Prashant Shah	Vadodra
222	Kailash Cancer Hospital	Vadodra
223	Patel Mayur Jagdishbhai	Surat
224	Wadekar Hospital	Surat
225	Inst. of Forensic Sciences University	Gandhi Nagar City
226	Dr. Kamal Patel	Mehsana
227	Dr. Pankaj Ishwarbhai Hotchandani	Ahmedabad
228	Dr. Mantra H. Parikh	Una
229	Dr. Mantra H. Parikh	Una
230	Setu Dental Clinic	Ahmedabad
231	Karnavati Medical & Educational Trust	Gandhi Nagar City
232	Dr. Prachi Kapuriya	Vadodra
233	Siddharth Desai	Valsad
234	Dr. Rushi Virani	Jamnagar

235	Dr. Bhargav A Shah	Ahmedabad
236	Dr. Krunal Jodiya	Surat
237	Dr. Manthan Rathi	Ahmedabad
<b>Haryana</b>		
238	Dr. Ravi Batra	Gurugram
239	Dr. Anil Yadav	Gurugram
240	Anjali Labs Jmjk Pvt. Ltd .	Hisar
241	Dr. Chander Prakash	Gurugram
242	Dr. Harish Yadav	Gurugram
243	Dr. Surinder Sharma	Panchkula
244	Global Health Private Limited	Gurugram
245	Hai Dent Cosmo Llp	Gurugram
246	Star Dental Centre Pvt. Ltd.	Haryana
247	Dr. Vijay Kumar Taneja	Panipat
248	Dr. Abhishek Khurana	Sirsa
249	Dr. Rakesh Raghav	Gurugram
250	Dr. Akshi Arvind	Gurugram
251	Dr. Nisha Bali Banari	Gurugram
252	Dr. Pooja Yadav	Gurugram
253	Dr. Vipul Goel	Gurugram
254	Dr. Rishi Rana	Gurugram
255	Star Dental Centre Pvt. Ltd.	Gurugram
256	Dr. Ravjot Ahuja	Faridabad
257	Star Dental Centre Faridabad	Faridabad
258	Manav Rachna Dental College	Faridabad
259	Dr. Anubhav Chopra	Gurugram
260	Civil Hospital	Faridabad
261	Dr. Ankur Jain	Gurugram
262	Dr. Harsh Yadav	Gurugram
<b>Himachal Pradesh</b>		
263	Dr. Raghav Verma	Dharamshala
264	Officer Commanding	Kangra
265	Dr. Heena Sharma	Kangra
267	Dr. Sachin Upadhyay	Kullu
268	Dr. Bhavna Devi	Sundar Nagar
<b>Jammu And Kashmir</b>		
269	SNM Hospital	Leh
270	Dr. Faiz Ahmad Bhat	Srinagar
271	Block Medical Office	Srinagar
<b>Jharkhand</b>		
272	Dr. Meenakshi Singh	Ranchi
273	Dr. Sanju Gupta	Ramgarh
274	Dr. Bhaskar Lal	Ranchi
275	Dr. Sagaramani Seth	Koderma
276	Dr. Manish Kumar	Girdih
277	M/S Digimax Imaging Centre	Dhanbad
<b>Karnataka</b>		
278	Dr. Mohd. Fayaz Pasha	Bengaluru
279	Special Smiles Pvt. Ltd.	Bangalore
280	Dr. Sharan Prakash Shetgar	Gulbarga

## Our Esteemed Clients of OPG

281	Dr. Ramesh Kaluti	Bagalkot
282	Thirthalli Diagnostic Centre Llp	Shimoga
283	Dr. B. N. Narase Gowda	Bengaluru
284	Dr. Prashanth	Bengaluru
285	Dr. Ramanath Dheemanth	Bengaluru
286	Dr. Sridhar N	Bengaluru
287	Dr. Jayaram Diagnostic Center Pvt. Ltd.	Bengaluru
288	Gulbarga Dental Scanning Center	Gulbarga
289	Sharma Dental Spa Llp	Bengaluru
290	Special Smiles Pvt. Ltd.	Bengaluru
291	Vats And Param Inc	Bengaluru
292	Shivam Diagnostic Centre	Coorg
293	Dr. Ajaz Pasha K M	Bengaluru
294	Dr. Niranjana Paramshetty	Hubli
295	Dr. Sudha B N	Chikkamagaluru
296	K. S. Satheeshkumar	Bengaluru
297	Core The Dentofacial Centre	Bengaluru
298	Dr. Km Pramod	Bengaluru (East & South)
299	Plaza Dental Care	Yadgir
300	Dr. Darshit Patel	Bengaluru
301	Dr. Sumalatha Mds	Haveri
302	Dr. Niranjana Paramshetty	Hubli
303	Agasthya Diagnostic Center	Koppal
304	Surya Diagnostics	Mandya
305	Alphacrown Healthcare Private Limited	Bengaluru
306	Dr. P. Manjunath	Bengaluru
307	Dr. Pallapoiu Vasavi	Bengaluru
308	KDC Dental Care	Bijapur
309	Dr. Shilpa S Kiran	Bengaluru
310	Vats And Param Inc	Bengaluru
311	Lakshmi Medical Agency	Bellary
312	Anjana Xray Centre	Bellary
313	Dr. Shashidhar Manikappa	Bidar
314	Dr. Yamini K	Bengaluru
315	Dr. Narendra Babu P N	Tumkur
316	Dr. Niranjana Paramshetty	Bengaluru
317	Dr. Basavaraj Shivappa Katakot	Bellary
318	KD Dental Care	Bagalkot
<b>Kerala</b>		
319	Mr. Jaisal P	Malappuram
320	Mr. Vishnu K. S.	Cochin
321	Dr. Bindu Rachel Thomas	Cochin
322	Dr. Bindu Rachel Thomas	Cochin
323	Dr. Nirmal George Saibu	Kollam
324	Dr. Sanjay Kumar	Palakkad
325	Dr. Wesley Kuruvila Abraham	Cochin
326	Dr. Shajahan P. A	Thrissur
327	Dr. John. F. Alapatt	Thrissur

328	Jubilee Mission Medical College Hospital	Thrissur
329	M/S Clinique Dentistry	Thrissur
330	Mr. Ramvinod Ramachandran Kuzhiyilayyathu	Kollam
331	Mr. Razal Ahamed Koya	Malappuram
332	Dr. Varghese K Paulose	Ernakulam
333	Gids Enterprises Pvt. Ltd.	Alleppey
334	Mr. Prakash Rose Vihar Kuttappan	Alappuzha
335	Military Dental Centre, Pangode	Trivandram
336	Dr. Naveen R	Trivandram
337	Mr. Vinuraj K. G.	Kottayam
338	Sankars Healthcare Scans And Diagnostics	Alappuzha
339	Dr. Tony Thomas	Palakkad
340	Mr. Jaisal P	Malappuram
341	Spring Garden Dental Care Centre	Thiruvananthapuram
342	Dr. Satheesh Sankar	Pathanamthitta
343	Dr. Sajjad Mohammed A	Kottayam
<b>Madhya Pradesh</b>		
344	Dr. Nitish Shrivastava	Gwalior
345	Dr. Gagan Namdev	Sehore
346	Ms. Tanya Garg	Sagar
347	RKDF Medical College Hospital And Research Centre	Bhopal
348	Dr. Atul Verma	Bhopal
349	Dr. Vipalv Joshi	Bhopal
350	Krishna Hospital	Sagar
351	Mayank X-Ray	Chhindwara
352	R.K.D.F.Dental Collage And Research Center	Bhopal
353	Dr. Vikas Batra	Ratlam
354	Dr. Neeta Marwaha	Bhopal
355	RKDF Medical College Hospital And Research Centre	Bhopal
<b>Maharashtra</b>		
356	Dr. Nilesh Mundada	Aurangabad
357	Dr. Danish Virani	Pune
358	Dr. Amrut V. Tamhankar	Panvel
359	Mr. Praful Kothari	Pune City
360	Dr. Rahul Upendra Vedpathak	Nagpur
361	Smile Plus Dental Care	Nagpur
362	Mr. Prashant	Mumbai
363	Dr. Rukhsana Sakarwala	Mumbai Central
364	Dr. Shahare Shobhan	Nagpur
365	Dr. Bharat Singh Rathod	Mumbai
366	Dr. Subodh	Thane
367	Dr. Harsh Ashok Vyas	Mumbai
368	Dr. Harsh Ashok Vyas	Mumbai
369	Aadiya Dental College	Parbhani
370	Dr. Ashish Shah	Grant Road
371	Dr. Shreyas Shah	Kharghar

## Our Esteemed Clients of OPG

372	Dr. Amit Maheshwari	Andheri
373	Dr. Lalit Manek	Mulund
374	Dr. Karanjit Singh Chaudhary	Mumbai
375	Dr. Anuradha Vyas	Grant Road
376	Dr. Rikin Gogri	Goregaon
377	Yavatmal Cbct Centre	Yavatmal
378	Dr. Abhirav Karve	Thane
379	Dr. Aishwarya Joshi	Panvel
380	Dr. Sharad Mishra	Mira Road
381	Dr. Vimal Gala	Mulund
382	Dr. Vishal Tapadia	Pune City
383	Dr. Twinkle Jain	Malad
384	Leena Builders	Thane
385	Asain Institute Of Medical Science	Dombivali
386	Dr. Ashish & Dr. Varsha Khasbage	Buldhana
387	Dr. Dhananjay Barde	Nagpur
388	Dr. Joshua Mall C/O Dr. Divya Raniwala	Pune
389	Dr. Prathmesh Joshi	Pune
390	Dr. Aditi Sameer Natu	Pune
391	Dr. R. Suryanarayan	Mumbai
392	Rastrasant Tukdoji Regional Cancer Hospital & Cancer	Nagpur
393	Tata Memorial Centre	Parle
394	Dr. Nikita Tejwani Motwani	Andheri
395	Dr. Hitesh Burhanpurkar	Mumbai
396	Way To Care And Cure Diagnostic Centre	Kharghar
397	Dr. Ajit Shetty c/o Core Mumbai	Mumbai
398	Dr. Sachin Gupta	Kandivali
399	Dr. Madhavi Jadav	Bhayandar
400	Orofit Pvt. Ltd.	Nashik
401	Orofit Pvt. Ltd.	Nashik
402	Dr. Aditi Sameer Natu	Sion
403	DR. SHIV CHADDA.	Bandra
404	Dr Dheeraj Nimbaji Patil	Mumbai
405	Dr. Nishant Gandhi	Powai
406	Dr. Nilesh Fatale	Pune City
407	Dr. Deepali Ananya Hazare	Nagpur
408	Dr. Payal Agarwal	Chami Road
409	Apurva Dental Clinic	Boriwali
410	Dr. Nitesh Jain	Boriwali
411	Dr. Trishla Kasliwal	Mumbai
412	Dr. Jenish Parmar	Chembur
413	Dr. Trishla Kasliwal	Mumbai
414	Dr. Chitrang Thaker	Goregaon
415	All India Institute Of Medical Sciences	Nagpur
416	Dr. Dinesh Hingorani	Pune
417	Smile Gallery Dental Clinic	Boriwali
418	Dr. Hetal Chheda	Boriwali
419	Madhav Mission C/o Dr. Ashutosh Deshpande	Kolhapur

Odisha		
420	The Dental Shoppe	Bhubaneswar
421	Dr. Kanhu Charan Sahoo	Bhubaneswar
Pondicherry		
422	Guarantee Clinical Lab	Pondicherry
423	Dr. V. Savariraju	Pondicherry
Punjab		
424	Dr. Bhupinder Singh Parhar	Jalandhar
425	Dr. Deepak Dawar	Zirakpur
426	Dr. Baljit Singh	Hoshiarpur
427	Dr. Anjali	Mohali
428	Dr. Jagdish Chander	Jalandhar
429	Shaheed Kartar Singh Sarabha Dental College	Ludhiana
430	Dr. Aman Preet Singh	Mohali
431	Dr. Parminder Singh New	Jalandhar
432	Dr. Parminder Singh New	Jalandhar
433	Kumar Dental Co.	Jalandhar
434	Kumar Dental Co.	Jalandhar
435	Dr. Deepak Dawar	Zirakpur
436	Dr. Ajay Saini	Mahilpur
437	Dr. Deepak Dawar	Zirakpur
438	Dr. Deepak Dawar	Zirakpur
439	Dr. Gursimran Singh Marwah	Jalandhar
440	Dr. Sindhuja Shreedhar.	Mohali
441	Dr. Vikas Kaushal	Kotkapura
442	Dr. Vikas Jindal	Ludhiana
443	Sushma Memorial Dental Hospital	Kaurthala
444	Dr. Garima	Mohali
445	Dr. Sanjay Bhardwaj	Hoshiarpur
446	Dr. Gourab Gupta	Mohali
447	Ranbaj Hospital	Mohali
448	Dr. Hemant Bansal	Patiala
449	Dr. Mandeep Singh Brar	Moga
Rajasthan		
450	Dr. Abhishek Jayaswal	Chittorgarh
451	Dr. Bhargav V Gupta	Sirohi
452	Dr. Bhargav V Gupta	Sirohi
453	Dr. Krishna Kant Bohra	Kankroli
454	Dr. Smita Singh	Udaipur
455	Dr. Yusuf Mohammed	Bhilwara
456	Star Dental Centre Pvt. Ltd.	Jaipur
457	Raj Rajeshwari Education & Research Society	Udaipur
458	Dr. Sourav Singh	Udaipur
459	Atharv Dental Care Centre	Banswara
460	Dr. Udai Raj Singh Jadon	Kota
Tamil Nadu		
461	Dr. Dhandapani Arunachalam	Chennai
462	Dr. Muthusamy Narasimman	Chennai

## Our Esteemed Clients of OPG

463	Dr. Sunil C Varghese	Chennai
464	Dr. S. Suganya	Cuddalore
465	Dr. K. Saravanan	Coimbatore
466	Dr. Suresh Babu Stephen	Thoothukudi
467	Dr. Vinoth Chandran S. R.	Dindigul
468	Rootz Dental Care & Implant Center	Chennai
469	Dr. B. Akilananth	Coimbatore
470	Saveetha Institute of Technical And Medical Sciences	Chennai
471	Anbu Dental Clinic	Madurai
472	Dr. N Madan	Tiruvannamalai
473	Dr. A Satish	Chennai
474	Dr. Archana Narayana Swamy	Chennai
475	Dr. D. Djaynishanth	Pondicherry
476	Dr. Kirubaharan	Coimbatore
477	Ms. Shanthy K	Chennai
478	Opal Dentistry	Chennai
479	RKM Dentoscan	Chennai
480	Sams Dental Lounge	Coimbatore
481	Saveetha Medical College And Hospital	Chennai
482	ANBU Dental Clinic	Madurai
483	Dr. Dharmesh Kumar Raja	Madurai
484	Dr. Rajesh MDS	Tirupur
485	Malligai Dental Hospital	Chennai
486	Dr. Bhagavathy	Tirunelveli
487	Dr. P. Ashwan	Chennai
488	Dr. Mithra Rajan	Dindigul
489	Dr. Jai Sudhaa Mds	Coimbatore
490	East Coast Hospital Ltd	Pondicherry
491	Dr. S. Suganya	Cuddalore
492	Salus Dental Scans	Tirupur
493	Dr. Selva Kumar, MDS	Chennai
494	Dr. Selva Kumar, MDS	Chennai
495	Dr. Fathima Rameesha	Paramkudi
496	Dr. G. Karthick Rajan	Coimbatore
497	Dr. Sathesh, M.D.S.	Tiruvannamalai
498	Rootz Dental Care And Implant Center	Chennai
499	Dr. R Arun Jaikumar	Cuddalore
500	Dr. J. Thabassum	Coimbatore
<b>Telangana</b>		
501	Amrutha Dental Private Limited	Hyderabad
502	Dr. Jitendar Reddy	Hyderabad
503	Mr. P V Ravi Chandra	Hyderabad
504	Virinchi Hospital	Hyderabad
505	Dr. Ch. Swathi Chaitanya	Hyderabad
506	Dr. Ramvilas Reddy	Hyderabad
507	Dr. Siva Nagini	Hyderabad
508	Opal Dentistry	Hyderabad

509	Dr. Shravan Kumar Nagole	Hyderabad
510	Dr. Atluri Padma Mohan	Hyderabad
511	Dr. Kadiyala Rajendra	Hyderabad
512	Dr. Meka Prasad	Hyderabad
513	Arya Health Care	Hyderabad
514	Dr. Alla Raghunadha Reddy	Hyderabad
515	Dr. K. Shravan Kumar	Hyderabad
516	Dr. Nadeem Kuresi	Hyderabad
517	Indira Diagnostic Centre	Kamareddy
518	Srikanth Super Speciality Dental Hospital	Karimnagar
519	The Tooth Company	Hyderabad
520	Dr. Anwesh Indo	Hyderabad
521	Dr. B. Vishnu Chaitanya	Hyderabad
522	Dr. Rayudu Naren Kishore	Kothapet
523	Eledent International Digital Dentistry	Hyderabad
524	Pro Dental	Hyderabad
525	Root Dental	Hyderabad
526	Arya Health Care	Hyderabad
527	Dr. Alla Raghunadha Reddy	Hyderabad
528	Dr. K Shravan Kumar	Hyderabad
529	Dr. Nadeem Kuresi	Hyderabad
530	Indira Diagnostic Centre	Kamareddy
531	Srikanth Super Speciality Dental Hospital	Karimnagar
532	The Tooth Company	Hyderabad
533	Dr. Anwesh Indo	Hyderabad
534	Dr. B. Vishnu Chaitanya	Hyderabad
535	Dr. Rayudu Naren Kishore	Kothapet
536	Eledent International Digital Dentistry	Hyderabad
537	Root Dental	Hyderabad
538	Advaita Reddys Dental Hospital	Hyderabad
539	Sampath Gowd Dr.	Hyderabad
540	Dr. Gowds Dental Hospital	Hyderabad
541	Dr. Srikant Goud	Hyderabad
542	Sree College Of Pharmacy	Khammam
543	Raju Dental	Hyderabad
544	Dr. Ramvilas Reddy	Hyderabad
<b>Uttar Pradesh</b>		
545	Dr. Sumit Tandon	Bareilly
546	Dr. Ashutosh Gupta	Raibareilly
547	Dr. Ashutosh Gupta	Raibareilly
548	Dr. Pranshu Singh	Meerut
549	Dr. Rahul Vaid	Meerut
550	Dr. Raj Kumar Sharma	Bazpur
551	Dr. Vipul Srivastava (Lucknow)	Lucknow
552	Akhil Kumar Goel And Sons Huf	Muzaffarnagar
553	Dr. Ajay Vikram Singh	Agra



## Our Esteemed Clients of OPG

554	Dr. Amit Sachdeva	Noida
555	Dr. Ashwani Kumar Verma	Gorakhpur
556	Dr. R. S. Dubey	Lucknow
557	Medicos Diagnostic Centre	Deoria
558	Sangam Dental Centre	Allahabad
559	Vedanta Health Centre	Meerut
560	Vivekanand Polyclinic & Institute of Medical Sciences	Lucknow
561	Military Dental Centre	Allahabad
562	Subharti Dental College	Meerut
563	Kailash Hospital And Research	Noida
564	Care Redefined	Noida
565	Dr. Ahujas Dental & Implant Clinic	Ghaziabad
566	Dr. Sumit Pathak	Greater Noida
567	Dr. Tarun Agrawal	Agra
568	Dr. Madhureema Chopra	Ghaziabad
569	Dr. Praveen Rai	Lucknow
570	Dr. Alok Sachan	Kanpur
571	Dr. Rohit Gupta	Kanpur
572	Kanti Devi Medical College Hospital & Research Center	Mathura
573	Medanta Holdings Pvt. Ltd.	Lucknow
574	Nayati Healthcare & Research Pvt. Ltd.	Mathura
575	New R. P. Diagnostic Centre	Ghaziabad
576	Nirmala Medical Store	Meerut
577	Satyam Diagnostic Centre	Lakhimpur
578	Satyam Diagnostic Centre	Firozabad
579	Dr. Sumeet Grover	Ghaziabad
580	Max Hospital	Vaishali
581	Star Dental Centre Pvt. Ltd.	Noida
582	Dr. Sumit Pathak	Greater Noida
583	Dr. Sanjeev Awasthi	Lucknow
584	Dr. Anand Vijay Singh	Shahjahanpur
585	Dr. Atul Tripathi	Allahabad
586	Aayush Pathology Lab & Digital X-Ray Center	Padrauna
587	Dr. Rakesh Kumar Gupta	Padrauna
588	Satyam Diagnostic Centre	Hardoi
589	Dr. Nirukt Yadav	Bulandshahr

590	Dr. Rohit Sharma	Gautam Buddh Nagar
591	Sushila Dental Clinic	Mathura
592	Dr. J Gupta	Prayagraj
593	Complete Prosthetic Solutions Lip	Agra
594	Chandra Dental College	Barabanki
<b>Uttarakhand</b>		
595	Dr. Vijay Kumar	Rishikesh
<b>West Bengal</b>		
596	Burnpur Hospital	Asansol
597	Dr. Santanu Pattanayak	Medinipore
598	Dental Avenue	Kolkata
599	Medisphere Polyclinic	Burdwan
600	North Bengal Dental Medical College	Siliguri
601	Avant Dental	Kolkata
602	Balaji Health Care	Siliguri
603	Dhuliyon Diagnostic & Healthcare Private Limited	Murshidabad
604	Dr. Bhaswati Barman Basu	North 24 Parganas
605	Dr. Vishal Kumar Poddar	Malda
606	Mr. Mahboob Alam	Uttar Dinajpur
607	Dr. Vishal Kumar Poddar	Malda
608	Upasana Healthcare And Diagnostic Centre	Medinipore

## Our Esteemed Clients of CBCT

S. No.	Doctor Name	City	State
1	Dr. Rahul Kumar	Purnea	Bihar
2	Dr. Vivek Kumar	Bhagalpur	Bihar
3	Mr. Sukhwinder Singh	Chandigarh	Chandigarh
4	Dr. Avni Dixit	Chandigarh	Chandigarh
5	Lumenare Dentofacial Imaging	Durg	Chhatisgarh
6	Dr. Radhika Sahni	Delhi	Delhi
7	Dr. Vikram Gandhi	Delhi	Delhi
8	Dr. Brij Sabharwal	Delhi	Delhi
9	College Of Dental Science And Research Centre	Ahemadabad	Gujarat
10	Karnavati School Of Dentistry	Gandhi Nagar	Gujarat
11	Dr. Shrey Italia	Ahemadabad	Gujarat
12	Dr. Pankaj Ishwarbhai Hotchandani	Ahmedabad	Gujarat
13	Dr. Vipul Patel	Rajkot	Gujarat
14	Manav Rachna Dental College	Faridabad	Haryana
15	SNM Hospital	Leh	Jammu & Kashmir
16	Celara Diagnostics Private Limited	Bengaluru	Karnataka
17	D. V. G. S. Dental Lab	Bengaluru	Karnataka
18	Dr. Tony Thomas	Palakkad	Kerala
19	Mr. Jaisal P.	Mallapuram	Kerala
20	Health Wave Diagnostics And Lab	Wayanad	Kerala
21	Dr. Surender Aggarwal	Bhopal	Madhya Pradesh
22	Dent Imaging Lip / CBCT Centre	Nashik	Maharashtra
23	Dr. Mahesh	Mumbai	Maharashtra
24	Dr. Naresh S Thakur	Mumbai	Maharashtra
25	Way To Care And Cure Diagnostic Centre	Kharghar	Maharashtra
26	Signature Smiles	Mumbai	Maharashtra
27	Diagnosys Plus Technologies	Pune	Maharashtra
28	Tata Memorial Centre	Parle	Maharashtra
29	Yavatmal CBCT Centre	Yavatmal	Maharashtra
30	Family Dental Care.. Nigeria	Overseas	Overseas
31	Dr. Deepak Dawar	Zirakpur	Punjab
32	Dr. Varun Chadha	Jalandhar	Punjab
33	Dr. Hardik Parekh	Amritsar	Punjab
34	Dr. Murugavel	Chennai	Tamilnadu
35	Dr. B. Akilanth	Coimbatore	Tamilnadu
36	Institute Of Dental Studies & Technologies	Modi Nagar	Uttar Pradesh



**WHERE TRUST COMES FIRST**



**Partnering with Dentists for over two decades  
creating a world full of healthy smiles together.**

**For any Sales & Support**

 9821184441, 9599281852, 8448398852

 [sales@unicorndenmart.com](mailto:sales@unicorndenmart.com)



SCAN TO VISIT OUR WEBSITE



Corporate Office: 3 Local Shopping Centre, MOR Land, Near J Block DDA Market,  
New Rajender Nagar, New Delhi – 110060

\* Accessories shown may not be a part of standard equipment. Specifications are subject to change without notice.

Ver 2/2024